

**Pick an instrument for your task.** Want one that can diagnose and calibrate itself? Or the one that combines several functions? How about the new breed of battery

powered types that match power efficiency with portability? Do you require an instrument that won't hurt other equipment or you. For more details, see p. 50.

gent metrological microprocessor-based function generators

programmable synergistic

scopes impedance measurements interface bus

microprocessor-based synergistic

computer-based synergistic safe intelligent

DVMs portable function generators

scopes impedance measurements

intelligent logic analyzers metrological

interface bus modular computer-based

calculator-based safe battery powered

V/Ms logic analyzers calculator-based

modular pulse measurements

**INSTRUMENTS**  
**'76**

Before You Read This Issue . . .  
**RENEW YOUR SUBSCRIPTION**  
Turn to card inside cover

# the **DIP** **HIGH** **SIP**

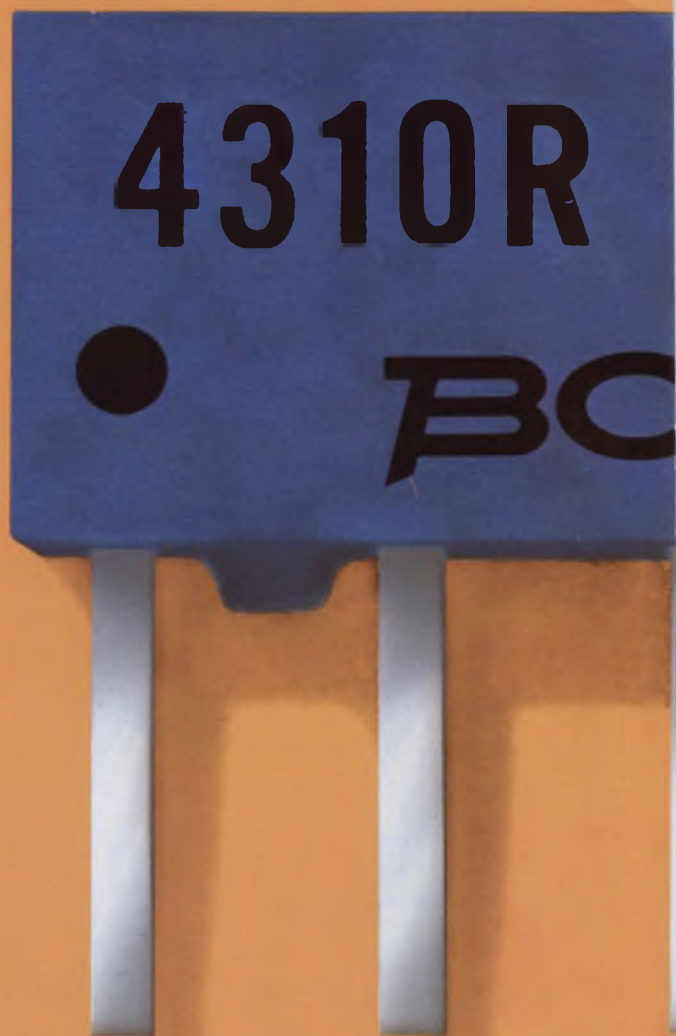

## Now in the only full line of super low profile SIP Resistor Networks.

If you haven't designed in Single In-line Package resistor networks because of their high profile, take another look. THE HEIGHT ON BOURNS SIPs IS ONLY .190 INCH! And that's standard for all 6, 8 and 10 pin configurations with:

- 5, 7 or 9 resistors and 1 common pin
- 3, 4 or 5 isolated resistors
- 12 resistors, dual terminator (8 pin)

Now you can fit the same number of resistors into less area and yet maintain close P.C. Board spacing. Something you can't do when using other SIP networks with .250 or .350 inch high profiles.

And only Bourns SIPs offer the same reliable Krimp-Joint™ lead termination design as our DIP packages, high-copper alloy leads and uniform molded package design. With added features like MACHINE INSERTABILITY, COMPETITIVE PRICING AND DISTRIBUTOR AVAILABILITY —

Why specify other than Bourns?



Bourns Krimp-Joint™ offers both a mechanical and electrical bond that lap or butt joint construction can't provide. The lead is crimped on the network element and a high-temp, reflow-resistant solder is used to prevent failure during wave soldering and in circuit thermal cycling and vibration.

### FREE SIP and DIP SAMPLES!

Write on your company letterhead and let us know your requirements, we'll rush you a SIP or DIP resistor network sample and complete specifications.

**TRIMPOT PRODUCTS DIVISION, BOURNS, INC.**, 1200 Columbia Avenue, Riverside, California 92507. Telephone 714 781-5415 — TWX 910 332-1252.



WATCH THIS SPACE FOR DETAILS

**WAVETEK** MODEL 172  
PROGRAMMABLE SIGNAL SOURCE

UNIT RCL AMPL SPEC LOAD



CIRCLE NUMBER 2

**T**his is the face of our new Model 172 programmable signal source.

It gives you 7 function generator waveforms over a frequency range of 0.0001 Hz to 13 MHz. It's GPIB compatible, has a microprocessor-controlled interface, plus a 5½ -digit synthesizer option.

We'll give you more details in the next installment. Meanwhile, circle the inquiry card or contact us direct. Wavetek, P.O. Box 651, San Diego, CA 92112. Phone (714) 279-2200. Or TWX 910-335-2007.

**WAVETEK®**

# The largest selection of "OFF-THE-SHELF" POWER SPLITTERS/COMBINERS Available!

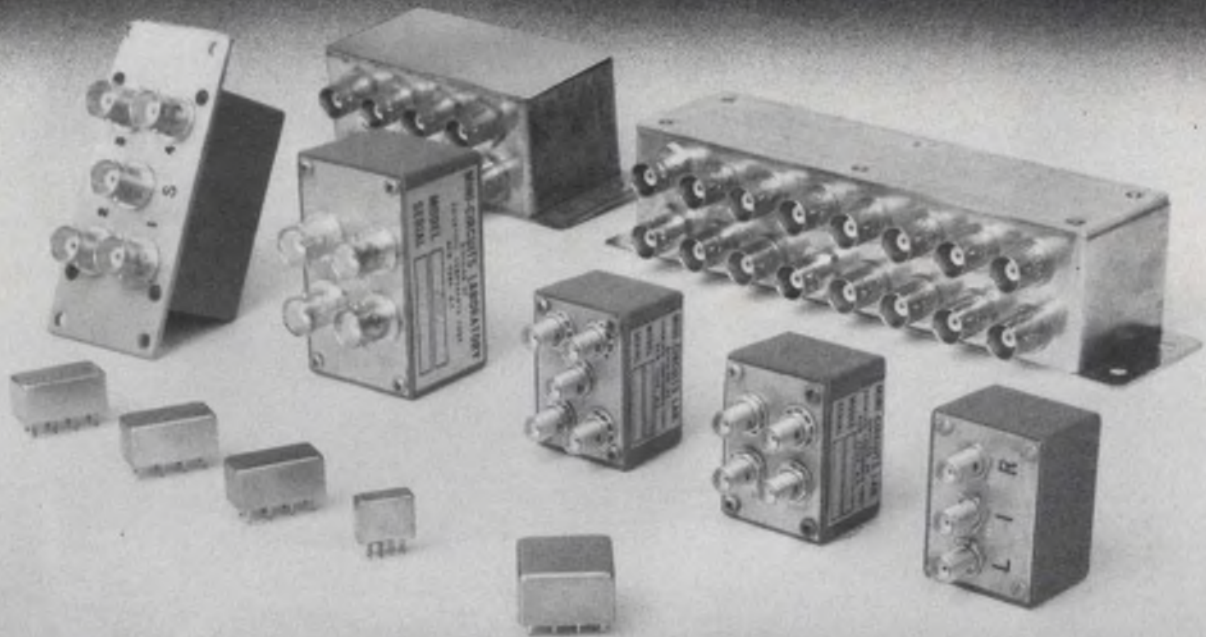

**NEW MODELS AND CASE STYLES AVAILABLE**

**We invite you to convince yourself... place your order now and check our product performance, reliability and delivery ... at the lowest prices!**

Model No.	Freq. range (MHz)	Isol. between outputs (dB) typ.	Insertion loss (dB) (typical)	Unbalance $\phi$ (deg)	Amp. (dB)	Price (Quantity)
<b>TWO-WAY 0°</b>						
PSC 2-1	0.1-400	25	0.4 above 3dB split	1	0.1	\$ 9.95 (6-49)
ZSC 2-1						\$24.95 (4-24)
ZMSC 2-1						\$34.95 (4-24)
PSC 2-2	0.002-60	40	0.3 above 3dB split	1	0.1	\$19.95 (6-49)
ZSC 2-2						\$34.95 (4-24)
ZMSC 2-2						\$44.95 (4-24)
ZFSC 2-2	10-1000	25	0.6 above 3dB split	0.8	0.08	\$39.95 (4-24)
PSC 2-1W	1-650	25	0.5 above 3dB split	3	0.20	\$14.95 (6-49)
ZSC 2-1W						\$29.95 (4-24)
ZMSC 2-1W						\$39.95 (4-24)
PSC 2-1-75°	0.25-300	25	0.4 above 3dB split	1	0.05	\$11.95 (6-49)
ZSC 2-1-75°						\$24.95 (4-24)
ZMSC 2-1-75°						\$34.95 (4-24)
MSC 2-1	0.1-450	30	0.4 above 3dB split	1	0.1	\$16.95 (6-24)
PSC 2375	55-85	35	0.3 above 3dB split	0.05		\$19.95 (6-49)
ZSC 2375						\$34.95 (4-24)
ZMSC 2375						\$44.95 (4-24)
<b>TWO-WAY 180°</b>						
PSCJ 2-1**	1-200	33	0.6 above 3dB split	2.5	15	\$19.95 (5-49)
ZSCJ 2-1						\$34.95 (4-24)
ZMSCJ 2-1						\$44.95 (4-24)
PSCJ 2-2	0.01-20	33	0.3 above 3dB split	1	0.05	\$29.95 (4-24)
ZSCJ 2-2						\$44.95 (4-24)
ZMSCJ 2-2						\$44.95 (5-49)
<b>TWO-WAY 90°</b>						
PSCQ 2-90	55-90	30	average of coupled outputs less 3dB 0.3	3	1.0	\$19.95 (5-49)
<b>THREE-WAY 0°</b>						
PSC 3-1	1-200	30	J.4 above 4.8 split	2	0.1	\$19.95 (6-49)
ZSC 3-1						\$34.95 (4-24)
ZMSC 3-1						\$44.95 (4-24)
PSC 3-2	0.01-30	40	0.25 above 4.8 split	2	0.1	\$29.95 (6-49)
ZSC 3-2						\$44.95 (4-24)
ZMSC 3-2						\$54.95 (4-24)
<b>FOUR-WAY 0°</b>						
PSC 4-1	0.1-200	30	0.5 above 6dB split	2	0.1	\$26.95 (6-49)
ZSC 4-1						\$41.95 (4-24)
ZMSC 4-1						\$51.95 (4-24)
ZSC 4-2	0.002-20	33	0.45 above 6dB split	2	0.1	\$64.95 (4-24)
ZMSC 4-2						\$74.95 (4-24)
PSC 4-3	0.25-250	30	0.5 above 6dB split	2	0.1	\$23.95 (6-49)
ZSC 4-3						\$38.95 (4-24)
ZMSC 4-3						\$48.95 (4-24)
PSC 4-6	0.01-40	32	0.4 above 6dB split	0.05		\$29.95 (6-49)
PSC 4-10	2-175	33	0.6 above 6dB split	0.08		\$26.95 (6-49)
<b>SIX-WAY 0°</b>						
PSC 6-1	1-175	30	0.75 above 7 dB split	4	0.2	\$59.95 (1-5)
<b>EIGHT-WAY 0°</b>						
PSC 8-1	0.5-175	30	0.8 above 9dB split	3	0.2	\$89.95 (1-5)
ZFSC 8-1						\$109.00 (1-3)
ZFSC 16-1	0.5-125	37	0.8 above 12dB split	2	0.08	\$174.95 (1-4)

**COMMON SPECIFICATIONS FOR ALL MODELS:** impedance all ports, 50 ohms. \*Except 75 suffix denotes 75 ohms VSWR:1.1-1.2 typical. Nominal phase difference between output ports, 0°. \*\*Except J suffix denotes 180°. Q denotes 90°. Delivery from stock: One week max. P prefix denotes pin models, Z prefix denotes BNC/TNC connector models, ZM prefix denotes miniature-SMA connector models.

For complete specs, performance curves and drawings, see pgs 161-303 of the 1976-77 MicroWaves Product Data Directory.



**Mini-Circuits Laboratory**

837-843 Utica Avenue, Brooklyn, NY 11203

(212) 342-2500 Int'l Telex 620156 Dom. Telex 125460

**International Representatives:**  AUSTRALIA General Electronic Services, 99 Alexander Street, New South Wales, Australia 2065;  ENGLAND Dale Electronics, Dale House, Wharf Road, Frimley Green, Camberley Surrey;  FRANCE S. C. I. E., D. I. M. E. S., 31 Rue George, Sand, 91120 Palaiseau, France;  GERMANY, AUSTRIA, SWITZERLAND Industrial Electronics GmbH, Klüberstrasse 14, 6000 Frankfurt/Main, Germany;  ISRAEL Velectronics, Ltd., 69 Gordon Street, Tel Aviv, Israel;  JAPAN Denzho Kaisha, Ltd., Equich, Building 8-1, Chome Hamamatsucho, Minato-ku Tokyo;  EASTERN CANADA B. O. Hummel, 2224 Maynard Avenue, Utica, NY 13502 (315) 736-7821;  NETHERLANDS, BELGIUM, LUXEMBOURG: Coimax Veilweg II, Hattem, Holland;  NORWAY Datamatik AS, Ostensjoveien 62, Oslo 6, Norway

**US Distributors:**  NORTHERN CALIFORNIA Cain, White & Co., Foothill Office Center, 105 Fremont Avenue, Los Altos, CA 94022 (415) 948-6533;  SOUTHERN CALIFORNIA, ARIZONA Crown Electronics, 11440 Collins Street, No. Hollywood, CA 91601 (213) 877-3550

CIRCLE NUMBER 3

---

## NEWS

- 21 **News Scope**
- 29 **Washington Report**
- 50 **Instrument '76 special issue**, featuring major trends in instrument technology.
- 52 **Smart instruments**—They've got computing power that boggles the mind.
- 60 **Portable instruments**—The specs are good but the battery life is short.
- 68 **Howard Vollum, Bill Peek and Wim Velsink of Tektronix** discuss scopes.
- 76 **Programmable instruments**—The standard 488 bus is playing a major role.
- 88 **Combined instruments**—They're often better than the sum of their parts.
- 96 **Ulrich Rohde** speaks on American and European engineers.
- 104 **Standards and calibration**—Instruments improve as standards are more accurate.
- 114 **Safe instruments**—Without safety in mind instruments could be hazardous.

---

## TECHNOLOGY

- 35 **MICROPROCESSOR DESIGN**
- 124 **Get on the IEC bus.** Soon to be an international standard for interfacing instruments, the bus brings many benefits—and a few problems too.
- 130 **Measuring capacitor loss:** Are S-parameters any good? They're not, but other methods—like the use of Q-bridges or resonant coaxial lines—are acceptable.
- 136 **Measure the characteristic impedance** of almost any line with this two-load technique, and avoid many of the limitations of traditional methods.
- 140 **Measure pulse-rate ratios** automatically to four-place accuracy. Simple circuit handles steady or random signal rates with ratios greater or less than unity.
- 146 **Don't sweat with thermocouple thermometers.** CMOS analog and digital devices make it easy to design an inexpensive thermometer.
- 152 **Low-cost data-acquisition systems** need not transmit analog signals. Two-chip integrating a/d converters need only two wires for data handling.
- 160 **Consider v/f converters** for data-acquisition systems. They offer high resolution and accuracy when used as analog-to-digital converters.
- 168 **Ideas for Design:** Inverter circuit handles bidirectional signal flow without latching up . . . Voltage-controlled oscillator provides symmetrical triangular and square waveforms . . . Control the data rate of a  $\mu$ P system with software instructions . . . Use TTY or CRT interchangeably on  $\mu$ P system . . . Stable constant-voltage supply uses current source to establish reference.
- 178 **International Technology**

---

## PRODUCTS

- 183 **Instrumentation:** DPM building blocks make 93 different instruments.
- 184 **Instrumentation:** Digital integrator reads watt or amp-hours.
- 209 **Modules & Subassemblies:** Compact 12-bit s/d converter cuts weight.
- 221 **Packaging & Materials:** Solderless breadboards handle 600-mil DIPs.
- 198 **Components**
- 204 **Discrete Semiconductors**
- 216 **Data Processing**
- 228 **Integrated Circuits**
- 236 **Power Sources**
- 238 **Microwaves & Lasers**

---

## DEPARTMENTS

- 47 **Editorial:** The old man at the bar
- 7 **Across the Desk**
- 240 **Application Notes**
- 243 **Evaluation Samples**
- 243 **Design Aids**
- 246 **New Literature**
- 248 **Bulletin Board**
- 248 **Vendors Report**
- 252 **Advertisers' Index**
- 254 **Product Index**
- 256 **Information Retrieval Card**

**Cover:** Cover designed by Art Director, Bill Kelly.

---

ELECTRONIC DESIGN is published biweekly by Hayden Publishing Company, Inc., 50 Essex St Rochelle Park, NJ 07662. James S. Mulholland Jr., President. Printed at Brown Printing Co., Waseca, MN. Controlled circulation postage paid at Waseca, MN and New York, NY, postage pending Rochelle Park, NJ. Copyright © 1976. Hayden Publishing Company, Inc. All right reserved. POSTMASTER: Please send form 3579 to ELECTRONIC DESIGN, P.O. Box 13803, Philadelphia, PA 19101.

# In-circuit emulation product can do while

The dream of design engineers is to develop, debug, and integrate hardware and software in their actual product environment—from day one. Thereby dramatically shortening the development time—and development cost—of their microcomputer-based products.

The Intellec® microcomputer development system makes the dream a reality. Because the Intellec system has everything you need to design microprocessor based products using Intel® 8080, Series 3000 and future Intel microprocessors.

You reverse the traditional product development flow which postpones hardware/software integration until late in the development cycle. Move from concept through design, system integration and debugging to production in a fraction of the time normally required.

With ICE-80 and ICE-30 Intellec's in-circuit emulation modules, you exercise your complete hardware/software prototype under control of high level diagnostic software. ICE-80 plugs into the 8080 socket in your prototype system and runs it in real time. Under Intellec system control, you single-step your system program, using Intellec's memory and I/O as though they were part of the prototype system. Powerful debug functions are extended into your system and you can examine or modify your system memory or Intellec memory using symbolic references instead of machine addresses.

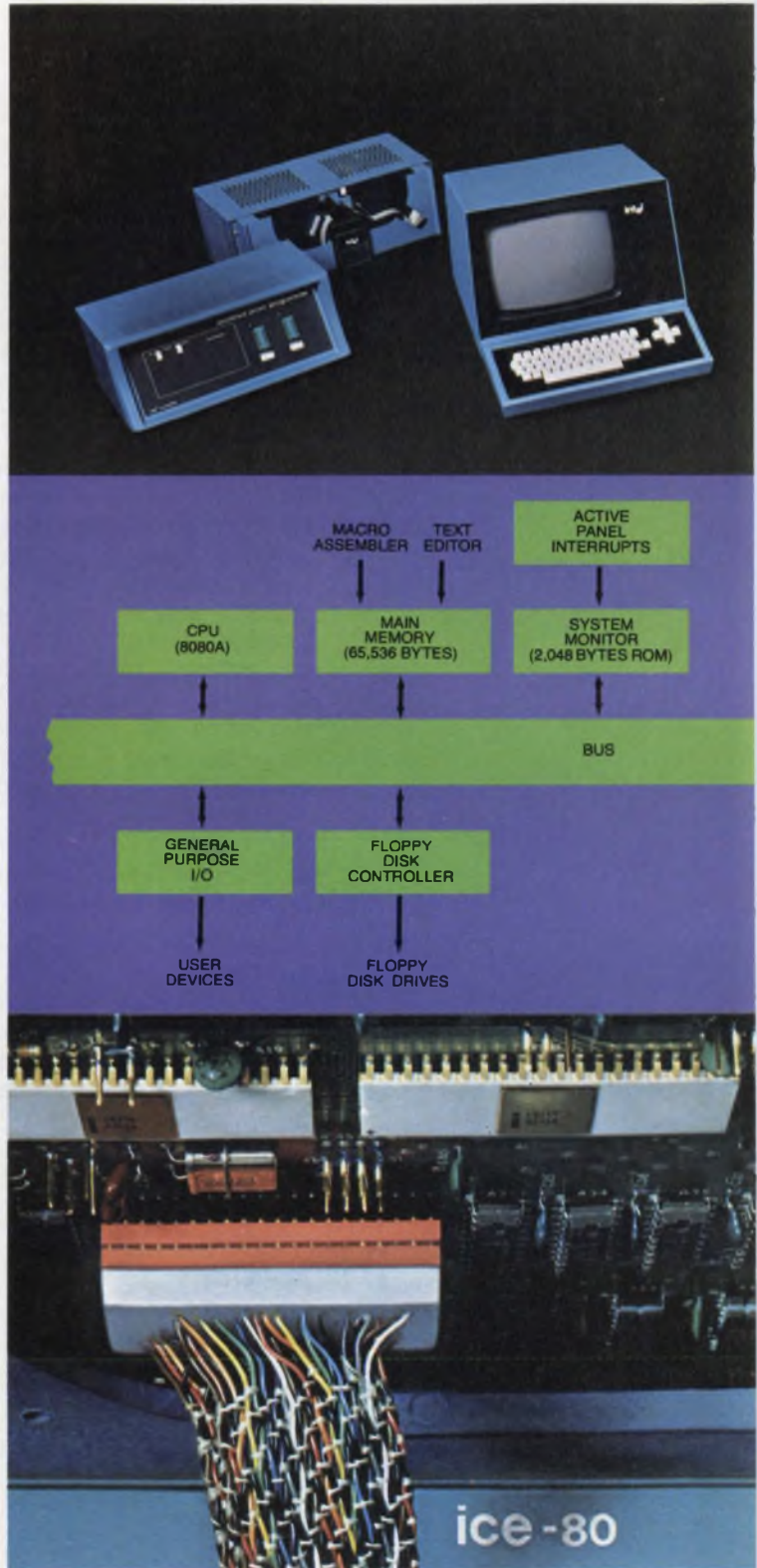

# lets you see what your it's still on the bench.

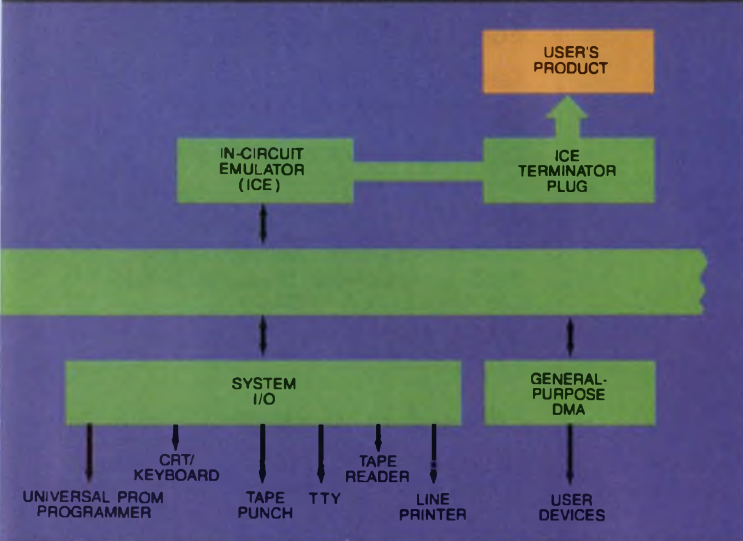
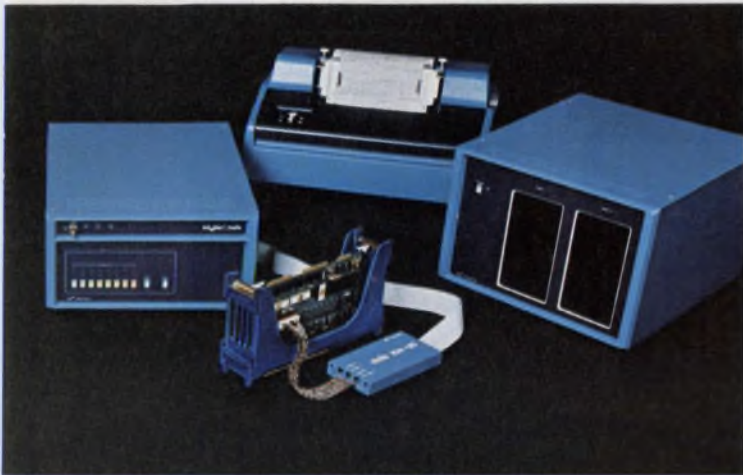

The Intellect system includes its own 8080 processor, memory, and a full range of peripherals designed to ease your development task. These include diskette operating system, CRT/keyboard, line printer, universal PROM programmer, high speed papertape reader, the in-circuit emulation modules, (ICE-80 and ICE-30) and interfaces for teletypewriter and high speed tape punch.

Under Intellect software you assemble, edit, execute and debug programs quickly. The diskette-based operating system, ISIS, performs all your program and file management tasks automatically. A wide range of system commands gives you complete control of your prototype, including the ability to set multiple hardware and software break point conditions.

The Intellect system provides the convenience of a complete in-house development system, backed with the quality support, service, training, and documentation you expect from the company that is the leader in microprocessor systems development. And the Intellect system is available for immediate delivery.

If you've always wanted to see how your product works while it's still on the bench, experience an Intellect system for yourself. For a demonstration or for technical information use the reader service card or write: Intel Corporation, 3065 Bowers Avenue, Santa Clara, California 95051.

**intel**<sup>®</sup>

Microcomputers. First from the beginning.

```
*GO FROM START UNTIL RSLT WRITTEN
EMULATION BEGUN

*DISPLAY CYCLES
STAT-ADR-DATA STAT-ADR-DATA STAT-ADR-DATA S
A2H-1326H-CDH 82H-1327H-E3H 82H-1328H-01H 0

*CHANGE DOUBLE REGISTER SP=13FFH
*BASE HEX
*EQUATE STOP=1333H
*GO FROM START UNTIL STOP EXECUTED THEN DUMP
EMULATION BEGUN
B=01H C=41H D=00H E=00H H=00H L=00H F=56H
```

CIRCLE 278 FOR TECHNICAL INFORMATION ONLY  
CIRCLE 279 FOR A DEMONSTRATION & TECHNICAL INFORMATION

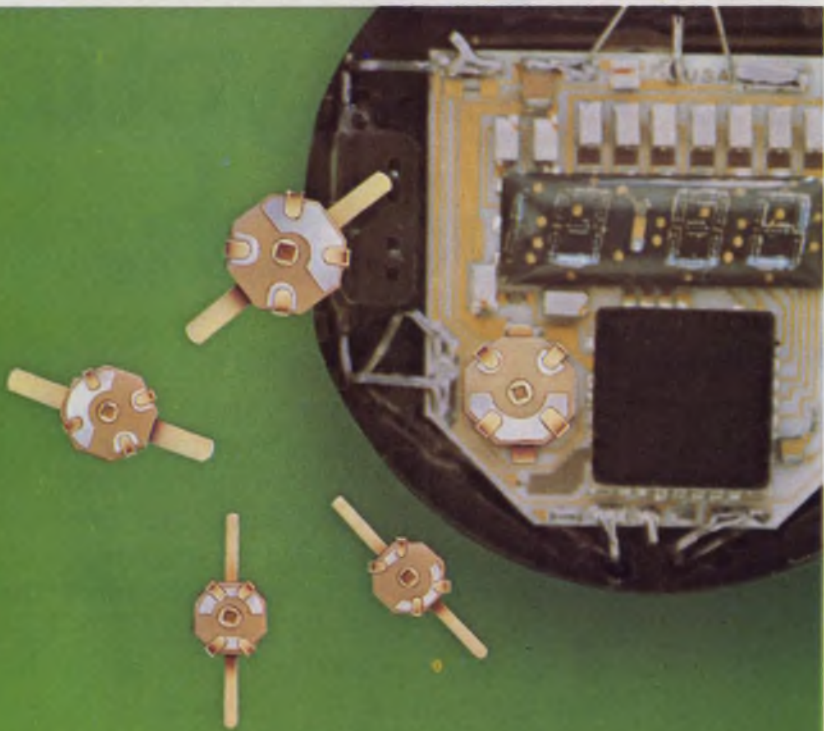

# Thin-Trim. capacitors

Tucked in the corner of this Pulsar Watch is a miniature capacitor which is used to trim the crystal. This Thin-Trim capacitor is one of our 9410 series, has an adjustable range of 7 to 45 pf, and is .200" x .200" x .050" thick.

The Thin-Trim concept provides a variable device to replace fixed tuning techniques and cut-and-try methods of adjustment. Thin-Trim capacitors are available in a variety of lead configurations making them easy to mount.

A smaller version of the 9410 is the 9402 series with a maximum capacitance value of 25 pf. These are perfect for applications in sub-miniature circuits such as ladies' electronic wrist watches and phased array MIC's.

Johanson Manufacturing Corporation  
Rockaway Valley Road  
Boonton, New Jersey 07005  
(201) 334-2676 TWX 710-987-8367

**Sr. Vice President, Publisher**  
Peter Coley

## Editors

Editorial Offices  
50 Essex St.  
Rochelle Park, NJ 07662  
(201) 843-0550  
TWX: 710-990-5071  
Cable: Haydenpubs Rochellepark

**Editor-in-Chief** George Rostky

**Managing Editors:**  
Ralph Dobriner  
Michael Elphick

**Senior Associate Editor**  
Stanley Runyon

**Associate Editors:**  
Sid Adlerstein  
Dave Bursky  
Samuel Derman  
Morris Grossman  
John F. Mason  
Max Schindler  
Michael Shunfenthal

**Contributing Editors:**  
Peter N. Budzilovich, John Kessler  
Alberto Socolovsky, Nathan Sussman

## Editorial Field Offices

### East

Jim McDermott, Eastern Editor  
P.O. Box 272  
Easthampton, MA 01027  
(413) 527-3632

### West

Dick Hackmeister, Western Editor  
8939 S. Sepulveda Blvd., Suite 510  
Los Angeles, CA 90045  
(213) 641-6544  
TWX: 1-910-328-7240

## Editorial Production

Marjorie A. Duffy, Production Editor  
James Keane, Copy Editor

## Art

**Art Director,** William Kelly  
Richard Luce, Anthony J. Fischetto

## Production

**Manager,** Dollie S. Viebig  
Helen De Polo, Anne Molfetas

## Circulation

**Director,** Barbara Freundlich  
Trish Edelmann

## Information Retrieval

Paula Greenleaf

## Advertising Promotion

Susan G. Apolant



## Across the Desk

### Wolfe's Law

Buried deep in some secluded mountain cave, there must be an archive where silent monks guard the profundities of our industry. This is where one should find Murphy's Law (if anything can go wrong, it will) and its corollaries. Here, too, one should find Wolfe's Law, propounded by the Vice-President of Gould Inc. and General Manager of the Centralab Electronics Div. Those less versed in the philosophical underpinnings of our industry should know that Wolfe's Law states that: "It requires more effort to change something than not to change it."

The principal corollaries belabor the obvious:

- The effort expended by the person who wants to change something is the square of the effort expended by the person who doesn't want it changed.

- Success is inversely proportional to resistance.

### Engineers, wake up: You are being raped

Recently, it seems, we have been deluged with a flood of Engineering Design Contests. There have been Microprocessor Contests, FPLA Contests, PLL Contests, etc. At first glance, these contests would seem to be a way for the engineer to exercise some creativity, while possibly winning a prize for his efforts. In reality, they are a great rip-off of the working engineer.

Who benefits from these contests? Clearly, only the contest sponsor. The sponsor gains in three ways. First, he obtains—at virtually no cost—an enormous

library of applications data. Second, those engineers submitting contest entries are more likely to use the sponsor's product than the product of a competitor. Third, the sponsor can now attract even more business because he can provide a great wealth of applications literature.

The engineer is getting raped and doesn't realize it. If the engineer charged a consulting fee for the effort that goes into a contest entry, he would likely do better than if he had won first prize. Yet the chance of "getting something for nothing" is enticing engineers to give away their services.

This brain picking would never work in any other profession. Imagine a large law firm asking independent lawyers to prepare a brief on a pending case. The lawyer who prepares the best brief wins a calculator.

Or think of a pharmaceutical company asking doctors to develop a new drug. The best one wins a trip to Florida. How insane that engineers don't realize that these so-called contests amount to the same thing.

If engineers are ever to obtain a truly professional status, they must start acting like professionals and stop giving away their services.

*Alan Rosenbaum*

*Manager of Computer Products  
General Microwave Corp.  
155 Marine St.  
Farmingdale, NY 11735*

### You want to be better, I want you to be better

I was intrigued by your editorial, "We Want to Be Better" (ED No. 17, August 16, 1976, p. 59), in

*(continued on page 11)*

Electronic Design welcomes the opinions of its readers on the issues raised in the magazine's editorial columns. Address letters to Managing Editor, Electronic Design, 50 Essex St. Rochelle Park, N.J. 07662. Try to keep letters under 200 words. Letters must be signed. Names will be withheld on request.

## Marcoflex. The switch that turns people on.



"... amazingly simple and reliable."  
"Why didn't I think of it?"

People are really getting turned on by our new Marcoflex 650 switches.

Which doesn't surprise us. After all, its patented flexing spring action is something of a *break-through*.

An incredibly simple design gives you electrical and mechanical characteristics associated with larger switches in a miniature, .625-inch package at an economical price.

Features include wiping action, multiple-point (bifurcated) contact, true snap action, high contact force, and positive tactile feel.

Plus alternate or momentary action, and excellent reliability.

Get turned on by Marcoflex yourself. Contact us today for full details.

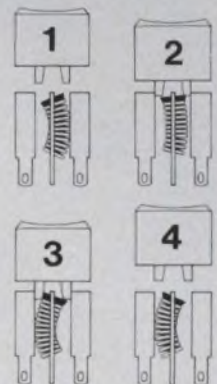

The patented Marcoflex  
mechanism.

### ILLUMINATED PRODUCTS INC.

A subsidiary of OAK Industries Inc.  
2620 South Susan St., P.O. Box 11930  
Santa Ana, CA 92711  
Telephone: 714/540-9471 TWX 910-595-1504

 COMPONENTS GROUP

CIRCLE NUMBER 6

# The only microcomputer with the power of a PDP-11. The PDP-11/03.

If you've been looking for a microcomputer with minicomputer power at a micro price, join the hundreds of OEMs who've already found it with the DIGITAL microcomputer. The PDP-11/03.

The 11/03 gives you everything you could ask for in a small computer. High performance. High reliability. And a low price — just \$1,357 in quantities of 50. And that micro price buys you mini features that quickly translate into benefits OEMs appreciate. Features like full PDP-11 instructions with eight general purpose

registers for fast program development. RAM (MOS or Core) and PROM memories that let you match the memory with the application. Hardware vectored interrupts with stack processing for real computer power. And multiple-sourced components for sure delivery.

Buying our 11/03 also buys you the chance to start small without staying small. Because you can add up to 32K words of memory, fast floating point instructions, and more. Whenever you and your customers are ready.

Besides growing bigger in size, the 11/03 lets you grow bigger in scope. It's software compatible with every other PDP-11 we offer. From our LSI-11 all the way up to our medium scale PDP-11/70. That means you can take full advantage of Digital PDP-11 software and services.

You can also take advantage of Digital's OEM Referral program — your chance to take on an international marketing and support team without hiring them. The OEM Referral program can help you locate new custom-

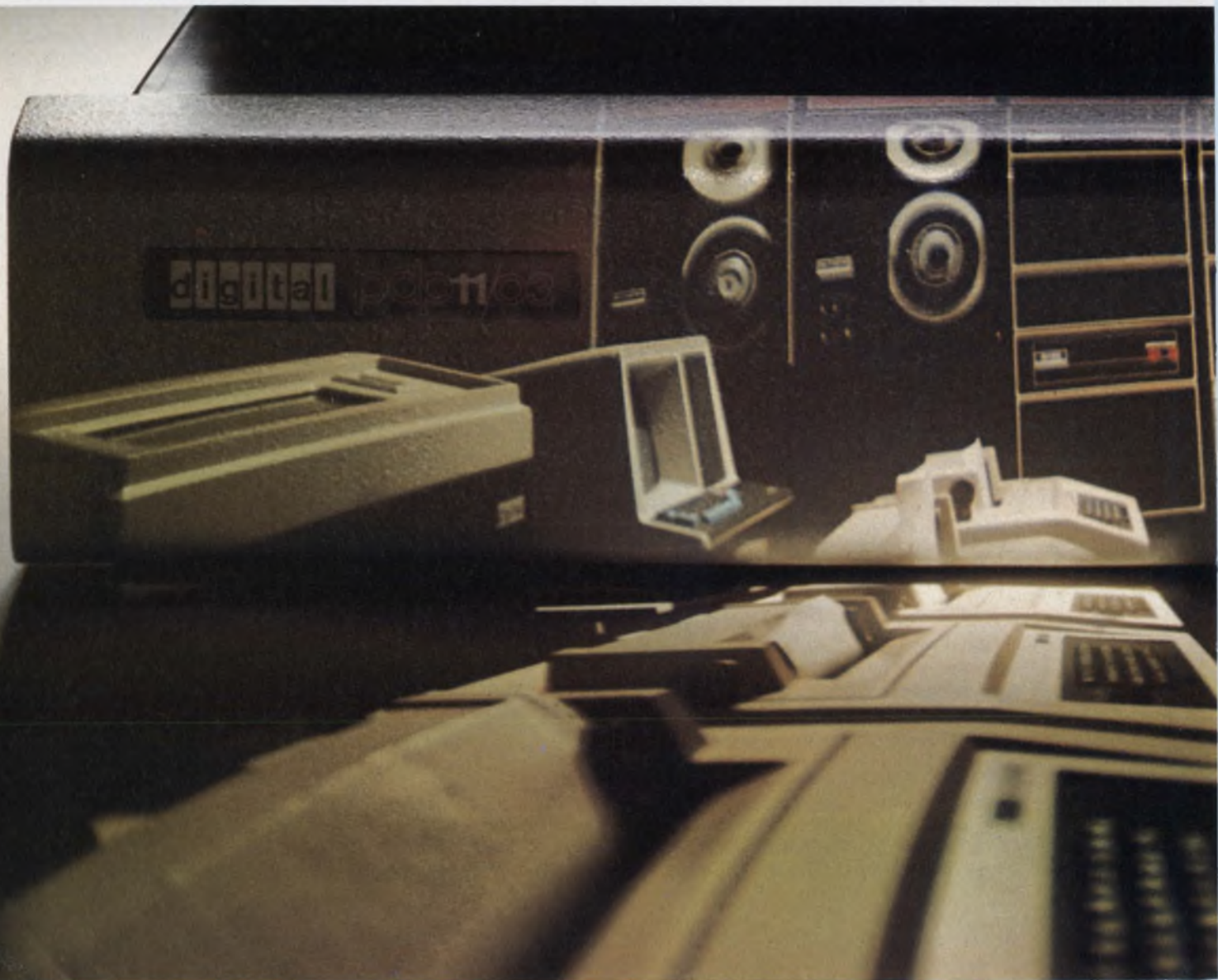

ers and new markets around town and around the world. And it can all start with the PDP-11/03.

So if you're looking for a

proven microcomputer with proven power and performance, get the micro with all the power and performance of a PDP-11.

Digital's PDP-11/03. Call your nearest Digital sales office. Or send the coupon to Digital Equipment Corporation, Maynard, Massachusetts 01754. (617) 897-5111. European headquarters: 81 Route de l'Aire, 1211 Geneva 26. In Canada: Digital Equipment of Canada, Ltd.

Digital Equipment Corporation, Maynard, Massachusetts

I'm interested. Please send information.

I'm more than interested. Please have your nearest Digital sales representative contact me.

Name \_\_\_\_\_ Title \_\_\_\_\_

Company \_\_\_\_\_

Address \_\_\_\_\_ Phone \_\_\_\_\_

City \_\_\_\_\_ State \_\_\_\_\_ Zip \_\_\_\_\_

ED116

**digital**

**50,000 computers saving managers millions.**

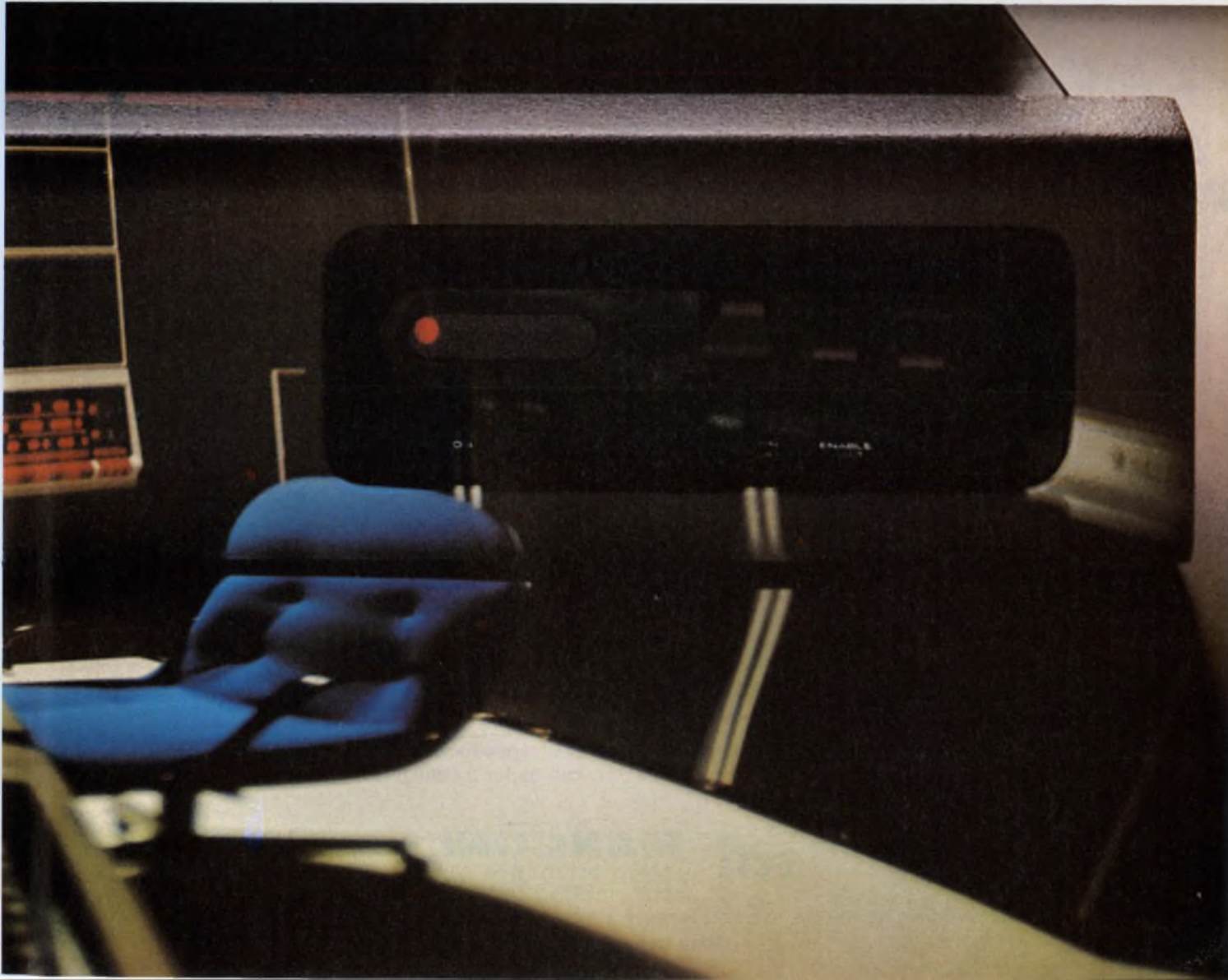

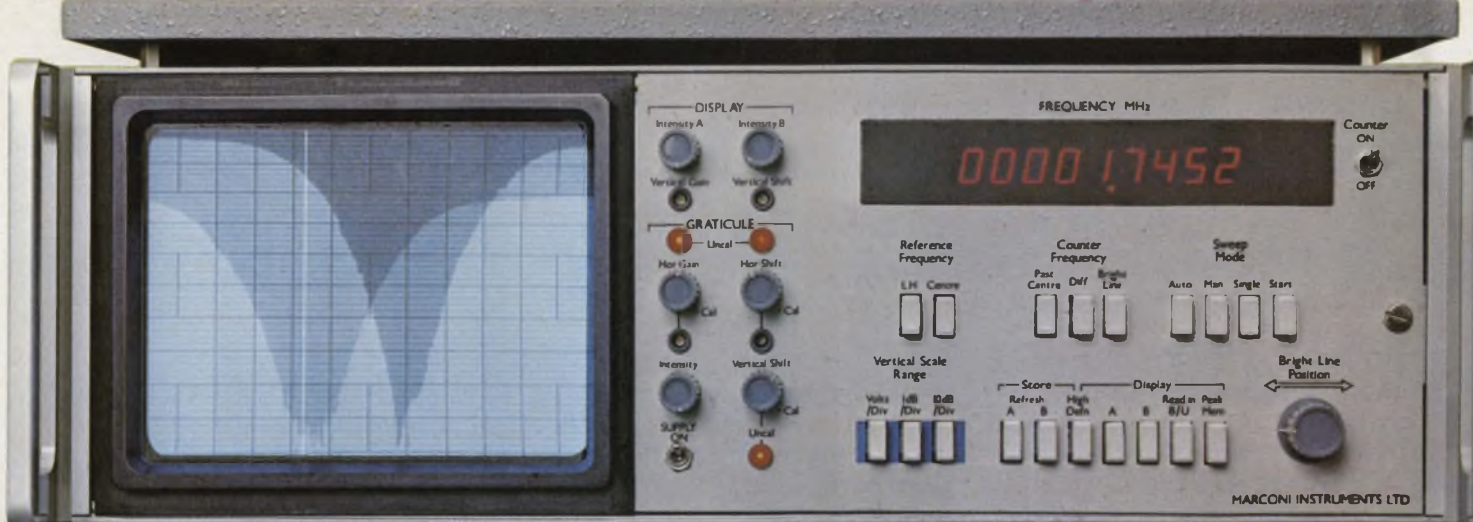

**Price  
Reduced**  
**\$13,795**

**We've always had unique features and better specs than our competition... now, in addition, OUR price is LOWER!**

Save your skilled engineers for more important work with **mi** Model 2370 Spectrum Analyzer. *Simplify* complicated measurements such as *response, level, gain, signal purity, modulation* and many more. Forget everything you have heard about spectrum analyzers. **mi** Model 2370 is unique. It employs advanced technology to make it as easy to operate as a multimeter. The facts speak for themselves.

- Flicker-free high brightness TV display (No more storage tubes to replace)
- Electronic graticule can pin point position of waveform display for rapid analysis and measurement.
- Choice of vertical scales: linear, 10dB/div for 100dB display, and 1dB/div for 0.1dB resolving power.
- Counter **automatically** displays center frequency, identifies the frequency corresponding to the manually

adjusted 'bright line cursor', or the difference frequency between the two. All to an accuracy of 2Hz.

- Integral synchronous signal source for measuring *networks, filters, amplifiers, etc.*
- For comparative measurements, memory storage can retain one display indefinitely, for simultaneous display with waveform from items under test.
- **Automatic** adjustment of amplifier gain to *optimize* noise performance.
- **Automatic** selection of *optimum* sweep speed.
- With the 5Hz filter, signals 100Hz from a response at 0dB can be measured to better than -70dB.

Such speed and accuracy must be seen to be believed, call us for an enlightening demonstration.



100 STONEHURST COURT, NORTHVALE, NEW JERSEY 07647 • TELEPHONE: 201/767-7250 • TWX: 710-991-9752

CIRCLE NUMBER 8

750R

## ACROSS THE DESK

(continued from page 7)

which you stressed that ED, unlike some of its competitors, admits to its editorial gaffs. Such honesty is commendable and certainly reinforces the reader's faith in your fine publication.

I wish to call attention to the article on CRTs in the same issue. Your editor wrote, "Almost as diverse a selection of CRTs is available from RCA's Industrial Tube Div., Lancaster, PA, and RCA's Electronic Components Div., Harrison, NJ." Historically, that statement would have been redundant since the Industrial Tube Division in Lancaster was a part of Electronic Components, headquartered in Harrison. But in March 1975, when RCA reorganized its Electronic Components activity, the Industrial Tube organization became an integral part of RCA Electro-Optics and Devices, now an organizational entity within the Solid State Division. It is therefore proper to identify RCA Electro-Optics and Devices, Lancaster, PA, as the CRT supplier.

Walter B. Dennen

Manager, News and Information  
RCA  
Solid State Division  
Route 202  
Somerville, NJ 08876

### Charlie and Clarence, and Clark and Jack

You may have had a good reason to oversimplify the concept of modern management in your "Scientific Management" editorial (ED No. 18, September 1, 1976, p. 61)—possibly to make a point with a specific segment of your readers. However, I'd appreciate equal time for the other viewpoint.

My position is Senior Engineer. Contrary to the flavor of your editorial, my preference, as a worker, would be the modern concepts. These include extensive group interaction, group participation in management decision making, self-scheduling and personal development.

A manager who claims to use the latest tools, but in fact is using only the latest bookkeeping methods, does not merit the manage-

ment title.

The management team I work for claims to be from the modern school. Nevertheless, the work is done without planning, production-line style, open door policy "with authorization," and one-way communication with the single goal of keeping the boss out of trouble. All the management books I've read place this philosophy in the old school.

Concerning your editorial specifically, you refer to "Charlie" as responsible for his staff, running things smoothly, getting things done and using the best tools. "Clarence" on the other hand is a production pusher with computer-generated numbers to prove his point.

If you would play engineer for a while and list side by side the comparative philosophies from the old and new schools, theory X vs theory Y, oldest vs latest tools, your own management articles possibly, I think you'd find yourself forced to put Clarence in the old school sporting some fancy new gadgets. Charlie would also be old-school.

If you want to meet a new schooler, look at Clarence's replacement, "Clark," who spent the first 2 weeks getting to know his staff, meeting their families, outlining their future objectives, organizing their likes, dislikes, observations, ideas. Clark identified "Chuck" as the group's self-appointed spokesman and asked him to help organize the group's ideas into working projects to iron out any bugs. Production was in fact down because so much time was being devoted to organization and meetings.

Within a week, Clark came to see Jack with a list of things to discuss. Unfortunately, each item had a price tag, some quite high, at a bad time in the economy. But unlike other VPs, Jack was determined to back his middle managers as far as he could until they either could handle the rope themselves or hang from it. After the proposed machine modifications were made, production began at 2000 subassemblies a day with 5 rejects. A week of fine timing brought that to 2500 and usually 1 reject a week. And despite the apparent radical appearance of the get together, Jack himself showed up at the bowling alley to pass out

(continued on page 16)

# RCL

## Offers

### "EXPRESS DELIVERY"

At Standard Pricing...

On Rotary & "PIP" Switches

Industry's Best Delivery at Non-Premium Prices.

PROTOTYPE OR PRODUCTION RUNS— ALL AT STANDARD PRICING

Send For New '76 Catalog Or Call our Hotline For Name Of Your Local Representative Or Stocking Distributor.

(201) 374-3311

AMF

### RCL Electronics

General Sales Office:  
700 So. 21st Street  
Irvington, N. J. 07111

CIRCLE NUMBER 9



# 1100 YEARS FROM NOW, YOU'LL STILL BE GLAD YOU BOUGHT OUR MEMORIES.

Eleven hundred years from now, our semiconductor memories will still be going strong.

Because right now we're selling MOS memories with MTBFs per device of from 5 to 10 million hours. Which is well over 1100 years.

Our bipolar memories, on the other hand, will last a few centuries longer. Their MTBFs go up to 14 million hours.

And if you think these terrific figures are just wild claims like you're used to seeing in semiconductor advertising, you probably haven't heard about how we spec our products: in a word, conservatively.

Of course, all this industry-leading

reliability wouldn't mean very much if we didn't deliver it in the kind of state-of-the-art products you need.

But we do.

We sell a comprehensive line of memories that includes everything from a family of 4K MOS RAMs with access times down to 135ns, to the industry's first 2K EEPROM that can match the requirements of microprogrammed control applications.

For the full story, just contact one of our reps or distributors.

Preferably within the current millennium.

NEC Microcomputers, Inc.,  
Five Militia Drive, Lexington, MA  
02173. 617-862-6410.

## **NEC** microcomputers, inc.

REPS: East - C & D Sales 301-296-4306, Contact Sales 617-273-1520, Trionic Assoc. 516-466-2300; South - Merino Sales 214-233-6002, Perrott Assoc. 305-792-2211, 305-275-1132, 813-585-3327, Space Eng. Sales 205-837-6060, Wolfs Sales Serv. 919-781-0164; Midwest - K-MAR Eng. & Sales 816-763-3466, McFadden Sales 614-221-3363, R.C. Nordstrom 313-559-7373, 616-429-8560, R.F. Specialists 312-698-2044; West - Mike Duffy Assoc. 303-934-7392, Electronic Component Marketing 714-524-9899, 714-295-6122, 213-340-1745, Summit Sales 602-994-4587, Trident Assoc. 415-967-7031, Tri-Tronix 505-265-8409, 206-454-0940; Canada - R.F.Q. Ltd. 416-626-1445, 514-626-8324 DISTRIBUTORS: Century Elect., Harvey Elect., Intermark Elect. (Sunnyvale, Santa Ana, San Diego, Seattle), Lionex Corp., G.S. Marshall (Sunnyvale), Mirco Elect., R-M Elect., Semiconductor Specialists.

# When price and performance both count

## Compact Timer/Counters at 80, 520 and 1,000 MHz

Until now, if you needed a high performance timer/counter with all the capabilities and versatility of a lab instrument, you expected a high price. That is, unless you could do without time interval averaging capabilities or if you could get by without trigger hold-off or if you could compromise on triggering capabilities or if you didn't mind the shortcomings of a plastic case. But, that's the way it was with timer/counters. Today, our new PM 6620 series offers performance without compromise in a compact, package at compact prices.

All three models provide for:

- 80 MHz direct frequency counting
- Single shot period and time interval measurements with 100 ns resolution
- Period and time interval averaging over  $10^2$ ,  $10^3$ , or  $10^6$  intervals
- Ratio and conditional pulse counting
- Comprehensive trigger facilities with accurate trigger level setting.

But that's not all!! Depending on your individual needs, select one of three models:

- PM 6622 with trigger hold-off for even more versatile T.I. measurements
- PM 6624 with 520 MHz frequency range
- PM 6625 with 1000 MHz frequency range

And it doesn't end there! Each model is available with either of four time base oscillators, BCD, IEEE Bus or analog output options, internal battery/charger, single or dual rack mounts and more.

Add it all up and you have the most versatile family of timer/counters available... and they are available at very attractive prices. Why settle for less performance at high cost?

For immediate detailed information on the PM 6620 series utilize our HOT LINE number - 800 645-3043. N.Y.S. residents call collect - (516) 921-8880., or contact Philips Test & Measuring Instruments, Inc.

In the United States:  
400 Crossways Park Drive  
Woodbury, N.Y. 11797

In Canada:  
6 Leswyn Road  
Toronto, Ontario  
Canada M6A 1K2



Test & Measuring  
Instruments

Philips Test & Measuring Instruments, Inc.  
A NORTH AMERICAN PHILIPS COMPANY

# PHILIPS

FOR INFORMATION CIRCLE #282

FOR DEMONSTRATION CIRCLE #283



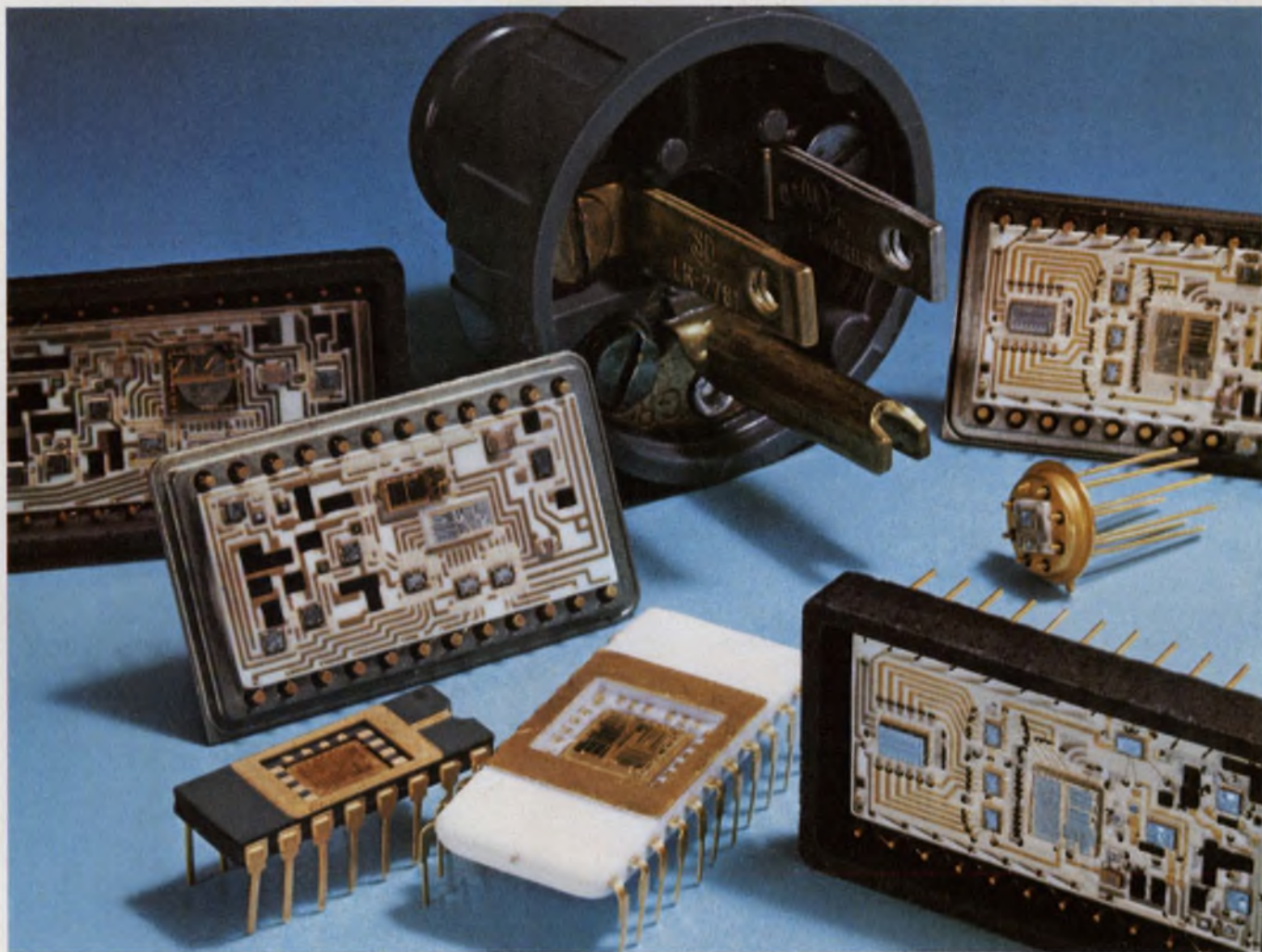

# Our new low-cost industrial converter products are standard, too.

Standards, like that plug, make life less complicated.

That's why we're leading the campaign to standardize converter products.

And the group you see here is just part of a growing family that starts as low as \$19.50 in the 100-piece quantity.

They're on-the-shelf, for quick delivery. A new line of DAC's and ADC's for designers who can use standard functions. Plus thin-film ladder networks and a precision voltage reference to give exceptional design flexibility.

These competitively priced, industry-standard converter products can save you engineering, manufacturing, and inventory time and money. And you have a wide selection of package types and temperature ranges to fit your exact applications.

Learn more about Beckman-quality, Beckman-backed hybrids. They'll make your life easier, too.

For data, write or call Helipot Division, Beckman Instruments, Inc., 2500 Harbor Blvd., Fullerton, CA 92634. Phone: (714) 871-4848, Ext. 1776.

## BECKMAN®

HELIPOT DIVISION

If you need hybrids, you should know about Beckman.

# Our newest air variable capacitor's biggest feature:



**It's small size.**

As you can plainly see, our new air variable capacitor is nearly as small as many sub-miniature ceramic trimmers. It also features the same mounting configuration which means you can use it in many of the same applications.

But small size isn't the only reason for buying our new Micro T™ capacitor. Because it's air variable, it offers you

great stability. Q is typically 1000 at 100 MHz. TC is  $+45 \pm 45$  PPM/°C. And it's available in maximum capacities of 3, 6.5, 12.7, and 19.0 pF in either vertical or horizontal tuning PC and stripline mounting versions. What's more, it gives you all this for a very small price.

E. F. Johnson Company/Dept. E.D., Waseca, MN 56093

Please send me technical information on sub-miniature air variable capacitors.

Please send me samples. You can call me at \_\_\_\_\_

Name \_\_\_\_\_

Firm \_\_\_\_\_

Address \_\_\_\_\_

City \_\_\_\_\_ State \_\_\_\_\_

Zip \_\_\_\_\_

For fast service, contact your local Johnson Distributor.



**JOHNSON**

CIRCLE NUMBER 13

## ACROSS THE DESK

*(continued from page 11)*

various awards, a few bonuses to exceptional idea people and offer the entire group one extra week of paid vacation. In six months, Chuck took over as supervisor and Clark became manager of systems engineering.

Come on, George, sign up for some courses in the new school. We don't discriminate against old timers, nor do we believe that old gods can't learn some and contribute some. Just beware of the pseudo-new schoolers.

*Bruce Nappi*

## Misplaced Caption Dept.



My company won't let us fly first class anymore.

Sorry. That's Honoré Daumier's "Third Class Carriage," which hangs in the Metropolitan Museum of Art in New York City.

## And it tasted great

I am trying to locate a source for a product I used several years ago. It consisted of a chemical powder, which, when applied with a dampened cloth to bare clean copper, would deposit a plating on the copper similar to a finely tinned surface.

I vaguely recall a name like AMP-ON, but I am not certain.

If you can advise me as to the best way to track down such a product, it will be greatly appreciated. Thank you.

*Peter J. Farrell  
Sperry Engineer*

60 Elliot Ave.  
Centereach, NY 11720

CIRCLE NUMBER 243 ►

**WELCOME TO ISSAQUAH**  
**HOME OF**  
**DATA I/O**

## Someday Issaquah will be famous.

Someday, people will say: "Issaquah, Washington, that's the home of Data I/O!"

But that's "someday." Today, more people remember us for our PROM programmers than for our name. We understand. After all, the 1500 companies who use our machines need programmers—not a name. So here's what's behind "Data I/O."

Our most popular programmer is the Model V. It is already out-selling every other PROM programmer in the world (including the former world champ, the Data I/O Programmer I). It can program all PROMs now available (165 at last count), and it's approved by the PROM manufacturers.

Our Programmer VI lets you program from one to eight MOS PROMs simultaneously with the same, or different programs.

(It can program an entire memory board in less than 30 seconds.)

Our new Programmer VIII is a completely portable, microprocessor based unit. You can take it anywhere and easily update it year after year.

Our Programmer X is for Programmable Logic Arrays (PLA's). It features CRT display, multiple inputs and outputs, and error detection through both logical and array verification. It's also microprocessor based.

Our Romulator lets you emulate any PROM configuration on the market today, develop a complete

program and debug it before you ever have to commit it to a PROM.

Data I/O offers a unique calibration standard which lets you calibrate to each PROM manufacturer's specs—before you program—for maximum yields and long term I-C reliability.

### Data I/O total three point service

1. Every Data I/O customer receives a quarterly update on currently available PROMs.
2. Through our direct (computerized) mailing program, Data I/O customers are kept constantly up-to-date on PROM specification changes and technological innovations.
3. Nine field offices in the U.S. and 22 distributors worldwide provide our customers with direct sales support, installation, and operator training.

## Get the facts

If you would like to know more about our products, or want copies of our quarterly PROM Comparison Chart and PROMBITS (our periodic technical bulletin on PROM applications and innovations), mail this coupon or call one of our offices. Data I/O Corporation, P.O. Box 308, Issaquah, Washington 98027.

Name \_\_\_\_\_

Title \_\_\_\_\_

Company \_\_\_\_\_

Address \_\_\_\_\_ M/S \_\_\_\_\_

City/State/Zip \_\_\_\_\_



# Data I/O

CIRCLE NUMBER 14

Data I/O offices: New York area—201/832-1487; Washington D.C. area—301/652-7240; Chicago area—312/884-1335; Dayton area—513/435-4440; Dallas area—214/349-0877; Tulsa area—918/865-4111; Los Angeles area—714/998-9151; San Jose area—408/732-8246; Boston area—603/888-3850; Seattle area—206/455-3990; Europe: Amsterdam—020/186855, TELEX—16616.



time  
domain.

data  
domain.

# Biomation's new logic analyzers give you both.

When your job is to interface, integrate and program a complex new digital logic system, you want as much information as you can get.

That's why we're providing a new set of tools which let you display timing information as well as logic word content—in the language of your choice.

Our new 1650-D logic analyzer gives you 16 channels at 50MHz. Our 851-D gives you 8 channels at the same speed.

Accessories can now give you a logic state (1's and 0's) display of any 16 stored words; hex or octal translation; and a vector map of memory contents. The 8 and 16-channel logic analyzers feature:

- Pretrigger and delayed trigger recording
- Trigger point can be easily identified
- Latch record mode for fast pulse capture
- Combinational triggering (true or false)
- Movable display cursor that stays with the data when you switch display modes
- Display expansion, mixed or full, X5, X10 or X20

These are complex instruments and we can't give you all significant details here. But please write, call, or use the reader service card. We want to get this useful information into your hands. Biomation, 10411 Bubb Road, Cupertino, CA 95014, (408) 255-9500. TWX: 910-338-0226.

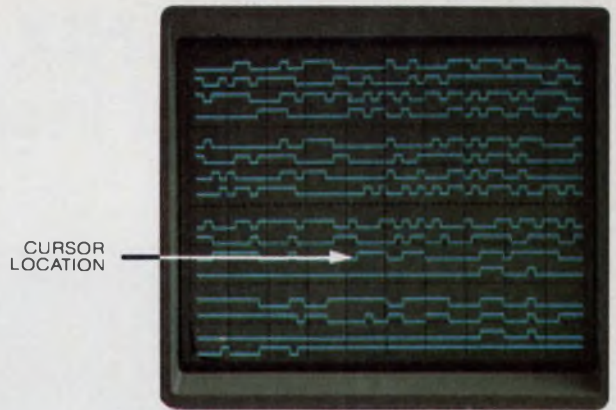

Biomation's new 1650-D produces a repetitive display output reconstructing precisely 500 bits per line for a 16-line timing diagram on a conventional oscilloscope or CRT display. Separate selection of individual channel outputs allows viewing of 1, 2, ..., 16 channels at one time with automatic vertical expansion.

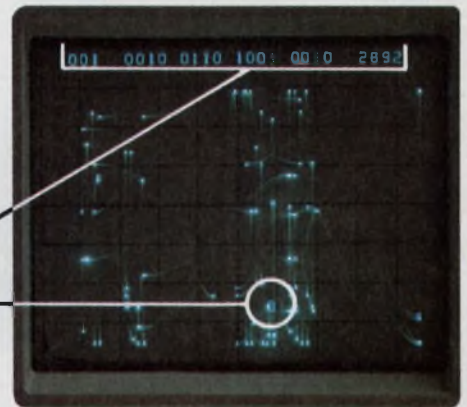

Map—each word in memory is transformed via two DAC's to form a unique dot which characterizes that word. All 512 words of the 1650's memory can be accessed for mapping. The cursor word is circled in the map as well as displayed at the top of the screen in alphanumeric form. The cursor may be moved to any of the points in the map for positive identification of that word. In addition, a map of only 16 words may be selected.

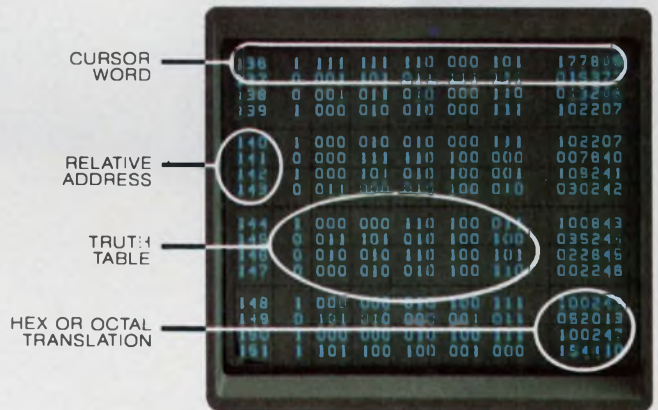

Logic state—provides memory address location, binary output of the 16 channels and selectable octal or hexadecimal translation. 16 words are displayed at one time with the cursor address location at the top of the screen. Movement of the cursor control allows accessing any 16 words of the entire 512 words stored in the 1650-D. The display control memory can store 16 words while a different set of 16 is selected from the 1650's main memory (or a new recording is made). These two sets of 16 words can then be overlaid on the CRT. Any differences will blink and be easily identified.

**biomation**  
Creating tools for technology

# TEKTRONIX now has 5 ways to look at logic.

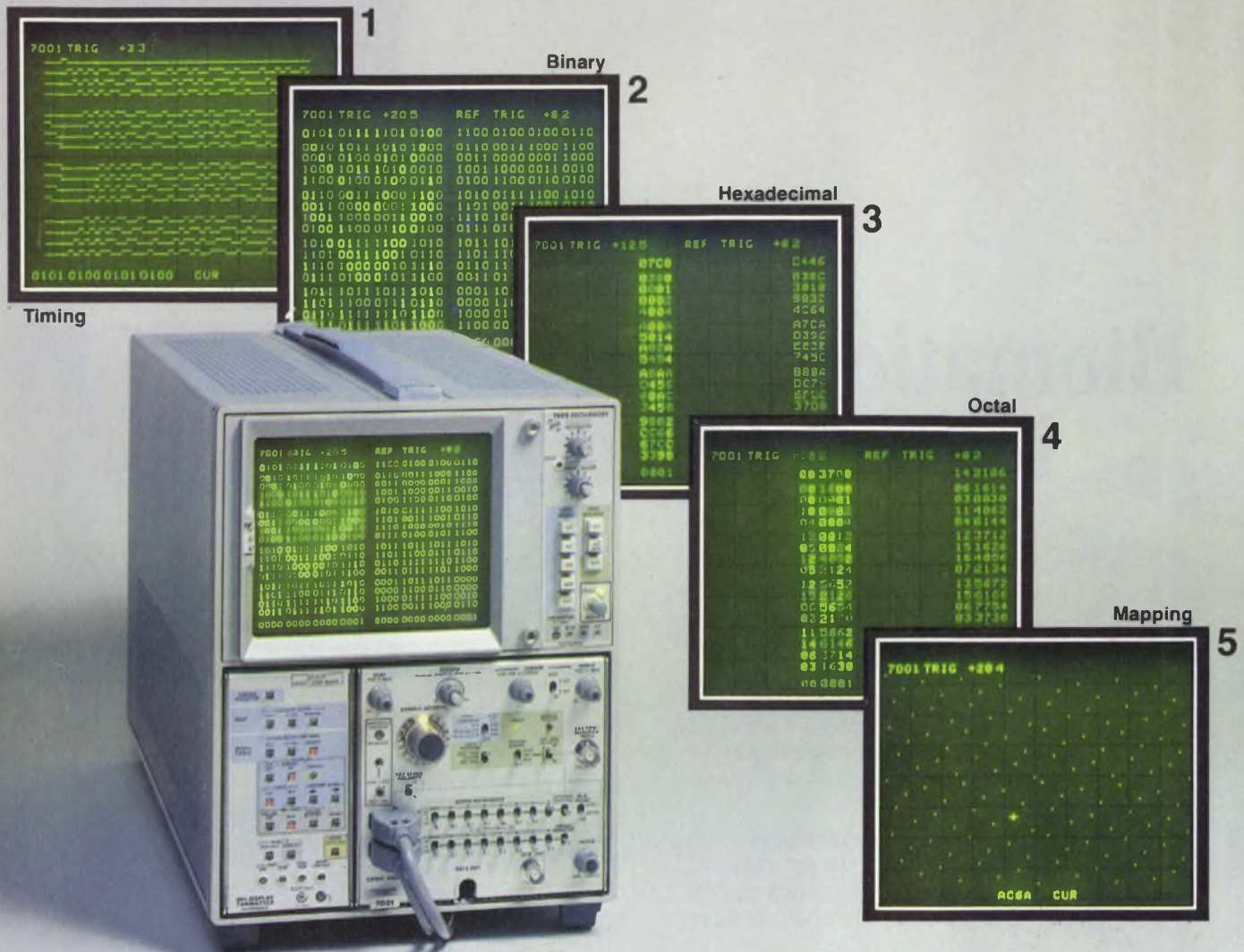

## The New DF1 Formatter

First, we gave you the timing display and binary readout with our 7D01 Logic Analyzer. Now, with the DF1 Display Formatter, which is dedicated to the 7D01, you have five display formats to operate from, all in a 7000-Series mainframe. Now you can convert a timing display into tables of words in Binary, Hexadecimal, Octal ... or a mapping configuration ... whatever your application requires.

A STATE TABLE mode of operation produces standard tables of up to 16 lines of 16-bit words. Using the 7D01's cursor, you can step through these tables word-by-word in Binary, Hex, or Octal. A 17th word is added to each table emerging from the 7D01's memory, to serve as a "key" and indicate you are indeed scrolling correctly through the long memory. The 7D01's fine cursor

control steps the display line-by-line, while the coarse control advances it table-by-table.

One of the most powerful analytical capabilities provided by the STATE TABLE mode is that you can display two tables—a reference table of "proved" data plus a "new" data table drawn from a system under test—on the same crt for side-by-side comparison. New data that is different from the reference data is automatically intensified ... you immediately know faulty data exists, and you know its location.

With the DF1 you can map, not just one, but three ways. The ability to map FAST, SLOW, or MANUAL lets you quickly recognize a word of interest, track it, isolate it, then pinpoint it for detailed analysis. The importance of mapping is derived from the speed with which you can isolate problems.

The logic analyzer package shown (7603 Option 1, 7D01, DF1) starts as low as \$5790. If you already own a 7000-

Series mainframe, add the 7D01-1 (7D01/DF1 combination) for only \$4390. Also consider that your money buys you these important 7D01 features: 1) Word recognition, 2) 16 channel operation, 3) 15-ns asynchronous timing resolution, 4) 4k formattable memory (4, 8 or 16 channels), and 5) High Z probes.

For more information or a demonstration of the DF1, contact a Tektronix Field Engineer near you. Or write Tektronix, Inc., P.O. Box 500, Beaverton, OR 97077.

\* United States sales prices are F.O.B. Beaverton, OR. For price and availability outside the United States, please contact the nearest Tektronix Field Office, Distributor, or Representative.



FOR TECHNICAL DATA CIRCLE # 241  
FOR DEMONSTRATION CIRCLE # 242

NOVEMBER 22, 1976

## Mag tape systems plug into IEEE 488 bus

The first magnetic tape systems designed to plug directly into the IEEE 488 standard bus and compatible with IBM and ANSI tape standards use an 8080 microprocessor for full tape control and tape-to-bus interface.

Designed by Information and Applications, Beltsville, MD, the type 4600 systems have an 8080 control box with only 75 chips, according to Scott McPhillips, system designer. "An equivalent IBM type of controller uses about 260 IC's," notes McPhillips.

The microprocessor makes it easy to interpret bus commands from any 488 bus controller such as a calculator or instrument. One bus pair is dedicated to tape data, while another provides a separate channel for tape control and status information, according to McPhillips.

Addressed as a listener, the 4600 records data from the instrument or calculator talking on the bus. Addressed as a talker, it reads back the tape.

"The microprocessor has allowed us to implement everything that a large IBM controller does, including one-track error correction," adds McPhillips. More over, all of the control for the tape drive is in software.

Read errors are eliminated by a system that recovers the data by rereading with different thresholds. If the error persists, the system reconstructs the data with IBM-compatible parity and error-correction codes.

Should a tape defect cause a recording error or even a marginal signal, the data are automatically erased and rewritten further along the tape.

The error-correcting function requires only two pages of the program.



The 4600 mag tape system uses an 8080  $\mu$ P for tape control.

Other low-speed, off-line tape systems don't incorporate these read and write error-correction features. They may record compatible-check characters, but they don't make use of them, according to McPhillips.

The microprocessor also provides full read and write data buffering and free format-command processing. The data buffer holds an entire block of data and transfers it over the bus, character by character, whenever the appropriate instrument calls for it.

The 4600 systems are available with 7, 8-1/2 and 10-in. reels that use 0.5-in. wide, 1.5-mil computer tape. The 10-in. reels operate at 45 ips, and the other two at 25 ips. Data-transfer rates are 0 to 3000 byte/s for the large-reel machine and 0 to 2500 byte/s for the smaller ones.

## JEDEC package outlines are now available

A complete collection of JEDEC-registered, solid-state package outlines and dimensional information has been issued by the Joint Electronic Device Engineering Council of the Electronic Industries Association (EIA) and the National Electronics Manufacturers Association (NEMA).

"JEDEC Registered and Standard Outlines for Semiconductor Devices" (JEDEC publication no. 95) supersedes and replaces EIA documents 12F, 13, 76 and RS-389.

The 600-page loose-leaf volume includes over 400 package outlines for diodes and transistors, microelectronic devices, uncased devices (such as beam-leaded components), carriers and magazines, gauges and military devices.

Complete dimensional information and detail drawings of all registered and standard package outlines come in both inch and metric versions with manufacturing tolerances. In addition, the volume contains illustrations, symbology and a guide for preparation of drawings. Indices and explanatory data are also provided for quick and accurate reference.

The collection can be ordered from EIA's Standard Sales Office, 2001 Eye St., NW, Washington, DC 20006, \$42.50 per volume. An optional subscription service, which provides new and revised update sheets, is available for an additional \$15 a year.

## $\mu$ C-based switchboard helps cut phone bills

Promising to cut a large corporation's telephone bill by 30 to 50%, a computer-based system that controls and records a company's outbound, long-distance calls has been announced by Datapoint Corp., San Antonio, TX.

Infoswitch first checks the priority rating of a caller's identity number and tries to select the least expensive route using WATS, FX (foreign exchange), tie lines or other voice-communications facilities. Then, if all these circuits are busy—and the priority number warrants it—the call is put through via Direct Dial.

After the call, Infoswitch records the caller-identity number, the number dialed, the facilities used and the call's duration on magnetic disc.

The heart of this economical system is a dual processor that employs a dedicated microcomputer for high-speed telephone switching and a Datapoint business computer for logging the calls, monitoring the system and generating management reports. A printer can be added for hard-copy output; a magnetic tape can be included for either storing accounting data on a long-term basis or transferring data to another processor.

The switching equipment consists of a Datapoint  $\mu$ P with a 300-ns cycle, a 16-k ROM program storage, a 4-k RAM temporary storage and a reed-relay switch matrix.

The processor—Datapoint's 5500—uses either diskettes, which store 250,000 characters each, or a cartridge disc system that stores 5-million characters on each disc. Copy is printed out at a speed of 80 copies per second.

Additional phone features include 3-digit code numbers for numbers frequently called and multistage call holding—the computer holds the caller on a low-cost circuit until a line clears. Length of the hold depends on the caller's priority number.

A 6-trunk system costs \$35,000, a one-year lease \$1113. A 55-trunk system costs \$175,000.

## Army computer system a super problem solver

A supercomputer with a demonstrated ability to achieve processing speeds of over 800-million instructions per second has been developed by System Development Corp., at its Huntsville, AL operation, with the help of Burroughs Corp. Known as Pepe (for parallel-element processing ensemble), the first system has been delivered to the Army's Ballistic Missile Defense Advanced Technology Center in Huntsville, to carry out ballistic-missile-defense experiments and tests.

Although the Army's Pepe system has a CDC 7600 master computer that is wired to control 288 slave elements, only 11 are operat-

ing to date. Each "slave" consists of three processors sharing a common data memory, and each processor has an arithmetic capability equivalent to a medium-scale scientific computer.

In general, the Pepe system employs parallel processing and associative-data techniques to take on problems so complex that their solutions require inherent parallelism and extensive computational power. Parallel processing allows the system to solve many lengthy scientific computations simultaneously. Associative data retrieval enables Pepe to perform multidimensional file searches.

Besides missile defense, weather forecasting, air-traffic control, image data processing, and signal processing can also benefit from the increased computational power.

While the Pepe system's gate-level logic design and the electrical and mechanical design come from Burroughs, the specifications and architectural design to the register level come from SDC. SDC has developed the Army system's support software and produced the real-time programs, and plans to run the ballistic missile defense experiments and tests.

## High-density RAM board has a good memory

A RAM board with a capacity of more than 1.3 Mbits has been developed by Intel Corp., Santa Clara, CA. Unveiled at the recent Mini/Micro Computer Conference and Exposition in San Francisco, the high-density memory board contains 147 packages—80 of which are 16-kbit dynamic RAMs—in a board of area of less than 90 sq. in.

Designed for custom medical applications, the memory array is organized in 16-k words of 80 bits each and includes CRT refresh logic for up to five pixels. (A pixel is the number of bits required to support a single dot on the face of a CRT.)

The very tight package spacing is possible because the board consumes only 70 W when operating and 18 W in standby. Intel 2116 chips provide 400-ns access time and 500-ns cycle time at the board level.

This high-density memory board

costs about 0.4¢ per bit in small quantities and 0.25¢ per bit in large quantities.

## Device emits all colors with applied voltage

A new kind of light-emitting device that produces light of all the colors of the spectrum by simply changing its applied voltage has been developed at the Ford Motor Co. research laboratory in Dearborn, MI.

A thin-film device consisting of two layers of metals separated by an insulator, the component is not only compatible with silicon-fabrication technology, but ultimately should become mass-produced at a low cost, according to Shaun L. McCarthy, senior research scientist and creator of the light source with staff scientist John Lambe.

The device fabricated to date employs a 500-Å-thick aluminum layer for one electrode, which is separated from a 300-Å-thick metal electrode—silver, gold, lead, or indium—by an insulating aluminum oxide layer 30-Å thick.

Applying 1.5 V across the device produces radiation at the red end of the spectrum. Increasing the voltage changes the color of the light through the orange into the blue at about 3 V. At 4 V, the optical energy radiated contains quanta of the full spectrum, and white light is visible.

The quantum efficiency of experimental devices is in the 0.001% range, much less than the 0.1% to 2% of off-the-shelf monochromatic LEDs. To excite radiation, the current used by the Ford researchers ranges from about 20 to 100 mA, which corresponds to the range of standard LEDs. But the Ford devices' light output is substantially lower because of their lower-quantum efficiency.

While the potential quantum efficiency of the thin-film devices is estimated to be in the range of a few percent, it is currently restricted by having to couple energy out of the device. The radiation is produced by "inelastic tunneling" of the electrons through the insulating barrier.

The frequency of the emitted light is related to within a few tenths of a percent of the voltage.





# Intro- ducing our new thumbwheel switch

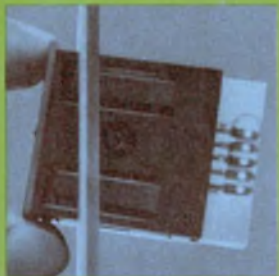

for 8-mm thumbs. It's a skinny switch that we call the 1800 Series. It has many of the features of our notorious 1776 Series —but simpler, more standardized, and cheaper. For example, just \$2.50 for one, less for more, with a choice of five codes, gloss or matte finish, with or without stops, and readable by 20/20 eyes from 10 feet away.

It's got PC board terminations for plug-in or solder connections, and it snaps into a panel for mounting (no tools needed).

It mounts singly or ganged (up to 20 stations), and will give at least 500,000 detent operations before it tires.

So now we've left you with no excuse for not choosing EECO when you need a thumbwheel switch. We've got more versions for more applications than any other switch maker in the country. And more offices to buy from (87 in the U.S. and Canada). For any thumbwheel switch, see us first.

WE'VE GOT YOUR SWITCH.

**EECO**

SWITCHES/PACKAGING/READERS

1441 East Chestnut Avenue, Santa Ana, California 92701 Phone 714/835-6000  
Distributed in the U.S. by Hall-Mark, C.S. Marshall, and Schweber In Canada by R.A.E.

CIRCLE NUMBER 17

# Accuracy.

## International Representatives

Australia	Burwood	Kennedy Electronics	(03) 288-7100	Israel	Ramat-Gan	M.R.B.D., Ltd.	738701
Brazil	Sao Paulo	Labo	228-0224	Italy	Milano	Radiel S.p.A.	209888
Belgium	Bruxelles	Etablissements De Greef, S.P.R.L.	(02) 345 39 18	Japan	Tokyo	Chitose Corporation	(03) 272-3321
Canada	Mississauga, Ont.	Webster Instruments	(416) 275-2270	Malaysia	Kuala Lumpur	E.M.I. (Malaysia) SDN. BHD.	23251
	Ottawa, Ont.	Webster Instruments	(613) 725-1931	Netherlands	The Hague	Koning en Hartman	(70-678380
	Pointe Claire, Que.	Webster Instruments	(514) 695-9787	New Zealand	Auckland	David J. Reid, Ltd.	492-189
	Vancouver, B.C.	National Electrolab Ltd	(604) 985-0511	Norway	Trondheim	Electro-Trade	26-753
	Zurich	Tettex	01/264-680	Pakistan	Karachi	International Industries Ltd	20111-4
Comecon Countries	Montes de Oca	Electrotecnica S.A.	21-32-42	Portugal	Lisbon	Sociedade Commercial Rualdo	PPC 363725
Costa Rica	Horsens	Instrutek	(05) 61 1100	Puerto Rico	Madrid	West Indies Sales Co.	(305) 592-8188
Denmark	Helsinki	Into Oy	90-171 123	Spain	Madrid	Hispano Electronics, S.A.	233-31-00
Finland	Antony	Eumtron	668-1059	Sweden	Upplands Vashy	Johan Lagercrantz KB	0760/861 20
France	Wetherby	Farnell	0937 3541	Switzerland	Zurich	Dimos	(051) 62 61 40
Great Britain	Munche	Neumuller GmbH	(089) 59911	Taiwan	Taipei	Everworth Enterprises Ltd.	511-6161
West Germany	Hyderabad	International Trade Agencies	31543	Turkey	Ankara	U.I.E. Muhendislik ve Ticaret Ltd.	267182
India	Tehran	Diplomat Company, Ltd	669 063-44581	Venezuela	Maracaihu	EI CA Telecommunications	72054



**The Model 175**  
the world's most accurate 3 1/2 digit miniature portable \$189.



**The Model 3400**  
the world's most accurate 4 1/2 digit lab and systems multimeter \$795.



**The Model 7500**  
the world's most accurate high speed 5 1/2 digit systems multimeter \$2995. base



**The Model 245**  
the world's most accurate 4 1/2 digit portable \$295.

**When  
you want  
the world's  
most accurate  
multimeters...**

**you want  
Data Precision  
multimeters.**

For a demonstration or a copy of our comprehensive Digital Instrumentation catalog contact Data Precision Corporation, Audubon Road, Wakefield, Mass. 01880, USA Phone (617) 246-1600, Telex (0650) 949341

Price U.S.A.

**DATA PRECISION<sup>®</sup>**  
**...years ahead**

FOR DEMONSTRATION CIRCLE # 284  
FOR ADDITIONAL INFORMATION CIRCLE # 285

# Get Everything You Always Wanted For Switchers From A Source That Always Has Everything. Us.



## Everything for control...



Switchmode\*linear IC regulator MC3420

For the first time, there's a unique control circuit available with everything you need to regulate the simplest to the most complex constant frequency switching supply: reference... oscillator... PWM... phase-splitter... dual alternating outputs... and unique 0-100% dead time comparator.

Just plug it in and your design work's done!

Specs include 10-30 V supply range, 2-100 KHz operation, 0.5 V-at-40 mA output sat voltage and 40 V blocking capability. Best of all, the MC3420 is priced at just \$5.75 (100 up).

## Everything for efficiency...



Switchmode\* Schottky rectifiers 1N5826-34 15A-40A

Efficiency like you've never seen is yours with Motorola Schottky rectifiers — at least 80% or more in most high frequency designs. In a 500 W switching supply this can mean a saving of 625 W of power!

Switchmode Schottkys offer performance and price advantage — lowest VF at rated current... guard rings that protect barrier junctions from spikes... thermal resistance that doesn't... speed you can't even measure... super  $dv/dt$ ... and, believe it or not, lower cost.

And they're reliable. Mil-type testing of *standard* units has shown excellent results. Nobody else passed initial screening.

## Everything for power...



Switchmode\* silicon power 2N6542-47, MJ10000/MJE13000 discretes & Darlington's, 1.5-20 A, 300-400 V

These are the only devices around designed and spec'd to bring you *into* the switcher design cycle instead of keeping you *out*!

Designers\* Data Sheets completely spell out all essential parameters for high-frequency, 100°C inductive use — RBSOA volt-ampere capability... high-temperature, clamped inductive load switching specs... switching times as functions of collector current and temperature... spec'd limits for active region SOA. No more "typicals" or empiricals!

Because no other source has taken time and effort to completely define necessary performance data of this state-of-the-power art.

Switchmode specs are presented with important applications info to aid you in device selection and use under *actual operating conditions*.

## Put 'em all together...

They spell SWITCHER. With a capital state-of-the-art.

The 20 KHz revolution in power supplies has taken hold of the designer's imagination and Motorola is the *only* semiconductor source able to supply you with *all* the devices you want to put your design skills to work... from IC to zener.

Nobody else can make that statement. Check it out.

And we can add an edge or two to your particular switching supply design through applications engineers who work on nothing but. Call us.

## Everything else for everything else...



- 72 Rectifier Bridges from 1 A to 35 A
- 85 Fast Recovery Rectifiers from 1 A to 40 A
- 132 Rectifiers from 1 A to 50 A
- 198 Triacs from 0.45 A to 40 A
- 377 SCRs from 0.5 A to 80 A
- 556 Small Signal Transistors from 10mW to 1 W
- 764 Voltage Reference Diodes from 6.2 V to 200 V
- 1,191 Zener Diodes from 1.8 V to 200 V

... and one sensational, new unique crowbar IC — MC3423 — that protects against transients or regulator failure with adjustable threshold voltage and programmable overvoltage duration for just a buck-and-a-half!\*

## Free Design Pack



Designers Data Sheets, application notes and engineering bulletins — including our new, "Showcase" switching supply — are available through any franchised distributor or Motorola Semiconductor Products, Inc., Box 20912, Phoenix, AZ 85036.

Get it.

Then get *everything* you want for your switcher from us.



# MOTOROLA Semiconductors

\*\*100-999 \*Trademark of Motorola Inc.

# LED Super-Brights

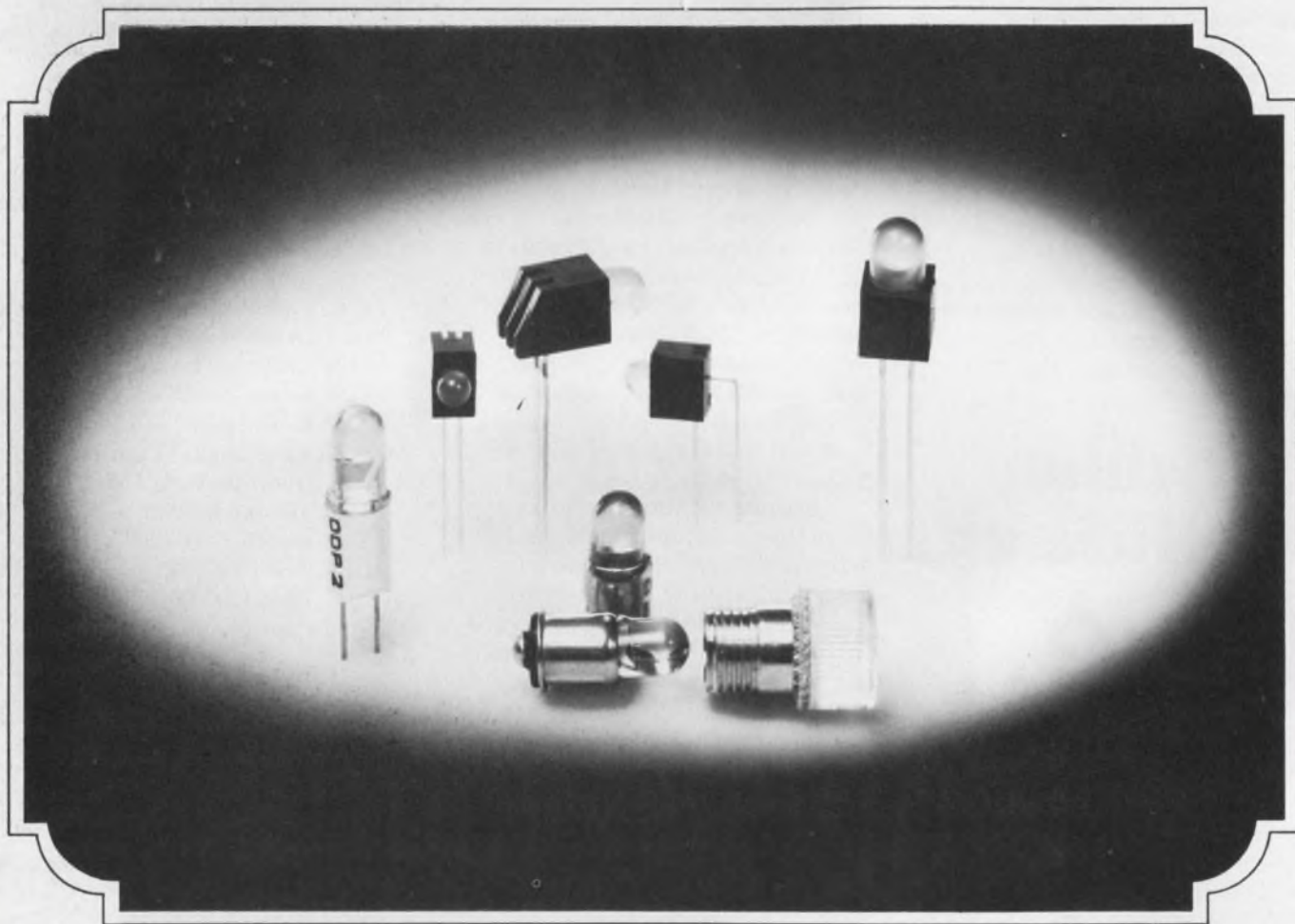

## Ideal replacements for incandescents!

Here come the LED Super-Brights . . . red, amber and green. Their high brightness (50 MCD @ 20mA — typical clear red) make them the perfect cost and power saving replacements for incandescents. Available with built-in resistors for all popular voltage ranges.

**PCB LED's** — Horizontal or vertical viewing . . . optional built-in resistor for 5V applications.

**Bi-Pin (T1-3/4) LED's** — Ideal for dead front panel applications, e.g. DEC's PDP Series computers.

**Midget-Flanged (T1-3/4) LED's** — Direct replacements for incandescents in panel light and switch applications.

**Replacement Lenses** — Specially designed for use with Midget-Flanged LED's.

There's lots more too, Send for our Catalog today: Data Display Products, 5428 W. 104th Street, Los Angeles, Ca. 90045, (213) 641-1232.

**We're the original "little light" people.**

**D**ATA DISPLAY PRODUCTS ● ● ●

# Washington Report

## Electronic warfare to get more DOD attention

Procurement of electronic-warfare (EW) systems by the Defense Dept. will average at least \$500-million annually over the next five years, said Dr. Malcolm Currie, director of defense research and engineering, at a meeting of the Association of Old Crows at the National Bureau of Standards, Gaithersburg, MD.

Two of the principal EW projects planned during this period are the Navy's Tactical Airborne Signal Exploitation Systems (TASES) and the Air Force's Compass Hammer program, which will take the lead in developing airborne electro-optical countermeasures. The two services will join forces in the Compass Go program to develop a common internal jammer for the Air Force's F-16 air combat fighter and the Navy's F-18 naval strike fighter, as well as any future fighters.

In the past, EW systems have been almost an afterthought in the development of new aircraft and other weapons, according to Currie. But a recent Pentagon directive, 46003, stipulates that electronic counter countermeasures (ECCM) be specifically considered in the design of every new military system.

"ECCM must become an integral part of our planning—not a patchwork, subsequent add-on," said Currie.

Present plans call for research and development for electronic warfare to increase 10% a year from its present base of about \$250-million over the next five years.

## More airports to get Category III ILS

Eight more U.S. airports will be upgraded to Category III instrument landing systems under a Federal Aviation Administration program to provide all-weather landing capability at key airports.

Category III operations require ILS guidance signals to permit landings without visual reference to the ground when the ceiling is zero and visibility on the runway is 700 feet.

The landing system uses solid-state components and includes a dual-channel localizer, dual-channel glide slope and three dual-channel marker beacons. A far-field monitoring system detects any shift in localizer-course alignment.

The system will be produced by Wilcox Electric Inc., Kansas City, MO, according to the terms of a \$3.7-million FAA contract. Deliveries will begin in late 1977 at a rate of two a month to New York Kennedy, Chicago O'Hare, Houston International, Kansas City International, Detroit Metropolitan, Seattle-Tacoma International, Los Angeles International and Portland International airports.

Four airports are already equipped with Category III equipment: Washington Dulles, Atlanta International, San Francisco International and

Denver Stapleton.

Under an earlier \$8.7-million contract to Wilcox, the FAA's largest single purchase of instrument-landing systems, the company will deliver 122 Category-I ILS units to smaller airports in early 1978. Category-I ILS requirements call for visibility of half a mile and the ability of the pilot to descend to a "decision height" of 200 feet, where he can see the runway and decide whether to land.

## Missile guidance to use satellite data

A missile-guidance system that will use the future Navstar global positioning satellite to guide the missile to its target is being developed at the Air Force's Armament Development and Test Center at Eglin Air Force Base, FL.

Small antennas on the missile's surface will receive position information from the Navstars at frequencies between 1.2 and 1.5 GHz (L-band), which will help update the inertial systems during the mid-course portion of the missile's flight.

The missile-guidance system is expected to be applied first to the GBU-15 glide bomb, a winged version of the television-guided "smart bombs" used in Vietnam, then to a number of other new tactical weapons, say officials at Eglin.

Hughes Missile Systems Group and Teledyne Systems have been funded about \$1-million each for the first year of the three-year development program. By mid-1978, breadboard hardware should be produced for captive flight testing at Eglin on the F-4 fighter. Concurrently, the Air Force is developing an airborne computer for the new guidance system under its Digital Guided Weapons Program.

## Weather radio growth predicted

By 1980, the National Oceanic and Atmospheric Administration's weather-radio service will serve 90% of the U.S. population with more than 300 transmitters, predicts an Administration spokesman.

Limited originally to boaters and fishermen in the mid-1960s, the network not only provides storm and flood warnings via 100 stations, but is also, since 1975, the only Government-operated radio system designated by the White House to warn against nuclear attack. Signals are broadcast at 162.40, 162.55 and 162.475 MHz, and the average effective radius is about 40 miles, according to NOAA.

**Capital capsules:** Nippon Electric has been chosen by Intelsat to develop a 14-GHz mixer/intermediate-frequency amplifier with state-of-the-art microwave integrated circuitry for communications-satellite applications. . . . Despite a crash in a flight test on Oct. 4, the Air Force's Air-Launched Cruise Missile (ALCM) development and pilot production are expected to be carried out concurrently next year to push up the initial operational capability date from December, 1981 to January, 1979. The inertial platform is being blamed for the crash, not the terrain contour-matching guidance. . . . The Air Force's Avionics Laboratory plans to develop an infrared search-and-track system for continental air defense. . . . Texas Instruments and Honeywell are in the final competition for the AAQ-9 common forward-looking infrared (FLIR) to be used in the Pave Tack pods of the Air Force RF-4. The winner should be selected around the beginning of 1977.



Announcing a breakthrough in

# FAST

# PULSE ANALYSIS

*A storage oscilloscope that captures 1.4 ns rise time.*



FOR TECHNICAL DATA CIRCLE # 289  
FOR DEMONSTRATION CIRCLE # 290

**Superior Performance.** A stored writing speed of 2500 cm/ $\mu$ s, enabling you to capture single-shot rise times to 1.4 ns, 3.5 cm high, at full reduced scan amplitude (or 900 ps 2.25 cm high). System bandwidths from 160 to 400 MHz, depending on plug-ins selected. Four storage modes . . . bistable and variable persistence, FAST bistable and FAST variable persistence . . . to cover a wide range of storage applications. Auto-erase for automatic display updating. A save control for 30 times longer viewing. Gated readout, which prevents the blooming that tends to occur between sweeps with nongated readout. Adjustable multi-trace delay for varying the crt view time prior to storing the next sweep when using FAST transfer mode.

**4-Compartment Flexibility.** Perform more than one measurement at the same time without switching plug-ins. For example, store a single-shot event and simultaneously measure pulse width with a digital counter. Choose from over 30 7000-Series plug-ins for the combination your application requires. The selection includes the 7A19 for full system bandwidth, the 7D11 for digital delay, the 7L5 for spectrum analysis.

**Future Expandability.** The 7834 represents a breakthrough in oscilloscope technology. It follows the 7633 mainframe which introduced the then-highest stored writing speed of 1000 cm/ $\mu$ s. The 7B80 and 7B85 time bases, establishing a convenient delta delay measurement technique. The 7D01 Logic Analyzer and DF1 Formatter transforming the oscilloscope into a logic state—logic timing analyzer with a choice of 5 display modes.

**The 7834.** For fast pulse analysis in the laser fusion lab. For single-shot or low-rep-rate fast pulse analysis, glitch detection, or ECL logic analysis in digital design. For single-shot fast pulse analysis in destructive and nondestructive component testing. When you buy into the 7000 Series, you're assured of technological advances that help set the pace for the oscilloscope world.

**The 7000-Series . . .  
more than an oscilloscope**

For a demonstration or more information, contact your local Field Engineer. Or write Tektronix, Inc., P.O. Box 500, Beaverton, OR 97077. In Europe, write Tektronix Limited, P.O. Box 36, St. Peter Port, Guernsey, Channel Islands.

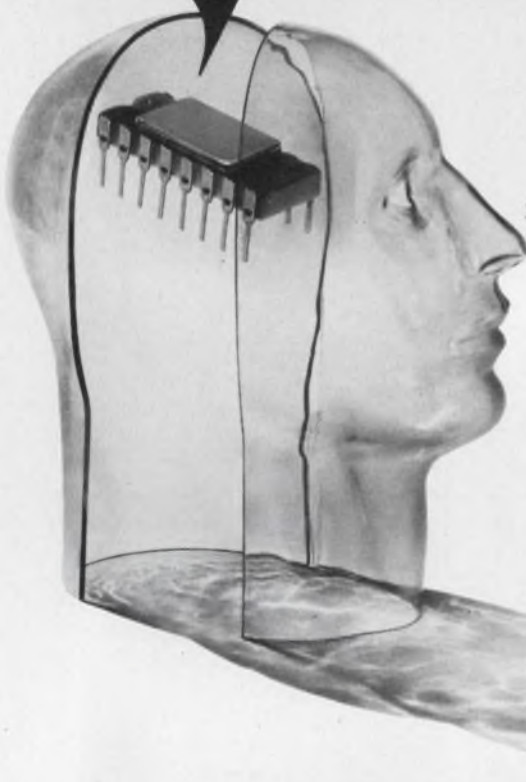
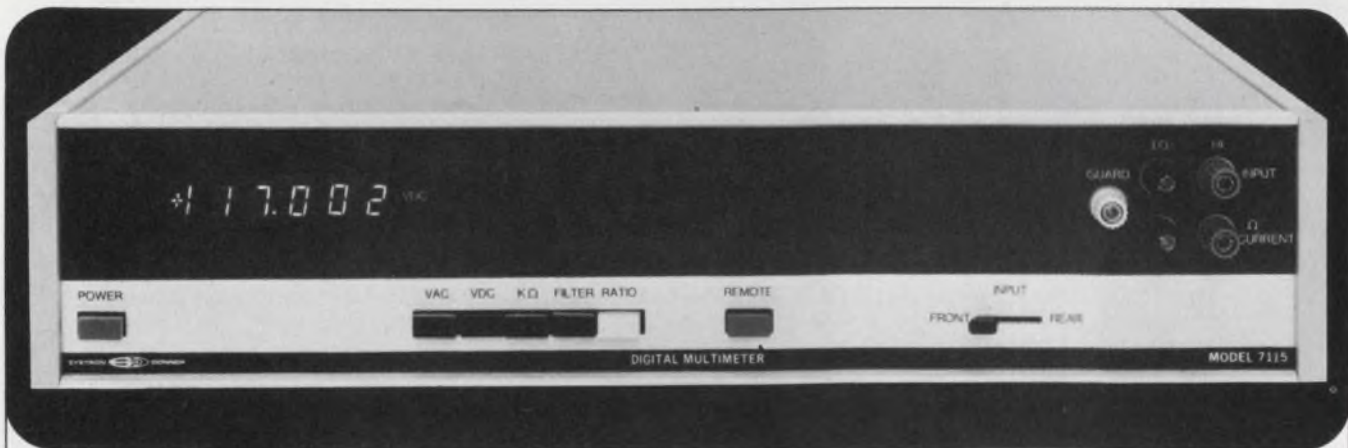

# Go SDVM\*

## \*Systron-Donner "smart" DVM

Meet Model 7115, the industry's first **microprocessor**-based digital multimeter. It does what no conventional DVM could hope to do:

**Automatic zero/self calibration.** Using its computing power and built-in memory, Model 7115 continually calibrates itself against drift and component aging. Similarly, it detects and corrects for zero drift and offset error. Result: accurate readings all the time!

**Self-diagnosis.** Microprocessor power again. Out-of-limit conditions or failures are signalled

on the front panel; internal LED's direct the operator to their location inside.

**High-speed autoranging.** A rapid new S-D autoranging technique finds the correct range, goes there immediately and reads. It's not only a big improvement for bench use, but systems users can now use autoranging.

**Command performances.** An optional keyboard for programming the Model 7115 allows it to linearize and normalize, run comparison programs for checking out-of-tolerance conditions, multiply by a constant, average readings... and much more.

**These features, too.** Up to 100 readings/sec. • DC accuracy of  $\pm 0.002\%$  rdg. • Parallel programming or ASCII option • True RMS AC volts option • High accuracy resistance measuring option.

Get the full story on the first SDVM from Scientific Devices, or contact us at 10 Systron Drive, Concord, California 94518. Phone (415) 676-5000. Overseas, contact Systron-Donner in Munich; Leamington Spa, U.K.; Paris (Le Port Marly); Melbourne.

SYSTRON  DONNER

# NEED

low-pass passive devices that perform as well as active filters but don't cost nearly as much? Investigate Sprague Series JW33 Audio Filters . . . you'll be pleasantly surprised at all they can do for you . . . at a price you can afford.

# AUDIO

filters in this new series utilize stock parts, permitting quick and precise construction to your requirements . . . your choice of attenuation characteristics (Chebyshev or Cauer), your choice of cut-off frequency (1 to 50 kHz), and your choice of operating impedance (250  $\Omega$  to 10 K $\Omega$ ).



# FILTERS

shown here are metal-encased to reduce pickup or cross-talk, hermetically-sealed to ensure dependable operation at environmental extremes, and solidly constructed to resist physical damage. Standardized pin terminal spacing and low profile (.500" height) make them ideal for PC boards.

# FAST?

Because Series JW33 Filters are pre-engineered and can be quickly customized to match the needs of your equipment, all orders are efficiently processed for fast shipment. Whether you want a few pieces for prototype use or a large run for production purposes, you can count on rapid delivery.

*For complete information, write or call  
Harris Johnson, Sprague Electric Company,  
P.O. Box 39, Annapolis Junction, Md. 20701.  
Telephone 301/792-7657*

***. . . and you thought we only make great capacitors.***



# Gotcha, DEC!



## SuperTerm

Yes, we gotcha DECwriter II and we did it with such standard features as: matrix impact printing (no thermal paper!), 132 column print width, microprocessor electronics, portability (SuperTerm weighs less than 45 lbs), high speed (10, 15, 30, 45 and 60 characters per second are standard with 120 and 180 cps being optional), an IBM Selectric configured keyboard, a 33 key alphanumeric "gear shifted" key pad and a quick loading cartridge ribbon system.

In addition, SuperTerm's unique "anvil" printhead design is warranted for the life of the terminal! This means that should you ever encounter defects in printhead workmanship, InterTEC will replace or repair the defective component(s).

OEM's will be pleased to learn that the InterTEC SuperTerm provides all of this capability and more at an OEM price of only \$1,400.

Low cost options available on every SuperTerm include: Super and sub-scripting, horizontal and vertical tabs, variable vertical pitch, forms control, pagination, direct X/Y addressing, adjustable left and right margins, reverse printing, double width characters, automatic CR on end of line, and a font programmable character set.

If your application calls for APL/ASCII, SuperTerm has that too. In fact, SuperTerm has got just about everything—except competition.

Want more? You've got it! A built-in micro-cassette (Supercette) is available to end users at only \$700 in single quantities with OEM discounts available.

In addition to unparalleled price and performance, every SuperTerm is backed by InterTEC's nationwide factory trained service network with over 160 service centers strategically located coast to coast.

For more information on the total performance and unparalleled low price that make the InterTEC SuperTerm the very best buy for your terminal dollar, just call InterTEC Data Systems, the only company with international sales, service and revolutionary SuperTerm.

## **INTERTEC DATA SYSTEMS**

**1851 Interstate 85 South • Charlotte, North Carolina 28208**  
**Telephone (704) 377-0300 • TWX: 810-621-7831**

CIRCLE NUMBER 25

# Microprocessor Design

## Can you evaluate $\mu$ Ps by examining their register architecture?

Recently introduced  $\mu$ Ps contain many more internal data registers than the earlier ones. Some of them have over 64 registers and are apparently very powerful. But often the number of registers is not as important as how easily the registers can be addressed and their data manipulated, according to one  $\mu$ P vendor. So with differing considerations in mind, how does the user evaluate the different register architectures and decide which  $\mu$ P to use? Opinions vary.

"The types of operations that you can perform on registers, through the instruction set, decides whether one set of registers is more useful than another," says Mark Eliot,

manager of applications at Zilog, Los Altos, CA.

"The simplest instruction would move data into and out of the registers. The Z-80 can move data to and from registers directly addressed as part of the instructions. Another instruction type permits registers to serve as pointers to memory—to hold addresses of memory locations.

"Other instructions let the registers perform ALU operations such as add, subtract, logic or increment," Eliot says.

"I think that evaluating  $\mu$ Ps by looking at their registers is pretty much nonsense," retorts Lionel Smith, applications engineer at Intel,

*(continued on page 36)*

## Industrial microcomputer system doubles as development tool

A microcomputer system that is flexible enough to do prototype development and still inexpensive enough to serve as an OEM industrial controller has been developed by Logical Services. At the heart of the Servant microcomputer system is an 8080A-based CPU.

Some key features of the Servant 8 system include a light pen and an oscilloscope-drive output in addition to a full complement of front-panel controls and indicators. The light pen and an oscilloscope make it possible to examine and modify the contents of registers and memory locations without the use of a terminal.

There are seven condition switches that allow breakpoint insertion in programs to permit examination of registers and memory locations.

Software for the operating system consists of a monitor program that can be automatically accessed when power is turned on. Also available are an assembler, a debug routine, a text editor and specialized macro and application programs.

Among the optional plug-in modules currently available are: a 16-channel analog input, 8-bit output circuit; an IEEE Standard ASCII bus interface; and a universal breadboard that permits customization.

Price of the basic development system, which includes the CPU, control panel, 4-k RAM, a TTY interface, chassis and ROM software, is \$2495. Individual module prices start at \$50 for the breadboard card and go up to \$350 for the control panel card. Delivery of all units is from stock.

*Logical Services Inc., 711 Stierlin Rd., Mountain View, CA 94043. (415) 965-8365.*



## MICROPROCESSOR DESIGN

(continued from page 35)

Santa Clara, CA.

"The only way you can really evaluate what an architecture can do for you is to try it out on some applications. A machine that has lots of internal memory is a beautiful machine if your applications require it," Smith adds.

"But if you have to go to external locations, and you don't have the addressing modes to get at the data, you are going to end up with a cumbersome system."

On the other hand, he says, "A machine that has a lot of addressing capability and registers but needs to access only a few variables would be a case of overkill. I don't think there is any way of just looking at register architectures and coming to a decision based on that alone."

---

## CMOS $\mu$ P comes in a console with display and keyboard



Now you can get RCA's CMOS  $\mu$ P in a console with a hexadecimal keyboard and four-digit LEDs for inputting and displaying data. The console, dubbed the UC1800 from Infinite, Inc., is available in kit form (\$249.95) or assembled (\$495). The unit consists of a separate CPU board and display, keyboard, and switch control modules that plug together with flat cables.

The 5.5  $\times$  8.5 in. CPU board contains the  $\mu$ P, all control logic, a regulated power supply, and a 72-contact rear-edge connector for system expansion.

The display module contains a voltage regulator, decoder and the seven-segment LED readouts. It measures 6.75  $\times$  2.75 in.

The keyboard model contains hex keyswitches and encoding logic. The switch module contains additional pushbutton switches that control the UC1800.

With the console, you get a 200-page manual and debug software so you can examine memory and modify programs.

*Infinite, Inc., Dept. INR, P.O. Box 906, 151 Center St., Cape Canaveral, FL 32920.  
(305) 783-9600.*

CIRCLE NO. 507

---

## New bipolar chip eases system interrupt control

Hardware control of the priority interrupt inputs to a microprocessor system are now possible with a new bipolar LSI chip introduced by Motorola. The device, called a Priority Interrupt Controller (PIC), eliminates the software interrupt-polling routine in systems containing eight or multiples of eight I/O devices.

Functionally, the PIC can change the interrupt vector, reserved in memory for hardware interrupts, into one of eight alternate vectors assigned to the I/O service routines. It modifies the low-order bytes of the reserved interrupt address. The second, third, fourth and fifth LSBs of the system address bus are used as inputs to the PIC; a bit pattern of 1100 (5th LSB to 2nd LSB, respectively) is required to initiate the vector translation.

The interrupt output of each I/O device is normally connected to one of eight prioritized latching inputs on the PIC. When enabled, each interrupt will cause a unique bit pattern to be generated and substituted for the 5th through 2nd LSB of the original interrupt vector. These eight alternate vectors are used to start the interrupt subroutines for the I/O devices.

A mask, which is programmed via the 5th through 2nd LSBs of the address bus, can be used to inhibit any or all of the interrupts at the eight inputs.

An output from the PIC, called the **STRETCH** signal, is available to lengthen a system clock cycle when accessing slow memories. When unselected, the PIC is transparent on

(continued on page 38)

# How to get a lot more into a lot less.

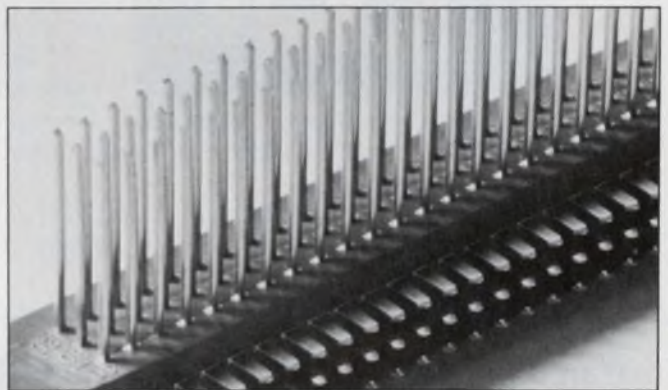
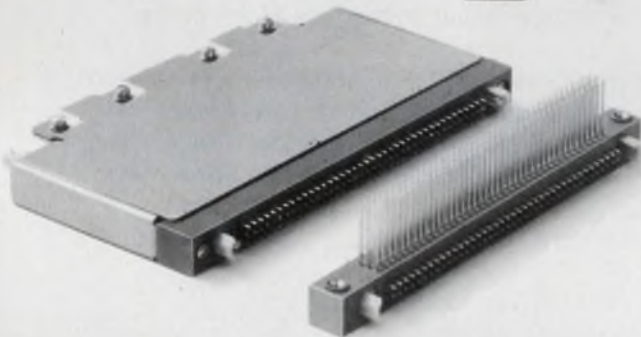
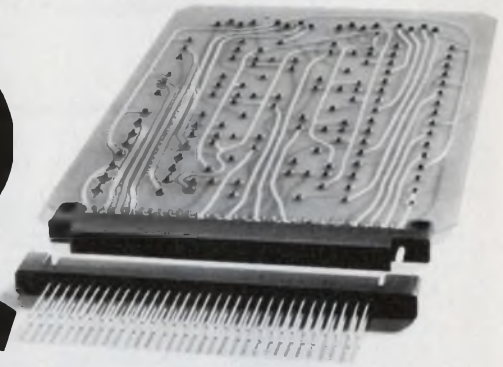

First, with 3 rows of contacts on .100 centers, Viking's unique Nordic 2-piece P/C board connectors and I/O I.C. panel plugs get a lot more contacts into a lot less space.

Second, our unusual polarizing system lets you key each mating pair to prevent cross mating with adjacent connectors of the same type. You can stack a series of Nordic connectors next to one another in cramped space and not worry that they might be cross mated.

Our full line includes 64 and 82 contact models as well as the 120. Contacts on I/O connectors are crimp, snap-in, removable, gold plated and use MIL-T- 22520 tools.

Diallyl Phthalate is the insulator in most models. And all connectors are designed to meet conditions of MIL-C-55302.

If you need them right now, our distributors have most models in stock. For details, use the coupon and get our latest catalog.

**O.K. Send me:**  Your latest catalog with details on the two-piece PC connectors ... and your nearest rep. I have some questions for him.

Name: \_\_\_\_\_

Position: \_\_\_\_\_

Company: \_\_\_\_\_

Address: \_\_\_\_\_

City: \_\_\_\_\_ State: \_\_\_\_\_ Zip: \_\_\_\_\_



# Viking

## CONNECTORS

Viking Industries, Inc., 21001 Nordhoff Street, Chatsworth, CA 91311

CIRCLE NUMBER 26

## MICROPROCESSOR DESIGN

(continued from page 36)

the address bus and will not affect the reserved interrupt vector. The PIC is offered in both ceramic and plastic 24-pin DIPs; the price is \$7.50 (100-999 qty.) for the plastic version.

Motorola Semiconductor Products, Inc., P.O. Box 20294, Phoenix, AZ 85036. (602) 962-2151.

CIRCLE NO. 508

### $\mu$ P-controlled time clock remembers data until queried



A 6800  $\mu$ P-controlled time clock keeps track of employee attendance and other information, then relays the data to a central computer.

The Smart Clock first reads up to 16 digits of Hollerith-coded data from an employee's plastic ID badge or IBM card. Then the employee punches in five more digits via pushbuttons. The terminal stores this information, as well as the time, in its own battery-powered memory. It checks each transaction for validity, sounds an alarm and activates visual indicators if an error has occurred.

The unit communicates with the computer via RS-232C serial lines or with a 600-baud modem interface.

If the central computer breaks down, the Smart Clock holds all the accumulated data, up to 14,000 characters,

until the computer is again able to receive data.

Up to 64 Smart Clocks can be connected in series through one RS-232C, ASCII-coded, 20-mA current loop.

The unit price is \$1600 for quantities of 10 to 24. Delivery takes 45 days. Coastal Data, 1592 N.W. 159 St., Miami, FL 33169. (305) 625-7123.

CIRCLE NO. 509

### Fortran compiler does its thing on an 8080 system

A Fortran compiler is reportedly the first to be resident on an 8080 system. The FORT/80 compiles a subset of ANSI Fortran IV, which produces 8080 machine-language object code.

It requires 16 kbytes of memory: 12 k for the compiler and the remainder for work space.

The object code produced by the FORT/80 can be linked to additional machine language subroutines to make a complete program.

Symbolic names containing 1 to 31 characters may be used. However, only single and double-byte integer arithmetic is permitted.

A library of useful subroutines and functions comes with the compiler, including absolute values (ABS), random 8-bit numbers (RANDU), and the square root of positive and SQRT integers (SQRT).

The software is supplied either on a floppy disc or on paper tape, and costs \$750.

Unified Technologies, Inc., 4800 Dundas St. W., Suite 209, Inlington, Ont. M9A 1B1. (416) 236-1159.

CIRCLE NO. 510

#### Micro Capsules

A new version of a popular software language, called Basic Etc., is optimized for business and game programming. It comes from Binary Systems Inc., Richardson, TX. . . . An 8-bit  $\mu$ P that contains ROM, RAM, I/O and clock chip will be introduced by General Instruments, Hicksville, NY. The PIC-1650 fits in a 40-pin DIP. . . . A \$60 prototyping kit from Intel Corp., Santa Clara, CA, contains chips for a 4-bit system. It has a 4040  $\mu$ P, 4269 keyboard/display interface, and EPROM, RAM and I/O chips.



# DARLINGTON

## POWER TRANSISTORS

*The Designer's Choice from General Electric*

### NPN - HIGH GAIN - 1/2 AMPERE

GE TYPE	$P_T$ $T_C = 25^\circ\text{C}$ Max. (W)	$V_{CE0}$ Min. (V)	$h_{FE}$ @ 5V, 200 mA		COMMENTS
			MIN.	MAX.	
D40C1	6.25	30	10,000	60,000	<ul style="list-style-type: none"> <li>• Very High Gain - 60k typical; High input impedance - 50k ohm typ; 1.2 watts <math>P_T</math> @ 25°C ambient.</li> <li>• Applications: IC Interface audio output, touch switch, oscillator, buffer, high power transistor driver, relay replacement.</li> </ul>
D40C2	6.25	30	40,000	-	
D40C3	6.25	30	90,000	-	
D40C4	6.25	40	10,000	60,000	
D40C5	6.25	40	40,000	-	
D40C7	6.25	50	10,000	60,000	
D40C8	6.25	50	40,000	-	

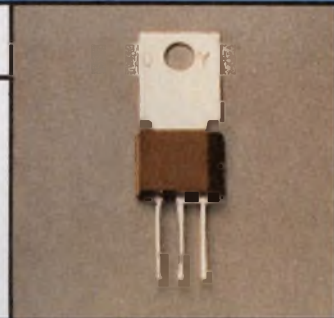

### COMPLEMENTARY - 2 AMPERES

GE TYPE		$P_T$ $T_C = 25^\circ\text{C}$ Max. (W)	$V_{CE0}$ Min. (V)	$h_{FE}$ @ 5V, 200 mA MIN.	COMMENTS
NPN	PNP				
D40K1	-	10	30	10,000	<b>Typical Applications:</b> <ul style="list-style-type: none"> <li>• IC Interface</li> <li>• Driver</li> <li>• Regulator</li> <li>• Touch Switch</li> <li>• Lamp Driver</li> <li>• Audio Output</li> <li>• Relay Substitute</li> <li>• Servo-Amplifier</li> <li>• TO-202 Package</li> </ul>
-	D41K1	10	-30	10,000	
D40K2	-	10	50	10,000	
-	D41K2	10	-50	10,000	
-	D41K3	10	-30	10,000	
-	D41K4	10	-50	10,000	

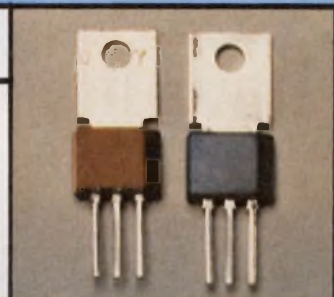

### COMPLEMENTARY - 10 AMPERES

GE TYPE		$P_T$ $T_C = 25^\circ\text{C}$ Max. (W)	$V_{CE0}$ Min. (V)	$h_{FE}$ @ 5V, 5 Amps MIN.	COMMENTS
NPN	PNP				
D44E1	-	50	40	1000	<b>Typical Applications:</b> <ul style="list-style-type: none"> <li>• IC Interface</li> <li>• Relay and Solenoid Driver</li> <li>• Regulator</li> <li>• Inverter Power Supply Switch</li> <li>• Audio Output</li> <li>• Relay Substitute</li> <li>• Oscillator</li> <li>• Servo-Amplifier</li> <li>• TO-220AB Package</li> </ul>
-	D45E1	50	-40	1000	
D44E2	-	50	60	1000	
-	D45E2	50	-60	1000	
D44E3	-	50	80	1000	
-	D45E3	50	-80	1000	

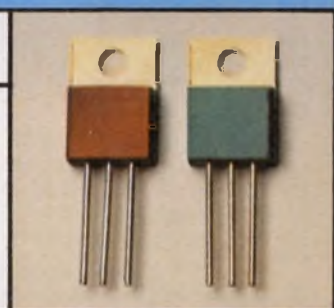

We'd like to show you our DARLINGTON POWER TRANSISTORS; for free sample, identify GE type and write on company letterhead to: General Electric Company, Semiconductor Products Dept., Electronics Park, 7-49, Syracuse, New York 13201.



# Ask CONTROL DATA for the Floppy Disk Drive more major OEM's specify.

## We have it.

One major OEM after another tested our Floppy Disk Drives. Ran them through rigorous evaluations. Compared them with competition. And chose ours. Either our Model 9400; or our Model 9404 with **double-density capability**.

Both have true IBM compatibility, with the write-current switched at track 43. Both offer ceramic heads; and hard and soft-sector capability. The 9400 has a star interface; the 9404 a daisy chain interface plus power reduction, write-protect option, and double-density capability.

Whether large OEM or small, we invite you to make your own tests and comparisons. Let us demonstrate our Floppy Disk Drives, right in your facility. Evaluate them, just as many major OEM's did. We know you'll make the same choice.

Two configurations available. Choose Model 9400 for single; Model 9404 for multiple drive applications. Model 9404 also offers double-density capability.

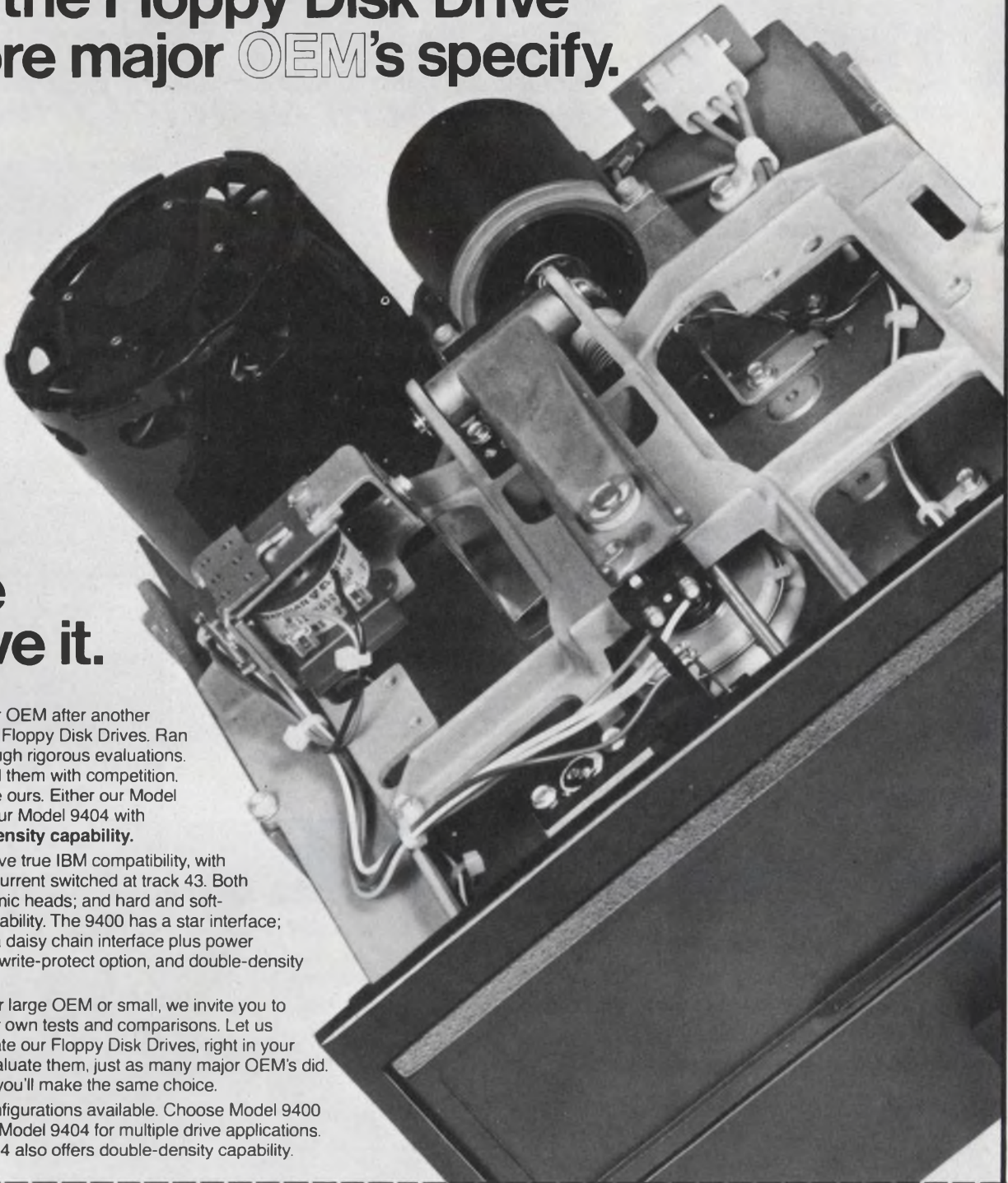

Call (405) 946-5421 or return coupon to: Terry J. Hardie, Control Data Corporation, 4000 NW 39th Street, Oklahoma City, OK 73112.

Please have your salesman bring me a Floppy Disk Drive for evaluation.

Tell me more about your OEM Floppy Disk Drives.

NAME \_\_\_\_\_ TITLE \_\_\_\_\_

COMPANY \_\_\_\_\_ ADDRESS \_\_\_\_\_

CITY \_\_\_\_\_ STATE \_\_\_\_\_ ZIP \_\_\_\_\_ AREA CODE \_\_\_\_\_ PHONE \_\_\_\_\_

Ask the CDC OEM people

**CD** CONTROL DATA CORPORATION

**HUGHES**

HUGHES AIRCRAFT COMPANY  
CONNECTING DEVICES DIV.

Today we  
supply the spark  
for America's  
defense.

Connections were much simpler 200 years ago. Torch the fuse and the cannon fired.

Supplying the vital spark that makes a modern weapon system do its job is a lot more complicated.

That's where we come in. For many years, primes and OEMs for military and aerospace products have depended on us to provide the vital links in their electronic systems—flat cable, etched circuitry, connectors, and total interconnection systems.

Our high-rel connections have to be the best. They're used in systems like Phoenix, Maverick, Lance, Minuteman, AWACS, F-14, F-15, Space Shuttle, Viking, Sonobuoy, F-4, A-7, Condor, Standard Missile, F-18, AAH, Cruise Missile, F-8, Trident, Hobo, Sprint and many more.

To learn how we can serve your interconnection needs, contact Jack Maranto or Dave Cianciulli: Hughes Connecting Devices, 17150 Von Karman Ave., Irvine, CA 92714.

Or call (714) 549-5701.

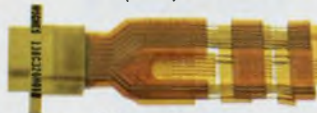

**Hughes  
Connecting Devices**

CIRCLE NUMBER 29

# HR-40

## 3 and 4 Channel Strip Chart Recorder

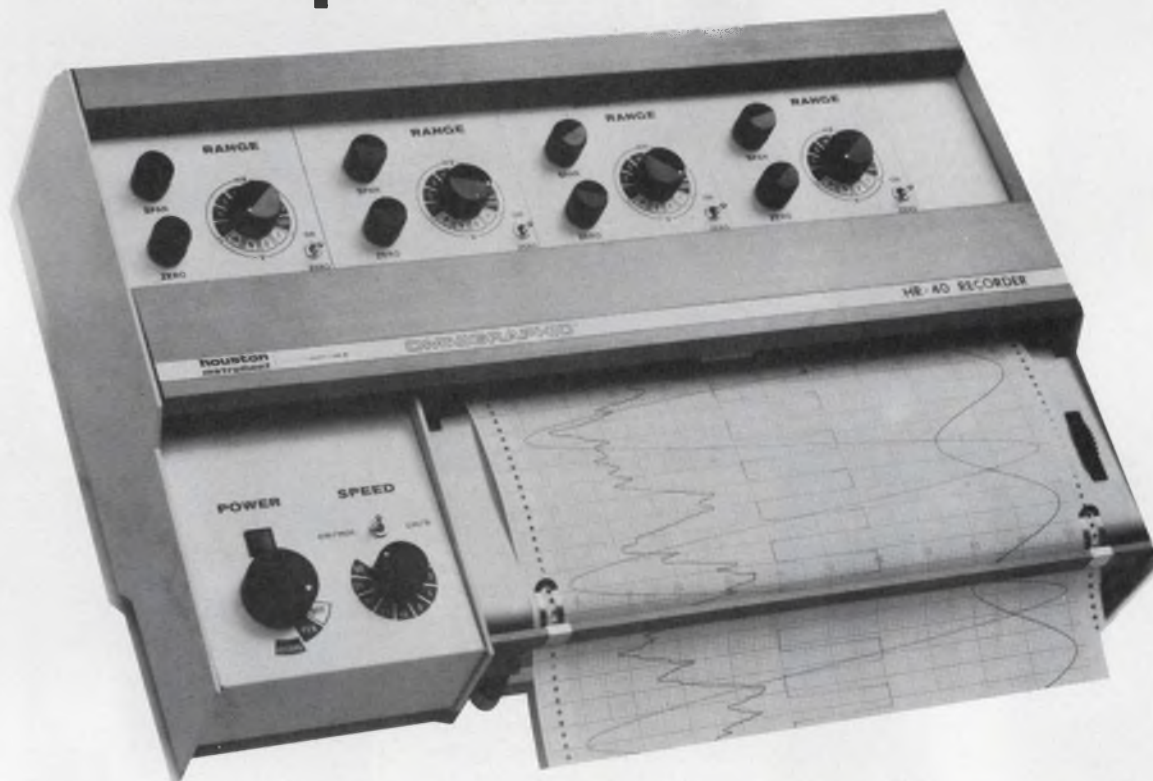

### OMNIGRAPHIC®

New from Houston Instrument

- Standard options available
- 10" or 250 mm recording width
- Disposable fiber tip cartridges in four colors
- All pens cover full chart width (Writing distance between channels only 2 mm)
- Price from \$3200.
- Full scale response ¼ sec.
- Choice of 2 interchangeable, plug in, input modules. 0.5mv to 200v full scale
- Either English or Metric chart speeds
- 16 Switch selectable chart speeds 1 inch/min. to 24 inches/hr.

**houston  
instrument**

® A registered trademark of Houston Instrument

DIVISION OF BAUSCH & LOMB

ONE HOUSTON SQUARE (at 8500 Cameron Road) AUSTIN, TEXAS 78753  
 (512) 837-2820 TWX 910-874-2022 cable HOINCO  
 EUROPEAN HEADQUARTERS Rochesterlaan 6 8240 Gistel Belgium  
 Phone 059/277445 Telex Bausch 81399

*"the recorder company"*

# O.K., you guys, back to the old drawing board.

Just when you've made all your panel lamp decisions Monsanto comes along with LED lamps so light-efficient, with choice of color, that you'll have to take another look. They'll give you the same light with less power, or more light with the same power — whichever will do your application the most good.

They're the result of our patented nitrogen doping process for GaAsP on GaP substrates. We don't think you can find a better LED lamp, anywhere.

They come as T-1 and T-1 $\frac{3}{4}$  replacement lamps in standard red, bright red, green, yellow and orange. All those colors will give you great flexibility in design. And you'll get still more flexibility from their two lens choices and two lead lengths.

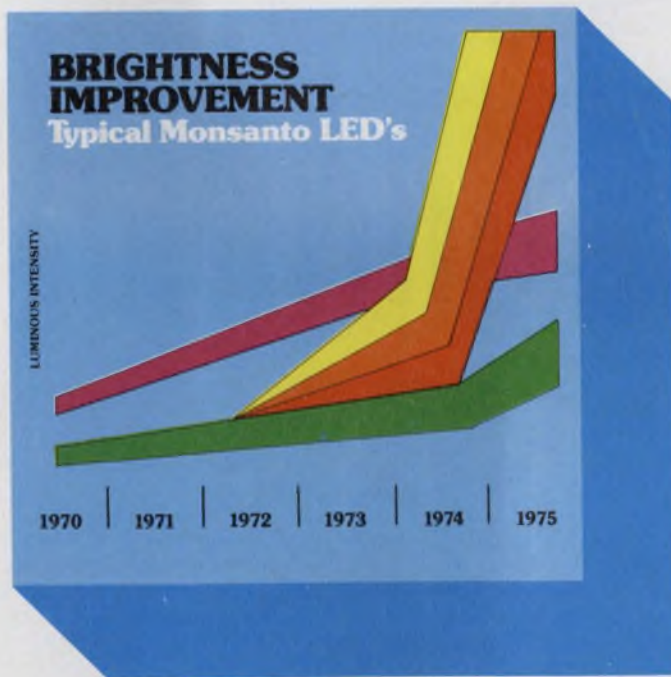

Model Number	Color	Size	Luminous Intensity	Viewing Angle
5174B*	Orange	T-1	5.0 mcd	90°
5274B*	Green	T-1	1.0 mcd	90°
5374B*	Yellow	T-1	4.0 mcd	90°
5774B*	Red	T-1	5.0 mcd	90°
5152**	Orange	T-1 $\frac{3}{4}$	40.0 mcd	28°
5252**	Green	T-1 $\frac{3}{4}$	15.0 mcd	28°
5352**	Yellow	T-1 $\frac{3}{4}$	45.0 mcd	28°
5752**	Red	T-1 $\frac{3}{4}$	40.0 mcd	28°

\*Models are also available with 1" lead lengths, low profile (.138" high) lens, or 180° viewing angle.

\*\*Models are also available with 24° and 65° viewing angles.

It used to be that some sockets demanded filament lamps in spite of their failure and replacement problems. But now you may find all the brightness you need in our long-life LED lamps.

In short, Monsanto LED's can add value to your product. Because of their long life, high reliability, and low power requirements.

To find out more, call your local Monsanto man. Or simply send us the coupon.

**Monsanto:**  
the science  
company.

IN EUROPE CONTACT: Monsanto Europe S.A.,  
Electronics Division, Avenue de Tervuren 270-272,  
B-1150, Brussels, Belgium

Please send me information on your newest LEDs.

Name  Title

Company  Street

City  State  Zip

Mail to Monsanto Electronics Division,  
Dept. MCD, 3400 Hillview Ave., Palo Alto,  
CA 94304. Phone (415) 493-3300.

ED-1 © Monsanto Company Electronics Division 1976







CIRCLE NUMBER 31

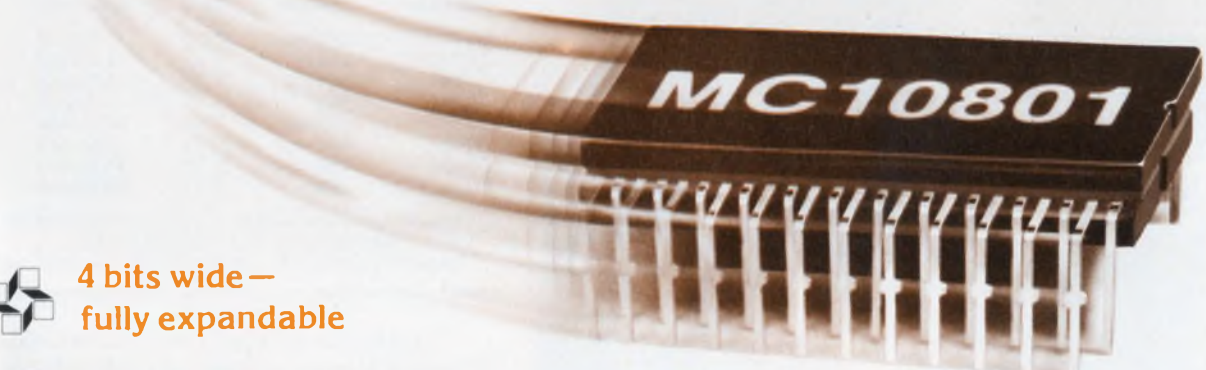

# M10800

## The world's fastest LSI processor family introduces...



-  **4 bits wide — fully expandable**
-  **16 powerful microinstructions**
-  **Control cycle 52 ns<sup>+</sup>**
-  **4 on-chip subroutine levels**
-  **Instruction or subroutine repeat**
-  **Standard MECL<sup>®</sup> LSI from the ECL leader**
-  **8 on-chip registers — including expandable 4 X 4 LIFO**

Speed alone would place the MC10801 in a microprogram controller class by itself, but with this remarkable MECL LSI building block, speed is just the beginning.

Its 16 microinstructions and on-board registers make the MC10801 the most powerful microprogram controller as well as the fastest. Maximum system flexibility is ensured by five data ports. Generation of the next control memory address is possible from any of seven different sources; either I or O bidirectional bus, next address field, incrementer, either repeat or instruction register, or LIFO stack.

When the MC10801's four

on-chip subroutine levels are not sufficient, expanding the LIFO stack via the I and O buses accomplishes nesting of more than four levels.

And there's still more. The repeat register permits big savings in control memory, particularly in large multiply or divide routines. Repeat capability for an instruction or subroutine is  $2^{4n}$ , with "n" as the number of 10801s in the system. So with just two, you get 256 repeats. The number 256 points out another MC10801 feature, Page Addressing. Using the status register, multiple pages of 256 words can be addressed,

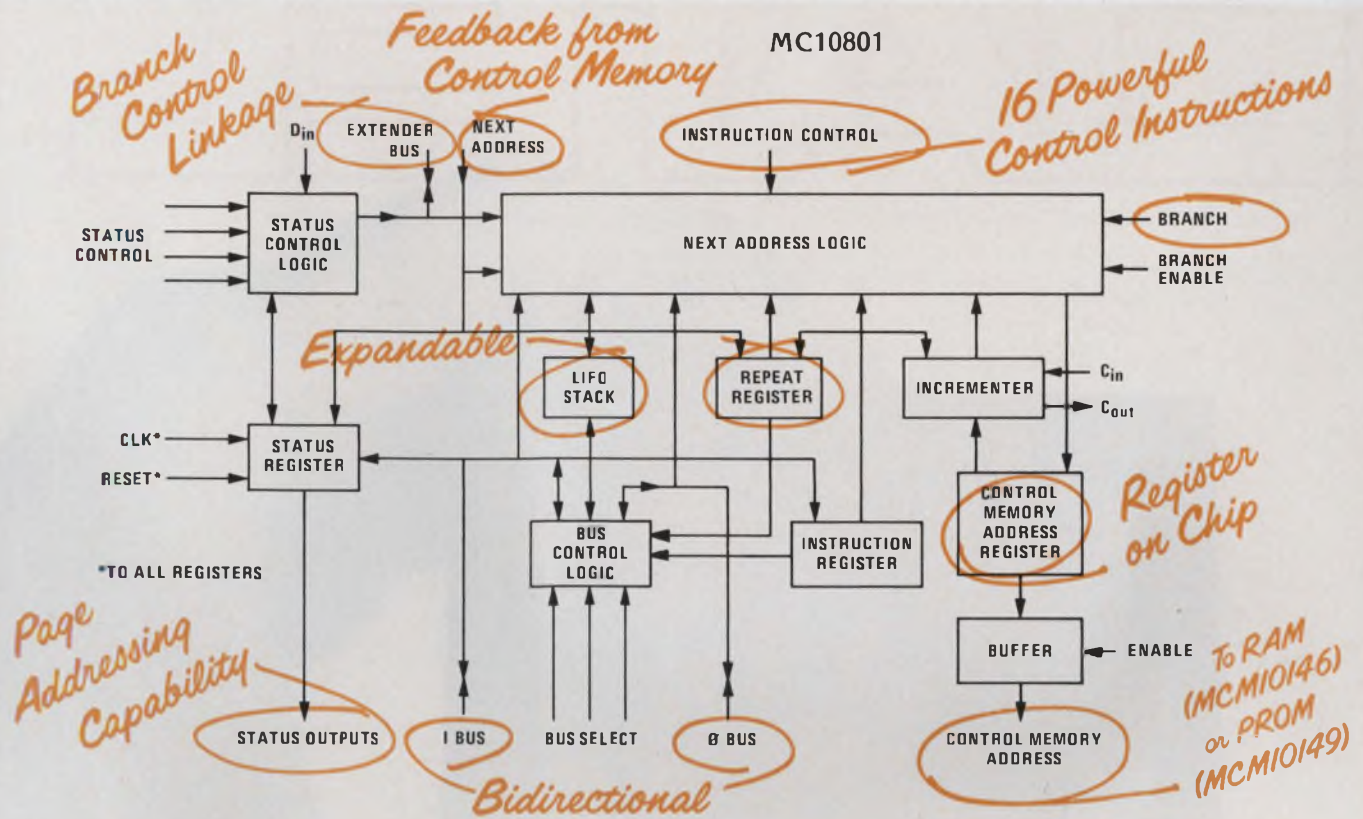

# the world's most powerful microprogram controller.

## Control Cycle Speed Calculation

(Logic delays - typical)

The MC10801 is the fastest microprogram controller by any measure, but nothing demonstrates that fact better than a system speed calculation like this.

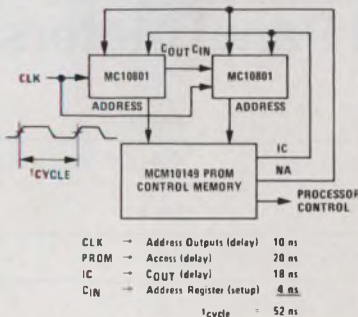

again with only two units in most systems.

We could go on, but you get the idea. Just a final word about

## M10800 Family Product Availability

MC10800	Now
MC10801	Now
MC10802	2nd Qtr '77
(Timing Function)	
MC10803	1st Qtr '77
(Memory Interface)	
MC10805	2nd Qtr '77
(Bus Translator)	
MC10806 (32 X 9 Dual Addressable Register)	2nd Qtr '77
MC10808 (Expandable 16-Bit Shifter)	2nd Qtr '77

prices. Our introductory MC10801 price (100-up) is just \$50.00, and we've already been able to cut our MC10800 price 40%, to \$30.00.

Whether your processor application is in disk controllers, radar and guidance, video or speech processing, minicomputers, signal processing, or whether you simply want to emulate your favorite instruction set... the performance of the MECL LSI M10800 Family mandates your consideration, now.

## MC10801 Control Instructions

- INC - Increment
- JMP - Jump to N.A. Inputs
- JIB - Jump to I Bus
- JIN - Jump to I Bus and Load Instruction Register
- JPI - Jump to Primary Instruction
- JEP - Jump to External Port (O Bus)
- JL2 - Jump to N.A. Inputs and Load Instruction Register
- JLA - Jump to N.A. Inputs and Load Address into Repeat Register
- JSR - Jump to Subroutine
- RTN - Return from Subroutine
- RSR - Repeat Subroutine
- RPI - Repeat Instruction
- BRC - Branch to N.A. Inputs on Condition otherwise Increment
- BSR - Branch to Subroutine on Condition otherwise Increment
- ROC - Return from Subroutine on Condition otherwise Jump to N.A. Inputs
- BRM - Branch and Modify Address with Branch Inputs (Multiway Branch)

For data, circle the reader service number or write to Motorola Semiconductor Products, Inc., P.O. Box 20912, Phoenix, AZ 85036. For real action, contact your favorite authorized Motorola distributor or Motorola sales office.



# MOTOROLA Semiconductors

— and you thought we were just a production house \*Trademarks of Motorola Inc.

# DATEL



## YOUR \$59\* DPM

Choose Datel's DM-350 for your next design . . .  
And take a look at these Datel Digital Panel Meters:

MODEL	NUMBER OF DIGITS	POWER SUPPLY	FEATURES	PRICE (1-9)
DM-350D1	3-1/2	+5VDC @ .3A	UNIPOLAR, LOW POWER, DISPLAY ONLY	<b>\$69</b> (1-9) <b>\$59</b> (100's) •
DM-350D2	3-1/2	+5VDC @ .3A	BIPOLAR, LOW POWER, DISPLAY ONLY	<b>\$75</b>
DM-350A1	3-1/2	115/230 VAC	UNIPOLAR, XFMR-ISOLATED, DISPLAY ONLY	<b>\$79</b>
DM-350A2	3-1/2	115/230 VAC	BIPOLAR, XFMR-ISOLATED, DISPLAY ONLY	<b>\$89</b>
DM-4000	4-1/2	+5VDC @ .6A	OPTOISOLATED RATIOMETRIC AUTO ZERO XTAL LINE FILTER	<b>\$219</b> less BCD <b>\$239</b> with BCD
DM-4300	4-3/4	+5VDC @ .6A	OPTOISOLATED RATIOMETRIC AUTO ZERO XTAL LINE FILTER	<b>\$235</b> less BCD <b>\$255</b> with BCD
DM-2000AR	3-1/2 DIGITS AUTORANGING OVER 3 DECADES	+5VDC @ .8A	AUTOMATIC RANGING OVER $\pm 200\text{mV}$ . $\pm 2\text{V}$ $\pm 20\text{V}$ FULL SCALE	<b>\$169</b> less optoisolation <b>\$218</b> with optoisolation



**DATEL**  
SYSTEMS, INC.

1020 Turnpike St., Canton, Ma 02021 • Phone (617) 828-8000  
• Santa Ana, Calif. (714) 835-2751 • Santa Ana (L.A. Exchange) (213) 933-7256  
• Sunnyvale, Calif. (408) 733 2424 • Gaithersburg, Md. (301) 840-9490

CIRCLE NUMBER 33



## The old man at the bar

Jack and Charlie were having one or two while watching the old-timer drink his lunch. "What do you suppose keeps that guy going?" Jack wondered aloud. "He's at least 80." "Well," Charlie began, pausing half a second to give the question the cogitation it deserved, "it's got to be the booze. Look at him. He's just finished his fourth martini, and he's still going strong." Then, getting philosophical, Charlie added that contrary to the advice of people concerned with health—even doctors—alcohol keeps you young. The living proof (80, at least) was lunching (or lurching) at the end of the bar.



"I don't know," Jack mused. "I think it's the womanizing. Heck, that guy's here every day with a different gorgeous gal. That's got to keep a guy going. It would keep *me* going."

"No," Charlie asserted. "It's got to be the smoking. I've never seen a guy smoke so much. He burned up half a dozen cigarettes in the last hour, and now he's on his second cigar. I guess tobacco must keep you young."

Before the discussion was allowed to die, Charlie approached the old gentleman. "Excuse me, pop," he said graciously. "To what do you attribute your venerable age?" And when the man muttered, "Well, son, mainly to the fact that I was born so long ago," Charlie chuckled, then tried again. "I mean, old-timer, how old are you?"

"I'm 29," the old man wheezed.

Well, everybody got a large charge out of the story when Bill told it at lunch. But some began to wonder if we don't all make similar mistakes. Too often we spend our time developing plausible theories for facts before the facts are all in. We try to discover *why* a circuit behaved a certain way before we determine *if* the circuit behaved that way. We sweat out the solution to a problem only to discover that the problem never existed. So we end up doing penance for sins that haven't been committed. And we offer theories to explain why Joe did something when, in fact, he didn't.

Jumping to conclusions is risky business.

GEORGE ROSTKY  
Editor-in-Chief



RECOGNIZED BY  
AMERICAN REVOLUTION  
BICENTENNIAL  
ADMINISTRATION

ELECTRONIC DESIGN is deeply honored to have received official recognition as a participant in the American Revolution Bicentennial Celebration, with authority to display the Bicentennial Symbol.

# Want simpler backplane connections? Come to the source.

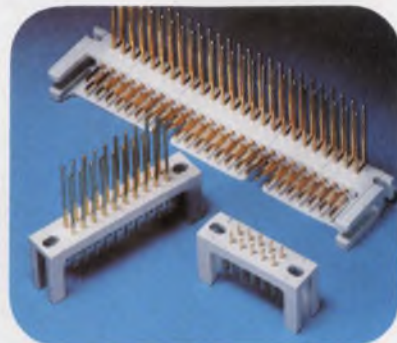
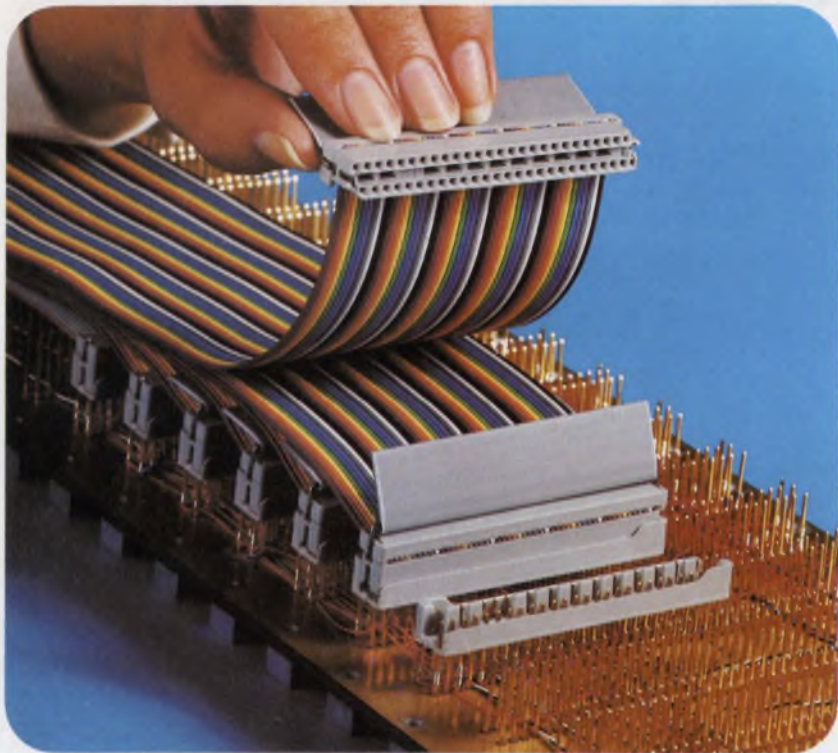

There are several more things you can get only from 3M. The broadest range of flat cables and complete system components. Best off-the-shelf availability. Proven performance. And the unmatched experience of the people who pioneered this reliable mass termination system.

"Scotchflex" is a registered trademark of 3M Co.

Now, a unique Scotchflex brand Socket Connector and Keying Header system lets you interface directly with backplane wire wrap pins and provides for easy, positive polarization and keying. The header design allows for thousands of unduplicated polarizing combinations without loss of backplane pins. The 50-position connector mates with .025" square pins on .100" x .200" grid spacing. Header allows space for and protects two layers of wrap below it. System also provides polarizing keys and strain relief handles.

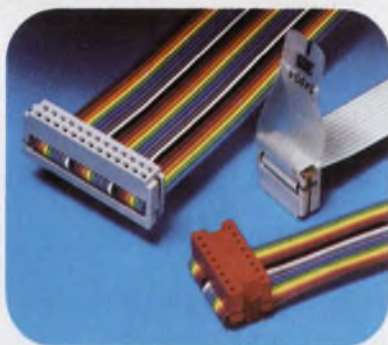

Need some other ways to simplify wiring and increase circuit density? 3M's Scotchflex line offers you a broad choice of mass terminating socket connectors, plus wire wrap or solder tail headers to suit your specific design problem. Keying capability is also provided.

## Scotchflex<sup>®</sup> systems from 3M. The source.



See our  
catalog in EEM,  
page 1056

# Interested in network variety? Select from a spectrum of 347 standards.

Allen-Bradley has the popular configurations you need. Pull-ups, Pull-downs. Line Terminators. Networks to complement Core Memory Sense Amplifiers. TTL to ECL Translators. O-Pad Attenuators. All styles available from your Allen-Bradley *Electronic Distributor*. Call for specs or check your EEM Catalog. If you need specials, contact your local Allen-Bradley district office for fast turn-around. Ask for Publication 5840. A-B is an experienced twin-film manufacturer, i.e. precision thin film and thick film.

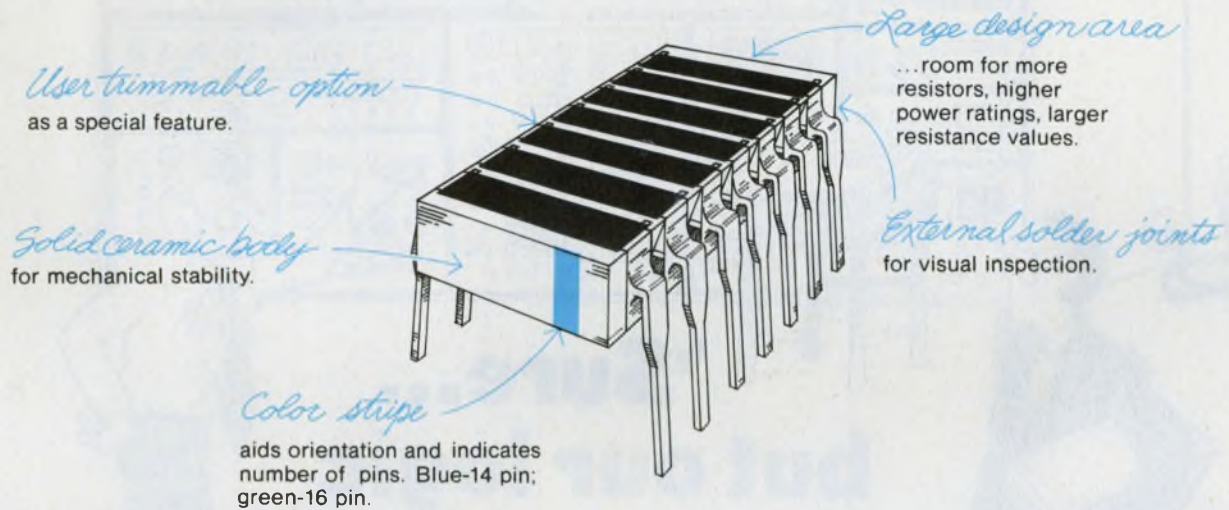

0347



## Quality in the best tradition.



**ALLEN-BRADLEY**

Electronics Division  
Milwaukee, Wisconsin 53204

CIRCLE NUMBER 191

EC111

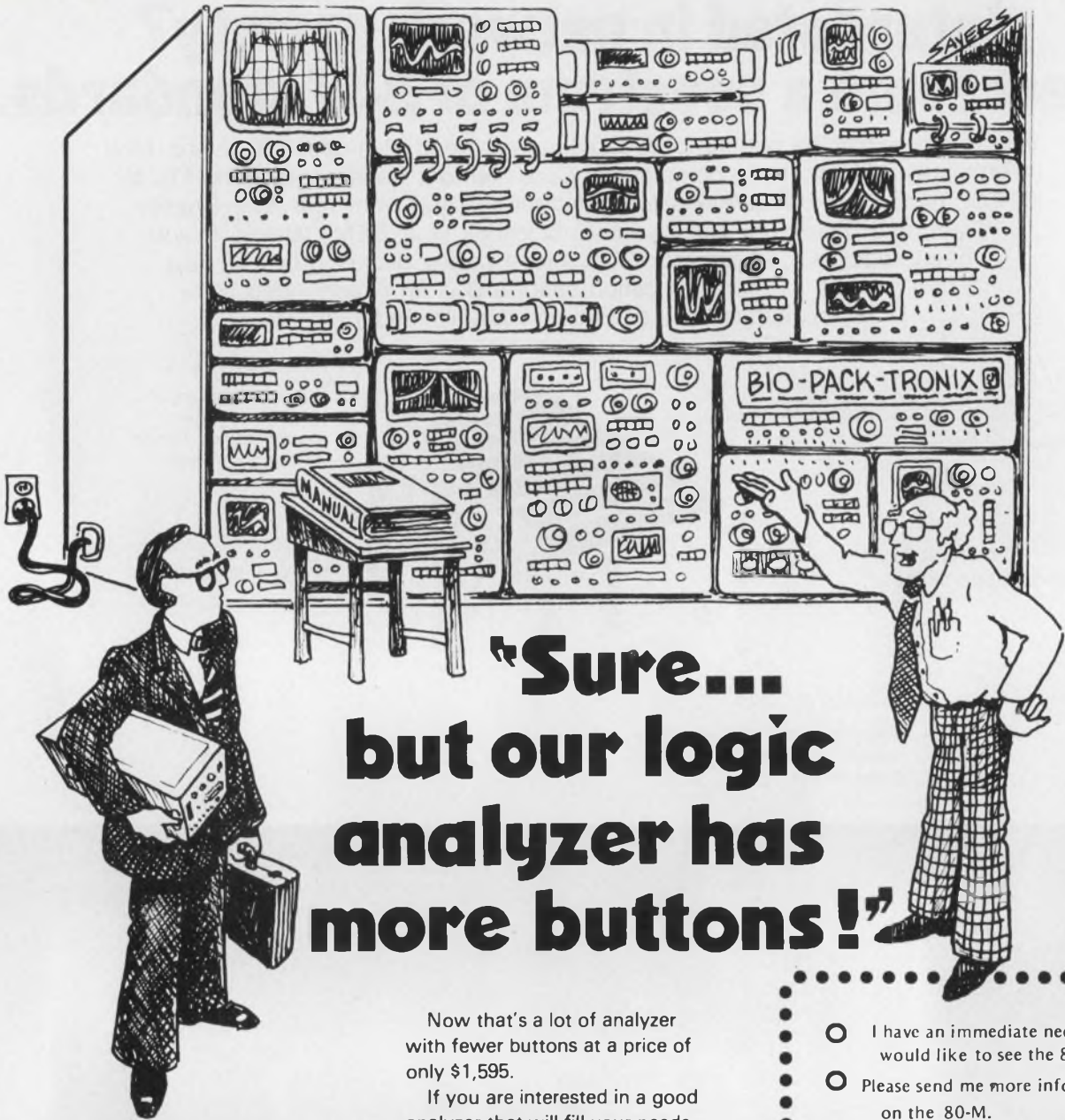

**"Sure...  
but our logic  
analyzer has  
more buttons!"**

True, but more buttons do not make a better analyzer. The 80-M Logic Analyzer from Digital Broadcast Systems can do many of the things the more expensive analyzers can do, such as, "snap shot" eight channels of digital logic, store the information in a 1K per channel memory and play it back on your scope or CRT. The 80-M has spike detection, real time and memory operation, eight bit word recognition, 10Mhz operation and much more.

Now that's a lot of analyzer with fewer buttons at a price of only \$1,595.

If you are interested in a good analyzer that will fill your needs with easier operation, circle the reader service card number or fill out the coupon and mail to us for faster response.



- I have an immediate need and would like to see the 80-M.
- Please send me more information on the 80-M.

My application would be:

NAME \_\_\_\_\_  
 COMPANY \_\_\_\_\_  
 PHONE \_\_\_\_\_  
 ADDRESS \_\_\_\_\_  
 CITY \_\_\_\_\_  
 STATE \_\_\_\_\_ ZIP \_\_\_\_\_

**dbS**  
**Digital Broadcast Systems**  
 4306 Governors Drive  
 Huntsville, Alabama 35805  
 (205) 837-2183

**dbS**

Digital Broadcast Systems  
 4306 Governors Drive, Huntsville, Alabama 35805 (205) 837-2183

CIRCLE NUMBER 192

**POWER MINI'S  
FOR LOGIC  
OR OPAMPS**



Terminal strip input/output connections on these miniature power modules eliminate the need for sockets or soldering. They mount in an area only 2.5" x 2.5". Ratings: 5 volt models to 2.5 amps, 15 volts to 5 amps. Other models from 1 to 75 volts, all with 3-day shipment guaranteed.

**NEED A  
POWER  
SYSTEM?**



Order multiple output power systems without searching through a catalog, preparing mechanical layouts, item-by-item pricing and detailed purchase requisitions. Instead, call Acopian. We'll listen to your needs, quote a firm price, and then ship your built-to-order system, fully wired and tested, in just 9 days.

**POWER  
FOR YOUR  
μ PROCESSOR**



Single, dual, and triple output power supplies in a broad selection of output voltage combinations. Output current ratings from 30ma to 60 amps. Various package styles suitable for virtually every application. Any module you select will be shipped within 3 days; rack mounting models, within 9 days.

**MATCHED OR  
DISSIMILAR  
DUAL OUTPUT**



Select the combination of matched or dissimilar outputs that you require. Hundreds of ratings available, from 1.5 to 150 volts. Outputs are isolated, and may be used in the same or opposite polarities. Acopian's 3-day shipment promise applies for any combination.

**HIGHLY  
ISOLATED  
POWER**



For applications requiring a power supply with unusually high isolation, such as for powering strain gage or other transducer circuits, Acopian offers models with ratings from 5 to 36 volts. Input-output isolation: 10,000 meg-ohms minimum, 1 pF maximum. Guaranteed 3-day shipment.

**POWER FOR  
RELAYS AND  
DISPLAYS**



Drive relays, lamps, small motors and similar loads with low-cost Acopian unregulated power modules. Built-in fusing protects against overloads or shorts. Series U models use terminal strip connections. Plug-in modules mount in standard socket sockets; many have adjustable outputs. Guaranteed 3-day shipment.

**RACK MOUNT  
POWER  
...TO 60 AMPS**



Designed for mounting in standard 19" RETMA cabinet racks, these power supplies are available in 76 different output ratings from 1 to 50 volts, and from 5 to 60 amps. Regulation:  $\pm 0.05\%$  or better; ripple: 1 mv rms or better. Options include metering and overvoltage protection. Shipment, 9 days after receipt of your order.

**SOLDER  
TERMINAL  
MODULES**



For applications where hard wiring is desired, Acopian offers modules with solder terminals. Included are single output models (regulated and unregulated) duals with two like or dissimilar voltages and high isolation supplies. Guaranteed 3-day shipment.

**MULTIPLE  
VOLTAGES  
FOR PCB'S**



Simplify pc board layout with multiple output power mini's. Duals supply two isolated like or dissimilar outputs, 1 to 25 volts each. Op amp supplies provide 12 or 15 volts. Triplets have two balanced, tracking outputs, a third for powering other circuits. Guaranteed 3-day shipment.

**MIL-TESTED  
PLUG-IN  
POWER**



MIL tested power supplies withstand unusually severe environmental conditions. These extended temperature plug-in modules exceed MIL specs for humidity, altitude, vibration and shock. Hundreds of single output models. Thousands of dual output combinations, all guaranteed for 3-day shipment.

**BENCHTOP  
POWER  
...FROM \$99**



Reliable yet low-cost power supplies for circuit development and component evaluation. Single, dual and triple output models. Ratings from 0.7 to 0-50 volts. All have adjustable current limiting, coarse and fine voltage adjustments and two meters. They may be stacked to conserve bench space. Regulation: 0.01% or 2 mv rms. Ripple: 0.25 mv rms.

**SUPPLIES  
THAT FIT IN  
THIN SPACES**



Measuring only 1.68" high, Acopian narrow profile power supplies fit where many others cannot. Available in a wide range of ratings from 1 to 150 volts, to 4 amps. Regulation to 0.005%. Tracking dual output models for op amps also available. Guaranteed 3-day shipment.

**SINGLE, DUAL  
PLUG-IN  
POWER**



A plug-in power module can be installed in seconds. Simply plug it into a standard octal-type socket. Single output models from 1 to 200 volts. Duals combining two matched or dissimilar outputs in one case available in over 10,000 combinations. Warranty 5 years. Shipment 3 days.

**ACOPIAN**

**POWER  
SUPPLY  
CATALOG**

Write for your copy of the Acopian 48-page catalog



Corp., Easton, Pennsylvania 18042 • Telephone (215) 258-5441

CIRCLE NUMBER 193

We said,  
 "OK, Angel,  
**PASS US  
 A MIRACLE**"

and she  
 produced the  
**AMAZING  
 1360  
 RELAY**

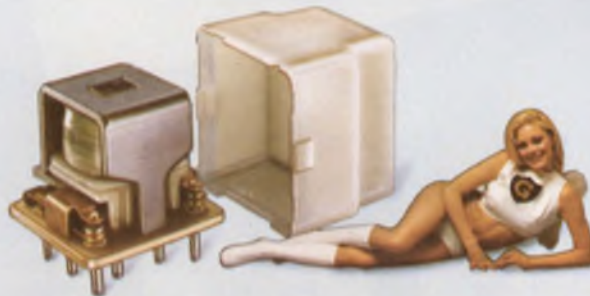

**IT'S SMALL...** all terminals on .1" grid spacing for standard PC board, weighs about an ounce.

**IT'S BIG...** rated up to 25 amps continuous... 50 amps inrush at 12VDC.

**IT'S HIGH...** in quality to meet uncompromising dependability demands.

**IT'S LOW...** in price to keep your product competitive.

**IT'S VERSATILE...** DPDT, DPST-NO; DPST-NC, SPDT, SPST-NO; SPST-NC... half amp to 25 amps, AC or DC. Solders right on PC board... or use mating socket.



Way to go, Angel...way to go!

**SEND FOR...** the complete story on the new 1360... plus all the other miraculous Guardian Relays. Circle the reader service number for your just-off-the-press RELAY CATALOG.



**GUARDIAN®**

GUARDIAN ELECTRIC MANUFACTURING CO. 1572 West Carroll Ave., Chicago, Illinois 60607  
 CIRCLE NUMBER 194

**0 - 100%**



**Linear Humidity and Temperature  
Measurement System**

## **Solid State Humidity Technology is Here**

Readout in Direct Engineering Units . . .

Solid State Thin Film Humidity Sensor . . .

- **Forget the Cal Curves**
- **No Mirrors to Clean**
- **Humidity Measurement Simplified**

### **Digital Systems Now Available**

Model HS-1CHDT-1A —Relative humidity  
and temperature  
(Temperature com-  
pensated 0—50° C)

Model HS-1CHD-PPM —0—2000 PPM

Model HS-1CHD-WS —Wind Velocity

Model HS-1CHDT-DP —Dewpoint and  
Temperature

BCD Option Available

Other economical modular or complete  
systems . . . accurate and reliable for  
all humidity requirements.

### **Monitor — Measurement Alarm — Control**

Call Thunder for an Applications Engineer . . .  
we can fabricate to your exact need.

505-265-8701



**THUNDER SCIENTIFIC** Corp.

623 Wyoming, S.E.

Albuquerque, New Mexico 87123

CIRCLE NUMBER 195

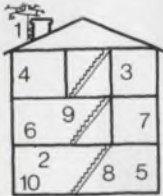
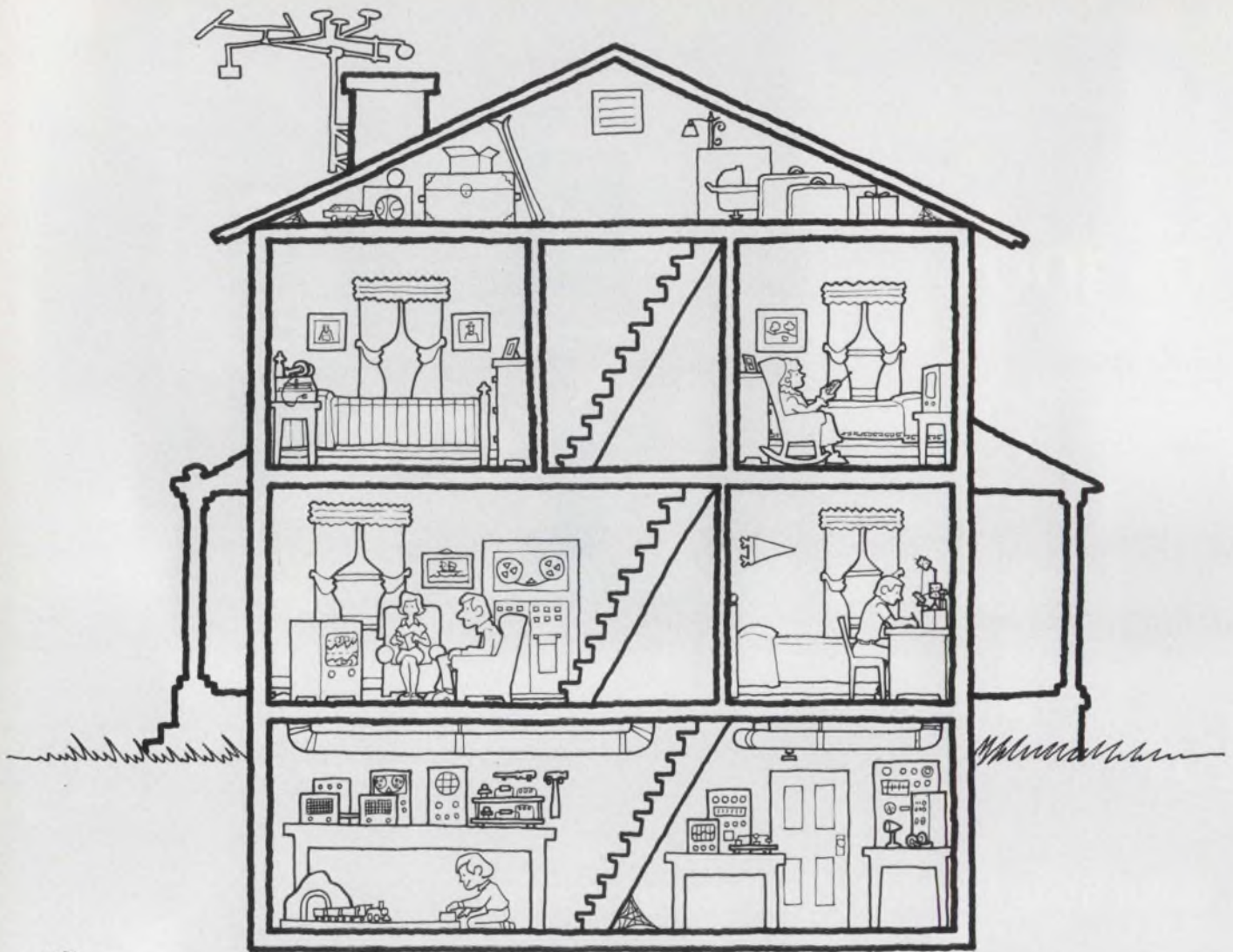

## Engineers gotta have fun, too!

Here are 10 hobby and project books that let the engineer use his special talents for improving his home or just having fun.

1. **HOW TO SELECT AND INSTALL ANTENNAS**, #0786-8, \$4.90. All aspects of antenna selection and installation. Instructions for putting up UHF, VHF, FM antennas or complete master TV systems.
2. **20 SOLID-STATE HOME AND HOBBY PROJECTS**, #0134-7, \$4.55. Two-station intercom, electronic siren, power regulator, metal detector, water-operated alarm, etc. Complete instructions, parts lists, diagrams.
3. **25 SOLID-STATE PROJECTS**, #5881-0, \$4.90. Auto burglar alarm, programmable auto-speed-minder, indoor-outdoor electrothermometer, telephone call timer, electronic dice, TV remote-sound system, etc., etc.
4. **50 IC PROJECTS YOU CAN BUILD**, #0723-x, \$4.95. Hi-fi headphone amp, auto tachometer, intercom, TV commercial killer, etc. Each project can be put together in one night with these simple instructions.
5. **BUILDING THE AMATEUR RADIO STATION**, #0709-4, \$4.30. Complete construction of amateur radio station. Schematic and wiring diagrams and chassis layouts for Novice and General Class stations.

6. **COLOR TELEVISION: Principles and Servicing**, #5929-9, \$5.70. Receiver troubleshooting and servicing techniques. Charts listing trouble symptoms, causes, and remedies. Instructions for using the latest test instruments.
7. **HOW TO BUILD A LOW-COST LASER**, #5934-5, \$4.95. How to build a laser at home, from readily available parts, for approximately \$100! Includes a collection of laser experiments.
8. **BENCH-TESTED COMMUNICATIONS PROJECTS**, #0788-4, \$3.75. Telephone broadcaster, party line listening, canned light music, rollaway ham

shack, VHF extender, 6-meter solid-state transmitter, etc.

9. **HOW TO BUILD A WORKING DIGITAL COMPUTER**, #0748-5, \$5.45. Step-by-step instructions for building an inexpensive digital computer simulator. Includes parts lists, theory of operation, and fundamental programming techniques for solving simple problems.

10. **110 THYRISTOR PROJECTS USING SCR'S AND TRIACS**, #5096-8, \$4.30. Burglar, fire and water level alarms, power control devices for electric tools, and other useful projects built and fully evaluated by the author.



**Hayden Book Company, Inc., 50 Essex St., Rochelle Park, N.J. 07662**

**I wanna have fun!** Please send me the books I've circled to read and use for 15 days FREE. At the end of that time, I'll send payment, plus postage, or return the book(s) with no further obligation. (To SAVE MONEY, enclose payment now. Publisher pays all shipping and handling charges. Same 15-day return guarantee.)

Name \_\_\_\_\_  
 Address \_\_\_\_\_  
 City \_\_\_\_\_ State \_\_\_\_\_ Zip \_\_\_\_\_

Prices subject to change without notice.

75-42



# Here's why REI can rent you what you want when you want it.



Our inventory. It's the biggest in the industry, with over 8,000 items of electronic test equipment in stock and ready to go. And it's getting better all the time, because we add more state-of-the-art equipment every month. This means we can deliver one special instrument... or a dozen... within hours of the time you place your order.

Now, more than ever, renting makes sense... to stretch your equipment budget, to fill temporary needs, and to avoid the long delivery lead times associated with purchasing. And renting from REI makes even more sense... because we're better equipped to fill your needs than any other rental company.

REI is backed by the tremendous resources of the PepsiCo organization, which gives us the financial strength to keep on hand whatever test equipment you may need. And renting from us helps *your* financial strength,

too. Since you pay only for the time you have your instruments, you'll never have to spend your money on idle equipment.

Send for our catalog today for a description of our rental, rental/purchase and leasing plans, and for our low rental prices. Or call the instant inventory center nearest you for immediate assistance.

Rental Electronics, Inc.,  
99 Hartwell Avenue, Lexington, Mass. 02173.  
Please send me your free instrument rental catalog:

Name \_\_\_\_\_ Title \_\_\_\_\_

Company \_\_\_\_\_

Address \_\_\_\_\_

City \_\_\_\_\_ State \_\_\_\_\_ Zip \_\_\_\_\_

Tel. Number \_\_\_\_\_

## Rental Electronics, Inc.

A PEPSICO LEASING COMPANY

Burlington, MA (617) 273-2770 • Gaithersburg, MD (301) 948-0620 • Oakland, NJ (201) 337-3757 • Ft. Lauderdale, FL (305) 771-3500  
Des Plaines, IL (312) 827-6670 • Dallas, TX (214) 661-8082 • Mountain View, CA (415) 968-8845 • Anaheim, CA (714) 879-0561  
Rexdale, Ontario (PLC Leasing Ltd.) (416) 677-7513

CIRCLE NUMBER 196

# .150" PROFILE

high density DIP sockets from R-N  
ICL SERIES



#### 26% LOWER PROFILE

Slim, low body design—actually 26% lower—cuts packaging space needs drastically.

#### .100" PROGRESSION

of socket leads permit maximum board density in either end-to-end or side-by-side arrangement. Cuts PC board drilling costs as well.

**IDEAL FOR HI-SPEED  
AUTOMATIC PRODUCTION**  
Self-lock leads hold socket firmly during high speed wave soldering.

#### MAXIMUM VIBRATION RESISTANCE

Unique R-N contact design assures that your IC lead maintains solid contact—even in most punishing applications.

## CUT COSTS, SPEED PRODUCTION

with these new ICL low-profile DIP sockets from Robinson-Nugent. Designed for high speed automatic assembly and maximum shock and vibration resistance. Has famous R-N "side-wipe" single leaf contacts, body meets UL94V-0 flammability rating. 8 thru 40 leads available.

Check the advantages of these high density sockets today! Write for complete specifications on this new R-N low-profile ICL DIP socket now.



For maximum package density with traditional R-N reliability, specify this new low cost, low-profile ICL DIP socket.

**RN ROBINSON  
NUGENT, INC.**

800 East Eighth Street, New Albany, Indiana 47150 • Phone: (812) 945-0211—TWX: 810-540-4082

CALL ME, I'M INTERESTED CIRCLE #178

SEND PRODUCT INFORMATION CIRCLE #269

# The Great



SEND FOR THE NEW CELCO YOKE GUIDE LISTING OVER 175 TYPES. SELECT THE ONE YOKE FOR *YOUR* SPECIAL DISPLAY APPLICATION.

# American YOKE Company

CONSTANTINE ENGINEERING LABORATORIES COMPANY

1150 E. Eighth Street, Upland, CA 91786

70 Constantine Drive, Mahwah, N J 07430



# INSTRUMENTS '76

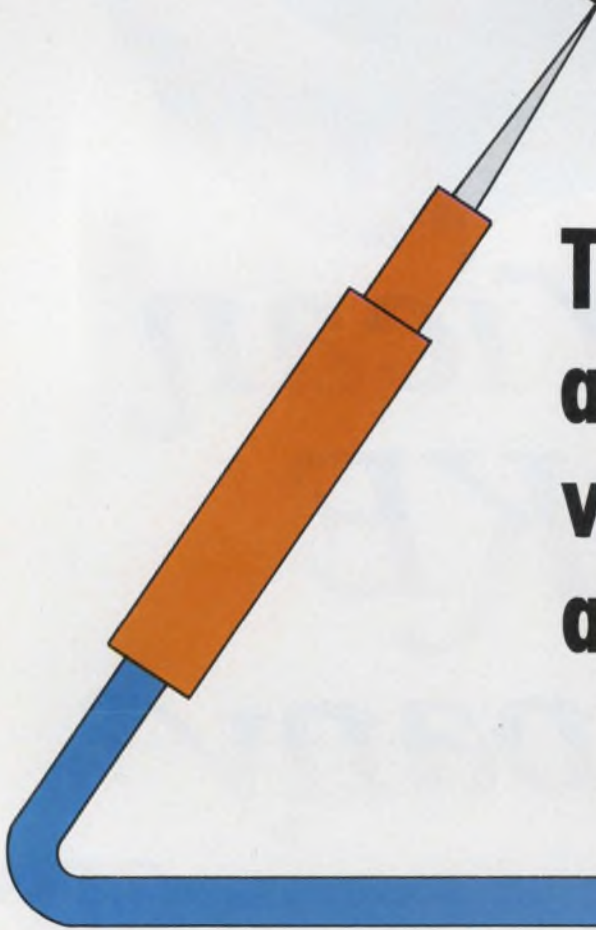

**Today's instruments  
are smart,  
versatile  
and safe**

## Contents

<b>Brainy instruments are taking top honors with computer power that boggles the mind</b> . . . . .	52
<b>Portable instruments: The specifications are fine, but their batteries are still short-lived</b> . . . . .	60
<b>Howard Vollum, Bill Peek and William Velsink of Tektronix speak on the future of scope</b> . . . . .	68
<b>The IEEE 488 bus is playing an important role in programmable instrument systems</b> . . . . .	76
<b>A combined instrument is one that often provides capabilities that exceed the sum of its parts</b> . . . . .	88
<b>Ulrich L. Rohde of Rohde &amp; Schwarz speaks on European and American engineers</b> . . . . .	96
<b>Calibration devices are better because the basic standards are more precise</b> . . . . .	104
<b>Instruments designed with safety in mind may be hazardous to your health</b> . . . . .	114

Smart instruments may have arrived, but they have brought problems with them. One of these is pinning down a definition of what smart means. To some a smart instrument means one that has memory, while to others it means the unit has a calculator chip or a microprocessor in it.

But a "brainy" instrument is not necessarily better than its "dumb" predecessor. Like the 21-transistor radio that used transistors for everything from diodes to resistors, instruments often contain a microprocessor simply for its promotional value.

But some instruments *do* take advantage of the added power a  $\mu$ P affords. And many of these use the  $\mu$ P to provide an interface between the instrument and the newly adopted IEEE Standard 488 Digital Interface Bus. The combination of microprocessors and the 488 bus is leading to a total system capability far beyond that originally envisioned for the bus. For example, it permits distributed computing systems to be built where processing can be done at the relative-

ly slow rate of 1 Mbyte/s.

Another trend in instrumentation is a move toward synergistic instruments, devices that integrate a variety of different functions into a single unit. Unlike other multifunction instruments that are simply a collection of individual units in one package, the more compact synergistic instruments have a capability that is generally greater than that provided by individual instruments being used together.

But are today's instruments safe? Manufacturers are going all out now to answer that question. The first thing one notices on new instruments is warning labels everywhere, especially where there is high voltage or even where there might be. Some companies have even gone to the extreme of putting illuminated warning labels on their equipment. These are particularly helpful on instruments being used by someone who is unfamiliar with the equipment.

To really appreciate these instrument changes, just turn to this special section.

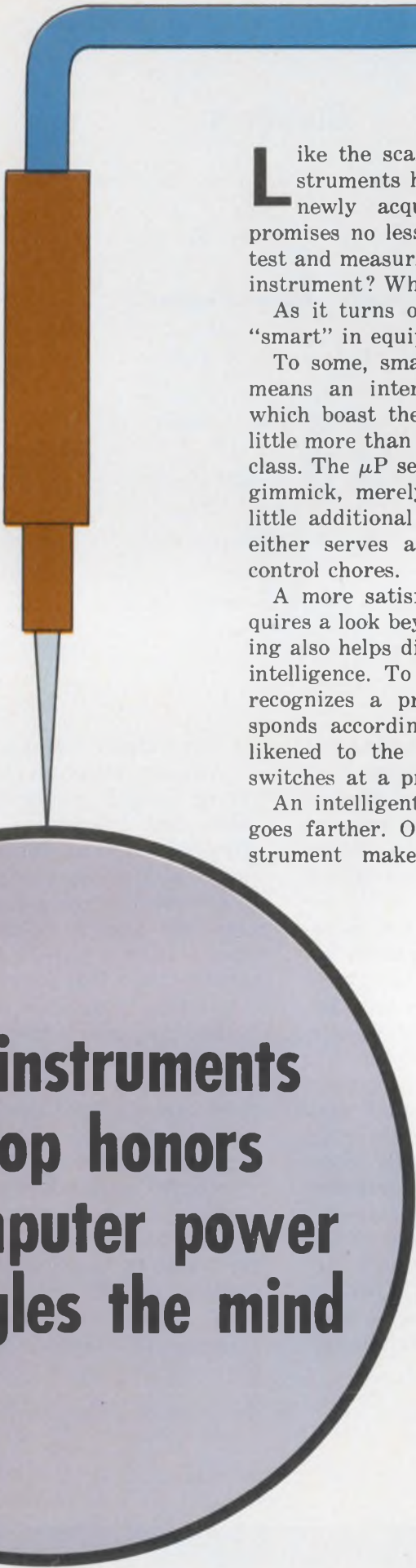

## Brainy instruments take top honors with computer power that boggles the mind

Like the scarecrow in the Wizard of Oz, instruments have finally acquired a brain. The newly acquired smartness or intelligence promises no less than to revolutionize the entire test and measuring industry. But what is a smart instrument? What is an intelligent one?

As it turns out, it's just as difficult to define "smart" in equipment as it is in people.

To some, smart means memory. To others, it means an internal  $\mu$ P. Yet some instruments, which boast the use of those ICs, appear to do little more than conventional instruments of their class. The  $\mu$ P seems to be there strictly as a sales gimmick, merely to replace existing logic, with little additional benefits. In other cases, the  $\mu$ P either serves as an interface or does internal control chores.

A more satisfying definition of smartness requires a look beyond form to function. Such probing also helps distinguish between smartness and intelligence. To some, then, a smart instrument recognizes a preprogrammed situation and responds accordingly. Smart, in this case, can be likened to the on-off response of a relay that switches at a predefined level.

An intelligent instrument, on the other hand, goes farther. One viewpoint: An intelligent instrument makes decisions based on previous actions; it can manipulate information, crunch numbers, then choose an action based upon the results.

More than a few instrument designers see programmability as a key aspect of smartness—that is, the equipment can go through a sequence of operations under external control. For example, a user can "key-board in" numbers and tell the smart equipment to use the values in one of several ways. Or the human operator can be replaced by a minicomputer or some other controller.

### The impact of microprocessing

Features like self-diagnosis, automatic calibration, autoranging and automatic zero don't necessarily make a machine

---

**Stanley Runyon**  
Senior Associate Editor



Slide the calculator-like keyboard out of the front panel, and you'll know immediately that the Dana 9000 is dif-

ferent. The world's first microprocessing timer/counter measures at the push of a button.

smart. These functions were around when  $\mu$ Ps weren't. And in spectrum analyzers, at least, arithmetic with standard TTL logic predates the LSI microprocessor concept.

Whatever distinctions are made between smartness and intelligence, two things are immediately clear:

1. Microprocessors have just begun to have an impact on instrumentation.
2. The features and capabilities now possible are more than can be handled reasonably from both an economic and a user's viewpoint—even at this early stage of application.

The advantages of digital processing over analog have been known for some time. But now, with the availability of low-cost computers on a chip, the processing can be moved inside the instrument. Theoretically, at least, whatever a mini can do externally, a  $\mu$ C can do internally.

For the user, the immediate benefits of digital processing include a reduction in physical size, and capabilities and features hitherto impossible or uneconomical. The user also gains more functions and features per dollar, and easier instrument interfacing.

All is not roses for users, however. Although the potential exists in  $\mu$ P-based equipment to clear up front-panel clutter and make an instrument easier to use, just the opposite can occur.



Microprocessor control brings new power to data loggers. With the Fluke 2240A, you can mix voltages, thermocouples and thermocouple types on adjacent channels.

A cursory survey of existing instruments uncovers at least one high-IQ box with nothing up front but a power switch; at the other extreme sits an instrument with 50 pushbuttons and half as many indicators.

Although comparing the two extremes is a bit unfair, the two pieces of equipment do serve to demonstrate the possibilities.

Ease of use isn't easily pinpointed from front-panel design. A blank front panel might signal nothing more than a remotely programmable instrument; 40 pushbuttons might be easier to use than 40 rotaries—but not necessarily. Once a button is punched, in some cases, the user is

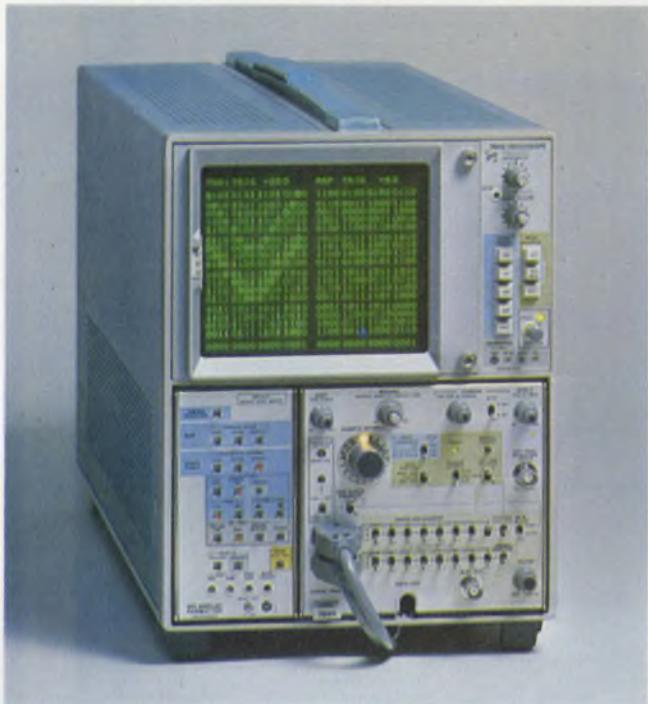

Check a  $\mu$ P-based system with a  $\mu$ P-based system. The DF1 display formatter boosts the capabilities of the Tektronix 7D01 logic analyzer.



Interactive digital plotting is a new concept brought to realization by the microprocessor. The Tektronix 4662 digitizes and transmits its pen position.

stuck with the entered number. Or the sequence of pushing is crucial—the wrong order brings weird results. Other limitations of smart instruments center around price or speed or reliability.

#### The price of brain power

Even though costs are dropping, the user must still pay a premium to own a  $\mu$ P-based instrument, because the cost of development is tacked

## Graduates from the college of knowledge

Intelligence has touched practically every class of measuring equipment today, and the honor roll gets longer each year. Those with digital processing power include the following:

*Counters:* Dana Laboratories Series 9000 Micro-processing Timer/Counter; Ballantine Laboratories 5500B Universal Counter/Timer.

*Data loggers:* Fluke Summa II Series; Doric Scientific Digitrend; E<sup>2</sup> Thermodot DDF-200 (turns a DMM into a smart data acquirer); also units from Acurex and Esterline Angus.

*DMMs and voltmeters:* Systron-Donner 7115 DMM; Hewlett-Packard 3455A; Fluke 8500A; Keithley 6900; Data Precision 7500.

*IC testers:* Offered by Fairchild, Hewlett-Packard, Mirco, Testline and others.

*Impedance bridges:* Boonton Electronic 76A; GenRad 1657; Electro Scientific Industries 296.

*Oscilloscopes:* Nicolet Explorer; Hewlett-Packard 1722A; Norland 2001; Tektronix Digital Processing Oscilloscope.

*Signal sources:* Fluke 6010A Synthesized Signal Generator; Fluke 6011A Signal Generator. Wavetek 172 Programmable Signal Source.

*Others:* Rohde & Schwarz Automatic Radio Test Set; California Instruments CP70 Calculating Processor; GenRad 2230 Component Tester; Moxon Microcomputer Gauging System.

on. Speeds of smart instruments are still restricted, and until  $\mu$ Ps get much faster, these restrictions will remain a fact of life.

What about reliability? With brainy instruments at present just babes in swaddling clothes, reliability figures are hard to come by. But, reportedly, complaints aren't.

Incongruously, a greatly accepted virtue of LSI is the seemingly contradictory promise of greater reliability with increased complexity. That premise may be true. But if the user can't fully test a chip, how can he be sure of its reliability? If he can't pin down all possible states at all possible temperatures and voltages, what then? And if the user marries a  $\mu$ P to a 4-k RAM plus 4 k of ROM or PROM. . . .

Counterpoint to the question of reliability is the increasing use of self-testing and self-diagnosis, brought about by dedicated LSI and  $\mu$ Ps. If reliability doesn't increase, then serviceability certainly will.

The designer of smart equipment—once he's





Is this the harbinger of tomorrow's instrument? In the Fluke 8500A, measurement and control modules sit on a computer-like bus structure.



Two  $\mu$ P's in the Hewlett-Packard smart DMM control measurements, compute correction factors, handle the HP-IB interface and perform mathematics.

passed the learning period—can enjoy a newfound freedom of design flexibility. As software or firmware takes over from hardware, the options to do any single measuring job or internal control function are practically limitless. But there are new headaches, too.

Design decisions now include how to partition the product—that is, what to do in software, what to do in hardware. Which RAM, ROM or PROM to use, and which new memories or  $\mu$ P's will soon appear are questions a designer must continually answer to maintain his product's competitive edge. And the increased difficulties in evaluating and testing LSI components are a new source of insomnia to already beleaguered engineers.

Marketers of smart instruments must also play a lead role in deciding which of all the possible features are important, what the front-panel should look like, and what performance will appeal to potential customers. In fact, many of the basic design decisions now fall squarely in the marketer's lap, not the designer's.

Still, designers are to be envied for several reasons:

1.  $\mu$ P-instruction sets are now powerful enough to produce the most complex algorithms

when the sets are combined with ROM-stored programs and data-handling RAMs.

2. One  $\mu$ P can take over all control jobs, from refreshing a display to managing data output to interpreting controls.

3. Discrete operations, in many cases, can replace analog processing, with all its inherent problems.

### Analog takes a back seat

One instrument that typifies the advantages of the new technology is the Fluke 8500A DMM. More a measurement system than a DMM, the 8500A is designed around a computer-type bus structure, with individual modules for measurement and control residing on the bus. Even the Fluke unit's unusual front panel can be considered a limited-use peripheral that occupies one slot of the bus.

Control is handled by an 8080  $\mu$ P, and the major operating characteristics are defined by software, not hardware.

Filtering noisy signals—ever a problem in measuring equipment—is implemented digitally in the 8500A by averaging many readings taken at a sample rate synchronized with the line frequency. Advantages: less hardware, the ability to program the number of samples per reading and, most important, greater noise rejection at operating speeds faster than analog circuits.

Other analog functions are ripe for simplification or even elimination. Circuits for tweaking or compensation (zero or offset) are candidates for the former category. Comparison, integration and sample-and-hold functions can all be performed digitally—as is done in GenRad's 1657 Digi-bridge.

The 1657 is a  $\mu$ P-based automatic bridge that measures R, L, C, D and Q in less than 1.3 s. A sample-and-hold function is achieved in the bridge with software, not hardware, and errors are stored and minimized by digital techniques. The  $\mu$ P also computes and makes decisions—it directs both the instrument and the user to achieve optimum ranging.

Besides speed, the Digi-bridge user also enjoys maximum resolution, repeatable results and low cost. With component count two-thirds less than conventional circuitry, the 1657 sells for \$995. Without the  $\mu$ P, says GenRad, the equivalent bridge would cost about \$6000.

Another bridge with the new look is the Electro-Scientific Industries 296. Because of the internal  $\mu$ P, the 296 can be programmed for limit comparison (up to 10 values), can display percentage or absolute deviation and can be con-



Computer power brings a new dimension to everyday optical measurements. Gamma Scientific's CR-1A is an intelligent radiometer with programmable response.



Turn your DMM or DVM into a smart data-acquisition system with the DDF-200 control unit from E<sup>2</sup> Thermotek, Carpinteria, CA. The unit handles up to 20 inputs.

trolled through the IEEE 488 bus.

Still another instrument—the Gamma Scientific CR-1A computing radiometer—further demonstrates the power of internal digital processing.

### Checking light with delight

Anyone who has made light measurements knows the problems of making adjustments for drifting zeros and dark currents. With the CR-1A, zero offset, dark current and ambient levels are digitally and automatically subtracted out. With eight keyboard-programmable constants, the user can punch in, update or change correction factors to shape response at various wavelengths. Each of eight registers stores a 3-1/2-digit number, a 1-1/2-digit exponent with sign and selected dimensional units.

The CR-1A takes further advantage of the  $\mu\text{P}$  with a self-calibrating algorithm, digital signal averaging and autoranging, among other features.

Self-calibration is a growing trend that may soon be a feature of all measuring instruments.

The designers of one smart instrument, Hewlett-Packard's 3455A digital voltmeter, have taken special pains with the "auto cal" feature of the unit. The user unplugs a removable reference, makes four adjustments, then plugs the reference unit in again. The meter then checks its own dc and ohms circuits and corrects for errors.

Controlling the calibration process and computing correction factors in the HP unit is, of course, a  $\mu\text{P}$ —one of two in the instrument. The two microprocessors also take care of mathematical computations and controlling both the measurement process and the unit's programmability—that is, the HP-IB, or IEEE 488 interface.

To circumvent the speed limitations of commercial, serially oriented  $\mu\text{Ps}$ , HP has designed a  $\mu\text{P}$  with parallel architecture to control the measurement functions. Such  $\mu\text{Ps}$  may soon be available commercially from other sources. But one problem designers face with such architecture is the increase in support chips as the  $\mu\text{P}$  grows more parallel. Thus, speed may be gained at the expense of cost, size, power consumption and reliability. Somewhere along the line, compromises will have to be made.

### A new force in $\mu\text{P}$ testing

Those who design with  $\mu\text{Ps}$  must also decide how to test the little buggers. To that end,  $\mu\text{P}$  or logic analyzers have appeared on the market, some  $\mu\text{P}$ -based themselves. One of the  $\mu\text{P}$ -based analyzers is HP's 1611A.

In appearance, the keyboard-controlled 1611A resembles a programmable calculator with a CRT display. In operation, the internal 8080 controls the keyboard, tests for trigger points, keeps hierarchical order and performs other housekeeping chores.

What makes the 1611A smart? Software does much of the work according to HP—counting events, measuring execution time, looking up tables for mnemonic readout, and performing other computations. Thus the 1611A relieves the user from much of the test burden. In effect, the 1611A fights fire with fire: Software checks software; a  $\mu\text{P}$  tests a  $\mu\text{P}$ .

Other manufacturers recognize the power of the  $\mu\text{P}$  as the basis for equipment meant to test other  $\mu\text{P}$ -based equipment. Two such tools are the E-H Research Labs 1330 and the Tektronix DF1. In the guts of the Tektronix DF1 display formatter sits a  $\mu\text{P}$ , along with four ROMs and nine RAMs, one RAM serving as a scratchpad memory.



The new look in signal generators: Fluke's 6011A stores frequencies and amplitudes and lets the user edit or modify the output from a keyboard.

When used with the company's 7D01 logic analyzer, the DF1 turns any 7000-series scope into a measuring tool that displays timing diagrams, logic maps and state tables in binary, octal or hexadecimal codes.

Using a SC/MP  $\mu$ P, the 1330 offers a wide variety of triggering criteria to perform both logic timing and state analysis.

Not only can smart equipment lift a load from its user, it can even do the same for other smart equipment—a host computer, for instance. Consequently, more and more peripherals are undergoing brain “transplants.” Conversely, with  $\mu$ Ps combined with the IEEE 488 standard interface, measuring instruments—when connected in a system application—are beginning to look more and more like peripherals.

One “peripheral” is smart enough to speak for itself. The Tektronix 4662 interactive digital plotter—the first with built-in processing, thanks to the MC6800  $\mu$ P—prints alphanumeric characters as well as draws whatever curve, plot or schematic the host processor dictates.

But give a machine a brain, and what happens? It talks back. The 4662, through use of an X-Y joystick, can send back current pen coordinates and other information.

Thanks again to the  $\mu$ P, the 4662 can work at high speeds, with acceleration, deceleration and vector generation all handled by the 6800. And the plotter can rotate or scale characters, change plot size and self-test its internal buffers.

With this kind of performance now being squeezed out of a design tool (the  $\mu$ P) that's barely five years old, the question arises: What next? New  $\mu$ Ps and memories are coming, with on-board complexities and functions that signal even more radical changes in instrument design.

Is the Fluke 8500 voltmeter, with its internal



Microprocessor-directed ranging removes the guesswork in this automatic bridge, the GenRad 1657. Maximum resolution is always achieved on the readout.

bus structure and functional modularity, the forerunner, the symbol of things to come? Perhaps. But the Fluke design raises more questions than it answers.

Are instrument designs all heading toward a common finale, focusing on a single, universal instrument capable of becoming anything a user would like merely by a change in programming or the dropping in of a few memory chips? One instrument—the RS-432 data and timing generator from Interface Technology, Covina, CA—already permits the user to program the  $\mu$ P section to control the word-generator section.

Or will instrument systems dominate, with clusters of dedicated (perhaps even dumb) equipment chatting away at each other over remote lines, busily measuring, chewing up data, spitting out final results?

Perhaps some other, hitherto unknown, concept will prevail. In the more immediate future, more “conventional” intelligence can be expected to show up in yet untouched or barely influenced equipment—small, low-cost portable DMMs, scopes or spectrum analyzers. Signal generators have just begun to show the effects of the  $\mu$ P. Wavetek's 172 13-MHz synthesizer, for example, uses a  $\mu$ P to simplify programming, to handle formatting and to permit keyboard numeric entry of frequencies. And dynamic RAMs or PROMs in the 172 store programs or subroutines.

Other sources are sure to follow. Whatever happens, it will be exciting to watch. ■■

# NEW FROM KEITHLEY: TWO "BEST BUY" DMMs.



Model 173



Model 172

**4½ DIGITS. 30000 COUNTS.  
UNDER \$500.**

Advanced features are found in both these general-purpose DMMs:

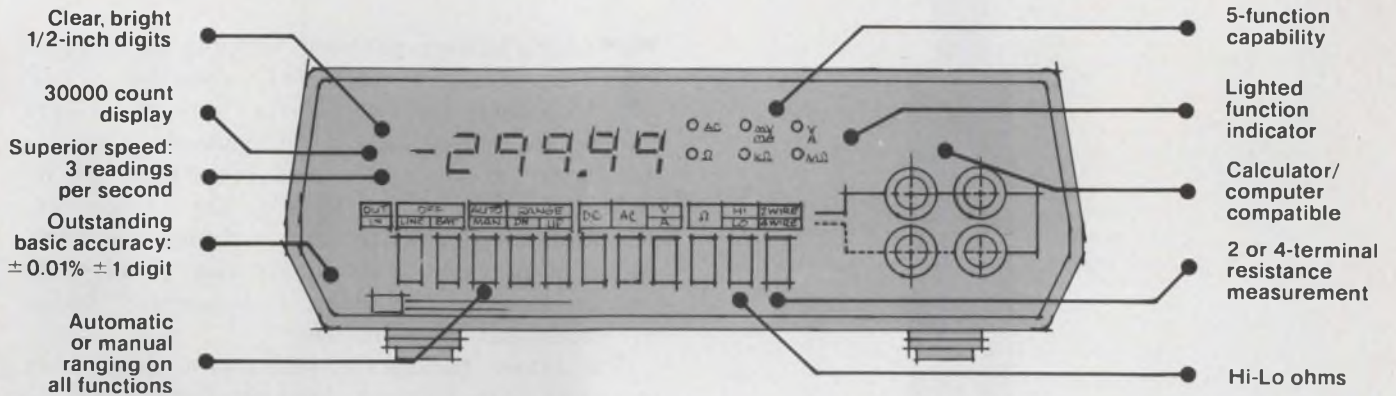

Take a look at the remarkable features of the new Keithley Digital Multimeters. They're unmatched in the industry.

Now consider price. At \$499 we think you'll agree the Keithley 172 is the best buy in a general purpose 4½-digit DMM.

There isn't another 4½ that matches the price-performance value of the 172. Except for its higher-rated companion, the Keithley 173.

**For \$499: the exceptional 172.**

To begin with, you get a dependable, durable, portable, easy-to-use, autoranging instrument with five functions. Designed for research, engineering or production applications.

Measure from 10 microvolts to 1200 volts dc, 10 microvolts to 1000 volts ac, 10 milliohms to 300 megohms, 10 microamps to 2 amps, ac or dc. DC accuracy is  $0.01\% \pm 1$  digit.

There's more: 3 month recal cycle. No-nonsense, full-year guarantee on parts, workmanship, and specs. 30000-count display yields maximum accuracy for 15, 18, 24 and 28-volt measurements.

**For \$625: the even more exceptional 173.**

The Keithley 173 is our top-rated 4½-digit DMM. It gives you all the performance and accuracy of the 172 plus superior autoranging current measurements from 10 nanoamps to 3 amps. This makes the 173 the most complete and versatile general purpose 4½-digit DMM in the world—at any price.

**More versatility. Now or later.**

Options and accessories expand the 172 or 173 to your specific needs: Rechargeable battery pack you can buy now or add later. Digital output/control. RF probe. 50-amp shunt. Clamp-

on ammeter. High-voltage probe. Rack mount kits. Test lead sets. Carrying case. IEEE 488 interface.

**Make this easy decision.**

For most 4½-digit DMM applications, the new Keithley 172 is your best buy. When you require more current measuring capability, the 173 is.

For convincing proof, send for detailed specs or request a demonstration. Or if you're already convinced, send your order to: Keithley Instruments, 28775 Aurora Road, Cleveland, Ohio 44139. (216) 248-0400. Europe: Heiglhofstrasse 5, D-8000 München 70, West Germany. (089) 7144065.

**DMMs for all your needs.**

We know you have a variety of measurement requirements. So we offer a growing family of DMMs to meet your application and price objectives. Send for details.

3½ digits	4½ digits	5½ & 6½ digits
<p><b>Model 168</b> General purpose. Low cost.</p> <p><b>Model 160B</b> 1 <math>\mu</math>V and 10 pA sensitivity.</p> <p><b>Model 616</b> Super-sensitive. 0.1 pA full-scale</p>	<p><b>Models 172 and 173</b> Two "Best-Buys."</p> <p><b>Model 171</b> 1 <math>\mu</math>V sensitivity. 5-functions.</p> <p><b>Model 174</b> 0.1 <math>\mu</math>V sensitivity. (coming soon)</p> <p><b>Model 180</b> 30 nV sensitivity.</p>	<p><b>Model 190</b> Multi-function. Low cost.</p> <p><b>Model 5900</b> 0.001% accuracy. High stability.</p> <p><b>Model 6900</b> Accuracy, stability and sensitivity measured in ppm.</p>

**KEITHLEY**  
The measurement engineers.

FOR DEMONSTRATION, CIRCLE 36  
FOR TECHNICAL DATA, CIRCLE 37

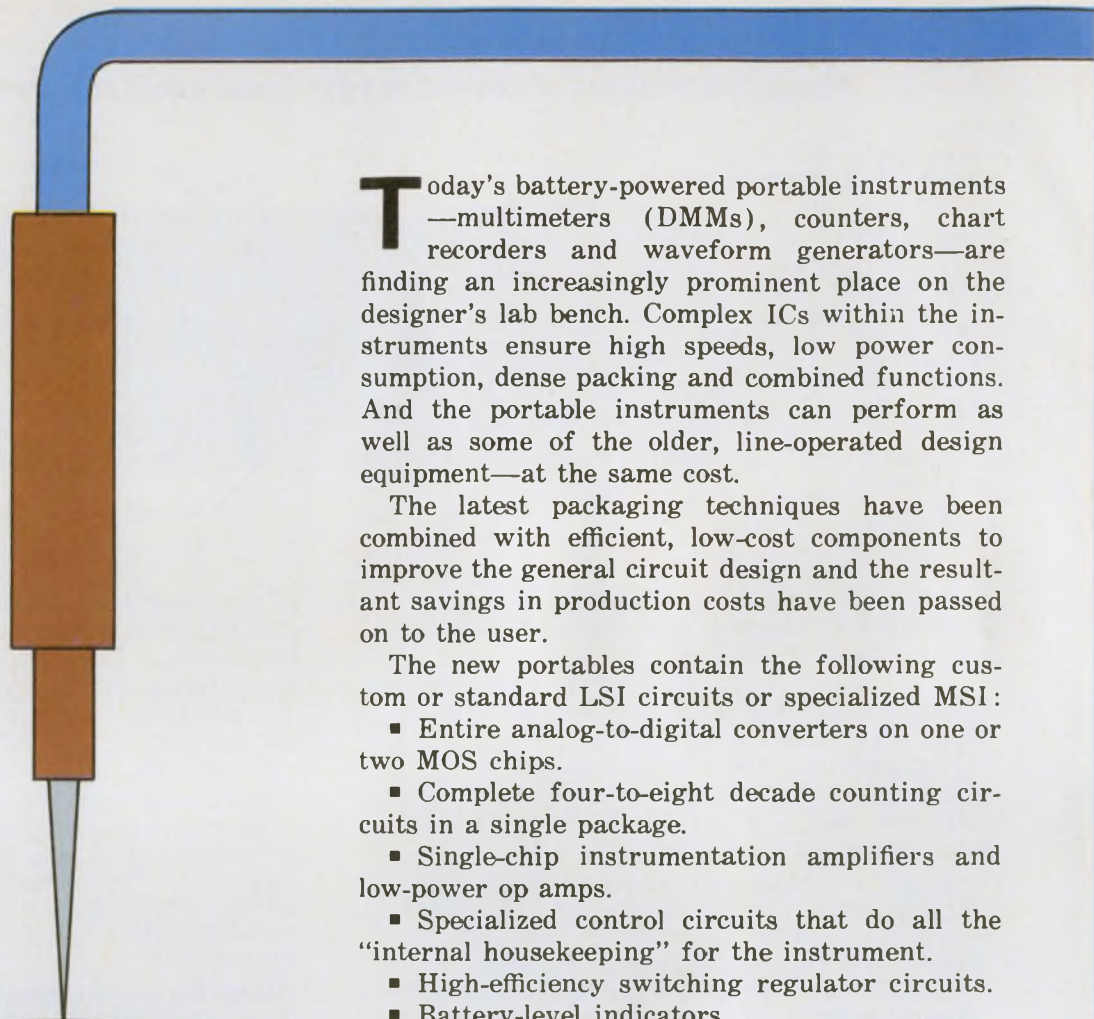

## Portable instruments: The specs are fine, but their batteries are still short-lived

**T**oday's battery-powered portable instruments—multimeters (DMMs), counters, chart recorders and waveform generators—are finding an increasingly prominent place on the designer's lab bench. Complex ICs within the instruments ensure high speeds, low power consumption, dense packing and combined functions. And the portable instruments can perform as well as some of the older, line-operated design equipment—at the same cost.

The latest packaging techniques have been combined with efficient, low-cost components to improve the general circuit design and the resultant savings in production costs have been passed on to the user.

The new portables contain the following custom or standard LSI circuits or specialized MSI:

- Entire analog-to-digital converters on one or two MOS chips.
- Complete four-to-eight decade counting circuits in a single package.
- Single-chip instrumentation amplifiers and low-power op amps.
- Specialized control circuits that do all the "internal housekeeping" for the instrument.
- High-efficiency switching regulator circuits.
- Battery-level indicators.

Battery-powered portables are no panacea, however. They often have a limited battery lifetime, a restricted operating temperature range and a high susceptibility to surrounding electrical fields. However, some new battery designs are overcoming these common power limitations.

### ICs cut parts, cost & power

MOS LSI circuits, with their high packing densities, have enabled instrument designers to reduce the number of components needed. Custom MOS circuits still predominate in use among instrument manufacturers, although many of the new off-the-shelf circuits (probably last year's custom circuits) are starting to offer designers the functions necessary to build their instruments.

---

**Dave Bursky**  
Associate Editor



Delivering true rms ac readings in addition to ohms and dc, the 7003 DMM by Systron-Donner can operate for up to six hours from its internal battery pack. Inside the

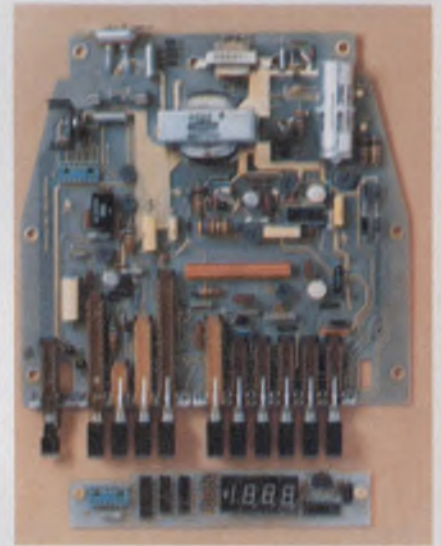

DMM, a single-chip a/d converter takes three readings per second that are displayed on a 3-1/2-digit, 0.4-in.-high light-emitting diode display.

Single and multiple-chip a/d converters in PMOS, CMOS and I<sup>2</sup>L technology reduce the size and power requirements of DMMs. Converter circuits, such as those developed by Analog Devices, Norwood, MA; General Instrument, Hicksville, NY; Intersil, Cupertino, CA; Motorola, Austin, TX; Siliconix, Santa Clara, CA; and Teledyne Semiconductor, Mountain View, CA, require only 100 to 200 mW. Many of these circuits are designed for single-supply operation, and so eliminate the drain caused by a dc-to-dc converter to get the second supply level. (For more information about a/d converters, see the Focus on data converters" in ED No. 19, September 13, 1976, p. 68, and the special report on monolithic a/d and d/a converters in ED No. 13, June 21, 1976, p. 28).

Almost every DMM manufacturer incorporates one form of these IC a/d converters in his meter—and if he hasn't found one suitable, he has designed his own. Hewlett-Packard, Palo Alto, CA, for instance, has designed a special conversion circuit and thin-film resistor network for its 3476B DMM. At a cost of \$275, with the built-in battery pack, the meter offers V and I on ac or dc and ohms, autoranging, autopolarity and a special range-hold feature.

HP's special circuit is a hybrid consisting of an NMOS control chip and a tantalum-nitride-on-sapphire resistor network. The control chip contains the counters, buffers, display scanner, 3500 bits of ROM program storage and all analog switches. The resistor chip contains 19 laser-

trimmed resistors matched to within 0.02%.

Another DMM, the Danameter from Dana Laboratories, Irvine, CA, has only two ICs—a digital CMOS circuit and a bipolar analog chip. This DMM is one of a few using liquid-crystal displays instead of LEDs or gas-discharge digits. Going this route keeps power requirements to a bare minimum—the Danameter can operate with a 9-V battery for about a year. Weston in Newark, NJ, also offers a DMM with an LCD readout.

Making wide use of CMOS, Logical Technical Services in New York has developed the Model 12T, a combination DMM and thermometer, for \$259. The unit fits in the palm of the hand, much like the hand-held DMM developed by Hewlett-Packard several years ago. The 12T uses not only digital-CMOS devices to cut power drain, but also tri-technology products like RCA's (Somerville,

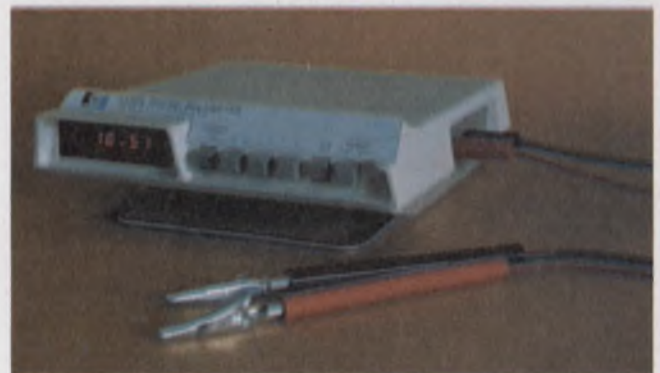

Using a specially designed hybrid circuit, the 3476B DMM developed by HP measures ac or dc voltage and current and ohms. Batteries provide an eight-hour life.



You can operate this scope and over a dozen other models from almost any voltage because Philips has incorporated a high-efficiency switching supply that eliminates the power transformer.

NJ) CA3130 op amp, which combines MOSFETs, JFETs and bipolar devices. MOSFETs on the op amp's front end provide high input impedance; the JFETs provide the current source; the bipolar devices in the middle provide gain; and the CMOS output provides up to 20 mA to within several millivolts of the power supply or ground level.

Power consumption is dependent on the number of readings taken per second—a factor often overlooked when portable DMMs are evaluated or designed. The slower the conversion and counting circuits operate, the less power consumed.

When monitoring signals that change at several hertz, DMMs designed for line operation will always have an edge over battery-powered units. For example, most portable DMMs, like the Logical 12T or the Hewlett-Packard 3476B, take only two or three readings per second, while line-operated units often take five or more readings. Slow, periodic fluctuations can easily be missed if the meter's converter is too slow.

Other portable DMMs have been recently introduced: the 8030A and 8040A 3.5 and 4.5-digit DMMs by Fluke, Mountlake Terrace, WA; the Model 248 4.5-digit DMM by Data Precision, Wakefield, MA, and the 172 and 173 30,000-count DMM by Keithley Instruments, Cleveland. In addition to the normal V/I/R functions, Fluke's 8030A has a diode-test capability and can run for eight hours on a single charge. The 8040A has an autoranging capability and does true rms-ac measurements at frequencies up to 20 kHz. Data Precision's Model 248 also has true rms capability. Similar to Data Precision's older 245, the 248 also makes use, internally, of a custom digital circuit originally designed for the company's inexpensive Model 175 DMM to do all the display control.

LSI counting circuits, such as the MK50395



Packing a bandwidth of 0.02 Hz to 2.2 MHz, Exact's Model 119P function generator delivers 10-V pk-pk into a 60- $\Omega$  load. The generator can operate from any 12-V-dc source, an internal battery or the ac line.

series of six decade counters from Mostek, Carrollton, TX, the ICM 7208 seven-decade unit from Intersil can form the heart of many compact, battery-operated frequency counters. These circuits can replace as many as 15 to 20 MSI devices and draw only about 200 mW.

Several companies are using this approach to make inexpensive, but very compact, frequency counters—but not all. "Non Linear Systems, Del Mar, CA, looked at this approach and decided not to use it," says Roland Johnson, chief engineer. "We decided we could get even better performance by using low-power Schottky TTL and CMOS to build our FM-7 seven-digit frequency counter." The FM-7 and its four rechargeable batteries all fit in a 4.5  $\times$  6.5  $\times$  9.6-cm ( $\approx$  2  $\times$  2.5  $\times$  4 in.) case. The FM-7 can handle input frequencies from 10 Hz to 60 MHz (100 mV rms sine-wave sensitivity) and has an accuracy of  $\pm 1$  digit  $\pm$  time-base accuracy.

While most of the portable counters have similar accuracy specs, input sensitivities vary from model to model. Most portables have sensitivities of 10 to 100 mV rms, whereas lab-bench units often have sensitivities down in the microvolt region—direct measurement of rf is commonplace.

Portable instruments with combined functions are on the rise. Both HP and Vu-Data offer portable oscilloscopes with built-in DMMs or frequency counters. Tektronix, Beaverton, OR, goes so far as to use the CRT screen of its Model 213 1-MHz scope to display the reading. The entire combined scope/DMM weighs only 3.7 lb and can operate for 3.5 hours with internal batteries. Inside the 213, Tektronix uses several custom circuits to do the display generation and control all the timing. Very-high-efficiency switching circuits are used to provide the acceleration voltages.

Philips, which has gone to great lengths to make an efficient switching regulator, now in-



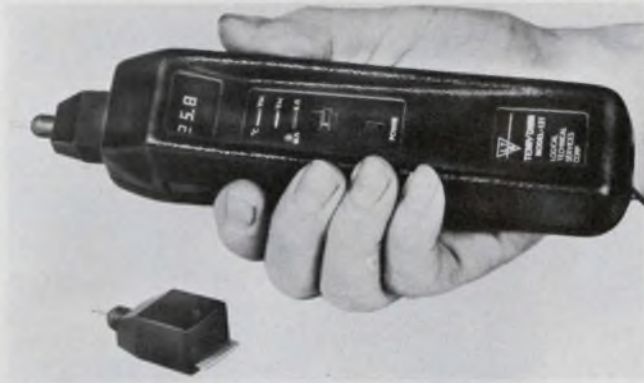

With over 150 components crammed into a hand-held DMM/thermometer, Logical Technical Services' Model 12T offers autoranging, autopolarity and 0.1% accuracy (V dc). The 12T provides a 3-1/2-digit answer and meas-

cludes its regulation circuit in almost every scope it sells. The circuit permits the Philips scopes to be used from almost any ac voltage source ranging from 90 to 270 V at 46 to 440 Hz or any dc source from 100 to 200 V. Power consumption, depending upon model, ranges from 20 to 30 W, and unit weights average about 20 lb.

#### Function generators demand power

Generating signals in portable packages takes a bit more than simply measuring them. Only a few manufacturers offer any signal source with a self-contained battery pack. With its Model 30, Wavetek, San Diego, CA, is probably the best known. But pressing Wavetek is Exact Electronics, Hillsboro, OR, with its Model 119P.

The Model 30 operates from a single 9-V transistor radio battery and delivers sine, square and triangle waves over a 1-Hz-to-100-kHz range. It can deliver 5-V pk-pk into a 600- $\Omega$  load (or about 41 mA, maximum). Of course, delivering that much current will drain the battery pretty quickly, so a \$25 rechargeable battery option is available for the \$150 instrument.

Although Exact's 119P is larger than the Model 30 and costs about twice as much—\$295—it offers more than 10 times the frequency range and twice the output voltage. The 119P spans 0.02 Hz to 2.2 MHz, delivers 10-V pk-pk into a 600- $\Omega$  load, and has a variable-time-symmetry adjustment.

While the battery-powered function generators deliver signals, the portable chart recorders can keep signal records. The go-anywhere recorders are available from such companies as Gulston, East Greenwich, RI; Hewlett-Packard in San Diego; Lab Data Control, Riviera Beach, FL, and Esterline-Angus, Speedway City, IN.

The HP 7155B runs from ac (85 to 130 V, 48 to 440 Hz), external dc (10.5 to 36 V) or from

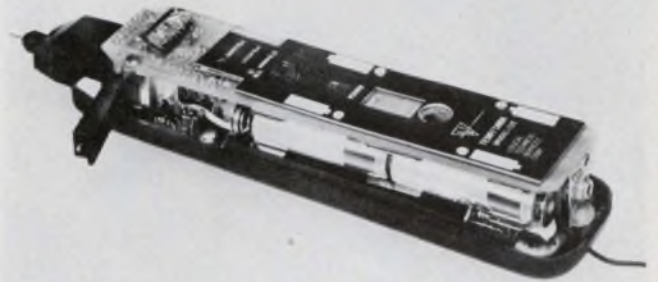

ures resistance from 1  $\Omega$  to 19.99 M $\Omega$ , dc volts from 1 mV to 750 V, ac volts from 200 mV to 750 V and temperature from -55 to 153.5 C. The NiCd batteries permit approximately 3-1/2 hours of use.



Capable of operating in any position, HP's 7155B chart recorder offers 16-input voltage ranges and 7 chart speeds. It can run for 9 hours off the internal batteries.

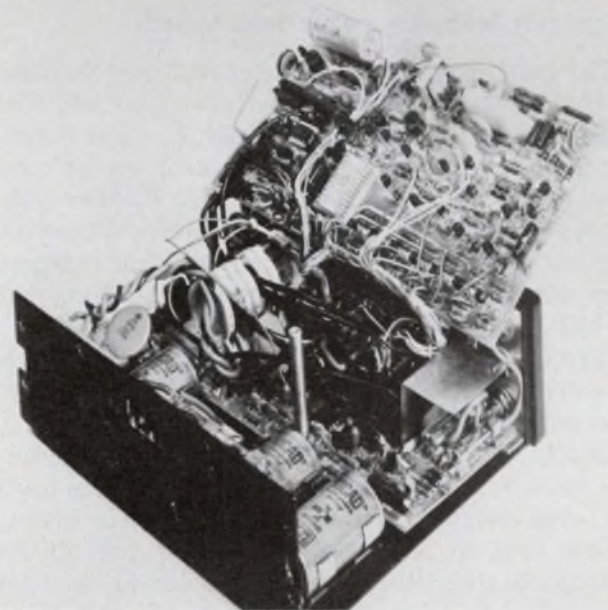

Although originally aimed at the hobbyist market, the IM2202 designed by Heathkit has an accuracy of 0.5% on dc and 1% on ac, which makes it suited for many lab-bench applications.

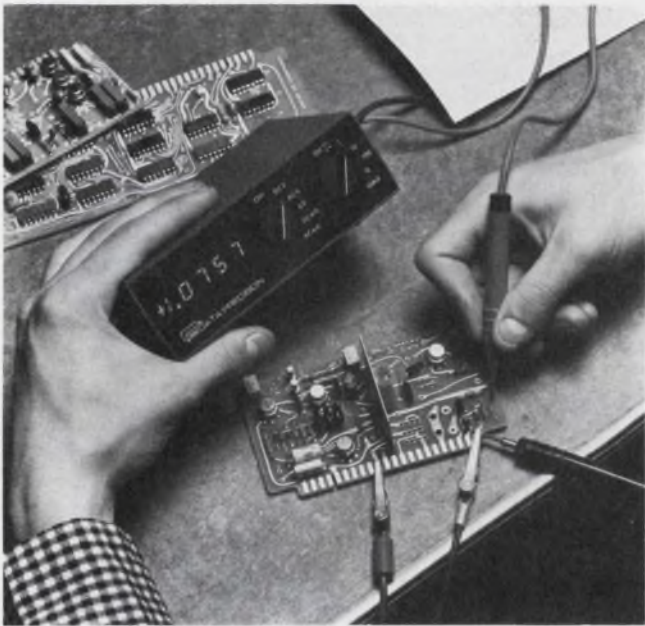

The just announced Model 248 DMM developed by Data Precision offers a 4-1/2-digit LED display and true-rms ac measurement capability.

internal, rechargeable batteries (up to nine hours on a full charge). There are 16 switch-selectable scale settings for the span (from 0.1 mV/cm to 10 V/cm) and seven chart speeds (from 10 s/cm to 30 min./cm). Scale accuracy is  $\pm 0.4\%$  of full scale, and chart speed is controlled to within  $\pm 1\%$ . This "Cadillac" of portable recorders goes for a stiff \$1400 and \$1700 with the internal, rechargeable battery pack.

#### Portability problems are far from solved

No matter which portable instrument is used, the greatest annoyance is to turn it on and find the batteries either weak or dead. So some manufacturers are incorporating "quick-charge" rechargeable batteries, long-shelf-life lithium cells, push-to-read controls and low-battery indicators. But no vendor has yet come up with an inexpensive way to determine how much operating life is left in a battery.

Since instrument manufacturers apparently are doing all they can to cut power consumption, the only other alternative is to increase battery capacity. To this end, many battery manufacturers have developed the sealed gel-electrolyte units and fast-charge nickel-cadmium cells. For instruments that sit on the shelf for long periods between use, the lithium battery is the answer for improved shelf-life. It has a shelf-life of 5 to 10 years. The lithium batteries are also the same size as carbon-zinc, but offer twice the voltage.

Specially designed circuits and batteries are



Combining both a DMM and a scope into a small, hand-held package, Tektronix' Model 213 uses the CRT to display the DMM reading.

starting to eliminate some of the guesswork in determining available battery life. Several low-power comparators from Intersil can be externally set to trigger whenever the battery voltage drops below a predetermined level. Once triggered, the circuit can be used to drive a LED indicator.

Battery manufacturers have developed several cells that have abrupt voltage drops when about 70% of their expected life has passed by. The drop is abrupt enough to trigger a circuit that can drive an indicator. Other batteries such as "super-fast"-charge NiCds nearly eliminate the problem. With charge times as short as 15 minutes—and typical NiCd charge times ranging from 4 to 16 hours—these new NiCds appear ideal for portable applications. ■■

# Hewlett-Packard presents the first family of calculators for Christmas.

Hewlett-Packard built the world's first advanced pocket calculator back in 1972. And has led the way ever since. Today, Hewlett-Packard still offers a combination of technology, features, human engineering, backup support and lasting value not available anywhere else. More than a practical gift—it's an investment in the career of someone important in your life. Hewlett-Packard calculators: recognized as the first family of advanced scientific and business calculators by more than one million owners worldwide. Here's why:

**First family design.** Hewlett-Packard was first—and continues to lead—in the translation of state-of-the-art technology into advanced pocket calculators. The result: professional products with innovative features that solve problems more easily and extend the user's capabilities beyond previous limitations. By design.

**First family performance.** Hewlett-Packard means performance. The kind of performance that includes RPN logic with four-memory stack. A full range of advanced functions. Powerful programmability on some calculators. On others, Continuous Memory CMOS technology. And more. In a word: performance. In a calculator: Hewlett-Packard.

**First family reliability.** When you buy a Hewlett-Packard calculator you get one year's protection on parts and labor. And a quick turn-around on most repairs. When Hewlett-Packard builds it, Hewlett-Packard backs it.

**First family support.** Every Hewlett-Packard calculator comes with a comprehensive Owner's Handbook. In addition, a complete selection of optional accessories increases the versatility of the calculator of your choice: Application Pacs with programs, programming worksheets, rechargers, battery packs, cases and desk-top security cases. Hewlett-Packard offers you more than just a calculator.

**The first family.** A heritage. A commitment. A promise. Your assurance that the pocket calculator you buy from us is first in technology, performance, reliability and value. Because we're willing to put our company behind it when we put our name on it.

Look over our calculators on the following pages and you'll begin to appreciate why.



# Hewlett-Packard Calculators:

## The HP-91 scientific portable printing calculator \$425.00\*

The HP-91 is a completely portable scientific calculator with integrated printer. Now you can generate a permanent record of each calculation to document your work, in the office, or at a job site in the field.

- Lightweight briefcase portability. Operates on battery power or AC.
- Full range of scientific and arithmetic functions complete with printed record.
- Built-in, sophisticated, quiet thermal printer.
- Extra large, easy-to-read display.
- Four dozen built-in functions and data manipulation operations.
- Pre-programmed for science, mathematics and statistics.
- 16 addressable memories.



## The HP-21 scientific \$80.00\*

The HP-21 makes short work of technical calculations. If you seek a calculator that does more than simple arithmetic, this is it.

- 32 built-in functions and operations.
- Performs all standard log and trig functions (in radians or degrees).
- Performs rectangular/polar conversion, register arithmetic and more.
- Addressable memory.
- Two selectable display modes: fixed point and scientific.
- Lowest-priced HP scientific calculator.



## The HP-22 business management \$125.00\*

The HP-22 easily handles the kinds of calculations most often faced in business management today. It can breeze through business math calculations and build existing statistical data into reliable forecasts. If you want a business management calculator, here it is.

- Combines financial, mathematical and statistical capabilities.
- Performs complex time-value-of-money including interest rates computations.
- Performs rates of return and discounted cash flows for investment analysis.
- Performs extended percent calculations, accumulated interest, amortization and more.
- 10 addressable memories.
- Full decimal display control.



## The HP-27 scientific/plus \$175.00\*

The HP-27 is for the scientist, engineer or business person responsible for budgets, cost analysis, resource allocations and more.

It features a comprehensive set of statistical and financial functions for planning, forecasting and analysis. For the first time, they've been added to HP's complete set of scientific functions.

- 10 financial functions for investment analysis. NEW – internal rate of return and net present value for uneven cash flows.
- 15 statistical functions for planning and forecasting.
- NEW – normal distribution and correlation coefficients.
- 28 pre-programmed exponential, log and trig functions for scientific and engineering calculations.
- 20 memories with selective clearing options for greater flexibility, 10 of which are addressable memories.



# The First Family.



## The HP-97 & the HP-67 powerful fully programmable calculators HP-97 \$750.00\* HP-67 \$450.00\*

The HP-97 and HP-67 are the most powerful fully programmable battery-operated portable scientific calculators you can buy. In fact, both offer about 3.4 times\*\* the programming power of our classic HP-65—the industry standard. Programs written for either the HP-67 or HP-97 can be run on the other without modifications of any kind. The HP-97's thermal printer is also remarkable—and unusually quiet.

- Handles up to 224 steps.
- All prefix functions and operations are merged.
- Directly records programs or contents of all 26 data storage registers onto magnetic cards.
- 10 user-definable keys.
- 3 types of addressing—Label, Relative and Indirect.
- 3 printing modes—Manual, Normal and Trace. (HP-97 only)
- Standard Application Pac with 15 programs of broad appeal included free. Optional Pacs in engineering, finance and other disciplines available at \$35.00 each.

\*\*Complete details on request.

## The HP-25C scientific programmable with continuous memory \$200.00\*

The HP-25C is our keystroke programmable. It can solve automatically the repetitive problems every scientist and engineer faces. What's more, its Continuous Memory capability lets you retain programs and data even when it's turned off.

- Continuous Memory capability.
- 72 built-in functions and operations.
- Keystroke programmability.
- Branching, conditional test and full editing capability.
- 8 addressable memories.
- We also offer the HP-25 (without the Continuous Memory feature) for \$145.00\*.



## The HP-80 financial \$295.00\*

The HP-80 performs calculations involving the relationship between time and money: bond prices and yields, conversions, trend line analysis, interest calculations and more. A built-in 200-year calendar figures number of days in bond or loan calculations.

- Financial functions: simple interest, payment per period, number of periods, present and future values, sum-of-the-years-digits depreciation.
- Bond functions: prices and yields, 200-year calendar.
- Statistical functions: mean, standard deviation, trend line.
- Mathematical functions: percentages,  $4^x \cdot y^z$  serial or chain calculations.
- Addressable memory.
- Selectable display modes: fixed point and scientific notation.



For more information on any of these Hewlett-Packard calculators and the name of your nearest dealer, simply telephone toll-free 800-648-4711 (in Nev. 323-2704 collect). Or write: Hewlett-Packard, Dept. 215B, 1000 N.E. Circle Blvd., Corvallis, Ore. 97330.

**HEWLETT hp PACKARD**

Sales and service from 172 offices in 65 countries  
Dept. 215B, 1000 N.E. Circle Blvd., Corvallis, Oregon 97330

CIRCLE NUMBER 39

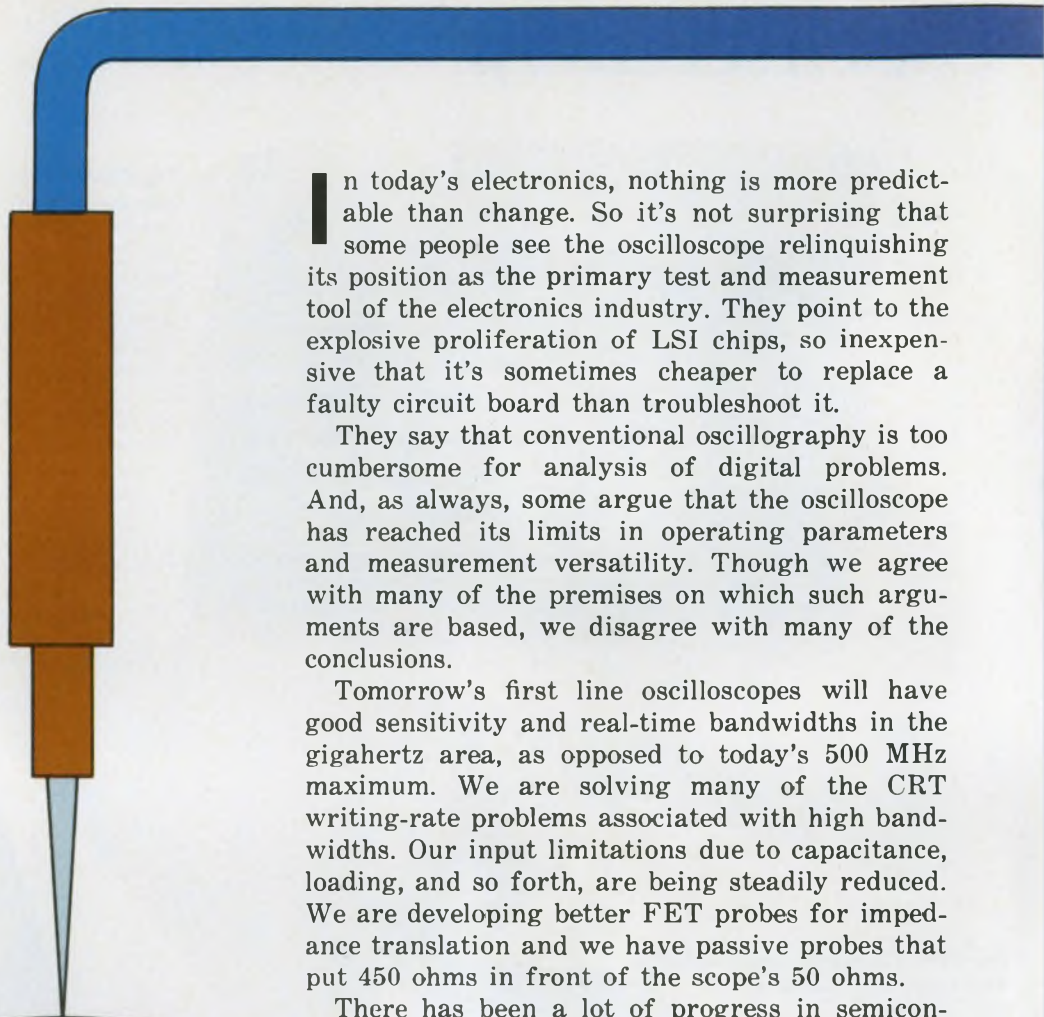

**Howard Vollum,  
Bill Peek  
and Wim Velsink  
of Tektronix  
Speak on  
The Future of  
the Scope**

In today's electronics, nothing is more predictable than change. So it's not surprising that some people see the oscilloscope relinquishing its position as the primary test and measurement tool of the electronics industry. They point to the explosive proliferation of LSI chips, so inexpensive that it's sometimes cheaper to replace a faulty circuit board than troubleshoot it.

They say that conventional oscillography is too cumbersome for analysis of digital problems. And, as always, some argue that the oscilloscope has reached its limits in operating parameters and measurement versatility. Though we agree with many of the premises on which such arguments are based, we disagree with many of the conclusions.

Tomorrow's first line oscilloscopes will have good sensitivity and real-time bandwidths in the gigahertz area, as opposed to today's 500 MHz maximum. We are solving many of the CRT writing-rate problems associated with high bandwidths. Our input limitations due to capacitance, loading, and so forth, are being steadily reduced. We are developing better FET probes for impedance translation and we have passive probes that put 450 ohms in front of the scope's 50 ohms.

There has been a lot of progress in semiconductor technology in terms of gain-bandwidth product, impedance transfer function and noise reduction. And when today's 7-7.5 GHz IC processes (which make 1-GHz scopes possible) reach their expected limits at about 10 GHz  $f_t$ , we can turn to gallium arsenide, gallium phosphide or other compounds now in development.

**Computer-aided design has come along at a fortunate time, too. In the days of discrete circuits, it wasn't too useful because you couldn't put in all the strays.**

If you added the strays with CAD, the problem became too complex, and if you didn't your circuit wouldn't work. But with ICs, the strays are smaller and more predictable. And we can work not only with surface

---

**George Rostky**  
Editor-in-Chief



Chatting with a visitor are (l-r) Bill Peek, Wim Velsink and Howard Vollum. In the background are the 511,

Tek's first oscilloscope, dating from about 1946, and the 7834, a superspeed storage scope, just introduced.

geometries, but also in the third dimension, designing resistivities along with metal patterns and mask layouts.

Of course higher bandwidths present triggering problems, but we see progress along this line, too. One of the basic departures from the historical approach for greater stability is the use of high-speed ICs, as opposed to tunnel diodes. And faster amplifiers with shorter delays have made it possible to use shorter delay lines with better performance.

Sensitivities in the millivolt region can be anticipated, even at the higher bandwidths. Amplifier noise is the limiting factor here, but semiconductor technology has made great strides in reducing this problem.

Obviously none of these developments would mean much without parallel advances in CRT technology. We've made great progress in this area too. CRTs with bandwidths of 3 to 4 GHz and deflection factors of 1 to 2 V/cm in both vertical and horizontal are a present reality, with photographic writing rates up to 3 cm/ns. You can actually see a single-shot trace with the naked eye. And we haven't reached the limits yet.

Research is pointing away from the mesh scan-expansion CRT toward designs that will give us

the nice crisp spot sizes we used to get with instruments like the 547—about 7 mils. And we'll eventually see these new CRTs in wide-bandwidth portables, where finer traces are much in demand.

Looking at the CRT as a display, we see an increased use of alphanumeric. We'll see new kinds of information displayed—information that will help the scope user do his job. It may be an instruction on what to do next, or a coded display—one/zero, hex, maps, signature, etc. A programmed logic analyzer might show you a picture for so many seconds and then ask you what you wanted next. Or a scope might instruct you to hook up this probe at this point and then tell you whether the reading is good or bad.

**The storage scope is really coming of age, too. Ideally, we'd like to make every oscilloscope a storage oscilloscope.**

Storage almost always works to your advantage. It lets you compare things, eliminates flicker and eases photography tremendously. Because you have a stationary picture of known brightness, there's no hassling—you know you're going to get it. If storage could be incorporated basically into every oscilloscope, even if it cost a little

more, probably everybody would use it.

Of course there were good reasons in the past for not doing this. But today we are getting to the point in storage technology where we can store as fast a signal as we can get on a conventional CRT. The new 7834 is spec'd at 2500 cm/s—fast enough to store a signal at its rated 400 MHz bandwidth. And our future advances in stored writing speed are expected to keep pace with bandwidth advances.

Storage is still the cheapest way to memorize a waveform. In spite of the many cheap A/D converters available, you still need a digital memory to take advantage of them.

**The future of the sampling oscilloscope is less clear. One of the problems is that the sampling scope is useful only with repetitive waveforms, and there just isn't a multiplicity of fast, repetitive waveforms that people want to look at.**

Really fast waveforms are usually single-shot, and the few exceptions can usually be handled by other techniques. Then, too, there has been a race between samplers and real-time scopes for a long time, and though real-time scopes haven't actually won it, in terms of being able to do everything the sampling scope can do, they have covered enough of the applications so that sampling has taken a back seat. And sampling has always had a problem in terms of the operator's confidence that what he sees is what is really there. Sampling scopes aren't easy to use, and there are modes you can get into that give a picture completely different from the real one. False triggering, for instance, and other operator traps. You might say that sampling scopes won the battle but lost the war.

Actually today's sampling scope is easier to use than it was in the past. The computer people, as they get into higher and higher speeds, will be using sampling techniques for some waveform analysis, especially in CPUs and communications links, where the highest speeds are encountered. To do this though, they'll have to program the computer to run in a repetitive mode in most cases.

Sampling techniques will also be used for a good while in time-domain reflectometry instruments like the Tektronix 1502 and 1503 portable TDR cable testers. This application is a natural for sampling. You generate a repetitive pulse and send it down a coax line, then display the reflection to determine the nature of any discontinuity or anomaly. You also measure the elapsed time between pulse and reflection and convert this to distance. With sampling techniques

## Howard Vollum



Charles Howard Vollum has been involved with oscilloscopes since 1933, when he designed and built one for the radio-repair work that helped finance his education at Reed College in Portland, Oregon. In March 1941, five years after graduating with a BS in Physics, Howard was drafted into the infantry. December of that year saw him commissioned 2nd Lieutenant in the Signal Corp and sent to England to work on high-resolution radar, in a lab directed by Sir John Cockcroft, the first man to split the atom. Working on a display for a 0.1  $\mu$ s radar, he became expert in wideband video-amplifier and fast-sweep techniques.

In 1946, when Howard left the Army, the fledgling oscilloscope market was dominated by one company, the big electronics companies having decided the oscilloscope didn't merit significant investment. Howard, though, saw a need for a scope that could measure (not just display) electrical waveforms. With a small group of newly released veterans he formed

you achieve the gigahertz bandwidth necessary for resolution measured in inches, at a relatively low cost.

The other dimension of sampling lies in its use in A/D converters—rapid acquisition and retention of a bit of information, long enough to convert it to digital information. We'll see a lot of development continuing in that area.

So much for the idea that the oscilloscope has reached its technological limits. Now let's look at the argument that it's becoming obsolete in the



Tektronix. The first product, the Type 511, a 10-MHz, triggered-sweep, calibrated scope using many of the wartime technological advances, was an immediate success.

Today Tektronix occupies more than 500 beautifully landscaped acres in Beaverton and Wilsonville, Oregon, employs more than 13,000 people, and reported over \$360 million in sales for fiscal 1976. The oscilloscope still accounts for the largest part of these sales, although Tektronix does a flourishing business in other electronic test and measurement instruments, TV monitors and signal processors, and a growing family of computer peripherals.

Despite his success, Howard remains a soft-spoken, mild-mannered individual, with an active concern for the welfare of his employees and a youthful enthusiasm for progressive ideas. He shuns public attention and attributes the success of Tektronix to the "wonderful, hard-working people" who work with him.

Nevertheless, he has been honored many times by his community, his country, and his peers in the academic and business worlds. He received the Legion of Merit with Oak Leaf Cluster for his contributions to military electronics projects during WW II. He has honorary doctorates in Science, Law and Humane Letters, is an honorary member of the ISA, and received a Medal of Achievement Award from the Western Electronic Manufacturer's Association. He is a Fellow of IEEE and received its Morris Leeds Award in 1973. He has received several distinguished service awards from various colleges, universities and institutes, and is a trustee or board member of three local colleges and one of Portland's largest hospitals.

Howard is married and has five children, ranging in age from 10 to 24 years. In his home, he has installed a full-size pipe organ, which he plays, he says, not nearly as well as his 22-year-old son. His other hobbies include photography and hi-fidelity magnetic recording.

world of the cheap integrated circuit and the smart microprocessor.

**There is no doubt that the scope of today is in for some significant changes. But wherever electronics goes, you find the oscilloscope follows.**

Remember the old fears that the computer would put everyone out of work? The idea that the oscilloscope will join the unemployed is no

more apt to see realization.

As we see it, there will be two main thrusts to future scope development. One is the use of intelligence. It's in this area that the microprocessor will have its greatest impact. What form this will take isn't clear yet. There are plenty of real opportunities here, but also a lot of problems to be solved and decisions to be made.

The other thrust will be toward cost reductions. We expect some severe price competition in segments of our product line. There is strong demand for a multifunction, 50 MHz, 5-mV, dual-channel, delayed-sweep oscilloscope at a lower and lower price. The situation may develop into a repeat of the minicomputer business. Today minis are not getting much faster, but you can get for \$2375 what you paid \$15 K for when DEC first came out with the PDP-11 series. We haven't seen much of this in the oscilloscope business in the past, but it's probably going to be with us in the next 10 years.

**But let's get back to the intelligent scope. Right away we run into a whole chain of considerations. You see, so much depends on how the oscilloscope is to be used.**

In the lab, for instance, you don't often know in advance what you want to do with a waveform. You just see what's there, and that leads you to step two and on to step three and so on. It's not a predetermined situation. So, except for very broad mathematical manipulations like FFT, signal averaging, etc., it is difficult to predict in advance what digital processes you are going to need—and you can't build enough of them into a scope to cover every contingency.

On the other hand, there are significant application areas—servicing and production mainly—where the need is well defined. Like measuring rise time, time delay, time between pulses, etc. The scope could be programmed to make these measurements automatically and provide a read-out on the CRT. Then if something came out wrong, the same scope could be used to troubleshoot the device.

It's in this area that the microprocessor will have its biggest impact. But we'll still have the problem of deciding what we want the scope to do. This means we'll probably have to provide custom programming software. Or we'll have to make it awfully easy for the customer to do his own programming. Probably we'll do both, in different kinds of instruments.

Some portable scopes may be designed for specific service applications. That is, a computer manufacturer may design a set of computers and

## Wim Velsink



Wim Velsink has been in the front lines of R&D at Tektronix for most of the 16 years he has worked there. After taking his BSEE from Hogere Technische School in 1960, and short stints with Philips and Siemens and Halske in the Netherlands, Wim came to the U.S. He started with Tektronix as a design engineer in the accessories division in 1963, became Project Manager, Advanced Circuitry, in 1965 and Manager, Advanced Project Development, in 1966. One of his more important responsibilities in this position was the development of the 7000 series oscilloscope line. Wim is now Director of Tektronix Laboratories, General Manager, New Ventures Division and Manager, Advanced Display Techniques Development. He became a vice president in 1973.

Wim is a bachelor and an outdoorsman who relishes the many opportunities for skiing, hiking and camping in Oregon.

we'll provide a scope that is identical to last year's model, except that there'll be new cards with PROMs or ROMs and a special service manual for that set of computers and peripherals.

In other scopes we may provide the basic arithmetic functions and a few others that you can operate on a waveform with. You could multiply voltage and current to get instantaneous power, or integrate a current waveform to get charge. These capabilities are useful to a design engineer. And a lot of single-value functions would also be useful—rise time, aberration amplitude, period of aberration ringing, pulse-width, integral under the curve, and many others.

These kinds of functions are valuable in characterizing and documenting circuits, aside from testing them in production or incoming inspection. This kind of a scope would eliminate much of the present drudgery, say, in integrating a waveform. Now the operator must measure the

waveform, digitize it point by point, then feed it into a computer, or use his calculator.

But building these functions into a scope isn't as easy as it seems. At first glance, it looks as if you'd only have to sample the waveform at a couple of points, measure the difference digitally, and show the readout on the screen. With this information, plus an examination of the waveform, you'd have a measurement you knew was valid. And this technique wouldn't be complicated or expensive. Actually it's not that easy.

We've found that many times it's just as easy to digitize the whole waveform and store it for viewing as it is to remember the two points and then try to correlate them back to the waveform position. Even the time required to turn the Z-axis on and off creates all sorts of problems in circuit and CRT design.

**So let's say we digitize the input signal. By what method? Well, with A/D conversion, if we want to stay within reasonable costs and power requirements we need emitter-coupled logic.**

This means a word rate of about 25 MHz or below, which gives us a 10-MHz scope at best. Or we can use scan-conversion techniques, as we did with the 7912. There's virtually no bandwidth limitation here, and you don't need a repetitive signal as you do with sampling. The principal limitation of the scan converter is in the length of the memory. How long a waveform can it remember? You're also limited to one sweep, at least presently, and the cycle between sweeps is relatively long compared to sweep time.

Of course, this limitation applies to all scopes. The only way to get around it is through continuous A/D conversion, and here you run into bandwidth limitations again. Even at a 25-MHz word rate, you fill a memory awfully fast. So you have to let the waveform run through the memory, decide what time slot you're really interested in, and pre- or post-freeze it, depending on the application.

This, incidentally, is one thing you can't do with the scan converter. Of course in the next five years we'll see the word-rate go up by an order of magnitude. We'll also see relatively low-speed scan converters being used as less costly A/D converters. Charge-coupled devices will probably play a big part in this.

One nice thing about scan conversion is the opportunity it affords in the display area. You can get any number of traces on one display in different colors if you have a scan converter in each channel and a color tube. And alphanumeric CRT readout could be color-coded to correspond

**Bill Peek**



Bill Peek came to Tektronix as a design engineer in 1962. A graduate of Oregon State University, he received his master of engineering degree in 1968. In 1975 after holding various managerial positions in circuit- and instrument-design groups, Bill was promoted to the post of General Manager of the Laboratory Instrument Division. This division is responsible for design, production and marketing of Tektronix Laboratory oscilloscopes, the TM 500 line of test and measurement instrumentation and the new family of logic analyzers.

Bill likes to go camping with his wife and two young sons, and also enjoys woodworking, a hobby that came in handy when he built his own home a few years ago.

to the color of the trace it applied to. This would really make a readout a lot easier—reduce operator error and generally make the scope easier to use.

In any event, once A/D conversion becomes a standard item in waveform analysis, a whole spectrum of operations is opened. Relatively, you have all the time in the world to decide what you want to do with the stored waveform—how you want to display it, what kind of information you want to add to it or get from it, etc.

**One thing is clear. We're not going to have a universal scope that's the equivalent of a hand-held calculator.**

There are too many differences in customer needs and too many limitations on digital conversion techniques to make that possible. There is no doubt that new instruments will supplant the oscilloscope as the principal troubleshooting tool in some applications. We've recognized this by entering the logic analyzer field. There is a possibility that within the next 10 years, due to the

tremendous impact microprocessors will have on all areas of industry, logic-analyzer sales may equal those of oscilloscopes.

Or a new instrument may appear that is even more suitable for the design, test and service of microprocessors. But eventually you still have pulse aberrations and timing relationships to troubleshoot, and power-supply circuits to debug in your microprocessor circuit. You're going to have a whole array of EEs designing controllers for sewing machines, washing machines, automobile carburetion and braking systems, etc.

Electronics, especially the microprocessor, is penetrating new areas every day—areas previously dominated by mechanics, hydraulics, fluidics, etc. And the oscilloscope will follow, maybe not as the principal, but nevertheless as an indispensable troubleshooting tool. For although a logic analyzer or similar instrument may tell you *what* is wrong, it takes a scope to find out *why* it's wrong.

Incidentally, when it gets down to servicing in these new areas, a few people are skeptical that a car mechanic may be using an oscilloscope to troubleshoot a microprocessor. Well, perhaps he won't. But the trouble may not be in the microprocessor itself. It may be in the wiring or in the connections, at the inputs and outputs of the device. Probably most of the problems will be of this kind. Diagnosing these problems will require a fair level of sophistication, and this brings up an interesting point.

Some years ago, when radio and television were coming along there was serious consideration given to the proposition that they would never be a success because there wouldn't be a group of people who could service them. With color television, it was considered impossible. Yet there are now thousands of people who are doing it. And auto mechanics aren't all that different from other people. Look at the military. They have to maintain all sorts of complex, sophisticated electronic equipment. People rise to a challenge in their profession or vocation. In the future it may be a common sight to see an auto mechanic with a special-purpose oscilloscope, finding out what's wrong in an electronic device.

In any event, we believe the oscilloscope has a bright future. Its general configuration, operating parameters, and variety of functions will change to meet the needs of our advancing electronics technology. But its primary function as a basic diagnostic tool will remain. Such tools have a way of staying with us. Remember that in spite of the millions of dollars expended each year on sophisticated medical diagnostic equipment, the physician still carries his stethoscope. ■■

**Now the line of AMP  
Coaxial Ribbon Cable Assemblies  
is wider than ever.**

**And so is your design range.**





The introduction of AMP Coaxial Ribbon Cable assemblies represented a major breakthrough in interconnection technology. Lower costs with no compromise in performance. Now, AMP has broadened the line to give you an extremely wide range of high speed, low noise interconnections.

AMP ribbon coax is available in 50-, 75- and 93-ohm ratings, 6 to 26 positions, on .100-inch centers. Or in a 95-ohm rating on .125-inch centers.

Multi-position connectors mate with .025<sup>2</sup>-inch posts, either 90° board-mount pin headers or I/O posts. Included are the new paddle-card and flanged types.

We can supply complete ribbon coaxial cable/connector assemblies of any length to fit your requirements. Or provide all the cable, connectors, and tooling you need to make your own.

Either way you get professional back-up by AMP field and home office engineers. They work with you from the prototype stage through production—and on to future design.

For more information on the design opportunities you get with AMP's extended range of Coaxial Ribbon Cable assemblies, call Customer Service at (717) 564-0100. Or write AMP Incorporated, Harrisburg, PA 17105.

**AMP**  
INCORPORATED

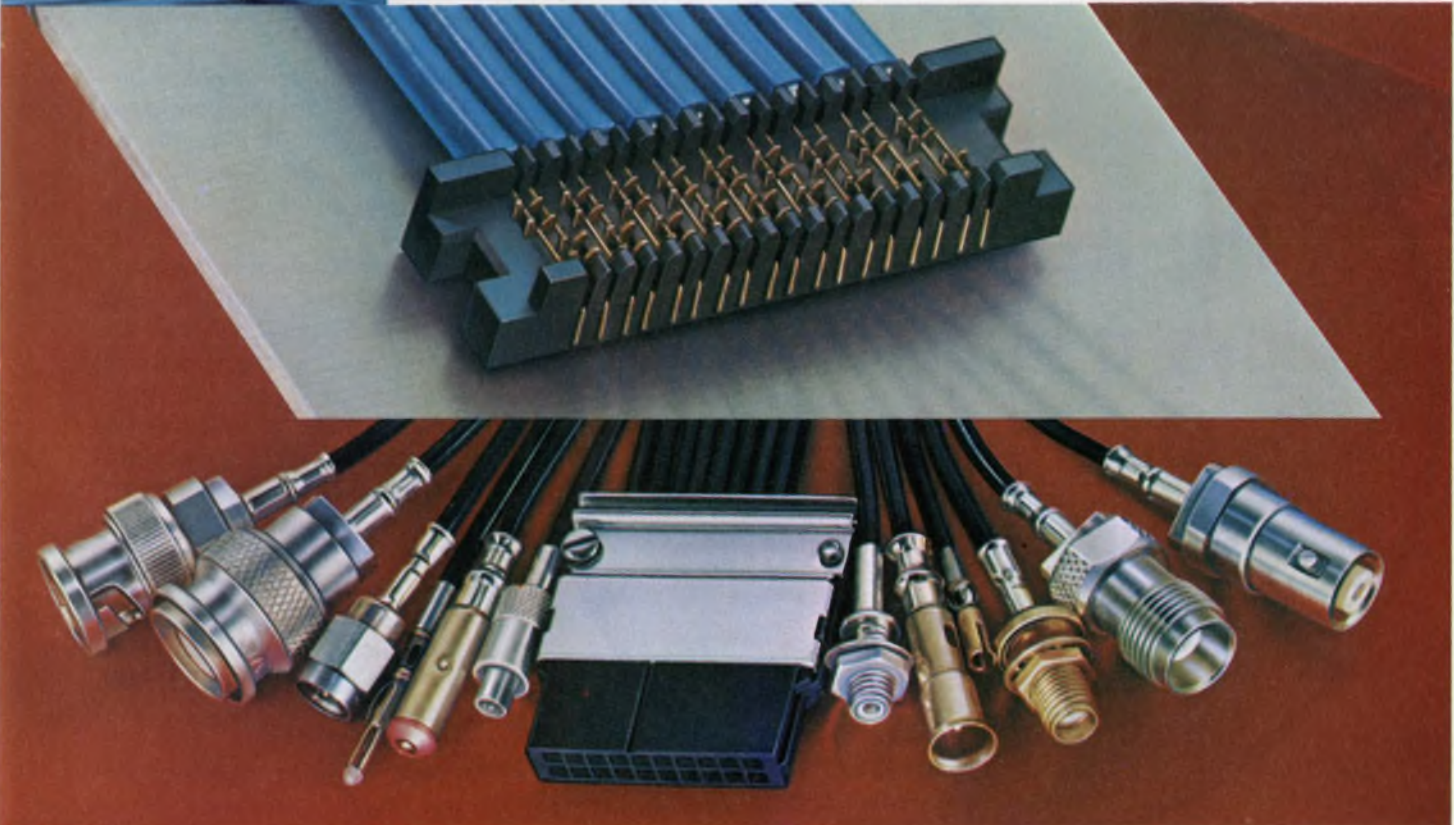

AMP is a trademark of AMP Incorporated.

CIRCLE NUMBER 40

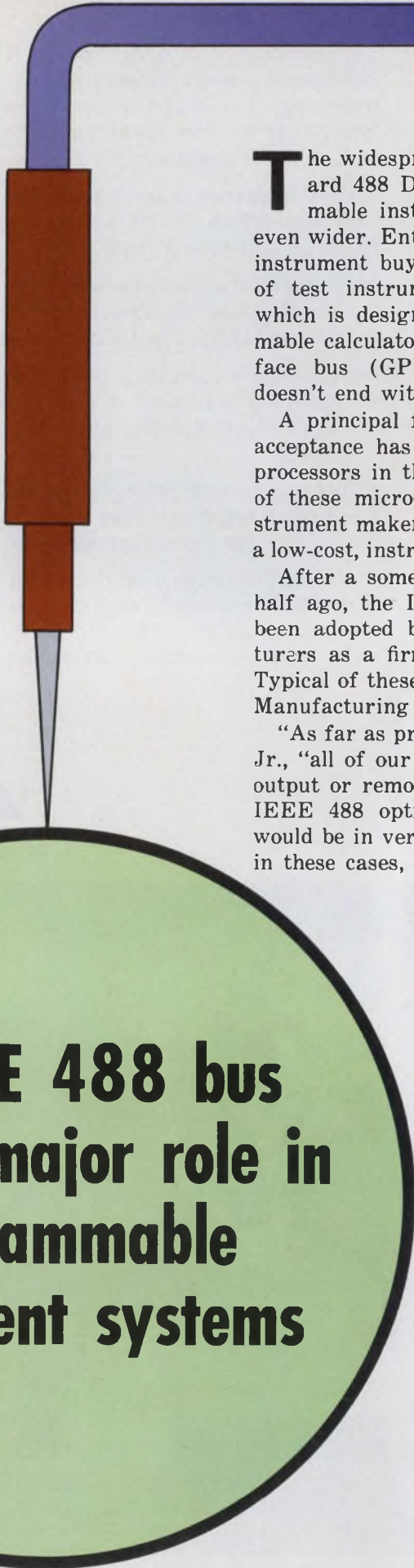

## The IEEE 488 bus plays a major role in programmable instrument systems

The widespread adoption of the IEEE Standard 488 Digital Interface Bus by programmable instrument manufacturers is getting even wider. Enthusiastic acceptance of the bus by instrument buyers is creating a new generation of test instrumentation, the vast majority of which is designed to be controlled by programmable calculators via this general purpose interface bus (GPIB). Moreover, use of the bus doesn't end with programmable instruments.

A principal factor in the rising tide of GPIB acceptance has been the proliferation of microprocessors in the last year or so. Increasing use of these microprocessors has permitted the instrument makers to provide, among other things, a low-cost, instrument-to-bus interface.

After a somewhat hesitant start a year and a half ago, the IEEE Standard 488 bus has now been adopted by some 50 instrument manufacturers as a firm option for their product lines. Typical of these manufacturers is the John Fluke Manufacturing Co., Mountlake Terrace, WA.

"As far as product planning," says John Fluke, Jr., "all of our new products that have a digital output or remote control capability will have an IEEE 488 option. The only possible exception would be in very low-cost portable products. And in these cases, they would have a crude form of data output to drive a simple bus converter."

The Fluke Model 8500A, a bus-structured, 8080-microprocessor-controlled DVM, is a prime example of the new generation of 488-bus-compatible instruments. "We built the voltmeter very much like a computer system," Fluke explains, "where each function to be performed by the voltmeter has a corresponding module that plugs into an internal bus. The digital interface to the outside world plugs into slots provided for that purpose."

Three interface cards are available for the instrument: an RS-232-C serial module, a duplex-parallel interface designed for interfacing directly to mini-computers, and the IEEE 488 interface.

---

**Jim McDermott**  
Eastern Editor

Microprocessors and the 488 busses are being combined in instrumentation to provide a total system capability far beyond that originally envisioned for the bus, according to Pete Silvernail, group engineer at Wavetek, San Diego. Distributed processing or networking makes use of the intelligence scattered throughout the system in each instrument interconnected by the bus, Silvernail explains.

The original intention for the 488 bus developed by Hewlett-Packard was that it enable the user to assemble a group of bench-top measuring instruments and signal sources into systems that could be easily assembled or reconfigured.

But now the bus is finding a home in military radar systems, process-control systems, interfacing with the IEEE Standard 583 Standard Modular Instrumentation and Digital Interface System, usually called Camac (Computer-automated measurement and control), as well as in large-scale automatic test equipment systems.

#### Bus gives distributed processing capability

The distributed processing capability of a system configured around the 488 bus provides a powerful tool for the instrumentation-system user, which means, according to Silvernail, that processing is shared by the calculator and the various microprocessors throughout the system. Thus, processing done at the relatively slow 1-Mb/s maximum speed of the 488 bus is substantially higher.

So Silvernail doesn't see any significant need for superspeed on the GPIB bus. But what he does see is a great need for the ability to tell instruments exactly what to do and for the instruments to respond by telling what they're doing.

These "command structures" have been incorporated into the Wavetek Model 172 Programmable Signal Source, according to Silvernail. The 172 is a combination oscillator, waveform generator, pulse generator and synthesizer, all of which are manually or remotely programmable. The instrument can generate sine, square, triangle, pulse, ramp, haversine, havertriangle and dc-level waveforms on command.

The 172 has the widest frequency range of any programmable function generator today, says Silvernail, and operates from 0.0001 Hz to 13 MHz, with the synthesizer portion operating from 10 Hz to 13 MHz.

In the 172's command structure, the instrument receives and stores a set of instructions



This 5-1/2-digit programmable multimeter provides 1000 conversions per second. The Model 7500, by Data Precision, is also a universal ratiometer accepting any input combination.



Up to 10 of these Wavetek Model 172 programmable function generators can be controlled at one time through a 488 interface with optical isolation.

from the calculator (or controller) during slack or initialization time. Only then is it necessary to use a hand-wave signal that essentially says: "Now do this or that." This type of distributed operation reduces traffic on the bus significantly.

#### The 172 talks back

The 172 is the first machine to have an alphanumeric display that states what is happening within the instrument in English, French or German. For example, upon entering either a front-panel or remote frequency, the display reads: "Frequency is XX kHz," in one of the three languages.

On the other hand, if the range is exceeded, the display states: "Frequency range exceeded," and the excess is not indicated by the usual blinking LED, as with other instruments.



This automatic test set for transceiver measurements, by Rohde & Schwarz, is controlled through the IEEE bus by a programmable calculator. Card readers can also be used for system control.

While the 488-bus interface has been implemented initially in measuring and signal-generating instruments, Silvernail foresees the bus being adopted by display and storage systems as well.

"Within five years, every printer and plotter will be interfaced with the GPIB," he predicts. "I also say that many magnetic tapes and floppy discs will have that interface."

### The move is to larger systems

In addition to being incorporated into programmable instruments, the 488 interface is being incorporated into computer-operated systems, according to Don Loughry, a Hewlett-Packard corporate interface engineer. Several other manufacturers are now providing bus-port interfaces, he adds.

A computer-controlled test system in Fairchild's new Logic System VII that uses multi-processor techniques employs the 488 bus to simplify the addition of programmable instrumentation. And the latest disc-based Logic-Circuit Test System from GenRad, Concord, MA—the 1795—has an optional 488 instrumentation port.

The 488 bus's distributed-processing capability that links a group of microprocessors has been

adapted to an application for which it was not originally conceived—an aircraft search system under development at MIT's Lincoln Laboratory. The bus's ability to connect several components of the radar system has simplified the system by eliminating the central computer needed in previous systems.

"While we've already used the bus on a small airborne radar, we have five or six other radar projects that we're going to use it on," says C. Ed Muhe, leader of the radar-techniques group at the Lincoln Laboratory.

### Bus is central system element

"With the usual digital system, the first thing you think about is the central computer," Muhe notes. "But with the bus, we do just the opposite, we think of the bus as the central element of the system. And all the functional modules tie onto the bus.

"The basic idea is to functionally divide the system into parts that require the minimum amount of communication between them. We put enough microprocessor intelligence into each part so that communication on the bus is fairly small.

"As an example, the digital display has to be refreshed about 30 times a second, and the refresh function is put into the display with a local microprocessor. The display is updated only when there are changes in it, and this update is easily handled by the bus using rates of about 0.5 Mbytes per second."

Slow or fast  $\mu$ Ps are used, depending on the requirements, Muhe points out, and the 8080 and 2901 are Lincoln Laboratory's favorite choices.

The bus saves substantial design time—a major advantage, according to Muhe. Using the 488 with standard building blocks to construct the radar systems means, for example, that a display can be connected with its  $\mu$ P into another radar. With the standard interface, it's necessary only to plug it into the bus.

"While I know the bus offers a tremendous advantage in designing several systems using the same functional units, I think that the bus means less design work even for one system," Muhe concludes.

### Programming is still a problem

Eugene Fisher, design engineer at the University of California's Lawrence Livermore Laboratory, Livermore, CA, is enthusiastic about using the 488 for interfacing instruments to mini-computers at the laboratory. With the proper bus interface, Fisher points out, he can acquire an





A microprocessor-based digital plotter, the Tektronix 4662, is a leader in the trend to provide plotters with the IEEE 488 general purpose interface as standard.

instrument for a particular instrumentation set-up and simply plug it in.

"All I have to do then," he notes, "is learn how to program it," notes Fisher, adding: "This is a continuing problem with each new instrument because each instrument manufacturer is interpreting the bus specification slightly differently."

Programming individual instruments has been a problem for some time because it has not been spelled out in the original specs.

"Work is continuing in the standards area relative to software," says Don Loughry. "I prefer to call software 'codes and formats.' Draft documents are being generated and will be reviewed this month at the International Level in Europe in the parent committee of Technical Committee 66."

Historically, the interface of early programmable instruments has been the parallel, four-bit BCD bus, which is still available in standard form in the majority of today's instruments. But the demand for it is falling while the demand for the 488 interface rises.

As a result, instruments already on the market, but still reliable and highly useful, are now being retrofitted with IEEE 488 interface cards or modules. The Model 605-145 ASCII interface developed for Exact Electronics Models 605 and 606 Programmable Waveform Generators is a good



The status of the HP-IB bus as well as the range and the function to which the meter is set are provided automatically by this Hewlett-Packard 3455A DVM.



Fully automatic frequency measurements from 0.02 to 24 GHz can be made with this Systron-Donner 6054B Microwave Counter. The IEEE interface is optional.

example. Only an inch and a half high, the new 488 interface module of the Hillsboro, OR, firm sits on top of the 3-1/2-in. rack package of the 605 and 606. The total package is only 5-1/4-in. high and fits into a 19-in. rack.

Keithley's new portable 4-1/2-digit, 30,000-count DMMs, Models 172 and 173, are being provided with a 6800  $\mu$ P-based IEEE 488 interface module (available in January, 1977).

Because these instruments are small, the interface module of the Cleveland manufacturer is a separate unit, not a plug-in card.

Three DVMs from Dana Laboratories—the 5000, 5900 and the 6900—are designed with integral BCD outputs. A piggyback package of the Irvine, CA, firm, the 55, designed with a microprocessor-controlled interface, is used for interfacing between the BCD outputs and the IEEE 488 bus.

For the Dana 9000 Counter-Timer, which uses

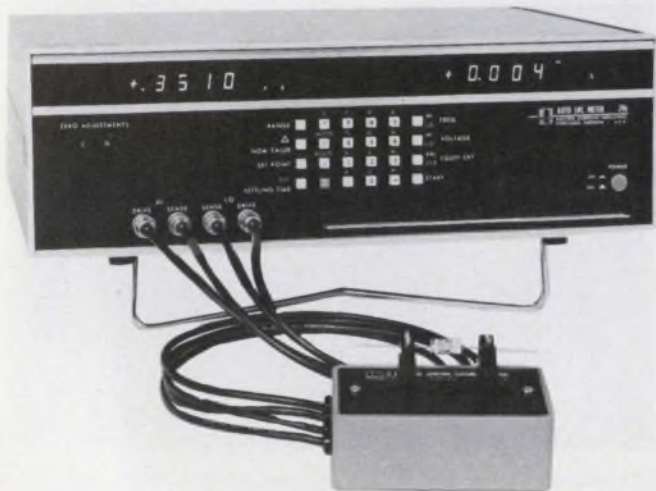

A complete automatic measuring system for production or incoming inspection is provided by this Electro Scientific Industries LCR bridge. It has a 6800  $\mu$ P.

an Intel 4004, the interface is incorporated within the box.

#### The number just gets bigger

Microprocessor interfaces are found in a number of other instruments. For example, the Model 296 wide-range LCR bridge from Electro Scientific Industries, Hillsboro, OR, incorporates a 6800  $\mu$ P to provide calculating power in the instrument as well as provide the 488 interface. The 2961 is not yet supplied with the standard BCD outputs.

"The instrument can be programmed remotely, including sequencing a mixture of tests," according to Jim Currier, instrument product manager. "For example, a capacitor can be measured, followed by a resistor. Or it can be controlled to provide multiple-component, high-speed testing.

"A 10-limit sorting capability is available, using a plug-in option card," Currier continues. "So, with one instrument you have a complete measuring system for production or incoming inspection."

A special feature incorporated in the digital bridge is the ability to do either percentage deviation or absolute deviation. Instruments have traditionally come with either deviation measurement.

The instrument program can be changed easily by simply substituting another program ROM in the  $\mu$ P, notes Currier.

The SMPU Test Assembly by Rohde & Schwarz, Fairfield, NJ, is a microprocessor-controlled, IEEE-bus compatible automatic test set for transceiver measurements. The system, whose



A calculator-controlled automatic test system for four-point probe applications, the Keithley System 53 contains a current source, DMM, 10-channel scanner and interface units.

deliveries have just begun, contains multiple instruments required to test both transmitters and receivers automatically.

Control comes from a card reader or through the Tektronix TEK 31 programmable calculator. Where more elaborate programming facilities are required, the Tektronix 4501 Graphic Computer system is used.

The SMPU is connected to the calculator through the IEEE bus.

The microprocessor is used for setting up and maintaining subroutines and for preventing erroneous and potentially destructive measurements. For example, if the transmitter test is selected by pushing the "transmitter" button, no type of receiver test can be called up, because the system will refuse it.

Not all microprocessors used in instruments function as a part of the bus interface. For example, the 4004  $\mu$ P in the Systron-Donner 7115 DMM provides intelligence for internal data calculations, self-calibration and troubleshooting.

In the 7115—and in three other of the Concord, CA, manufacturer's instruments that interface with the 488 bus—the DPS 50 Power Supply, the 1600-series Microwave Synthesizers and the 6054B Microwave Counter are normally supplied with the BCD and the 488 interfaces as plug-in card options.

#### Camac systems take the 488 bus

The influence of the GPIB is spreading to the process-control field. Users of the Camac systems (IEEE 583) are providing the 488 bus with interfaces so that instruments that are physically incompatible with the Camac modular system of hardware—programmable attenuators, DVMs, and displays, among others—may be added.

Use of the Camac system is pretty much divided between nuclear instrumentation and process-control instrumentation. ■■

# Trace quality. GOULD/Brush Recorders have it.

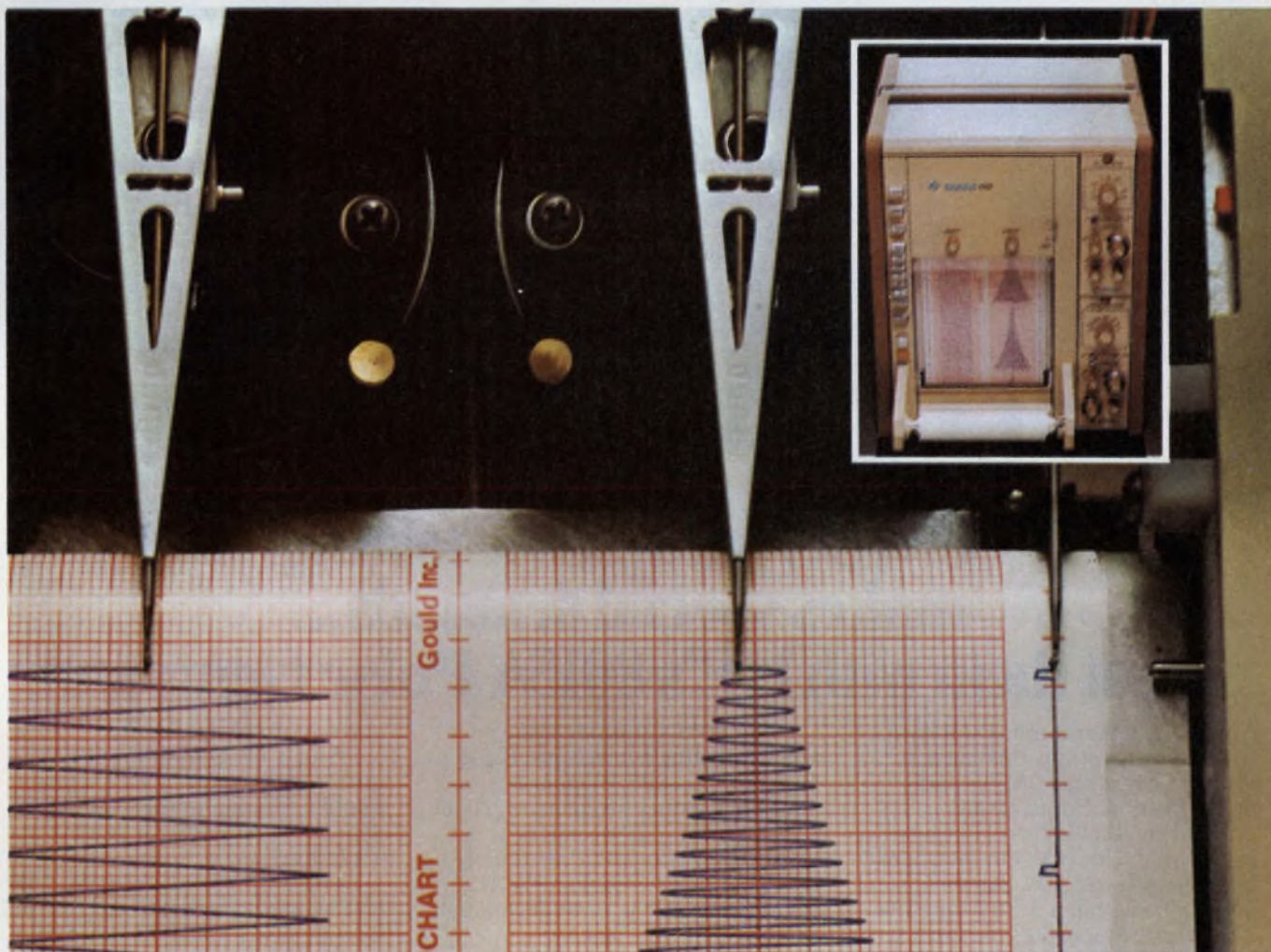

## Regardless of pen velocity.

The exclusive GOULD pressurized fluid writing system assures you constant width traces regardless of pen velocity. The ink is injected into the paper and is wiped dry instantly by the high pen pressure seal. In combination

with GOULD low cost chart paper, your traces are permanent. They won't fade or deteriorate as do other writing methods.

An event that may only occur once demands the highest trace quality you can buy . . . GOULD.

For more information write Gould Inc., Instrument Systems Division, 3631 Perkins Ave., Cleveland, Ohio 44114. Or Gould Allco S.A., 57 rue St. Sauveur, 91160 Ballainvilliers, France.

For brochure, call Gould toll-free at (800) 325-6400, Ext. 77.  
In Missouri: (800) 342-6600

 **GOULD**  
The product development company



Instrument as shown has pulse-burst option and optional handles.

## CMOS parametric testing makes special demands... Meet them with HP's 8015A Pulse Generator.

This pulse generator has standard features and options that make it ideal for MOS and CMOS parametric testing. For example:

You get dual-channel outputs, each variable to 16V. Or, they combine into a single 30V channel adjustable within a  $\pm 16V$  window. That versatility makes the 8015A compatible with CMOS, and most MOS devices. You can delay channel B with respect to A for generating 2-phase nonoverlapping clocks. And combine the adjustable B delay with A + B to generate three-level signals.

Selectable source impedance on both channels lets you choose the best output termination configuration for your application. Of course you can vary the width (10ns to 1s), transition time (6ns to 0.5s), and rate (1Hz to 50 MHz). High-speed capability lets you work with advanced TTL and HTL logic as well as MOS. And low rep. rates or manual operation let you slowly step through logic states.

The 8015A options makes CMOS testing even easier. Pulse Burst (option 002) eliminates conventional gating problems. Just set the exact number of pulses you want (from 1 to 9,999) on thumb-wheel switches. That's exactly the number you get...independent of pulse-rate settings.

Upper Output Level Tracking (option 006) automatically keeps clock and data-pulse amplitudes at the proper level relative to the supply voltage. This prevents CMOS circuit damage due to overvoltage on the inputs, even if the power supply is turned off.

Direct Output Amplifier Access (option 004) lets you convert word generator outputs, or TTL signals, to MOS/CMOS levels, or amplify low-level analog control signals to MOS/CMOS levels.

With Remote Control (option 003), you can build the 8015A into a test system and control all pulse parameter ranges with digital signals. Verniers are controlled by

current or voltage inputs.

And TTL Output (option 005) gives you a separate TTL compatible, 50-ohm output that tracks channel A output with fixed TTL levels.

The 8015A, starting at \$2,250\*, gives you parametric testing flexibility and saves valuable setup time.

Or, if your need is for functional CMOS testing, consider HP's 8011A. Priced at just \$525\*, it gives you high amplitude (to 16V) pulses at rates from 0.1 Hz to 20 MHz, and offers the Pulse-Burst Option.

Contact your local HP field engineer for all the details. Or, write for the 8015A and 8011A data sheets and our Application Note 195 — "Pulse Generator Techniques in CMOS Applications."

\* Domestic U.S.A. prices only.

HEWLETT  PACKARD

Sales and service from 172 offices in 65 countries.  
1507 Page Mill Road, Palo Alto, California 94304

# Accuracy. GOULD/Brush Recorders have it.

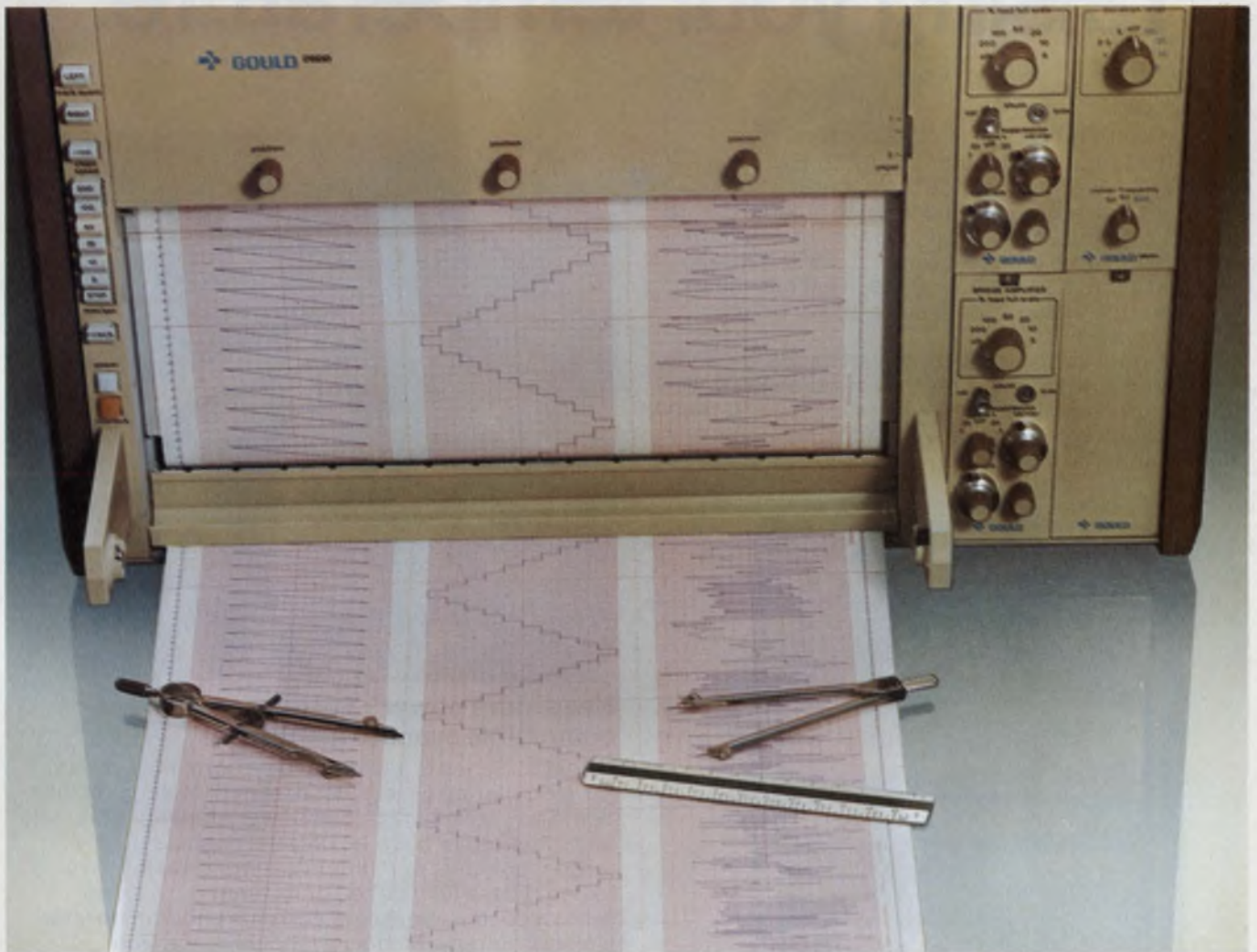

## 99.65% linearity.

Only GOULD Recorders offer you this exceptional accuracy because only GOULD Recorders give you a 100 gm/mm High Stiffness Pen Motor, a non contact METRISITE® position feedback

element having infinite resolution, and a unique servo drive system which anticipates changes in signal amplitude and velocity.

Accuracy is built into every GOULD direct writing recorder.

For more information on the best, write Gould Inc., 3631 Perkins Ave., Cleveland, Ohio 44114. Or Gould Allco S.A., 57 rue St. Sauveur, 91160 Ballainvilliers, France.

For brochure, call Gould toll-free at (800) 325-6400, Ext. 77.  
In Missouri: (800) 342-6600

 **GOULD**  
The product development company

# Trigac VI digital-to-synchro converter gives you accuracy and power without raising your temperature.

The closest thing yet to a Solid State Synchro, Kearfott's Trigac VI Modular Digital-to-Synchro/Resolver Converters provide the accuracy and power you need, with a bonus. In addition to standard 4 arc minutes of accuracy at 1 volt ampere, the transformation ratio remains constant within  $\pm .25\%$ . We also have units constant within  $\pm 0.1\%$ . That can make the difference between delivering power or just throwing it away.

Let us help you be cost effective. Standard options range from industrial grades thru hi-reliability units, from accuracies of  $\pm 20$  arc minutes to  $\pm 1$  arc minute and, in addition, special designs and packaging as you require.



## Need more power? Try our line of compatible synchro amplifiers.

Our 3185 Series is designed to perform the synchro power buffering or resolver to synchro (Scott-T) function. They provide matched power amplifier channels and transformer coupled outputs capable of driving torque repeaters or multiple control transformers up to 5 va. These fully potted units feature overload protection, low-quiescent currents and transformer-isolated outputs. Models available range from industrial to full MIL-SPEC high-reliability grades.

NEED ADDITIONAL POWER? We have units available with power outputs to 50 va, 60 or 400 Hz operation, and options of built in digital converters and/or power supplies.

For details on our converters and amplifiers, contact The Singer Company, Kearfott Division, 1150 McBride Avenue, Little Falls, New Jersey 07424.

**SINGER**  
AEROSPACE & MARINE SYSTEMS

# Versatility.

## GOULD/Brush Recorders have it.

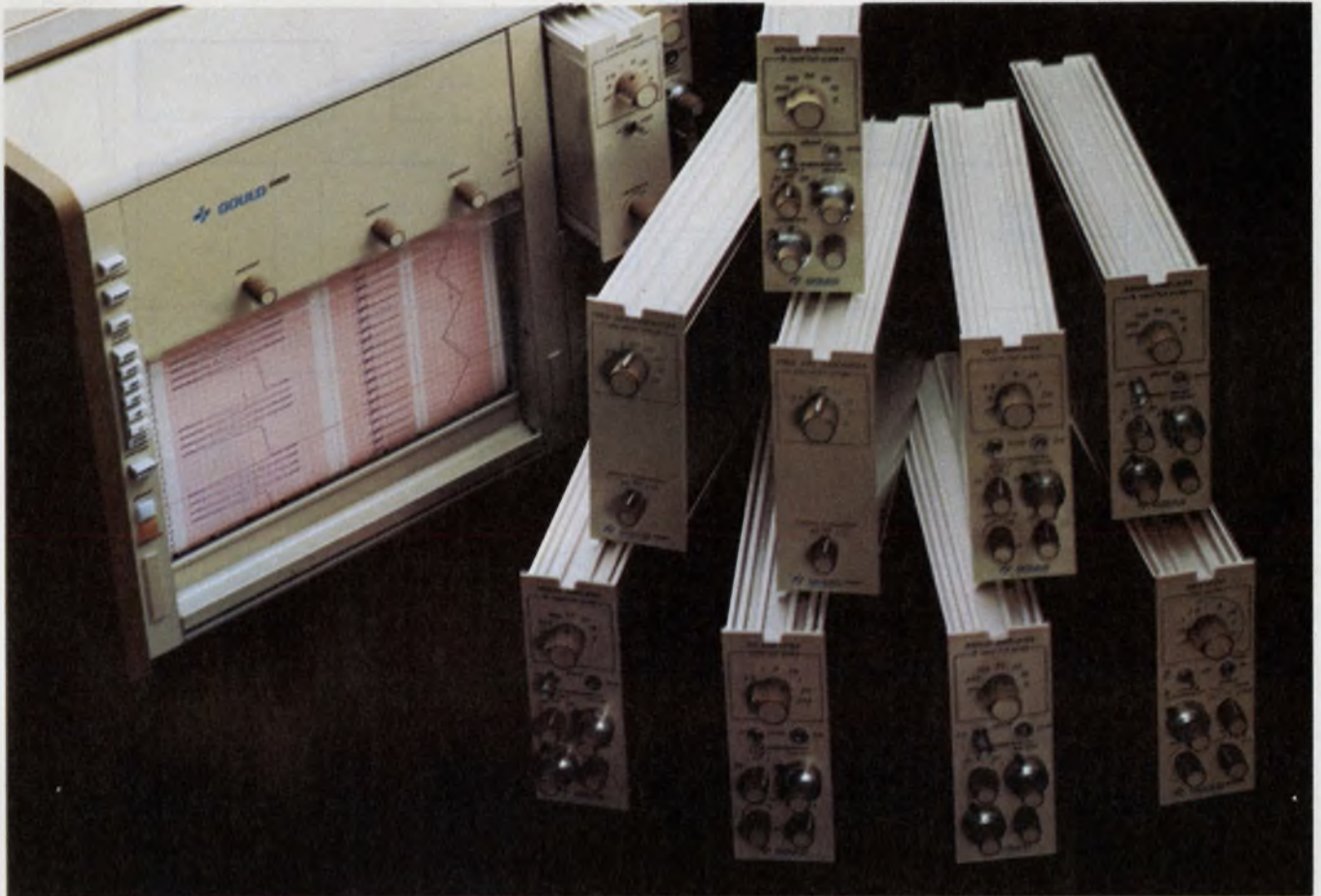

**You can: amplify, convert, attenuate, suppress, reject, filter, expand, add, linearize, subtract, display, multiply, invert, square, divide, integrate, isolate, detect, alarm, control, demodulate...**

Its modular design and interchangeable signal conditioners mean you get a recorder system "customized" to your needs with the ability to change input

parameters at will through the addition of appropriate plug-in conditioners. Let us tell you more. Write Gould Inc., Instrument Systems Division, 3631 Perkins

Ave., Cleveland, Ohio 44114. Or Gould Allco S.A., 57 rue St. Sauveur, 91160 Ballainvilliers, France.

For brochure, call Gould toll-free at (800) 325-6400, Ext. 77.  
In Missouri: (800) 342-6600

 **GOULD**  
The product development company

CIRCLE NUMBER 45

# How To Transmit Precision Data...

## Even where Isolation is a problem

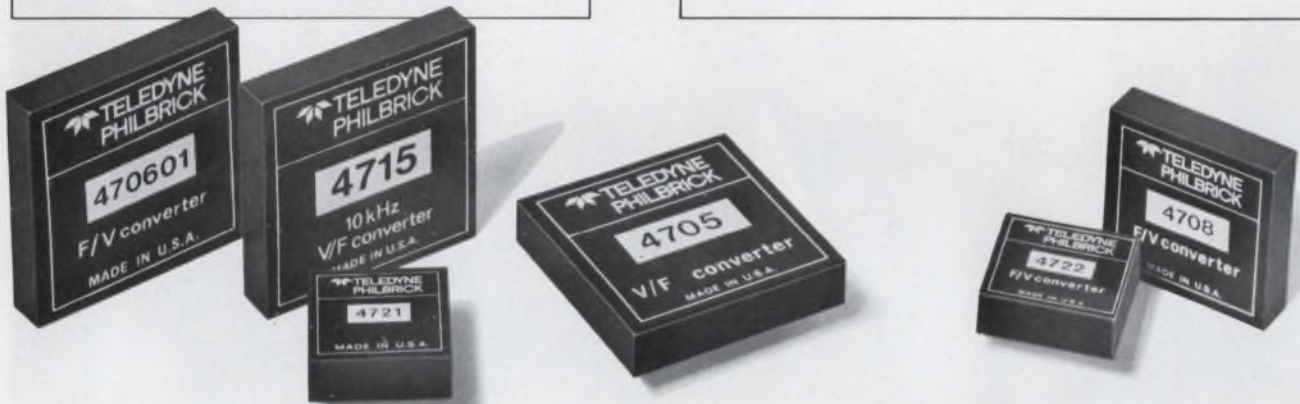
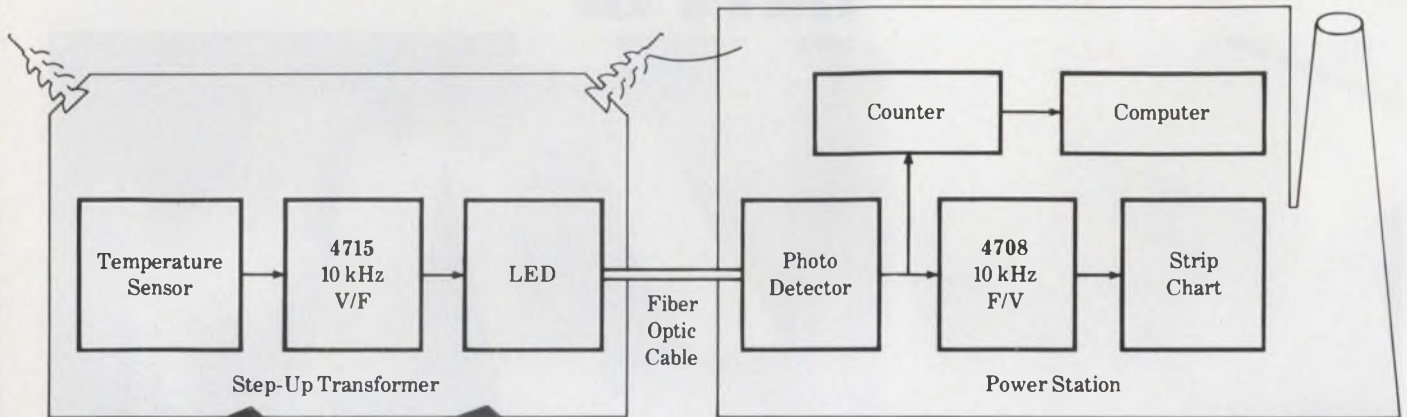

Use Teledyne Philbrick Voltage-to-Frequency and Frequency-to-Voltage Converters.

Whatever your analog data transmission application, mated pairs of TP V/F's and F/V's provide unique, cost-effective performance.

Difficult isolation problems are easily solved by connecting fiber optics, optical isolators, etc., between the V/F's and F/V's.

Just check our guaranteed V/F/V performance.

For Highest Precision, Low Frequency data, the 10 kHz 4715 series V/F's and 4708 series F/V's provide 0.005% nonlinearity, a Full Scale TC of 5 ppm/°C, and V/F operation from  $\pm 6$  V to  $\pm 18$  V power.

For Lowest Cost, use the 10 kHz 4721 V/F and 4722 F/V and still retain better than 1/4% accuracy (without external trims).

For High Frequency data, the 1 MHz 4705 V/F and 4706 F/V (with simple offsetting)

transmit dc to 50 kHz data or sub-millisecond transients.

All V/F's accept a wide variety of voltage or current inputs while providing outputs compatible with all standard logic types. F/V's accept virtually any input wave shape or logic signal and provide any output voltage span between  $\pm 13$  Volts.

Teledyne Philbrick's leadership in V/F/V technology is available to you. A new series of V/F/V application notes can ease your design problems. Write for them today.

Teledyne Philbrick, Allied Drive, Dedham, MA 02026 — Telephone (617) 329-1600, TWX (710) 348-6726.

In Europe, Telephone 673.99.88, Telex 25881, or write 181 Chaussee de la Hulpe, 1170 Brussels.

 **TELEDYNE PHILBRICK**

CIRCLE NUMBER 46



# Reliability.

## GOULD/Brush Recorders have it.

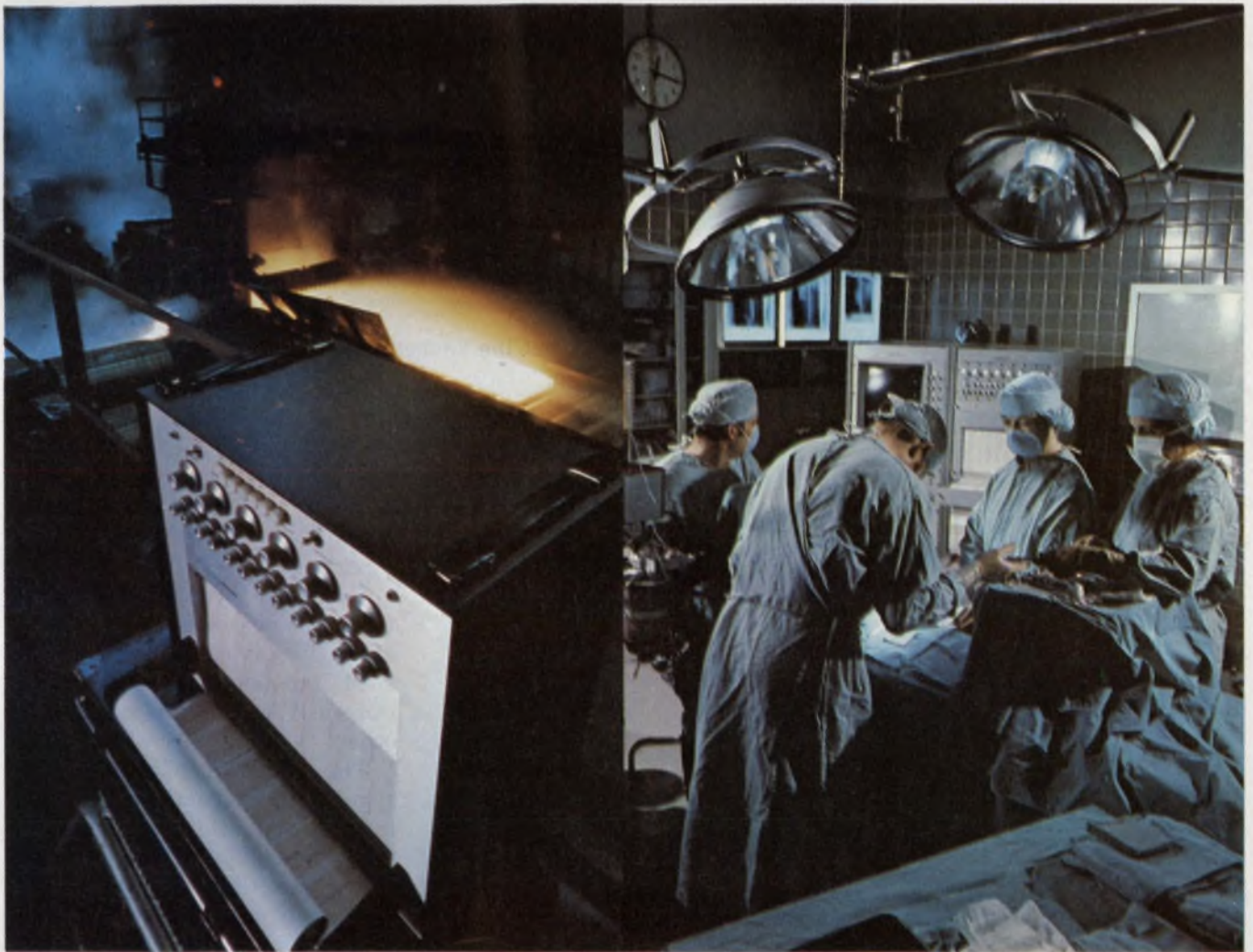

## When you need it.

When there are no second chances, you need us — for a measurement you must have reliability. Gould gives it to you in every recorder. Rugged structural components and

proven design. Pressurized fluid writing for consistent trace quality. Very little maintenance required. It's what you'd expect from the leader.

Let us show you how we've

cut the element of risk. Write Gould Inc., Instrument Systems Division, 3631 Perkins Ave., Cleveland, Ohio 44114. Or Gould Allco S.A., 57 rue St. Sauveur, 91160 Ballainvilliers, France.

**For brochure, call Gould toll-free at (800) 325-6400, Ext. 77.**  
In Missouri: (800) 342-6600

 **GOULD**  
The product development company

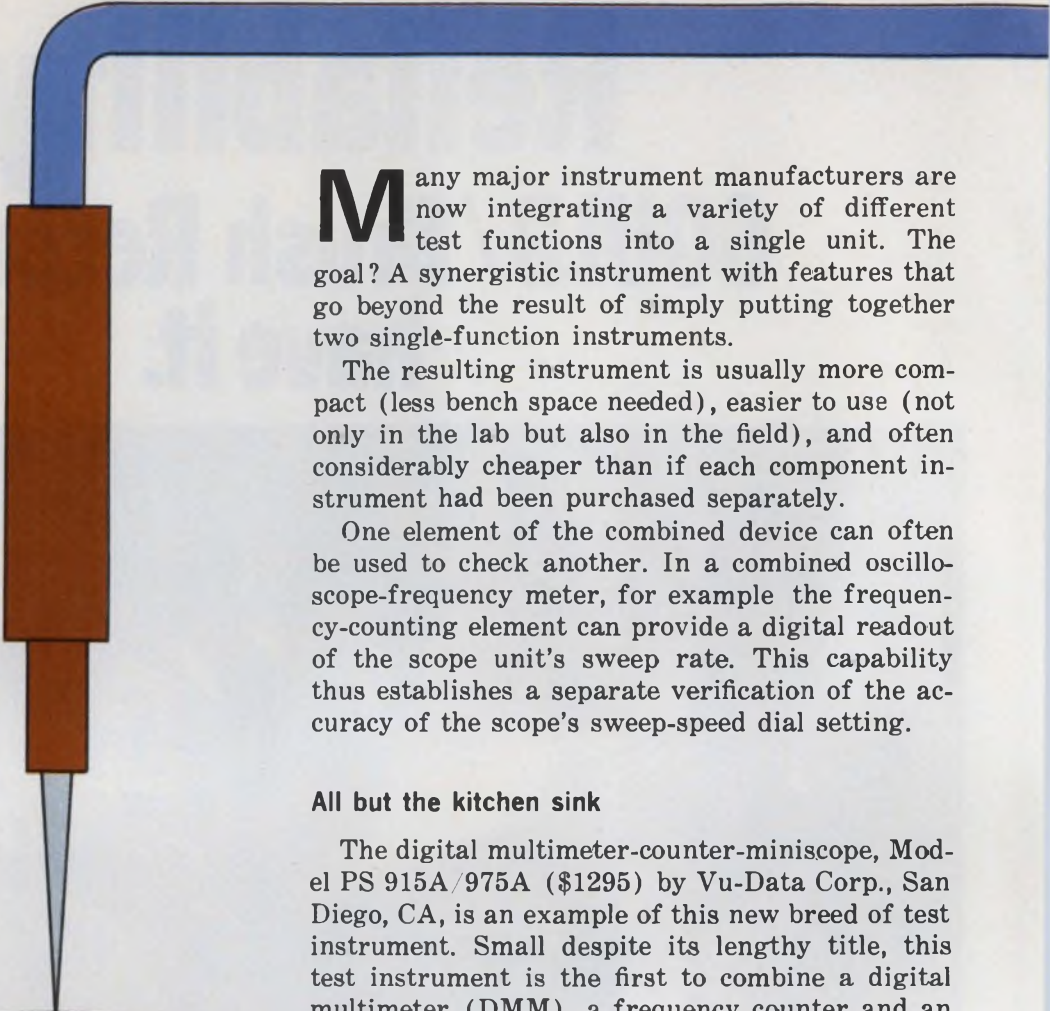

**M**any major instrument manufacturers are now integrating a variety of different test functions into a single unit. The goal? A synergistic instrument with features that go beyond the result of simply putting together two single-function instruments.

The resulting instrument is usually more compact (less bench space needed), easier to use (not only in the lab but also in the field), and often considerably cheaper than if each component instrument had been purchased separately.

One element of the combined device can often be used to check another. In a combined oscilloscope-frequency meter, for example the frequency-counting element can provide a digital readout of the scope unit's sweep rate. This capability thus establishes a separate verification of the accuracy of the scope's sweep-speed dial setting.

#### All but the kitchen sink

The digital multimeter-counter-miniscope, Model PS 915A/975A (\$1295) by Vu-Data Corp., San Diego, CA, is an example of this new breed of test instrument. Small despite its lengthy title, this test instrument is the first to combine a digital multimeter (DMM), a frequency counter and an oscilloscope in one package.

Each of these measurement functions possesses its own dedicated display, and each may be used independently or simultaneously, or to complement each other.

The PS 915A/975A provides synergistic convenience by connecting all three component units internally. Only a single probe (to the item tested) is needed to permit test measurements. This arrangement eliminates the often cumbersome external wiring interconnections required among the three instruments when used separately or even together.

Performing a conventional set of measurements on a power-supply circuit provides a good example of the convenience offered by such a combined instrument. The DMM portion can

**A combined instrument  
often provides  
capabilities that exceed  
the sum of its parts**

---

**Samuel Derman**  
Associate Editor



Measuring time intervals (to 1% accuracy), voltage, resistance, and even temperature (all digitally) is possible with the Tektronix DM 44 scope option.

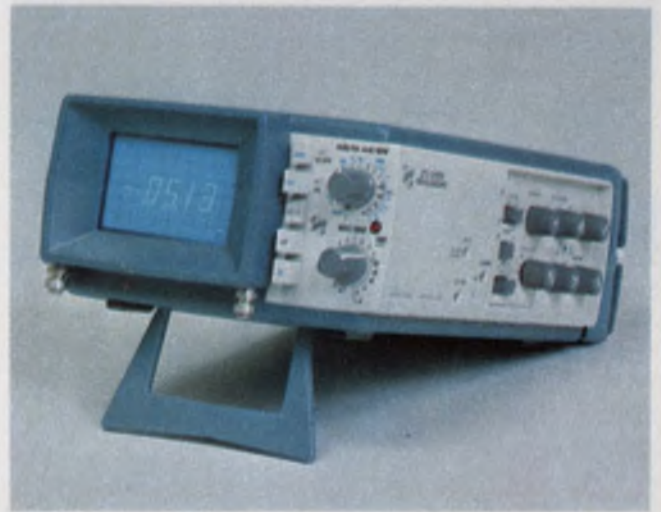

Tektronix Model 213, a combined DMM oscilloscope, weighs 3.7 lb. The 3-1/2-digit display appears on the CRT of the dc-to-1-MHz scope.

measure and display the dc level, while the ac ripple amplitude is displayed on the scope's CRT. At the same time, the ripple frequency is monitored and displayed digitally by the counter.

The Vu-Data PS 915A/975A is basically three instruments in one:

- An autoranging DMM, with its readings displayed on a 3-1/2-digit LED panel, measures ac and dc voltage as well as resistance.
- The scope, which carries its own model number, PS 915, provides vertical sensitivity of 10

mV per division at a 20-MHz bandwidth. Fastest sweep rate is 100 ns per division with the possibility of an increase to 20 ns per division by a five-times magnifier.

- The frequency counter, which is activated by the scope's trigger pulses, digitally presents the frequency of the signal displayed on the scope's CRT.

An "external-trigger" scope mode is also available, so that the frequency of the externally applied signal can be measured, whether this signal is displayed on the scope or not. A full four-digit LED display supplies the frequency readout.

In the "ac volts" mode, the device's DMM will give the RMS value of a sine wave appearing on the scope, so "eyeball" measurements of the peak-to-peak voltage amplitude, followed by the usual calculation to reduce this measurement to RMS value, are unnecessary.



A DMM, frequency counter and scope, all in one compact package, Vu-Data Corp.'s Model PS 915A/975A can be used on ac, dc, or battery.

### Compact capability

A serious competitor in the combined-instrument race is the Versatester by Systron-Donner Corp., Concord, CA. Designed not only for R&D work but also as a production and service test instrument, Versatester combines a multimeter, a signal generator and a frequency counter in a compact package. A single four-digit LED display with automatic decimal point supplies the readout for all component instruments.

Versatester offers a useful variety of devices and functions:

- 20-MHz frequency counter with autoranging.
- 20-MHz pulse generator.



Systron-Donner's Versatester generates pulse, square and sine waves from 20 Hz to 20 MHz. It also functions as a dc power supply and as a 4-digit multimeter.



Lab-All, manufactured by UFAD Corp., uses a precise filter to perform a wide variety of signal phase, spectrum and distortion analyses.

- 20-MHz square-wave generator.
- 20-MHz sine-wave generator.
- Dc-power supply (available voltages are +5 V,  $\pm 15$  V and  $\pm 30$  V).
- Multimeter (ac, dc and ohms) with a four-digit readout. In ac-voltage mode, voltages can be measured whose frequency is as high as 20 MHz.

Versatester's instruments all run continuously. For example, a sine-wave output is available simultaneously with pulse or square-wave output. Also, the multimeter modes can operate at the same time any one of the signal-generating modes is used.

The digital readout permits precise digital setting of sine-wave amplitude, upper and lower levels of the pulse and square-wave outputs, and power-supply output voltage to  $\pm 10$  V. Resolution in the dc-measurement mode is 0.1 mV and 0.1 mV RMS for ac.

The Versatester's synergism results in cost effectiveness, convenience, and portability. The cost is appreciably less than the sum of the costs of Versatester's individual components, says Norm Whitla, Systron-Donner's product manager. There are hidden savings too, Whitla adds. Fewer spare parts need be stocked, and only the one, basic instrument must be calibrated.

#### Pint-sized test package

Joining the race is a digital multimeter (DMM) and oscilloscope (\$1200) from Tektronix, Beaverton, OR.

Weighing in at 3.7 lb and occupying a space  $3.0 \times 5.2 \times 8.9$  inches, the Model 213 is small enough to be held in a hand, or carried in a briefcase or tool kit.

Unlike the Systron-Donner Versatester and the Vu-Data PS 915A/975A, which use LEDs for the digital display, the 213's numeric figures are projected directly on the CRT face (in 3-1/2-digit format). Although this arrangement does not permit the operator to view the waveform and read the voltage simultaneously, a single pushbutton switch permits instant changeover from one type of display to the other.

The DMM can measure voltage (dc and RMS ac), ohms and current. Measurable dc voltages range from 0.1 V to 1000 V, and measurable current from 0.1 mA to 1 A full-scale. Resolution of the DMM is specified as 100  $\mu$ V for voltage measurements and 100 nA for current readings. Frequency range of the 213's scope is from dc to 1 MHz. The scope can also display current waveforms, unlike most field scopes of this type.

A second multifunction test device from Tektronix, the DM 44, is not a complete piece of test gear, but an attachable module for the Tektronix 464, 465, 466, 475 and 475A portable oscilloscopes. This optional feature provides:

- 3-1/2-digit LED readout.
- Direct numerical readout (with 1% accuracy) of the time interval between two signals presented on the scope's CRT.
- Delta-delayed sweep for very fast time measurements (i.e., pulse width, rise time).
- Dc-voltage measurements with 0.1% accuracy.
- Resistance measurements with 0.25% accuracy.
- Temperature measurement from  $-55$  C to  $+150$  C.

Linking the DM 44 module to an oscilloscope produces a highly versatile piece of test equipment—one that can make precise timing measurements (1% accuracy) and can perform gen-

eral circuit troubleshooting. The DM 44 option adds \$410 to the price of the selected oscilloscope. The temperature probe can be omitted if not required, however, and the price drops to \$335.

### A DMM you can count on

For applications that require a frequency counter combined with the capabilities of a DMM, Valhalla Scientific Inc., San Diego, CA, has a 4-1/2-digit multimeter counter Model 4440.

For \$299 (plus an extra \$50 for the counter option), the purchaser gets several capabilities: dc and ac (RMS) voltage measurements from 200 mV to 1000 V, input impedance of 1000 megohms on the 200-mV and 2-V ranges and 10 megohms on all other ranges, current measurement (dc and ac) from 200  $\mu$ A to 2000 mA, resistance measurements from 200  $\Omega$  to 20 k $\Omega$ , and frequency counting from 2 kHz to 20 MHz, with accuracy of 0.01%  $\pm$  0.005% of full scale.

The frequency counter is actually usable 7 MHz beyond its 20 MHz limit for measuring citizens band (CB) signals, says Harold Clark, Valhalla's president. Above 20 MHz, the counter indicates "overflow," and the first significant digit of the readout is missing. However, since CB frequencies all fall into the 26 and 27-MHz range, the value "2" for the first digit is understood.

A variety of available options extends the capability of the Model 4440.

For data-communications measurements, the user can determine the time duration of the tone burst signal—a low frequency sine wave burst sent over telephone lines to indicate that a remote operator wishes to communicate with a computer. The duration of such signals must be precisely controlled, and in cases where dozens, even hundreds of telephone lines link up to a central computer, checking out these time intervals can be exceptionally tedious. The 4440's data-communication option speeds up this testing process.

Temperatures can be measured via an optional probe that generates a dc voltage of 1 mV/ $^{\circ}$ C. When the user switches the digital multimeter to the 200-mV range, the meter becomes a direct reading thermometer up to a maximum of 150 C. Temperature resolution is specified as 0.01 C, but over-all temperature accuracy is limited to 2 C.

A pulse generator/power supply package, the Logiklab 151 (\$79.50) from Integral Electronics Corp., Commack, NY, is designed to be both a lab-testing device and a teaching tool.

The power supply is highly regulated, short-circuit proof and capable of delivering 1 A at 5 V dc. The signal source in the astable mode



A combined frequency counter and DMM with 4-1/2-digit readout, Valhalla Scientific's Model 4440 measures voltages to 1000 V and frequencies up to 20 MHz.

simultaneously provides true and complementary TTL-compatible square waves and pulses ranging from 10 Hz to 100 kHz.

In the monostable mode, single pulses whose widths vary continuously from 5  $\mu$ s to 50 ms are produced by either a manual or remote trigger.

### Multimeter race is on

A tendency within the combined-instrument trend is to add temperature-measuring capability to the gamut of multimeter functions. Harold Clark, president of Valhalla Scientific, explains:

"Let's say a design engineer—one who typically uses a multimeter—has designed something that uses a power transistor. The power transistor gets hot, and the engineer needs to know just what the temperature rise is. That's a pretty universal need.

"Now he's not willing to go out and spend \$1000 on a temperature-measuring digital meter. So if you (the manufacturer) have a low-cost temperature-measuring option on your multimeter, the engineer will buy your product."

Philips Test and Measuring Instruments, Woodbury, NY, and Logical Technical Services (LTS) Corp., New York City are just two of a growing number of firms that currently offer a multimeter that can measure temperature.

Philips has two models available, the PM2513 and the PM2527. Using an LSI circuit, the 2513 multimeter functions with 26 ranges and a temperature-measuring option (-50 to 200 C)—all

within its 3-lb package. A 3-1/2-digit LED read-out provides the display.

Higher accuracy, autoranging, extended dc-voltage range, 4-1/2-digit display, and wide bandwidth on ac measurements (30 Hz to 100 kHz) come with Model 2527. This version not only can read surface temperatures between -60 and +200 C, but also can measure the surface temperature to 99% of final value within 10 seconds (See ED No. 11, May 24, 1976, p. 137).

A small hand-held DMM from LTS uses a semiconductor junction tip to provide tempera-



**Philips Model PM 2513 DMM** is also equipped to measure temperatures. Temperature range is -50 C to +200 C, with resolution to 0.1 C and accuracy of  $\pm 1$  degree.

ture-measuring capability. Autoranging and autopolarity also come with this Model 12T, which supplies readings via a 3-1/2-digit LED display. Accuracy for dc-voltage measurements is specified as 0.1%, and temperature-measurement range is -55 to +153.5 C.

Four AA-sized rechargeable NiCd batteries provide power for the 12T, which also has an ac adaptor/charger. (See "Portable Instruments: The Specs Are Fine, but Their Batteries Are Still Short-Lived," p. 60.)

### A new phase in measurements

A single low-cost (\$2495) instrument from UFAD Corp., Grand Rapids, MI, simultaneously measures phase shift, voltage gain, and network distortion.

Known as Lab-All, the device uses a filter to select a precise band of frequencies. The exact bandwidth can be set to customer's specifications anywhere from 0.01 to 3000 Hz.

Determining the frequency components of a complex signal is just one of the many functions this filter can perform. Not only can the filter's

center frequency be positioned manually anywhere in the band from 30 Hz to 100 kHz with a front-panel control, but the filter can also be caused to sweep through a range of frequencies—in the manner of a spectrum analyzer—by injecting an external sawtooth voltage.

Lab-All comes with the following:

- Tracking bandpass filter (constant area filter). Shape of bandpass is such that at 60 dB down, bandwidth is only twenty times the 3 dB bandwidth.

- Quadrature outputs. At the selected frequency, dc voltages proportional to both the sine and cosine components of the signal are available as separate outputs.

- Tracking notch filter.

- Sweep filter.

- Wave analyzer.

- Spectrum analyzer.

- Distortion analyzer. (The rejected frequencies are available as a separate output.)

In addition to its wide variety of general applications, the Lab-All has been used in many special situations, according to Tony Heibel, UFAD's vice president:

- "Nondestructive testing" of humans to determine the degree of hardening of the arteries. A broadband noise signal was applied to a portion of a human limb in an experiment conducted at Michigan State University. After the signal had passed through the subject's body, Lab-All examined its frequency spectrum. The researchers discovered, interestingly enough, that the blood flowing through arteries coated with fatty deposits affected the transmitted signal so that its frequency spectrum differed measurably from a similar signal passing through subjects with lower arterial deposits.

Lab-All was used because its precise narrow-band capabilities could pick out the frequency differences.

- Balancing rotating machinery, such as crankshafts. Lab-All can accurately determine the amount of unbalance by measuring frequency variations.

- Tracking signals buried in noise or measuring signal phase with the aid of a scope. Lab-All is such a precise tracker, Heibel points out, that it can track a signal as low (relatively) as the 101st harmonic of a square wave.

- Other applications include measurements of noise and doppler frequency shifts and speaker and microphone testing.

- A scope CRT overlay, calibrated in both amplitude and phase is provided. By varying Lab-All's frequency, a Nyquist plot is generated on the scope screen. ■■



# NOW AVAILABLE IN AMERICA TOO...

from the people who brought you the EMI-Scanner.

## SERIES 7000



### Portable Instrumentation Recorder

Designed to match laboratory-quality performance in a compact modular portable.

- Complete electronics for 14-channel record and reproduce...FM, DR, or PCM in any mix.
- Built-in, auto-switched calibrator...eliminates all external test gear.
- 8 standard speeds (15/16-120 ips)...up to 25 hours continuous recording time at 15/16 ips.
- Integral all-solid-state-switched filtration, equalization, and calibration at all 8 speeds...not a patch lead required.
- Up to 42-channel capability.
- Thousands of dollars less than comparable units.

CIRCLE NUMBER 295

## MODEL SE6150



### Ultra-Violet Oscillograph

Lowest price ever in a quality high-speed multi-channel oscillographic recording system.

- 12 channels...6 with built-in signal conditioning.
- Wide range of linear, servo-regulated chart speeds...0.008 to 40 inches/sec.
- Superior optical system...self-generates grids, timing/reference/event markers
- High writing speed...to 50,000 inches/sec.
- Economical and easy to operate.
- Extremely competitive pricing...in all capacities and modular combinations.

CIRCLE NUMBER 296

## MODEL SM215



### Programmable and Autoranging Transfer-Standard DVM

A true secondary transfer-standard instrument.

- 6½-digit display, with autopolarity.
- Stability: 2PPM (short term); 11PPM (3 months); 15PPM/year...all without any adjustment.
- Linearity: significantly better than 1PPM; Resolution: 1µV.
- High common-mode and noise rejection.
- Input Impedance: 100,000 MΩ; Input Current: 10pA.
- Unequaled performance and reliability.

CIRCLE NUMBER 297

## MODEL SM2001A



### High-Performance Transfer-Function Analyzer

Most convenient, economical, and versatile in its class.

- Frequency Range: 0.00001 to 999 Hz...optionally to 1 MHz.
- Digital display in Cartesian, Polar, and Log/Polar Modes (for Nyquist, Bode, or Nicholls plots).
- Integral harmonic analysis capability...measures system non-linearity.
- 0.1° Resolution.
- Unbelievably easy to use...can be readily operated by unskilled personnel.

CIRCLE NUMBER 298

## Why haven't you heard of these **EMI** instruments before?

Because they have never before been marketed in America. Throughout Western Europe they have established new standards of quality and performance in direct competition with the same instruments available to you in the U.S. They are typical of the superb-quality electronic devices which come from the EMI Group.

EMI Limited is a diversified billion-dollar multi-national company with more than four decades of achievement in a broad spectrum of high-technology research, development, and manufacturing. Its electronics activities range from airborne radar to computerized x-ray scanning, from color-TV cameras to laboratory instrumentation, and from data-processing to electronic security systems.

The revolutionary EMI-Scanner, acclaimed world-wide for computerized x-ray diagnosis of brain conditions and abnormalities in other parts of the human body, is just one of many examples of the creative talent and development skill that go into all EMI products.

The Instrumentation Division of **EMI TECHNOLOGY INC.**, a U.S.-based member of the EMI Limited Group, now brings selected EMI-developed data acquisition/measurement/analytical instrumentation to the U.S. market.

# EMI TECHNOLOGY INC.

P.O. Box 1264, Danbury, Connecticut 06810 (203) 744-3500 • TWX 710-456-3068

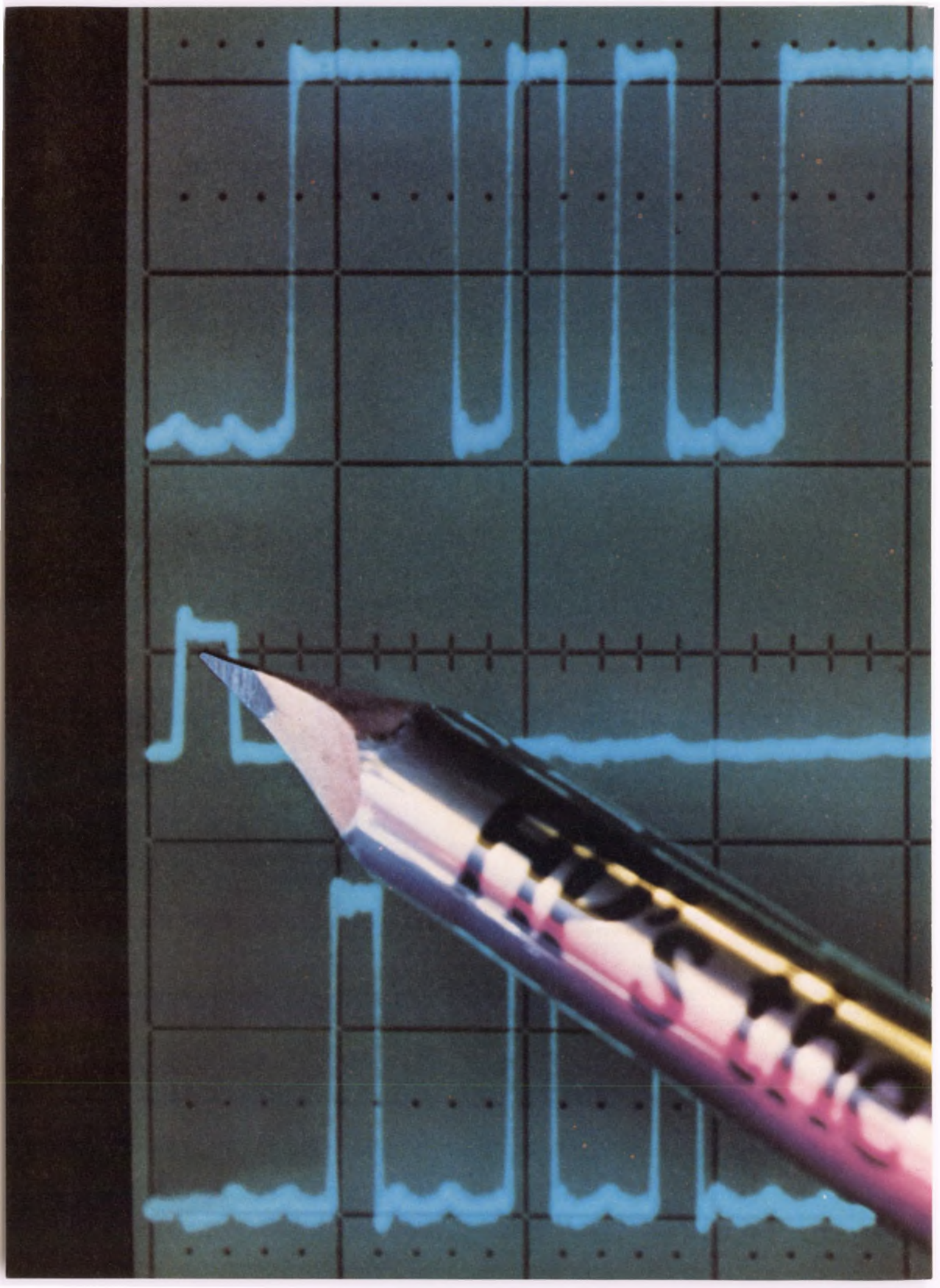



# When logic demands variable persistence, storage plus third channel trigger view...

## HP's the Answer.

HP's new 1741A variable persistence/storage scope, with 100 cm/ $\mu$ s writing speed, gives you the combination of features you need in a 100 MHz scope. Storage for studying single-shot events; variable persistence for clear viewing of glitches and low-duty-cycle traces; and third-channel trigger view for accurate trigger-to-event timing.

**Excellent variable persistence** means a bright, sharp trace you'd expect only on a non-storage scope. The result is a bright display of fast, low-duty-cycle repetitive signals.

**Auto erase/Auto store.** In Auto erase you adjust the number of displays per second up to 10 seconds. After that, it's all automatic, which means you simplify your set-up time and you eliminate smeared displays of digital data. It's a powerful tool for capturing those elusive glitches in data streams.

In Auto store, your 1741A is armed,

ready to trigger and store those random, single-shot events when they occur.

**Third-channel trigger view** lets you observe an external trigger signal simultaneously with Channel A and B traces. This gives you a simple way to make accurate timing measurements from the trigger signal to events on either or both channels. In most applications you can consider this to be a third channel. (The center horizontal graticule line is the internal and external trigger level point.)

For measurement convenience, the 1741A has a selectable 50 $\Omega$  input in addition to the standard 1 M $\Omega$  input. A 5X magnifier permits two channel measurements as low as 1 mV/div. to 30 MHz, without cascading. The 1741A is priced at \$3,950\*.

Call your local HP field engineer today for all the details.

\*Domestic U.S.A. price only.



HEWLETT  PACKARD

Sales and service from 172 offices in 65 countries.

1507 Page Mill Road, Palo Alto, California 94304

For assistance call Washington (301) 948-6370, Chicago (312) 677-0400,  
Atlanta (404) 434-4000, Los Angeles (213) 877-1282

088 11

CIRCLE NUMBER 49



**A**merican engineers and their European counterparts are both engaged in the same thing: designing. But they go at it in very different ways.

**The American engineer has a way of cost-thinking that the European doesn't. He has a better feeling for how much money he should put into the design of a new instrument.**

I know of one European company whose product planning meetings always started at the wrong end: They began with the customer's needs when they should have begun with his money. How much was the customer prepared to spend? How much performance and reliability could he get for this amount? How much resolution? How many functions?

The American engineer is a master of compromise and of doing things inexpensively. The color television set, for example, is a remarkably complicated machine that is produced very inexpensively.

Europeans haven't really learned compromise yet: they look first at performance. They get a block diagram and say, "let's design this instrument." Only later, after it is produced, do Europeans try to see how to make it cheaper.

The American engineer is much more adjusted to reality than the European. The European engineer wants to design the best in the world. The American engineer wants to design the most marketable.

European pride in design is overvalued and runs up the cost. Not only does this pride cause more performance to be designed into an instrument than the customer needs or wants to pay for, but it even stifles teamwork.

I recall once when two groups of engineers were designing synthesizers—each group was building "the best synthesizer in the world." Eventually, they became so competitive they wouldn't speak to each other. No one wanted to give any tips away to the opposing team. So

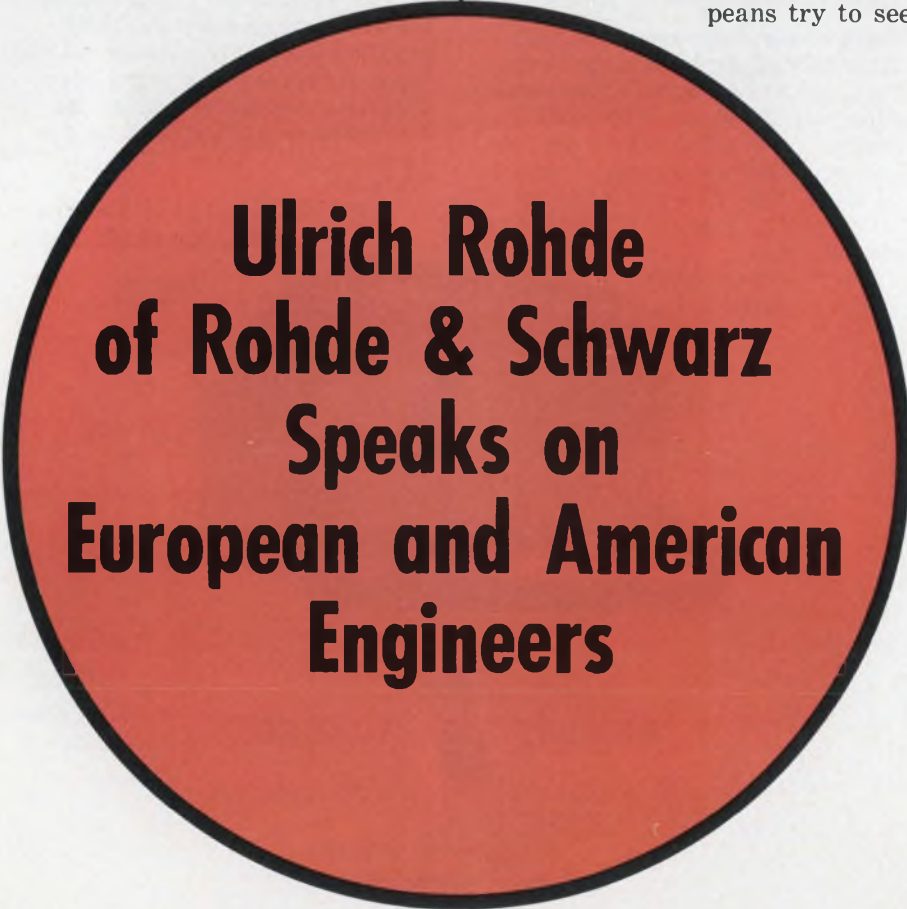

**Ulrich Rohde  
of Rohde & Schwarz  
Speaks on  
European and American  
Engineers**

---

**John F. Mason**  
Associate Editor



**Ulrich L. Rohde**, whose father is co-founder of Rohde & Schwarz, Munich, not only markets company products in

the United States, but also designs instrumentation to be built in the United States.

they ended up with two excellent synthesizers—both so expensive no one would ever be able to afford them. So they had to be redesigned.

In America, the two groups would have talked with each other—possibly at lunch or while playing baseball—and they would have turned out one synthesizer in half the time and at a much lower cost.

European engineers—and the Japanese, apparently—are brought up to think that to earn money, they have to spend years and years designing something that's never been equalled before. But by the time it is finished, the product is no longer needed or new. European engineers should settle on some in-between point of view that's less theoretical and more practical.

Another reason Europeans design instruments with high performance specs is that most European governments require them.

This "excellence" works to the Europeans' disadvantage when they try to sell in America.

Americans say, "You have a fantastic machine, but it does too much; we don't want to pay for what we're not going to use." For example, Rohde & Schwarz has an excellent signal generator used for blocking tests as required in Germany, but such stringent tests and specifications are not required here. Hewlett-Packard has a similar machine that does only what the FCC now requires and costs less than Rohde & Schwarz's. So how do we convince an American to pay more for something he doesn't need?

European manufacturers will probably adopt American practicality in the next five years or so, anyway, because of the increasing availability of information. Not only are the American journals like *ELECTRONIC DESIGN* well read in Europe, because so many European engineers learn English in school, but now there's more personal contact with Americans. With the devaluation of the dollar, Europeans can now afford to travel to the United States to attend symposia and trade fairs,

and visit U.S. government agencies and industries. The dollar was devalued in 1968. So, actually Europeans have only had eight years of this personal exposure to American ideas.

One thing I don't understand is how American engineers can buy an instrument that not only barely does the job, but becomes obsolete in a couple of years.

Europeans like to have instruments that go far beyond their needs. But I suppose the American engineer can't be blamed completely; it's the management point of view that prevails.

**The difference between the European and the American engineer begins in school. The American's education is more practical, the European's more theoretical.**

I'm sure the German engineer, fresh out of school, typically knows more mathematics than the American. He goes more deeply into things. I'd also bet that the European engineer in general knows much more, mathematically, about the circuit he designs, and why he did it that way, than the American.

I have talked with people who admire me for some particular detail I happen to know. But, actually, the detail has very little meaning; I just learned it in school because I had to. Anyone can memorize a lot of formulas and equations—and later forget them or not even need them.

The Japanese have a similar in-depth background. Look at any copy of *Proceedings of the IEEE* and you'll find that most of those articles that contain those almost unreadable mathematical descriptions are authored by Japanese.

After the first two years in a German engineering school, every student must take on a special project—usually a mathematical problem—that he must finish successfully in order to get his diploma. Here in America, the special project would be to build a product, not solve a mathematical problem. The result is that the American is much better prepared for his job than the European; indeed, he's about two years ahead of a German engineer. If a German engineer is hired right out of school, it usually takes about a year before he can be used.

Another way the American engineer and the European differ is in their motivation. The American wants excitement and glamour. He likes to move from one job to the other. And he wants to work where he can play golf or swim or whatever it is he likes.

The American is more extroverted than the German. He dresses better, and—this is a metaphor for his whole point of view—his house and

car are more flamboyant. He's more caught up in status than the German.

The European in general is more interested in job security, fringe benefits and retirement plans. He also wants to excel at his work and be recognized for his engineering skills and achievements.

American engineers differ *radically* from their European counterparts in their willingness to exchange information.

**Americans like to talk about what they're doing, while in Europe everything is a big secret.**

I have seen things at Hewlett-Packard, for example, that I would never see at a German company as a visitor.

Maybe Americans are more open because of pride—they like to show people what they've



"I'm here to learn how to sell European products in America, what changes in design and philosophy are needed to be successful here."

achieved. More likely, however, Americans realize—whereas Europeans don't—that most proprietary secrets don't mean very much. If Rohde & Schwarz, for example, learned all of American Company X's techniques for making better oscilloscopes, Company X would still make better oscilloscopes. It would probably have its own IC department, make its own CRTs, and would have evolved its own manufacturing procedures. However, I'm sure that Company X wouldn't find it so easy to produce military communications to compete with Rohde & Schwarz in Europe.

Communication is important because people are like wolves. They occasionally like to be by themselves, but they do best when they're together. If someone is isolated, he's either sick or in

trouble. Once when I was a development manager, I instituted weekly meetings where engineers could tell their colleagues what they were doing.

Are Americans good salesmen?

I used to meet American salesmen who had come to Germany to sell semiconductors or instruments. And I admired them tremendously. They had the courage to come to a foreign country where they couldn't speak the language. They had to rely on finding enough German engineers who spoke English to be able to function.

If these men didn't make a sale, however, it was usually because their company didn't back them up. The company couldn't assure its salesman that the component he was trying to sell would still be in production by the time the European customer needed it in large quantities. It has also happened that by the time the European company has finished a design, the desired component was no longer being produced, and we had to start over again.

American salesmen are even good in America, considering the red tape everyone must go through to sell to an American firm.

In Germany, a department head often needs about five internal signatures to buy instrumentation for his company. Here in the United States, I've seen companies that require 10 or 12. Any salesman who can get through all this red tape has to be admired.

European engineers also differ from Americans in their approach to writing specs; the Europeans are more conservative than aggressive. European engineers promise the very minimum a product can achieve so the customer who gets the one product out of a hundred that falls to that level won't be disappointed.

Americans, on the other hand, pride themselves on their "specsmanship." A clever sales force can put an instrument's best spec forward, so to speak. Or specs can be written in a way that's hard to interpret for all cases. Europeans haven't done this yet.

How do Europeans sell to the American market? That's what I'm here to find out.

Back in 1967, before the dollar was devalued, American instruments were expensive in Europe and European products were cheap in America. Rohde & Schwarz sold easily in America, but Europeans found it difficult to buy American products. I remember the HP spectrum analyzer—it was practically the only one being made, and it was unbelievably expensive.

Then the dollar went down, and American products were in great demand in Europe. They hadn't suddenly become better, just cheaper.

European-made products are more expensive to

## Who is Ulrich Rohde?

Ulrich L. Rohde is winding up his second year as president of Rohde & Schwarz Sales Co. (USA), which has offices in Fairfield, NJ, and a territory that covers the entire United States including Puerto Rico.

Besides marketing products manufactured by Rohde & Schwarz, Munich (Rohde's father, Dr. Lothar A. Rohde, is one of the company's founders), Rohde himself is also designing products for manufacture here in the United States.

Born in 1940, Rohde studied communications engineering at the technical universities of Munich and Darmstadt, and after working for other companies became head of the Research and Development Div. for Military Communications Equipment of AEG-Telefunken in Ulm, West Germany.

A Senior Member of the IEEE, Rohde has published more than 40 articles in the field of communication engineering. While still in school, he wrote a book on the behavior of transistors at very high and ultra-high frequencies.

"My father had always said that if you wanted to become an expert in a subject, write about it. I did and it was a great success; it sold 20,000 copies, which is a lot for a book published in German. But it didn't win me any friends at school. People thought I was presumptuous, I suppose, writing a technical book while still an undergraduate.

"How did I get from Munich to Fairfield, NJ? I'm here to learn how to sell European products in America, what changes in design and in philosophy you need to be successful here. Because once you are successful in America, you're successful worldwide."

produce than American-made products because, first of all, European labor is expensive—there are so many fringe benefits that Americans don't have. For one thing, it's almost impossible to fire a German engineer. Germany is probably the only country I know that has a strong engineer's union.

Also, some European products contain American-made high-technology components, which means the factory in Europe has had to wait to receive the shipment from the United States; it's no doubt had to hassle with customs, and it has had to deal with, and pay, distributors.

The solution is to produce a reliable product that's in demand and that's economically competitive, which rules out digital voltmeters and counters right away. I'd like to know how many people got burned making these devices. The

number of them being offered is unbelievable.

Rohde & Schwarz's latest really successful instrument is not an inexpensive, bread-and-butter product; it is the SMPU, a fully automatic, radio-telephone test set assembly.

Rohde & Schwarz is selling the SMPU for less than HP's comparable Bigfoot. Our SMPU is about \$45,000. We've sold to RCA and General Electric, which use them in the production of their communication equipment.

**How did we do it? It was very simple. We used a lot of things we already had available, and we put them all into one box, using only as much of a device as we needed and no more.**

We took the most significant assemblies of a digital voltmeter, an audio-distortion analyzer, a power meter—only those portions that we needed—and automatically, the SMPU became cheaper. Basically, we ended up with a computer-controlled magazine full of PC boards and one  $\mu$ P. The main cost was for the software.

Learning to produce more for less is the only way to compete. And we're learning. We have several more instruments in the works that we also feel will be successful.

Why did I go with the competition? I didn't go with my father's company for several good reasons.

I wanted to be on my own. I didn't want people to think that I was qualified by heritage alone. I knew I was a good design engineer, and I wanted to prove it. At Rohde & Schwarz, I knew I'd be handicapped in my day-to-day work by being the president's son. If you were my boss, for example, you'd feel a little funny knowing that my father was president. Also, I knew if you and I should reach a roadblock on a technical issue, and we went to my father, he'd side with you.

I thought it was better to gain experience by working in a company other than Rohde & Schwarz, Munich, which my father and Dr. Schwarz started in 1933.

My first contact with an outside company, however, would never have turned out well if I hadn't been able to deliver the goods—if I hadn't been a good designer at 19, when I was still in school.

One day, one of Telefunken's top engineers, Prof. Werner Nestel, came to our house for lunch and, noting my studied silence, asked me afterwards what was wrong. So I told him. After school, I had built an amateur radio receiver in the cellar of the house, and it had worked like a charm. But when my father came down to see it, he unfortunately grasped an uninsulated wire.

To teach me a lesson for my negligence, he locked the cellar door when we left, and I couldn't get back in.

Don't worry, the professor told me. He would do something. What? Get the key? No, he couldn't do that. But a few days later, I received a handful of transistors—the very first vhf/uhf transistors ever built in Germany. And with them I built an FM radio, probably one of the first in Germany. I sent it, and my thanks, to the professor, who in turn sent me his thanks and a check for the design. Telefunken then produced the radio.

After finishing my education and working for several small companies I was hired by Prof. Nestel at Telefunken as a design engineer and division manager.

Here in New Jersey, I'm a salesman. But I spend quite a few week-ends here in the office building synthesizers. One was for a microwave project. I have already sold the first piece.

Now I couldn't have done this at Rohde & Schwarz in Munich or at Telefunken. They're both too big. I'd have ended up with difficulties. And that's normal. There must be rules. Everyone can't go around doing whatever he likes. But I'm the boss here in this sales office and I can do what I like—on week-ends.

Do you know what I always wanted to do? I had good experience in Europe with big companies and I would really have liked to see how a big American company works from the inside. I'd like to have worked as vice-president of engineering for something like Hughes Aircraft, or another big company, where I could work with radio communications designers.

But now I enjoy promoting Rohde & Schwarz and other companies in the United States and have even organized some manufacturing here.

America spoils me. If I had the choice of going back or staying here, I think I'd be in trouble. I like it here, my wife does. We have a 15-month old daughter who has an American passport. I have a house here I couldn't have near Munich—there's not that much space near Munich. No one there has a one-acre lot.

I am able to keep in touch with my friends in Germany. I get up every morning at six and talk to them by my short-wave radio at home. It's their lunch time then. And would you believe that just outside of Fairfield, here in the woods of New Jersey, there's a very good little German restaurant? Good German beer, wurst, sauerbraten—whatever you like. Let's go! And when we come back, I'll give you some Leberkäse to take home; there's a good German butcher not far from here. ■■



# Powerhouse.

Dale makes more power wirewounds... E-Rel, precision, industrial, commercial... has more QPL's... more ways to meet your special housing and performance requirements... and just plain works harder to make sure you're satisfied.

*Here are four ways to prove it:*

- For Complete Cross Reference Guide, Circle 351
- For Comprehensive Wirewound Resistor Wall Chart, Circle 352
- For Guide to Non-Standard Wirewound Resistors, Circle 353
- Call 402-564-3131 for immediate information.

DALE ELECTRONICS, INC., 1300 28th Avenue, Columbus, Nebr. 68601  
In Canada: Dale Electronics Canada Ltd.  
In Europe: Dale Electronics GmbH, 8 Munchen 60, Falkweg 51, West Germany  
A subsidiary of The Lionel Corporation



*Our complete product line can be found in Electronic Design's GOLD BOOK.*



# nichicon

## We help keep your world turned on.

A great name in automobiles, CB's, stereos, electronic ignitions, digital clocks, gauge alert devices, testing equipment, burglar alarms, electronic fuel injections, engine sensors, intermittent wipers, wheel lock, cruise controls, traction controls, controls, light dimmers...

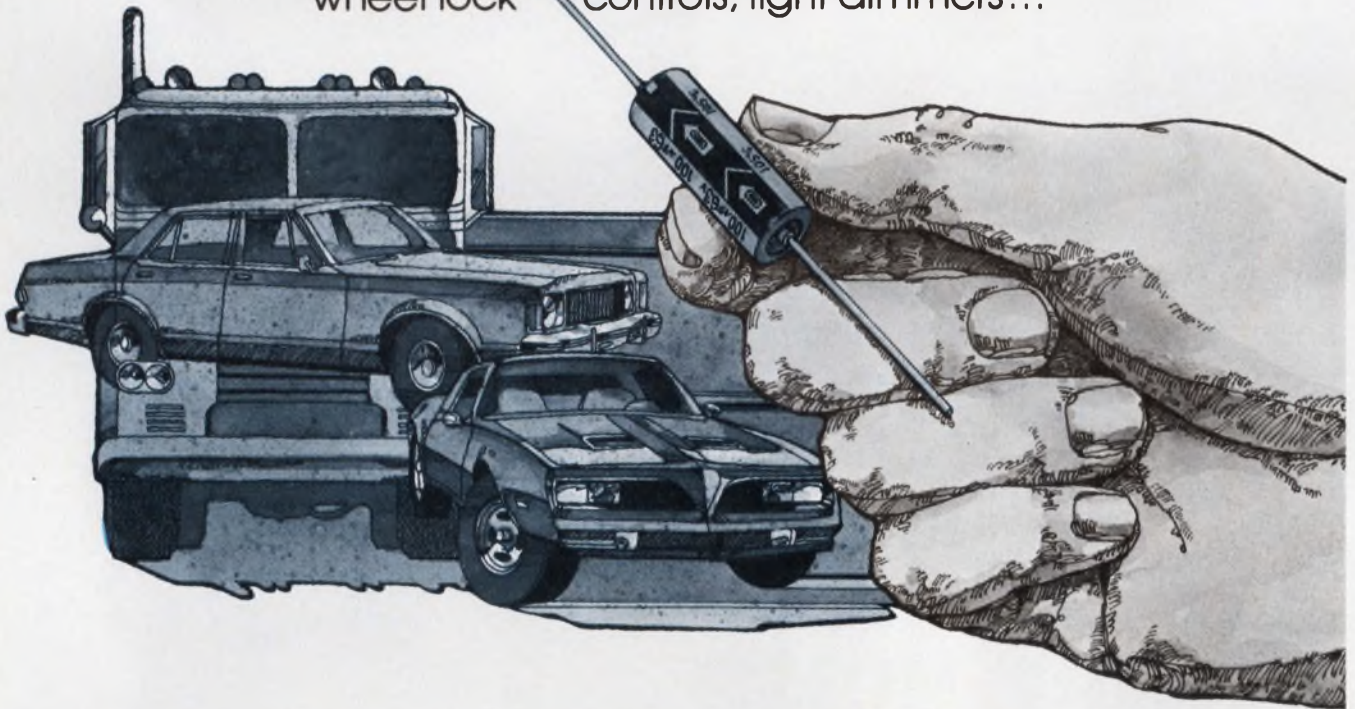

If you're in automotive related electronics, Nichicon (America) Corporation can offer you one of the broadest lines of highly reliable capacitors for mobile circuit applications . . . under the dash, under the hood, on the axle or in test equipment.

We can provide you with aluminum electrolytic capacitors, ceramic discs, polyester film and metalized polyester film capacitors, as well as mica capacitors at high reliability levels to meet automotive demands

. . . higher engine operating temperatures and on-the-road use.

In fact Nichicon's R-10 Series Aluminum Electrolytic Capacitors were specifically designed and tested for under-the-hood electronic applications calling for an extended temperature range

(-40°C thru 105°C), low impedance at low temperature, a tighter capacitance tolerance, an all-welded construction and improved electrolyte and end seal.

And remember, Nichicon also offers a wide choice of commercial grade capacitors. For complete specifications and free engineering samples, write to Nichicon (America) Corporation, 6435 N. Proesel, Chicago, IL. 60645, Phone (312) 679-6530, NICHICON LCWD Telex: 72-4374.



Nichicon (America) Corporation: 6435 N. Proesel • Chicago, IL 60645 • (312) 679-6530  
New York Branch: 40 Orville Dr. • Bohemia, N.Y. 11716 • (516) 567-2994  
Division NICHICON CAPACITOR LTD., Kyoto, Japan

CIRCLE NUMBER 51



# Just as you can count on water to freeze at 32° F,



## you can count on Synchron motors.

When you buy a motor for installation in your product, the last thing you want is a troublemaker. You want to install it and forget it.

Despite many similarities, all synchronous motors aren't the same. Not by a long shot. No matter what anyone may claim.

You can't judge performance and dependability by data sheets alone. Or by price. Or delivery. Or the flip of a coin. The big difference often is the brand name. And what's behind it. The integrity of the company that makes the motor. The expertise



of the designer and the people who put it together and test it.

We make Synchron motors as if our name were on your product. Total quality, total dependability. Designed right and built right, to do the job right. That's the only way we do business.

Call or write for our specification sheets and the name and location of our representative in your area.

Choose from five principal styles of Synchron motors—60 or 50 Hz—from one revolution per week to 900 rpm—from 8 thru 98 oz-in torque at 1 rpm—from hundreds of different outputs.

**MALLORY**



**HANSEN MANUFACTURING CO.**  
a division of P. R. MALLORY & CO. INC.  
Princeton, Indiana 47670

We make every Synchron motor as if our name were on your product

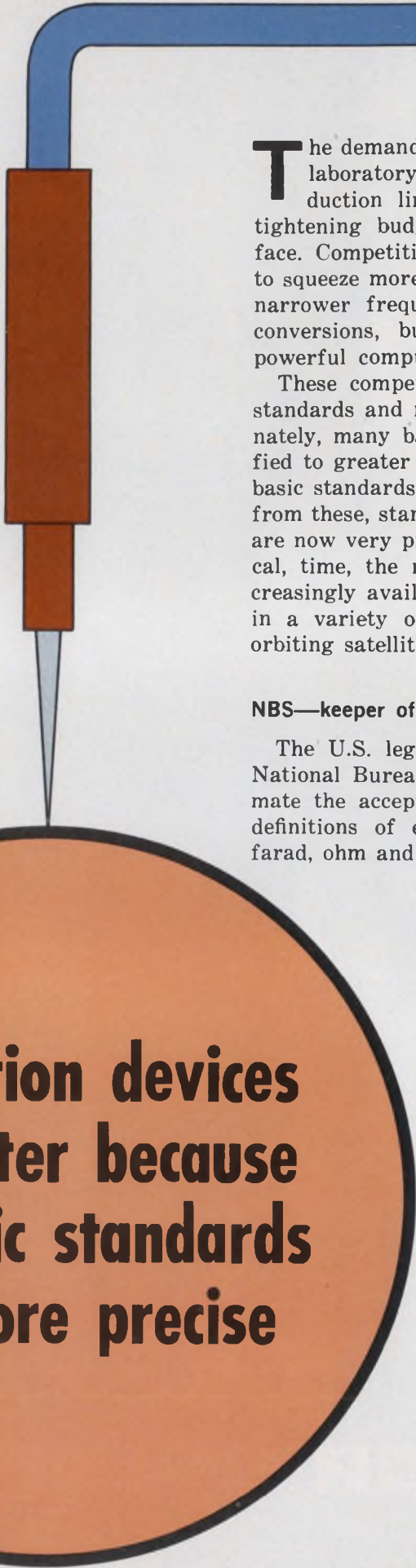

**T**he demand for ever greater precision in the laboratory, on the bench and on the production line continues in the face of the tightening budgets that design engineers must face. Competition is forcing engineers not only to squeeze more information capability onto ever narrower frequency bands and more bits into conversions, but also to interface with more powerful computers.

These competitive advances require improved standards and measuring equipment, and, fortunately, many basic standards can now be specified to greater accuracies than ever before. The basic standards for voltage and capacitance, and from these, standards for resistance and current, are now very precise. Frequency and its reciprocal, time, the most precise parameters, are increasingly available in standalone hardware and in a variety of existing broadcast or planned orbiting satellite distribution systems.

#### **NBS—keeper of the keys**

The U.S. legal standards, maintained by the National Bureau of Standards (NBS), approximate the accepted international (MKS system) definitions of electrical measuring units. Volt, farad, ohm and ampere standards are set by the Electricity Division of NBS in Gaithersburg, MD; the nation's master clock is the responsibility of the Time and Frequency Division in Boulder, CO. The standards are stringent: for electricity, NBS measures accuracy down to parts per million; for the master clock, accuracy is a matter of picoseconds.

NBS makes every effort to disseminate these extremely accurate values to industry; conversely, secondary (industrial) standards sent to NBS by its industrial customers are calibrated against its primary standards. Measurement Assurance Programs (MAPs) ensure that industrial total measurement processes are reliable. Time and frequency are distributed via VLF radio transmission and satellites.

**Calibration devices  
are better because  
the basic standards  
are more precise**

---

**Sid Adlerstein**  
Associate Editor



**Repeatable color performance from monitors** is obtained with Tektronix' J16 photometer. Any number of monitors corrected to a color temperature of 6500 K can be matched for color even at separate locations.

But how accurate are the values of the basic standards themselves? The entire measurement process depends on the precision of the NBS standard. Fortunately, some of the basic standards have recently been made extremely precise.

#### The volt is now more precise

Increased precision for the standard volt has been achieved by using the ac Josephson effect to calibrate the average value of the voltage standard itself, a bank of Weston cells. The ac Josephson junction is the most accurate voltage source ever, and its voltage, a series of steps, is known to a few parts in  $10^6$ .

The Josephson junction is a frequency-to-voltage converter in which, the tunnel junction of two superconductors—separated by a thin insulator, properly biased with dc current and irradiated with microwaves—produces a series of voltage steps proportional to the microwave frequency. Its proportionality constant depends on the values of the electron's charge and Planck's constant, and is known to better than one part in  $10^6$ .

As a standard, the Josephson reference has three advantages:



**Calibration skills are maintained** in the cassette library of Julie Research's Locost test system. Programs question the operator who responds via the keyboard.

- The junction itself is readily reproduced.
- The thin films are permanent structures that require no mechanical adjustments before calibration.
- The junction requires no cleaning or reconditioning.

There are drawbacks, however. The superconducting junction requires nearly absolute zero temperature; output voltage is only 5 mV per junction; and the process is time-consuming. NBS uses two junctions in series for 10-mV output, but the circuitry needed to scale the output up to the 1-V level at cryogenic temperatures is a source of error. Because calibration with the Josephson effect takes so long, even the NBS doesn't calibrate its standard cell bank more than once a month.

#### Capacitance is the most precise electrical unit

Currently, the most attainable electrical standard is the unit of capacitance, the farad. With the Thompson-Lampard capacitor as the basis for calibration, the U.S. legal farad standard is calibrated to 0.02 parts per million of the international definition.

The Thompson-Lampard is a variable-cross-type capacitor, with a grounded conductor rod passing through its center. Moving the rod between its extremes results in a 1/2-pF change in capacitance. This value is precisely calculable to less uncertainty than two parts in  $10^6$ , in terms of only one variable—the distance the rod is

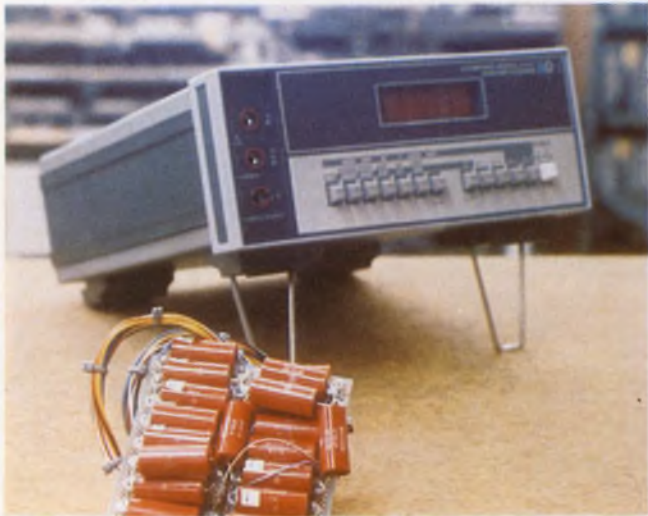

moved. This distance is measured on a stabilized laser interferometer built into the device.

The U.S. legal farad standard consists of a bank of five fused-silica dielectric capacitors, each with a value of 10 pF.

Resistance is calibrated to the capacitance standard. The equipment used to perform this calibration is so accurate that the U.S. legal ohm is less than 0.06 parts per million from the internationally defined ohm—despite the numerous calibration steps involved.

The precision to which the ohm and volt standards are known have limited the fluctuation in yet another standard—the ampere. An absolute determination of the ampere is carried out at NBS only once every ten years or so because the procedure is so cumbersome and inexact. A balance measures the force produced by current flowing in two conductors. But this method has as much as 15 parts-per-million error. The volt and ohm standards can be used to produce the ampere to an accuracy of 0.07 parts per million.

#### Frequency is the most precise standard

The most accurate standard available, frequency, is derived from the hydrogen maser. The hydrogen maser is capable of stabilities of 1 part in  $10^{14}$  for 100-s averaging and 2 parts in  $10^{15}$  for 1000-s averaging.

While they are ultra-precise, hydrogen masers are also expensive, large, heavy and sensitive to shock and vibration. But precision hydrogen masers have been made that have a diameter of only 19 in., a height of 30 in. and a weight of 80 lb. These have been applied in airborne-relativity experiments.

Since, for most applications, the maser's ulti-



**Tantalum nitride fine-line resistors** (right) provide long-term accuracy and temperature stability for HP's 3465A five-function bench or field DMM (left). Fine-line resistors and MOS ICs in its a/d converter give the unit a one-microvolt sensitivity for dc voltage.

rate precision is superfluous anyway, the less precise atomic-frequency standards, cesium and rubidium, are widely used in industry. Also, quartz-crystal standards are now available that offer surprising stability and spectral purity. The frequency stability is usually of the order  $10^{11}$  for rubidium standards and either  $10^{12}$  or  $10^{13}$  for cesium standards. On the other hand, quartz-crystal oscillations boast stabilities of  $10^{10}$  and even better.

In addition to atomic and crystal standards, precise frequency is available through WWVB, a VLF standard broadcast station run by NBS.

An alternative to WWVB for obtaining precise frequency is the use of a TV color sync-burst comparison. All four major TV networks (ABC, NBC, CBS and PBS) have extremely stable carrier frequencies. The frequency in their color bursts (3.58 MHz) is synchronized with atomic clocks.

The TV-color-sync-burst technique is accurate to 1 part in  $10^{11}$ . TV network time is offset from the rest of the world's agreed time (UTC time) by 3000 parts in  $10^{11}$ . Normal TV-network-broadcast signals are the NBS signal minus 3000 parts in  $10^{11}$ .

Two NBS stationary Geophysical Orbiting Earth Satellites (GOES) now broadcast to the earth and cover the North American continent.

#### Industrial low-frequency standards

Today, low-frequency electrical instrumentation offers the variety of a flea market. Streamlined and softly colored five-and-six-digit meters stand alongside the walnut and black of the older, more staid analog devices, while stable components, using new materials and processes re-



Accurate rms measurements at zero dBm and zero dB levels are provided by W & G's EPM-1 milliwatt test set. Probe circuitry prevents thermocouple burn-out.



Removable reference assembly simplifies calibration of dc functions and ohms in Hewlett-Packard's 3455A, a guarded integrating 5-1/2 or 6-1/2-digit multimeter.

place prosaic wire wound resistors. In the precision-instrument bazaar, a new generation of automatic equipment vies with the older, manual hardware. Nearly ultimate accuracy and lower, but cheaper, precision come in almost every instrument.

A reference that can maintain a unit of voltage with a 1-ppm precision at the one-volt level is now available from Superconducting Technology, Mountain View, CA. It consists of a Josephson junction with low-temperature Dewar, microwave and dc-bias junction sources, and a potentiometer.

In addition to its line of impedance standards and precision bridges, GenRad of Concord, MA, has introduced an inexpensive capacitance standard with 0.25% accuracy over seven range selections, from 1  $\mu$ F to 1 F. The GR 1417 costs \$775 and can be used as a standard for dissipation factor (D).

A fine-line process at Hewlett-Packard, Palo Alto, laser trims resistors on a sapphire substrate to ratios of 0.01%. The fine-line process was first used in HP's 3465 multimeter. Now, every DVM on the HP drawing boards uses the stable fine-line processed resistors whose values range from 5  $\Omega$  to 10 M $\Omega$ .

Automated standards are the trend at Ballantine Laboratories, Boonton, NJ. Ballantine's Model 1500A auto-balance ac-to-dc transfer standard, for measuring true rms-ac voltage, brings the precision of the standards lab to the calibration and manufacturing areas. Featuring 0.005% precision and calibration from 2 Hz to 30 MHz, this remotely programmable instrument reportedly can be used even beyond 100 MHz.



Seven ranges of capacitance from 1  $\mu$ F to 1 F can be selected with the GR 1417. The four-terminal standard also acts as a standard for dissipation factor.

The feeling at Electro Scientific Instruments, Portland OR, about measuring dc resistance in the ppm range is that the measuring instrument's long term stability is degraded when its size is reduced and its speed increased. Consequently, the calibration cycle must be shortened.

Architected systems for test and calibration are a major involvement at Julie Research Labs in New York. Its Locost line of automated precision test and calibration systems are controlled by master programs on cassettes. The software asks the operator a series of questions to which he replies via keyboard entries.

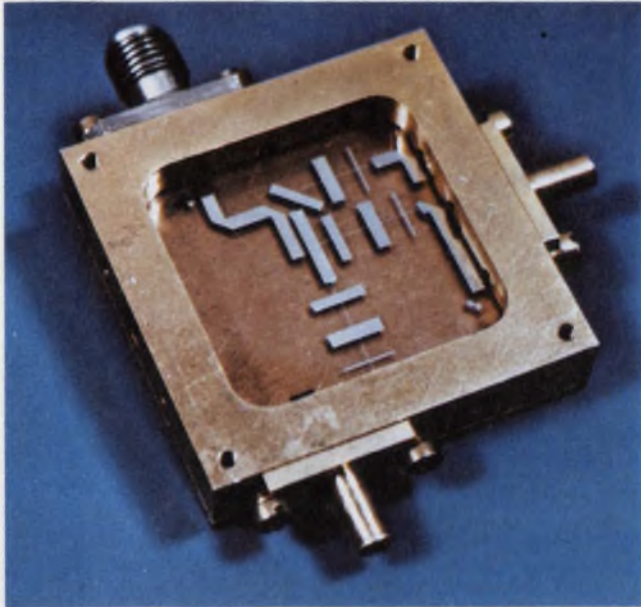

The world's most accurate voltage standard, the Josephson junction (left) is mounted in a microstrip enclosure for microwave irradiation while held at  $-77$  K or less. Capacitance is a distance function in the Thompson-Lampard variable cross capacitor (right).

Time bases for counters and local oscillators (LOs) for communication systems require precise frequency. Frequency counter time bases require frequency stability, while modulated-carrier communications devices are concerned primarily with having a phase noise (spectral purity) of low spectral density, especially near the carrier. This is especially true of digital systems where channels are spaced only 10 to 15 kHz apart; obviously, phase noise near the carrier is a crucial consideration when information is phase-modulated onto a carrier. And in the upcoming area of gigahertz timing, both phase noise and stability are important.

#### Frequency hardware is available

Fortunately, industrial frequency sources abound. New component quartz-crystal oscillators from Austron of Austin, TX claim a phase noise of  $-110$  dB at 1-Hz deviation  $-155$  dB at 10 Hz and  $-180$  dB at and beyond 1 kHz.

For Austron's 2010B Disciplined Frequency Standard, stability of a few parts in  $10^{13}$  per day is maintained for several months by the instrument's third-order servo loop. The unit's quartz oscillator is corrected from an input, say a cesium-beam standard or a Loran-C signal. The device then "learns" its frequency offset and aging rate and constantly corrects itself.

Hewlett-Packard's quartz oscillators emphasize long-term stability rather than spectral purity.

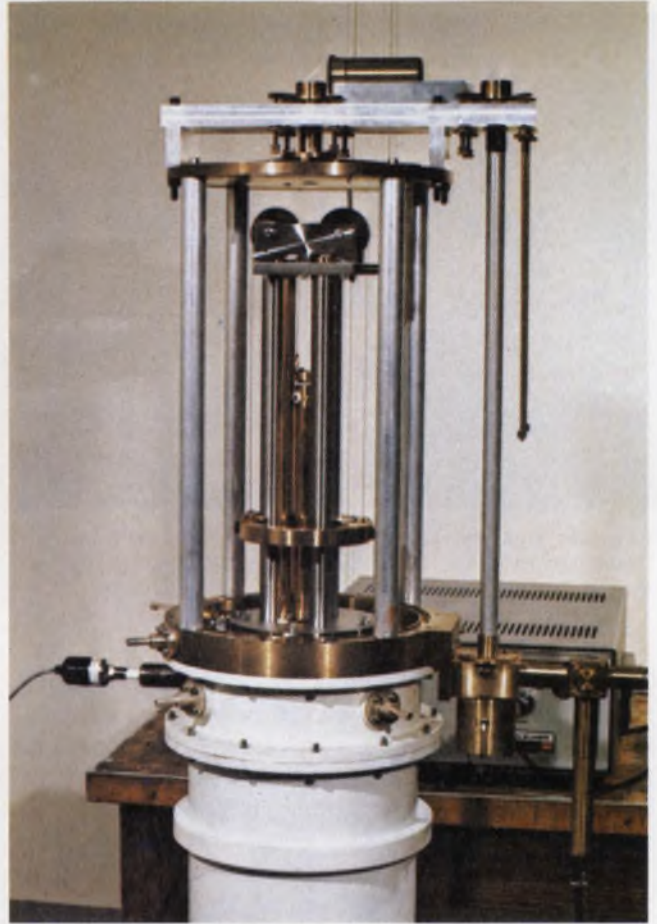

HP's 10544A instrument is intended for use in communications systems as a counter's time base rather than a LO. The unit has a long term stability of 5 parts in  $10^{10}$  per day. However, the 10544A has pretty respectable phase noise characteristics— $-83$  dB at 1 Hz to  $-145$  dB at 1 kHz.

The  $-145$  dB noise floor is partly the fault of the unit's switching regulator. At the beginning of 1977, HP's 10544B quartz oscillator will be available. This new instrument will have its internal dc generated by a linear regulator, and the noise floor for the unit will be lowered to  $-150$  dB at and beyond 1 kHz from the carrier.

Arbiter Systems of Goleta CA, markets a Model 1011B frequency comparator for under \$3000, which compares a unit under test to the standard TV broadcast color burst. The comparator requires eight cycles of the 3.58-MHz color burst to phase-lock. No warm-ups or adjustments are needed, and like any phase locked system, the uncertainty (error) is reduced by increasing the sampling time (averaging). However, averaging times with this system are in seconds rather than days, as with VLF systems. For example: a frequency may be tested to an accuracy ( $\pm 1/2$  LSB) of  $10^3$  in 1 s or up to  $10^{11}$  in 1000 s. ■■

# a new generation oscilloscope

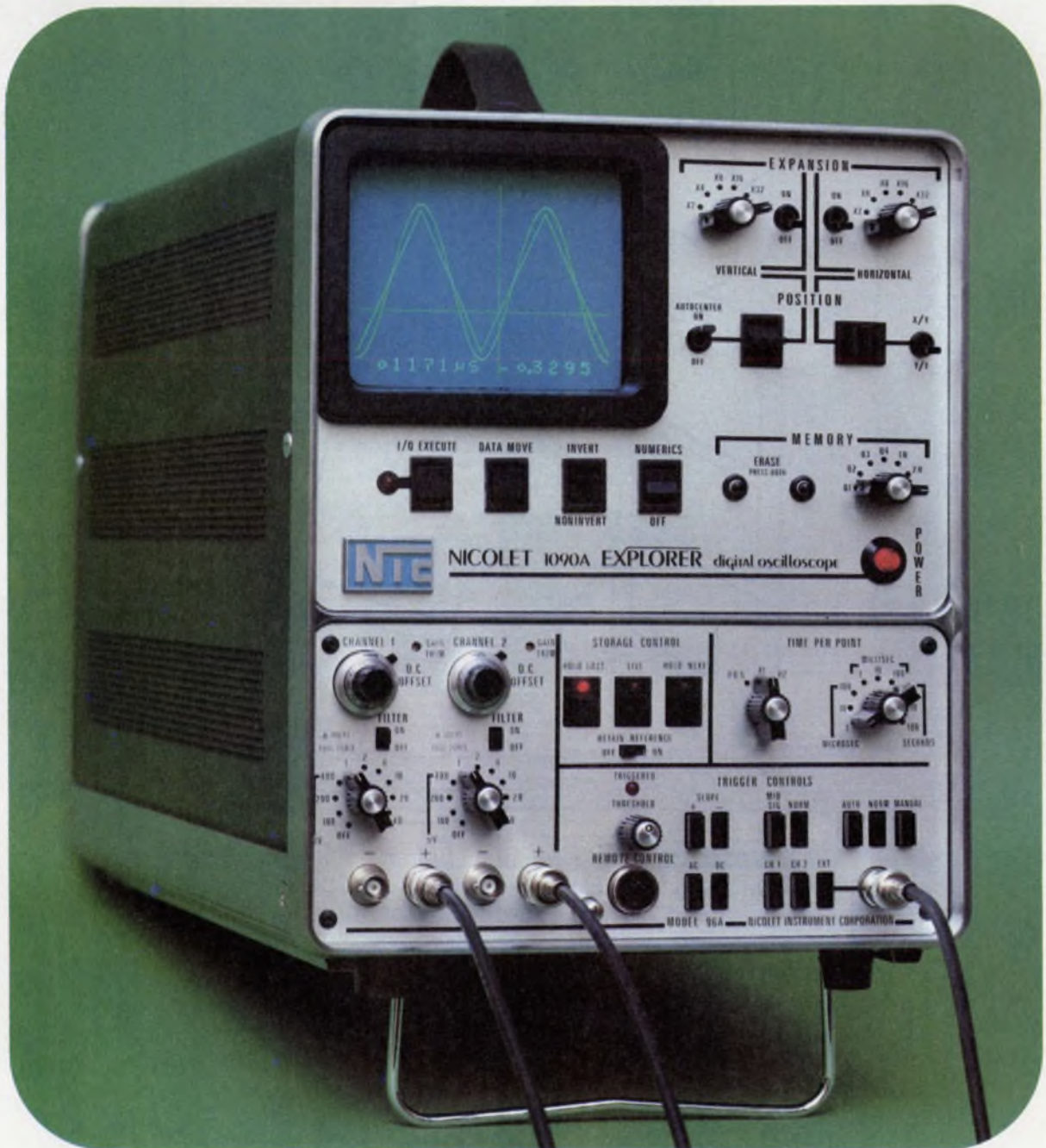

## HAVE YOU EVER NEEDED STORAGE 'SCOPE RESOLUTION THAT JUST WASN'T THERE?



In a storage 'scope you need better, not lower resolution, because what you capture will be all you'll ever see if the signal occurs just once.

Nicolet's general purpose storage oscilloscope provides 20 times better resolution than the next best storage 'scope. And you don't need binoculars or a microscope. You can electronically zoom in on any detail of interest. Quickly and easily, whether the signal is stored or live.



## Hide a Waveform???

Some storage oscilloscopes can hold a trace, without fading, for so long a time that the instrument specifications merely say "holds until erased".

This is true of Nicolet's storage oscilloscope, **EXPLORER**. And a fine additional feature is that you can cause the stored information to be hidden away, out of sight, until you want to see it again. This means that you can use the **EXPLORER** for normal operations in the meantime. It isn't tied up by the holding process. You can tuck away several waveforms, out of sight. And can recall any of these, or all of them at once superimposed, for examination and comparisons. A minute, an hour, days, or weeks later.



## Write-through Storage!

If you want to see the effects of small changes while they are occurring in a circuit system, it's great to be able to store the original waveform and continue to see live, ongoing signal waveforms superimposed on the original waveform.

Especially in the case of the **EXPLORER**, which allows up to 64X expansion of corresponding regions of both the stored and live waveforms. Changes of as little as 0.02% can be clearly seen and there's no limit to the length of time this can be continued. The stored signal doesn't degrade in the least.

## What's Automatic Persistence?

Variable persistence storage oscilloscopes are useful for observing signals that don't occur often. The persistence time can be adjusted so that the trace fades by the time the next signal is expected.

Automatic persistence is better. The trace remains, without fading, right up to the time the next signal occurs. It doesn't matter how long or short the interval between signals, and no adjustments are needed. Nicolet's **EXPLORER** oscilloscope has automatic persistence.

**NIc** NICOLET  
INSTRUMENT  
CORPORATION

## Simple Signal Capture!

To capture a signal with the **EXPLORER** just press a "hold" button. To return to live action, press the "live" button.

There's no mode switching, no enhancement, no beam adjustment, no erase step and no sweep arming. The **EXPLORER** is much quicker and much easier to use.

To speed up reaction time, use a remote sensor to choose the interesting signal. It can decide before, during or after. That's important because sometimes neither you nor the sensor know that the signal should be held until the signal has started or ended.



## Store a Week-Long Signal!

Storage oscilloscopes are handy for observing very slow signals. Sweep times as long as a minute, in a non-storage scope, result in a display that's not much more than a slowly moving dot. But a storage scope generates a clear trace representing the signal waveform, which is much better.

For longer sweep times you'd better borrow a pen recorder. Or use Nicolet's storage oscilloscope which has sweep times that range from microseconds to days.

Even if very slow signals are not your immediate interest, it's handy (fun, in fact) to record overnight or over-weekend changes in such variables as temperature or line voltage. With high accuracy and better resolution than a high precision pen recorder.

These are half a dozen significant new capabilities of the **EXPLORER**. There are half a dozen more, and a few more of less importance.

Hundreds of pleased **EXPLORER** users find them easy and natural to operate. In the words of one, "Anyone who has ever actually used an **EXPLORER** in his work will never want to go back (to the older 'scopes) again." Evaluated by one of the nation's largest laboratories, "An excellent oscilloscope — providing significant advantages."

**EXPLORER** is a low frequency, general purpose oscilloscope. Bandwidth, 1, 2 or 5 MHz depending on plug-in.

The **EXPLORER** is pictured here with the Model 96A plug-in for two-input, 1 MHz applications.

To discuss details, order a brochure, or arrange a demonstration please contact Applications Engineer John Gericke.

**NTC** NICOLET  
INSTRUMENT  
CORPORATION

5225 Verona Road • Madison, Wisconsin 53711 • Telephone: 608/271-3333

CIRCLE NUMBER 56

## New! Bi-polarity Silicon Transient Suppressors!

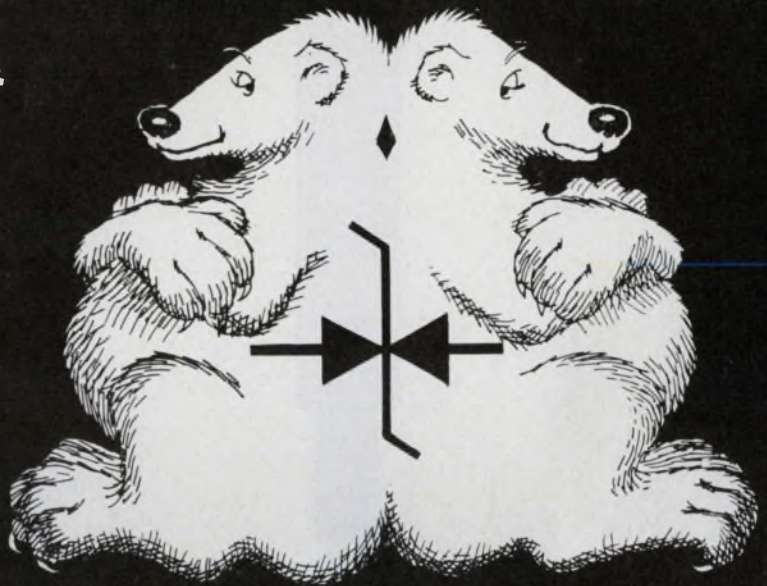
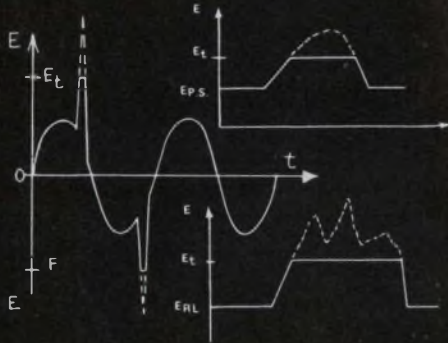

**LOWEST DYNAMIC IMPEDANCE!**

Can be supplied as JAN, JANTX or JANTXV  
to MIL-S-19500/516 (EL)

This new series of silicon bi-polarity transient suppressors is unique in that a single device will provide voltage transient protection symmetrically (i.e., provide protection for A.C. signals in addition to D.C.). This new series of devices has peak pulse power ratings of 500 to 1500 watts for 1 millisecond and its response time is effectively instantaneous (less than  $1 \times 10^{-12}$  sec.). Therefore, these versatile devices have many protection applications where large voltage transients can permanently damage voltage-sensitive components. The devices are encased in Semtech's Metoxilite, fused directly to the high temperature metallurgically bonded assembly. For use in commercial, industrial, military and space programs.

### 500 Watt

Peak Pulse Power

Types: IN6102 through IN6137

Break down Voltage V(BR):

From 6.8 to 200Vdc  $\pm 10\%$

Peak Surge Voltage (Vsm): 11.0 to 286.0V

Peak Surge Current (Ism): 45.4 to 1.7A

Temperature Coefficient of V(BR): .05 to .11%/°C

Case Size (Max.): 140" D x 165" L

### 1500 Watt

Peak Pulse Power

Types: 1N6138 through 1N6173

Breakdown Voltage V(BR):

From 6.8 to 200Vdc  $\pm 10\%$

Peak Surge Voltage (Vsm): 11.0 to 286.0V

Peak Surge Current (Ism): 136.4 to 5.2A

Temperature Coefficient of V(BR): .05 to .11%/°C

Case Size (Max.): 180" D x 165" L

☆☆☆☆☆☆☆☆☆☆

### 4-LAYER DIODE IN METOXILITE!

Reduce circuit costs and increase reliability!

Semtech's 4 Layer Diode (PNPN) is a silicon switch that is controlled by the amount of voltage applied. The application of this diode to a circuit often reduces the number of associated components which in turn, leads to cost reduction and increased reliability. Now available in Semtech's proven Metoxilite construction as two terminal, fast-switching devices specifically designed for low voltage applications such as logic circuits, pulse generators, memory and relay drivers, relay replacements, alarm circuits, multivibrators, ring counters, and telephone switching circuits.

Types: 1N5779 thru 93, 1N5158 thru 60

Switching Voltage: 10 to 15V

Switching Speeds: t(on) = 75ns, t(off) = 250ns.

Junction Capacitance: 150pF

Case Size (Max.): .070" D x .165" L

1975 NATIONAL SBA SUBCONTRACTOR OF THE YEAR



**SEMTECH  
CORPORATION**

652 Mitchell Road, Newbury Park, California 91320  
(805) 498-2111 • (213) 628-5392 • TWX 910-336-1264

CHICAGO (312) 352-3227 • DALLAS (214) 387-3551  
FLORIDA (305) 644-5404 • MARYLAND (301) 424-6663  
NEW JERSEY (201) 654-4884 • SAN FRANCISCO (415) 494-0113  
EUROPEAN SALES: Bouvris AG Zug, Switzerland (042) 232-242

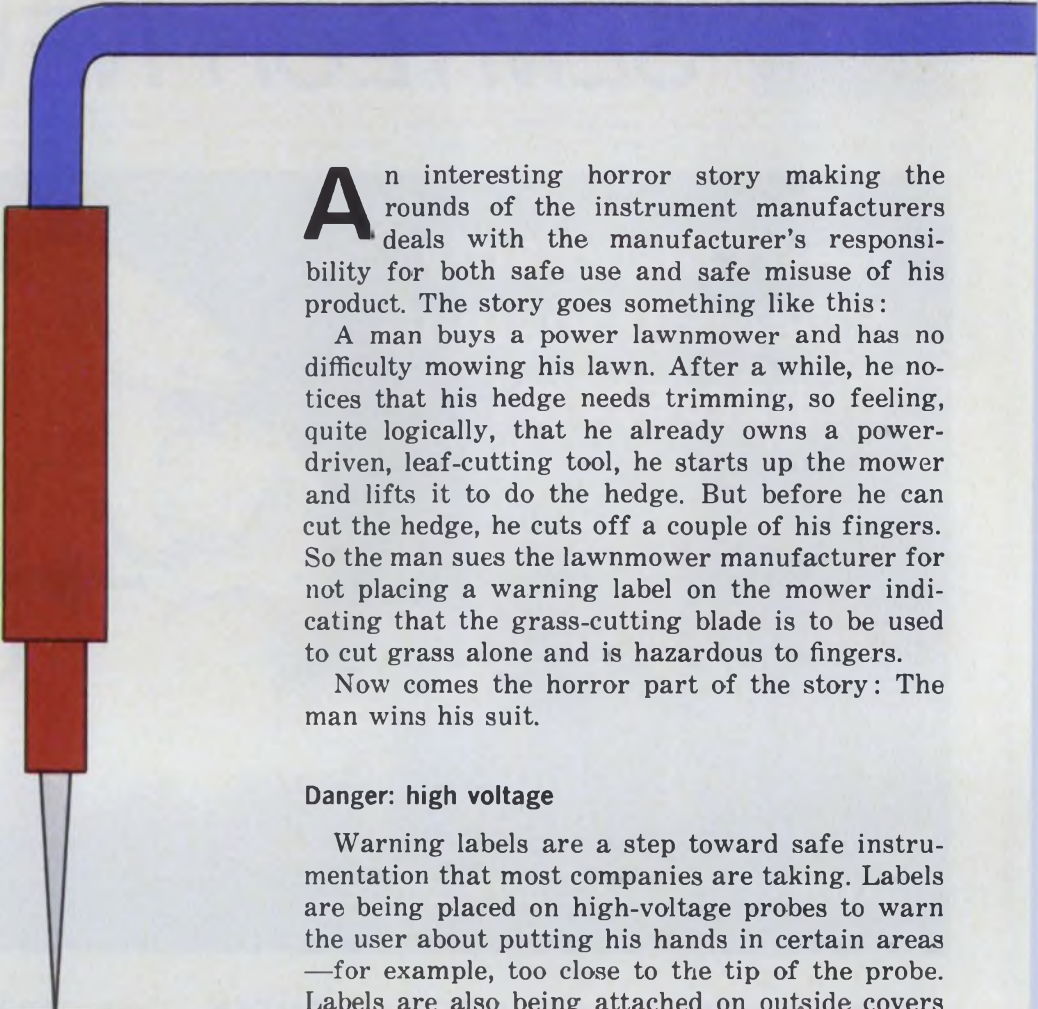

**A**n interesting horror story making the rounds of the instrument manufacturers deals with the manufacturer's responsibility for both safe use and safe misuse of his product. The story goes something like this:

A man buys a power lawnmower and has no difficulty mowing his lawn. After a while, he notices that his hedge needs trimming, so feeling, quite logically, that he already owns a power-driven, leaf-cutting tool, he starts up the mower and lifts it to do the hedge. But before he can cut the hedge, he cuts off a couple of his fingers. So the man sues the lawnmower manufacturer for not placing a warning label on the mower indicating that the grass-cutting blade is to be used to cut grass alone and is hazardous to fingers.

Now comes the horror part of the story: The man wins his suit.

#### **Danger: high voltage**

Warning labels are a step toward safe instrumentation that most companies are taking. Labels are being placed on high-voltage probes to warn the user about putting his hands in certain areas—for example, too close to the tip of the probe. Labels are also being attached on outside covers of high-voltage instruments, and internal cages that cordon off the specific high-voltage sections.

A red lightning-bolt design is becoming standard on front panels of instruments with high-voltage connectors. Some companies are even using the lightning bolt where lethal voltages may appear—for example, on voltmeter-input connectors. Here, the instrument doesn't generate high voltage on its input, but the input terminals become "hot" when high voltages are measured.

Liberal warnings can now be found within the text of specific measurement or calibration procedures outlined in instruction manuals. To make their point, these warnings are often printed or outlined in red and set off from the rest of the text.

Some companies have even

**Instruments designed  
with safety in mind  
may be hazardous  
to your health**

---

**Jim Gold**  
Western Editor



A lighted warning label that tells the user to be careful of high voltages is a new safety feature that is starting

to appear on instruments such as this precision power amplifier from Fluke.

gone to the extreme of putting lighted warning labels on their equipment. For example, an automated test system developed by John Fluke, Mountlake Terrace, WA, is capable of performing preprogrammed tests on many pieces of equipment. A good number of these tests have potentially lethal voltages crossing between the automatic tester and the tested device. The interface between them is a transition panel with a lightning-bolt label that lights up when the programmed test involves dangerous voltages.

Illuminated warning labels are especially useful when an instrument is meant to be used by someone unfamiliar with high voltage and its effects. But what about those who are supposedly familiar with high voltage—the engineers and technicians who deal with it every working day? Has anyone not been zapped by a “familiar” piece of equipment at one time or another?

Familiar with the moral of the story of the man and his lawnmower, most instrument manufacturers provide safety interlocks on their equip-

ment that are designed to protect the user. Many even go to the extent of incorporating double interlocking switches in situations where lethal high voltage exists.

#### Double interlocks maintain integrity

Double interlocks are used to guard against the failure of any single interlock switch to maintain the integrity of the protective interlock system.

Clear plexiglas shields are commonly employed with the interlocks over internal portions of the instrument where high voltages may be present. Besides permitting the area to be inspected and the curiosity of the purchasing engineer to be satisfied, the shield prevents access to the high-voltage area.

The exacting requirements of the medical electronics industry have led to the production of clear plastic, ac-line-cord plugs. The visibility of all connections from the insulated line cord to the

metal prongs of the plug helps ensure that the cord wires are connected to the proper prongs.

The instrument manufacturer's concern for safety has expanded to include his own safety devices. Fuses, which are included in equipment design for safety, are now being analyzed themselves by cautious instrument manufacturers. Fuse holders are being incorporated into equipment as an integrated fuse-hold-and-line-cord-receptacle combination that sometimes includes a cover-interlock switch for the instrument. This combined fuse holder and line-cord receptacle is outfitted with its own fuse cover, which prevents contact with the fuses while the equipment is plugged in. The cover slides over the receptacle in which the fuse is located. This ensures that the power is physically disconnected from the instrument.

Since the fuse cover is generally clear plastic, the fuses may be observed while the equipment is in operation to check for any burn-outs.

Similarly, when an old-style, black-bakelite, panel-mounted fuse holder is used in an instrument, the power (hot) line of the fused circuit is generally connected to the rear (tail) of the fuse rather than the front (head). So the fuse clamped into the holder by its head can be removed by unscrewing the front of the fuse holder and avoiding any directly exposed line voltage. The hot line is deep inside a hole in the fuseholder and can only be reached by touching the bottom of this hole with a probe whose diameter is limited to a quarter of an inch.

### Proper grounding a must

Properly grounding all exposed metal parts on the outside of an instrument is essential to the safety of operating personnel. Standard practice requires that a solid connection be established between all exposed metal parts and the ground wire in a three-wire ac line cord. In fact, one proposed international specification requires that all exposed metal parts on an instrument measure not more than one ohm to the ground pin on the ac line plug.

Instrument power-line switches are also being scrutinized by safety engineers. Double-pole-single-throw switches that break both the hot and neutral sides of the power line are replacing the old single-pole-single-throw ac line switches to assure complete isolation from the power line when the equipment is switched off. Only the ground connection is left intact. The neutral side of the power line is not at ground potential in many cases, and allowing "power-off" adjustment of switched-off equipment with a portion of the

instrument's circuitry at other than ground is a risk many instrument manufacturers are choosing not to take.

### Volt-ohmmeter goes boom

Volt-ohmmeters are particularly suited to misuse and potential failure. Since they generally have multiple ranges and sensitivities, they can be easily connected to large voltages even while set improperly. This usually happens while attempting to measure voltages with the meter set to measure either resistance or current.

Traditionally, ohmmeter manufacturers have protected their products by building them to withstand up to 30 V on the input when inadvertently connected to a live circuit, then have



Double insulated cases make battery operated instruments safer. Used in instruments such as this dual trace scope from Philips, the double insulation permits the user to float the instrument so that signals riding on high voltages can be displayed.

relied on a fuse to save the meter above 30 V. Now ohmmeters are equipped with semiconductor protection circuits that enable them to withstand a guaranteed 250-V application, on the theory that the meters should not be harmed when connected to the ac power line accidentally.

However, as illustrated by the case of a man measuring voltages with a volt-ohmmeter held between his knees, meter manufacturers have more to worry about than protecting their own products. The man had the range switch set for current, and as he probed a power line, the volt-ohmmeter exploded. Fortunately, the man was not injured, and the volt-ohmmeter manufacturer learned the same lesson as the lawnmower manufacturer, but at a much cheaper cost.

But attempts to solve safety problems must be considered for their own safety value. The acci-

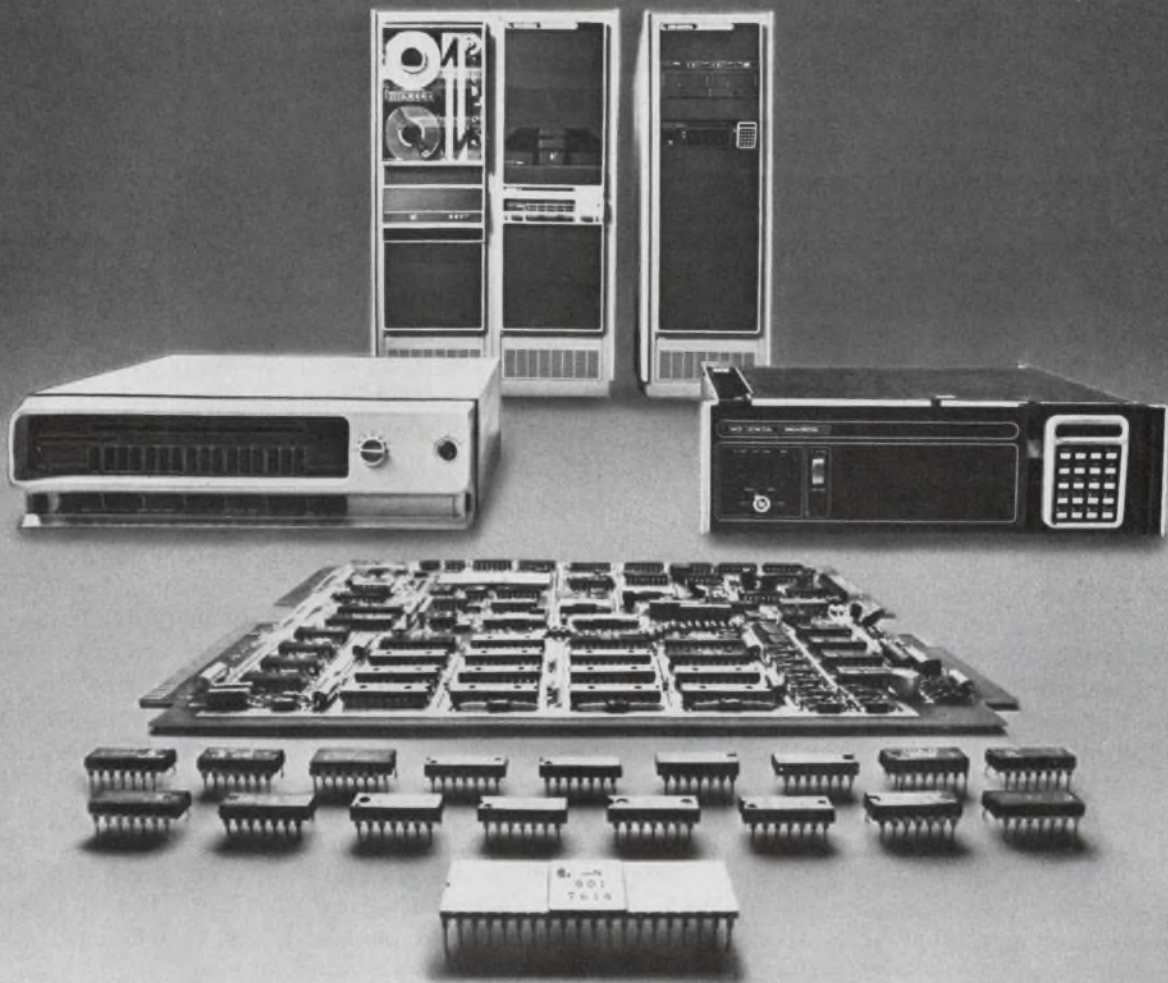

# With a line of minis and micros like ours, we don't have to push any one of them.

With other companies, you might set out to buy a micro-processor chip and end up with the whole chassis. Or get a box when all you need is a board.

But Data General doesn't work that way. We don't have to push you into buying something you weren't really looking for. Because we can let you choose from microprocessor chip sets, microcomputer boards, completely packaged MOS minis and full-blown NOVA 3 systems. All four are compatible. And they give you a range of performance with a range of prices.

So, if you're a component user, there are both high-performance microNOVA chip sets and microcomputer boards that feature Data General's mN601 microprocessor. The mN601 is a full 16-bit NOVA-on-a-chip. And the microcomputer is a full 4K-word computer-on-a-board. You package them yourself, for greatest economy. (Speaking of economy, the board costs only \$589 in OEM quantities of 100.)

And if you're not ready for components yet, there's our fully-packaged microNOVA MOS minicomputer. It's available with up to 32K words of MOS memory and peripherals like

our diskette subsystem. And it's supported by our Real-Time Operating System and diskette-based Disc Operating System. You can get our mini with 4K words of MOS memory for only \$1995. Or as a complete development system with the diskette.

If you need bigger systems capabilities, take a look at our NOVA 3 computer. It's compatible with our microNOVA family. And it runs with high-performance peripherals, sophisticated software like Real-Time Disc Operating System, high-level languages like FORTRAN 5 and BASIC, and memory expansion to a full 128K words.

We've got it all. But we won't try to sell it all. Unless it's what you really need. If you don't believe that line, call us. Dial 800-225-9497 (in Massachusetts, 1-617-485-9100, extension 2509) and ask for information on microNOVA and on the free half-day microNOVA seminars that happen this fall all over the country.

Or write for our microNOVA and NOVA 3 brochures. And see for yourself.

## DataGeneral

Data General, Route 9, Southboro, Mass. 01772 (617) 485-9100. Data General (Canada) Ltd., Ontario.  
Data General Europe, 15 Rue Le Sueur, Paris 75116, France. Data General Australia, Melbourne (03) 82-1361  
NOVA is a registered trademark of Data General Corp.

dent just described caused one volt-ohmmeter manufacturer to install a 250-V rated protective fuse in one probe of his meter. But this in turn caused other problems. In one instance, a maintenance man was probing a 480-V busbar with his volt-ohmmeter accidentally set on current instead of voltage. The fused probe blew up in the man's hand, although the meter was apparently saved from damage.

Placing a guard chassis within the main cabinet of the instrument is a technique well suited to making measurements float with respect to ground. Typical proposed breakdown specifications for this application are 1000 V rms plus twice the maximum voltage expected between the guard chassis and ground. Since standard operating procedure in the United States is to use input-power transformers with 1.5-kV dielectric breakdown voltages, the guard's chassis-to-ground potential is limited for the immediate future to a ratable 250 V.

### Floating exposes trouble

Currently, there are few instruments in the 3-to-5-kV, common-mode-input rating range, but many more will be available within the next two years, as safety standards become more common.

But now the standard laboratory technique for floating measuring instruments from ground, disconnecting the ground pin of the equipment's ac power-line cord, is coming under fire from the safety engineers. When this floating takes place, every exposed metal part of an oscilloscope, for example, rises to the common-mode voltage of the measured signal and presents a great opportunity for electrical shock. Because of this shock hazard, safety engineers are talking of redesigning the BNC connector to eliminate its exposed metal.

The alternative is to redesign the inputs to the oscilloscope and make all measurements differentially. This alternative, however, would raise the price of the oscilloscope from a few hundred to a few thousand dollars and reduce the bandwidth from a few hundred megahertz to a few megahertz.

To permit floating at virtually any potential, many companies are going to battery operation. But one specification is extremely important for the safe use of battery-powered instruments: leakage. If a battery-operated voltmeter, for example, is being used to measure voltage between the legs of a three-phase powerline, every part of the meter is above ground potential. If there is any leakage current flowing through the instrument's case, it may end up flowing through the person making the measurement.

Safety specifications for this type of test equipment are not easily generated. For example, capacitors must be tested to see if they withstand a certain voltage. And, if they are of the oil-filled variety, the dielectric may become polarized during the testing process. When discharged, these capacitors will present a safety hazard in themselves after—as well as during—the measurements. The reason: the oil-filled recharge without connection to external circuitry.

### Binding posts are hazardous too

Even the lowly binding post is due for a redesign, because its exposed metal parts allow all too easy contact between an instrument user and hazardous voltages. Hazardous voltages are currently defined by safety engineers as 30-V rms for sinusoidal signals and 60 V for dc, with variations for nonsinusoidal waveforms.

Today's thinking is that ordinary five-way binding posts are unsafe for use with these voltages, and that something without exposed metal must be designed to take their place. But so far no one has designed anything that can connect to wires and banana plugs as efficiently as the standard five-way binding post.

Providing banana jacks recessed from the mounting panel so that only the mating banana plug can make contact with the jack has been reasonably successful. This method solves the problem at one end of the cable, but the other end of the cable needs to make contact, too. Thus either the other end of the cable has banana plugs with unsafe voltage on them, or some other connector is devised.

Binding posts are a safety problem whether they are located on sources of power or on the inputs to measuring instruments that never act as a source. Once the connection is made between the source and measuring circuit, all of the binding posts in the completed path are live.

### Sinking sources save

Two notable ways to prevent instruments from damaging one another by misconnection are making sources capable of sinking current as well as sourcing it, and alternatively, disconnecting themselves from devices under test if required to sink current.

An ac calibrator from John Fluke has a transient detector that shuts down the calibrator and equipment under test before a destructive arc can occur. The calibrator does this by detecting the corona discharge that precedes an arc discharge. ■■



Protection that adds value. . .

# You came to the right place.

Because a Heinemann circuit breaker just might solve that design or procurement problem you're wrestling with right now.

You'd be surprised at how many things we can do so well in the general area of circuit protection, on/off switching, remote actuation, and even limit control.

We back this claim with competent application assistance from your nearby Heinemann representative and an open line to Sales Engineering Services at the factory. Plus a choice of three protection technologies geared to helping you get the job done right the first time at the lowest possible cost. . . just one more way our products add value to your products.

Read all about it in your free Protector Selector—a handy reference chart loaded with specs, capabilities, and even dimension drawings for twelve top-selling protector lines. Get it from your nearby Heinemann representative (listed in EEM) or Heinemann Electric Company, Trenton, NJ 08602. (609) 882-4800.

May we help you?



#### Hydraulic-magnetic

circuit breakers—invented and perfected by Heinemann. For precise, temperature-stable protection at any integral or fractional rating from 0.010 to 225 amp.

#### Solid-state

protectors for electronics applications requiring superfast tripping and remote reset, and for regulator protection of motor-generator loads.

#### Clever hybrids,

like the patented JA-10<sup>®</sup> combining the best of electromechanical and solid-state operation, to guard semiconductor circuits against spike damage and protect inductive loads against brownout.



**another reason Heinemann is No. 1 in OEM circuit protection.**



# HEINEMANN

**We keep you out of trouble.**

Factories in Trenton, Montreal, Dusseldorf, Johannesburg, and Melbourne

# Borrow my coffee cup... but never my C-Meter.

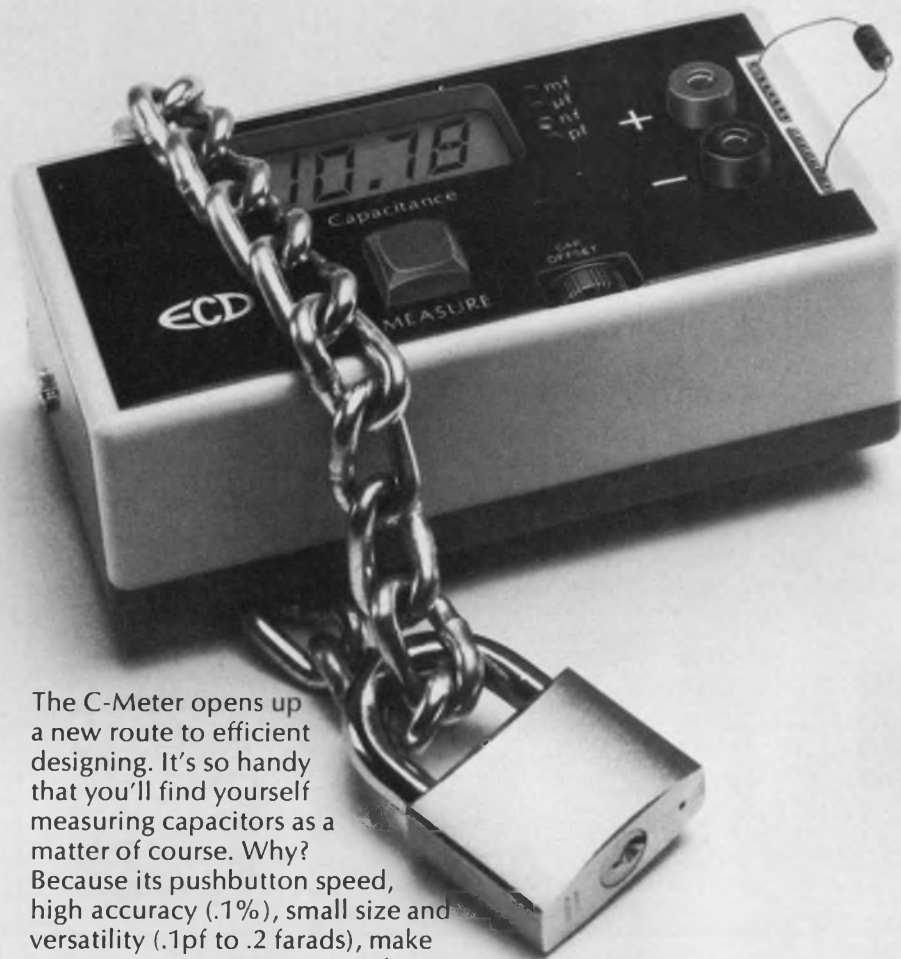

The C-Meter opens up a new route to efficient designing. It's so handy that you'll find yourself measuring capacitors as a matter of course. Why? Because its pushbutton speed, high accuracy (.1%), small size and versatility (.1pf to .2 farads), make capacitors easier to measure than resistors.

With the C-Meter, you'll waste no time twiddling, and nulling, and you'll cut the need for expensive tight-tolerance capacitors or tweak pots in your circuits. You'll be a much more efficient engineer. And popular too, because people just can't keep their hands off the C-Meter.

You owe it to yourself to try one. Our reps are stocking them at **\$289.**



**ECD CORP.**  
196 BROADWAY, CAMBRIDGE, MASS. 02139  
(617) 661-4400

SALES OFFICES: AL, Huntsville (205) 533-5896; AZ, Scottsdale (602) 947-7841; CA, Costa Mesa (714) 540-7160; CA, Sunnyvale (408) 733-8690; CO, Denver (303) 750-1222; FL, Winter Haven (813) 294-5815; GA, Chamblee (404) 457-7117; IL, Elk Grove Vill (312) 593-0282; IN, Indianapolis (317) 293-9827; MD, Silver Spring (301) 622-4200; MA, Burlington (617) 273-0198; MN, Minneapolis (612) 781-1611; NJ, Camden (215) 925-8711; NM, Albuquerque (505) 299-7658; NY, Great Neck (516) 482-3500, (212) 895-7177, Syracuse (315) 446-0220; NC, Raleigh (919) 787-5818; OH, Centerville (513) 433-8171; TX, Houston (713) 688-9971; TX, Richardson (214) 231-2573.

CIRCLE NUMBER 60

# Industry asked us for hundreds of variations of these switches. Evidently we're pushing the right buttons.



And we intend to keep pushing them.

So that every time one of your new ideas creates a design problem, MICRO SWITCH will be ready with the miniature manual switch that solves it.

At last count, we offered hundreds.

The Series 8 lineup of miniature manuals includes toggles, pushbuttons, paddles and lighted or unlighted rockers. They're UL listed at 6 amps, 125 VAC. And every one is available in a low energy version as well.

Choose terminal variations ranging from solder to quick-connect to PC board or wire wrap. There's also a choice of panel and bushing-sealed pushbuttons and toggles. And non-threaded bushings on PC mounted toggles. Even colored sleeves and integral colored tips for the toggles.

And of course, you'll find one feature you won't find anywhere else — the quality you've come to expect from MICRO SWITCH. Series 8 switches are inspected to a 1% Acceptable Quality Level (AQL).

That's quality you can put your finger on.

For your immediate product needs, see your nearest MICRO SWITCH Authorized Distributor. If you have other requirements, contact a MICRO SWITCH Branch Office or call 815/235-6600.

## **MICRO SWITCH**

FREEPORT, ILLINOIS 61032  
A DIVISION OF HONEYWELL

MICRO SWITCH products are available worldwide through Honeywell International.

CIRCLE 271 FOR DATA; 272 FOR SALESMAN CALL

**"HEY, BUD.**

**WANNA  
MAKE  
SOMETHIN'  
OUT OF  
IT?"**

# YOU BET!

Tell us about that special enclosure you need -- basic specifications or a brief description, even a rough sketch will do -- and we'll make something out of it. Something special.

## It's your brainstorm.

You did it: designed a new instrument or system. Now you need a special enclosure to house it. One designed, built and priced right. Get it -- get it all. From Bud.



**A doodle'll do it.** Mail us a sketch of the enclosure you want. Our design people will take that idea and design your enclosure. They've designed hundreds. They know what they're doing. Know what to do for you. Get what you want -- someone who will take your idea and turn it into a fact. From Bud.

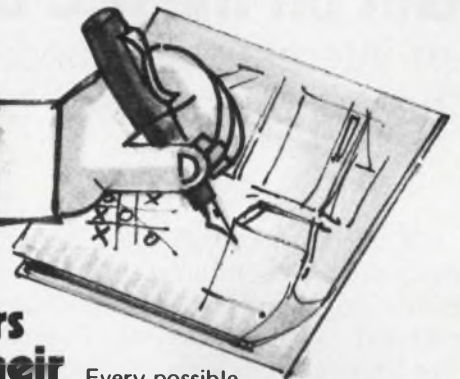

**Estimators sharpen their pencils.** Every possible economy is worked into your special enclosure. Our production capabilities keep costs down. Our tremendous selection of dies are on hand to help form your enclosures -- which, alone, means considerable savings. Get what you want -- economies. Phone Bud, toll free.

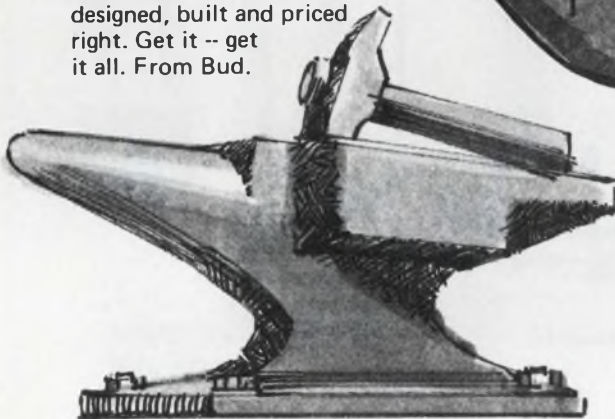

## The last thing you need.

A local "metal bender" could bang out your enclosures. Trouble is, his business isn't enclosures. Why risk amateurism? You have too much riding on that new instrument or system. Get what you want -- professionalism. From Bud.

## We steer you the right way.

Tell us what you need and Bud gives you options. We can take any one of our standard enclosures and convert it into a special. Or we can design and build a custom model. Get what you want -- a choice. From Bud.



**Then it happens.** Your job is plugged into a sophisticated manufacturing facility. Everything's on hand: high-production machinery, knowledgeable people, tight quality controls, tighter inspection, plus nearly 50 years experience. Get what you want -- when you want it. From Bud.

## Give us a buzz.

Phone Bud, toll free! We'll mail you a folder describing our special enclosure capabilities, some of the specials we've built for other groups -- and a simple form you can use to spec-out and sketch the enclosure you have in mind. If you have something urgent afoot, give us your ideas over the phone. Either way, Bud will make something out of it. Something special. Bud's toll-free numbers: (800) 321-1764; in Ohio, (800) 362-2265.

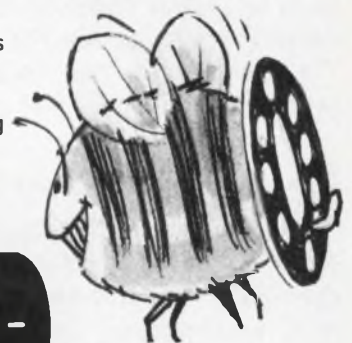

# BUD

BUD RADIO, INC.  
4605 East 35th Street  
Willoughby, Ohio 44094

BUD WEST, INC.  
3838 North 36th Avenue  
Phoenix, Arizona 85019

## Get on the IEC bus. Soon to be an international standard for interfacing instruments, the bus brings many benefits—and a few problems too.

Think international when you interconnect test equipment. An interface for measuring instruments will soon be a world standard of the International Electrotechnical Commission (IEC). The Standard has been adopted by the IEEE (Std. 488-1975), with a change in the connector proposed by the IEC.

Many benefits accrue from the standard. With it, you can connect up to 15 different instruments, spaced up to a total of 65 cable feet (20 meters). The instruments can come from practically any vendor—only minor software adjustments are sometimes necessary (Fig. 1).

The proposed IEC standard uses a byte-serial, bit-parallel format, with bidirectional lines for both data flow and addressing. Alterations to accommodate special needs can be made with simple and inexpensive reprogramming. And since the system is modular in concept, you can start small and work up as necessary.

Other advantages of an international standard include the following:

- No engineering costs are tied up in developing special interfaces.
- Instrument manufacturers can concentrate on producing instruments, not interface systems.
- Specialized modules can be easily produced; for example, power-supply makers can concentrate on power supplies and not worry about designing a system for the supplies to fit into.
- Instruments can be optimized internally to satisfy the international standard.

### Details of the IEC standard

Maximum speed of the standard is 1 Mbyte/s with three-state drivers and 250 kbyte/s with open-collector drivers, speeds high enough for most applications. Transfer of one 8-digit word (8 characters) takes about 32  $\mu$ s.

The specified cable has both male and female

Manfred Richter, Interface Engineer, Philips Electronic Industries GmbH, Hamburg, Germany.

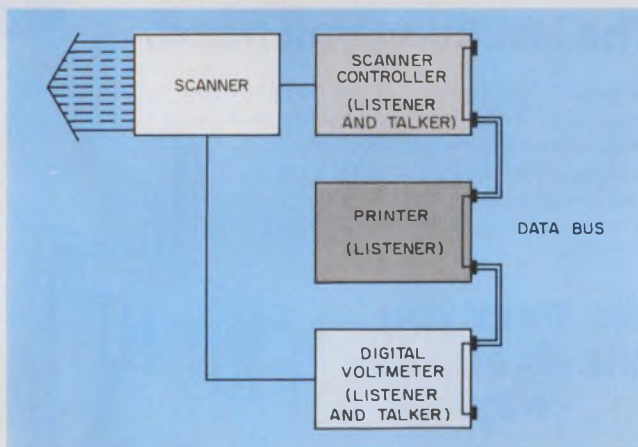
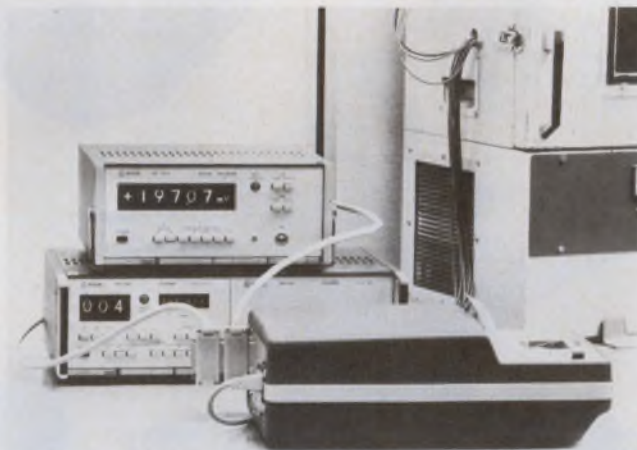

1. With the new IEC standard, "small" test systems are just as easy to interface as large ones (top). How the equipment interconnects is shown at the bottom.

connectors, so that plugs can be stacked piggy-back fashion, thus saving space on instrument back panels (Fig. 2). This makes expansion of the system very simple.

In general, any communications link requires three active devices: a listener, a talker and a controller. The controller decides the role each device plays at any time; any device not addressed remains inactive. Of course a device can perform more than one role at different times.

The proposed IEC bus system carries all mes-

## Why an international interface standard?

The basis of the IEC standard is a set of objectives that define the bus but leave designers free to select the necessary interface capability. The objectives are:

- To provide cost-effective capability for simple bench systems.
- To be compatible with simple controllers. However, a system limited to just two devices must be able to use the link without controllers.
- To serve the needs of a wide variety of products—such as controllers, processors and instrumentation.

- To be compatible with the ISO, a 7-bit code for address and command data that's easy to generate, display and read.

- To provide for flexible data rates and communication paths with a minimum of timing restrictions.

- To provide capability to accommodate multiple listeners and direct communication paths—without buffering in the controllers.

- To permit a mode for transfer of basic data with unrestricted codes.

- To minimize the number of wires.

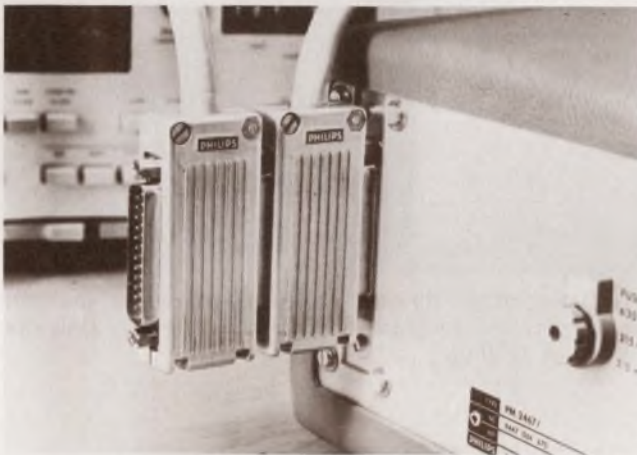

2. Space is saved and system expansion is easy with connectors that allow piggy-back stacking.

sages on a set of 16 lines: eight data-input/output lines, three data-transfer lines and five bus-management lines (Fig. 3).

The three data-transfer lines carry information from an addressed talker to an addressed listener or listeners. The Data-Valid (DAV) line indicates the availability and validity of data, the Not-Ready-For-Data (NRFD) line indicates the condition of readiness to receive data and the Non-Data-Accepted (NDAC) line indicates acceptance completed. These three lines operate in what is called a three-wire interlocked handshake process to transfer each data byte across the interface (Fig. 4). The sequence of operations runs as follows:

1. Initial conditions are set up in talkers and

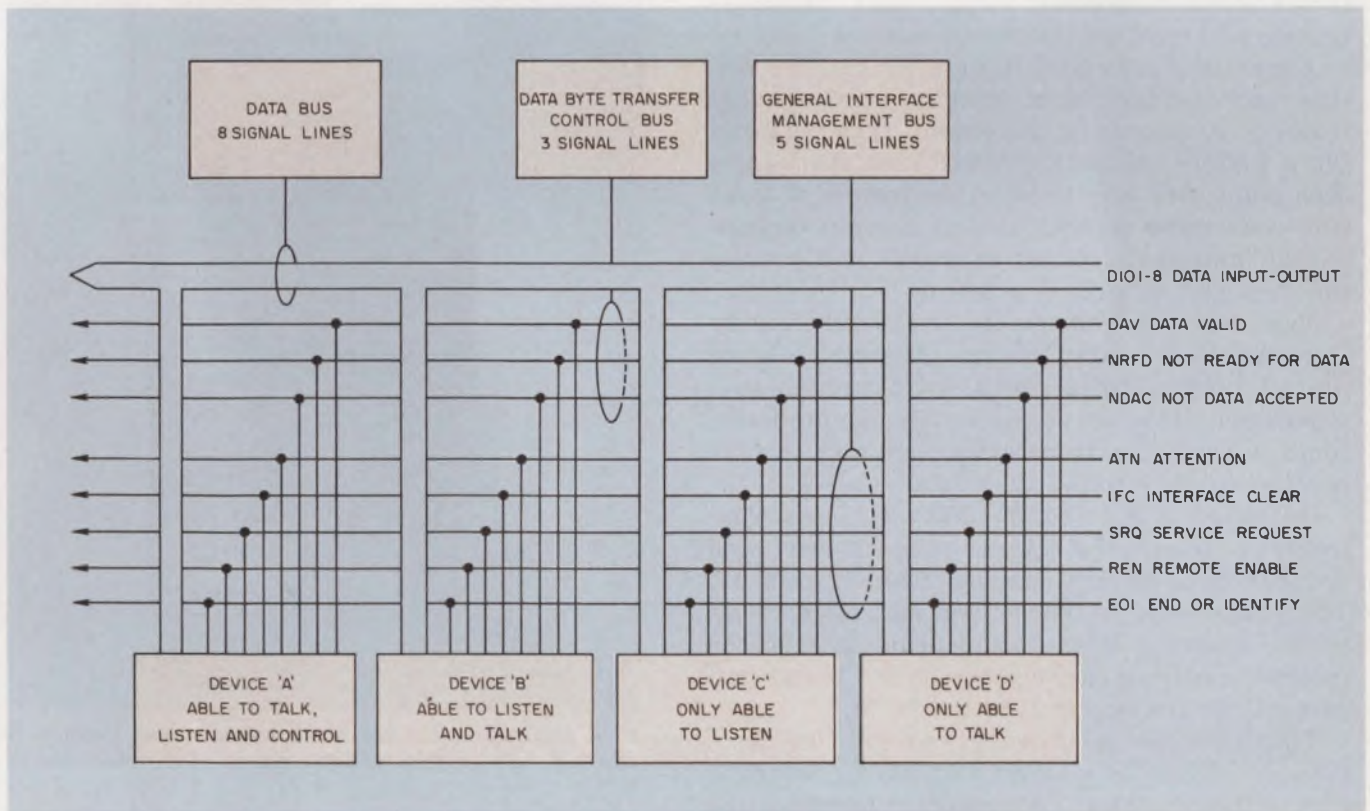

3. What the various bus wires do: 16 lines take care of data flow, data transfer and general housekeeping chores.

listeners—the DAV line is set to high (data not valid), the NRFD set to low (no listener ready for data) and NDAC to low (no listener has accepted data).

2. The talker checks the line conditions, then puts a data byte on the lines.

3. Listeners are ready to accept data, so the NRFD line goes high—this cannot happen before all listeners are ready.

4. When a talker senses that NRFD is high, it sets DAV low to indicate that the data are valid.

5. The first listener sets NRFD to low to indicate that it is no longer ready and starts to accept data. The other listeners follow at their own pace.

6. First listener to finish sets NDAC to high to indicate it has accepted the data.

7. When the final listener has indicated that it has accepted the data, NDAC goes high.

8. The talker senses NDAC high and sets DAV high to indicate that the data are no longer valid.

9. Talker removes the data from the line.

10. The listeners, sensing DAV is high, set NDAC low in preparation for the next cycle.

11. All three lines are now in the initial states.

A typical example of how the IEC data bus can be used is demonstrated by a system for the analysis of the stresses in prototype railway cars and passenger carriages. (Fig. 5).

### A practical example of the bus

Upwards of 300 strain gauges are connected to the vehicle under test. Bridges and voltmeters process and read the transducer outputs.

A manually controlled test system requires setting each bridge value, selecting the relevant transducer, measuring the output, then performing a further calculation to establish the load at each point. One way to avoid the tedium of these time-consuming chores: Design a computer-controlled, automatic system to collect and process the data and produce a printout.

Even trying to connect the series of necessary instruments in a star system—scanner, scanner control, bridge, digital voltmeter, computer, teletypewriter—involves serious wiring problems. Since a computer is necessary anyway, it's no problem to use it to control a data bus.

Operation is simple. The computer, as a controller, addresses the scanner—the listener—and requests data from a selected-strain transducer. The bridge—also a listener—is addressed to set up the relevant bridge components to take the information from the scanner. So the bridge can present the analog signal to the DVM.

The voltmeter is instructed to act first as a listener, second as a talker to pass the information to the computer. The computer processes the information and commands the printer to listen

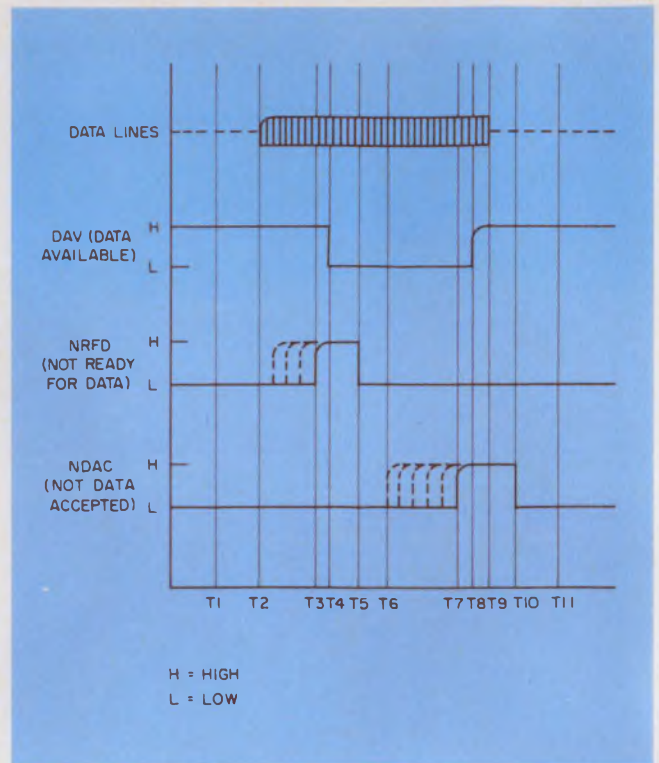

4. Timing of the three-line handshake process, in which data bytes are transferred across the interface. Only one data line is shown.

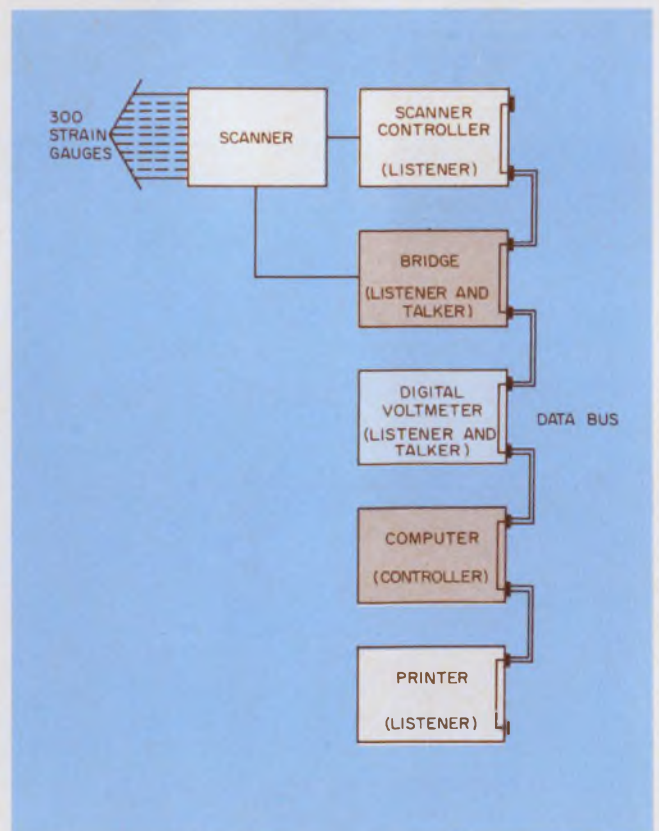

5. A practical use of the bus involves stress analysis of railroad cars. Strain gauges collect the raw data, a bridge forms the analog outputs, and a DVM reads and converts the signals. A computer controls the entire system automatically.



and do its job. Of course, if the information is wanted only for external processing, the printer can control the system and produce a series of output-voltage readings for later use.

The operation of the strain-gauge test system conforms to the following sequence:

1. The computer—as a controller—uses the IFC (Interface Clear Line) to start the system.
2. The controller sends a DCL (Device Clear) message to set all devices to an initial state.
3. The controller sends the listen address of the scanner control, followed by data, to select a particular strain gauge.
4. The controller sends an “unlisten” command, then the listen address of the bridge, followed by data for matching a selected strain gauge.
5. The controller again sends an “unlisten” command, then the listen address of the DVM, then data to read the output of the bridge on the analog line.
6. The controller sends an unlisten command, sets itself to listen, then sends the talk address of the DVM.

7. When the DVM has the measurement information, it sends the data to the computer.

8. When the computer has processed the information, it again clears the interface and sends the listen address of the printer, followed by the required output information.

9. When the printer has typed all information, the controller can restart the sequence.

Sometimes, output information is needed in several forms—say, in a tape memory as well as a printout. If so, bear in mind that a tape drive is obviously much faster than a printer and can supply a data-accepted signal as soon as it is finished. But a controller will not react until all devices receiving information have sent data-accepted signals, that is, the controller must wait until the NDAC line goes high.

### Unresolved problems

For distances longer than 20 m, the problem becomes more complicated. The present IEC system can be applied up to 330 ft (100 m) with some upgrading of hardware. For much longer distances, from 2000 up to 3000 m (2 to 3 km), it is necessary to go to full serialized busses with only one or two wires.

Much more work is necessary before all the interconnection problems are solved. But the IEC bus is the most practical step yet taken. Its success depends on people making an effort to understand and use the bus.

Further work is also underway in the field of “software,” for example, data formats. The problem here is to decide where to stop. If the description is taken too far, individual designers can be unnecessarily restricted. ■■

# Dialight INDICATOR LIGHTS

The widest choice for your every application.

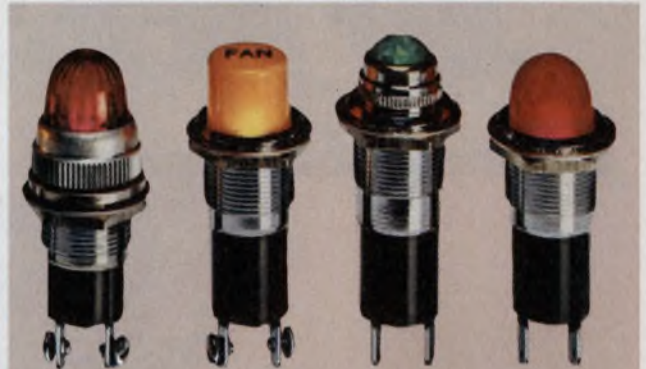

**MINIATURE INCANDESCENT OR NEON INDICATORS**—1,500,000 varieties to choose from. MIL-L-3661 and UL approved. Red, green, amber, blue, white, yellow or colorless lenses in wide range of shapes, legends, finishes. Stocked by local distributors.



**LARGE INCANDESCENT OR NEON INDICATORS**—As above, but larger size. Unlimited varieties to choose from. Stocked by local distributors.



Dialight, the company with the widest choice in switches, LEDs, indicator lights and readouts, looks for needs . . . your needs . . . and then they develop solutions for your every application. No other company offers you one-stop shopping in all these product areas. And no other company has more experience in the visual display field. Dialight helps you do more

with these products than any other company in the business, because we are specialists that have done more with them. Talk to the specialists at Dialight first. You won't have to talk to anyone else. Send for your free new copy of Dialight's current catalog.

**DIALIGHT**

Dialight, A North American Philips Company  
203 Harrison Place, Brooklyn, N. Y. 11237  
(212) 497-7600

# See Dialight.

# ANNOUNCING THREE NEW BREAKTHROUGHS IN SOLDERLESS BREADBOARDING

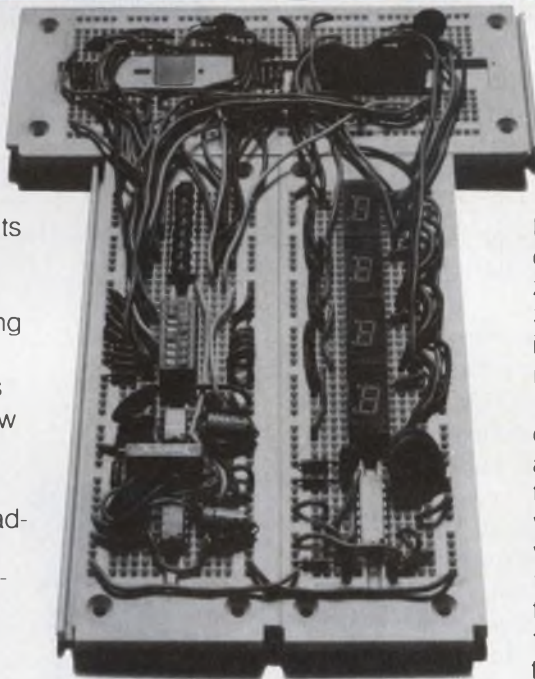

Whether you design or build circuits for fun or for profit, you owe it to yourself to discover how fast and easy CSC solderless breadboarding can be. Now, more than ever. Because of three new breakthroughs in breadboard design. And our new EXPERIMENTOR™ sockets\*\* that make the most of them.

**1. Price** Who says a quality breadboard has to be expensive? For as little as \$9.95, CSC's EXPERIMENTOR sockets let you design, assemble and modify circuits as fast as you can push in — or pull out — component leads. On a rugged one-piece socket with 550 solderless tie-points (94 five-point terminals and two 40-point bus strips).



Sockets lock together, snap apart to handle any size circuit with ease.

But don't let the low price fool you: EXPERIMENTOR sockets are precision-molded of durable, abrasion-resistant material, and feature CSC's non-corrosive, prestressed nickel-silver contacts for positive connections and longer life. All contacts are identified, too... with molded-in designations for easier circuit assembly and diagramming.

**2. Compatibility** CSC EXPERIMENTOR sockets end the "big-chip blues." They're the only ones with full fan-out capabilities for microprocessors and other larger DIP's, as well as 4-16-pin units. EX-

PERIMENTOR 600's 6/10" center is ideal for microprocessor's, clock chips, RAM's, ROM's, PROM's, etc. While EXPERIMENTOR 300's smaller 3/10" center is perfect for smaller DIP's. Both units, of course, accept transistors, LED's, resistors, capacitors, pot's — virtually all types of components with plug-in ease. As well as #22-30 solid hook-up wire for interconnections. Eliminating heat and lead damage to expensive components. And saving you more money, on parts.



Mix or match both models; arrange them vertically or horizontally.

**3. Flexibility** With CSC EXPERIMENTOR sockets, you can arrange your breadboard to suit your circuit... instead of vice versa. An exclusive snap-together inter-

locking system lets you instantly connect them. Vertically or horizontally. So you can mix or match 3/10 and 6/10" centers... expanding or contracting to meet your requirements.

CSC EXPERIMENTOR sockets can be used alone, or mounted on any convenient flat surface, thanks to molded-in mounting holes and vinyl insulation backing that prevents shorts. You can mount them with 4-40 flat-head screws from the front, or 6-32 self-tapping screws, from the rear. But however you use them, EXPERIMENTOR sockets are an unbeatable way to build and test twice the projects in half the time.



Both models feature 94 five-point terminals (vertical lines) and two 48-point bus strips (one strip shown).

**WHY WAIT?** CSC EXPERIMENTOR sockets are available now from your CSC dealer, or by phone from CSC, at \$9.95\* for the 300 and \$10.95\* for the 600. Call 203-624-3103 (East Coast) or 415-421-8872 (West Coast) — major credit cards are accepted.

\*Manufacturer's suggested list price. Prices subject to change without notice. U.S. Pat No D235,554

CONTINENTAL SPECIALTIES CORPORATION



44 Kendall Street, Box 1942, New Haven, Ct 06509  
203-624-3103/TWX: 710-465-1227  
West Coast office: Box 7809, San Francisco, CA 94119  
415-421-8872/TWX: 910-372-7992

CIRCLE NUMBER 65

**Who provides the  
industry's broadest  
line of electronic  
packaging hardware  
... including  
Edgeboard Connectors?**

SAE does! Our injection molding equipment produces an almost endless variety of connector configurations.

You can choose between .100", .125", .150" or .156" contact spacings. Single or dual readouts. Pierced eyelet, dip solder or wire-wound terminations in one, two or three levels. Even right-angle terminals if that's what you need. You can pick either 10, 30 or 50 mils gold over nickel plating; thru-hole or tapped insert mounting styles; in-contact or between contact polarizing keys; and phenolic or thermoplastic housings.

And if we haven't described one you like, we'd be pleased to quote a custom connector to your specification! Our new 128 page packaging handbook gives complete details, and also describes our entire line of electronic packaging and interconnection hardware.

For an immediate reply, call the following toll-free "ZIP QUOTE" number at the factory ... 800-538-6843.

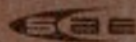
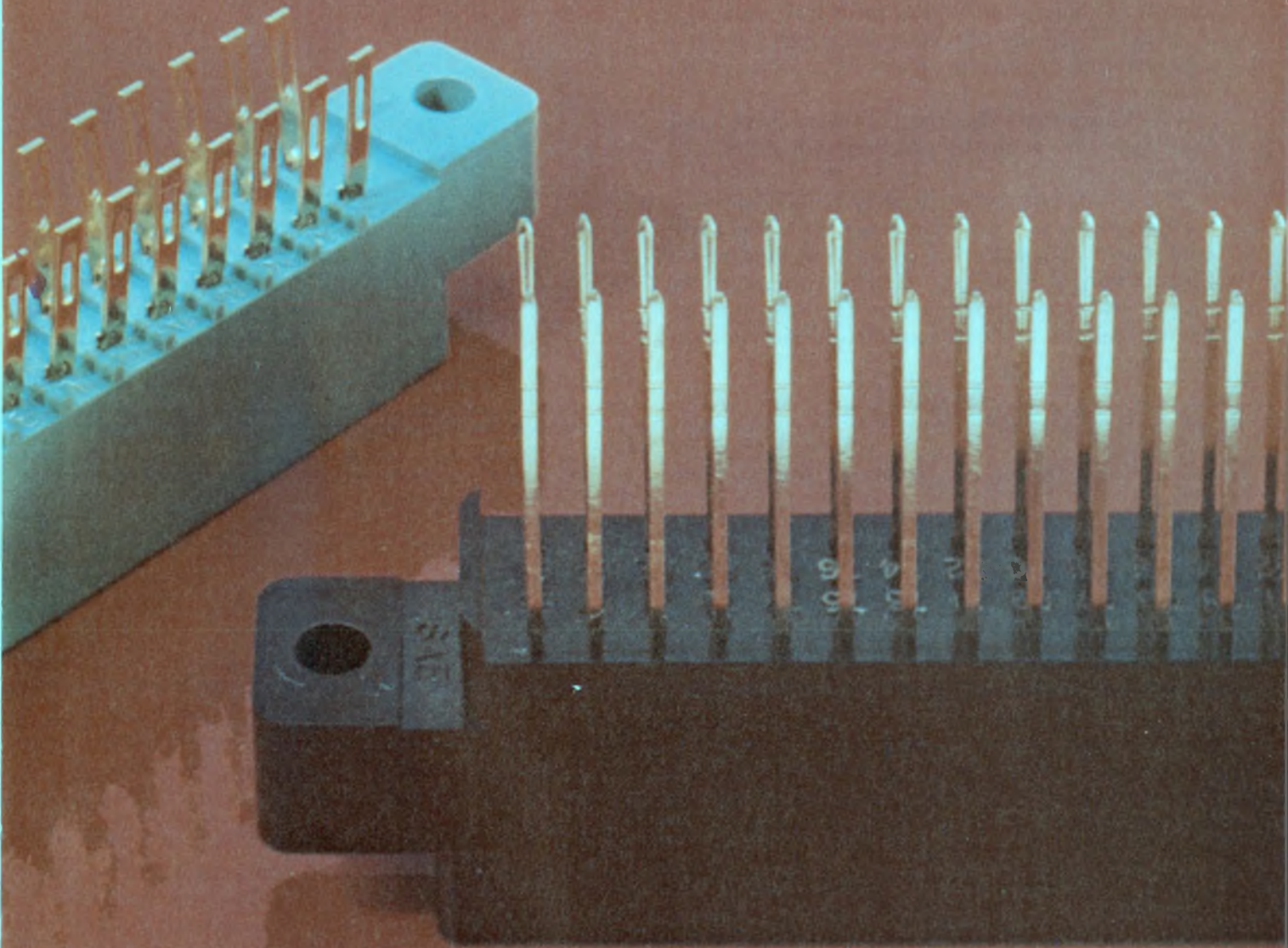

**Stanford Applied Engineering, Inc.**

340 Martin Ave., Santa Clara, CA 95050  
(408) 243-9200 TWX 910-338-0132

CIRCLE NUMBER 66

# Measuring capacitor loss: Are S-parameters any good? They're not, but other methods—like the use of Q-bridges or resonant coaxial lines—are acceptable.

In determining the losses of microwave capacitors, the Q values calculated from measured S parameters are worthless. Perhaps this is the reason that articles endorsing S parameters for capacitors emphasize the importance of low series resistance, but seldom give measured values of  $r_s$  or  $Q_c$ .<sup>1,2,3</sup> In the few instances when such data can be found, no hint is given of the origin of the values.

Valid techniques do exist, however, those using Q-bridges or resonant transmission lines, for example.

The two S parameters usually published to describe microwave capacitors are  $S_{11}$ —the input reflection coefficient of a series capacitor and a termination,  $Z_0$ , and  $S_{21}$ —the forward insertion loss of the same combination. The Q of the capacitor relates to these parameters through the expression:

$$Q_c = \frac{2|S_{11}||S_{21}|}{1 - |S_{11}|^2 - |S_{21}|^2} \quad (1)$$

A recent treatment<sup>4</sup> of the subject states that the Q of a capacitor can be found from  $S_{11}$  alone, giving:

$$Q_c = \frac{\sin \theta}{\cos \theta - S_{11}} \quad (2)$$

where  $\theta$  is the phase angle of  $S_{11}$ .

Although Q is acknowledged as a key parameter, no values are given. Instead, the "insertion loss" is tabulated for several capacitors over a wide range of frequencies. The loss is correctly defined as the sum of the reflective and dissipative losses, but the insertion loss is based on the expression for the reflection loss only.

For capacitors of high, or even modest Q values, it is true that the dissipated power is extremely small compared to the reflected power, but the correct relationship includes both and is given by:

$$\text{Insertion loss} = 10 \log_{10} \left( \underbrace{1 - |S_{11}|^2}_{\text{reflected}} + 10 \log_{10} \left( \underbrace{\frac{|S_{21}|^2}{1 - |S_{11}|^2}}_{\text{dissipated}} \right) \right) \quad (3)$$

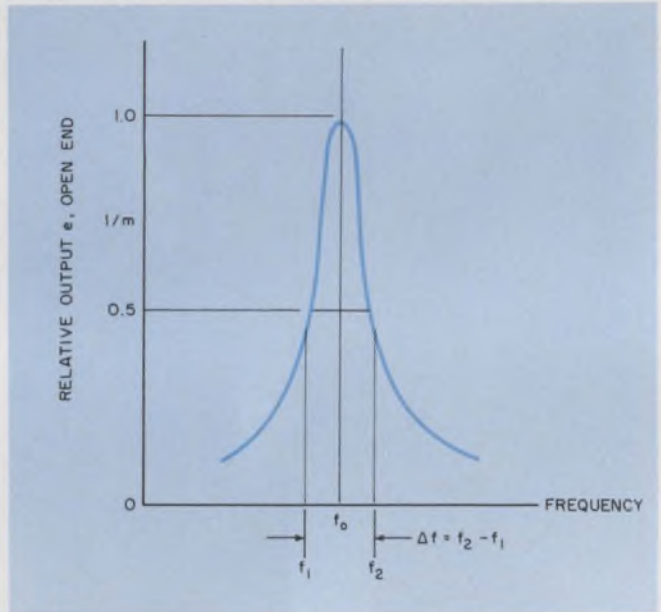

1. Using a transmission line to measure capacitor loss: An rf millivoltmeter reads the line output at resonance and also reads the output at two points on either side of resonance. The Q of the capacitor is then calculated from the frequency deviations.

or Insertion loss =  $10 \log_{10} |S_{21}|^2$ .

You may well wonder why insertion loss for capacitors is emphasized. For small values of capacitance, at frequencies in the order of a few hundred megahertz, the insertion loss is naturally high. The loss drops as either the capacitance or frequency increases, and it is almost entirely a function of the reactance.

### Is insertion loss of any value?

To attribute a low Q factor to a high insertion loss would be folly. The only redeeming value of insertion loss, other than characterizing reactance as a function of frequency, is to discover resonances in the capacitor or the test fixture.

The equations already given by  $Q_c$  are correct. Then where does the problem lie? The limitation is in the measuring system. Most equipment cannot resolve the small values of resistance and the resulting small differences of phase. Remember, the capacitor loss must be detected in the

R. E. Lafferty, Vice President and Engineering Manager, Boonton Electronics Corp., Route 287 at Smith Road, Parsippany, NJ 07054.

presence of a total resistance equal to twice the characteristic impedance of the system (100 Ω). What little effect the series resistance has on both  $S_{21}$  and  $S_{11}$  is lost in the uncertainty of S-parameter measurements.

Example: A 22-pF capacitor with a Q of 200 at 300 MHz has calculated values of 0.234160 for  $S_{11}$  and 0.971028 for  $S_{21}$ . If the series loss could be reduced to zero, calculated values would be 0.234424 and 0.972134, respectively, a change of only 0.11%, or approximately 0.01 dB. In a meas-

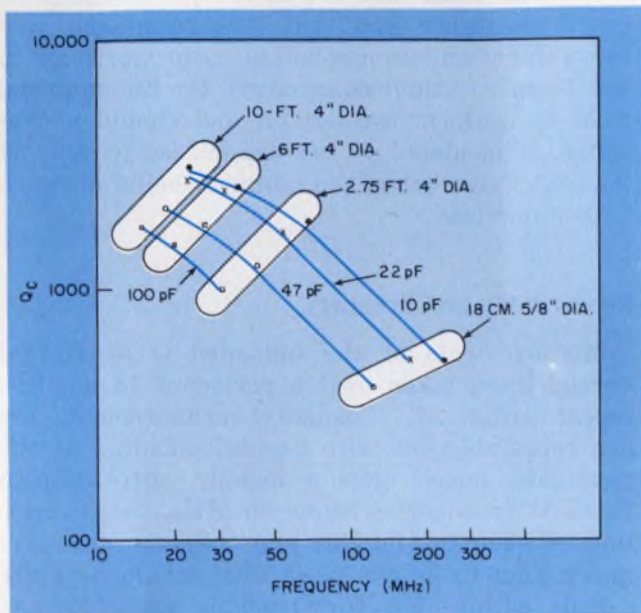

2. How the Q's of ceramic capacitors vary with frequency: At high frequencies, the slope of the plots vary approximately with the  $-1$  power of frequency. At very high frequencies, when the skin depth becomes less than the plate thickness, Q will vary as  $(f)^{-1.5}$ .

uring system with two-digit resolution, there would be no detectable differences in the S values.

The failure of S parameters to provide significant values of Q is clearly illustrated in a table of calculated Q values for several capacitors. Measured values of  $S_{11}$  and  $S_{21}$  have been taken from published data, and the results of both equations (1) and (2) are listed. The absurd values of  $Q_c$  obtained with either equation are a convincing argument against using S parameters to measure capacitor loss.

### Is there a better way?

How can the high-frequency loss of a capacitor be measured? A Q-bridge is a good means of directly measuring Qs up to 10,000 for capacitors from 20 to 1000 pF at frequencies of 0.1 to 50 MHz.

For frequencies above 50 MHz, the only suitable method known to the author requires a resonant coaxial transmission line. A quarter-wave

coaxial line is coupled loosely to a stable signal generator. The outer-to-center conductor spacing of the line should be compatible with the terminal spacing of the capacitor to be measured, provided the Q of the line can be held to a high value. The generator should have a digital display of the output frequency; if it doesn't, a counter must be used.

An rf millivoltmeter, lightly coupled to the open end of the line, detects the voltage at the resonant frequency,  $f_0$ , and on each side of resonance (Fig. 1).

The Q of the line at  $f_0$  may be calculated from:

$$Q_0 = (f_0/\Delta f) \sqrt{m^2 - 1}, \quad (4)$$

where  $Q_0$  denotes the measured Q of the unloaded quarter-wave line, m equals the ratio of resonant to off-resonant voltage, and  $\Delta f$  equals the total bandwidth between the off-resonant voltage points. If the half-voltage points are used, Eq. 4 reduces to:

$$Q_0 = \sqrt{3} (f_0/\Delta f) \quad (5)$$

### Measuring $Q_c$ .

Connect the capacitor to be tested across the open end of the line. Resonance will now occur at a lower frequency,  $f_1$ , where the reactance of the line equals the reactance of the capacitor. The generator frequency is again adjusted above and below resonance where the coupled voltage falls to half of its resonant value.  $Q_c$  can now be calculated using the following equation:

$$Q_c = \frac{\cos \beta_{1l}}{\sqrt{D_1 D_2 / 3 - (\pi/4Q_0) \sqrt{f_1/f_0} D_3}}, \quad (6)$$

$$\text{where } D_1 = \cos \beta_{3l} - \frac{\sin \beta_{3l}}{\tan \beta_{1l}} \left[ \frac{f_3}{f_1} \right],$$

$$D_2 = \frac{\sin \beta_{2l}}{\tan \beta_{1l}} \left[ \frac{f_2}{f_1} \right] - \cos \beta_{2l},$$

$$D_3 = \sin \beta_{1l} + \frac{\cos \beta_{1l}}{\tan \beta_{1l}},$$

and  $\beta_{1l}$ ,  $\beta_{2l}$ , and  $\beta_{3l}$  are the electrical lengths of the line at frequencies  $f_1$ ,  $f_2$ , and  $f_3$ , respectively.

$$\beta_{1l} = (f_1/f_0) 90^\circ$$

$$\beta_{2l} = (f_2/f_0) 90^\circ$$

$$\beta_{3l} = (f_3/f_0) 90^\circ$$

Example: With a 6-ft copper line having an I.D. of 4 in. and an O.D. of 1.125 in., the natural resonant frequency is 41 MHz, and  $Q_0 = 2190$ . When a 22-pF capacitor is connected across the open end, the resonant frequency drops to approximately 31.76 MHz. The measured frequencies at which the voltage falls to half of the resonant voltage are:

$$f_2 = 31.7766 \text{ MHz and } f_3 = 31.7448 \text{ MHz.}$$

Therefore  $f_1 = (f_2 + f_3) / 2$ , which equals 31.7607 MHz.

With the aid of a calculator the following terms can be found:

$$\beta_{1l} = (31.7607/41) 90^\circ = 69.718610^\circ$$

$$\beta_{2l} = (31.7766/41) 90^\circ = 69.753512^\circ$$

$$\beta_3 l = (31.7448 / 41) 90^\circ = 69.683707^\circ$$

$$\text{and } \sin_1 = 0.938002$$

$$\cos_1 = 0.346631$$

$$\tan_1 = 2.706052$$

$$\sin_2 = 0.938213$$

$$\cos_2 = 0.346060$$

$$\sin_3 = 0.937790$$

$$\cos_3 = 0.347202$$

You can now solve for  $D_1$ ,  $D_2$ , and  $D_3$ , and then  $Q_c$ :

$$D_1 = 8.2292 \times 10^{-4}$$

$$D_2 = 8.2299 \times 10^{-4}$$

$$D_3 = 1.066097$$

$$Q_c = 2500.$$

An investment in a stable signal generator, a sensitive rf millivoltmeter and a programmable calculator will be well worth the cost if you intend to use this technique. Incidentally, if you use a generator with phase lock, be sure that the display of frequency follows the vernier control in the locked mode.

Because of the rigorous interrelationship of the measuring frequency, the capacitance and the length of the line, an unfortunate constraint is imposed with this method. For a given line, you may select capacitance or frequency, but not both. The parameters are related as follows:

$$C = \frac{1}{\omega_1 Z_0 \tan(1.91 \times 10^{-10} \omega_1 l_{\text{mm}})} \quad (7)$$

It is convenient to draw a graph of capacitance vs frequency for each line.

### Sources of error

For the signal source, the major requirement is frequency stability. Accurate measurements can't be made with a generator that drifts. Residual AM or FM will not affect the measurement.

A small loop inserted at the shorted end of the line should be sufficient to excite the line and give a good reading on a loosely coupled rf millivoltmeter without introducing noticeable loss in the line. A terminating resistor in series with the loop will reduce the SWR on the connecting cable. Whether or not the induced voltage is a function of frequency is of little consequence because of the small deviation needed for the measurement.

There are a few requisites for the rf millivoltmeter: a high-impedance probe is important; it should be coupled loosely to the open, or test end of the line; and both the full-scale and half-scale readings on the ranges to be used (probably 1, 3, and 10 mV) should be calibrated.

For large-diameter lines, you can thread the probe directly through the outer wall. For smaller lines, a threaded bushing can be soldered to the outer wall, with some form of insulated feed-through connector to couple the probe tip to the center conductor of the line.

Probe loading with loose coupling does not in-

fluence the measured  $Q$ . This is proven by coupling the millivoltmeter at both the open end and as far down as a sixteenth of a wavelength. There is no measurable difference in the results. Calculations made with the measured capacitance between the probe and the line, and with the input resistance of the probe, also confirm a negligible contribution by the probe to line loading.

Errors of a few percent in the millivoltmeter calibration will cause similar errors in the measured  $Q$  and, with calibration, errors should remain less than 2%.

Eq. 6 assumes that the entire line loss is from series resistance and that this resistance, and hence the attenuation constant, is proportional to  $\sqrt{f}$ . To satisfy this requirement, the line material must be uniform throughout and should not be plated. If insulated screws are needed to support the center conductor, the number should obviously be minimized.

### Repeatability and accuracy

Measurements of the unloaded  $Q$  of several coaxial lines, taken over a period of 18 months, repeat within 2%. Loaded  $Q$  measurements are less repeatable but with regular cleaning of the terminals, measurements usually agree within 10%. At frequencies below 50 MHz, the correlation between coaxial line and  $Q$ -bridge measurements (not to be confused with a  $Q$ -meter) are usually within 15% for  $Q$  values under 2000.

For  $Q$  values less than 2500, and assuming the  $Q$  of the line is greater than that of the test capacitor, the accuracy of this method may be within 15 to 30%. All factors considered, it is not now prudent to place a better figure of uncertainty on the outlined measuring technique. Regardless of the absolute accuracy, the measurement provides reasonable  $Q$  data— $S$ -parameter measurements do not.

A plot of  $Q$  vs frequency for a few ceramic capacitors approximates the expected slope of  $1/f$  at high frequencies for capacitors of low dielectric loss and with effective plate thickness less than the skin depth (constant  $r_s$ ). Such a plot is given in Fig. 2.

Users of  $Q$ -meters who have experienced difficulty in measuring the loss of capacitors may be concerned that the transmission line measurement suffers from the same deficiencies. Two important differences between the two techniques yield a significant improvement in accuracy for the transmission line.

First, when you connect a capacitor to a line, the attendant lowering of the resonant frequency is accompanied by a predictable change in line loss (within a few percent). But when you connect a capacitor to the  $Q$ -meter, the internal variable capacitor is reduced to restore resonance.

# Tabulated Q values calculated from published data for $S_{11}$ and $S_{21}$

C (pF)	f (MHz)	$S_{11}$ (Re)	$S_{11}$ (Im)	$S_{21}$ (Re)	$S_{21}$ (Im)	$Q_c$ (from $S_{11}$ & $S_{21}$ )	$Q_c$ (from $S_{11}$ )
10	100	0.54	-0.65	0.29	0.44	109	3.7
	110	0.47	-0.67	0.33	0.46	96	3.3
	120	0.41	-0.69	0.37	0.47	-480	2.9
	130	0.36	-0.70	0.41	0.49	-36	2.7
	140	0.30	-0.69	0.44	0.50	-103	2.6
	150	0.25	-0.68	0.47	0.50	237	2.5
	160	0.20	-0.67	0.50	0.49	47	2.3
	170	0.15	-0.66	0.53	0.49	47	2.1
	180	0.11	-0.65	0.55	0.49	43	2.0
	190	0.07	-0.64	0.58	0.48	52	1.9
200	0.04	-0.62	0.61	0.48	84	1.8	
22	100	0.17	-0.55	0.68	0.46	-175	3.4
	200	-0.09	-0.32	0.89	0.31	482	1.6
	300	-0.14	-0.18	0.94	0.22	28	0.94
	400	-0.15	-0.09	0.97	0.16	119	0.50
	500	-0.15	-0.03	0.98	0.13	-432	0.17
	700	-0.11	0.04	0.98	0.09	13	-0.32
	1000	-0.02	0.09	0.98	0.05	6.3	-3.2
	1500	0.07	0.03	0.99	0.03	11	0.47
	2000	0.03	-0.05	0.99	0.01	7.0	-1.9
	2500	-0.04	-0.03	0.99	-0.01	5.7	0.71
100	100	-0.02	-0.16	0.97	0.15	30	3.5
	110	-0.03	-0.14	0.98	0.14	-567	2.8
	120	-0.03	-0.13	0.98	0.13	54	2.7
	130	-0.03	-0.12	0.98	0.12	25	2.7
	140	-0.04	-0.11	0.98	0.11	17	2.1
	150	-0.04	-0.10	0.99	0.10	-126	1.9
1000	100	-0.01	-0.03	0.99	0.01	3.3	2.7
	200	-0.02	-0.03	1.00	0.00	-55	1.4
	300	-0.03	-0.03	0.99	-0.01	4.7	0.94
	400	-0.05	-0.02	1.00	-0.02	-33	0.38
	500	-0.05	-0.01	1.00	-0.02	-30	0.16
	600	-0.06	0.01	0.99	-0.03	7.9	-0.16

The change in the capacitance affects the loss of the internal capacitor, but the extent of the change is difficult to determine, and the repeatability is suspect. As a result, it is usually ignored, and the measured Q is generally higher than the correct value—and it may even be negative!

Second, the intrinsic Q values of transmission lines are substantially higher than those of the work coils used with a Q-meter. Consequently, capacitors of moderately high Q have a pronounced influence on the effective loss of a coaxial

line. The same capacitor on a Q-meter may barely change the reading. ■■

## References

1. Perna Jr., V. F., "A Guide to Judging Microwave Capacitors," *Microwaves*, August, 1970.
2. Perna Jr., V. F., *Chip Capacitor Dielectric Effects on Hybrid Microwave Amplifiers*, presented at the ISHM Conference, October, 1971.
3. Perna Jr., V. F., "Insertion Loss, Capacitor Q, and the S-Parameter," *Microwave Systems News*, March/April, 1971.
4. *Vitramon News*, Vol. 11, No. 5, November/December, 1975.

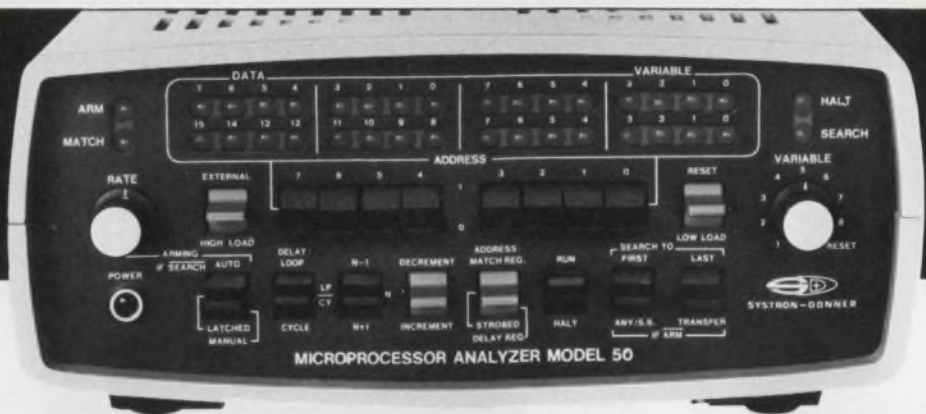

## THE HOT NEW S-D MICROPROCESSOR ANALYZER

**ONLY \$865** but Model 50 does more than a 32-channel logic analyzer costing 3 times as much.

**First Universal Analyzer:** Useable with **all** microprocessor families that have accessible bus structure.

**Display:** 16 bits of data and 16 bits of address.

**Unique Search Modes:** Identify the first and last instruction in a program loop, then step forward or backward through programs.

**Passive or Interactive:** Use as a passive real time monitor.

Find out more about the time-saving (to put it mildly) Model 50 features such as delay by loops, single step, dual clock, N-1/N+1 strobe, multiple unit capability, etc. Contact:



10 Systron Drive • Concord, CA 94518 • Phone (415) 676-5000

CIRCLE NUMBER 67

# Power to the $\mu$ P



**Sola offers DUAL and TRIPLE OUTPUT POWER SUPPLIES for MICROPROCESSORS and accessories: RAM's, PROM's, ROM's, FEPROM's, CLOCKS and IO devices.**

All available from your local electronic distributor. At competitive pricing. From a name you can count on—Sola.

Our versatile power supplies offer fully isolated independent outputs for either positive or negative operation. Series or parallel operation. Plus, remote sensing/programming, and complete serviceability. Just call or write for Catalog 648.

For added protection, consider our minicomputer regulators, UPS, and Standby units. Everything you need for MPU power and protection.

Sola Electric, 1717 Busse Road, Elk Grove Village, Ill. 60007 (312) 439-2800.

**SOLA ELECTRIC**



## Think of us as your supply line.

CIRCLE NUMBER 68

CIRCLE NUMBER 69 ►





**A touch of class ...  
Rogan knobs and dials  
on your control panel.**

Our catalog has 28 pages of ideas for your knob and dial requirements. Samples of particular items will be sent upon request.

**ROGAN**  
CORPORATION

3455 Woodhead Drive  
Northbrook, IL 60062  
Phone (312) 498-2300

# Measure the characteristic impedance

of almost any line with this two-load technique, and avoid many of the limitations of traditional methods.

Here's a two-load method for determining the characteristic impedance,  $Z_0$ , of almost any audio or rf transmission line of any length without having to assume a no-loss condition. The new method avoids most of the disadvantages of traditional approaches.

Traditional methods of determining  $Z_0$  of uniform transmission lines (Fig. 1) include:

- Calculating from the geometry or distributed constants of the line.
- Measuring open and short-circuited line impedances.
- Measuring a shorted eighth-wavelength line section.



## Traditional methods have practical disadvantages

All three approaches have practical disadvantages that limit accuracy, convenience or both.<sup>1,2,3</sup> In the first method, the constants must be found over the frequency range of interest—not an easy task, since distributed resistance, capacitance and inductance are all frequency sensitive to some degree. Also, calculating the impedance from line-material properties and cable geometry is tedious, unless simplifying assumptions are made.

The open and short-circuit method is the most widely used, but is accurate only for short lengths of low-loss sections. Furthermore, it's unusable for lengths near quarter-wave multiples, because the extreme impedance values obtained lead to poor accuracy. And when lengths are very near the critical quarter-wave multiples, the high impedance values are usually outside the measurement range of most commercial bridges.

Finally, only the magnitude of  $Z_0$  is measured directly with the shorted eighth-wavelength method. And not only is the eighth-wavelength method limited to very low-loss lines, but also the length must be determined precisely.

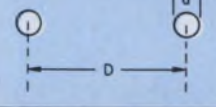
Except for the calculation method, these traditional methods assume low-loss lines. However, a

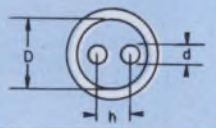
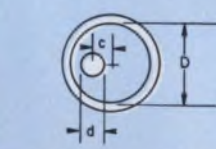
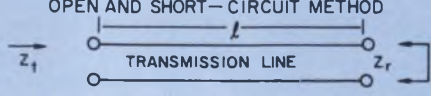
Traditional ways of determining $Z_0$	
Calculations from line geometry	
REPRESENTATIVE EXAMPLES	
LINE GEOMETRY	CHARACTERISTIC IMPEDANCE
 <p>OPEN TWO-WIRE LINE IN AIR</p>	$Z_0 = 120 \cosh^{-1} \frac{D}{d}$ $\approx 276 \log_{10} \frac{2D}{d}$
 <p>SINGLE COAXIAL LINE</p>	$Z_0 = \frac{138}{\sqrt{\epsilon}} \log_{10} \frac{D}{d}$ <p><math>\epsilon</math> = dielectric constant = 1 in air</p>
 <p>BALANCED SHIELDED LINE</p>	<p>For <math>D \gg d, h \gg d</math>,</p> $Z_0 = \frac{276}{\sqrt{\epsilon}} \log_{10} \left[ 2v \frac{1 - \sigma^2}{1 + \sigma^2} \right]$ <p><math>v = \frac{h}{d}</math>      <math>\sigma = \frac{h}{D}</math></p>
 <p>ECCENTRIC LINE</p>	<p>For <math>d \ll D</math>,</p> $Z_0 = \frac{138}{\sqrt{\epsilon}} \log_{10} \left[ \frac{D}{d} \left[ 1 - \left( \frac{2c}{D} \right)^2 \right] \right]$ <p>For <math>c/D \ll 1</math> this is the <math>Z_0</math> of coaxial diminished by approximately</p> $\frac{240}{\sqrt{\epsilon}} \left( \frac{c}{D} \right)^2 \text{ ohms}$
<p>OPEN AND SHORT-CIRCUIT METHOD</p>  <p>MAKE TWO MEASUREMENTS — <math>Z_1 = Z_{oc}</math> WHEN <math>Z_r = 0</math> AND <math>Z_1 = Z_{sc}</math> WHEN <math>Z_r = \infty</math></p> $Z_0 = \sqrt{Z_{sc} Z_{oc}}$ $Z_{oc} \text{ (open circuit)} = Z_0 \coth \gamma l$ $Z_{sc} \text{ (short circuit)} = Z_0 \tanh \gamma l$	
<p>SHORTED 1/8-WAVELENGTH LINE</p> $ Z_1  =  Z_0 $ $l = \lambda/8$	

1. Traditional methods of determining a line's characteristic impedance usually require assumptions not always true in practice, especially for long lossy lines operating at audio frequencies.

James E. McKay, Project Engineer, WSB Radio, 1601 W. Peachtree St. NE, Atlanta, GA 30309.

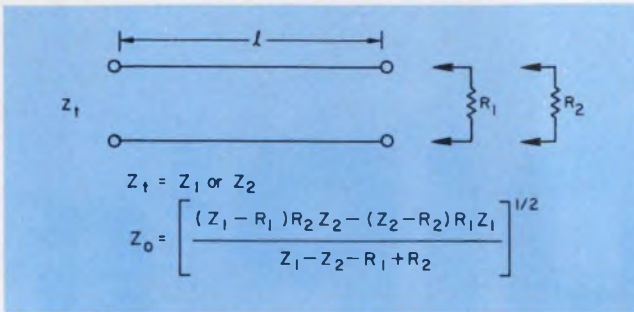

2. Using two known load impedances,  $R_1$  and  $R_2$ , to produce easily measured line input impedances, overcomes most of the shortcomings of the traditional methods for determining the  $Z_0$  of a line.

low-loss condition can't be assumed for low frequencies as in many telephone voice and data lines.

Several special techniques are also used, including the use of slotted lines to compare  $Z_0$  with a standard, time-domain reflectometry<sup>1</sup> and the complicated Chipman method<sup>2</sup> of resonance-curve plotting. These methods are generally limited to microwave frequencies and require that line losses be negligible.

### New method needs two measurements

Using two different known load impedances avoids many of the previously mentioned limitations (Fig. 2). The new method applies to both audio and rf lines of any length, and no assumption of negligible loss is required. The method uses the general-transmission line equation,

$$Z = Z_0 \frac{R + Z_0 \tanh \gamma \ell}{Z_0 + R \tanh \gamma \ell}, \quad (1)$$

where

$Z_0$  = characteristic impedance

$R$  = load impedance

$\gamma$  = propagation constant

$\ell$  = line length

$Z$  = impedance at a distance  $\ell$  from the load

Solving Eq. 1 for  $\tanh \gamma \ell$  yields

$$\tanh \gamma \ell = \frac{Z_0 (Z - R)}{Z^2_0 - RZ} \quad (2)$$

Two measurements are made at the frequency of interest. The first is a measurement of the line impedance,  $Z_1$ , with a known terminating impedance,  $R_1$ . The second measures an impedance,  $Z_2$ , with another known load impedance,  $R_2$ . Impedances or, preferably, resistances  $R_1$  and  $R_2$  are chosen to yield readily measurable values of  $Z_1$  and  $Z_2$ ; otherwise, they are arbitrary.

Note that  $\gamma$  depends entirely on the line constants, and  $\ell$  is a fixed length, hence  $\tanh \gamma \ell$  is the same for both measurements. Writing Eq. 2 for each measurement and equating them results in

$$\tanh \gamma \ell = \frac{Z_0 (Z_1 - R_1)}{Z^2_0 - R_1 Z_1} = \frac{Z_0 (Z_2 - R_2)}{Z^2_0 - R_2 Z_2}. \quad (3)$$

Solving for  $Z_0$  yields

$$Z_0 = \left[ \frac{(Z_1 - R_1) R_2 Z_2 - (Z_2 - R_2) R_1 Z_1}{Z_1 - Z_2 - R_1 + R_2} \right]^{1/2}. \quad (4)$$

The  $R_1$  and  $R_2$  quantities on the right side of Eq. 4 are selected for easy measurement. Note that  $Z_0$  is independent of line length or losses. The error sources in Eq. 4 involve the normal measurement tolerances, not theory or assumptions.

If terminating impedances  $R_1$  and  $R_2$  are chosen to be pure resistances, the measured impedances  $Z_1$  and  $Z_2$  are, in general, complex; therefore, Eq. 4 can yield complex values for  $Z_0$ . This result is expected for some lossy lines, and all practical lines at low frequencies.

In the special cases of half-wave, low-loss lines or extremely short sections, be particularly careful when selecting the load impedances,  $R_1$  and  $R_2$ . They should be selected to best resolve the differences,  $(Z_1 - R_1)$  and  $(Z_2 - R_2)$ , between the measured and load impedances. ■■

### References

1. Paris, D. T. and Hurd, F. K., *Basic Electromagnetic Theory*, McGraw-Hill, New York, NY, 1969.
2. King, R. W. P., *Transmission Line Theory*, McGraw-Hill, New York, NY, 1955.
3. Johnson, W. C., *Transmission Lines and Networks*, McGraw-Hill, New York, NY, 1950.
4. Oliver, B. M., "Time Domain Reflectometry," *Hewlett-Packard Journal*, Palo Alto, CA, February, 1964.

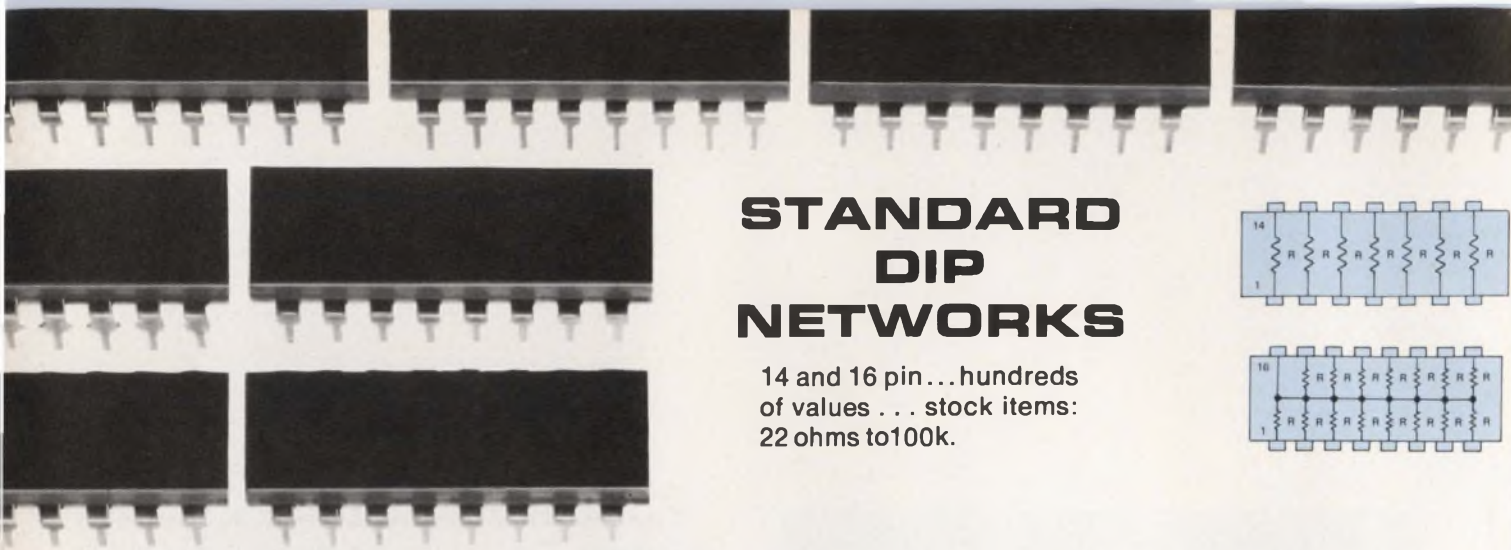

## STANDARD DIP NETWORKS

14 and 16 pin... hundreds  
of values... stock items:  
22 ohms to 100k.

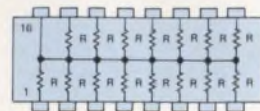
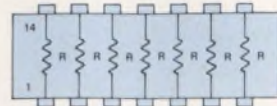

# THICK FILM RESISTOR

# DIP's

## CUSTOM DIP NETWORKS

Our computer controlled laser has solved thou-  
sands of custom designed dip and sip networks  
... use it to solve your's!

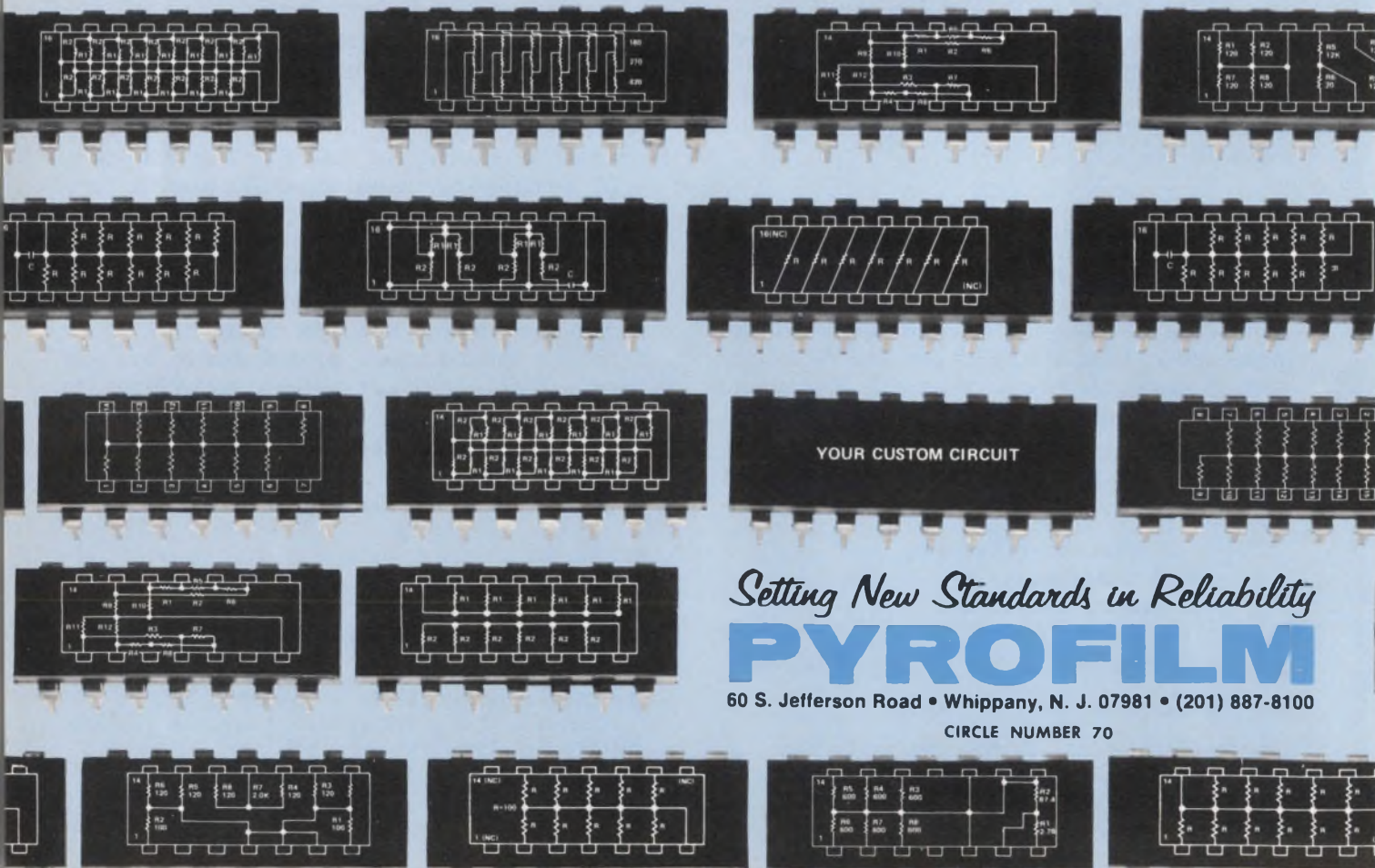

YOUR CUSTOM CIRCUIT

*Setting New Standards in Reliability*

# PYROFILM

60 S. Jefferson Road • Whippany, N. J. 07981 • (201) 887-8100

CIRCLE NUMBER 70

# The narrow **NEW** thumbwheels with wide application

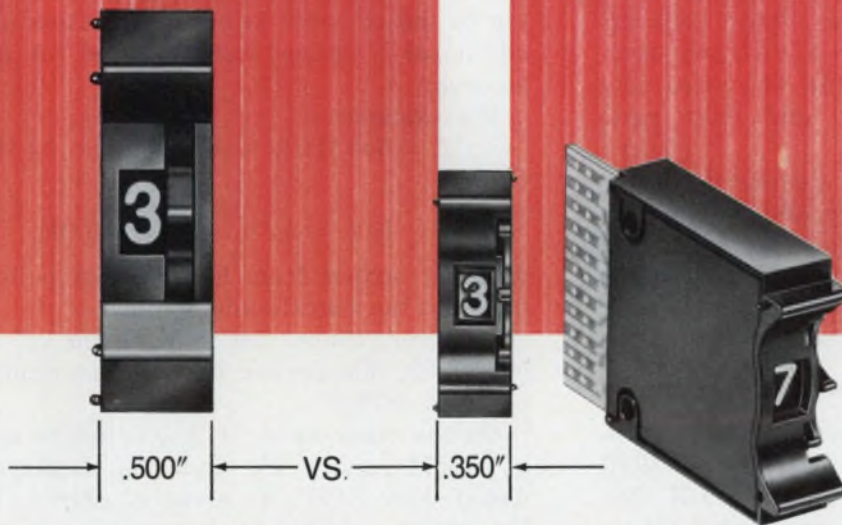

**Two new slim thumbwheels...with slim prices, too.**

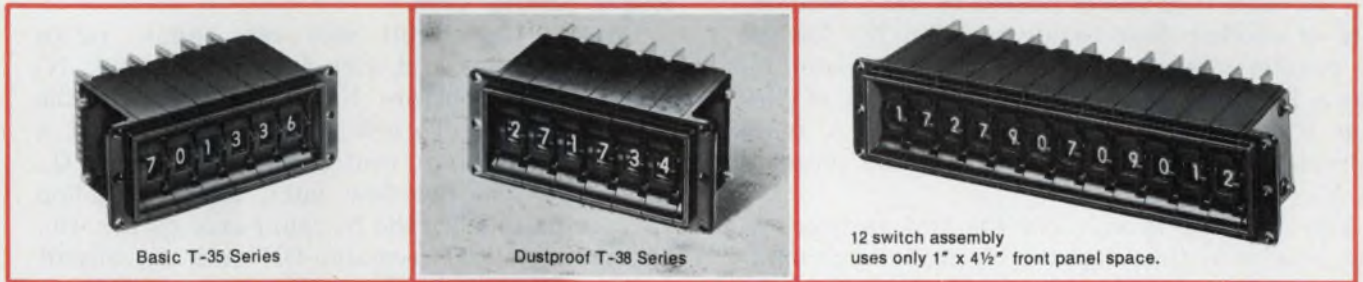

Two modestly-priced, slim subminiature thumbwheel switches offering substantial savings in panel space. The more switches you need, the more space you save. Available in two new designs:

**The easy and accurate to use Series T-35 Basic Thumbwheel** with all the high quality engineering and construction features that establish **Cherry** Thumbwheels as the standard by which you judge other thumbwheels.

**The Series T-38 Dustproof Thumbwheel** with a clear

plastic window that covers the dial character opening to keep dust and dirt **outside** where they can't foul or contaminate the mechanism and contacts **inside**.

Best of all, these narrow new thumbwheels are available in 8, 10, 12 and 16 positions in your "most wanted" output codes.

For all the **NARROW** facts and **SLIM** prices in a hurry, just TWX 910-235-1572 . . . or PHONE 312-689-7700.



**CHERRY ELECTRICAL PRODUCTS CORP.**  
3609 Sunset Avenue, Waukegan, IL 60085  
Cherry switches now available locally from distributors.

See Cherry at Electronica-Munich (Nov. 25-Dec. 1) Hall #3, Booth #3110.

CIRCLE NUMBER 71

## Measure pulse-rate ratios automatically to four-place accuracy. Simple circuit handles steady or random signal rates with ratios greater or less than unity.

To determine the ratio of two signal pulse-rates, you don't need to separately record the individual rates and obtain the ratios with manual arithmetic. A simple counter-circuit arrangement (Fig. 1) provides a virtually real-time, 4-digit display of the ratio. The rates may be either regular or random, and their ratio greater or less than unity.

For random-pulse rates, the statistical accuracy—and for regular pulse rates, the absolute accuracy—depends on how long you are willing to wait for the result. The circuit works in the same way for random and regular signals.

### Gated counters determine the ratio

In the simplified arrangement of Fig. 1, the input-pulse rates,  $f_1$  and  $f_2$ , enter the two NOR gates,  $IC_{1-1}$  and  $IC_{1-2}$ , respectively. A J-K flip-flop latch circuit,  $IC_{2-1}$ , controls the state of these gates.

Pulses passed by  $IC_{1-1}$  accumulate in a four-decade register,  $N_1$ , formed by counter circuits  $IC_3$  through  $IC_6$ ; pulses passed by  $IC_{1-2}$  accumulate in another four-decade register,  $N_2$ , formed by counter circuits  $IC_7$  through  $IC_{10}$ . Register  $N_2$  has a  $1 \times 10^4$  overflow circuit consisting of flip-flop  $IC_{2-2}$ , transistor  $Q_1$  and a LED. A four-decade, numerical readout displays the contents of  $N_2$ .

The counting time,  $t_1$ , of the two registers is the amount of time register  $N_1$  needs to accumulate a count selected with switch  $S_{1-1}$ . When  $N_1$  accumulates the selected count, latch  $IC_{2-1}$  operates and closes gates  $IC_{1-1}$  and  $IC_{1-2}$ . The circuit then holds and displays the contents of  $N_2$  until the circuit is manually reset with  $S_2$ .

Clearly the ratio of the pulse rates  $f_1$  and  $f_2$  are related to the counts,  $n_1$  and  $n_2$ , accumulated in the corresponding registers,  $N_1$  and  $N_2$ , by the following equation:

$$f_2/f_1 = n_2/n_1.$$

The  $n_1$  counts are the powers of ten— $10$ ,  $10^2$ ,

$10^3$  or  $10^4$ —for easy interpretation of the displayed ratio. A switch section,  $S_{1-2}$ , automatically illuminates the proper decimal point corresponding to the  $n_1$  count selected. As explained later, additional  $N_1$  stages can be added for increased accuracy.

For example, if

$$f_1 = 580 \text{ Hz}, f_2 = 45 \text{ Hz}, \text{ and } n_1 = 10^3,$$

then

$$f_2/f_1 = n_2/n_1 = \frac{77}{10^3} = 0.077$$

with the second from left decimal point illuminated on the four-decade display.

However, since the true ratio of  $f_2/f_1$  is 0.0775862, this answer has a measurement error of about 0.75%.

On the other hand, if  $S_{1-1}$  is set to count  $10^4$ ,  $n_2$  would equal 775, and the displayed ratio would show .0775—an error of only 0.11%. But the reading time for this greater accuracy is 17.24 s vs 1.724 s for the first example. If  $n_1$  could be greater than  $10^4$ , then even greater accuracy could be attained, but, of course, at an even longer reading time.

Clearly, the circuit also can handle ratios greater than one. But with  $f_2$  greater than  $f_1$ ,  $N_2$  might overflow before  $N_1$  has accumulated the selected number. To indicate such a condition, a LED overflow lamp, controlled by transistor  $Q_1$ , turns ON. The overflow latch circuit, flip-flop  $IC_{2-2}$ , actuates when the  $N_2$  count exceeds  $1 \times 10^4$ . The overflow LED remains ON until the circuit is manually reset by  $S_2$ .

### Determining errors of random-pulse ratios

When the input pulse rates are random and have a Gaussian distribution, the ratio-measuring procedure—whether  $f_1$  is greater or less than  $f_2$ —is the same as for the regularly spaced pulse inputs just described. However, now the accuracy of the measured ratios becomes a statistical quantity.<sup>1</sup>

The standard deviation,  $\sigma$ , of the measured ratio of random inputs is given by the expression:<sup>2</sup>

$$\pm \sigma = \frac{n_2}{n_1} \left( \frac{1}{n_1} + \frac{1}{n_2} \right)^{1/2} \quad (1)$$

H.A. Cole, Chartered Engineer, Atomic Energy Research Establishment, Harwell, Oxfordshire, England.

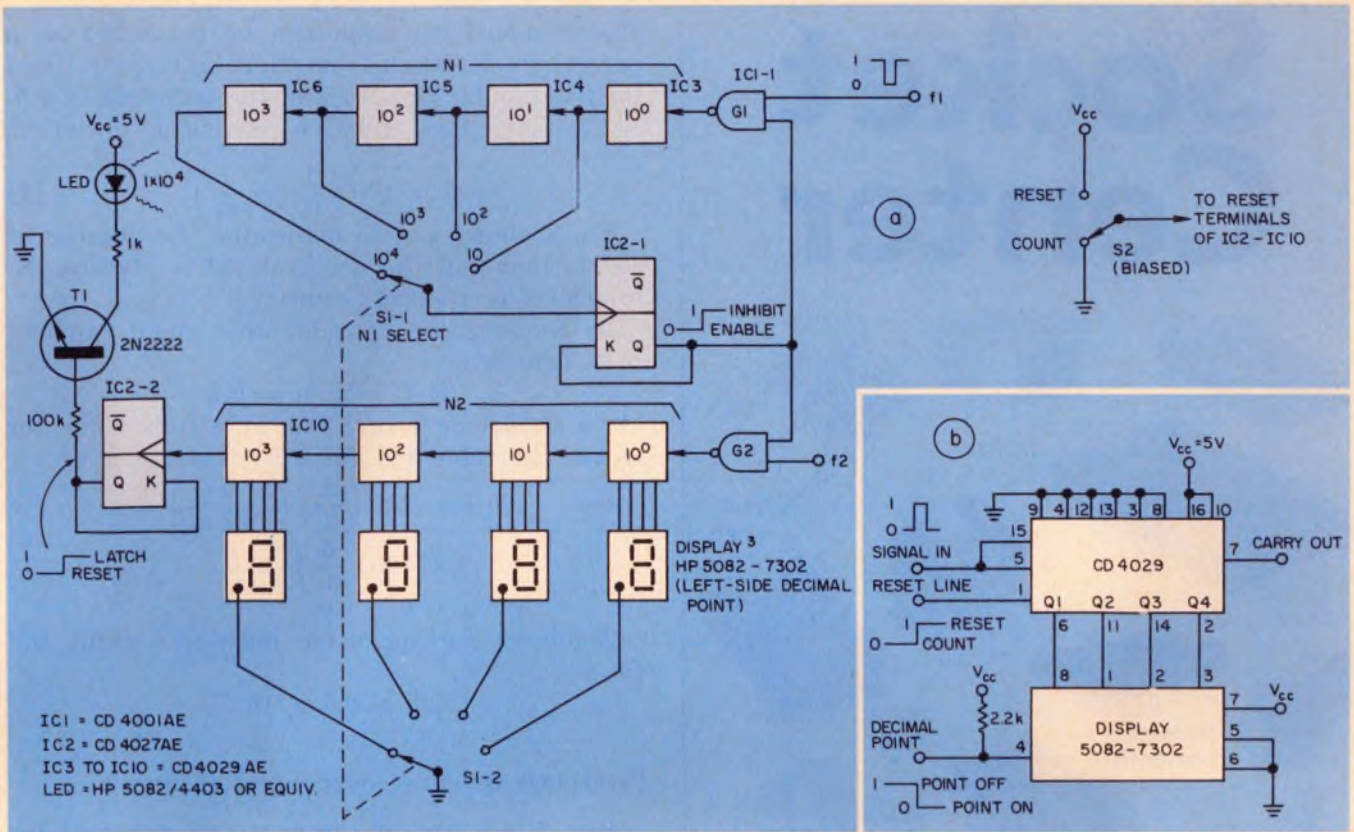

1. The decimal point of the four-place readout for the rate-ratio circuit (a) is automatically established by the

setting of switch  $S_1$ . Counter-to-indicator connections (b) for each counter in the  $N_2$  chain are identical.

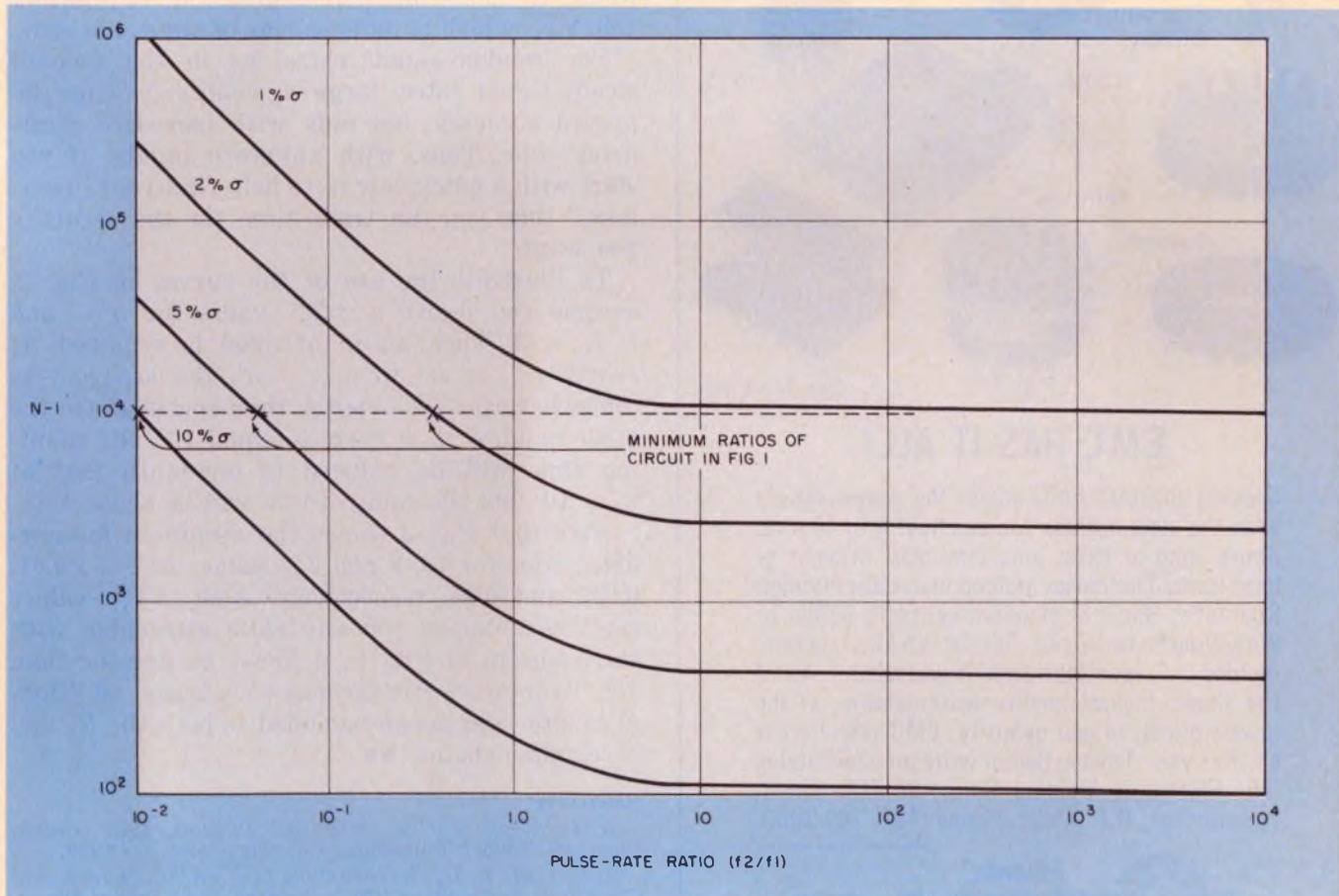

2. For random pulse-rate signals, the count of chain  $N_1$ , as set by switch  $S_1$ , determines the expected pre-

cision of the ratio measured in terms of a percentage relative standard deviation,  $\sigma$  %.

# Socket Center

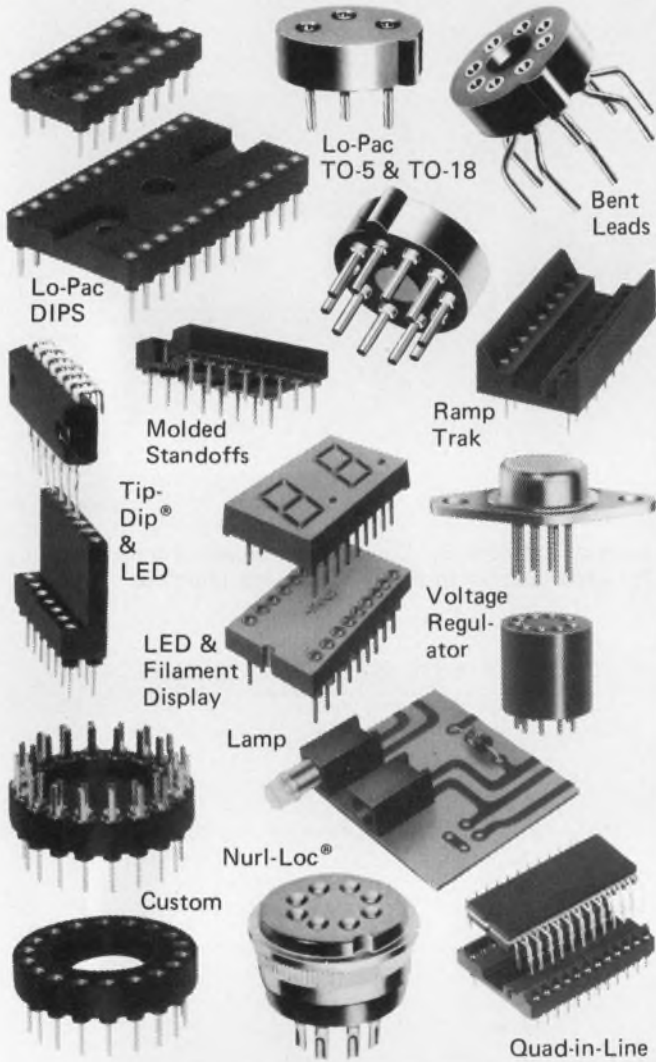

## EMC HAS IT ALL!

Seeking sockets? EMC stocks the widest variety with the most options you can buy! 6 to 48 pins. Short, long or extra long terminals. Straight or bent leads. Thermoset molded materials. Platings. Standoffs. Short or standard contacts. Solder or Wire-Wrap® terminals. Special sockets custom-molded . . . even fabricated if you need it. All of the finest, highest quality workmanship, at the lowest prices, in any quantity. EMC does have it all. For you. Today. Call or write for new Catalog '76. Electronic Molding Corp., 96 Mill Street, Woonsocket, R.I. 02895. Phone (401) 769-3800.



CIRCLE NUMBER 72

The standard deviation can be expressed as a percentage deviation from the true mean ratio of the two inputs. This form of the deviation is called a percentage relative standard deviation,  $\sigma\%$ :

$$\pm\sigma\% = 100 \left( \frac{1}{n_1} + \frac{1}{n_2} \right)^{1/2} \quad (2)$$

Eq. 2 allows you to determine the number of counts that must be accumulated in register  $N_1$  to achieve a specified accuracy.

As an example, consider this mean random-pulse-rate ratio:

$$f_2/f_1 = n_2/n_1 = 0.2$$

and a required  $\sigma\%$  of  $\pm 1\%$ . Substitute  $0.2 n_1$  for  $n_2$  and the value  $1\%$  for  $\sigma\%$ , then

$$\pm\sigma\% = 100 \left( \frac{1}{n_1} + \frac{1}{0.2 n_1} \right)^{1/2},$$

$$1 = 100 \left( \frac{6}{n_1} \right)^{1/2},$$

$$\text{and } n_1 = 6 \times 10^4.$$

Similarly, for the same pulse-rate ratio, but for  $\sigma\% = 5\%$ ,

$$n_1 = 2.4 \times 10^3.$$

### Percentage deviation independent of large $n_2$

Fig. 2 is a plot of the  $n_1$  counts required for given percentage relative standard deviations,  $\sigma\%$ , over a range of random input ratios from  $10^{-2}$  to  $10^4$ . It is interesting to note that in Eq. 2, when  $n_2 \gg n_1$ , the expression approaches  $100/\sqrt{n_1}$ , which is independent of the value of  $n_2$ .

For random-signal rates, as in the case of steady-signal rates, large  $n_2$  counts provide improved accuracy, but only with increased measuring time. Thus, with unknown inputs, if you start with a quick, low  $n_1$  to help find your "bearings," then you can trade time for the accuracy you want.

To illustrate the use of the curves in Fig. 2, assume you desire a  $\pm 2\%$  value for  $\sigma\%$ , and  $f_2/f_1 = 3$ . Then an  $n_1$  of 3200 is required. If switch  $S_{1-1}$  is set to  $n_1 = 10^4$ , the accuracy is somewhat over  $1\%$ —better than specified. On the other hand, if  $n_1$  is made to equal  $10^3$ , the counting time will be reduced to one-tenth that at  $n_1 = 10^4$ , but the value of  $\sigma\%$  will be about  $4\%$ .

Note that Fig. 2 shows the minimum measurable ratios for 10, 5 and 2% values of  $\sigma\%$ : 0.01, 0.043 and 0.35, respectively. Also,  $\pm 1\%$  values can't be obtained for any ratio attainable with the counters in Fig. 1;  $n_1$  must be greater than  $10^4$ . To improve measurement accuracy, additional counter stages can be added to both the  $N_1$  and  $N_2$  counter chains. ■■

### References

1. *Handbook of Chemistry and Physics*, 49th edition, Chemical Rubber Publishing Co., Cleveland, p. A253.
2. Harvey, B. G., *Introduction to Nuclear Physics and Chemistry*, 2nd edition, 1969, Prentice-Hall International, Englewood Cliffs, NJ, pp. 358-361.
3. *Hewlett-Packard Application Note 934* (5082-7300 series), Palo Alto, CA.



# Licon® non-lighted PB switches offer you the greatest possible value with good-as-gold quality and reliability at terrific prices!

Know something?

Our Licon lighted PB's have been glowing so brightly that they've cast our *non*-lighted PB's into undeserved shadow.

And therein lies an opportunity you may have been missing. Because, quite frankly, Licon non-lighted PB's are a terrific deal in every way!

You'll find that there's one for just about every .25 to 10 Amp switching application you can dream up. Plenty of sizes to choose from, even down to our Series 78, which is possibly the smallest non-lighted PB made. Variety of key tops, lens cap colors and bezel mountings. Momentary and alternate types of action. Choice of terminal configurations in single or double pole. U.L. listed and C.S.A. approved.

Most non-lighted PB models feature Licon's exclusive, ultra-reliable Butterfly® switching mechanism.

Best of all, though, is the pleasant surprise you get when you check Licon pricing on 1,000-piece and larger orders. Look into it. You'll be pleased.

Contact your local Licon distributor or call or write for our Switch Catalog: Licon, 6615 West Irving Park Road, Chicago, Illinois 60634. Phone (312) 282-4040. TWX 910-221-0275.



**LICON**

A DIVISION OF ILLINOIS TOOL WORKS INC.

## Golden Opportunity Pushbutton Switches!





## Why is the 280 at \$99<sup>95</sup> our fastest selling multimeter ever?

The reasons are easy to understand. The 280 is a battery-operated portable, full-feature digital multimeter at less than the price of a precision analog meter. The 280 features a large three-digit LED readout, automatic polarity indication, automatic decimal point placement and out-of-range indication. The 280 is fully overload protected for reliability and has an industry-standard input impedance of 10 megohms for all voltage ranges.

It has High/Low power ohms ranges for accurate in-circuit measurements. And digital accuracy  $\pm 0.5\%$  DCV thru lowest ranges;  $\pm 1\%$  1000 V range.  $\pm 1\%$  ACV thru lowest ranges;  $\pm 2\%$  1000V range.  $\pm 1\%$  typical ohms and digital resolution (1mV, 1 $\mu$ A, 0.1 ohm).

No compromises on range either—DC and AC voltage ranges to 1000 V, DC and AC current ranges to 1000 mA and ohms ranges to 10 megs. There are actually 22 operating ranges controlled by the smooth rotary range and function switches.

B&K-PRECISION also has a full complement of optional accessories for the 280:

- LC-28 carrying case (\$6.00) protects your 280 and provides test lead storage.
- MS-28 wire tilt stand (\$3.00) allows positioning the 280 on two convenient viewing angles.
- BC-28 AC adapter/charger (\$8.00) offers AC operation and battery recharging.
- PR-28 high-voltage probe extends the 280's capability to 40,000 volts.
- PR-21 direct/isolation probe (\$10.00) prevents capacitive loading when measuring DC in an RF circuit.

Our fastest seller ever? We're not surprised.  
**IN STOCK AT YOUR DISTRIBUTOR.**

**B&K PRECISION**

**PRODUCTS OF DYNASCAN**

6460 West Cortland Avenue • Chicago, Illinois 60635 • (312) 889-9087

In Canada: Atlas Electronics, Toronto



# An automatic RLC tester for \$ 995? you've got to be kidding!

There's more to the new GR 1657 RLC Digibridge™ than its low \$995\* price. It's designed with features to lower your R, L, and C component testing cost. That's what it's all about — isn't it?

**Measures R, L, C, D and Q.**

A microprocessor performs a combination of measurement and control functions in addition to lowering the GR 1657 unit cost.

**Fast testing time** of three measurements per second, unqualified.

**0.2% Accuracy** for R, L, and C.

**Five full-digit LED display** for R, L and C and four full digits are displayed for D and Q. All numbers go to 9.

**Wide measurement ranges** allow you to test a greater number of component values. Test R from 00.001  $\Omega$  to 99.999 M $\Omega$ , L from 0.0001 mH to 9999.9 H, C from 0.0001 nF to 99999.  $\mu$ F, D from .0001 to 9.999, and Q from 00.01 to 999.9.

**Microprocessor-directed ranging** takes the guesswork out of setting the correct range. Lighted arrows on the front panel indicate which range

button is to be depressed and the correct range is identified automatically.

**Three range positions** provide measurements in multiples of 100, since each range has two full decades of measurement capability, a feature made possible by automatic decimal point positioning.

**Automatic decimal point positioning** causes the measurement to be made on the lowest possible range, so maximum resolution is always achieved.

**Selectable test frequencies** of 1 kHz or 120 Hz (100 Hz) are switched by the operator.

**Selectable series or parallel measurement modes** are operator specified across the full measurement range of every test parameter.

**Hi-Rel Kelvin test fixture** accommodates axial and radial lead components.

Now you know there's more to the GR 1657 RLC Digibridge than its low price. We're not kidding!

*\*U.S.A. domestic price only.*



## GenRad

# At Telonic, we do 5 things well. SWEEP DISPLAY. FILTER. ATTENUATE.



For example, Telonic *sweep generators* are used in well over 5,000 labs and production lines internationally. With a 20-year history of specialization in sweeper design, we invite any comparison with our newest solid-state 1200-Series. They offer you a broad choice of frequency ranges to 1.5 GHz, selectable band widths, precise frequency marking, and real-time dependability.

To make your test results even more visible, we also provide large-screen X-Y *display oscilloscopes* in single and dual trace versions, Models 121 and 122. Their sensitivity and stability make them well suited for the design bench or the production area. And for the OEM who wishes to incorporate a display in his own system, we even supply a naked display (Model 4060) – no case – just a basic chassis, interfaced to your specifications.

In the *filter* business, our customers in instrumentation, radar, E.W. and communications make up the top 100 of the electronics industry. The product line extends from low pass and band pass tubulars to cavities, interdigitals, combine, subminiature, and tunables, up to 12 GHz in some models. In addition to fine performance, these filters offer the user two other significant advantages – low price and fast delivery.

Our *attenuators* are another first choice by major instrument manufacturers. We use thick film substrates for precision and extra long life. We keep them small to minimize panel space. We design them for handling high power to simplify circuitry. We even modify them to meet your requirements.

And that 5th thing we do well is to *back up our products* – like our 5-year warranty on filters. With factory support nationally, and 35 distributors overseas, Telonic has a man close at hand to assist you with application know-how, replacement parts, and service.

The information number below will provide a short form catalog, but if you need information on specific products right now, phone or write our Marketing Department directly. Call TOLL-FREE 800-854-2436.



**TelonicAltair** 

2825 Laguna Canyon Rd. • Box 277, Laguna Beach, California 92652 • Tel: 714 494-9401 • TWX: 910 596-1320 • Cable TELENG

**Telonic – the No. 1 name when you want to sweep, display, filter or attenuate.**

CIRCLE NUMBER 186

# Opening new frontiers with electro optics

## PMTs with GaP dynode give scientists outstanding PHR.

If you're a nuclear or plasma scientist, you should know about RCA photomultipliers with gallium-phosphide first dynodes. They provide a gain of 30 to 50, vs. the usual 4 to 8 using conventional dynode materials. This high gain provides a PHR (Pulse Height Resolution) capability that permits the discrimination of up to 5 photoelectron events — impossible with conventional PMTs. Our 8850 PMT and larger 8854 have these GaP first dynodes. They're part of RCA's line of bi-alkali and S-11 types for the nuclear physicist.

Let us help you choose the PMT best suited to your needs.

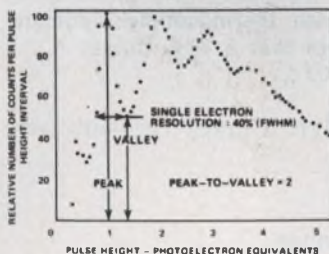
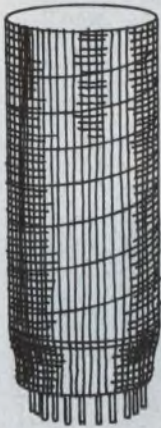

Circle 201

## Timesaver for spectroscopists: PMT circuit in a socket.

No longer do you have to design circuitry to get the right voltages for photomultipliers. We've done it for you. Just plug the PMT into one of our compact solid state power supplies, apply 12 volts dc, and here's what you get: regulated — 500 to — 1250 V controlled by resistance or voltage programming (Model PF1042) or — 100 to — 1250 V that varies directly with input voltage (PF1043). Both power supplies work with most side-on PMTs in RCA's broad line, covering UV to near IR (165 to 1200 nm). Some have broad range, others focus on the visible region. Ask for in-depth applications help from RCA.



Circle 202

## RCA announces a new Si Imaging Device. Better performance, lower price.

Using buried channel techniques, we've improved horizontal resolution in our new Silicon Imaging Device (SID). And we're subjecting units to more stringent blemish criteria. RCA's "Big SID" is a 512 x 320 array, 163,840 pixel, charge-coupled device that produces a standard interlaced 525-line TV picture with ultra low blooming and no lag or microphonics. SID52501, priced under \$1000 is available with 30-day delivery. Or get Big SID in our TC1160 camera for less than \$2000.

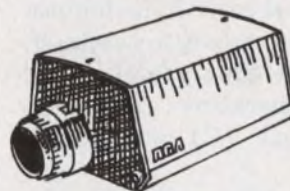

Circle 203

## Hi-speed IR emitters for fiber-optic communications.

The speeds are right: 100 MHz min. analog bandwidth (C30119) or 40 MHz min. (C30123). And so is the size: A 6-mil edge emitter in an OP-18 package with removable cap that assures good collection efficiency with single fibers or bundles. (Also available in hermetically sealed package.) These IR emitters are rated at up to 200 mA forward current for continuous operation and 1.5 A peak forward current for pulse operation. Competitively priced, they're available from stock.

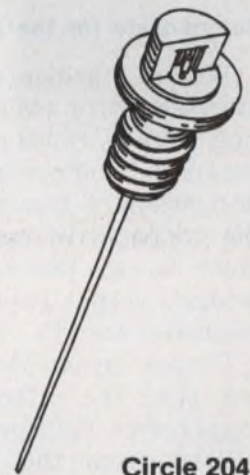
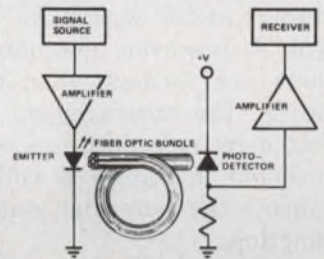

Circle 204

If electro optics can solve your problem, remember: EO and RCA are practically synonymous. No one offers a broader product spectrum. Or more success in meeting special needs. Call on us for design help or product information. RCA Electro Optics, Lancaster, PA 17604. Phone 717-397-7661. Sunbury-on-Thames, Middlesex TW16 7HW, England; Ste. Anne de Bellevue H9X 3L3, Canada; Belo Horizonte, Brazil; Hong Kong.

# RCA

## Don't sweat with thermocouple thermometers.

CMOS analog and digital devices make it easy to design an inexpensive thermometer.

Thermocouples (TCs) are reliable and low-cost temperature transducers, but they have two major disadvantages:

- Low output (millivolts).
- Reference-junction drift.

The problems can be avoided by using inexpensive linear-CMOS-chips as low-level signal conditioners, and a bucking voltage for reference-junction compensation. The complex electronics and temperature control of past designs are not needed. Thus TCs are now attractive transducers, even for temperatures as low as 0 to 100 C (see Fig. 1).

Thermocouple probes, as we know, are made by simply welding together the ends of two dissimilar-metal wires. As shown schematically in Fig. 2, however, not one but at least two junctions are formed when a TC is used. In other words, the measurement is differential and affected by reference-junction temperature. Therefore we introduce a voltage that automatically cancels the potential generated at the reference junction.

### Compensate for the reference junction

We use a bridge (Fig. 3) containing a temperature-sensitive resistor to generate a compensation voltage. Since only a small output voltage is required, a copper wire with a resistivity tempo of  $0.00393/^{\circ}\text{C}$  is sufficient. For accurate tracking, the copper-wire resistor and the reference TC must be at the same temperature; also, the bridge's output (in terms of  $\mu\text{V}/^{\circ}\text{C}$ ) must match the reference TC.

Proper layout yields good temperature tracking (i.e., the reference TC is placed near the copper-wire resistor, and both are thermally insulated from the ambient.) The temperature sensitivity of the bridge is then matched to the reference TC by  $R_{\text{adj}}$  (Fig. 3), which controls the

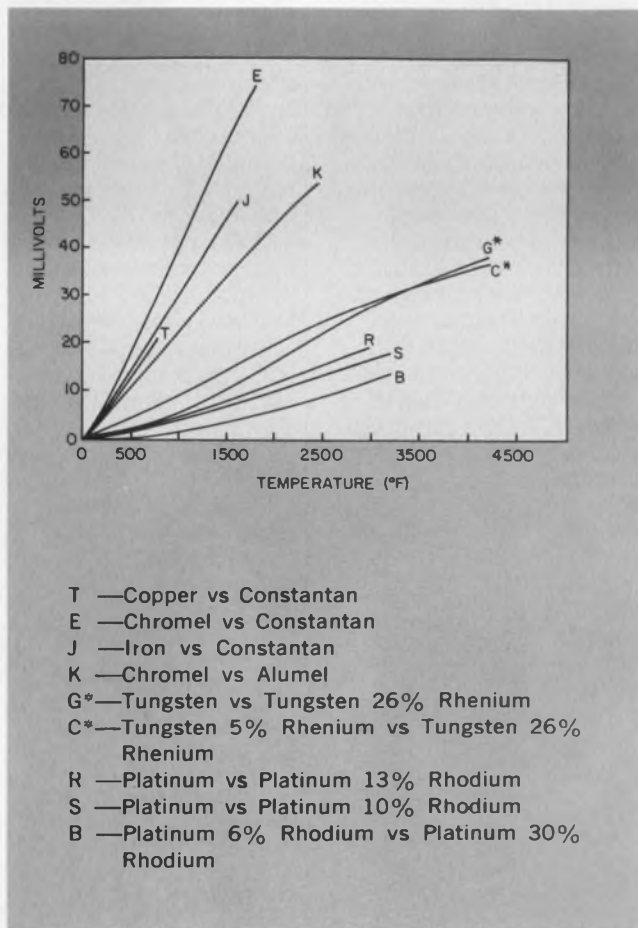

1. The sensitivities of common thermocouples indicate that the thermometer can work over a wide range.

current through the bridge. Finally, offsets are adjusted using  $R_{\text{offset}}$ .

### Design a compensation circuit

Let's analyze the circuit for automatic reference TC compensation (Fig. 3). For illustration, we will use a Chromel/Alumel couple. The TC's sensitivity at room temperature ( $S_{\text{TC}}$ ) is  $39 \mu\text{V}/^{\circ}\text{C}$ . This must be matched by the voltage variation across the copper-wire resistor ( $R_{\text{Cu}}$ ) as a function of temperature. If a  $15\text{-}\Omega$  copper-wire resistor is selected, the current through it ( $I_{\text{Cu}}$ ) is

Dr. S. Ben-Yaakov, Head, and Y. Sanandagi, R & D Technician, Institute of Electronics, Ben-Gurion University of the Negev, Beer-Sheva, Israel.

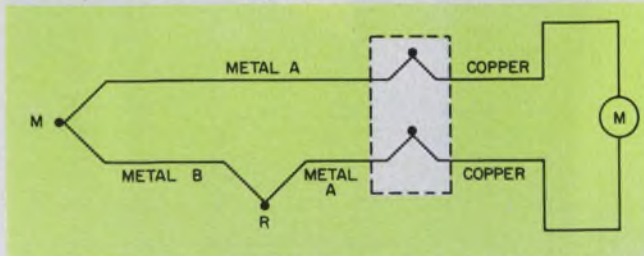

2. Thermocouple temperature measuring involves a measuring-junction M, and a reference-junction R. If the junctions with the copper wire are kept at the same temperature, their potentials cancel.

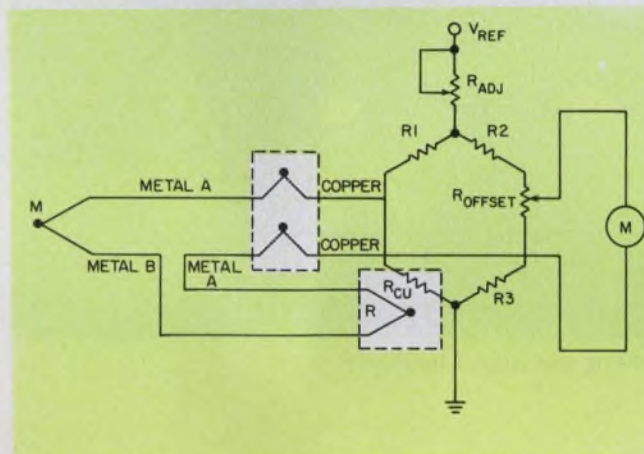

3. The bridge, using a copper-wire resistor ( $R_{Cu}$ ), produces a temperature dependent output voltage for reference-junction compensation. The voltage is made equal and of opposite polarity to the reference junction.

$$I_{Cu} = \frac{S_{TC}}{R_{Cu} \times S_{Cu}}$$

where  $S_{Cu}$  is the temperature coefficient of resistivity of copper, which is equal to  $0.00393 / ^\circ C$ . The required current is

$$I_{Cu} = \frac{40 \times 10^{-6}}{3.93 \times 10^{-3} \times 15} = 0.678 \text{ mA}$$

Assuming a symmetrical bridge, the current through  $R_{adj}$  ( $I_{adj}$ ) should be

$$I_{adj} = 2 \times I_{Cu} = 1.36 \text{ mA}$$

and the expression for  $R_{adj}$ :

$$R_{adj} = \frac{V_{ref} - I_{Cu} (R_1 + R_{Cu})}{I_{adj}}$$

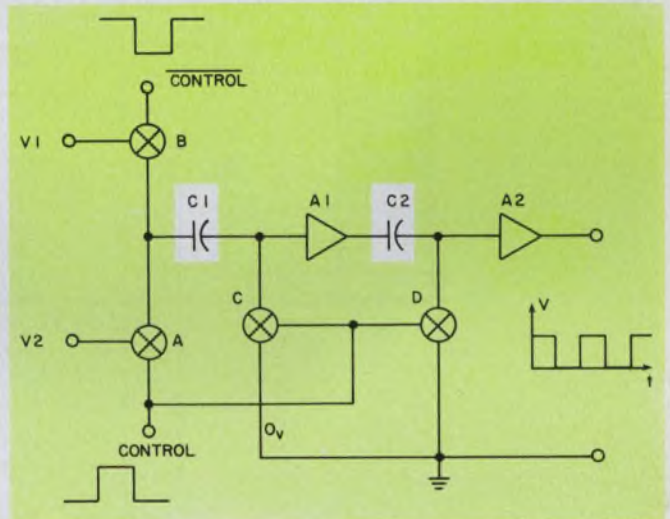

4. Automatic-offset-correcting dc amplifier's output is proportional to the difference of  $V_1$  and  $V_2$ . The analog switches conduct when their control line is high.

Selecting  $R_1$  to be  $5 \text{ k}\Omega$  and assuming a reference voltage ( $V_{ref}$ ) of  $5 \text{ V}$ ,

$$R_{adj} = \frac{5 - 0.678 \times 10^{-3} \times 5.015 \times 10^{-3}}{1.36 \times 10^{-3}}$$

$$R_{adj} = 1.18 \text{ k}\Omega.$$

#### Eliminate dc-amplifier offset

A major problem in the design of TC thermometers stems from the extremely low dc levels involved. Offsets in dc amps tend to mask the signal. We overcome this problem, while using standard CMOS op amps, with an automatic offset-correction circuit. The major components of the circuit are shown in block form (Fig. 4). Operational amplifiers, analog switches and series capacitors are used.

The switches are driven by a square-wave (see Fig. 4). The switches conduct when the drive is high. During the offset-adjustment period, switches A, C, and D conduct.  $C_1$  charges to  $V_1$ , and  $C_2$  charges to the offset-dc error at the output of  $A_1$ . The charge on  $C_1$  and  $C_2$  is maintained during the temperature-measuring half-cycle. The output voltage of  $A_2$  is therefore proportional to

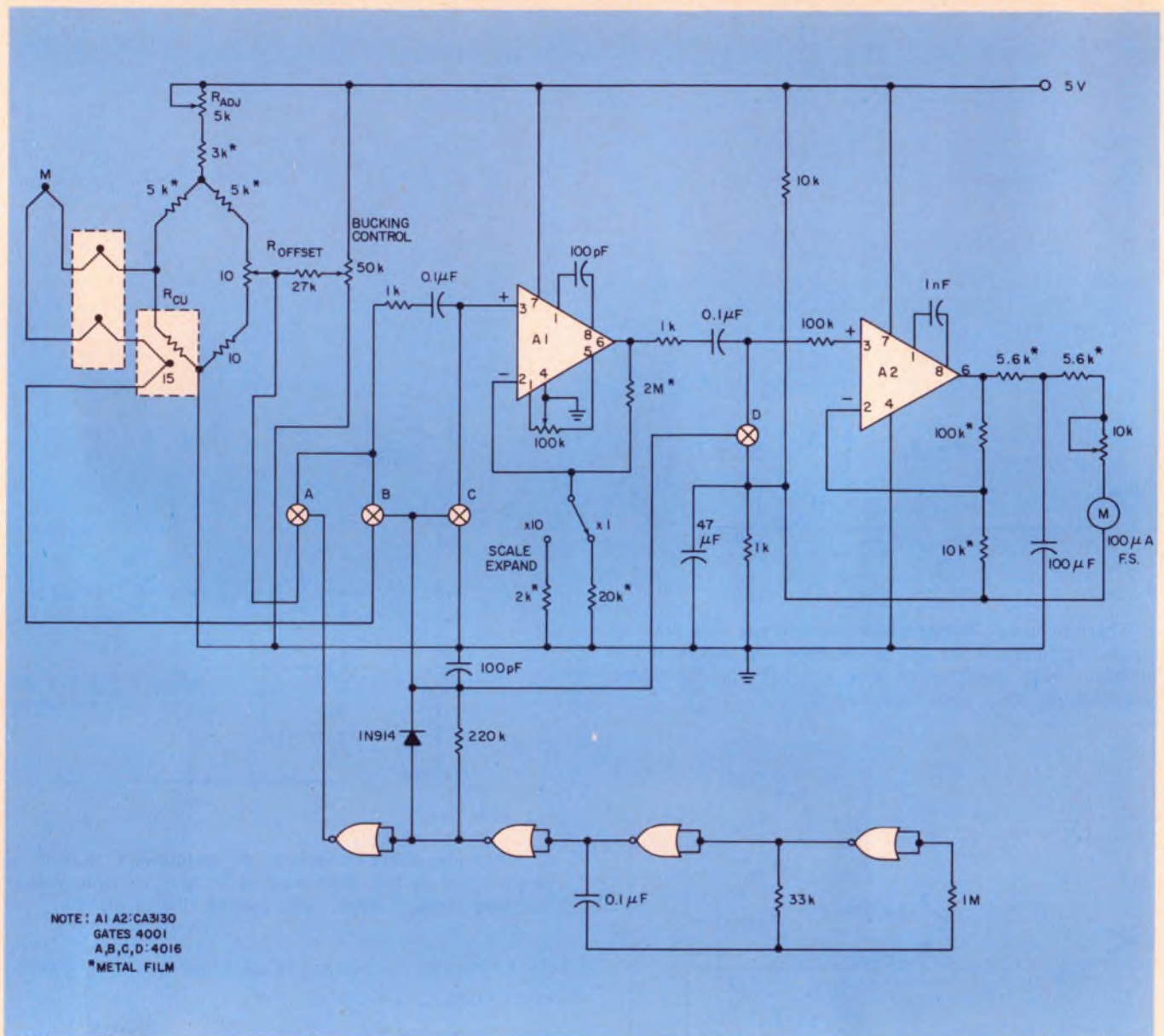

5. Thermocouple thermometer uses all CMOS chips for both analog and digital functions.

$V_1 - V_2$  and is free of the offset voltage at  $A_1$ , which is subtracted out by the voltage across  $C_2$ .

### Use CMOS circuits throughout

The design principles presented here are applied in the all-CMOS circuit of Fig. 5. It includes an RC oscillator, analog gates and op amps. The op amps' CMOS input-and-output stages have two useful features:

- *Very low input bias current.* A value of 10 pA is typical. Hence, capacitor discharge (the droop) is negligible during the 5-ms temperature measuring cycle.

- *Ability to operate from a single supply.* The op amps' input-and-output terminals are permitted to reach ground potential. This simplifies the power supply, an important feature in bat-

tery-operated instruments.

With the values shown in Fig. 5, the amplifier has an over-all gain of about 1000 and an offset-voltage drift of less than  $0.3 \mu\text{V}/^\circ\text{C}$ . Assuming a duty cycle of 50%, the over-all gain to the filtered output is 500. Use of a Chromel/Alumel TC produces a full scale of 400 mV for a 0-to-100-C temperature span. With a proper series resistor, the signal conditioner can drive a 100- $\mu\text{A}$  moving-coil meter.

Two additional features are:

- Expanded-scale capability.
- Variable bucking voltage.

Using these features together, you can buck out a reading, then expand the scale to measure small superimposed temperature fluctuations with a sensitivity greater than 0.1 C. This procedure produces a resolution less than  $4 \mu\text{V}$ . ■■



# Coming through...



with wire, cable and cord  
that delivers quality,  
performance, economy...

Belden has it: a total service capability. Extensive design and application know-how. What it takes to deliver complex cable configurations, special harnesses, cords, lead wires, and even special packages to fit your requirements.

Our specialists and engineers will meet with your people at your plant to discuss problems in processing, assembly, installation, ordering, human engineering, color coordination, physical and electrical parameters, opportunities for cost reduction. And when we can't help you using standard products, we'll innovate a solution to your problem.

Talk to a Belden specialist about your new applications, product ideas, processing problems—all your wire, cable and cord needs. He has thousands of standard items to draw from. And standard or special, he'll come through with the best wire buy around. For answers right now, phone:

317-966-6661 Electronic Div. or mark No. 400 on reader service card  
312-986-1600 Electrical Div. or mark No. 401 on reader service card  
312-887-1800 Transportation Div. or mark No. 402 on reader service card,  
or write Belden Corporation, 2000 S. Batavia Ave., Geneva, IL 60134.



**Coming through...**

*with new ideas for moving electrical energy*

# The world's smallest complete Isolation Amplifier has



## the world's smallest price.

We knew what you needed in isolation amplifiers. Smaller size, lower cost, better performance. So, we did it. We designed the Model 284J Isolation Amplifier to give you the kind of performance and versatility you need for a broad range of applications.

The 284J costs only \$41 in 100s, yet delivers all the key parameters in a small (1.5" x 1.5" x 0.62"), self-contained module. It even includes isolated power supply outputs for input pre-amplifiers or calibration signals. And because it requires no external DC/DC converter, the 284J is the smallest and least expensive isolation amplifier available today.

The 284J's total noise referred to input is a mere  $8\mu\text{V}$  p-p in a 100 Hz bandwidth. Add an adjustable gain of 1 to 10V/V, a CMV of 5000V pulse or 2500V continuous and a minimum CMR of 110dB. And you've got all you need for a myriad of applications where optimum measurement accuracy and safety are concerned.

We didn't stop there with the product line. Consider our higher performance, Model 277 Instrument Grade Isolation Amplifier. Its uncommitted op amp front end gives you extreme versatility. Its CMR of 160dB and its gain nonlinearity of less than 0.025% for a full 20V swing plus a drift of less than  $1\mu\text{V}/^\circ\text{C}$  give you exceptional performance. The 277's versa-

tility and performance at a price of \$114 (1-9) make it an excellent alternative in your most demanding instrumentation applications.

Then there's our Model 275 Industrial Grade Isolation Amplifier, \$79 (1-9), that is gain programmable over a range of 1 to 100 by a single resistor with nonlinearity to less than 0.05%. And our Model 285 is like the 275 but features a low impedance op amp output. And our Models 279, 282 and 283 for multichannel applications.

We could go on and on about this line. But our free Analog Devices Isolation Amplifier Handbook says it all. Ask for a copy along with the data sheets on our new Isolation Amplifiers. Write Analog Devices, the real company in isolation amplifiers.



The real company in isolation amplifiers

Analog Devices, Inc., Norwood, Massachusetts 02062  
East Coast: (617) 329-4700, Midwest: (312) 894-3300, West Coast: (213) 595-1783, Texas: (214) 231-5094. Belgium: 03 38 27 07, Denmark: 97 95 99, England: 01/94 10 46 6, France: 686-77 60, Germany: 089/53 03 19, Japan: 03/26 36 82 6, Netherlands: 076-122555 and representatives around the world.

CIRCLE NUMBER 77



# Divide and conquer

Pick a Plessey prescaler and you've conquered the major problems in your high-speed counters, timers and frequency synthesizers.

Because we can give you everything from ultra-fast dividers that tame the terrors of TACAN to inexpensive IC's that cut the costs of your CB's.

They're all guaranteed to operate from dc to at least the frequencies shown. They all provide low power consumption, low propagation

delays and easy system interfaces, with most of them available in commercial and MIL-temp versions.

And they're all available now, so contact us for details or a demonstration.

We'll show you a winner.



## PLESSEY SEMICONDUCTORS

1674 McGaw Avenue, Irvine, CA 92714  
Tel: (714) 540-9945. TWX: 910-595-1930  
Represented world-wide.

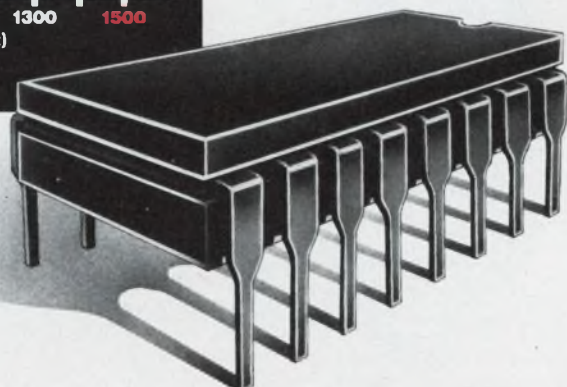
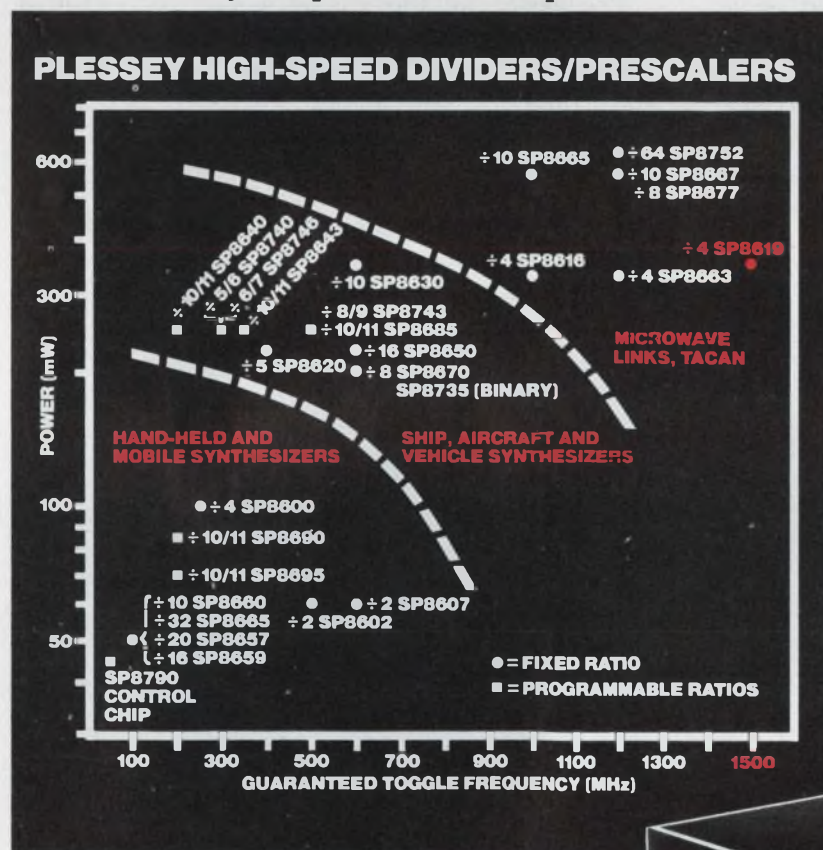

## State-of-the-art brought down to earth

Ultra-fast fixed and programmable dividers □ Linear and digital communications circuits

CIRCLE NUMBER 78



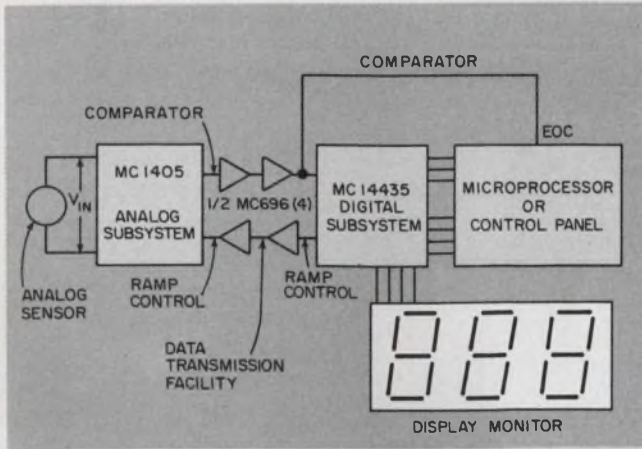

2. The 1405 analog-converter subsystem permits you to remotely locate a small part of the total data collection system, yet still retain complete control of conversion.

solve the transmission problem, but increase the costs.

A two-chip a/d converter system—the MC-1405/14435, for example—can provide an intermediate solution when up to 3-1/2 digit resolution is needed (Fig. 2). The 1405 analog subsystem and the 14435 digital subsystem communicate through only two digital signal lines—a ramp control and a comparator output. As a result, the analog subsystem can be remotely located from the digital half.

To multiplex the different 1405 subsystems to a single 14435, a central controller must be able to start and stop the conversion process of each 1405 at any time. This is easy enough to do: just bring the ramp control line HIGH and the 1405 comparator output will be LOW. However, in this idle state there are two stringent requirements for the integrating capacitors.

1. The capacitor, during idle conditions, will see reverse dc voltages and so must be nonpolar. The required capacitance is a function of supply voltage, clock frequency and maximum allowed input, and can be calculated from:

$$C_1 = (V_{IN(max)} / 2.7 \text{ k}\Omega) (1000 / [f (V_{CC} - 3.3)]).$$

The system clock should be high enough in frequency to allow a convenient value of  $C_1$ . (Frequencies between 100 kHz and 1 MHz are possible.) At a  $V_{IN}$  of 1 V, a  $V_{CC}$  of 12 V and an  $f = 500$  kHz,  $C_1$  is 0.15  $\mu\text{F}$ .

2. The dielectric absorption of the capacitor must be low if the first conversion after restart is to be accurate. If 0.1% accuracy for the first conversion is required, an expensive polycarbonate capacitor with a value in tenths of a microfarad must be used. You can get away with a lower cost Mylar capacitor if two conversions at each remote site are permitted. At a 500-kHz frequency, each conversion requires about 15 ms.

A typical remote a/d converter station using the 1405 can operate from a single supply, use

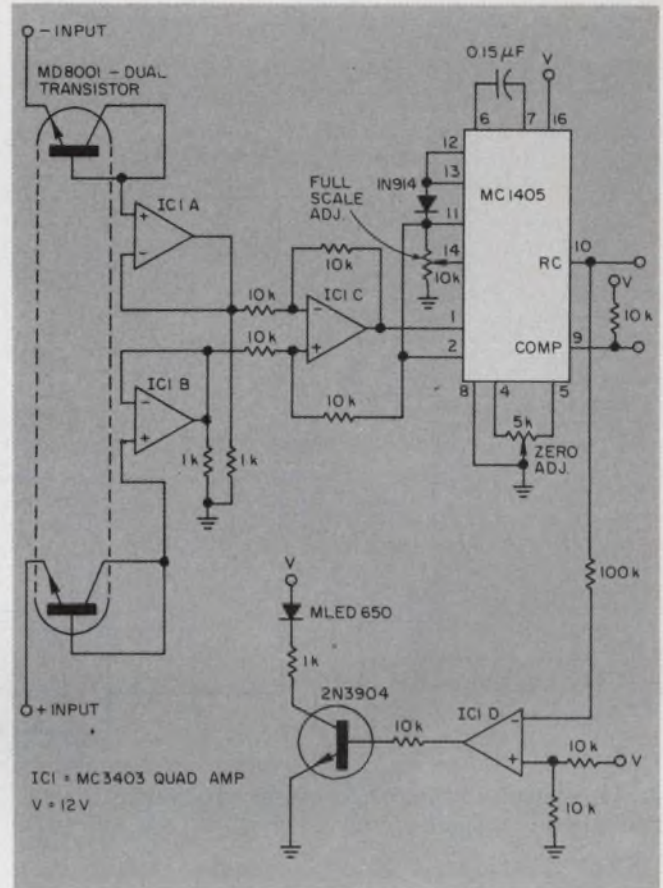

3. A typical remote station using the 1405 offers a full differential input and only uses two wires to communicate with the 14435 digital subsystem in the controller.

the MC3403 quad op amp as an input buffer, have true differential inputs and have a common-mode input range to zero (Fig. 3).

### Multiplexing the 1405 is easy

The circuit shown in Fig. 4 can be used to multiplex four remote stations with a 14435 digital subsystem. By extending the counter chains and multiplexing gates, you can expand the system to 32 channels and provide three updates per second for each channel. The ramp control signal drives half of the 14520 dual binary counter. Outputs  $Q_2$  and  $Q_3$  from the 14520 provide the station scan addresses and commit the 14435 to the station for each conversion.

During the first conversion of each channel the strobe line remains LOW (controlled by  $Q_1$  of the 14520), thus keeping the incorrect 14435 output from reaching a display or processor. The second conversion result gets strobed out since the  $Q_1$  output goes LOW.

When the comparator signal from the remote 1405 goes LOW, it inhibits the 14435 clock. Data get strobed into the 14435 latches and the counters and ramp control are reset. The ramp control change also advances the address counter, which

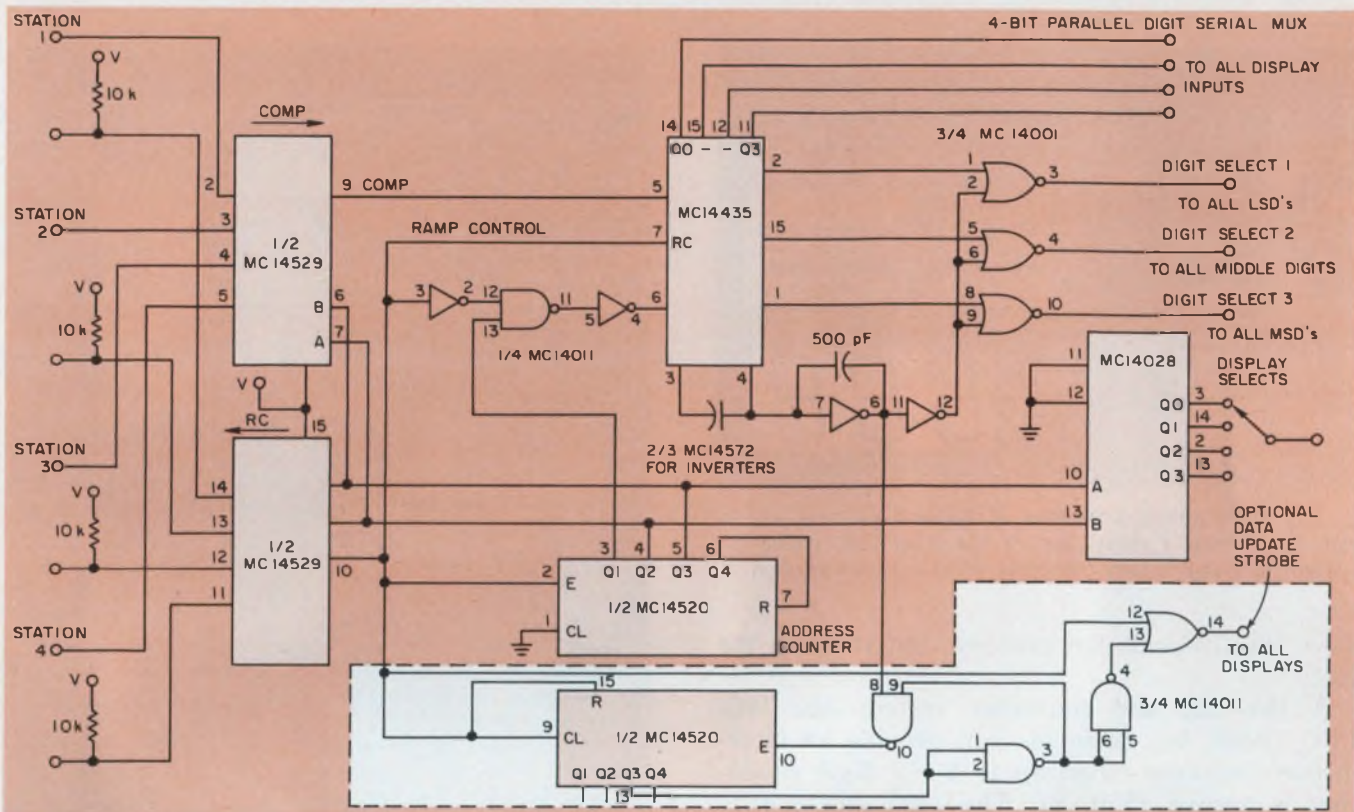

4. To receive and control the sensor data, a four-channel multiplexer, a counter and some gates are all that's

needed. The circuit delivers multiplexed BCD signals that can be fed to a display or to a processor.

## Basic operation of the 1405/14435 a/d converter

The MC1405 and 14435 ICs form a dual-slope a/d converter that delivers a 3-1/2 digit BCD output (max. count 1999). The digital subsystem chip (14435) controls the direction of integration in the analog subsystem (1405) through its ramp control output. A logic ZERO initiates a ramp-up operation and a ONE starts the ramp-down function. A comparator output of the 1405 controls the clock of the 14435.

At the start of a conversion cycle, the ramp control and comparator lines are at ZERO. The integrator then ramps upward through the internal comparator threshold, changing the comparator output to ONE, and thus starting the clock in the 14435. The integrator in the 1405 continues to ramp upward until the internal counter of the 14435 reaches a count of 1000, at which point the ramp control line of the 14435 goes HIGH. Now, the integrator starts ramping down, with a slope determined by an internal reference.

The comparator output remains HIGH until the down-going ramp voltage crosses the comparator threshold. During the downward ramp the 14435 counts pulses from a stable oscillator and latches the count when the comparator output goes LOW. The counters and other internal control circuitry are also reset and the ramp control line returns to ZERO, thus initiating the next conversion.

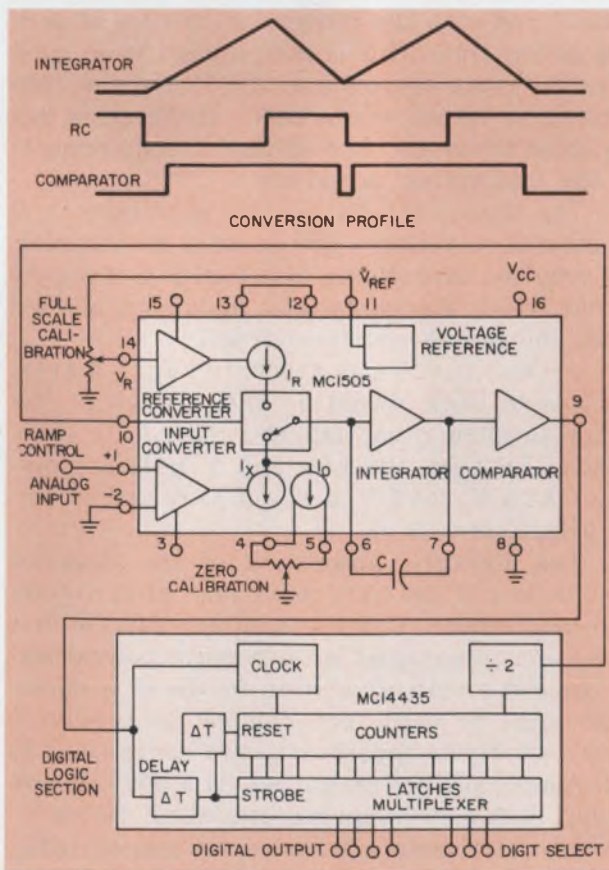

in turn opens the first channel's MC14529 transmission gate. With the transmission gate held open, the 10 kΩ resistor keeps the ramp control line HIGH and the 1405 integrator voltage ramps to zero and stays there.

As the first channel's ramp voltage crosses the comparator threshold, the next channel gets a ramp-up command from the 14435 and the process repeats. The MC14028 binary-to-one-of-eight decoder monitors the address scanner and delivers a display-select output that is held HIGH during each conversion so that the display shows the results of any channel that is selected.

The half of the 14520 that hasn't been used yet can provide a data-update strobe signal that goes HIGH with the ramp-up command and returns to the LOW state after the third clock pulse of the conversion cycle. Thus, you can use it to enable and disable the redundant digit-select pulses available from the NOR gates in Fig. 4.

Interfacing the output data from the 14435 can be done in several different ways. The circuit of

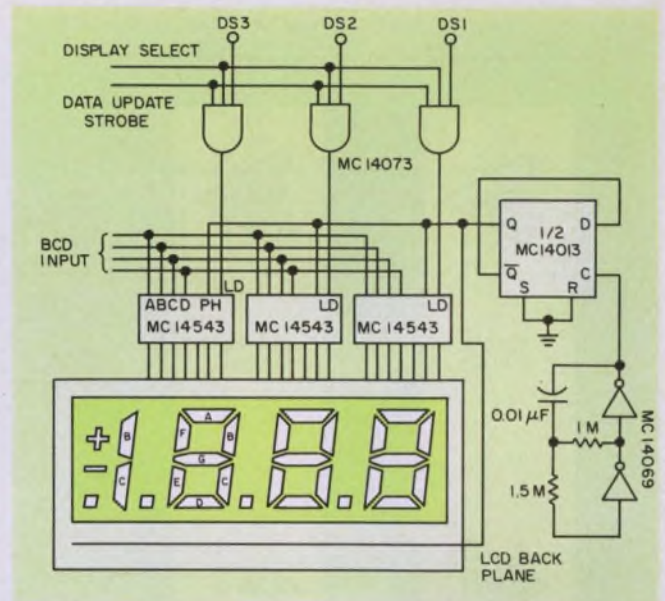

5. Simple control and drive circuitry can decode the multiplexed BCD data and display it on a 3-1/2-digit liquid-crystal display.

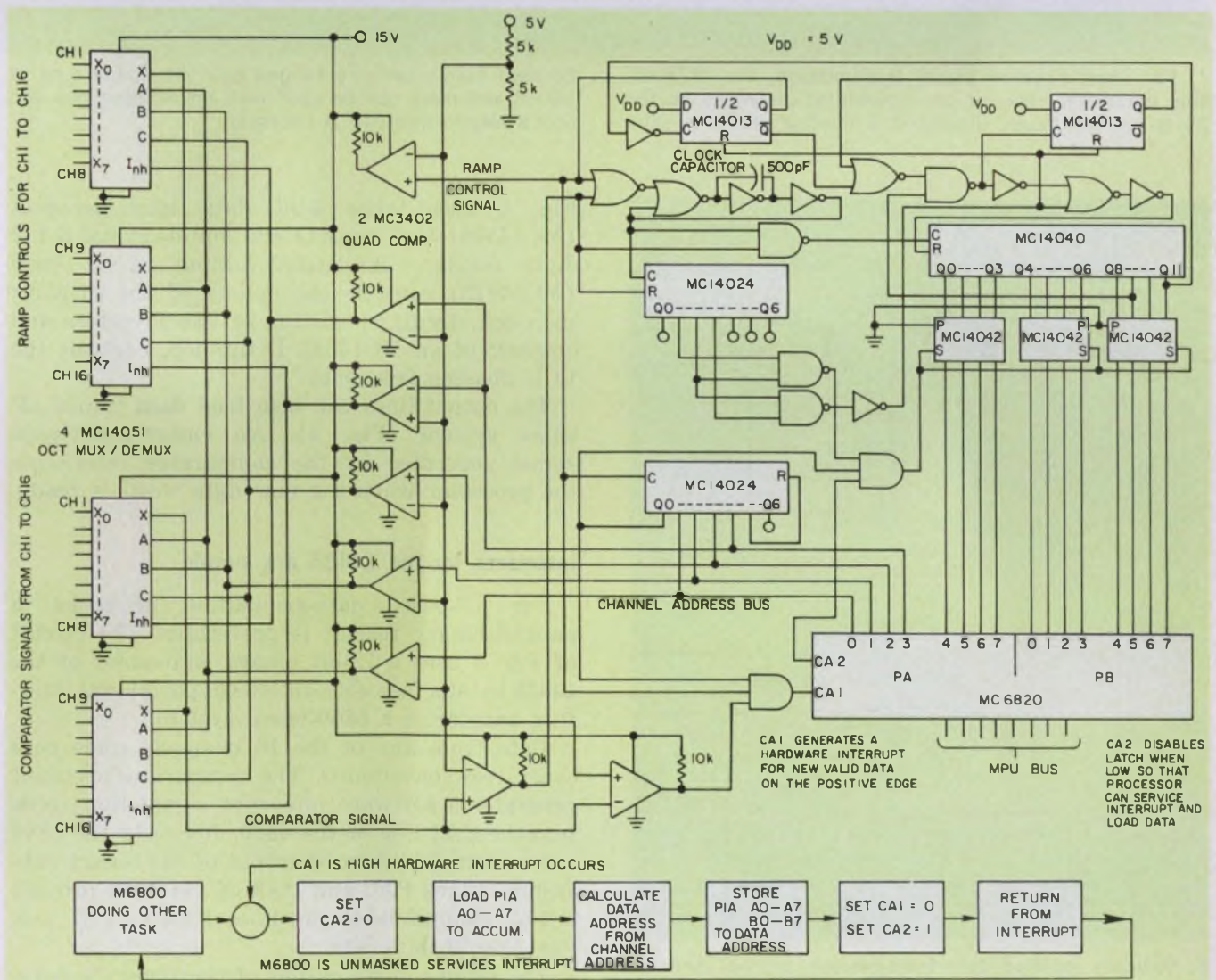

6. A complete 16-channel system using a binary-output digital subsystem can feed all data into a microproces-

sor-based controller under software command. The 6820 PIA generates the software interrupt.

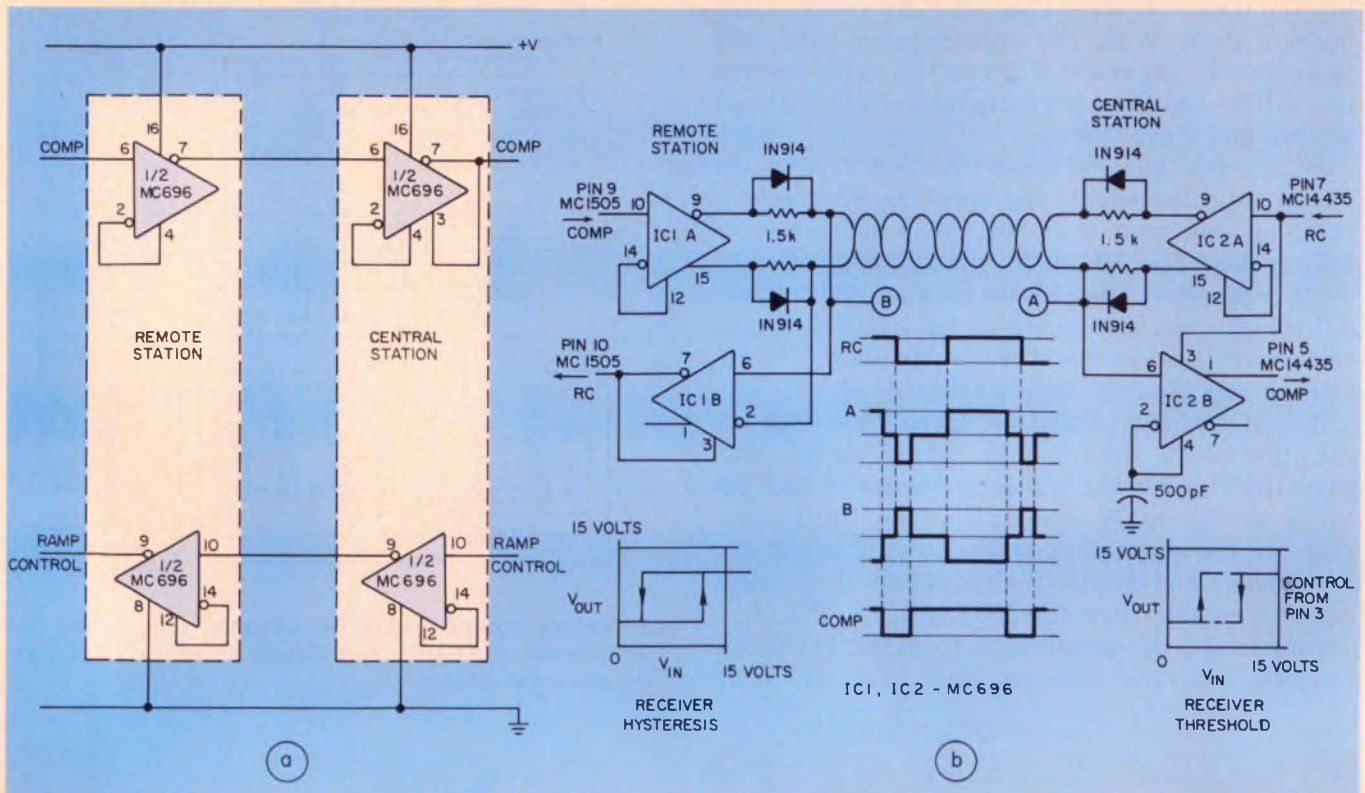

7. For short-distance signal transmission, the MC696 dual line-driver/receiver can operate at distances up to 25 ft (a). For longer distances, a floating data bus can

be used over a two-wire twisted pair (b). Cable runs of 100 ft and more can be used with the floating bus and only a twisted-wire pair is necessary.

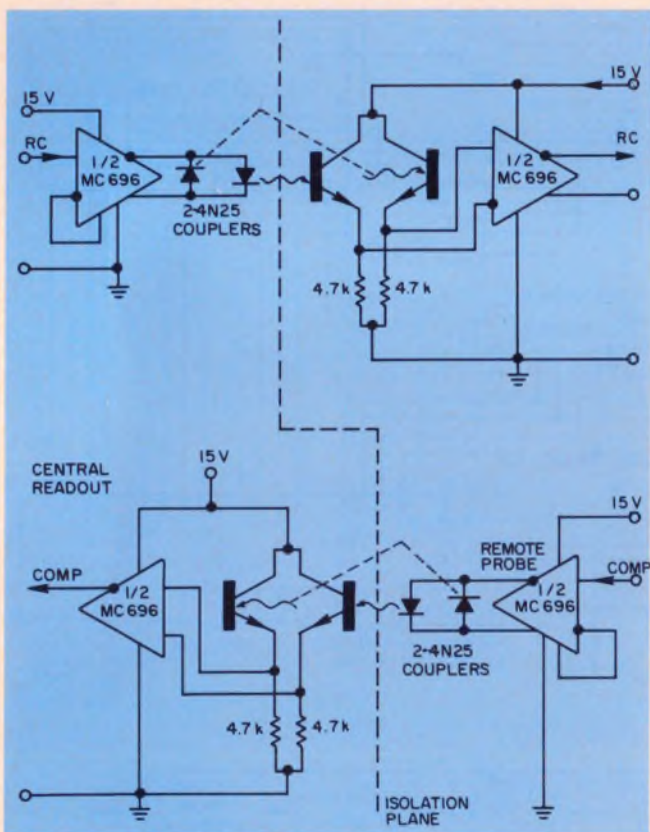

8. Optically isolated data transmission can be used in areas where ground potentials present damaging levels to the circuits. For long cable runs emitter followers provide the drive capability.

Fig. 5 uses three 4-bit data latch/decoders (MC14543) and the MLC400 liquid-crystal 3-1/2 digit display. A triple 3-input AND gate (MC14073) controls the update of the display; the clock circuit, consisting of two inverters and one-half of an MC14013 D flip-flop, controls the LCD phasing frequency.

The output lines can also feed data into a  $\mu$ P based system (Fig. 6). An end-of-conversion signal generated by the comparator interrupts the processor when the new data word is ready.

### Interfaces for the 14435 are simple

For  $\mu$ P-based data-acquisition networks, a parallel-binary format is preferable. The circuit of Fig. 6 uses a 12-bit binary equivalent of the 14435 to interface with an M6820 peripheral interface adapter in a 6800-based system.

Data from any of the 16 channels come once every two conversions. The comparator's output generates a software interrupt signal that feeds into the CA1 line of the 6820. It causes the 6800 to store the 16-bit word output of the binary subsystem. Lines PA0 and PA3 of the 6820 provide a 4-bit channel label and lines PA4 to PB7 provide the 12 data bits.

The ramp control output of the binary subsystem advances the MC14024 counter, thus incrementing the scan address. If either the 14435 or



the binary subsystem is used, the processor can provide channel addresses under software control.

Digital CMOS signals are not ideal for long-distance transmission. Requirements will vary, of course, depending upon your application, but let's look at several line driving schemes using the MC696 dual line driver/receiver.

#### Do the signal transmission with line drivers

For distances of 25 ft or less the 696 can be used directly as a single-ended line driver (Fig. 7a). If capacitive decoupling of power supplies for the circuits is not possible at remote locations, you can use an MC7812 regulator to power the 696 circuit. Over short distances the cost of a four-wire cable is probably less than the cost of a remote supply.

When distances increase to more than 25 ft, a single twisted-wire pair can be used to transmit the digital data (Fig. 7b). This method parallels the output of one driver with the input of another and can send data over distances of more than 100 ft.

This "floating bus" method uses the real-time nature of the control signals. Conversion information is contained in the time between ramp control transitions and comparator signals, and the nature of these signals guarantees that the two will always alternate. Any voltage caused by the transmission-line delay can be calibrated out by the 1405's zero adjust.

The voltage between points A and B on the schematic of Fig. 7b can be positive, negative or zero depending on the outputs of IC<sub>1A</sub> and IC<sub>2A</sub>. The diode-resistor networks on each output modify the signals to form sink and source nodes.

You are still able to decode the information since the alternating-edge constraint keeps everything in sync. Also, one of the signals is locally generated and the other must be received and decoded at the sensor. IC<sub>1B</sub> generates the ramp-control signal simply by using its internal hysteresis. The comparator signal at IC<sub>2B</sub> is derived from the switching of the receiver threshold each time the ramp control line changes state. A 500-pF capacitor connected to IC<sub>2B</sub> slightly delays the ramp control signal to ensure that the line driver cannot detect the edge that switches the threshold.

In many instrumentation systems, large ground-potential differences can create interconnect problems to a central collection point. Optoisolators can be used on the outputs or inputs of the 696s to provide isolation of up to 2500 V (Fig. 8). Back-to-back LEDs from two 4N25 couplers operate at about 8 mA and provide bidirectional signal handling. If extremely long lines are used, emitter followers can increase the line-driving capability. ■■

# OSCILLATORS

1 MHz to 40 MHz

± 1 %  
± 5 %  
± 10 %  
± 25 %

DEVIATION



± 1 %  
± 2 %  
± 4 %  
± 10 %

LINEARITY



SERIES 77 is ACCUTRONICS latest edition to its line of oscillators. A LCVCO supplying wide frequency deviation with excellent Linearity. Temperature compensation gives frequency stabilities of 0.1% over 0°C to 60°C. Various output levels are available including TTL compatibility and also sine wave.

INTERESTING? Call WAYNE BENSON 312-232-2600 and he will be glad to fill you in on all the details and send you our new catalog.

1 Hz to  
300 MHz  
Oscillators

accutronics

Please write or  
call for

**NEW 1976 CATALOG**

Take a look at our new Series 76 a PAGE OF OSCILLATORS from 1 Hz to 300 MHz without outputs of CMOS, TTL, ECL and SINE WAVE. Also three neat conversion charts.

**accutronics**

A HAMMOND CORP. CO.

628 NORTH STREET • GENEVA, ILLINOIS 60134

CIRCLE NUMBER 79

# DELCO'S NEW 25-AMPERE HIGH VOLTAGE DARLINGTONS WITH THE SPEED AND ENERGY CAPABILITY YOU ASKED FOR.

Good news for motor speed control designers who have expressed a need to upgrade horsepower ratings. The 25-ampere gain of these new Darlington permits increased horsepower ratings of existing AC motor speed control systems and a reduction in paralleling in new designs. However, grouping of  $t_{off}$  is available for current sharing in designs

## MAJOR PARAMETER LIMITS

Type	$h_{FE}$ @ 25A	$h_{FE}$ @ 10A	$V_{CEO}$ (sus)	$V_{CE}$ (sat) @ 20A	$I_{CEO}$ @ 600V
DTS-4066	5	75	350V	3.5V	0.25mA
DTS-4067	10	150	350V	2.0V	0.25mA
DTS-4074	5	75	350V	3.5V	0.25mA
DTS-4075	10	150	350V	2.0V	0.25mA

## TYPICAL SWITCHING

	DTS-4066 DTS-4067	DTS-4074 DTS-4075
$t_r$	$0.5\mu s$	$0.5\mu s$
$t_s$	$5.0\mu s$	$3.2\mu s$
$t_f$	$4.5\mu s$	$1.0\mu s$

NPN triple diffused silicon Darlington is packaged in solid copper cases conforming to JEDEC TO-3 outline dimensions.

## SAFE OPERATING CURVES

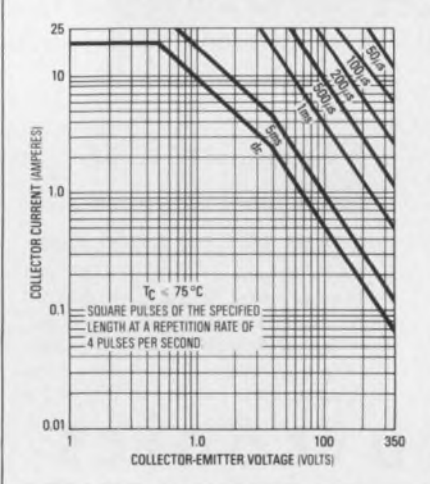

with parallel Darlington. A speed-up diode is built into the DTS-4074 and DTS-4075 permitting data sheet  $t_f$  typicals of  $1.0\mu s$ . Drive circuit techniques involving  $I_{B2} \geq 2A$  and a Baker clamp produce  $t_f$  typicals in the  $0.4-0.6\mu s$  range for the DTS-4066, DTS-4067, DTS-4074, and DTS-4075.

Our experience with tolerances, faults, transients, and start-stall conditions in most systems convinces us that these Darlington have the right trade-off between speed and peak power handling capability. Note the greater than 10 kVA region of the reverse bias safe operating graph. All this, and you still get Delco's traditional solid copper TO-3 hermetic package that has a conservative  $0.75^\circ C/W$  thermal resistance.

These Darlington are already in high volume production and are available on distributor shelves. Prices, applications literature, and data sheets from your nearest Delco sales office or Delco distributor can complete the story on these new Darlington.



## Features of Delco's new DTS-4066, 4067, 4074, 4075 Darlington.

- Upgrade existing motor speed control horsepower ratings.
- Reduce need for paralleling in new systems.
- Offer switching speed improvements over our earlier types.
- Achieve greater than 10 kVA peak power dissipation.
- Available with  $t_{off}$  grouping
- Delco hermetic copper package with  $0.75^\circ C/W$ .
- Currently in high volume production.

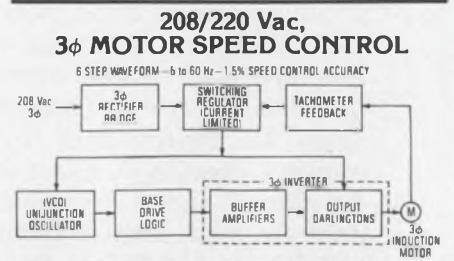



## NOW AVAILABLE FROM THESE DISTRIBUTORS IN PRODUCTION QUANTITIES.

### ALABAMA

**BIRMINGHAM**  
Forbes Distributing Co., Inc.  
(205) 251-4104

**HUNTSVILLE**  
Powell Electronics  
(205) 539-2731

### ARIZONA

**PHOENIX**  
Sterling  
Electronics, Inc.  
(602) 258-4531

### CALIFORNIA

**GARDENA**  
Electronics  
Distributors Div.  
Bell Industries  
(313) 321-5802

**GOLETA**  
R.P.S. Electronics, Inc.  
(805) 964-6823

**LOS ANGELES**  
Kierulff Electronics, Inc.  
(213) 685-5511

**R.P.S. Electronics, Inc.**  
(213) 748-1271

**PALO ALTO**  
Kierulff Electronics, Inc.  
(415) 968-6292

**SAN DIEGO**  
Kierulff Electronics, Inc.  
(714) 278-2112

**R.P.S. Electronics, Inc.**  
(714) 292-5611

**SUNNYVALE**  
Bell Industries  
(408) 734-8570

### COLORADO

**DENVER**  
Kierulff Electronics, Inc.  
(303) 371-6500

### CONNECTICUT

**NORWALK**  
Harvey Electronics  
(203) 853-1515

### FLORIDA

**CLEARWATER**  
Diplomat/Southland  
(813) 443-4514

**MIAMI SPRINGS**  
Powell Electronics/Florida  
(305) 592-3260

### ILLINOIS

**ELK GROVE VILLAGE**  
Kierulff Electronics, Inc.  
(312) 640-0200

**SKOKIE**  
Bell Industries  
Electronics Distributors Div.  
(312) 282-5400

### INDIANA

**INDIANAPOLIS**  
Graham Electronics  
Supply, Inc.  
(317) 634-8202

### MARYLAND

**BALTIMORE**  
RESCO/Baltimore  
(301) 823-0070

### MASSACHUSETTS

**BILLERICA**  
Kierulff Electronics, Inc.  
(617) 935-5134  
(617) 667-8331

**NEWTON**  
The Greene-Shaw Co., Inc.  
(617) 969-8900

### MICHIGAN

**LIVONIA**  
Pioneer/Michigan  
(313) 525-1800

### MINNESOTA

**MINNEAPOLIS**  
Stark Electronics Supply Co.  
(612) 332-1325

### MISSOURI

**KANSAS CITY**  
Walters Radio Supply, Inc.  
(816) 531-7015

**ST. LOUIS**  
LCOMP-St. Louis  
(314) 647-5505

### NEW JERSEY

**CINNAMINSON**  
Wilshire Electronics/  
Philadelphia  
(609) 786-8990  
(215) 627-1920

**CLIFTON**  
Wilshire Electronics/  
New Jersey  
(201) 340-1900  
(212) 244-8930

### NEW MEXICO

**ALBUQUERQUE**  
Sterling Electronics  
(505) 345-6601

### NEW YORK

**BINGHAMTON**  
Harvey Electronics  
(607) 748-8211

**BUFFALO**  
Summit Distributors, Inc.  
(716) 884-3450

**FARMINGDALE**  
Wilshire Electronics/  
Long Island  
(516) 293-5775

**FREEPORT**  
Milgray/New York  
(516) 546-6000

**WOODBURY**  
Harvey Electronics  
(516) 921-8700  
(212) 895-9260

### OHIO

**CINCINNATI**  
United Radio, Inc.  
(513) 761-4030

**CLEVELAND**  
Pattison Supply Co.  
Industrial Electronics Div.  
(216) 441-3000

**DAYTON**  
Pioneer/Dayton  
(513) 236-9900

### OREGON

**PORTLAND**  
Almac/Stroom Electronics  
(503) 292-3534

### PENNSYLVANIA

**PHILADELPHIA**  
Almo Electronics  
(215) 698-4000

**PITTSBURGH**  
CAM/RPC Electronics  
(412) 782-3770

### SOUTH CAROLINA

**COLUMBIA**  
Dixie Radio Supply Co., Inc.  
(803) 779-5333

### TEXAS

**DALLAS**  
Sterling Electronics  
(214) 357-9131

**HOUSTON**  
Harrison Equipment  
Co., Inc.  
(713) 652-4700

Sterling Electronics  
(713) 627-9800

### WASHINGTON

**SEATTLE**  
Almac/Stroom Electronics  
(206) 763-2300

Kierulff Electronics, Inc.  
(206) 763-1550

**SPOKANE**  
Almac/Stroom Electronics  
(509) 928-0679

### IN CANADA:

Zentronics Ltd.  
Toronto (416) 787-1271  
Ottawa (613) 238-6411  
Montreal (514) 735-5361

### OVERSEAS: EUROPEAN INQUIRIES:

European Parts &  
Accessories Marketing  
Group  
General Motors Continental  
Plant 2, Noorderlaan,  
Postbus 9  
B-2030, Antwerp, Belgium

### ALL OTHER OVERSEAS INQUIRIES:

General Motors Overseas  
Operations  
Parts & Accessories Dept.  
767 Fifth Avenue  
New York, N.Y. 10022  
(212) 486-4412

### DELCO ELECTRONICS REGIONAL SALES OFFICES

Charlotte, North Carolina  
28209  
4600 Park Road  
(704) 527-4444

Van Nuys, California 91404  
Box 2968  
(213) 988-7550

### GENERAL SALES OFFICE

700 E. Firmin, Kokomo,  
Ind. 46901  
(317) 459-2175

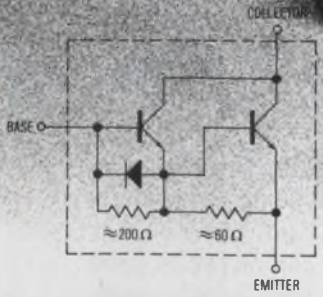

**SPEED-UP DIODE  
USED ON DTS-4074/4075 ONLY**

### 3 $\phi$ DARLINGTON INVERTER DTS-4066-4067

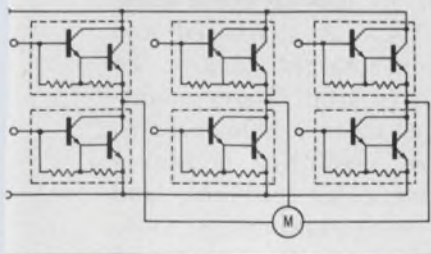

### CLAMPED INDUCTIVE SWITCHING PERFORMANCE

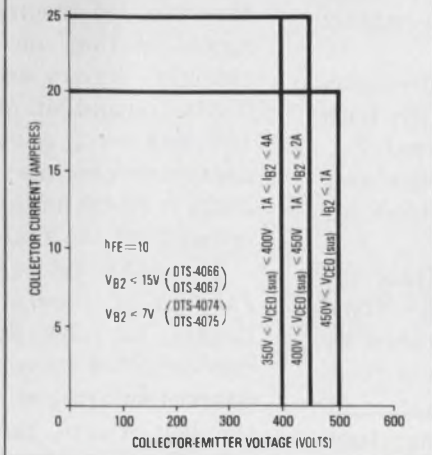

CIRCLE NUMBER 81

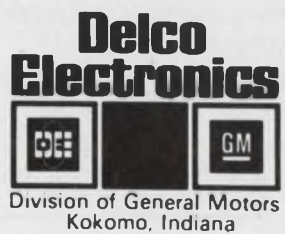

## Consider v/f converters for data-acquisition systems. They offer high resolution and accuracy when used as analog-to-digital converters.

Examine the performance specifications of voltage-to-frequency converters before you pick an analog-to-digital converter for your application. Three relatively inexpensive (under \$100) methods—the successive-approximation, dual-slope and voltage-to-frequency conversion schemes—can deliver equal accuracy, but each is used best in a different application (Table 1).

Look at the key converter specifications (Table 2) to evaluate the performance of v/f converters compared to the two other methods. Some of the most commonly specified parameters are resolution, linearity, conversion time, temperature stability and monotonicity (no missing codes).

### V/f conversion: an alternative a/d method

Seldom used until a few years ago, v/f conversion techniques are rapidly becoming popular as an alternative to successive-approximation or dual-slope techniques. There are several ways to build a v/f conversion circuit, but the charge-balancing method (Fig. 1a) is the most popular.

If  $V_{in}$  is positive, the integrator output ramps down until its output voltage  $V_{i1}$  crosses the comparator's threshold (ground, in this case) and causes the comparator to change state. The transition, in turn, triggers a precision timing circuit that delivers a constant-width pulse. The pulse gets fed to two places: a buffer circuit that then feeds the output; and the integrator, where the pulse causes the integrator output to rapidly ramp up (Fig. 1b).

The timing circuit is, in effect, a precision one-shot multivibrator that is stable with both time and temperature. The reference current,  $I_{ref}$ , must also be stable, and a precision regulator with a voltage reference source is included for that purpose.

Since the reference current is pulled from the integrator summing junction for a fixed amount of time, and at intervals determined by the input voltage, the positive-input current feed-

ing the integrator balances the current pulses being pulled out. The integrator can be made extremely linear and, when combined with the charge-balancing feedback loop, can achieve nonlinearities as low as 0.005%.

To form an a/d converter with the v/f technique, the output of the v/f circuit must feed a counter that is gated for the desired maximum count (for a converter with a 10-kHz output, a four-digit BCD counter or a four-stage binary counter can be used).

### Nail down the definitions first

Before you start comparing specifications, make sure the specs are defined. Resolution tells you the smallest quantity the converter can distinguish. Even though the quantity is usually an analog voltage the resolution is given in terms of bits: 8, 10, 12 or more.

The usable resolution of a converter can be less than the stated resolution. However, because it's a function of linearity and stability, the usable resolution can often change with time and temperature.

In the v/f form of an a/d converter, the resolution is determined by the full-scale frequency, the time base and the capacity of the counter used (Fig. 2). If a 10-kHz v/f converter is used with a time base of 1 second and four decade counters, its resolution is one part in 10,000, or four binary-coded decimal (BCD) digits. Successive-approximation or dual-slope converters with straight binary coding would have to deliver a digital output of at least 13 bits to come close (13 bits = 1 part in 8192). A v/f-based a/d converter can also deliver straight binary. To make a 12-bit unit, use three 4-bit binary counters and set the time base equal to 0.4096 seconds.

In dual-slope converters, resolution is also a function of integration time, clock frequency and counter capacity. Successive-approximation units use weighted current sources, and the number of sources determines the resolution. The higher the number of bits, the harder it becomes to maintain the linearity of the weighted sources.

## Table 1. Typical converter applications

A/d converter type	Common applications
Successive approximation	High-speed data-acquisition systems Pulse-code-modulation systems Waveform sampling & digitizing Automatic test systems Digital process control systems
Dual slope	Digital multimeters Digital panel meters Laboratory measurements Slow-speed data-acquisition systems Monitoring systems Ratiometric measurements Measurements in high-noise environments
Voltage to frequency	Digital multimeters Digital panel meters Remote data transmission Totalizing measurements Measurements in high-noise environments High-voltage isolation measurements Ratiometric measurements

## Table 2. Comparison of a/d converter types

Specification	Successive approximation	Dual slope	Voltage to frequency
Resolution	12 bits	12 bits	12 bits
Missing codes	none by careful design	none, inherent	none, inherent
Nonlinearity	$\pm 0.012\%$ max.	$\pm 0.05$ to $0.01\%$ max.	$\pm 0.005\%$ max.
Diff. nonlinearity	$\pm 1/2$ LSB	$\approx 0$	$\approx 0$
Tempco	10 to 50 ppm/ $^{\circ}\text{C}$	10 to 50 ppm/ $^{\circ}\text{C}$	10 to 50 ppm/ $^{\circ}\text{C}$
Conversion time	2 to 50 $\mu\text{s}$	5 to 77 ms	0.041 to 0.41 s
Noise rejection, 60 Hz	None	40 to 60 dB	33.8 dB*

\*For 0.41-s conversion time.

Linearity is the acid test of any a/d converter specification since resolution can be unusable if linearity error doesn't hold to less than  $\pm 0.5$  LSB (1 LSB at the worst). At a fixed temperature, linearity is the only error that remains after offset and gain errors have been adjusted out.

The linearity error of a converter is the maximum deviation of the output values from a straight line drawn from zero to the maximum output. For 12-bit a/d converters a "good-quality," successive-approximation unit has a non-

linearity of about  $\pm 0.012\%$ , a dual-slope unit about  $\pm 0.05$  to  $\pm 0.01\%$  and a v/f converter about  $\pm 0.01$  to  $\pm 0.005\%$ .

The nonlinearity characteristic of successive-approximation converters differs fundamentally from that of the dual-slope or v/f. Typical nonlinearity curves are shown (slightly exaggerated) in Fig. 3.

Both the v/f and dual-slope converter linearity characteristics tend to have a bow that is caused by the operational integrators used in the con-

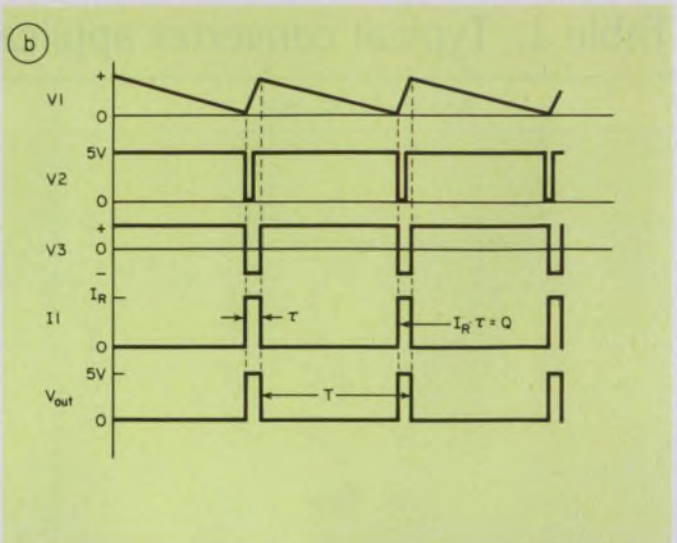
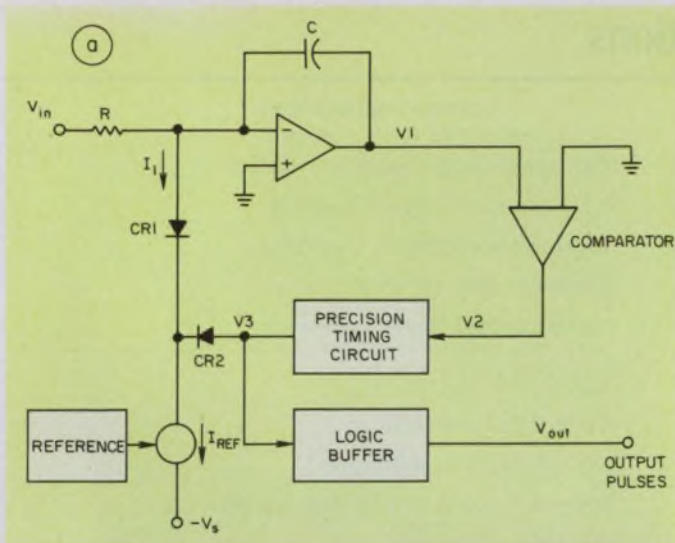

1. The basic charge balancing v/f converter (a) uses an operational integrator with a precision timing circuit con-

nected in a feedback loop. The output pulse width (b) is proportional to the charge stored in the capacitor.

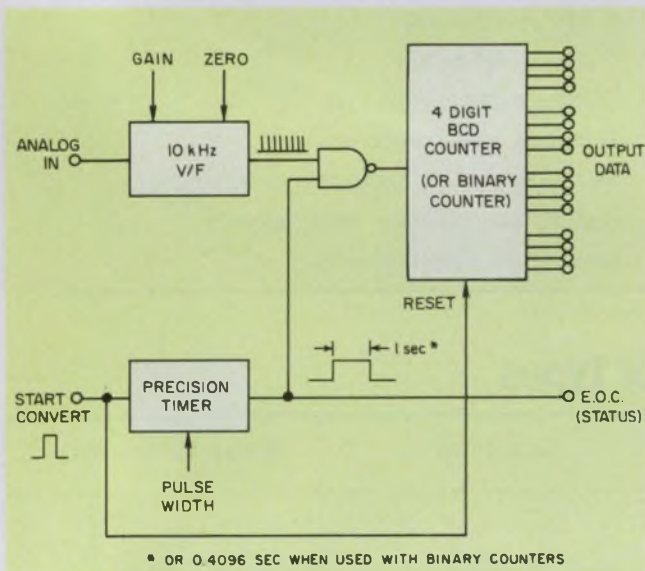

2. By using a v/f converter and a precision timer, you can build an a/d converter that delivers a BCD output.

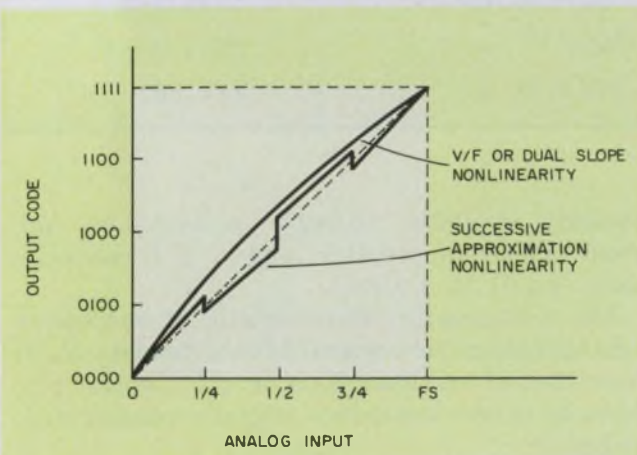

3. Nonlinearities of v/f and dual-slope a/d converters appear as a slight bow in the curve. However, successive-approximation nonlinearities make the curve jagged.

verters. By contrast, the successive-approximation converter's linearity is determined by the major-carry transitions of the weighted current sources. These points are located chiefly where  $1/2$  and  $1/4$ -scale current values are switched in or out during the conversion process.

As shown in the graph of Fig. 3, a jump in the curve signifies when a major-carry current value is slightly off its correct value. A very linear converter restricts these jumps to very small amounts ( $\pm 0.012\%$  for a 12-bit converter).

### Don't let the converter slow you down

The v/f converter takes the longest to do a complete conversion. The time base used in Fig. 1 is 1 second for a single conversion—rather slow for most applications. Dual-slope converters are faster, with conversion times ranging from 5 ms to 100 ms.

Successive-approximation converters are the fastest of the three, with conversion times as short as  $2 \mu\text{s}$  for 12-bits. Most successive-approximation converters have conversion times between 3.5 and  $50 \mu\text{s}$ .

However, if time isn't a problem, you can increase the time base to 10 seconds, add another decade counter and, voila: a converter with a resolution of one part in 100,000. Such a long conversion time could cause difficulty in many applications. And, the linearity of the 10 kHz unit would not be commensurate ( $\pm 1/2$  LSB) with the increased resolution.

Since the time for conversion can be made equal to the inverse of the line-voltage frequency, the dual-slope converter can be designed to reject much of the noise caused by the power line. The integrating technique used by dual-slope and v/f converters gives them the ability to reject

# Successive approximation and dual slope conversion methods

The successive-approximation approach is the most widely used (Fig. A) of the three most popular conversion schemes. It compares the output of an internal d/a converter against the input signal, one bit at a time. Therefore, N fixed time periods are needed to deliver an output N bits long, but the total time needed is independent of input-voltage value.

The first step after the start pulse in a successive-approximation conversion cycle is turning on the MSB, which sets the d/a converter's output at half-scale (Fig. B). This analog signal is then fed back to the comparator. The MSB is left on if the d/a converter's output is smaller than the analog input, and turned off if the output is larger.

Next, the second bit is turned on, and the quarter-scale value added to the d/a converter output and the comparator again does its job. This process continues until the LSB has been tested and the final comparison made. When the process is complete, the converter signals this by changing the state of its end-of-conversion (status) output. The final digital output can then be read from the output of the successive-approximation register of the converter.

Successive-approximation converters can achieve conversion speeds of 100 ns/bit in medium-priced

(\$250 to \$350) 8 and 10-bit units. Converters with 12-bit outputs are typically available with conversion times ranging from 2 to 50  $\mu$ s.

## Dual-slope units slow the pace

The dual-slope converter uses a simple counter to indirectly measure the input signal after an operational integrator converts a voltage into a time period (Fig. C). This scheme is the second most commonly employed method and is used, almost exclusively, in such instruments as digital multi-meters and panel meters.

The conversion cycle begins when the analog-input signal is switched to the input of the operational integrator. The voltage is integrated (Fig. D) for a fixed time period determined by the clock frequency and the counter size. At the end of the period, the integrator input is switched to an internal reference whose polarity is opposite that of the original analog input. The reference is then integrated until the output reaches zero and triggers the comparator.

During the second integration, the clock is gated into a counter chain that accumulates the count until the comparator inhibits the clock. When the clock signal stops, the conversion is complete.

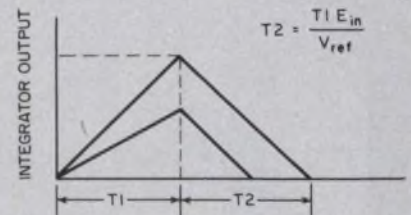
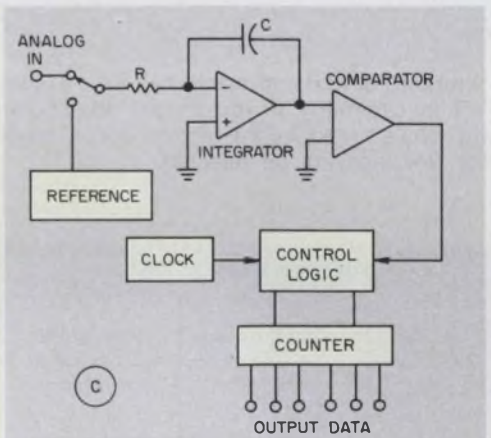
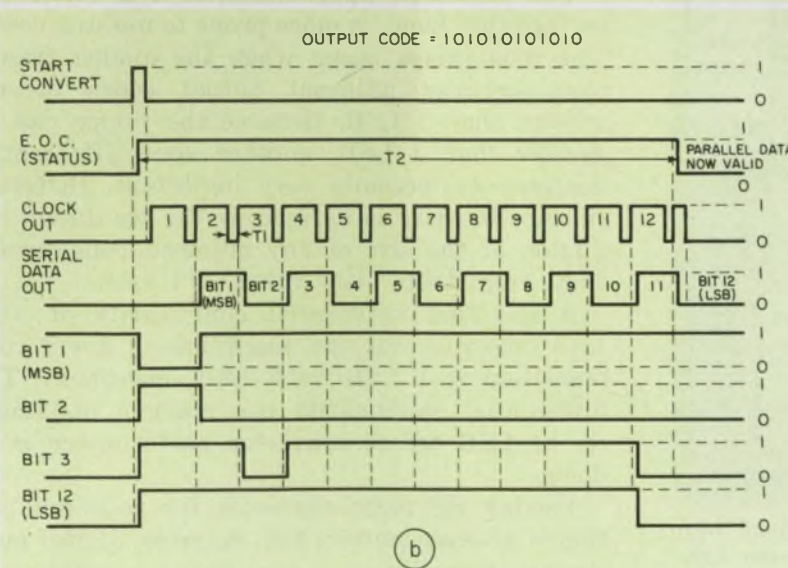
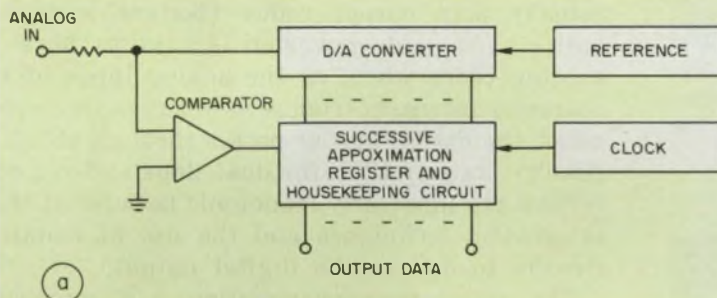

high levels of input noise.

For these two integrating converters, the longer the signal is integrated, the better the noise attenuation. When the integration period equals a multiple of the inverse of the line frequency (for dual-slope units), the noise rejection becomes infinite at integral values  $Tf_n$ , where  $T$  is the integration period and  $f_n$  is the noise frequency (Fig. 4).  $V/f$  converters don't, in general, use a period that is a multiple of any periodic noise, and so the asymptote of the noise-rejection curve is used to determine the rejection at a given  $Tf_n$ .

The  $v/f$  converter's noise-rejection asymptote rises by 20 dB per decade, and, for a 60-Hz power

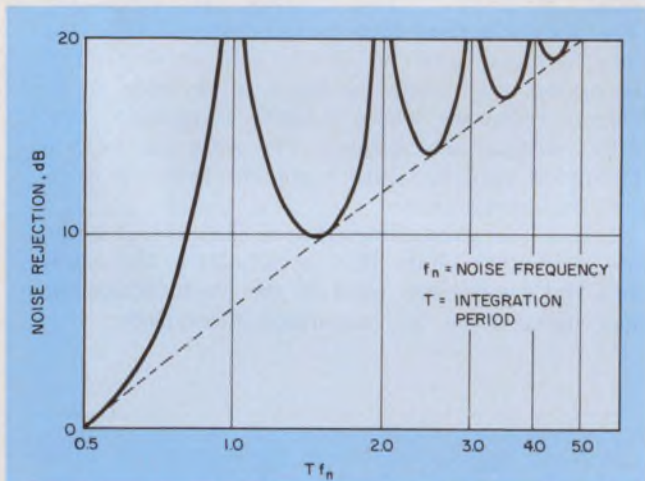

4. Integrating a/d converters can have exceptional noise-rejection capability if you merely adjust their measurement cycle to equal the period (or a multiple) of the noise frequency to be rejected.

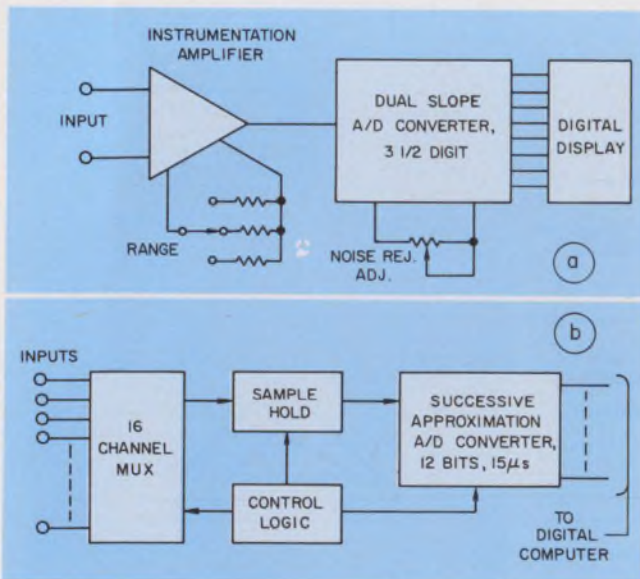

5. Simple digital measuring systems can be built with dual-slope (a) and successive-approximation (b) converters. Both systems shown usually require signal conditioning for each input.

line and a 0.41-s conversion time, the rejection can be computed at 33.8 dB. Dual-slope converters have rejection ratios as high as 60 dB when conversion is synchronized with the noise frequency.

Successive-approximation converters have no noise-rejection capability whatsoever. Input noise at any time during the conversion process can cause significant conversion errors. (Noise feeds directly to the comparator and can change the decision point.) The only way to minimize noise is to add an input noise filter to the converter.

#### Temperature coefficients change converter specs

Operation at different temperatures can tremendously alter converter performance, no matter which converter type you select. These changes affect offset and gain, two important converter parameters. Even though offset and gain are adjusted during calibration, they can change significantly with temperature.

Offset is a function of current-source leakage, comparator bias current and comparator input voltage offset. Gain (sometimes called scale factor) is a function of the voltage reference, resistor tracking and semiconductor-junction matching—and is usually the most difficult parameter to control. Absolute accuracy is affected by offset and gain changes, so if these change during operation, output errors will occur.

And, if the linearity degrades, a converter can actually skip output codes (become nonmonotonic). (An a/d converter is said to have no missing codes when, as the analog input of the converter increases from zero to full scale or vice-versa, the digital output passes through all of its possible states.) Both the dual-slope and  $v/f$  converters are inherently monotonic because of their integration techniques and the use of counting circuits to deliver the digital output.

The successive-approximation a/d converter, on the other hand, is more prone to missing codes. The code jumps occur when the analog transitions between adjacent output codes become greater than 1 LSB. Because the jumps can be greater than 1 LSB, another spec differential nonlinearity, becomes very important. Differential nonlinearity is defined as the maximum deviation of the size of any adjacent code transitions from their ideal value of 1 LSB.

A specified differential nonlinearity of  $\pm 0.5$  LSB tells you that the magnitude of every code transition is  $1 \text{ LSB} \pm 0.5 \text{ LSB}$ , maximum. The differential nonlinearity can reach a maximum of  $\pm 1$  LSB before converter performance is in doubt.

Picking the right converter for your application is no easy matter. For example, digital multimeters typically use a dual-slope converter since high speed isn't necessary but high noise rejection



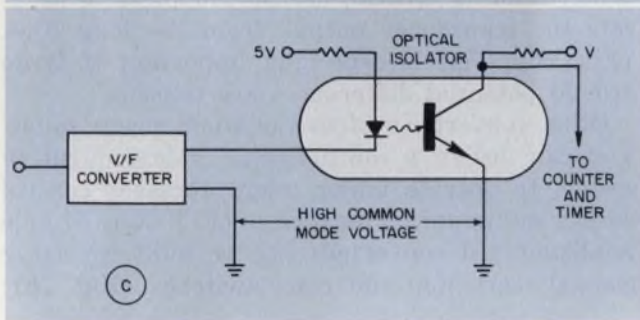
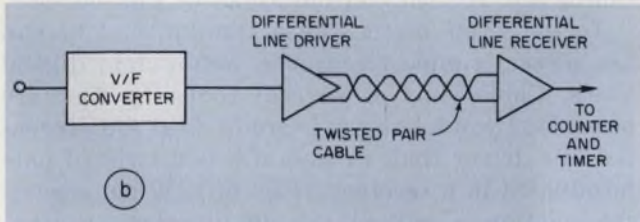
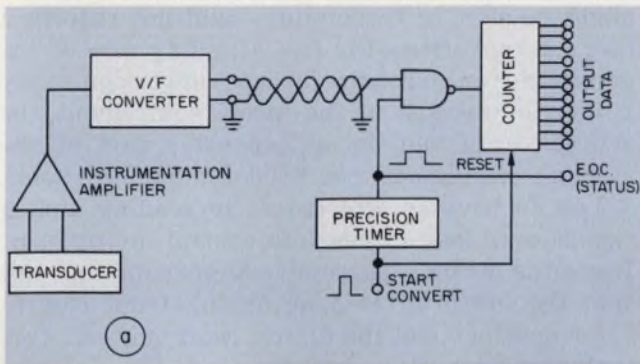

6. V/f converters can be used in simple, remote data-gathering applications since only a twisted pair of wires is needed to transmit the signals (a). Differential line drivers can be added if long transmission distances are required (b), or an opto-isolator can be used to eliminate large, common-mode voltage problems (c).

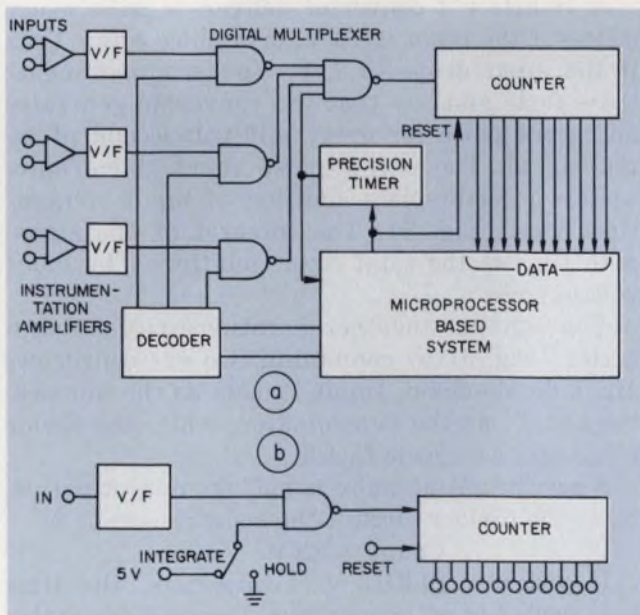

7. A microprocessor or computer-based controller can be used to make a multiple-channel data-collection system with a v/f converter at each point (a). If manual switches are used instead of a timer, you can turn a v/f-based a/d converter into an "infinite" integrator (b).

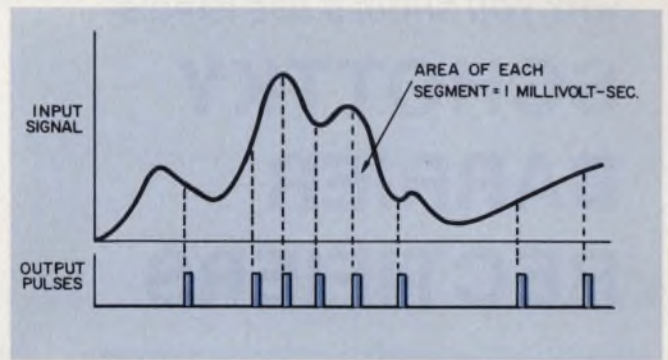

8. The integration process in a v/f converter can be defined in terms of millivolt-seconds for each pulse delivered. To get the total area, simply multiply the total count by 0.001.

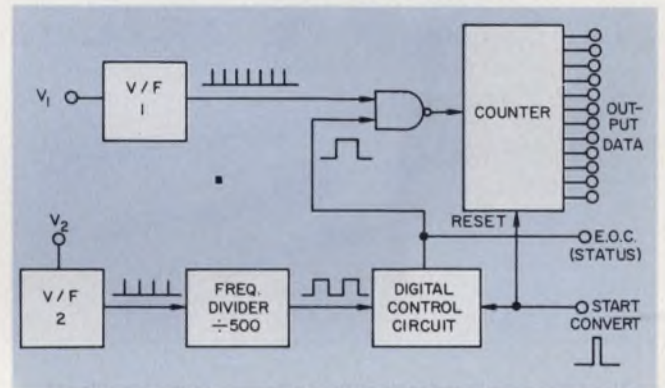

9. If you use two v/f converters, you can make a high-accuracy, ratiometric a/d converter. Because of the wide frequency span covered, the dynamic range of the converter can reach 10,000:1.

tion is. However, in other applications, such as in fast-throughput data acquisition, the successive-approximation converter must be used.

Dual-slope converters are widely used in applications requiring human interface in measurement and control. A simple digital measurement system (Fig. 5a) that uses a 3-1/2 digit, BCD-output converter can handle various signal inputs. The instrumentation amplifier used on the front end offers flexible gain settings with a single resistor value change.

The converter can be either a modular unit manufactured by several vendors or one made from the various IC building blocks. In many industrial and even in some lab environments, pick-up from 60-Hz radiation or magnetic coupling can cause measurement problems. By including a conversion time adjustment, you can synchronize the clock to the 60-Hz line and obtain noise rejection of more than 40 dB.

When multiple channels of data must be handled and you need all the data quickly, use the speedy successive-approximation converter. The circuit shown in Fig. 5b is a commonly used system organization for multichannel data acquisition. Although various analog-input devices

WHY YOU SHOULD USE VARO'S

# SCHOTTKY BARRIER RECTIFIERS

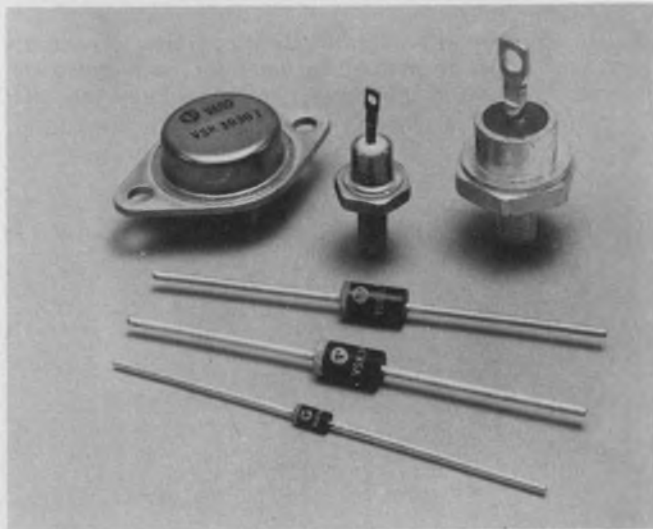

Varo Schottky Barrier Rectifiers offer you many significant advantages:

#### VERY LOW FORWARD VOLTAGE DROP ( $V_F$ )

Because of the large metal-barrier-to-silicon junction,  $V_F$  ranges are from 550 mV,  $I_F = 1$  A, to 620 mV,  $I_F = 40$  A. This results in less heat dissipation, low power loss, and greatly improved efficiency.

#### EXTREMELY FAST RECOVERY TIMES ( $t_{rr}$ )

Typically  $\leq 10$  nsec. Schottkys are ideally suited for low-voltage power supplies, free-wheeling diode and flyback diode applications, and polarity protection in high-speed switching circuits.

#### MAJORITY CARRIER CONDUCTION

In addition to fast recovery, Schottky barrier construction results in high surge capacity and low stored charge. Schottkys are not subject to conventional P-N diode forward and reverse recovery transients caused by minority carriers.

#### OTHER VARO SCHOTTKY FEATURES ARE:

- -65 to +150°C junction operating temperatures
- 1 A, 3A, 5A, 15A, 30A and 40A ( $I_O$ ) ratings
- 20V, 30V, and 40V ( $V_{RRM}$ ) ratings
- Low reverse leakage
- Epoxy axial lead, DO-4, DO-5, and TO-3 package configurations
- Competitive pricing

Try one in your circuit; you will see for yourself these advantages and more.

For more information and data sheets on all Varo Schottky Barrier Rectifiers call Mike Hawkins, 214/272-4551



Design us in . . . we'll stay there

VARO

**VARO SEMICONDUCTOR, INC.**

P.O. BOX 676 1000 N. SHILOH, GARLAND, TEX. 75040  
(214) 272-4551 TWX 910-860-5178

EUROPEAN OFFICE: UK: VARO SEMICONDUCTOR INTERNATIONAL, INC.  
Deapdene House, Bellegrave Road, Welling, Kent, England DA163PY, 01-304-6519/0

CIRCLE NUMBER 82

might be slow in responding—and not require a fast a/d converter—the fast scanning rate of the multiplexer may require a new conversion every 2 to 30  $\mu$ s. Because of the speed requirement, the a/d converter can be an expensive part of the system—costing between \$100 and \$300 by itself.

You do have an alternative to sending analog signals over long cables to a central multiplexer. Instead of using a successive-approximation unit split the converter into an analog front end (a v/f converter) and the digital receiving end (the timing and counting circuits) as in Fig. 6a.

To get even better noise immunity, you can use several simple circuits to manipulate digital levels. Cable runs of several thousand feet are possible if you let the v/f circuit feed a differential line driver that, in turn, feeds a twisted pair terminated in a receiver (Fig. 6b). When electrical isolation is critical, use optocouplers to separate the transducer output from the long lines (Fig. 6c). This is especially important if large ground potential differences are present.

Other converter-system variations are possible. You can design a multichannel data-acquisition system to operate under microprocessor control with a minimum of hardware (Fig. 7a). Simple totalizing a/d converters can be built by using manual start/stop and reset switches (Fig. 7b).

#### Drift-free integration is only one bonus

Unlike analog integrators that must use "super high quality" components when the integration period extends past several minutes, the v/f integrator uses inexpensive components and can even hold its value indefinitely.

A 10-kHz v/f converter delivers a pulse every 0.1 ms if the input is 10 V, or a pulse every 1 ms if the input drops to 1 V. You can manipulate these facts and say that the converter generates an output pulse for every millivolt-second of input signal. The output-pulse count then represents a piece-by-piece addition of input voltage/time area (Fig. 8). The integral of the signal with time is the total count multiplied by 0.001 volt-seconds.

You can put together a ratiometric a/d converter (Fig. 9) by combining two v/f converters and a divide chain. Input  $V_1$  acts as the numerator and  $V_2$  as the denominator, while the divide chain acts as a scale factor.

Since the gating pulse is half the output period,  $N$ , of the divider circuit, the counter output is

$$\text{Count} = 2NV_1/V_2.$$

If you use 10-kHz v/f converters, the time base period is no longer than 1 second for ratios of up to 1000 to 1. Unlike other ratio-measurement methods that have rather limited dynamic ranges, using two v/f converters permits a possible dynamic range of 10,000 to 1. ■■



**Tom and Barbara Herrold just bought their spacious Wabash, Indiana home for \$31,500.**

**What do you think relays are going for around here?**

ten rooms, 8 fireplaces, 6 porches, 11 foot ceilings, oak paneling, choice neighborhood, mint condition—all for \$31,500. That's Wabash value. And that's why our relays are in such demand. They are made right here—switches and all—to rigid specifications in a hospital-clean environment where heat, humidity and dust are controlled so quality can be assured. Just to be certain, 3 billion test cycles are run every day.

When you purchase Wabash relays you get the kind of quality the Herrold's got in their home. And at a price that gets you the kind of value the Herrold's got. We've got over 6,000 variations of dry reed relays for sale. Contact us. When you see the asking price, you will know you found a new home for your relay requirements.



The Econo-Miser. The most automatically manufactured dry reed relay available. 1 and 2 pole standard types. Less than one dollar in quantity.

*Coils, Relays & Transformers*

**wabash**

of  
**Wabash, Indiana**

and Huntington, Indiana; Farmington, Missouri;  
Tipton, Iowa and South Boston, Virginia

For information and quotes write or call:

Wabash, Inc., Dept. RA-1, 810 N. Cass St., Wabash, Ind. 46992 Tel: 219/563-2191 TWX 810-290-2722

CIRCLE NUMBER 83

# Ideas for Design

## Inverter circuit handles bidirectional signal flow without latching up

This unusual two-terminal circuit not only inverts logic pulses or levels, but also each of its terminals can serve as either an input or an output. Positive input signals to its terminal 1 are inverted to negative outputs at terminal 2. Conversely, negative-input signals must enter terminal 2 to provide positive outputs at terminal 1. This bidirectional circuit can be used in low-power applications such as CMOS circuits, because it draws current only when a signal level is being inverted.

The problem of latch-up that results if such a circuit is built with the usual logic modules is solved with one inhibitor circuit,  $Q_2$  or  $Q_3$ , for each inverter. As a result, only one inverter,  $Q_1$  or  $Q_4$ , respectively, functions at a time.

Diodes  $D_1$  and  $D_2$  discriminate between incoming and outgoing logic levels at their respective terminals; therefore, corresponding inverters turn ON only when an input terminal has a signal.

For example, with a positive pulse applied to terminal 1,  $D_1$  becomes reversed-biased, and  $Q_3$  remains cut off, but inverter  $Q_1$  turns ON to bring terminal 2 near ground. Thus, the positive signal at terminal 1 is inverted. Transistor  $Q_2$  also turns ON and keeps inverter  $Q_1$  OFF, which prevents  $Q_1$  from latching  $Q_1$  ON.

Similarly, a negative signal into terminal 2 reverse biases  $D_2$  to keep  $Q_2$  OFF and also turns  $Q_4$  ON. Transistor  $Q_3$  turns  $Q_4$  ON, which then holds  $Q_4$  OFF to prevent  $Q_4$  from latching. Terminal 1, therefore, is now the output and provides a negative signal.

Component values for the circuit are not critical. They can be chosen to conform to individual power-supply and logic-drive requirements. Diodes  $D_1$  and  $D_2$  can be general-purpose germanium switching diodes when used with low-threshold logic, such as TTL.

Larry Acker, Engineering Associate, Steiner-Parker Co., 356 S. 900 East C, Salt Lake City, UT 84102.

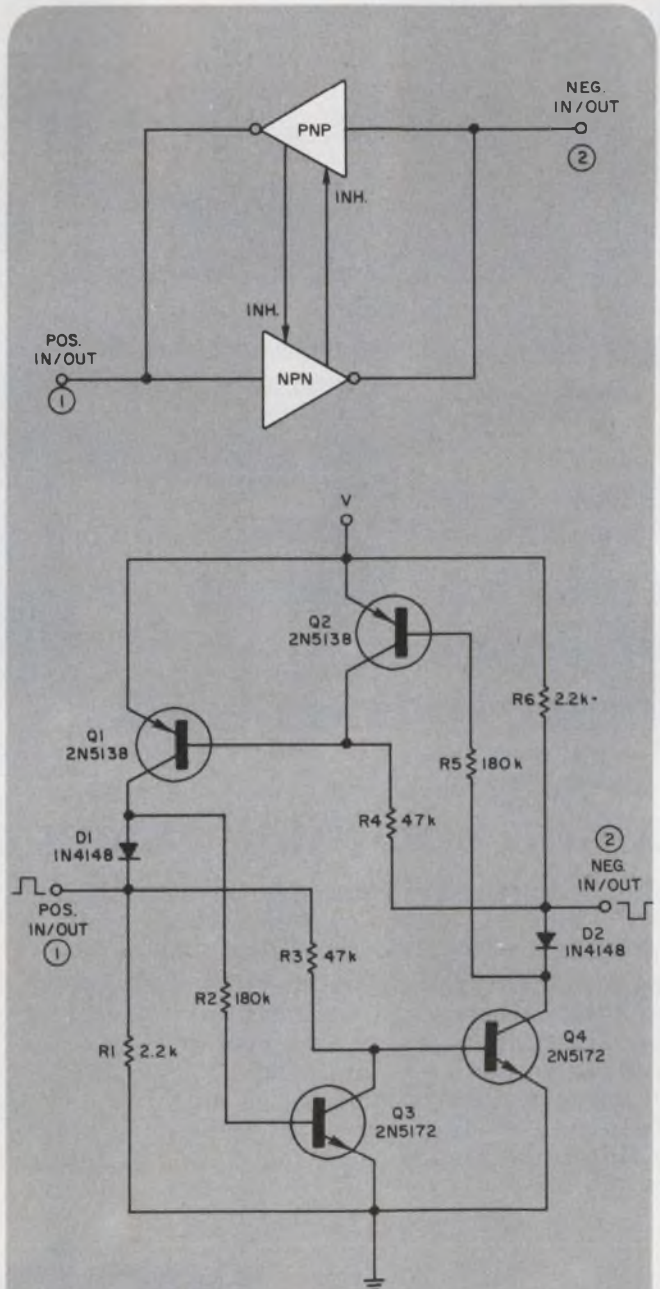

A bidirectional inverter is prevented from latching by the use of inhibitor circuits that allow only one inverter at a time to be turned ON.

CIRCLE NO. 311

If you need panel instruments with **custom** dials, cases, accuracy, tracking, resistance, response time, or practically any combination of unusual specs...

Buy **Triplett's** designed-for-you **Panel Instruments**

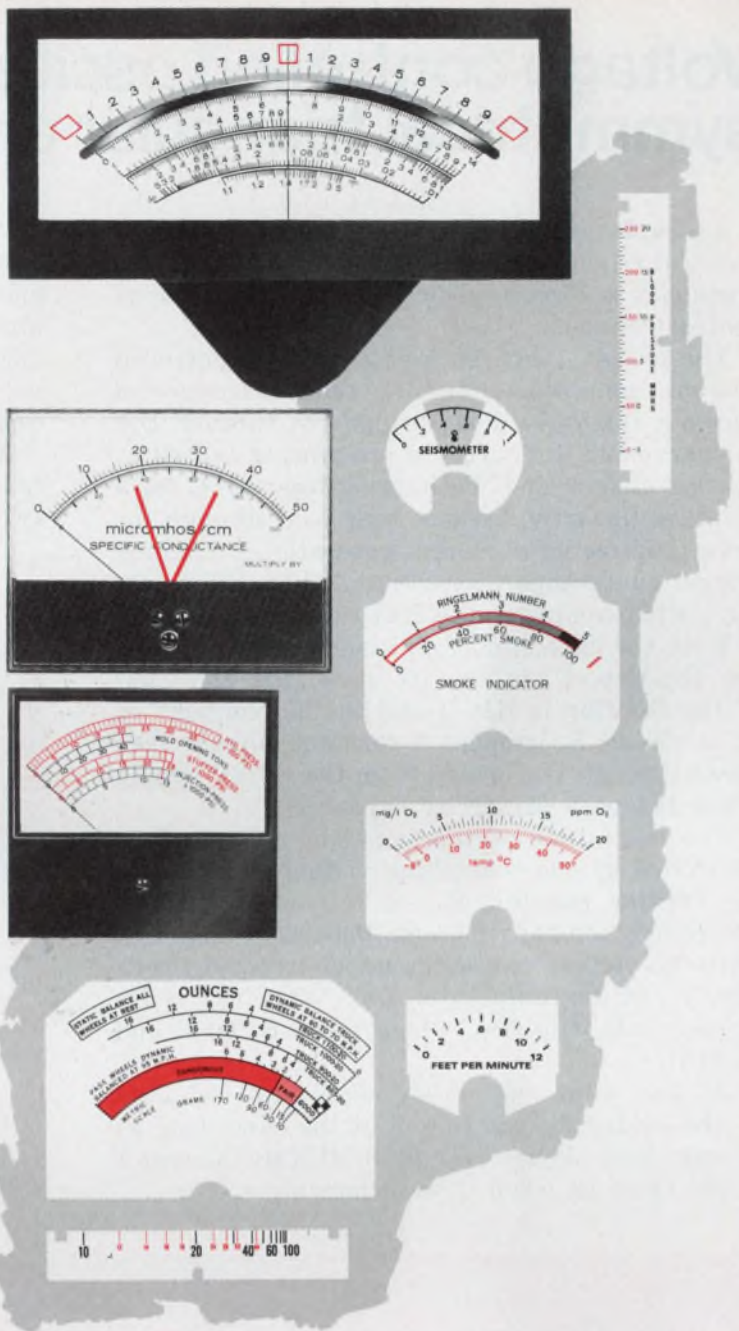

Although we stock some 1369 different styles, sizes and types of standard panel instruments, a very large proportion of our customers buy custom instruments.

Because they need:

**custom dials**

reading in such units as pH, roentgens, mm Hg, rpm, %, inches.

**custom cases**

square, round, rectangular, edge-wise (horizontal and vertical), wide, narrow, shallow.

**custom accuracy**

to within 1/2% with mirror scales and knife-edge pointers.

**custom tracking**

to match the specific needs of existing or new instrument designs.

**custom resistance**

for low circuit loading with tolerances as low as  $\pm 1\%$ .

**custom damping**

to meet stringent electrical and vibration requirements.

For instance, one of our customers had us design and manufacture a custom instrument to replace — in every detail of physical and electrical specifications — one which he was using on a delicate piece of medical instrumentation. Rejects from his previous source had risen to over 20%. He rejected only 3 of the first hundred we shipped — with almost negligible rejections from the many hundreds we've shipped since.

What custom panel instrument specifications do you need to make your

product more reliable, more accurate, more rugged and — in the long run — less expensive? For quick, dependable delivery of small quantities of Triplett's "designed-for-you" panel instruments, contact your Triplett Sales/Service/Modification Center. For prototypes or production quantities, contact your Triplett representative. He'll put you in touch with our Instrument Designers/Engineers who'll help you analyze the problem and suggest the optimum cost/result solution.

**TRIPLETT**  
BLUFFTON, OHIO 45817  
Manufacturers of the World's most complete line of V-O-M's

CIRCLE NUMBER 280 FOR INFORMATION  
CIRCLE NUMBER 281 FOR FREE DEMONSTRATION

# Voltage-controlled oscillator provides symmetrical triangular and square waveforms

A simple technique accurately generates symmetrical triangular and square waveforms whose frequency is directly proportional to an external control voltage.

The circuit (Fig. 1) uses a voltage-controlled current generator (VCCG) that is connected across a full-wave diode bridge (D<sub>1</sub> through D<sub>4</sub>) to charge and discharge an integrating capacitor, C. The charge and discharge paths for C have identical linearity, because they pass through the same unidirectional current generator. A Schmitt-trigger dual-comparator circuit and an SPDT analog switch completes the free-running circuit.

With the capacitor, C, initially discharged and the flip-flop, F, in the set state, the X output of the flip-flop is HIGH and the S<sub>1</sub> "contact" of S<sub>A</sub> is closed; S<sub>2</sub> is open. A constant current then flows through the bridge from the +10-V supply along the path MLKN to capacitor C.

The magnitude of this constant current, I, is controlled by the controlling voltage, V<sub>c</sub>, and by the emitter resistor, R<sub>E</sub>, of transistor Q<sub>1</sub>. The controlled constant-current linearly charges C until the voltage passes the upper-trip-point voltage, V<sub>U</sub>, of the comparator, CO<sub>1</sub>. When CO<sub>1</sub> trips, it resets the flip-flop, which turns S<sub>1</sub> OFF and S<sub>2</sub> ON.

At this point, the -10-V supply rail connects to the bridge discharging C at the same rate as it was charged, but over path NLKM. Current I is the same as when C was charging.

When the discharging voltage at node N crosses the lower trip-point voltage, V<sub>L</sub>, CO<sub>2</sub> provides a signal that sets the flip-flop back to the initial condition. A free-running symmetrical triangular waveform appears at node N. The output terminal of the flip-flop provides a TTL-compatible square waveform.

A CA 3098 dual-level detector with memory can be used to replace the Schmitt and analog switch and thus reduce the number of required

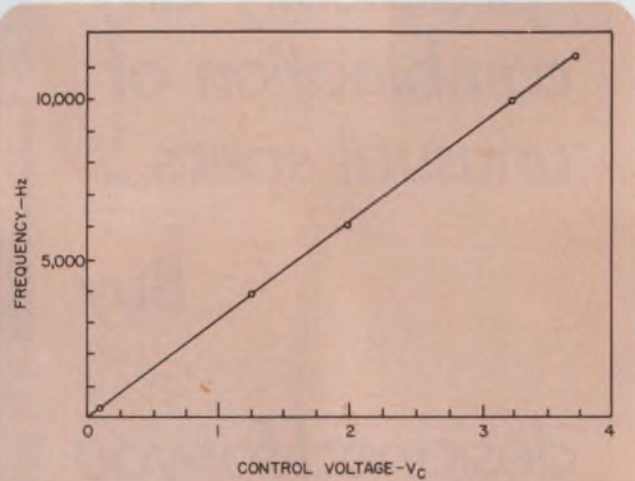

2. Not only is the triangular wave linear, but also the control of the frequency is linear with respect to variations in the control-voltage, V<sub>c</sub>.

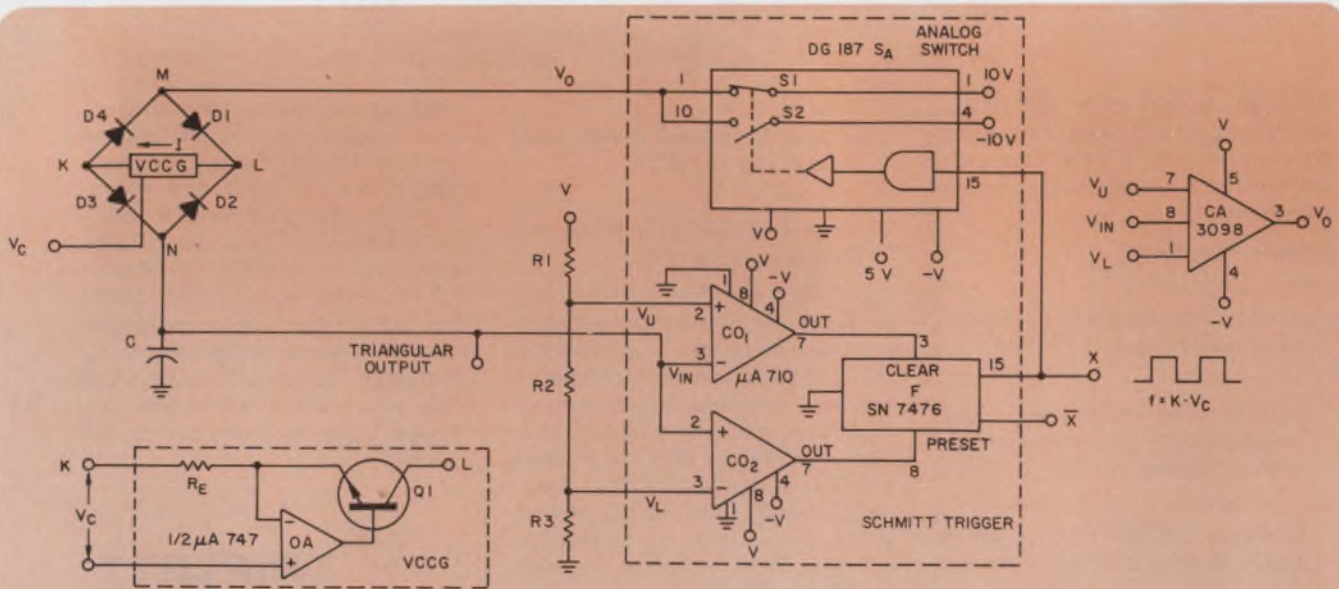

1. A triangular and square-waveform generator is linearly voltage controlled by a constant-current generator. A diode bridge allows the use of the

same current generator for both charging and discharging the timing capacitor—and thus produces symmetrical waves.

# "When he says it's 5 volts, it's 5 volts"

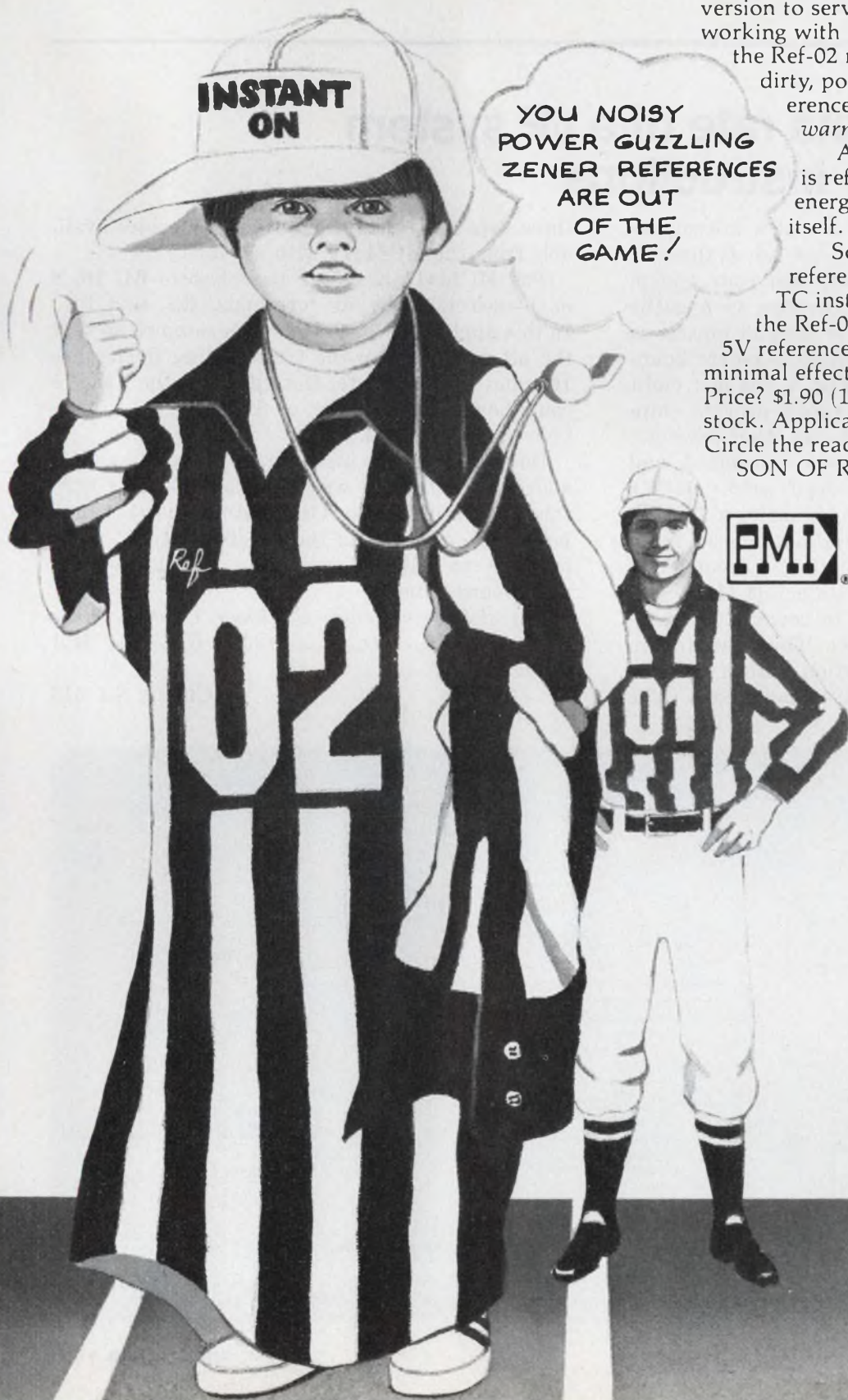

Son of Ref-01! The instant success of our Instant-On 10V monolithic Ref-01 made it only logical that we'd do a 5V version to serve designers who are working with 5V systems. Instantly-on, the Ref-02 replaces all those noisy, dirty, power guzzling zener references, with *essentially zero warm-up* time.

And like the 10V Ref-01, it is referenced to the bandgap energy of the silicon substrate itself.

So if you need low drift reference circuits for your low TC instruments (like 3ppm/°C), the Ref-02 will provide a stable 5V reference, *adjustable by 6%* with minimal effect on temperature stability. Price? \$1.90 (100's). Delivery? From stock. Application notes? You bet. Circle the reader number or write SON OF REF at address below.



Precision Monolithics, Inc.  
1500 Space Park Drive  
Santa Clara, CA 95050  
(408) 246-9222  
TWX: 910 338 0528  
Cable MONO.

CIRCLE NUMBER 85

components. Also, the CA 3098 has a large driving capability, so its output square waveform can swing almost fully from +V to -V and thereby eliminate the requirement for an analog switch.

The charging time,  $T_1$ , of the capacitor C is

$$T_1 = \frac{(V_U - V_L) C}{V_C/R_E} = V \cdot C \cdot R_E / V_C,$$

where,  $V = (V_U - V_L) =$  peak-to-peak amplitude of the triangular waveform. Similarly, the

discharging time,  $T_2$ , of the capacitor is

$$T_2 = V \cdot C \cdot R_E / V_C.$$

The frequency of oscillation is then

$$f = 1/T = 1/(T_1 + T_2) = V_C / 2 \cdot C \cdot R_E \cdot V = k \cdot V_C.$$

Fig. 2 shows the linear f-vs.- $V_C$  output that the circuit can deliver.

Rana Dattagupta, Dipak K. Basu, and Pradip K. Das Computer Centre, Jadavpur University, Calcutta, India 700032. CIRCLE NO. 312

## Control the data rate of a $\mu P$ system with software instructions

You can control the data rate of a microprocessor system with software by the use of three or four ICs (Fig. 1). It's possible that your system already contains a bit-rate generator, such as the MC14411, and a 3-to-8 line demultiplexer—a 74LS138. The 74LS138 generates 1-k-byte boundary chip-select signals. In Fig. 1, the last eight 1-k steps of the addressing range provide chip-select signals for ROM, RAM and other devices.

One of these bytes,  $Y_1$ , when inverted and NANDed with an inverted read/write (R/W) signal, provides a new write signal to a 74LS75 four-bit latch. The 74LS75 need not be used to its full capability, since eight of the 16 frequencies generated by the MC14411 with a 1.84-MHz crystal are more than adequate to cover most data-communications requirements. Thus the fourth bit could be used in conjunction with a LED to provide diagnostics or status indications. The

three data bits select the 1-of-8 frequencies available from the MC14411 with a 74LS151.

The MC14411 has four time bases—64, 16, 8 or 1—selectable by its terminals,  $RS_n$  and  $RS_{in}$ . In this application base 16 is programmed so that the bit rates sent to the transmitting device are 16 times the data rate. Output  $Q_1$  of the 74LS75 could be connected to  $RS_n$  of the MC14411 to provide bases 16 or 64.

During power-on procedures, firmware should address E400H and write 000 on the data bus; thus the circuit selects 110 baud for starting purposes. The control can then be transferred to an operator to make a new data-rate selection via a keyboard entry.

Garret Spears, Senior Engineer, Chem-Nuclear Systems, Inc., P.O. Box 1866, Bellevue, WA 98009.

CIRCLE NO. 313

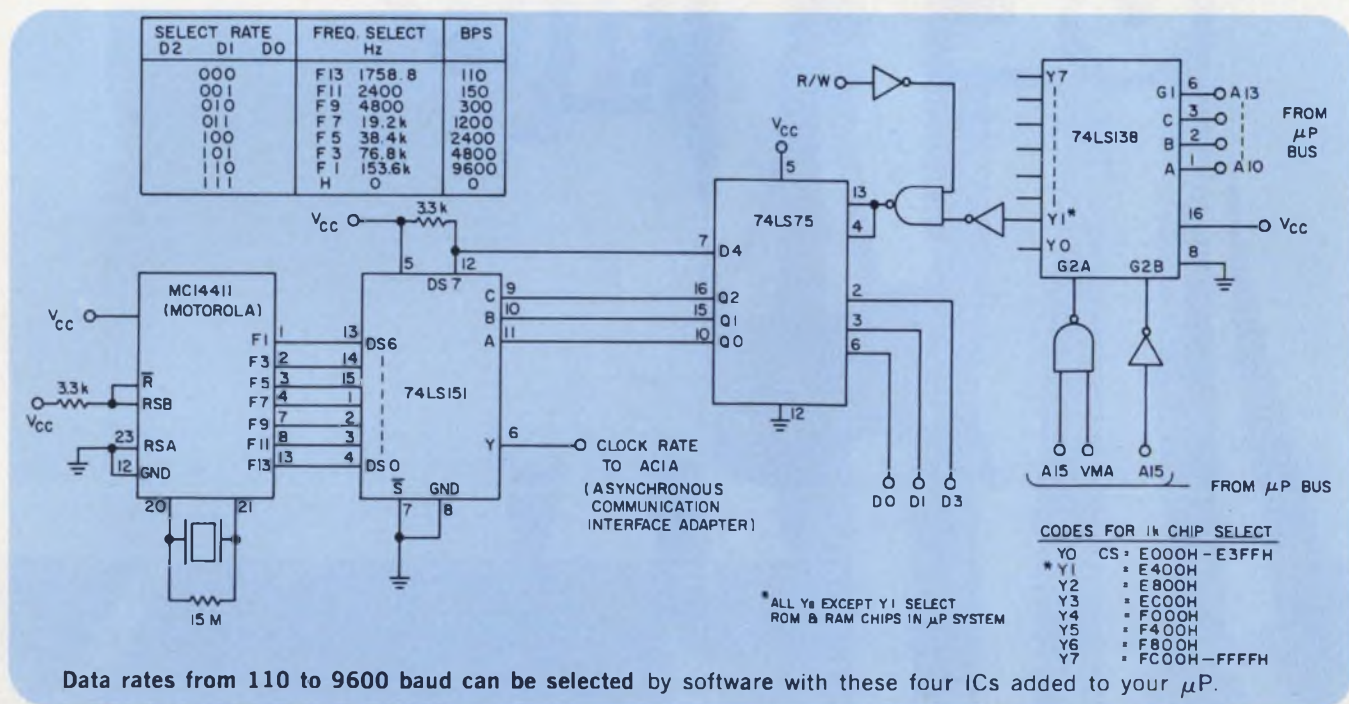



# PRECISION.

The mark of a Pro. Like P&B.  
Time delay relays with up to  $\pm .05\%$  repeatability.  
And delay times to a year or more.



That's the kind of precision you get with Potter & Brumfield **CG Series** relays. And there are many more P&B time delay relays to meet virtually any requirement. Including . . .

**R12, R13, R14, R15 Series.** Sophisticated circuitry usually found in more expensive relays. Repeatabilities to  $\pm 3\%$ ; time delays to 600 sec.

**Low cost R16 Series.** Easily mounted p.c. board module. Delay on operate ranges: 0.2 to 2, 2.0 to 30, 5.0 to 100 sec. Potentiometer or resistor adjustable.

**R52 modules.** Inexpensive way to make all but a few 6,12 or 24 VDC P&B relays into time delays. Resistor adjustable timing ranges from 0.2 to 100 sec.

Also low profile, solid state hybrid, adjustable and non-adjustable—even dry reed. With every type of termination, too!

Design for precision. Specify P&B. See your P&B sales representative, or P&B Pro Shop Distributor. Or, contact Potter & Brumfield Division AMF Incorporated, Princeton, IN 47671. Telephone: 812-386-1000.

European address: Electrical Products Group, AMF International Limited, AMF House, Whitby Road, Bristol BS4 4AZ, England. Telephone: (0272) 778383, Telex: 449481, AMMAFOCO, BRSTL.

Go with the Pros and you can't go wrong.

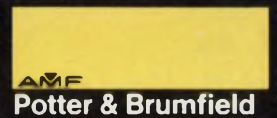

# Use TTY or CRT interchangeably on $\mu P$ system

The 6800 microprocessor family contains an Asynchronous Communication Interface Adapter (ACIA). The ACIA provides data formatting and control to interface to the microprocessor such serial I/O devices as TTYs, CRTs, and thermal printers.

A problem arises when the ACIA is used in a system in which a TTY or CRT terminal may be interchanged. A TTY requires 11 bits of serial data (2 stop bits) at 110 baud, while most other serial I/O devices—such as CRTs or thermal printers—require 10 bits of serial data (1 stop bit) at rates above 300 baud.

Although the baud rate can be readily varied manually with a switch, the 10 or 11-bit (1 or 2 stop bits) format must be programmed into the ACIA by the microprocessor. Since there are no external inputs to the ACIA for identifying whether 10 or 11 bits are required by the I/O device, a simple method was devised to inform the microprocessor how to program the ACIA.

The method uses the image locations created by "don't cares" in the address decoding. A typical addressing technique for ACIAs is shown in Table 1. Other images—8014-8017, 8024-8027, . . .—may be eliminated by decoding address bits A14 through A4, as required.

Locations 8004 through 8007 are used as examples only; this technique may be used at any address. By not decoding address bit A1, locations 8004 and 8006 respond identically and are images of the Control and Status registers. Locations 8005 and 8007 are images of the Input/Output registers.

If the register-select (RS) pin of that ACIA is tied to A1 rather than A0, then locations 8004 and 8005 are images of the Status and Control register while 8006 and 8007 become images of the Input/Output register.

During initialization, the MPU compares locations 8004 and 8006 (Table 2). If they are equal, the ACIA is programmed for 11 bits, otherwise the ACIA is programmed for 10 bits. Locations 8004 and 8007 are always used as Control/Status and Input/Output, respectively.

Fig. 1 is a block diagram of a typical ACIA implementation. The advantages of this method are:

- No address decoding, other than switch S<sub>1</sub>, is required.



## MINIATURE CERMET TRIMMERS 49¢ EACH

(1,000 piece price)  
High performance... low profile... low price. That's the story of MEPCO/ELECTRA's new ET 14 series single turn trimmer. It's the smallest size professional trimmer of its type available today. The 1/4" ET 14W has a maximum height of .150" and features a unique slider design and a CRV of 1% max. 0.25% average, regardless of direction of rotation.  
Want more information? Call or write MEPCO/ELECTRA, INC., San Diego, CA 92121 (714) 453-0353.



CIRCLE NUMBER 205

- Switch S<sub>1</sub> does not load address lines.
- Switch S<sub>1</sub> may be incorporated with the baud rate switch, S<sub>2</sub> at the 110-baud position.

No tests need be made on locations 8005 or 8006 after initialization, since 8004 is always Status and Control and 8007 is always I/O.

The method allows software to remain the same when hardware changes.

Wallace E. DeShon, Engineer, Applied Automation, Inc., Pawhuska Rd., Bartlesville, OK 74004.

CIRCLE No. 314

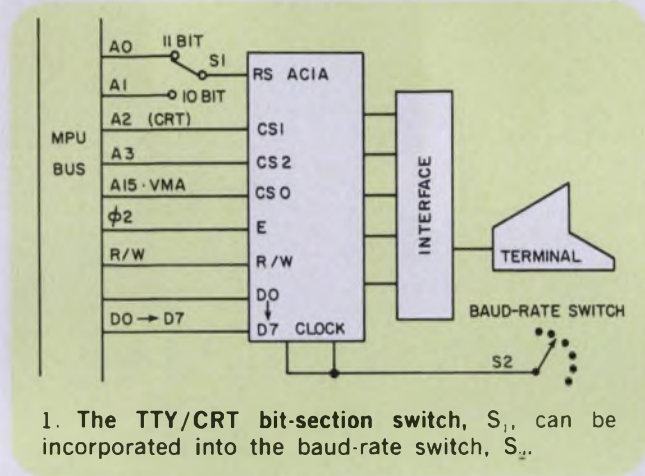

1. The TTY/CRT bit-section switch, S<sub>1</sub>, can be incorporated into the baud-rate switch, S<sub>2</sub>.

TABLE 1. ACIA ADDRESSING TECHNIQUE

CS0	CS2	CS1	DON'T CARE X	RS	LOCATIONS
A15-VMA	A3	A2	A1	A0	8004-8006 8005-8007
A15-VMA	A3	A2	A0	A1	8004-8005 8006-8007

TABLE 2. ACIA INITIALIZATION ROUTINE

n+0	CE	LDA I	
n+1	80		SETS INDEX REGISTER ON ACIA
n+2	04		
n+3	86	LDA I	
n+4	03		MASTER RESET ACIA
n+5	A7	STA X	
n+6	00	(8004)	
n+7	44	LSR A	
n+8	A7	STA X	STORES A0 IN ACIA CONTROL REGISTER FOR TTY (11 BITS)
n+9	00	(8004)	
n+A	A6	LDA X	
n+B	00	(8004)	
n+C	A1	CMPA X	READS ACIA STATUS AND COMPARES IT TO LOCATION 8006
n+D	02	(8006)	
n+E	27	BEQ	IF EQUAL LEAVE ACIA PROGRAMMED FOR TTY
n+F	04	(n+14)	
n+10	86	LDA I	
n+11	09	RS232 CONTROL WORD STA X	
n+12	A7	(8004)	IF NOT PROGRAM ACIA FOR IO BIT OPERATION
n+13	00		

# THE MOST COMPACT FILM RESISTOR IN ITS CLASS...

## 1/2W OF POWER IN A 1/4W PACKAGE

Now, Mepco/Electra offers a film resistor designed with the compactness of a 1/4W and the power handling capacity of 1/2W. The new SPR4045 is a versatile, conformally coated film resistor that can be used as an RL07 or an RL20 as well as an RN55, RN60 and RN65.

The SPR4045 is available in the 610 values between 10 ohms and 22 megohms with a maximum CWV of 350 volts and a resistance tolerance of one percent. The temperature coefficient of resistance is  $\pm 100$  PPM and the SPR4045 will operate at ambient temperatures to 165°C.

For full technical information call or write Mepco/Electra Inc., P.O. Box 760, Mineral Wells, Texas 76067 (817) 325-7871.



**MEPCO/ELECTRA, INC.**

A NORTH AMERICAN PHILIPS COMPANY

CIRCLE NUMBER 206

# Stable constant-voltage supply uses current source to establish reference

The circuit shown employs a FET and an op amp to achieve low output resistance, high supply rejection and a low temperature coefficient (TC). A 7.5-V avalanche diode is used only to force the circuit into the correct mode at switch-on, so the circuit is free of avalanche noise.

The FET,  $Q_1$ , is a low pinch-off p-channel device. It serves as a current source for reference current  $I_c$ , which establishes a reference voltage across  $R_x$ . A variable resistor,  $R_1$ , can adjust the gate-source voltage of  $Q_1$  to a region of its characteristic curve where its drain current doesn't vary significantly with temperature. Over a limited temperature range,  $R_1$  can be adjusted to compensate for the TC of both the op amp and the circuit resistors by operating the FET in a region where its current changes are in opposition.

The reference current typically is less than 1 mA, and doesn't appreciably reduce the available output current. A common op amp, such as a 741 or a 101, can source and sink 3 mA as well as provide sufficient gain to attain a load coefficient of less than  $10 \mu\text{V}/\text{mA}$  for the regulator circuit.

Because the FET is terminated between two constant-voltage points, the regulator's voltage coefficient is less than  $10 \mu\text{V}/\text{V}$ . Also, an over-all TC of less than  $20 \mu\text{V}/^\circ\text{C}$  can be achieved over the temperature range of 0 to 70 C.

With op amps that were selected at random, and not particularly for low noise, a noise voltage of only 20 to 30  $\mu\text{V}$  rms was measured in a noise bandwidth of 10 Hz to 10 kHz.

A convenient alternative to the FET is the recently introduced Siliconix CR068 current-regulator diode. The diode passes 680  $\mu\text{A}$  and features a typical TC of  $0.02\%/^\circ\text{C}$ .

*John A. Roberts, Senior Engineer, Computing Devices Co., P.O. Box 8508, Ottawa, Ontario, Canada K1G3M9.*

CIRCLE No. 315

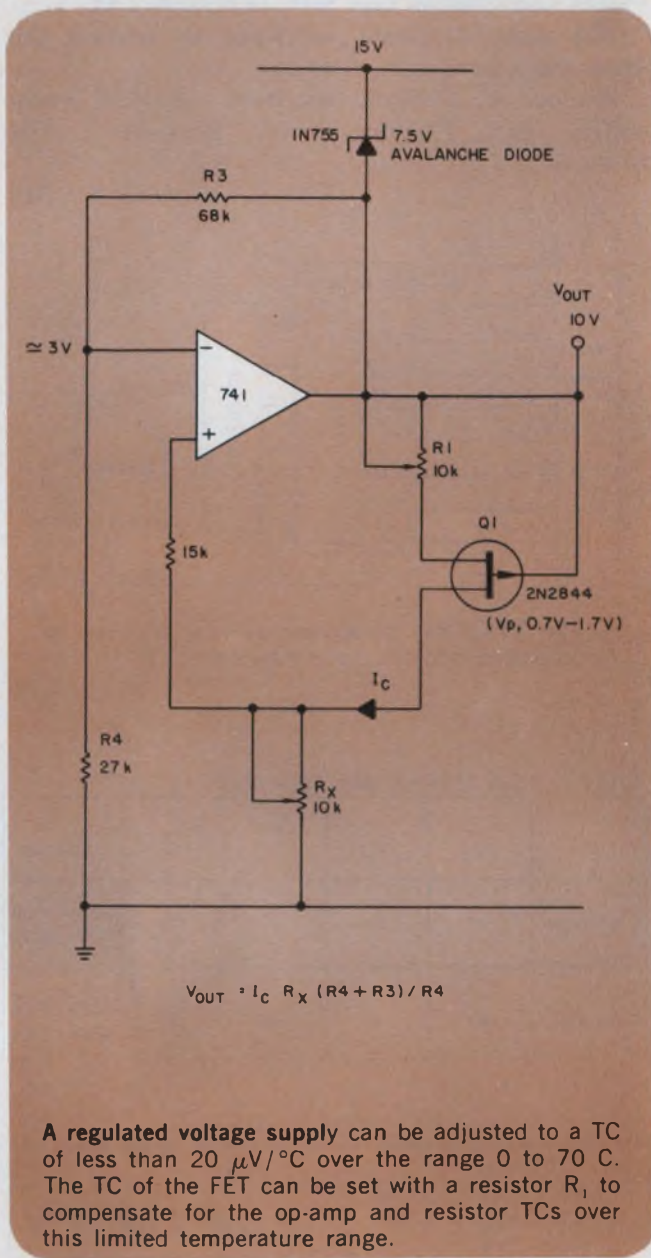

A regulated voltage supply can be adjusted to a TC of less than  $20 \mu\text{V}/^\circ\text{C}$  over the range 0 to 70 C. The TC of the FET can be set with a resistor  $R_1$  to compensate for the op-amp and resistor TCs over this limited temperature range.

## IFD Winner of July 19, 1976

Paul Kranz, Products Manager, and John Seger, Associate Engineer, Dytron Inc., 241 Crescent St., Waltham, MA 02154. Their idea "A Simple Battery Charger for Gel Cells Detects Full Charge and Switches to Float" has been voted the Most Valuable of Issue Award.

Vote for the Best Idea in this issue by circling the number for your selection of the Reader Service Card at the back of this issue.

**SEND US YOUR IDEAS FOR DESIGN.** You may win a grand total of \$1050 (cash)! Here's how. Submit your IFD describing a new or important circuit or design technique, the clever use of a new component or test equipment, packaging tips, cost-saving ideas to our Ideas for Design editor. Ideas can only be considered for publication if they are submitted exclusively to ELECTRONIC DESIGN. You will receive \$20 for each published idea, \$30 more if it is voted best of issue by our readers. The best-of-issue winners become eligible for the Idea of the Year award of \$1000.



# It also comes assembled.

If you need dials, we have dials. If you need handsets, we have handsets. If you need Touch Calling keysets, we've got 'em by the thousands. Ringers and hook-switches, too. Or, if you need complete telephones, we have them for you in all the latest styles and colors.

You get communications components faster from GTE Automatic Electric because, outside of the Bell System, we're the largest manufacturer of telephone equipment in the U.S. If you need it, we have it.

Use the coupon below for a complete

catalog. Or if you're in a real hurry, call John Ashby at (312) 562-7100, extension 250.

When it comes to quality components, call THE SOURCE: GTE Automatic Electric.



Please send your catalog of communications components.

Please send more information and prices on \_\_\_\_\_ of \_\_\_\_\_

(Quantity)                      (Product)

Name \_\_\_\_\_ Title \_\_\_\_\_

Company \_\_\_\_\_

Address \_\_\_\_\_

City \_\_\_\_\_ State \_\_\_\_\_ Zip \_\_\_\_\_

Telephone \_\_\_\_\_

Mail to: Mr. J. D. Ashby, B-4, GTE Automatic Electric, Northlake, Illinois 60164.

**GTE AUTOMATIC ELECTRIC**

## More efficient diode developed by Siemens

New double-drift Impatt diodes with outputs of 3 W at 7 GHz are expected to be applied where semiconductors hitherto have not been used—i.e., in radio relay systems. Developed by Siemens, West Germany, these diodes have relatively high efficiencies of 11% and result in high outputs. The diode's case contains four mesas, which are mounted on a silver heat sink that can handle thermal losses of up to 30 W. But only two of the four mesas are actually bonded to the heat sink, and these two are selected only after extensive performance tests on the multi-mesa

configuration. The result of this approach, says Siemens, is a high-efficiency diode.

Fabricating a double-drift Impatt diode requires such advanced techniques as multilayer epitaxy and ion implantation. The diode's two drift regions are accurately matched to the resonant frequency. Electrons pass through an n-type region, while holes pass through a p-type region.

Further improvements, predicts Siemens, will lead eventually to 10-W devices and will displace traveling-wave tubes in many applications.

vehicles located in bad-reception areas. Error-correcting codes known to reduce the error rate considerably can do nothing in this situation.

A combination of error-correcting codes and sideband diversity transmissions might give the best possible results for data transmission, according to Professor Gashing, head of the Bath Electronics School.

## 'Sideband diversity' cuts transmission-error rate

A 10<sup>4</sup> improvement in the data transmission error rate has been achieved with an experimental mobile radio system using "sideband diversity," a data-modulation method developed at Bath University, England.

The new method, which can be used for speech transmission as well, has been tested by placing three fixed transmitters about 15 miles apart. Vehicles equipped with the special receiving equipment (also developed at Bath) and traveling in areas of varied terrain have obtained signals with error rates of only  $6.8 \times 10^{-3}$ .

Sideband diversity can be operated with two or more transmitters. Identical signals are sent out from each transmitter, but the modulations on the transmitters are phase-shifted relative to each other.

In the three-transmitter experimental system, the modulators are phase shifted 120° with respect to each other, but this angle is not critical.

At the receiver, an amplitude comparator looks for the strongest sideband and automatically selects the strongest part of the signal. This selection ensures that any interruption in the signal that might occur because of the terrain will not result in a total loss of signal at the receiver. At least one sideband of the signal will always get through to carry the transmitted information.

The results of the trials conducted so far have shown that errors are almost random, with only slight variations caused by terrain.

One advantage of the sideband-diversity method is that it overcomes the problem of stationary

## Acoustic wave oscillator works at high frequency

An acoustic-wave oscillator developed by Thomson-CSF is said by the company to exhibit noise and short-term stability characteristics on a par with those of resonating bulk-crystal types—but without the latter's upper-frequency limitation.

The fundamental acoustic-wave oscillator operates from 100 to 800 MHz, and work is in progress to push the upper limit up to 2 GHz. Combining this oscillator with a frequency multiplier can produce signals of up to 10 GHz.

To provide acoustic-wave oscillation, an acoustic-wave delay line is connected in the feedback loop of an amplifier adjusted to yield a net loop gain greater than unity.

Unlike a conventional, crystal-controlled oscillator, the acoustic, delay-line control element does not resonate. Its operating frequency and mode selection are determined by delay-line parameters, which provide design flexibility.

Long and short-term stabilities of 1 in 10<sup>-5</sup> and 1 in 10<sup>-6</sup> parts per year, respectively, have been demonstrated. The noise figure is -120 dB/Hz, with respect to the fundamental. Output power up to +20 dBm is possible as well as the ability to modulate frequency.

# When RFI problems get sticky, try *stickn* fingers®

**Attaches faster, shields better than anything else!**

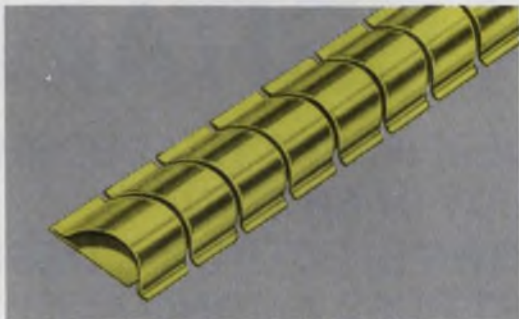

**SERIES 97-500** The original Sticky Fingers with superior shielding effectiveness.

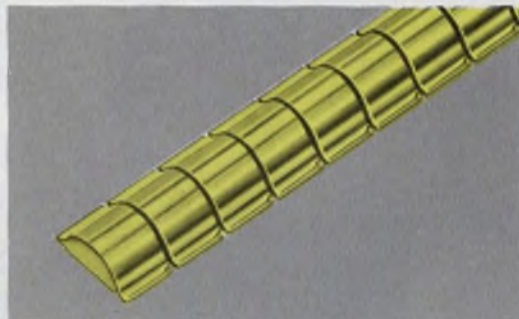

**SERIES 97-520** A smaller size Sticky Fingers for high shielding effectiveness in less space.



**SERIES 97-555** New Single-Twist Series for use when space is at a premium. Measures a scant  $\frac{3}{8}$ " wide.

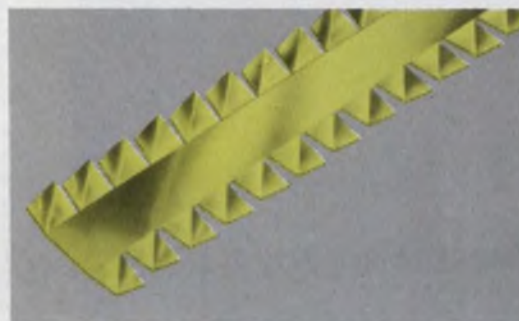

**SERIES 97-560** New  $\frac{1}{2}$ " wide Double-Twist Series, ideal for panel divider bar cabinets.

Now you can specify the exact type beryllium copper gasket that solves just about every RFI/EMI problem. Perfect for quick, simple installation; ideal for retro-fitting. Self-adhesive eliminates need for special tools or fasteners. Write for free samples and catalog.

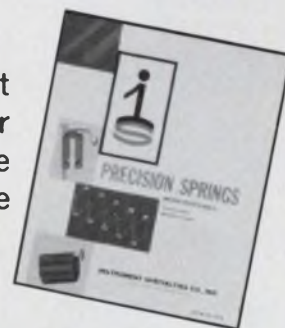

**INSTRUMENT SPECIALTIES COMPANY**, Dept. ED-65

Little Falls, N.J. 07424

Phone—201-256-3500 • TWX—710-988-5732



# Electronic Design BEATS Electronics IN BRITAIN!

## INDEPENDENT READERSHIP STUDY IN BRITAIN SHOWS ELECTRONIC DESIGN BEST READ AMONG ALL U.S. AND INTERNATIONAL PUBLICATIONS

A recent series of face-to-face, in-plant, interviews with 613 chief design engineers and design engineers in 188 geographical locations throughout England, Scotland and Wales shows that your magazine, *Electronic Design*, leads all U.S. and international electronics publications in every readership measurement tested.

- ELECTRONIC DESIGN LEADS IN "AVERAGE ISSUE" READERSHIP
- ELECTRONIC DESIGN LEADS IN "ANY ISSUE" READERSHIP
- ELECTRONIC DESIGN LEADS IN ALL INDUSTRY SECTORS MEASURED
- ELECTRONIC DESIGN LEADS IN BOTH SMALL AND LARGE PLANTS

The study was commissioned by Morgan-Grampian (Publishers) Ltd. and was conducted by NOP Market Research Ltd. It's the first study ever to be carried out on such a scale for Britain's electronics industry.

If your company markets in Europe, you need make no more assumptions. There's no more guessing. Despite claims, *Electronic Design* leads McGraw-Hill's *Electronics* by 38/26, 32/26 and 40/25 on average issue readership, average issue readership in small plants, and average issue readership in large plants. Among those design engineers in Britain who read any publication at all, *Electronic Design* won 62/53 over *Electronics*.

So pass the word to your sales and marketing people. If your company wants to reach engineers, like you, in Europe, *Electronic Design* is the way to travel. Copies of the complete study available on request.

# Electronic Design

BEST READ ELECTRONICS MAGAZINE IN THE WORLD



# TEN-FOUR, CB-LAND, DO YOU COPY?



... Hammer up and lay an eyeball on this copy for a minute. We don't want to overmodulate, but we've got four handbooks that, for not much lettuce, can have you doing your thing in the left lane in no time.

How to get your license from Uncle Charley. How to select and set up a rig. How it works. How to fix your set when something's dusting your ears. Do you copy ... it's all here!

Whether you're a green apple or a trucking guy, even if you drive a pregnant roller skate and want help the next time you get bubble trouble, here's the information, tips and techniques you need.

Use the coupon and put down your handle (name) and 10-20 (address) to order the book(s) you want. They come with a 15-day money back guarantee. And keep the wheels spinning and the beavers grinning.



**HAYDEN BOOK COMPANY, INC., 50 Essex St., Rochelle Park, N. J. 07662**

**MOST OFTEN ASKED QUESTIONS AND ANSWERS ABOUT CB RADIO**  
*CB Magazine Staff*

Everything from "WHAT DOES CB MEAN?" to "HOW DO RG-58 and RG-59 CABLE DIFFER?" Over 160 questions sent in to *CB Magazine* cover all you need to know to really enjoy your rig. 5747-4, \$3.95.

**PRACTICAL CB RADIO SERVICING Revised 2nd Edition**  
*R. R. Freeland*

How to handle just about every problem you'll ever face. Step-by-step instructions, including spot-testing and troubleshooting. Filled with charts, diagrams, illustrations. 0869-4, \$6.95.

**CITIZENS BAND RADIO Revised 2nd Edition**  
*Allan Lytel*

Compares different types of equipment ... how they work ... maintenance and repair ... the FCC and you. 5737-7, \$4.90.

**CBers' HOW-TO BOOK**  
*Leo G. Sands*

How to select and install equipment, including mobile and base stations ... codes and channels ... how to modify your rig for greater convenience and performance. 0718-3, \$4.95.

Please send the books checked on 15-day examination. Enclosed is my check for \$\_\_\_\_\_. Include your state sales tax (NJ-5%, CA-6%, FLA-4%) and 65¢ per book for postage & handling. I understand that I may return the book(s) within 15 days for a complete refund if not satisfied.

Name \_\_\_\_\_

Address \_\_\_\_\_

City \_\_\_\_\_

State/Zip \_\_\_\_\_

# Arrow-M Amber Relays

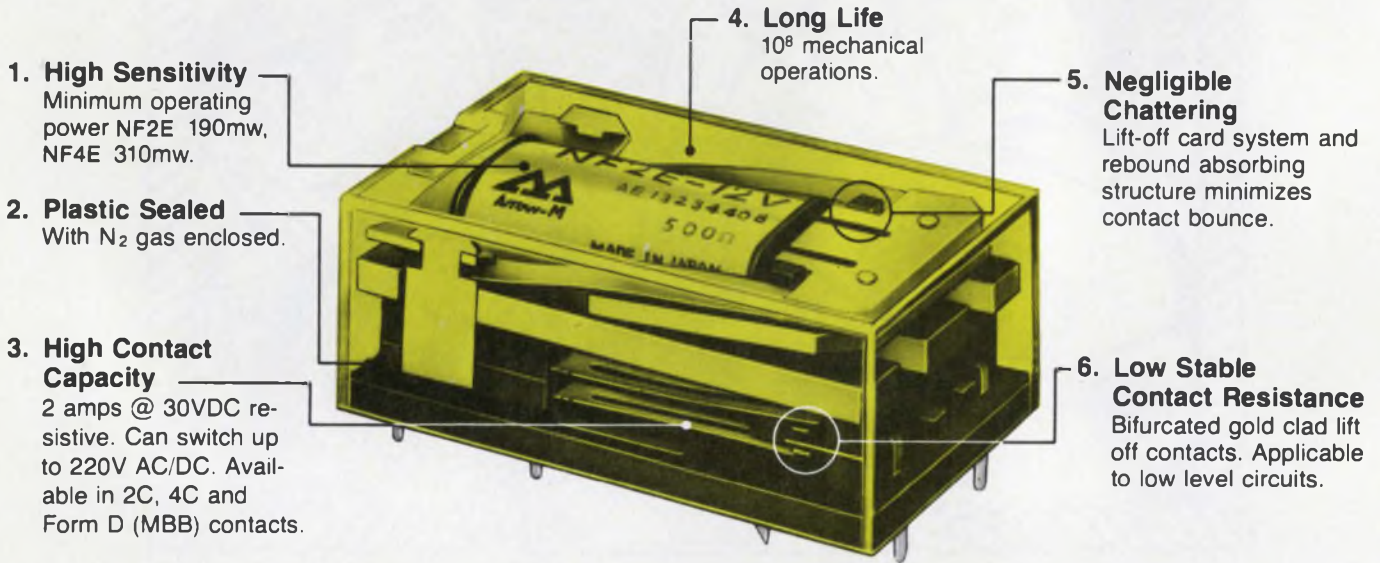

## Sound advice for the alarm industry.

You know better components make a better alarm system. So it pays to install the most reliable relays available today: Arrow-M NFE Amber Relays . . . supported by our unique and advanced manufacturing techniques. They offer you:

**Reliability** — The secret is a unique automated modular assembly coupled with lift off bifurcated contacts and a rebound absorbing mechanism. Installed in a sensitive alarm, it can go unused for long periods of time and still work when needed.

**Sensitivity** — NFE Amber Relays use only half the power of ordinary relays.

**Automatic Wave Soldering** — NFE Amber Relays are plastic sealed with N<sub>2</sub> gas.

**High Packaging Density PC Board Mounting** — flatpack NFE Amber Relays are only 0.425 inches high.

The proven dependability and sensitivity of Arrow-M Amber Relays is based on more than 50 years of meeting the advancing needs of modern technology. So for relays that make it easier to make a better alarm, rely on Arrow-M NFE Amber Relays.

For evaluation samples, or for more information on exact specifications, write or call your nearest Arrow-M office.

**Arrow-M Corporation**  
250 Sheffield Street  
Mountainside, N.J. 07092  
(201)232-4260

*Western Office:*  
22010 S. Wilmington Ave.  
Suites 300 & 301  
Carson, Calif. 90745  
(213) 775-3512



**Arrow-M**

Member of Matsushita Group

Relays for Advanced Technology

CIRCLE NUMBER 90

## New Products

# DPM building blocks make 93 different instruments



United Systems Corp., 918 Woodley Rd., Dayton, OH 45403. (513) 254-6259. See text; stock to 2 weeks.

Putting together a measurement system is easier than ever with Digitec's new line of digital panel meters. Building blocks let you construct over 93 different instruments and consist of 3-1/2 and 4-1/2-digit DPMs, compact adapter modules and a comparator block.

These three elements—plus a three-state logic BCD output—provide the basis for measurement of physical parameters, and for display of readings in convenient engineering units.

The adapter modules attach to the rear of the DPM and condition the input signal. All adapters are interchangeable with either of the basic DPMs. By changing the adapter, you can shift, say, from thermocouple temperature measurements to scaled-and-offset millivolt readings.

With the three-state logic BCD, or single-line enable, you can hook up any number of outputs in parallel on a common data bus. Then, by energizing a single TTL-compatible control line, you can call up coded output data from any instrument (see illustration). Thus cumbersome external switching of many BCD lines is avoided.

The comparator building block,

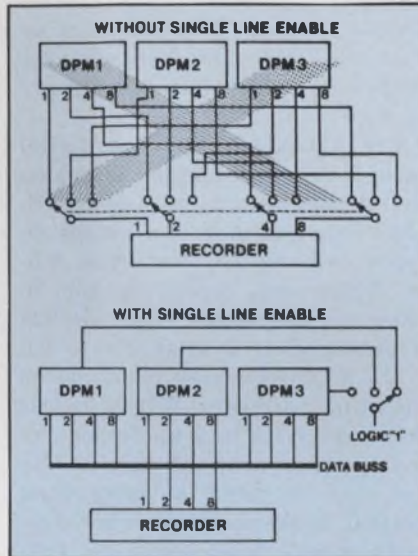

an internal PC board, watches for alarm conditions, and it can monitor any number of points. Alarms are "sounded" by relay closure or by a logic-level output when a predetermined, programmable limit is exceeded.

Programming of the comparator is accomplished with jumpers or with external BCD switches. You can also tell the comparator to indicate the alarm momentarily or to lock-and-hold above or below a limit.

Performance specs of the Digitec DPMs include accuracies to 0.01% of reading (4-1/2-digit unit), 115/230-V-ac or 5-V-dc operation, and common-mode rejection of 129 dB (both DPMs). Tempo of the 4-1/2-digit model (the 2780) is 0.001% of full scale per °C. The 3-1/2-digit unit (the 2770) provides an automatic zero.

Prices of the basic DPMs run from \$139 to \$229, the adapter ranges from \$79 to \$170, and the comparator sells for \$129 (2770) or \$149 (2780). The single-line enable feature costs \$60 in the 3-1/2-digit 2770 and \$75 in the 4-1/2-digit 2780.

CIRCLE NO. 305

## Unit shows single events to $\pm 100$ -ps resolution



Eldorado, 2495 Estand Way, Pleasant Hill, CA 94523. (415) 682-2100. \$4850; 12 wks.

Model 797 time-interval meter is specifically designed for single-event measurement and provides an accuracy and resolution of  $\pm 100$  ps throughout the measurement range of 0 to 999,999,999.9 ns. In addition to measuring the time interval between two separate pulses, the 797 measures the width of a single pulse or one period of a repetitive signal. The start and stop points can be independently controlled so that pulse parameter or waveform measurements can be made. In a programmable system, the 797 can be sequenced to measure rise time, pulse width, and period. BCD or IEEE Std 488-1975 (GPIB) and remote programming are available.

CIRCLE NO. 320

## Chart recorder operates from 12-V power source

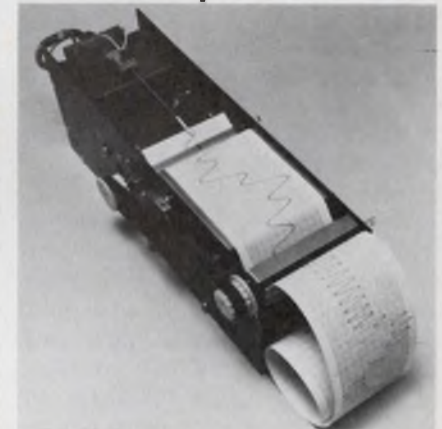

Astro-Med, Atlan-Tol Industrial Park, West Warwick, RI 02893. (401) 828-4000. \$425; 2 wk.

A single-channel chart recorder operates directly from a 12-V-dc power source. The recorder, Model 102 XLA, takes 6 W of power. It provides an accuracy of 0.5% of full scale and meets the frequency-response specifications of the American Heart Association. The 102 XLA uses no ink; it writes on thermal paper. The trace width is 50 mm. The recorder dimensions are 4 x 6 x 6.25 in.

CIRCLE NO. 321

## Digital integrator reads watt or amp-hours



Yokogawa Corp. of America, 5 Westchester Plaza, Elmsford, NY 10523. (914) 592-6767. \$1200.

With energy conservation on everyone's mind these days, a digital integrator that keeps track of watt-hours or ampere-hours is right in tune with the times. The Model 2513 from Yokogawa attaches to the company's 2504 digital ac meter and provides a 6-digit display of any equipment's energy consumption.

Resolution of the 2513 always matches that of its companion. If the 2504 (which measures true-rms voltage, current and power) is set to resolve 0.1 W, the integrator will resolve 0.1 W-h. The combined accuracy of the sister meters is about 0.35% of full rated input. Repeatability is 0.1% or better.

The 2513's integration time runs from about 100 to 833 h at rated input, so the top readings are 10,000 kW-h or 10,000 A-h. With dc-input modules, the 2513 can integrate dc current as well.

The integrator has BCD output that can be used in a feedback loop to control current flow in a process-control application. The unit can be interrogated at any time without affecting the total integrated value. Addressing the 2513 can be accomplished manually or remotely with a rear connector.

Operation is simple. Three front-panel pushbuttons are used to start, stop or reset the unit. Range of the 2504 varies from 15 W fs (30 V, 0.5 A) to 12 kW fs (600 V, 20 A) so that almost any equipment can be monitored. Five input modules provide single or multi-range operation or combined dc and ac operation.

The 2513-2504 combination prices out under \$4000, depending on the choice of input plug-in. Delivery takes 6 to 8 weeks.

CIRCLE NO. 304

## Compact DPM aims at analog meter market



Analog Devices, Route 1 Industrial Park, P.O. Box 280, Norwood, MA 02062. (617) 329-4700. \$39 (100s); 30 days.

The AD2026 is the first digital panel meter to integrate all analog and digital circuitry on one I<sup>2</sup>L LSI chip. The unit is a 3-digit, 5-V-powered device, featuring 0.5-in. LEDs and priced at \$39 in 100-piece quantities. The AD2026 is packaged in a small 3.4 × 2.0 × 0.7-in. snap-in case requiring no mounting hardware. Weight is less than 2 oz. With just 14 components and a power draw of only 0.6 W, the unit is rated at more than 250,000 hours MTBF. Other features include 0.1% accuracy, full-scale range of -99 mV to 999 mV, bias current of 110 nA, balanced differential input and overvoltage protection of ±15 V dc. Gain tempo is 50 ppm/°C and zero tempo is 10 μV/°C.

CIRCLE NO. 322

## Logic analyzer accepts 16 channels

Biomation, 10411 Bubb Rd., Cupertino, CA 95014. (408) 255-9500. \$5000; 30-60 days.

Model 1650-D, a 16-channel, 50-MHz logic analyzer, is functionally similar to the company's 851-D eight-channel unit. The 1650-D can freeze the input signals in its 16 × 512-bit memory. The unit then displays the stored data in a 16-line timing-diagram format on a CRT display or oscilloscope. Also offered is an accessory, the 116 display control, which expands the unit into a full data-domain analyzer. The display control produces a truth-table data format, complete with hex or octal characters, plus a vector-map display format and data-compare function.

CIRCLE NO. 323

## 4-terminal probes test PC boards

Electro Scientific Industries, 13900 N.W. Science Park Dr., Portland, OR 97229. (503) 641-4141. \$95; stock to 60 days.

You can use these probes for making four-terminal resistance measurements on microcircuits. Small enough to probe a pad of 20 mils square, they are useful for checking PC board stripes as well as components. The probe tips are spring loaded into a pen-sized holder. They can be used for extremely low-ohm measurement at high accuracy because a true four-terminal technique, which eliminates lead resistance effects, is employed. Slivers on printed circuit boards, shorts in ICs and open conductor stripes under dual-in-line packages can be detected with these probes, when used with the company's Model-1700 digital ohmmeter. These probes are also useful for resistance measurement of physically large parts such as rods and cable couplings.

CIRCLE NO. 324

## Instruments compatible with TM-500 line

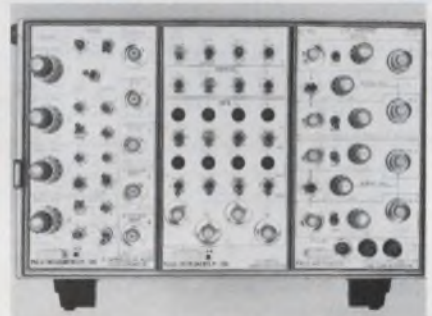

Pulse Instruments, P.O. Box 1655, San Pedro, CA 90733. (213) 541-3204. PI-100, \$695; PI-200, \$850; PI-400, \$595; January to March, 1977.

Three plug-in units are designed to fit the Tektronix TM-500 series of modular instruments. The units are the PI-100 four-channel, 50-MHz delay width clock generator; the PI-200 four-channel × 32-bit, 50-MHz word generator; and the PI-400, a four-channel, 5-V interface driver with ±5-V offset. The units are intended for high-speed digital and analog testing applications. When used together they form a compact, but expandable, multichannel signal source system.

CIRCLE NO. 325



**You'll like  
Burr-Brown's  
one word price story...  
Down.**

You've always expected high quality from Burr-Brown. Now you can expect Burr-Brown to keep your costs down, too. Take a look at the prices of these high quality Burr-Brown units:

**ADC 80:** Lowest priced hybrid 12 bit A/D on the market. ADC 80 is complete with clock, comparator and reference, and is especially applicable in designs where space is crucial. With a conversion speed of 25  $\mu$ sec, price is only \$47.50 (in 100's).

**DAC 80:** 12 bit DAC's price cut by half. The DAC 80 is a truly self-contained D/A converter with guaranteed monotonicity. It includes internal reference source, output buffer amplifier, maximum non-linearity of  $\pm 1/2$ LSB, and a price of only \$19.50 (in 100's).

**3650/3652 Isolation Amp:** Breakthrough in price and size. Thanks to a new optical coupling technique, you now have a low cost alternative. Under one cubic inch in volume, the 3650HG, with 0.3% gain non-linearity and 1500V continuous isolation is only \$26.50 (in 100's).

**3626 Instrumentation Amp:** Modular performance at lower cost. The laser-trimmed 3626 family offers the performance you need. Input offset drift as low as 1  $\mu$ V/ $^{\circ}$ C at G = 1000, <2  $\mu$ V/ $^{\circ}$ C at G = 5, gain non-linearity is 0.01%. Prices start at \$13.00 (in 100's).

**4127 Log Amp:** Low-cost solution to signal processing problems. 4127 is the first hybrid log amp to accept inputs of either polarity—up to 4 decades of voltage or 6 decades of current input. It functions as a logarithmic, log ratio, or antilog amplifier, and is only \$26.00 (in 100's). Five circuits—typical examples of Burr-Brown's commitment to cost savings. Over the past year, Burr-Brown has cut prices on a substantial number of products, some by more than 50%.

To find out more on how Burr-Brown can help you meet those crucial cost vs. performance specifications, write or call: Burr-Brown, International Airport Industrial Park, Tucson, Arizona 85734. (602) 294-1431.



**Still at the top,  
except in price**

CIRCLE NUMBER 92

# MEET OUR FAMILY OF ELECTRONIC TEST ACCESSORIES

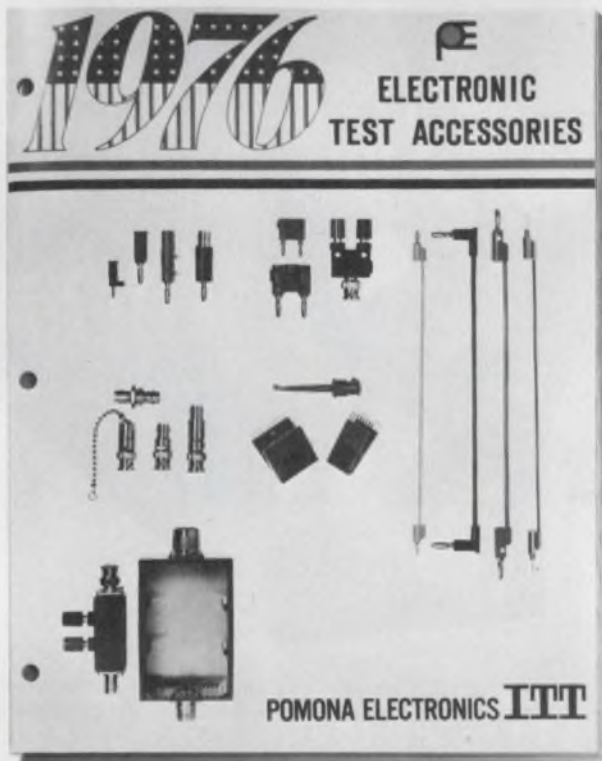

This new General Catalog is our latest family portrait. In the past twenty-five years (1976 is our Silver Anniversary year) it has grown from a handful of items to almost 500 products for the electronics industry.

Our catalog has grown to 76 pages for 1976, and we are introducing 65 new items this year. It describes and illustrates every member of our family. You're bound to find the solution to your testing problem with one or more of these quality products.

For your free copy, circle the reader service number listed below, or write:

## ITT POMONA ELECTRONICS

1500 East Ninth St., Pomona, Calif. 91766  
Telephone (714) 623-3463. TWX: 910-581-3822



CIRCLE NUMBER 93

## INSTRUMENTATION

### Phase locked sig gen costs only \$2600



Wavetek Indiana, 66 N. First Ave.,  
Beech Grove, IN 46107. (317) 783-  
3221. \$2600.

Model 3001 signal generator operates from 1 to 520 MHz and is phase-locked in the FM mode. Built-in frequency programmability is standard. An optional external reference input enhances the unit's accuracy of  $\pm 0.001\%$ . Stability is rated at 0.2 ppm/h. A  $5 \times 10^{-9}$ /day stability option is available. Price of the 3001 is said to be about half that of other phase-locked units.

CIRCLE NO. 326

### PCM-link tester spans 5 Mbit/s range

EMR-Telemetry, P.O. Box 3041,  
Sarasota, FL 33578. (813) 371-  
0811. \$6000.

EMR's Model 721 bit-error-rate tester provides complete end-to-end performance testing of communication links, tape recorders, bit synchronizers, or any PCM system having a bit rate within 1 bit/s to 5 Mbit/s. Two basic data patterns are generated: (1) a 16-bit word with each bit front panel selectable and (2) a 2047-bit pseudorandom word. With either pattern, frame length is selectable from one to 512 words per frame, in increments of powers of two. A bit-blanking function is provided for bit synchronizer flywheeling or coasting measurement. An internal counter and front-panel display counts bit errors and gives clock slippage and acquisition periods. Jitter simulation is provided by an internal voltage-controlled oscillator. Other tests include threshold level, transition density, pattern sensitivity, capture and tracking limits and loop-width performance.

CIRCLE NO. 327

# Electronic glass. All you need is vision.

Here is a designer's dream come true. Minimum form with maximum function.

It's PPG's electronic glass.

It lets you combine the sleek, simple elegance of glass and the dazzling magic of solid-state technology.

Which means you can literally change the faces of

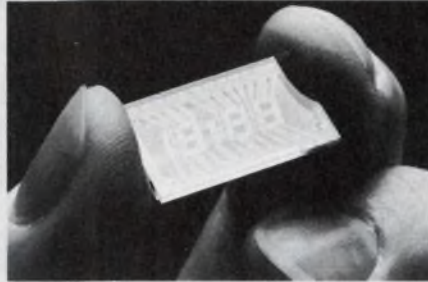

Digital watches will never be the same. Electronic glass can make them more efficient and more affordable.

appliances, timepieces, visual displays, and instrumentation of every description.

The secret is the permanent conductive metallic-oxide coating on the glass.

It can be made to trigger functions at the mere touch of a finger. Like timing a roast, choosing a station, starting the wash, or even figuring the square root of 34.

In short, if it can be done electronically, it can probably be done a little better with electronic glass.

And, since the coating can be applied to form letters, numbers, or any visual display imaginable, there's almost no end to what you can do.

Digital clocks, wristwatches, speedometers, odometers, oscilloscopes, and radar screens are just a few of the obvious possibilities.

As for its reliability, there's really nothing to go wrong. No moving parts. No knobs, dials, switches, buttons—just glass.

It's here. It's now. It's ready. All it needs is you, and all you need is the vision to use it.

So test your vision. Send the coupon today.

Displays simulated.

This is a control panel for a microwave oven. Just one of the many possibilities for a countdown timer and digital display.

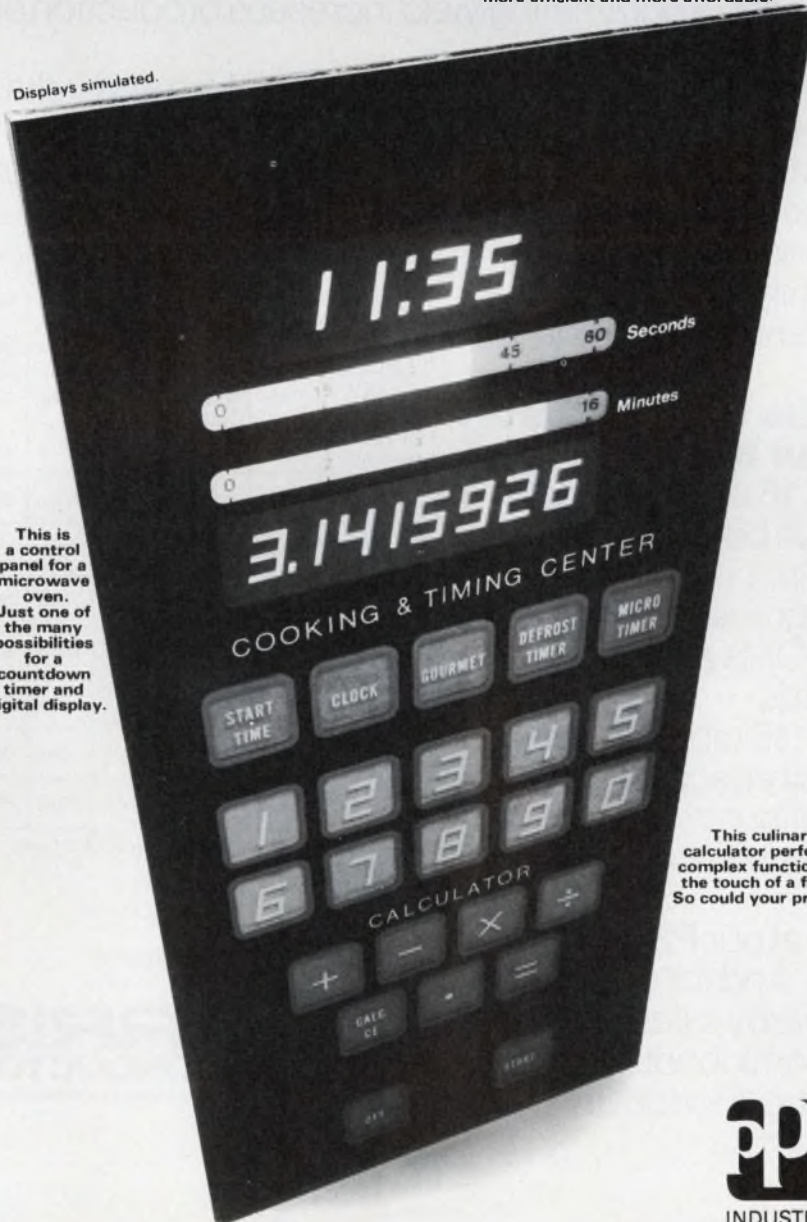

This culinary calculator performs complex functions at the touch of a finger. So could your product.

## PPG: a Concern for the Future

PPG Industries, Inc.  
Industrial Glass Products  
One Gateway Center  
Pittsburgh, Pa. 15222

I want to test my vision.  
Send me more information about  
PPG's exciting electronic glass.

Name \_\_\_\_\_

Company \_\_\_\_\_

Address \_\_\_\_\_

City \_\_\_\_\_

State \_\_\_\_\_ Zip \_\_\_\_\_



# Why Do More Top Designers Insist On Working With Harris Generic PROMs?

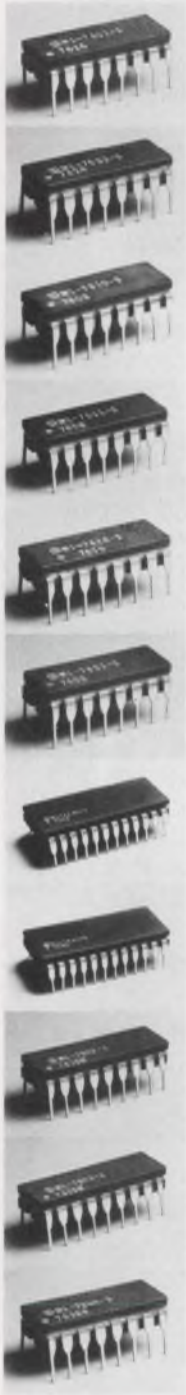

The compatibility and depth of our Generic PROM family simplifies selection, application, and production. But that's only the beginning. Here are a few specific reasons for choosing Harris.

- ✓ Identical programming specifications means that one programmer programs the entire family.
- ✓ Single pulse one millisecond per bit programming achieves fast programming and superior reliability.
- ✓ Industry's highest programming yield increases production efficiency, regardless of PROM size.
- ✓ Access times are guaranteed over full temperature and voltage ranges and any random addressing sequence.
- ✓ Harris is the only JAN-38510 QPL-1 approved PROM supplier.
- ✓ Proven Nicrome fuse design and Schottky technology.

Complete family availability from prototype quantities to production volumes.

## Now See How The 1Kx4 PROM Can Improve Your System.

- ✓ High-density 16 or 18 pin packages greatly reduce board area.
- ✓ HM-7644 (16 pin, no enables) provides direct upgrade for systems using 1K or 2K PROMs and having less than 1024 words.
- ✓ HM-7642/43 (18 pin, 2 enables) extends high density packaging to large memory configurations.
- ✓ Low power per bit: ( $I_{CC} < 140$  ma or  $< 180 \mu W/bit$ ).

For a quick look at our PROM family check the chart. And for complete details call your nearby sales location or write to Harris Semiconductor, P.O. Box 883, Melbourne, Florida 32901.

Device #	No. of Bits	Organi- zation	No. of Pins	Max. Access Time*	
				Com.	Mil.
HM-7602 (open coll)	256	32x8	16	40ns	50ns
HM-7603 (three state)	256	32x8	16	40ns	50ns
HM-7610 (open coll)	1024	256x4	16	60ns	75ns
HM-7611 (three state)	1024	256x4	16	60ns	75ns
HM-7620 (open coll)	2048	512x4	16	70ns	85ns
HM-7621 (three state)	2048	512x4	16	70ns	85ns
HM-7640 (open coll)	4096	512x8	24	70ns	85ns
HM-7641 (three state)	4096	512x8	24	70ns	85ns
HM-7642 (open coll)	4096	1024x4	18	70ns	85ns
HM-7643 (three state)	4096	1024x4	18	70ns	85ns
HM-7644 (active pullup)	4096	1024x4	16	70ns	85ns

\*Access time guaranteed over full temperature and voltage range.  
Industrial ( $T_A = 0^\circ C$  to  $70^\circ C$ ,  $V_{CC} \pm 5\%$ )  
Military ( $T_A = -55^\circ C$  to  $125^\circ C$ ,  $V_{CC} \pm 10\%$ )

Proven PROM Capability



**HARRIS**  
SEMICONDUCTOR  
A DIVISION OF HARRIS CORPORATION



**HARRIS SEMICONDUCTOR  
GENERIC PROM  
INFORMATION CENTERS  
OEM SALES OFFICES**

**CALIFORNIA:** Long Beach (213) 426-7687; Palo Alto (415) 964-6443

**FLORIDA:** Fort Lauderdale (305) 971-3200; Melbourne (305) 724-7430

**ILLINOIS:** Hinsdale (312) 325-4242

**MASSACHUSETTS:** Wellesley Hills (617) 237-5430

**MINNESOTA:** Minneapolis (612) 835-2505

**NEW YORK:** Endwell (607) 754-5464; Melville, L.I., (615) 249-4500

**OHIO:** Dayton (513) 226-0636

**PENNSYLVANIA:** Wayne (215) 687-6680

**TEXAS:** Richardson (214) 231-9031

**SALES REPRESENTATIVES**

**ALABAMA:** Huntsville (205) 533-6640

**ARIZONA:** Scottsdale (602) 948-5590

**CALIFORNIA:** Los Angeles (213) 870-9191; Mountain View (415) 961-8121; San Diego (714) 565-9444

**COLORADO:** Denver (303) 773-0666

**CONNECTICUT:** East Norwalk (203) 838-1493

**FLORIDA:** Boca Raton (305) 395-6108; Oviedo (305) 365-3283; Tampa (813) 933-1759

**ILLINOIS:** Elk Grove Village (312) 640-1850

**INDIANA:** Indianapolis (317) 849-6454

**IOWA:** Cedar Rapids (319) 377-8275

**KANSAS:** Wichita (316) 943-6221

**MARYLAND:** Lanham (301) 459-1556

**MASSACHUSETTS:** Burlington (617) 273-1313

**MICHIGAN:** Farmington (313) 476-2446

**MISSOURI:** Hazelwood (314) 731-5799; Independence (816) 737-1100

**NEW JERSEY:** Keasbey (516) 567-5900; West Caldwell (516) 567-5900

**NEW MEXICO:** Albuquerque (505) 265-5655

**NEW YORK:** Albany (518) 489-7408 or 4777; Huntington Station (516) 567-5900

**NORTH CAROLINA:** Winston-Salem (919) 722-5151

**OHIO:** Cleveland (216) 831-8292; Dayton (513) 890-2150

**OREGON:** Beaverton (503) 643-1644

**PENNSYLVANIA:** Allison Park (412) 487-4300; King of Prussia (215) 265-0634

**SOUTH CAROLINA:** Greenville (803) 268-1125

**TEXAS:** Dallas (214) 691-4592; Houston (713) 661-3007

**VIRGINIA:** Charlottesville (804) 973-6672

**WASHINGTON:** Bellevue (206) 454-0300

**CANADA:** Mississauga (Toronto) (416) 676-1042, (416) 678-0401;

Montreal (514) 626-6723, (514) 389-8051; Ottawa (613) 749-0740,

(613) 226-3491

**INSTRUMENTATION**

**Logic clip eases  
debugging of logic cards**



*Micro, 10888 N. 19th Ave., Phoenix, AZ 85021. (602) 997-5931. \$40,000 to \$60,000; 2-4 wk.*

The Magiclip system, with guided clip/probe, enables production workers to troubleshoot logic boards with a minimum of time and training. To locate a fault, the operator simply follows simple instructions which automatically appear on the CRT. The system rapidly detects faults to chip, node or run level. Magiclip is an option of the 6500 test/programming station, a modular turnkey system, which enables users to generate board-test programs in-house and perform comprehensive testing and troubleshooting. Optional peripherals include high speed printer, console with dual floppy discs, high speed paper tape punch/reader, card reader, CRT and keyboard, Magiclip guided clip/probe and 500-series test head.

**CIRCLE NO. 328**

**Scope trace drawn on  
strip-chart recorder**

*Gould Advance Ltd., Roebuck Rd., Hainault, Essex, England.*

An output module, the 4001-1, for the company's OS4000 digital-storage scope, provides automatic printout of a trace onto a strip-chart recorder after an input has been stored. On receipt of a transient, the scope stores the input and switches to a "stored" condition. Immediately, the output unit switches to the printout condition and at the same time selects a predetermined speed for the recorder in use. Front-panel contacts start the strip-chart motor, and a single sweep is plotted. At the end of the sweep the scope automatically reverts to the primed condition, ready to accept, and then plot, a further input.

**CIRCLE NO. 329**

**Lightweight scope  
features multiplication**



*Philips Test & Measuring Instruments, 400 Crossways Park Dr., Woodbury, NY 11797. (516) 921-8880. \$3395.*

A built-in 40-MHz multiplier and comprehensive storage facilities are features of a new, lightweight, 50-MHz scope. The PM-3243 has two channels with 5-mV sensitivities and both the product and one of the original signals can be displayed simultaneously. Variable persistence and variable storage allow the study of single-shot events. The use of a direct conversion power supply allows operation from almost any voltage or frequency, including dc, without switching. Any ac supply between 90 and 264 V from 46 to 440 Hz or any dc supply between 100 and 200 V suffice. Power consumption is 39 W.

**CIRCLE NO. 330**

**Ultracompact DMM  
fits in attache case**



*John Fluke Manufacturing Co., P.O. Box 43210, Mountlake Terrace, WA 98043. (206) 774-2211. \$250; 7 wks.*

Model 8030A DMM is designed for service and maintenance applications and is said to be the first 3-1/2-digit instrument to offer features such as true rms ac voltage and current measurements and diode testing. The compact design lets the unit be easily carried in a tool kit or attache case. The diode measurement feature permits the forward drop (in millivolts) across a diode or transistor to be checked, with the semiconductor junction biased at 1 mA. Dc accuracy is  $\pm 0.1\%$  of reading +1 digit.

**CIRCLE NO. 331**

# The smaller, lighter self-contained Cesium Frequency Standard

...from OSCILLOQUARTZ

one of the world's largest and most technically competent manufacturers of quartz crystal oscillators, comes this new Primary Frequency Standard. Now, a new source of precision time and frequency generation and measurement systems plus a new standard of reliability and operating simplicity. Most competitively priced.



It is complete — with 110/220 VAC and 24 VDC Power Supplies, a 5-hour Internal Standby Battery, Monitoring and Control Devices — in a 19" rack with 1, 5 and 10 MHz outputs on front and rear.

Heart of this self-contained Primary Standard is the compact cesium beam tube developed by Frequency & Time Systems to permit the exceptional performance-to-size ratio of the Model 3200. ALSO NEW—the Oscilloquartz low-cost Model 3000 Cesium Beam Frequency Source in 1/2 ATR Rack Size.

Complete engineering and performance specifications available on Model 3200 Cesium Frequency Standard and Model 2200 Quartz Frequency Standard and Clock.  
Write: 182 Conant St., Danvers, MA 01923 or call (617) 777-1255  
TELEX 94-0518

MODEL 3200	
Accuracy (0°C to +50°C)	$\pm 1 \times 10^{-11}$
Reproducibility	$\pm 5 \times 10^{-12}$
Stability	$\pm 2 \times 10^{-13}$
Outputs	1, 5 & 10 MHz
Power Supplies	110/220 VAC $\pm 10\%$ primary (45 - 440 Hz) 20 - 30 VDC (floating) secondary
Standby Battery	5 hrs at 25°C (fast charging)

"A STEP AHEAD . . . IN TIME"

**Frequency and  
Time Systems**

CIRCLE NUMBER 96

## INSTRUMENTATION

### Digital unit reads pressure and temp



Prime Manufacturing, 7730 S. 6th St., Oak Creek, WI 53154. (414) 764-1400. \$400 to \$700; 4-7 wk.

The Model 769 digital gauge accurately measures both pressure and temperature from a single self-contained unit. The gauge measures absolute pressures up to 999 lb/in<sup>2</sup>, with a  $\pm 0.5\%$  variation over the entire range. And it measures temperatures up to 999 F with variations of  $\pm 0.1\%$  over the range. The unit contains four probes for any pressure and temperature combination. Buttons on the display-front select one of the four sensors being monitored. Probes are easily installed and can be equipped for remote use, up to 200 ft, without loss of accuracy. Probes are available for almost any media. The unit has a zeroing button to check the system's calibration. It has an easily read display which accommodates rapid changes in pressure or temperature.

CIRCLE NO. 332

### 4-1/2-digit DMM ranges automatically

John Fluke, P.O. Box 43210, Mountlake Terrace, WA 98043. (206) 774-2211.

The 8040 is an ultracompact 20,000-count multimeter with five measurement facilities, autoranging and autozero. The design enables the unit to be carried conveniently in an attache case or as part of a service kit. Measurement capabilities include dc voltages from 200 mV fs to 1100 V fs, to an accuracy of  $\pm 0.05\%$  of reading +2 digits; and ac voltages from 200 mV fs to 750 V fs using a true-rms conversion technique, to an accuracy of 0.5% of reading +10 digits. True rms is also used on ac-current ranges.

CIRCLE NO. 333

# CRT YOKES FOR FLIGHT

Take a plane -military, commercial, or private. Chances are 9 out of 10 you'll find Syntronic Deflection Yokes and Focus Coils in critical cathode ray tube display equipment; weather radar, navigation, weapons systems, landing, monitoring, communicating. The U.S. Navy's/Lockheed S3A anti-submarine plane uses 14 Syntronic components in 7 critical displays.

Other aircraft display applications include the B52 Retrofit, F4 (D&E), F5E, A6, A7, F111, A10A, S3A, F14, F15, F16, AWACS, MCRA, Mirage, Viggen, 707, 727, 737, 747, DC-8, DC-9, DC-10, L1011 and many private aircraft. Call or write Syntronic Instruments, Inc. (312) 543-6444. Ask for Syntronic's Yoke Selection Guide to high-flying, high-performance yokes.



**syntronic  
instruments. inc.**

SYNTRONIC INSTRUMENTS, INC.  
100 Industrial Road • Addison, IL 60101  
(312) 543-6444

## IC tester checks DIPs at 1.3-MHz rate

*Biomation, 10411 Bubb Rd., Cupertino, CA 95014. (408) 255-9500. \$4500; 60 days.*

Model 2400 benchtop digital IC tester is designed for those who use small quantities of many dif-

ferent digital IC types. The 2400 is primarily a functional tester with a test rate of up to 1.3 MHz. It is completely operator programmable and will handle a wide variety of ICs with up to 24 pins, including CMOS, NMOS, ECL and all TTL families, plus open-collector and three-state output devices. The price represents the cost of a 16-pin unit including a program library for over 1000 different devices. Model 2400 also measures some parametric values.

CIRCLE NO. 334

## Counter line features 10 new models



*Philips Test and Measuring Instruments, 400 Crossways Park Dr., Woodbury, NY 11797. (516) 921-8880. PM6661, \$325; PM6664, \$625.*

A bunch of brand new timer/counters, universal counters and automatic frequency counters mark the company's attempt to capture a large chunk of the market for frequency/time-measuring products. Included are three timer counters, covering 80, 520 and 1000 MHz (PM6620 series), four universal counters (PM6610) and two automatic frequency counters, with an on-off switch as the only control. Both the 80-MHz PM6661 and the 520-MHz PM6664 offer automatic triggering, noise suppression, range selection and leading-zero blanking. The timer/counters feature nine digits, 20-mV sensitivity and resolution as low as 1 ns.

CIRCLE NO. 335

## DMM uses LCDs, reads temperature, too



*Gould Advance, Roebuck Rd., Hainault, Essex, England.*

The Beta is a portable, battery-operated 3-1/2-digit multimeter using a large, liquid-crystal display and a single CMOS IC chip for all analog and digital functions. Among the Beta's 29 ranges is a 10 A ac and dc current range via a separate input, plus temperature-measurement capability with direct reading between -20 and 120 C. Beta operates for over 300 h from four C cells.

CIRCLE NO. 336



# P/rel<sup>TM</sup>

## the programmable rotary encoded logic switch everyone will be talking about...

... because no other rotary switch has as much versatility with as low a cost as Standard Grigsby's P/rel switch!

The economy is twofold. This switch not only lends itself to full automation, but installed costs are lower by the use of our printed circuit terminals (solder terminals are also available).

A specially processed printed circuit disc is fully

programmable to the truth table of any code. We provide 100% program disc inspection to customer specifications. Up to 60 detent positions are available with our new double ball Dual Flex detent. And, the use of concentric shafts allows up to 120 detent positions from a single switch!

Everyone will be talking about P/rel . . . so will you!

Send for your free "Yes" button and literature.



**standard grigsby, inc.**

920 Rathbone Avenue, Aurora, Illinois 60507. Phone (312) 897-8417

CIRCLE NUMBER 96

# Some people just can't leave well enough alone.

Last March, while the other guys were making promises, Advanced Micro Devices was making Am9130's and Am9140's—the first family of 4K static RAM's.

Terrific. Everyone loved them. But were we satisfied? Did we stop there? No.

Advanced Micro Devices announces the 1Kx4/4Kx1 Am91L30/L40, low-power versions of our Am9130/40.

These new circuits provide access times down to 250 nanoseconds with power dissipation of only 367mW. That's half the power of the original. (And that's the same power

as the industry standard 1K static RAM. You're getting four times the memory for the same power. Wow!)

There's more. These beauties do everything on a 5-volt power supply. The logic levels are identical to TTL. You get all the features of the original, including full military temperature range availability and, as always, MIL-STD-883 for free. Plus: a freshly minted set of application notes and data sheets awaiting your call, wire or letter.

Some people just can't leave well enough alone.

## Advanced MOS/LSI



Advanced Micro Devices • 901 Thompson Place, Sunnyvale, California 94086 • Telephone (408) 732-2400 •  
Distributed nationally by Hamilton/Avnet, Cramer and Schweber Electronics

CIRCLE NUMBER 99



## New Power Transformers For +5V and $\pm 15V$ Triple Output Five Plug-ins Five With Standard Leads

Triad has five new plug-ins and five units in open construction with leads for logic and op-amp power supplies—either regulated or unregulated. Dual secondaries of 9VCT and 24VCT, or 15VCT and 32VCT. Primaries, 115V, 50/500 Hz. Outputs: 1.5 W, 4.5 W, 7.5 W in plug-ins; 4.7 W, 20.3 W, 62 W, 92 W and 122 W in lead types. Specifically designed for "in-house" power supply construction where density packaging and flexibility are important. So call your distributor today for prices, delivery, technical information and Triad quality.

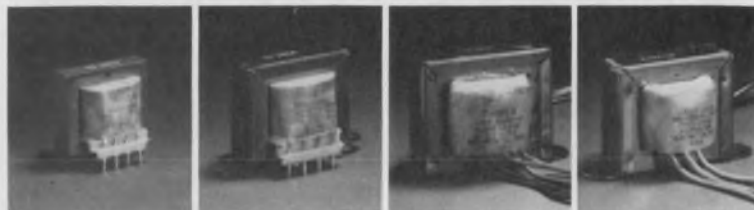
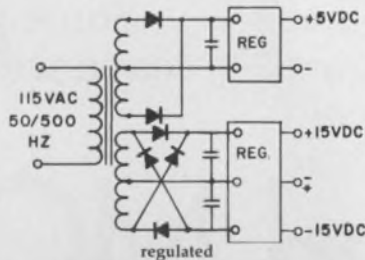
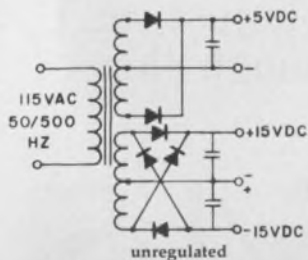

 **TRIAD-UTRAD**  
Litton Distributor Services

305 North Briant Street, Huntington, Indiana 46750

CIRCLE NUMBER 100

## INSTRUMENTATION

### UV outshines visible for oscillographs



EMI Technology, 20 Old Ridgebury Rd., Danbury, CT 06810. (203) 774-3500. From \$2000; stock to 30 days.

Unlike conventional light-beam designs, which sacrifice deflection to achieve wide bandwidth, series-SE6150 multichannel ultra-violet beam oscillographs feature writing speeds of 50,000 in/s, bandwidths of 0 to 10 kHz and deflections of more than 1.2 in. Each instrument in this series offers up to six recording channels, with access to galvanometers either directly or via built-in modular adjustable-gain drive-amplifiers which are calibrated directly in V/cm. Galvanometer modules (magnet blocks) are provided for up to 12 direct channels with 500-V-dc insulation, or up to six channels with 5 kV dc insulation. Modules are thermostatically stabilized at  $45 \pm 3$  C for stability of sensitivity. Each instrument has auxiliary recording capabilities: to trace its own grids and timing lines over the full 6-in. width of the chart; to control trace and grid intensities; and to add reference markers and event markers. Timing intervals are selectable by panel push-buttons at 0.01, 0.1, 1, 10 and 100 s or may be controlled by external trigger. Twelve servo-regulated chart speeds from 0.008 to 39.37 in/s are selectable by panel push-buttons. Chart-drive linearity is  $\pm 3\%$ , in both automatic and continuous modes. The channel-amplifier panel-controls offer a selection of 10 attenuation steps, for sensitivities from 0.008 to 8 in/V, plus a 3:1 vernier adjustment. Input impedance is 10 M $\Omega$  up to 1 cm/V and 1 M $\Omega$  from 2 to 20 cm/V. The system frequency response is dc to 10 kHz ( $\pm 1$  dB); noise and cross-talk are less than 0.2% of full-scale deflection. The instrument measures  $17 \times 5 \times 18.5$  in. and weighs 31 lb.

CIRCLE NO. 337

MHz	Service
4	RADIO NAVIGATION
	MARITIME MOBILE
10	AERONAUTICAL MOBILE
24	FIXED LAND MOBILE
25	C.B. — BUSINESS — GOVERNMENT
70	PUBLIC SAFETY
75	INDUSTRIAL
88	F.M.
100	COMMON CARRIER
170	TV — CATV
200	AMATEUR
215	FLIGHT LINE TELEMETERING
400	METEOROLOGICAL
450	LAND TRANSPORTATION
500	STANDARD BROADCASTING
600	TV LINKS
800	STUDIO — TRANSMITTER LINKS
960	UHF TV



# ONE CLEAN SWEEP

## For under \$1200

FROM 1 MHz TO 960 MHz IN ONE SWEEPER

### WB-713 SPECIFICATIONS

- |                                 |                         |            |  |
|---------------------------------|-------------------------|------------|--|
| ● Frequency Range — Band I:     | 1 to 500 MHz            | ● Markers: | Provisions for up to 7 plug-in harmonic or single frequency markers. |
| Band II:                        | 450 to 960 MHz          |            | Marker Tilt Control  |
| ● Sweep Width — Bands I and II: | 0.1 to 500 MHz          |            | Marker Clip Control  |
| ● Output:                       | +10 dBm                 |            | Marker Width Control from 20 kHz to 300 kHz                          |
| ● Flatness:                     | ± 0.25 dB               |            |  |
| ● Distortion — Band I:          | - 35 dB                 | ● Weight:  | 15 lbs.  |
| Band II:                        | - 30 dB                 | ● Size:    | 9" x 4 3/16" x 12 5/8"   |
| ● Residual FM:                  | Less than 10 kHz        |            |  |
| ● Sweep Rate:                   | 0.01 to 100 Hz variable |            |  |
| ● Linearity:                    | 1%                      |            |  |

Texscan has sweep generators covering from Audio to 2350 MHz. Please contact your local Texscan representative for a demonstration.

# Texscan

Texscan Corporation 2446 North Shadeland Ave. Indianapolis, Indiana 46219 (317) 357-8781

CIRCLE NUMBER 101

## INSTRUMENTATION

### Low-cost pulser offers versatile operation

Viz Test Instruments Group, 335 E. Price St., Philadelphia, PA 19144. (215) 844-2626. \$119; stock.

Model WR549A pulse generator is continuously variable over a range of 5 Hz to 5 MHz, positive, negative, or pos/neg square wave.

Pulse width and repetition rate are independently adjustable. WR549A operates within 5% (at the calibration points) of the dial settings over the entire range and maintains a pulse width of 100 ns to 0.1 s over an unlimited cycle. Rise and fall time is less than 20 ns on all ranges. Output is adjustable for both TTL and CMOS, covering a range of 0 to 15 V pk-pk. Impedance is selectable at 50 or 600  $\Omega$ .

CIRCLE NO. 338

# 5½ DIGIT ACCURACY. 4½ DIGIT PRICE.

The 4600 is our brand new 4½ digit multimeter. It gives you the accuracy and resolution of typical 5½ digit multimeters. At half the cost.

And the 4600 stays accurate longer than other DVM's. DC accuracy stays within 0.01%  $\pm$  one digit for six months at a time. We guarantee it.

80dB normal mode noise rejection produces a 10,000:1 reduction of excess noise. A full decade better than the 1,000:1 reduction of comparable instruments.

Loading errors are virtually eliminated by the 4600's 10,000M $\Omega$  input impedance on the two lowest DC voltage ranges.

There's a lot more. Send for a free catalog on our new 4½ digit 4600 multimeter. And find out how to get 5½ digit accuracy without paying for it.

Dana Laboratories, Inc.,  
2401 Campus Drive, Irvine,  
California 92715. 714/833-1234.

**DANA**

**Others measure by us.**



"NOW AVAILABLE THROUGH ELECTRO RENT"

FOR PRODUCT DEMONSTRATION  
CIRCLE # 102

FOR LITERATURE ONLY  
CIRCLE # 103

### Amplifier delivers 75 W from dc to 100 kHz

Krohn-Hite Corp., Avon Industrial Park/Bodwell St., Avon, MA 02322. (617) 580-1660. \$1500; 8 wks.

Model 7500 direct-coupled dc-to-1-MHz amplifier is said to be the first such amplifier to offer up to 75 W of continuous power (150 W at dc) and 125 V rms over a bandwidth from dc to 100 kHz. Output is 10 W at 1 MHz. Frequency response is flat to within  $\pm 0.1$  dB over most of the range. Total harmonic distortion at full power output is less than 0.05% from dc to 20 kHz. Voltage gain is noninverting, and can be selected for either fixed gains of 20 dB (X10) or 40 dB (X100). Gain is continuously adjustable from zero to 40 dB.

CIRCLE NO. 339

### Unit checks your contact's chatter

Associated Testing Labs, Northwest Industrial Park, Burlington, MA 01803. (617) 272-9050. See text.

The Contact Monitor is a solid state, chatter checker capable of detecting openings between a set of normally closed contacts, or closure between a set of normally open contacts. The unit detects contact chatter in electrical and electronic components having movable electrical contacts, such as relays, switches, circuit breakers, etc., where it is required that the contacts do not open or close momentarily, for longer than a specified time duration under environmental conditions, such as vibration, shock or acceleration. Model NCNO 4-5, the four-channel device, meets the requirements of MIL-STD-202D, method 310, paragraph 2.1.2., test conditions A, B, C, D, and E. For calibration, an oscilloscope with calibrated time base from 1  $\mu$ s to 5 ms/cm and a dc-VTVM are needed. The instrument measures 5.25  $\times$  8.3  $\times$  13.25 in. It has a detection accuracy of  $\pm 3\%$  and a detection ratio (normal time to detection time) of 10:1. Price of the four-channel unit is \$700 and a six-channel model is available for \$980.

CIRCLE NO. 340



# SWAP MEET

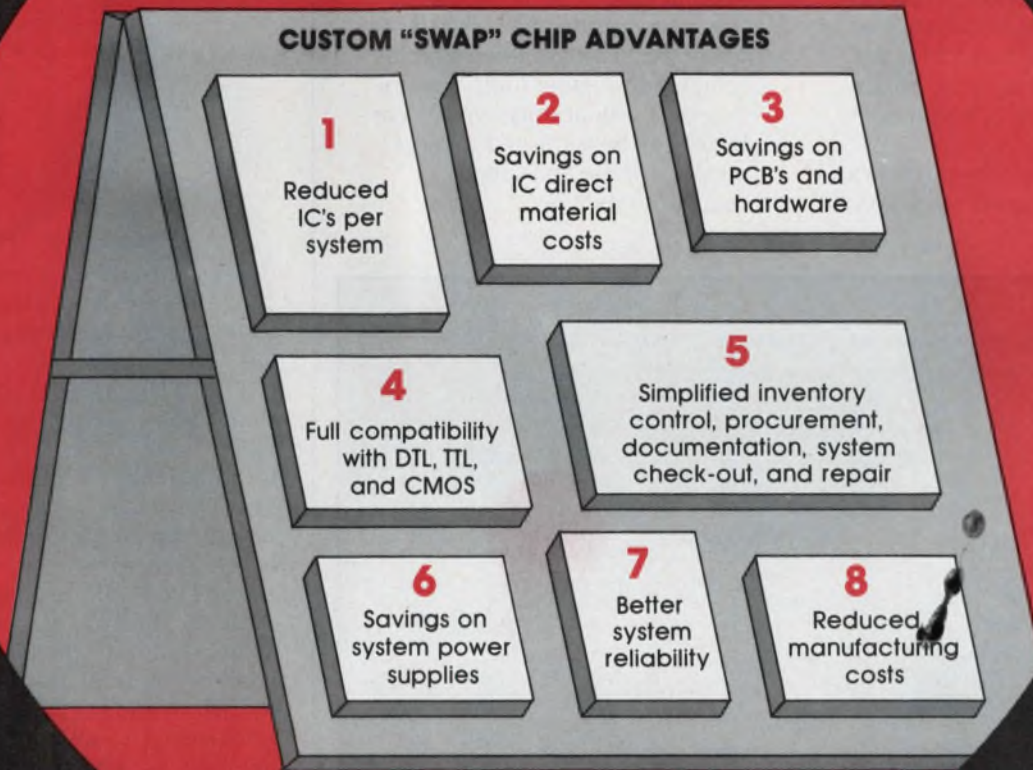

## Now you can trade in your SSI and MSI circuits for all these custom I<sup>2</sup>L "SWAP" chip advantages!

Now with "SWAP"—Stewart Warner Array Programming—you can have all these custom chip benefits without paying the usual custom chip penalties. No large tooling costs and huge entry fees. No gigantic production order requirements. No long waits for

deliveries. For as low as \$1800, you have delivery of your first custom I<sup>2</sup>L "SWAP" prototypes in four weeks.

"SWAP" is the major price breakthrough in custom logic circuits that makes it easy for you to take that first step. To climb aboard the bandwagon

with your buddies in the industry, all you need is \$25. That buys you your new SWAP Kit including the Design Manual, vellum work sheets, and 15 sample I<sup>2</sup>L devices illustrating some of the functional blocks that can be used in a SWAP design. Send for yours!

Okay, here's my \$25.00 (or P.O. No. \_\_\_\_\_). Rush me my I<sup>2</sup>L SWAP Design Kit.

I need more information, please have a representative call me.

Tell me about your standard off-the-shelf DTL, TTL, and CMOS circuits. (We have these in stock.)



SYMBOL OF  
**SW**  
EXCELLENCE  
STEWART-WARNER MICROCIRCUITS DIVISION  
**STEWART-WARNER CORPORATION**  
730 E. Evelyn Ave. • Sunnyvale, Ca 94086 • (408) 245-9200

Name \_\_\_\_\_

Company \_\_\_\_\_

Phone \_\_\_\_\_

Address \_\_\_\_\_

City \_\_\_\_\_ State \_\_\_\_\_ Zip \_\_\_\_\_

# If low cost and high performance are criteria... our new 82000 Series permanent magnet steppers are the answer.

Here's a new permanent magnet stepper motor line created to meet the design needs of analytical instrumentation and computer peripherals. Applications include tape drives, printer and chart drives and optical disc drives. Both 5 volt and 12 volt models are available.

All utilize 4-phase stators and permanent magnet rotors. Most

have 24-pole rotor construction. As a result, they offer excellent pull-in rates and good stepping accuracy. Another advantage is low temperature rise...over 50% lower than comparable variable reluctance stepper motors operating on a similar duty cycle. Gear boxes can be furnished to meet varying torque and speed requirements.

Write for information today!

Available pull-in torques from .750 oz-in. to 7.50 oz-in.  
Available stepping rates from 210 steps/sec to 440 steps/sec.

Our 4-page *Permanent Magnet Logic Stepper Motor* catalog provides all basic details including performance data and charts, dimensional drawings, as well as electronic drive information. Send for a copy.

45 — 4-Phase Logic Drive  
models for analytical  
computer peripherals.

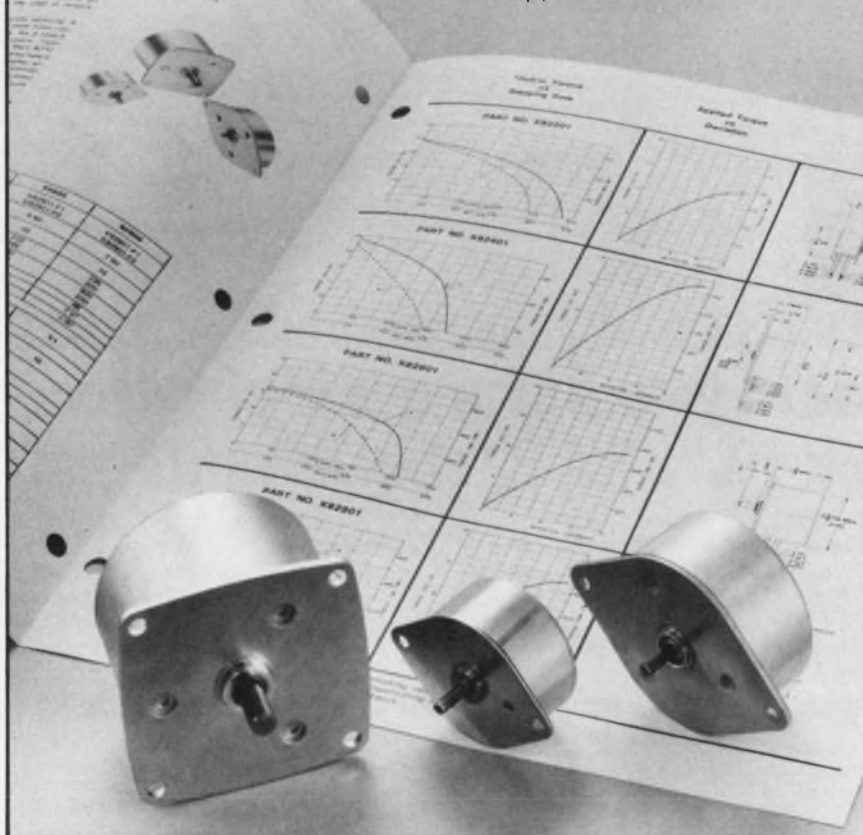

A. W. HAYDON CO. PRODUCTS

**NORTH AMERICAN PHILIPS CONTROLS CORP.**

Cheshire, Conn. 06410 • (203) 272-0301  
CIRCLE NUMBER 105

## COMPONENTS

### Small thumbwheel switch features J-pin terminals

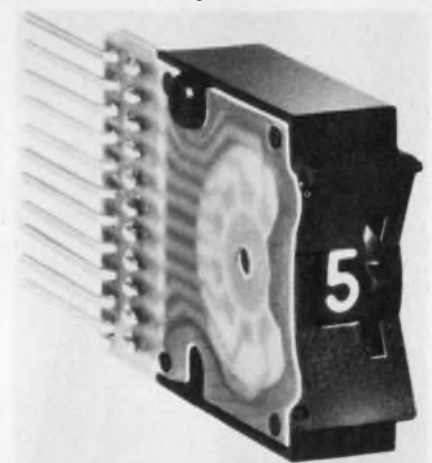

Cherry Electrical Products Corp.,  
3600 Sunset Ave., Waukegan, IL  
60085. (312) 689-7702. \$3.33 (2000  
up).

The T50J-01M is the smallest thumbwheel switch on the market today with 1/2-in. J-shaped pin terminations, according to Cherry. This makes the thumbwheel readily adaptable for both motherboard and wire-wrapping applications. The J-pins are made of brass with a bright tin finish. The switch is matte finished, has a 10-position decimal thumbwheel with in-line readout, and is modular constructed to allow ganging large numbers of switches. A 40-switch assembly uses a panel opening only 3/4-in. high and less than 13-in. wide.

CIRCLE NO. 341

### Thick-film pots now range to 100 MΩ

TRW Inc., 401 N. Broad St., Philadelphia, PA 19108. (215) 922-8900.  
\$0.42 (10,000 up); 2 to 4 wks.

A high-voltage thick-film potentiometer with previously unavailable resistance and stability characteristics now has a resistance range of 1 to 100 MΩ. It also features a shield to minimize dust accumulation. Temperature coefficient is a low  $\pm 400$  ppm. Snap-in installation is standard, but mounting with a self-threading nut is also possible. For added flexibility, the control will accept different types of shafts. Over-all dimensions of the unit are 1-in. wide, 1.277-in. deep and 1.06-in. high.

CIRCLE NO. 342



## TCX...the new aluminum capacitors with the super electrolyte.

TCX'tra! For a lot of extra pluses at extra-competitive prices.

Our new electrolyte system is the key. It provides the properties that make TCX capacitors ideal for even the most demanding commercial duty — such as high frequency, power supply, EDP applications.

Great stability, for instance, over a very broad

temperature range up to 105°C. Which is about 20° higher than with almost every other capacitor of this type.

Along with low leakage, high ripple current, good volumetric efficiency. And a higher voltage/MFD range . . . 3 to 100 V, 10 to 22,000 MFD.

TCX'tra! Read all about it in our TCX literature. Just ask your Mallory representative.

**MALLORY**

**MALLORY CAPACITOR COMPANY**

a division of P. R. MALLORY & CO. INC.  
Box 372, Indianapolis, Indiana 46206; Telephone: 317-636-5353

Electrical and Electronic Components • Timing Devices and Motors • Metallurgical Products • Batteries

CIRCLE NUMBER 106

COMPONENTS

**Switches and indicators receive seismic approval**

Stacoswitch Inc., 1139 Baker St., Costa Mesa, CA 92626. (714) 549-1616. \$8.95 to \$30 per channel; 4 to 8 wks.

Stacoswitch switches and indicators are now seismic qualified to requirements of IEEE Standard

344-1975 and TVA 2200 appendix "C" for use in nuclear-fueled power-generating plants. One-to-four lighted status-message displays per control channel and one-to-one-hundred channels per control unit are available as standard assemblies. Up to 4PDT circuit switching with momentary, maintained or magnetic-latching actions for each control channel provides wide control versatility.

CIRCLE NO. 343

**Projected LED light brightens PB switches**

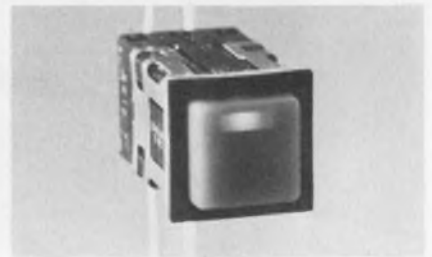

Micro Switch, 11 W. Spring St., Freeport, IL 61032. (815) 232-1122. Under \$5 (OEM qty).

The projection of strong LED rays through a big indicator window gives the AML series lighted pushbuttons a bright look. The new design makes the LED easier to see in ambient light and visible from many angles denied most LED indicators, according to the manufacturer. A funnel-shaped reflector at the base of the diode helps beam red, yellow or green lights to the display surface of the pushbutton/indicator. Rated for 5, 10 or 15 V dc, the units have an internal resistor to maintain current at a nominal 20 mA. The switches are available with momentary or two-level alternate actions, and in one and two-pole form-C arrangements.

CIRCLE NO. 344

**Anywhere high efficiency power conversion is needed . . . look to Arnold Magnetics!**

**Look at the performance:** AC (115-230 VAC, 47-500 Hz) and DC (12, 28, 48, 115, and 150 VDC) inputs . . . 1 to 6 isolated and regulated DC outputs from 4.2 to 300 VDC . . . line and load regulation to 0.1% . . . efficiencies to 85% . . . 3.9 watts delivered per cubic inch . . . short circuit and transient protected.

**Look at the design:** Over 1200 input/output configurations are available using off-the-shelf sub-modules. You specify to your needs using our exclusive "Design-As-You-Order" specification form that eliminates engineering cost, lost design time and long delivery schedules.

**Look at the package:** Compact, lightweight . . . your complete Power Conversion System is provided in a tested and encapsulated miniaturized, conduction cooled package.

Looking for high efficiency power conversion? Look to Arnold Magnetics . . . today!



**ARNOLD MAGNETICS CORPORATION**

11520 W. Jefferson Blvd.  
Culver City, CA 90230  
(213) 870-7014

**Popular potentiometer now has slip clutch**

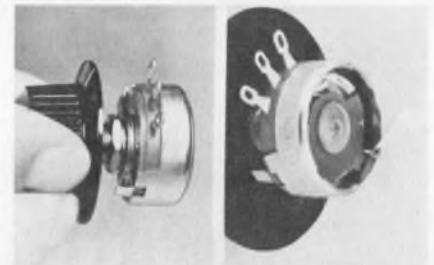

Allen-Bradley, 1201 S. Second St., Milwaukee, WI 53204. (414) 671-2000. \$1.50 (1000 up); 6 to 8 wks.

The type EJ potentiometer, a million-cycle rotational-life component, widely used in electronic games now is offered with an optional slip-clutch. The clutch prevents internal damage to the pot or the external knob if the shaft is turned with excessive force. Clutch action allows the shaft to be rotated beyond the stops, and then resume normal electrical operation when the rotating is reversed.

CIRCLE NO. 345



CIRCLE NUMBER 107

# ChipStrates<sup>TM</sup> cost up to 40% less than other power SCRs and Triacs.

## And that's only the beginning.

ChipStrates are glassivated power SCR or Triac chips mounted on solderable ceramic substrates. Since they eliminate the need for expensive metal packages, they cost up to 40% less than other power SCRs or Triacs.

For example, our 55A, 400V, ChipStrate goes for just \$3.80 in quantities of 5,000. The electrically equivalent press fit Triac will run you \$5.00 in the same quantity.

But that's not all.

ChipStrates are available in ratings from 3 to 55A and up to 800V

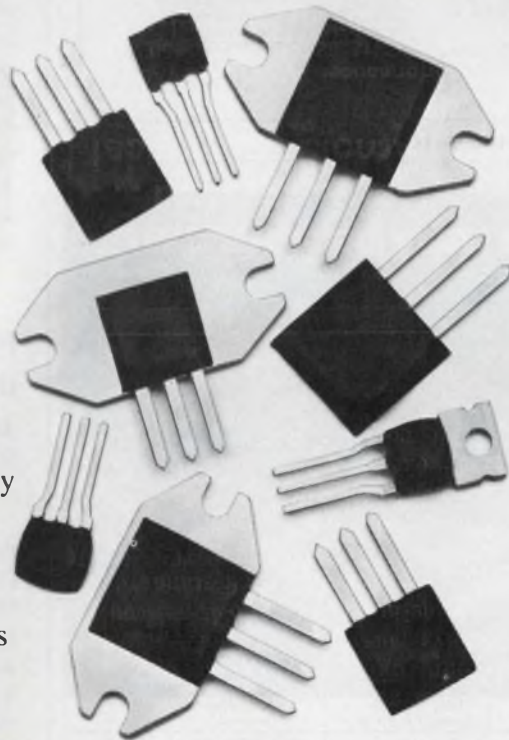

and come in a rugged, electrically insulated package.

Their exceptionally good form factor will simplify the packaging of your system.

And their reliability is unmatched.

ChipStrate. The new concept in SCRs and Triacs that gives you more. And costs you less.

For the full story, just call or write: Carl Uretsky, Unitrode Corporation, 580 Pleasant St., Watertown, MA 02172. 617-926-0404.



**UNITRODE**

<sup>TM</sup>ChipStrate is a trademark of Unitrode Corporation.

CIRCLE NUMBER 108



# STACOSWITCH...

## dependability you can afford

**SWITCHES** Military or industrial/commercial single lamp switches built to exacting specifications for dependability and long service life. Choice of circuit control contact arrangement and solder or new PC terminations.

**PUSHBUTTONS** All sizes, styles, colors, and legend styles including new photographic film legends with visible or hidden messages. Color matched for visual recognition and operator convenience.

**LOW COST** Check the bottom line and you'll find Stacoswitch's low purchase price combined with quick and easy installation and maintenance make these your best buy in single lamp pushbutton switches. Write today for General Catalog giving complete description on single lamp and 4-lamp switches and indicators. When you think switch... think Stacoswitch.



Other STACO Company products: Custom Transformers, STACO, INCORPORATED, Richmond, Indiana; Variable Transformers, STACO, INCORPORATED, Dayton, Ohio.

CIRCLE NUMBER 109

## COMPONENTS

### New pots designed for electronic games

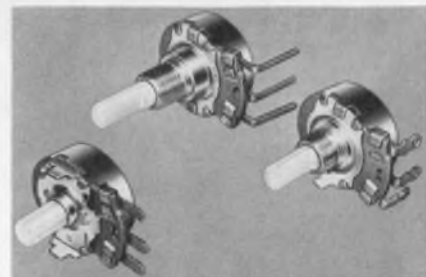

Centralab Electronics, Div. Globe-Union, 5757 North Green Bay Ave., Milwaukee, WI 53201. (414) 228-2911.

A new potentiometer designed for the electronic-game market (Ultralife Model 2) has excellent life and low-noise characteristics. Mechanical life is in excess of 250,000 cycles. Its contact-spring design results in an initial contact-resistance variation of 0.5%. End-of-life contact-resistance variation (CRV) is less than 1.5% of total resistance. The following additional features are provided: resistance range from 5000  $\Omega$  to 5 M $\Omega$ ; linear taper; a power rating of 1/2 W at 40 C; PC or solder-lug terminals; and a bushing for twist-tab mounting.

CIRCLE NO. 346

### Precision-pot element is conductive plastic

Maurey Instrument Corp., 4555 W. 60th St., Chicago, IL 60629. (312) 581-4555. \$21 (100 up).

The 112-P19 is a low-cost, solid-molded raised track, conductive-plastic potentiometer. It offers infinite resolution, long life and extremely rugged vibration characteristics. The unit features a high-pressure wiper-assembly design and high-quality wiper-contact material to obtain rotational life under extreme environment that exceeds conventional film devices. Gold-plated terminals, beryllium-copper wiper spring as well as a stainless-steel shaft and ball bearings are standard. Size is 1-1/8-in. dia. with a 1/8-in. dia. shaft. Resistance range is 500  $\Omega$  to 100 k $\Omega$ , standard linearity  $\pm 0.5\%$  and life is in excess of 100-million revolutions.

CIRCLE NO. 347

## The time you save may be your own.

Used to be you'd get a circuit idea, lay out a pc board, print it, solder everything together, troubleshoot, change your layout, try a new board, and spend absolutely too much time breadboarding. Now A P ACE All Circuit Evaluators let you breadboard in a fraction of the time. Make your changes immediately. Keep full leads on your components. Avoid the heat damage possible with repeated soldering and desoldering. And have a pattern for your board—if you need a board—sitting in front of you. In about as long as it takes to sketch a schematic. Get cooking with ACE. The All Circuit Evaluator from A P Products.



Part No.	ACE Model No.	Tie Points	DIP Capacity	No. Buses.	No. Posts	Board Size (inches)	Price Each
923333	200-K (kit)	728	8 (16's)	2	2	4-9/16x5-9/16	\$18.95
923332	208 (assem.)	872	8 (16's)	8	2	4-9/16x5-9/16	28.95
923334	201-K (kit)	1032	12 (14's)	2	2	4-9/16x7	24.95
923331	212 (assem.)	1224	12 (14's)	8	2	4-9/16x7	34.95
923326	218 (assem.)	1760	18 (14's)	10	2	6-1/2x7-1/8	46.95
923325	227 (assem.)	2712	27 (14's)	28	4	8x9-1/4	59.95
923324	236 (assem.)	3648	36 (14's)	36	4	10-1/4x9-1/4	79.95

Ohio and California Residents Add Sales Tax  
All orders subject to acceptance at factory.  
Write us for the full line A P Products catalog

For quick phone service, call  
the A P distributor nearest you:



**A P PRODUCTS  
INCORPORATED**  
Box 110-F  
Painesville, OH 44077  
(216) 354-2101  
TWX: 810-425-2250

(201) 224-8032 (602) 277-7661  
(206) 682-5025 (314) 863-7800 (612) 488-0201  
(213) 768-3800 (412) 782-2300 (617) 273-1860  
(213) 875-2862 (415) 326-5432 (617) 879-0860  
(215) 698-4000 (415) 969-9240 (713) 350-6771  
(216) 441-3000 (513) 236-9900 (713) 777-1666  
(216) 587-3600 (516) 483-9200 (714) 549-8611  
(312) 298-8580 (516) 883-0999 (714) 560-0515  
(313) 525-1800 (914) 664-0088 (803) 253-5333

Our Distributor List is growing daily. If none in your area call toll Free 800-321-9668.

CIRCLE NUMBER 110

## Panel controls set X-Y position

Cambridge Thermionic, 445 Concord Ave., Cambridge, MA 02138. (617) 734-1055. From \$2000; 4 wks.

Cambi-Grid is a two-axis positioning control for use where all movements along either axis are some multiple of a fixed increment such as 0.1 in. Applications include drilling, insertion, inspection, punching, packaging, etc. The system is programmed directly on its own control panel as opposed to paper-tape programmed systems. Features include nonvolatile program memory, programmable tool function, manual and automatic operation modes, adjustable control of positioning-motor speeds. The rack mountable unit has a G4 instruction memory, which allows the programming of up to 960 X-Y coordinates. A line of compatible stepping motor drivers is available.

CIRCLE NO. 348

## Pressure transducer offered in new packages



National Semiconductor, 2900 Semiconductor Dr., Santa Clara, CA 95051. (408) 737-5000. \$79 (25 up); stock.

The LX1700 series pressure transducers, in new package designs, are designated PX7-1 in zinc packages and PX7N-1 and PX7D-1 in nylon packages. They feature internal captive O-rings that eliminate leakage. The devices are fully signal conditioned and temperature compensated (operating range 0 to 85 C). And they can measure pressure ranges from  $\pm 5$  psi to 0 to 300 psi. In addition a flexible cable is key locked so it can't be pulled out of the package. They come with five-pin connectors for easy insertion into a test socket or PC board.

CIRCLE NO. 349

**N**ow, a single integrated circuit, our TAD-32 (Tapped Analog Delay), can provide filtering with passband-to-stopband ratios of 40 DB or more per device. Simple variation of the clock sampling rates over 5 decades will accordingly shift a given filter characteristic. Transversal or recursive filters can be constructed with over 60DB dynamic range and linear phase. Tapped delays up to several hundred milliseconds are possible.

Discrete time analog signal processing using charge transfer devices is a reality at RETICON.

The TAD-32 is just one device in this growing family.

**We don't just talk about them, we make them.**

## THIS DIP DOES IT ALL.

TAPPED DELAYS  
MATCHED FILTERS  
CORRELATION  
CONVOLUTION



**RETICON®**

910 Benicia Avenue, Sunnyvale, California 94086  
PHONE: (408) 738-4266 TWX: 910-339-9343

CIRCLE NUMBER 111

## DISCRETE SEMICONDUCTORS

### 20-A rectifiers offer 35-ns turn-off time

NAE, Inc. Semiconductors, 69 Bennett St., Lynn, MA 01905. (617) 598-4800. \$7.80 to \$16.25 (1-99); stock.

A new series of superfast 20-A rectifiers for dc applications—in-

verters, converters, choppers and switching regulators—handles up to 200 V. Designated 1N5812 through 1N5816 with voltage ratings from 50 to 150 V in 25-V increments, these new 35-ns units have a low forward drop of 0.9 V at 10 A, and they are housed in the JEDEC DO-4 packages. The 200-V version, designated NSR-7025, offers the same recovery features as the lower-voltage units.

CIRCLE NO. 350

### LED numerical displays need 1/3 usual power

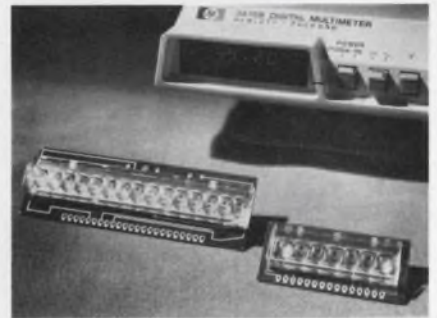

Hewlett-Packard, 1501 Page Mill Rd., Palo Alto, CA 94304. (415) 493-1501. \$11.25: 5 digits, \$31.95: 15 digits (200-999).

LED seven-segment numerical displays, 0.175-in. high, require only 2 mA per segment, about 1/3 the power required by presently available displays. These HP 5082-7265, 7275, 7285 and 7295 indicators are available in five and 15-digit packages. Models 5082-7265 and 7275 five and 15-digit clusters, respectively, have a center decimal point. Models 5082-7285 and 7295, also five and 15-digit clusters, have a right decimal point. Devices may be mounted with edge connectors or with soldered wires.

CIRCLE NO. 354

### 700-V transistors feature 0.7 $\mu$ s fall time

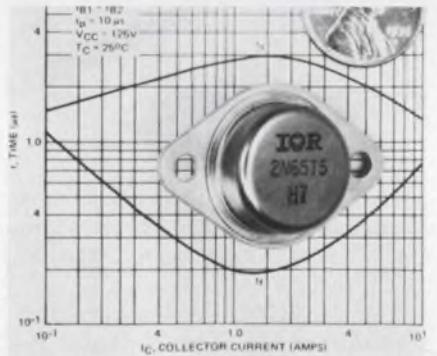

International Rectifier, 233 Kansas St., El Segundo, CA 90245. (213) 322-3331. \$3.78 to \$4.79 (100-999); stock.

A new series of power transistors, 2N6573 through 2N6575, with very fast switching times and ratings to 700 V at 15 A, features fall times as fast as 0.7  $\mu$ s. Hard-glass passivation of the chips provides high-temperature stability and long operating life for application in TV deflection circuits, switching regulators and high-voltage switching power supplies.

CIRCLE NO. 355

**Q:** Is there a recorder just for spectrum analyzers?

**A:**

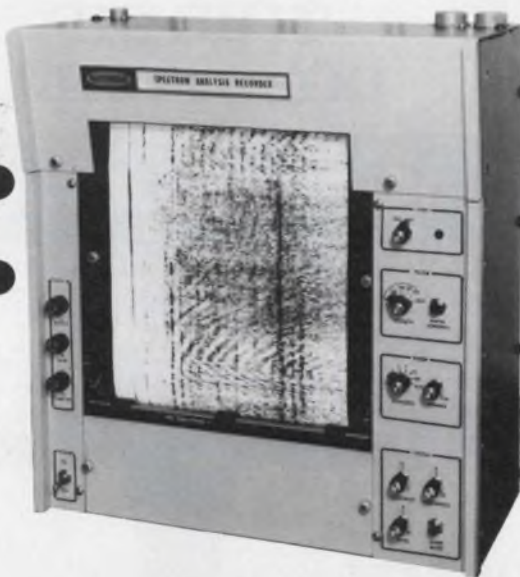

The new 19" rack-mounting SPECTRUM ANALYSIS RECORDER from Raytheon. It's the first dry paper line scanning recorder specifically developed for direct plug-in operation with commercially available spectrum analyzers.

Any new or existing spectrum analyzer equipped with the SAR-097 will have a lot more going for it. Like infinitely variable 100:1 speed range—5 sec/scan to 50 milliscan... stylus position encoder... automatic recorder synchronization... computer/analyzer compatibility... high resolution and dynamic range... all-electronic drive. And more.

If you design and build—or buy and use—spectrum analyzers, you don't have to settle for multi-purpose recorders any more. The SAR-097 is here. For full details write the Marketing Manager, Raytheon Company, Ocean Systems Center, Portsmouth, Rhode Island, 02871. U.S.A. (401) 847-8000.

RAYTHEON

CIRCLE NUMBER 112



# The best buy ever in an Autoranging Portable DMM

Look at what you  
get from Weston<sup>®</sup>  
for only \$195.



Performance, quality, reliability and price. The Weston Model 6000 is a total value package and the best buy ever in a portable digital multimeter. It offers the simplicity and speed of automatic ranging at 0.35% accuracy. Superior performance at minimum cost through use of custom LSI microcircuitry and laser trimmed resistor networks. Specially developed LCD display for long life and high legibility, even in bright sunlight. Powered by two inexpensive, easily available 9v transistor batteries with more than 200 hours of operating life. Weston has packed the Model 6000 with every type of performance and convenience feature... at an unbeatable price.

To get the full details, contact any Weston distributor. Or, write direct to Weston.

Weston Instruments, Inc., 614 Frelinghuysen Ave., Newark, N.J. 07114.  
Canada: 1480 Dundas Highway, Mississauga, Ontario  
Europe: Ingolstadter Str. 67a 8 Munchen 46, W. Germany.

**WESTON<sup>®</sup>** WESTON  
Schlumberger

CIRCLE NUMBER 113

## DISCRETE SEMICONDUCTORS

### Fast diode chips rated to 100 A

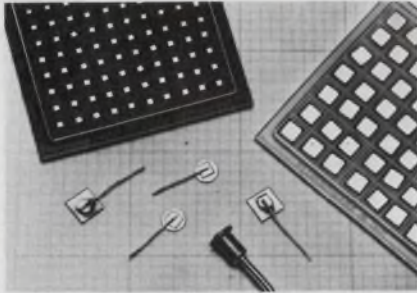

Solid State Devices Inc., 14830 Valley View Ave., La Mirada, CA 90638. (213) 921-9660. \$0.25 to \$5 (100 up); stock.

A new line of 1-to-100-A ultra-fast-recovery diode chips allows hybrid manufacturers to obtain circuit performance previously obtainable only with packaged devices, according to Solid State Devices. The HSR and HVE chip families are processed with Epion ion-implantation techniques to give 9-to-90-ns reverse-recovery times—about 10 times faster than conventional devices. The HSR Series are 20-to-150-V-peak reverse-voltage chips with 1 through 100-A forward-current capabilities. Maximum reverse-recovery times are 9 to 75 ns. Maximum full-cycle average forward-voltage drop is 450-mV, and maximum instantaneous forward-voltage drop is 900-mV. Leakage currents range from 50  $\mu$ A for the 1-A units to 500  $\mu$ A for the 100-A devices. Maximum surge currents are 10 times greater than rated currents on the 100-A units and 50 times greater on the 1-A devices. The HVE Series chips have peak reverse voltages ranging from 200 to 600 V with the same rated currents, leakage and maximum-surge currents as the HSR chips. Reverse recovery times are 15 to 90 ns. Maximum average forward-voltage drop is 500 mV, and maximum instantaneous forward-voltage drop is 1.2 V.

CIRCLE NO. 356

#### Filler

*It wasn't a miracle, Joyce Lekas of Tektronix informs us, when sharks formed a clear-passage corridor for the patent attorney swimming ashore from his sinking boat. It was professional courtesy.*

THIS TIME  
MICRODATA  
HAS GONE TOO FAR!

THEIR OEM PERIPHERALS WERE UNFAIR BEFORE. BUT LODESTAR IS TOO MUCH! NOW THEY'VE FOUND A WAY TO PUT 10 MEGABYTES ON A 3M-TYPE CARTRIDGE. 6400 BPI ON 1/4 INCH TAPE!

TALK ABOUT UNFAIR COMPETITION! THAT'S TWICE THE CAPACITY OF MY BEST 3M CARTRIDGE DRIVES. AND LODESTAR IS PLUG AND SOFTWARE COMPATIBLE WITH STANDARD REEL-TO-REEL SYSTEMS.

EVEN AT THOSE HIGH DENSITIES, LODESTAR'S MTBF IS OVER 4000 HOURS. AND IT'S SO DARN COMPACT YOU CAN MOUNT TWO OF THEM IN 7 INCHES OF VERTICAL RACK SPACE. BOY, THEY DON'T MISS A TRICK.

I HOPE NONE OF MY OEM CUSTOMERS FIND OUT ABOUT THIS ONE!



• Unformatted Storage Capacity: 11.5 megabytes at 6400 bpi • Recording Method: Serial, 4 tracks • Transfer Rate: 192 KHz at 6400 bpi • Full Tape Write: 10 minutes • Full Tape Read: 8 minutes, bi-directional • Error Rate: less than 1 bit in  $1 \times 10^8$  • MTBF: over 4000 hours • MTTR: less than 1/2 hour • Size: mechanism, data and motion electronics, 5"H x 8"W x 11"D; optional single or dual drive rack mount version with formatter and power supply, 7"H x 17"W x 12"D.

REFLEX? HERE'S MY REFLEX!  
IT'S INCREDIBLE! NOW MICRODATA'S  
UNHOOKING MY DISC MEMORY  
BUSINESS!

THIS NEW REFLEX DRIVE HAS THE  
RELIABILITY OF FIXED MEDIA AND  
THE SPEED OF WINCHESTER TECHNOLOGY  
AT A LOWER COST PER BIT THAN ANY-  
THING ELSE ON THE MARKET.

THEY'VE CUT ACCESS TIME WITH FASTER  
HEAD POSITIONING, FASTER ROTATION  
AND TWO HEADS PER SURFACE. THERE'S  
EVEN A FIXED HEAD-PER-TRACK OPTION.

YOU'D THINK THAT WOULD BE ENOUGH.  
BUT NOT FOR MICRODATA, THEY LOVE  
TO PILE IT ON. COMPATIBILITY WITH  
STORAGE MODULE. BETTER RELIABILITY,  
BETTER PERFORMANCE,  
COMPACT 7-INCH RACK MOUNT  
PACKAGE. IT JUST NEVER  
STOPS.



MY ONLY HOPE IS MAYBE  
THEY CAN'T DELIVER.

Sorry, Chuck, we're taking orders right  
now. OEM's should call or write  
directly to Microdata Corporation,  
P.O. Box 19501, Irvine, California 92713,  
Telephone: 714/540-6730.



- Unformatted Storage Capacity: 12.5, 37.6 or 62.7 megabytes • Bit Density: 5,636 bits/inch • Data Transfer Rate: 7.08 MHz • Rotation Speed: 2964 rpm
- Track Density: 300 tpi • Position Time: 30 msec avg. • Track-to-Track Position Time: 6 msec • Error Rate: Recoverable, 1 bit in  $1 \times 10^{10}$  bits; Nonrecoverable, 1 bit in  $1 \times 10^{13}$  bits • MTBF: 6500 hrs.
- Size: 7" H x 17" W x 28" D.

## Microdata

Microdata Corporation, 17481 Red Hill Avenue, Irvine, CA 92714,  
Telephone: 714/540-6730. TWX: 910-595-1764.

FOR IMMEDIATE USE CIRCLE NUMBER 114

FOR INFORMATION ONLY CIRCLE NUMBER 115

## Fast recovery rectifiers handle to 30 A



TRW Power Semiconductor, 14520  
Aviation Blvd., Lawndale, CA  
90260. (213) 679-4561. \$2.48: 1N-  
3899, \$3.10: 1N3909 (100-999);  
stock.

Two series of fast-recovery power  
rectifiers feature peak-inverse  
voltages of 50 to 400 V. Series  
1N3899 through 1N3903 has an  
average forward current of 20 A  
and a reverse-recovery time of 200  
ns maximum. The operating tem-  
perature range is -65 to 150 C.  
The 1N3909 through 1N3913 se-  
ries also has a reverse-recovery  
time of 200 ns maximum, but an  
average forward current of 30 A.  
Both series are JEDEC registered.

CIRCLE NO. 357

## Voltage regulators provide low impedance



Semtech Corp., 652 Mitchell Rd.,  
Newbury Park, CA 91320. (213)  
628-5392. \$6.55 (100 up); stock.

Mini-stud, types MY6.8 through  
MY120—a series of voltage regu-  
lators—offers low dynamic imped-  
ance and good efficiency as voltage  
regulators. The units also are  
suited for use as transient-voltage  
suppressors. Encased in Metoxi-  
lite, which makes the units her-  
metic and rugged, they can handle  
peak pulse power of 30 W at nomi-  
nal voltages from 6.8 to 120 V  
( $\pm 5\%$ ). The temperature coeffi-  
cient of the regulators is 0.05 to  
0.10%/°C.

CIRCLE NO. 358

## If we're Number 1, it's your fault.

Computer Products, Inc., is the world's leading manufacturer of encapsulated power supplies. And we owe it all to you, for recognizing the value of:

- "Triple-testing" before delivery to insure reliable performance
- Internal short circuit protection
- 24 month warranty
- Flexibility...single and dual outputs from 3.6V to 28V with output currents from 65mA to 2,000mA.

- Low cost and fast delivery.

With 49 models to choose from, chances are we can fill your every need. Like to find out more? Just circle our number on the Reader Service Card, and we'll send you our new Power Supplies catalog. If you just can't wait, give Bill Ford a call at 305-974-5500. He can't wait to send it to you.

 Computer Products, inc.



1400 NW 70 Street, Fort Lauderdale, Florida 33309 (305) 974-5500, TWX (510) 956-9895

CIRCLE NUMBER 116

# Power Supplies

## DISCRETE SEMICONDUCTORS

### LED lamps sealed in metal case

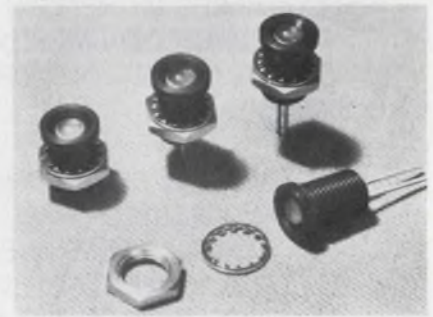

Hewlett-Packard, 1501 Page Mill Rd., Palo Alto, CA 94304. (415) 493-1501. \$15.55: 4787; \$17: the other models; (10-99); stock.

In four colors, these hermetically sealed solid-state lamps are designed for high-reliability applications and for protection against RFI panel leakage. The lamps are easily mounted by drilling a 0.323-in. hole (P drill). Mounting hardware includes a lockwasher and hex nut. The metal case is electrically isolated. Three models have a typical forward current of 20 mA. Model 5082-4787 is red with an axial luminous intensity of 1 mcd typical; Model 5082-4687 is high-efficiency red, with 2.5 mcd typical; and Model 5082-4587 is yellow with 2.5 mcd. However, Model 5082-4987 is green with typical operating forward current of 25 mA and axial luminous intensity of 1.6 mcd typical.

CIRCLE NO. 359

## Gulton's New Quiet Non-Impact Thermal Numeric Printer

Featuring...ultra quiet operation...seven columns of numbers or six columns of numbers with  $\pm$  sign...fast paper roll loading...up to four line per second print rate...complete with interface electronics...compatible with all popular digital panel meters.



Introducing Gulton's answer to noisy, complicated mechanical printers. The NP-7 panel-mounting printer requires only one moving part, the paper advance motor, which sends the

paper silently beneath a non-impact thermal print head. You'll be pleased at the price, too.

Write or call for detailed catalog.

**gulton**<sup>®</sup>

Measurement & Control Systems Division  
Gulton Industries Inc., East Greenwich, Rhode Island 02818  
401-884-6800 • TWX 710-387-1500

CIRCLE NUMBER 117

### 3 and 4-A rectifiers reverse recover in 50 ns

Microsemiconductor Corp., 2830 S. Fairview, Santa Ana, CA 92704. (714) 979-8220. \$5.20 to \$7.34 (100-499); stock to 2 wks.

Fast, high-voltage 3 and 4-A rectifiers, designated MX2130 to 2160 and MY3130 to 3160, handle from 300 to 600 V. Reverse recovery times for all of these miniature glass-package units is typically 50 ns. The units are hermetically sealed in hard glass cases, are metallurgically bonded and are voidless. Leads are solderable silver, markings are solvent resistant and the cathode band is a contrasting color.

CIRCLE NO. 360

# Compact 12-bit s/d converter cuts size, weight by 50%

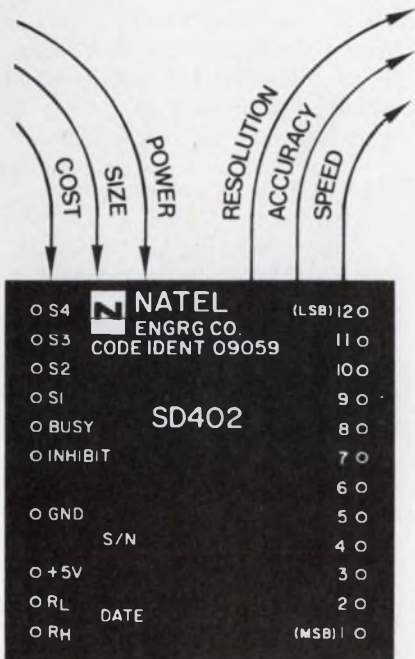

Natel Engineering, 8954 Mason Ave., Canoga Park, CA 91306. (213) 882-9620. See text: stock to 45 days.

Not only does the SD402 synchro-to-digital converter offer 12-bit resolution, but it does so at half the size and price of its 12-bit competitors. Developed by Natel Engineering, the unit measures 2.625 x 2.625 x 0.42 in. and costs only \$199 in single-unit quantities. It is also, reportedly, the first s/d that can operate from a single +5-V supply.

The s/d converter uses a continuous tracking circuit in a Type II servo loop to eliminate lag and zero-velocity error at input rates of up to 8000°/s. Over-all accuracy of the converter checks in at ±15 arc minutes and holds for tracking rates of up to 10,800°/s.

Even though the converter weighs just 3 oz, all inputs are transformer-isolated, and both synchro and resolver inputs are accepted. The standard SD402 is designed for 400-Hz signals and handles 11.8 or 90-V rms for synchro in-

puts, 11.8, 26 or 90-V rms for resolver inputs, and 26 or 115-V rms for the reference input. The reference input has an impedance of 100 kΩ. For 60-Hz operation, a separate transformer module (\$50) is required.

The 12-bit digital output is constantly available, except during the converter-update period (indicated by a converter-busy signal). Updating can be prevented by applying a ZERO to the inhibit line, and the converter can be kept in the hold-mode as long as the ZERO remains on the inhibit line.

Some of the SD402's competitors feature higher tracking rates and less power consumption for a price.

The SDC1700 12-bit converter from Analog Devices, Norwood, MA, has an accuracy of ±8.5 arc minutes and a tracking rate of 12,960°/s. It does, however, require ±15 and +5-V supplies and costs \$365. But even though the SDC-1700 from Analog Devices requires three supplies, it does draw less power—only 1.1 W vs 1.5 W for the Natel SD402.

Recently introduced hybrid converters, series HSDC-10, from ILC Data Device Corp., Bohemia, NY, provide tracking rates of 36,000°/s and are even smaller than the Natel SD402. However, these hybrids are only 10-bit single-package units and require +15 and +5-V supplies. And they cost \$345. For 12-bit resolution, DDC has larger modules in its 522/622 series that start at \$395.

In addition to its commercial SD402, Natel offers a militarized version that operates over a -55 to +105 C range and costs \$299 (1 to 24 pieces), as well as 14 and 16-bit converters with slightly larger packages.

Natel  
Analog Devices  
ILC Data Device Corp.

CIRCLE NO. 301

CIRCLE NO. 302

CIRCLE NO. 303



## TEXTTOOL AXIAL LEAD ZIP STRIPS

**Get zero insertion pressure operation at "plug-in" socket prices!**

The new line of TEXTTOOL axial lead ZIP STRIPS offers easy, convenient zero insertion pressure operation at "plug-in" socket prices!

That's right. The per-position cost of a 16 position axial lead ZIP STRIP featuring zero insertion pressure is competitive with that of currently available conventional "plug-in" sockets. And, ZIP STRIPS are designed for testing and aging of all axial or radial lead devices (diodes, capacitors, resistors, etc.) with lead diameters from .015 to .040 inches.

The ZIP STRIP combines all the features of TEXTTOOL's other zero insertion pressure sockets, virtually eliminates mechanical rejects and has a typical life of 25,000 to 50,000 insertions.

In addition, a unique design allows ZIP STRIP contacts to literally wrap themselves around device leads to prevent their "walking out." This is especially important in applications where ZIP STRIPS are subjected to oven vibration or where they are mounted in an inverted position.

The mechanical action of the ZIP STRIP is the utmost in simplicity. This feature, coupled with a unique system of ramps and bevels to guide the devices, makes it ideally suited for rapid loading and unloading by either hand or mechanical means.

ZIP STRIPS are available in either polysulfone (150°C) or teflon (200°C) to meet specific test or aging requirements.

**Detailed information on these and other products from TEXTTOOL . . . IC, MSI and LSI sockets and carriers, power semiconductor test sockets, and custom versions . . . is available from your nearest TEXTTOOL sales representative or the factory direct.**



**PRODUCTS, INC.**

1410 W. Pioneer Drive • Irving, Texas 75061  
214/259-2676

CIRCLE NUMBER 118

## MODULES & SUBASSEMBLIES

### Vhf amplifier modules simplify design

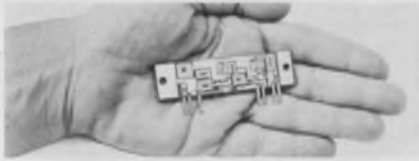

Amperex Electronic Corp., Hicksville, NY 11802. (516) 931-6200. \$52.90 (1-9); stock.

The BGY36 amplifier module, operating at 148 to 174 MHz, delivers better than 18 W with a drive power of under 150 mW. It contains internal matching networks for broadband operation. The amplifier therefore remains stable into a 3:1 VSWR, any phase. VSWRs of up to 50:1, any phase, cause no damage, for heat-sink temperatures up to 70 C. A similar unit (BGY32) operates at 68 to 88 MHz; both connect to 12.5 V.

CIRCLE NO. 361

### Nonlatch multiplying d/a is self-contained

Micro Networks, 324 Clark St., Worcester, MA 01606. (617) 852-5400. \$59 (1-25); 3 wks.

The MN3100 four-quadrant multiplying d/a converter is a self-contained, hermetically sealed unit, ready to use. It includes an internal op amp and laser-trimmed resistors, and is guaranteed not to latch up. Linearity is better than  $\pm 1/2$  LSB from 0 to 70 C and settling time for a full 20-V step is 50  $\mu$ s. The unit has CMOS inputs, consumes 210 mW of power and is packaged in an 18-pin DIP.

CIRCLE NO. 362

## Need answers on rechargeable power sources?



Call the guys who've been there  
**800-433-2684**  
in Texas 800-792-8767

Call our Hot Idea-Hotline toll-free and we'll help you design a nickel-cadmium sealed cell power package to fit your specific needs. In addition, we'll give you hard facts on sizes, ampere hours, configurations, prices, delivery. Chances are, all the applications we've done on hand tools, appliances, calculators, toys, and communication equipment will provide some short cuts for you. Call us. We'll deliver. Marathon Battery Company, P.O. Box 8233, Waco, Texas 76710.

A division of Marathon Manufacturing Company.

marathon battery company



### Store 3D display data from a microprocessor

Optical Electronics Inc., P.O. Box 11140, Tucson, AZ 85734. (602) 624-8358. \$261 (10-29 qty); stock.

The 6711 interfaces with standard 8-bit microprocessors and its recirculating memory stores 256 three-dimensional points, with 8-bit resolution. The device provides three analog outputs representing each of the three mutually perpendicular axes and may be hard-wired directly to the company's Model 6114, 3-D display-generator module. A  $\mu$ P accesses the 6711 as a memory location. The module connects to a  $\mu$ P's 8-bit data bus, or an 8-bit data-output port, and two address lines. In addition the unit requires a strobe or read/write command and sends the  $\mu$ P an execution bit when it is ready to receive a data byte. Programs can be furnished for the F-8, 8080A, 6800, 2650, 1802 and SC/MP  $\mu$ Ps. Interfacing details are also available showing exact connections to the various evaluation kits that use these microprocessors. The module operates from standard  $\mu$ P power (+5 V at 300 mA and -12 to -15 V at 100 mA). It outputs analog currents of  $\pm 1$  mA max. Data can be written in at random or at any rate up to 1.2 kHz. Information is read-out at 300 kHz. Internal address-counters can be incremented by the  $\mu$ P or left to free run. These address counters simplify addressing by the  $\mu$ P.

CIRCLE NO. 363

CIRCLE NUMBER 119

# NEW SIMPSON SERIES 2850 DIGITAL PANEL METER



NOW... at the right price...  
a single DPM for popular  
domestic and IEC/DIN cutouts



STANDARD CUTOUT  
1.682" x 3.622"  
(42.72 mm x 92 mm)



IEC/DIN CUTOUT  
1.77" x 3.622"  
(45 mm x 92 mm)



OTHER DOMESTIC CUTOUT  
1.682" x 3.92"  
(42.72 mm x 99.57 mm)

- 3½ digit readout
- Automatic zero and polarity
- 0.1% of reading accuracy
- BCD output is standard
- Input/output edge connector included
- Highly reliable LSI circuitry
- Choice of 120/240 VAC, 50-400 Hz or 5 VDC operation
- OEM quantity prices available upon request.

ORDER FROM YOUR ELECTRONICS DISTRIBUTOR

**Model 2850** 120/240 VAC input; 0.55" planar gas discharge display complete with panel mounting clips, edge connector and manual. . . . . **\$138**

**Model 2851** 5 VDC input, 0.55" planar gas discharge display complete with panel mounting clips, edge connector and manual. . . . . **\$138**

**Model 2852** 120/240 VAC input, 0.43" LED display complete with panel mounting clips, edge connector and manual. . . . . **\$138**

**Model 2853** 5 VDC input, 0.43" LED display complete with panel mounting clips, edge connector and manual. . . . . **\$138**

STOCK DC CURRENT RANGES: 20 & 200  $\mu$ A; 2, 20 & 200 mA  
STOCK DC VOLTAGE RANGES: 200 mV; 2, 20 & 200 V  
OTHER RANGES ON SPECIAL ORDER



## SIMPSON ELECTRIC COMPANY

853 Dundee Avenue, Elgin, Illinois 60120 • (312) 697-2260

CABLE: SIMELCO • Telex: 72-2416

IN CANADA: Bach-Simpson, Ltd., London, Ontario

IN ENGLAND: Bach-Simpson (U.K.) Ltd., Wadebridge, Cornwall

IN INDIA: Ruttonsha-Simpson Private, Ltd., Vikhroli, Bombay

CIRCLE NUMBER 120

KATY INDUSTRIES



INDUSTRIAL  
EQUIPMENT  
GROUP

# Print Analog/ Graphics Data the easy way



with the versatile  
DM1096

## Thermal Printhead

- Fixed Heads
- No Servo Drive
- Simplified Mechanism
- Multiplexable
- Expandable
- Print Grid Pattern
- 99 High Density Dots  
on 25 Per cm. Pitch
- Integral Heatsink
- Isolation Diodes
- Quiet; Long Life

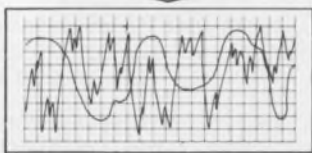

Also, thermal pen, 7-segment,  
digital and custom heads.

Call or write . . .

# gulton

ELECTRONIC COMPONENTS DIVISION  
212 DURHAM AVENUE • METUCHEN, NJ 08840  
(201) 548-2800, EXT. 201 • TWX 710-998-0592

CIRCLE NUMBER 121

## MODULES & SUBASSEMBLIES

### 10-to-12-bit a/d blends speed and price

*Burr-Brown, International Airport Industrial Park, P.O. Box 11400, Tucson, AZ 85734. (602) 294-1431. See text; stock.*

If you don't need hermeticity and very-low drift, the ADC84, a new high-speed 10 and 12-bit a/d converter, is said to offer savings over similar units. This converter module comes with built-in clock, comparator, reference and input buffer-amplifier. Conversion times for the ADC84 are 10  $\mu$ s for 12 bits and 6  $\mu$ s for 10 bits. You can select from analog input ranges of  $\pm 2.5$ ,  $\pm 5$ ,  $\pm 10$ , 0 to +5 or 0 to +10 V. Linearity error is less than  $\pm 0.012\%$  ( $\pm 1/2$  LSB) for 12-bits and  $\pm 0.048\%$  ( $\pm 1/2$  LSB) for 10 bits. Gain and offset errors can be externally trimmed to zero. The converter is guaranteed to be monotonic and to have no missing codes over the operating range of 0 to +70 C. Its gain drift is  $\pm 30$  ppm/ $^{\circ}$ C max. Parallel-digital outputs are available in the following codes: complementary-bipolar-offset binary (COB), complementary two's-complement (CTC) and complementary straight-binary (CSB). CSB and COB codes are also available in serial form. Corresponding clock and status signals are provided. All digital input and output signals are DTL/TTL compatible. The module comes in a 32-pin ceramic dual-in-line package. Price for the 12-bit ADC84KG-12 is \$119 (1-24), \$103 (25-99) and \$96 (100-249). The 10-bit ADC84KG-10 is \$100 (1-24), \$96 (25-99) and \$89 (100-249).

CIRCLE NO. 472

### Intrusion alarm listens for suspicious sounds

*Mountain West Alarm Co., 4215 N. 16th St., Phoenix, AZ 85016. (602) 263-8831.*

An electronic decision-maker can select intrusion sounds from normal noises. The A-18 uses existing public address, paging or background-music speakers to monitor protected space. Sounds of intrusion such as breaking glass, hammer blows or footsteps cause the output relay to operate.

CIRCLE NO. 473

### S/d adjusts itself to frequency and voltage

*Transmagetics, 210 Adams Blvd., Farmingdale, NY 11735. (516) 293-3100. \$640 (1-4 qty); stock-to-4 wk.*

The 1651-03, a 14-bit tracking synchro-to-digital converter, automatically senses and adjusts its operation to input frequencies of 50/60 or 400 Hz and reference voltages of 26 or 115-V rms. Line-to-line reference voltages of 11.8 or 90-V rms are available. Accuracy is  $\pm 4$  arc min over the temperature range; models for 0 to +70 or  $-55$  to +85 C operation as well as hermetically sealed and hi-rel units are available. Tracking rate goes up to 16 rps without jitter and the converter has full transformer isolation. It is claimed that the unit will work with 98% of the synchros now on the market. The converter measures  $3.13 \times 3.63 \times 0.82$  in.

CIRCLE NO. 474

### Drive capacitive loads with 1-kV op amp

*Burleigh Instruments, Inc., 100 Despatch Dr., Box 270, East Rochester, NY 14445. (716) 586-7930. \$435; stock to 4 wk.*

The PZ-70 can drive large-capacitance or low-impedance loads to the unit's full output voltage capability of 1 kV. Its 20-mA-rms (60 mA-peak) current capability is said to make it the fastest high-voltage dc op amp available today. It features a slew rate of 5 mV/s while its small-signal bandwidth is 5 kHz. Noise and ripple are less than 30-mV rms. This inverting amplifier has a 0-to-200 continuously adjustable gain and a dc-bias adjust of 0 to +1000 V. A fast-acting current-limit automatically shuts the instrument down if its output current exceeds 20 mA rms. A LED indicates that the limit circuit has been activated. A current-limit reset pushbutton is standard. BNC connectors are standard for the direct high-voltage output and the monitor output ( $\div 100$ ). A suitable high-voltage connector is also available. A digital-readout is optional. The rack-mountable unit is  $17 \times 3.75 \times 10.5$  in.

CIRCLE NO. 475



# The Raytheon 2900 family gains five new members

**Whereas:** Raytheon is the established alternate source for the Am2901 and Am2909, (franchised distributors stocked), and,

**Whereas:** Raytheon brought you RAYASM, the powerful micro-assembler available on the NCSS computer network,

**Now Therefore:** Raytheon announces five additional 2900 family components, giving us a total of seven, To Wit:

**2901** A 4-bit Microprocessor Slice—the fastest, most powerful LSTTL microprocessor in the world. With its cycle-saving two-address architecture, the 2901's speed can't be touched.

**2905** A 4-bit Bus Transceiver— general purpose open collector bus interface device. Data to the 100 milliamper bus drivers is provided by a 4-bit register with a two-way multiplexer at its inputs. Data from the bus receiver may be held in the 4-bit receiver latch on its way to the three state receiver outputs.

**2906** A 4-bit Bus Transceiver with parity —is equivalent to the 2905 but with the addition of an on-chip parity generator/checker.

**2907** A 4-bit Bus Transceiver—similar to the 2906 with the two-way multiplexer at the input to the bus driver register elimi-

nated to allow the device to be packaged in the space saving 20-pin DIP.

**2909** A Microprogram Sequencer—that can branch anywhere in memory, perform sub-routines, then return with up to four levels of sub-routine nesting. The device is a cascable 4-bit slice which allows addressing of up to 4K words of microprogram with three devices.

**2918** A General Purpose 4-bit Register—with two sets of outputs: TTL and three state. This useful combination can reduce your package count for those status, command, and instruction registers which must drive both your control logic and a data bus.

**93415** A 1024 × 1-bit Fully Decoded Random Access Memory—for your high-speed data and control stores.

Raytheon LSI is on the move. More 2900 family components soon to come include PROM's, sequencers, look-ahead carry generators, additional RAM's, and other goodies now in process.

For complete details, contact your local distributor or Raytheon Company, Semiconductor Division, Dept. 2900, 350 Ellis Street, Mountain View, CA 94042, (415) 968-9211.

# Am 2900 SOLD & SUPPORTED HERE



**SEMICONDUCTOR DIVISION**

CIRCLE NUMBER 122

## FVCs aren't fussy about input shape

*Dynamic Measurements, 6 Lowell Ave., Winchester, MA 01890. (617) 729-7870. Under \$40; 10 days.*

The 9001 frequency-to-voltage converters accept ragged input

waveforms without pulse-shaping. Internal timing makes them insensitive to variations in input-waveform duty cycle. They offer standard input-frequency ranges of 100, 20 and 10 kHz, with all units factory-trimmed within 0.4% (max) of full-scale. Typical linearity is within 0.01%, and peak ripple is typically less than 25 mV. Gain tempo is 100 ppm-max. All models operate from a single +15-V supply.

CIRCLE NO. 364

## The cool one from Tecnetics

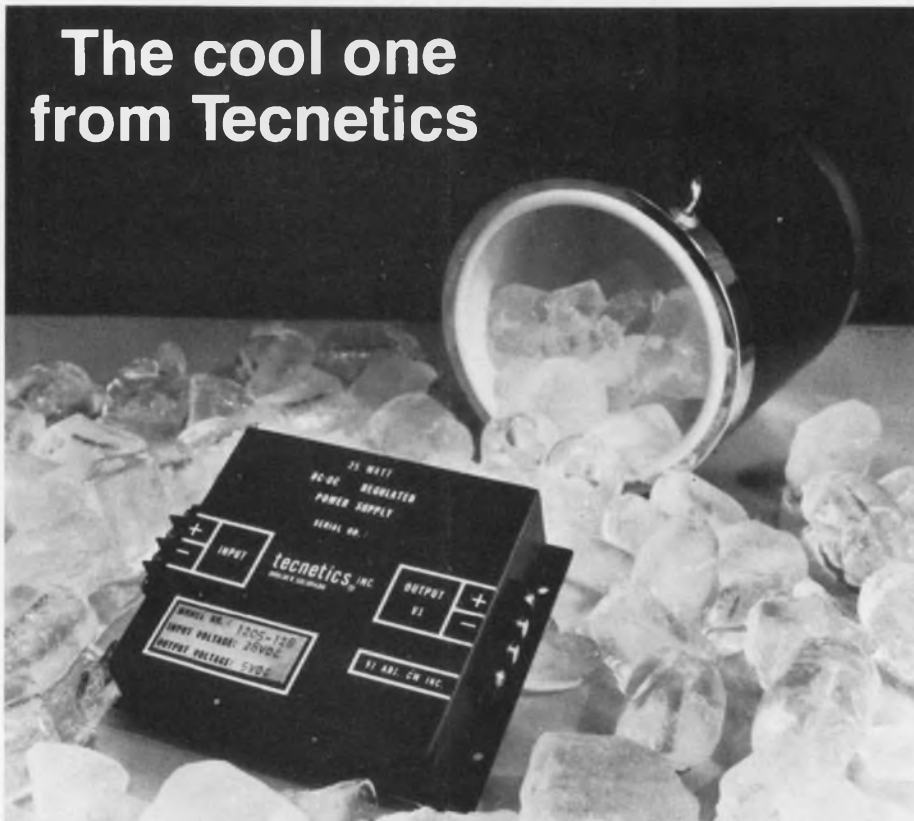

### 55% efficiency in a 25 watt DC to DC Converter

Why pay for useless heat when you want power? That's the philosophy behind the new high efficiency 1200 Series 25 volt regulated converter from Tecnetics.

With efficiency as high as 55% at full load under normal conditions, an integral heat sink, improved circuitry and a black anodized aluminum case, this converter operates within a range of -20°C ambient to +100°C case temperature.

Available with a single output, this series features full input-output isolation to 500VDC allowing the user to change polarity and prevent ground loops. Compact size and sturdy barrier strip terminals make this the perfect converter for a wide

variety of military, industrial, aerospace and telecommunication applications.

For more information on the 1200, and hundreds of other power supplies, write for our 26 page catalog.

#### SPECIFICATIONS: 1200 Series 25 watt DC to DC converter

Inputs: 12 ± 2VDC to 48 ± 6VDC  
 Outputs: 12, 24, 28 and 48VDC  
 Dimensions: 5" x 4.1" x 1.25" (typ)  
 Weight: 16 oz.  
 Price: Single Output - \$198.00

**tecnetics**® The Power Conversion Specialists P.O. Box 910,  
 1625 Range Street, Boulder, Colorado 80302 (303) 442-3837 TWX 910-940-3246

CIRCLE NUMBER 123

## You choose input code with this micro-TTE

*Telenetics, 4120 Birch St., Suite 109, Newport Beach, CA 92660. (714) 752-6363. \$28 (1000 qty); stock to 4 wk.*

The 7603-01 telephone-tone encoder (TTE), a 32-pin dual-in-line hybrid, is 0.3 × 0.9 × 1.8-in. You get standard telephone dual-tone multiple-frequency (DTMF) outputs from three logic-selectable input codes: 1-of-16 lines, 2-of-8 lines in a row-column keyboard-type matrix, or parallel binary. The device can be hardwired to generate a four-or-eight-digit telephone number on command. Either a dedicated-line or the input data itself actuates the automatic dialing feature. Positive station-identification can be established for individual stations, seeking access to a computer bank, reporting alarms or sharing a communications voice-channel. Applications for the encoder range from manual-keyboard entry (for standard telephone service) to automatic alarms, repertory dialers, point-of-sale terminals and mobile-telephone signaling. This low-voltage PMOS device uses 3 to 8 V with a non-operating current-drain of 500 μA. Signal-frequency stability over temperature and time is controlled by a quartz oscillator. Harmonic distortion is less than 1%.

CIRCLE NO. 365

## Analog multiplexer settles in 3 μs

*Teledyne Philbrick, Allied Dr. at Rte. 128, Dedham, MA 02026. (617) 329-1600. \$125 (unit qty).*

Model 4550 16-channel analog multiplexer contains digital input buffers, decoder logic, analog switches, and an output buffer amplifier—all in a single package. The multiplexer accepts an input voltage range of ±10 V and has an output accuracy of ±0.01%. The input is overvoltage protected even with no supply voltage to the unit. Digital inputs are buffered with Schmitt-trigger logic and have an overvoltage capability of ±19 V. Output settling time for a 20-V step to ±1 mV is 3 μs maximum, including a 1-μs switching time.

CIRCLE NO. 366

# Ise introduces five new ways to make the competition turn green.

Your competition probably already thinks they're using the perfect display in whatever it is they make. Let them keep thinking it. While you prove them wrong with a new Itron display. They're designed to make the competition turn green. Which also happens to be the color of the segments.

All 17 of them on the 17-digit Itron. All 5 on the FG-512A1. Next comes an Alfa-Numerical Itron. A Linear-Analog Itron. And a Digital Clock Itron. Five ways to be heartless if you put a little heart into it.

## *itron*<sup>®</sup>

Alfa-Numerical Display



**F6209M2**

ef = 10V  
ec = eb = 40Vp-p  
ic = 10mA-p-p  
ib = 8mA-p-p  
Wd. 205mm  
Lg. 40mm  
Segment 9mm

Instruments & Large Calculator Display



**F6179F2**

ef = 7V  
ec = eb = 35Vp-p  
ic = 7mA-p-p  
ib = 5.5mA-p-p  
Wd. 170mm  
Lg. 40mm  
Segment 9.5mm

Instruments & Terminal Units Display



**F6512A1**

ef = 3.5V  
ec = eb = 24Vp-p  
ic = 4mA-p-p  
ib = 3mA-p-p  
Wd. 100mm  
Lg. 40mm  
Segment 12mm

Digital Clock Display



**FG425A1**

ef = 5.5V  
ec = eb = 35Vp-p  
ic = 8mA-p-p  
ib = 6.5mA-p-p  
Wd. 140mm  
Lg. 59mm  
Segment 25mm

Linear Analog Display

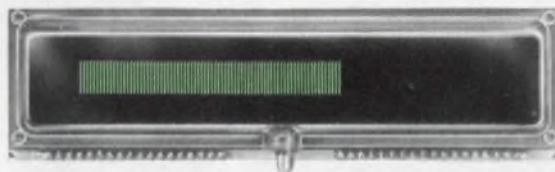

**F6120S1**

ef = 5.5V  
ec = eb = 35Vp-p  
ic = 4mA-p-p  
ib = 0.2mA-p-p  
Wd. 140mm  
Lg. 40mm  
Segment 8mm

## **NORITAKE CO., LTD.**

### Electronics Office (U.S.A.)

22410 Hawthorne Blvd. Torrance California 90505,  
U.S.A.  
Phone: (213) 373-6704.  
Telex: "230674910"

### Electronics Division

1-1, Noritake-Shinmachi, Nishi-ku, Nagoya-City,  
Japan.  
Phone: NAGOYA (052) 561-7111.  
Telex: J59738 NORITAKE

## **ISE ELECTRONICS CORP.**

### London Office

c/o NORITAKE (U.K.) LTD.  
Noritake House 2, York Street W1H 1 Be, England  
Phone: (01) 535-7543 Cable: LUCTUAL LONDON  
Munachen Office  
c/o NEUMULLER GmbH 8 Muenchen 2 Karlstrasse 55,  
West Germany Phone: 592-421 Telex: 522106

### Hong Kong Office

Room 1403 Shing Loon Bldg  
24-26 Stanley Street, Hong Kong  
Phone: 5-232420 Telex: HX83151  
Taipei Office  
72-3 SEC 2, JEN AI RD, Taipei  
Phone: 351-0293 Telex: 11176

CIRCLE NUMBER 124

**PROFESSIONAL  
DISCOUNT  
PRICES  
AVAILABLE ON**

**Texas  
Instruments  
Engineering  
Calculators**

**PHONE TOLL-FREE  
800-638-8906**

**FOR THE CURRENT LOW DISCOUNT PRICE  
OF THE LATEST MODEL TEXAS  
INSTRUMENTS CALCULATOR OF  
YOUR CHOICE**

**Texas Instruments SR-52**



Programming power from Texas Instruments. Easy hand held programming for scientists, engineers, students — anyone who works with advanced mathematics. Check these features: 224 program locations, 20 addressable memory registers, 23 pre-programmed key functions, indirect addressing, permanent program storage on magnetic cards.

**Texas Instruments SR-56**



More power from Texas Instruments. Hand held key programmable calculator. 100 program steps, 5 program levels (up to 4 levels of subroutine may be defined). Easy single step editing. Main features include 26 preprogrammed key functions, 10 addressable memory registers, algebraic logic and 9 levels of parentheses.

**PC-100**

Lock down printer; for a hard copy of your results; step by step listing of programs, or "debugging" programs. The PC-100 printer may be used with the SR-56 or SR-52.

**OTHER MODELS AVAILABLE**

SR-50A, SR-51A, TI 255011, TI 250011, TI 5100

**ALL THE FAMOUS  
TEXAS INSTRUMENTS  
ELECTRONIC CALCULATORS  
ARE AVAILABLE AT DISCOUNT PRICES**

Mail and phone orders accepted. Master Charge and BankAmericard accepted. Add \$2.50 per unit for shipping and handling. Maryland residents add 4% sales tax.

Use our toll free phone: 800-638-8906 (Maryland residents phone: (301) 340-7200) to order or for current discount quotations on the leading brands of electronic calculators: Texas Instruments, Hewlett-Packard, Rockwell, Ricoh, Kingspoint, Corvus, Novus, and many more.

**THE GUARANTEE**

10 day money back trial. If you are not completely satisfied you may return the Texas Instruments calculator you order within 10 days for a cash refund or charge cancellation. In addition Texas Instruments Inc. and Capital Calculator Co. Inc. warrant each calculator for a period of one year against defective parts and workmanship.

**Capital Calculator Company**

**701 East Gude Drive  
Rockville, Maryland 20850**

CIRCLE NUMBER 125

**DATA PROCESSING**

**Portable programmer  
has personality**



*Pro-Log Corp., 852 Airport Rd., Monterey, CA 93940. (408) 372-4593. \$995.*

A series-92 PROM programmer, weighing 15 lb, consists of the M920 master control unit and a plug in PROM personality module, packaged in an attache case. Using the same personality modules as the company's earlier series 90 PROM programmer, this system can program all major MOS or bipolar PROMs. Prices for personality modules range from \$350 to \$550. The Series 92 features a 20-mA current loop and is compatible with any terminal, computer or microprocessor development system having this interface. You can use this system to program, list, duplicate and verify PROMs. The duplicate function is controlled by a single pushbutton. Run and fail lights indicate machine status and whether or not a PROM has been successfully programmed. PROMs are mounted into the unit via quick-load, zero-insertion-force sockets. Options include an RS232 interface, a parallel interface and an ultraviolet erase light.

CIRCLE NO. 367

**Data set transmits  
over one mile**

*Versitron, Inc., 6310 Chillum Pl., Washington, DC 20011. (202) 882-8464. \$544.*

A data set accepts serial data and transmits that data over one mile of four-wire cable. The unit is called the Nodem, because it is "not a modem." The Nodem generates a balanced-current signal at synchronous or asynchronous rates up to 19.2 kbit/s.

CIRCLE NO. 368

**Label reader senses  
a change in color**

*Scientific Technology, Inc., 1201 San Antonio Rd., Mountain View, CA 94043. (415) 965-0910. \$169; 2 wk.*

A color label sensor, the Model 8010 Omnimark, uses a multi-colored solid-state light source and matched detector. The unit can detect all colors including green or blue. In operation, a background color reference is established from the surface under inspection. When the color changes as the unit scans, an output is generated. Two separate outputs are provided, one indicating a change from a dark background to a light mark and one from light to dark. Each output is a 5-V digital signal. The sensor-head size of the Model 8010 is 35 × 74 × 48.25 mm.

CIRCLE NO. 369

**Numeric-data terminals  
can be tailored**



*Hewlett-Packard, 1501 Page Mill Rd., Palo Alto, CA 94304. (415) 493-1501. 10-up prices: \$1308 (3070A); \$1143 (3071A).*

The 3070A and 3071A numeric-data entry terminals have a set of keys and LED indicators that can be labeled by the user to match special computer programs. The 3070A operates with the manufacturer's computers, and the 3071A connects to other type computers. Both models have numeric-only keypads and 16-digit displays. The 3070A can also connect to an industry-standard bus, the HPIB. The terminals weigh 10.3 lb and measure 10.9 × 4.6 × 15.7 in.

CIRCLE NO. 370

CIRCLE NUMBER 126 ►

# New unique design OAK rotary switch

**Accurate.**  
**Dependable.**  
**Long life.**  
**Up to 60 positions.**  
**Logic programmable.**  
**Low cost.**

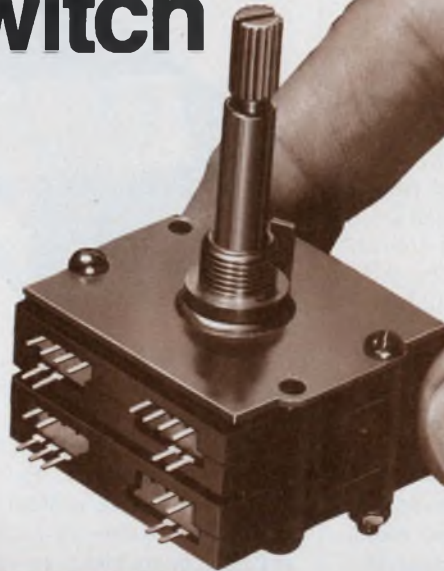

## OAK ROTOR DESIGN

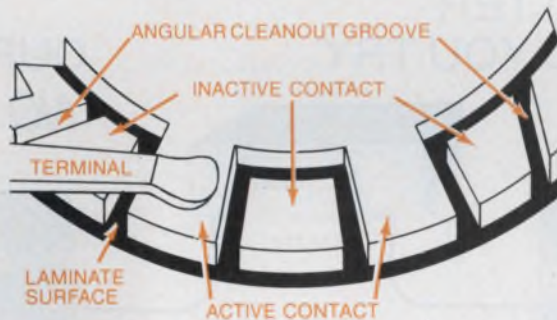

## CONVENTIONAL ROTOR DESIGN

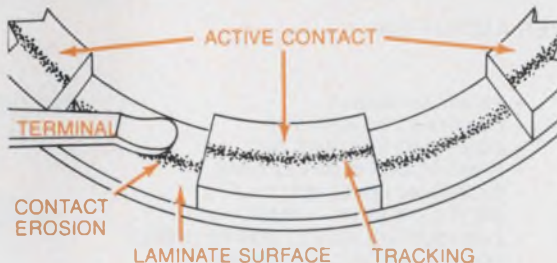

The Oak Communicator Series switch features a patent-applied-for rotor design for long term contact registry and integrity. Programming is accomplished on a metal-clad, laminated rotor of exclusive construction.

High dependability is assured because the stationary wiping contacts never touch the insulation surface. Instead, they move from electrically live to electrically inactive metal surfaces. Tracking is eliminated due to Oak's exclusive clean-out grooves and rotor circuit design. In addition erosion or the formation of particles between contact and insulation surface is drastically reduced.

Intermittent opens or shorts are almost impossible.

Complex wiring problems are eliminated, because all switching logic, wiring and contact arrangements are programmed within the factory-assembled switch.

Small size (1.665 x 1.5 x 0.4), simple construction, accurate registration and low cost permit the Oak Communicator Series to be adapted to almost any application.

For additional information and specifications, contact your nearest Oak sales office or call 815-459-5000.

**OAK Industries Inc.**

**SWITCH DIVISION / CRYSTAL LAKE, ILLINOIS 60014**

TELEPHONE: 815 • 459 • 5000 ■ TWX: 910 • 634 • 3353 ■ TELEX: 72 • 2447

## CRT terminal handles APL characters

Hewlett-Packard, 1501 Page Mill Rd., Palo Alto, CA 94304. (415) 493-1501. \$4100 (single qty).

The 2641A CRT terminal can be switched from APL to ASCII operation. It offers a full 28-character APL set, a 64-character APL overstrike set and a 64-character upper-case Roman set that can be optionally expanded to 128 characters. The terminal's CRT displays the complete APL overstruck characters. It operates either in an asynchronous or synchronous (bi-sync) mode at selectable transmission rates from 110 to 4800 baud. The unit is RS232C-compatible, and transmits synchronous ASCII data point-to-point in character or block mode. A multipoint polling option allows as many as 32 terminals to be connected on the same line. The unit's 5 x 10-in. display has a 24-line by 80-column format.

CIRCLE NO. 371

## Memory system requires 1/4 the space of others

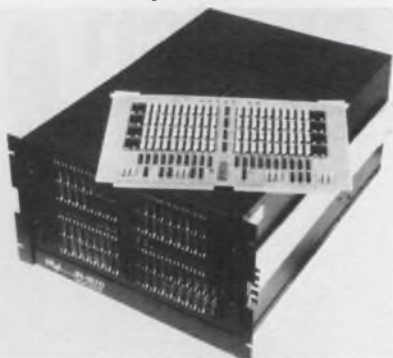

Intel Memory Systems, 1302 N. Mathilda Ave., Sunnyvale, CA 94086. (408) 734-8102.

The in-1670 offers up to 4 Mbyte of add-on memory for the DEC PDP-11/70. The system is said to offer four times as much as competing memories in the same amount of space. The memory's cycle and access periods run 750 and 550 ns, respectively. The system includes error correction checking and error logging circuits. All single-bit failures are automatically corrected.

CIRCLE NO. 372

## Optical bar-code reader observes from 0.5 in.

Identicon Corp., One Kenwood Circle, Franklin, MA 02038. (617) 528-6500. \$400 (single qty).

The Model 515 reads codes printed on badges or envelopes. It is available in two versions, one reading at a distance of 0.25 in., the other at 0.5 in. from the reader's face to the label. The depth of field is greater than 0.125 in. The units resolve bar-to-bar spacings down to 0.008 in. The Model 515 uses a large-area silicon photodetector and a diamond-shaped reading aperture, so that the signal is integrated over 0.3 to 0.36 in. of bar length. This allows the reader to ignore voids in dark bars and spots in white bars. The optical system is sealed by a hard-surface sapphire window. The internal light source consists of infrared LEDs operating at 900 nm. Output is a 100-mV signal at a dynamic impedance of less than 100 Ω. Bandwidth is in excess of 20 kHz. Both gain and offset are adjustable.

CIRCLE NO. 373

IT DOESN'T MATTER  
HOW HARD YOU TRY.....

OUR LM310 HAS  
NO WRINKLES!



THE WORLD'S FINEST RF POWER AMPLIFIER!

FEATURES:

- FLATNESS ± 0.3dB
- BANDWIDTH 0.5-300MHz
- POWER OUT 10 WATTS
- BUILT-IN BLANKER
- BUILT-IN MODULATOR
- BUILT-IN LEVELER
- MEASURES POWER AT THE LOAD
- CORRECTS FOR CABLE LOSSES
- PROGRAMMABLE
- CONSTANT POWER OUT
- CONSTANT VOLTAGE OUT
- REMOTE CONTROL FEATURE
- EXTERNAL LEVELING
- METER—WATTS—VRMS
- PUSHBUTTON SELECT POWER LEVELS
- CORRECTS FOR CABLE VSWR

Remote Sensor  
RS-1

Remote Control  
RC-1



R.F. POWER LABS, INC.

11013 118th Place N.E. • Kirkland, Washington 98033 U.S.A. • Tel: (206) 822-1251  
CABLE: Powerlabs, TELEX: 32-1042

## Paper-tape reader connects to the PDP-8A

*Forte Technology, Inc., 15 Strathmore Rd., Natick, MA 01760. (617) 655-5885. \$1195; 30 days.*

The Model 400 paper-tape reader connects to the DEC PDP-8A computer. It is interfaced with DEC software codes by an eight-word interface. Six additional words and flags remain on the interface for other data input requirements. The system includes a 150 char/s photoelectric reader, a power supply, cabinet, cable, and the eight-word interface board.

CIRCLE NO. 374

## Programmer also simulates PROMs



*Electro Design, Inc., 8141 Engineer Rd., San Diego, CA 92111. (714) 277-2471. \$3000; 60 days.*

The ED6000 simulates and programs TTL-compatible PROMs. The instrument consists of an addressable simulator, a cassette-tape unit and a programmer. Data come either from a hex keyboard having address and data LED readouts, an 8-bit data bus, RS-232 or current-loop driver. A switch controls data transfer between the ED6000 and external circuits through a plug-in cable connected to a 16 to 24 pin socket. Address incrementing is either automatic or manual. Data are accessible in 4-bit increments.

CIRCLE NO. 375

## Acoustic-coupler kit fits TI's 733 terminal

*Omnitec Corp., 2405 S. 70 St., Phoenix, AZ 85034. (602) 258-8244. \$289.32 (1 up); stock.*

An acoustic-coupler kit enables Texas Instruments' Model 733 terminal to communicate over phone lines. The kit, called the Model 1733, is installed in 10 minutes. All parts, including modem card, muff assembly and hardware are included.

CIRCLE NO. 376

# We've got

# R D Q

## Reliability Dependability Quality

Servo-Tek's reputation for superiority in the control and measurement field is based on our ability to produce products of matchless reliability, dependability and quality at truly economical prices. We are known for our efficient, modern production methods and innovative engineering programs.

Our complete line of instrument-type dc generators, dc servomotors, adjustable-speed drives, Bi-Mode servos, analog and digital speed indicating systems, control meter relays and low ripple generators are produced under rigid quality control.

Our repeat list of customers, the nation's top industrial and commercial manufacturers, know they can rely on Servo-Tek's RDQ.

FREE CATALOG of rotating components available.

## SERVO-TEK

PRODUCTS COMPANY

1086 Goffle Road  
Hawthorne, NJ 07506  
201-427-3100

Servo-Tek of California, Inc.  
8155 Van Nuys Boulevard  
Van Nuys, CA 91402  
213-786-0690

**SERVO-TEK**  
ALL AMERICAN  
ENGINEERED

# NOW!

## LINISTORS™

sensitive linear  
negative temperature  
coefficient thermistor  
assemblies

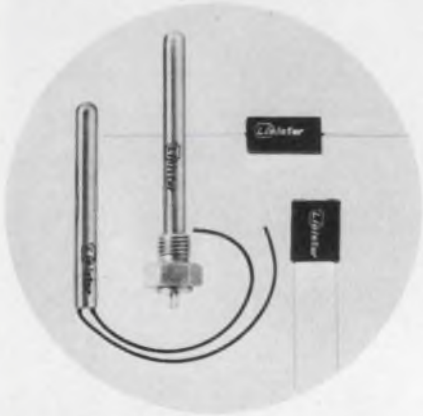

Linistor assemblies will provide you with an accurate straight line resistance/temperature plot from 0°C to 100°C.

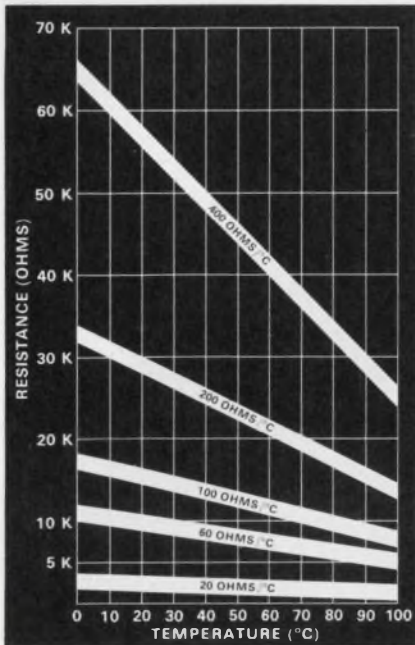

Linistors are ideal for temperature sensing and temperature compensating devices. They are now available in four standard encasements to satisfy most design applications. Write for Data Bulletin L-601.

**Keystone**  
CARBON COMPANY

Thermistor Division  
St. Marys, PA 15857  
814/781-1591 • Telex 91-4517

CIRCLE NUMBER 129

## DATA PROCESSING

### Computer-in-a-cable drives four tape units

Computer Automation, Inc., 18651  
Von Karman, Irvine, CA 92713.  
(714) 833-8830. \$300.

A parallel-interface magnetic-tape intelligent cable (MTIC) drives up to four phase-encoded (PE) or nonreturn-to-zero (NRZ) magnetic-tape units. The MTIC is used with the manufacturer's distributed I/O system and an external-tape formatter. The unit incorporates microprogrammed control using a self-contained processor that supports standard magnetic tape-drive control functions. The functions include transfer, device protocol, device status monitoring and interrupt generation. The control processor is embedded in a 6-ft cable near the tape formatter, and mounts to any flat surface by screws or adhesive. The formatter is compatible with standard tape speeds up to 75 in./s, with densities from 200 to 1600 char/in., and with seven or nine tracks.

CIRCLE NO. 377

### Interface unit relays data at 1-Mbaud rate

Computrol Corp., Berkshire Industrial Park, Bethel, CT 06801. (203) 792-4060. \$32840; 120 days.

The Model CCI-4000 transmits data over coaxial cable at a 1 megabaud rate. The unit connects to a 16 or 32 bit-per-word computer, or peripherals. Up to 64 CCI-4000s, each having a unique address, can connect to one cable. The unit accepts data in the form of two 16-peripherals. Up to 64 CCI-4000s, bit words, then serializes these data and formats them into a 32-bit word. Current drivers couple the serial data into the coaxial cable. In a network, one computer initiates data transmission through its own CCI-4000. When another unit recognizes its address it transfers the received data to its own associated computer. Optional peripheral-driver boards can also plug into a CCI-4000. One board drives eight individually-addressable peripherals and costs \$795. Up to five peripheral-driver boards may be installed in a CCI-4000.

CIRCLE NO. 378

### Printer head moves under software control



Practical Automation Inc., Trap Falls Rd., Shelton, CT 06484. (203) 929-5381. \$200-up (single qty); 6 wk.

The DMTP-6 series printer makes the ASCII set of 64 characters. The printer-head movement is under software control. Both the pitch of 8, 10 or 12 character/in. and character enhancement can be programmed. Characters are formed by a 7 × 5 needle matrix that forms characters with dimensions of 0.110 × 0.08 in. Three models of the series take rolls of paper having widths of 3.438, 6 or 8 in. Other models accept fanfold paper. The units print, on ordinary paper, one to five copies. The paper advances with a programmable motor or ratchet mechanism, depending on model. The effective print rate is 120 char/s. Input is via eight-bit parallel characters, through serial RS-232C or 20-mA current loop.

CIRCLE NO. 379

### Minicomputer has a standard adapter port

General Robotics Corp., 57 N. Main St., Hartford, WI 53027. (414) 673-6800. \$4995 (5-9); 30-45 days.

The GRC11/03 central processor has the DEC LSI-11 microcomputer module, and a PDP-11 Unibus adapter port. The GRC11/03 includes the extended instruction set, floating-point arithmetic, 20-k words of RAM, memory addressing capacity of 512-k words and a serial I/O module with switch selectable data rates. It also has a pseudo switch register accessible with software or ODT, and eight additional dual-height module slots.

CIRCLE NO. 380



## Solderless breadboards easily handle 600-mil DIPs



Continental Specialties Corp., 44 Kendall St., P.O. Box 1942, New Haven, CT 06509. (203) 624-3103. Unit-qty prices: \$9.95 (300); \$10.95 (600); stock.

Solderless breadboards never seem to have enough tie points when you design circuits with 600-mil wide DIPs. To solve this prob-

lem, Continental Specialties developed the Experimentor 600, a solderless breadboard with 550 tie points and 600-mil center spacing.

Although many of the older 300-mil center solderless breadboards offered at least as many tie points, about 30 to 50% of these points were of no use since the 600-mil-

wide DIPs covered them. On the old sockets only one or two tie points for each DIP lead were available; with the Experimentor 600, four points for each pin are available.

There are two versions of Continental Specialties' breadboard available: the Experimentor 600 and the Experimentor 300. Both have a thickness of 0.375 in. and a length of 6 in., but the 600 has a width of 2.4 in. while the 300 is only 2.1 in. wide. The 300 has a 0.3-in.-wide center channel and the 600, a 0.6-in.-wide channel.

Sockets can be snapped together and mixed or matched to provide optimum configurations for any circuit breadboard. Both models also have two 40 point power busses.

CIRCLE NO. 310



## There's a Hoffman enclosure for almost every electronic application you can think of.

Case in point: our consoles. They're designed to rigidly controlled parameters, so they can meet your exacting specifications. They answer your requirements for electronic enclosure applications in dust-filled industrial environments, including process-control computers.

They're components of a 1700-product Hoffman line, including free-standing enclosures, consoles, instrument boxes, and new electronic rack enclosures, in an extensive array of materials and sizes.

There is a Hoffman enclosure for almost every electronic application you can think of. All you need to do is think of us. Check with your local Hoffman distributor, or write directly for detailed specifications. Then see how well Hoffman quality will perform for you.

For complete data write:  
HOFFMAN ENGINEERING COMPANY  
Division of Federal Cartridge Corporation  
DEPT. ED652, ANOKA MN 55303

**Hoffman**  
ELECTRICAL ENCLOSURES

CIRCLE NUMBER 130

## Thermocouple connector features small size

Omega Engineering, Inc., Box 4047, Stamford, CT 06907. (203) 359-1660. \$3.70 per pair (1-10); stock.

The SMP series of thermocouple connectors is claimed to be the smallest quick-disconnect thermocouple connector available. The

series comes in 10 different thermocouple calibrations, including tungsten-rhenium. Each connector consists of male and female mates, with insulation of glass-filled nylon. The connector takes fine-gauge thermocouple wires and protection tubes. Tube clamps are not required because each male connector is supplied with several different-sized brass bushings to which protection tubes can be soldered or braised.

CIRCLE NO. 381

## Digital micrometer resolves 0.0001 in.



Columbia Laboratories, Inc., Macdade Blvd. & Bullens Lane, Woodlyn, PA 19094. (215) 532-9464. See text.

The CM-400-D digital micrometer displays displacement data directly in inches. It permits the operator to resolve changes in displacement to  $\pm 0.0001$  in. Front-panel indicators monitor the status of the control circuitry, warn of over, within or under a set tolerance reading. System accuracy is 0.25 to 1.0%, full scale, depending on the transducer used. It can be interfaced with computers or remote data printout systems. A front-panel potentiometer provides a  $\pm 2\%$  full-scale vernier adjustment to calibrate the system to standard gauge-block references. For \$1295 you get the readout unit, one transducer, stand, mounting adaptors and test points.

CIRCLE NO. 382



## electrocube capacitors

...in new combination plastic film models, offer extremely low temperature coefficients in a miniature 100 and 200 VDC line. This unique combination material results in a lower priced capacitor than the polycarbonate units now used in low TC applications. For higher voltage units, consult the factory. Get complete information on these unique capacitors from Electrocube, 1710 So. Del Mar Ave., San Gabriel, CA 91776; (213) 573-3300.

FREE...data file on request



# COOL CAP

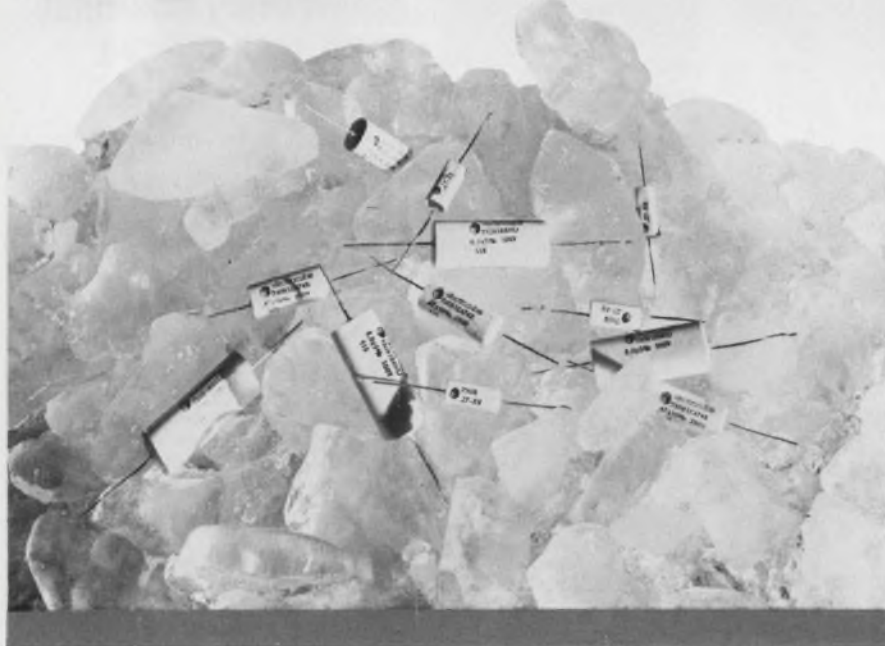

... also available in REEL PACKAGING.

CIRCLE NUMBER 131

## Paper-like ceramic resists 2300 F

Cotronics Corp., 5008 Ave M, Brooklyn, NY 11234. (212) 531-9376. Prices: \$122 (0.02 in., 400 ft<sup>2</sup>), \$126 (0.04 in., 250 ft<sup>2</sup>), \$124 (0.08 in., 120 ft<sup>2</sup>).

The 300 series of ceramic paper has a melting point of 3200 F. The paper can be used to 2300 F. It is made from high-purity refractory fibers containing no asbestos. It can be cut with ordinary hand scissors and formed into complex shapes. The ceramic paper can be folded, wrapped or rolled. The paper comes in thicknesses of 0.020, 0.040 and 0.080 in. Rolls of the material are 24 in. wide.

CIRCLE NO. 383

# PROM ERASER

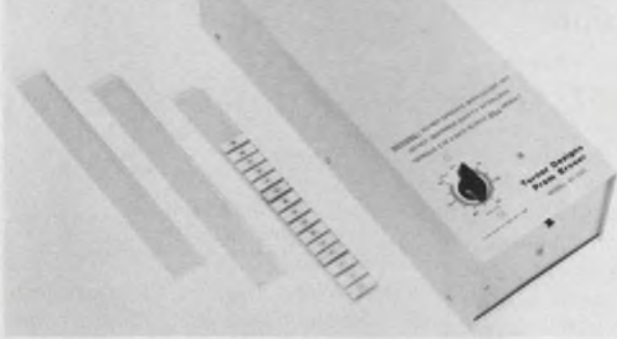

Designed specifically to deliver a calibrated dose of ultraviolet at the correct wavelength and intensity to assure long-term data retention. Tested by leading manufacturers of EPROMs, it meets data-sheet requirements of Intel, National, AMD, AMI, Mostek and others.

- SAFE - Operator protected against uv and ozone
- SMALL - 7 in. wide, front loading
- AUTOMATIC lamp start and timer
- CONVENIENT - Metal-tray loading
- FLEXIBLE - One to 60 PROMS per cycle
- AVAILABLE from current stock

Write or call for further data, or to order

**TURNER DESIGNS**  
 2247A Old Middlefield Telephone  
  
 Mountain View, CA 94043  
 415/965-9800

CIRCLE NUMBER 132

# AUTHOR'S GUIDE



If you've solved a tricky design problem, if you have developed special expertise in a specific area, if you have information that will aid the design process... share it with your fellow engineers—readers of *Electronic Design*.

Articles you have authored not only raise your own professional status, but help build your company image as well. The readers benefit, your company benefits.

To help you prepare material that meets *Electronic Design's* high editorial standards, our editors have prepared a special author's guide entitled "Writing for *Electronic Design*." It covers criteria for acceptability, form, length, writing tips, illustrations, and payment for articles published. It's available without cost.

It's easy to write for *Electronic Design*, but it's often hard to get started. Send for your copy of our Author's Guide today.

Circle No.  
250

## Want A Safer Product And Lower Manufacturing Costs Too?

On the one hand choose the **MICROTEMP®** thermal cutoff

On the other hand, don't overlook the new **PICOTEMP** thermal cutoff



A reliable, accurate easy to install, "one shot" thermal limiter.

- temperature tolerance— $\pm 1.7^\circ\text{C}$ .
- temperature ratings— $58^\circ$  to  $242^\circ\text{C}$ . ( $136^\circ$  to  $468^\circ\text{F}$ )
- current capacity—up to 30 amps at 240 VAC.
- compact—diameter, .157"; length, .457" (exclusive of leads).
- economical
- easy to install—assorted terminations, mounting packages and insulations available.
- Recognized under the Component Program of Underwriters' Laboratories, Inc. UL File #E40667A. CSA approved. BSI Certificate #5041 approved. Recognized by MITI and VDE. Military approval.

Used where installation or space restrictions rule out MICROTEMP® thermal cutoffs.

- temperature tolerance— $+0^\circ\text{C}$ .— $-3.3^\circ\text{C}$ .
- temperature ratings— $63^\circ$  to  $150^\circ\text{C}$ . ( $146^\circ$  to  $300^\circ\text{F}$ )
- current capacity—to 5 amps. at 120 VAC. Will hold this rating up to and including 240 VAC.
- compact—.236" x .389" x .087/.104" (exclusive of leads).
- economical
- Package is completely insulated, leads are 26 gauge silver plated wire.
- Recognized under the Component Program of Underwriters' Laboratories, Inc. UL File #40667A. MITI approved. CSA approved.

Both devices are completely sealed against the atmosphere. Because of their unique design and construction, they won't derate. And they're unaffected by age or extended use. You not only get positive, yet low cost protection against malfunctions in circuits and components caused by equipment failure or user abuse, but you eliminate costly and unnecessary service calls caused by nuisance tripping.

PICOTEMP or MICROTEMP? Which is best? Depends on your needs. Tell us about them.



**MICRO DEVICES**



DIVISION OF EMERSON ELECTRIC CO  
 1881 SOUTHTOWN BLVD  
 DAYTON OH 45439 513-294-0581

CIRCLE NUMBER 133



**our products  
are more fully  
developed...**

Standard Condenser capacitors are indeed fully developed to produce the optimum in performance and durability. Standard is in one business only, the design and manufacture of the world's finest capacitors. We have designed and delivered thousands of specialized capacitors for industry. In fact, what you think of as "special" may be among the many designs already available from stock at Standard. However, if you require capacitors of unusual shape, size, value and material, our engineering department will help you design and produce them to your exact specifications at stock prices. For immediate action, send us a sketch and complete details.

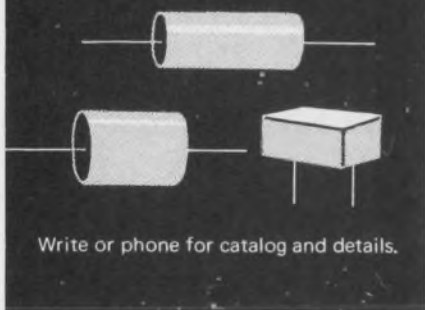

Write or phone for catalog and details.

**Standard**  
**CONDENSER CORPORATION**

Dept. ED-5 1065 West Addison Street  
Chicago, Illinois 60613 • (312) 327-5440

CIRCLE NUMBER 135

## PACKAGING & MATERIALS

### High voltage bushings operate in a vacuum

*Ceramaseal, Inc., New Lebanon Center, New York, NY 12126. (518) 794-7800. See text.*

A line of insulating bushings is specified for high-vacuum use. They leak at a rate less than  $1 \times 10^{-9}$  atm/cc/s of helium. The bushings are open-ended with gaskets having voltage ratings from 10 to 100 kV rms. Flashover is 25% above rated voltage, and all units leak less than 5 pC. The bushings operate continuously at 150 C and intermittently to 200 C. They have either porcelain insulation and stainless steel conductors, or high-alumina ceramic with nickel-iron conductors. For the 50-kV bushing, part no. 947-B-9373-1, the 10-up price is \$38.

CIRCLE NO. 384

### DIP-socket board has a card-edge connector

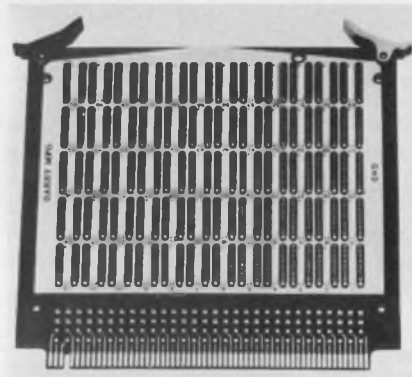

*Garry Mfg. Co., 1010 Jersey Ave., New Brunswick, NJ 08902. (201) 545-2424. \$120 (1-4); 2-4 wk.*

A series of wire-wrappable boards comes with 60 DIP positions and a 61-pin card-edge connector. Designated the EP120 series, the boards are constructed of 0.125-in. glass epoxy. The boards also have 2-oz solder-plated copper voltage and ground planes. Options include one, two, or three-level wrapped-wire posts, 14 or 16-pin positions, and voltage and ground sockets. Each DIP position can be provided with a socket for a decoupling capacitor. The socket terminals may have 10, 30, 40 or 100  $\mu$ m. of gold plating, over 50 or 100  $\mu$ m. of ductile nickel plating.

CIRCLE NO. 385

### PC cards hold up to 50 wafer probes

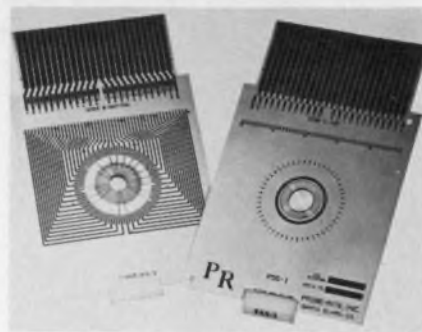

*Probe-Rite, Inc., 2725 Lafayette St., Santa Clara, CA 95050. (408) 249-1255. See text; stock to 2 wk.*

The P50 probe-card series holds semiconductor-wafer probing and holding fixtures. The series contains four basic cards and each card holds 50 individual probe points. The P50 series cards are fabricated on white laminate for photon shielding. They contain die stepping, serialization and product identification. Either 48-pin or 110-pin card-edge connectors are available. You may also build your own card to accept three types of wafer-probe point assemblies. Prices run \$18 for a blank card to \$300 for a complete assembly.

CIRCLE NO. 386

### Kit contains 17 types of epoxies



*Tra-Con Inc., Resin Systems Div., 55 North St., Medford, MA 02155. (617) 391-5550. \$25 (single qty).*

The 51-piece EpoxyLab kit contains 17 different epoxy adhesives. The assortment includes fast curing, thixotropic, heat resistant, rigid, low outgassing, steel filled, flexible, high dielectric, low density, low viscosity, high impact, and clear epoxies. Each adhesive comes in an individual package that contains resin and hardener.

CIRCLE NO. 387

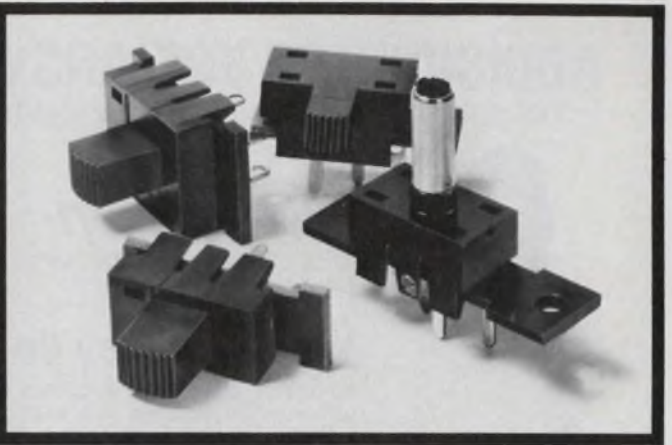
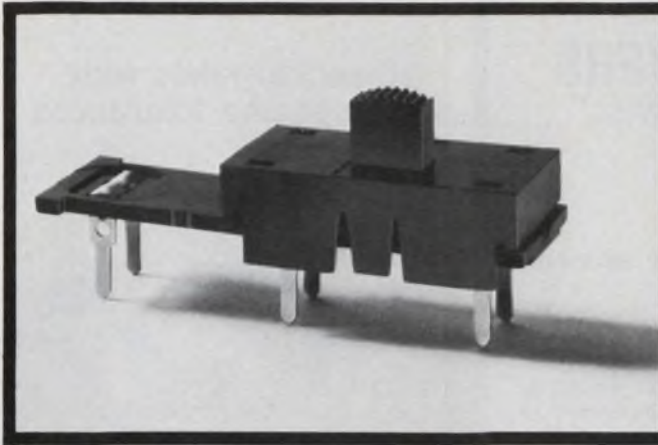

## We've come out of our shell and gone into isolation with our new SL line.

UID just introduced the most versatile and cost-efficient line of slide switches available: the new Shell-less SL switches. Star of the SL line is our RF isolation switch, FCC-tested and approved in a video game under TV-199. But UID's Shell-less SL switches are practical choices for any installation where rugged, durable, high-quality slide switches are required.

UID's SL series has no metal shell, resulting in reduced stray radiation. And since the Shell-less switch weighs about 60% less, you'll save on shipping costs. Our SL's have a tough, self-lubricating nylon construction that meets 94V-2 Flammability specs, and also meets UL 1054 and the new UL impact standards for portable

appliances. The SL's highly-conductive silver-plated contacts provide a life of over 10,000 cycles. Positive detenting provides a reassuring quality "feel."

For more information and a free sample, come out of your shell and write or call Sal Mucario, UID Electronics Division, AMF Incorporated, 4105 Pembroke Road, Hollywood, Florida 33021. Telephone (305) 981-1211.



CIRCLE NUMBER 136

## MICROPAC

LOW-COST OFF-THE-SHELF  
HYBRID VOLTAGE  
REGULATORS



4 TO 10 amp  
output current

- 5 to 36 fixed voltage range
- Positive & Negative voltages
- 120 Watts power dissipation
- Internal short circuit protection
- External components not required
- Standard TO-3 Package
- Available from stock
- Economically priced

**CUSTOM PRODUCTS ALSO AVAILABLE  
WRITE FOR OUR FREE FACILITIES BROCHURE**



**MICROPAC INDUSTRIES, INC.**

905 E WALNUT ST. GARLAND, TEXAS 75040 Tel. 214-272-3571  
TWX 910-860-5186

CIRCLE NUMBER 137

ELECTRONIC DESIGN 24, November 22, 1976

## semiconductor overload protection... murata's posistors<sup>®</sup> make it simple

Murata's PTH487A Posistors are designed to sense the case temperature of high power semiconductors and appropriately reduce power dissipation when dangerous power and/or current limits are approached. No other components are required, recycling is automatic and reliability is outstanding. Write for complete specifications.

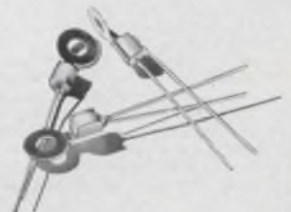

**muRata**

CORPORATION OF AMERICA

Rockmart Industrial Park, Rockmart, Georgia 30153  
Phone: 404-684-7821/Telex: 54-2999/TWX: 810-766-1340

CIRCLE NUMBER 138

# ADDISON HAS THE ANSWERS

*to your continuity test requirements*



## What are they?

The Bits 1K and 2K portable Backplane Integrated Test Systems.

## What will they do for me?

Save you thousands of dollars and thousands of hours . . . provide you with 100% error-free testing of cables, complex harness assemblies, backplanes, and bare printed circuit boards.

## How can they do it?

- Self-learn assembly wire patterns
- Eliminate all programming
- Perform high speed tests
- Provide permanent records on a magnetic tape cartridge.

## Where can I get them?

By contacting

# ADDISON

201-233-6010

DIVISION OF MUIRHEAD INC.

1101 BRISTOL ROAD, MOUNTAINSIDE, NEW JERSEY 07092

CIRCLE NUMBER 139

LEADER LBO-506A

# your lowest priced DUAL TRACE 5" SCOPE. SYNC'S TO 35 MHz

COMPLETE PRICE  
**\$599.<sup>95</sup>**

### Automatic Trigger! Variable Horizontal Sweep! Variable Vertical Input!

Accurate operation is the key and error-free results your bonus! With this unique 5" dual chan/dual trace scope you can test h & w, color, audio or CB circuits. The advanced design lets you read between ranges in any position as easily as you can with analog VTVM's or VOM's. Features high reliability PC board construction; a high intensity CRT with excellent contrast; and special attenuator networks for proper pulse shape and stability. Important plus features are: Automatic X-Y, separate or simultaneous sweep mode display for ch 1 & 2 . . . alternate, chopped, auto or norm trigger, including pre-set TV-V and TV-H comp.; direct RF signal input to 100 MHz; and X5 sweep mag. to 100nanosec. The LBO-506A not only performs every test with accuracy and minimal chance for error, it also checks delay lines and stereo amplification . . . checks for proper color burst phase and fly-back pulse arrival . . . and, you'll use it for any and all measurements to test color circuitry stage by stage. Whatever your needs, the LBO-506A offers solid dependability, and easy-to-use operation!



### Includes all accessories... worth \$45 and more! Here are important features:

- Automatic Trig.
- Variable Vert. Input Gain.
- Variable Hzt. Sweep
- Compact, lightweight with low power consumption
- DC to 10MHz Bandwidth.
- Sync's to 35MHz
- 10mVp-p/cm to 20 Vp-p/cm Vert sensitivity in 11 calibrated steps.
- Separate or simultaneous Sweep Mode Display of Ch 1 & 2 — alternate, chopped, automatic trigger.
- Monolithic dual FET's provide undetectable DC trace drift.
- Dual, in-line package DIP transistor arrays for accurate vertical input amplification.
- Direct input for RF signals up to 100MHz
- Sweep Range: 0.5 $\mu$  S/cm to 0.25/cm, 18 steps calibrated
- X5 Sweep mag — 100ns/cm max. speed
- X-Y display less than 3° phase shift
- Vectorscope display for color phase adjustments.
- Ideal for industry, education, service and maintenance.
- Complete with these accessories: 2 Direct Lo/Cap Probes; 2 Terminal Adapters; & 3 Leads w/Banana Plugs & Alligator Clips. Write for catalog.

**LEADER**  
Instruments Corp

Tests More . . . Tests Better . . . for Less.  
151 Dupont Street, Plainview, N.Y. 11803 516-822-9300

CIRCLE NUMBER 140

## PACKAGING & MATERIALS

### IC socket takes wide pin-spacing tolerances

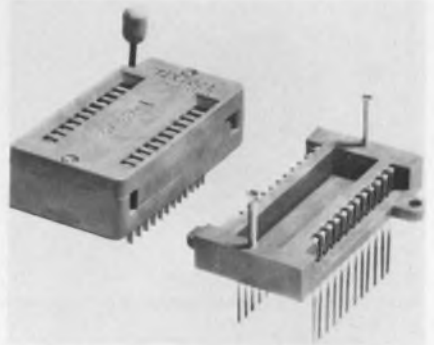

Textool Products, Inc., 1410 W. Pioneer Drive, Irving, TX 75061. (214) 259-2676. Socket, \$2.93-\$5.74; receptacle, \$4.98-\$9.41 (100-up).

The Zip Dip II series consists of disposable zero-insertion-force sockets that plug into chassis mounted receptacles. Each socket features an enlarged entry that accepts a wide range of pin spacing. The IC pins may vary  $\pm 0.13$  in. from the nominal row spacings of 0.3 to 0.6 in. Contacts in the rows are spaced in increments of 0.1 in. Sockets are available for ICs with 14 to 40 pins. The socket has a typical life of 25,000 to 50,000 IC insertions. A built-in "stop" ensures that the locking handle can't be overstressed. Top mounted assembly screws facilitate replacing worn internal parts.

CIRCLE NO. 388

### PC board is either flexible or rigid

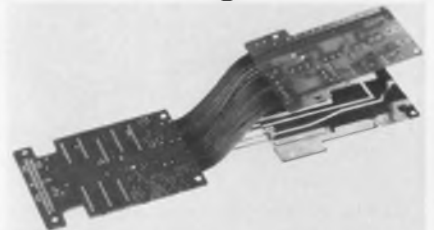

Schoeller and Co., Elektronik GmbH 3552 Wetter, Postfach 20, West Germany.

A multilayer circuit board, called Multiflex, can be made partly rigid and partly flexible. The Multiflex circuits contain flexible printed wiring inside a rigid multilayer PC board. The flexible layer extends beyond the rigid material to provide electrical connections to other PC boards, connectors and controls.

CIRCLE NO. 389

**SOUTH BAY CABLE  
SOLVES  
TOUGH  
CABLE  
PROBLEMS!**



For computer applications,  
business machines... or  
a custom design to fit your  
particular requirement.  
Write for catalog or send  
details of your needs.

Manufacturers of cable for electronic  
use both military and commercial.



Idyllwild, California 92349 • Tel. (714) 659-2183

CIRCLE NUMBER 141

Design better equipment

## OEM servo recorder

Esterline Angus original equipment Miniservo™ recorder gives more design freedom. The basic unit lists at just \$320, with generous quantity discounts available. Your customers benefit from reliable simplicity, easy use, and state-of-the-art. Nationwide repair network backs every unit.

*Short specifications:* 100 mm-wide Z-fold or rolled servo chart recorder with 100 MVDC (10 MV optional) and 4 chart drive choices, 0.5 sec. response,  $\pm 0.5\%$  accuracy, disposable ink/pen cartridge. Request Bulletin F612. Esterline Angus Instrument Corp., P.O. Box 24000, Indianapolis, IN 46224, Tel. 317-244-7611.



CIRCLE NUMBER 142

ELECTRONIC DESIGN 24, November 22, 1976

it's so simple

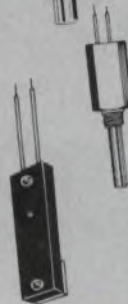
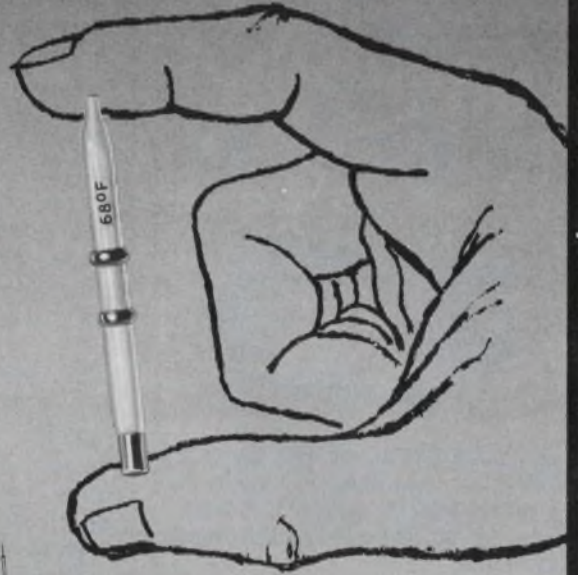

why  
didn't I  
think  
of this  
thermostat?

More and more engineers are asking themselves that question when they see and learn of the advantages of using P.S.G.'s Mercury and Solid State Thermostats.

<b>ACCURACY</b>	$\pm .05^{\circ}$ C to $2^{\circ}$ C
<b>DIFFERENTIAL</b>	$.05^{\circ}$ C to $10^{\circ}$ C
<b>SHOCK</b>	100 G
<b>VIBRATION</b>	20G at 2000 cycles per second
<b>LOAD</b>	5 M.A. to 5 amps
<b>SIZE</b>	length 5/16 and up - diameter 3/32 and larger

All types of mountings. Simple, no moving parts and they are low cost, ranging from \$2.10 each up (depending on model and quantity).

*We find it simple to solve temperature control problems. Let us have yours.*



**P.S.G. Industries, Inc.**  
MANUFACTURER OF PRECISION THERMO AND ELECTRONIC CONTROLS  
1225 Tunnel Road, Perkasie, Pa. 18944



CIRCLE NUMBER 143

# 1 Relay Miss every 2-Billion Cycles



Series E Relay  
(actual size)

We tested 129 of our new Series E Relays at loads from dry circuits to 3 Amps. After 35-billion operations, only 10 single-cycle misses were monitored.

#### Series E Relays offer:

- Indefinite life
- No contact bounce
- Operation in all positions
- Contacts stable to  $\pm 0.015$  ohms over life
- Reliability at dry circuit or power loads
- Self-healing contacts
- Hermetically sealed contacts
- 1250V rms contact breakdown
- Low cost

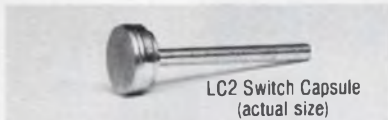

LC2 Switch Capsule  
(actual size)

Series E Relay uses a rugged LC2 welded capsule rather than a fragile glass reed switch. This patented design holds a film of mercury securely to the metal walls of the capsule. With every operation, the mercury film renews the switch contacts. You get the reliability of mercury relays, but with complete freedom of mounting orientation. LC2 welded capsule reliability is proven by hundreds-of-thousands of units in the field, as well as billions of cycles under stringent laboratory conditions.

Send for a FREE SAMPLE of the LC2 welded capsule on your letterhead. Circle the reader service card number for Series E Relay information.



## Fifth Dimension, Inc.

P.O. Box 483  
Princeton, N.J. 08540  
Tel: (609) 452-1200

CIRCLE NUMBER 144

## INTEGRATED CIRCUITS

### Digital clock circuits provide six functions

Intersil, 10900 N. Tantau Ave., Cupertino, CA 95014. (408) 996-5000. Die prices: \$6.20 (100-up); stock.

Two digital clock circuits, the ICM7210 and ICM7210A, offer 4-digit displays and six-function capabilities. The 7210A can drive liquid crystal displays to read out hours, minutes, day, date, month and seconds. It has a perpetual calendar that needs resetting only once every four years. The ICM-7210, in addition to all of the 7210A's features, provides outputs for AM/PM annunciators. Both circuits contain an oscillator, frequency divider, alphanumeric decoder, voltage multiplier, voltage doubler/tripler and 32-Hz display drivers. The only external components required for a complete system are a display, one 1.5-V silver-oxide battery, a trimming capacitor, two spst switches, and two or three external capacitors for the voltage doubler/tripler. Power consumption with the display off is 2  $\mu$ A typical. Both circuits are guaranteed to operate over a -10 to +60 C range.

CIRCLE NO. 390

### 8-decade counter drives BCD & 7-segment units

LSI Computer Systems, 22 Cain Dr., Plainview, NY 11803. (516) 293-3850. \$8.15 (100-up); stock to 6 wks.

A cascadable eight-decade up-counter, the LS7030, can operate from dc to 5 MHz. All counter outputs are latched and data are available in multiplexed BCD and seven-segment format. Digit strobes are guardbanded so they occur totally within valid BCD data times. The multiplexed scan counter may be driven by an external clock or by an on-chip oscillator whose frequency is 500 kHz. The on-chip oscillator frequency can be reduced by adding an external capacitor. Leading zero blanking is used to make the display readable. The circuit operates from a single power supply, between 5 and +18 V and is supplied in a 40-pin DIP.

CIRCLE NO. 391

### Sampler kit contains 13 interface circuits

Standard Microsystems, 35 Marcus Blvd., Hauppauge, NY 11787. (516) 273-3100. \$99; stock.

To aid the designer of computer peripheral equipment, Standard Microsystems has developed a sampler kit of 13 MOS LSI interface circuits. Included in the kit are three UARTs, one USRT, one dual baud-rate generator, one single baud-rate generator, two keyboard encoders, one general interface controller, two character generators and two quad programmable static shift registers. All device data sheets, along with the ICs, are housed in a looseleaf binder.

CIRCLE NO. 392

### Three-terminal regulator series has 7 fixed units

Texas Instruments, P.O. Box 5012, Dallas, TX 75222. (214) 238-2011. \$1.38 (100-up); stock.

The 7800 and 7900 series of three-terminal positive regulators are available with seven fixed output voltages. Ranging from 5 to 24 V, the regulators are designed for use in logic systems, instrumentation, hi-fi and other solid-state applications. They are pin-for-pin equivalent to the Fairchild 7800 and 7900 series. The units are housed in plastic TO-220 packages. Regulator features include internal thermal-overload protection, output transistor safe area protection and internal short-circuit current limit.

CIRCLE NO. 393

### IC timer has delays of microseconds to hours

Micro Components Corp., 99 Bald Hill Rd., Cranston, RI 02920. (401) 463-6000. Less than 50¢ (OEM qty.); stock.

The MCC-555 timer circuit, available in a standard 8-lead DIP, acts as either a time delay (monostable mode) or as an oscillator (astable mode). All input-output terminals are TTL/DTL compatible. Resettable time delays ranging from microseconds to hours can be accurately obtained over the single power supply range from 5 to 15 V. The output of the MCC-555 can either sink or source up to 200 mA.

CIRCLE NO. 394



## New Low Cost TIME CODE GENERATOR/READER



Time Code Reader ..... \$890.  
Generator/Reader ..... \$1265.

The new LOW COST Series 9000 Time Code Units generate and read serial IRIG Time Codes used in analog magnetic tape instrumentation, hard wire transmission and telemetry systems. In addition, they provide buffered parallel BCD outputs, TTL compatible, for digital storage devices and computer inputs. Options include Multi-code units, Day-of-Year Calendars and Millisecond BCD outputs.

Write or call Chrono-log Corporation, 2 West Park Road, Havertown, Pa. 19083, (215) 853-1130



CIRCLE NUMBER 145

## PHOTO ETCH™ PRINTED CIRCUIT KIT Makes circuits **THREE WAYS**

- 1 FULL SCALE ARTWORK MASTER
- 2 MAGAZINE ART ILLUSTRATION → FILM POSITIVE → NEGATIVE → DEVELOPED PHOTO RESIST IMAGE ON COPPER CLAD CIRCUIT BOARD → ETCHED CIRCUIT BOARD
- 3 DIRECT ETCH DRY TRANSFERS APPLIED TO COPPER CLAD BOARD

**NO** CAMERA DARKROOM FILM CUTTING TRACING

**USES DATAK'S POS-NEG PROCESS**  
The revolutionary photographic way that makes **PERFECT** printed circuits from original art or a printed page.

KIT CONTAINS 5' x 6' steel printing frame, 4 sheets 5' x 6' photocopy film, yellow filter, chemicals for 1 pint film developer and 1 pint film fixer, 5' x 6' copper clad board, 3' x 4 1/2' copper clad board, spray can of photo etch resist, 1 pint resist developer, 2 sheets 8 1/2" x 11" layout film, 1 roll 1/16" printed circuit tape, 1 roll 1/32" printed circuit tape, 8 sheets dry transfer direct etch PC patterns including pads, transistors, round can and flat pack ICs, DIP ICs, edge card connectors, lines, circles, logs, etc. & 1 lb anhydrous ferric chloride to make 1 pint etchant, instructions.

ER-4 COMPLETE PHOTO ETCH SET ..... \$26.95  
ER-2 PC patterns and tapes—refill ..... 3.95  
ER-3 1/4 pound dry etchant—refill ..... 1.49  
ER-5 6 sheets photocopy film—refill ..... 3.95  
ER-6 Film process chemicals—refill ..... 1.95  
ER-7 Photo resist spray, 2.5 oz.—refill ..... 2.95  
ER-8 Resist developer, 16 oz. can—refill ..... 2.95

AT YOUR DISTRIBUTOR OR DIRECT

the **DATAK** corp.  
65 71st St. • Guttenberg, N. J. 07093

CIRCLE NUMBER 146

ELECTRONIC DESIGN 24, November 22, 1976

# FABRI-PAK™

## THE INTEGRATED BACKPANEL SYSTEM

Here's an all-in-one backpanel featuring edgecard circuit connectors integrated with the p.c. backpanel for single and multiple board sandwiching.

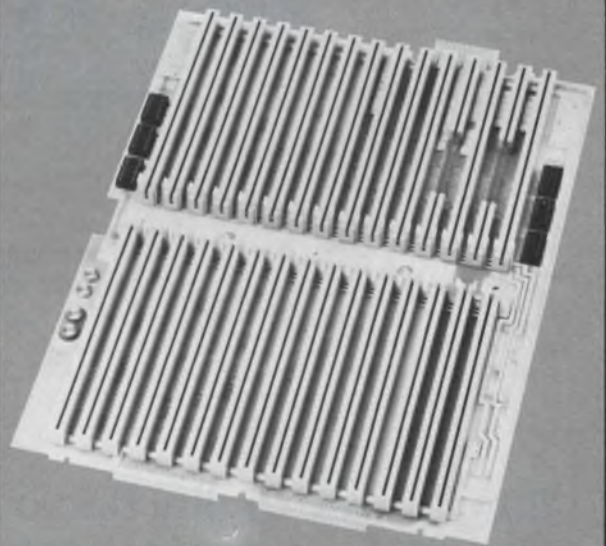

**Versatile:** Accommodates up to 8 planes of circuitry, two-sided and multilayer boards. Unlimited choice of p.c. edgecard terminations.

**Reliable:** Press-fitted contacts provide gas tight interfaces. No soldering. Easy field repair of contact and housing elements.

**Low cost:** Ground planes, voltage busses, signal lines etched directly into p.c. board. No external wiring required.

**Grid spacings available:** .100, .125, .150, .156.

We design and manufacture the entire system to your specifications. Superior quality, quick delivery. Write or call for details.



**FABRI-TEK** INC.  
NATIONAL CONNECTOR DIVISION

9210 Science Ctr. Drive/Minneapolis, MN 55428/(612) 533-3533

CIRCLE NUMBER 147

# Rubidium TIME/FREQUENCY SYSTEMS

For stability, accuracy, reliability...specify a Rubidium Oscillator/Frequency Standard from the leading company, EFRATOM. For navigation, communication, data transmission, television, meteorology, time transport lab equipment...specify EFRATOM Time and Frequency Systems.

*It is time to call EFRATOM for economical prices and complete technical data.*

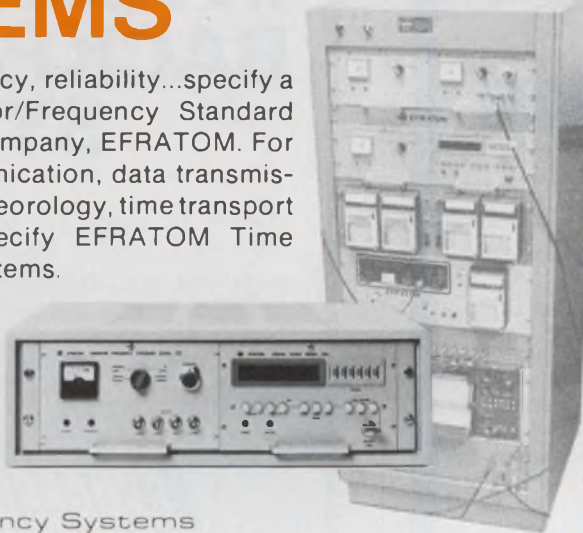

Time and Frequency Systems

**EFRATOM CALIFORNIA, INC.**

**EUROPE:**

EFRATOM 8 MUNICH 90 • LANGOBARDENSTR. 7  
PHONE (089) 647138 • TELEX 529701 EFRAD - D

3303 HARBOR BLVD., SUITE E1-E2  
COSTA MESA, CALIFORNIA 92626  
(714) 556-1620 • TWX 685-635

CIRCLE NUMBER 148

## For Optical, Digital Radio and Coaxial Communications Testing Model MN-1/MB-1 BERT

**TRANSMITTER . . .** DC to 75 MHz. Six pseudo-random codes with frame sync and clock. RZ and NRZ formats. Encode/decode modes.

**RECEIVER . . .** Automatic synchronization to received code. Bit error rate, block error rate (10, 100, 1000 bits), burst error LED. Four-digit LED counter. Phase adjust and phase/amplitude LED indicators.

**RELATED MODULES . . .** Error preamble inject, special bi-polar code generators, level converters and fixed-word generators.

*For product data or a demonstration . . . call or write*

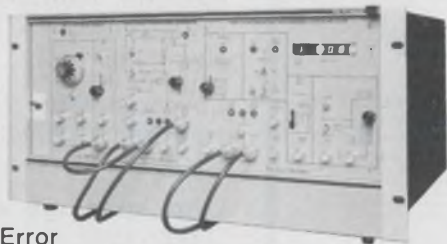

**tau-tron**  
INC

11 Esquire Road, North Billerica, Mass. 01862 Tel: (617) 667-3874

CIRCLE NUMBER 149

## INTEGRATED CIRCUITS

### Low cost ARLS works with 75-ns clock

*Fairchild Bipolar Memory, 464 Ellis St., Mountain View, CA 94042. (415) 962-3816. \$12 (100-up); stock.*

An arithmetic logic register stack (ALRS), the 9405A, operates with a 75-ns clock period. It is claimed to be 30 ns faster than guaranteed operating times of the nearest competitive circuits. The 9405A has a two-address architecture, in which addresses are multiplexed to achieve cost advantages that make the circuit the industry's lowest priced four-bit slice, the company claims.

CIRCLE NO. 395

### Analog multiplexers handle big overvoltages

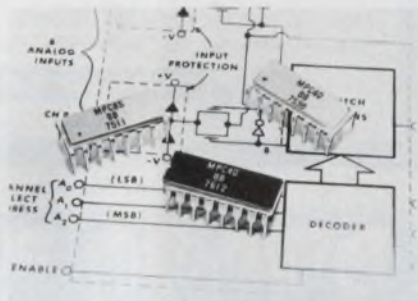

*Burr-Brown, International Airport Industrial Park, P.O. Box 11400, Tucson, AZ 85734. (602) 294-1431. \$10 (100-up); stock.*

Monolithic analog multiplexers, the MPC4D and MPC8S, provide input overvoltage protection of up to 20 V above either supply. Channel interaction is eliminated during overvoltage conditions and also during power loss. In addition, the CMOS construction keeps the power dissipation to only 7.5 mW standby and 15 mW operating at 100 kHz. The MPC4D is a 4-channel differential input/output multiplexer and the MPC8S is a single-ended 8-channel device. Both units have access times of 500 ns typical, sampling rates to 200 kHz, and accuracies compatible with 12-bit converter systems. The multiplexers have break-before-make switching to protect input sources. Off-channel isolation is 65 dB typical. The supply range spans  $\pm 5$  to  $\pm 20$  V and the input/output range is equal to the supply voltage.

CIRCLE NO. 396

# A/D and D/A Converters... Call the Can-Do Company



CPS specializes in medium-to-high resolution and fast settling time devices for data acquisition, instrumentation, process control and many other signal converter applications where product reliability is a must.

CPS function modules are backed by more than eight years of know-how in producing standard or custom high-technology products which are tailored for specific OEM industrial or

Mil-Spec needs. And we've solved a lot of engineering design problems that others tend to stay away from.

Our production capability is backed by a stringent QC program which ensures a quality product along with on-time delivery schedules.

Call or write CPS, the "Can-Do" company, for the economical answer to your signal converter requirements.

**CPS** INC.  
**CYCON**

722 E. Evelyn Avenue  
Sunnyvale, California 94086  
Phone (408) 738-0530 Telex 357-450



CIRCLE NUMBER 150

*Bodine has doubled  
its AC horsepower*



AVAILABLE FROM STOCK

And our new 48-frame TEFC parallel shaft and right angle gearmotor designs are shorter, too. Proven gearheads with ratios from 5:1 through 60:1. Speeds from 340 through 28 Rpm. And torques through 330 Lb-in. Available in all popular AC windings and voltages. In a wide range of mounting configurations. You can get continuous duty ratings through 1/3 Hp—with gearhead or without. But get all the facts. Write for Catalog S.

ADE (After Delivery Economies)  
make Bodine a better fhp buy

**BODINE**  
**ELECTRIC**  
**COMPANY**

Bodine Electric Company, 2500 W. Bradley Place, Chicago, IL 60618.

CIRCLE NUMBER 151

ELECTRONIC DESIGN 24, November 22, 1976

**ALCOSWITCH**®



... unequivocally, your No. 1 source for miniature and subminiature switches. We boast all types and descriptions of the best variety with the latest innovations.

Why not investigate how you could benefit with prompt deliveries from our vast inventory of stock or our ability to satisfy your special needs.

Please call (617) 685-4371 for technical assistance, samples and pricing info.

**ALCO** ELECTRONIC PRODUCTS, INC.  
1551 OSGOOD STREET, NORTH ANDOVER, MA 01845 U.S.A.

Tel: (617) 685-4371

TWX: 710 342-0552

A SUBSIDIARY OF **AUGAT**® INC.

CIRCLE NUMBER 152

# AMPERITE

**TOP QUALITY**  
Still at **LOW PRICE!**

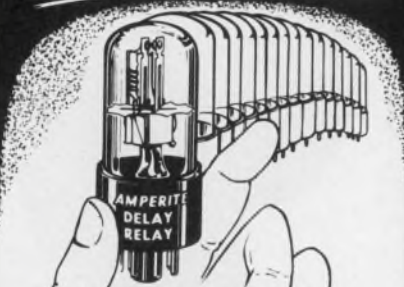

## Thermostatic DELAY RELAYS

Hermetically Sealed for Maximum Stability

**Delays: 2 to 180 Sec.\***

Hermetically sealed — not affected by altitude, moisture, or climate changes... **SPST only** — normally open or normally closed... Compensated for ambient temperature changes from  $-55^{\circ}\text{C}$  to  $+80^{\circ}\text{C}$ ... **Rugged, explosion-proof, long-lived**... Standard radio octal and 9-pin miniatures.

Price, standard or min., under \$4.00 ea.

\*Miniatures delays: 2 to 120 seconds.

**PROBLEM?** Send for Bulletin No. TR-81.

## New! LONG DELAYS

**240 & 300 Sec.**

Same rugged construction, hermetic sealing and stability as the shorter Delay Relays described above... For delays beyond 300 seconds, these Relays may be used in series.

Price, under \$6.00 ea.

Write for Bulletin No. LD-73.



## DIFFERENTIAL RELAYS

For automatic overload, over-voltage or under-voltage protection... Made only to specifications for 70V, 80V, 90V and 100V.

Price, under \$6.00 ea.

## AMPERITE BALLAST REGULATORS

Automatically keeps current and voltage at a definite value. For AC or DC... Hermetically sealed, rugged, vibration-resistant, compact, most inexpensive.

Price, under \$3.00 ea.

Write for 4-p. Bulletin No. AB-51.



# AMPERITE

600 PALISADE AVE., UNION CITY, N.J. 07087

Telephone: 201 UNION 4-9503

In Canada: Atlas Electronics, Ltd.,  
50 Wingold Ave., Toronto 19

CIRCLE NUMBER 153

## INTEGRATED CIRCUITS

### Bipolar RAMs dissipate only 125 mW but are fast

National Semiconductor, 2900 Semiconductor Dr., Santa Clara, CA 95051. (408) 737-5832. From \$3.73 (100-up) stock.

Low-power bipolar memories with full military capabilities, the DM74LS289 and 74LS189, can handle 16 four-bit words. The random-access memories require only 25 mA maximum input current while maintaining the high speed (35 ns) of the older DM5489D and DM7599D, which they replace. Available with either open-collector (DM74LS289) or three-state outputs (DM74LS189), the RAMs are ideal for scratch-pad applications. Both commercial and MIL-temp-range versions are available.

CIRCLE NO. 397

### Dual memory drivers handle up to 600 mA

Fairchild Camera & Instrument, 464 Ellis St., Mountain View, CA 94042. (415) 962-3816. From \$2.62 (100-up); stock.

Dual memory drivers, the 55/75326 and 55/75327, can sink or source up to 600 mA and operate from a 5-V supply. The 55326 and 75326 can only sink 600 mA. Their output-transistor base current can be increased by connecting an external resistor. Each output collector is protected from voltage surges during inductive switching by a clamp diode in parallel with an internal pull-up resistor. The 55327 and 75327 memory switches can source or sink up to 600 mA, and operate from one 5-V supply and one 4.5-to-24-V supply. Each switch can function either as a sink driver or source driver. An internal base-drive resistor is available on the chip, and can be used by connecting two pins externally. All memory drivers are available in either ceramic DIPs (55326DM, 55327DM) or military flatpacks (55326FM, 55327FM) for operation over the military temperature range. For commercial use these circuits are available in both ceramic (75326DC, 75327DC) and plastic (75326PC, 75327PC) DIPs.

CIRCLE NO. 398

### Monolithic v/f converter operates from 5 to 36 V

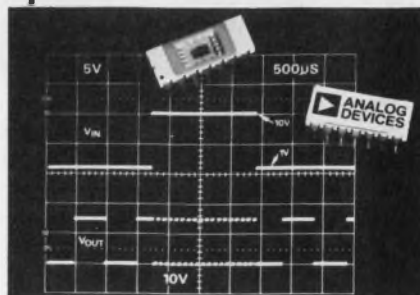

Analog Devices, Rte. 1 Industrial Park, P.O. Box 280, Norwood, MA 02062. (617) 329-4700. 100-up prices: \$9.50 (J), \$13.75 (K); \$19.50 (S); stock.

Able to operate from a single 5-to-36-V supply, the AD537 series of voltage-to-frequency converters have typical nonlinearity of 0.05% at 10 kHz. The single-chip converter requires only a single external RC network to set up any full-scale frequency up to 100 kHz and any full-scale input voltage up to +30 V. The converter maintains its linearity even down at low frequencies (0.001 Hz). Over-all tempo of the v/f converter is typically  $\pm 30$  ppm/ $^{\circ}\text{C}$ . A temperature proportional output, scaled to 1 mV/ $^{\circ}\text{K}$ , permits the AD537 to also be used as a temperature to frequency converter. The output of the v/f converter is a square wave that can drive up to 20 TTL loads. Quiescent-current drain of the AD537 is only 1.2 mA. On the input is a low drift ( $1 \mu\text{V}/^{\circ}\text{C}$ ) amplifier that has a 250 M $\Omega$  input impedance. There are three versions of the 14-pin-DIP-housed unit: The AD537J, K and S. The J and K are specified for 0-to-70-C operation and the S for  $-55$  to  $+125$  C.

CIRCLE NO. 399

### 4-k static RAMs run from only a 5-V source

Electronic Memories & Magnetics Corp., 12621 Chadron Ave., Hawthorne, CA 90250. (213) 644-9881. \$15.10 (100-up); stock.

Two 4-k static RAMs, the 4801 and 4804, use only one 5-V power source. The devices are configured as  $1 \text{ k} \times 4$  and  $4 \text{ k} \times 1$ , and both are housed in 18-pin packages. Typical device power at room temperature is 225 mW. Maximum access and cycle time is 450 ns, even at 70 C.

CIRCLE NO. 403

# 4 SWITCHED ON ADVANTAGES!

**DIPSWITCH** was the industry's first rotary switch for DIP sockets. It offers the designer the versatility and reliability only experience can bring. Here are four reasons you should consider **DIPSWITCH** for your switching needs.

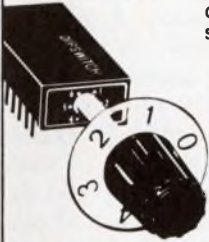

- 1 if multilayered boards are part of your design, **DIPSWITCH**'s .230" profile is about half anybody else's. You can stack as close as 1/4".
- 2 if you need additional switch closures, **DIPSWITCH** can be tandem coupled using extended shafts.
- 3 if savings board space is important, you can piggyback an IC right onto **DIPSWITCH**.
- 4 if you need special switch closure programming, **DIPSWITCH**'s six independent cams can be factory assembled to perform your programming.

**DIPSWITCH** is a Registered Trademark of the McGraw-Edison Company, Pat. No. 3621157



**EDISON ELECTRONICS**  
a McGraw-Edison Company Division  
Granier Field Municipal Airport, Manchester, New Hampshire 03103 603-669-0940

CIRCLE NUMBER 154



Lowest price Keyboard and Encoder kit we've seen. General purpose ASCII keyboard for data terminal applications. Could be used for TV, RTTY, Code Transmission, Altair and other Mini Computers, etc. Utilizes 2-key rollover MOS memory allowing encoded outputs to be strobed out on each key's depressed. Uses double side pc board. Electronic shift lock, not mechanical on keyboard. Keyswitches, one integral assembly not individual keys. Keyboard: 63 keys (49 encoded keys). 4 mode: normal, shift and control. 3 internal function keys: shift, leach, side of board, shift lock and control. 3 functions: Key Break, Here Is, Repeat. 7 additional functions (can be assigned by user). Electrical specs: voltage requirements plus 5 volts and minus 12 volts, 200mw, negative or positive logic output, jumper, selectable. Output connector. On the PC board we have A NEW KEYBOARD TEST FEATURE. 7 LEDs! These LEDs display visually the ASCII code for the depressed key. TTL compatible. Kit includes: 63 key keyboard, pc board, ROM, 7 LEDs, resistors, capacitors, TTL IC's and SOCKETS. Include diagram and wiring instructions. ROM code. Wt. 3 lbs. Size overall: 13 x 5 1/2 x 2".

## KEYBOARD & ENCODER KIT

• Double Outputs — standard sided ASCII 7 bits PC board plus strobe  
• Bit 5 shifted  
• Bit 7 control

WIRED \$69.95 100 3209  
Cat. No. 1003208  
**\$59.95** KIT  
No. 1003099 Keyboard only 29.95

"THE GREY INCH" PRECISION

2 for \$1  
POTS

By FAIRCHILD! "Exactly 1 1/4" long x 5/16 x 3/16". Features 23 turns, linear, similar to Bourne 2249 5% tolerance, 1 watt. Hermet gray in color. With 3 gold plated leads. Screw driver adjust.  
Ohms Ohms Ohms  
 25  500  10K  
 50  1K  25K  
 100  2.0K  50K  
 200  2.5K  100K  
 5K  250K  
Cat. No. 1003436

3 for \$12.  ECC INDUSTRIAL SPEED CONTROL  
**\$4.95**

Repeat of a sellout! A \$30 item, made by ECC famous for semiconductors, designed and built this speed control for XEROX. Controls home, shop and industrial lighting too. Rated at 1200 watts. A very elaborate circuit for controlling many electrical and electronic devices. Easily controls speeds of electric drills, brush-type motors, etc. Built with heavy duty aluminum framing. Complete with external 50K pot. for variable speed control, and series resistor. Heavy duty colored wires for 115VAC 60 cycles, and item to be controlled. 10/32 mounting stud. Outperforms our previous sellout. With hookup diagram. Use as temperature controller too. Wt. 2 lbs. Cat. No. 1003392

"Fast Charge" **\$1.69**  
AA NICAIDS 3 FOR \$4.50  
Most commonly used nicad battery: 1.2VDC 500 mils. Fast charge, only requires 5 hours, others 12 to 24 hours. Cat. No. 1003453

Terms: Add postage. Rated: net 30  
Phone: Wakefield, Mass. (617) 243-3829  
Retail: 16-18 1st Currier St., Wakefield.  
MINIMUM ORDER — \$8.00 Send for FREE  
Fall-Winter CATALOG  
P.O. BOX 942 LYNNFIELD, MASS. 01940  
©Poly Paks Inc., Wakefield, Mass., U.S.A. 1976

CIRCLE NUMBER 155

ELECTRONIC DESIGN 24, November 22, 1976

# YEW's POWERFUL FAMILY!



## AC WATTS

And, that's a lot of accuracy, even with low power factors and distorted waveforms. The YEW 2885 is renown throughout the world as the AC power measuring instrument. YEW's APR-2, on the right is used as a standard by many countries in the world.

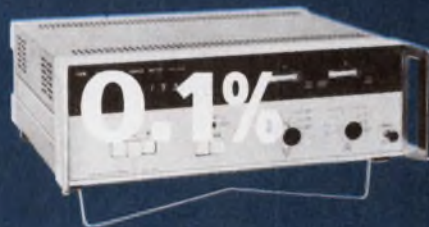

## TRUE RMS V-A-W

Accuracy and versatility have generated a reputation for the YEW 2503 True RMS V-A-W instrument that's hard to beat. Distorted waveforms and low power factor hardly phase it at all.



## TRUE RMS V-A-W

If 0.25% accuracy with 0.01% resolution fills your True RMS requirements, YEW's new 2504 can't be beat for pure dollar efficiency. It takes low power factors and distorted waveforms in stride, too.

## PORTABLE WATTMETERS

YEW has made more precision analog portables than anyone else in the world . . . and they're usable to 2 KHz and not expensive.

Write for our technical information package.

**YEW** YOKOGAWA CORPORATION OF AMERICA  
5 Westchester Plaza, Elmsford, N.Y. 10523  
Tel. 914/592-6767 TWX: 710-567-1256

"Visit us at ISA Booth 547"

CIRCLE NUMBER 156

# Digitize Color TV at 3 times NTSC (11 MHz)!



Less than \$1200

## High-Speed A/D Converter MATV-0811

- 8-bit accuracy
- DC to 11 MHz word rate (3 times NTSC)
- TTL compatible



Less than \$400

## High-Speed D/A Converter MDD Series

- 8 & 10-bit accuracy
- 20 MHz word rate
- TTL compatible

A perfect pair of A/D & D/A Converters for color TV digitization, time-base correction, and frame sync applications.

**COMPUTER  
LABS**

COMPUTER LABS, INCORPORATED • 505 EDWARDIA DRIVE • GREENSBORO, N. C. 27409 • (919) 292-6427

CIRCLE NUMBER 157

## WE SUPPORT YOUR FLOPPY!!

...With a complete line of Floppy-Disk power supplies for single and dual drive applications.



### Another New Series of Microcomputer dedicated models from Power-One.

Our Disk-Drive Series offers three new triple-output models designed to power virtually any Floppy system on the market today.

Disk-Drive Model	Output Ratings			Price (Single Qty.)
	+24V	+5V w/OVP	-5V w/OVP	
CP-205	1.7A	1A	0.5A	\$69.95
CP-206	3.4A	2.5A	0.5A	91.95
CP-162	6A	3A	0.6A	120.00

Check our complete line of standard "off-the-shelf" models. All available for immediate delivery. For your custom requirements, just give us a call. Discover for yourself why more major Microcomputer System manufacturers rely on Power-One than any other source.



**It's a Fact!**

531 Dawson Dr. Camarillo, CA 93010  
Phone: 805/484-2806 TWX: 910-336-1297

**POWER-ONE, INC.**

CIRCLE NUMBER 158

## INTEGRATED CIRCUITS

### CMOS RAMs require only 50 nW/bit

American Microsystems, 3800 Homestead Rd., Santa Clara, CA 95051. (408) 246-0330. From \$15.25 (100-up); stock.

The S5101 family of CMOS RAMs is organized as  $256 \times 4$ . Standby power required by the RAMs is only 50 nW/bit and only a +5-V supply is needed. The devices are completely static and require no refresh signal. Access time of the 5101s is 450 ns, with other versions available at 650 ns. Outputs of the RAMs are three-state. With the device deselected, current drawn is either 10 or 140  $\mu$ A, depending on the model. Units are available with guaranteed data retention at power-supply voltages as low as +2 V. The RAMs are housed in 22-pin plastic or ceramic DIPs.

CIRCLE NO. 404

### 8-bit registers have new package

Advanced Micro Devices, 901 Thompson Pl., Sunnyvale, CA 94086. (408) 732-2400. From \$4.30 (100-up); stock.

Three new high-speed low-power eight-bit registers come in a new 20-pin configuration. These low-power, serial-in/parallel-out universal shift-registers are available with either synchronous-or-asynchronous-clear modes and three-state outputs. The low-power Schottky devices (Am25LS23, Am25LS299 and Am154/74LS299) offer four modes of operation—hold (store), shift left, shift right and load data. The Am25LS23 has a synchronous clear function while the Am25LS299 has an asynchronous clear. Both devices have a typical shift frequency of 50 MHz. The Am54/74LS299—pin compatible with a like-numbered TI unit—is a reduced-performance version of the Am25LS299. All three circuits are available in molded and hermetic DIP packages, and are specified for operation over the commercial and military temperature ranges. They undergo 100-percent processing to the requirements of MIL-STD-883.

CIRCLE NO. 405

# Big Little DMM

You get bench-size accuracy and performance with our new, hand held, 3½-digit VOM. It's in a class by itself.

- Highly readable, field-effect LCD
- Semi-autoranging
- Fast, accurate response
- Small size, battery operated (ac optional)
- Low power consumption
- Built-in overload protection

See it at your VIZ distributor

**VIZ Test  
Instruments Group  
of VIZ Mfg. Co.**

335 E. Price St.  
Phila. PA 19144



**WD-751A  
\$179.00**

© VIZ  
6721

Formerly  
**RCA**  
Instruments

CIRCLE NUMBER 159

## COST-CUTTING WESTON BREAKTHROUGH!

### 3/8" MULTITURN CERMET TRIMMER

FOR ONLY **99¢** (1,000-Pc. Price)

Same High Weston Quality  
At A Real Savings In Price!



Weston has done it with the new #850! We took this widely used square multiturn trimmer, and by radically improving manufacturing techniques have been able to trim the price without sacrificing quality, performance or uniformity. It can give you an important new competitive edge.

WRITE FOR SPECS AND DETAILED  
PRICE INFORMATION.

**SANGAMO WESTON  
Schlumberger**

WESTON COMPONENTS & CONTROLS  
A Division of Sangamo Weston, Inc.  
Archbald, Pa. 18403  
Tel (717) 876-1500  
TWX 510 656-2902  
Telex 83-7443

CIRCLE NUMBER 160

ELECTRONIC DESIGN 24, November 22, 1976

## ENGINEERS & DESIGNERS

**Kearfott's success and stability  
offers a continuing pattern of  
growth — yours and ours!**

KEARFOTT's long and continuing role as an innovator and leader in aerospace navigation and computer technology has never been more filled with promise than it is today.

Career opportunities are available for experienced engineers who can participate in advanced development work on challenging avionic projects such as F-16, MRAALS, Space Shuttle, TALONS and others. Our current backlog of assignments offers excellent career advancement opportunities and long-term stability.

If you're seeking new challenges and steady growth with a highly successful organization, where your contributions are recognized, let's get together.

*Immediate positions available in the following areas:*

### LOGIC DESIGNERS

Opportunities involving sequential, high-speed and I/O interface logic and microprocessor applications in digital, signal processing, communication and aerospace systems. Familiarity with MS1/LS1 desirable. Requires several years experience in progressively more challenging logic design. BS/MSEE.

### MAGNETIC MEMORY DESIGN ENGINEER

Needs extensive background in core memory organization, circuits and magnetics, and familiarity with logic design. Experience in the design of precise high current, high frequency digital circuits essential. BS/MSEE.

### COMPUTER ENGINEER

Requires BS/MSEE and 10 years diversified experience in design & application of digital computers to airborne applications; customer liaison experience; ability to formulate responses to customer requirements as well as satisfactory execution of contractor requirements in a computer development program.

### SIGNAL PROCESSING ENGINEERS

Involves analysis and design of Signal Processing-Digital Communications Equipment for avionics plus TDMA and ICNI applications. Requires BSEE degree, Master's preferred, plus 2-5 years experience in communications theory, digital filters, coding theory, signal processing techniques, A/J analysis, error correction, phase locked loops, and related digital and RF hardware design.

### SIMULATION ENGINEER

Requires BS/MSEE and 2-5 years experience with the development of FORTRAN programs to simulate electronic systems for signal processing of RF, Baseband, noise, etc.

*Additional openings for experienced, degreed engineers in the following areas:*

- ANALOG CIRCUIT DESIGN
- COMPUTER SYSTEMS DESIGN
- AIRBORNE ELECTRONIC PACKAGING
- NAVIGATION SYSTEMS DESIGN & ANALYSIS

Please forward resume specifying position for which you are applying, and include salary requirements, to:  
**D. DeGennaro, Singer Co., 1150 McBride Avenue, Little Falls, New Jersey 07424.**

## SINGER

AEROSPACE & MARINE SYSTEMS

*An equal opportunity employer, m/f  
Who creates opportunities*

CIRCLE NUMBER 161

MILITARY  
APPLICATIONS

# AD CONVERTERS

by  
**MSK**

Accuracy

Speed

Size

Repairability

Military

Temp. Range  
-55°C to +125°C



- 4 Bit/50 nSec; Low Cost
- Ideal for Radar Scan Converters
- Holds Absolute Accuracy Over Temperatures
- Tracks a 10 MHz Analog Input



- 9 Bit/200 nSec.
- < 2 Bit Drift Over Temperature
- Insensitive to Clock Frequency

For Further Information Call or Write  
**M.S. Kennedy Corp.**  
Pickard Drive, Syracuse, New York 13211  
Tel. 315-455-7077

CIRCLE NUMBER 162

## POWER SOURCES

### $\mu$ P supplies in unit qty at high qty prices

*Deltron Inc., Wissahickon Ave., North Wales, PA 19454. (215) 699-9261. \$77: MPS-1, \$88: MPS-2 (unit qty); stock.*

The MPS Series  $\mu$ P power supplies are now UL recognized. Deltron's MPS series is interchangeable with Lambda's MPU series and sells for less than half the price. Two models are available: Model MPS-1 is rated 5 V dc at 3 A, 12 V dc at 0.6 A and 9 to 12 V dc at 0.6 A or 5 V dc at 0.38 A; Model MPS-2 is rated at 5 V dc at 7 A, 12 V dc at 1 A and 9 V dc at 1.2 A or 5 V dc at 0.75 A. Both units are mechanically interchangeable with other competitive units, and are covered by a full one-year warranty.

CIRCLE NO. 406

### Module watches the input line



*Calex Mfg., 3305 Vincent Rd., Pleasant Hill, CA 94523. (415) 932-3911. \$49; stock to 2 wk.*

The Model 829 Linesensor protects equipment against "brown-out" and overvoltage conditions. The module monitors the average value of an ac line voltage and provides a logic-level indication of the out-of-tolerance condition. Also, the unit is sensitive to sudden drops in line voltage. The nominal input is 115 V, 50 to 440 Hz. Other power sources are not needed—the module operates from the line voltage being monitored. Its comparator output is isolated from the input by means of a phototransistor (Model 829T) or by a set of relay contacts (Model 829R).

CIRCLE NO. 407

### Dc/dc converter outputs regulated to 0.2%



*Stevens-Arnold Inc., 7 Elkins St., South Boston, MA 02127. (617) 268-1170. \$160.00 (1-9); stock to 6 wks.*

Single-output 25-W low-noise isolated and regulated dc/dc converter modules, the P Series, accepts input levels of 12, 24 or 48 V dc and supplies dc outputs of 5 V, 5 A; 6 V, 4 A; 8 V, 3 A; 12 V, 2 A; or 15 V, 1.6 A. Regulation is  $\pm 0.2\%$  max. Output setting accuracy is typically  $\pm 0.5\%$ ; average voltage is  $\pm 0.01\%/^{\circ}\text{C}$ ; and stability is  $\pm 0.05\%/24$  h. Sense leads are also provided for point-of-load regulation and the reduction of IR-voltage losses normally experienced when delivering amperes of load current. Power transfer efficiency is 65%; isolation is  $1 \times 10^6 \Omega$  min at 500 V dc min; wideband noise is 40 mV pk-pk over a 5-Hz-to-20-MHz bandwidth; and converter switching frequency is 20 kHz and inaudible.

CIRCLE NO. 408

### 'Dynamic Variac' fakes brownouts

*Berman Corp., Box 1043, Nashua, NH 03060. (603) 888-1300. 2-3 wks.*

Why would anybody want a power source that produces mini-brownouts on purpose? To determine the "ride-through" capability of your product, of course. The PLM103 will deliberately drop from one to 999 half-cycles of line power, if you simply set the desired number on thumbwheel switches. Both manual and automatic operation (0.3 to 5 Hz) are provided. When used in conjunction with the Model CT-50 current transformer, surge current values and waveforms can be measured.

CIRCLE NO. 409





## Tenney finds 25 year old working Chamber!

Dick Wagner, Chief Engineer The Triplett Corporation, leading manufacturers of test instruments and panel meters, Bluffton, Ohio accepts contest prize from Bob Schiffman Executive Vice President of Tenney.

In 1951 Triplett ordered two chambers (models TH10 a humidity chamber and 12T-85200 a programmed -85°F chamber) both having mechanical refrigeration and both still in daily operation.

Proof positive of Tenney's quality, reliability and durability.

Shouldn't you also rely on the oldest and largest manufacturer of environmental equipment?



**Tenney**  
ENGINEERING, INC.

1090 Springfield Rd., Union, New Jersey 07083  
(201) 686-7870 • (212) 962-0332

747

CIRCLE NUMBER 163

## MODEL SP-G11 SPEEDEX RECORDER

Model SP-G11 is equipped with a built-in A/D converter in addition to common analog recorder functions. Since output terminals are also provided. It can be readily used in computation and for connection to a printer or paper tape punch.



### FEATURES

1. Digital output terminal (10-bit binary or 3-digit BCD)
2. External clock terminal permits chart drive by external clock.

### SPECIFICATIONS

1. Chart width ..... 250mm
2. Pen speed ..... 0.8 secs full scale
3. Measurement voltage ..... 0.5, 1, 5, 10, 50, 100, 500mV, 1, 5, 10, 50, 100V full scale
4. Chart speed ..... 10, 20, 50, 100, 300, 600mm/hr  
20, 50, 100, 300, 600mm/min
5. Digital output (A or B) ..... A...10-bit binary full scale at 1000 digit.  
1 digit 0.1%  
B...3-digits BCD  $10^2 10^1 10^0$  full scale 999

Please write us on your letterhead for detailed information.

**Riken Denshi Co., Ltd.**

5-5-2, Yutenji, Meguro-ku, Tokyo, Japan.  
TEL: 711-6656 TELEX: 0246-8107

CIRCLE NUMBER 164

ELECTRONIC DESIGN 24, November 22, 1976

## Meet the "low cost" Bowmar TP-3120 Thermal Printer

Available off-the-shelf, the new Bowmar TP-3120 thermal printer does a lot more than many of the others for a lot less. With a speed of 1.07 lines per second, this quiet printer continues to maintain its economical advantage by using low-cost, high contrast, non-smear paper. Small in size and cost, yet big in capabilities, it's equipped with such Bowmar quality features as 12 position, dual read-out standard connector, right or left justification and 5x5 matrix design. Other highlights of the new Bowmar TP-3120 include:

- 18-Column Alpha/Numeric Printout
- 29.4 Characters Per Second
- Low Power Consumption
- MOS Compatible
- Immediate Delivery

So if you're looking for a better and less expensive way to meet your thermal print-out needs, just send us the completed coupon and we'll send you full and detailed information on Bowmar's new "low cost" TP-3120 thermal printer by return mail.



Please send me full information on Bowmar TP-3120 Thermal Printer.

Name \_\_\_\_\_

Company \_\_\_\_\_

Street \_\_\_\_\_

City \_\_\_\_\_

State \_\_\_\_\_ Zip \_\_\_\_\_

Mail to: Bowmar Instrument Corp.  
Dept. ED, 8000 Bluffton Road  
Fort Wayne, IN 46809



**Bowmar**

CIRCLE NUMBER 165

237

# TEMPERATURE COMPENSATED CRYSTAL DIP OSCILLATORS

\$75.00 EA.  
(10 UNITS)

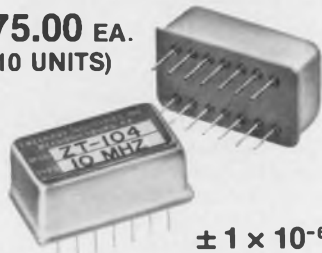

$\pm 1 \times 10^{-6}$

MODEL ZT - 104  
TTL COMPATIBLE  
10 MHZ

(other frequencies available)

CALL OR WRITE



**Greenray Industries, Inc.**

840 West Church Rd.  
Mechanicsburg, PA 17055  
Phone 717-766-0223

CIRCLE NUMBER 166

## PROGRAMMABLE DC SOURCES

CONSTANT CURRENT,  
CONSTANT VOLTAGE  
CONSTANT CURRENT/VOLTAGE  
FOR COMPUTER  
CONTROLLED SYSTEMS



- 12 or 16 Bits Resolution
- 10 ppm Stability
- Local Manual Programming Option
- Unipolar and True Bipolar
- High Precision Automatic Crossover in Current/Voltage Models
- 14 Standard Models to suit most requirements

**North Hills Electronics, INC.**

GLEN COVE, N.Y. 11542 • 516-671-5700

CIRCLE NUMBER 167

## MICROWAVES & LASERS

### VCOs to replace reflex klystrons



Hughes Aircraft Co., Electron Dynamics Div., 3100 W. Lomita Blvd., Torrance, CA 90509. (213) 534-2121. \$1550 up; 30 days.

Voltage-controlled oscillators of the 414XXH series cover 26.5 to 110 GHz with up to 100 mW at the lower, 50 mW at the higher frequencies. The Impatt oscillators perform comparably to reflex klystrons, with the advantages of smaller size and lower voltages. Longer life is also claimed. Inputs range from 20 to 50 V dc at 500 mA max, the tuning voltage for 100-MHz deviation is 0 to 10 V. Six frequency ranges are available: Ka, Q, U, V, E and W-band. In addition to the cavity-mounted Impatt diode, the units are supplied with in integrated isolator, attached regulator, and heat-sink stand.

CIRCLE NO. 410

### Broadband isolators span 2 to 8 GHz

Western Microwaves, 1260 Birchwood Dr., Sunnyvale, CA 94086. (408) 734-1631. \$450 (1 to 9); 30 days.

Covering a frequency range of 2 to 8 GHz, the PMI-2280 series of broadband isolators can handle loads of up to 10 W cw. There are three models available: one unit spans 2 to 2.2 GHz; the next, 2.2 to 6 GHz; and the last, 6 to 8 GHz. Isolation losses are 20 dB for the first two models and 17 dB for the last unit. Insertion losses are 1.25, 1.1 and 1.3 dB, respectively, and the VSWR stays at 1.3:1 for all three models. All isolators have an operating range of 0 to 55 C and measure 3.23 x 2.08 x 1.08 in. (excluding connectors, which are SMA female).

CIRCLE NO. 411

### Bandpass filters use YIG tuning at 20 MHz/mA

Syston-Donner, Advanced Components Div., 735 Palomar Dr., Sunnyvale, CA 94086. (408) 735-9660. From \$700 to \$1200; stock.

YIG-tuned reciprocal bandpass filters are available in two, three, four, or dual two-stage versions. The SDYF-4000 series covers seven frequency bands from 0.5 through 26.5 GHz. Typical characteristics include an insertion loss of 1 dB (or less) per stage, basic 3-dB bandwidth varying from 3% at 500 MHz to 0.3% at 18 GHz and a skirt selectivity of 6 dB/octave per stage. Typical tuning sensitivity is 20 MHz/mA, while the tuning rate is less than 10 ms/frequency band. Standard packages are 1.45 in. and 1.7 in. cubes, with a maximum weight of 9 and 17 oz, respectively.

CIRCLE NO. 412

### Rotary attenuators span 2-GHz range

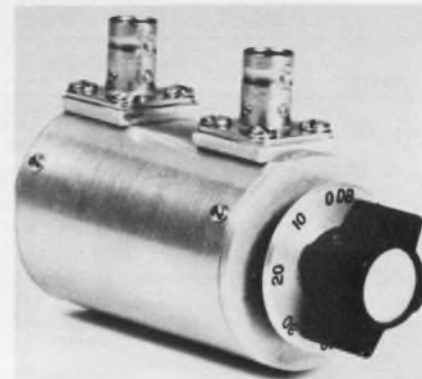

Kay Elemetrics, 12 Maple Ave., Pine Brook, NJ 07058. (201) 227-2000. \$109; 15 days.

These miniature rotary attenuators provide VSWRs of less than 1.3 to 1 and insertion losses of less than 0.5 dB over a 2-GHz frequency range. Repeatability over time comes from the use of printed circuits and self-cleaning rotary-switch action. All units take 2.5 in. of panel depth and weigh less than 10 oz. Models 502A (50 Ω) and 530A (75-Ω) provide 0-to-70-dB attenuation in 10-dB steps. Models 500A (50 Ω) and 510A (75 Ω) provide up to 10-dB of switchable attenuation in 1-dB steps. Models 1/500A (50 Ω) and 1/510 (75 Ω) provide fine-decimal step-attenuation control.

CIRCLE NO. 413

# selectivity you can count on!

## Murata Piezoelectric I.F. Filters for Communication Systems.

Marine, Amateur, Public Service, Citizens Band . . . Murata has a miniature piezoelectric ceramic I.F. filter that can provide the long-term selectivity, stability and performance you need, even under the most adverse environmental conditions. Ladder filters, series resonators, interstage coupling filters in a variety of I.F. frequencies and with dozens of selectivity curves are included in the line. Write for our complete technical information package, today.



**muRata**  
CORPORATION OF AMERICA  
2 WESTCHESTER PLAZA, ELMSFORD, NEW YORK 10523  
Phone: 914-592-9180 Telex: 13-7332

CIRCLE NUMBER 168

# 4 SWITCHED ON 4 ADVANTAGES!

**DIPSWITCH** was the industry's first rotary switch for DIP sockets. It offers the designer the versatility and reliability only experience can bring. Here are four reasons you should consider **DIPSWITCH** for your switching needs.

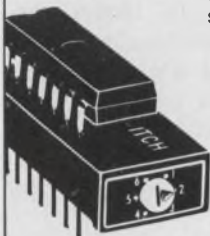

- 1 if savings board space is important, you can piggyback an IC right onto **DIPSWITCH**.
- 2 if you need additional switch closures, **DIPSWITCH** can be tandem coupled using extended shafts.
- 3 if multilayered boards are part of your design, **DIPSWITCH**'s .230" profile is about half anybody else's. You can stack as close as 1/4".
- 4 if you need special switch closure programming, **DIPSWITCH**'s six independent cams can be factory assembled to perform your programming.

**DIPSWITCH** is a Registered Trademark of the McGraw-Edison Company. Pat. No. 3621157



**EDISON ELECTRONICS**  
a McGraw-Edison Company Division  
Greiner Field Municipal Airport, Manchester, New Hampshire 03103 1503-659-0940

CIRCLE NUMBER 169

ELECTRONIC DESIGN 24, November 22, 1976

# Need High Performance Instrument CRTs?



it's an easy choice...

## DuMont for

- Working bandwidths up to 350 MHz (900 MHz cutoff @ -3dB)
- Superior pattern geometry and linearity
- Exclusive quadrupolar lens scan expansion
- Outstanding performance per dollar cost

For top performance in demanding instrumentation applications, DuMont gives you your choice of phosphors, including proprietary multi-color and multi-persistence, with aluminumized screen and internal graticule. For superior contrast and ease of viewing, DuMont provides a selection of phosphor-matched contrast filters and laminated non-glare or edge-lighted panels as well as bonded safety panels. Available electrical options include beam gating, dynamic focusing, twist coils, external conductive coating, and post acceleration (single or multi-gap, linear or non-linear spiral).

For any CRT, DuMont should be your first choice. After all, no other company has as much CRT experience.

For more information about our high-performance instrument CRTs, or for fast help for any CRT need, call our Sales Department, (201) 773-2000.



Subsidiary of **THOMSON-CSF**

# DuMont

 Electronics Corporation

750 Bloomfield Avenue, Clifton, New Jersey 07015

CIRCLE NUMBER 170



## The Accuracy Policy of Electronic Design Is:

- To make diligent efforts to ensure the accuracy of editorial matter.
- To publish prompt corrections whenever inaccuracies are brought to our attention. Corrections appear in "Across the Desk."
- To encourage our readers as responsible members of our business community to report to us misleading or fraudulent advertising.
- To refuse any advertisement deemed to be misleading or fraudulent.

This statement of accuracy has appeared in every issue of *Electronic Design*, from the very first one. Staff members are imbued with it, from their very first day.

### Electronic Design

50 Essex Street  
Rochelle Park, New Jersey 07662  
(201) 843-0550

## Application Notes

### Microwave detectors

The *Narda Probe* describes the physical properties of semiconductor diodes, their application in microwave detectors and typical characteristics and trade-offs required in selecting detectors for system and bench applications. Narda Microwave, Plainview, NY

CIRCLE NO. 414

### Capacitors

"Effect of DC Life on the Discharge Life of Pulse Capacitors," a seven-page paper, discusses the interaction of both dc and pulsed conditions and the effect of different types of power supplies on capacitor life. Capacitor Specialists, Escondido, CA

CIRCLE NO. 415

### Liquid-crystal displays

"Basic Guide to the New Liquid-Crystal Displays," a 20-pager, traces the development of liquid-crystal technology from 1888 to the present day. Advantages and disadvantages of field-effect LCDs vs dynamic scattering LCDs are discussed. Shelly Associates, Irvine, CA

CIRCLE NO. 416

### Terminal blocks

How to select terminal blocks is covered in an eight-page brochure. Cogenel Inc./Entrelec Div., Elmsford, NY

CIRCLE NO. 417

### Conversion counters

"New Digital Techniques Applied to Rate Measurement" describes recipromatic computation principle and basic operation of time-interval conversion counters and their applications. Orbit Controls, Cheltenham, Glos GL51 8PL, England.

CIRCLE NO. 418

### GaAs FETs

New techniques of circuit design and device handling required when designing with gallium-arsenide field-effect transistors at microwave frequencies are covered in a 12-page brochure. Plessey Microsystems, Irvine, CA

CIRCLE NO. 419

### Op amp parameters

Three application bulletins detail op-amp, log-amp and power-supply parameters and their measurements. Teledyne Philbrick, Dedham, MA

CIRCLE NO. 420

### Uhf amplifiers

Designs for four high-performance uhf amplifiers are described in a paper. The paper contains construction hints, photos of the circuits, schematics and parts list. Communications Transistor, San Carlos, CA

CIRCLE NO. 421

### Filters

The effective use of filters in signal-processing systems is given in *The Application of Filters to Analog and Digital Signal Processing*, a 24-page handbook. Rockland Systems, West Nyack, NY

CIRCLE NO. 422

### Pattern analyzer

The use of the HP 1620A pattern analyzer in oscilloscope-based troubleshooting of digital instruments is described in an application note. Hewlett-Packard, Palo Alto, CA

CIRCLE NO. 423

### Power amplifiers

"Add Power to your Network Analyzer," a four-page brochure, demonstrates how linear power amplifiers permit network analyzers to measure complex impedance of high-power components over the 100-MHz-to-12-GHz frequency range. Microwave Power Devices, Plainview, NY

CIRCLE NO. 424

# DO YOU NEED A RUGGED CONTROL SYSTEM SHAFT ENCODER?

## BEI HAS IT!



BEI Series 3700 optical shaft, incremental encoders will meet machine tool specifications. . .

- rugged- 3.5" dia. construction, sealed and protected against severe environments.
  - rugged- industrial grade solid state light source.
  - rugged- high shaft loads, 40 lbs.
- . . . plus dual inch/metric resolutions...plus direction sensed counts to 12,700 per revolution...plus noise immune, low impedance TTL line driver outputs.

For best performance, best reliability in your digital control system phone or write BEI today.



### BEI Electronics Inc.

CONTROLS AND INSTRUMENTS DIVISION  
1101 McAlmont Street, Little Rock, Ark. 72203  
Telephone: 501-372-7351 TWX: 910-722-7384

CIRCLE NUMBER 172

# NEW! - FIRST DIGITAL STROBOSCOPE/TACHOMETER



## "DIGISTROBE"

- Easy to use
- No range switches
- No scales to read
- No calibration
- Freeze motion and get instant RPM
- External input
- 200 to 12,000 RPM or FPM (up to 100,000 with harmonics)

\$395<sup>00</sup>  
F.O.B.  
Skokie, Ill.

5 BIG  
3/8" HIGH L.E.D.'s

MADE IN  
U.S.A.

QUARTZ  
CONTROLLED  
ACCURACY  
±1 RPM

Distributor Inquiries Invited

6995C

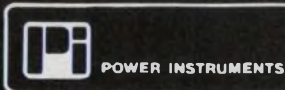

Integrity Since 1960

### POWER INSTRUMENTS INC.

7352 North Lawndale  
Skokie, Illinois 60076  
Telephone (312) 676-2300

CIRCLE NUMBER 173

ELECTRONIC DESIGN 24, November 22, 1976



# FAST BASIC I begins where Hewlett-Packard left off.

FAST BASIC I is the most powerful general-purpose ROM ever developed for the HP 9830A/B.\*

With 28 statements, commands and functions, it brings the machine language up to big system level.

Consider this. Array manipulations can now be executed **hundreds** of times faster than a '30 with a MAT ROM, and **thousands** of times faster than the basic machine. If your machine has mass memory, FAST BASIC I provides equally important system enhancements.

But don't take our word for it! Try this amazing ROM for yourself completely free of charge. Just mail the coupon and you will promptly receive FAST BASIC I for your own evaluation. After 30 days, if you do not want to purchase it, return it and you have no further obligation whatsoever. Otherwise remit \$675 (the full purchase price) and keep your '30 running **FAST BASIC**.

\*a product of Hewlett-Packard.



## Infotek Systems

733 EAST EDNA PLACE • COVINA, CALIFORNIA 91723  
(213) 966-7431 • TWX 910-584-1812

Infotek Systems  
P. O. Box 1436  
Covina, CA 91722

ED

Please rush FAST BASIC I to me free of charge. If I do not want to purchase it after using it for 30 days, I will return it to you at your expense.

Name (Please Print) \_\_\_\_\_

Company \_\_\_\_\_

Address \_\_\_\_\_

City/State/Zip \_\_\_\_\_

Position \_\_\_\_\_ Serial No. \_\_\_\_\_  
of my 9830

CIRCLE NUMBER 174

# TOUCH-TONE\*

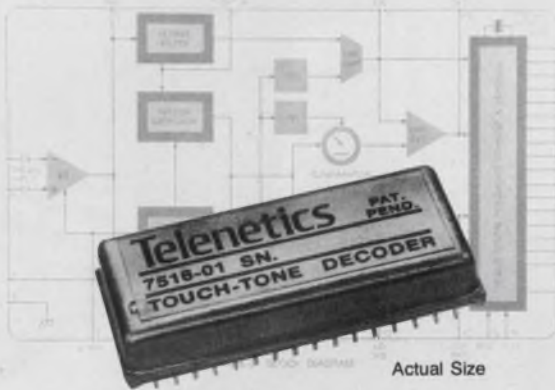

Telenetics' 7516-01 is a complete Touch-Tone Decoder in a 1/2 cubic inch, 32 pin DIP. Telephone Standard 2-of-8 tones are received, processed and decoded into discrete 1-of-16 or BCD (plus strobe) outputs. Input signal ranges -22 to +4 dBm with a balanced, capacitively coupled, 50 K $\Omega$  impedance. Operating voltage range is 8 to 28V dc (single supply); temperature range -30 to 70°C.

Telenetics 7516-01 gives you one-tenth the size at one-third the cost of comparable Touch-Tone Receivers. Telenetics also offers these other devices:

- 7603 Touch-Tone Encoders
- 7511 Address Selector
- 7507 A complete line of Multiplexers and Analog Switches
- 7635 Touch-Tone Keyboards

Write or call today for a catalog—and pricing information:

## Telenetics

Telenetics, Inc., 4120 Birch Street,  
Newport Beach, California 92660  
Phone: (714) 752-6363

\*R- Registered trademark of AT&T

CIRCLE NUMBER 175

# LINEAR POWER AMPLIFIER 10-1000 MHz · 1 Watt



Type : 10-22-10  
Inst. Bandwidth: 10-1000 MHz

Gain : 22 dB

Flatness :  $\pm 1$  dB

IMP 3<sup>rd</sup> order : + 40 dBm

IMP 2<sup>nd</sup> order : + 62 dBm

NF : 10 dB

Output Power (1dB comp) : +29 dBm

Impedances 50 ohms ; VSWR : 2/1

+ 24 Vdc — 0.8 A



SCD NUCLETUDES

27<sup>Ter</sup> rue du Progrès 93107 MONTREUIL

FRANCE Tel : 374-44-33

CIRCLE NUMBER 176

# new from Hayden!

*“... well-organized, extremely well written ...  
highly recommended for practicing engineers...”*

IEEE Transactions

## DIGITAL SIGNAL ANALYSIS

Samuel D. Stearns

This is an ideal master handbook on today's signal processing procedures and systems, containing recent advances, new design material, and a comparison between continual and digital systems that's extremely helpful to newcomers to the field. Featuring a foreword by Richard Hamming, the book contains a review of linear analysis; sample-data systems; analog-to-digital and digital-to-analog conversion; the discrete Fourier transform and the fast Fourier transform algorithm; spectral computations; non-recursive and recursive digital systems; computer simulation of continual systems; analog and digital filter designs, and more. 288 pages

*“Jacobi's book is great ... a new, original, readable, usable book on writing for business and professional people. ...”*

Jim Lufkin, Mgr. Professional Publications, Honeywell

## WRITING AT WORK: Dos, Dont's, and How Tos

Ernst Jacobi, Xerox Corporation.

This guide to better writing follows its own principles by being lively, informative, and easy to read. More than a collection of pat rules and formulas, the book is a storehouse of practical advice for business and professional people to make their writing sharper, more interesting, and more informative. It shows you how to overcome procrastination and change your entire attitude toward writing, making it easier and more enjoyable for you! 208 pages.



**HAYDEN BOOK COMPANY, INC.**  
50 Essex Street, Rochelle Park, New Jersey 07662

**Order today—15-day examination!**

Please send me the following book(s) to read and use FREE for 15 days. At the end of that time, I'll either send the amount indicated, plus postage and handling, or return the book(s) with no obligation.

- DIGITAL SIGNAL ANALYSIS, #5828-4, \$19.95  
 WRITING AT WORK, #5730-X, \$10.95

Name \_\_\_\_\_

Company/Institution \_\_\_\_\_

Address \_\_\_\_\_

City/State/Zip \_\_\_\_\_

**SAVE MONEY! Payment Enclosed.** Publisher will pay all shipping and handling charges. Same 15-day return privilege and full refund if not satisfied

## Evaluation Samples

### Temperature recorders

Miniature, self-contained  $\pm 1\%$  accuracy temperature recorders are easily applied to electronic components and can be read at a glance. As each indicator is exposed to heat exceeding its calibrated temperature, it turns permanently and irreversibly black. Maximum thickness is 0.01 in. William Wahl Corp., Temp-Plate Div.

CIRCLE NO. 425

### Lever handle

The J60 lever handle is an actuator option for many of C&K's subminiature switches. The support bracket provides a longer life-span for this switch option by virtually absorbing all of the actuation stress. C&K Components.

CIRCLE NO. 426

### Heat sinks

Low-wattage aluminum semiconductor heat sinks are available in a sample kit. Aavid Engineering.

CIRCLE NO. 427

### Synchro clamps

Synchro clamps are quick releasing, self-locking and instant nulling. The clamps' integral stops permit their position to be felt in the locked and unlocked positions. They lock and unlock simply with a half-turn of the screw. Timber-Top.

CIRCLE NO. 428

### Metal bellows

Miniature metal bellows are used in a variety of industrial applications. Specifications and dimensions for the "Workhorse Bellows" are: O.D., 0.250 in.; I.D., 0.150 in.; wall thickness, 0.0012 in.; 22 active convolutions; spring rate of 3.3 lb/in.; compression capability of 0.179 in. and a pressure rating of 185 psi. Servometer.

CIRCLE NO. 429

## Design Aids

### Control panels

"Control Panel Layout Design Guide" discusses such design considerations as operator requirements, environmental considerations, manual controls, visual displays and maintainability, as well as the use of color in panel and control housing, coding and illumination. Micro Switch.

CIRCLE NO. 430

### Washers

Flat, shoulder and finishing washers designed to be used with threaded and unthreaded fasteners as spacers, insulators, seats, shims, seals and bearings are listed on a wall chart. Sherman Metal Works.

CIRCLE NO. 431

### Triacs and SCRs

A 32-page cross-reference guide indicates the RCA types recommended as replacements for more than 2100 triacs and silicon controlled rectifiers. RCA.

CIRCLE NO. 432

### IC sockets

A fold-out easy-to-read selection chart shows each group of Cambion IC sockets. Detailed dimensional drawings as well as part numbers are included. Cambridge Thermionic.

CIRCLE NO. 433

### Component parts

Nylon, acetal, polyester and phenolic parts for use in product assemblies are shown in a 16-page design guide. Sample parts are available. Security Plastics.

CIRCLE NO. 434

### Relays

An 18-page relay selection guide provides an easy reference for selecting and specifying the right relay for a particular application. Arrow-M.

CIRCLE NO. 435

**Q.** How do you resolve two signals spaced 1 Hz apart at 2 MHz?



**A.** With EMR's new Model 1520 Digital Spectrum Translator and Model 1510-03 Digital Real-Time Spectrum Analyzer.



Why go partway in analyzing data? Get the resolution performance edge of our Model 1510-03 Digital Real-Time Spectrum Analyzer, then go it one better. Enhance frequency resolution still more by adding the Model 1520 Digital Spectrum Translator to concentrate the full resolution of the Analyzer about a selectable point of interest in the spectrum. For that matter, why stop there? Step up from 25.6 kHz to a full 2 MHz upper frequency limit by adding the optional Model 1521 Range Extension Module, too!

Other features of the unequalled 1520 Translator: nine translatable frequency ranges from 25.6 Hz to 10.24 kHz; center frequency selectable in 1-Hz steps and automatic gain ranging — each with an easy-to-read LED display; plus, an automatic frequency sweep. Full-scale out-of-band signal to minimum-detectable in-band signal exceeds 100 dB.

**EMR** Schlumberger

EMR Telemetry  
Weston Instruments, Inc.  
Box 3041, Sarasota, Florida 33578  
(813) 371-0811

# Electronic Design's 1976-77 GOLD BOOK



**THE INDUSTRY'S  
BEST DIRECTORY  
GETS EVEN  
BETTER!**



# MOST COMPREHENSIVE ELECTRONICS DIRECTORY IN THE WORLD

THE GOLD BOOK HAS  
**5,280**  
PRODUCT HEADINGS  
AND CROSS-REFERENCES  
(EEM HAS ONLY 3,281)

THE GOLD BOOK LISTS  
**7,648**  
MANUFACTURERS  
(EEM LISTS ONLY 4,195)

THE GOLD BOOK LISTS  
**83,930**  
SALES OUTLETS  
(Sales offices, reps, export offices  
and distributors under manufacturers)  
(EEM LISTS ONLY 40,268)

THE GOLD BOOK LISTS  
**2,198**  
DISTRIBUTORS  
(EEM HAS DROPPED ITS  
DISTRIBUTOR DIRECTORY THIS YEAR)

THE GOLD BOOK LISTS  
**7,812**  
TRADE NAMES  
(EEM HAS DROPPED ITS TRADE  
NAME DIRECTORY THIS YEAR)

## THE GOLD BOOK KEEPS ON GROWING

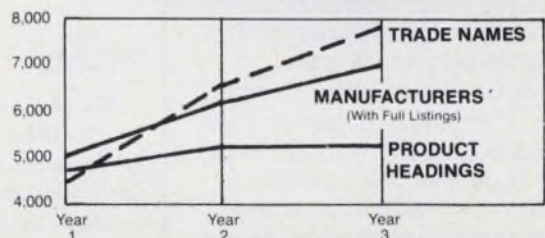

SPEED YOUR FIRST-STEP SEARCH FOR PRODUCTS  
SIMPLIFY CONTACT WITH SUPPLIERS  
OBTAIN IMMEDIATE SPECIFYING INFORMATION AND DATA

**IF IT'S ELECTRONICS...IT'S IN THE GOLD BOOK**

# The PRD programmable vector voltmeter measures nearly everything...

It goes all the way up to 2.4 GHz. It measures ■ network parameters ■ harmonic generators ■ components ■ radars ■ crystals ■ antennas ■ parasitic effects ■ amplifiers ■ gain attenuation ■ circuits ■ group delay ■ receivers ■ phase shift ■ crystals ■ frequency response ■ filters ■ voltage/power ratio ■ transistors ■ voltage/power level ■ mixers ■ reflection ■ isolators ■ return loss ■ attenuators ■ complex impedance ■ delay lines ■ AM index ■ cables ■ s, h, y, z parameters ■ and much, much more.



Still the only programmable Vector Voltmeter available is the PRD 2020. It has 50-ohm coaxial inputs (no probes); and its control functions can be programmed through a single rear-panel connector by standard TTL logic levels. Planning to automate your RF and microwave testing? Learn more about the cost-effective P2020 Vector Voltmeter... send for latest application notes on our Vector Voltmeter series. Write: Harris Corporation, PRD Electronics Division, 1200 Prospect Avenue, Westbury, L.I., N.Y. 11590



**HARRIS**  
PRD ELECTRONICS

CIRCLE NUMBER 179

## New Literature

### TIME DELAY RELAYS



#### Time-delay relays

A 28-page time-delay catalog includes application data, descriptions of delay functions, a glossary of terms and complete specifications, selection guide and dimensional drawings. Magnecraft Electric, Chicago, IL

CIRCLE NO. 436

#### Computing system

The 2200 portable computing system is described in a four-page brochure. The brochure discusses a variety of optional features and peripherals, and photos and specifications illustrate the capabilities of this system. Wang Laboratories, Tewksbury, MA

CIRCLE NO. 437

#### PROMs

Features that make TI's Schottky PROM family a low-cost, highly reliable, space-saving solution for system designers are described in a four-page brochure. Texas Instruments, Dallas, TX

CIRCLE NO. 438

#### Fluoropolymers

Properties and performance of Tefzel fluoropolymers as wire insulation are listed in a 12-page guide. Dupont, Wilmington, DE

CIRCLE NO. 439

#### Circular connectors

Standard circular connectors designed to MIL-C-5015 are highlighted in a 32-page brochure. ITT Cannon Electric, Santa Ana, CA

CIRCLE NO. 440

#### Switches

Photos, line drawings, specifications and ordering information on over 300 switches are contained in a 24-page catalog. Chicago Switch, Chicago, IL

CIRCLE NO. 441

#### Minicomputer

Complete specifications of the GA-16/440 16-bit systems and OEM minicomputer are detailed in a 24-page brochure. Hardware features and options are covered. General Automation, Anaheim, CA

CIRCLE NO. 442

#### Industrial switches

A well-illustrated, 256-page publication describes position sensing and manual switches designed for pilot duty industrial applications. The catalog is organized into three sections: no-touch position sensing controls; electromechanical position sensing switches and manually operated controls. Micro Switch, Freeport, IL

CIRCLE NO. 443

#### Security equipment

An informative 64-page guide to alarm equipment application includes alarm system discussion, installation procedures and detailed connection diagrams. Mountain West Alarm Supply, Phoenix, AZ

CIRCLE NO. 444

#### Linear circuit tester

Testing methods for a wide variety of op amps, comparators, voltage followers and regulators plus other linear ICs are described in a 10-page brochure. The tests are defined and illustrated in block diagrams. GenRad, Concord, MA

CIRCLE NO. 445

## Rechargeable batteries

Rechargeable nickel-cadmium batteries are described in a 14-page Microprocessor Battery Selector Guide. The guide explains the phenomena of voltage depression—memory—and cell reversal. General Electric, Battery Dept., Gainesville, FL

CIRCLE NO. 446

## Connectors

Circular electrical/electronic connectors are covered in a 32-page catalog. The catalog outlines 11 series of connectors and includes military specifications and configuration drawings as well as accessories. Malco, Montgomeryville, PA

CIRCLE NO. 447

## Sealed relays

Engineering specifications, outline drawings and mounting information on sealed relays are provided in a 16-page catalog. Arrow-M, Mountainside, NJ

CIRCLE NO. 448

## Transistors or chips

Npn small signal transistors or chips are described in a series of six data sheets. Sprague Electric, North Adams, MA

CIRCLE NO. 449

## Programmable controllers

Photos, system descriptions and schematics highlight a 12-page programmable-controller catalog. Allen-Bradley, Cleveland, OH

CIRCLE NO. 450

## Voltage regulators

A Voltage Regulator Handbook places special emphasis on design techniques. The handbook starts with the basics of power-supply design and covers transformer specification, rectifier circuits and how to specify them, filtering and load effects. To buy this handbook, send \$3 (CA residents add 6% sales tax) to the Marketing Services Dept., National Semiconductor, 2900 Semiconductor Dr., Santa Clara, CA 95051.

INQUIRE DIRECT

## SCR power supplies

Specifications and pricing information on single and three-phase SCR power supplies, ranging from 50 to 10,000 W, are given in a 14-page catalog. Electronic Measurements, Neptune, NJ

CIRCLE NO. 451

## $\mu$ P controller system

The EPTAK microprocessor controller system—designed for process control, machine control and other applications calling for advanced programmable control—is described in an eight-page brochure. Eagle Signal, Davenport, IA

CIRCLE NO. 452

## Rental program

A new leasing/rental/installment purchase program offered by the 3M Industrial Electrical Products Div. is described in an eight-page brochure. 3M, St. Paul, MN

CIRCLE NO. 453

## Ironless rotor dc motor

An illustrated bulletin shows the 9904 120 12601 series of 12-V-dc ironless rotor motors. A specification chart provides essential operating characteristics. North American Philips Controls, Cheshire, CT

CIRCLE NO. 454

## $\mu$ C development system

A four-page brochure describes the Servant-8 microcomputer development system. Logical Services, Mountain View, CA

CIRCLE NO. 455

## Data-conversion components

A 288-page engineering product handbook contains information on the following products: a/d and d/a converters, sample-holds, analog multiplexers, op amps, power supplies, dc-dc converters, DPMs, digital panel printers, digital panel instruments, data-logging instruments, data-acquisition systems and computer analog I/O systems. Datel Systems, Canton MA

CIRCLE NO. 456

# All you need to know about synthesizers

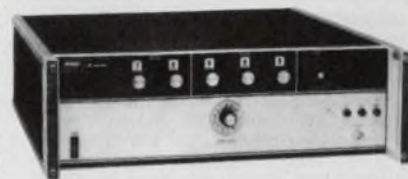

## ...and amplifiers.



### The highlights:

The PRD 7828 Frequency Synthesizer has 1 kHz phase-lock steps from 1 kHz to 80 MHz, has optional vernier, is fully programmable and offers excellent stability. The PRD 7808 Signal Generator/Frequency Synthesizer-Sweeper has digital synthesizer performance yet provides AM, FM and pulse modulation and sweep capabilities. Both are remarkably cost-effective.

The PRD 7805 Broadband Linear RF Amplifier is an all-purpose, 10-watt instrumentation amplifier in the 0.05 to 80 MHz range. The PRD 7815 Tunable Amplifier is ideal for obtaining up to 8 watts in the 10 to 500 MHz range. Both are perfectly matched to the synthesizers.

### The whole story:

Everything else you need to know is in our "PRD RF and Microwave Catalog." Ask for it today. Call (516) 334-7810. Or write:



HARRIS CORPORATION  
PRD Electronics Division  
1200 Prospect Avenue  
Westbury, L.I., N.Y. 11590



**HARRIS**  
PRD ELECTRONICS

CIRCLE NUMBER 180

## classified ad

**MANAGER OF DEVELOPMENT** — Plan, coordinate and perform R&D leading to patentable combinations of plastic and electronic components for unique radome antenna products and applications. Design, develop and manage the prototype construction, measurement, test and manufacture of resulting products. Create market potential and assist sales effort in introducing new and existing products to fields such as radar, communications and special electronic applications. Significant professional expertise and previous experience required. Please send resume and salary requirements in complete confidence to:

Box #CM  
ELECTRONIC DESIGN  
50 ESSEX ST  
ROCHELLE PARK NJ 07662  
An Equal Opportunity Employer

Help your  
Heart...  
Help your  
Heart Fund

American Heart Association



The President's Committee  
on Employment of the Handicapped  
Washington, D.C. 20210

## Bulletin Board

Vishay now stocks its S102-type Bulk Metal precision resistors in all the standard values outlined by the MIL-R-55182 0.5% resistor tables. The resistors are available either immediately from stock or within 10 days at reduced prices.

CIRCLE NO. 457

Fairchild has set a new pricing range for its 5-V, logic-powered DPMs. Prices for the Model 32 3-1/2-digit meters are \$75 (1-49), \$71 (50-99), and \$67 (100-up). Pricing for the Model 42 4-1/2-digit meters are \$119, \$110 and \$99 for the same quantity ranges.

CIRCLE NO. 458

Intech/Function Modules has introduced the A-733J, a multiple-function mathematical module, which is a direct replacement for Analog Devices' 433J. The A-733J is priced at \$70 (1-24).

CIRCLE NO. 459

Biomation has reduced prices for its Model 810-D logic analyzer and 810-D accessories. The 810-D has been reduced from \$1995 to \$1495. Probes for the 810-D have been reduced to \$100.

CIRCLE NO. 460

Electro Corp. has redesigned its line of 5/8-in. thread magnetic sensors. The improvements include integral connector designs, improved magnetic efficiency, a uniform monolithic encapsulation method and fewer internal components.

CIRCLE NO. 461

Monolithic Systems has reduced the price on its fully hardware and software compatible PDP-11, including the 11/04, MONO-STORE® VII add-in memory system. Single quantity prices are \$795 for 4 k × 16, \$1075 for an 8 k × 16 and \$1350 for a 12 k × 16 system.

CIRCLE NO. 463

## Vendors Report

Annual and interim reports can provide much more than financial position information. They often include the first public disclosure of new products, new techniques and new directions of our vendors and customers. Further, they often contain superb analyses of segments of industry that a company serves.

Selected companies with recent reports are listed here with their main electronic products or services. For a copy, circle the indicated number.

**Indian Head.** Utilities and communication products, metal and automotive products; containers and microfilm.

CIRCLE NO. 464

**Milton Roy.** Industrial and health-care products.

CIRCLE NO. 465

**RCA.** Electronic consumer products and services; broadcasting; communications; solid-state components; government business and R&D.

CIRCLE NO. 466

**Hoffman Electronics.** Airborne navigation systems; military and civilian communications systems and multimedia education systems.

CIRCLE NO. 467

**Technicon.** Automated instruments and systems for analysis of blood and serum.

CIRCLE NO. 468

**Philip A. Hunt Chemical Corp.** Chemicals used in image-forming processes.

CIRCLE NO. 469

**Dynascan.** CB radios, precision test equipment and radio remote control systems.

CIRCLE NO. 470

**Bliss & Laughlin Industries.** Metal products.

CIRCLE NO. 471

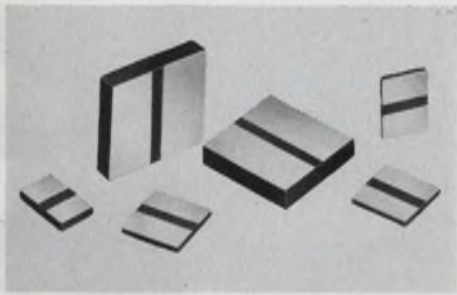

**CERAMIC CHIP CAPACITORS. SPLIT-CHIP**, is a new concept in ceramic chip capacitor technology. These new units have two broad electrodes on one face and eliminate conventional wrap-around end terminations. This new concept provides lower cost and easier assembly. SPLIT-CHIPS are available in five standard sizes from .040" x .030" to .130" x .090" and .015" thick and in all popular dielectrics and capacitance ranges. JOHANSON DIELECTRICS, INC., Box 6456, Burbank, Ca. 91510 213-848-4465

CERAMIC CHIP CAPACITORS

212



**SPEED LEAD BENDING OPERATIONS.** Cut costs by 50%! Fast, exact, thumbwheel control adjusts to precise measurements. Match pointers with eyelet holes in circuit boards by adjusting knurled wheel with thumb, automatically spacing bends for insertion of component into boards. All axial lead components accommodated. From 1/2" x 1 1/2" long with max. distance between inside of bends of 1.725". Harwil Co., 1548 17th Street, Santa Monica, CA. 90404. (213) 829-2310

COMPONENT LEAD BENDER

215



**RCA FLAMEPROOF FILM RESISTORS.** Design engineers prefer them because they won't flame or short under the most severe conditions. These resistors have a 2% tolerance, and are available in 1/4 watt, 1/2 watt, 1 watt, and 2 watt ratings. Resistance values range from 10 Ohms to 1.5 Megohms, depending on wattage rating. 475 film resistors to choose from. RCA Distributor & Special Products Division, Sales Promotion Services, Cherry Hill, N. J. 08101.

FILM RESISTORS

218

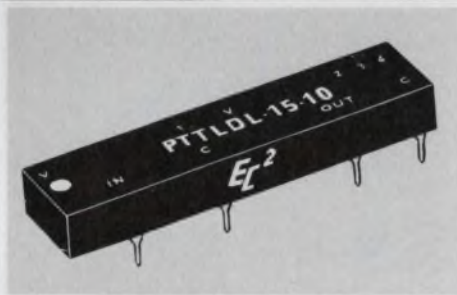

**EC<sup>2</sup>'s new Digitally Programmable T<sup>2</sup>L** Logic Delay lines feature Schottky T<sup>2</sup>L input and output; 15 models with time delays to a max of 255ns; 16 delay steps available with 1ns, 2ns, 3ns, 5 ns, 10 ns or 16ns resolution; propagation delays fully compensated; 32-pin dip package (.250 high); 4ns max rise time on all delays; 10 T<sup>2</sup>L fanout; programming by remote switching or automatically by computer-generated data. Engineered Components Company, P.O. Box Y, San Luis Obispo, Ca. 93406 (805) 544-3800

LOGIC DELAY LINE

213



**Basic Electricity & Basic Electronics** by Van Valkenburgh, Nooger & Neville, Inc. Derived from the COMMON-CORE Training Program initially developed for the U.S. Navy. Thorough, comprehensive coverage. Available in separate paperbacks or cloth volume. Write for FREE brochure. Hayden Book Co., Inc., 50 Essex St., Rochelle Pk, N.J. 07662 (201) 843-0550.

TRAINING TEXT

216

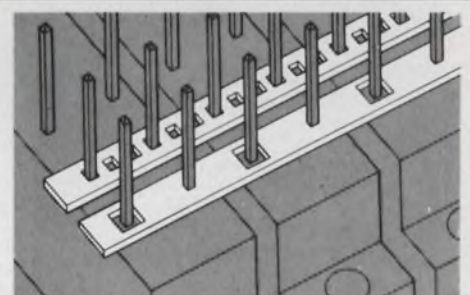

**STRIP/BUS BY ROGERS.** Low Cost Bussing Systems; easy installation, reliable solder joints; greater pin exposure. Write or call for details. Rogers Corporation, Chandler, AZ 85224. Phone (602) 963-4584. (EUROPE: Mektron NV, Ghent, Belgium; JAPAN: Nippon Mektron, Tokyo)

STRIP/BUS

219

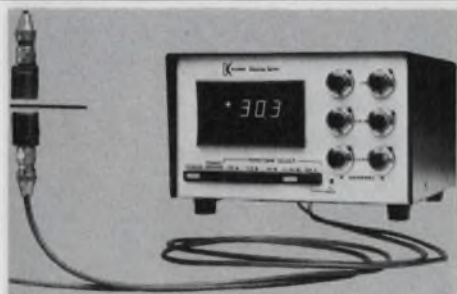

**New Electronic Gage, Easy To Use.** Thickness, Alignment . . . diameter or deviation measurements, concentricity, orbit tracing, etc. Accuracy up to ± micro-inches (± 0.001 inch), resolution <10 microinches. Utilizes non-contacting inductive measuring techniques—unaffected by oil, grease, or water. Replaces LVDT, air gage, dial indicator, micrometer, \$1,995. Ask for information on KD-2602-2S. Kaman Sciences Corporation, P.O. Box 7463, Colorado Springs, Colorado 80933. (303) 599-1500

ELECTRONIC GAGE

214



**PREFORMED PRINTED CIRCUIT BOARD JUMPERS.** Stop wasting your valuable production time cutting, stripping and bending P. C. B. jumper wires. SQUIRES ELECTRONICS jumpers feature: • Bare, PVC or teflon insulation. • No tooling or setup charges for standard sizes • All wire meets Mil or U.L. specifications • Low - low cost. • Fast delivery. For literature and pricing contact: SQUIRES ELECTRONICS, 8900 S.W. Burnham Rd., Tigard, OR. 97223 (503) 620-4686

JUMPER WIRES

217



**MEMODYNE INCREMENTAL LOW POWER DATA LOGGER** Model 2221, is ideal for remote or unattended collection of sporadic measurements. Features 16 channels, 0 to +10 volt analog input, 12 bit resolution, over 2 megabit capacity per 300 foot cassette. Standby current is less than 50 microamps. Available for line or battery operation. Unit price is \$1670.00. Memodyne Corporation, 385 Elliott Street, Newton Upper Falls, Massachusetts, 02164. (617) 527-6600.

LOW POWER DATA LOGGER

220



Krohn-Hite Model 5800A function generator, budget priced at \$245, offers sine, square and triangle waveforms over a range of 0.2 Hz to 2 MHz. Distortion is typically less than 0.3%. Simple 1000:1 frequency tuning dial. Pushbutton controls. 50-ohm output adjustable from 5 mv pk-to-pk to 15 volts. Auxiliary 1-volt pk-to-pk square wave output. Stock delivery. KROHN-HITE, AVON INDUST. PARK, AVON, MA 02322

FUNCTION GENERATOR

221

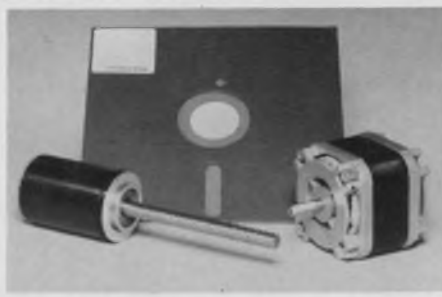

**FLOPPY DRIVE TEAM!** Now, drive motors and stepping motors specifically for flexible disc systems—both from EAD. The drive motor has excellent torque, precise repeatable speeds, 1/1000 hp, 1500 rpm @ 50 Hz, 1800 rpm @ 60 Hz. Stepping motors are Size 18 and 20, with single of multiple start lead screw, 3- or 4-phase, 24 step/15°. Write or call: Eastern Air Devices, Holtzer-Cabot Motors, Dover, N.M. 03820, (603) 742-3330, TWX (510) 297-4454. Syn & Ind Motors • Gear Motors • Fans • Blowers.

DRIVE & STEPPING MOTORS

224

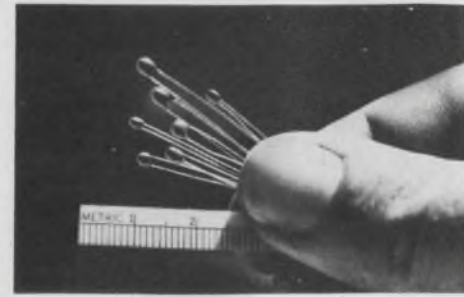

Chip Thermistors with leads and coating are highly reliable, exceptionally predictable, low cost components with small and miniature dimensions more compatible with modern circuit design. R @ 25°C 30 ohms to 3 meg ohms, tolerances  $\pm 10\%$  to  $\pm 1\%$ . Curved matched interchangeables  $\pm 1^\circ\text{C}$  to  $\pm .3^\circ\text{C}$ . Point matched interchangeables for temperature control R, to  $\pm 1\%$ . WESTERN THERMISTOR Corporation, 403 Via El Centro, Oceanside, CA 92054. (714) 433-4484.

THERMISTORS

227



Free New '76 catalog contains over 34,500 quality power supplies from the world's largest manufacturer, Power/Mate Corp. Power Supplies for every application including submodulars, open frame, variorated, encapsulated, laboratory & system. All units UL approved and meet most military and commercial specs for industrial and computer uses. Power/Mate Corp., 514 S. River St., Hackensack, NJ 07601 (201) 343-6294

POWER SUPPLIES

222



**PRACTICAL DESIGN FOR ELECTROMAGNETIC COMPATIBILITY**, ed. by R. Ficchi. A complete guide to elec. compatability for electronic systems and equipment, including semiconductor, microelectronic, and digital computer equipment. Numerous charts, graphs, and nomographs. #5685-0, 272 pages, \$17.20. Circle the Info Retrieval Number to order 15-day exam copy. When billed, remit or return book with no obligation. Hayden Book Co., 50 Essex Street, Rochelle Park, N.J. 07662.

DESIGN GUIDE

225

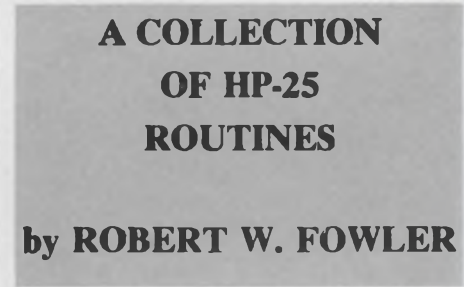

**HP-25 POCKET CALCULATORS:** 26 routines compute engineering and mathematical problems elegantly. Find all roots of 7th-degree polynomials. Evaluate LAPLACE polynomials of 7th-order. Do partial fraction expansion of 7 real roots; find residues. Solve ordinary differential equations using 4th-order Runge-Kutta. Find Bessel functions. 172 pages show examples & solutions. \$8.90 includes Book/Postage/Handling. Order your copy from Robert W. Fowler, 12104 Arbie Rd, Silver Spring, MD 20904

POCKET CALCULATORS BOOK

228



**MICROPROCESSOR-COMPATIBLE POWER SUPPLIES.** SMP Series of multiple output units in various combinations of 5, 9 and 12 Vdc, to directly interface with individual operating levels of popular  $M_{ij}$  families 6800, 8080, 9080, PACE, SC/MP, F8, etc. Solid-state line/load regulation to  $\pm 0.1\%$ . Universal 115/230Vac inputs from 47 to 440Hz. Single unit prices from \$49. STANDARD POWER Inc 1400 So. Village Way, Santa Ana, CA 92705 (714) 558-8512.

POWER SUPPLIES

223

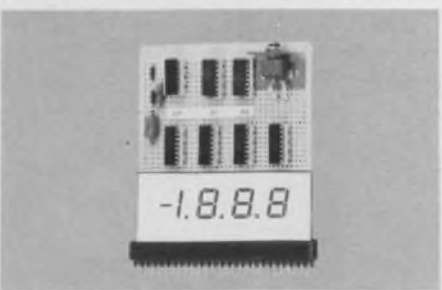

**LOW POWER DIGITAL DISPLAY WITH LATCH DECODER DRIVER.** OEM sub-system component with built-in counter, will accept BCD, decode and drive 4 digit UCE 3600 series liquid crystal display. 4LDD-7 is a full four digits with decimal. The display is a sharp contrast, wide angle planar presentation useful in both portable and panel instrumentation. UCE also supplies on quick turn-around, custom displays, light valves, shutters and other LCD functions. UCE, 20 No. Main, Norwalk, CT 06854 (203) 838-7509

LCD DECODER DRIVER

226



**LEARN MICROPROCESSORS** first hand from the original hands on people. Short courses, with free take home micro-computer, are being offered January through March in Dayton, OH; St. Petersburg Beach, FL; Los Angeles, Palo Alto, Philadelphia, Washington, D.C., Boston, Chicago, Huntsville, AL. Tuition \$495. For further information call Alice Anderson (317) 742-6802 or write: WINTEK Corporation, 902 N. 9th St., Lafayette, IN 47904

MICROPROCESSOR COURSE

229

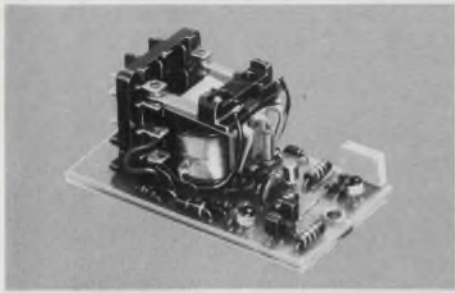

**P&B CZS-01 Ground Line Integrity Monitor** is intended for application where continuous verification of ground line integrity is required. When the potential difference between ground and neutral exceeds 15V rms—due to ground conditions—the CZS-01 contacts open removing power from the system. Power must be manually disconnected and reapplied after the ground fault has been corrected before the output contacts can be closed. Potter & Brumfield Division AMF Incorporated, Princeton, Indiana 47671, (812) 386-1000.  
**INTEGRITY MONITOR 230**

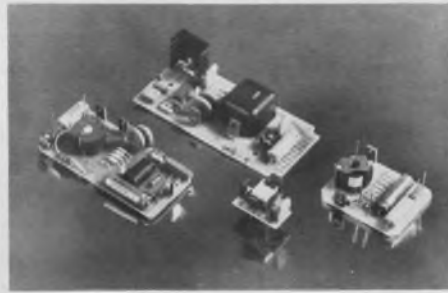

Activate gas discharge readouts! Custom designed and produced DC-to-DC power supplies to activate gas discharge displays, or for other applications. Regulation I/O options, packaging (encapsulated, aluminum shell or open frame), size and configuration, heat dissipation, mounting (PC board pins, edge connectors), etc., can be tailored to meet individual specifications. Price and delivery discussed after specifications are submitted. Endicott Coil Co., Inc., 31 Charlotte Street, Binghamton, N.Y. 13905 (607) 797-1263.  
**CUSTOM DESIGNED POWER SUPPLIES 233**

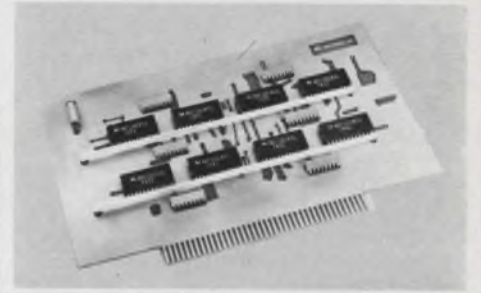

**EASIER ECL VOLTAGE AND GROUND DISTRIBUTION SYSTEMS**—Reduced system noise, high packaging density and less design time for PC boards with ECL circuits are yours with Mini/Bus®, the Rogers way to eliminate the cost of multi-layer boards by off-board voltage and ground distribution. Rogers Corp., Chandler, AZ 85224 (602) 963-4584. (EUROPE: Mektron NV, Ghent, Belgium; JAPAN: Nippon Mektron, Tokyo)

**MINI/BUS 236**

**236**



**THE NEW CATCH-A-PULSE LOGIC PROBE** is compatible with RTL, DTL, TTL, CMOS, MOS, and Microprocessors using a 3.5V to 15V power supply. Thresholds automatically programmed for multi-logic family operation. Automatic resetting memory for single or multi pulse detection. No adjustments. Visual indication of logic levels showing HI, LO, bad level or open circuit logic or pulses (60 Nsec). Protective cap over tip and removable coiled cord. \$24.95. AVR Electronics, Box 45167, San Diego, CA 92145, (714) 566-1570.  
**LOGIC PROBE 231**



**DIGITAL SIGNAL ANALYSIS**, S. Stearns. Contains the most recent advances, brand-new design material, and a comparison between continuous and digital systems, making it an ideal master reference to today's signal processing techniques and systems. #5828-4, 288 pages, \$18.95. Circle the Info Retrieval Number to order 15-day exam copy. When billed, remit or return book with no obligation. Hayden Book Co., 50 Essex Street, Rochelle Park, N.J. 07662.

**DIGITAL SIGNAL ANALYSIS 234**

**234**

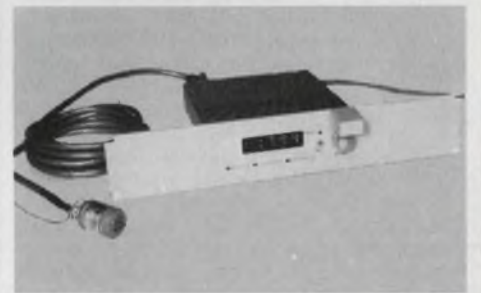

**ABSOLUTE ENCODER**—± 1 Part in 3600 System Accuracy, Electro-Magnetic Transducer + LED Display + BCD, Binary, and DC Output—Infinitely Adjustable Scale Factor (0 to 9999)—Hi Noise Immunity—Zero Offset—Single and Multi-Channel Units From \$375/Axis (1 pc.) Other CCC products are Synchro to Digital, Synchro to Linear DC, Digital or DC to Synchro Converters, and Solid State C.T.'s or CDX's. Send for Free Catalog & Application Notes. Computer Conversions Corp., East Northport, N.Y. 11731 (516) 261-3300.

**ENCODER 237**

**237**

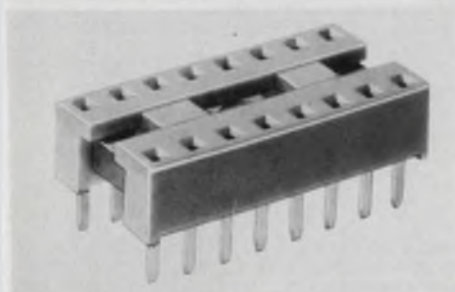

**NEW "KEL" DIP SOCKETS** offer advantages of sockets costing 5 times more! Samtec now offers a new low cost socket of premium quality. Features include: side-swipe contacts for positive electrical contact; 2-piece bodies provide closed-entry IC lead-in; SIDE/SIDE and END/END mounting for maximum board density. You save on gold—even more on tin. Available in 14-16-24-28 or 40 contact models. For specs and prices write: SAMTEC, 2652 Charlestown Road, New Albany, Indiana, 47150.

**"KEL" DIP SOCKETS 232**

**232**



**EC's new Digitally Programmable T<sup>L</sup> Logic Delay Line** feature Schottky T<sup>L</sup> input and output; 15 models with time delays to a max of 255ns; 16 delay steps available with 1ns, 2ns, 3ns, 5ns, 10ns or 16ns resolution; propagation delays fully compensated; 32-pin dip package (.250 high); 4ns max rise time on all delays; 10 T<sup>L</sup> fanout; programming by remote switching or automatically by computer-generated data, Engineered Components Company, P.O. Box Y, San Luis Obispo, Ca. 93406 (805) 544-3800

**LOGIC DELAY LINE 235**

**235**



**WOUND TOROID TURNS TESTER**—The Model 2000 allows non-technical test personnel to quickly and accurately measure the number of turns in toroids having single, multiple and tapped windings. The answer is directly presented on an easily read, front panel mounted, 3-1/2 digit, bright LED display. The model 2000 is ideal for both user incoming inspection, as well as producers' in-process and final test applications. Unit price \$1,495. SEMICONDUCTOR CIRCUITS, INC., HAVERHILL, MA 01830 (617) 373-9104

**WOUND TOROID TURNS TESTER 238**

**238**

# Electronic Design

ELECTRONIC DESIGN's function is:

- To aid progress in the electronics manufacturing industry by promoting good design.
- To give the electronic design engineer concepts and ideas that make his job easier and more productive.
- To provide a central source of timely electronics information.
- To promote communication among members of the electronics engineering community.

**Want a subscription?** ELECTRONIC DESIGN is sent free to qualified engineers and engineering managers doing design work, supervising design or setting standards in the United States and Western Europe. For a free subscription, use the application form bound in the magazine. If none is included, write to us direct for an application form.

If you do not qualify, paid subscription rates are as follows: \$30.00 per year (26 issues) U.S., \$40.00 per year (26 issues) all other countries. Single copies are \$2.00 U.S., \$3.00 all other countries. The Gold Book (27th issue) may be purchased for \$30.00 U.S. and \$40.00 all other countries.

If you change your address, send us an old mailing label and your new address; there is generally a postcard for this bound in the magazine. You will have to requalify to continue receiving ELECTRONIC DESIGN free.

**The accuracy policy** of ELECTRONIC DESIGN is:

- To make diligent efforts to ensure the accuracy of editorial matter.
- To publish prompt corrections whenever inaccuracies are brought to our attention. Corrections appear in "Across the Desk."
- To encourage our readers as responsible members of our business community to report to us misleading or fraudulent advertising.
- To refuse any advertisement deemed to be misleading or fraudulent.

Microfilm copies are available of complete volumes of ELECTRONIC DESIGN at \$19 per volume, beginning with Volume 1, 1952 through Volume 20. Reprints of individual articles may be obtained for \$3.00 each, prepaid (\$.50 for each additional copy of the same article) no matter how long the article. For further details and to place orders, contact the Customer Services Department, University Microfilms, 300 North Zeeb Road, Ann Arbor, Michigan 48106 telephone (313) 761-4700.

**Want to contact us?** If you have any comments or wish to submit a manuscript or article outline, address your correspondence to:

Editor  
ELECTRONIC DESIGN  
50 Essex Street  
Rochelle Park, N.J. 07662

## Advertiser's Index

Advertiser	Page	Advertiser	Page
A P Products Incorporated.....	202	Edison Electronics, A McGraw Edison Company Division.....	233, 239
AMF. VID Electronics.....	225	Efratom California, Inc.....	230
AMP. Incorporated.....	74, 75	Electrocube Corp.....	222
AVR Electronics.....	251	Electronic Design 144D, 180, 223, 256	
Accutronics, A Hammond Corporation Company.....	157	Electronic Molding Corporation.....	142
Acopian Corp.....	48C	Endicott Coil Co., Inc.....	251
Addison Division of Murihead Inc.	226	Engineered Components Company	249
Advanced Micro Devices.....	193	Esterline Angus Instrument Corporation.....	227
Alco Electronic Products, Inc.....	231		
Allen Bradley Co.....	48A	Fabri-Tek, National Connector Division.....	229
Amperite Co.....	232	Fifth Dimension, Inc.....	228
Analog Devices, Inc.....	150	Fowler, Robert.....	250
Arnold Magnetics Corp.....	200	Frequency & Time Systems.....	190
Arrow-M Corp.....	182		
B & K Products of Dynascan Corporation.....	144	GTE Automatic Electric.....	177
BEI Electronics Inc.....	241	General Electric Company, Semiconductor Products Department.....	39
Beckman Instruments, Inc. Helipot Division.....	15	General Radio Company.....	144A
Belden Corporation.....	149	Gold Book, The.....	48H, 244, 245
Biomation.....	18, 19	Gould Inc., Instruments Systems Division.....	81, 83, 85, 87
Bodine Electric Company.....	231	Greenray Industries, Inc.....	238
Bourns, Inc., Trimpot Products Division.....	Cover II	Guardian Electric Manufacturing Company.....	48D
Bowmar Instrument Corporation.....	237	Gulton Industries, Inc.....	208, 212
Brown, W. A.....	128A-B		
Bud Radio, Inc.....	122, 123	Hansen Manufacturing Co.....	103
Bunker-Ramo, Amphenol Connector Division.....	Cover III	Harris PRD Electronics.....	246, 247
Burr-Brown Research Corporation.....	185	Harris Semiconductor, A Division of Harris Corporation.....	188, 189
		Harwil Co.....	249
		Hayden Book Co., Inc.....	176A-B, 180, 181, 242, 249
CPS, Inc.....	231	Heinemann Electric Company.....	119
Capital Calculator Company.....	216	Hewlett-Packard.....	65, 66, 67, 82, 94, 95
CELCO (Constantine Engineering Laboratories Company).....	49	Hoffman Engineering Company.....	221
Cherry Electrical Products Corp.....	139	Houston Instruments, A Division of Bausch & Lomb.....	42
Chrono-Log Corp.....	229	Hughes Aircraft Company, Connecting Devices.....	41
Computer Automation, Inc.....	16A-H		
Computer Conversion Corp.....	251	ISE Electronics Corporation.....	215
Computer Labs, Inc.....	234	ITT Pomona Electronics.....	186
Computer Products, Inc.....	208	Illuminated Products Co.....	7
Constantine Engineering Laboratories Company (CELCO).....	49	Infotek Systems.....	241
Continental Specialties Corporation.....	128	Instrumentation Survey Card.....	112A-B
Control Data Corporation.....	40	Intel Corporation.....	4, 5, 32A-F
		Instrument Specialties Company.....	179
		Intertec Data Systems.....	34
Dale Electronics, Inc.....	101		
Dana Laboratories, Inc.....	196	Johanson Dielectrics, Inc.....	249
Data Display Products.....	28	Johanson Manufacturing Corp.....	6
Data General Corporation.....	117	Johnson Company, E. F.....	16
Data I/O Corporation.....	17		
Data Precision Corporation.....	24, 25	Kaman Sciences Corp.....	249
Datak Corporation, The.....	229	Keithley Instruments, Inc.....	58, 59
Datel Systems, Inc.....	46	Kennedy Corporation, M. S.....	236
Delco Electronics, Division of General Motors Corporation.....	158, 159	Keystone Carbon Company.....	220
Dialight, A North American Philips Company.....	127	Krohn-Hite Corporation.....	250
Digital Broadcast Systems.....	48B		
Digital Equipment Corporation.....	8, 9	Leader Instruments Corp.....	226
DuMont Electronics Corporation.....	239		
ECD Corp.....	120		
EECO.....	23		
EMI Technology.....	93		
EMR Telemetry, Weston Instruments, Inc.....	243		
Eastern Air Devices.....	250		



Advertiser	Page
Licon, Division of Illinois Tool Works, Inc. ....	143
3M Company .....	48
Mallory Capacitor Company.....	199
Marathon Battery Company.....	210
Marconi Instruments .....	10
Memodyne Corporation .....	249
Mepco/Electra, Inc. ....	174, 175
Micro Devices Corp. ....	223
Microdata Corporation .....	206, 207
Micropac Industries, Inc.....	225
Microswitch, A Division of Honeywell .....	121
Mini-Circuits Laboratory, A Division of Scientific Components Corp. ....	2
*Molex, Incorporated .....	208B-C
Monsanto Company .....	43
Motorola Semiconductor Products, Inc. ....	26, 27, 44, 45
MuRata Corporation of America .....	225, 239
NEC Microcomputers, Inc.....	12, 13
Nichicon America Corporation.....	102
Nicolet Instrument Corporation .....	109, 110, 111, 112
North American Philips Controls Corp. ....	198
North Hills Electronics Inc.....	238
Nucleudes .....	242
Oak Industries, Inc.....	217
PPG Industries, Inc.....	187
PSG Industries, Inc.....	227
*Philips Electronic Components and Materials .....	10
*Philips Industries .....	208D
Philips Test & Measuring Instruments, Inc. ....	14
Plessey Semiconductors ...	*12, *13, 151
Poly Paks Inc. ....	233
Potter & Brumfield, Division of AMF, Incorporated .....	173, 251
Power Instruments .....	241
Power/Mate Corp. ....	250
Power One, Inc.....	234
Precision Monolithics, Incorporated.....	171
Pyrofilm Corporation .....	138
RCA Distributor & Special Products Division, Sales Promotion Services.....	249
RCA Electro Optics.....	145
RCA Solid State.....	Cover IV
RCL Electronics, Inc.....	11
R. F. Power Labs, Inc. ....	218
Raytheon Company, Submarine Signal Division .....	204
Raytheon Semiconductor .....	213
Rental Electronics, Inc. ....	48G
Reticon .....	203
*Rifa of Sweden .....	14
Riken Denshi Co., Ltd.....	237

Advertiser	Page
Robinson Nugent, Incorporated .....	48H
Rogan Corporation .....	135
Rogers Corporation .....	249, 251
*SE Labs (EMI) Limited.....	208A
Samtec .....	251
*Schoeller & Co.....	14
Semiconductor Circuits, Inc.....	251
Semtech Corporation .....	113
Servo-Tek Products Company.....	219
Simpson Electric Company.....	211
Singer Company, The.....	235
Singer Company, Inc., Kearfott Division .....	84
*Sodeco SAI SA .....	15
Sola Electric, Division of Sola Basic Industries .....	134
South Bay Cable Corp.....	227
Sprague Electric Company.....	33
Squires Electronics .....	249
Stacoswitch, A Staco Inc. Company.....	202
Standard Grigsby, Inc. ....	192
Standard Condenser Corporation.....	224
Standard Power, Inc.....	250
Stanford Applied Engineering, Inc. ....	129
Stewart Warner Corporation.....	197
Systron Instruments, Inc. ....	191
Systron-Donner .....	32, 134
Tau-Tran, Inc. ....	230
Tecnetics, Inc. ....	214
Tektronix, Inc. ....	20, 31
Teledyne Philbrick .....	86
Telenetics .....	242
Telonic Altair .....	144C
Tenney Engineering, Inc.....	237
Texscan Corporation .....	195
Textool Products, Inc.....	209
Thunder Scientific Corporation .....	48E
Triad/Utrad .....	194
Triplett Corporation .....	169
Turner Designs .....	223
UCE .....	250
*U. S. Department of Commerce.....	128D
Unitrode Corporation .....	201
Varo Semiconductor, Inc. ....	166
Viking Industries, Inc. ....	37
Viz Manufacturing Co. ....	235
Wabash, Inc. ....	167
Wavetek San Diego, Inc. ....	1
Western Thermistor Corporation .....	250
Weston Components .....	235
Weston Instruments, Inc. ....	205
Wintek Corporation .....	250
Yokogawa Corporation of America .....	*177, 233
Zivy & CIE SA, N. ....	251

\*Advertisers in non-U.S. Edition

## Advertising Sales Staff

Tom W. Carr, Sales Director  
Jean Bunfield, Sales Coordinator  
**Rochelle Park, NJ 07662**  
Robert W. Gascoigne  
Daniel J. Rowland  
Thomas P. Barth  
50 Essex St.  
(201) 843-0550  
TWX: 710-990-5071

## Philadelphia

Thomas P. Barth  
(201) 843-0550

## Boston 02178

Gene Pritchard  
P.O. Box 379  
Belmont, MA 02178  
(617) 489-2340

## Chicago 60611

Thomas P. Kavooras  
Berry Conner, Jr.  
200 East Ontario  
(312) 337-0588

## Cleveland

Thomas P. Kavooras  
(312) 337-0588

## Los Angeles 90045

Stanley I. Ehrenclou  
Burt Underwood  
8939 Sepulveda Blvd.  
(213) 641-6544

## Texas

Burt Underwood  
(213) 641-6544

## San Francisco

Robert A. Lukas  
3579 Cambridge Lane  
Mountain View, CA 94040  
(415) 965-2636

## London

Constance McKinley  
50 Essex St.  
Rochelle Park, N.J. 07662  
Phone: (201) 843-0550

## Amsterdam, Tokyo, Seoul

Sanders, W. J. M.  
Raadhuisstraat 24  
Graft-De Ryp, Holland  
Phone: 02997-1303  
Telegrams: Euradteam-Amsterdam

## Haruki Hirayama

Electronic Media Service  
5th Floor, Lila Bldg.,  
4-9-8 Roppongi  
Minato-ku, Tokyo, Japan  
Phone: 402-4556  
Cable: Electronicmedia, Tokyo

## Mr. O-kyu Park, President

Dongbo Intl Corp.—  
World Marketing  
C.P.O. Box 4010  
Seoul, Korea  
Tel. 76-3910/3911  
Cable: DONGBO SEOUL  
Telex: EBKOREA K27286

# Product Index

**Information Retrieval Service.** New Products, Evaluation Samples (ES), Design Aids (DA), Application Notes (AN), and New Literature (NL) in this issue are listed here with page and Information Retrieval numbers. Reader requests will be promptly processed by computer and mailed to the manufacturer within three days.

Category	Page	IRN	Category	Page	IRN	Category	Page	IRN
<b>Components</b>			computing system (NL)	246	<b>437</b>	probes	184	<b>324</b>
CRT deflection yokes	49	<b>35</b>	controller, tape drive	220	<b>377</b>	pulse generator	196	<b>338</b>
CRT yokes	191	<b>97</b>	data set	216	<b>368</b>	pulse generators	82	<b>42</b>
CRTs	239	<b>170</b>	data transfer unit	220	<b>378</b>	recorder	237	<b>164</b>
capacitor	16	<b>13</b>	floppy-disc drive	40	<b>28</b>	recorder, strip-chart	42	<b>30</b>
capacitors (AN)	240	<b>415</b>	light sensors	216	<b>369</b>	scope	189	<b>330</b>
capacitors	6	<b>5</b>	memories	13	<b>10</b>	scope module	189	<b>329</b>
capacitors	102	<b>51</b>	memory, minicomputer	218	<b>372</b>	scope, storage	95	<b>49</b>
capacitors	222	<b>131</b>	minicomputer	220	<b>380</b>	scopes	226	<b>140</b>
capacitors	224	<b>135</b>	minicomputer (NL)	246	<b>442</b>	signal generator	186	<b>326</b>
capacitors, electrolytic	199	<b>106</b>	minis & micros	117	<b>58</b>	signal source	1	<b>2</b>
circuit breakers	119	<b>59</b>	numeric printers	208	<b>117</b>	spectrum analysis		
connectors (NL)	247	<b>447</b>	OEM peripherals	207	<b>115</b>	recorder	204	<b>112</b>
delay relays	232	<b>153</b>	paper tape reader	219	<b>374</b>	spectrum analyzer	243	<b>177</b>
filters	33	<b>24</b>	printer	220	<b>379</b>	stroboscope/tachometer	241	<b>173</b>
garmotors	231	<b>151</b>	programmer, PROM	216	<b>367</b>	tester, telemetry bit	186	<b>327</b>
generator/reader	229	<b>145</b>	programmer, PROM	219	<b>375</b>	time/frequency systems	230	<b>148</b>
indicator lights	127	<b>64</b>	reader, bar code	218	<b>373</b>	timer/counters	14	<b>282</b>
industrial switches (NL)	246	<b>443</b>	terminal	34	<b>25</b>	wattmeters, portable	233	<b>156</b>
ironless rotor dc motor (NL)	247	<b>454</b>	terminals, data entry	216	<b>370</b>	word generator	184	<b>325</b>
logic switch	192	<b>98</b>	<b>Discrete Semiconductors</b>			<b>Integrated Circuits</b>		
motors	129	<b>66</b>	Darlingtons, high-voltage	159	<b>81</b>	converter, v/f	232	<b>399</b>
motors, garmotors	219	<b>128</b>	diode chips	206	<b>356</b>	counter, eight-decade	228	<b>391</b>
posistors	227	<b>141</b>	LED lamps	208	<b>359</b>	drivers, memory	232	<b>398</b>
potentiometer	200	<b>345</b>	LED numerical displays	204	<b>354</b>	IC	234	<b>405</b>
potentiometer	202	<b>347</b>	rectifiers	204	<b>350</b>	ICs, interface	228	<b>392</b>
potentiometers	198	<b>342</b>	rectifiers	207	<b>357</b>	I <sup>2</sup> L design kit	197	<b>104</b>
potentiometers	202	<b>346</b>	rectifiers	208	<b>360</b>	LSI	213	<b>122</b>
power transformers	194	<b>100</b>	rectifiers, Schottky-barrier	166	<b>82</b>	LSI	230	<b>395</b>
relays	228	<b>144</b>	regulators, voltage	207	<b>358</b>	memories bipolar	232	<b>397</b>
relays, amber	182	<b>90</b>	transistors, high voltage	204	<b>355</b>	memories, static	232	<b>403</b>
relays, time-delay	173	<b>86</b>	<b>Instrumentation</b>			multiplexers, CMOS	230	<b>396</b>
resistor DIPs	138	<b>70</b>	amplifier	196	<b>339</b>	PROMs	188	<b>95</b>
resistor networks	11	<b>262</b>	backplane test systems	226	<b>139</b>	PROMs (NL)	246	<b>438</b>
resistors, wire-wound	101	<b>353</b>	chart recorder, mini	183	<b>321</b>	prescalers	167	<b>83</b>
rotary switch	239	<b>169</b>	contact chatter checker	196	<b>340</b>	RAMs	193	<b>99</b>
steppers, PM	198	<b>105</b>	counter	183	<b>320</b>	RAMs, CMOS	234	<b>404</b>
switch	7	<b>6</b>	counters	192	<b>335</b>	reference voltage	171	<b>85</b>
switch, thumbwheel	23	<b>17</b>	DMM	144	<b>74</b>	regulators, voltage	228	<b>393</b>
switch, thumbwheel	198	<b>341</b>	DMM	189	<b>331</b>	tapped analog delay	203	<b>111</b>
switchers	27	<b>20</b>	DMM	190	<b>333</b>	timer, IC	228	<b>394</b>
switches	11	<b>9</b>	DMM	192	<b>336</b>	watch circuit, LED	228	<b>390</b>
switches	121	<b>61</b>	DMM	235	<b>159</b>	<b>Microprocessor Design</b>		
switches	202	<b>109</b>	DMM, portable	205	<b>113</b>	computer console	36	<b>507</b>
switches	231	<b>152</b>	DMMs	59	<b>37</b>	IC priority interrupt	36	<b>508</b>
switches, PB	143	<b>73</b>	DPM	184	<b>322</b>	microcomputer	35	<b>506</b>
switches, PB	200	<b>344</b>	DPMs	183	<b>205</b>	PROM eraser	223	<b>132</b>
switches, lighted	200	<b>343</b>	DPMs	211	<b>120</b>	PROM programmer	17	<b>14</b>
switches, rotary	217	<b>126</b>	DVM	196	<b>103</b>	software, 8080 $\mu$ P	38	<b>510</b>
switches, rotary	233	<b>154</b>	DVMs	32	<b>23</b>	time clock, $\mu$ P based	38	<b>509</b>
switches, thumbwheel	139	<b>71</b>	energy meter	184	<b>304</b>	$\mu$ C development system	5	<b>286</b>
thermal cutoffs	223	<b>133</b>	IC tester	192	<b>334</b>	$\mu$ P analyzer	134	<b>67</b>
thermistor assemblies	220	<b>129</b>	linear circuit tester (NL)	246	<b>445</b>	<b>Microwaves &amp; Lasers</b>		
thermostats	227	<b>143</b>	logic analyzers	19	<b>15</b>	attenuators, rotary	238	<b>413</b>
transducer pressure	203	<b>349</b>	logic analyzers	184	<b>323</b>	filters, YIG-tuned	238	<b>412</b>
trimmers, cermet	235	<b>160</b>	logic card tester	189	<b>328</b>	isolators, broadband	238	<b>411</b>
trimmers, cermet	235	<b>161</b>	meter temp-pressure	190	<b>332</b>	oscillator, v.c.	238	<b>410</b>
XY positioner	203	<b>348</b>	multimeters	25	<b>285</b>	<b>Modules &amp; Subassemblies</b>		
<b>Data Processing</b>			oscilloscope, UV	194	<b>337</b>	a/d converter	212	<b>472</b>
acoustic coupler kit	219	<b>376</b>	oscilloscope, storage	31	<b>289</b>	alarm intrusion	212	<b>473</b>
CRT terminal	218	<b>371</b>	oscilloscope	109	<b>56</b>	amplifier	210	<b>361</b>
calculators	67	<b>39</b>	primary frequency			analog multiplexer	214	<b>366</b>
calculators	216	<b>125</b>	standard	190	<b>96</b>			
coaxial comm testing	230	<b>149</b>						
computers	16A-H	<b>248</b>						

Category	Page	IRN
comm. components	177	88
converter, a/d	236	162
converter, d/a	210	362
converter, dc-to-dc	214	123
converter, d/s	84	44
converters, f/v, v/f	86	46
converter, s/d	209	301
converters, a/d, d/a	234	157
data-conversion comp. (NL)	247	456
decoder	242	242
display interface	210	363
electro-optics	145	201
filters, i-f	239	168
freq. to voltage conv.	214	364
hybrid voltage regulators	225	137
LEDs	28	21
LEDs	43	31
modules	185	92
OEM servo recorder	227	142
op amp, HV	212	475
oscillators	157	79
oscillators	238	166
panel instruments	169	280
power amplifier	242	243
rf power amplifier	218	127
s/d converter	212	474
shaft encoder	241	172
surplus electronic equipment	233	155
thermal printer	237	165
touch tone encoder	214	365
<b>Packaging &amp; Materials</b>		
backpanel system	229	147
backplane connections	48	34
beryllium-copper gaskets	179	89
breadboards, solderless	221	310
bushings	224	384
cable	225	138
cable assemblies	75	40
circuit evaluator	202	110
circular connectors (NL)	246	440
connections	41	29
connectors, thermocouple	222	381
digital micrometer	222	382
electronic glass	187	94
enclosure	221	130
enclosures	123	63
epoxy kit	224	387
fluoropolymers (NL)	246	439
kit, PC	229	146
knobs, dials	135	69
PC board	226	389
PC board connectors	37	26
PC card, wafer probe	224	386
packaging hardware	103	52
paper-like ceramic	222	383
socket card, DIP	224	385
socket, IC	226	388
sockets	128	65
sockets	142	72
test accessories	186	93
test chamber	237	163
wire, cable, cord	149	400

Category	Page	IRN
<b>Power Sources</b>		
converter, dc/dc	236	408
line voltage sensor	236	407
power conversion system	200	107
power line modifier	236	409
power sources	210	119
power supplies	134	68
power supplies	208	116
power supplies	234	158
power supplies, $\mu$ P	236	406
prog dc sources	238	167

### new literature

circular connectors	246	440
computing system	246	437
connectors	247	447
data-conversion components	247	456
fluoropolymers	246	439
industrial switches	246	443
ironless-rotor dc motor	247	454
linear-circuit tester	246	445
minicomputer	246	442
PROMs	246	438
power supply catalog	15	12
programmable controllers	247	450
rechargeable batteries	247	446
rental program	247	453
SCR power supplies	247	451
sealed relays	247	448
security equipment	246	444
switches	246	441
time delay relays	246	436
transistors or chips	247	449
$\mu$ C development system	247	455
$\mu$ P controller system	247	452

### application notes

capacitors	240	415
conversion counters	240	418
filters	240	422
GaAs FETs	240	419
liquid-crystal displays	240	416
microwave detectors	240	414
op-amp parameters	240	420
pattern analyzer	240	423
power amplifiers	240	424
terminal blocks	240	417
uhf amplifiers	240	421

### design aids

component parts	243	434
control panels	243	430
IC sockets	243	433
relays	243	435
triacs and SCRs	243	432
washers	243	431

### evaluation samples

heat sinks	243	427
lever handle	243	426
metal bellows	243	429
synchro clamps	243	428
temperature recorders	243	425

Step-by-step coverage of defense radar system design . . .

# INTRODUCTION TO DEFENSE RADAR SYSTEMS ENGINEERING

James N. Constant

This all-inclusive handbook covers virtually every facet of radar technology that must be mastered in order to design a complete defense radar system. In fact, it concludes with a *step-by-step procedure for specifying and designing a complete radar system for a given application*. Separate chapters cover target characteristics; radar detection; radar receivers; radar system error model; flight of a ballistic missile; ballistic reentry trajectories; trajectory prediction; radar data processing; reflector antennas; and array antennas. Order your 15-day examination copy today! #9194, 344 pages, cloth, illustrated, \$22.95



## 15-DAY FREE EXAMINATION!



Hayden Book Company, Inc  
50 Essex Street  
Rochelle Park, N.J. 07662

- Please send me my copy of INTRODUCTION TO DEFENSE RADAR SYSTEMS ENGINEERING to read and use for 15 days. At the end of that time, I'll send a check or money order for \$22.95, plus postage and handling, or return the book and owe absolutely nothing.
- I want to save money! I have enclosed full amount. Publisher pays postage and handling. I get a complete 15-day money-back guarantee.

Name \_\_\_\_\_  
Firm \_\_\_\_\_  
Address \_\_\_\_\_  
City/State/Zip \_\_\_\_\_

# ITT CANNON FOUND OUT...



## Electronic Design IS BEST READ BY ITS CUSTOMERS AND PROSPECTS

Theodore Knudson, an American dedicated to assisting the European aerospace community at ESTEC, Noordwijk, Holland, states: "I usually read each issue of *Electronic Design* for its unique features. I also find E.D. useful in the form of a resource material depicting recent state-of-the-art advances that is not totally theoretical and therefore can be suggested for application in our real life designing and procurement processes."

If you read *Electronic Design*, you're in good company. Almost 90% of those firms who have taken the trouble to find out which magazines their customers read, rank *Electronic Design* in first position.

For example: ITT Cannon mailed 1,000 questionnaires to a portion of their prospect list (respondents to advertising and publicity releases in many publications).

The survey asked: "Designate in order of importance those publications which you are now receiving and read on a regular basis." Here are the top winners:

PUBLICATION	READ REGULARLY (ITT Cannon Prospect List)	
	REPLIES	RANK
<b>ELECTRONIC DESIGN</b>	<b>732</b>	<b>1</b>
EDN	668	2
ELECTRONICS	416	3

### PASS THE WORD

Maybe your advertising brass doesn't know as much about the power of *Electronic Design* as you do. If your company wants to reach engineers and engineering managers . . . *pass the word*. Tell your sales, marketing and advertising people which publication will bring highest readership among the engineers who make the wheels go round in this industry . . . *Electronic Design*.

# Electronic Design

**BEST READ ELECTRONICS PUBLICATION IN THE WORLD**

*Our FIRE-PLUG™  
connectors already  
meet UL 94V-0  
flammability tests.*

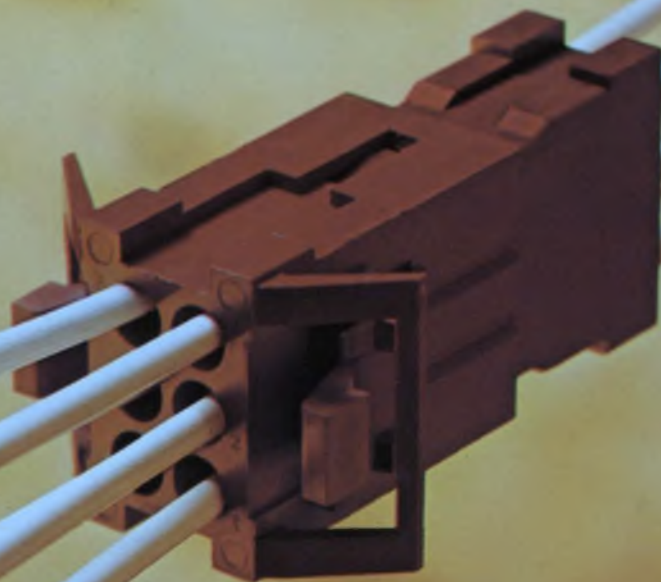

*And you can't beat our price.*

**These new Amphenol® connectors** are classified 94V-0 for flame resistance by Underwriters Laboratories. That's the most stringent test of plastic material flammability conducted by UL. And these connectors are also listed by CSA.

What's more, FIRE-PLUG connectors exceed UL's upgraded standards for thermoplastic materials scheduled to go into effect July 1, 1977. So you can upgrade your products now.

**They cost no more than what you're buying now.** FIRE-PLUG connectors are priced no higher than commercial connectors sold under the less stringent UL 94V-2 rating.

**Interchangeable, too.** FIRE-PLUG connectors are interchangeable, intermatable, and intermountable with the most popular types of commercial connectors.

**Save time and labor with faster panel mounting.** The FIRE-PLUG has mounting latches that flex easily. Only fingertip pressure is needed to push and lock the housing into a panel. Cable-to-cable styles are also available.

**You can get them now — in quantity.** Just call your Amphenol Industrial Distributor for fast delivery. Or write or call: Ray Hayer, Amphenol Connector Systems, Bunker Ramo Corporation, 900 Commerce Drive, Oak Brook, Illinois 60521. (312) 986-3749.



*Semi-automatic crimping machine.  
Hand tools also available.*

*The right idea  
at the right time.*

**AMPHENOL** Connector Systems **BUNKER RAMO**®

CIRCLE NUMBER 263

New RCA kit makes it easy ...

# Evaluate CMOS microprocessing for yourself.

Here's a microprocessor kit that lets you prove how cost-effective the all-CMOS RCA 1800 system can be.

You'll quickly see how the RCA COSMAC architecture and a repertoire of 91 powerful instructions give you maximum performance with minimal memory. And how you can take advantage of CMOS low power dissipation, single wide-range power supply, full operating temperature range, high noise immunity, and single-phase clock.

## Multi-purpose Tool

Build this inexpensive kit to evaluate not only the benefits of its CMOS CPU, but also CMOS memory and CMOS I/O. Use it for easy prototyping and debugging. Exercise it with start, stop, and single-step controls. And, via the utility ROM,

generate, evaluate, and verify software.

The CDP18S020 Evaluation Kit comes complete with the RCA CDP1802 COSMAC CPU plus clock and control, display, memory and I/O sections, and all passive components needed for a low-cost microcomputer system. For just \$249. Build it in four to eight hours. Add a power supply and I/O terminal and you're into CMOS microprocessing. With built-in room to expand.

To get your kit or more information, contact RCA or your local RCA representative.

Write: RCA Solid State, Box 3200, Somerville, N.J. 08876; Sunbury-on-Thames, Middlesex TW16 7HW, England; Ste. Anne de Bellevue H9X 3L3, Canada; Fuji Building, Tokyo, Japan.



RCA 1800. Cost-effective microprocessing.