

Electronic Design.20

FOR ENGINEERS AND ENGINEERING MANAGERS

VOL. 23 NO. 9
SEPT. 27, 1975

Switching regulators shine with the highest efficiency, coolest operation and smallest size per watt in a regulated power supply. But you'll have to spend more

and settle for higher ripple and noise. Transient performance must be relaxed, too. And then there's the big question: Are switchers reliable? Learn more on p. 52.

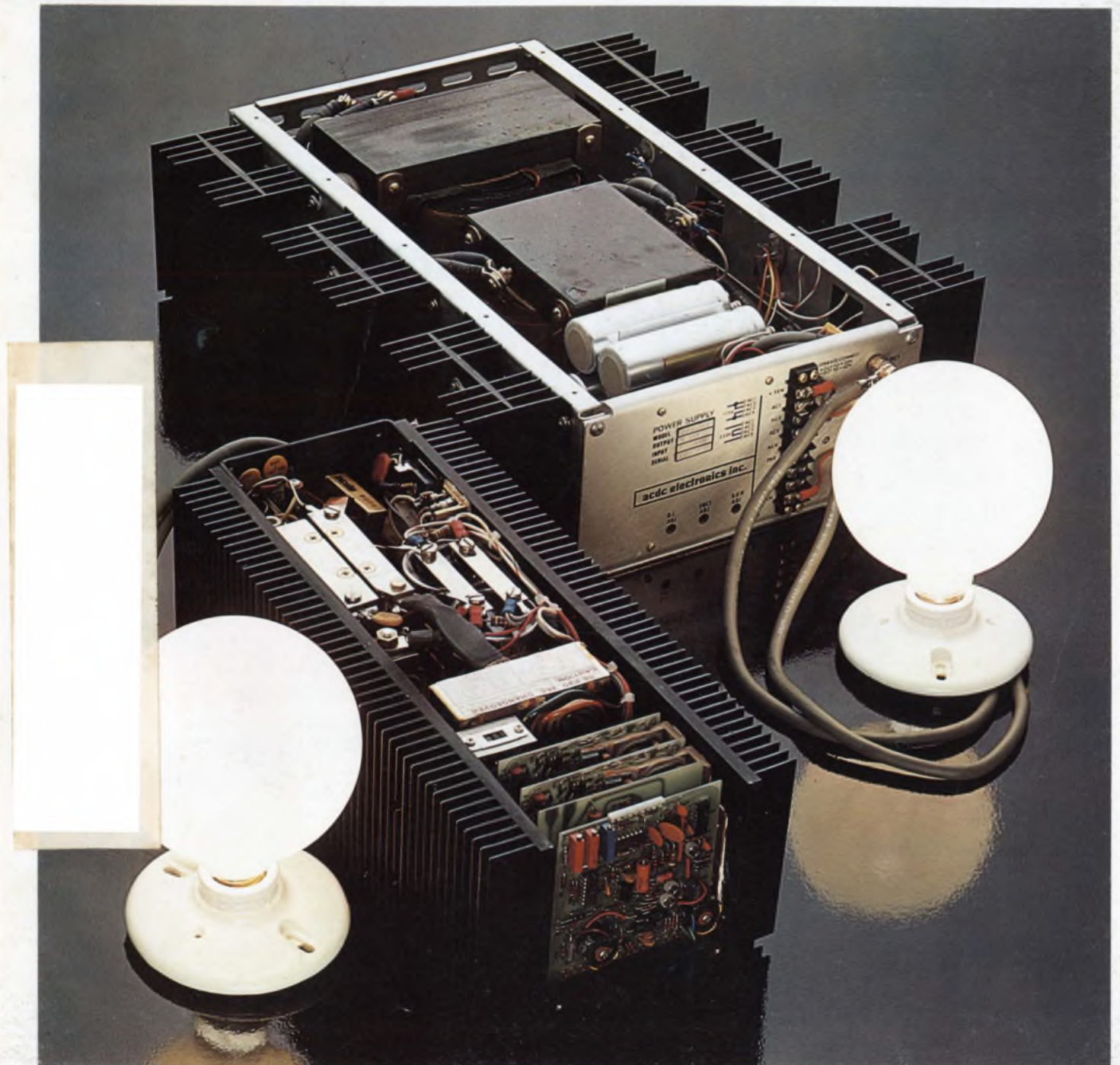

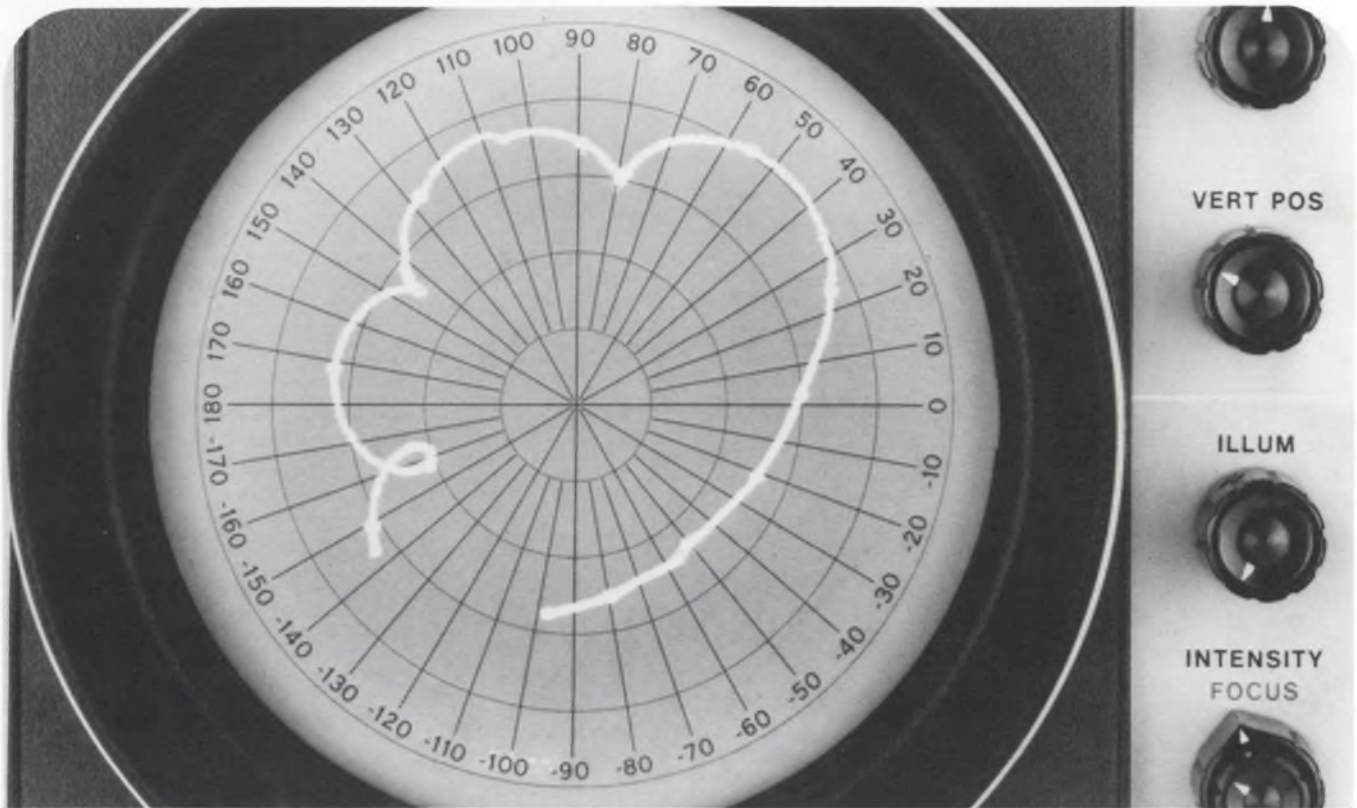

Reflection (s.) of broadband transformer, 200-1000 MHz, with 50 MHz frequency markers.

Here's the way to make multi-octave RF and microwave vector measurements.

A total system that now lets you make broadband swept measurements of magnitude and phase from 100 to 2400 MHz or from 2 to 18 GHz in one continuous sweep.



The familiar HP 8410 Network Analyzer now has automatic tuning to track the wide sweeps of the HP 8620A sweeper with its new broadband plug-ins.

Sweep 2-18 GHz with the HP 86290A plug-in and 100-2400 MHz with the new HP 86222A/B. The HP 86222B adds unique digitally-processed birdie markers for precise frequency identification.

Why not find out more about this complete high-frequency vector system? All the details are yours by calling your nearby HP field engineer, or writing.

HEWLETT  PACKARD

Sales and service from 172 offices in 65 countries.
1501 Page Mill Road, Palo Alto, California 94304

Hoo boy, have we got a deal for you! Ordinarily you'd expect to pay at least \$965 for a good sweeper without a scope? So we're offering you both at this incredibly low price.

First there's our Model 1050A, a compact, laboratory-quality sweeper covering the frequency range of 1 to 400 MHz. It features excellent linearity, PIN diode leveling and has a built-in detector. Naturally, the 1050A is all solid state and

has provisions for up to 6 plug-in marker modules.

The other half of this combo is our Model 1901B X-Y Display Oscilloscope. It has a big 12-inch diagonal CRT and incorporates a very stable, low-noise vertical amplifier with sensitivities from 1mV per division. Just hook it up to your 1050A sweeper and you have the perfect test setup for measuring frequency response in the VHF region.

And that's not all. We're

also throwing in all the cables you'll need to connect these little winners. The complete set-up can be ordered as FRS-400.

If you can pass up a deal like this, you're crazier than we are. WAVETEK Indiana Incorporated, P.O. Box 190, 66 North First Avenue, Beech Grove, Indiana 46107, Phone (317) 783-3221, TWX 810-341-3226.

WAVETEK[®]
INFORMATION RETRIEVAL NUMBER 2



It doesn't matter that Mini-Circuits' mixers are used in more systems than any other.

What matters is why.

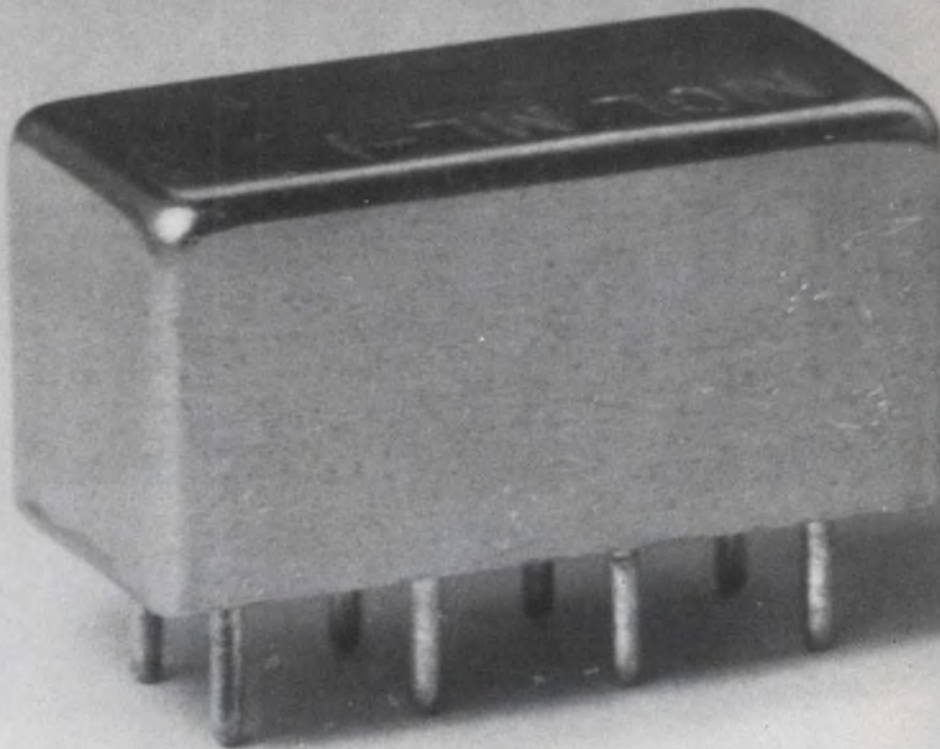

Mini-Circuits ships thousands of units each week to more than 500 companies throughout the world. These mixers are included in over 300 critical military programs as well as communications, medical, CATV, telephone transmission and instrumentation applications.

Our years of experience in high-volume production result in high reliability units with guaranteed repeatability of performance at lowest cost. That's why more and more systems engineers are specifying Mini-Circuits' mixers, directional couplers and power splitter/combiners as the industry's standard.

For complete specs, performance curves and application notes, see *MicroWaves 1974 Product Data Directory* (p. 187-311) or circle Reader Service No. 3 for your personal 132-page catalog.

For complete product specifications and U.S. Rep. listing see *MicroWaves' "Product Data Directory,"* *Electronic Designs' "Gold Book"* or *Electronic Engineers Master "EEM"*

Mini-Circuits Laboratory
A Division Scientific Components Corp

MCL

837-843 Utica Avenue, Brooklyn, NY 11203

(212) 342-2500 Int'l Telex 620156 Domestic Telex 125460

Foreign Sales Representatives: **AUSTRALIA** General Electronic Services, 99 Alexander Street, New South Wales, Australia 2065; **ENGLAND** Dale Electronics, Dale House, Wharf Road, Frimley Green, Camberley Surrey; **FRANCE** S C I E - D I. M. E. S., 31 Rue George - Sand, 91120 Palaiseau, France; **GERMANY, AUSTRIA, SWITZERLAND** Industrial Electronics GMBH, Klüberstrasse 14, 6000 Frankfurt/Main, Germany; **ISRAEL** Vectronics, Ltd., 69 Gordon Street, Tel-Aviv, Israel; **JAPAN** Denso Kaisha, Ltd., Eguchi Building, 8-1-1 Chome Hamamatsucho Minato-ku, Tokyo; **EASTERN CANADA** B. D. Hummel, 2224 Maynard Avenue, Utica, NY 13502 (315) 736-7821; **NETHERLANDS, BELGIUM, LUXEMBOURG:** Coimax, Veldweg 11, Hattem, Holland.

US Distributors: **NORTHERN CALIFORNIA** Cain-White & Co., Foothill Office Center, 105 Fremont Avenue, Los Altos, CA 94022 (415) 948-6533; **SOUTHERN CALIFORNIA, ARIZONA** Crown Electronics, 11440 Collins Street, No. Hollywood, CA 91601 (213) 877-3550

NEWS

- 23 **News Scope**
- 28 **Under-the-hood microprocessors could turn up in 1979 U.S. cars.** Initial applications will minimize fuel consumption.
- 33 **Optical scanning is improved with an unusual mirror technique** that yields greater angular rotation.
- 34 **Microprocessors to be permanent riders on Toronto's transit system.** Vehicle position is continuously monitored.
- 43 **Washington Report**

TECHNOLOGY

- 52 **FOCUS on switching power supplies:** Filters out the special problems indigenous to this type of supply and shows a specifying engineer how to avoid trouble.
- 72 **Design your own microcomputer** by using bipolar/LSI processor slices. An example shows how to build a 16-bit processor and develop its instruction set.
- 82 **Bond chips with conductive epoxies.** Their low curing temperatures avoid damage to parts, while the assembly process is inexpensive and easily automated.
- 88 **Keep your op-amp circuits quiet.** By isolating and minimizing the different sources of noise you can take advantage of today's high performance ICs.
- 96 **Squelch RFI in switching supplies.** Proper heat-sink connections, plus filters and screens, can steer unwanted currents away from input/output terminals.
- 100 **Ideas for Design:**
Circuit turns on tape recorder only when sound is detected.
Pulse amplifier can deliver over 500 V with frequencies to 100 kHz.
Optocoupler is zero-crossing detector and isolator in SCR power control.

PRODUCTS

- 107 **Modules & Subassemblies:** 18-pin DIP houses speedy 8-bit hybrid a/d converter.
- | | |
|---------------------|-----------------------------|
| 110 Power Sources | 120 Integrated Circuits |
| 113 Instrumentation | 121 Microwaves & Lasers |
| 116 Components | 122 Discrete Semiconductors |
| 118 Data Processing | 124 Packaging & Materials |

DEPARTMENTS

- | | |
|---|--------------------------------|
| 49 Editorial: Look, men. Females | |
| 7 Across the Desk | 132 Advertisers' Index |
| 125 Application Notes | 134 Product Index |
| 126 New Literature | 134 Information Retrieval Card |
| 128 Vendors Report | |

Cover: Photo by Harry Chamberlain, courtesy of ACDC Electronics, Oceanside, CA

ANY OTHER 12-BIT DAC EITHER COSTS MORE OR DOES LESS.

INTRODUCING THE AD563. \$27.

First there were modules. Then hybrids using up to nine chips.

But now there's the AD563. A 12-bit DAC with its own internal reference in a 24-pin DIP containing just three chips.

That's right, three chips. That's all we needed, thanks to our CMI (Compound Monolithic Integration) construction which uses a minimal amount of bonding to give you the highest reliability and the lowest cost you can get in any DAC with true 12-bit resolution.

And along with that true 12-bit accuracy, you also get: a maximum gain temperature coefficient of 10 ppm/°C, including the reference; a maximum error

at +25°C of ¼ LSB; and monotonicity guaranteed over the full temperature range.

In addition, the AD563 is TTL/DTL and CMOS compatible and priced from just \$27 in 100's.

AD563. A new level of integration for 12-bit DACs.

And it can only get better.

Analog Devices Semiconductor. Components for test and measurement instruments and control systems. Norwood, Mass. 02062.

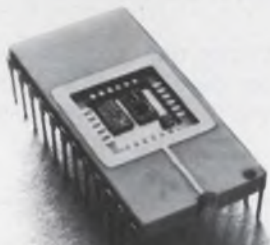

East Coast: 617-329-4700.

Midwest: 312-894-3300.

West Coast: 213-595-1783.

Texas: 214-231-5094.



INFORMATION RETRIEVAL NUMBER 4

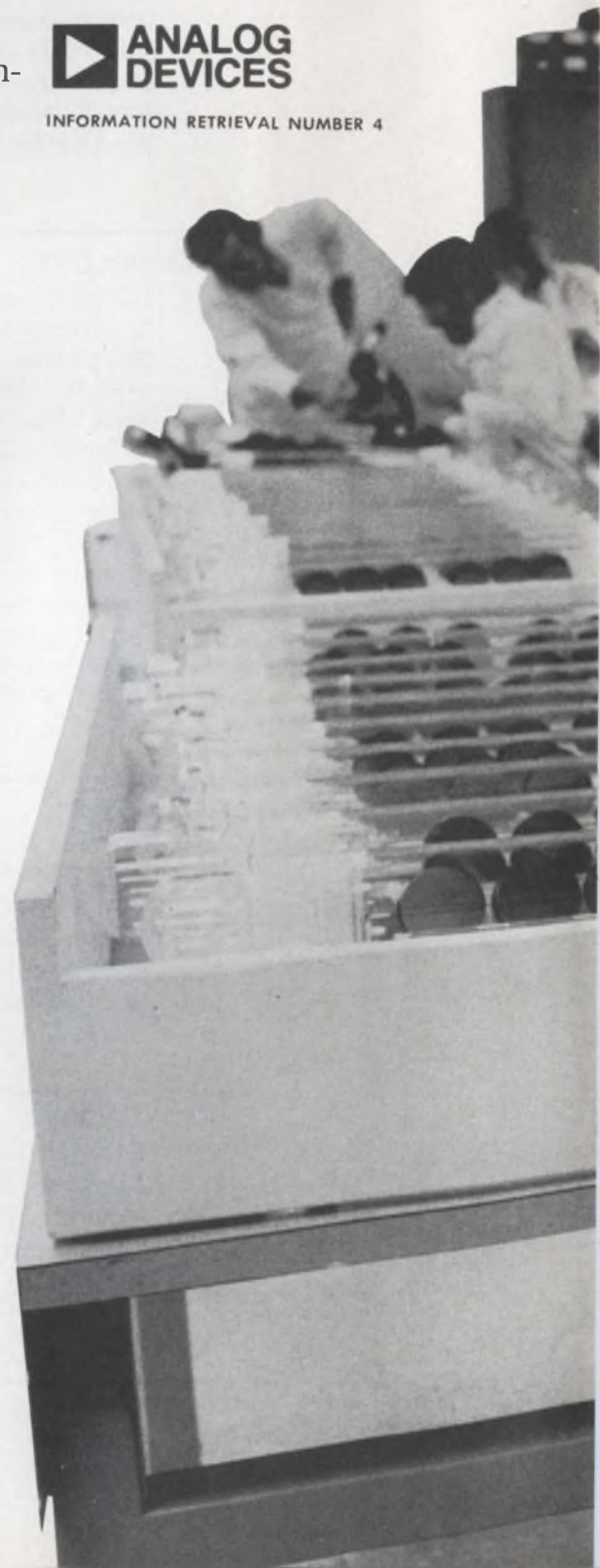



multi-conductor capability
...in all directions!

■ If you have a multi-conductor problem, just direct it to the wire company with multi-capability... design, engineering and efficient production. We have successfully designed and manufactured multi-conductor cable of all types. No matter how unusual your requirements, our engineers can work with you to achieve the results you want... with the dependable high quality that has made Victor the standard in wire, cable and cord sets. ■ Put our problem solving capability to work for you. At Victor! Write or phone with your specifications.

Victor Electric Wire & Cable Corp., 618 Main Street, West Warwick, Rhode Island 02893
Tel. 401 821-1700
TWX: 710-382-1534



Victor

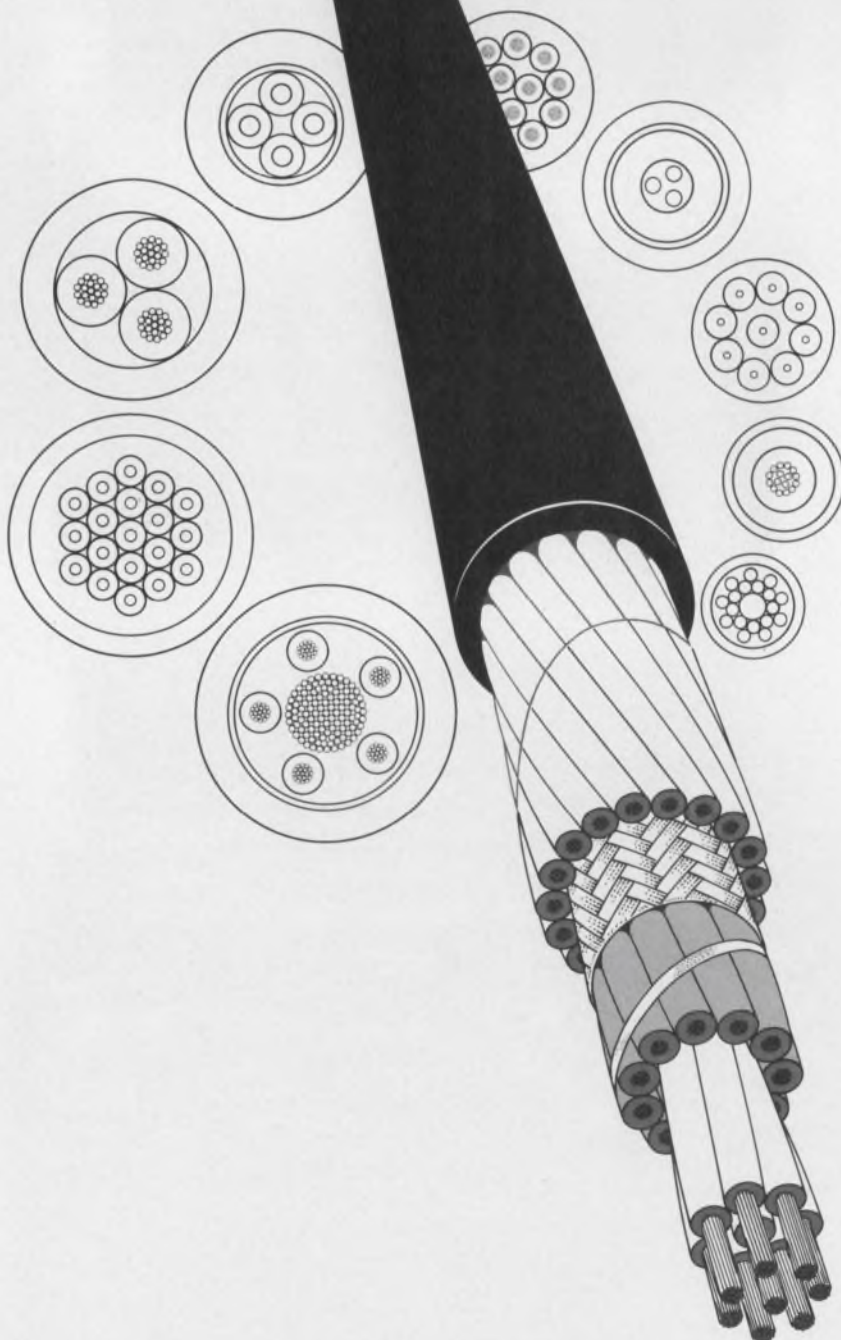

Sr. Vice President, Publisher
Peter Coley

Editors

Editorial Offices
50 Essex St.
Rochelle Park, NJ 07662
(201) 843-0550
TWX: 710-990 5071
Cable: Haydenpubs Rochellepark

Editor-in-Chief George Rostky

Managing Editors:
Ralph Dobriner
Michael Elphick

Associate Editors:

Dave Bursky
Jules H. Gilder
Morris Grossman
John F. Mason
Stanley Runyon
Edward A. Torrero

Contributing Editors:

Peter N. Budzilovich
Alberto Socolovsky
Nathan Sussman

Editorial Field Offices

East

Jim McDermott, Eastern Editor
P.O. Box 272
Easthampton, MA 01027
(413) 527-3632

West

David N. Kaye, Senior Western Editor
8939 S. Sepulveda Blvd.,
Suite 510
Los Angeles, CA 90045
(213) 641-6544
TWX: 1-910-328-7240

Editorial Production

Marjorie A. Duffy

Art

Art Director, William Kelly
Richard Luce
Anthony J. Fischetto

Production

Manager, Dollie S. Viebig
Helen De Polo
Anne Molfetas

Circulation

Manager, Evan Phoutrides

Information Retrieval

Peggy Long

Promotion, Creative Layouts

Manager, Albert B. Stempel
Maxine Correal
Nancy Gordon (Reprints)

Across the Desk

Calculator user notes () () () () trouble

Apropos of your recent articles on RPN calculators vs algebraic notation (ED No. 2, Jan. 18, 1975, p. 50; ED No. 12, June 7, 1975, p. 8 and p. 80), I would like to point out that some of the algebraic models with parentheses make mistakes.

The problem has to do with the parentheses and the y^x function. Two examples of problems that give incorrect solutions are

$$\begin{aligned} 1 + (1) &= 1 \\ ((2/4)^3)^3 \cdot ((4/2)^3)^3 \\ &= 3.81469723 \times 10^{-6}. \end{aligned}$$

The correct answer for the first problem is 2, and for the second problem, it is 1. The incorrect answers were obtained on my Bowmar MX-140, but since this calculator is now available for only \$39, I suppose I shouldn't be too concerned.

The difficulty in the first example is that if you use a parenthesis without needing it—that is without doing any calculations inside it—the calculator ignores the previously stored part of the answer. Sometimes it is not entirely obvious that the problem has an unneeded parenthesis, as for example in

$$1 + (\sin 45^\circ)^2 = 0.5.$$

The difficulty in the second problem is that the y^x key on some calculators is treated completely differently from any other function key—namely, it closes all preceding parentheses.

I believe the moral is that regardless of which scientific calculator you buy—whether it be RPN or algebraic, with or with-

out parentheses—you will have to take time to learn its features and its quirks.

Peter A. Stark

196 Forest Dr.
Mount Kisco, NY 10549

He sharpens the focus on pulse transformers

I read with great interest "Focus on Pulse Transformers" in the June 21 issue. The first paragraph on p. 80, though—a discussion of problems that can result from the use of sine-wave inductance instead of pulse inductance—may have confused some readers. A few added sentences may help to clarify it:

To illustrate the problem . . . of less than 50%. Without consideration of the peak current drawn by the load from the transformer, the selection of a transformer with a 1-mH sine-wave inductance, instead of a 1-mH pulse inductance, may cause the core to be driven near saturation and the 50% pulse droop will be exceeded. To get a 1-mH pulse inductance for this application, you might actually need a transformer with a 2.2-mH sine-wave inductance and a larger voltage-time product.

The ET rating of a pulse transformer is usually defined by a 20% maximum nonlinearity of the primary magnetizing current rather than by saturation-limiting of the core. Therefore both the required peak primary current and pulse inductance must be known to select a transformer with the

(continued on page 10)

Thin-Trim[®] capacitors



 Tucked in the corner of this Pulsar Watch is a miniature capacitor which is used to trim the crystal. This Thin-Trim capacitor is one of our 9410 series, has an adjustment range of 7 to 45 pf., and is .200" x .200" x .050" thick. The Thin-Trim concept provides a variable device to replace fixed tuning techniques and cut-and-try methods of adjustment. Thin-Trim capacitors are available in a variety of lead configurations making them very easy to mount.

 A smaller version of the 9410 is the 9402 series with a maximum capacitance value of 25 pf. These are perfect for applications in sub-miniature circuits such as ladies electronic wrist watches and phased array MIC's.

Johanson Manufacturing Corporation,
Rockaway Valley Road., Boonton, N.J.
07005. Phone (201) 334-2676, TWX 710-
987-8367.

Electronic Design welcomes the opinions of its readers on the issues raised in the magazine's editorial columns. Address letters to Managing Editor, Electronic Design, 50 Essex St. Rochelle Park, N.J. 07662. Try to keep letters under 200 words. Letters must be signed. Names will be withheld on request.

GENERAL INSTRUMENT'S CP 1600

THE WORLD'S MOST POWERFUL SINGLE-CHIP MICROPROCESSOR

AND ALL THE SUPPORT THAT GOES WITH IT

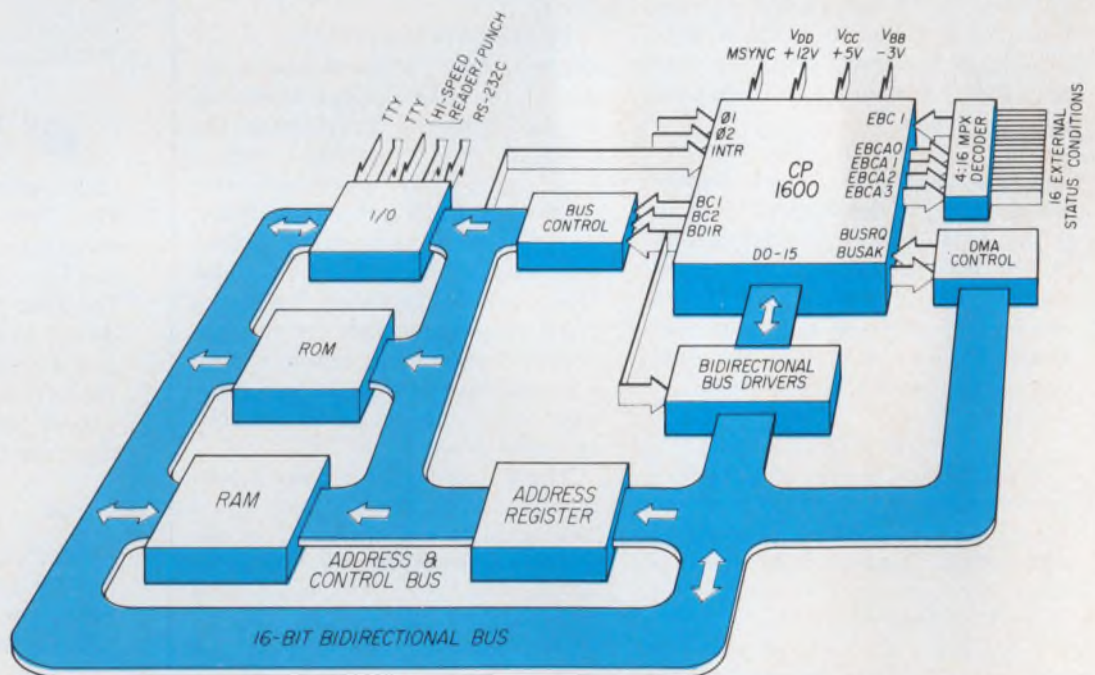

CP 1600 GENERAL INSTRUMENT'S 16-BIT MICROPROCESSOR

CP 1600 is the first single-chip 16-bit microprocessor with third generation minicomputer architecture. The only one. And, together with its powerful and continually growing support package, provides a new level of microprocessor system capability.

Let's start with the chip. It uses eight high-speed, general purpose 16-bit registers. Twice as many as the competition's 16-bit unit.

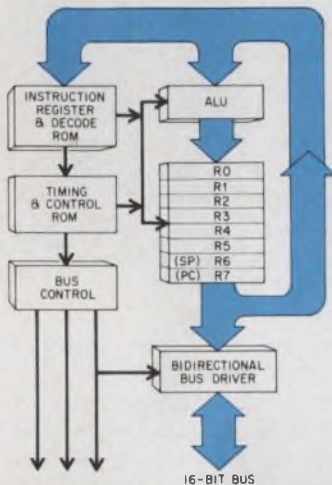

And it's twice as fast. Register to register operations take only 3.6 μ s. Memory to register and Input/Output operations, only 4.8 μ s. But speed is only one of the CP 1600's outstanding features. 16-bit word length and four addressing modes permit efficient access to 64K of memory—in any combination of program, data storage, or peripheral devices. So, I/O data can be manipulated just like memory. By all 87 instructions.

Regarding stack storage or program interrupts. CP 1600 has unlimited stack depth and self-identifying, nested interrupt capability with priority resolution. The competition's chip has only a 16 level stack and 4 interrupt levels.

AND ALL THE SUPPORT THAT GOES WITH IT

With a chip like the CP 1600, it's only right to maximize its support. So, we have a complete family of processor and memory products. ROMs from 4K to 16K... to optimize program storage efficiency and provide 16-bit computing power at 8-bit density. All fully static. All with a single 5 volt power supply. Plus static RAMs from 1K to 4K bits. And there's a continually growing family, including the Programmable Interface Controller chip, coming in January.



Development Hardware

The Series 1600 MicroComputer System will simplify your design cycle. It will provide you with a test bed for interfaces and related hardware, as well as full program preparation facility with resident on-line hardware and software debug aids. Peripheral interfaces you can use include TTY, high-speed paper tape equipment, serial line printer and magnetic tape cassettes. And all card level modules of the Series 1600 system ranging from microcomputers, memory and I/O modules, to general purpose arrays, are available on an OEM basis for further system integration.



Complete Software Support, Too

Among the Series 1600's sophisticated program preparation tools are extensive resident software and a fully compatible Cross Software package for popular minicomputers. There's the powerful, easy-to-use On-Line Debug program to aid in checkout. The Text Editor. The Assembler. The Relocating Linking Loader. The Memory Dump Program. The Monitor and Utility routines. And coming up... the Macro Processor and Language Generation package. An expanding library of application sub-routines and complete documentation are, of course, available. As are strategically located Test Centers and applications assistance.

The kind of support you'd expect for the world's most powerful microprocessor system. And the kind of support you'll get.

Please send further information on your Series 1600 Microprocessor System

Name _____
Title _____
Company _____
Dept/MS _____
Address _____
City _____
State _____ Zip _____

Mail to: General Instrument Corp.,
Microelectronics, Dept. M 13,
600 W. John St., Hicksville, N.Y. 11802

GENERAL INSTRUMENT CORPORATION
MICROELECTRONICS



INFORMATION RETRIEVAL NUMBER 7

CIRCUIT DESIGNERS...

GET MORE VERSATILITY AND FLEXIBILITY IN YOUR BREADBOARDING.

Experience the convenience of

MULTI-COMP[®] DIP Multiple-Section Ceramic Capacitors

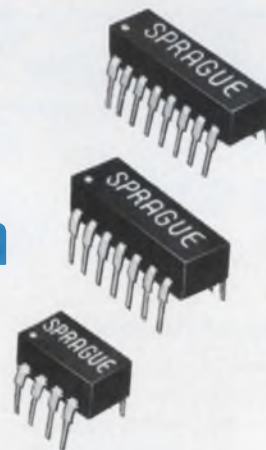

Breadboarding is a lot easier with Sprague Multi-Comp Monolythic[®] Ceramics. They readily plug in and out of standard DIP sockets for fast changes during experimentation. They come as 4-, 7-, and 8-section capacitors, in popular most-frequently-used capacitance values. By connecting capacitor sections in parallel, you can obtain



practically any value your circuit needs. With a few Multi-Comp capacitors on hand, there's no need to keep heavy stocks of individual capacitors for breadboarding purposes. There's less soldering and unsoldering, too.

And when your final capacitance determinations are made, you can either stay with DIP Multi-Comps, or switch to Sprague Single-Section Monolythic[®] Capacitors, which have the same layer-built construction and the same electrical characteristics.

**GET THE DIP HABIT —
TRY MULTI-COMP[®] MONOLYTHIC[®] CAPACITORS IN YOUR NEXT
BREADBOARD DESIGN — THEY'RE READILY AVAILABLE FROM
YOUR SPRAGUE INDUSTRIAL DISTRIBUTOR!**

For more information, write or call
Ed Geissler, Mgr., Specialty Components
Marketing, Sprague Electric Company,
347 Marshall Street, North Adams, Mass. 01247.
Tel. 413/664-4411.



ACROSS THE DESK

(continued from page 7)
proper ET rating. The sine-wave inductance should be used only as a reference.

Walter V. Manka

Senior Design Engineer

Delevan Div.

American Precision Industries Inc.

270 Quaker Rd.

East Aurora, NY 14052

Transformer maker 'forced to take issue'

Congratulations for a creditable job on an elusive subject, "Focus on Pulse Transformers," in the June 21 issue. As a manufacturer of those devices for over 25 years, we are familiar with the problems. We are, however, forced to take issue with you over statements that indicated it was difficult to reproduce sample units on a production basis.

Technitrol believes this places an unwarranted reservation in the mind of many transformer users or potential users. While much of what you say is true with regard to variations in cores and people, Technitrol has gone to great pains and expense to build core testing equipment and to provide manufacturing controls to prevent just such occurrences. The transformer design itself is reviewed again and again for producibility and reproducibility.

W. A. Chamberlin

General Sales Manager

Technitrol, Inc.

1952 E. Allegheny Ave.

Philadelphia, PA 19134

Ending ambiguities when calculating

In "Another Counting Idea for Pocket Calculators" (ED No. 14, July 5, 1975, p. 7), David W. Thompson notes an ambiguity when the count ends in zero. This can be easily overcome on calculators that are not equipped to add a constant to the accumulator, if one additional step is added to the programming. The

(continued on page 15)

THE BROAD-LINE PRODUCER OF ELECTRONIC PARTS

INFORMATION RETRIEVAL NUMBER 8

ELECTRONIC DESIGN 20, September 27, 1975

SIEMENS

S.V.P.[®] SURGE VOLTAGE PROTECTORS



Low-cost protection against damaging voltage transients.

Electronic equipment—especially solid state—needs protection from sudden surges in voltage that can lead to costly maintenance, long operational down-time or even loss of equipment.

Siemens Surge Voltage Protectors provide this protection. If you are now using or contemplating the need for gas tubes or spark gaps, check out Siemens SVP's on performance, price and delivery.

Highly reliable and of proven design, Siemens SVP's offer:

- High current capability.
- Accurate breakdown voltage.
- Low capacitance.

- High insulation resistance.
- Ability to withstand extreme environmental and operational extremes.
- A broad line: power, fail safe and 3-electrode types.

Beyond typical telephone and communications uses, Siemens SVP's have a variety of non-protective "switching" applications. Strobe/flash warning lights, photography, ignition or almost anywhere a voltage sensitive switch is required.

To learn more about Siemens SVP's, write for literature, free samples or applications engineering data. Immediate delivery is available from current stock.

Siemens Corporation
Special Components Division

186 Wood Avenue South, Iselin, New Jersey 08830 (201) 494-1000

Introducing the Unswitcher.

Power/Mate's answer to the switching power supply.

Switching Power supplies have always been intriguing. And every bit as baffling. Because they're good for certain jobs and totally wrong for others.

Well, we at Power/Mate decided to find an alternative.

(We didn't get to be a leader in the field just by sitting back.)

After a year of intensive development and testing our engineering managers found the answer.

The uniquely unusual Unswitcher.

The Unswitcher is the perfect alternative for two reasons.

First, it's simpler. A lot fewer working parts make it a lot more reliable.

And when it comes to looking at power supplies, reliability is one thing you should never overlook.

How did we make it so simple? Our engineers will be glad to tell you.

Second, it's priced competitively. Which means it'll make you happy while making our competition unhappy.

So if you're looking for a power supply of quality from a company of quality, look no further.

The answer is right in front of your nose.

Right now the Unswitcher comes in two models (specs shown below) with additional models on the way.

CF-5-G/50A

Input 100V-130 VAC, 57-63HZ
Output Voltage 4.5-5.5V Adjustable
Load Regulator ± 10 MV
Line Regulator ± 25 MV
Ripple Less than 50MV RMS
Response Time: (50-100% Load Change) 100 milli seconds
Stability (8 hr): Less than 1%
Temperature Coefficient: 0.05%/C
Ambient Operating Temperature: -20°C to +55°C
Storage Temperature: -40°C to 85°C
Cooling: Convection Cooled
Overload Protection: Current Limited
Isolation Voltage: 600 volts to chassis
Overvoltage Protector: Built in
Efficiency: 70%
Case Size: 50A 10 $\frac{1}{2}$ "W x 6 $\frac{1}{2}$ "H x 12L
Price: Only \$345.00

CF-5-J/100A

Input 100V-130 VAC, 57-63HZ
Output Voltage 4.5-5.5V Adjustable
Load Regulator ± 10 MV
Line Regulator ± 25 MV
Ripple Less than 50MV RMS
Response Time: (50-100% Load Change) 100 milli seconds
Stability (8 hr): Less than 1%
Temperature Coefficient: 0.05%/C
Ambient Operating Temperature: -20°C to +55°C
Storage Temperature: -40°C to 85°C
Cooling: Convection Cooled
Overload Protection: Current Limited
Isolation Voltage: 600 volts to chassis
Overvoltage Protector: Built in
Efficiency: 70%
Case Size: 100A 10 $\frac{1}{2}$ "W x 6 $\frac{1}{2}$ "H x 16L
Price: Only \$395.00

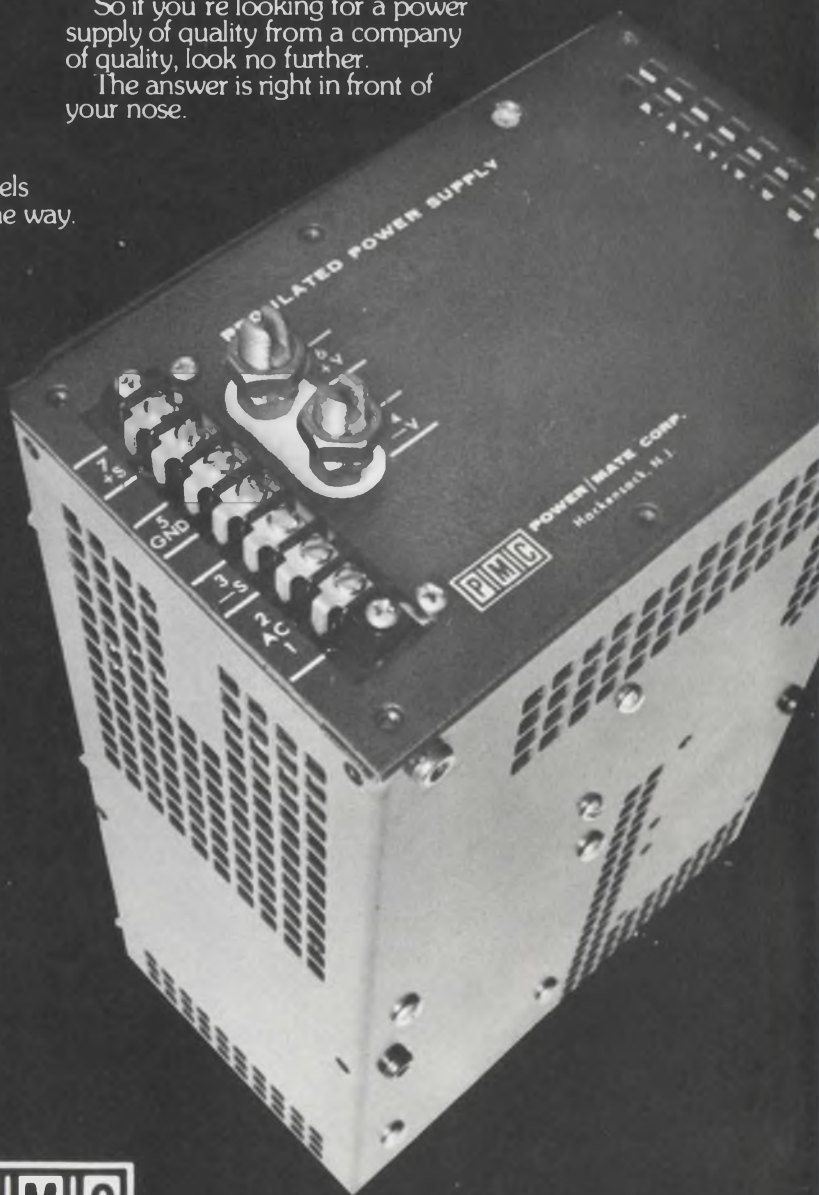

POWER/MATE CORP.

514 S. River Street/Hackensack, N.J. 07601/ (201) 343-6294/ TWX 710-990-5023

If you need HYBRIDS...

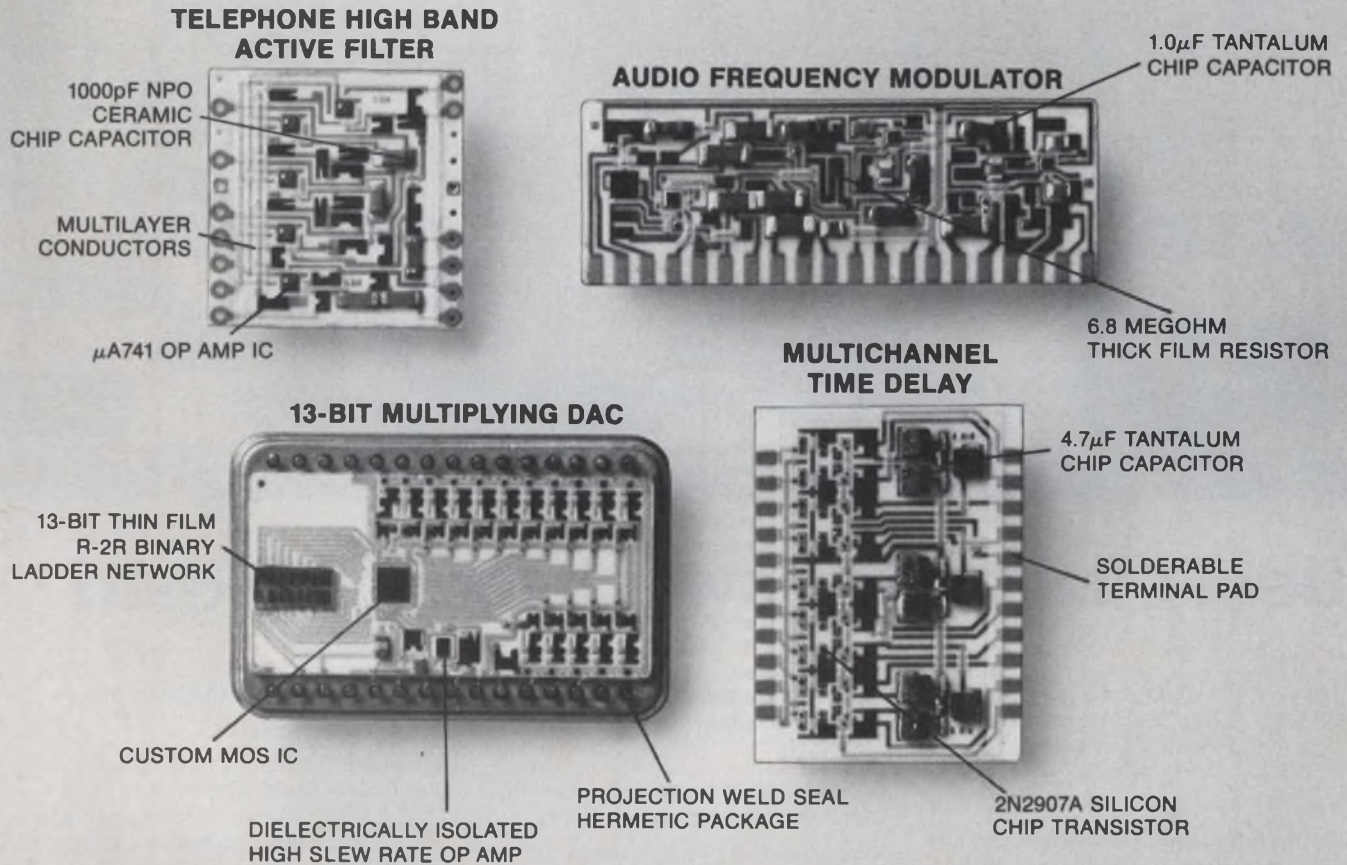

you should know about BECKMAN!

We offer *expert* application assistance and *quality* products at *competitive* prices.

Beckman Hybrids can solve your system packaging problems in:

- Active Filters and Telephone Tone Filter/Modem products
- DACs and ADCs from Industrial to Military standards
- Power Linears from Amplifiers to Voltage Regulators
- Complex Customs from Passive Substrates to Multilayer Digital hybrids

For fast response, call (714) 871-4848, Ext. 1776

Beckman®

HELIPOT DIVISION

INFORMATION RETRIEVAL NUMBER 11

When it's your move ...check Centralab

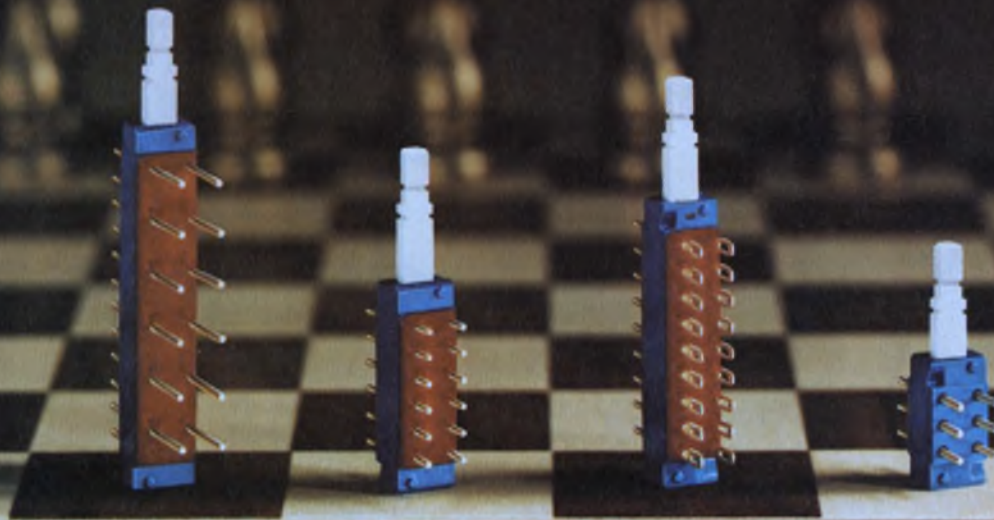

Best pushbutton switch for your board

Don't be checkmated. Only Centralab offers you the best low-cost switch module, plus so many extra-quality options.

THE BEST SWITCH—The basic Centralab pushbutton switch module is unique because of its inherently simple and rugged construction. High speed machinery produces the parts and performs assembly operations simultaneously, ensuring that the parts always fit the assembly perfectly. Stationary and movable contacts are enclosed in a high-dielectric thermoset housing to protect the smooth, positive wiping

action of the slider bar and contacts. And Centralab switches are 100% tested.

Centralab pushbutton switches meet these demanding specifications:

Insulation Resistance: Up to 10^{12} ohms.

Dielectric strength: 1,500 volts.

Contact resistance: .004 ohms.

Life and reliability: Up to 250,000 MTBF in ganged assemblies. Over 500,000 operations on contact systems.

Shock and Vibration: 100g's and 10g's low frequency.

Electrical rating: Covers range from dry circuits to 1 ampere, and low millivolts to 120 volts.

If your requirements go beyond the basic Centralab module, consider these optional moves:

HIGHEST INSULATION RESISTANCE—Centralab offers diallyl phthalate housing material, in addition to phenolic.

BEST CONTACT RESISTANCE—Gold contacts and terminals are standard options. Best for dry circuit applications and contaminating environments.

NO INTERNAL CONTAMINATION—Epoxy sealed terminals prevent

failure from solder flux and other contaminants.

Proven in use by more quality-conscious users, Centralab 2, 4, 6 and 8 pole pushbutton switches are available in four types of lockout for momentary, push-push or interlocking action. Both PC and solder lug terminals are available. PC terminals can be selectively cut to your desired lengths.

PLUS THESE NEWEST ADDITIONS

—A new 5 amp line switch, a new low-cost lighted switch and a new visual display for non-lighted switches.

Get all the technical help you need from our 19 assembly distributors or network of experienced sales engineers. They'll help you select the best pushbutton switch for your board. Now it's your move!

Isostat Licensed



CENTRALAB

Electronics Division
GLOBE-UNION INC.

5757 NORTH GREEN BAY AVENUE
MILWAUKEE, WISCONSIN 53201

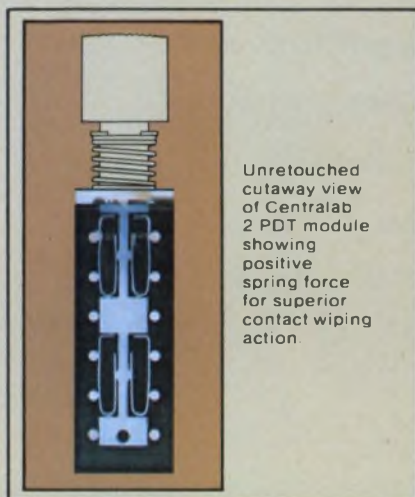

Unretouched cutaway view of Centralab 2 PDT module showing positive spring force for superior contact wiping action.

ACROSS THE DESK

(continued from page 10)
steps are as follows:

1. Turn on "K switch."
2. Clear accumulator and constant (C).
3. Enter 1.0000001.
4. Press the multiply key.
5. Enter 10000001.
6. Successive key strokes of the (+=) key will then count events by incrementing the least-significant digits, 10000002, 10000003, etc., and there is no ambiguity when the count reaches 10000010.

When using the J.C. Penney Model MM3R, the procedure works as stated. On some models, such as the Texas Instruments TI-2500, steps 3 and 5 must be interchanged.

Daniel Barnes
Senior Design Engineer

Magnavox Co.
1700 Magnavox Way
Fort Wayne, IN 46804

Misplaced Caption Dept.



"Whew! I thought he'd never sign."

Sorry. That's Pierre-Auguste Renoir's "Bather on the Rock," which hangs in the collection of Durand-Ruel in Paris.

Thank you, thank you Elizabeth deAtley

I always admire your editorial judgment, but never more than recently when you paid me a per-

sonal compliment in the pages of your magazine. Imagine my appreciation of your abilities when I discovered on p. 14 of your issue No. 15, July 19, 1975, a verbatim copy of the "Idea Killers" that had appeared some time before in No. 15 of Stanford Research Institute's *Investment in Tomorrow*, of which I am editor.

And instead of the usual clutter at the end of the piece—such as an acknowledgment of your source—you maintained a discreet white space, classic in its simplicity.

Elizabeth deAtley
Editor

Stanford Research Institute
Menlo Park, CA 94025

Ed. Note: Your letter, with classic impact, pierces without verbiage directly to the point—somewhere between the second and third lumbar. Sorry the credit was omitted.

We flipped

In ED No. 16, Aug. 2, 1975, p. 124, the New Product photo for Electronic Engineering Co.'s microprocessor board was placed inadvertently with the product above it—Tempil's temperature-indicating coating.

Reader spots error in a design aid

In reading your issue of July 5, 1975, I came across an error in "Design Aids" on p. 95. When following the sample program given with my HP-21, I noticed that when the number "a" is entered, then stored in the machine, a wrong answer resulted. The second line of the program should read

```
a STO 2 X
```

for the HP-21 calculator only.

When the sample program was worked out on an HP-35, the results were correct.

Allen R. Maslowski
Product Development Engineer
RCA
Route 202
Somerville, NJ 08876

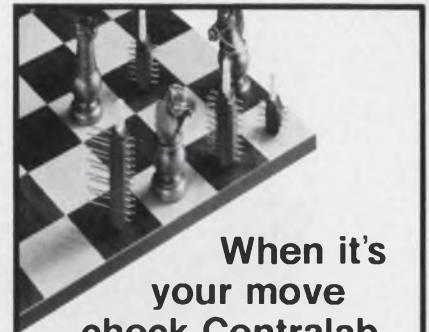

When it's
your move
check Centralab

High quality
pushbutton
switches at
a low cost



Centralab switches are engineered for quality. Then they're produced on high-speed automated machines to keep your cost down. This means...

Low Price: A Centralab 2-pole lighted switch, for example, costs only \$1.36 including lamp, in 1,000 quantities.

Quality: Up to 250,000 MTBF in ganged assemblies. Over 500,000 operations on contact systems.

Plus Options: Diallyl phthalate housings • gold contacts • epoxy-sealed terminals • 2, 4, 6 and 8 poles • four types of lockouts • and much more for *only pennies more*.

Newest Additions: Non-lighted status indicator • low-cost lighted switch • 5 amp line switch.

When you can have quality *and* low price from Centralab, why settle for less? For full information, call your Centralab Pushbutton Distributor or send reader service card, or write...

Isostat Licensed



CENTRALAB

Electronics Division
GLOBE-UNION INC.

5757 NORTH GREEN BAY AVENUE
MILWAUKEE WISCONSIN 53201

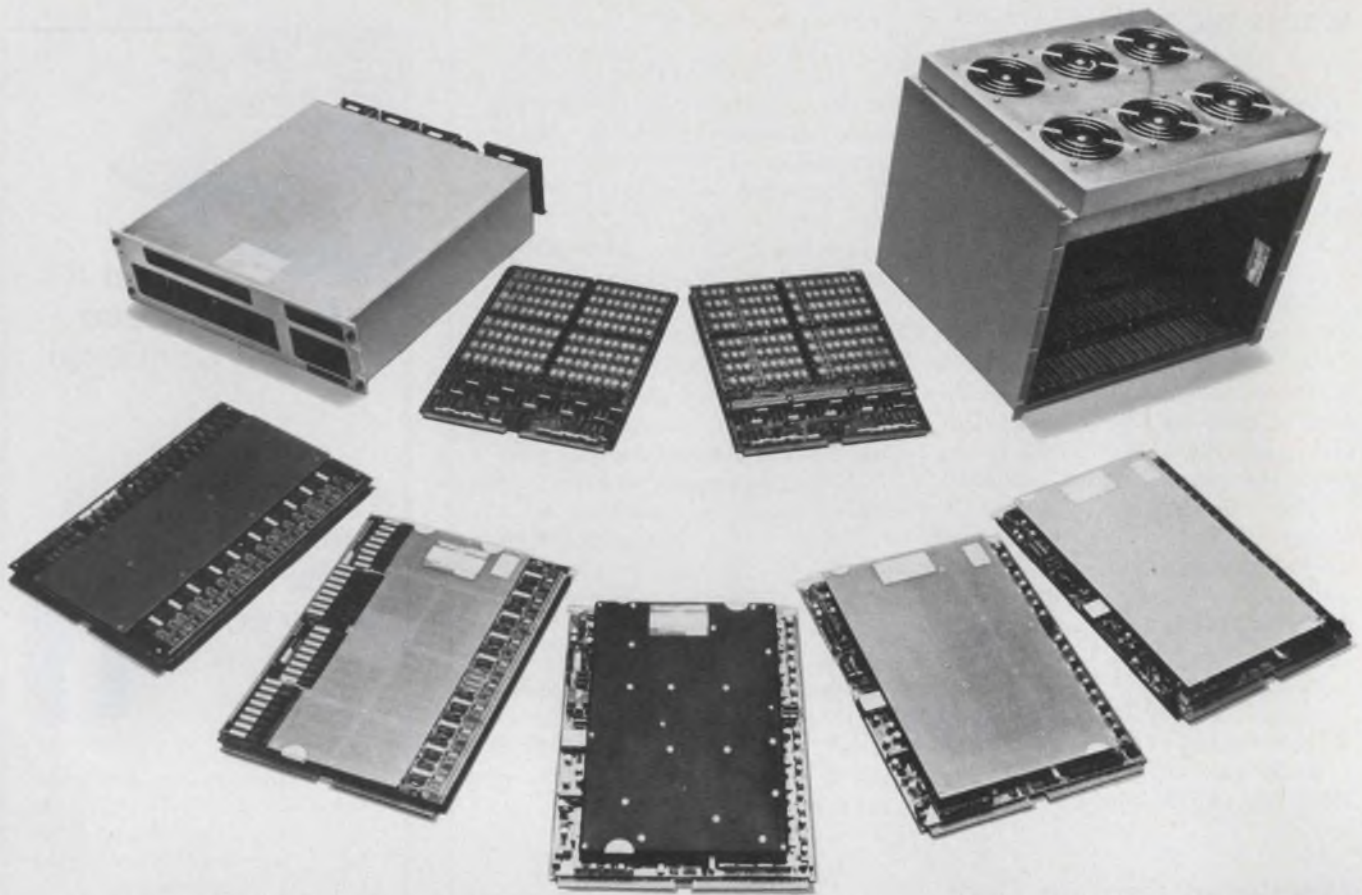

Only EMM Offers Core & NMOS Memories You Can Mix & Match

That's the MICROMEMORY 3000 family. Probably the most versatile family of memory systems available today. Or tomorrow.

Start, for example, with the basic, reliable MICROMEMORY 3000 8K x 18 core memory card — which can be depopulated down to 4K if you want. There's a standard chassis with power supply to hold four of these plus interface card, self test card, other accessories. Or you can substitute the 16K MICROMEMORY 3000DD card. Or the 32K MICROMEMORY 3000QD card. Make it NMOS with our MICRORAM 3000N 16K x 20 card memory. Or the MICRORAM 3400N 32K memory using our new SEMI 4402 4K static RAM.

The beauty of it is, you can mix or match any of these in the same 5¼" chassis, and go from 4K core to 32K NMOS cards without any basic change in the support electronics. (There's even a vertical chassis which holds up to 16 cards totalling a megabyte if you need that much.)

Call your nearest EMM sales office to find out how you can build the precise memory system you need today. And tomorrow.

EMM ELECTRONIC
MEMORIES
COMMERCIAL MEMORY PRODUCTS

A Division of Electronic Memories & Magnetics Corp.
12621 Chadron Ave., Hawthorne, Calif. 90250

EMM OFFICES: WESTERN REGION, Regional Office, San Francisco (408) 247-9711, Los Angeles Area (213) 644-9881, Orange County Area (714) 639-5811, Phoenix Area (602) 968-2492, EASTERN REGION, Regional Office, Boston (617) 861-9650, Chicago Area (312) 297-7090, New York Area (516) 423-5800, Ohio Area (216) 867-5435, INTERNATIONAL OFFICES, European Headquarters, Belgium (031) 76.69.75, United Kingdom (01) 751-1213, West Germany (089) 714 30 40

REPRESENTATIVES: Gentry Associates; Orlando (305) 894-4401, Huntsville (205) 534-9771, Burlington, N.C. (919) 227-3639, The Thorson Co., Washington/Oregon (206) 455-9180 In Canada: Megatronix, Ltd.; Toronto (416) 742-8015, Montreal (514) 488-0404, Ottawa (613) 729-4004, Vancouver (604) 526-3312 In Japan, Nissho Electronics (03) 544-8396.

INFORMATION RETRIEVAL NUMBER 14

the monochip:[®] offers three advantages no other IC can match

A custom design for \$1800

The price is so low it seems impossible.

Interdesign does it by stocking four standardized chips, the largest carrying 300 bipolar components, but with no interconnections yet between components. You simply tell us which components you want connected, we perform the final integration, and —PRESTO— you have a custom IC.

To help you get started, Interdesign provides a \$39 design kit. It contains discretely corresponding to the components on our four Monochips plus a complete design handbook.

From the kit you make a breadboard of your circuit. Then you select the Monochip that best fits your design and send us an interconnection diagram.

Completely processed in 3 weeks

Three weeks after we receive your interconnection diagram, you'll get your



We start with a standard chip carrying unconnected components.

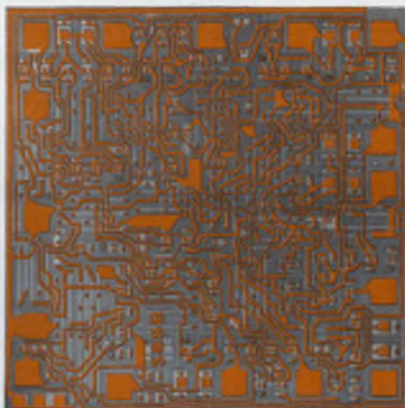

Then add an interconnecting overlay to create a custom circuit which is economical, quick to produce and easy to revise.

first 50 custom ICs. All for \$1800 total. After that you can move straight into production — at a large saving if you are now using PC boards with discrete components and standard ICs.

Easy to revise

The Monochip is so economical and simple to revise that you can do some of your development work right on the chip. In contrast to a completely custom IC, you don't have to risk \$40,000 and 8 months time when you order your first ICs. You can improve and update your circuit progressively.

Send now for our new brochure on Monochip design. See how simple it is to design your own ICs.

Interdesign, 1255 Reamwood Ave.,
Sunnyvale, Calif. 94086. Phone (408)
734-8666.

Interdesign[™]

THE SWITCHERS VS THE UGLIES™

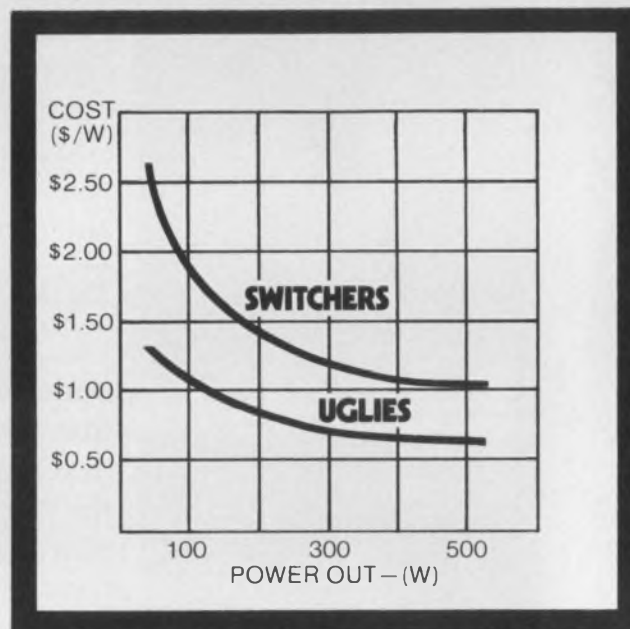

When it comes to price and performance, our modular dc supplies aren't just UGLY, they're downright mean.

They're series-pass regulated, so you don't have any problems with EMI compatibility and filtering. They use fewer parts than switchers, so long term reliability is higher. And because of their straightforward design, modifications are much simpler and a great deal less expensive.

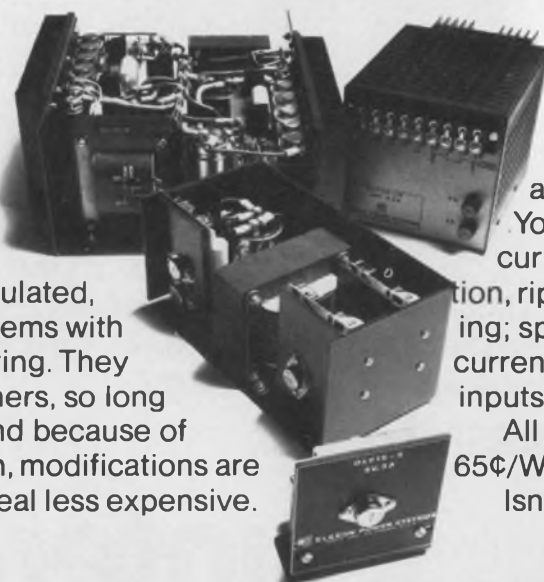

The UGLIES will solve 90% of your computer peripheral and instrumentation problems. You get a choice of 16 voltages; currents to 100 A; $\pm 0.1\%$ regulation, ripple-and-noise; remote sensing; spike suppression; foldback current limiting; and 120/240 V inputs.

All standard for as little as 65¢/W (100 qty).

Isn't that a switch?



©Elpac, Inc. 1975

Elexon: The ugliest dc supplies on earth.

Get UGLY at Cramer, Newark, MIL-COMM, QPL or Terminal Electronics. Or call 714/979-4440.

INFORMATION RETRIEVAL NUMBER 16

NI 2001 Programmable Calculating Oscilloscope



Just 11 keys let you program your scope controls to automate complex signal analysis.

Requires No Special Programming Language — or Experience.

It's no surprise that industrial and scientific users of test and measurement instrumentation are acclaiming the NI 2001. More than just a better instrument for the acquisition, processing and manipulation of electrical data, its innovations make it an entirely new generation of instrumentation. It ushers in a new era of ease and accuracy in analyzing signal data because it combines all the capability of a digital oscilloscope and micro-processor in a single mainframe. It eliminates interfacing requirements, computer instructions and requires no programming experience.

Only a demonstration can prove how unbelievably versatile the NI 2001 really is. No other instrument gives you the freedom and convenience of *programmability*. With the exception of time base, all front panel controls for mode and display, as well as the entire 81-key interactive keyboard can be programmed. The 11 keys of the keyboard's PROGRAMMING section, shown here, let you automate complex signal analysis. You merely press the PROGRAM key, perform the desired sequence once and press the END key. The NI 2001 will then repeat the sequence whenever the RUN key is pushed. You can store up to 200 instructions with complete editing freedom for additions or corrections. You can pause and review during any



data sequence or perform an operation a step at a time, editing as you go. And, as special-purpose plug-ins become available, like FFT for instance, you can include them in your programs too.

The programmability of the NI 2001 combined with its capability for conditional branching further emphasizes its versatility. Predetermined conditions can be programmed, which when met will allow the NI 2001 to perform decision-making functions. And with options, it can output a control pulse to extend its application as a controller for an experiment or ongoing process.

Programming is just one of a host of features you'll find only in the NI 2001. Get complete details and discover how you can make waveform analysis easier than you dreamed possible. Send the reader service card or write Norland Instruments Dept. E-2.



NORLAND INSTRUMENTS
A Subsidiary of Cordis Corporation

FOR DEMONSTRATION CIRCLE 261

Norland Drive
Fort Atkinson, Wisconsin 53538
Tel. (414) 563-8456 U.S.A.

FOR INFORMATION ONLY CIRCLE 262

Who's who in high performance linear I.C.'s? We are.

Teledyne Philbrick. The ones who started it all some 29 years ago. Today we have the best line of bipolar and FET input high performance linear I.C.'s. Some 17 different I.C. families in all... general purpose, wideband, high speed/fast settling and ultra-low drift bipolar I.C.'s. General purpose, low cost, high accuracy, ultra-low bias current, ultra-fast and wideband/fast settling FET I.C.'s.

Linear I.C.'s that give you low-cost, high reliability and high performance without any of the usual trade-offs. So you get all the performance you need at competitive prices that will surprise you. Dependable I.C.'s with the experience to back them up.

We've got a wideband bipolar I.C., our 1321, that boasts a settling time of 500 nsec. to 0.1%, better than any competition and sells for \$6 in 100's.

Or we'll give you the same specs in a FET input I.C., our 1433, for \$9.50 in 100's.

How about our 1340, an ultra-low drift bipolar I.C. with $0.2 \mu\text{V}/^\circ\text{C}$ E_{osTC} and $5 \mu\text{V}/\text{year}$ long-term stability that sells for \$25 in 100's.

Or the fastest FET I.C. op amp on the market, our 1430, that gives you a settling time of 200 nsec. to 0.01%, max. and 10 V @ 50 mA output.

We could go on and on. But you get the idea. If you want the best high performance linear I.C.'s check us first.

Write for our new Linear/ Nonlinear Catalog. Or "DIAL" (our Direct Information Access Line) 617-329-1600.

Teledyne Philbrick, Dedham, MA 02026. In Europe, Telephone 673.99.88, Telex: 25881. Or write 181 Chaussee De La Hulpe, 1170 Brussels.

 **TELEDYNE
PHILBRICK**

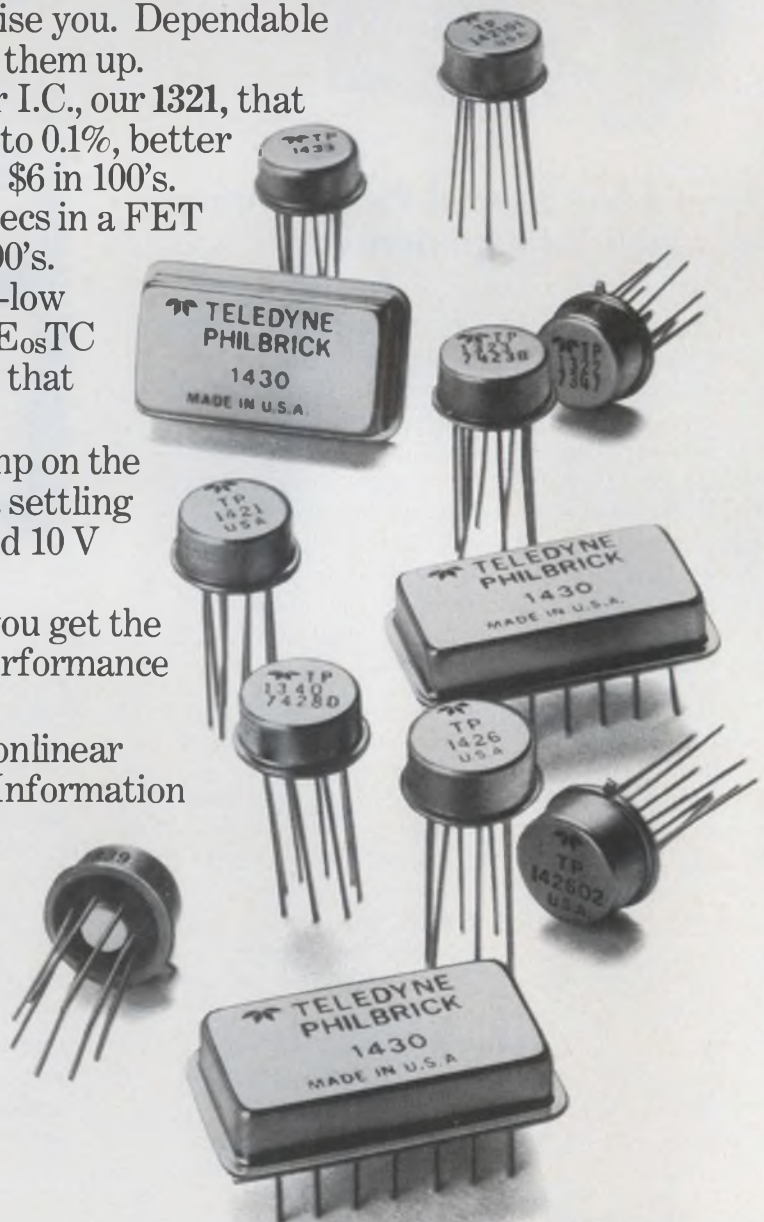

NEW BENCHTOP POWER ...FROM \$99



SEPARATE METERS FOR VOLTAGE AND CURRENT

These reliable, yet low-cost power supplies have the performance and features ideally suited for circuit development, component evaluation and other laboratory applications. Line and load regulation, $\pm 0.01\%$ or 2 mv. Ripple, 0.25 mv rms. All models have coarse and fine output voltage controls, and adjustable current limiting. Models K7S200 and K7S500 also have adjustable overvoltage protection. Dual and triple output models also available. Shipment from stock. Write for brochure.

OUTPUT VOLTAGE RANGE	OUTPUT CURRENT AMPS.	PRICE	MODEL
0-7	1.0	\$99	K7S100
0-7	2.0	135	K7S200
0-7	5.0	190	K7S500
0-18	0.6	99	K18S60
0-18	1.0	120	K18S100
0-32	0.35	99	K32S35
0-32	0.6	120	K32S60
0-50	0.35	120	K50S35



Corp., Easton, Pa. 18042. Telephone: (215) 258-5441.

INFORMATION RETRIEVAL NUMBER 19

welcome addition to the family



TRW/Cinch low cost Series 90 P.C. edge connectors

These TRW/Cinch Edge Connectors were created to beat rising material costs while maintaining product performance. Designed with 20 micro-inches of gold—at the contact areas only, over 30 microinches of nickel underplate—with high capability, glass-filled polyester insulators, they cost about 20% less than our standard commercial units, 50% less than our military types. The use of nickel, an effective barrier to base metal migration, rather than copper underplate, provides a longer wearing, more stable gold layer.

CC-7508

As with other members of TRW/Cinch Edge Connector family, you have a choice of seven sizes from 6 to 25 positions, in both dip solder and solder tab terminations—and delivery is when you expect it, from TRW/Cinch Connectors or its distributors.

For more information call your nearest sales office or distributor (listed in EEM)—or contact TRW/Cinch Connectors, An Electronic Components Division of TRW, Inc., 1501 Morse Avenue, Elk Grove Village, Illinois 60007, (312) 439-8800.

TRW® **CINCH CONNECTORS**

INFORMATION RETRIEVAL NUMBER 20

SEPTEMBER 27, 1975

Acousto-optics pushes up laser-recording standards

Two laser recording systems—one digital and one analog—that use unique acousto-optic modulators and deflectors to achieve new standards of throughput and resolution will be highlighted in papers at the Electro-Optics/International Laser Conference at Anaheim, CA, Nov. 11-13.

The digital system is a holographic record-playback system with a present throughput of over 600 Mbits per second and a potential of several gigabits. The system, designed by researchers at the Electronic Systems Div. of the Harris Corp., Melbourne, FL, records data on, and reads it off of a vertically moving 35-mm film.

The analog system is a recorder that uses a 4-mW helium-neon laser to produce high-resolution, 875-line TV images on 8-mm dry silver film. Developed by the Isomet Corp., Springfield, VA, the system uses an acousto-optic modulator and a pair of special acousto-optic deflectors to paint the image on the film.

In the digital system, the critical design breakthrough was the development of a holographic page composer, says Anthony Bardos, head of the Harris engineering group and co-author of a paper entitled "Multigigabit Digital Recording."

"The composer," Bardos points out, "generates the holographic data input using 128 original acousto-optic modulators, each in a glass cell. Laser light through each cell is modulated at about 6 MHz per data channel, and with 128 channels, we get over 600 Mbits of data through," Bardos explains.

"The maximum system data rate is 750 Mbits," Bardos notes, "which includes—as well as data—error-correction coding and house-keeping information.

"The incoming 600 Mbits of data

are multiplexed into the 128 data channels of the composer, where they are converted to 128 optically modulated laser elements."

A reference beam is combined with the modulated elements to form the 128 holograms, which are aligned in a raster-type scan across the 35-mm film. The film moves down at 4 m/s, and exposed film is automatically developed in 30 minutes.

"This is a real-time system," Bardos points out, "in the sense that the readout rate is the same as the recording rate."

For recovery of data, the developed film is put back into the system, and the reference beam scans the film, reading out the holograms as light and dark data bits.

The holographic data come out on 128 optical channels, which feed 128 fiber-optic elements that carry the data to 128 discrete silicon diode detectors.

"The photodiode outputs are multiplexed, along with error and time-base correction signals to produce the 600 Mbit serial data stream," Bardos says.

The Harris development is sponsored by the Air Force's Rome (NY) Air Development Center, but Bardos also sees commercial applications where many channels of data are needed, as in seismic recording.

In the analog laser recording system by Isomet, the key element, says Jason Eveleth, marketing manager, is a "chirp deflector," a proprietary opto-acoustic device that solves a major problem of these systems—simple generation of a fast horizontal scan of the laser beam.

"Whereas the Isomet system is all solid state," Eveleth notes, "previous scanning systems used rotating mirrors or prism scanners

with speeds up to 90,000 rpm."

With the chirp deflector, the beam is deflected with the speed of sound in the deflector-cell material. At a rate of 0.616 mm/ μ s, a full TV frame is scanned in 33 ms.

"The chirp deflector," Eveleth explains, "is a Bragg cell that is excited by chirp pulses—signals that start at a relatively low frequency and sweep to a high one. The chirp pulse also serves to focus the laser beam to some distant point. In this case it is on 8-mm film."

The system, which was designed as a military mission recorder for the Naval Air Development Center, Warminster, PA, is virtually real time, Eveleth explains, because the dry film requires only three seconds to develop with heat. The deflector is described in a paper co-authored by Eveleth, "Solid-State Laser Beam Recorder for 875-line TV."

Low-power rectifiers get better packages

A high-reliability method for packaging low-power rectifiers, announced by General Instrument Corp., is said to provide glass reliability and performance at plastic prices.

The packaging scheme takes the best of the two commonly used methods—molded epoxy and glass beads. According to Bob Brown, product manager for rectifier products, "the new Superrectifier package looks identical to the plastic DO-41, 15 or 27 on the outside, but inside there's a world of difference."

To bypass the faults of available methods—poor hermeticity and temperature cycling in epoxy cases,

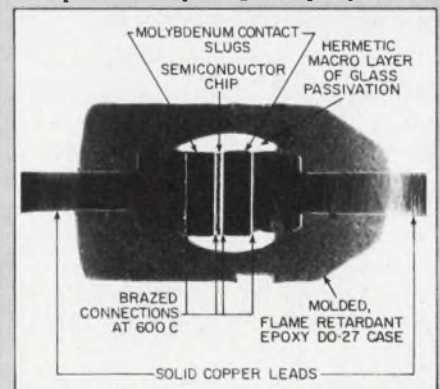

Cutaway view of a 3-A diode in the Superrectifier series.

varying size and the difficulty of handling glass beads—engineers at General Instrument in Hicksville, NY, developed a five-step process:

1. Sand-blasting of circular rectifier chips from a wafer. The blasting creates a beveled pellet that has improved voltage ratings and lower reverse leakage currents than square rectifier chips.

2. Brazing of the chip and molybdenum and copper lead and frame assembly at 600 C. This eliminates any opens, intermittents or voids usually found in soldered assemblies.

3. Cleaning of the brazed assembly and chip to remove impurities. This removes any materials that could cause deteriorated operation.

4. Application of a void-free macro-coating of glass passivation that covers the molybdenum and chip with a hermetic seal. The coating is about 50 to 60 mils thick—about 10 times the typical passivation thickness.

5. Sealing of the glass passivated assembly in a flame-retardant molded epoxy case that meets UL 94VE-O requirements. The epoxy provides additional mechanical strength and makes the diodes easier to handle.

All component parts of the rectifier are matched for thermal coefficients, so that no stresses are present during temperature changes.

As an initial offering, General Instrument will have rectifiers with current ratings of 1 to 3 A and reverse-voltage ratings of 50 to 1600 V. Prices start at 5 cents each in 100,000-piece lots.

CIRCLE NO. 319

Feedback laser emits several wavelengths

A new type of injection laser emits several different, near-infrared wavelengths simultaneously. The laser, developed by Aerospace Corp., El Segundo, CA, is based on the company's previously developed distributed feedback laser (see "Lasers Get Powerfully Efficient and Efficiently Small in R&D Lab," ED No. 19, Sept. 13, 1974, p. 34).

Whereas the original gallium-arsenide laser had a single corrugated metal grating on the outer

side of the p part of the p-n diode and the periodicity of the corrugations determined the output wavelength of the laser, the new laser has a set of corrugations with blank areas in between. According to Dr. Harold M. Stoll and Dr. David H. Seib, members of the technical staff at Aerospace: "The blanking is periodic, so that the structure is effectively square-wave modulated. The period of the blanking and the period of the corrugations determine the additional simultaneous frequencies that are generated."

To date, as many as three lasing wavelengths have been observed to oscillate collinearly and simultaneously in the 0.83-to-0.86- μ region. The laser works at a temperature of 77 K.

"Potential operational advantages," Dr. Stoll says, "include a reduction in total laser power requirements, since, in principle, several wavelengths can be obtained for essentially the threshold power cost of only one."

Rockwell and National sign processor pact

In an effort to capture a larger share of the \$80-million microprocessor market and at the same time allay some customer fears about sole-source products, Rockwell International and National Semiconductor have entered into a joint second-source agreement for microprocessor products.

According to Charles V. Kovac, vice president and general manager of Rockwell's Microelectronic Device Div., the new agreement establishes Rockwell and National as direct competitors and provides each company with the broadest microprocessor line in the industry.

Termed a "supported alternate source" agreement, the new pact differs from other second-source agreements that have become standard in the semiconductor industry in that it calls for a two-way exchange of technical information and expertise. It covers all current microprocessor products of each company, provides options on second-sourcing modifications and establishes the machinery for the periodic review of new microprocessor developments.

Most second-source agreements

the industry has seen to date require one company to purchase the rights and technology from the company that developed the product to be second-sourced. And that's where it ends.

In the Rockwell-National pact, not only is each party contributing to the exchange, but each also guarantees that the other will be able to make the products. Personnel from each company will teach the other how to produce its product. In addition the agreement covers applications support, which includes extensive software libraries.

Rockwell's Kovac points out that the agreement is not exclusive and either company can enter into similar agreements with other companies. And he hints that more two-way pacts are in the offing for Rockwell, though he won't reveal details now.

Computers to shop by beginning to turn up

Computers not only are ringing up sales in the marketplace in the form of point-of-sale terminals; they are beginning to be used as shopper's aids to generate sales. The Electronic Wine Captain may be the first of many such aids. It is meant to be placed in a store and used by shoppers to plan menus and select the right wines.

Developed by Sheila Hoffman Associates, New York, the device uses the Model 810 intelligent terminal from Sanders Data Systems, Nashua, NH. The terminal contains 100 k of 8-bit data memory and 8 k of 16-bit program memory. Most of the data are stored on a disc memory system produced by Caelus Div. of EM&M, San Jose, CA.

According to Douglas Kolb, a Los Angeles consultant, programming is done with the new Sanders IMP language. Kolb agrees that the 810 terminal is overkill. Future versions of the device will probably use a microprocessor-based CRT terminal with floppy disc storage, he says.

Hoffman Associates looks at the system as the precursor of computers in the kitchen that will serve as shopping aids and menu-planning devices.

HP's New 5 Volt 100 Amp Switching Supply is Ready For the Most Important Test in the World...

YOURS

We designed the Model 62605M Switching Supply to give the top performance and reliability demanded by today's OEMs. But, more importantly, you want to know exactly how it will perform for you, in your system. So check designs, examine the modular construction, put it through your own tests. We think you'll find the kind of conservative, sophisticated design and careful attention to detail that adds up to lasting product value.

Of course, the 62605M offers all the benefits of a technologically advanced 20KHz switching supply — high efficiency — small size — low heat dissipation. We've added important "standard" features like a soft-start circuit to hold down in-rush current, plus overvoltage and overcurrent protection. And, it's UL recognized.

The 62605M operates from 120/220/240 Vac, 48-63Hz, with 70% conversion efficiency. Regulation is 0.1%, with ripple and noise of 15mV rms, 50mV p-p. The supply measures 5"H x 8"W x 12"D, and weighs only 14 pounds.

There's a lot more, so get the complete story including the generous OEM and quantity discounts from your local HP Field Engineer.

HEWLETT  PACKARD

Sales and service from 172 offices in 65 countries.
1501 Page Mill Road, Palo Alto, California 94304

21502

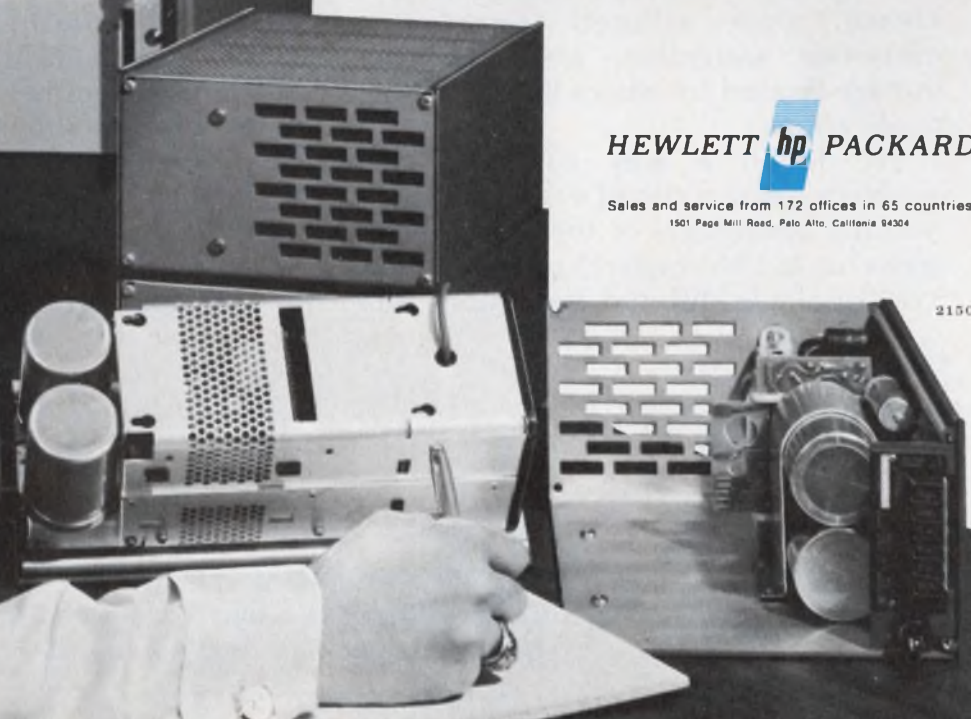

Would you like to build a better power supply for less money? We found a way to do it!

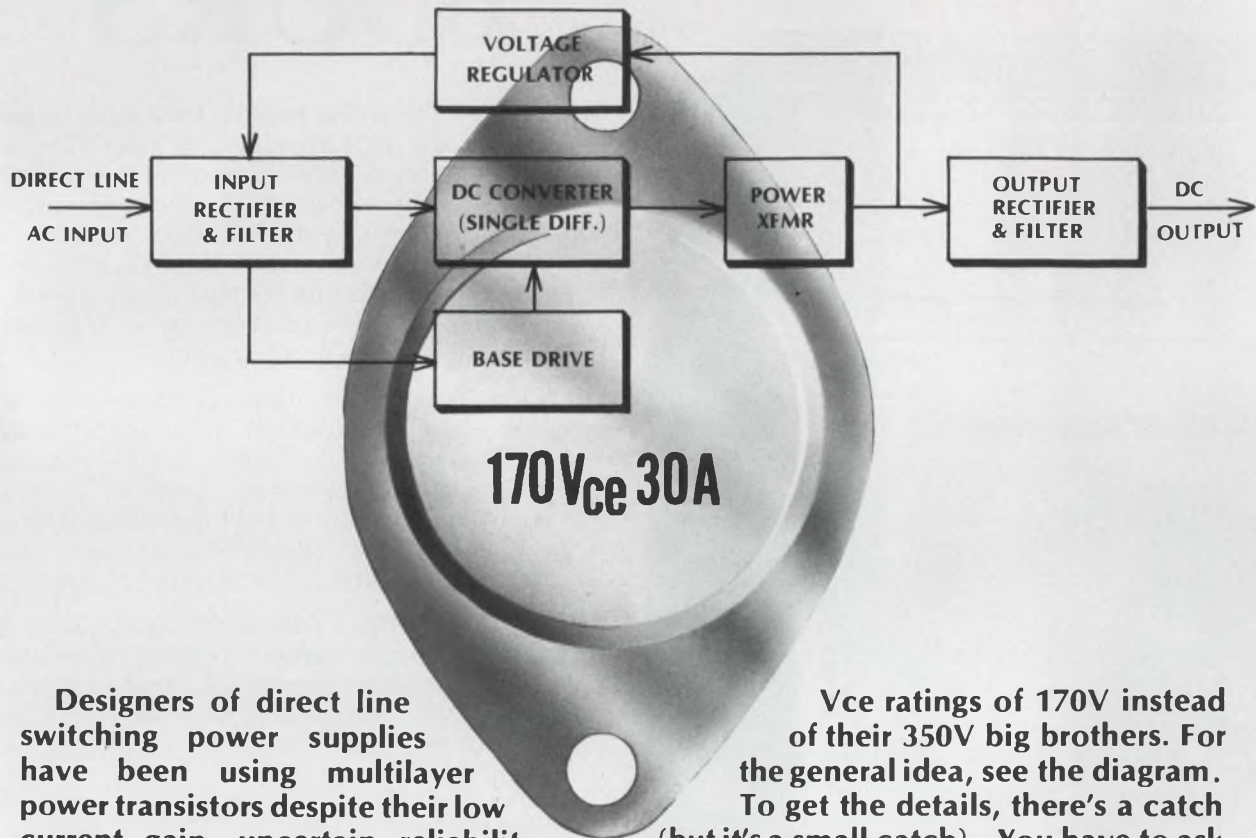

Designers of direct line switching power supplies have been using multilayer power transistors despite their low current gain, uncertain reliability and high cost. They didn't really have a choice: single diffused transistors, otherwise preferable, were just too voltage-limited for direct line switching applications.

We found a way to solve that problem — with a circuit design that gives you the advantages of the high current gains (up to 10A), high reliability and low cost of single diffused transistors with

V_{ce} ratings of 170V instead of their 350V big brothers. For the general idea, see the diagram. To get the details, there's a catch (but it's a small catch)...You have to ask for our Application Note that shows all, tells all. Sure, we'd like to sell you the transistors to build these more reliable switching power supplies for less money, but we can talk about that later. Today, call or write Carl Fischer, our Chief Applications Engineer, for your copy of "How to Design Direct Line Switching Power Supplies with Single Diffused Power Transistors."



Sensitron Semiconductor

A DIVISION OF RSM ELECTRON POWER, INC.
221 West Industry Court • Deer Park, N.Y. 11729
Telephone 516-586-7600 • Telex 96-7737

INFORMATION RETRIEVAL NUMBER 22

Get more for your money!

Use This New 3/8" Square Cermet Trimmer From Allen-Bradley

Our new TYPE E trimmer is a high performer with a realistic price. It has some important advantages: • Immersion seal is tested in 85°C water (not 50° or 70°). • Temperature characteristic is 100 PPM/°C for stability. • Multifingered contact for excellent adjustability. • \$0.49 each—1000 piece price. For more information call your A-B distributor or write for Publication 5219.

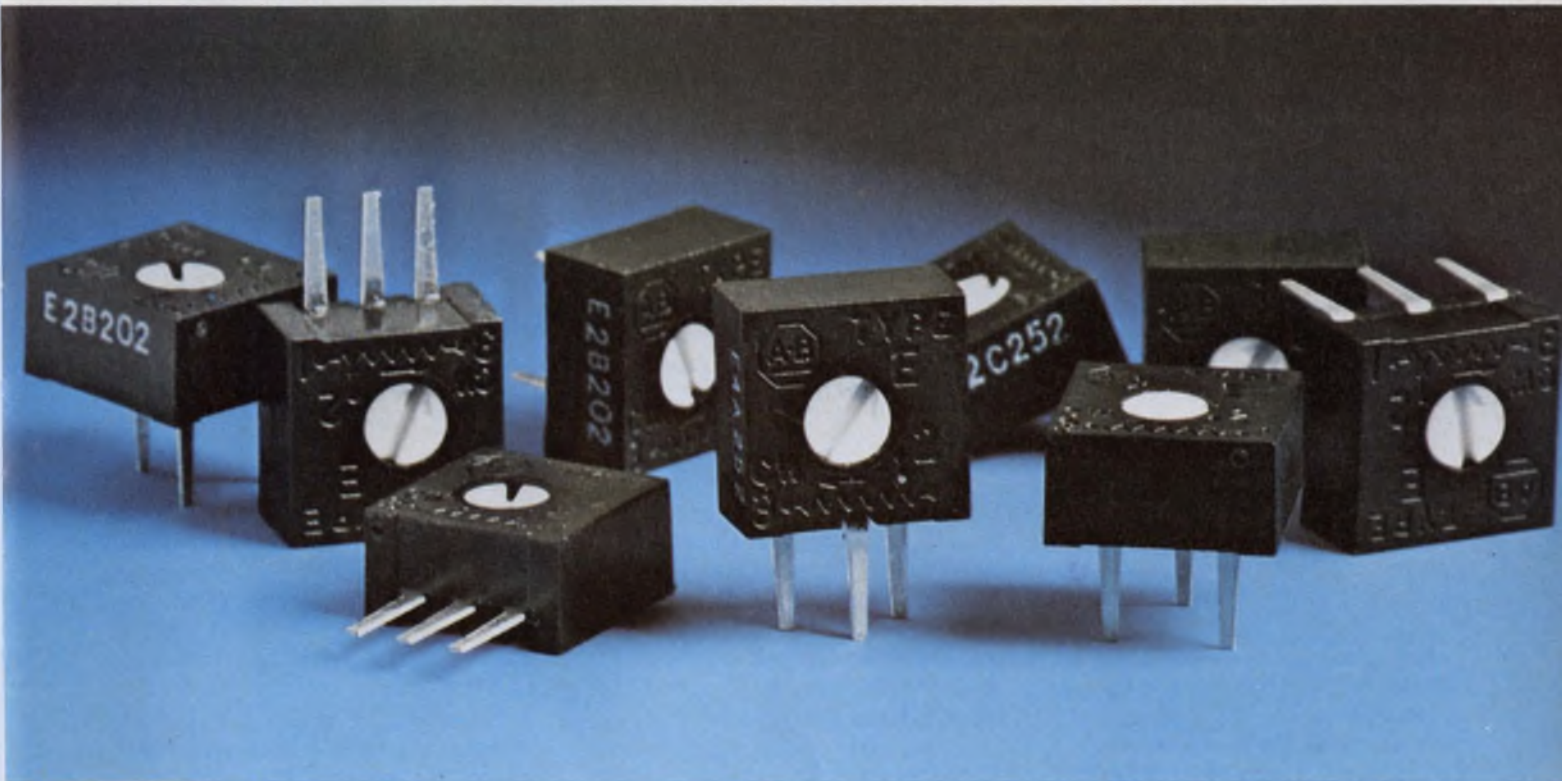
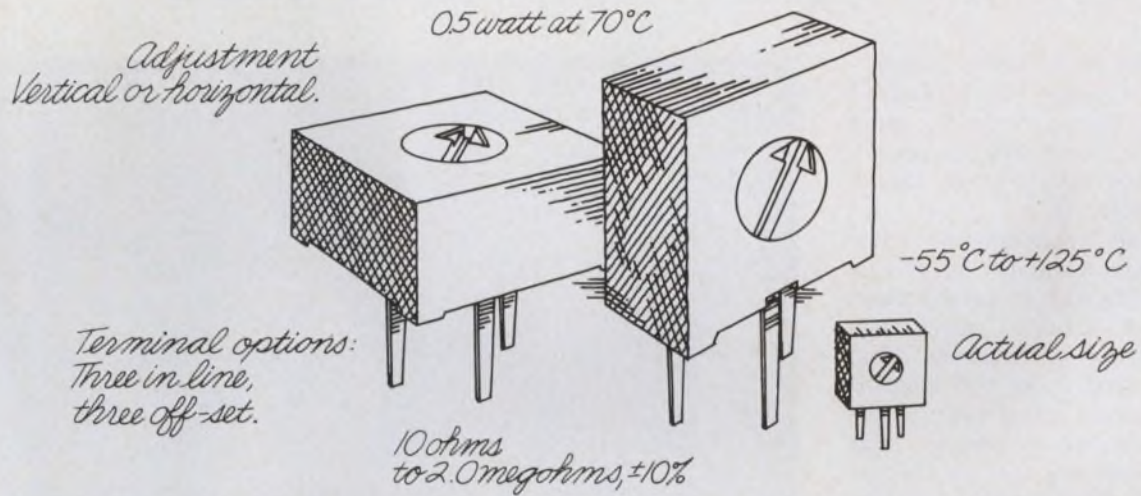

Quality in the best tradition.



ALLEN-BRADLEY
Electronics Division
Milwaukee, Wisconsin 53204

Under-the-hood microprocessors could turn up in 1979 U.S. cars

By 1979—maybe even sooner—most cars coming out of Detroit will have microprocessors under their hoods, according to knowledgeable sources in this closed-mouth community.

The small computer-like chips will compare a variety of engine measurements with preprogrammed norms and actuate valves and other controls in response. Most likely, the first units will monitor the spark and air fuel ratio in the carburetor—measurements that will help conserve fuel as the car accelerates, slows down or climbs a hill.

The microprocessor also may monitor the engine's speed and temperature. When conditions pass prescribed limits, the computer chip will actuate a digital display or else cause the engine to make the proper adjustments.

A computer chip can also be used to monitor atmospheric temperature and pressure, to diagnose problems and impending problems and to decide which measurements, if any, should be shown to the driver. These and many more tasks await the microprocessor under an automobile's hood.

Next, the microprocessor will move into the passenger compartment to handle passenger-related equipment—the air conditioning, the radio volume or the electric clock.

Also under discussion among car makers are the relative merits of thick-film devices and printed circuits. Both kinds of components have already found their way into cars and will be used in more applications as electronic subsystems find greater acceptance.

John F. Mason
Associate Editor

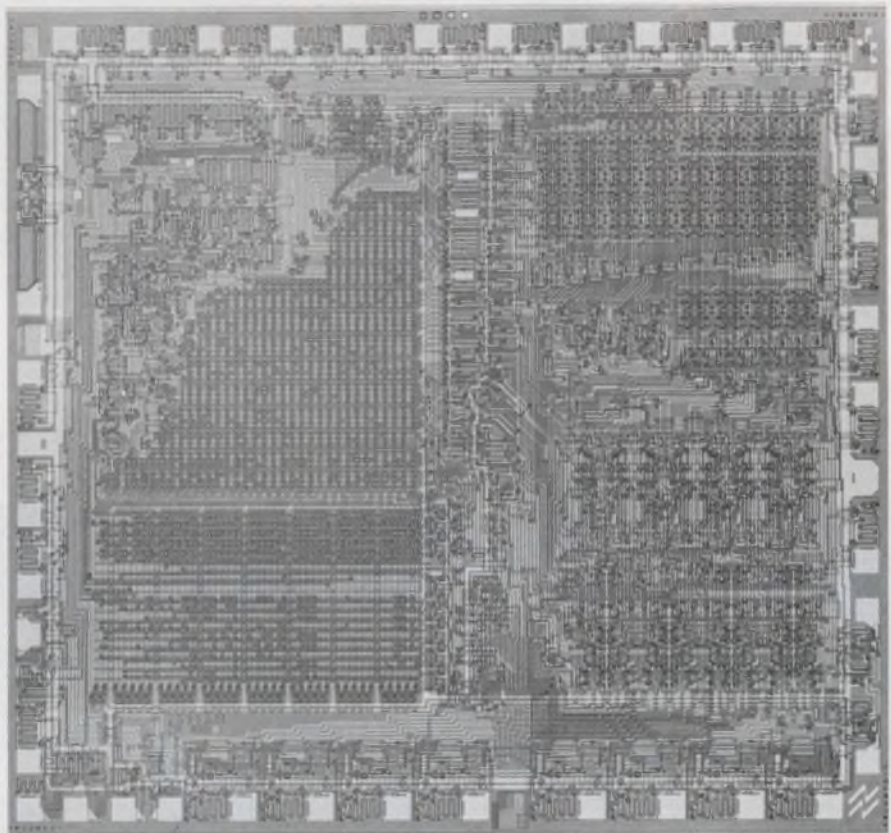

National Semiconductor expects its low-cost, general-purpose Scamp microprocessor to fill a number of automotive needs.

There's room for both kinds of components, according to Adrian Pocock, an automotive applications engineer with National Semiconductor. The choice will depend on the characteristics of each when the components are subjected to the environmental conditions of each portion of the car.

Prototype cars being tested

Right now, the three major car manufacturers all have prototype cars with microprocessors installed, but they're not talking—particularly to one another—about their next moves.

The major push at this time, according to Pocock, is to get good sensors and actuators first. "The car makers aren't so concerned about equipment to perform the signal processing but in getting devices to acquire the information," he says.

Being sought by Detroit, Pocock reports, are good, low-cost transducers to measure pressure, temperature and speed. The car makers want magnetic pickups—"any sensor needed in a vehicle to make it run properly."

Detroit's schedule could run something like this, Pocock says:

- 1976—A small advance in the

Announcing Mostek's "I Need Help Counting" Counter Contest

If you're an engineer with special counting needs, if you've used all your fingers and toes and still need to keep on counting, then Mostek's new six decade, up-down counter is for you. It's one of the most versatile circuits we've ever designed. Application possibilities are virtually unlimited. **Here's how the MK 50395 counts.**

It's a six decade synchronous, up-down counter/display driver with both compare register and storage latches. The counter as well as the register can be loaded, digit-by-digit, with BCD data. The counter has an asynchronous clear function.

Scanning is controlled by the scan oscillator input, which is self-oscillating or can be overdriven by an external signal. The six-decade-register is constantly compared to the state of the six-decade-counter and when both the register and the counter have the same content, an EQUAL signal is generated. The contents of the counter can be transferred into the 6-digit latch which is then multiplexed from MSD to LSD in BCD and 7-segment format to the output. The seven-segment decoder incorporates a leading-zero blanking circuit which can be disabled by an external signal. The MK 50395 interfaces directly with standard CMOS logic and features single power supply operation, Schmitt-trigger on the count input, look-ahead carry or borrow and direct LED segment drive.

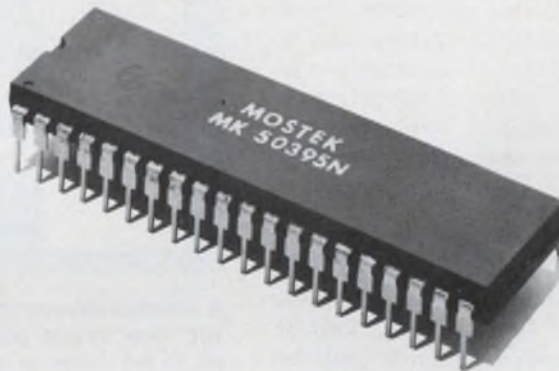

Enter Mostek's design contest. Win a Super Counter for yourself.

Once you get your great idea for a MK 50395 application you've got a shot at a prize to help with your own everyday counting chores.

First prize. A programmable HP-65! It does it all.

Second through fifth prizes. A Corvus 500 engineering calculator.

Twenty more prizes! Mostek CheckMasters for the most complicated math chore of all — checkbook arithmetic.

Here's how to enter. Take a copy of this ad to your Mostek distributor for a MK 50395 data sheet, an entry form and a MK 50395 (at a special contest price) submit your design idea, including application description and schematic, to:

Mostek Counter Contest
1215 West Crosby Road
Carrollton, Texas 75006

Entries will be judged by a committee of Mostek application engineers based on the uniqueness of the design and the relation of the product to the design. Mostek employees, sales representatives, or their families are ineligible. All entries must be postmarked on or before Oct. 30, 1975. Entries must include name, address and telephone of the entrant. We'll announce the winners by mail before November 30.

Incidentally, if you want to design the MK 50395 into your application, don't hesitate. They're available in volume through Mostek distributors.



MOSTEK®

P.O. Box 169
Carrollton, Texas 75006

quantity of electronics in a vehicle.

■ 1977—A considerable upsurge in electronics in the vehicle, including stand-alone controls—black boxes to control the exhaust and to save fuel. More analog devices will be used in these subsystems than digital.

■ 1978—More complex stand-alone controls that will start “talking” to one another. New systems will be digital rather than analog. And some microprocessors might be introduced.

■ 1979—Microprocessors under the hood. At the same time microprocessor-based electronics will be introduced into the passenger compartment—“maybe a digital clock, a digital radio, or solid-state displays rather than electromechanical.”

Multiprocessor network envisioned

Several microprocessors could be installed by 1980 or 1982. Two or more microprocessor units could be tied together to form a multiprocessor network, which could distribute the work. If the microprocessor in the engine failed, for example, the one in the passenger compartment would take over.

National Semiconductor now has available a “simple, cost-effective applications microprocessor” called Scamp. The design of the computer chip is based on an eight-bit arithmetic logic unit served by an eight-bit accumulator and extension register.

Data and instructions in external, standard, IC memory devices are accessed over an eight-bit Tri-State data bus. Addresses are generated through manipulations on four 16-bit pointer registers. A 12-bit address (allowing 4096 bytes of memory) is available directly from the 12-bit Tri-State address bus—the full 16-bit address requires use of an external 4-bit latch. A status register provides static flag outputs and sense inputs as well as arithmetic carry and overflow information and an interrupt enable flag.

Power requirements are served by a single ± 12 -V supply. The processor can interface directly to standard TTL or CMOS parts.

The processor timing is generated on the chip, thus saving the cost of providing an external timing element with the attendant

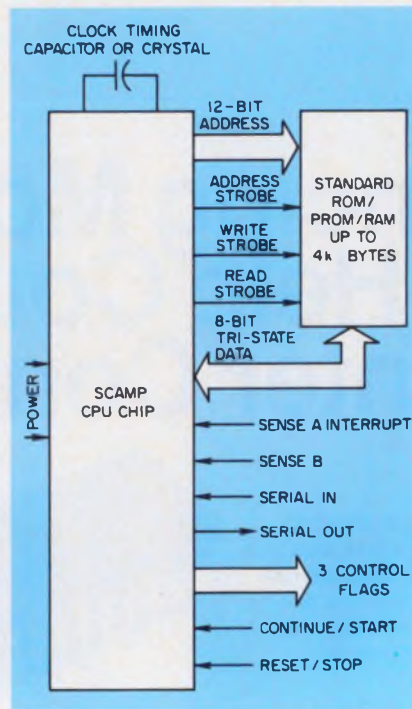

A simple microcomputer can be built with one Scamp microprocessor and up to 4-k bytes of standard memory.

problems of transmitting high-speed timing pulses.

A feature of major interest in Scamp, which greatly facilitates the structuring of direct-memory-access systems, is that the data-transfer control signals are completely separate from the bus access control. The bus access system is designed to allow direct implementation of a multiprocessor system that can share common memory and peripheral resources. For very simple systems, the Bus Request need not be used. The IC is then permanently enabled.

1979—a year to watch

Many 1979 cars will be equipped with approximately \$100 in electronic equipment, not counting the electronics for entertainment, predicts Norman R. Weldon, executive vice president of CTS Corp., Elkhart, IN. About half this amount will be spent for discrete components, including semiconductors. Some \$35 worth of the electronics will go for ICs and \$15 for hybrids. The semiconductors will be used mainly for a clock-driven module to feed signals to the microprocessor.

At present the electronic components being studied for cars are not designed specifically for this environment, Weldon points out. They're being adapted. But when the microprocessor becomes standard automobile equipment, he predicts, the electronics industry will be motivated to design new devices. “Until we do this,” Weldon continues, “the opportunity for us in Detroit won't move too fast.”

A point many electronics companies still haven't fully realized, Weldon says, is that reliability for cars actually means survivability. “A component has to operate for only 2000 hours, but it must do this in heat and cold, undergoing tremendous vibration and coated with dirt.”

Designing for this environment “is one of the greatest challenges the industry has faced to date,” Richard Kramer told the recent Automotive Electronics Conference and Exposition in Detroit. Kramer is a reliability assurance manager for National Semiconductor.

The electronics industry's accomplishments in the harsh environment of space would appear to be helpful in designing for Detroit, but cars make special demands, Kramer points out. Semiconductor packages used in space are too expensive for cars, and they are not suitable for high-volume circuit-board assembly lines. And the screening procedures used by the device manufacturer to find reliability risks include “overkill” tests, which can add 1000% or more to the cost of the finished device.

But there are ways to get around these problems, Kramer contends. Extremely rugged and reliable packages are now available that are cheap enough to interest Detroit. Dual-in-line packages, for example, in either molded epoxy or solder-glass sealed ceramic are relatively inexpensive and have the potential for high reliability in the automotive environment. The actual in-use reliability will, of course, depend on the manufacturer's ability to control his assembly processes and to perform effective screening tests to remove infant failures.

But good design, even with extensive testing, won't necessarily assure success, Kramer warns, adding: “It takes an integrated and disciplined program that includes

NEW 5V/30A SWITCHER FROM ACDC

VOLTS	AMPS	MODEL NO.	PRICE*
5	30	JP5N30	\$265
5	60	JP5N60	\$436
5	100	JP5N100	\$535
5	150	JP5N150	\$765
5/±12	50/5	JT301	\$491
5/±15	50/4	JT302	\$491

*100 piece quantity

This mini-switcher is the newest addition to ACDC's 5 volt power supply line. It operates from a selectable input of 115/230 VAC, 47-63 Hz or 48-60 VDC. Like most power supplies, it's rated for full output at 40°C, but will also deliver over 83% of rated output at 50°C without internal fans or forced air cooling.

THE MOST DEPENDABLE SWITCHERS ON THE MARKET. AND YOU CAN PROVE IT

Just ask for an evaluation unit and put it through its paces...at your plant...under your own supervised test conditions. ACDC switchers will work better, longer and more dependably than any other switcher you can buy.

HOW CAN WE BE SO SURE?

Switchers are complicated devices...tricky, temperamental and tough to build, but we've been building them for over six years and have eliminated all the major problems.

We start with a proven electrical design, proper derating of quality domestic components and rigid, comprehensive, in-process controls. All semiconductors, the most common cause of switcher

failure, are thermally shocked for three cycles from 0°C to 100°C, followed by a 48-hour bake at 150°C. A thorough electrical test eliminates marginal devices and isolates potential failures due to thermal stress and infant mortality.

A second phase of testing occurs after final assembly. Each power supply is subjected to a no load/full load burn-in at elevated temperatures for a minimum of 24 hours, then put through another test cycle before it gets an inspector's stamp of approval.

ACDC switchers are designed to work when you get them and built to last so you can depend on them.

A WIDE RANGE OF POWER SUPPLIES SOLD AND SERVICED INTERNATIONALLY

In addition to these 5 volt switchers, ACDC also offers 12, 15, 20 and 24 volt switchers rated at 150, 300, and 500 watts. These switchers and 200 other conventional power supplies are available from stock and serviced at eighteen service centers throughout the world. The complete line is detailed in our new 72-page catalog. Write for it. It's free.

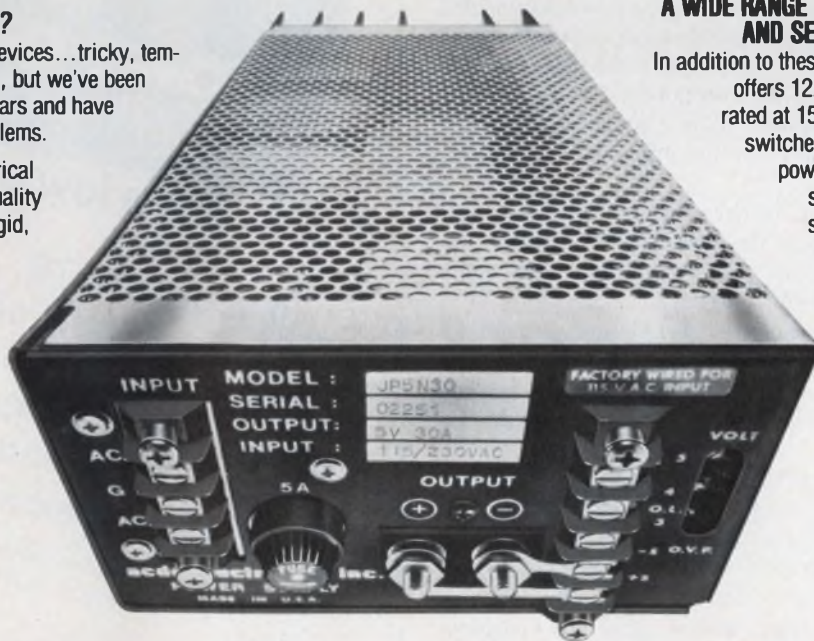

acdc electronics

401 Jones Road Oceanside, California 92054 (714) 757-1880

INFORMATION RETRIEVAL NUMBER 25

in-line process controls and screens, 200% electrical testing, cost-effective stress-screening for freaks, product-reliability audits and effective failure analysis."

Thick film or PC boards?

"Designers may feel more comfortable with PC boards than with thick-film hybrids because they're more familiar," says Hugh W. Maxwell, an automotive engineer in the Micro-electronic Device Div. of Rockwell International. "But both have their application."

He says it depends on where the circuit is used and how it is affected by the environment.

While paper-based phenolic board may be adequate in the passenger compartment, Maxwell says, glass-epoxy is better in the engine because of the intense heat there. Ceramic substrates used for hybrids can easily handle any automotive temperatures. The limitation is components, Maxwell says, not circuit-board materials.

In hybrids the use of a ceramic, which is many times more heat-conductive than phenolic or glass epoxy, can reduce the need for special heat sinks, Maxwell says.

Both PC and thick-film methods are capable of withstanding automotive shock and vibration, the automotive engineer says. The limitation is design, not materials. A large unsupported area on a PC board, for example, can resonate and break component leads. A ceramic substrate that's too thin can crack under shock and vibration. Of course, problems increase when sudden temperature changes are combined with mechanical stress.

As for servicing, PCs are easier to repair than thick-film devices. Components can usually be removed and replaced easily, or a solder joint can be touched up. The same, of course, can be done with components soldered into thick-film circuits, Maxwell explains. But because of the good thermal conductive characteristics of ceramic, it's necessary to preheat the substrate to a few degrees below the melting point of solder before proceeding with the repair. This preheating may be impossible if the substrate is assembled to something else.

But it may be cheaper to throw away than to repair the high-volume electronic devices used in automobiles.

And if miniaturization is important, thick film wins hands down, Maxwell notes.

Humidity poses a problem. In hybrids, active devices are mounted uncased onto the substrate. To prevent damage from humidity, a suitable protective coating must be provided, or the substrate must be hermetically sealed.

General Motors' Delco Electronics believes the thick-film hybrid circuit is "ideal for automotive applications," according to Gary M. Wagner, manager of manufacturing development engineering. Delco used the first thick-film hybrid circuit under the hood in 1968 in a voltage regulator, and in 1973 the company used the circuit in an ignition system.

The hybrid was ideal, Wagner says. It provided the advantages of a normal solid-state ignition system, and Delco was able "to functionally adjust the device after assembly to peak it to optimum performance." ■

NEW '76 POWER SUPPLY SELECTOR

More new products . . .

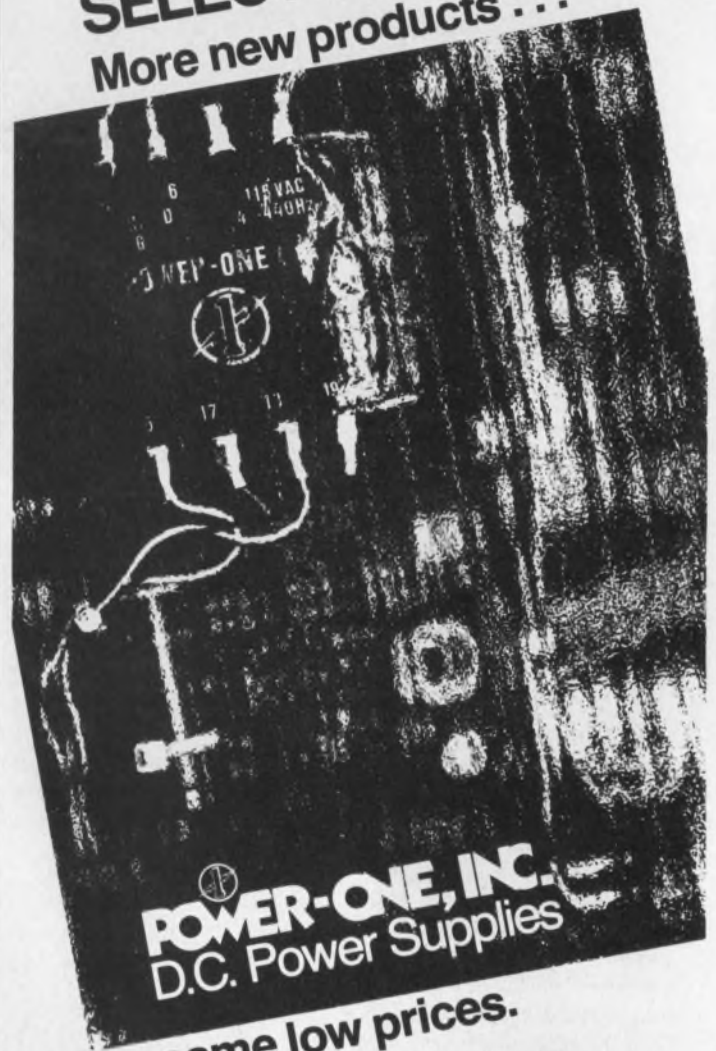

... same low prices.

If your new '76
power supply selector
has already been
removed, simply
circle the reader service
number below.

For immediate product information, contact
Power-One or your local factory representative.



531 Dawson Dr. Camarillo, Ca. 93010
Phone: 805/484-2806 TWX: 910-336-1297

POWER-ONE, INC.

INFORMATION RETRIEVAL NUMBER 298

Optical scanning improved with unusual mirror technique

A resonant optical scanner for laser TV systems, large-scale optical displays and point-of-sale systems is said to give five times greater angular mirror rotation at a given scanning frequency and mirror size than an equivalent tuning-fork device. In addition, insensitivity to radial motion (mirror wobble) is improved by a factor of 10 over the tuning fork at the same frequency and amplitude.

A key element of the scanner, invented by Jean Montagu, president of General Scanning, Watertown, MA, is a torsion bar with a small mirror mounted on the free end and the opposite end fixed in the device. To rotate the scanning mirror, the bar is twisted at its center by a special magnetic driving structure of four elements, one every 90°.

The advantage of this design is twofold, Montagu says. First, the torsion bar requires no bearings. Second, the radial forces of the drive, which tend to pull the bar and the mirror out of vertical alignment, are only one half those of a drive with two elements 180° apart.

For amplitude control and for synchronizing the mirror rotation with scan-system signals, the Montagu unit—called an Isogonic scanner—has an inductive velocity pickoff. It is ordinarily difficult, if not impossible, to place this type of pickoff close to a large magnetic driving field, Montagu points out. The noise generated in the pickoff frequently is larger than the signal.

However, in the Montagu design the pickoff and drive coils are placed in orthogonal planes with respect to each other. Consequent-

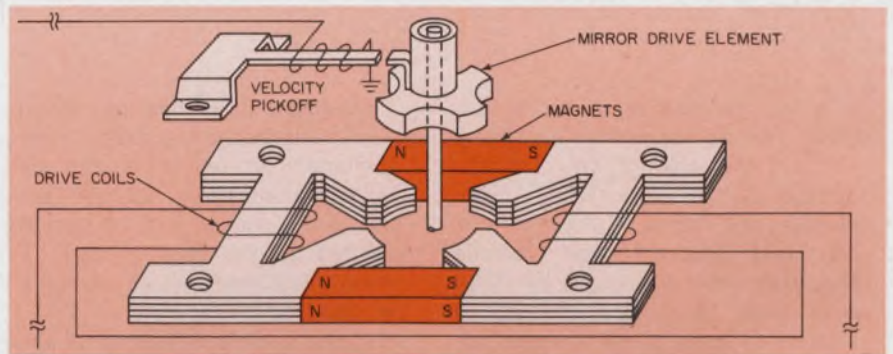

Typical Isogonic scanners are (left) a 4-kHz unit with a 10° peak-peak scan of a 7-mm square mirror; (center) a 25-kHz unit with a 4° peak-peak motion of a 3-mm mirror and (right) a 1200-Hz unit with a 30° peak-peak scan of a 10-mm mirror. The light beam scan is twice that of the mirror motion.

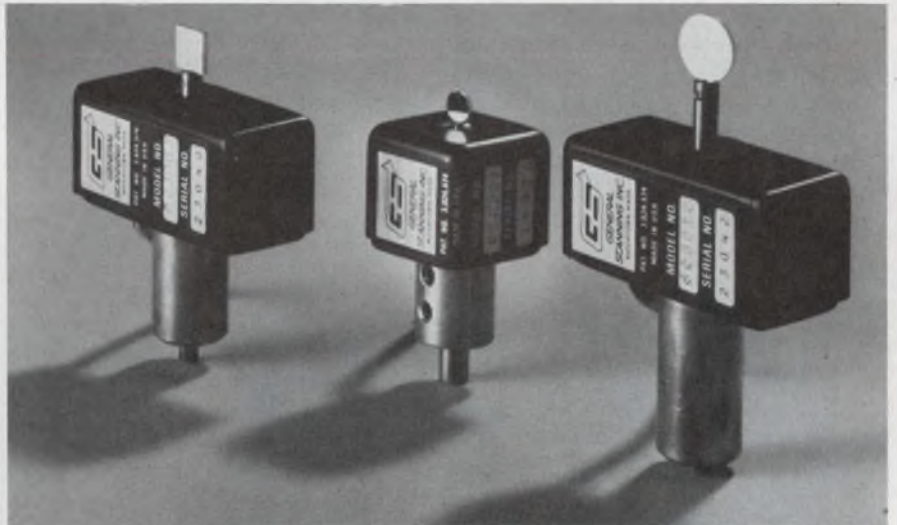

Velocity pickoff uses leakage flux for operation and is designed to eliminate extraneous pickup from drive coils of the Isogonic scanner.

ly there is negligible undesirable cross-coupling between them.

Another unusual feature of the pickoff design is that while these inductive devices usually require their own magnetic field for operation, in the Montagu scanner the leakage field of the magnetic drive circuit—normally undesirable—energizes the pickoff.

Use of the torsion bar contributes to faster response and to high-temperature stability. The tempo is 0.01% of the driving

frequency per degree C.

The highest scan frequency successfully demonstrated to date has been 45 kHz. The amplitude of mirror rotation varies with operating frequency. Typically, Montagu says, a 10-kHz resonant system will swing the mirror 10°, peak to peak using a 5-mm diameter mirror. For a 1/4-in.-sq. mirror the upper frequency is 4 kHz. For a 1-kHz device, mirror rotation increases to 30°, and for a 25-kHz unit, it is 6°. ■■

Jim McDermott
Eastern Editor

Microcomputers to be permanent riders on Toronto's transit system

"A microcomputer in every bus, trolley bus and streetcar by 1985."

That's the goal of the Toronto Transit Commission (TTC). Ten vehicles are being equipped now with test systems that include these tiny processors and two-way radio links. And the aim in 10 years is to have these systems installed in 5000 vehicles. The result will be a fully integrated communications and information network for Toronto's entire public transit system.

A control center—there may be one main center or several regional centers—will query each of the small computer chips every 10 seconds for the bus's location. It will also ask the microcomputer for other information it might have stored, such as the number of passengers.

Standard questions and instructions directed to the driver will be displayed on one of eight small dedicated message tablets, about one-inch square, with a message printed on the face of each. Unusual questions or instructions will be transmitted by voice radio.

If the vehicle is behind or ahead of schedule a button lights up advising the driver to speed up or slow down. It can tell him to pass up the next stop, or the bus directly ahead, or to take an alternate route due to traffic. It can also speak directly to the passengers in the vehicle by public address system, with or without telling the driver first.

The driver has 16 fixed messages he can send to central control by pressing one of 16 buttons. He can call for the police by pressing one

of them with his foot or his knee. Other buttons report traffic jams, or request medical help or permission to talk.

Central control signals back when it's ready to assign the driver a voice channel. At the same time it signals the vehicle's microcomputer to switch the radio from a data link to a voice channel.

The driver has two loudspeaker systems—one to his passengers and one outside the vehicle to talk to people waiting at a stop.

The microprocessor was designed in-house, according to Transit Commission engineer Milan Pristupa. "We couldn't get industry to respond fast enough for our time frame," he says. The design was based on Intel's 8080 microprocessor and its peripheral chips. "We

(continued on page 38)



Control center in Toronto's projected communications and information system will query each of the city's transit system vehicles 10 times a second for its location



and other pertinent data. Information is collected automatically on each vehicle and stored in a microprocessor, whose design was based on the Intel 8080.

THE TRIMLINE SERIES

DISTINCTIVE ELECTRONIC ENCLOSURES



PREMIER METAL PRODUCTS COMPANY

A DIVISION OF SUNSHINE MINING COMPANY

337 MANIDA STREET, BRONX, N. Y. 10474 (212) 991-6600



Data comm spoken here



It's the M6800's native language

Data Comm is native to the MC6800 Microprocessor because the M6800 Family was designed for Data Communications from conception; born to it, you might say. The results speak for themselves.

Our diagram of a hypothetical data communications application suggests a cost-effective way to use specially designed data communications

devices to add asynchronous AND synchronous data comm links to micro-computer systems.

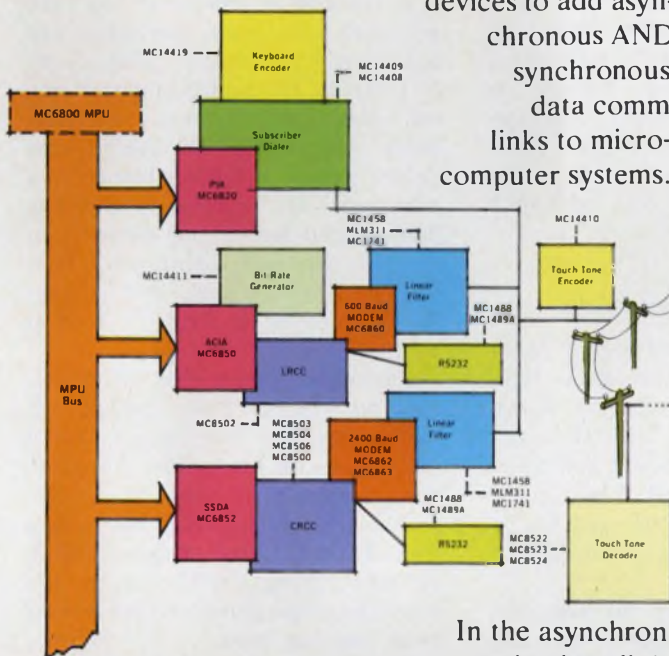

In the asynchronous communications link, the MC6850 ACIA converts parallel data to asynchronous serial format, and vice versa. The MEGALOGIC* LRCC/Data Register, the MC6860 MODEM and a CMOS Bit-Rate Generator fill it out, with EIA standard RS232 Linear circuits handling interface between separated system elements.

In the synchronous system, parallel-to-serial data conversion, and the reverse, is executed by the soon to be announced MC6852 SSSA, with MEGALOGIC CRCC units and the impending two-chip MODEM (MC6862/MC6863) assisting.

The combined capabilities of the MC6820 PIA and several CMOS subsystems are used to establish both dial-pulse and touch-tone telephone links between local and remote sites.

M6800 support: speeds the design job, makes it easier ... at lower cost

*The EXORciser** (M68SDT). Here's

the first systems development tool that lets you completely emulate your system application with significant reductions in hardware design and development costs.



Evaluation Module (MEC6800). It's a complete board, with all of the M6800 LSI circuits. Evaluate the parts in a basic minimum system.

Documentation: we wrote the book

M6800 Manuals. The utilitarian M6800 Programming Manual is complemented in our growing document library by the M6800 Applications Manual, where we truly wrote the book.

Choice of software packages

Commercial timesharing.

M6800 software is presently available on three commercial timesharing services — G. E.,

United Computing Service, and Motorola Timesharing.



EXORciser and host packages. A resident software package is available for the EXORciser, as are host computer cross assembler and simulators.

A complete program for microcomputer system design

Complete! Yet, there's more...if you need it.

Like memory and I/O modules for the EXORciser. Like floppy disks, disk controllers and tape readers. Like a complete staff of systems applications engineers ... in the field and at the factory. And they, indeed, speak Data Comm!

If you'd like to converse with them or peruse our literature on the subject — signal us at: P.O. Box 20912, Phoenix, AZ 85036.

*Trademark of Motorola Inc.



MOTOROLA M6800
Benchmark family for microcomputer systems.

INFORMATION RETRIEVAL NUMBER 27

MIX 'n MATCH "Vise Grip" Collet Knobs & Accessories



The largest selection of knobs and accessories for your panel components. Color coded, color pointed dial plates eliminate high cost of panel marking.

Choose the set-up you require. Color coded for safety . . . for convenience.

No set screw, yet provides firmer grip than conventional type knobs.

Call our hotline for prompt service and delivery.

(201) 374-3311

AMF

RCL Electronics

General Sales Office:

700 So. 21st Street
Irvington, N. J. 07111

NEWS

(continued from page 34)

felt the 8080 offered the most of any available device plus the fact that it has high-level language support."

Called Trump, for transit universal microprocessor, the device has been designed with 4096 bytes of PROM—16 chips with 256 bytes each (Intel's 8702). This portion of the memory holds the vehicle's programs that manipulate all the standard data it receives. Besides this, Trump has 1000 bytes of RAM, which stores on-the-spot, real-time information coming in and going out. The system has nine input ports and nine output ports—each of which is 8 bits wide, thus providing 72 bits of input and 72 of output.

Low-power radio uses relays

A Motorola Micor two-way radio was chosen for the data link, Pristupa says, "because we found it easy to interface with the computer." The Micor is FM and operates in the uhf band. The control center transmits 410 and 411.5 MHz and the vehicle, from 415 to 416 MHz.

The bandwidth is divided into 60 channels. The power is kept low—10 W—to prevent interference, thus enabling the same frequency to be used in several sections of the city. "We like to keep a distance of about 20 miles," Pristupa says.

Ten relay stations throughout the city pick up signals in the vicinity of each and transmit them back to central control by microwave or telephone wire.

When a vehicle's signal begins to get weak, the computer automatically tells a radio's synthesizer to switch to a frequency being used by a closer relay station. Each vehicle is equipped to operate on any of the 60 channels.

Each channel will handle approximately 100 buses. Each bus has a code number and on the basis of it, Trump accepts or rejects the call.

Being tested now, Pristupa says, is voice transmission running full duplex, with all switching being

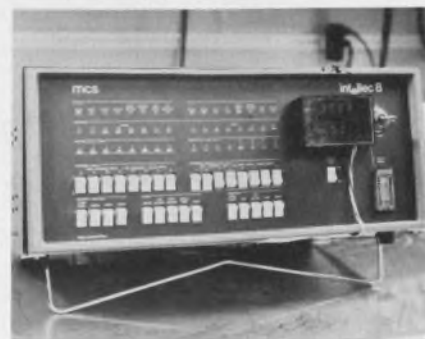

Intellec 8 central control asks for position data every 10 seconds.

handled by the computer.

A magnetic odometer on the front wheel of each bus gives two pulses each revolution. This count is fed into the microcomputer and converted to distance traveled. Since the route is known—the driver pushes a button identifying his route—the distance traveled is known, and hence the position of the bus, accurate within ± 5.6 feet. The position of each bus is kept up to date on a CRT in central control.

Passenger count, for those getting on and for those getting off, is maintained by two infrared beams at the door. The direction the passenger is headed is determined by which beam he breaks first. Infrared was chosen because systems using visible light are sometimes triggered by reflections from passing cars.

Automatic driver identification

A driver identifies himself to central control when he boards his bus to start his run by inserting a special badge into a slot. The badge is built with edge connectors which make electrical contact in the slot. A diode in the badge carries a code which the computer in central control reads.

The system's power supply is designed to operate with all the different voltage levels required, regardless of the vehicle's own power supply, which may vary from 10 V to 36 V. The voltage levels needed by the communications and information system's chips range from +12 V to -12 V.

Central control operates with its Motorola Micor two-way radio, an Intel Intellec 8 microcomputer and an eight-color CRT display built by Xerox. ■■

The terrific trio from T.I.D. for easier, more accurate dynamic measurements.

Combine these two leaders in test instrumentation with our new Model 1887 TCD plug-in signal conditioning module and you've got synergism working... in the field or in the lab.

We'll stack the performance of our 8¾-inch-high Model 1858 data acquisition system up against anybody's 18-channel system, no matter how big, heavy and cumbersome it may be. And our 5600 series portable, lab quality tape recorder is the acknowledged leader in its class.

How do we make two winners twice as good?

By developing a single set of signal amplifiers that condition signals for *both* oscillograph and tape recorder.

Just plug the 1887 TCD module into the Model 1858. A convenient front-panel switch selector on the 1887 allows parallel recording on the 1858 and tape recorder,

or serial playback recording from tape to graphic. Switching from tape record to tape playback does not require change of connections or sensitivity settings. Time scale compression and expansion is made simple with the Model 1858. For example, high frequency data signals can be conditioned for tape recording at fast tape speeds, and then played back slower (64:1 maximum). Similarly, long-term slow-speed tape recordings can be played back at high speed and in just a few seconds yield a complete time history of the data on a short record.



For complete specifications, write or call: Lloyd Moyer, Honeywell Test Instruments Division, P.O. Box 5227, Denver, CO 80217. (303) 771-4700.

FOR DEMONSTRATION CIRCLE 251



**TEST
INSTRUMENTS
DIVISION**

Honeywell

MICROPROCESSORS: HOW TO CHOOSE THEM AND USE THEM

You have to be a lot more than just smart to cope with all the problems involved with selecting, developing, purchasing and implementing microprocessor and microcomputer-based products and systems. NOW, the world-famous Integrated Computer Systems, Inc. "Learning Tree"[™] is immediately available to give you all the information you need to know about what micros are, who makes them, what they cost, how they're supported, and how you can use them.



With each course purchased, three separate publications are delivered. Basic course notes are individually bound in a handsome 3-ring binder, such as shown above. The newest course is hot-off-the-press, **MOTOROLA'S 6800 VS. INTEL'S 8080**, which is a side-by-side comparison (objective and unbiased) of two of the most discussed and newsworthy microprocessor families.



Purchasers of any I.C.S. course also receive two 8½" x 11" perfect bound books **ABSOLUTELY FREE** . . . a 200-page volume of 21 carefully selected technical articles on microcomputer topics, and a 500-page bound volume of manufacturer's literature (to our knowledge, the only such collection in existence), including product descriptions on microprocessors and support chips, microcomputers and system development units, software, peripherals and hardware debug equipment. **THESE FREE BOOKS ARE AVAILABLE WITH ALL COURSES ORDERED BEFORE OCTOBER 31, 1975.**

Hundreds of manufacturers have jumped on the microprocessor bandwagon in the last several years. A potential user of microprocessors can be literally inundated with differing claims on product performance, availability and manufacturer support. If he doesn't possess all the background knowledge and familiarity with microcomputer technology that is readily available to him — through any of seven Integrated Computer Systems, Inc. courses — he could be getting a lot more (or less) than he bargained for. You're hard put to make that objective decision of whether or not to use a microprocessor if you don't have all the objective information. And that's exactly what the I.C.S. texts provide you . . . realistic, up-to-date and factual information, objectively presented, on the microprocessors and microcomputer products available today. I.C.S. starts with the basics and then looks long, hard and without bias at hardware, software, architecture, speed, memory, I/O, support circuitry, microcomputer card sets, development systems, how specific companies support your efforts, second sources, reliability, testing and much more. In detail — objective, unbiased detail. This invaluable information is presented to you in an A to Z, easily understandable format, which helps you make an intelligent choice. It's available to you immediately.

More than 3,000 managers, system designers, engineers, technicians and research personnel from more than 700 companies throughout the world have taken I.C.S. courses and enthusiastically endorsed them because of the totally unbiased, non-vendor-oriented nature of the course materials. "Learning Tree"[™] texts can impart the same essential data to you. THESE TEXTS HAVE NEVER BEFORE BEEN AVAILABLE WITHOUT MANDATORY COURSE ATTENDANCE. EACH IS AVAILABLE TODAY FOR IMMEDIATE SHIPMENT TO YOU. EACH IS BACKED BY A NO-QUESTIONS-ASKED MONEY BACK GUARANTEE IF YOU AREN'T COMPLETELY SATISFIED! (Incidentally, not one of the more than 3,000 I.C.S. course attendees worldwide has EVER asked for a refund!)



INTEGRATED COMPUTER SYSTEMS, INC.

Publishing Group, 111 Main Street, Los Altos, California 94022 (415) 941-9090

COURSE 102: MICROPROCESSORS/MICROCOMPUTERS This basic course provides a comprehensive technical introduction and survey of more than 400 pages. Includes full background information on both microcomputers and microprocessors, suitable and unsuitable applications; alternatives and tradeoffs; applications examples; typical system configurations; a review of fundamental computer concepts; basic elements of a microprocessor system (CPU, RAM, ROM, PROM, I/O structures and techniques, hardware and software); system development, including analysis of requirements, selection, the design cycle, software and hardware, and system integration and debug techniques; a technical survey of available microprocessors; how to get started; and how to estimate costs.

COURSE 168: MOTOROLA'S 6800 VS. INTEL'S 8080 A new, up-to-the-minute course presenting step-by-step comparisons and valid conclusions on two of the most talked-about microprocessor families. Includes a complete analysis of every factor influencing 6800 and 8080 performance, development and production with facts, figures, schematics, benchmark programs and comprehensive documentation. Features an overview, comparison with other 4-bit, 8-bit and 16-bit contenders, and factors influencing selection and costs, architecture; speed benchmarks; memory (including cost); I/O (including circuitry, a comparison of LSI I/O chips, interrupt systems, DMA, and comparative schematics for common interfaces); support circuitry (including what you need and what it costs — including "hidden" costs); the availability and descriptions of microcomputer card sets; a comparison of the EXORciser and the MDS; availability and considerations of development software; a comprehensive cost analysis; customer support, second sources, reliability of components and software, environmental ruggedness and testing; what lies ahead, and a summary of conclusions. AVAILABLE AFTER 9/8/75.

COURSE 134: SOFTWARE DEVELOPMENT AND APPLICATIONS TECHNIQUES FOR MICROCOMPUTERS Provides details on programming microprocessors and interfacing them to external devices. Includes fundamental concepts; software/hardware tradeoffs; how software affects micro selection; digital logic functions (flow-charting, assembly language programming, loading the program into PROM, execution, creating control signals and pulses, monitoring input lines and testing bit patterns, binary and BCD arithmetic, and applications examples); comparison programs for Intel 4004/8080, Motorola M6800, National IMP-16 and Rockwell PPS-4; PL/M language; how to use development software and systems; interfacing techniques; and applications case histories.

COURSE 201: MILITARY MICROPROCESSOR SYSTEMS Designed to meet the needs of the specification, design, advanced research or procurement of electronic systems for military applications. Includes extensive introduction; basic elements of a microprocessor system; LSI technologies and the military environment (including TTL, SOS, CMOS, PL, PMOS and NMOS); standardization; technical survey and comparison of available microprocessors (commercial, existing and imminent militarized processors); design considerations in military systems; development, applications; advanced system configurations; and a comprehensive summary with conclusions. AVAILABLE AFTER 9/20/75.

COURSE 101: A MANAGER-LEVEL OVERVIEW OF MICROPROCESSORS AND MICROCOMPUTERS Complete and comprehensive details on capabilities, availabilities and applications; importance and impact on production, marketing and sales; factors influencing decisions; alternatives and tradeoffs; costs; a survey of devices and systems; and how to get started.

COURSE 106: MINICOMPUTER/MICROCOMPUTER REAL-TIME SOFTWARE SYSTEM TECHNIQUES AND APPLICATIONS Ties dependence of minicomputer applications upon the real-time supporting operating system software, including differing requirements of different applications and the suitability of minicomputer or microcomputer operating system software to each. Includes key considerations (memory management, files and data structuring, intertask communication and task scheduling); effects of hardware on software structure/performance (including multiprocessors and distributed processors); and real-time systems for specific applications.

COURSE 105: FUNDAMENTAL CONCEPTS OF MINICOMPUTERS AND MICROCOMPUTERS Comparisons and contrasts of minis and micros; successful applications development; pitfalls to avoid; basic elements of a mini/micro system; application analysis; system configuration; choice of language; interfacing to external devices; and a complete components survey.

Complete the coupon below and mail to:



**INTEGRATED
COMPUTER
SYSTEMS, INC.**

Publishing Group
111 Main Street, Suite C
Los Altos, California 94022 (415) 941-9090

COMPLETE AND RETURN THIS COUPON NOW, ADDING YOUR CHECK, MONEY ORDER, BANKAMERICARD OR MASTER CHARGE NUMBER. ALL ORDERS WILL BE SHIPPED PREPAID WITHIN 10 CALENDAR DAYS AFTER RECEIPT OF ORDER! IF YOU ARE NOT COMPLETELY SATISFIED WITH YOUR I.C.S. TEXTS, PLEASE RETURN ALL THREE BOOKS WITHIN 10 DAYS FOR YOUR MONEY BACK.

1 SET OF ALL 3 TEXTS \$110; 2 SETS \$200; 3 SETS \$280; 4 SETS \$360; 5 SETS \$440; 6 SETS \$510; 7 SETS \$580.

QUANTITY	TITLE	PRICE
<input type="checkbox"/>	102: MICROPROCESSORS/MICROCOMPUTERS	\$
<input type="checkbox"/>	168: MOTOROLA'S 6800 VS. INTEL'S 8080	\$
<input type="checkbox"/>	134: SOFTWARE DEVELOPMENT AND APPLICATIONS TECHNIQUES FOR MICROCOMPUTERS	\$
<input type="checkbox"/>	201: MILITARY MICROPROCESSOR SYSTEMS	\$
<input type="checkbox"/>	101: A MANAGER-LEVEL OVERVIEW OF MICROPROCESSORS AND MICROCOMPUTERS	\$
<input type="checkbox"/>	106: MINICOMPUTER/MICROCOMPUTER REAL-TIME SOFTWARE SYSTEM TECHNIQUES AND APPLICATIONS	\$
<input type="checkbox"/>	105: FUNDAMENTAL CONCEPTS OF MINICOMPUTERS AND MICROCOMPUTERS	\$
<input type="checkbox"/>	FOUR QUARTERLY UPDATES (PLEASE SPECIFY UPDATES DESIRED BY COURSE NUMBER) AT \$85 PER COURSE	\$

ADD

\$7.00 PER SET SHIPPING AND HANDLING TO ALL U.S. AND CANADIAN ORDERS AND \$25.00 PER SET TO ALL OVERSEAS ORDERS. (NOTE AVERAGE WEIGHT OF SET IS 11 LBS.)

TOTAL REMITTANCE \$ _____

CHARGE TO MY CREDIT CARD, PLEASE!

BANKAMERICARD # _____

MASTERCHARGE # _____

4-DIGIT M.C. # _____ CARD EXPIRATION DATE _____

SIGNATURE _____

SHIP MY ORDER IMMEDIATELY TO:

NAME _____

ADDRESS _____

COMPANY _____

CITY _____ STATE _____ ZIP _____

Surprise! \$2.95

(10-49)

Wideband Transformers

SURPRISE! Wide bandwidths, .015-600 MHz
SURPRISE! Low insertion loss, 0.5 dB
SURPRISE! Microminiature, .230" x .270" x .300"
SURPRISE! One week delivery



DESIGNERS KIT AVAILABLE:
 2 TRANSFORMERS OF EACH TYPE
 T1-1, T2-1, T4-1, T9-1, T16-1
 KIT # TK-1 ... **\$32.00**

NO "MAKE OR BUY" DECISION HERE... it costs less to buy Mini-Circuits wideband transformers and there's no delivery delay. Impedance levels from 12.5 to 800 ohms with insertion loss typically less than 0.5 dB

MODEL	T1-1	T2-1	T4-1	T9-1	T16-1
Impedance Ratio (50 Ω pri. imp.)	1	2	4	9	16
Bandwidth (MHz)	1db loss	2-50	.05-200	2-100	2-40
	3db loss	.15-400	.015-600	.2-350	15-200
Price (10-49)	\$2.95	\$3.45	\$2.95	\$3.45	\$3.95

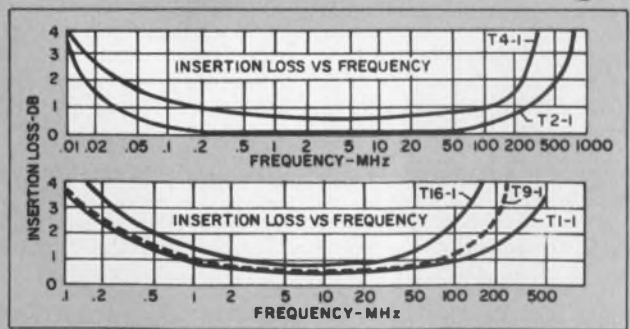

For complete product specifications and U.S. Rep. listing see MicroWaves' "Product Data Directory," Electronic Designs' "Gold Book" or Electronic Engineers Master "EEM"

Mini-Circuits Laboratory
 A Division Scientific Components Corp

837-843 Utica Avenue, Brooklyn, NY 11203
(212) 342-2500 Int'l Telex 620156 Domestic Telex 125460

Foreign Sales Representatives: AUSTRALIA General Electronic Services, 99 Alexander Street, New South Wales, Australia 2065; ENGLAND Dale Electronics, Dale House, Wharf Road, Frimley Green, Camberley Surrey; FRANCE S C I E - D I M E S, 31 Rue George - Sand, 91120 Palaiseau, France; GERMANY, AUSTRIA, SWITZERLAND Industrial Electronics GMBH, Klüberstrasse 14, 6000 Frankfurt/Main, Germany; ISRAEL Vecronics, Ltd., 69 Gordon Street, Tel-Aviv, Israel; JAPAN Densho Kaisha, Ltd., Eguchi Building, 8-1-1 Chome Hamamatsucho Minato-ku, Tokyo; EASTERN CANADA B. D. Hummel, 2224 Maynard Avenue, Utica, NY 13502 (315) 736-7821; NETHERLANDS, BELGIUM, LUXEMBOURG: Coimex, Veldweg 11, Hattem, Holland

US Distributors: NORTHERN CALIFORNIA Cain-White & Co., Foothill Office Center, 105 Fremont Avenue, Los Altos, CA 94022 (415) 948-6533; SOUTHERN CALIFORNIA, ARIZONA Crown Electronics, 11440 Collins Street, No. Hollywood, CA 91601 (213) 877-3550

Washington Report

Big vs small carriers: A battle looms

The next "great naval battle" is shaping up, this time over the size of future aircraft carriers. Carrier admirals plan to replace existing carriers with large-deck, nuclear-powered Nimitz-class vessels that displace 90,000 tons. Cost-conscious opponents, led by Defense Secretary James R. Schlesinger, favor less expensive and smaller carriers. Some defense experts contend that the smaller vessels would cost 35% less than a \$1.2-billion Nimitz-class vessel, but would be only 70 to 80% as effective.

Hints of the brewing conflict came recently in the form of leaks of planning documents sent by the Defense Dept. to the Navy. Confirmation came from Navy Secretary J. William Middendorf 2d in a speech to the American Legion Convention in Minneapolis on Aug. 15.

Noting the cost squeeze, the Navy's civilian chief told of an ongoing study of a new class of aircraft carriers, saying: "This ship would be smaller than our Nimitz-class carriers and displace about two-thirds the tonnage of the 90,000-ton Nimitz. What we would lose in single-ship capability we would gain in having numbers available to meet the vast majority of anticipated commitments."

World standards data offered to manufacturers

American manufacturers can now get from the National Technical Information Service up-to-date information on technical requirements that affect the acceptability of their products in countries throughout the world. The national service recently concluded an agreement with the British Standards Institution for its service called Technical Help to Exporters. This is considered to be the world's largest and most authoritative collection of international standards. The Commerce Dept. is offering the data to manufacturers for a fee. Included in the offering is international regulatory information on product safety standards, performance criteria and coding and certification systems.

Chinese electronics: 'Like trying to read tea leaves'

There are mixed assessments of the degree of success of the recent visit to Red China by a 10-man delegation from the Electronic Industries Association. Those anticipating a flood of purchases were disappointed, but old China watchers say things went along as expected—and as the Chinese preordained.

John Sodolski, the EIA vice president who heads the communications division and who put the program together, says it is too early to know

the extent of the Chinese electronics market. To attempt to predict it at this time, he asserts, is like "trying to read tea leaves."

Sodolski left Peking with the impression that the Chinese hadn't yet made up their minds on what they want to do about telecommunications and that they were trying to develop a plan for inclusion in their next five-year plan, starting next year.

The delegation was impressed with the quality and state of the art of Chinese electronic research. From what was seen, it appears that the Chinese are 10 years behind in technology and 20 years behind in production techniques.

Spurt expected in Citizen Band market

Citizen Band radio operators and manufacturers have won a big concession from the Federal Communications Commission, and if other proposals win approval, there's the distinct possibility of a billion-dollar annual market within a year or two for this section of the electronics industry.

Recently the FCC removed a ban against the use of CB equipment as a hobby. The change simply recognizes that many owners of the gear, including truck drivers, farmers and businessmen use the sets to chat for pleasure. The FCC couldn't control this, and in the future it will concentrate on halting the use of overpowered transmitters, obscene talk and malicious interference.

More and more sets are now expected to appear in autos. A further stimulus will come if the FCC expands the available channels from 23 to 40, as proposed.

As yet, no authoritative figures are available on the total market. About 60 to 70% of the sets now offered are Japanese imports, although U.S. sales are said to have picked up in the last year and are now estimated at from \$350-million to \$700-million. Next year the total could hit \$1-billion. Last year the FCC issued 425,000 permits and this year it could easily grant one million.

Capital Capsules: The Army Materiel Command is decentralizing its headquarters to concentrate on resource management, policy and performance evaluation. The focus will be on acquisition and readiness. The Army, which calls the new staff setup a "hard-hitting, corporate type headquarters," expects to cut its present force of 2100 by 700. . . . The Federal Aviation Administration says it has completed a 10-year program to automate and computerize all 20 air route traffic-control centers. The final block was activation of a radar data-processing unit at Miami. . . . The Air Force is taking the first deliveries of Pave Spike target-acquisition systems for use on F-4D/E aircraft. The Westinghouse-built system gives the aircraft the capability of delivering laser-guided bombs or of acting as a laser target designator. . . . ERDA has awarded a contract to General Electric to test electric utility transformers to determine causes of insulation breakdown. One phase will involve an attempt to verify the gas bubble theory of insulation breakdown. . . . The Air Force Systems Command has put basic research programs under a single manager in the Office of Scientific Research, separating them from development. In the future they won't compete for funding. . . . A new avionics system is being developed for the Air Force's F-4 aircraft that is to provide more accurate navigation, improved bombing accuracy and an automatic aerial reconnaissance capability. Lear-Siegler, Grand Rapids, MI, has a \$9.7-million development contract with \$42-million in contract options for production of up to 262 operational units.

Announcing..... A New Portable from Tektronix

The TEKTRONIX 455

- 50 MHz bandwidth. ● Dual trace. ● Delayed sweep. ● Sweep rates to 50 ns/div with 2% accuracy (5 ns/div with 3% accuracy.)
- Vertical deflection factors to 5 mV/div with 3% accuracy.
- Large 8 x 10 cm CRT display ● \$1695.

And that's not all. The 455 offers this performance combined with more convenience features to speed measurements and reduce human error. All at a budget-conscious price. Measurements are made easier and faster with trigger view; trigger hold-off; lighted deflection factor indicators; and a functionally laid out, easily understood control panel.

Servicing the 455 is faster and less expensive. Although monolithic in design, the instrument contains easily removable vertical amplifier and time-base modules for ready access to all components. That means quicker repairs and less down time. And the entire unit is housed in a shock-resistant, reinforced plastic case to withstand rough handling in factory or field environments.

Optional battery pack provides operation at remote sites and eliminates noise due to line transients. The 455 will operate up to 4 hours without a battery recharge. When AC power is available, the battery pack can be detached to reduce weight.

For specialized applications, the 455 can be equipped with emi protection or tv sync separator.

The 455 is the latest entry in the Tektronix 400 Series of Portable Oscilloscopes. Other dual channel delayed sweep units offer:

- 5 mV/div sensitivity at 100 MHz (the 465)
- 2 mV/div sensitivity at 200 MHz (the 475)
- 5 mV/div sensitivity at 350 MHz with simultaneous displays of intensified and delayed waveforms (the 485)
- Unique single-shot storage to 100 MHz (the 466)

For complete information on how the 455 Portable Oscilloscope delivers the performance, versatility, and cost-saving effectiveness you need, contact your local Tektronix Field Engineer. Or write: Tektronix, Inc., Beaverton, Oregon 97077, for the new 455 applications and specifications brochure. In Europe, write Tektronix Limited, P.O. Box 36, St. Peter Port, Guernsey, Channel Islands.

U.S. Sales Price FOB Beaverton, Oregon



TEKTRONIX®

committed to
technical excellence

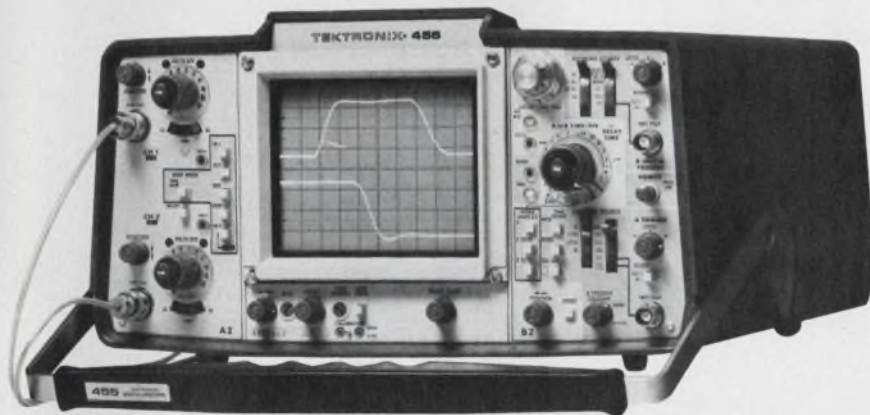

FOR TECHNICAL DATA CIRCLE 34

FOR DEMONSTRATION CIRCLE 35



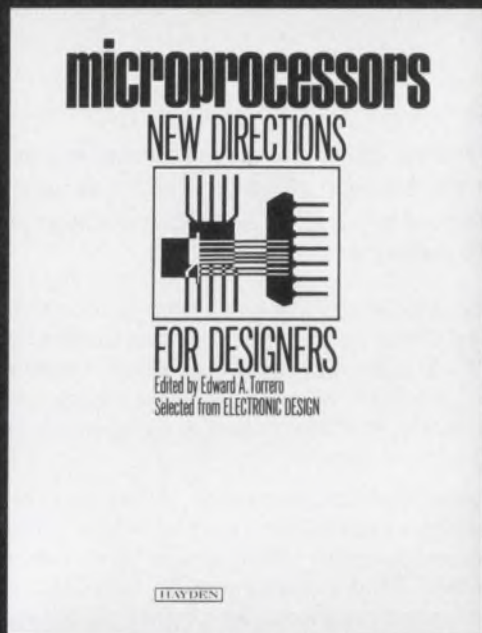

Two years
of a wealth
of
information
on

MICROPROCESSORS

brought right
up to date

by
Electronic Design

Electronic Design can really help you out when it comes to microprocessors. We sifted through a whole pack of recent issues—going back two full years—and came up with an incredible amount of practical news, data and advice on how to select micros for specific purposes...how to use them to best advantage...and how to improve them for better speed and broader application.

We compiled it all neatly into one convenient handbook—*MICROPROCESSORS: New Directions for Designers*. Without a doubt, this is the “last word” in micros. Because it’s all ready-to-use, up-to-the-minute information. Because it covers everything from micro buying to special modifications. And because it’s written by your own colleagues in direct, on-the-job talk.

Over 20 pro’s speak frankly here, fresh from their own experience, on the various points and pitfalls in micro buying...the very latest applications in instrumentation and industrial electronics...different hardware features, capabilities, and operating techniques...how to make a micro run faster...how to eliminate micro limitations with specific techniques and circuitry...how to use a minicomputer to de-bug microprocessors systems, and much, much more. Everything’s been carefully edited by *Electronic Design*’s IC Editor, Edward Torrero.

If you’d like to see a copy of this new handbook, just cut out the coupon below and send it in. We’ll send you *MICROPROCESSORS: New Directions for Designers* to read and use FREE for 15 days. When you’re completely satisfied that it will help you time and time again, just send in a check for \$8.95 and it’s yours to keep. Otherwise, just return it within 15 days and owe absolutely nothing. Fair enough?



HAYDEN BOOK COMPANY, INC. 50 Essex Street, Rochelle Park, N.J. 07662

Hayden Book Company, Inc. 50 Essex Street
Rochelle Park, New Jersey 07662

- Please send me *MICROPROCESSORS: New Directions for Designers* (#5777-6), edited by Edward Torrero, to read and use FREE for 15 days. At the end of that time, I will either send a check for \$8.95 or return the book.
- I want to save money! I have enclosed full payment with order. I understand that the publisher pays all postage and handling. I still get the 15-day money-back guarantee.

Name _____

Address _____

City/State/Zip _____

Introducing ChipStrate™ power SCRs and triacs.

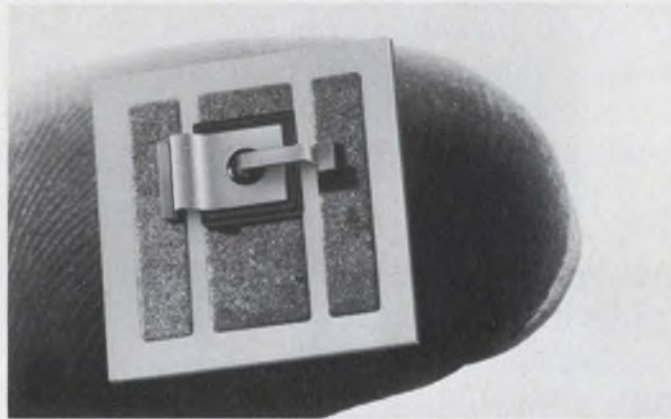

We take a glass-passivated chip (a power SCR or triac), mount it on a solderable ceramic substrate, test it and specify it. That's a ChipStrate.

Save a bundle over conventional components. Because we've eliminated the expensive metal package, ChipStrates cost up to 40% less than packaged devices. And they take up a good deal less space on the board.

Improve the reliability of your circuit. ChipStrates come with the same guaranteed performance

The reliability of a package for the price of a chip.

specifications as a packaged device. And due to their improved thermal design, they can handle more power, more reliably than either a packaged device or a chip.

No special equipment, no risks. ChipStrates are complete devices — attach them to a heat sink or directly onto thick-film metalization. No need for a heavy investment in capital equipment, no worries about yield, none of the

problems associated with unmounted chips.

Send for our free brochure. ChipStrate SCRs and triacs are available in currents from 1 A to 55A and in voltages up to 600V. Our brochure tells the whole story. Just circle our number on the reader service card.

Unitrode Corporation,
580 Pleasant Street,
Watertown,
Mass.
02172.



™ ChipStrate is a trademark of Unitrode Corporation.



UNITRODE

INFORMATION RETRIEVAL NUMBER 38

Look, men. Females

For several weeks we had been on maneuvers in the wilds of Alabama, not far from our base, Ft. McClellan. Lacking many of the benefits of civilization—even Ft. McClellan civilization—we were not entirely joyous as we crawled on our bellies to the crest of another damn hill. Suddenly, our spirits soared when Charlie, crawling over the crest, shouted: "Look, men. Females!"

I confess. Females occupied some of our thoughts in those miserable weeks. So you can imagine our chagrin when, reaching our hilltop, we saw in the valley, a herd of cows.

As I recall, we may have made some uncharitable comments to Charlie. But I'm sure this bore no relationship to the snake he found in his bed sheets some weeks later—a female snake, I understand.

Of course, when Charlie shouted, "Females," we all felt he had a warped and malicious sense of humor. But as I think of it now, I believe Charlie was an unsung genius. He was a man able to see things in a different light. Where all of us bitched about miserable forced marches when we should have been enjoying the beauties of Birmingham, or even Anniston, Charlie thought of the fresh air, sunshine and exercise we were getting absolutely free. All of us had unkind words for one of our less popular meals, chipped beef on toast. But Charlie would describe it as a French menu might gush over an elegant dish with a sublime sauce.

And that's a key to genius. If Charlie went into engineering after our sojourn in the infantry, I'm sure he became a magnificent engineer. I'm sure he would always look for different ways to do things. You'd never find him on the beaten, rutted track. He was a genius. Of course, we treated him like a nut. We were all certain that if Charlie shook his head, it would rattle.

But isn't that the way we treat all our colleagues who see and do things differently?



A handwritten signature in dark ink, which reads "George Rostky". The signature is written in a cursive, slightly slanted style.

GEORGE ROSTKY
Editor-in-Chief

Inherently rugged, these triple-diffused devices permit circuit operation directly from rectified 117V or 220V line — eliminating transformers. Ideally suited for inverters, converters, switching regulators, motor controls and wherever there's hi-rel applications. The exploded view demonstrates our single chip design and packaging

TYPE #	(pk.) I _c	V _{CE}	h _{FE} @ I _c	Switching Speed (Typ.)
PT-3512	70A	325	10 @ 30A	t _r = .5 μs
PT-3513	70A	400	10 @ 30A	t _s = 1.2 μs
PT-3522	90A	325	10 @ 50A	t _r = .5 μs
PT-3523	90A	400	10 @ 50A	

350 Watt Power Rating Guaranteed SOAR

concept which makes high-voltage, high-current transistors off-the-shelf availability possible. Pre-rating and pre-testing techniques of chip allows choice of solid copper packages. For further information

and application assistance, call Sales Engineering, PowerTech, Inc., 9 Baker Court, Clifton, N.J. 07011. (201) 478-6205.

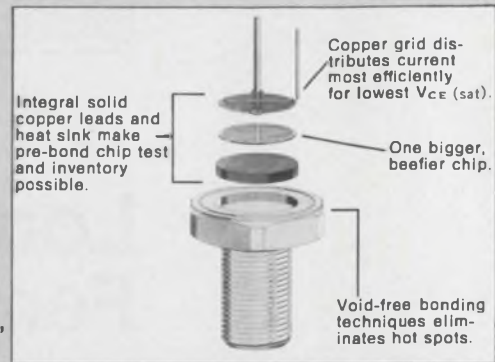

PowerTech, Inc.

"BIG IDEAS IN
BIG POWER"

400v90AMP



NPN Silicon
Power Transistor
Switch — Highest KVA
at lower cost,
weight & space.

SPECIAL EVALUATION OFFER!		
Type No.	Regular Price (1-24 pcs.)	Limited Offer Price
PT3512	\$173.25	\$ 99.00
PT3513	216.10	123.50
PT3522	216.10	112.50
PT3523	260.75	149.00

OFFER EXPIRES: Nov. 1, 1975
LIMIT: Any combination of these
devices—limit 10 per customer



Your house or ours.

Why it is better to buy DC-to-DC power supplies.

Sure, you can probably build that power supply yourself. First you get out the old breadboard and start designing. When you think you have it, you start testing and compiling reliability data. Then you assemble a load of components. Maybe you have some, maybe you wait for purchasing to buy them. Finally, you set up inventory, inspection, quality control and manufacturing procedures.

All time consuming, and surprisingly expensive. Probably more expensive than you anticipated. Especially when you consider valuable engineering time which could have been put to more creative use.

There's another way. You call up Tecnetics and tell us what you need. And you've got it. Ready to go. You see, we've already done all the designing, engineering, testing, and purchasing. We've been doing it since 1959.

So by now, most of the power supplies you need are in our catalog. Regulated and unregulated, commercial and mil type, hybrid and modular, even our new DC high efficiency types. But if it's something unique, we have the expertise to make it for you. To your specifications.

Quickly, with fully documented reliability, and at a price that's more than competitive with in-house production.

Because that's all we do. You see, they don't call us "The Power Conversion Specialists" for nothing. Reputations like ours don't come easy.

So send for our 26-page power supply catalog. It has all the specs, plus prices. And we'll send along an analysis of the economics inherent in the make or buy decision.

tecnetics® The Power Conversion Specialists

Please rush me your catalog plus an analysis of the "Make or Buy" decision.

Name _____

Company _____

Address _____

City _____ State _____

P.O. Box 910, 1625 Range Street, Boulder, Colorado 80302
(303) 442-3837 TWX 910-940-3246

Focus on Switching power supplies

Lord Kelvin once remarked that we know little of a subject unless we can measure it and express it by a number. This hits home when the subject happens to be the switching-regulated power supply.

To pick such a supply from a data sheet alone is to court disaster. True, the switcher has come far in performance and reliability. But designs are still evolving in this relatively young area, and vendors aren't always candid about the shortcomings of their products.

Take efficiency. It's the No. 1 asset of switchers, yet is it guaranteed to be as high as the impressive—and heavily promoted—figure? In most cases, it isn't. Efficiencies of 80%, and even higher, may dazzle you with visions of ice-cool operation or the relief of squeezing a 250-W unit into a leftover volume that is too small for any linear supply. But don't relax. Take another look at the spec.

Look for wording that says "up to," "above," "better than," "average greater than," and the like. All these can warn you that a switcher's nonsinusoidal input current makes efficiency tough to measure exactly. And since efficiency isn't fixed—it can vary with the operating point—such wording is designed to highlight the best rather than the worst-case condition.

Funny, it only works on Wednesdays

The word "typical" should trigger another warning. This can mean that a supply pulled off the assembly line at 3 pm on a rainy Wednesday morning happened to meet the listed number. Or typical can refer to one model of a series (you can almost bet it's not the one in which you're interested).

Stanley Runyon
Associate Editor



Outputs to 1500 W at less than a dollar per watt mark the 800 Series from LH Research. High efficiency plus a fan keep weight down to 15 lb.

What you'd like to know is the minimum efficiency you'll get and the range of efficiencies under the expected variations of load and line. Be aware that a switcher's input current decreases with increasing input voltage, so the low-line spec is of prime interest.

Remember, too, that it's harder to get high efficiency at the lower output voltages—in the 5 or 12-V levels that most applications call for. Though there are 5-V units for which 80% efficiency is claimed, one well-known switcher vendor warns that it's unlikely that a "fully isolated 5-V supply" can be much better than about 70% efficient. (Note the qualifier, "fully isolated.")

Another manufacturer—one who offers only custom switchers—goes even further and flatly states that at low output voltages the efficiency advantage of the switcher is lost. Equivalent efficiency at lower cost, this vendor continues, is offered by a ferroresonant preregulator combined with a linear, series-regulated supply. And there are added benefits of such an arrangement: greater noise attenuation and protection from power-line disturbances, both of which boost system reliability.

Don't get hung up on high efficiency for its own sake. If you're willing to give up a few percentage points you can still get the small size you need—and save money. In any case, it is usually not "high" efficiency in itself that's important, but rather, how much heat the supply must dissipate and how you can get rid of it.

You may think that a neatly compact, super-

switchers are more critical than in linear units, performance will be poor. Or reliability suffers and the supply dies young.

Keeping cool isn't easy

So you can't tuck the supply into an enclosure and conveniently forget about cooling it—even if the spec sheet does. You've got to keep the temperature within safe limits for continuous operation. But just how do you do it? And where do you measure the temperature? Those are the problems.

How you do it depends on the supply, of course. Two units, otherwise identically rated, may differ by as much as 50% in temperature rating. One unit may be designed with heat sinks for convection cooling, the other with internal fans for forced air. Still other supplies need forced



Newest offerings from ACDC Electronics include a triple-output unit, 5 V and ± 12 or ± 15 V (silver case), and a 5-V, 120-A supply (gold case) that accepts dc inputs.



More than any other type, switching-regulated supplies need burn in and life testing to weed out infantile failures and to check new designs (courtesy of Sorensen).

efficient, switching supply doesn't need cooling. And the spec sheet may reassuringly reinforce that impression, with its lack of information on cooling. But you may be wrong—dead wrong.

Even a unit that converts 80% of its input power to usable output dissipates 60 W in delivering, say, 240 W. Though the wasted power may be three times less than that in a linear unit, that 60 W still must somehow be eliminated. If it isn't, the supply's temperature will push up and up until the capacitors sizzle. If a portion of the heat is removed, nothing may melt—at least not immediately—but the supply probably will run hotter than it should. Since temperature effects in

air but you provide the fan. This may be satisfactory—as long as you know about it.

With convection cooling, heat sinks must be mounted in the proper orientation and with adequate clearance for circulation above, below and alongside the sink. Units with fans can be mounted along any axis, with clearance for intake or exhaust.

Ask some questions: Is forced air required? If so, at what maximum back pressure for safe operation? If self-cooled, what is the maximum back pressure the unit can exhaust into? How does back pressure affect the supply's derating, if any?

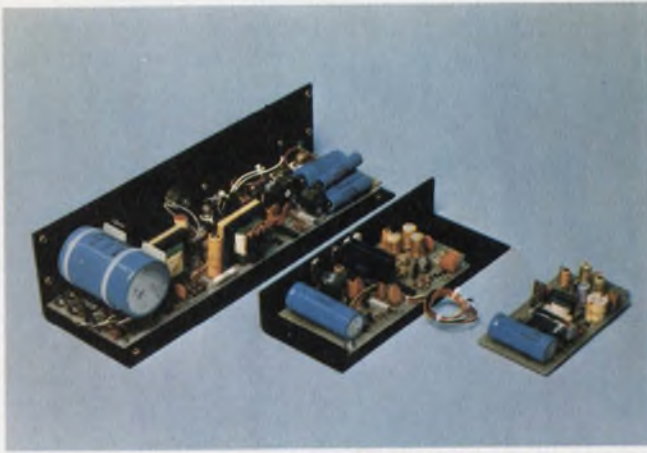

Open-frame switchers from Boschert Associates include 10, 60 and 300-W models. Up to four outputs per supply are offered, customized to the application.

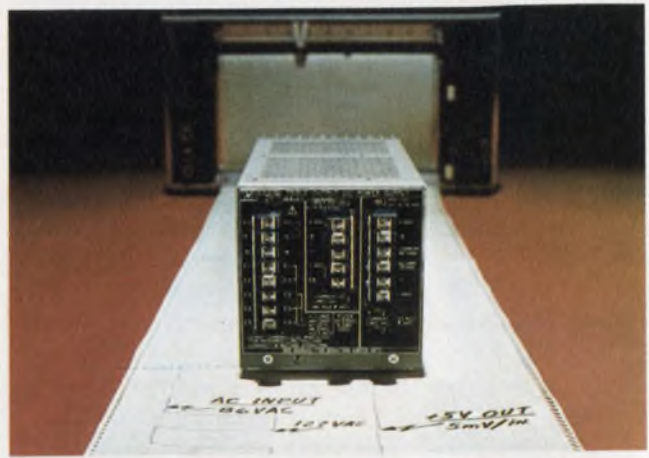

Open up Hewlett-Packard's 63315D, a 110-W, triple-output unit, and you'll find just one wire. The unit exemplifies the latest trend: plug-together modularity.

If you do supply air, make sure it isn't preheated by an upstream source (such as another power supply). Keep the air moving—don't let it stagnate or recirculate around several sources of heat.

Forced air versus convection is an old controversy that's been debated ad infinitum. As in any dispute, the pros and cons must be weighed to see which way the scale tips. Fans, of course, can reduce package size or allow more power in the same size. But they do tend to burn out or fail mechanically. With switchers there's an added consideration: Fans use power. So you might ask the vendor: Does the efficiency spec include the fan's consumption?

Many supplies are derated so that less output current is available as temperature rises. Watch for this. The spec sheet may not say that you can't get the maximum current at the maximum operating temperature. To derate, and to keep semiconductors and other components at safe temperatures, just which temperature do you measure? The ambient? The case or heat sink? Exactly where is the ambient? Perhaps at the fan intake or exhaust? Or it is some point above the unit?

Which temperature: oral or . . . ?

The vendor may mean any of these when he talks about temperature. But he may not clearly say which. He may not even turn on his supply when he measures "ambient." Thus the self-heating of the supply isn't counted.

Because the ambient is rather vague, and because the possibilities for mounting (or mis-mounting), rate of air flow, self-heating and other heat-source contributions are endless, perhaps the heat-sink temperature is the best approach. Another way out: Look for units with thermal shutdown. With this protection, the supply shuts itself off if the internal temperature

rises too far or too fast. Thermal shutdown, of course, isn't a substitute for proper cooling. But if something goes wrong, at least the transistors won't burn out.

Other things you should know but the spec sheet may not tell you: What is the storage and operating temperature range of the supply? (At a storage of -55 C , watch out for damage to plastic-cased transistors or ICs.) What is the supply's tempo? (Plus-and-minus before the figure neatly chops it in half.)

Games with numbers can be played in other areas too. For example, the figures for regulation, overshoot and response time can vary significantly, depending on how much load or line change is specified. The smaller the load or line variation, the better the specs look.

Be especially wary in evaluating dynamic and transient performance. This is one area that some manufacturers tend to downplay for good reason—the switcher's dynamic characteristics are inferior to those of the linear supply by one to two orders of magnitude.

If your load never changes, then you won't care how a switcher can react. But if you're powering, say, a memory or modulated power amplifier—or any stepped or pulsed load—then you certainly should know that a switching regulator can have serious drawbacks. In fact, the switcher may not do the job in these applications. But don't rely on the spec sheet to tell you.

First, the information just isn't there on many spec sheets. Second, when transient response is mentioned, frequently only half the story is told. What you need to learn is not just the response time, but under what load change (magnitude and frequency or risetime) and for what maximum voltage excursion. And check these too: Between which two points is the response time defined, and at what line voltage?

A "short" response time sounds terrific—until you find out the vendor's load hardly budged

Modular construction by function, 24-hour burn-in, master/slave operation and other features describe Power-tec's SS Series—12 lb of efficient power.

Units that deliver 50 to 1000 W are marketed by Trio Laboratories. The company's 5-V, 200-A supply stands out with 82% efficiency—high for a 5-V unit.

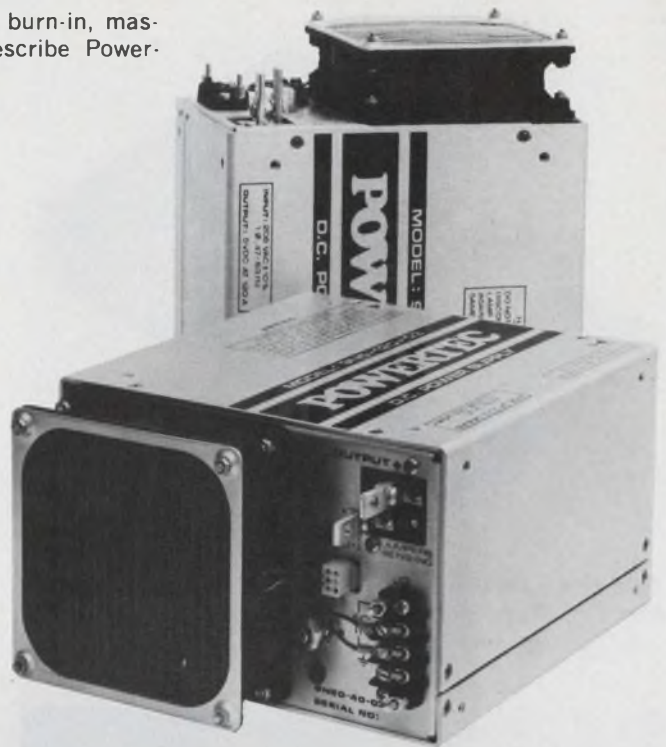
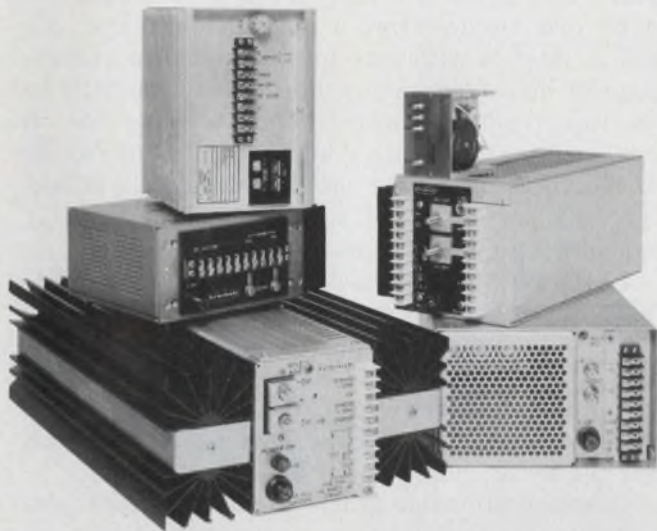

when he measured the time. Or until you measure it yourself and grimace at the 0.5-V leap in the 5-V output during that "short time." If your circuitry is immune to such excursions, fine. If the excursion never leaves the stated or desired regulation band, that may be OK, too. Yet keep in mind that the peak deviation is usually more important than the response time.

Those peaks can reach lofty—and dangerous—levels if your load transients unluckily occur at the resonant frequency of the switcher's output filter. As one vendor's director of engineering candidly admits: Some supplies will even blow up. When you evaluate dynamic performance, remember that practically all power-supply specs are given at the supply terminals. What your load sees is another story.

Between the power supply and its load in most cases sits a distribution bus. With low or static currents, you may not care that the bus has inductance or resistance. But with 50 or 100 A flowing, or with the load varying by 50 A, the bus impedance makes a difference. With a 5-V source, for instance, the dynamic specs can crumble at the load—by a factor of five over the specs at the supply's terminals.

Remember that static regulation—no matter how good—is meaningless with a time-varying load. Look instead for low dynamic output impedance in the frequency range of interest, and don't overlook the distribution impedance. With sufficiently low output Z , you may not have to hang large capacitors on the bus to get the needed performance.

Bear in mind that just five feet of heavy-

gauge leads can represent about 4 μH of inductance. Though this sounds small, a 50-A load change in 10 μs produces a 20-V drop across the leads. This disturbance can play havoc at both ends of the line—and lead to instability.

Don't expect to improve dynamic regulation with remote sensing, either. This is strictly a static technique, one which you'll probably need to deliver high currents to a remote load. Just 5 m Ω bus resistance in a 5-V, 200-A system is enough to drop 1 V along the way. With a TTL load that's three quarters of a volt too much.

And to top it off, 200 W will be lost in the 5-m Ω distribution system. This means you've got to write off 20% of the power you bought an efficient supply to get. The moral: Watch the bus and all external connections as well as the supply

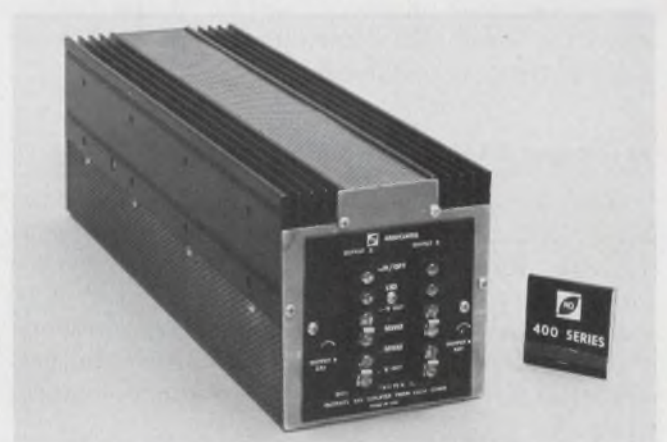

The 400 Series is RO Associates' high-power package. The 5-V units in the series can be paralleled to get thousands of amps with no control interconnections.

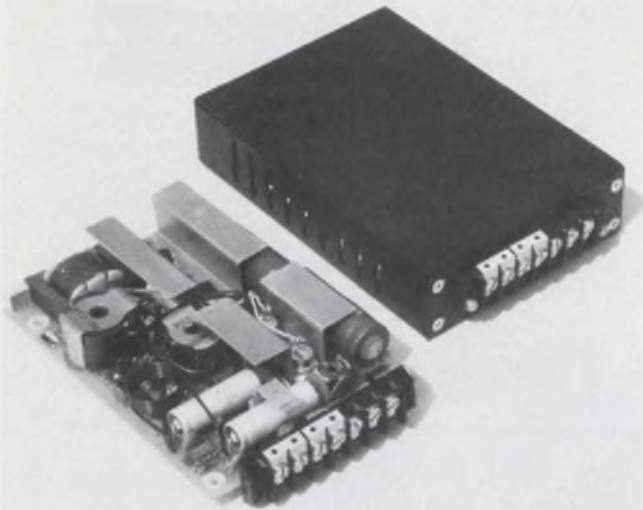

First of a new line is this 50-W switcher, Model HE237 from Computer Products. The entire unit is built on just one PC board and delivers 10 A at 5 V.

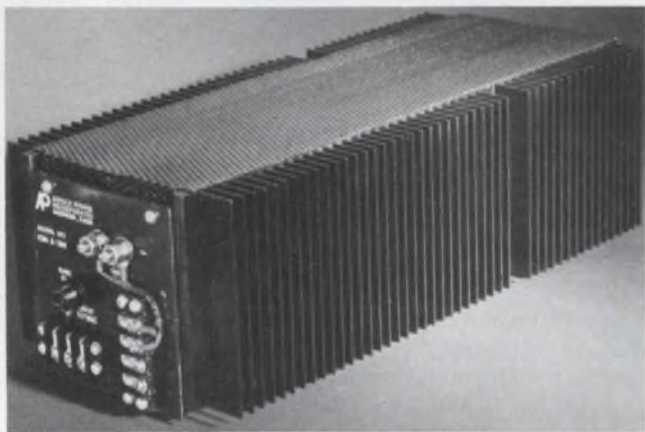

In an unusual approach to switching-regulator design, Adtech Power drops power transistors in favor of SCRs. Advantages include fewer components, better regulation.

itself. Other options: Check into distributed power, point-of-load regulators and the like.

A switcher's transient response is largely controlled by the supply's output LC filter—perhaps the single most important section of the supply, since the filter also determines ripple and noise and contributes to the efficiency spec.

The output filter: key to performance

The supply designer would like to keep the filter inductance down to boost response (di/dt). But a low inductance results in more ripple current into the capacitor, greater switching losses and increased peak primary currents. So the designer must walk a tight rope and balance the parameters for a satisfactory compromise.

What does this mean to a user or specifier? Be suspicious if fast response times are coupled with low ripple and noise on the spec sheet. Most com-

mercial, off-the-shelf switchers can't recover in less than 500 μ s for a 50% load change, and you can't expect better than about 50-mV pk-pk combined ripple and noise in a 20-Hz-to-10-MHz bandwidth.

Watch for imaginative spec writing that disguises the switcher's limitations with respect to noise and ripple. Since ripple is sinusoidal, it's OK to label it with rms units. But noise and especially high-frequency spikes contribute little to an rms reading. These should be specified in terms of peak-to-peak. And since the bandwidth of the noise-measuring equipment directly affects the results, you've got to know this parameter to make the numbers meaningful.

In the NEMA standard for the industry, PY1-1972, ripple and noise are lumped together into PARD—periodic and random deviations. PARD, says the standard, should be measured within the range of 20 Hz to 10 MHz. But some manufacturers state that the measurement bandwidth for the noise should be 20 MHz or greater.

Other questionable practices: listing ripple and noise as "typical," or as a percentage without saying of what. Check for these.

With the switcher, of course, fast spikes can be especially prevalent—and an especial nuisance. And ripple comes out at two frequencies: 120 Hz and 40 kHz (in 20-kHz units). Though the two frequencies are usually combined into one spec, sometimes you may want to know the individual figures.

Switching spikes can not only damage sensitive circuits but can produce ringing in long output leads and contribute to EMI. Unfortunately, a single measurement of output noise doesn't give the whole picture. Reflected ripple and "common-mode" noise are needed too.

Little ripples become big waves

Reflected ripple—also called conducted or back-noise current—can contaminate the ac input line. But because it's hard to measure you won't find a reflected ripple spec on most data sheets. Even if you do, chances are you won't be able to duplicate the results in your own lab. What really counts is how much noise you'll get in your own application, whether the noise can affect other loads on the ac line, and whether the ac line can be adequately decoupled, if necessary.

Also seldom specified is common-mode ripple and noise—unwanted spikes or other hash that appear at the supply's common output terminal (measured with respect to the input common terminal or the case). This noise penetrates the load through a ground loop and can, for example, saturate a differential op amp or other low-level analog circuit.

Both reflected ripple and common-mode noise

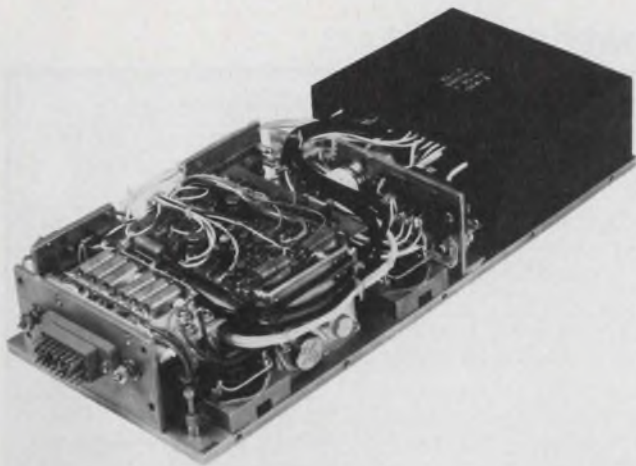

Both commercial and military units are built by Electro-Module, a company which specializes in marine, airborne and exotic switchers, such as the one shown.

can be dealt with—at a price. An input filter adds to a switcher's cost, of course. And the filter cuts into efficiency—one spec the vendor likes to keep high. So some vendors leave the filter out or offer it as an option. One vendor points out that if conducted noise at the input is to conform to the requirements of, say, MIL-STD-461, the required filter could be as large as a 50-W supply in some cases. This, however, is an extreme case.

You can certainly add your own filter to decouple the line. But since the dynamic input impedance of a switching-regulated supply can be negative (current increases as voltage decreases), don't be surprised if oscillations are touched off when you add the filter. Perhaps this may never happen. But, with the right combination of filter and switcher input impedances, it's a possibility you shouldn't overlook.

To combat common-mode noise, you can throw a capacitor across the supply's common terminals or from output common to ground. This is a simple, inexpensive solution—one which the vendor may have already implemented. But like many too easy solutions, there may be a penalty—in this case, degraded input/output isolation or inadvertent ground loops.

Careful inspection of a switcher's circuit design and layout can help you sidestep this potential headache. You can be almost certain the data sheet won't help. In fact, most sheets don't mention isolation at all.

Isolated isolation specs

Because of the filter networks, which tie the input and output lines to the chassis, switching regulators generally don't provide the high isolation found in linear supplies. So some manufacturers keep the isolation spec off the data sheet, hoping that nobody will ask about it.

But you'll find out about the limitation soon enough—when fast line faults, transients or

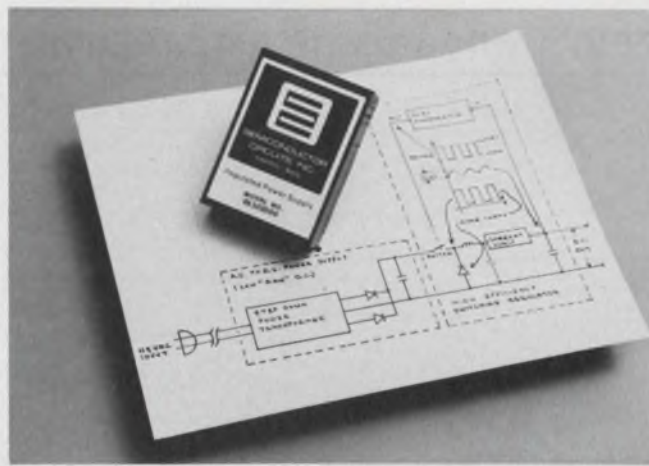

Encapsulated modular switchers for PC-board mounting are offered by Semiconductor Circuits in its ES/EA Series. Size is just 2.5 × 3.5 inches.

other power-line garbage punch through the supply and zap your sensitive load. You can always drop the input filter—or look for a unit with high isolation (which could mean the vendor did the dropping)—but with no input filter the supply turns turtle and spits hash back into the line. Somewhere between these extremes lies a reasonable compromise or a clever design that boosts isolation.

Even when isolation is given, it isn't always simple to compare competing units because no standard for isolation exists. Consequently, you'll find "isolation" listed variously as an input/output capacitance, capacitance to chassis, resistive/capacitive coupling, or in terms of various breakdown voltages. Perhaps the best way out here is to measure isolation yourself.

While you're in a measuring mood, you might want to determine the possible effects of EMI in your own setup and how much filtering is really needed. This is probably the safest and most accurate approach. Remember that EMI can be radiated, as well as conducted, out of the supply. Shielding can contain radiation, of course, but at the expense of size and cost.

Again, there's no US standard for EMI, except for military specs, which may be too stringent for many commercial applications. Therefore, you may want to look into VDE 0875/7.71—the widely accepted German standard, which gives definitions, levels and test procedures (available from McDonald Associates, 933 Sixth St., Santa Monica, CA 90403). Some test set-ups are also given in the NEMA standard.

Before you sit down to make any measurements, however, be certain that the supply isn't a time bomb waiting to throw on the switch. With inadequately protected switchers, it's a real possibility.

Because of the very nature of its design, a switcher has more ways to blow itself up than its linear counterpart. If it doesn't destroy itself,

Who's who in switching-regulated power supplies

Company	Capabilities, special features, outstanding models & other information
Abbott Transistor Laboratories	Model VN: Hermetically sealed units, 25, 50 or 100 W, meet MIL-STD-461 for EMI and MIL-STD-810 for environmental requirements. Guaranteed transient protection.
ACDC Electronics	Outstanding models in JP series include the 150 & 750-W units. Featured are modular PC board construction & field changeable heat sinks. Triple-output unit delivers 300 W. Company "wings out" semiconductors per MIL-STD-833 & burns in after assembly.
Acme Electric	MS Series includes 5-V family, rated for 5.5 V at 50 or 100 A with convection cooling at 40 C. Units accept 110/220-V, 50 to 400-Hz inputs or dc input. Extensive fuse & other protection included.
Adtech Power	Unusual design uses SCRs instead of power transistors in Models CDS5-60 & CDS5-100 (the Controswitchers). Advantages include: fewer components, boosted regulation ($\pm 0.01\%$) & smaller, lighter units.
Advanced High Voltage	Specialist in high-voltage units. Series ARRXXO delivers 150 W. Six models range from 3 kV at 50 mA to 30 kV at 5 mA, and weigh about 9 lb. Voltage & current meters are included.
Arnold Magnetics	Submodular "thin mods" system lets you design your own power conversion package. Choose from a selection of input modules and regulator output modules. To 1000 W.
Boschert Associates	New line includes 3 models, 10, 60 & 300 W, competing on cost, among other things. The 300-W unit delivers quad outputs & sells for \$400 (1-25).
Bikor Corp.	ATS Series delivers 10, 20 or 30 A at 5 V. Submodular construction, convection or conduction cooled.
Computer Products	Model HE237 delivers 5 V, 10 A, is built on single PC board. Overvoltage, current limiting & short-circuit (continuous) protected.
Control Data	Introducing new line early 1976. Modular design plugs 300 or 600-W submodules into "bulk" module. Featured are: Full power to 60 C, high isolation (input can swing to 2100 V pk), filters & safety std conformance.
Datel Systems	Miniature units housed in a $2 \times 2 \times 0.4$ -in. case & weighing 2.5 oz. Outputs are 5 V at 350 mA or ± 15 V at 60 mA. Regulation is 0.05%, tempco is $\pm 0.005\%/^{\circ}\text{C}$, high I/O isolation.
Electro-Module, Inc.	"Off-the-shelf" FEC Series offers 24 models to 300 W in various voltages to 30 V. Three-year warranty. Model DLR 5100 (5 V, 100 A) is 80% efficient, weighs 13 lb.
Electronic Measurements	Units geared toward xenon, mercury & other arc lamps. Ratings from 35 to 1000 W, 115/230-V inputs. Special attention to turn-on surges & power interruptions.
Hewlett-Packard	Extensive family covers 5 to 28 V, 110 to 600 W. Outstanding Models 62605M (5 V, 100 A) & 63315D (5 & ± 15 V, 110 W) conform to U.S. & international safety stds. Plug-apart modularity. Life tests show 3 failures in 124,000 hours for the "M."

it may try to kill the ac power source, the line switch or the load. Or, as if to prove that turn-about is fair play, the ac line or load can do the same to the supply. So protection is a must. The problem is to find out how much, where it's needed and under what conditions.

Internal fuses, links or circuits are used to protect the switcher against its own complexity or from the effects of component failure. In general, the switching and bias circuits are most problem prone, as are such crucial components as the rectifiers and electrolytic capacitors.

Remember that the performance of power transistors especially, and other components that work at relatively high voltages and high frequencies (> 20 kHz), isn't well documented. Transistors still burn out mysteriously—even when protected against second breakdown or other potential failures. Switching power transistors are usually specified with resistive loads and at room temperature. But does the transistor

see 25 C in a supply? Probably not. Is the load resistive? Chances are, its inductive.

Just how many internal fuses or protective circuits are needed is anybody's guess. One viewpoint holds that too many indicates design weakness. Perhaps this is true. But how many is "too many"? And if there's even a remote possibility of failure—even with good designs—you've got to weigh the cost of extra protection against that of potential catastrophe.

Some internal protection can't be avoided. For instance, in pulse-width modulated regulators—a design that most switchers use—supply designers must keep the two switching transistors from being on simultaneously. That is, one transistor must be completely off before the other turns on, or—poof. Of if the on transistor comes out of saturation too soon or a transformer saturates, get out the fire extinguisher. The designer, you see, has his hands full.

Other protection—from the line or load—may

Company	Capabilities, special features, outstanding models & other information
LH Research	Comprehensive line includes models to 1500 W (800 Series). Characterized by high efficiency & modular, unpluggable construction. Brand new line, the MM features units with up to 6 outputs at up to 62 W/lb.
Power Dynamics Div. of ASI	Four series to 1000 W offer up to triple outputs. Fan cooling keeps heat rise down. Soft-start, modular packaging. Units mount in 1/2 rack or 19-in. panels.
Powertec	Latest from this well-known Co. is the SS series featuring: modular, functional construction that eliminates internal harnessing; fan cooling; 24-hour, cyclic, high-temperature burn-in; 30-ms carryover, slow turn-on; and master/slave operation: Up to 4 units share load equally.
Power/Mate Corp.	PSW Series operates to 50 C with convection cooling. Outputs range from 5 to 28 V, 200 to 300 W. Overvoltage, overcurrent, overtemperature & reverse voltage protection are standard.
RO Associates	Over 25,000 units delivered in 6 years makes RO an "old-line" company in a relatively young field. Three major series provide 50 to 360 W in various packages. Two stages of switching in 400 Series for isolation & regulation. 5-year warranty. Single & multiple outputs.
Semiconductor Circuits, Inc.	Encapsulated miniatures, ES/EA Series, in 3.5 × 2.5-in. package. Eight models deliver 4 to 15 W with > 60-dB line transient immunity. Case temperature kept to 15 C rise max.
Sola Electric	Specializes in custom designs, which make up about 12% of the company's production.
Sorensen	40 units in STM Series offer 4 power levels to 700 W in wide range of voltages. Line filters meet MIL-STD-461A for conducted noise. Input is ac or dc (150 V). Overvoltage & current limiting are adjustable.
Tecnetics	Up to 100 W with 400-Hz input is delivered by the 4000 Series. Voltages range from 5 to 48 V and efficiencies from 70 to 86%. Low output impedance, high I/O isolation, Filtered.
Trio Laboratories	Power to 1000 W in 3 series. 5-V, 200-A unit is 82% efficient. 300, 500 & 600-W units are UL recognized, accept 115 or 220 V. Fan cools 600-W unit. Inrush current limiting & margin capability are standard. Single, dual & triple output models.
Trygon Electronics	SHA Series offers 1.83 W/in ³ , 0.006-Ω output impedance at 10 kHz & 12 mV pk pk ripple. Fast response: 300 μs to return to regulation band after load transient. 10% load pulse causes max departure from regulation band of 25 mV.
Velonex	Precision high-voltage bench supplies. Models 180 & 190 give adjustable output to 30 kV, digital voltage selection. Output stays within 1 V for "instantaneous" full-load application.
Wilmore Electronics	Triple-output Model 1256 delivers 5 V at 10 A & ±12 V at ±1 A. Unit weighs 2.2 lb, operates open frame with customer's heat sink to 40 C at full load. Custom OEM units, too.

also be essential. Most switchers rectify and filter the ac line before regulation takes place. This means some fairly beefy capacitors are sitting there waiting for the line switch to click on. When it does, a hefty current suddenly surges in to charge the capacitors—and burn out your line switch. If the ac line goes out and then reappears, surges can still occur. Even when you're up and running, you're not OK yet. A line transient can come along and—pow. In each case, how high is the surge? How long does it last? Is there any inrush or transient protection? If so what kind? Better ask.

More deadly inclinations

Find out also how long it takes for the dc to come up after the ac turns on. Look into other possible turn-on quirks. Throw a variable transformer on the input and drop the voltage significantly below your "normal" low line. If the sup-

ply isn't protected for low input voltages, stand back.

Vary the load and see what happens. Does the output oscillate or show instability at a certain load or rate of change? Can the supply handle any load from a short to an open? Some supplies must be loaded before you dare energize them. Be especially careful with multiple-output units.

Overload protection of switchers is more difficult than linear units. Thus the unit may be protected for shorts only. One vendor offers this advice: Repeatedly short the output while you simultaneously turn the ac on and off at maximum line voltage. If the design isn't up to par, bye-bye switching transistors.

One characteristic many manufacturers are quick to enumerate is a spec variously termed carryover, hold-up, dropout, fallout or storage time. This spec tells you how long a supply's output remains within the unit's regulation band after a loss in input power. Typically, switchers

can store energy for 20 to 30 ms—about ten times better than linear supplies.

What vendors aren't quick to point out is that carryover isn't necessarily a constant. When the line voltage drops, so can the storage time. Unless the spec is otherwise qualified, you can be almost certain that it is given for nominal, or even high, line and not for the worst case.

Other ways of safeguarding the load or supply include overvoltage, reverse voltage and thermal, or over-temperature, protection. Any of these may be necessary, depending on the application. Note that, unlike linear units, a failure in the switching section of a pulse-width-modulated converter usually results in zero or low output voltage. Thus a crowbar to guard the load may not be needed. (But other failure modes can cause overvoltage—as many as 13 modes are possible, claims one supply vendor.) What you may need, however, is something to guard your safety—and your sanity. Which brings us to the nebulous areas of reliability, serviceability and product safety.

Can switchers be trusted?

Because of the many potential failure modes, and because of the increased parts count, the switcher understandably has made many would-be users nervous. And there's no doubt that early units—and some present-day designs—were prone to failure. Vendors rightly point out, however, that much progress has been made and that the switcher's reduced heat tends to boost reliability.

Whatever the arguments and counter arguments, users must still determine a unit's reliability for themselves. To do this, forget about calculated MTBFs—they're useless. Ignore sales pitches for special features or hot-shot designs. Instead, look into the vendor's reputation. Check for a demonstrated field record. Question satisfied—and not-so-satisfied—customers, if you can get a list.

Visit the vendor and see how he builds. Of particular importance: Does he life test? How? Get the results.

Practically every major supplier of switchers states that it's a costly mistake not to evaluate a unit in your own set-up. And this must be done over a fairly long period of time to detect weaknesses that may not show up initially. Effects of reverse leakage current, for example, may be cumulative and not appear for six months to a year.

Those manufacturers who have lived with switchers for many years have learned this the hard way. They've learned to life test at elevated temperatures and to debug their units over a long period of refinement. Our advice: Do the

same if you want to be sure.

Safety and serviceability are other areas in which vendors are working to erase the bad marks of early units. Remember: That innocent-looking black box stores enough high-voltage energy to blow a hole in a PC board, start a fire—or send the careless owner to that great design lab in the sky.

More and more, UL approval is becoming a must. If you don't require it, chances are your customer will or the city or state to which you're shipping. But watch out. The word "UL" doesn't guarantee a safe product.

A statement such as "UL recognized (UL-478)" means that the supply has been examined by an independent agency and found to conform with specific safety requirements. One that says, "designed to conform to UL478" is a potential booby trap. Read the UL statement carefully. Keep in mind, too, that only the line cord or other components may have qualified.

Some vendors recommend that you don't try to repair a switching supply yourself. If you do, hook-up an isolation transformer whenever you remove the cover. Look for current-probe loops and test points that ease testing and reduce the hazard. Storage capacitors and switching transistors should be shielded or insulated.

Other safety specs you can look into, besides UL478 for data products, are UL114 for office equipment, IEC 348, also for office equipment, IEC-435 for data products and the German (VDE) specs.

Lift the lid and peak in

If you do remove the cover, watch for tip-offs to possible trouble: Are the storage caps operated beyond the ripple rating? How about the rectifiers—are peak and reverse currents within ratings? Do components heat up until they crackle? (Careful what you touch.) What do the switching waveforms look like? Is there any ringing? Are the transistors fully saturated?

What does the wiring look like—neat or a hodgepodge? Newer supplies—with modular construction—may have little or no internal wiring. Check component quality, especially the switching transistors, rectifiers and capacitors.

The latest designs may take advantage of the recent advances made in these components: power transistors with higher operating voltages and frequencies, high-temperature Schottky rectifiers and four-terminal capacitors, with especially low impedance. But don't forget that many of these are relatively new components, with no established, long-term failure rate.

And don't make these mistakes when you evaluate a switcher: Don't buy on dollars per watt or watts per cubic inch alone. Don't specify a

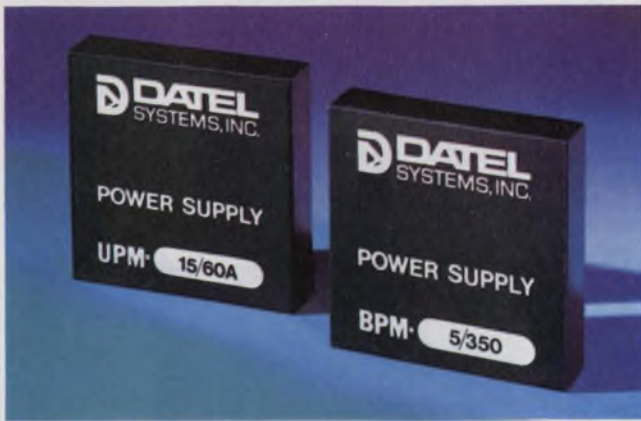

Miniature modules, from Datel Systems, are housed in a 2 x 2 x 0.4-in. case and weigh just 2.5 oz. Despite the small size, specs rival those of larger units.

switching unit as you would a linear supply—you can't replace one for the other, spec for spec.

Be extra wary with multiple-output switchers or with units tied together for more power. In dual or triple-output (5 V and ± 12 or 15 V) units, does each auxiliary output have its own regulator (usually a linear regulator) or are all regulated off the main output (5 V)? Does the regulation spec cover the auxiliary levels? How about the other specs?

Do the auxiliary outputs function without some loading of the main output, or is a 5 or 10%

loading essential? Are load transients reflected from the main into the auxiliary outputs? Does the extra parts count cut into the reliability?

Though each output is rated for a maximum current, this doesn't mean you'll necessarily get all maximums simultaneously. The supply will probably carry a maximum wattage rating so that you'll have to juggle the currents to stay within that power rating.

If you need lots of power (> 1000 W), you'll have to bring units together to multiply the current. When you do this, you can easily multiply your problems too. With straight parallel connections, watch for additive ripple and noise, interactions between units and problems in load sharing—one unit can loaf while the other carries almost the full load or goes into limiting. Look into master/slave capability for equal load sharing.

With all its potential for disaster, should you avoid the switcher? Not at all. You can walk around the hazards—if you first chart the mine field.

Remember that the switcher is at the acme in efficiency—which means it saves energy and slashes your electric bill. For the highest in power density, again, the switcher is tops. And it stays on the top for cool operation. So learn the good and the bad. Then step into the marketplace. ■■

Need more information?

The products cited in this report don't represent the manufacturers' full lines. For additional details, circle the appropriate information retrieval numbers. For data sheets and more vendors, consult ELECTRONIC DESIGN'S GOLD BOOK.

Abbott Transistor Laboratories, Inc., 5200 W. Jefferson Blvd., Los Angeles, CA 90016. (213) 936-8185. (R. Baldarrama). Circle No. 401

ACDC Electronics Inc., 401 Jones Rd., Oceanside, CA 92054. (714) 757-1880. (W. Hirschberg). Circle No. 402

Acme Electric Corporation, Cuba, NY 14727. (716) 968-2400. (R. J. Milne). Circle No. 403

Adtech Power Inc., 1621 S. Sinclair St., Anaheim, CA 92806. (714) 997-0034. (J. McNulty). Circle No. 404

Advanced High Voltage Co., Inc., 14532 Armita St., Van Nuys, CA 91402. (213) 997-7222. (M. Alexander). Circle No. 405

Arnold Magnetics, 11520 W. Jefferson, Culver City, CA 90230. (213) 870-7014. (F. M. Arnold). Circle No. 406

Autronics Corp., 180 N. Vinedo Ave., Pasadena, CA 91107. (213) 681-3545. Circle No. 430

Bikor Corp., 1228 253 St., Harbor City, CA 90710. (213) 325-2820. (R. Pizer). Circle No. 407

Boschert Associates, 3010 Lawrence Expwy., Santa Clara, CA 95051. (408) 732-2440. (D. Snyder). Circle No. 408

Computer Products, Inc., Box 23849, Fort Lauderdale, FL 33307. (305) 974-5500. (W. Ford). Circle No. 409

Control Data, Magnetic Components Div., 7801 Computer Ave., Minneapolis, MN 55435. (612) 830-5800. (L. Muehleisen). Circle No. 410

Datel Systems, Inc., 1020 Turnpike St., Canton, MA 02021. (617) 828-8000. (E. Zuch). Circle No. 411

Dressen-Barnes Electronics Corp., 2695 E. Foothill Blvd., Pasadena, CA 91107. (213) 795-7731. Circle No. 431

Dynage Inc., 1331 Blue Hills Ave., Bloomfield, CT 06002. (203) 243-0315 (J. A. Pflugsten). Circle No. 432

Electro-Module Inc., 2855 Metropolitan Pl., Pomona, CA 91767. (714) 593-3565. (G. Churchouse). Circle No. 412

Electronic Measurements Inc., 405 Essex Rd., Neptune, NJ 07753. (201) 922-9300. (R. J. Hill). Circle No. 413

Hewlett-Packard, 1501 Page Mill Rd., Palo Alto, CA 94304. (415) 493-1501. Circle No. 414

LH Research Inc., 2052 S. Grand Ave., Santa Ana, CA 92705. (714) 546-5279. (J. Cooper). Circle No. 415

Nippon Electronics Memory Industry Co., Ltd., Park Ave., 1-20-1 Sendagaya, Shibuya-Ku, Tokyo 151, Japan. Circle No. 416

NJE Corp., P.O. Box 50, Dayton, NJ 08810. (201) 329-4611. Circle No. 433

North Electric Co., Electronics Div., P.O. Box 688, Galion, OH 44833. (419) 468-8100. (J. D. Neff). Circle No. 417

Parko Electric Co., 16722 Milliken Ave., Irvine, CA 92705. (714) 549-8301. Circle No. 434

Pioneer Magnetics Inc., 1745 Berkley St., Santa Monica, CA 90404. (213) 829-3305. Circle No. 435

Power Dynamics Div. ASI Inc., Box 965, Acton, MA 01720. (617) 263-9100. (W. Boyden). Circle No. 418

Power/Mate Corp., 514 S. River St., Hackensack, NJ 07601. (201) 343-6294. (M. Charter). Circle No. 419

Powertec Incorporated, 9168 Desoto Ave., Chatsworth, CA 91311. (213) 882-0004. (J. Poturny). Circle No. 420

RO Associates Inc., 3705 Haven Ave., Menlo Park, CA 94025. (415) 322-5321. (F. Kamp). Circle No. 421

Semiconductor Circuits Inc., 306 River St., Haverhill, MA 01830. (617) 373-9104. (J. Parent). Circle No. 422

Sola Electric Div., 1717 Busse Rd., Elk Grove Village, IL 60007. (312) 439-2800. (R. Tucker). Circle No. 423

Sorensen Co., 676 Island Pond Rd., Manchester, NJ 02103. (603) 668-4500. (K. W. Lent). Circle No. 424

Tecnetics Inc., 1626 Range St., Boulder, CO 80302. (803) 442-3837. (V. L. Garrison). Circle No. 425

Topaz Electronics, 3855 Ruffin Rd., San Diego, CA 92123. (714) 279-0831. Circle No. 436

Trio Laboratories, Inc., 80 Dupont St., Plainview, NY 11803. (516) 681-0400. (J. Crawford). Circle No. 426

Trygon Electronics, Sub. of Systron-Donner Corp., 1200 Shames Dr., Westbury, NY 11590. (516) 997-6200. (E. Weiss). Circle No. 427

Velonex Div. Varian 560 Robert Ave., Santa Clara, CA 95050. (408) 244-7370. (E. Rudee). Circle No. 428

Wilmore Electronics Company, Inc., P.O. Box 2973, West Durham Station, Durham, NC 27705. (919) 489-3318. (J. L. Harris). Circle No. 429

If you haven't had a Model 3500 demo yet here are 7 reasons why you should.

Data Precision's Model 3500 5½ digit multi-meter gives you more at reduced costs.

1. BCD Output and Digital Control

Parallel BCD output and digital control signal capability at *no extra cost*.

2. Ratio Measurements

DC/DC and AC/DC ratio measurement capability at *no extra cost*.

3. High Normal Mode and Common Mode Rejection

Model 3500 performance is significantly more effective in rejecting normal mode and common mode signals up to 80dB NMRR and up to 160dB CMRR.

4. Hi-Frequency Measurements

The Model 3500 AC voltage measuring capability is specified up to 100KHz.

5. High and Low Range ACV Measurement Capability

Provides a measurement capability of AC voltages on 5 range scales, including the low scale with 1µV resolution and a high scale to 700 volts RMS.

6. Zero Stability

Model 3500 incorporates Tri-Phasic™ auto-zeroing performance eliminating the need for zero adjustment between measurements on any range and any function.

7. Price

High quality performance and accuracy for \$995 complete.

The Model 3500 has a 6 months basic DC accuracy of ±0.007% of reading ±1 LSD, full auto-ranging from 1 microvolt to 1000V (DC or AC peak) and 1 milliohm through 12 Megohms resistance, 20% overranging and an easy-to-read ½ inch planar display.

The Model 3500 also features our Tri-Phasic™ conversion cycle, Ratiohm™ resistance mode, and Isopolar™ referencing, circuit techniques that increase performance and decrease price.



To arrange an immediate demonstration or for technical data and a comparative analysis of the Model 3500 contact:
Data Precision, Audubon Road,
Wakefield, MA. 01880 (617) 246-1600.

 DATA PRECISION
...years ahead

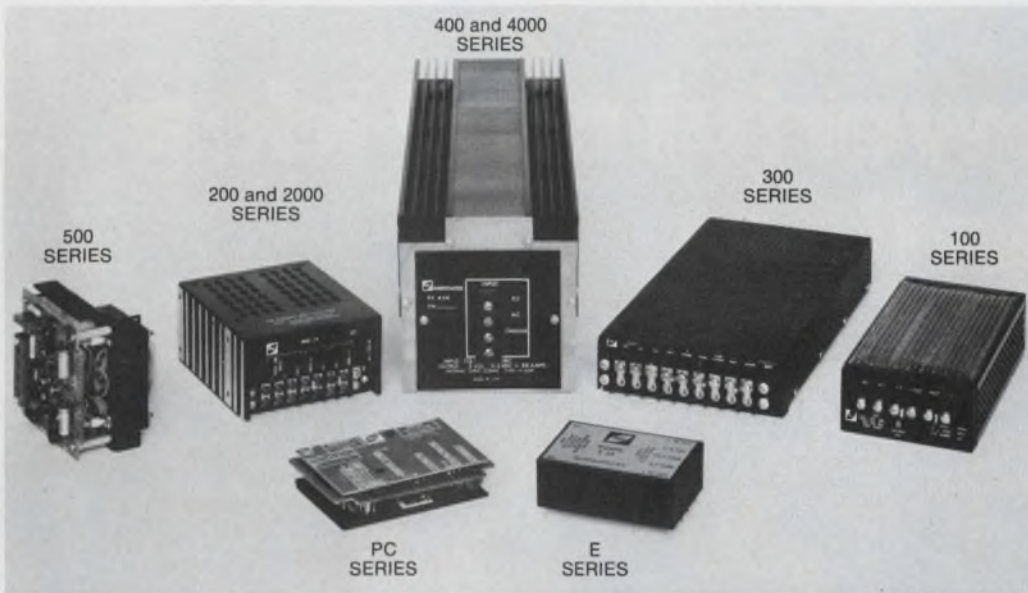

'switchers'

reliable with a five year warranty
 now from the leader in 20kHz switching power supplies

This increase in warranty coverage is offered because of the success we have enjoyed in producing in excess of 25,000 SWITCHERS at a very low failure rate. It is proof of the confidence we have in our proven designs and production techniques. Extensive in-process quality control and 100% burn-in practically eliminates infant mortality, thus guaranteeing you long trouble-free operation.

Please consult the manufacturers' directory section for a listing of our sales representatives offices.

Call or write for our complete catalog which includes the informative article, "The Principles and Facts About Switching Power Supplies."



RO ASSOCIATES, INCORPORATED / 3705 Haven Avenue / Menlo Park, CA 94025 / (415) 322-5321 / TWX 910-378-5929

INFORMATION RETRIEVAL NUMBER 42

5 YEAR WARRANTY

A powerful new idea in ferrites



It's the new Power E core . . . the first ferrite core specifically designed for switched mode power supplies.

Because of its unique shape, it has the power to . . . reduce size, weight, and cost . . . reduce component count for greater assembly ease and higher reliability . . . increase overall equipment efficiency.

Virtually a pot core with the two sides removed — or an E core with a round center leg — the new Series EC core provides an external magnetic field that is a compromise between these other two core types. Because it has a circular cross section for the center leg, turn length of windings is minimized, reducing copper losses. The more compact winding reduces leakage inductance. And the

open side design provides for maximum ease of winding and termination.

Accessories available, too. A complete line of standard bobbins has been designed and tooled to accept the new core. And specially designed mounting hardware helps make for easiest possible assembly.

If you're not yet using ferrites for power converters, you're not yet on to a good thing. And if you haven't investigated this newest and most powerful idea in ferrites yet, perhaps you'd better.

For further information, or quantities from stock, write or phone Ferroxcube or any of the offices listed below.



FERROXCUBE CORPORATION, SAUGERTIES, N.Y. 12477 □ 914•246-2811
A NORTH AMERICAN PHILIPS COMPANY

Distributed through North American Philips Electronic Components Corp. — warehouses in Boston, 617•899-7103; New York, 516•538-2300; Saugerties, 914•246-5861; Philadelphia, 215•836-1616; Chicago, 312•593-8220; San Diego, 714•453-5440; Toronto, 416•425-5161

19172

INFORMATION RETRIEVAL NUMBER 43

CAUTION: 50,000 VOLTS

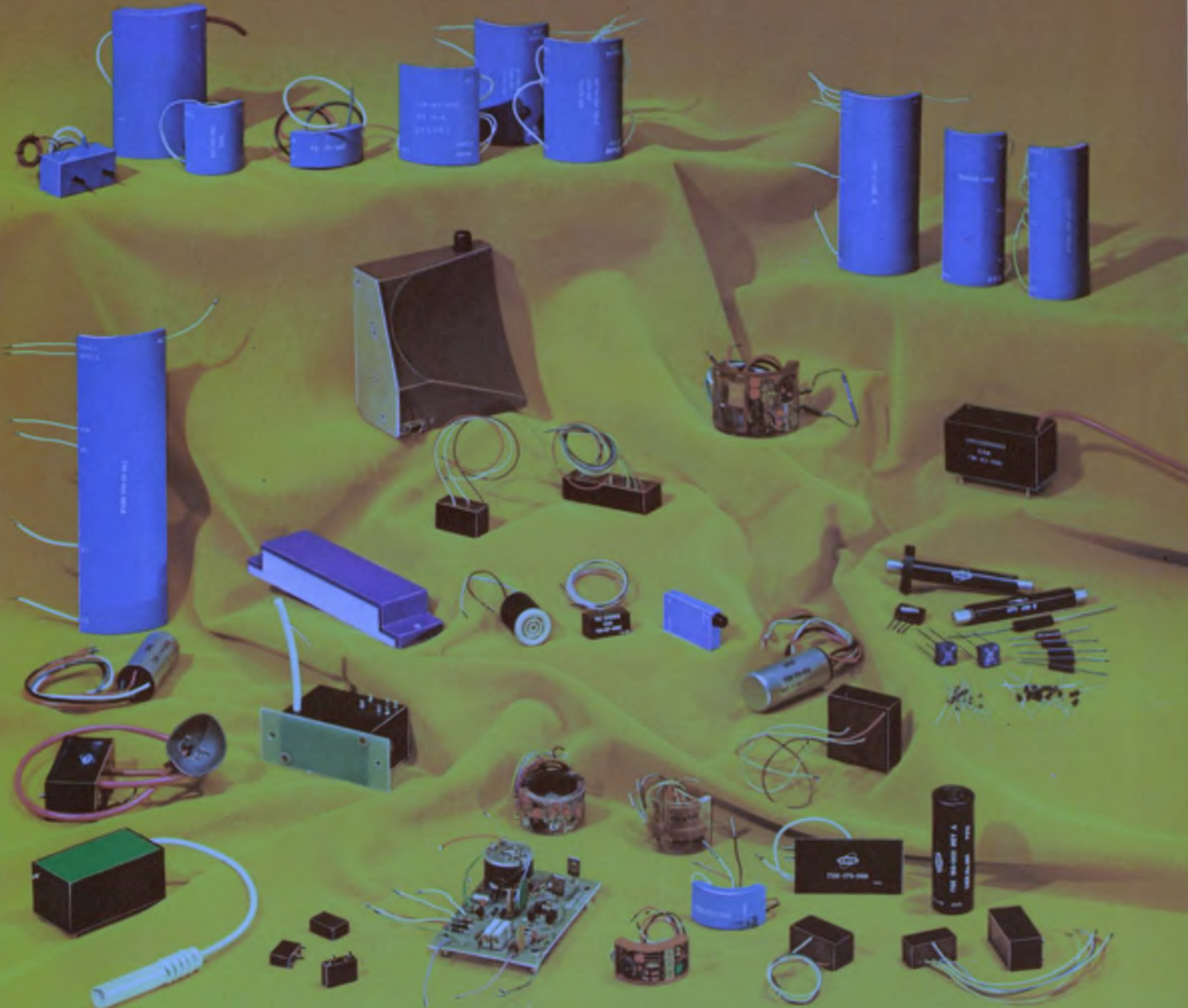

LET ERIE DESIGN and BUILD YOUR HIGH VOLTAGE POWER SUPPLIES and VOLTAGE MULTIPLIERS

When you talk about designing and packaging miniature, low current High Voltage Power Supplies and Voltage Multipliers, the name ERIE should come to mind first. Why? *No other manufacturer of these sophisticated devices has its own capacitor and rectifier technology in-house.* Only ERIE does it all. Our many years experience in producing State of the Art high voltage capacitors and high voltage silicon rectifiers — plus an unsurpassed technology in circuit designing, packaging and encapsulation, makes ERIE an ideal source for your high voltage component needs. From very low input voltages, ERIE can produce output voltages up to 50,000 volts. Application for these compact, high reliability devices includes night-vision image intensification systems. Apollo TV cameras. CRT displays. Avionics systems exposed to rugged environments. Industrial, commercial and military equipments ... an almost infinite variety of applications. So bring ERIE in early. Let us design and build *your* High Voltage Power Supplies and Voltage Multipliers. We're equipped to handle large or small volume orders ... in-house.

Write for our 32-page catalog
High Voltage Components and
Devices ... or for technical
assistance, call
613/392-2581

ERIE TECHNOLOGICAL PRODUCTS, INC.
Erie, Pennsylvania 16512

ERIE

International Rectifier.

New 10 Amp device makes one-stop shopping easy for fast-switching power transistors.

Now, IR is your source for a wide variety of 3, 5 and 10 Amp JEDEC fast-switching power transistors, to simplify your buying. These hard-glass passivated devices are the ones to use for better reliability and lower costs in line operated power supplies, whether you're chopping line voltages at 20 KHz or inverting and stepping down at high frequency.

Fast Switching Speed—Cooler Operation . . . the oscillographs show typical fall times in the one-micro-second and lower range. Gives extremely low switching losses for cooler operation and higher reliability.

Lower Leakage — High Temperature Stability . . . with ICEO in the micro-amp range, IR devices are about one-tenth the accepted leakage rates of others. Provides the higher stability important for high performance at elevated temperatures.

High Second Breakdown — High Reliability . . . high second breakdown helps provide a broad safe-operating area for an extra margin of safety.

Glass Passivation — Long Term Reliability . . . high reliability and long term stability is achieved by hard glass passivation. Also, if you're using chips to make your own circuits,

IR's glass passivation gives you the most stable, easy to assemble chips you can start with, making your yields higher.

If you are paralleling devices, the tight gain, switching time and saturation voltage control of these transistors make the job easier. And through 100% testing of key parameters we can provide even closer matching if necessary.

JEDEC types listed are immediately available, so contact your local IR salesman, rep or distributor today. International Rectifier, 233 Kansas Street, El Segundo, California 90245. (213) 678-8261.

New International Rectifier Fast Switching Power Transistors									
IR Part No.	V _{CEO} (sus) (Max V)	I _C Peak (A)	h _{FE} (min/max)	β @ I _C (A)	V _{CE} (sat) (Max V)	β @ I _C (A)	P _d (W)	t _r /t _f (μs)	
2N6306	250	16	15/75	3.0	0.8	3.0	125	.6/.4	
2N6307	300	16	15/75	3.0	1.0	3.0	125	.6/.4	
2N6308	350	16	12/60	3.0	1.5	3.0	125	.6/.4	
2N6542	300	10	7/35	3.0	1.0	3.0	100	.7/.8	
2N6543	400	10	7/35	3.0	1.0	3.0	100	.7/.8	
2N6544	300	16	7/35	5.0	1.5	5.0	125	1/1	
2N6545	400	16	7/35	5.0	1.5	5.0	125	1/1	
2N6249	200	30	10/50	10.0	1.5	10.0	175	2/1	
2N6250	275	30	8/50	10.0	1.5	10.0	175	2/1	
2N6251	350	30	6/50	10.0	1.5	10.0	175	2/1	

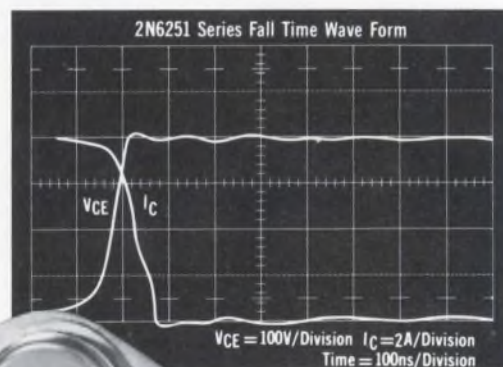
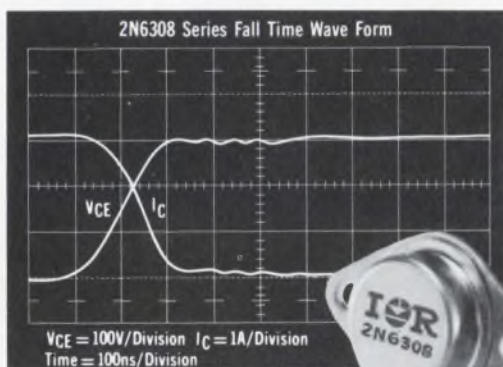

INTERNATIONAL RECTIFIER
the innovative power people



SEMICONDUCTOR DIVISION, 233 KANSAS STREET, EL SEGUNDO, CALIFORNIA 90245, PHONE (213) 678-6281

INFORMATION RETRIEVAL NUMBER 53



SWITCHERS

The world's largest manufacturer of high power switching regulated power supplies—whose only product line is high power switchers—announces

The **NEW "MIGHTY MITES"**

(MM) Series *

**The most dramatic and revolutionary
breakthrough ever made
in the power supply industry.**

- **Most comprehensive line of switchers ever developed** — one, two, three, four, five and six outputs.
- **Most watts/in.³** — up to 2.26 watts/in.³ — more than 2 times denser than competitive switchers; 5 to 6 times denser than conventional linears.
- **Most efficient** — up to 80% efficient.
- **Most economical** — less than 60¢/watt in quantity.
- **Most reliable** — only LH Research guarantees all models for two years.
- **Most modular** — any pc board may be removed and re-installed in less than two minutes.
- **Smallest size** — 5V - 75 amp model is only 5" x 4" x 12"; 5V - 150 amp 5" x 5" x 12.75".
- **Lightest weight** — up to 62 watts/lb.
- **All models designed to meet UL 478.**

*Patent Pending

LH "MIGHTY MITES"

16 models with the most advanced specs in the industry.

Efficiency

Up to 80%.

Input

115VAC \pm 10% 47-63 Hz.
or 230VAC \pm 10% 47-63 Hz.
115/230VAC \pm 10% 47-63 Hz optional.

Output

(see listings under individual models)
Any output between 2 volts and 70 volts available. Contact factory.

Line Regulation

0.4% on primary output over entire input range.
0.2% on 2nd, 3rd and 4th.

Load Regulation

0.4% from no load to full load.

Note: Multiple output supplies require a minimum of 10% load on main output to maintain voltage on minor outputs.

Interaction

0.1% maximum.

Ripple and Noise

1% P-P or 50 MV.

Over-voltage Protection

Standard on primary output, factory set at 125% \pm 5%. OVP available for other outputs as an option.

Overshoot and Undershoot

2% maximum deviation for a 25% load change at 5A/ μ s.

Response Time

200 μ s to 1% after a 25% load change at 5A/ μ s.

Drop Out Time

Supply will remain in regulation for 15 ms after removal of nominal AC power.

Current Limit

All outputs have "fold-back" current limiting. Constant current limiting available as an option.

Temperature Coefficient

\pm .02%/°C.

Storage Temperature

-55°C to 85°C.

Operating Temperature

0°C to 70°C (see derating curve).

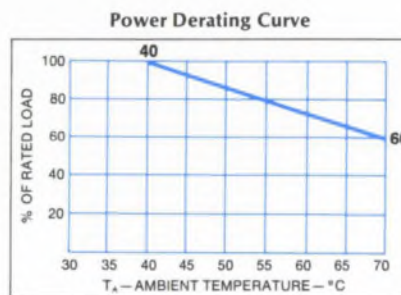

Minimum Load

Zero for single output models; 10% on primary output for multiple output models.

Output Polarity

Single output models:
Either output terminal may be grounded or left floating up to 100V off chassis ground.

Multiple output models:
Outputs of these supplies are floating and independent and may be referenced as desired up to 100V off chassis ground.

Input Connections

AC input is provided through a heavy duty non-breakable terminal block.

Output Connections

Primary outputs that have ratings up to 375 watts use nickel plated 1/4 x 20 studs. Primary outputs that have ratings up to 750 watts have nickel plated 5/16 x 18 studs. Other outputs on multiple supplies are provided through a heavy duty non-breakable terminal block.

Output Adjustment

All outputs have voltage adjustment potentiometers accessible from the front panel. Current limit and OVP adjustments are internal and factory set.

Standard Features

- Remote sense on primary outputs. Compensation for up to 250 MV load cable

loss can be accommodated. Remote sense is also provided on 2nd and 3rd outputs of 2 and 3 output supplies.

- Internal thermal switch. Will turn off the power supply in case of overheating.
- Input RFI line filter. Independent LC section on each side of the AC line.
- Reverse voltage protection. All outputs have reverse voltage protection up to 100% of rated current on primary outputs. 3 amps average on all other outputs.
- Limited inrush current. AC input inrush current is limited to 2½ times normal running current when averaged over one cycle.
- Automatic internal sensing. Internal sensing is automatic through resistors if the sense lines are opened.

Optional Features

- Power fail detection. Upon AC removal, power fail signal will drop to a logic zero at least 10 ms before loss of DC output. This signal is referenced to the (-) output stud.
- Remote on-off. The power supply output(s) can be activated by customer supplied switch or transistor circuit. (Consult factory for further details.)
- Master/slave parallel. Up to 10 single output units can be paralleled. Advantages are: current sharing between units to within 10%. Voltage adjustment made at master unit. All supplies switch at the same frequency.
- Straight paralleling. (no master) Single output supplies are available with constant current overload to allow reliable turn on when units are to be used in straight parallel.
- Special AC inputs. Units can be built with wider AC input ranges to give added protection against brown out.
- DC inputs. Most MM Series units can be configured for 28, 48, and 120 VDC.

Look how the "Mighty Mites" compare against competitive switchers.*

	ACDC	ACME	H-P	PIONEER	POWERTECH	SORENSEN	TRIO	LH
Power/Watts	500	500	500	500	600	500	500	750
Cost	\$595	\$605	\$650	\$595	\$625	\$650	\$650	\$590
Size (in. ³)	523	397	507	480	400	525	461	331
Cost/Watt**	\$1.19	\$1.21	\$1.30	\$1.19	\$1.04	\$1.30	\$1.30	\$.78
Watt/in. ³	.96	1.25	.98	1.04	1.5	.95	1.08	2.26

*Specifications and prices based on published information. **Based on single unit price.

MM-300 One output, 750 watts

5V, 150 amps 18V, 41 amps
 12V, 62 amps 24V, 31 amps
 15V, 50 amps

Price \$590.00, 1 to 9 supplies

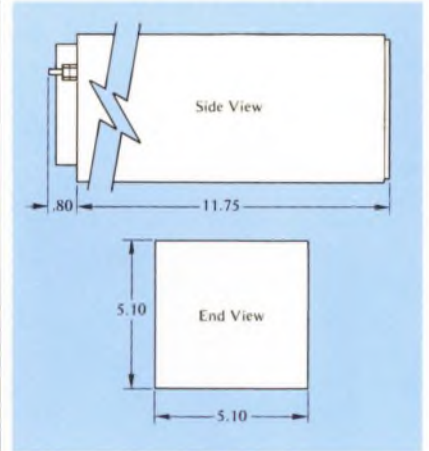

MM-420 Two outputs, 750 watts

Primary voltage:
 5V, 150 amps
 2nd voltage: (these voltages also available
 at twice the current ratings shown).
 2V, 12 amps 15V, 10 amps
 5V, 12 amps 18V, 8 amps
 12V, 10 amps 24V, 5 amps

Total wattage of all outputs not to exceed
 750 watts

Price \$650.00, 1 to 9 supplies

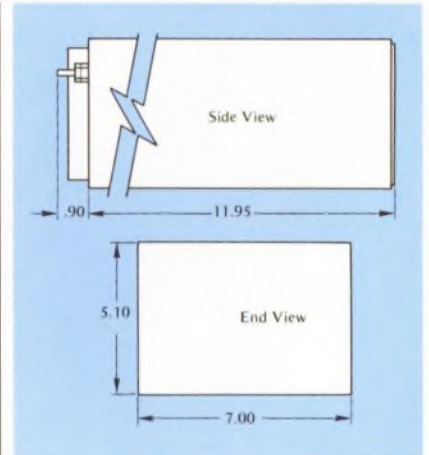

MM-430 Three outputs, 750 watts

Primary voltage:
 5V, 150 amps
 2nd and 3rd voltages:
 ± 5V, 12 amps ±18V, 8 amps
 ±12V, 10 amps ±24V, 5 amps
 ±15V, 10 amps

Total wattage of all outputs not to exceed
 750 watts

Price \$695.00, 1 to 9 supplies

MM-440 Four outputs, 750 watts

Primary voltage:
 5V, 150 amps
 2nd voltage:
 2V, 12 amps 15V, 10 amps
 5V, 12 amps 18V, 8 amps
 12V, 10 amps 24V, 5 amps

3rd and 4th voltages:
 5V, 5 amps 18V, 4 amps
 12V, 5 amps 24V, 3 amps
 15V, 5 amps

Total wattage of all outputs not to exceed
 750 watts

Price \$745.00, 1 to 9 supplies

MM-450 Five outputs, 750 watts

Primary voltage:
 5V, 150 amps
 2nd, 3rd, 4th and 5th voltages, any com-
 bination of the following:
 5V, 5 amps 18V, 4 amps
 12V, 5 amps 24V, 3 amps
 15V, 5 amps

Total wattage of all outputs not to exceed
 750 watts

Price \$775.00, 1 to 9 supplies

MM-520 "Dual" — Two 375 - watt outputs, 750 watts total

No. 1 and No. 2 primary voltages, any combination of the following:
 2V, 75 amps 15V, 25 amps
 5V, 75 amps 18V, 21 amps
 12V, 31 amps 24V, 15 amps

Price \$750.00, 1 to 9 supplies

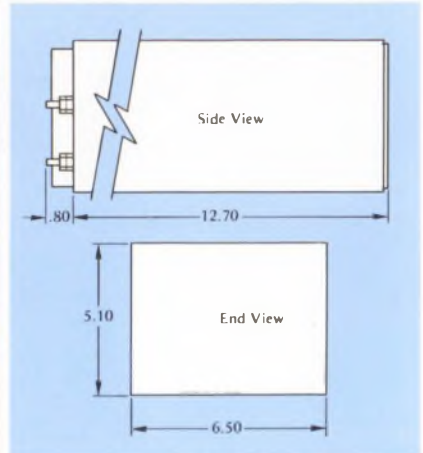

MM-630 Three outputs, 750 watts: 2 high power and 1 low power

No. 1 and No. 2 primary voltages, any combination of the following:
 2V, 75 amps 12V, 31 amps
 5V, 75 amps 15V, 25 amps

3rd voltage*: (these voltages also available at twice the current ratings shown)
 2V, 12 amps 15V, 10 amps
 5V, 12 amps 18V, 8 amps
 12V, 10 amps 24V, 5 amps

Total wattage of all outputs not to exceed 750 watts

*Third voltage plus the No. 1 primary cannot exceed 375 watts.

Price \$810.00, 1 to 9 supplies

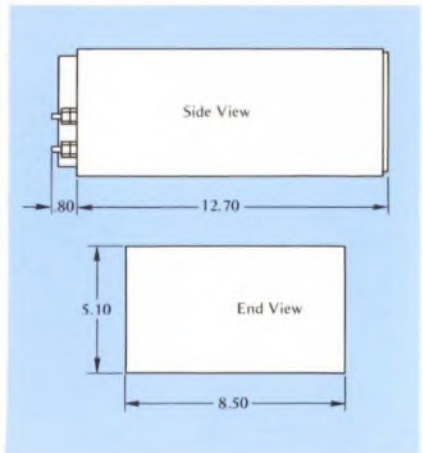

MM-640 Four outputs: 2 high power and 2 low power, 750 watts total

No. 1 and No. 2 primary voltages, any combination of the following:
 2V, 75 amps 12V, 31 amps
 5V, 75 amps 15V, 25 amps

3rd and 4th voltages*, any combination of the following:
 2V, 12 amps 15V, 10 amps
 5V, 12 amps 18V, 8 amps
 12V, 10 amps 24V, 5 amps

Total wattage of all outputs not to exceed 750 watts

*Combination of third voltage and the No. 1 primary cannot exceed 375 watts.

*Combination of fourth voltage and the No. 2 primary cannot exceed 375 watts.

Price \$855.00, 1 to 9 supplies

MM-650 Five outputs: 2 high power and 3 low power, 750 watts total

No. 1 and No. 2 primary voltages, any combination of the following:
 2V, 75 amps 12V, 31 amps
 5V, 75 amps 15V, 25 amps

3rd voltage*:
 2V, 12 amps 15V, 10 amps
 5V, 12 amps 18V, 8 amps
 12V, 10 amps 24V, 5 amps

4th and 5th voltages*, any combination of the following:
 5V, 5 amps 18V, 4 amps
 12V, 5 amps 24V, 3 amps
 15V, 5 amps

Total wattage of all outputs not to exceed 750 watts

*Combination of third voltage and the No. 1 primary cannot exceed 375 watts.

*Combination of fourth and fifth voltages and the No. 2 primary cannot exceed 375 watts.

Price \$905.00, 1 to 9 supplies

MM-660 Six outputs: 2 high power and 4 low power, 750 watts total

No. 1 and No. 2 primary voltages, any combination of the following:
 2V, 75 amps 12V, 31 amps
 5V, 75 amps 15V, 25 amps

3rd, 4th, 5th and 6th voltages*, any combination of the following:
 5V, 5 amps 18V, 1 amp
 12V, 5 amps 24V, 1 amp
 15V, 5 amps

Total wattage of all outputs not to exceed 750 watts

*Combination of third and fourth voltages and the No. 1 primary cannot exceed 375 watts.

*Combination of fifth and sixth voltages and the No. 2 primary cannot exceed 375 watts.

Price \$935.00, 1 to 9 supplies

MM-100 One output, 375 watts

5V, 75 amps 18V, 21 amps
 12V, 31 amps 24V, 15 amps
 15V, 25 amps

Price \$445.00, 1 to 9 supplies

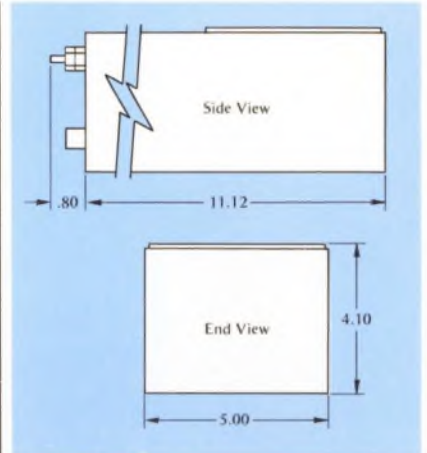

MM-220 Two outputs, 375 watts

Primary voltage:
 5V, 75 amps
 2nd voltage:
 2V, 12 amps 15V, 10 amps
 5V, 12 amps 18V, 8 amps
 12V, 10 amps 24V, 5 amps
 Total wattage of all outputs not to exceed
 375 watts

Price \$495.00, 1 to 9 supplies

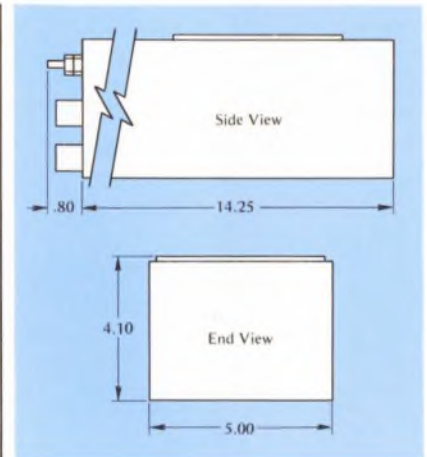

MM-230 Three outputs, 375 watts

Primary voltage:
 5V, 75 amps
 2nd and 3rd voltages:
 ±12V, 8 amps
 ±15V, 8 amps
 ±18V, 6 amps
 Total wattage of all outputs not to exceed
 375 watts

Price \$530.00, 1 to 9 supplies

MM-240 Four outputs, 375 watts

Primary voltage:
 5V, 75 amps
 2nd voltage:
 2V, 12 amps 15V, 10 amps
 5V, 12 amps 18V, 8 amps
 12V, 10 amps 24V, 5 amps
 3rd and 4th voltages, any combination of
 the following:
 5V, 5 amps 18V, 2 amps
 12V, 3 amps 24V, 2 amps
 15V, 3 amps

Total wattage of all outputs not to exceed
 375 watts

Price \$565.00, 1 to 9 supplies

MM-250 Five outputs, 375 watts

Primary voltage:
 5V, 75 amps
 2nd, 3rd, 4th and 5th voltages, any com-
 bination of the following:
 2V, 5 amps 15V, 3 amps
 5V, 5 amps 18V, 3 amps
 12V, 3 amps 24V, 2 amps

Total wattage of all outputs not to exceed
 375 watts

Price \$595.00, 1 to 9 supplies

MM-730 "Flat Pak" — Three outputs, 375 watts

Primary voltage:
5V, 75 amps

2nd and 3rd voltages:
± 2V, 12 amps ±15V, 10 amps
± 5V, 12 amps ±18V, 8 amps
±12V, 10 amps ±24V, 5 amps

Total wattage of all outputs not to exceed
375 watts

Price \$530.00, 1 to 9 supplies

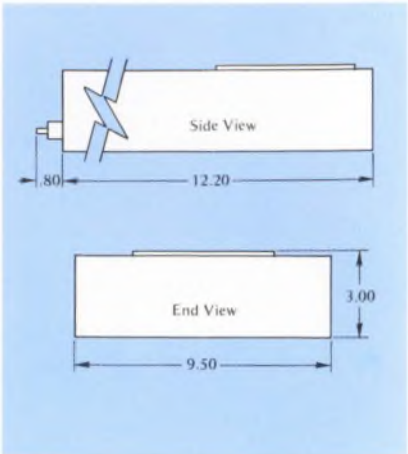

How to order MM Series Switchers

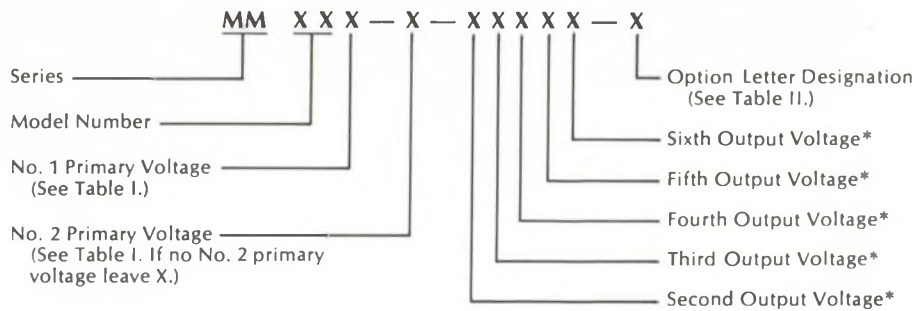

**TABLE I.
OUTPUT VOLTAGE CODE**

0 = 2 VOLTS	3 = 15 VOLTS
1 = 5 VOLTS	4 = 18 VOLTS
2 = 12 VOLTS	5 = 24 VOLTS

**TABLE II.
OPTION ORDER CODE**

O = REMOTE ON-OFF
P = POWER-FAIL DETECTION
C = CONSTANT CURRENT LIMITING

*For *each* output which needs over-voltage protection (where it is not standard) add the letter Y immediately following the output voltage code, i.e. 1Y, 3Y, etc.

Typical example: MM 661 — 1 — 1Y2Y3Y5-P

The above Model Number describes a MM 660 Series Switcher with a 5-Volt No. 1 primary output voltage, a 5-Volt No. 2 primary output voltage, a 5-Volt second output voltage with over-voltage protection, a 12-Volt third output voltage with over-voltage protection, a 15-Volt fourth output voltage with over-voltage protection, a 24-Volt fifth output voltage *without* over-voltage protection, and the power-fail detection option.



These semiconductor cooling ideas can slash unit cost of high-production circuits

No. 25 of a Series

Our low-cost dissipators and dissipator/retainers will let you use the lower-cost semiconductors while you get the reliability of high-priced devices and save money at the same time. Or you can use these thermal

management components to reduce the number of semiconductors required to perform your circuit's function. These heat dissipator benefits add up to the kind of savings that makes your industrial or consumer

product competitive. Here are some examples of how designers of high-production equipment used IERC dissipator/retainers costing only pennies each to cut unit cost and get the competitive edge.

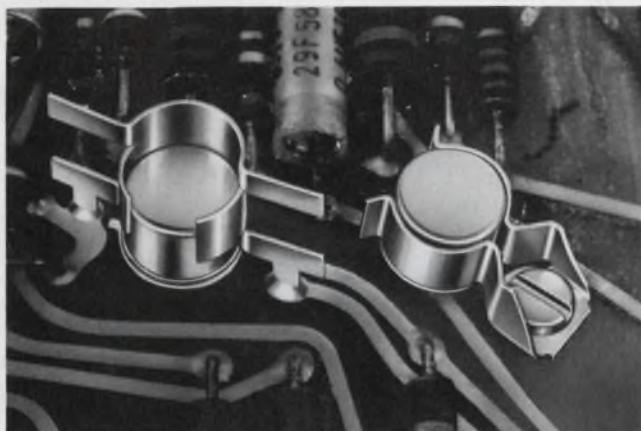

High-priced reliability for this high-speed switching circuit was achieved for pennies by using IERC heat dissipators/retainers. Low-cost ceramic and plastic semiconductors plus dissipators (priced from 2.5¢ to 3.9¢ each in 100K quantities) gave same reliability as next higher grade semiconductors that cost twice as much.

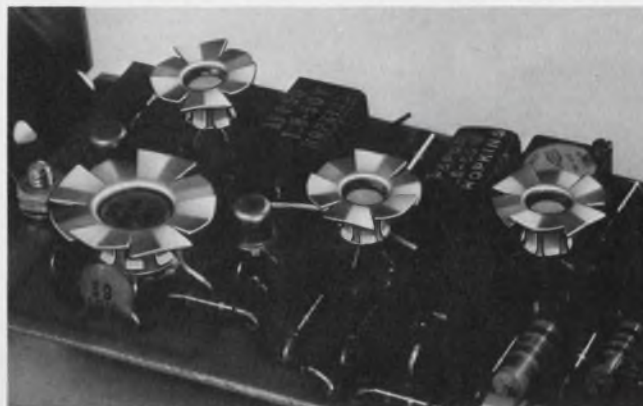

Big savings and neat, uncrowded board resulted when designer of this regulator got rid of three TO-18 devices by using press-on Fan Top dissipators that permitted 2N706 transistors to operate at twice the power rating with the same 75°C case rise. Available for a variety of transistor cases, Fan Tops cost under 4¢ each in 100K quantities.

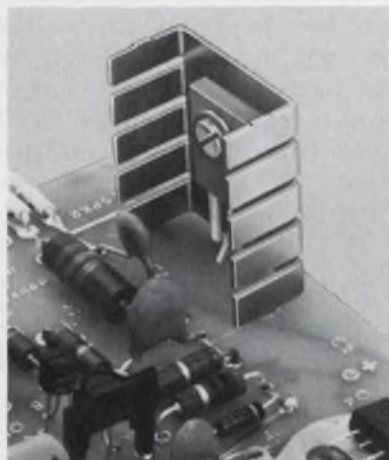

Stand-up heat dissipator takes little investment in board real estate or money but it let designer of this power supply double power of 2N4442 power pack plastic transistor with same substrate temperature rise above ambient as the bare device. Nickel plated dissipator solders to board along with other components.

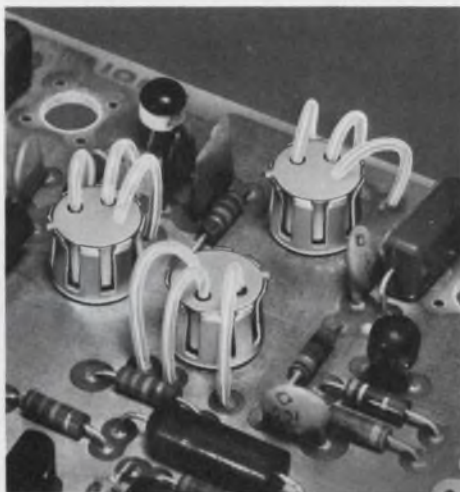

Shaky washing machine environment dictated strong TO-5 device retention while designer got enough cooling from Thermal Links to go to a cheaper transistor for this solid-state controller. Soldered, riveted, or eyeletted to board, Thermal Links lowered case rise 25°C with same power. Cost for OEM quantity was under 6¢ each.

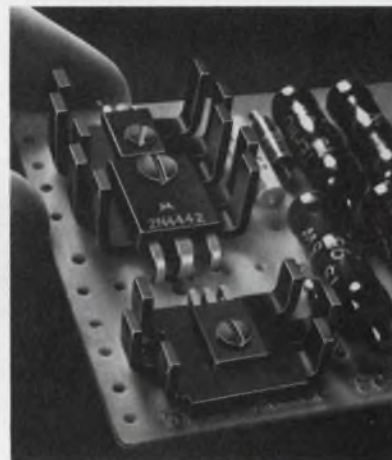

Double the power for a nickel netted a big cost savings for this amplifier circuit. IERC PA and PB Staggered Finger dissipators maintain safe case temperatures for Power Pack, Power Tab and other flat-case plastics while permitting up to twice the dissipation. They cost about 4¢ to 6¢ in OEM quantities.



For more information

on heat sinks and dissipators for milliwatts to kilowatts, send for the IERC Short Form Catalog today. It covers the most complete line of thermal problem solving devices available anywhere.



Heat Sinks/Dissipators

INTERNATIONAL ELECTRONIC RESEARCH CORPORATION / A SUBSIDIARY OF DYNAMICS CORPORATION OF AMERICA / 135 WEST MAGNOLIA AVENUE, BURBANK, CALIFORNIA 91502

INFORMATION RETRIEVAL NUMBER 44

Design your own microcomputer by using bipolar/LSI processor slices. An example shows how to build a 16-bit processor and develop its instruction set.

Bipolar/LSI microprocessor slices offer several advantages over their MOS cousins. The bipolar speeds of "bit slice" processors, or microcontrollers, assure a precise emulation of conventional systems, which employ standard-bipolar circuits. By using microprogramming techniques, designers can replace scores of SSI and MSI packages at reduced power. And in applications such as minicomputers, processor slices provide the hardware flexibility to reduce equipment size without changes in existing software.

In essence, the bit-slice approach lets you design your own microprocessor and develop a variety of specialized instruction sets. For example, a 16-bit processor (Fig. 1) can be built with 24 ICs that typically use 9.4 W. It has an instruction set that can handle programs written for popular minicomputers—and speeds to match. The microcycle time is 300 ns, and instruction execution times are 0.9 to 1.2 μ s.

Processor uses four microcontrollers

The processor employs four 4-bit microcontroller chips (Fig. 2). Each chip consists of a 16-register file that may be read simultaneously by two address multiplexers, A and B. Data contained in the selected registers pass through the respective latches. The B-address input are also used to select the register to be loaded with new data. When the register is loaded, the A and B latches hold output data, thereby providing edge-triggered, master/slave operation.

The chip also contains an ALU (arithmetic logic unit) similar to the popular 74181 and variant multiplexers to provide data routing and shifting of results prior to their storage. An internal Q register, with its own shift multiplexers, can be used for temporary storage of results and for double-precision shift operations.

The microcontrollers provide 16 GPRs (general-purpose registers) and an ALU. If we assign

one of the registers as the program counter, this still leaves 15 GPRs. Other circuits needed to complete the CPU are an instruction register, a memory-address register and instruction-execution control logic.

To design the instruction-execution logic, we must define the instruction format and the execution sequence for each instruction. The instruction format determines how the instruction will be decoded. The execution sequence defines the steps required to execute the instruction.

The instruction execution for each depends on the instruction word size, the number of GPRs (15 in our example) and the total number of instructions. We have a memory word size of 16 bits and a total of 18 instructions to implement a general purpose set (see box). This means that our operation code field must be at least five bits in size to specify each of the 18 instructions.

Each instruction also requires modifier fields. These are determined from additional information needed to execute the instruction. For instance, in a Load Register instruction we must specify one of the 15 GPRs to be loaded and a 16-bit address for the memory data. After listing all required modifier data, similar instruction formats are then reduced to a minimum number.

Specifying the instruction format

For our computer, all instructions can be specified by a single instruction format (Fig. 3). This format consists of an 8-bit operation-code field and two 4-bit fields that define up to two GPRs.

A second modifier word, following the instruction, defines memory addresses and immediate data for GPR Load and Store, Load PC (program counter) and Test instructions.

The instruction-execution control logic generates a sequence of operations to perform the following tasks:

1. Get the next instruction from memory and load it into the instruction register. (Memory location is defined by the contents of PC).
2. Decode the instruction to select the execution sequence.
3. Step through the sequence (this can involve

David C. Wyland, Manager, Microprocessor Design, Monolithic Memories, 1165 E. Arques Ave., Sunnyvale, CA 94086.

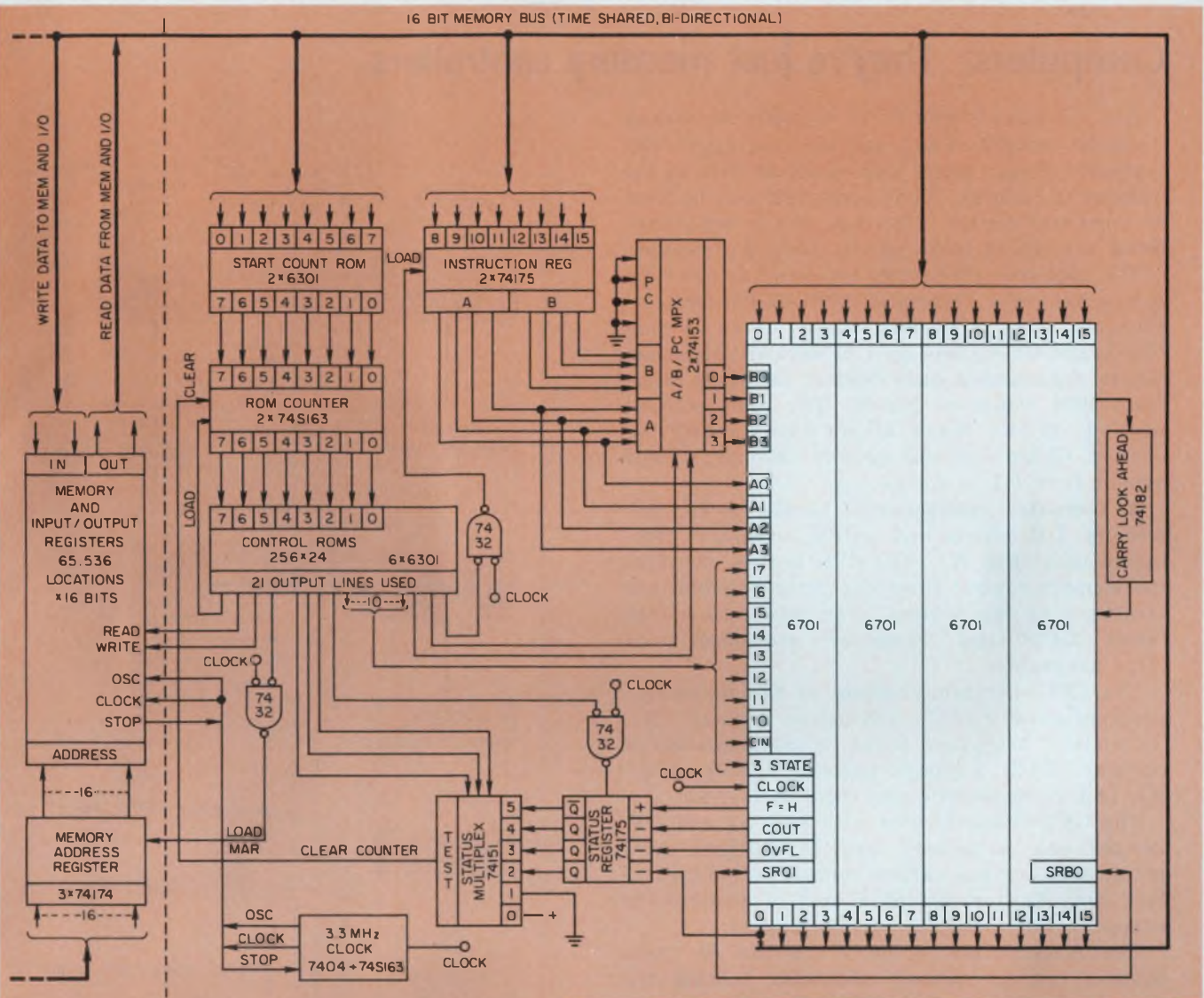

Performance Summary

WORD SIZE	16 BITS
ADDRESSING CAPABILITY	65,536 WORDS
MIROCYCLE TIME	300 NANOSECONDS
ADDRESSABLE I/O REGISTERS	65,536 SHARED WITH MEMORY
INSTRUCTION EXECUTION TIMES:	
Add 2 Registers	0.90 Microseconds
Load/Store Direct	1.50 Microseconds
Load/Store through REG	1.20 Microseconds
Test	1.20 Microseconds
PARTS COUNT (Excluding memory and MAR)	24 CHIPS
POWER REQUIRED	9.4 WATTS TYPICAL (1.88 amps @ 5.0 volts)

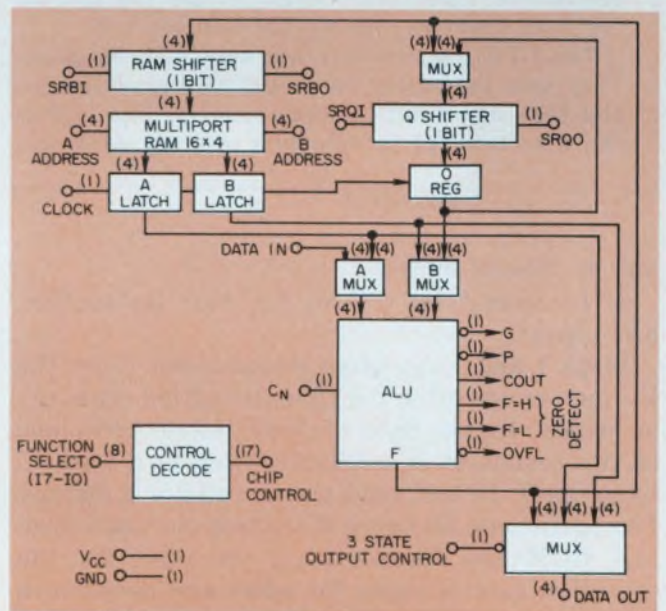

1. A 16-bit bipolar microcomputer employs four 4-bit microcontroller chips. The complete microcomputer uses 24 ICs that dissipate less than 10 W. Typically instructions can be executed in 1.2 μ s or less.

2. The 4-bit microcontroller contains an arithmetic logic unit and 16 general-purpose registers that can be read from either of two multiplexers. The chip employs an external control ROM.

Computers: They're just memory controllers

Any computer—from micro to super mainframe—can be thought of as a memory controller. The computer simply moves and combines data in the memory it controls. Thus computers can be used as universal digital interfaces, if the equipment being interfaced looks like a computer memory.

The only real differences between various computers are these: size and speed of the memory, efficiency with which data can be moved or combined, and limitations on I/O devices. Minicomputers, for example, have memory sizes that range from 4096 words to 32,768. The most popular width is 16 bits, which allows direct addressing of up to 65,536 words of memory. Memory speeds extend from 0.1 to 2.0 μ s.

A computer conveniently breaks down into memory, I/O devices and a CPU, or central processing unit (Fig. A). The CPU portion provides the memory control function; thus it defines the structure of the system. For this reason, the terms "CPU" and "computer" are often used interchangeably.

The CPU, in turn, consists of the following: program counter (PC), instruction register (IR), instruction execution logic, a memory-address register (MAR), a general-purpose register (GPR) file, and an arithmetic and logic unit (ALU).

The CPU communicates with memory and I/O devices over a memory bus. In different computers this bus has various names, including I/O bus, data bus or one of a host of proprietary names.

The memory bus actually consists of three busses: one for memory addresses, another for data to the CPU and the third for CPU data to the memory. Typically these three time-share a single bus. The MAR—which defines the address for data transfer—drives the address bus.

The GPR file typically has two-to-16 registers. They hold temporary memory data and addresses, and they move and combine memory data. GPRs can also be used to calculate memory addresses

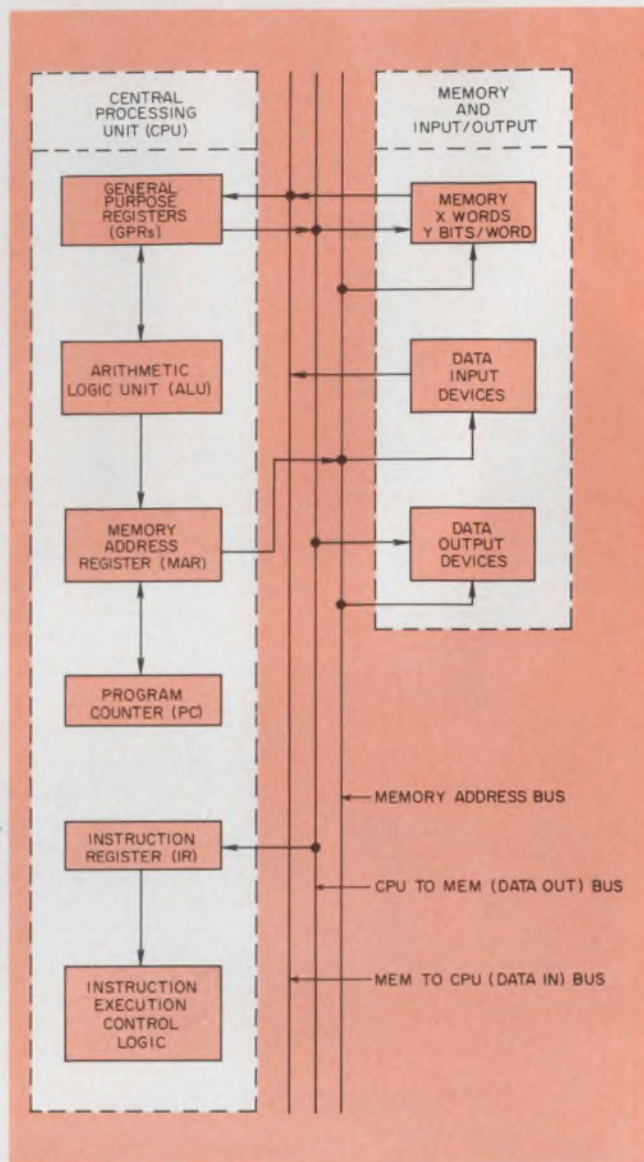

A. Internally a computer interfaces its central-processing unit with memory and I/O devices.

one or several steps).

4. Increment the PC to the next instruction, and repeat.

Steps 1 and 4 can often be combined. Then the PC increments after the IR (instruction register) is loaded. In the case of Test instructions, one of two sequences is selected in Step 3: a load-PC sequence if the test condition is valid or a dummy (no operation) sequence if the test isn't satisfied.

A ROM and counter form the basis for the execution control logic. To select and generate a timing sequence, we set the counter to the start value and increment it for each step. The ROM decodes each counter value to activate appropriate ROM-output lines. This technique is called micro-

program control, since the contents of the ROM control the sequence of operations.

Forming the microprogram control

The microprogram control in Fig. 1 contains the following major blocks: an 8-bit ROM counter, a 256×24 -bit control ROM, the IR, a 256×8 -bit start-count ROM and a multiplexer to select the A or B fields of the IR or the PC (register 15). Also included are a 4-bit status register, a counter-controlling multiplexer and a clock oscillator.

The 8-bit ROM counter, a 74S163 type, increments, loads or clears on the trailing (negative-

1. LOAD REGISTER

- A. From address specified by instruction
- B. From calculated address specified by register

2. STORE REGISTER

- A. To specified address
- B. To calculated address

3. COMBINE REGISTERS

- A. COPY: $A \rightarrow B$
- B. ADD: $B + A \rightarrow B$
- C. SUBTRACT: $B - A \rightarrow B$
- D. AND: $B \wedge A \rightarrow B$
- E. OR: $B \vee A \rightarrow B$
- F. INVERT: $\bar{A} \rightarrow B$

4. MODIFY REGISTER: SHIFT

- A. SHIFT LEFT: $B \times 2 \rightarrow B$
- B. SHIFT RIGHT: $B \div 2 \rightarrow B$

5. LOAD PROGRAM COUNTER (JUMP)

- A. With address specified by instruction
- B. With calculated address specified by register

6. LOAD PROGRAM COUNTER AND SAVE OLD VALUE (JUMP TO SUBROUTINE)

7. TEST- RESULT OF PREVIOUS COMBINE OPERATION AND LOAD PC IF:

- A. Result was zero
- B. Result was negative
- C. A carry was generated

8. ILLEGAL INSTRUCTION

B. A general instruction set offers many of the features of popular minicomputers.

for move and combine operations.

Computers manipulate memory data according to a list of instruction words stored in the same memory. The PC defines the location of the next instruction to be executed. The IR holds the instruction word for the current instruction being executed. The instruction-execution logic causes each instruction to be retrieved—or fetched—from memory, decoded and then executed. The instruction logic performs these functions in the following three ways:

1. The contents of the PC are sent to the MAR to define the location of the next instruction.

2. The contents of the memory at the address are loaded into the IR.

3. The execution of the instruction in the IR may then involve many steps and many transfers between memory and the GPR file.

A general-purpose instruction set (Fig. B) covers a variety of current minicomputers. Note the following four features:

1. In the modify-register instruction (4), the bit shifted out is saved, and a zero or a specified bit shifts into the location vacated.

2. The load program counter and save old instruction (6) provides the ability to set the PC to a new value, execute a list of instructions and then return to the original list and continue. Thus programs can be partitioned into subroutines.

3. No instructions have been included for hardware input and output. Individual registers for hardware I/O are assumed to have memory addresses, so that I/O operations do not appear different from other transfers/between GPRs and memory. This technique is used in the Digital Equipment Corp. PDP-11 minicomputer, among other computing systems.

4. An illegal instruction is included. This covers the case of hardware or software errors that result in the accidental interpretation of data as an instruction.

to-positive) edge of the clock pulse. The counter increments unless the load or clear lines are activated. The control ROM decodes the counter and sets up data transfer paths and clock gates. All registers are loaded on the trailing edge of the clock pulse.

All logic levels, except inputs and outputs from the ROM counter, are negative active: logic ONE = 0.0 V, logic ZERO = +5.0 V. This provides these three features:

1. Noise immunity for inactive high lines in TTL greatly exceeds that for inactive low.

2. When not in use or disconnected, the data bus lines float to an all-zero state, and the control lines float to the inactive state.

3. Open collector drivers can be used on the data bus, as long as pull-up resistors are employed.

Fetch and execute operations

Instruction fetch and execute proceeds according to the flow chart of Fig. 4. The instruction is decoded to select one of 256 possible execution sequences. This is done by decoding the first eight bits of the instruction to generate an 8-bit starting address. After the last execution step, the ROM counter clears to zero and a fetch of the next instruction begins.

For example, consider the fetch and execute

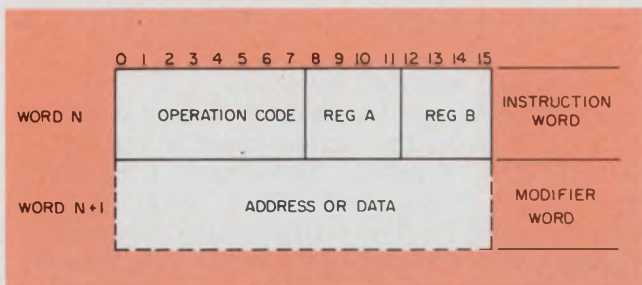

3. A single-instruction format can be used with the 16-bit microprocessor. The instruction word contains three fields: one that defines the operation code and two that define general-purpose registers.

procedure for a Register-to-Register Add instruction, which requires three steps. The ROM counter begins with a count of 0, State 0:

State 0. The contents of PC transfer to the MAR (memory-address register). The contents of PC also increment at the end of the state. This occurs when the control ROM decodes the values of zero in the ROM counter and sets up the following four conditions:

1. The B-input multiplexer is forced to an all-low output, thereby selecting register 15.
2. The microcontroller is set to perform the function, $B \rightarrow$ output, $(B + 1) \rightarrow B$. This gates out the old PC value and simultaneously increments PC at the end of the cycle.
3. The microcontroller's three-state drivers are gated onto the bus and the MAR load clock is enabled.
4. The ROM counter steps from 0 to 1 at the end of the state.

State 1. The next instruction enters the IR. The contents of memory at the location defined by MAR enter the bus, and the IR load clock is enabled. Instruction decode is then performed by the 256×8 -bit start-count ROM. One of 256 possible instructions are decoded directly from bits 0 to 7 of the data bus. However, only 18 of the 256 possible instructions will be decoded; the remainder decode as illegal instructions.

Since we have decoded a Register-to-Register Add instruction, the start count becomes 15. Thus we go immediately from State 1 to State 15.

State 15. The control ROMs decode the count of 15 in the ROM counter and set up the microcontroller to perform an $(A + B) \rightarrow B$ ADD function. Also, the control ROMs set up the status multiplexer for an unconditional clear function: The multiplexer will select a logic ONE condition and enable the clear-gate line to the 74S163, the 8-bit ROM counter. Since the 74S163 is a synchronous clear counter, the ROM counter is cleared to zero by the clock pulse at the end of State 15. Thus the machine returns to State 0 and begins the execution of another fetch sequence.

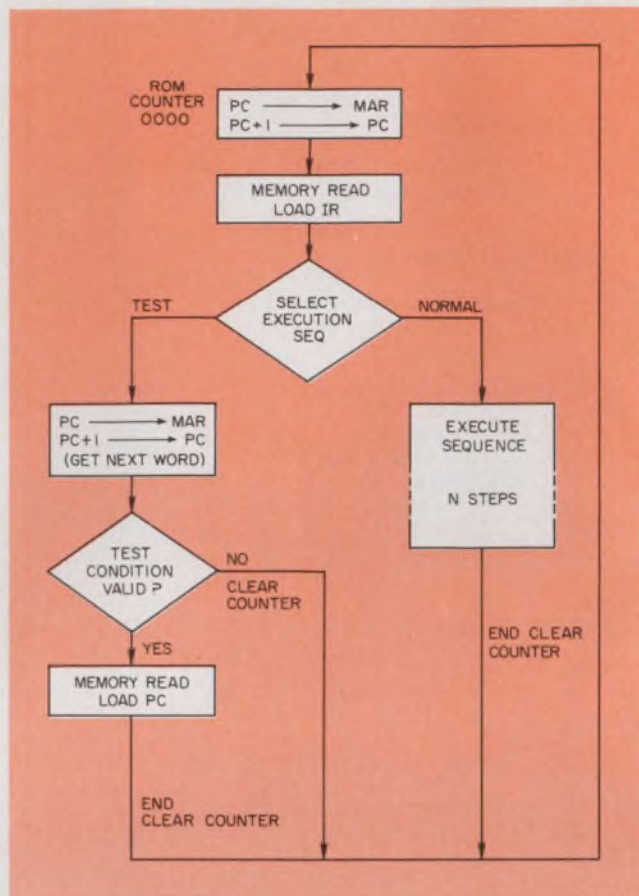

4. The instruction execution flow chart begins with two steps—for instruction fetch and decode—that are common to all instructions.

All instructions are executed in this manner. However, each instruction has its own starting count and may be one or several steps in length before it returns to State 0.

Note that State 0 performs two functions: It sends the contents of PC to memory as an address, and it increments the contents of PC after instruction fetch. State 1 loads and decodes IR, while State 15 executes the instruction.

Defining the instruction set

The processor instruction set is intended to be a general-purpose one (Fig. 5). Register-load-from-memory and store-to-memory instructions use the B field to define the register. The A field defines the register to be used as the source of the memory address in calculated-address instructions.

A second word of memory following the instruction defines the address for Load and Store instructions; the address is defined as part of the instruction. The second word is fetched from memory in a manner similar to the initial fetch of the instruction. And the program counter increments to point to the following word. An ad-

OP CODE	A	B	WORD 1
ADDRESS/DATA			WORD 2 (Optional)

OP CODE	INSTRUCTION
0	Illegal: Load PC with 0000
1	Load Register B, address follows instruction
2	Load Register B, address in Register A
3	Load Register B, data follows instruction
4	Store Register B, address follow instruction
5	Store Register B, address in Register A
6	Copy A to B: A → B
7	ADD: B + A → B
8	SUBTRACT: B - A → B
9	AND: B ^ A → B
10	OR: B v A → B
11	INVERT: \bar{A} → B
12	Rotate left A and B, A = most significant
13	Rotate right A and B, A = most significant
14	Load PC with Word 2, Save old PC in B
15	Test Zero: Load PC with Word 2 if zero FF ON
16	Test Sign: Load PC with Word 2 if sign FF ON
17	Test Carry: Load PC with Word 2 of carry FF ON
18	Test Overflow: Load PC with Word 2 if overflow FF ON
19	Not used (ILLEGAL)
↓	↓ ↓ ↓
255	Not used (ILLEGAL)

5. A simplified version of the microprocessor's instruction set uses the format of Fig. 3. The word following instructions defines addresses or data.

ditional mode permits the direct loading of the second word into a register rather than the word's use as a memory address.

Shift instructions use the internal Q register. The A and B fields define two registers that are shifted as a single 32-bit word. The instruction is executed when the register specified by the B field is loaded into Q. Simultaneously the register defined by the A field is shifted with Q, and then the contents of Q transfer back to B. The B and Q shifters yield the 32-bit result, with the least-significant bit of the B shifter becoming the most-significant bit of Q. Zeros are shifted into the least-significant bit of Q or most significant bit of B for, respectively, Shift Left and Shift Right instructions.

The program counter can be loaded directly by any of the load or register-modify instructions. The Load Program Counter and Save Old Value instruction uses the B field to specify the register that will receive the old PC value. The new PC value is loaded from the word immediately.

The Test and Conditional Load Program Counter instructions use the status multiplexer. The execution sequence for these instructions appears as a load program-counter sequence, with

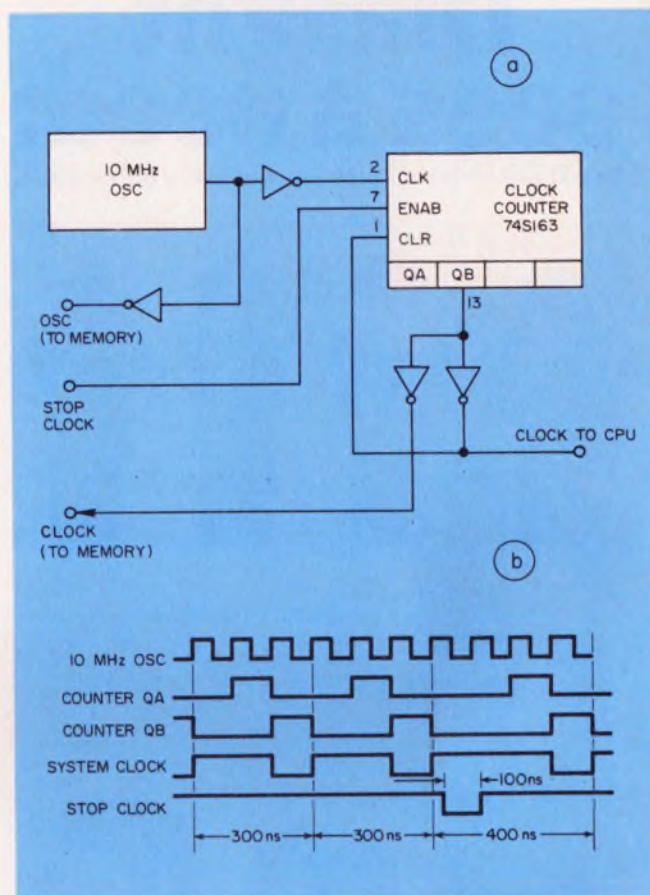

6. The microprocessor's clocking requirements can be met by an oscillator-counter circuit (a) and its associated timing diagram (b).

the new PC contents following the instruction word in memory. However, the status multiplexer terminates the sequence early if the tested status condition isn't met. The termination occurs just before the PC would be loaded with the new value.

Illegal instructions select ROM address 255. This location contains a restart sequence that clears the PC to 0000 and then restarts the program at zero. It's common to reserve all zeroes and all ones as illegal operation codes for these three reasons:

1. If the PC points to an address outside of existing memory, an all-zero instruction results.
2. Most data consist of small positive or negative numbers. Their first eight bits are, respectively all zeroes or all ones.
3. The illegal-instruction restart feature can be used as a manual restart by momentarily disabling the start-count ROM so an all-high output results.

The clock circuitry and timing diagram for each microcycle appear in Fig. 6. A stop-clock line can be used to halt the clock during the first part of any microcycle. This line can be used by a slow memory to force the processor to wait until it has completed its read or write cycle. It can also be

Dialight sees a need:

(Need: The widest choice for your every application.)



MINIATURE INCANDESCENT OR NEON INDICATORS—1,500,000 varieties to choose from. MIL-L-3661 and UL approved. Red, green, amber, blue, white, yellow or colorless lenses in wide range of shapes, legends, finishes. Stocked by local distributors.



LARGE INCANDESCENT OR NEON INDICATORS—As above, but larger size. Unlimited varieties to choose from. Stocked by local distributors.



Dialight, the company with the widest choice in switches, LEDs, indicator lights and readouts, looks for needs . . . your needs . . . and then they develop solutions for your every application. No other company offers you one-stop shopping in all these product areas. And no other company has more experience in the visual display field. Dialight helps you do more

with these products than any other company in the business, because we are specialists that have done more with them. Talk to the specialists at Dialight first. You won't have to talk to anyone else. Send for your free new copy of Dialight's current catalog.

DIALIGHT

Dialight, A North American Philips Company
203 Harrison Place, Brooklyn, N. Y. 11237
(212) 497-7600

See Dialight.

INFORMATION RETRIEVAL NUMBER 45

ROM ADDRESS	OPERATION	COMMENTS
0	PC → MAR PC + 1 → PC	Instruction Fetch
1	MEM → IR Decode and Load Start Count	
2	PC → MAR PC + 1 → PC	OP = 1. Load B @ ADDR
3	MEM → MAR	
4	MEM → B END	
5	A REG → MAR	OP = 2. Load B @ A
6	MEM → B END	
7	PC → MAR PC + 1 → PC	OP = 3. Load B Data
8	MEM B END	
9	PC → MAR PC + 1 → PC	OP = 4. Store B @ ADDR
10	MEM → MAR	
11	B → MEM END	
12	A → MAR	OP = 5. Store B @ A
13	B → MEM END	
14	A → B END	OP = 6. Copy
15	B + A → B END	OP = 7. Add
16	B - A → B END	OP = 8. Subtract
17	B ^ A → B END	OP = 9. AND
18	B v A → B END	OP = 10. OR
19	B̄ → B END	OP = 11. Invert
20	B → Q	OP = 12. Rotate Left A & B
21	Shift Left A & Q	
22	Q → B END	
23	B → Q	OP = 13. Rotate Right A & B
24	Shift Right A & Q	
25	Q → B END	
26	PC → MAR PC + 1 → PC	OP = 14. Load PC. Save Old
27	PC + 1 → B	
28	MEM → PC END	
29	PC → MAR PC + 1 → PC END if Zero FF OFF	OP = 15. Test Zero
30	MEM → PC END	
31	PC → MAR PC + 1 → PC END if Sign FF OFF	OP = 16. Test Sign
32	MEM → PC END	
33	PC → MAR PC + 1 → PC END if Carry FF OFF	OP = 17. Test Carry
34	MEM → PC END	
35	PC → MAR PC + 1 → PC END if OVFL FF OFF	OP = 18. Test OVFL
36	MEM → PC END	
37	Not used	
254	Not used	
255	0 → PC END	OP = X. Illegal OP (Restart @ 0)

7. The processor's complete microprogram employs only 37 out of 256 possible steps.

used with external logic to obtain single-step operations.

Specifying processor capabilities

Speed of execution depends on the settling times of the ROM counter, control ROMs and the microcontroller. A 300-ns clocking interval—practical for our computer—results in a 900-ns register-to-register add time when we assume a 150-ns access memory.

The full microprogram appears in Fig. 7. Note that only 37 out of 256 possible steps implement 19 out of 256 possible instructions. Furthermore the instruction set can be expanded to include more powerful instructions. For example, two additional instructions might be the following:

1. Indexed Register Load and Store. This combines the contents of a specified register with contents of the word following, thereby defining the memory address for the data transfer.

2. Byte Swap. This shifts a register eight spaces to simplify the handling of 8-bit characters. ■■

Our Super Switcher is three years old.

**Should
we call
it new?**

We're not sure. We noticed our competitors are calling their switching regulated power supplies "new". And why shouldn't they? After all, switching technology itself is new, isn't it?

Or is it?

To them, maybe. Not to Powertec.

Ours have been around about 3 years now.

Over 2500 of them. You might even call them *field proven* (now, there's a phrase the other boys have studiously avoided. We wonder why.) Still, we've got to admit that with 24 new models, up to 24V, up to 200A output, our 9N Series *is new*. *All new*.

Only there's a difference.

Our *new* is based on experience, unique design innovations, and the best craftsmanship in the industry. Their "new"? Well, their new is just plain old new.

So take a look. Here are just a few 9N features.

OUTPUT RATING CHART

MODEL*	DC OUTPUT		PRICE
	VOLTAGE NOMINAL	CURRENT @ +40°C	
9N2-200	2.0V	200A	\$695
9N5-150	5.0V	150A	\$695
9N5-120	5.0V	120A	\$625
9N12-50	12.0V	50A	\$625
9N15-50	15.0V	50A	\$625
9N17-42	17.0V	42A	\$625
9N20-40	20.0V	40A	\$625
9N24-33	24.0V	33A	\$625

* Add dash number for desired input:
115VAC, -01; 208VAC, -03; 220VAC, -04

- Up to 80% efficiency
- 24 hour elevated temperature "burn-in" with cyclic testing
- Logic inhibit
- Programmable
- Most second-sourced package
- Modular construction by function for maximum reliability
- "Motherboard" design eliminates internal cabling
- Master/slave adapter for paralleling up to 4 units (equal load sharing)
- 30 ms energy storage
- Long-life fan and dust screen
- Immediate delivery

Call us for an evaluation unit. Or, if you're still not convinced, we'll send you a Switcher Evaluation Guide.

POWERTEC

Powertec, Inc. • 9168 DeSoto Avenue, Chatsworth, Calif. 91311 • (213) 882-0004 • TWX (910) 494-2092

INFORMATION RETRIEVAL NUMBER 46

"HEADLINE" SIX YEARS OF SUCCESSFUL SWITCHERS

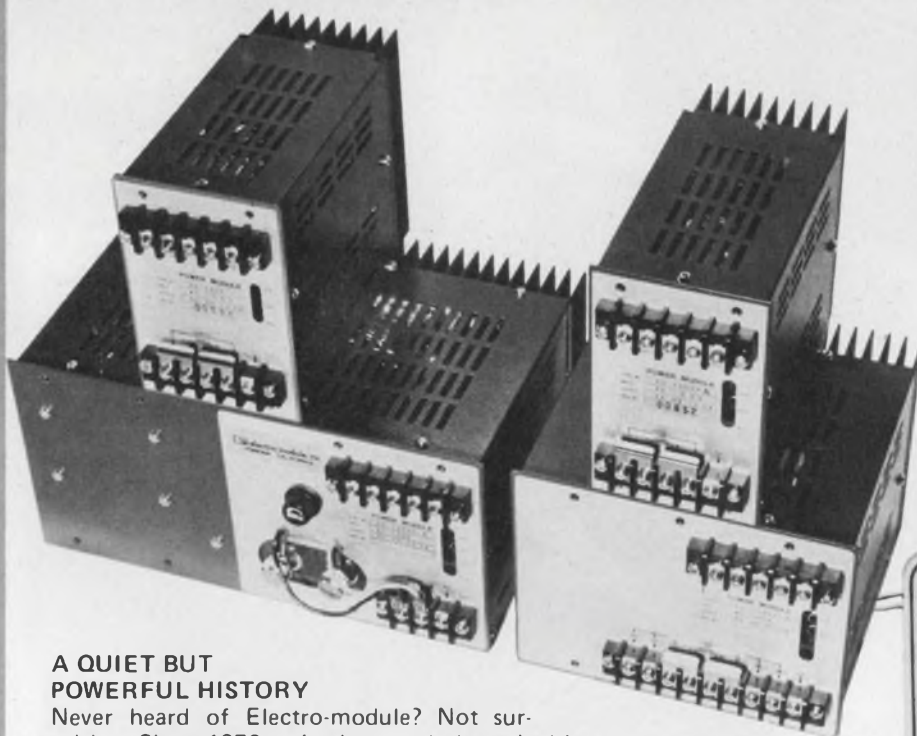

24 NEW MODELS THIS YEAR!

A QUIET BUT POWERFUL HISTORY

Never heard of Electro-module? Not surprising. Since 1970 we've been quietly and without fanfare turning out thousands of switchers and standard and custom high performance power source products. We make a heck of a lot of equipment: AC/DC converters, DC/DC converters, DC/AC inverters, series regulator supplies and switching regulators. Also custom systems, amplifiers, inverter modules and uninterruptible power systems (UPS), Mil spec systems, miniaturized and modularized supplies, not to mention data acquisition and computer power sources.

POWER UP—COSTS DOWN

Now, what about those switchers in the picture? They're a few units from our sensational new FEC Switching Regulator Series. We've teamed low-cost and small size with high reliability and maximum efficiency in 24 standard catalog modules with compatible line noise filters. They're specially designed to fit a wide range of OEM applications in computer peripherals, data processing, communications and process control applications.

Efficiency is in the range of 70-80%. Line/load regulation is less than 1% with an input voltage of

115VAC ± 15%
single phase at
40 to 500 Hz.
The 24 incre-
mental output

voltages available range from 5 to 30 VDC at 1.5 to 60 amps with less than 50 mv peak-to-peak ripple (5, 9, 12, 15, 24, 30 VDC—50, 100, 150, 300 watts). All models feature overvoltage and overload protection with remote sensing standard. And there's lots of features we don't have room for here including B.I.T.E. Availability is stock to 6 weeks, depending on quantity. Nice? How about prices like from \$160 for 50 watt models to just \$388 for 300 watt models?

WHAT ARE YOU WAITING FOR?

Now that we've answered your questions, what are you waiting for? Check out the FEC Switching Regulator Series completely. Punch the bingo card or send us a letter for our 4 page brochure with complete specs and features. Or call us collect for a quote.

FROM
\$160 50 WATT
MODELS
TO
\$388 300 WATT
MODELS



electro-module, inc.

2855 Metropolitan Place • Pomona, California 91767 • (714) 593-3565 • Telex 6703399

NOBODY STACKS UP TO OUR MULTILAYER CERAMIC CAPACITORS

Mepco/Electra has made
the 100-layer ceramic capacitor
a reality!

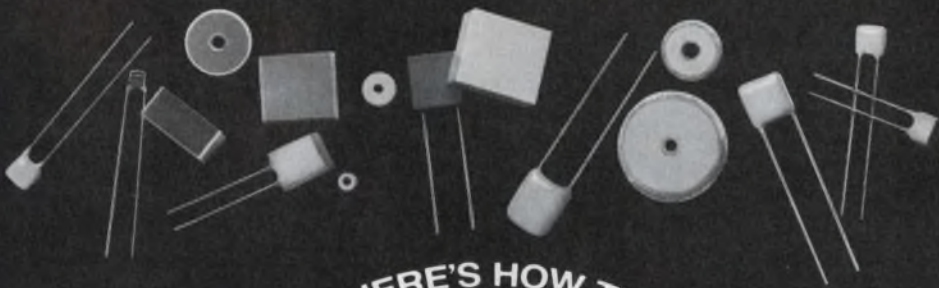

MAGNIFIED — HERE'S HOW THEY STACK UP



Now a new, exclusive manufacturing capability enables us to offer *the highest capacitance ever found in a single unit!* Yes, now we can provide ceramic capacitors of up to 100 layers with no loss in quality, no cracks, no shorts, no delamination.

This means you can eliminate the space, assembly and interconnection problems associated with multiple parts because just one Mepco/Electra multilayer device does the work of many.

And it gives you higher yields and greater reliability in less space.

Don't delay. Start to get high value ceramic capacitor performance in a single package today. Write Mepco/Electra Ceramic Capacitor Marketing Department, 111 North Street, Canandaigua, New York 14424 or call (315) 394-1900



**THE ACTIVE
COMPANY FOR
PASSIVE
COMPONENTS.**

SOLD THROUGH
NORTH AMERICAN PHILIPS
ELECTRONIC COMPONENT
CORPORATION

Regional Sales Offices:

North Hollywood, CA
(213) 762-2118
Elk Grove Village, IL
(312) 593-8220
Waltham, MA
(617) 899-7100
Hicksville, NY
(516) 931-6200

Bond chips with conductive epoxies.

Their low curing temperatures avoid damage to delicate parts, while the assembly process is inexpensive and easily automated.

Epoxies have found wide acceptance for the attachment of active semiconductors, chip capacitors and resistors and other small parts to hybrid microcircuits. Their use gives the designer a high degree of freedom when building complex units, and they allow employment of easily automated processes that provide good yields.

Of the three attachment methods currently in use—gold-silicon eutectic bonding, soft solder and conductive epoxy—epoxy is the fastest growing technique. Epoxy techniques include the following advantages:

- Conductor-pattern requirements are not demanding, and a wide range of conductor materials can be used. Epoxies allow the use of low-cost palladium-silver or platinum-silver conductor patterns.

- Epoxies can be applied by accurate pneumatic dispensing or screen printing—both low-cost, easily automated processes.

- Low-temperature curing—as low as 150 C—removes a possible source of damage to delicate components, especially active devices. High yields of over 99% are readily attained.

- Any wire-bonding method may be used with epoxy-attached devices. The epoxy can withstand thermocompression temperatures of even 320 C for short periods.

Historically, eutectic bonding was the method first used. But this process places many restrictions on the freedom of component layout. Expensive pure-gold, or gold-bearing conductors such as platinum-gold, must be used as the eutectic material. The bonding process takes place at a higher temperature than epoxy curing—about 380 C. And a nitrogen atmosphere must be used to reduce chip degradation. Finally, the expected yield is only about 95%.

Though soft-solder methods give the advantage of a high chip yield, problems result from the need to use flux to make a good joint. And the choice of a wire-bonding method is limited to a

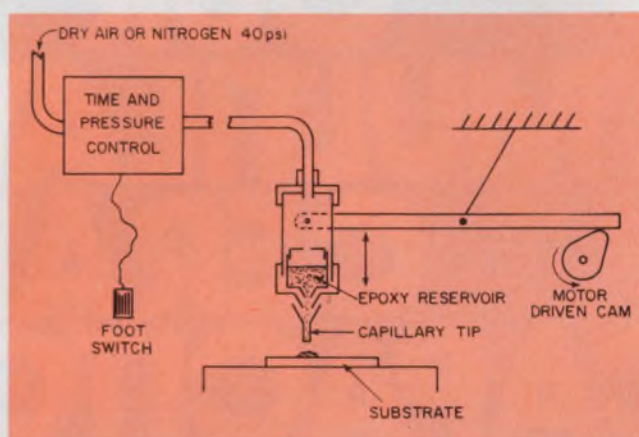

1. A hypodermic needle with timed and controlled air pressure can dispense calibrated amounts of conductive epoxy to mount chip components on substrates. Epoxy spot diameter can go as low as 0.25 mm.

cold-substrate method. Thermocompression wire bonding cannot be used.

Applying epoxies

Epoxy can be dispensed via a hypodermic needle by compressed air (Fig. 1). Epoxy is stored in a plastic reservoir, which usually holds about 2 ml, and the compressed air can be adjusted over a range of 5 to 20 psi. A timer-controlled solenoid valve provides a predetermined shot pulse of epoxy to the needle. At the end of the dispense time, a cam-actuated mechanism brings the needle momentarily in contact with the substrate metallization. An accurate epoxy spot is left on the substrate. Epoxy spots as fine as 0.25-mm diameter can be obtained with a good epoxy and well-designed dispensing system (Fig. 2).

However, epoxy spots, or pads, can be reproduced more consistently by screen printing. Printing allows a controlled quantity of epoxy to be deposited accurately in the same position on the substrate. A great advantage is that the process can be carried on with the setup conditions and screen materials that are already familiar to thick-film engineers. The same conditions that apply for obtaining good results with any thick-film paste also hold for most attachment epoxies.

David R. Hetherington, Chief Development Engineer, Newmarket Transistors, Ltd., Exning Rd., Newmarket, Suffolk, England.



2. Epoxy pads for mounting components can be accurately placed by well-designed machines.

A 250-mesh stainless-steel screen with indirect emulsion can provide a cured print thickness of as little as 15 to 20 microns.

The epoxy can be printed with either automatic or hand printers. In Fig. 3, a simple but effective hand printer uses an etched-foil screen on a 50-mm-square frame. The squeegee used is a rectangle of silicon rubber that is hand held and wiped across the screen.

But not all epoxies are suitable for both application methods. One material, when tested for needle application, tended to separate into its silver filler and carrier components in the needle. With another material—a high viscosity epoxy—the upward motion of the needle left a tail that could produce short circuits. And though many epoxies are sold as “screen printable,” some tend to dry on the screen and clog the mesh. Consequently, the choice of epoxy must not only suit the circuit’s electrical requirements, but also the way the epoxy is to be applied to the substrate.

Attaching a silicon device

To achieve low electrical and thermal resistance in the attachment of a silicon device, the silicon slice’s reverse side must be etched or lapped to remove oxide and diffusion material and

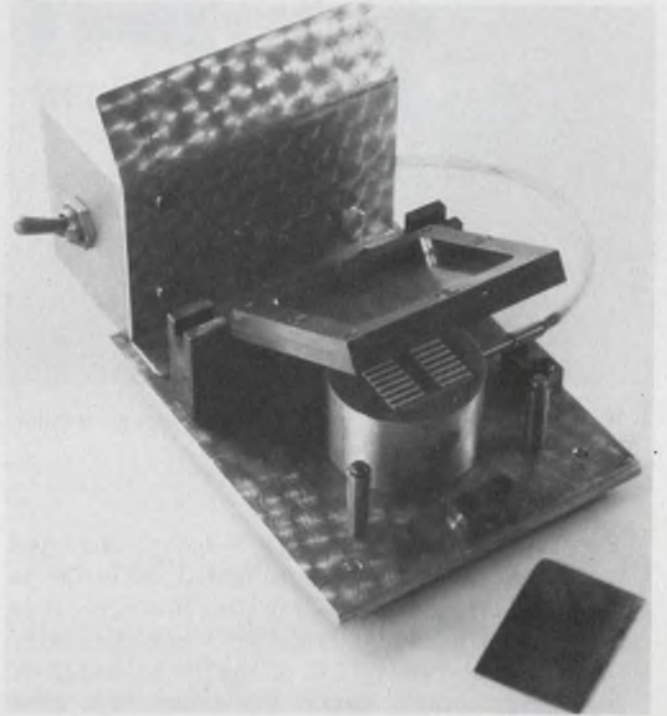

3. Epoxy mounting pads can be applied by printing. This hand printer uses an etched-foil screen, but automated printers and wire-mesh screens can be used.

to reduce the slice to a thickness of 100 to 150 microns. This is done with the slice’s active side held with wax against a glass block. After a washing cycle and removal from the etching block, the slice must be metallized immediately to prevent the formation of silicon oxide, which is an insulator. Metals normally used are nickel, titanium-gold or gold-arsenic.

The slice is then diamond-scribed into dice sections. A plastic backing film applied to the slice, when stretched, separates the slice into individual dice, or chips. Chips can now be placed on the hybrid’s epoxy spots with a vacuum pickup mechanism. Its stainless-steel pickup needle is first lowered to an epoxied spot, the vacuum removed, and the weight of the needle presses the die into the epoxy. Dice 0.5-mm square require about 20 gm, and 3 mm about 300 gm, to press the epoxy into a thickness falling into the range of 10 to 15 microns.

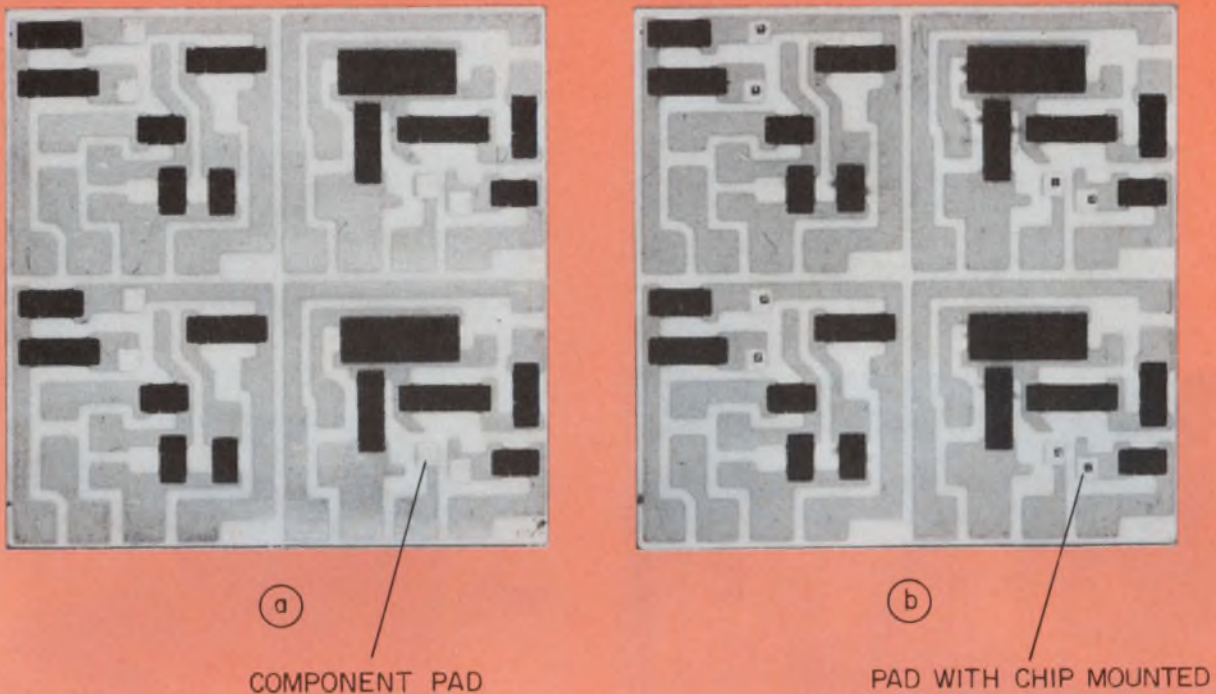

4. Printed epoxy pads (a) must be large enough to allow room for component positioning tolerances (b).

For pneumatically dispensed epoxy, the spot size is ideal when it has sufficient material to spread out on all sides of the die. However, it is generally considered satisfactory when the epoxy is visible around only 75% of the die's periphery.

For print-applied epoxy, the attachment area should be four times that of the die for dice sizes to 0.5 mm square. For larger dice, a border around the die of 0.25 mm is sufficient. In any event, the epoxy area must be large enough to allow for the placement tolerances when automatic die-positioning equipment is used.

Epoxy printing is particularly desirable when automatic placement equipment is used. The screens can be made from the same master that is used for the conductor-pattern thick-film work. Also, the same printer line-up targets are used. Thus good location tolerances for the epoxy can be obtained.

If the substrate is located on the die bonder with the same X-Y coordinates used on the printer, the placement accuracy for a small die can be as close as ± 0.1 mm.

Fig. 4 shows a substrate with printed epoxy pads before and after die placement. Note that the tiny chips are not placed exactly in the center of their pads, but they all fall within the pad's area.

No easy tests can determine the shelf life or manufacturing quality of epoxy at incoming

inspection. However, some epoxies tend to develop a yellow tinge towards the end of their shelf life and their viscosities usually increase with age. With experience, an operator soon learns to recognize when all is not well with the epoxy. Old material tends to block needle applicator capillaries and to flow at a reduced rate. Or screens clog during printing and parts of the epoxy pattern are not printed.

The most reliable test of an epoxy is to use it to mount several samples of an active device, and then to monitor specific characteristics of the device. The characteristic that best shows the quality of an epoxy is the saturated forward-voltage drop from base to collector, V_r , of a transistor. For example, a BC108 silicon transistor at 10 mA has a V_r that ranges between 810 and 900 mV. If the initial value of V_r increases by more than 10% after, say, 168 h at 150 C, then the epoxy bonding is suspect.

Epoxies are usually supplied in 28 or 550-gm containers. But a 28-gm quantity can print 1800 cm², which translates into a huge number of mounting pads. For 0.5-mm-square pads this is sufficient to bond 700,000 devices. Thus even a small amount can last a long time.

Since the cost of epoxy per die is insignificant but the cost of a wafer is considerable, it can be an expensive mistake to use epoxy near the end of its shelf life. Therefore it may be advisable

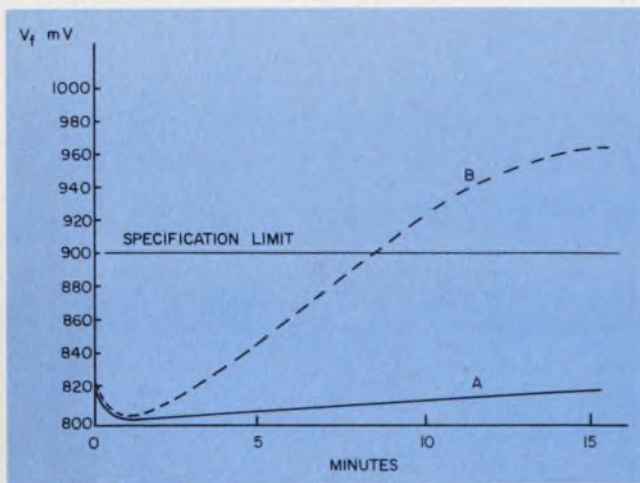

5. Fresh epoxy (curve A) provides better V_f stability than the three-month-old epoxy (curve B) when the transistor is subjected to 325 C during wire bonding. Curve B fails the spec limit after 7 min.

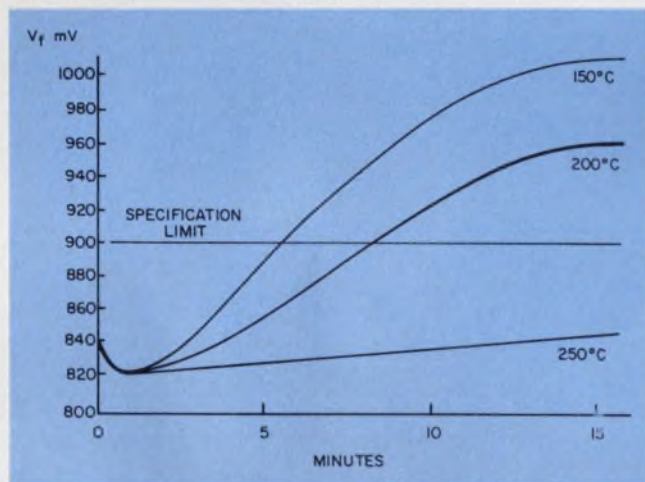

6. A cure temperature of 250 C results in best V_f stability, when the transistor is heated.

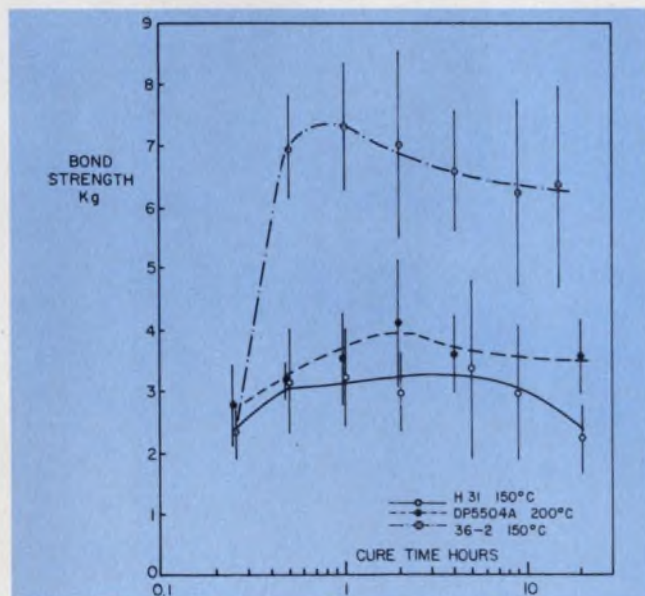

7. Different epoxy materials require different curing times to attain maximum bonding strength.

to buy epoxy in 1 cc syringes.

Many syringes are made to fit the dispenser heads of pneumatic spotting equipment. Also, the epoxy from a syringe can be easily dispensed onto printing screens. After, say, one day of use, even if the syringe is not empty, it may be wise to throw it away and start with a fresh one the next day.

Epoxy manufacturers advise that the storage life of most epoxies is no more than six months when stored at -15°C and only 90 days when kept in the regular compartment of a standard refrigerator at 4°C . The storage life in a freezer at -6°C is somewhat more than 90 days. Also, the temperature conditions during packing and shipping are important. Now, many British suppliers of USA-made epoxies, ship them at -40°C , with indicators to warn of the temperature conditions during shipment.

The deleterious effects of long storage time and excessive temperature are clearly demonstrated in tests on the V_f of silicon transistors (Fig. 5). When thermocompression gold-wire bonding is used to wire a transistor into a hybrid circuit, the substrate may reach 325°C for several minutes. This heating can affect V_f appreciably. Curve A is for a transistor that was attached with epoxy immediately after the epoxy was received. However, the epoxy was held at -40°C for three weeks during shipment. Curve B is the same type epoxy, but this material was three months old and stored at only -5°C . Note that curve B fails the spec limit after only 7 min on the wire bonder.

To avoid this problem use fresh epoxy. Also keep the time of exposure to high temperatures to a minimum. A cold bonding method is helpful.

The epoxy cure temperature also strongly affects the V_f of a transistor. A cure temperature of 250°C provided greater stability than 150°C , when test samples were exposed to 325°C (Fig. 6).

Cure time determines bond strength

In addition to high electrical and thermal conductivity, the epoxy attachment should provide a strong bond. Here cure time is the important factor. Tests of bond strength vs cure time for three different silver-loaded epoxies are shown in Fig. 7. The components tested were 0.6-mm-thick ceramic resistors with a bond area at each end of 1.25×0.5 mm. The bonds were tested with a hook arrangement and with the substrates firmly held. For each of the epoxy types, the manufacturer's recommended cure time was 1 h. Note that epoxy type 36-2 has a decreasing bond strength after 1-h cure, but the strength of the other two materials still increase somewhat to about 2-h of cure, and then taper off. ■■

Meet the first scope with a microprocessor.

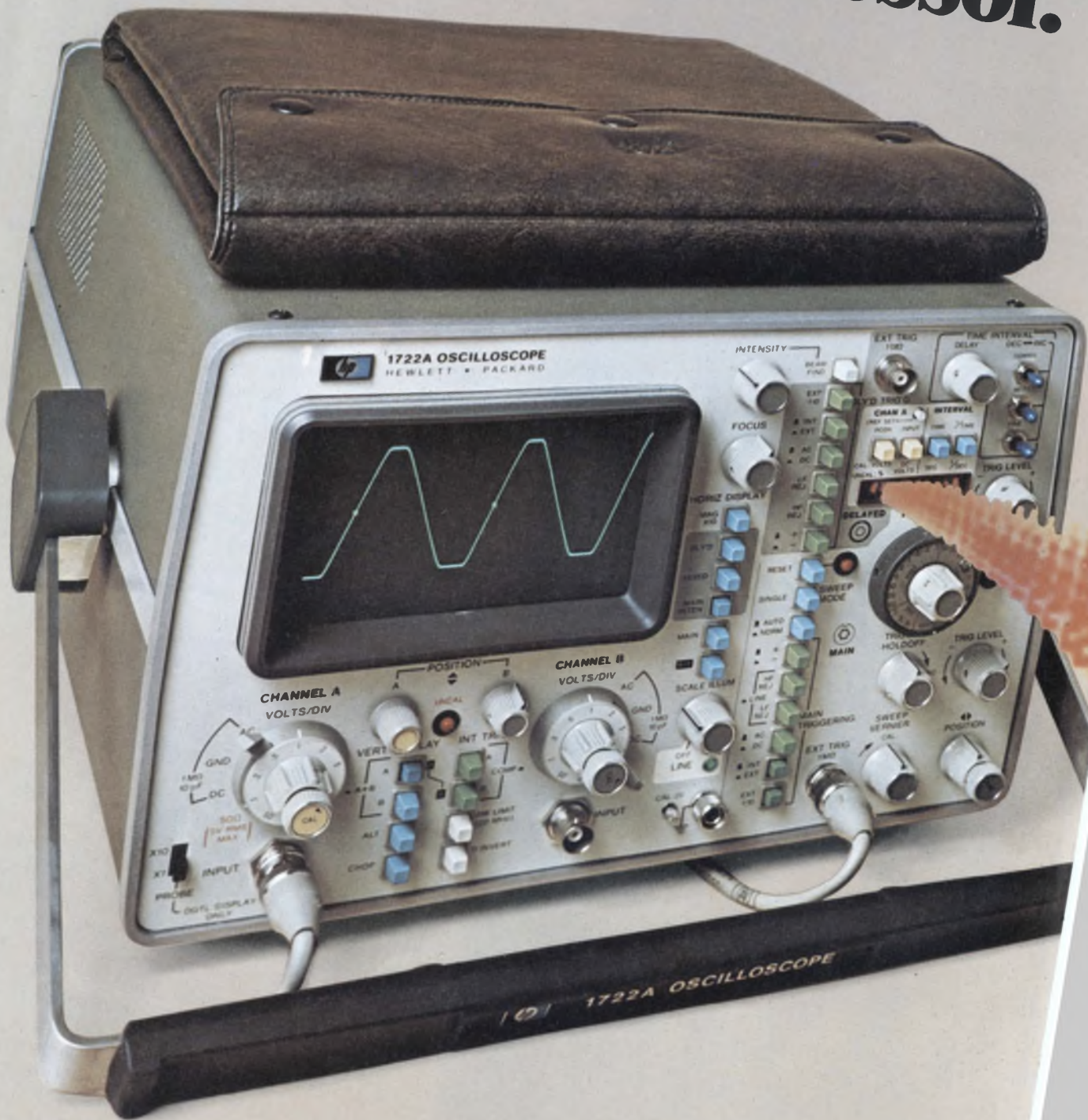

It counts, calculates, and improves accuracy too.

Now, HP has combined a high-performance scope, a microprocessor, and an LED display to put an end to graticule counting, mental calculations, and the conventional 5% scope error. The 1722A gives you a giant leap in measurement accuracy and convenience. It's a working lab partner that speeds measurements of time intervals, frequency, instantaneous or dc voltage levels, and relative amplitude. It allows you to make all these measurements more accurately... with less chance of human error.

The microprocessor takes over several tasks you used to perform. It keeps track of

ing of your measurements... in seconds, hertz, volts, or percent. Working with the 1722A is like having an assistant that takes care of the mental gymnastics.

There's another reason for easier, more accurate measurements—HP's unique Dual Delayed Sweep. It gives you two adjustable intensified markers for displaying the start and stop points of a time interval. The microprocessor then gives you an automatic read-out of the time interval between the markers. This speeds digital timing measurements and simplifies the adjustment of circuits to meet a timing spec.

The combination of a proven 275 MHz dual-channel scope, microprocessor, LED display, and Dual Delayed Sweep gives you faster, more complete waveform characterization than you'll get from conventional scopes costing twice as much.

And instead of the conventional 3 to 5 percent reading errors typically associated with voltage and time

measurements, the 1722A puts you in the 0.5 to 1 percent range.

The 1722A begins a new era of measurement technology by giving you faster answers, more accurate answers, even answers you couldn't get before. And at a price of just \$4,500.*

Let your local HP field engineer introduce you to the new scope generation. Call him today. Or, write for our informative 8-page brochure.

dial settings, automatically computes time intervals and voltage levels, converts time measurements to frequency, and calculates percent. It even signals if you make an erroneous setting. In addition, the microprocessor drives a 3½-digit LED display to give you a direct digital read-



* Domestic USA price only.

HEWLETT  PACKARD

Sales and service from 172 offices in 65 countries.
1501 Page Mill Road, Palo Alto, California 94304

INFORMATION RETRIEVAL NUMBER 49

Keep your op-amp circuits quiet.

By isolating and minimizing the different sources of noise you can take advantage of today's high performance ICs.

To take advantage of today's high-performance op amps, you must first minimize the effects of external circuit noise. The solution is twofold: (1) Identify the noise sources; (2) Eliminate as much of the noise as possible with improved bypassing of the power supply leads, more complete shielding and better understanding of what noise is.

For most applications, noise is any signal that appears in the output of an op amp that can't be predicted by ac or dc input error analysis. The noise can be random or repetitive, narrow or wideband, high or low frequency, current or voltage, and internally or externally generated.

You must determine the bandwidth and location in the frequency spectrum of the noise source. In Fig. 1, examples of some of the more common sources are compared over an 11-decade frequency spectrum. Noise-source bandwidths overlap; thus noise is a composite quantity at any frequency.

Most externally generated noise is repetitive rather than random and can be examined at a specific frequency. For example, 60-Hz power-line pickup commonly appears at an op amp's output as a sine wave with a 16-ms period.

The basic tool for examining external noise is the oscilloscope. To help do the measurements, at least one scope manufacturer produces pre-amplifiers that have variable bandwidths and frequencies. Another basic tool is the simple low-pass filter (Fig. 2), where the corner frequency can be calculated by

$$f_o = 1/2 \pi RC.$$

With this filter, you can change the input bandwidth to the scope from about 10 Hz to 100 kHz (change C from 4.7 μ F to 470 pF). Once you identify the noise from an external source, you can try any of the methods outlined in the accompanying table to minimize the noise.

Don't forget power-supply noise

Engineers usually don't consider power-supply ripple at 120 Hz as noise, but they should. In most op-amp applications, you can easily have a 120-Hz component that is equal in magnitude to

Donn Soderquist, Applications Engineer, Precision Monolithics, 1500 Space Park Dr., Santa Clara, CA 95050.

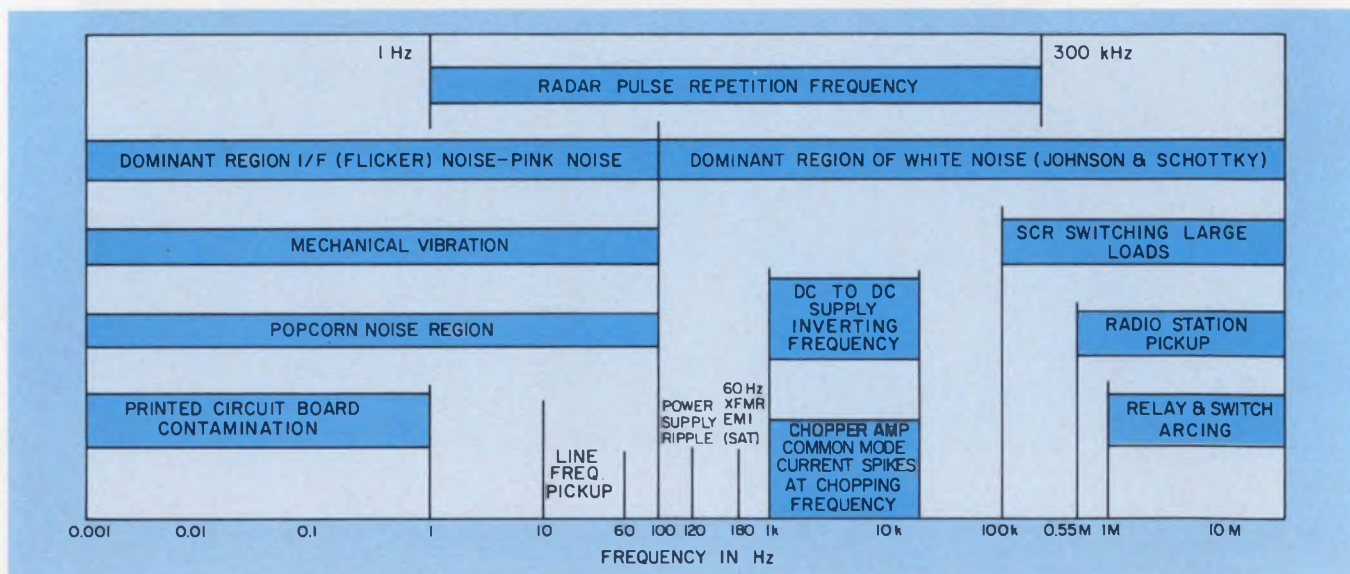

1. This frequency range chart covers most of the sources of noise that can affect op-amp performance.

all other noise sources combined.

To be negligible, 120-Hz ripple noise should not be greater than 100 nV when referred to the op-amp input. To achieve this low level, you must consider these three factors when selecting an op amp:

1. The op amp's 120-Hz power-supply rejection ratio (PSRR).
2. The regulator's ripple rejection ratio.
3. The regulator's input capacitor value.

The PSRR for an op amp can be found in most manufacturers' data sheet curves of PSRR vs frequency (Fig. 3a). For the amplifier characteristics shown, 120-Hz PSRR is about 74 dB. For the 120-Hz noise to be less than 100 nV, referred to the input, ripple at the amplifier power-supply terminals must be less than 0.5 mV. Most IC regulators provide about 60 dB of ripple rejection. Thus if the rejection is about 60 dB, the regulator input capacitor must be made large

Noise sources external to the op amp

Source	Nature	Causes	Minimization methods
60-Hz Power	Repetitive interference	Power lines physically close to op-amp inputs. Poor CMRR at 60 Hz. Power transformer primary-to-secondary capacitive coupling.	Reorientation of power wiring. Shielded transformers. Single point grounding. Battery power.
120-Hz Ripple	Repetitive	Full-wave rectifier ripple on op-amp's supply terminals. Inadequate ripple consideration. Poor PSRR at 120 Hz.	Thorough design to minimize ripple. RC decoupling at the op amp. Battery power.
180-Hz	Repetitive EMI	180 Hz radiated from saturated 60-Hz transformers.	Physical reorientation of components. Shielding. Battery power.
Radio stations	Standard broadcast AM through FM	Antenna action anywhere in system.	Shielding. Output filtering. Limited circuit bandwidth.
Relay and switch arcing	High frequency burst at switching rate	Proximity to amplifier inputs, power lines, compensation terminals or nulling terminals.	Filtering of hf components. Shielding. Avoidance of ground loops. Arc suppressors at switching source.
Printed-circuit-board contamination	Random low frequency	Dirty boards or sockets.	Thorough cleaning at time of soldering, followed by a bake-out and humidity sealant.
Radar transmitters	High frequency gated at radar pulse repetition rate	Radar transmitters, from long-range surface search to short-range navigational—especially near airports.	Shielding. Output filtering of frequencies \gg PRR.
Mechanical vibration	Random < 100 Hz	Loose connections, intermittent metallic contact in mobile equipment.	Attention to connectors and cable conditions. Shock mounting in severe environments.
Chopper frequency noise	Common-mode input current at chopping frequency	Abnormally high-noise chopper amplifier in system.	Use of balanced source resistors, bipolar input op amps instead of a chopper amplifier or use of a premium low noise chopper amplifier.

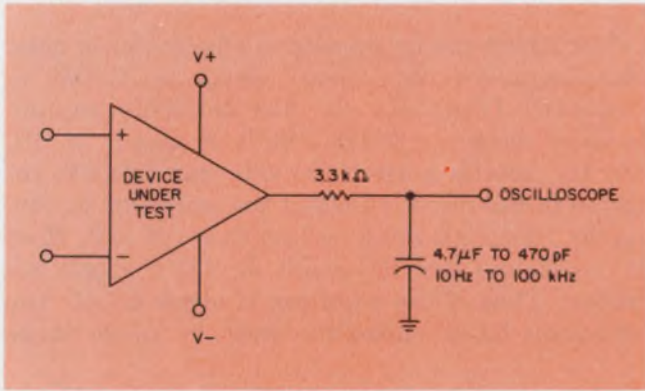

2. A simple low-pass filter helps to identify the different types of noise at an op-amp's output.

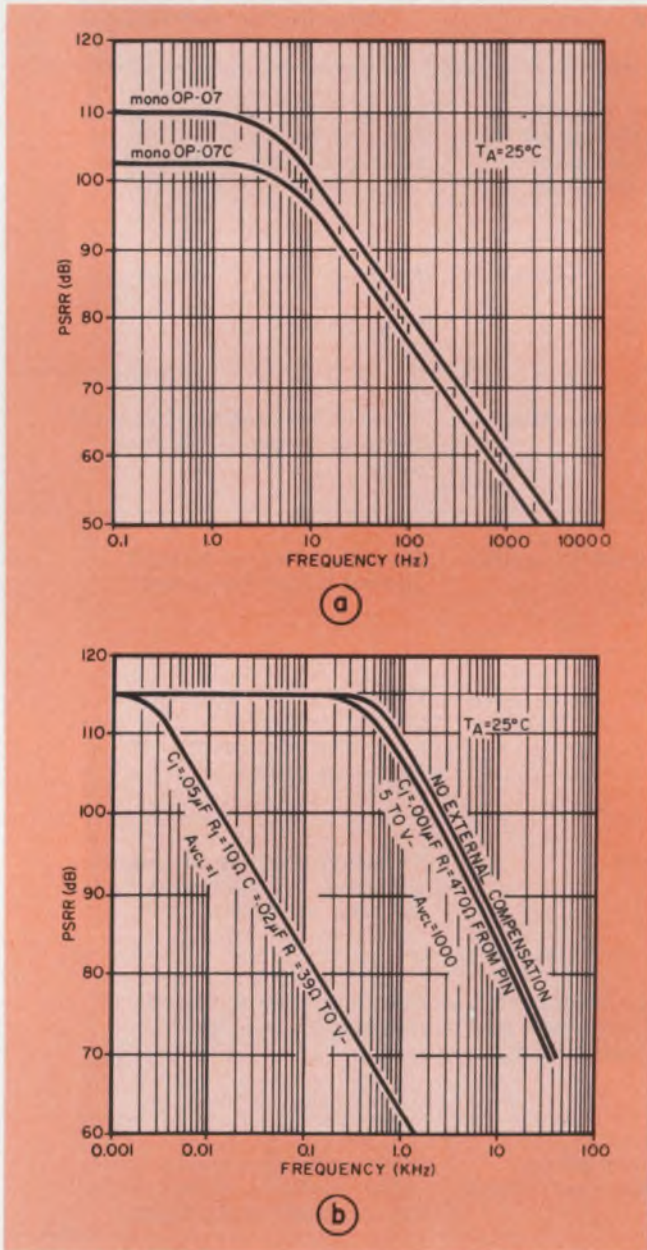

3. Power-supply noise rejection decreases as ripple frequency increases for all op amps. Internally compensated op amps have low PSRRs (a) compared with externally compensated op amps (b) when the externally compensated units are connected for high closed-loop gain applications.

enough to limit regulator input ripple to about 0.5 V.

Externally compensated op amps can provide improved 120-Hz PSRR in high closed-loop gain applications (Fig. 3b). When the op amp is compensated for a closed-loop gain of 1000, the 120-Hz PSRR increases to 115 dB. As noise frequencies increase, the PSRR will start to drop because of internal amplifier circuit leakage paths.

The 120-Hz ripple is not the only power-supply noise problem. Series-regulator outputs typically contain at least 150 μ V of noise in the 100-Hz-to-10-kHz range. Switching regulator types generate even more.

Unpredictable amounts of induced noise from other sources can also be present on power leads. Since high-frequency PSRR decreases at 20 dB/decade, these higher-frequency supply noise components must not be allowed to reach the op amp's power terminals. RC decoupling can adequately filter most wideband noise (Fig. 4). Some caution, though, must be used with this type of decoupling, since load-current changes may modulate the voltage at the op amp's supply pins.

Any change in power-supply voltage has an effect on the op amp that you can refer to the amplifier's input. For the op amp curves in Fig. 3a, the PSRR at dc is 110 dB (3 μ V/V). Power supplies for low-noise op-amp applications should be both low in ripple and well-regulated. And don't mistake inadequate supply regulation for low frequency noise internally generated by the op amp.

Complete data sheets specify current and voltage noises in a 1-Hz bandwidth and low frequency noise over a range of 0.1 to 10 Hz. Let's look at random noise mechanisms of the basic op amp and some simple methods to calculate the total input-referred noise.

Characteristics of random noise

Op-amp noise currents and voltages are random, aperiodic and uncorrelated. They also have a Gaussian amplitude distribution—the highest noise amplitudes have the least likelihood of occurring. Gaussian distributions permit random noises to be expressed as rms quantities, and by multiplying the rms value by 6, you can get the peak-to-peak value that will not be exceeded 99.73% of the time.

The two basic types of noise associated with internal op-amp problems are white noise and flicker (1/f) noise. White noise contains equal amounts of power in each 1 Hz of bandwidth. Flicker noise contains equal amounts of power in each decade of bandwidth (Fig. 5).

Above a certain "corner" frequency, white

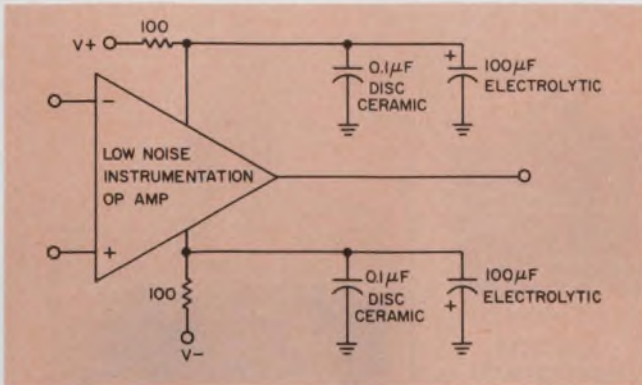

4. Bypass the power-supply terminals of a low noise op amp if you don't want any noise to enter from the source or from pickup on the power-supply leads.

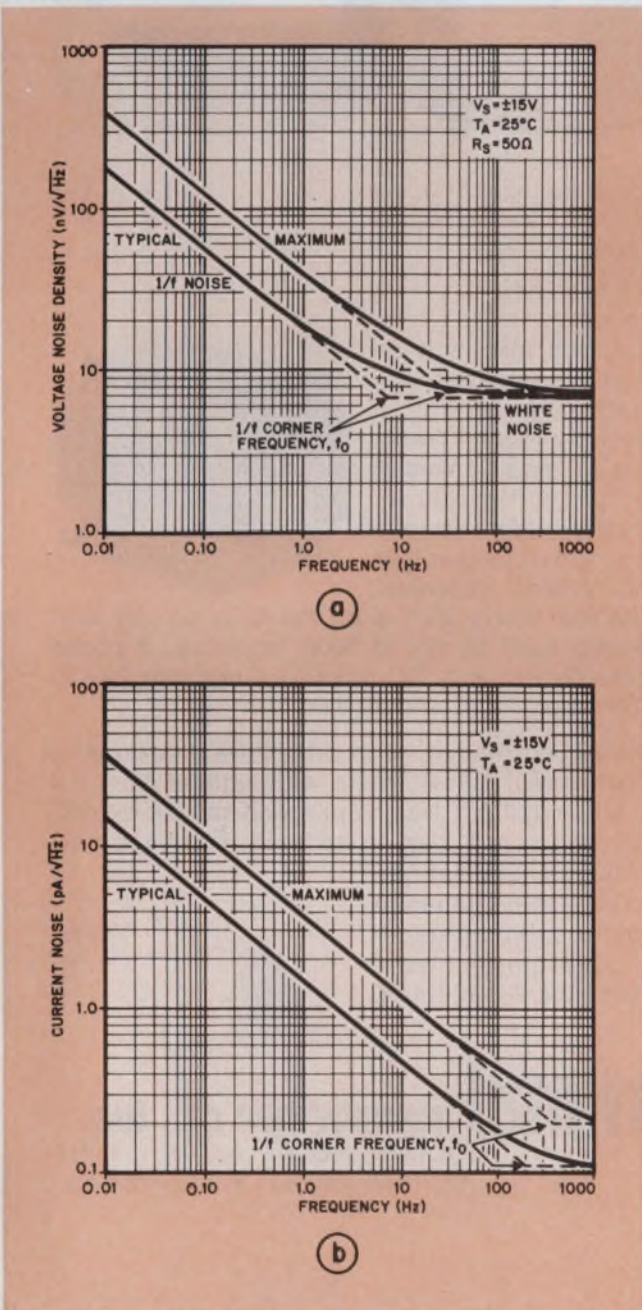

5. You can determine the corner frequencies for flicker noise by using plots of voltage-noise density (a) and current-noise density (b) vs. frequency.

noise dominates the noise content. Below the same frequency, $1/f$ noise dominates. A low corner frequency is the distinguishing factor between general-purpose and low-noise op amps.

The spectral density of noise can be written as $e_n^2 = d(E_n)^2/df$ and $i_n^2 = d(I_n)^2/df$,

where

$$E_n = \sqrt{\int_{f_L}^{f_H} e_n^2 df} \quad \text{and} \quad I_n = \sqrt{\int_{f_L}^{f_H} i_n^2 df}$$

In these equations, e_n and i_n are the spectral noise densities, E_n and I_n are the total rms values of the noise, f_H is the upper frequency limit and f_L the lower frequency limit.

To evaluate the total noise voltage or current, you must know the values of the upper and lower frequency limits and the way the noise behaves as the frequency changes.

When you substitute the equations for E_n and I_n into the spectral density equations, e_n and i_n , the resulting equations express the spectral density of white noise in terms of volts/ $\sqrt{\text{Hz}}$ or amperes/ $\sqrt{\text{Hz}}$, where $f_H - f_L = 1 \text{ Hz}$. When $f_H \gg 10f_L$, the white-noise equations reduce to

$$E_n(f) = e_n \sqrt{f_H} \quad \text{and} \quad I_n(f) = i_n \sqrt{f_H}$$

Since the flicker noise content in each decade of bandwidth remains constant, you can find the total flicker noise if the noise in one decade is known. The 0.1-to-1-Hz decade noise content (K) is widely used for this purpose, because the white-noise contributions below 10 Hz are usually negligible. Thus

$$E_n(f) = K \sqrt{1/f} \quad \text{and} \quad I_n(f) = K \sqrt{1/f}$$

If you substitute these two equations into the equations for E_n and I_n , you get

$E_n(f) = K \sqrt{\ln(f_H/f_L)}$ and $I_n(f) = K \sqrt{\ln(f_H/f_L)}$. When you know the corner frequencies of the noise, the simplified expressions for the total voltage and current noise can be combined to give

$$E_N(f_H - f_L) = e_n \sqrt{f_{c_v} \ln(f_H/f_L) + f_H - f_L} \quad (1)$$

$$I_N(f_H - f_L) = i_n \sqrt{f_{c_i} \ln(f_H/f_L) + f_H - f_L} \quad (2)$$

In these equations e_n is the white-noise voltage in a 1-Hz bandwidth, i_n the noise current in a 1-Hz bandwidth, f_{c_v} the voltage-noise corner frequency, f_{c_i} the current-noise corner frequency, and E_N and I_N represent total voltage and current noise, respectively.

The two most important design rules for low-noise applications—limit the circuit bandwidth and use op amps with low corner frequencies—stem from Eqs. 1 and 2.

A complete model of an op amp, with all noise sources referred to the input, splits the noise into five equivalent sources: E_N , I_{N1} , I_{N2} , E_{t1} and E_{t2} (Fig. 6). The noise current generators produce noise voltage drops across their respective source resistors, R_{s1} and R_{s2} . And the source resistors generate thermal noise voltages, E_{t1} and E_{t2} , that must be included.

Thus the total rms input-referred noise volt-

How sweet it is...



To find over 1000 ratings on the shelf at Old Fashioned prices!



First we'd like to put a "Plug-In" for our Printed Circuit Power Transformers since they are the *most complete and diversified selection available*. There are 5 basic sizes, each available with

115V or 115/230V 50/60 Hz primaries and secondary voltages from 5V to 120V. Our smallest is rated 1 VA and is 0.83 inches high. This allows 1 inch board spacing. The largest is rated 24 VA (e.g., 24V @ 1A) which is virtually impossible to find as a standard item (except at Signal) and, it is only 1 3/8 high.

A special "plug" is warranted for our "LP" series of Flat Plug-Ins which is designed for 6VA with a height of *only 0.85 inches*. Special features are humbucking construction, non-concentric winding, dual 115/230V primaries and outputs from 5 to 230V. This is a Signal exclusive!



You will also find on Signal's shelves the most extensive line of Rectifier Power Transformers and Chokes (5 to 300V, 0.1 to 200 A). They are ideal for use in single or dual output DC power supplies.

The real heavy stuff is on the floor nearby with ratings such as 12V at 1000 Amps and 3 phase transformers with DC output ratings like 24V at 200 Amps.



Something really new is our "2-for-1" series of small power transformers with ratings from 2.4 to 60 VA. A fresh design approach has cut weight, size and cost almost in half with improved performance. Special features include non-concentric winding, solder or quick-connect terminals, and 2500V hipot.



signal transformer co., inc.

1 Junius Street, Brooklyn, N.Y. 11212
Tel: (212) 498-5111 • Telex 12-5709

and Signal has it in Stock!

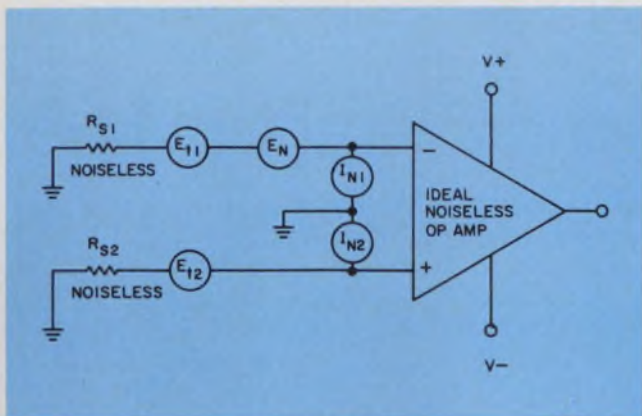

6. The "ideal" op amp has all the noise sources removed from inside the amplifier. Then you can evaluate the circuit separately.

age, E_{NT} , over a given bandwidth becomes

$$E_{NT}(f_H - f_L) = \sqrt{E_N^2 + (I_{N1}R_{s1})^2 + (I_{N2}R_{s2})^2 + E_{t1}^2 + E_{t2}^2}$$

Let's look at the two types of white-noise—thermal and shot—and the two low-frequency noise types—flicker and popcorn.

Examine the noise sources

Thermal, or Johnson, noise is created by the random movement of thermally charged carriers in a resistance. In most op-amp circuits this is the noise produced in the series resistance of each input element. The rms value of the thermal noise can be found from

$$E_t = \sqrt{4kTR(f_H - f_L)}$$

where k is Boltzmann's constant, T is absolute temperature in degrees Kelvin, and R is the resistance in ohms.

At room temperature this equation simplifies to

$$E_t = 1.28 \times 10^{-10} \sqrt{R(f_H - f_L)}$$

To minimize thermal noise caused by R_{s1} and R_{s2} , keep the source resistances as small as possible and avoid excessive system bandwidths. You can't do much about internally generated thermal noise; since it usually is caused by the base-spreading resistances ($r_{bb'}$) of the input stage transistors.

Shot, or Schottky, noise is related to the amplifier's dc input bias currents:

$$I_{sb} = \sqrt{2qI_{BIAS}(f_H - f_L)}$$

where I_{sb} is the rms value of shot noise in amperes, q is the charge of an electron, and I_{BIAS} is the dc bias current in amperes.

At room temperature the equation simplifies to

$$I_{sb} = 5.64 \times 10^{-10} \sqrt{I_{BIAS}(f_H - f_L)}$$

Flicker and popcorn noise are internally generated disturbances that you must live with, unless you can design your own op amps. Only the IC manufacturer can minimize the noise caused by either of these sources. ■ ■

asking about super bright LED DISCRETES?

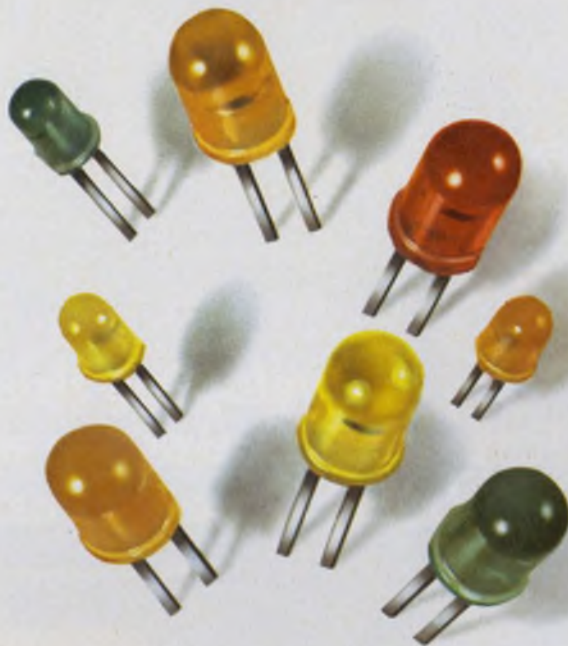

CHICAGO MINIATURE HAS THE ANSWER!



Here are some bright answers for you . . . passion red, clean green, screaming yellow, and flaming orange! In both T-1 and T-1 3/4 sizes. With *guaranteed* minimum luminous intensities, and up to 85 mcd typical intensity at rated current. Plus tin-plated leads for easier soldering. For more information, or expert design help with your applications, contact us at 4433 N. Ravenswood Avenue, Chicago, Illinois 60640.

CHICAGO MINIATURE LAMP

SUBSIDIARY OF
GENERAL INSTRUMENT CORPORATION 

INFORMATION RETRIEVAL NUMBER 51

**Developing this new pushbutton was
a little like coming up with a Ferrari that gets 32 mpg,
holds 12 people and costs less than a Pinto.**



Until now, there have been some good-looking lighted pushbuttons and indicators.

And there have been others with varied electrical capabilities. But there's never been a line that gave you harmonious panel design, electrical flexibility, and low cost. All at the same time. Until now.

Introducing the MICRO SWITCH Advanced Manual Line—AML.

The most sophisticated line of pushbuttons and indicators ever designed. And you can see a few of the reasons why right here. The AML button height, bezel size and visual compatibility of the square and rectangular sizes "harmonizes" your panel. To give you a panel with a clean, good-looking geometric face. And a panel with increased efficiency, because it doesn't distract. The low-profile square and rectangular buttons are available in five colors: white, red, yellow, green, and blue. Display capabilities include split screen, hidden color, and a unique three segment lens cap indicator. Illumination can be transmitted or projected. But what you can't see here is what helps to make these the most advanced line of lighted pushbuttons and indicators available: their extreme electrical flexibility.

Solid state operates at 5V or 6-16V with a built-in regulator, sink (TTL) and source (CMOS).
Electronic control is capable of handling low energy circuits and has a maximum rating of 3 amps, 120 VAC,

with single or double pole double throw.

And power control, DPST, with a rating of 10 amps at 120 VAC.

The AML has snap-in mounting from the front of panel and can also be subpanel mounted. There's a choice of individual or strip mounting.

All devices are the same shallow depth behind the panel to provide a unique single level termination system. The result is ease of wiring and neat appearance.

There are 5 types of terminals available: solder, quick-connect, wire-wrap, push-on or p.c. board mount. Relamping is



accomplished from the front of the panel. And it's done without a tool. With a choice of lamps including a T-1 3/4 wedge base lamp, neon and LED. To provide international acceptance, every AML device has been designed to comply with essential IEC, CEE24, UL and CSA standards.

For more information on the AML, call your nearest MICRO SWITCH Branch Office. Or write for our literature.

What you'll see is a line of lighted pushbuttons and indicators that give you a completely harmonious panel design in the front.

And the utmost in electrical flexibility behind the panel.

All products shown on this page are actual size.

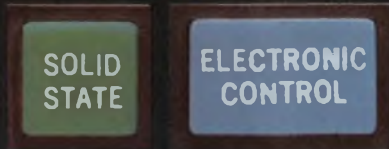

MICRO SWITCH

FREEPORT, ILLINOIS 61032

A DIVISION OF HONEYWELL

Squelch RFI in switching supplies.

Proper heat-sink connections, plus filters and screens, can steer unwanted currents away from input/output terminals.

Switched-mode power supplies need not be a troublesome source of interference. There are a number of steps you can take in practically any switching supply to keep RFI within specified limits.¹

Direct radiation, for instance, is easily stopped: Just enclose the supply in a perforated metal box and pay careful attention to the layout of internal wiring.

Interference conducted through the input or output terminals, however, is a bit more difficult to suppress. But careful placement and design of line filters, transformer shields, heat sinks and other components can do the job.

Limits for RFI and corresponding measurement methods are set by many national and international standards organizations. One such test circuit measures interference injected into the line current (Fig. 1).

In the figure, impedances Z_1 and Z_2 divert interfering currents through capacitors C_3 and C_4 and shunt the currents into resistors R_1 and R_2 . These resistors, combined with the 50- Ω input resistance of the measuring receiver, M , represent the 150- Ω impedance typical of a supply in the frequency range from 0.15 to 30 MHz.

Fig. 2 shows commonly accepted limits of interference across 150 Ω . More stringent standards exist in some countries. But if you ignore the particularly severe requirements of special receiving sites, a power supply is acceptable in all countries if the RFI voltage above 150 kHz at the input terminals is less than +54 dB above 1 μ V, or 500 μ V.

Watch for heat-sink capacitance

In a typical switched-mode power supply, the output switching transistor, TR_1 , is mounted with an insulating washer on a grounded heat sink (Fig. 3). Two separate iron-core chokes, L_2 and L_3 , plus capacitor C_1 attenuate line-to-line interference.

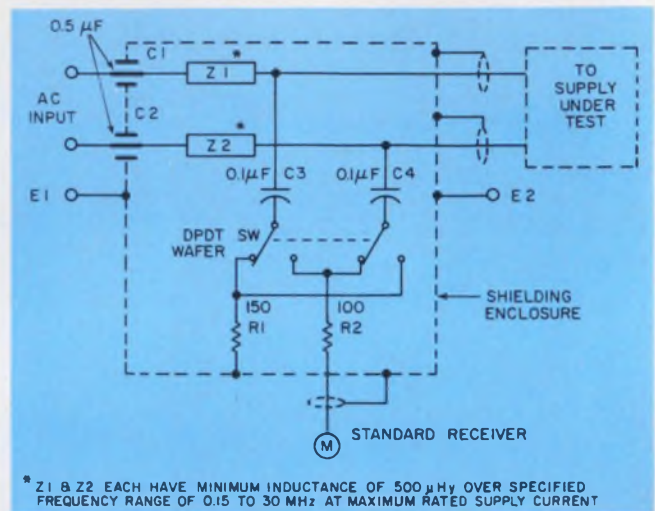

1. Unwanted currents reflected into the input terminals can be a problem in switching supplies. The currents can be measured with an interference receiver.

Similarly a bifilar-wound, high-inductance ferrite choke, L_1 , plus the 5-nF capacitors, C_2 and C_3 , limit line-to-ground RFI currents generated in the collector-to-heat-sink capacitance, C_5 . These currents must be prevented from flowing into the 150- Ω input impedance and should be routed along the path indicated by the arrows in Fig. 3. Note that since the 60-Hz currents flowing in the bifilar windings of L_1 cancel out each other, the ferrite core does not saturate.

To remain within specifications, the voltage across the 150- Ω resistors must not exceed 500 μ V. Since the switching waveform at the transistor collector has an amplitude of about 500 V, this requires an over-all attenuation of at least 10^6 from the collector to the line.

At 150 kHz, a practical line filter can attenuate line-to-ground interference voltage by 40 dB (100 times). Furthermore the first relevant harmonic is usually about 10% of the peak-to-peak collector voltage. This leaves an attenuation of about 10^3 to be achieved. For safety, the values of C_2 and C_3 are limited to 5 nF, for total attenuation capacitance of 10 nF. To obtain the required attenuation of 1000, the total capacitance, C_5 , must not exceed about 10 pF from

John Turnbull, Ferroxcube Corp., Old Kings Highway, Saugerties, NY 12477.

collector to ground.

Most often, the capacitance between a TO-3 encapsulated transistor and its heat sink is 100 pF when a mica insulating washer is used. Therefore expect a power supply so constructed to produce about 10 times more interference than is permitted.

One solution is to connect the heat sink to the transistor emitter or positive supply line instead of to ground. This ensures that the current in the collector-to-heat-sink capacitance remains in

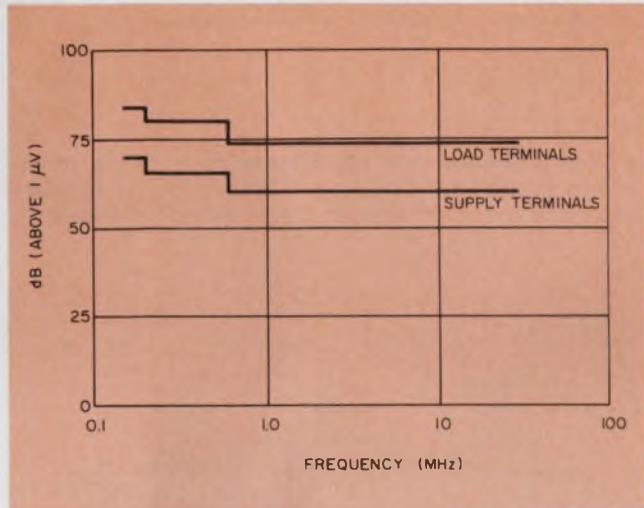

2. Commonly accepted limits of interference across 150 Ω. Some sites require more stringent limits. Anything better than 50 dB above 1 μV is usually good.

the primary circuit and won't flow into the line via the ground connection. Another solution is to enclose the heat sink within a screen that connects to the dc supply line.

Screens reduce intercapacitances

Still a third solution, but proprietary to Advance Electronics Ltd., is to construct a screen between the transistor and the heat sink (Figs. 4 and 5). The optimum solution depends on the electrical and mechanical details of the individual power supply.

Providing another path for interference currents is the unwanted capacitance that couples the harmonics of the switching waveform to ground—that is, the interwinding capacitance in the output transformer. The solution here is to place a thin copper screen between the primary and secondary of the output transformer, so that capacitive current from the primary returns harmlessly to the supply line.

For low-output-voltage supplies, a screen may be adequate. However, in high-output units, the switching waveform on the transformer secondary can produce unwanted interference current

through the capacitance between the secondary and the screen. A second screen therefore becomes necessary. Capacitive currents caused by the switching waveform in the primary now return to the primary, and those caused by the switching waveform in the secondary are returned to the secondary.

Capacitance between the output transformer primary and its ferrite core can also produce excessive interference if the core is simply clamped to a grounded mounting bracket. If you

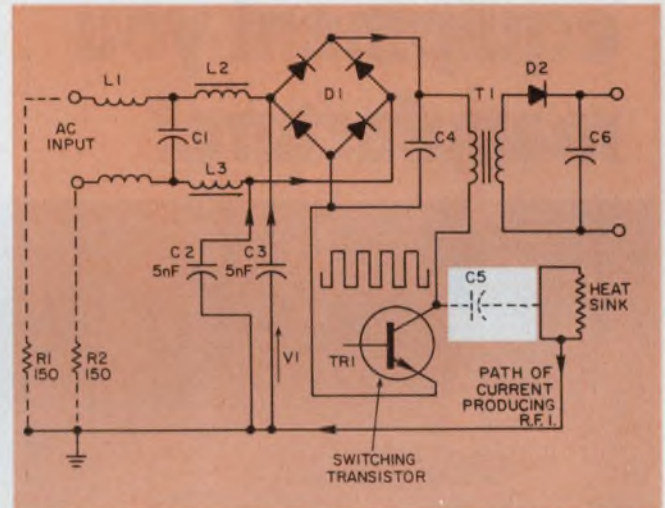

3. To keep interfering currents away from a supply's input impedance, provide a shunt path as shown. The level across R_1 or R_2 shouldn't exceed 150 μV.

connect the core to the positive supply line, however, the primary will be adjacent to the core, and any capacitance between a high-voltage secondary and the core won't be a problem.

The suppression principles described should be applied to each part of a circuit that carries switching waveforms. These include interwiring capacitance, the capacitance from wiring to ground and interwinding capacitance in any base-drive or feedback transformers. In addition you must minimize unwanted inductive coupling in conductors carrying switching currents.

Frequency effects

Interference voltage at the line terminals of a switched-mode power supply is normally maximum at the lowest frequency of measurement, and it falls rapidly with increasing frequency. This is because the efficiency of the line filter increases with frequency and because the amplitudes of the switching harmonics decrease with frequency. It is often found, however, that at frequencies in the range of 10 to 20 MHz the interference voltage reappears, rising with increasing frequency. The culprit: fast switch-

Is your warranty service as good -- and as salable -- as the biomedical equipment you manufacture?



As a manager in biomedical OEM, you know that today's hospital management demands a comprehensive warranty service program as a condition of purchase.

And, while you may find it economically feasible to support a service organization regionally or in some major metro areas, how many sales are you losing nationally?

Nationwide, professional service is available. From one established, world-famous source. Honeywell. Currently providing calibration, maintenance and repair service for more than 500 hospitals. More than 50 instrumentation manufacturers.

Skilled technicians — backed by the best and newest equipment — can provide fast response to your user's service problems. And we stock a complete parts inventory. Locally, immediately available when needed.

If you're losing sales because of inadequate national service capability, find out how Honeywell can help. For a free brochure that details the Honeywell Medical OEM service program, write or call: Dick Janes, Honeywell Biomedical Service, P.O. Box 5227, Denver, Colorado 80217. (303) 771-4700.

Honeywell

INFORMATION RETRIEVAL NUMBER 54

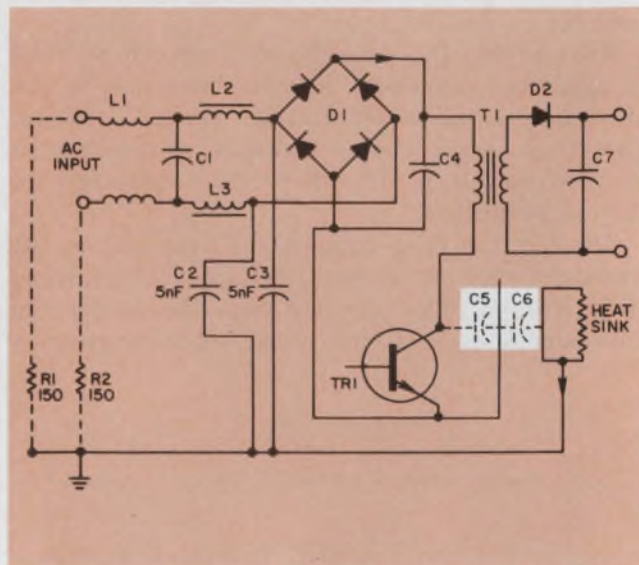

4. Collector-to-heat-sink capacitance is a source of interference currents. One way to minimize the problem is to place a screen between the sink and transistor.

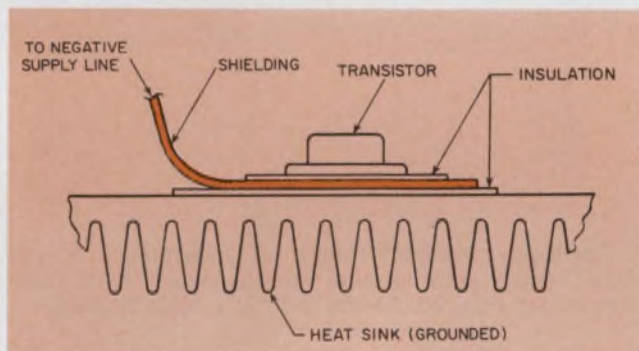

5. Shielding construction needed to reduce an output transistor's capacitance to ground. Each supply has its own optimum arrangement.

ing transients produced by diode "snap-off."

Typically the fall time of the reverse current at snap-off is about 10 ns. At very high frequencies this sudden current change can result in ringing, depending on transformer leakage inductance, wiring inductance and stray capacitance. Because the frequency is very high, interference can easily couple into all parts of the power-supply circuit, and it can develop appreciable voltage across connections, grounds and across the metal case enclosing the supply.

Snap-off can also cause malfunctioning of control circuits within the supply, resulting in output-transistor failure or instability in the control loop. The solution is to use soft recovery diodes when possible or to connect small capacitors across the offending diodes. You must also minimize circuit resonances that can sustain ringing after the diode currents drop to zero. ■■

References

1. Jansson, L. E., "Radio Frequency Interference Suppression in Switched-Mode Power Supplies," *Mullard Technical Communications*, Oct., 1973, Vol. 12, No. 120.

In a highly sophisticated military system or a familiar computer terminal, the equipment is only as reliable as its power supply.

Engineering excellence is the criterion.

Trio meets this requirement with the most complete line of switching regulator power supplies. AC/DC, DC/DC and point-of-load. The widest range of ratings and configurations, from 2 to 50 volts. They're small, lightweight and highly efficient. Their engineering excellence makes them the standard of reliability and performance in the industry.

To complement this standard product line, Trio maintains a custom capability for design, development and manufacture of special purpose power supplies. Trio technology is at the highest level with quick response to customer requirements.

If your power supply applications demand maximum efficiency, minimum size and weight, and the highest reliability, check your requirements with John Crawford. Trio Laboratories, 80 Dupont Street, Plainview, New York 11803. 516/681-0400.

INFORMATION RETRIEVAL NUMBER 55

Trio Power Supplies

Brownout protection. Trio power supplies assure operation of computer terminals and memories despite wide input voltage fluctuations.

Equivalent of 10 years MTBF and counting! And Trio power supplies are aboard.



Circuit turns on tape recorder only when sound is detected

The circuit for a long-term audio remote-monitoring system can be built simply for less than \$10. It makes use of the built-in microphone and amplifier of any common transistorized cassette tape recorder to do the monitoring until sound is detected. Sound of sufficient amplitude turns on the tape motor, and recording starts.

Low standby power allows long-term battery operation. No recorder modifications are required. Access to the recorder circuitry is via the recorder's external "monitor" and "remote" jacks.

With the tape recorder in the record mode, the recorder's monitor jack is connected to the inverting input of comparator CO₁. The comparator's noninverting input is connected to an adjustable bias potentiometer, R_s, which sets the sound level that will start the recorder. The comparator output circuit has an uncommitted output transistor that is connected in a Darlington configuration with external transistor Q₁.

Network R₁, R₂ and C₁ provides time delays for fast-start and slow-stop of the tape-drive motor under control of Q₁ and the time constant of R₁, R₂ and C₁. Transistor Q₂ inverts and sharpens the signal to turn on transistor Q₃, which then operates the tape-drive motor.

Under silent conditions, the CO₁ output is low and transistor Q₁ is cut off. This allows capacitor C₁ to charge via resistors R₁ and R₂. When the charging current ceases, Q₂ and Q₃ also are cut off. If the sound level exceeds the preset threshold, Q₁ is driven into saturation to discharge C₁ rapidly. Transistors Q₂ and Q₃ turn on, and the recorder motor runs.

The presence of sound keeps C₁ in a discharged condition and the recorder running.

Michael L. Roginsky, Staff Engineer, Engineering Data Systems Dept., Lockheed-Georgia Co., Marietta, GA 30063.

CIRCLE NO. 311

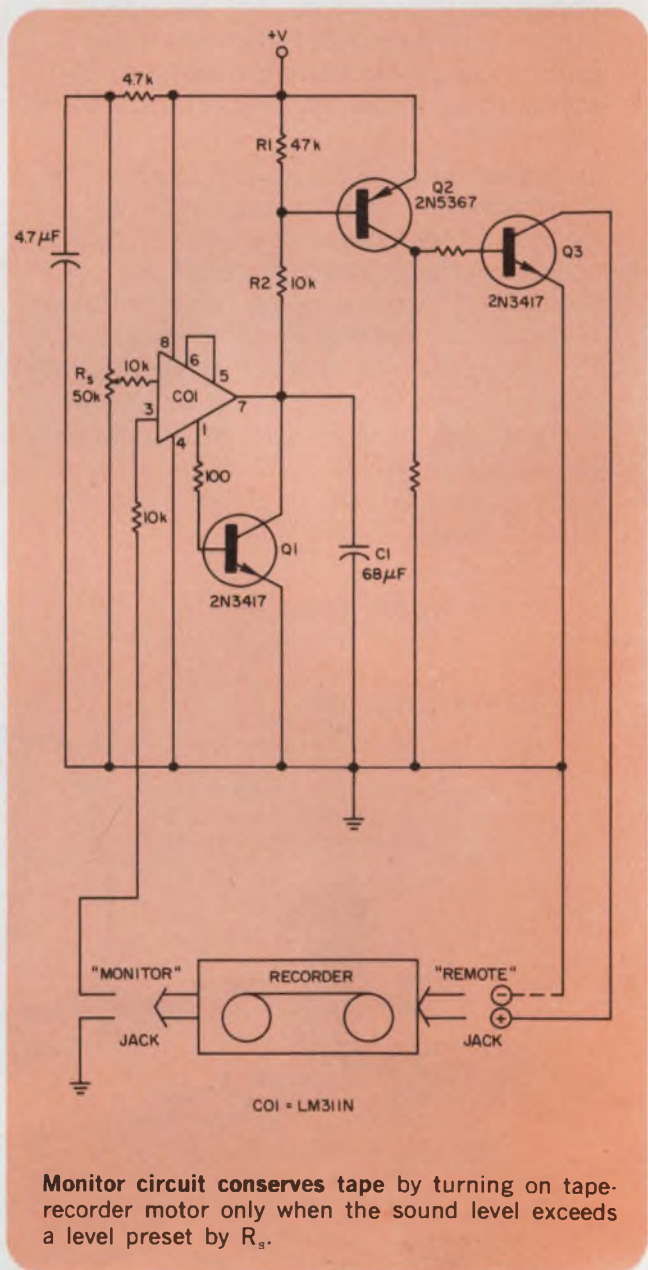

Monitor circuit conserves tape by turning on tape-recorder motor only when the sound level exceeds a level preset by R_s.

There's a reason why we're so open about our **Q Series** Open Frame Power Supplies. We want you to know everything about them. Like our one year warranty. And stock delivery. And our socketed semiconductors which makes field spares support a snap.

About our thermal design, the best around, making our heat sensitive parts run cooler and operate longer. And we're the *only* maker of Open Frame Power Supplies where *all* components operate well within mfrs. specs.

That's why Deltron "Open Frames" save you money three ways: When you buy them. By avoiding costly downtime. And by lasting longer.

We want you to compare Deltron "Opens" with others. In fact, we'll send you our Comparative Engineering Reports matching Deltron against other major mfrs. You'll find as others have that Deltron is unsurpassed for quality and performance.

For some more open talk about Deltron Q Series and a copy of our Comparative Engineering Reports, write or call collect to Deltron, Inc. Wissahickon Avenue, North Wales, Pa. 19454. Telephone: 215-699-9261, TWX 510-661-8061.

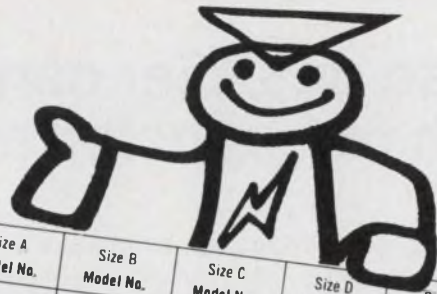

Size A Model No.	Size B Model No.	Size C Model No.	Size D Model No.	Size F Model No.
volts — amps	volts — amps	volts — amps	volts — amps	volts — amps
Q 5 — 3.0	Q 5 — 6.0	Q 5 — 9.0	Q 5 — 12.0	Q 5 — 18.0
Q 6 — 3.0	Q 6 — 6.0	Q 6 — 9.0	Q 6 — 12.0	Q 6 — 18.0
Q 12 — 1.7	Q 12 — 3.4	Q 12 — 5.7	Q 12 — 7.0	Q 12 — 10.8
Q 15 — 1.5	Q 15 — 3.0	Q 15 — 4.8	Q 15 — 6.3	Q 15 — 9.5
Q 18 — 1.3	Q 18 — 2.6	Q 18 — 4.0	Q 18 — 5.2	Q 18 — 7.8
Q 20 — 1.3	Q 20 — 2.6	Q 20 — 4.0	Q 20 — 5.2	Q 20 — 7.8
Q 24 — 1.2	Q 24 — 2.4	Q 24 — 3.3	Q 24 — 4.8	Q 24 — 7.2
Q 28 — 1.0	Q 28 — 2.0	Q 28 — 3.1	Q 28 — 4.2	Q 28 — 6.0
Dimensions: 4 7/8 x 4 x 1 3/8	Dimensions: 5 5/8 x 4 7/8 x 2 1/2	Dimensions: 7 x 4 7/8 x 2 3/4	Dimensions: 9 x 4 7/8 x 2 3/4	Dimensions: 14 x 4 7/8 x 2 3/4
Price: 1 — \$32.00 100 — \$26.00 250 — \$24.00	Price: 1 — \$54.00 100 — \$44.00 250 — \$41.00	Price: 1 — \$67.00 100 — \$54.00 250 — \$51.00	Price: 1 — \$87.00 100 — \$70.00 250 — \$66.00	Price: 1 — \$113.00 100 — \$ 91.00 250 — \$ 85.00

Some open talk about open frame power supplies

Socketed power semiconductors.
Iridited aluminum chassis.
Computer grade electrolytics.
Special circuits to protect IC.

Forward and reverse voltage protection.
Barrier block interface.
Infinite resolution adjustments.
Full interchangeability.
115/230 vac, 47-440 hz.

Socketed IC regulation system.
Filters meet mfrs. ripple ratings.
Glass epoxy PC boards.
Loss of sense protection.
Designed for U.L. Recognized
Component Index.

For some more open talk about Deltron Q Series and a copy of our Comparative Engineering Reports, write or call collect.

Deltron inc.

Pulse amplifier can deliver over 500 V with frequencies to 100 kHz

Few pulse amplifiers can handle a wide voltage range—0 to 700 V—and a wide frequency range—dc to 100 kHz.¹ Here is a circuit that can perform both functions economically and is suitable for driving capacitive loads.

An optical coupler allows isolation of the bias voltages for Q_1 and the high-voltage transistor, Q_4 . Thus only TTL level voltage swings can control the base-emitter junctions of both output transistors Q_2 and Q_3 . They are the only transistors that swing the entire output-voltage range.

Note that the circuit requires a floating 4.5-V power supply, which is provided by three D cells.

Unlike the circuit in the reference, which merely opens and closes a path to a voltage source, this pulse amplifier drives the load between ground and the positive voltage. Thus the load can be capacitive.

Reference

1. Anderson, Stephan D., "High-speed Switch Handles ± 400 -V Peak," *Electronic Design*, Jan. 18, 1975, p. 74.

Donald Limuti, Research Engineer, Digital Development Group, Stanford Research Institute, Menlo Park, CA 94025.

CIRCLE No. 312

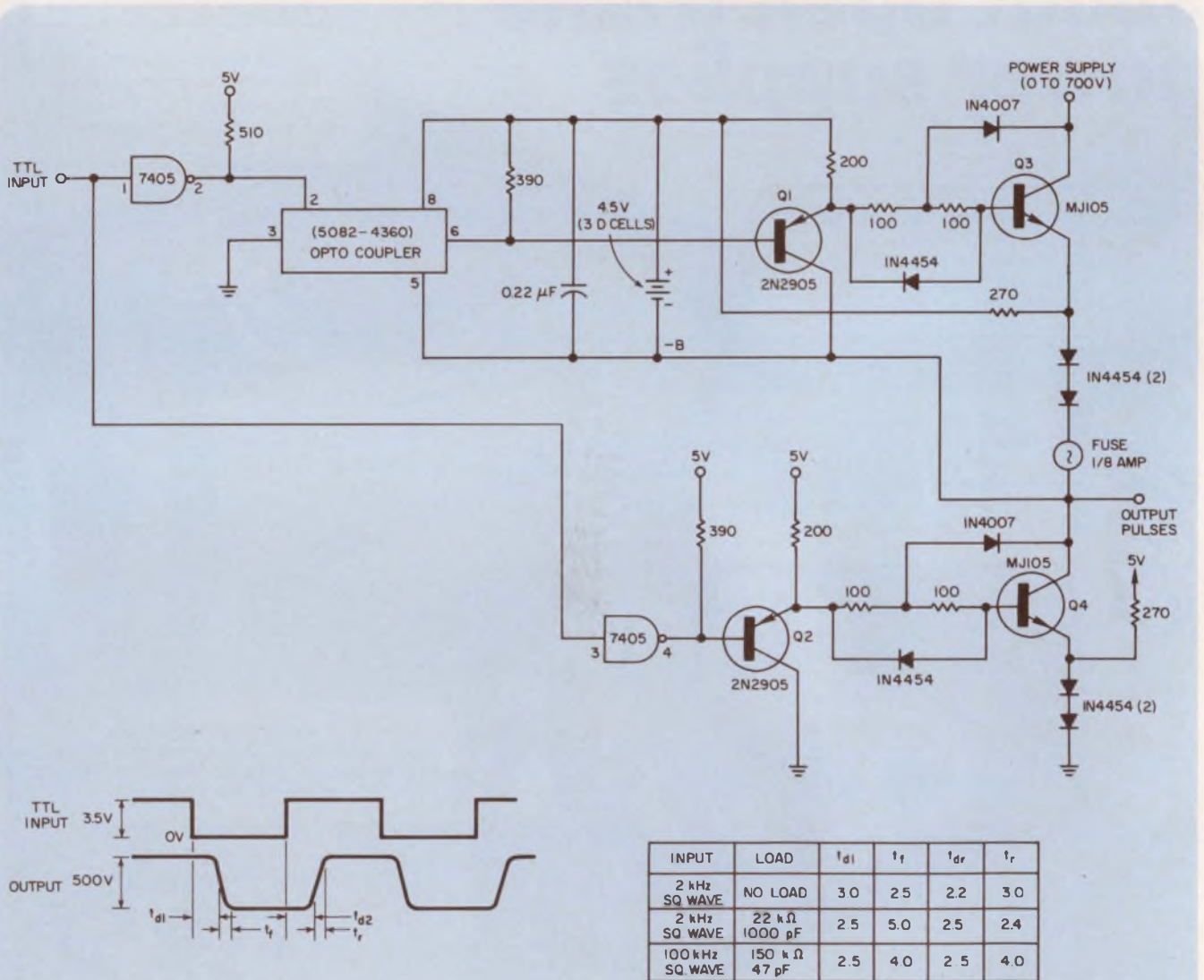

High-voltage pulse amplifier uses an optocoupler to enable TTL levels to control greater than 500 V

of output. It does, though, require an isolated 4.5-V power supply.

POWER DARLINGTONS



DARLINGTON POWER TRANSISTOR PRODUCT SELECTION GUIDE

Type	Ic	Beta	Vceo	Polarity	Package
Single Diffused					
SDM 20301/02/03/04	5A	1000 @5A	40/60/80/100	NPN	TO-3
SDM 21301/02/03/04	5A	1000 @5A	40/60/80/100	PNP	TO-3
SDM 20311/12/13/14	10A	1000 @10A	40/60/80/100	NPN	TO-3
SDM 21311/12/13/14	10A	1000 @10A	40/60/80/100	PNP	TO-3
SDM 20321/22/23/24	15A	750 @15A	40/60/80/100	NPN	TO-3
High Voltage, Single Diffused					
SDM 22301/02/03	5A	150 @2A	150/250/350	NPN	TO-3
SDM 22311/12/13	5A	70 @5A	150/250/350	NPN	TO-3
Complementary Planar					
SDM 3103/04/05	2.5A	1000 @2.5A	40/60/80	NPN	TO-66
SDM 3203/04/05	2.5A	1000 @2.5A	40/60/80	PNP	TO-66
SDM 3303/04/05	2.5A	1000 @2.5A	40/60/80	NPN	TO-66
SDM 3403/04/05	2.5A	1000 @2.5A	40/60/80	PNP	TO-66
SDM 3100/01/02	5A	1000 @5A	40/60/80	NPN	TO-33
SDM 3200/01/02	5A	1000 @5A	40/60/80	PNP	TO-33
SDM 3300/01/02	5A	1000 @5A	40/60/80	NPN	TO-33
SDM 3400/01/02	5A	1000 @5A	40/60/80	PNP	TO-33
High Voltage Planar					
SDM 6000/01/02/03	15A	100 @10A	400/450/500/600	NPN	TO-3

Solitron
DEVICES, INC.

1177 Blue Heron Boulevard
Riviera Beach, Florida 33404
Tel: (305) 848-4311
TWX: (510) 952-7610

Now you can pinpoint your Power Darlington transistor needs at a glance from Solitron's **PRODUCTION SELECTION GUIDE**. Reprinted here, it graphically illustrates the wide line of Darlington Series types available for your design requirements. Clip and save this page for future reference. For complete data sheets, write... **Solitron Devices.**

FROM SOLITRON

Optocoupler is zero-crossing detector and isolator in triac power control

An optocoupler can provide both isolation and zero-crossing detection, as often required by solid-state relays and other power controls, without use of expensive transformers or complex circuits.

In the zero-crossing detector in Fig. 1, the output transistor of the optocoupler conducts continuously, except for a very brief period near the zero-volt crossing of the line voltage, when the coupler's internal LED turns off for about 1 ms. The width of the output pulse when the LED turns off can be increased by use of a higher value for resistor R_2 . And the pulse can be advanced with a capacitor placed in series or parallel with R_1 to phase-shift the current flow through the LED portion of the optocoupler.

Fig. 2 shows how the zero-crossing detector circuit of Fig. 1 can be used to trigger a triac only when ac power is traversing zero. This action reduces transients and RFI noise.

Pekka Ritamaki, Electronics Engineer, Oy Nokia Ab Cable Works, Capacitor Factory, Pl. 60, 33101 Tampere 10, Finland CIRCLE No. 313

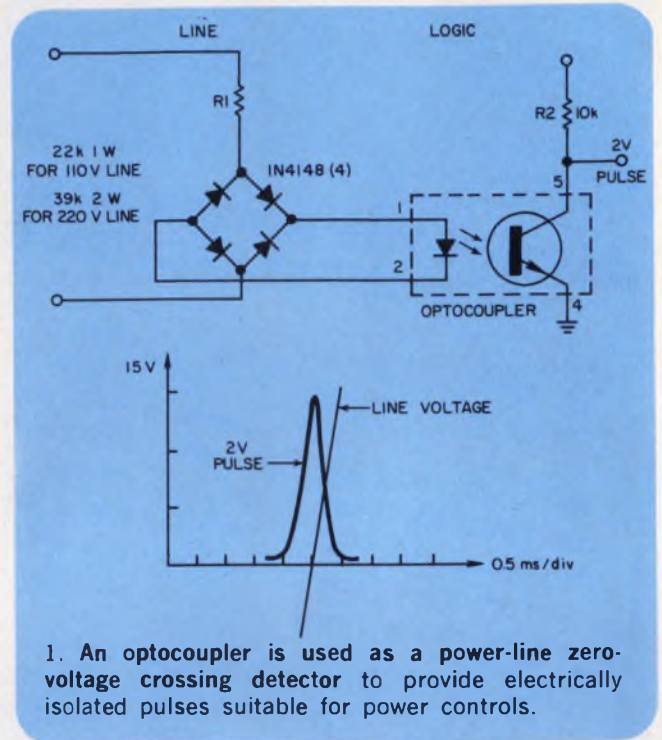

1. An optocoupler is used as a power-line zero-voltage crossing detector to provide electrically isolated pulses suitable for power controls.

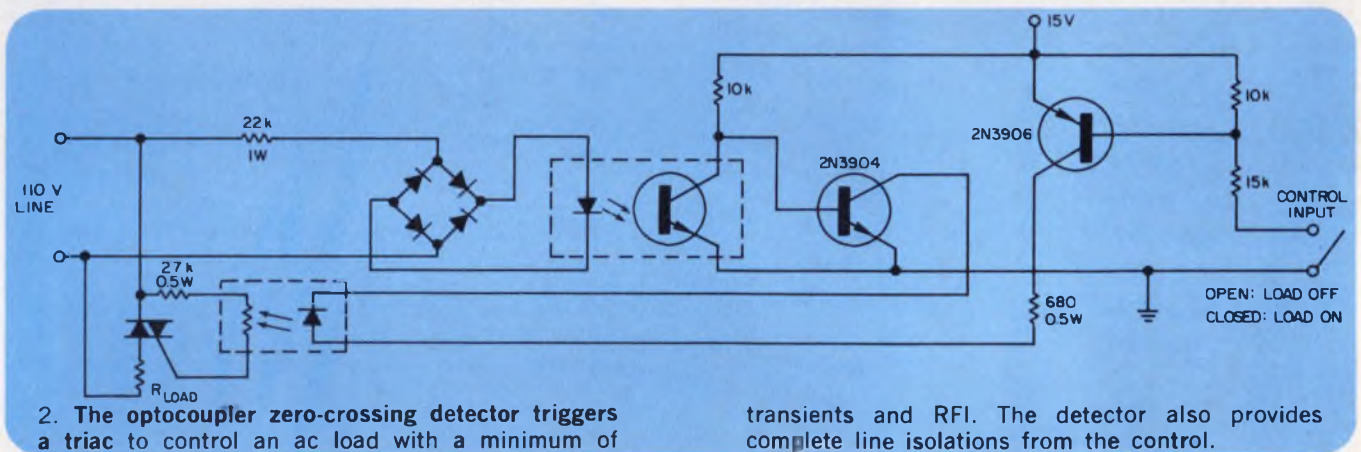

2. The optocoupler zero-crossing detector triggers a triac to control an ac load with a minimum of

transients and RFI. The detector also provides complete line isolations from the control.

IFD Winner of May 24, 1975

Leonard Kaplan, Member of Technical Staff, RCA Solid State Div., Route 202, Somerville, NJ 08876. His idea "CMOS Audio Amplifier Features ± 15 -dB Bass/Treble Control Range" has been voted the Most Valuable of Issue Award.

Vote for the best Idea in this issue by circling the number for your selection on the Information Retrieval Card at the back of this issue.

SEND US YOUR IDEAS FOR DESIGN. You may win a grand total of \$1050 (cash)! Here's how. Submit your IFD describing a new or important circuit or design technique, the clever use of a new component or test equipment, packaging tips, cost-saving ideas to our Ideas for Design editor. Ideas can only be considered for publication if they are submitted exclusively to ELECTRONIC DESIGN. You will receive \$20 for each published idea, \$30 more if it is voted best of issue by our readers. The best-of-issue winners become eligible for the Idea of the Year award of \$1000.



Which of these
spring contacts
can you get
from Instrument Specialties?

None of them!
(But we'll make some just for you!)

Sorry, we can't sell you any of the springs shown here. They're all proprietary. Each was designed for a specific application at a particular company. A very particular company. Which is why each one came to I/S!

But I/S can do the same *kind* of thing for you. Specialists in the design and manufacture of beryllium copper springs, we can create springs with your choice of many types of gold, silver, or other precious metal contacts.

Perhaps you require large welded contacts, with precious metal bonded to inexpensive base material. Or, small welded contacts in which precious metal is welded directly to the spring. Or, riveted contacts offering close tolerances with either single or double headed contacts. Instrument Specialties supplies all of them!

One other thought: Sometimes, you may *think* you need welded or riveted contacts. However, our engineers may feel that our CONTIP® bonding technique, or our gold selective plating process, or the use of inlay material, can meet your needs at considerably less cost. If so, we'll tell you that, too.

Our latest catalog contains complete information on all types of I/S spring contacts. For your free copy, circle the Reader Service Card or write us at Dept. ED-81.

Specialists in beryllium copper springs since 1938

INFORMATION RETRIEVAL NUMBER 60



INSTRUMENT SPECIALTIES CO., INC.
Little Falls, New Jersey
Phone 201-256-3500



For Precision Phase Measurement
 the only logical choice
DRANETZ SERIES 305
 for 7 logical
 reasons...

- 1** HIGHEST ATTAINABLE ACCURACY.
 $\pm 0.03^\circ$ absolute, over wide rated level/frequency ranges.
- 2** HIGHEST CALIBRATION STABILITY.
 - Short-Term: $\pm 0.005^\circ$ repeatability
 - Long Term: 30-day drift, 0.05° max.
 - Temperature: $\pm 0.001^\circ/\text{C}$ max.
- 3** WIDEST FREQUENCY RANGE.
 2 Hz to 11 MHz, performance-optimized by plug-in modularity. Auto-tuned averager optimizes response speed.
- 4** WIDEST DYNAMIC RANGE.
 1 mV to 300 V, with autoranging and gain programming.
- 5** MOST VERSATILE PROGRAMMABILITY.
 Automatic or Remote (computer-compatible) programming of every range and function.
- 6** ABSOLUTE FREEDOM FROM AMBIGUITY
 Patented technique (U.S. Pat. #3,725,781) eliminates noise-triggering anomalies; exclusive double-zero-crossing averaging for waveform and duty-cycle independence.
- 7** GREATEST INTERFACE FLEXIBILITY.
 Choice of 9 different plug-ins and 4 mainframe options provide for virtually every application . . . developed over a decade of design evolution.

Send today for your free copy of this brand-new engineering monograph. Hundreds of diagrams, equations, graphs, charts, etc. on precision phase measurement.



DRANETZ

18-pin DIP houses speedy 8-bit hybrid a/d converter

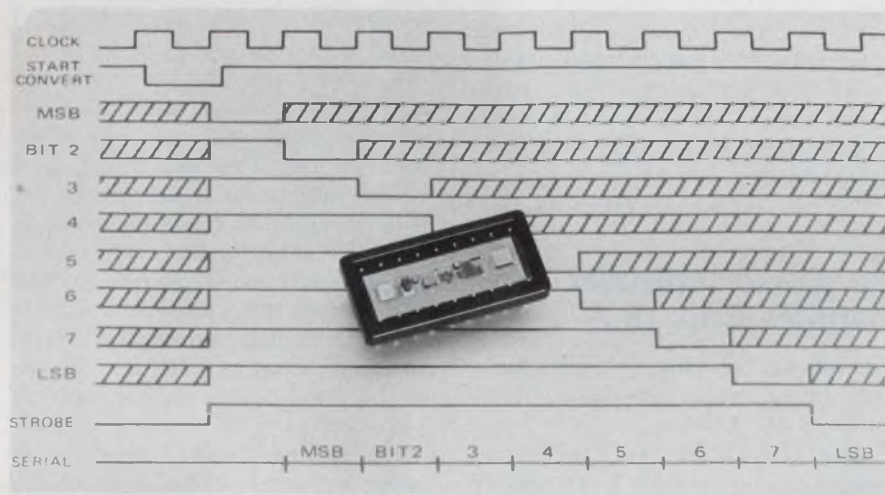

Micro Networks, 324 Clark St., Worcester, MA 01606. (617) 852-5400. P&A: See text.

Many companies offer modular eight-bit analog-to-digital converters for under \$100. And a few companies even have lower cost IC versions—but many of these are slow and most require external components, such as a voltage reference or comparator.

Micro Networks now offers a third alternative—the MN5120 series of hybrid-microelectronic eight-bit a/d converters. These are successive-approximation units that cost only \$59 in unit quantities and are housed in 18-pin hermetic DIPs.

The MN5120 units include their own reference and comparator, but need an external clock signal. They deliver an eight-bit data word in only 6 μ s, maximum. Nonlinearities are only ± 0.5 LSB over an operating temperature range of 0 to 70 C. The worst-case absolute accuracy is ± 1 LSB at 25 C and ± 2 LSB over the 0-to-70-C range.

There are four units in the MN-5120 series: the MN5120, 5121,

5122 and 5123. They are identical, except for their analog input ranges, which are: 0 to -10 , -5 to $+5$, -10 to $+10$ and 0 to $+10$ V, respectively. Input impedance for all models is 5 k Ω except for the MN5122 for which it rises to 10 k Ω . All versions deliver serial and parallel data outputs in straight binary form.

Power requirements for the MN-5120 series are low. Total power for any of the units is 1 W, maximum; all units need ± 15 and $+5$ -V supplies. Power supply tolerance should be tighter than $\pm 3\%$ to ensure full accuracy.

The converter comes completely pre-trimmed and uses nichrome, thin-film resistor networks for high stability.

Competitive single package, successive approximation, converters include the AD7570J CMOS a/d converter from Analog Devices (Norwood, MA) the ADC-EH-8B from Datel (Canton, MA), the 540-8 from Hybrid Systems (Burlington, MA) and the MM5357 from National Semiconductor (Santa Clara, CA).

The Datel and the Hybrid Systems units are discrete component modules, measuring 2 \times 2 \times 0.4 in., while the converter from Analog Devices is a single 28-pin IC and the National unit is housed in an 18-pin DIP. The AD7570J, though, does require an external comparator, clock and voltage reference and the MM5357, just a clock and reference, while the Datel and Hybrid Systems units have a built-in clock source, so all that's needed is the convert command.

The AD7570J and the MM5357 beat the Micro Networks converters for low power consumption—the 7570J requires only 20 mW for operation, not including the current needed for the comparator or reference and costs \$52 and the 5357 requires only 170 mW, not including the reference, and costs only \$12. Also, the Datel unit is faster than the units from Micro Networks—it converts in 4 μ s or less and costs \$85. However, it does require almost double the power—1.675 W, maximum. The Hybrid Systems 540-8 converts in 5 μ s and requires the same power as the MN5120 units—only 1 W, maximum and costs \$85. Conversion time for the Analog Devices and National IC units is slower—under 20 μ s for the AD7570J and 40 μ s for the MM5357, respectively. Analog Devices, though, does offer a 10-bit converter the AD7570L, which costs \$69 in unit quantities.

The Micro Networks converters are available from stock.

For Micro Networks **CIRCLE NO. 301**
 Analog Devices **CIRCLE NO. 302**
 Datel **CIRCLE NO. 303**
 Hybrid Systems **CIRCLE NO. 304**
 National Semiconductor

CIRCLE NO. 305

Universal v/f and f/v converter spans 100 kHz

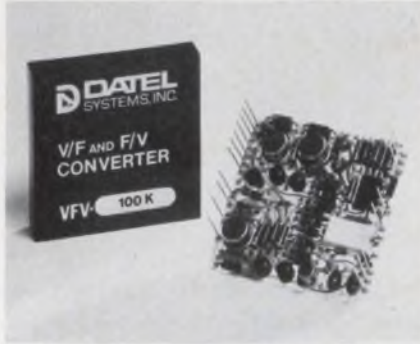

Datel, 1020 Turnpike St., Canton, MA 02021. (617) 828-8000. \$179; stock to 4 wk.

The VFV-100K universal voltage-to-frequency or frequency-to-voltage converter has a large number of operating characteristics determined by pin connection. With a frequency range of 0 to 100 kHz, the unit has a resolution of one part in 100,000. The input and output also have a minimum over-range of 10%. Some of the pin-programmable characteristics include: 0 to +10 or 0 to -10 V inputs, 0 to +1 or 0 to -1 mA inputs, positive or negative going output pulses, 5 to 15 V amplitudes and operation as either a v/f or f/v converter. The output pulses have a constant width of 7 μ s and the output is short circuit proof. Other features include a 0.05% maximum nonlinearity, 100 ppm/ $^{\circ}$ C maximum temperature coefficient, and a 10 k Ω input impedance. The VFV-100K is packaged in a 2 \times 2 \times 0.375 in. case.

CIRCLE NO. 306

Thermocouple linearizer provides 1 $^{\circ}$ resolution

San Diego Instrument Lab, 8098 Engineer Rd., San Diego, CA 92111. (714) 292-0646. \$287 (1 to 9); stock.

The Model 201 digital thermocouple linearizer receives parallel binary or BCD data from digitized thermocouple data and linearizes the data in conformance with NBS thermocouple tables. Each linearizer consists of an input/output module and a processor module, and measures 3.5 \times 4.5 \times 0.6 in. Inputs and outputs are TTL/DTL compatible; control timing is provided internally. Full-range linearization is offered for thermocouple wire types J, K, T, E, R, S and B, with 1 $^{\circ}$ resolution for Celsius and Fahrenheit models.

CIRCLE NO. 307

Ac phase controller handles 6 to 15 A

Omnetrics, P.O. Box 113, Syracuse, NY 13211. (315) 699-5262. From under \$1 to \$7.22.

The Omnephase ac phase controller can be used for incandescent lamp dimming, heating element temperature control and speed control of universal and induction motors. Six models of the integrated functional control are offered in two package configurations. Current/voltage combinations that range from 6 to 15 A at 230 V ac are available. Forward voltage drop is 1.8 V at maximum on-state current. Conduction angles range typically from 30 to 155 $^{\circ}$ at 15% hysteresis. Operating temperature range spans -40 to +100 C.

CIRCLE NO. 308

Noncontacting sensor uses modulated IR beam



Scientific Technology, 1201 San Antonio Rd., Mountain View, CA 94043. (415) 965-0910. \$139.50; 4 to 6 wk.

The 2050-series Optaxial control concentrates a modulated IR LED beam precisely along the axis of the solid state detector, without attenuation due to mirrors, beam splitters, fiber optics or any other such devices. The unit detects any visible object or material in its field of view. It reads code marks or color changes and can see or see through, as required by the application, transparent and translucent materials, liquids or clouds. Its range is up to 6 ft (1.8 meters) in the proximity mode and to 50 ft (15 meters) when a 3 in. (8 cm) diameter retarget is used. Increasing target size also increases retroreflective range. The rugged, sealed sensor head of the 2050-series measures 1.4 \times 1.75 \times 3.25 in. (3.6 \times 3.8 \times 8.3 cm) and may be remotely mounted up to 100 ft (30 meters) from the control electronics. The control is available for any 2.5-W input from 12 V dc to 240 V ac and the control output may be selected to meet any requirement. Standard plug-in control option modules include time delays, one shots, latches and predetermined counters.

CIRCLE NO. 309



ANALOGY

A-TO-D OR D-TO-A. THERE'S AN INTECH CONVERTER MODULE WITH HIGH ACCURACY AT BIG COST SAVINGS. WE STOCK 20 DIFFERENT TYPES WITH BINARY RESOLUTIONS FROM 8 TO 16 BITS FROM 4 TO 5 1/2 BCD DIGITS. LINEARITIES TO BETTER THAN $\pm 0.0025\%$. EVEN OUR LOWEST COST DACS REMAIN MONOTONIC THROUGHOUT TEMP RANGE WITH CONVERSION TIMES TO 800 NS.

intech/FMI
282 BROOKAW RD. SANTA CLARA, CA 95050 (408) 244-0500

Instrumentation amp accurate to 0.002%

Analog Devices, P.O. Box 280, Route 1 Industrial Park, Norwood, MA 02062. (617) 329-4700. Unit prices: \$69 (J); \$85 (K); \$98 (L); stock.

The Model 606 instrument amplifier has an almost constant bandwidth over a gain range of 1 to 10,000 V/V. It is also claimed by the manufacturer to be the most accurate unit available, with an accuracy of 0.002%. Precision performance is further assured by a $0.5 \mu\text{V}/^\circ\text{C}$ maximum input offset drift combined with a 90 dB minimum CMRR and $1 \mu\text{V}$ pk-pk maximum input noise. Total drift from all sources is guaranteed to be less than $0.5 \mu\text{V}/^\circ\text{C}$ referred to the input when measured at a gain of 1000. The Model 606 has a 10 MHz gain bandwidth product and 50 μs settling to 0.01%, making it fast enough for most high speed applications. A 12 kHz full power response independent of gain, and a gain stability of 15 ppm/ $^\circ\text{C}$ and 6 ppm/month are further assurances of long time reliability. The amp consumes only 75 mW, operates over a ± 9 to ± 18 V dc power supply range and is housed in a $2 \times 2 \times 0.4$ in. module.

CIRCLE NO. 320

D/s converters provide 14-bit resolution

Transmagnetics, 210 Adams Blvd., Farmingdale, NY 11735. (516) 293-3100. \$495 (1 to 4); stock to 6 wk.

The Model 1673, 14-bit digital-to-synchro converter is accurate to within 4 minutes of angle. The unit continuously converts a 14-bit parallel-binary coded angle input into a three-wire synchro or four-wire resolver output. Digital inputs are TTL/DTL compatible. Synchro output and reference are transformer isolated. Standard output voltages are 11.8 or 90 V rms line-to-line, 50 to 400 Hz. Full power output can be supplied up to +85 C. The 1673 has continuous short-circuit and overcurrent protection and can be supplied for 0 to +70 C or -55 to +85 C operation. The module measures $3.125 \times 2.625 \times 0.82$ in. and requires ± 15 -V-dc and +5-V-dc supplies.

CIRCLE NO. 321

1024 Element Analog Delay 75 DB S/N

RETICON's SAD-1024 Serial Analog Delay is the most recent in our line of analog signal processing devices. It is designed for variable or fixed delay of analog signals including various audio applications (e.g., reverberation, echo and chorus effects in electronic organs and musical instruments, speech compression, voice scrambling, etc.) It is packaged in a 16 lead DIP and is priced at less than 1¢/bit in OEM quantities.

Other units offer up to 12 MHz sampling frequency, independent read-in/read-out, and can be used to perform analog storage, digital filtering, convolution, correlation, real time Fourier transforms and many other functions.

There are over 70 salesmen and 16 distributors to serve you worldwide.



RETICON®

910 Benicia Avenue
Sunnyvale, Ca. 94086
(408) 738-4266
TWX: 910-339-9343

If you want to hurt the 240L RF Power Amplifier



**...you've got to do more
than short circuit its output.**

As a matter, of fact, this *brand new* instrument will deliver more than 40 watts of Class A linear power and up to 150 watts of CW and pulse power to any load impedance (from an open to a short circuit). Immune to load damage and unconditionally stable the 240L covers the frequency range of 20 KHz to 10 MHz with a flat 50 db gain. Completely *solid state* the 240L will faithfully reproduce input waveforms from any signal or function generator in its range.

If you need a transducer drive source for ultrasonics, RFI/EMI, biological research, electro or acousto optics the 240L was designed for you.

Solid state reliability is here at \$1595.00.

For further information or a demonstration contact ENI, 3000 Winton Road South, Rochester, New York 14623 (716) 473-6900 or TELEX 97-8283



ENI

**The world's leader
in solid-state power amplifiers.**

POWER SOURCES

60-W switcher offers dual outputs

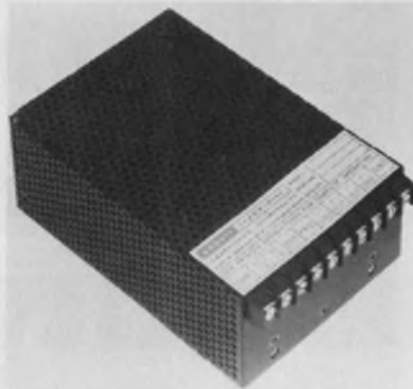

Abbott Transistor, 5200 W. Jefferson Blvd., Los Angeles, CA 90016. (213) 936-8185. \$349.

Model ZZ expands the spectrum of the company's Model Z by offering a dual-output, switching-regulated ac-to-dc power supply. This unit converts low-frequency (47 to 440 Hz) ac lines (100 to 132 V rms) to 60 W of regulated power in a package measuring $4 \times 7\text{-}1/2 \times 2\text{-}1/2$ in. and weighing 3 lb. Model ZZ15T2.0 offers an adjustable output voltage from 14.5 to 15.5 V and delivers 2.0 A per channel. Regulation is within 0.15% for input voltage changes of 100 to 132 V rms and load changes of no load to full load, while the ripple is less than 5 mV rms or 100 mV pk-pk.

CIRCLE NO. 322

Forty models comprise open-frame series

Deltron Inc., Wissahickon Ave., North Wales, PA 19454. (215) 699-9261. \$32 to \$113.

Forty models make up the "Q" Series open-frame, power-supply line. Featured are reverse and forward-voltage protection, loss of sense protection, socketed semiconductor, an IC regulation system, infinite resolution adjustments and a barrier-block interface. In addition, the "Q" Series has remote sensing and programming capabilities along with automatic series and parallel operation. Line regulation is 0.02%, load regulation is 0.05%, ripple and noise are 0.01%.

CIRCLE NO. 323

Switchers work at up to 82% efficiency

Trygon Electronics, 1200 Shames Dr., Westbury, NY 11590. (516) 997-6200. From \$650.

A new series of modular units with 20-kHz switching regulators, the SHA series is available in nominal voltages of 1.25, 3, 5, 12, 15, 24, 28, and 48 V dc with currents ranging from 15 to 120 A. Other features include no turn-on/turn-off transients, soft-start, low-inrush turn-on current, 0.1% load and source effect, less than 20 mV rms pard (ripple and noise) and stability of 0.1%. Overvoltage protection is standard on all units below 5 V dc and optional on all others.

CIRCLE NO. 324

Benchtop units meter both volts & amps



Acopian Corp., Easton, PA 18042. (215) 258-5441. \$99 to 190; stock.

K series, a new family of benchtop-mount laboratory power supplies, includes models with voltage ranges from 0-7 to 0-50 V, and with output current ratings to 5 A. Unlike most other power supplies in their price range, even the \$99 models have two meters, so that voltage and current may be monitored simultaneously. The units can be stacked to conserve bench space. Solid top and side surfaces ensure that a stray bit of wire or solder can't fall in and cause a short circuit. The case-work is constructed of gold-finished extruded aluminum. A recessed carrying handle is provided.

CIRCLE NO. 325

Current source offers digital readout



Probex Corp., 999 Commercial St., Palo Alto, CA 94303. (415) 321-1800. \$665; stock.

Model 200A is a combination digital readout/power supply for resistivity measurements of semiconductor material. The unit can be used with all currently available permanent and nonpermanent four-point probes. Featured is a programmable constant-current generator offering pushbutton selection of five current modes: 0.01, 0.1, 1.0, 10.0 and 100.00 mA. Voltage compliance is 100 V min in all ranges except 100 mA, where it is 90-V max. Three dc-voltage ranges from 200 mV to 20-V fs are also included and are selected by pushbutton switches.

CIRCLE NO. 326

Ac source smooths input-line variations

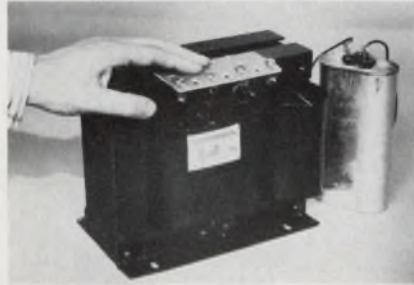

Frequency Technology, Inc., TDC Div., Box 365 Whitcomb Ave., Littleton, MA 01460. (617) 456-3374. Start at \$309 (2 kVA).

Series OC1 stable ac sources are offered for a wide range of nominal ac input and output voltage levels. For example, actual specifications of $\pm 15\%$ line regulation for $\pm 3\%$ output variation means that the OC1 source will handle an actual 102-to-138-V input voltage variation, yet deliver a 116.4-to-123.6-V stabilized output. If input voltage remains constant, but the load changes from half to full, output may vary by as much as 5%.

CIRCLE NO. 327

DIP-like sources deliver regulated power



Reliability, Inc., 5325 Glenmount, Houston, TX 77036. (713) 666-3261. \$3325.

A new series of regulated "V-PAC" dc/dc power sources operates with 5-V input and provides users with regulated positive or negative 3, 5, 9, 12, or 15-V output, depending upon device type. They provide isolation, built-in short-circuit and thermal overload protection as well. Prefixed V5R, the sources offer output voltage tolerance of $\pm 5\%$; output ripple of 100 mV pk-pk max, line regulation of $\pm 0.2\%$; and load regulation of 150 mV, no load to full load. V-PAC sources occupy less than 0.3 cubic inches. Their pins are on standard 0.1-in. centers and fit 24-pin DIP sockets. Or they may be soldered to PC cards.

CIRCLE NO. 328

One of today's
lowest cost
SPDT GP
relays!



Actual Size

...and probably the most compact!

Think of it...these low cost Series 27 miniature GP relays provide low level to 3 amp switching in a 0.526" cube. And they're priced at only \$1.05 each in 1,000-piece lots for 3, 6 and 12 vdc units—slightly more for 24 vdc relays.

Designed for high density PC board mounting on .69" centers, our Series 27 relay weighs only 0.5 oz. and has a 450 mw pick-up sensitivity. (Also available at 180 mw.) Contact rating is 3 amp res @ 28 vdc, 120 vac and contact resistance is 0.10 ohm max.

Small size...small price...big performance. Consider it for appliance controls, industrial process and machine controls. It's ideal for large volume applications because each and every unit is subject to computerized inspection and individualized contact adjustment.

Write for information today!

NORTH AMERICAN PHILIPS CONTROLS CORP.

Frederick, Md 21701 • (301) 663-5141

CIRCLE 281 FOR INFORMATION ONLY
CIRCLE 282 FOR IMMEDIATE NEED

LOGIC SERIES No. 1

WHAT'S A
BI-DI I/O
PORT?

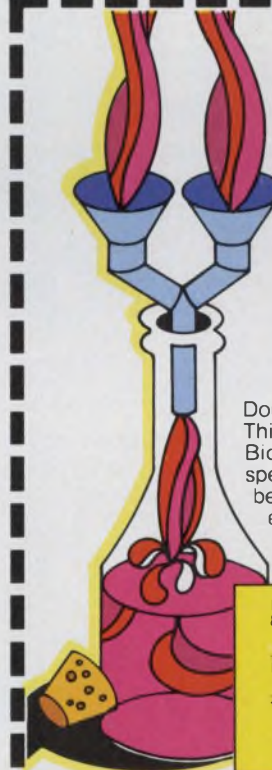

Double value in a single package. This 8-bit latch with 2 sets of Bidirectional I/O's performs high-speed standard interface between processor, bus & peripherals. #8T31 saves 6 parts plus pre-test & manufacturing costs

Rush data sheet on #8T31, your 8-bit Bi-Di I/O Port.

Name _____

Tel. _____ Ext _____
Clip coupon to letterhead

THINK

Signetics

811 E. ARQUES, SUNNYVALE, CALIF. 94086

INFORMATION RETRIEVAL NUMBER 65

POWER SOURCES

15-W class 81 sources offer $\pm 0.2\%$ regulation

Sola Electric, 1717 Busse Rd., Elk Grove Village, IL 60007. (312) 439-2800. \$29 to \$89.50; stock.

A new series of 15-W Class 81 IC-regulated dc power supplies is designed as a low-cost alternative for bench and rack installations. Features include low noise and rip-

ple of 0.1% pk-pk and combined line/load regulation of $\pm 0.2\%$. Automatic short-circuit protection is built in, with automatic return upon removal of the short. Manual adjustments are provided for both current limiting and output voltage. Operating temperatures range from 0 to 50 C without derating, and extend from -20 to 70 C with minor derating. Tempco is 0.03%/°C.

CIRCLE NO. 330

High-voltage sources deliver to 250 W

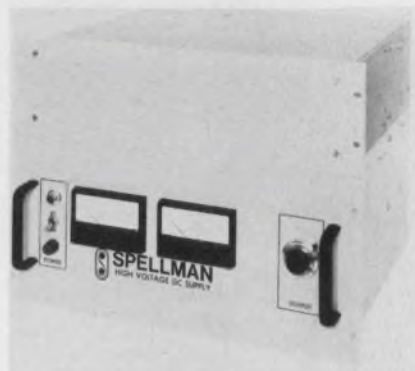

Spellman High-Voltage Electronics, 1930 Adec Ave., Bronx, NY 10469. (212) 671-0300. Start at \$445; 6 wks.

The company's RHR line of rack-mounted, high-voltage power supplies—previously limited in output power to 120 W—is now available with output powers up to 250 W. These higher power models can be selected with maximum output voltage ratings of 5, 10, 15, 20, 30, 40, 50, 60, 80 and 100 kV. The line features 0.01% regulation for both line and load and 0.02% rms ripple. Output polarity can be selected to be either positive, negative, or reversible with respect to ground. All RHR units are overload, short-circuit and arc protected.

CIRCLE NO. 329

Ultra-fast speed and reliability is a new reality for high-current, computer and fast switching power supply applications, brought together by SOLID STATE DEVICES. In fact, nowhere in the semiconductor industry can you find the combined superior performance now offered by EPION and EPITRAN.

a new performance team that introduces true speed and reliability to switching power supply designs.

EPION™ ULTRA-FAST RECOVERY RECTIFIERS

Truly unique, the EPION™ Ion-Implantation Process has enabled mass production of these single-chip rectifiers, in current ratings from 1 to 100 AMPS, eliminating the inherent reliability problems experienced with schottky and diffused multiple-junction devices. Available in popular DO-4, DO-5, TO-3 and TO-66 JEDEC packages, these HSR Series devices provide ultra-fast recovery speeds from 10 to 75 nsec maximum to 100 AMPS and 150 Volts, average forward voltage drop of 450mv maximum*, and -55°C to +200°C storage and Operating Temperature. Units are hermetically sealed, and meet thermal shock requirements of MIL-STD-202, Method 107, not available in competitive devices.

EPITRAN™ HIGH-PERFORMANCE EPITAXIAL POWER TRANSISTORS

Now available in current ranges from 10 to 90 AMPS, and voltages to 375 V. EPITRAN™ Multiple Epitaxial transistors feature improved switching efficiency at high operating frequencies. Faster turn-on 300-600 nsec maximum and turn-off 300-450 nsec maximum and high voltage provides increased safety margins. All devices feature hard-solder construction for thermal fatigue protection. High linear gain across entire current range reduces driver transistor requirements.

The EPITRAN™ Series is available in popular TO-3, TO-61, TO-63, TO-66, TO-111 and TO-114 packages, making SSD's Epitaxial transistors ideal for use in a variety of applications including power supplies, voltage and switching regulators.

Truly, this dynamic product pair offers new performance standards to any applications area where efficiency and reliability are the way you would like to design your power supply. Get the full story today.

*MAX FULL CYCLE AVERAGE FORWARD VOLTAGE DROP @ $I_T = 55^\circ\text{C}$



SOLID STATE DEVICES, INC.

14830 Valley View Avenue
La Mirada, California 90638
Telephone (213) 921-9660/TWX 910-583-4807

Sources let you vary outputs from 0 to 30 V

Power/Mate Corp., 514 S. River St., Hackensack, NJ 07601. (201) 343-6294. Start at \$110; stock.

SUPER/UNI series replaces the company's older UNI series of power supplies. The series consist of nine models, each of which may be operated at any voltage from zero to 30 V at currents to 36 A. Thus the nine units literally replace thousands of more-expensive narrow-range slot supplies. The units mount on any of three sides and meet MIL spec environmental requirements. They are also UL recognized, short-circuit proof and contain built-in solid state overload protection. Line and load regulation are better than $\pm 0.05\%$, with ripple less than 250 μV .

CIRCLE NO. 393

INSTRUMENTATION

Thermocouple simulator permits accurate setting



Victory Engineering Corp., Victory Rd., Springfield, NJ 07081. (201) 379-5900. \$299; 4 to 6 wk.

The Model 20 thermocouple simulator not only checks the output from thermocouples or similar sources but also generates its own precision voltage to simulate these sources. The portable instrument is powered by rechargeable batteries or can be plugged into a 115-V-ac line. The digital dial maximizes resolution and minimizes reading error. Built-in automatic cold junction compensation eliminates panel complexity and constant manual temperature correction. Dimensions without cover are 5 in. high, 7.5 in. long and 5.5 in. wide. The unit is available in either °C or °F for all standard thermocouples.

CIRCLE NO. 331

Minis join instruments on standard bus

Hewlett-Packard, 1501 Page Mill Rd., Palo Alto, CA 94304. (415) 493-1501. \$1535; 6-8 wks.

With a plug-in card, Model 59310A, any of the company's 2100 or 21MX minicomputers may be hardware-interfaced to instruments that are programmable via the HP Interface Bus. The HP-IB is HP's implementation of IEEE Standard 488-1975, "Digital Interface for Programmable Instrumentation." All minicomputers of the HP 2100 series, and the new semiconductor-memory 21MX series, have a number of powered input-output channels, each one able to accept a plug-in PC interface board. A variety of these is offered, so the HP minis interface readily to many different peripheral devices.

CIRCLE NO. 332

Built to amplify, no matter what the impedance.



The DC-300A power amplifier drives low impedance loads at full rated power as long as needed. Dependable AC or DC power for servo motors or force transducers.

Rated power 150 watts per channel (600 watts balanced single channel) into 8 ohms. Maximum power

depends on exact load impedance and operation of thermal overload protection. Essentially flat frequency and phase response from DC to 20KHz. Not affected by shorted, mismatched or open loads. Will not self-destruct under any conditions of use.

Sounds expensive? For three years your total cost is the original list price of \$799.00. Crown guarantees that the DC-300A will work as specified during that time or we'll fix it free—and pay shipping costs.

Interested? Send for spec sheet.



CROWN INTERNATIONAL

Industrial Products Division
1718 W. Mishawaka Road, Elkhart, IN 46514

INFORMATION RETRIEVAL NUMBER 69

Hit Switcher



For the highest efficiency in your power switching circuits the fast switching 2N6340 series of STC Power Transistors features a max. fall time of 250 ns. at 10 Amps. with VCEO sus. up to 150 Volts.

Whatever your power transistor needs you can get the *RIGHT* one.



SILICON TRANSISTOR CORP. ... THE POWER SOURCE

KATRINA ROAD, CHELMSFORD, MA 01834 (617) 256-3321

Get complete data on these and other STC Power Transistors

INFORMATION RETRIEVAL NUMBER 70

ALLISON

'OPTO-ELECTRIC'
The BEST...the ULTIMATE
of ALL Ignition Systems!



Never wears out or needs any Maintenance!



gives you Maximum Power
with continuous PEAK PERFORMANCE

...while reducing Maintenance
and Operating Costs!



★ The Allison OPTO-ELECTRIC System eliminates the Points and Condenser, replacing them with an OPTO-ELECTRONIC TRIGGER, using a Light-Emitting Diode and Photo Transistor. The System operates on a beam of Light. As there are NO moving parts in rubbing contact, Friction-wear is completely eliminated. Timing adjustments are PERMANENT.

● Gives 40-Times more Timing accuracy than ANY system using Mechanical Breaker-Points! UNLIMITED RPM!
● Electronically-Controlled DWELL automatically supplies HIGHEST Performance at both Low and High speeds. Spark strength does not fall off at high RPM. POSITIVE SPARK helps eliminate "Misfire" for faster acceleration and improved Engine Performance. Sparkplugs LAST 3 to 10-Times LONGER.

● Easier Starting under any condition! Smoother running... (NO TIMING FLUCTUATION as with Magnetic Impulse Units). All SOLID-STATE Components UNAFFECTED By Temperature, Moisture, or Vibration! Only Highest grade materials used. Guarantees you Solid, Dependable Performance!

● PERFECT TIMING INCREASES Engine Efficiency and Gas Mileage. SAVES Precious Fuel! Allison gives you MAXIMUM Engine Efficiency 100% of the Time... and that's the name of the game for the BEST in GAS MILEAGE AND ECONOMY.

★ Perfect Timing and Dwell never change.

● Pays for itself! Eliminates ignition Tune-Ups forever!
● "INFINITE LIFE". Once installed, Never needs replacing!



★ PROVEN RELIABILITY!
Each Unit Tested to 15,000 RPM.

● Road and Race Proven.
(Opto-Electric Systems won at INDY Two years in a row!)

★ You CAN install the ALLISON System in ALL the U.S. made & Foreign Cars! (4, 6, or 8-Cylinder).

"EASIEST-TO-INSTALL" UNIT ON THE MARKET.
(Not necessary to dismantle Distributor as with other systems)

★ If you want the BEST...and SAVE! This is IT!

ORDER with CONFIDENCE...
SATISFACTION GUARANTEED

10-YEAR FACTORY WARRANTY!
(Free Repair or Replacement)

● Send Check or M.O.

State Make, Year, Engine Size. (Call Res. add Tax)

★ (So New...it's Sold ONLY FROM FACTORY DIRECT).

● You may use your MASTER CHARGE or BANKAMERICARD.
Send us (1) Your Number, (2) Interbank No., (3) Exp. Date.

★ Before buying any other Type ignition system.

Send Postcard for our FREE BROCHURE.

★ If you have already installed a C-D ignition system,
Modernize and Increase its Efficiency...

CONVERT YOUR "C-D" UNIT TO BREAKERLESS!
Opto-Electric "TRIGGER UNIT"...Only \$34.95

● Our BEST Salesmen are the users of our ALLISON System!



America's Oldest and Largest Mfg. of
Opto-Electronic Ignition Systems.

ALLISON
AUTOMOTIVE COMPANY

1267-F, East EDNA PL., COVINA, CAL. 91722

INSTRUMENTATION 4-1/2-digit DPM claims mini title



Datel Systems, 1020 Turnpike St.,
Canton, MA 02021. (617) 828-
8000. \$219; stock-4 wks.

Said to be the world's smallest 4-1/2-digit, 5-V-powered DPM, the DM-4000 is shorter and nearly 1-in. narrower than most comparable units. Outstanding features include a 0.43-in.-high red LED display, ratiometric operation and optional full-parallel BCD output. Full-scale input is ± 1.9999 V and 120-dB CMR rejection is achieved over the ± 300 -V common-mode range with opto-isolation. Other specs include automatic zero correction and 60-dB NMR. Input impedance exceeds 100 M Ω and input bias current is 100 pA. Accuracy of the DM-4000 is $\pm 0.01\%$ of reading ± 1 digit.

CIRCLE NO. 333

Pulse gen emphasizes clean waveforms

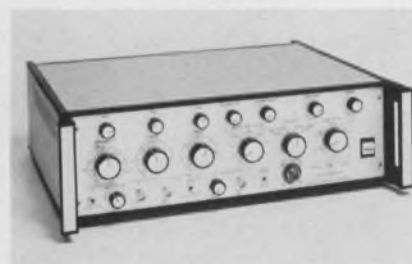

E-H Research Laboratories, 515
11th St., Box 1289, Oakland, CA
94604. (415) 834-3030. \$2195.

Clean waveforms are the most important feature of the Model 137A pulse generator, with distortion of less than 5% peak-to-peak. Other key specs include a rep rate of 10 Hz to 125 MHz, rise and fall time variable from less than 2 ns to more than 160 μ s, amplitude of ± 5 V into 50 Ω , ± 10 V into an open circuit.

CIRCLE NO. 334

Tester self-programs, tests boards in 6 s



Faultfinders, Inc., 15 Avis Dr.,
Latham, NY 12110. (518) 783-
7786. Under \$20,000.

SHORTFINDER FF202 is a self-programming system that tests loaded PC boards, isolates shorts and opens, and prints out data for circuit repair. Programs are derived from a known good board and may be stored in a mag tape cassette. Microprocessor-controlled, the FF202 can generate a test program for a typical board in 6 m and test it in 6 s. The unit can also check the integrity of bare PC boards, testing for shorts, continuity, opens and leakage between circuit paths.

CIRCLE NO. 335

Sweeper covers 0.1 to 120 MHz in one band



Telonic Altair, 2825 Laguna Canyon Rd., Laguna Beach, CA 92652.
(714) 494-9401. From \$1075; 6 wks.

Model 1202A sweep generator covers a full 100-kHz to 120-MHz range in a single band. Attenuation at 50- Ω impedance is 100 dB in 1-dB steps and 80 dB at 75 Ω . The unit combines a complete sweep oscillator system with accurate output attenuators, and up to seven crystal-controlled frequency markers, single or harmonic, in a compact housing. The instrument measures only 7 \times 9 \times 13 in. Flatness is ± 0.25 dB.

CIRCLE NO. 336

The designer's dream memory.

SOS
RAMs
are here.

From
Solid State
Scientific.

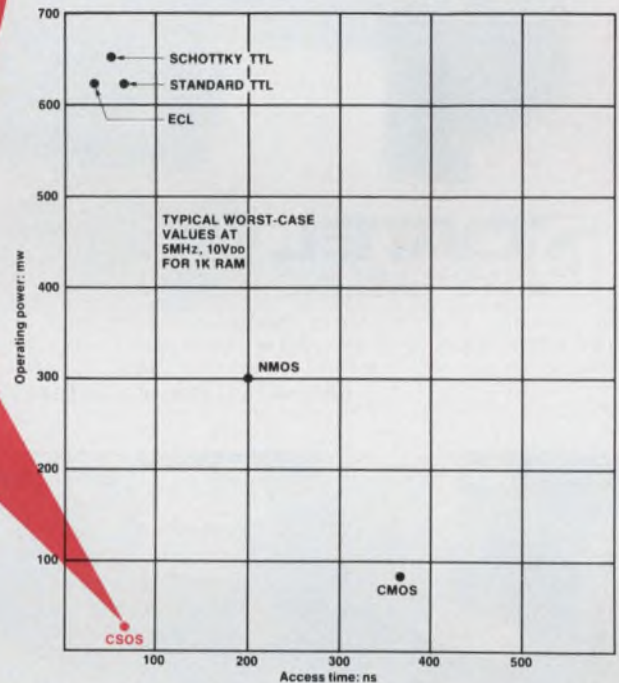

Speeds as fast as Schottky TTL.

Access time is less than 100 nsec. Typical values from our production measure 50-80 nsec.

Low drain. Typical operating power is 5 mw. No more need to trade-off power for speed. Battery back-up needs only two volts to store data.

Fully static. No need for refresh circuitry.

Attractive prices. Our manufacturing process, developed specifically for CSOS, has high yield and fewer steps than bulk silicon processing, so we can offer lower prices.

First of our CSOS RAM line, now in volume production, is a 256 bit device that is pin compatible with comparable bipolar and n-channel MOS RAMs.

Soon to come are 1024 bit RAMs, both 1024 x 1 and 256 x 4. Ask us for prices and specs. You'll be pleasantly surprised.

And look for future CSOS developments from Solid State Scientific: more RAMs, quad switches, and the most advanced microprocessors.



SOLID STATE SCIENTIFIC INC.
Montgomeryville, Pa. 18936/(215) 855-8400/TWX 510-661-7267

INFORMATION RETRIEVAL NUMBER 72

Imagine, a low cost, OEM - reliable Panel Mounting Thermal Printer... Better still, install it!

Mount this little 2.3LB, 7 column printer on your panel right alongside your digital panel meter or any digital instrument. The DPP-7 printer accepts BCD data directly from your TTL source (no extra electronics are needed). Only 2 moving parts are used, assuring OEM reliability. The thermal printhead does away with ink, ribbons, printwheels and hammers. Power the DPP-7 from AC or +5V.



DATTEL
SYSTEMS, INC.

DPP-7 Features

- 6 Digits and sign up to 3 lines/second
- Accepts full parallel BCD TTL levels
- Positive or negative true selectable inputs
- Self-cleaning thermal printing uses no ink or hammers
- \$475 (singles)

COVERED BY
GSA CONTRACT
NO. GS-00S-27959

Send for your
FREE Brochure

1020 TURNPIKE STREET, CANTON, MASSACHUSETTS 02021 TELEPHONE (617) 828-8000
● SANTA ANA, CALIF. (714) 835-2751 ● SANTA ANA, CALIF. (LA EXCHANGE) (213) 933-7256
● SUNNYVALE, CALIF. (408) 733-2424

INFORMATION RETRIEVAL NUMBER 73

COMPONENTS

Gear motor features oil or grease-filled case

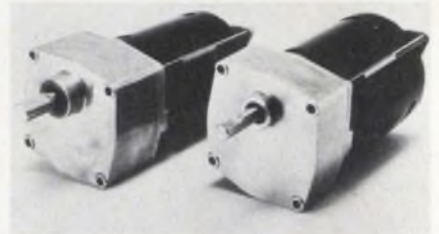

Molon Motor & Coil Corp., 3737 Industrial Ave., Rolling Meadows, IL 60008. (312) 259-8700.

A heavy-duty 1/10 or 1/15-hp reversible-gear motor, Model EM5, is 3-3/8-in. square by 6-in. long with a parallel-shaft design to make it interchangeable with existing Molon lines. The gear case is available in two versions—oil filled or grease filled. The oil-lubricated version, recommended for high-torque loads, uses heavy-duty needle-roller output bearings, wide-faced hardened-steel gears and has a 1/2-in. shaft diameter. Output speeds from 8 to 300 rpm and torques through 75 lb-in. are available. The grease-filled version is recommended for light output loads. The case is grease lubricated and the unit has porous-bronze bearings and a 3/8-in. diameter output shaft. Output speeds are from 70 to 300 rpm.

CIRCLE NO. 337

WW resistor/fuse safe with 1000 times overload

TRW Inc., 401 N. Broad St., Philadelphia, PA 19108. (215) 922-8900. \$0.15: 5% tolerance, \$0.115: 10% (100 up); stock.

Wirewound resistor, the BW-20F, has predictable overload fusing characteristics and remains flame-proof under fault conditions up to 1000-times rated power. Maximum rated voltage is 1000 V. The new resistor has a 1-W rating in a 1/2-W size and is available in 0.1-Ω to 1-kΩ resistance values with tolerances of ±5% and ±10%. It offers the circuit designer savings by elimination of the need to use both resistors and fuses, and in some cases also thermistors or diodes.

CIRCLE NO. 338

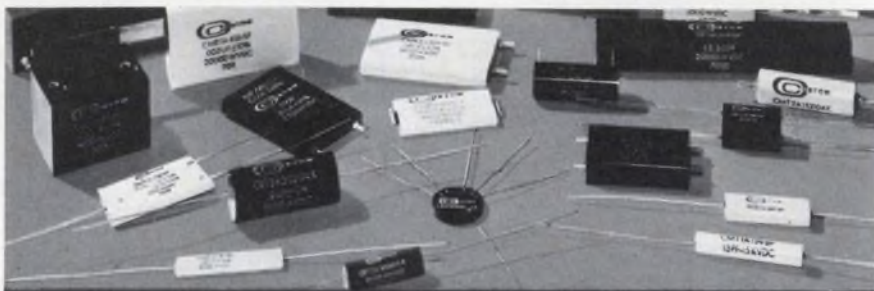

Long on Reliability BUT Short on Delivery

Mica Capacitors by Custom Electronics

Custom can meet your capacitor needs better, because each process in our capacitor production begins and ends with quality control to avoid failure in the field. Let us show you how we can fill your requirements.

Write for FREE descriptive TechniTip, includes sample of mica dielectric.



Send for FREE Product Brochures
CUSTOM ELECTRONICS, INC.
4 Browne Street Oneonta, N.Y. 13820
PH: (607) 432-3880 TWX: 510-241-8292

Check these specifications on typical units —

CMR — Wrap & Fill Type				Typical 1-10 ea. Price
Cap & Tol	WVDC	L x W x T		
0.1 μf ± 10%	3000	2.562" x 1.620" x 0.270"		\$ 9.25
CEM — Epoxy Housed Type				Typical 1-10 ea. Price
Cap & Tol	WVDC	L x W x T		
0.2 μf ± 10%	8000	2.812" x 2.0" x 0.469"		\$11.85
CEM — Epoxy Molded Type				Typical 1-10 ea. Price
Cap & Tol	WVDC	L x W x T		
0.5 μf ± 10%	2000	2.0" x 0.812" x 0.562"		\$14.00

INFORMATION RETRIEVAL NUMBER 74

Semiprecision resistors operate at 200 C



American Components, Inc., RPC Div., Eighth Avenue at Harry St., Conshohocken, PA 19428. (215) 825-6200. \$0.28 to \$1.50; stock to 8 wks.

A family of semiprecision resistors for high-temperature operation is noninsulated and can operate in standard and inert atmospheres, and also in oil and vacuum applications. Construction is completely inorganic, and there is no outgassing. The resistors, ACI Type HVW, have ratings of 0.5 through 2.6 W at 200 C. Deratings are to 350 C. The voltage range is 3.5 to 15.0 kV, depending on resistor type. Standard tolerance is 5%, and tighter tolerances are available. Resistance range coverage is from 1 k Ω to 1000 M Ω . Resistor lengths vary from 0.6 to 2.075 in. and diameters from 0.14 to 0.275 in.

CIRCLE NO. 339

DIP resistor networks in ceramic package



Allen-Bradley, 1201 S. Second St., Milwaukee, WI 53204. (414) 671-2000. Stock to 6 wks.

A new ceramic package for thick-film DIP resistor networks provides higher power ratings and larger resistance values than previously available. In addition, external solder joints permit easy visual inspection. These I-DIP networks can be factory-adjusted to a predetermined tolerance or designed for functional calibration by the user. The new package also provides a color-coded identification stripe—blue for 14-pin, green for 16—for quick package orientation. A-B distributors offer 347 standard networks, which include six new circuit configurations, an expanded resistance range and pull-up/pull-down termination networks from 22 Ω to 100 k Ω .

CIRCLE NO. 340

V3 case houses Hall-effect switch



Micro Switch, 11 W. Spring St., Freeport, IL 61032. (815) 232-1122. \$1.50 (OEM qty).

Micro Switch's new Hall-effect XL line of solid-state miniature switches is compatible with the firm's traditional V3 switch configuration. A 0.050-in. IC is actuated by a plunger-driven magnet. There are no contacts and the output is bounce free. The circuit allows the use of an unregulated 6-to-16-V-dc power supply. Temperature range for the new line is from -40 to 100 C. The XL is available with either current-sinking or current-sourcing outputs, and it can be used directly with most electronic circuits, according to Micro Switch.

CIRCLE NO. 341

THE INTERCHANGEABLES

MAGNETEC'S "INDUSTRY STANDARD" SOLENOIDS

Here is a series of D-Frame solenoids completely interchangeable with industry recognized standard sizes. These solid performers are priced to be real COST SAVERS.

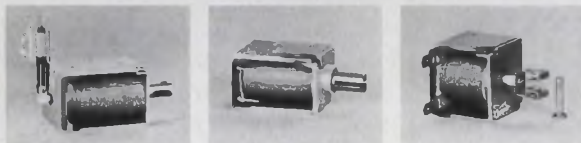

G11

G22

G28

Standard options include choice of clevis, push or pull, and plunger operated switch.

Available also are hundreds of tooled variations of the standards with which Magnetec can satisfy the majority of those "special requirements".

FOR LOW COST SOLUTIONS, CONSULT THE COMPANY WITH TOTAL CAPABILITY . . . CONSULT MAGNETEC

Write for a Free Catalog Today



MAGNETEC CORP.

96 Granby St., Bloomfield, Conn. 06002
Tel: (203) 243-8941 TWX: HIGINC 710-420-0592

A Subsidiary of HI-G INC



INFORMATION RETRIEVAL NUMBER 75

ELECTRONIC DESIGN 20, September 27, 1975

MEMORY SERIES No. 5

WE MAKE ONE FAST RAM DO THE JOB OF NINE

Why string up nine 64-bit RAMs, when a single 64x9 package does the same job—at 45ns. Savings? Obvious: less parts to buy, less power to burn. Quantity stock available now. Ask for high-speed #82S09.



THINK **Signetics**

311 E. ARQUES, SUNNYVALE, CALIF. 94086

INFORMATION RETRIEVAL NUMBER 76

117

High Efficiency REGULATORS

MAGNETIC AMPLIFIER VS. SWITCHING TRANSISTOR



100 W, 60 Hz
TR-Switching
Transistor
Power Supply

100 W, 25 KHz
Inverter-Mag Amp
Regulated
Power Supply

A gloves off comparison.

A Transistor-Rectifier followed by a Switching Transistor Regulator, compared with a 25 KHz Inverter followed by a Magnetic Amplifier Regulator. The following parameters are for 100 watt units, each operating from 115 V, 60 Hz with reasonable conductive cooling, fully adjustable, regulated and protected.

Parameters	TR-Switcher	Inverter Mag Amp
Density (W/in ³)	0.4	10
Inputs	AC	AC or DC
Weight (lbs)	6.0	1.5
Efficiency (%)	80	82
Regulation (%)	0.1	0.1
Thermal Time Constant (of power controlling element)	20 μ s	20 sec.
Overvoltage Failure Modes*	13	1
Auto Recovery (from overvoltage)	No	Inherent

*Number of likely faults which could cause output to rise 20%.

Convinced that the Mag Amp Power Supply is a better way to go? Here's our clincher. Arnold Magnetics offers an exclusive "Design-As-You-Order" specification system. You choose the input/output configuration for your specific need from off-the-shelf sub-modules. There are over 1200 configurations . . . operating from 12 VDC to 230 VAC, with up to 6 isolated outputs. **Send for our Catalog and "Design-As-You-Order" Specification Form today.**



ARNOLD MAGNETICS CORPORATION

11520 W. Jefferson Blvd.
Culver City, Ca. 90230 • (213) 870-7014

DATA PROCESSING

Floppy-disc storage imitates paper tape



Tri-Data Corp., 800 Maude Ave., Mountain View, CA 94043. (415) 969-3700. See text, stock.

The FlexiFile 10 is a floppy-disc system that mimics paper tape. Plug-compatible with most current readers and punches, the FlexiFile 10 reduces the time required to load long programs and offers random access to any track on the disc. The unit has both read and write capability, thus enabling replacement of both paper-tape reader and punch with a common system. Selection of read or write operation is from the front panel. The flexible disc used is a Memorex FD V or equivalent with a capacity of 192 bytes/sector, 3072 bytes/track (16 sectors) and 98,304 bytes disc (32 tracks). The transfer rate is 1 to 40 kbytes/s asynchronous at 100 rpm.

CIRCLE NO. 342

Processor faster than microprocessor

Display & Decision Systems, Ltd., 80 Galaxy Blvd, Unit 11, Rexdale, Toronto, Canada M9W 4Y8. (416) 678-7525. \$880 (unit qty).

The Extra-80 is a new processor compatible with Intel's 8080 but it has a higher speed and more instructions. The approximate speed of an 8 \times 8-bit multiply is 3 μ s. This is approximately 40-times faster than the 8080. The new processor uses LSI Schottky bipolar 3000 logic and is available on an 8 \times 9-in. board with an 86-pin connector. Additional features include a 5-V supply, three-state outputs, a 10-TTL load capability and TTL-compatible inputs. User specified op codes available at a nominal fee.

CIRCLE NO. 343

Semi ROM is nonvolatile and easily altered

Plessey Microsystems, 1674 McGaw Ave., Santa Ana, CA 92705. (714) 540-9945. See text; 30 days.

More efficient than ultraviolet-erasable PROMs, the PM-1000 is designed for applications that require frequent or periodic program changes. The PM-1000 uses MNOS storage devices and achieves a write time of 11 ms, read time of 3.5 μ s and access time of 2.0 μ s. Capacity is expandable in increments of 256 \times 4 to 1024 \times 16. Memory data are erasable in 100 ms and can be rewritten without removal of the memory card from the user's system. The PM-1000 provides unpowered data retention for up to 10 years. Sold in two basic configurations, the prototype version is equipped with programming aids, and the bare version is for volume applications. A 1 k \times 16 unit sells for \$1000 in quantity.

CIRCLE NO. 344

CPU wired on board for quick systems design

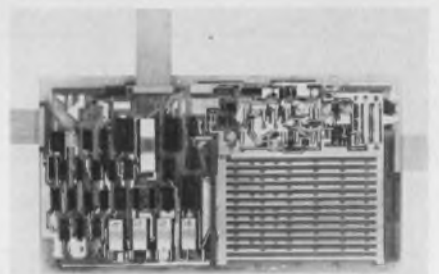

Mycro-Tek, Suite 214, 6631 E. Kellogg, Wichita, KS 67207. (316) 686-3311. See text.

A general-purpose microcomputer on a single board costs less than \$600 in quantity. The board has a large wrapped-wire section to allow tailoring to a wide range of microcomputer applications. Called the MT 8080 PB, the single board is built around an Intel 8080 CPU and includes clock generator, power inverter, bus interface, timing logic and provisions for 1k \times 8 PROM memory. The over-all size of the board is 7-1/2 \times 13-1/2 in., and it is Augat frame-compatible. An on-card power inverter allows the system to be operated from a single 5-V power source to reduce system costs further.

CIRCLE NO. 345

Master/slave acquisition system is local & remote



Quantalog, 42 Enterprise Dr., Ann Arbor, MI 48106. (313) 769-4936. From \$5000; 15 to 60 days.

Model 1740/C is a data-acquisition instrument capable of local or remote acquisition, processing and storage. A control station manages 16 channels plus any number of slaves; total capacity is 256 channels. The control uses programmable MOS memory and cassette recorder storage. It contains an a/d converter and 16-channel multiplexer. Slaves report to the master via 8-bit ASCII data by direct wire link, radio or phone line.

CIRCLE NO. 346

CMOS memory includes standby battery supply

Monolithic Systems Corp., 14 Inverness Drive East, Englewood, CO 80110. \$1160 (unit quantity); 4 wks.

Monostore IX/Planar is a CMOS nonvolatile memory system with a battery backup. The system is designed around a 1024×1 CMOS static RAM. A single board provides up to $4\text{-k} \times 8\text{-bit}$ word capacity, and several boards can be combined for 64-k , 8-bit words on the same bus. Access and cycle time are 450 ns, and input and output levels are TTL-compatible. Each memory board includes timing, control, module decode and address register, input and output data register, backup battery and memory array. A single +5-V-dc supply powers the board. Standby power of +3.25 V dc at $120 \mu\text{A}$ is supplied by the battery. The backup battery has a 450 mAh capacity and is rechargeable at a rate of 45 mA/hr. Board dimensions are 7.475×10.78 in. and total weight is 0.75 lb.

CIRCLE NO. 347

Smart calculator has low price tag



Tektronix, P.O. Box 500, Beaverton, OR 97005. (503) 644-0161. \$2495; stock.

The E31 calculator retains many of its predecessor's features but costs \$355 less. Like the basic 31, it has 512 program steps and 74 data registers. The memory of the E31 can be expanded to 8192 program steps and 256 data registers (Option 10), or to 2048 program steps and 1000 data registers (Option 8), or a combination of both. A magnetic tape cartridge is provided for programs or data, adding even more memory without detracting from the machine's internal memory. The calculator has user-definable overlays and 24 user-defined keys for special programs.

CIRCLE NO. 348

MINIATURE PC TOGGLE



MTA-PC SERIES

Alcoswitch Green Series PC Toggle switches are the best in the industry. Features include: Molded-in terminals to prevent contamination; gold flash on terminals; no-tear shoulder and many more, all at no added cost. Available as right angle mount; with or without threaded bushing.

Call (617) 685-4371 for more detailed information and prices.

INFORMATION RETRIEVAL NUMBER 78

RIGHT ANGLE PC TOGGLE

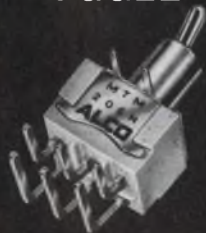

MTM-RA SERIES

Our miniature RIGHT ANGLE PC TOGGLE switches may cost a little more, only because they are the best in the industry! Available as 1 or 2 pole. Most important are our technical features, of which there are too many to list in this small ad.

Call (617) 685-4371 to discover why our competitors charge extra for our standard features.

INFORMATION RETRIEVAL NUMBER 79

ALCO ELECTRONIC PRODUCTS, INC.
1551 OSGOOD STREET, NORTH ANDOVER, MA 01845 U.S.A.

TEL: (617) 685-4371 FAX: 710 362-0552

A SUBSIDIARY OF **AVGAT** INC.

ANALOG SERIES No. 1

USE DMOS FETS FOR CLEANEST ANALOG SWITCHING.

DMOS, the key to transient-free switching. DMOS analog switches boost state-of-the-art performance with lowest parasitic capacitances, low on-resistance (30Ω) and high speed (1.5ns).

SD210 series for singles;
SD5000 for quads.

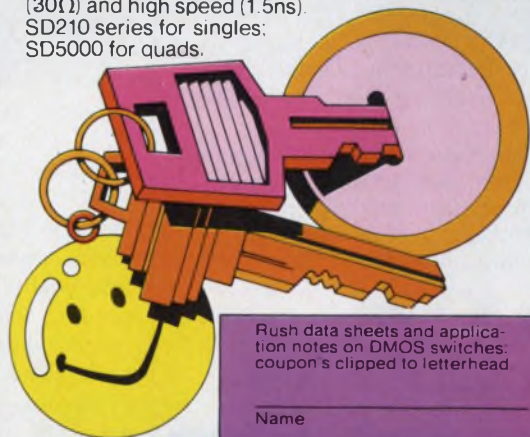

Rush data sheets and application notes on DMOS switches. coupon s clipped to letterhead

Name _____

Tel. _____

Ext _____

THINK

Signetics

311 E. AROQUES SUNNYVALE, CALIF. 94086

INFORMATION RETRIEVAL NUMBER 80

1.5 μ sec

total conversion time

8 Bit A/D



Micro Networks MN5100 is the industry's first ultra high speed A/D in a dip.

The MN5100 features:

- 9 Selectable Input Analog Ranges.
- $\pm 1/2$ LSB Linearity (0 to 70C).
- Hermetic Dual-in-Line Package.
- Military Reliability and Construction.
- 0.6 μ sec Conversion Time for 5 Bits.
- Low Cost.

The combined breakthrough in speed performance, and packaging results in cost-space and reliability improvements for military, avionics and communications equipment.

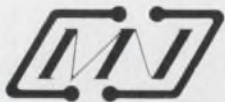

For complete data write or call—
Jerry Flynn
Tel. 617 852-5400.

MICRO NETWORKS CORPORATION

324 Clark Street, Worcester, MA. 01606

INFORMATION RETRIEVAL NUMBER 81

120

INTEGRATED CIRCUITS

CMOS driver/converter handles 4 channels

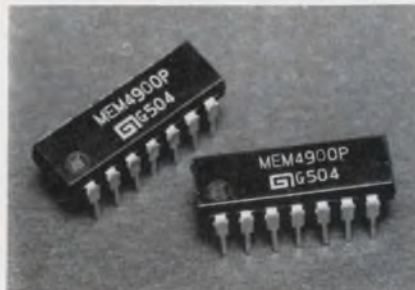

General Instrument Corp., 600 W. John St., Hicksville, NY 11802. (516) 733-3036. \$1.90 (1000).

The MEM 4900 CMOS four-channel driver and bidirectional voltage level-converter features TTL compatibility and provides logic operations via a "chip enable" control. Output-signal swings up to 15-V pk can be generated by input amplitudes of 0 to 3 V. Other features include quiescent power of typically 2.5 μ W, output capacitance of 8 pF, propagation delay of 180 ns and response to 5 MHz.

CIRCLE NO. 349

Program this logic array in the field



Intersil Inc., 10900 N. Tantau Ave., Cupertino, CA 95014. (408) 257-5450. \$25.00 (100-999).

A field-programmable logic array, the IM5200, has 14 inputs and eight outputs. The electrically programmable array has a total of 48 product terms, provides a complexity of more than 480 four-input logic gates and uses the company's avalanche-induced migration process. The IC comes in a 24-pin Cerdip and is pin compatible with the 7576 mask-programmable logic array. The new FPLA uses a single 5-V supply. Typical propagation delay is 65 ns.

CIRCLE NO. 350

MNOS ROMs boost board densities

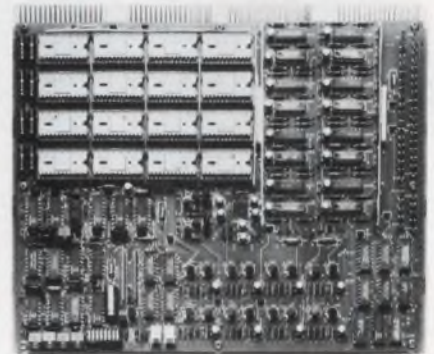

Plessey Microsystems Inc., 1674 McGaw Ave., Santa Ana, CA 92705. (714) 540-9945.

A nonvolatile, electrically alterable ROM, the PM-1000, permits storage capacities in increments of 256×4 -bits up to 1024×16 bits on a single 8×10 -in. card. Using MNOS technology, the PM-1000 has a write time of 11 ms, a read time of 3.5 μ s and an access time of 2.0 μ s. Memory data are erasable in 100 ms and can be rewritten without removing the memory card from the system. The PM-1000 provides unpowered data retention for up to 10 years.

CIRCLE NO. 351

Darlington IC delivers 3 A

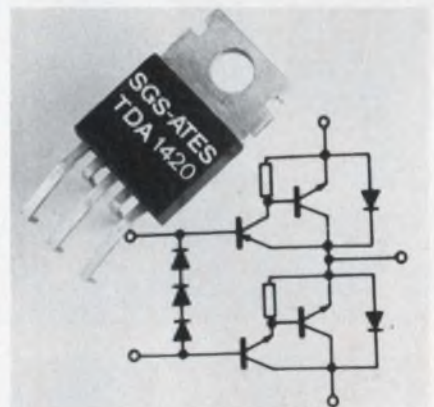

SGS-ATES Semiconductor Corp., 435 Newtonville Ave., Newtonville, MA 02160. (617) 969-1610. \$1.60 to \$2.00 (100 up).

A quasi-complementary Darlington pair, the TDA1420, comes with associated biasing system in a Pentawatt—five lead TO-220—package. Each Darlington can deliver a current in excess of 3 A and can withstand a supply voltage of 44 V. Also available is a 36-V version, the TDA1410.

CIRCLE NO. 352

MICROWAVES & LASERS

0.1-to-1-GHz linear amp delivers 6-W



Microwave Power Devices Inc.,
Adams Court, Plainview, NY
11803. (516) 433-1400.

The Model LWA110-6, a class-A power amplifier, operates over the frequency range of 100 to 1000 MHz with a 900-MHz bandwidth, and it provides a power output of 6 W at 1-dB compression and saturated power output of 10 W. Other features include a gain of 46 dB, harmonics of -20 dB minimum, intercept point of +48 dBm and gain flatness of ± 1 dB. The unit has a 9-dB noise figure, and it operates from a 24-V supply, drawing 4.5 A.

CIRCLE NO. 353

Rf front end aims for compact radars



Engelmann Microwave Co., Skyline Dr., Montville, NJ 07045.
(201) 334-5700.

The Model AY-93 rf front end for collision-avoidance applications contains three microstrip boards on Duroid and a cavity-type oscillator. The unit's specifications include an input frequency of 1607 MHz and output frequency of 60 MHz. Gain is 7 dB minimum and noise figure, with one antenna port terminated, is 12.5 dB maximum. LO frequency is 1547 MHz ± 2 MHz and image reradiation is -35 dBm. The unit lists a transmitter power of 1 kW pk.

CIRCLE NO. 354

Low Cost DC-DC Converters 10 to 19 Watts

For powering:

- Portable instrumentation
- U.P.S. systems*
- Railroad signaling equipment
- Automotive testing systems
- Aircraft on-board electronic systems
- Computer-controlled heavy equipment
- Oil and land surveying equipment

Powercube's second generation high-reliability, low-cost DC to DC converters are available now in off-the-shelf Cirkitblock® modules.

Like all Powercube products, our new DC-DC converters offer great flexibility in custom power module configurations with total output power from 10 to 19 watts. You can specify up to four isolated, regulated, short circuit and overvoltage protected outputs and a DC-AC inverter input, all in one encapsulated 2" x 2" x 1" package weighing six ounces at most!

Ruggedly constructed Powercube modules assure unmatched reliability in hostile environments from -20 to +85°C. Outputs to meet your requirements are available for all standard battery input voltages, all for less than it would cost you to make them yourselves. Request your free power module application handbook today.

Prices range from \$75 to \$150 in small quantities.

*Uninterruptible power systems.

Typical Powercube DC to DC Converter

+15 V at .3 amps**
+5 V at 1 amp
+5 V at 1 amp
24-32 V input**

**Other input/output voltages available.



POWERCUBE CORPORATION
214 CALVARY STREET, WALTHAM, MASS. 02154 (617) 891-1830
SUBSIDIARY OF UNITRODE CORPORATION

INFORMATION RETRIEVAL NUMBER 82

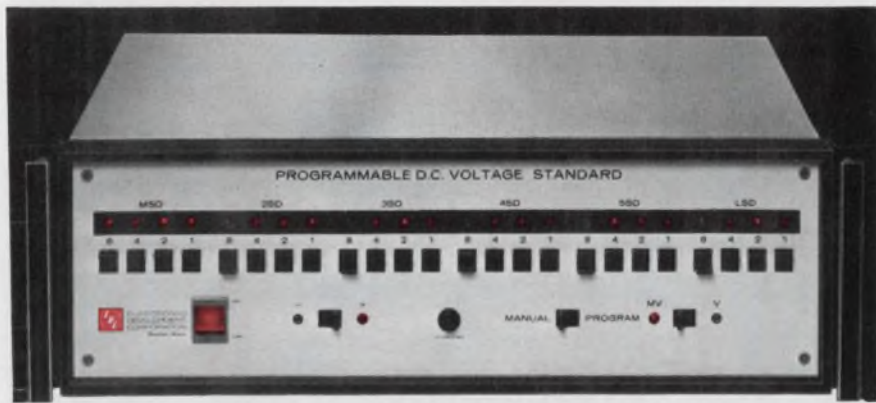

programmable microvolts for \$1,485

The EDC third generation 501 H has:

- Speed:** 50 μ s switching and settling time
- Ranges:** 100 mV, 10 V, 100 V, 200 V DC
- Resolution:** 1 ppm to steps of 0.1 μ V
- Accuracy:** \pm 0.005% of programmed value
- Programming:** TTL, BCD 8-4-2-1; other codes available including binary and ASCII
- Options:** Added resolution, ranging, CMOS compatibility
- Accessories (field installable, plug-in):** Serial-to-parallel converter, memory register, opto-isolators, ranging amplifier

For complete specs and prices on the 501 H and other EDC calibrators and standards, circle reader service number. To evaluate the 501 H in your application call Bob Ross at 617-268-9696.



INFORMATION RETRIEVAL NUMBER 67

DISCRETE SEMICONDUCTORS

Low noise FET designed for transducers

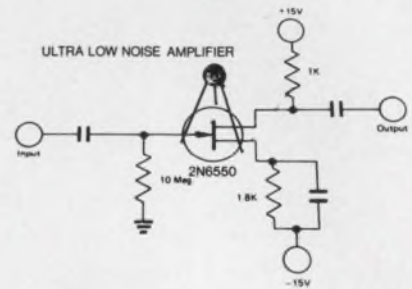

Teledyne Crystals, 147 Sherman St., Cambridge, MA 02140. (617) 491-1670. \$10 (100-up); stock.

The 2N6550 is an ultra-low-noise n-channel JFET. It is designed for use at the front end of low frequency amplifiers and in transducer applications. The device has a noise figure of only 2 nV/ $\sqrt{\text{Hz}}$ at 1 kHz, and has an I_{DSS} that can span 10 to 250 mA.

CIRCLE NO. 394

Schottky diodes cover 100 MHz through X-band

Microwave Associates, South Ave., Burlington, MA 01803. (617) 272-3000. From \$9.23 (100-up); 4 to 6 wk.

Two series of broadband Schottky diodes in stripline packages are designed for use in MIC, stripline and microstrip—for frequencies from 100 MHz through X-band. These diodes, which are also available as matched pairs, have good conversion efficiency. The MA-40060 series is for up-converter applications; the MR-40080 series, for modulator use. The miniature stripline package (MA Style 137) is plastic coated to protect the diode from shock and abrasion. Its gold plated copper leads provide transmission to the diode, which is in series with the line. The leads can also be soldered per MIL-STD-202, method 208, with a maximum solder temperature of 230 C for 5 s. The package has a capacitance of 0.05 pF. All models are rated for 100 mW rf cw power, and 4 W rf peak pulse power at 25 C.

CIRCLE NO. 395



Staco's lighted pushbutton switches look great and work even better

Built-in quality and good looks make Stacoswitch single lamp pushbutton switches and indicators your best buy. Rugged... dependable... choice of styles, colors, circuitry, and actions... plus LOW TOTAL COST. When you think switch... think STACOSWITCH and save.



1130 BAKER STREET, COSTA MESA, CALIF. 92626
(714) 549-3041

Other STACO Company products: Fixed Ratio Transformers, STACO, INCORPORATED, Richmond, Indiana; Variable Transformers, STACO, INCORPORATED, Dayton, Ohio.

INFORMATION RETRIEVAL NUMBER 68

What makes GENERAL SCANNING OEM RECORDER MODULES

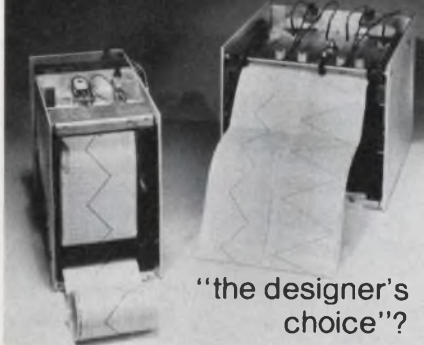

"the designer's
choice"?

A better selection of standard 'specs' to easily fit particular applications. We developed our complete line of strip chart recorder modules — with OEM needs in mind. Needs like reliability, accuracy, compactness, flexibility and, of course, low cost.

Chances are General Scanning has a standard off-the-shelf recorder module just right for your application. If we don't, our modular construction method makes it simple to fill the most unique requirements. A sample of 'specs' to choose from:

- **Number of Channels**
single through eight
- **Channel Widths**
20, 40, 50, 80 & 100 mm
- **Paper Feed**
roll
fan fold
- **Chart Speeds**
multi-speed, electrically
selectable
- **Pen Motor Operation**
open loop
velocity feedback
closed loop
- **Inkless Thermal Writing**

We offer packaged recorders for your lab, portable DC recorders and precision pen motors, too. Make "the designer's choice", call or write for full details. The general awaits your orders.

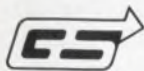

GENERAL SCANNING INC.
150 Coolidge Avenue
Watertown, MA 02172
TEL: (617) 924-1010

INFORMATION RETRIEVAL NUMBER 83
ELECTRONIC DESIGN 20, September 27, 1975

N-channel FETs handle up to 300 V loads

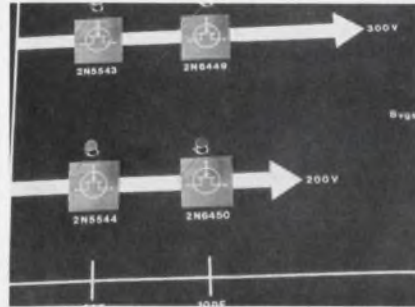

Teledyne Crystalonics, 147 Sherman St., Cambridge, MA 02140. (617) 491-1670. From \$2.40 (100-up); stock.

Four high voltage n-channel FETs are available in TO-39 packages. Two of the new devices, the 2N6449 with a gate breakdown voltage rating (BV_{GSS}) of 300 V min. and the 2N6450 with a BV_{GSS} rating of 200 V min., are capable of dissipating 5 W. The other two units, the 2N5543 at 300 V min. and the 2N5544 at 200 V min., are similarly rated except for extremely low reverse transfer capacitance, 2 pF, when measured at 1 MHz.

CIRCLE NO. 357

Low leakage photodiodes have currents of 20 pA



Vactec, 2423 Northline Industrial Blvd., Maryland Heights, MO 63043. (314) 872-8300. From \$1.50 (1000-up).

The VTB series of ultra-low leakage photodiodes is intended for use in the short circuit photovoltaic mode. Applications include calorimetric analytical instruments as well as photographic and illumination measuring instruments. Characteristics include reverse leakage current of less than 20 pA at -0.1 V, for a 100 mil square chip, and less than 10 pA for a 60 mil square chip. The diodes have a spectral response at 400 nanometers of typically 35% and are available with or without an integral infrared cutoff filter.

CIRCLE NO. 358

LOW X_L @ UHF



NOW HEAR THIS ...

Connect to your microstrip circuitry with ATC low inductance MS (microstrip) silver leaded capacitors

Take advantage of the stable, low R_S , ATC line of capacitors in an "easy on production" configuration.



...AND GET THIS FREE

MINI MARKUS or your postman will deliver your free sample of an ATC 100-B-300-J-MS [that's 30 pf]. Just circle the number below.

For samples of other lead styles and capacity values, call Ralph Wood (516) 271-9600.



ONE NORDEN LANE,
HUNTINGTON STATION, NEW YORK 11746
516/271-9600 • TWX 510-226-6993

INFORMATION RETRIEVAL NUMBER 84



The only single output power supplies

that combine:

- High efficiency over entire input range — up to 85%
- Pin compatibility with conventional encapsulated designs
- Cooler operation — up to 15°C cooler
- Line transient immunity >60dB

SCI's Series ES & EA

These modular Power Supplies[®] utilize a unique regulation technique that dissipates less power internally — allowing units to operate much cooler than conventional power supplies. And, the low pass filter within the regulator provides the additional performance benefit of line transient immunity. The result — more power in a smaller package, with a lower case temperature rise and greater reliability.

Model ES5800 — a compact 3.5" x 2.5" x 0.875" unit with output of 5Vdc, 800mA — priced at \$52.95 (1-9) is just one of the modules in this series. For full information contact us.



SEMICONDUCTOR CIRCUITS, INC.

306 River Street, Haverhill, Massachusetts 01830
Telephone: 617-373-9104 • TWX: 710-347-0269

INFORMATION RETRIEVAL NUMBER 85



electrocube capacitors

...are now offered in miniature AC rated models, of metallized polypropylene and with foil, in 135 VAC and 270 VAC versions with ratings to 10 mfd. Smaller than existing units, this may be the only 270 VAC dry capacitor available. And these can also be used for DC applications, to 200 VDC with 135 VAC units and to 400 VDC with 270 VAC capacitors. Get more data on these new components...write or call Electrocube, 1710 So. Del Mar Ave., San Gabriel, CA 91776; (213) 573-3300.

FREE...data file
on request

DOUBLE EXPOSURE

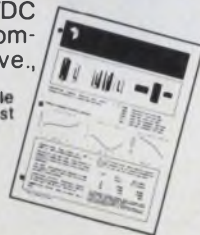

AC RATED...DC, TOO

INFORMATION RETRIEVAL NUMBER 86

PACKAGING & MATERIALS

IC desoldering tool cleans PC-board holes



Micro Electronic Systems, 8 Kevin Dr., Danbury, CT 06810. (203) 746-2525. \$295; stock.

The Remove-A-DIP IC desoldering station combines the heating element, the removal tool and the cleaning of the PCB holes into a single action system. The tool is light and includes a handheld vacuum system. The vacuum chamber is evacuated prior to desoldering and at the end of the desoldering period is released by the trigger on the pistol grip, sucking the solder out of the PC-board holes. A DIP removal operation is less than one minute and the DIP is usable for further test or reuse.

CIRCLE NO. 359

Fused power-connector has see-through cover

Corcom, 2635 N. Kildare Ave., Chicago, IL 60639. (312) 384-7400. From \$5.95 (list); stock.

The Models 6J1 and 6J4 voltage selecting fuse connectors are designed for the manufacturer who markets his product worldwide. The unit eliminates the need for internal wiring changes and special power supplies. The connector can handle currents of up to 6 A and uses type 3AG fuses. Only one rectangular panel cut-out is required and spring actuated mounting tabs eliminate the need for mounting hardware regardless of panel thickness. The fuse and voltage selector card are enclosed behind a see-through cover, which cannot be removed until the power cord is removed from the equipment. This provides complete safety when changing fuses or selecting new operating voltages. The connector is also available with an RFI power line filter.

CIRCLE NO. 360

Application Notes

Phase sequence indicator

Component selection, construction and operation of an inexpensive, portable phase sequence indicator are discussed in Tech Tips 5-4. Westinghouse Electric, Semiconductor Div., Youngwood, PA

CIRCLE NO. 361

SCR handbook

A 528-page handbook incorporates state-of-the-art applications information for silicon controlled rectifiers. The handbook is illustrated with circuit schematics, performance curves and photos. Appendices include a glossary of symbols and terms and a review of device specifications. Price is \$3. International Rectifier, 233 Kansas St., El Segundo, CA 90245

INQUIRE DIRECT

Antenna measurements

"Basic Antenna Measurements," a 12-page booklet, discusses antenna pattern, directivity, gain and polarization measurements. Coordinate systems and the important factors in setting up an antenna range are included. Scientific-Atlanta, Atlanta, GA

CIRCLE NO. 362

Thermoplastics

A "Rigid Foam Designers Handbook" outlines the advantages of rigid foam, gives comparative properties and details specifications. FCM Div., Gulf & Western Manufacturing, Grand Rapids, MI

CIRCLE NO. 363

FM data gathering

Problems encountered when recording large quantities of FM multiplex data on multitrack instrumentation recorders are discussed in a booklet. Head configuration drawings and block diagrams illustrate the problems and their possible solutions. EMR-Telemetry, Sarasota, FL

CIRCLE NO. 364

X-ray diffraction system

A new and simple method for quantitative analysis of lead sulfate accumulations in automobile catalytic converters is described in an application note. Ortec, Oak Ridge, TN

CIRCLE NO. 365

Flexible discs

Hard-sector formatting for flexible disc drives is described in a 12-page bulletin. Formulas are given and discussed for timing factors, computing sector and speed tolerances and computing the size of the data field. Pertec, Chatsworth, CA

CIRCLE NO. 366

Waveguide breakdown

"The Effects of System Waveguide Breakdown on Crossed-Field Devices," a 20-page booklet, discusses the pulse length, pressure, altitude, VSWR, duty factors and other characteristics on the reliability and life potential of the devices. Varian, Beverly Div., Beverly, MA

CIRCLE NO. 367

PHOTO ETCHTM

PRINTED CIRCUIT KIT

Makes circuits **THREE WAYS**

- 1 FULL SCALE ARTWORK MASTER
- 2 MAGAZINE ART ILLUSTRATION → FILM POSITIVE → NEGATIVE → DEVELOPED PHOTO RESIST IMAGE ON COPPER CLAD CIRCUIT BOARD → ETCHED CIRCUIT BOARD
- 3 DIRECT ETCH DRY TRANSFERS APPLIED TO COPPER CLAD BOARD

NO CAMERA DARKROOM FILM CUTTING TRACING
USES DATAK'S POS-NEG PROCESS
The revolutionary photographic way that makes PERFECT printed circuits from original art or a printed page.

KIT CONTAINS 5" x 6" steel printing frame, 4 sheets 5" x 6" photocopy film, yellow filter, chemicals for 1 pint film developer, and 1 pint film fixer, 5" x 8" copper clad board, 3" x 4 1/2" copper clad board, spray can of photo etch resist, 1 pint resist developer, 2 sheets 8 1/2" x 11" layout film, 1 roll 1/16" printed circuit tape, 1 roll 1/32" printed circuit tape, 8 sheets dry transfer direct etch PC patterns including pads, transistors, round can and flat pack ICs, DIP ICs, edge card connectors, lines, circles, logs, etc. 1 lb anhydrous ferric chloride to make 1 pint etchant instructions.

ER-4 COMPLETE PHOTO ETCH SET	\$24.95
ER-2 PC patterns and tapes—refill	3.39
ER-3 1/4 pound dry etchant—refill	1.25
ER-5 6 sheets photocopy film—refill	3.39
ER-6 Film process chemicals—refill	1.79
ER-7 Photo resist spray, 2.5 oz.—refill	2.95
ER-8 Resist developer, 16 oz. can—refill	2.95

AT YOUR DISTRIBUTOR OR DIRECT

the **DATAK** corp.
 65 71st St. • Guttenberg, N. J. 07093

INFORMATION RETRIEVAL NUMBER 87

ELECTRONIC DESIGN 20, September 27, 1975

ANALOG SERIES No. 2

**AT LAST:
 HIGH-CURRENT REGULATORS
 WITH
 SHORT CIRCUIT PROTECTION.**

You've asked for high power capability requiring fewer external parts. Our field-proven 7800 series delivers. Unique voltage regulators with short circuit protection that really works. 7 voltages from 5-24V; TO-220 or TO-3.

Send me full specs on 7800 voltage regulators; coupon's attached to my letterhead.

Name _____
 Tel _____ Ext _____

THINK
Signetics
 811 E. ARQUES, SUNNYVALE, CALIF. 94086

INFORMATION RETRIEVAL NUMBER 88

Grayhill's
value
leader

switcher
from logic levels
up to
1/4 amp

1/2" diameter
enclosed construction rotaries
priced lower than many
"open wafers"

- contamination-free construction, gold plated contact system, diallyl phthalate insulation, molded-in terminals.
- up to 12 positions, 30° or 36° angle of throw, up to 6 poles per deck, up to 12 decks
- fixed or adjustable stops, solder lug or PC terminals, 1/8", 1/4", or 4 mm shaft diameters, concentric shafts also available.

You have never seen so much switching versatility and quality in a compact switch at any price... yet Grayhill has engineered its Series 71 to reflect state-of-the-art capabilities and state-of-the-economy pricing. Review the many available features and options... and see why this switch family is revolutionizing switch specification standards throughout the industry. For complete information, consult EEM or ask Grayhill for Series 71 Rotary Switch data.



561 Hillgrove Avenue • La Grange, Illinois 60525
Phone (312) 354-1040

New Literature



miniature power supplies

Power supplies

Modular, encapsulated power supplies are described in a 12-page catalog. Included with each catalog is an introductory offer. A coupon is provided that enables the customer to buy any two power supplies and get a third one free. Cal-ex Manufacturing Co., Pleasant Hill, CA

CIRCLE NO. 368

Illuminated lamps

Specifications and ordering information on lighted pushbutton switches, indicators, lamps, sockets and rear-projection indicators are listed in a 20-page catalog. Compu-Lite, Irvine, CA

CIRCLE NO. 369

Programmable controllers

Programmable controllers are featured in a 12-page catalog. Photos, tables and specs are included. CIT-ALCATEL, 92120 Montrouge, France

CIRCLE NO. 370

Noise, vibration analyzers

Portable analyzers suited to analysis of sound and vibration data under field conditions are highlighted in an eight-page brochure. B & K Instruments, Cleveland, OH

CIRCLE NO. 371

**WHEN THE
PRESSURE'S ON
...THINK XECON™
...CALL METEX**

Xecon™ is the most advanced conductive elastomer ever developed for EMI/RFI shielding and pressure sealing. Available in a wide range of sizes, shapes, and strength/durometer combinations, this unique new material is much lighter, more resilient, and more stable (thermally, electrically, and mechanically) than any other conductive elastomer.

The secret of Xecon's superiority is in the conductive filler, uniformly dispersed through the silicone medium. (Flouro-Silicone also available.)

Gaskets, molded shapes, bulk sheets, or shapes vulcanized-to-metal parts—Metex makes them all. Shielding effectiveness is outstanding.

Perfect pressure seals to above 100 psi. Conductivity is preserved despite flexing, stretching, compression and continuous environmental exposure.

Call or write, for full data and free representative samples. Metex Corp., 970 New Durham Rd., Edison, N. J. 08817, (201) 287-0800, or Cal-Metex Corp., 509 Hindry Ave., Inglewood, Calif. 90301, (213) 641-8000.

**FOR ANY
CONFIGURATION
OF EMI/RFI
SHIELDING.**



We call the signals in shielding
METEX

Gaussmeters

Three data sheets give practical information on the use of gaussmeters. F.W. Bell, Columbus, OH

CIRCLE NO. 372

RFI/EMI filters

More than 100 RFI/EMI filters are featured in a brochure. RtroN, Skokie, IL

CIRCLE NO. 373

Production furnaces

The design, engineering and construction of production furnaces and equipment are illustrated in a 12-page brochure. Watkins-Johnson, Scotts Valley, CA

CIRCLE NO. 374

Sweep generators

Five low-cost, solid-state sweep/signal generators capable of covering frequency ranges to 1500 MHz are described in a 12-page brochure. Telonic Altair, Laguna Beach, CA

CIRCLE NO. 375

10-A gp relays

Fully illustrated, a two-page bulletin provides outline and mounting dimensions and specifications and coil data for 10-A general-purpose relays. North American Philips Controls, Cheshire, CT

CIRCLE NO. 376

Electronic enclosures

Modular electronic enclosures are featured in an eight-page catalog. Ingersoll Products, Chicago, IL

CIRCLE NO. 377

Conformal coatings

Photos, tables and graphs illustrate a 16-page conformal coating catalog. Union Carbide, New York, NY

CIRCLE NO. 378

Software

Features and capabilities of the Real-Time Executive operating software, RTE-III, are described in a 20-page booklet. Hewlett-Packard, Palo Alto, CA

CIRCLE NO. 379

Multipoint recorder

A 16-page bulletin, "Multipoint Recorder with Thermal Matrix Printing," details print pattern programming, print/skip channel format, alarms and how the recorder's servo mechanism provides even printing and fast response. Esterline Angus, Indianapolis, IN

CIRCLE NO. 380

Data comm monthly

What mother never told you about Bell's Digital Dataphone Service (DDS) is the subject of a new monthly publication for people involved with on-line data-communication networks. Intertel, Burlington, MA

CIRCLE NO. 381

Standard systems

A 20-page catalog describes standard models based on the System 390 automatic test systems. Diagrams and photographs illustrate various sections. Instrumentation Engineering, Franklin Lakes, NJ

CIRCLE NO. 382

INTRODUCING MURATA'S 100 VOLT, REDUCED TITANATE SUPERCAPS®!



- HIGH CAPACITY, SMALL SIZE
- ±10% CAPACITY TOLERANCE
- X5P TEMPERATURE COEFFICIENT
- FAST DELIVERY

muRata

CORPORATION OF AMERICA
Rockmart Industrial Park, Rockmart, Georgia 30153
Phone: 404-684-7143 Telex: 54-2999

ANALOG SERIES No. 3

IF YOU'RE SICK & TIRED OF CALLING AROUND FOR ANALOG...

Read on. Here's one major analog supplier where one call can cover all needs: high technology, broad selection, low cost. One-stop shopping: over 150 basics, over 750 temp/pack combos (Hi Rel too). Dist shelves now.

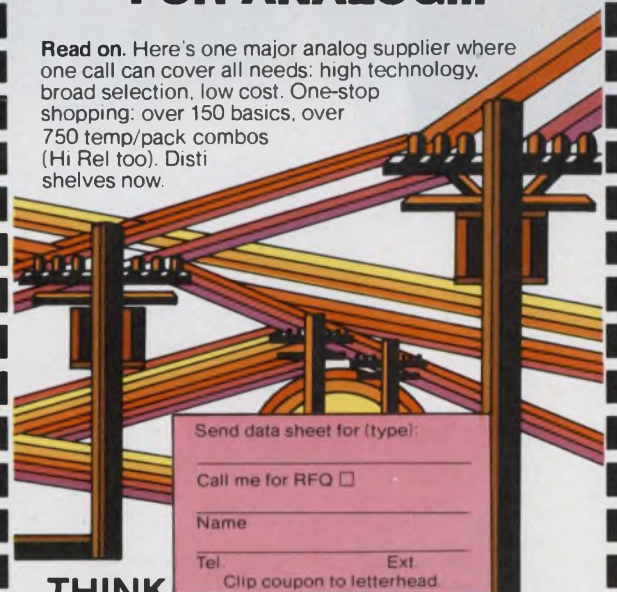

Send data sheet for (type):

Call me for RFQ

Name

Tel.

Ext.

Clip coupon to letterhead.

THINK

Sinnetics

811 E. ARQUES, SUNNYVALE, CALIF. 94086

INFORMATION RETRIEVAL NUMBER 91

ELECTRONIC DESIGN 20, September 27, 1975

INFORMATION RETRIEVAL NUMBER 92

THE SOURCE FOR POWER SUPPLIES!

New 66 page Technipower design data catalog #731.

YOURS FREE!



Technipower presents the widest range of commercial, industrial, and mil-qualified power supplies ever compiled – all backed by a comprehensive 5-year warranty.

Complete engineering specifications are provided. Special sections are devoted to extensive thermal data tables, a glossary of the new NEMA terminology, a metric guide, and other technical information.

Write or call today for your free copy.

TECHNIPOWER, INC. 
A **BENRUS** DIVISION

Benrus Center, Ridgefield, Connecticut 06877
Telephone (203) 431-1300 • TWX 710-467-0666

INFORMATION RETRIEVAL NUMBER 101

From the first family of fixed filters... **TUNABLES**

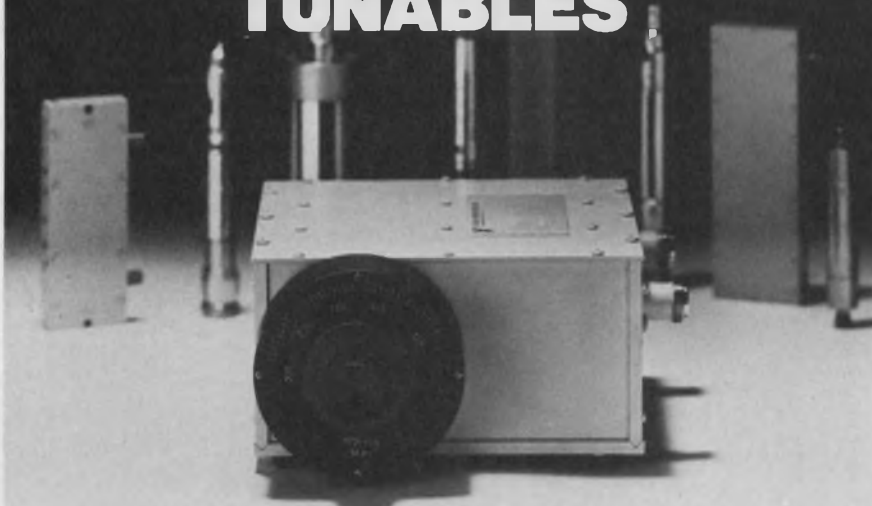

Telonic filters are now available in two tunable versions — band reject and band pass. Band reject models cover 1 octave, up to 1 GHz, with notch depths to 70 dB. Band pass types also cover an octave, up to 4 GHz, with pass bands of 1% to 10%.

These tunable models are another reason Telonic should be your first source for RF and microwave filters. The wide range of our product line lets you select a standard filter for your special applications.

We supply tubular low pass and band pass filters, cavities, interdigital and combline types to a broad spectrum of OEM and end users. Let us know your needs. We'll make a recommendation or forward our 50-page catalog of complete filter data.

TelonicAltair  2825 Laguna Canyon Rd. • Box 277
Laguna Beach, California 92652
Tel: 714 494-9401 • TWX: 910 596-1320 • Cable: TELENG

INFORMATION RETRIEVAL NUMBER 102

Vendors Report

Annual and interim reports can provide much more than financial-position information. They often include the first public disclosure of new products, new techniques and new directions of our vendors and customers. Further, they often contain superb analyses of segments of industry that a company serves.

Selected companies with recent reports are listed here with their main electronic products or services. For a copy, circle the indicated number.

The Bendix Corp. Automotive electronics and aerospace.

CIRCLE NO. 383

Data General. Computers.

CIRCLE NO. 384

Celesco. Aerospace and underwater research, defense systems, industrial process control, environmental quality control and automated arc welding.

CIRCLE NO. 385

Fluke. Test and measurement instruments.

CIRCLE NO. 386

Pertec. Computer peripheral equipment.

CIRCLE NO. 387

Gulf & Western. Natural resources, automotive replacement parts, manufacturing and consumer products.

CIRCLE NO. 388

Penril. Data communications and test equipment.

CIRCLE NO. 389

Comtech. Satellite communication earth stations and subsystems and communications products and systems.

CIRCLE NO. 390

Analog Devices. ICs, interface products and DPMS. An 18-page report, "Structural Changes and New Opportunities in the Electronics Industry," is also available.

CIRCLE NO. 391

Electronic Design's **GOLD BOOK** **IS WORKING FOR ME**

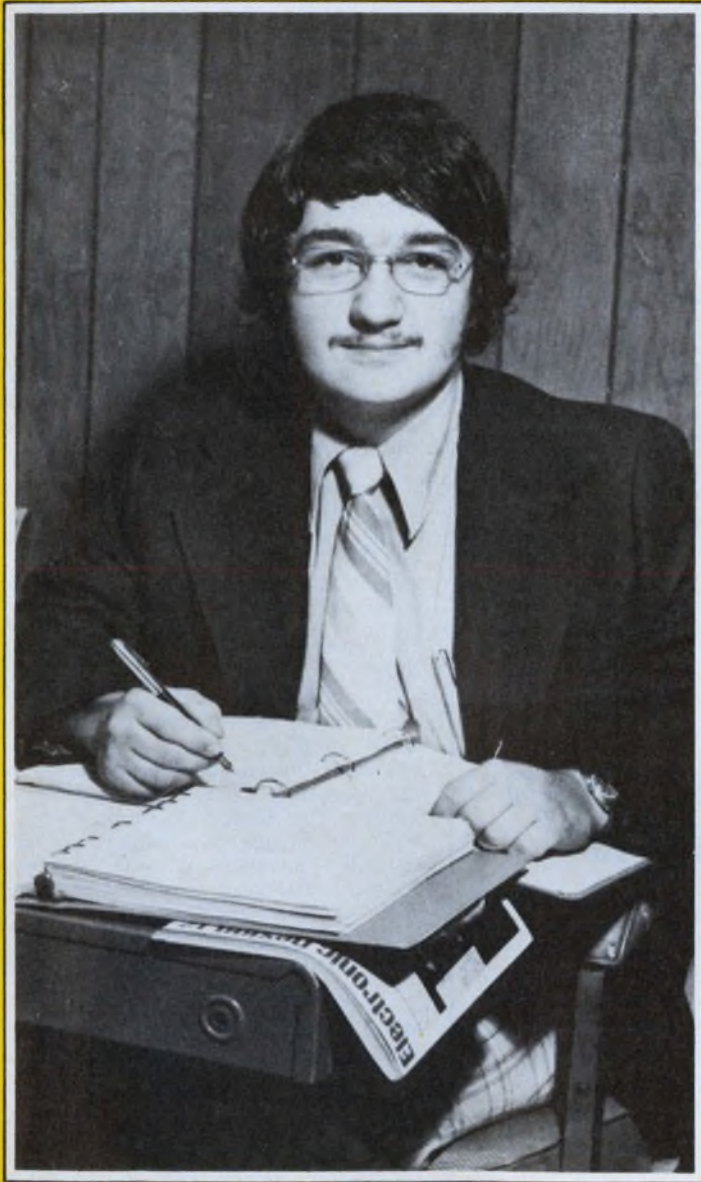

I USE IT

Martin A. Sala is Chief Design Engineer, Precision Systems, Cheektowaga, New York. He heads the research division at Precision and is primarily concerned with artificial intelligence and cybernetics. Accustomed to purchasing \$80,000 worth of equipment annually, Sala reports that he has referred to *Electronic Design's* GOLD BOOK frequently and finds it useful in his work. "I keep it on my library shelf and use it quite often as a major source for information. In fact it's the only industry directory I use. Advertisements in the GOLD BOOK recently helped us to place orders for both memory and arithmetic circuits."

**ELECTRONIC DESIGN'S GOLD BOOK IS WORKING — ALL DAY, EVERY DAY —
THROUGHOUT THE U.S. AND OVERSEAS**

Electronic Design / GOLD BOOK

ELECTRICAL DESIGN ENGINEERS

DESIGN AND TEST FIRE DETECTOR/FIRE ALARM SYSTEMS

Simplex, a leading manufacturer of fire alarm systems has outstanding growth opportunities in its R&D Department for Engineers with the following backgrounds.

FIRE ALARM DETECTORS

Positions require a B.S. or M.S. in Physics or Electrical Engineering or the equivalent. Responsibilities will include the design and evaluation of fire alarm detectors. Background must include "hands-on" fire detector design experience and detailed knowledge of the "art" and physics of detectors. You should also be familiar with fire detecting laboratory testing techniques and equipment, circuit design capability using MOS integrated circuitry and FET's, fire alarm systems codes and U/L regulations.

FIRE ALARM SYSTEMS ENGINEERS

B.S.E.E. Or Equivalent

Responsibilities will include designing new solid-state circuit fire alarm control systems. Qualifications must include relevant "hands-on" fire alarm systems design experience; good working knowledge of peripheral equipment such as detectors, bells, and horns; and familiarity with local codes and U/L regulations. Communications line knowledge is also desirable.

Excellent starting salaries and numerous opportunities for professional growth. For prompt consideration, please send resume to John McKinnon.

SIMPLEX TIME RECORDER COMPANY
26 South Lincoln Street
Gardner, Massachusetts 01440

An Equal Opportunity Employer M/F



recruitment and classified ads

**FREE DISCOUNT BOOK CATALOG
ELECTRONICS—DATA PROCESSING—MATH**
Our 1975 catalog describes over 1000 state-of-the-art, professional-level books, grouped in 31 technical interest categories, from 16 major publishers. All NEW books . . . not used or over-stock.

TECHNI-BOOKS
P.O. Box 11665, Santa Ana, CA 92711
(714) 633-6015
A Mail Order Technical Book Service

CIRCLE NO. 270

Help your
Heart...
Help your
Heart Fund

American Heart Association



Please Help Children Live

Research is our only weapon against childhood cancer.

St. Jude Children's Research Hospital, which is non-sectarian, is the largest childhood cancer research center in the world.

Please join in the fight against childhood cancer.

Send your special gift now.



**ST. JUDE
CHILDREN'S
RESEARCH
HOSPITAL**

Danny Thomas, Founder

Send contributions to:
MEMPHIS, TENN. 38101

This space donated by publication

Electronic Design

ELECTRONIC DESIGN's function is:

- To aid progress in the electronics manufacturing industry by promoting good design.
- To give the electronic design engineer concepts and ideas that make his job easier and more productive.
- To provide a central source of timely electronics information.
- To promote communication among members of the electronics engineering community.

Want a subscription? ELECTRONIC DESIGN is sent free to qualified engineers and engineering managers doing design work, supervising design or setting standards in the United States and Western Europe. For a free subscription, use the application form bound in the magazine. If none is included, write to us direct for an application form.

If you do not qualify, you may take out a paid subscription for \$30 a year in the U.S.A., \$40 a year elsewhere. Single copies are \$1.50 each.

If you change your address, send us an old mailing label and your new address; there is generally a postcard for this bound in the magazine. You will have to requalify to continue receiving ELECTRONIC DESIGN free.

The accuracy policy of ELECTRONIC DESIGN is:

- To make diligent efforts to ensure the accuracy of editorial matter.
- To publish prompt corrections whenever inaccuracies are brought to our attention. Corrections appear in "Across the Desk."
- To encourage our readers as responsible members of our business community to report to us misleading or fraudulent advertising.
- To refuse any advertisement deemed to be misleading or fraudulent.

Microfilm copies are available of complete volumes of ELECTRONIC DESIGN at \$19 per volume, beginning with Volume 1, 1952 through Volume 20. Reprints of individual articles may be obtained for \$3.00 each, prepaid (\$.50 for each additional copy of the same article) no matter how long the article. For further details and to place orders, contact the Customer Services Department, University Microfilms, 300 North Zeeb Road, Ann Arbor, Michigan 48106 telephone (313) 761-4700.

Want to contact us? If you have any comments or wish to submit a manuscript or article outline, address your correspondence to:

Editor
ELECTRONIC DESIGN
50 Essex Street
Rochelle Park, N.J. 07662



Versatile 1"x.100" GRID Reed Relays

Many
Options
for Most
Applications

New CR-2000 Series utilizes the popular 1" x .100" grid pattern, with 1 to 6 poles and a variety of options and contact forms for almost any application. Reliable low-level switches may be conditioned by special run-in and dynamic testing. Models can be epoxy-encapsulated or simply encased for added economy. Ask for Bulletin MR 11.1 for full details.



**COTO-COIL
COMPANY, INC.**
59 Pavilion Ave.
Providence, R. I. 02905
Tel: (401) 467-4777

INFORMATION RETRIEVAL NUMBER 104

SUBSCRIBER SERVICE For prompt service include the addressed label when writing about your subscription.

CHANGE OF ADDRESS

city	company address	division/department	company	name	NEW ADDRESS
state				title	
zip					

If you're moving, please let us know six weeks before changing your address. If you have a question, place your magazine address label here and clip this form to your letter.

MAIL TO: ELECTRONIC DESIGN Circulation Dept. Hayden Publishing Co., Inc., 50 Essex Street, Rochelle Park, NJ 07662

Electronic Design

Advertising Sales Staff

Tom W. Carr, Sales Director
Rochelle Park, NJ 07662
Robert W. Gascoigne
Daniel J. Rowland
(Recruitment, Quick Ads, Classified)
50 Essex Street
(201) 843-0550
TWX: 710-9990-5071

Philadelphia

Thomas P. Barth
50 Essex Street
Rochelle Park, NJ 07662
(201) 843-0550

Boston 02178

Gene Pritchard
P.O. Box 379
Belmont, MA 02178
(617) 489-2340

Chicago 60611

Thomas P. Kavooras
Berry Conner, Jr.
200 East Ontario
(312) 337-0588

Cleveland

Thomas P. Kavooras
(Chicago)
(312) 337-0588

Los Angeles 90045

Stanley I. Ehrenclou
Burt Underwood
8939 S. Sepulveda Boulevard
Suit 510
Los Angeles, CA
(213) 641-6544

San Francisco 94040

Robert A. Lukas
3579 Cambridge Lane
Mountain View, CA 94040
(415) 965-2636

London, Amsterdam, Tokyo, Seoul

John Ashcraft
12, Bear St.
Leicester Square
London WC2H 7AS England
Phone: 01-930-0525

W. J. M. Sanders

John Ashcraft & Co.
Herengracht 365
Amsterdam C., Holland
Phone: 020-24-09-08

Haruki Hirayama

Electronic Media Service
5th Floor, Lila Bldg.,
4-9-8 Roppongi
Minato-ku, Tokyo, Japan
Phone: 402-4556

Cable: Electronicmedia, Tokyo

Mr. O-kyu Park, President

Dongbo Int'l Corp.—
World Marketing
C.P.O. Box 4010
Seoul, Korea
Tel. 76-3910/3911
Cable: DONGBO SEOUL
Telex: EBKOREA K27286



ONLY SCHAEVITZ MAKES HERMETICALLY SEALED DC LVDT'S WITH ALL THESE SPECS

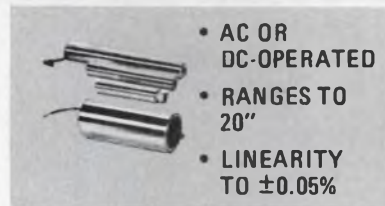

- AC OR DC-OPERATED
- RANGES TO 20"
- LINEARITY TO $\pm 0.05\%$

- • • OP AMP OUTPUT $\pm 10V$ DC
- • • STOCK DELIVERY

WRITE FOR
24 PAGE
LVDT
APPLICATION
BULLETIN
AND
SELECTION
GUIDE



schaevitz
engineering

(609) 662-8000
P.O. BOX 505, CAMDEN, NEW JERSEY 08101

INFORMATION RETRIEVAL NUMBER 105

Circuit Savers



DC
95¢
1000 pcs.
**TRANSIENT
SUPPRESSOR**



The TSD-1.5 Series are ideal for protection of long signal lines from damage from induced lightning etc. Reaction time is in nanoseconds.

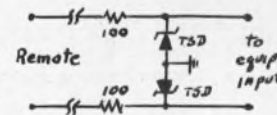

2 units (back to back) will protect sensitive components from a 5KV, 1ms duration transient. Clamp voltages from 5V to 200V. Call Mike Coyle for applications assistance. Full line of protection modules for every hi-lo voltage/current requirement. Write or call for Catalog 749.

279 Skidmore Road
Deer Park, New York 11729
Telephone: 516-586-5125

MCG Electronics

See Gold Book Vol 2, p. 320-322

INFORMATION RETRIEVAL NUMBER 106

SWITCHING POWER SUPPLY



HR0510

High Efficiency

Compact and Lightweight

Competitive Price



ELECTRICAL CHARACTERISTICS HR0510

Output	5V10A
Efficiency	74%
AC Input voltage	117V±10%
Line Regulation	±0.2% or less
Load Regulation	±0.2% or less
Ripple & noise (p-p)	20mV (typical) 50mV (max)
Overload protection	Current Limit Type
Overvoltage protection	Signal Inhibit Type
Output on/off control level	TTL
Withstand voltage	1.5KV AC for one minute
Isolation resistance	100MΩ or more at 500V DC
Temperature rise	30°C or less
Ambient temperature range (operating)	0-50°C
Temperature coefficient	±0.02%/C°
Weight	1.7 pounds
Size (WxHxD)	1.77"x4.72"x7.87"

HR0510-HR0520-HR0530-HR0905-HR1204-HR1503
5V 10A 5V 20A 5V 30A 9V 5A 12V 4A 15V 3A

HR1506-HR1510-HR1802-HR2402-HR2404-HR2406
15V 6A 15V 10A 18V 2A 24V 2A 24V 4A 24V 6A

HR2410-HR2420-HR3005-HR4801-HR4810-HR4820
24V 10A 24V 20A 30V 5A 48V 1A 48V 10A 48V 20A

NEMIC

**NIPPON ELECTRONICS MEMORY
INDUSTRY CO., LTD.**

PARK AVENUE
1-20-1 SENDAGAYA
SHIBUYA-KU TOKYO 151, JAPAN
PHONE: (03) 478-3935
TELEX: 3862-405 242-3111

Advertiser's Index

Advertiser	Page	Advertiser	Page
ACDC Electronics, Inc.....	31	MCG Electronics	131
Acopian Corp.	21	Magnetec Corp.	117
Alco Electronic Products, Inc.....	119	*Membrain Limited	11
Allen Bradley Co.....	27	Mepco/Electra, Inc.	81
Allison Automotive Company.....	114	Metex Corporation	126
American Technical Ceramics.....	123	Micro Networks Corporation.....	120
Analog Devices, Inc.....	4, 5	Micro Switch, A Division of Honeywell	94, 95
Arnold Magnetics Corp.....	118	Mini-Circuits Laboratory, A Division of Scientific Components Corp.	2, 42
Beckman Instruments, Inc. Helipot Division	13	Mostek Corporation	29
Centralab, The Electronics Division of Globe-Union, Inc.....	14, 15	Motorola Semiconductor Products, Inc.	36, 37
Chicago Miniature Lamp Works.....	93	MuRata Corporation of America.....	127
Coto Coil Company, Inc.....	131	NCR Corporation, Scott Electronics Division	Cover III
Crown International, Inc.....	113	Nippon Electronics Memory Industry Co., Ltd.....	132
Custom Electronics, Inc.....	116	Norland Instruments	19
Data Precision Corporation.....	62	North American Philips Controls Corp.	111
Datak Corporation, The.....	125	Perfection Mica Company.....	134
Datel Systems, Inc.....	116	Power Cube Corporation.....	121
Deltron, Inc.	101	Power/Mate Corp.	12, 133
Dialight, A North American Philips Co.	78	Power-One, Inc.....	32, 32 P1, thru 32 P16
Dranetz Engineering Laboratories, Incorporated	106	Power Tech, Inc.	50
E-T-A Products Co. of America.....	133	Powertec, Inc.	79
Electrocube	124	Premier Metal Products Company.....	35
Electro Industries	133	RO Associates Incorporated.....	63
Electro Modules, Inc.....	80	RCA Solid State.....	Cover IV
*Electronic Design	17	RCL Electronics, Inc.....	38
Electronic Development Corporation.....	122	RMS Sensitron	122
Electronic Memories, Commercial Memory Products	16	Reader Service Card.....	134 A-B
Electronic Navigation Industries.....	110	Reticon	109
Elxon Power Systems.....	18	Schaevitz Engineering	131
Erie Technological Products, Inc.....	64A	Semiconductor Circuits, Inc.....	124
Etatech, Inc.	133	Siemens Corporation	11
Ferroxcube Corporation	64	Signal Transformer Co., Inc.....	92
General Instrument Corporation.....	8, 9	Signetics Corporation	111, 117, 119, 125, 127
General Scanning Inc.....	123	Silicon Transistor Corporation.....	113
Gold Book, The.....	*21, 129	Solid State Devices, Inc.....	112
Grayhill, Inc.	126	Solid State Scientific, Inc.....	115
Hayden Book Company, Inc.	*13, *19, 46, 47, 133	Solitron Devices, Inc.....	103
Hewlett-Packard	Cover II, 25, 86, 87, 133	Sprague Electric Company.....	10
Honeywell, Biomedical Service.....	98	Stacoswitch, A Staco Inc. Company.....	122
Honeywell Test Instruments Division	39	TRW Cinch Connectors, an Electronic Components Division of TRW, Inc.	22
Instrument Specialties Company, Inc.....	105	Technipower, Inc., A Benrus Division	128
Intech, Incorporated	108	Tecnetics, Inc.	51
Integrated Computer Systems, Inc.	40, 41	Tektronix, Inc.	45
Interdesign	17	Teledyne Philbrick	20
International Electronic Research Corporation	71	Telonic Altair	128
International Rectifier Corporation.....	64B	Trio Laboratories, Inc.....	99
Johanson Manufacturing Corp.....	7	*United States Department of Commerce	27
Johanson/Monolithic Dielectrics Division	133	Unitrode Corporation	48
Johnson Company, E. F.....	133	Victor Electric Wire & Cable Corp.	6
LH Research, Inc.	65, 66, 67, 68, 69, 70	Wavetek Indiana Incorporated.....	1
La Marche Mfg. Co.....	133		

*Advertisers in non-U.S. edition.



New crimp type miniature coaxial connectors. Straight cable plugs and jacks, can be crimped with standard tool. Connectors compatible with SMA types cost considerably less. Available in gold or copper plated brass bodies, teflon insulators, beryllium center contacts. E. F. Johnson, Co., Waseca, Mn., 56093, Dept. EP-9 (612) 835-5222

COAXIAL CONNECTORS 601



Solid State Digital Power Line Monitor is ideally suited for use with power generation equipment, computer systems, control panel installation labs where power sources must be monitored for assuring test equipment accuracies. Four models available. From \$129 ea. Electro Industries, P.O. Box 3542, No. New Hyde Park N.Y. 11040. (516) 621-6652

POWER LINE MONITOR 604

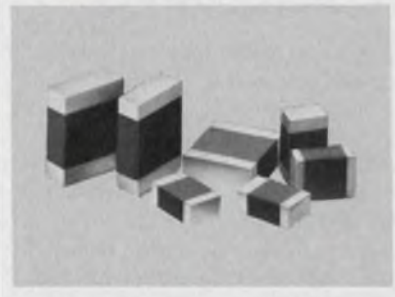

HIGH Q MULTILAYER CAPACITORS feature very high quality factors at microwave frequencies. Offered in three standard sizes: .050 x .040, .080 x .050, .125 x .095. Capacitance values from 0.1 pf to 1000 pf with close tolerance and voltages to 1000 VDCW. Johanson/Monolithic Dielectrics Div., Box 6456, Burbank, Ca. 91510, (213) 848-4465.

MULTILAYER CHIP CAPACITORS 607



Free catalog of 34,500 power supplies from the worlds largest manufacturer of quality Power Supplies. New '74 catalog covers over 34,500 D.C. Power Supplies for every application. All units are UL approved, and meet most military and commercial specs for industrial and computer uses. Power Mate Corp. (201) 343-6294.

POWER SUPPLY 602



Introduction To Defense Radar Systems Engineering. Excellent introduction and practical reference to radar systems design and applications. #9194, 260 pp., \$22.95. Circle the Info Retrieval No. to order 15-day exam copy. When billed, remit or return book with no obligation. Hayden Book Co. 50 Essex St. Rochelle Park, N.J. 07662

RADAR SYSTEMS 605



COMPLETE, INDUSTRIAL-QUALITY IC course-Model 5035T comes with text & workbooks, parts, fully-decoded LED numeric displays, and interconnecting wires. Handy proven HP Probe, Pulser, and Clip included. HEWLETT-PACKARD 1501 PAGE MILL RD. PALO ALTO, CAL. 94304

IC COURSE 608

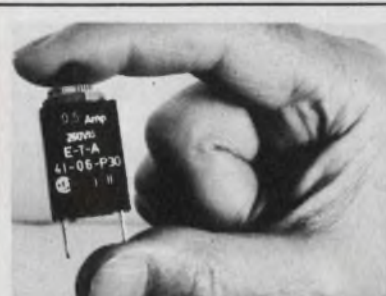

Overcurrent Protector, manual reset eliminates fuse replacement. Convenient panel mounting. 15 fractional ratings from 0.1 to 3 amp. Other models up to 400 amp. Trip-free and fool-proof, UL and CSA approved. High quality, low cost \$1.29 ea. in 1000 lots. E-T-A Products Co. of America, 7400 N. Crounse Rd., Chicago, Ill. 60648. Tel: (312) 647-8303. Telex: 253780.

CIRCUIT BREAKER 603

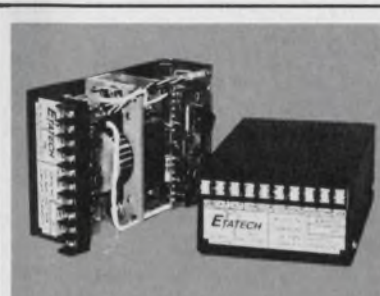

ETATECH'S 100 WATT STITCHERS BREAK POWER DENSITY BARRIER: 2w/cu. in and 40w/lb. in an off-line, fully regulated module. The highly efficient (75% min. @ 5v) units are easy to cool (33w maz. loss). Excellent reliability of 71K Hrs. MTBF. Outputs 5 to 60VDC. ETATECH, INC. 187M W. Orangethorpe, Placentia, CA 92670 (714) 996-0981.

WATT SWITCHES 606



New Model ERD & ERT (time delay) solid state dc relays for use with supervisory control equipment to initiate control. Nominal voltage: 6-250 vdc. Maximum reset time: 50 msec. Repeat accuracy: 0.1%. Also ac models. LaMarche Mfg. Co., 106 Bradrock Drive, Des Plaines, IL 60018 (312/299-1188).

ERD/ERT DC RELAYS 609

the facts about E.M.I. SHIELDING

Design information from Mag-Shield's
30 years experience in E.M.I. shielding.

WHAT IS THE ADVANTAGE OF USING NETIC OR CO-NETIC SHIELDING ALLOYS?

These alloys are especially prepared and treated to attain optimum E.M.I. shielding efficiency. They are available in thicknesses up to .010" for continuous foil, and up to .062" for sheet stock. Shielding foil is easily hand-formed into shields for prototype testing or small production runs. Stress annealed sheet stock has maximum workability properties. Fully hydrogen annealed sheet stock provides maximum permeability.



Netic and Co-Netic foil is easily shaped into simple shield configurations.

HOW DO I KNOW WHICH MATERIAL TO USE?

The high saturation capability of Netic material is ideally suited for attenuating high intensity E.M.I. fields. High permeability Co-Netic material provides maximum attenuation at low field intensities.

CAN YOU SERVICE MY SHIELD DESIGN AND PRODUCTION NEEDS?

Mag-Shield offers complete shield design and fabrication service. And, we can provide immediate delivery on standard shields that will accommodate a wide variety of components. Just circle the reader service number, or write Mag-Shield direct to receive complete information on sample materials and specifications.

MAGNETIC SHIELD DIVISION



Perfection Mica Company
740 Thomas Drive
Bensenville, Illinois 60106
(312) 766-7800 TWX (910) 256-4815

Product Index

Information Retrieval Service. New Products, Evaluation Samples (ES), Design Aids (DA), Application Notes (AN), and New Literature (NL) in this issue are listed here with page and Information Retrieval numbers. Reader requests will be promptly processed by computer and mailed to the manufacturer within three days.

Category	Page	IRN	Category	Page	IRN
Components			Integrated Circuits		
capacitors	116	73	analog delays	109	63
capacitors	123	84	analog ICs	127	92
capacitors	124	86	bidirectional I/O ports	111	65
capacitors	127	91	CSOS RAMs	115	72
capacitors, ceramic	10	8	counters	29	24
filters	128	102	DAC, 12-bit	9	7
LVTDS	131	105	Darlington	120	352
power transformers	99	55	driver/converter, CMOS	120	349
relays, gp	111	281	field PLA	120	350
relays, reed	131	106	ICs	92	50
resistor, fuse	116	338	ICs, linear	20	18
resistor networks	117	340	MNOS ROMs	120	351
spring contacts	105	60	microprocessors	37	27
suppressor, dc transient	131	104	regulators	125	88
switch, PB	95	291	64 x 9 RAMs	117	76
switch, Hall-effect	117	341			
switch, miniature toggle	119	78	Microwaves & Lasers		
switch, right-angle	119	79	mixers	2	3
switches	126	89	transformers	42	33
switches, PB	14	12			
switches, PB	15	13	Modules & Subassemblies		
switches, PB	112	68	a/d converter, 8-bit	120	81
trimmers	27	23	a/d, d/a converters	62	108
			amp, instrumentation	109	320
Data Processing			controller, phase	108	308
acquisition, data	119	346	converter, a/d	107	301
calculator, prog.	119	348	converter, v/f & f/v	108	306
memories	26	22	converters, d/s	108	321
memory, CMOS	119	347	hybrids	13	11
memory, floppy-disc	118	342	ignition systems	114	71
microcomputer	118	345	linearizer, thermocouple	108	307
microprocessor	118	343	sensor, noncontacting	108	309
ROM, alterable	118	344			
thermal printer	116	74	Packaging & Materials		
			connector, power	124	360
Discrete Semiconductors			connectors, PC-edge	22	20
DMOS FETs	119	80	enclosures	35	26
FETs, n-channel	123	357	heat sinks	71	44
indicators	78	45	tool, desoldering	124	359
indicators, snap-in	123	355	wire and cable	6	5
LED discretes	93	51			
photodiodes	123	358	Power Sources		
power Darlington	51	40	dc/dc converters	121	82
power SCRs and triacs	48	38	dc/dc power supplies	103	57
power transistor switch	50	39	dc supplies	18	16
power transistors	64	43	high-voltage units	112	329
SCRs, high current	123	356	magnetic shielding	134	108
			mini-switcher	31	25
Instrumentation			open-frame source	112	330
biomedical equipment	98	54	open-frame sources	110	323
DPM	114	333	power supplies	32	298
interface card	113	332	power supplies	101	56
network analyzer	11	242	power supplies, benchtop	21	19
phase meter	61	106	power supply	132	107
power amplifiers	64	110	power supply	111	243
power amplifiers	113	69	power supply catalog	128	101
pulse generator	114	334	power supplies	124	85
oscilloscope, calculating	19	262	regulators	118	77
oscilloscopes	87	49	switchers	79	46
oscilloscopes, portable	45	34	switchers	80	47
simulator, thermocouple	113	331	switchers	110	324
sweeper-scope	1	2	switchers, 20-kHz	63	42
test instruments	39	251	switching supply	25	21

INFORMATION RETRIEVAL NUMBER 108

Stop spinning your wheels looking for the unit you need.



Get a souped-up, high performance, customized power supply in record time.

When you need a power supply to meet a specific need, don't start from scratch. We'll modify one of our custom jobs to work like it was made just for you.

Our supplies have proven track records. They've met the challenge of commercial quantity needs, military quality needs, hi/lo voltage/current combinations, and come up winners every time.

Our champions include the Model 502 switching design, 5VDC, 150 amp mini-computer supply that can function in master or slave mode in parallel operation. The Model 774 linear design bank terminal supply with a high power to cost ratio enabling throw-away replacement. The long lasting mini-CRT display supply. And the programmable voltage, multi-application guided missile system supply that delivers better than 2 watts per cubic inch at 75 percent-plus efficiency. Plus many more — there's one that fits your needs.

Give us the green light to modify a custom supply for you.
You'll get the checkered flag every time.

NCR

NCR Corporation

Scott Electronics Division 2525 Shader Road

P.O. Box 7637 Orlando, Florida 32804 (305) 295-5850

INFORMATION RETRIEVAL NUMBER 243

What's new in solid state...

RCA "Gold CHIP" LICs. Hermeticity in plastic at plastic prices.

Plastic LICs may have caused you some worries about field failures, actual or potential. But you didn't want to pay the price of ceramic or frit seal. Or, maybe the expensive hermetic packages you did use were damaged during insertion.

Now, the solution. RCA "Gold CHIP" linear integrated circuits. With gold metalization plus Chip Hermeticity In Plastic (CHIP). For reliability *plus* the economy and ruggedness of plastic.

Gold CHIP LICs have noncorroding gold metalization and leads. No aluminum with its potential problems. We make the chip itself hermetic. And put it in our advanced plastic package

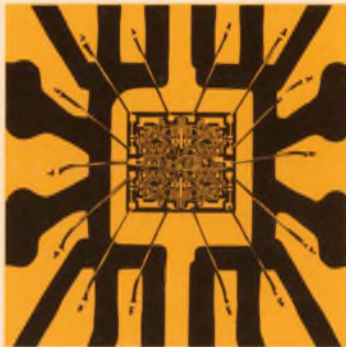

with proven outstanding reliability. Result: truly cost-effective hermetic LICs at the price of standard plastic LICs.

How reliable are they? We experienced zero failures in the following tests (data available): Temperature/Humidity/Bias, Operating Life, Thermal Fatigue, Pressure Cooker, Thermal Shock, Temperature Cycle.

Free Gold CHIP Sample

Evaluate them yourself! We'll send you one of the 6 off-the-shelf "G" standards listed here, free: CA741CG op amp; CA747G dual op amp; CA324G quad op amp; CA339G quad voltage comparator; CA3724G high voltage transistor array; CA3725G high voltage transistor array. Just specify which one, on a self-addressed label.

To find out more, contact your local RCA Solid State distributor. Or RCA.

Write: RCA Solid State, Box 3200, Somerville, New Jersey 08876; Ste. Anne de Bellevue 810, Canada; Sunbury-on-Thames, U.K.; Fuji Bldg., Tokyo, Japan.

RCA

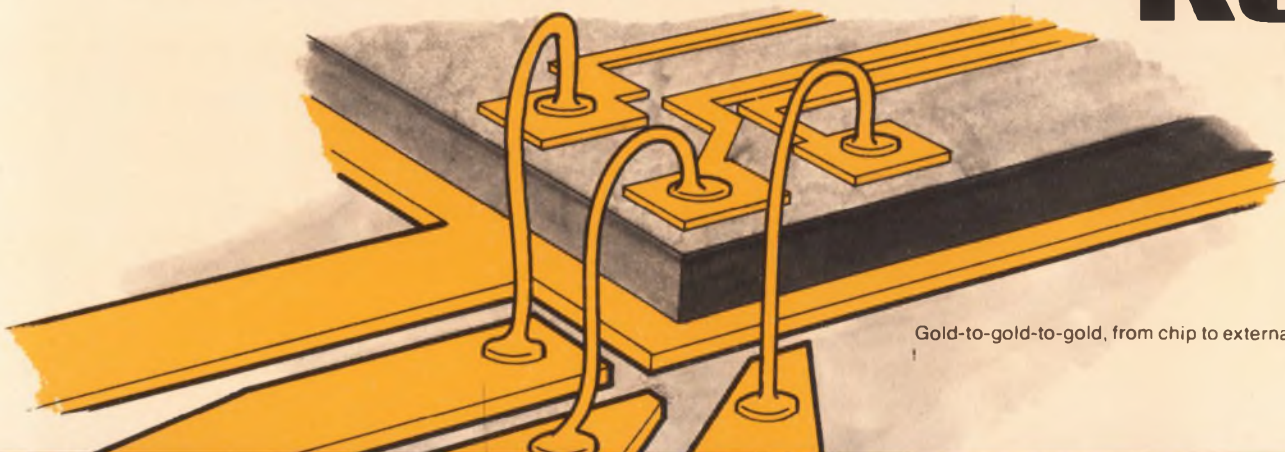

Gold-to-gold-to-gold, from chip to external world.

RCA. Full house in Linear ICs.