

Electronic Design 19

VOL. 23 NO.

FOR ENGINEERS AND ENGINEERING MANAGERS

SEPT. 13, 1975

The pervasiveness of displays has made proper selection more important than ever. But recent improvements in technology make the choice tougher. LEDs have

become bigger, brighter and more pleasing to the eye, while LCDs have increased their switching speed and life expectancy. Shed light on the problems, see page 52.

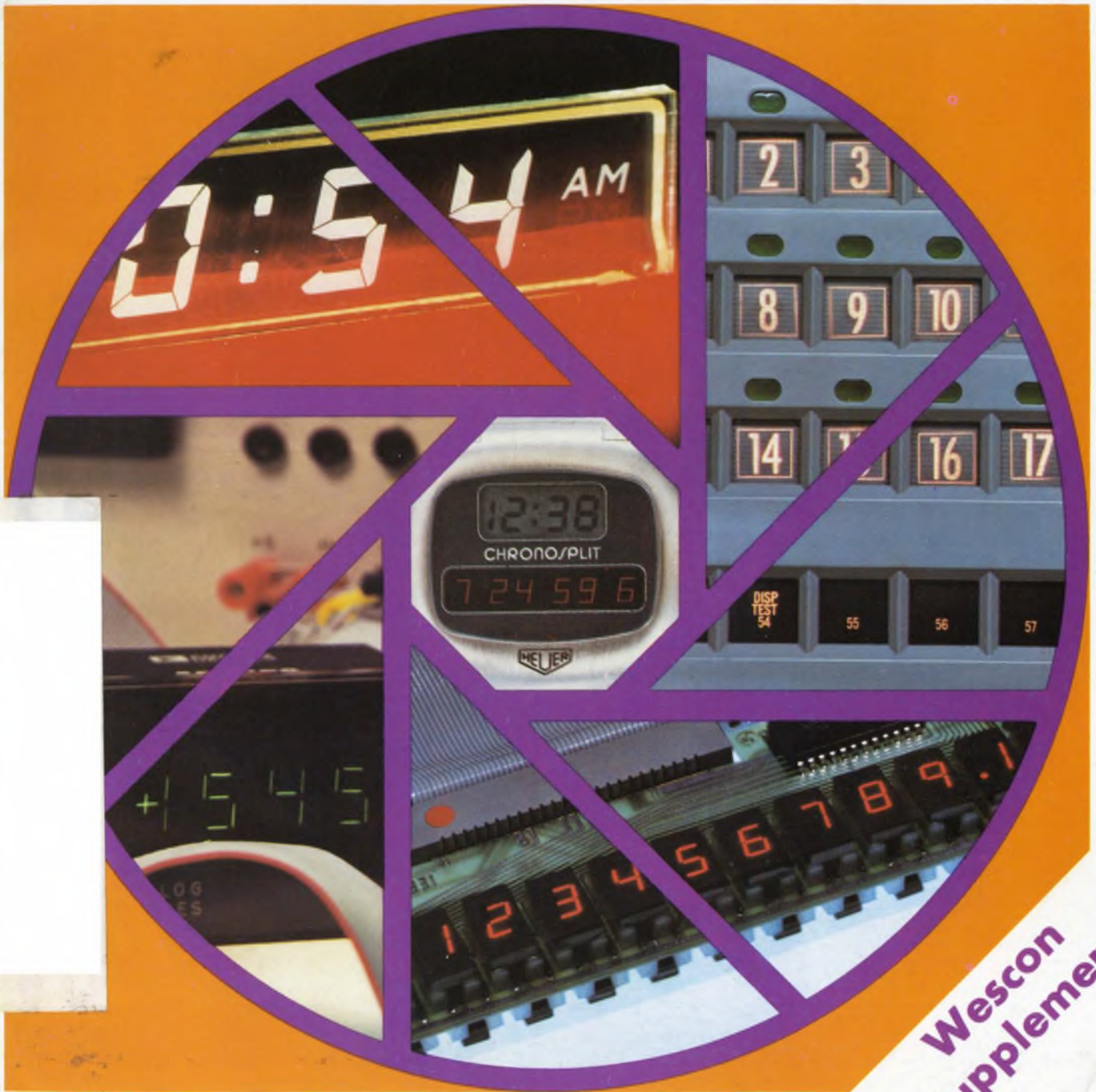

**Wescon
Supplement**

The resistance stretchers.

Use DALE
Film Resistors
to go from .27 to
one trillion ohms—and
handle lots of special
functions in between.

Call DALE when you need a non-standard resistor. Our broad metal film line gives you instant access to special high and low values, plus high voltage, power and frequency handling capabilities. We've combined the best of metal film, carbon film and metal oxide technologies to meet your parameters with practical parts backed by years of application history. Don't hesitate to move beyond the limits of standard resistors. Dale can quickly supply the special part you need.



ULTRA HIGH VALUE

Types M & MH:
Values 30M to 1000KM.
1/4 and 1/2 watt
sizes. Tolerance 1%
through 20%. Vacuum
sealed in glass
envelope or encapsulated in irradiated
polyolefin sleeve.

ULTRA LOW VALUE

Type A: Values:
.27 Ω to 27 Ω .
Tolerances 1%
through 10%. 1/2
and 2 watt sizes.
Molded or
conformal
coated.

HIGH VALUE

Type M: Standard precision metal film styles with values to 100 Meg. Up to 300 Meg. on special request. 1/4 thru 2 watt sizes. Tolerances .05%, 1%. Molded or conformal coated.

HIGH FREQUENCY

Type I: Carbon film tubular styles with excellent high frequency characteristics for high power, high accuracy RF measurement applications. Standard types available include power (free air) to 120 watts.

HIGH VOLTAGE

Type F: Excellent stability in high voltage and pulse applications. 1/2 and 1 watt sizes. Values to 150KM. Pulse voltages to 50KV, working voltages to 14KV. With leads and/or threaded caps.

Call 402-371-0080 or write

DALE ELECTRONICS, INC. Box 74, Norfolk, Nebraska 68701

A subsidiary of The Lionel Corporation

In Canada: Dale Electronics Canada Ltd.

INFORMATION RETRIEVAL NUMBER 263



SURPRISE!



The first 24 mcd LED lamp!

And that's 24 mcd at only 10 mA for our brightest red lamp. At 20 mA you can get over 48 mcd of light output.

	RED	YELLOW	GREEN
NARROW BEAM 5082 -	4658	4558	4958
	4657	4557	4957
WIDE BEAM 5082 -	4655	4555	4955
	4650	4550	4950

HP's new high efficiency material makes these new bright LED's possible. With our brightest yellow you get 16 mcd at 10 mA. Our brightest green offers 16 mcd at 20 mA.

Three colors, two beam angles, and two luminous intensity categories are available in the popular T 1-3/4 package. Twelve new LED's, one just right for your application.

All are available for immediate delivery, just \$0.89* each or \$1.15* each at the 100 piece level, depending on brightness category.

Contact Hall-Mark, Schweber, Wilshire or the Wyle Distribution Group (Liberty/Elmar) for immediate delivery. Or, write us for more details. They offer you new ways to apply solid-state technology in your products.

HEWLETT  PACKARD

Sales and service from 172 offices in 65 countries.
1501 Page Mill Road, Palo Alto, California 94304

01502 *Domestic USA Prices Only.

INFORMATION RETRIEVAL NUMBER 2

A big hit: Teledyne TO-5 relays.



Improve shallow depth operation. Counter target decoys. Enhance rejection of false echoes. Tough goals for any torpedo acoustic guidance/control system. But Northrop did it — turning misses into hits — with a little help from Teledyne TO-5 relays. Whenever military, commercial or industrial switching jobs call for high packaging density, low power consumption and low heat dissipation

— coupled with high reliability — we answer the need with our TO-5 relays. They're less than half the size and weight of 1/2 crystal can relays, and use up to 75% less coil power. What's more, our TO-5's are all-welded, hermetically sealed, and fully qualified to MIL-R 39016B, "L" and "M" levels. And you have your pick from a wide selection of TO-5 relays — including ultra-sensitive types, maglatches, internal suppression diodes and drive transistors, and many contact arrangements. In short, there's a Teledyne TO-5 relay ready to meet your requirements. For full data or applications help, contact your local Teledyne Relays people. We're sure to make a big hit with you, too.

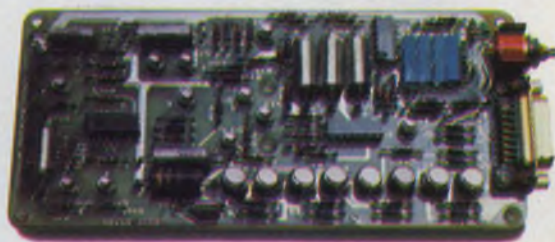

Logic Package Module for
NT 37C Torpedo Guidance System
(with 8 Teledyne TO-5 Relays)



NT 37C Torpedo
Courtesy of Northrop Corp.

 **TELEDYNE RELAYS**

3155 West El Segundo Boulevard, Hawthorne, California 90250
Telephone (213) 973-4545

INFORMATION RETRIEVAL NUMBER 3

NEWS

- 19 **News Scope**
- 26 **Medical electronic instruments** are getting smarter, thanks to increased use of microprocessors.
- 30 **Omissions in IEEE Interface Standard 488** are cited by instrument designers.
- 34 **Domestic communications satellites** are readied to carry enormously increased volumes of traffic.
- 43 **Washington Report**

TECHNOLOGY

- 52 **FOCUS on displays.** Get a better grip on the problems you'll face when selecting displays by being aware of confusing specs and avoiding the mistakes engineers most commonly make.
- 66 **Consider LCDs for your next design.** Liquid-crystal displays need little power. They can show complex images, and present them clearly.
- 72 **Mate synchros with computers** by using solid-state conversion modules. S/d and d/s converters can minimize mechanical interfacing while boosting reliability.
- 80 **Keep Newton on your side** when you select a direct-writing recorder. Sir Isaac's laws of basic dynamics help refute specious product claims.
- 86 **Joe Keithley of Keithley Instruments** speaks on planning your projects.
- 94 **Ideas for Design:**
Floating regulator gives 0.1% regulation over 0-to-100-V-dc, 200-mA range.
Match antenna over 1.5-to-30-MHz range with only two adjustable elements.
400-Hz power supply for servos delivers up to 0.5 A at 11.8-V rms.
- 102 **International Technology**

PRODUCTS

- 105 **Integrated Circuits:** 1024-bit NMOS RAM offers bipolar speed at low power.
- 124 **Modules & Subassemblies:** Lowered feedthrough lets d/a performance shine through.
- 126 **Modules & Subassemblies:** Speedy a/d converts input signals in less than 2 μ s.
- 128 **Modules & Subassemblies:** 16-bit d/a converter claims highest accuracy, lowest drift.
- 110 **Components**
- 113 **Instrumentation**
- 116 **Discrete Semiconductors**
- 120 **Packaging & Materials**
- 121 **Data Processing**

DEPARTMENTS

- 49 **Editorial:** Remember 'pervasiveness'?
- 7 **Across the Desk**
- 130 **Bulletin Board**
- 130 **Application Notes**
- 132 **New Literature**
- 140 **Advertisers' Index**
- 142 **Product Index**
- 144 **Information Retrieval Card**

Cover: Cover designed by Art Director, Bill Kelly, photographs courtesy of Analog Devices, Heuer, Industrial Electronic Engineers and RCA.

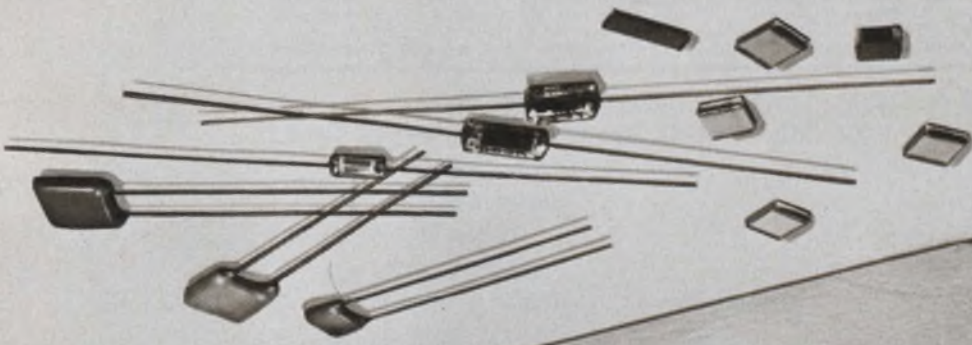

**JOIN OUR BME
CAPACITOR
SAVINGS PLAN**

TM

**SAVE 30% TO 50%
ON THE COST OF MONOLITHIC
CERAMIC CAPACITORS**



This major cost saving is the result of our new BME™ capacitor technology. We've eliminated precious metals entirely from the electrodes and terminations of our BME™ capacitors. No precious metals means lower cost. So now we offer you our complete line of monolithic ceramic capacitors — BME Chips™, BME Radials™ and BME Axials™ — at a genuine savings of 30% to 50%.

This significant reduction is not based on a momentary drop in precious metal prices. This is a long-term solution due to the replacement of precious metals by non-noble metals which are not subject to the same dramatic cost spirals.

SAVE WITH RELIABILITY

Our BME™ capacitors have not sacrificed the inherent electrical and mechanical Ceramolitic® quality. Their reliability can be demonstrated by the extensive test procedures to which they have been subjected. Write to our Applications Engineering Department for complete test reports.

**SAVE WITH DESIGN
FLEXIBILITY**

Now you can seriously consider monolithics to replace micas and tantalums. Our BME™ capacitors feature non-polarity, a wide range of

**TYPICAL SELLING PRICES PER UNIT FOR
USCC'S BME-KAPS™ ON
QUANTITIES OF 5000 OR MORE**

BME™ "J" DIELECTRIC (COG)	BME-Chip™	BME-Axial™	BME-Radial™
1 thru 100 pF, 5%, 50WVDC	5.1¢	6.8¢	7.5¢
1000 pF, 5%, 50WVDC	12¢	16¢	16¢
BME™ "S" DIELECTRIC (X7R)	BME-Chip™	BME-Axial™	BME-Radial™
.01 µF, 20%, 50WVDC	3.5¢	5.8¢	5.8¢
.1 µF, 20%, 25WVDC	9¢	16¢	14¢
1.0 µF, 20%, 25WVDC	52¢	—	73¢
BME™ "R" DIELECTRIC (Z5U)	BME-Chip™	BME-Axial™	BME-Radial™
.1 µF, +80 —20%, 25WVDC	5.7¢	8.8¢	8.8¢
.47 µF, +80 —20%, 25WVDC	13¢	16.5¢	16.5¢
1.0 µF, +80 —20%, 25WVDC	19¢	27¢	25¢
2.2 µF, +80 —20%, 25WVDC	35¢	—	49¢

capacitance value, low leakage, high volumetric efficiency, availability in chip, radial and axial packages at prices competitive with mica below 1000pF and tantalum up to 2.2µF.

SAVE ON DELIVERY TIME

Elimination of precious metal material costs have permitted us to stockpile chips. We now have five to ten million units in over 40 popular values ready for two-week delivery in chip style or four-week delivery in leaded configurations.

**JOIN THE USCC/CENTRALAB
BME™ CAPACITOR
SAVINGS PLAN**

Get all the details today. Write on your company letterhead for your

concise Savings Plan Price list — your pass book to the lowest monolithic ceramic capacitor prices available. Compare it with anyone else's price list and see.

Remember, USCC/Centralab—
Quality, Volume, Savings.



USCC/Centralab

Electronics Division • Globe-Union Inc.

4561 Colorado Boulevard ■ Los Angeles, Ca. 90039

(213) 240-4880



SEE US AT WESCON75 BOOTH NO. 1156

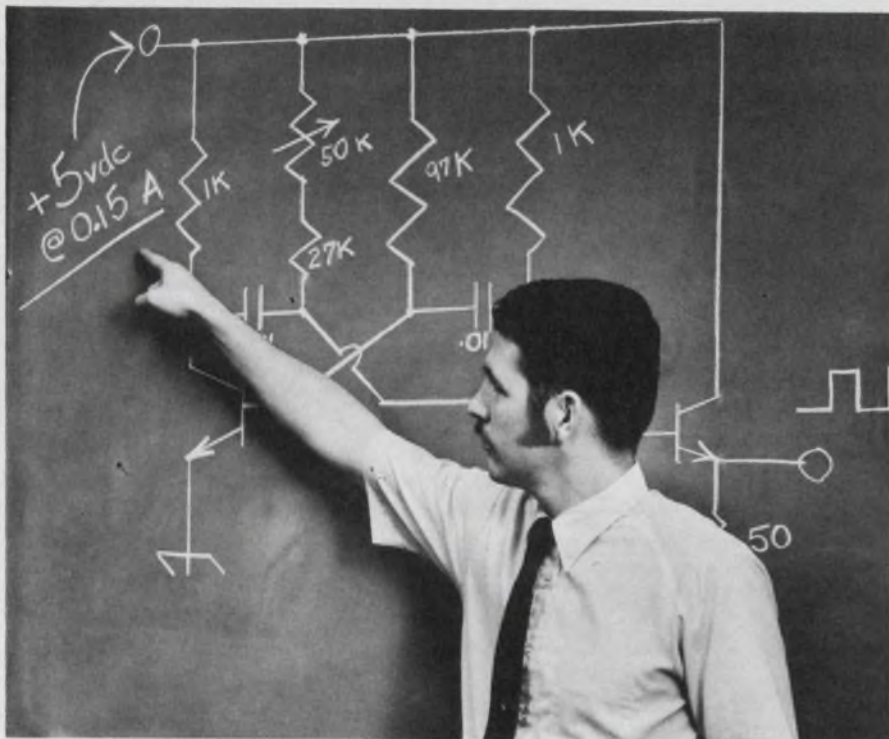

How to Design Your Power Supply for \$72

You get the **complete schematic diagram, and parts list** with operating and installation instructions when you spend \$72 for an Abbott Model "RN" power supply. Two years in development, this model represents the latest state of the art in power module design. It features close regulation (0.1%), low ripple (0.02%), automatic short circuit and complimentary overvoltage protection and continuous operation in a 160°F ambient.

Abbott Engineers followed specific design criteria in engineering these modules. First, the electrical design was carefully engineered to insure that all components operate well within their limits, under "worst case" operating conditions. Second, the thermal design, including case construction, was carefully made to insure that the maximum temperature limits of all components are never exceeded. Then the size and weight of these modules were controlled to a minimum, without sacrificing reliability. Finally these units were thoroughly tested to make certain that all design and performance specifications were met.

So, you can build your own power supply using our schematic diagram if you want to—but we think we can build it more

Please see pages 307-317 Volume 1 of your 1974-75 EEM (ELECTRONIC ENGINEERS MASTER Catalog) or pages 853-860 Volume 3 of your 1974-75 GOLD BOOK for complete information on Abbott Modules.

Send for our new 60 page **FREE** catalog.

reliably and for less cost, simply because we have been doing it for ten years. Put our power supply in your system first and try it. Examine its performance. We think you will be pleasantly surprised at the quality, adherence to specifications, and the reliability you find in the Abbott Model "RN".

Any output voltage from 5 to 100 volts DC with current from 0.15 to 20 amperes is available. *Many of the popular voltages are carried in stock for immediate delivery.* Please call us for attractive O.E.M. discount prices.

Abbott also manufactures 3,000 other models of power supplies with output voltages from 5.0 to 740 volts DC and with output currents from 2 milliamperes to 20 amperes. They are all listed *with prices* in the new Abbott catalog with various inputs:

- 60 A to DC
- 400 A to DC
- 28 VDC to DC
- 28 VDC to 400 A
- 12-38 VDC to 60 A

Sr. Vice President, Publisher
Peter Coley

Editors

Editorial Offices
50 Essex St.
Rochelle Park, NJ 07662
(201) 843-0550
TWX: 710-990 5071
Cable: Haydenpubs Rochellepark

Editor-in-Chief George Rostky

Managing Editors:

Ralph Dobriner
Michael Elphick

Associate Editors:

Dave Bursky
Jules H. Gilder
Morris Grossman
John F. Mason
Stanley Runyon
Edward A. Torrero

Contributing Editors:

Peter N. Budzilovich
Alberto Socolovsky
Nathan Sussman

Editorial Field Offices

East

Jim McDermott, Eastern Editor
P.O. Box 272
Easthampton, MA 01027
(413) 527-3632

West

David N. Kaye, Senior Western Editor
8939 S. Sepulveda Blvd.,
Suite 510
Los Angeles, CA 90045
(213) 641-6544
TWX: 1-910-328-7240

Editorial Production

Marjorie A. Duffy

Art

Art Director, William Kelly
Richard Luce
Anthony J. Fischetto

Production

Manager, Dollie S. Viebig
Helen De Polo
Anne Molfetas

Circulation

Manager, Evan Phoutrides

Information Retrieval

Peggy Long

Promotion, Creative Layouts

Manager, Albert B. Stempel
Maxine Correal
Nancy Gordon (Reprints)

abbott transistor

LABORATORIES, INCORPORATED
general offices eastern office

5200 W. Jefferson Blvd./Los Angeles 90016
(213) 936-8185 Telex: 69-1398

1224 Anderson Ave./Fort Lee, N.J. 07024
(201) 224-6900 Telex: 13-5332

INFORMATION RETRIEVAL NUMBER 5

Across the Desk

Further reflections on 'noble' electronics

My sensibilities were stunned by a letter from James Rieger in the May 10, 1975 issue ("Parking-Meter Sensor Makes Him Blow Fuse," ED No. 10, p. 7). Here is a man who is anguished by the inhumane use of a Hall-effect device as a parking-meter sensor, and he says that "a less noble use of electronics is hardly imaginable."

If he would want to imagine a "less noble use of electronics," I suggest that he look into his own engineering files and those of his fellow engineers at the Naval Weapons Center, where some of the most fiendish weapons of mass destruction are devised with his beloved electronics.

*David Wald
Staff Engineer*

American Videonetics Corp.
795 Kifer Rd.
Sunnyvale, CA 94086

A kind word about the rotating UPS

Your May 10 issue concerning the multifaceted computer world was very good. I particularly enjoyed "Focus on Uninterruptible Power Supplies and Inverters," because we are developing equipment in this field. Your article seemed very comprehensive in the static inverter technique, but failed to mention other ways to do the job. Several manufacturers of rotating equipment supply UPS for the computer industry, and Precise Power Corp. is one of them.

Our system uses a new variable-speed, constant frequency generator with inherent flywheel energy storage. A simple induction motor

drives the generator, whose output is crystal-controlled through low-density electronics for frequency stability of better than 0.025%. Voltage regulation is better than +5%. Energy storage times range from a few seconds to several minutes, with use of flywheels.

We can also clutch in a combustion engine to the mechanical shaft after a few seconds to provide UPS indefinitely, if required. Thus we would have an engine-generator on line within seconds, without any change in output. A well-designed static UPS requires a backup engine generator (beyond battery capability). The Precise Power system eliminates the batteries, battery charger, inverters and filters. An induction motor, a clutch and a small electronic controller replace these.

Because all of the power to the computer is derived through the shaft, the UPS is an absolute line-isolation system. The system can also be designed as a frequency converter (we have 60-to-400-Hz units) and as a phase converter, to make three-phase power output available with single-phase input while the inherent UPS requirement is supplied.

Ninety per cent of the usual power line interruptions last less than two seconds, but battery systems are designed for five minutes to an hour. They can't be designed for shorter durations, due to limitations on allowable rates of discharge. Flywheels are not rate-limited; so they can be designed for optimum energy storage. Besides eliminating batteries, the Precise Power system can be designed for three-phase output from a single machine. This means that the price can be reduced to one-

(continued on page 11)

Electronic Design welcomes the opinions of its readers on the issues raised in the magazine's editorial columns. Address letters to Managing Editor, Electronic Design, 50 Essex St. Rochelle Park, N.J. 07662. Try to keep letters under 200 words. Letters must be signed. Names will be withheld on request.

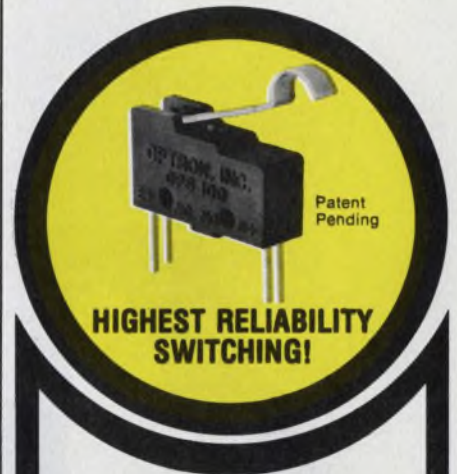

OPTICALLY COUPLED LIMIT SWITCHES

OPTRON OPS-100
SWITCH LIFE FIVE TIMES
THAT OF
CONVENTIONAL SWITCH

OPTRON's new subminiature high reliability optically coupled limit switch features switch life exceeding 25,000,000 cycles, five times that of conventional switches.

The new OPS-100 limit switch combines the non-contact switching feature of popular optically coupled interrupter modules with the mechanical characteristics of conventional smaller limit switches. It consists of an infrared LED optically coupled to a phototransistor to provide solid state reliability in a conventional mechanical switch package.

The switch lever arm of the OPS-100 actuates an optical shutter mechanism to interrupt the light beam changing the state of the switch. The shutter is unique in that the switch can be converted at any time by the user from "normally open" to "normally closed" or vice versa. In addition, the OPS-100 eliminates contact bounce and RFI while offering an input-to-output isolation voltage exceeding 5 kV.

The optically coupled limit switch has a guaranteed minimum current output of 0.4 mA and is specified for interfacing directly with low power TTL or CMOS circuits. Selected units are available for interfacing with standard TTL circuits.

New OPS-100 limit switches are available from stock.

Detailed technical data on the OPS-100 limit switch and other OPTRON optoelectronic products... chips, discrete components, isolators, assemblies, and PC board arrays... is available from your nearest OPTRON sales representative or the factory direct.



OPTRON, INC.

1201 Tappan Circle
Carrollton, Texas 75006, U.S.A.
214/242-6571 • TELEX-73-0701
TWX-910-860-5958

Eliminate RF Design Time



TRW far more capability at

**TRW push pull amplifiers
with thin film
hybrid circuitry:**

Wider dynamic range

Wider bandwidth

Lower noise figure

Higher output

**Greater channel capacity
and cascability**

Over 400,000 in the field

3 billion operating hours

100% burn in before shipping

Environmental/mechanical testing

Costs \$35 - \$55

broadband linear amplifiers provide less cost than your custom design

It doesn't figure to spend your time designing a custom RF amplifier. TRW has already done it for you, and is now mass producing them with off-the-shelf delivery, applications assistance, unmatched performance and reliability. Curious? Check the specs on the three typical parts below and then send for a complete file on TRW's design time eliminators.

You owe it to your own new design to get the facts on TRW's hybrid linear amplifiers. For a detailed description of TRW's superb manufacturing and testing procedures as well as complete specs, call Tom Cable at (213) 679-4561, use the coupon or bingo number below.

Part Number	CA2800	CA2810	CA818
Bandwidth	10-400 MHz	10-350 MHz	5-150 MHz
Gain	17 db	33 db	18 db
Noise Figure (TYP)	6 db	5.5 db	6 db
P ₀ (1 db comp)	800 MW	800 MW	800 MW
3rd Order Intercept	+43 dbM	+42 dbM	+44 dbM

TRW RF Semiconductors
An Electronic Components Division of TRW, Inc.
14520 Aviation Boulevard, Lawndale, California 90260

Please send me your 8-page booklet, Hybrid Reliability and complete specs on your line of hybrid linear amplifiers and discrete transistors.

NAME _____

COMPANY NAME _____

ADDRESS _____

CITY _____ STATE _____ ZIP _____

TRW® RF SEMICONDUCTORS

INFORMATION RETRIEVAL NUMBER 7

When it's your move ...check Centralab

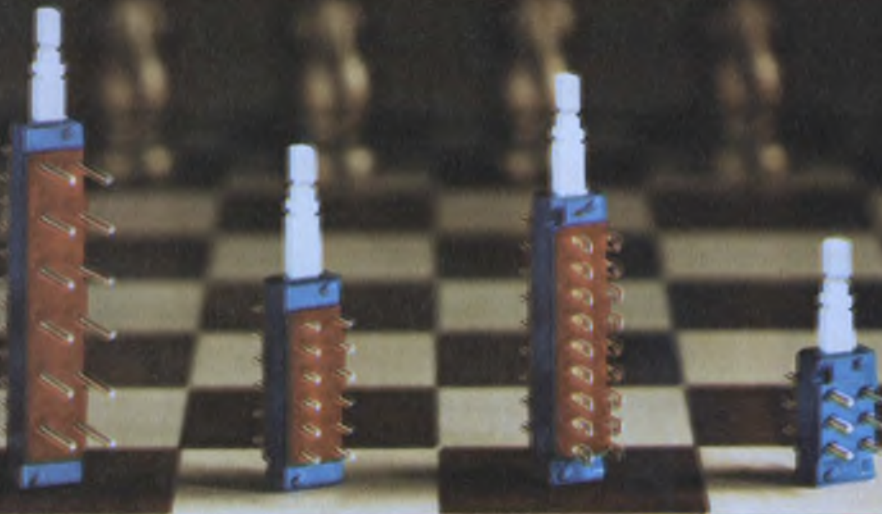

Best pushbutton switch for your board

Don't be checkmated. Only Centralab offers you the best low-cost switch module, plus so many extra-quality options.

THE BEST SWITCH — The basic Centralab pushbutton switch module is unique because of its inherently simple and rugged construction. High speed machinery produces the parts and performs assembly operations simultaneously, ensuring that the parts always fit the assembly perfectly. Stationary and movable contacts are enclosed in a high-dielectric thermoset housing to protect the smooth, positive wiping

action of the slider bar and contacts. And Centralab switches are 100% tested.

Centralab pushbutton switches meet these demanding specifications:

Insulation Resistance: Up to 10^{12} ohms.

Dielectric strength: 1,500 volts.

Contact resistance: .004 ohms.

Life and reliability: Up to 250,000 MTBF in ganged assemblies. Over 500,000 operations on contact systems.

Shock and Vibration: 100g's and 10g's low frequency.

Electrical rating: Covers range from dry circuits to 1 ampere, and low millivolts to 120 volts.

If your requirements go beyond the basic Centralab module, consider these optional moves:

HIGHEST INSULATION RESISTANCE — Centralab offers diallyl phthalate housing material, in addition to phenolic.

BEST CONTACT RESISTANCE — Gold contacts and terminals are standard options. Best for dry circuit applications and contaminating environments.

NO INTERNAL CONTAMINATION — Epoxy sealed terminals prevent

failure from solder flux and other contaminants.

Proven in use by more quality-conscious users, Centralab 2, 4, 6 and 8 pole pushbutton switches are available in four types of lockout for momentary, push-push or interlocking action. Both PC and solder lug terminals are available. PC terminals can be selectively cut to your desired lengths.

PLUS THESE NEWEST ADDITIONS

— A new 5 amp line switch, a new low-cost lighted switch and a new visual display for non-lighted switches.

Get all the technical help you need from our 19 assembly distributors or network of experienced sales engineers. They'll help you select the best pushbutton switch for your board. Now it's your move!

Isostat Licensed

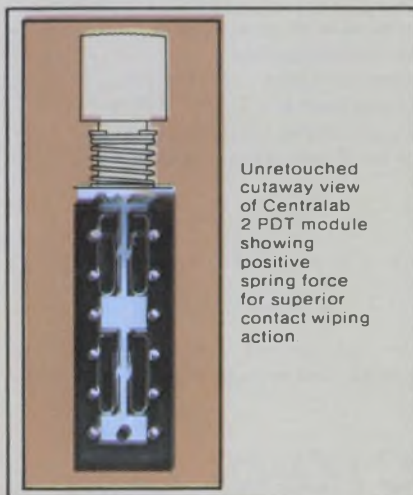

Unretouched cutaway view of Centralab 2 PDT module showing positive spring force for superior contact wiping action



CENTRALAB

Electronics Division
GLOBE-UNION INC.

5757 NORTH GREEN BAY AVENUE
MILWAUKEE, WISCONSIN 53201

ACROSS THE DESK

(continued from page 7)

half that of solid-state inverters.

Finally, the combination of rotating machinery for high-power output and solid-state controls at low-power densities provides promise of high reliability.

A kind word about rotating-machinery UPS devices would be appreciated.

R. T. Morash
Mechanical Engineer

Precise Power Corp.

P.O. Box 1905

Bradenton, FL 33506

Ed note: To keep the article within reasonable bounds, we limited discussion exclusively to solid-state UPS systems.

Misplaced Caption Dept.



"I can type and do wire bonding and die attach."

Sorry. That's Pierre-Auguste Renoir's "Young Woman Against a Blue Background," which hangs in the Henri Bernstein collection in Paris.

About that misplaced 'misplaced caption'

Some detractors say that engineers are Philistines, too wrapped up in numbers and "things" to appreciate beauty. ELECTRONIC DESIGN has proof positive that this simply is not true. A freschet of let-

ters has cascaded into the editor's office to point out that a great work of art was mislabeled in the July 19, 1975 issue (ED No. 15, "Misplaced Caption Dept.," p. 10). The picture displayed, as many readers point out, is not Edouard Manet's "Lunch on the Grass."

One reader said that it was "The Gleaners" and suggested timidly: "Corot?" Most identified it correctly without hesitation: "The Gleaners," by Jean François Millet. It hangs in the Louvre in Paris.

The misplaced "misplaced caption" was one of those rare printer's errors in which the three lines of type were rerun after having been published in the May 24 issue (ED No. 11, p. 16).

It's nice to know there are so many art lovers out there.

A different language

Tom Nawalinski of Hewlett-Packard reports that recent world developments are making him consider the advisability of studying Arabic. He's concerned, though, with the numbering system which, he understands, is very complex.

VCO for music rings a bell

Idea for Design "Voltage-Controlled Music Oscillator Has Linear Properties" (ED No. 5, March 1, 1975, p. 66) will probably result in a small collection of letters saying, "There's a better way!" Mr. Berkowitz has made it easier to use an 8038—very attractive for electronic music—though some people have had trouble making it work well. However, electronic-music enthusiasts are fond of nonlinear VCOs. Bob Moog found out a long time ago that an exponential frequency-vs-voltage characteristic is more versatile. A scale factor of 1 V per octave has become a "standard."

Thus modern electronic music VCOs have no need for range switches to cover the audio range. Also, different control voltages can be summed at the VCO's inputs

(continued on page 14)

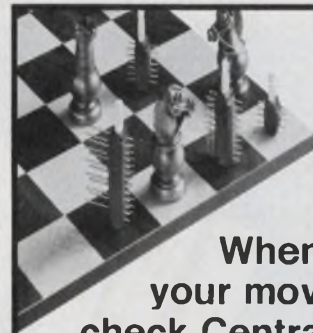

When it's
your move
check Centralab

High quality
pushbutton
switches at
a low cost



Centralab switches are engineered for quality. Then they're produced on high-speed automated machines to keep your cost down. This means...

Low Price: A Centralab 2-pole lighted switch, for example, costs only \$1.36 including lamp, in 1,000 quantities.

Quality: Up to 250,000 MTBF in ganged assemblies. Over 500,000 operations on contact systems.

Plus Options: Diallyl phthalate housings • gold contacts • epoxy-sealed terminals • 2, 4, 6 and 8 poles • four types of lockouts • and much more for *only pennies more.*

Newest Additions: Non-lighted status indicator • low-cost lighted switch • 5 amp line switch.

When you can have quality *and* low price from Centralab, why settle for less? For full information, call your Centralab Pushbutton Distributor or send reader service card, or write...

Isostat Licensed



CENTRALAB

Electronics Division

GLOBE-UNION INC.

5757 NORTH GREEN BAY AVENUE
MILWAUKEE, WISCONSIN 53201

INFORMATION RETRIEVAL NUMBER 9

MOS 6502

**the second of a low cost
high performance
microprocessor family**

MCS 6501—MCS 6502 a great microprocessor family “the software compatibles”

mcs6501—pin compatible to the MC6800

mcs6502—eliminates outboard clock circuits

PRICE!

- LOWEST COST STARTER SET
- LOWEST COST SOFTWARE
- LOWEST COST DOCUMENTATION
- LOWEST COST I/O (M6800 Compatible)

EASE OF USE!

- EASIEST DOCUMENTATION TO USE
- SIMPLE, EASY-TO-FOLLOW INSTRUCTIONS (SIMILAR TO PDP-11)
- EASIEST TO USE DESIGN-IN SYSTEM

PERFORMANCE!

- MORE USEFUL ADDRESSING CAPABILITY:
 - TWO REAL INDEX REGISTERS
 - TWO POWERFUL INDIRECTS
- HIGHEST PERFORMANCE (A-H SYSTEMS BENCHMARKS)
- SECOND SOURCE APPOINTED
- READY (RDY) FOR SLOW MEMORY OR DMA

This is still only the beginning—

Don't miss 
at **WESCON75**

HEADQUARTERS—MOS Technology, Inc. 950 Rittenhouse
Rd., Norristown, Pa. 19401 (215) 666-7950

EASTERN REGION—Mr. William Whitehead, MOS Technology,
Inc., 410 Jericho Turnpike, Suite 312, Jericho, N.Y. 11753
(516) 822-4240

WESTERN REGION—MOS Technology, Inc., 2172 DuPont
Dr., Suite 221, Patio Bldg., Newport Beach, Calif., 92660
(714) 833-1600

ELECTRONIC DESIGN 19, September 13, 1975

MOS 6502 SAVES MORE MONEY

~~*Eliminates
\$10 - \$50
Clock
Drivers~~

*You still need a resistor
and capacitor OR a crystal.

Last Month We Introduced
MCS6501 for

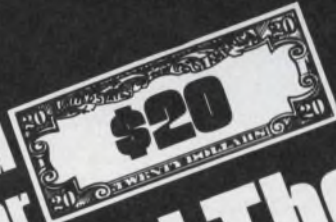

This Month We Added The
MCS6502 For



Note: If you get clocks for less than \$5, buy the mcs6501
and give your purchasing agent a bonus.

Try either product
at WESCON75
booth 1010

(If you can't make a copy of our documentation,
\$10.00 more gets you your very own set!)

MOS

MOS TECHNOLOGY, INC.
VALLEY FORGE CORPORATE CENTER, NORRISTOWN, PA. 19401 (215)666-7950

BETTER COMMUTATING CAPACITORS FOR SCRs

(and other non-sine wave voltage applications)



THE CAPACITORS:

Type 355P and 356P, newest members of the proven Sprague Clorinol® Capacitor family . . . paper and paper/polypropylene film dielectrics with non-flammable synthetic askarel impregnant.

THE APPLICATIONS:

Chopper circuits such as those in d-c motor control, inverter circuits for induction heating, high frequency lighting, high frequency power supplies, ultrasonic cleaners.

THE ADVANTAGES:

Volt-ampere ratings as much as 250% higher than those of older designs. Deliver large peak currents with lowest possible inductance and dissipation factor.

For complete technical data, write for Engineering Bulletin 4701 to Technical Literature Service, Sprague Electric Co., 347 Marshall St., North Adams, Mass. 01247.



THE BROAD-LINE PRODUCER OF ELECTRONIC PARTS

INFORMATION RETRIEVAL NUMBER 11

ACROSS THE DESK

(continued from page 11)

without upsetting the musical scale, which is a big advantage.

On a studio synthesizer, you can thus tune any key on the keyboard to any frequency within a range of several octaves, and the oscillator can still provide a complete musical scale. This can't be done with a linear VCO without an antilog circuit, like that in National Semi's Linear Application Note AN-30.

Nicholas Bodley
Technical Consultant

Electronic Music
300 W. 108th St.
New York, NY 10025

Sine-wave circuit 'put in perspective'

Your "International Technology" section (ED 13, June 21, 1975, p. 104) featured an interesting circuit principle for doubling an input sine wave and providing a sine wave output.

But just to put things in perspective, this circuit concept is based on the trigonometric identity (the haversine) $\sin^2(1/2 \omega t) = 1/2(1 - \cos \omega t)$. The $i_2 I_2$ term in the article serves to cancel the offset term in the haversine identity. This same result can be achieved with an analog multiplier. If the multiplier has the transfer function $XY/10$, simply tie X and Y together, put $\sin(1/2 \omega t)$ in and out comes $1/2(1 - \cos \omega t)$. You can ac-couple or offset and scale, as you desire.

These multipliers are available in either IC or modular form. Intronics offers a complete line that range in accuracy to 0.05% and in frequency to megahertz.

In addition we offer a module that computes $Z = \sqrt{X^2 + Y^2}$, so the equation that was implemented in the article ($i_o = \sqrt{i_2^2 - i_1^2}$) can be implemented directly by an available low-cost module.

Bucky Crowley
Senior Engineer

Intronics
57 Chapel St.
Newton, MA 02158

INFORMATION RETRIEVAL NUMBER 12 ►

SHELLY'S PAGEANT OF SUPERSTARS ...PICK THE WINNER & WIN A PRIZE



SHELLY'S PAGEANT OF SUPERSTARS ...PICK THE WINNER & WIN A PRIZE



1 Brite-Eye. The T1 indicator lamp that can be installed without hardware. Relampable from the front, too. With more cap styles (7) and colors (10) than anyone. Including the exclusive digi-cap.



2 Trans-Eye. The Brite-Eye with a built-in hybrid amplifier. Eight different base/circuit configurations to choose from. Or specify your own. Shelly has put the drive circuitry into the indicator to save you time and expense.

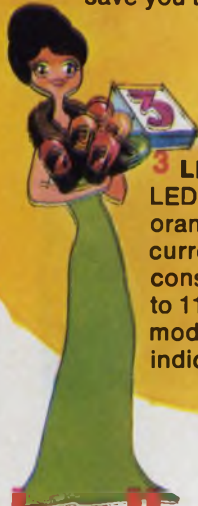

3 LED-Eye. Industry's first T1 LED package. In red, green, orange & yellow. Plus a current regulated LED for constant intensity from 4.5V to 11V. And a voltage sensing model for battery status indication.

Why are we giving away a Polaroid SX-70 camera and 12 electronic calculators? To acquaint you with six Super Shelly products — each designed to brighten up your newest product or prototype.

How to win? Just use the coupon to tell us which Shelly product has, in your opinion, the brightest future and why, in 25 words or less. Pick the winner and you'll participate in the big drawing.

So enter today. You just can't lose with Shelly.

5 The 64 Message Module.

Shelly's SRO-64 is the new look in multi-message displays. Imagine, 64 messages on a tiny "slip-chip" that snaps in and out. This amazing display operates like a miniature slide projector. Even better, since it has true random access in response to a 6 bit input code.



6 The Versatile Multi-Message Module.

Our SRO-600 series comes in 3 versions to fit commercial, industrial or military needs. Up to 12 messages can be displayed on the 0.7" by 0.59" single-plane viewing screen. Can be mounted individually or in vertical and/or horizontal groups. TTL compatible binary to decimal plug-in available.



4 The Mini Multi-Message Module.

That's our SRO-90, industry's smallest multi-message display. Up to 12 random access messages (with as many as 5 lines per message) displayed on a 0.43" by 0.34" screen. Anything that can be photographed can be displayed. In black & white or living color.



Be a Shelly Winner

Check the Shelly product you feel has the brightest future. Tear out coupon. Staple to your letterhead and state reasons why in 25 words or less.

Mail to: Shelly Assoc., 1562 Reynolds Ave., Santa Ana, Ca. 92705

- | | |
|---------------------------------------|---------------------------------------|
| 1. Brite-Eye <input type="checkbox"/> | 2. Trans-Eye <input type="checkbox"/> |
| 3. LED-Eye <input type="checkbox"/> | 4. SRO-90 <input type="checkbox"/> |
| 5. SRO-64 <input type="checkbox"/> | 6. SRO-600 <input type="checkbox"/> |

Name _____
Dept. _____
Company _____
Address _____
City _____ State _____

Please contact me regarding _____

Contest ends Oct. 30, 1975. All entrants will be notified of winners.

shelly associates

A Subsidiary of Datatron, Inc.

1562 Reynolds Ave., Santa Ana, California 92707 • (714) 549-3414

Mailing Address: P.O. Box 11427, Santa Ana, California 92711 • TWX 910-595-1589

Now You Can Record Data On 70mm Film From 4600 Line CRT With CELCO's DSC-III Photo Recorder.

Everything you need for data recording is here for you to start producing high-resolution photographs on 70mm film. Right now! Our Photo Recorder is fully integrated to accept digital and/or analogue inputs. All the necessary power supplies, electronics, and logic are included to operate this self-contained system.

The CELCO digitally controlled camera includes transport drive, lens, shutter and photomultiplier assembly which can be directly interfaced to TTL control lines from a computer. Film transport speeds are available from one second per frame, and faster. Unique camera optics of the CELCO camera accommodates a variety of film transports and magazines.

THE CELCO DSC-III 70mm photo recorder provides new flexibility for diverse applications. Satellite "Quick Look" monitors for immediate recording or ERTS photos. Complete systems for Large-Format Scanning ("MASTERSCAN") to digitize photos, letter masters and x-rays can be recorded on this 70mm Photo Recorder for hard copy and/or digital storage and retrieval.

Operate on digital data obtained in biological experiments from a scanning CRT microscope or other method for hard copy selective storage and retrieval.

If you have a data recording application, write or call CELCO today for more information on how you can start producing your own high-resolution photographs on 70mm film.

Celco

CONSTANTINE ENGINEERING LABS CO.

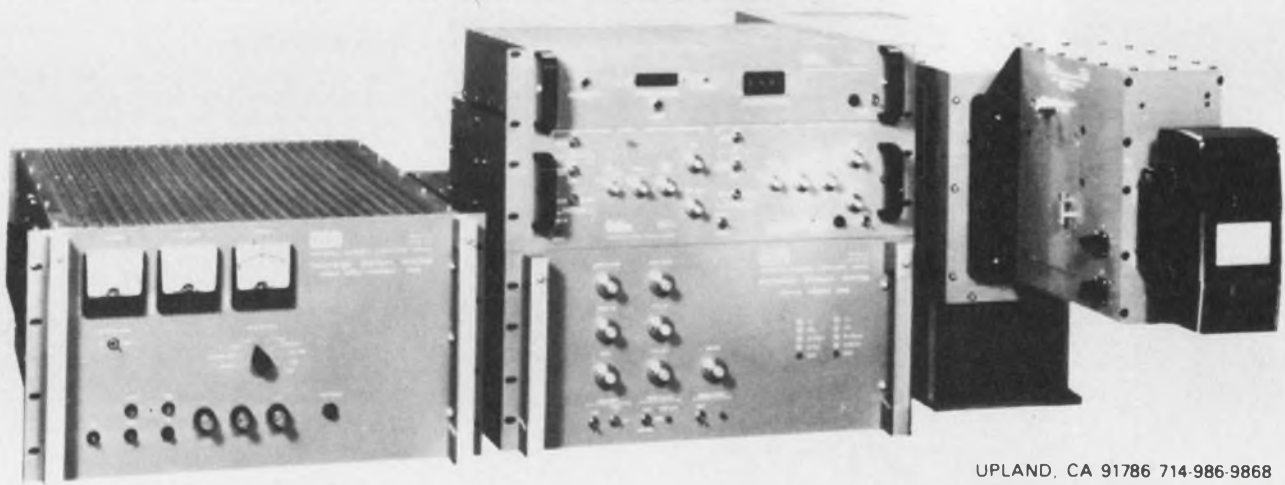

UPLAND, CA 91786 714-986-9868
MAHWAH, NJ 07430 201-327-1123

INFORMATION RETRIEVAL NUMBER 13

ELECTRONIC DESIGN 19, September 13, 1975

New series of generic PROMs— a family affair.

Stand alone PROM designs are now a thing of the past. Now the diverse requirements for density, modularity and performance within a system can be satisfied with Harris' new family of PROMs featuring generic characteristics.

This generic concept of PROMs offers many unique advantages. For instance, each device within the series will feature identical DC electrical specifications plus common programming requirements, permitting easy use of other family elements. So learning is just once per family.

In addition, these PROMs have fast programming speeds. Equivalent I/O

characteristics for easy upgrading. Faster access time, guaranteed over temperature and voltage. Improved testability.

Right now, the first two PROM devices are in volume production. The 256 x 4 organization (1K) and the 512 x 4 (2K). Other PROM devices will be available in the months ahead (see table).

So instead of settling for PROMs with unique performance capability and diverse programming requirements, get the new Harris generic family of PROMs. Lower your system costs and make your life easier.

For details see your Harris distributor or representative.

Important features of Harris' new generic family of PROMs.

- Simple, high speed programming procedure (Typically less than 1 second per thousand bits).
- Inputs and outputs TTL compatible; Low input current: 400 μ A logic "0," 40 μ A logic "1." Full output drive: 15 mA sink, 2 mA source.
- Fast access time—guaranteed over voltage and temperature (see table).
- Expandable—three-state or open collector—"wired-or" outputs with chip select.
- Industry standard pin-out.

Device #	No. of Bits	Organization	No. of Pins	Max. Access Time* comm./mil.	Availability
HM-7602 (open coll.) HM-7603 (three-state)	256	32 x 8	16	40/50ns	in stock
HM-7610 (open coll.) HM-7611 (three-state)	1024	256 x 4	16	60/75ns	in stock
HM-7620 (open coll.) HM-7621 (three-state)	2048	512 x 4	16	70/85ns	in stock
HM-7640 (open coll.) HM-7641 (three-state)	4096	512 x 8	24	70/85ns	in stock
HM-7642 (open coll.) HM-7643 (three-state)	4096	1024 x 4	18	70/85ns	January '76
HM-7644 (active pullup)	4096	1024 x 4	16	70/85ns	January '76

*Access time guaranteed over full temperature and voltage range.
Industrial ($T_A = 0^\circ\text{C}$ to 70°C , $V_{CC} \pm 5\%$)
Military ($T_A = -55^\circ\text{C}$ to 125°C , $V_{CC} \pm 10\%$)



HARRIS
SEMICONDUCTOR
A DIVISION OF HARRIS CORPORATION

P.O. Box 883, Melbourne, Florida 32901 (305) 724-7412

WHERE TO BUY THEM: OEM SALES OFFICES: CALIFORNIA: Long Beach, (213) 426-7687; Palo Alto, (415) 964-6443 **FLORIDA:** Melbourne, (305) 724-7430 **ILLINOIS:** Hinsdale, (312) 325-4242 **MASSACHUSETTS:** Wellesley Hills, (617) 237-5430 **MINNESOTA:** Minneapolis, (612) 835-2505 **NEW YORK:** Endwell, (607) 754-5464, Melville, L.I., (516) 249-4500 **OHIO:** Dayton, (513) 226-0636 **PENNSYLVANIA:** Wayne, (215) 687-6680 **TEXAS:** Richardson, (214) 231-9031.

SALES REPRESENTATIVES: ARIZONA: Scottsdale, (602) 948-5590 **CALIFORNIA:** Los Angeles, (213) 870-9191; San Diego, (714) 565-9444 **COLORADO:** Denver, (303) 771-4920 **FLORIDA:** Boca Raton, (305) 395-6108; Oviedo, (305) 365-3283; Tampa, (813) 933-3183 **ILLINOIS:** Elk Grove Village, (312) 640-1850 **MARYLAND:** Randallstown, (301) 922-1248 **MASSACHUSETTS:** Lawrence, (617) 685-7973 **NEW JERSEY:** Middletown, (516) 549-4283 **NEW YORK:** Albany, (518) 489-7408 or 4777; Huntington Station, (516) 567-5900 **NORTH CAROLINA:** Raleigh, (919) 828-0575 **OHIO:** Cleveland, (513) 831-8292; Dayton, (513) 890-2150 **OREGON:** Beaverton, (503) 643-1644 **PENNSYLVANIA:** Allison Park, (412) 487-4300; King of Prussia, (215) 265-0634 **TENNESSEE:** Shelbyville, (615) 684-4544 **TEXAS:** Dallas, (214) 827-8043; Houston, (713) 661-3007 **VIRGINIA:** Falls Church, (703) 534-1673; Troutville, (703) 345-3283; Virginia Beach, (804) 481-7200 **WASHINGTON:** Bellevue, (206) 454-0300.

INFORMATION RETRIEVAL NUMBER 14

**You can buy
this Spectrum Analyzer
and take a big chunk
out of your budget.**

**You can rent
this Spectrum Analyzer
and get more
equipment out of
your budget.**



Even the best equipment budget can only go so far. And at the price you pay for electronic test equipment nowadays, that's not very far at all.

Unless you rent your equipment from REI.

When you rent from us, there's no large cash outlay. You pay only for the time you have your instruments, and you return them when you're through. So you never have to spend your money on idle equipment.

Getting more for your money is just one reason for renting from REI. Immediate delivery is another. We have over \$10 million in inventory in fully stocked centers around the country. And, when you have short-term needs, you can rent equipment for just as long as you need it, and make it pay for itself.

REI stocks over 8,000 fully checked-out test instruments, and they're ready whenever you are. For the full story on renting, as well as our low prices, send in the coupon for prompt delivery of our free illustrated catalog... or call us now for your immediate requirements.

Rental Electronics, Inc.
99 Hartwell Avenue, Lexington, Mass. 02173
Please send me your free instrument rental catalog:

Name _____ Title _____

Company _____

Address _____

City _____ State _____ Zip _____

Tel. Number _____

Rental Electronics, Inc. 

A DEPSICO LEASING COMPANY

Burlington, MA (617) 273-2770 • Gaithersburg, MD (301) 948-0620 • Oakland, NJ (201) 337-3757 • Ft. Lauderdale, FL (305) 771-3500
• Des Plaines, IL (312) 827-6670 • Dallas, TX (214) 661-8082 • Mountain View, CA (415) 968-8845 • Anaheim, CA (714) 879-0561
• Rexdale, Ontario (PLC Leasing Ltd.) (416) 677-7513

SEPTEMBER 13, 1975

Electron-beam system cuts IC-mask production time

A major advance in commercializing electron beam lithography has been announced by Bell Laboratories, Murray Hill, NJ, where researchers have developed a production-oriented electron beam exposure system.

According to Donald Herriott, head of lithographic systems development for Bell Labs, the new system, known as EBES, can produce IC master pattern masks at half the cost of currently used photolithographic techniques. He also points out that the EBES masks can be made faster and with fewer defects.

Describing the system, Herriott notes that it uses an electron beam that is deflected over a field only 1/8 mm on each side. This compares with a deflection of several millimeters generally used in research electron beam machines.

Because it deflects over such a small area, the new system eliminates many problems commonly found in such devices, namely aberrations, resolution, beam brightness and speed of deflection.

In addition, the Bell device uses a raster scan to write information, thus requiring the same amount of time to make any mask, regardless of its complexity. The scanning technique, combined with a moving table on which the mask blank is mounted, makes it possible to write a 128 μ -wide stripe at a rate of 2 cm/sec. This, says Herriott, makes it possible to produce a mask for a 3-in. wafer in an hour or less. When compared with the multistep process used to make an optical mask, which could take several hours, it is a significant improvement.

The electron beam system, Herriott reports, can go directly from computer-aided design to final mask. And, he continues, by eliminating the intermediate steps need-

ed by optical techniques, the EBES system can result in greater throughput with a fourth as many people.

Unlike other electron-beam machines, which write one device at a time, the Bell unit breaks up the device to be written into an array of 1/2 μ -squares and writes one line at a time in every device on the wafer. Then the next line pattern is entered into memory and is written in every device until the entire array has been written.

Commenting on yield, Herriott points out that each of the three steps required for the optical approach result in a 50% yield, while the electron-beam approach consistently has a yield of well over 50% and more commonly 75%.

Magnetic monopole may be discovery of century

A particle described as the basic unit of magnetism has been detected that if captured and controlled could have a major impact on science and technology. "The find could rank as one of the major scientific events of the century," according to the American Institute of Physics in New York.

Responsible for the observations are research teams from the University of California in Berkeley and the University of Houston.

The reported particle—called a monopole because it consists of a single charge or pole rather than two—has a role in magnetism comparable to the electron in electricity. It is said to be much heavier than a proton and have a magnetic charge far stronger than the electrical charge of an electron.

Because of its strong magnetism the particle could respond readily to an electric field and thus could be an efficient source of energy.

If enough of the particles could be captured and held in one place, the effect of the earth's magnetic field on the monopole group could propel a ship across the ocean.

Even if one of the particles were captured it could probably be used to make others.

Control of the particles could also result in more powerful particle accelerators than those that now exist. A monopole accelerator six feet long would surpass in energy a circular accelerator of the present type a half mile long. Extremely small and efficient motors and generators could be built. And new cancer therapies might result by guiding them to destroy tumors in the body while doing far less damage to healthy cells than present radiation therapy.

The evidence that monopoles were, in fact, detected was a series of conical shapes, or tracks, made on a detector that consisted of plastic sheets, photographic emulsion and film that was carried on a balloon 130,000 feet above Iowa in a cosmic-ray experiment in 1973. Numerous cosmic-ray tracks, as usual, were found in the emulsion, during nearly two years of microscopic examination by the cosmic-ray group. The Berkeley group then studied the plastic sheets in their search for other particles.

One unusual track was discovered in all parts of the detector, caused, it was believed, by a magnetic monopole with a mass more than 200 times greater than the mass of a proton and traveling at roughly half the speed of light. The magnetic pole strength of the particle was found, as predicted by British physicist P. A. M. Dirac in 1931, to be so strong that the force between two monopoles would be over 18,000 times greater than the force between two electrons placed equal distances apart.

Micros future rosy for analytical instruments

"By 1982, 65% of all the analytical instruments sold in the U.S. will incorporate microprocessors," says Lynwood Eikrem, director of programs for Darling & Alsobrook, a Los Angeles-based management consulting firm.

Eikrem points out that the U.S.

market for analytical instruments in 1982 will be about \$1.32-billion, up from \$0.5-billion in 1975. He feels that the trend in equipment redesigns for the immediate future will be directed toward the special purpose or functional instrument. This instrument will be highly automated with microprocessors and designed to meet a heavy duty-cycle or continuous operation demand with up-time well in excess of 90%.

"For scientific instruments," he points out, "one of the microprocessor's most important functions is control of the instrument itself, replacing expensive relay logic and increasing the automation aspect and safety features. This permits the use of nontechnical personnel, while actually decreasing the probability of error. Error rate will be further decreased when the microprocessor is extended to automatic calibration and standardization, and eventually into artificial test and diagnostic troubleshooting routines."

In some applications, he predicts, using a microprocessor within the instrument to calculate and automatically apply error correction—to compensate, for example, for temperature/pressure variations or instrument drift—will be much less costly than other schemes to control those parameters.

Coherent rf energy beam easily melts ceramics

A new kind of coherent, laser-like radiation concentrates kilowatts of 13.56 MHz rf energy into a thin, pencil beam capable of easily melting high-temperature refractory materials.

Called the Energy Beam by its inventor, Thomas E. Fairbairn vice president of R&D for Energystics, Inc., Toledo, OH, its immediate use is expected in industrial heating and fabricating processes such as brazing, welding and hole drilling. But Fairbairn sees it eventually used to modulate megawatt lasers for long-range space communications and in industrial applications.

The source of the Energy Beam is a 13.56-MHz industrial rf generator, Fairbairn explains. The

output of the generator is fed to an output matching network where the rf energy is drawn off of a special copper-tubing tank coil at a high-voltage point.

The rf output is applied to a three-element, coaxial nozzle that is attached to the end of a section of the copper tubing. The nozzle has a central molybdenum electrode which is surrounded by a cylindrical copper sheath. The copper, in turn, is surrounded by an outside metal or ceramic cylinder. The rf is fed to the central electrode.

Gases—helium, argon, nitrogen, and even air—are pumped through the tank coil and the nozzle and a two-layer coaxial laminated flow is established.

"Some of the rf energy," says Thomas J. Sheperak, president of Energystics, "ionizes the gas that forms the coaxial sheath around the center electrode, and some energy is used to ionize a small column of gas that the rf rides on inside the ionized conduit.

"The rf energy at 13.56 MHz is conducted through this coaxial flow of gas directly to a target material," Sheperak points out.

The effect of the beam varies with both beam power and also with the target material. For example, with 1-kW input the beam melts most metals, according to Sheperak, while at higher inputs—in the order of 5 kW—it has melted ceramics with melting points between 3000 and 6500 F.

Temperatures outside the nozzle orifice are in the order of 100 to 200 F while temperatures at the target to which the beam is directed have been estimated to be as high as 35,000 F.

The effectiveness of the Energy Beam, according to inventor Fairbairn, is dependent upon the coherent rf energy reacting with nuclear magnetic resonant structure of the target material.

It creates intense molecular vibration, producing heat, much like the effect that microwave and industrial ovens have on materials irradiated by their rf energy. However, in the Energy Beam, the energy is concentrated in a tiny area, thus producing exceptionally high energy density, similar to that in lasers.

A substantial difference between the Energy Beam and the laser, Fairbairn points out, is in effi-

ciency. While that of lasers is only a few per cent, that of the Energy Beam is 75% and higher.

YIG switch to handle high power radar pulse

A microwave switch that can successfully handle the high peak-power generated by radars has been developed by the Harry Diamond Laboratories, Adelphi, MD.

The switch operates in the Y-band, and is made of yttrium iron garnet. It has a high peak-power handling capacity of 40 kW and is packaged in a waveguide 1.75 inches long.

The switch, designed to protect a mapping radar receiver during the high-power transmit pulse, incorporates the YIG in an absorption modulator waveguide configuration, according to Frank Reggia, research and electronic engineer at the Laboratories.

"The YIG was the only type of device that could handle the high power," says Reggia. "We looked at diodes, but the best power handling capability we might get, even with a development program would be about 2 kW. And ferrite materials we examined weren't satisfactory because they become nonlinear above a few kilowatts of impressed power."

YIG switches developed during the program showed an insertion loss of less than 0.5 dB and an isolation greater than 25 dB in the 15-to-17-GHz band, Reggia points out.

In addition to the small size, the Diamond Laboratories switch has other advantages, Reggia notes, including a magnetic control field of less than 50 Oe and a capability of operating at temperatures in excess of 100 C.

This high temperature operation is necessary, Reggia explains, because in the absorption mode the switch must dissipate the power that it is blocking.

Early models of the device had switching times of less than 100 μ s, Reggia says. But he points out that the intrinsic response time of the YIG type material is less than 15 ns. And in the Diamond Laboratories program speeds better than 1 μ s were achieved with later devices, though they did not have 40 kW power capability.

.05 MHz
to
3 GHz
(+17dBm LO)

HIGH-LEVEL

Double Balanced Mixers

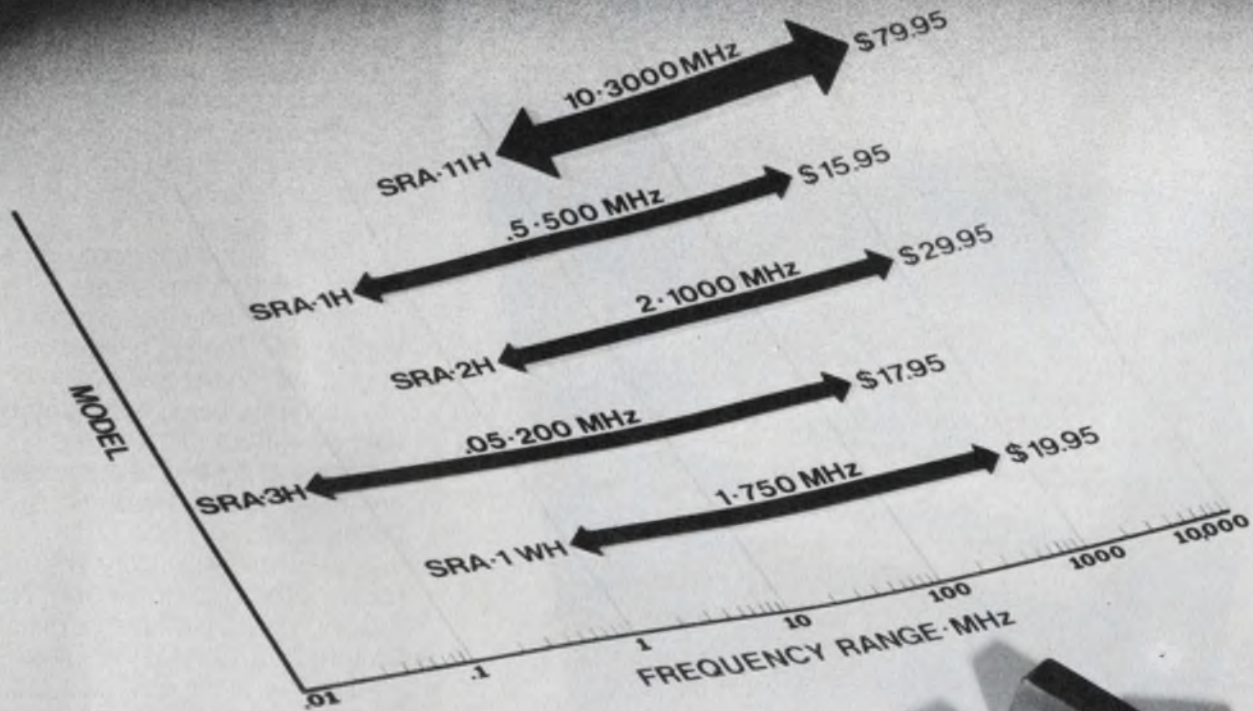

Model	Frequency Range (MHz)	Conversion loss (dB) Total Range	Isolation, dB						Price Quant.
			Lower band edge to one decade higher		Mid range		Upper band edge to one octave lower		
			LO-RF	LO-IF	LO-RF	LO-IF	LO-RF	LO-IF	
SRA-11H	RF, LO-10-3000 IF - DC-1000	9.5 typ. 12 max.	27 typ. 20 min.	27 typ. 20 min.	25 typ. 18 min.	25 typ. 18 min.	23 typ. 16 min.	23 typ. 16 min.	\$79.95 (1-24)
SRA-1H	RF, LO-.5-500 IF - DC-500	6.5 typ. 8.5 max.	55 typ. 45 min.	45 typ. 35 min.	45 typ. 30 min.	40 typ. 30 min.	35 typ. 25 min.	30 typ. 20 min.	\$15.95 (5-24)
SRA-2H	RF, LO-2-1000 IF - DC-1000	7.5 typ. 9.5 max.	50 typ. 40 min.	45 typ. 35 min.	45 typ. 25 min.	40 typ. 25 min.	35 typ. 25 min.	25 typ. 20 min.	\$29.95 (4-24)
SRA-3H	RF, LO-.05-200 IF - DC-200	5.5 typ. 7.5 max.	55 typ. 45 min.	45 typ. 35 min.	45 typ. 30 min.	40 typ. 30 min.	35 typ. 25 min.	30 typ. 20 min.	\$17.95 (5-24)
SRA-1WH	RF, LO-1-750 IF - DC-750	5.5 typ. 7.5 max.	50 typ. 40 min.	45 typ. 35 min.	45 typ. 25 min.	40 typ. 25 min.	35 typ. 25 min.	30 typ. 20 min.	\$19.95 (5-24)

Conversion compression: 1 dB at +10 dBm rf input

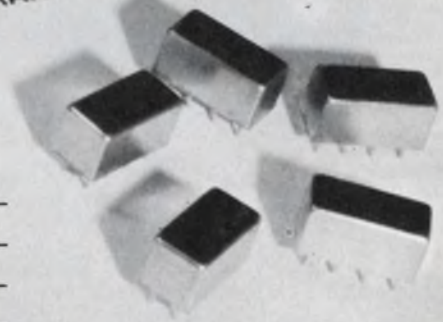

Mini-Circuits Laboratory
A Division Scientific Components Corp

MCL

837-843 Utica Avenue, Brooklyn, NY 11203
(212) 342-2500 Int'l Telex 620156 Domestic Telex 125460

Foreign Sales Representatives: AUSTRALIA General Electronic Services, 99 Alexander Street, New South Wales, Australia 2065; ENGLAND Dale Electronics, Dale House, Wharf Road, Frimley Green, Camberley Surrey; FRANCE S. C. I. E. - D. I. M. E. S., 31 Rue George - Sand, 91120 Palaiseau, France; GERMANY, AUSTRIA, SWITZERLAND Industrial Electronics GMBH, Klüberstrasse 14, 6000 Frankfurt/Main, Germany; ISRAEL Vectronics, Ltd., 69 Gordon Street, Tel-Aviv, Israel; JAPAN Densho Kaisha, Ltd., Eguchi Building, 8-1 1 Chome Hamamatsucho Minato-ku, Tokyo; EASTERN CANADA B. D. Hummel, 2224 Maynard Avenue, Utica, NY 13502 (315) 736-7821; NETHERLANDS, BELGIUM, LUXEMBOURG: Coimex, Veldweg 11, Hattem, Holland.

US Distributors: NORTHERN CALIFORNIA Cain-White & Co., Foothill Office Center, 105 Fremont Avenue, Los Altos, CA 94022 (415) 948-6533; SOUTHERN CALIFORNIA, ARIZONA Crown Electronics, 11440 Collins Street, No. Hollywood, CA 91601 (213) 877-3550

INFORMATION RETRIEVAL NUMBER 16

Electronic glass. All you need is vision.

Here is a designer's dream come true. Minimum form with maximum function.

It's PPG's electronic glass.

It lets you combine the sleek, simple elegance of glass and the dazzling magic of solid-state technology.

Which means you can literally change the faces of

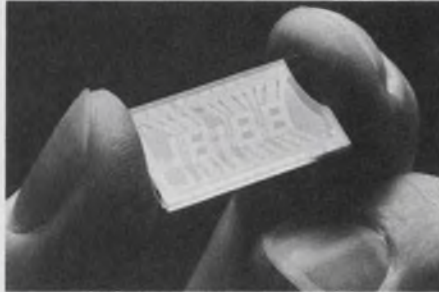

Digital watches will never be the same. Electronic glass can make them more efficient and more affordable.

appliances, timepieces, visual displays, and instrumentation of every description.

The secret is the permanent conductive metallic-oxide coating on the glass.

It can be made to trigger functions at the mere touch of a finger. Like timing a roast, choosing a station, starting the wash, or even figuring the square root of 34.

In short, if it can be done electronically, it can probably be done a little better with electronic glass.

And, since the coating can be applied to form letters, numbers, or any visual display imaginable, there's almost no end to what you can do.

Digital clocks, wristwatches, speedometers, odometers, oscilloscopes, and radar screens are just a few of the obvious possibilities.

As for its reliability, there's really nothing to go wrong. No moving parts. No knobs, dials, switches, buttons—just glass.

It's here. It's now. It's ready. All it needs is you, and all you need is the vision to use it.

So test your vision. Send the coupon today.

Displays simulated.

This is a control panel for a microwave oven. Just one of the many possibilities for a countdown timer and digital display.

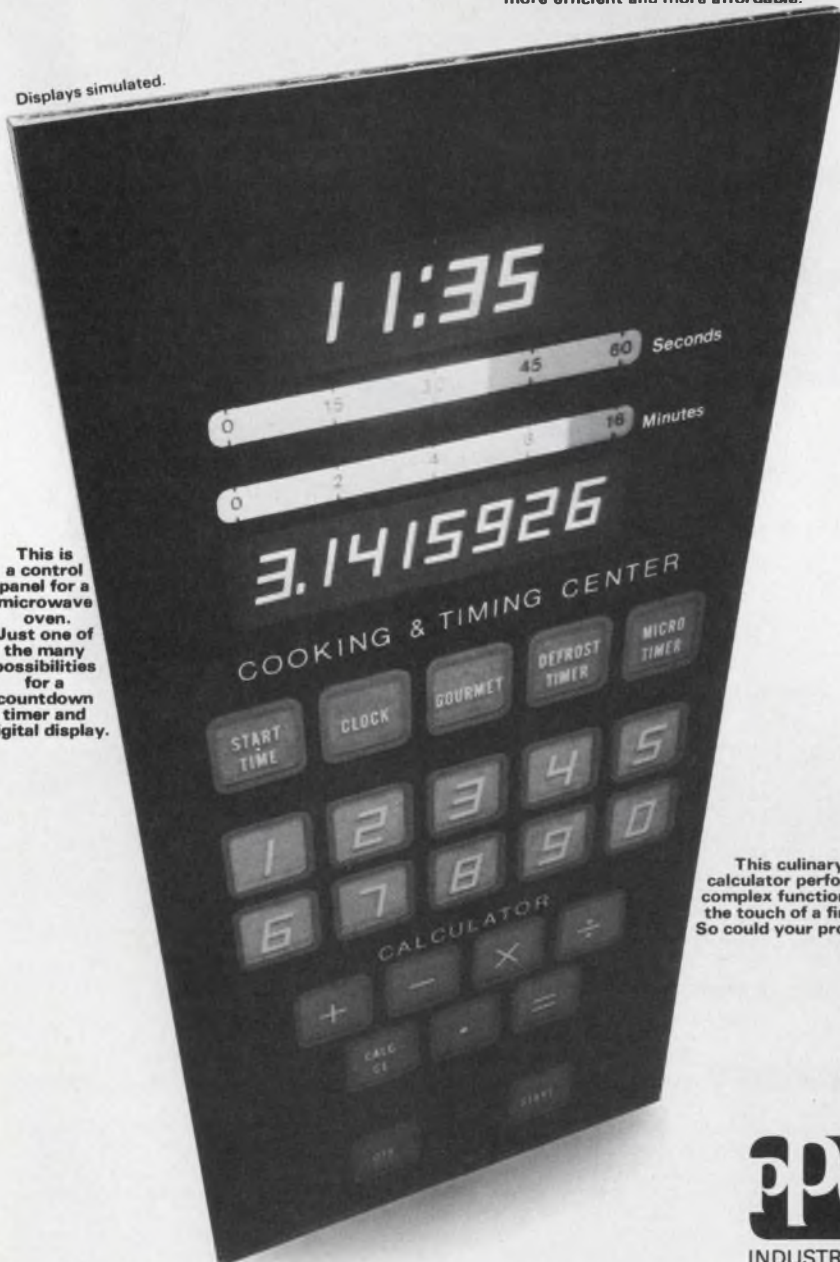

This culinary calculator performs complex functions at the touch of a finger. So could your product.

PPG: a Concern for the Future

PPG Industries, Inc.
Industrial Glass Products
One Gateway Center
Pittsburgh, Pa. 15222

I want to test my vision.
Send me more information about
PPG's exciting electronic glass.

Name _____

Company _____

Address _____

City _____

State _____ Zip _____



FOR INFORMATION ON ELECTRONIC GLASS CIRCLE NUMBER 17

ELECTRONIC DESIGN 19, September 13, 1975

Four good reasons to buy your next scope from Heath.

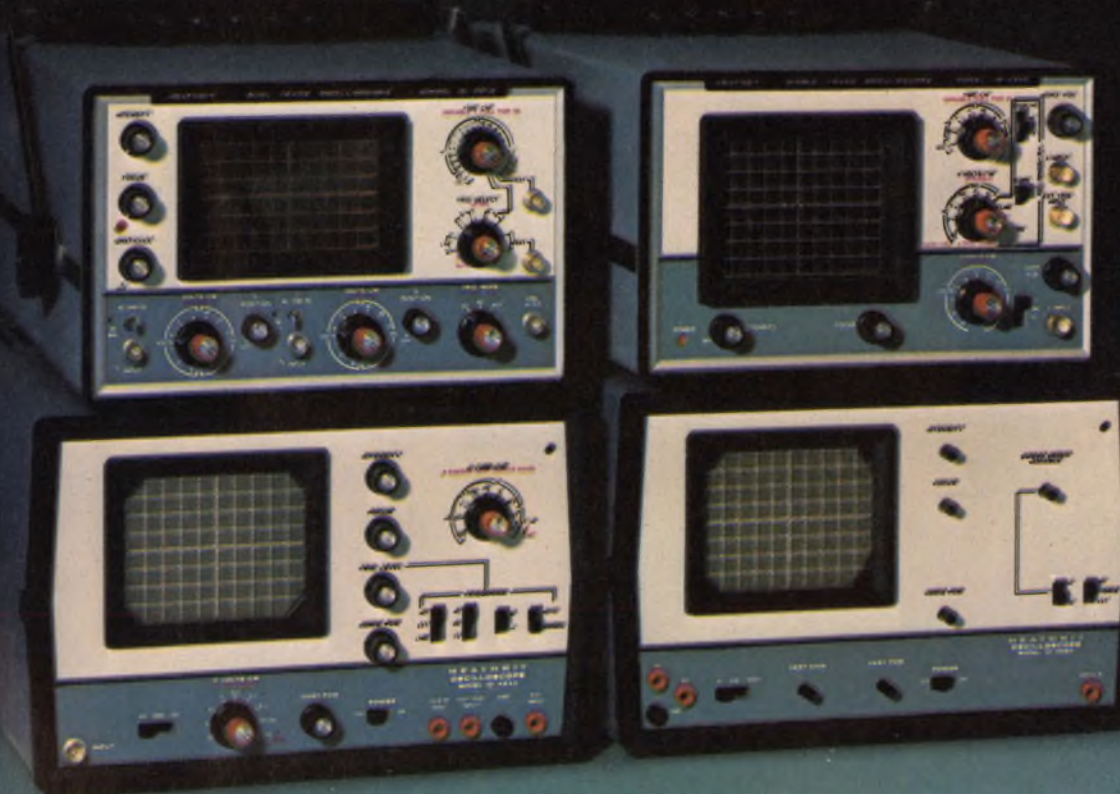

Looking for a low cost oscilloscope with performance and features that will make it more than just a "visual voltmeter"? Well, your search is over. Heath has a new family of scopes that offer more performance per dollar than the industry has seen in years.

Our 4510 is a dual trace 15 MHz scope that can display high-speed waveforms without losing the leading edge. Both vertical inputs have delay lines for complete waveform display. Sensitivity is 1 mV over the *entire* bandwidth — and it will typically trigger on signals up to 45 MHz! Other features include post-accelerated CRT for brighter trace and faster writing speeds . . . true X-Y operation . . . and easy-to-service design. And the best part is the low price. Only \$569.95* kit, \$775.00* assembled.

Heath's 4530 sets a new standard for single trace scopes. And it's easy to see why. The DC-10 MHz bandwidth, sensitive 10 mV input and TV coupling give you real versatility at a low price. It's one of the few single trace scopes available with two input channels — a calibrated X-input is provided for X-Y operation. Trigger circuits are digitally controlled, requiring

only level control and slope switch adjustments. \$299.95* kit, \$420.00* assembled.

The 4540 is probably the best general purpose triggered scope value available today. It can quickly provide an accurate display of any waveform from DC to 5 MHz. Vertical input sensitivity is 20 mV with nine calibrated attenuator positions up to 10 V/cm. Special TV coupling allows the 4540 to easily trigger on TV signals, making it an even more valuable service tool. Only \$179.95* kit, \$275.00* assembled and calibrated.

The Heathkit IO-4560 now makes it possible for everyone to have a high performance scope. It offers DC-5 MHz bandwidth, 100 mV sensitivity, *automatic triggered* sweep from 20 ms to 200 ns/cm, external horizontal input. A great low-cost scope for general design and service work for the unbelievably low price of \$119.95*.

Get complete information and specs on the above scopes, and all Heath instruments, in our latest Heathkit and Assembled Instruments catalogs. You may not be aware of what Heath instruments can do for you — and how little they cost. After all, we're not the industry standard . . . yet.

HEATH

Schlumberger

Heath Company
Dept. 511-090
Benton Harbor, Michigan 49022

Please send: My free Heathkit Catalog.

My free Assembled Instruments Catalog.

HEATH COMPANY, Dept. 511-09, Benton Harbor, Michigan 49022

NAME _____

ADDRESS _____

CITY _____

STATE _____

ZIP _____

MAIL ORDER PRICES, F.O.B. FACTORY.

PRICES AND SPECIFICATIONS SUBJECT TO CHANGE WITHOUT NOTICE.

EK-469



Unique Action Pins solve panel-production problems.

**No more rupturing of plated-thru holes. Fewer rejects.
Wide commercial tolerances on plated-thru hole diameters.
Increased contact area. Higher production yields. Stable
electrical properties. Highest reliability. Low cost.
Now you can get them all with AMP ECONOMATE Panels
loaded with new Action Pins. Or in your panels with our
Action Pin Components.**

HOW ACTION PINS WORK. AMP Action Pins incorporate a spring section to give a higher degree of compliance than ever before possible. The diagonal measurement of the spring section—before insertion—is larger than the hole diameter (Fig. 1). When the Action Pin is inserted, the two opposing spring members readily compress, and after insertion, exert a force sufficient to effect a gas-tight interface with the plated-thru hole walls (Fig. 2). Yet their rounded corners prevent rupture of the plated-thru hole. They come with a variety of configurations: card-edge contacts, .025² feed-to and feed-thru posts, and SEM (NAFI-style) two-piece receptacle-and-blade contacts. All are compatible with wrap-type terminations or I/O connections.



Fig. 1



Fig. 2

AMP ECONOMATE panels are made to your specifications and consist of two elements: the pc board—either two-sided or multi-layer with plated-thru holes—and the AMP ECONOMATE Action Pin contacts.

ECONOMATE I card-edge contacts, and ECONOMATE II two-piece receptacle-and-blade, SEM (NAFI-style), contacts both feature snap-on housings for maximum maintainability of panels. Posted panels feature .025² feed-to and feed-thru posts for automatic, semi-automatic, or manual point-to-point wiring. All types hold costs to a minimum through AMP's high-speed automated assembly process.



MAKE OR BUY. AMP can supply all your panel requirements. Or, you can make them yourself using our reliable Action Pin components. Contacts come in strip for high-speed, low-cost gang insertion at rates up to 10,000 an hour with our high-productivity assembly tools.

Action Pins solve the problems that bother you most. They won't broach, rupture, tear, distort or damage the plated-thru hole—giving you the ultimate in reliability.

When it comes to panels, AMP is where the action is. Get the whole story. Call (717) 564-0100 or write AMP Incorporated, Harrisburg, PA 17105.

AMP and ECONOMATE are trademarks of AMP Incorporated.

AMP
INCORPORATED
INFORMATION RETRIEVAL NUMBER 19

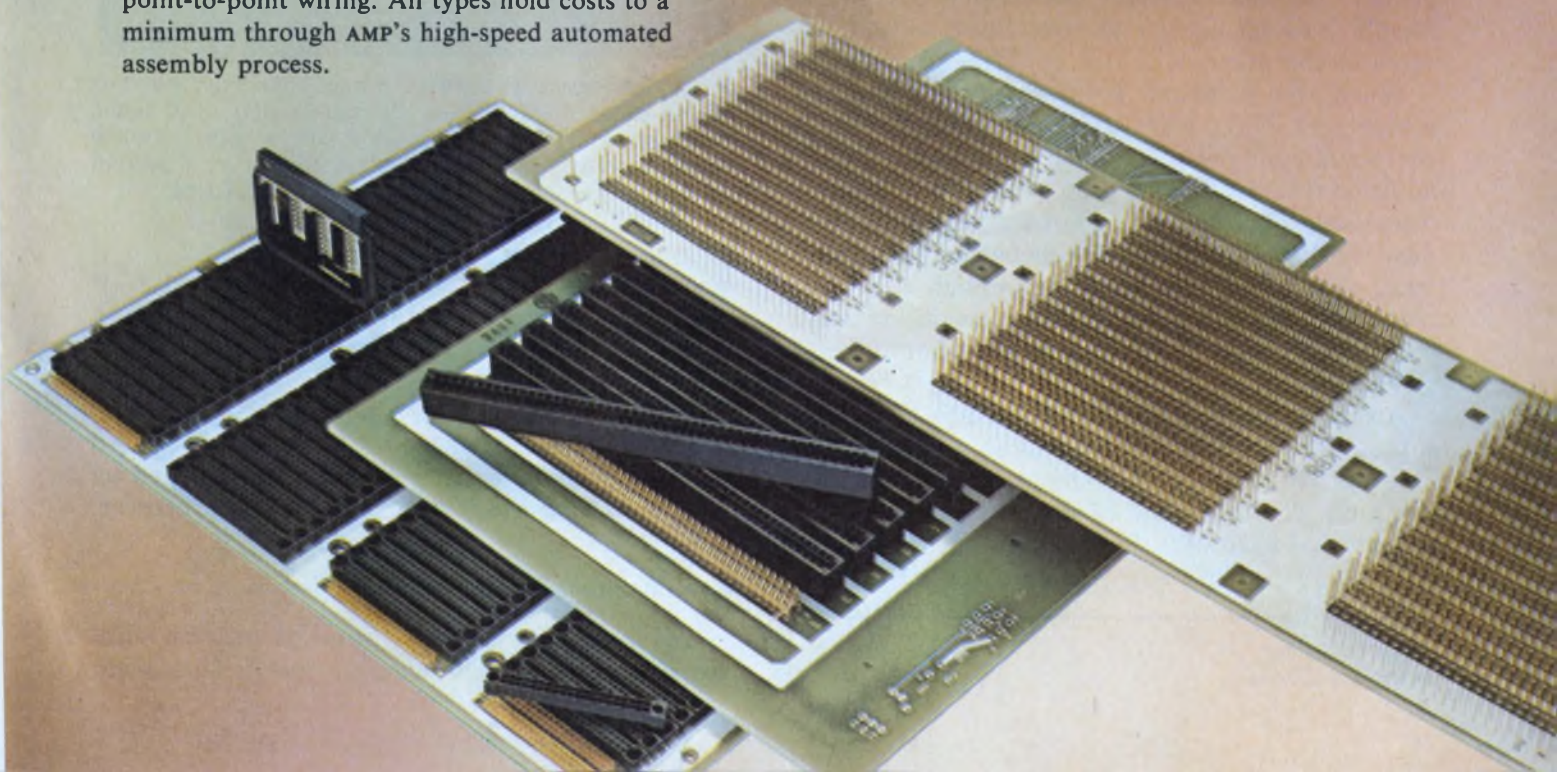

WESCON SPECIAL

Microprocessors making medical equipment 'smart'

With microprocessors invading everything from computer terminals to pinball machines it's not surprising that designers of medical electronic equipment are considering making their equipment smarter by including these computer chips.

What steps are required to incorporate micros into a piece of medical gear, how to use them and when to use them are discussed in Session 24, "Microprocessors in Medical Instrumentation," at the Western Electronic Show and Convention in San Francisco.

Paul Mitzen, an engineer from Beckman Instruments' Advanced Technology Operation in Anaheim, CA, points out that microprocessors are changing the design engineer's task. In the past, he notes, an engineer had to design a complete system to a spec.

But with the advent of the microprocessor, he no longer has to design hardware to take care of all the computational algorithms; that's done in software. And a lot of the mundane sequential control of the instrument is being taken over by the micro, too. Thus 90% of the actual hardware design, reports Mitzen, has been reduced to simply interfacing the various input/output devices to the processor.

Since the software is now taking over the major part of the work that hardware used to do the equipment designer is now faced with some additional tasks that he didn't run across before. Previously, most of the design techniques he used dealt with what hardware can be put in for the least amount of money to accomplish the task. Now, says Mitzen, the designer must decide what can be done best in hardware and what in software.

An illustration of the problem, notes Mitzen, is a piece of equipment that contains a multiplexed display. The engineer now has to decide whether the multiplexing should be done by the micro, or by external hardware. Some of the considerations involved, he points out, are does the CPU have

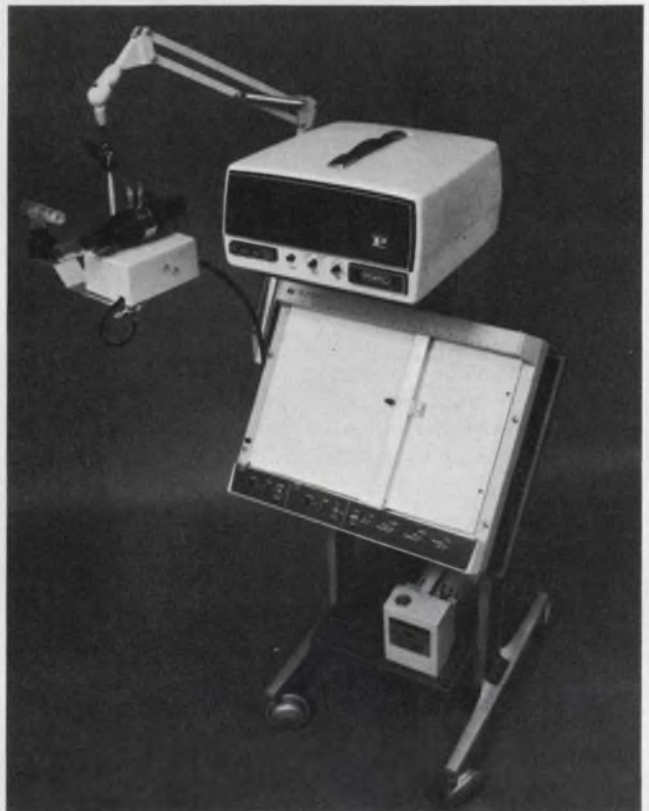

A microprocessor is used in a new pulmonary function tester called REMAC from Puritan-Bennett. The micro processes input data, compares it with standard normal values stored in ROM and displays results as a percent of normal. It replaces manually operated systems.

enough time to do the multiplexing? And is it going to cost more for the extra ROM required to do the multiplexing than it would for the external logic?

Another result of the inclusion of a micro, Mitzen says, is that there isn't as much of a need for test circuits. Testing can be accomplished by simply writing a test program for the processor.

Several problems encountered

The actual design of a piece of medical electronic equipment and some of the problems en-



More Super-Fast Silicon Rectifiers

Featuring 30 nanoseconds Reverse Recovery Time

A breakthrough in junction technology makes Super-Fast silicon rectifiers possible. These new high speed silicon rectifiers feature low forward voltage drop at higher operating currents and reverse recovery time better than 30 nanoseconds. In addition, these devices have extremely low reverse leakage and high surge ratings. Super-Fast rectifiers use Semtech's proven Metoxilite non-cavity monolithic high temperature construction. Designed for high frequency applications, such as high speed switching regulators and converter circuits. Semtech's Super-Fast silicon rectifiers are stocked for immediate delivery.

LO-V_F Metoxilite

Available as JAN, JAN TX & JAN TXV
to MIL-S-19500/503 (EL)

Types: 1N6073, 74 & 75 (T_{rr} 30ns)

PIV: 50, 100 & 150V
Reverse Current (Max.): 1 μ A DC @ 25°C
Instantaneous Forward Voltage @ 1.5A:
1.0V @ 100°C
Capacitance @ 12V DC (Max.): 24 pF
Single Cycle Surge Current: 35A
Dimensions (Max.): Body .070" D x .165" L
Leads .031" D x 1.25" L

Types: 1N6076, 77 & 78 (T_{rr} 30ns)

PIV: 50, 100 & 150V
Reverse Current (Max.): 5 μ A DC @ 25°C
Instantaneous Forward Voltage @ 3.0A:
1.0V @ 100°C
Capacitance @ 12V DC (Max.): 58 pF
Single Cycle Surge Current: 75A
Dimensions (Max.): Body .110" D x .165" L
Leads .040" D x 1.10" L

Types: 1N6079, 80 & 81 (T_{rr} 30ns)

PIV: 50, 100 & 150V
Reverse Current (Max.): @ 25°C 10 μ A DC
Instantaneous Forward Voltage @ 5.0A:
.8V @ 100°C
Capacitance @ 12V DC (Max.): 230 pF
Single Cycle Surge Current: 175A
Dimensions (Max.): Body .165" D x .165" L
Leads .040" D x 1.10" L

"State-of-the-art"

Types: FF30, FF40 & FF50 (T_{rr} 30ns)

PIV: 300, 400 & 500V
Reverse Current (Max.): 1 μ A @ 25°C
Instantaneous Forward Voltage @ .5A:
1.5V @ 25°C
Capacitance @ 12V DC (Max.): 15 pF
Single Cycle Surge Current: 10A
Dimensions (Max.): Body .070" D x .165" L
Leads .031" D x 1.25" L

Types: 3FF30, 3FF40 & 3FF50 (T_{rr} 30ns)

PIV: 300, 400 & 500V
Reverse Current (Max.): 5 μ A @ 25°C
Instantaneous Forward Voltage @ 1A:
1.5V @ 25°C
Capacitance @ 12V DC: 20 pF
Single Cycle Surge Current: 25A
Dimensions (Max.): Body .154" D x .165" L
Leads .040" D x 1.10" L

LO-V_F DO-4 Stud

**Types: SFF05, 10 & 15 and
*2SFF05, 10 & 15 (T_{rr} 30ns)**

PIV: 50, 100 & 150V
Reverse Current (Max.) IR:
10 & *20 μ A DC @ 25°C
Instantaneous Forward Voltage:
VF @ 10A DC: 1.1V @ 25°C
*VF @ 20A DC: 1.2V @ 25°C
Single Cycle Surge Current: 125 & *250A
Dimensions (Max.): Body .424" D x .405" H

DO-4 Doublers & Center Taps

Types: Sdff05, 10 & 15;

SNff05, 10 & 15,

& SPff05, 10 & 15

(T_{rr} 30ns)

PIV: 50, 100 & 150V
Reverse Current (Max.): IR @ PIV:
10 μ A DC @ 25°C
Instantaneous Forward Voltage VF @ 10A:
1.1V @ 25°C
Single Cycle Surge Current: 125A
Dimensions (Max.): Body .424" D x .405" H

LO-V_F DO-5L Stud

Types: STFF05, 10 & 15 (T_{rr} 40ns)

Add "R" to type number
for reverse polarity
PIV: 50, 100 & 150V
IR (Max.) @ PIV:
@ 25°C 0.1mA &
@ 100°C 3mA
VF (Max.) 10A:
@ 25°C .84V; @ 100°C .70V; @ 150°C .63V
VF (Max.) 30A:
@ 25°C .96V; @ 100°C .85V; @ 150°C .78V
VF (Max.) 50A:
@ 25°C 1.05V; @ 100°C .93V; @ 150°C .90V
Dimensions (Max.): Body .64" D x .50" H
Stud 1/4 28 UNF x .43" L

NEW

LO-VF DO-5DL Isolated Stud

**Types: STFF05DL,
10DL & 15 DL
(T_{rr} 30ns)**

PIV: 50, 100 & 150V
Reverse Current (Max.): IR 20 μ A @ 25°C
Instantaneous Forward Voltage @ 10A:
1.2V @ 25°C
Single Cycle Surge Current: 250A
Dimensions (Max.): Body .64" D x .50" H
Stud 1/4 28 UNF x .43" L

★★★★

1975 NATIONAL SBA SUBCONTRACTOR
OF THE YEAR



**SEMTECH
CORPORATION**

652 Mitchell Road, Newbury Park, California 91320
(805) 498-2111, (213) 628-5392 / TWX: 910-336-1264

CHICAGO: (312) 352-3227

DALLAS: (214) 387-3551

FLORIDA: (305) 644-5404

MARYLAND: (301) 424-6663

NEW JERSEY: (201) 654-4884

SAN FRANCISCO: (415) 494-0113

EUROPEAN SALES HDQ: Bourns AG Zug,

Switzerland (042) 232-242

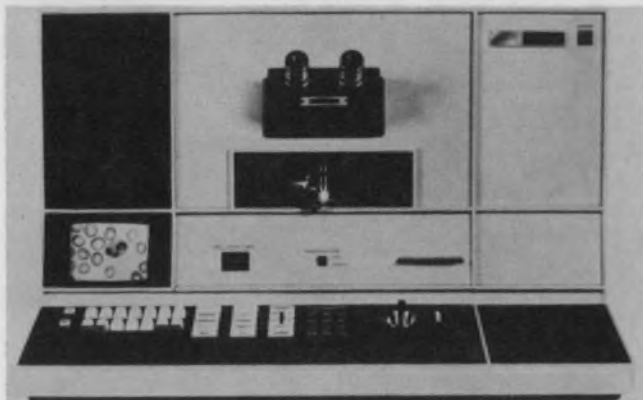

The ACS 1000 from Honeywell combines a microprocessor, color television and a microscope to produce a machine that will do differential white blood cell counts.

countered are described in the second paper, "Consideration in Designing a Microprocessor into a Commercial Medical Instrument." Randolph S. Carlson, another Beckman engineer, notes that the functional, environmental and reliability requirements applicable to medical equipment affects the way micros are used.

Medical equipment is generally calibrated a lot more than other types of equipment. For example, Carlson says, blood gas analyzers are calibrated before and after each measurement. So, he goes on, if a system that makes calibration automatic can be designed—and it can with a micro—operation of the instrument can be made a lot simpler.

One of the biggest problems in designing medical equipment is allowing for changes in line voltages and emi.. Hospitals are notorious for their poor power lines. It is best not to use the power line to derive timing signals, he points out. The reason is that the voltage looks like a sine wave only some of the time. And, it is not uncommon to find 2000 and 3000-V spikes on the line. Sure, he continues, you can stick gigantic filters across the line and extract the 60 Hz signal, but it just may wind up costing you more than putting in a crystal oscillator. Also, the time the equipment will probably be needed most is when the power fails and the emergency generator is producing a signal that varies between 47 and 63 Hz.

But, problems don't only crop up in the design of microprocessor-based medical equipment, says Carlson. Testing is also a big problem. Conventional analyzers, for example, consist of a sensor, an amplifier and a meter. So, when the machine is calibrated with a known sample, the operator in effect is checking out all of the circuitry.

With microprocessor equipment however, calibration won't always check out the whole ma-

chine. This is particularly true if part of a stored table is used in the sample mode and not in the calibration mode. All the locations of the memory must be checked. In the analyzer Beckman designed, which has yet to be announced, this is done by adding up all of the memory bits and combining it with a control word. The sum of the memory contents and the control word must be zero, or a warning light comes on. This check is made everytime the microprocessor starts to operate.

Microprocessor instruments abound

The Beckman blood gas analyzer is not the only piece of medical equipment to use micros, says Erich Pfeiffer, chief of the Biomedical Engineering Section at the VA Hospital, Sepulveda CA. In his paper, "Potential Applications of Microprocessors in Medical Instrumentation," Pfeiffer points out that there are already many pieces of equipment that use micros out on the market.

One is an automated drug detector known as Olfax from Universal Monitor Corp., Pasadena, CA. It is particularly helpful, he says, for overdose cases where physicians have to quickly determine what drug is involved. It uses a mass spectrometer and an Intel 8008 processor to check blood samples for specific drugs, according to the program card inserted. In addition to identifying the drugs, the machine prints out a confidence index which indicates the probability that its analysis is correct.

An 8008 microprocessor is also used in an automated computerized scanning system for hematological studies that was developed by Honeywell Medical Systems Center, Hopkins, MN. This system, Pfeiffer notes, does differential white blood cell counts. While there are many devices currently available that count white blood cells, he points out, none until now could break them down into subgroups and do differential counts. But by combining a microscope, color television monitor and a microprocessor, Honeywell's ACS 1000 can automatically locate a cell, focus in on it and allow the operator to push a button identifying it.

A less specialized piece of equipment, says Pfeiffer, is REMAC—a respiratory measurement and comparison system from Puritan-Bennett of Kansas City, MO. The REMAC, he continues, is used to perform a respiratory function test. A patient breaths into the device and it performs certain calculations and measurements. The results for a patient of a specific sex, age, weight and height are then compared with standard values stored in ROM. The measured values are then displayed as a percentage of normal. This unit uses a 4-bit microprocessor, says Pfeiffer. ■



Hughes image memory systems are used by more people, for more applications, than any other image memories in the world.

A lot of people must be happy with Hughes image memories. Because they're used in many ways, by thousands of people every day—helping them do their jobs better and quicker.

Like doctors, commercial airline pilots, blood analysts, production inspectors, baggage

inspectors, quality control technicians, teachers, ship-board fire controllers, medical technicians (ultrasound, x-ray, thermography), aircraft radarmen, records management personnel,

and many, many more.

If you'd like literature or application assistance, call (714) 729-9191. Or write: 6855 El Camino Real, Carlsbad, California 92008.



HUGHES
 HUGHES AIRCRAFT COMPANY
 INDUSTRIAL PRODUCTS DIVISION
 IMAGE DEVICES

Creative Image Processing.

WESCON SPECIAL

IEEE standard found weak for instrument interfacing

You want to give a test instrument the capability of operating with other instruments in an automatically controlled environment, so you consult IEEE Standard 488. Are your problems ended? They may only be starting in earnest, according to speakers at Wescon's Session 3, "Instrument Interfacing with the IEEE Standard Bus."

The problems, they say, arise not from what the spec includes but rather what is omitted. For example, Tom Coates, development engineer for Hewlett-Packard, Santa Clara, CA, points out in his paper, "Interfacing to the Interface: Practical Considerations Beyond the Scope of IEEE Standard 488," that while the standard itself details how to send information from one point to another, it doesn't tell the designer what the information is or in what format to send it.

Coates, designer of the instrument interface for the HP 5341 microwave counter, says that while Standard 488 covers the first interface—how to send an 8-bit byte from a controller to an instrument—it places no limits on how many bytes can be sent or on the order in which they are sent.

What Coates defines as a "secondary interface," unique to an instrument and placed in it, determines the organization of such data. But this secondary interface is not defined in the 488 standard, Coates points out. And the designer may not discover this until he gets deeply involved in using the standard, he notes.

Others in the industry, he says, have also pointed out the lack of such a secondary-interface standard and have indicated a need for it.

The secondary interface acts as an interpreter of the bytes coming off the IEEE 488 standard bus, Coates explains, serving to translate the incoming bits into a language that can control a particular instrument.

"For example," he says, "if the instrument interface sees an 'R 6,' it may say, 'Set the range switch to position 6.' Further, the local interface

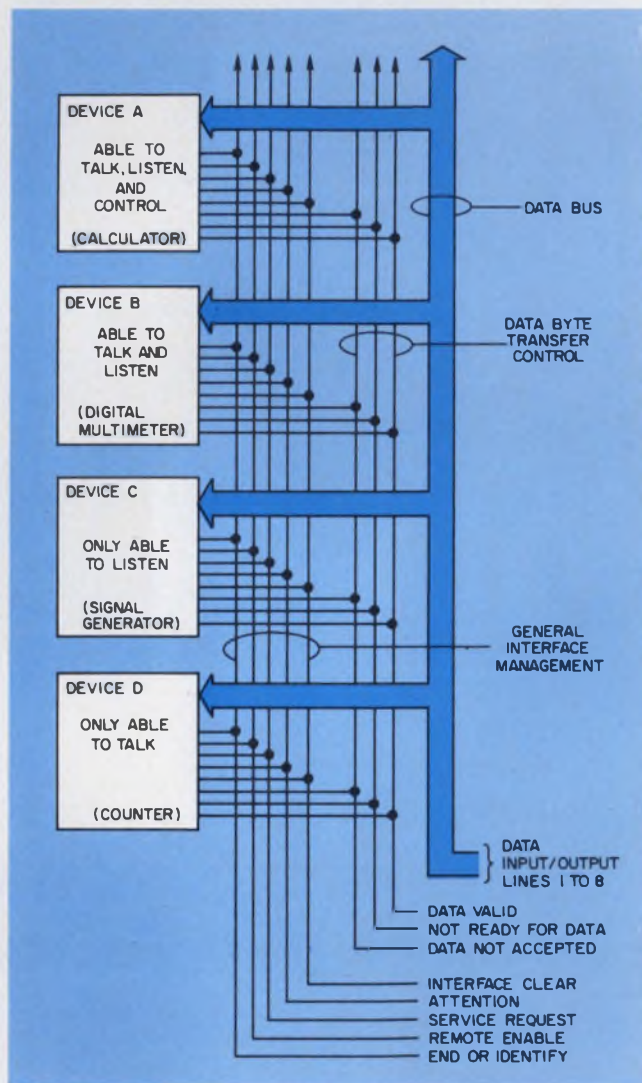

The data bus—eight lines of the IEEE 488 interface—carries data between the instruments and controller. Data transfer control requires three lines and the general interface management uses five more.

serves to translate the answer or output of the instrument—it may be in BCD from a display—into characters of 8-bit bytes that can be sent back out over the bus to other instruments or a controller.

"Hopefully, this is done in a format that a lot

Hot-molded resistors provide low temperature coefficient and unmatched reliability.

The Resistance Temperature Coefficient of Allen-Bradley hot-molded fixed resistors is typically less than 200 PPM over the entire resistor range shown in the normal equipment operating temperature of +15°C to +75°C. Excellent RTC ratings have always been an Allen-Bradley benefit. And consistency of Allen-Bradley resistors means repeatable results and tight performance patterns. Allen-Bradley resistors offer the **lowest cost—on the board—**where it counts!

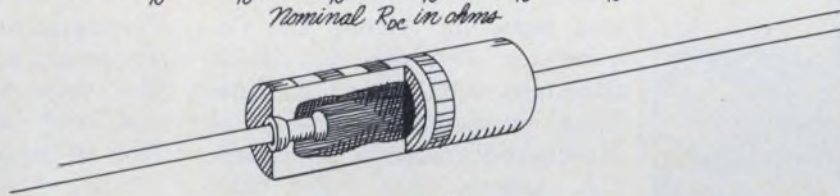
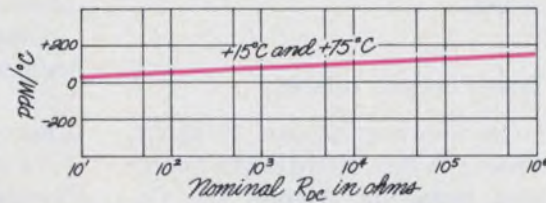

Reliability

is unsurpassed. Over 700 million unit test hours without a single failure.

No coatings

Insulation and resistance element integrally molded into one solid structure.

Pulse handling

characteristics offer outstanding protection against surges and transients.

Quality in the best tradition.



ALLEN-BRADLEY

Electronics Division
Milwaukee, Wisconsin 53204

Thin-Trim[®] capacitors



Tucked in the corner of this Pulsar Watch is a miniature capacitor which is used to trim the crystal. This Thin-Trim capacitor is one of our 9410 series, has an adjustment range of 7 to 45 pf., and is .200" x .200" x .050" thick. The Thin-Trim concept provides a variable device to replace fixed tuning techniques and cut-and-try methods of adjustment. Thin-Trim capacitors are available in a variety of lead configurations making them very easy to mount.

A smaller version of the 9410 is the 9402 series with a maximum capacitance value of 25 pf. These are perfect for applications in sub-miniature circuits such as ladies electronic wrist watches and phased array MIC's.

Johanson Manufacturing Corporation,
Rockaway Valley Road., Boonton, N.J.
07005. Phone (201) 334-2676, TWX 710-
987-8367.

MANUFACTURING CORPORATION

of people can understand. In most cases it's an ASCII character format that follows the standard definition."

Probably the biggest decision the instrument designer has to make is how to send out his data. Coates leans toward floating-point format. But it turns out that this is the hardest to generate, he notes, usually requiring more hardware in the instrument to generate the words.

Seven options offered

In another Session 3 paper, "Identifying, Understanding and Selecting Among the Capabilities Provided by IEEE Standard 488," Daryl E. Knoblock, development engineer at Hewlett-Packard, Cupertino, CA, asserts that "the basic standard is nothing more than the connection to the cable."

"The standard defines only the interaction between the bus and the instrument rather than the logic required for it," he notes. "Some designers will use state machines, others will use random logic, and still others will use microprocessors for the interaction needed. To implement the full standard is expensive."

But Knoblock points out that the best way to minimize instrument interface design costs is to use only those features of 488—he calls them "options"—that are needed for a particular instrument function.

The controllers of most instrument systems are computers or calculators, Knoblock points out. And interaction between the controller and the instruments is, according to 488, performed through 8-bit coded commands "broadcast" by the controller through the data bus to all instruments within the system. Also, asynchronous transfer of interface commands is specified so that the bus can accommodate instruments of varying data speeds.

The instruments on the bus must contain circuitry that permits them to recognize and remember when they have been instructed to send or receive.

Thirty-one interface commands are allocated as "listen addresses," Knoblock points out, while 31 more are allocated as "talk addresses." Data transfer begins, he explains, when the controller changes the Interface Command state of the bus and allows data bytes to be sent.

Choice of the options and the logic to implement them depends upon the instrument function, Knoblock notes.

"For example," he says, "sending data is particularly important for a voltmeter. And the voltmeter designer might not need the Interrupt operation to interrupt the computer. On the other hand, receiving—not sending—is important for a printer.

"If you wish to send data, then you'd choose the Send Data option. This is a pair of interface functions, one called the talker and one called the handshake. If a microprocessor is used, then each option represents more microcode."

The problem of designing the interface for instruments that are not compatible with Standard 488 but are tied together on the standard bus is complicated by the fact that 488 omits much information needed for software interface design, says John Fluke Jr., author of a Session 3 paper on "System Considerations in Using the IEEE Digital Instrument Bus."

"While the standard is exceptionally explicit about hardware interfacing details," notes Fluke, technical director of automatic test equipment for John Fluke Manufacturing Co., Seattle, "it leaves out a lot of the details with respect to software.

"Probably what should have happened is that there should have been some kind of a software standard and no hardware standard." ■■

It's good to know that in low power dividers you don't have to be constantly comparing which is best, which is new, on and on.

Just look to Plessey Semiconductors if you're working on hand-held or mobile synthesizers, or high-speed instrumentation.

It makes sense. Plessey offers the most comprehensive line of dividers with frequencies of up to 1.2 GHz, and division ratios of 2, 4, 5, 10, 10/11, 16, 20 or 32. Three guaranteed temperature ranges are available: -40°C to $+85^{\circ}\text{C}$, 0°C to $+70^{\circ}\text{C}$, or -55°C to $+125^{\circ}\text{C}$ on MIL grades.

Most important, you get an incredibly low power drain. For example:

	Type	Description	Power Consumption
Motorola	MC12012	$\div 10/11$ at 200 MHz	95 mA typical
Plessey	SP8695	$\div 10/11$ at 200 MHz	20 mA typical
Fairchild	95H90	$\div 10/11$ at 200 MHz	70 mA typical
Plessey	SP8690	$\div 10/11$ at 200 MHz	14 mA typical

Other examples of Plessey's extremely low power devices with no competition:

Type	Description	Power Consumption
SP8667	$\div 10$ at 1.2 GHz	80 mA typical
SP8602	$\div 2$ at 500 MHz	12 mA typical
SP8685	$\div 10/11$ at 500 MHz	45 mA typical
SP8655	$\div 32$ at 200 MHz	10 mA typical
SP8660	$\div 10$ at 200 MHz	10 mA typical
SP8790	$\div 4$ at 200 MHz	10 mA typical

Still scratching your head, and saying, "Well, maybe...?" Then we've got something for you. Request copies of our data sheets with all the facts. The truth is there for all to see.



PLESSEY SEMICONDUCTORS

1674 McGaw Avenue, Santa Ana, California 92705,
Tel: (714) 540-9979, TWX: 910-595-1930; Cheney Manor,
Swindon Wiltshire, England, Tel: (0793) 6251, Telex: 449637;
West Germany, Tel: 811 3516021, Telex: 5215322; France,
Tel: 727-4349, Telex: 62789; Italy, Tel: 3491741, Telex: 33245;
Sweden, Tel: (08) 23 55 40, Telex: 10558.

INFORMATION RETRIEVAL NUMBER 23

Compare Plessey's low power, high-speed dividers with the competition? Rubbish!

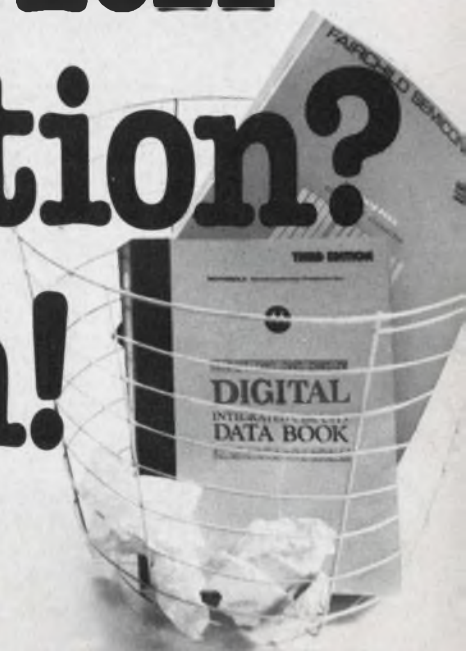

Designers cramming more traffic into satellite communications net

Satellite communications has matured to the point where domestic communication satellites are now ready to carry huge volumes of traffic. But the technology doesn't stop growing. Designers are pushing toward multiple use of the same frequency, time-division multiplexing, multiple polarization and higher frequencies with larger bandwidths to increase capacity still further.

Frequencies in the mm-wave region (30 GHz and up) will be used for high-bandwidth satellite and ground links. In addition optical communications is already with us. Data links are appearing in military programs. By 1980, commercial fiber-optic links may be in use by the Bell system. Free-space optical links are improving all the time.

"Our main thrust is to provide more circuits per satellite at a lower cost per circuit," says Dr. Sydney Metzger, chief scientist at Comsat in Washington, DC. He points to several steps that could lead to increased satellite capacity. Some are already in use in a few military and civilian satellites.

Stretching frequency use

"First on the agenda," he notes, "is frequency reuse. If you use the same frequency band over and over again, you multiply your capacity by the number of times you reuse the frequency band."

This is already being applied in the current generation of Intelsat satellites. The Intelsat IV-A, built by Hughes Aircraft, El Segundo, CA, has a pair of 53-in. high-gain dish antennas. These can each use the same frequency band to communicate with different installations. Intelsat IV-A contains 20 transponders, yielding 20 channels, each 36 MHz wide.

When AT&T launches its domestic Comstar I early next year, it will use another technique for frequency reuse. This satellite will use a pair of



Satellite communications antenna is located at Philco-Ford Corp.'s WDL Div. in Palo Alto, CA.

orthogonal polarizations, with each polarization having full use of the available bandwidth. The satellite will contain 24 transponders, each carrying a 40-MHz channel. The down-link frequency will be 4 GHz and the up-link 6 GHz. The satellite will also contain beacons for testing the feasibility of an 18-GHz down-link and a 30-GHz up-link.

Intelsat IV-A uses a 4-GHz down-link and a 6-GHz up-link. While only 500 MHz of bandwidth is available at 4 and 6 GHz, 2500 MHz is available at 18 and 30 GHz. RCA's 4 and 6-GHz satellite, due to be launched late this year, will also be capable of dual-polarization frequency reuse.

Another frequency band of interest—one be-

David N. Kaye
Senior Western Editor

ANOTHER REASON HEINEMANN IS NO. 1 IN OEM CIRCUIT BREAKERS.

THE CUSTOM BREAKER

WE CAN HELP YOU GET MORE FOR YOUR CIRCUIT PROTECTION DOLLAR BY GIVING YOU SOMETHING A LITTLE SPECIAL.

It's just plain easier (and cheaper) to use tightly specified circuit protection than to design extra tolerances into your components and circuits. So it's obvious that a custom protector, one that exactly matches your requirements, would save you money—if you could afford a custom protector.

You can.

Because what you may call custom is standard fare at Heinemann. Each breaker we sell for a specific application is actually custom built. You specify the precise trip-current rating, the right time delay, and the operating voltage and internal circuit you need. Even the type and color handle that will look best on your equipment panel.

All this at standard prices. But with not-so-standard savings. Take one of our customers, in the heavy-duty field. He saves an appreciable amount of copper every year because close-tolerance Heinemann circuit protection lets him use finer-gauge wire. And that's just one example.

If our standard design specifications don't give you everything you need, we have some *real* specialty capabilities to offer. And a fast-response custom engineering group, right in

our sales department, ready to work with you on your specific problem.

Especially today, with the pressure to reduce costs, overall economy of design should be important to you. Help in getting it is closer than you might think. There's a Heinemann representative in your area fully qualified to work out your OEM protection problem.

He is in a position to offer you more solutions than anybody else: circuit breakers in any integral or fractional rating from 0.010A to 225A, a choice of extra-value built-in control circuits, and now a choice of technology: hybrid and all solid-state, in addition to electromechanical breakers. Plus protection against over- and undervoltage, as well as overcurrent and short circuits.

Your Heinemann representative can also tell you about Quick-Draw delivery, our exclusive five-year warranty, and manufacturing facilities in the U.S., Canada, West Germany, South Africa, and Australia. Give him a call or write us for a copy of our Engineering Guide, Bulletin 202. Heinemann Electric Company, Trenton, NJ 08602. Phone (609) 882-4800.

HEINEMANN

We keep you out of trouble.

INFORMATION RETRIEVAL NUMBER 24

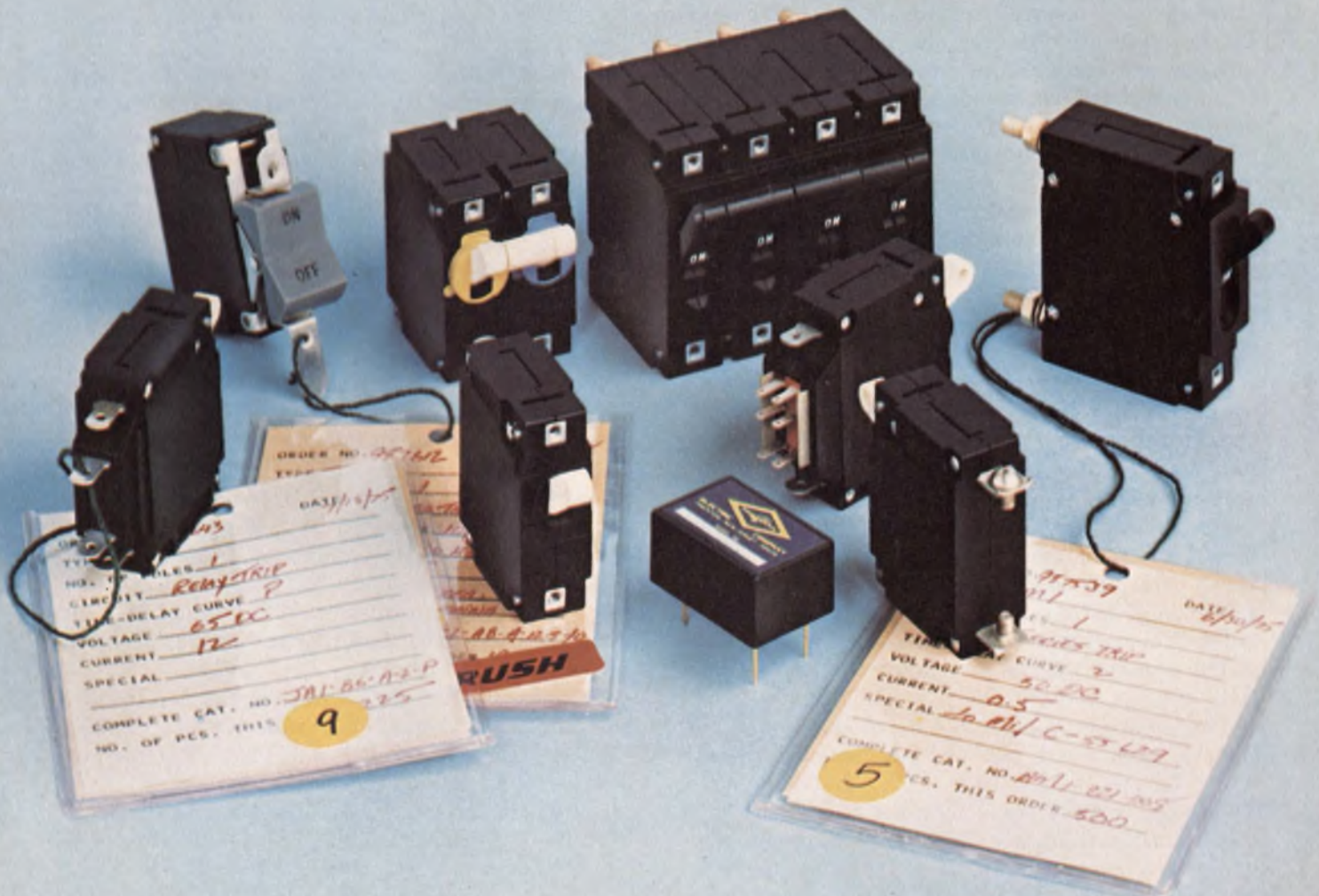

ing used experimentally by Canada's domestic communications Telesat—is a 12-GHz down-link and 14-GHz up-link. Only 500 MHz of bandwidth is available at these frequencies.

Next, according to Metzger, will be a switch from frequency-division multiplex modulation to time-division multiplexing (also called TDMA, or time-division multiple access). Telesat and Eurosat, the European domestic communication satellite, will contain TDMA. Intelsat IV-A doesn't have it now, but might get it at a later date. TDMA results in an approximate doubling of capacity.

Metzger also points to full digital satellites. With these, digital switching can be used to switch messages from one channel to another in an attempt to keep all channels in maximum use. This technique is called digital speech interpolation.

Finally the alternative of just putting up additional satellites to increase capacity might be attractive. Metzger notes that all alternatives are being considered in the design of the next generation of Intelsats, to be known as Intelsat V.

Higher and higher frequencies

AT&T's experimentation with 30 GHz as a communication frequency is but one example of the application of mm waves to communications. Bell Telephone Laboratories at Holmdel, NJ, has developed a mm-wave guided system to operate in the 40-to-110-GHz region. Through a 2.5-in. circular waveguide, Bell can transmit upward of a quarter million telephone channels. Researchers feel that there is a potential for a half million channels in the near future.

For protection, the waveguide is sustained on rollers and surrounded by a steel tubular shell. An experimental system has been installed underground and is being tested.

Kerns Powers, director of the Communications Research Laboratory at RCA Laboratories, Princeton, NJ, says: "I think that guided mm-wave links are just an interim solution that will ultimately be replaced by fiber-optic links. Fibers should ultimately be the major guided-wave communication trunk line."

However, Dr. Powers sees free-space mm-wave communications as a useful technology for local distribution systems of up to a few miles. He says: "Initially the 31-to-35-GHz band lends itself to all-weather links of up to 1 mile. Later, when the spectrum gets too crowded at 31 to 35 GHz, systems will be developed to use the 90-GHz window in atmospheric attenuation."

The greatest promise lies in optical communications, researchers say. Optical communications will take two forms, each with two variations. The two forms are free space and fiber-optic, and the two variations are LED and laser sources.



The Hughes Intelsat IV-A satellite contains 20 transponders, permitting 20 channels, each 36 MHz wide, to operate through twin 53-in. dish antennas. It uses a 4-to-6-GHz downlink and 6-GHz uplink.

Free-space optical communications has been around for some time. Several years ago Computer Transmission Corp., El Segundo, CA, introduced a system called Optran. This system, still on the market, uses an infrared GaAs LED as a source to transmit digital data up to 1000 ft at a data rate of up to 250 kb/s. With a GaAlAs LED, the range is extended to 4000 ft, but the data rate drops to 19.2 kb/s. The military and a few other companies also make optical free-space data links.

Meret Corp., Santa Monica, CA; American Laser Systems, Santa Barbara, CA, and Motorola Communications in Schaumburg, IL, all make LED free-space, short-distance links for video transmission. Meret has a 6-MHz bandwidth system, good to a range of 1 km. American Laser's system has a 15-MHz bandwidth and Motorola's 4 MHz. Among the main applications for these systems is the transmission of high-quality television pictures from building to building as part of a security system.

Stephen W. Harting, a member of the technical staff at Computer Transmission, notes: "We're planning a digital link that will transmit 1.544 Mb/s for better than a half mile. This would compete across rivers and highways with AT&T's T-1 carrier phone links. Our link will

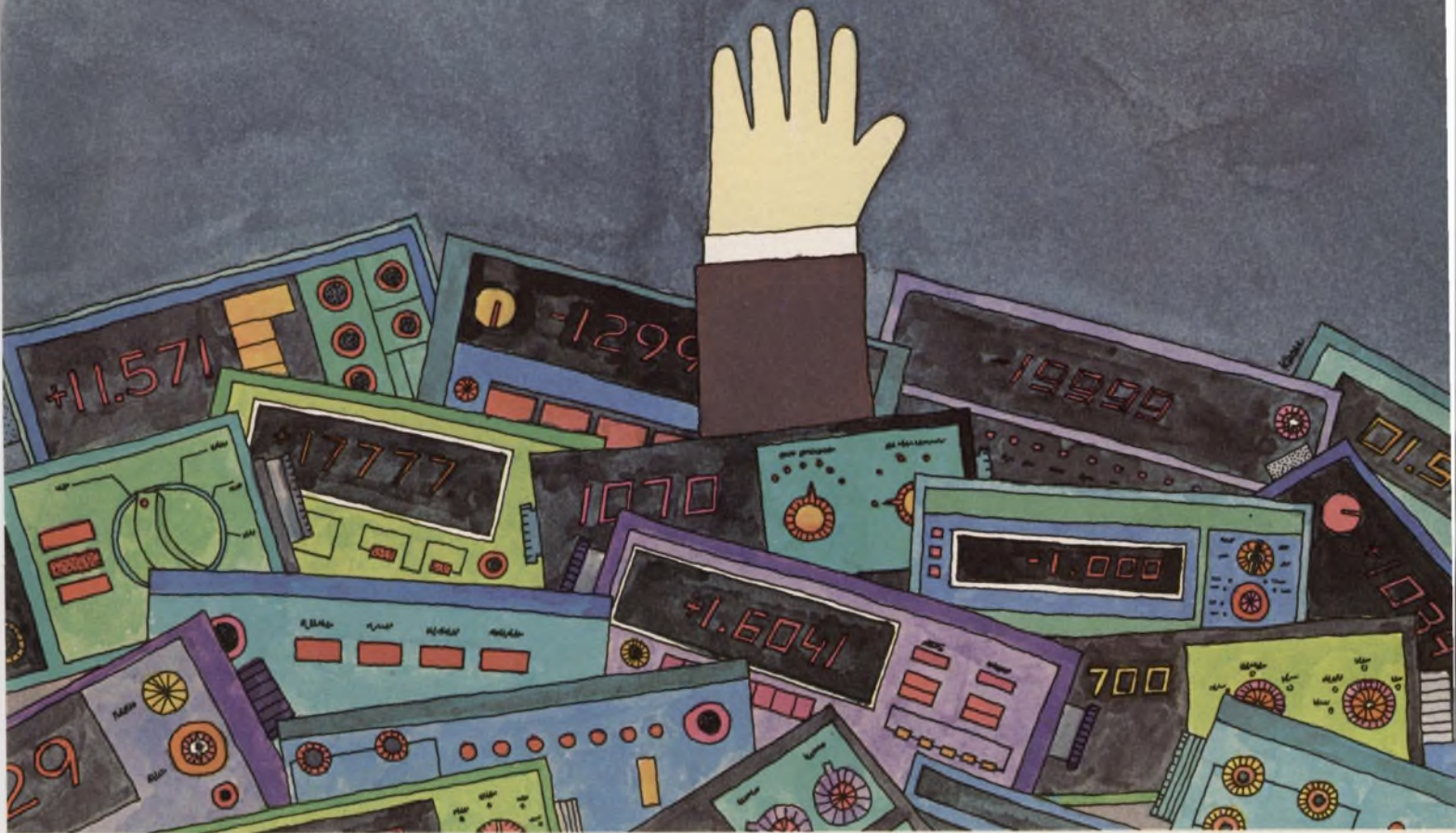

When it comes to picking the right 4½ digit multimeter, are you drowning in a sea of sales claims?

Check the Fluke truth table for all the important facts.

	4½ Digit Multimeter Competitors #										FLUKE 8600A
	1	2	3	4	5	6	7	8	9	10	
Five-range AC/DC volts to 1200V											•
Five-range AC/DC current to 2A			•						•		•
Six-range resistance to 20 megohms					•			•	•		•
Autorange through all ranges plus individual range selection manually									•		•
10,000 Hour demonstrated MTBF											•
Continuous overload specified for all ranges/functions with overload indication								•		•	•
Environmental capability specified and defined											•
Automatic zeroing		•	•				•	•			•
Full line of accessories offering HI volts to 40 KV, RF to 500 MHz, current to 600A											•
Rechargeable battery option, completely built-in and self-contained					•		•	•		•	•
7W or less power consumption for reliability								•			•
Basic DC accuracy of 0.02% for 90 days at 15° C to 35° C	•										•

Ten companies claim to offer a 4½ digit multimeter competitive to the Fluke 8600A. As you can see from the truth table, no one measures up to Fluke. Some have more features than others. None have all the fine features of the Fluke 8600A. For a modest \$599 (U.S. Price), you can put the 8600A to work right away.



John Fluke Mfg. Co., Inc., P.O. Box 43210, Mountlake Terrace, WA 98043. For data out today, dial our toll-free hotline 800-426-0361. For a demo circle 25. For literature only, circle 26. For information on the rest of the Fluke line see our ad in

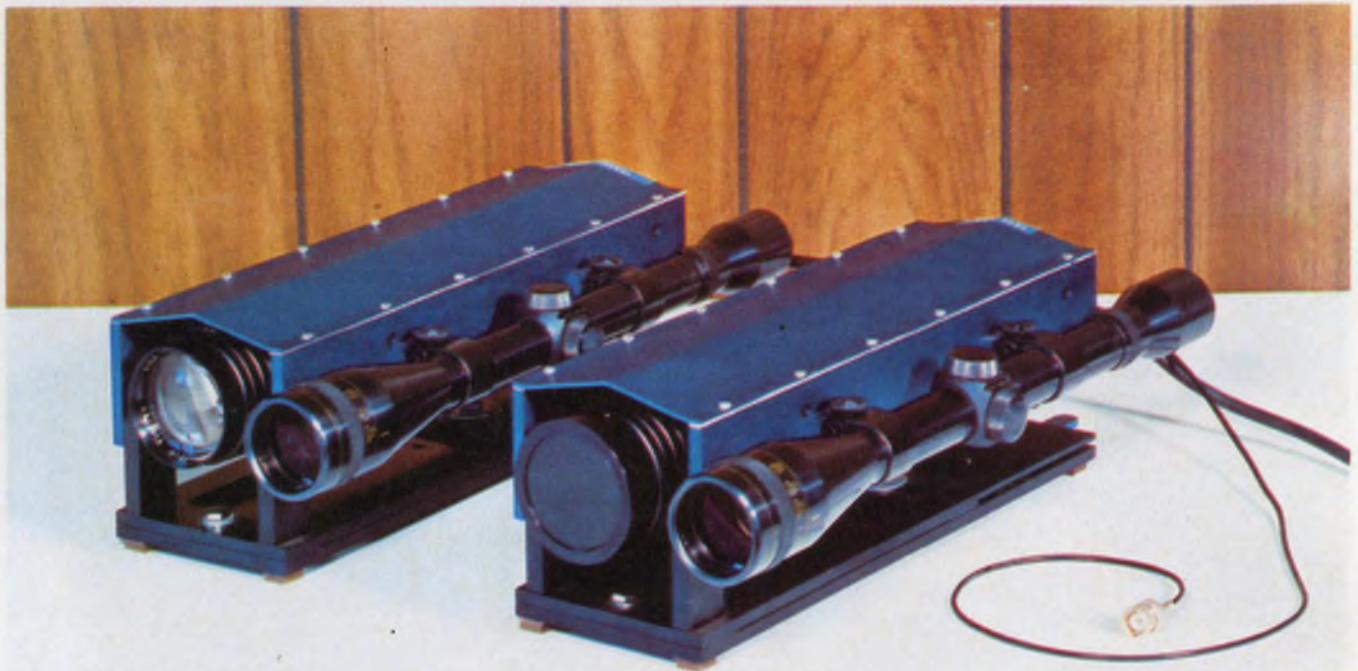

American Laser's compact laser communicator transmits data at up to 1.5 Mb/s with 99.99% reliability. Its

range is between one and three miles. Such equipment may find use in high-quality TV security systems.

use the same transmit diode as the lower bandwidth link, but we will go to an 8-in. lens instead of a 3-in. and use better spectral filtering and a narrower beam-width receive envelope."

While others are also working optical links that are like the T-1, Bell Laboratories has recently released information on an updated T-1 link called T-1C. It will have bandwidth capability of 3.152 Mb/s.

Powers of RCA feels that short optical links will complement short mm-wave links. He says: "Optical links are better in rain, and mm-wave links are better in fog. We might see a combination of the two at the same installation."

Free-space laser links are also being worked on. American Laser Systems sells one that uses a GaAlAs room temperature laser diode that has a 1.5 Mb/s data rate and a range of over 3 mi. The error rates are about 1 in 10^{10} during clear weather.

Many companies are working on military free-space laser projects. Typical of the hardware is a laser communicator, about the size of a large pair of binoculars, built by the Hughes Santa Barbara Research Center in CA. It uses pulse rate modulation at a 5-to-6-kb/s typical rep rate. With it, says Robert J. Cinzori, project manager at Hughes, "you can usually communicate about 20% farther than you can see."

Two or three years ago 20 dB/km was considered a very-low-loss optical fiber. Now several fiber manufacturers are down below 5 dB/km.

The best results have been recorded by Bell Laboratories and Corning Glass Works, Corning, NY. They both have achieved 1.1 dB/km. Close behind is the ITT Electro-Optical Products Div., Roanoke, VA, at 2 dB/km. With such low loss, long-distance fiber-optic communication links become practical.

Stuart E. Miller, director of the Guided Wave Research Laboratory at Bell Laboratories, Holmdel, says: "We hope there will be commercial fiber-optic links by 1980."

Miller expects the earliest practical systems to use multimode fibers rather than single-mode. Multimode fibers are several times larger in diameter and contain transmission in several modes. Because of their larger size, it is easier to couple energy into the fiber. In fact, if the source is to be a LED, multimode fibers must be used. Only a laser can feed a practical amount of energy into a single-mode fiber of $10\ \mu$ or less.

Although the low-loss fibers exhibit pulse dispersion of better than 1 ns/mi (allowing for theoretical data rates of 1 Gb/s or better), few researchers are looking at data rates higher than 300 Mb/s.

Miller feels that the most practical systems will use GaAlAs diode lasers as sources. Until recently, the lifetime of these devices, when operated at room temperature, has been a concern. However, in the last year or so major developments have led to diode lasers with demonstrated lifetimes of 10,000 hours and more. ■■

WARRANTY 1 Year PLUS



What's your warranty? Beckman will match it!

Beckman Planar Gas Discharge Displays carry the best warranty in the industry and we're very proud of it. Simply stated, our warranty is good for a *minimum* of one year. That, in itself, beats a lot of competitive warranties, but ours has a big PLUS.

Our warranty is *extendible* to match the warranty our customer puts on his finished product. For example, if a customer manufactures DPM's using Beckman displays and warrants his units for three years, then we will extend our warranty to three years.

Our one-year *plus* warranty can be the sensible approach to your design requirements. But Beckman Planar Gas Discharge Displays offer you even more. Here are some other significant reasons why these

Beckman displays are finding their way into hundreds of new designs:

- Crisp, easy to read, unbroken numerals
- Eye pleasing neon orange color (filterable to red)
- Easily read in direct sunlight
- Choose from 1/3", 1/2", or 1" character sizes

All of this, plus low cost, ease of use and reliability. It adds up to the ideal display for today's designs. For additional information contact your Beckman sales office or write Beckman Instruments, Inc., Information Displays Operations, P. O. Box 3579, Scottsdale, Arizona 85257. In Continental Europe and the United Kingdom, contact Beckman Instruments, Ltd., Queensway Glenrothes, Fife, Scotland KY7-5-PU.

Beckman[®]

INFORMATION DISPLAYS OPERATIONS

There's more eye appeal in Beckman Displays!

A few of the electronic products now being made in Puerto Rico:

Electronic precision instruments • Mini-computers • Thermostats • Electric and electronic measuring instruments • Capacitors • Monolithic electronic modules • Potentiometers • TV, Radio and Phono assemblies • Tape recorders • Two-way communications radios for cars and boats • Color TV electron gun mounts • Magnetic core memories • Radial detectors



A few of the reasons Puerto Rico has attracted so many of your competitors

Electronics is now Puerto Rico's second-largest industry.

In the past five years, shipments of electrical and electronic products from the island are up an average of more than 90%*.

If you're thinking of opening a new plant, you should know why electronics manufacturing thrives in Puerto Rico. The key reasons are these:

1. Unheard-of profits

Unheard of on the mainland, that is. Your competitors in Puerto Rico show an average 25.7% profit-to-sales ratio. That's 5 times better than on the U.S. mainland.**

No wonder companies like R.C.A., Digital, Technicon, Bell & Howell, G.E., Westinghouse, GTE Sylvania, Instrument Systems Inc., AMP Inc. and Motorola like the business climate in Puerto Rico.

2. No federal income tax

None at all. Puerto Rico is not subject to any federal taxes. So these companies pay no United States income tax, personal or corporate. And neither will you.

3. 100% local tax exemption up to 30 years

Companies can be exempt from local taxes of any kind. That means no corporate income tax, no real and personal property tax.

Tax exemption is granted for a minimum of ten years to a maximum of thirty years, depending on where you locate your plant on the island. And there are many

excellent locations available throughout the island.

4. Workers who produce

U.S. companies report that the productivity of their Puerto Rican workers is at least equal to—and often surpasses—that of their mainland counterparts.

Over 100,000 such workers are immediately available for employment. A young, eager labor force capable of producing anything from capacitors to the most complex electronics instruments.

And Puerto Rico wages remain reasonable. Companies find they're much lower than those paid in any other industrial area in the U.S. In fact, you can expect to save an average of \$1.50 an hour.

5. 2-year wage incentive

Eligible companies can benefit from government reimbursements of up to 25% of production wages paid in their first two years of operations in Puerto Rico.

If you qualify, this incentive would be paid back to you in your third and fourth years on the island.

6. In Puerto Rico, U.S. companies are on U.S. soil

Obviously, American companies find this an enormous business advantage over foreign locations. Life is much simpler when you're dealing with the same post office, legal system—and the same money. Imagine what you'll save by avoiding currency fluctuation headaches alone.

7. Puerto Rico's great air/sea connections

Fifteen scheduled airlines and thirty ship-

ping lines service the international port of San Juan. Four airlines offer daily airfreight links to the U.S. mainland. Air cargo from Puerto Rico gets to New York in 3¼ hours, to Los Angeles in 8½.

Modern container and roll-on/roll-off ships reach New York in 3½ days; sailing time to Pacific ports is about 12 days. By air or sea, shipments are *domestic*—no special documentation needed.

Intrigued? Send for free report

Now you have a general idea of why so many electronics companies are already in Puerto Rico. For the complete, in-depth information you need to make your decision, mail the coupon below.

*Source: Puerto Rico Planning Board: *External Trade Statistics*: re: shipments to the U.S., the Virgin Islands and foreign countries, 1969-1974.

**Source: Latest available profitability figures (1973). Commonwealth of Puerto Rico, Economic Development Administration, Office of Industrial Economics and Promotional Services.

**Commonwealth of Puerto Rico
Economic Development Admin.
Dept. ED-1, 1290 Ave. of the Americas
New York, N.Y. 10019**

Please send me a "Report on the Electrical and Electronics Industry in Puerto Rico" today, including details on Puerto Rico's irresistible profit incentives.

The equipment I am thinking of manufacturing is:

Name _____

Title _____

Company _____

Address _____

City _____ State _____ Zip _____

©1975 Commonwealth of Puerto Rico

Visit Puerto Rico at Wescon '75 September 9-16 Booth 1633

INFORMATION RETRIEVAL NUMBER 29

ELECTRONIC DESIGN 19, September 13, 1975

You can't think thermometry without thinking DigiTec...

DigiTec introduced the first digital thermometer to the world in 1964. Since that beginning, DigiTec and digital thermometry have been synonymous. Especially if you're accustomed to broad ranged, precision thermometers.

Our Thermocouple, Thermistor or Platinum Resistance thermometers display in both °C and °F and deliver the accuracy, confidence and reliability that reinforces the DigiTec commitment to quality instrumentation.

5800 Series, Thermistor, °C or °F \$435.

251A Series, Thermistor/PT 100, °C or °F \$825.

590 Series, Thermocouple, any type, °C or °F \$849.

Exclusive LSI circuitry plus extensive use of plug-in IC's, displays and circuit boards assures dependability and maintainability. Selected models also supply the features your specific application requires; portability, line or battery operation, LED displays, isolated BCD outputs, and systems capability. A complete line of accessories make the DigiTec thermometry line most versatile. Write or call now for assistance in selecting the most suitable thermometer for your needs.



Call your nearest United Systems representative for complete specifications.

DigiTec

UNITED SYSTEMS CORPORATION

918 Woodley Road • Dayton, Ohio 45403 • Ph: (513) 254-6251 • TWX: (810) 459-1728

These instruments available under GSA Contract GS-OOS-27741

FOR INFORMATION ONLY, CIRCLE 271

FOR DEMONSTRATION ONLY, CIRCLE 272

five important reasons to specify the **KEPCO JQE** power supply



TYPICAL 1000 WATT JQE POWER SUPPLY

- **JQE deliver their rated output right up to +71°C without any derating whatever.** Moreover, they run cool! Internal blowers actually help circulate the air in your system to keep hot spots from developing.

YOUR MECHANICAL PEOPLE WILL APPRECIATE THIS.

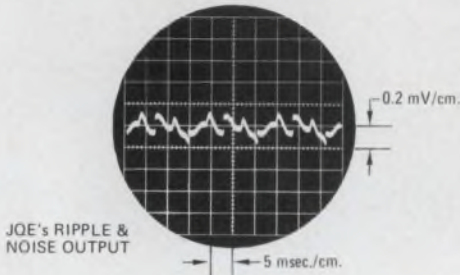

JQE's RIPPLE & NOISE OUTPUT

- **JQE produce clean d-c,** less than 0.2 mV rms ripple and noise (1.0 mV p-p including spikes up to 10 mHz). The output varies less than 0.0005% for the worst sort of line variation, and long-term drift is less than 0.01%.

YOUR LOAD WILL APPRECIATE THIS.

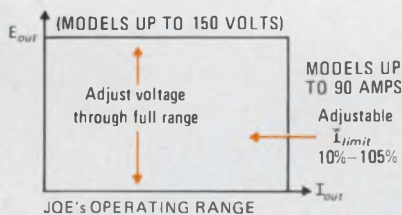

JQE's OPERATING RANGE

- **JQE are wide-range instruments.** Every JQE can be set from zero to its rated output. What's more, they all have one *additional* volt capacity so that wire drops do not subtract from the voltage available to your load. Buy a 0–15V model to cover the 5V, 6V, 8V, 10V, 12V and 15V loads. A 0–36V model to take care of 18, 24, 28, 32 and 36V jobs.

YOUR BUDGET WILL APPRECIATE THIS.

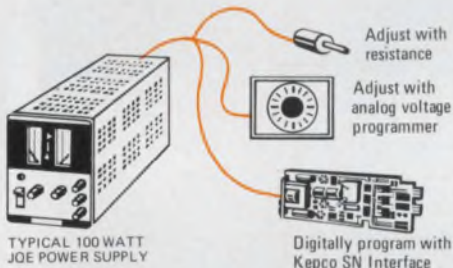

TYPICAL 100 WATT JQE POWER SUPPLY

- **JQE are fully programmable**—by resistance (1000Ω/volt) or by voltage (any gain ratio you choose) or by parallel binary or BCD logic. That means you can easily interface your JQE with a computer control bus. (Use the Kepco SN Programmer)

YOUR SYSTEM WILL APPRECIATE THIS.

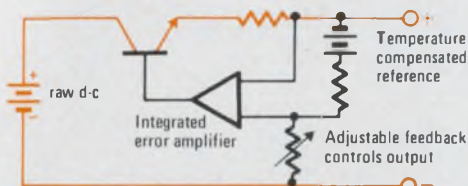

JQE IS AN OPERATIONAL POWER SUPPLY THAT BEHAVES LIKE A LARGE LINEAR AMPLIFIER

- **JQE are linear voltage stabilizers**—which means that JQE are a lot simpler and more reliable than switching machines. (You get a 5-year warranty.) A linear JQE will respond in microseconds to a load shift; will maintain its low output impedance into high frequency pulsed loads; produces no RFI/EMI and doesn't hack up the power line like SCR types.

YOUR NEIGHBORS WILL APPRECIATE THAT.

JQE

is a premium quality voltage stabilizer for the no-compromise job

Write Dept. V-05 for the new Kepco Catalog and Handbook.

KEPCO

131-38 SANFORD AVENUE • FLUSHING, N.Y. 11352
(212) 461-7000 • TWX #710-582-2631

INFORMATION RETRIEVAL NUMBER 31

Washington Report

GAO assails NASA's cost and work estimates

The General Accounting Office, after surveying 25 major unmanned satellite projects of the National Aeronautics and Space Administration, has criticized the space agency for cost and schedule estimates that "frequently have been optimistic"—possibly to the tune of a billion dollars in cost overruns and delays of up to 29 months.

The agency is particularly critical of NASA's method of allocating costs, such as not including launch-vehicle support, tracking and data acquisition, Civil Service personnel, and facilities that are directly identifiable with the projects. The GAO, noting that NASA is to provide Congress with reports on its major projects, suggests that Congress may want to discuss the problems with the space agency.

The GAO concludes that costs have grown by \$1.02-billion over the original \$1.79-billion initially estimated for the projects. NASA puts the overrun at \$256.1-million.

Nuclear development budget appears intact

Despite some futile last-ditch Senate efforts to cut funds for nuclear weapons and nuclear energy, it appears certain that the first budget for the Energy Research and Development Administration will be approved pretty much as proposed.

Before heading home for the summer recess, the Senate passed a \$6.1-billion authorization for the new agency to carry it through the 15 months that started on July 1. The House, which passed a similar measure on June 20, differed with the Senate by \$171-million. A short conference will work out the differences.

Most of the Senate debate was on slowing development of the first liquid-metal fast-breeder reactor, which is to be located on the Clinch River in Tennessee. Soundly defeated also was a proposal to delete \$232-million from the nuclear-weapons authorization and to limit the U.S. nuclear arsenal to its present size.

Electronic control of jet engines studied

Still another promising market for electronics appears on the threshold, this time to substitute digital electronics for increasingly costly and complex hydromechanical systems to operate jet-engine air inlets, afterburner and nozzle units.

Under a \$7.9-million contract to the Air Force, Boeing is developing and testing the new control technique, called an Integrated Propulsion Control System. Ground tests have been reported successful, and the final proof is to come this fall in a flight test program using a modified

F-111E aircraft.

One of the two engines and its inlet, afterburner and nozzle have been modified to operate under the control of a computer installed in an insulated capsule in the aircraft's weapons bay. One expected benefit: reduced fuel consumption. If this saving is realized, commercial aviation will undoubtedly be highly interested, especially with fuel prices zooming upward.

A Bureau of Telecommunications sought

In a move to elevate the status of telecommunications in the Federal Government, Rep. Harley Staggers (D-WV), chairman of the House Commerce Committee, has introduced a bill to establish a Bureau of Telecommunications in the Dept. of Commerce.

If passed, the legislation would upgrade the present Office of Telecommunications to a bureau. The goal would be the development of a broadband communications system in the U.S. The proposal by Staggers follows a decision by Secretary of Commerce Rogers Morton not to consolidate the present office with the National Bureau of Standards.

Capital Capsules: The Air Force has shelved its plans to close the Rome Air Development Center at Griffis AFB, NY, and transfer its functions to Hanscom AFB in Massachusetts. Political pressure caused the reversal. Now the Rome center will report to the Electronics System Div. at Hanscom, which accomplishes the realignment of electronic R&D, as planned, but without personnel savings. . . . McDonnell Douglas has unveiled its YC-15 medium short-takeoff-and-landing transport, which is to compete with the Boeing YC-14 for an order of 300 or so aircraft by the Air Force to replace the aging Lockheed C-130s. Boeing's entry is to make its maiden flight next July 4. Then the two planes will enter a flyoff to determine the winner. . . . RCA has given the Army a successful preview of EQUATE—Electronic Quality Assurance Test Equipment. Designated the AN/USM-410(V), the system is a test bed for the Army's Automatic Test Support System. It will diagnose and fault-isolate both digital and analog equipment and circuits in depot and field environments. A six-month test is under way at Fort Hood, TX. . . . The Federal Railroad Administration is proposing radio standards and procedures to govern the use of radio communications in railroad operations. The impetus comes from Federal safety officials, who cite accidents that could have been avoided through communications. . . . The Air Force has announced it will acquire two preproduction models of a mobile air-traffic-control simulator from Hydrosystems Inc., Farmingdale, NY. . . . NASA has the Boeing Co. studying two potential satellite power-generating systems, one a thermal engine converter, the other a thermionic converter. A microwave power system would transfer the energy to an earth station. Boeing has a whopper station on the drawing board, measuring 22 square miles, that would produce the electric power equivalent of the Grand Coulee Dam. Between 35 to 40 stations could handle all U.S. needs. Cost: \$60-billion a copy. . . . The National Library of Medicine is turning to electronics to halt unauthorized removal of books, journals and other materials. The library is seeking a vendor who has a system that will give both an audible and visible signal when a theft is attempted. A key requirement is an adhesive strip that can be installed in random fashion in a book. It would be difficult to detect and remove by light-fingered readers.

If you design with ECL or TTL, You need to know about Tektronix TM 500

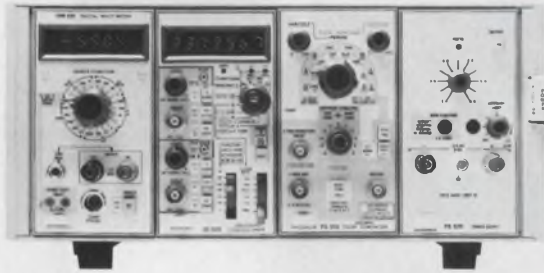
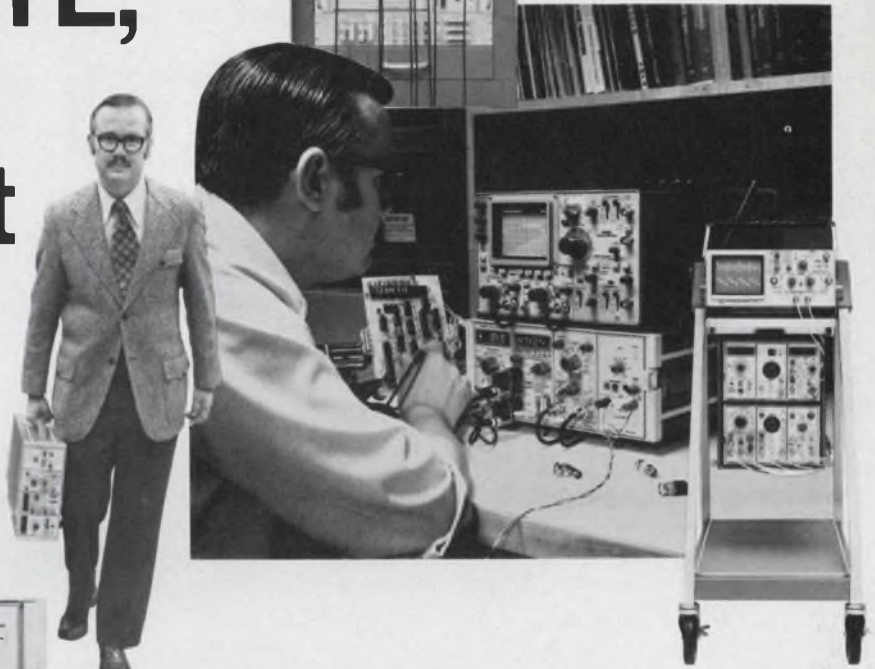

If You're into High Speed Logic,

the Tektronix TM 500 High Speed Logic Instrumentation plus the Tektronix 485 Oscilloscope (350 MHz) or 475 Oscilloscope (200 MHz) provide all the instrumentation you need for TTL or ECL up to 250 MHz. The four plug-ins of the TM 500 High Speed Logic system are a PG 502 Pulse Generator (\$1295) with 1 ns rise time and independently variable logic 1 and 0 levels . . . a DC 505A Digital Counter (\$1395) with 10 ns single shot resolution and averaging to 100 ps . . . A DM 501 Digital Multimeter (\$575) with temperature measurement capability added to all its conventional functions (so you can verify operating temperatures of logic IC's and detect hot spots in tightly packed circuitry) . . . and the PS 505 Power Supply (\$195) with the 3.0 to 5.5 V dc high-current (4 A) output essential for breadboarding or testing TTL and ECL devices. Also, you can expand the capabilities of the system to provide jitter-free oscilloscope triggering for viewing any segment of long pulse sequences by including the DD 501 Digital Delay (\$625). The 485 Oscilloscope features dual trace, 1 ns rise time, and delayed sweep.

Whatever Pursuit in Electronics You're Into, you should learn more about TM 500 instrumentation. A particular group of plug-in modules in a four-hole mainframe provides the instruments most often needed in telecommunications, another fulfills the needs of industrial instrumentation calibration and troubleshooting, another for medical instrumentation, others for education, and so on.

The TM 500 Concept,

TM 500 is a growing, compatible family of 29 plug-in modular instruments, accessories, and one, three, and four-hole mainframes providing the common power supply. *It's multi-functional:* The plug-ins include 11 signal sources, 5 counters, 2 digital multimeters, 5 power supplies, 3 signal processors, 1 oscilloscope, 1 X-Y monitor and even a blank plug-in kit, so you can assemble the specialized circuits you require. *It's versatile:* You can select from general-purpose instruments, such as the DM 501 Multimeter, or highly specialized instruments such as the TG 501 Time Mark Generator. You can select a system of instruments exactly tailored to your needs. *It's synergistic:* The instruments can "work together" through a common interface circuit board, so your lab bench needn't be cluttered with interconnecting cables. *And it's neatly configurable:* The TM 501 (one), TM 503 (three), and TM 504 (four-compartment) mainframes are attractive and compact. Since the typical four-instrument system only weighs about 20 pounds, it can be hand-carried as easily as it goes onto a bench. The TM 504 (\$180) is only 11" W x 6" H x 20" D. In rack mounting, each bay contains six instruments. And Tektronix SCOPE-MOBILE® carts let you put your entire instrumentation requirements on wheels.

Find Out What TM 500 Can Do For You. Get the new TM 500 Booklet A-3072 with full specifications and suggested package configurations, or contact your local Tektronix Field Engineer for a demonstration. Or write to Tektronix, Inc., P.O. Box 500, Beaverton, Oregon 97077. In Europe, write Tektronix Limited, P.O. Box 36, St. Peter Port, Guernsey, Channel Islands



U.S. Sales Prices FOB Beaverton, Oregon

FOR TECHNICAL DATA, CIRCLE 281

FOR DEMONSTRATION, CIRCLE 282

You may be going steady with the wrong resistor.



Carbon Composition. Industry's workhorse. Broadest resistance range, low cost. Available in packaging suited to automatic assembly.



Metal Glaze™. Unique thick metal film design provides *real* stability, power handling at surprising low cost. Rugged molded construction.

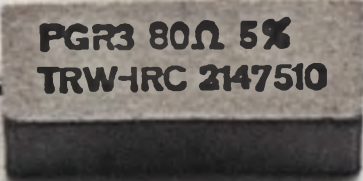

Ceramic Power. Ceramic insulated, fireproof, and low cost. Both wirewound and glaze constructions. Fusible and TC compensating versions available.



Molded Wirewound. Saves space and money over other 1 and 2W devices. From 0.1Ω up. Fusible, and TC compensating versions available.



Network. Molded TO-116 DIP networks. Installed cost savings and TaNFilm™ stability can be significant advantages.

Consider General Purpose Resistors.

Some suppliers give you a choice of one, or two. Not TRW. We make five different types of general purpose units . . . for good reason:

So you can select the *right* resistor for your application. No force-fits, no compromises.

The result is improved circuit layout, better performance and quite often a cost savings.

For the broadest choice in resistors for all types of applications, write or call TRW/IRC Resistors, an Electronic Components Division of TRW, Inc., 401 N. Broad Street, Philadelphia, Pa. 19108, Tel. 215-922-8900.

TRW[®] IRC RESISTORS
We give you a choice.

INFORMATION RETRIEVAL NUMBER 34

What Would You Call an Easy-to-Use, Low Cost, Portable, Flexible, Time-Saving, Four Channel Test Instrument?

Most people would call it unbelievable.

We call it the Bell & Howell® Datagraph Model 5-144, probably the most convenient test instrument you'll ever use.

With a frequency response of up to 10,000 Hz, the Model 5-144 records both analog and digital data with equal ease.

Four channels are available for viewing simultaneous events, such as timing sequences or multiple, inter-related functions.

The Model 5-144 contains all electronics needed to record information. There's no need to make special cables or calculate complicated damping networks. Just plug in your scope probes and record your data.

And after you've captured that data, the Model 5-144 provides a hard-copy for further examination.

In fact, think of it as a scope with a screen 200 feet wide.

Other user features include trace polarity reversal, ac or dc coupling, and three selectable timing reference line spacings.

Two choices of gridlines and ten recording speeds are also available.

Total weight for all of this capability is only 34 pounds.

For more information or a demonstration, circle the appropriate reader service number below or write the CEC Division of Bell & Howell.

The Datagraph Model 5-144 will make a believer out of you.

CEC DIVISION

360 Sierra Madre Villa, Pasadena, California 91109

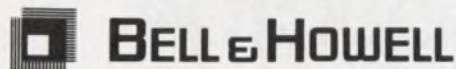

(In Canada: 125 Norfinch Drive, Downsview, Ontario M3M 3B5)

CEC is a registered trademark of Bell & Howell.

© Bell & Howell 1975

INFORMATION RETRIEVAL NUMBER 35



HiNIL Interface

Prevent CMOS latch-ups and failures with a high noise immunity logic I/O.

CMOS systems are subject to latch-ups and failures in the field because of high voltage transients, static charge and improper field maintenance procedures. Moreover, due to their increased output impedance, CMOS is more susceptible to transient errors than corresponding bipolar logic.

A simple solution to these problems is to use Teledyne's bipolar High Noise Immunity Logic (HiNIL) as the system I/O interface. The I/O design approach shown in Figure 1 has solved these problems in applications such as business equipment, industrial controls and electronic games. The HiNIL interfaces protect the delicate CMOS inputs with a rugged bipolar "front end" not susceptible to CMOS failure modes. Also system noise immunity is maximized, and the HiNIL output devices provide direct, high current logic drive of relays, displays and long lines.

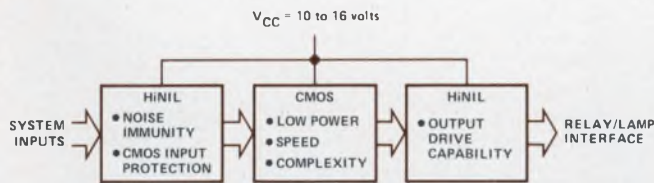

Figure 1. HiNIL input interface protects CMOS inputs while HiNIL outputs directly drive long lines and peripheral devices

The two families are directly compatible at the 10 to 16 volts V_{CC} range. The designer can take full advantage both of HiNIL's capabilities and of CMOS' low power dissipation, supply voltage flexibility and improved noise margin at higher supply voltages.

Parasitic SCR latch-up is an all too common CMOS malfunction. Large noise transients and DC input levels below ground or above V_{CC} could force CMOS input diodes into forward conduction, causing SCR action in the four-layer diodes formed by the diode and parasitic p-n substrate junctions. This condition leads to device latch-up, increased I_{CC} current and, when current is not limited, to gate destruction. Maximum protection can be obtained by using

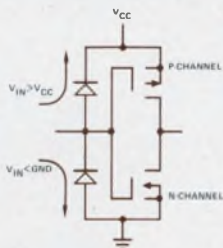

Figure 2A. CMOS latch-up causes

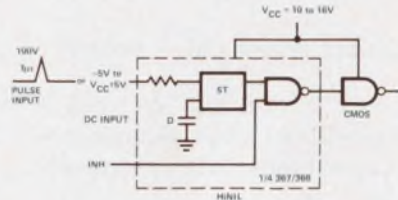

Figure 2B. HiNIL input protection

HiNIL Schmitt triggers. They prevent latch-up at DC input levels from -5 volts to $V_{CC} + 5$ volts and suppress 100 volts transients as wide as $1\mu\text{sec}$ (Figure 2).

HiNIL inputs on plug-in cards will protect a CMOS system from problems associated with "on power" fault isolation, a widely used TTL system maintenance method. Plugging CMOS into powered connectors has led to latch-up failures because it allows inputs to see logic "1" signals before V_{CC} rises on the card. The failure is frequently catastrophic if input current is not limited.

HiNIL's lower output impedance and DC noise margin of 3.5 volts ignore large voltage noise transients that can cause CMOS logic errors. Also, static charges large enough to rupture CMOS oxide regions are often generated in dry environments by movement of materials and users. A HiNIL input gives more immunity to static and maximizes noise protection.

Examples of HiNIL Interface Devices

301 Dual 5-Input Power Gate	65mA relay or lamp driver
302 Quad Power NAND Gate (OC)	
323 Quad NAND Gate (OC)	Input noise protection plus open-collector pullup to other logic levels
332 Hex Inverter (OC)	
334 Strobed Hex Inverter (OC)	
350 8-Bit Multiplexer	Drive longer lines than TTL with 10X noise immunity ($I_{OH} = 12\text{mA}$)
351 Dual 4-Bit Multiplexer	
361 Dual Input Interface	361 directly connects HiNIL to DTL/RTL/TTL
362 Dual Output Interface	362 and 363 connect DTL/RTL/TTL to HiNIL
363 Quad Output Interface	
367 Quad Schmitt Trigger	Suppress 100V/1µs spikes, protect CMOS, decode switches, etc.
368 Quad Schmitt Trigger (OC)	
380 BCD to Decade Decoder	
381 BCD to Decade Decoder (OC)	Provide decode/drive for lamps, LEDs, gas discharge displays, etc.
382 BCD to Decade Decoder	
383 BCD to 7-Segment Decoder	
390 Interface Buffer Series	250mA HiNIL driver series will be available soon.

HiNIL reliability insurance costs little since the I/O circuits—unlike filters and shielding—generally replace other logic and drive circuits. So, don't wait until your new CMOS system runs into costly problems in the field. We'll show you how to build foolproof low-power systems. Call or write today for HiNIL application notes and specifications.

TELEDYNE SEMICONDUCTOR

1300 Terra Bella Avenue, Mountain View, California 94043 Tel: (415) 968-9241 TWX: 910-379-6494 Telex: 34-8416

ENGLAND: Heathrow House, Cranford, Hounslow, Middlesex, Tel: (44) 01-897-2503 Telex: 851-935008

WEST GERMANY: Albert Gebhardtstrasse 32, 7897 Tiengen, Tel: 7741-5066 Telex: 841-792-1462

JAPAN: Nihon Seimei-Akasaka Bldg. (3F), 1-19, Akasaka 8-chome, Minato-ku, Tokyo 107, Tel: 03-405-5738 TWX: 781-2424241

Additional offices in West Germany, Hong Kong and the United States. Representatives and distributors worldwide.

INFORMATION RETRIEVAL NUMBER 37

Remember 'pervasiveness'?

A few years ago "pervasiveness" was all-pervasive. Wherever you went you could hear somebody holding forth about the pervasiveness of electronics and, more particularly, of semiconductors. Because of their pervasiveness—in automobiles, appliances, entertainment goods, time-keeping products, data-processing equipment and other areas still undreamed of—the course of electronics would forever be onward and upward.

There could be minor dips, of course, but these would be unimportant and brief. And then, WHAM! When our industry took its plunge everybody forgot about pervasiveness. The people who had been hailing the glories of pervasiveness were wailing that the world was falling down. They were wrong—again.

But they'll be back. They'll return with new buzz words and with a renewed feeling that the present moment is the totality of history. They'll forget that society in general, and our industry in particular, move on relentlessly and pay no attention to our slogans and buzz words. They'll become so entranced with their slogans that they'll mistake them for reality.

I know one chap who often finds new catch phrases to impose on his staff as words of eternal wisdom. He expects engineers to design with these sacred verities and salesmen to sell them as if they were something real. But since the marketplace obeys its own laws, he often finds that the words that so enchant him have no effect. Unfortunately, he finds no fault with buzz words, which remain holy, but rather with inadequate attention and inept execution by his engineers and salesmen.

Unfortunately, he's not alone. Many of us fall prey to our own slogans and mistake them for reality. We invent a pretty phrase and become so enamored of it that we permit it to obscure product weaknesses that we should correct. We take solid concepts and etherealize them till they lose their concrete meanings and become mere slogans.

While slogans can be useful for summarizing the features of a product, they can be dangerous when we forget that they are mere representatives of a product—not the product itself. They can be disastrous if we see them as a substitute for the reality underlying the words.

Believing our own baloney can be a dangerous disease. How many of us are immune?



A handwritten signature in dark ink, which appears to read "George Rostky". The signature is written in a cursive, flowing style.

GEORGE ROSTKY
Editor-in-Chief

VACTEC optoelectronics

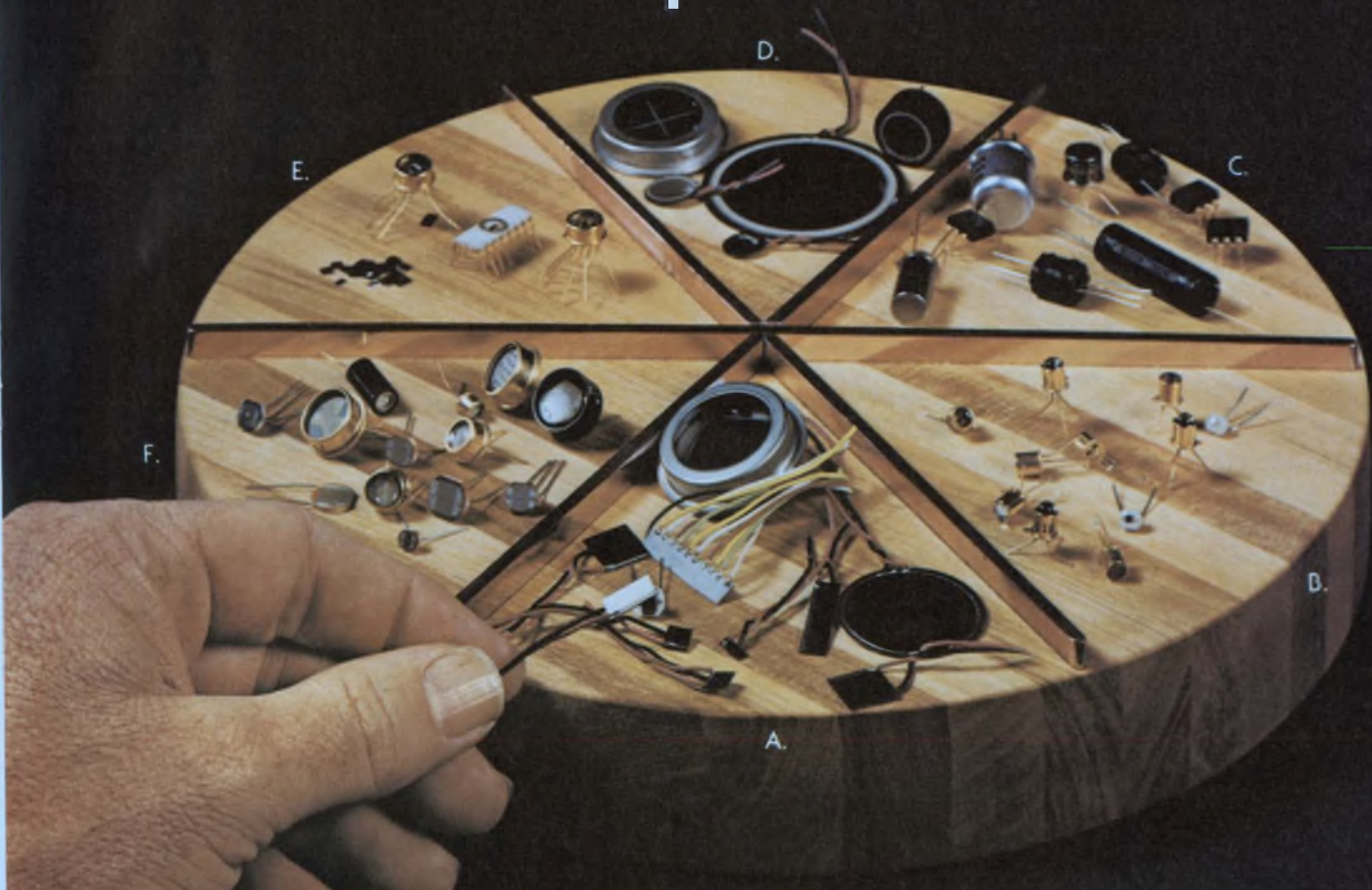

New High Speed Silicon Photovoltaic Cells

Ten times faster with excellent linearity, high temperature stability, and high low-light sensitivity.

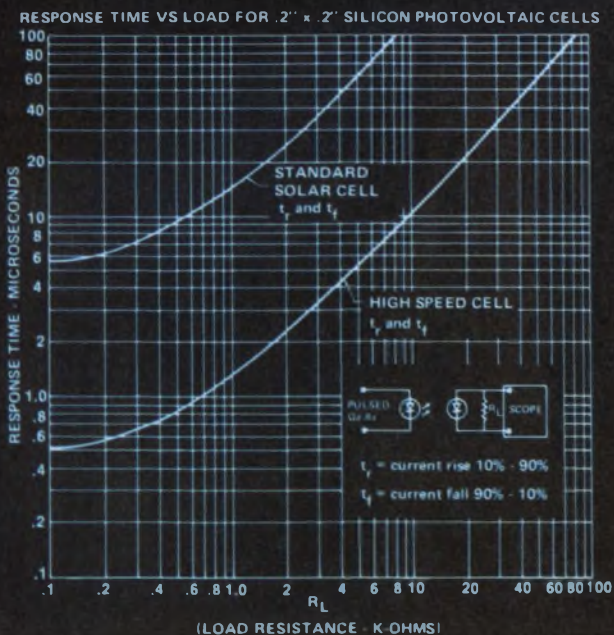

THE INDUSTRY'S BROADEST LINE:

- A. Standard and high speed silicon photovoltaic cells.
- B. Phototransistor and photodarlington.
- C. Opto-Couplers (three types).
LED/Photoconductor
LED/Phototransistor
Lamp/Photoconductor
- D. Selenium photovoltaic cells.
- E. C-MOS and Bi-polar custom I-C's.
- F. CdS and CdSe Photoconductors.

Write today for more details.

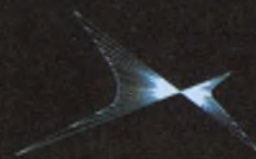

Vactec, Inc.
2423 Northline Industrial Blvd.
Maryland Heights, Mo. 63043
Phone (314) 872-8300

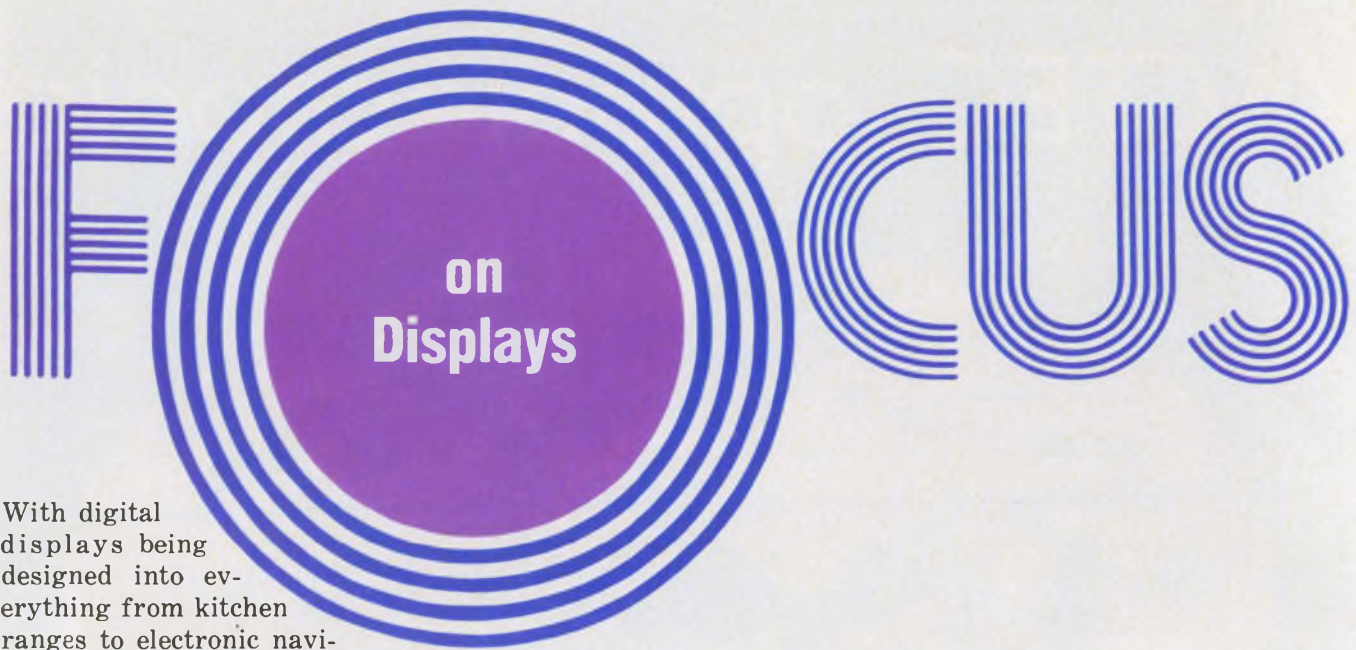

Focus on Displays

With digital displays being designed into everything from kitchen ranges to electronic navigation equipment, choosing the right display and applying it properly is more important than ever.

The field has narrowed somewhat, making selection easier. For numeric and alphanumeric displays, the principal contenders today are light-emitting diodes, liquid crystals, incandescents, fluorescents and multi-character, planar, gas-discharge displays. The stacked-character, single-digit, gas-discharge display (like the Burroughs Nixie), which completely dominated the market a few years ago, is no longer an important contender for most applications.

One display, the liquid crystal, was formerly rejected by many engineers because of early deficiencies, some of which have since been cured or modified. Principal among these was the fact that its life expectancy was unknown or brief—3000 to 5000 hours. Improvements in processing and materials have extended the expectancy to respectable figures, sometimes approaching 100,000 hours.

Temperature sensitivity has been improved, too. Early liquid-crystal displays died after exposure to temperatures below -20°C or so. Most of today's LCDs recover after being returned to more moderate temperatures.

And the newer LCDs, those using field-effect technology, allow multiplexed operation (difficult or impossible with dynamic scattering types) to cut the cost of driving multiple digits.

Thus with all these improvements, deciding which one to use becomes a difficult task. To add to the confusion, designers using displays also have to consider the nebulous factor of aesthetics. Will the display look right in the final unit? Will the customer prefer a different color display? Or

one with a different character font? All of these subjective parameters must be considered before a display is chosen.

Furthermore, the engineer who designs a display into his equipment must also wade through spec sheets that are often laden with misleading and confusing specs.

Beware the brightness spec

Probably the most confusing and misleading parameter found on display data sheets is the brightness spec. The ambiguity that surrounds this spec stems from the complexity of brightness. It can be measured with several different methods—each having a number of variations depending on color (or mixture of colors) and the measuring equipment used.

Some manufacturers specify brightness in millicandelas; others use foot-lamberts and still others use lumens. Where a point source is the critical factor, then the luminous intensity in candelas and the flux in lumens are the meaningful measurement units. Where a broad-area source is being measured, the luminance—also known as photometric brightness—in foot-lamberts and the luminous emittance in foot candles are the appropriate units of measure.

To add to the confusion caused by the terminology, manufacturers often spec brightness according to the brightest small area that can be found on the display. This is a relatively useless way of specifying data since the human eye tends to see surfaces—not points or spots which yield better numbers. Another confusing aspect of the brightness game is that some manufacturers list the brightness with one segment lit up, while others list it with all segments lit.

Therefore, since brightness ratings are not al-

Jules H. Gilder
Associate Editor



Alphanumeric characters can be displayed by 16-segment LCDs. These one-inch-high units from Hamlin can be read at 30 ft.



Incandescent displays are best for high brightness. Full color capability is another big plus for incandescents. These CM5 devices from Chicago Miniature Lamp are said to last 100,000 hours.

ways comparable, it's usually smarter to use data sheet information only as a very general guideline. Once the display technology is selected, and the size and color of the display have been determined, the engineer should ask all potential suppliers for samples that represent their respective lines.

After evaluating these samples at the electrical input levels planned for the actual application—and also under any extreme ambient conditions that will exist—one can select a supplier. Samples then should be used as correlation standards to write the final purchasing specs and to calibrate the equipment that will be used for testing incoming shipments.

If you do this, it doesn't really matter what measurement units are assigned to the brightness factor. As long as the measured value of bright-



One of the first 1-in. LED displays to be announced is this one from IEE. It uses two LED chips per segment and, therefore consumes twice as much power as the small half-inch displays.

ness of the displays you receive is similar to the measured value of an acceptable sample, the display's appearance will be satisfactory.

Displays that do not emit light have no brightness spec. An example of this type of display is the liquid crystal readout, which either reflects or refracts light. Instead of a brightness spec, liquid crystals have a spec called contrast ratio. Contrast specs are inadequate because they can vary, depending on the light source and the exact type of measuring equipment being used.

Display life is another parameter that can confuse the unwary engineer. At what point is a display judged to be dead? You don't always know,

because the definition of end of life is omitted from most data sheets. And in those instances when it is listed, you can't always trust it.

An example of how display manufacturers can deceive the engineer on life specs pops up when the display's brightness is being investigated. Often a very high brightness will be listed for the display. But what is not pointed out is that operation at that brightness level will drastically reduce the lifetime of the unit. In such a situation, the life spec that is listed is for 1/10 of the brightness level on the data sheet.

Many factors affect the life of a display. Some of these include heat, overcurrent, vibration, shock and ac vs dc operation.

One common definition that is used to specify end of life is, "When the brightness decreases to 50% of its original value the display is dead." The problem is to find out when it has decreased to that value. It's not too difficult to make measurements in the lab, but checking a display out in the field to see if it's living up to its claim of long life can be difficult.

Another thing to consider is what a display looks like at the end of its life. Many function fairly well, but fluorescents become irregular, liquid crystals fade and darken and their response time goes up, while filaments droop on incandescent displays.

When life considerations are paramount, most display makers agree that LEDs are best. Their brightness degradation vs time is negligible—usually they stop working due to some catastrophic failure such as a bond opening up. In general, however, if a LED display lasts more than four hours, it will outlive the equipment that it's used in, note LED manufacturers. Some life-expectancy figures for LEDs indicate that they have an operating life of 1 million hours—or more than 114 years.

Optical considerations are largely ignored in display data sheets. For a piece of gear that uses displays, it is important to minimize optical problems such as those that can be caused by reflections and incident light. But alas, no information on the required filter characteristics appears in data sheets.

Similarly, spec sheets don't show how best to position the display so that it won't be washed out by high ambients. And manufacturers don't tell you that green displays, when used in direct sunlight or under fluorescent lighting, will exhibit a poor contrast ratio.

An important point to remember about green displays is that the eye is extremely sensitive to green and will detect slight differences in the intensity of two adjacent displays or display segments. That's one reason they are so difficult and expensive to manufacture.



A mixture of different message formats such as alphanumeric and fixed messages can be combined into one unit using the National Electronics Plasmac display.

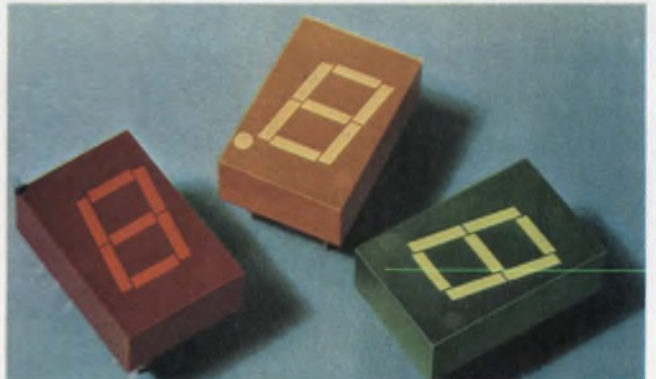

High efficiency and extremely low drive currents are the key features associated with these 0.43-in. displays from Hewlett-Packard. They are part of the company's 5082-7600 Series.



LED displays from Dialight come with heights up to 0.625-in. and can be supplied with a bezel that holds up to 10 digits. It comes with or without decoders.

In many cases you can underestimate the complexity of driving circuitry. On data sheet schematics, manufacturers often make the drive circuitry seem much less complicated than it really is. They do this by drawing a block diagram and labeling a box "driver" or "control," rather than giving the complete schematic. Always insist that the vendor tell you the exact drive requirements. The cost of drivers can significantly raise the cost of what appears to be an inexpensive display.

For example, a planar gas-discharge display might cost \$1.20 per digit in quantities of 10,000, while a LED for the same quantity would cost about \$1.50 per digit. Although the gas-discharge display appears to be 20% cheaper, when the cost of the decoder-driver is added—\$1 for gas discharge and 70¢ for LED—the cost of using the two displays is the same.

Try multiplexing for economy

If more than four digits are going to be used in the display, consider the possibility of multiplexing the devices. This can economize on drivers and PC board space. But be careful. Not all displays can be multiplexed effectively. Dynamic scattering liquid-crystal devices are generally too slow. But researchers at RCA Laboratories report that progress is being made with field-effect liquid-crystal devices.

A common deficiency in display data sheets is environmental data. It is very important to know under what temperature and humidity conditions the displays will work. Plastic packaged LEDs, for example, must work below 85 C. If the package goes above 85 C it will melt. Also some displays, such as Schiff-base liquid-crystal types, are very sensitive to moisture.

Environmental data are often omitted because of "lack of space." It's true that such data tend to require a lot of explanation and qualification to cover all possible conditions. But you can usually get the information you need by contacting the factory.

Look out for these common errors

The mistakes made most commonly by display users are related to light output. If you fail to double-check the data sheet with your own tests for things like brightness, color consistency, segment-to-segment matching and dimming capability, you risk buying displays that don't look the way you intended. This is especially true when individual display units are mounted side by side to form a multidigit array.

Another mistake, a classic one in many areas of electronic design, is to evaluate the device as a single entity and not as part of a total system.

This type of oversight can force you to use extra components—perhaps even an extra power supply. All this can boost the final cost of your system. Shooting for the lowest parts cost is perhaps the major blunder of inexperienced display users. Little attention is paid to maintenance cost and to the cost of peripheral circuitry.

In battery-operated equipment, for example, a designer might choose gas discharge displays because they look good and cost less than LEDs. What he may not consider, however, is that a dc-to-dc converter is needed to supply the high voltages that these devices need.

When choosing a display, make sure it suits the ambient light conditions. If the display is to be used in high ambient light, three factors must be considered: (1) color, (2) contrast and (3) intensity. Amber, in general, is the most visible.

Display contrast can be enhanced significantly by using a dark, nonreflective background so that the unused segments of the digits don't show. This will prevent incident light from washing out the display, and will help assure unambiguous readings.

If gas-discharge displays are used, a few rules of handling will prevent a lot of unnecessary seal failures. First, don't take the display out of its shipping package until it is ready for use. If you want to check one, borrow a trick from neon-lamp users; just bring the display near the terminals of a high voltage transformer and watch it light up.

When soldering glass-packaged displays, avoid exceeding the allowable temperature differential between the glass and the pins. A handy way to lower the differential is to use an infrared lamp to heat up the entire display unit.

Help the vendor

If you work with potential vendors close enough, specifying displays will become a lot easier. Tell them your requirements. How many digits per assembly will be required? What is the lowest current that will be available to the display? Displays that seem well matched under normal operating conditions may look quite different when operated at low currents.

Are there any electrical restrictions? How about space requirements? Will the displays be operated continuously or multiplexed?

Temperature-range requirements should be spelled out for all applications in which the ambient will span wide extremes. Also consider how much heat the display will generate, and see if there's adequate ventilation.

Other things to discuss with vendors are character size, viewing angle, mounting dimensions and back panel depth. If individual units are going to be made into an array, make sure the

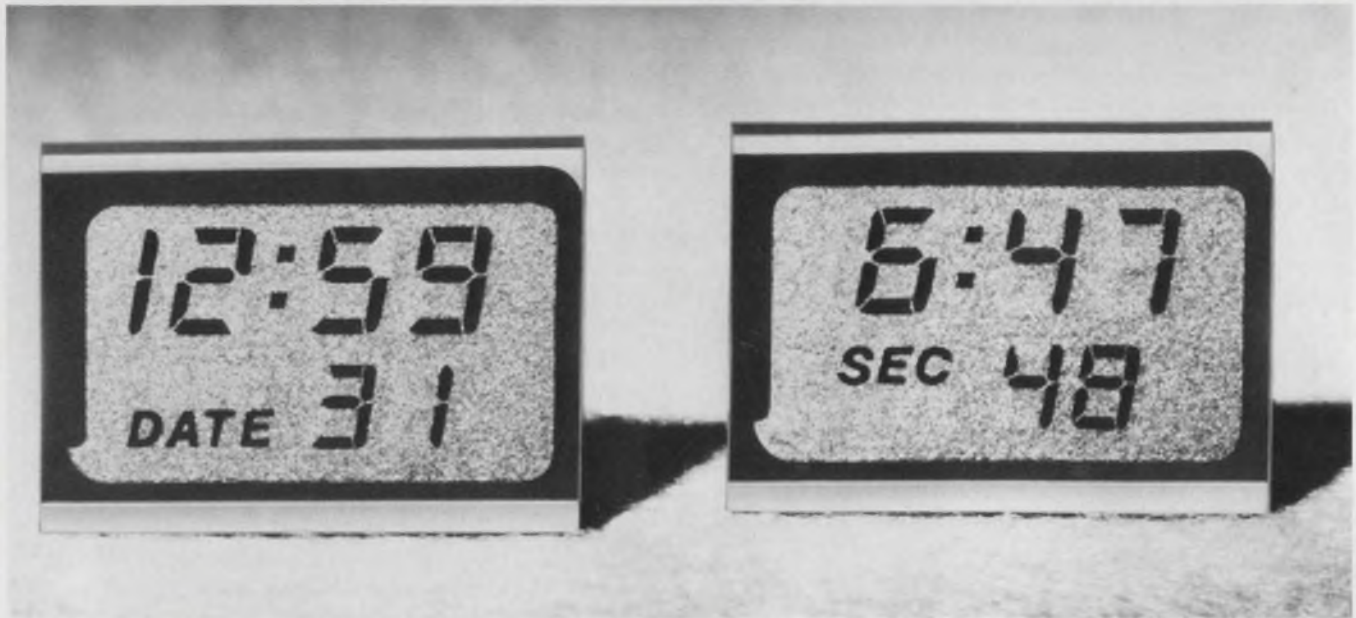

Field-effect liquid-crystal displays from Beckman can be built with as many as 5-1/2 digits and can be supplied

with one of two annunciator words. They're part of the company's 705 Series of displays.

mechanical tolerances are tight enough so that there are no layout problems.

While they can be used efficiently in cold ambients, LEDs grow dim and their lifetime decreases in hot ambients. At 100 C the brightness drops to 50% of what it is at 25 C. Available colors are restricted to red, orange, yellow and green. And their small size and brightness usually limits them to applications in which they will be viewed from fairly close range. The maximum viewing distance of 0.3-in. displays is 10 ft.

But longer distance viewing will become possible as the brand new one-inch LEDs come into production and become commercially available in large quantities. At least three companies have announced the availability of the new large LEDs. The companies are Litronix, Fairchild Semiconductor and IEE. The displays from IEE—the 1720 common-anode and the 1723 common-cathode—are manufactured by Sharp in Japan. IEE however has the world marketing rights. Like the other one-inch displays just introduced, the IEE devices use two LED chips to illuminate each segment. This means that the devices will consume twice the power of half-inch devices. Each segment of the one-inch displays requires 3.3 V at 20 mA.

The one-inch displays also look slightly different from the smaller units because the aspect ratio has been changed. Customers in the past had complained that 7-segment LEDs were too fat. So the one-inch display is twice as high as it is wide.

Texas Instruments has also developed a one-inch LED display, but it doesn't plan to introduce it until some time next year. The feeling at TI is

that one-inch displays are larger than needed for volume applications, and that most engineers will continue to design with the smaller displays.

A new trend is developing in LED packaging. Semi makers are extending the assembly techniques they originally developed for pocket calculators to the larger digits. It is now possible to get arrays of up to seven half-inch-digit displays in a single package.

As far as costs go, an instrument maker who uses different types of displays says that even at the 10,000 to 20,000 piece level, LEDs are 10 to 20 percent more expensive to use than gas-discharge displays. Semi makers dispute this.

In the competition between LEDs and liquid crystals, results from a survey of the only U.S. market—digital watches—that uses both types extensively shows that LED watches outsell LCD versions by 10 to 1. Reasons for this include the bad reputation LCDs have had for reliability and their poor visibility at low light levels.

While liquid crystals are improving, so are LEDs. The drive-current requirements have decreased from several milliamps per segment to a few tenths of a milliamp. Efficiencies continue to improve, and soon it will be possible to drive LEDs directly from improved MOS circuits—without using special lamp drivers.

Some LEDs, such as those in the Hewlett-Packard 7650 series and the Monsanto MAN4000 series, feature a high luminous intensity that results from improved packaging and material efficiency. While the Monsanto devices are available in red, orange, yellow and green, HP offers only red, yellow and green.

Calculator displays are finding increasing use

in a variety of noncalculator applications such as tape-footage indicators, elapsed-time meters, event counters, blood-pressure monitors and stop watches. The reason for this widespread usage is that calculator arrays are built by the millions and designers can take advantage of these low cost standard parts.

Planar gas discharge getting bigger

Like the LEDs, planar gas-discharge displays have grown in size and one-inch-high digits are now commonly available. Gas discharge displays offer very good readability—even with bright ambient light—and are relatively inexpensive. And the cost is still coming down, due mainly to new fabrication techniques.

Unlike LEDs, gas-discharge displays are limited in color to orange and colors, like red, that can be filtered from orange.

Another disadvantage of gas-discharge devices is that they require relatively high voltages—usually from 135 to 200 V. This leads to two other problems: (1) more expensive decoder drivers, and (2) a special high-voltage supply—which may require Underwriters' Laboratory approval.

But the high-voltage requirement can become an asset if the equipment is to be line operated. Supply design is then very simple and inexpensive. And though they require higher voltages, gas-discharge displays always consume less power than LEDs. Also, dc-to-dc converters that are barely larger than ICs are now available. These can be mounted adjacent to the display to eliminate high voltage wiring.

Like the LEDs used in most calculator applications, some planar gas discharge displays are internally connected for multiplex operation so that the number of pins required is reduced. Displays such as the Panaplex II from Burroughs and the Plasma-Lux from Cherry Electric can easily be multiplexed, even in arrays containing up to 16 digits. Other display devices such as liquid crystal and fluorescent ones, become limited by response time, the complexity of the multiplexing circuitry and the magnitude of the peak currents.

Another form of gas-discharge technology is used for matrix display panels—like the Burroughs Self-Scan. These are used primarily to display large amounts of alphanumeric data.

The original Self-Scan panels from Burroughs are good for applications requiring between 10 and 600 characters. The latest development, the Self-Scan II, consists of a basic 20-character display that can be butted horizontally and stacked vertically to produce extra large display systems that have capacities of 2000 or more characters.

In addition to its expandability, the Self-Scan



The world's largest LCD system can display more than 600 alphanumeric characters. Produced by Hitachi, it may one day compete with plasma panels and CRTs for computer-terminal applications.

II differs markedly from the original Self-Scan in that the characters are formed by a fixed 5-by-7 dot-matrix format. In the earlier panels, character format was variable and if a 4-by-6 or a 7-by-9 format was desired, it could be used.

The Self-Scan II has a light output that exceeds 300 microcandelas per glowing dot. This makes the display visible at up to 50 ft. Production quantities will be available in the fourth quarter of this year. The price, with drive electronics, is \$99.50 each in 1000-unit quantities.

IEE is also offering some new plasma panels. It is coming out with 64, 128 and 256 character models—in either red or green. The green is produced by using the glowing neon gas to excite a phosphor. The panels also come with either "mini" 0.2-in. characters or "maxi" 0.3-in. characters. There is no price differential for the different sized characters, but there is a minor additional charge for the green color. IEE is also offering a new 4-line, 88-character, scrolling display. Data in this display are inserted, by the line, left to right from the bottom, with the over-

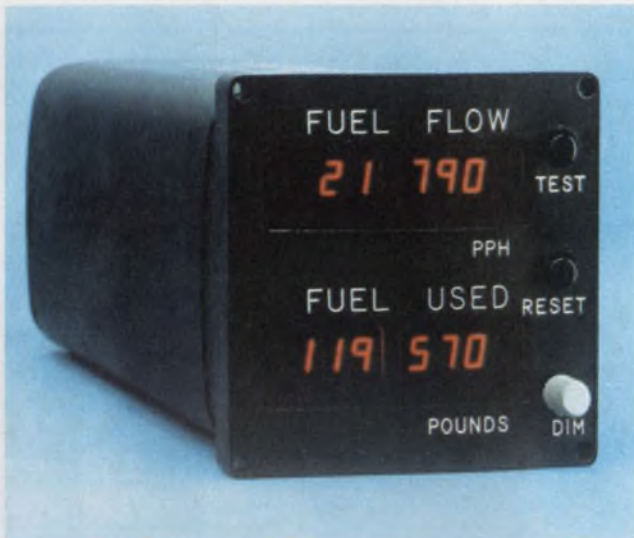

Gas discharge displays, like these from Beckman, feature high visibility even in bright ambients.

available from any miniature display.

Contrary to popular opinion, multifilament incandescents can have fairly good shock and vibration characteristics. This is demonstrated by the fact that they meet MIL-STD-202C shock and vibration requirements and can be used in airplane cockpits. Unlike many other types of displays, incandescents can work at temperatures ranging from -55 C to $+125\text{ C}$. But they also generate a lot of heat. So if many displays are being used, some sort of ventilation or cooling may be required.

Although incandescents require more power than LEDs—250 mW to 1 W versus 10 mW to 140 mW—like LEDs they can directly interface with TTL or DTL logic. While the character height of these displays is seldom larger than a half inch, their good brightness eliminates many visibility problems.

Incandescent displays, such as those from Chicago Miniature, Dialight, Pinlites and RCA, are the only ones that can provide an output in any color. This is done by simply adding a filter of the correct color.

Also, incandescent displays are not as short lived as many think. In fact, typical life ratings are 100,000 hours. A disadvantage to incandescents, however, is that they may require additional drive circuitry. But the parts are readily available.

A display that is finding increasing popularity because of its pleasing blue-green color is the vacuum fluorescent. The dominant manufacturers are Japanese companies that include Ise Electronics Corp., Futaba Electronic Industries and Nippon Electric Corp. They are also made in the U.S. by LFE Corp. in Massachusetts.

Fluorescent displays have a few disadvantages. They require between 20 and 50 V for operation



Fluorescent displays produce a pleasing green glow when lighted. They require low power and low voltage, but are susceptible to shock because of their glass package.

and come in a glass package that is susceptible to damage from shock. Also they contain filaments which continuously drain power. And filament breakage can make it necessary to discard a multidigit display.

Nevertheless many users feel that the attractiveness of the display outweighs its disadvantages.

Try magnetic discs for size

If large size is a prime requirement for your display, electromagnetic discs that are painted in fluorescent colors and arranged in dot matrices are a good choice.

Like the liquid-crystal display, this type is reflective and looks better as the ambient light level increases. The absence of lamps or other active elements in the display results in an operating life in excess of 20 million hours. And the display has inherent memory. This means it requires only a single current pulse to change the data and no power to maintain it. Thus, this type of display can be easily multiplexed without refresh circuits and consumes very little power.

The electromagnetic display is also available in segmented character configurations. Ferranti-Packard is the major vendor. ■■

(continued on page 60)

Need more information?

We wish to thank the companies that provided information for this report. The products cited in here have been selected for their illustrative, or in some cases, unique qualities. However, manufacturers not mentioned in the report may offer similar products. Readers may wish to consult manufacturers listed here and ELECTRONIC DESIGN's GOLD BOOK for further details.

- Actron Ind. Inc., 700 Royal Oak Dr., Monrovia, CA 91016. (213) 359-8216. (R.H. Carpenter) **Circle No. 401**
- AEL, P.O. Box 552, Lansdale, PA 19446. (215) 822-2929. (B. Bernard) **Circle No. 402**
- Aircraft Instruments Co., Commerce Dr., Montgomeryville, PA 18936. (215) 368-0175. (J. C. Rychlak) **Circle No. 403**
- American Microsystems, 3800 Homestead Rd., Santa Clara, CA 95051. (408) 246-0330. **Circle No. 404**
- Ametek, Straza Div., 790 Greenfield Dr., El Cajon, CA 92021. (714) 442-3451. (S. A. Walker) **Circle No. 405**
- Amperex Electronic Corp., Providence Pike, Slatersville, RI 02876. (401) 762-9000. (E. Feinberg) **Circle No. 406**
- Anacom General Corp., Med-Tek Div., 8560 B Roland St., Buena Park, CA 90621. (714) 521-0577. (W. K. Haines) **Circle No. 407**
- Analog Devices Inc., P.O. Box 280, Norwood, MA 02062. (617) 329-4700. (J. Corsi) **Circle No. 408**
- Antex Industries, Inc., 455 E. Middlefield Rd., Mountain View, CA 94043. (415) 961-1111. (D. A. Holst) **Circle No. 409**
- Automation Displays Inc., 3833 N. White Ave., Eau Claire, WI 54701. (715) 834-9595. (J. F. Carpentier) **Circle No. 410**
- Aydin Corp., 401 Commerce Dr., Fort Washington, PA 19034. (215) 643-7500. (R. Ashcroft) **Circle No. 411**
- Beckman Instruments, 2500 Harbor Blvd., Fullerton, CA 92634. (714) 871-4848. (D. Rime) **Circle No. 412**
- Bowmar Instrument Corp., 8000 Bluffton Rd., Fort Wayne, IN 46807. (219) 747-3121. **Circle No. 413**
- Burroughs Corp., Elec. Components Div., P.O. Box 1226, Plainfield, NJ 07061. (201) 757-3400. (S. Kuchinsky) **Circle No. 414**
- Cherry Electrical Products Corp., 3600 Sunset, Waukegan, IL 60085. (312) 689-7600. (J. U. Dernehl) **Circle No. 415**
- Chicago Miniature Lamp Works, 4433 N. Ravenswood Ave., Chicago, IL 60640. (312) 784-1020. (M. Gordon) **Circle No. 416**
- Dale Electronics, 1376 28 Ave., Columbus, NE 68601. (402) 564-3131. (N. Newman) **Circle No. 417**
- Data Display Products, 5428 W. 104 St., Los Angeles, CA 90045. (213) 641-1232. (P. Lodhie) **Circle No. 418**
- Dialight Corp., 203 Harrison Pl., Brooklyn, NY 11237. (212) 497-7600. (C. Dombroski) **Circle No. 419**
- Digilite Corp., 91 Rome St., Farmingdale, NY 11735. (516) 694-6544. (G. A. Franco) **Circle No. 420**
- Display Devices Inc., 130 W. E. St., Encinitas, CA 92024. (714) 753-0113. (R. C. Ross Jr.) **Circle No. 421**
- Dyma Engineering Inc., Rt. 1/Box 51, Taos, NM 87571. (505) 758-2686. (C. G. Cunningham) **Circle No. 422**
- Econolite, A Div. of Altco Corp., P.O. Box 6150, Anaheim, CA 92806. (714) 630-3700. (J. T. Gillis) **Circle No. 423**
- Electrodota Concepts, 69 Connecticut Ave., Norwalk, CT 06854. (203) 853-2792. (R. J. Borstelmann) **Circle No. 424**
- Elec Research Co., Div. Tetrax, P.O. Box 913, Shawnee Mission, KS 66201. (913) 631-6700. (J. Muttix) **Circle No. 425**
- ES Enterprises, 10418 La Cienega, Inglewood, CA 90304. (213) 674-3021. (R. M. Mayers) **Circle No. 426**
- Fairchild Semiconductor, 4001 Miranda Ave., Palo Alto, CA 94304. (415) 493-3100. (Ralph Miller) **Circle No. 427**
- Ferranti-Packard Ltd., Elecs. Div., 121 Industry St., Toronto, Ont., Canada. (416) 762-3661. (D. W. Smart) **Circle No. 428**
- Futaba Electric Ind. Limited, Super Bldg., 1-11-5 Sotokanda Chiyoda-ku, Tokyo, Japan 03-25 5-5881. (M. Yamamoto) **Circle No. 429**
- General Electric Co., Instrument Products, Dept. 40, Federal St., West Lynn, MA 01910. (617) 594-7049. (J. A. Pittman) **Circle No. 430**
- General Instrument Corp., Electronic Systems Div., 600 W. John St., Hicksville, NY 11802. (516) 733-3000. (J. S. Adams) **Circle No. 431**
- Genisco Technology Corp., 18435 Susana Rd., Compton, CA 90221. (213) 537-4750. (W. R. Esser) **Circle No. 432**
- Goerz-Inland Systems Div., 301 Alpha Dr., Pittsburgh, PA 15238. (412) 782-3516. (G. Economou) **Circle No. 433**
- Hamlin Inc., Lake & Grove Sts., Lake Mills, WI 53551. (414) 648-2361. (R. T. Armantrout) **Circle No. 434**
- Hewlett-Packard HPA Div., 640 Page Mill Rd., Palo Alto, CA 94304. (415) 493-1501. (R. Kniss) **Circle No. 435**
- Hughes Aircraft Co., Centinela & Teale St., Culver City, CA 90230. (213) 391-0711. (J. L. Winkel) **Circle No. 436**
- IEE Inc., 7740 Lemona Ave., Van Nuys, CA 91405. (213) 787-0311. (W. E. Hartman) **Circle No. 437**
- Info-Lite Corp., 46-10 104 St., Corona, NY 11368. (212) 476-1287. (Joseph M. Cartelli) **Circle No. 438**
- Integrated Microsystems, 1215 Terra Bella Ave., Mountain View, CA 94040. (415) 965-3900. (P. R. Kemp Jr.) **Circle No. 439**
- Interface Technology Inc., 10500 Kahlmeyer, St. Louis, MO 63132. (314) 426-6880. (A. H. Koester) **Circle No. 440**
- Inter-Market Inc., 1920 Waukegan Rd., Glenview, IL 60025. (312) 729-5330. (R. Scott) **Circle No. 441**
- ISE Electronics Corp., P.O. Box 46, Ise City, Japan 516-1. (059) 635-2121. (K. Aoyagi) **Circle No. 442**
- Keltron Corp., 223-225 Crescent St., Waltham, MA 02154. (617) 894-0525. (T. Chadurjian) **Circle No. 443**
- LFE Corp., Process Control Div., 1601 Trapelo Rd., Waltham, MA 02154. (617) 890-2000. (R. W. Gubisch) **Circle No. 444**
- Litronix Inc., 19001 Homestead Rd., Cupertino, CA 95014. (408) 257-7910. (I. Cooper) **Circle No. 445**
- LVC Industries Inc., 135-25 37 Ave., Flushing, NY 11354. (212) 939-9777. (N. Marino) **Circle No. 446**
- Master Specialties, 1640 Monrovia Ave., Costa Mesa, CA 92627. (714) 642-2427. (J. Carpenter) **Circle No. 447**
- Monsanto, Electronic Special Products, 3400 Hillview Ave., Palo Alto, CA 94304. (415) 493-3300. (Alex Findlay) **Circle No. 448**
- Motorola Inc., Quartz Timepiece, 3102 N. 56 St., Phoenix, AZ 85018. (602) 244-4406. (C. T. Johnson) **Circle No. 449**
- National Electronics Inc., P.O. Box 269, Geneva, IL 60134. (312) 243-4300. (W. W. Bishop) **Circle No. 450**
- National Semiconductor Corp., 2900 Semiconductor Dr., Santa Clara, CA 95051. (408) 732-5000. (C. Signor) **Circle No. 451**
- Nationwide Electronic Systems Inc., 1536 Brandy Pkwy., Streamwood, IL 60103. (312) 289-8820. (R. Lounsoucy) **Circle No. 452**
- Novelite Corp., 226 N. 6 St., Brooklyn, NY 11211. (212) 388-4833. (R. Sanchez) **Circle No. 453**
- Okidata Corp., 111 Gaither Dr., Moorestown, NJ 08057. (609) 235-2600. (J. R. Powell) **Circle No. 454**
- Oki Electronics Of America Inc., 4031 N. E. 12 Ter., Fort Lauderdale, FL 33307. (305) 563-6234. (T. J. Tsevdos) **Circle No. 455**
- OPCOA Inc., 330 Talmadge Rd., Edison, NJ 08817. (201) 287-0355. (J. Bernick) **Circle No. 456**
- Oppenheimer Precision Products, 2475 Wyandotte Rd., Willow Grove, PA 19090. (215) 659-6000. (T. Kirk) **Circle No. 457**
- Owens-Illinois Inc., P.O. Box 1035, Toledo, OH 43666. (419) 242-6543. (J. D. Schepman) **Circle No. 458**
- Panel Tech Inc., P.O. Box 587, Lewistown, PA 17044. (717) 242-1411. (W. T. O'Donnell) **Circle No. 459**
- Pinlites Div. Refac., P.O. Box 453, Caldwell, NJ 07006. (201) 575-8820. (D. Rovine) **Circle No. 460**
- RCA Solid State Div., Box 3200, Somerville, NJ 08876. (201) 722-3200. (P. L. Farina) **Circle No. 461**
- Readouts Inc., P.O. Box 149, Del Mar, CA 92014. (714) 755-2641. (C. Fortin) **Circle No. 462**
- Refac Electronics Corp., P.O. Box 809, Winsted, CT 06098. (203) 379-2731. (W. Gillis) **Circle No. 47A**
- Sakata International Inc., 651 Bonnie Ln., Elk Grove Village, IL 60007. (312) 593-3211. (G. Lundt) **Circle No. 463**
- Shelly Assoc., 1562 Reynolds, Santa Ana, CA 92705. (714) 540-9330. (R. Sears) **Circle No. 464**
- Shigoto Ind. Ltd., 350 Fifth Ave., New York, NY 10001. (212) 695-0200. (M. Rubin) **Circle No. 465**
- Siemens Corp., 186 Wood Ave., South Iselin, NJ 08830. (201) 494-1000. (B. Mayer) **Circle No. 466**
- Signalite, Div. General Instrument, 1933 Heckt Ave., Neptune, NJ 07753. (201) 775-2490. (R. C. Kolts) **Circle No. 467**
- TEC Inc., 9802 N. Oracle Rd., Tucson, AZ 85704. (602) 297-1111. (E. Tatman) **Circle No. 468**
- Telectro Systems Corp., 96-18 43 Ave., Corona, NY 11368. (212) 651-8900. (J. P. Sussman) **Circle No. 469**
- Teledyne Brown Engineering, Cummings Research Pk., Huntsville, AL 35807. (205) 532-1208. (I. W. Owen) **Circle No. 470**
- Texas Instruments Inc., P.O. Box 5012, Mail Station 84, Dallas, TX 75222. (214) 238-2011. (R. Hailey) **Circle No. 471**
- Transparent Conductors Inc., P.O. Box 549, Goleta, CA 93017. (805) 968-3561. (B. Feldman) **Circle No. 472**
- Vari-Light Corp., 9770 Conklin Rd., Cincinnati, OH 45242. (513) 791-6330. (J. L. Schenz) **Circle No. 473**
- Vemaline Products Co., 455 W. Main St., Wyckoff, NJ 07481. (201) 891-3200. (C. J. Dawkins) **Circle No. 474**
- Wagner Electronic Corp., Tung Sol, 630 W. Mt Pleasant Ave., Livingston, NJ 07039. (201) 992-1100. (J. L. Emaus) **Circle No. 475**
- Xciton Corp., 5 Hemlock St., Latham, NY 12110. (518) 783-7726. (A. Ligorner) **Circle No. 476**
- Xtel Inc., 2421 W. Hillcrest Dr., Newbury Park, CA 91320. (805) 498-6601. (M. K. Kilcoyne) **Circle No. 477**

LED Show Stoppers



Bright lights from a cast of thousands.

A great show of LED Panel and PCB lights from Data Display Products. Vivid colors . . . red, yellow, green and amber. Outstanding performance . . . brighter than many incandescents (50 MCD @ 20 mA — typical clear red). Direct replacements for incandescents. Immediately available at popular prices.

Subminiature Panel LED's (also suitable for PCB mounting) — available in hundreds of sizes, shapes and styles.

PCB LED's — horizontal or vertical viewing.

Bi-Pin (T1-3/4) LED's — direct replacements for incandescent types.

Midget Flanged (T1-3/4) LED's — direct replacements for incandescent types.

Send for our Catalog on the whole show: Data Display Products, 5428 W. 104th Street, Los Angeles, Ca. 90045, (213) 641-1232.

Produced by the Original "little light" people.



INFORMATION RETRIEVAL NUMBER 40



A Subsidiary of THOMSON-CSF

Introducing four important features in cockpit display CRTs:

RED YELLOW GREEN ORANGE

DuMont is now offering a complete line of cockpit displays in four colors. These CRTs can present two or three times the information capacity of monochrome screens, and yet they make the data far more coherent and more quickly comprehensible than can a monochrome display or a mechanical gauge.



Take energy management, for instance. One DuMont color CRT can display the total fuel remaining, the normal energy consumption according to the flight plan, the fuel reserves for loitering and the fuel reserves for extraordinary fuel demand situations. The pilot can read any or all of these functions at a glance; each is displayed in its own color, and all can be continuously updated. Thus the considerable time and attention required of a pilot by the conventional collection of mechanical gauges is greatly reduced by the use of even one color CRT.

DuMont's color CRTs provide the exceptionally high performance and high resolution that are demanded by cockpit displays in Digital Avionics Integrated Systems. Display precision is completely unaffected by airframe vibration. Line widths as fine as 4 mils are available on most standard designs.

DuMont's proprietary multicolor penetration screen permits the display of data in up to four colors by varying the voltage of a single electron beam. It eliminates the complicated convergence

circuitry required by conventional multi-gun color CRTs.

Two typical display formats that are enhanced by multicolor penetration screens are shown below. The EADI mode clearly presents information needed for take off, cruise, approach and final flight control bearings. A simplified moving map display showing distance to stations, course, relative station position, station identification and selected course outbound is at the bottom, right.

All DuMont color CRTs will withstand vibrations exceeding 60Gs and up to 90Gs with state-of-the-art vibration isolation.

DuMont head down displays also provide superior brilliance and contrast, and perform beautifully in raster-scan and dot-matrix applications, as well as in random-address, stroke-writing systems. There is a wide choice of available CRT models with dimensions ranging from 1.9 x 3.4 to 7.6 x 7.6 inches.



DuMont

Electron Tubes & Devices Corp.



EADI Display

Moving Map Display

For complete specs and information on the most advanced color cockpit CRTs in the world, contact us at: 750 Bloomfield Avenue, Clifton, N. J. 07016 (201) 773-2000.

INFORMATION RETRIEVAL NUMBER 41

Liquid Crystal Displays: An Application Report

Design and function of liquid crystal displays are stimulating increased interest and expanding application of this versatile, digital readout. Although the LCD is a late comer in the display field, it is presenting a strong challenge to the other types, principally the light emitting diode — LED.

LCD advantages are greatly responsible for the fast development and lower cost of exciting new products. And for improved design of conventional equipment and machines. For example, simple sandwich construction of Hamlin's LCD fits limited space. Alphanumeric displays (transmissive and reflective) provide side-by-side mounting versatility. Light control film offers a choice of colored displays. There's no washout in high ambient light levels. Microwatt power requirements, few parts, good viewing angle, exceptional reliability over extended life period are more reasons for the switch to LCDs.

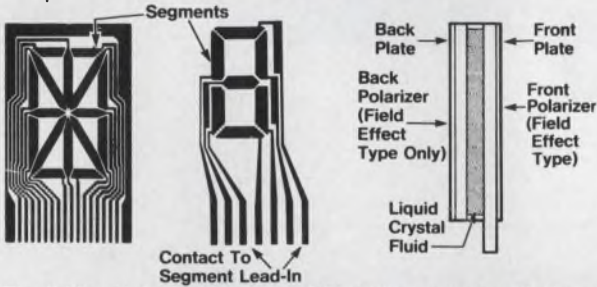

Flexibility of design permits LCDs to be scaled up or down to meet product needs. For example, Hamlin makes a display used in a ladies watch that measures only .450" x .575" (11.25 x 41.375 mm), but production facilities permitting, a display could be almost any size. Type of artwork used for creating the display design also provides an inexpensive way to customize with a logo, product illustration, etc.

A choice of lighting methods permits LCDs to match a wide range of applications. Because liquid crystal displays are not self-illuminating, ambient light must be used to best advantage, or the light source must be placed to cast light through or on the display. To meet viewing needs in relation to product design, Hamlin suggests a variety of lighting techniques:

Louwer backlighting with ambient light for transmissive displays utilizes a plastic film at the back of the displays which permits the angle, depth and color to be varied. It provides a dark background while the activated display appears a frosty white. It is suitable for battery powered calculators, desk clocks, portable instrumentation, etc.

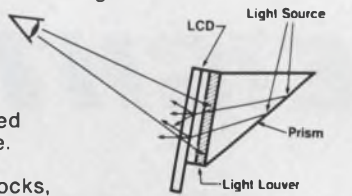

Louwer Backlight-Ambient Light Transmissive

Cavity mount, employing a light source and reflector, achieves a high contrast white-on-dark display. Designed for transmissive displays, the light is hidden from the viewer. This arrangement is ideal for line cord operated instruments such as calculators.

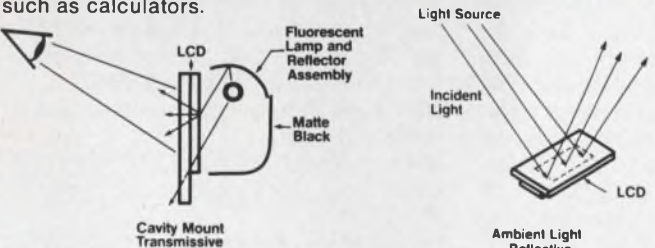

Cavity Mount Transmissive

Ambient Light Reflective

Ambient lighting (reflective displays) is the simplest of all arrangements, but the display should be mounted as closely as possible to the panel with minimum recess to receive maximum illumination. For good contrast, a dark background such as a matte black surface on the back plate should be used.

Edge lighting offers a low power, compact method for reflective displays. Flat pack arrangement permits the display to be viewed by ambient light by day, and edge lighting by night.

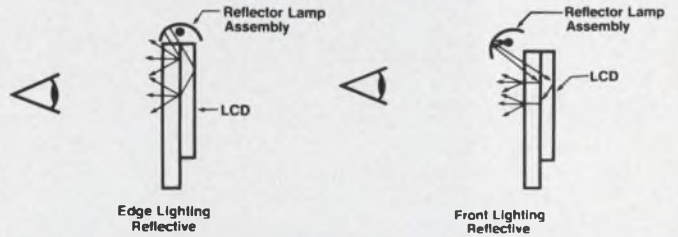

Front lighting (reflective design) uses incandescent lamps or a fluorescent (typically 3-watt). It provides the advantage of viewing with ambient light by day and artificial light at night.

Mounting techniques with large LCDs are applicable to most equipment designs. Two most common types are:

Panel Mounting requires a special bracket to hold the display in the panel. The panel can be sloped to place the display viewing surface perpendicular to the operator's line of sight, or a bezel can be used to attain the same effect. Type of display and lighting will, of course, determine the mounting.

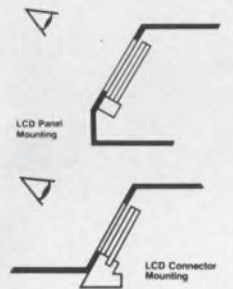

Connector Mounting is made with an edge board connector to hold the display and for making electrical hook up.

Determining viewing distance vs character size is a critical factor in adapting liquid crystal displays. Character height, width, spacing; segment width, separation between each and slope of characters are all to be considered. Examples illustrate viewing distance in relation to character height.

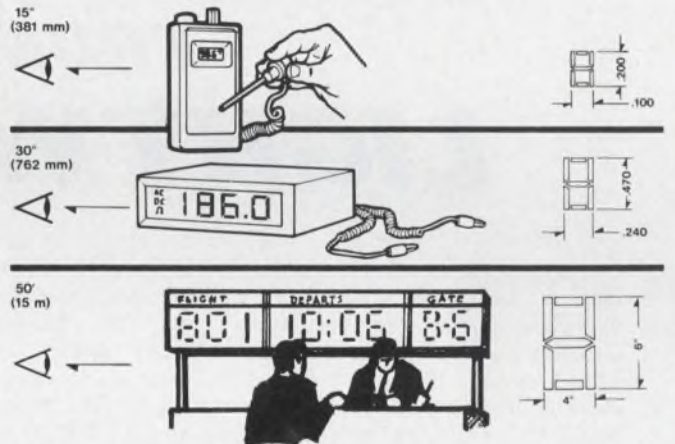

In application, liquid crystal displays meet the needs of an almost unlimited number of products — from watches to office equipment, flight instruments to appliances. In fact, where MOS and C/MOS compatibility, flexibility of design, low power requirements are factors, LCDs provide an efficient and practical solution.

Hamlin stocks several standard LCDs in both dynamic scattering and field effect types (transmissive and reflective) for immediate delivery. Special displays with virtually any image can be produced to order with surprisingly low preparation costs. And LCD's simplicity means lead time of just a few weeks. For detailed specifications and application data, write Hamlin, Inc., Dept. #614 Lake Mills, WI 53551, 414/648-2361. Evaluation samples are available at moderate cost.

HAMLIN

INCORPORATED

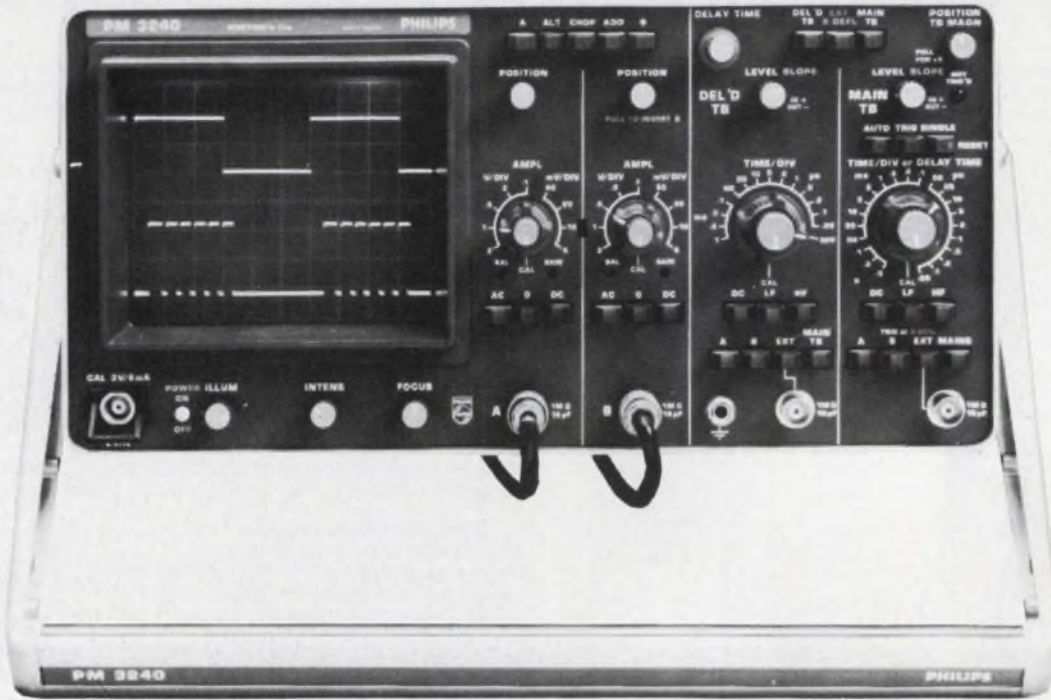

HEAVYWEIGHT PERFORMANCE FROM A LIGHTWEIGHT

Lugging excess weight around on service calls under all kinds of environmental circumstances doesn't improve the efficiency or enthusiasm of servicemen. That's why more and more of the purchasing decisions are being influenced by weight besides the price and performance of a portable oscilloscope.

The Philips PM3240, a 50 MHz dual trace oscilloscope, has the facilities you need for the majority of your service applications - - - generally below 50 MHz. This ultra lightweight (only 18.5 lbs.) dual time base oscilloscope with the bright 8 x 10 cm display has been designed with specific emphasis on ease of use. Every control falls naturally and

quickly to hand. The controls are grouped in four vertical sections; Ya, Yb, delayed and main time bases - with all the main controls on exactly the same level. In this way, the desired switch is found without even having to look away from the screen, while the clear separation of the two timebases eliminate confusion and a possible source of error. This low priced PM3240 gives the operator full control of the triggering parameters, but uses LED's which immediately indicate when triggering conditions are not correct.

The chances are that before the Philips PM3240 was available, you were forced to buy an expensive instrument more transportable than

truly portable - - - with more bandwidth than was necessary - - - for more money than you wanted to pay. Aren't you glad you've got a better choice now? To get further information or have a field engineer contact you for a demonstration of the Philips PM3240, utilize our toll free HOT LINE 800 645-3043.

New York State residents call collect (516) 921-8880

Philips Model PM3240 50 MHz/50mV dual trace oscilloscope priced at \$ 1470.00.

Philips Model PM3240X includes TV sync separator, priced at \$ 1570.00

Philips Test & Measuring Instruments, Inc.
A NORTH AMERICAN PHILIPS COMPANY

400 Crossways Park Drive
Woodbury, N.Y. 11797



FOR DEMONSTRATION CIRCLE 48

PHILIPS

INFORMATION RETRIEVAL NUMBER 49

ELECTRONIC DESIGN 19, September 13, 1975

There's Plenty More Where These Came From...

DIP'S BY PYROFILM

Thick Film Networks ... Hundreds of Values ...
Hundreds of Thousands In Stock ... 14 and 16 Pin
... Standard and Custom Circuits ... Available Now

Setting New Standards in Reliability

PYROFILM

60 S. Jefferson Road • Whippany, N. J. 07981 • (201) 887-8100

INFORMATION RETRIEVAL NUMBER 43

Consider LCDs for your next design.

Liquid-crystal displays need little power. They can show complex images, and present them clearly.

Probably you've already considered liquid-crystal displays for use in your system. If so, you made a decision for or against LCDs—versus, say, light-emitting-diode displays. But now improved LCDs have come along. And they make a new appraisal a must.

Perhaps you already selected earlier LCDs simply because of their low-power requirements. That's still a major advantage. However, today's LCDs also offer the following benefits:

- They can mix alphanumeric characters of any font style, pictures and symbols in a single package (Fig. 1). In essence, any image that can be photographed can be presented as an LCD.

- Various color combinations of images and backgrounds can be obtained. Images can be presented in black or even blue against sharply contrasting backgrounds.

- LCDs combine readily with CMOS (complementary-MOS) circuits to produce compact, portable equipment that has long operating life. In line-powered systems, the combination of LCD and CMOS simplifies drive and supply circuitry and reduces cooling requirements. Thus system costs can be decreased.

LCDs dissipate microwatts

The low-power benefits of LCDs extend to both field-effect (also called twisted-nematic) and dynamic-scatter displays—the two types of LCDs. As part of a digital watch, a field-effect display typically requires a mere microwatt to energize all segments. A dynamic-scatter display, operating at 12-to-20-V levels, dissipates about 40 to 50 μ W. By comparison, a four-digit LED-watch display typically uses 60 mW when operated at 3 V.

Both types of LCDs sandwich the liquid-crystal

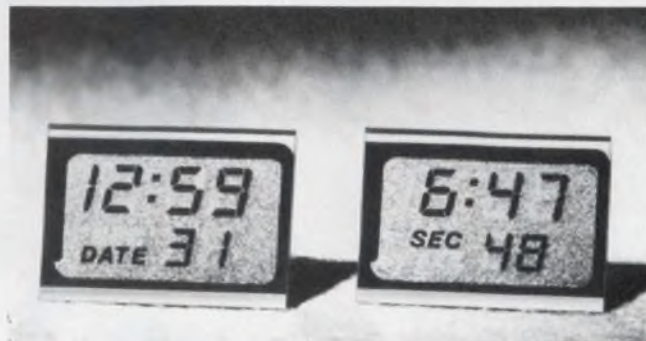

1. Liquid-crystal displays for clocks can combine hours and minutes with seconds or dates. These units are the 705-series from Beckman Instruments, Helipot Div.

material between two glass plates, separated by about one-half mil, or 12 μ . The plates are sealed around their perimeter. The image appears between two layers of conductive material—one etched on the surface of each glass plate.

In operation, voltages applied to the display change the molecular orientation of the liquid-crystal material, thereby modifying the light passing through.¹ Dynamic-scattering displays present white images on a clear or reflective background. Field-effect displays usually have black or dark images on a clear or lighter-colored background. However, the color combination may be reversed by rotating one of the polarizers (needed to orient light correctly in field-effect LCDs) by 90 degrees.

Various color combinations of digits and backgrounds can be obtained by varying the tint, or percent transmission, of the polarizers used. For example, a black digit is usually obtained with a 42%-transmission polarizer. At the higher transmission of 55%, the digits appear blue. Typically 42 to 45%-transmission polarizers are used, because of their wide availability. Black digits are most popular, because they present a sharp contrast against light backgrounds.

LCDs emit no light. Thus, they require no power for this purpose. Both field-effect and dynamic-scattering displays can be used in either a reflective or transmissive mode. In the reflective mode, ambient light passes through the cell

Daniel J. Renn, Chief Engineer for Display Devices, Lyle F. Pittroff, Product Manager Hybrid Microcircuits, Beckman Instruments, 2500 Harbor Blvd., Fullerton, CA 92634, and John D. Dunn, Display Systems Manager, American Microsystems, 3800 Homestead Rd., Santa Clara, CA 95051.

and reflects back through the cell toward the viewer. However the absence of emitted light renders reflective-mode LCDs less readable in very low light levels.

A transmissive-mode display, properly back-lighted by an external source, provides low-light-level performance equivalent to a gas-discharge or LED display. The trade-off, however, is increased power consumption of the light source. This partially neutralizes the LCD low-power advantage. Of course, the light source need not be operated continuously; it may be switched on only during low-ambient conditions.

Both reflective and transmissive-mode displays show increased readability in high ambient light. Newer digital LCD watches employ a transmissive-mode display and a light source that can be turned on and off by the watch wearer. This is the only display technique today that allows a watch to have excellent readability in high ambient light levels and provision for nighttime viewing.

But LCDs also have disadvantages. These include slow turn-on and turn-off times and somewhat limited operational temperature ranges. However, there have been recent advances in materials, packaging, and the understanding of failure modes. These advances have led to improved display parameters and heightened display-life projections.

LCDs: nonlinear circuits

The equivalent LCD circuit consists of temperature-sensitive nonlinear capacitors and nonlinear resistors in parallel. The resistance and capacitance values also depend on display threshold. At 25 C, the capacitance below the threshold level is about 40% of the capacitance above the level, while the resistance below threshold is about one-half of the resistance above threshold (Fig. 2).

Typical drive requirements are 12 to 20 V ac for dynamic-scattering devices, and 2 to 8 V ac for field-effect units; capacitance above threshold typically ranges from 5 to 35 pF per segment. Resistance above threshold is typically 1 to 10

LCD type	Dynamic scatter	Field effect	
Operating voltage—V		3	6
On	> 12	> 2.5	> 5
Off	< 5	< 0.5	< 1
Dc current drain per cm ² —mA	12	0.1	
Ac power per cm ² — μ W	150	3	
Capacitance per cm ² —pF	300	600	
Turn-on delay (@25 C)—ms	100	150	
Turn-off delay (@25 C)—ms	100	200	

2. Typical specifications for LCDs show power consumption to be in the microwatt region.

M Ω for dynamic-scattering, and over 400 M Ω for field-effect units.

The effects of temperature changes can be seen from an examination of threshold-transmission curves (Fig. 3). With both LCD types, an increase of temperature within the 0-to-50 C operating range reduces drive requirements. The difference is more significant for field-effect devices, since their drive requirement is lower. Below -15 C LCDs lose their liquid-crystal characteristics. However the devices aren't damaged by the low temperatures; they will again function properly when returned to higher temperatures. Similarly, above the operating temperature range, LCDs lose their liquid-crystal characteristics. But again this loss is reversible.

Switching times (Fig. 4) depend on several factors: temperature, drive levels, the liquid-crystal material, and the distance separating the front and back plates of the display cell. Reduced plate spacings result in faster switching times. But manufacturing tolerances then become more difficult to maintain. And the problem worsens when display cells become larger, as they do for some instrumentation displays. Generally large-area displays require a special blending of liquid-crystal materials.

It's important to know that different manufacturers define switching, or response, times in different ways. Some vendors specify switching time as the period between 10% and 90% of complete turn on. This approach hides an initial delay time that often adds an extra 50 to 100 ms.

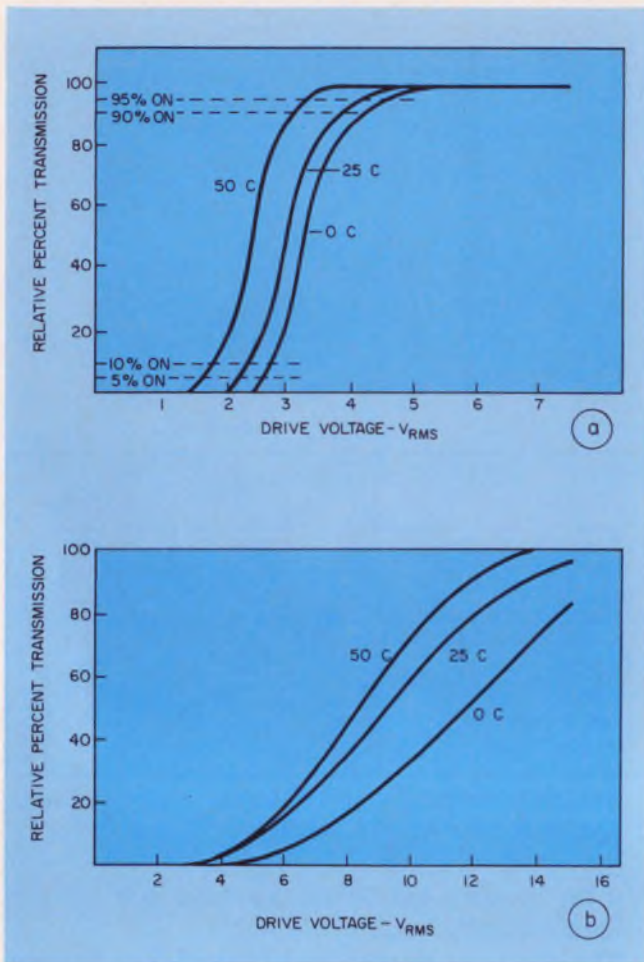

3. Temperature variations affect LCD transmission of light. The change is greater for field-effect units (a) than for dynamic-scatter (b), because field-effect LCDs have lower thresholds.

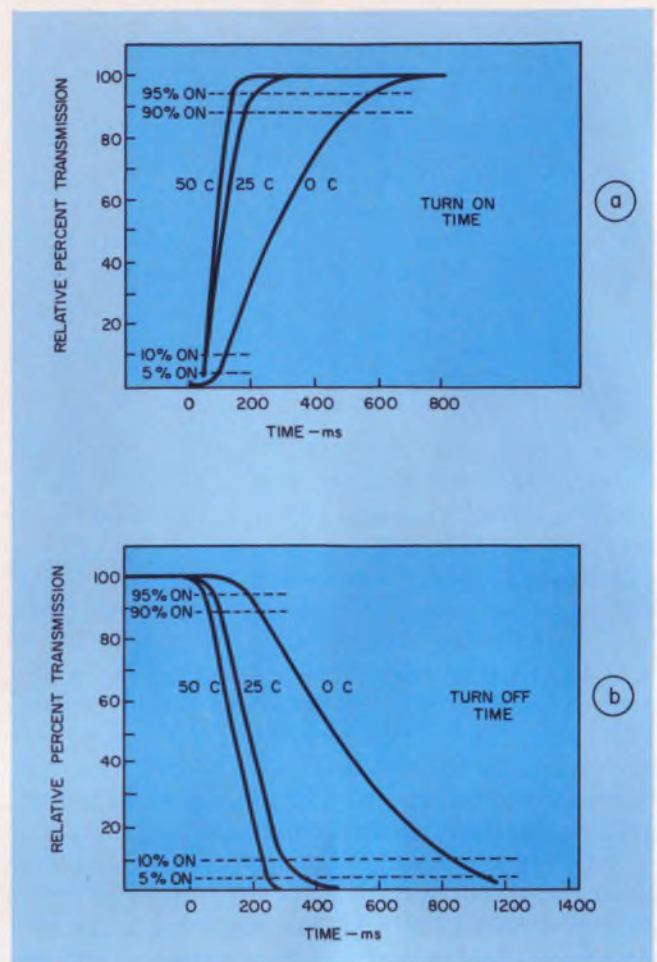

4. Switching times for a 3-V field-effect LCD also depend on temperature. At 25 C, turn-on time (a) from trigger signal to 90% on is 200 ms. Turn-off time (b) at the same temperature is 350 ms.

A better approach defines response time as the period beginning with the application of the trigger signal and ending when the device is 90% on. Actually LCDs have fast switching times above 25 C, but they become slower as temperatures decrease to 0 C. Recent and continuing advancements in materials technology are gradually improving switching characteristics.

Ac drive signals are necessary

LCDs require an ac drive signal that may range from 25 Hz to 1 kHz. Watches typically use a frequency of 32 Hz, while 50 to 60 Hz is the standard for line-powered instruments. A completely symmetrical ac signal is ideal, though small dc offsets—below 25 mV—appear to have no degrading effect.

Several single-digit, seven-segment, decoder-drivers are available in standard CMOS logic families. An Exclusive-OR circuit—like the RCA CD4055 and CD4056, or Motorola MC14511 and MC14543—can be used to drive a display (Fig. 5). However, costs can be reduced by the

use of a dedicated CMOS LSI circuit. The LSI chip replaces several less-complex circuits that primarily provide the display's parallel-drive signals. Several suitable LSI chips have been introduced, and more are expected.

The multiplexing of LCDs would seem to be the next advance. A simple three-digit, seven-segment, display with a common backplane requires only 22 pins, and each output has its own drive circuit. With more digits, the pinouts and associated drive circuits become more complex. Hence a multiplexed subsystem should result in lowered equipment cost.

However multiplexing has thus far been achieved only with dynamic-scattering displays, and for groups of four digits. These displays employ multiple-voltage and multiple-frequency addressing techniques. As for field-effect displays, the industry has yet to introduce a display that can be multiplexed over a reasonable temperature range.

Most LCDs use either screening or photolithographic techniques. Thus the term "price-per-digit" doesn't really apply. All digits are batch

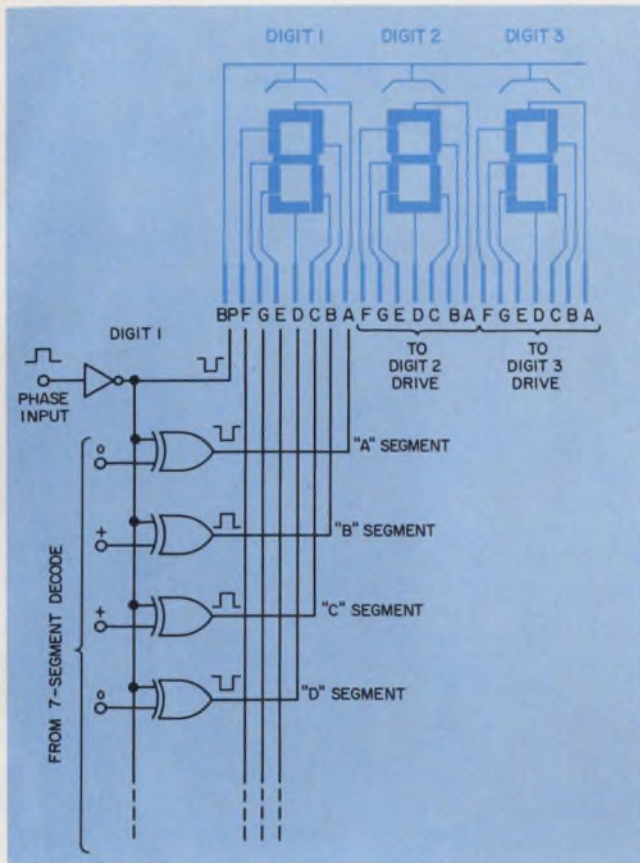

5. LCD uses CMOS Exclusive-OR gate to obtain parallel-drive signals and achieve low over-all power consumption.

fabricated, so it's the price per cell that counts. And that depends on display area, image complexity, materials, quantity, and yields.

How it's made affects the price

For example, a 4-digit watch display that sells for \$5.00 in 100,000-piece quantities has a price per digit of \$1.25. But the same sized cell with six smaller digits to display hours, minutes and seconds might be built for the same price assuming screening or photo tolerances permit the same yields.

With small displays, the major constraint on yield is line resolution. Current screening techniques limit resolution to 6-mil lines and spaces. Photo techniques allow much tighter lines and spaces—about 2 to 3 mils—with good yields.

Large-area LCDs have poorer yields—and hence, higher costs—than do small displays. The increased area heightens the chance that bubbles, specks, or lesions will develop. For example, a speck only seven mils in diameter is visible. Depending on location, this speck might cause the cell to be discarded. ■■

Reference

1. Tannas, Larry E., Jr., "Liquid Crystal Displays Are Great—but . . .," *Electronic Design* No. 14, July 5, 1974, pp. 76-80.

Now... AC MEASUREMENTS GO DIGITAL!

- True RMS Volts
 - True RMS Current
 - AC Watts
- ... all in YEW's new 2504 AC DMM!

The new 2504 digital AC instrument offers unexcelled accuracy and versatility for the measurement of sinusoidal and non-sinusoidal waveforms and for measurements at low power factors. Flexible design allows optional purchase of just the measuring functions required while push-button controls provide ease of operation.

The YEW 2504 is **the** AC DMM. Its 0.25% accuracy and 0.01% resolution, standard analog output, and low cost (Prices start at \$1,590.) make it the ideal instrument for quality control, lab, field maintenance, and instrument calibration applications. Write for details.



Standard ranges (Multirange Model):
30V/60V/100V/150V/300V,
0.5A/1A/2A/5A/10A (15W to 3,000W)
Frequency range: 25 Hz to 1 kHz

YEW

YOKOGAWA
CORPORATION
OF AMERICA

5 Westchester Plaza, Elmsford, New York 10523
Telephone: 914-592-6767

60 Years of Measuring & Recording Instrumentation

Let's hear it for 1" high LEDs!

Digital clock readout

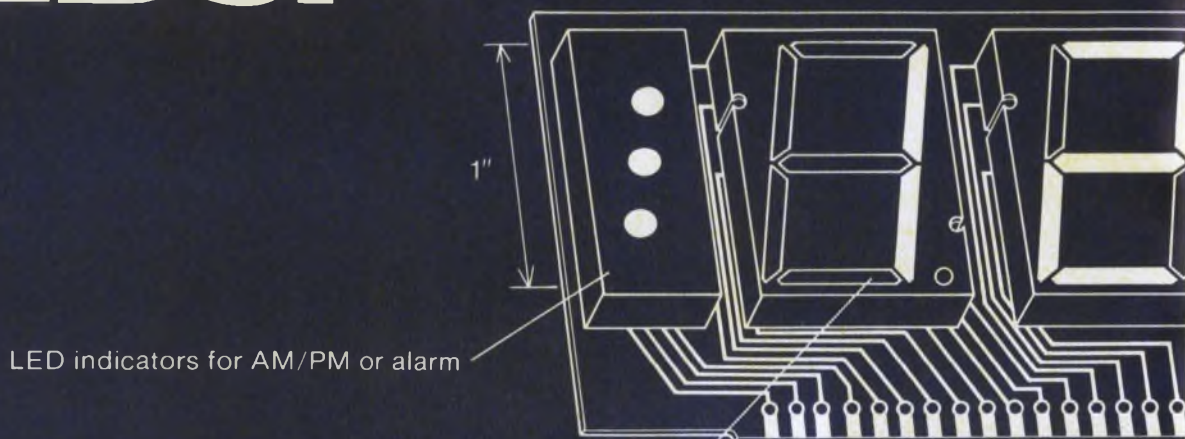

White-walled cavity reflects and directs light

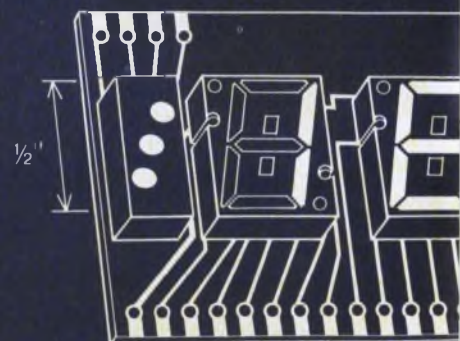

The first ever.

See?

Good things are worth waiting for.

Litronix (who else?) is pleased to announce the industry's first 1-inch high LEDs—big, beautiful, and bright. You can easily read them from 60 feet away without squinting.

That's nice news for manufacturers of digital clocks and panel meters.

But that's not all the news.

These 1-inch digits (as well as our new ½-inch digits) use a new technology to reduce costs. This means a price saving to you of more than 10%. For example, our ½-inch reflective

model costs less than 90¢ per digit vs. about \$1.00 per digit for our ½-inch light-pipe model. Nice?

Here's the clincher. You can get an entire array of 2 to 8 digits already mounted on a single PC board—with colon, AM/PM sign, or ± sign, and over-range "1" as required. All this reduces your assembly costs. Makes the production easier. And simplifies testing and inventory.

If you've been looking at the super reliability of LEDs (average MTBF of 50,000 hours), our 1" LEDs should make your eyes light up.

Get details today from the innovative people who did it first. Contact Litronix, Inc., 19000 Homestead Road, Cupertino, Calif. 95014. Phone (408) 257-7910.

**No wonder
we're No.1
in LEDs**

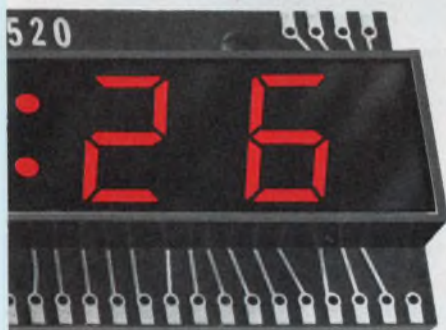
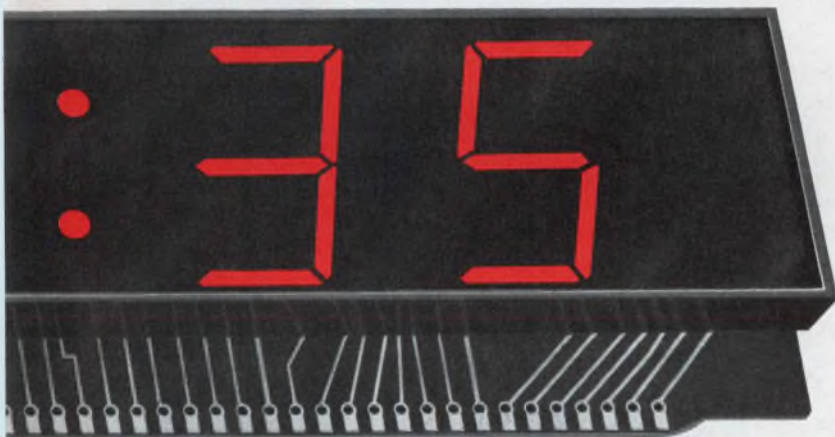

litronix

INFORMATION RETRIEVAL NUMBER 45

Mate synchros with computers

by using solid-state conversion modules. S/d and d/s converters can minimize mechanical interfacing while boosting reliability.

Eliminating the moving parts in any computer-controlled measuring system can increase the over-all reliability. You can do this in mechanical synchro and resolver based systems by replacing the gear trains and mechanical shaft encoders with solid-state synchro-to-digital and digital-to-synchro converters.

Synchros, though more widely known than resolvers, require more circuitry to handle their outputs. The synchro transmitters provide a three-wire, three-phase modulated-carrier signal, where each phase is shifted by 120° . This type of signal cannot be easily handled by digital controllers or processors. The resolver transmitters, on the other hand, provide a four-wire, two-phase modulated-carrier signal that is shifted by only 90° —much easier for digital processing equipment to work with. (For more resolver and synchro basics, see the article "Consider Using Resolvers and Synchros," ED No. 17, Aug. 16, 1975, pp. 70-72.)

Richard Ferrero, Product Manager, Synchro Converters, Analog Devices, Rte. 1 Industrial Park, Norwood, MA 02021

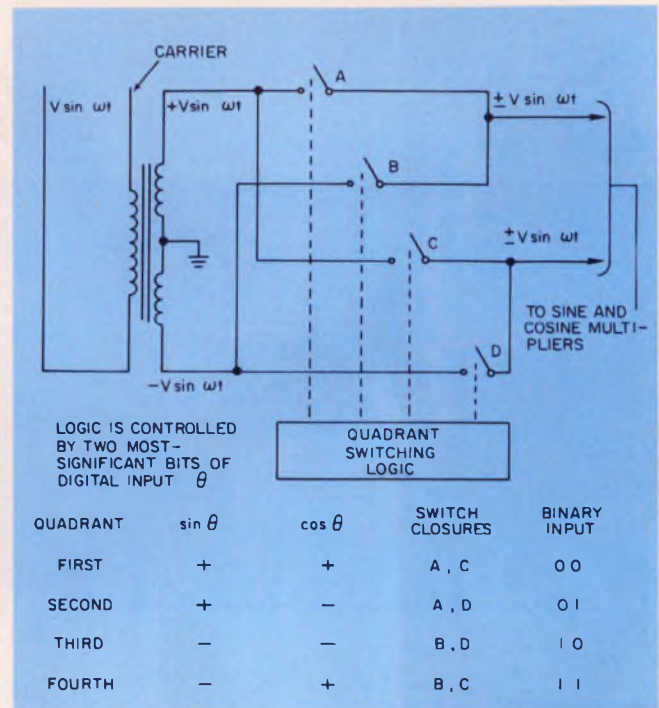

2. The four-quadrant d/r converter uses switching logic, controlled by the two MSBs of the digital input word, to change the signal polarity.

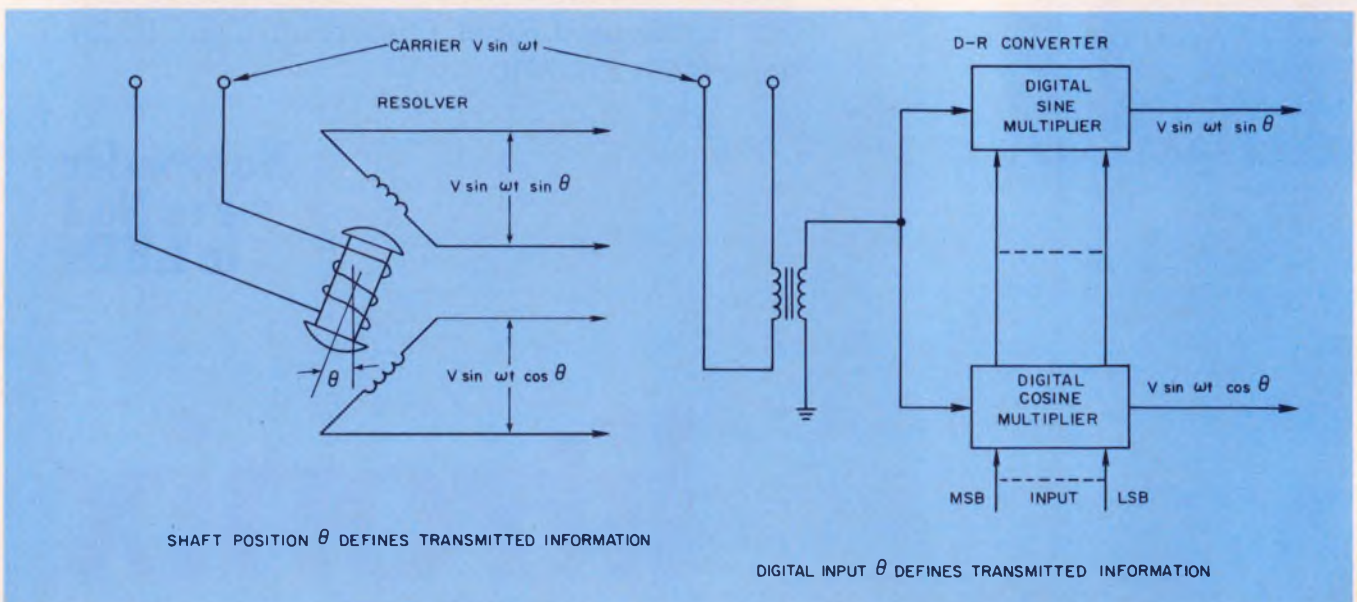

1. The digital-to-resolver converter simulates the modulated-carrier resolver signals under digital command.

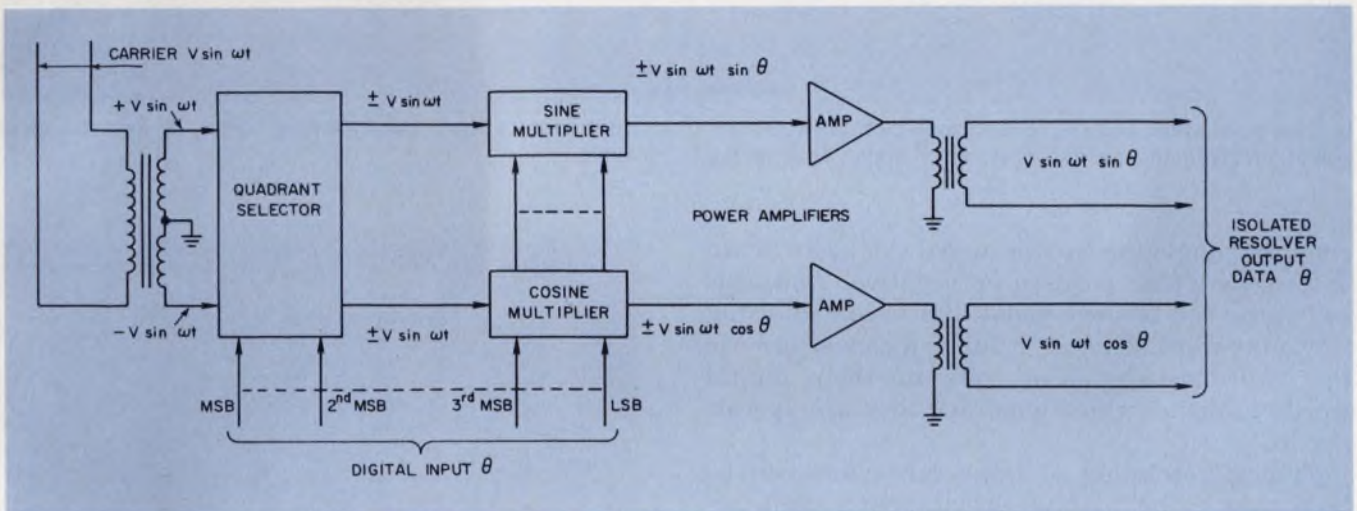

3. Power amplifiers can be added to the d/r converter to better drive the resolver receivers. Transformers can

be added to the converter to isolate the output and prevent short circuit damage.

To simplify the conversion and signal-processing circuitry, synchro signals must first be converted into resolver-type signals by the use of Scott-T transformers on the input lines. In fact, most commercial s/d or d/s modules are really resolver-to-digital or digital-to-resolver (r/d and d/r) modules with built-in Scott-T networks.

Inside the solid-state resolver

To simulate the electromechanical action of the resolver transmitters, the solid-state units use sine and cosine digital multipliers. These multipliers duplicate the variable coupling of the actual moving stator (Fig. 1). The two multipliers produce modulated-carrier outputs that are 90° out of phase with each other. They develop outputs of $V(\sin \omega t)\sin \theta$ and $V(\sin \omega t)\cos \theta$ in response to a digitally coded input signal that corresponds to angle θ . In most d/r or r/d converters, the digital multiplier is a variable reference digital-to-analog converter.

The circuit shown in Fig. 1 is good only if the amount of rotation to be simulated is less than 90°. For larger angles, the sign of the output voltage must correspond to the graphical quadrant of the angle θ (Fig. 2). To simulate this

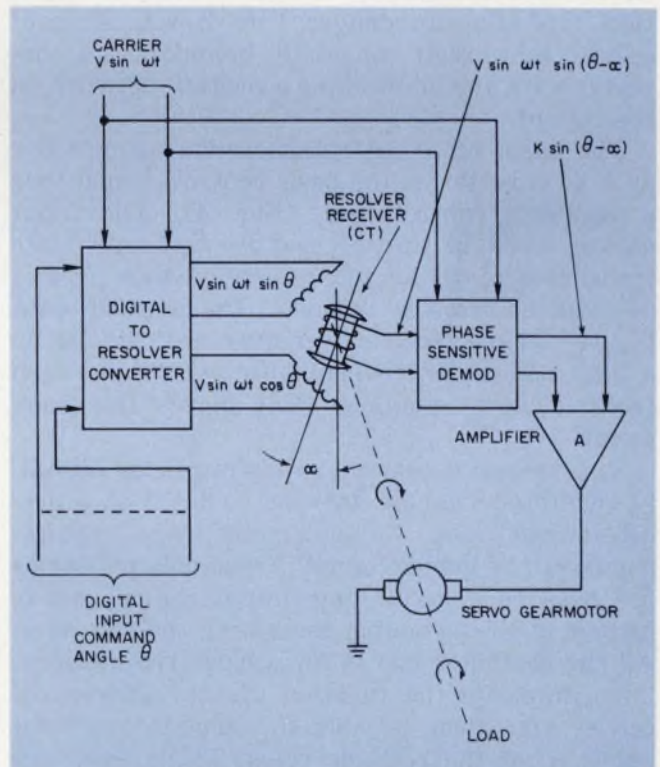

4. A basic closed-loop servo system puts the output of the resolver rotor through a phase-sensitive demodulator to control a gearmotor.

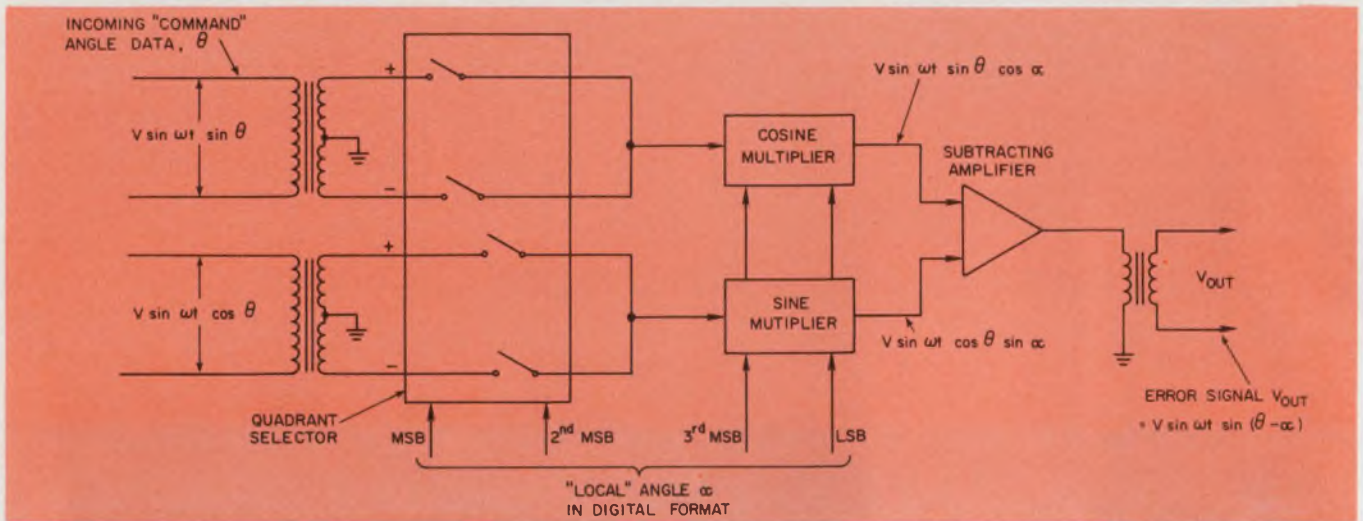

5. The solid-state control transformer simulates the resolver receiver and produces an error signal that is the

difference between the incoming angle, θ , and the local angle α .

changing angle the carrier signal can be switched to become either positive or negative. And, this switching can be done under digital control using a two-bit word. Thus, d/r and r/d converters use the two most-significant bits of their digital words to define which quadrant they are operating in.

Typical resolution of these converters can be then said to be 14 bits—even though their accuracy is usually limited to 12 bits. The full four-quadrant d/r converter shown in Fig. 3 comes complete with reference, output isolation, quadrant selection circuitry and power output stages that typically can deliver 1 to 2 VA. And, of course, the circuit can easily become a d/s converter with the addition of a Scott-T network on the output.

The basic servo controlled system using a d/r or d/s converter as the basic control element has a feedback control loop (Fig. 4). The input digital word is transformed by the solid state transmitter into angular signals which feed a mechanical resolver receiver. The angular data induced in the receiver armature are decoded by a phase-sensitive demodulator which in turn feeds a power amplifier that drives the gearmotor.

This system becomes a rate servo if the digitally generated angular data get updated at a predetermined rate. Computer software requirements can be kept minimal if read-only memories are used to generate the digital control words instead of the computer generating the raw data. All the computer has to do is clock the memory.

To duplicate the function of the resolver receiver, you must be able to simulate the local angle, α , of the resolver rotor. To do this, you can use a circuit similar to the circuit of Fig. 3, except that there are two input transformers (Fig. 5).

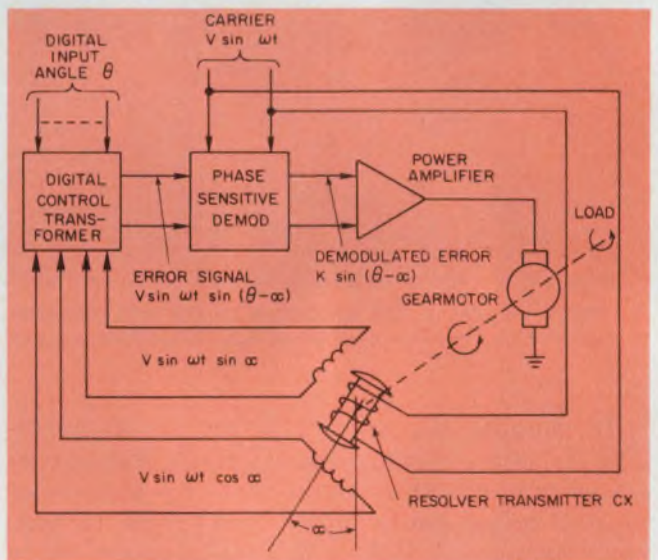

6. This digitally driven servo system can replace the system shown in Fig. 4. It doesn't need the power amplifiers used in the earlier circuit to drive the resolver receiver since just logic signals are needed.

The local angle can thus be fed into the digital inputs of the solid-state resolver receiver (sometimes known as a control transformer). The resulting output of the receiver circuit is a difference signal that can be used for servo control.

By using a control transformer instead of the d/r converter, you can again build a circuit that functions similarly to that of Fig. 4. Both Fig. 6 and Fig. 4 do the same job, but accomplish it by different methods.

From an applications point of view, the circuit of Fig. 4 is optimized if the d/r transmitter is located close to the computer, with the target angle transmitted to a distant servo in analog format. The high-voltage, low-impedance, resolver signals provide fairly good noise immunity and thus can be transmitted over long dis-

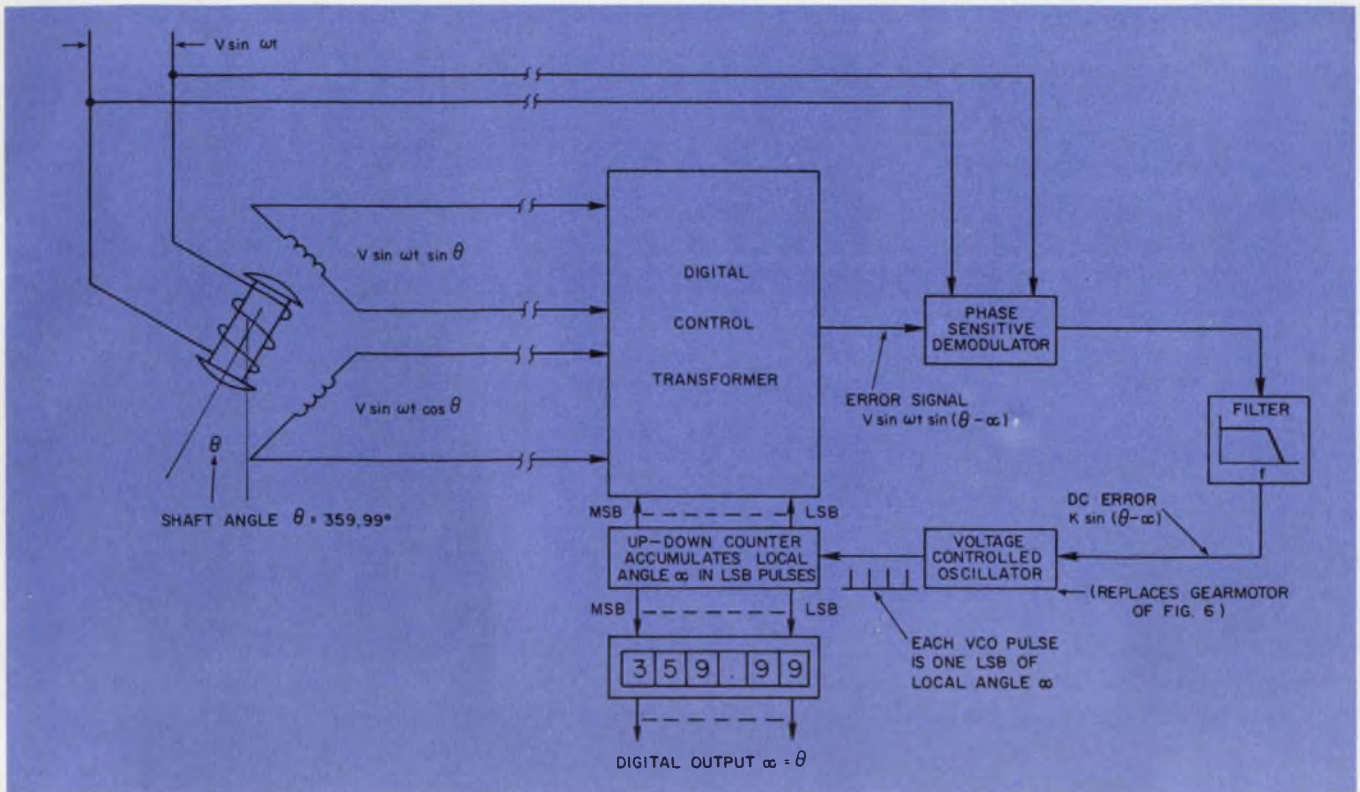

7. A solid-state control transformer can make the circuit needed for a digitally displayed shaft angle very simple.

tances with negligible error.

The circuit of Fig. 6 works better if the control transformer is located close to the servo, rather than to the computer, to avoid long distance transmission of low-level signals. In this case, data are transmitted digitally from computer to a solid-state control transformer. Serial or parallel data transmission is possible, although the circuit shown uses parallel. To get serial transmission all you have to do is use a parallel input register—such as is included in the Analog Devices SERDEX data transmission module.

The electrical design of the two similar systems is also radically different. For instance, in Fig. 4 a d/r converter is used instead of a resolver transmitter. Thus angular data being transmitted must have sufficient power (several VA) to energize the resolver receiver's stator coils. Thus the d/r will need some outboard power amplifiers.

On the other hand, the circuit of Fig. 6 has solid-state circuits that must handle only computer level data—no power amplifiers are needed and thus the circuit could be made smaller. And, the lower power requirements also tend to place less stress on the components, thus increasing reliability.

If you need a digital display to indicate the angle of the shaft, don't despair. You can easily add a display by including a string of up down counters, a voltage-controlled oscillator and a low-pass filter, as shown in Fig. 7. The entire circuit, aside from the resolver, can be built on a

The circuit needs no power amplifiers and no complex mechanical linkages.

single circuit card and mounted in the computer.

A comparable electromechanical system would require motors, gears, mechanical readouts and a digital shaft-angle encoder to re-transmit the digital data. The system in Fig. 7 contains only one integrator—the combination of the VCO and counter—so in classical servo theory, the system can be classified as a Type I servo.

Watch out for error sources

Rarely will the resolver conversion circuits be required to digitize data from stationary rotors. In numerical-control machine-tool applications the converter must keep the processor informed of cutting-tool position throughout the cutting cycle. Thus errors associated with the rotating shafts—usually referred to as rate and acceleration errors—must be specified.

The VCO used in the tracking converter system shown in Fig. 7 must have a finite input voltage to sustain the train of LSB input pulses to the count chain. And, to produce this VCO drive voltage, there is an inevitable lag, known as velocity lag, between the input angle θ and the digitally generated local angle α . Also, the faster the input data change, the higher the VCO voltage must become to keep the counter updated.

This dynamic lag is known as velocity error and is expressed in terms of the hardware's basic velocity constant, K_v , and the actual input angular rate, $d\theta/dt$:

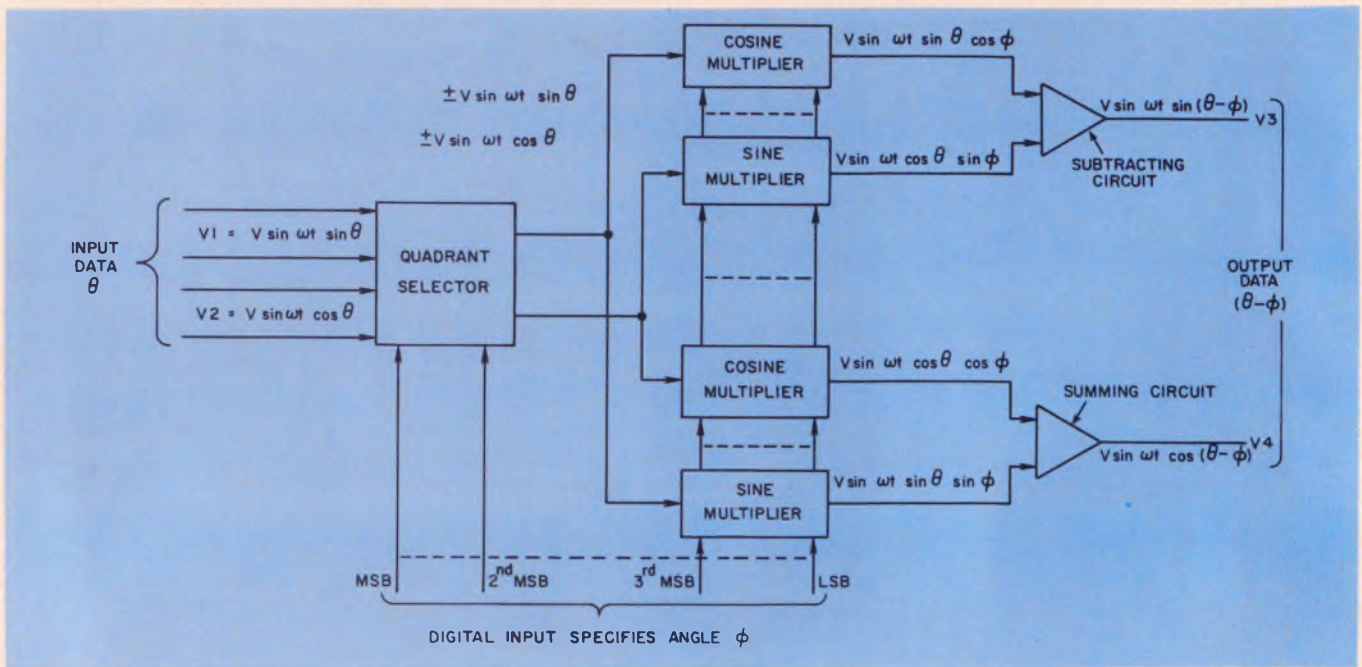

8. The differential control transmitter has dual sine and cosine multipliers that provide a difference voltage

which corresponds to the angle between θ and ϕ . This voltage is also modulated by the carrier.

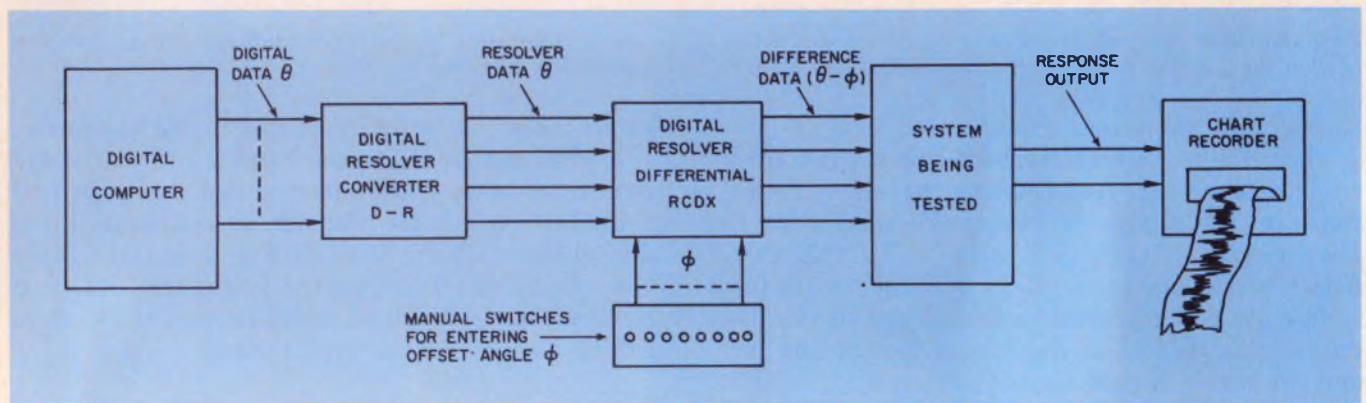

9. A simple computerized test system uses the differential transmitter to manually enter any offsets that can

compensate for variations in the system being tested and thus customize every unit.

$$\text{Velocity error} = (d\theta/dt)/K_v.$$

For a converter designed for a $K_v = 20,000$ and $d\theta/dt = 1200^\circ/s$ (about 180 rpm), the lag between digitized output and angular input becomes 0.06° . A short table compares angular accuracies for different levels of converter performance.

You can reduce the dynamic lag by introducing a second stage of integration within the servo loop. However, if you reduce the lag error, you must pay the price with a more sluggish system—increased acceleration error. In some applications, though, this increased error may not be important—such as in constant-velocity N/C machine-tool operations.

Locate the second integrator just before the VCO of the circuit of Fig. 7 so that the VCO responds to the time-integral of the demodulator output. This system is classically categorized as

a Type II servo.

The phase-sensitive demodulator used in the system also helps to keep errors down. It minimizes any errors caused by random noise, harmonics and quadrature. The demodulator also develops an output of the correct polarity so that the servo loop appropriately counts up or down. And, since the error voltage is averaged over several carrier cycles, instantaneous errors from large, short-duration spikes are minimized.

Differential transmitters are needed, too

The last solid-state equivalent to the electro-mechanical resolvers is the differential control transmitter. This device provides a pair of output signals that represent the difference between the input angle θ and the digital input angle ϕ (Fig. 8). Inside the transmitter are two resolver

Digital resolution vs digitizing error

Number of bits (n) in system	Digitizing Error (2^{-n})*			
	as a fraction	as a decimal	as percent	as angle in degrees
6	1/64	0.0156	1.56%	5.6°
7	1/128	0.0078	0.78%	2.8°
8	1/256	0.004	0.4%	1.4°
9	1/512	0.002	0.2%	0.70°
10	1/1024	0.001	0.1%	0.35°
11	1/2048	0.0005	0.05%	0.176°
12	1/4096	0.00025	0.025%	0.088°
13	1/8192	0.000125	0.0125%	0.044°
14	1/16,384	0.000061	0.0061%	0.0221°
15	1/32,768	0.000031	0.0031%	0.011°
16	1/65,536	0.000015	0.0015%	0.005°

* Where the total number of bits represents one revolution of the system (360°)

control transformers that process the resolver voltages $V(\sin \omega t)\sin \theta$ and $V(\sin \omega t)\cos \theta$ to create the equivalent of a differential transformer's induced voltage components. These components are fed into a subtractor circuit which develops the output $V(\sin \omega t)\sin(\theta - \phi)$, and $V(\sin \omega t)\cos(\theta - \phi)$.

A simple application of this type of circuit occurs in the computer controlled test system shown in Fig. 9. In this system the computer puts the electromechanical device through its paces by feeding it digitally generated resolver command angles. The differential transmitter permits you to introduce manual offsets in the angular data reaching the item under test.

There are many other ways that solid-state resolver modules can be used to modify mechanically generated resolver data. For instance, by using digital divider circuits between two sets of multiplier circuits you can simulate a rough and fine control adjustment of the servo system. The divider circuit replaces the gear ratio that would be found in the mechanical servo system.

Another modular system that uses the solid-state converters is found in pulse-position indicating radar systems. Here, the resolver input data feed into an r/d converter that in turn feeds two d/a converters that reconstruct sine and cosine waveforms from the digitized signals. ■■

HERE'S A LOW COST LOAD CELL THAT'S NOT AFRAID OF WATER



■ In the past, low cost load cells could only be used in closely controlled environments. That meant no water splashes, no steam, and no condensation. Times have changed. With the new Sealed Super-Mini Load Cell from Interface, you don't have to worry about outdoor environmental conditions, and you don't have to worry about a high price either.

■ The rugged Sealed Super-Mini is designed to replace all those costly load cells you've been using and provide you with guaranteed performance of $\pm 0.05\%$ non-linearity, $\pm 0.03\%$ hysteresis, $\pm 0.01\%$ non-repeatability, $\pm 0.03\%$ creep, and a list price of just \$295. Standard ranges are 0 to ± 500 , and 0 to ± 1000 pounds and they can be provided with either a rugged electrical connector or an integral cable.

■ For complete information on these load cells and others in ranges from 5 pounds to 100 tons, call or write Ted Johnson at Interface, today.

interface

7401 East Butherus Drive / Scottsdale, Arizona 85260
Telephone (602) 948-5555

MEMORY SERIES NO. 9 4K MOS RAMS: FASTEST DELIVERY ON RECORD

AVAILABLE NOW:
dynamic 4096-bit RAMS, with most dynamic delivery offered yet! Call your local distributor today for our #2604 standard—he'll ship immediately from volume stocks, competitively priced.

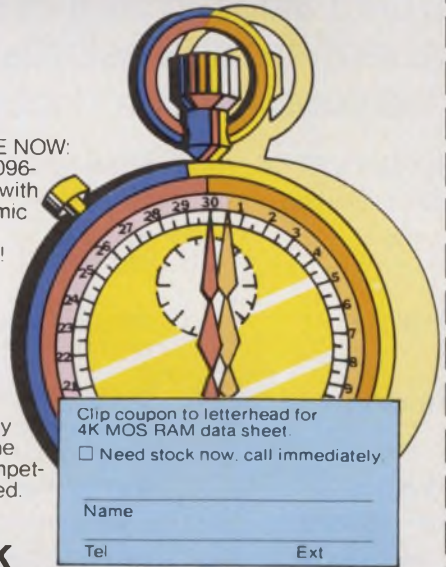

Clip coupon to letterhead for 4K MOS RAM data sheet
 Need stock now, call immediately.

Name _____

Tel _____

Ext _____

THINK Sinnetics

811 E. ARQUES, SUNNYVALE, CALIF 94086

TOTAL FILM RESISTORS

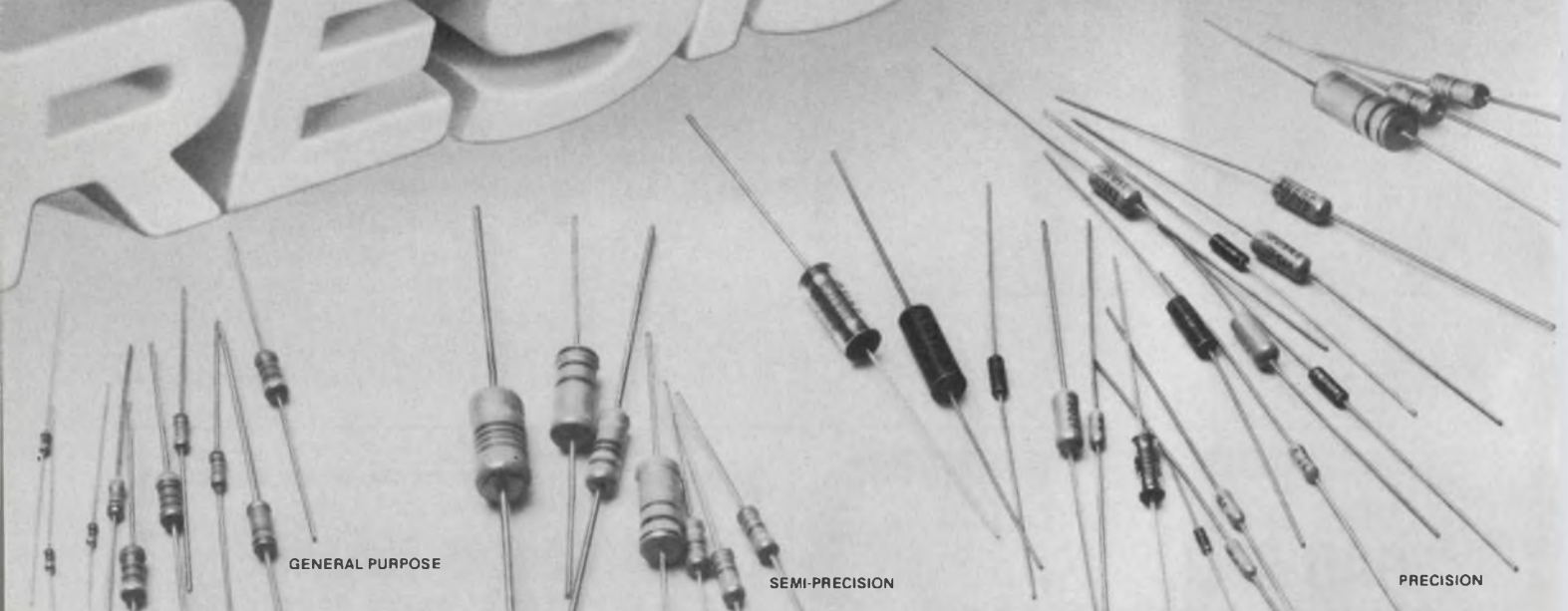

GENERAL PURPOSE

SEMI-PRECISION

PRECISION

Only Mepco/Electra offers Total Film Resistor Capability... from ultra-stable .05% metal films through general purpose 5% carbon films... from hermetic seal established reliability through conformal coated consumer products.

GENERAL PURPOSE	SEMI-PRECISION	PRECISION
5% to 10% tolerance	2% tolerance	1%-.05% tolerance
carbon film	metal film cermet film	metal film carbon film cermet film
conformal coat	conformal coat molded	conformal coat molded hermetic seal
1/8W-1/4W-1/2W	1/20W-1/10W- 1/8W-1/4W-1/2W 1W-2W	1/20W-1/10W- 1/8W-1/4W-1/2W 1W-2W
1 Ω -10 Meg	4.3 Ω -50 Meg	4.99 Ω -30.1 Meg
+ 200 to -500 PPM	\pm 100 PPM	\pm 100 PPM- \pm 5 PPM
Industrial/Consumer	Industrial/Consumer Established reliability	Industrial/Consumer Established reliability

**Talk to the
man from
MEPCO/
ELECTRA**



Sold through
North American Philips
Electronic Component
Corporation



Doesn't it make sense to deal with the company with the most to offer in product, experience and expertise?

For catalogs, samples or further information about Mepco/Electra's "Total Film Resistor" capability, call or write our nearest sales office. San Diego, CA 92121 (714) 453-5440, Elk Grove Village, IL 60007 (312) 593-8220, Waltham, MA 02154 (617) 899-7100, Hicksville, NY 11802 (516) 931-6200. Or contact one of our local distributors.

DAK LIGHT EMITTING DIODE LOW PROFILE SWITCH



 The
error
eliminator



This Series 415 LED is a momentary switch with an LED on an independent circuit.

Add another dimension of accuracy and speed of operation to your data systems with this reliable (10,000,000 operations minimum) Oak switch.

Use it to indicate key depression, input acceptance by computer, etc. Control the light by remote source, clearing key, automatic timing, or any other method that fits your system.

The 415 LED is .610" square, and is available in a wide range of keytop colors, with white, black, blue and gray as standard.

FOR IMMEDIATE DELIVERY FROM STOCK—through your Oak distributor. Call toll-free to 800-435-6106 for the location of the distributor nearest to you or write us for technical information.

FOR:
Point of Sale Terminals
Research Systems
Credit Card Systems
Security Systems
and other
data entry equipment

Keyboard and panel assemblies: Oak will build complete assemblies to your specifications including purchase of all required parts. Call our sales administrator for details.

DAK Industries Inc.
SWITCH DIVISION/CRYSTAL LAKE, ILLINOIS 60014
TELEPHONE: 815-459-5000 ■ TWX: 910-634-3353 ■ TELEX: 72-2447

INFORMATION RETRIEVAL NUMBER 50

Keep Newton on your side when you select a direct-writing recorder. Sir Isaac's laws of basic dynamics help refute specious product claims.

When you look for a recorder, don't be fooled by the claims and counterclaims for superior performance parameters. All galvanometers are electromagnetic second-order dynamic systems. As such, performance is determined by the inertia of the rotor stylus, the spring constant (mechanical or simulated with a position detector) and the damping (obtained from back-EMF, tachometer feedback or derived).

Arguments abound for the advantages of strengthening one parameter or another. Many manufacturers claim equivalent performances for their recording systems—at least when they leave the factory. But in some cases only an expert can make the system perform as stated. The buyer, left to his own judgment, should keep in mind a few rules:

- The relative cost of recorders generally is a function of weight and power consumption.

- From basic dynamics, it follows that smaller and lighter devices are faster. Heavier systems, even when their performance is equivalent to lighter ones, are not necessarily more rugged, as they need proportionally higher forces and hence more power.

- The looks of the recorded trace traditionally exert a strong influence on system choice. Numerous factors come into effect: writing medium and method, dynamic and electrical performances, etc. Actual fidelity of reproduction often places second to tradition.

- Instruments using recent technology and materials, such as samarium-cobalt magnets, titanium-clad metals, LSI circuitry, and gelled-electrolyte batteries, are likely to give more for the money.

- Numbers alone should not serve as the basis for selection of a strip-chart recorder.

Three ways to drive stylus

At present 75,000 recording channels a year are manufactured in the U.S., mostly for biologi-

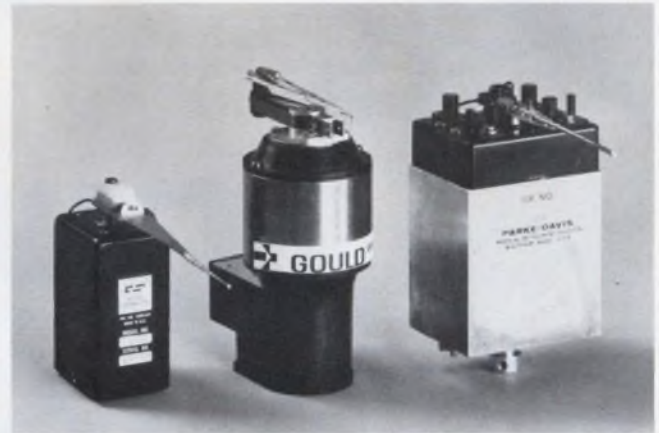

Velocity-feedback galvanometers of equivalent performance: The two larger units are intended for EKG recording with heated stylii, while the smaller unit uses ink for recording EEGs.

Table 1. Characteristics of open-loop recording galvanometers with back-EMF damping

Manufacturer	GSI Z-139	MFE R-154
Rated torque (g-cm)	950	750
Natural frequency with stylus (Hz)	68	62
Power supply required (VA)	4.2	7.5
Weight (oz)	16	16

cal function measurements. Equipment manufacturers competing in this market offer three basic galvanometer-stylus drives. In each, reliability, weight and cost are crucial factors—along with performance, of course. The methods are (1) Open-loop galvanometers with back-EMF damping; (2) Galvanometers with active velocity feedback; and (3) Galvanometers with position and velocity feedback.

Each method has been promoted at one time or another as the most desirable. But new materials,

Jean Montagu, President, General Scanning, Inc., 150 Coolidge Ave., Watertown, MA 02172.

use of ICs and new designs have blurred the lines between the various types.

As a rule, practically all direct-writing recorders attempt to meet the American Heart Association's (AHA) guidelines for frequency response and amplitude. Roughly, these are:

1. Chart span = 50 mm pk-pk.
2. Frequency response (dc to 50 Hz) = $\pm 1/2$ dB and (dc to 100 Hz) = -3 dB. Both at 10 mm pk-pk.
3. Maximum overshoot = $1/2$ dB pk-pk for a



Galvanometers with position servos: The center unit uses pressurized ink while the two others write with indirectly-heated stylus. The thermal units, though, usually require the use of heat sensitive chart paper.

Table 2. Characteristics of recording galvanometers with active velocity damping (velocity servo)

Manufacturer	GSI GR-760	Technirite TM-215	Sanborn 607
Rated torque (g-cm)	600	300	245
Natural frequency with stylus (Hz)	50	30	45
Power supply required (VA)	2.5	7.0	N.A.
Weight (oz)	16	32	100

10-mm square wave.

In all recorder methods, high torque is continually stressed as desirable. But equivalent performance is available in galvanometers with peak torques ranging from 250 g-cm to 2000 g-cm. It's easy to see why. The minimum torque to meet a required frequency response is obtained from Newton's Law.

$$T = I \frac{d^2\theta}{dt^2},$$

where I is the combined inertia of the rotor and

stylus and θ is the sinusoidal angular motion with a frequency ω . Therefore the maximum torque required is:

$$T = \omega^2 \theta I.$$

This equation explains why a machine with a 100-Hz response at 10 mm, pk-pk, will have a 45-Hz response at 50 mm, pk-pk. Both displacements require the same torque.

Conversely, to move a 25 g-cm² stylus rotor at 100 Hz over 0.105 radian, pk-pk (equivalent to 10 mm, pk-pk), approximately 400 g-cm of torque is required.

The overshoot requirement indicates that the frequency response must be monotonically decreasing. For a spring/mass-damped, second-order system, overshoot also defines the minimum resonant frequency of 82 Hz to meet AHA requirements.

Tradeoffs in the open-loop approach

Though the open-loop design with back-EMF damping is the most direct approach, it calls for a very strong magnetic coupling. Only moving-iron galvanometers are now built to operate in this fashion. These are fixed-coil devices, but at small excursions they behave much like the moving-coil design. Open-loop performance is quite successful when the rotor stylus inertia is kept below 25 g-cm². As inertia increases, the damping and gain become sensitive to the temperature of the galvanometer coil, and temperature control may be necessary to compensate for dc drift.

Table 1 shows the performances of commercial open-loop devices. These achieve their frequency response through a high resonant frequency, which brings much higher demands on torque and damping than those determined by Newton's Law. In practice, RC networks and low-pass and high-pass filters are used to improve the frequency response.

Moving-iron galvanometers with open-loop driving meet the demands of cardiac measurements (EKG) but don't quite do for electroencephalograms (EEG), where the stylus inertia typically is 45 g-cm² and the angle of motion 7-1/2 degrees.

Adaption of an EKG galvanometer for an EEG recorder yields about the same resonance, but the damping requirement is doubled. Since EEGs call for physically narrower galvanometers, the damping ratio deteriorates even more, and frequency response cannot be controlled. And since torque and inductance vary with angular position, the frequency response of the system varies with the position of the base line. Consequently these devices aren't suitable for applications that demand uniform frequency response across the entire chart width. Typically, a system set for 5% overshoot on a square wave in the center of

Table 3. Characteristics of galvanometers with position servos

Manufacturer	HP	Gould	G.S.I.	Parke-Davis	Cambridge Inst.
Inertia of rotor stylus (g-cm ²)	40	85	25	40	25
Torque available (g-cm)	900	2000	1000	900	500
Power (VA)	10	18	2.5	10	13
Spring constant (gm-cm/radian)	2800	small	500	2800	0
Position detector	Capacitor	Inductive	Capacitor	Capacitor	Potentiometer
Velocity	Derived	Pick-off	Derived	Derived	Back EMF
Writing	Rectilinear and edge writing	Rectilinear and edge writing	edge writing Rectilinear and	Edge writing	Tip writing
Patents	Detector	Detector and stylus	Galvanometer and detector	Stylus	Stylus

the chart, will have 20% overshoot three-quarters up the chart.

In the velocity servo—the second type of galvanometer—a second-order system is heavily damped (a ratio of about 5) to make its frequency response similar to that of a first-order system. Then, by addition of a first-order lead network, a stable system is realized, with flat frequency response, good damping and ease of control. Frequency and phase response are much superior to an equivalent second-order system, so it is possible to use only the torque constraint of Newton's Law to meet AHA performance.

Coupling is a problem

One difficulty with this type of pen motor is the need to generate a velocity signal free of any coupling with the drive current. The signal must then be amplified to give the needed damping. Moving-coil galvanometers, which cannot be built with torque-to-inertia ratios comparable to those of moving-iron, traditionally are constructed with an auxiliary velocity pick-off winding on the drive coil. But inductance effects—which increase with the second power of frequency—limit performance, especially at resonance where induced drive currents change phase relative to the velocity.

Moving-iron galvanometers can't be built this way because the mutual inductance of two coils on a common magnetic core is enormous—just as it is in a transformer.

The classic solution is to install a velocity pick-off that rides piggyback on the galvanometer and is sufficiently remote to be free of coupling. The Gould motor, for example, has an auxiliary, independent d'Arsonval movement that serves as a

tachometer; it is located approximately one inch away from the drive coil. Table 2 shows the performance of such commercial devices.

At present the cost of a recorder using a velocity servo is lower than that of a recorder of equivalent performance but using open-loop or position servos. This is especially true for battery-operated recorders.

The position servo—the third galvanometer type—separates the three functions of a classic second-order system so each can be controlled independently. The functions are: a torque generator, a position detector and a tachometer. Often the velocity signal, used for damping and stability, is derived from the position signal to ensure the accurate reproduction of the information.

Position devices have all the problems of velocity servos plus a few of their own. All signals must be added in adequate proportion and proper phase relationship. And corrections must be made for all detector and processor quirks.

Like the velocity servo, the torque requirement is defined only by Newton's Law. The major difficulty, however, is stability. If damping isn't introduced, the system destroys itself. Stylus motions and internal vibrations—which are detected by the position pick-off and amplified—tend to make the system "whistle" at various conditions. This is not only disturbing but can also cause fatigue failure of either the stylus or contact detectors, such as potentiometers.

Stability is achieved by various methods, such as the conventional spring return coupled with a very rugged, heavy stylus or use of a self-damped stylus. Or an additional velocity detector is sometimes used. Table 3 shows the performance of typical devices. ■■

SIEMENS

If you need a low cost T.C. Zener...

How about a Siemens 6.2V, 0.002% / °C for under 50¢*?

Siemens single chip Temperature Compensated Zeners have been reduced in price. Now you can apply these high quality devices where previously cost had precluded their use. What's the secret? Simple. We've coupled our single chip construction with highly automated testing techniques available at our Scottsdale, Arizona facility, and are passing our production cost savings on to you.

But Siemens single chip Temperature Compensated Zeners offer you more than reasonable prices. All devices have completely passivated junctions with a thermally grown silicon oxide. **These Zeners have the only fully protected single chip construction available on the market today.**

These low cost T.C. Zeners are available in the D.O.-7 glass package for the 1N821 through 1N829 and 1N4565A through 1N4584A series with JAN, JANTX, and JANTXV versions. They are also available in chip form. These are 6.2V or 6.4V devices with temperature coefficients in the range of 0.01 to 0.0005% / °C.

When you need a high quality, low cost Temperature Compensated Zener, think Siemens. Units are available from stock. Write us today for detailed data sheets and our new Zener Diode Quick Reference Guide.

**And, remember . . .
Where Quality Is The Measure,
Siemens Is The Rule.**

*1N825 1,000 piece quantity 48¢ FOB Scottsdale.

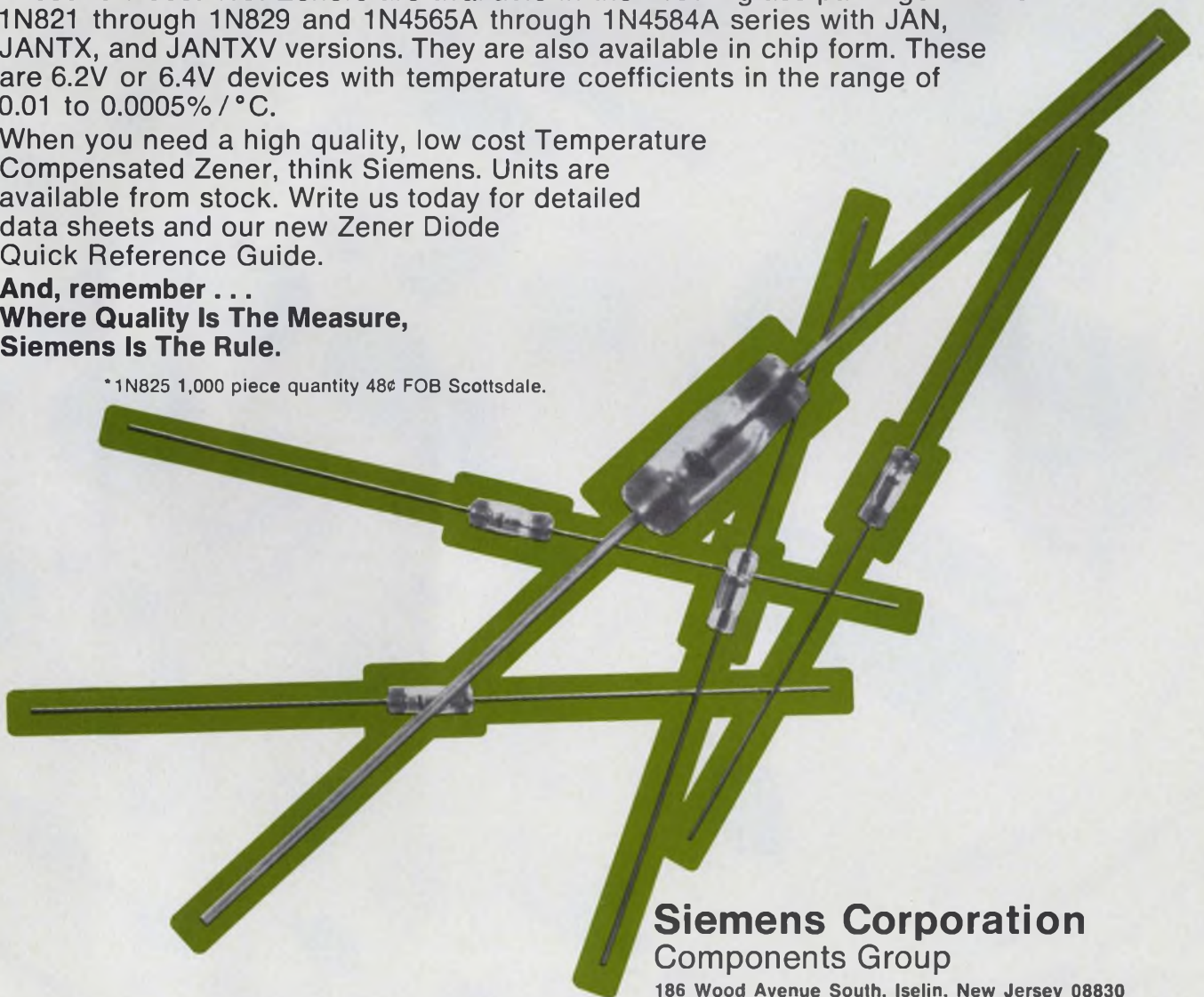

Siemens Corporation
Components Group

186 Wood Avenue South, Iselin, New Jersey 08830
Phone: (201) 494-1000 TWX 710-998-0588 Telex 844-491

INFORMATION RETRIEVAL NUMBER 51

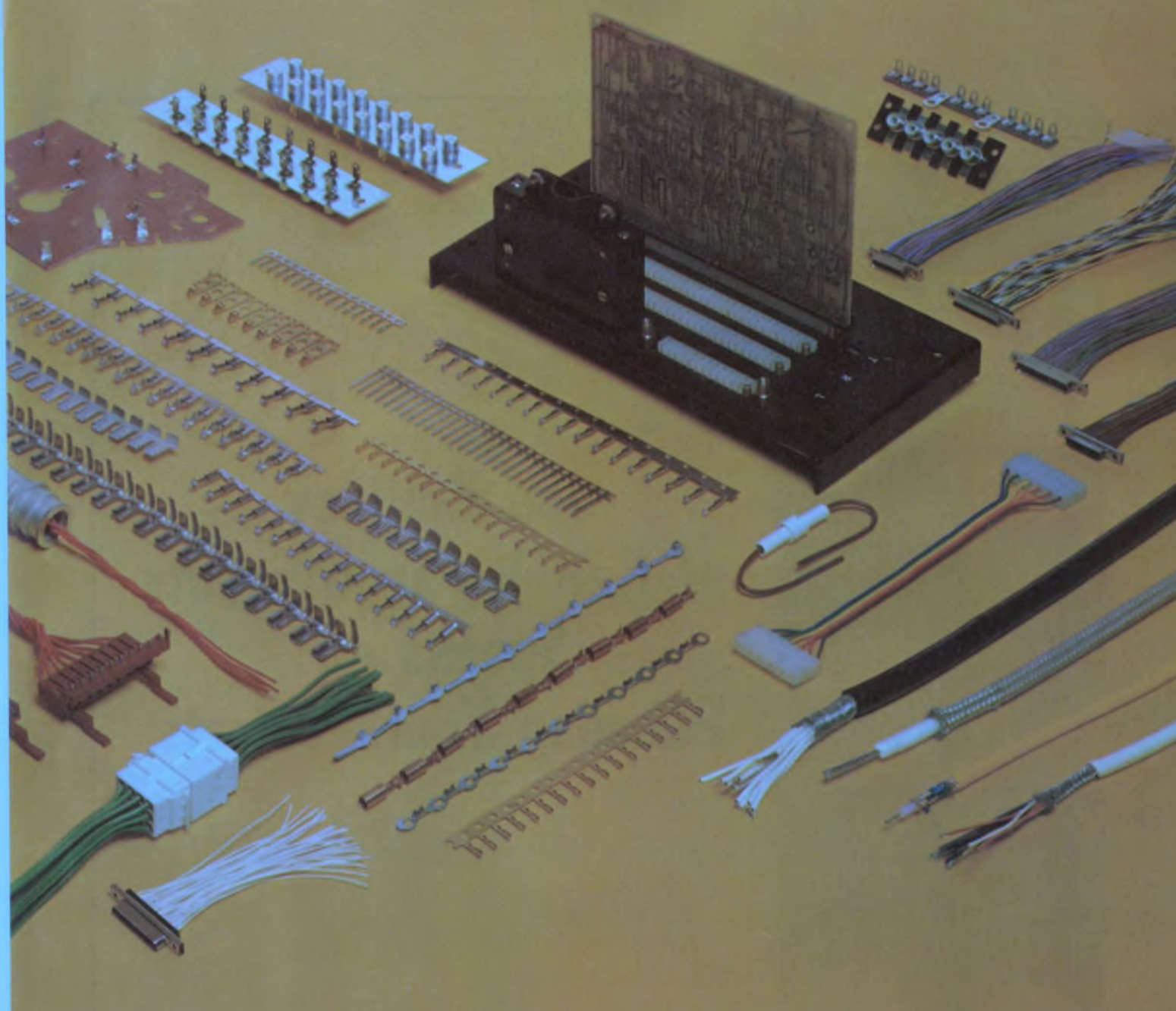

**Malco makes it all...
everything you see
and anything
you want to see.**

Malco makes it all. A complete line of quality connectors and terminals for every possible application. If you don't see it, ask for it. And if you're worried about the impossible, let us worry for you. Malco has a talented staff of engineering innovators who can develop the connectors you need to solve your interconnection problems.

If you've never looked at Malco before, look now. You'll find everything from back planes to the smallest micro-miniatures you can get anywhere, sophisticated or simple, the only contact you need for all your connectors. And when you look at Malco, you'll find prices that cut your costs, dependable quality, and service we don't renege on. Write Malco, 12 Progress Drive, Montgomeryville, Pennsylvania 18936 or call ... (215) 628-9800.

MALCO
A Microdot Company
Helping industry put things together.

INFORMATION RETRIEVAL NUMBER 52



Joe Keithley of Keithley Instruments Speaks on Planning Your Projects

Take a project to an engineer and he'll tell you it's, say, a four-month job. Maybe it is. But maybe it isn't. It might well take twice that long. And therein lies a problem.

Time can mean the difference between success and failure, profit and loss.

What you need, of course, are realistic estimates. But how do you get them? For starters, you get accurate, historical records describing work accomplished and the time each element took—the engineering man-hours. Of course, a sticky element comes in here—time cards. A

dirty word to the free-spirited engineer. But how else can you calculate engineering costs?

Almost any experienced engineer can look at an instrument and determine the materials cost. And you can probably make a close stab at the manufacturing cost. But the engineering cost—which, of course, is a very significant part of the over-all cost—is more difficult.

Time cards are a big help in determining the cost of engineering. When an engineer with time cards tells you he can do a project in four months and you ask him how come it took him 18 months on a previous project, he might be able to tell you. Using his time cards to measure

the number of engineering man-hours the entire project took, he might be able to remember what portion of the time each individual element requires.

There are probably things he can steal from earlier designs. So he subtracts this design time from the new project. Lots of circuits don't have to be designed twice. He might be able to swipe the display module from an earlier design and simply add another digit. If he designed a good attenuator on his last job, he can use it on this one.

Records alone, of course, aren't enough. You've got to use judgment. And that's what engineering managers are for. You still have to judge the person. You have to know which engineer tends to be optimistic and which is a pessimist. You have to know, for example, that the young engineer, when left to himself, may overlook certain time-consuming obstacles.

The young engineer—I'm speaking from personal experience—is terribly optimistic. He thinks he can do anything.

The young fellow out of school thinks he can do anything in no time at all.

He realizes that he can tweak some circuits to get a decent response. But tweaking can be costly when it's necessary to make many instruments on a production line. The more experienced engineer, even without making a worst-case analysis, knows what's necessary. He knows where he's been burned over the years.

Even the mature engineer can be over-optimistic on his time estimates, unless he is experienced in keeping track of time. If he's had that discipline, however, he'll be pretty good.

As a matter of policy, we try to encourage our engineers to think in terms of the time it takes to get things done. We're not always completely successful. Some guys think it's poppycock to spend so much time doing "book work." And there are engineers who feel that time-consciousness is too commercial and beneath their dignity. They want to deal with theory and equations, not with dollars. But these are the guys who get a year behind on their projects if you don't keep an eye on their progress.

But most of our people do a splendid planning job. They get their projects done when they promised, and their promises are realistic. They don't estimate "four years"; anybody can do things in four years. They establish good reasonable schedules, and they meet them. They are systematic, methodical engineers.

Of course, problems peculiar to a particular project often crop up. We know from time cards

how long it takes to create an instrument, but we can't tell from these records how long it takes to build part of an instrument—a particular circuit this project calls for. Here's where engineering management comes in. A manager might recall that an identical circuit was designed for another project he supervised. He finds out how much that engineering job cost and then subtracts the time and the cost from the project at hand.

A good manager can look back and know where to swipe an idea from an old project. But he also sees the pitfalls.

On the bright side, I remember using the same package for several different instruments. They were plastic housings. We saved money.



Then there was the power transformer designed for a popular instrument that we also used for several low-volume instruments. This was fine until the popular instrument was redesigned and a different transformer put in. What happened? The low-volume instruments that were getting a bargain ride with the high-volume transformer were left high and dry. The high-volume transformer became low-volume, and its price shot up.

Moral? Someone should be told when changes like this occur. Maybe the power transformer shouldn't have been changed, or maybe it should have been but the new transformer should also have been used in the low-volume instruments.

There were probably several good solutions, all better than letting the bill for the transformers come as a surprise.

This is one way an experienced engineer differs from a beginner. He thinks of the implications of everything he does.

Your managers should value money.

If you hire a technical genius who considers money beneath him, you have a problem. He'll be too lofty to measure time. But he may learn. People like to see their projects run smoothly and mesh. It's a good feeling when things happen on schedule and fit in with the schedules of other departments. You can push these advantages and help him to see the light.

Schools, incidentally, are not much help here. They don't teach us how long things take or how much they cost.

Even when people do start thinking about costs, it's amazing how many engineers will figure out the cost of a project and leave out their own time and salary. Sometimes I tell one of these fellows: "Hey, that's very nice. You're going to work for us free for the next few months?" This usually gets the point across.

Frankly, I had an advantage because I went to a school that stressed costs. Towards the end of our sophomore year we had to list all the equipment we used in the lab and go out and find out how much it cost. This was a real shocker. I remember my surprise that the decade-resistor box cost \$100. And those were the days when a year's tuition was \$500.

So here we make engineers conscious of time and money. After an engineer has designed an instrument, he prepares a parts list, which may include 300 parts.

We've had some problems in procedure to iron out. A fellow lists just the electronic components and ignores the housing or the switches, knobs or connectors—all of which cost money. We've had engineers who don't count things like resistors because "they're cheap." Or they feel they'll get tremendous quantity discounts on ICs but forget they're only going to build seven instruments a month.

Again, here's where a good engineering manager pays off. He trains his engineers to count dollars—even the small ones. Only then can he help make plans.

Once a fellow has a firm background in understanding the cost of things and the time it takes to build them, he can participate in planning.

The planning process starts when someone comes along and says: "Let's build a meter

Who is Joe Keithley?

Listening to him play the clarinet, Joe Keithley's mother decided that he was not cut out to be a musician. Instead, she noted, when he was 12 years old, the number of radios he had built by using cigar boxes, Boy Scout knives and galena crystals. She decided, then and there that Joe would study electrical engineering at MIT. And that settled that.

After he got his master's in EE from MIT in 1938, he went to work for Bell Telephone Laboratories in New York City. That was very good experience, he points out, because it taught him how to be methodical and how to design for a 30-year service lifetime. It also showed him how to work in a professional engineering organization.

He learned some practical things that he didn't quite master in school—like how to get oscillators to oscillate and bridges to balance. Using some of what he had learned from three of his MIT profs—Dr. Harold Edgerton, Dr. Kenneth Germeshausen and Dr. Herbert Grier, experts in stop-motion photography and later founders of EG&G, Inc.—Keithley used his spare time working with a photographer, Gion Mili. Together they used stop-motion photography to cover theater and sporting events.

In this activity, as the customer of his own designs, he learned the importance of making equipment that works when the customer wants it to work. He learned that it's not good

like . . ." Or somebody asks what kind of instruments you need to make a viable product line. You may get suggestions from the engineering department or the marketing department, or from friends on the outside—or, of course, from customers. Customers contribute some of your most important ideas.

A potential buyer may say about a product: "If only it had . . ." You have to be careful about acting on every suggestion. Your salesman may lose a sale because a customer wanted purple knobs. The salesman might then run in wanting you to redesign your whole line with purple knobs.

Ideas are easy. But at some stage you have to translate them into a proposal and then invest money. "Let's spend X dollars and investigate this"—that's when the thing gets serious.

Now, how do you turn a suggestion into a formal proposal?

Someone usually comes up with an idea that he is willing to carry through. "If we had a



Joe Keithley, right, holds frequent meeting with company president Thomas G. Brick.

enough merely to hope that the customer isn't bitten too badly.

In 1940, working for the Naval Ordnance Laboratory on equipment related to mine detection, Keithley was able to follow some of his designs from conception to implementation in war theaters. So he developed a further sensitivity to the reality of design. Most engineers, he points out, are too distant from

the users of their designs.

When he came home from the war in 1945, Keithley bought an HP oscillator, a DuMont scope, a Ballantine voltmeter, a General Radio impedance bridge and decade resistor boxes, an RCA Voltohmyst, a Simpson 260 VOM, a soldering iron, a drill press and some surplus work benches. He moved into an \$8.50-a-month shop with a leaky roof and started to build high-input-impedance isolation amplifiers.

He sold these to friends in Washington and elsewhere on the East Coast and did consulting work for General Electric in Nela Park (Cleveland).

1948 was a turning point, personally and in business. He got married, set up an office—in his bedroom, and acquired a secretary—his wife, Nancy.

Keithley's original high-impedance amplifier gave birth, in time, to electrometers, micro-voltmeters, digital multimeters and, more recently, data-acquisition systems—all of which contribute to an annual sales volume of some \$8-million for Keithley Instruments.

When not engaged in his duties as chairman of the board of Keithley Instruments (Thomas G. Brick is president), Keithley enjoys photography and collecting art. He has an extensive collection of lithographs. He likes sports cars, is a linguist (fluent French and German) and a patron of the Cleveland Symphony.

\$500 voltmeter with these particular features," he might say, "we could sell 50 a month for five years." If he's right, he's talking about a gross of \$1.5-million.

You then ask what it takes to get one of the boxes built. Looking back from the vantage point of a semi-scarred veteran, you recall that it took so many engineering dollars to build Model X, so many for Model Y and so many for Model Z. So you use your good judgment to decide how much the engineering for this one is likely to cost. Later you go to marketing and ask how many they can sell, then to manufacturing to find out what it will cost to tool up.

This we call preliminary screening. After this you're ready to move into the serious study phase. You do some real market research to find out if enough people out there really want the beautiful product you've dreamed up. And perhaps you design some prototype circuits.

So by the time you get to the study phase, you already have something written on strategy

and a fair idea on what it's going to cost for engineering, marketing and manufacturing. In addition, you have a fair idea of how many per month you're likely to sell and what the product's market lifetime will be.

Also, you'll have a decent idea of your costs for materials, labor and overhead. And you will decide pretty quickly that if your expenditures are close to your selling price, you're in trouble. Your selling price should cover all your costs over the life of the product, then leave something for the development of the next instrument plus something for the shareholders. That, in essence, is the plan for a new instrument.

By now you know how serious you should be about the project. You think, for example, that an investment of \$100,000 can get you a before-tax profit of \$300,000 over the product's lifetime. That sounds attractive enough. So you move on into the evaluation phase.

Here you check things more carefully, and you begin to catalog unknowns. Can you really

Dialight sees a need:

(Need: The widest choice for your every application.)



730 SERIES Your choice . . . a red or green LED readout with large 0.625" characters . . . low power, operates with standard IC power supply levels. Comes in plus-minus module. Display uses standard or high brightness LEDs for maximum light output arranged in a seven-segment format. Available with or without on-board decoder/driver. Unique lens design generates bright, highly legible characters.

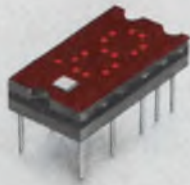

745-0007 LED hexidecimal display with on-board logic operates from 5 to 6 volt supply, low power consumption. Integral TTL MSI chip provides latch, decoder and drive functions. 0.270" character display has wide angle visibility and mounts into standard 14-pin DIP socket.



Dialight, the company with the widest choice in switches, LEDs, indicator lights and readouts, looks for needs . . . your needs . . . and then they develop solutions for your every application. No other company offers you one-stop shopping in all these product areas. And no other company has more experience in the visual display field. Dialight helps you do more with these products than any other company in the business, because we are specialists that have done more with them. Talk to the specialists at Dialight first. You won't have to talk to anyone else. Send for your free new copy of Dialight's current catalog.

DIALIGHT

Dialight, A North American Philips Company
203 Harrison Place, Brooklyn, N. Y. 11237
(212) 497-7600

See Dialight.

INFORMATION RETRIEVAL NUMBER 53

build the product for so many dollars? Will the zero drift really be so many nanovolts? And will you need terribly expensive input components to get low drift and low noise? Will a \$100 transistor be needed in the front end or will a 25-cent component do?

You decide to spend, say, \$5000 or \$10,000 to find out. Meanwhile marketing is trying to get a better fix on how many of these instruments are likely to be sold, to whom and whether they would fit into your regular distribution channels. If they don't, you want to know about that pretty quickly.

When your serious study phase is over, you are ready to define your project more precisely. By this time you've studied the competitive situation carefully and you know what features you want to include and what features you don't. You know your selling price and the number of instruments you're likely to sell. Manufacturing has told you it can build the instrument without having to build a whole new factory. And your engineers have done some testing and bread-boarding. "Yes," they'll tell you, "it looks like a pretty good shot." That's when you're ready to spend money to build engineering samples. So you begin converting rat's-nest wiring to printed circuits and ICs. And you're in the engineering development phase.

You manufacture a few engineering samples and call them demonstration units, and you show them to a few key customers who can give you some good advice on modifications. But watch out! Don't let a few customers "modify" you into a completely new design—unless your old design was really bad. And don't let one or two customers alter your design so that you won't be able to sell it to anybody else.

Finally, if you've done everything right, you can move smoothly into manufacturing and distribution. An important key to your success will be the carefulness of your planning and the accuracy of your time and cost records. But you need some flexibility, too. And here's where something we call short-step iteration comes into the picture. It allows you to step back from one phase to an earlier one when you see the need for modification. You don't want to adhere slavishly to a plan if it will lead to disaster—even if you get there on time. So if you think during engineering development, for example, that you have omitted a feature that could substantially increase the market for an instrument, then go back to the serious study phase and check into it more carefully.

These iterations take time and money. But if you plan for them and keep them short, their benefits will far outweigh their penalties. The road to success is paved with careful planning. ■■



The value engineers' connector
WEDGE-EZE™
cuts costs... automatically.

Combine low cost, fast assembly, wide versatility. Add superior electrical characteristics and outstanding performance. That's Wedge-Eze.

With only three parts, Wedge-Eze connectors can cut cable assembly costs up to 60% and their unique design virtually eliminates shorting inside the connector. Cable clamping is positive with allowance for wide tolerance variation of the cable used. Colored wedge caps differentiate cable sizes.

Wedge-Eze connectors mate with MIL-C-39012 connectors of the same series and can be used wherever a UG connector is specified. Available in numerous styles in series BNC, TNC, N and C.

Complete coupon for information and samples.

AUTOMATIC
CONNECTOR 

516/543-5000

Automatic Connector, Inc.
400 Moreland Road
Commack, New York 11725

I need Wedge-Eze connectors, send:

data sheets samples prices series _____

Name _____

Company _____

Address _____ Zip _____

Phone _____

1 subsidiary of **Arco** Electronics, Inc.

WEDGE-EZE™ Automatic Connector, Inc., Manufactured under U.S. Patent #3,264,602

A beautiful put-up
can wrap up a great saving

BELDEN 

... new ideas for moving electrical energy

INFORMATION RETRIEVAL NUMBER 234



To us, put-ups are more than shipping containers that get our wire, cable, and cords to you in performance shape.

Put-ups are also a potential source of cost reduction at your end. The "right" put-up usually pays off via reduced assembly time, longer runs, storage efficiencies, or less spoilage.

For example, there's our new cost-cutting UNREEL™ put-up.* A packaged wire dispenser. Wire flows freely stops instantly when pulling stops. No reel inertia to overcome. No snarls or backlash. No need for tensioning devices. No reels or spools to return or dispose of. Saves man hours.

With Belden, put-up analysis is part of our total engineering approach to the applica-

tion of wire, cable and cords.

When you're ready to explore the potential cost reduction of put-ups with Belden, you can benefit from our comprehensive applications support. We not only have the capability to provide all the standard forms where they work best, we also have developed proprietary techniques to meet a variety of usage needs. And if we can't optimize a put-up from standard and proprietary methods, we'll innovate one for you. For answers right now, phone:

(317) 966-6681, Electronic Division

(312) 887-1800, Transportation Division

(312) 681-8920, Electrical Division

Or write Belden Corporation, 2000 South Batavia Ave., Geneva, Illinois 60134.

*Available on a widening selection of Belden wire, cable and cordage.

H-3-4



Floating regulator gives 0.1% regulation over 0-to-100-V-dc, 200-mA range

For a continuously variable, high-voltage, floating regulator, you can't use most monolithic voltage regulators. They can handle output voltages to only 30 or 40 V. The regulator in the figure, however, can provide 0 to 100 V at load currents to 300 mA. Short-circuit protection is also included.

The circuit is powered by an auxiliary supply of 15 to 20 V at 40 mA. This supply must be isolated from the high-voltage input, V_{IN} . Pin 5 of an MC1723 is floated by zener Z_1 at a voltage of $V_{OUT} - V_{Z1}$ with respect to ground. This ensures an adequate common-mode range for the MC1723's internal error amplifier, A_1 .

The reference-voltage source, pin 4 of the MC1723, is used to derive a reference current, I_{REF} . The value of I_{REF} is given by

$$I_{REF} = \frac{V_{REF} - V_{BEQ1}}{R_6} \approx 1 \text{ mA.}$$

Transistors Q_2 and Q_3 form a "current mirror" whose output is equal to I_{REF} . This current flows through adjustable resistor R_1 to establish the output voltage, V_{OUT} . The output voltage is

$$V_{OUT} = I_{REF} \times R_1 \approx 1 \text{ mA} \times R_1.$$

Resistor R_1 can be set for any output voltage

from 0 to 100 V.

Resistors R_2 and R_3 form a voltage divider to provide a voltage at pin 2 that compensates for offset voltage at the input of A_1 . This offset voltage is

$$V_{R3} = (V_{REF} - V_{Z1}) \frac{R_3}{R_2 + R_3} \approx 18 \text{ mV,}$$

and it allows adjustment of the output voltage to zero.

The short-circuit current limit is set at 300 mA and can be safely drawn continuously. Diodes D_1 through D_3 , capacitors C_1 through C_3 and resistors R_4 and R_5 provide transient protection for the MC1723.

Load regulation of the circuit was found to be 0.1% for output currents from 0 to 200 mA. Better than 0.1% line regulation was obtained for $V_{AUX} = 15$ to 20 V and $V_{IN} = 105$ to 115 V. All measurements were taken at 20 C and $V_{OUT} = 100$ V.

Henry Wurzburg, Applications Engineering, Motorola Semiconductor Products, Inc., 5005 E. McDowell Rd., Phoenix, AZ 85008.

CIRCLE NO. 311

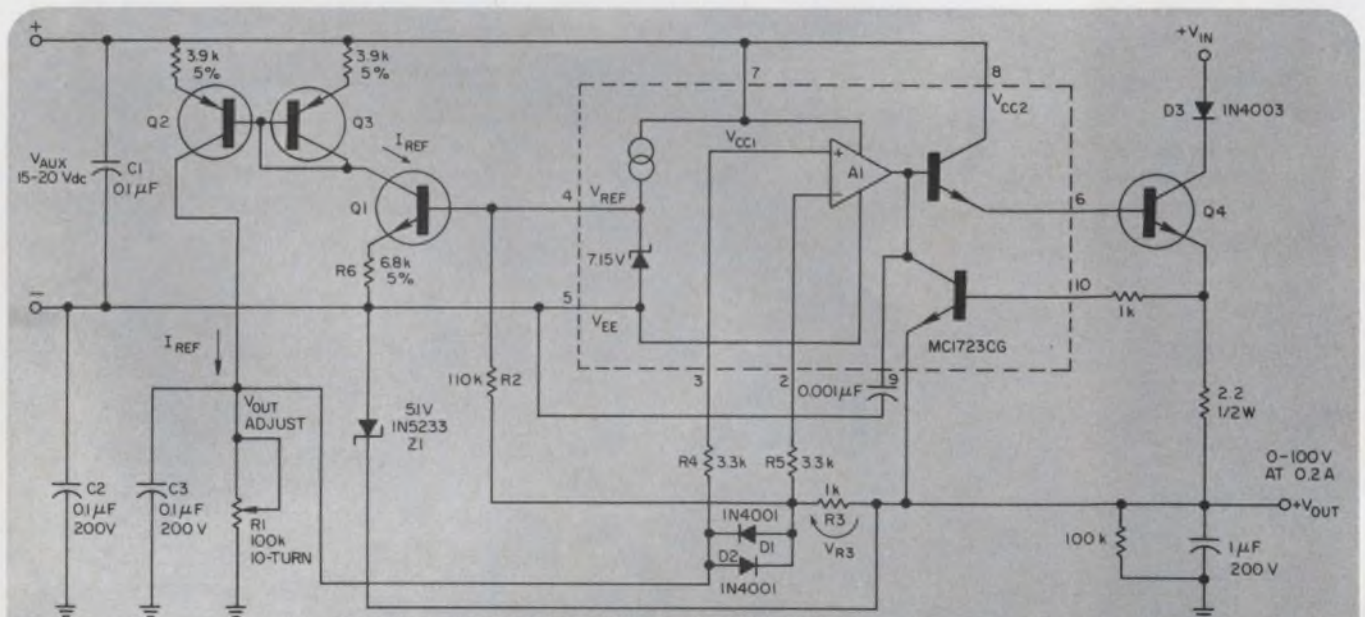

Q1 MPS5172 - Q2,3 MPS470 - Q4 MJ410, ON 3°C/W HEATSINK

The 0-to-100-V range of this floating regulator is adjusted by the 10-turn potentiometer, R_1 .

If you need panel instruments with **custom** dials, cases, accuracy, tracking, resistance, response time, or practically any combination of unusual specs...

Buy **Triplett's** designed-for-you **Panel Instruments**

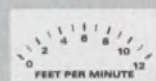
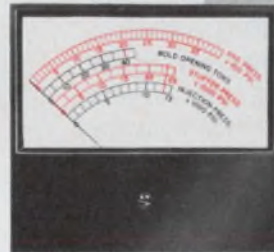
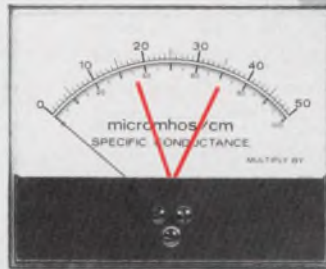
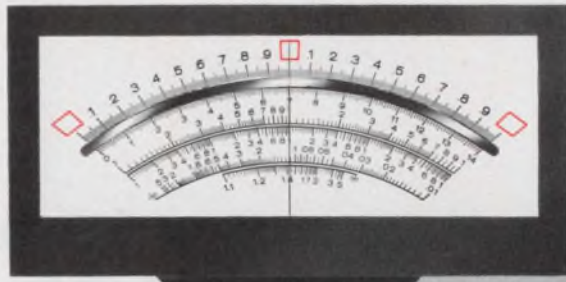

Although we stock some 1369 different styles, sizes and types of standard panel instruments, a very large proportion of our customers buy custom instruments.

Because they need:

custom dials

reading in such units as pH, roentgens, mm Hg, rpm, %, inches.

custom cases

square, round, rectangular, edge-wise (horizontal and vertical), wide, narrow, shallow.

custom accuracy

to within 1/2% with mirror scales and knife-edge pointers.

custom tracking

to match the specific needs of existing or new instrument designs.

custom resistance

for low circuit loading with tolerances as low as $\pm 1\%$.

custom damping

to meet stringent electrical and vibration requirements.

For instance, one of our customers had us design and manufacture a custom instrument to replace — in every detail of physical and electrical specifications — one which he was using on a delicate piece of medical instrumentation. Rejects from his previous source had risen to over 20%. He rejected only 3 of the first hundred we shipped — with almost negligible rejections from the many hundreds we've shipped since.

What custom panel instrument specifications do you need to make your

product more reliable, more accurate, more rugged and — in the long run — less expensive? For quick, dependable delivery of small quantities of Triplett's "designed-for-you" panel instruments, contact your Triplett Sales/Service/Modification Center. For prototypes or production quantities, contact your Triplett representative. He'll put you in touch with our Instrument Designers/Engineers who'll help you analyze the problem and suggest the optimum cost/result solution.

TRIPLETT
BLUFFTON, OHIO 45817
Manufacturers of the World's most complete line of V-O-M's

INFORMATION RETRIEVAL NUMBER 56

Match antenna over 1.5-to-30-MHz range with only two adjustable elements

The antenna matching circuit in Fig. 1 provides both the huge transformation range and the adjustment simplicity needed for short antennas, as in manpack transceivers. The circuit's impedance-matching range covers several decades. The worst-case antenna impedance is a combination of a highly capacitive load with extremely low ground loss—about 5000- Ω capacitive and 6- Ω resistive. At the other extreme, the load is slightly inductive and about 40- Ω resistive.

In addition, because manpack units are often used by people with little training, the circuit has only two variable elements, unlike conventional arrangements, such as Collins filters.

Impedance is transformed down in a 4:1 transformer from 50 to 12.5 Ω . The transformer consists of two parallel 50- Ω lines wound through a ferrite toroid. The ferrite should have a cut-off frequency of 10 MHz and an A_1 factor of at least 80 to achieve the Q necessary for wideband performance. The matching circuit that follows consists of a low-pass L-section filter paralleled with an inductance of 1 μ H and a 500-pF capacitor in series with the antenna.

The Smith diagram (Fig. 2) shows how the 1- μ H parallel inductance enables the circuit, at low frequencies, to transform impedances as low as 6- Ω resistive. At high frequencies, this inductor has little influence.

The 500 pF series capacitor allows use in the filter of a small variable shunt capacitor. Without the series capacitor, a shunt capacitor with a maximum value as high as 4000 pF would be required to cover the impedance range. In the circuit, less than half this value does the job.

A whip antenna has a capacitance of approximately 8 pF/m; a popular military 7-m whip has only about 56-pF capacitance. Thus the series 500-pF capacitor of the circuit doesn't appreciably affect such an antenna's capacitive impedance component. The effect of the capacitive or inductive component of long antennas and wide-band dipoles is reduced, however, by this series capacitor.

Ulrich L. Rohde, President, Rohde & Schwarz Sales Co., Inc., 14 Gloria Lane, Fairfield, NJ 07006. CIRCLE NO. 312

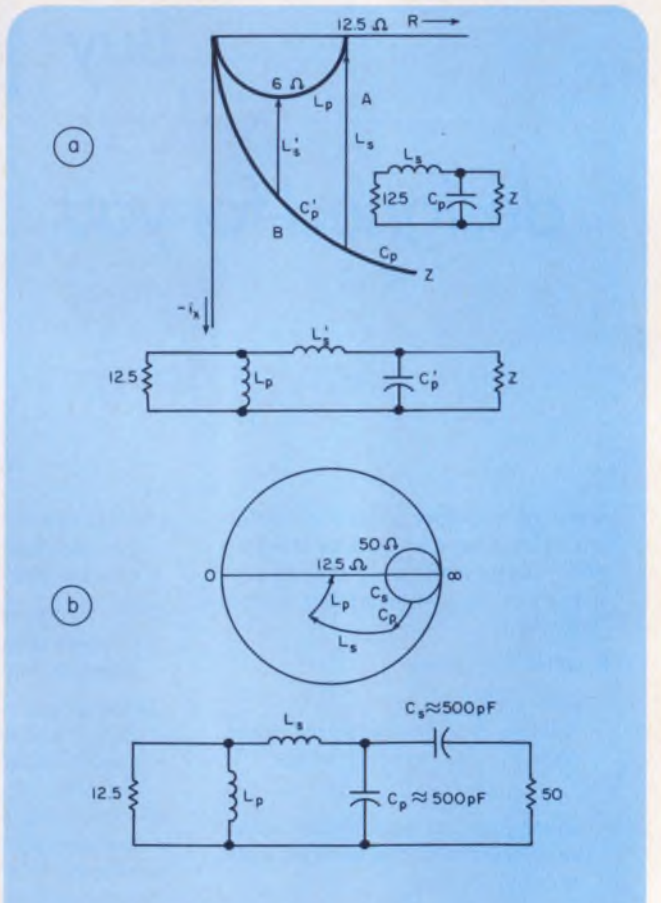
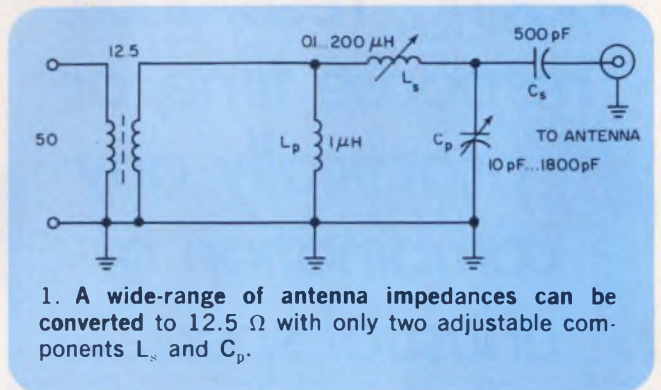

**Microprocessor technology has
brought you this far.**

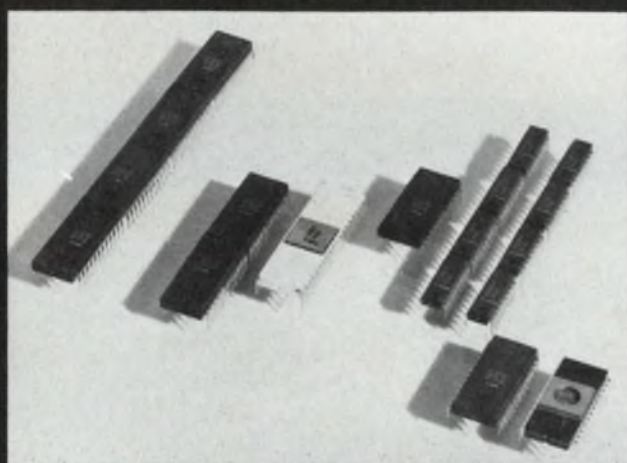

400-Hz power supply for servos delivers up to 0.5 A at 11.8-V rms

Very frequently the electronics engineer needs a power source to test his small servo-system designs. A common standard operating voltage for servo components is 11.8 V rms at 400 Hz. This peak-to-peak level of more than 35 V is too large a swing for electronic circuits built with standard monolithic op amps; these usually operate on only ± 15 V. But a high-voltage LM343H op-amp oscillator circuit with a discrete transistor output stage can easily deliver up to 0.5 A of 11.8-V-rms, 400-Hz power. The circuit operates conservatively on ± 24 V, since the op-amp's maximum is ± 40 V.

For amplitude control, two 1N4454 diodes provide the needed nonlinear action in the oscillator. The diodes are off-the-shelf and generally are more easily obtained than special light bulbs or

thermistors. The 47-k Ω resistor, in series with the diodes, limits their clipping action, so only a small amount of distortion results.

The frequency of the oscillator can easily be changed to 800 Hz if the values of the two 100-k Ω bridge resistors, R, are halved. The frequency is given by

$$f = \frac{1}{2\pi RC}$$

And the circuit can provide higher outputs by operating with a ± 38 -V supply.

Henry Olson, Stanford Research Institute, 333 Ravenswood Ave., Menlo Park, CA 94025.

CIRCLE No. 313

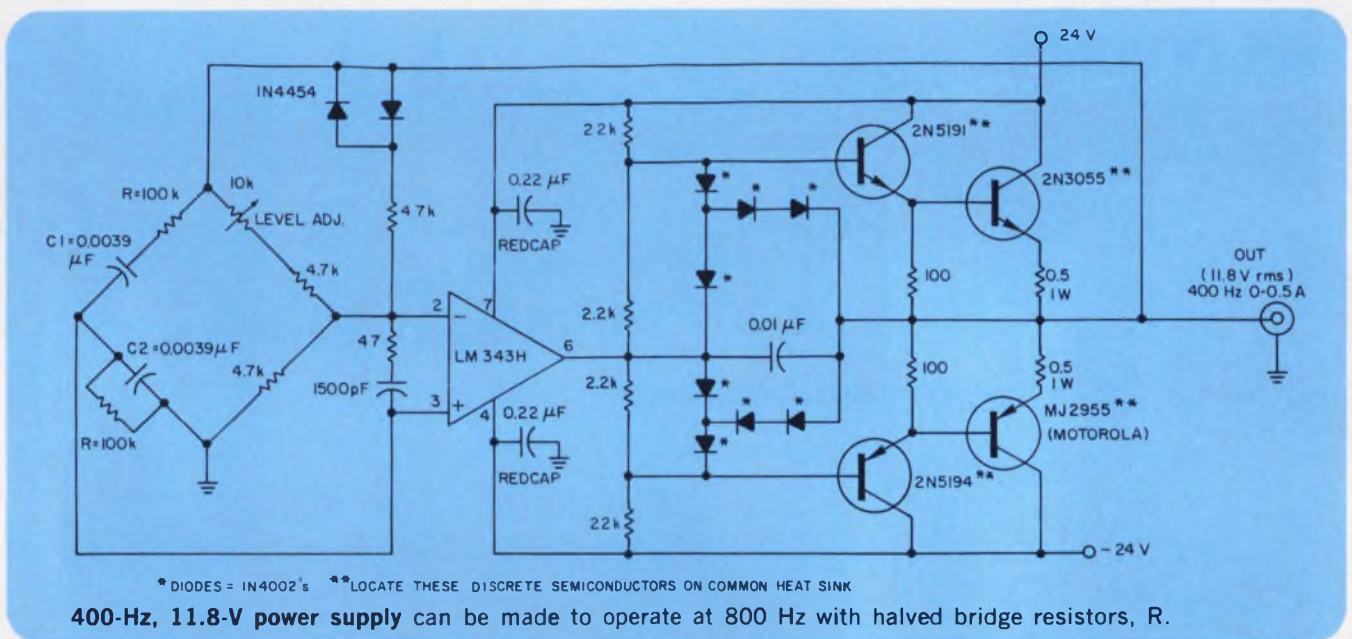

IFD Winner of May 10, 1975

Jim Wyland, Signetics Corp., 811 E. Arques Ave., Sunnyvale, CA 94086. His idea "Power Op Amp Provides ± 100 -mA Output and Up To 100-V/ μ s Slew Rate" has been voted the Most Valuable of Issue Award.

Vote for the Best Idea in this issue by circling the number for your selection on the Information Retrieval Card at the back of this issue.

SEND US YOUR IDEAS FOR DESIGN. You may win a grand total of \$1050 (cash)! Here's how. Submit your IFD describing a new or important circuit or design technique, the clever use of a new component or test equipment, packaging tips, cost-saving ideas to our Ideas for Design editor. Ideas can only be considered for publication if they are submitted exclusively to ELECTRONIC DESIGN. You will receive \$20 for each published idea, \$30 more if it is voted best of issue by our readers. The best-of-issue winners become eligible for the Idea of the Year award of \$1000.

ELECTRONIC DESIGN cannot assume responsibility for circuits shown nor represent freedom from patent infringement.

Now, go all the way...

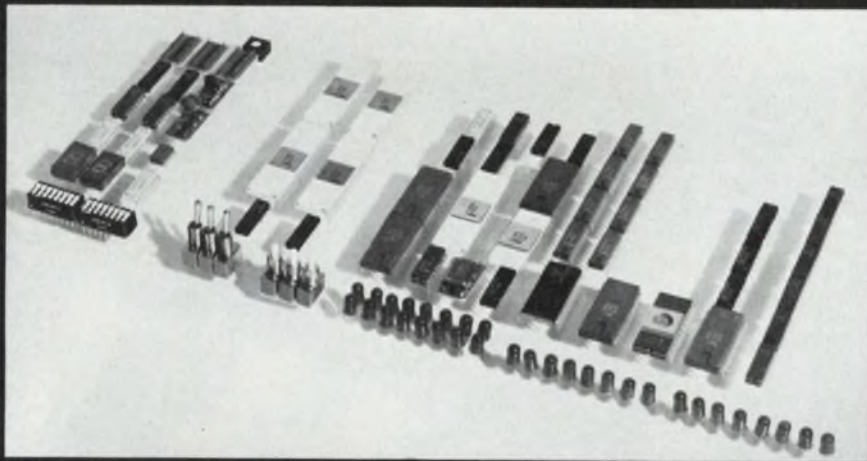

with the only microcomputer kit
with real guts.



cram

Cramerkit. The first microcomputer kit with enough capacity to solve real problems and with detailed design documentation and software so simple that it can be wired and used immediately. Each kit includes all the components you need as well as a full schematic so you don't have to spend valuable time before you begin. Here is a microcomputer concept so bold that only Cramer dared develop it. And a design so thorough that only Microcomputer Technique could have conceived it. This is the product you'd design for yourself if you had the time and experience.

You can design any microcomputer you need with your Cramerkit. Start with the clean, clear configuration included in the Cramerkit. Then, add your own expertise and experience to create a unique and personalized microcomputer designed for your particular application. You can be as fancy or as simple as you like.

Even if you've never programmed before, you'll be able to use the Cramerkit. Of course, if you have done some programming, you'll be impressed by the power added to the kit's basic microprocessor. The software furnished in each Cramerkit is both useful and comprehensible.

There's enough input/output and memory capacity in each Cramerkit to implement a point-of-sale terminal, an instrument controller, a data communications interface, an industrial robot, a sophisticated game, or a complex sequencer. You can replace 50 to 1000 TTL chips, 25 to 800 relays or great carloads of electromechanical gadgetry.

Because you are already active in the field, you're likely to have your own power sources and favorite packaging materials. We encourage you to use them. However, supplementary kits, optional power supplies and wire-wrap panels, cards, and cages are available from Cramer.

Cramerkits are the most economical and least painful way to build microcomputers. All you pay for are the basic parts. But look at all you get: **MICROPROCESSOR** — Your choice of the most popular microprocessors available: Intel 8080A, Motorola M6800, T.I. TMS 8080. Coming soon: AMD 9080, MOSTEK F8, RCA COSMAC and bipolars using the T.I. SPB 0400, AMD 2901, Intel 3001, and Motorola 10800.

RAM — 1024 eight-bit bytes for your own programs and data, expandable up to 65,536 bytes (and decoding is provided for the first 16,384 bytes).

EROM — 1024 eight-bit bytes in a preprogrammed erasable chip. That means you have software to start with and later change or replace.

I/O — at least four input and four output ports, each eight bits wide (expandable up to 512 ports with decoding for 16 included).

SUPPORT CIRCUITRY — including master clock, complete buffering, control and synchronization logic, interrupts, DMA controls... everything needed to fully utilize and easily expand the microprocessor.

CONTROLS AND DISPLAYS — Switches, LED's and hexadecimal displays let you control and watch everything in real-time or as slow as you want.

INTERFACES — circuitry and software are provided to help you program

through front-panel switches and LED's, a teletypewriter, any RS-232 compatible terminal and cassette tapes. **SOFTWARE** — the erasable ROM contains a system monitor that makes your microcomputer useful as soon as you turn it on. Programs can be entered, modified, examined and executed under control from switches or typed commands. A cassette full of other useful programs is included to help you debug and demonstrate your microcomputer.

USER'S MANUAL — it explains everything you need to know about your microcomputer, with hints on programming and how to expand it to your special needs. It's complemented by a wallchart schematic for your ready reference. You also receive the manufacturer's manuals on the microprocessor itself.

One would think that, with millions of dollars worth of technology plus thousands of dollars in design time, these kits would be prohibitively expensive. You be the judge.

Intel 8080A	Regular Parts Cost depending on the quantity ordered would total as high as \$746.00	Cramerkit pricing including 59 different devices totalling almost 200 parts and all software is only \$495.00
T.I. TMS 8080		
Motorola 6800		

Where can you get a Cramerkit? Simply ask your local Cramer salesman or call collect to our headquarters Microprocessor Design Center at (617) 969-2175 for more pricing and ordering information.

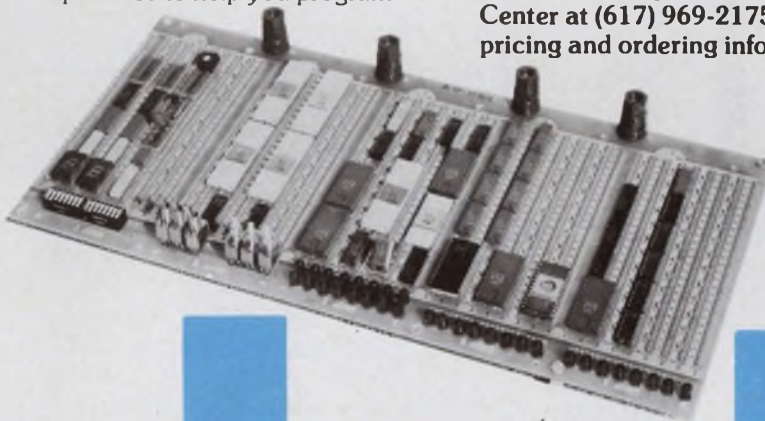

erkitTM

Avalanche circuit gives fast-rise pulses

High-power, fast-rise pulses have been produced by a circuit designed at the Institut für Elektronik of the Ruhr University, West Germany. Developed in collaboration with Dornier System GmbH in Friedrichshafen, the circuit gives pulses with a rise time of 150 ps and a fall time of 200 ps. The pulse duration can be varied between 0.3 and 120 ns, while maximum amplitude is maintained at 15 V.

Use of avalanche transistors—epitaxial silicon planar transistors working in the avalanche-breakdown mode—provides the high speeds. In a conventional avalanche-transistor circuit (Fig. 1),

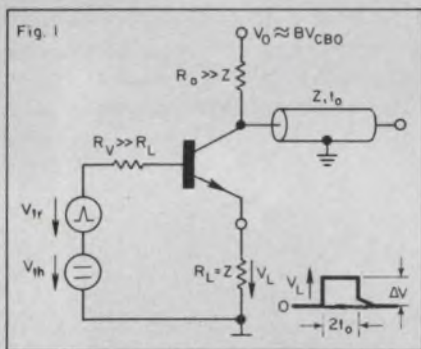

Bubble memory needs only one mask per chip

An experimental bubble memory requiring only one mask per chip instead of the usual three or more has been produced at Philips Research Laboratories, Eindhoven, the Netherlands. Writing, reading and erasure are achieved by temporary changes of the sense of rotation of the drive field. Bubbles are propagated in the new memory by means of the well-known Permalloy T-bar structures, while special transfer switches have been incorporated

with a delay-line pulse shaper (Z), the triggering pulse, V_{tr} , causes the transistor to discharge the delay line through R_1 . The pulse is terminated by the reflected pulse turning the transistor off.

The new German circuit (Fig. 2) uses a second transistor (T_2) to provide the turn-off pulse. The delay line between X_1 and X_2 de-

ouples the two transistors. Duration of the pulses is determined by the time difference between trigger pulses at the bases of T_1 and T_2 , which can be varied by monostable multivibrator MM_2 . Additional circuit elements— R_1 and L plus C and the 50- Ω resistor—further improve pulse shape. A clean 0.3 to 120-ns pulse results.

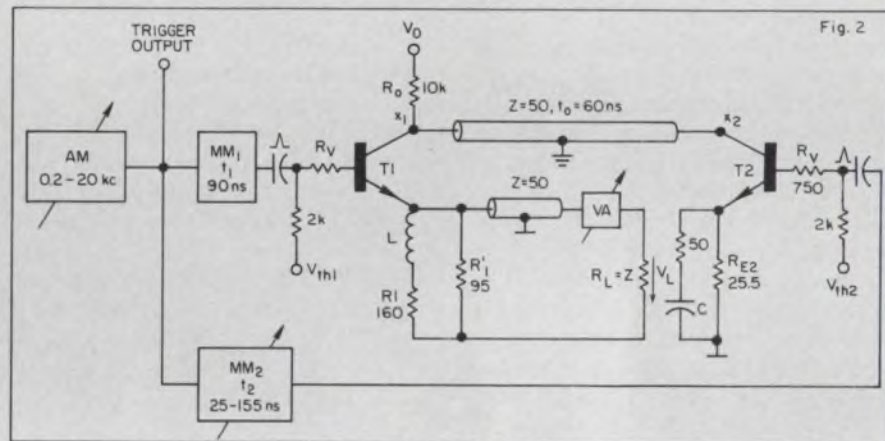

to perform writing, erasure and transfer between the major and the minor loops.

Bubbles originating from the generator can be passed selectively into the major loop and can circulate inside the loop. Storage can take place in a parallel manner in various sub-loops, and the bubbles can be switched to these loops by activation of the input switches, which control the sense of rotation. Reading is a reverse operation in which the bubbles are switched from the storage loops to the main loop.

Compared with a conventional current-controlled bubble memory, the Philips prototype has a somewhat longer access time for writing and erasure, and the bit density is less.

Monolithic inductors operate up to 6 MHz

Monolithic IC inductors that operate at 4.43 and 6 MHz have been developed at the Mullard Research Laboratories in England. Gyrator circuits were used in combination with integrated junction capacitors.

The new circuits are reported to provide resonators with Q_s up to 30 and trap circuits with rejection of better than 40 dB. Each resonator employs 15 transistors and occupies a 1-mm² chip.

The experimental circuits combine five resonators to make a single-chip TV filter that is able to separate luminance, chrominance and sound i-f signals. The filter is tuned by variations in the bias voltage on the junction capacitors.



A whole new crop of trimmers to pick from.

Mature, fully developed, and at their peak. It's our family of ceramic trimmers.

All of them offer good stability, a variety of capacitance ranges, ceramic stators, linear tuning, and a precision rotor.

• Our Micro-J Capacitor is the Cadillac of the group, and features high performance, monolithic design, and horizontal and vertical PC and stripline mounts.

Our Micro-K Capacitor is the newest member of the family. Tiny enough for quartz watches. And it has a precision lapped titanate stator and finely machined brass rotor.

Our 10mm model is low cost and mounts interchangeably with similar ceramic disc trimmers.

The 5mm type is even less expensive and can be used in the same applications as monolithic types where maximum stability isn't required.

Just send in the coupon for more information about our newest crop of trimmers. We think they're ripe for the times.

E. F. Johnson Co./ED 9/Waseca, MN 56093

Please send me technical information.

I desire test samples. Please call me at

()

Area Code

Name _____

Title _____

Firm _____

Address _____

City _____ State _____ Zip _____



E. F. JOHNSON COMPANY
WASECA, MINNESOTA 56093

Status symbols



**the first thing
pushbutton controls
indicate is the
quality of your product**

In a world where first impressions mean so much, why settle for esthetically (and functionally) inferior pushbutton switches, when you can choose EAO pushbutton controls at competitive prices? EAO holds the line on price, AND quality. With EAO on your panel you don't have to accept second-class appearance or performance... hot spots, fuzzy legends, tinny-looking bezels, uncoordinated configuration and size, and faulty human engineering. EAO controls enhance your product.

And EAO gives you complete design freedom. You can select mechanical or electronic switches... combine up to 9 lens colors with bezels in rectangular, round, square or dual

rectangular shapes... choose switch and contact combinations from 1 to 4 poles momentary or alternating action... even harmonize the full range of lighted and non-lighted pushbutton controls with compatible key lock designs.

Available contact arrangements and contact materials have ratings from low-level to 10A @ 250 VAC. No matter how complex or wide-range your needs, EAO Status Symbols allow you to single-source all requirements.

Write or call today for samples, technical data, and prices on these and other Unimax LPB switches. Unimax Switch Corp., Ives Road, Wallingford, Connecticut, 06492; Tel. (203) 269-8701.

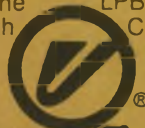

Unimax Switch

INFORMATION RETRIEVAL NUMBER 61

1024-bit NMOS RAM offers bipolar speed at low power

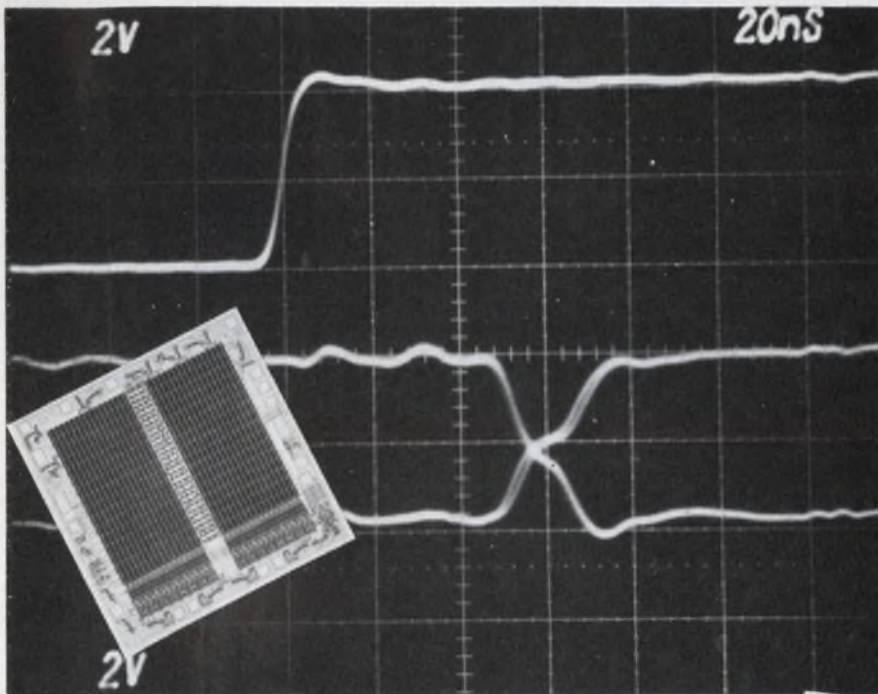

Intel, 3065 Bowers Ave., Santa Clara, CA 95050. (408) 246-7501
P&A: See text.

A new RAM, with MOS density and low-power operation, competes with bipolar memories for many high-speed cache applications. The MOS alternative provides an access time of less than 100 ns with dissipation of less than 600 mW.

Intel now offers the 2115-2, an NMOS 1024-bit random-access memory with worst-case access time of 70 ns and dissipation of 525 mW, max. The memory is fully static and works off a single 5-V power supply. It comes in a standard 16-pin ceramic package (with a plastic version to follow soon).

At present the cache-memory field is dominated by the 93415 Isoplanar bipolar memory from Fairchild, Mountain View, CA. Intel's new memory is pin-compatible with the 93415, which has

the advantage of many thousands of units in the field and strong product acceptance, but the disadvantage of 815-mW, maximum dissipation.

Other bipolar alternate sources for the 93415 include the IM5508 from Intersil, Cupertino, CA, and the 82S110 from Signetics, Sunnyvale, CA. While the Signetics memory is identical to the Fairchild in power dissipation, the Intersil dissipates 630 mW.

About to enter the fray is the bipolar AM93415 from Advanced Micro Devices, Sunnyvale, CA. This will be similar to the Fairchild memory, but details on it are as yet unreleased.

A pair of CMOS memories—the IM6508A-1 from Intersil and the TA6780 from RCA, Somerville, NJ—are also challenging the 93415. However, both require more than 5 V to get anywhere near speeds

of the Intel unit and the competing bipolar memories.

Intersil's CMOS chip requires 11 V to get down to 90-ns access time. But it dissipates only about 10 mW. In addition it has a standby mode, where it dissipates only a few μ W. The RCA TA6780 only gets down to 120 ns at 10 V. It dissipates 20 mW. RCA says this memory will be down under 100 ns in a few months. Both of these CMOS devices are pin-compatible with the 93415.

There are a whole flock of quasi-static MOS chips on the market. Some are as fast as or faster than the 93415, but all require more than one power supply, and they are not pin-compatible with the 93415 and are somewhat more difficult to use.

Versions of the 2115 are available with max access times of 70 ns, 90 ns and 120 ns. These have open collector outputs and sell, in 100-999 quantities, for \$28.00, \$17.95 and \$16.95, respectively. Three-state output versions are also available at each speed.

The 93415 sells for \$28 in the same quantities. Up in the 100,000-quantity range, where prices are negotiable, both the 93415 and the Intel memories will sell in the vicinity of \$7 to \$8.

All devices are specified to operate a 0-to-70-C range.

The outputs on the 93415 and Intel chip can both handle up to 10-TTL loads.

Intel	CIRCLE NO. 306
Advanced Micro Devices	CIRCLE NO. 307
Fairchild	CIRCLE NO. 308
Intersil	CIRCLE NO. 309
RCA	CIRCLE NO. 310
Signetics	CIRCLE NO. 320

INTEGRATED CIRCUITS

Keyboard encoder creates custom codes

Electronic Arrays, Inc., 550 E. Middlefield Rd., Mountain View, CA 94043. (415) 964-4321. \$9.90 (100); stock.

The EA2030, a 99-key four-mode encoder, simplifies the customer-encoding of keyboards. The IC identifies each key and mode with a sim-

ple binary number. With that binary input, a PROM may be programmed within a few hours. The IC features a 10-bit code output, an on-chip clock generator, built-in keybounce suppression, complete N-key rollover, electronic shift lock, error detection for simultaneous key depressions, complete compatibility with TTL logic signals and operation with standard +5 and -12-V supplies.

CIRCLE NO. 326

μ P costs plunge while versatility increases

MOS Technology, Valley Forge Corporate Center, Norristown, PA 19401. (215) 666-7950. P&A: See text.

A full 8-bit microprocessor for under \$20 in unit quantities? That's right. MOS Technology has developed the MCS6501—a microprocessor chip that is pin compatible with the MC6800 microprocessor developed by Motorola.

The pin compatibility of the MCS6501 permits the use of existing parts which are not available from MOS Technology yet, but a complete range of RAMs, ROMs and I/O devices is under development. Programming, though, is not interchangeable between the Motorola unit and the MCS6501.

Addressing features of the MCS6501 include true indexing, two types of indirect addressing and two index registers. These features are claimed by MOS Technology to make the MCS6501 outperform all other 8-bit microprocessors on standard industry benchmarks.

The unit operates from a single 5 V supply and is fully TTL compatible. This permits simplification of much supportive circuitry. The MCS6501 is built by use of n-channel, silicon-gate, ion-implanted, depletion-load processing.

A cross assembler and a Fortran-like emulator will be available shortly for user purchase or rental on time sharing networks. The microprocessor is available from stock.

Booth No. 1010 Circle No. 327

12-bit CMOS register simplifies ADC

National Semiconductor Corp., 2900 Semiconductor Dr., Santa Clara, CA 95051. (408) 732-5000. \$7.45 (100); stock.

A 12-bit successive-approximation register contains all of the digital control and storage needed for a 12-bit ADC. The MM74C905 operates over a supply range of from 3 to 15 V, and has a guaranteed noise margin of 1.0 V. The register can be expanded or truncated, and it functions in either a start/stop mode or in a continuous-conversion mode.

CIRCLE NO. 328

Give 'em hell.

They can take it. And come back for more. Beautifully.

You've spent a great deal of time and money designing your equipment to work in the field. That means unpredictable conditions, rough handling and plenty of abuse. And when your product is 200 miles from the nearest service center, it had better work.

Give it the extra protection of Zero Centurion™ carrying cases, combining the best in classic styling with rugged durability. Durability that's been proven by people like yourself in environmental extremes around the world.

Choose from 59 standard sizes for two week delivery A.R.O., with unlimited modification capabilities. And the price is surprisingly low. Consider it low cost life insurance on your equipment.

Write for your free catalog today.



The Final Touch



ZERO MANUFACTURING CO.

Burbank, CA 213/846-4191 · Monson, MA 413/267-5561 · Clearwater, FL 813/531-8991

8-bit DAC ensures monotonicity

Analog Devices, Route 1 Industrial Park, P.O. Box 280, Norwood, MA 02062. (617) 329-4700. \$5.95 to \$8.55 (100 up); stock.

A monolithic 8-bit d/a converter, the AD559, uses thin-film resistors to provide 2 ppm of FSR/°C differential nonlinearity tempco. Hence, monotonicity can be guaranteed over the full operating temperature range. Also the unit has a maximum initial accuracy of $\pm(1/2)$ LSB, and a maximum zero error of 200 nA. Internal compensation is provided. The AD559 can replace Motorola's Model 1408/1508 DAC.

CIRCLE NO. 483

Encoder provides 10⁷ programmable codes

TMX, Inc., 250 Park Ave., New York, NY 10017. (212) 661-9400.

The TMX 2141, an IC pulse-width encoder housed in a 14-pin DIP, can supply over 10-million discrete codes, each a unique combination of five pulses. The width and sequence of each pulse are programmed with external RC networks. The encoder includes a clock-pulse generator and a binary counter that provides the following: seven counts for "clear," starting times for the five pulses and "steps." Also contained are five one-shot delay circuits and an intergroup delay generator.

CIRCLE NO. 484

4-MHz CMOS clock IC uses single supply

Intersil, Inc., 10900 N. Tantau Ave., Cupertino, CA 95014. (408) 257-5450. \$4.40 (100-999).

The ICM7049 CMOS quartz-clock circuit operates at 4 MHz and uses a single 1.5-V battery instead of the standard two-battery supply. Thus power consumption, size and cost of quartz clock modules are reduced. Using a 4-MHz quartz crystal, the ICM7049 consumes approximately 25 μ A of current from a 1.5-V power source. Operation is guaranteed to 1.2 V over the temperature range of -20 to +70 C. The new clock circuit pulses a unipolar stepper motor once a second.

CIRCLE NO. 485



RUBIDIUM OSCILLATOR MODEL FRK - H/L

... but we did invent the world's smallest/most accurate atomic frequency standard.

Incredibly precise time-keeping frequency control and position information can now be derived from a rugged 4 inch cube, 2.9 pounds, priced as low as \$3000. Hundreds of units have been proven in service over a 4 year period.

Write for complete information.

Time and Frequency Systems

EFRATOM
CALIFORNIA, INC.

3303 HARBOR BLVD., SUITE E1-E2
COSTA MESA, CALIFORNIA 92626
(714) 556-1620 • TWX 685-635

Atomic Frequency
Standard, Model FRT



Digital Clock, Model EDU

Standard + Receiver/Controller
Model EFR - FRT

In West Germany :

EFRATOM 8 MUNICH 90 • LANGOBARDENSTR. 7 • PHONE (089)647138
TELEX 529701 EFRAD - D

INFORMATION RETRIEVAL NUMBER 63

Thirty years of designing and manufacturing cord sets, wire and cable has given us the kind of experience which can solve your problems. Whether you are stumped by a complex design requirement or a sticky cost situation, our engineering and production staffs can come up with the right answers. In fact, many of our now standard designs were created as solutions to specific customer problems. And, our reputation for ingenuity is equalled

only by our reputation for quality.

Test us with your special requirements. You'll discover why Victor has become the standard of quality in cord sets and other wire specialty items.

Victor Electric Wire & Cable Corp.
 618 Main St., West Warwick, R.I. 02893
 Telephone: 401-821-1700
 TWX: 710-382-1534



There is no limit to our capability in cord sets or wire & cable!

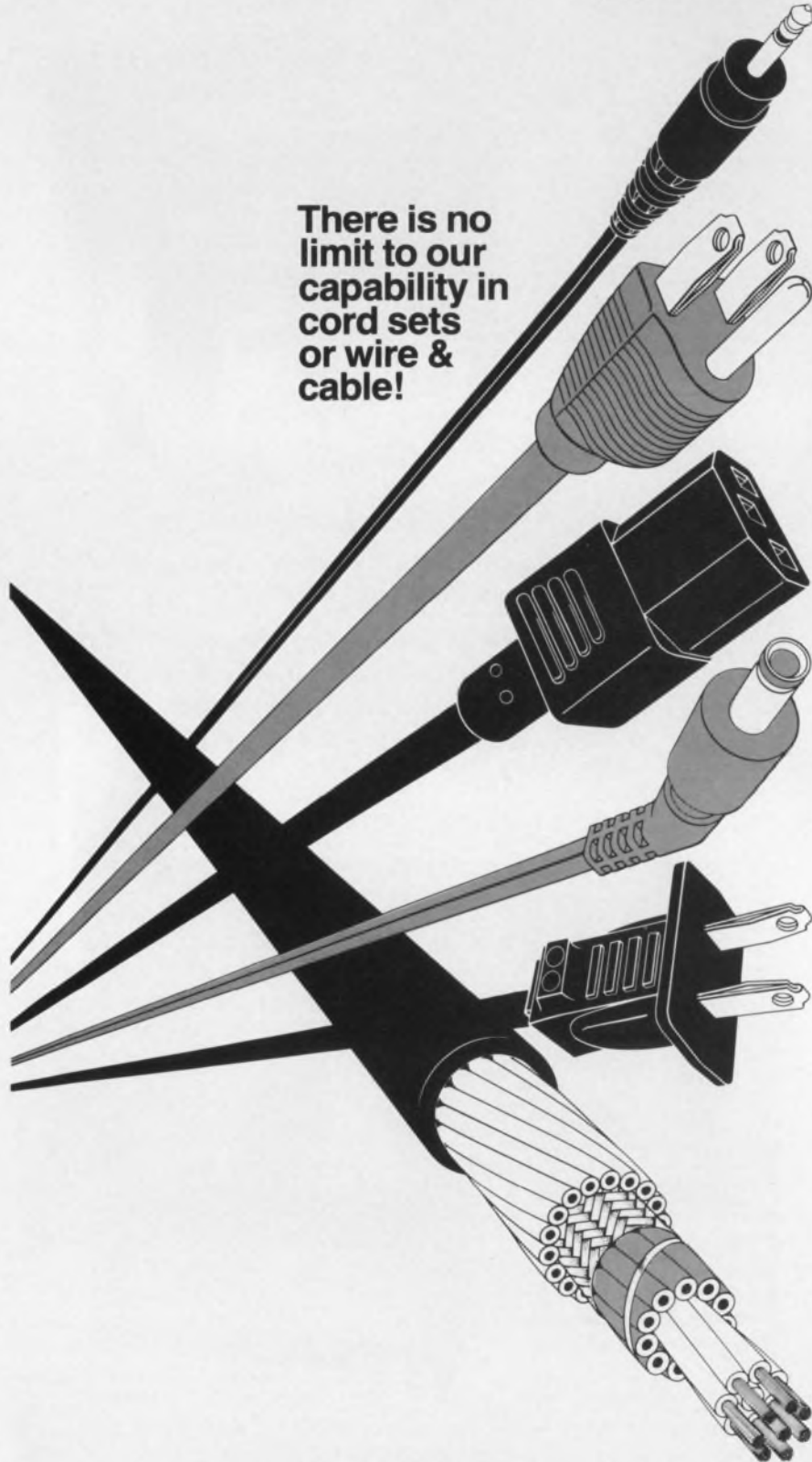

INTEGRATED CIRCUITS

1-k static RAM accesses in 70 ns

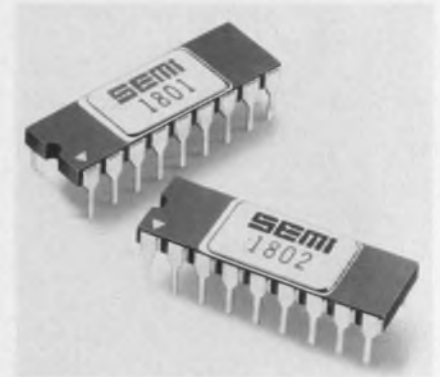

EMM Semi, 3883 N. 28th Ave., Phoenix, AZ 85017. (602) 263-0202. \$6 (1000).

Two 1024-bit static RAMs have access times of 70 and 90 ns—the 1802 and 1801, respectively. The 1801 features TTL-compatible inputs and outputs, and the 1802 features two complementary data-out signals that can be used to drive a differential amplifier. Both memories are organized as 1024 words by one bit, and they come in standard 18-pin DIPs.

CIRCLE NO. 329

LSI circuits extend Isoplanar CMOS line

Fairchild Integrated Circuits Group, 464 Ellis St., Mountain View, CA 94042. (415) 962-3816.

The company's 34000 series of Isoplanar CMOS circuits now includes four LSI chips: the 34702 programmable bit-rate generator, 34720 256-bit RAM, 34710 16 × 4-bit clocked RAM, and the 34731 quad 64-bit shift register. The 34702 generates all 13 commonly used bit rates with an on-chip oscillator and an external crystal. One 34702 can control up to eight output channels. The 34710, a static read/write memory, feeds a clocked output register and provides bus-oriented, three-state outputs. The 34720 RAM operates over a voltage-supply range of 3 to 15 V, and it has a typical access time of 80 ns at 10 V. Each of four independent static 64-bit shift registers in the 34731 operates from dc to 4 MHz, and each has separate clock, input and output, and direct TTL-logic drive.

CIRCLE NO. 330

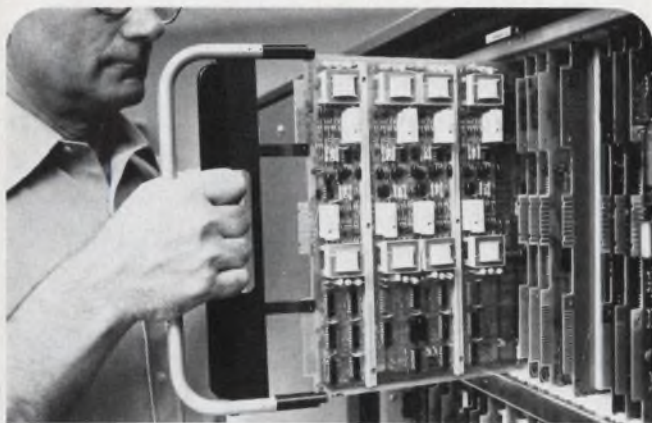

END CIRCUIT BOARD DAMAGE

Protolab extractors protect expensive circuit boards by positive "balanced force" removal. They exert equal pressure against the card cage and board for smooth, even release. They are fast, certain, convenient . . . and boards stay on the extractor so they won't be dropped on the floor. Pin-mounted Protolab extractors are ideal for large PCB's, or boards with test points, connectors and components mounted near the front edge. Ask about a Protolab extractor for your equipment.

PHONE COLLECT TODAY FOR PRICES (415) 961-8033

PROTO LAB

295 Polaris Avenue
Mountain View, California 94043

INFORMATION RETRIEVAL NUMBER 65

GaP LED Snap-In Indicators from OSHINO LAMPS

High brightness GaP LEDs are molded in nylon bodies designed for front panel mounting. D-304, D-305 have resistors built-in for voltage applications of 5~6V, 12~14 and 24~28V.

D-Lite 300 Series

• 210 degree wide angle viewing. • Available in Red, Green and Yellow. • 0.120" dia. lens, 0.200" dia. frame. • Panel opening 0.173" dia.

D-302

Bi-Pin Leads



D-303

Color coded
150mm
Insulated Leads



D-304

Built-in
Resistors,
Bi-Pin Leads



D-305

Built-in
Resistors, Color
coded 150mm
Insulated Leads



• Ask informations to:

WAMCO Technical Sales, Inc.

705 W. 16th Street, Costa Mesa, California 92627 TEL: (714) 642-5100
TELEX: 678459

OSHINO ELECTRIC LAMP WORKS, LTD.

TOKYO, JAPAN

INFORMATION RETRIEVAL NUMBER 66

ELECTRONIC DESIGN 19, September 13, 1975

Complete 12 Bit D/A

\$4900*



Actual Size

Micro Networks MN3200 Series
of thin film hybrid converters
are the industry's first low cost
family of "complete" 12 bit D/A's.

*100 pc. quantity

These converters incorporate the internal reference and output amplifiers—and are totally adjustment free. The converters guarantee $\pm 1/2$ LSB linearity from 0 to 70C as well as monotonic performance because of the laser trimmed ultra-stable nichrome resistor networks employed.

Other salient features of the MN3200 are:

- User Selectable Output Ranges.
- Hermetic Sealed Dip.
- Unipolar (MN3200), Bipolar (MN3201) and BCD (MN3202).

The MN3200 Series are available for immediate delivery.



For complete data
write or call—
Jerry Flynn.
Tel. 617 852-5400.

MICRO NETWORKS
CORPORATION

324 Clark Street • Worcester, Mass. 01606

INFORMATION RETRIEVAL NUMBER 67

MORE POWER MORE BANDWIDTH

Our Model 503L is an ultra-wideband RF power amplifier whose wide range of frequency coverage and power output provides the user with the ultimate in flexibility and versatility in a laboratory instrument. Easily mated with any signal generator, this completely solid state unit amplifies AM, FM, SSB, TV, pulse and other complex modulations with minimum distortion.

Constant forward power is continuously available regardless of the output load impedance match, making the 503L ideal for driving highly reactive loads.

Unconditional stability and instantaneous failsafe provisions in the unit provide absolute protection from damage due to transients and overloads. This low cost instrument, covers the frequency range of 1.6 to 540 MHz with a linear power output of 3 watts . . . and there's no tuning. Priced at \$995.*

Applications include:

- Laboratory instrumentation
- Communication systems
- Laser modulation
- RFI/EMI testing
- Spectroscopy

*USA and Canada



For further information or a demonstration contact

ENI, 3000 Winton Road South,
Rochester, New York, 14623.

Call 716-473-6900.

Or TELEX 97-8283 ENI ROC.

ENI
The World's Leader
in Solid State
Power Amplifiers

SEE
Electronic Design's
GOLD BOOK
FOR COMPLETE
PURCHASING
INFORMATION

INFORMATION RETRIEVAL NUMBER 92

COMPONENTS

Commercial connector is flame retardant

Bunker Ramo Corp., Amphenol Industrial Div., 1830 S. 54th Ave., Chicago, IL 60625. (312) 242-1000. \$0.12 pair; 94V-0, 9 contact (10,000 up); \$0.07 per contact (100,000); stock.

Low-cost electronic connectors, the 32 Series, are the first available with housings of a flame-retardant material classified 94V-0 by UL, according to Amphenol. They are designed for high-volume applications that require from 2 to 15 contacts operating up to 250 V and 12 A per contact. The connectors are also CSA listed. Connectors molded of the 94V-0 material are designated Fire-Plug, while those of a standard nylon 94V-2 material are called Econo-Plug. The nylon units come in six colors.

The Amphenol 32 Series connectors are interchangeable with similar types of other vendors. Housings fit into existing panel cut-outs, contacts fit into competitive housings and competitive contacts fit into Amphenol's 32 Series housings.

Only fingertip pressure is required to push and lock the housing into a panel. And the connector's mounting latches and wings self-adjust automatically so the housing fits snugly in panels 0.031 to 0.093-in. thick. Fingertip pressure on the latches releases the connector from either side of the panel. Connector housings mate only one way to eliminate incorrect connections in assembly or testing.

Three wire-barrel sizes accept 14-to-30-AWG wire and carry 1 to 12 A. When wire of 24 AWG or heavier is used, contacts can be inserted into the housing without a tool. For lighter-gauge wire, an inexpensive tool provides easy insertion. The same tool is also used to remove all sizes of contacts from housings.

A range of available termination equipment includes hand-operated, semi-automatic and automatic terminating equipment for production rates up to 9000 crimps per hour.

CIRCLE NO. 333

dependable power

custom designed



to suit your application

silvercel® by yardney

Silvercel rechargeable batteries pack the most useable power into the smallest and lightest weight modular package available today. In fact, this compact, rechargeable power source delivers 3 to 4 times the energy of common rechargeable batteries and does it with flat, non-tapering discharge voltage characteristics.

Silvercel batteries have been custom designed as essential components in aircraft, missiles, torpedoes, submarines, medical equipment, communications equipment and many other applications where a portable power source is required.

When it comes to dependability and performance, Silvercel produces. And if, by chance, one of our standard sizes doesn't suit your application, we'll design a battery for you. Silvercel is really all you have to know in batteries.

Yardney
ELECTRIC CORPORATION

82 MECHANIC STREET,
PAWCATUCK, CONNECTICUT 02891

INFORMATION RETRIEVAL NUMBER 93

ELECTRONIC DESIGN 19, September 13, 1975

Assemble custom pots from prototype kit



Allen-Bradley, 1201 S. Second St., Milwaukee, WI 53204. (414) 671-2000. \$97.50 (unit qty).

MPIP, or Mod Pot Instant Prototype, is a kit assortment of modules and hardware, sufficient for the design engineer to assemble 10-single, eight-dual, six-triple or four-quadruple-section potentiometer controls, or combinations of these multisection controls. Each assortment is packaged in a carrying case with an assembly fixture, tools, manual and other materials. The 5/8-in. square Mod-Pot family offers a large variety of switch, shaft, bushing and terminal configurations. MPIP is available only through Allen-Bradley distributors.

CIRCLE NO. 334

Proximity sensor works on Hall-effect principle



Micro Switch, 11 W. Spring St., Freeport, IL 61032. (815) 232-1123. \$2.50 (OEM qty).

The 400SR solid-state proximity sensor operates at speeds to 100,000 times per second and weighs just 1/4 oz. Hall-effect actuated, the sensor operates on a 6-to-16-V-dc power supply, withstands temperatures from 40 to 150 C and is provided with solder or quick-connect terminals. This no bounce, no-touch, sensor provides either current sourcing or current sinking outputs that interface directly with nearly all logic families. And there is no need for signal amplification in most applications. Output current is 40-mA maximum.

CIRCLE NO. 335

Chip capacitors allow fine and course adjust

Vitramon, Inc., P.O. Box 544, Bridgeport, CT 06601. (203) 268-6261. \$99.50 (unit qty); stock.

Vee Cal adjustable/fix chip capacitors in two kit packages enable engineers to design and fabricate preproduction circuits for quick evaluation. Kit VC-1 contains 60 parts—five chips in each of 12 base values ranging from 10 through 130 pF; kit VC-2 contains 48 parts—four chips in each of a dozen base values ranging from 160 through 680 pF. Each kit includes epoxy for making permanent connections and a 9H pencil and eraser for making and removing connections. An instruction book and technical bulletin illustrate how to add or subtract capacitance. A maximum of six adjustments provides coarse adjustment on one side and fine adjustment on the opposite side of each chip. The chips have a standard tolerance of $\pm 10\%$ prior to adjustment, and they can be adjusted only upward.

CIRCLE NO. 336

The ties that bind.



Nytyes by Heyco.

Choose from the widest line of Self-Locking Nylon Cable Ties.

Heyco NYTYES provide a secure method for bundling cables, wires, and hoses from 1/16" to 8-1/8" in diameter. They're easily assembled by hand or tool and available for regular, heavy duty and mountable applications. Most NYTYES come with bent tips for easy insertion.

Tie one on. Write for free samples.

HEYMAN MANUFACTURING COMPANY

KENILWORTH, NEW JERSEY 07033 WAUKESHA, WISCONSIN 53186
(201) 245-2345 • TWX: 710-996-5986 (414) 542-7155 • TWX: 910-265-3668



160

MEMORY SERIES No. 3

SUPER GIVEAWAY: 6 YEARS OF PROM RESEARCH



FREE for the asking: our PROM reliability report. The kind of hard-nosed data you need on nichrome fusing, and the critical conditions governing reliability maximization. A strong evaluation of our PROM research, further supporting RADC findings.

FREE COPY of Signetics PROM Reliability summary: attach coupon to letterhead

Name _____

Tel. _____

Ext. _____

THINK

Signetics

311 E. ARQUES, SUNNYVALE, CALIF 94086

INFORMATION RETRIEVAL NUMBER 70

INFORMATION RETRIEVAL NUMBER 69

ELECTRONIC DESIGN 19, September 13, 1975

111

Gates introduces the future in energy cells.



There's now a new energy source that's a superb alternative: Rechargeable, sealed lead-acid batteries from Gates.

We call these batteries the future in energy cells. And for good reason.

They have all the product advantages you need plus economic advantages that may well give a new dimension to your product pricing.

Advantages: Gates Energy Cells are as compact as nickel cadmium or gelled type cells. And they are completely sealed, so that no acid vapor can leak out (they also include a self-sealing vent for extra safety). Gates Energy Cells provide low internal impedance for high discharge rates (more than 100 amps from the D cell and 200 amps from our X cell for short periods of time). And can be operated or stored in any position.

Gates Energy Cells offer great packag-

ing flexibility. In fact, our individual cell availability allows you to choose your own specific voltage (in 2-volt increments) and current, as well as configuration.

Just as important as what Gates Energy Cells have to offer is what they don't have to offer. Like outgassing problems. Or cell reversal. Or "memory" problems.

Because Gates Energy Cells are made from low-cost materials that are readily available, they're very high in watt-hr. per dollar value. Which means that if you specify them, you'll probably save your company more than a few dollars. And make yourself into something of a hero in the bargain.

To find out more about the future in energy cells, circle our reader service number or write us. We'll send you *free* literature containing features, application information, ratings and specifications. George Sahl, Gates Energy Products, Inc., 1050 S. Broadway, Denver, CO 80217.



Energy Products

*Where the
energy future is now*

INSTRUMENTATION

OEM panel meter sells for \$139



Newport Laboratories, 630 E. Young St., Santa Ana, CA 92705. (714) 540-4914. \$139 (100); 30 days.

Model 2003 4-1/2-digit DPM features an extra bright 1/2-in.-high LED display rated for 11 years of continuous operation. Standard features include 1000-M Ω input impedance, automatic polarity and a third-wire ratio input. An automatic-zero circuit precludes the need for manual zero adjustment. BCD data outputs are standard in the Model 2003, which is housed in a high-impact, fire-retardant case and fits the standard 1.68 x 3.92-in. (42.7 x 99.6 mm) panel cutout.

CIRCLE NO. 337

150-MHz scope multiplies 2 inputs



Philips Test & Measuring Instruments, 400 Crossways Park Dr., Woodbury, NY 11797. (516) 921-8880. \$2550.

A new 150-MHz, dual-trace portable scope offers a 100-MHz analog multiplication facility. Designated the PM3265, the unit is useful for dynamic power measurements, servo analysis or where the product of two signals must be measured or calculated. Electric output of mechanical transducers can be multiplied in real time to show, for example, horsepower as a result of rpm and torque. The unit has a 5 mV/div sensitivity and a fastest sweep rate of 2 ns/div.

CIRCLE NO. 338

Plug-in extends range of synthesizer



Adret Corp., 1887 Lititz Pike, Lancaster, PA 17601. (717) 569-7059. \$7500; stock.

Model 6315 is a frequency synthesizer plug-in module that extends the frequency range of the company's 6100 and 6101 mainframes. The 6315 covers 400 kHz to 600 MHz with 1-Hz resolution (0.01 Hz optional). Programming is accomplished by BCD TTL levels with a switching speed of 500 μ s. Phase noise in a 1-Hz band is down over 115 dB at 25 kHz from the carrier, and 130 dB at 1 MHz. The output level of the 6315 is adjustable from +10 to -110 dBm, and is displayed on a panel meter in V rms and dBm. In the remote programming mode, the level is programmable from +13 to -139.9 dBm in steps of 0.1 or 1 dB. Cw, AM, FM, and phase-modulation operating modes are selectable by panel pushbuttons.

CIRCLE NO. 339

Convert X-Y recorder to roll-chart unit

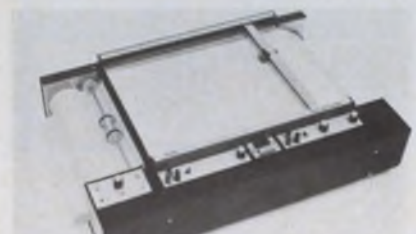

Houston Instrument, One Houston Sq., Austin, TX 78753. (512) 837-2820. \$765; stock.

Model SCA-1 strip-chart adapter converts the company's OMNIGRAPHIC Model 2000 X-Y recorder to continuous roll chart operation, yet retains all X-Y recorder capabilities. In addition, the SCA-1 provides single frame (11 x 17-in. chart) advance or reverse on command at the recorder or from a remote station. Chart speeds are 1, 2, 5, 10, 20, 50 and 100 s/in. All controls can be driven with TTL or switch closure.

CIRCLE NO. 340

Advertisement

ELECTRONIC PACKAGING

500 lb. capacity cabinet won't tilt, won't sway



Bud Radio, Inc., 4605 E. 355 St., Willoughby, O. 44094, (216) 946-3200. Immediate delivery.

The Stylist from Bud. Duo-rimmed anodized aluminum extrusions frame front panel. Full-width flanges add strength at corners, no tilt or sway. Bustle-type door clears knobs, dials, switches, etc. Doors for front, rear; left or right opening. Louvered rear panel for peak ventilation. Stackable. 16-gauge cold rolled steel. No internal framework. Six sizes. For further information phone —

1-800-321-1764, TOLL FREE

IN OHIO, 1-800-362-2265, TOLL FREE

Custom-made look, yet standard enclosures.



Bud Radio, Inc., 4605 E. 355 St., Willoughby, O. 44094, (216) 946-3200. The sleek TR Series.

Available at your Bud Distributor. Four sizes, plus accessory chassis. Also accepts P.C. boards. Body, .050 aluminum; front panel, .090 aluminum. Top and bottom removed easily for access to dust-free interior. Carrying handle used as tilting bail. Handle/bail, front panel and self-adhesive rubber feet included. Finished in mar-resistant, durable Nextel. Compare delivery, value, shipping economies. For further information, phone —

1-800-321-1764, TOLL FREE

IN OHIO, 1-800-362-2265, TOLL FREE

ELECTRONIC PACKAGING

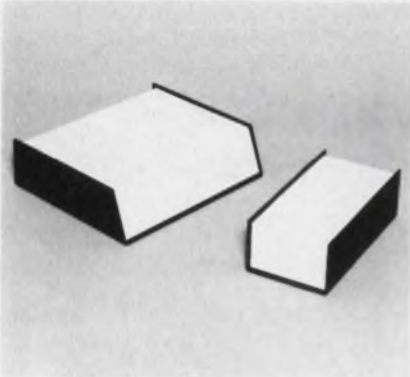
Versatile enclosures,
economical too

Bud Radio, Inc., 4605 E. 355 St., Willoughby, O. 44094, (216) 946-3200. All aluminum.

Each is immediately available in two configurations at your Bud Distributor: the Slope (left), the Linear (right). Both offer an economical means for enclosing sub-systems and instrumentation. One-piece covers are easily removed. No visible fasteners on panel areas. All aluminum: covers, .057; base, $\frac{3}{8}$ ". Rubber feet furnished. Black texture with smooth white enamel finish. For further information, phone —

1-800-321-1764, TOLL FREE
IN OHIO, 1-800-362-2265, TOLL FREE

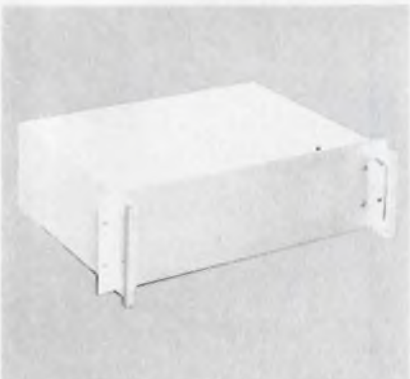
Aluminum enclosures
come in 10 sizes

Bud Radio, Inc., 4605 E. 355 St., Willoughby, O. 44094, (216) 946-3200. Comes completely assembled.

The economical Valu/Line Series. Use independently or in a standard E.I.A. 19" cabinet rack. Two detachable rack mounting brackets and rubber feet are included. Sides, $\frac{3}{8}$ " aluminum; white textured enamel; base, rear and top, .057 aluminum; white enamel finish. Adhesive-backed paper protects panel, provides a surface for marking position for drilling, punching. Bails and slides available. For further information, phone —

1-800-321-1764, TOLL FREE

114 IN OHIO, 1-800-362-2265, TOLL FREE

INSTRUMENTATION

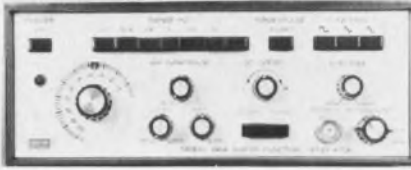
Sweep/function gen
gives 50- Ω output

Dana Exact, 455 S.E. 2nd Ave., Hillsboro, OR 97123. (503) 648-6661. \$350; stock.

Model 196A is a low-cost sweep/function generator with 50- Ω output. The unit offers sine, triangle, square, pulse and sweep waveforms over a frequency range of 0.1 Hz to 1 MHz. Signal amplitudes of 20-V pk-pk open circuit or 10 V pk-pk into a 50- Ω load are available from a 50- Ω output. 70 dB of attenuation is provided in 20-dB fixed steps and 30-dB variable. The Model 196A has an internal generator to sweep the frequency of the main generator with a variable sweep width up to three decades (1000:1). The sweep rate is adjustable from 1 ms to 10 s.

CIRCLE NO. 341

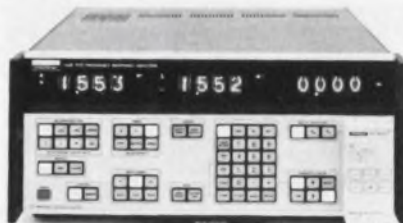
Unit analyzes
servo systems

EMR/Schlumberger, P.O. Box 3041, Sarasota, FL 33578. (813) 371-0811. \$10,990 to \$16,790; 2 wk.

This frequency-response analyzer determines the dynamic behaviour of feedback controlled servo systems. The 1170 Series is a dual-channel, point-to-point, incrementally swept analyzer featuring sweep up/down; logarithmic/linear, as well as sweep and hold conditions. It covers the range 0.0001 Hz to 9.999 kHz with fully floating and isolated inputs and outputs and displays the systems response in terms of (1) in-phase and quadrature components ($a+jb$), (2) amplitude and phase shift (R, θ) and (3) gain and phase shift ($\log R, \theta$).

CIRCLE NO. 342

Word generator offers
memory expansion

Tau-Tron, 11 Esquire Rd., North Billerica, MA 01862. (617) 667-3874. \$4000; 8-10 wks.

Model MG-3 programmable word generator module provides operational speeds up to 50 MHz. The unit contains 1024 bits of random access semiconductor memory programmable from front-panel controls via an optional remote bus. The 1024 bits are arranged in a matrix of 128 words by 8 bits. An auxiliary ninth channel is also standard. Data outputs may be in either 8-bit parallel format or serial format, RZ or NRZ selectable. The output word length or bit length in either serial or parallel modes is controllable in integer steps.

CIRCLE NO. 343

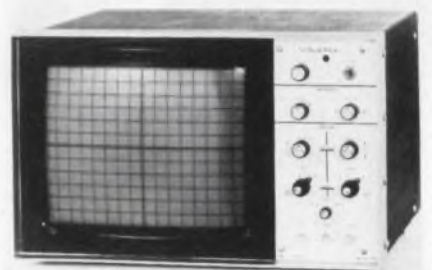
X-Y scope features
dual 12-in. display

Wavetek Indiana, 66 N. 1st Ave., Beech Grove, IN 46107. (317) 783-3221. \$595; 30 days.

A 15-kHz bw and a 12-in. dual display describe the Model 1910 scope. Vertical amplifiers offer sensitivities from 1 mV per division. The dual-trace presentation alternately sweeps from channel 1 to 2 but incorporates a P-1 phosphor CRT, which eliminates the blinking sometimes found in other magnetic deflection dual-trace scopes. Protection circuits automatically blank off both traces in the event of loss of horizontal input to prevent burnout of the CRT phosphor.

CIRCLE NO. 344

Think Large. Think Small. Think Ise

Think our three jolly green giants for desk-top electronics. Our two pint-size pigmies for carry-in-the-pocket display designs. But don't stop there. Think low operating voltages, low power consumption, glass encapsulation all around, and wafer-thin thickness and dip clip pins for fast efficient mounting.

itron[®]

FG-159A2

ec = eb = 35Vp-p
ic = 4.5mA p-p
ib = 3.5mA p-p



Wd 138mm
Lg 40mm
Segment 9.5mm

FG-139A2

ec = eb = 30Vp-p
ic = 3.6mA p-p
ib = 2.8mA p-p

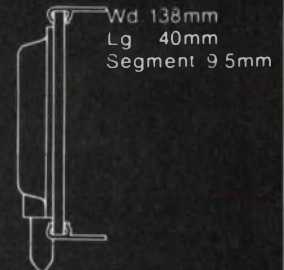

Wd 138mm
Lg 40mm
Segment 9.5mm

Our jolly
green giants

FG-99A2

ec = eb = 24Vp-p
ic = 3.5mA p-p
ib = 2.5mA p-p



Wd 100mm
Lg 40mm
Segment 9.5mm

FG-125A2

ec = eb = 24Vp-p
ic = 2.0mA p-p
ib = 2.0mA p-p

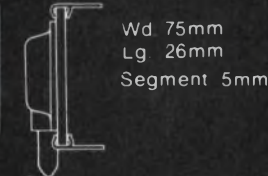

Wd 75mm
Lg 26mm
Segment 5mm

Our pint-size
pigmies

FG-95A

ec = eb = 24Vp-p
ic = 2.0mA p-p
ib = 1.5mA p-p



Wd 65mm
Lg 24mm
Segment 5mm

Something else to think about

Think Ise for digital readouts for instruments, clocks and other products, too.

The Brighter Side of Electronics

ISE ELECTRONICS CORP.

Main Office:

P.O. Box 46, Ise City, Mie Pref., Japan
Tel: (05963) 5-2121 to 4. Telex: 4969523

Tokyo Office:

2-7-7 Shigashi, Shinbashi, Minato-ku, Tokyo, Japan
Tel: (03) 433-6616 to 9. Telex: 1126546

Noritake Electronics Office:

22410 Hawthorne Blvd., Torrance, California 90505, U.S.A.
Tel: (213) 373-6704. Telex: 230674910

DISCRETE SEMICONDUCTORS

High-voltage/current diode has 3-kV PIV



Electronic Devices, 21 Gray Oaks Ave., Yonkers, NY 10710. (914) 965-4400. \$2.90 (1000-up); stock.

The 3W3 high voltage and high current silicon rectifier diode has a surge capacity of 300 A. The diode has a 3000 V PIV rating at 2-A forward current. Two other similar designs are available with PIVs of 2000 and 2500 V. Fast recovery types are also available. The 3W3 diodes are housed in axial lead packages that have diameters of 0.22 in. and lengths of 0.38 in.

CIRCLE NO. 345

Magnetic flux sensing diodes have V_R of 50 V

Shigma, P.O. Box 71, 1550 Northwest Highway, Park Ridge, IL 60068. (312) 298-6160. 10,000 up prices: \$2.30 (130C), \$6 (230A); stock.

The MD130C and MD230A magneto-sensitive diodes are available either as a single unit (130C) or a matched pair (230A). The diodes can handle surge currents of 10 mA and have reverse voltages of 50 V. When subjected to a magnetic flux of +1000 Oersteads the 130C produces a voltage change of +0.7 V while the 230A produces a change of 0.8 V, minimum. For a flux of -1000 Oe the minimum voltage change is 0.4 or 0.8 V, respectively. At zero flux, the bias voltage across the 130C is typically 4.2 V and the center potential for the matched pair (230A) is typically 3 V.

Booth No. 1650-52 Circle No. 346

65 watts of reliable power in frequencies of 10 to 2500 MHz.



And here's what we built into our new 15122.

- solid state circuitry
- short and open circuit protection
- frequency stability $\pm .001\%$
- external pulse or AM modulation
- internal square wave modulation
- low tube cost/operating hour
- qualified to MIL-STD-461 and 810

It has six different plug-in heads

Model	Freq. (MHz)	Pwr. (MIN)
6047	10-50	65
6048	50-200	65
6049	200-500	65
6050	400-1000	65
6051	1000-2000	40
6052	2000-2500	35

You have now ended your search for a stable, reliable 65 watt oscillator. Just call or write for detailed engineering data. Or ask for a demonstration

MCL, INC.,
10 North Beach Avenue,
LaGrange, Illinois, 60525.
(312) 354-4350



High output LEDs come in four colors

Chicago Miniature, 4433 N. Ravenswood Ave., Chicago, IL 60640. (312) 784-1020. \$0.63 (1000-up); stock.

A line of 12 high-intensity LED lamps in yellow, orange, green and red offers a choice of wide-angle or forward-view light patterns. For each color, there are three combinations of luminous intensity and viewing angle. A clear-lens unit provides a "spot" light pattern for backlighting, and two diffused-lens units provide either a 24° pattern for directional applications or a 65° pattern for general applications. In yellow (CM4-580B Series) the clear-lens unit has a typical intensity of 45 mcd, the diffused-lens, narrow-angle unit, 10 mcd and the wide-angle unit 6 mcd. In the orange/amber (CM4-480B Series), the green series (CM4-380B) and the red (CM4-280B) the light output is slightly lower. All lamps have cylindrical T-1-3/4 cases that are colored to match the color of light output. Typical peak wavelengths, important for color-consistency matching in all nonred LEDs, are 635 nm for orange, 585 nm for yellow and 565 nm for green.

CIRCLE NO. 347

EDL TII CIRCLE SURGE PROTECTION

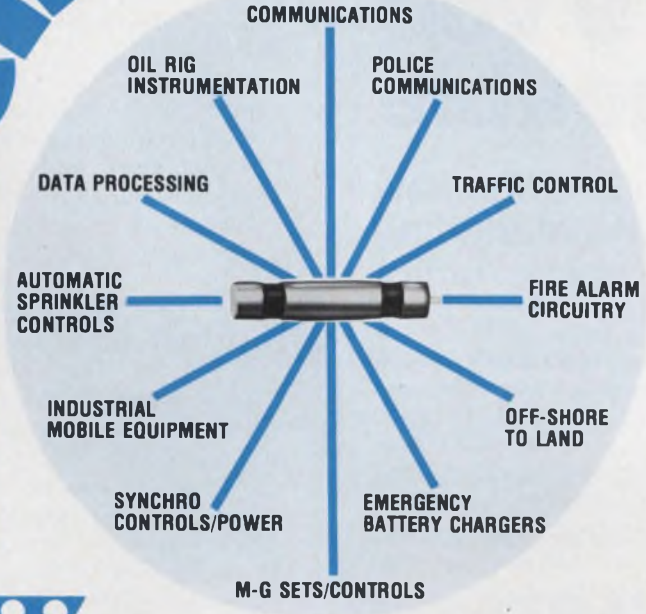

Protect your solid state equipment from junction damage caused by high-current surges due to power switching and lightning transient induction. Ordinary protective devices ground only one wire, allowing currents to reach your equipment through the "other" wire. TII 3-Electrode Gas Tube Surge Arresters simultaneously ground both wires of a signal or power pair. TII protection can end unnecessary service calls and customer complaints. To learn more about surge and how to



protect against it, write for your free copy of "Surge Protection for Solid State Circuitry" or circle the appropriate reader reply number.

Worldwide Patents:
 1,121,266; 1,120,261; 1,488,348;
 2,284,425; 2,612,000; 2,553,757;
 3,246,421; 2,642,000; 2,622,288;
 3,528,770; 3,522,870; 3,781,711

U.S. Listed and
 REA Accepted
 Multiple Availability

Licensed by M-O Valve Co., Ltd.,
 and by Western Electric Co.
 Made in U.S.A.



TELECOMMUNICATIONS INDUSTRIES, INC.
 More than 2,000,000 TII Gas Tube Surge Arresters in Service.

1375 Akron Street
 Copiague, New York 11726
 (516) 842-5000 • Telex: 144631

INFORMATION RETRIEVAL NUMBER 74

You don't have to buy a new car to get an electronic ignition.

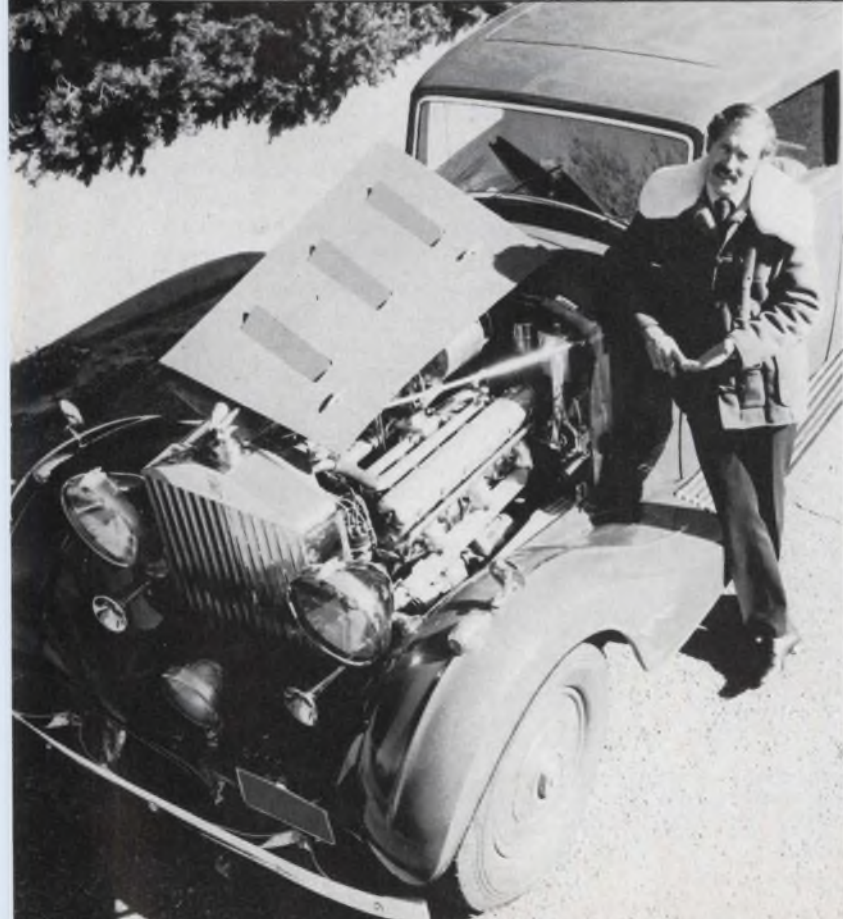

Let's face it. After 37 years, even a Phantom III can use a lift. That's why I put a Delta Mark Ten B Capacitive Discharge Ignition on my Phantom . . . to give her a spark I'd pit against any '75 model car. I went to Delta because they aren't Johnny-come-latelys. Delta's been making electronic ignition systems for over a decade.

Whatever kind of car you drive, you can give it the same great Delta performance I gave mine.

- Mark Ten B Capacitive Discharge Ignition Systems are manufactured by Delta Products, Inc., a company with a conscience, and with a proven record of reliability both in product and in customer relations.
- The Mark Ten B really does save money by eliminating the need for 2 out of 3 tune-ups. Figure it out for yourself. The first tune-up or two saved pays for the unit, the rest is money in your pocket. No bunk!
- Because the Mark Ten B keeps your car in better tune, you actually can save on expensive gasoline.
- With a Mark Ten B, spark plugs stay clean and last longer . . . fouling is virtually eliminated.



I want to know more about Mark Ten B CDI's. Send me complete no-nonsense information on how they can improve the performance of my car.

Name _____

Address _____

City _____ State _____ Zip _____

DELTA PRODUCTS, INC.
 P. O. Box 1147, Dept. ED, Grand Junction, Colo. 81501
 303-242-9000

Mark Ten B, assembled	\$64.95 ppd	Standard Mark Ten, assembled	\$49.95 ppd
Mark Ten B, kit	\$49.95 ppd	DeltaKit@	\$34.95 ppd

INFORMATION RETRIEVAL NUMBER 75

announcing the new 9 volt rechargeable

an exciting new
design and marketing
opportunity

The VARTA Ni-Cad TR 7/8.
Looks like a 9 volt primary.
Takes no more space than a 9 volt primary—
but it can be recharged!
Over 500 times...

Perfect for calculators, transistor radios,
dictation equipment, etc.

For specifications and technical assistance
call or write today.

VARTA
Batteries Inc.
85 Executive Boulevard
Cross Westchester Executive Park
Elmsford, N.Y. 10523
(914) 592-2500



VARTA. Europe's largest battery manufacturer.
Known around the world for quality and reliability.

DISCRETE SEMICONDUCTORS

Laser diode arrays operate at room temp

RCA Electronic Components, 415
South Fifth St., Harrison, NJ
07029. (201) 485-3900. From \$87;
30 to 60 day.

Eight GaAs laser arrays are designed for use in illuminators, target designation, gated viewing and intrusion alarm systems. These devices, designated C30002 through C30009, have minimum power outputs ranging from 25 to 300 W at a drive current of 25 A and room temperature. The peak wavelength of spectral radiant intensity at 27 C is 904 nm. The C30002 through C30009 may also be operated at cryogenic temperatures (-196 C) if desired. The individual arrays consist of one, two, or four strips of series-connected laser diodes and, depending on the type, from 10 to 15 diodes are typically used in a strip. All of the arrays are packaged in an OP-4A case.

CIRCLE NO. 348

Numeric LED displays available in four colors

Monsanto, 3400 Hillview Ave., Palo
Alto, CA 94304. (415) 493-3300.
\$2.65 (1000-up); stock.

A 0.4-in.-high LED display comes in a choice of four colors and has a high readability font. There are three standard configurations in the new series, each available in red, yellow, orange and green. The orange unit has a typical intensity of 2000 microcandelas at 20 mA and 500 microcandelas at 5 mA per segment. The models available are a common-anode, right-hand decimal digit; a common-cathode, right-hand decimal digit; and a common anode, over-flow (± 1) digit with right-hand decimal. The units in the series feature very high brightness segments in all colors: green, 500 microcandelas at 565 nanometers; orange, 2000 microcandelas at 630 nanometers; red, 300 microcandelas at 660 nanometers; and yellow, 1200 microcandelas at 586 nanometers, all measured at 20 mA dc.

CIRCLE NO. 349

Power transistors made for switching high loads



Motorola Semiconductor, P.O. Box 20912, Phoenix, AZ 85036. (602) 244-6900. From \$2.25 (250-up); stock.

The Switchmode series of power transistors is designed for high-voltage power switching applications. The first devices in this series are the 2N6542 through 2N6547 npn, triple-diffused, silicon transistors. The transistors have a V_{CE0} that ranges from 300 to 400 V, $V_{CE(SAT)}$ from 2 to 2.5 V, I_c (peak) from 10 to 30 A and P_D from 100 to 175 W. All ratings are specified for inductive loads and 100-C operation.

CIRCLE NO. 350

High voltage diodes rated up to 25 kV

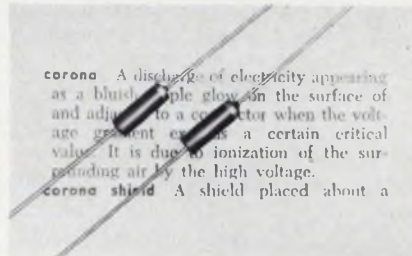

Microsemiconductor Corp., 2830 S. Fairview St., Santa Ana, CA 92704. (714) 979-8220. From \$8; 4 to 8 wk.

A line of corona-free switching and nonswitching rectifiers is available with PIVs ranging from 2 to 25 kV. The diodes have an average reverse current of 500 mA to 50 mA, respectively. Reverse recovery times range from 0.3 μ s for switching devices to 5 μ s for non-switching units. The devices exhibit less than 50 picocoulombs of corona. One or more diode chips are sealed in a DO-7 size voidless glass package and potted. Dual-tungsten studs ensure rapid heat dissipation.

CIRCLE NO. 351

Small-signal uhf devices operate up to 6 GHz



Amperex, Solid State and Active Devices Div., Slatersville, RI 02876. (701) 762-9000. From \$2 (1000-up).

Ten small-signal uhf transistors have gain-bandwidth products from 2 to 6 GHz at collector currents between 100 μ A and 150 mA. The transistors offer low intermodulation distortion and low cross-modulation distortion. Noise figures as low as 1.9 dB at 500 MHz are also available. The 10 types bring the number of small-signal GHz transistor types available from Amperex to 23. Included are all conventional package types: plastic Micro-T, ceramic Micro-T, JEDEC TO-39 and TO-72 metal cans, and stud-mounted strip-line types.

CIRCLE NO. 352

ZiraloTM polarizers for liquid crystal modules.

Baum Chemical high efficiency Ziralo light polarizers are used by some of the leading manufacturers of liquid crystal displays.

- Available in 45% and 55% Transmissions
- Heat and Humidity Resistant
- Outstanding Physical and Optical Uniformity
- Prompt Deliveries

Write, phone or Telex for technical data and samples to:

Baum Chemical Corporation
Subsidiary of Foster Grant Co., Inc.

16267 Lindbergh Street Van Nuys, CA 91406
Phone: 213-785-7432. Telex: 69-8408 (BAUM CHEM LSA)

INFORMATION RETRIEVAL NUMBER 77

ELECTRONIC DESIGN 19, September 13, 1975

MEMORY SERIES No. 4

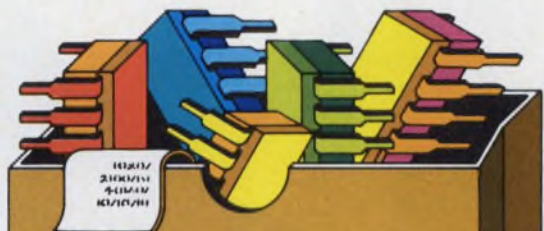

THERE'S HARDLY A BIPOLAR MEMORY WE CAN'T SHIP FROM STOCK.

Supermarket convenience: one stop fills all your memory reqs. Take your pick from the industry's broadest line of proven hi-performers. More of the fastest, all the standards—volume stocked now. (MIL, too.)

Clip coupon to letterhead for Bipolar Line Card.

Name _____

Tel. _____ Ext. _____

THINK

Signetics
811 E. ARQUES, SUNNYVALE, CALIF. 94086

INFORMATION RETRIEVAL NUMBER 78

Marking pencils handle light or dark ceramics

Electro Materials Corp. of America, 605 Center Ave., Mamaroneck, NY 10543. (914) 698-8434. \$15/dozen; stock.

Special marking pencils are made specifically for marking ceramic substrates. The markings will remain visible and stable in air or

nitrogen up to 1200 C even after prolonged temperature exposure. Above 1200 C, the markings will gradually begin to lose their color with the color completely burning off at 1550 C. Markings are not affected by chlorinated hydrocarbons, alcohols or other commonly used cleaning agents. To meet industry requirements for white and dark ceramics, pencils are available with either brown or white marking colors.

CIRCLE NO. 353

Molded plastic knobs available in many styles



Buckeye Stamping, 555 Marion Rd., Columbus, OH 43207. (614) 445-8433. From \$0.55 (1 to 99); stock.

The line of Imperial knobs is functionally designed to enhance the appearance of instruments and control panels. The knobs are precision molded of ABS in a tapered design with recessed fluting. Features include all popular sizes in standard, concentric and bar types that can be modified by skirts and a variety of markings. Aluminum bushings with Allen-Head screws are precisely set into each knob to assure concentricity. Stocked colors include: black with white ring, dark grey with white ring, red with white ring and light grey with black ring. Other combinations are available.

Booth No. 1513, 1515 Circle No. 354

Plastic mat removes dirt from shoes easily

Dycem Plastics Ltd., 26 Strawberry Hill, Stamford, CT 06902. (203) 324-7536. From \$116.

A plastic mat can collect foot-borne contamination as personnel enter a clean room. The mat requires only washing for maintenance. Its permanently tacky surface not only holds dust and dirt but also shows when it is in need of cleaning. The Protect-a-Mat is made of a translucent substance whose surface has a very high coefficient of friction. Dust and dirt on shoes clings to the mat from which it is easily removed by a mild soap and water solution. On drying, the original tackiness returns. The nonslip material is highly durable—with a minimum life of one year—and is neither damaged nor tracked by carts. The mat measures 4 x 2 ft.

CIRCLE NO. 355

New SCRs FOR YOUR DESIGNS

NEW NL-C601



1200 amperes rms
800-1700 volts

NEW NL-C602



950 amperes rms
1700-2500 volts

NEW NL-F701



1600 amperes rms
500-1700 volts

POINT THE WAY TO PROFITS

- Power and inverter SCRs available in assembled Heat Exchangers.
- Other SCRs available from 16 amps and 25 volts.
- Call or write for full details



NATIONAL ELECTRONICS

a varian division

geneva, illinois 60134 (312) 232-4300

Learning aid teaches power of microprocessor

Technitrol, Inc., 1952 E. Allegheny Ave., Philadelphia, PA 19134. (215) 426-9105. \$2000 (unit qty); 4 to 6 wks.

The Primer 4/8 is a learning aid to help hardware-oriented engineers master microprocessors. The unit for any 4 and 8-bit microprocessor on the market allows: entry of memory address and instructions in machine language; display of memory address and data by front-panel LEDs, increment, decrement or force-load of program memory address; display of results of CPU operation; and single-step operation to facilitate learning and program debugging. The primer can execute all instructions in the CPU manufacturers instruction set and give the operator an immediate feel for the power of the set and the advantage of software solutions to hardware problems.

CIRCLE NO. 356

Dispatcher's display identifies vehicle



Coded Communications Corp., 1620 Linda Vista Dr., San Marcos, CA 92069. (714) 744-3710. \$1600; 45 days.

A digital identification display, Model MB/D/1U, for use in mobile radio vehicles, provides the radio dispatcher with instantaneous vehicle identification and emergency alert notification. Display has a four-digit LED readout for numbers from 0001 to 2047 and a built-in decoder for two messages—a vehicle-identity message and a functional or emergency message. The unit can be desk-top or console mounted. It can be powered from either 13.8 V dc or 117 V ac and it measures 3 H x 8 W x 9-1/2 D in.

CIRCLE NO. 357

CCD memory circuits start with 16 k bits

Intel Corp., 3065 Bowers Ave., Santa Clara, CA 95051. (408) 246-7501. See text.

The first 16 kbit CCD (charge-coupled device) memory is now a commercial product. The Model 2416, a single-chip 18-pin package, contains an array of 64 shift registers, each 256 bits long. Access to data is a fast 200 μ s and transfer rate is 6 Mbit/s. Thus speed and access rate vastly exceeds that of normal disc storage. Access to the memory is similar to that for disc: an address code selects the register and one or a succession of registers is accessible between shift cycles. A megabit demonstration card provides access to any location in a time frame of 100 to 200 μ s and consumes less than 4 W. Available as 18-pin plastic dips or 22-pin ceramic packages, the 18-pin version costs \$85.50 (single) to \$55.50 (100 to 999); the 22-pin prices range from \$89 to \$58 for similar quantities.

CIRCLE NO. 358

The Revolutionary PowerDIP™ AC & DC SOLID-STATE RELAYS*

- Operate Directly from CMOS (500 μ a) control sensitivity)
- TTL/DTL Compatible (7 milliamp control current std. models)
- Switches up to 4 amps without heat sinking
- Fits standard 16 pin DIP sockets
- "Lockout" feature prevents false triggering by transient pulses



*Patent Pending



and...
Less than \$3.00
in Quantity

THETA-J RELAYS, INC.

2 Linden Street • Reading, MA 01867
(617) 942-0390

MEMORY SERIES No. 6 8192 BITS- NO EXTRA PIECES NEEDED.

8K MOS ROM #2608.

Use this big fast memory (1024x8 at 650ns) without costly supportive parts. TTL compatible: no interface required. Static logic: no clocks. Single +5V means no extra power supplies. Volume stock now.



Rush coupon on letterhead, for specs on #2608 8K MOS ROM.

Name _____

Tel _____

Ext _____

THINK
Signetics

311 E. ARQUES, SUNNYVALE, CALIF. 94086

Heat exchangers that fit where others won't.

Compact Lytron heat exchangers fit tight spaces... pump heat out, efficiently.

Solve heat buildup problems with these compact, space-saving Lytron heat exchangers. Choose from 24 standard models, aluminum or copper.

Exclusive INNER-FIN[®] construction increases internal cooling surface and saves up to 50% of ordinary coil space.

Ideal for cooling electronic cabinets, lasers, machine tools, computer systems, X-ray machines, space vehicles, airborne and mobile equipment... and a variety of electronic or mechanical equipment where unwanted heat builds up in tight quarters.

Compact Lytron heat exchangers — they fit where others won't. Special designs for special problems also available. As well as applications engineering assistance.

For compact size, minimum weight, proven reliability, prompt service and delivery at low cost, contact Lytron Incorporated, 2 Dragon Court, Woburn, Massachusetts 01801. Phone: (617) 933-7300.

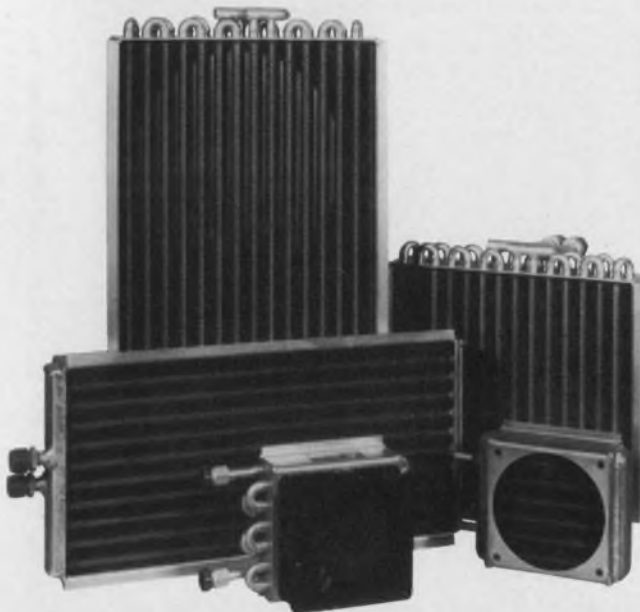
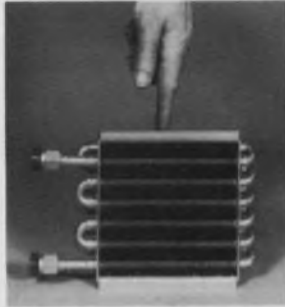

INFORMATION RETRIEVAL NUMBER 82

Rogan knobs look better and are built better,



and we'll prove it with a free sample.

After you receive our catalog, send us a note outlining your specific requirement and the quantity involved.

Or furnish us with our competitor's part number and we will cross-reference it.

Our samples and quotation will be returned promptly.



3455 Woodhead Drive, Northbrook, Illinois 60062 (312) 498-2300

INFORMATION RETRIEVAL NUMBER 83

New 121-page handbook for those who have time (code) on their hands... only \$3.50.

Here's a valuable reference prepared by Systron-Donner's team of time code specialists. The handbook covers such subjects as accuracy and synchronization of standards; time codes and formats; and systems and instruments for time code generation, reading and tape search.

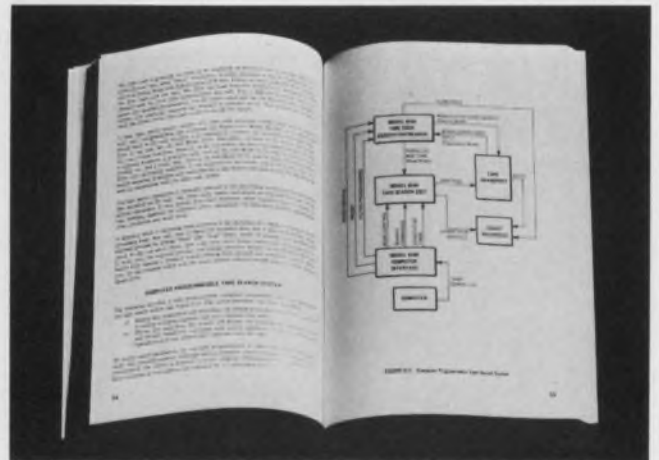

For your copy of "Precision Timekeeping and Tape Search," send your check payable to Systron-Donner Corporation, Data Products Division, 935 Detroit Avenue, Concord, CA 94518.



INFORMATION RETRIEVAL NUMBER 84

DATA PROCESSING

Plotter features built-in microprocessor



Glaser Data Co., 225 Forest Ave., Palo Alto, CA 94301. (415) 321-1348. \$14,000; 60 to 90 days.

Glaser's DP-1600 plotter can handle 22 x 34-in. drawings at plotting speeds to 800 increments per second. The device attains an accuracy of 0.004 in., and a built-in microprocessor simplifies the drawing of straight lines. Its slope generator requires the specification of only the two end points of the line. In addition, an internal 55-character symbol generator reduces software and data-transmission needs.

CIRCLE NO. 359

Analog I/O systems compatible with μP

Burr-Brown Research, International Airport Industrial Park, Tucson, AZ 85734. (602) 294-1431. See text.

To an Intellec microcomputer, the new Burr-Brown 4-to-16-channel acquisition units look like memory locations. But one simple instruction enters a 12-bit data word from the system or to the outside world. Any of the three systems—MP8104, 8208 or 8216—plugs into any memory or I/O slot of the microcomputer. The 8104 output system includes four 12-bit DACs and buffer registers. The MP8208 and 8216, both complete acquisition units, contain analog multiplexers, instrumentation amplifiers, sample-and-hold and 12-bit converter and all interface logic. During conversion (20 μs) these systems send a wait request to the CPU until ready. The input ranges are $\pm 10 V$, 0 to 10 V, 25 V and 0 to 5 V, with specified accuracy of $\pm 0.025\%$. The 8104 sells for \$695 in single quantity; the 8208 and 8216 single price is \$795.

CIRCLE NO. 360

Minicomputer plus disc includes smart interface

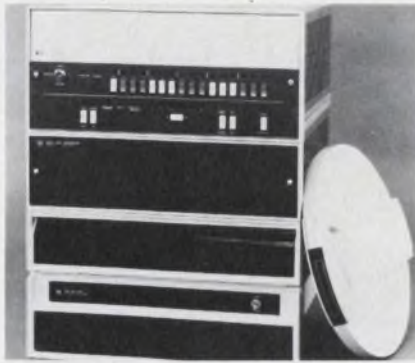

Hewlett-Packard, 1501 Page Mill Rd., Palo Alto, CA 94304. (415) 493-1501. See text; 60 to 120 days.

A 64 k-word 21MX minicomputer and fast cartridge disc provide extensive software capability. The disc, HP's new 7905A, adds 15 Mbytes memory with 25-ms average access time and a transfer rate of 936 Mbytes a second. Pre-wired and checked out as a package, the MX/65 system sells for less than the sum of its parts. It consists of a 21MX minicomputer, a 7905A disc, and a microprocessor-equipped control unit. The minicomputer is microprogrammable. Direct memory access through the processor's dual-channel port controller makes programs assignable to any I/O channel; the port controller also provides independent word count and address registers. The disc subsystem is expandable to 120 Mbytes with additional discs and allows access by up to eight CPUs. Quantity prices start at \$15,675 with 16-k CPUs, with a 128 kbyte CPU (the largest) the price is \$23,946.

CIRCLE NO. 361

Microcomputer memory and cassette offered

Micromation, 11339-K Sorrento Valley Rd., San Diego, CA 92121. (714) 452-0101. See text.

Users of Intel's 8080 μP or Model 80 computer can replace paper tape with the MM2000, a dual-cassette storage device. Selling for \$950 (qty 1), the unit's interface board plugs into the host and interfaces with Intel software via a PROM program. Also offered are plug compatible memories, Model MM1000, of 8 k x 8 bits for \$895 (1-9 qty).

CIRCLE NO. 362

LASER MARKED UHF/MICROWAVE CHIP CAPACITOR KITS

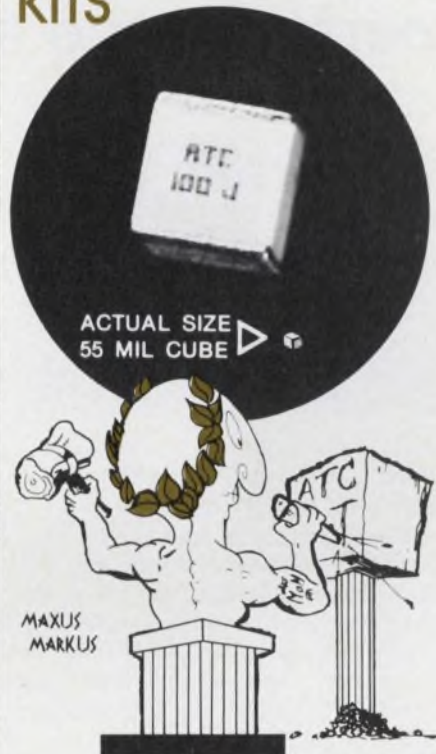

DESIGN VALUE KITS:

40 MARKED POPULAR VALUES IMMEDIATELY AVAILABLE IN KITS OR SEPARATELY.

BUY ANY DESIGN VALUE KIT OF 100 ATC 100 LOW LOSS PORCELAIN CHIP CAPACITORS FOR \$77.00.



Just circle the number below for more information on ATC's new laser marked chip capacitor kits.

american technical ceramics

ONE NORDEN LANE,
HUNTINGTON STATION, N.Y. 11746
(516) 271-9600 • TWX 510-226-6993
INFORMATION RETRIEVAL NUMBER 85

Lowered feedthrough lets d/a performance shine through



Analog Devices, Route 1 Industrial Park, Norwood, MA 02021. (617) 329-4700. P & A: See text.

Feedthrough in multiplying digital-to-analog converters prevents them from maintaining their accuracy when the analog reference signal increases in amplitude or frequency. Analog Devices has changed that with the introduction of its Model 1125.

The DAC1125 has a four-quadrant feedthrough of only 0.5 LSB maximum at a maximum frequency of 40 kHz. The DAC accepts 12-bit data words and settles to within 0.03% accuracy in under 10 μ s (3 μ s typical).

Input lines of the DAC are complementary-binary coded in the two-quadrant mode and can be programmed for offset-binary or two's complement coding in the four-quadrant mode.

Differential nonlinearity and gain temperature coefficients are

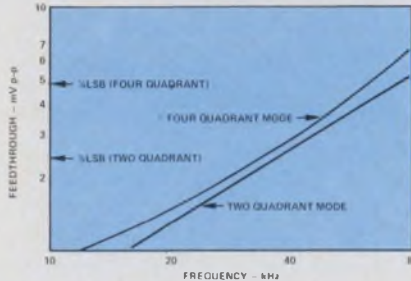

kept to a low 3 ppm/ $^{\circ}$ C. Monotonicity over a 0-to-50-C range is guaranteed in the four-quadrant mode; in the two-quadrant mode it's guaranteed from 0 to 70 C. Rejection of ripple from the power supply is better than 80 dB.

The reference input can handle signals that vary over a ± 10 -V range, and has a 450-kHz, -3-dB bandwidth. Slew rate of the reference input is a high 20 V/ μ s, while the phase shift, input-to-output, is less than -0.5° at 5 kHz.

Some units that compete with the DAC1125 include the Model 869 from Beckman (Fullerton, CA), the CY2219 from Cycon (Sunnyvale, CA), the DAC-MV12B from Dattel (Canton, MA), the 412-BIN from Function Modules (Costa Mesa, CA), the DAC316-12 from Hybrid Systems (Burlington, MA) and the 4072 from Teledyne Philbrick (Dedham, MA).

Compared with these multiplying

DACs, the DAC1125 from Analog Devices is one of the more expensive units—it costs \$295 in unit quantity, compared with a low of \$135 for the Hybrid Systems DAC-316-12 and a high of \$315 for the Philbrick 4072.

Of course, the lower priced units sacrifice performance. For example, the Hybrid Systems unit has a feedthrough of 2 LSB at 20 kHz and has only a 100-kHz bandwidth. Its tempco is also higher—at 30 ppm/ $^{\circ}$ C. Most of the other units have tempcos ranging from 5 to 30 ppm/ $^{\circ}$ C and bandwidths that range up to 200 kHz.

The Analog Devices DAC1125 is housed in a 2 \times 2 \times 0.4 in. (51 \times 51 \times 10 mm) module and requires a positive supply that ranges from 13 to 17 V at 17 mA max, and a negative supply that provides -12 to -18 V at 10 mA. It is available from stock.

Analog Devices	CIRCLE NO. 303
Beckman	CIRCLE NO. 304
Cycon	CIRCLE NO. 305
Dattel	CIRCLE NO. 486
Function Modules	CIRCLE NO. 487
Hybrid Systems	CIRCLE NO. 488
Teledyne Philbrick	CIRCLE NO. 489



ANALOGY

FEED TRANSDUCER DATA FROM TOUGH ENVIRONMENTS TO REMOTE MINIS THROUGH THE FIRST CRYSTAL CONTROLLED VOLTAGE-TO-FREQUENCY CONVERTER MODULES WITH TOTAL ISOLATION AND 15-BIT ADC PERFORMANCE. INTECH'S NEW A-841 HAS BUILT-IN OPTICAL ISOLATOR. A-842 DRIVES 2000 FT. OF CABLE THROUGH ITS PULSE TRANSFORMER, BOTH AT TTL LEVELS. WE ALSO SUPPLY BETTER ADC, DAC, SEH, OP AMP AND MATH MODULES AT PRICES THAT SAVE.

intech/FMI
282 BROKAW RD. SANTA CLARA, CA 95050 (408) 244-0500

Broadband amplifiers span 5 to 500 MHz

Aydin-Vector, P.O. Box 328, Newtown, PA 18940. (215) 968-4271. \$120 (1 to 9); stock to 2 wk.

Two hybrid circuit broadband transistor amplifiers, Models MHD-151 and MHD-152, are available in four-pin DIPs. Both units cover the 5-to-500-MHz frequency range. The MHD-151 has a gain of 21 dB and the MHD-152 has 31 dB. The noise figure is 5 dB and the power output +9 dBm, for both units. Power required by the amplifiers is +12 V dc at 65 mA for the 152 and 45 mA for the 151. These units are electrically and mechanically interchangeable with the discontinued Fairchild FMA-131 and FMA-135. CIRCLE NO. 363

16-bit DAC squeezes into 24-pin DIP

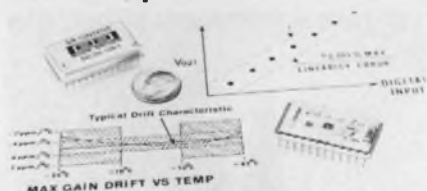

Burr-Brown, International Airport Industrial Park, Tucson, AZ 85734. (602) 294-1431 From \$119 (1 to 9).

The DAC-70 d/a converter provides 16-bit resolution and 14-bit accuracy. The converter is housed in a 24-pin metal DIP. The unit comes complete with internal reference and scaling resistors for driving an external amplifier. The internal thin-film ladder network is trimmed to $\pm 0.003\%$. Nonlinearity and drift match the IC current switches and zener reference to keep the maximum gain drift to ± 7 ppm/ $^{\circ}\text{C}$ over -25 to $+85$ C. DAC-70 versions are available with either 16-bit binary or four-digit BCD input coding. Outputs are in the form of current with ranges of ± 1 mA and 0 to -2 mA. Settling time to $\pm 0.003\%$ of full scale range is $50 \mu\text{s}$ for a full scale output current change. Input power requirements are ± 15 V at ± 30 mA and $+5$ V at $+25$ mA. The 24-pin DIP measures $1.4 \times 0.8 \times 0.2$ in. and is hermetically sealed. CIRCLE NO. 364

CUSTOM HYBRID MICROCIRCUITS

For Military/Aerospace Applications

CIRCUIT TECHNOLOGY INCORPORATED

160 Smith Street, Farmingdale, N.Y. 11735
Phone (516) 293-8686 • (213) 374-7446

INFORMATION RETRIEVAL NUMBER 87

If it's a thick film resistor network...

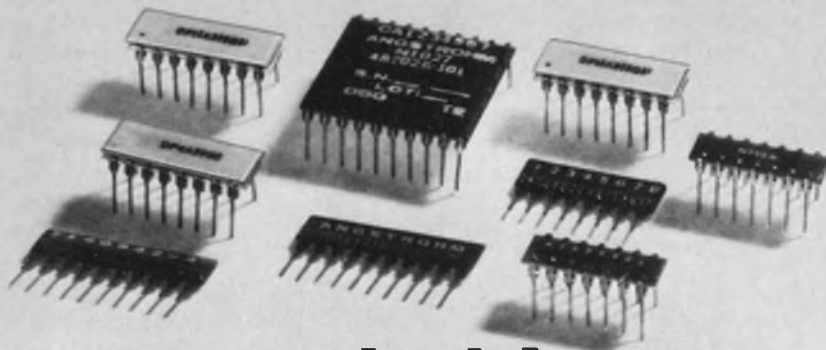

we make it!

SIPs, DIPs, Binary Ladders, all manufactured to meet the most critical specifications. SIPs and DIPs are offered in tolerances up to $\pm 1\%$, Binary Ladders to $\pm \frac{1}{2}$ LSB. What's more, we can provide custom resistor networks in almost any configuration to the very tightest tolerances possible. Write for complete technical details today.



angstrom precision, inc.

one precision place/hagerstown, maryland 21740
telephone: 301-739-8722 twx: 710-853-6834

INFORMATION RETRIEVAL NUMBER 88

ESL
presents another
THICK FILM HIT...

THE COPPER STORY

...a real
conductive thriller

This new copper conductive
coating #2310 comes on
like GANG BUSTERS

Featuring that unique team
never before assembled in
one production:

- ★ Excellent Conductivity
- ★ Good Solderability
- ★ Good Solder
LEACH RESISTANCE

co-starring the ever popular

★ Low Cost

and as a
special added attraction

★ Ultrasonic or
Thermocompression
Bonding Capability

CRITICS RATE THIS
THICK FILM WORTH
SCREENING ABOUT
FOR MICROWAVE
AND PACKAGING
APPLICATIONS

Rated **T** for Thick Film
Applications

For the best in Thick Films



**ELECTRO-SCIENCE
LABORATORIES, INC.**

1601 Sherman Ave., Pennsauken, NJ 08110
(609) 663-7777 Telex: 83-4788
Cable: ELECTRO-PESN

France: 7 Rue Decrus,
75014 Paris (531 43-65)
W. Germany: 8000 Munchen 40,
Ellaenbothstrasse 81 (0811-188042)
U.K.: 38 Bennet Rd.,
Reading RG2 0QX Berkshire (0734) 83139

MODULES & SUBASSEMBLIES

Speedy a/d converts input signals in less than 2 μ s

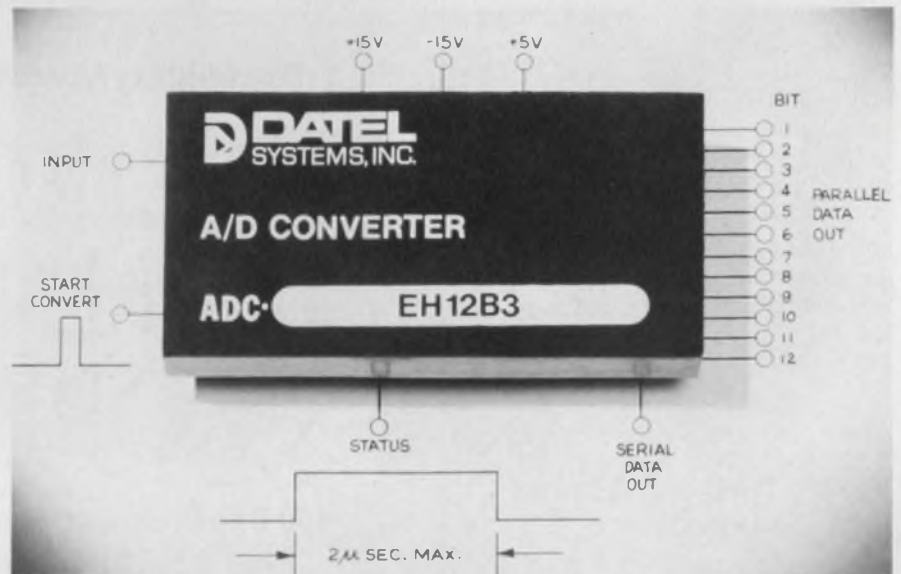

Dadel Systems, 1020 Turnpike St.,
Canton, MA 02021. (617) 828-8000.
P & A: See text.

Fast a/d converters, with conversion times of 2- μ s or better, have tended to be very expensive. Now Dadel, with its ADC-EH12B3, has slashed the cost by several hundred dollars. The Dadel EH12B3, successive-approximation a/d converter provides a 12-bit word only 2 μ s after the convert command is given, and it costs just \$299 in unit quantities.

The converter handles inputs of 0 to 10 V when connected for unipolar operation and ± 5 V for bipolar. The input impedance for either operating mode is 1.5 k Ω .

At 25 C, accuracy and linearity errors are ± 0.5 LSB. The differential linearity is also 0.5 LSB and has a tempo of 3 ppm/ $^{\circ}$ C max, which ensures monotonicity over the operating temperature range of 0 to 70 C. The gain tempo for the EH12B3 is ± 30 ppm/ $^{\circ}$ C.

The a/d converter consumes only 2.3 W, maximum, and is housed in a 2 \times 4 \times 0.4-in. module. An internal clock provides all the timing necessary, so only a start command is needed.

Of course, there are plenty of other 12-bit a/d converters. But at conversion speeds near 2 μ s, the

range of available units shrinks drastically. Available units include the ADC-1103 from Analog Devices (Norwood, MA), the MP-2712 from Analogic (Wakefield, MA), the ADC-591-12A from Hybrid Systems, (Burlington, MA) and the 4133 from Teledyne-Philbrick (Dedham, MA).

Conversion times for these units start at 2.5 μ s for the 4133 from Philbrick, rise to 3.5 μ s for the Analog Devices and Hybrid Systems units and increase to 4 μ s for the Analogic converter. Costs, though, start at \$229 for the Analogic converter, jump to \$425 for the Hybrid Systems converter, to \$495 for the Analog Devices unit and to \$585 for the Philbrick.

Physically these converters, except for the Philbrick, are almost double the volume of the Dadel unit, measuring 2 \times 4 \times 0.75 in. The Philbrick units are slightly smaller—2 \times 4 \times 0.375 in.

The Dadel ADC-EH12B3 is available from stock to 4 weeks.

Dadel	CIRCLE NO. 301
Analog Devices	CIRCLE NO. 302
Analogic	CIRCLE NO. 490
Hybrid Systems	CIRCLE NO. 491
Teledyne-Philbrick	CIRCLE NO. 492

MODULES & SUBASSEMBLIES

Synchro-to-dc converters accurate to ± 6 minutes

Computer Conversions, 6 Dunton Ct., East Northport, NY 11731. (516) 261-3300. \$350 (prod. qty.): 4 wk.

The SLD214 series of synchro-to-linear-dc converter modules can track at input rates up to $1440^\circ/\text{s}$. The modules measure $2.6 \times 3.1 \times 0.82$ in. and have standard accuracies of ± 6 , ± 15 or ± 30 minutes of arc. They convert synchro or resolver inputs of 11.8 or 90 V, 400 Hz; or 90 V, 60 Hz into a linear dc voltage proportional to the shaft angle. Dc outputs of ± 10 V representing $\pm 180^\circ$, 0 to $+10$ V representing 0 to 360° or ± 10 V representing $\pm 90^\circ$ are available. This series of converters is insensitive to $\pm 10\%$ amplitude and frequency variations and $\pm 5\%$ power-supply variations. The converters have transformer isolated reference and synchro inputs, and units that maintain ± 6 minutes of arc accuracy over military temperature ranges are available.

CIRCLE NO. 365

Watt transducers work over 50 Hz to 10 kHz

F. W. Bell, 4949 Freeway Drive East, Columbus, OH 43229. (614) 888-7501. \$39 (100-up).

Two watt transducers are designed to measure one and three phase electrical power at various frequencies from 50 Hz through 10 kHz. The output is a power-proportional dc voltage. Fast response and wide bandpass operation enable the PX-2000 and the PX-4000 series to accurately measure power from distorted waveforms. The low frequency PX-2000 series features models with fundamental frequencies of 60, 180 and 360 Hz. High frequency PX-4000 models center at 1 and 3 kHz. Each model consists of a potential transformer, a Hall-effect multiplier and corrective circuitry that reduces the influence of low power factor and of ambient temperature variations. Each transducer is epoxied in a small nylon case with through mounting holes and wire leads. The case measures $3.5/16 \times 1.13/16 \times 1.5/16$ in.

CIRCLE NO. 366

Hybrid a/d converter includes s/h amplifier

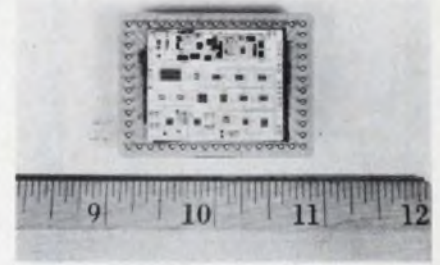

Aydin Vector, P.O. Box 328, Newton, PA 18940. (215) 968-4271. \$400.

The ADH-10 series analog-to-digital converter uses thick-film multilayer technology and CMOS logic. The unit is a completely self-contained 10-bit converter, with internal sample-and-hold and clock. It is available in a hermetic package that measures 1.8×1.3 in. and weighs less than 1 oz. The circuit is built to meet the environmental requirements of MIL-STD-883 and has a conversion time of $25 \mu\text{s}$ for 10 bits. The internal s/h circuit has a decay of $100 \mu\text{V}/\mu\text{s}$ and can acquire a signal in $5 \mu\text{s}$ to 0.1% accuracy.

CIRCLE NO. 367



The Digisec[®] Encoder keeps little bits from becoming big mistakes.

As some people have found out the hard way, all bits are not of equal length. And what may appear to be just a small error—say a fraction of an arc-second, can lead to a large accumulated error.

As the long recognized leader in encoders, Itek realizes the importance of maintaining accuracy commensurate with resolution. And Digisec Encoders have resolutions and accuracy up to 22 bits/revolution. But that's just part of the story.

Write for our free catalog. Read all about Digisec Encoders. They're more than a bit ahead of their time.

Itek Measurement Systems

A Division of Itek Corporation
27 Christina Street, Newton, Mass 02161

INFORMATION RETRIEVAL NUMBER 90

ELECTRONIC DESIGN 19, September 13, 1975

MEMORY SERIES No. 1

THE DO-IT-YOURSELF 2K PROM

Program it on your own home ground. With our big, fast, Field Programmable 512x4 PROM. #82S130/131. Twice the memory for your money. 2048 bits with same pins, same high performance rating as a 1K PROM.



Coupon clipped to letterhead gets you data sheet on #82S130/131—2K PROM.

Name _____

Tel. _____

Ext. _____

THINK

Sinnetics

311 E. ARQUES SUNNYVALE CALIF 94086

INFORMATION RETRIEVAL NUMBER 91

NEW DPVM's FROM NEWPORT



**BRIGHT 13MM
LED DISPLAY,
BCD OUTPUT,
RATIO AND 2-YR
WARRANTY**

\$8100*

FOR **81** 3½ DIGIT MODEL 203

- Four full scale ranges
- Auto-Polarity ± 1999 counts
- Voltage, Current and Ratio measurements
- Automatic Zero-Front panel F.S. adjust

(Model 2003, 4½ digit \$139*)

Whether you need 3½ or 4½ digits, Newport will deliver the most reliable and versatile Digital Panel Volt Meter (DPVM) available. With a great reduction in parts and the addition of the new ½-inch LED display, we can now increase our warranty to a full 2 years. The life expectancy of the display is greater than 11 years. Full scale ranges are 200 millivolts, 2, 20, and 200 volts... and BCD output comes free.

Newport now has worldwide stocking representatives providing off-the-shelf deliveries and local support. For complete data, call or write: Newport Laboratories, Inc., 630 East Young Street, Santa Ana, CA 92705.

For immediate response, CALL COLLECT (714) 540-4686

(In Europe-Tele. Amsterdam [20] 45-20-52)

*Quantities of 100

NEWPORT

Visit ISA Booth 513

INFORMATION RETRIEVAL NUMBER 101

MODULES & SUBASSEMBLIES

16-bit d/a converter claims highest accuracy, lowest drift

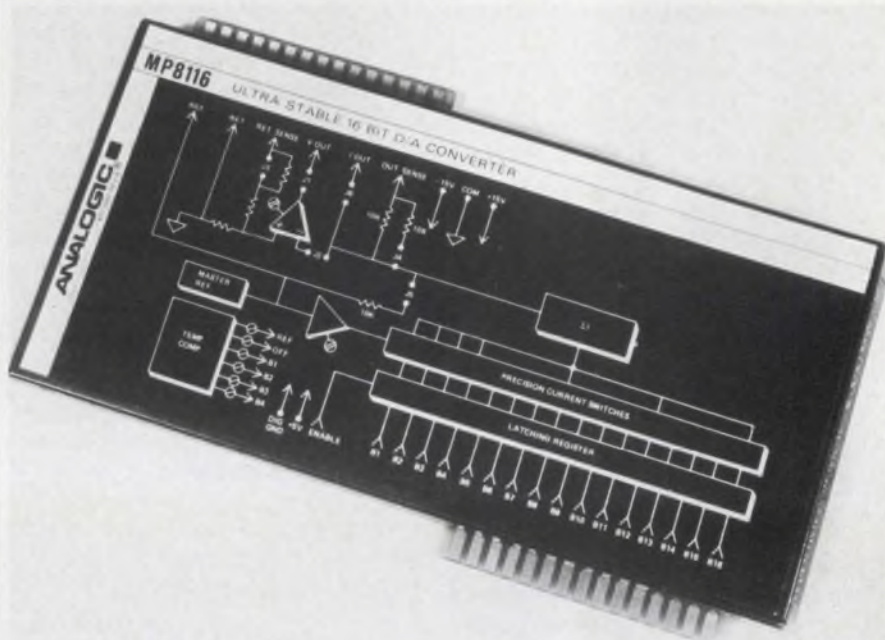

Analogic, Audubon Rd., Wakefield, MA 01880. (617) 246-0300. P&A: See text.

True 16-bit accuracy for d/a converters is here. So says Analogic with its MP8116 converter. The d/a provides accuracy to within 4 ppm and has a 2-ppm uncertainty traceable to the National Bureau of Standards.

Not only is the unit accurate, but it holds its accuracy with changes in temperature. The temperature coefficient of gain is given as only ± 0.4 ppm/ $^{\circ}\text{C}$, max, and the tempco of offset only 0.3 ppm/ $^{\circ}\text{C}$. The differential linearity is held to 0.24 bit, max, while its tempco is 0.25 ppm/ $^{\circ}\text{C}$, max.

For worst-case conditions, the tempcos total to less than 1 ppm/ $^{\circ}\text{C}$, and thus, over a ± 10 C range, the stability of the converter is 10 ppm, maximum—which, in turn, causes a drift less than one bit.

The converter has a built-in amplifier and can provide either a voltage or current output. The specs given, so far, are for the voltage output, and they get even better for the current output, since the tempcos of the output ampli-

fier are eliminated.

Noise inside the converter is only 1.5 ppm, while the converter settling times are 25 μs for the voltage output and about 10 μs , max, for the current output. The converter can deliver a current of 2 mA; it requires 1.4 W for operation.

The output can be connected for four-wire balanced sense operation to ensure effective correction of losses between the d/a output and the load. A completely shielded 3.5 \times 7-in. case protects the unit and can be opened to permit total recalibration when necessary.

Prices for the MP8116 start at \$1500 for 1 to 9 pieces. Substantial discounts are available for 10 or more pieces. The converters are available from stock to 4 weeks.

Several other companies offer 16-bit converters, but none come close to the tempcos that are available in the Analogic MP8116. For instance, Analog Devices (Norwood, MA) has the DAC-16QG, which lists drifts that are about 10 times worse and settling times that are 10 times longer. There

(continued on page 129)

For Systems Design, Applications and Production Engineers Only...

Engineers Whose Design and Test Problems Can Be Solved More Effectively Through the Combination of Optical and Electronic Technology.

150 Papers presented by distinguished scientists, engineers and designers representing all levels of technology in industry, education and government.

INTRODUCING The LASER APPLICATIONS SYMPOSIUM dedicated to helping the design engineers who apply lasers to specific applications throughout all industry.

Electro/Int'l Optics/Laser

CONFERENCE & EXPOSITION

NOVEMBER 11, 12, 13, 1975

Anahelm Convention Center, Anaheim, California

SUPPORTED BY an extensive exhibition of the latest electro-optical and laser components, subsystems, hardware, materials and test instruments, including products suitable for use in computer peripherals,

CO-SPONSORED BY:

ELECTRO-OPTICAL SYSTEMS DESIGN Magazine

... and These

Distinguished Organizations:



THE SOCIETY OF PHOTOGRAPHIC SCIENTISTS AND ENGINEERS (SPSE)



Official Conference of THE LASER INSTITUTE OF AMERICA (LIA)

process control equipment and hundreds of other such applications.

Conference Program

TUESDAY, NOVEMBER 11

9:00 AM - 12:00 PM

TECHNICAL SESSION I

"OPTICAL COMPUTING I — EXTENDING THE FLEXIBILITY OF COHERENT OPTICAL PROCESSING"

Chairman: Joseph W. Goodman, Stanford University

TECHNICAL SESSION II

"WIDEBAND LASER RECORDING I — ADVANCES IN COMPONENT DEVELOPMENT"

Chairman: A. J. Jamberdino, Rome Air Development Center

TECHNICAL SESSION III

"OPTICS IN THE SOLAR ENERGY FIELD"

Chairman: Eric M. Wormser, Wormser Scientific Corp.

TECHNICAL SESSION IV

"ELECTRO-OPTICS IN ATMOSPHERIC MEASUREMENTS — I"

Chairman: John R. Yoder, Beckman Instruments

TECHNICAL SESSION V (LIA)

"LASER ISOTOPE SEPARATION"

Chairman: Jack P. Aldridge, Los Alamos Scientific Lab.

TECHNICAL SESSION VI

"INTEGRATED AND FIBER OPTIC COMPONENTS — I"

Chairman: Prof. Chen Tsai, Carnegie-Mellon Univ.

1:30 PM - 4:00 PM

LASER WORKSHOP (LIA)

"LASERS IN THE PRESENT ECONOMY — AN INVESTMENT POTENTIAL"

Chairman: Carl Bailey, Laser Investments Inc.

WEDNESDAY, NOVEMBER 12

9:00 AM - 12:00 PM

TECHNICAL SESSION VII

"OPTICAL COMPUTING II — HYBRID OPTICAL/DIGITAL PROCESSORS"

Chairman: David Casasent, Carnegie-Mellon University

TECHNICAL SESSION VIII

"WIDEBAND LASER RECORDING II — STATE-OF-THE-ART AND FUTURE TRENDS IN LASER RECORDING AND DATA HANDLING SYSTEMS"

Chairman: A. J. Jamberdino, Rome Air Development Center

TECHNICAL SESSION IX

"IMAGING DEVICES AND SYSTEMS — I"

Chairman: Herbert Lavin, General Electric Co.

TECHNICAL SESSION X

"ELECTRO-OPTICS IN ATMOSPHERIC MEASUREMENTS — II"

Chairman: John R. Yoder, Beckman Instruments

TECHNICAL SESSION XI

"ACOUSTO-OPTICS DATA PROCESSING"

Chairman: Prof. Glen Wade, University of California

TECHNICAL SESSION XII

"INTEGRATED AND FIBER OPTIC SYSTEMS — II"

Chairman: Professor Chen Tsai, Carnegie-Mellon Univ.

1:30 PM - 4:00 PM

LASER WORKSHOP (LIA)

"LASER DAMAGE SYMPOSIUM UPDATE"

Chairman: Dr. Arthur Guenther, AFWL, Kirtland AFB and Alex Glass, Lawrence Livermore Lab.

THURSDAY, NOVEMBER 13

9:00 AM - 12:00 PM

TECHNICAL SESSION XIII

"OPTICAL COMPUTING III — COHERENT OPTICAL DEVICES"

Chairman: Dr. H. J. Caulfield, Block Engineering, Inc.

TECHNICAL SESSION XIV (LIA)

"LASERS IN GRAPHICS"

Chairman: Stephen Johnson, Spectra-Physics

TECHNICAL SESSION XV

"IMAGING DEVICES AND SYSTEMS — II"

Chairman: Herbert Lavin, General Electric Co.

TECHNICAL SESSION XVI (LIA)

"LASER RANGING, TRACKING AND GUIDANCE"

Chairman: Dr. David Flinchbaugh, International Laser Systems

TECHNICAL SESSION XVII

"GLASS FIBER WAVEGUIDES"

Chairman: Madhu A. Acharekar, Galileo Electro-Optics Corp.

TECHNICAL SESSION XVIII (LIA)

"POWER SUPPLIES AND ENERGY STORAGE SYSTEMS FOR ELECTRO-OPTICS AND LASERS"

Chairman: R. Stapleton, Los Alamos Scientific Laboratory

LASER APPLICATIONS SYMPOSIUM (LIA)

COMMERCIAL I

Tuesday, November 11 — 5:00 PM - 6:10 PM

Chairman: Dr. Ralph Wuerker, TRW Systems

COMMERCIAL II

Tuesday, November 11 — 6:30 PM - 8:00 PM

Chairman: Dr. Ralph Wuerker, TRW Systems

INSTRUMENT

Wednesday, November 12 — 5:00 PM - 6:10 PM

Chairman: Jose Cruz, Cummins Engine Co.

COMMUNICATIONS

Wednesday, November 12 — 6:30 PM - 8:00 PM

Chairman: Jose Cruz, Cummins Engine Co.

MATERIAL PROCESSING I

Thursday, November 13 — 1:30 PM - 2:40 PM

Chairman: David Belforte, Belforte Associates

MATERIAL PROCESSING II

Thursday, November 13 — 3:00 PM - 4:30 PM

Chairman: David Belforte, Belforte Associates

PROFESSIONAL ADVANCEMENT COURSES

PAC I

"INTRODUCTORY COURSE ON APPLICATION OF SOLAR ENERGY IN THE HEATING AND COOLING OF BUILDINGS"

Monday, November 10 — 9:00 AM - 12:00 PM and 1:30 PM - 4:00 PM

Course Leader: Eric M. Wormser, President, Wormser Scientific Corp.

PAC II

"INTRODUCTION TO ELECTRO-OPTICS"

Tuesday, Wednesday, Thursday, November 11, 12, 13 — 1:30 PM - 4:00 PM

Course Leader: Prof. J. Gaskill, Optical Sciences Center, University of Arizona

PAC III (LIA)

"SHORT COURSE ON EFFECTS OF LASER RADIATION, RE TISSUE SAFETY, RADIOMETRY, ETC."

Monday, November 10 — 9:00 AM - 12:00 PM and 1:30 PM - 4:00 PM

Course Directors:

R. James Rockwell, Jr., University of Cincinnati
James F. Smith, IBM Corp.
David H. Sliney, U.S. Army Environmental Hygiene Agency

PAC IV (LIA)

"LASER MEASUREMENTS"

Tuesday, November 11 — 1:30 PM - 4:00 PM

Course Leader: Dr. W. Tiffany, Moletron Corp.

PAC V (LIA)

"ENVIRONMENTAL AND NON-DESTRUCTIVE TESTING BY LASERS"

Thursday, November 13 — 1:30 PM - 4:00 PM
Organized by LIA

SPSE SEMINARS

SEMINAR I

"MICRODENSITOMETRIC READOUT OF PHOTOGRAPHIC INFORMATION"

Tuesday, November 11 — 1:30 PM - 4:00 PM

Chairman: Prof. Fawwaz T. Ulaby, University of Kansas

SEMINAR II

"LASER RECORDING MATERIALS — TECHNICAL ADVANCES AND PANEL WORKSHOP"

Wednesday, November 12 — 1:30 PM - 4:00 PM

Chairman: Dr. Arthur Diamond, Diamond Research Corp.

LIA ANNUAL MEETING & LUNCHEON

Wednesday, November 12, 11:30 AM

Anahelm Convention Center

Honored Speaker
for 1975

Professor Abraham Hertzberg
University of Washington

EXHIBITION HOURS

Tuesday, Wednesday and Thursday
11:30 AM - 5:30 PM

Use Advance Registration Form on Reverse Side to Register for the Conference Program and/or the Exhibition!

Electro/Int'l Optics/Laser '75

CONFERENCE & EXPOSITION

**For Systems Design,
Applications and Production
Engineers Only . . .**

**NOVEMBER 11-13, 1975 / ANAHEIM CONVENTION CENTER
800 W. Katella Avenue, Anaheim, California**

SEE REVERSE SIDE FOR DETAILS ABOUT THE CONFERENCE PROGRAM . . . THEN FILL OUT COUPON BELOW, DETACH, PLACE IN ENVELOPE, STAMP AND MAIL . . . TODAY!

ADVANCE REGISTRATION

COURTESY OF:

Electronic Design.

NOTE: All registrants for the TECHNICAL PROGRAM and/or the EXHIBITION must complete and return this form. Only qualified personnel are invited to attend. MAKE COPIES OF THIS COUPON FOR YOUR ASSOCIATES.

PLEASE PRINT

My company's business _____

My job function _____ I supervise _____ people.

I would be interested in receiving information on exhibiting in future events.

INITIALS _____ LAST NAME _____

TITLE _____
Abbrev. Pres, VP, GM, Frm, Supt, Dir, Mgr, Supv, Eng, ChEng, Mts, Prod, Tech, Mkt, Sis, PA, etc.

COMPANY NAME _____

ADDRESS _____

CITY _____ STATE _____ ZIP _____

Please send complimentary application for exhibition and program information to my associates:

INITIALS _____ LAST NAME _____ TITLE _____

INITIALS _____ LAST NAME _____ TITLE _____

INITIALS _____ LAST NAME _____ TITLE _____

I am interested in the following products:

- | | |
|---|--|
| <input type="checkbox"/> 11 Gas Lasers | <input type="checkbox"/> 23 Optical Hardware/Mounts/Benches |
| <input type="checkbox"/> 12 Fiber Optics | <input type="checkbox"/> 24 Injection Lasers |
| <input type="checkbox"/> 13 Lenses/Prisms/Optical Components | <input type="checkbox"/> 25 Modulators/Beam Deflectors/Beam Splitters/Scanners, etc. |
| <input type="checkbox"/> 14 Solid State Lasers | <input type="checkbox"/> 26 Light/IR/UV Detectors |
| <input type="checkbox"/> 15 Light IR/UV Sources | <input type="checkbox"/> 31 Holographic Systems & Equipment |
| <input type="checkbox"/> 16 Cameras—CRT/High Speed, etc. | <input type="checkbox"/> 32 TV Systems/LLTV |
| <input type="checkbox"/> 17 Coatings & Films | <input type="checkbox"/> 33 Chemicals/Solvents/Materials |
| <input type="checkbox"/> 18 Image Detectors/Intensifiers | <input type="checkbox"/> 34 Grinding & Polishing Equipment/Supplies |
| <input type="checkbox"/> 19 GaAs, GaAsP, KDP & other Crystals | <input type="checkbox"/> 35 Dye Lasers |
| <input type="checkbox"/> 20 Cryogenics/Environmental Controls | <input type="checkbox"/> 36 Test Instruments & Instrumentation |
| <input type="checkbox"/> 21 Electrical/Electronic Support Devices | <input type="checkbox"/> 37 Laser Power Supplies & Pulsers |
| <input type="checkbox"/> 22 CRT/Display Devices | <input type="checkbox"/> 38 Laser Optics |

PLEASE REGISTER ME FOR:

EXHIBITS ONLY — COMPLIMENTARY ADMISSION WITH THIS COUPON (Save \$5.00 Admission Charge at Door)

TECHNICAL SESSIONS, WORKSHOPS AND SYMPOSIUM SESSIONS: (Plans A, B, C, and D include complimentary admission to exhibits for all three days)

- | | |
|---|----------|
| <input type="checkbox"/> Plan A: One Day (Circle Day — T W TH) | \$15.00 |
| <input type="checkbox"/> Plan B: Two Days (Circle Days — T W TH) | \$22.50 |
| <input type="checkbox"/> Plan C: All Three Days | \$30.00 |
| <input type="checkbox"/> Plan D: Plan C, plus copy of Proceedings | \$65.00 |
| <input type="checkbox"/> _____ Extra Copies of Proceedings @ \$40.00 each | \$ _____ |

PLUS THE FOLLOWING OPTIONAL ITEMS

PROFESSIONAL ADVANCEMENT COURSES:

NOTE: PAC I and II include text materials, complimentary admission to Technical Sessions, Workshops, Symposium Sessions and Exhibits for all three days.

- | | |
|--|---------|
| <input type="checkbox"/> PAC I: Introductory Course on Application of Solar Energy in the Heating and Cooling of Buildings | \$90.00 |
| <input type="checkbox"/> PAC II: Introduction to Electro-Optics | \$90.00 |

NOTE: PAC III, IV and V include text materials and complimentary admission to exhibits for all three days.

- | | |
|--|----------|
| <input type="checkbox"/> PAC III: Short Course on Effects of Laser Radiation, Re Tissue Safety, Radiometry, Etc. (LIA) | |
| LIA Member: \$50.00 Non-Member: \$65.00 | \$ _____ |
| <input type="checkbox"/> PAC IV: Laser Measurements (LIA) | |
| LIA Member: \$30.00 Non-Member: \$45.00 | \$ _____ |
| <input type="checkbox"/> PAC V: Environmental and Non-Destructive Testing by Lasers (LIA) | |
| LIA Member: \$20.00 Non-Member: \$35.00 | \$ _____ |

NOTE: SPSE Seminars include complimentary admission to exhibits for all three days.

- | | |
|--|---------|
| <input type="checkbox"/> SPSE SEMINAR I: Microdensitometric Read-Out of Photographic Information | \$10.00 |
| <input type="checkbox"/> SPSE SEMINAR II: Laser Recording Materials | \$10.00 |
| <input type="checkbox"/> SPSE SEMINARS I and II | \$15.00 |

- | | |
|--|----------|
| <input type="checkbox"/> LIA ANNUAL MEETING AND LUNCHEON | |
| LIA Member: \$5.50 Non-Member: \$7.00 | \$ _____ |
| (Reservations must be received by Oct. 28) | |

PRICE OF PLAN SELECTED \$ _____
TOTAL OF OPTIONAL ITEMS \$ _____
TOTAL ALL ITEMS \$ _____

Signature _____ Date _____

Check or money order enclosed, payable to Industrial & Scientific Conference Management, Inc. Please send a signed receipt for expense accounting.

Please bill me. I understand my registration will not be confirmed until payment is made.

Send me a hotel reservation form.

NOTE: After October 31, do not mail in request. Instead, take it to the Registration Desk at the Exhibition.

RETURN TO:

INDUSTRIAL & SCIENTIFIC CONFERENCE MANAGEMENT, INC.
222 West Adams Street • Chicago, IL 60606 • (312) 263-4866

HOTEL INFORMATION

Rooms have been set aside for Electro-Optic/Int'l Laser '75 in these hotel/motels:

ROYAL INN (Headquarters)
QUALITY INN
DISNEYLAND HOTEL
HOLIDAY INN

For complete details and to make reservations, please contact:

Nan Parsons
ANAHEIM VISITOR & CONVENTION BUREAU
800 West Katella Avenue
Anaheim, Calif. 92802 / Phone (714) 533-5536

In order to qualify for special rates, you must mention Electro-Optic/Int'l Laser '75 when telephoning for reservations or information!

MODULES & SUBASSEMBLIES

(con't from p. 128)

are, though, many different options for the DAC-16, with prices starting at less than \$800 for the basic converter.

Burr-Brown (Tucson, AZ) has the DAC-70, Datel (Canton, MA) the DAC-HR16B and Function Modules (Irvine, CA) the 416—all of which have higher drifts than the MP8116 but cost between \$119 and \$500. Many of these units, though, don't include all the features of the Analogic MP8116. For instance most don't have internal storage registers, voltage outputs, four-wire outputs or trimming adjustments.

Analogic	CIRCLE NO. 321
Analog Devices	CIRCLE NO. 322
Burr-Brown	CIRCLE NO. 323
Datel	CIRCLE NO. 324
Function Modules	CIRCLE NO. 325

Synchro-to-sin/cos conv. is accurate to 12 min.

ILC Data Device, Airport International Plaza, 105 Wilbur Pl., Bohemia, NY 11716. (516) 567-5600. \$585 (1 to 9).

The Model STDC converter accepts three-wire synchro or four-wire resolver data and delivers ± 10 -V-dc at ± 5 -mA sine and cosine data accurate to ± 12 minutes (ratio sin/cos). It can do this even in the presence of $\pm 3\%$ input power variations and $\pm 10\%$ swings in input signal amplitude and frequency. The STDC accepts synchro inputs (line-to-line) of 90 V at 60 Hz, 90 V at 400 Hz or 11.8 V at 400 Hz. Other voltages and frequencies are available. Synchro input angle rates are 0 to $\pm 360^\circ/s$ for 400-Hz units and 0 to $\pm 60^\circ/s$ for 60-Hz units. Initial acquisition time is less than 25 ms. Under worst-case conditions, the sin/cos dc output will be smoothly varying and free of spikes, with rms noise below 2 mV and peak noise less than 5 mV. Two operating temperature ranges are available: 0 to +70 and -55 to +85 C. The converter requires: 15 V dc, $\pm 3\%$ at less than 50 mA and measures 2.625 x 3.125 x 0.82 in.

CIRCLE NO. 368

NEW Continental Specialties Logic Monitor

FASTER THAN A SCOPE! SAFER THAN A VOLTMETER! BRINGS ICs TO LIFE!

Made in USA

* Patent Pending

The amazing self-powered, self-contained, pocket-size Logic Monitor requires no adjustments or calibrations as it simultaneously displays static and dynamic logic states of DTL, TTL, HTL or CMOS DIP ICs. Now you can watch your signals work their way through counters, shift registers, timers, adders, flip-flops, decoders, even entire systems! High intensity LEDs turn on when lead voltages exceed the threshold (2V). **No power supply is needed!** The power-seeking gate network locates DIP supply leads and feeds them into the Logic Monitor. Forget about grounds, pin counting or sync polarity.

Simply clip the Logic Monitor to any DIP IC up to 16 pins. Precision plastic guides and a flexible plastic web insure positive connections between non-corrosive nickel/silver contacts and the IC leads. Logic levels appear instantly on 16 large (.125" dia.) high intensity LEDs. Logic "1" (high voltage)-LED ON. Logic "0" (low voltage or open circuit)-LED OFF. Yes, now you can see your designs come alive. Order your fast, versatile, accurate, indispensable Logic Monitor today!

ORDER TODAY! 84⁹⁵

Add \$2.50 postage/handling.
Foreign orders add 15%.
Prices subject to change.



Continental Specialties Corporation

Box 1942, New Haven, CT 06509 • 203/624-3103

W. Coast Off.: Box 7809, S. Fran., CA 94119 • 415-421-8872 Canada: Available thru Len Finkler Ltd., Ontario

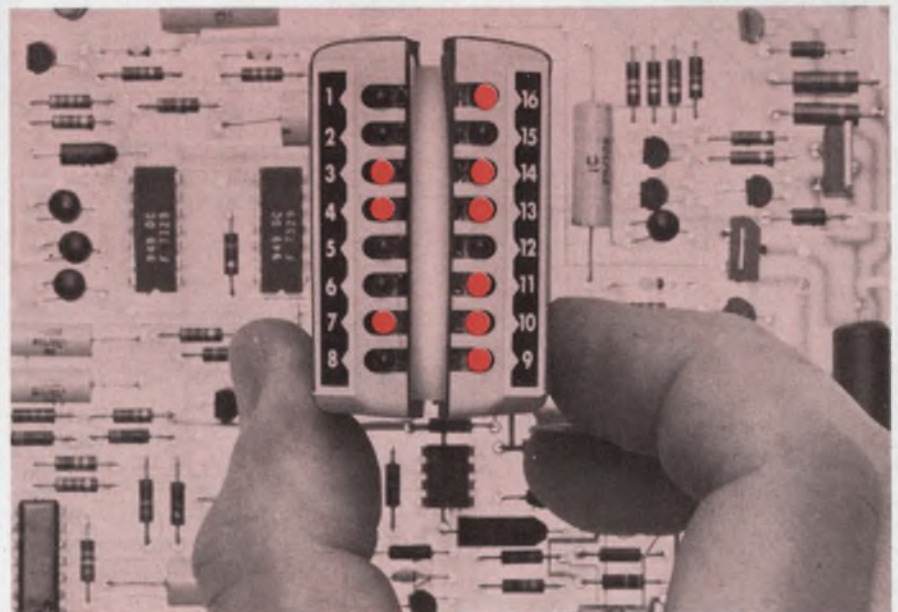

INFORMATION RETRIEVAL NUMBER 102

1
AMERICAN MADE

Tolerance
SCHAUER
1-Watt
ZENERS

**Immediate Shipment
Low Prices**

ANY voltage from 2.0 to 16.0

Quantity	Price each
1-99	\$1.07
100-499	.97
500-999	.91
1000-4999	.86
5000 up	.82



Write for complete
rating data and other
tolerance prices.

**Buy the kit-
Save
a lot**



Kit contains a 51-piece assortment of SCHAUER 1% tolerance 1-watt zeners covering the voltage range of 2.7 to 16.0. Three diodes of each voltage packaged in reusable poly bags. Stored in a handy file box. Contact your distributor or order direct.

A \$54.57 value for
ONLY \$24⁵⁰

Semiconductor Division

SCHAUER
Manufacturing Corp.

4511 Alpine Ave. Cincinnati, Ohio 45242
Telephone: 513/791-3030

Bulletin Board

Enhancements to the Xerox 1200 computer printing system increase performance, expand compatibility and simplify control functions of the system.

CIRCLE NO. 369

Ex-Cell-O, Remex, has introduced software which permits users of PDP-11 minicomputers with limited software capabilities to put a flexible disc system on-line to replace or enhance paper tape I/O devices.

CIRCLE NO. 370

Control Data offers two new services—SYSCAP II (System of Circuit Analysis Programs) and CC-TEGAS3 (Test Generation and Simulation System)—for circuit design and testing.

CIRCLE NO. 371

Training centers with programs specializing in the use of microprocessors and microcomputers have been established by National Semiconductor.

CIRCLE NO. 372

Doubled memory capacity, cardless computing and a program providing remote job entry support to operate under OS/VS1 or OS/VS2 have been added to the capabilities of IBM's System/3 Model 15.

CIRCLE NO. 373

Sprague's Filter Div. engineering laboratories can perform rf interference measurements and suppression measurements in accordance with foreign and international specifications.

CIRCLE NO. 374

Teledyne Semiconductor's Series 74C CMOS ICs now have an extended temperature range of -40 to +85 C.

CIRCLE NO. 375

Electronic Instrument & Specialty is offering its re-designed MINI-INCH reed relay series at a cost savings of 20 to 30%.

CIRCLE NO. 376

Application Notes

Pair cable fault locator

Application of the Anritsu Electric Model MW32B pulse echo tester and its use in locating faults in the event of water absorption, wire breakdown, short-circuit and erroneous connection of plastic communication cables are discussed in a 10-page catalog. Tau-Tron, North Billerica, MA

CIRCLE NO. 377

Signal analysis

"A New Modular System for Noisy Low-Level Signal Processing" points out analogies between devices supplied with two correlated channels: lock-in amplifier, boxcar averager and Fourier analyzer. Tekelec Airtronic, 92310 Sevres, France

CIRCLE NO. 378

Load cell instrumentation

Acquisition of remote load cell data often requires involved instrumentation and transmission circuitry. A new approach using a v/f converter is covered in a four-page bulletin. Dynamic Measurements, Winchester, MA

CIRCLE NO. 379

Conductive paints, inks

Ten basic ways by which scientists and engineers use conductive paints and inks are listed in a brochure. It contains a selector chart, description of the coatings and an offer to purchase a full range of paints at discounts up to 20%. Micro-Circuits, New Buffalo, MI

CIRCLE NO. 380

Low-pass filters

"Filter Characteristics" provides amplitude response, group delay and equivalent noise bandwidth figures for the most commonly used low-pass filters for telemetry and communication applications. EMR Telemetry, Sarasota, FL

CIRCLE NO. 381

ROLL'EM SMOOTH

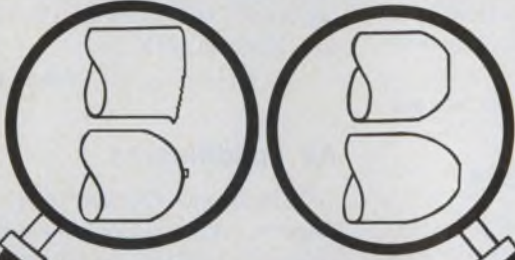

**DON'T BUY
BURRS**

**BUY SMOOTH
RADII**

Mating, feeding, assembly, and electrical contacts are easier, more reliable and faster with radiused or bullet nosed smooth blended cut-offs. Available by special techniques from Auto-Swage for probably less money than those with burrs, sharp corners, cutoff tits or insufficient tumbled corner breaks. Ask about our capabilities. They can smooth out your problems.



auto-swage
PRODUCTS, INC.

726 River Road, Shelton, Conn. 06484. Tel. (203) 929-1401

INFORMATION RETRIEVAL NUMBER 104

WHEN IT'S TIME FOR A SWITCH...

It's time for Shigoto. Because every Shigoto switch is backed by solid engineering know-how. A reliable piece of equipment you can count on. To perform every time. We've got toggle and rocker, lever and leaf, push button, panel, rotary, radio, knife, slide and snap action switches. All sizes, all ratings. Leaf through our Catalog and pick the switch that's compatible with your requirements. If we haven't already made it, we can, specially for you. And while you're at it, check out our other outstanding O.E.M. components, too.



SHIGOTO. A STANDARD FOR INDUSTRY
Write or phone for our catalog and more information

Shigoto Industries Ltd.

350 Fifth Ave., N.Y., N.Y. 10001/(212) 695-0200/Telex 224219
One of the World's Largest Manufacturing Importers

INFORMATION RETRIEVAL NUMBER 105

ELECTRONIC DESIGN 19, September 13, 1975

Minisert™ Low-Profile P.C. Socket... provides repeated pluggability for I.C.'s, DIP's, etc.

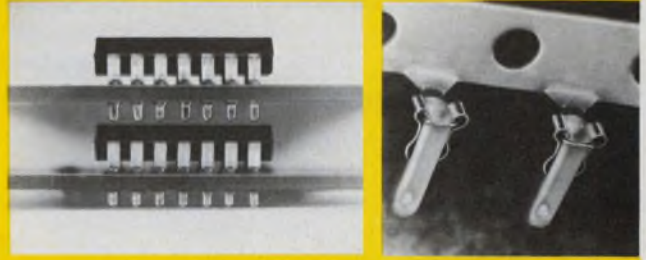

For use where space is restricted... extends just .030" above and .088" below board... allows .400" board-to-board spacing. One size Minisert* socket fits wide range of hole sizes... .050" to .058" in diameter... and accepts round or flat leads of DIP's, LED's and LSI's. Elastomeric seal keeps foreign matter out of socket. Free standing design can be used in any socket pattern. Semi-automatic machine inserts at rates up to 2000 per hour. Write for Bulletin 120 or call.

*Sockets sell for \$20.00 to \$30.00 per thousand in volume quantities.



**BERG
ELECTRONICS**
Division of E. I. du Pont de Nemours & Co. Inc.

New Cumberland, Pa. 17070 Phone: (717) 938-6711

INFORMATION RETRIEVAL NUMBER 141

BergStik™ Straight and Right-Angle Headers... for production line or prototype.



Here's an inexpensive method of inserting .025" square pins in boards for wire-wrapping or input/output usage. Header consists of drawn wire pins (3/4-hard phosphor bronze) molded in position in glass-filled nylon carriers. Result: A stronger pin with no rough edges. Headers are available on .100", .125" and .150" centers. Carriers are notched to allow the user to break to length for any desired number of pins. BergStik Headers also have tongue-and-groove design to facilitate side-by-side stacking. Headers can be loaded like components and do not interrupt flow on the assembly line. Just plug 'em in! (Write for Bulletin 140)



**BERG
ELECTRONICS**
Division of E. I. du Pont de Nemours & Co. Inc.

New Cumberland, Pa. 17070 Phone: (717) 938-6711

INFORMATION RETRIEVAL NUMBER 142

New Literature

Electronic components

Color-coded indexing and pages make it easier to locate product groups in a components catalog. The catalog describes glass, glass-ceramic, ceramic and microminiature solid tantalum capacitors and metal-film resistors. Corning, Corning, NY

CIRCLE NO. 389

Photomultiplier tubes

In addition to picturing and detailing photomultiplier tubes, a 20-page volume discusses related subjects such as environmental limitations, voltage dividers, the anode circuit, considerations in tube selection and other applications. EMI Gencom, Plainview, NY

CIRCLE NO. 384

Information systems

"The Information Connection" is dedicated to building an understanding of three cornerstones in information systems technology: program management, data base management and applications for management. Computer Sciences Corp., Los Angeles, CA

CIRCLE NO. 387

Motors and gearmotors

Two brochures contain information on the K-2 line of industrial instrument and servo motors and their companion gearmotors. The two eight-page bulletins detail performance data as well as typical performance curves. Bodine Electric, Chicago, IL

CIRCLE NO. 388

Miniature accelerometers

Specifications and typical uses of single axis, biaxial and triaxial miniature accelerometers are covered in a 16-page brochure. Entran Devices, Little Falls, NJ

CIRCLE NO. 385

Delay lines

Precision delay lines, laboratory decade delay lines, fixed attenuators and video equalizers are presented in a 24-page catalog. A discussion on "how to specify delay lines" is included. Allen Avionics, Mineola, NY

CIRCLE NO. 390

Air conditioners

"Electronic Cabinet Air Conditioners: Application/Selection/Operation" contains a six-page discussion of the subject, together with a time-saving selection nomogram. Kooltronic, Princeton, NJ

CIRCLE NO. 391

Temp indicating paints

Temperature indicating paints and crayons which change color at specific temperature levels are described in a four-page brochure. Specifications and color photographs are included. Telatemp, Fullerton, CA

CIRCLE NO. 386

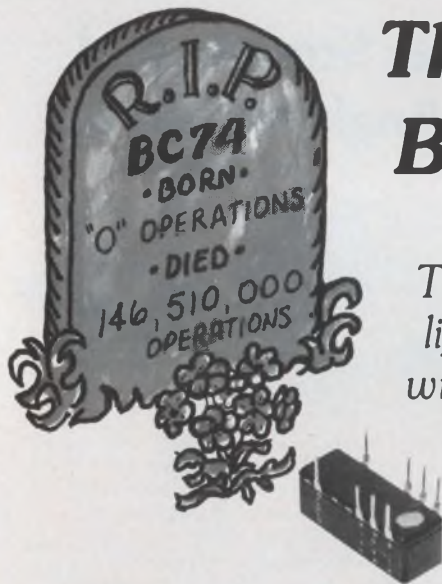

The Life Story of the Babcock BC-74 Relay

This BC-74 DIP Armature Relay started out in life by attaining 310,000 operations as a DPDT with lampload 28 volts at 40 milliamps (.5 amp minimum inrush current), **THEN . . .**

continued on to complete 128,000,000 operations mechanical life **THEN . . .**

The ultimate achievement was accomplished with 18,200,000 operations as a double-make with 100 volts, 100 milliamps, 1 KM phone line load, 33 ohms series resistor.

Death was due to an ERODED STATIONARY. . . R.I.P.

To buy ESTERLINE'S new Long-Life BC-74 contact Al Martin at Esterline Electronics Corp., 3501 Harbor Blvd., Costa Mesa, CA. 92626, (714) 540-1234.



ESTERLINE ELECTRONICS

AN ESTERLINE COMPANY

MICROPROCESSOR POWER

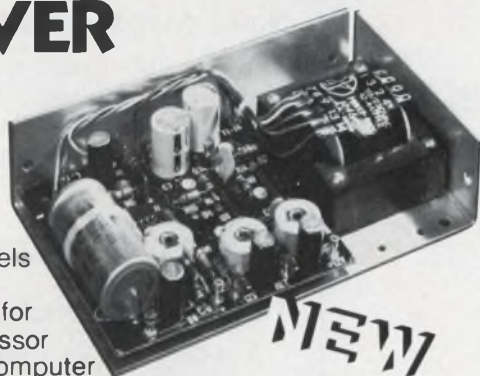

New dual and triple output models designed specifically for microprocessor and microcomputer applications.

MODELS

DUAL: HAA512, 5V @ 2A W/OVP	\$44.95
9 to 15V @ 0.5A	Single Quantities
TRIPLE: HTAA-16W, 5V @ 2A W/OVP	\$49.95
±9 to ±15V @ 0.2A	Single Quantities

FEATURES: 115/230 VAC Input • OVP on 5V Outputs • ±.05% Regulation • I.C. Regulated • 1.5 mv Ripple • Foldback Current Limit • Full Rated to 50°C • 2 Hour Burn-in • 2 Year Warranty

See our complete product listing in EEM & GOLDBOOK

For a copy of our NEW 1976 D.C. POWER SUPPLIES CATALOG, contact Power-One or your local factory representative.

Visit us at WESCON, BOOTH 1558



531 Dawson Dr. Camarillo, Ca. 93010
Phone: 805/484-2806 TWX: 910-336-1297

POWER-ONE, INC.

INFORMATION RETRIEVAL NUMBER 108

THE PROTECTORS...

MURATA'S PTH60
CURRENT LIMITING POSISTORS®!



- 100 TO 370 mA PROTECTION THRESHOLD
- LOW COST
- RESETTABLE
- DELIVERY FROM STOCK
- FOR TRANSFORMER, SEMICONDUCTOR, TV ANTENNA PREAMP POWER SUPPLY, ETC. PROTECTION

muRata

CORPORATION OF AMERICA

Rockmart Industrial Park, Rockmart, Georgia 30153
Phone: 404-684-7143 Telex: 54-2999

INFORMATION RETRIEVAL NUMBER 109

ELECTRONIC DESIGN 19, September 13, 1975



THE BIG RED

"1"

AN INDUSTRY FIRST, IEE introduces its HERCULES Series 1720/1723R "1", "light-pipe", LED Digital Display. Designed to meet applications which require **extended** viewing distances or which smaller, more conventional readouts cannot satisfy, this **big beauty** can be easily read at up to **60'**, and through angles of **>160°**. Slimline configuration embodies 14-pin, DIP connections on .600" spacing, and **"KING-SIZE"** (1.00"/26mm high), dual chip per segment, ruby-red digits which are molded into a nonconductive, plastic-compound base. High contrast brightness is 250μcd at 20mA/3.3V_F, peaking at 655nm in the visible red spectrum. Be the **first one** to add the **"eye-easing BIG RED 1"** to your system design today.

INFORMATION RETRIEVAL NUMBER 210



Industrial Electronic Engineers, Inc.

7740 Lemona Ave., Van Nuys, Calif. 91405
Phone: (213) 787-0311
TWX 910-495-1707

European Office: 6707 Schifferstadt, Eichendorff-Allee 19, Germany.

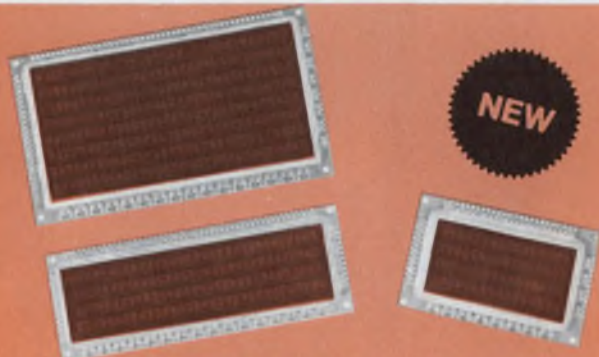

TAKE YOUR PICK!

NOW, IEE OFFERS A CHOICE! You can select the Message Panel **best suited** to your needs, rather than accept just what's available. IEE's new ARGUS Dot Matrix Message Panels are **NOW AVAILABLE** in your choice of **twelve** or more configurations: **64, 128 or 256** character capacity; **red or green**; and **"mini"** (.2") or **"maxi"** (.25" - .33") characters... not to mention soon-to-be-announced 4-line/88-character **"scrolling"**, and 2-line/32-character **"scratch pad"** models. Designed with human factors considerations in mind, these slimline **"space-misers"** are ideal for either input or output displays and terminals, and require minimal panel depth and area. Why not find out **"WHAT'S NEW"** in Message Display Panels, and then pick the **ARGUS** model that really meets your system's requirements?

INFORMATION RETRIEVAL NUMBER 211

19¢^{*} ea.

An integrated bridge rectifier in a miniature dual in-line package

DIB

DUAL IN-LINE BRIDGE

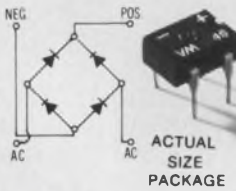

- 4-pin, low-profile DIP
- Leads on standard .10" (2.54 mm) grid
- Compatible with automatic testing, handling and inserting
- 1 Amp at 40°C (I_o)
- 25V to 1000V (V_{RM})
- Call Lee Miller 214/272-4551, Ext. 206 for more information.

* 100V; 100,000 qty.

Design us in . . . we'll stay there

VARO SEMICONDUCTOR, INC.

P O BOX 676, 1000 N. SHILOH, GARLAND, TEX 75040 (214) 272-4551 TWX 910-860-5178

INFORMATION RETRIEVAL NUMBER 111



NEW LITERATURE

Noise analysis equipment

Instruments and systems for analyzing vibration, noise and shock in machinery, vehicles and structures are illustrated in a 16-page catalog. Spectral Dynamics, San Diego, CA

CIRCLE NO. 392

Thick-film materials

A catalog details a line of thick-film materials. Plessey EMD, Melville, NY

CIRCLE NO. 393

Measuring instruments

280 pages present electrical and mechanical specifications, as well as application information, curves and charts on measuring instruments. Rohde & Schwarz, Fairfield, NJ

CIRCLE NO. 394

Electron beams

Illustrated with drawings, photos and tables, a 20-page booklet describes six models of the HP Febetron pulsed radiation sources. Hewlett-Packard, Palo Alto, CA

CIRCLE NO. 395

Connectors and cables

Mass-terminating connectors and cables are described in a 55-page catalog. Charts, drawings and design specifications in both English and metric dimensions are provided. 3M, St. Paul, MN

CIRCLE NO. 396

Mounts, clamps and cable ties

Cable ties, mounts and clamps are featured in a six-page, two-color brochure. Hoffman Electronics, Industrial Products Div., Farmingdale, NY

CIRCLE NO. 397

Capacitors

A quick guide to MIL-style CQR09, CQR12 and CQR13 hermetically sealed capacitors abstracts all important data from MIL-C-19978 in an easy-to-use format. Sprague Electric, North Adams, MA

CIRCLE NO. 398

The Attache Kit

For the engineer who makes house calls

We want you to take the SPC-88 along on your next field service call. Our rugged llama-grain case is outfitted with the finest precision-made tools to help you do the job quickly, easily and professionally.

SPC also custom builds other electronics tool kits from a complete line of top quality, name-brand hand tools. We can provide you with individual tools or a complete kit. Just tell us what you need — we can deliver!

Make your rounds with the SPC-88 or one of our other custom kits.

Who knows? You may get invited to stay for dinner!

Send for free brochure and product information.

SPECIALIZED PRODUCTS COMPANY

2324 SHORECREST DRIVE
DALLAS, TEXAS 75235 / 214-358-4663

INFORMATION RETRIEVAL NUMBER 112

Magnetic tape transport

A buffered magnetic tape transport system is highlighted in an eight-page brochure. Tables aid the user in determining proper transport speed and buffer size. Pertec, Peripheral Equipment Div., Chatsworth, CA

CIRCLE NO. 399

Rental equipment

Descriptions, pricing and an index by manufacturer and model number of over 8000 rental instruments are included in a short-form catalog. Rental Electronics, Lexington, MA

CIRCLE NO. 400

Optical components

Glass and metal components are featured in a 24-page catalog. The user can locate, at a glance, the wavelength in which he is interested and find relevant information on lenses, mirrors, filters, prisms, etc. Special Optics, Little Falls, NJ

CIRCLE NO. 479

Instrumentation

Over 2000 sizes and types of analog, digital and AnaLed panel meters, chart recorders, meter relays, pyrometers, controllers, digital and analog test equipment and a variety of portable instrumentation are detailed in a 60-page catalog. Simpson Electric, Elgin, IL

CIRCLE NO. 480

Decapsulation service

A 12-page brochure describes a decapsulation service, which safely and selectively removes potting, molding and encapsulating materials from components or assemblies. Amphenol Cadre Div., Endicott, NY

CIRCLE NO. 481

Indicator lights

Designed to help the user select the indicator light best suited for his application, a six-page product guide contains information on cartridge lamps and lampholders, sub-miniature and miniature lampholders, and snap-mount plastic lites. Littelfuse, Des Plaines, IL

CIRCLE NO. 482

The SPACEMAKER

NEW MINIATURE SOLID STATE RELAY

Make extra space on high-density boards with Crydom's miniature PCB-mount power SSR's. Available in two models — PS 101 (120V) and PS 201 (240V). Each offers unequalled high-power performance for DC control applications where space is critical. In stock at Crydom for delivery now!

- Only 0.57" High
- 1-AMP RMS Rating
- Zero Voltage Switching
- All Solid State
- Photo-Isolated
- Logic Level DC Control

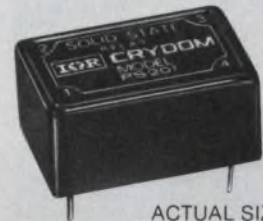

ACTUAL SIZE

THE DESIGNER'S FIRST CHOICE . . .
THE BUYER'S BEST BUY.

Write or call Crydom for a new Data Sheet and prices.

INTERNATIONAL RECTIFIER **IOR** CRYDOM
RECTIFIER DIVISION

1521 Grand Avenue, El Segundo, California 90245 • (213) 322-4987

INFORMATION RETRIEVAL NUMBER 113

With Vector Cards, It's Easy To

PICK A WINNER!

FROM OVER 100
"Off-the-Shelf"
MODELS
Plus Matching
Terminals

SPECIALS
AVAILABLE



FOR
MORE
VECTOR
EEM
Vol. 3,
pp. 722-726

GOLD
BOOK
Vol. 3,
pp. 227, 269

Vector



ELECTRONIC COMPANY, INC.

12460 Gladstone Avenue, Sylmar CA 91342
(213) 365-9661 TWX 910-496-1539 37415

INFORMATION RETRIEVAL NUMBER 114

Design Data from Manufacturers

Advertisements of booklets, brochures, catalogs and data sheets. To order use Reader-Service Card (Advertisement)

Electronic Design

"THE HOW AND WHY OF REAL-TIME SPECTRUM ANALYSIS OF NOISE AND VIBRATION"



New 16-page brochure on latest Ubiquitous® 500-line Real-Time Spectrum Analyzer/Calculator UA-500A-1 contains complete application data & a "how to" section. The "why" explains the need for resolution, real time, & averaging. The "how to" section solves typical analysis problems: "how to be sure correct data is being analyzed," "how to analyze transients," "how to interface to a computer," "how to cancel background noise," "how to analyze rotating machinery."

Model UA-500A-1 is specifically designed to simplify machine diagnosis, rotating machine analysis, noise source identification, mechanical signature comparisons, underwater signal analysis, & noise reduction. Includes such features as automatic harmonic identification, direct digital readout in RPM, & the ability to make relative amplitude & frequency measurements digitally.

Demo, circle 171—
Lit., circle 172—

Nicolet Scientific Corp. (formerly Federal Scientific)
245 Livingston Street, Northvale, New Jersey 07647
(201) 767-7100. TWX: 710-991-9619

Real Time Spectrum Analyzer Provides Simultaneous On-Line and Averaged Displays

**SD335
RTA**

Dual
Spectrum
Displays

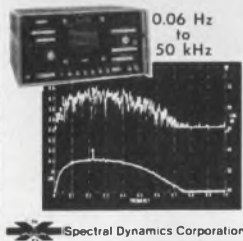

The new SD335's built-in scope and dual memory display instantaneous (on-line) frequency spectra with averaged spectra (up to 1024 ensembles) from 0.06 Hz to 50 kHz, while overall RMS level of input data appears at right of screen. Its 500-line resolution, 10 analysis ranges, greater than 60 dB dynamic range, and 5-digit readout of frequency and amplitude (linear or log) provide instant identification for even the smallest signals hidden in noise. Unique harmonic cursor automatically places an intensified dot on each integer harmonic of a selected fundamental component. SIMULPLOT feature allows simultaneous viewing and X-Y plotting under complete analyzer control. Instrument is specially designed for noise, vibration and communication systems analysis.

Spectral Dynamics Corporation

P. O. Box 671, San Diego, CA. 92112
(714) 565-8211

CIRCLE NO. 173

Share in the nation's top managerial policies, strategies, techniques . . .

MANUFACTURING MANAGEMENT SYSTEMS

New Challenges and Opportunities Edited by Fred Gruenberger



By crystallizing the results of the 1973 Informatics/UCLA Symposium, this book offers a powerful blend of technical and managerial expertise for enhancing the overall success and profitability of today's manufacturing management systems. Some of the nation's top industrial and technical leaders speak freely and in depth of their organization's objectives and specific operations, as well as their personal strategies and methods. You'll find the newest computerized tools available to manufacturers . . . crucial managerial skills for directing progressive systems . . . the tact and care needed for the sensitive human problems of system implementation, and more. #5940-x, 160 pages, \$10.50. Circle the Info Retrieval No. to order a 15-day exam copy. When billed, remit or return book. No obligation.

CIRCLE NO. 174

Hayden Book Company, 50 Essex St., Rochelle Pk, N.J. 07662

ELECTRONIC DESIGN's function is:

- To aid progress in the electronics manufacturing industry by promoting good design.
- To give the electronic design engineer concepts and ideas that make his job easier and more productive.
- To provide a central source of timely electronics information.
- To promote communication among members of the electronics engineering community.

Want a subscription? ELECTRONIC DESIGN is sent free to qualified engineers and engineering managers doing design work, supervising design or setting standards in the United States and Western Europe. For a free subscription, use the application form bound in the magazine. If none is included, write to us direct for an application form.

If you do not qualify, you may take out a paid subscription for \$30 a year in the U.S.A., \$40 a year elsewhere. Single copies are \$1.50 each.

If you change your address, send us an old mailing label and your new address; there is generally a postcard for this bound in the magazine. You will have to requalify to continue receiving ELECTRONIC DESIGN free.

The accuracy policy of ELECTRONIC DESIGN is:

- To make diligent efforts to ensure the accuracy of editorial matter.
- To publish prompt corrections whenever inaccuracies are brought to our attention. Corrections appear in "Across the Desk."
- To encourage our readers as responsible members of our business community to report to us misleading or fraudulent advertising.
- To refuse any advertisement deemed to be misleading or fraudulent.

Microfilm copies are available of complete volumes of ELECTRONIC DESIGN at \$19 per volume, beginning with Volume 1, 1952 through Volume 20. Reprints of individual articles may be obtained for \$3.00 each, prepaid (\$0.50 for each additional copy of the same article) no matter how long the article. For further details and to place orders, contact the Customer Services Department, University Microfilms, 300 North Zeeb Road, Ann Arbor, Michigan 48106 telephone (313) 761-4700.

Want to contact us? If you have any comments or wish to submit a manuscript or article outline, address your correspondence to:

Editor
ELECTRONIC DESIGN
50 Essex Street
Rochelle Park, N.J. 07662

recruitment
and
classified ads

WE SHIP IN 1 DAY
FROM OUR 42000 SQ FT FACILITY

MINIS— DEC • DG • CAI
CASC • HP • HIS • IBM • INT
Lock • Micro • Sel • Tempo
Univac • Varian • XLO

PRINTERS

ODEC 1321 110LPM \$2000
1322 200LPM 1500
MDS 4330 300LPM 2950
DP 2440 700LPM 7500
DP 4300 1333LPM 7500

CARD READERS

Documation M200 \$ 950
M600 1500
GDI 100, 110A 450

PAPER TAPE

Digitronics 2500 \$350
Chalco 5401 350
BRPE Punch 21 250

MAGNETIC TAPE

Pertec 7830 \$ 250
6840 1450
Wangco 1137 1450

617-261-1100

**AMERICAN USED
COMPUTER CORP**

Box 68, Kenmore Sta., Boston, MA 02215
member COMPUTER DEALERS ASSOC.

CIRCLE NO. 270

RADAR SYSTEMS

TRACKING ANTENNA SYSTEMS

Nike Hercules, Nike Ajax, M-33, MPS-9, SCR-584,
TPS-1E, TPS-28, FPS-6, FPS-14, FPS-18, FPS-75,
UPX-6, MPO-10A, IBM 705 Computers,
HUNDREDS MORE. LARGEST INVENTORY OF
RADAR AND MICROWAVE EQUIPMENT IN THE
WORLD.

RADIO RESEARCH INSTRUMENT CO.
3 QUINCY ST., NORWALK, CONN.
(203) 853-2600

FREE DISCOUNT BOOK CATALOG
ELECTRONICS—DATA PROCESSING—MATH

Our 1975 catalog describes over 1000 state-of-
the-art, professional-level books, grouped in 31
technical interest categories, from 16 major pub-
lishers. All NEW books . . . not used or over-
stock.

TECHNI-BOOKS
P.O. Box 11665, Santa Ana, CA 92711
(714) 633-6015
A Mail Order Technical Book Service

CIRCLE NO. 269

Electronic Design

Advertising Sales Staff

Tom W. Carr, Sales Director
Rochelle Park, NJ 07662
Robert W. Gascoigne
Daniel J. Rowland
(Recruitment, Quick Ads, Classified)
50 Essex Street
(201) 843-0550
TWX: 710-9990-5071

Philadelphia

Thomas P. Barth
50 Essex Street
Rochelle Park, NJ 07662
(201) 843-0550

Boston 02178

Gene Pritchard
P.O. Box 379
Belmont, MA 02178
(617) 489-2340

Chicago 60611

Thomas P. Kavooras
Berry Conner, Jr.
200 East Ontario
(312) 337-0588

Cleveland

Thomas P. Kavooras
(Chicago)
(312) 337-0588

Los Angeles 90045

Stanley I. Ehrenclou
Burt Underwood
8939 S. Sepulveda Boulevard
Suite 510

Los Angeles, CA
(213) 641-6544

San Francisco 94040

Robert A. Lukas
3579 Cambridge Lane
Mountain View, CA 94040
(415) 965-2636

London, Amsterdam, Tokyo, Seoul

John Ashcraft
12, Bear St.
Leicester Square
London WC2H 7AS England
Phone: 01-930-0525

W. J. M. Sanders
John Ashcraft & Co.
Herengracht 365
Amsterdam C., Holland
Phone: 020-24-09-08

Haruki Hirayama
Electronic Media Service
5th Floor, Lila Bldg.,
4-9-8 Roppongi
Minato-ku, Tokyo, Japan
Phone: 402-4556

Cable: Electronicmedia, Tokyo
Mr. O-kyu Park, President
Dongbo Int'l Corp.—
World Marketing
C.P.O. Box 4010
Seoul, Korea
Tel. 76-3910/3911
Cable: DONGBO SEUOL
Telex: EBKOREA K27286



Plug Us In



Turn Us On



Quietly

Measuring low level signals is tough enough without adding noise—so our preamplifiers are quiet. To find out more about our wide range of quiet preamps, write or call for our handy full color wall chart; it will help you in selecting the best preamp for your application. Princeton Applied Research Corporation, P.O. Box 2565 Princeton, New Jersey 08540, 609/452-2111. In Europe, contact Princeton Applied Research GmbH, D8034 Unterpfaffenhofen, Waldstrasse 2, West Germany.



INFORMATION RETRIEVAL NUMBER 115

SUBSCRIBER SERVICE For prompt service include the addressed label when writing about your subscription.

CHANGE OF ADDRESS

city	company address	division/department	company	name	NEW ADDRESS
state				title	
zip					

If you're moving, please let us know six weeks before changing your address. If you have a question, place your magazine address label here and clip this form to your letter.

MAIL TO: ELECTRONIC DESIGN Circulation Dept. Hayden Publishing Co., Inc., 50 Essex Street, Rochelle Park, NJ 07662



Thin-Trim variable capacitors provide a reliable means of adjusting capacitance without abrasive trimming or interchange of fixed capacitors. Series 9401 has high Q's and a range of capacitance values from 0.2-0.6 pf to 3.0-12.0 pf and 250 WVDC working voltage. Johanson Manufacturing Corporation, Boonton, New Jersey (201) 334-2676.

THIN-TRIM CAPACITORS 601



HANDSOME, RUGGED ENCLOSURES Custom-crafted laminated Formica-wood-Formica construction, internally reinforced corners, rich wood grain or solid color exteriors. Superb workmanship, competitive prices, any quantity. W. A. Miller Co., Inc., 307 Mingo Loop, Oquosoc, Maine 04964. Phone: 207/864-3344

ENCLOSURES, CASES 604

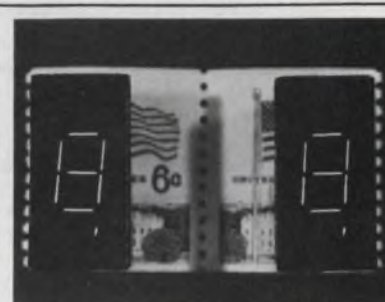

The Proven Incandescent Readout Standard 16 Pin DIP Flat Pack. All units 5 Volt 100,000 hrs. plus 3015F-BM 08ma/seg 700 ft/lam 3015F-BM10 10ma/seg 1700 ft/lam 3015F-BM15 15ma/seg 4500 ft/lam Field tested over 4 years in many applications. READOUTS, INC. P.O. Box 149, Del Mar, Ca. 92014 Tel. 714-755-2641 Telex 69-7992.

DISPLAY 607

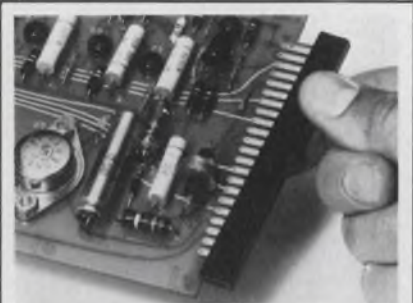

Boardshorts. Protect your MOS Assemblies during shipment and storage from static electricity. Available in lengths to 36 in. or cut to standard lengths. Unterminated traces leading directly to MOS devices can still allow burn out. For standard 1/16-in. thick boards. Samples available. WESCORP, 2164 Old Middlefield Way, Mt. View CA. 415-948-1592.

BOARDSHORTS 602



Introduction To Defense Radar Systems Engineering. Excellent introduction and practical reference to radar systems design and applications. #9194, 260 pp., \$22.95. Circle the Info Retrieval No. to order 15-day exam copy. When billed, remit or return book with no obligation. Hayden Book Co. 50 Essex St. Rochelle Park, N.J. 07662

RADAR SYSTEMS 605



DIGITAL TIMER Programmable timer offers 3 timing periods: 1-99 min., 1-9.9 min., and 1-99 sec. Has switched outlets: one normally on and one normally off. Audible tone and foot switch optional. Priced \$154.95. Manufacturing of custom timers. KNOL ENTERPRISES, 200 Suburban Rd., San Luis Obispo, Ca. 93401, (805) 544-4881

DIGITAL TIMER 608

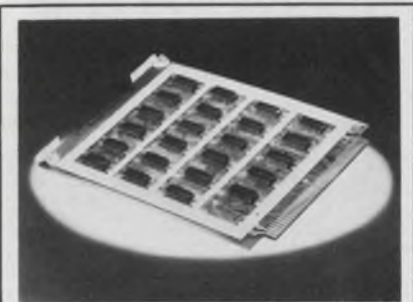

T:L Power Distribution—Noise attenuation and highest packaging density for P.C. boards with T:L logic are yours with Mini/Bus[®], the Rogers way to eliminate the cost of multilayer boards by off-board power distribution. Rogers Corporation, Chandler, AZ 85224. Phone (602) 963-4584.

PC POWER DISTRIBUTION 603



Free catalog of 34,500 power supplies from the worlds largest manufacturer of quality Power Supplies. New '74 catalog covers over 34,500 D.C. Power Supplies for every application. All units are UL approved, and meet most military and commercial specs for industrial and computer uses. Power Mate Corp. (201) 343-6294.

POWER SUPPLY 606

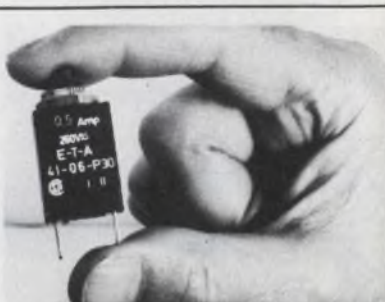

Overcurrent Protector, manual reset eliminates fuse replacement. Convenient panel mounting. 15 fractional ratings from 0.1 to 3 amp. Other models up to 400 amp. Trip-free and fool-proof, UL and CSA approved. High quality, low cost \$1.29 ea. in 1000 lots. E-T-A Products Co. of America, 7400 N. Croname Rd., Chicago, Ill. 60648. Tel: (312) 647-8303. Telex: 253780.

CIRCUIT BREAKER 609



Model 5035A—easy, solderless breadboarding tool for complex TTL circuits. Has 6 bounceless HI-LO data switches, two clocks, & 4 LED indicators, allows easy design and checkout for circuits containing 16 DIPS on one removable breadboard. 1-amp supply can power several breadboards. Hewlett-Packard; 1501 Page Mill Rd.; Palo Alto, CA 94304
BREADBOARDING TOOL 610

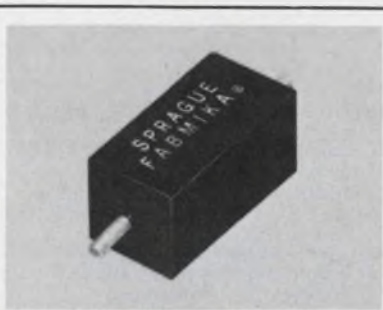

High-Voltage Epoxy/Fiberglass-Encased Type 305M Fabmika® Capacitors. Reconstituted mica dielectric, offering uniformity of performance and quality impractical with sheet mica. Impregnated with epoxy resin, forming solid capacitor section . . . no oil leak. Sprague Electric Co., 347 Marshall St., No. Adams, MA. 01247. (413) 664-4411.
HIGH-VOLTAGE CAPACITORS 613



SYSTEMS MANUAL describes a complete line of microelectronic packaging systems and hardware. Mechanical and electrical specifications of wire wrap* panels, panel rack assemblies, connectors, cable assemblies and related accessories are included. Use card or write Mupac Corporation, 646 Summer St., Brockton, MA 02402. *G-D tm
WIRE WRAP* PANELS 611

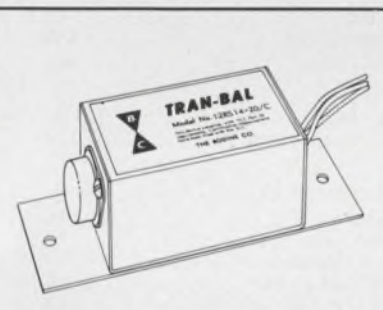

TRAN-BAL, INVERTER BALLAST; allows designer to utilize fluorescent lamp for long photo-electric light source by eliminating flicker associated with 60 H. Operation. Models available for all lamps through 40 watts. Input voltage 12 to 48 v.d.c. The Bodine Co., 236 Mt. Pleasant Rd., Collierville, TN (901) 853-7211
INVERTER BALLAST 614



"Timing Products Shortform Catalog" provides complete listing of standard Datametrics digital clocks, time code generators and readers, remote time display products. Includes operation theory of clocks and generators, application of time code for synchronization, calibration, indexing, distribution. Datametrics, 340 Fordham Rd., Wilmington, MA 01887
TIMING CATALOG 612

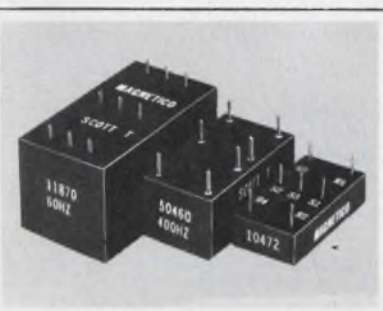

Scott T Transformer. 11870: 60HZ, 90v, L-L in. 1.1x2.1x1.1. 50460: 400HZ, 90v, L-L in. 7/8x1-5/8 x11/16. 50642: 400HZ, 11.8v, L-L in. 7/8x1-5/8-11/16. 10472: 400-HZ, 11.8v, L-L in. 3/4x1-1/2x3/8. All with 6v RMS sine & cosine output. MAGNETICO, INC., 182 Morris Ave, Holtsville, N.Y. 11742 516-654-1166.
TRANSFORMER 615

Advertisers wishing to reserve Quick Ad units should note the following mechanical requirements: Specs—Supply glossy photo of product and approximately 40 words which will set no more than 10 lines of 34 characters each. AFTER SUBMISSION NO COPY CHANGES CAN BE ACCEPTED. Quick Ads cost only \$325 per insertion, less for frequency advertisers.

RATES:

1x
\$325

7x
\$300

13x
\$275

19x
\$270

26x
\$265

39x
\$260

52x
\$255

104x
\$250

Advertiser's Index

Advertiser	Page	Advertiser	Page	Advertiser	Page
AMP, Incorporated	24, 25	Heyman Manufacturing Company	111	RCA Solid State	Cover IV
Abbott Transistor Laboratories, Inc.	6	Hughes Aircraft Company, Industrial Products Division	29	*Rafi-Raimund Finesterholz	97
Allen Bradley Co.	31	ISE Electronic Corporation	115	Reader Service Card	144A, 144B
American Technical Ceramics	123	Industrial Electronic Engineers, Inc.	133	Readouts, Inc.	138
Amphenol Connector Division, Bunker-Ramo Corporation	Cover III	Industrial & Scientific Conference Management	128A, 128B	Rental Electronics, Inc.	18
Angstrom Precision, Inc.	125	Intech, Incorporated	124	Rogan Corporation	122
Auto Swage Products Inc.	131	Interface Inc.	77	Rogers Corporation	138
Automatic Connector, Inc.	91	International Rectifier, Crydom Division	135	Schauer Manufacturing Corp.	130
Baum Chemical Corporation	119	Itek Measurement Systems Division of Itek Corporation	127	Semtech Corporation	27
Beckman Instruments, Inc., Information Displays Operations	39	Johanson Manufacturing Corp.	32, 138	Shigoto Industries, Ltd.	131
Belden Corporation	92, 93	Johnson Company, E. F.	103	Shelly Associates	15
Bell & Howell, CEC Division	47	Kepeco, Inc.	42	Siemens Corporation, Components Group	83
Berg Electronics, Inc.	131	Knol Enterprises	138	Signetics Corporation	77, 111, 119, 121, 127
Bodine Co., The	139	Litronix, Inc.	70, 71	Simpson Electric Company	50
Bud Radio, Inc.	113, 114	Lytron Incorporated	122	Specialized Products Co.	134
Bunker-Ramo Corporation, Amphenol Connector Division	Cover III	MCL, Inc.	116	Spectral Dynamics Corporation	136
CELCO (Constantine Engineering Labs Co.)	16	Magnetico, Inc.	139	Sprague Electric Company	14, 139
Centralab, The Electronics Division of Globe-Union, Inc.	10, 11	Malco, A Microdot Company	84, 85	Systrom-Donner	122
Circuit Technology, Inc.	125	Mepeco/Electra, Inc.	78	TRW/IRC Resistors, an Electronic Components Division of TRW, Inc.	46
Commonwealth of Puerto Rico	40	Micro Networks Corporation	109	TRW RF Semiconductors, an Electronic Components Division of TRW, Inc.	8, 9
Constantine Engineering Labs Co. (CELCO)	16	Miller Co., Inc., W. A.	138	Tekelec Inc.	144
Continental Specialties Corporation	129	Mini-Circuits Laboratory, A Division of Scientific Components Corp.	21	Tektronix, Inc.	45
Cramer Electronics Inc.	97, 99, 100, 101	Monsanto, United Systems Corporation Subsidiary	41	Telecommunications Industries, Inc.	117
Dale Electronics, Inc.	Cover II	Mos Technology, Inc.	12, 13	Teledyne Relays, A Teledyne Company	2
Data Display Products	61	Mupac Corporation	139	Teledyne Semiconductor	48
Datametrics	139	MuRata Corporation of America	133	Theta-J Relays, Inc.	121
Delta Products, Inc.	117	National Electronics, A Varian Division	120	Triplett Corporation	95
Dialight, A North American Philips Company	90	Newport Laboratories, Inc.	128	USCC/Centralab Electronics Division, Globe-Union, Inc.	4, 5
DuMont Electron Tubes & Devices Corp.	62	Nicolet Scientific Corp.	136	Unimax Switch Corporation	104
E-T-A Products Co. of America	138	Oak Industries, Inc.	79	United States Department of Commerce	144
Efratom California, Inc.	107	Optron, Inc.	7	United Systems Corporation, A Subsidiary of Monsanto	41
Electro Science Laboratories, Inc.	126	*Oscilloquartz SA	99	Vactec, Inc.	51
Electronic Navigation Industries	110	Oshino Electric Lamp Works, Ltd.	109	Varo Semiconductor, Inc.	134
Endicott Coil Co., Inc.	142	PPG Industries, Inc.	22	Varta Batteries, Inc.	118
Esterline Electronics Corp.	132	*Philips Electronic Components and Materials	18	Vector Electronic Co., Inc.	135
Fluke Mfg. Co., Inc., John	37	*Philips Industries, Test and Measuring Instruments	100, 101	Victor Electric Wire & Cable Corp.	108
Gates Energy Products, Inc.	112	*Philips Instrumentation Recording	31	Wescorp	138
General Electric Company, Miniature Lamp Products Department	141	Philips Test & Measuring Instruments, Inc.	64	Weston Components	141
Gold Book, The	*10, 143, 144	Plessey Semiconductors	33	World Wide Purchases, Inc.	97
Hamamatsu Corp.	144	Power/Mate Corp.	138	Yardney Electric Corporation	110
Hamlin, Incorporated	63	Power One, Inc.	133	Yokogawa Corporation of America	69
Harris Semiconductor, A Division of Harris Corporation	17	Precision Metal Products Co.	141	Zero Manufacturing Co.	106
Hayden Book Company, Inc.	*64, *99, 136, 138	Princeton Electronic Products, Inc.	137		
Heath Company	23	Protolab	109		
Heinemann Electric Company	35	Pyrofilm Corporation	65		
Hewlett-Packard	1, 139				

*Advertisers in non-U.S. edition

GE's June, 1975 miniature catalog has over 500 data changes that could affect your current design. Send for it. It's free.



(3-5169)

NEW. June '75 Miniature Lamps:

40 pages. 500 changes. Data covers over 500 miniature lamps ranging up to 20,000 hours rated average life. With a design voltage range of from 1.2 to 55, and candle-power range from .02 to 250. Diameter range from $1\frac{1}{32}$ " to $2\frac{1}{16}$ ".

Circle Product Card # 251



(3-6252R1)

NEW. Feb. '75 Sub-Miniature Lamps:

24 pages. 91 changes. Data covers over 210 sub-miniature lamps. Diameters $\frac{1}{4}$ " and smaller. Rated voltage 1.3 to 60. Candle-power range from .006 to 15. Rated average lamp life up to 60,000 hours.

Circle Product Card # 252

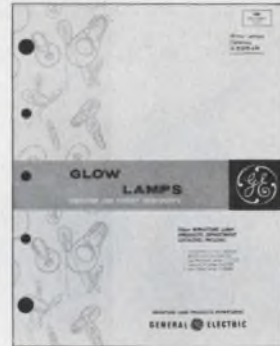

(3-6254R)

NEW. Dec '74 Glow Lamps:

8 pages. 50 changes. Data covers 83 Neon Glow Indicator and Circuit Component lamps. Diameters ranging from $\frac{1}{4}$ " to $1\frac{3}{4}$ ". Wire terminal lengths $\frac{1}{2}$ ", $\frac{3}{8}$ ", $\frac{3}{4}$ " and $1\frac{1}{16}$ ".

Circle Product Card # 253

To get the catalogs you need, free of charge, circle the product card number shown under each catalog, or write General Electric, Miniature Lamp Products Department, 3382-L, Nela Park, Cleveland, Ohio 44112.

GENERAL  ELECTRIC

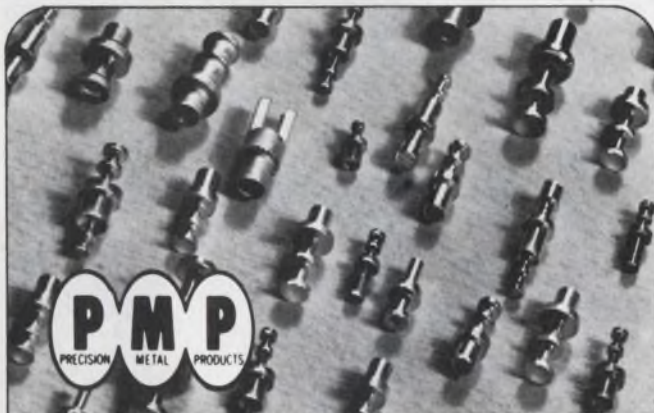

SOLDER TERMINALS

low prices, fastest delivery, highest quality...and more standards in stock than anyone!

More than 25 years of know-how, the broadest line of standards in the industry, a complete selection of plating options... it all adds up to savings in costs and on-time deliveries everytime. Got a special? Send us your print and we'll respond instantly with price and delivery information that will please and surprise you. Call us today.



PRECISION METAL PRODUCTS CO.
41 ELM ST., STONEHAM, MASS. 02180
Telephone: (Area Code 617) 438-3650

NEED A COMPETITIVE EDGE?

CHECK OUT WESTON POTS

FOR COST DELIVERY • PERFORMANCE

EXAMPLE:

Model #830P

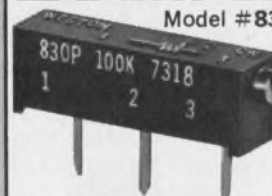

WESTON RECTILINEAR $\frac{3}{4}$ " CERMET TRIMMER

PRICE (1000 Piece Orders) **\$.91 EA.**

Comparable prices — all sizes — Square • Round • Cermet • Wirewound

WESTON Schlumberger

WESTON COMPONENTS
ARCHBALD, PENNSYLVANIA 18403
TEL. (717) 876-1500
TWX 510 656-2902
TELEX 83-7443

"Light" your gas discharge displays from low voltage DC lines!



with
**DC-to-DC
POWER
SUPPLIES**
from Endicott Coil

When you must convert low DC line voltages to nominal 200 or 250 V DC levels in order to activate gas discharge displays, ask us to recommend the DC-to-DC power supply that's right for your application.

Various models available:

- Standard inputs—5, 9, 12, 15 V DC; others under 5 V DC and up to 48 V DC.
- For seven-segment and matrix-type displays.
- Regulated and unregulated.
- Single and dual output, capable of up to 12 W total.
- Outputs from 5 V to 1500 V DC.

Compact size and light weight help give easy portability to equipment in which they are used!

For liquid crystal and electroluminescent displays, as well as fluorescent lamp applications, ask about variations of our DC-to-DC power supplies.

Write for free literature:

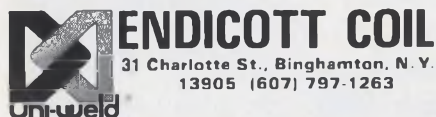

Product Index

Information Retrieval Service. New Products, Evaluation Samples (ES), Design Aids (DA), Application Notes (AN), and New Literature (NL) in this issue are listed here with page and Information Retrieval numbers. Reader requests will be promptly processed by computer and mailed to the manufacturer within three days.

Category	Page	IRN	Category	Page	IRN
Components			photo recorder	16	13
capacitors	5	4	plug-in modular instr.	45	32
capacitors	14	11	rf power amplifier	108	64
capacitors	123	85	scope	113	338
circuit board	109	67	scopes	23	18
circuit breakers	35	24	sweep/function generator	114	341
connectors	85	52	synthesizer	113	339
connectors	91	54	test instruments	47	35
connectors	110	333	time-code handbook	122	84
contacts	131	104	X-Y scope	114	344
DIPs	65	43			
detectors	144	120	Integrated Circuits		
diodes, zener	132	107	ADC register	106	328
displays, gas discharge	39	28	bipolar memory	119	78
film resistors	11	263	DAC	107	483
indicators	15	12	dividers	33	23
indicators	90	53	HiNIL/CMOS	48	37
knobs	122	83	hybrid converters	109	67
LED digital display	133	210	hybrid microcircuits	125	87
LEDs	1	2	MNOS ROMs	108	331
LEDs	61	40	microprocessor, 8-bit	106	327
LEDs	71	45	PROMs	17	14
load cell	77	46	PROMs	111	70
miniature lamp catalog	141	116	RAM	108	329
optoelectronics	51	39	RAM, NMOS	105	306
pins	25	19	2-k PROM	127	91
polarizers	119	77	4-k MOS	77	47
potentiometer, kit	111	334	8-k MOS ROM	121	81
potentiometers	141	118			
protector, surge	117	74	Modules & Subassemblies		
protectors, surge	133	109	converter, a/d	126	301
proximity sensor	111	335	converter, d/a	124	303
rectifier, bridge	134	111	converter, d/a	125	364
relays, solid-state	135	113	converter, synchro	129	368
resistors	31	22	encoder	127	90
resistors	103	60	ignition, electronic	117	75
resistors	125	88	memory systems	29	21
switch, optical	7	6	preamplifiers	137	115
switch, pushbutton	104	61	transducers, watt	127	366
switches, pushbutton	79	50	v/f converter modules	124	86
Data Processing			Packaging & Materials		
acquisition, data	123	360	cable	111	69
memory, CCD	121	358	cases, transport	106	62
mini system	123	361	circuit board	135	114
			coatings, conductive	126	89
Discrete Semiconductors			cords	110	68
diodes, laser	118	348	electronic glass	22	17
displays, numeric	118	349	heat exchangers	122	82
power transistor	119	350	knobs, plastic	120	354
rectifiers, silicon	27	20	solder terminals	141	117
SCRs	120	79	tool kit	134	112
			wire, cable & cord	93	234
Instrumentation			Power Sources		
CRTs	62	41	batteries	130	103
DPM	113	337	battery	112	71
DPVM	128	101	battery	118	76
digital ac instrument	69	44	power supplies	6	5
logic monitor	129	102	power supplies	142	119
multimeter, 4-1/2-digit	37	25	voltage stabilizer	42	31
oscillator, rf	116	73			
oscilloscope	78	48			
panel meters	50	38			

Electronic Design 's **GOLD BOOK** **IS WORKING FOR ME**

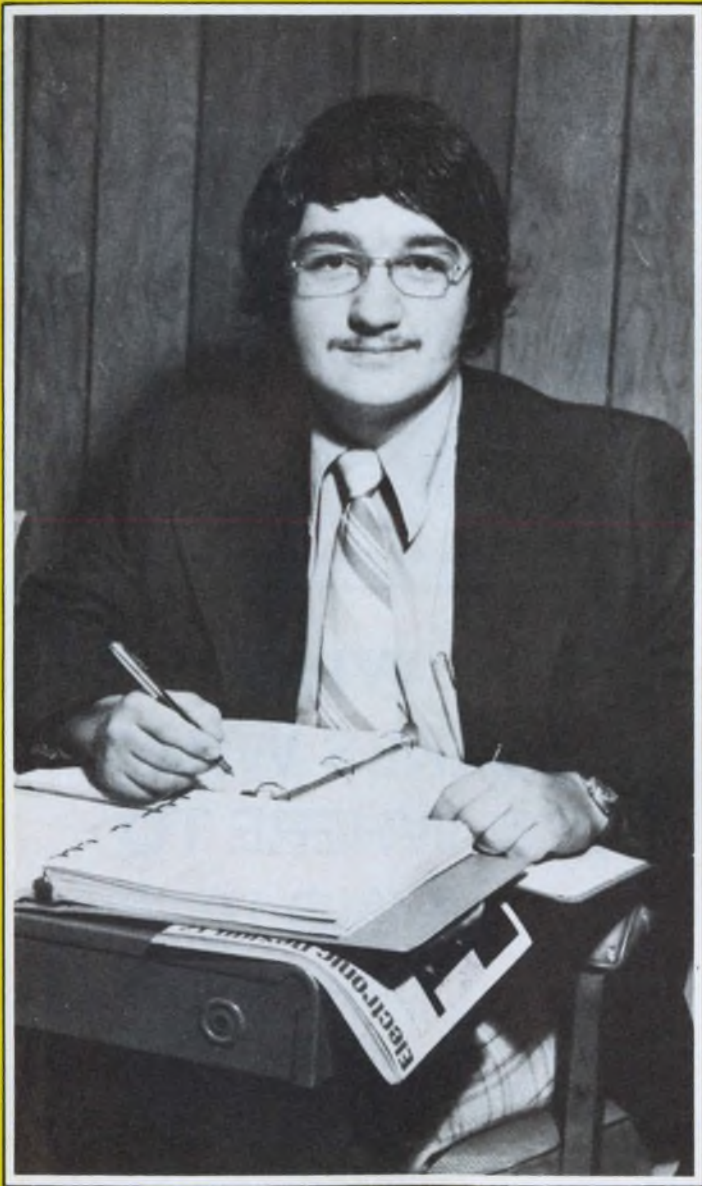

I USE IT

Martin A. Sala is Chief Design Engineer, Precision Systems, Cheektowaga, New York. He heads the research division at Precision and is primarily concerned with artificial intelligence and cybernetics. Accustomed to purchasing \$80,000 worth of equipment annually, Sala reports that he has referred to *Electronic Design's* GOLD BOOK frequently and finds it useful in his work. "I keep it on my library shelf and use it quite often as a major source for information. In fact it's the only industry directory I use. Advertisements in the GOLD BOOK recently helped us to place orders for both memory and arithmetic circuits."

**ELECTRONIC DESIGN'S GOLD BOOK IS WORKING — ALL DAY, EVERY DAY —
THROUGHOUT THE U.S. AND OVERSEAS**

Electronic Design / GOLD BOOK

TEKELEC, INC. TA



4-1/2 Digits - \$125ea*
Need I say more?

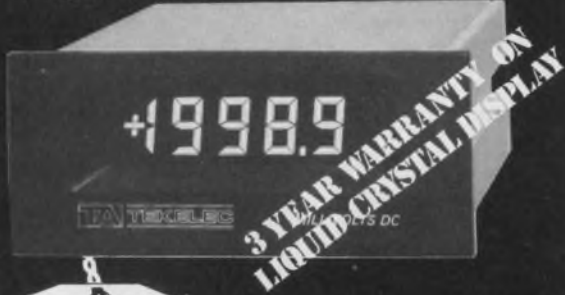

\$125 ea*

**4-1/2 DIGIT
 PANEL METERS**

- Field effect liquid crystal display
- 13 voltage and current ranges
- Shielded transformer power supply
- Isolated parallel BCD output (opt.)
- 220 V RMS Common mode voltage
- Bi-polar operation with automatic polarity indication
- All metal case with sculptured bezel
- Overvoltage indication
- 2 1/2 and 3 1/2 digit models also available

2623 Saddle Ave., Oxnard, CA 93030 • (805) 485-5445
 *100 QUANTITY

INFORMATION RETRIEVAL NUMBER 120

ELECTRONIC COMPONENTS EXHIBITION

U.S. Trade Center
 Paris, France
 December 8 to 12, 1975

Announcing A Unique Sales Opportunity

The French market for electronic components is estimated at \$310 million and is expected to increase to \$412 million in 1977. France's imports of electronic components amounted to \$128.6 million accounting for about 45% of the total market. U.S. manufacturers were the source of more than one-third of France's annual imports in recent years and are expected to maintain that percentage of the market in the next several years. U.S. exporters can anticipate sales to France in excess of \$50 million in 1977.

This Exhibition is intended to provide you with a direct route into the market so that you can take full advantage of outstanding sales opportunities available. Professional Trade Center staff will help identify and attract to your booth the relevant decision-makers and buyers of the companies most interested in your products.

Whether your objective is to test that market, make immediate sales, cultivate customer relations or locate suitable representation; this event is designed to help you accomplish it.

All manufacturers of electronic components who wish to participate or who desire further information, please contact:

MYRA L. TRIPPLET
 Project Officer, France Section.
 United States Department of Commerce
 Washington, D.C. 20234
 phone: (202) 967-5373

INFORMATION RETRIEVAL NUMBER 122

**IS A
 DETECTOR WITH
 SUB NANOSECOND
 RISE-TIME OF VALUE
 TO YOU?**

IF YES-

Can you live with an S-1, S-5, S-13, S-20, or S-25 cathode?

IF YES-

Will you pay \$190 for it?
 Or \$520 in a housing?

IF YES-

Write, or call me personally
 (Ralph Eno) and let's talk about it.

IF NO-

But you do need quality detectors such as Photomultipliers, Vidicons, Silicon Detectors, InAs, InSb, and others ranging in price from \$1 to \$6,000, send for our full catalog.

**HAMAMATSU
 CORPORATION**

120 Wood Avenue
 New Jersey 08846
 (201) 469-6640

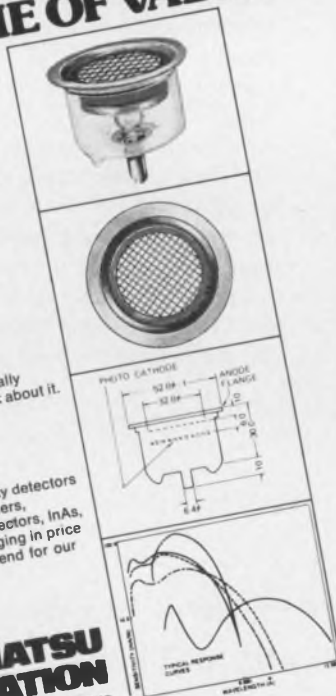

**WHO
 MAKES WHAT
 & WHERE TO
 FIND IT**

Volume 1 of **Electronic Design's GOLD BOOK** tells all. And, when you look up an item in its **PRODUCT DIRECTORY** you'll find each manufacturer listed **COMPLETE WITH STREET ADDRESS, CITY, STATE, ZIP AND PHONE.** Save time. There's no need to refer elsewhere to find missing information.

**IT'S ALL THERE
 in
 Electronic Design
 GOLD BOOK**

INFORMATION RETRIEVAL NUMBER 121

Amphenol Scot Pot.[™]
 Amphenol trimmers.
 Two bargains
 your competitors
 may not know about...
YET.



The word is out — Amphenol offers a big selection of quality precision pots and trimmers. They can replace what you're using now — in form, fit, and function — and save you money in the bargain.

Our Scot Pot is as good as (or better than) any other 10-turn wirewound miniature precision pot on the market. It has improved electrical, mechanical, and environmental characteristics. Yet Scot Pots cost as much as 25% less than other equivalent pots.

And that's news that won't stay secret for very long.

Our 3/4" rectangular trimmers come in a full range of resistances and in all popular pin spacings. They're sealed to withstand automatic board cleaning. And they're highly stable — no drift. Two series to choose from: 3810 wirewound (available with Vista-Trim for fast, approximate visual settings). And 6034 cermet trimmers. Both series save you plenty. Ask for a quote and see how much you can beat the competition by.

For off-the-shelf delivery, call your local Amphenol Industrial Distributor. Your competitors may have already discovered his great service — so should you. Give him a call. Or for more information (and spec sheets on our pots and trimmers) contact: George Boyd, Amphenol Connector Division, Controls Operation, 2801 South 25th Avenue, Broadview, Illinois 60153. Phone: (312) 261-2000.

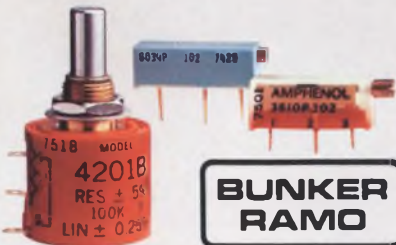

*When you can connect it
 and forget it...that's quality.*
AMPHENOL

What's new in solid state...

RCA expands the COS/MOS universe three ways.

Now RCA offers 3 galaxies of COS/MOS integrated circuits, all with these new performance features: 100% testing to limit max. quiescent current at 15 V (A types), 20 V (B types). 1 V noise margin for better protection than TTL. Low max. input leakage of 1 μ A at rated voltages.

More standard "A" types

Rated at 3-15 volts, 92 of these "industry standard" types are available in quantity, off-the-shelf. October introductions will include important new MSI functions. By January 1976 we'll offer a total of 112 "A" types.

New high-voltage "B" types

Rated at 3-20 volts, "B" types feature standardized symmetrical outputs for ease in design. Future additions will include new multiplexers, demultiplexers and arithmetic circuits. By January 1976 we'll offer 76 "B" types.

Expanded High Rel program

COS/MOS types screened to MIL-M-38510 or MIL-STD-883 requirements already total 96 types. New additions by January 1976 will bring the High Rel total to 123 types.

Send for a complete designer's planning package including reliability data and information on our Extra Value Program. Contact your local RCA Solid State distributor. Or RCA.

Write: RCA Solid State, Box 3200, Somerville, New Jersey 08876; Ste. Anne de Bellevue 810, Canada; Sunbury-on-Thames, U.K.; Fuji Bldg., Tokyo, Japan.

RCA

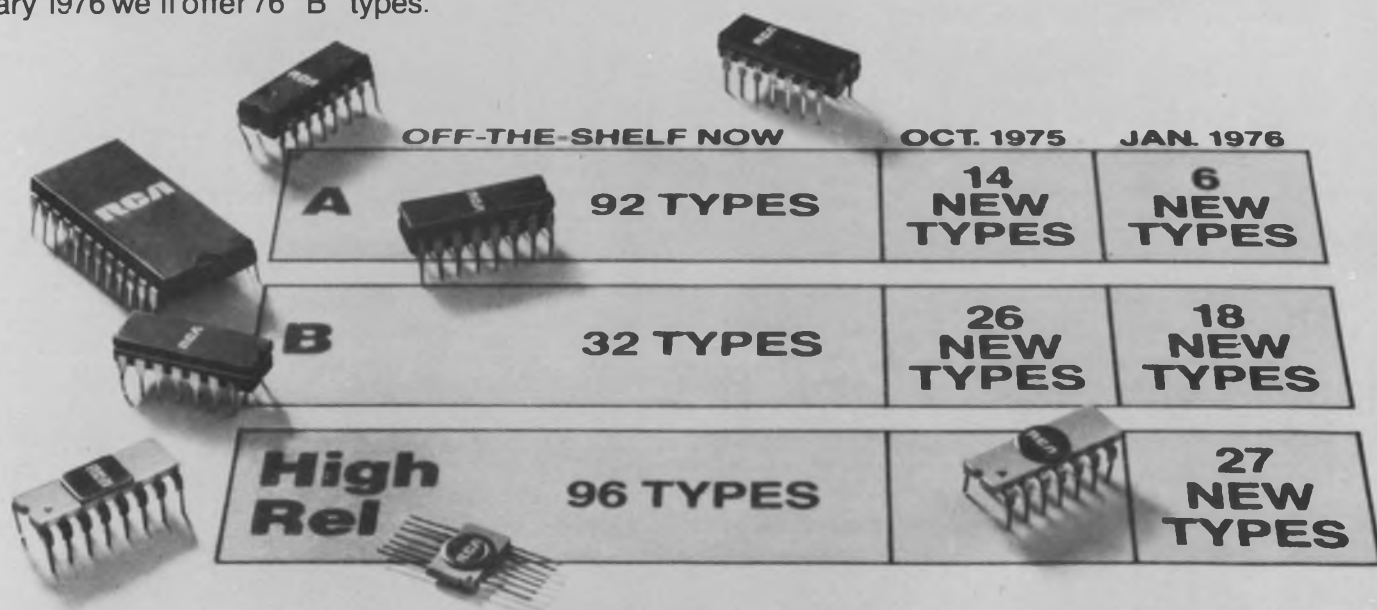

	OFF-THE-SHELF NOW	OCT. 1975	JAN. 1976
A	92 TYPES	14 NEW TYPES	6 NEW TYPES
B	32 TYPES	26 NEW TYPES	18 NEW TYPES
High Rel	96 TYPES		27 NEW TYPES

RCA. First house in CMOS.

INFORMATION RETRIEVAL NUMBER 265