

IC switch/multiplexer advances overcome traditional headaches, like latchup and wide resistance variations. But the very circuit innovations that boost analog IC

capabilities are accompanied by subtle tradeoffs affecting system performance. And data sheets don't always show the sacrifices. Get the full story on page 64.

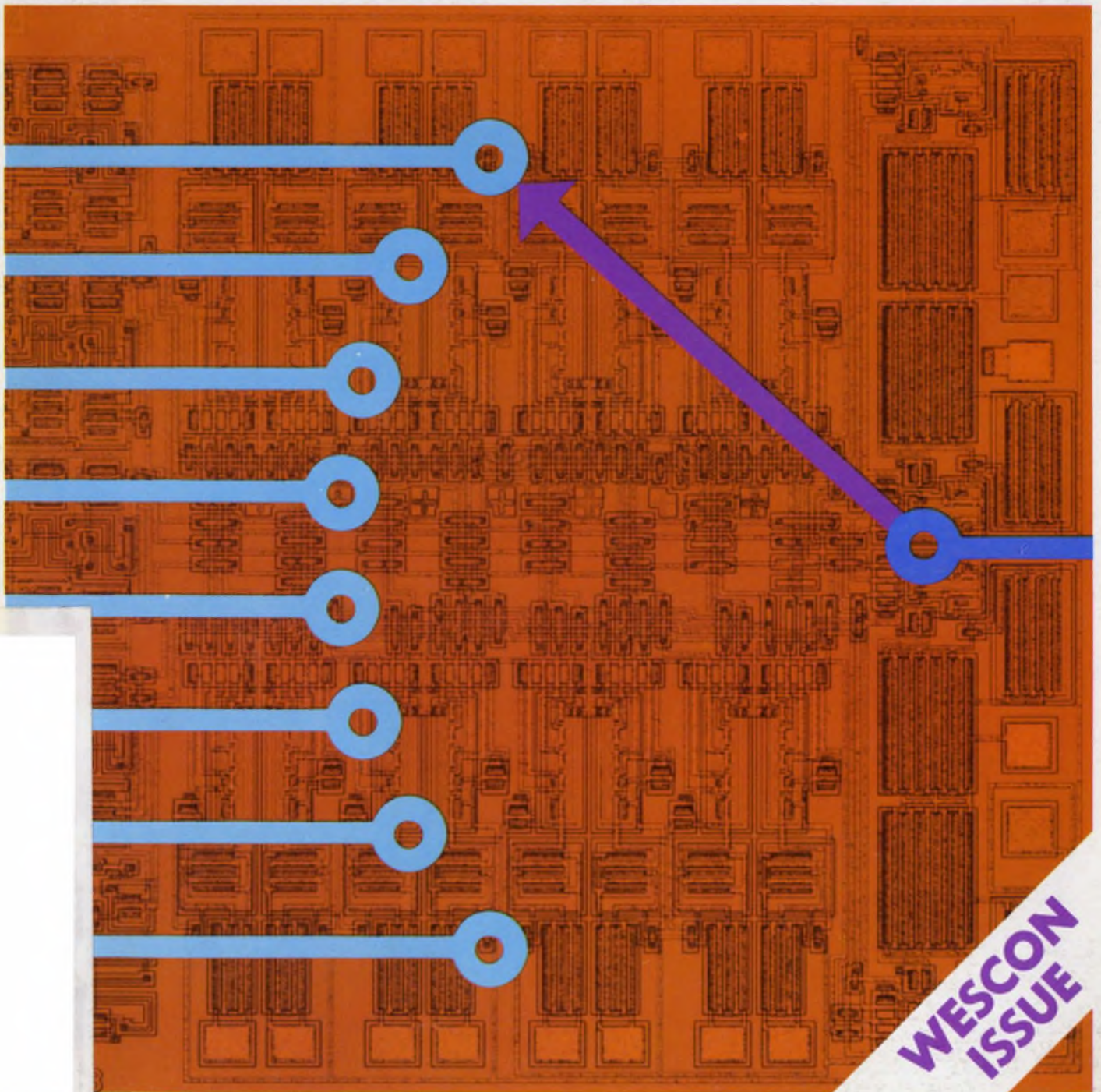

**WESCON
ISSUE**

The right DMM decision means
1 μ V sensitivity, 0.03% accuracy,
and a \$425* price.

Introducing HP's 3465A DMM.

Now you have a five-function DMM with the needed accuracy, sensitivity, and low cost to solve your bench or field service requirements. See how HP's 3465A Digital Multimeter combines capability, convenience, and confidence with low cost to bring you to the right decision.

Capability: Take a look at the front panel. It has all the functions and ranges you'd expect, and more. You get ohms, ac/dc volts, and ac/dc current. Extra resolution is obtained with a full-scale readout of 19999. Accuracy is $\pm 0.02\%$ of reading $\pm 0.01\%$ of range on dc, meeting the needs for most field or bench applications. The 10 mV dc range and 100 mV ac range provide performance typically found only in more expensive 5½-digit multimeters.

Convenience: The 3465A's functional design means easy rack and stack with other instruments in the lab, while its compactness and low power consumption result in a handy field-service instrument. It will operate from four different sources of power: 1) Four standard D-cell** batteries. 2) The ac line using an HP hand-held calculator charger. 3) The ac line using its own internal power supply. 4) Rechargeable Nickel Cadmium batteries.

Confidence: Fewer components and higher reliability are achieved through the use of a newly developed Tantalum-Nitride on Sapphire thin-film resistor. Easy calibration and improved performance are obtained with a new dual-slope integrator that uses a single reference supply. All these design features, plus input protection, give you the performance you'd expect from HP.

Cost: The standard 3465A costs \$500* and is equipped with an internal power supply, a battery recharging circuit, and Nickel-Cadmium batteries. If you don't need the rechargeable batteries, order Option 001 for \$480* and save \$20* Order Option 002 for \$425* and save \$75* by powering the HP 3465A from dry-cell batteries. Also, Option 002 can operate from the ac line when using one of HP's Model 82002A chargers (supplied with most HP pocket calculators).

When you consider its capability, convenience, and cost, you can be confident that the 3465A is the right decision. Contact your local HP field sales engineer, or, write for more information.



*Domestic U.S.A. Price Only **U-2 Batteries in Europe

**HP DVM's...
the right decision**



HEWLETT  PACKARD

Sales and service from 172 offices in 65 countries.
1501 Page Mill Road, Palo Alto, California 94304

INFORMATION RETRIEVAL NUMBER 292

The most accurate word in function generators is XCG.

When we introduced the first of the 180 Series last month, we said we hadn't told you everything. What we didn't tell you about is XCG.

Now it can be told [or XCG revealed]

XCG stands for xtal-controlled-generator — which stands for a degree of accuracy never before found in any function generator. In both the Models 181 and 183, generator output is locked to a crystal at up to 25 discrete points on the frequency dial. This means they will produce waveform frequencies with synthesizer accuracy of 0.01% of dial setting. When you dial a frequency, you know it's precise, and you don't need a counter to prove it.

The Model 181 XCG/Sweep Generator \$495

Besides being the most accurate function generator ever, the 181 is also a full sweeper — from 0.1 Hz to 2 MHz, with internal 1000 to 1 sweep. It provides sine, square, and triangle wave outputs (20V output p-p), as well as dc voltage, dc offset, and separate TTL output. And with full

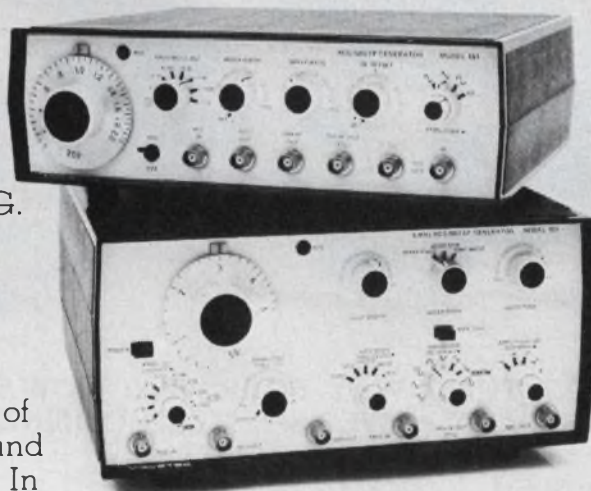

More 180s from Wavetek.

attenuation, you get ultra-clean signals down to -50dB . The only way you can come close to this performance is to buy the Model 180, which gives you everything but XCG for only \$275.

The Model 183 5 MHz XCG/Sweep Generator \$695

As you can see, the Model 183 is a couple of hundred bucks more than the 181. Here's what that buys you: The 183 has a top frequency of 5 MHz, and provides continuous, triggered, and gated operation. For precise adjustment of continuous sweep, there's a control to individually set start and stop points. There's also a variable symmetry control and another for amplitude — down to -60 dB . All of this, plus XCG, add up to the most versatile and accurate function generator ever produced.

Our Conclusion

Now that you know something about the Wavetek 180s, you'll want to know more. So for complete specs or demonstration, just contact Wavetek, P.O. Box 651, San Diego, CA 92112. Or call (714) 279-2200.

WAVETEK®

The largest selection of "OFF-THE-SHELF" POWER SPLITTERS/COMBINERS Available!

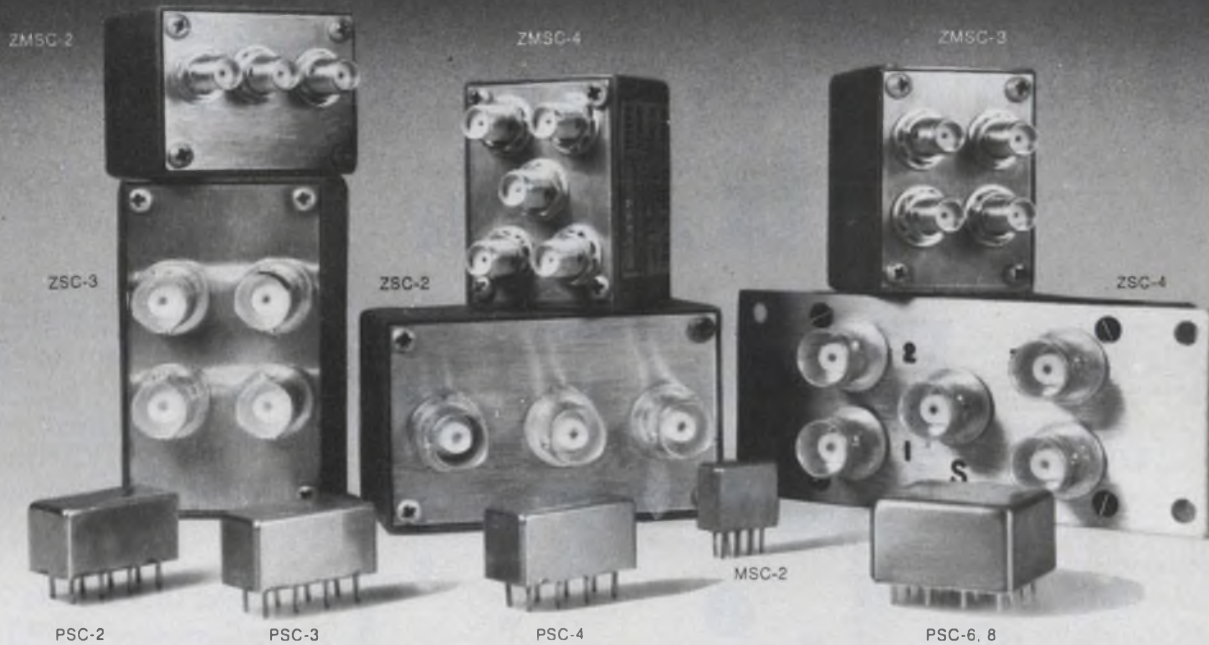

TWO-WAY, THREE-WAY, FOUR-WAY, SIX-WAY AND EIGHT-WAY POWER SPLITTER/COMBINERS

Model No.	Freq. range (MHz)	Isolation between outputs (dB) typical	Insertion loss (dB) (typical)	Unbalance		Price (Quantity)	Model No.	Freq. range (MHz)	Isolation between outputs (dB) typical	Insertion loss (dB) (typical)	Unbalance		Price (Quantity)
				ϕ (deg)	Amp (dB)						ϕ (deg)	Amp (dB)	
Two-way 0°							Three-way 0°						
PSC 2-1	0.1-400	25	0.4 above 3dB split	1	0.1	\$ 9.95 (6-49)	PSC 3-1	1-200	30	0.4 above 4.8 split	2	0.1	\$19.95 (6-49)
ZSC 2-1						\$24.95 (4-24)	ZSC 3-1						\$34.95 (4-24)
ZMSC 2-1						\$34.95 (4-24)	ZMSC 3-1						\$44.95 (4-24)
PSC 2-2	0.002-60	40	0.3 above 3dB split	1	0.1	\$19.95 (6-49)	PSC 3-2	0.01-30	40	0.25 above 4.8 split	2	0.1	\$29.95 (6-49)
ZSC 2-2						\$34.95 (4-24)	ZSC 3-2						\$44.95 (4-24)
ZMSC 2-2						\$44.95 (4-24)	ZMSC 3-2						\$54.95 (4-24)
Two-way 90°							Four-way 0°						
PSC 2-1W	1-650	25	0.5 above 3dB split	3	0.20	\$14.95 (6-49)	PSC 4-1	0.1-200	30	0.5 above 6dB split	2	0.1	\$26.95 (6-49)
ZSC 2-1W						\$29.95 (6-49)	ZSC 4-1						\$41.95 (4-24)
ZMSC 2-1W						\$139.95 (6-49)	ZMSC 4-1						\$51.95 (4-24)
PSC 2-1-75*	0.25-300	25	0.4 above 3dB split	1	0.05	\$ 9.95 (6-49)	ZSC 4-2	0.002-20	33	0.45 above 6dB split	2	0.1	\$64.95 (4-24)
ZSC 4-2							ZMSC 4-2						\$74.95 (4-24)
MSC 2-1	0.1-450	30	0.4 above 3dB split	1	0.1	\$16.95 (6-24)	PSC 4-3	0.25-250	30	0.5 above 6dB split	2	0.1	\$23.95 (6-49)
ZSC 4-3							ZMSC 4-3						\$38.95 (4-24)
Two-way 180°							Six-way 0°						
PSCJ 2-1**	1-200	33	0.6 above 3dB split	2.5	1.5	\$19.95 (5-49)	PSC 6-1	1-175	30	0.75 above 7.8dB split	4	0.2	\$59.95 (1-5)
ZSCJ 2-1						\$34.95 (5-49)	Eight-way 0°						
Two-way 90°							PSC 8-1	0.5-175	30	0.8 above 9dB split	3	0.2	\$59.95 (1-5)
PSCQ 2-90	55-90	30	average of coupled outputs less 3dB 0.3	3	1.0	\$19.95 (5-49)							

COMMON SPECIFICATIONS FOR ALL MODELS: Impedance all ports, 50 ohms *Except 75 suffix denotes 75 ohms VSWR:1.1-1.2 typical Nominal phase difference between output ports, 0° **Except J suffix denotes 180° Q denotes 90° Delivery from stock; One week max.

For complete product specifications and U.S. Rep. listing see MicroWaves' "Product Data Directory," Electronic Designs' "Gold Book" or Electronic Engineers Master "EEM"

Mini-Circuits Laboratory
A Division Scientific Components Corp

MCL

837-843 Utica Avenue, Brooklyn, NY 11203
(212) 342-2500 Int'l Telex 620156 Domestic Telex 125460

Foreign Sales Representatives: AUSTRALIA General Electronic Services, 99 Alexander Street, New South Wales, Australia 2065; ENGLAND Dale Electronics, Dale House, Wharf Road, Frimley Green, Camberley Surrey; FRANCE S. C. I. E. - D. I. M. E. S., 31 Rue George - Sand, 91120 Palaiseau, France; GERMANY, AUSTRIA, SWITZERLAND Industrial Electronics GMBH, Klüberstrasse 14, 6000 Frankfurt/Main, Germany; ISRAEL Vectronics, Ltd., 69 Gordon Street, Tel-Aviv, Israel; JAPAN Densho Kaisha, Ltd., Eguchi Building, 8-1-1 Chome Hamamatsucho Minato-ku, Tokyo; EASTERN CANADA B. D. Hummel, 2224 Maynard Avenue, Utica, NY 13502 (315) 736-7821; NETHERLANDS, BELGIUM, LUXEMBOURG: Coimex, Veldweg 11, Hattem, Holland

US Distributors: NORTHERN CALIFORNIA Cain-White & Co., Foothill Office Center, 105 Fremont Avenue, Los Altos, CA 94022 (415) 948-6533; SOUTHERN CALIFORNIA, ARIZONA Crown Electronics, 11440 Collins Street, No. Hollywood, CA 91601 (213) 877-3550

NEWS

- 21 News Scope
- 28 **Slowly but surely, power semiconductor devices have been getting faster, heftier and cheaper.**
- 34 **What's new in RF microwave semiconductors? They're up in power and down in noise figures.**
- 41 **Washington Report**

Wescon '75—A special section, Pages 50 to 59

TECHNOLOGY

- 64 **FOCUS on analog switches and multiplexers**—Vendors have vastly improved key specifications for new switches and multiplexers. But some specs have been sacrificed, and data sheets don't always show the tradeoffs.
- 76 **Mating microprocessors with converters** calls for treating the a/d's and d/a's as memory locations. This can simplify the programming and input/output design.
- 84 **Field-PLAs simplify logic designs** by permitting extensive compression of truth tables. But FPLA programming and testing procedures tend to be complicated.
- 94 **Need to operate SCRs in parallel?** Watch out. Transient effects, like finger voltage and latching current, are as important to match as steady-state performance.
- 100 **Gordon Moore of Intel** speaks on moving from lab to production.
- 106 **Ideas for Design:**
 - Dynamic power-supply load tests dual supplies to 1.25 A at 45 V.
 - Precision reference source eliminates power-supply regulation errors.
 - Drift-free integration with a v/f converter and digital counter.

PRODUCTS

- 117 **WESCON '75 Products**
- 134 **Modules & Subassemblies:** Low cost dedicated divider comes trimmed to within 0.025%.
- 136 **Modules & Subassemblies:** Peak-holding analog memory can store data for 3 months.
- 132 Data Processing
- 141 Integrated Circuits
- 143 Components
- 148 Instrumentation
- 152 Packaging & Materials
- 154 Discrete Semiconductors

DEPARTMENTS

- 47 **Editorial:** My secretary's pants
- 7 Across the Desk
- 155 Design Aids
- 156 New Literature
- 159 Vendors Report
- 164 Advertisers' Index
- 166 Product Index
- 168 Information Retrieval Card

Cover: Designed by Art Director, Bill Kelly. Background chip, a 16-channel multiplexer, courtesy of Intersil, Cupertino, CA.

UNRETOUCHED

MICROPHOTOS

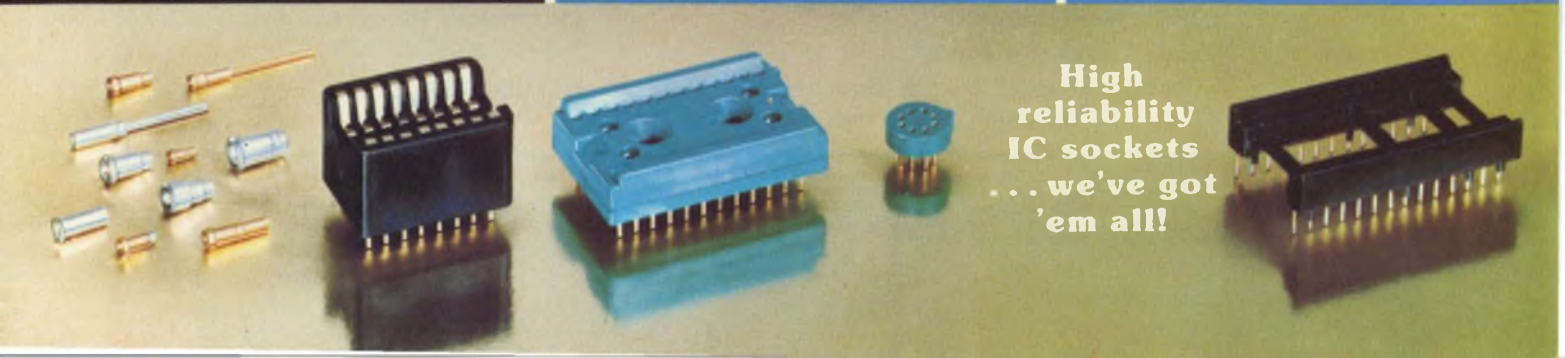
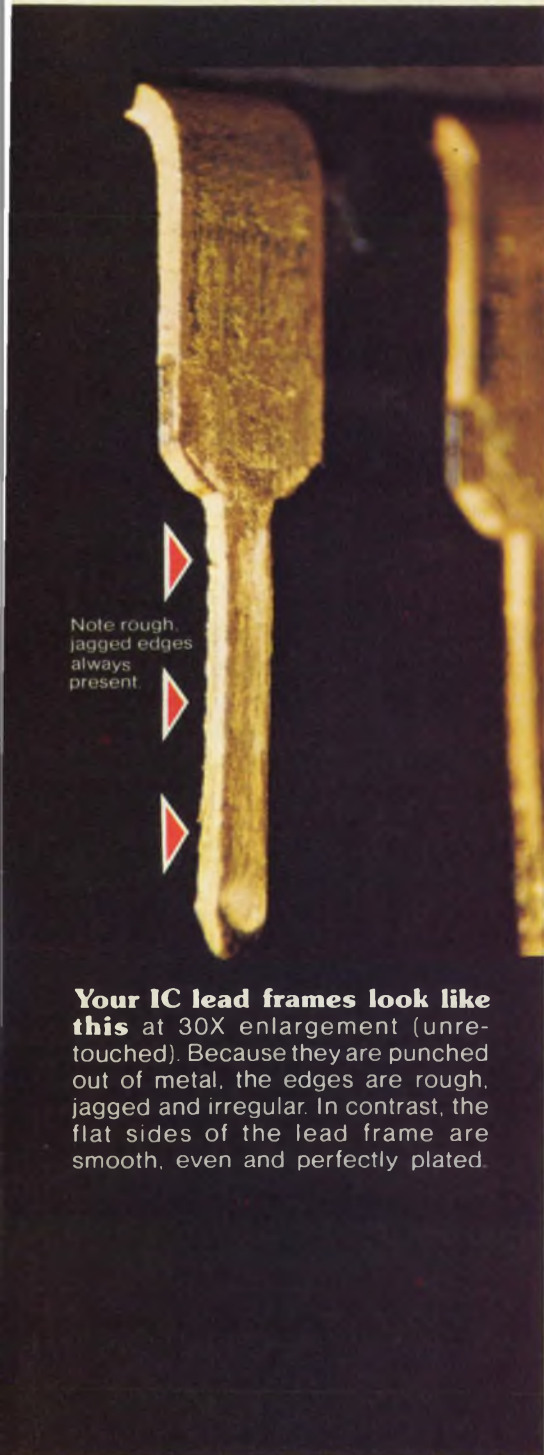

expose 'junk' socket problems

Secret of RN high reliability **'side-wipe' DIP sockets** **revealed by microphotos**

Here's microscopic proof that high reliability Robinson-Nugent "side-wipe" DIP sockets make 100% greater contact than any edge-bearing socket on the market. This advance design provides constant low contact resistance, long term dependability—trouble-free IC interconnects. Yet RN high reliability DIP sockets cost no more than ordinary sockets!

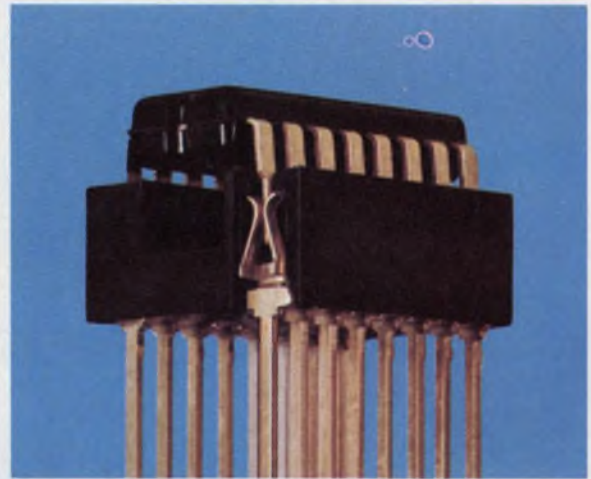

Get the high reliability that eliminates trouble. RN "side-wipe" DIP sockets make contact with the wide, flat sides of your IC leads. You get 100% greater surface contact for positive, trouble-free electrical connection.



WRITE TODAY

for catalog and informative book "What to Look for in IC Interconnects." Free from Robinson-Nugent—the people who make more kinds of high reliability IC sockets than anyone.



They're even packaged for high reliability. "Protecto-pak"® packaging delivers consistently perfect RN sockets to your production line—for automated or manual assembly.

RN **ROBINSON NUGENT, INC.**

800 East Eighth Street, New Albany, Indiana 47150 • Phone: (812) 945-0211

INFORMATION RETRIEVAL NUMBER 4

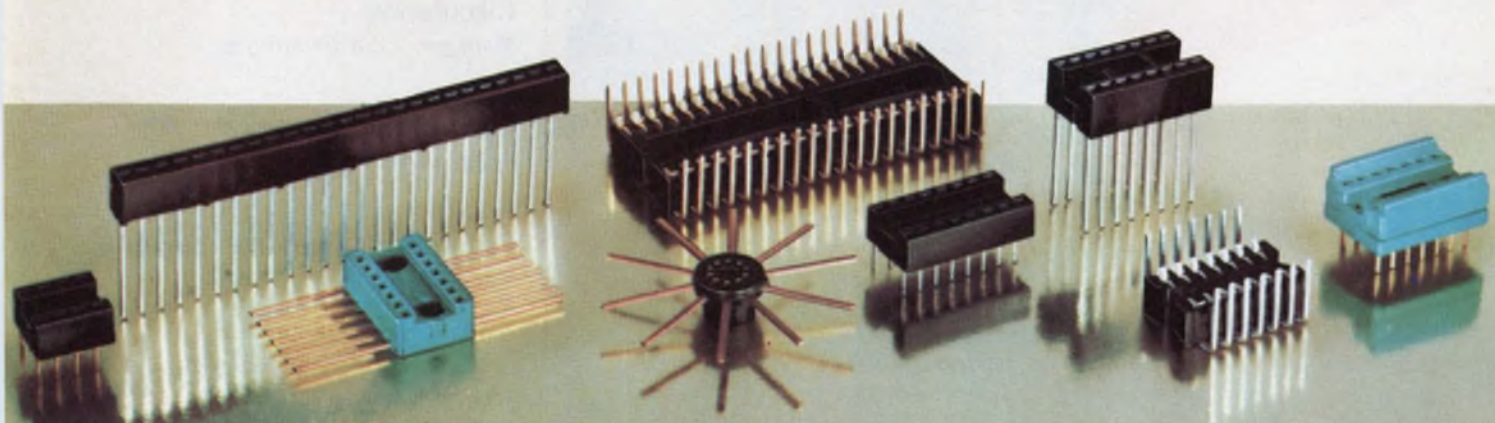

HARNESSES

Simple jumpers to massive power signal assemblies. Flat ribbon form or programmed, multi-purpose, multi-layer. Machine made or hand-tied. Delivered in absolute conformance to your system requirements and ready for drop-in. Flat woven cabling gives you broadest design capability, superior control and performance characteristics of individually insulated leads and precise positioning.

For maximum benefits, let us assist in planning. End those harness hang-ups. Think Woven—your complete source for flat interconnects.

WOVEN ELECTRONICS

P.O. Box 189/Mauldin, S.C. 29662
(803) 963-5131

Sr. Vice President, Publisher
Peter Coley

Editors

Editorial Offices
50 Essex St.
Rochelle Park, NJ 07662
(201) 843-0550
TWX: 710-990 5071
Cable: Haydenpubs Rochellepark

Editor-in-Chief George Rostky

Managing Editors:

Ralph Dobriner
Michael Elphick

Associate Editors:

Dave Bursky
Jules H. Gilder
Morris Grossman
John F. Mason
Stanley Runyon
Edward A. Torrero

Contributing Editors:

Peter N. Budzilovich
Alberto Socolovsky
Nathan Sussman

Editorial Field Offices

East

Jim McDermott, Eastern Editor
P.O. Box 272
Easthampton, MA 01027
(413) 527-3632

West

David N. Kaye, Senior Western Editor
8939 S. Sepulveda Blvd.,
Suite 510
Los Angeles, CA 90045
(213) 641-6544
TWX: 1-910-328-7240

Editorial Production

Marjorie A. Duffy

Art

Art Director, William Kelly
Richard Luce
Anthony J. Fischetto

Production

Manager, Dollie S. Viebig
Helen De Polo
Anne Molfetas

Circulation

Manager, Evan Phourides

Information Retrieval

Peggy Long

Promotion, Creative Layouts

Manager, Albert B. Stempel
Maxine Correal
Nancy Gordon (Reprints)

Across the Desk

Misplaced Caption Dept.



"Pardon, can you direct me to Electronic Design's booth?"

Sorry. That's Hieronymus Bosch's Garden of Delights which hangs in the Prado Museum, Madrid.

Corrections given for software article

Here are corrections that should be made in the article "With New, Powerful Software, Designers Can 'See' a System Work Before It's Actually Built" (ED No. 10, May 10, 1975, pp. 80-87):

1. NCSS offers a product called ISPICE not SPICE (p. 83).
2. TYMSHARE did not add the

features stated on p. 83 to SPICE. These features are in the package available from Berkeley.

3. NCSS offers SIMSCRIPT II.5 (1973), a later version than is listed on p. 86.

4. Scientific Calculations has written a product called SCI-

(continued on page 14)

Electronic Design welcomes the opinions of its readers on the issues raised in the magazine's editorial columns. Address letters to Managing Editor, Electronic Design, 50 Essex St. Rochelle Park, N.J. 07662. Try to keep letters under 200 words. Letters must be signed. Names will be withheld on request.

Thin-Trim[®] capacitors



Tucked in the corner of this Pulsar Watch is a miniature capacitor which is used to trim the crystal. This Thin-Trim capacitor is one of our 9410 series, has an adjustment range of 7 to 45 pf., and is .200" x .200" x .050" thick. The Thin-Trim concept provides a variable device to replace fixed tuning techniques and cut-and-try methods of adjustment. Thin-Trim capacitors are available in a variety of lead configurations making them very easy to mount.

A smaller version of the 9410 is the 9402 series with a maximum capacitance value of 25 pf. These are perfect for applications in sub-miniature circuits such as ladies electronic wrist watches and phased array MIC's.

Johanson Manufacturing Corporation, Rockaway Valley Road., Boonton, N.J. 07005. Phone (201) 334-2676, TWX 710-987-8367.

Johanson

MANUFACTURING CORPORATION

INFORMATION RETRIEVAL NUMBER 6 ▶

DELCO'S NEW FAS HIGH-GAIN TRANSIS

MAJOR PARAMETER LIMITS

TYPE	h_{FE} @ 10A	V_{CBO}	V_{CEO} (sus)	V_{CE} (sat) @ 7A	t_f (typical) @ 5A)
DTS 515	3.5	300V	250V	5.0V	0.25 μ sec
DTS 516	4	400V	250V	1.9V	0.25 μ sec
DTS 517	5	500V	250V	1.6V	0.25 μ sec
DTS 518	5	600V	275V	1.4V	0.25 μ sec
DTS 519	5	700V	300V	1.4V	0.25 μ sec
2N6573	5	500V	250V	1.6V	0.25 μ sec
2N6574	5	600V	275V	1.4V	0.25 μ sec
2N6575	5	700V	300V	1.4V	0.25 μ sec

NPN triple diffused silicon transistors. Packaged in solid copper cases conforming to JEDEC TO-3 (TO-204MA) outline dimensions.



Our newest high-energy silicon power transistors have increased capabilities over our earlier types in current ratings, gain and switching speeds. These improvements were achieved without sacrificing the useful peak power handling capacity that is characteristic of Delco's transistors.

Fall time of these transistors is typically 0.25 microseconds. Their biggest advantage, however, is their high current gain as shown on the accompanying beta curves.

A new characterization feature offered with the DTS-515 series is a graph of capabilities for reverse bias clamped inductive switching. Parameter variables, dealt with in the graph, are voltage, collector current, temperature, and forward and reverse base current. As can be seen in the

" $V_{BE}(\text{reverse}) \geq 5V$ " notation, emitter diode avalanche is recommended under certain conditions.

And, of course, these high-energy silicon power transistors come in Delco's solid copper TO-3 packages to ensure low thermal resistance.

The accompanying curves, charts and circuits tell part of the story. Prices, applications literature and electrical data from your nearest Delco sales office or Delco distributor can supply another part.

But the most important part of the story is how well these new transistors function in your applications.

You can order them today; they're in stock at your Delco distributor's.

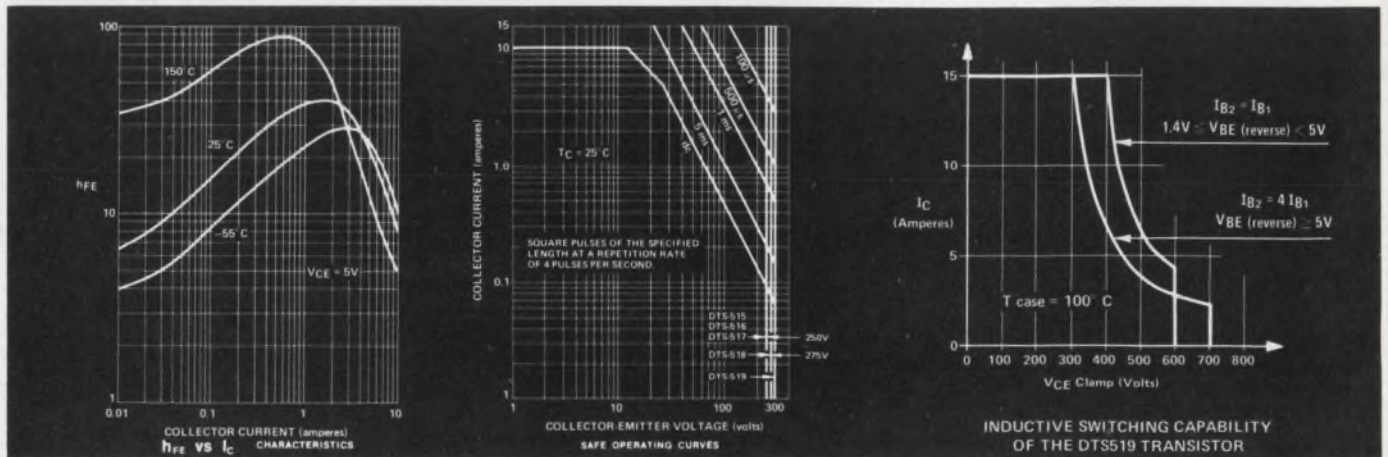

TER SWITCHING, TORS NOW IN STOCK.

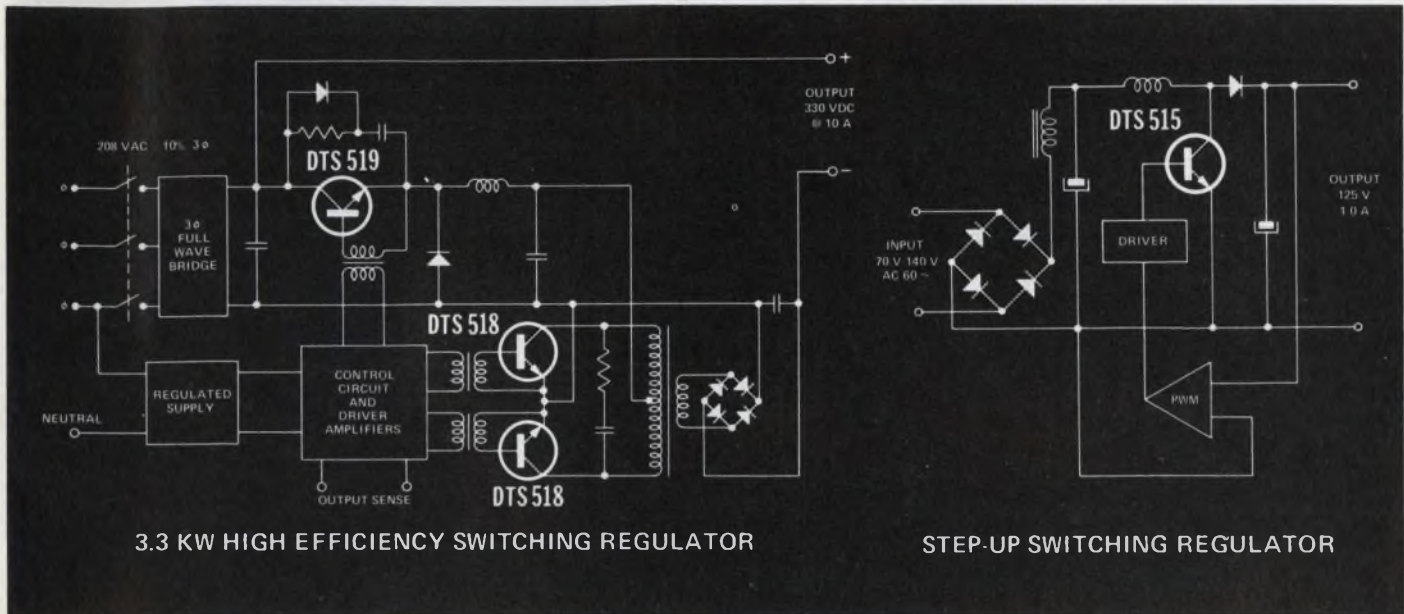

NOW AVAILABLE FROM THESE DISTRIBUTORS IN PRODUCTION QUANTITIES.

ALABAMA, Birmingham
Forbes Distributing Co., Inc.
(205) 251-4104

ALABAMA, Huntsville
Powell Electronics
(205) 539-2731

ARIZONA, Phoenix
Sterling Electronics, Inc.
(602) 258-4531

CALIFORNIA, Gardena
Bell Industries
Electronics Distributors Div.
(213) 321-5802

CALIFORNIA, Goleta
R.P.S. Electronics, Inc.
(805) 964-6823

CALIFORNIA, Los Angeles
Kierulff Electronics, Inc.
(213) 685-5511

CALIFORNIA, Los Angeles
R.P.S. Electronics, Inc.
(213) 748-1271

CALIFORNIA, Palo Alto
Kierulff Electronics, Inc.
(415) 968-6292

CALIFORNIA, San Diego
Kierulff Electronics, Inc.
(714) 278-2112

CALIFORNIA, San Diego
R.P.S. Electronics, Inc.
(714) 292-5611

CALIFORNIA, Sunnyvale
Bell Industries
(408) 734-8570

COLORADO, Denver
Kierulff Electronics, Inc.
(303) 371-6500

CONNECTICUT, Norwalk
Harvey Electronics
(203) 853-1515

FLORIDA, Clearwater
Diplomat/Southland
(813) 443-4514

FLORIDA, Miami Springs
Powell Electronics/Florida
(305) 592-3260

ILLINOIS, Rosemont
Kierulff Electronics, Inc.
(312) 678-8560

ILLINOIS, Skokie
Bell Industries
Electronics Distributors Div.
(312) 282-5400

INDIANA, Indianapolis
Graham Electronics Supply, Inc.
(317) 634-8202

MARYLAND, Baltimore
Radio Electric Service Co.
(301) 823-0070

MASSACHUSETTS, Billerica
Kierulff Electronics, Inc.
(617) 935-5134
(617) 667-8331

MASSACHUSETTS, Newton
The Greene-Shaw Co., Inc.
(617) 969-8900

MICHIGAN, Livonia
Pioneer/Michigan
(313) 525-1800

MINNESOTA, Minneapolis
Stark Electronics Supply Co.
(612) 332-1325

MISSOURI, Kansas City
Walters Radio Supply, Inc.
(816) 531-7015

MISSOURI, St. Louis
LCOMP-St. Louis
(314) 647-5505

NEW JERSEY, Cinnaminson
Wilshire Electronics/Philadelphia
(609) 786-8990 (215) 627-1920

NEW JERSEY, Clifton
Wilshire Electronics/New Jersey
(201) 365-2600 (212) 244-8930

NEW MEXICO, Albuquerque
Sterling Electronics
(505) 345-6601

NEW YORK, Binghamton
Harvey Electronics
(607) 748-8211

NEW YORK, Buffalo
Summit Distributors, Inc.
(716) 884-3450

NEW YORK, Farmingdale
Wilshire Electronics/Long Island
(516) 293-5775

NEW YORK, Woodbury
Harvey Electronics
(516) 921-8700 (212) 895-9260

OHIO, Cincinnati
United Radio, Inc.
(513) 761-4030

OHIO, Cleveland
Pattison Supply Co.
Industrial Electronics Division
(216) 441-3000

OHIO, Dayton
Pioneer/Dayton
(513) 236-9900

PENNSYLVANIA, Philadelphia
Almo Electronics
(215) 698-4000

PENNSYLVANIA, Pittsburgh
Cameradio Electronics
(412) 288-2600

SOUTH CAROLINA, Columbia
Dixie Radio Supply Co., Inc.
(803) 253-5333

TEXAS, Dallas
Adleta Electronics Company
(214) 741-3151

TEXAS, Dallas
Sterling Electronics
(214) 357-9131

TEXAS, Houston
Harrison Equipment Co., Inc.
(713) 224-9131

WASHINGTON, Seattle
Kierulff Electronics, Inc.
(206) 763-1550

IN CANADA: ONTARIO, Scarborough
Lake Engineering Co., Ltd.
(416) 751-5980

ALL OVERSEAS INQUIRIES:
General Motors Overseas
Operations
Power and Industrial Products
Dept.,
767 Fifth Avenue, New York, N.Y.
10022
PHONE: (212) 486-3723

Delco Electronics Regional Sales Offices
Union, New Jersey 07083
Box 1018 Chestnut Station
(201) 687-3770

Van Nuys, California 91404
Box 2968
(213) 988-7550

General Sales Office
700 E. Firmin, Kokomo, Ind. 46901
(317) 459-2175



Division of General Motors

INFORMATION RETRIEVAL NUMBER 7

Get up to speed on high frequency power switching for just 10¢



A 10¢ stamp gets you the basics on what you need to know about using high-power, fast-switching Darlington transistors to reduce the size, weight and costs of switching regulated power supplies and motor controls.

Want to know how the Darlington figures in Buck, Boost or Buck-Boost Regulators, Full Bridge, Half Bridge, or Push-Pull Regulator Converter circuits?

Want to replace SCR's and associated commutation circuitry in inverter circuits below 30kva?

TRW has put down the facts for quick study in a free brochure. All you have to do is fill out the coupon and mail it in. If you want the facts faster, call John Power (213) 679-4561 at TRW Power Semiconductors, an Electronic Components Division of TRW, Inc., 14520 Aviation Blvd., Lawndale, California 90260.

TRW POWER SEMICONDUCTORS

TRW Power Semiconductors

14520 Aviation Boulevard, Lawndale, California 90260

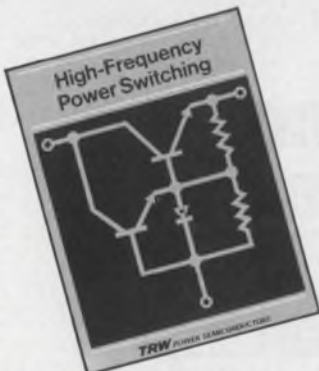

**Please rush
me your
free brochure
on high
frequency
power
switching.**

NAME _____

POSITION _____

FIRM NAME _____

ADDRESS _____

CITY _____

STATE _____

ZIP _____

Amphenol Scot Pot.TM Amphenol trimmers.

Two bargains
your competitors
may not know about . . .

YET.



3810 wirewound



6034 cermet

The word is out — Amphenol offers a big selection of quality precision pots and trimmers. They can replace what you're using now — in form, fit, and function — and save you money in the bargain.

Our Scot Pot is as good as (or better than) any other 10-turn wirewound miniature precision pot on the market. It has improved electrical, mechanical, and environmental characteristics. Yet Scot Pots cost as much as 25% less than other equivalent pots.

And that's news that won't stay secret for very long.

Our 3/4" rectangular trimmers come in a full range of resistances and in all popular pin spacings. They're sealed to withstand automatic board cleaning. And they're highly stable — no drift. Two series to choose from: 3810 wirewound (available with Vista-Trim for fast, approximate visual settings). And 6034 cermet trimmers. Both series save you plenty. Ask for a quote and see how much you can beat the competition by.

For off-the-shelf delivery, call your local Amphenol Industrial Distributor. Your competitors may have already discovered his great service — so should you. Give him a call. Or for more information (and spec sheets on our pots and trimmers) contact: George Boyd, Amphenol Connector Division, Controls Operation, 2801 South 25th Avenue, Broadview, Illinois 60153. Phone: (312) 261-2000.

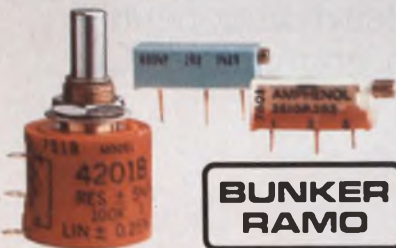

*When you can connect it
and forget it... that's quality.*

AMPHENOL

How to buy a m

Which comes first—the hardware or the software? You need both, of course, to create new products with microcomputers. The tougher question is: How do you assure product profitability? That gets you into questions of hardware availability, software support, design assistance and confidence in your supplier. When an electronics publication recently asked readers to rank their microcomputer buying criteria, it came as no surprise to Intel that availability, software support and supplier reputation topped the list.

Intel can supply you today with five general-purpose CPUs, supported by numerous peripheral, I/O and memory components, software packages and development manuals, and the industry's largest library of users' applications programs. Our five microcomputers span a 1000:1 performance range and include the lowest cost, highest performance and most popular designs available today. Their applications are

equally broad, from electronic games to high speed controllers and processors. We want to make sure that our customers don't begin designing with pieces of the hardware/software puzzle missing. To minimize development and assembly cost, each CPU is backed up by more than a score of performance-matched system components—advanced programmable I/O

INTEL MICROCOMPUTER SYSTEM FAMILIES					
MICROCOMPUTER SYSTEM	MCS™ 4	MCS™ 40	MCS™ 8	MCS™ 80	Series 3000
CENTRAL PROCESSOR	4004	4040	8008	8080	3001, 3002, 3003
Technology	PMOS	PMOS	PMOS	NMOS	Schottky Bipolar
Parallel Bits	4	4	8	8	2 per 3002 CPE
Instruction Cycle	10.8μS	10.8μS	12.5μS	2μS	100nS
SUPPORT COMPONENTS					
RAMS (including CMOS)	4	4	5	5	8
PROMS	3	3	3	4	7
ROMS	4	4	3	3	6
*Peripheral Interfaces	6	6	6	6	8
Interrupt Unit			1	1	1
Clock Generator	1	1	1	1	TTL
*I/O Units	5	5	3	3	3
Total Component Choices	23	23	22	23	33
SYSTEMS SUPPORT					
Software Packages					
Microassembler					1
Assemblers	2	2	2	2	
Compiler			1	1	
Monitor	1	1	1	1	
Simulator	1	1	1	1	
Text Editor			1	1	
Manuals	6	6	5	6	1
User's Library	Yes	Yes	Yes	Yes	Yes
Intellic® Development System	Yes	Yes	Yes	Yes	In development

* Five additional I/O and peripheral devices will be available in 2nd half of 1975.

Microcomputer.

subsystems, peripheral interfaces, clock generators, priority interrupt and other control units, and the broadest selection of erasable and bipolar PROMs, compatible metal mask ROMs, CMOS and NMOS RAMs.

Moreover, Intel software packages include resident monitors, assemblers and text editors available on Intellec[®] microcomputer development systems. Assemblers, simulators and compilers

are also available as cross products on magnetic tape or on leading time share networks. With these aids programs can be written and debugged in a fraction of the time required a few years ago.

You may need design assistance before the meter starts running in the research and development lab. Intel has the industry's most experienced microcomputer field applications engineering group. If your staff needs help to get started, we have regional training centers, workshops, seminars and on-site training courses available.

With Intel, there's no shell game about hardware or software delivery, no guessing whether the supplier can handle all your production commitments. Intel has been

delivering microcomputers in volume since 1971. Our reputation speaks for itself. We've already delivered more general-purpose microcomputers than the rest of the industry combined.

If you have tough questions about which microcomputer will make your new products most profitable, call or write Intel for our solutions. Intel Corporation, 3065 Bowers Avenue, Santa Clara, California 95051 (408) 246-7501.

intel[®] Microcomputers. First from the beginning.

INFORMATION RETRIEVAL NUMBER 11

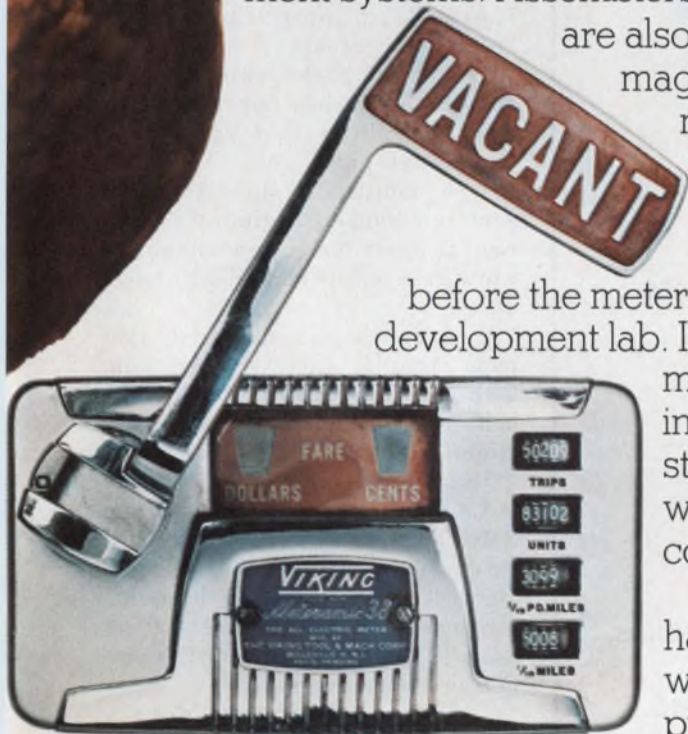

HIGH-VOLTAGE CAPACITORS NEED NOT HAVE FRAGILE GLASS OR CERAMIC CASES... THE UNBREAKABLE FABMIKA® IS HERE!



THE CAPACITORS:

Sprague Epoxy/Fiberglass-Encased Type 305M. Reconstituted mica dielectric, offering uniformity of performance and quality impractical with sheet mica. Impregnated with epoxy resin, forming solid capacitor section . . . no oil to leak. Ideal where impregnant seepage can't be tolerated.

THE APPLICATIONS:

Airborne electronics, high-voltage power supplies, induction heating equipment, electrostatic precipitators, pressurized sonar equipment, etc.

THE ADVANTAGES:

Meet or exceed major electrical specifications of high-voltage glass-encased or ceramic tubulars . . . but virtually unbreakable. High dielectric strength, high-temperature performance, low temp. coefficient of capacitance, corona resistance.

For complete technical data, write for Engineering Bulletin 1732 to: Technical Literature Service, Sprague Electric Co., 347 Marshall St., North Adams, Mass. 01247.

THE BROAD-LINE PRODUCER OF ELECTRONIC PARTS



INFORMATION RETRIEVAL NUMBER 12

ACROSS THE DESK
(continued from page 7)

CARDS, not CYCARDS (p. 87), and it is available exclusively on NCSS.

Roger E. Brady
Manager, Vendor Products
National CSS, Inc.
300 Westport Ave.
Norwalk, CT 06851

I would like to clarify several inaccuracies appearing in the table "Sampling of Commercially Available Design Programs," ED No. 10, May 10, 1975, p. 84.

D-LASAR is proprietary to Digitest Corp., Dallas, TX. The program separately identified as DLG is actually an integral part of the D-LASAR system.

In addition to the features listed, D-LASAR has two important analytic capabilities that are invaluable design aids:

1. A multistate simulator that performs complex initialization and race analysis for both nominal and worst-case component delay tolerances.

2. A timing-analysis module that plots timing diagrams, showing both steady-state and dynamic circuit signal activity for every stimulus pattern.

Users can choose to access D-LASAR either in-house on an SMC 3020 Design Aid and Test Generation Facility available from Digitest on a lease/purchase arrangement or on a time-sharing basis through the University Computing Co. network.

Kenneth R. Bowden
Vice President

Digitest
1949 N. Stemmons Frwy.
P.O. Box 10611
Dallas, TX 75207

We flipped

In ED No. 12, June 7, 1975, a photograph of the HEI Corp. optical switch at the top of the column on p. 123 was mistakenly placed with the item about Codi Semiconductor's reference diodes at the bottom of the column.

Let's get the facts straight on IC packaging panels.

The IC packaging panel, or "Augat board," has become so widely accepted, you'd think Augat would be happy.

But frankly, we're concerned.

People have gotten so used to IC panels that they may have lost sight of the reason for buying panels in the first place: flexibility in design, production and service. With the result that they may not be getting all the benefits panels can provide.

We'd like to correct this situation by reviewing exactly what's at stake in your choice of a panel supplier.

GETTING THE RIGHT PANEL.

People often select a panel from a limited catalog without realizing the wide selection of stock panels available.

When in fact, they can get exactly what they need right off the shelves of Augat distributors all over the world.

With the largest product line anywhere, we're sure to have a standard board that fits virtually all your development and production needs—including ECL and Schottky.

For really special requirements, though, you should probably consider a custom-designed panel. If you're dealing with an experienced engineering staff like Augat's, it's surprisingly easy. And it won't cost you any premium—it might even save you money.

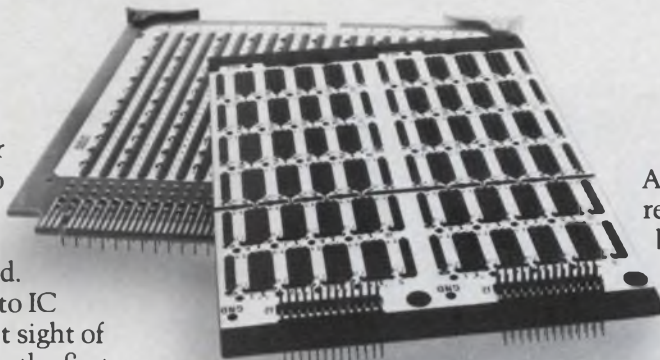

Whatever your requirements, you shouldn't settle for an approximation. Because you don't have to.

HOW GOOD IS GOOD ENOUGH?

The payoff for getting the right panel is faultless performance. No surprises in product development, production, or field service.

It's the reason for Augat's no-compromise approach to quality control. And it's why Augat uses the best precision-machining technology in the world, rather than conventional stamping methods, to produce the contact assemblies that are the heart of Augat panels.

The result speaks for itself. The elimination of these common contact pitfalls:

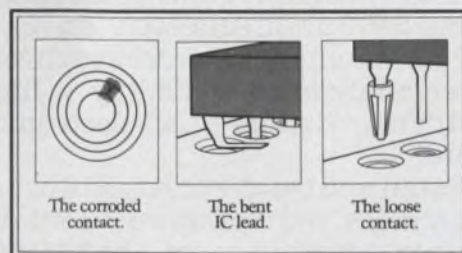

When others succeed in duplicating Augat's machining technology, the result will be better panels for everybody. But until then, there's only one place in the world to get this degree of fail-safe protection: Augat.

DELIVERY YOU CAN COUNT ON.

In 1974 Augat completed a multi-million-dollar program to automate production and bring the manufacture of IC panels under 100% in-house control.

Result: The fastest turnaround the industry's ever seen.

Most standard panels are on the shelf. But if the one you want isn't, you can still get it in no more than 2 weeks. And our custom panels are being turned out in volume to meet the most stringent delivery standards in the industry.

So next time you're selecting IC panels, consider all the facts. For full information, send for our new brochure. Or phone George P. Howland, Engineering Manager, at (617) 222-2202. Augat, Inc., 33 Perry Avenue, Attleboro, Massachusetts 02703.

YOU ONLY GET IT ALL FROM AUGAT.

AUGAT[®]

Europe—Augat N.V., Boulevard A. Reyers, 103, 1040 Brussels, Belgium, Tel. (02) 7369399.

Japan—Kyokuto Boeki Kaisha Ltd., New Otemachi Bldg., 2-1, 2-Chome Otemachi, Chiyoda-Ku, Tokyo 100-91, Japan, Tel. (03) 244-3788.

Canada—A.C. Simmonds & Sons Ltd., 285 Yorkland Blvd., Willowdale, Ont. M2J1S8, Tel. (416) 491-1010.

INFORMATION RETRIEVAL NUMBER 13

Q.

Is there a recorder just for spectrum analyzers?

A.

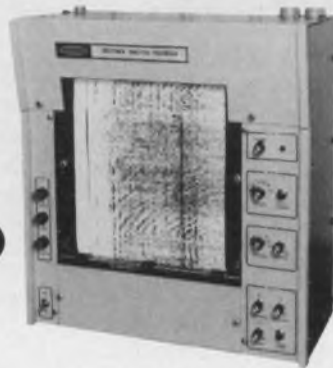

The new 19" rack-mounting SPECTRUM ANALYSIS RECORDER from Raytheon. It's the first dry paper line scanning recorder specifically developed for direct plug-in operation with commercially available spectrum analyzers.

Any new or existing spectrum analyzer equipped with the SAR-097 will have a lot more going for it. Like infinitely variable 100:1 speed range – 5 sec/scan to 50 millisecc/scan . . . stylus position encoder . . . automatic recorder synchronization . . . computer/analyzer compatibility . . . high resolution and dynamic range . . . all-electronic drive. And more.

If you design and build – or buy and use – spectrum analyzers, you don't have to settle for multi-purpose recorders any more. The SAR-097 is here. For full details write the Marketing Manager, Raytheon Company, Ocean Systems Center, Portsmouth, R.I. 02871. (401) 847-8000.



SIEMENS

If you need a low cost T.C. Zener...

How about a Siemens 6.2V, 0.002% / °C for under 50¢*?

Siemens single chip Temperature Compensated Zeners have been reduced in price. Now you can apply these high quality devices where previously cost had precluded their use. What's the secret? Simple. We've coupled our single chip construction with highly automated testing techniques available at our Scottsdale, Arizona facility, and are passing our production cost savings on to you.

But Siemens single chip Temperature Compensated Zeners offer you more than reasonable prices. All devices have completely passivated junctions with a thermally grown silicon oxide. **These Zeners have the only fully protected single chip construction available on the market today.**

These low cost T.C. Zeners are available in the D.O.-7 glass package for the 1N821 through 1N829 and 1N4565A through 1N4584A series with JAN, JANTX, and JANTXV versions. They are also available in chip form. These are 6.2V or 6.4V devices with temperature coefficients in the range of 0.01 to 0.0005% / °C.

When you need a high quality, low cost Temperature Compensated Zener, think Siemens. Units are available from stock. Write us today for detailed data sheets and our new Zener Diode Quick Reference Guide.

**And, remember . . .
Where Quality Is The Measure,
Siemens Is The Rule.**

*1N825 1,000 piece quantity 48¢ FOB Scottsdale.

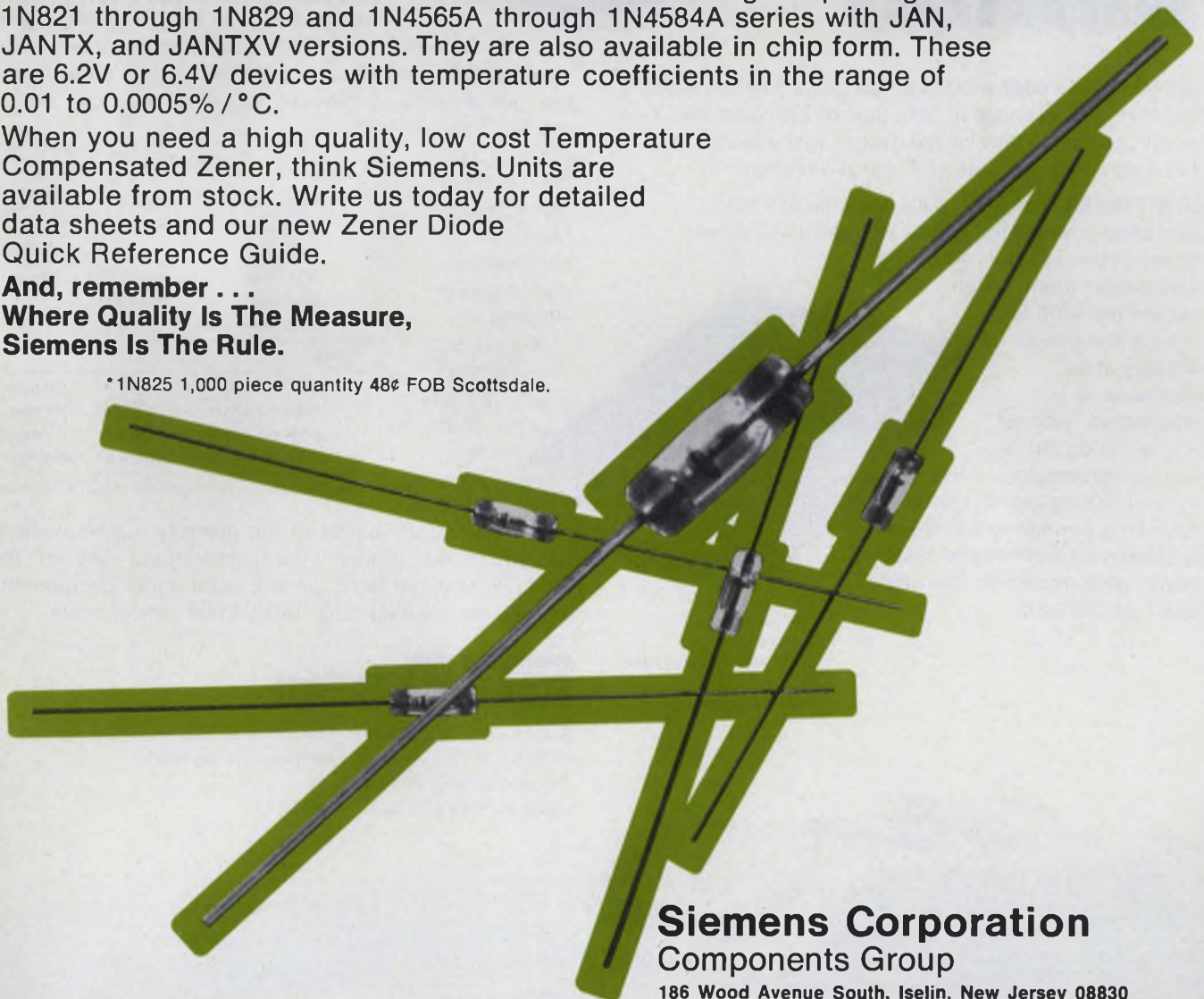

Siemens Corporation
Components Group

186 Wood Avenue South, Iselin, New Jersey 08830
Phone: (201) 494-1000 TWX 710-998-0588 Telex 844-491

INFORMATION RETRIEVAL NUMBER 15

TAKE THE LEAD WITH THE 2ND NEW 4K STATIC RAM FROM EMM

TTL-COMPATIBLE; FULLY STATIC.

The new SEMI 4200 is fully static like the 4402 we recently introduced. But in addition it is TTL-compatible, output as well as input. Thus you can not only forget about refresh and charge pump circuitry when designing high performance MOS memory systems, you can also forget about drive amplifiers.



225 NANOSECOND ACCESS. The SEMI 4200 4K static RAM has a worst case access time of 225 nsec, and a worst case cycle time of 400 nsec. *It is the fastest TTL-compatible 4K static RAM in production.*

LOW POWER. The SEMI 4200 requires 450 mw operating power. And, just as with the 4402, power conservation is achieved by the Chip Select Input, which causes the 4200 to enter a low power standby state whenever it is unselected. Normal V_{DD} is 12Vdc, but V_{DD} can be reduced to 4 volts without risking loss of stored data, thus permitting the design of effectively non-volatile systems. Power consumption in this mode is less than $2\mu W/bit$.

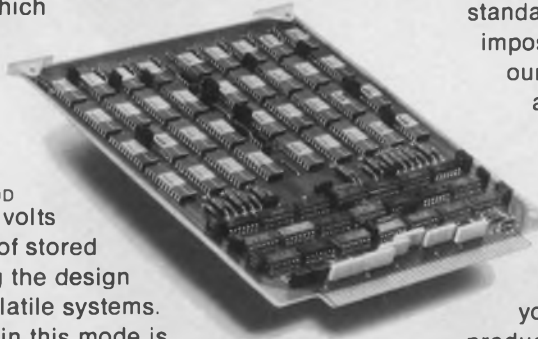

MICROGRAM 1240.
16K x 8/9 using
SEMI-4200 4K Static RAM
Ideal for
microprocessor applications.

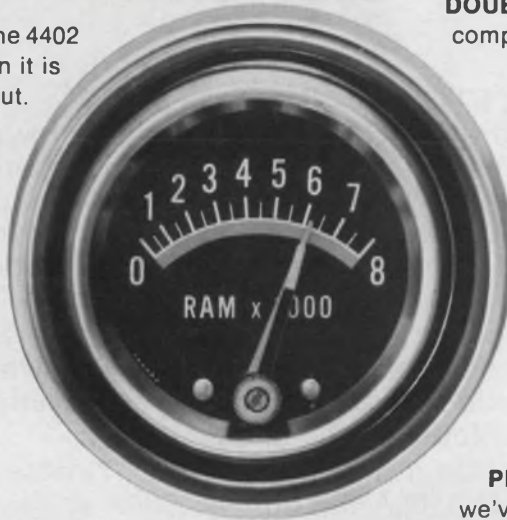

DOUBLE TESTED. Like all SEMI NMOS components, the 4200 TTL-compatible 4K static RAM must meet our own tough test standards, since we use it in our memory systems. In fact, our normal procedure requires 100% ac and dc testing of all components twice — at wafer and again in the package.

MODEL SELECTION. EMM SEMI offers you a growing line of static RAM and ROM components to help you take the design lead. Pick out the one that best meets your needs from the adjacent chart.

PROVEN TRACK RECORD. At EMM we've been making memory components and systems since 1961. Unlike memory suppliers who market components only, all EMM components are performance proven in our own systems. When you buy from EMM, you get the benefit of the unusually high acceptance standards we impose on ourselves, as well as our years of experience in

Part No.	Bit Org.	Access Time
RAMS		
SEMI-4200	4096 x 1	225 nsec
SEMI-4402	4096 x 1	200 nsec
SEMI-1801	1024 x 1	90 nsec
SEMI-1802	1024 x 1	70 nsec
SEMI RA-3-4256	256 x 4	1 usec
SEMI RA-3-4256B	256 x 4	1 usec
ROMS		
SEMI RO-3-4096	512 x 8	500 nsec
SEMI RO-3-5120	512 x 10	500 nsec
SEMI RO-3-16384	4096 x 4	1 usec
SEMI RO-3-8316A	2048 x 8	850 nsec

More new products to come ... additional 4K static RAMs, ROMs

meeting the needs of the memory marketplace. If you'd like further information about any of the products featured here, or any other EMM components or systems, contact your local EMM office today.

EMM SEMI

A subsidiary of Electronic Memories & Magnetics Corporation
3883 North 28th Avenue, Phoenix, Arizona 85017
Telephone (602) 263-0202

INFORMATION RETRIEVAL NUMBER 17



Design with the complete flat cable/connector system.

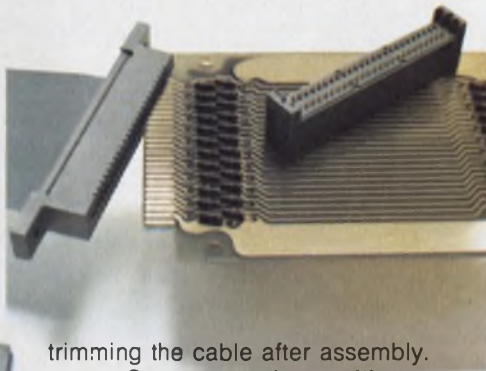

trimming the cable after assembly.

Connector units provide positive alignment with precisely spaced conductors in 3M's flat, flexible PVC cable. The connector contacts strip through the insulation, capture the conductor, and provide a gas-tight pressure connection.

With cable, connectors and assembly tools from one design and manufacturing source, you have added assurance the connection will be made surely, with no shorts or "opens."

And "Scotchflex" now offers you more design freedom than ever. From stock you can choose shielded and non-shielded 24-30 AWG cable with 10 to 50 conductors, and an ever-increasing variety of more than

The 3M DELTA pin and socket connector.



Assembly-cost savings are built in when you design a package with "Scotchflex" flat cable and connectors. But more important, 3M Company offers you the full reliability of a one-source system: cable *plus* connectors *plus* the inexpensive assembly aids that crimp the connections quickly and securely (with no special operator training required).

The fast, simple "Scotchflex" assembly sequence makes as many as 50 simultaneous multiple connections in seconds, without stripping, soldering or

100 connectors to interface with standard DIP sockets, wrap posts on standard grid patterns, printed circuit boards, or headers for de-pluggable applications. 3M's DELTA "D" type pin and socket connectors are now also available. For full information, write Dept. EAH-1, 3M Center, St. Paul, MN 55101.



3M's "Scotchflex" line.

"Scotchflex" is a registered trademark of 3M Co.

INFORMATION RETRIEVAL NUMBER 18

A crisis hinged on this one passenger

There would have been less panic if the "passenger" had been able to leave earlier on a regular cargo plane. But this was the only flight available, and time was running out. Our customer was on the verge of closing down a production line — all for the lack of this package: Vital ceramic cylinders. Rod Stoddard, an expeditor at Coors Porcelain Company, was the one who personally went to the airport to buy a ticket and put the package on the plane. He'd do the same thing again for you in a crunch. Extra hours, doing the extraordinary, that's our way.



We've developed the knack of bending over backwards to please our customers. Put Coors Porcelain Company to the test. One of our sales representatives is within your reach. State your demands. And we'll book passage on an icebreaker if that's what it takes to put a crucial ceramic product in your hands.



Coors Porcelain Company

600 Ninth Street / Golden, Colorado 80401 / (303) 279-6565 / Telex 45-593

INFORMATION RETRIEVAL NUMBER 19



SEPTEMBER 1, 1975

IEEE balloting pits Dillard against a maverick, Feerst

"This time I'm going to win, and you will never see IEEE the same again."

Is this a promise or a threat by Irwin Feerst? That depends, of course, on what you think of the Institute of Electrical and Electronics Engineers and the way it is run now, and how you rate Feerst and his plans for the institute if he's elected president.

An engineering consultant who for years has been battering the walls of the institute with proposals for change, Feerst now believes he has the backing to move in and make them. His name on the ballots that IEEE is mailing to members today marks the first time a candidate has appeared on the ballot who was not nominated by the IEEE's board of directors. Feerst got on by petition.

Nominated by the IEEE directors and running against him is Joseph K. Dillard, manager of advanced-systems technology for Westinghouse Electric in Pittsburgh. Dillard is now the institute's executive vice president and has also served as treasurer and

vice president for technical activities.

If elected, Feerst says he will do the following:

- "Give IEEE back to the working EE. The organization is run now by academicians and corporate executives. Put working EEs on the director's board by increasing its number from 10 to 30, thus reducing the amount of time each member must donate."

- "Emphasize IEEE's American, rather than international, base. Foreigners have disproportionate representation on the board of regional directors and in the IEEE publications."

- "Make EE a lifetime career of challenging, remunerative work; not a job that stops at the age of 40. IEEE will accredit engineering school departments for quality and quantity, tightening standards and limiting the number of graduating EEs the way the American Medical Association controls medical schools and their graduates."

- "Verify the accuracy of predictions of engineering shortages, which are used to attract gullible

high school students and their advisers into engineering schools. How can there be engineering shortages when engineers over 40 are fired?"

- "Sell IEEE's building in Pascataway, N.J., and use the money as a legal-defense fund to help engineers who've been fired because of their age."

- "Rethink IEEE's policy of investing institute funds, particularly investments in securities. Publicize the nature of these investments—IEEE's capital assets decreased more than \$500,000 in 1974. Also, publish all board meeting minutes in IEEE's Spectrum magazine."

- "Get rid of Maj. Gen. H. Schulke, IEEE's general manager. Reduce the frequency of IEEE's more esoteric publications."

On the other hand, Dillard says that if he's elected, he will do the following:

- "Maintain the IEEE's technical excellence. All decisions will be measured by their effect on preserving and enhancing this."

- "Unify the engineering professional societies to permit professional activities to be handled by a single umbrella organization—this could give the engineer the clout he needs on the economic and political scene. Much attention will be devoted to this effort."

- "Make engineering a true profession—strive for admissions quotas, compulsory state registration, internship and direct control over accreditation of engineering schools; emulate the medical and legal professions. However, IEEE would not engage in collective bargaining or take adversary positions between employer and employee."

On involvement of the EE in the social implications of his work, Dillard believes that the individual does have such a responsibility but that the institute must be careful not to establish value judgments or to moralize on behalf of its diverse membership.

Joseph K. Dillard



Irwin Feerst

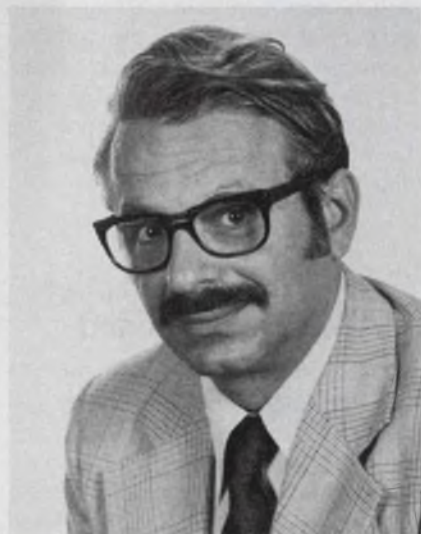

GaAs varactor gets natural passivation

A natural gallium-oxide passivation has been grown on gallium arsenide, opening the way for

microwave gallium-arsenide field-effect transistors to be used unpackaged but protected by a passivation coating.

Until now, GaAsFETs have been packaged, with the package parasitics causing degradation in performance at microwave frequencies.

Joseph Calviello, research scientist at the AIL Div. of Cutler-Hammer, Melville, NY, reports the construction of a new GaAs tantalum Schottky-barrier varactor with a natural gallium oxide passivation. It exhibits high resistance to burnout and an unusually long lifetime. The varactor has a cut-off frequency in excess of 1000 GHz at 0 V. Its application will be in ultra-low-noise paramps and mm-wave varactor multipliers.

Microwave transistor operates at 20 GHz

A new solid-state microwave device—essentially a microwave transistor with an Impatt diode as the collector structure—promises to provide microwave power amplification at as high as 20 GHz. Today's best commercially available transistors operate at 3 GHz.

Developed by scientists at the General Electric Research and Development Center, Schenectady, NY, the new device—called a Controlled Avalanche Transit Time (CATT) triode—has other advantages, says Alan Bennett, manager of the solid-state communications branch at the center. He lists the following:

- The new solid-state structure reduces the base-widening, or Kirk effect, which limits the peak power outputs of conventional microwave transistors. As a result, the CATT is capable of higher pulsed power than transistors, according to Se Puan Yu and Wirojana Tantraporn, the GE researchers who conducted the development program.

- The CATT can be used in simple circuits without need for the frequency multiplication now required by conventional microwave transistors. And use of the CATT also eliminates other circuit complications encountered when Impatt diodes are used as microwave power generators.

The key to CATT performance lies in the increased gain from the unique semiconductor structure, Bennett says.

"You can think of the device as being a transistor with a collector region that is an Impatt diode," he explains. "We modify the collector in the transistor by giving it the doping profile characteristic of the Impatt device.

"So, in addition to the voltage multiplication, one has with a transistor, we also obtain the current gain, due to the Impatt avalanche mechanism."

Because of the inherent increase in gain caused by the avalanche effect, the CATT can always perform better at higher frequencies than an equivalent microwave transistor can, Bennett says.

"We have made measurements on our device up to about 4 GHz as an upper limit," he reports.

But he points out that the fabrication technology of the 4-GHz unit is the same as that used for a 1-GHz transistor.

"By using 5-GHz transistor technology," he contends, "we should get useful gain and have a device suitable for 10 GHz. And all the evidence indicates that by using 10 GHz transistor technology—it requires 1/2- μ m resolution for the emitter-to-base structure—we can fabricate a CATT that can produce useful power gain as high as 20 GHz."

Experimental CATT devices have been operated at 3 GHz with a 13-dB gain at a 12-W output, and at 4 GHz with 6-dB gain at 5-W output.

An important use of the CATT will be in the S-band region, Bennett predicts, where the applications require pulsed power. Measurements at about 2.5 GHz have produced pulsed-power outputs on the order of 20-W average, he notes.

Floppy disc/controller for \$200 envisioned

The key to bringing down the cost of floppy disc/controller systems is the cost of the controller," says a spokesman for Rockwell-International's Microelectronic Device Div. in Anaheim, CA. And

Rockwell is about to bring out a controller on a chip to solve the problem.

The company believes that with the new controller chip, seven PPS-8 microprocessor chips and a floppy disc drive, a floppy disc/controller system can be made to sell for about \$200 in quantities of 1000.

The new chip will provide all control functions necessary for operation of any IBM-compatible floppy-disc drive. The chip even includes cyclic redundancy check generation. It uses PMOS metal gate technology and will sell for \$80 in quantities of 100 to 999. In 1-24 quantities, it will cost \$125.

CIRCLE NO. 422

Project giving all homes access to a computer

A computer for every home—or at least access to one—is the goal now being implemented in a planned community called Rossmoor in Phoenix, AZ.

In every residence being built by the Rossmoor Corp. is a two-way cable TV system linked by a home terminal to a municipal Interdata Model 70 minicomputer. Every six seconds the minicomputer asks each home terminal if everything's all right—if there's a fire (there are two automatic fire sensors in every house) or if anyone needs medical assistance or the police (there are plug-removable pull boxes for that).

If the minicomputer receives an affirmative answer to its questions, it automatically prints out an alarm message for an on-duty security officer, nurse station or fire station, along with the address of the problem home.

Subscribers will also be able to participate in opinion polling experiments by pressing five response buttons, says Brian Belcher, director of engineering for Tocom, Inc., of Dallas, which is building the system. Combinations of four of the buttons will provide 15 different responses. The fifth button will clear the terminal for a different response.

Remote control of lights, sprinkler valves, motors, alarms or relays is also possible.

Nuts to you!

And a connector too.

Top quality connectors for peanuts.

It's hard to improve on the quality of these miniature connectors — so we've improved the price:

Circular Connectors.

Two types: low cost Thorkom Series for general instrumentation requirements — or the sophisticated Snap-Lock Series for aerospace environmental needs.

Vikord Cable Assemblies.

Whatever type of harness you need, we can do it better, quicker, and at a lot lower cost than you can.

Rectangulars.

Get more contacts into less space with these input/output rack and panel connectors. Both high and low voltage models.

MIL-T-81714 Terminal Junction Systems.

It's a full line. Both feed-back and feed-thru assemblies.

Relay Sockets.

We have available, off-the-shelf, the broadest line of quality sockets on the market today.

Your nearest distributor should have our connectors in stock, and he can tell you just how good a price we have.

Or for literature and samples, use the coupon. We'll even send some nuts to you, too.

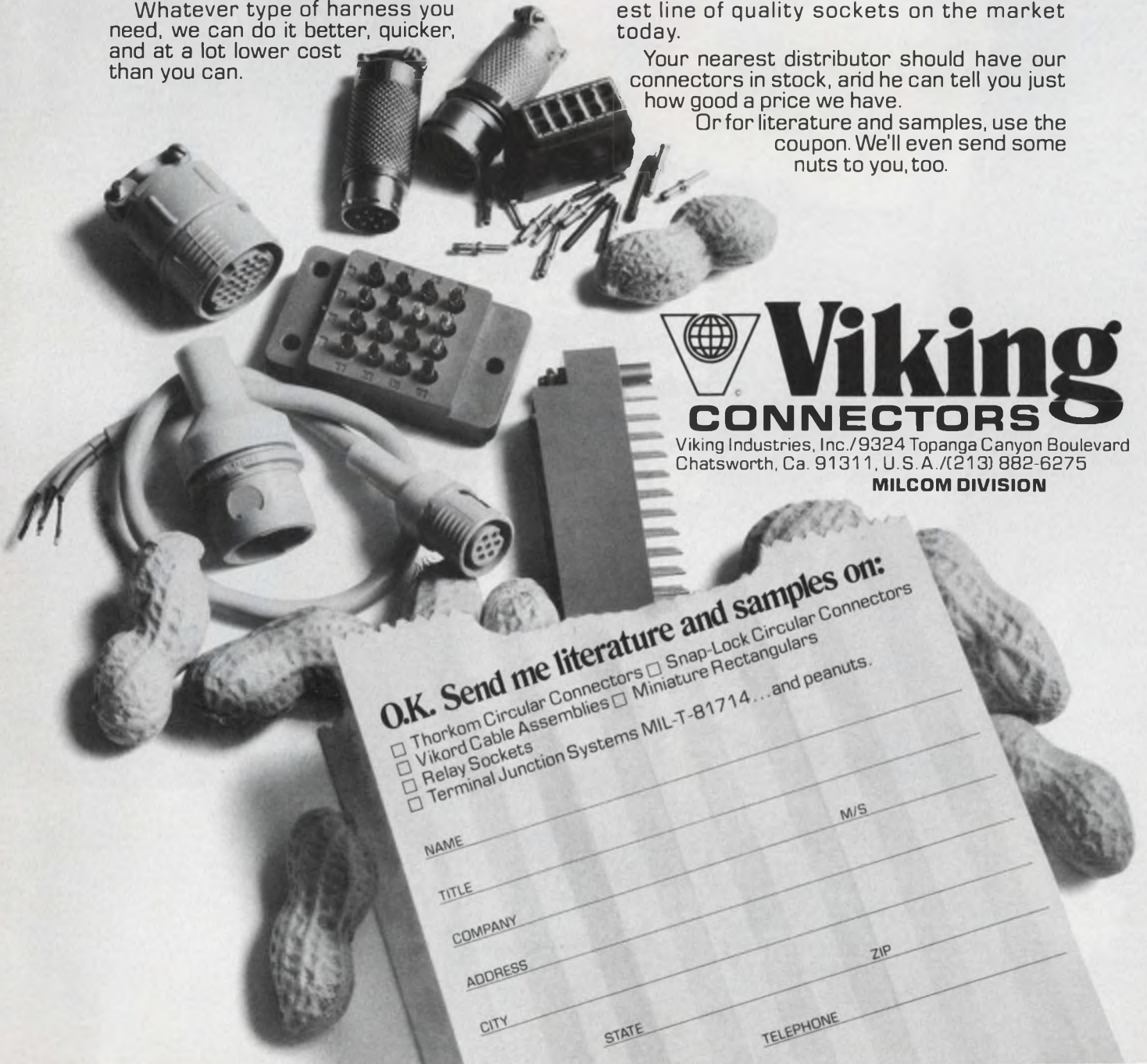

Viking

CONNECTORS

Viking Industries, Inc./9324 Topanga Canyon Boulevard
Chatsworth, Ca. 91311, U.S.A. / (213) 882-6275

MILCOM DIVISION

O.K. Send me literature and samples on:

- Thorkom Circular Connectors
- Snap-Lock Circular Connectors
- Vikord Cable Assemblies
- Miniature Rectangulars
- Relay Sockets
- Terminal Junction Systems MIL-T-81714...and peanuts.

NAME _____

TITLE _____

COMPANY _____

ADDRESS _____

CITY _____

STATE _____

TELEPHONE _____

M/S _____

ZIP _____



**Recession
be damned.**

We're out to win!



Win with our ceramic capacitors!

Win with our guaranteed deliveries!

Win with our innovative new products!

We can't — and won't sit around waiting for the government to bail out the economy.

Damn the recession! We're charging full speed ahead, with new and improved products, faster precision production, crash-through delivery and a gung-ho determination to make the Varadyne V stand for Victory!

It's a way of business life we've maintained through good times and bad. A way of doing business that benefits our customers — and that could include you!

We built a business on quality chips.

If you know Varadyne, you know and probably depend on Varadyne quality resistor and capacitor chips. Our reputation for dependability rests on the wide range of chips we make to meet most standard requirements. Now you can get that same quality in devices to meet your leaded applications. Products, in stock and ready to ship, like these:

Axial Leaded Ceramic G2 Caps.

Unrivalled dependability in an axial leaded capacitor, hermetically sealed in glass. Available in Ultra Stable, Stable and General Purpose formulations that meet requirements of MIL-C-11015 and MIL-C-39014. Three standard case sizes with tin plated, copper

clad, steel leads. Reel packaged for automatic insertion with diode and resistor machines.

Rugged Radial Leaded Clover Caps.

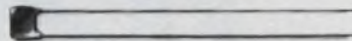

Ultra Stable, Stable and General Purpose capacitors, completely sealed in epoxy for performance dependability and long life. Six sizes that meet applicable requirements of MIL-C-11015. Solder coated, copper clad, steel leads. Complete electrical and physical interchangeability with all other radial leaded monolithic coated capacitors.

Delivery?

You name the date and we'll deliver the goods! Off-the-line or off-the-shelf from one of our nation-wide distributors. We won't leave you waiting when we're out to win!

And as for prices —

With our combination of superb quality and high speed, volume production, we guarantee that we can compete with anyone! If price is a problem, let us bid on your next order. You'll be in for a surprise. A good one!

If we make what you need — and you need more information, don't circle a Bingo card. Get action immediately.

Call Ms. Pat Bowling, our Marketing Services Manager, collect! (213) 829-2991



VARADYNE

Varadyne Industries, Inc.
1547 18th St., Santa Monica, California 90404
Phone: (213) 829-2991 • TWX (910) 343-6856

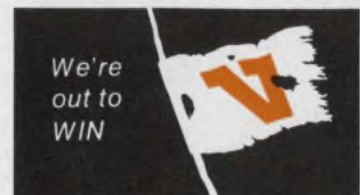

Block 1.

Simultaneously-molded stationary contact and coil block assures excellent insulation and high stability, even after long use.

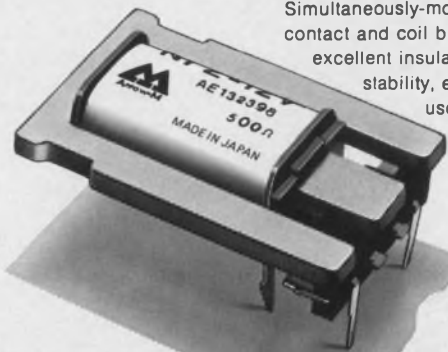

Block 2.

Armature, adjusting plate and hinge spring are block-built and contribute to maintain long life.

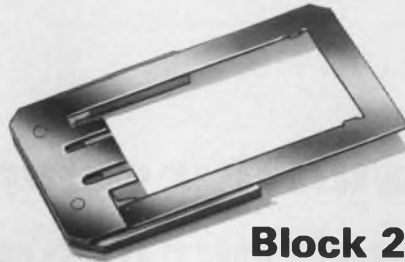

Block 3.

From stamping of springs, through simultaneous-molding and welding process of contacts, this block is systematically manufactured. It prevents parts from loosening even under high-temperature conditions.

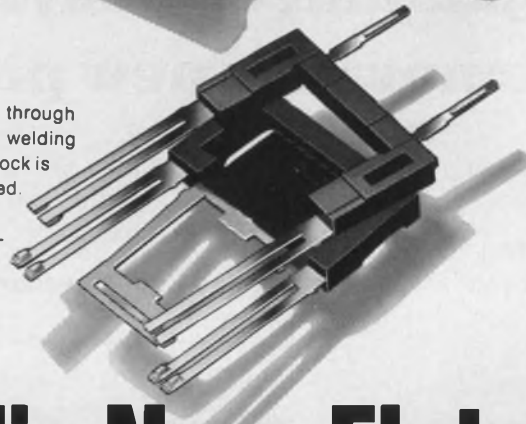

Arrow-M's New Flatpack Relay. Block-Built For Total Reliability.

Arrow-M's block-building system eliminates the hand-assembly operations which cause relay failure. Arrow-M's NF relay has three blocks and a cover. Each block of parts forms a monolithic unit.

Each is automatically or semi-automatically assembled, without screws, to the exact specifications of hundreds of thousands of preceding blocks.

Furthermore, based upon over 50 years of experience in manufacturing techniques, our production system, which includes product design, production process design, as well

as fabrication of production equipment, is completely and systematically utilized in our factories to insure top-level reliability of Arrow-M relays.

But reliability is only part of NF's superiority.

These relays operate on half the power of similar flatpacks and at IC signal levels.

They're fast, with negligible bounce and chatter.

NF relays switch 2 amps, come in 2 and 4 Form C types, both in standard dust covers and plastic hermetically-sealed versions.

NF relay production process

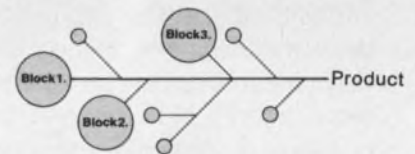

Conventional production process

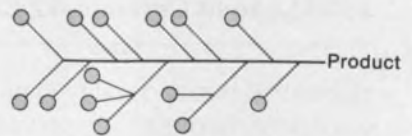

Relays for advanced technology

Visit us at WESCON Booth 1149



Arrow-M

Convince yourself. Send for comprehensive data. Or call your nearest Arrow-M representative.
Arrow-M Corporation, 250 Sheffield Street, Mountainside, N.J. 07092. Phone: 201-232-4260. A member of the Matsushita Group.



Cut out shorts.

Unique, low-cost, all-plastic AMP right-angle connector. Now circuit paths can be located directly under the connector without shorting. The need for insulating the right-angle mounting brackets used with metal shell connectors is eliminated. The new AMP 94V-0 thermoplastic AMPLIMITE HDP-20 right-angle miniature pin-and-socket connector has .109" centerlines. This low-cost high-density connector intermates with all other similar connectors. Plus AMP's standard HDM-20 and HDP-20 connectors. The gold-flashed or selectively gold-plated precision-formed phosphor-bronze contacts are preloaded with posts bent 90°. Housings have built-in stand-off relief. Available in 15-, 25- and 37- position plug and receptacle versions. All this and economy, too!

And short-cut costs.

Mass-terminate any standard flat-cable fast.

We put teeth in low-cost mass termination with the 25-position AMPLIMITE HDF-20. A simple arbor press terminates all insulation-displacing contacts to the cable simultaneously. Two fork-like teeth penetrate the cable from opposite sides, trapping each conductor and interlocking with the housing. HDF-20 plug and receptacles are intermateable with all existing 25-position connectors.

Accommodate *any* 26-position solid or stranded round-conductor flexible cable on 0.050" centers—with no preparation other than squaring the end. Use the HDF-20 for highest production rates and lowest applied cost.

For further details on the unique AMPLIMITE HDP-20, or HDF-20, call (717) 564-0100. Or write AMP Incorporated, Harrisburg, PA 17105.

AMP & AMPLIMITE are trademarks of AMP Incorporated.

AMP
INCORPORATED

Slowly but surely, power semis are getting faster, heftier, cheaper

Because the semiconductor field is characterized more by evolution than revolution, changes in power semiconductor devices may be overlooked. But in the last year or so, voltage and current ratings have increased, efficiencies have improved, switching speeds have decreased and costs have dropped. Here are some of the present or

Dave Bursky
Associate Editor

soon-to-be-available devices and developments:

- Neutron-irradiated silicon for SCRs that can switch 2000 A and withstand 5000 V. This will boost the power-handling capability of single devices by close to 50%.
- Super large-diameter silicon wafers (3 to 5 in.) for single SCRs that have surge-current capabilities of 80,000 A; present devices are just starting to reach 3 in.
- Gate-turn-off SCRs that can

handle up to 200 A and block 1000 V, compared with presently available 10 to 20 A, 600 V units.

- Reverse-switching rectifiers that handle thousands of watts instead of 5 to 10 W (diacs).

- Package-less thyristors and transistors suitable for direct heat-sink mounting. These devices provide improvements of up to 30% in cooling efficiency.

- Monolithic Darlington transistors that handle 2 to 5 kV at currents between 3 and 20 A. The upper power-handling limits of Darlington transistors are presently about 6 to 8 kW.

- Schottky rectifier diodes that handle 60 to 100 A and have reverse voltages up around 100 V. Limits for these devices are presently about 50 A at 40 V.

- Ion-implanted rectifier diodes that handle several hundred amps at close to 1 kV but switch off in less than 100 ns. Present limits are about 100 A at 800 V.

Semis for power transmission

Available SCRs are limited in current and voltage to about 1800 A (on) at 3000 V (off), have turn-off times that range from 1 μ s for low-power devices to 100 μ s for the megawatt units, and have maximum wafer diameters of about 2.5 to 3 in. However, to handle the high voltages of the transmission lines—typically in the hundreds of kilovolts—SCRs must be stacked so that blocking voltages add.

To reduce the stack size, development programs are under way at the Big 3 power SCR manufacturers—General Electric, International Rectifier and Westinghouse. Dave Cooper, vice president of engineering product development for International Rectifier predicts the availability of devices that can block 5000 V and pass 2000 A in



Fast-switching transistors, power Darlington transistors and Schottky diodes are key components in high-efficiency power supplies, like this 1000-W off-line unit designed by TRW Power Semiconductors. Efficiency is better than 80%.

New from Potter & Brumfield

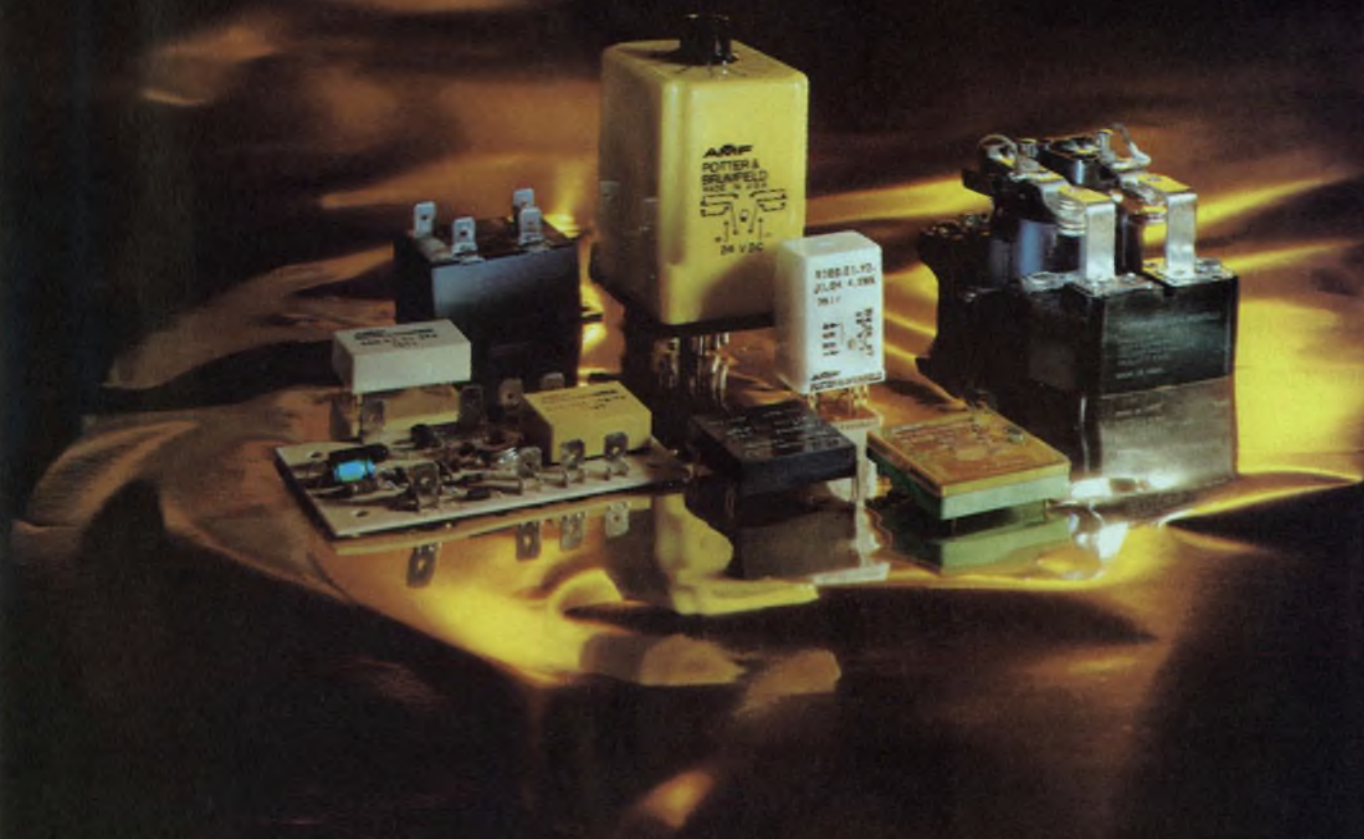

8 major P&B relays to solve today's design challenges.

1. R10S. Sensitivity to 5mW per pole. Available in 1, 2, and 4 Form C contacts. Ratings from dry circuit to 3 amps. Less than \$3.00 in lots of 500.

2. R50 relays. Help you solve cost and space problems. Less than \$2.00 in quantity, the R50 allows 0.6" center-to-center pc board spacing.

Coil ratings of 5, 6, 12, 24, and 48 VDC. Available in 1 and 2 Form C contacts.

3. CG relay. Extended-range CMOS IC time delay or interval timer. Repeatability including first cycle is typically .01% for DC units and 0.1% for AC units. Time delays up to 100 minutes standard.

4. R16 time delay module. Offers big savings at under \$7.00 in quantities. Timing ranges, potentiometer adjustable, are 0.2 to 2, 2 to 30 and 10 to 100 seconds for delay on operate.

5. T10 series relays. Only 0.375" high. Ideal for high density applications — permit pc boards to be mounted on 0.5" centers. Two and 4 Form C contacts provide 0.1 to 3 amp switching @ 30 VDC. Coil ratings: 6, 12, 24 and 48 VDC.

6. JDO relays. Solid state switching with total opto-coupler isolation. Zero voltage turn on and zero current turn off minimizes EMI and RFI. Low profile

permits pc board mounting on 0.5" centers. Coil ratings: 5, 6, 12 and 24 VDC. Shockproof.

7. EOT series relays. Opto-coupled, all solid state. Solve high cyclic switching problems. Synchronous zero crossover switching virtually eliminates EMI and RFI. Output: 2, 4, 5 or 7 amps @ 120 VAC standard.

8. PRD series power relays. New improved design. Interchangeable with famous PR series. Save 50¢ at list price! UL and CSA listed. Rugged terminals designed for power screwdrivers.

For detailed product specifications, contact the Potter & Brumfield sales representative or authorized distributor nearest you, or write Potter & Brumfield Division AMF Incorporated, Princeton, Indiana 47671. Telephone 812-385-5251.

EUROPE: Electrical Products Group,
AMF International Limited, AMF
House, Whitby Road,
BRISTOL BS4 4AZ.

England
Telephone:
(0272) 778383
Telex: 449481
AMMAFOCO
BRSTL

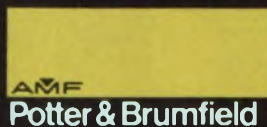

Solving switching problems is what we're all about.



Wafer sizes for power SCRs have increased from the small, stud-mounted units made by GE in the late 1950s to the large 1 and 2-in. diameter devices available today that handle megawatts.

the next few years. To get ratings this high, manufacturers are using:

- **Neutron-irradiated silicon.** Thermally activated neutrons bombard the silicon and change the silicon atoms into phosphorous in precisely controlled amounts, resulting in higher voltage capability and fewer hot spots within the wafer.

- **Larger chip slices.** Devices are going to reach diameters of 4 to 5 in.—which means higher current-handling ability, with surge currents up to 80,000 A.

SCRs, whether megawatt or milliwatt, have one major problem: turn-off. For ac power, they're fine; when the current passes through zero, they turn off. But for dc power, complex commutative circuits must be used.

Or must they? RCA has recently introduced a commercial series of comparatively low-power gate-turn-off SCRs—the G5000 series—that turn off when a negative voltage pulse is applied to the gate.

Available devices have ratings of up to 15 A at 800 V, max, although RCA, GE and several other companies are developing 200-A, 1000-V GTOs that should be available in a year or two. At present the three main application areas include CRT deflection circuits, induction heating equipment and automotive ignition systems.

Westinghouse is about to announce a thyristor—a reverse-switching rectifier—that is an apparent extension of the diac family. These devices are two ter-



Very-large-diameter wafers, like these made by International Rectifier, carry thousands of amps.

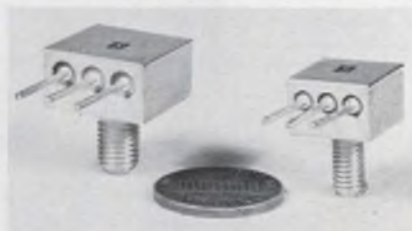

Squared-off stud-mounted packages from Solitron are said to boost power dissipation by almost 50%.



Uncased power semiconductors mounted on ceramic substrates can cut costs 40%, claims Unitrode.

minial units designed for high rate-of-rise pulse switching, with peak pulse-current ratings of 1200 A and di/dt capabilities of 2000 A/ μ s. Blocking voltage for units in the T40R series approaches 1000 V at 125 C. Turn-off times are about 100 μ s—just a little slower than conventional SCRs. Primary application areas for these RSRs include pulse modulation for radar and sonar systems.

Asymmetrical SCRs, a development recently announced by RCA, are fast-switching devices that have high ratings—but only in one direction. SCR blocking voltages are usually symmetrical. When off, SCRs will block equal positive or negative voltages. The ASCRs, though, will block high positive voltages, but they have reverse ratings of only 10 to 20 V. These devices will work fine in dc circuits, since only forward blocking capability is needed in most cases.

Triacs (bidirectional SCRs) are also getting heftier. International Rectifier recently released units capable of blocking 1200 V and passing 50 A, and RCA has units that can handle 800 V at 40 A. IR says the units in its 50-AC series are the largest available units in standard DO-65 packages.

Whenever power is switched, the heat generated within the semiconductor must be dissipated. Both General Electric and Unitrode have developed “caseless” devices that can be mounted directly onto heat sinks. Edward Rodriguez, marketing manager for Unitrode, and John Seefkin, product planner for GE, agree that these uncased devices can dissipate about 20 to 30% more power and can cost 30 to 50% less than equivalent packaged devices.

GE's Subscresets and Unitrode's Chipstrates contain glass passivated thyristor and transistor chips mounted on alumina or beryllia substrates. The substrates are, in turn, mounted on heat sinks, and leads are attached right to solder pads on the substrate. Just about any semiconductor is available in “unpacked” form—diodes, SCRs, triacs and transistors—with ratings up to about 55 A at 800 V.

Single-chip power transistors can't approach the high power ratings of the big thyristors. “High voltage and high current are mutually exclusive in transistors,”

What Every Designer or Specifier Should Know About RESISTOR NETWORKS!

A wise man once said, "A chain is only as strong as its weakest link".

That phrase says as much for electronic circuitry today . . . as it originally did for the value of the individual quality of man. For example, the failure of a single tiny printed conductor path in a resistor network can cause the failure of an entire circuit . . . or system.

Bourns doesn't want that to happen to one of your circuits. For that reason, we want to share some "inside" information about the design and manufacture of thick-film networks . . . so that you can be a more knowledgeable and more selective specifier.



1. Lead Termination Failure

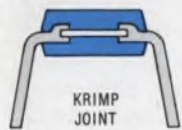

During Bourns initial design program, customer interviews indicated that commonly used "lap joint" and "butt joint" lead termination designs were subject to failure due to weakening of the solder termination during PC board wave soldering operations, and in-circuit heat cycling and vibration. These design-types depend heavily on solder alone for both mechanical and electrical bonding of leads to the substrate.

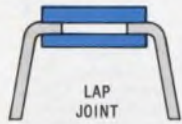

With this in mind, Bourns engineers developed the "Krimp-Joint™" lead frame termination design to protect customers from this hazard.

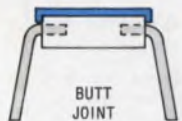

Bourns Krimp-Joint leads are firmly crimped onto the network element, much like a vise grasps a piece of lumber. To "cinch" the electrical connection, a special high temperature, reflow resistant solder is also used.

3. The Packaging

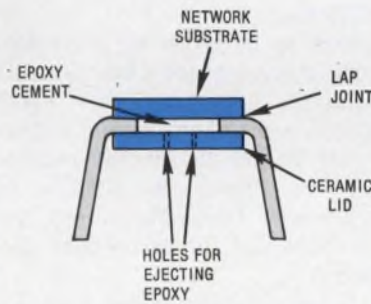

Various types of DIP packaging are utilized of which the molded and "sandwich" types seem most common. One problem that frequently occurs with the sandwich types is delaminating. This happens when air in tiny voids remaining in the epoxy filler (bonds the substrate to the sandwich "lid") expands in hot operating environments to the extent that the package comes apart and fails.

Bourns Krimp-Joint networks are encased in a homogenous molded thermoset plastic package, which is highly heat resistant. Both 14- and 16-pin DIP models are machine insertable, and are available in handy cartridge packages.

4. Power

Bourns uses a high-copper alloy lead material to enhance power dissipation capacity. Other materials — ferrous and brass alloys — do not have comparable performance. Furthermore, there is potential for rust with the ferrous alloy material. The high-copper alloy costs us more . . . but we think your satisfaction is worth it.

5. A Good Coat Is Important

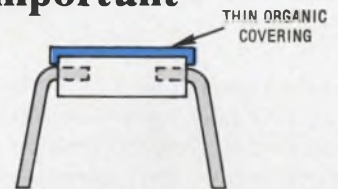

Our little network package must "weather" the homo sapien as well as the electrical environment. Example? Some users report that marking the top of thinly coated networks actually changed internal resistor values. With the tight board spacing found in most equipment cabinets, components occasionally get scraped when boards are inserted and/or removed. Customers report that some thinly protected networks have shorted-out or opened under these conditions. Bourns networks wear a heavy coat of molded plastic to weather the homo sapien climate.

2. Krimp-Joint Eliminates "Edge-Arounds"

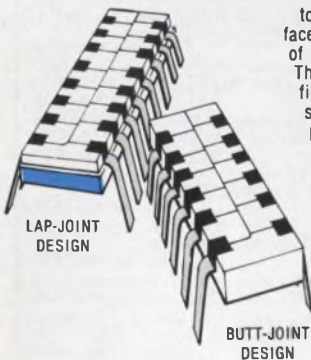

EDGE-AROUND CONDUCTOR PATHS

"Edge-around" thick-film printing techniques are required by some designs to electrically connect the network circuit — printed on the horizontal surface of the substrate — to pin leads which are always "butted" to the edge of the substrate, or are "lap-jointed" to the opposite side of the substrate. The latter condition exists with lap-joint designs when more complex thick film circuits are executed which require printing on both sides of the substrate (such as resistor/capacitor networks, dual terminators, special application circuits, etc.). Edge-around printing leaves a natural conductor path weakness on the fine edges of the substrate, resulting in the possibility of a very "tenuous" connection. Such connections are subject to failure after exposure to heat cycling, shock, vibration, etc., and can result in an open circuit condition. Sometimes an intermittent condition results, which makes fault diagnosis more difficult.

Since most packages are not tested at full rated power during manufacturing QC, weak edge-arounds sometimes pass final tests . . . and then burn-out (like a fuse), when subjected to full power in an operating circuit.

Bourns Krimp-Joint mechanically contacts both top and bottom surfaces of the resistor network substrate, resulting in a strong, positive connection between pin lead and both sides of a network circuit. No edge-around paths are required.

FREE SAMPLES

Try the Bourns "Krimp-Joint" Resistor Network Design. Write to us on your company letterhead telling us

1. current manufacturer's part number you are now using,
2. what resistance values you need . . .

and we will send samples for your evaluation. We'll also include a complete data packet, with a handy cross-reference guide.



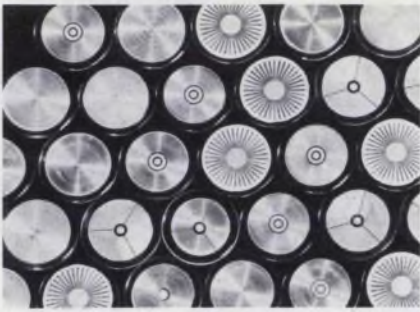

Different gate designs for power SCRs from Westinghouse provide faster or slower turn-off times.

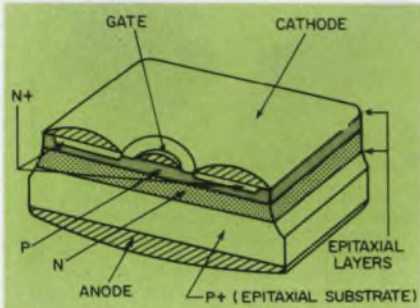

The structure of asymmetrical SCRs, as developed by RCA, permits design of fast switching units with high forward blocking voltages.

says Alex Polner, VP of marketing and sales for Power Tech, "because the complex emitter structures needed don't permit easy removal of the heat generated by large currents."

Transistors are getting bigger

Today you can get high-voltage transistors, such as the TIP-300 series, from Texas Instruments, that handle between 5 and 10 A at voltages up to 2000 V and have turn-off times down around 1 μ s. Companies like Delco, Motorola and many others are also developing or have similar units. Application areas for high-voltage transistors include CRT deflection systems, direct line-operated switching power supplies and line-operated motor controls.

Transistors used as high power switches have been hard to specify, since most data needed are not included on typical data sheets. However, Motorola and several other companies have revised specs and tested devices specifically for switching applications. For instance, Motorola offers its Switch-mode series of power transistors

designed for switching supplies.

Single transistor collector-current ratings range from lows of milliamps up to hundreds of amps, with the Models PT9501 and 9503 from Power Tech probably the largest. These units are rated for 500 A. peak, at collector voltages of 60 or 80 V. High-voltage, high-current units are also available—such as the PT4503, which handles 100 A at 400 V and can turn off in less than 0.5 μ s. Power Tech expects to have a 600-V, 100-A device by early 1976. Solitron offers 300 A, 100 V devices, in its 5800 series.

Power Darlington, because of their high gain and low base-drive requirements, are ideal for interfacing logic and motor control systems, as well as for use in CRT deflection systems and automotive ignitions.

Soon to be available monolithic Darlington include units from International Rectifier that handle collector-emitter sustaining voltages of 900 V and 20 A. peak collector currents. Power Monolithics has high-power Darlington, but they are optimized for series-pass operation.

Under development at RCA is a three-transistor Darlington that will provide current gains of 400 to 500 while operating at voltages near 1000 V. Carl Turner, Division VP, Solid State Power Devices, for RCA says "turn-off times will be about the same as those of presently available Darlington—at 1.5 μ s.

Power rectifiers needed

Also needed are efficient devices to convert ac power into dc.

To obtain low forward-voltage drops and fast recovery times, power-supply engineers are turning to Schottky and ion-implanted rectifiers made by companies like GE, International Rectifier, Motorola, Solitron, and TRW.

"Schottky rectifiers have been been available with ratings up to about 6 A at 40 V or so for several years, but they've been somewhat unstable above 100 C," says Dick Knaub, marketing manager of power products for TRW. "Schottkys, though, offer power savings of up to 40% due to increased efficiency."

Ion-implanting like that done by Solid-State Devices in its Epion

series of diodes also offers advantages similar to those of the Schottky.

Also available are fast-recovery diodes that use special junction designs to get the high speed. They do, though, have higher forward voltage drops than the Schottky or ion-implanted devices. Semtech has devices with recovery times as low as 30 ns. Diode stacks are available that can handle 1 MV at 3 A—and still turn off in less than 2 μ s.

Current requirements above the present 50-to-60-A range will be met in the next few years with the development of 100 and 200-A power Schottky diodes. ■■

Need more information?

We wish to thank the following companies for their time and help in compiling this report. This list is far from complete, but it does contain most of the power semiconductor manufacturers:

- Delco Electronics Div., 700 E. Firmin St., Kokomo, IN 46901. (317) 457-8461. **Circle No. 425**
- General Electric, Semiconductor Products, Electronics Park Bldg., 7-49, Box 1122, Syracuse, NY 13201. (315) 456-2798. **Circle No. 426**
- International Rectifier, Semiconductor Div., 233 Kansas St., El Segundo, CA 90245. (213) 678-6281. **Circle No. 427**
- Motorola Semiconductor Products Inc., 5005 E. McDowell Rd., Phoenix, AZ 85008. (602) 244-6900. **Circle No. 428**
- Power Monolithics, 121 International Dr., Corpus Christi, TX 78401. (512) 883-6551. **Circle No. 429**
- Power Tech Inc., 9K Baker Ct., Clifton, NJ 07011. (201) 478-6205. **Circle No. 430**
- RCA Solid State Div., Box 3200, Somerville, NJ 08876. (201) 722-3200. **Circle No. 431**
- Semtech Corp., 652 Mitchell Rd., Newbury Park, CA 91320. (213) 628-5392. **Circle No. 432**
- SGS-ATES Semiconductor Corp., 435 Newtonville Ave., Newtonville, MA 02160. (617) 969-0610. **Circle No. 433**
- Siemens Corp., 186 Wood Ave. S., Iselin, NJ 08830. (201) 494-1000. **Circle No. 434**
- Silicon Transistor Corp., Katrina Rd., Chelmsford, MA 01824. (617) 256-3321. **Circle No. 435**
- Solid-State Devices, 14830 Valley View Ave., La Mirad, CA 90638. (213) 921-9660. **Circle No. 436**
- Solitron, 1177 Blue Heron Blvd., Riviera Beach, FL 33404. (305) 848-4311. **Circle No. 437**
- Texas Instruments, P.O. Box 5012, Mail Station 84, Dallas, TX 75222. (214) 238-2011. **Circle No. 438**
- Thyrotek, P.O. Box 5407, Arlington, TX 76011. (817) 265-7381. **Circle No. 439**
- TRW Semiconductor, 14520 Aviation Blvd., Lawndale, CA 90260. (213) 679-4561. **Circle No. 440**
- Unitrode Corp., 580 Pleasant St., Watertown, MA 02172. (617) 926-0404. **Circle No. 441**
- Westinghouse Semiconductor, Youngwood, PA 15697. (412) 925-7272. **Circle No. 442**

Get more for your money!

Use This New 3/8" Square Cermet Trimmer From Allen-Bradley

Our new TYPE E trimmer is a high performer with a realistic price. It has some important advantages: • Immersion seal is tested in 85°C water (not 50° or 70°). • Temperature characteristic is 100 PPM/°C for stability. • Multifingered contact for excellent adjustability. • \$0.49 each—1000 piece price. For more information call your A-B distributor or write for Publication 5219.

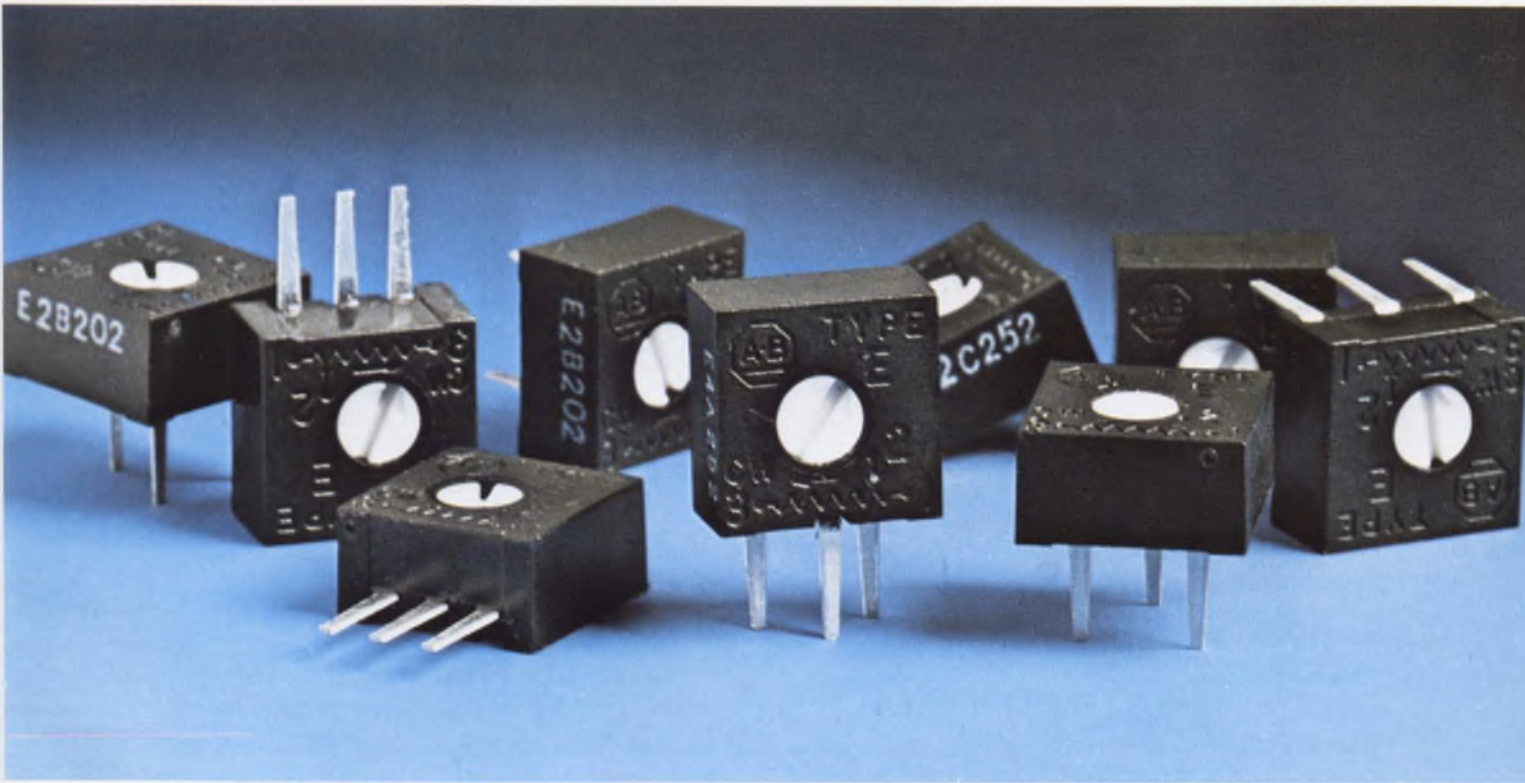
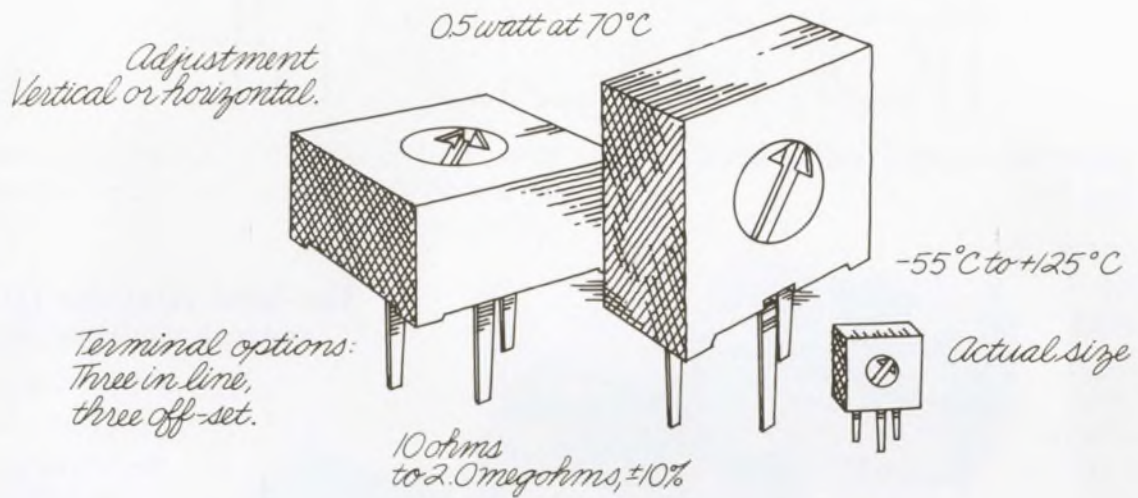

Quality in the best tradition.



ALLEN-BRADLEY

Electronics Division
Milwaukee, Wisconsin 53204

EC108

INFORMATION RETRIEVAL NUMBER 251

New Modular SOLID STATE RELAYS from CLARE

The modular relays you've been looking for.

If you need fast, positive switching for heavy duty AC applications . . . or DC control applications . . . look to the new 222 and 223 modular solid-state relays from C.P. Clare & Company. Both are 100% solid-state and DTL/TTL compatible. Both also offer opto-isolation and a choice of three terminal versions. But that's only the beginning . . .

The ideal relay for heavy duty AC applications.

The new 222 series offers heavy duty, zero-crossing synchronous switching capabilities with 5 or 10 ampere ratings at 140 or 250 Vac—ideal for computer peripheral, process control and inductive load applications. One cycle surge is 1000% of rated current. Operating and storage temperatures range

from -30°C to $+80^{\circ}\text{C}$. Order with your choice of .032" pins, quick connect or screw terminals.

The ideal relay for DC control applications.

The new 223 series boasts fast 100 micro-second switching capabilities with 2 or 5 ampere ratings at 50 Vdc—perfect for motor and servo controllers in process control and machine tool applications. Operating temperatures range from

-40°C to $+80^{\circ}\text{C}$; storage temperatures from -55°C to $+100^{\circ}\text{C}$. Order either .032" pins, quick connect or screw terminals.

For More Information . . .

The 222 and 223 series relays are in stock, ready for shipment. So contact your nearest Clare sales office or distributor for specification data. For more extensive application information, write Rick Prieto, C.P. Clare & Company, 3101 W. Pratt Avenue, Chicago, Illinois 60645. Or phone: (312) 262-7700.

QUALITY, SERVICE, RELIABILITY

C. P. CLARE & COMPANY a subsidiary of
GENERAL INSTRUMENT CORPORATION



222 AC

223 DC

OEM buyers:
Ask
Control Data
 for increased cartridge disk
 drive capacity.

We have it.



9427 H CDD
 12 MB capacity standard,
 6 MB or 3 MB optional
 200 or 100 TPI
 Average access 35 ms
 Data Rate: 312 K bytes/sec.



**9747 DSU with Cartridge
 Disk Drive interface**
 60 MB capacity
 Industry standard 11 high pack
 Average access 35 mc
 Data Rate: 312 K bytes/sec.

21 OEM offices, in 11 countries,
 specializing in service to the mini OEM.

Call (612) 830-5624 or return coupon.

Bruce Bergman, Product Sales Manager
 Control Data Corporation, Dept. ED-915
 7801 Computer Ave. So., Minneapolis, MN 55435
 Please send information on your Cartridge Disk Drives.

NAME		TITLE	
COMPANY		ADDRESS	
CITY			
STATE	ZIP	PHONE	



I want to give you a Stripswitch.

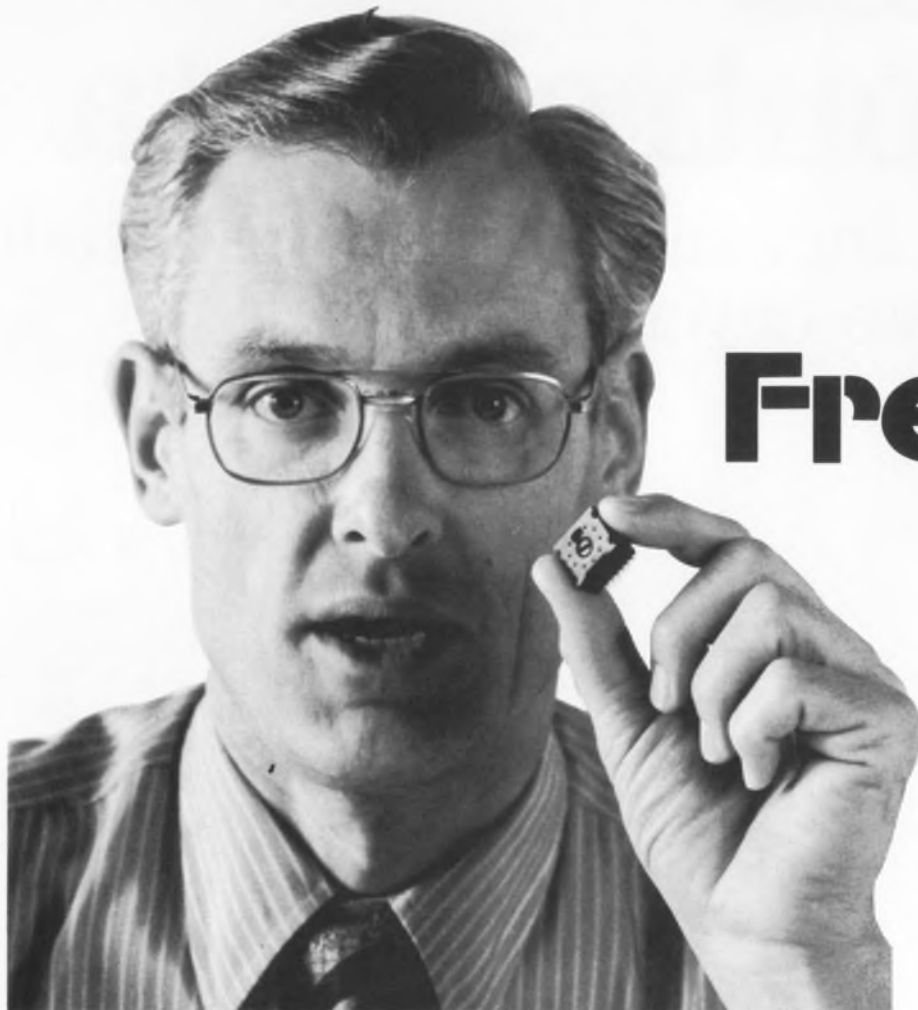

FREE.

My name is Tom Price. I am Switch Products Manager at EECO. And I will give you a real, functioning Strip-switch absolutely free if you will write me on your letterhead. There are no other qualifications or requirements.

I am doing this because I have found that Stripswitch itself is the best salesman I've got.

When you get one of these little marvels in your own hands, you'll see how beautifully it is conceived and



designed for circuit board applications. You'll perceive the clarity of its readout and the multiplicity of its actuation. You'll appreciate its variety of coded outputs, and all the other choices of features and options.

I can tell you all of that, as I just did, but you won't *believe* until you get one of your own.

Write me for your free Stripswitch. It's something to believe in. Honestly.

EECO
FOR SWITCHES

1441 East Chestnut Avenue, Santa Ana, California 92701
Phone 714/835-6000

INFORMATION RETRIEVAL NUMBER 254

THIS REVOLUTIONARY NEW INSTRUMENT IS A BREAKTHROUGH IN CURRENT MEASUREMENT METROLOGY



The Bell Model 1776 digital current meter provides features never before available. For example, its ability to measure ac, dc, (and ac on dc) currents with a non-contact clamp-on probe. No longer is it necessary to break the circuit to make a current measurement! This time-saving feature alone is extremely useful in the troubleshooting, repair and design fields. Now, it is possible to obtain current measurements more easily and safely than voltage measurements. And that's not all!

Other extremely useful advantages are that the Bell 1776 introduces virtually no load on dc readings and extremely low inductance on ac readings. Accurate readings can be made down to the 10 miliampere level while the upper limit is 1000 amperes dc or peak ac . . .

a dynamic range of 100,000 to 1.

The 1776 is the only current meter of its type in the world!

SPECIFICATIONS

Current Ranges	10, 100, 1,000 amperes, F.S.
Accuracy	
D.C.	±0.5%, F.S.
A.C. (Sinusoidal)	±2.0%, F.S.
Peak Detection	
(D.C. Accuracy)	±0.2%, F.S.
Frequency Response	D.C. to 10 kHz
Readout	Digital (3½ digit)

FEATURES

DIGITAL READOUT

A 3½ digit LED readout provides a direct indication of current.

PEAK, READ AND HOLD

This feature permits the 1776 to read and hold the peak current of a time varying wave form for those difficult transient current measurements.

HIGH RESOLUTION, WIDE DYNAMIC RANGE

A unique circuit design coupled with the digital readout provides high resolution and a wide dynamic range.

PORTABLE

Internal rechargeable batteries permit completely portable operation. They are on trickle or full charge when plugged into a suitable ac source.

CLAMP-ON PROBE

Three clamp-on probes are available to measure current in the 10, 100 and 1000 ampere ranges. Complete with autoranging, each probe is dynamically stabilized to correct for different magnetic conditions automatically!

LOW INSERTION IMPEDANCE

The current measurement probe affects the measured circuit only minutely. The disturbance is orders of magnitude less than with measurement by other means.

**N
E
W**

from
Bell

The
Gaussmeter
People

SEE US AT WESCON!

A Subsidiary of
The Arnold Engineering Company

4949 Freeway Drive, East
Columbus, Ohio 43229
Phone: (614) 888-7501
TWX: 810-337-2851



A better answer

The new Slim-Line II audio connector line from Switchcraft, the leading supplier of audio and microphone connectors. A new money-saving interchangeable connector system provides the design flexibility equipment and instrument manufacturers need for quick and inexpensive model changes.

Before Switchcraft's interchangeable connector system, you could get connectors two ways. First you could buy male or female line cord plugs and receptacles completely assembled, and at times, packaged individually. (This required disassembly before installation and adds at least 10% to the price of the connector alone.) Secondly, you could specify a disassembled connector which required long delays in obtaining special part numbers and prices.

Now the people who brought you the Q-G (Quick Ground) Audio Connector bring you the best of two worlds. The first complete audio/microphone connector line that gives you economy and flexibility using a unique interchangeable connector system.

The Slim-Line II line cord plugs consist of only four parts for simple trouble-free installation, assembly and low cost. The receptacles consist of

only two parts, plus mounting hardware.

The inserts available from 2 to 5 pins and/or contacts, plus a shunt circuit, can be assembled into any line cord plug or receptacle housing. Using Switchcraft's established listings of Slim-Line II connector components, manufacturers can choose any combination of components and assemble any type of male and/or female connector...without costly labor or component revision.

This is the new Slim-Line II audio connector line from Switchcraft, a dependable low cost connector line for instrumentation, recorders, microphones, computers, industrial controls, broadcast and telecommunication apparatus, and other equipment where a connector is required. For more information write for Engineering Specification Catalog C-520a to Switchcraft, Inc., 5555 N. Elston Avenue, Chicago, Illinois 60630.

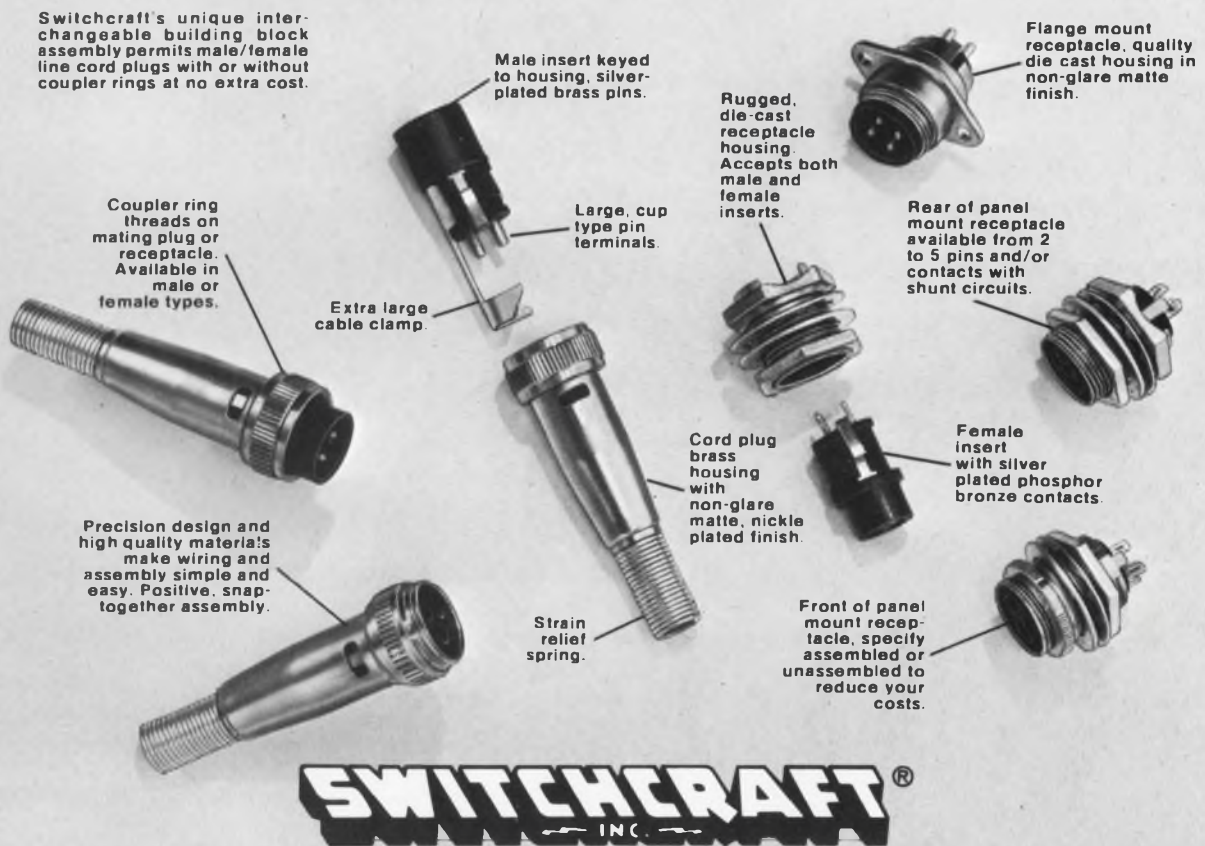



It also comes assembled.

If you need dials, we have dials. If you need handsets, we have handsets. If you need Touch Calling keysets, we've got 'em by the thousands. Ringers and hook-switches, too. Or, if you need complete telephones, we have them for you in all the latest styles and colors.

You get communications components faster from GTE Automatic Electric because, outside of the Bell System, we're the largest manufacturer of telephone equipment in the U.S. If you need it, we have it.

Use the coupon below for a complete

catalog. Or if you're in a real hurry, call John Ashby at (312) 562-7100, extension 250.

When it comes to quality components, call THE SOURCE: GTE Automatic Electric.



Please send your catalog of communications components.

Please send more information and prices on _____ of _____

(Quantity) (Product)

Name _____ Title _____

Company _____

Address _____

City _____ State _____ Zip _____

Telephone _____

Mail to: Mr. J. D. Ashby, B-4, GTE Automatic Electric, Northlake, Illinois 60164.

GTE AUTOMATIC ELECTRIC

Rf and microwave semis rising in power and declining in noise

Two to three years ago the best microwave power transistor that you could buy was a 6-to-8-GHz device with a noise figure of about 6 dB. What a difference those few years of development have made.

You can now buy a 14-GHz transistor with a noise figure of 4 dB or an 8-GHz transistor with a noise figure of 3 dB. The noise figures are as low as those achieved by varactor parametric amplifiers just a few years back.

Power transistors now put out 15 W at 3 GHz and 1 W at 10 GHz. Two to three years ago the best you could get from a 3-GHz device was about 5 W, and 10-GHz transistors did not exist.

In addition Gunn and IMPATT diodes are getting better, as are microwave Schottky diodes.

Until recently, most microwave and rf transistors were made of silicon (Si) bipolar construction. As these devices pushed higher in frequency, many experts realized that gallium arsenide (GaAs) was a better material for devices above 8 GHz. Some still hold out for Si up to 10 GHz or more. The transistors that are made with GaAs are all field-effects (FETs). According to Fred Sterzer, director of the Microwave Technology Center at RCA Laboratories, Princeton, NJ, "the most exciting area of development in rf and microwave semiconductors is GaAsFET devices."

GaAsFETs are quiet

Dr. Sterzer reports a GaAsFET device with a noise figure of 1.5 dB at 4 GHz. "That," he says, is getting pretty close to paramp performance."

David N. Kaye
Senior Western Editor

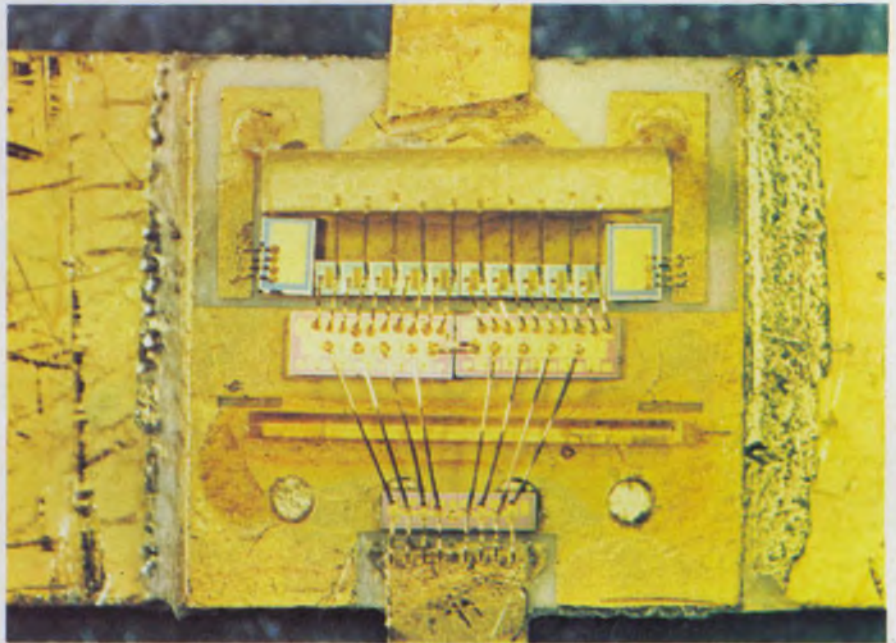

TRW's new 12-W, 2-to-2.3-GHz microwave transistor (MRAL 2023-12) contains 10 transistor cells on two chips. Ballast resistors are silicon-diffused and the metalization is all gold.

At Avantek, Santa Clara, CA, GaAsFETs are being built with noise figures of 2.25 to 2.5 dB at 6 GHz and with 10 dB of gain. Avantek is also producing devices that have 3-dB noise figures at 8 GHz with 8 dB of gain. These devices are capable of 20% bandwidths in a package and octave bandwidths unpackaged.

"Our devices all have a 1- μ gate width now," reports Richard Hejmanowski, research and development manager. "But we're working on 1/2- μ gate structures that should yield a 4-dB noise figure at 14 GHz with 8 to 10 dB of gain. We believe in GaAsFET technology because of high gain and low noise figure at high frequencies. In addition the devices that can now be produced are much more stable, reproducible transistors than ever before."

From 2 to 6 GHz, Si bipolar transistors have typically produced noise figures that are 1/2 dB higher than those of GaAsFETs.

A long-awaited entry into the GaAsFET field is Hewlett-Packard, which has disclosed to ELECTRONIC DESIGN that it is about to take the plunge. Through Hewlett-Packard Associates in Palo Alto, CA, GaAsFETs will be available before the end of 1975. Two devices will be produced.

One will be useful from 4 to 8 GHz with a mid-band noise figure of 3.5 dB, max, and about 10 dB of gain. The other will work over 8 to 12 GHz with a mid-band noise figure of 4.5 dB and about 6 to 8 dB of gain. Both devices will have internal impedance matching for ease of use and will come in a new type of package.

Leading the performance horse-

power race in GaAsFETs is Nippon Electric of Japan, whose products are sold in this country by California Eastern Laboratories of Burlingame, CA. Most researchers in the field feel that Nippon Electric has grabbed the lead with the NE244, a 1- μ device with a noise figure of 3 dB at 8 GHz, and the NE388, a 1/2- μ device with a noise figure of 4 dB at 14 GHz.

The NE388 is the first transistor to become commercially available with a 1/2- μ gate width. Sterzer of RCA notes that 1/2- μ gate widths are the wave of the future. "They will allow," he says, "GaAsFETs to be built up into the 20-to-30-GHz region within the next year or two."

Lewis E. Miller, head of the Semiconductor Device Development Dept. at Bell Laboratories in Reading, PA, points out that "1/2- μ gate widths will probably require electron-beam lithography for the devices to reach mass production."

"Right now," he says, "the devices are just being made in small quantities in research laboratories."

A major problem that researchers at Bell Laboratories and elsewhere are facing is the elimination of parasitic reactances from the transistor package. The key to a solution is getting rid of the tiny bonding wires that characterize most lower-frequency devices. These wires introduce too much inductance.

Bell is making beam-leaded devices to eliminate the wires. Other researchers are simulating beams on a substrate and bonding the device to the beams, and still others are looking into broad strips of foil for contact rather than thin wires. The best approach has not yet been determined.

A company that is working on new package approaches and that is targeting Nippon Electric as a competitor for high-performance GaAsFET transistors is Plessey-Semiconductors, Santa Ana, CA. "We are already producing 1- μ GaAsFETs similar to NEC's and 1/2- μ devices are in the lab," says William Foster, microwave applications engineer at Plessey.

GaAs vs Si in power, too

Just as GaAs is taking over in small-signal microwave above 8

GHz, it is about to make inroads in power devices as well. At Fujitsu in Japan. GaAs devices have been constructed with output power of more than 1 W at 10 GHz. The best Si device, about a watt at 8 to 10 GHz, is from Texas Instruments in Dallas. Both of these devices are still in the laboratory.

Commercial microwave power transistors are all Si so far. For high powers, all of the manufacturers use a multi-cell approach that is actually two or more tran-

ally been deposited on a fairly thick oxide layer, causing heat-flow problems. According to most industry experts, problems with ballasting become most serious above 2 GHz.

Communication Transistor Corp., San Carlos, CA; Microwave Semiconductor, Somerset, NJ, and Solid State Scientific, Montgomeryville, PA, all use nichrome thin-film ballasting networks. Nichrome has been around the longest of any material, but it also has caused

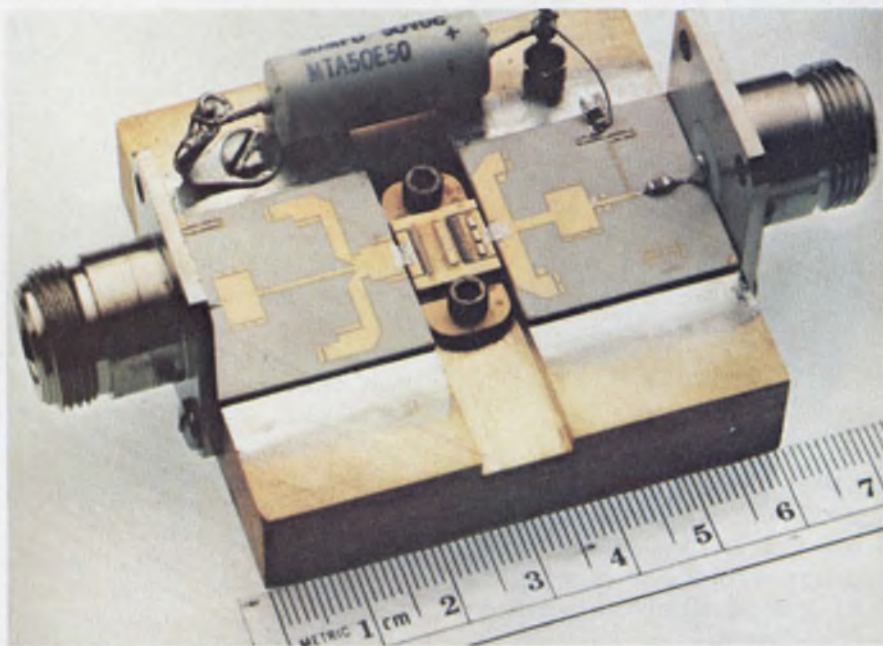

This broadband amplifier puts out 250 W from 960 to 121.5 MHz. It uses Power Hybrid's TAC-250 power transistor, which employs gold metalization and thin-film ballast resistors.

sistor chips coupled in a single transistor package. The cells are balanced with an emitter ballasting scheme. Different types of emitter ballasting are used by different manufacturers who are divided into two camps. The largest camp uses thin-film ballasting and the smaller diffused ballast resistors.

Thin-film ballasting has been around for some time; diffused is a much more recent development. The strongest advocate of diffused ballasting is TRW Semiconductors, Lawndale, CA. Fred Meyer, assistant plant manager explains: "Diffused ballast resistors eliminate the problems with hot spots at high-current densities that have made thin-film resistors the most unreliable part of a microwave power transistor."

Thin-film resistors have gener-

some problems in high-performance devices.

An improved technique for devices over 2 GHz at high-power levels has been developed by Power Hybrids, Torrance, CA. "We use tantalum over a thin oxide for our thin-film network," says Vahan Garboushian, president. He asserts that his resistors, which are passivated with silicon nitride, have a larger cross-sectional area than the nichrome resistors, resulting in less hot-spot trouble.

A trend among manufacturers of microwave power transistors is to use gold instead of aluminum metalization. Power Hybrids led the switch a few years ago. TRW has followed, and Microwave Semiconductor is now using gold metalization in new devices. Motorola Semiconductor, Phoenix, AZ, is using gold in the 900-MHz, land-

RCL

Introduces
the

"PIP" SWITCH

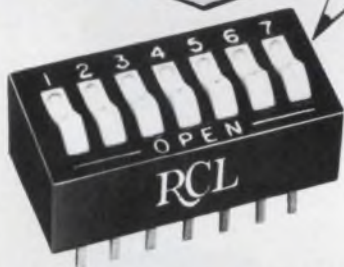

RCL's "Programmable In-Line Package" switch provides a highly reliable, low cost means of manually programming various types of electrical/electronic equipment.

- Provides true self-wiping action for low & uniform contact resistance.
- 2-10 stations per package.
- Replaces Slide Switches, Thumbwheels, Toggle Switches, etc.
- Positive detent action.
- Withstands ultrasonic cleaning.
- Wave solderable.
- Long life expectancy (3,000 operations per rocker min.)
- Competitively priced.
- Delivery from stock

ALSO AVAILABLE
WITH LOW PROFILE
RECESSED ROCKERS

Call our hotline for prompt
service and delivery.
(201) 374-3311

AMF

RCL Electronics

GENERAL SALES OFFICE

700 South 21st. Street
Irvington, N.J. 07111

mobile band. Gold enhances the long-term reliability of microwave power transistors and eliminates the problem of opens caused by metal migration.

Most power transistors today have built-in impedance matching structures on their inputs and outputs. Some small-signal devices are featuring the same type of network.

TRW is pushing the concept of ability to stand an infinite VSWR on the output as a desirable feature. Garboushian of Power Hybrids notes that infinite VSWR capability is nice. But, he adds, "you must realize that there is a tradeoff in efficiency and power output that must be paid for the feature."

Typical collector efficiencies for this type of device are in the range of 25 to 35%. Garboushian contends that the efficiency can be 10% better.

Power Hybrids makes a 10-cell, 15-W transistor at 3 GHz with 5 dB of gain. At 4 GHz the power drops to 1 W.

TRW produces single cells that have 1.5-W of output with 6 dB of gain to 2.3 GHz and 0.8 W with 6 dB of gain to 3 GHz. "We use these cells to build higher-power devices," says James Frazier, plant manager. TRW uses from two to 10 cells in every transistor from 600 MHz on up.

Where the hot action is

More rf transistor development is going on in the 900-MHz land-mobile band than anywhere else. The leader is Communication Transistor with a 40-W, 12-V device. The firm expects to be delivering a 75-W, 28-V transistor before the end of the year. Motorola is producing a 15-W gold-metalization and 28-W aluminum-metalization devices for 900-MHz.

Solid-State Scientific has a 30-W, 12-V device at 900 MHz and Microwave Semiconductor a 30-W, 28-V transistor at 900 MHz. All of the 900-MHz devices have 45 to 60% collector efficiencies.

Gunn diodes are now being used as amplifiers as well as oscillators. The leader in this technology is Varian Associates, Palo Alto, CA. "Broadband Gunn amplifiers are being produced from 18 to 26 GHz

and from 26 to 40 GHz," says Berin Fank, manager of device development. He notes that a single Gunn diode now gives 5 to 6 dB of gain with a noise figure of 15 to 17 dB in the range of 18 to 40 GHz.

Fank believes that the future for Gunn diodes lies in indium phosphide material rather than GaAs. He feels that noise figures of only 10 dB are possible over the range of 18 to 40 GHz. In addition, he points out, the devices will be more stable over temperature and have twice the efficiency of GaAs.

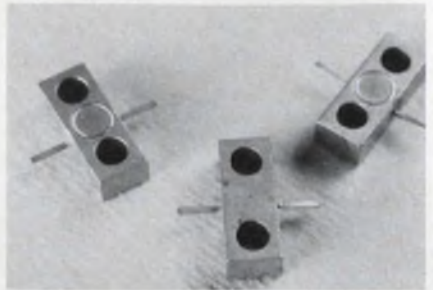

Hermetic stripline packages from Hewlett-Packard allow broadband performance to 18 GHz. They can be matched to 50 Ω at both input and output.

Also, since the mobility of indium phosphide is higher than GaAs, the devices can be larger at mm-wave frequencies and easier to handle. Fank sees indium phosphide being used to at least as high as 150 GHz. Typical mm-wave performance now is 20-mW output at 94 GHz with efficiency of 0.7%.

Much of the IMPATT development is in the mm-wave area. Bell Laboratories is working on a 1/4-W device at 120 GHz. The Hughes Electron Dynamics Div. in Torrance, CA, and Plessey are both producing IMPATTs that put out about 200 mW to 60 GHz and 100 mW up to 100 GHz. Richard Wieneke, product marketing manager at Hughes, says: "We can do about three times those levels in the lab. In the next 18 months our catalog products should be about twice the output of what we have now." ■■



Before you buy indicator lights, check these facts:

- LITTELITES** include Cartridge Lamps and Lampholders, Subminiature and Miniature Lampholders, and Snap-Mount Plastic Lites. We offer a wider selection among these four product groups than any other single manufacturer.
- LITTELITES** are made with all new tools and molds. This plus total in-house production capabilities make Littelites the finest quality lights on the market today.
- LITTELITES** are all U.L. Recognized or Listed and Certified by C.S.A.
- LITTELITES** Snap-Mount Plastic Lites feature unique flex arms to ensure positive retention and protection against shock and vibration. Absolutely no additional mounting hardware required.
- LITTELITES** are available off-the-shelf from a nationwide network of Littelites distributors. For large volume requirements, you can depend on a fast turn-around on orders.
- Our **LITTELITES** team of R & D and sales engineers is ready to assist you at any time with standard or special applications.

Then check the source... Littelfuse

Send for your Littelites Product Guide today!

LITTELFUSE

Subsidiary of Tracor

800 E. Northwest Highway • (312) 824-1188 • Des Plaines, Illinois 60016

Meet the all-purpose instrument. It's a digital oscilloscope. It's programmable. It calculates. It utilizes all the power of a microprocessor. It's Norland Instruments



NI 2001

All the function and instrumentation capability you'll probably need is yours in this single mainframe. The first Programmable Calculating Oscilloscope is available now — only from Norland.

Here is the ultimate instrument for the acquisition, processing and manipulation of electrical data. It completely eliminates the need to compromise your requirements with a jumbled array of separate instruments. The NI 2001 combines all the capabilities of a digital oscilloscope and a microprocessor in a single mainframe. It brings you flexibility, convenience, accuracy and reliability you won't find anywhere else.

This — the first Programmable Calculating Oscilloscope — is the product of many years of technological research and instrumentation engineering. With the advent of microprocessor technology, Norland Instruments engineers were quick to recognize the power available to the instrument designer and first applied a microprocessor to the Norland line of medical instruments. That experience ultimately led to the use of microprocessor technology in the development of the NI 2001 — the first truly new generation of test and measurement instrumentation for the industrial and scientific user.

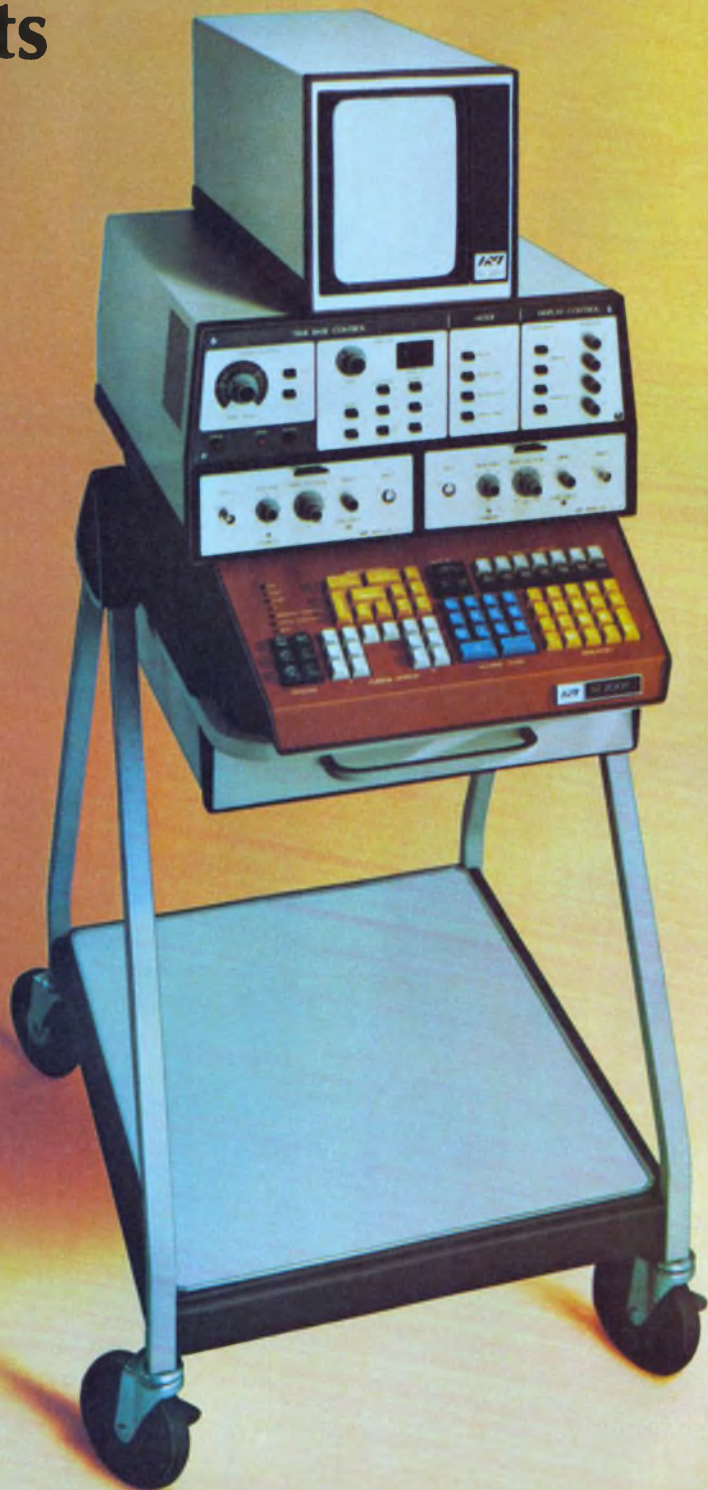



Useful data the easy way

Picture yourself at the keyboard. You control the DISPLAY of both waveforms and alphanumeric. You can use all, halves or quadrants of the data memory to display one to four independent signals and even do X-Y displays. You have the most convenient means for storing waveform data and recalling it from memory for manipulation and display. You've never experienced the versatility and performance that the NI 2001 now puts at your fingertips.

Calculating Power Without Interfacing. The calculating power available in this new instrument eliminates the need for a separate calculating unit. It operates on entire arrays of data as well as individual numbers. Not only can you perform common arithmetic functions, you can also quickly and accurately convert data into required units. Voltage levels can be instantly converted to current, power, energy, acceleration, velocity, displacement, torsion, temperature or other units.

You'll particularly appreciate the way the NI 2001 simplifies complex calculations required in your analysis. Eighteen of the most common engineering and scientific calculations are controlled by fixed-function OPERATORS, pre-programmed at the factory. There's no easier

way to calculate differentials, definite and indefinite integrals, peak areas, N-point averaging, coordinates and delta-coordinates, rise time, peak-to-peak measurements and true RMS values.

Easily Programmable. Repetitive and lengthy data acquisition and manipulation sequences are both simplified and automated because of the ability to program the NI 2001. It requires no computer background — is as simple to program as a programmable calculator and allows easy editing of any program. You can store up to 200 keystrokes. And — the NI 2001's conditional branching ability puts an almost unlimited number of decision-making procedures at your disposal without interfacing with a computer or other peripheral equipment.

Sensibly Priced. With all its versatility, convenience and reliability, the NI 2001 is also sensibly and surprisingly priced. The instrument shown, with monitor and two single-channel plug-ins can be yours for \$17,300!

Why wait? For a demonstration and complete information send the reader service card or write Norland Instruments, Dept. C-2.

For Demonstration Circle #168
For Information Circle #169



NORLAND INSTRUMENTS
A Subsidiary of Cordis Corporation

Norland Drive
Fort Atkinson, Wisconsin 53538
Tel. (414) 563-8456 U.S.A.

Mini-Circuits' answer to holding down your costs of Double Balanced Mixers

Specify our model SRA-1...

1971 - \$7.95*
SRA-1 (in 500 quantities)

Mini-Circuits Laboratory, now the world's largest supplier of double-balanced mixers, guarantees to maintain its famed low-price structure throughout 1975 and 1976. \$7.95 (model SRA-1, 500 quantity). You, the design engineer, have made this offer possible. Your large volume orders, from over 500 companies throughout the world, have enabled us to purchase our components and packages at lowest possible costs with guaranteed delivery schedules from our vendors. And we think it's appropriate to pass these savings to you. Need fast delivery? One week or better is routine; for your emergency needs, 24-hour turnaround is possible.

1974 - \$7.95*
SRA-1 (in 500 quantities)

1972 - \$7.95*
SRA-1 (in 500 quantities)

1975 - \$7.95*
SRA-1 (in 500 quantities)

1973 - \$7.95*
SRA-1 (in 500 quantities)

STILL ONLY \$7.95*
IN 1976
SRA-1 (in 500 quantities)

Our history of quality and performance is unmatched. All our units are unconditionally guaranteed for 1 year. Every Mini-Circuits employee, from the president to the final test operator, is committed to excellence in performance and quality for every unit produced. For reliability, performance and quality more and more systems engineers are specifying Mini-Circuits mixers as the industry standard.

*\$9.95 (1-49)

SRA Series

Frequency Range (MHz)	Conversion Loss (dB) Total Range	Isolation (dB)						Price (Quantity)
		Lower band edge to one decade higher		Mid range		Upper band edge to one octave lower		
		LO-RF	LO-IF	LO-RF	LO-IF	LO-RF	LO-IF	
SRA-1 LO-0.5-500 RF-0.5-500 IF-DC-500	6.5 typ. 8.5 max.	50 typ. 35 min.	45 typ. 30 min.	45 typ. 30 min.	40 typ. 25 min.	35 typ. 25 min.	30 typ. 20 min.	\$9.95 (1-49)
SRA1-1 LO-0.1-500 RF-0.1-500 IF-DC-500	6.5 typ. 8.5 max.	60 typ. 45 min.	45 typ. 30 min.	45 typ. 30 min.	40 typ. 25 min.	35 typ. 25 min.	30 typ. 20 min.	\$11.95 (6-49)
SRA-1W LO-1-750 RF-1-750 IF-DC-750	6.5 typ. 8.5 max.	60 typ. 45 min.	45 typ. 30 min.	45 typ. 30 min.	40 typ. 25 min.	35 typ. 25 min.	30 typ. 20 min.	\$14.95 (6-49)
SRA-2 LO-1-1000 RF-1-1000 IF-0.5-500	6.5 typ. 8.5 max.	45 typ. 30 min.	45 typ. 30 min.	35 typ. 20 min.	35 typ. 20 min.	30 typ. 20 min.	30 typ. 20 min.	\$24.95 (1-24)

Common specifications for all models:
Signal: 1 dB compression level - 1 dBm
Impedance all ports 50 ohms
Phase detection - DC offset - 1 mV typical
DC polarity - negative

Frequency Range (MHz)	Conversion Loss (dB) Total Range	Isolation (dB)						Price (Quantity)
		Lower band edge to one decade higher		Mid range		Upper band edge to one octave lower		
		LO-RF	LO-IF	LO-RF	LO-IF	LO-RF	LO-IF	
SRA-4 LO-5-1250 RF-5-1250 IF-0.5-500	6.5 typ. 8.5 max.	50 typ. 40 min.	50 typ. 40 min.	40 typ. 20 min.	40 typ. 20 min.	30 typ. 20 min.	30 typ. 20 min.	\$26.95 (1-24)
SRA-3 LO-0.025-200 RF-0.025-200 IF-DC-200	6.5 typ. 8.5 max.	60 typ. 50 min.	45 typ. 35 min.	45 typ. 35 min.	40 typ. 30 min.	35 typ. 25 min.	30 typ. 20 min.	\$12.95 (6-49)
SRA-6 LO-0.003-100 RF-0.003-100 IF-DC-100	6.5 typ. 8.5 max.	60 typ. 50 min.	60 typ. 45 min.	45 typ. 30 min.	40 typ. 25 min.	35 typ. 25 min.	30 typ. 20 min.	\$19.95 (5-24)
SRA-8 LO-0.005-10 RF-0.005-10 IF-DC-10	6.5 typ. 8.5 max.	60 typ. 50 min.	60 typ. 50 min.	50 typ. 40 min.	50 typ. 40 min.	45 typ. 35 min.	45 typ. 35 min.	\$24.95 (5-24)

For complete product specifications and U.S. Rep. listing see MicroWaves' "Product Data Directory," Electronic Design's "Gold Book" or Electronic Engineers Master "EEM"

Mini-Circuits Laboratory
A Division Scientific Components Corp

837-843 Utica Avenue, Brooklyn, NY 11203

(212) 342-2500 Int'l Telex 620156 Domestic Telex 125460

Foreign Sales Representatives: AUSTRALIA General Electronic Services, 99 Alexander Street, New South Wales, Australia 2065; ENGLAND Dale Electronics, Dale House, Wharf Road, Frimley Green, Camberley Surrey; FRANCE S.C.I.E.-D.I.M.E.S., 31 Rue George - Sand, 91120 Palaiseau, France; GERMANY, AUSTRIA, SWITZERLAND Industrial Electronics GMBH, Klüberstrasse 14, 6000 Frankfurt/Main, Germany; ISRAEL Vectronics, Ltd., 69 Gordon Street, Tel-Aviv, Israel; JAPAN Denso Kaisha, Ltd., Eguchi Building, 8-1-1 Chome Hamamatsucho Minato-ku, Tokyo; EASTERN CANADA B. D. Hummel, 2224 Maynard Avenue, Utica, NY 13502 (315) 736-7821; NETHERLANDS, BELGIUM, LUXEMBOURG: Coimex, Veldweg II, Hattem, Holland

US Distributors: NORTHERN CALIFORNIA Cain-White & Co., Foothill Office Center, 105 Fremont Avenue, Los Altos, CA 94022 (415) 948-6533; SOUTHERN CALIFORNIA, ARIZONA Crown Electronics, 11440 Collins Street, No. Hollywood, CA 91601 (213) 877-3550

For complete U.S. Rep listing and product line see MicroWaves' Product Data Directory

Washington Report

EIA briefs China on communications advances

Although it's still not clear what electronic equipment the People's Republic of China would like to buy from the West, the Electronic Industries Association's trade delegation to the Chinese mainland has given the government there an overview of the latest communications equipment and techniques.

The American group, which arrived on July 28 for a two-week stay, held a seminar that included descriptions of submarine cable applications and private automatic branch exchanges (PABX); electronic central telephone switching and recording systems; and transmission systems integrated with satellite communications.

Also featured were how a low-cost earth-satellite network could evolve; power-line carrier systems and teleprinters; broadcast equipment; new applications for mobile radios; small central office exchanges for rural communications and telecommunications network planning.

Wind shear indicators could spur spending

If the proposal to equip airliners with heads-up displays that indicate the presence of wind-shear becomes mandatory, it could mean sales of up to \$172-million in electronic equipment.

While the indicators would not actually detect the wind-shear phenomenon it would reveal any sudden position displacement of the aircraft which could mean that wind-shear conditions were present.

Advocating the installation of such equipment is the Air Line Pilots Association president, J. J. O'Donnell. His pilots want a heads-up display, while Federal Aviation Administration officials appear to favor a ground-based system.

Cost estimates for the airborne displays vary depending on the amount of electronics already in an aircraft. Estimates range from \$15,000 per aircraft to \$75,000. With 2300 jets in the airlines' inventory, the cost could range from a total of \$35-million to \$172-million. Business aircraft would, of course, account for more. A prime supplier is Paris-based Thomson CSF.

Legal battle looms over Navy selection of F-18

LTV Aerospace has protested to the General Accounting Office that the Navy violated the Defense Appropriations Act of 1975 in selecting the McDonnell Douglas-Northrop F-18. According to the 1975 act, the Texas-based aircraft manufacturer argues, the Navy was supposed to buy a carrier-based version of General Dynamics' Air Force F-16 which

would be built by LTV.

The Navy and McDonnell Douglas insist that the law was not violated because the F-16 was not suitable for carrier operations. The F-18, they explain, has a beefed up landing gear, a more powerful GE fanjet engine and different avionics. Also, the F-18 is a twin-engine plane while the F-16 has only one.

The Comptroller General may render an opinion on the LTV protest but informed sources predict that he may wait until Congress convenes and hand the problem to it.

Meanwhile, the Navy and McDonnell Douglas are going ahead with a four-month engineering study on the F-18. Among other things the study will determine the electronic package that must accommodate the Sparrow missile system. As a ballpark figure, approximately one-fourth of the \$5.8-million per aircraft will go for electronics.

Meanwhile, a fight against the F-18 is being led in Congress by Sen. William Proxmire (D-WISC) and Sen. John Tower (R-TEX).

1976 defense procurement back in limbo

A last-minute victory in the Senate by budget-conscious Senators puts the Defense Dept. procurement and R&D authorization for the coming 15 months in a state of limbo.

Soon after voting a fat pay raise for itself and for top-level bureaucrats, generals and admirals, the Senate balked at approving a conference report on the defense budget authorization for fiscal 1976 and for a three-month transition period. The opposition was led by Sen. Edmund S. Muskie (D-MA), chairman of the new Senate budget committee. He complained that the authorization was \$300-million over the planned actual outlays for the budget and \$900-million over the amount programmed for future spending.

So it is back to the drawing board for the conferees. Now the question is where to cut \$300-million in actual outlays to satisfy the Senate and still placate the House. If the approach is to slice a bit here and a bit there to keep all the programs alive, it could mean lengthy bargaining. Or, in exasperation, the conferees may take a meat-ax approach, such as cutting the AWACS authorization from six aircraft to three. That alone would slash \$215.25-million. Or they may whack out the \$203.9-million for a nuclear frigate (DLING+ 42), which was voted by the House and opposed by the Senate.

Capital Capsules: The Custom Service has backed off on its ruling that when semiconductors are large enough to have technical data printed on them, the manufacturer must also put on the devices the country of origin. Its OK to import them in bulk in repackaged containers if the containers—and not necessarily the semis themselves—are marked to show the country of origin. . . . Congress, as it normally does, **split the difference to compromise on the fiscal 1976 authorization for the National Science Foundation.** The total is \$787-million, which is \$36.5-million more than the House voted and \$36.5-million less than the Senate. . . . The Air Force is going to **conduct research in one of its avionics laboratories on the characterization and identification of defects in compound semiconductors.** The Air Force Systems Command, which is soliciting sources to perform the research, says emphasis will be placed on defects (native and foreign impurity) and those surface properties that yield high purity.

TEKTRONIX ANNOUNCES

A new concept in portable instrumentation

The TEKTRONIX TM 515 Traveler Mainframe looks like fashionable flight luggage, compact and easy to carry, or slide under an aircraft seat. In reality, it's a five-compartment power module/mainframe that provides power and interface connections for TM 500 plug-in modular instrumentation. Plug in the new (two-wide) SC 502 15-MHz dual-channel oscilloscope, and you have the beginnings of a powerful take-along instrumentation system.

You can optimize a TM 500 system to your needs by selecting from more than 30 plug-in modular instruments. With the TM 515 Traveler Mainframe and SC 502 Oscilloscope as a nucleus, select from DMM's, counters, generators, power supplies, signal processors, and even blank plug-ins for your "home-built" circuits. Intended applications include areas from digital field service to medical, from audio/communications to on-site industrial controls maintenance.

The SC 502 is Tektronix quality, featuring clean triggering characteristics, delay line input, trigger view, trigger holdoff, 1 mV sensitivity, and the capability of working through the rear interface circuit board with other TM 500 instruments. It features a specially brilliant crt designed and built by Tektronix for use in areas of high ambient light. Include a DD 501 Digital Delay alongside the SC 502 and gain the capability of delay-by-events—you can then obtain stable digital displays from electromechanical sources like disc drives that would otherwise be too jittery for accurate viewing on any conventional oscilloscope. Include the DC 505A Universal Counter and DM 502 Digital Multimeter to complete your TM 515 package, and discover the benefits of simultaneous counter and DMM capability with trigger level readout at the touch of a push button.

The TM 500 concept lets you take along on field servicing trips the same instruments you use in the lab or for production testing, thereby enabling you to maintain the same standards on the "outside". The SC 502 Oscilloscope, for example, may be used as a bench instrument in any multiple-compartment TM 500 mainframe, and it offers unique systems capabilities, as well, when operated in a rack in the RTM 506.

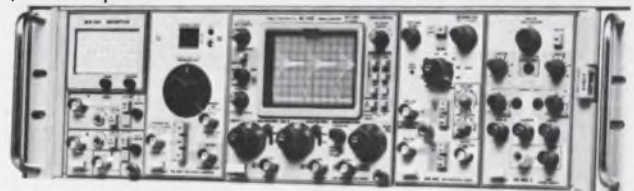

Contact your local Tektronix Field Engineer or circle the appropriate reader service number for a demonstration of TM 500 instrumentation or additional technical information on the TM 515 Traveler Mainframe and SC 502 Oscilloscope. For an up-to-date TM 500 Catalog write to Tektronix, Inc., P. O. Box 500, Beaverton, Oregon 97077. In Europe write Tektronix Limited, P. O. Box 36, St. Peter Port, Guernsey, Channel Islands.



TEKTRONIX®

committed to
technical excellence



You're not alone anymore...

Meet Omron.

Omron's exceptionally broad lines of control components didn't create themselves—*people* made them. And people continue to be the most important ingredient in Omron's success as a world-wide leader in control components.

In our expanding American operations, Omron has brought together

some of the world's finest professionals in engineering, manufacturing, and marketing. They come from some of this country's best-known companies, as well as from our international staff.

The professionals shown have a total of 259 years of experience—the kind of experience necessary to fill your needs, both at home and abroad.

Omron is committed to both quality products and service. Ask us for design and applications help. You'll get an answer to your phone inquiries for key performance data within 48 hours. And with Omron's production capabilities and inventories, you'll get *what you need, when you need it.*

The people at Omron will prove that you're not alone anymore.

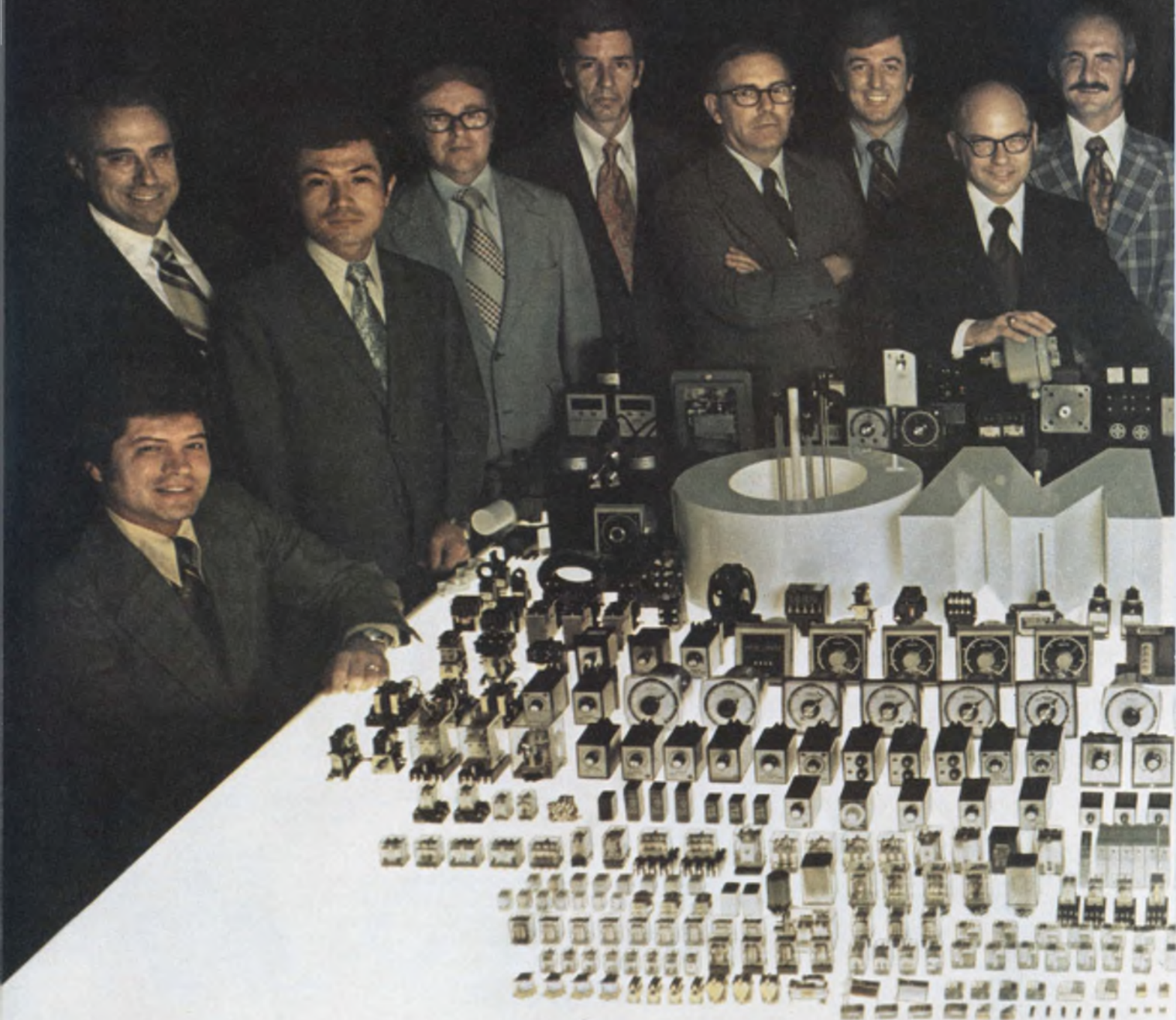

**Omron
Representative
Organization**

EASTERN REGION

**Andres Component
Sales, Inc.**
(716) 244-2445
Upstate New York

The Candor Co., Inc.
(803) 448-8361
No. Carolina, So. Carolina,
Tennessee, Mississippi,
Georgia, Alabama, Florida

Gerber Sales Co., Inc.
(617) 890-8040
Maine, Vermont,
New Hampshire,
Massachusetts,
Connecticut,
Rhode Island

S-J Associates, Inc.
(212) 291-3232
Metro New York,
Northern New Jersey

Trinkle Sales, Inc.
(215) 922-2080
Southern New Jersey,
Delaware, Maryland,
Virginia, West Virginia,
Pennsylvania, D.C.

CENTRAL REGION

**Bear Marketing-Neal
Bear Corp.**
(216) 659-3131
Ohio

Mark Kruvand Co., Inc.
(214) 827-8043
Arkansas, Louisiana,
Oklahoma, Texas

R. C. Nordstrom & Co.
(313) 559-7373
Michigan

Quantum Sales, Inc.
(612) 831-8583
North Dakota, South
Dakota, Minnesota,
Western Wisconsin

The John G. Twist Co.
(312) 593-0200
Eastern Wisconsin,
Illinois, Iowa, Kansas,
Missouri, Eastern
Nebraska

James Woolgar Co.
(317) 546-6888
Indiana, Kentucky

WESTERN REGION

N. R. Schultz Company
(206) 454-0300
Washington, Oregon,
Northern Idaho, Western
Montana, Alaska

Straube Associates, Inc.
(415) 323-2476
Northern California,
Nevada, Colorado, Utah,
New Mexico, Wyoming,
Eastern Montana,
Southern Idaho, El Paso
County, Texas,
Western Nebraska

O. T. Wiles & Associates
(213) 478-0183
Southern California,
Arizona, Hawaii

For more information on
branch offices, call
representative's office
or contact Omron Sales
and Service office



Omron Corporation of America
Corporate Headquarters
Sears Tower, Chicago, Illinois

Sales and Service
1051 State Parkway
Schaumburg, Illinois 60172
Phone: (312) 885-9500



Meet the 1500W zener.

The zener with the specs of a transient suppressor.

When you use power zeners as transient voltage suppressors, you need to know whether the zener will protect your circuit. And the usual specs aren't much help.

Here's the zener you've been waiting for. It's designed and spec'd as a suppressor, with 1500W peak pulse power

capability — higher than any conventional zener. And it's available at a very reasonable price — about a third of what you'd pay for a 50W zener.

For qualification samples, call Howard Kaepfle at 617-926-0404. Or circle

our number on the reader service card — we'll send you the whole story on our 1N5629A series of power zeners.

Unitrode Corporation,
580 Pleasant St., Watertown,
Massachusetts 02172.

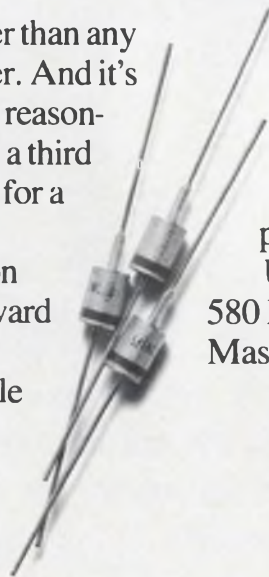

UNITRODE

INFORMATION RETRIEVAL NUMBER 36

My secretary's pants

Ralph, an old boss of mine, decided one day that things were getting too lax around our shop. The company, he felt, would do a lot better if we were more businesslike.

I guess he figured that to *be* businesslike, you've got to *look* businesslike. So he issued a memo directing that women were not to wear pants at the office. In a business environment, he reasoned, pants were proper attire only for men.

My secretary, Rita, who did great things for pants, promptly removed hers and tossed them onto my desk. I thought this was a rather admirable demonstration of (among other things) her annoyance with a stupid memo.

Without unseemly haste, I brought Ralph her pants and congratulated him on the effectiveness of his memo writing. Fortunately, at this point he recognized the idiocy of the whole operation and rescinded his memo.

Now most of us don't spend much time issuing memos about what women in the office should or shouldn't wear. But how much effort do we waste on other nutty issues?

When we face real problems do we try to tackle them? Or do we allow ourselves to be diverted into solving nonproblems? Do we exercise our authority by making decisions on proper attire, the arrangement of stuff on desks and lab benches, operating procedures and other trivia?

I visited a company where everything was perfectly shipshape. It was obvious that somebody worried about these things because the walls were spotless; the desks all looked the same; the lab benches all looked the same; and, by golly, the engineers all looked the same. Everything seemed to be perfectly controlled except for one small matter; the company's products were dull and behind the times. And the company's sales and earnings were plummeting.

The company was being clobbered by an outfit whose people spent their time designing the most desirable, most profitable products. They had no time to worry about anything else.



GEORGE ROSTKY
Editor-in-Chief

DO YOU MEASURE DYNAMIC OR TRANSIENT PHENOMENA?

If you view slowly changing waveforms or fast single-shot events (up to $1.3 \mu\text{s}$), variable persistence storage offers you an easy, accurate way to evaluate them.

The variable persistence oscilloscope stores a bright, high-contrast display of new information as the old information fades from the crt. Variable persistence is available in both portable and laboratory oscilloscopes.



But there's a lot more to be said. Variable persistence storage has applications in spectrum analysis, mechanics, biophysics, and many other areas. Just fill out the coupon and we'll send you our guide, "Variable Persistence Storage Applications," or, if you prefer, arrange for a demonstration.

DO YOU NEED TO RETAIN SIGNALS ON A CRT FOR LONG PERIODS OF TIME?

If you do, bistable storage offers you an easy, inexpensive way to store information for an hour or longer.

A bistable storage oscilloscope makes it easy to store nonrepetitive signals and low-rep-rate waveforms with rise times as fast as 20 ns.

You can get bistable storage in portable and labo-



ratory oscilloscopes. With the split-screen feature, you can store a reference waveform on one half of the crt screen and compare it with incoming signals on the other half.

If you aren't familiar with bistable storage, we'd like to help. Send for our guide, "Bistable Storage Applications," or request a demonstration.

DO YOU CAPTURE, RECORD, AND ANALYZE VERY FAST EVENTS?

If you do, FAST storage allows you to record rise times as fast as 3.5 ns and to store information at full bandwidth—100 MHz. Only our mesh-to-mesh transfer technique makes it possible to store at such fast writing speeds.

This technique also makes it possible to combine different kinds of storage in a single instrument. Variable persistence and FAST variable persistence are available together in our portable scopes. Bistable, variable persistence, FAST bistable, and FAST variable persistence

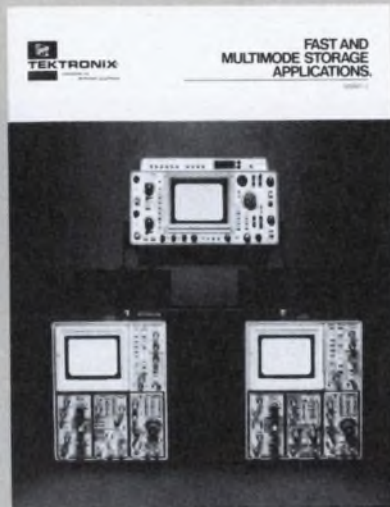

are combined in our laboratory oscilloscopes with multimode storage.

To find out more about FAST storage, write for our guide, "FAST and Multimode Storage Applications," or request a demonstration.

To request a demonstration of our storage oscilloscopes, contact your Tektronix Field Engineer or write us at Tektronix, Inc., P.O. Box 500, Beaverton, Oregon 97077. In Europe, write Tektronix Limited, P.O. Box 36, St. Peter Port, Guernsey, Channel Islands.

ONLY TEKTRONIX OFFERS ALL THREE KINDS OF STORAGE. FIND OUT ABOUT THE ONE THAT'S RIGHT FOR YOU.

TEKTRONIX®
committed to
technical excellence

Wescon '75: It's a sellout show with heavy interest in microprocessors



Contents

Design trends in major engineering areas		Packaging and Materials	118
Test and Measurement	52	Instrumentation	123
Computers	54	Modules and Subassemblies	127
Semiconductors	56	Data Processing	128
Consumer Electronics	58	Microwaves and Lasers	130
Outstanding new products		Power Sources	131
Components	117		



The Western Electronic Show and Convention is being held this year in San Francisco's Civic Center (left). More than 27,000 visitors are expected at the exhibitor's



booths in Brooks Hall, and a good portion of these will attend the technical sessions. The show's theme is "Electronics in the next thousand days."

Nowhere is the soaring interest in microprocessors more evident than at this year's Western Electronic Show and Convention (Wescon). Of the 32 technical sessions, nearly half are devoted solely or in part to the technology and applications of microprocessors and microcomputers.

One paper in Session 27 deals with the challenge of microprocessor chip testing, while a paper in Session 21 is about the first microprocessor-controlled serial printer. All of Session 1 is devoted to microcomputers, while Session 24 covers the high level of interest in micros for medical instrumentation. The list goes on.

The 24th annual Wescon is being held Sept. 16-19 in Brooks Hall and the Civic Auditorium in San Francisco. The theme of both the product exposition and the technical program is "Electronics in the Next Thousand Days," with the emphasis on near-term rather than blue-sky technology.

Wescon officials say the show is a sellout, with 300 exhibitors signed up for 492 booths.

Attendance is expected to match the 27,436 pulled in by Wescon in 1973, when the show last was held in San Francisco.

The half-day technical sessions are being held in the Civic Auditorium mornings and afternoons on Tuesday, Wednesday and Thursday, and also on Friday morning.

Among the more important technical papers are those in Session 13, "Automating Test Generation—Answers to the Explosion in Digital Test Programming." They point out that programming costs for putting automatic test equipment on line is of increasing concern to the electronics industry. Papers zero in on various

hardware and software approaches to lowering these expensive programming and related startup costs.

Session 27, "Automatic Testing in the Manufacturing Process," points out the need for low-cost, dedicated testers for microprocessors. Present general-purpose test equipment is considered too expensive.

Whether you purchase processor chips and design a dedicated computer, purchase available board-level processors and design a specific interface or purchase available boxed processors, the problems are discussed in a Session 6 paper, "Microprocessor Selection Process."

During the next three years (or thousand days) the industry will finally see the design of significant system containing microcomputers. Many of these systems will use printers, the most common of all computer peripherals. Selecting printers and interfacing them to microcomputers is the subject of Session 21: "So You Want a Printer for Your Mini or Microcomputer System?"

The field-programmable array, or FPLA, is a special associative read-only memory that usually has more inputs than other ROMs. It is used to translate input codes of one type into output codes of another type. A paper in Session 26 believes that FPLAs are going to be a major factor in the industry in the years ahead.

In consumer electronics the attention is, as might be expected, on two of the hottest areas: electronic watches and pocket calculators. As pointed out in papers in Session 12, "Electronic Watches—Part I," two of the biggest remaining problems in digital watches—the inability to see LEDs in sunlight or liquid crystals at night—seem to have been overcome.

Papers in Session 29, "Present and Future of Sophisticated Pocket Calculators," cover the rapid developments and changes in these arithmetic and scientific machines. ■■

The following editors contributed to this Wescon special report: Jules Gilder, David Kaye and Jim McDermott.

Test and Measurement

Simpler and cheaper testers are urged for logic circuitry

During the past five years, automatic logic-circuit test systems have been widely used to analyze increasingly complex PC boards. Sales of these systems and software will exceed \$50 million this year, according to Robert E. Anderson, vice president of Omnicomp, Phoenix. But further growth has been slowed by the difficulty and cost of test program generation.

In his Session 13 paper on "Survey of Test Generation Techniques," Anderson says that the individual approach to the problem can shift the area of principal cost.

Manual generation of programs by engineers requires less investment in hardware, Anderson points out, but production takes much longer. On the other hand, larger systems with automatic test pattern generation cost hundreds of thousands of dollars but require minimum manual time.

"People tend to look at investments in automatic production testers in terms of the hardware," says Donald P. Allen, vice president of marketing for Fluke-Trendar, Mountain View, CA. Allen, organizer and chairman of Session 13, points out in "Answers to the Explosion in Digital Test Programming" that not all testers in use are software devices. "Some are the hardware equivalent of software. But in any event, the important job is to figure out which test will be appropriate, and that is where the main cost is," he notes.

The objective is to verify and modify a test sequence so that it will detect all the potential faults on a board and will produce close to 100% confidence, he says.

The new simulators are effective in cutting auditing costs or in assessing the true productivity of a program. But, he points out, "there is nothing new among the commercial tester manufacturers today that truly automates the creation of a program in the software area."

The use of automated testing in four different areas can play an important role in reducing over-all product cost, says Stephen E. Grossman,



A dual magnetic tape cassette with an autosearch feature in this Faultfinder FF101A test system simplifies the programming, editing and test program debugging.

senior staff engineer, Faultfinders, Inc., Latham, NY. These include incoming inspection, testing PC boards without components on them, testing boards after the components are soldered in place; and testing in the final assembly, when the boards are incorporated in the system.

Grossman, organizer and chairman of Session 22, points out in "Automated Testing, Productivity and the Manufacturing Process," that the number of components that are put on the boards is mounting rapidly. "And if you put on enough components that have not previously been tested," he points out, "the likelihood is excellent that the board won't work. This," he says, "is a good argument for incoming component testing.

"It is also an argument for in-circuit testing, because at this point testing catches not only bad components but also workmanship errors, such as the solder shorts that cause some 60% to 90% of the troubles today."

A new concept in testing that lowers the cost of PC boards while providing a 100% check of



Four million 128-bit words can be generated by this Fluke-Tendar 2000A logic tester. Here, software is replaced by combination of pseudo-random codes.

the wiring pattern is described in a Session 22 paper by Rollin Mettler, Jr., Circuit-Wise, Inc., North Haven, CT. In "Testing Printed Circuit Boards Prior to Components Loading," Mettler insists that electronic testing of PC board patterns before the parts are inserted is vastly superior to visual or optical inspection. "We were the first to adopt this test over a year ago," Mettler says. "What it boils down to is that we have a bed of 'nails' forming contacts to two-sided PC boards with plated-through holes. We have a pre-programmed tester using a DEC computer. We put the board into a test fixture and check for opens and shorts in all the wiring patterns."

The system detects flaws not ordinarily found because "no inspector catches all the hairline shorts and cracks."

Also, Mettler points out, an inspector's efficiency at 8 A.M. is substantially higher than at the end of the day. Further, an operator takes 20 minutes to check for 3000 possible flaws on a board, while the tester can do the same job in about 1.5 seconds.

The need for low-cost microprocessor testing is not satisfied by any of the large testers on the market, says Dan Izumi, director of microprocessor engineering for National Semiconductor and author of a Session 27 paper, "The Challenge of Microprocessor Chip Testing."



Testing the conductor patterns of bare PC boards on this Circuit-Wise computer-controlled setup has revealed a surprising number of defects not detected visually.

"There is a definite need for low-cost, dedicated testers for microprocessors," Izumi notes. "At present," he points out, "because the test requirements are very general in nature, testers required for this purpose are expensive."

"Since microprocessors are not extremely large volume products, you can't justify the cost of such equipment. Consequently," he states, "more dedicated and less sophisticated capability is required to fill this need."

The emergence of lower-cost, dedicated testers is important, Izumi explains, not only because the manufacturer can use such equipment, but because the end user can acquire the same system for his incoming inspection. This results in direct correlation between the manufacturer and the customer.

It would be desirable to get a tester in the range of \$20,000 to \$30,000, Izumi says. Today, the large general-purpose testers are in the order of \$150,000 to \$200,000, he points out, while even the dedicated test systems, those oriented to memory testing, cost about \$75,000.

Izumi points out that National currently uses several large pieces of equipment, including a Fairchild Century 600—a very large system. Within the microprocessor group, internally designed dedicated equipment is used.

Izumi concedes that some manufacturers use the large general-purpose equipment. But, he points out, it's only being used because nothing else is available.

"The larger users are using any means available today to get on the air quickly. But if you look at the cost of microprocessors in terms of the product life and the quantity that is produced, as well as the complexity of developing test programs, the total cost is excessive for the large systems," Izumi concludes. ■■

Computers

Assemble or buy it? A look at the 'how to' with micros

Practical "how-to" information on the use of microprocessors is now flooding the literature. Wescon has four sessions devoted to this type of material. These range from design aids and support systems through applications examples and on to the use of printers with microprocessors.

Sessions 6 and 15 concentrate on design aids and support systems for both hardware and software. Robert Van Naarden, product manager for component computers at Digital Equipment Corp., Marlboro, MA, notes in a Session 6 paper that you must go through a make or buy decision process when deciding upon the level of integration that is best for you. You must decide, he says, whether to: purchase processor chips and design a dedicated computer; purchase available board-level processors and design your specific interface; or purchase available boxed processors, with all parts integrated, for which you will pay a premium. He notes that this decision hinges heavily upon the capabilities of your company and the volume of systems that you plan to produce.

Designing it in

Many hardware and software aids are available to the engineer when designing a microprocessor into a system. Representatives of Intel, Santa Clara, CA, National Semiconductor, Santa Clara, CA, and Motorola Semiconductor, Phoenix, AZ, describe the aids available for designing their microprocessors in Sessions 6 and 15. Two Intel papers in each session describe the company's new Microcomputer Development System that can be used to simulate the system environment in which the microprocessor will ultimately operate.

Van Lewing, manager of microcomputer marketing for Motorola, describes the EXORciser system in his Session 15 paper. The EXORciser provides interfaces to a variety of peripherals as well as software debug aids to ease the woes of the microprocessor system designer.

Gerry Madea, product marketing engineer at National Semiconductor, discusses advanced soft-

ware design aids in his Session 6 paper. These include software simulation routines, higher level languages and the details of assembly language.

Assembly language programming is difficult for many designers. Granino A. Korn, professor of electrical engineering at the University of Arizona, Tucson, AZ, describes a novel technique that makes it easy for applications-oriented nonprogrammers to write efficient microcomputer programs without any need to learn assembly language. According to Korn, "the user specifies an analog computer-like block diagram whose block operators specify standard mathematical operations (addition, multiplication, integration, etc.) and input output operations, analog/digital conversion, switching, sensing and so forth. These standard operations are implemented as subroutines in the microcomputer read-only memory."

Korn describes an interactive editor/translator

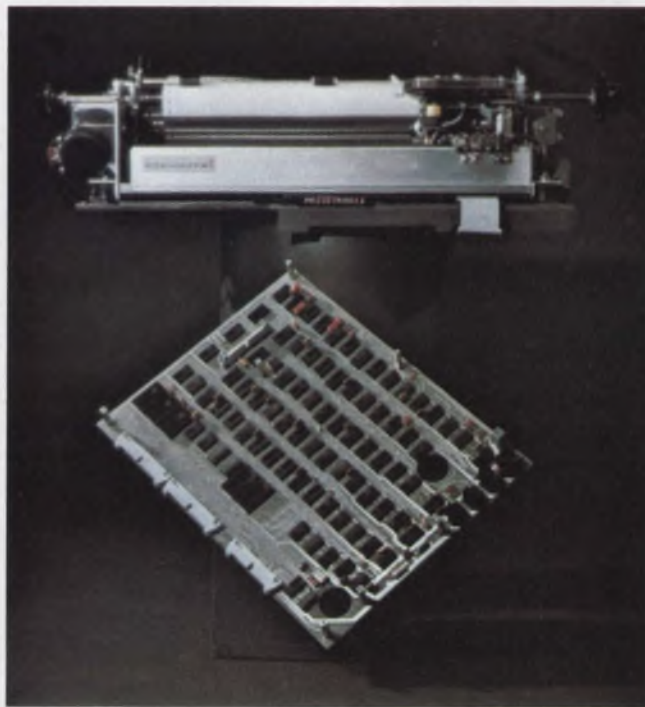

Interdata's Carousel printer is the first microprocessor-controlled serial printer. It prints at 30 cps.

program running on a small minicomputer that translates the block-diagram specifications into a simple address table and loads it into the microcomputer memory. This address table represents the block-diagram operation sequence and specifies successive jumps to the correct standard subroutines in ROM and data fetching/storing operations in the random-access memory.

Distribute the computing

Two Wescon papers discuss techniques of distributed processing using microcomputers or microprocessors. Dr. Robert L. Britton with the Dept. of Computer Science at California State University at Chico, describes in a Session 1 paper, a structure—not unlike a three-wire, three-dimensional core memory—in which microprocessors and their associated memories would be located in positions that are geometrically analogous to where cores are located in memory. Any microprocessor within this structure could communicate over three different orthogonally arranged busses.

J. E. Bass, manager of microprocessor applications at Rockwell International in Anaheim, CA, in his Session 6 paper, claims that distributed processing is best applied to I/O control, such as direct memory access and intelligent memory ports and also to peripheral controllers. "The main advantage of distributed computing," he says, "is speed. It allows you to have more than one task going on simultaneously and also eases the load on the main CPU."

Micros combine with printers

Session 10 papers describe how microprocessors have been designed into a variety of applications such as a floppy disc system, a blood sample analyzer and a communications processor.

Session 21 considers the use of microprocessors with the most common of all peripherals, the printer. Ted L. Nichols, manager of peripheral products with General Automation, Anaheim, CA, describes the various considerations in selecting the type of printer. He notes that some of the key considerations are: total cost of ownership; peak speed as opposed to volume per day; communication channel requirements; line width and format; and the need for preprinted forms or multiple copies.

Paul Davies, president of Educational Data Systems, Irvine, CA, stresses the different techniques for interfacing to and controlling printers. He describes a technique of multiplexing all peripherals to the processor on a single I/O channel.

Davies also discusses single device controllers which are specifically designed for the computer

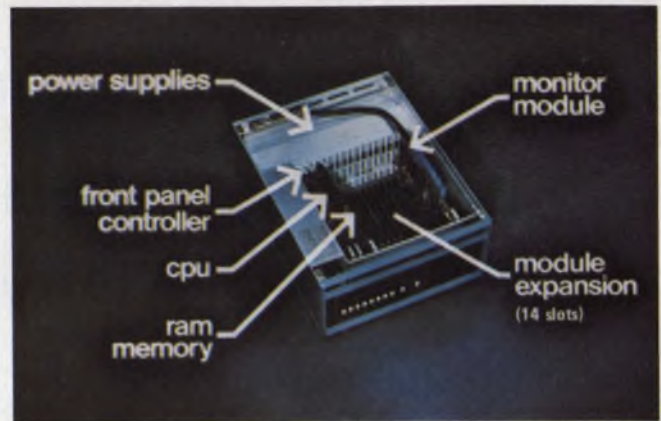

Intel's Microcomputer Development System allows the microcomputer to be tested in the same environment in which it will ultimately have to operate.

and printer as well as microprogrammed controllers that can be adapted through appropriate firmware to any of a number of printers.

A Low-cost 300-lpm line printer

Finally, two of the newest printers are described and demonstrated by Interdata, Randolph, NJ, and Printronix, Irvine, CA. The Interdata printer is the first microprocessor-controlled serial printer. David Ratcliffe, manager of systems and software, notes that the microprocessor has extra capacity for other jobs as well as controlling the printer. It can be used for such things as word processing and communications processing. The user must provide the additional software, firmware and memory that might be needed, he observes.

The Printronix 300 is a low cost 300-lpm line printer that uses matrix printing. David W. Mayne, vice president of operations, describes many advantages of matrix printers over full character printers. In addition to fundamentally lower cost, he notes that, "to strike an M or W solid character requires 10 to 20 times the hammer pressure that a single dot requires. For this reason, in the matrix printer, the design of the hammer and hammer driver, to strike only dots, can be considerably simplified."

Mayne notes that to print a single character, a drum or belt printer must sequentially present to each print position all 64 characters from which one is selected. With characters spaced 0.1 in. apart this means a total of 6 or 7 in. for each character selected.

However, he observes, a matrix printer with a single hammer has only to move 35 separate dot positions to construct a single 5 by 7 (or 9 by 7, with half-dot positions) matrix character. Total movement is only 0.5 in. Thus operation of the matrix printer is a simpler dynamic problem, according to Mayne. ■■

FPLAs: If you haven't heard of them yet, you will in time

Field-programmable logic is a term engineers are going to be seeing more often. It encompasses several types of devices such as microprocessors, ROMs and field-programmable logic arrays (FPLAs). The latest developments in field-programmable logic and the pros and cons of different approaches are discussed in Session 26.

According to Robert Frankenberg, manager of 21 MX computer development at Hewlett-Packard and the lead-off speaker at the session, FPLAs are going to play an important role in the electronics industry in the coming years.

The FPLA is a special kind of ROM—an associative ROM—and it usually has more inputs than other ROMs. It is used to translate input codes of one type into output codes of another type. The device generates outputs that are sums of partial products. These have the data inputs as variables. Product terms consist of logic AND functions, and these are ORed together to form the output.

Frankenberg reports that although FPLAs compete to some extent with microprocessors and ROMs, in general, they don't make a lot of sense for a production environment. There are two reasons for this, he notes. One is cost. The other is speed. Currently, says Frankenberg, ROMs or even random logic are often less expensive than FPLAs. But, he goes on, FPLAs are still relatively new and the pricing picture could change as they mature.

FPLAs are out for applications where speed is important, the HP manager reports. Right now devices are available that operate at 100 ns, and some people are even talking about 55-ns units. But when you compare that with random logic, where speeds as high as 15 ns are easily achieved, FPLAs aren't that attractive, he says.

The real big advantage of FPLAs is that they can greatly compact the number of bits required for interfacing, notes Frankenberg. When PROMs are used to implement logic functions, it is necessary to program all the possible logic states. But with FPLAs all you have to do is program the TRUE states. Thus, he continues, the FPLA re-

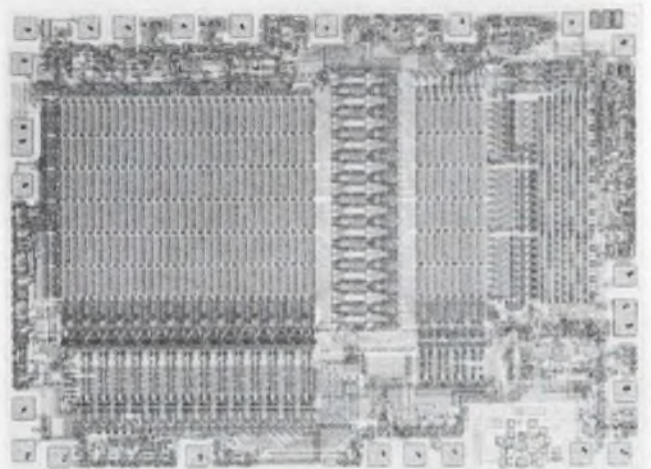

One of the first field programmable logic arrays was this IM 5200 from Intersil. It can accommodate as many as 14 inputs and eight outputs. Fusible links are used.

duces the number of bits required to express something.

The advantage of FPLAs over random logic is that they are structured and it is possible to achieve much better area efficiency with them than it is with random logic LSI.

Describing some of the future applications of FPLAs, Frankenberg notes that they'll probably be used a lot to emulate minicomputers on micros.

While it is possible to use a PROM to do this, he explains, if the instruction set is large—like those used in the PDP-11 or HP 21 MX—a lot of memory would be needed. FPLAs on the other hand are very efficient in this type of task. Frankenberg emphasizes, however, that the use of FPLAs will result in poorer speed performance.

FPLAs are slow but . . .

In another paper at the same session, Gene Miles, director of memory marketing for Intersil, agrees with Frankenberg's statement that FPLAs are slower than PROMs. But he's quick to point out that it is very important to take a careful look at the application. Many designers, he goes

on, simply use brute force to solve a problem and increase the speed of the components. They don't take the time and trouble to rethink the total structure of the logic to gain the increased speed. If they did, they would see that it is often possible to use slower parts, like the FPLA, and get good performance too.

Best applications for FPLAs, says Miles, are those that involve a lot of logic gating, where the logic can be partitioned into a relatively small number of input and output functions. Commenting on the capabilities of FPLAs, Miles notes that if the logic involves random gating and can be partitioned into 14 inputs and eight outputs, with groups of 48 product terms or less—then one FPLA can be used to perform that logic. Using TTL devices, it might take 25 ICs to accomplish the same thing.

Miles strongly takes issue with Frankenberg's statement that FPLAs are more expensive than random logic. He points out that in the case where 25 TTL parts are required to implement a logic function, even if the TTL ICs were free, it would be cheaper to use FPLAs at the 100 quantity level. Explaining further, he notes that the supporting hardware such as the power supply, the PC board space as well as the cost of testing all those TTL parts on incoming inspection and the logistics of stocking so many parts cause the

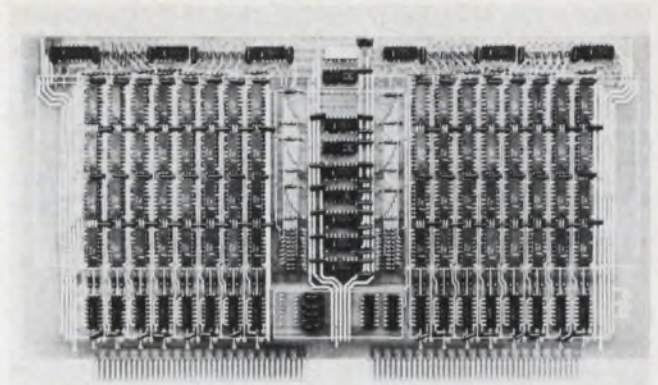

A CCD memory system capable of storing 128 kilobytes of data has been constructed by Intel from 64 of their 16-k serial memory chips. The 16-k CCD memory chips are designated 2416 and are available.

TTL approach to be more expensive.

"An FPLA kind of works like a broken PROM," declares Robert Green, an application engineer from Intel, in a third paper presented at Session 26. This statement is prompted, says Green, by the lack of an apparent array. An FPLA cannot be visualized as a rectangular array the way a PROM can. Also, unlike FPLAs that might have 14 inputs and only eight outputs, every input to a PROM will lead to an output.

Addressing the areas of application for FPLAs,

NEW FROM AUGAT.

Programming jumper plug assembly gives you more flexibility at lower cost than DIP switches. Available in standard units of from 1 through 9 poles. Special assemblies available with contacts on both .100" and .300" centers. Available now from your Augat distributor.



AUGAT

Augat Inc., 33 Perry Avenue, P.O. Box 779, Attleboro, Massachusetts 02703

Name _____
 Title _____
 Company _____
 Address _____
 City _____ State _____ Zip _____

ANALOG SERIES No. 3

IF YOU'RE SICK & TIRED OF CALLING AROUND FOR ANALOG...

Read on. Here's one major analog supplier where one call can cover all needs: high technology, broad selection, low cost. One-stop shopping: over 150 basics, over 750 temp/pack combos (Hi Rel too). Dist shelves now.

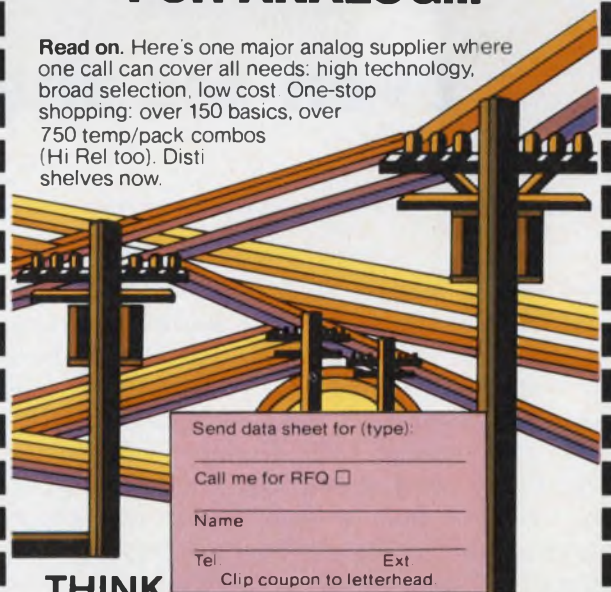

Send data sheet for (type): _____

Call me for RFO

Name _____

Tel. _____

Ext _____

Clip coupon to letterhead

THINK

SiNETics

811 E. ARQUES, SUNNYVALE, CALIF. 94086

INFORMATION RETRIEVAL NUMBER 37

ELECTRONIC DESIGN 18, September 1, 1975

INFORMATION RETRIEVAL NUMBER 38

Green notes that even though they may be slower, FPLAs are definitely competition for microprocessors. If the design for a minicomputer, for example, was approached from a Boolean point of view and FPLAs were used wherever the same equations kept appearing, it's conceivable that FPLAs could be used to replace gates and logic all over the place, and at a lower cost.

I²L and CCDs discussed

Recent developments in integrated injection logic and charge-coupled devices are covered in Session 19, "I²L and CCD Applications." Some of the unusual things that designers will be faced with when they start to use I²L are described by Stan Bruederle, advanced products manager for Signetics.

The first thing that will be evident, says Bruederle, is that a different type of power supply will be needed. Instead of using the common 5-V supply, an engineer will have to use a current supply. And an external resistor will have to be connected to the IC to control the value of the current, which will also control the amount of power dissipated and the performance.

This, he continues, turns out to be an interesting benefit, because now the circuit designer has

the option of selecting the type of performance and power dissipation he wants by simply changing one resistor.

Another thing that will face the I²L user is open collectors, unless the circuit is designed with two power supply pins—one for the current source and one to which internal pull-up resistors can be connected.

In the area of MOS technology, Kamal Gunsager, an engineer from Fairchild Semiconductor, describes, "A CCD Line-Addressable Memory." The new device, known as a LARAM, is a memory with a new format. It is not completely random access, like the RAM, and not serial like other CCD memories. It is a combination of both.

The LARAM, says Gunsager, provides random access to a line of memory. This line addressed concept gives the device faster access times, lower clock capacitance and higher data rates than are available with the other CCD memories, like the Intel 2416.

The 2416, he points out, has four clocks, each of which has a capacitance of 500 pF. The 16 kilobit LARAM has only two clocks with a capacitance of 100 pF each. What this means, he explains, is that because of the lower capacitance, it is possible to connect many memory devices on one board with a common clock driver. ■■

Consumer Electronics

Time marches on—and you can even see the displays now

Two of the biggest display problems of electronic watches—the inability to see LEDs in sunlight or liquid crystal displays at night—have been overcome, according to speakers at the Wescon consumer electronics sessions.

"The efficiency of LED displays has been improved to the point where they are now substantially brighter than a year or so ago," says Juergen Staudte, Statek Corp., organizer and chairman of Session 12: "Electronic Watches, Part I."

Staudte, president of the Orange, CA, firm, points out that optical aids such as lenses also help provide more easily readable figures.

"For example, I have one of the latest Litronix watches," he says, "and the display is large and bright enough so that I can see it in direct sunlight, which was just not possible with early displays."

The problem of seeing liquid crystal digits in the dark has been solved by backlighting the displays, says Dr. Robert Schnurr, manager of watch engineering for Micro Display Systems in Dallas and author of a Session 12 paper on "LCD Watches—State of the Art."

For backlighting, a tiny incandescent lamp is incorporated into the watch, and the wearer presses a button to turn it on.

"It was a tough problem to integrate the lamp into the watch," Schnurr says. "But we are not the only ones incorporating this feature. It will eventually be used throughout the liquid crystal watch industry."

Use of such a lamp minimizes a prime advantage of crystal watch displays—very low battery drain.

"The power that the backlight takes is about the same as that for a LED display," says Schnurr. "But the number of times a year that the user will operate the backlight is significantly less than the number of times a LED-watch user wants to know what time it is in that same period. So on the whole," he notes, "the LCD still will use very much less power."

Like the LED displays, the field-effect liquid crystal displays have been markedly improved.

"The reliability of these displays is much better than a few years ago," says Schnurr. "And the viewability of the field-effect devices has, in most environments, been improved an order of magnitude over dynamic scattering systems.

"The advent of these low-voltage displays—typically we now need 3 to 4.5 V to drive the field-effect units—has proved important in giving longer battery life. Back when we started," Schnurr points out, "we needed 15 V.

"We believe that with the use of the field-effect

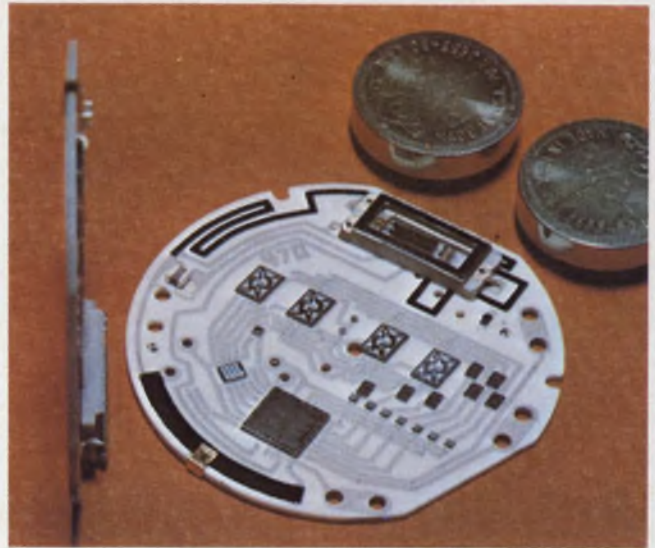

Use of tuning-fork crystals in electronic watches is on the rise. On this chip a Statek crystal is sealed under a glass cover through which the crystal is laser-trimmed.

displays and backlighting, this kind of watch will compete on an even basis with LEDs," Schnurr declares.

However, there is one aspect of the LCD displays that at present limits the number of segments that can be used in a watch. Unlike LEDs, the LCDs cannot be scanned or multiplexed.

NO ONE

Customizes Switches Like CDI
Nor Has a More Complete Line

THUMBWHEEL SWITCHES



Completely sealed against hostile environments.

Mounts on 1/2" centers, retrofits most panel openings for miniature thumbwheel switches.

ROTARY SWITCHES

Snap-in, snap-out modules in seconds, eliminating downtime.

Tabet Pat.
2841660,
2971066,
3015000,
2956131,
2988607.



PUSHBUTTON SWITCHES



Miniature add/subtract units retrofit most minithumb-wheel switch panel openings.

CDI earns its reputation every day for Consistently High Quality, Consistently Good Delivery.



CHICAGO DYNAMIC INDUSTRIES, INC.

PRECISION PRODUCTS DIVISION
1725 Diversey Blvd., Chicago, Illinois 60614
Phone: 312, 935-4600

MEMORY SERIES No. 2

1K RAMS: WHAT YOU NEED IS WHAT YOU GET.

Well-proven, well-sourced, this 1024x1 RAM delivers the most-requested high performance specs.

Upgrade systems with 30ns speed, low input loading, TTL compatibility.

Industry standard pinouts, standards or MIL: #82S10/11; 93415A/425A.

Please rush 1K RAM data for #82S10/11 & 93415A/425A.

Name _____

Tel. _____

Ext. _____

Clip coupon to letterhead

THINK

Signetics

811 E. ARQUES SUNNYVALE CALIF 94086



A steady reduction in the cost of scientific calculators, like these Novus machines, is being achieved through the use of fewer chips with more circuits on each chip.

The poor reliability of electronic watches has been a major problem, but this has been considerably improved by Novus, according to Dr. Douglas Bosomworth, director of timepiece operation for the National Semiconductor Division in Sunnyvale, CA, and author of a Session 12 paper entitled "The Anatomy of a Reliable Low-Cost LED Digital Watch Module."

"Our design is conservative," says Bosomworth, "from a mechanical as well as electronic point of view. We've paid particular attention to wiping contacts, good spring contacts and good battery contacts, because at low watch voltages and currents, contact design is very important. We've also shock-mounted our crystal," he notes. But one problem beyond the electronic watchmaker's control is short battery life. For LED watches this is presently well under a year.

Unfortunately, the outlook for batteries with higher energy and longer life is not too encouraging at present, according to James Southworth, regional engineering manager for Union Carbide in Chicago.

Two systems will be used for some time, says Southworth, author of a Session 12 paper on "Watch Batteries." One system is the monovalent

Timetable to the technical sessions at WESCON '75

TUES. Sept. 16 10 AM	1. Microcomputers—How to Get Started	2. Sources of Capital in Difficult Times	3. Instrument Interfacing with IEEE Standard Bus	4. Computer Aids for LSI Design and Tooling	5. Telephone Private Branch Exchanges (Electronic PBXs)
TUES. Sept. 16 1:30 PM	6. Microprocessor/Microcomputer Hardware & Software Support	7. ESOPs for High-Tech Companies	8. IC Packaging and Interconnection	9. Laser Detection and Ranging Devices (LADAR)	
WED. Sept. 17 10 AM	10. Microprocessor Applications	11. Fielding a Winning Sales Team	12. Electronic Watches I	13. Explosion in ATE Test Generation	14. Energy Policy Decisions: Opportunities & Uncertainties
WED. Sept. 17 1:30 PM	15. Microcomputer Design Aids	16. Purchasing: Limits of Responsibility	17. Electronic Watches II	18. Synchronous Data Link Control	"Psychotronics" Evening Session: 7 p.m.
THURS. Sept. 18 10 AM	19. I ² L and CCD Applications	20. Needs and Trends in Medical Electronics—1975	21. High-Speed Printers for Minis and Micros	22. ATE in Board and Component Mfg. Process	23. Promoting Women? What's the Problem?
THURS. Sept. 18 1:30 PM	24. Microprocessors in Medical Instrumentation	25. Hybrid Micro Clinic on Beam-Leads	26. Field Programmable Logic	27. ATE in IC Manufacturing Process	28. How to Succeed in International Business
FRIDAY Sept. 19 10 AM	29. Present and Future of Sophisticated Pocket Calculators	30. The Engineer and His Profession	31. Electronic Identification Systems	32. Communications Satellite Systems	

silver oxide (Ag_2O), which is in use today, and the second system is divalent silver oxide (Ag_2O_2), which should be coming into use within a few months.

"The divalent will probably have about 50% greater energy density," Southworth points out, "but the cost will not be much more, because with the divalent type only half the silver is needed."

Calculator price plunge continues

Calculator prices for scientific machines as well as simple arithmetic units have continued a steady downtrend, says Robert B. Johnson, director of calculator-IC engineering for National Semiconductor. Just what the prospective purchaser may expect in the near future is pointed out by Johnson in his Session 29 paper, "Low Cost Calculators."

The lowered costs have been produced primarily by reducing the number of chips, Johnson points out. Presently, he notes, we are at the stage of the one-IC-plus-display models. But to further reduce prices, tradeoffs must be made which will eliminate some of the frills available on present machines.

"For example," Johnson says, "there will be a number of new, competing lines of scientific calculators coming out for this Christmas. But instead of having a 14-digit display—10 digits for the mantissa plus two for the exponents, plus two for signs—we're going to see several with a five digit mantissa, plus two for the exponents and two for the signs.

"What you're giving up here," he points out, "is a little accuracy. But if you can buy a good scientific machine for \$50, the loss of the last five digits of the mantissa—except for highly specialized calculations—is acceptable, since most of us throw them away, anyway."

Mike Cochran, manager of advanced design in Texas Instruments' calculator division sees other changes coming in his Session 29 paper, "Present and Future Trends in Sophisticated Pocket Calculators."

"Each new MOS generation comes out with significant improvements over the previous generations," Cochran says. "We keep cramming more and more capability onto smaller and fewer chips." And this, he points out, is the result of two things: MOS technology is improving constantly and calculator designers are getting smarter.

"I don't think we'll see much reduction in the hand-held calculator size," notes Cochran, "because of the human factors involved in keyboard operation." ■■

Special

Technical session order form

Please send me the following Wescon technical session preprints at \$2.00 per numbered session (average: four papers per session), \$4 for special Psychotronics session, plus \$1 mailing charge per complete order. I understand this order will be mailed to my address within two weeks after receipt. Offer good until Dec. 1, 1975.

Session No.	Quantity	Session No.	Quantity
1		18	
2		19	
3		20	
4		21	
5		22	
6		23	
8		24	
9		26	
10		27	
11		28	
12		29	
13		30	
14		31	
15		32	
17		"Psychotronics"	

Total Session × \$2.00 = \$ _____
 "Psychotronics" × \$4.00 = \$ _____
 Plus \$1.00 Mailing Charge = \$ _____
 Total Cost = \$ _____

Make check payable to Wescon technical papers and mail with this form to:

Wescon
3600 Wilshire Blvd.
Los Angeles, CA 90010

DATE _____

NAME _____

FIRM _____

STREET ADDRESS _____

CITY, STATE, ZIP CODE _____

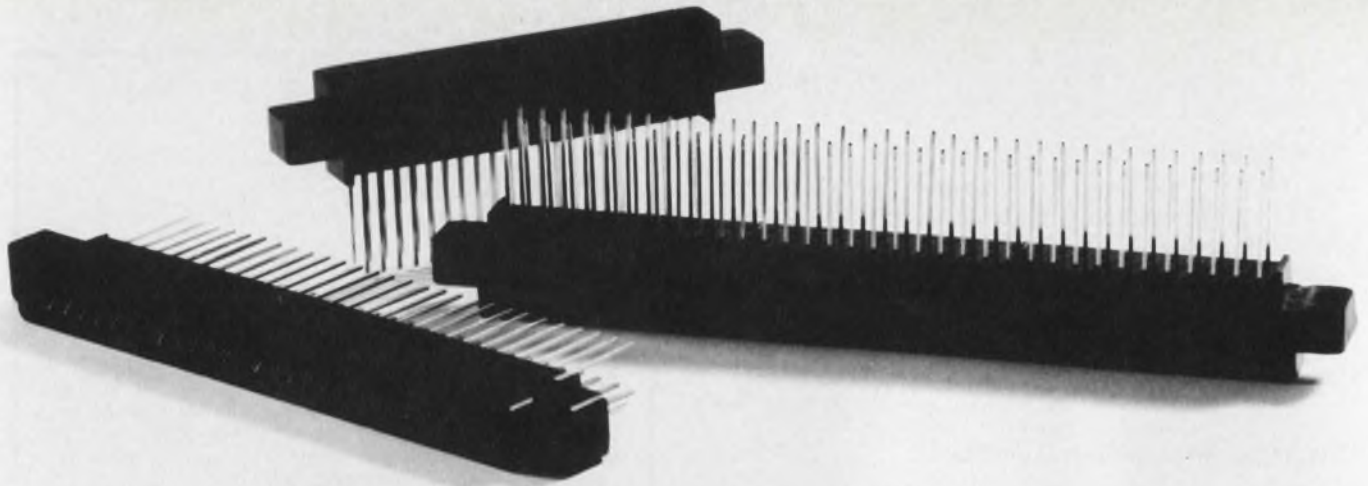

Presenting our better-mouse-trap line. No frills at all.

When you cut price without cutting quality, soon no one thinks of it as a cut price. That's where our Norsman line of Wire-Wrap* P/C connectors is headed. Here's why:

The insulator — it's tough, resilient, non-conductive—everything you need in a Wire-Wrap body. And it's made out of low cost phenolic, not the higher cost diallyl phthalate (if you need to meet mil specs, we have that in one of our other lines).

Contacts are semi-bellows and gold-plated — but

plated with our unique AuTac (TM) process. You get .000050" gold plate all along the mating surfaces for a sure, gouge-proof, pop-off-proof contact — but that's it. No wasted gold.

And you can find the size you need — Norsman is a full line from 15/30 to 50/100 contacts, in either .100 or .125 contact centers.

The whole Norsman idea is as simple as it is old: keep performance up and cost down. It works.

Send for details. We haven't told you everything.

*Wire-Wrap — registered trademark of Gardner-Denver Company.

Tell me everything. Send me detailed literature.

Name _____ Title _____

Company _____ Telephone _____

Address _____

City _____ State _____ Zip _____



Viking Industries, Inc./21001 Nordhoff St./Chatsworth, Calif. 91311/(213) 341-4330

New snap-in rockers with Cutler-Hammer reliability.

Here's a completely new line of snap-ins, each engineered with the kind of solid dependability you expect in Cutler-Hammer Rockette® switches. Bright metal bezels, illuminated and non-illuminated, A-c and D-c capabilities up to 20 amps.

Sub-panel rockers in a variety of colors, rocker or paddle designs in standard, special, or proprietary models.

Switches snap in and stay in permanently. Speed up assembly time, cut costs.

Flush-mounted rockers in the same wide range of designer-oriented colors and styles. One- and two-pole models.

Illuminated single-pole rockers. Choice of red, green, amber, white, or clear. Hot-stamped legends indicate switch functions.

For more information, call your Cutler-Hammer Sales Office or Switch Distributor.

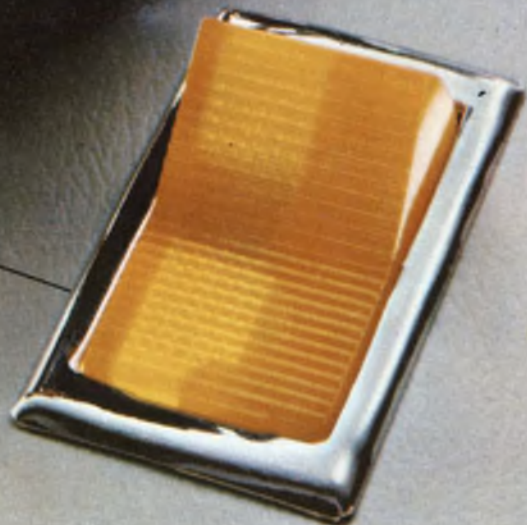

CUTLER-HAMMER
SPECIALTY PRODUCTS DIVISION, Milwaukee, Wis. 53201



on IC analog switches and multiplexers

When high-voltage complementary-MOS (CMOS) analog switches and multiplexers first appeared several years ago, their performance far exceeded that of earlier p-channel and n-channel-MOS (NMOS) versions. Suddenly monolithic switching circuits could handle a wide range of analog input voltages without large changes in their ON resistances. But there was some bad news, too. Some of those early CMOS units were prone to latchups and occasionally even burnouts.

Now improved monolithic circuits have arrived, and they overcome the deficiencies of their predecessors. In fact progress has showered us with several alternatives, not only in CMOS but in NMOS and junction FETs (JFETs) as well.

However, the very advances that boost IC performance also introduce subtle tradeoffs in a circuit's over-all performance. For example, manufacturers have achieved tremendous gains

in reliability, but often at the expense of some key specifications. Unfortunately these sacrifices aren't always indicated on a data sheet, making comparisons—not to mention selection—a difficult task.

Avoiding the latchup problem

Even now, virtually no data sheet warns you in advance that a switch or multiplexer could latch under normal operating conditions. At best, remedies are recommended to minimize the problem. These may include the use of external components, the avoidance of transients or even, the turning on of power supplies in special sequences.

But for a host of applications—especially industrial and military—such recommendations can't be applied easily. And the problem worsens for multiplexers, which often must face the harsh "outside world," as compared with switches. The latter tend to be used internally in controlled

Edward A. Torrero
Associate Editor

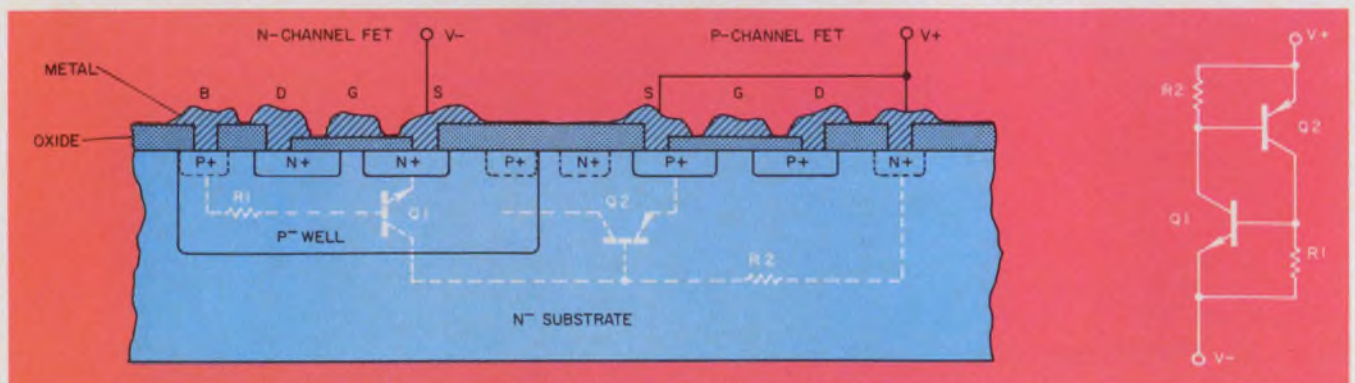

Parasitic pnp and npn devices form an SCR, or pnpn diode, in conventional CMOS structures. One or more forward-biased pn junctions trigger the SCR, which then

acts like a short circuit between supplies. The short persists until power is removed or until the circuit destroys itself.

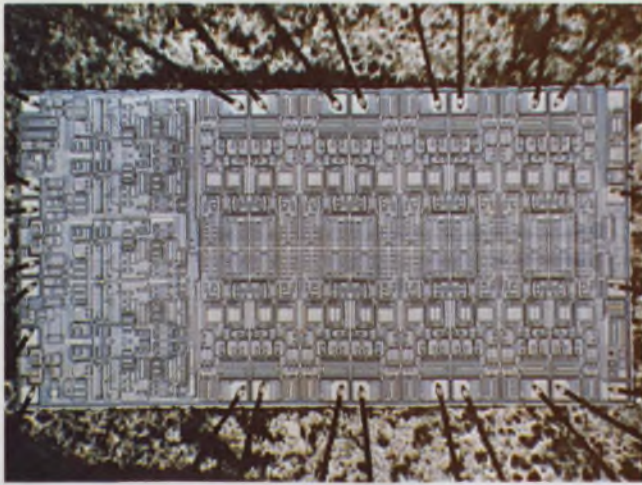

Adjacent devices are separated from one another by a glass-like nonconductive barrier in Harris Semiconductor's dielectric isolation. The technique is used in the

environments.

The latchup problem is actually an inherent one for any CMOS process that provides only conventional junction isolation between devices. The conventional structure contains parasitic four-layer devices, which behave like SCRs, or four-layer diodes. For example, the junctions between a p-channel source, the substrate, the n-channel body and the n-channel source combine to form a npn structure. And it can latch on whenever either source voltage exceeds the body voltage (power supply) for even a few nanoseconds. The IC could then burn out unless supply current were limited.

Aiming to overcome the problem—while maintaining analog input swings of $\pm 15\text{-V}$ (30 V, pk-pk) or so—three manufacturers have developed different CMOS fabrication techniques:

- Harris Semiconductor uses dielectric isolation (DI) to eliminate most parasitic effects altogether. A glass-like nonconductive barrier separates each device from its neighbors.

- Intersil employs a floating-body concept in which the usual connection from the n-channel body to the negative supply has been removed. An additional diode ties the body to the positive supply.

- Siliconix inserts a buried layer beneath the n-channel body. Like floating body the modification seeks to reduce the beta product of parasitic npn and pnp devices to less than one—the minimum value needed for SCR action.

Critics of the Harris approach say the increased complexity of the DI process raises manufacturing costs, so that DI products can't be price-competitive in high volume. Moreover, they point out, many DI circuits have suffered from a high ON resistance of about 2000 Ω due to internal overvoltage-protection circuitry.

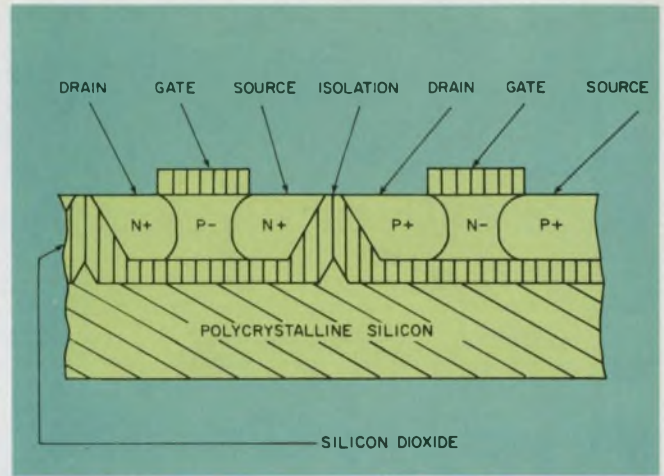

company's HI-506A, a 16-channel multiplexer. The integrated circuit offers extensive fault protection without the need for external components.

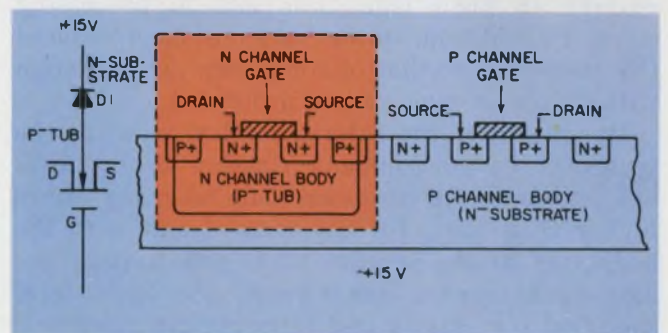
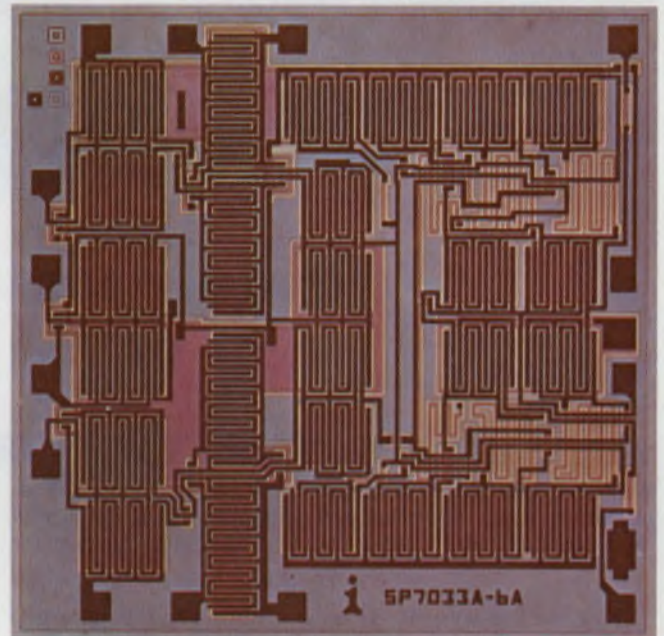

By not tying the n-channel body to the negative supply, Intersil achieves an overvoltage tolerance of up to 10 V in excess of either supply. The body voltage comes from a diode structure that connects to the positive supply. Called floating body, the technique is used in the company's line of CMOS switches such as the IH 5040, a single-pole, single-throw circuit. Intersil also offers a series of floating-body multiplexers.

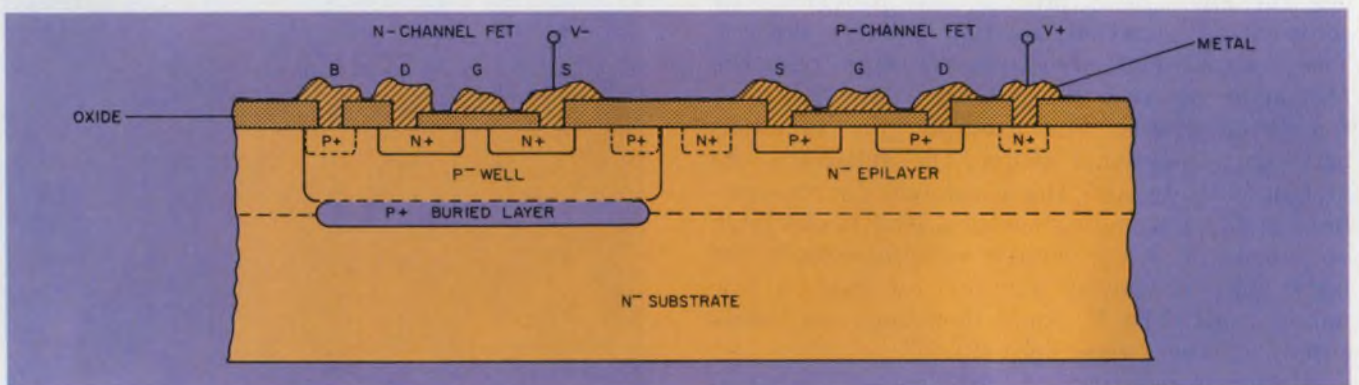
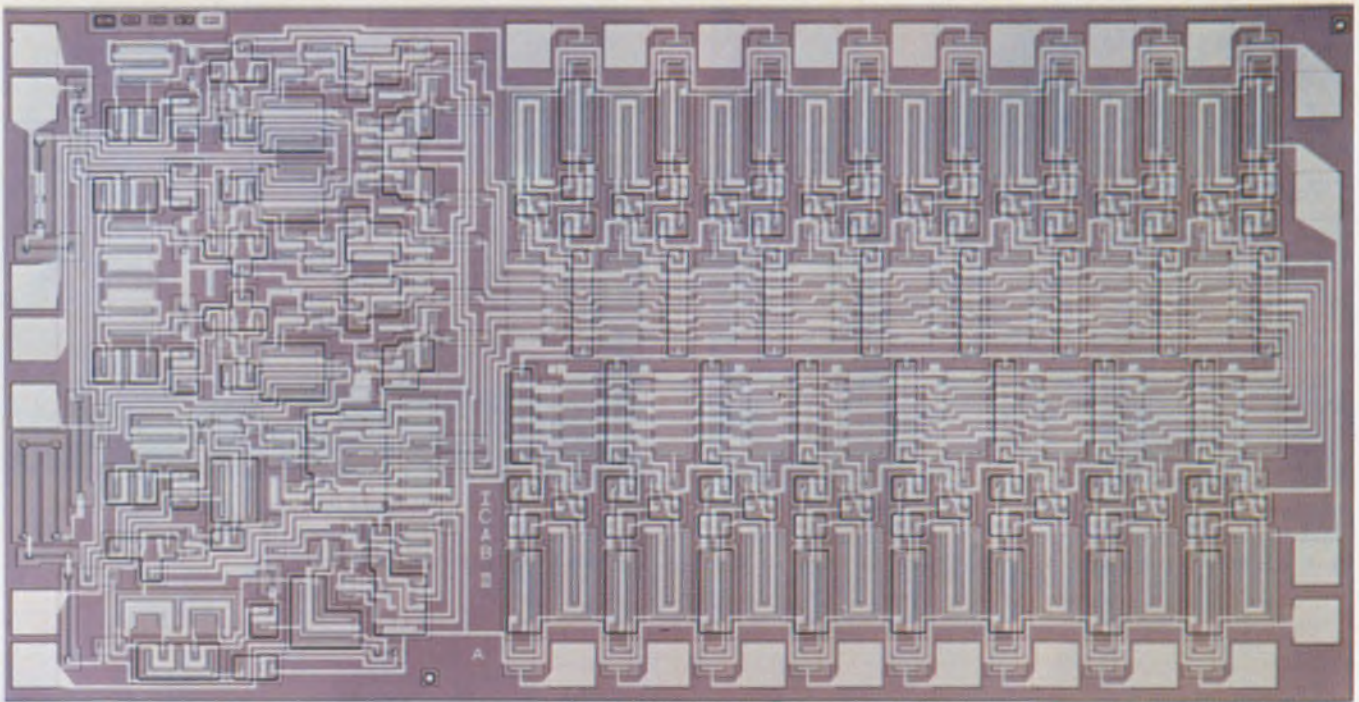

With the addition of a buried layer beneath the n-channel body, the product of npn and pnp-device betas can be slashed to less than unity, the minimum needed for

SCR action. Siliconix employs the technique for such CMOS ICs as the DG506, a 16-channel multiplexer. Switches spec a maximum peak output of 100 mA.

Not so, responds Harris. Though DI is complex, the process allows reduced chip sizes, regaining in yield what was lost in processing steps. In addition, newer versions have reduced ON resistance to that of competing units, though with a loss of overvoltage protection.

Opponents of the Intersil method point to the tradeoffs that accompany floating body. Leakage currents, for instance, can be many times higher than those for the same circuit with the body tied to the supply. Also, peak-to-peak analog-signal inputs don't reach the 30-V level specified for Harris and Siliconix circuits.

Countering the argument, Intersil says that floating-body circuits can be designed to reduce high leakage and other detrimental effects. Further, floating body automatically provides overvoltage protection without external components.

Siliconix, in turn, claims that the buried-layer approach allows specifications for up-

graded models to meet or actually exceed those of earlier versions. And all digital inputs directly accept TTL levels without the aid of additional components. However, the cost of this compatibility tends to be high chip dissipation.

CMOS alternatives have limitations, too

Other manufacturers eliminate latchup problems simply by avoiding CMOS altogether. National Semiconductor, for one, integrates bipolar drivers and JFET switches. This approach achieves essentially constant ON resistance over the operating voltage range, and equal resistance for each switch on the chip. Signetics uses a modified NMOS process called DMOS that greatly reduces parasitic capacitances. So analog signals can be switched with little interaction, low distortion and at very high speeds.

However, bipolar-JFET ICs, called BI-FETs

by National, have constant resistance only for an analog range of ± 10 V. Likewise the range of Signetics' DMOS circuits is less than that of equivalent CMOS ICs. Moreover the DMOS process doesn't readily integrate switches and drivers on the same chip.

Still other alternatives can be found in 4000-series CMOS switches and multiplexers, originally introduced by RCA. For the most part, these ICs use conventional CMOS processes, and they have input signal ranges of only ± 7.5 V, or 0 to 15 V, though newer versions allow ± 9 V.

And while many of these ICs might seem better suited for switching digital—rather than analog—signals, they have two important advantages: A host of alternate sources exist for the ICs, and they bear the lowest price tags. In volume quantities, for example, a single switch in a package of four costs 25 cents or less.

Of course, older PMOS and NMOS switches and multiplexers are still around, too. However, most vendors have adopted the practice exemplified by American Microsystems. The company supplies PMOS units as replacement parts, but has quietly dropped them from current catalogs.

Beware of misleading specs

Ideally one should be able to select an IC switch or multiplexer on the basis of published data. But one of the most widely used specifications—ON resistance—demonstrates why this isn't always a reliable approach. Typical published values can be much less than the values you're likely to encounter. And even worse, the maximum values may be more than the listed "maximum."

Data sheets for some older CMOS switches show several ON resistances that correspond to different test conditions. But the manufacturer may conveniently omit those test conditions that produce a very high resistance. Of course, the data sheet may include curves that "fill in" the gaps. But these curves don't show worst-case values.

And ON resistance, by itself, doesn't reveal the output error, or "offset" voltage, that the resistance generates. For this spec, you may have to search for the right leakage current, buried among the five or so usually listed, and calculate the error.

"Deadbands" are another unpublicized characteristic of digital switches that try to play an analog role. At low supply and input levels, the switch simply stops transmitting, though it passes signals at somewhat higher or lower levels. The problem doesn't arise when the IC switches digital signals, because the deadband occurs during transitions. In any case, the data sheet doesn't distinguish between analog and

digital performance.

Many data sheets for newer switches and multiplexers fail to indicate clearly all the variations that can occur over rated operating conditions. Besides ON resistance, such key specs as switching times can change by 50% or more as analog inputs and temperature change.

And a manufacturer may list OFF isolation at a high frequency where the spec approximately equals that for a competing unit. However, the two units may have vastly different isolations at lower frequencies. The solution is to check feedthrough capacitance and then calculate the isolation of the competing switches for the frequencies and load conditions of your system.

Many data sheets declare boldly that circuits incorporate "break-before-make" action—switches already closed are conveniently opened before other switches are closed. But closer examination of the data sheet may reveal that this action depends on digital-input levels. And it also might change to "make-before-break" with shifts in supply levels and operating temperatures. In any case, break-before-make switching can occur only when the switch turn-on time exceeds turn-off time.

Where digital input levels are the culprit, the connection of an external resistor can usually ensure break-before-make. The additional component may also be needed to provide increased noise immunity, or to keep IC-generated transients from getting back into the driver circuitry, or to protect MOS inputs from electrostatic charge. And all of these precautions may be needed by a circuit that boasts "TTL compatibility"—about as ubiquitous a claim as "break-before-make."

The term "TTL compatibility" would seem to imply—at the very least—that the IC's drive circuitry can interface directly with TTL circuits. But a check of the data sheet may show that the digital interface levels aren't even those needed for compatibility.

Other CMOS circuits don't claim direct TTL compatibility but do promise low-power dissipation. However, to interface with TTL, you must again resort to external resistors at the driver-input terminals. And if the IC doesn't already have adequate protective circuitry, you could end up with a network of diodes and other resistors for each analog-input and power-supply line. The power required by pull-up resistors can easily exceed that of the circuit. So total power drain—not to mention board space—becomes much larger than expected.

Further, power dissipation in CMOS circuits increases as switching speeds increase. The first power spec you see on data sheets is often the quiescent, or standby, rating. It might be in the

microwatt range or lower. But at high switching rates, the "low-power" CMOS circuit can dissipate tens of milliwatts or higher. And some ICs may be in danger of exceeding their dissipation ratings.

Specs may not be listed

Manufacturers don't always publish all the specs you might need. The reasons range from oversight and limited test procedures to just plain poor performance. For example, one or more of the following won't appear on an IC switch or multiplexer data sheet:

- Variation of ON resistance from one switch to another on the same chip.
- Guaranteed maximum switching rates.

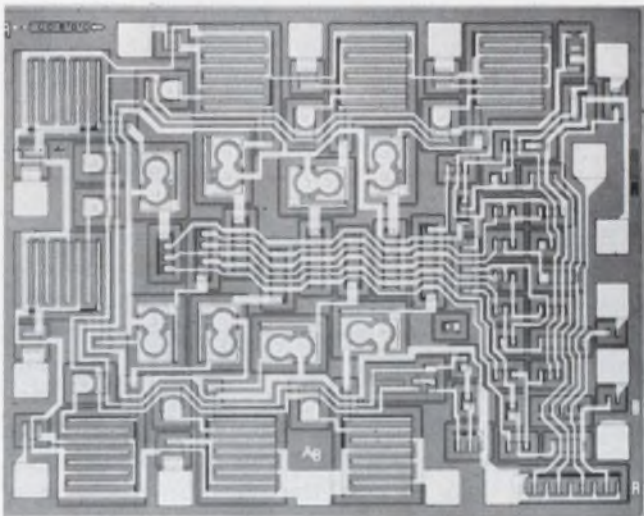

By combining bipolar drivers and JFET switches on the same monolithic chip, National Semiconductor achieves vastly improved resistance characteristics. The LF 11305, an 8-channel multiplexer, specifies resistance variation as a mere 1% over the input-voltage range.

- Thermal, or inverse-frequency ($1/f$), noise, which limits the transmission of low-level signals.
- Crosstalk between two switches when one or both are closed.
- Transmission frequency, or the 3-dB point, and distortion for wideband and audio applications.

Moreover data sheets tend to ignore the fact that switches and multiplexers generate transient spikes under a variety of normal operating conditions. For instance, a break-before-make switch produces input current spikes when the output capacitance charges to a new level. These spikes are twice as large as those caused by any make-before-break overlap. In some multiplexers, transients arise when inadvertent, built-in delays cause momentary selection of the wrong channel.

More importantly, data sheets usually don't

specify charge injection, or transfer—the charge coupling between switch gate to drain. Called "the worst spec to spec" by some engineers, charge coupling leads to errors that can't be compensated for easily. In sample-and-hold applications, for example, charge dumps onto the holding capacitor and causes a critical error.

Still, the advantages offered by IC switches and multiplexers easily outweigh the difficulties in selecting them. Monolithic switches can replace electromechanical relays, eliminating troublesome contact-bounce transients and increasing switching speed to less than a microsecond. IC multiplexers allow computer-controlled switching of analog signals in front ends of discrete-intelligence systems. These systems are growing in use because of LSI microprocessors.

For these reasons and more, manufacturers are responding to the increasing demand for switches and multiplexers in unique ways.

Harris modifies DI

Early multiplexers from Harris Semiconductor employed the company's older dielectric-isolation technique, intended more for digital circuits than linear. Now those units have been replaced with upgraded versions and new types that handle high-voltage inputs and supplies. And most offer extensive fault protection—those that carry the suffix A in their model numbers.

For example, the manufacturer's HI-507A, a dual 8-channel multiplexer, offers these protective features: It can tolerate signals at the input even with no power supplies connected, and it can safely handle signals that are ± 20 V in excess of supply. Further, the circuit's inputs can tolerate static potentials in excess of 600 V for 10 μ s.

The company's HI-507, the standard-DI version, requires current limiting to achieve the same degree of protection. Competing pin-compatible CMOS multiplexers either don't offer the protective features of the A version or, like the HI-507, they do when current limited. But the A version has the highest ON resistance—up to 2000 Ω (at high temperatures) vs 500 Ω or less for the other units.

However, the high ON resistance provided by fault-protected DI usually doesn't cause a high offset, or error, voltage. This is because the circuits have a low leakage current of around 0.25 μ A. As a result, the offset is only about 0.5 mV. Moreover the HI-507A dissipates only 15 mW at a switching rate of 100 kHz, although its quiescent rating is 8 mW.

Reduced leakage and very low dynamic dissipation are among the direct benefits from

DI. The process involves conventional diffusion steps, but it uses a specially prepared wafer. To make a DI wafer, deep grooves are first etched into an n-type, single-crystal wafer. Then polycrystalline silicon fills in the grooves to form a flat, nonconducting substrate. The final step involves a lapping operation that exposes isolation walls—the valleys of the original grooves.

Though DI automatically avoids parasitic four-layer structures, circuits can be damaged by continuous currents of greater than 50 mA or current spikes of greater than several hundred milliamps—hence the need for protective circuitry. By incorporating the circuitry on the chips, Harris eliminates up to 40 external components that would otherwise be needed for a 16-channel multiplexer. Moreover if one channel becomes shorted, the remaining channels can continue to transmit data.

Besides the HI-507A, other fault-protected multiplexers are the 506A, 508A and 509A—16, 8 and differential 4-channel units respectively. Similar circuits—the HI-506 and 507 (without the A)—trade off overvoltage protection to decrease the ON resistance to about 500 Ω .

Also offered by Harris are the HI-200 and 201, dual and quad, single-pole-single-throw (spst) switches. Like the 506 through 509 multiplexers, these switches are DI versions of units originally introduced by Siliconix. Both switch types have circuits that feature ON resistances of less than 100 Ω . In addition the 5040 through 5051 circuits, containing combinations of four switches and based on ICs introduced by Intersil, have ON resistances of 75 Ω (the value for Intersil's switches) and 30 Ω .

Intersil floats MOSFETs

The IH5040 through 5047 switches from Intersil represent the first use of the floating body structure. The manufacturer has also employed the technique for 16 and dual 8-channel multiplexers called, respectively, the IH5060 and IH5070. These units are pin-compatible with similarly numbered Siliconix and Harris versions.

The term "floating body" refers to the fact that a p-type well (for n-channel devices) can float electrically, without a direct voltage applied. Instead, the body voltage comes through a back-to-back diode voltage divider. The diode structure results automatically because the well, or body, isn't tied to the negative supply.

The diode structure provides direct protection against overvoltages without the need for external components. With the IH5040 family, the input signal level can be exceeded by up to ± 25 -V overvoltage when the circuit operates from ± 15 -V supplies. And for any input signal between -11 and $+11$ V, switches in the family have a

maximum ON resistance of 75 Ω . The IH5040 family consists of spst, spdt, dpst, dpdt, 4pst and dual versions of each. Both the switches and the multiplexers have built-in, additional gate delays that ensure break-before-make overlap.

The floating-body technique, however, does have some drawbacks: primarily, increased leakage and reduced peak-to-peak voltage capability. Off-leakage current, specified at 5 nA and higher, exceeds the typical value of 1 nA in conventional CMOS circuits. And in applications where each side of the switch goes to opposite-polarity supplies, peak handling capacity is specified as 22 V (pk-pk) minimum, and about 26 V (pk-pk) typical. Thus you cannot switch 30-V pk-pk with ± 15 V supplies, as you can with other CMOS versions.

Interestingly, Intersil also uses floating-body

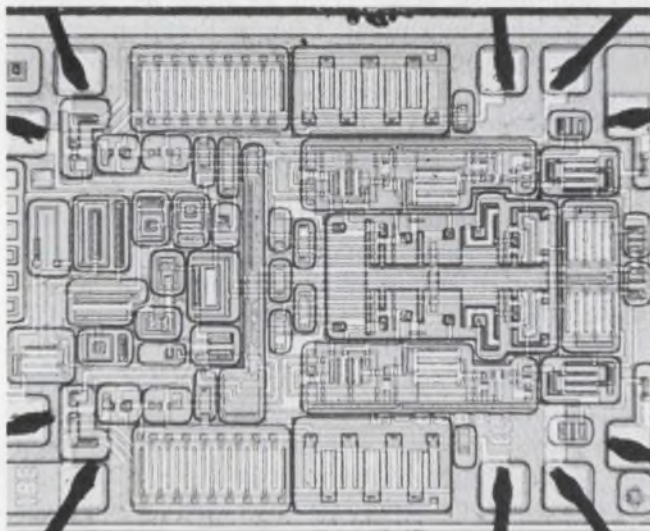

A dual single-pole single-throw CMOS switch—the HI-200 from Harris Semiconductor—features ON resistances of less than 100 Ω .

CMOS in hybrid circuits for applications requiring low leakage and ON resistances of 30 Ω or less. Based on the Siliconix DG 180 through 191 hybrid switches, the Intersil versions (IH5048 through 5051) employ CMOS drivers and separate varactor-diode-FET switches. Circuits can turn on in 150 ns and off in 100 ns.

The monolithic multiplexers feature a second level of multiplexing, or two-tier design, that simplifies extension to a 32, 64 or higher channel system. Intersil says it also leads to reduced output leakage and capacitance. With two IH5060s, for example, in a 1-of-32 multiplexer system, the company estimates there is about 10 nA of typical room-temperature leakage. Further, the throughput speed would be 0.8 μ s (switch turn-on) and the throughput channel resistance about 250 Ω . System performance for other than

typical specs isn't indicated in preliminary application notes.

Siliconix upgrades established models

The first 16-channel CMOS multiplexers were pioneered in the DG506 series from Siliconix—the company generally regarded as the leading manufacturer of IC and hybrid analog switches and multiplexers. Siliconix also introduced CMOS spst transmission gates in its DG200 series.

But the original circuits inadvertently introduced the terms “latchup” and “SCR action” into the lexicon of system designers. So back to the drawing board went the chip designs. Now Siliconix has come up with a process modification that overcomes those early problems while maintaining, or even boosting, the original specs.

The modified process inserts a buried layer beneath the n-channel body. The effect of the layer is to slash the product of parasitic npn and pnp-device betas from as high as 1000 or more to less than unity. Thus SCR action cannot be triggered under any condition. However, new models using this process still require current limiting to protect against conditions that lead to input levels that are higher than supply or to inputs without supplies.

With the elimination of latchups, Siliconix has been able to boost current capabilities to new highs. The DG200, a dual spst, now can deliver up to 100 mA for 1 ms over a 10% duty cycle. On a continuous basis, the IC can output 20 mA.

Other specs have come through the process transformation with little change. New models still allow a ± 15 -V analog signal range when the same supply levels are employed. The upgraded versions list maximum ON resistances of 70 and 175 Ω for the DG200 and DG201 switches, respectively. A maximum resistance of 400 Ω applies to the DG506 through 509 multiplexers.

Further, Siliconix guarantees TTL and CMOS compatibility over the full MIL-temperature range without external components. However, total dissipation can exceed 150 mW, most of which results from the TTL-to-CMOS converter circuitry.

National integrates JFETs

Meanwhile, National Semiconductor has developed two separate monolithic processes that employ JFETs for improved resistance characteristics. The BI-FET process combines bipolar drivers and JFET devices on the same switch or multiplexer chip; the other process leads to monolithic all-JFET switches. Both product families aim for sockets currently occupied by CMOS or hybrid circuits.

The BI-FET units encompass 16, dual-8 and 8-channel multiplexers in the LF11300 series and quad switches in the LF11330 series. These circuits are pin-compatible with functionally similar CMOS models. The IC JFETs include the AM0181 switch family (with pinouts based on the DG181 hybrid line) and the AM 9709 current-mode series, monolithic versions of the 5009 series of hybrid switches from National and Intersil.

Compared with competing CMOS versions, the BI-FET 8 and 16-channel multiplexers offer lower typical ON resistances—250 to 350 Ω vs 400 Ω and higher for CMOS. In addition ON

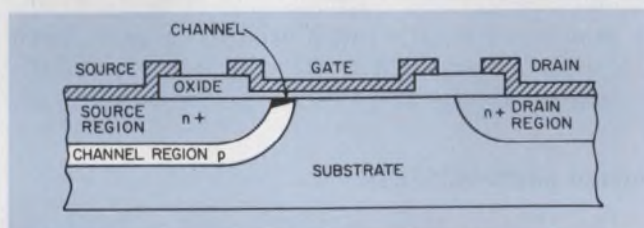
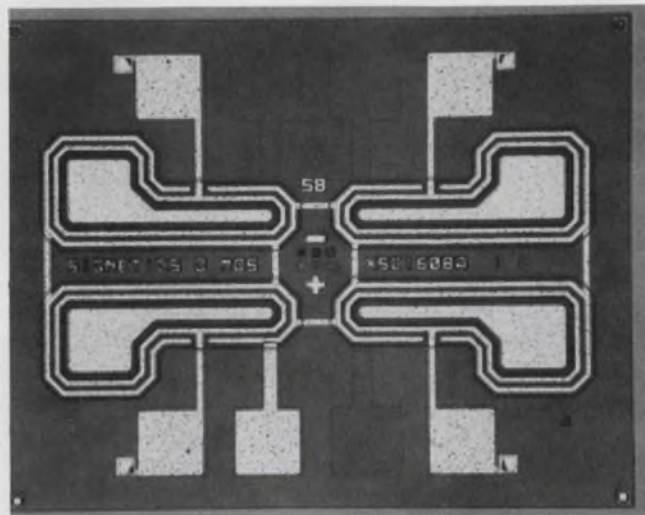

An additional p-type region between source and drain accounts for the reduced parasitic capacitances of DMOS—Signetics' approach to switches and multiplexers. The device's channel (as short as 0.9 μ) is formed where the p-type region comes to the chip's surface. The SD 5100, a DMOS 4-channel multiplexer, has an input range of 0 to 30 V.

resistances have a variation of only 2% between channels, and the resistances are virtually constant over much of the analog input-signal range. National specs 1% resistance variation for input signals of -10 to $+10$ V and for frequencies up to 100 kHz. CMOS versions list much higher percentages for ON resistance variations.

Other specs are also impressive. The BI-FET multiplexers have low leakage currents of about 0.05 nA at the inputs and 0.4 at the outputs. Further, the ICs reduce crosstalk to -94 dB at 1 kHz and increase the transmission frequency to a range of 15 to 18 MHz. Break-before-make

switching is guaranteed over the range of operating temperatures and analog swings.

The BI-FET process relies on ion-implantation techniques to construct p-channel JFETs along with other devices in a monolithic analog circuit. With conventional approaches, JFETs would have maximum breakdown voltages of 6 V—too low for switches—while offsets and drifts would be too high. The BI-FET approach overcomes these and other deficiencies in a process that National says doesn't increase manufacturing costs. The company expects volume quantities of the quad switches to sell for less than \$3 a unit, or below the price of competing units.

Similarly the AM series uses ion implantation to achieve a relatively inexpensive reduction in the variation across a JFET wafer of key parameters, such as pinch-off voltage. As a result, switching speeds are well under 100 ns, and ON resistances between switches can be matched to within a few ohms. The AM0181 series includes a proprietary switch that increases the number of independent switches, and their drivers, to four.

Signetics pioneers DMOS

For applications requiring very low ON resistance, very fast switching speed and high signal purity, no monolithic switch array can beat the Signetics SD5000 series. The double-diffused MOS (DMOS) family boasts an ON resistance of only 30 Ω and a turn-on time of just 1.5 ns. Moreover the family specs a crosstalk between switches of -105 dB and an output-to-input isolation of -120 dB. Like National's new AM9709 current-mode switches, the Signetics SD5000 family provides monolithic replacements for the 5009 hybrid line.

The high-speed DMOS technique is an enhancement-mode, n-channel MOS process that previously had been applied to rf devices. Unlike conventional NMOS structures, DMOS has an extra p-type region between source and drain. The channel is formed where this region comes to the chip's surface. And its length can be controlled accurately by a double-diffusion technique similar to that used to fabricate bipolar devices.

Typically channel lengths are only 0.9 to 1 μ . Hence the amount of parasitic capacitance per unit of ON resistance can be reduced drastically. For the SD5000 circuits, input, output and feedback capacitances are, respectively, just 1.0, 0.1 and 0.3 pF.

Each IC in the SD5000 family consists essentially of four monolithic switches, but with different analog-signal ranges. The SD5000 can handle a full ± 10 -V range, while the SD5001

has a ± 5 -V analog capability. Unipolar ranges are specified in four-channel multiplexer versions. The SD5100 multiplexer has a 0-to-30-V input range, and the SD5101 handles 0 to 15 V.

More recently, Signetics has applied DMOS to a crosspoint switch intended for telephone applications. Called "the ultimate analog switch" by Signetics, the new circuit involves 16 analog switches and a memory that can be addressed by shift registers. So any switch can be turned on until the memory is addressed to turn it off. The telephone application creates stringent requirements for an analog switch because of the need for low crosstalk and insertion loss.

Other ICs enhance basic capabilities

For other manufacturers, the major switch and multiplexer offerings were intended to be duplicates of older, popular types. But on the way to market, subtle enhancements have been built into the products. And many of these have led to direct improvements in one or more key specifications.

The models for most have been the CMOS switches and multiplexers introduced by RCA in the 4000-series of COS/MOS circuits. Though primarily a digital family, the series contains several ICs for analog switching. From among the host of 4000-series alternate sources, you're likely to find, at the very least, the 4016 quad switch and its upgraded version, the 4066. The popular multiplexers include the 4051, 4052 and 4053 series of 8, dual-4 and triple 2-channel units, respectively.

Higher-channel-capacity multiplexers are emphasized in recent additions to the RCA line. The CD4067BD and CD4097BD multiplexers provide 16 and dual-8 channels, respectively. And they allow supply voltages of 3 to 18 V, though key specs are listed for supply levels no higher than 0 and +15 V, or ± 7.5 V.

Within this range, typical ON resistance varies from 140 to 400 Ω , while resistance variation between channels is only 5 to 10 Ω . The data sheet also lists sine-wave distortion—not usually specified—at 0.1 to 2% typical. When all channels are off, the highest typical leakage spec of ± 3.2 mA results.

One alternate source for the 4016 is Analog Devices. This manufacturer offers the equivalent AD7516. Other catalog listings are based on circuits originally introduced by vendors other than RCA. Analog Devices' AD7506 and 7507 multiplexers, for example, are pin-compatible with like numbered units from Siliconix; other ICs base pinpoints on Harris parts.

A major enhancement in the Analog Devices versions is reduced quiescent dissipation. The manufacturer employs digital techniques to fab-

ricate the IC's TTL-to-CMOS level converter, and thus avoids the usual comparator-type circuitry found at digital inputs. The digital approach decreases static dissipation to a few hundred microwatts or less.

Staying with 4000-series ICs, Fairchild Semiconductor plans to add the new 4067 multiplexer to its line of popular COS MOS-based circuits. Introduction is scheduled for the next quarter. Standard CMOS circuits at Fairchild employ the company's Isoplanar process, which leads to reduced chip sizes and hence lowered manufacturing costs. Like most manufacturers of the 4000 series, Fairchild has extended supply levels to 18 V and decreased some of the wide variations in ON resistance—a limitation of early circuits.

In other improvements, Motorola's MC14016 (the company's 4016 version) eliminates the so-called deadbands of older models. In the forthcoming MC14066, digital noise immunity will be increased to 45% of supply levels through the addition of buffered control. And the new switch won't be prone to the current gain (and resulting instability) found in 4016-type switches. Motorola plans further enhancements in the MC14051 through 14053 multiplexer ICs when they, like the MC14066, are introduced next quarter.

At Siltek, switch/multiplexer designers have reduced ON resistance while boosting dynamic performance. Typical ON resistance values for the SIL-4051B through 4053B multiplexers are 100 Ω with a 10-V supply and 70 Ω at 15 V. Worst-case resistances at these supply levels are, respectively, 300 Ω and 175 Ω . Typical multiplexer propagation delays, from address input to output, are 100 ns with a 10-V supply and 80 ns at 15 V—with a 50-pF and 10-k Ω load.

Further, the Siltek multiplexers don't exhibit the transient spikes that can arise in competing units because of differential address delays. These delays cause momentary selection of channels not addressed. Other transients can appear when inadvertent inhibit-circuit delays, like those in 4051-type units, cause the momentary selection of the seventh channel on removal of the inhibit signal.

Aiming for 506/507 multiplexer sockets, rather than 4000-series sockets, Teledyne Philbrick offers the Model 4552 (16-channel) and 4551 (dual 8). The multiplexers guarantee overvoltage of ± 35 V with ± 15 -V supplies. However, the room-temperature ON resistance is 1.8 k Ω , and data sheets suggest the use of pull-up resistors for TTL compatibility.

Enter silicon-on-sapphire

In a departure from the usual trend of 4000-series sources to stay with bulk CMOS, Solid-

State Scientific employs silicon-gate, silicon-on-sapphire (SOS) techniques in a quad switch, the SCL 4066S.

The SOS circuit trades off higher leakage for higher speed. Compared with an equivalent bulk-CMOS circuit—also offered by Solid-State Scientific and designated with a suffix A—the SOS version increases speed by a factor of three. And it has an ON resistance of 50 Ω or less. However, it also increases leakage by a factor of three, for a worst-case value of about 300 nA.

In standard CMOS, Solid-State Scientific has tackled the latchup problem by enlarging device geometry in bilateral switches. The result is a reduction in the beta product, so that the possibility of latchup is reduced. Further, several chip designs have been made symmetric, to avoid the usual directional tendency exhibited by ON parameters in competing circuits. ■■

Need more information?

Readers may obtain more information on manufacturers' products by consulting ELEC-TRONIC DESIGN's Gold Book or by circling the appropriate information retrieval number in the following list.

- American Microsystems, Inc., 3800 Homestead Rd., Santa Clara, CA 95051. (408) 246-0330. (Stephen Jasper) **Circle No. 401**
- Analog Devices, Inc., P.O. Box 280, Route 1 Industrial Park, Norwood, MA 02062. (617) 329-4700. (Richard Ferrero) **Circle No. 402**
- Burr-Brown Research Corp., 6730 S. Tucson Blvd., Tucson, AZ 85734. (602) 294-1431. **Circle No. 403**
- Dionics, Inc., 65 Rushmore St., Westbury, NY 11590. (516) 997-7474. (George Seaton) **Circle No. 404**
- Fairchild Semiconductor, 464 Ellis St., Mountain View, CA 94042. (415) 962-5011. (Larry Wittenbaugh) **Circle No. 405**
- General Instrument Corp., 600 W. John St., Hicksville, NY 11802. (516) 733-3000. **Circle No. 407**
- Harris Semiconductor, P.O. Box 883, Melbourne, FL 32901. (305) 727-5400. (Frank Abreu) **Circle No. 408**
- Hughes, Microelectronics Products Div., 500 Superior Ave., Newport Beach, CA 92663. (714) 548-0671 **Circle No. 409**
- ILC Data Device Corp., Airport International Plaza, Bohemia, NY 11716. (516) 567-5600. (Jack R. Alford) **Circle No. 406**
- Intersil, Inc., 1333 Lawrence Expressway, Santa Clara, CA 95050. (408) 996-5264. (George Krautner) **Circle No. 410**
- ITT Semiconductor, 3301 Electronics Way, West Palm Beach, FL 33407. (305) 842-2411. **Circle No. 411**
- Motorola Semiconductor Products, P.O. Box 20912, Phoenix, AZ 85036. (602) 244-3810. (Steve Goodfellow) **Circle No. 412**
- National Semiconductor Corp., 2900 Semiconductor Dr., Santa Clara, CA 95051. (408) 732-5000. (Adib Hamade) **Circle No. 413**
- RCA Solid State Div., Route 202, Somerville, NJ 08876. (201) 722-3200. (George Granieri) **Circle No. 414**
- Signetics, 811 E. Arques Ave., Sunnyvale, CA 94086. (408) 739-7700. (Russ Hansen) **Circle No. 415**
- Siliconix, Inc., 2201 Laurelwood Rd., Santa Clara, CA 95054. (408) 246-8000. (Jim Spicer) **Circle No. 416**
- Siltek International Ltd., Airport Industrial Pk., Bromont, Quebec, Canada, JOE 1LO. (514) 534-2255. (Roger T. Griffin) **Circle No. 417**
- Solid State Scientific, Inc., Montgomeryville Industrial Center, Montgomeryville, PA 18936. (215) 855-8400. (Bruce H. Benjamin) **Circle No. 418**
- Teledyne Crystalonics, 147 Sherman St., Cambridge, MA 02140. (617) 491-1670. **Circle No. 419**
- Teledyne Philbrick, Allied Dr. at Route 128, Dedham, MA 02026. (617) 329-1600. (Al Lukas) **Circle No. 420**
- Teledyne Semiconductor, 1300 Terra Bella Ave., Mountain View, CA 94043. (415) 968-9241. **Circle No. 421**
- Texas Instruments, P.O. Box 5012, Mail Station 914, Dallas, TX 75222. (214) 238-3741. **Circle No. 422**

VACTEC brings you BLUE



Unlike our little Japanese friend, photodetectors have always been insensitive to blue. Until now.

Vactec's latest development is a new Blue Enhanced Silicon (BES) photodiode with exceptionally low dark current for efficient response in the blue region (200 - 400 nm). Made in Missouri, U.S.A., it performs equally well in an expensive Japanese SLR camera or in an American-made colorimetric analyzer as well. And you'll like the price, which could be as big a breakthrough as blue sensitivity. Vactec also introduces a new line of PIN photodiodes that operate at high voltages, low noise levels, and fast rise times, with about half the blue sensitivity of the BES photodiode. For larger areas, Vactec offers a complete range of Blue Enhanced Silicon photovoltaic cells up to 1 1/8" diameter.

Vactec now supplies the broadest line of photodetectors in the industry, including:

- silicon solar cells
- hi-speed / low-leakage silicon cells
- NPN phototransistors
- NPN photodarlington
- CdS & CdSe photoconductors
- CMOS & bi-polar custom ICs
- opto-couplers
 - a) LED / photoconductor
 - b) LED / phototransistor or darlington
 - c) lamp / photoconductor
- selenium photovoltaic cells

Call or write today:



Vactec, Inc.

**2423 Northline Industrial Blvd.
Maryland Heights, Mo. 63043
(314) 872-8300**





Nichicon quality makes a world of difference

Today, selecting the right capacitor is more than a job. It's an art. Applications vary so much. Home entertainment. Computer. Automotive. Industrial electronics.

To meet your capacitor needs and to do it right, you need a special kind of capacitor. A Nichicon capacitor. We make Electrolytic Capacitors, Ceramic Capacitors, Film Capacitors, Oil-Filled Capacitors (without P.C.B. available), Metallized Paper Capacitors, Wax Paper Capacitors, Mica Capacitors, and even Hybrid IC's and

P.T.C. Thermistors.

So call Nichicon or the Nichicon representative/distributor in your area. Discuss your specs with him or write us direct for your free technical catalogs. You'll see for yourself that Nichicon does make the difference. With quality capacitors, personal attention—a kind of human, one-on-one way of doing business.

A capacitor that's reliable and dependable, too? It's more than possible. It's available. Just give us a call.

REPRESENTATIVES

ALABAMA
Interep Assoc., Inc.
(205) 881-3677

ARIZONA
Chaparral
(602) 996-9648

CALIFORNIA (Northern)
Caltron/Pyle
(415) 964-3244

CALIFORNIA (L.A.)
Varigon Associates
(213) 679-0621

CALIFORNIA (San Diego)
Varigon Associates
(714) 299-5413

COLORADO
Component Products
Sales
(303) 444-2730

CONNECTICUT
Impact Sales Co., Inc.
(203) 281-1331

FLORIDA (Southern)
Reptronics, Inc.
(305) 251-5478

FLORIDA (Northern)
Reptronics, Inc.
(813) 522-8220

GEORGIA
Interep Assoc., Inc.
(404) 394-7756

ILLINOIS
Midwest Electronic Inds.
(312) 777-9700

INDIANA
Midwest Electronic Inds.
(317) 253-0590

IOWA
Midwest Electronic Inds.
(319) 362-4410

KANSAS
Mid-America Electronics
(913) 236-4800

MARYLAND
Component Sales
(301) 484-3647

MASSACHUSETTS
Impact Sales Co., Inc.
(617) 893-2850

MICHIGAN
Greiner Assoc.
(313) 499-0188

MINNESOTA
Robert W. Marshall
Co., Inc.
(612) 929-0457

NEW YORK METRO
Nichicon America Corp.
(516) 567-2994

NEW YORK STATE
Leonard D. Allen, Inc.
(315) 458-7470

NORTH CAROLINA
Component Sales
(919) 782-8433

OHIO (Cleveland)
K W Electronic Sales, Inc.
(216) 831-8292

OHIO (Dayton)
K W Electronic Sales, Inc.
(513) 890-2150

PENNSYLVANIA (Western)
K W Electronic Sales, Inc.
(412) 487-4300

TEXAS
William Reese Assoc.
(214) 638-6575

WASHINGTON
Ray Over Sales
(206) 454-4551

WISCONSIN
Midwest Electronic Inds.
(414) 542-5129

WEST COAST DISTRIBUTORS
SEATTLE, WASH.
Bell Industries
(206) 747-1515

LOS ANGELES
JACO Electronics
(213) 887-6400

MID WEST
MINNEAPOLIS, MINN.
Hall Mark Electronics
(612) 925-2944

CHICAGO, ILL.
Hall Mark Electronics
(312) 437-8800

CHICAGO, ILL.
Midwest Electronic Inds.
(312) 777-9700

DALLAS, TEXAS
Hall Mark Electronics
(214) 231-5101

EAST COAST
PHILADELPHIA, PA.
Hall Mark Electronics
(215) 355-7300

HUNTSVILLE, ALA.
Hall Mark Electronics
(205) 539-0691

ORLANDO, FLA.
Hall Mark Electronics
(305) 855-4020

CANADA
TORONTO, ONTARIO
Audio Electronics, Inc.
(416) 495-0720

MONTREAL, QUEBEC
Audio Electronics, Inc.
(514) 735-6197



nichicon

We help keep your world turned on.

NICHICON (AMERICA) CORP., 6435 N. Proesel Ave., Chicago, Ill. 60645 • 312/679-6530
New York Branch: 40 Orville Dr., Bohemia, N.Y. 11716 • 516/567-2994
Division of **NICHICON CAPACITOR LTD.**, Kyoto, Japan

Burroughs SELF-SCAN[®]... panel

NEW DIMENSIONS in electronic displays

Now, there's a whole new dimension in electronic readouts: Burroughs' new SELF-SCAN II display panels . . . the most advanced, most versatile display ever. There's nothing else like it in the world. SELF-SCAN II panels, with bright, large multi-digit alphanumeric characters, permit an entirely new display concept.

SELF-SCAN II panels can open up new applications for electronic displays. As single panels, they are ideal for point-of-sale displays, computer applications, moving message centers, and others; as modular building blocks, for attention-getting displays in airport terminals; for surface communication systems; for store window displays. Whatever the application, their high brightness and extra-wide viewing angle make them more cost effective, more visible and readable than other readouts.

VERSATILE The modular design of the 20-character SELF-SCAN II panel means it can be butted horizontally, and stacked vertically to appear as one large display. You can assemble displays of almost unlimited size in various combinations without sacrificing performance.

READABLE The large, 0.7-inch high characters can be read easily at 50 feet in high ambient light. The viewing angle is extra wide: 165°. The gas

plasma technology means that all characters are uniformly bright and sharp: no matching or alignment problems.

UNIQUE Combining the best of Burroughs' famous display products, SELF-SCAN and PANAPLEX[®] displays, the planar construction with screened electrodes of SELF-SCAN II means nothing moves . . . nothing wears. Only 18 external connections are required for 20 alphanumeric characters!



LOW COST

The price will amaze you—LESS THAN \$5 PER DRIVEN ALPHA-NUMERIC CHARACTER! Price includes display, drive electronics and modified 64-character ASCII subset character generator, in 1000-piece quantity.

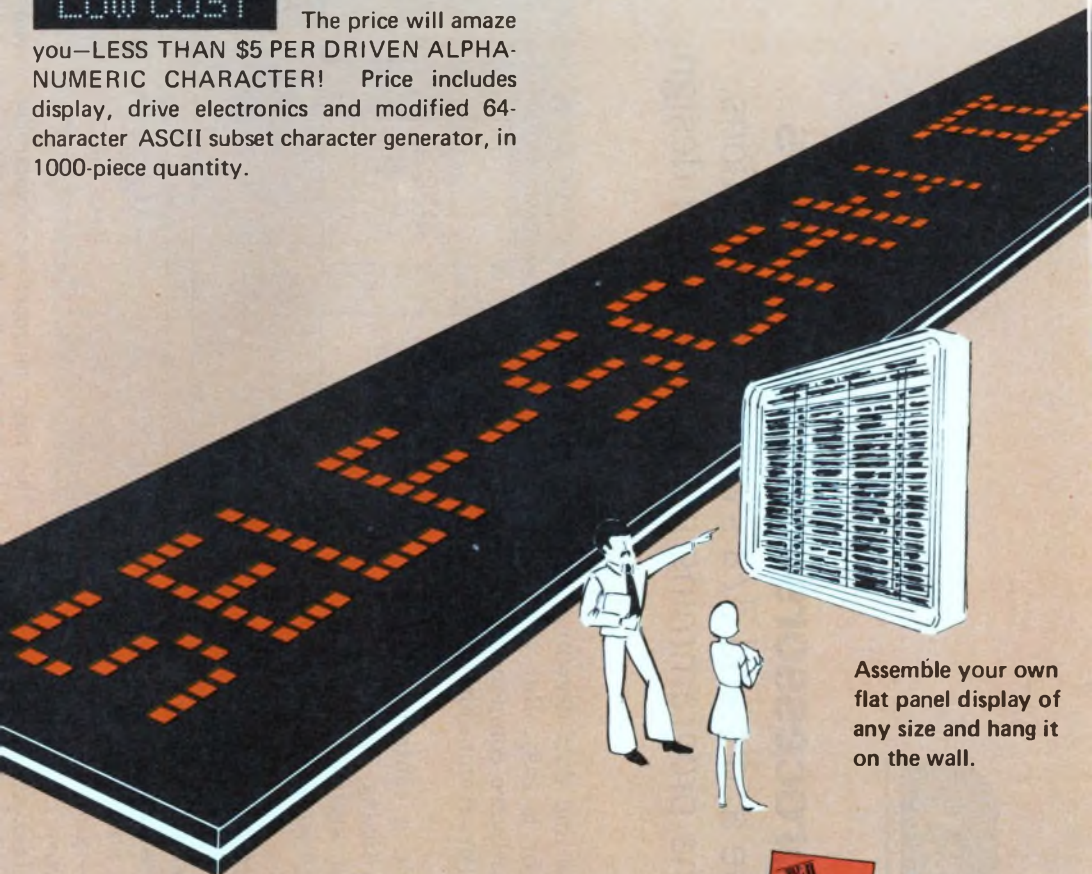

Assemble your own flat panel display of any size and hang it on the wall.

Burroughs' new SELF-SCAN panels are designed to interface with microprocessors. And they are available . . . NOW!!

To find out how you can build the information display you want with SELF-SCAN II panel displays, write or call Burroughs Corporation, Electronic Components Division, P. O. Box 1226, Plainfield, New Jersey 07061; or call our special sales/applications assistance number, (201) 757-3400, or (714) 835-7335 in California.

Write for:
"Self Scan II:
Important product information
from Burroughs"



Burroughs



INFORMATION RETRIEVAL NUMBER 45

Mating microprocessors with converters

calls for treating the a/d's and d/a's as memory locations. This can simplify the programming and input/output design.

Interfacing data-acquisition and data-decoding systems with a microprocessor is easy. But you must be familiar with all hardware components, the software requirements (programming) and circuit timing needs.

Use of a microprocessor in a control system that has analog sensors and analog actuators or displays requires the analog signals from the sensors be digitized and the processor outputs be converted to analog form.

With over a dozen different microprocessor chip sets and hundreds of different analog-to-digital and digital-to-analog converters available, complex tradeoffs between software and hardware are needed. Ideally you should try to minimize processor execution time and the processor-to-converter interface hardware.

But how would you begin in a system like the one in Fig. 1? It consists of a National IMP-16C microprocessor,^{1,2} a Micro Networks MN-7000 data-acquisition module³ and a Burr-Brown DAC-85 d/a converter.⁴ To put the system together, follow three basic guidelines:

- A/d and d/a converters should be addressed as part of the main memory, because they can respond just as quickly.
- A software-initiated converter-to-processor transfer requires little interface hardware and a minimum of processor time, and the method introduces the least delay on the signal.
- A chain consisting of a processor, a d/a and an a/d permits very simple end-to-end system testing for self-calibration and performance checking.

Converters: Small, fast peripherals

Peripherals such as tape readers or typewriter terminals are usually slow devices. They communicate with the computer over a separate data bus tied into the computer bus with a set of switches. In the conventional approach, a special set of instructions must be used to fetch data

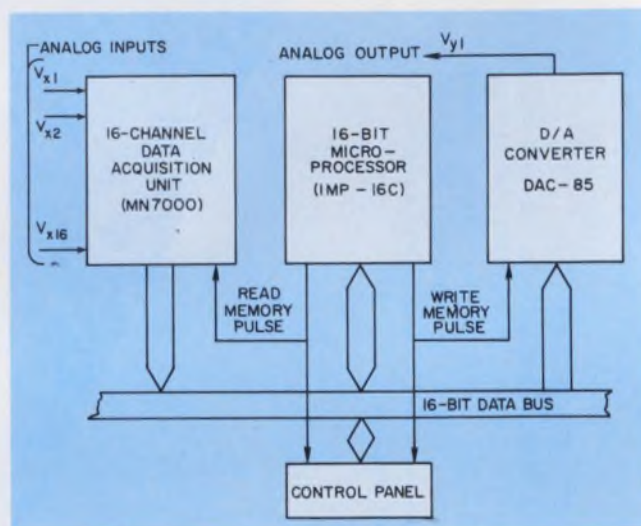

1. This basic microprocessor-controlled data-acquisition system consists of a 16-channel a/d converter, a 12-bit d/a converter and a processing unit, all connected through the data bus.

from or load data into the peripherals. For the required input/output operations (I/O), a control word—similar to an address word—is first transmitted to the peripheral. Approximately one microcycle later the data word is either fetched or sent.

A/d and d/a converters differ from the common type of peripheral because they are small, fast and usually placed close to the computer. Some converters also have built-in storage: A/d's for storing the converted data and d/a's for holding the computer data word until the convert signal is given.

To the processor, an a/d or d/a converter can be made to appear as a memory location, with data being fetched from the a/d or stored in the d/a. This approach offers the following benefits:

- The memory-reference operations are faster than conventional I/O operations.
- No separate I/O bus is required.
- No additional bus switching circuits are needed.
- All memory-reference instructions can be used; the operand can be added directly to any of the computer's accumulators.

However, to access the converter directly a

Hermann Schmid, Senior Engineer, and George Mrozowski, Design Engineer, General Electric Co., P.O. Box 5000, Binghamton, NY 13902.

suitable address must be provided for the converters. Thus part of the memory should be allocated to these special peripherals. Let's assume that within the IMP-16C computer we have 64 k words of memory available, and let's divide the memory up as follows:

- Read-only-memory (ROM) locations (32 k): B15 = 1, B14 = 0.
- Peripheral locations (16 k): B15 = 0, B14 = 1.
- Random-access-memory (RAM) locations (16 k): B15 = 0, B14 = 0.

Now a 16-bit converter address can be formed, where B14 and B15 select the peripherals out of memory, B8 to B11 their mode of operation, B6 and B7 the type of peripheral and B0 to B3 the desired device or the channel in a multichannel system (Fig. 2).

Transferring data isn't difficult

Once the converter is addressed as a memory location, outputting data to a d/a or inputting data from an a/d is straightforward. D/a converters are easy to control—just execute a store

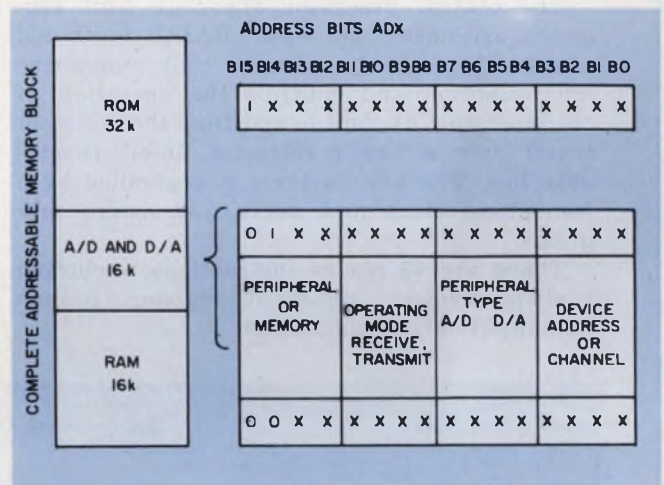

2. The 64 k words of directly addressable memory can be separated into three sections (a). Each address word is divided into four 4-bit control bytes (b).

operation to transfer data from the processor to the desired converter. Multichannel a/d converters are much more complex, since the desired channel must first be selected and conversion initiated before the processor can fetch the data.

D/a converters are easy to control—just use

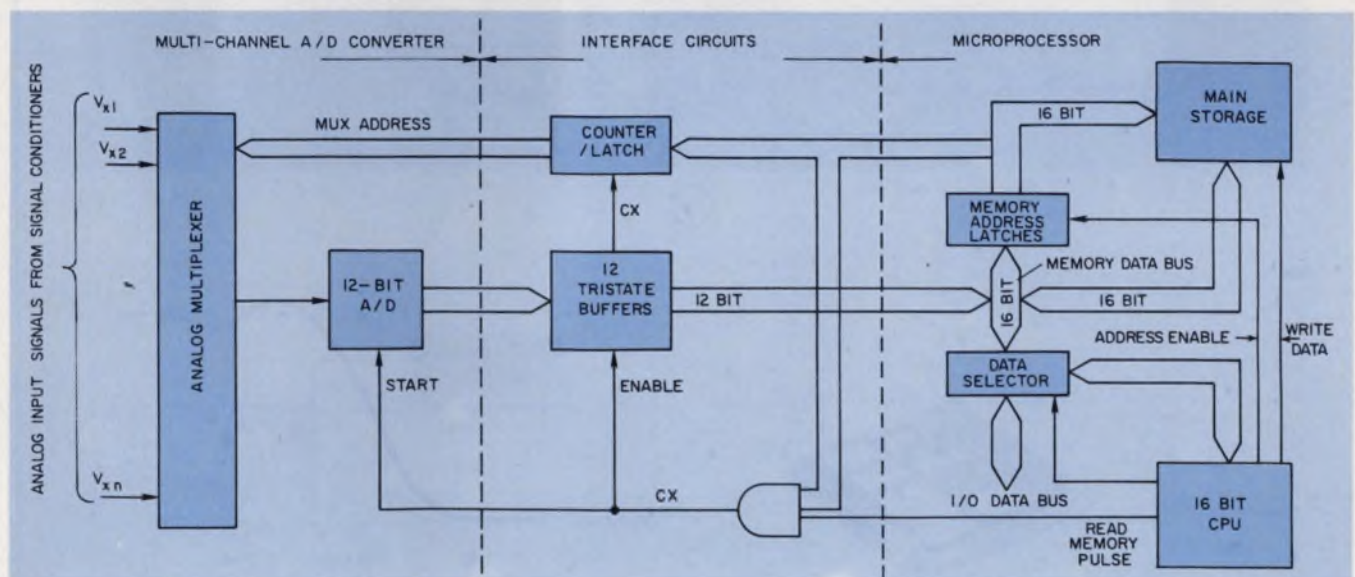

3. Converter-to-processor interface circuits connect the multichannel a/d converter to the processor, address

the desired channel and buffer the a/d output signals so the next sample can be worked on.

A look inside the three building blocks

What's inside the three major building blocks used in the accompanying article to form the microprocessor-based data-collection and control system?

The National IMP-16C is a 16-bit microprocessor mounted on a printed-circuit card. It consists of a central processing unit made from five LSI chips, a 256×16 -bit random-access memory, a 512×16 -bit read-only memory, clock and timing circuits, bus control logic and some other control circuits (Fig. A).

The central processor has four 4-bit registers, arithmetic and logic (RALU) units and a control read-only memory that stores the microprogram and controls the operation of the processor. All data to and from the processor travel over a time-multiplexed 16-bit parallel data bus. The bus, in turn, is controlled by a four-phase clock and micro and macro programs.

There are 43 macro instructions, including various memory, register-to-register, branch and input-output commands.

The MN-7000 a/d converter subsystem from Micro Networks contains a 16-channel multiplexer, a differential buffer amplifier, a sample-and-hold circuit, a high-speed, 12-bit successive-approximation a/d converter, a reference supply, a clock and control logic (Fig. B). The converter operation starts with control signals from the processor or internally generated trigger pulses. After the desired channel is selected from the multiplexer, the actual conversion begins.

After 12 clock periods, the conversion is completed, and the result is stored in the successive-approximation register. The "end of convert" signal is also generated when the data word is stored.

Burr-Brown's DAC85 d/a converter is a 12-bit hybrid-IC unit in a 24-pin metal dual in-line package (Fig. C). It is relatively high-speed (1 to 5 μ s), and it has an internal reference and output amplifier. The unit accepts a wide variety of input codes just by pin-jumping, and you also have a choice of output ranges. ■■

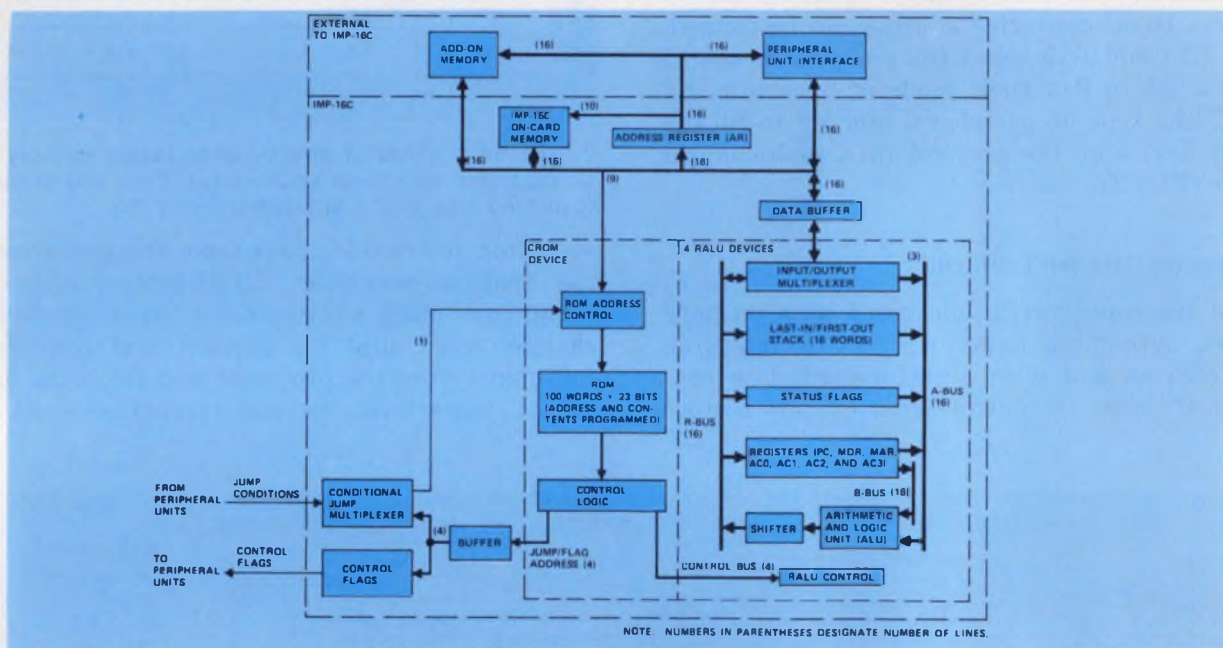

(A)

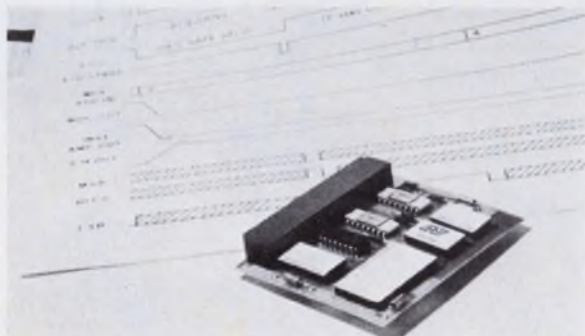

(b)

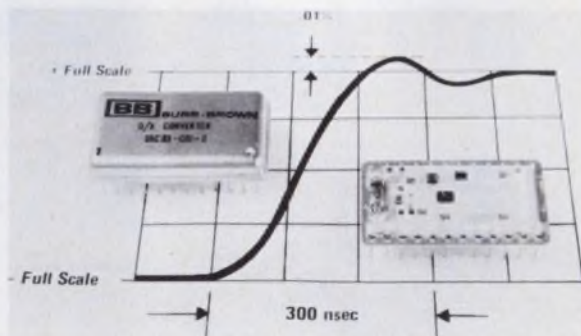

(c)

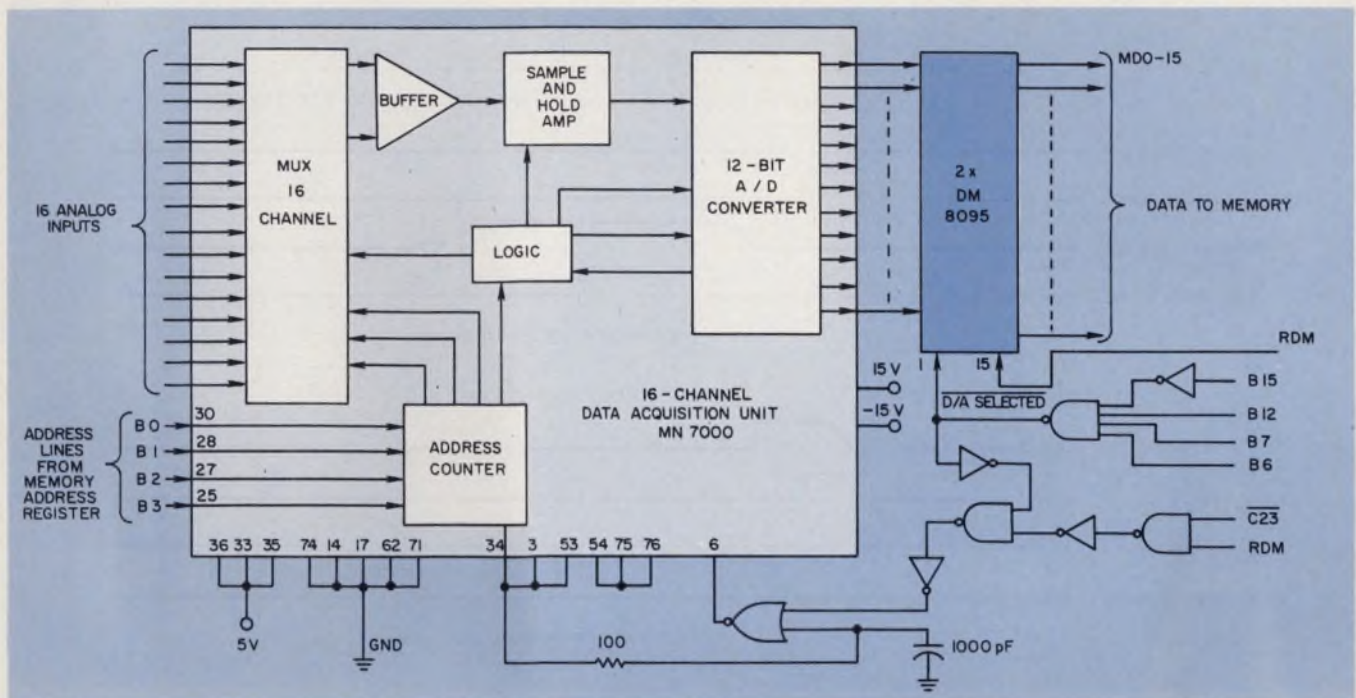

4. Logic circuits needed to control the Micro Networks MN-7000 data-acquisition module are very simple. They

provide complete processor control of the system under software command.

a store operation and then transfer the data in the memory location to the desired peripheral. Three conventional methods are used to fetch converter data from a multichannel a/d. In each, the converter initiates the transfer of data.

1. Interrupt-initiated transfer.
2. Direct-memory access (DMA) transfer.
3. Auxiliary memory transfer.

The interrupt method first addresses the a/d converter, selects the desired input channel and initiates the conversion process. When the conversion process is complete, the converter's end-

of-convert (EOC) signal interrupts the processor, which in turn fetches the converter data. This method requires little additional interface hardware, but it does need plenty of processor time and up to 12 macro instructions that must be stored in the computer memory.

Direct memory access permits the converter to run continuously, and after each conversion the EOC signal initiates a transfer of the converted signal to the main storage. Unfortunately this transfer can take place only when the data bus is not being used by the processor. Thus

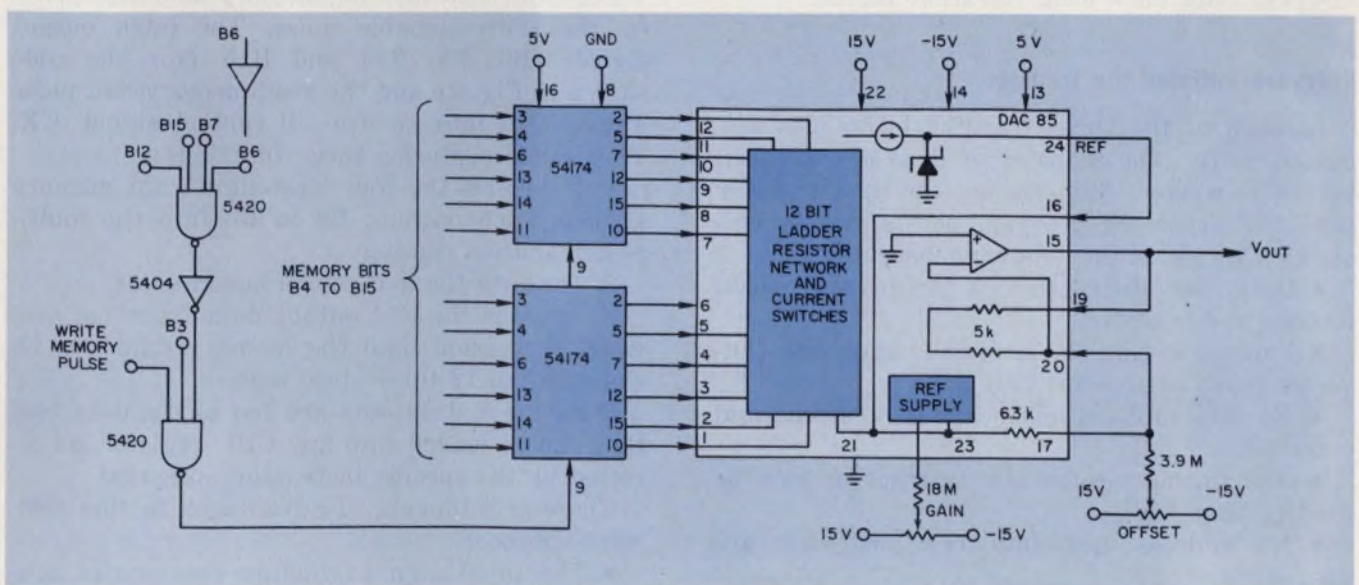

5. D/a converters can be interfaced easier than a/d's. All you need are several gates to enable two hex D flip-

flops, which then transfer the data, into the d/a converter weighting network or buffer register.

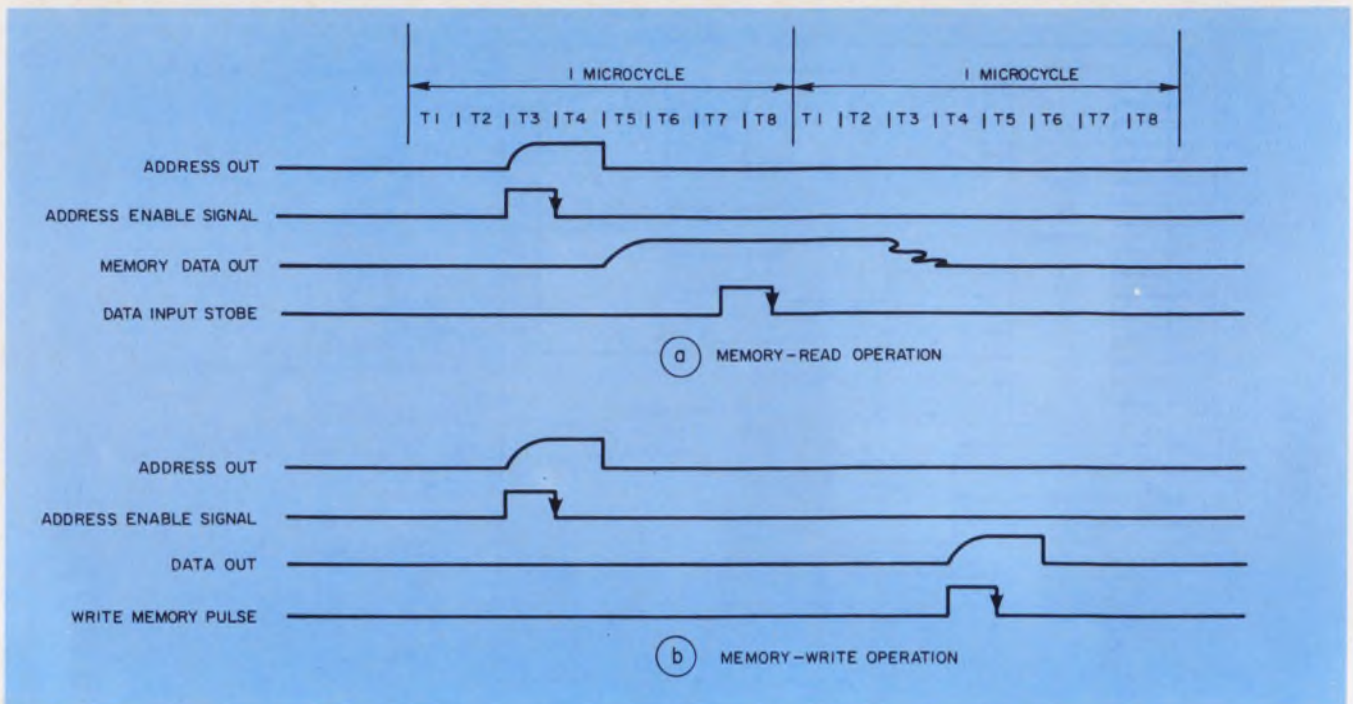

6. **Microprocessor timing pulses** for the memory-read (a) and memory-write (b) operations control inputs from

a/d's and outputs to d/a's. The timing pulses are initiated by software store or read commands.

additional interface hardware is needed and large delays are introduced (up to one iteration period), but no processor time is lost.

Auxiliary memory transfer works in the same way, except that the converter data are stored in an auxiliary memory, from which the processor reads the data. If the read and write cycles require only a half microcycle, they can be interlaced so little control hardware is needed. Processor time is also kept low, but delays are introduced, since the signals to be measured are sampled only once each iteration period.

Software initiates the transfer

In each of the three transfer techniques discussed so far, the transfer of data is controlled by the converter. But starting the data transfer with the processor program boosts system efficiency and yields the following benefits:

- Only one instruction is needed to select, initiate and transfer.
- Processor time is minimal, since the converter must be accessed only once.
- No interrupt subroutine must be stored and executed.
- Any memory-reference instruction can be used to transfer.
- No address and data bus switching are needed.
- The processor always receives the most up-to-date data with minimum delay.

The system in Fig. 3 operates the a/d converter under software control and addresses it like a memory location. Macro programs contain instructions to fetch converter data. Each time such an instruction is executed, the processor first outputs an address. The address, which selects the channel to be converted, starts the conversion process and fetches the previously converted word.

When the system operates, the central processor (CPU) transmits a 16-bit memory address, which is strobed into the memory address latches by the address-enable pulse. The latch output signals—B6, B7, B14 and B15 (for the code shown in Fig. 2) and the read-memory flag pulse are ANDed into an over-all control signal, CX. This signal performs three functions:

1. It presets the four least-significant memory address latch outputs B0 to B3 into the multiplexer address counter.
2. It starts the a/d conversion process.
3. It loads the a/d output data from the previous conversion onto the memory data bus by enabling the 12 three-state buffers.

Once the a/d outputs are fed to the data bus, they can be loaded into any CPU register, as directed by the specific instruction executed.

There are, though, disadvantages to this software approach:

- The input signal-sampling rate varies proportionately with the speed of program execution, especially when branching operations occur.

■ An additional burden is placed on the programmer; the processor must fetch the previously converted data while addressing the data needed next.

Interfacing circuits are simple

To interface the a/d with a processor, you need only initiate the operation with the decoded address signal and connect the converter output briefly to the memory data bus. Two hex three-state buffers (DM-8095) and a few logic gates are all that's needed (Fig. 4).

When the selected address and the "read memory" pulse are present, the three-state buffers are enabled. Simultaneously the "a/d selected" line and the "read memory" signal start the converter operation, and load the 4-bit channel address into the counter latch of the MN-7000.

The converter output data are then connected to the CPU input data bus with four 4-bit data selectors (DM-8123), just as if they were memory data in the IMP-16C.

To interface the processor with a d/a, store the computer output at the proper time and hold it until it is replaced by a new value. This can be achieved simply with two hex D-type flip-flop ICs (SN54174) and a few gates for decoding the address (Fig. 5).

Note that the address is stored in the address register of the microprocessor, just as when a memory store operation takes place. The data for the d/a are available from the start of T_1 ON (Fig. 6). When the write memory pulse signal goes low with the T_1 of the next microcycle, the computer output is loaded into the set of D flip-flops and held there until it is replaced by a different value. The d/a produces an analog voltage that is proportional to the value stored, and thus the voltage changes when the new value replaces the old one.

Troubleshooting the system

You've completed the wiring, turned on the power, but the system doesn't work. Now what?

Here are some simple steps you can follow to troubleshoot such a microprocessor-based data-acquisition system.

- Check the microprocessor without any converter or interface circuits.
- Test the converters alone.

Testing the converters alone calls for the following:

1. Jumping the a/d output to the d/a input.
2. Connecting +5 V or ground to the address inputs, as required by the converter address.
3. Using an external pulse generator to start

Subroutine for system self-testing

Task	Address	Machine instruction	Mnemonic	Comments
I	80	10C0	per Addr.	Input x + mux addr
	81	0400	R1N	
	82	0880	PFLG 8	Load AC2 with per addr Complement ACO (x) d/a addr
	83	89FC	LD2, -4	
	84	5000	CAIO	
	85	A00A	STO M10	
86	A2C2	STO, D/A		
II	87	850B	LD1, +9	Load mask into AC1 Mux addr a/d addr = per add + mux addr
	88	3483	RAND0, 1	
	89	3200	RADD2, 0	
8A	A80C	ST2, M12		
	III	8B	8200	LDO, AD-X
8C	A008	STO, M11		
IV	8D	C00A	ADDO, M10	x = a/d - x Right justify result Output result JMP to repeat conv.
	8E	5CFC	SHR SELO	
	8F	0600	ROUT	
	90	21EE	JMP-16	
	91	000F	MASK	

the a/d and a delayed pulse to strobe the d/a input latches.

4. Connecting a dc voltage to the addressed a/d input line and comparing the d/a output with the input voltage. Repeat this for several voltage levels.

Once the system is set up, you can test the a/d and d/a converters with the microprocessor and a simple software routine.

The subroutine lets you select, with the control panel, each a/d converter channel and the test voltage (see table). The number representing the test voltage is stored in the d/a memory. The difference between the input number, X, and the a/d output is displayed on the panel. The program performs four major tasks:

1. Fetches the number X from the control panel and loads the d/a converter.
2. Fetches the multiplexer address from the control panel and selects the input channel.
3. Reads and stores the a/d output.
4. Calculates and displays the error. ■■

References

1. Data sheet for IMP-16C microprocessor set, National Semiconductor, Santa Clara, CA 95051.
2. Reyling, G., "Extend LSI-Processor Capabilities," *Electronic Design* No. 22, Oct. 25, 1974, pp. 90-95.
3. Data sheet for the MN-7000 data-acquisition subsystem, Micro Networks, Worcester, MA 01604.
4. Data sheet for the DAC-85 12-bit d/a converter, Burr-Brown, Tucson, AZ 85706.

These Reliable Workers Give You Pinpoint Accuracy

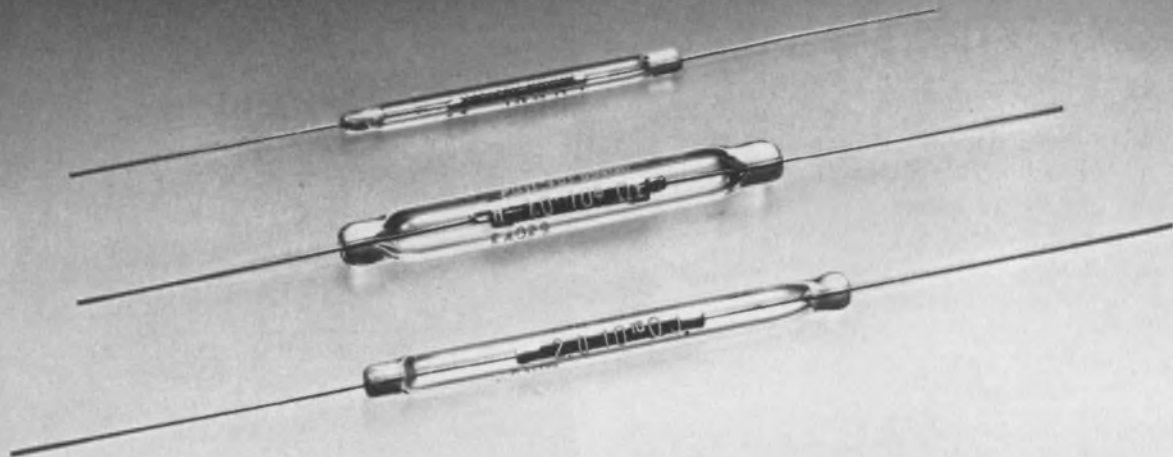

New High Megohm Resistors From Fujitsu



Fujitsu TERAOHMs, featuring ultra high resistance ($10^8 \sim 10^{14} \Omega$), function with outstanding accuracy and long term stability in electrometer circuits where high reliability is critically important.

They consist of two element characters: S and H. The S type resistor element is a carbon coated glass rod with nominal dimensions of 37mm x 2.8mm ϕ and 50mm x 4.5mm ϕ . The H type is a metal oxide coated ceramic rod of 50mm x 5.5mm ϕ . Wire leads extended from the ends of the element are sealed in a glass envelope specially treated to keep the element moisture free. Ideal for environmental contamination measuring equipment, automatic survey meters, radiation measuring equipment and calibration equipment for industrial control.

Specifications

Character	Resistance (Ω)	Tolerance (%)	Max. Working Voltage (V)	Change of Resistance for Load Life	Max. Temp. Coefficient ($\% ^\circ\text{C}^{-1}$)
S	$10^8 \sim 10^{14}$	5, 10	1,000	$\pm 3\%$ max./1,000 hr.	± 0.15
H	$10^8 \sim 10^{11}$	1, 2, 5	1,000	$\pm 0.5\%$ max./1,000 hr.	± 0.10

FUJITSU LIMITED
Communications and Electronics
Marunouchi, Tokyo, Japan

For further information please contact

Components Division: Syuwa Onarimon Bldg., 1-1, Shinbashi 6-chome, Minato-ku, Tokyo 105, Japan
(Head Office) Phone Tokyo (03)437-2111 Cable FUJITSU LIMITED TOKYO Telex 2422808 FT SIN J
New York Office: 680 Fifth Avenue, New York, N.Y. 10019. Phone: (212)265-5360
Fujitsu California, Inc.: 1135 East Janis Street, Carson, California 90746 Phone: (213)636-0858, (213)537-8930

MAIN PRODUCTS Telephone Exchange Equipment Carrier Transmission Equipment Radio Communication Equipment Space Electronics Systems Electronic Computers & Peripheral Equipment (FACOM) Telegraph & Data Communication Equipment Remote Control & Telemetry Equipment Electronic Components

We've got it all together -quality, performance, price.

1220A:
\$750*
Bright 8 x 10 cm display for trouble-free viewing.

Internal graticule eliminates parallax error.

Small, crisp spot size shows sharp details of your signal.

Automatic switching from alternate to chop.

TV sync mode automatically locks on line or frame, depending on sweep speed selected.

2 mV/cm to 10 V/cm deflection factors allow both low level and general purpose measurements.

1222A:
\$895* gives you all the above plus:

Delay line shows leading edges and greatly simplifies digital timing measurements.

Auto/normal trigger selection for easy detection of signals with low repetition rates or fast, narrow pulses.

Sum and difference ($A \pm B$ modes) give fast, accurate differential measurements for balance and symmetry checks.

X-Y operation through A and B channel amplifiers for simultaneous phase magnitude measurements.

One quick look tells you that these dual channel, 15 MHz scopes have just the features you need for making those difficult audio, video, and logic measurements. They give you big-scope capability—but at a budget price. For work in which it's important to see the leading edges of your signal, take a good look at our 1222A. At \$895*, it gives you all the benefits of its look-alike twin plus a delay line and more. For measurements that don't call for all the capability of the 1222A, the 1220A

at \$750* is a popular choice. And if you can do your job with a single-channel scope, HP can meet your needs with the 1221A; it's just \$695*.

Before you choose a scope, let us give you all the information you need for a price/performance comparison for your particular application. Just call your nearby HP field office. Or write for complete details. You'll be surprised at how much HP quality you can get in a low-cost scope.

*Domestic USA Price Only.

HEWLETT  PACKARD

Sales and service from 172 offices in 65 countries
1501 Page Mill Road, Palo Alto, California 94304

FOR TECHNICAL INFORMATION 261

FOR IMMEDIATE APPLICATIONS ASSISTANCE 262

Field-PLAs simplify logic designs

by permitting extensive compression of truth tables. But FPLA programming and testing procedures tend to be complicated.

With the availability of field-programmable logic arrays (FPLAs), digital designers now have a vastly more efficient alternative to programmable read-only memories (PROMs) for the replacement of hardwired logic.

Besides entailing fewer IC packages than PROMs generally do, FPLAs permit substantial compression of truth tables. So a complete set of logic states, generated by control variables, need not be programmed fully. FPLAs even have an editing capability that allows post-programming design changes. Thus FPLAs can be used for a host of combinational and sequential-logic tasks that just aren't practical for PROMs.

FPLAs are best suited for designs calling for a small subset of the total number of logic states possible. Examples include the 12-bit Hollerith code, which contains only 96 graphic characters out of 2^{12} coding states. Similarly, a typical 16-bit microprogrammed machine may really need only 50 or so subroutine-start addresses out of a total of 2^{16} .

But the use of FPLAs does entail some difficulties, too. For example, programming involves three successive steps. The requirements of one step differs from that of the next. More importantly, FPLA post-programming testing—unlike that for PROMs—is no trivial task, owing in part to an FPLA's large number of inputs and its different addressing modes. The result: Verification procedures may dictate the use of automated techniques.

FPLA vs PROM

The number of input variables represents the key selection factor between an FPLA and PROM. When more than nine are involved, the FPLA generally becomes the economical choice. This is partly due to the organization of current PROMs; the largest units have a 512×8 -bit structure. Another reason is the need to program all of the possible logic states.

Napoleone Cavlan, Manager of Advanced Products, and **Ron Cline**, Senior Engineer, Signetics, 811 E. Arques Ave., Sunnyvale, CA 94086.

X_{16}	...	X_3	X_2	X_1	F
0	...	0	0	0	0
0	...	0	0	1	1
0	...	0	1	0	0
...
...
...
...
1	...	1	1	1	1

(2¹⁶ - 1) minterms
F = 0 by default

1. An FPLA can provide the required logic response with just 33 storage locations, compared with all of 2^{16} with a PROM approach. The FPLA generates minterm False states by default, without having to allocate storage.

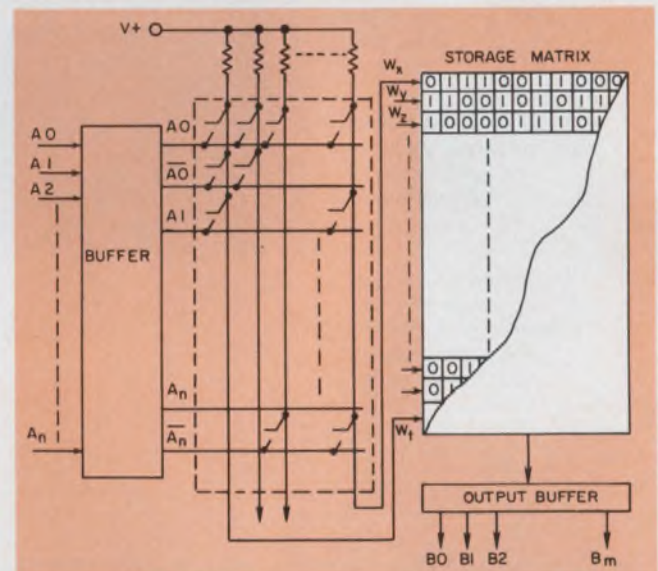

2. An internal programmable address matrix is the source of an FPLA's logic-compression capability. The matrix can choose a small fraction of a large number of input states.

Consider, for example, the truth table (Fig. 1) for function F of 16 variables. The simple function is True when all variables are True, and False otherwise. A PROM approach requires that all 2^{16} minterms be represented in memory. But an FPLA approach requires only 33 locations: two for each input and one for the output.

Of course, the logic response can be readily provided by a 16-input AND gate. But what if

M_n	INPUTS				CONCURRENT P-terms
	13	12	11	10	
0	0	0	0	0	None (Default state term)
1	0	0	0	1	P0
2	0	0	1	0	P1
3	0	0	1	1	P0, P3
4	0	1	0	0	P4
5	0	1	0	1	P0, P2, P5
6	0	1	1	0	P1, P9
7	0	1	1	1	P0, P5, P9
8	1	0	0	0	P10
9	1	0	0	1	P0, P6, P10
10	1	0	1	0	P1, P7, P10, P11
11	1	0	1	1	P0, P3, P6, P7, P10, P11
12	1	1	0	0	P4, P12
13	1	1	0	1	P0, P2, P8, P12
14	1	1	1	0	P1, P11, P12
15	1	1	1	1	P0, P8, P11, P12

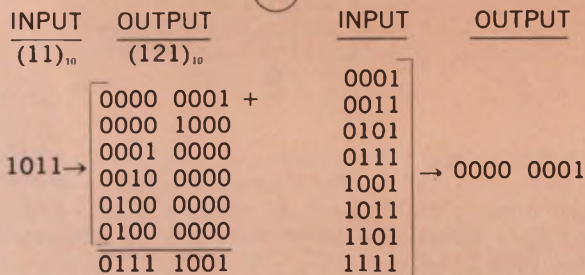

5. The simultaneous selection of P-terms with a min-term generator (a) reveals an FPLA's concurrent and multiple addressing-mode capabilities. In concurrent addressing, a single input selects several words (a). Multiple addressing leads to the selection of a single word by several input combinations (b).

map (involving the ordered P-terms), which in turn leads to the final Program Table (Fig. 4). Note that the squaring matrix has been compressed from 16 minterms (in the original truth table) for a PROM solution to 13 P-terms for an FPLA. The reduction implicitly makes use of the "concurrent" and "multiple" addressing modes characteristic of FPLAs (Fig. 5). These modes become apparent when Fig. 5 is looked at in the following ways.

Consider each row of the Program Table as an FPLA word selected by the corresponding P-term address. The concurrent addressing is dramatically seen as the simultaneous selection of words P₀, P₃, P₆, P₇, P₁₀ and P₁₁. The words are generated by the FPLA as a result of a binary 1011 input. Similarly, for multiple addressing, observe that word P₀ is selected by eight different input combinations (in a manner reminiscent of virtual memory storage).

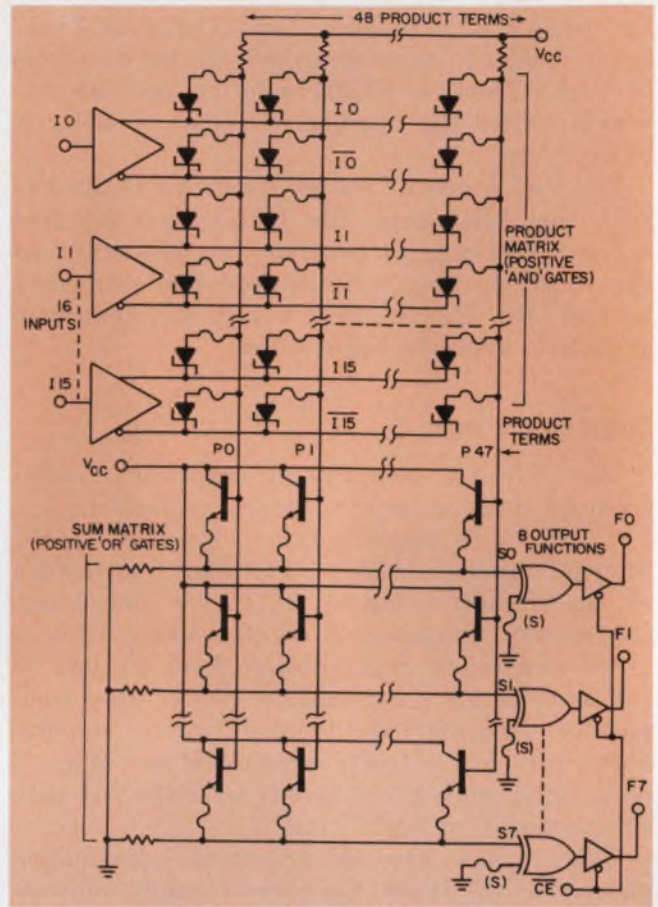

6. A commercial FPLA has 16 inputs, allows 48 product terms and generates eight output functions. Product terms formed in the upper AND matrix are summed by the lower OR matrix. Signetics' circuit employs fusible nichrome links as the programming elements.

In general, a P-term can be addressed by several minterms in accordance with the following relationship:

$$(M_n)_T = 2^{m-r}$$

where m = total number of input variables, r = number of active inputs (true or complement) contained in the P-term. Thus, for $P_0 = XXXI_n$, $m = 4$ and $r = 1$, then the number of minterms, $(M_n)_T$, equals 8.

Note that the above implementation isn't unique, because the Program Table is not unique. This results from the individual, rather than the simultaneous, minimization of the output function set. For example, equivalent forms for, say, F_1 , F_2 and F_3 can be obtained readily, though no net reduction in the number of P-terms would necessarily result. However progress has been made to reduce a set of logic functions of several variables to a minimum set of prime implicants, or P-terms. The required minimization process involves special algorithms that have been developed. Current efforts center on the translation of such an algorithm into an efficient software program.

The block diagram of a commercially available

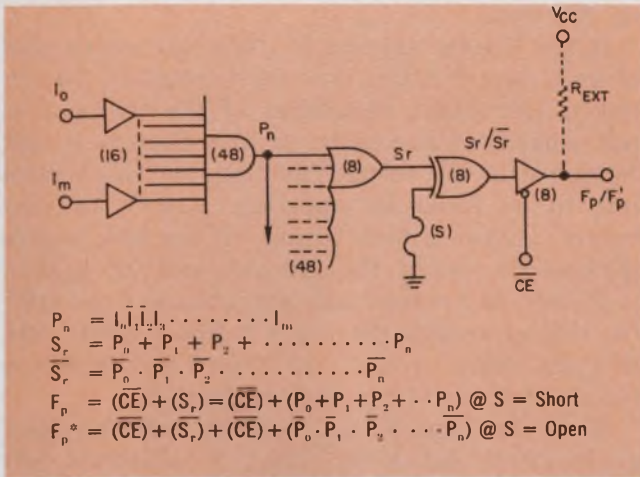

7. The equivalent logic path for an FPLA illustrates the fact that either an active-HIGH or active-LOW output function can be obtained. Hence FPLAs can be thought of as PROMs, as well as AND-OR logic blocks.

FPLA that employs fusible nichrome links (Fig. 6) illustrates the circuit's distinguishing AND and OR matrices. The upper AND matrix contains 48 product-term columns (P-terms), and a lower OR matrix contains eight sum-term rows (S-terms), one for each output function. Each P-term in the AND matrix couples to each input variable via two Schottky diodes, thereby completing a programming path. Also each P-term couples to each S-term in the OR matrix via an emitter follower and an emitter fuse. The latter connection causes the summing node to pull HIGH when the P-term is activated. Each S-term, in turn, couples to its respective output via an EX-OR gate. And each gate has a programmable transmission polarity.

In the initial unprogrammed state all nichrome links are intact, so that:

- Each P-term contains both true and complement values of every input I_m . Hence all P-terms are in the NULL state (always LOW).
- Each S-term contains all 48 P-terms.
- The polarity of each output is set to active-HIGH (F_p function). Since all P-terms are inactive, all outputs will be at a LOW level when the chip is enabled ($\overline{CE} = \text{LOW}$), regardless of input condition.

Unused P-terms require no programming at all, and can be skipped over during a programming sequence. But if P_n contains I_m , the $\overline{I_m}$ link is fused, and vice versa. If I_m is a Don't Care in P_n , both the I_m and $\overline{I_m}$ links must be fused. And if fewer than 16 variables are used in any application, the unused variables represent Don't Care conditions for all used P-terms, and their corresponding I_m and $\overline{I_m}$ links must be fused.

The response of each output function to the presence of active P-terms is programmed in the OR matrix. If any product term P_n logically Negates an output function, the link coupling

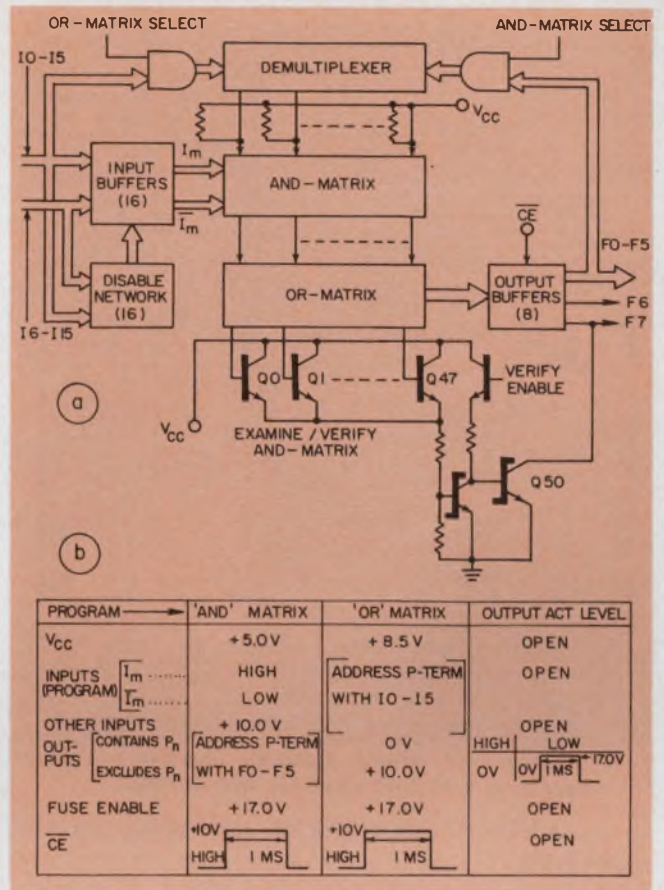

8. Functional blocks activated during FPLA programming (a) also play a role in any verification tests. Programming requires three successive steps (b) for the AND matrix, OR matrix and the transmission polarity of EX-OR gates.

that output function to the P-terms must be fused. If it Asserts the output function, the link must be left intact.

Of course, no programming is required of OR matrix links coupling any P to S-terms when unused output functions are involved. Finally, to program an output function True active LOW when logically Asserted by any P-term, the corresponding links must be fused.

After programming, the FPLA can be described by the following set of logic equations:

$$F_p = (\overline{CE}) + (S_r) \quad (@ S = \text{Short})$$

$$F_p^* = (\overline{CE}) + (\overline{S_r}) \quad (@ S = \text{Open})$$

$$S_r = f(\Sigma_{0}^{47} P_n)$$

where

$$P_n = \Pi_{0}^{15} (k_m I_m + j_m \overline{I_m})$$

$r = p = 0, 1, \dots, 7$
 $n = 0, 1, 2, \dots, 47$
 $k = 0, 1, X \text{ (Don't Care)}$
 $j_m = k_m = 0 \quad \text{(Unprogrammed state)}$
 $j_m = \overline{k_m} \quad \text{(Programmed state)}$

The transmission through the FPLA can be traced along the equivalent logic path shown in Fig. 7. Note that for each of the eight inputs, either the function F_p (active HIGH) or F_p^* (active LOW) is available, but not both at the same time. This emphasizes the dual aspects of FPLAs in that they can be viewed as PROMs

			Program desired logic function into any unused P-Term. Blow S-Term link(s) coupling P-Term to undesired output functions.
ADD	P-Term To F_p/F_p^*	YES	
	$I_m/\overline{I_m}$ To P-Term	NO	Delete erroneous P-Term. Add new, corrected P-Term.
DELETE	P-Term From F_p/F_p^*	YES	Blow S-Term link coupling P-Term to F_p/F_p^* .
	$I_m/\overline{I_m}$ From P-Term	YES	Blow both links coupling the input variable to the P-Term.
CHANGE	$F_p \rightarrow F_p^*$	YES	Blow EX-OR link of output to be inverted.
	$I_m/\overline{I_m} \rightarrow X$	YES	Delete $\overline{I_m}/I_m$ from P-Term.
	$I_m \leftrightarrow \overline{I_m}$	NO	Delete erroneous P-Term and add a new P-Term.
	$F_p^* \rightarrow F_p$	NO	Use spare active-HIGH output.

9. A summary of editing features illustrates another FPLA capability that isn't available with PROMs.

or as AND-OR logic blocks, depending on the application.

FPLA programming involves three successive steps for the AND matrix, the OR matrix, and the transmission polarity of the output EX-OR gates (Fig. 8). To program the AND matrix, for example, disable the output buffer (via \overline{CE}). Individually address each P-term (from 0 through 47) by applying a binary code to outputs F_0 through F_5 . Apply 10 V to the inputs to disconnect the variables from the P-terms. Then set links to blow one at a time by lowering each variable in turn from +10 V to a TTL logic HIGH or LOW level, depending on which state is required.

Actual fusing of the link takes place when the Fuse Enable input increases to +17 V, and a pulse on the \overline{CE} input changes the HIGH level to +10 V for about 1 ms. If an input variable in the P-term is a Don't Care, both fuses are successively blown.

Functionally, the programming of the AND matrix forces every P-term to a HIGH logic level only if the following is true: the logic combination appearing at the FPLA input is logically included in the input state programmed in the P term. Whether any output function responds to a P-term forced HIGH depends only on the programming status of the OR-matrix links.

To program the OR matrix, inputs I_0 through I_5 now provide the address to each P-term. Disable all input buffers simultaneously by raising V_{cc} to +8.5 V, thereby disconnecting all input variables from the P-terms. Set emitter links coupling P to S terms to be fused one at a time,

as required.

If the P-term appears in the logic expression of an output function, the corresponding S-term link is left intact, regardless of the chosen output polarity. Conversely, if the P-term is not contained in the output function, set the S-term link to be fused by applying +10 V to that output. Again, actual fusing of the link occurs through the use of Fuse Enable and \overline{CE} inputs.

Finally, to program any output to active-LOW, the link grounding the input to the EX-OR gate must be blown. Apply +17 V to that output pin for about 1 ms, with no power applied.

Note that the FPLA has an inherent program-editing capability (Fig. 9). P-terms left intact after initial programming can be programmed subsequently and added to any output function. Similarly, any P-term can be removed from any output function by fusing the corresponding OR-matrix link. To remove a P-term from all output functions, fuse all eight links coupling the unwanted P-term to the S-terms.

The logic structure of a pre-programmed P-term can also be changed, but with some restrictions. While it's possible to remove input variables by a reprogramming to the Don't Care state, you can't add variables to a P-term or change their programmed state from a HIGH to LOW, and vice versa. A simple solution deletes the erroneous P-term, and forms a new one, which can be easily added to the outputs. Finally, outputs programmed active HIGH can be reprogrammed active LOW.

A check of logic function would seem to provide an adequate enough test of a programmed FPLA. However, it is a useless tool for determining the FPLA stored program. What is needed is a map of the status of every link in the circuit. Such a map can be obtained through the use of an array-verify test sequence, involving three tests for links in the output EX-OR, the AND matrix, and the OR matrix.

Internal FPLA peripheral circuitry incorporates networks for the test sequence (Fig. 8). To sense the status of the AND-matrix links, the OR matrix includes an extra row of non-fusible emitter followers Q_0 through Q_{17} that can be monitored via Q_{30} , which is collector-ORed with output F_7 . This stage doesn't interfere with F_7 during normal operation, because Q_{30} gets base drive only during a verify mode. All tests require a grounding of the fuse-enable input.

The output active-level test need be performed only once, preferably at the start of the full array-verify sequence. However, it is the most critical test; its results interpret the outcome of the OR-matrix test. To perform the test, monitor outputs F_0 through F_7 while applying +8.5 V to V_{cc} , ground to \overline{CE} , and HIGH logic level to input variables I_0 through I_5 (Fig. 10). Under

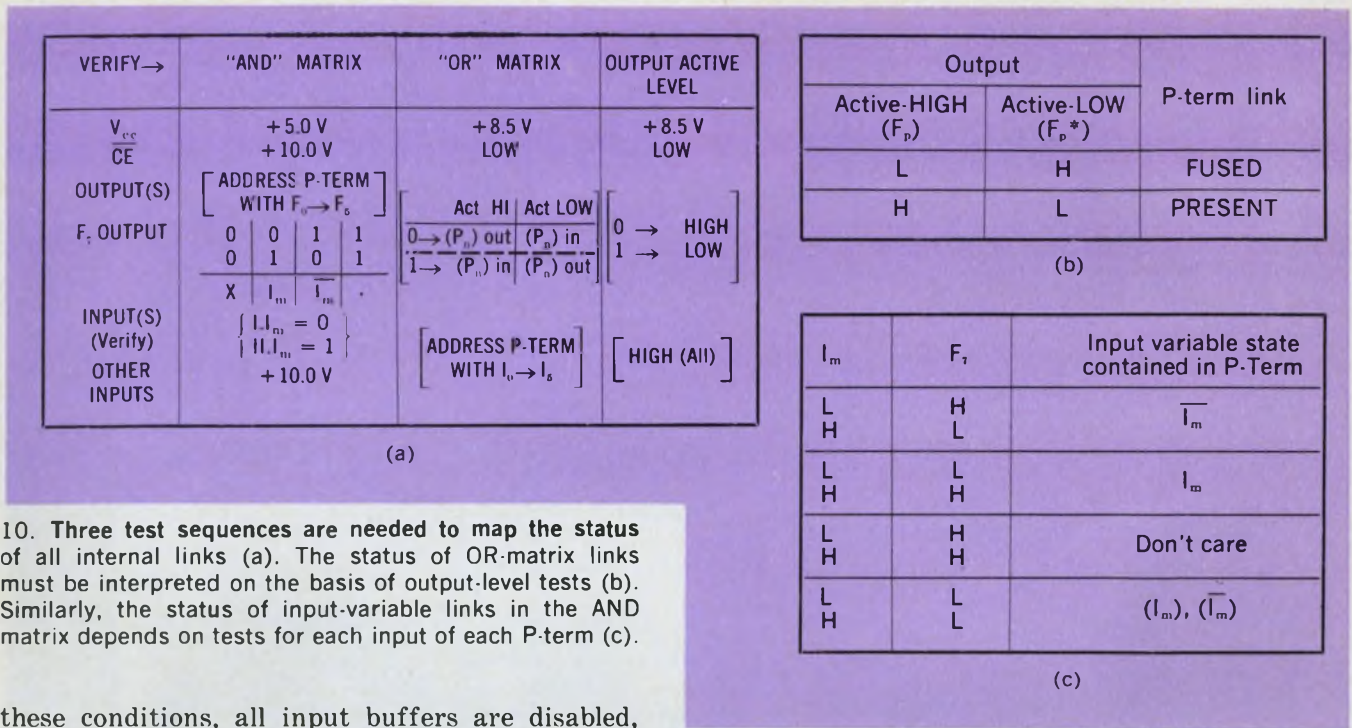

10. Three test sequences are needed to map the status of all internal links (a). The status of OR-matrix links must be interpreted on the basis of output-level tests (b). Similarly, the status of input-variable links in the AND matrix depends on tests for each input of each P-term (c).

these conditions, all input buffers are disabled, and the inputs from all P-term columns in the AND-matrix are disconnected.

Activate the OR-matrix select input to decode the binary input count of 63₁₀ through the demultiplexer. Since this points to a nonexistent P-term, all P-term columns go LOW, as do the S-term rows. The output buffers servicing each S-term sense this LOW level and force the corresponding output HIGH or LOW (depending on whether the EX-OR inverting link is fused or not).

To examine the OR-matrix, again ground CE. But set V_{cc} to +8.5 V and address each P term through inputs I₀ through I₆. Simultaneously sense the logic state of outputs F₀ through F₇. Interpret test results with the table (Fig. 10b). Similar procedures apply to the AND matrix, except that tests are required for each input of each P-term. And tests must be interpreted according to a different table (Fig. 10c).

Verifying logic

After programming and a contents examination, there should be little reason to suspect that the FPLA won't exhibit the correct logic functions. However, device defects, programming-equipment problems, coding inexperience, and other conditions may result in system failures traceable to an FPLA. And that FPLA may appear to contain the correct program table.

In these cases, ultimate verification of FPLA performance is required. This entails an exhaustive check of the logic function. It must be obtained by a cycling of the FPLA inputs through all 2¹⁶ combinations. Then you must compare the actual output table with the ex-

pected one. This involves a composite overlay of the program table for all concurrent and multiple address selections.

A practical solution is to automate a verification procedure within the programming system. In essence, the programming system then functions as an FPLA simulator with the ability to produce the full truth table of the FPLA as if it were just a "black box."

The logic verify procedure must be fast, if it is to be useful. It should be able to complete a circuit within 5 to 10 sec.—hence, the need for a hardwired algorithm (Fig. 11) and a CRT display for readouts. The algorithm manipulates program-table data, which is stored in main memory (MM) and the active-level register (ALR) according to the formats in Fig. 11.

Before loading the Program Table, MM and the ALR must be cleared of all previously stored fusing commands. A binary counter functions as a minterm generator that addresses the FPLA with all 2¹⁶ input combinations. The FPLA output for each M_n input is stored in register B.

All 48 P-terms, fetched one at a time from the program table, are examined to determine whether they logically include each minterm. (The criteria are indicated in Fig. 11d.) If the test fails, a new P-term is fetched and the test repeats until all terms have been exhausted. Alternatively if the test indicates that M_n is contained in the P-term, the F-set field of the MDR (associated with the addressed P-term) is overlaid in register A. Meanwhile, the MM address of the P-term is stored in a stack containing the concurrent P-term list. The set-

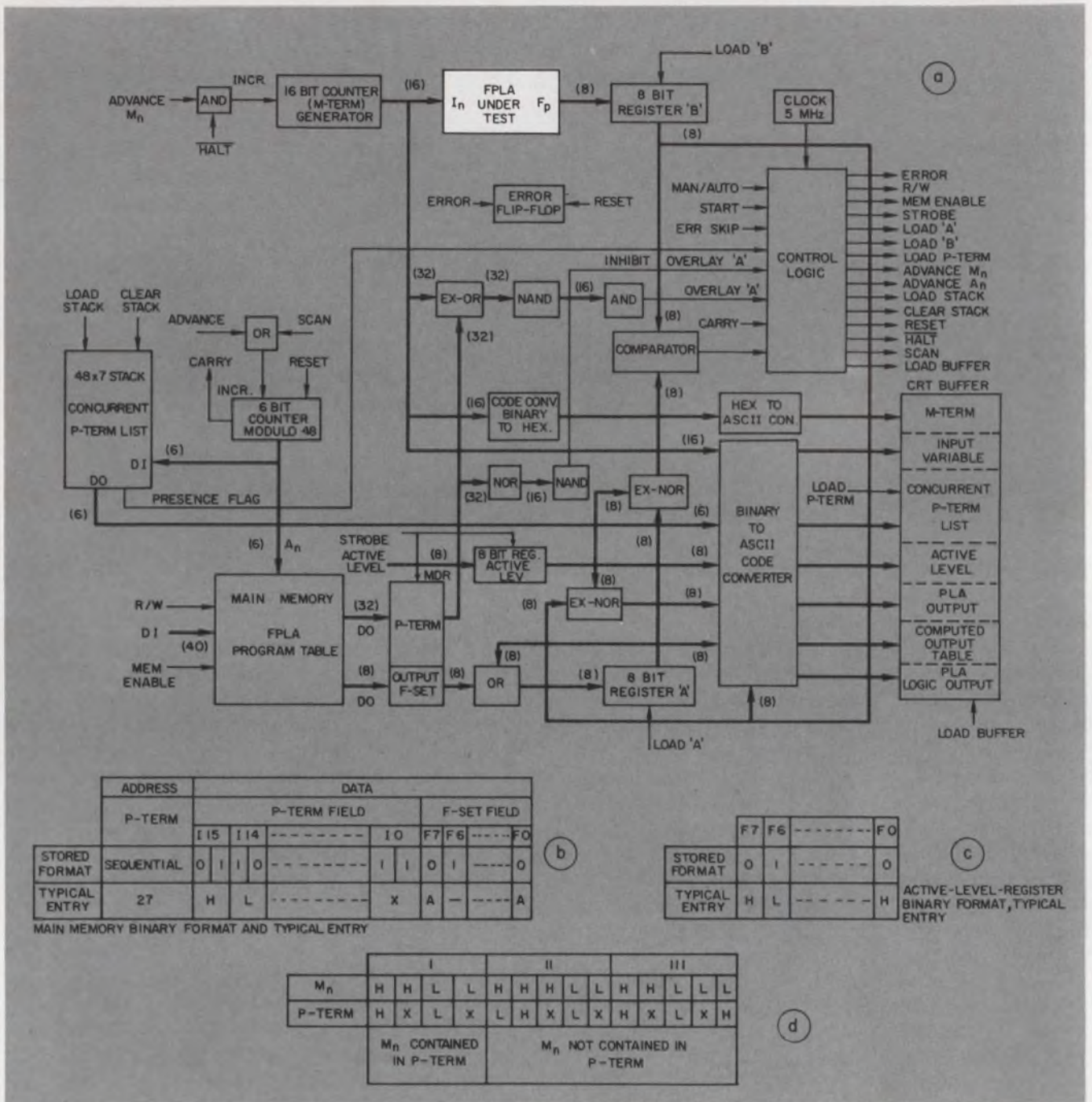

11. A hardwired algorithm (a) performs the logic-verify test sequence. The algorithm manipulates program-table data stored in both main memory (b) and the active-level

register (c). A comparison of logic states is made for each of 48 P-terms and all 2^{10} minterms (d). The hardwired circuit requires a CRT display for readouts.

ting of a flag indicates the address is valid.

Testing continues until all 48 P-terms have been compared with the M_n count. At this point, register A contains a composite FPLA output table. This table merges with the contents of ALR to produce a composite binary F-set. This, in turn, is compared with the contents of register B. If they are equal, the concurrent P-term list is stored in the CRT buffer and then cleared. The M_n generator increments and the test sequence repeats with M_{n+1} until the last minterm.

If the contents of registers A and B differ, an error flag sets, and the M_n count halts. While

the system waits for a continue command, the following "housekeeping" readouts appear on the display:

- The concurrent P-term list.
- The contents of the M_n generator.
- Results of the EX-OR merger of register B with the contents of the ALR. (This yields the actual output table.)
- The contents of the ALR.
- The contents of register A. (They indicate the composite output expected from the FPLA.)
- The contents of register B. (They indicate the logic levels at the FPLA outputs.) ■■

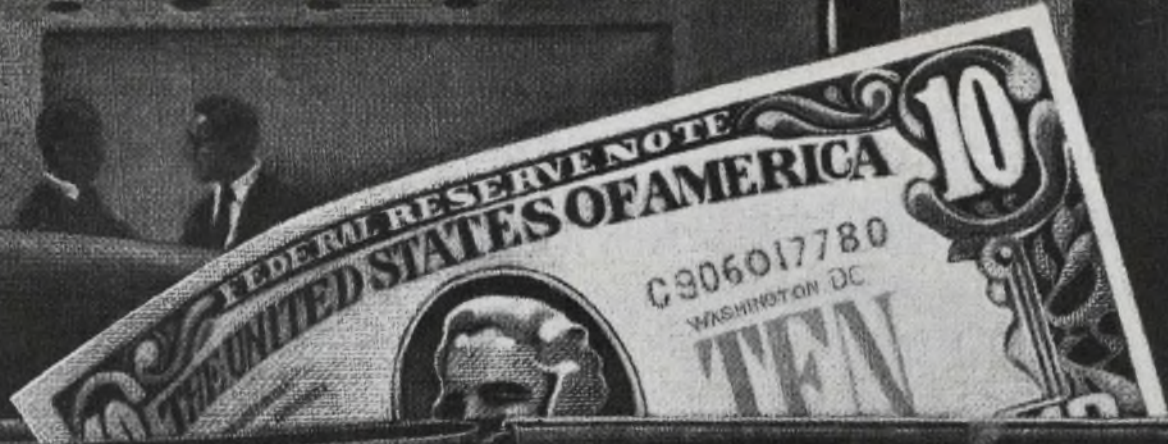

Give us one of these. And we'll give you a magnetically operated solid state proximity switch and some change.

The advantage of a mechanical proximity switch is its low price.

The advantage of a solid state proximity switch is its reliability.

The advantage of a MICRO SWITCH 103SR is that it gives you both.

For under \$10, the 103SR offers you the almost infinite cycle life of solid state design. Because its design is based on the Hall-effect chip.

And, because the 103SR is magnetically operated, you get added design flexibility. It senses only magnetic targets, not other metals.

The bushing is threaded aluminum, for easy mounting and adjustment. And the aluminum housing is environmentally sealed.

It's built to handle two



different voltage ranges: 5 VDC; or 6 to 16 VDC with a built-in voltage regulator. Also, it provides sensing speeds from 0 to in excess of 10 KHz—in a temperature range from -40°C to $+150^{\circ}\text{C}$.

Each unit comes with six inches of lead wire and is available with either digital or analog output. There's a choice of various magnetic targets, including multiple pole, or ring magnets. Special magnet mounting hardware is also available.

If you'd like to find out how the 103SR can lower your costs and increase your productivity, call your nearest MICRO SWITCH Branch Office. Or write for literature.

MICRO SWITCH

FREEPORT, ILLINOIS 61032

A DIVISION OF HONEYWELL

MICRO SWITCH products are available worldwide through Honeywell International.

Circle #289 for Data, #290 for Salesman to call.

The health of the system depends on the condition of the heart

We make sound hearts for systems — power supplies that are also twice as efficient, more than twice as compact, and price competitive with conventional series-pass types.

The 40 models in the Sorensen STM family are modular switching power supplies designed for OEM systems, 3.0 to 56 Vdc. Despite their compactness and efficiency, they retain all of the advantages inherent in the series-pass design.

The physical fitness of your system begins with a good look at our catalog. Simply circle the inquiry number. Sorensen Company, a unit of Raytheon, 676 Island Pond Road, Manchester, N.H. 03103. (603) 668-4500.

Sorensen
POWER SUPPLIES

INFORMATION RETRIEVAL NUMBER 50

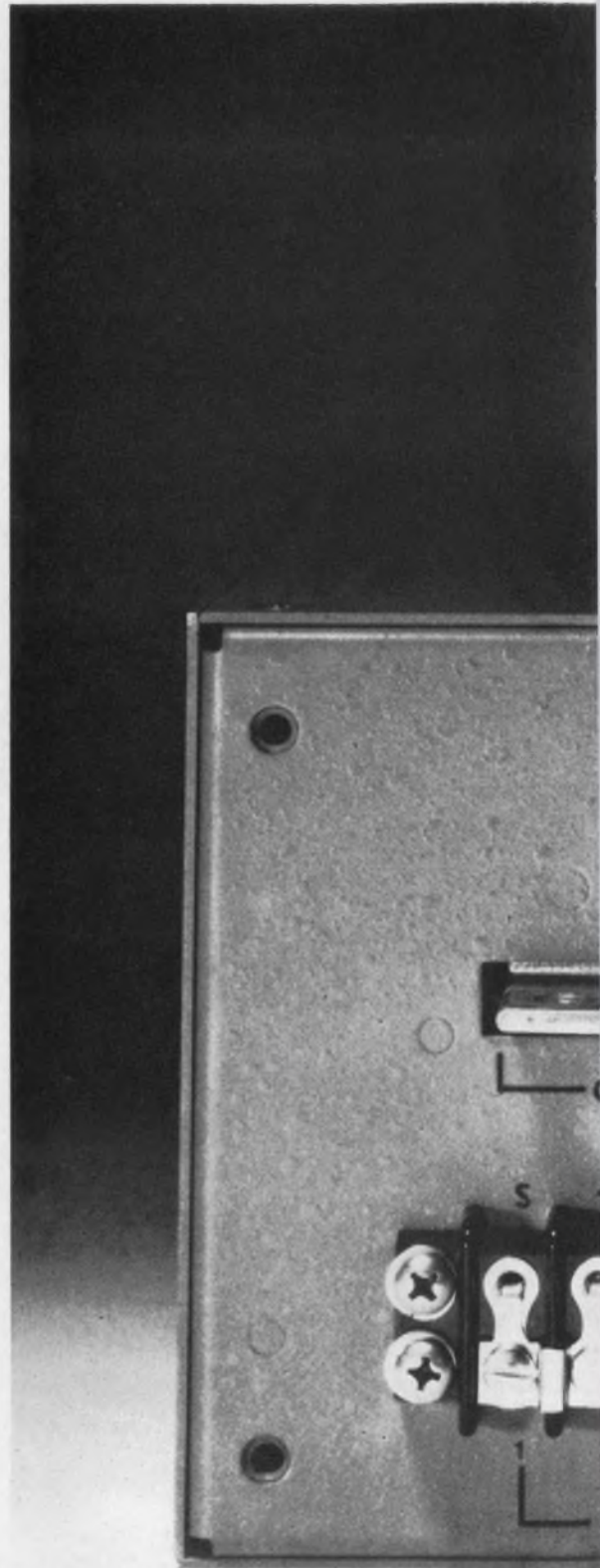

"SEE US AT WESCON BOOTHS 1411-1419"

Sorensen
POWER SUPPLIES

STM

5-60



OVP
VOLT

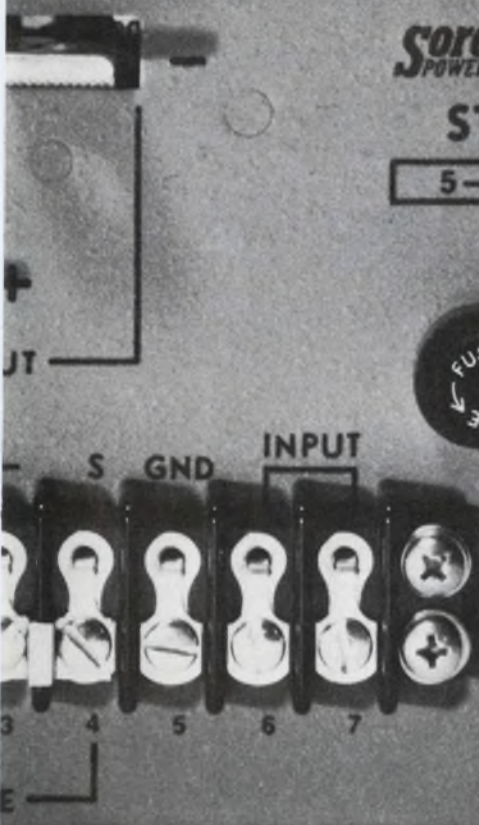

Need to operate SCRs in parallel? Watch out.

Transient effects, like finger voltage and latching current, are as important to match as steady-state performance.

When man first tried to hitch two oxen abreast to double the pull power for his plow, he soon learned that if it wasn't done properly, he was worse off than before. The animals had to be matched and the harness arranged to help equalize the load; otherwise most or all of the load ended up on one beast and the other was only a hindrance. The same principle applies when you parallel thyristors (SCRs).

You can't simply wire them together and expect each automatically to share the load equally. Both their transient and steady-state properties must be considered in the circuit's design.

If the triggering sensitivity of one—say, device A in Fig. 1a—is even slightly greater than the other, it will fire first, and the B unit may never turn on. The anode-to-cathode voltages across the thyristor that fires first may be lower than the so-called finger voltage—the minimum voltage needed to fire the second unit. This may occur especially if there is little inductance in the current path of the fired thyristor.

Paralleled SCRs need inductance

With enough inductance in the load-current paths of the paralleled thyristors, all devices will turn on. Of course, inductance can be built into the SCR's circuit or discrete inductors can be introduced. However, even if all SCRs do fire, they still may not attain equal current during the short conduction intervals of a cyclic on-off application. Even if the SCRs are matched for equal forward voltage at some nominal steady-state current near the units' rated value (Fig. 1b), the instantaneous currents are not necessarily equal before this point is reached. The different triggering delays of the SCRs, combined with the short conduction interval, allow insufficient time for the currents to reach equality (Figs. 1c and 1d).

One method of equalizing the delay is to select

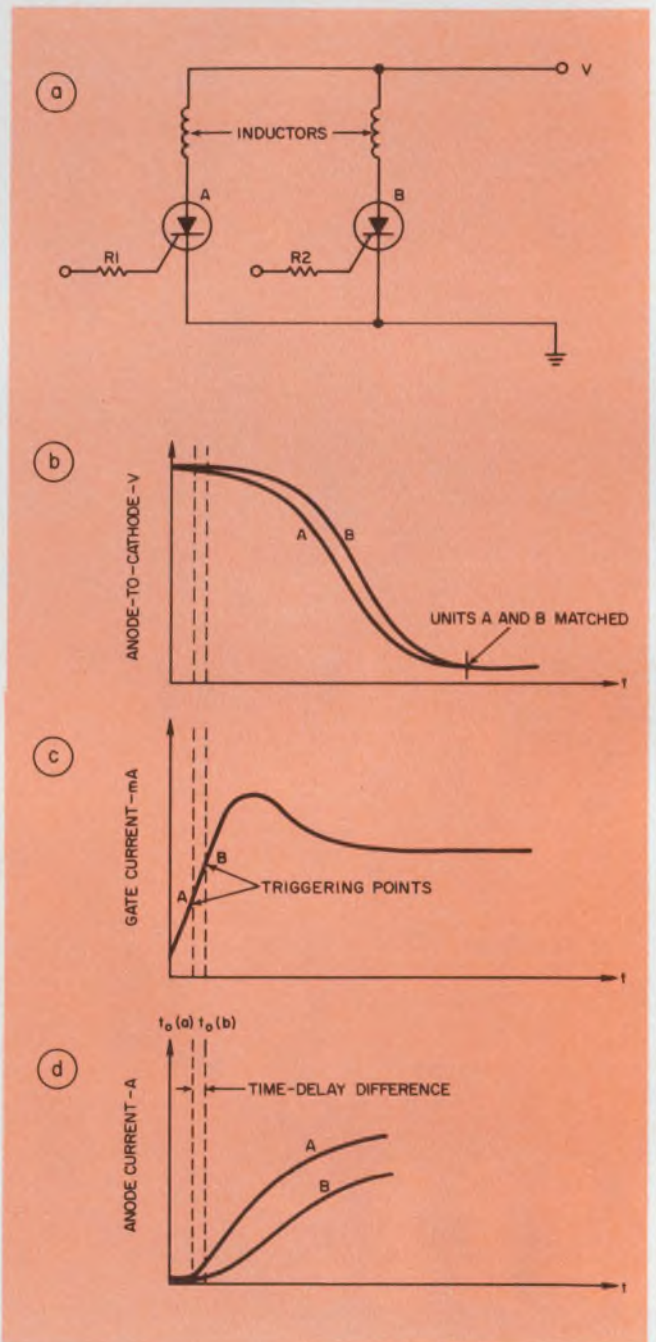

1. To ensure turn-on of all paralleled SCRs, some inductance is needed in the anode-cathode current loop of each SCR. And with alloy-diffused units, selected resistors in series with the gates are needed to equalize the trigger times among the SCRs.

David Cooper, Vice President of Engineering, Semiconductor Div., International Rectifier Corp., El Segundo, CA 90245

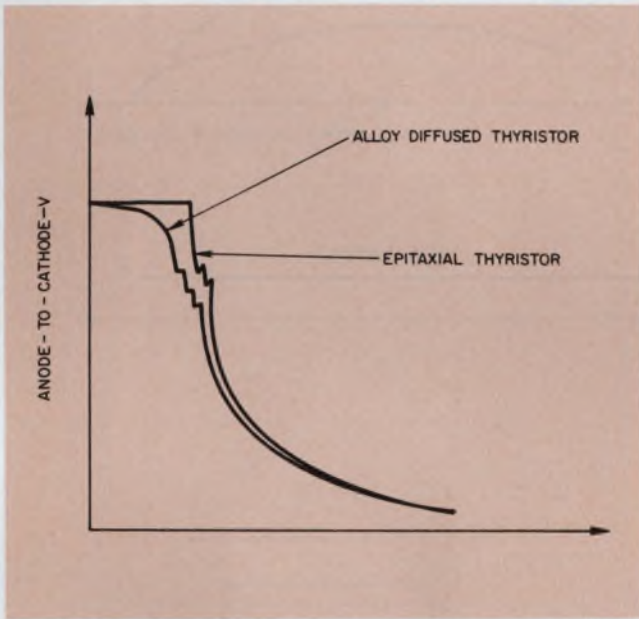

2. Epitaxial diffused SCRs provide more uniform delays and trigger sensitivities than alloy-diffused units do.

series resistors for each SCR gate. Higher-valued resistors in series with the gates of the more sensitive units would delay triggering to match the slower SCRs.

Epitaxial-diffused SCRs more uniform

The curves in Figs. 1b through 1d are typical of alloy-diffused SCRs. But epitaxial-diffused units, which have hyper-abrupt junctions, produce a flat top at the start of their anode-to-cathode voltage-vs-time turn-on curve (Fig. 2). The flat region represents the epitaxial devices' built-in turn-on delay. Both the delay and the trigger sensitivity of epitaxial devices are much more uniform than for alloy-diffused units. Thus with epitaxials, the use of gate resistors may not be necessary. If the well-defined delay period of epitaxial SCRs is matched to, say, 0.25 to 0.5 μ s for a given anode-to-cathode voltage and gate drive, then with sufficient inductance in series with each SCR, good load equalization can be achieved among the paralleled unit.

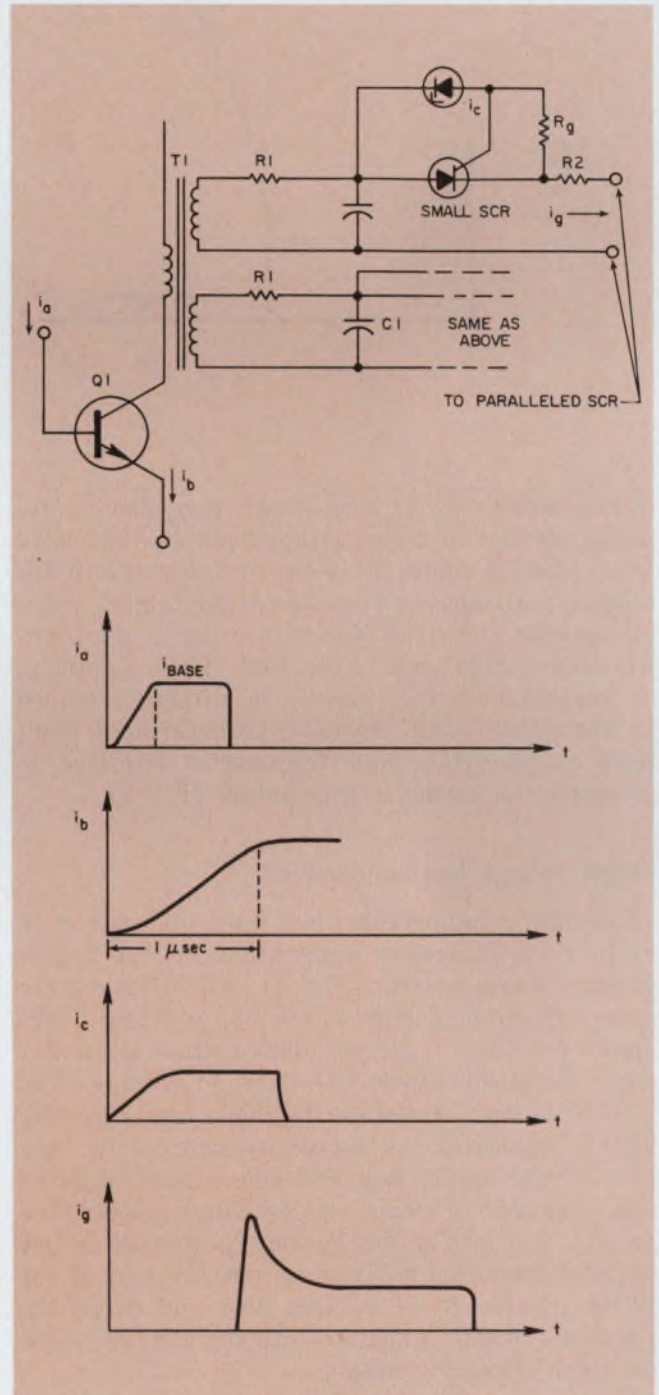

3. A pulse-sharpener circuit helps reduce the mismatching effects of differences in SCR turn-on delays when the thyristors are operated in parallel.

4. **Finger voltage**—the minimum anode voltage needed to fire an SCR—should be applied before the trigger current is applied.

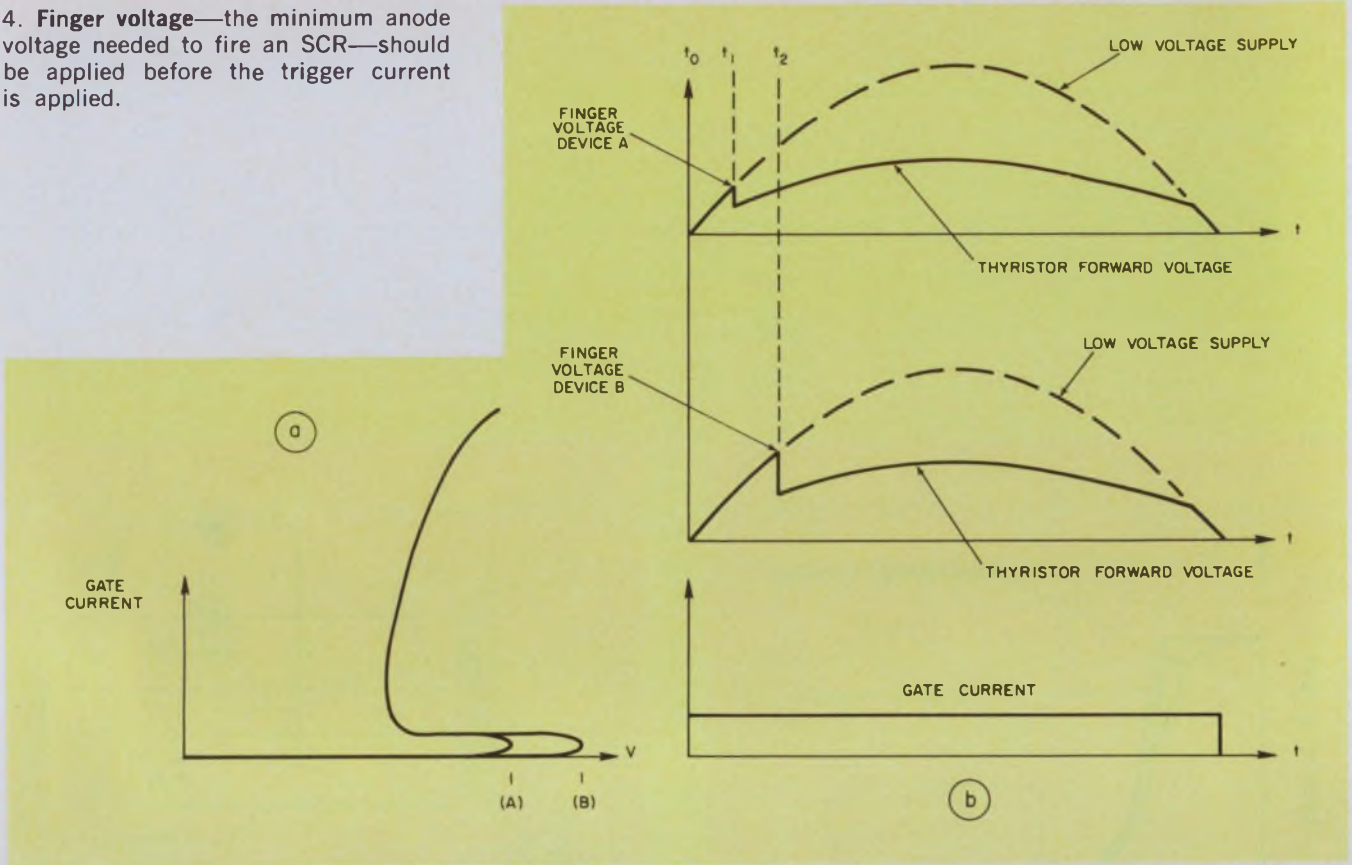

The effects of turn-on delay can also be reduced by use of input trigger pulses that have steep leading edges. This ensures that the SCR's trigger gate current rises above the trigger point of the least sensitive SCR before the SCR's built-in delay period ends. Note that if the squaring, or pulse-generating, circuit is directly coupled to the SCR, input isolation transformers don't have to pass the high frequencies required to generate the steeply rising pulses (Fig 3).

Finger voltage least understood

Of major importance, but least understood in cyclic on-off thyristor applications, is the finger-voltage characteristic (Fig. 4). All SCRs require some minimum anode-to-cathode, or finger, voltage to fire when triggered. This voltage is greater than the steady-state, ON forward voltage. And it must be applied before the SCRs are triggered. This specification is especially critical in very low voltage application and where parallel SCRs are triggered in cyclic anode-voltage application. In Fig. 4 a low ac anode voltage applied to two parallel-connected SCRs may not fire one of the SCRs—device B—if A fires first and drops the parallel circuit's anode-to-cathode voltage below device B's finger voltage.

This finger-voltage effect is most pronounced in thyristors made with high-resistivity silicon and wide base regions. Designers of parallel SCR

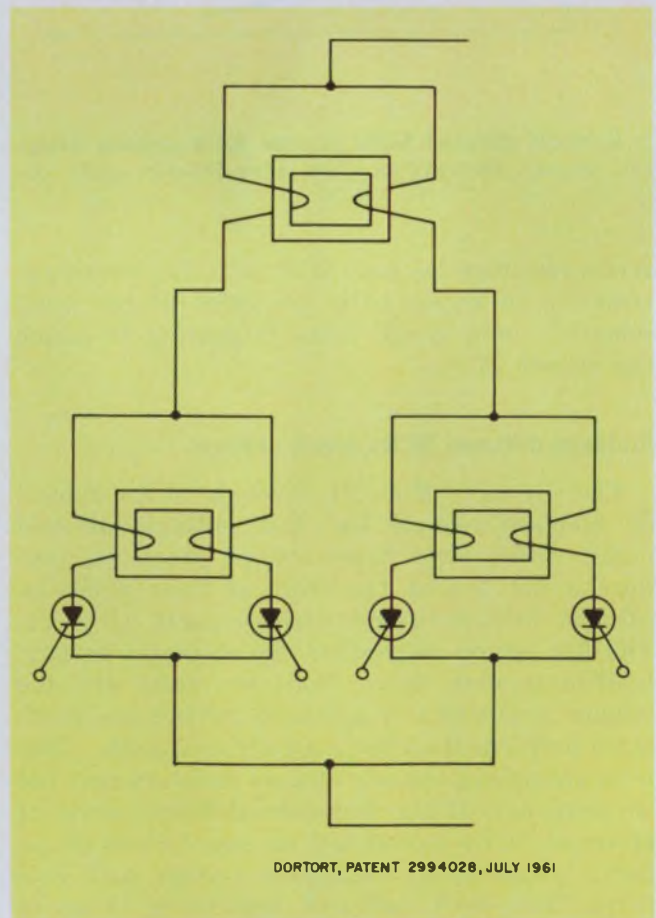

5. Equal current flow in the SCRs is forced by this arrangement of balancing reactors.

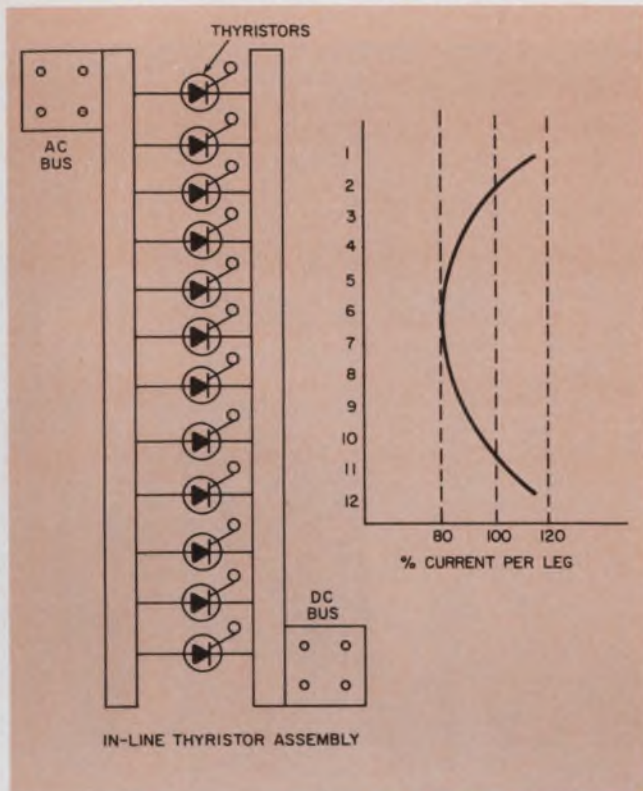

6. An in-line bus assembly for paralleling SCRs provides a $\pm 20\%$ current mismatch.

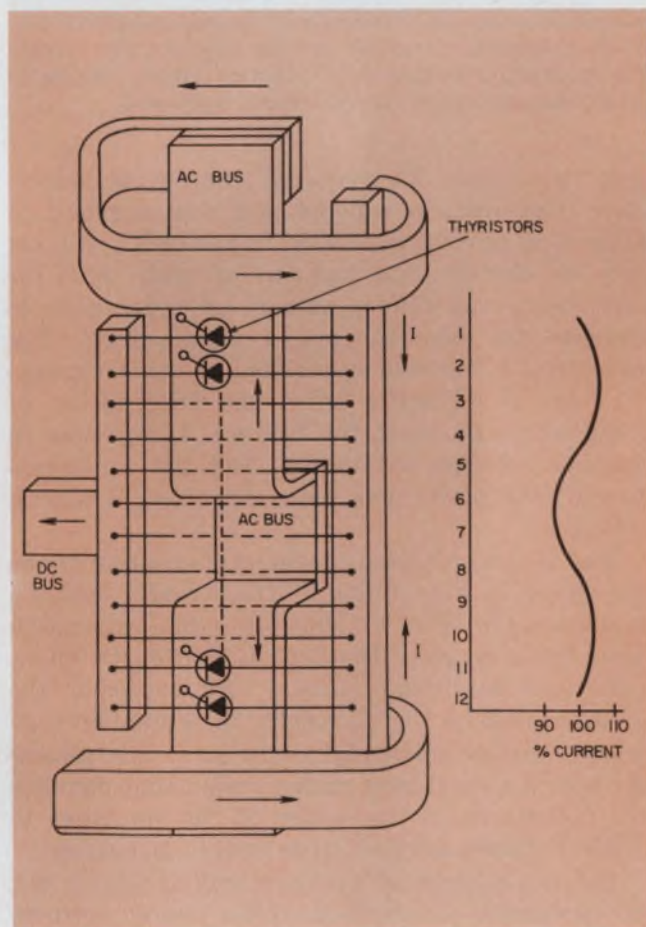

7. A specially configured bus arrangement equalizes the current variations to within $\pm 10\%$.

Circuits should take special note of this characteristic and, where it's not supplied, should ask the SCR manufacturer to specify its value and the expected tolerance spread. The designer can then intelligently match SCR units for parallel operation and specify sufficient inductance in the individual thyristor current loops to ensure adequate finger voltage for the worst-case expected spread of the tolerance.

Latching and holding currents differ

Once an SCR fires, it requires an initial high-level, but only short-term, anode current—called the latching current—to establish the SCR's ON state before the trigger current is removed. This latching current is three to five times greater than the holding current needed merely to sustain conduction. Many manufacturers do not distinguish between latching and holding-current requirements in their SCR specs. Thus SCR circuits often work unsatisfactorily when the designer fails to ensure an adequate latching-current surge.

If a thyristor doesn't experience the latching current level, it may turn off when the trigger current is removed. As before, inductance is needed in the anode-current loop. But now it also must have sufficient volt-second capability to provide this extra latching current surge.

When selecting an inductance to supply latching current, the designer should be aware that the latching-current requirement—and also the holding current—increases as the device's temperature rises. However, a higher gate current or anode voltage would allow the use of a lower latching and holding current.

Taking care of steady-state conditions

In addition to these transient effects, the circuit's steady-state conditions also must be controlled, of course, to ensure equal sharing of the load current. The steady-state forward-voltage drops of the paralleled SCRs should match closely at the maximum operating current and temperature that each unit is expected to carry. And since forward-voltage drop is strongly temperature-dependent, all SCRs should be closely thermally coupled.

Discrete inductors can be selected individually to help equalize the current among the paralleled SCRs during initial conduction. However, the Dortort arrangement in Fig. 5 automatically forces equalization of the individual loop currents. But this series of balancing reactors is not often used because of the expense of multi-winding core devices.

The most popular approaches use the mechanical assembly not only to support the SCRs but

our multi-media multi-station printers

We give you the choice of one, two, or three station printers. All with alphanumeric capability.

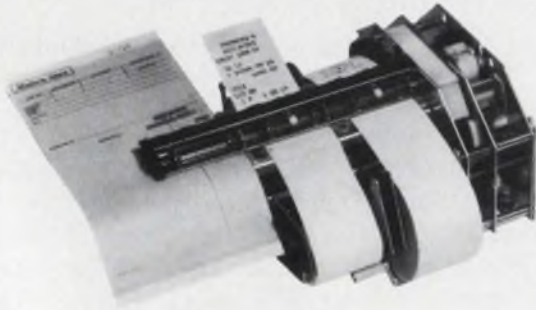

MODEL SV PRINTERS

unique segment matrix character format

Can simultaneously print different data at each independently controlled station. At 2 lines per second.

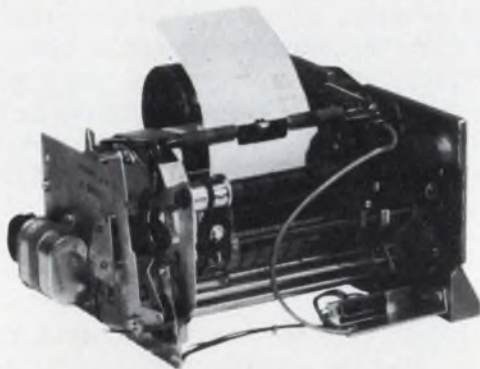

MODEL 700/800 PRINTERS

30-column serial printers

Two models, each with different external dimensions for greater applications flexibility. Print up to 44 alphanumeric and special characters. At 37 characters per second. Can print on unit front inserted forms. Journal take-up spindle provided.

WESCON-BOOTH 1810

for full details, write or call



OEM PRODUCTS

SWEDA INTERNATIONAL

34 Maple Avenue, Pine Brook, N.J. 07058/(201) 575-8100

IN U.K. — ADLER BUS. SYSTEMS/OEM PRODS., Airport House, Purley Way, Croyden, Surrey, England

IN FRANCE — SWEDA INTERNATIONAL/OEM, 103-107 Rue de Tocqueville, 75017 Paris, France

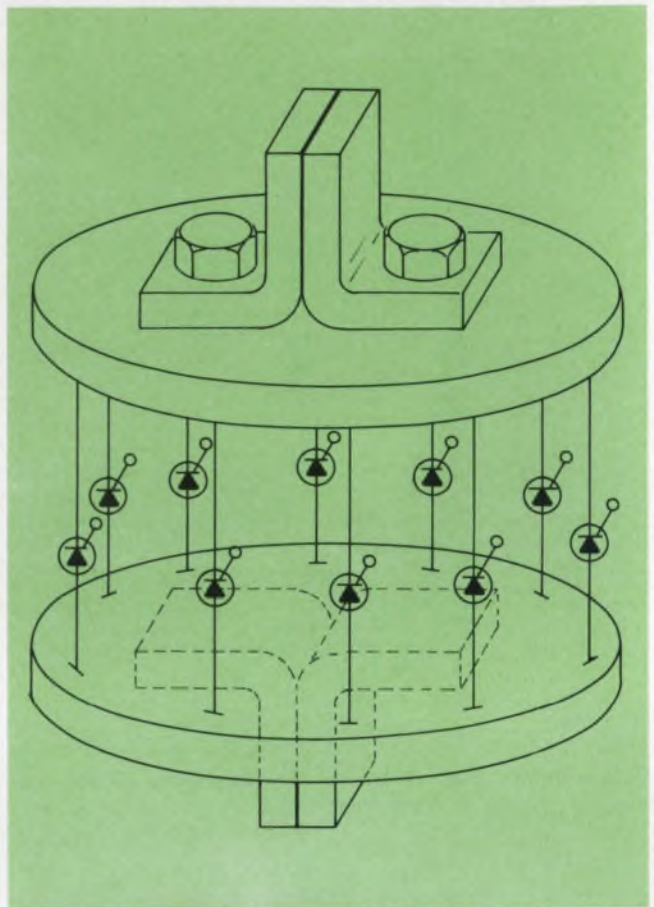

8. A cylindrical assembly should theoretically provide the most uniform current distribution among paralleled SCRs because of the configuration's symmetry.

also to provide the required equalizing inductance. However, to support and cool a group of large SCR devices connected in parallel, you must get the current into and out of each thyristor and supply the proper amount of inductance to equalize the current—not a simple task. The proximity of ferrous materials and other conductors can significantly affect the distribution of inductance and upset the balance. Differences in spacing between conductors, and the configuration of the power bus bars, also have a strong influence.

The frequently used mechanical configurations are shown in Figs. 6 and 7. The straight-through bus assembly (Fig. 6) shows a $\pm 20\%$ mismatch from the average of the devices that carry maximum and minimum current. By contrast, the arrangement in Fig. 7 results in a smaller mismatch. Instead of straight bus bars, this assembly uses a special loop configuration that changes the inductance in the center of the structure to achieve a more uniform distribution of current.

But the cylindrical arrangement of Fig. 8 has the potential of attaining even more uniform current distribution among paralleled SCRs, at least in theory. ■■

RIGHT ON TARGET AGAIN



Bearing it well!

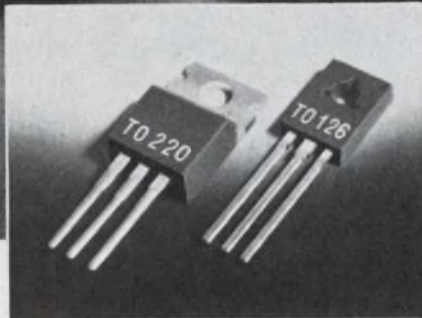

Complementary power pairs in plastic

Epitaxial-base darlingtons

4 Amperes - TO 126 pack

NPN	PNP
2N 6037	2N 6034
2N 6038	2N 6035
2N 6039	2N 6036
SJE 800	SJE 700
SJE 801	SJE 701
SJE 802	SJE 702
SJE 803	SJE 703

8 Amperes - TO 220 pack

NPN	PNP
BDX 53/A/B/C	BDX 54/A/B/C

Epitaxial-base transistors

2 Amperes - TO 126 pack

NPN	PNP
2N 4921/22/23	2N 4918/19/20
SJE 720/21/22	SJE 710/11/12

4 Amperes - TO 126 pack

NPN	PNP
2N 5190/91/92	2N 5193/94/95
SJE 220/1/2/3/4/5	SJE 230/1/2/3/4/5

4 Amperes - TO 220 pack

NPN	PNP
2N 6121/22/23	2N 6124/25/26
SIP 31/A/B	SIP 32/A/B

SGS-ATES Semiconductor Corporation - Newtonville, Mass. 02160 - 435 Newtonville Avenue - Tel: 617-9691610 - Telex: 929428.
Stocking Distributors: Edmar Electronics Co., Des Plaines, ILL, (312) 298-8580 - Energy Electronic Products, Los Angeles, CA, (213) 670-7880 - Esco Inc., Dayton, OHIO, (513) 226-1133 - KA Electronic Sales, Dallas TX, (214) 634-7870 - Radar Electric Co., Seattle, WA, (206) 282-2511 - Re-Coil Electronics Inc., Santa Clara, CA, (408) 984-0400 - Rosyl Electronics, Bayshore, NY, (516) 586-1800 - Wilshire Electronics, Burlington, MASS, (617) 272-8200 - Prelco Electronics Ltd., Montreal 357, Quebec, (514) 389-8051



Gordon Moore of Intel Speaks On Moving from Lab to Production

If you're in an industry that moves as fast as the semiconductor industry, you always have to contend with the problem of getting laboratory developments into production quickly. Actually you face this problem in any electronics company, but it's tougher to cope with as you grow larger. It's important because getting your product to the market fast can have a major impact on your profits.

When you're small it's relatively easy to move quickly. But when you get bigger it's like a big AND gate. Everybody has to say yes before something happens. Before you move something into production, you normally have to get Quality Assurance to agree and then the manufacturing engineers have to agree and marketing has to agree.

You find that the easiest time to get everybody to agree is after a competitor has brought out a product and proved that it is viable.

Trying to avoid that kind of situation is one of the principal challenges you have because you really want to keep things going fast in this business.

The way we cope with the problem at Intel, in essence, is to move the lab onto the production line. We do our product development directly in the manufacturing line. Manufacturing gets involved in all our new products—even high-technology products—right at the beginning.

Right from the start, we try to do as much as we can as if we were manufacturing a regular production product. Even for research and prototype products, we use the same production equipment and the same production-line people as far as possible. We try to make our research device just like a production device.

The only things we do outside the production line are unique processes or dramatically different technologies. But we do all standard processes right on the line. For example, the photo-masking operations are likely to be standard for almost any product we might develop. Wafers for a brand new product will go through the same furnaces as conventional wafers.

A brand new circuit might go through 10 steps that are exactly the same as steps followed by a production item. Then it might be taken off the line to an adjacent area for a special operation, then returned to the production line again. Fortunately, most devices have a great deal of processing in common.

An example of a brand new product on the line was the charge-coupled device that we recently introduced. Everything except a unique part of the process involving the double poly

structure was done on our regular production lines right from the day we started the development.

In general our approach lets us do very well things that are closely related to things we're doing already. But it doesn't give us any real capability with a completely different approach. For example, we'd have trouble doing magnetic bubbles. It's a dramatically different technology. But when we develop a device that requires an extension of our existing technology or a refinement of that technology, that's fine.

Now the obvious objection to our approach is that it violates a whole bunch of traditional rules in our industry—like keeping the lab away from the production line and keeping specials away from the main line. And in fact, our procedure does interfere a bit with the efficiency of the line. It is sometimes a burden, though in most cases, it doesn't disrupt the line at all.

Sure, we commit a fraction of our capacity—people and equipment—to running engineering slices and specials. So we pay a penalty in production costs that are probably higher because development projects may have slowed the production process.

But we get many payoffs. Most important, we don't get many surprises. We're never in the position of the people who suddenly discover, just as they're ready to go into production, that they really don't know how to make the part.

By the time we decide to manufacture a part, we know that we really know how to make it because we've been making it on the production line all along. We don't have trouble transferring a product to production because once we decide we have something that works, it's already there. It already exists in the production environment. But our really big payoff comes with new technology.

A new technology is a very delicate deal. It's carefully balanced and it works only because somebody believes that it works.

If you move a new technology to people who are not believers and ask them to make it fly, the first thing that happens is that everything stops working. It has to be completely re-engineered by the production-engineering people.

We don't have that trouble. We don't get a new group of people who feel they have to re-develop everything before they can get an interest in making it work. That's a real problem that often exists when something transfers from one organization to another.

That was one of the things frankly, that was frustrating back at Fairchild. We had great dif-

faculty transferring new technology from the lab to the factory. But Fairchild still was more successful than most companies in getting new ideas into production.

There was one place where Fairchild fell down—MOS—and I personally deserve a lot of blame for that weakness. I didn't recognize MOS for what it was when it came along. It's not that I didn't recognize its importance, but I viewed MOS, simply, as just another way of making circuits. So I sent circuits from the lab down to the same group that was making DTL and linear circuits.

MOS wasn't just another way of making circuits. It was a religion. You had to have a priest and zealots to make it go.

The things you could get away with in other technologies, you couldn't get away with in MOS. That was a very difficult thing to teach people who were used to running relatively sloppy bipolar processes. They had to be really careful with MOS. Yet MOS didn't look all that scary in the lab.

And that was the kind of problem we wanted to avoid when we set up Intel, and one of the things that led to our lab-on-the-line approach. There's yet another advantage to our approach that I didn't mention.

There's no development line that works anywhere near as well as a good production line. Those people on the line do the same kind of thing every day, under tight supervision, and with a lot of pressure constantly to improve quality and yield. You never get this kind of pressure or experience in an R&D environment where you're not likely to do anything the same two days in a row. You don't get that good discipline.

In the usual lab, most development programs eventually get into what I call the constant-time-to-completion phase—when they get *almost* done. At this point, lots of things start to converge and you're almost there—but you don't quite make it.

When you see enough of these things happen, you don't get too upset; you don't get completely shocked. You have to be careful, though, that such delays don't occur with, say, a watch circuit, which is very seasonal, so you might miss a whole year.

Our procedure helps change the pace of the engineers since they're so intimately tied to the production line. It frees them from having to reinvent the wheel but, more important, it discourages them from doing things in nonstandard ways that might hurt us.

If an engineer had to set up his own masking operation in the lab, for example, his tendency

Who is Gordon Moore?

When Dr. William Shockley (co-inventor of the transistor) invited him to join a fledgling semiconductor company in 1956, Gordon Moore was ready. The basic research he was doing at the Applied Physics Laboratory at Johns Hopkins University was beginning to lose its appeal. He knew he was ready for a change when he found himself calculating the cost per word to the taxpayer of the reports he was publishing.

He was ready for something more practical. Though Moore hardly knew what a semiconductor was at the time, Shockley felt that his doctorate in chemistry from Caltech was a suitable background. So, one bright Monday morning, he reported to work at Shockley Laboratories just three days after Robert Noyce started there.

For about a year and a half they worked on advanced semiconductors, like four-layer diodes. Following some disagreements on the direction of the operation, eight members of the staff decided to leave. Then, financier Arthur Rock suggested that they start a semiconductor company. Rock tracked down Fairchild Camera and Instrument Corporation, which didn't know yet that it wanted to get into the semiconductor business. But in 1957 eight engineers from Shockley Laboratories started making double-diffused transistors—the first on the market—at Fairchild. In about a year they were making mesa transistors and then, in 1959, the first planar transistors. That was Fairchild's springboard into the integrated-circuit business—close on the heels of the introduction of the first IC by Jack Kilby at Texas Instruments. But Fairchild's early ICs offered significant advantages over the early TI devices, thanks to planar, rather than chip-and-wire mesa construction.

As director of the research lab at Fairchild, Moore felt he had the best job in the industry. But in 1968 Fairchild seemed to be going through some traumatic management changes and Moore didn't want to be around when the dust settled. Neither did Robert Noyce. So, at 39, Moore joined Robert Noyce in founding Intel (which derives from Integrated Electronics).

At first they didn't know exactly what Intel was going to do. They knew it couldn't be some-

might be to use some nonstandard technique, or do something in some unique way that might work well in the lab and be a disaster in production. Or he might have to do a lot of his own process development.

Then, when we wanted to move into production, we would either have to set up a new process or convert his process to our production

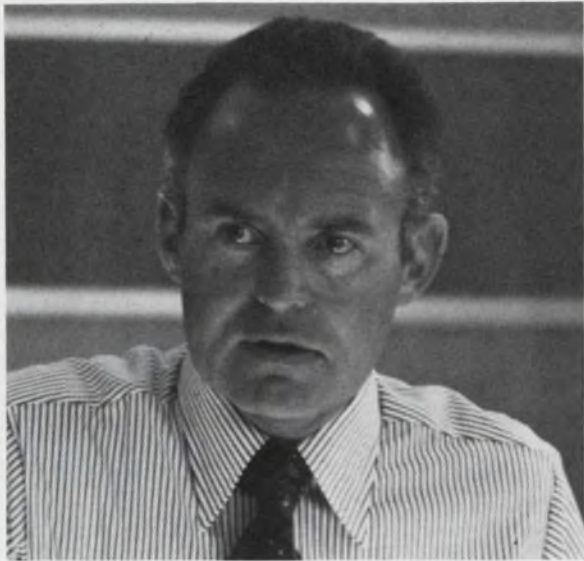

thing that would give a large company an automatic advantage. It had to depend on brains, not financial brawn—something that depended heavily on the processing of silicon, for example, rather than on packaging. They wanted rather complex chips that could be sold in high volume. They wanted to avoid a small-volume business because, in such a business, you simply sell engineering and they felt they couldn't build a business on that. So they wound up making semiconductor memories—the first important exploitation of large-scale integration.

Since they had come through an exciting growth period at Fairchild, it would have been difficult for them to settle for something less. So they wanted Intel to grow. It did. Last year the company's revenue exceeded \$134 million. At the annual shareholders meeting this April, Moore was elected President as Robert Noyce moved to the position of Chairman of the Board.

Though it sometimes seems that Moore spends all his time at Intel, that's not quite true. On weekends, if he's not home with his wife, Betty and their sons Ken, 20, and Steve, 15, Moore is on his boat in San Francisco Bay. "I fish as much as I can," he says, "but I'm not a specialist. I fish for anything that swims. But sometimes, I'm more a fishing-tackle collector than a fisherman."

technique. You never know what's different between the lab environment and the production environment. So if you're working in the usual lab, you might be tempted to ignore certain design rules. You might say, for example, "Heck, they can make lines this thin," and "Sure they can make these. I made one."

That kind of problem we just don't have. ■■

Multiple choice

**1,700 answers
to electrical enclosure needs
by Hoffman.**

Quick answers too. Hoffman offers you "off-the-shelf" shipment on most of over 1,700 standard electrical/electronic enclosures.

Each of them is built to meet the quality standards that made Hoffman's reputation. They include:

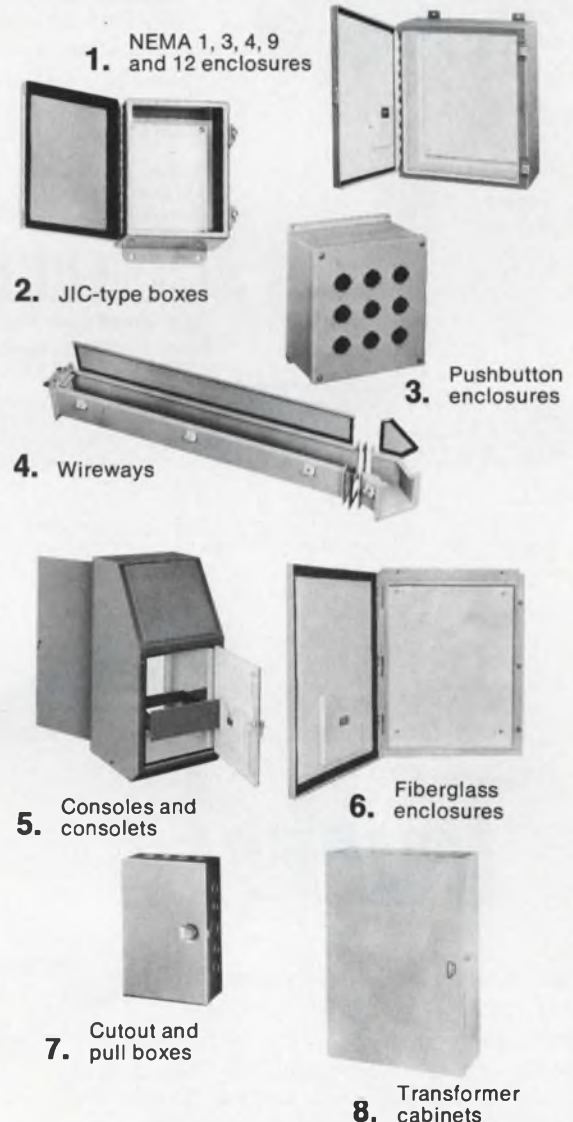

If you have a need that isn't met by one of our over 1,700 standard enclosures, we can modify them or custom engineer and fabricate per your specifications. Our free catalog gives details on quality Hoffman enclosures and is available on request. Put Hoffman to the test.

Hoffman **ELECTRICAL ENCLOSURES**
HOFFMAN ENGINEERING COMPANY
 Division of Federal Cartridge Corporation
 ANOKA, MN 55303 DEPT ED 522

INFORMATION RETRIEVAL NUMBER 53

Consider all the ins and outs of your new circuit design. Then consider Curtis® Terminal Blocks.

Tangled, twisted, and loose wires can snarl up even the best circuit design. So don't tangle with trouble. Curtis offers 19 electronic and electrical terminal blocks with hundreds of model variations available to straighten out almost any wiring layout problem.

Here are just a few of the features offered----

- capacities ranging from 5 amps/300 volts to 250 amps/600 volts
- modular, channel-formed, closed-back, feed-thru and fully insulated feed-thru designs offered
- choice of tab, screw, clamp, PC pin or taper pin termination
- heavy duty lug and tubular, high pressure solderless types available for high current applications
- full mechanical thread system incorporated in many units

Specify Curtis electronic and electrical terminal blocks and you'll have the best line in the industry to work with. Specify anything less and you may be tangling with trouble.



CURTIS INDUSTRIES, INC.

8000 West Tower Avenue, Milwaukee, Wisconsin 53223

Call (414) 354-1500 for the name of a representative or distributor near you.

In Canada: A.C. Simmonds & Sons, LTD, Willowdale, Ontario.

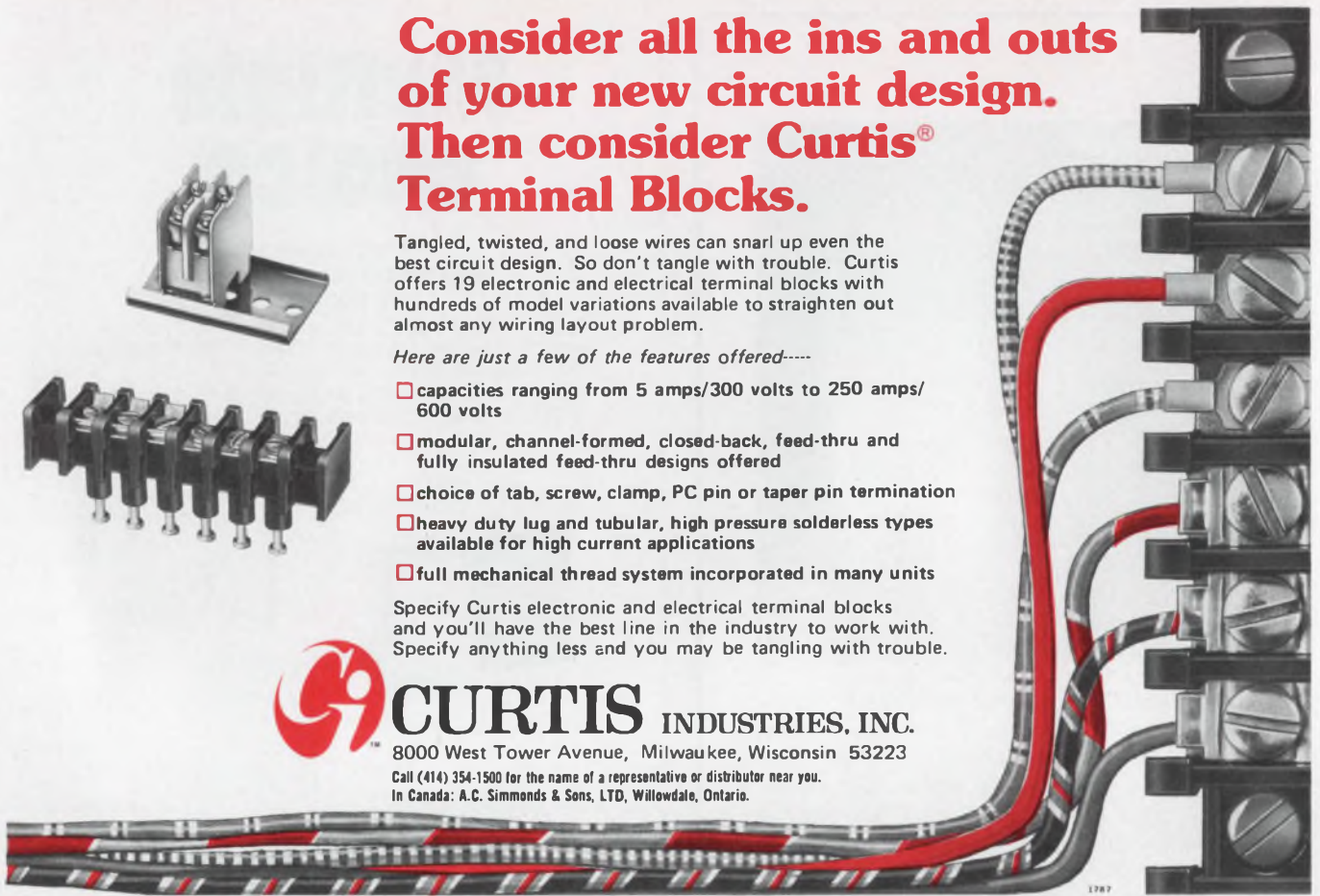

INFORMATION RETRIEVAL NUMBER 54

Touché!

Target: to eliminate the warp problem in space-saving $\frac{1}{8}$ " plug-in panels.

The winning combination: EMC's Wire-Wrap® Panels with Nurl-Loc® Terminals. EMC panels stay flat, without stiffeners, because Nurl-Loc's splined cylinder distributes stress evenly throughout board thickness, even on boards as large as 15" x 18" (shown). A flat panel means more accurate true positioning between pins for better wrapping. Nurl-Loc also permits easy pin removal without damage. And the four-finger contact holds any I.C. lead firmly, even as small as .011 dia. Call Allan Klepper (401) 769-3800 for your copy of the interesting and informative "Inside Story", or write Electronic Molding Corp., 96 Mill St., Woonsocket, Rhode Island 02895.

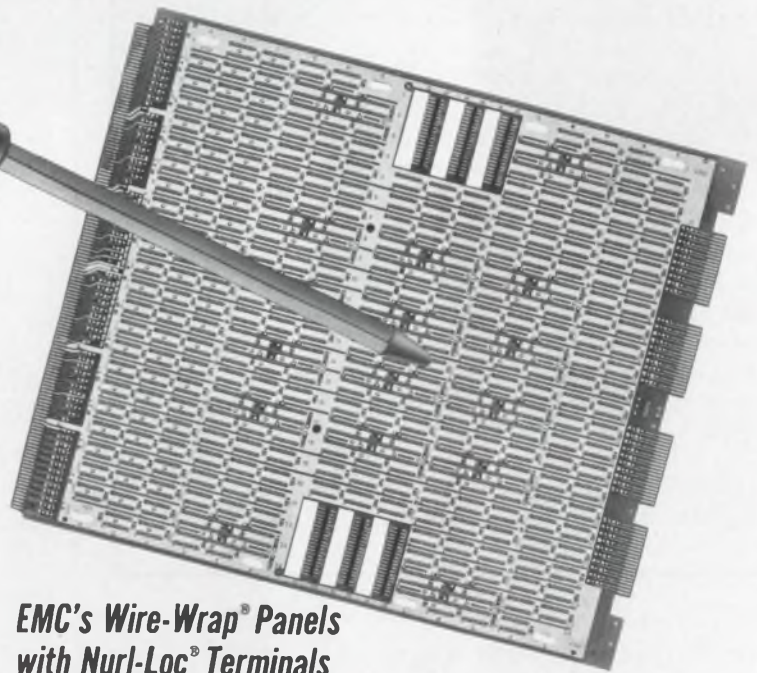

**EMC's Wire-Wrap® Panels
with Nurl-Loc® Terminals
... better performance by design!**

EMC
Interconnection Specialists

Wire-Wrap® Gardner-Denver Co.

INFORMATION RETRIEVAL NUMBER 55

The Ten Most WANTED INSTRUMENTS

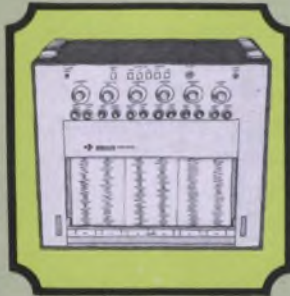

Brush Oscillograph 260

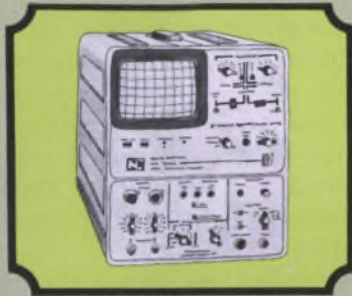

Nicolet
Digital Storage Oscilloscope



Brush Oscillograph 481



Data Research
Transient Voltage Recorder



Esterline Angus Chart Recorder

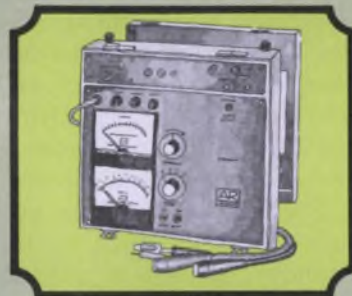

Associated Research
Insulation Tester

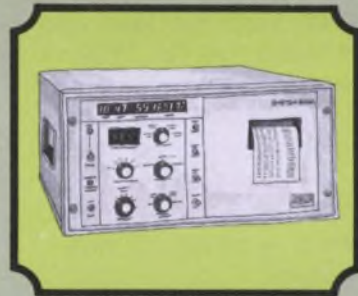

Kaye Data Acquisition System



Tektronix Oscilloscope



Biddle Megger

RENT'EM FROM GE

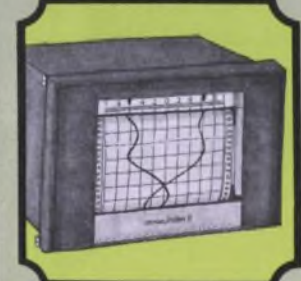

Texas Instruments
Temperature Recorder

What's at the top of your Most Wanted List? Quick•rental instruments has rounded up over 5,000 different instruments from all the manufacturers. Our 100 Sales/Service Centers are major-city located, coast-to-coast. And we'll ship

your instruments on the day you call, calibrated to the manufacturer's specs.

Short or long term rentals...money-savers when you want instruments. Want more information? Call 518-372-9900 collect.

GENERAL  ELECTRIC

COME SEE US AT WESCON '75
BOOTHS 1223 & 1225

Dynamic power-supply load tests dual supplies to 1.25 A at 45 V

A balanced and tracking dynamic-load circuit is needed for proper testing of dual-voltage power supplies. The load circuit in the figure has complementary symmetry. It can be set for dc load current levels of 1.25 A at 45 V, and the load current can be modulated around this dc level by frequencies from 10 Hz to over 20 kHz. An ac voltage-to-current ratio that is thus obtained can directly give the power-supply output impedance.

If the dc load current is set to 500 mA, a 1-V pk-pk modulation signal can vary the load current by approximately 450-mA pk-pk. With a modulation signal in excess of 2.2-V pk-pk, the load current can be made to swing from cutoff to over 1 A. And if R_1 and R_2 are lowered to 1 Ω , the current swing can be increased to 2.5-A pk-pk. But with these resistors equal to 100 Ω , the maximum current swing is about 25 mA—ideal for small dc-dc converters.

Five monolithic transistors, Q_2 through Q_6 , contained in a CA3096, form a complementary current mirror. Three sections of an LM324 quad op amp, A through C, and their associated transistors act as voltage-controlled current sources or sinks. And the fourth op-amp, section D, is an impedance converter that couples the ac modulation input to the circuit. The output transistors, Q_1 and Q_{10} , must be mounted on heat sinks that are adequate for the dissipation of about 50 W. True Darlington transistor pairs in a single housing—with no internal resistors—may be substituted for the output stages shown, but quasi-Darlington units will not work properly in this circuit.

Differences among the transistors in a CA3096 can cause over 10% variation in tracking between the positive and negative output voltages developed by Q_1 and Q_{10} . However, resistor values for R_9 and R_{10} can be selected to improve the tracking. In the prototype design, R_9 was 3.9 Ω and R_{10} was shorted. With these values, the tracking was within $\pm 5\%$ over a 5:1 variation in control current—adequate for most testing.

Because of the low standby power requirements of the LM324, battery power can be used. Standby current is a little over 1 mA and the total battery current is less than 10 mA at the maximum load-current setting. But for maximum stability during long-term tests, regulated voltage to R_4 is desirable.

Because of the low standby power requirements of the LM324, battery power can be used. Standby current is a little over 1 mA and the total battery current is less than 10 mA at the maximum load-current setting. But for maximum stability during long-term tests, regulated voltage to R_4 is desirable.

Ralph Tenny, Senior Research Assistant, Texas Instruments Inc., P.O. Box 5936, Dallas TX 75222.

CIRCLE NO. 311

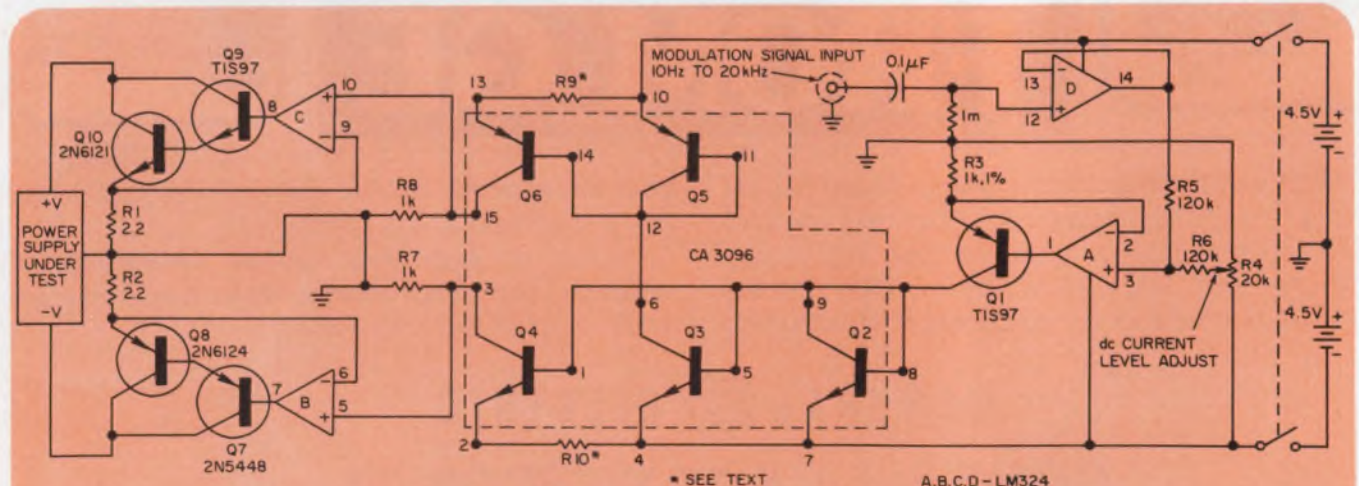

Dual power supplies can be tested and their output impedances determined from 10 Hz to 20 kHz

with this dynamic tracking tester that is built from a quad op amp and transistor array.

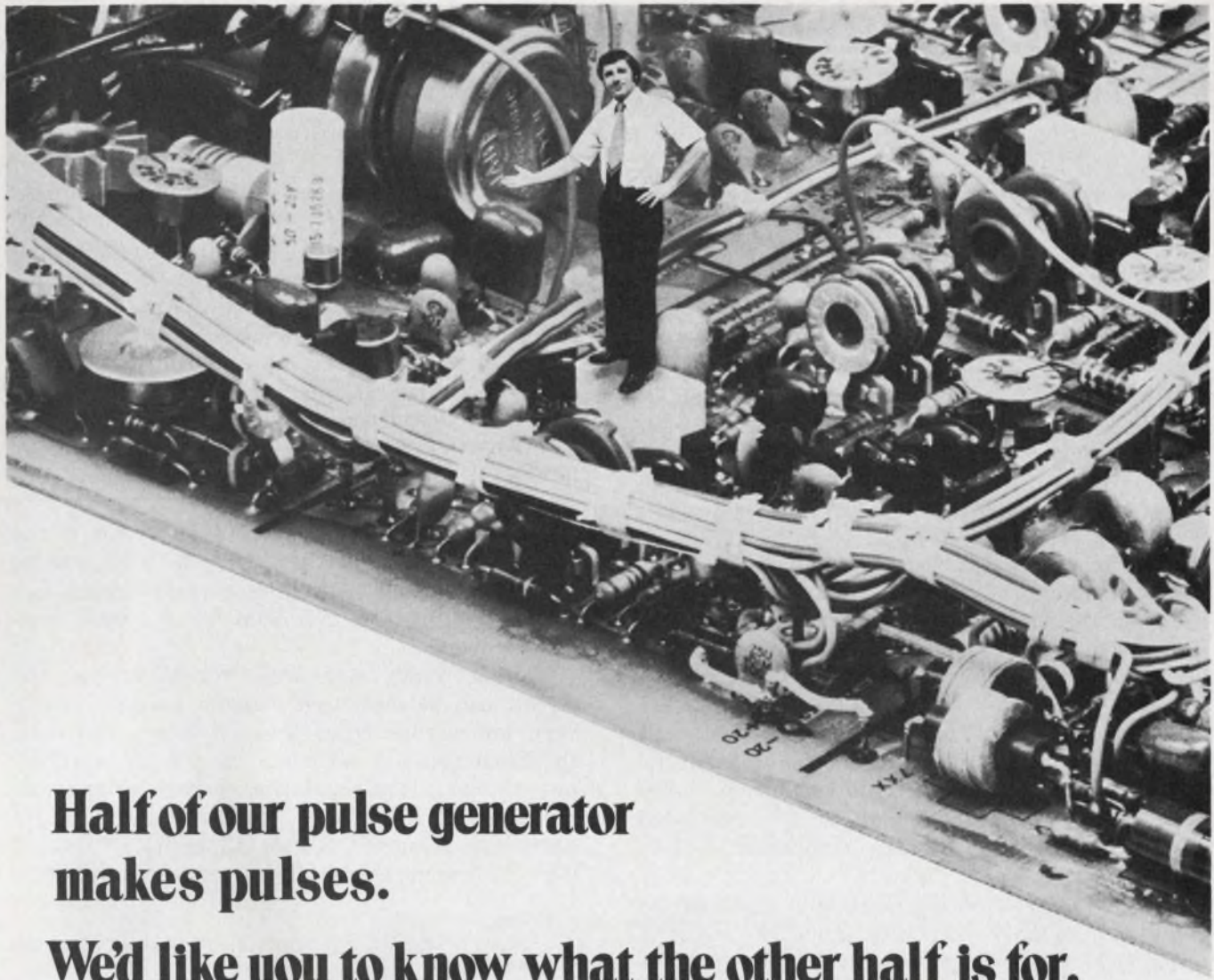

**Half of our pulse generator
makes pulses.**

We'd like you to know what the other half is for.



Pulse generators make pulses — everybody knows that. The half everybody **doesn't** know about is that today's general-purpose pulse generators (like Interstate's SERIES 20) can:

- 1) **Make your life easier.** With Interstate's constant duty cycle mode, for example, you don't have to reset width and pulse period every time you change the frequency when testing a differential amplifier or an analog computing circuit over a wide range of frequencies. The width-to-period ratio remains constant as you change the frequency. Much easier.
- 2) **Give you an infinitely more versatile pulse.** Clock and sync outputs on Interstate's SERIES 20 Pulse Generators are squarewaves, instead of those other skinny, 10-nanosecond trigger pulses. So when you're testing low-speed stuff, like electromechanical machines or reed relays, or even some of the new microprocessors, you won't have to keep switching the scope over to high speed to make sure the trigger is there. Interstate's sync pulse is readily visible — and immediately usable.
- 3) **Allow you to use the pulse generator for other jobs.** SERIES 20's pulse amplifier mode can restore levels and transition times in MECL testing, for instance, so you can avoid having to jerry-rig some complex kluge of equipment.

Put the other half of your pulse generator to work. Interstate has just produced "Today's General-Purpose Pulse Generator Report" in which our SERIES 20 Pulse Generators, together with the major pulse generator models in the 50 MHz, 3.5 ns rise/fall time, 10 V output (into 50 ohms) category, are detailed and cross-compared, and application notes reveal methods and techniques for practical pulse problem-solving. For your free copy, write to:



**INTERSTATE
ELECTRONICS CORPORATION**

Subsidiary of A-T-O Inc.

P.O. Box 3117, Anaheim, California 92803 • (714) 549-8282 • TWX U.S.A. 910-591-1197 TELEX 655443 & 655419

INFORMATION RETRIEVAL NUMBER 57

Precision reference source eliminates power-supply regulation errors

A precision reference source circuit goes far beyond standard circuits¹ to minimize regulated power-supply errors resulting from V_{ref} changes. In the figure, A_1 is the error amplifier, and the reference is a three-terminal device, the AD580M.

Another three-terminal device, the 78L05 regulator, operates as a pass transistor. Op-amp A_1 drives the 78L05's common terminal to maintain the regulator's output. And the power-supply terminals of A_1 and the reference are connected to the regulated output. This bootstrap arrangement helps reduce common-mode and power-supply-shift errors.

The three-terminal regulator is desirable as a pass transistor, because it has built-in current limiting, thermal-overload protection and is easily driven from the op-amp output. Also, it is less expensive than equivalent discrete circuitry would be.

Resistor R_1 provides a voltage pedestal at start-up to reverse-bias D_1 . This allows the 78L05's output to rise uninhibited until A_1 takes over to establish equilibrium at the regulated output level—10 V for the component values used in the figure.

The AD580 device is specifically designed as a low-power, 2.5-V reference. The "M" suffixed units have the lowest available temperature coefficient—10 ppm/°C max. Resistors R_1 and R_2 should be a closely tracking matched pair,

trimmed for final output calibration. Op-amp A_1 should be a low-drift type; the recommended AD301AL has 2 ppm/°C max drift. Independent wiring, as shown in the figure, is recommended for the error-sensing bridge consisting of R_1 , R_2 and AD580M. This wiring should carry only the bridge's current and be connected directly at the output terminals of the circuit.

Though the circuit in the figure is limited to 25-mA output by the 78L05, the same technique is feasible with higher-current regulators such as the 7800 or 109 types.

The major error source of this circuit is the temperature drift of the AD580M. This can be minimized by enclosing the sensing-bridge circuit, including the AD580M in a small component oven.

Neither input nor load regulation of the circuit can be measured directly because of the very low errors from these sources. However, the input error is estimated as 0.1 $\mu\text{V}/\text{V}$ of input change, load-regulation error is approximately 1 $\mu\text{V}/50\text{ mA}$ of load, and temperature causes an error of roughly 13 ppm/°C. Over a 0-to-70-C range, the total error is 6 mV, or 0.06%.

Reference

1. Jung, Walter G., "IC Op Amp Cookbook," Howard W. Sams & Co., 1974.

Walter G. Jung, 1946 Pleasantville Rd., Forest Hill, MD 21050.

CIRCLE NO. 312

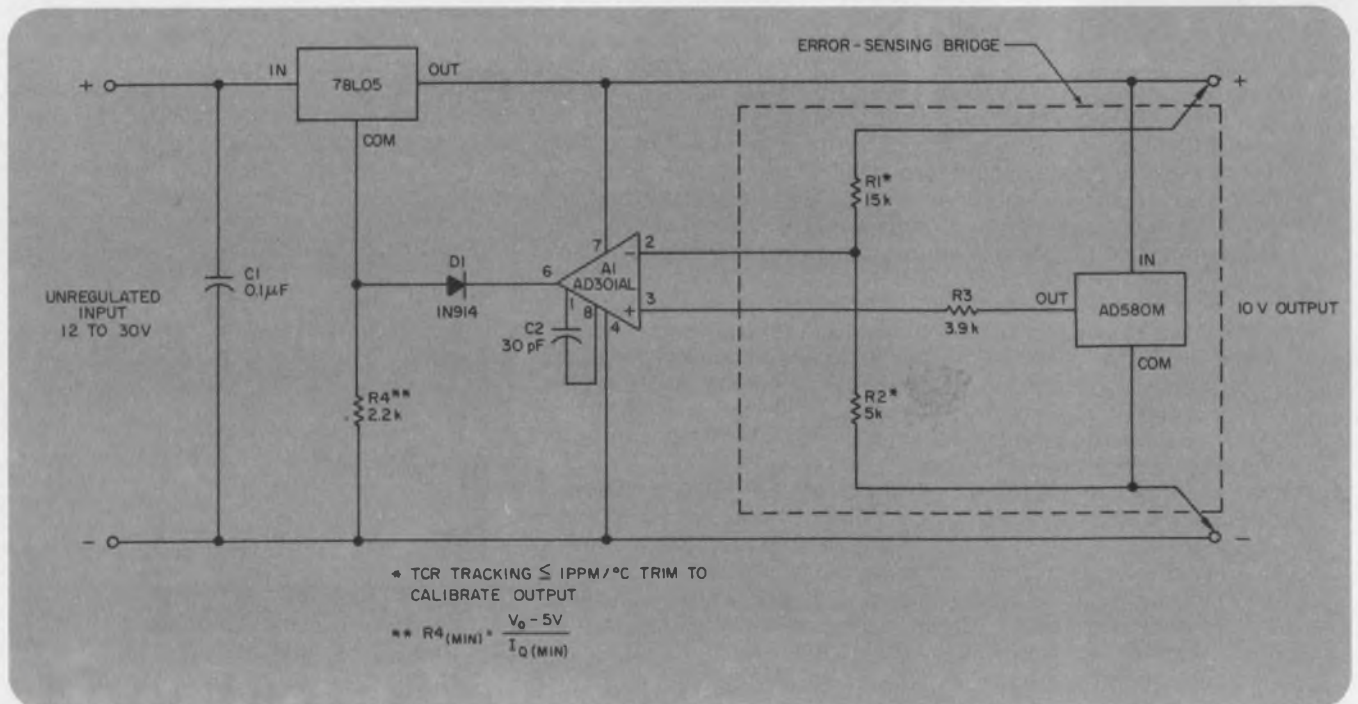

A precision reference reduces power-supply output errors below directly measurable levels.

POWER FOR YOUR IC'S OR OP AMPS

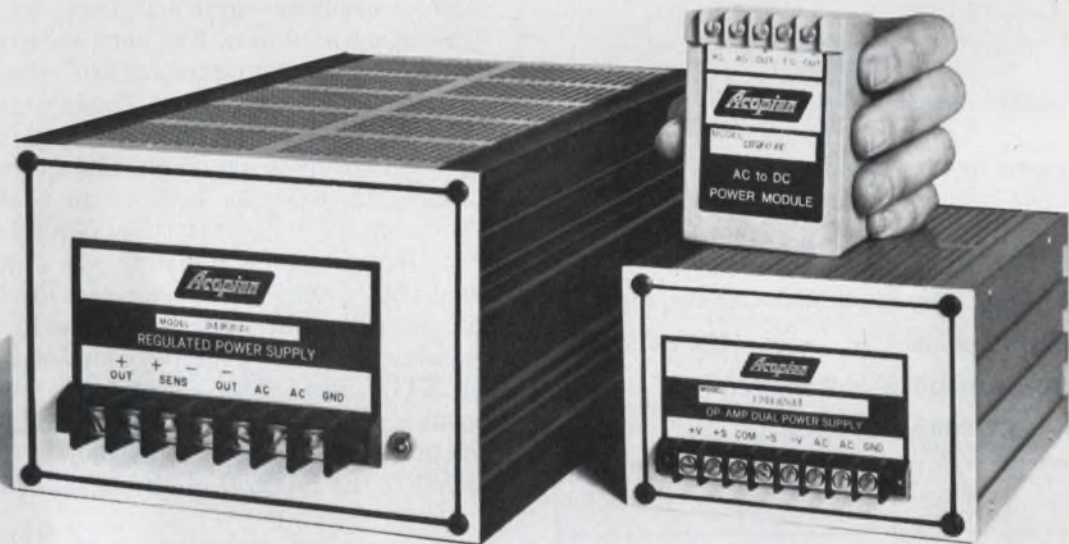

ALL MODELS U.L. RECOGNIZED

5 VOLTS

OUTPUT CURRENT AMPS	SIZE INCHES	PRICE	MODEL
.5	3.5 x 2.5 x 1.4	\$55	5EB50
1.0	3.5 x 2.5 x 1.6	75	5EB100
2.0	3.5 x 2.5 x 2.4	115	5EB200
2.5	3.5 x 2.5 x 2.4	130	5EB250
5.1	3.4 x 5.1 x 6.6	150	A5MT510
9.0	3.4 x 5.1 x 9.3	180	A5MT900
12.0	3.4 x 5.1 x 13.3	200	A5MT1200
22.0	5.1 x 7.4 x 11.3	270	A5HT2200
32.0	5.1 x 7.4 x 16.0	320	A5HT3200

±15 VOLTS

OUTPUT CURRENT AMPS	SIZE INCHES	PRICE	MODEL
.1	3.5 x 2.5 x 1.4	\$55	DB15-10
.15	3.5 x 2.5 x 1.4	65	DB15-15
.2	3.5 x 2.5 x 1.4	75	DB15-20
.4	3.4 x 5.1 x 5.1	85	TD15-40
1.0	3.4 x 5.1 x 5.1	125	TD15-100
1.6	3.4 x 5.1 x 6.6	150	TD15-160
2.5	3.4 x 5.1 x 9.3	160	TD15-250
4.5	3.4 x 5.1 x 13.3	225	TD15-450
8.5	5.1 x 7.4 x 11.3	299	TD15-850

Line/Load Regulation: \pm .1% or better; Ripple: 1.5 mv or less; Input: 105-125 VAC

Three day shipment guaranteed. Complete details on these plus a comprehensive line of other power supplies and systems are included in the Acopian 73-74 catalog. Request a copy.



Corp., Easton, Pa. 18042. Telephone: (215) 258-5441.

INFORMATION RETRIEVAL NUMBER 58

CHOPPER PERFORMANCE at Bipolar Prices!

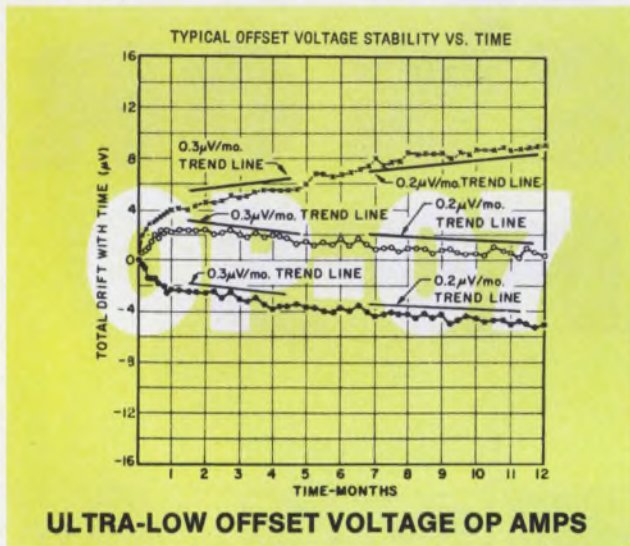

- No Choppers or Chopper Noise
- Ultra-Low V_{OS} $10\mu V$
- Ultra Stable vs Time $0.2\mu V$ /Month
- Reliable Single Chip Monolithic Construction
- True Differential Input CMRR 126dB
- No External Components Required
- Fits 725, 108A/308A, 741 Sockets

Model Number	OP-07A	OP-07	OP-07E	OP-07C
Temperature Range	-55 to +125°C	-55 to +125°C	0 to +70°C	0 to +70°C
V_{OS} Maximum	25 μV	75 μV	75 μV	150 μV
TC V_{OS} Maximum	0.6 $\mu V/^\circ C$	1.3 $\mu V/^\circ C$	1.3 $\mu V/^\circ C$	1.8 $\mu V/^\circ C$
I_b Maximum	2.0 nA	3.0 nA	4.0 nA	7.0 nA
TC I_b Maximum	25 pA/°C	50 pA/°C	35 pA/°C	50 pA/°C
Input Noise Voltage 0.1Hz to 10Hz Max.	0.60 μV p-p	0.60 μV p-p	0.60 μV p-p	0.65 μV p-p
Input Noise Current 0.1Hz to 10Hz Max.	30 pA p-p	30 pA p-p	30 pA p-p	35 pA p-p



1500 SPACE PARK DRIVE, SANTA CLARA, CALIFORNIA 95050
TEL. (408)246-9222 • TWX 910-338-0528 • CABLE MONO

INFORMATION RETRIEVAL NUMBER 59

Drift-free integration with a v/f converter and digital counter

An excellent solution to the problem of accurately integrating an analog signal over a relatively long time—from minutes to hours—is to use a simple analog-to-digital integrator technique that employs a voltage-to-frequency (v/f) converter. Accurate operational integrators are limited by drift. Even with the best of components, it is most difficult to build an integrator with reasonable accuracy over an integration time of even 10 min. For very long-term integration, chemical integrators are often used, but these have low resolution. Though the v/f idea is not new, the recent availability of low cost, accurate v/f modules has made the method practical.

The v/f converter accepts an analog input in the range of 0 to +10 V and puts out a pulse rate that is proportional to the input over the range of 0 to 10 kHz. These pulses are then counted by an electronic counter. Almost any type is satisfactory, even a simple counter assembled out of TTL units. The counter is stopped either manually or automatically at the end of the integration period. The output count is then proportional to the integral of the input signal:

$$\int_0^T E(t) dt = \int_0^T Kf(t) dt = K \int_0^T \frac{dN(t)}{dt} dt = KN,$$

where f is the instantaneous frequency of the v/f converter, K is a constant, and N is the total count.

Almost any v/f converter can be used, but it

IFD Winner of April 26, 1975

Dr. A. Engelter, Signal Processing Div., National Electrical Engineering Research Institute, CSIR Naval Headquarters, Simonstown, South Africa. His idea "Passive Low-Pass Filter Recovers Signals Buried in High Ripple" has been voted the Most Valuable of Issue Award.

Vote for the Best Idea in this issue by circling the number for your selection on the Information Retrieval Card at the back of this issue.

ELECTRONIC DESIGN cannot assume responsibility for circuits

This 10 MHz Triggered Scope is 1/3 the size of comparably performing scopes.

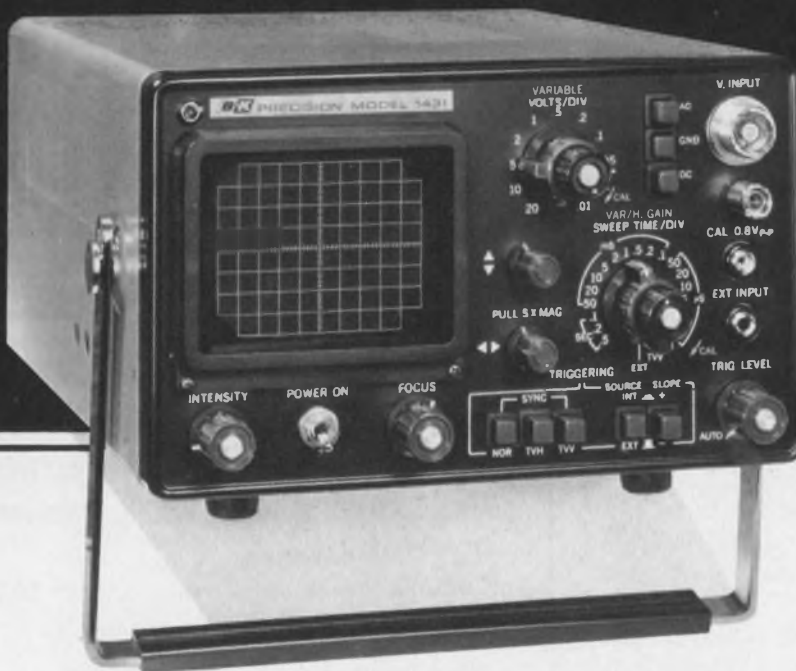

MODEL 1431 \$399.00

It's a lightweight 13 pounds in your hand and a heavyweight performance wideband scope with a 35 nanosecond rise time on your bench or jobsite. Whether you're servicing or designing industrial equipment or TV, there's the right sweep speed and sync for easiest operation. If you know our Model 1460, the leader in wideband 5" CRT scopes, you know our new 3" Model 1431 which gives you the same high performance in one third the size. (Only 4 $\frac{3}{4}$ "H x 7 $\frac{7}{8}$ "W x 12 $\frac{7}{8}$ "L)

Servicing, production, inspection, quality control and lab applications are all easier with this versatile all solid-state instrument. Triggering is accomplished with only 0.5V peak-to-peak. Ten millivolts per division sensitivity, 0.5 usec/cm to 0.5 sec/cm automatic and triggered sweep in 19 calibrated ranges, and external trigger input are just a few of the reasons you'll like it.

If you have been waiting to buy a portable scope until you could get all the features you'll ever need at a price you want to pay, you've been waiting for Model 1431. Contact your distributor or write Dynascan Corporation.



Shown with optional carrying cover and probe pouch.

B&K PRODUCTS OF
DYNASCAN
1801 W. Belle Plaine Ave.
Chicago, IL 60613 • (312) 327-7270

Think Large.

Think Small.

Think Ise *itron*[®]

Think our three jolly green giants for desk-top electronics. Our two pint-size pigmies for carry-in-the-pocket display designs. But don't stop there. Think low operating voltages, low power consumption, glass encapsulation all around, and wafer-thin thickness and dip clip pins for fast efficient mounting.

FG-159A2

ec = eb = 35Vp-p
ic = 4.5mA p-p
ib = 3.5mA p-p

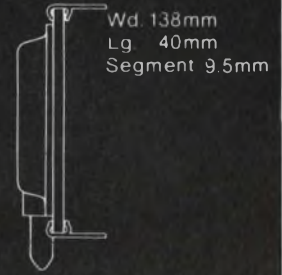

FG-139A2

ec = eb = 30Vp-p
ic = 3.6mA p-p
ib = 2.8mA p-p

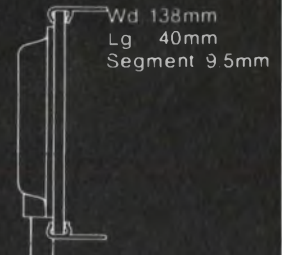

Our jolly green giants

FG-99A2

ec = eb = 24Vp-p
ic = 3.5mA p-p
ib = 2.5mA p-p

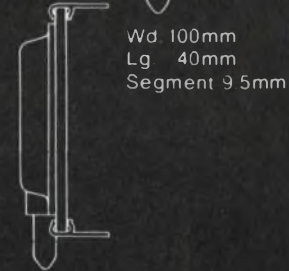

FG-125A2

ec = eb = 24Vp-p
ic = 2.0mA p-p
ib = 2.0mA p-p



Our pint-size pigmies

FG-95A

ec = eb = 24Vp-p
ic = 2.0mA p-p
ib = 1.5mA p-p

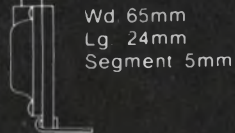

Something else to think about

Think Ise for digital readouts for instruments, clocks and other products, too.

The Brighter Side of Electronics

ISE ELECTRONICS CORP.

Main Office:

P.O. Box 46 Ise City, Mie Pref. Japan
Tel. (05963) 5-2121 to 4, Telex: "4969523"

Tokyo Office:

2-7-7 Shigashi, Shinbashi, Minato-ku, Tokyo, Japan
Tel. (03) 433-6616 to 9, Telex: "J26546"

Noritake Electronics Office:

22410 Hawthorne Blvd. Torrance California 90505 U.S.A.
Tel. (213) 373-6704, Telex: "230674910"

INFORMATION RETRIEVAL NUMBER 62

CCD shift register distortion is solved

The problem of harmonic distortion in charge-coupled devices operated as analog shift registers has been solved by researchers at the University of Edinburgh in Scotland. The distortion, produced by the introduction into the device of a charge representing an analog signal, has been overcome by adding a differential amplifier (see figure) to the device.

In the Edinburgh approach, the input signal is applied to a differential amplifier whose output is connected to a diode diffusion at the CCD input. Adjacent to this diffusion is a gate whose potential is pulsed high after the start of the second-phase pulse, and returned to low before the end of the succeeding third-phase pulse.

When the gate is high, minority carriers flow from the input diffusion to the potential well below the first-tap electrode. The charge residing in this well is sensed by the biased-gate tapping technique, and the output of the sense amplifier is fed back to the differential amplifier. For reasonable gains, the transfer function is linear over the signal-charge range.

The circuit technique was tried with a single-level metal CCD fabricated on $10 \Omega \text{ cm}$, $\langle 100 \rangle$ -orientation, n-type silicon. The tap and the transfer electrodes were 8 and $4 \mu\text{m}$ long, respectively, with $2\text{-}\mu\text{m}$ gaps. The differential amplifier gain was 100, giving an overall open-loop gain of approximately 25. An improvement in linearity over earlier circuits was obtained even for the low open-loop gain used. The only distortion visible occurred just before saturation.

Although the use of a differential amplifier at the CCD input

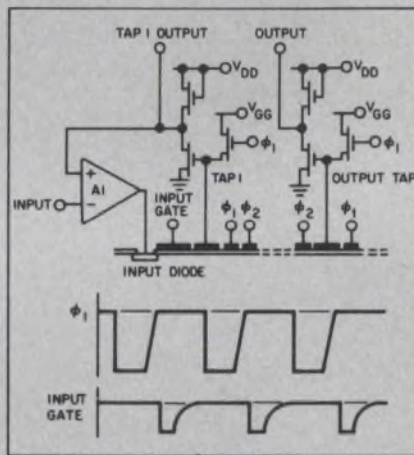

appears to be a disadvantage, in applications such as recursive filtering a differential amplifier is essential. Consequently when the amplifier is introduced with a CCD, it allows other signal-processing functions to be performed, such as signal summation and multiplication. The differential amplifier should preferably be produced so that it can be integrated monolithically with the CCD.

New crystal technique lowers cost of GaP

A refined Czochralski crystal-pulling technique should make gallium phosphide crystals cost-competitive with gallium arsenide phosphide. This may result in more widespread production and use of green, amber and yellow LEDs according to researchers at Britain's Metals Research Company.

Currently, gallium phosphide epitaxial wafers cost more than three times those of gallium arsenide

phosphide, the principal source of red LEDs. The British company predicts that gallium phosphide pulled with the new equipment will be competitive with GaAsP in the watch industry, where the lower power consumption of the gallium phosphide LEDs is also an important consideration.

Metals Research's prototype puller will produce crystals up to 5 kg in weight and 3 in. in diameter, with the diameter controlled to within 1 mm.

Acoustic-wave device offers cost advantage

A length-weighted standing acoustic-wave structure that eliminates lossy reflections and reradiations at the transducer fingers is said to have the performance of the split-finger transducer but with none of the manufacturing limitations that would make it costly to produce.

Designed at Mullard Research Laboratories in Redhill, Surrey, England, the device has transducer fingers in the active regions of normal width. But fingers in the inactive regions are split into one-eighth wave widths with quarter-wave spacing.

The fabrication yield of the length-weighted device is reported to be higher than that for the split-finger type because short-circuits between the two parts of a split finger are not important, since they connect two points of equal potential. The chance of a break in both parts of a split finger is also less than that in a single, narrow electrode.

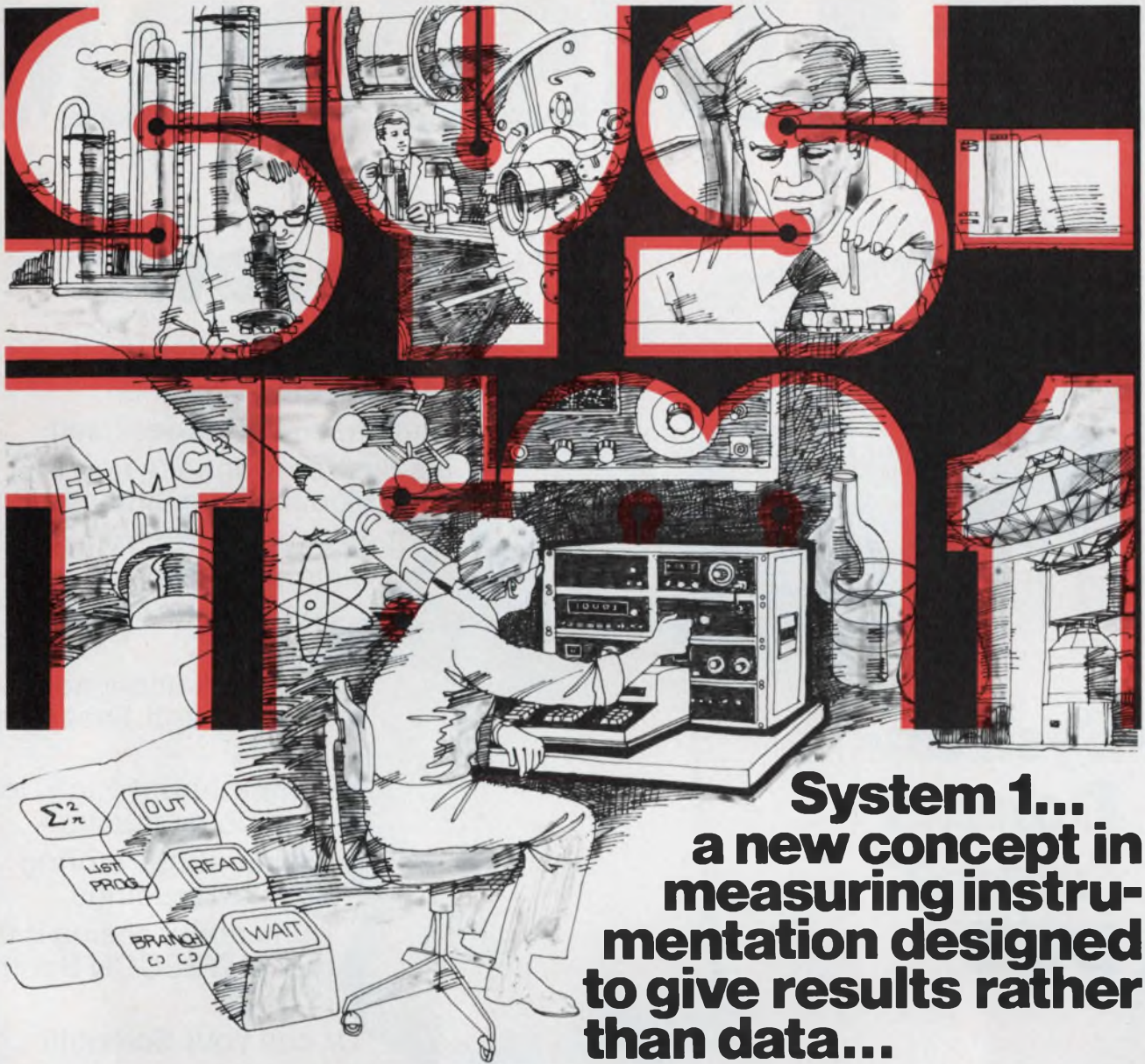

System 1... a new concept in measuring instru- mentation designed to give results rather than data...

The unique System 1 from Keithley... more than just an instrument. System 1 is a whole family of versatile measuring instruments, sources, and interfaces—all functioning automatically under the control of a powerful programmable calculator. Data can be logged into a program exactly when it's needed, manipulated algebraically, and the resultant *information* can be output, stored, or used to control an experiment or process.

The data that System 1 can handle is virtually limitless: nanovolts to kilovolts, picoamperes to amperes, milliohms to millions of megohms, picocoulombs to coulombs—all are in the realm of System 1. So too are time, temperature, pressure, displacement and any other phenomenon that can be converted to an electronic signal.

Operating and programming the Keithley System 1 is as easy as running a calculator. A few simple, logical keystrokes operate instruments, input data,

and output results or decisions. A few more unleash the mathematical prowess of the calculator's microprocessor.

Flexibility is a byword of System 1. Plug-to-plug compatible interfacing accommodates standard measuring instruments. Expansion, contraction, and reconfiguration are all quick and easy—and the instruments can be used in other applications when not part of System 1.

The Keithley System 1 is affordable, too. The low investment it takes to own System 1 is paid back quickly in the time-saving, error-free results it produces.

Whatever the needs of your application, your lab, your experiment, your tests, your process... System 1 can simplify your measurements. Let us show you how. Send for complete details or phone (216) 248-0400.



**KEITHLEY
INSTRUMENTS**
U.S.A. 28775 AURORA ROAD, CLEVELAND, OHIO 44139
EUROPE: 14, AVENUE VILLARDIN, 1009 PULLY, SUISSE

INFORMATION RETRIEVAL NUMBER 64

BRAINSTORM

The first SDVM*

It automatically **calibrates** itself.

It automatically **tests** itself.

It automatically **zeroes** itself.

It's Systron-Donner's new 5½ digit Model 7115 multimeter.

It gets its smarts from a microprocessor.

So, let your imagination run wild.

Think about normalizing and linearizing inputs.

Think about high/low limit comparisons.

Think about storing high/low readings.

Think about seeing it for real at WESCON Booths 1523-28.

Or call your Scientific Devices man.

Or ask us for a brochure.

Good-bye DVM's, hello SDVM's.

***Systron-Donner "smart" DVM**

SYSTRON  DONNER

1 Systron Drive, Concord, CA 94518
Phone (415) 676-5000.

Overseas, contact Systron-Donner GmbH, Munich; Systron-Donner Ltd., Leamington Spa, U.K.; Systron-Donner S.A., Paris (Le Port Marly); Systron-Donner Pty. Ltd., Melbourne.

WESCON '75 products

Slash monolithic ceramic capacitor prices with base-metal electrodes and terminations

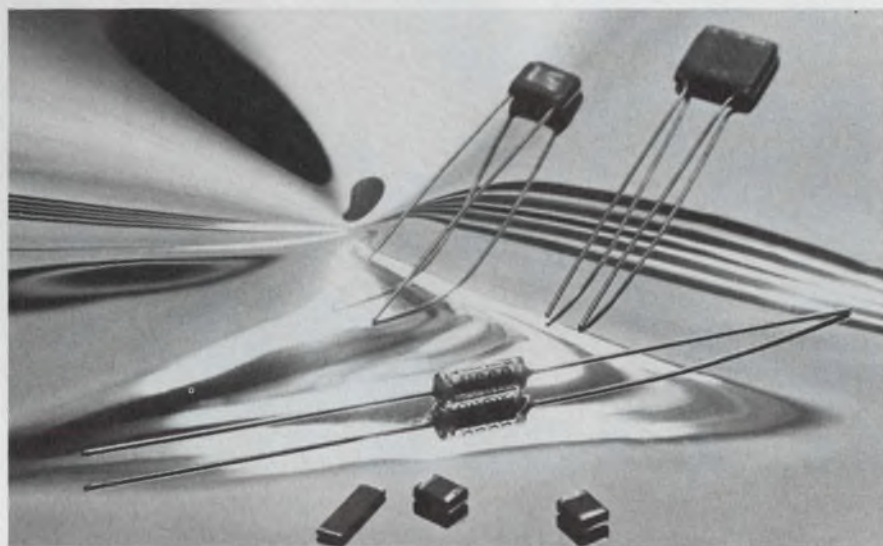

USCC/Centralab, 4561 Colorado Blvd., Los Angeles, CA 90039. (213) 240-4880. See text.

Monolithic ceramic capacitors, traditionally, are not cost competitive with other capacitor types in industrial/commercial applications. The customers for these capacitors are found mainly among military/aerospace users. In these applications, high capacitance per unit volume, light weight, a wide choice of dielectric characteristics and versatility in mechanical configurations are of prime importance, and price is secondary.

Now, USCC/Centralab says that it can produce monolithic ceramic capacitors at a low selling price "to attract industrial/commercial designers who are looking for replacements for mica, tantalum and Mylar units." The breakthrough came about when USCC/Centralab learned how to substitute a nickel-based material for the expensive noble metals, such as platinum palladium or gold, usually used for the capacitor electrodes and terminations.

In addition, automated techniques developed by USCC have substantially reduced labor costs. And, a policy of sustained high-volume production to supply standard items for stock has enabled USCC to offer generous volume discounts. A quantity of only 5000 capacitors allows the size of discount other manufacturers might give for quantities of, say, 100,000, according to Jim Bright, manager of technical services for USCC/Centralab. "These prices provide average cost savings between 30 and 50%, and standard capacitors are available off-the-shelf," he explained.

In general, ceramic has several technical advantages over other types of dielectric materials for monolithic capacitors. With the exception of tantalum, ceramics have the highest capacitance per unit volume. Also, ceramics offer a wide choice of different dielectric formulations. For example, low-K ceramics have all of the desirable features of materials such as mica or polystyrene; mid-K

ceramics can compete with Mylar and polycarbonate types; and high-K dielectrics have been used to an increasing extent at the expense of tantalum up to around 2.2 μF .

Further, monolithic ceramic construction provides a solid, homogeneous structure—immune to the shock and vibration problems of other dielectrics. It is nonpolar, and it has a high safety factor against breakdown by high voltage transients.

General specs for monolithic ceramics show that they can be life tested at twice the rated voltage, but Mylar and tantalum units are life tested at only 1.4-times rated. And the ceramic-dielectric withstanding voltage (resistance to spikes) is 250% of the voltage rating—compared with only 200% or so for other dielectrics. In fact, the monolithic structure generally can take five-times rated voltage before actual breakdown occurs.

And now, USCC's new base-metal electrode and termination fabrication system makes the monolithic ceramic also price competitive. The fabrication system includes special compatible ceramic formulations that are equivalent to the popular dielectric types—the stable-NPO dielectric, the mid-range-K, called X7R, and the high-K, Z5U. And USCC can supply the capacitors in several styles—chip capacitors for hybrids, axial-lead Monoglass units and radial-lead dipped Monocap types.

Some typical prices in quantities of 5000 or more are:

Dielectric	Size	Chip	Axial	Radial
NPO	1000 pF	\$0.12	\$0.17	\$0.17
X7R	0.1 μF	0.09	0.16	0.16
Z5U	1.0 μF	0.22	0.28	0.26

Booth No. 1156 Circle No. 302

Large Lens LED's

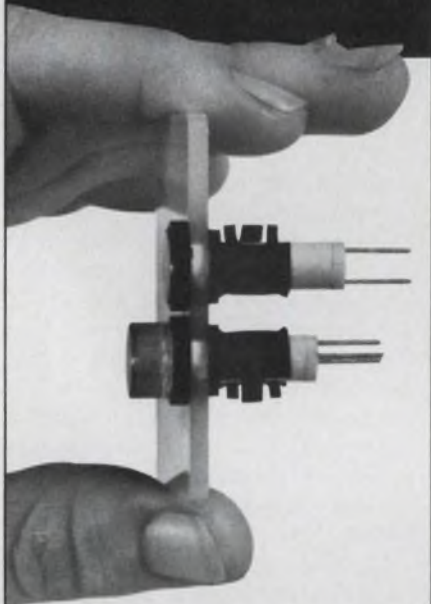

Green, Yellow, Amber, Red

- With or without built-in resistors.
- Large, bright viewing area (.4" diameter).
- Ideal for backlighting (dead front panels etc.) or hot stamped legends.
- Can be PCB mounted.
- Small mounting diameters (.250" or .290") for easy wiring and close spacing.
- 2 to 28V models.
- Optional built-in drivers.
- Low cost, immediate availability.

And we've got more! LED, Incandescent and Neon sub-miniature panel lights . . . PCB lights. We're your "one-stop-shop" for indicator lights.

The "original" little light people!

DATA DISPLAY PRODUCTS

5428 W. 104th St., Los Angeles, Ca. 90045
(213) 641-1232

INFORMATION RETRIEVAL NUMBER 66

PACKAGING & MATERIALS

Flat cable combines twisted pairs and flat sections

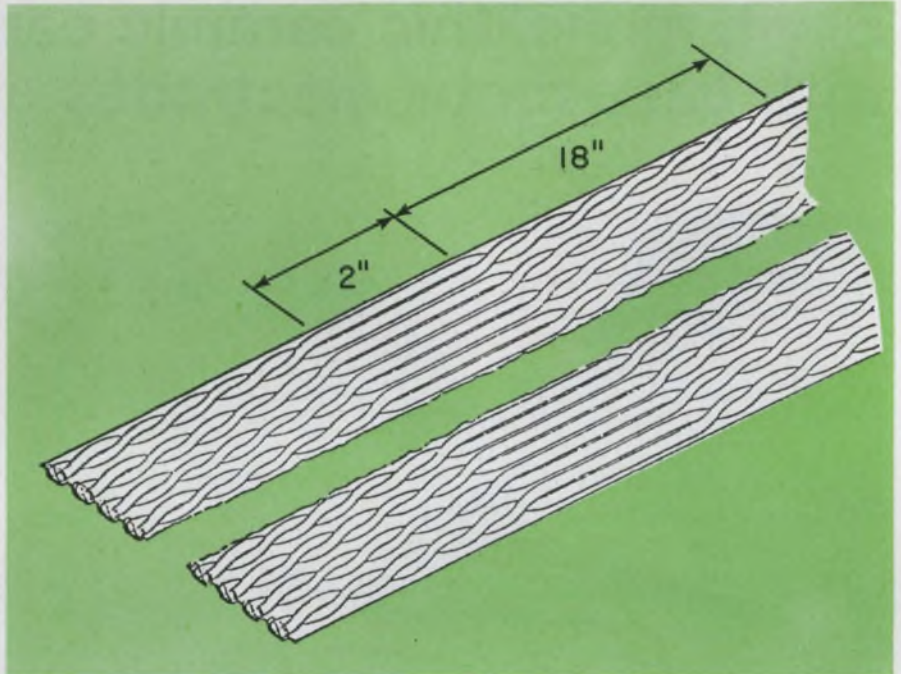

Spectra-Strip Corp., 7100 Lampson Ave., Garden Grove, CA 92642. (714) 892-3361. See text.

Twisted-pair flat cable has been next to impossible to attach to multipin PC-board connectors because of the constantly changing wire position. Spectra-Strip has eliminated the problem with its Twist-N-Flat—a multiconductor flat cable.

The new technique combines twisted pairs of PVC insulated cable with lengths of parallel conductors in a laminated flat cable. This permits low-cost, "instant termination," insulation-displacing connectors to be used instead of manually unwrapping each wire and hand-terminating it to the connector.

Twist-N-Flat cables are available with up to 25 twisted pairs, with parallel conductors spaced at 0.05 or 0.085 in. The twisted section contains two twists per inch for a length of 18 in. Pitch at the twist is 0.1 in. for the 0.05-in. spaced cable and 0.17 in. for the 0.085-in. cable. Each twisted section is followed by a 2-in. length of parallel conductors. Standard,

10-color identification clearly marks all wires.

The conductors used in the cables are UL recognized as style 1601 (CSA Class SR-PVC) and are rated at 80 C and 300 V. They are laminated between sheets of 0.005-in. clear PVC for permanent positioning. Average line impedance for the Twist-N-Flat is about 10% higher than standard twisted-pair cable.

Two styles are presently available: The type SS-455-248 has 0.05-in. spacing and uses 28 AWG, seven-strand, PVC-insulated wire; and type S-455-249, with 0.085-in. spacing and 24 AWG, seven-strand, PVC-insulated wire. Soon to be available are 20, 26, 34, 40 and 50-conductor cables, with wire sizes from 24 to 30 AWG.

Price of the Twist-N-Flat cable is about 2¢ per conductor foot in quantity, and delivery is from stock. Custom cable configurations, including spacing, number of twists per inch, number of conductor pairs, insulation coloring (including stripes) and twisted and flat spacing are also available.

Booth No. 1052-54 CIRCLE NO. 301

Your Automatic Choice

The **Automatic** Noise
Loading Test System



mi
Model 2090C

The **Automatic** AM/FM
Modulation Meter



mi
Model 2304

The **Automatic** TV
Signal Quality Analyzer

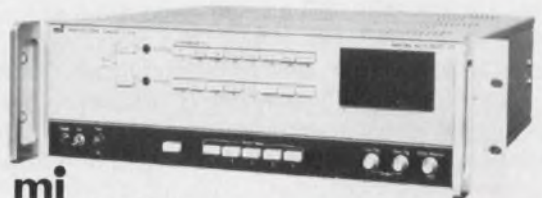

mi
Model 2914

The **Automatic**
Spectrum Analyzer



mi
Model 2370

*For These and Other Quality
Telecommunication Test Instruments ...
Visit Us At WESCON BOOTH 1127-1129*

mi MARCONI
INSTRUMENTS
DIVISION OF MARCONI ELECTRONICS INC

100 STONEHURST COURT, NORTHVALE, NEW JERSEY 07647
TELEPHONE 201/767-7250 • TWX 710-991-9752

719

INFORMATION RETRIEVAL NUMBER 67

HOW TO MEASURE NOISE FIGURE— Accurately, Easily & Automatically

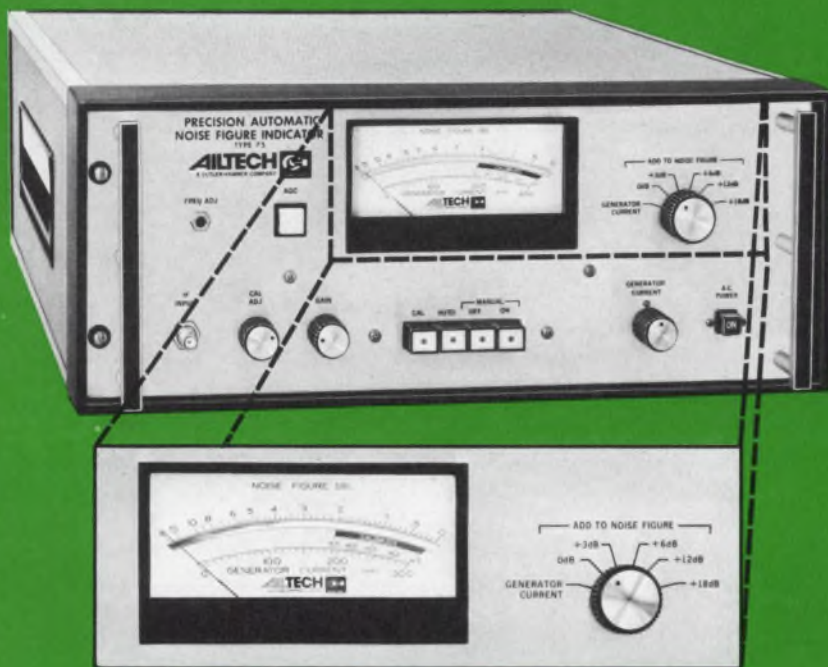

AILTECH'S 75

The Precision Automatic Noise Figure Indicator (PANFI)

The AILTECH 75 PANFI has become the noise figure measurement standard in many laboratories around the world. Why? Because its operational features simplify what used to be a difficult, cumbersome measurement.

Its basic ± 0.15 dB tracking accuracy almost eliminates the need for manual Y-factor measurements and tedious calculations. Features such as front panel signal level monitoring, high-resolution readout—with an offset range switch that lets you take full advantage of it, and calibration for the noise generator you are using, eases the measurement and provides full confidence in its validity.

When you have a noise figure measurement problem, the AILTECH 75 PANFI could be the solution. In addition, we back our instruments with many years of experience and proven, recognized expertise in receiver noise measurements.

Call or write us for free consultation and your AILTECH Noise Figure Slide Rule.



EAST COAST OPERATION • 815 BROADHOLLOW ROAD • FARMINGDALE, NEW YORK 11735
TELEPHONE: (516) 595-6471 • TELEX: 510-224-6558

WEST COAST OPERATION • 19535 EAST WALNUT DRIVE • CITY OF INDUSTRY, CA. 91748
TELEPHONE: (213) 965-4911 • TELEX: 910-584-1811

INTERNATIONAL OFFICE • FRANCE — La Garenne-Colombes, Telephone 7885100, Telex 842-62821

GERMANY — Munich, Telephone (0811) 5233023, Telex 841-529420

UNITED KINGDOM — Crowthorne, Telephone 5777, Telex 851-847238

JAPAN — Tokyo, Telephone (404) 8701, Telex 781-02423320 (Nippon Automatic)

INFORMATION RETRIEVAL NUMBER 68

PACKAGING & MATERIALS

PC card retainers use wedges to lock cards



Calmark Corp., 408 S. Gladys Ave., San Gabriel, CA 91776. (213) 287-0451. From \$2.25 (100-up); stock to 30 day.

The Series 225 Wedge-Lok heat-sinking card retainer does not use spring-action to hold the PC card. Instead, it uses screw-activated wedging action to positively lock PC cards in place. This ensures maximum contact between thermal paths, plus maximum resistance to shock and vibration. Screw activation also allows zero insertion and extraction forces. The Series 225 units are available in any length for either PC card or chassis mounting.

Booth No. 1507, 1509 Circle No. 323

Plastic equipment boxes have metal front & rear

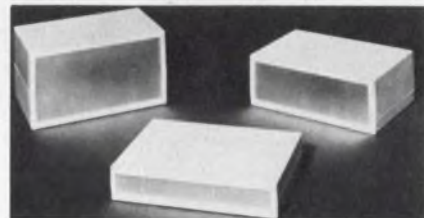

Vero Electronics, 171 Bridge Rd., Hauppauge, NY 11787. (516) 234-0400. From \$9; stock.

The plastic Veroboxes now have clear anodized aluminum panels at front and rear. The boxes are available in three sizes from 1.6 × 8.1 × 5.5 in. to 4.3 × 8.1 × 5.5 in. and are molded in a gray, high impact polystyrene. Top and bottom sections are held together by four screws entering through the base and concealed by plastic feet through which they pass. In addition, the bottom sections contain threaded inserts to use as PC board standoffs for horizontal card mounting and molded-in card guide slots for vertical PC-board mounting.

Booth No. 1508, 1510 Circle No. 324

Wiring pencil saves time eases circuit design

Vector Electronic Co., 12460 Gladstone Ave., Sylmar, CA 91342. (213) 365-9661. \$9.50 (Pencil with two 250 ft. rolls of wire); stock.

The wiring pencil consists of a light plastic housing, a replaceable spool of wire, and an extended tip to guide and cut the wire. The average time required to make a connection is only seconds—about three times faster than conventional soldering or manual wrapped wiring. The 36 gauge wire is routed directly between terminals or component leads. Correct tension is maintained by finger pressure on the wire as it emerges from the plastic body and enters the metal tip. The wire may be cut with the tip when the run is completed. Because the wire is insulated routing may be point-to-point. Nylon wire spacers which press onto 0.1-in. matrix breadboards are available to hold wires and reduce the chance of short circuits or accidental damage by hot irons. When heat is applied to the wrapped connection points with a fine-tipped soldering iron, the insulation melts and produces a solder bond.

Booth No. 1444 Circle No. 325

Filter pump pulls out 1-micron particles

Sethco Manufacturing Corp., One Bennington Ave., Freeport, NY 11520. (516) 623-4220. Stock.

The "Amphib" filter system assures reject-free electroplating. Periodic or continuous "Amphib" filtration removes damaging insoluble particle contamination, the cause of nodules, pores, voids, roughness and other imperfections that reduce plating finish quality. The replaceable cartridge-type Amphib ZDX-100A filters out particles down to one micron. Individual pump and chamber provide greater interchangeability for three-way mounting: all outside the tank, pump inside and filter chamber outside the tank, or as an instant start-up self-priming system, all in the tank. The pump systems are available in sizes from 10 to 1000 gallons.

Booth No. 1817 Circle No. 326

SLIM-MOX

**NOW VICTOREEN
QUALITY COSTS LESS
THAN A DOLLAR.**

Victoreen announces SLIM-MOX, our new, thick-film, flat substrate resistor.

Compact in design, it carries with it all the quality and dependable performance you have come to expect from Victoreen.

SLIM-MOX, right now, is available from stock in a wide range of standard resistance values. More important, SLIM-MOX will deliver the same proven performance in high-voltage applications that you find in more expensive resistors with more bulk.

Specify SLIM-MOX in any standard resistance value and your unit cost will be less than one dollar in OEM quantities. Truly a major cost breakthrough for resistors designed for miniaturized

electronic networks and equipment, or other critical applications that demand stability and reliability.

Standard tolerance is $\pm 15\%$ for all standard resistance values which include 1, 2,

5, 10, 20, 50, 100, 200, 500, 1000, 2000, and 5000 megohm. All in stock. With a voltage coefficient of better than 5 ppm/volt, full-load drift typically less than 0.5% in 1000 hr at 70°C, and 250 ppm TCR or less to 5000 megohm, SLIM-MOX is a little, big performer. For less than a buck.

From a name you know you can count on. Victoreen.

Victoreen Instrument Division,
Sheller-Globe Corporation,

10101
Woodland
Avenue,
Cleveland,
Ohio 44104



SHELLER-GLOBE CORPORATION

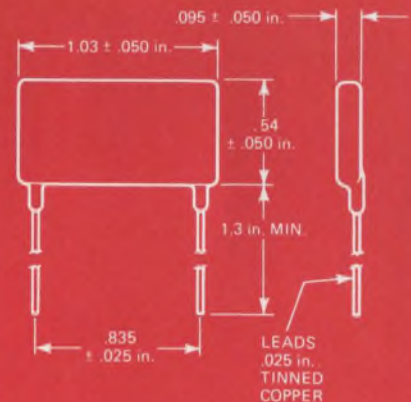

SLIM-MOX SPECIFICATIONS

Resistance Range	1M-5,000M
Power Rating @ 70°C	2W
Maximum Operating Volts	(Applicable above critical resistance)
	10,000V
Available Tolerance	15%
Critical Resistance	50M
Max. Service Temperature	150°C

**New, easy-action
swivel
cord.**

**Smooth,
reliable
360° rotation.**



Victor offers you a high quality swivel cord with outstanding flexibility and ease of handling. Its advanced-design 360° rotation effectively eliminates kinking and snarling. Ideal for personal care equipment and similar small appliances. Standard cords available, but our engineers can provide you custom designs for your special application. Units are easy to assemble and

provide remarkably trouble-free performance.

Write or phone for details, and find out why Victor has become the standard of quality in cord sets and other wire specialty items.

Victor Electric Wire & Cable Corp.
618 Main St., West Warwick, R.I. 02893
Telephone: 401 821-1700

INFORMATION RETRIEVAL NUMBER 70

PACKAGING & MATERIALS

Flat signal cables have PVC protection jacket

Ansley Electronics, 3208 Humboldt St., Los Angeles, CA 90031. (213) 223-2331. \$0.03/conductor ft. (large qty.).

The Blue Streak PVC jacketed cable terminates to standard insulation displacing connectors. It is claimed by the company to be the first U.L. listed cable to do so. To mount a connector, a small portion of the outer cable jacket is removed and the core cable is placed into a connector. Termination is completed with either a standard hand or bench tool. Up to 50 conductors can be simultaneously terminated to the connector contacts in a matter of seconds. The 28 AWG stranded cable is available in 75 ft rolls with 0.05-in. conductor spacing and in widths of 10 to 50 conductors. With a U.L. temperature rating of 75 C and voltage rating of 90 V, the jacketed Blue Streak cable offers an alternative to systems that normally require jacketed twisted pair wires.

Booth No. 1854

CIRCLE NO. 327

Lead forming machine does 60,000 parts/hour

Shephard Components, 16152 Covello St., Van Nuys, CA 91406. (213) 787-4610. \$5995; stock to 6 wk.

The WA74K automatic lead forming machine can form the leads of axial, taped components in both horizontal and vertical configurations, without changing or use of any dies. Due to its continuously adjustable forming, cutting and crimping wheels, the WA74K will process over 1000 components per minute (over 70,000 per hour), and is claimed to be 3 to 5 times more accurate and faster than its closest competitor. The machine comes complete with counter-shutoff mechanism, electronic variable speed control, reversing switches, safety OSHA cover, and reel holder. It weighs 38 pounds, operates on 117 V ac, is completely portable and measures only 20 × 11 × 12 in.

Booth No. 1758

CIRCLE NO. 328

INSTRUMENTATION

Sweeper covers 2.3 GHz in one fell swoop



Hewlett-Packard, 1501 Page Mill Rd., Palo Alto, CA 94304. (415) 493-1501. \$3300.

This wideband rf sweeper unit covers 10 to 2400 MHz and is a plug-in for the company's 8620A sweep oscillator mainframe. The 86222's entire range can be covered in one continuous sweep with internally leveled signal flatness of ± 0.025 dB and calibrated power levels from 0 to +13 dBm. Frequency accuracy, linearity, stability, residual FM, harmonics and spurious are said to match any other sweeper in its frequency range.

Booth No. 1227-1238 CIRCLE NO. 329

Low-priced scopes take center stage



Tektronix, P.O. Box 500, Beaverton, OR 97005. (503) 644-0161. See text.

At prices ranging from \$695 to \$1250, including probes, the T-900 Series of oscilloscopes are sure to raise a few eyebrows. Five models offer various bw's from 10 to 35 MHz, 2-mV sensitivity and 3% accuracy on vertical and horizontal channels. Features include dual-trace operation, TV sync and trigger holdoff for stable triggering on complex digital word trains.

Booth No. 1423-1426 CIRCLE NO. 330

DMMs cut input noise and loading errors



Dana Laboratories, Inc., 2401 Campus Dr., Irvine, CA 92664. (714) 833-1234. \$299.

Six new products to be shown at Wescon include the Model 3800B, a 3-1/2-digit DMM that sells for \$299, and the Model 4200, a 4-1/2-digit DMM. Both units feature 1000- Ω input impedance plus a three-pole active filter and an integrator to keep noise down. Other instruments include a 6-1/2-digit precision DVM, two 200-MHz counters and a new, more accurate version of the Danameter, the company's popular portable DVM.

Booth No. 1022, 1024, 1026

CIRCLE NO. 331

10 KV SILICON RECTIFIERS

NOW ONLY

2 1/2¢ per KV

10,000 V, 25 mA, 300 ns. t_{rr} silicon rectifiers only 25¢ each for 100,000 quantities with minimum 10,000/month released. Delivery from stock. Size .4" long.

FREE SAMPLES

Write on your company letterhead, outlining your application for free samples.

Buy from the specialist.



electronic devices

21 Gray Oaks Ave., Yonkers, N.Y. 10710, Telephone: 914 965-4400

INFORMATION RETRIEVAL NUMBER 71

ELECTRONIC DESIGN 18, September 1, 1975

CAPABILITY SERIES No. 1

TO CUT IC FAILURES DON'T DEPEND ON LUCK.

Don't gamble on rework, field failures, pre-tests. Our SUPR II Reliability Program, for a few cents a part, processes to 10x industry standard quality levels through military visuals and burn-in.

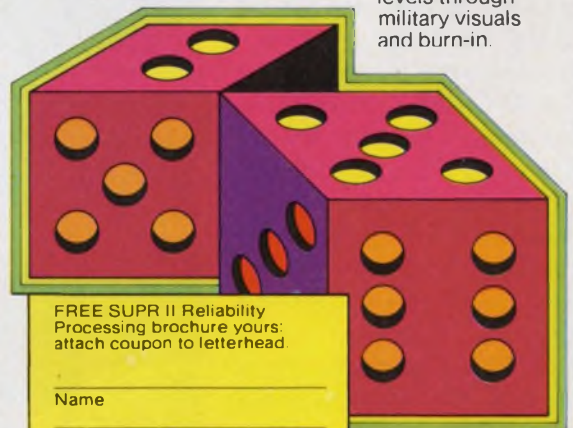

FREE SUPR II Reliability Processing brochure yours: attach coupon to letterhead

Name _____

Tel. **THINK** Ext _____

Signetics

311 E. ARQUES SUNNYVALE CALIF 94086

INFORMATION RETRIEVAL NUMBER 72

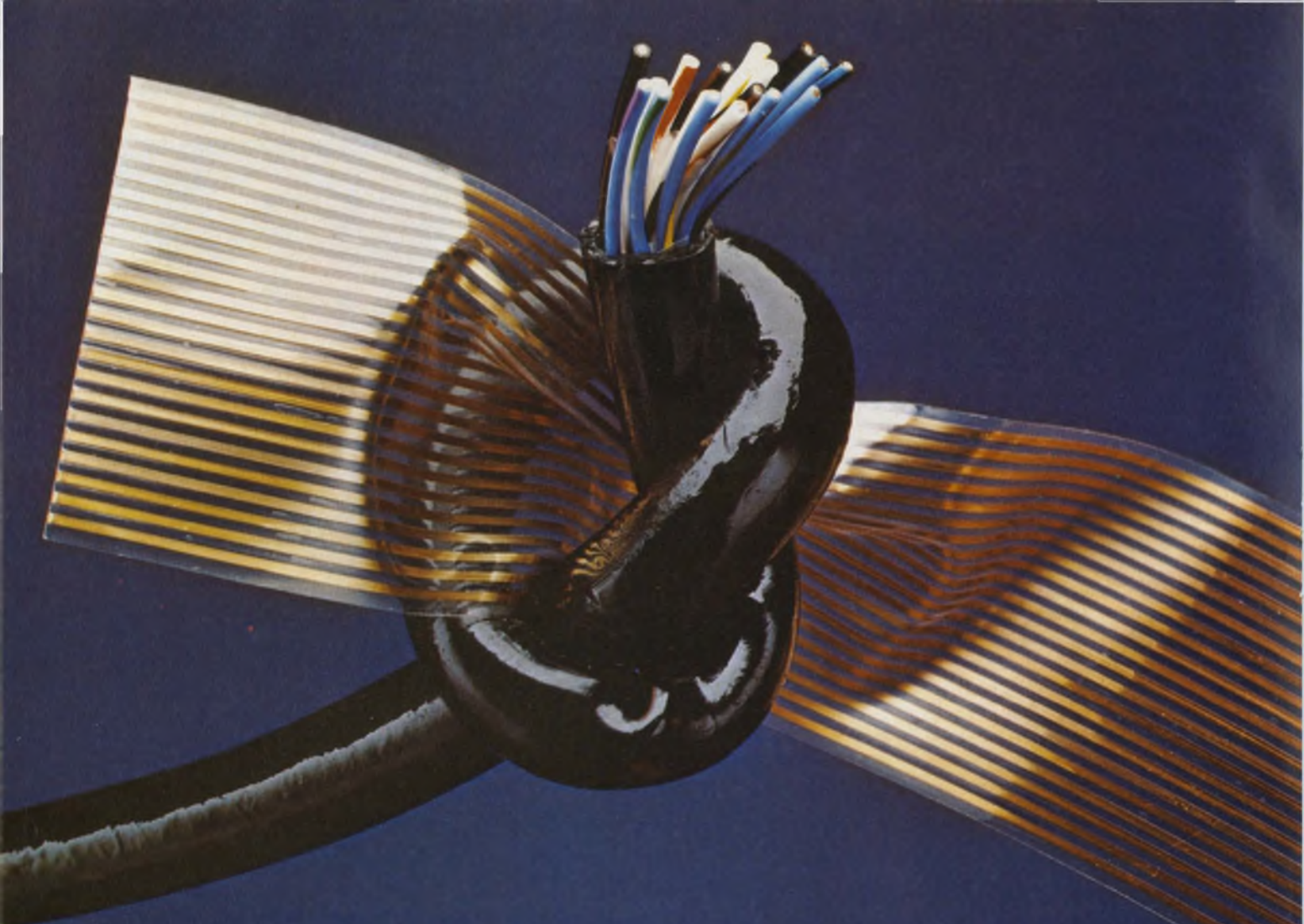

How do you connect round cable to flat?

Now it's easier than ever to connect round cable to flat. Or flat cable to flat. Or round to round.

Because now Hughes introduces the HAC-PAK Connectors—a whole new connector family offered in three types of contacts: crimp/removable rear-release (non-environmental, environmental or potted); RFI/EMI fixed filter contacts; and fixed solder-tail contacts.

HAC-PAK Connectors are intermateable and intermountable with one another—and with Hughes front-release subminiature rectangular connectors. (W and WSS Series.)

Our exclusive PolarHex™ center jackscrew coupling assures alignment, provides positive polarization with a choice of keying

It's a snap.

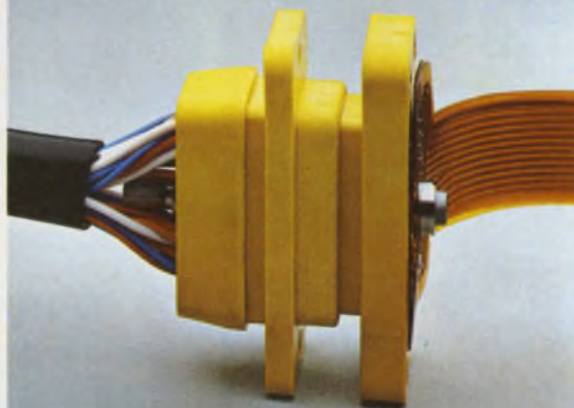

The new Hughes
HAC-PAK™ Connector.
 (MIL-C-28804)

INFORMATION RETRIEVAL NUMBER 73

positions, and prevents mismatching.

HAC-PAK subminiature connectors have the highest density of number 22 contacts in the industry. (.085" centers.)

To get all the details, make a connection with Ron Ross at (714) 549-5701, or write: Hughes Connecting Devices, 17150 Von Karman Avenue, Irvine, CA 92705.

HUGHES MICROELECTRONICS LTD.:

UNITED KINGDOM — Clive House, 12-18 Queens Road, Weybridge, Surrey, England. Telephone Weybridge 47262

BELGIAN BRANCH — Passage International 29, 1000 Bruxelles 1 Belgium Telephone 2179172.



We crack the tough ones.

INSTRUMENTATION

Lock-in analyzer operates to 200 kHz



Ithaco, Inc., 735 W. Clinton St., Ithaca, NY 14850. (607) 272-7640. \$2695; 45 days.

Dynatrac 3 lock-in analyzer measures noisy signals in the 0.1-Hz-to-200-kHz frequency range. Input levels from picovolts to volts are handled. The unit measures signals in extremely narrow bandwidths—orders of magnitude narrower than is possible with conventional filtering techniques. Center frequency is determined either by an externally provided signal at the frequency of interest or by a front-panel dial setting. Available outputs include in-phase, quadrature, vector magnitude, and an optional output which provides the phase angle of the vector.

Booth No. 1137 CIRCLE NO. 340

Data logger expands processing capability



Doric Scientific, 3883 Ruffin Rd., San Diego, CA 92123. (714) 565-4415. 220, from \$4000; stock.

The Digitrend 220 data logger, with microprocessor power, has four new options: (1) Keytemp Model 4304 remote manual access keyboard; (2) Satellite booster Option 226, for sensors over 3000 feet away; (3) RTD multiplexing option 52 for four-wire bridge inputs; and (4) "Alarm-store" option group for setting up to 4000 individual alarm setpoints in a 1000-point scanning system. New at WESCON will be the company's Series 400 Digital Temperature Trendicators, which uses a proprietary LSI chip that does practically everything, analog and digital. Prices start at \$299.

Booth No. 1214 CIRCLE NO. 341

DPMs welcome requests for special ranging



Simpson, 853 Dundee Ave., Elgin, IL 60120. (312) 697-2260. \$138; stock.

Four DPMs, Models 2850, 2851, 2852 and 2853, have been designed to enable special ranging at little or no additional cost. Models 2850 and 2851 use gas-discharge displays with 0.55-in-high numerals. Models 2852 and 2853 are supplied with LED displays and 0.43-in-high numerals. Each of the meters provides BCD output as a standard, no-charge feature. Power requirements for the 2850 and 2852 are 120 or 240 V ac. For the 2851 and 2853, the power requirement is 5 V dc. All four DPMs in the 2850 series maintain an accuracy of 0.1% throughout their 100% overrange.

Booth No. 1435, 1437

CIRCLE NO. 342

Miniature scope weighs just 5 lb.

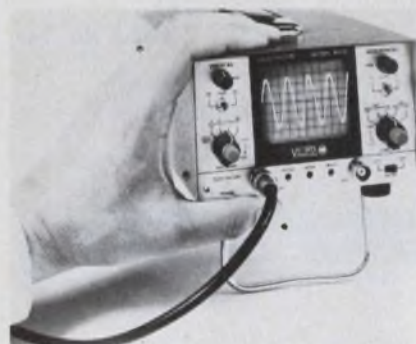

Vu-Data Corp., 7170 Convoy Ct., San Diego, CA 92111. (714) 279-6572. \$495; stock-30 days.

Model PS121A single trace miniature scope features dc-to-5-MHz bandwidth, 50 mV/div sensitivity and up to 100 ns/div sweep rate. This unit weighs less than 5 lb. and is small enough to fit into a tool kit or brief case. Front panel dimensions are only 3 x 5 in. Featuring automatic triggered sweep, the PS121A is easy to operate. External trigger is also included.

Booth No. 1529 CIRCLE NO. 343

Advertisement

ELECTRONIC PACKAGING

Versatile enclosures come in 10 sizes



Bud Radio, Inc., 4605 E. 355 St., Willoughby, O. 44094, (216) 946-3200. Now in stock.

ShowCase — available at your Bud Distributor. Use as a desktop instrument case, in systems, racks or as a portable enclosure. Front, rear panels and bail included. Lightweight. Sturdy. Side gussets give additional strength. Recessed handles secured firmly into top for safe handling. Top, sides and bottom .060 aluminum; front panel, .090; rear panel, .050. Five accessory chassis. Two color combinations. For further information, phone —

1-800-321-1764, TOLL FREE
IN OHIO, 1-800-362-2265, TOLL FREE

Racks delivered pre-assembled; 27 sizes



Bud Radio, Inc., 4605 E. 355 St., Willoughby, O. 44094, (216) 946-3200. Off-the-shelf delivery.

Series 60 upright and inclined panel racks from Bud. Interiors easily accessible from front and rear. 19" panel space. Upright: 14 sizes; clear inside depths, 20½" and 24". Clear inside depth of seven extra-deep units, 29¾". Inclined: three sizes; clear inside depth, 20½". Clear inside depth of three extra-deep units, 29¾". "U" braces. Adjustable mounting rails. Available at your Bud Distributor. For further information, phone —

1-800-321-1764, TOLL FREE
IN OHIO, 1-800-362-2265, TOLL FREE

ELECTRONIC PACKAGING

Widest selection of relay rack panels — 84

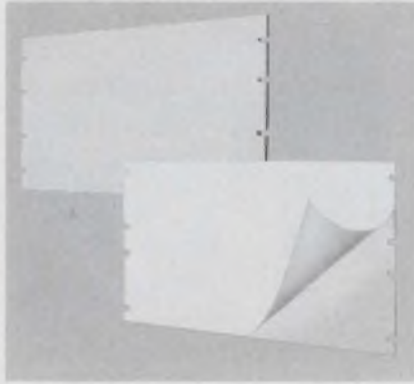

Bud Radio, Inc., 4605 E. 355 St., Willoughby, O. 44094, (216) 946-3200. A choice of seven finishes.

At your Bud Distributor! Steel: $\frac{1}{8}$ ", 19" wide, 12 heights. Standard aluminum: $\frac{1}{8}$ ", 19" wide, 12 heights; $\frac{3}{16}$ ", 19" wide, 12 heights. 2024 T-3 aluminum: $\frac{1}{8}$ ", 19" wide, 12 heights; 24" wide, 12 heights. "Surface Shield" panels: $\frac{1}{8}$ " and $\frac{3}{16}$ ", each in 12 heights, 19" wide; mill-finish aluminum alloy; white pressure sensitive paper protects panel, provides surface for indicating drilling or punching position. For further information, phone —

1-800-321-1764, TOLL FREE
IN OHIO, 1-800-362-2265, TOLL FREE

Standard enclosures with custom features

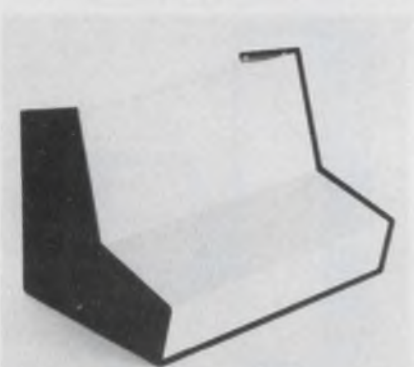

Bud Radio, Inc., 4605 E. 355 St., Willoughby, O. 44094, (216) 946-3200. Your Bud Distributor has it.

Compucah by Bud. Dual-slope, off-the-shelf enclosures with custom-designed configurations. Use for a range of instruments. Maximum visibility — no fasteners on panel area. All aluminum. Cover and back in smooth white enamel. Base and sides, black textured enamel. Knockouts in rear panel. Rubber feet furnished. Two styles. Shipping economies. For further information phone —

1-800-321-1764, TOLL FREE
IN OHIO, 1-800-362-2265, TOLL FREE

INSTRUMENTATION

100-MHz scope aims at digital applications

Hewlett-Packard, 1501 Page Mill Rd., Palo Alto, CA 94304. (415) 493-1501. \$1995; gold-button option, \$105; 60-90 days.

Special characteristics target the Model 1740A 100-MHz scope to digital uses. To relate timing events in a pulse system accurately to one another, and to the triggering event, the external trigger is displayed as a third trace. Center screen is always the trigger threshold so the viewer always sees which portion of the triggering signal initiates the sweep. The time relation between the external trigger and the vertical signals is held at 2.5 ns \pm 1 ns. Sensitivity is 5 mV/div at 100 MHz. And 1 mV/div at 40 MHz is obtained with a times-5 magnifier. An optional gold button instantly exchanges displays, alternately calling up on the screen time-domain waveforms or a data-domain picture of the same signal, triggered on a unique word in the data stream and formatted in 0's and 1's by an associated logic state analyzer, Model 1607A.

Booth No. 1227 to 1238

CIRCLE NO. 344

Digital ohmmeter resolves 10 $\mu\Omega$ 

Valhalla Scientific, 7707 Convoy Ct., San Diego, CA 92111. (714) 277-2732. \$895; stock.

Model 4100TC digital ohmmeter features a resistance range of 0.10000 Ω full scale. The unit is a multirange instrument designed specifically for motor and transformer testing. The ohmmeter automatically compensates for ambient temperature variations at a coefficient equal to that of copper or aluminum to allow temperature rise type testing independent of ambient variations.

Booth No. 1111 CIRCLE NO. 345

Synthesizer lets you vary output phase

Adret Corp., 1887 Lititz Pike, Lancaster, PA 17601. (717) 569-7059. \$3550.

Model 3100 programmable frequency synthesizer features 0-to-200-kHz range with 8-digit resolution and 5 ppm/day accuracy as a synthesizer. Included are dual-phase-quadrature outputs and a selection of accessory-function plug-in modules (up to three). The unit provides phase-adjustable outputs with 0.01-Hz/0.1-degree resolution. The synthesizer in the mainframe provides eight frequency-selection decades, programmable from 0.01 to 199,999.99 Hz in steps of 0.01 Hz. Programming is manual by panel switches or remote by parallel-entry, digital TTL-logic, BCD signals. Frequency switching takes less than 2 ms and is transient-free.

Booth No. 1211, 1213

CIRCLE NO. 346

Analyzer offers 0.01% accuracy, 0.1% linearity



Nicolet Scientific Corp., 245 Livingston St., Northvale, NJ 07647. (201) 767-7100. Under \$10,000.

The 440A Mini-Ubiquitous is said to be the first real-time analyzer to include electronically generated alphanumeric annotation, as well as an electronic graticule on its built-in CRT. Photographing the display therefore records all control settings and scales. It is also claimed to be the first analyzer to read amplitude and frequency simultaneously at a movable cursor. These readings are also "written" on the CRT. Capabilities include 400-line resolution and plotting of the time function stored in input/digital memory.

Booth No. 1532 CIRCLE NO. 347

MODULES & SUBASSEMBLIES

Fast 8-bit a/d converter housed in 24-pin DIP

Micro Networks, 324 Clark St., Worcester, MA 01606. (617) 852-5400. From \$195 (unit qty.); 2 to 4 wk.

The MN5100 8-bit a/d converter has a maximum conversion time of 1.5 μ s. The converter is housed in a 24-pin hermetic DIP. No adjustments are needed to maintain ± 0.5 -LSB linearity over the 0-to-70-C range for the MN5100 and over -55 to $+85$ C for the MN5100H. The converter can be "short cycled" if fewer output bits are needed—thus providing a conversion time as low as 600 ns for a 5-bit output. Power requirements are ± 15 V and $+5$ V. Worst-case dissipation is 1.55 W. Six unipolar and three bipolar input voltage ranges are available—just by using external jumpers.

Booth No. 1451 CIRCLE NO. 348

Signal conditioner linearizes temp sensors



Yellow Springs Instrument Co., Box 279, Yellow Springs, OH 45387. (513) 767-7241. From \$130; stock.

Thermivolt precision temperature-to-millivolt signal conditioners convert temperature sensed by resistance temperature elements to a linear, dc voltage. The sensor outputs are scaled so they produce a direct, accurate reading of temperature in $^{\circ}$ C or $^{\circ}$ F. This permits direct hookup to computers, digital equipment, indicators, alarms, recorders and other process equipment. Thermivolts are available for use with two types of sensors: platinum RTDs and linear thermistor composites. This covers temperatures from -40 to $+600$ C (-40 to $+1112$ F). Both enclosed and open printed-circuit board models are offered.

Booth No. 1245 CIRCLE NO. 349

Be selective turn to **SERVO-TEK**

for superior quality products produced by efficient, modern manufacturing techniques. These products — Bi-Mode Servos, Control Meter Relay Systems, Adjustable-Speed Drives, Permanent-Magnet Servomotors, Speed Indicating Systems and Tachometer Generators — are products of proven design versatility and reliability. Turn to us for advice on your design problems and information on standard unit modifications too! Be selective.

FREE CATALOG of rotating components available.

SERVO-TEK[®] PRODUCTS COMPANY

1086 Goffle Road
Hawthorne, NJ 07506
201-427-3100

Servo-Tek of California, Inc.
8155 Van Nuys Blvd.
Van Nuys, CA 91402
213-786-0690



INFORMATION RETRIEVAL NUMBER 76

Excel For all your pluggable panel needs.

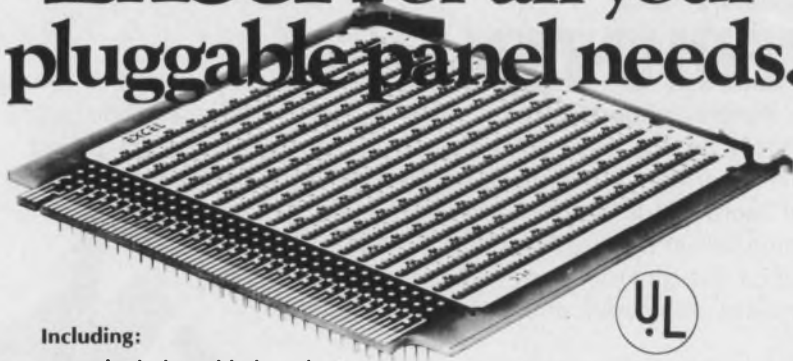

Including:

- Standard pluggable boards
- Custom boards—P.C. boards
- Pins & Sockets—DIP sockets—Backpanels—Mother-daughter boards
- Racks—Enclosures—Wire Wrapping—Artwork—Programming drive tapes.

*Registered Trade Mark of Cardner-Denver Company

Excel is the only completely vertically integrated company, in the U.S.A., in the pluggable field. Everything is made completely "in house" in New Jersey. All boards are fully interchangeable with Augat's and others.

Pins & Sockets

Bodies of sockets are precision Swiss Screw machined. Beryllium

Springs — the best on the market. Highest retention forces. Springs staked into bodies — can't vibrate out. All types of pins and sockets available.

DIP Sockets, Plugs & Headers

Complete line—machined or stamped and formed — 8 pin to 40 pin. Low profile. Narrow width. Powerful retention. G.E. Valox bodies will hold short leads .016" thru .022" —solder tail, wire-wrap any length, soldercup, bifurcated. **A complete line of pins—no matter what your needs.**

Complete Wire Wrapping Capabilities

We are the largest independent wire wrap capability in the U.S.A. Automatic or semi. We program —make tapes—from/to lists —special routing— special wrapping. Competitive prices. All types of enclosures and racks.

EXCEL

because you deserve the very best

Please send—name & address on letterhead for complete literature.

EXCEL PRODUCTS COMPANY Inc. PHONE: AREA CODE 201. 249-6600
401 JOYCE KILMER AVE., P.O. BOX 168, NEW BRUNSWICK, N.J. 08903 USA

Available at the following distributors:

MILGRAY/CALIFORNIA
Sepulveda, California 91343
213-894-4011
TWX 510-225-3673

DIPLMAT/SOUTHLAND
Clearwater, Florida 33515
813-443-4514
TWX 810-866-0436

MILGRAY/FLORIDA
Orlando, Florida 32810
305-647-5747
TWX 810-853-9215

MILGRAY/KANSAS CITY
Overland Park, Kansas 66202
913-236-8800
TWX 510-225-3673

TULLY ELECTRONICS
Baltimore, Maryland 21228
301-788-4200

MILGRAY/WASHINGTON
Hyattsville, Maryland 20781
Wash. 301-864-1111
Balt. 301-723-3993
TWX 710-826-1127

MILGRAY/NEW ENGLAND
Burlington, Massachusetts 01803
617-272-6800
TWX 510-225-3673

MILGRAY/DELAWARE VALLEY
Cherry Hill, New Jersey 08002
N.J. 609-424-1300
Phila. 215-228-2000
TWX 510-225-3673

MILGRAY/NEW YORK
Freeport, New York 11520
516-546-6000
TWX 510-225-3674

MILGRAY/CLEVELAND
Cleveland, Ohio 44103
216-881-8800
TWX 810-421-8573

DATA PROCESSING

Ticket printer uses impact dot matrix



Practical Automation, Trap Falls Rd., Shelton, CT 06484. (203) 929-5381. \$263 (100 up); 4 wks.

Model DMTP-5 printer prints alphanumeric information across the width of a standard multipart ticket. Both horizontal-character and vertical-line pitch are variable. The unit can be programmed to print virtually any character or symbol in almost any position on the ticket. The printer uses an impact dot-matrix mechanism. The operator presents the ticket to the printer where it is sensed, captured and motor driven to an internal stop. After the machine prints up to 37 lines, the ticket is ejected. Data input is ASCII bit-parallel, serial, parallel-binary or RS232C. Print rate is approximately 2 lines/s with a line length of 25 characters.

Booth No. 1632

CIRCLE NO. 332

Printer handles three data inputs at once

Sweda International, 34 Maple Ave., Pine Brook, NJ 07058. (201) 575-8100.

Model SV alphanumeric printers can simultaneously print different data at each of three independently controlled stations, at 2 lines/s. The printer uses a segment-matrix character format of 64 characters, which consists of 10 numerals, 32 alphabet characters and 22 symbols. The unit accommodates roll paper and cut forms. Forms are inserted at the side, through an open throat, to allow for variable widths. A cartridge ribbon provides 3-million character impressions. Some features include paper rewind, automatic paper cut-off, roll paper supply and out-of-paper alarms.

Booth No. 1810

CIRCLE NO. 333

**Your education represents
an important
personal investment---**



What have you done with it so far?

"Got a job" isn't quite the full answer, is it? You're you. And there's more to life than just "a job"—or should be.

**What could you expect if you joined us?
A quality of life that means the difference
between "a job" and a way of living.**

We design and manufacture complete electronic systems of various kinds for business, industry and government. It is our practice to hire very able people and then put them to work doing what they most like to do.

Because we are a large company, we offer a total career growth-potential that is as big as we are. And because we work in relatively small product-oriented divisions, your abilities and contributions are highly visible from the time you join us, with prompt recognition of superior performance.

Whether you work for us in California, New York, Ohio, Florida, Kansas or Delaware, you'll find yourself looking forward to coming to

work in the morning. And your technology won't become obsolescent in 5 or 10 years, because, to remain a leader, we must continue to work on the leading edge of the current state of the art.

Professional involvement . . . continuing development as an engineer . . . an environment of individual responsibility that encourages new ideas and rewards initiative. These are good dividends on the personal investment you've already made on your education!

If you're not realizing them now, write:

**Mr. Thomas A. Payne, Dept. ED-9
Corporate Executive &
Professional Recruitment
NCR Corporation
Dayton, Ohio 45479**

NCR

An Equal Opportunity Employer

INFORMATION RETRIEVAL NUMBER 901

plug in & check out circuits **FAST** with **A P High Performance devices**

Super-Versatile™ TERMINAL & DISTRIBUTION STRIPS . . . for fast, plug-in, solderless buildup of experimental circuits.

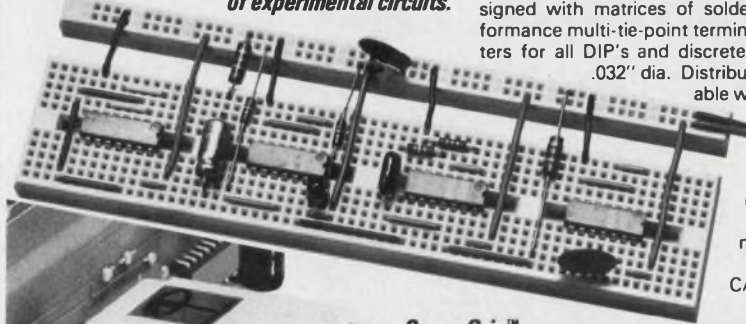

Circuit building is quick and easy — just plug in components and interconnect with any solid wire up to No. 20. No soldering required. Designed with matrices of solderless, high-performance multi-tie-point terminals on .10" centers for all DIP's and discretes with leads to .032" dia. Distribution strips available with 2 or 6 buses.

New, integral, non-shorting instant-mounting backing included. Choose from 10 quality models; from \$2. Send for FREE CATALOG today.

Super-Grip™ IC TEST CLIPS . . . for fast, non-shorting access to all leads on dual-in-line packages.

Clips on quickly for signal input, tracing, troubleshooting etc. Patented precision, "contact comb" design guarantees no shorting between DIP leads. Probes can hang no-hands" free on Test Clip terminals in card racks (unique — see photo). Engineered Mechanical clamping plus gold-plated phosphor bronze terminals provide superior electrical contact. Also unequalled as a DIP removal tool.

Sizes to fit all DIP's: TC-16 fits 16-pin DIP's, etc.

TC-14 . . . \$4.50
TC-16 . . . 4.75
TC-24 . . . 13.85

Add \$1.00 shipping & handling. Ohio & California orders add tax. We honor B.A.C. and M.C. (F.O.B. Painesville on P.O.'s.)



All products are guaranteed to meet or exceed published specifications

A P PRODUCTS INCORPORATED
BOX 110-F • PAINESVILLE, OHIO 44077 • (216) 354-2101
INFORMATION RETRIEVAL NUMBER 79

SHAPE FOIL INTO MAGNETIC SHIELDS

in minutes . . . with scissors . . . low cost

No waiting. Solves many shielding problems. Use a single formula (ask us) to determine thickness and number of layers. Combine this with practical trial and error. After cutting, hand trim AD-MU foil to the correct outline and fit it around the component to be shielded.

If you need relatively few shields, or are experimenting, that's it. You've eliminated designing, tooling and manufacturing costs for prefabricated shields.

Especially good also for hard-to-get-at places and to make assemblies more compact by placing magnetically reacting components closer together without performance degradation.



Comprehensive 18-page magnetic shielding catalog with 4-page reprint from Electronic Design on request.

AD-VANCE MAGNETICS, INC.

226 E. SEVENTH ST., ROCHESTER, IND 46975
(219) 223-3158 TWX 810 290 0294

Our 3rd Decade of Magnetic Shielding Leadership



MICROWAVES & LASERS

Coax wattmeter has sampling port



Bird Electronic Corp., 30303 Aurora Rd., Cleveland, OH 44139.
(216) 248-1200. \$245.

The Model 4527 rf directional wattmeter measures forward or reflected cw power. The rack-mounted, coaxial unit is designed for $\pm 5\%$ power measurement from 100 mW to 1000 W from 2 to 200 MHz and up to 500 W from 200 to 512 MHz. No plug-in elements are needed for rf analysis: The sample signal is available from a BNC output port at about 53 dB below the main signal level. Below 10 MHz, the coupling decreases gradually to -70 dB. The Model 4527 has a VSWR of 1:05:1 max.

Booth No. 1318 Circle No. 334

Filters hold distortion to $\pm 3^\circ$

Allen Avionics, Inc., 224 E. 2nd St., Mineola, NY 11501. (516) 248-8080. \$300.

Gaussian-type linear-phase bandpass filters have a frequency range of 1 kHz to 25 MHz with impedances from 50 to 10-k Ω in 2%-to-70% bandwidths. Maximum phase distortion over 3-dB passband is $\pm 3^\circ$, with typical delay variation of 5%. Epoxy encapsulated or sealed in metal cans, sizes range from $2 \times 1-5/8 \times 1-1/8$ in. to $4-1/2 \times 2-1/2 \times 1-3/8$ in.

Booth No. 1657 Circle No. 335

Detectors span 10 MHz to 18 GHz

Narda Microwave Corp., 75 Commercial St., Plainview, NY 11803. (516) 433-9000. \$185 (stock).

The Models 503 and 4503 detectors operate over the frequency range of 10 MHz to 18 GHz. They have a VSWR of less than 1.8:1 and sensitivity of 0.4 mW/ μ W. These SMA and type-N detectors also feature field-replaceable diodes.

Booth No. 1336-38 Circle No. 336

POWER SOURCES

Low-cost, open-framers targeted for OEMs

Power-Pac Inc., 18 Marshall St., South Norwalk, CT 06854. (203) 866-4484. Begin at \$26 per unit; stock.

Low-cost power supplies are aimed at the OEM market. The line features convection cooling and open-style construction. Voltage output levels include: 5, 6, 12, 15, and 24 V dc in single outputs; ± 5 , ± 6 , ± 12 and ± 15 V dc in dual outputs; and $\pm 12/5$ and $\pm 15/5$ V dc in triple outputs. Current outputs range from 1 to 50 A. Regulation is $\pm 0.15\%$, line and load combined; ripple and noise is 2 mV rms and 10 mV pk-pk. Built-in short-circuit protection with automatic recovery is provided, along with optional over-voltage protection.

Booth No. 1245 Circle No. 337

Open-frame unit claims high reliability

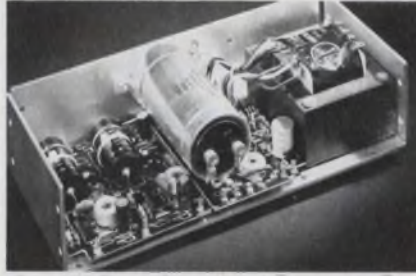

Power One, Inc., 531 Dawson Dr., Camarillo, CA 93010. (805) 484-2806. \$110 (1-9); stock.

The company has expanded its triple-output Hi-Vol Series with the addition of a new high-reliability version. The CP-131 provides precise power for combinations of TTL, ECL, I²L, MOS, linear and other devices. A chassis-mounted, 64,000- μ F filter capacitor is used on the 5-V, 8-A output to enhance reliability, as well as a 15-A TO-3 rectifier assembly and additional pass transistor on the 5-V output. Standard features include 115/230 V ac $\pm 10\%$ input, $\pm 0.05\%$ line and load regulation and built-in OVP.

Booth No. 1558 Circle No. 338

Ac line regulator receives UL recognition

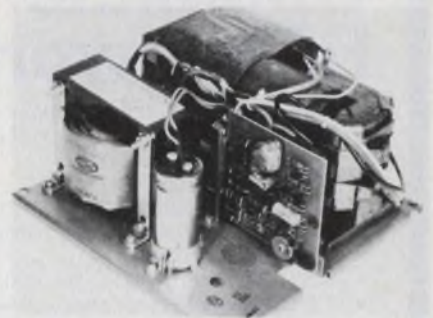

Tele-Dynamics, 525 Virginia Dr., Fort Washington, PA 19034. (215) 643-3900. \$121; stock.

A new Varax line regulator and brownout protector is recognized under the component recognition program at UL. The C474/UL provides $\pm 1\%$ true rms regulation of line and load, operating over a 90-to-130-V range, with an output rating of 2000 VA. It has greater than 90% efficiency at full load and is insensitive to line frequency variations. The Varax uses closed-loop feedback to obtain better regulation than ferromagnetic devices, and $\pm 3\%$ is standard.

Booth No. 1049 Circle No. 339

SPEED PRODUCTION...
SAVE SPACE AND WEIGHT...
REDUCE ASSEMBLY COSTS...
WITH BUCKBEE-MEARS FLEXIBLE CIRCUITRY

BMC flexible circuitry offers significant advantages over conventional hand wiring of discrete circuits. It can simplify assembly, reduce costs, and greatly improve wiring accuracy and reliability.

Buckbee-Mears' Circuits Division also can provide as much—or as little—engineering assistance as you require . . . from preliminary drawings through testing to finished products. This team of flexible circuit specialists can help define your requirements, then work with you in developing the circuitry to fit your exact application. For information, write or call Ed Dugan.

FLEXIBLE CIRCUITRY DIVISION
BUCKBEE-MEARS COMPANY
bmc
345 EAST SIXTH STREET
ST. PAUL, MINNESOTA 55101 612-228-8253

INFORMATION RETRIEVAL NUMBER 81

ELECTRONIC DESIGN 18, September 1, 1975

MEMORY SERIES No. 7

DON'T SETTLE FOR OFF-THE-MARK SPEED/POWER TRADEOFFS.

1K MOS RAM in 12 combos. One dozen versions lets you target our #2102 static RAMs to application. Optimize speed, minimize power—pay only for what you can use. 10 fast standards + 2 in MIL. Quantity-stocked now.

Send complete specs on #2102 1K MOS RAM family. Clip coupon to letterhead.

Name _____
Tel. _____ Ext. _____

THINK
Sinnetics
811 E. ARQUES, SUNNYVALE, CALIF. 94086

INFORMATION RETRIEVAL NUMBER 82

Complete RF Network Analysis

- **0.4 to 500 MHz** in three overlapping bands; log, linear, CW, and $f_0 + \Delta f$ modes.
- **115-dB Dynamic Range** — 80 dB direct display.
- **0.005-dB Resolution** — 0.05 dB flatness per 10 MHz; 0.4 dB full-band flatness.
- **Absolute Level in dBm** — direct swept display 0 to -80 dBm.
- **Phase and Group-Delay Measurements** — direct-reading swept displays.
- **50 and 75 Ω** — interchangeable measuring circuits with complete selection of coaxial components for each impedance level.
- **Measure** filters, amplifiers, antennae, cables, delay networks, equalizers, components, transistors, etc.
- **Display Simultaneously** magnitude and phase, magnitude and absolute level, magnitude and group delay, transmission and reflection.
- **Synthesizer-Based Systems from 0.2 to 500 MHz** — for precision narrow-band measurements on devices such as crystal or surface-wave filters, consider the GR 2261 Synthesizer Network Analyzer.



GR's 1710 RF Network Analyzer is the instrument that provides the complete RF network analysis described above. Call or write for complete information, application assistance, or for a demonstration.



For High-Frequency Measurements General Radio

300 BAKER AVENUE, CONCORD, MASSACHUSETTS 01742
GR COMPANIES • Grason-Stadler • Time Data

NEW YORK (N.Y.) 212 964-2722, (N.J.) 201 791-8990
BOSTON 617 646-0550 • DAYTON 513 294-1500
CHICAGO 312 992-0800 • WASHINGTON, D.C. 301 948-7071
ATLANTA 404 394-5380 • DALLAS 214 234-3357
LOS ANGELES 714 540-9830 • SAN FRANCISCO 415 948-8233
TORONTO 416 252-3395 • ZURICH (01) 55 24 20

INFORMATION RETRIEVAL NUMBER 78

New Products

Printer/plotter features
0.2% plotting accuracy



Gould Inc., 3631 Perkins Ave.,
Cleveland, OH 44114. (216) 361-
3315.

Model 5200 high-speed electrostatic printer/plotter can both plot graphics and print alphanumeric. The unit provides 0.2% accuracy in plotting, and it can produce variable character spacing on each line to approximate a graphic-arts output, according to Gould. Specially coated paper becomes electrically charged and fluid-toned as it travels through the unit. The toner adheres to the charged areas of the paper and emerges dry from the machine. A resolution of 200 dots/in. both vertically and horizontally can produce smooth curves. And in printing, the 5200 can generate 132 characters per line with fixed character spacing on 11-in.-wide paper. Data are printed at 1.65 in/s. Both Helvetica Medium and Times Roman type fonts are available as standards, with a full ASCII 96-character, 16 × 16 dot matrix in upper and lower-case letters.

Booth No. 1324-26-28

CIRCLE NO. 350

COSTS DOWN!

WIRE

FORMS

PRECISION UP!

BY ARTWIRE. Art Wire's high speed, automatic machines and production economies mean BIG SAVINGS for you . . . with guaranteed precision from the first to the millionth unit. Widest variety of metal fabricated parts including wire forms, stampings, cold headed parts, etc. Made for today's automatic production lines, delivered on schedule to assure uninterrupted work flow. **Send a Sample or Blueprint for Estimates**

Write for catalog.



ART WIRE & STAMPING COMPANY
116 Wing Drive, Cedar Knolls, New Jersey 07927

INFORMATION RETRIEVAL NUMBER 83

Quiet teleprinter is 80% solid state

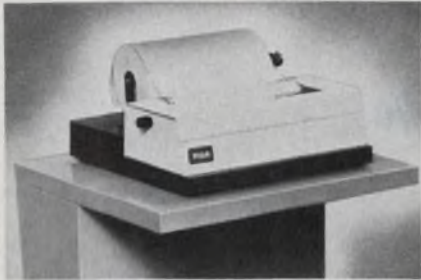

RCA Service Co., Cherry Hill Offices, Camden, NJ 08101. (609) 779-4129. \$55 per mo; 1 yr. lease; stock.

The Extel series AF receiver-only teleprinter is a quiet, mechanically simple solid-state printer that is fully compatible with all standard teleprinter signals and equipment. It offers five-level Baudot coding (75 or 100 wpm) and optional eight-level ASCII coding (100 or 150 wpm). The teleprinter needs no ribbon because it prints on pressure-sensitive paper, which can make up to three copies. Printing is done with a 5 x 7 dot matrix.

CIRCLE NO. 351

Tape transport stores 1/2-million bytes



Cipher Data Products, 7510 Clairemont Mesa Blvd., San Diego, CA 92111. (714) 279-6550. \$6000; stock.

A rugged incremental tape transport, the 70HB with speeds to 1250 char/s, stores up to 1/2-million bytes and is available in 7-in. reel size and seven-track, 556 or 800 bpi or nine-track, 800-bpi densities. Precise byte-to-byte spacing is maintained by a direct-drive capstan motor, velocity tachometer and closed-loop servo optical encoder. Continuous IBM-compatible tape read-and-write speeds to 25 ips are available as a standard feature for accurate checking or processing.

CIRCLE NO. 352

Baseplate converts typewriter to I/O unit



Tycom Systems Corp., 26 Just Rd., Fairfield, NJ 07006. (201) 227-4141. \$575 (OEM qty); 30 to 45 days.

A new baseplate converts the Sperry-Remington SR 101 electric typewriter to an economical I/O typewriter. Depressed keys on the typewriter are instantly converted to data for transmissions to computers, terminals and peripherals with the appropriate electronics. The unit is available either as an OEM stand-alone product or as part of a complete terminal system. The familiar keyboard allows a standard typewriter operator to operate the machine without time-consuming training.

CIRCLE NO. 353

SOUTH BAY CABLE SOLVES TOUGH CABLE PROBLEMS!



For computer applications, business machines . . . or a custom design to fit your particular requirement. Write for catalog or send details of your needs.

Manufacturers of cable for electronic use both military and commercial.

SOUTH BAY  **CABLE CORP.**

Idyllwild, California 92349 • Tel. (714) 659-2183

INFORMATION RETRIEVAL NUMBER 84

ELECTRONIC DESIGN 18, September 1, 1975

MEMORY SERIES No. 8

INTERFACE SAVERS: 20 TTL COMPATIBLE MOS SHIFT REGISTERS

In stock now, and in love with TTL, our MOS registers save on go-betweens. Zero interface cuts parts and power costs. Max design flexibility, all from one source: 20 gives you plenty to pick from.



FREE Short Form Catalog lists all 20 MOS S-Rs. Clip coupon to letterhead for your copy.

Name _____

Tel. _____

Ext. _____

THINK

Signetics

811 E. ARQUES, SUNNYVALE, CALIF. 94086

INFORMATION RETRIEVAL NUMBER 85

Low cost dedicated divider comes trimmed to within 0.25%

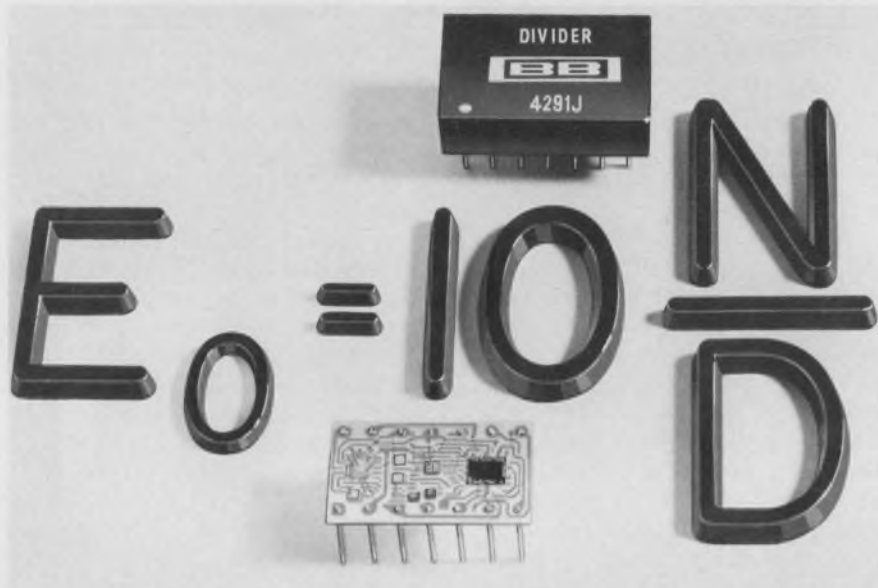

Burr-Brown, International Airport Industrial Park, Tucson, AZ 85734. (602) 294-1431. P&A: See text.

The new 4291 series of pre-trimmed analog divider circuits from Burr-Brown have accuracies to within 0.25%. The units are laser trimmed at the factory and are housed in 14-pin, DIP-like, packages with dimensions of 0.8 × 0.5 × 0.25 in. (20.3 × 12.7 × 6.4 mm).

There are three models in the series, the 4291H, 4291J and 4291K. All are hybrid microelectronic, two quadrant, dividers. They have accuracies of 1%, 0.5% and 0.25%, respectively. They range in price from \$34 for the 1% unit to

\$53 for the 0.25% version (for 1 to 9 pieces).

The hybrid circuits have a dynamic range of 10 mV to 10 V for the denominator input voltage. Since the 4291 circuit uses log/antilog techniques, the accuracy stays constant with denominator voltages as low as 100 mV. Additional external trimming resistors can be added to permit operation with denominator voltages as low as 10 mV. These resistors can also boost the divider accuracy to 0.1%.

Divider bandwidth for small-signal response is 400 kHz; bandwidth drops to 20 kHz for full power output. The internal ampli-

fiers have a slew rate of only 1.25 V/μs. Both the numerator and denominator inputs have an impedance of 25 kΩ. The divider output can deliver ±10 V signals at currents of ±5 mA, min. Output impedance is a low 0.1 Ω.

The Burr-Brown 4291 dividers require dual supplies with voltages from ±14 to ±16 V dc. The quiescent current drain from the supplies is +15 mA, -8.5 mA. The output error of the divider varies by 0.15%/ % of supply voltage change. As the ambient temperature changes, the divider output accuracy varies by 0.03%/°C.

Noise at the divider output depends on the magnitude of the denominator voltage—it is over 10 mV with a denominator voltage of 10 mV, and less than 1 mV when the denominator voltage reaches 10 V.

The closest competing units to the Burr-Brown 4291 units are the 433 series from Analog Devices (Norwood, MA). These are discrete component modules that measure 1.5 × 1.5 × 0.62 in. and are available in accuracies of 0.5 and 0.25%. The Analog Devices units, though, cost about \$40 more.

Prices for Burr-Brown's 4291 are as follows: \$34 for the 4291H, \$42 for the 4291J and \$53 for the 4291K—all in 1-to-9 quantities. Delivery is from stock.

Burr-Brown CIRCLE NO. 320
 Analog Devices CIRCLE NO. 321

ANALOG

IM DOING MY INCOME TAX WITH THIS NEW WIZARD CALCULATOR.

ARE YOU SURE YOU KNOW HOW TO USE IT?

SIMPLE. THERE YOU GO. I OWE UNCLE SAM $\sqrt{\pi}$?

ANALOGY

SAVE ON ANALOG COMPUTATIONS WITH FMI MATH MODULES. OUR NEW RMS-TO-DC CONVERTER IS FASTER AND MORE ACCURATE THAN THERMAL RMS METERS. IT COMPUTES TRUE RMS LEVELS BY AVERAGING SQUARING AND SQUARE-ROOTING. OUR DIVIDERS ACHIEVE 0.1% ACCURACY AND WIDE BANDWIDTH OVER A 100:1 DIVISOR RANGE. OUR 90 μ s 4-QUADRANT MULTIPLIERS ALSO DIVIDE, SQUARE, SQUARE-ROOT, ETC., AT ACCURACIES TO 0.1%. AND FOR SCALING OUR LOG AMPLIFIERS REMAIN PRECISE OVER AN 8-DECADE RANGE.

intech/FMI
 282 BROOKAW RD. SANTA CLARA, CA 95050 (408) 244 0500

Finally...the "NO-COMPROMISE" swept radius SMA connector

PAT. PENDING

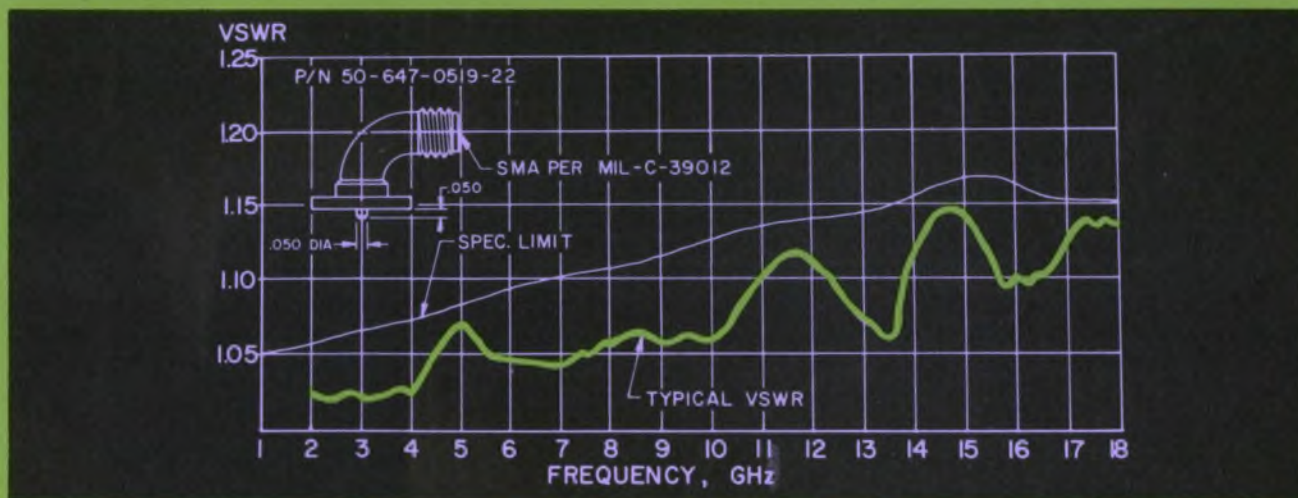
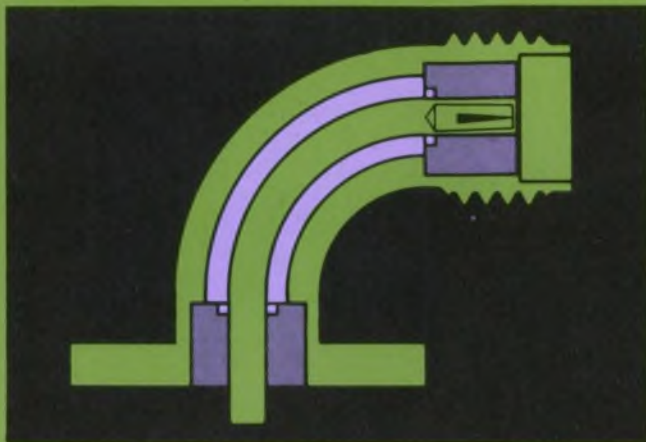

You've seen them all — with all their compromises. Long delivery waits, and when you do get them you find non-concentric contacts, non-heat-treated contacts, non-uniform electrical performance. Now, a brand-new concept from Sealectro eliminates these problems. A combination of Teflon and air dielectrics makes possible an assembly utilizing a pre-formed, heat-treated center conductor, assuring uniformly high mechanical and electrical performance, certified by independent testing laboratory.

Suddenly — The right right angle for top performance!

Facts about Sealectro SRM swept radius connectors

1. Center conductor is fully heat treated for dependable matings time after time. (min. 500 matings per MIL-C-39012)
2. Optimum concentricity maintained throughout connector for predictable, low, low VSWR.
3. Interface contacts dead center for perfect mechanical mating every time.
4. Available in all popular cable and bulkhead configurations.



R F COMPONENTS DIVISION

SEAELECTRO CORPORATION

MAMARONECK, N.Y. 10643

PHONE: 914 698-5600 TWX: 710-566-1110

Sealectro West:

14011 Ventura Blvd., Suite 215 Sherman Oaks, Ca 91423, (213) 990-8131

1901 Old Middlefield Way, Suite 19, Mountain View, Ca. 94043 (415) 965-1212

Sealectro Ltd. Portsmouth, Hants, England

Sealectro S.A., la Garde 83, France

CIRCUIT COMPONENTS ■ R F COMPONENTS ■ PROGRAMMING DEVICES

Peak-holding analog memory can store data for 3 months



now you have
a choice!

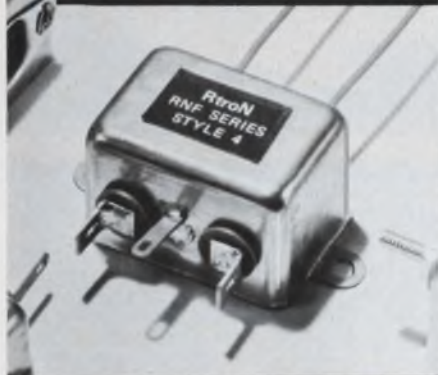

RFI/EMI FILTERS

For Data Processing,
Industrial Control and
Instrument Application

Rtron's RNF Type Filters represent three series of the most widely used, low cost filters available. Over 100 combinations of current and case style to choose from. "L" Series - low cost for general applications to combat line to ground noise. "P" Series - for suppression of line to line as well as line to ground interference. "T" Series - most effective for low impedance load applications. All types are U.L. Recognized and meet C.S.A. requirements. Rated at 115/250 VAC. Low leakage current insures safety.

For complete catalog and details, write.

Rtron Corporation

P.O. Box 743, Skokie, Illinois 60076
(312) 679-7180

INFORMATION RETRIEVAL NUMBER 88

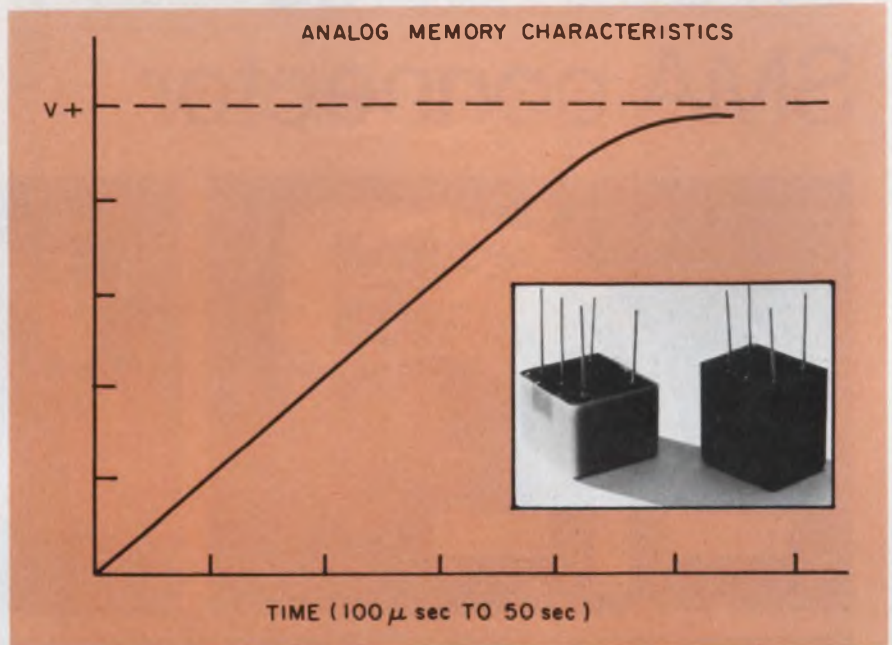

Matsushita Electric Co. of America,
One Panasonic Way, Secaucus, NJ
07094. (201) 348-7292. P & A: See
text.

Have you ever wanted to store the peak value of a voltage waveform, only to find that someone shut the equipment off soon after you've taken the measurement? Matsushita's AMM series of non-volatile peak-memory modules will let you store positive or negative voltages for over a year with almost negligible change without using any "keep-alive" power.

The signal stored by the analog memory modules decays only 2% after being held for 1000 hours—and decays only 5% after 10,000 hours of storage. The circuits can be programmed to acquire the peak signal in as short a time as 100 μ s or as long as 50 s. The analog memories can deliver output voltages as low as 30 mV or as high as 90% of the supply voltage. The output impedance is 1 k Ω .

There are three units in the series—the AMM-1, AMM-2 and the AMM-3.

The AMM-1 requires a ± 20 -V supply and delivers up to ± 14 V for a maximum input swing of

± 20 V. It can also deliver up to 10 mA of load current.

Both the AMM-2 and AMM-3 require only single supplies of 20 V max. The AMM-2 can handle input voltages of up to 200 V and provides scaled outputs of 18 V max at current loads of up to 9 mA. Similarly, the AMM-3 accepts inputs of 20 V max and provides outputs of up to 15 V at currents of 9 mA max.

Power consumption for the AMM-1 and AMM-2 modules is 200 mW and for the AMM-3 rises to 300 mW. All units have an operating temperature range of -25 to $+80$ C. Package size for the AMM-1 and AMM-3 is 1.05 \times 1.2 \times 0.79 in., while for the AMM-2 the size increases to 0.8 \times 1.05 \times 1.06 in.

Applications for the memory modules include noncontacting electronic dimming controls, electronic tuning circuits and, of course, peak reading instrumentation.

Prices for the AMM modules start at \$20 for the AMM-2 and \$25 for the AMM-1 and AMM-3 in sample quantities down to \$5 for the AMM-1 and 3 and \$3.25 for the AMM-2 in 1000-up lots. Delivery is four weeks. CIRCLE NO. 310

**If it weren't for its frequency response
of 30 Hz at 100 mm,
its 99.65% linearity,
its pressure-ink writing,
its highest quality traces,
its full range of plug-in conditioners,
its 12 chart speeds, and
its wide channels,
the GOULD/Brush 2400 would be like
most any other direct writing recorder.**

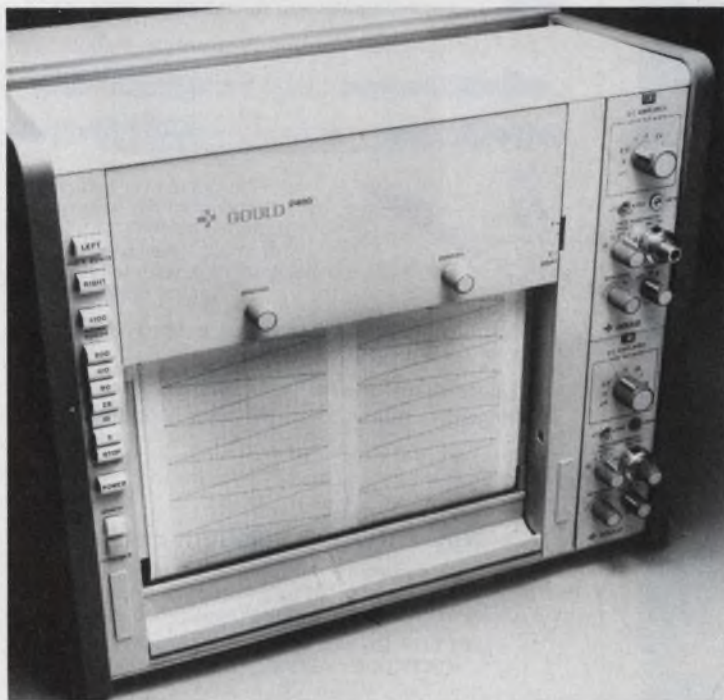

But because of all this, it's the best performing direct writing recorder on the market today. When you see it, you'll believe it. So call your nearest Gould Sales Engineer today for a demonstration. Or, for more details, write Gould Inc., Instrument Systems Division, 3631 Perkins Avenue, Cleveland, Ohio 44114. Or Gould Allco S.A., 57 rue St. Sauveur, 91160 Ballainvilliers, France.

 **GOULD**

PHONE TOLL FREE TODAY FOR TECHNICAL BROCHURE (800) 648-4990.

INFORMATION RETRIEVAL NUMBER 89

economy model

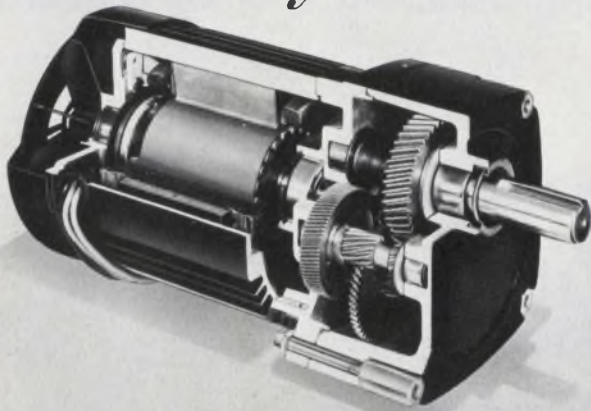

Bodine makes quality fhp motors and drive systems. Some may cost a little more. Initially. But, in the long run they cost less to use.

After Delivery Economies (ADE) are the reason. You get fewer rejects. Consistent quality, motor to motor, lot to lot. Less profit robbing service and downtime problems. Bodine motors perform. Reliably. Run stronger and last longer. Help protect your reputation and profit.

If you're concerned about today's bottom line costs and tomorrow's repeat sales, take a close look at Bodine. (1/2000 thru 1/4 Hp.)

ADE (After Delivery Economies) make Bodine a better fhp buy



Bodine Electric Company, 2528 W. Bradley Place, Chicago, IL 60618
INFORMATION RETRIEVAL NUMBER 90

22 Modules plug in to the X-Y and strip chart main frame to bring you every desired function at lowest cost.

Model 2000
\$890
+ modules

OMNIGRAPHIC 75

LEADER IN X-Y RECORDING
FROM THE RECORDER COMPANY

The best known and most versatile in the world — the Omnigraphic X-Y Model 2000. Outperforms all others and still beats their price. Look at these features:

- 30 in/sec speed (40 in/sec available)
- \pm 0.2% accuracy
- Highest axis isolation
- Same servo rates on both axes
- Best common mode rejection

Model 6650
Incremental plotter used from labs to marine navigation
\$2850

Model 3000
Strip Chart Recorder based on reliable 2000 X-Y design
\$890 + modules

Write today for prices, details.
OEM discount available.



houston
instrument



ONE HOUSTON SQUARE (at 8500 Cameron Road) AUSTIN, TEXAS 78753
(512) 837-2820 TWX 910-874-2022 cable HOINCO

TELECOPIER EUROPEAN OFFICE Rochester, N.Y. 14620 Gistel, Belgium
Phone 059/777445 Telex Brussel 19399
"the recorder company"

* A registered trademark of Houston Instrument

INFORMATION RETRIEVAL NUMBER 92

JANCO MAKES THE FINEST ROTARY SWITCHES ON EARTH

...and other places!



When the best rotary switches for the Apollo flights to the moon were needed . . . they chose JANCO! They liked Janco rotary switches for the same reason you will . . . reliability . . . performance . . . long life. They wouldn't settle for less, so why on earth should you! Janco's 28 years in business embraces a very wide span of rotary switch capability. New models and types of switching mechanisms emerge almost daily at Janco. Take advantage of engineering excellence and know-how . . . call Janco today.



3111 Winona Ave., Burbank, California 91504
Phone 213-845-7473 • TWX 910-498-2701

INFORMATION RETRIEVAL NUMBER 91

FLASHTUBES and RELATED EQUIPMENT

XENON corporation

Lamps and Equipment for the Generation of Light.

FEATURES: High Volume Production Reliability



We can deliver a reliable product in the quantities required by the OEM user. Our lamps have consistently higher quality, with longer and more uniform life.

In addition, we can solve the problem of having to build your own circuitry with our:

- Trigger Transformers
- Chokes
- Trigger Modules
- Power Modules

All are part of the engineering and manufacturing package Xenon can deliver and we can offer the most advanced technical assistance in the industry.

NEW PRODUCT ANNOUNCEMENT

Contact our factory for information on our new inner seal design. Its unique insulating and cooling properties have solved problems in many OEM application areas:

SEND FOR OUR COMPLETE PRODUCT CATALOG. XENON ASSURES QUICK DELIVERY.

66 Industrial Way, Wilmington, Massachusetts (617) 658-8940

INFORMATION RETRIEVAL NUMBER 93

MODULES & SUBASSEMBLIES

Instrumentation amp has 1-kHz bandwidth

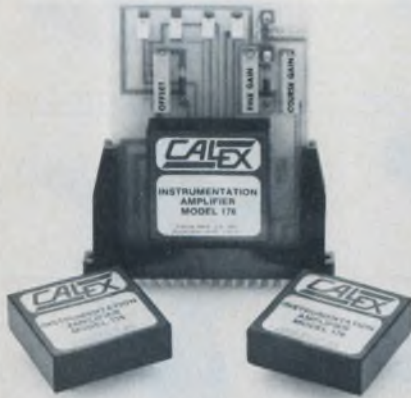

Calex Mfg., 3305 Vincent Rd., Pleasant Hill, CA 94523. (415) 932-3911. From \$29 (unit qty.); 2 to 4 wk.

The Model 176 instrumentation amplifier has a differential-input and high gain. The gain is adjustable between 10 and 1000 by means of a single external resistor. The amplifier is encapsulated in a 1.5 × 1.5 × 0.5 in. module and is rated for operation from 0 to 70 C. Amplifier bandwidth is 1 kHz at a gain of 1000, which allows it to be used for shock and vibration analysis as well as low frequency applications. The 10-M Ω differential input impedance allows the unit to handle a signal-source impedance unbalance as high as 10 k Ω with almost no effect on CMR. Two amplifier versions are available: The Model 176J has a drift of $\pm 3 \mu\text{V}/^\circ\text{C}$ and the Model 176K a drift of $\pm 1 \mu\text{V}/^\circ\text{C}$.

Booth No. 1335

CIRCLE NO. 392

Low-pass filter card has 60 dB/octave cutoff

Digitan Systems, 5001 16 Ave., Brooklyn, NY 11204. (212) 436-3777. \$315; 3 wk.

The Model F312 low-pass anti-aliasing filter card provides a cutoff characteristic of 60 dB per octave. This elliptic filter design permits digital control with TTL-compatible signals of 12 cutoff frequencies from 5 to 20,000 Hz. The standard cutoff frequencies are: 5, 10, 20, 50, 100, 200, 500, 1000, 2000, 5000, 10,000 and 20,000 Hz.

CIRCLE NO. 393

Data and clock drivers handle 10-MHz signals

Versatile Integrated Modules, 3058 A Scott Blvd., Santa Clara, CA 95050. (408) 241-0228. From \$21 (100-up); stock.

The VIM Series 100 single and dual data and clock drivers handle repetition rates from dc to 10 MHz with minimum pulse widths from 20 ns at a 5-V swing. Propagation delays are less than 2 ns and dual

driver versions limit skew between two outputs to less than 1 ns. The dual driver's V_{hi} and V_{lo} phase amplitudes can be independently adjusted with a 25-V range. V_{hi} is programmable from -8 to +20 V and V_{lo} is programmable from -20 to +8 V. The user may specify any supply voltage from ± 5 to ± 15 V at no additional cost. The driver modules measure 1.1 in. square × 0.4 in. high.

CIRCLE NO. 394

The first impression is only the beginning.

Beneath the rugged good looks of Zero's Matrix IV electronic cabinets you'll find something more. You'll find outstanding design engineering that brings you more strength, versatility, and quality per dollar.

Zero combines standard pre-engineered all-steel components with an extensive list of accessories. So it's easy to tailor a home for your product that is distinctive, economical, and available.

A Matrix IV cabinet looks good. But it's that final built-in quality that makes the difference. Write for your free catalog today.



The Final Touch



ZERO MANUFACTURING CO.
Burbank, CA 213/846-4191 • Monson, MA 413/267-5561 • Clearwater, FL 813/531-8991

FOR PRODUCT DEMONSTRATION, CIRCLE 161
FOR LITERATURE, CIRCLE 162

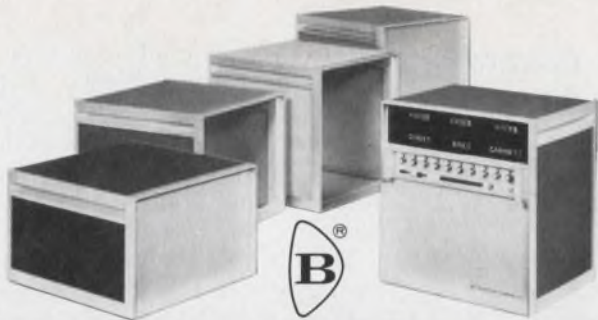

BUCKEYE CABINETS

Buckeye's classic cabinetry line of aluminum enclosures is colorful, strong and budget priced. Universal 19" front panels, with heights from 12.25" to 28". You can also depend on Buckeye for other instrument-packaging needs: Designer Cases of all types and sizes — Patented card guide modules — PCB racks — Retractable, locking tilt-stands — and the recognized high quality matching instrument knob line.

the **BUCKEYE stamping co.** Write today for
555 Marion Rd., Columbus, Ohio 43207 free colorful literature!

"QUALITY PRODUCTS SINCE 1902"



GUIDES • CASES • KNOBS • RACKS

See Us at Wescon—Booth 1513-1515
INFORMATION RETRIEVAL NUMBER 102

DRIREED RELAYS



GENERAL PURPOSE



LOW SILHOUETTE



DIP



RUGGED-MIDSIZE

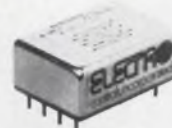

RUGGED DUTY



CURRENT SENSORS

Immediate Availability from Stock or Custom Designed for Your Application

- 6 to 26 VDC coils
- Contact ratings to 200 VDC
- Gold alloy or rhodium contacts
- 5×10^6 operations at rated load
- Low in cost, High in value!

Write Today for Complete Catalog

ELECTRO controls, incorporated
Matthews Ave., Canton, Miss. 39046
(601) 859-5511/TWX (810) 990-0938

INFORMATION RETRIEVAL NUMBER 105

Introducing the efficient little 82900 stepper motor



It gives you an edge on compactness, torque and price.

It's new. It's bidirectional. It has a 7.5° step angle. It gives you maximum pull-in/pull-out torque of 23 oz-in @ 200 pps. It's rated at 12.38w @ 5vdc and runs at lower than average temperatures.

The 82900 has a lot to offer, particularly in impact and non-impact printers, small X-Y plotters and computer peripherals. It's powerful, compact and moderately priced. And it's reliable. So reliable — in fact — that it can also be used to control pumps and valves in medical instruments and similar devices. In many applications it can replace larger, bulkier steppers at much lower cost.

Standard construction provides 2-phase operation (requiring simplified, low-cost circuitry), a 7.5° step angle and roller bearings. However, 4-phase operation, a 15° step angle or sleeve bearings can be furnished as options.

Write for information today!

A W HAYDON CO. PRODUCTS

NORTH AMERICAN PHILIPS CONTROLS CORP.

Cheshire, Conn. 06410 • (203) 272-0301
CIRCLE 241 FOR INFORMATION ONLY
CIRCLE 242 FOR IMMEDIATE NEED

WHO MAKES WHAT & WHERE TO FIND IT

Volume 1 of **Electronic Design's GOLD BOOK** tells all. And, when you look up an item in its **PRODUCT DIRECTORY** you'll find each manufacturer listed **COMPLETE WITH STREET ADDRESS, CITY, STATE, ZIP AND PHONE.** Save time. There's no need to refer elsewhere to find missing information.

IT'S ALL THERE
in
Electronic Design
GOLD BOOK

INTEGRATED CIRCUITS

4-k static RAM accesses in 225 ns

EMM Semi, Inc., 3883 N. 28th Ave., Phoenix, AZ 85107. (602) 263-0202. \$24 (100).

A TTL-compatible 4-k static RAM features a cycle of 400 ns and a worst-case access time of 225 ns. Operating power is less than 150 mW. And since V_{DD} can be reduced from 12 to 4 V dc without risking loss of stored data, standby power consumption can be as low as $2 \mu\text{W}/\text{bit}$. The unit comes in a 22-pin DIP. **CIRCLE NO. 444**

8-bit microprocessor simplifies interfacing

Signetics, 811 E. Arques Ave., Sunnyvale, CA 94086. (408) 739-7700. Under \$100 (1000); stock.

An 8-bit NMOS microprocessor, the 2650, requires a single 5-V power supply and is completely TTL compatible on all input/output pins, including the single phase, TTL clock input.

Also known as the PIP, for Programmable Integrated Processor, the 2650 has an 8-bit bidirectional data bus and a separate 15-bit address bus. The fixed instruction set includes 75 arithmetic, logical, branch and control instructions. The processor has seven general-purpose registers, a main arithmetic logic unit and separate address adder, an eight-level return address stack and a BCD arithmetic capability.

Three input/output modes include single and two-byte parallel, and a special serial input/output mode that uses the flag and sense lines.

Addressing modes, in addition to the usual register-to-register, include immediate, absolute and 128-byte relative indexed modes. Both the relative and absolute modes have an indirect option that permits branching to various areas within the basic 32-k of either program or data storage.

The 2650 uses static logic. Hence the clock can be stopped in its low state for indefinite periods without loss of status or data.

CIRCLE NO. 445

Image sensor resolves 8-1/2-in. page



Reticon Corp., 910 Benicia Ave., Sunnyvale, CA 94086. (408) 738-

4266. \$3800; stock.

With a single RL-1872 self-scanning photodiode array, it's possible to read a full 8-1/2-in. page with better than 5-mil resolution. Along with 1872 photodiodes, the chip contains shift registers and multiplex switches for internal scanning and serial readout. The device can operate at sample rates up to 20 MHz, corresponding to line rates up to 10 kHz.

CIRCLE NO. 446

Dish it out. They can take it beautifully.

When your customer takes your equipment into the field, be prepared for the worst to happen.

Don't take chances. You've spent a lot of time and money designing your equipment. Your customer has invested in the results you promised him. And the extra strength, quality and reliability of a Zero Centurion™ aluminum carrying case can mean the difference between equipment success or failure.

With the distinctive good looks of a Zero Centurion case going for you, most people just naturally seem to treat your equipment better. But for those that don't, Zero Centurion cases will take all the abuse they can dish out.

The anodized silver "Elite" line and the textured blue "Valuline" are available in 59 standard sizes for two week delivery A.R.O.

Send for your free catalog today.

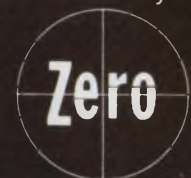

The Final Touch



ZERO MANUFACTURING CO.

Burbank, CA 213/846-4191 · Monson, MA 413/267-5561 · Clearwater, FL 813/531-8991

FOR PRODUCT DEMONSTRATION, CIRCLE 163
FOR LITERATURE, CIRCLE 164

SCR POWER SUPPLIES YOU CAN RELATE TO

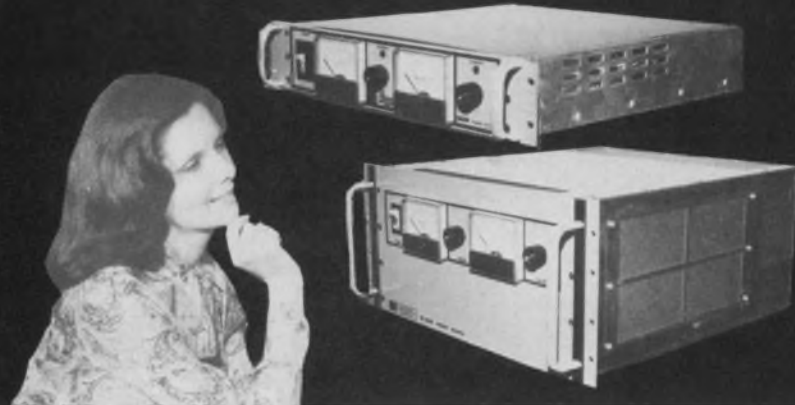

Enter into a permanent relationship with either of these Phase Controlled E/M Power Supplies. The SCR model on top is a single phase input unit offering from 500 to 2,400 watts of power and precise 0.1% regulation in both voltage and current modes.

The bottom unit is our three phase input SCR model boasting power ratings in the 2,500 through 10,000 watt range. It too features 0.1% regulation. Both types offer the highest power output per mechanical volume in the industry.

Check these superior benefits:

- High Efficiency
- Remote Sensing
- Remote Programming
- Series or Parallel Operation
- 5 Year Warranty
- Rack or Bench Mount
- Overvoltage Protected
- Constant voltage or current with automatic crossover
- Optional Input Voltages

For technical information, Phone TOLL FREE (800) 631-4298

SCR MODELS														
VOLTS	1 ϕ INPUT								3 ϕ INPUT					
	500 Watts		800 Watts		1600 Watts		2400 Watts		2500 Watts		5000 Watts		10,000 Watts	
	A	S	A	S	A	S	A	S	A	S	A	S	A	S
0 - 6											600	2300		
0 - 7.5			100	650	180	850	250	1100	300	1600				
0 - 10	40	450	80	600	150	850	210	1100	250	1500	500	2300		
0 - 20	25	450	40	600	80	800	120	1000	125	1400	250	1900	500	2900
0 - 30									100	1400	200	1900		
0 - 40	13	425	20	500	40	750	60	900	60	1400	125	1800	250	2700
0 - 50													200	2900
0 - 60	9	450	13	500	26	850	40	1000						
0 - 80	6	450	10	500	20	850	30	1000	30	1400	60	1800		
0 - 100													100	2900
0 - 120									20	1400	40	1800		
0 - 150	3	425	5	500	10	850	15	1000						
0 - 160									15	1400	30	1800	60	2700
0 - 250									10	1400	20	1900	40	2900
0 - 300	1.5	475	3	550	5	850	8	1000						
25 - 500									5	1600	10	2300	20	2900
0 - 600	.75	500	1.5	650	3	850	4	1100						



ELECTRONIC MEASUREMENTS INC.

405 Essex Road, Neptune, N. J. 07753
Phone: (New Jersey) 201 - 922-9300 • (Toll-Free) 800 - 631-4298
Specialists in Power Conversion Equipment

INTEGRATED CIRCUITS

2-k bit EPROMs access in 750 ns

Advanced Micro Devices Inc., 901 Thompson Pl., Sunnyvale, CA 94086. (408) 732-2400. \$24 to \$34 (100 up).

Two 2048-bit electrically alterable PROMs—the Am 1702 and Am 1702A—feature access times of 750 ns to 2.3 μ s. The EPROMs have a 256 \times 8-bit organization and the same pinouts as like-numbered units offered by Intel. Programming of the Am 1702A unit can be completed in less than two minutes while the Am 1702 requires from 18 to 20 minutes. The contents of an individual device can be erased with ultraviolet light.

CIRCLE NO. 395

CMOS PLL can work at 5 MHz

Solid State Scientific Inc., Montgomeryville, PA 18936. (215) 855-8400. \$3.25 (100-999).

A CMOS phase-locked loop, the SCL 4446, has frequency capability up to 5 MHz. It is pin compatible with the CD 4046. External resistance values can be as low as 2 k Ω .

CIRCLE NO. 396

Flasher permits LED to work off 1 V

National Semiconductor Corp., 2900 Semiconductor Dr., Santa Clara, CA 95051. (408) 732-5000. 70c (100 up); stock.

With the LM3909 pulse-generating IC, a light-emitting-diode can flash for over a year with power from a single C-size flashlight battery. The new monolithic flasher can actually be used to drive LEDs from 1-V supplies, even though 1.6 V is normally needed to turn the LED on. In LED-flasher applications, the average power drain is only 700 μ W. With an external resistor, the LM-3909 can operate up to 200 V, making it practical for other applications. The LM3909 can deliver 200-mA pulses, or oscillate at over 200 kHz.

CIRCLE NO. 397

COMPONENTS

In-line switch handles 2-to-10 stations

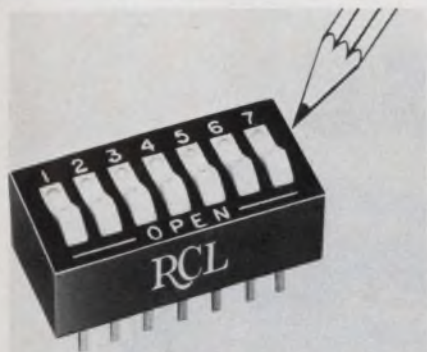

RCL Electronics, 700 S. 21st St., Irvington, NJ 07111. (201) 374-3311.

A 2-to-10 station miniature PIP switch provides standard switching or BCD coding for computer peripherals, communications equipment and traffic signal controllers. Features include positive detent action, long life, self-wiping and wave solderability. Operating temperature ranges from -40 through 190 F.

CIRCLE NO. 398

Relay accommodates 50-A wiring

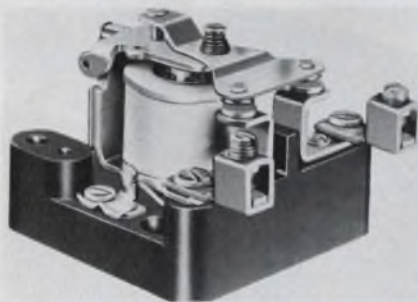

Magnecraft Electric Co., 5575 N. Lynch Ave., Chicago, IL 60630. (312) 282-5500.

Magnecraft says its Class 99D relay is the first in its class to accommodate full-sized continuous-duty 50-A wiring. It can handle 2-HP with double-make contacts on ac or dc operation. Connector adaptors enable the connection of the large sized wires. These solderless connectors provide a clamping connection for wire sizes 14 through 6 AWG. Only a screwdriver is needed to fasten the connectors to the relay and to clamp external wiring to each connector.

Booth No. 1644 Circle No. 399

12-bit ladder network accurate to 1/2 LSB

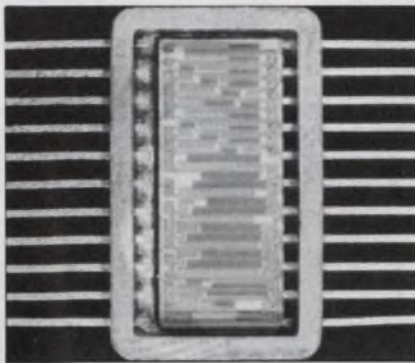

Halex, Inc., 3500 W. Torrance Blvd., P.O. Box 2940, Torrance, CA 90509. (213) 542-3555. \$24: DIP (100-500); stock.

The primary use for the HX50-12, 12-bit ladder network is in d/a converters. A low ON-resistance switch ($< 10 \Omega$) must be used to ensure converter accuracy of 1/2 LSB. Bipolar switching is the most economical, and it can provide both speed and accuracy when designed properly. Both TTL and CMOS inputs can be used. A custom option lets the designer specify his switch preference. The input resistors in the HX50-12 are then custom trimmed to compensate for the switch's ON resistance. The resistance material is nickel-chromium, thin-film sputtered onto an alumina surface. The alumina substrate provides low capacitance coupling to increase speed, which silicon substrates cannot match.

Booth No. 1457 Circle No. 400

Transformer for dc-dc conversion weighs 0.3 oz

Microtran Co., Inc., 145 E. Mineola Ave., Valley Stream, NY 11582. (516) 561-6050. \$5.20 (100 up); stock.

A series of 20-kHz dc-dc converter transformers is designed for 5-V-dc input. They are supplied with a typical schematic and suggested component list. One transformer type, P/N M8121, is for use in power supplies for glow-type displays. Its output is 190 V dc at 15 mA; it measures 9/16 D \times 11/32 H in.; and it weighs only 0.3 oz. Its open construction allows packaging flexibility.

Booth No. 1748 Circle No. 443

THE INSIDE STORY OF CHIP CAPACITORS

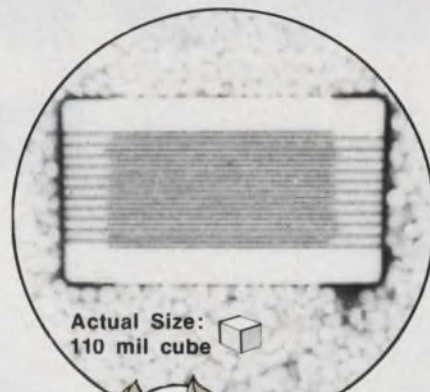

Actual Size:
110 mil cube



NOW HEAR THIS ...

If you're interested in the basics of monolithic chip capacitor construction, circle the reader service number below for your copy of "The Inside Story" and a sectioned ATC 100 chip capacitor.

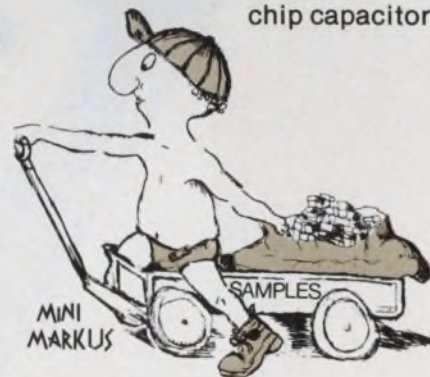

If you'd like samples of any other ATC UHF / Microwave Capacitors, call Ralph Wood at (516) 271-9600.

**american
technical
ceramics**

ONE NORDEN LANE,
HUNTINGTON STATION, N.Y. 11746
(516) 271-9600 • TWX 510-226-6993

INFORMATION RETRIEVAL NUMBER 108

**NOW OFF THE
PRESS!**

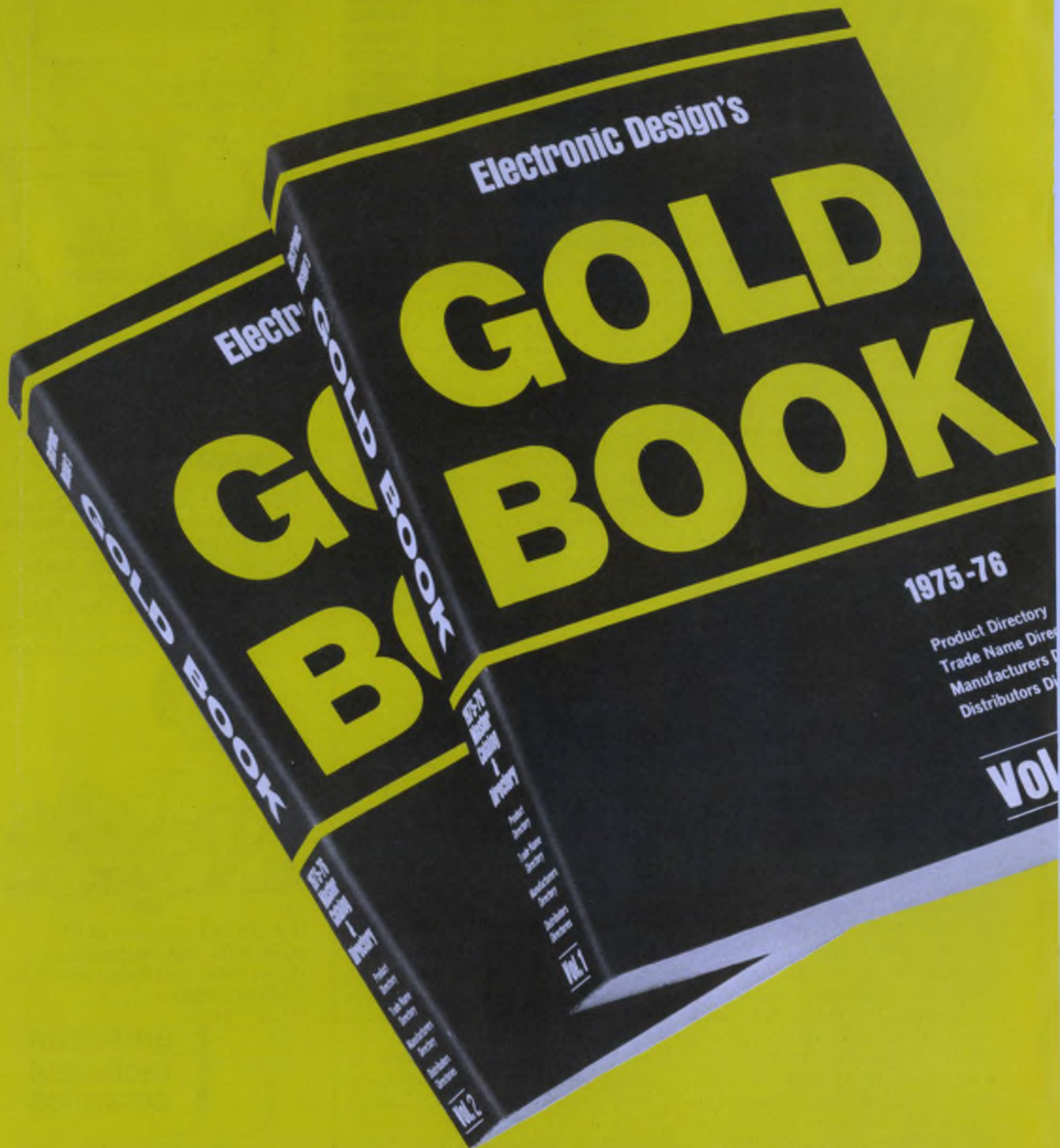

THE INDUSTRY'S BEST

Electronic Design's ALL NEW 1975-76 GOLD BOOK

POWER SUPPLIES, LOGIC 5V

American Power Sys Corp 51 G Jackson St Worcester MA 01608 Vol 3/903-905	(617)753-8103
Amphenol Sls Div, Components Group, Bunker Ramo Corp 2875G S 25 Av Broadview IL 60153 Vol 3/910,911	(312)345-4260
Computer Prods, Dept G, Box 23849 Ft Lauderdale FL 33307 Vol 3/918,919	(305)974-5500
Dynage Inc 1331G Blue Hills Av Bloomfield CT 06002 Vol 3/922	(203)243-0315
ELDEC Corp 16700G 13 Av W PO Box 100 Lynnwood WA 98036 Vol 3/930	(206)743-1313
Electrostatics Inc, Dept G, 7718A Clairemont Mesa Blv San Diego CA 92111 Vol 3/943	(714)279-1414
Elpac Inc/Elexon Power Sys, Dept G, 3131 S Standard Av Santa Ana	

If you were among the 99% of our surveyed readers who reported *Electronic Design's* 1974-75 GOLD BOOK equal or SUPERIOR to all other industry directories *here's good news*. The 1975-76 edition is even better.

It contains *more* product listings, *more* cross-references, *more* detailed information about companies — *more* sales outlets, reps, sales office, and distributor listings.

USE THE GOLD BOOK TO . . .

SPEED your first-step search for products.

SIMPLIFY your contact with companies or their reps or distributors.

FIND specific product information.

LOCATE *complete* company names, addresses, zip codes and phone numbers. You'll also often have access to TWX; TELEX; facsimile equipment (by make and call number); toll-free numbers; cable addresses; number of engineers; number of employees; key officials and financial data.

BUY what you need without necessarily having to see a salesman.

The GOLD BOOK puts the entire electronics industry at your fingertips. Reach for it *first*. Distribution began in mid-July — FREE to qualified *Electronic Design* subscribers. Others may order copies while they last for \$30 per set domestic or \$40 elsewhere.

DIRECTORY GETS EVEN BETTER

COMPONENTS

Cermet trimmers offered in many terminal styles

CTS of Berne Inc., 406 Parr Rd., Berne, IN 46711. (219) 589-3111. See text; samples available.

New single-turn, 3/8-in.-diameter cermet trimmers, Series 375, are available in six terminal styles. Low production quantities cost only 25¢ each (terminal styles

375X, 375S or 375T). Terminal types 375Y, 375E or 375V cost only a penny or two more. Design features include an adjustment knob, which doubles as a dust cover; a TC of ± 100 ppm/°C; gold-plated, multipaddle contactors, and contact resistance variations of 2%; settability of 0.03%; and a power rating of 1 W at 40 C and 1/2 W at 70 C. Both mounting standoffs and a squared substrate base ensure stability in mounting. Booth No. 1854 CIRCLE NO. 361

Switches join LEDs in DIP configuration

Licon, Div. of Illinois Tool Inc., 6615 W. Irving Park Rd., Chicago, IL 60634. (312) 282-4040. \$4 (OEM qty).

Pushbutton switches, NO or SPST, with miniature T-1-sized red LEDs in a DIP mount directly on a PC card. The terminals are on standard 0.1 × 0.3-in. spacings. Over-all height, from the bottom of the package to the top of the LEDs, is 0.44-in., and the area covers 1 × 0.38 in. The switches have been tested to over 100,000 cycles. Three configurations, all in the same package size, are available: one switch and four LEDs; five switches and four LEDs; and four LEDs only.

Booth No. 2722-2724

CIRCLE NO. 362

Solid-state counters replace mechanical units

Electronic Counters & Controls Inc., 1500 McCormick Ave., Mundelein, IL 60060. (312) 362-8910.

A solid-state unidirectional preset counter can directly replace mechanical counter units. It can be retrofitted in a matter of minutes. The MCR 100, in four basic types, has five-decade capacity with one or two presets and 10-A lock-in relays for 117 or 220 V ac. The counters employ modular construction with CMOS noise-immunity circuitry, easily readable 0.1-in. LED displays, manual reset and rugged cast-aluminum enclosures.

CIRCLE NO. 363

Matrix slide switch gives panoramic view

LVC Industries Inc., 125-25 37th Ave., Flushing, NY 11354. (212) 939-9777.

Matrix slide switches for manual data entry offer positive detent positioning, a panoramic view of switching functions and rugged enclosed construction. Standard sizes have up to 25 outputs per switching line, and each contact slider can provide as many as 25 positions. Special switches can handle up to 5000 switching positions.

Booth No. 1448

CIRCLE NO. 364

HP's newest counter 520 MHz - only \$795.

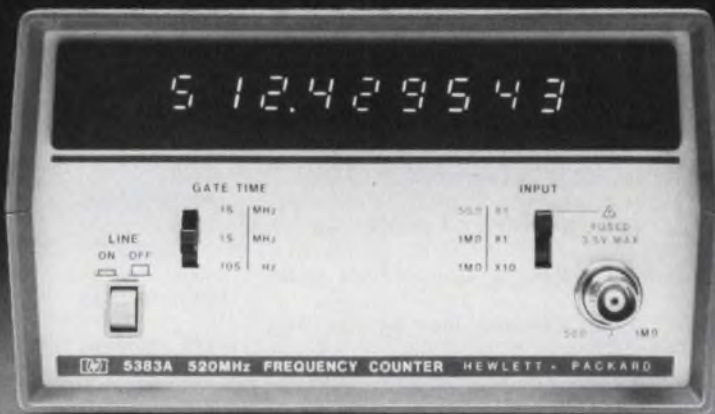

COUNT THE FEATURES

- Direct counting, 10 Hz to 520 MHz; no prescaling to slow it down
- Sharp 9 digit LED readout
- High stability internal time base
- Optional TCXO time base for communications calibration
- 25 mV sensitivity, fuse protected input to prevent overload damage
- Switchable 50Ω or 1 MΩ input
- Rugged cast aluminum case

OTHER LOW COST MODELS

225 MHz 8 Digit 5382A — only \$495
80 MHz 7 Digit 5381A — only \$275

All three counters have an external oscillator input for a house standard or ratio measurement.

All come with a full instrumentation warranty and meet IEC safety specifications. For more information call your nearby HP field engineer. Or write. (Domestic USA prices only.)

HEWLETT  PACKARD

Sales and service from 172 offices in 65 countries.
1501 Page Mill Road, Palo Alto, California 94304

02515A

INFORMATION RETRIEVAL NUMBER 110

NEW!

CATALOG MT-40A
JUST OFF PRESS

For your copy:

1 stop off at our
WESCON Booth #1744
(and get free samples)

or

2 Circle the
Information
Retrieval No.

or

3 Call us, or your
nearest J-B-T Rep.
as listed in EEM or
Gold Book

J-B-T

SUB-MINIATURE SWITCHES



TOGGLES

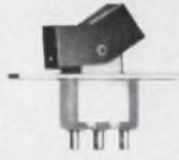

ROCKERS

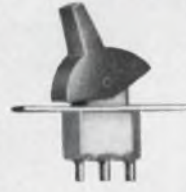

PADDLES



PUSHBUTTONS

Full 5 amp rating @ 125 VAC, or dry circuit (low current) types.

1-, 2-, 3-, and 4-Pole, double throw.

Lever, bushing, terminal, finish and mounting options
and combinations including printed circuit board types.

For J-B-T standard-size general purpose, industrial and
military toggles — Catalog TS-7.

J-B-T INSTRUMENTS, INC.

424 CHAPEL STREET • NEW HAVEN, CONNECTICUT 06508

INFORMATION RETRIEVAL NUMBER 111

Good things come in small packages.



MS Series
Reed Relays

Prices
reduced 20%!

IMMEDIATELY.

For delivery within 48 hours, call (617)-438-5300

- Popular .100" × 1.00" grid
- Micro-sized reed relays for high-density circuit packaging
- High insulation resistance, 10¹² typical
- Epoxy encapsulated
- Available in 5, 6, 12 and 24 volts
- Perfect for high-speed switching in computer, telemetry, instrument applications

Electronic Instrument & Specialty Corp.

42 Pleasant Street
Stoneham, Mass. 02180 (617)-438-5300

• See us
in EEM, Vol. 2

Phenolic Rods

**PAPER
BASED
(XXX)**

**LINEN
BASED
(LE)**

**GLASS
EPOXY
(G-10, G-11)**

**Glass
Supported
TEFLON
(GB-112T)**

- Largest inventory in the world
- Stock sizes from 1/32" to 1 1/4" available in increments of .001
- Absolute accuracy to ± .001
- Lowest prices guaranteed

Distributors' Inquiries Invited

Send for our
latest price list

ATLAS FIBRE COMPANY
6980 N. Central Pk. Ave., Chicago, Ill. 60645
Phone (312) 465-1234

INFORMATION RETRIEVAL NUMBER 112

INFORMATION RETRIEVAL NUMBER 113

mammoth power miniature price



1350w RMS, 4Ω. Forever. The M-600 won't blow up, quit or sulk no matter how you hook it up. Put two together for 2700w, 8Ω. Also forever.

It's cheap. \$1,695 of the best quality amplifier you can buy. Others in the DC-20KHz range may cost you more, but they won't do more. Write for your free copy of M-600 performance specs.



CROWN INTERNATIONAL
1718 W. MISHAWAKA ROAD ELKHART, INDIANA 46514 219-294-5571
INFORMATION RETRIEVAL NUMBER 114

INSTRUMENTATION

Digital trigger recognizes 8-bit words

Hewlett-Packard, 1501 Page Mill Rd., Palo Alto, CA 94304. (415) 493-1501. \$495; 6-7 wks.

Upon recognizing a preset, parallel 8-bit word in a stream of data, this instrument—small enough to be held in one's hand—delivers a pulse suitable to trigger any modern scope or logic analyzer. Model 1230A logic trigger operates at rates up to 15 MHz. Recognition can be made to depend on a synchronized clock pulse or it may be independent by use of a ninth-bit qualifier for asynchronous operation. The trigger can be delayed by a preset number of clock pulses, from 1 to 9998. Because this delay depends on a count, waveform displays remain jitter-free.

Booth No. 1227-1238 CIRCLE NO. 365

Tester checks 900 points on complex PC boards



Faultfinders, 15 Avis Dr., Latham, NY 12110. (518) 783-7786. Approx. \$40,000; 8-10 wks.

The FF101A, in-circuit component test system, can apply as many as 900 points to boards with circuit area up to 17-1/2 × 25-1/2 in. Test speed is twice as fast as the earlier FF101 when operated from a punched paper tape. In-circuit component test systems use a fixture that applies test points to the bottom of the circuit board under test. A guard circuit electrically isolates the circuit under test. Thus the FF101A can test completed PC boards for shorts, opens, reversed components and can measure the value of each component. Measured values are displayed on a DPM. Defects are identified by a printer, which delivers a diagnostic printout identifying the circuit defect and its location.

CIRCLE NO. 366

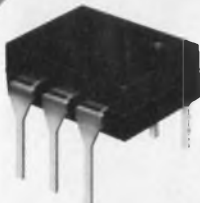

SPECTRONICS 5KV OPTICAL ISOLATORS IN 6-PIN DIPS

Spectronics offers the first 5KV isolator in the popular 6-pin dual in-line package. These components are directly interchangeable with standard industrial 6-pin isolators.

Circle #151

LOW-COST PHOTODETECTORS & LEDs

Spectronics provides industry's largest selection of standard off-the-shelf detectors and LEDs. Direct replacements for such popular industrial types as GE, TI, Monsanto and Motorola.

Circle #152



STANDARD OPTICAL SWITCHES

Six, low-cost off-the-shelf optical switches are available as direct replacements for such popular devices as the H13A1, A2; H13B1, B2; MCA 8, 81 and MCT 8, 81. Both phototransistor and photodarlington versions are furnished.

Circle #153

Call Spectronics for everything you need in opto. We make optoelectronics work... for you!



Spectronics
INCORPORATED

830 E. Arapaho Rd.,
Richardson, Texas 75080
(214) 234-4271

INFORMATION RETRIEVAL NUMBER 154



ganged switches

flexible, with up to 5 circuits per button and interrelated switching logic . . .

push buttons

all shapes and sizes, single or split lens, non-illuminated, built-in or replaceable lamps . . .



indicator lights

from 1/4" diameter indicators to 2" x 3" display panels . . .



LEDEX INC.
123 Webster Street
Dayton, Ohio 45401
(513) 224-9891

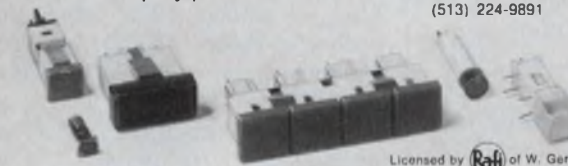

Licensed by of W. Ger.

To really appreciate the variety, beauty, and workmanship in the complete line of Ledex push buttons and indicators, it's best to see them. We'll be glad to arrange a personal demonstration. Just call this toll free number for the name of your Ledex representative: 800-645-9200.

INFORMATION RETRIEVAL NUMBER 141

You won't believe the low price.

Low Voltage Miniature LAMP ASSEMBLY

- Reliable long-life
- Easy to mount
- With 6" leads, stripped and tinned
- Choice of five colored caps — round, square or domed.
- UL/CSA approved
- Fully guaranteed

WRITE FOR SAMPLE ON COMPANY LETTERHEAD



50 South Service Road
Jericho, N.Y. 11573

TELEX: 967-879 PHONE: (516) 334-2700

MURALITE Users All Over America:

Burroughs Corp.
Collins Radio
Electronic Instrument Co. (EICO)
Fischer Radio
General Electric
Hoffman Radio
Harman Kardon
Honeywell Inc.
Hickok Electronic Instrument
Jerrold Corp.
K.L.H.
Lafayette Instrument
LTV-University
MacIntosh
Magnavox
Microwave Corp.
Montgomery Ward
Pace Communications
RCA
Simpson Electric
Telex
Toledo Scale
V-M Corporation
Weston Instrument
Westinghouse
Wells-Gardner
Western Electric Co.
Wurlitzer
Zenith



12 Bit A/D in a dip...



1 μ sec per bit

The MN5210 Series of 12 bit A/D converters guarantees total conversion time of 13 μ sec maximum...a clock rate of 1 MHz.

Micro Networks 12 bit A/D's are:

- Totally adjustment free and factory trimmed. The need for range and zero adjustments is totally eliminated, thereby effecting savings in space, component count, assembly, and test labor.
- Hermetically sealed 24-pin dip package — guarantees high reliability and space savings.
- Low power (700 mw) — reduces system power drain.
- Guaranteed $\pm 1/2$ LSB linearity over the full temperature range — assuring no missing codes.
- Available to the full MIL temperature operation of -55 to +125C.
- Optionally available processed to MIL-Std-883, Class B.

Prices: MN5210 (1-24)...\$275
MN5210H (1-24)...\$425

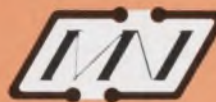

Available from stock.
Technical data available on request. Write or call ...today.
Tel: 617-852-5400

MICRO NETWORKS CORPORATION

324 Clark Street • Worcester, Mass. 01606

INFORMATION RETRIEVAL NUMBER 142

ELECTRONIC DESIGN 18, September 1, 1975

INFORMATION RETRIEVAL NUMBER 143

149

FREE!

the 1976
Lafayette
Electronics
Catalog



The complete Catalog
featuring a full line of
Lafayette and Criterion
Products Plus Top Brands

See the latest in electronic parts, solid-state devices, mics, test instruments, optics, switches, tools, panel meters, cables, electronic calculators, books and More at Lafayette's competitive prices.

• Ampex • Amprobe • Belden • Cornell Dubilier • Electro-Voice • Leader • Littelfuse • Mallory • Raytheon • Sencore • Simpson • Sprague • Stancor

Lafayette

the electronics shopping center

Mail Coupon
Today!

FREE

Dept. 45095
Lafayette Radio Electronics
111 Jericho Turnpike
Syosset, L.I., N.Y. 11791

Send me your FREE 1976 Catalog.

Name _____ Apt. _____
Street _____
City _____ State _____
Zip

Send a 1976 Catalog to my friend.

Name _____ Apt. _____
Street _____
City _____ State _____
Zip

INFORMATION RETRIEVAL NUMBER 116

INSTRUMENTATION

Portable mainframe lets you measure on the road

Tektronix, P.O. Box 500, Beaverton, OR 97077. (503) 644-0161. \$325; November.

TM 515 Traveler/Mainframe looks and feels like quality flight luggage, but unsnap the end caps and you discover full operating provisions for five of the company's TM 500 plug-in, modular test and measurement instruments. For example, the SC 502 plug-in scope takes two compartments. Inside the TM 515 is an interface circuit board that allows the instruments to talk to one other and a shared power supply with forced-air ventilation. A factory-installed option (Option 5, \$75) allows users to interconnect the instruments via the rear interface board without soldering.

Booth No. 1423-1426

Circle No. 447

Printer features print-rate control



Keithley Instruments, 28775 Aurora Rd., Cleveland, OH 44139. (216) 248-0400. \$1075; stock-30 days.

Model 750 printer records data from DMMs, electrometers, picoammeters and nanovoltmeters. Plug-to-plug interfaces are available for most of the company's digital instruments, and cards for interfacing non-Keithley instruments are also available. With a Keithley interface, the 750 prints all information available in the measuring instrument's digital output, including range and engineering units for many. A unique feature is the continuously variable print-interval control on the front panel. The control allows the print rate to be slowed to a more convenient speed without the need to interface an external timer.

Booth No. 1138 Circle No. 354

Spectrum analyzer takes analog or digital data



Rockland Systems, 230 W. Nyack Rd., West Nyack, NY 10994. (914) 623-6666. Start at \$7900; Oct., 1975.

Model FFT 512/S, single-channel, real-time spectrum analyzer can be expanded into a dual-channel system to perform cross-channel analysis. To expand, just combine two Model FFT 512/S units with the Model FFT 512/C cross-channel adapter. Using Fast-Fourier Transforms, the unit accurately calculates either the narrowband or 1/3-octave spectrum of a signal. It accepts either analog or digital data and produces analog (for display and recording) and digital data out. A built-in averager provides true power spectrum.

Booth No. 1204-1206

Circle No. 355

4-3/4-digit DPM features compact package size



Datel Systems, Inc., 1020 Turnpike St., Canton, MA 02021. (617) 828-8000. \$235; stock—4 wks.

DM-4300 is said to be the world's smallest 4-3/4-digit, 5-V-powered DPM—shorter and nearly an inch narrower than most comparably rated units. Outstanding features include an 0.3-in-high red LED display, ratiometric operation and optional full-parallel BCD output. DM-4300 offers a fs input of +3.999 V and 120-dB CMR over the ± 300 -V common-mode range. Accuracy is $\pm 0.01\%$ of reading ± 1 digit and resolution is $100 \mu\text{V}$ (40,000 count). Tempco is less than $\pm 15 \text{ ppm}/^\circ\text{C}$ over 0 to 50 C.

CIRCLE NO. 356

skinny DIP CLIP

DESIGNED TO TEST HIGH DENSITY INTEGRATED PACKAGES

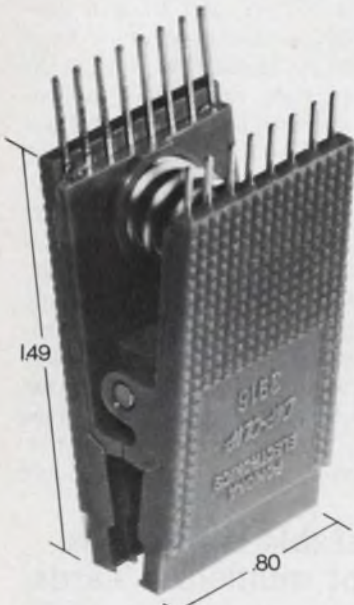

Count on Pomona Electronics to keep pace with the industry's trend toward high density Dual In-Line packaging. We've slimmed down our Model 3916 DIP test clip 1/8th of an inch so you can now test two adjoining high density-mounted 16-pin DIP's at the same time. Unique new design features 0.025" square pins to accept wire-wrap receptacles. Friction grip contacts improve holding power. And it's a great DIP remover too!

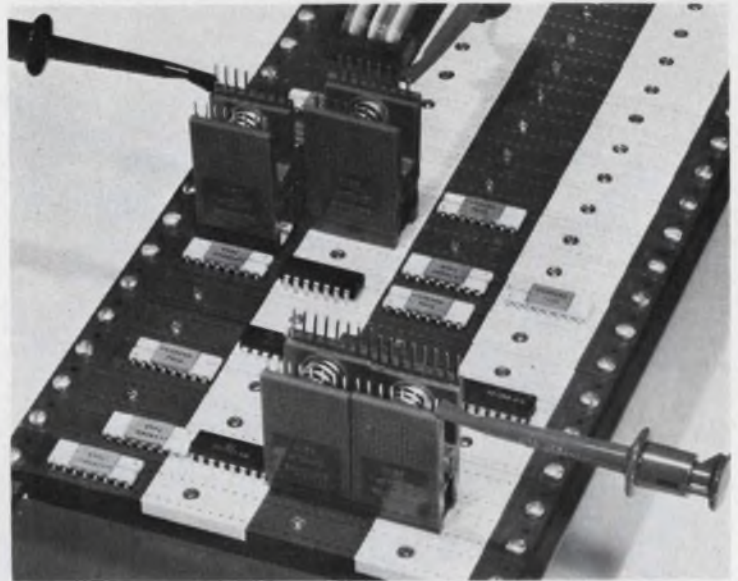

Original wide body DIP CLIP shown at rear for size comparison.



POMONA ELECTRONICS

A Division of ITT

1500 East Ninth St., Pomona, California 91766 Tel: (714) 623-3463

INFORMATION RETRIEVAL NUMBER 117

GaP LED Snap-In Indicators from OSHINO LAMPS

High brightness GaP LEDs are molded in nylon bodies designed for front panel mounting. D-304, D-305 have resistors built-in for voltage applications of 5~ 6V, 12~ 14 and 24~ 28V.

D-Lite 300 Series

• 210 degree wide angle viewing. • Available in Red, Green and Yellow. • 0.120" dia. lens, 0.200" dia. frame. • Panel opening 0.173" dia.

D-302

Bi-Pin Leads



D-303

Color coded 150mm Insulated Leads



D-304

Built-in Resistors, Bi-Pin Leads



D-305

Built-in Resistors, Color coded 150mm Insulated Leads

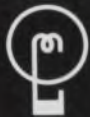

• Ask informations to:

WAMCO Technical Sales, Inc.

705 W. 16th Street, Costa Mesa, California 92627 TEL: (714) 642-5100
TELEX: 678459

OSHINO ELECTRIC LAMP WORKS, LTD.

TOKYO, JAPAN

INFORMATION RETRIEVAL NUMBER 118

ELECTRONIC DESIGN 18, September 1, 1975

NEW PROGRAMMABLE TIME DELAY RELAYS

For R&D, low volume & production requirements.

Featuring CMOS digital circuitry; DPDT contacts—10 amps resistive; no "false" operation on delay on make function; competitive pricing; low inventory requirements.



Model TDP-1: Each unit easily field selected for delay on make or break; for 24VDC, 24VAC, or 120VAC; and for delay ranges of 0.3 to 10, 3 to 80, or 10 to 300 seconds—adjustable to min/max of each range.

Low cost conventional, adjustable and fixed, single mode timers also available.



for further information contact

Hi-G, Inc./Windsor Locks, CT 06096

Area Code (203) 623-2481

see complete Hi-G line in EEM

INFORMATION RETRIEVAL NUMBER 119

custom options at compact prices

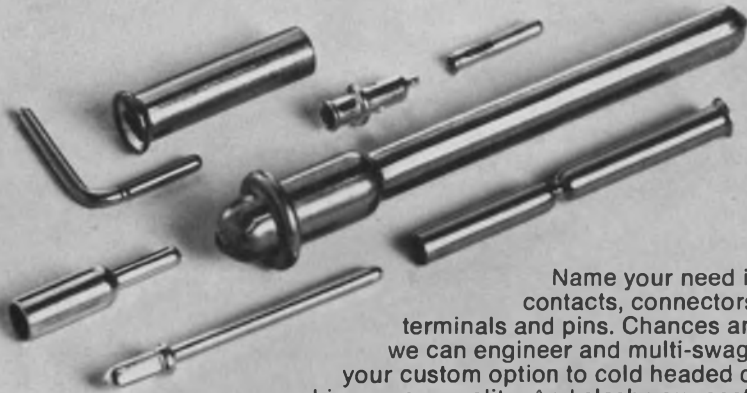

Name your need in contacts, connectors, terminals and pins. Chances are we can engineer and multi-swage your custom option to cold headed or machine screw quality. And slash your costs 40% or more. Delivery is when you want it, too. Get all the details in our new catalog. Write or call.



bead electronics

A Division of Bead Chain Manufacturing Co.
58 Mountain Grove St., Bridgeport, Conn. 06605
Phone: (203) 334-4124

INFORMATION RETRIEVAL NUMBER 120

SMALLEST CORELESS DC MOTOR

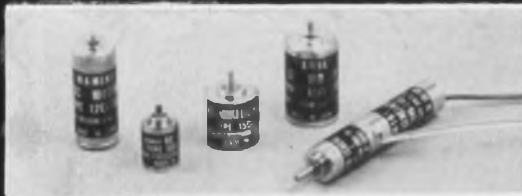

- HIGHEST EFFICIENCY
- LONG LIFE
- LOW CURRENT DRAIN
- CUSTOM DESIGNING

The Namiki Coreless DC Motor is highly efficient using Rare Earth Cobalt magnets, with a unique structure adopting an ironless core. Motors available with fully interchangeable gear heads, and also available as a Tachogenerator. Diameter sizes from .394 to .984 inches. Write for brochures.

**MOTORS
BUILT TO YOUR
SPECIFICATIONS**

TYPE	Dia (Inches)	Length (Inches)	NO Load Speed (r.p.m.)	Stall Torque (OZ inch)	Time Constant (msec) rms
10CL - 2001	.394	.787	13500	.083	14.0
12CL - 3002	.472	1.181	7000	.389	5.0
15CL - 1501	.591	.591	10400	.149	15.0
15CL - 2402	.591	.945	5300	.444	7.0
18CL - 2401	.709	.945	6500	.556	10.0
18CL - 3201	.709	1.260	3000	.903	6.0
22CL - 2401	.866	.945	5400	.90	10.0
22CL - 3201	.866	1.260	5000	1.46	7.5



NAMIKI PRECISION JEWEL COMPANY, LTD.

NAMIKI U.S.A.
ONE WORLD TRADE CENTER, SUITE 8905
NEW YORK, NEW YORK, 10048

INFORMATION RETRIEVAL NUMBER 121

PACKAGING & MATERIALS

Relay socket assemblies handle 10 A at 750 V

Curtis Industries, 8000 W. Tower Ave., Milwaukee, WI 53223. (414) 354-1500. From \$1.99 (100-up).

Models CUS12 and CUS16 unitized relay socket assemblies have 10 A/250 V capacities. The sockets accept eight and 11-pin square-base, barrier-type plug-in relays. Assemblies are constructed of Zytel nylon and are designed to snap into the company's TR3 vinyl mounting track. Up to 28 assemblies can be snapped into a four-ft length. Conductors are made of electro-tinned brass for corrosion resistance and improved electrical conductivity. Nickel-plated steel terminal screws accept wire sizes up to No. 12 AWG.

Booth No. 1856 Circle No. 357

Adjustable card cages accept multisized cards



Unitrak Div. Calabro Plastics, 8738 W. Chester Pike, Upper Darby, PA 19082. (215) 789-3820. From \$23; stock.

Ten standard-sized PC card cages are now available for use with standard 19-in. electronic cabinetry. PC cards from 3.5 to 9.25 in. wide and up to 9.75 in. deep can be housed. The cages feature heavy gauge end plates with slots for adjustment to meet varying sized cards. Also, cards can be spaced on 0.2, 0.5 and 0.75-in. centers with the pre-punched bars that hold Unitrack card guides. All parts (except the polycarbonate Unitrack card guides) are iridized aluminum. Cages can be quickly assembled with only a screwdriver. Complete cages or parts are available. Special sized cages can also be ordered.

Booth No. 1503, 1505 Circle No. 358



**our products
are more fully
developed...**

Standard Condenser capacitors are indeed fully developed to produce the optimum in performance and durability. Standard is in one business only, the design and manufacture of the world's finest capacitors. We have designed and delivered thousands of specialized capacitors for industry. In fact, what you think of as "special" may be among the many designs already available from stock at Standard. However, if you require capacitors of unusual shape, size, value and material, our engineering department will help you design and produce them to your exact specifications at stock prices. For immediate action, send us a sketch and complete details.

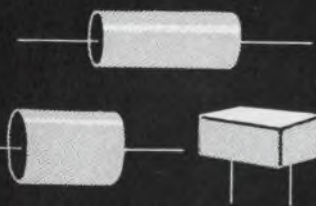

Write or phone for catalog and details.

Standard

CONDENSER CORPORATION

Dept. ED-9 1065 West Addison Street
Chicago, Illinois 60613 • (312) 327-5440

INFORMATION RETRIEVAL NUMBER 122
ELECTRONIC DESIGN 18, September 1, 1975

Transit cases meet ATA-300 specifications



Thermodyne International, 12600 Yukon Ave., Hawthorne, CA 90250. (713) 679-0411. From \$38.70 (1 to 5); stock.

Transit cases made from high-density polyethylene and ABS meet Air Transport Association Specification 300-CAT-1. These containers are a fraction of the weight of metal, wood and other types of materials and provide equivalent protection. All hardware is recessed for physical protection. Wall ribbing adds strength and flex under drop loads to reduce shock input. Latches, handles and hinges are permanently press locked into extrusion channels, which eliminates holes and rivets through the container wall. Cases are vacuum-formed from high-strength plastic with corrosion resistant hardware. Any color may be ordered, stock color is white. Cases are offered in 58 sizes ranging from 12 x 8 x 8 to 55 x 36 x 25 in. Custom-foam cushioning is also available for case interiors.

Booth No. 1611 Circle No. 359

Pluggable terminal strip allows quick disconnect

Magnum Electric, 6385 Dixie Hwy., Erie, MI 48133. (313) 848-2555.

The RS 100 line of single row depluggable terminal strips allows removal of all field wiring from a circuit board. The connectors are rated at 20 A and 300 V and are available in 3/8 and 7/16 in. center spacing with up to 30 contact positions. Plastic guide posts provide strip alignment during insertion and removal. Spring locking fingers built into the guide posts hold the strips fully inserted during use.

Booth No. 1507, 1509 Circle No. 360

1

**NEW
\$275 SWEEP FUNCTION
GENERATOR FROM**

**DANA[®]
EXACT**



MODEL 121

FEATURES:

- Low cost
- Sine, square, triangle, ramp, pulse
- 0.02 Hz to 2.2 MHz dynamic frequency range
- VCF (voltage controlled frequency) 1000:1
- Internal sweep Generator 1 msec to 10 sec continuously variable
- Hi output 20V p-p open circuit 10V p-p into 50 ohms
- Lo output 30 db down from Hi output
- Variable attenuation 30 db
- Separate TTL pulse output
- Variable DC offset
- Variable sweep width

EXACT electronics, inc.

*(Subsidiary of Dana Electronics Inc.)
BOX 160 HILLSBORO, OREGON 97123
(503) 648-6661 TWX 910-460-8811*

INFORMATION RETRIEVAL NUMBER 191

JOIN THE REVOLUTION AGAINST CUSTOM POWER SUPPLIES



Now is the time to put an end to high cost custom power supplies . . . and the long lead times they require. Join the Arnold Magnetics "Design-As-You-Order" revolution. Choose from over 1200 miniaturized off-the-shelf input and output submodules to meet your specific needs. Save time, save space, save money . . . and get outstanding performance.

- Single or dual inputs:
115-220 VAC, 47-500 Hz,
12, 18, 48, 115, 150 VDC.
- Multiple isolated and regulated DC outputs
from 4.2 to 300 VDC.
- Line & load regulation to 0.1%.
- Up to 800 watts per output.
- Efficiencies to 85%.
- Completed units provided in tested and
encapsulated, conduction cooled packages.

Phone or write for your "Declaration Of Non-Dependence" (our new Catalog and Specification Form) on custom power supplies . . . join the revolution today!



ARNOLD MAGNETICS CORPORATION

11520 W. Jefferson Blvd.
Culver City, Ca. 90230 • (213) 870-7014

INFORMATION RETRIEVAL NUMBER 124

DISCRETE SEMICONDUCTORS

Sensitive gate triacs handle loads to 4 A

Thyrotek, P.O. Box 5407, 611 109 St., Arlington, TX 76011. (817) 265-7381. \$0.70 (1000-up); 4 to 6 wk.

The TA series of 3 and 4-A ($i_{T(RMS)}$) sensitive gate triacs have 3, 4, 5, 10 and 25-mA gate trigger currents with all quadrant gating. Voltage ranges are 50, 100, 200, 300, 400, 500 and 600 V (V_{DROM}). The triacs can be driven directly with MOS or other IC devices. All chips feature an extremely dense, void-free glass passivation. The 3-A version is packaged in a hermetically sealed TO-5 case and the 4-A series is available in an electrically isolated or nonisolated thyrotab plastic package.

CIRCLE NO. 367

Uhf power transistor delivers up to 50 W

Communications Transistor Corp., 301 Industrial Way, San Carlos, CA 94070. (415) 592-9390. \$168 (100-up); stock.

The CD2501 wideband, internally matched, uhf power transistor provides 50 W. The transistor operates in the 100-to-500-MHz frequency range and is intended for vhf and uhf applications, Class A, B, AB or C. The CD2501 is aimed primarily at ECM equipment and aircraft radio.

CIRCLE NO. 368

Switching transistors handle up to 50 A

General Semiconductor Industries, Inc., P.O. Box 3078, Tempe, AZ 85281. (602) 968-3101. 100-up prices: From \$16.40 (TO-3 case), from \$39 (80-63 case); stock.

The 2N6274 through 2N6277 npn power transistors are primarily designed for high current switching applications of up to 50 A. Maximum collector-emitter voltage ranges from 100 V in the 2N6274 to 150 V in the 2N6277. The transistors have a maximum power dissipation of 250 W and are housed in TO-3 metal cases. These devices are also available in a TO-63 case and are designated as the 2N6278 to 2N6281.

CIRCLE NO. 369

EAGLE



SINCE

1843

PICHER

Carefree[®]
RECHARGEABLES

LEAD-ACID BATTERIES

- SEALED ● RUGGED
- NO MAINTENANCE
- SAFE ● SPILL-PROOF
- WIDE TEMPERATURE
OPERATING RANGE
- LONG LIFE



RELIABLE ECONOMICAL
RECHARGEABLE POWER
for

- Alarm Systems
- Emergency Lighting
- Electromedical Apparatus
- Telephone Carrier Equipment
- Portable Television
- Communication Equipment
- Portable Instrumentation
- Computer Standby Systems
- And Many More

To Find Out How to Make
Your Battery System

Carefree[®]

Call or Write

EAGLE-PICHER INDUSTRIES, INC.
Commercial Products Dept. ED
P.O. Box 130, Seneca, Mo. 64865
Telephone (417) 776-2258

INFORMATION RETRIEVAL NUMBER 125

"off the shelf"
 a rugged, well
 constructed,
 high quality switch
 from **Capitol** it has the
 same solid reputation
 as our custom
 ordered switches

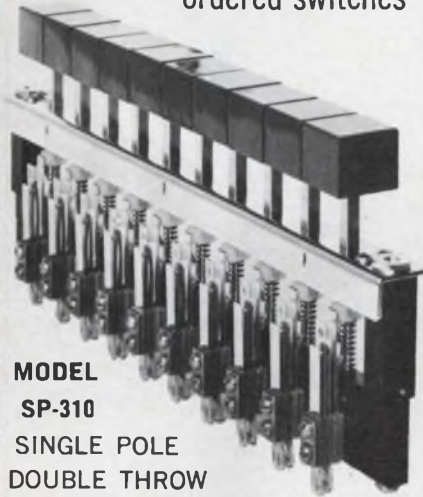

**MODEL
 SP-310**
 SINGLE POLE
 DOUBLE THROW
 CONTACT
 SQUARE BUTTON,
 NON-ILLUMINATED

Contacts: Palladium
 rated at 3 amp, 110VAC, non-inductive

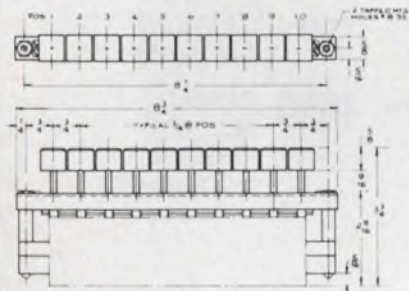

NOTES: CONTACTS FORM & EACH POS SEC.
 MECHANICAL ACTION INTERLOCKING WITH POSITIVE (LOCK) BETWEEN POS.
 SWITCHES 21 TO 30

We manufacture
 top quality push button
 and lever circuit
 selector switches
 single switches or
 banked assemblies.
 Write for our catalog.

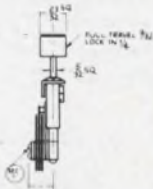

Representatives in principal cities.

CAPITOL SWITCHES

THE CAPITOL MACHINE & SWITCH CO.
 87 NEWTOWN RD. DANBURY, CONN. 06810
 (203) 744-3300

Design Aids

Circular connectors

General-purpose circular connectors—over 200 possible insert configurations, nine different shell styles and contact sizes from 16 to 0 gauge—are illustrated in a 24 × 36-in. wall chart. Amphenol Connector Div. **CIRCLE NO. 370**

Drafting time calculator

Estimating the time it takes to make an engineering drawing is made easy using the drafting time calculator. MA-DA Associates. **CIRCLE NO. 371**

Semiconductor fuses

Additions to semiconductor fuses, as well as several new voltage ratings including the 600-V series, are listed in a cross-reference guide. International Rectifier, Semiconductor Div. **CIRCLE NO. 372**

LED lamps and displays

Lens descriptions, power dissipations and typical luminous intensities for five groups of gallium-phosphide lamps are given in a four-page bulletin. Opcoa. **CIRCLE NO. 373**

Lubricating greases

By using a General Electric silicone lubricating greases and compounds guide, you can quickly determine the right grease to meet your application. Norelcom Electronics. **CIRCLE NO. 374**

Varistor calculator

A varistor calculator is useful in such applications as power supplies, motor controls and industrial electronics. It can also be used for solving most consumer or light industrial line-cord transient problems by using the power level (kVA) of the system under consideration. General Electric, Semiconductor Products. **CIRCLE NO. 375**

2

**NEW
 5MHz FUNCTION
 GENERATOR FAMILY
 FROM**

**DANA[®]
 EXACT**



504/506/507

FEATURES:

- Low Cost, 504 \$450, 506 \$495, 507 \$595
- Sine, square, triangle, ramp, pulse
- 0.01 Hz to 5 MHz dynamic frequency range
- Frequency multiplier — 10 turn type resolution
- VCF (voltage controlled frequency) 1000:1 manually, externally or internally
- 20 Hz to 20 KHz range
- 20V p-p open circuit, 10V p-p into 50 ohms
- Variable DC offset
- 80 db attenuation 10 db steps 20 db variable
- Sync output
- Variable symmetry
- Gate and trigger modes
- Internal sweep generator 100 sec. to 10 μ sec (506/507)
- Logarithmic sweep generator

EXACT electronics, Inc.

(Subsidiary of Dana Electronics Inc.)
 BOX 160 HILLSBORO, OREGON 97123
 (503) 648-6661 TWX 910-460-8811

INFORMATION RETRIEVAL NUMBER 192

from
Grayhill

the different DIP switch



- **Exclusive sliding ball contact system for positive wiping action**



- **Life tested to 50,000 mechanical operations**, with commensurate electrical life
- **Available in 9 sizes**, even a hard-to-find 2 rocker version, on up to 10 rockers
- **All SPST**, each switch independent, rocker actuated

Of course, the different DIP Switch—Grayhill's Series 76—also offers the standard DIP benefits of easy PC board mounting, compact high density design and a multitude of cost savings. Get the full story, including detailed specifications and prices, in Grayhill Engineering Bulletin #247 available free on request.



561 Hillgrove Avenue • La Grange, Illinois 60525
Phone (312) 354-1040

New Literature

Engineer an RF chain reaction
chain reaction
with RF semiconductors

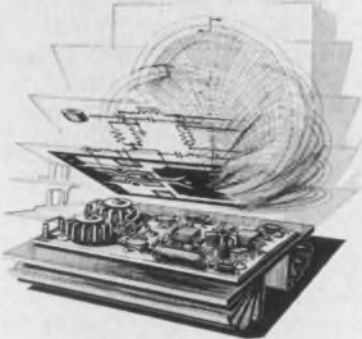

from Motorola, the RF chainmaker.
RF DESIGN DIVISION 41-1

Rf semiconductors

Rf devices from 2 MHz to 2 GHz are listed in a 16-page catalog. An industry cross-reference list and package outline dimensions are included. Motorola, Phoenix, AZ

CIRCLE NO. 376

CMOS circuits

A 246-page paperback handbook contains data sheets, specifications, diagrams, charts, graphs, application information and a cross-reference on the Series 54C/74C and CD4000 CMOS logic circuits. National Semiconductor, Santa Clara, CA

CIRCLE NO. 377

Deposition system

The Model 1500 deposition system is described in a 12-page catalog. Advantages of induction heating over conventional heating for evaporation techniques, such as resistance or electron beam, are detailed. Applied Materials, Santa Clara, CA

CIRCLE NO. 378

Custom MOS

A six-page booklet describes the design procedure as well as the manufacturing and testing facilities for custom MOS designs, ranging from single logic to large-scale systems. Hughes Microelectronic Products, Newport Beach, CA

CIRCLE NO. 379

A GOLD MINE OF INFORMATION & DATA

- **520** CATALOG PAGES ON ICs & SEMICONDUCTORS
- **300** CATALOG PAGES ON INSTRUMENTS
- **290** CATALOG PAGES ON POWER SUPPLIES
- **210** CATALOG PAGES ON WIRE & CONNECTOR PRODUCTS
- **150** CATALOG PAGES ON SWITCHES
- **2800** CATALOG PAGES ALL TOLD IN 52 PRODUCT CATEGORIES

Electronic Design's GOLD BOOK puts the entire electronics industry at your fingertips. Use it for product search, selection, specification and purchase. It's the most thorough industry master catalog & directory ever compiled.

When you need Information . . .

Electronic Design's

GOLD BOOK IS THE PLACE TO LOOK

DIRECT FROM STOCK

5V3A

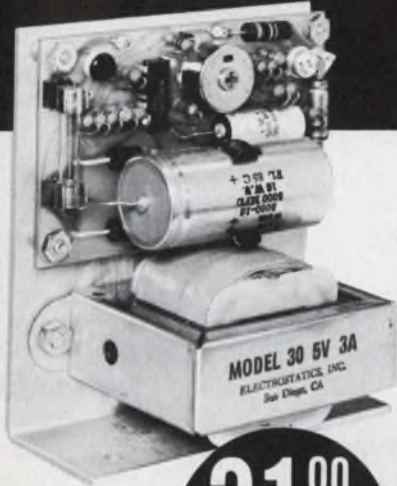

31⁰⁰
(1-9)

\$23.70 - 100 pcs.

Excellent regulation and ripple.

SPECIFICATIONS

Size: 4 x 4.5 x 2.75 overall
 Input: 105-125V, 47-420 Hz
 Output: Any DC voltage 3 to 30
 Regulation: Line — 0.005%
 Load — 0.05%
 Ripple: Less than 250 Microvolts
 Temp: Operative —40 to +71°C
 Storage —65 to +85°C
 Coefficient —0.01%/°C Max.
 Current Limiting: Fixed Foldback Type
 Overvoltage: Optional

MODEL	VOLTAGE	AMPS
30-5	5.0	3.0
30-10	10.0	1.8
30-12	12.0	1.5
30-15	15.0	1.2
30-24	24.0	1.0
30-28	28.0	1.0

ORDERING INFORMATION

QUANTITY	PRICE	WITH O.V.
1-9	\$31.00	\$36.00
10-24	29.20	33.70
25-49	26.60	29.90
50-99	25.10	28.20
100-	23.70	26.90

CALL (714) 279-1414 FOR DELIVERY

Electrostatics, Inc.
 7718 CLAIREMONT MESA BLVD. • SAN DIEGO, CA 92111

High-rel CMOS

"CMOS High Reliability Integrated Circuits," a 12-page booklet, describes the reliability assurance program available from the company for its CMOS devices. Solid State Scientific, Montgomeryville, PA

CIRCLE NO. 380

Telephone interconnects

Plug-in transformers, specifically developed for the telephone interconnect market, are highlighted in a brochure. TRW/UTC Transformers, New York, NY

CIRCLE NO. 381

Power Darlingtons

100-W, high-voltage monolithic Darlingtons featuring glass passivation are described in a data sheet. Graphs, diagrams and ratings and specifications are included. International Rectifier, Semiconductor Div., El Segundo, CA

CIRCLE NO. 382

Fault monitoring systems

Features of digital fault monitoring systems are graphically explained in a four-page brochure with the help of a two-page illustration with call-outs. Siemens, Iselin, NJ

CIRCLE NO. 383

Fans and blowers

Up-dated performance curves, rating tables, specifications, application data, dimensional drawings and ordering information covering fans, blowers and fan motors are contained in a 20-page brochure. Howard Industries, Milford, IL

CIRCLE NO. 384

Rf and microwave devices

Solid-state rf and microwave devices are described in an up-to-date brochure. A quick-selection guide shows power-vs-frequency curves. RCA Solid State, Somerville, NJ

CIRCLE NO. 385

Power semiconductors

High-power transistors, rectifiers, SCRs and assemblies are illustrated in a 30-page catalog. Westinghouse Electric, Youngwood, PA

CIRCLE NO. 386

3

NEW
**11MHz FUNCTION
 GENERATOR FAMILY
 FROM**

DANA[®]
EXACT

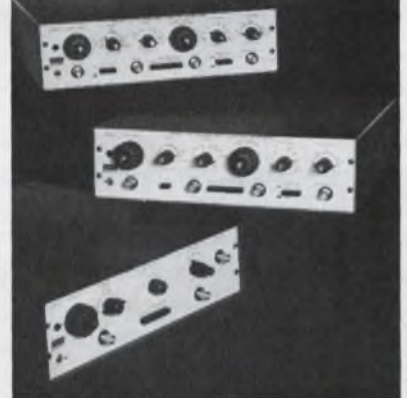

513/516/517

FEATURES:

- Low cost, 513 \$525, 516 \$695, 517 \$795
- Sine, square, triangle, ramp pulse
- 0.01 Hz to 11 MHz dynamic frequency range
- Frequency multiplier — 10 turn type resolution
- VCF (voltage controlled frequency) 1000:1 manually, externally or internally
- 20 Hz to 20 KHz range
- 20V p-p open circuit, 10V p-p into 50 ohms
- Variable DC offset
- External offset capability
- 80 db attenuation — 10 db steps, 20 db variable
- Sync output
- Gate and trigger modes
- Variable start/stop phase
- Internal sweep generator
- Set sweep start/stop frequencies accurately
- Pulse & burst modes
- Logarithmic sweep generator

EXACT electronics, inc.

(Subsidiary of Dana Electronics Inc.)
 BOX 160 HILLSBORO, OREGON 97123
 (503) 648-6661 TWX 910-460-8811

SWITCH DEPENDABILITY BEGINS ON THE INSIDE

LOOK INSIDE ONE OF OURS!

High contact pressure gives low contact resistance

Fast transfer time reduces arcing effects

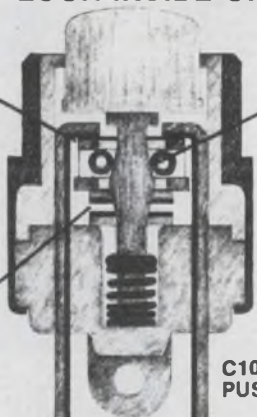

Taper and shorting bar combination gives true over-center snap-action resulting in fast transfer of contacts independent of actuation rate

C100 SERIES PUSHBUTTON

Control Switch's unique taper mechanism results in dependable make and break... every time! The contacts go through maximum contact pressure at the snap point. This positive make and break with minimum arcing gives extended contact life.

This C100 Series of Control Switch pushbuttons features life to 125,000 cycles — Load to 10 amps — Bounce less than 1 ms — Low actuation force.

SEND FOR PORTFOLIO OF TECHNICAL BULLETINS.

CONTROL SWITCH



A CUTLER-HAMMER COMPANY

1420 DELMAR DRIVE, FOLCROFT, PA. 19032 215/586-7500

I-1

INFORMATION RETRIEVAL NUMBER 144

NEW LITERATURE

Photon counting

"Photon Counting—What Is It?" uses circuit diagrams, schematics and graphs to explain the principle of photon counting, which is a technique used to measure low level signals from photomultipliers or electron multipliers. Princeton Applied Research, Princeton, NJ

CIRCLE NO. 387

Delay lines

Schematics, outline drawings, signal and switching characteristics and pin connection diagrams for electromagnetic delay lines are given in a mini-engineering handbook. RCL Electronics, Irvington, NJ

CIRCLE NO. 388

PM drive system

Data for application and selection of permanent magnet adjustable speed/torque drive systems and individual PM drives are presented in a 12-page catalog. Dimensions, mounting recommendations, electrical operation requirements and wiring connection information are included. Bodine Electric, Chicago, IL

CIRCLE NO. 389

Brownout dangers

Will Dr. Frankenstein's experiments be ruined? Will his extraordinary equipment be damaged? Will the power company representative escape from the castle? Will Igor succeed in his plot? The answers to these and other baffling questions can be found in a 12-page comic book entitled "Frankenstein Meets Brownout." Tele-Dynamics, Fort Washington, PA

CIRCLE NO. 390

Thermistor capsule course

The what, where and how's of thermistor sensors and thermistor sensor assemblies for use in temperature measurement, indication and control applications are condensed in a 24-page booklet, which includes 10 instructional courses. Fenwal Electronics, Framingham, MA

CIRCLE NO. 391

Circuit Savers

DC **95¢** 1000 pcs.

TRANSIENT SUPPRESSOR

FOR FURTHER INFORMATION SEE OUR TECH. GOLD BOOK

The TSD-1.5 Series are ideal for protection of long signal lines from damage from induced lightning etc. Reaction time is in nanoseconds.

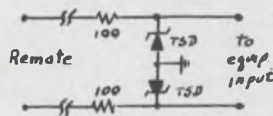

2 units (back to back) will protect sensitive components from a 5KV, 1ms duration transient. Clamp voltages from 5V to 200V. Call Mike Coyle for applications assistance. Full line of protection modules for every hi-lo voltage/current requirement. Write or call for Catalog 749.

279 Skidmore Road
Deer Park, New York 11729
Telephone: 516-586-125

MCG Electronics

See Gold Book Vol 2, p. 320-322

INFORMATION RETRIEVAL NUMBER 145

SUBSCRIBER SERVICE For prompt service include the addressed label when writing about your subscription.

CHANGE OF ADDRESS

NEW ADDRESS

name _____ title _____

company _____

division/department _____

company address _____

city _____ state _____ zip _____

If you're moving, please let us know six weeks before changing your address. If you have a question, place your magazine address label here and clip this form to your letter.

MAIL TO ELECTRONIC DESIGN Circulation Dept. Hayden Publishing Co., Inc., 50 Essex Street, Rochelle Park, NJ 07662

Here's all you need for computer/process interface!

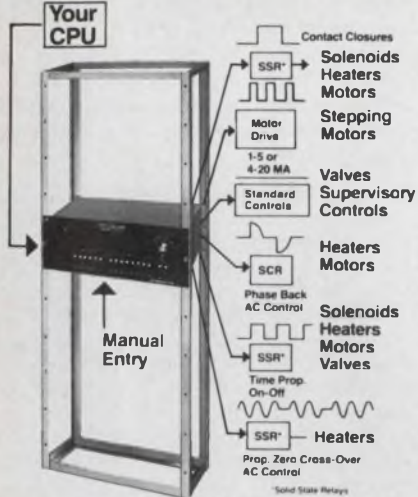

UNI-DRIVER, the one *stand-alone* interface between your computer and *all* commonly used final control elements. It maintains process control at the last command level, even with the computer shut down, and provides "back up" manual control.

Mix or match any combination of control cards to drive contactors, heaters, motors, pumps, power controllers, valves, set points, motor speeds, solenoids, shutters, louvers, fans, lamps, stepping motors, you call the shots. Up to 64 proportional outputs or 512 on-off outputs per Uni-Driver.

Eliminate a rack full of "black boxes!" Call collect (612) 941-3300 and ask for UNI-DRIVER! Also, ask about ANA-PLEXER. That's our combination Mux & A/D converter for sampling process control signals of almost any analog transducer or sensor. Directly interfaces with your CPU without external I/O.

184

Direct Digital Control Division
RESEARCH INC
 BOX 24084 MINNEAPOLIS MINNESOTA USA 55424
 PHONE (612) 941-3300

INFORMATION RETRIEVAL NUMBER 146
 ELECTRONIC DESIGN 18, September 1, 1975

Vendors Report

Annual and interim reports can provide much more than financial-position information. They often include the first public disclosure of new products, new techniques and new directions of our vendors and customers. Further, they often contain superb analyses of segments of industry that a company serves.

Selected companies with recent reports are listed here with their main electronic products or services. For a copy, circle the indicated number.

Harris Corp. Commercial electronics, government electronic systems and printing equipment.

CIRCLE NO. 455

Remote Computing Corp. National data network.

CIRCLE NO. 456

Hewlett-Packard. Test and measuring instruments and systems, computers and computer systems, electronic calculators, medical electronics and instrumentation for chemical analysis.

CIRCLE NO. 448

Recognition Equipment. Large-scale OCR systems for data input market.

CIRCLE NO. 449

Polarad Electronics. Commercial test and measuring instruments and marine navigation instruments.

CIRCLE NO. 450

Methode Electronics. Packaging products and telecommunication products.

CIRCLE NO. 451

Extex. Rental of microfilm storage and retrieval terminals and duplicators.

CIRCLE NO. 452

Fabri-Tek. Memories, connectors, PC boards and computer systems and services.

CIRCLE NO. 453

The National Easter Seal Society. Nonprofit organization.

CIRCLE NO. 454

4

PROGRAMMABLE FUNCTION GENERATORS AND FREQUENCY SYNTHESIZERS FROM

DANA[®]
EXACT

600 SERIES PROGRAMMABLE GENERATORS

- 0.001 Hz to 1 MHz
- Front panel or remote programming
- Sine, square, triangle, ramp, pulse
- 1 mV p-p to 9.99 V p-p into 50 ohms
- BCD programming standard
- 0.5 mSEC programming time
- Voltage controlled frequency 1000:1
- 1.66 MHz and 15.99 V p-p (remote only)
- Prices as low as \$1250

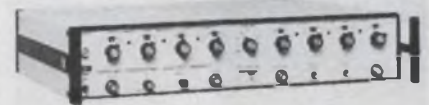

800 SERIES FREQUENCY SYNTHESIZERS

- 1 Hz to 20 MHz (.01 Hz optional)
- 10 PPM stability, accuracy
- All plug-in card construction
- Constant dial resolution over extremely broad band
- Optional BCD or ASCII programming
- -69.99 dbm to +26.99 dbm into 50 ohms
- 0.05 dbm amplitude accuracy
- Prices as low as \$2195

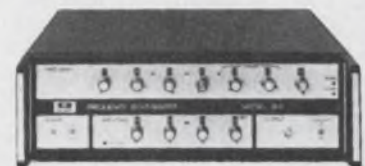

EXACT electronics, Inc.

(Subsidiary of Dana Electronics Inc.)
 BOX 160 HILLSBORO, OREGON 97123
 (503) 648-6661 TWX 910-460-8811

INFORMATION RETRIEVAL NUMBER 194

Design Data from Manufacturers

Advertisements of booklets, brochures, catalogs and data sheets. To order use Reader-Service Card (Advertisement)

Electronic Design

ELECTRONIC DESIGN's function is:

- To aid progress in the electronics manufacturing industry by promoting good design.
- To give the electronic design engineer concepts and ideas that make his job easier and more productive.
- To provide a central source of timely electronics information.
- To promote communication among members of the electronics engineering community.

Want a subscription? ELECTRONIC DESIGN is sent free to qualified engineers and engineering managers doing design work, supervising design or setting standards in the United States and Western Europe. For a free subscription, use the application form bound in the magazine. If none is included, write to us direct for an application form.

If you do not qualify, you may take out a paid subscription for \$30 a year in the U.S.A., \$40 a year elsewhere. Single copies are \$1.50 each.

If you change your address, send us an old mailing label and your new address; there is generally a postcard for this bound in the magazine. You will have to requalify to continue receiving ELECTRONIC DESIGN free.

The accuracy policy of ELECTRONIC DESIGN is:

- To make diligent efforts to ensure the accuracy of editorial matter.
- To publish prompt corrections whenever inaccuracies are brought to our attention. Corrections appear in "Across the Desk."
- To encourage our readers as responsible members of our business community to report to us misleading or fraudulent advertising.
- To refuse any advertisement deemed to be misleading or fraudulent.

Microfilm copies are available of complete volumes of ELECTRONIC DESIGN at \$19 per volume, beginning with Volume 1, 1952 through Volume 20. Reprints of individual articles may be obtained for \$3.00 each, prepaid (\$.50 for each additional copy of the same article) no matter how long the article. For further details and to place orders, contact the Customer Services Department, University Microfilms, 300 North Zeeb Road, Ann Arbor, Michigan 48106 telephone (313) 761-4700.

Want to contact us? If you have any comments or wish to submit a manuscript or article outline, address your correspondence to:

Editor
ELECTRONIC DESIGN
50 Essex Street
Rochelle Park, N.J. 07662

GIANT FREE CATALOG



New 164-page catalog! Packed with 1,000's of hard-to-find buys in Optics, Science, Electronics. Loaded with optical, scientific, electronic equipment available from stock. Rare surplus buys. Many "one-of-a-kinds". Ingenious scientific tools. Components galore: lenses, prisms, wedges, mirrors, mounts, accessories. 100's of instruments: pollution test equipment, lasers, comparators, magnifiers, microscopes, projectors, telescopes, binoculars, photo attachments, alternate energy sources. Shop, save by mail! Request free Catalog "DA".

CIRCLE NO. 171

Edmund Scientific Co.

America's Largest Science-Optics-Electronics Mart
300 Edscorp Bldg., Barrington, New Jersey 08007 (609) 547-3488

New Translator Extends Frequency Range and Increases Resolution of Real Time Spectrum Analyzers

The new Model SAI 506 Frequency Translator, which provides increased resolution and extended frequency coverage for SAI Series 50 Real Time Spectrum Analyzers, features: up to 4 selectable plug-in frequency windows 20 Hz to 50KHz; maximum frequency coverage to 250KHz; built-in frequency synthesizer; center frequency selection in 10 Hz steps, 1 Hz with optional external synthesizer.

The SAI 506 allows the standard frequency ranges of the analyzer to be translated up to a selectable point of interest in the spectrum. Standard bandwidths of 20, 50 and 200 Hz can be translated up to 90 KHz and those between 500 Hz and 50 KHz can be translated up to 250KHz.

The Translator is useful in applications where a spectrum analysis above 50 KHz is needed, or where improved resolution is required within the existing analyzer ranges. Details in Bulletin S506.

CIRCLE NO. 172

Signal Analysis Operation

Honeywell, Inc.
595 Old Willets Path, Hauppauge, N.Y. 11787



The Model 315B is designed to make resistor NOISE INDEX measurements in accordance with the recommendations of the National Bureau of Standards. (Method 308 of MIL-STD-202B). NOISE INDEX is defined as the measured ratio of microvolts of noise per volt of applied DC voltage in a decade of frequency.

The Model 315B has been developed to meet the more exacting requirements of the latest technologies in thick and thin film component processes. By using the latest noise measuring techniques in conjunction with very low noise solid state components, the sensitivity of the Model 315B for measuring noise in low value resistors has been increased enormously. It is now possible to make comparative measurements of contact noise in reed and other relays, as well as in plug-in connectors, diode junctions, thermistors and other low resistance devices. Resistors from 1 ohm to 25 megohms can be measured with a Noise Index down to minus 40 dB without the use of correction factors.

CIRCLE NO. 173

QUAN-TECH

Division of Scientific-Atlanta, Inc.
Randolph Park West, Randolph, N.J. 07801 (201) 361-3100



recruitment
and
classified ads

FREE ALARM CATALOG

Huge selection of burglar & fire systems, supplies. Motion detectors, infrared beams, controls, door switches, bells, sirens 500 items, 99 pp packed with technical details, notes.



(Outside U.S. send \$1.00.)

mountain west alarm
4215 n. 16th st., phoenix, az. 85016



CIRCLE NO. 201

FREE DISCOUNT BOOK CATALOG

ELECTRONICS—DATA PROCESSING—MATH
Our 1975 catalog describes over 1000 state-of-the-art, professional-level books, grouped in 31 technical interest categories, from 16 major publishers. All NEW books . . . not used or over-stock.

TECHNI-BOOKS

P.O. Box 11665, Santa Ana, CA 92711
(714) 633-6015
A Mail Order Technical Book Service

INFRA-RED TUNNEL OVENS

Free Catalog Describing Complete Line of Bench and Floor Models.

IR Radiant Energy, the newest stage of Product Heating Evolution. Ovens tuned to the matching absorptive wave length character of product chemistry. Produces clean, fast, dry heat. Has replaced batch Hot Air types. Every Lab must have one. Many sizes.

OAL ASSOCIATES, INC.
P.O. 64, Escondido, CA. 92025

GRAMOLIN—CONTACT CLEANER

"The less you use—the better it works!"
Cleaner, Lubricant, and Corrosive for use on metal electrical contacts. Reduce contact resistance. Will bring back electronic system performance. Protects against corrosive atmospheres. Safe. Liquid or Spray. Free Data Sample available.

CAIG LABORATORIES, INC.
P.O. 64, Escondido, CA. 92025

**Protect Your Heart
HAVE REGULAR MEDICAL
CHECK UPS**



Give Heart Fund



Electronic Design

Advertising Sales Staff

Tom W. Carr, Sales Director

Rochelle Park, NJ 07662

Robert W. Gascoigne

Daniel J. Rowland

(Recruitment, Quick Ads, Classified)

50 Essex Street

(201) 843-0550

TWX: 710-9990-5071

Philadelphia

Thomas P. Barth

50 Essex Street

Rochelle Park, NJ 07662

(201) 843-0550

Boston 02178

Gene Pritchard

P.O. Box 379

Belmont, MA 02178

(617) 489-2340

Chicago 60611

Thomas P. Kavooras

Berry Conner, Jr.

200 East Ontario

(312) 337-0588

Cleveland

Thomas P. Kavooras

(Chicago)

(312) 337-0588

Los Angeles 90045

Stanley I. Ehrenclo

Burt Underwood

8939 S. Sepulveda Boulevard

Suit 510

Los Angeles, CA

(213) 641-6544

San Francisco 94040

Robert A. Lukas

3579 Cambridge Lane

Mountain View, CA 94040

(415) 965-2636

London, Amsterdam, Tokyo, Seoul

John Ashcraft

12, Bear St.

Leicester Square

London WC2H 7AS England

Phone: 01-930-0525

W. J. M. Sanders

John Ashcraft & Co.

Herengracht 365

Amsterdam C., Holland

Phone: 020-24-09-08

Haruki Hirayama

Electronic Media Service

5th Floor, Lila Bldg.,

4-9-8 Roppongi

Minato-ku, Tokyo, Japan

Phone: 402-4556

Cable: Electronicmedia, Tokyo

Mr. O-kyu Park, President

Dongbo Int'l Corp.—

World Marketing

C.P.O. Box 4010

Seoul, Korea

Tel. 76-3910/3911

Cable: DONGBO SEOUL

Telex: EBKOREA K27286

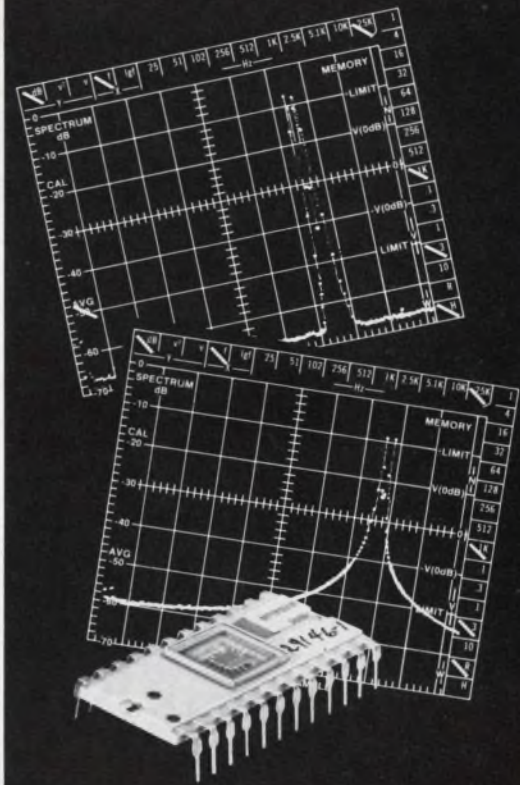

**Only with an
EMR Real-Time
Spectrum
Analyzer..**

**Change a PROM,
Change a
Window Function**

In a spectrum analyzer, the shape of the window function is an important factor affecting resolution and measurement accuracy. In the EMR 1510 Real-Time Spectrum Analyzer, the window function is digitally defined by a field replaceable PROM. Rectangular and Hanning windows are standard and switch selectable. Need a Lehmann or other special functions? Add or change a PROM.

That's not all . . . 60dB dynamic range, LED readout, computer interface, CRT status display, and much more!



**Only
From
EMR!**

EMR EMR
Schlumberger

EMR Telemetry
Weston Instruments, Inc.
Box 3041, Sarasota, Florida 33578

ABP

BPA

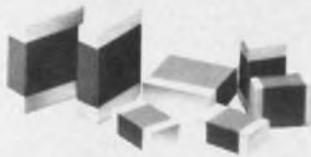

HIGH Q MULTILAYER CAPACITORS feature very high quality factors at microwave frequencies. Offered in three standard sizes: .050 x .040, .080 x .050, .125 x .095. Capacitance values from 0.1 pf to 1000 pf with close tolerance and voltages to 1000 VDCW. Johanson/Monolithic Dielectrics Div., Box 6456, Burbank, Ca. 91510, (213) 848-4465.

MULTILAYER CHIP CAPACITORS 601

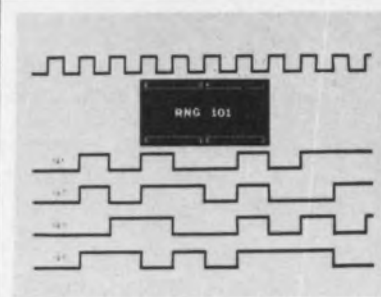

LOW POWER CMOS: RANDOM NUMBER GENERATOR. The RNG-101 is a true-random bit generator whose output is a four-bit random integer. Ideal for applications precluding software or pseudo-random generation. Clock I/O all CMOS compatible. \$39.95, 1-24. From stock. WESTERN LABS, 728 So Marengo, Pasadena, CA 91102 (213) 793-0148

RANDOM GENERATION 604

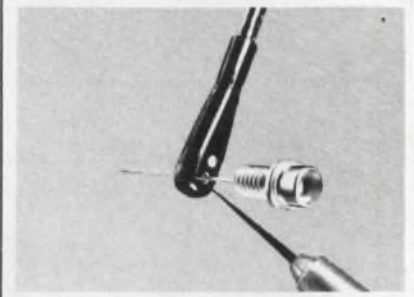

MINIATURE WIDEBAND CURRENT PROBE. Low impedance Model 711 probe allows insertion in current path of high-speed circuits without affecting circuit operation. 8KHz-100MHz BW gives 3.5ns risetime and sensitivity of $1V/A \pm 2\%$. Use in all high speed current circuits. \$33.00. American Laser Systems, Inc. 106 James Fowler, Goleta, CA 93017

MINIATURE PROBE 607



Free Catalog. 112 pages of hard-to-find precision tools—pliers, tweezers, tool kits, etc. Contains more than 2,500 items. Also includes ten pages of useful "Tool Tips" to aid in tool selection. Jensen Tools and Alloys, 4117 No. 44th St., Phoenix, AZ 85018 (602) 959-2210.

PRECISION TOOL CATALOG 602

Power Supply Catalog



POWER.MATE CORP

Free catalog of 34,500 power supplies from the worlds largest manufacturer of quality Power Supplies. New '74 catalog covers over 34,500 D.C. Power Supplies for every application. All units are UL approved, and meet most military and commercial specs for industrial and computer uses. Power Mate Corp. (201) 343-6294.

POWER SUPPLY 605



Solid tantalum capacitors for high performance with minimum size and cost include type 100D hermetically sealed, 100DE epoxy sealed sub-miniature, 100 DNP non polar, 113 DR micro miniature, 120 DF micro miniature, 711D epoxy dipped miniature. From stock. ACUSHNET CAPACITOR CO. Bx B-972, New Bedford MA 02741 (617) 999-3291.

CAPACITORS 608

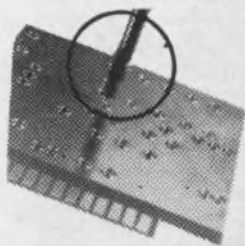

DRILL/MILL tools allow fabrication of small quantity and experimental circuit boards from full-size artwork without etching. Isolated-pad technique allows duplication of any etched board layout, even for breadboards. \$27.50 set of 3 (.20", .15", .10"). Saves builders time, money. AFS Precision Tools, Bx 354, Cupertino, CA 95014 (408) 252-4219

DRILL/MILL 603



MINIATURE S/D CONVERTERS. Series 168C function from 50 to 1200-Hz with a reference of 10 to 130Vrms. Accuracy ± 4 min. ± 0.9 LSB. 14 bit resolution. Tracking rates to 3600°/sec. Size: 3.1 x 2.6 x 0.8H. \$495 ea. 10 bit version \$350 ea. CONTROL SCIENCES, INC. 8399 Topanga Cyn. Blvd., Canoga Park, CA. 91304; (213) 887-7344.

SYCHRO/DIGITAL 606



MP12 Small Computer System. Configure your own application system with 4k MP12 CPU with programmed I/O, interrupts, DMA. Interface cards for teletype, modems, floppy disk, paper tape, A/D, printer, card reader, mag. tape. Real-time operating system, full supporting software. Fabri-Tek, Inc. 5901 S. Cnty. Rd. 18, Mpls, MN 55436 (612) 935-8811

COMPUTER SYSTEM 609



OSCILLATORS: 10 MHz - 10 GHz for all applications: Low Noise VCO's for phase lock loops, crystal oscillators, VCXO's, Multipliers, etc. EMF SYSTEMS INC. P.O. Box 1009, State College, Pa. 16801 (814) 237-5738.

OSCILLATORS

610

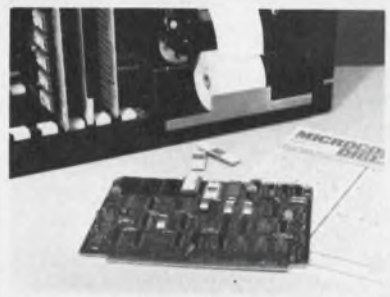

MICROCOMPUTER SYSTEMS • Development • Hardware/Software • Education • Manufacturing • Consulting • Publications. We're specialists in microcomputer systems and publishers of the MICROCOMPUTER DIGEST. Microcomputer Associates Inc., 10440 N. Tantau Ave., Cupertino, CA 95014 (408) 247-8940. Booths 1108-1110 WESCON 75

MICROCOMPUTER SYSTEMS 613

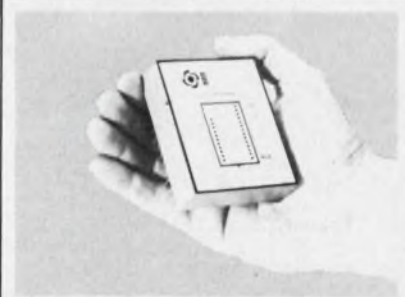

"Synchro to digital converters - 10, 12, or 14 bit output, errorless tracking up to 4 r.p.s., accuracy ± 4 min. of arc $\pm .9$ LSB, resolution - 1.3 minutes, 60 or 400 Hz input, Module 2.6 x 3.1 x .82" H, Price From \$350 in qty. Computer Conversions Corp., East Northport, N.Y. 11731 (516) 261-3300."

SYNCHRO TO DIGITAL

616

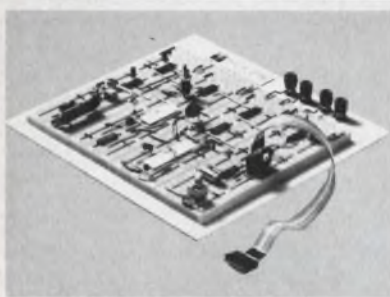

"ACE" All-Circuit Evaluator: 7 new breadboards from \$18.95 to \$79.95 for solderless circuit checkout with standard and LSI dips plus any discretes with leads to .032" dia. Universal .10" matrix plus integral power, ground and signal buses. Use 22-ga. wire jumpers A P Products Inc. Box 110-D, Painesville, OH 44077

"ACE" BREADBOARDS

611

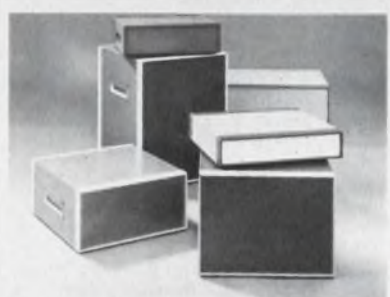

Optima Instrument Cases available in 72 sizes for 19 and 24 panel-mounted instruments. Accessories include: Doors, slides, tiltstands, detachable tops, chassis, side handles, support angles and perforated panels. Choose from 16 colors. Delivered assembled. Optima Division, Scientific-Atlanta, Inc. 2166 Mountain Industrial Blvd. Tucker, Ga. 30084

CABINETS

614



Miniature filters for Highpass, Lowpass Bandpass and Band Reject signal conditioning applications are described in the new catalog. Flat passbands and sharp cutoffs are featured. Specify any frequency from sub-audio to UHF. TT Electronics, Inc., 2214 Barry Ave., Los Angeles 90064. (213) 478-8224.

ELEC WAVE FILTERS

617



REMOVE-A-DIP, 14/16 pin IC desolder, remove and self contained vacuum system for cleaning solder out of the plated through holes. Works from solder side of PCB so high density is no problem. MICRO ELECTRONIC SYSTEMS, INC. Danbury, Ct.

REMOVE-A-DIP

612

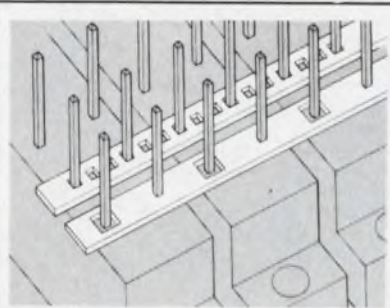

STRIP/BUS BY ROGERS. Low Cost Bussing Systems; easy installation, reliable solder joints; greater pin exposure. Write or call for details. Rogers Corporation, Chandler, Arizona 85224. Phone (602) 963-4584.

STRIP/BUS

615

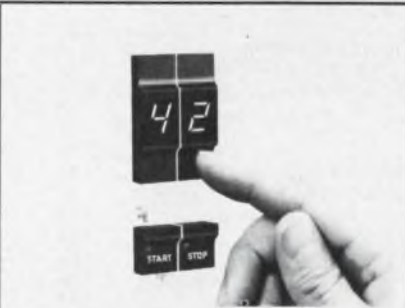

Solid-State Digital Advance Switch— The thumbwheel switch you activate with only a TOUCH! No rotating of cumbersome ratchet wheels. Simply touch the "touch plate" and the switch advances, step-by-step, until you remove your finger. Stepping rate 0.3 seconds/digit. Master Specialties, 1640 Monrovia, Costa Mesa, Calif. 92627.

TOUCH ADVANCE SWITCH

618

Advertiser's Index

Advertiser	Page	Advertiser	Page	Advertiser	Page
A P Products Incorporated	130, 163	FabriTek, Inc.	162	*Philips Electronic Components and Materials	37
AFS Precision Tools	162	Fujitsu Limited	82	Pomona Electronics, A Division of ITT	151
ALL, A Division of Cutler-Hammer	120	GTE Automatic Electric	33	Potter & Brumfield, Division of AMF, Incorporated	29
AMP, Incorporated	27	General Electric Company, Instrument Rental Division	105	Power/Mate Corp.	162
Acushnet Capacitor Co.	162	General Radio Company	132	Precision Monolithics, Incorporated	110, 111
Acopian Corp.	109	Gold Book, The	144, 145, 156	Quan-Tech, Division of Scientific Atlanta, Inc.	160
Ad-Vance Magnetics, Inc.	130	*Gold Book, The	38, 39, 44	RCA Solid State	Cover IV
Ailtech, A Cutler-Hammer Company	120	Gould Inc., Instrument Systems Division	137	RCL Electronics, Inc.	36
Allen-Bradley, Electronics Division	32A	Grayhill, Inc.	156	Raytheon Company, Ocean Systems Center	16
American Laser Systems, Inc.	162	*Hayden Book Company, Inc.	45, 119	Reader Service Card	168A, 168B
American Technical Ceramics	143	Hayden Book Company, Inc.	162, 168	Research, Inc.	159
Amphenol Connector Division, Bunker-Ramo Corp.	11	Hewlett-Packard	Cover II, 17, 146	Robinson Nugent, Incorporated	4, 5
Arnold Magnetics Corp.	154	Hi-G, Inc.	151	Rogers Corporation	163
Arrow-M Corp.	26	Hoffman Engineering Company	103	Rtron Corporation	136
Art Wire & Stamping Co.	132	Houston Instrument, The Recorder Company	138	SGS Ates Semiconductor Corporation	99
Atlas Fibre Co.	147	Hughes Aircraft Company, Connecting Devices	124	Scientific-Atlanta, Inc.	163
Augat, Inc.	15, 57	ISE Electronics Corporation	113	Seaelectro Corporation	135
B & K Products of Dynascan Corporation	112	Intech, Incorporated	134	Servo-Tek Products Company	127
Bead Electronics	152	Intel Corporation	12, 13	Siemens Corporation, Components Group	17
Bell, Inc., F. W.	32E	Interstate Electronics Corporation	107	Signal Analysis Operation, Honeywell, Inc.	160
Bodine Electric Company	138	J.B.T. Instruments, Inc.	147	Signetics Corporation	10, 57, 59, 123, 131, 133
Bourns, Inc., Trimpot Products Division	31	Janco Corporation	138	Sorensen Company, A Unit of Raytheon Company	92, 93
Buckbee-Mears Company	131	Jensen Tools & Alloys	162	South Bay Cable Corp.	133
Buckeye Stamping Company, Inc., The	140	Johanson Manufacturing Corp.	7	Spectronics, Incorporated	148
Bud Radio, Inc.	125, 126	Johanson/Monolithic Dielectrics Division	162	Sprague Electric Company	14
Burroughs Corporation	75	Keithley Instruments	115	Standard Condenser Corporation	153
Capitol Machine & Switch Co., Inc., The	155	Lafayette Radio Electronics	150	Sweda International, OEM Products	98
Chicago Dynamic Industries, Inc.	59	Ledex, Inc.	149	Switchcraft, Inc.	32E
Clare & Co., C. P.	32B	Littelfuse, Subsidiary of Tracor	37	Systrom-Donner	116
Computer Conversions Corp.	163	3M Company	19	TT Electronics, Inc.	163
Control Data Corporation	32C	MCG Electronics	158	TRW Power Semiconductors, an Electronic Components Division of TRW, Inc.	10
Control Sciences	162	Magnecraft Electric Company	Cover III	Tekelec, Inc.	140
Control Switch, A Cutler Hammer Company	158	Marconi Instruments	119	Tektronix, Inc.	43, 48, 48A, 48B, 49
Coors Porcelain Company	20	*Marconi Instruments Limited	99	Tenney Engineering, Inc.	167
Crown International, Industrial Products Division	148	Master Specialties	163	Unitrode Corporation	46
Curtis Industries, Inc.	104	*Membrain Limited	109	Vactec, Inc.	73
Cutler-Hammer, Specialty Products Division	63	Microcomputer Associates, Inc.	163	Varadyne Industries, Inc.	24, 25
Data Display Products	118	Micro Devices Corp.	167	Victoreen Instrument Division, Shellar-Globe Corporation	121
Delco Electronics, Division of General Motors Corporation	8, 9	Micro Electronic Systems, Inc.	163	Victor Electric Wire & Cable Corp.	122
EECO	32D	Micro Networks Corporation	149	Viking Industries, Inc.	23, 62
EMF Systems Inc.	163	Microswitch, A Division of Honeywell	91	Wavetek San Diego, Inc.	1
EMR Telemetry, Weston Instruments, Inc.	161	Mini-Circuits Laboratory, A Division of Scientific Components Corp.	2, 40	Western Laboratories	162
Eagle-Picher, Inc.	154	Mura Corporation	149	Woven Electronics	6
Edmund Scientific Company	160	Namiki Precision Jewel Company Ltd.	152	Xenon Corporation	138
Electro Controls, Incorporated	140	Nichion Corporation	74	Zero Manufacturing Co.	139, 141
*Electronic Design	82	Norland Instruments, A Subsidiary of Cordis Corporation	38, 39		
Electronic Devices	123	North American Philips Controls Corp.	140		
Electronic Instrument & Specialty Corp.	147	Omron Corporation of America	44, 45		
Electronic Measurements, Inc.	142	*Oscilloquartz SA	33		
Electronic Memories & Magnetics Corp.	18	Oshino Electric Lamp Works, Ltd.	151		
Electronic Molding Corporation	104				
Elektronik	165				
Electrostatics, Inc.	157				
Exact Electronics, Inc.	153, 155, 157, 159				
Excel Products Company, Inc.	128				

*Advertisers in non-U.S. edition

Funkschau + Elektronik

The leading two electronic publications on the german speaking market.

Please visit our booth
Wescon '75 - Nr. 1009

Bildfernseh-System mit Spot-Wobbelung
Pieps I - Menschenrettung aus Lawinen
Einfaches Prüfen von Hi-Fi-Anlagen
Bauanleitungen: Elektronische Tastatur,
Herstellung von Sensorfeldern

Funkschau

Radio - Fernsehen - Elektroakustik - Elektronik



102 000
fortnightly -
for Radio, TV,
HiFi and
Industrial Electronics

B 2594 EX
12
Dezember 1974
5,50 DM

Sonderbericht von der INTERKAMA
Publidum-Gasezellfrequenznormal
Ein neues A/D-Integrationsverfahren
Digital programmierbare Konstanter

Elektronik

Fachzeitschrift für angewandte Elektronik und Datentechnik.



23 000 monthly -
for applied
electronics and
Data Technology

★ most read ★ largest circulations
★ only paying readers

Franzis-Verlag

the largest publishing house for Electronics
in Federal Germany

Advertisement Department
Karlstraße 37, D 8 Munich 2, W. Germany



Sales Offices in USA

New York - INTA Advertising Inc.
1560 Broadway, New York, N. Y. 10036
Los Angeles - Galusha Corporation
12062 Valley, View Street, Suite 209
Garden Grove, CA 92645,
714/995-1650. 213/431-0220

Name _____

Company _____

Address _____

Please send me your rate card 1975/76 and media-
information Funkschau/Elektronik

INFORMATION RETRIEVAL NUMBER 136

Product Index

Information Retrieval Service. New Products, Evaluation Samples (ES), Design Aids (DA), Application Notes (AN), and New Literature (NL) in this issue are listed here with page and Information Retrieval numbers. Reader requests will be promptly processed by computer and mailed to the manufacturer within three days.

Category	Page	IRN	Category	Page	IRN	Category	Page	IRN
Components			DPM	150	356	circuit board	130	79
capacitors	14	12	digital thermometers	125	341	circuit boards	128	77
capacitors	143	108	digital trigger	148	365	circuits	130	79
capacitors	143	122	function generators	1	2	circuits, flexible	131	81
capacitors, ceramic	117	302	lock-in analyzer	125	340	connectors	23	20
components	33	26	measuring instruments	115	64	connectors	62	41
components	127	76	ohmmeter	126	345	connectors	152	120
counters, solid-state	146	363	oscilloscope	123	330	cord	122	70
dc motor	152	121	PC-board tester	148	366	DIP sockets	5	4
DIP switch	156	128	portable mainframe	150	447	enclosures	103	53
flash tube	138	93	printer	150	354	IC packaging panels	15	13
gearmotor	147	113	recorder	16	14	machine, lead-forming	122	328
ladder network, DIP	143	400	recorder	116	65	magnetic shields	130	80
motors	138	90	scope	125	343	panels	15	13
PIP switch	36	27	scope	126	344	pencil, wiring	121	325
RFI/EMI filters	136	88	scopes	17	15	pump, filter	121	326
relay	26	22	spectrum analyzer	126	347	retainer, PC card	120	323
relay	143	399	spectrum analyzers	150	355	strips, terminal	153	360
relay	147	112	sweep generator	123	329	terminal blocks	104	54
relays	140	105	synthesizer	126	346	wire forms	132	83
resistor, thick film	121	69	XY recorders	138	92			
resistors	31	25				Power Sources		
resistors	149	115	Integrated Circuits			ac line regulator	131	339
suppressor, transient	159	133	circuits, analog	57	38	batteries	154	125
switch	91	138	flasher	142	397	open-frame source	131	338
switch, DIP	143	398	image sensor	141	445	open-frame sources	131	337
switch, matrix slide	146	364	memories, MOS	133	85	power supplies	154	124
switches	63	42	microprocessor	141	445	supplies, power	109	58
switches	138	91	PLL	142	396	supplies, power	142	107
switches & LEDs, DIP	146	362	PROM, erasable	142	395	supply, power	157	129
transformer, dc-dc	143	443	RAM	141	444			
trimmer, cermet	146	361	1 k MOS RAM	131	82			
			1 k RAMs	59	39			
			8 k MOS ROM	123	72			
Data Processing			Microwaves & Lasers					
cartridge disk	83	47	detectors	130	336	new literature		
I/O converter, typewriter	133	353	filters	130	335	brownout dangers	158	390
memory board	13	11	wattmeter	130	334	CMOS circuits	156	377
printed plotter	132	350				catalog, fire alarms	158	211
printer	128	333				fault monitoring systems	157	383
printers	98	51	Modules & Subassemblies			high-rel CMOS	157	380
tape transport	133	352	amplifier, instrument	139	392	MOS	156	379
teleprinter	133	351	card, filter	139	393	PIN drive systems	158	389
ticket printer	128	332	conditioner, signal	127	348	photon counting	158	387
			converter, a/d	127	349	power Darlington	157	382
			divider, dedicated	134	321	power semiconductors	155	386
Discrete Semiconductors			drivers, data	139	394	rf and microwave		
LEDs	118	66	memory, analog	136	310	devices	157	385
LEDs	151	118	modules	134	86	rf semiconductors	156	376
transistor, UHF	154	368				telephone interconnects	157	381
transistors	9	7	Packaging & Materials			thermistor capsule		
transistors	10	8	assemblies, socket	152	357	course	158	391
transistors, power	99	52	boxes, plastic	120	324			
transistors, switching	154	369	cabinets	140	102			
triacs	154	367	cable	6	5			
			cable, flat	118	322			
			cable, flat	122	327			
			cables	133	84			
			cables, connector	19	18			
			cages, card	152	358			
			cases, transit	153	359			
			ceramics	20	19			
			circuit board	57	38			
Instrumentation						design aids		
amplifier	148	114				circular connectors	155	370
analyzer, rf network	132	82				drafting time calculator	155	371
catalog	150	116				LED lamps and displays	155	373
counter	43	282				lubricating greases	155	374
counter	146	110				semiconductor fuses	155	372
DMM	123	331				varistor calculator	155	375
DMM	11	292						
DPM	125	342						

Everybody loves the JR's.



Tenney Jr. that is. Portable, 1¼ cu. ft. capacity, benchtop unit drops from ambient 75°F to -120°F (24°C to -84°C) in 55 minutes or zooms to +350°F (177°C) in 35 minutes . . . ±¼°F control. Or check our **TH Jr.** . . . another small, 3 cu. ft. unit for temperature 10°F to 200°F (-12°C to +93°C) as well as humidity testing (20% to 98% RH). And you'll love them. Everyone loves the Jr. and the TH Jr.!

For complete details, call or write today.



1090 Springfield Rd., Union, New Jersey 07083
(201) 686-7870 • (212) 962-0332
Wescon Booth 1016

730

INFORMATION RETRIEVAL NUMBER 130

LOOKING FOR A DISTRIBUTOR NEAR YOU?

Electronic Design's GOLD BOOK lists 5,700 distributors with access both **alphabetic**, by distributor name, and **geographic** by location.

When you need information . . .

**Electronic Design's
GOLD BOOK
IS THE PLACE
TO LOOK**

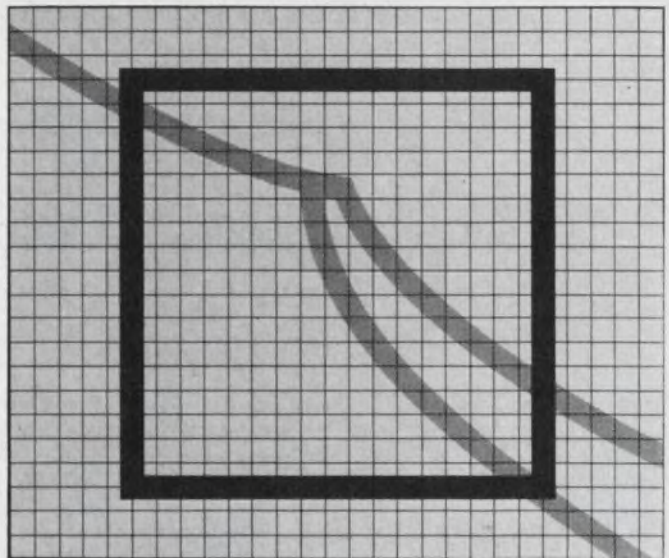

New From Micro Devices A Unique Slow-Blow Current Limiter.

It's the new MICROTEMP[®] 5P Series MultiProtector. A versatile, yet extremely accurate slow-blow current limiter that lets you design-in protection for a specific current requirement within a precise time and current window.

triggering the exclusive pellet-type opening mechanism.

When properly applied, 5P will not nuisance trip reducing costly and annoying "in warranty" service calls.

No other commercially available slow-blow fuse even comes close to matching the 5P's ability to handle high current surges without being derated.

5P's unique opening mechanism design guarantees life time rating stability and excellent surge absorption. Conventional slow-blow fuses operate through a metallic, current carrying element making them extremely susceptible to surging and derating. Thanks to MICROTEMP's patented non-current carrying, temperature sensitive opening mechanism, it reacts only when current put through the heater element generates temperatures capable of

Here's more:

- current values - 500 milliamps to 10 amps.
- ambient temperature range -25 to 100° C.
- can be designed to withstand surges up to 100 amps for 30 milliseconds
- operates within 130% of rated current
- designed and manufactured to comply with U.L. Standard 492.7. Our tests show these standards are being met. Units are now being tested by U.L. for Yellow Card listing



For more information, check the reader service card, or call or write:



MICRO DEVICES CORP.

1881 Southtown Blvd., Dayton, Ohio 45439
Ph: (513) 294-0581 Telex: 28-8087

INFORMATION RETRIEVAL NUMBER 131

Two years of a wealth of incredible information on MICROPROCESSORS brought right up to date by Electronic Design

We sifted through the last two years of ED and found an incredible amount of practical information and advice on selecting micros . . . using them to your best advantage . . . improving them for better speed and broader application. We compiled it all into one

convenient handbook — **MICROPROCESSORS: New Directions for Designers**. If you'd like to see a copy, circle the information retrieval number below and we'll send you one to read and use FREE for 15 days. At the end of time, just send in a check for \$8.95, or return the book.

Hayden Book Company, Inc.

50 Essex Street
Rochelle Park, N.J. 07662
(201) 843-0550

INFORMATION RETRIEVAL NUMBER 95



Just How Broad is the MAGNECRAFT Stock Relay Line?



**free
wall
chart!**

Magnecraft's stock relay line consists of 1200 versions derived from 17 categories - - - - that is the largest and broadest line in the industry.

Oh? Did I read that correctly?

Yes, Magnecraft Electric provides 1200 relay versions in stock through our nationwide distributor network. Those 17 categories include; low profile, general purpose, power, mercury displacement, sensitive, coaxial, telephone type, air dashpot time delay, solid state, latching types, high voltage, mercury wetted reeds, dry reeds, and dip reed relays.

Magnecraft can offer you the design engineer, a quality product, local distributors, and the broadest relay line in the industry to choose from. If we don't have the relay in stock we will custom design a relay to meet your requirements.

Full color 22"x 34" relay specification chart.



Magnecraft ELECTRIC COMPANY

5575 NORTH LYNNCH AVENUE • CHICAGO, ILLINOIS 60630 • 312 • 782-5500 • TWX 910 221 5271

What's new in solid state...

RCA expands the COS/MOS universe three ways.

Now RCA offers 3 galaxies of COS/MOS integrated circuits, all with these new performance features: 100% testing to limit max. quiescent current at 15 V (A types), 20 V (B types). 1 V noise margin for better protection than TTL. Low max. input leakage of 1 μ A at rated voltages.

More standard "A" types

Rated at 3-15 volts, 92 of these "industry standard" types are available in quantity, off-the-shelf. October introductions will include important new MSI functions. By January 1976 we'll offer a total of 112 "A" types.

New high-voltage "B" types

Rated at 3-20 volts, "B" types feature standardized symmetrical outputs for ease in design. Future additions will include new multiplexers, demultiplexers and arithmetic circuits. By January 1976 we'll offer 76 "B" types.

Expanded High Rel program

COS/MOS types screened to MIL-M-38510 or MIL-STD-883 requirements already total 96 types. New additions by January 1976 will bring the High Rel total to 123 types.

Send for a complete designer's planning package including reliability data and information on our Extra Value Program. Contact your local RCA Solid State distributor. Or RCA.

Write: RCA Solid State, Box 3200, Somerville, New Jersey 08876; Ste. Anne de Bellevue 810, Canada; Sunbury-on-Thames, U.K.; Fuji Bldg., Tokyo, Japan.

RCA

	OFF-THE-SHELF NOW	OCT. 1975	JAN. 1976
A	92 TYPES	14 NEW TYPES	6 NEW TYPES
B	32 TYPES	26 NEW TYPES	18 NEW TYPES
High Rel	96 TYPES		27 NEW TYPES

INFORMATION RETRIEVAL NUMBER 294

RCA. First house in CMOS.