

Clean up your spectra: Digital averaging cuts noise and gives faster sweep rates. Store two signals in digital memory, then compare them on the display.

Read center frequency on the CRT to 6 digits and amplitude in 1-dB steps. A microprocessor sets the optimum bandwidth and sweep rate automatically. P. 66.



**IEEE
ISSUE**



Resistance functions ...packaged to go!

Thirty watts and 10 KVDC from a discrete thin film network? Sure! It's all in a day's work for Dale. We're specialists in tailoring the advantages of thin (metal or carbon) discrete film resistors to meet your unique and urgent needs. Dale discrete thin film network capabilities range from simple voltage dividers to complex binary D/A ladders with accuracy to 1/2 LSB.

Packaging can vary from coated or molded, single or dual in-line to custom shapes and

enclosures for unusual space and/or heat dissipation requirements. Resistor pairs or sets matched for ratio, T.C. tracking and/or tolerance can also be packaged to go. When what you need isn't in the catalog, call Dale. We cater to special needs. For immediate help with special film resistors, call **402-371-0080**



DALE ELECTRONICS, INC.
P. O. Box 74, Norfolk, Nebraska 68701
In Canada: Dale Electronics Canada Ltd.
In Europe: Dale Electronics GmbH,
8 Munchen 60, Falkweg 51, West Germany
A subsidiary of The Lionel Corporation

Our complete product line can be found in Electronic Design's GOLD BOOK.

Build a switching regulator in half the time.

You know that a switching regulator can quadruple the efficiency of your power supply. It'll save power, cut heat loss, simplify your design, save board space, weigh less, and maybe cost less than a linear regulator.

But until now, if you wanted a switching regulator, you had to start from scratch. It took a lot of time and a lot of effort.

Our power switching circuit is the breakthrough you've been waiting for.

The power circuit is the trickiest part of the switching regulator to design, since it involves choosing the commutating diode and switching transistors, then fiddling with

the circuit to get the best drive and bias conditions.

We've taken care of all that. And the power circuit is the one that can contribute most in terms of improving the regulator's performance.

We've taken care of that, too. Thanks to our special design and packaging, you can expect faster response time and lower noise than you could design in yourself. And because of the faster switching time, you can reduce the size and cost of other components and operate at frequencies up to 100KHz.

Our PIC-600 Series power switching circuits are available with positive and negative outputs, in current ranges

from 5 to 15 amps and voltage capabilities up to 80 volts.

To make your life even easier, we've got a 24-page booklet that'll tell you everything you need to know about designing a switching regulator. It's the only booklet of its kind available, and it's free. To get yours, along with detailed specs for our power switching circuits, circle our number on the reader service card.

Unitrode Corporation,
580 Pleasant St.,
Watertown,
Mass.
02172.



Total cost effectiveness. TO-5 relays from Teledyne.

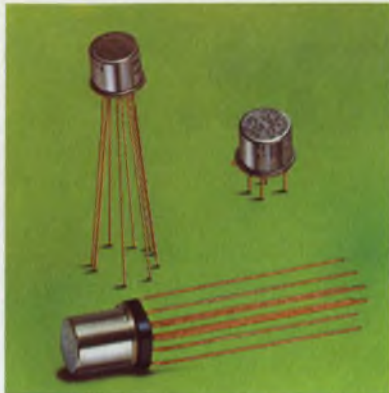

Whether you design commercial aircraft equipment, or MIL avionics, control and communications devices – the tough parameters are the same. High packing density, low power consumption and heat dissipation, utter reliability and always – cost effectiveness.

TO-5 relays from Teledyne are the unqualified answer. High density, PC board pinout, **half** the size and coil power of comparable multi-pole

switching devices. And they are **more reliable** and **less expensive** than semiconductor arrays for multi-switching functions.

Teledyne has the greatest choice of TO-5 relays available to you – ultra-sensitive types, maglatches, internal suppression diodes, internal drive transistors and many contact arrangements. All – welded and hermetically sealed; all fully qualified to MIL-R 39016 B, level “L” and “M” reliability. Specify them for your most exacting designs. Teledyne TO-5 relays – the totally cost effective switching solution. There’s an economical Commercial/Industrial line, too – and they’re in stock near you. Call your nearest Teledyne Relays office for location of your local representative or distributor.

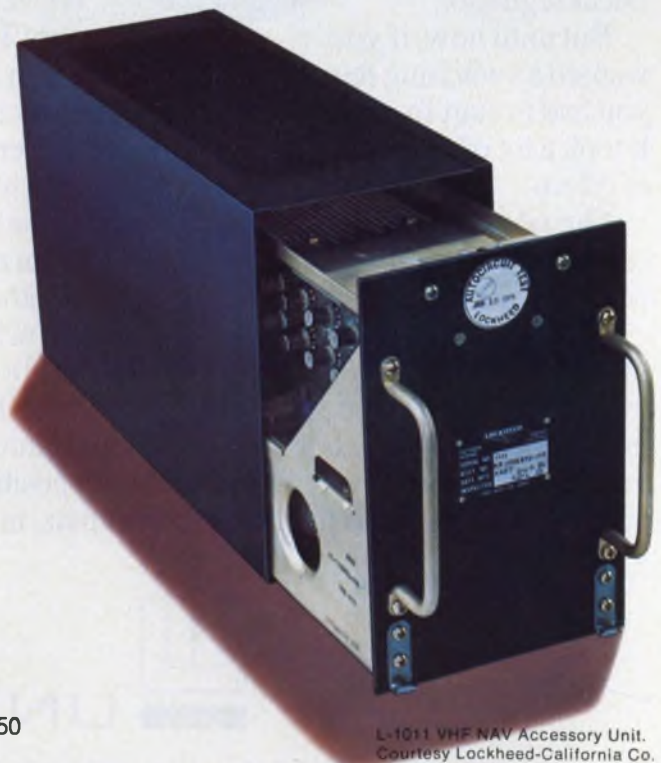
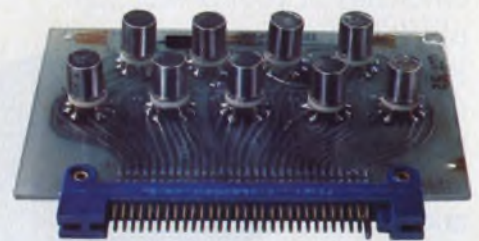

L-101 VHF NAV Accessory Unit.
Courtesy Lockheed-California Co.

TELEDYNE RELAYS

3155 West El Segundo Boulevard, Hawthorne, California 90250
Telephone (213) 973-4545

Burgstrasse 6-8, 62 Wiesbaden, West Germany
Telephone: 06121-302031/2 Telex: 04-186851 (Trel-D)

Heathrow House, Bath Road, Cranford, Hounslow, Middlesex, U.K.
Telephone: 01-8972501 Telex: 935008

INFORMATION RETRIEVAL NUMBER 3

NEWS

- 21 **News Scope**
- 26 **Military is turning to CMOS/silicon-on-sapphire** technology for radiation-hardened circuitry.
- 31 **New sensors** spur 2nd try to gasify unmined coal.
- 34 **First IC ignition system in cars** offers better engine performance.
- 36 **Plasma-panel displays** modified to transmit images via telephone.
- 45 **Washington Report**

-
- 52 **IEEE Intercon '75**—A special section devoted to this year's big show.
-

TECHNOLOGY

- 98 **FOCUS on Semiconductor memories:** They are getting bigger, faster and cheaper than ever before. And even better memories are on the way. But designers must be wary of vendors' claims and data-sheet pitfalls.
- 110 **Use v/f converters** for analog data transmission. Here are four circuits that provide conversion accuracies from 0.4% to 0.01% and dynamic ranges of 10,000:1.
- 116 **Switch your high-power supply** design to an off-line regulation technique. The benefits include less energy wastage, simpler designs and lower cost.
- 124 **Stretch electrolytic capacitor life** by avoiding six deadly no-no's. And use core temperature, not ambient, when interpreting manufacturer's specs.
- 128 **Ideas for Design:** Active filter improves tracking and capture ranges of PLL . . . Complete phase-locked loop made from part of a quad EX-OR gate . . . High-voltage power supply from 5-V source regulated by timer feedback circuit.
- 134 **International Technology**

PRODUCTS

- | | |
|-----------------------------|---------------------------|
| 137 Data Processing | 146 Packaging & Materials |
| 140 Instrumentation | 150 Microwaves & Lasers |
| 144 Modules & Subassemblies | |

DEPARTMENTS

- | | |
|---------------------------|--------------------------------|
| 95 Editorial: Jobs | 160 Advertisers' Index |
| 7 Across the Desk | 162 Product Index |
| 154 Application Notes | 162 Information Retrieval Card |
| 155 New Literature | |

Cover: Photo by Larry Jackson, courtesy of Tektronix, Inc., Beaverton, OR

Intel's 18-pin 16K single card memories

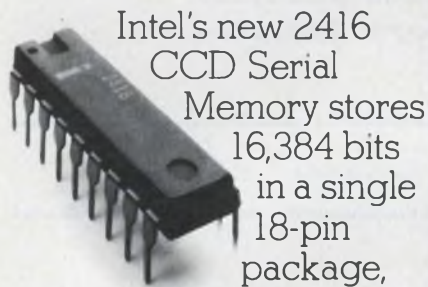

Intel's new 2416
CCD Serial
Memory stores
16,384 bits
in a single
18-pin
package,

allowing you to build bulk memories with a density of at least a million bits per card. Furthermore, the Intel 2416 is organized as 64 recirculating 256-bit shift registers, so it has the speed and format flexibility of an assembly of small registers. In a program swapping operation, for example, your system could transfer data as fast as any CPU could use it.

Any of the 16,384 bits can be accessed in less than 200 microseconds at a shift cycle of 750 nanoseconds. Between shift cycles, you can read or write a bit, a byte or a word at serial data rates faster than 2 megabits per second (a speed easily multiplied at the system level). A RAM-like I/O control with a cycle time less than 500 nanoseconds makes any register or a succession of registers accessible between shift cycles.

Yet the Intel 2416 is economical to use, with its standard +12, -5V supplies and standard 18-pin plastic DIP (or 22-pin ceramic DIP). You can build fast, versatile bulk memories into computers or microcomputers, business equipment, POS

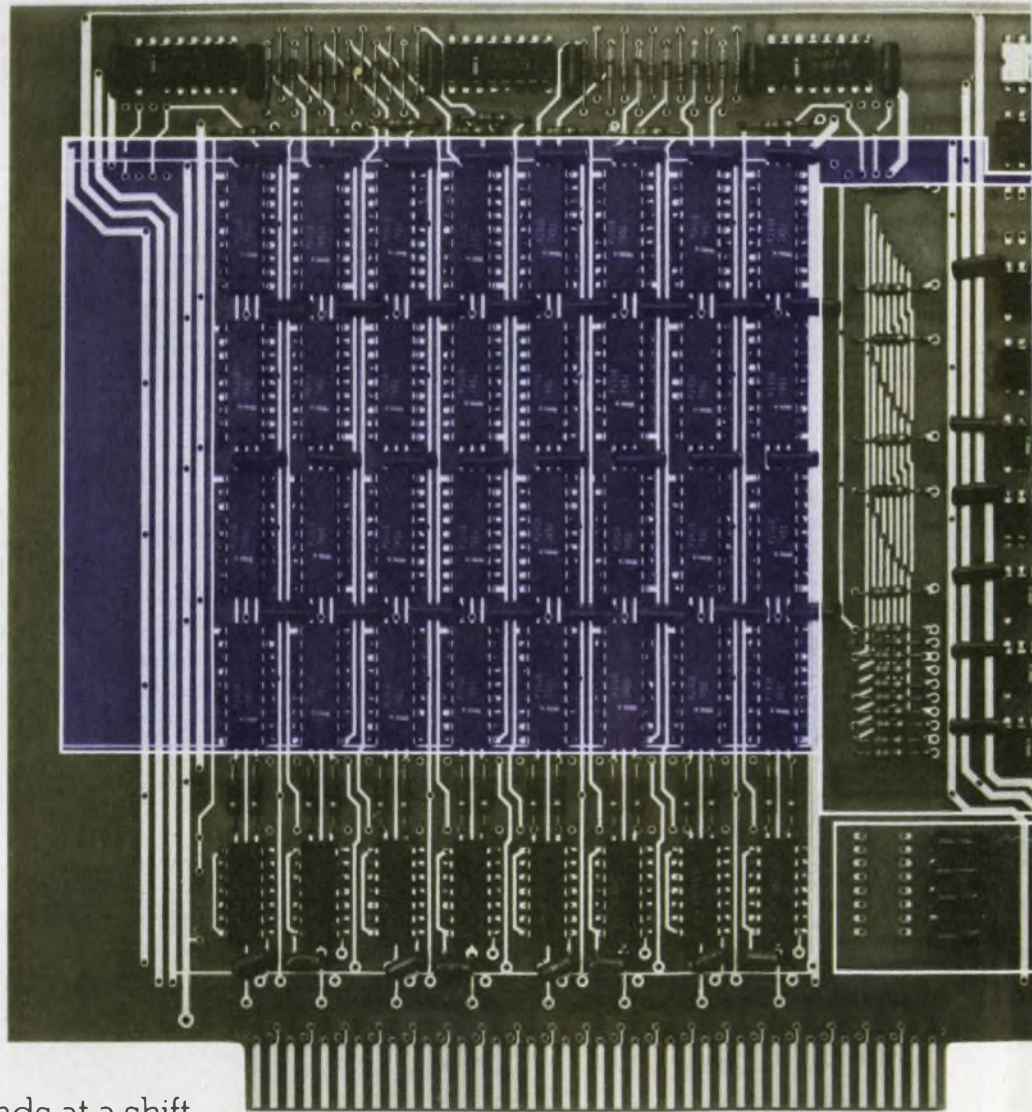

1,048,576-BIT MEMORY CARD USING

CCD makes megabit a reality today.

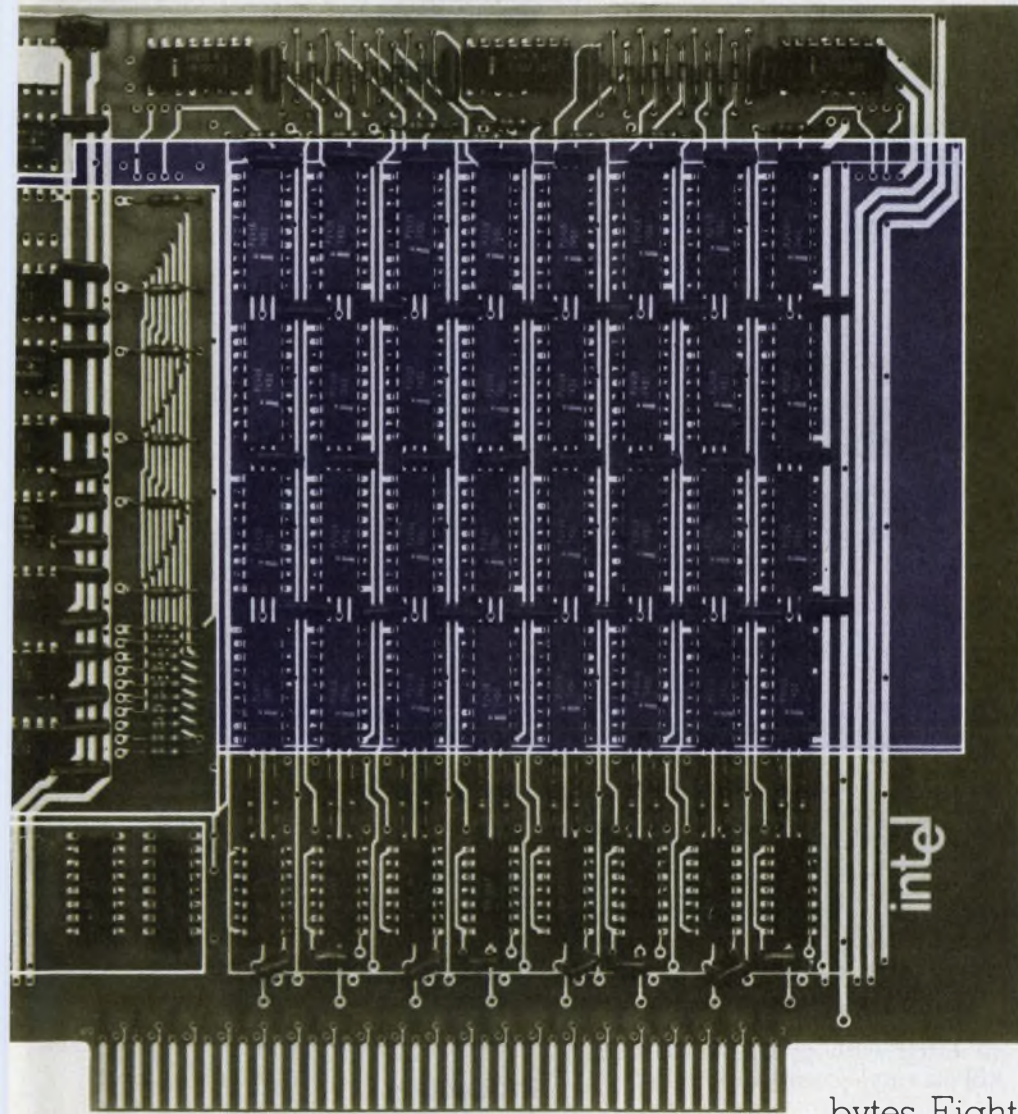

64 INTEL 2416 CCD MEMORIES

systems and programmable calculators, or replace conventional shift registers at low cost in CRT terminals, instruments and communications buffers. And it readily emulates any small disc or drum system wherever the lower cost of CCD, better speed, high reliability, compactness and low power are needed.

For instance, the single-card, million-bit serial memory system shown here can work in disc or drum modes with a maximum latency of 200 μ sec and data rates to 64 megabits per second. The 64 Intel 2416 packages are organized as 128 kilobytes. Eight identical cards would operate as a megabyte system.

Start upgrading your bulk memories from electro-mechanical to solid state today. For immediate delivery of the Intel 2416, contact Almac/Stroum, Component Specialties, Inc., Cramer, Hamilton/Avnet, Industrial Components, Inc., Sheridan, and L. A. Varah Ltd. For more information, phone an Intel regional office: (714) 835-9642, west coast; (214) 661-8829, southwest; (513) 890-5350, midwest; (617) 861-1136, New England; (215) 542-9444, east. Or write: Intel Corporation, 3065 Bowers Avenue, Santa Clara, California 95051.

intel[®] delivers.

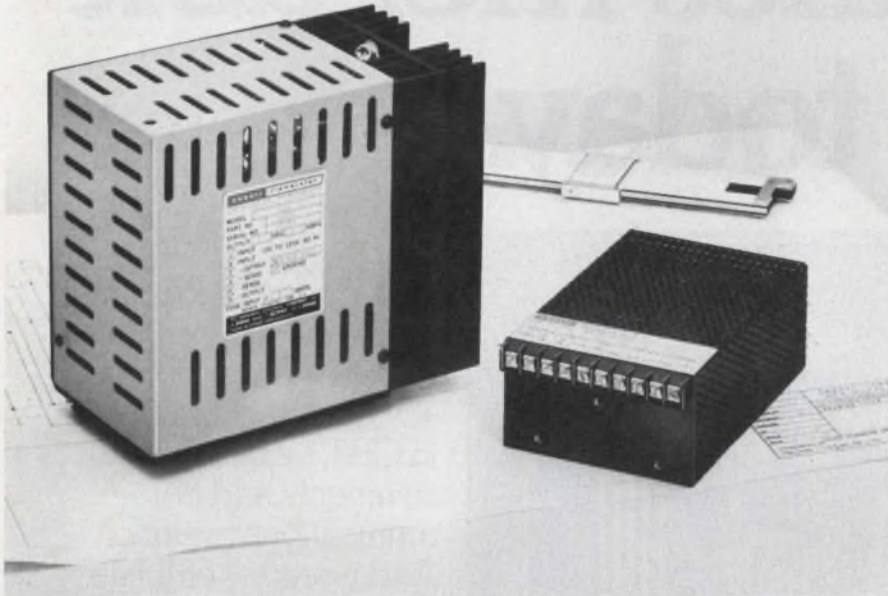

Reduce Your Power Supply Size and Weight By 70%

A new way has been found to substantially reduce power supply size and weight. Consider the large power supply shown at left in the above photo — it uses an input transformer, into a bridge rectifier, to convert 60 Hz to 5 volts DC at 5 amperes. This unit measures 6½" x 4" x 7½" and weighs 13 pounds. Abbott's new model Z5T10, shown at right, provides the same performance with 70% less weight and volume. It measures only 2½" x 4" x 6" and weighs just 3 pounds.

This size reduction in the Model Z5T10 is primarily accomplished by eliminating the large input transformer and instead using high voltage, high efficiency, DC to DC conversion circuits. Abbott engineers have been able to control the output ripple to less than 0.02% RMS or 50 millivolts peak-to-peak

maximum. This design approach also allows the unit to operate from 100 to 132 Volts RMS and 47 to 440 Hertz. Close regulation of 0.15% and a typical temperature coefficient of 0.01% per degree Celsius are some of its many outstanding features. This new Model "Z" series is available in output voltages of 2.7 to 31 VDC in 12 days from receipt of order.

Abbott also manufactures 3,000 other models of power supplies with output voltages from 5 to 740 VDC and with output currents from 2 milliamps to 20 amps. They are all listed with prices in the new Abbott catalog with various inputs:

60 A to DC
 400 A to DC
 28 VDC to DC
 28 VDC to 400 A
 12-28 VDC to 60 A

Please see pages 307-317 Volume 1 of your 1974-75 EEM (ELECTRONIC ENGINEERS MASTER Catalog) or pages 853-860 Volume 3 of your 1974-75 GOLD BOOK for complete information on Abbott Modules.

Send for our new 60 page FREE catalog.

abbott transistor

LABORATORIES, INCORPORATED
 general offices eastern office

5200 W. Jefferson Blvd./Los Angeles 90016
 (213) 936-8185 Telex: 69-1398

1224 Anderson Ave./Fort Lee, N.J. 07024
 (201) 224-6900 Telex: 13-5332

INFORMATION RETRIEVAL NUMBER 5

Vice President, Publisher

Peter Coley

Editors

Editorial Offices
 50 Essex St.
 Rochelle Park, NJ 07662
 (201) 843-0550
 TWX: 710-990 5071
 Cable: Haydenpubs Rochellepark

Editor-in-Chief George Rostky

Managing Editors:

Ralph Dobriner
 Michael Elphick

Associate Editors:

Dave Bursky
 Jules H. Gilder
 Morris Grossman
 Seymour T. Levine
 John F. Mason
 Stanley Runyon
 Edward A. Torrero

Contributing Editors:

Peter N. Budzilovich
 Alberto Socolovsky
 Nathan Sussman

Editorial Field Offices

East

Jim McDermott, Eastern Editor
 P.O. Box 272
 Easthampton, MA 01027
 (413) 527-3632

West

David N. Kaye, Senior Western Editor
 8939 S. Sepulveda Blvd.,
 Suite 510
 Los Angeles, CA 90045
 (213) 641-6544
 TWX: 1-910-328-7240

Editorial Production

Marjorie A. Duffy

Art

Art Director, William Kelly
 Richard Luce
 Anthony J. Fischetto

Production

Manager, Dollie S. Viebig
 Helen De Polo
 Anne Molfetas
 Christopher G. Hill

Circulation

Manager, Evan Phoutrides

Information Retrieval

Peggy Long

Promotion

Manager, Walter G. Salm
 Karen Kerrigan (Reprints)

Creative Layout Services

Manager, Albert B. Stempel

The Sucaba—A powerful computational tool

As much as possible ELECTRONIC DESIGN tries to report on New Products as quickly as possible and, in most cases, a product sees the first light of print in these pages. In some cases, unfortunately, a product is bumped from one or more earlier issues because of space limitations. The story of The Sucaba is one such, so we are publishing it now, admittedly somewhat late. The technical information was furnished by Calvin R. Graf of San Antonio, Texas.

The Sucaba, a computing device, is equipped with a number of keys to perform the four standard functions of add, subtract, multiply and divide. It can also calculate square roots and cube roots and is usually equipped with 13-digit readout. A unique "sinking" decimal point concept permits the decimal to be inserted at any location of the display and entry keys.

Unlike most recently introduced calculators, which use algebraic, arithmetic or reverse-Polish for data entry, the Sucaba uses Japanese. Entry into the keyboard is made from right to left. Entry can be made using the left or right hand, depending on operator dexterity.

The Sucaba is an all solid-state device and is usually packaged so that it can survive a drop on a concrete sidewalk. However, the digits would have to be manually

reset to zero. No electrical power is consumed while calculating, though a slight amount of heat might be generated by friction during a rapid series of digit manipulations. Memory storage is infinite; the nonvolatile memory is not dumped when power is removed.

The Sucaba digits are displayed indefinitely without consumption of power, the liquid-crystal display being the nearest competitor in terms of power consumption. As with the liquid crystal, the Sucaba display operates off reflected ambient light, the display getting brighter with brighter light. Its superiority is most apparent in full sunlight where most other displays (except the liquid crystal) are completely washed out.

A moderately stable platform must be provided for the Sucaba operator, as improper orientation could destroy the display memory. The Sucaba is believed to be the only pocket calculator capable of changing each number column without disturbing adjacent entries. Any number in storage can be immediately recalled with a glance at the digit display. This device permits stored data to be observed without movement of any function or operation key and is considered unique compared with other calculators on the market or on the R&D drawing boards.

(continued on page 8)

Electronic Design welcomes the opinions of its readers on the issues raised in the magazine's editorial columns. Address letters to Managing Editor, Electronic Design, 50 Essex St. Rochelle Park, N.J. 07662. Try to keep letters under 200 words. Letters must be signed. Names will be withheld on request.



OPTRON OPTICALLY COUPLED ISOLATORS

FREE BURN-IN OF COMPLETE
LOW COST "DIP" SERIES
ASSURES STABILITY

Now, every OPTRON plastic dual-in-line isolator receives a burn-in at no extra cost to offer maximum reliability at bargain prices. This eliminates the initial instability in transfer ratio normally encountered with ordinary "DIP" isolators.

OPTRON's extended "DIP" series has 16 types, includes photo-transistor and photodarlington outputs, features complete interchangeability with popular industry types and provides an inexpensive coupler for every application. Devices are available with isolation voltages of 1500 or 2500 volts with minimum current transfer ratios ranging from 2.0 to 500%.

OPTRON's "DIP" and a full line of other isolator packages with isolation voltages to 50 kV provide the versatility required for maximum electrical and mechanical design flexibility.

1.5 kV isolation with 60% current transfer ratio. Phototransistor base lead available. Hermetic TO-5 package.



OPI 102

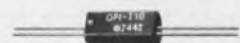

OPI 110

10 kV isolation and 40% current transfer ratio. 4 μ sec switching time in low cost miniature plastic package.

Detailed technical information on "DIP" and other isolators as well as all OPTRON optoelectronic products . . . chips, discrete components, assemblies, and PC board arrays . . . is available from your nearest OPTRON sales representative or the factory direct.



OPTRON, INC.

1201 Tappan Circle
Carrollton, Texas 75006
214/242-6571

(continued from page 7)

No rfi is generated by the Sucaba, and further, its memory and logic can withstand extremely strong irradiation by radio or other fields without suffering damage or alteration of the displayed digits.

Because of these unique features the Sucaba is attracting new attention. It is marketed, mainly, under its more popular name, the Abacus.

He questions accuracy of TV color signal

In your News Scope for Jan. 4, 1975, "Oscillator Calibrated With TV Color Signal" (ED No. 1, p. 21), you state in part that the color-burst signal is "present only in live color broadcasts." It should be pointed out that the burst signal is present in all color broadcasts (and regrettably in some black-and-white broadcasts, but that's another story). But the atomic-standard accuracy is present only in those broadcasts originating in New York that are not time-delayed for viewing in other time zones.

Such broadcasts may be filmed features, since the color sync is generated "live," but such apparently live programs as the Carol Burnett Show come from videotape, and although a lot of correction is provided, I doubt such an accuracy is maintained. On sports broadcasts I believe the color sync is generated at the remote site, so accuracy is not necessarily assured.

The evening newscasts are assembled in round-robin fashion and contain every kind of sync but kitchen, and local stations often insert local advertising within network programs if the network did not sell that local area to the national sponsor. Accuracy on a randomly selected color-burst frequency is between one and two parts per million, by Federal Communications Commission requirements. Locally generated cable TV color

signals, live or taped, are often even less accurate.

Suffice it to say that one had better be sure of what he is measuring.

James Rieger
Electronic Engineer

Code 3735
Naval Weapons Center
China Lake, CA 93555

Misplaced Caption Dept.



"Watch it. Here comes that guy from engineering with the cold hands."

Sorry. That's Jean-Baptiste Regnault's "The Three Graces," which hangs at the Louvre Museum in Paris.

Corrections needed on optical-coupler idea

Some errors crept into my Idea for Design, "Optical Coupler Helps Transmit Data and Clock Signals on Single Wire Pair" (ED 26, Dec. 20, 1974, p. 104) during editing.

The optical couplers, OC₃ and OC₄, in the diagram, should have been designated similarly in the text instead of G₃ and G₄, respectively. Further, the polarity of the input diode OC₄ should be reversed to be opposite that of the polarity of the input diode on OC₃.

Richard Gunderson
Senior Project Engineer

ADC Telecommunications
4900 W. 78th St.
Minneapolis, MN 55435

Helping hand is viewed as investment in future

As a sales/applications engineer, I read with great interest your editorial on "Nice Young Girls and Consultants" (ED No. 25, Dec. 6, 1974, p. 51). It was excellent. I would quarrel with only one part of your conclusion. As I suspect is the case with the nice young girls and consultants, it is often difficult to tell who is an unlikely prospect. So, like those whom you met, I tend to err on the side of trying to "help" almost everyone, if I can. One never knows if that student or pesky technician will someday turn into a customer, or if they will mention to someone how they were helped by your company.

J. E. Wurtz
Senior Applications Engineer
Electro-Optical Devices

Litton Industries
Electron Tube Div.
960 Industrial Rd.
San Carlos, CA 94070

Jumping for joy . . .

is how we received the news that American Business Press has bestowed on editors of Electronic Design two of its coveted Jesse H. Neal Award Certificates for editorial achievement. The Neal awards are considered the business-press equivalent of Pulitzer Prizes.



Electronic Design's FOCUS series won the award for "Best Staff-Written Series of Feature Articles." The other award was for the "Best Series of Editorials."

In comments to the staff, Editor-in-Chief Rostky said: "We're always delighted to get one Neal Award. But two? I'm almost speechless—and you know how rare that is."

(continued on page 19)



MEASUREMENT COMPUTATION

innovations from Hewlett-Packard

NEWS

APRIL, 1975

in this issue

Basic Analysis Mapping
on a calculator

Auto ranging digital
power meter

New computer central
links minicomputers



HP-21: New powerful pocket-sized scientific calculator at a more affordable price—\$125

The smallest scientific pocket calculator in our line—the HP-21 delivers extraordinary problem solving power in the Hewlett-Packard tradition.

Now you can have Hewlett-Packard quality craftsmanship in a low-price calculator, the HP-21.

The HP-21 has more capability than our pace-setting HP-35. There are 32 pre-programmed functions and operations, including:

- all log and trig functions, the latter in radians or degrees
- full Display formatting. Allows you to choose between fixed decimal and scientific notation
- underflow feature will not allow you to confuse a smaller number with a 0. Automatically reverts to scientific notation.

(continued on third page)

BAMP on a Calculator for Microwave Circuit Design

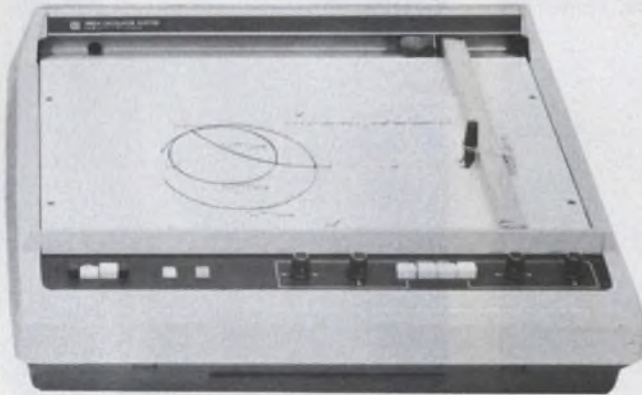

BAMP 30 and an HP 9830A calculator gives you systematic and efficient solutions in the design or analysis of high frequency and microwave circuits.

HP introduces BAMP 30 (Basic Analysis and Mapping Program), the software package now available for designing or analyzing high frequency and microwave circuits.

Originally developed for use on a time-shared computer system, the full power of BAMP is now available on a HP 9830A Programmable Calculator.

BAMP 30 is a collection of programs for obtaining the frequency-domain response of linear electronic circuits that can be built up by interconnecting two ports. BAMP 30 is a two-port program. This means:

Elementary two-ports are used as basic building blocks.

The overall or composite circuit built up by BAMP 30 is in turn a two-port.

The first result of any analysis performed by BAMP 30 is the scattering, or s-matrix, for the overall circuit. The s-matrix is stored in the 9830A Calculator as a function of frequency and can

be used to compute, print, and plot numerous additional outputs.

BAMP 30 will help you design better circuits in less time. Circuit models can now be made as complex as necessary to accurately represent physical circuits, without danger of losing control over the design process. Analysis is more comprehensive and circuits can be as optimum as physical laws will allow them to be. The greater the circuit complexity, the greater the savings through BAMP 30.

If your design problem is too troublesome for manual analysis but does not warrant the time and expense of a computer, try the HP calculator-aided design solution. The BAMP 30 software pack may be ordered under Part No. 09830-71103.

To receive an Application Summary on Basic Analysis Mapping on the 9830, check Q on the HP Reply Card.

Calculator based system monitors complex variables; boosts productivity

Monitoring the pH and precisely controlling the amount of caustic that should be used to neutralize the acid in order to prevent damage to the bacteria in a municipal sewage plant is shown below as HP helps control the effluents from the manufacturing plant in Loveland, Colorado.

The new HP 3050B Data Acquisition System is coupled with a programmable calculator providing a system that replaced multiple recorders previously required throughout the facility.

The system is programmed for precise pH levels. It continuously monitors pH and indicates an alarm condition when the limits are not in specification.

Measuring multipoint physical parameters to monitor or analyze phenomena and control devices will provide many varied applications of the HP 3050B System. Transmission of the data may be possible over thousands of miles using the HP-IB Common Carrier Interface and an optional modem.

For more information and other ideas on applications where data acquisition, analysis and control are critical, check E on the HP Reply Card.



On-site data acquisition with remote control and analysis.

Interface Bus compatible Solid State Sweeper has new options

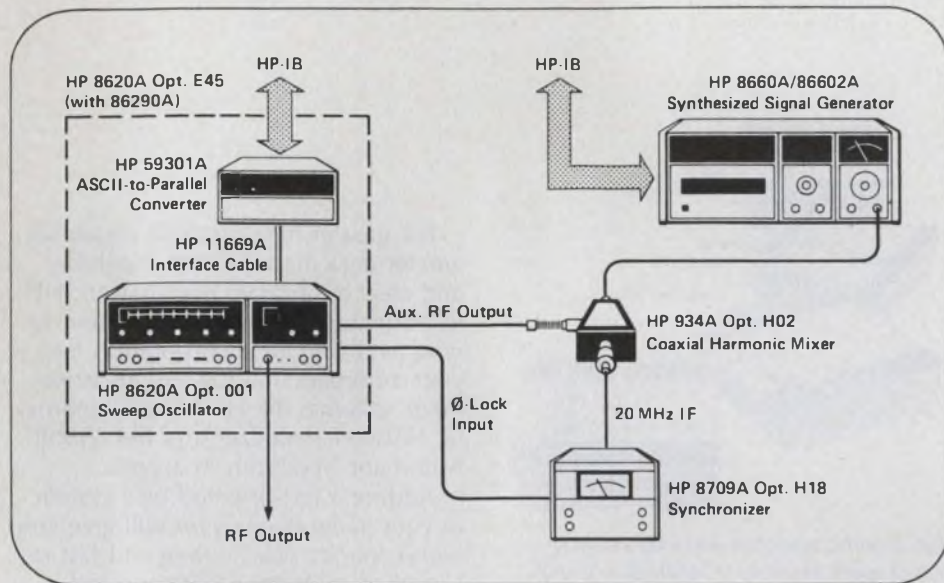

Synthesizer accuracy to 18 GHz is easily obtained via the HP-IB.

(continued from page one)

NEW Scientific Calculator—

- 10-digit display and 2-digit exponent
- 4-register arithmetic. Allows you to add, subtract, multiply and divide in the storage registers.
- performs basic data manipulations: $1/x$, y^x , \sqrt{x} , $x \approx y$, π , e^x
- converts polar to rectangular coordinates and back again
- calculates a common antilog (10^x) with a single keystroke
- RPN logic system
 - continuous and immediate display
 - all operations are sequential—backtrack if you make an error
 - re-use numbers without re-entering them
- completes pre-programmed functions in 1 sec. or less
- error display if you key in an impossible instruction
- five total memory registers

The HP-21 solves long and complex equations. Challenge it with your numerical problems—personal or professional.

The HP-21—a quality calculator. \$125.

For more information, check A on the HP Reply Card.

Now the HP Interface Bus can be used with HP 8620 sweepers to achieve calculator control of frequencies from 3 MHz to 18 GHz. The 8620A Opt E45 sweeper with appropriate RF plug-in becomes a source with 1000 points per band programmability. The HP 86290A, our new 2 to 18 GHz plug-in, is ideal for HP-IB systems because of its flexibility, excellent frequency accuracy and linearity. The bus-controlled 8620A/86290A can quickly step through as many as 3000 frequencies—typically with ± 5 MHz accuracy. For higher accuracy, add the HP 5340A counter plus D/A converter to automatically correct frequency to within 100 kHz. Even greater precision (to 25 Hz) can be obtained by phase-locking the sweeper to the HP 8660 synthesized signal generator and programming both the sweeper and 8660 via the HP-IB. Precision power level control of the sweeper is also possible using the new 436A digital power meter. (See sixth page)

These plus other practical microwave signal sources are described in our data sheet.

For more information on the HP Interface Bus controlled sweeper mainframe, check O on the HP Reply Card.

Mini DataCenter now gives computer power directly to the users

Hewlett-Packard now makes it possible to distribute computer power directly to the people who need it, when they need it.

The HP 3000CX Mini DataCenters are designed to meet the needs of stand alone and distributed computer networks with cost-saving efficiencies. You now can have distributed power for your department, region or division—serving the needs of manufacturing, administration, science, engineering, and real time applications.

The four 3000CX models (50CX, 100CX, 200CX, 300CX) implement timesharing, multiprogramming, and virtual memory operations. This is accomplished by separating programs into code and data modules, processing segmented programs into several modules, and stacking data to meet the needs of executing programs.

Several users can run their own programs concurrently using BASIC, RPG, COBOL, FORTRAN, or HP's SPL.

Input-output spooling capability is permitted at terminal or batch devices. Mini DataCenters offer a communications subsystem to link CX Series systems to each other and to larger computers as well.

A 32-bit LSI ROM microprocessor is at the heart of every Mini DataCenter. This microprocessor implements 182 instructions, has a cycle time of 179 nano-seconds, utilizing overlapped microinstructions to provide as many as 5.27 million operations per second.

Choose from the four 3000CX models to fit your job, your site, and your budget.

For details to help you choose the model best for you, circle D on the HP Reply Card.



For extra capability, the next logical step in automatic testing

HP's distributed systems capability has been expanded by the addition of a new, complete interface package to link Automatic Test Systems to a distributed system network.

The package includes both software and hardware for automatic microwave network analysis, spectrum analysis, and general purpose stimulus response measurement systems.

Linking the HP 9500 and 8500 systems to a central computer system (HP 9600E series) gives you the advantages of stand-alone intelligent systems functioning as a distributed system satellite.

The satellites can each request off-line data manipulation and report generation at the central.

The central system supports the automatic test system satellites by providing mass storage, greater efficiency in program preparation, and shared peripherals.

The distributed system satellites provide specific automatic testing capabilities including precision microwave phase and amplitude measurements, computer controlled spectrum analysis, and computer controlled testing of a wide range of modules from DC to 18 GHz.

If you have automated your testing already and have stand-alone 8500 or 9500 series systems in your operation, investigate the expanded capability you can have with this new distributed systems package.

For details, check M on the HP Reply Card.

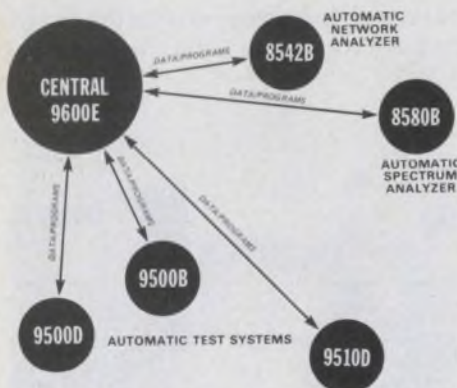

Link your automatic test systems to a distributed system network.

New more sensitive X-Y recorder expands choice to meet your needs precisely

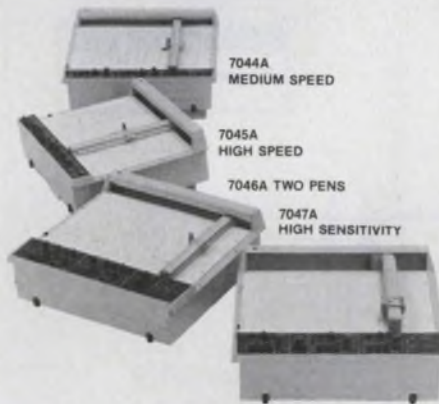

High dynamic response and tough environmental specs available in family of X-Y and X-Y/Y recorders.

The new 7047A recorder, with high sensitivity and unique input circuits, is the newest addition to our family of 11 x 17" X-Y recorders. Starting with the 7044A medium speed, the 7045A general purpose, and the two pen 7046A, you now have a wide choice if you want high quality recordings without sacrificing ruggedness or reliability.

A wide range of quick-changing signals can be reproduced accurately and dependably. If you need speed, the 7045A and 7047A offer Y-axis acceleration exceeding 7620 cm/sec² (3000 in/sec²).

Arbitrary full scale voltage ranges may be established with the vernier control in conjunction with the calibrated dc ranges.

These recorders are equipped with front panel polarity switches to reverse pen direction, eliminating the need for reversing the input leads.

The trouble-free Autogrip electrostatic hold-down platen solidly grips any size paper up to 11 x 17" (28 x 41.9 cm) including European DIN A3. Disposable pens are available in four colors.

Options available include the Time Base (standard on the 7047A), Event Marker and Metric Scaling.

For detailed specifications, check K on the HP Reply Card.

Now, disc capability enhances microwave measurement systems

For greater measurement capability, greater data management capability and ease of program preparation, HP's test-oriented disc operating system is now available for incorporation into your automatic microwave measurement systems: the HP 8542B Automatic Network Analyzer and the 8580B Automatic Spectrum Analyzer.

Adding a test-oriented disc system to your network analyzer will give you high capacity disc storage and fast retrieval of calibration data and test procedures by means of single statements.

Or, adding a test-oriented disc system to your spectrum analyzer will enhance your capability to generate application programs. In applications such as spectrum management, a disc will provide storage for the large amounts of needed data.

For more information on the test-oriented Disc System for the 8542B Network Analyzer and for the 8580B Spectrum Analyzer, check N on the HP Reply Card.

Increase measurement thruput with easy storage and fast retrieval of both programs and stored data.



Counter sets new mark for capability and compactness with economy

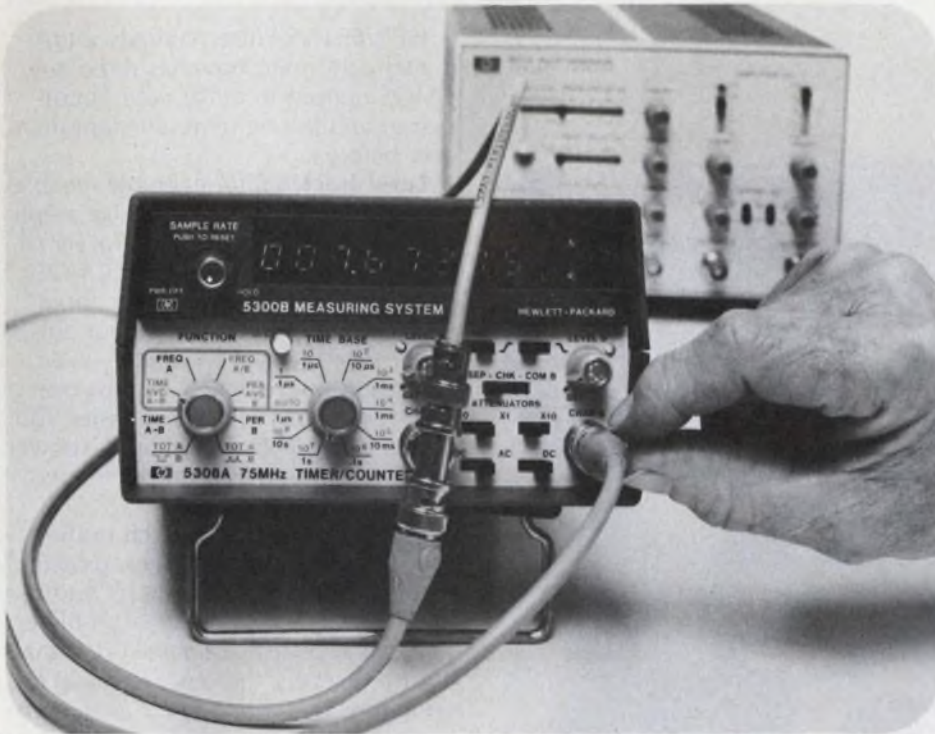

Measuring the electrical length of a coaxial cable using Time Interval Averaging on the 5308A Counter.

For the most electronic counter/timer capability available in such a small package and at such a low price—see the new 5308A 75 MHz Counter/Timer module. Not only does this instrument offer the frequency, frequency ratio, period, period average, time interval, scaling and totalizing capability of full rack width universal counter/timers, it also offers sub nanosecond time interval averaging plus unique HP features in the area of automatic ranging, totalizing, and trigger level setting.

AUTO RANGING: Now, you can auto range time interval averaging and frequency ratio measurements in addition to frequency, and period average. Furthermore, the Time Base selector can be left at Auto most of the time, even for the non-auto ranged functions. This is because in Auto these functions go to their highest resolution range, wherein the eight-digit display can totalize up to 10^8 counts or measure periods or intervals to 10 sec.

TOTALIZING: The stop and start signals for totalizing are conditioned by the same versatile slope, level and attenuator controls that apply to time interval measurements. Also, events on Channel A can be totalized while Channel B

is low, or between events on Channel B, as needed in bit-error-rate counting, for example. Use it as an electronic stopwatch, too with ranges from 100 sec ($1 \mu\text{sec}$ resolution) to 10^{10} sec.

TRIGGER LEVEL SETTING: LEDs indicate triggering and are pulse stretched so even a nanosecond input pulse gives a visible blink, as in a logic probe with pulse stretching. Trigger levels are switch-presetable around 0 volts or TTL or ECL levels for convenient measurement and troubleshooting of digital circuits. Also there's access to trigger level circuits for precise setting via external voltmeter, and a gate signal for scope Z-axis modulation.

Since the 5308A is part of HP's snap-together 5300 Series measurement system, you can snap on any of the other seven modules to convert to other instruments, including a 1100 MHz counter and digital multimeter. Or, add to any combination: a battery pack, D/A converter and/or HP Interface Bus module.

For detailed specifications, check 1 on the HP Reply Card.

Two new HP scopes offer dual-delayed sweep

The dual-delayed sweep technique exclusively available in the new HP 1722A microprocessor and 1712A oscilloscopes give you improved accuracy for precise interval measurements in digital circuits. Now you can have improved accuracy and repeatability for such time measurements as rise times, propagation delay, clock phasing, and other high-speed applications with resolution to 100 picoseconds.

The 1712A displays two intensified markers which are two delayed sweeps displayed alternately. The first delayed sweep is controlled by the TIME INTERVAL START pot. The time between markers is scaled according to the main sweep, and delivered as an analog voltage to outputs at front and rear. Thus, the 1712A can be used with any DVM for direct readout of time intervals.

Dual-delayed sweep with its digital readout capability helps to avoid measurement errors of forgetting or selecting the wrong graticule line, reduces the chance of misreading a dial, and calculation errors. Dual-delayed sweep is also auto-zeroing, making calculations or manual zeroing unnecessary.

For details on this dual-delayed scope, check C on the HP Reply Card.



With dual-delayed sweep, two markers select time period to be measured and a proportional voltage output is provided for DVM readout.

New programmable autoranging power meter offers new level of accuracy and ease of operation

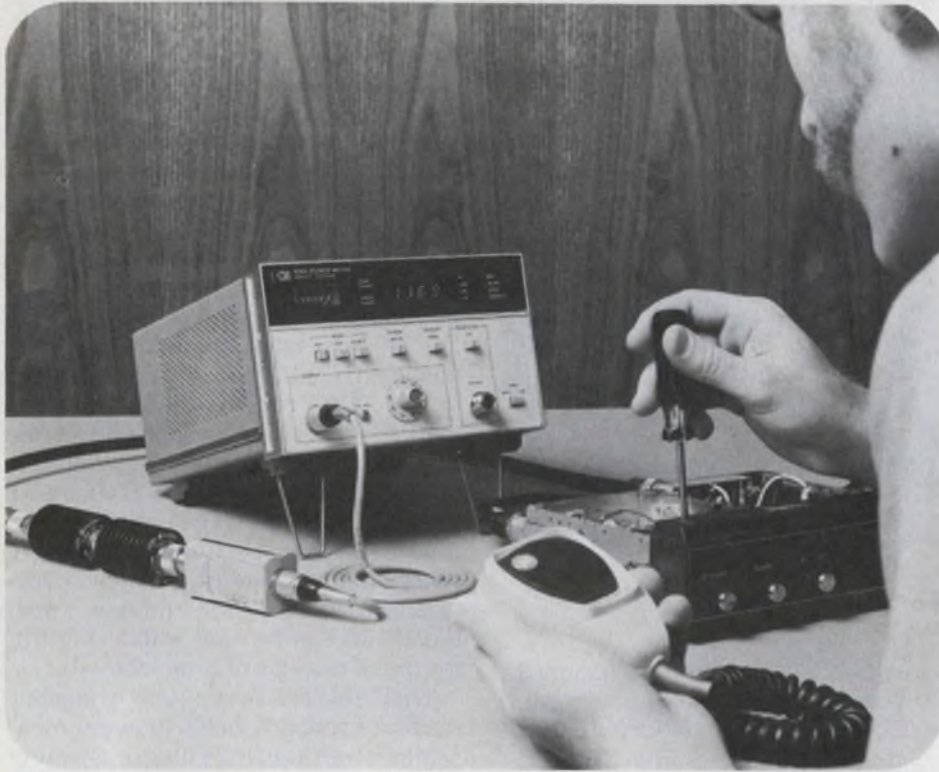

A new digital microwave power meter, the HP 436A, has built-in firmware 'intelligence' to switch automatically among its five power ranges, to translate its reading into watts, dBm or dB Relative, to recognize which of several possible sensors is connected and calibrate its display accordingly, and to locate the displayed decimal correctly.

The 436A measures either absolute or relative power and displays the results in either watts (mw, μ w, and nw) or dBm. Relative power is displayed in dB relative to a reference value set by push-button.

Instrumentation uncertainty is less than $\pm 0.5\%$ (1% in range 5) of reading. Power and frequency range depend on the sensor used; it may be from 100 kHz to 18 GHz in a power range from -30 dBm to +35 dBm. All thermocouple sensors of the 8480 series are compatible.

Readings are indicated on a large 4-digit LED display. Autoranging makes

operation "hands off" but may be disabled with a push-button to "hold" a given power range. In addition to the digital display, an analog meter indicates fast-changing power levels and permits tuning and adjustment of power output.

The 436A is fully programmable (except CAL FACTOR). Interface for control and readout may be via the HP Interface Bus or BCD. With these capabilities, the 436A power meter will be a powerful addition to most mini-systems used in microwave production test applications.

This completely new instrument is designed to stay out of the user's way while doing his job. It is an ideal general purpose power meter for the RF and Microwave engineer.

For details, check B on the HP Reply Card.

New CMOS options extend versatility of high voltage pulser

HP's 8015A Pulser, already a top digital performer, now has three new CMOS options to make your circuit design and testing more efficient than ever before.

Level tracking, for example, enables you to control the 8015's pulse amplitude with an external DC control signal. With the 8015A tracking the CMOS power supply, you can forget about circuit damage caused by input pulses larger than the supply voltage, even when power is removed. Testing over a range of supply voltages is easier, too, because you need only adjust the power supply and the pulser output follows automatically.

Direct access inputs to each of the 8015A's linear output stages, provided by the second new option, let you use the 8015A as an analog signal amplifier. You can also easily convert TTL signals to CMOS levels, thereby extending the usefulness of existing word generators and other TTL equipment.

The **TTL output** option is especially useful whenever CMOS and TTL IC's are used together. The option gives you an extra pulse output with preset levels set for TTL compatibility.

The 8015A itself is a 50 MHz, 16 volt pulser with transition times fully variable down to 6 ns. Its two independent output channels may be delayed with respect to one another to make setup time measurements or to generate two-phase clocks. They may even be added to provide 30V test pulses.

For details, check L on the HP Reply Card.



Pulse burst is generated upon receipt of trigger pulse. Length is determined by thumbwheel switches.

A new 5V, 100A switching supply stays cool under stress

HP's new 500-watt modular supply, the 62605M, combines the high efficiency and small size of an advanced 20-kHz switching regulator with an integral forced-air cooling system that eliminates conventional heat sinks.

The result is an efficient, compact and trouble-free power supply. The supply is regulated to 0.1% with ripple and noise of 15 mV rms, 50 mV p-p (20 Hz to 20 MHz). It will output 5 volts at 100 amps continuous from 0 to 40°C, with linear derating to 60 amps at 70°C. All of this is packaged in a 5" x 8" x 11½" case

weighing only 14 pounds (6.4 kg).

Operating costs are reduced due to the supply's higher efficiency. Additional savings may be realized from the reduction in supplementary in-cabinet cooling and the power it uses.

For reliability, "cool-operation", small size and lasting value consider the HP 62605M.

For full details about this new power supply's many advantages, check J on the HP Reply Card.

Modular power supply with overvoltage, overcurrent, overtemperature and reverse voltage protection.

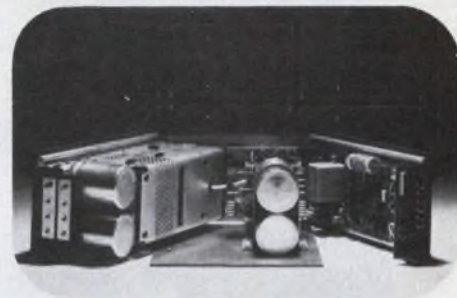

HEWLETT-PACKARD COMPONENT NEWS

New transistor for high reliability applications

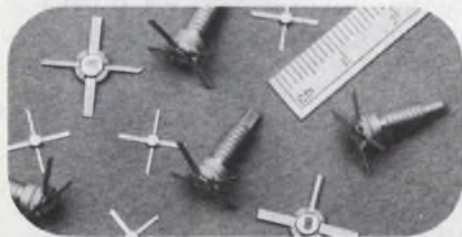

New transistors offer guaranteed tuned gain and meet military standards for environmental and test.

HP offers two new general purpose microwave transistors. Model 35828E, a small signal NPN bipolar transistor with guaranteed tuned gain at 2 GHz, is available in the H Pac 70 GT, a rugged metal-ceramic hermetic package.

The Model 35829E, optimized for high gain at 2 GHz, utilizes a co-fired alumina package. For both transistors, the tuned gain is guaranteed under fixed optimum source and load conditions simplifying the designer's job in extracting the maximum performance from the devices.

For specifications and reliability data, check F on the HP Reply Card.

High intensity displays in three colors

The new HP 5082-7650 series LED displays, available in high efficiency red, yellow and green, are five times brighter than our previous .43" displays at the same operating current. High brightness means they can be read easily in outdoor applications. The new high efficiency red (635 nm) has been shifted towards the orange to enhance readability.

At an operating current of 20 mA per segment, luminous intensity per segment is 1720 microcandelas.

For improved readability, the bodies of the displays are color-coordinated to hide the unlighted segments.

For more information on these displays: 5082-7650 High efficiency Red, 5082-7660 Yellow, 5082-7670 Green. check H on the HP Reply Card.



High-brightness, low-power displays, readable up to 20 feet.

Sharp on/off transition in new voltage sensing LED



Designed for use as a built-in push-to-test battery voltage tester for cameras, radios, test instruments and other appliances.

With very high sensitivity to the threshold voltage, the new HP 5082-4732 VSLED is ideal for applications where precise voltage level indication is required, including V-U meters, logic level indicators, and other voltage indicating arrays.

This solid state lamp combines an IC and a red GaAsP LED in a standard red diffused T-1 LED package that snaps on sharply at a nominal 2.5 volts, ± 10 millivolts. The effective threshold voltage can be increased to any desired level with the use of a resistor, diode or zener in series.

For rating and characteristic information, check G on the HP Reply Card.

New satellites and new central computer expand HP Distributed System capabilities

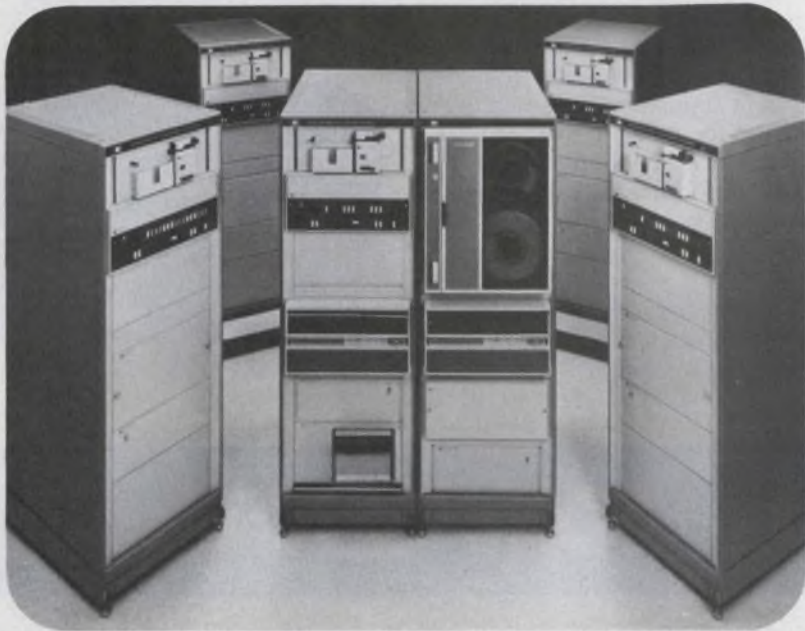

Five new minicomputer satellite systems and a new system specially configured to function as the central can now be incorporated in HP distributed systems. With these additions, 9600MX series measurement and control systems, 8500 series microwave network and spectrum analyzer system, and 9500B and 9500D series automatic test systems can all serve as distributed systems satellites. Interface between satellites and the new 9700A distributed systems central system is via high-speed data communications hardware and

distributed systems software. The central supports the working-level operations of the satellites with disc-based storage for programs and data, and data processing assistance.

HP distributed systems make it practical and economical to automate large-scale operations in science and industry with minicomputers, with implementation accomplished in easy stages, satellite-by-satellite. Because each satellite can function on its own, unaffected by the failure of another, the distributed systems network provides

better reliability and faster response to local needs than a big computer. At the same time, interconnection gives big-computer advantages—disc-based program development that doesn't interrupt productive operations at the satellites, central program storage, sharing of data processing workloads, and multi-satellite access to a large common data base.

The 9700A central can communicate with IBM 360/370 systems at EDP centers, tapping the tremendous processing power and extensive library of data processing and report generating programs there.

Today, over 50 companies use HP distributed systems for computer-aided manufacturing, lab automation, materials handling, product testing, and process control. You can, too. For many applications, distributed minicomputer systems that think and work together offer many advantages including faster response to the needs of the distributed application, better reliability, and easier implementation.

For more information on linking your HP systems, check P on the HP Reply Card.

HEWLETT  **PACKARD**

East-4 Choke Cherry Road, Rockville, MD 20850
Ph. (301) 948-6370.

South-P.O. Box 28234, Atlanta, GA 30328,
Ph. (404) 434-4000.

Midwest-5500 Howard Street, Skokie, IL 60076,
Ph. (312) 677-0400.

West-3939 Lankershim Blvd, North Hollywood, CA
91604, Ph. (213) 877-1282.

Europe-P.O. Box 349, CH-1217 Meyrin 1, Geneva,
Switzerland, Ph. (022) 41 54 00.

Canada-6877 Goreway Drive, Mississauga, Ontario,
L4V 1L9, Ph. (416) 678-9430.

Japan-Yokogawa-Hewlett-Packard Ltd., Ohashi
Bldg., 59-1 Yoyogi, 1-chome, Shibuya-ku,
Tokyo 151, Ph. 03-370-2281/92.

ACROSS THE DESK

(continued from pg. 8)

Pnp circuits available for driving LEDs

In the article "Should You Use LCD or LED Displays?" (ED No. 23, Nov. 8, 1974, pp. 88-94), the authors, David Laws and Roger Ady, say on p. 92: "In the absence of low-cost monolithic pnp arrays, later designs have turned generally to a high-gain npn emitter-follower configuration."

I am afraid this statement has given an erroneous impression to your readers, in that monolithic pnp circuits designed for driving LED displays have been available for some time on the open market. Dionics Inc. is one company producing such circuits. They are being used in production quantities by a half dozen LED wristwatch manufacturers.

*George R. Seaton
Marketing Manager*

Dionics Inc.
65 Rushmore St.
Westbury, NY 11590

He'd rather fight than switch

While I agree with William Adams' sentiments regarding IEEE's value to the practicing EE ("Join the IEEE? He Asks, 'Why?'" ED No. 1, Jan. 4, 1975, p. 7), I am disappointed that he dropped out of the organization. IEEE claims to speak for 160,000 EEs, it controls the engineering schools, and it distributes career propaganda that is detrimental to the establishment of engineering as a profession.

Every practicing engineer who drops out of IEEE increases the proportion of nonpracticing IEEE members who dominate the organization today.

I believe that the way to establish engineering as a profession is by widespread PE licensing and through reform of IEEE.

Philip G. Dragonetti

13864-106th Ave. N.
Largo, FL 33540

A year ago we introduced 7 new JCM miniature RF coaxial connectors that "do the job for a fraction of SMA prices."

Here, by popular demand, are 8 more.



If you don't require all the electrical performance built into SMA type connectors, why pay for it? Up to 3 GHz for flexible cable assembly and even beyond 6 GHz for semi-rigid assembly, our new JCM series gives you the same electrical performance as the far more expensive SMA types. The series includes connectors for both panel and PC mounting. All are interchangeable and intermateable with the standard, expensive SMA connectors. So you can use them without making any changes . . . and without compromising required performance. There are JCM connectors to accept virtually any miniature size cable, so you don't have to stock a big variety. It's worth looking into, isn't it? All it costs is a stamp.

E. F. JOHNSON COMPANY / Waseca, Minnesota 56093

Dept. ED-4

Please check for technical information or test samples of our new low-cost series 142-0200-001 JCM connectors.

Please send technical information.

I desire test samples. Please call me at _____

NAME _____

FIRM _____

TITLE _____

ADDRESS _____

CITY _____

STATE _____

ZIP _____



E. F. JOHNSON COMPANY

INFORMATION RETRIEVAL NUMBER 7

**You can buy
this signal generator
for a 3-month job,
and then let it
gather dust.**

**You can rent
this signal generator
for a 3-month job,
and return it
when you're done.**



When you buy electronic test equipment for a short-term project, you're stuck with the equipment after the project is completed. Maybe it'll sit around gathering dust and costing you money. Or maybe you could sell it at a loss.

Or maybe, you should have rented it from REI.

When you rent equipment from us, you keep it only as long as you need it. When you're through with it, you send it back. Since you pay only for the time you have your instruments, you never have to spend your money on idle equipment. Short-term needs are just one reason for renting. Immediate delivery is another. Because we maintain over \$10 million in inventory in fully stocked instant inventory centers around the country, you can get delivery within hours.

REI stocks over 8,000 fully checked-out test instruments. And they're ready whenever you are. For the full story on renting as well as our low prices, send in the coupon for prompt delivery of our free illustrated catalog. Or call us now for your immediate requirements.

Rental Electronics, Inc.,
99 Hartwell Avenue, Lexington, Mass. 02173.
Please send me your free instrument rental catalog:

Name _____ Title _____

Company _____

Address _____

City _____ State _____ Zip _____

Tel. Number _____

Rental Electronics, Inc. 

A PEPSICO LEASING COMPANY

Burlington, MA (617) 273-2770 • Gaithersburg, MD (301) 948-0620 • Oakland, NJ (201) 337-3757 • Ft. Lauderdale, FL (305) 771-3500
Des Plaines, IL (312) 827-6670 • Dallas, TX (214) 661-8082 • Mountain View, CA (415) 968-8845 • Anaheim, CA (714) 879-0561
Rexdale, Ontario (PLC Leasing Ltd.) (416) 677-7513

INFORMATION RETRIEVAL NUMBER 8

Display show sees a future for electrochromic readouts

Electrochromic displays, which industry pundits predict will start replacing liquid crystals in two or three years, will be discussed in detail April 22-24 at the Society for Information Display's 1975 International Symposium and Exhibition in Washington, DC.

According to Dr. Ifay Chang, chairman of a panel session and a research staff member at IBM's center in Yorktown Heights, NY, electrochromic displays offer the advantages of good appearance and low power.

An electrochromic display is a reflective passive device with a very wide viewing angle, Chang notes. Another interesting feature is that, by choice of proper materials, it is possible to select background and display colors.

As if this weren't enough, Chang points out that electrochromic displays can be designed to have memory. What this means is that power is needed only to produce a change in the display. This can lead to significant reductions in power consumption.

Research work in progress includes the development of displays small enough for electronic wrist-watches and large enough for television applications.

Some stumbling blocks must be overcome, however, before electrochromic displays become viable. One is packaging. Electrochromic materials can be liquid, semi-liquid or solid, and experience is needed to develop the best package.

Another problem is that, like liquid crystals, electrochromic displays are slow. While this is not a major problem for such applications as electronic watches, it can be serious for TV or terminal uses. This problem, Chang reports, can be overcome by use of a beam-addressing approach. With this technique, a fast photoconductive

material is serially addressed by a beam, and it subsequently turns on the electrochromic display in parallel.

Another way of using electrochromic displays in a panel application, Chang notes, is in conjunction with thin-film transistors. These can be deposited on the same substrate as the display.

Although development work must still be done before the displays become commercially feasible, Chang believes that electrochromic watch displays can come as early as 1977.

In papers to be presented at another session on electrochromic displays, researchers from American Cyanamid and Zenith Radio will discuss the development of a display that uses solid inorganic films and another one that uses a reversible chemical reaction to produce a display with memory.

Refinements reported in ultrasonic imaging

For several years, medical researchers have used ultrasonic imaging to observe body tissues that can't be seen with conventional optical and X-ray equipment. But they have had no way of knowing precisely the intensity or pattern of the ultrasonic waves being used.

An ultrasonic measuring system from RCA is reported to overcome these problems. In addition the new system is said to make it possible for researchers to determine the effect that increasing or decreasing the frequency or intensity of the sonic waves has in detecting malignancies and other tissue malformations.

The system consists of an ultrasonic transducer in a water tank that contains a gold-plated mem-

brane. The membrane is 15 cm in diameter and just a few millionths of meter thick, and it functions like the diaphragm in a telephone, vibrating in proportion to the intensity of the sound waves that hit it.

The vibrations are detected by a scanning laser beam that is phase-modulated by the reflected light. An interferometer then compares the modulated beam with an unmodulated reference beam and produces corresponding electrical signals. These signals, which can be measured by meters or displayed on a cathode-ray tube, indicate the amount of sound that is being transmitted through the object.

According to Dr. Reuben S. Mezrich, a member of the RCA team that developed the equipment, use of a 15-mW laser with the system gives a potentially high sensitivity of about 5 nW per square centimeter. The dynamic range extends from several nanowatts to several watts per square centimeter.

The frequency response of the system ranges from 0.5 MHz to about 10 MHz, Mezrich says, and it can be used in a transmissive or reflective mode.

2 large computers join Univac line

Sperry Univac has unveiled two general-purpose, large-scale computers in its 1100 series, the 1100/20 and 1100/40. The machines have abandoned core memory for IC semiconductory memory. They provide new mass-storage capacity, new communications capability, better security and remote maintenance, according to the Roseville, NM, company.

The internal logic cycle time of the 1100/20 is 125 ns, allowing the semiconductor storage to be used at 875 ns per instruction. The 1100/40, the larger of the two machines, can execute one instruction every 300 ns.

The basic 1100/20 configuration can be expanded from a unit processor with 131,072 words of storage to one with 524,288 words.

A new mass-storage family for both the 1100/20 and 1100/40 consists of three disc subsystems that can be configured to a customer's

requirements. A fixed-head disc storage unit is available in two models, one providing 1.37 million words of storage and the other 680,000. Two removable pack discs provide 17 million and 34 million words of storage.

The communications system for the 1100/40 plugs into a terminal controller that is already in use with earlier 1100 series models. Requiring about half the floor space of the controller and using less power, the communication accommodates, via multiplexing, up to 32 half or full duplex lines. It can communicate concurrently with almost any mix of low, medium and high-speed data lines at from 45,000 to 50,000 bits per sec.

To protect against accidental data destruction, the 1100/20 features extensive control functions. And an identification/password combination protects against unauthorized access to data.

For remote maintenance, the user can connect his 1100/20 to the company's Total Remote Assistance Center in Roseville, where specialists can diagnose the problem and come up with solutions.

First customer deliveries of the 1100/20 are planned in July, and the 1100/40 in August.

Stepping motor curbs unwanted shaft motion

A serious drawback of stepping motors—uncontrollable, random motion of the motor shaft when operated in the region of system resonance, usually between 100 and 150 cycles—has been eliminated in a stepper unit that has optical, instead of salient-pole, steps.

In addition the new device, called Synstep by Dahmen Burnett Electronics, Londonderry, NH, can run either in a stepping mode or as a free-running slewing motor.

The key to the device, says James Burnett, its inventor, is the integration of an optical encoder with the rotor of a high-performance servo motor. When operating in the stepping mode, it is a true servo, with the output of the encoder driving the motor.

This combination greatly improves the damping ratio, Burnett points out, without sacrifice in high-speed performance or settling

time. The latter is on the order of 3 to 5 ms.

Another advantage, Burnett notes, is small power drain when the unit is standing still. Most other steppers, he says, draw from 20 to 200 W of full rated power when idle.

The Synstep design is also TTL-compatible, Burnett reports, using 0-to-5-V, 10- μ s pulses to run at more than 2000 steps per-second. The present encoder, which uses two phototransistors and two LEDs looks at two edges of encoder slots. The encoder has 200 elements, each 1.8° apart. Changes in the encoder design can vary the number of stepping increments, Burnett points out.

'Inside-out' generator mounts in plane's wing

An ac generator with four-and-one-half-inch hole through its center, to permit waveguide and signal and power cabling to pass through, has an "inside-out" design.

As developed by the Bendix Electric and Fluid Power Div., Eatontown, NJ, the relative positions of the alternator's rotor and stator are inverted. Whereas the rotor usually turns inside the stator, the Bendix rotor is secured to a fixed, large-diameter shaft whose center is hollow. The stator rotates around the outside of this assembly.

The generator is designed for mounting in the wing of a military aircraft. Rated at 20 KVA at 400 Hz, the moving portion rotates at 6000 rpm, according to Ralph Adams, engineering director at Bendix. The unit is about 5 in. long and has a diameter of 9 in.

Custom tests offered for logic diagrams

Give Bendix Test Systems Div. just the logic diagram of your circuit, and they will furnish you with test patterns and fault-isolation lists almost to the gate level. Proprietary software, not a circuit designer, does the job.

The program provides the following:

- A sequence of digital test inputs and corresponding outputs

that certify with 90% confidence that the circuit operates.

- A list of faults should the output pattern deviate from the calculated pattern.

This service is performed at Teterboro, NJ, on a 16-k mini called the BDX 6200. The output, furnished on cards and printer in Atlas language, can be used on your own in-house testing system. Atlas is very easy to read by a nonprogrammer and is standard with the airline industry.

A main advantage of the system is that it tends to generate rather short test sequences, compared with patterns that might be suggested by a designer. It also is less prone to error.

The system can handle circuits up to the equivalent of 1000 gates. CAFIG, as the system is called (Circuit Analyzer and Fault Isolation Generator), is already in use on the Air Force F-15 Repair Depot Program.

The cost of the service is \$1000 to \$3000 for a 100-gate board.

CIRCLE NO. 319

Study doubts wide use of multilayer PCs

Multilayer printed-circuit boards account for only 12.6% of the world's use of printed circuits, according to researchers at Darling & Alsobrook, Los Angeles-based management consultants. The finding is far short of the 25 to 30% penetration being indicated by some industry observers.

A study by the researchers notes a rapid rise in the popularity of multilayer boards in recent months, however.

Although multilayers are used at the high annual rate of 19.8%, our study shows that the consumption of both two-sided boards and flexibles will grow even faster through 1980," says Dr. John Salzer, vice president of Darling & Alsobrook. "While flexible circuits will only account for about 5% of the \$7.86-billion worldwide total PC consumption in 1980, they will have grown at an annual average of 29% to reach that level."

Other studies, Dr. Salzer believes, have projected the growth rate for multilayer boards too high because of their recent spectacular rise in acceptance.

Surprise! \$2.95

(10-49)

Wideband Transformers

- SURPRISE! Wide bandwidths, .015-600MHz**
- SURPRISE! Low insertion loss, 0.5dB**
- SURPRISE! Microminiature, .230" x .270" x .300"**
- SURPRISE! One week delivery**

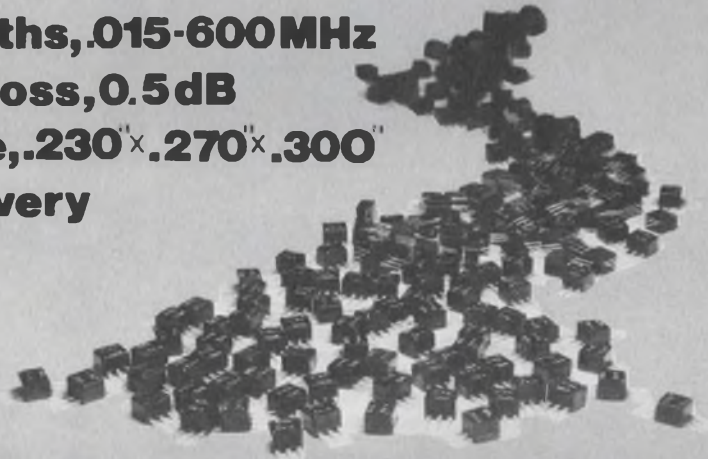

DESIGNERS KIT AVAILABLE:
 2 TRANSFORMERS OF EACH TYPE
 T1-1, T2-1, T4-1, T9-1, T16-1
 KIT # TK-1... **\$32.00**

NO "MAKE OR BUY" DECISION HERE... it costs less to buy Mini-Circuits wideband transformers and there's no delivery delay. Impedance levels from 12.5 to 800 ohms with insertion loss typically less than 0.5 dB

MODEL	T1-1	T2-1	T4-1	T9-1	T16-1
Impedance Ratio (50 Ω pri. imp.)	1	2	4	9	16
Bandwidth (MHz)	1db loss	2-50	.05-200	2-100	2-40
	3db loss	.15-400	.015-600	.2-350	.15-200
Price (10-49)	\$2.95	\$3.45	\$2.95	\$2.95	\$3.45

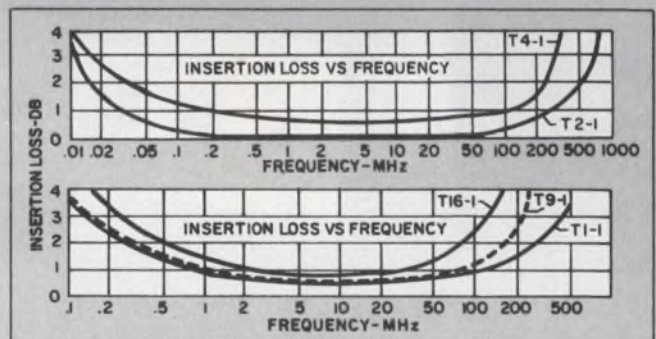

WE'VE GROWN

Customer acceptance of our products has been so overwhelming, we've been forced to move to larger facilities — THANKS.

Mini-Circuits Laboratory
 A Division Scientific Components Corp.

MCL

OUR NEW ADDRESS IS: 837-843 Utica Avenue, Brooklyn, NY 11203 (212) 342-2500 Int'l Telex 620156

Foreign Sales Representatives: AUSTRALIA General Electronic Services, 99 Alexander Street, New South Wales, Australia 2065; ENGLAND Dale Electronics, Dale House, Wharf Road, Frimley Green, Camberley Surrey; FRANCE S. C. I. E. - D. I. M. E. S., 31 Rue George - Sand, 91120 Palaiseau, France; GERMANY, AUSTRIA, SWITZERLAND Industrial Electronics GMBH, Klüberstrasse 14, 6000 Frankfurt/Main, Germany; ISRAEL Vectronics, Ltd., 69 Gordon Street, Tel-Aviv, Israel; JAPAN Densho Kaisha, Ltd., Eguchi Building, 8-1-1 Chome Hamamatsucho Minato-ku, Tokyo; EASTERN CANADA B. D. Hummel, 2224 Maynard Avenue, Utica, NY 13502 (315) 736-7821; ITALY Microel Italia s.r.l. via M. Loria 50, 20144 Milano & via Senafe 27, 00199 Roma; NETHERLANDS Coimex, Veldweg 11, Hallem, Holland

US Distributors: NORTHERN CALIFORNIA Cain-White & Co., Foothill Office Center, 105 Fremont Avenue, Los Altos, CA 94022 (415) 948-6533; SOUTHERN CALIFORNIA, ARIZONA Crown Electronics, 11440 Collins Street, No. Hollywood, CA 91601 (213) 877-3550

For complete U.S. Rep listing and product line see MicroWaves' Product Data Directory

NORLAND INSTRUMENTS
Announces the newest generation of
test and measurement instrumentation.



Military turning to CMOS/SOS for radiation-hardened circuitry

While commercial ventures into SOS (silicon on sapphire) technology have been marked more by failure than success, military-sponsored research is in hot pursuit of CMOS/SOS because of its inherent resistance to radiation.

Tests have shown that conventional MOS and bipolar circuits are apt to be damaged by the X-rays and gamma rays of nuclear explosions but that SOS can take considerable punishment.

Some commercial attempts at developing SOS circuitry have fizzled after much ballyhoo—a microcomputer that Rockwell International was to build for General Automation, for example. Inselek in Princeton, NJ, has filed for bankruptcy after a big investment in commercial SOS. And RCA has been slow getting off the mark with commercial SOS, though its first products employing the technology have finally reached the market.

The Air Force Space and Missile Systems Organization at Norton AFB, San Bernardino, CA, has just let two contracts, each for two years, to Rockwell International and the Northrop Research and Technology Center, Hawthorne, CA, for the study of radiation-hardened circuits for the MX advanced computer. Although the Air Force doesn't require it, both companies have indicated that they plan to use CMOS/SOS for the processor and MNOS/SOS for the memory in the study programs.

In addition to the Air Force program, extensive study is being funded by the Naval Research Laboratory in Washington, DC. RCA, Hughes Aircraft at Newport Beach, CA, and others are

attempting to perfect CMOS/SOS LSI for the Navy as a radiation-hard technology.

Capt. Joe Dunn, components manager on the MX project at the Air Force Space and Missile Systems Organization, says: "We are interested in CMOS/SOS technology because of its radiation hardness, speed and low power dissipation. Although CMOS/SOS is not a requirement of the MX con-

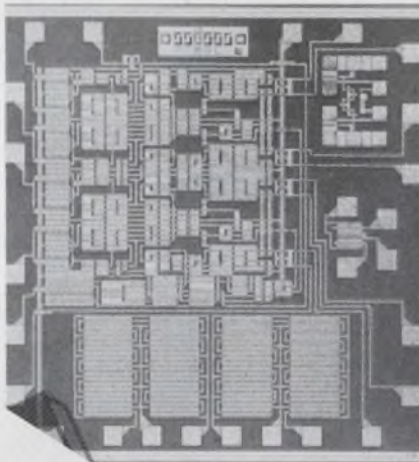

CMOS silicon-on-sapphire circuits, such as this 4008-type 4-bit adder from Rockwell International, are undergoing tests to develop radiation-hardened MOS/LSI circuits. This chip has 170-transistor complexity and a chromium-doped gate oxide.

tracts, it may be required to do the job."

Dr. Harold Hughes, head of experimental devices at the Naval Research Laboratory, notes: "We have seen encouraging results so far in experiments with simple CMOS/SOS inverters and adders. We are now developing and testing 8-bit adder circuits with respect to radiation hardness. When these tests are completed, we hope to commit CMOS/SOS technology to some hardware programs. This

could happen within a year."

H. Dean McKay, president of AH Systems, Chatsworth, CA, says that the main advantage of SOS in a radiation environment "is the reduction of transient photocurrent generation." The military calls this ionizing dose rate tolerance.

Improved dose rate tolerance

Photocurrent generation is proportional to the volume of the bulk silicon in the channel between the source and the drain. In a conventional MOS device the circuit sits on a large chunk of silicon that has a large volumetric area through which the photocurrents can flow. In an SOS structure only a thin layer of silicon is deposited over a single crystal of sapphire.

The area in which the photocurrents can flow is so greatly reduced that, according to James E. Bell, director of engineering sciences at the Electronics Research Div. of Rockwell International, Anaheim, CA, "we see a three-to-four-order-of-magnitude improvement in ionizing dose-rate tolerance." The tolerance goes from about 10^6 rads/s to better than 10^9 rads/s, he says.

An increase in the tolerance to total ionizing dose can be achieved in more than one way. Rockwell builds CMOS/SOS with an aluminum gate and a silicon-dioxide gate insulator. Rockwell finds that chromium doping of the gate oxide increases total ionizing dose tolerance.

Bell points out that it is a two-step procedure. First, an ultra-clean gate oxide must be deposited. This is followed by shallow doping of chromium in the silicon dioxide. The doped gate insulator is not only resistant to charge trapping

David N. Kaye
Senior Western Editor

The NI 2001 Programmable Calculating Oscilloscope

Here is the ultimate instrument for the acquisition, processing and manipulation of electrical data. It completely eliminates the need to compromise your requirements with a jumbled array of separate instruments. The NI 2001 is a *complete* unit that combines all the capabilities of a digital oscilloscope and a microprocessor in a single mainframe. It brings you flexibility, convenience, accuracy and reliability you won't find anywhere else.

This — the first programmable calculating oscilloscope — is the product of many years of technological research and instrumentation engineering. With the advent of microprocessor technology, Norland Instruments engineers were quick to recognize the power available to the instrument designer and first applied a microprocessor to the Norland line of medical instruments. That experience ultimately led to the use of microprocessor technology in the development of the NI 2001 — the first truly new generation of test and measurement instrumentation for the industrial and scientific user.

The NI 2001 gives you the precision of a digital oscilloscope for data acquisition and display *plus* the built-in capability of a microprocessor for data reduction. You can make exact

calculations of rise times, integrals, differentials, peak areas, RMS values, peak-to-peak measurements, n-point averaging, and an almost unlimited range of other operations. It increases your productivity by letting you measure, display, digitize, store and process data faster and more accurately than ever before. The NI 2001 will analyze data and, through conditional branching, function as a decision making instrument. It is easily programmable — without computer instructions — so repetitive operations can be completely automated. Its mainframe, through modular design, has provisions for a wide range of plug-in modules to let you expand your system to meet individual requirements. It can even be interfaced to control other equipment.

Now, consider the economics. Surprisingly, the NI 2001 mainframe is \$8,500. The instrument shown here, with monitor and two single-channel plug-ins, can be yours for \$13,400!

You've waited a long time for an instrument as versatile as the Norland Instruments NI 2001. Wait no longer. To arrange for a demonstration and complete information, send the reader service card or write Norland Instruments, Department A-2.

See the NI 2001 at IEEE INTERCON, April 8-10, Coliseum, New York, Booth 2732-4.



NORLAND INSTRUMENTS

A Subsidiary of Cordis Corporation

Norland Drive, Fort Atkinson, Wisconsin 53538 U.S.A.

INFORMATION RETRIEVAL NUMBER 10
FOR DEMONSTRATION 180

The \$125 bargain.

It's MMI's 6701 bipolar microcontroller.

Replaces up to 25 packages of 7400 logic. At standard TTL cost per gate—but without the interface problems and costly PC real estate required by smaller devices. Whether they want it to emulate a CPU or replace a lot of MSI TTL, your designers can design **with** our 6701, not **around** it. At \$125 each in small quantities, it's a real bargain. Now available from stock at:

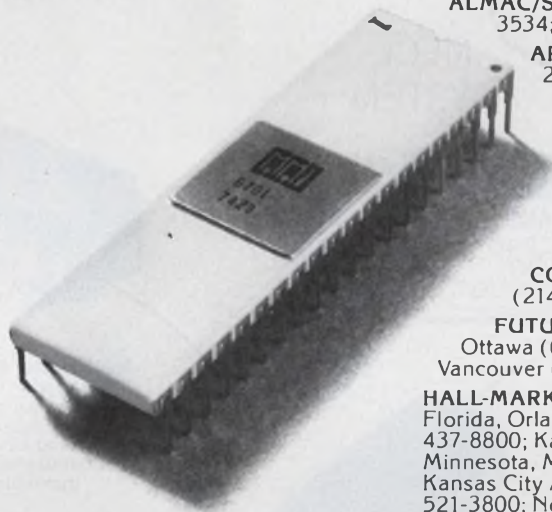

ALMAC/STROOM: Oregon, Portland (503) 292-3534; Washington, Seattle (206) 763-2300.

ARROW: Connecticut, Hamden (203) 248-3801; Maryland, Baltimore Area (202) 737-1700; Massachusetts, Boston Area (617) 273-0100; Minnesota, Minneapolis Area (612) 888-5522; New Jersey, Saddlebrook (201) 797-5800; New York, New York City Area (516) 694-6800; Ohio, Cleveland (216) 464-2000, Dayton (513) 253-9176; Pennsylvania, Philadelphia Area (609) 235-1900.

COMPONENT SPECIALTIES: Texas, Dallas (214) 357-4576, Houston (713) 771-7237.

FUTURE: Canada, Montreal (514) 735-5775, Ottawa (613) 232-7757, Toronto (416) 677-7820, Vancouver (604) 261-1335.

HALL-MARK: Alabama, Huntsville (205) 539-0691; Florida, Orlando (305) 855-4020; Illinois, Chicago (312) 437-8800; Kansas, Kansas City Area (913) 888-4747; Minnesota, Minneapolis (612) 884-9056; Missouri, Kansas City Area (913) 888-4747, St. Louis (314) 521-3800; North Carolina, Raleigh (919) 832-4465; Oklahoma, Tulsa (918) 835-8458; Texas, Dallas Area (214) 231-6111, Houston (713) 781-6100; Wisconsin, Milwaukee (414) 476-1270.

INTERMARK: California, San Francisco Bay Area (408) 738-1111, Los Angeles Area (213) 436-5275, San Diego (714) 279-5200; Colorado, Denver (303) 936-8284; Washington, Seattle (206) 767-3160.

KIERULFF: Arizona, Phoenix (602) 273-7331; California, San Francisco Bay Area (415) 968-6292, Los Angeles Area (213) 685-5511, San Diego (714) 278-2112; Colorado, Denver (303) 343-7090; District of Columbia (301) 948-0250; Maryland, Baltimore Area (301) 948-0250; Massachusetts, Boston Area (617) 935-5134; New Jersey, Rutherford (201) 935-2120.

PIONEER: Indiana, Indianapolis (317) 849-7300; Michigan, Livonia (313) 525-1800; Ohio, Cleveland (216) 587-3600, Dayton (513) 236-9900; Pennsylvania, Pittsburgh (412) 782-2300.

SUMMIT: New York, Buffalo (716) 884-3450, Rochester (716) 334-8110.

TECHNICO: Maryland, Baltimore Area (301) 828-6416.



do not live memories alone...

MC10177 Triple MECL-to-MOS Translator (N-Channel)
Designed for NMOS memory systems as a Read/Write, Data/Address driver. May be used for other applications requiring the capability to drive high-capacitive loads.

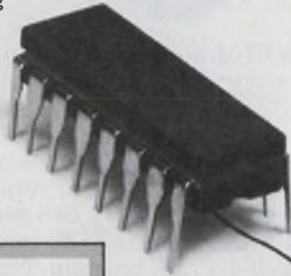

Your selection of NMOS memories for that new system is only the first step in providing a high-performance, cost-effective memory system. To fully utilize NMOS technology capabilities you have to consider interfacing trade-offs that affect overall system performance.

Motorola's new interface functions draw upon linear and MECL 10,000 processing technologies to create a new generation of interface devices that reduce system trade-offs to a minimum. These new functions offer higher speed, greater drive capabilities, and increased package functionality. Take a look at a few typical application areas.

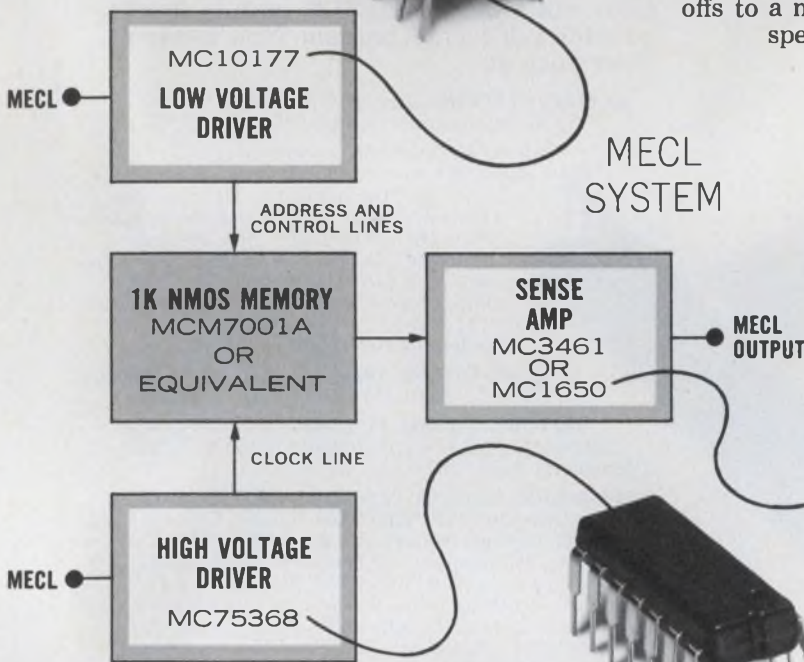

MC1650 Dual A/D Comparator
Used to maximize speed in MECL systems, typical prop delay 3.5 ns. Requires a low overdrive, low switching current, and has a latch for data storage. Complementary outputs permit maximum utility.

MC75368 Dual NMOS Driver
Accepts standard MECL 10,000 and IBM grounded-reference ECL input signals and creates high-current and high-voltage output levels suitable for driving MOS circuits. May also be used as MECL-to-MTTL translators.

MC75365 Quad MOS Clock Driver
Ideal for driving highly capacitive Address, Control and Timing inputs on a variety of MOS RAMs such as the "1103" and "6605" types. Usable over a wide latitude of supply voltages.

Interfacing is on the Move!

Your NMOS memory can't go it alone. Advanced memories dictate new interfacing specifications. Future functions have already been defined to keep pace with NMOS RAM expansion and innovations such as microprocessor chips and high-speed minicomputers.

Applications and device specifications for the functions displayed here are available on request from Motorola Semiconductor Products Inc., P.O. Box 20912, Phoenix, AZ 85036 or any authorized Motorola distributor and OEM sales office. Evaluate your interfacing requirements now . . . we'll help you face up to your problems!



MOTOROLA LINEAR
Interface—The End Is Nowhere In Sight

INFORMATION RETRIEVAL NUMBER 132

System designers by NMOS

MC3459 Quad NMOS Memory Address Driver
Specifically designed to supply highly capacitive address line requirements. Especially useful in larger systems where paralleling of numerous memories requires a powerful driver.

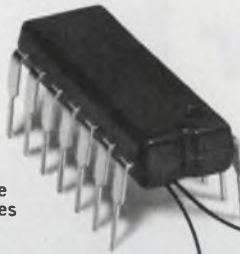

MC3461 Dual NMOS Memory Sense Amplifier
A complete functional block to overcome problems of level shifting, input termination resistors, odd power supply requirements, and long propagation delays. Typical response prop delays; Amplifier (5.0 ns), Enable (2.5 ns), Latch (1.0 ns).

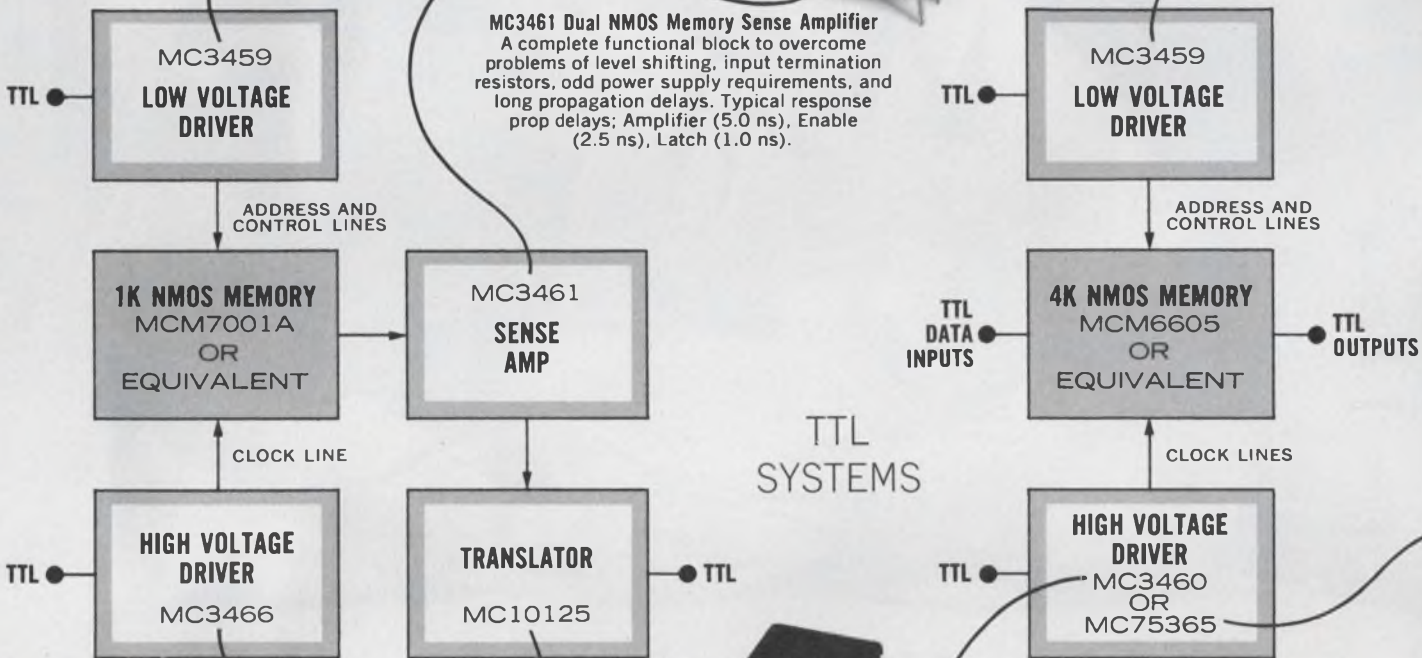
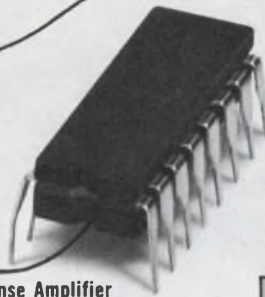

MC3466 Quad NMOS Memory Clock Driver
Meets the higher clock line voltage needs of "7001" type memory systems. With proper inputs, all four drivers may be deactivated for standby operation; or single driver may be activated for READ/WRITE operation.

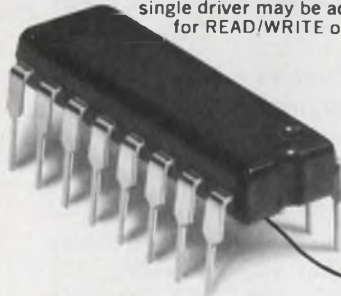

MC10125 Quad MECL-to-MTTL Translator
A versatile device for interfacing the sense amplifier MECL outputs to saturated logic sections of digital systems. Typical prop delay is 4.5 ns.

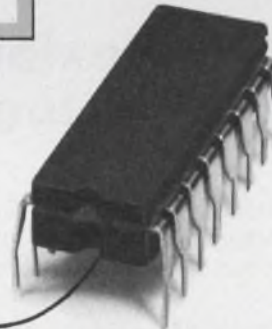

MC3460 Quad NMOS Memory Clock Driver
Similar to the MC3466 but is specified for 4K memory applications. Prop delay times with a 480 pF load and operating in the READ/WRITE mode are less than 25 ns. All four drivers may be activated for REFRESH operation.

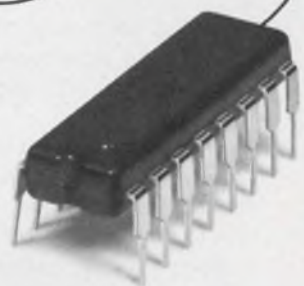

Be serene in your logic.



Attain flexibility with TRW/Cinch logic boards.

You can be master of logic changes. Total flexibility in the interconnection of integrated circuits is the soul of I.C. logic boards from TRW/Cinch Connectors.

For prototyping and short production runs, TRW/Cinch has assembled a line that gives you these features and options:

- High density DIP boards in 14 and 16-pin patterns (in 30-pattern multiples up to 180) or universal boards that accept 8 to 40-lead IC's.
- Socket terminals accept rectangular or round pins. Have two or three-level wire wrap* terminals.
- FR-4 epoxy glass $\frac{1}{8}$ " boards, with power and ground planes on opposite sides.
- Complete line of interconnection accessories.

Since we believe in flexibility, our application engineers are available to assist in the development of custom board designs.

Fast, off-the-shelf delivery is available through these distributors and their branches in all major market areas:

- Pioneer-Standard Electronics • Rampart Components • RESCO Electronics • Sterling Electronics • Wilshire Electronics

Write or call your local TRW/Cinch logic board distributor or your local TRW/Cinch sales office or TRW/Cinch Connectors, an Electronic Components Division of TRW Inc., 1501 Morse Avenue, Elk Grove Village, Illinois 60007, phone (312) 439-8800.



We make deliveries

FMC 40C Thyristors are available for off-shelf delivery and immediate installation. Designed in a T065 case, this power semiconductor replaces bulky T094 and T083 packages and upgrades 35 amp devices to 40 amp.

The FMC 40C Thyristor is equivalent to IR-40RCS and GE-C147 and operates at a higher case temperature of 95°C.

For detailed information, contact:
FMC Corporation
Semiconductor Products Operation
Homer City, Pa. 15748
(412) 479-8011

FMC Special
Products

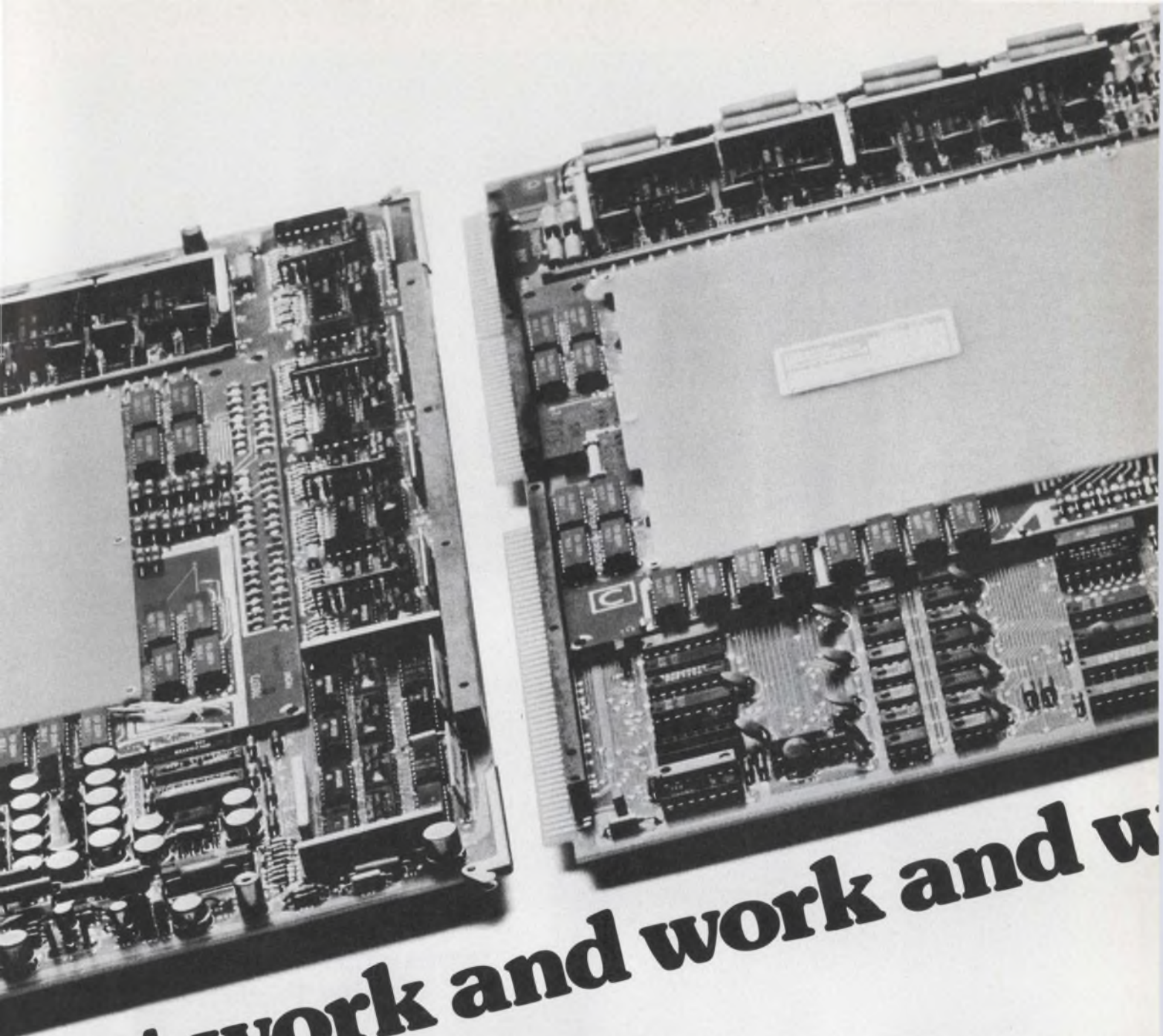

that work and work and work

If you've got a NOVA mini, Plessey Memories can save you more than money.

Our 16k PM-216 core memory module saves time on your NOVA 2/4 or 2/10, with a cycle time of just 800 nS.

Our PM-816 saves a slot in your NOVA 800, 820 and 840 cpu, with 16k words on a single plug-in card. It is also plug-compatible with the NOVA 830. And with the 800 nS Plessey PM-816 an expanded NOVA 840 costs less than a slower NOVA 830 with DGC memory.

There's just no reason to pay more for less.

So use the bingo card and get all the details on our NOVA (and DEC) add-ons—compatible memories, memory management and support equipment. They're all competitively priced and available off-the-shelf.

Or if your problems won't wait, phone for a demo and get Plessey Memories working for you today.

Plessey
Memories (714) 540-9945
The mini expanders

U.S.A., Santa Ana (714) 540-9945 Canada, Ottawa (416) 661-3711 United Kingdom, Towcester (0327) 50312 Switzerland, Geneva (022) 33-97-30 France, Paris (01) 727-43-49 Germany, Munich (089) 351-6021 Netherlands, Noordwijk (01719) 4847 Belgium, Brussels (02) 3745971 Italy, Milan (02) 349-1741 Sweden, Stockholm (08) 23-55-35 Spain, Madrid (01) 241-3230

Plessey's contribution to the Nova

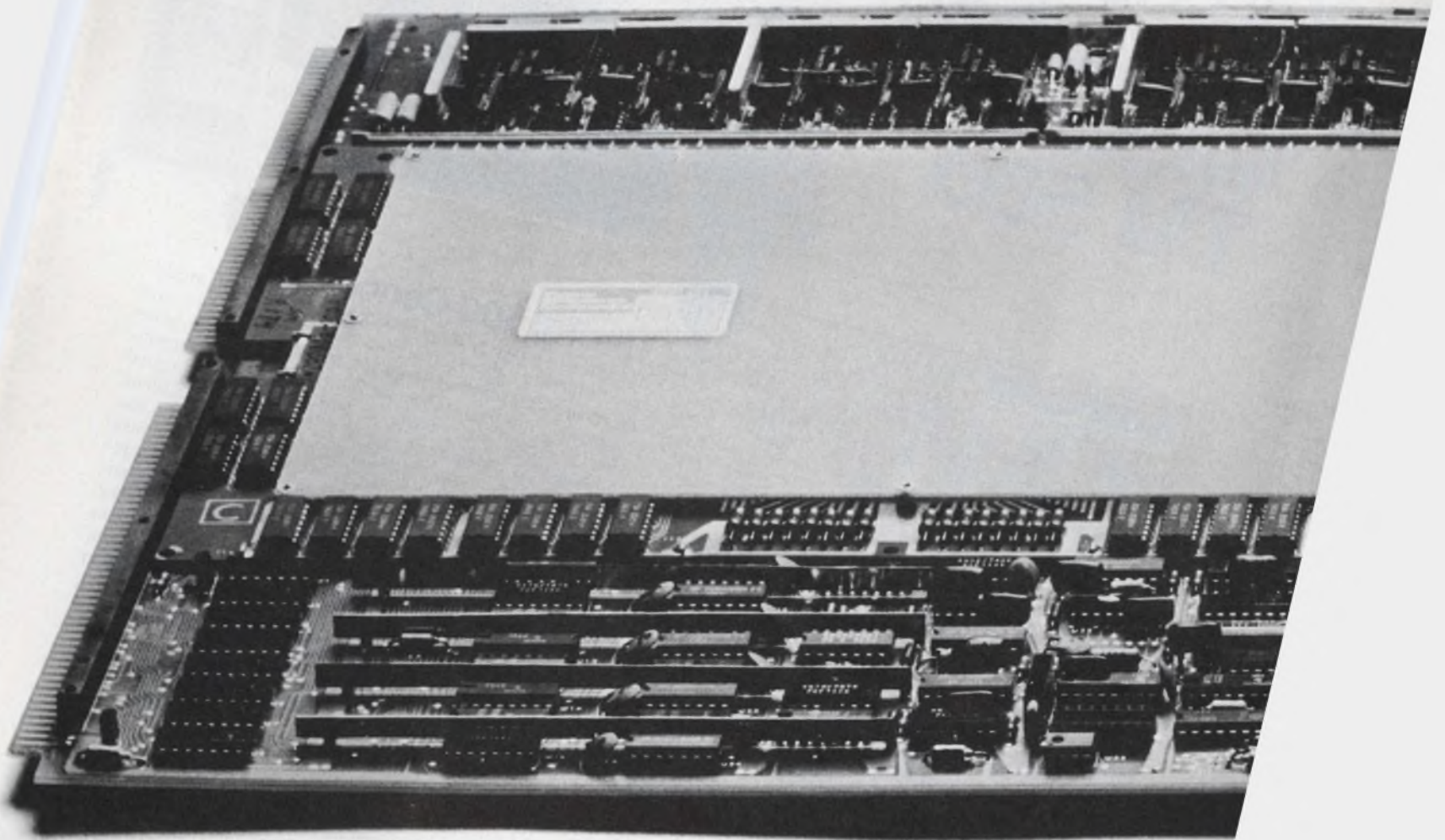

Memory add-ons

If you design with ECL or TTL, You need to know about Tektronix TM 500



If You're into High Speed Logic, the Tektronix TM 500 High Speed Logic Instrumentation plus the Tektronix 485 Oscilloscope (350 MHz) or 475 Oscilloscope (200 MHz) provide all the instrumentation you need for TTL or ECL up to 250 MHz. The four plug-ins of the TM 500 High Speed Logic system are a PG 502 Pulse Generator (\$1195) with 1 ns rise time and independently variable logic 1 and 0 levels... a DC 505 Digital Counter (\$1395) with 10 ns single shot resolution and averaging to 100 ps... A DM 501 Digital Multimeter (\$550) with temperature measurement capability added to all its conventional functions (so you can verify operating temperatures of logic IC's and detect hot spots in tightly packed circuitry)... and the PS 505 Power Supply (\$175) with the 3.0 to 5.5 V dc high-current (4 A) output essential for breadboarding or testing TTL and ECL devices. Also, you can expand the capabilities of the system to provide jitter-free oscilloscope triggering for viewing any segment of long pulse sequences by including the DD 501 Digital Delay (\$495). The 485 Oscilloscope features dual trace, 1 ns rise time, and delayed sweep.

Whatever Pursuit in Electronics You're Into, you should learn more about TM 500 instrumentation. A particular group of plug-in modules in a four-hole mainframe provides the instruments most often needed in telecommunications, another fulfills the needs of industrial instrumentation calibration and troubleshooting, another for medical instrumentation, others for education, and so on.

The TM 500 Concept,

TM 500 is a growing, compatible family of 29 plug-in modular instruments, accessories, and one, three, and four-hole mainframes providing the common power supply. *It's multi-functional:* The plug-ins include 11 signal sources, 5 counters, 2 digital multimeters, 5 power supplies, 3 signal processors, 1 oscilloscope, 1 X-Y monitor and even a blank plug-in kit, so you can assemble the specialized circuits you require. *It's versatile:* You can select from general-purpose instruments, such as the DM 501 Multimeter, or highly specialized instruments such as the TG 501 Time Mark Generator. You can select a system of instruments exactly tailored to your needs. *It's synergistic:* The instruments can "work together" through a common interface circuit board, so your lab bench needn't be cluttered with interconnecting cables. *And it's neatly configurable:* The TM 501 (one), TM 503 (three), and TM 504 (four-compartment) mainframes are attractive and compact. Since the typical four-instrument system only weighs about 20 pounds, it can be hand-carried as easily as it goes onto a bench. The TM 504 (\$225) is only 11" W x 6" H x 20" D. In rack mounting, each bay contains six instruments. And Tektronix SCOPE-MOBILE® carts let you put your entire instrumentation requirements on wheels.

Find Out What TM 500 Can Do For You. Get the new TM 500 Booklet A-3072 with full specifications and suggested package configurations, or contact your local Tektronix Field Engineer for a demonstration. Or write to Tektronix, Inc., P.O. Box 500, Beaverton, Oregon 97077. In Europe, write Tektronix Limited, P.O. Box 36, St. Peter Port, Guernsey, Channel Islands



tion by the most competent organizations. And to counter cries that the Government should never grant an exclusive license for a patent it owns, he said this was a good way of ensuring sometimes that an invention would not be used. In summary, Dann commented: "The more important the technological goal—whether it be energy, the environment, medicine or anything else—the more important become the incentives which patents provide."

FCC reconsiders overseas communications

The pace of technology is prompting the Federal Communications Commission to take a new look at its guidelines for licensing facilities for overseas communications. In 1970 the agency drew up the guidelines for use in the decade—such as promoting the development of both cable and satellite systems and authorizing systems with due regard for efficiency, economy, diversity and redundancy. Progress, however—particularly in long-distance submarine cables and satellite communications—plus the growth in requirements, has convinced the FCC its concepts may be in danger of being outdated.

So it's starting a re-evaluation of the trans-Atlantic situation as a starter, looking at expected traffic, available facilities and the proper mix, among other things. It will also review the state of technology, the expected service life of facilities and compare the facilities envisioned for the late '70s and early 1980s.

Capital Capsules: Random interlace cameras have been manufactured since the development of industrial television cameras, but there hasn't been a standard waveform for this class. Now the Electronic Industries Association has one: **RS-420 "Electrical Performance Standards for Monochrome Closed-Circuit Television Cameras 525/60 Random Interlace."** Also new from the EIA is a revision of "Minimum Standards for Portable/Personal Land-Mobile Communications FM or PM Equipment 20-1000 MHz," **RS-316-A.** . . . The Dept. of Commerce has **extended the life of its Telecommunications Equipment Technical Advisory Committee for two years.** This industry unit advises on technical matters and licensing procedures that may affect export controls on telecommunication equipment. . . . A one-year program to establish **quality-assurance criteria for hybrid microcircuit manufacturing lines** is a new project of the Army Electronics Command. . . . Companies or organizations interested in building and operating a **demonstration centrifuge enrichment facility** for ERDA now have until Sept. 2 to respond to a request for proposal from that agency instead of April 1. . . . The Air Force is **identifying companies that can participate in planned improvements** to the existing 487L survivable low-frequency communications system and the advanced airborne command post very-low-frequency/low-frequency system. . . . Under way is a **program for the development and production of a unique calibration receiver for the Navstar global positioning system.** The Air Force Systems Command says it's seeking sources among firms that have experience in receivers, calibration equipment, spread-spectrum technology and psuedo-noise and code-correlation techniques. . . . NASA officials say that **on-going research on gaseous fuel nuclear reactors indicate they may have a unique characteristic** that could make them prime candidates for the future—they can burn up the nuclear waste materials they generate. The theory is that radioactive wastes can be rendered harmless by bombardment by neutrons, which such units generate in large numbers.

washington report

Solar energy progress linked to silicon sheets

The nation's 1985 solar-energy objective is to establish a large-scale plant that could supply 500 MW of sun power a year, but success hinges on finding an automated process of producing silicon sheets. Other major tasks, according to the National Aeronautics and Space Administration, are developing higher-grade, lower-cost silicon, the automated assembly of solar-cell arrays and a successful program to prove technical feasibility by 1980.

If all goes well, several pilot manufacturing plants could be constructed in the early 1980s and a full-scale solar plant by 1985. There's a way to go yet, as pointed out by Jet Propulsion Laboratory specialists in a recent briefing on the nation's 10-year solar photovoltaic energy program. At present annual production of silicon photovoltaic devices in the U.S. amounts to only 60,000 W capacity, 90% of which is being used in the space program.

HEW hopes to replace its computer equipment

The Dept. of Health, Education and Welfare is planning the "fully competitive replacement" of all its large-scale computer equipment.

Working with General Services Administration, it will put the plan into operation in phases to minimize disruption. The first procurement of equipment will start in July. The procurement for most offices involved—such as the Social Security Administration, National Institutes of Health and departmental units—will span two to three years. HEW officials point out that the long-range acquisitions must be approved by the Office of Management and Budget, the Office of Telecommunications Policy and that final big hurdle—Congress.

Radical patent changes not in the cards

Don't look for great changes in the nation's patent policy, despite strong efforts by reformers in Congress and elsewhere. The Commissioner of Patents and Trademarks, C. Marshall Dann, speaking for the Ford Administration, recently chastised those "who are much more concerned with dividing up rights in whatever technology we have or may create than in providing the best climate for the creation of new technology."

In response to arguments that all inventions emerging from Government-funded research should belong to the Government to the exclusion of the contractor, he warned that this would tend to discourage participa-

KEPCO

your source for digitally programmed d-c power supplies



This, for example, is a typical digitally-controlled voltage stabilizer, comprising a standard Kepco plug-in power supply with the new Kepco SN Digital Interface.

The combination produces 0–100 volts, 0–200 mA with 12-bits resolution. The power supply is a Model PCX 100–0.2MAT programmed by an SN–12 Digital Interface Card mounted on a slide adapter and fitted to a dual-slot bench style enclosure.

There are hundreds of similar Kepco Power Supplies, ranging from 0–6V @ 90 A to a model that can produce –5000V @ 5 mA. Because they're rated as *operationally programmable*, these models can be combined with one of the five Kepco SN Digital Interfaces to produce a custom digital voltage or current source, tailored to your needs.

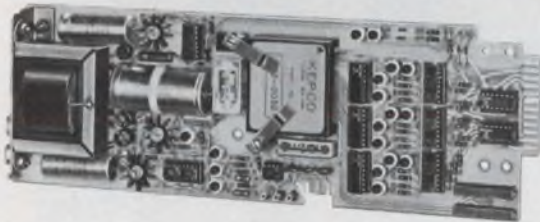

The SN Digital Interface Card accepts your data input on parallel lines, strobed for noise immunity, and stores the data in a buffer register. For isolation, the program is transferred across optical couplers so that your digital signal and the power supply it controls can be up to 1000V apart. The five SN Cards offer a choice of BCD or complementary binary programming.

The analog output from the SN Card is in the form of a 0–1V/0–10V range selected signal* that is linearly amplified by the companion power supply to produce the desired output. In the illustrated combination of SN–12 and a Kepco Model PCX 100–0.2MAT, the power supply functions as a fixed gain-of-ten power amplifier to produce a digitally-controlled output, 0–100V with 12-bits (0.024%) resolution. The range selector on the SN allows the full resolution to be spread over the lowest 10% of the output: 0–10V d-c.

*The SN Card also produces $\pm 10V$ & $\pm 5V$ outputs to control bipolar power supplies and 0.5V, 1.0V outputs to control current stabilizers.

SN CARDS AVAILABLE

MODEL	RESOLUTION	LINEARITY
SN–2	2 BCD	$\pm 0.2\%$
SN–3	3 BCD	$\pm 0.05\%$
SN–8	8-bit	$\pm 0.2\%$
SN–10	10-bit	$\pm 0.05\%$
SN–12	12-bit	$\pm 0.01\%$

These SN Cards are fully self-contained digital programmers, featuring an on-card line operated power supply. Kepco offers a variety of housings and accessories to accommodate them to various programmable power supplies. As many as eight cards can be accommodated in a standard 5¼" x 19" panel.

For complete specifications, write Dept. EW - 5

KEPCO®



KEPCO, INC. • 131-38 SANFORD AVENUE • FLUSHING, N.Y. 11352 • (212) 461-7000
TWX = 710-582-2631 • Cable: KEPCOPOWER NEWYORK

INFORMATION RETRIEVAL NUMBER 26

are critical...

to your board and connector needs

CONNECTOR



RACK AND PANEL

*Microminiature . . . Subminiature
Miniature . . . Removable Contact*

Choose from a wide variety of rectangular plug and socket connectors that meet or exceed applicable paragraphs of MIL-C-27848 specifications. Available with four to 104 contacts and optional polarizing screwlocks, aluminum hoods, protective shells and guide pins and guide sockets.

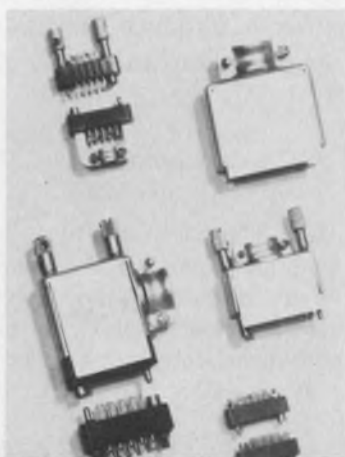

CATALOGS AVAILABLE!



CONTINENTAL CONNECTORS

CONTINENTAL CONNECTOR CORPORATION • WOODSIDE, NEW YORK 11377

connections

find the answers
printed circuit
rack and panel
from
CONTINENTAL

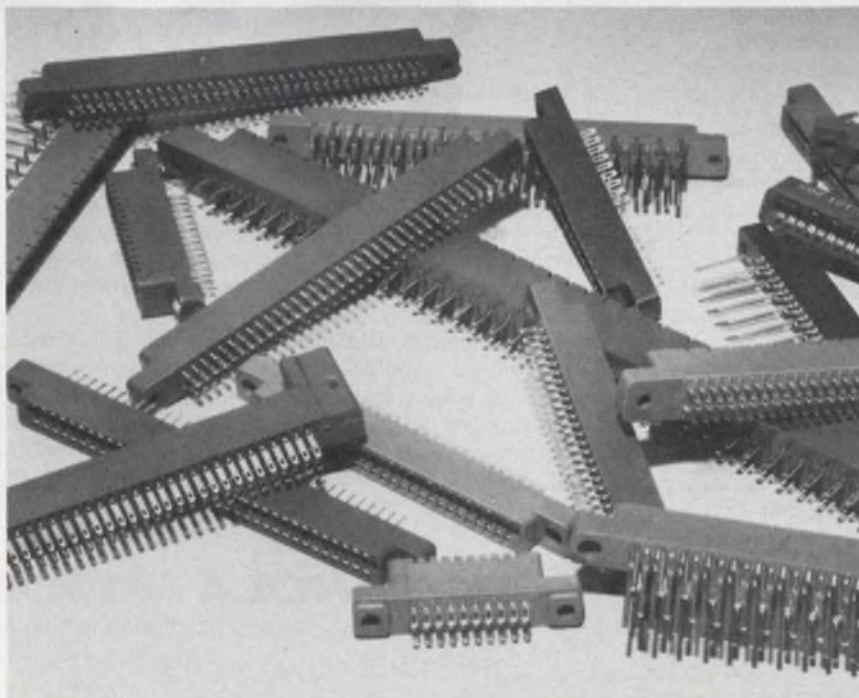
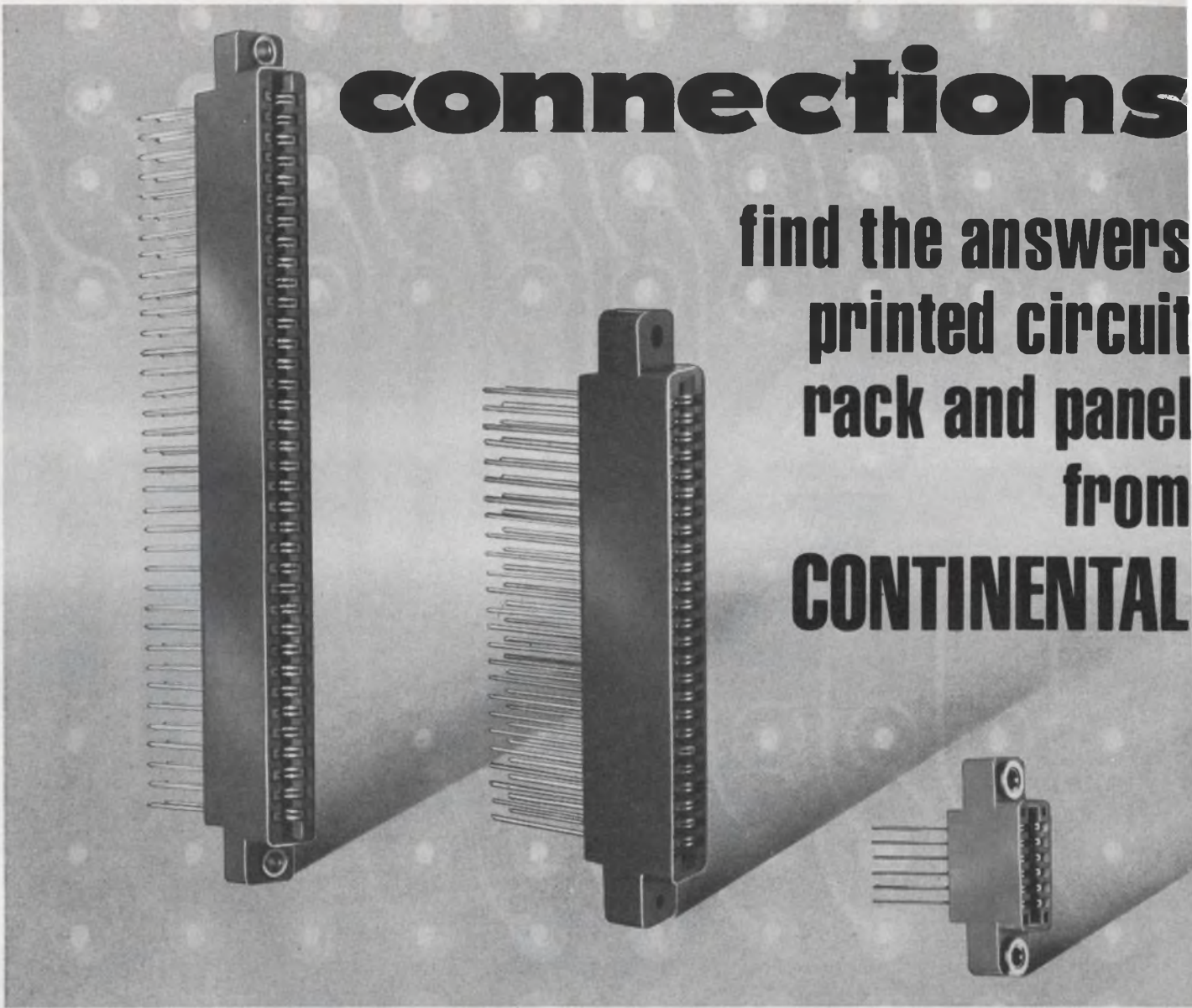

PRINTED CIRCUIT BOARD CONNECTORS

Extensive lines of receptacles, right angle plug and socket and test point provide positive, space-saving connections between printed circuitry and conventional wiring through pc boards, tape cable or "plug" mounted sub-assemblies. Receptacles accommodate 1/32", 3/64", 1/16", 3/32" or 1/8" board thickness with single or dual readouts on .050", .075", .100", .125", .150", .156" and .200" contact centers. Wiring styles include terminations for wire-wrapping (.025" and .045" square terminals), eyelet lug and dip solder.



*For the Sales Representative
Nearest You, See Our Listings
in EEM & Gold Book Directories,
or Phone (212) 899-4422 for
Immediate Action*

M68000

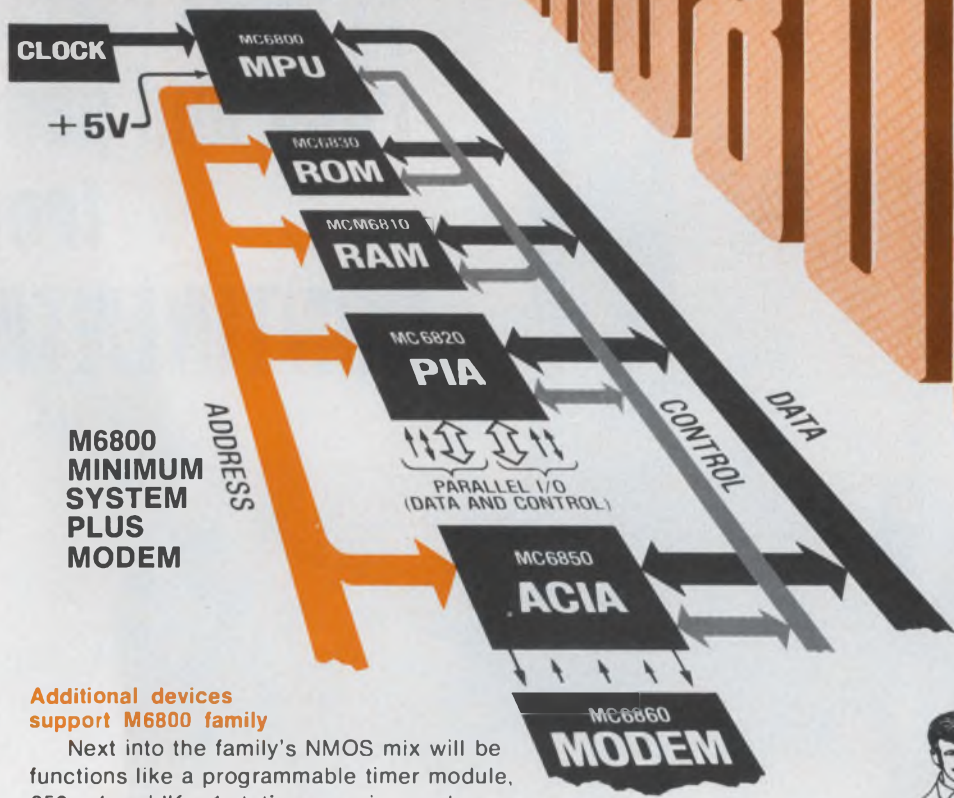

**M6800
MINIMUM
SYSTEM
PLUS
MODEM**

Retailers and their customers are taking advantage of MPU-based intelligent terminals.



Consumers are beginning to see typical bookkeeping and control functions handled by micro-computer systems.



Additional devices support M6800 family

Next into the family's NMOS mix will be functions like a programmable timer module, 256 x 4 and 1K x 1 static memories, and a synchronous serial data adapter. While the family includes memories, others are often desirable. Additional appropriate Motorola memories are the MCM6831 8K ROM, the MCM6832 16K ROM, and the MCM6815 dynamic 4K RAM.

Motorola's Linear products group has designed a new family of interface functions around the memories and MPU family, and our CMOS people have come up with supplemental functions including a bit rate generator available now, and a new RAM and Tone Encoder on the way.

M6800 Software and Hardware Motorola's M6800 support software is a cohesive, interactive system for program development and checkout available on both G. E. and United Computing Service timesharing. A Fortran IV source deck cross assembler for 16 and 32-bit machines is available for customer host computers.

Hardware system development tools are the MEC6800 Evaluation Module, a complete minimum microcomputer system on a single board with RS232 interface, and the EXOR-ciser*, a system prototyping minicomputer complete with power supply and functional board options.

Other diverse support activities include a three-day technical design seminar in Phoenix and major U.S. cities throughout '75.

What it's all about: Simplify design, reduce costs!

All this distills to the simple idea that the M6800 family system architecture is designed to achieve •Minimization of components •Minimization of support packages •Interface simplicity •Minimization and simplicity of power requirements •System throughput.

There's a Motorola salesman ready to help you keep up with the leaders . . . and ahead of the rest. Get more detailed information by writing to Motorola Semiconductor Products Inc., P.O. Box 20912, Phoenix, AZ 85036. Discover why the M6800 family creates a new age as the standard against which all others must be measured: Why M6800 is now the benchmark family for microcomputer systems.



MOTOROLA M6800
Benchmark family for microcomputer systems.

*Trademark of Motorola Inc.

Motorola's M6800 family

Creates the new age for microcomputer systems design

The M6800 family is the first LSI family designed as a coherent modular building block approach to the implementation of microcomputer systems. From the deceptively powerful MC6800 Microprocessor to the byte-organized family memories, to the capability expanding peripheral and communications interface adapters, the M6800 family plays together as the total product solution for microcomputer designs.

Shared qualities place M6800 family in leadership position.

Family devices are all state-of-the-art high performance N-channel Silicon Gate units requiring only a single common +5 V power supply. All peripheral bus devices are directly bus and TTL compatible. Among the many notable family features are •Basic 1 MHz operation •Direct Memory Access capability •64 kilobytes of directly accessible memory in any combination of ROM, RAM, or peripheral registers •Bi-directional data bus and wide address bus •Simple yet powerful instruction set with enhanced addressing modes. Beyond all else, the family is distinguished by a set of intelligent programmable logic interface adapters for I/O communications requirements.

Meet the family members



MC6800 Microprocessor. The executive control and processing block of Motorola's total product for microcomputer systems is the 8-bit MC6800 Microprocessor. The MC6800 is fast establishing a reputation for performance and throughput based on varied factors, including •Simple universal bus structure, powerful programming modes, and interrupt handling features •16-bit address bus for direct address of up to 65,536 memory locations •8-bit bi-directional parallel processing on a three-state data bus. These features only scratch the surface. MC6800 is a super 8-bit MPU.



A revolution is anticipated in word processing.

MC6820 Peripheral Interface Adapter. The totally unique PIA is a universal interface between peripheral equipment and the MPU bus. It's a flexible method, virtually without external logic, of connecting the MPU to status line or byte-oriented peripherals. The PIA features •8-bit bi-directional data bus for MPU communications •Two 8-bit bi-directional peripheral interface buses •Handshake control logic for input and output peripheral operation. The functional configuration of the PIA may be changed by the MPU during system operation.

There's more, but just remember this. The MC6820 provides total programmable logic for complete I/O task management.



Memories designed for microprocessors

Another system advantage of the M6800 family is the set of byte-organized memories designed to maximize efficiency in many systems. Just as useful in some situations is the fact that non-family memories also fit in, usually without sacrifice. Here are the family memories.

MCM6810 Static RAM. This 128 x 8 memory is designed for bus-organized systems. It needs no clocks or refreshing. Memory expansion is achieved with six chip select inputs. Two versions are available. The MCM6810L-1 is faster, with an access speed of 575 ns (max). Access time of the MCM6810L is 1 μ s.

MCM6830 ROM. The MCM6830 also is byte-organized for application in bus-organized systems. It's a mask programmable 1024 x 8-bit ROM with a maximum access time of 575 ns. Expansion is achieved with four programmable chip select inputs.



Communications power

One distinctive advantage of the M6800 family in the new wave of serial data communications systems is the inclusion of the necessary interface devices and MODEMs in the basic family.

MC6850 Asynchronous Communications Interface Adapter. The ACIA provides the data formatting and control to interface serial asynchronous data communications information to bus-organized systems.

The ACIA includes control lines for direct MODEM interface and features •8-bit and 9-bit transmission •Odd, even, or no parity •One or two stop bits •Optional divide by 1, 16, and 64 clock modes.

Functional configuration of the ACIA is programmed via the data bus during system initialization, using a control register programmed by the MPU. When all is said, the ACIA provides complete I/O task management for serial communications.

MC6860 MODEM. This 600 bps MODEM provides the necessary modulation, demodulation, and supervisory controls to implement a serial data communications link over a voice grade telephone channel.

The MC6860 offers compatible functions for 100 series data sets and 1001 A/B data couplers. Of course the MODEM interfaces directly with the ACIA in microprocessor-based data comm systems.



M6800 family second source

Motorola has solved the alternate source problem of many engineering and purchasing managers by signing an agreement with AMI for a true second source, where we share similar processes and the same masks.

is synchronized with the array to respond only to light emitted during the normally dark periods, thereby only picking up the row that's flashing out of sync.

When the flashing row sweeps beneath the light pen, it is detected, and the row is thus identified. For example, if the pen picks up light and vertical row No. 3 is the only row flashing, the vertical line of position of the light pen is known. The horizontal row is then established and the point on the panel determined. This information is passed on to the array at the other end of the telephone wire, and remote writing takes place.

Images to be transmitted, such as photographs or diagrams, are photographed by a television camera or are line-scanned. The gradations between white and black are put into digitized form and transmitted by wire to appear on the

screen of the remote terminal.

Bell's laboratory model has already proved that it can do the following:

- Record a person's signature and then display it on command.
- Reproduce pictures and charts at the rate of a few a minute.
- Display a list of telephone numbers. When the light pen is pointed at one, the number is automatically dialed.
- Serve as a desk-top calculator.
- Display the time and date on command.
- Display a typewriter keyboard, allowing hunt-and-peck entry to a computer.

The Bell unit is still in the research stage and not for sale at this time. The goal at this time is to reduce the control-circuit costs and lower the power needed to light the panel. ■■

Typewriter for handicapped uses special solenoid unit

Severely handicapped people can use a conventional electric typewriter when it's equipped with a specially designed keyboard for the feet and a solenoid unit to act as an interface.

Palmstienas Mekaniska Verkstad AB in Sweden, which built the keyboard, has also produced several other keyboards that can be operated by other parts of the body. The solenoid unit was manufactured by Magnetic Devices Ltd., Suffolk, England.

The foot keyboards are enlarged, modified versions of a standard typewriter keyboard. Pushbutton switches are mounted on a single printed-circuit board which links the switch terminals to a cable that plugs into the interface.

The unit is mounted over the keyboard by means of a simple clamp. Each solenoid is aligned so that when activated it pushes down the right key.



Operator controls are provided on a single three-way switch mounted on the interface unit. They allow the machine to be turned on and off and operated at various speeds, which are selected by varying a resistor in a time-delay circuit. ■■

Thin-Trim[®] capacitors



Tucked in the corner of this Pulsar Watch is a miniature capacitor which is used to trim the crystal. This Thin-Trim capacitor is one of our 9410 series, has an adjustment range of 7 to 45 pf., and is .200" x .200" x .050" thick. The Thin-Trim concept provides a variable device to replace fixed tuning techniques and cut-and-try methods of adjustment. Thin-Trim capacitors are available in a variety of lead configurations making them very easy to mount.

A smaller version of the 9410 is the 9402 series with a maximum capacitance value of 25 pf. These are perfect for applications in sub-miniature circuits such as ladies electronic wrist watches and phased array MIC's.

Johanson Manufacturing Corporation, Rockaway Valley Road., Boonton, N.J. 07005. Phone (201) 334-2676, TWX 710-987-8367.

Johanson

MANUFACTURING CORPORATION

AIRPAX™

TYPE 209 E-Frame Circuit Breakers

Airpax Type 209 molded-case circuit breakers are designed for use by the original equipment manufacturer. The hydraulic/magnetic principle provides stable trip points over a wide ambient temperature range. Typical applications include: refrigeration, air conditioning, power supplies, computers, and others.

Features:

U.L. listed for branch circuit protection.

Current ratings to 100 amperes.

Voltage: 125V dc 120/240V ac
240V ac 277/480V ac

Construction: Series, relay, shunt, auxiliary switch.

Terminations: Solderless connector, screw or stud terminals.

Time Delays: Instant, short, medium, or long.



Here's the inside story of the Airpax Type 209 Circuit Breaker:

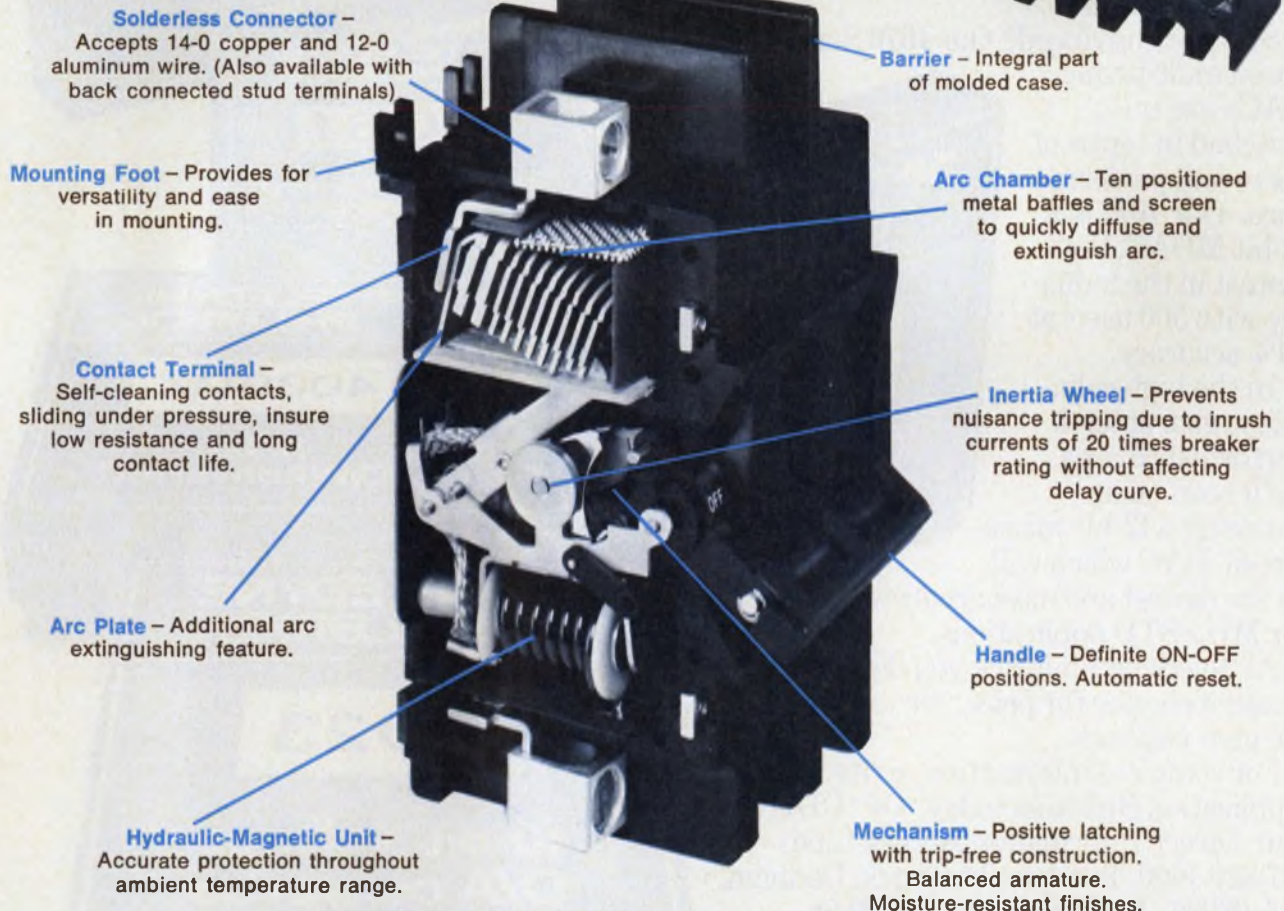

Airpax Electronics
Cambridge, Maryland 21613
Phone (301) 228-4600

AIRPAX™

Cambridge Division

Want to know more about these compact, competitive Type 209 breakers? Write for Airpax Bulletin 2012.

You won't get a better DAC deal. Anywhere.

Because Teledyne Philbrick offers you the broadest line. The tightest specs. The best price/performance.

We're talking about our economy line DACs, for starters. The 4020 Series of 8, 10, and 12-bit DACs feature adjustment-free high performance at very low cost.

And our 4039QZ general purpose 12-bit DAC gives you a pin-for-pin, price-for-price edge in second sourcing the DAC-12QZ.

Our 4060 Series high speed current DACs have a guaranteed settling time of 60 nsec. to $\pm 0.1\%$ and give you a competitive and compatible option to Analog Devices and Datal.

Still not convinced? Our 4070 Series high speed multiplying DACs are unmatched in terms of specs and performance. Our 4072 is a 12-bit MDAC, the fastest in the industry with 500 nsec. at .01% accuracy.

In the high reliability, guaranteed performance area, we'll soon be announcing a 12-bit micro-circuit DAC which will be the fastest and most accurate for MIL-STD applications.

At Teledyne Philbrick you don't have to sacrifice spec for price. Or vice versa. We give you both.

For complete information, write for our Application Bulletins today. Or "DIAL" (our Direct Information Access Line) 617-329-1600. Teledyne Philbrick, Dedham, MA 02026. In Europe, Tel. 673.99.88, Telex: 25881. Or write, 181 Chaussee De La Hulpe, 1170 Brussels.



See us at Salon des Composants Allée F-93

INFORMATION RETRIEVAL NUMBER 20

the amplitude of oscillations to a level at which discrete transistor Q_c interrupts the coil current. When the oscillator amplitude has decreased below the switching level, a variable-feedback system in the IC maintains a minimum amplitude of oscillation.

System performance is comparatively independent of dQ/dt —that is, pulse amplitude and noise immunity are maintained over a wide range of rotor speeds. Capacitor C2 parallel-resonates the circuit at between 200 and 400 kHz.

An output circuit produces a switching signal, ϕ , at terminal 4 and its complement, $\bar{\phi}$, at terminals 6 and 7; signal ϕ is high in

response to a high-amplitude oscillator state. When ϕ is high, Darlington-connected transistors Q_b and Q_c are driven by base current supplied via resistors R_1 and R_2 , so current flows through the primary winding of the ignition coil. The peak coil current is limited by a current-setting transistor, Q_a , in response to the voltage drop developed across current-sampling resistor, R_3 .

A spark is generated when output pulse ϕ goes low and $\bar{\phi}$ goes high. Switching is initiated by a low signal at terminal 4 that turns transistors Q_b and Q_c off.

When the current flowing through the coil primary is interrupted, its stored energy is trans-

ferred to the secondary circuit, where it produces a high voltage that fires a spark plug.

Diode D1 protects Q_b and Q_c against excessive negative voltages and the application of reverse battery voltage. Components C1, R_c , D3, C5, R_1 , plus the output amplifier assure that noise won't affect switching.

The 0.063-by-0.075-in. custom bipolar chip is in a 14-lead dual-in-line plastic package.

Sanquini notes that although the IC is designed mainly for automotive use, it is equally suited to a variety of industrial applications such as tachometers, speed-control and proximity detectors. ■■

Plasma-panel displays modified to transmit images via telephone

A flat-screen video system that transmits handwriting, reproduces pictures and can communicate directly with a computer has been demonstrated by scientists at Bell Telephone Laboratories, Holmdel, NJ.

Instead of the conventional CRT display, the system uses a commercially available plasma display, the Owens-Illinois Digivue 80-33, modified for added capability. The panel consists of an 80-by-256-element array of neon-gas cells.

With logic and control circuitry, the panel can detect the position on the panel of a passive, light-sensing pen. A grid coordinate corresponding to the pen's position is transmitted by telephone to a second display. Researchers can write or draw on a panel with a light pen and have the same image appear on the display connected by telephone many miles away.

Plasma panels were chosen instead of CRT for these reasons: They are flat, which makes them convenient to put in a desk-top terminal. They are completely digital, whereas a CRT is analog.



Flat-screen plasma panel transmits photographs, drawings and writing to remote panel by telephone wire.

And they have inherent memory; once a cell is lighted, it stays on.

To alter a picture—to change one portion of a drawing, for example—only the changes are transmitted. This permits a tremendous cut in required bandwidth. To change an element in a picture on a CRT, the entire picture must be retransmitted. This need for large hunks of bandwidth has been a deterrent to the picture telephone.

How is the light pen's position detected? William Ninke, head of Bell Laboratories' Digital Systems Research Dept., explains:

The array's cells are programmed to flash simultaneously for 1 μ s once every 10 μ s. This means that they are all dark for 9 μ s out of 10. The eye doesn't detect this, of course, but sees instead a steady glow.

To use the light pen, the operator first touches the pen to the panel, thereby activating special circuitry that causes the panel cells, row by row, to begin flashing at an offbeat time during the 9- μ s dark period.

The pen, a passive light sensor,

750 Volt Output in less than 12 nsec. from a new pulse amplifier

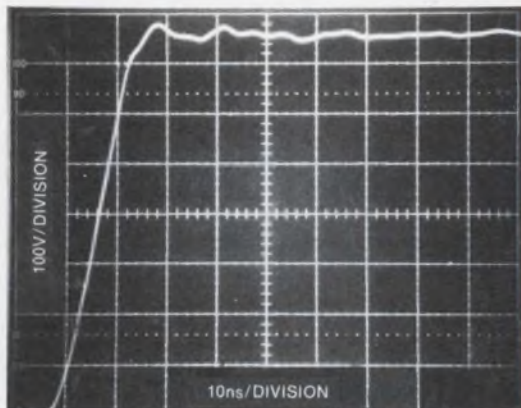

(Typical WJ-3680 Performance)



(Photo of WJ-3680)

Now available from Watkins-Johnson, this Electron Bombarded Semiconductor (EBS) has been designed for high-speed, short-delay, fast-rise-time switching and modulation applications.

The WJ-3680 provides up to 750 volts of peak output voltage and over 7 amperes of peak output current for fast-rise-time modulation of capacitive loads. Thus, this amplifier can produce a 750-volt pulse across a 100 pF load with a risetime of less than 12 nanoseconds, a pulse width of up to

50 microseconds and a 4 percent duty factor. Even faster risetimes can be achieved with lower load capacitance. Delay time is less than 5 nanoseconds and pulse-to-pulse jitter is negligible.

Applications include:

- Grid modulation of high-power microwave tubes
- Pulsers for electro-optical modulators
- CRT modulation
- Modulation of power semiconductors

...only from W-J

For further information, contact your nearest Watkins-Johnson Field Sales Office, or EBS Applications Engineering in Palo Alto at (415) 493-4141, ext. 391.



WATKINS-JOHNSON

Watkins-Johnson—U.S.A.: 3333 Hillview Ave., Palo Alto, CA 94304 • (415) 493-4141 • TWX: 910-373-1253 • Telex: 34-8415 • Cable: WJPLA • 700 Quince Orchard Rd., Gaithersburg, MD 20760 • (301) 948-7550 • TWX: 710-828-0546 • Telex: 89-8402 • Cable: WJCEI • **United Kingdom:** Shirley Ave., Windsor, Berkshire SL4 5JU, England • Tel: Windsor 69241 • Cable: WJUKW-WINDSOR • Telex: 847578 • **West Germany:** 8033 Planegg, Muenchenerstr. 17 • Tel: (089) 859-9441 • Cable: WJDBM-Muenchen • Telex: 529401 • **Italy:** Piazza G. Marconi, 25 00144 Roma-EUR • Tel: 59 45 54 • Cable: WJROM-ROMA • Telex: 60117

INFORMATION RETRIEVAL NUMBER 19

First IC ignition system in cars offers better engine performance

What is reported to be the first use of an IC in a commercial electronic ignition system is giving every 1975 American Motors car an improved breakerless ignition system.

Details of the circuit were revealed at the recent Solid-State Circuits Conference in Philadelphia in a paper by Richard Sanquini, director of IC products at RCA's Solid State Div., Somerville, NJ, and William Roberts, engineer at the Prestolite Electrical Div., Toledo, OH.

Electronic ignition eliminates the need for breaker points in controlling the ignition coil used to fire spark plugs. Points are a significant maintenance item and, if worn, can directly affect engine performance.

The circuit approaches that car manufacturers are using for electronic ignition differ significantly. General Motors—the first company to introduce such a system—employs a "unitized" ignition system consisting of hybrid thick-film circuits. Both Ford and Chrysler use

discrete semiconductors on a PC board.

The RCA circuit is part of a new electronic ignition system developed by Prestolite—a major manufacturer of electrical parts.

Nonmagnetic sensor used

The complete breakerless ignition system consists of a distributor containing a toothed metallic trigger wheel, a nonmagnetic pick-



Electronic ignition hardware consists of distributor with trigger wheel, printed-circuit board with IC, sensor coil (mounted on distributor housing) and enclosure.

up coil (mounted on the distributor housing), an electronic control unit (with IC and other circuitry) and an ignition coil.

According to Sanquini, the unique feature of the breakerless system is that it contains a nonmagnetic sensor in place of the magnetic pickup used in other commercial electronic ignition hardware.

"In today's systems using magnetic sensors, the sensor output varies from about 40 mV when cranking (about 2 rpm) to about 80 V at 6000 rpm," he notes. "This results in a considerable dynamic range problem and complex processing circuitry to assure the proper ignition coil voltage level—about 14 kV in a typical auto ignition system."

In the nonmagnetic sensor system, the sensor output voltage varies over a much smaller range (between 1.5 V and 8 V pk-pk). It does not depend on rotor (engine) rpm thereby assuring a good spark even at low battery voltages and at very low auto speeds.

Sanquini says the system is capable of delivering 17 kV pk at 5.5 V, at an engine rpm rate of less than 200 and a temperature of -40°C . At 5000 rpm, a 24-V supply and a temperature of $+25^{\circ}\text{C}$ the system delivers 30 kV pk.

Inductor doubles as sensor

Operation of the circuit (see diagram) is based on the accurate amplitude modulation of a resonant-circuit oscillator, in which the inductor acts as the sensor. When the conductive material of the trigger wheel in the distributor enters the field of the sensor (L), eddy-current losses in the nonmagnetic wheel tooth reduce the Q of the resonant circuit. This decreases

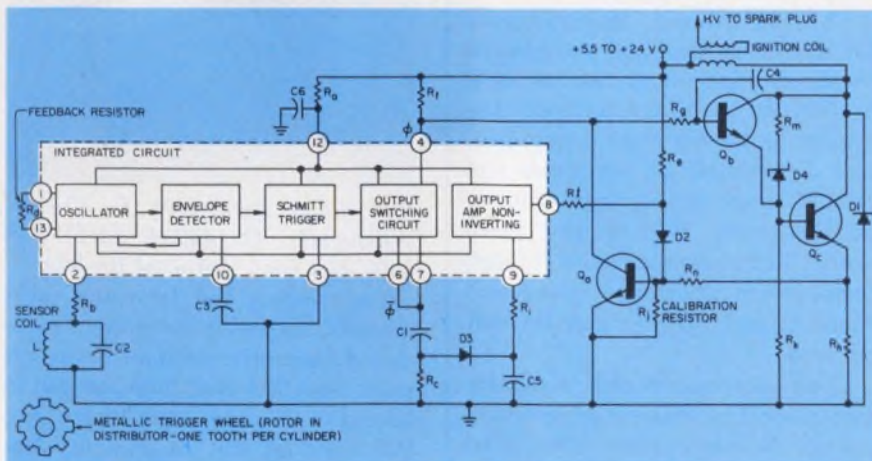

Operation of the integrated circuit in the breakerless ignition system depends on the accurate amplitude modulation of a resonant circuit oscillator in which the inductor—acting as the sensor—interacts with the trigger wheel in the distributor. The IC is manufactured by RCA for Prestolite.

Standard enclosures with custom features

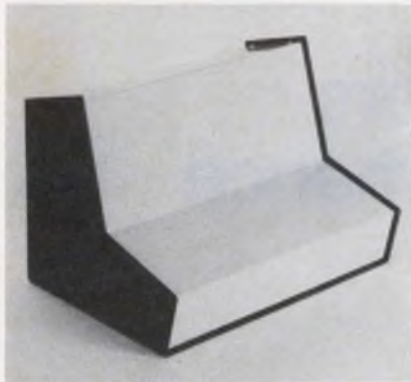

Bud Radio, Inc., 4605 E. 355 St., Willoughby, O. 44094, (216) 946-3200. Your Bud Distributor has it.

CompuCab by Bud. Dual-slope, off-the-shelf enclosures with custom-designed configurations. Use for a range of instruments. Maximum visibility — no fasteners on panel area. All aluminum. Cover and back in smooth white enamel. Base and sides, black textured enamel. Knockouts in rear panel. Rubber feet furnished. Two styles. Shipping economies. For the name of your local Bud Rep or Distributor —

PHONE (800) 645-9200, TOLL FREE

Compact enclosures, versatile, economical

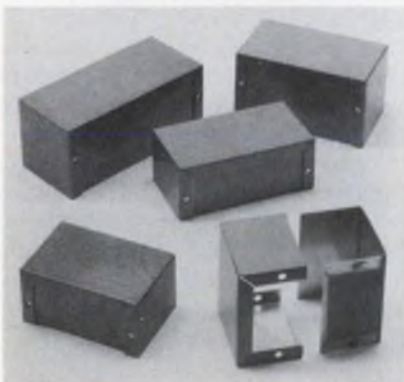

Bud Radio, Inc., 4605 E. 355 St., Willoughby, O. 44094, (216) 946-3200. Available in 18 sizes.

Miniboxes from Bud. Use as separate housings or as part of a larger assembly. Flanges give assured shielding. Projecting covers on cowl-type units minimize glare, protect controls, dials. .040 and .050 aluminum alloy. Immediately available. Shipping economies. One of nearly 3000 products from Bud Radio. For the name of your local Bud Distributor or Rep —

PHONE (800) 645-9200, TOLL FREE
ELECTRONIC DESIGN 7, April 1, 1975

the use of three acoustic receivers to point to the origin of the noise. The near-surface instrumentation includes acoustic and seismic arrays. Subsurface instrumentation consists of resistivity probes, geophones, gas-sampling tubes, gas-pressure gauges, tilt meters and displacement gauges.

To study characteristics of the burn front firsthand, thermal sensors will be used to determine its position, its uniformity, the rate of temperature increase ahead of the advancing front.

Resistivity sensors will be used on the surface of the earth to determine changes in resistivity at depth.

Tilt meters will be installed at one or more points above the seam in holes that the flame will pass. Changes in gauge position with respect to the vertical will indicate bending in the roof structure that may precede settling.

A differential displacement gauge may be used in selected holes nearest the center of a burn, in an attempt to measure the time and nature of settling.

Some of the equipment for the tests has already been selected:

Geophones will be the Geotech SC 20Es, capable of a response from 20 to 800 Hz. These receivers will be used for vertical displacement measurements.

Two-axis tilt meters made by Humphrey, Inc., San Diego, will have a sensitivity of ± 0.5 deg. Sensitivity has been sacrificed for temperature hardness, Northrop says. The meters have been repackaged in waterproof cannisters with a Bendix compass.

Chromel Alumel thermocouples are magnesia-insulated and inconel sheathed. Special junctions and branchings have been added to the devices by Sandia engineers to provide differential measurements and circuit diagnostics. Later phases of the work will require more exotic thermocouples with higher temperature resistance. Tungsten, rhenium and other materials will be used.

"For displacement measurements, we'll be making gauges ourselves," Northrop says. "They'll be based on the constant-torque spring made by Celesco. The devices give you a potentiometric readout of displacement." ■■

Cabinet racks: upright, inclined, big, deep



Bud Radio, Inc., 4605 E. 355 St., Willoughby, O. 44094, (216) 946-3200. Shipped ready for use.

Series 2000 cabinet racks from Bud. Standard uprights, 16 sizes. Clear inside depths, 20 $\frac{1}{2}$ ", 24". Eight extra-deep units have 29 $\frac{1}{4}$ " clear inside depth. Outside heights, 30 $\frac{1}{2}$ " to 88". Mounting rails adjusted horizontally. Six inclined units. Clear inside depths, 20 $\frac{1}{2}$ ", 29 $\frac{1}{4}$ ". Front panel, 20° off vertical. Compare value, shipping economies. For the name of your local Bud Rep or Distributor —

PHONE (800) 645-9200, TOLL FREE

Special fabrication of electronic housings



Bud Radio, Inc., 4605 E. 355 St., Willoughby, O. 44094, (216) 946-3200. Get what you want for less.

Bud designs and fabricates racks, cabinets, enclosures for new or re-designed electronic instruments or systems. Standard Bud housings can be altered to fit many applications. Original housings can be designed and produced. In addition, Bud's Imlok system can be used for short runs, test or pilot models. For the name of your local Bud Rep or Distributor —

PHONE (800) 645-9200, TOLL FREE

Only Sprague bantam 4-pin DIP capacitors can give you these advantages . . .



guaranteed max. high frequency impedance



low inductance and low ESR . . .
4-terminal connection mode option



preferred capacitance values to optimize performance when tantalum and ceramic capacitors are paralleled



automatic insertion capability



your choice of layer-built ceramic or solid-electrolyte tantalum

Type 935C MONOLYTHIC CERAMIC CAPACITORS

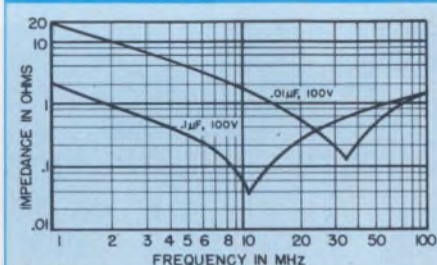

Proven multi-layer construction. C0G(NP0) and X7R temperature characteristics. Preferred ratings are .01, .047, and .1 μF @ 100 WVDC. Operating temperature range, -55C to $+85\text{C}$.

INFORMATION RETRIEVAL NUMBER 271

For complete technical data on Type 935C or 935D Capacitors, write for Engineering Bulletins 6242.3 or 3542.3, respectively, to: Technical Literature Service, Sprague Electric Company, 347 Marshall St., North Adams, Mass. 01247.

Type 935D TANTALEX SOLID-TANTALUM CAPACITORS

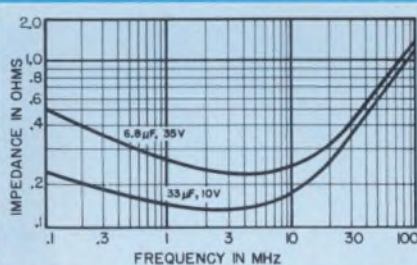

Dual in-line plastic package for mechanical protection and increased reliability. Preferred ratings are 6.8 μF @ 35 V, 15 μF @ 20 V, 22 μF @ 15 V, and 33 μF @ 10 V. Operating temperature range, -55C to $+85\text{C}$.

INFORMATION RETRIEVAL NUMBER 272

SPRAGUE

THE MARK OF RELIABILITY

THE BROAD-LINE PRODUCER OF ELECTRONIC PARTS

burning, Sandia must drill a hole down to the coal seam for the injection of air and oxygen. The gas created by the heat—chiefly hydrogen and carbon monoxide—then escapes through other holes to the surface, where it is used to generate electricity.

A fairly large coal deposit can supply a generator for many years, according to Sandia's project manager for the experiment, David A. Northrop.

Precise and continuous knowledge of the burn front's location is needed so more—or less—oxygen can be supplied either to accelerate the burn, slow it or stop it altogether. Sandia's goal is to develop a process-control system that will make this almost automatic.

The first step will be to evaluate instrumentation sensors and measurement techniques in an in-situ coal gasification experiment. This work will be conducted from April through October near Hanna, WY, by the Energy Research Development Administration's Laramie Energy Research Center. The coal seam is about 30 ft thick and some 300 ft below the surface.

Detecting from the surface

Sandia wants to see how well various sensors can pinpoint the burn front as it proceeds through the coal seam, and at what distances they can do this.

Eventually Sandia hopes that sensors near the surface will be able to detect the burn front's location deep down in the seam. In the experiment, however, deep measurements will be made to learn more about the front's characteristics and to evaluate remote techniques.

Does the burn front make distinctive noises that will identify it? And if it does, will these noises be sensed over distances great enough for use in a process-control system?

It's possible that geophysical noises might block the burn front's noises or distort the readout.

To test this, the experimenters will induce their own noises by detonating small explosives of known power and location.

How will the burn front be pinpointed? A possible solution, Sandia says, is by triangulation—

Where you can find out
more about the finest.

NEWS

New sensors spur 2nd try to gasify unmined coal

UNITED STATES

General Radio Company: N.C., Fla., Ala., Ga., Tenn., S.C., Miss.: 404/394-5380, 813/531-0148, 919/722-4819, 205/883-7538

Scientific Sales Co.: Tex. (except El Paso), Ark., La., Okla.: 214/231-6541, 713/666-5318

Measurement Consultants: N.M., Ariz., Colo., Ida., Wyo., Utah, El Paso, Tex., Mt., and Clark County, Nev.: 505/265-6471, 602/994-9519, 505/526-2491, 303/449-5294, 801/268-3181

Loren F. Green & Assoc.: No. Ill., Ind., Minn., Iowa, Ky., N.D., S.D., Wisc.: 312/593-0282, 317/293-9827, 612/781-1611

General Radio Company: No. Calif., Nev., Wash., Ore.: 415/948-8233, 206/747-9190

Sel-Tronics, Inc.: D.C., Md., Va.: 301/589-3391

KLS Associates, Inc.: L.I., Metro. N.Y., No. N.J.: 201/227-2900, 212/233-4849

Group Ten: Ohio, Mich., W. Penn., W. Va.: 513/277-6531, 216/486-2800, 313/549-3910

J & J Associates: New England States: 617/272-2606, 203/624-7800

Lahtronic Incorporated: Upstate New York: 315/454-9314, 716/685-4111, 607/748-0509, 518/372-6649, 914/471-2806

Technical Representatives, Inc.: Mo., Kan., So. Ill., Neb.: 314/731-5200, 913/782-1177, 319/363-2489

Robert Meyers Associates: E. Penn., So. N.J., Del.: 215/224-1663

Measurement Associates: So. Calif.: 714/540-7160, 213/671-7651, 714/284-2511

CANADA

Radionics Limited: Montreal, Que.: 514/735-4565, Telex: 05-827558; Downsview, Ont.: 416/638-0218, Telex: 06-22144; Ottawa, Ont.: 613/521-8252, 613/728-4624; Vancouver, B.C.: 604/732-7317, Telex: 04-54573; Winnipeg, Man.: 204/475-1732

EUROPE AND THE MIDDLE EAST

Ing. Otto Foler: Vienna, Austria: 57/3387

Regulation-Mesure S.P.R.L.: Brussels, Belgium: 771-20-20, Telex: 21520

Havulinna Oy: Helsinki, Finland: (90) 661-451, Telex: 12426 Havul SF., Cable: Havula Helsinki

Tekelec Airtronic: Sevres, France: 626-02-35, 626-24-38, Telex: Protec 25,997F

Radat International Co., Ltd.: Tel-Aviv, Israel: 474412, 478216-7, Cable: RADATCO Tel-Aviv, Telex: 032-143 (radat il)

Tekelec Airtronic Spa: Milan, Italy: (02) 7380641, Telex: 33402 Tekelec

Tekelec Airtronic N.V.: Amsterdam, Netherlands: 020-928766/67, Telex: 844-16009

Unitronics, S.A.: Madrid, Spain: 266.34.09, Telex: 22596 UTRON

M. Stenhardt AB: Vallingby, Sweden: 08/87 02 40, Telex: 10596, Cable Address: Stenhardt AB

Traco Trading Co., Ltd.: Zurich, Switzerland: 01/36071, Telex: 54318, Cable: Traco Trading Zurich

Euro Electronic Instruments, Ltd.: London, England: 01-267-2748-9, Telex: 23920 (Livingshire), Cable: Euroinst

Tekelec Airtronic GMBH: Munich, West Germany: 08 11/594621, Telex: 5/22241

AFRICA, ASIA, AUSTRALIA

Parameters Pty. Ltd.: Victoria, Australia: 439-3288

Hons International: Taipei, Taiwan, Republic of China: 529/068, 571/034

David J. Reid (N.Z.) Ltd.: Auckland, New Zealand: 492-189, Telex: Davredak N.Z. No. NZ2612

S'Electronics (Pty) Limited: Johannesburg, South Africa: 838-2169, Cable: Seletronic, Johannesburg

EASTERN EUROPE

General Radio Co.: Zurich, Switzerland; Poland, Czechoslovakia, German Democratic Republic, Rumania, Hungary, Yugoslavia, Bulgaria, Albania: 01/552420, Telex: 53638

Wouldn't it be convenient if we could just burn coal in the ground, where nature put it, without ever having to dig it up? The heat would create gas, which could be piped to the surface to make electricity. The process would be cheaper than mining and infinitely less disturbing to the environment.

Well, the concept has been tried, but it's going to be tried again. About 15 years ago the Bureau of Mines attempted in-situ gasification of coal in Alabama, but the process was expensive, compared with the cost of natural gas at that time. And there were technical problems—they couldn't keep the fire going. At about the same time the bureau also tried to make liquid gas from coal deposits in Missouri, but this also was too expensive.

John F. Mason
Associate Editor

Today costs are regarded differently, instrumentation has improved and the minicomputer is capable of producing real-time maps of what's going on in the coal deposit. All this makes it possible to develop a process-control system for in-situ gasification, the U.S. Energy Research and Development Administration reasons.

As for keeping the fire going, this can be achieved, it is believed, if a thicker seam of coal is worked than the one in Alabama.

Undertaking the task for the new Federal energy agency is Sandia Laboratories' Energy Technology Dept. in Albuquerque, NM.

The test will require hundreds of sensors to be planted just beneath the earth's surface and others in 18 deep wells, or tubes, near the burning coal seam. A minicomputer and sensor readers will be housed in a trailer.

To ignite the coal and keep it

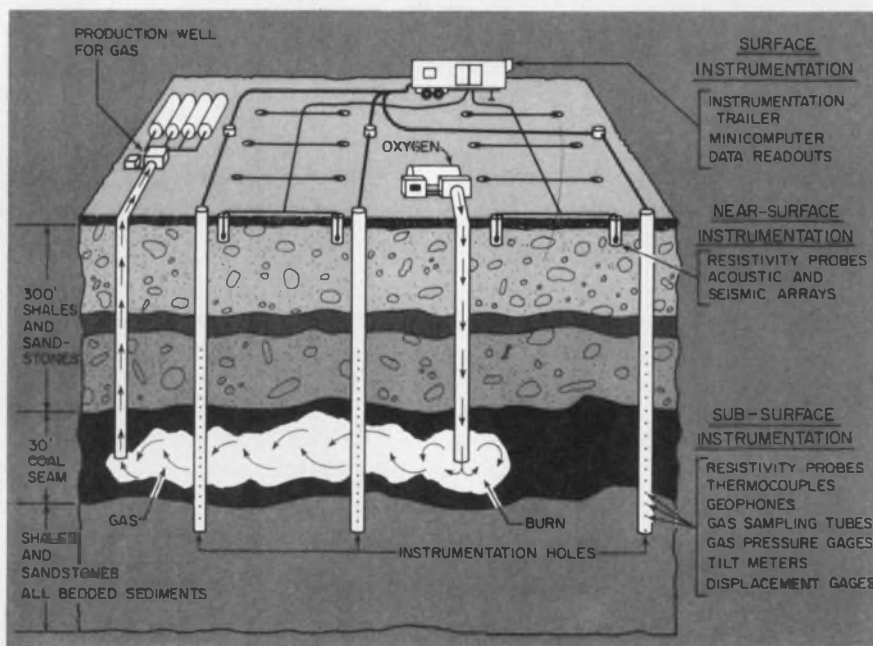

Near-surface instrumentation alone will ultimately monitor burning coal hundreds of feet below the earth's surface in an attempt to generate electricity. Initial tests, however, will require instruments near the burning coal, so the actual performance of the remote sensors can be accurately evaluated.

Why you can afford the very finest in function generators.

Because Interstate's new F77 truly is a universal signal source. With F77's 0.00002 Hz to 20 MHz range, you can test with frequencies from infrasonics through video, and beyond. There are 6 output waveforms, 7 operating modes, and precision interface controls (waveform inversion and a 5/95% waveform variable symmetry vernier, for example) that can be actuated with remarkable variations. And output amplitude is specified at 15 volts p-p into 50 ohms — that's 50% more voltage swing than most 20 MHz function generators provide.

Because the F77 also incorporates a very capable, independent sweep generator offering linear and logarithmic performance, with a selection of auxiliary outputs. Sweep up or down, sweep reset control, and continuous, triggered, burst, sweep-and-hold modes, too. Interstate's special frequency dial has a direct-reading sweep limit cursor, plus two calibration scales (X1 and X2) to improve resolution and permit continuous tuning across the 20 Hz-to-20 KHz audio band.

Because this function generator is the first of its kind to deliver real pulse generator capability. The F77 produces a 15 ns rise time pulse to 20 MHz with



constant width setability from 30 ns to 10 milliseconds, and full offset and mode flexibility. The generator's fully-calibrated attenuator gives you 15-volt unipolar pulses into high impedance loads, particularly useful for testing MOS, or millivolt pulses down to 1.5 mv.

Because there's also a constant duty cycle pulse (in addition to F77's standard pulse) for a variety of digital signal response applications. Circuit sensitivity to duty cycle on/off times can be tested using varying pulse rates without adjusting the width control.

Because the F77 can be used as an analog power amplifier to amplify externally applied signals as much as 600%. Even TTL pulses can be amplified to drive 50-ohm loads, and the resulting output has controlled dc offset and attenuation.

Because the F77 gives you many other high performance and human engineering features, like VCF capability for sweeping frequency-sensitive devices, and "oscilloscope-style" triggering with a variable start-stop phase control to generate haversines and havertriangles. There's even a "brown-out" switch to allow the instrument to operate at low line voltages.

Because the F77 only costs \$1,095.*

*U.S. price; other 20 MHz Series 70 models available from \$695.



INTERSTATE ELECTRONICS CORPORATION

707 E. Vermont Ave., P.O. Box 3117, Anaheim, California 92803 (714) 772-2811

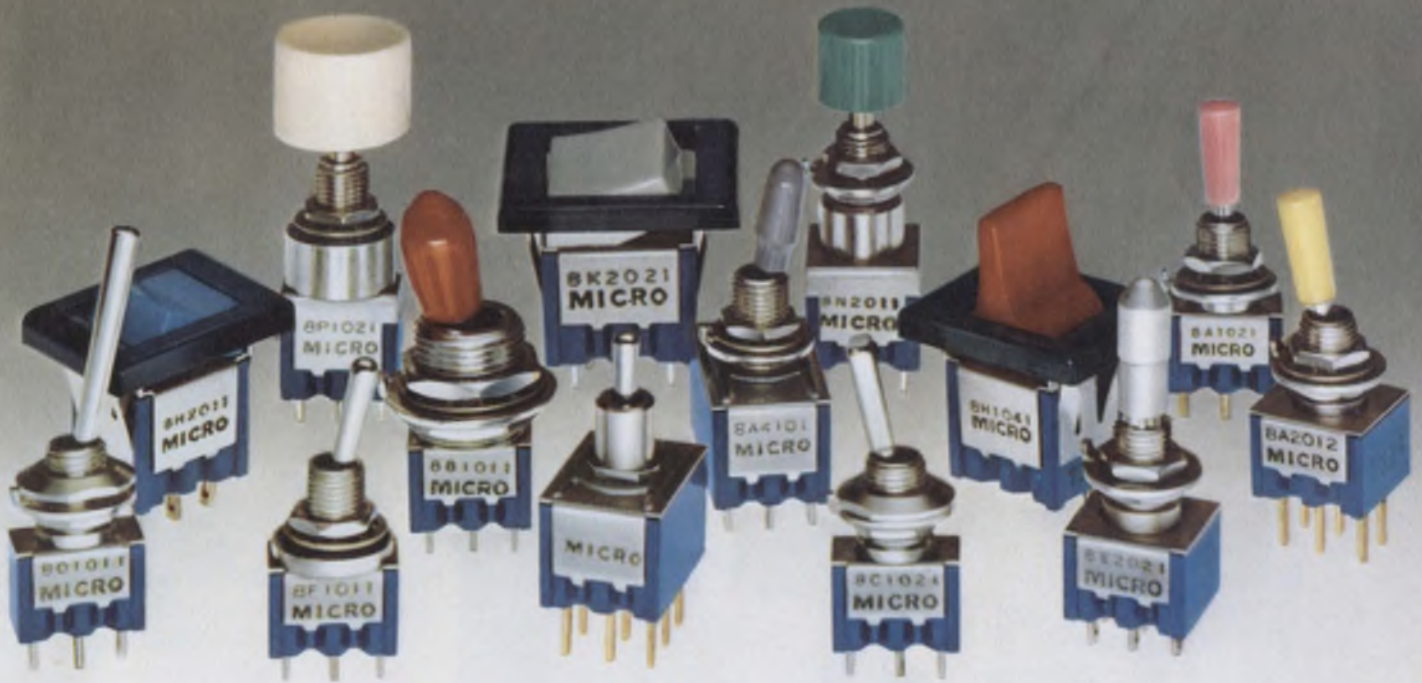

They look like miniature manual switches. But they're really just responses.

Every one of the miniature manual switches in the MICRO SWITCH Series 8 line is the direct result of a design need.

And, because design needs change continually, so do the miniature manuals we offer.

In the last year alone, we've added hundreds.

So you can choose from toggles, paddles, rockers—lighted and unlighted—and pushbuttons. With terminal variations that include solder, quick-connect, PC board and wire wrap.

They're all U.L. listed at 6 amps, 125VAC. With low energy versions available in every design.

And they all come with standard features like traditional MICRO SWITCH quality. Including inspection to a one percent Acceptable Quality Level. And nationwide, off-the-shelf availability, so there's no waiting.

They're also available with new features, like panel and bushing-sealed pushbuttons and toggles. A non-threaded bushing on PC mounted toggles. And colored sleeves for the 15/32-inch diameter bushing toggles.

If you'd like more information on the MICRO SWITCH Series 8 miniature manual switches, call, toll-free, 800/645-9200 (in N.Y., call 516/294-0990, collect) for the location and phone number of your nearest MICRO SWITCH Branch Office or Authorized Distributor.

Find out why you need only one source for the right miniature manual switch, at the right price, at the right time.

And how that source will work with you, just in case it doesn't make exactly what you need. Yet.

MICRO SWITCH products are available worldwide through Honeywell International.

MICRO SWITCH

FREEPORT ILLINOIS 61032
A DIVISION OF HONEYWELL

but also increases the thermal stability of the MOS device.

RCA's Solid State Technology Center in Somerville, NJ, is also an active researcher into hardened MOS/LSI. But Stanley Rosenberg, manager of custom monolithics, reports: "We are looking into CMOS/SOS as well. We use a silicon-gate process and do not do any chrome doping of the gate oxide. Our approach uses conventional CMOS processing steps, but we grow the silicon gate at a much lower temperature than normal."

The RCA process, which is also reported to require an ultra-pure gate oxide, has the advantage of being self-aligning, resulting in faster circuits. RCA has demonstrated ionizing dose tolerance of better than 10^5 rads so far, according to Rosenberg, and he expects to achieve 10^6 rads shortly.

Rockwell also plans to go to a self-aligned structure in the next few months. It will still be a metal-gate process, but for alignment, the company will use a silicon-nitride layer that is deposited before the gate oxide. Once the channels are made, the nitride layer can either be removed or left in place to become part of a sandwich with a conventional silicon-dioxide gate insulator. Rockwell will probably try a silicon-gate process as well, but later in the program.

A third approach to the gate structure is being pursued at Hughes Aircraft under contract to the Navy. According to Kenneth Aubuchon, senior staff physicist: "Our devices are CMOS/SOS aluminum gate. We don't use chrome doping. We rely on a pure, controlled gate oxide. In tests on a triple inverter we have achieved ionizing dose tolerance of better than 10^6 rads."

Hughes is working on an 8-bit adder with a complexity of several hundred devices per chip. It also has worked with a nitride-layer, self-aligned gate process.

So far just logic

Most of the testing so far has been on logic circuits. Rockwell has done some work with 32-bit shift registers but has primarily concentrated on the 4007-type CMOS triple inverter. RCA has done most of its testing with 4007 CMOS 4-bit adders. These are MSI circuits

Three radiation problems cause concern

The three radiation problems of most concern to the military are ionizing dose tolerance, ionizing dose-rate tolerance and neutron fluence tolerance.

X-rays and gamma rays cause photocurrents to flow from source to drain while the rays are impinging upon an MOS device. A dose rate of 10^6 to 10^8 rads/s is enough to change the logic state of most MOS devices. For a device to be considered hardened, it must be able to withstand an ionization dose rate of better than 10^6 rads/s. Once the X-rays and gamma rays cease, the photocurrents stop.

However, in addition to the creation of photocurrents, the X-rays and gamma rays cause charge to be trapped in the gate oxide. This charge is cumulative as long as the bombardment by radiation continues. The charge-trapping causes the threshold voltage of the MOS device to move to a higher level.

At about 10^4 rads the

threshold voltage starts to change rapidly in most MOS devices. The ionization dose tolerance required before a device can be said to be fairly hard is on the order of 10^6 rads—that is, the threshold must not start changing significantly until the total dose exceeds 10^6 rads. These radiation dose numbers are approximate and vary with device, materials and construction technology.

In addition to X-rays and gamma rays, the circuit is likely to be bombarded with neutrons. The rate of bombardment in neutrons/cm² is called the neutron fluence. MOS devices are inherently resistant to neutrons. The neutron-fluence tolerances for MOS devices, even commercial ones, are in excess of 10^{15} neutrons/cm².

Neutron fluence is a problem in bipolar devices, however. It leads to degraded current gain. Gold doping is used to lessen the problem in TTL integrated circuits and other bipolar devices.

with 170-transistor complexity.

Rockwell's program calls for later testing with a 550-transistor, 8-bit adder, a 714-transistor, 64-bit random-access memory and, ultimately, a circuit with at least 1000 transistors.

Everyone is aiming for good results at very high levels of complexity. Hughes notes: "We hope to be able to analyze chips with higher-level LSI, such as a microprocessor, within a year to 18 months. Until we get there, we won't truly know the extent of the problems involved in radiation-hardened LSI."

McKay of AH Systems observes: "Microprocessors might even allow alternate paths to the solution of some radiation problems. For example, with a microprocessor, a fast shutdown program would help avoid transient failures. We don't know yet whether the chips will be fast enough to do this."

An additional problem that Rockwell is working on is the formation of a back channel in the silicon by the trapping of charge in the sapphire itself. Impurities in the sapphire lead to charge trapping. These charges excite a layer of charge in the silicon that causes leakage current when the MOS transistor is otherwise off. The result is that the device has higher stand-by power dissipation. A possible cure, Bell notes, is boron doping of the silicon near the sapphire interface. This would be done with deep ion implantation.

Rosenberg of RCA points out: "A pleasant fact to report is that the process of hardening MOS/LSI does not seem to affect the electrical performance of the circuits in any adverse way. It ultimately looks like we will achieve the same densities and performance with hardened MOS that we now achieve with commercial chips." ■■

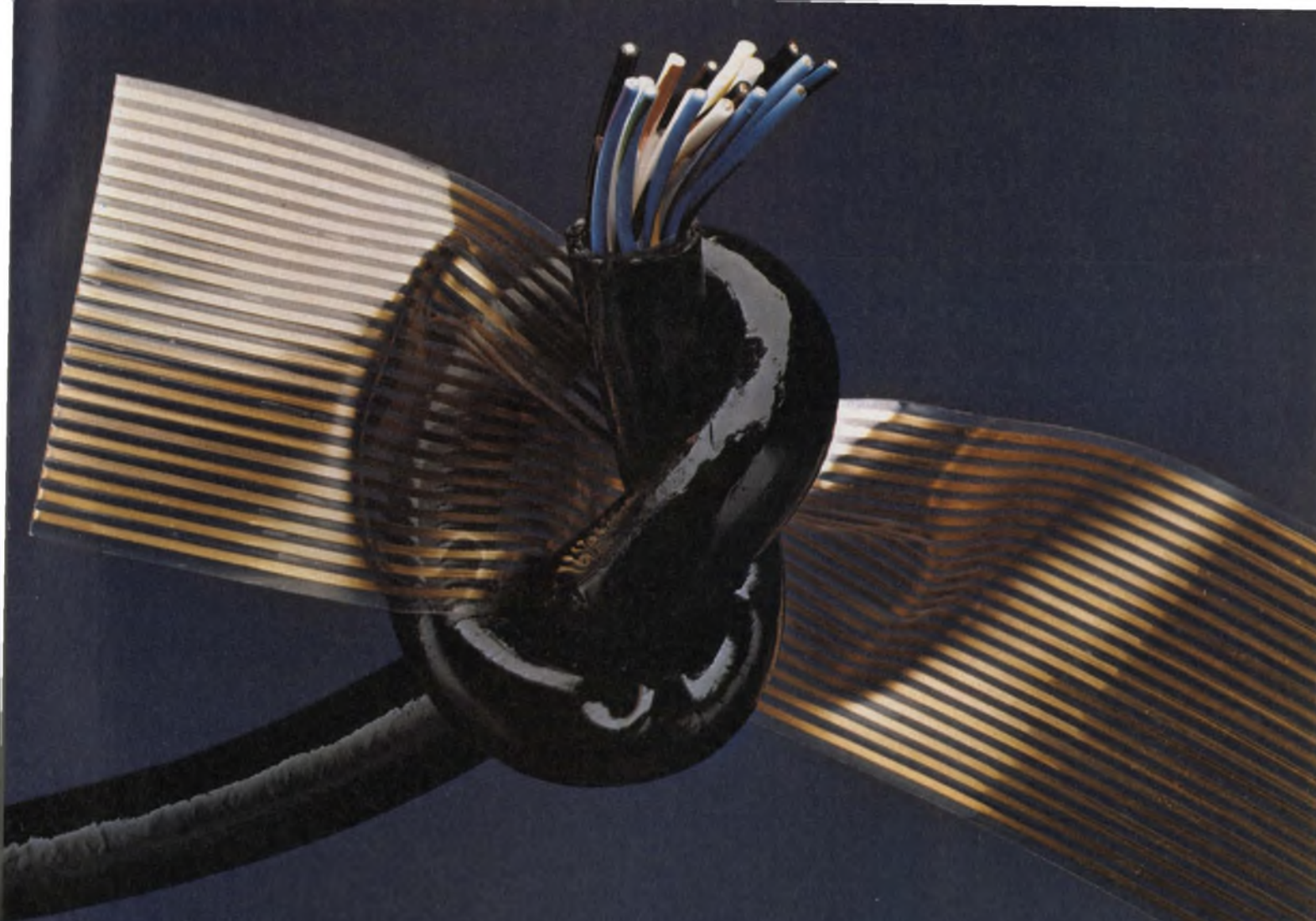

How do you connect round cable to flat?

Now it's easier than ever to connect round cable to flat. Or flat cable to flat. Or round to round.

Because now Hughes introduces the HAC-PAK Connectors—a whole new connector family offered in three types of contacts: crimp/removable rear-release (non-environmental, environmental or potted); RFI/EMI fixed filter contacts; and fixed solder-tail contacts.

HAC-PAK Connectors are intermateable and intermountable with one another—and with Hughes front-release subminiature rectangular connectors. (W and WSS Series.)

Our exclusive PolarHex™

It's a snap.

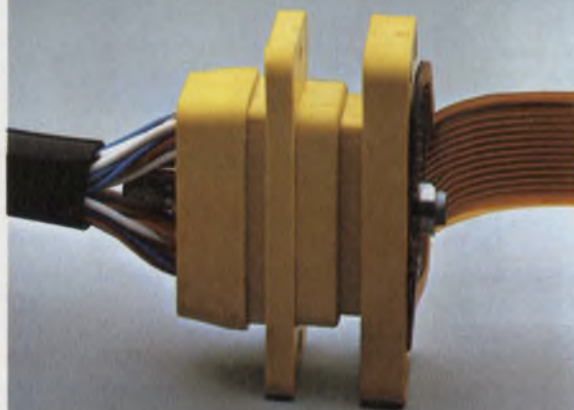

The new Hughes
HAC-PAK™ Connector.
(MIL-C-28804)

center jackscrew coupling assures alignment, provides positive polarization with a choice of keying positions, and prevents mismatching.

HAC-PAK subminiature connectors have the highest density of number 22 contacts in the industry. (.085" centers.)

To get all the details, make a connection with Ron Ross at (714) 548-0671, or write: Hughes Connecting Devices, 500 Superior Avenue, Newport Beach, CA 92663.

HUGHES
HUGHES AIRCRAFT COMPANY
CONNECTING DEVICES

We crack the tough ones.

HOW DO YOU GET FROM THE SENSOR TO THE COMPUTER?

Very carefully.

Low-level multiplexers can get you there if you're not seriously concerned with performance. Instrumentation amplifiers will get you there if money is no object. A system you build yourself might even get you there if you're lucky.

The Neff 620 amplifier-per-channel data acquisition system will get you there for sure. It won't cost you more than about \$200 per channel. And you'll have plenty of performance all the way. Plus expandability. And everything you need in one compact box.

If you're interested in avoiding all the potential pitfalls that lie in the path from the sensor to the

computer, give us a call. Or write. Ask for our thoroughly informative brochure on the Neff 620. It could simplify your life.

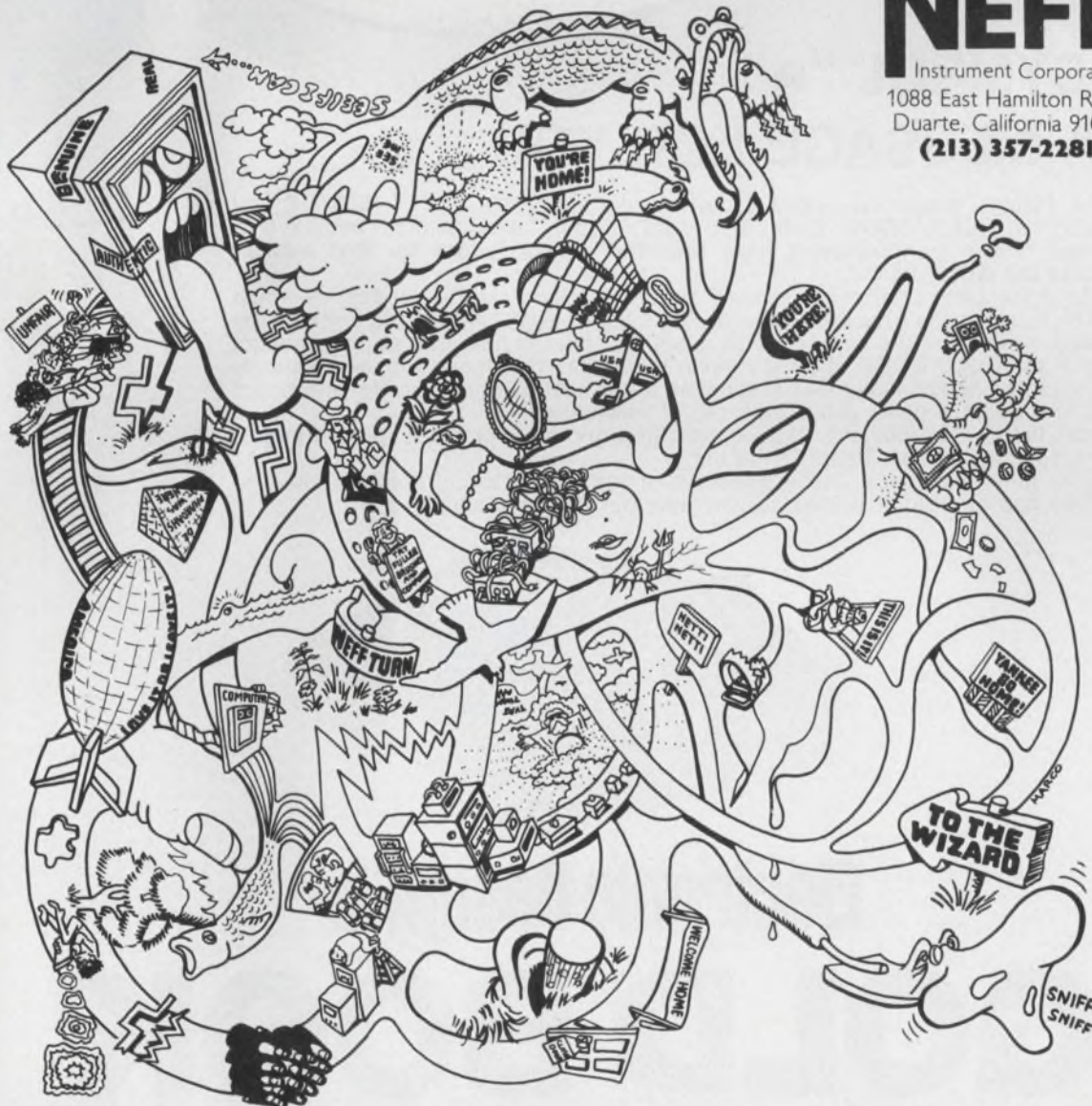
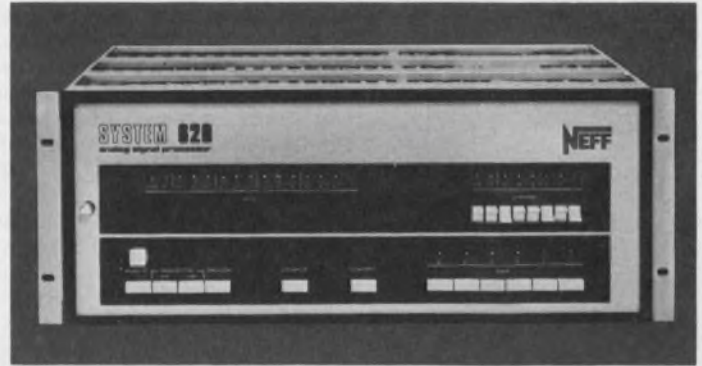

NEFF

Instrument Corporation
1088 East Hamilton Road
Duarte, California 91010
(213) 357-2281

INFORMATION RETRIEVAL NUMBER 134

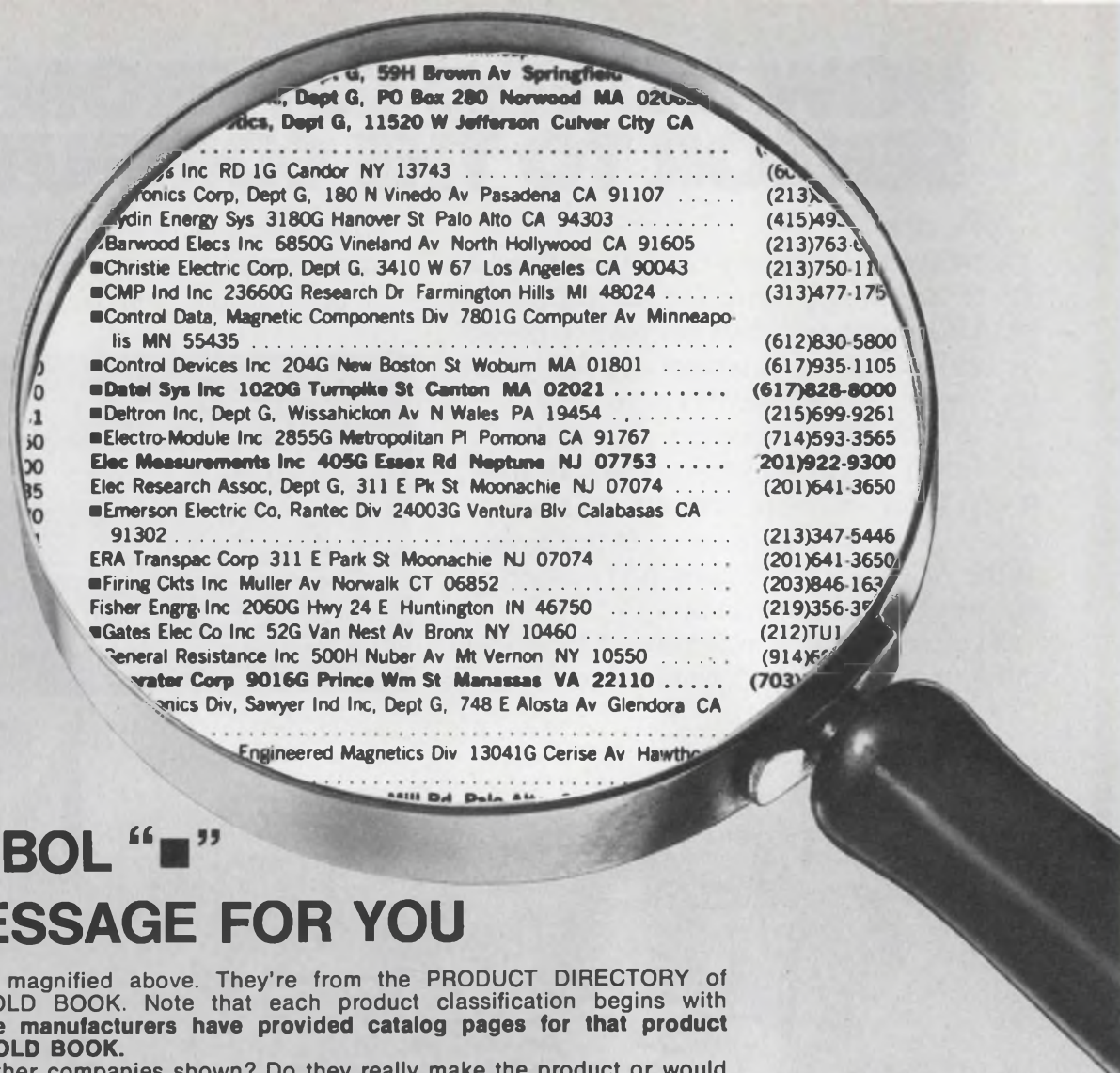

THIS SYMBOL "■" HAS A MESSAGE FOR YOU

Look at the listings magnified above. They're from the PRODUCT DIRECTORY of *Electronic Design's* GOLD BOOK. Note that each product classification begins with boldface listings. These manufacturers have provided catalog pages for that product in vols. 2 or 3 of the GOLD BOOK.

But what about the other companies shown? Do they really make the product or would they merely *like* to make the product if your order is big enough? A printer's bullet (■) in front of its name means that the company has submitted printed literature on that product to the editors of the GOLD BOOK. It's reasonable to assume that these suppliers actually make the product, for its not likely that a supplier would prepare literature for a product he can't ship. The bullet ■ gives you a measure of verification.

Manufacturers listed in boldface in the second sub-group have provided catalog pages, but not for the specific product heading the list.

In a constantly moving industry, these measures of verification are of course subject to change. Yet they can be helpful guides as you seek out potential suppliers.



Electronic Design's GOLD BOOK

BIGGEST AND BEST ELECTRONICS MASTER CATALOG
& DIRECTORY IN THE WORLD

**RF Microwattmeters—
Analog and Digital—
FS Sensitivities from
10 nW to 10 mW**



MODEL
42B/42BD

Boonton rf microwattmeters offer unrivalled sensitivity: 10 nW fs to 10 mW fs; from 200 kHz to 18 GHz, at highest stability ever attained at these sensitivities. Analog (42 B) or digital (42 BD) versions, both with linear DC outputs and logic-level programmability. BCD outputs are standard on digital version, autoranging and dB display (0.01 dB resolution) optional. Boonton Electronics, Parsippany, N.J. 07054

INFORMATION RETRIEVAL NUMBER 255

**Wide-Range
Programmable
Capacitance Meters**



MODEL
72B/72BD

Boonton analog (72B) and digital (72BD) provide rapid, accurate, 3-terminal and differential measurements, at 1 MHz, from 1 pF fs. Measures semiconductor-junction capacitance at low (15 mV) test level, with provision for external DC bias. Phase-sensitive detector measures accurately even at Q=1. Logic-level range programmability and fast-tracking DC output are ideal for ATE. Model 72BD has standard BCD output and autoranging. Boonton Electronics, Parsippany, N.J. 07054

INFORMATION RETRIEVAL NUMBER 256

**Direct Capacitance Bridge
0.00005 to 1000 pF
and 0.01 to 1000 mho**



MODEL
75D

Boonton Model 75D Direct Capacitance Bridge is designed for 1 MHz capacitance and loss measurement. Capacitance range, 0.00005 pF to 1000 pF; basic accuracy, 0.25%. Conductance range: 0.01 mho to 1,000 mho, basic accuracy, ±5%. Internal bias from -6 V to +150 V. Adjustable test level, 1 mV to 250 mV, at 1 MHz. Two modes of operation allow either conventional capacitance and loss measurements or one-control balance for capacitance only. 3-terminal input configuration. Boonton Electronics, Parsippany, N.J. 07054

INFORMATION RETRIEVAL NUMBER 257

INFORMATION RETRIEVAL NUMBER 258 ▶

Happy birthday, price-less.

Introduced just one year ago, our 102A FM/AM Signal Generator is celebrating a well-earned sales success against the HP8640B that once had the market sewn up. It's no wonder when you can save thousands of dollars and still get all you really need.

With our generator you get a well shielded, low noise source from 4.3 to 520 MHz that is both stable in frequency and accurate in level. We've shrunk warmup to 15 minutes and weight to 30 lbs.

We have the best residual FM spec around: 100 Hz resolution with a 6-digit display, individual metering of modulation and RF output, true peak monitoring, and 0-300 kHz internal FM deviation on all bands—external FM deviation can be as wide as 2 MHz peak-to-peak even at the lowest frequencies.

The 102A is engineered for your convenience. That's why we've designed a front panel that is easy-to-use and understand, why we have the specifications decaled on the top of the instrument in plain view, why we've added a unique adjustable "feel" main drive mechanism for easy narrow-band receiver setting, and why we have a full list of optional goodies—like a detected AM output to verify our negligible phase-shift for VHF omnitesting, fused RF output with replaceable elements, and external clock input.

Call or write today for data and/or a demo and you'll call the 102A price-less, too. Boonton Electronics Corp., Rt. 287 at Smith Rd., Parsippany, N. J. 07054; (201) 887-5110.

Price \$3575.

BOONTON

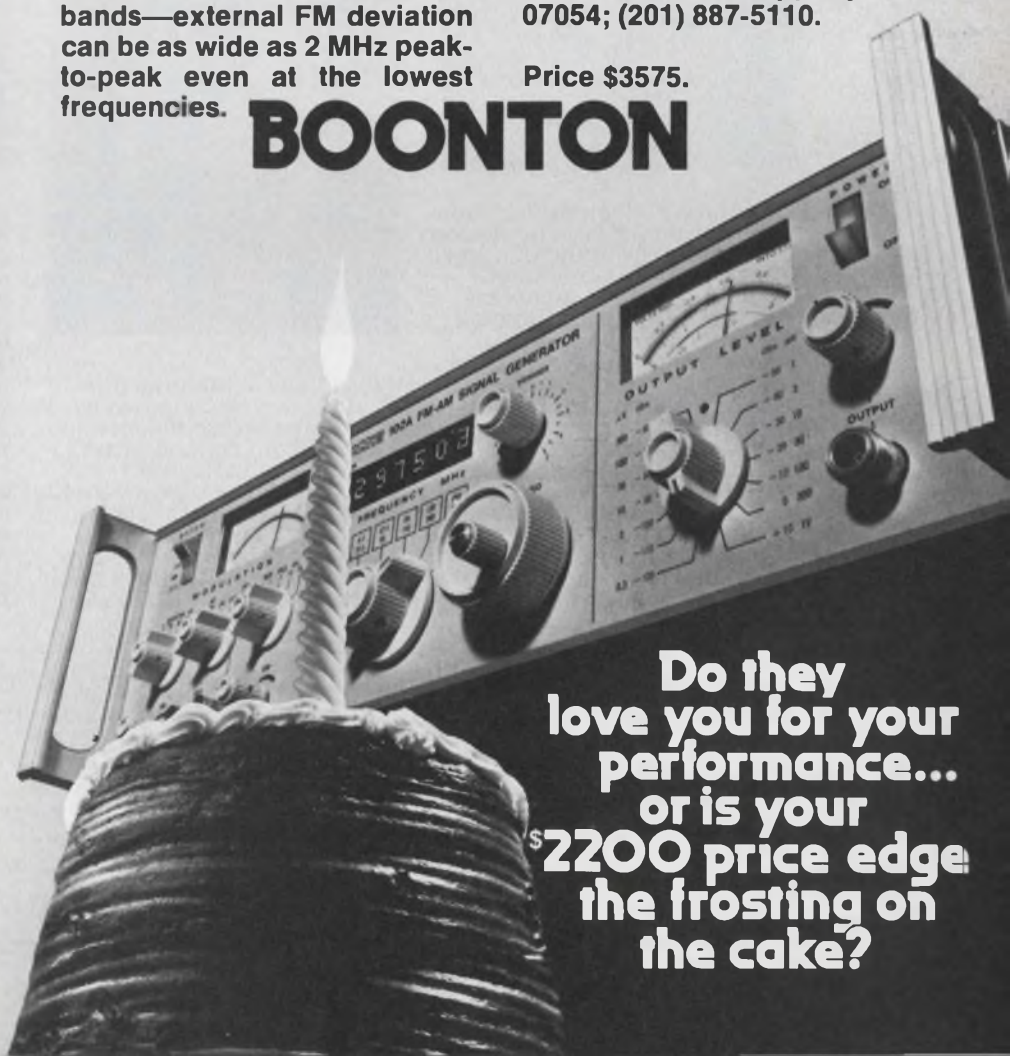

Do they
love you for your
performance...
or is your
\$2200 price edge
the frosting on
the cake?

IT'S REALLY NO SECRET-

But did you know that the greatest growth in the world's professional electronics industry is in the sector of communications?

We did, and that is why we have produced-

communications international

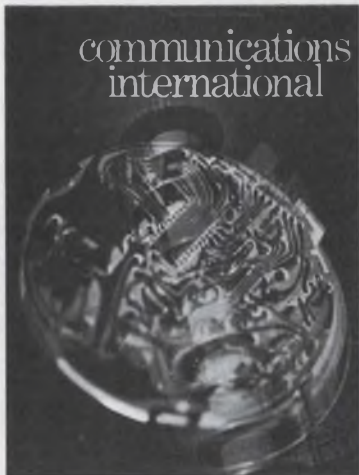

the new monthly journal for the world's manufacturers, designers & users of systems, equipment & components in the field of communications.



Circulation: Communications International has a circulation of 5,000 copies in the UK, 9,000 copies on the mainland of Europe and 4,000 copies are sent to countries throughout the rest of the world.

Advertising: The Publication offers highly competitive advertisement rates ranging from £340 for a whole page black and white to £94 for a quarter page in black and white. Series discounts are available and colour is charged extra. Communications International is published from the UK but its readership is global and its editorial coverage is carefully

selected from material provided by a worldwide network of foreign correspondents and articles from eminent international technologists. Communications International concerns itself with four broad editorial areas of communication and these are line and data, mobile radio, fixed radio and defence. Within these

areas it provides up-to-the-minute news of the world industry, its business aspects and in depth technical information aimed at aiding engineers to solve specific problems. Communications International also presents regular international features on the most technically efficient and economic options available to managers and purchasers of communications equipment and it includes a meticulously screened and researched section which every month is devoted to new products appropriate to the communications industry.

Mail this form today to: The Publisher, COMMUNICATIONS INTERNATIONAL
49-50 Hatton Garden London EC1N 8XS ENGLAND. Telephone: 01-278 6571

Please send:

- Advertisement Rates & Data
 Subscription Details

Name _____
Status _____
Company/Address _____
Country _____ ED

If you've got the microprocessor, we've got the socket board.

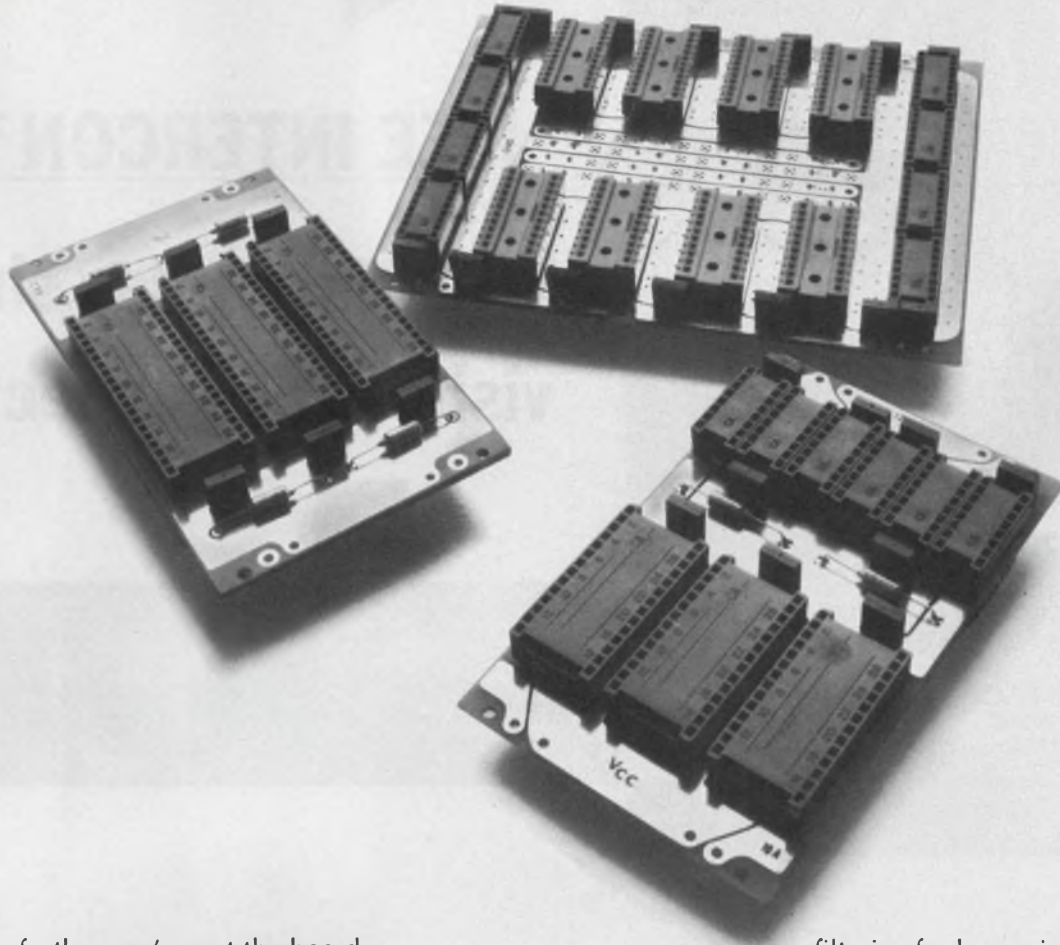

Look no further, we've got the board for your microprocessor. And your PROM. And your RAM. Off the shelf. At standard prices.

These new socket boards are the latest designs in our 2D family of socket boards:

H-2954 Eight 22-pin sockets and eight 16-pin sockets, \$75.

H-2955 Three 28-pin sockets and six 16-pin sockets, \$42.

H-2961 Three 40-pin sockets, \$59.

These socket boards come to you sized and spaced for instant LSI mounting. Like our entire 2D family of socket boards, they include built-in

filtering for low noise. On the reverse side the only wire-wrap pins you have to cope with are those of the sockets themselves. Power connections to these sockets are made with our unique soldered wire loops.

We can also give you complete support hardware, including frames, drawers, I/O connectors, and tools. Not to mention our automated wiring service.

We're ready for you right now. And so is our nationwide distributor, G. S. Marshall. So call either of us today. Or tear out this page and keep it as a reminder until you are ready.



EECO

FOR PACKAGING

1441 East Chestnut Avenue, Santa Ana, California 92701
Phone 714/835-6000



IEEE INTERCON '75

**It's a 3-day show
visitors are expected**



Big changes are in store for the IEEE show the next two years. Breaking with tradition, Intercon '75 moves into a new month and will be held in April instead of March. It also becomes a three-day event rather than four.

In 1976 a new IEEE convention and product exposition called "Electro" will debut. This follows the merger last year of IEEE's Intercon and the Northeast Research and Engineering Meeting (NEREM). Electro '76 will be held in Boston and then move back to New York in 1977, alternating between the two cities in succeeding years.

Today's uncertain economic picture makes Intercon size predictions difficult, but estimates are that some 300 companies will show their products in 340 booths—an increase of about 10% over 1974. Attendance is expected to be in the neighborhood of 25,000.

The exhibition will be held April 8-10 in the New York Coliseum. The major technical pro-

gram will be in the Hotel Americana and will consist of 37 three-hour sessions—six concurrently on the mornings and afternoons of April 8, 9 and 10, with a highlight session Wednesday evening dealing with the social implications of nuclear power plants.

On Monday, April 7, there are 10 specialized sessions, organized by IEEE groups and societies to serve more "vertical" interests. These sessions will be on:

- Data Privacy and Security.
- Systems Approach to Energy Management.
- Control and Reduction of Automotive Pollution.
- Energy: The View From 2000.
- Space-Shuttle Experiments.
- Technology Forecast—The Future of Components.
- The Engineer in Transition to Management.
- Advanced Industrial Applications of Infra-red Techniques.

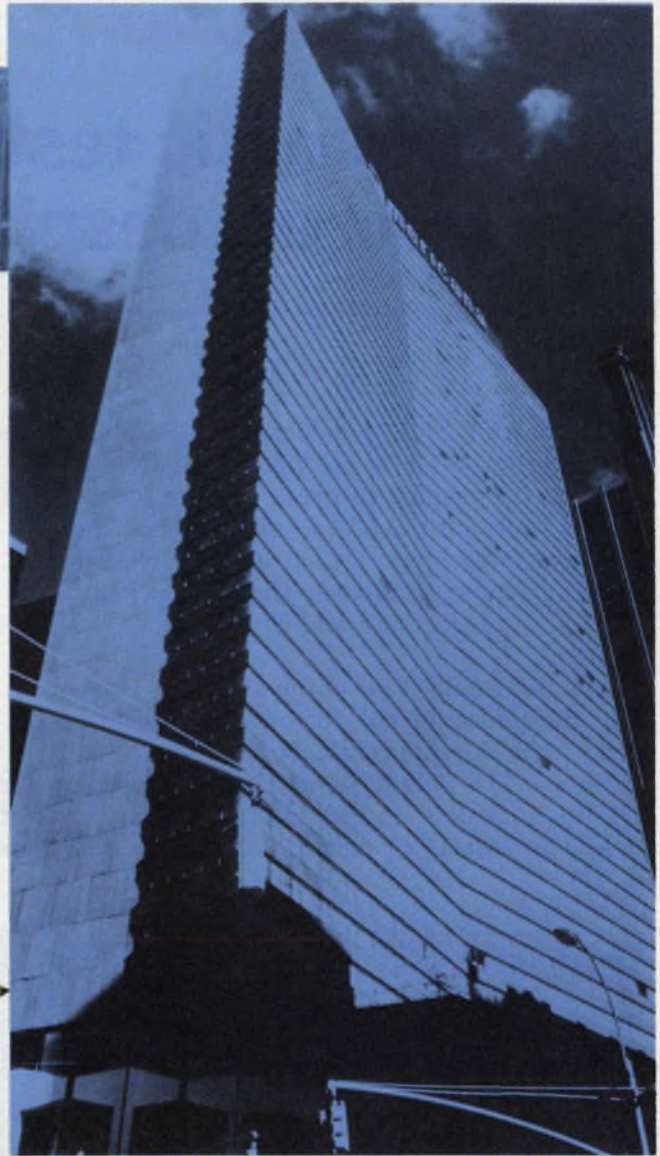

now, but 25,000 to tour 340 booths



- Open Forum on the Society-Technology Interface.

- A Forecast of Computer Hardware and Software 1975-1985.

The technical papers cover the latest technological developments and trends in several key areas. Session 15, for example, looks at ways of simplifying the testing of LSI devices, while Session 33 reports on new measurement techniques in telecommunications.

In computers, the action is still in microprocessors but, as reported in Session 1, the scene has shifted from discussions of different designs to new uses for these versatile devices.

The latest design trends in digital logic devices are covered in Session 18. Papers here discuss renewed interest in triple-diffusion technology and a movement among manufacturers of small-scale CMOS parts to buffered output devices.

A wrapup of these and other significant technical papers is offered in the following pages.

Design trends in major engineering areas

Test and Measurement	54
Computers	56
Semiconductors	58
Communications	61
Industrial	62

Outstanding new products on display at the New York Coliseum exhibit areas.

Instrumentation	66
Modules and Subassemblies	80
Packaging & Materials	86
Microwaves & Lasers	91

Automatic testing of LSI devices favored, despite some problems

The testing of LSI devices, like ROMs, RAMs and microprocessors, has become costly, says Arnold M. Greenspan, project engineer for the AAI Corp., Baltimore. And the problem is compounded, says Greenspan, organizer and chairman of IEEE Session 15, because the LSI package is becoming a subsection of larger, more complex systems.

His solution? Use automatic test equipment. But designers do not yet have too much experience with this approach, he concedes.

Session 15, "Test Generation Techniques for Digital Circuits," is considering how to make it easier to test LSI devices. Jon Squire, manager

of operational software at the Westinghouse System Development Div., Baltimore, points out that whereas tests for PC boards with many ICs can be simplified by the addition of more test points to the board, this cannot be done with LSI. It requires too much chip area.

As an example of these test problems, Squire points to long shift registers, which may be 64, 28 or even 1024 bits. On a PC board a reset line can be included to set all the flip-flops into a known state, but an equivalent LSI chip has no space for the reset line, Squire notes in his paper, "Generating Tests for Digital Circuits Employing LSI Technology."



Charge-coupled devices must be tested in real time because information on the device is volatile. For test they

require a special type of computer, like this Macrodata MD415 that handles simultaneous data fields.

The solution here, he explains, is to add to the chip one small circuit consisting of a NAND gate, an AND gate and an input pad. This can provide resets to all of the shift-register stages.

One problem when LSI circuits are analyzed for automatic testing, Squire says, is that it is difficult to model the circuit and to simulate it accurately. This can be simplified, he continues, by use of a clump of gates—instead of individual transistors—for the functional model. This approach, he reports, has enabled Westinghouse to produce accurate test tapes.

A unique test-design approach for a new 16-bit microprocessor by General Instrument has substantially decreased the design, development and debugging time of that company's CP-1600, says Richard Rubenstein, a member of the technical staff in the General Instrument Corporate Technical Center, Clifton, NJ.

In his Session 32 paper, "A Total Test Plan for a 16-Bit Microprocessor," Rubenstein explains that General Instrument uses the assembler it developed for the microprocessor to write the test patterns—an application of advanced software techniques to support testing.

"What we did," says Rubenstein, "was to fabricate the full CPU chip and another test chip on which we isolated the data path of the processor from the main-state ROMs, the control ROMs and the branching ROMs. With the test chips, we were able to debug the full CPU, the memory portion of the chip and the data-path portion—all independently of each other. This was possible because the art work of the microprocessor and its memories can be laid out so they can be easily separated for testing."

Rubenstein says General Instrument used the state diagrams of the device to generate the automatic test sequences. "We inserted bit patterns as a function of the state patterns and the instruction set," he notes.

A new LSI device—the charge-coupled device—presents a unique test problem because it is a volatile array that must be tested in real time, according to Roger Standridge, application manager of large systems for Macrodata, Woodland Hills, CA. In his Session 32 paper, "Charge-Coupled Device Testing," he describes the testing of a CCD photosensitive array, like the type used in CCD cameras.

"These area arrays have a set of bucket-brigade shift registers," Standridge explains. "A set of vertical registers feeds into horizontal registers to produce a serial line scan. We set the chip up in the dark and inject a specific dark current that corresponds to a gray level.

"We couple the CCD to a high-speed pattern-generator microprocessor—the Macrodata MD-154—which is a parallel microprocessor that can handle three separate data fields simultaneously.



The use of telephone voice channels for digital data transmission requires special line quality measurements. This Hewlett-Packard 4940A Transmission Impairment Measuring Set separates and simultaneously measures six types of transient line disturbances.

The CCDs typically run at 7.5 MHz, so a decision must be made by the computer in about 130 ns as to whether an individual cell of the array is good or bad.

"The computer looks for variations in the output about the specified test input-current level—that is, you're looking for a gray level, but you may get a dark spot or a light spot.

"If the output of an individual cell is above or below a given gray-level tolerance, we store the address of that cell in a high-speed memory. The test data are then reduced and put on a nine-track magnetic tape from which a batch-process analysis of the test is made to detect the flaws."

The demand for new data-communication facilities has far outstripped the construction of high-quality data networks, consequently most data-communication equipment uses low quality voice-band telephone circuits, and this presents problems in the testing and monitoring of line quality. Many factors that can be ignored for voice alone can contribute substantially to data-transmission error. A review of these problems and trends in the design of equipment to cope with them are the subject of Session 33: "Advances in Telecommunications Measurement Techniques."

Robert H. Allen, engineering manager of Hewlett-Packard's Delcon Div., Mountain View, CA, is the co-author with John H. Wetzel, product manager of a Session 33 paper on "Trends in Testing Analog Parameters for Data Transmission." The paper points out that these factors can produce data errors: amplitude distortion; drop-outs, or abrupt large decreases in channel gain; gain hits, or sudden positive or negative gain change exceeding a preselected level; phase hits, or sudden shifts of channel phase beyond preselected limits; impulse noise; phase noise, or jitter; frequency shift, and longitudinal noise, or

noise from line to ground. Allen sees two main trends in phone-line test-equipment design; (1) The combining of several formerly independent analog test sets into one master test set (like the HP 4040A Transmission Impairment Measuring Test Set), and (2) The increasing use of digital

signal analysis (the HP 5453A Transmission Parameter Analyzer).

In the HP 5453A, a test signal is sent over the line and digitized on the receiving end. Signal analysis and line evaluation are accomplished by digital computer processing. ■■

COMPUTERS

Rise of microprocessors is cutting data processing and memory costs

Single-chip microprocessor devices can now perform many of the functions of the central processor in conventional computers, and this may just be the beginning. The use and application of these versatile circuits is the subject of Sessions 1 and 7.

Another computer-related subject of increasing importance, the design of fault-tolerant digital systems, is treated in Session 11.

Carver A. Mead of the California Institute of Technology, Pasadena, CA, says of microprocessors in his Session 1 paper: "Historically a large fraction of the costs of a computing system has been in the central-processing unit and associated memory. The availability of single chips with the complexity of our current larger computing system reduces the cost of data processing and memory to an insignificant level. Computational horsepower can be distributed in all the nooks and crannies of a data-processing system."

Looking to the future, Mead observes: "No information will be sent over communications links without first being highly processed and formatted, having all its irrelevancies removed and being put in the most optimum form for its receiver."

A decade away, Mead predicts an LSI read-only memory will be available with a capacity of 10^7 bits and access time of approximately $1 \mu s$. "Ultra-fast cycle times are not needed," he notes, "nor will they be available at this level of complexity." System cycle times will, however, be shorter than those of today, he says. This follows from the fact that the signal paths will be very short.

Practical microcomputer systems require low-cost peripherals, and Richard M. Smets of Q1 Corp., Farmingdale, NY, considers this problem in a Session 1 paper.

"Floppy disk drives have reduced the cost of direct-access storage so that it will be compatible

with other microcomputer system costs," he points out. "The small storage capacity of floppy disks need not be a prohibitive limitation, because the disks can be changed so quickly and easily that putting a file on several disks becomes feasible."



The first 16-bit microprocessor on a single chip is the Pace from National Semiconductor. It has a 45-instruction set that cannot be modified. Instruction cycle time is typically $10 \mu s$. Shown also is the Pace microcomputer card prototyping systems.

Smets notes further that electrostatic printers will be as cheap as serial-impact printers, yet be able to print thousands of lines per minute. In addition, he says, solid-state memory should get so cheap that it won't even be necessary to use disks. With mass solid-state memory and fast microprocessors, he believes, a microcomputer system will be able to handle data processing that is now done by a medium-sized computer center.

2 microprocessor advances stressed

Two significant technological contributions have been made by microprocessors, according to William H. Davidow of Intel Corp., Santa Clara, CA: (1) Microprocessors and their associated circuits, including memories, have reduced by an order of magnitude the cost of putting significant amounts of computational and control complexity into a device, and (2) Microprocessors have caused users to standardize on processors, LSI peripheral circuits and subsystem design, thereby permitting manufacturers to economize in component manufacture.

Doug Clifford of Hewlett-Packard, Loveland, CO, in a Session 7 paper, suggests that buyers ask the following when picking microprocessors:

- How many inputs and outputs are needed?
- How fast must the system operate?
- Is the job mainly one of software?
- How much software support is available?
- Is a second source required?
- How much TTL must be driven?
- How much room is available for circuitry?
- How much extra circuitry is needed around the processor?
- How much will it cost?

In a paper on the design of microprocessor-based computer terminals, Ronald K. Bell of Sperry Univac, Salt Lake City, UT, notes that a key advantage of the microprocessor is control of the communications interface. He says:

"The microprocessor-controlled communications interface uses the existing MOS/LSI transmitter and receiver circuits both to assemble input data into words, which are then passed to the processor, and to serialize output words for transmission to the host or other interface. All the procedures for the communication lines are contained in the software program. This includes message recognition, message synthesis, status, error recovery and error checking. The complexity of these functions is now under software control, and a significant reduction in hardware can be realized."

Session 11 emphasizes fault tolerance in computer design. Dale G. Holden of the NASA Langley Research Center in Hampton, VA, describes the design of a fault-tolerant computer known

as HOME (Hard-Over Monitoring Equipment). It is a special-purpose computer that monitors the flight-control commands in a helicopter. According to Holden, "HOME detects the issuance of a hazardous, hard-over command for any of the four flight-control axes and transfers the control of the helicopter to the flight-safety pilot. The design of HOME incorporates certain reliability and fail-safe enhancement design features, such as triple modular redundancy, majority logic voting, fail-safe dual circuits, independent status monitors, in-flight self-test and a built-in preflight exerciser."

T. Basil Smith of the C. S. Draper Laboratory, Cambridge, MA, is concerned with digital communications networks and their vulnerability to damage. He notes that "the conventional bus organization currently in use in distributed digital systems is highly vulnerable to damage." He prefers a network using alternate data paths.

In his paper, Smith analyzes a variety of data-path techniques and settles on a hierarchical network of supervisory and subordinate nodes. ■■



Digital Equipment Corporation's new midcomputer, the PDP 11/70, employs a special memory architecture in which a 2 k byte bipolar cache memory acts as a buffer between main memory and the unit's general purpose registers. 32-bit internal data paths carry data to and from the cache memory, permitting data transfers between memory and registers to approach the 300-ns execution time of the central processor.

Yield, density, performance increasing through new trends in chip fabrication

Triple-diffusion semiconductor technology has been around for a long time. Its recognized advantages are simplicity, high yield and high density. But without LSI bipolar chip fabrication, interest in it was limited. Now this has changed.

There is also a new trend among manufacturers of small-scale CMOS ICs. They are switching to buffered output devices. Won't this make CMOS SSI chips larger? Yes, but it will also improve the performance of the devices.

These and other developments in semiconductor technology are discussed in Session 18, "Configurations and Characteristics of Future Digital Logic Devices."

Triple diffusion is an early technology that has only recently been revised for LSI chip fabrication. Renewed interest has been expressed in the process, because of its simplicity, high yield and high density characteristics, notes Jim Buie, an engineer for TRW Systems, Redondo Beach, CA.

In his paper, "3D-LSI Compatible Logic Family," Buie notes that during the last three years, over 50 LSI designs have been produced at TRW, with chip sizes ranging from 100 × 100 to 300 × 300 mils. Densities as high as 20,000 devices per chip have been realized.

According to Buie, a main reason for the use

of triple-diffused technology, instead of the more prevalent epitaxial method, is higher yield. Although present 3D practice produces devices with lower alpha cutoff frequencies than epitaxial devices, this is not a particular handicap for medium-speed applications that require frequencies between 5 and 30 MHz.

Defining triple diffusion, Buie notes that it is a bipolar process that offers the simplest means of producing electrically isolated transistors and resistors on the same chip. This process consists of impurity deposition and distribution, done three times in sequence.

Npn transistors and resistors are self-isolated by pn junctions. Pnp's are vertical devices, with collectors common to the substrate. The resistors are n-type and are either of the collector or collector-pinned variety.

Triple-diffused technology has been used primarily for digital applications, Buie notes. It is generally considered less attractive for analog functions because of the limited voltage breakdown and gain-bandwidth of the transistors. However, it has been used in the analog mode to provide reference voltage control and in digital-to-analog converters.

CMOS is covered by two authors at the same session. Jim Foltz, Motorola Semiconductor's manager of digital systems research and development, discusses conventional CMOS, while Walter Kalin, CMOS marketing manager for Solid State Scientific, discusses CMOS/SOS.

According to Foltz, there is a trend developing among manufacturers of small-scale CMOS ICs to switch to buffered output devices. While this would make SSI chips larger, it would also improve the performance of these devices.

SSI devices, says Foltz, suffer from pattern-sensitivity problems. With the addition of a two-stage inverter to the output of SSI devices, this sensitivity can be reduced. Almost all CMOS manufacturers will be switching to buffered outputs for gate-level components, Foltz says.

For MSI and LSI devices, the goal is to increase density. The density of CMOS devices has traditionally been limited by interconnects, gate alignment and the need for guard rings. Techniques to overcome these limitations are being investi-

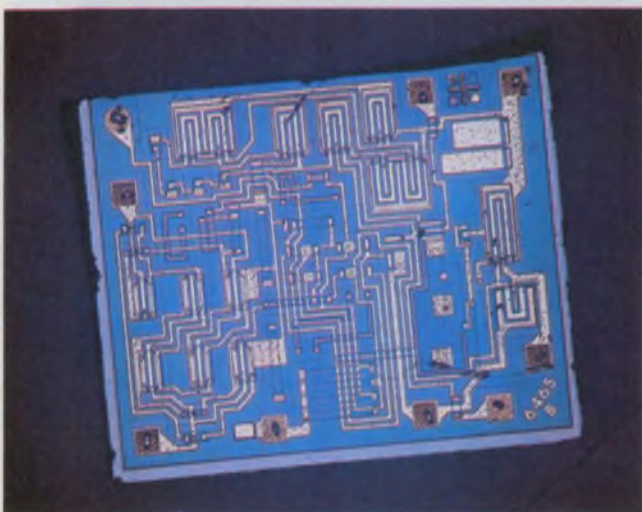

Operation and applications of the CA3130, RCA's tri-technology op amp are discussed in Session 24.

Timetable to the technical sessions at Intercon '75

Tuesday, April 8		Wednesday, April 9		Thursday, April 10	
10:30 a.m. - 1:00 p.m.	2 p.m. - 5 p.m.	9:30 a.m. - 12:30 p.m.	2 p.m. - 5 p.m.	9:30 a.m. - 12:30 p.m.	2 p.m. - 5 p.m.
Session 1 The Microcomputer Revolution	Session 7 Microprocessors: An Alternative to Random Logic Design	Session 13 Will Robotics Answer Industry's Needs?	Session 19 Microprocessors in Instrumentation	Session 25 Access to Computer Networks	Session 31 Computer Systems for Medical Applications
Session 2 Electronic Instrumentation in Medicine	Session 8 Loop Electronics—The New Frontier	Session 14 Trends in Electronic Measuring Instruments	Session 20 Impact of New Technology on Hierarchical Memory and Storage Systems	Session 26 Computer Technology During Hard Times (Panel)	Session 32 Testing LSI Devices
Session 3 Future Projections of Instrument Design	Session 9 The Reality of Standardization in Automatic Test Equipment (Panel)	Session 15 Test Generation Techniques for Digital Circuits	Session 21 Diagnostic Techniques for Logic-Circuit Boards	Session 27 Maintenance and Service of Automatic Systems	Session 33 Advances in Telecommunications Measurement Techniques
Session 4 Advanced Techniques for Automatic Test Equipment (ATE)	Session 10 Controversial Topics in Digital Communications	Session 16 Electronics in Modern Transportation	Session 22 Instrumentation in Oceanography	Session 28 Efficient Product Planning and Development	Session 34 Hybrid Microelectronics Clinic on Component Parts
Session 5 Conservation of Communication Channel Capacity and Network Capability	Session 11 Practical Aspects of Fault-Tolerant Computer Design Techniques	Session 17 Marketing Strategy in the New Markets	Session 23 Computer Communication Techniques	Session 29 Satellite Communications Systems	Session 35 Advanced Navigation Concepts for Low Cost Applications
Session 6 Component Specs and Applications: "What You Don't Know Can Hurt You"	Session 12 Establishing Effective Semiconductor User/Supplier Relations	Session 18 Configurations and Characteristics of Future Digital Logic Devices	Session 24 Monolithic Linears—The Sleeping Giant Awakens	Session 30 The Role of Hybrids in Producibility	Session 36 Component Infant Mortality—Causes and Cures
			Highlight Session 7 - 10 p.m. Social Implications of Nuclear Power		

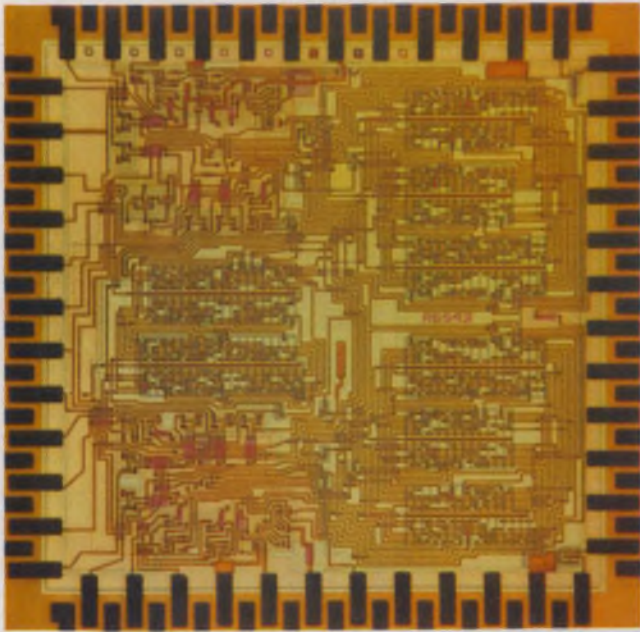

Random logic I²L array fabricated by Bell Laboratories has the equivalent of 256 gates on it.

gated. Included are a low-voltage process that will reduce the necessary guard area, the use of surface or subsurface oxide-guarding techniques and the use of SOS to eliminate the guard rings.

Because the SOS substrate is an insulator, guard rings are not needed, Kalin notes. In comparing the two major SOS fabrication techniques—aluminum-gate and silicon-gate—Kalin says that silicon gate results in higher density.

Commenting on future developments the Solid State Scientific marketing manager sees a number of 4000-series devices being produced in CMOS/SOS. Further down the road, he says, is an 8-bit microprocessor that his company is developing with General Electric and a 4-k SOS RAM. The microprocessor is expected to be completed by the fourth quarter of this year and the 4-k RAM sometime in 1976.

I²L technology described

In a Session 18 paper on "I²L—An MOS Competitive Bipolar Logic Technique," Richard A. Pedersen, supervisor for bipolar IC development at Bell Telephone Laboratories, Allentown, PA, says that I²L can lead to significant system simplification through reduction or elimination of special interfaces between the system and the LSI function.

I²L can be fabricated with standard buried collector technology, he notes, and is therefore compatible with other, more conventional circuitry on the same chip. The flexibility of having digital and linear interface circuitry on the same chip, he continues, adds to the attractiveness of I²L for LSI functions.

The basic logic element in I²L is an inverter that is formed from a multicollector npn transistor. The base drive for the npn is supplied by the collector of a lateral pnp transistor operating in a current source mode. The emitter of this pnp is referred to as the injector.

I²L is unusual in that it is free from dependence on resistors. All logic is powered from the lateral pnps, and the current that reaches each logic element is simply the total injector current multiplied by the alpha of the lateral pnp and divided by the number of units associated with the injector. What this means, Pedersen points out, is that a single design can be operated over a wide range of currents and speeds, simply by alteration of the total current flowing into the injector.

Developing trends in linear ICs are discussed in Session 24: "Monolithic Linears—The Sleeping Giant Awakens." The papers are all product-oriented, and according to the session organizer and chairman Art Fury of National Semiconductor, each of the papers discusses products that are deceptively simple on the outside and complex inside.

In a paper on "Integrated Circuits for Communications Applications," Gary Kelson, an engineer for Signetics, Sunnyvale, CA, describes two newly developed ICs for use in both high-performance and low-quality receivers.

One device is a front-end circuit that contains two dual-gate FETs for use as rf amplifiers and mixers. The IC is fabricated with double-diffused technology (DMOS), which combines the high-frequency, low-noise performance of bipolar devices with the low distortion of FETs. The front-end circuit is designated SD6000, and it incorporates one dual-gate DMOS device optimized for rf amplification and another dual-gate device optimized as a mixer in an economical eight-pin mini-DIP.

The SD6000 can be used for both AM and FM front ends, Kelson notes, and for narrow or wide-band reception up to 250 MHz.

The second IC developed especially for communications is the NE563, a phase-locked-loop demodulator. It has several advantages as a frequency-selective FM demodulator, Kelson says. It eliminates the inductors generally used and makes it easy to get a high Q circuit.

At the same time the 563 eliminates the problem of a limited dynamic range and VCO temperature drift associated with some phase-locked loop circuits.

The operation and applications of a recently introduced operational amplifier that is constructed with CMOS, MOS and bipolar technologies will also be discussed at the session. The amplifier, RCA's CA3130, features operation from both single and dual power supplies. ■■

Satellites and fiber optics gain favor for the transmission of digital data

Satellites are receiving increasing attention as vehicles for digital communications over long distances. For shorter distances, fiber optics is moving to the forefront. Session 29 looks at various aspects of satellite communications, and Session 5 emphasizes fiber optics.

William L. Cook and Ashok K. Kaul of Comsat Laboratories, Clarksburg, MD, cite the many advantages of satellites for digital data transmission. They include the following:

- Communications costs are lower. They depend only on total network traffic and are independent of the number of nodes in the system.
- A single random-access channel can service a multitude of nodes.
- Speeds in excess of 30 Mb/s can be transmitted almost error-free.
- Enormous capacity can be shared by a number of users on a demand-assignment basis, thereby tailoring the resources to individual needs.
- Point-to-multipoint (broadcast) capability is available. This permits simultaneous transmission to all nodes in the network.

According to Cook and Kaul, multiple narrow-beam antennas are desirable for computer networks. Central computer facilities are often clustered near one or more metropolitan areas. Narrow spot beams can be used to increase the

data-transmission rates to those points.

Time-division multiplexing (TDMA) as the multiple-access technique for future communications satellites is emphasized in three papers concerned with European (Eurosat), Canadian (Telsat) and international (Intelsat) satellite communications systems. Pierre J. Bartholome and Simon E. Dinwiddy of the European Space Research Organization (ESRO) in Noordwijk, the Netherlands, argue that TDMA is the technique to use for maximum satellite capacity. They also suggest the use of phase-shift-key modulation for maximum capacity. The first phase in the development program in Europe is the design of an orbital test satellite for operation in 1976. It will not use the Intelsat 6 and 4-GHz up-and-down-link frequency bands. Rather ESRO has selected an up-link band of 14 to 14.5 GHz and down-link bands of 10.95 to 11.2 GHz and 11.45 to 11.7 GHz. These frequencies were chosen to avoid conflict with Intelsat signals. ESRO expects significant atmospheric attenuation at 11 and 14 GHz in heavy precipitation, but it plans to build sufficient gain margins into the equipment to minimize the problem.

Light weight, freedom from interference and broad bandwidth are key advantages of fiber-optic communications systems. John E. Fulen-



Synthetic speech is being produced with 1/50th the previously required digital information. The digital coding scheme developed at Bell Laboratories is ideal for transmission over a fiber-optic link. The screen shows a graphic representation of synthetic speech.

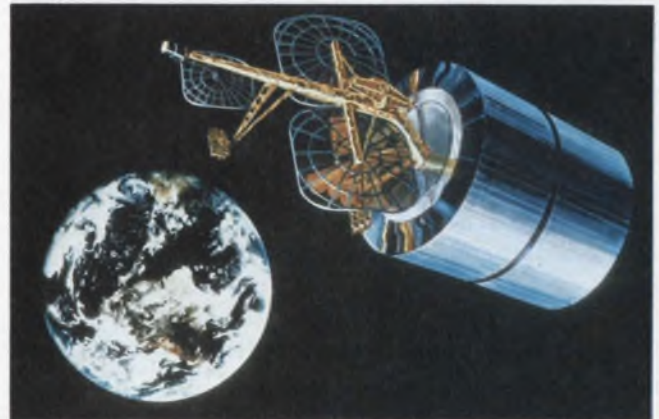

Intelsat IV A communications satellites will use time-division multiplexing for maximum channel capacity. TDMA also makes the satellite an efficient data-communications vehicle. Shown here is the current generation of satellites built by Hughes Aircraft.

wider of GTE Laboratories, Waltham, MA, devotes his Session 5 paper to the potential impact of fiber optics and integrated optics on world communications. He sees significant application in military systems, cable television and telephone systems.

"In vehicles such as ships and aircraft," he points out, "optical transmission cables have advantages due to their small size and light weight. Electrical isolation of the points in communication permits more freedom in packaging and installation, since a common system ground is not needed."

Fulenwider sees optical cables and integrated

optics as significant steps towards the much maligned "wired city" goal of cable TV. Laser sources would be required to achieve the high light outputs in such a system, according to Fulenwider. But the cables would be immune to lightning, he notes, and optical cable could be installed overhead without surge protectors.

In telephone systems, the main use for fiber optics will probably be in interoffice trunking, Fulenwider says. Fewer repeaters are required per circuit than with screened metallic cable. And savings accrue from the light weight, lower installation costs and potentially lower cable costs. ■■

INDUSTRIAL

New workers for factories promised: Intelligent robots that 'feel' and 'see'

"By 1983 the industrial robot will have as large an impact on manufacturing as farm automation has had on agriculture."

So says J. Engelberger, president of Unimation, Inc., Danbury, CT, producer of programmable machines that are loosely called robots. His prediction answers without qualifications the question posed by Session 13: "Will robotics answer industry's needs?"

Engelberger, who has just returned from visiting factories in the Far East and Europe, says in a paper at the session that Japan leads the world in the number of active robotic developments, with "approximately 30, while Europe has about 15 and the United States, 10."

Approximately 200 types of industrial machines are doing routine jobs in plants in the world, Engelberger says, but those under development will be able to do much more work.

At present a programmable machine is taught a job. It is manually led through an operation, overriding the hydraulic system. With this record-playback programming technique, the machine can then do over and over again what it has been taught.

A real robot, of course, Engelberger explains, is one that can do a host of different things, and it should be able to "feel and see."

Besides tactile sensors, Unimation is studying the use of a TV scanning camera to give the robot sight. The image is digitized, then returned to analog form to give the robot an idea of what's going on. Also possible for providing sight is

the use of a laser range finder to tell the robot the shape and distance of objects.

Work to develop intelligent industrial devices at the C. S. Draper Laboratories, Cambridge, MA, is described by James L. Nevins and D. E. Whitney in their paper "Assembly Research at Draper Labs."

"The things we've got now aren't robots," Nevins says. "We have put-and-place machines that remove a screw here and put it over there, repeating this routine until the machine is turned off."

"At the labs, devices are being developed that have sensor arrays to measure force at the wrist joint. They measure three linear forces and three



Robots don't look like people, but they can do routine chores endlessly without suffering boredom or injury. Unimation is working to give its factory machines both sight and hearing.

torques. What we're trying to do is to take information that you can measure when two pieces interact during assembly, and from this information try to construct control algorithms that can later be used during assembly to keep tolerances within prescribed limits."

Draper and the MIT Mechanical Engineering Dept. under the sponsorship of the National Science Foundation are exploring possibilities for developing such intelligent systems for industrial assembly lines.

"If we add to these sensors imaging systems that permit the machine to react to the environment, or more importantly to the changes in the environment, we will have systems that are adaptable as well as programmable," Nevins says.

Stanford Research Institute, Menlo Park, CA, is emphasizing the cost-effectiveness of units to handle a wide variety of chores, such as materials handling, inspection and assembly. The work is described by C. A. Rosen and D. Nitzen in a paper on "Overview of SRI's Industrial Assembly Project."

To date, advanced systems have been built primarily to "demonstrate principles," the authors say, without enough attention to questions of cost and program complexity—questions of major importance to industry.

Programs to test robots with visual capability, for example, have been too elaborate, Rosen and Nitzen say. The robots have been designed to see and identify every object they encounter, where in an actual factory situation they would need only to recognize a relatively small number of parts. It's not necessary for the assembly-line machine to be nearly as expensive as the elaborate test device, the authors point out.

The first goal, the paper says, is to develop computer programs that control a system of manipulators and also visual, tactile and force sensors, end-effectors and auxiliary devices that will perform a wide range of tasks, such as materials handling, inspection and assembly.

Second, SRI is developing a user's language, so that the programs can be operated by factory personnel who do not have computer expertise.

SRI has had good results with its tests so far, Rosen and Nitzen report. In one experiment an automotive casting was randomly placed on a moving conveyor. A robot called Unimate, equipped with visual and tactile sensors, acquired the casting and then transported and deposited it at a specified position and orientation.

To investigate the possibilities of computer-controlled mechanical assembly, IBM has built an experimental system—hardware and software—to assemble mechanical objects. The work is described in a paper by Peter M. Will and David D. Grossman, members of IBM's T. J. Watson Research Center, Yorktown Heights, N.Y. ■■

Exclusive Technical session order form

Please send me the following IEEE technical session preprints at \$3 a session (average: four papers a session), plus \$1 mailing charge for the complete order. I understand this order will be mailed to my address within three weeks following the convention. Offer good until July 1, 1975. (Note: Papers are bound by sessions; no individual papers available.)

Session No.	Quantity	Session No.	Quantity
1		17	
2		18	
3		19	
4		20	
5		21	
7		22	
8		23	
10		24	
11		25	
12		29	
13		31	
14		33	
15		35	
16		36	

Total Sessions × \$3 = \$ _____

Plus \$1 Mailing Charge = \$ _____

Total Cost = \$ _____

Make check payable to IEEE/Intercon and mail with this form to:

**IEEE/Intercon
3600 Wilshire Blvd.
Los Angeles, Calif. 90010**

DATE _____

NAME _____

FIRM _____

STREET ADDRESS _____

CITY, STATE, ZIP CODE _____

MICROPHOTOS

...of high-reliability



22X magnification,
unretouched

ROBINSON-NUGENT "SIDE-WIPE" SOCKET CONTACT

after 5 insertions of DIP lead frame. Contact has been spread apart to show inside faces of contact. See how the RN contact—because it mates with the *smooth, flat side of the IC lead frame*—retains its surface integrity. This 100% greater lead frame contact results in minimum electrical resistance — continued high reliability for your IC connections.

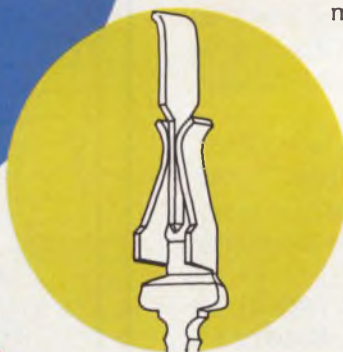

Lead frame in place in RN
"side-wipe" contact.



22X magnification,
unretouched

AN ORDINARY EDGE-BEARING SOCKET CONTACT

after 5 insertions of DIP lead frame. Contact has been spread apart to show inside faces of contact. Notice how the contact has scars and abrasions from *rough, irregular edge of IC lead frame*. Electrical contact is degraded and resistance is increased. Reliability is obviously reduced.

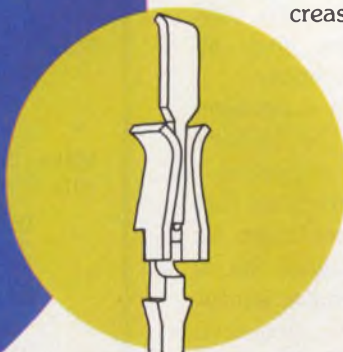

Lead frame in place in an ordinary
edge-bearing contact.

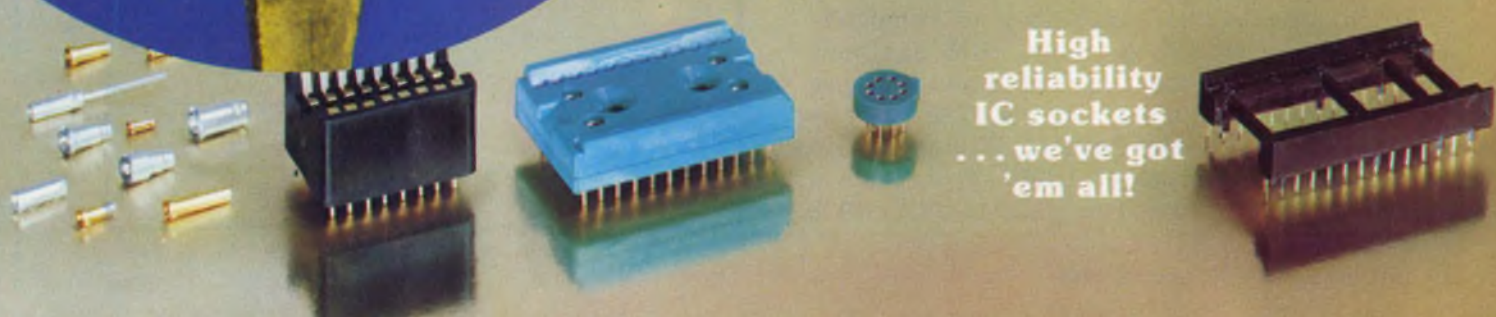

High
reliability
IC sockets
... we've got
'em all!

REVEAL **RN** SECRET

"SIDE-WIPE" DIP sockets

Here's microscopic proof that high reliability Robinson-Nugent "side-wipe" DIP sockets make 100% greater contact than any edge-bearing socket on the market. This advance design provides constant low contact resistance, long term dependability—trouble-free IC interconnects. Yet RN high reliability DIP sockets cost no more than ordinary sockets!

At 30X enlargement, all IC lead frames look like this. Because they are punched out of metal, *the edges are rough, jagged and irregular.* In contrast, the flat sides of the lead frame are smooth, even and perfectly plated. Microphoto unretouched.



WRITE TODAY for catalog and informative book "What to Look for in IC Interconnects." Free from Robinson-Nugent—the people who make more kinds of high reliability IC sockets than anyone.

RN **ROBINSON NUGENT, INC.**

800 East Eighth Street • New Albany, Indiana 47150 • Phone: (812) 945-0211

INFORMATION RETRIEVAL NUMBER 32

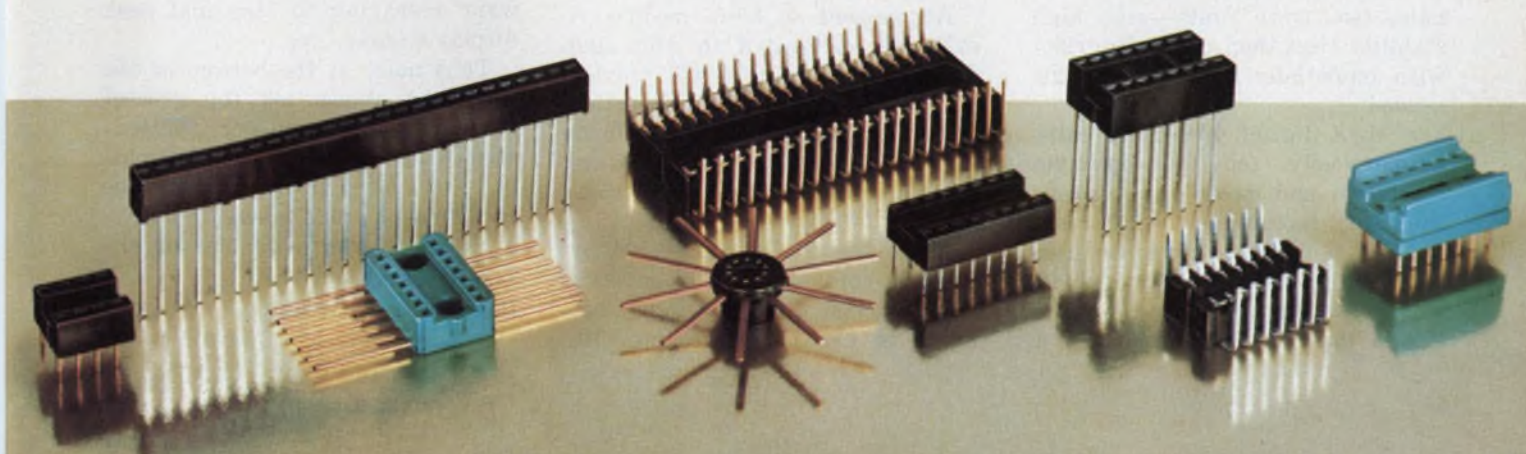

5-MHz spectrum analyzer averages signals digitally to cut noise

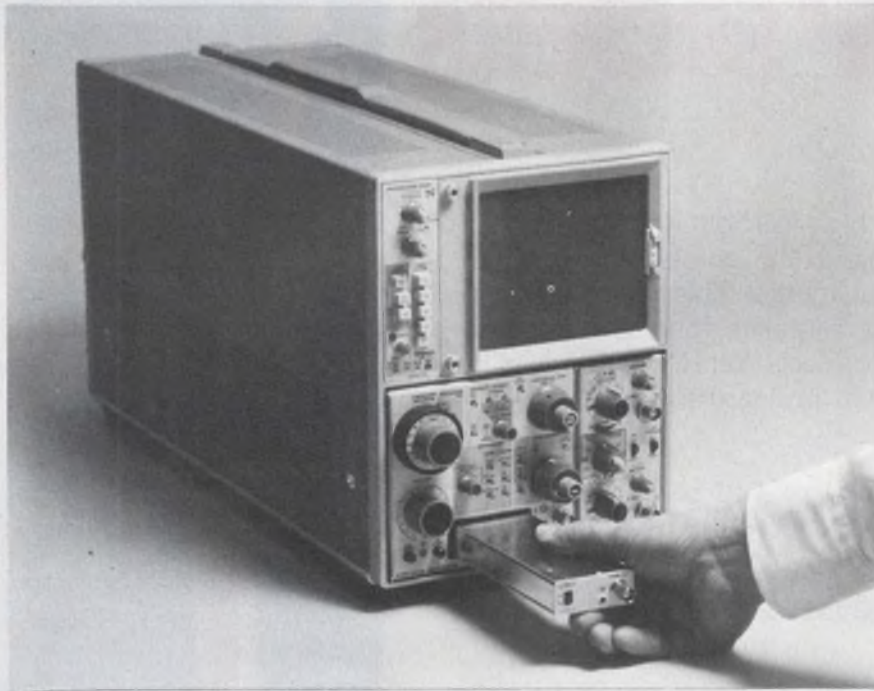

Tektronix Inc., P.O. Box 500, Beaverton, OR 97005. (503) 644-0161. See text.

One word—digital—describes the new 7L5 5-MHz spectrum analyzer from Tektronix. From controls to storage to readout, an all-digital design brings improved performance and gives the user a number of benefits either previously unattainable or available only at a much higher price. Among the improvements are these:

- Digital averaging—a first in spectrum analyzers—cleans signals with no need to increase sweep times.

- Front-end digital frequency synthesis and digital control of signals—two more firsts—give high stability (less than ± 5 Hz/h drift) with essentially no warmup time needed.

- MOS digital processing chips automatically set the optimum resolution and sweep rate, change the scale factors and CRT readout units, and also give the user 151 discrete level settings in 1-dB steps.

And these benefits aren't all. A

preprogrammed turn-on sequence ensures that the 7L5 always comes on at a +16-dBm reference level and zero input frequency. This means you won't readily burn out the input mixer or have to search for the 0-Hz marker on the CRT.

Two other innovations of the Tektronix unit—which plugs into any 7000-series scope—are its input buffer control and a plug-in front end: a plug-in within a plug-in. The input buffer control trades attenuation for i-f gain to give over 80-dB of intermodulation distortion immunity (so you can pinpoint the source of the IM), while the plug-in module lets you change the input characteristics.

At present a 50- Ω module is available, calibrated in dBm and dBV. Future modules will provide differential/single-ended operation and other impedances and calibrations. Gains and scale factors are automatically switched to accommodate the module in use.

Frequency in the 7L5 is set by a single control—actually an optically encoded digital switch—that works in two modes: coarse (10-

kHz steps) or fine (250-Hz steps). Settings are displayed in six digits directly on the CRT. Also displayed are span/div, volts/div, dBm or dBV, reference level and resolution bandwidth.

A small dot, called the frequency dot, can be horizontally positioned along the screen, and the numeric display then shows the frequency at the dot's location.

Resolution bandwidth of the 7L5 ranges from 10 Hz to 30 kHz in eight steps, while the span and sweep rate vary, respectively, from 50 Hz/div to 500 kHz/div and 0.1 ms/div to 10 s/div.

Other key specs include a dynamic range of 80 dB, a residual FM of less than 1 Hz (pk-pk) for spans between 0.05 and 2 kHz/div and a filter shape factor (60 to 6-dB ratio) of 10 or better (10 Hz to 1 kHz), and 5 or better from 3 to 30 kHz.

Equivalent input noise of the Tektronix unit depends on the selected BW: at 30 kHz, noise is -110 dBm (or less); at the narrowest BW, of 10 Hz, noise drops to -140 dBm. Range in the log-2 dB/div mode is from -130 to +21 dBm.

While split digital storage and peak hold aren't new in an analyzer, Tektronix has added a few wrinkles of its own. Not only can two signals be memorized and compared, you can digitally average and set the level at which the vertical display is either peak-detected or averaged—that is, you can move a horizontal cursor on the screen to the point where you want averaging to stop and peak display to take over.

Thus noise at the bottom of the display is minimized for greater sensitivity, while larger (pulsed) signals are detected simultaneously. And you can bypass storage to display signals conventionally.

No price was available for the 7L5 at press time.

Booth No. 2302-2307

Circle No. 306

Front panel components should look good.

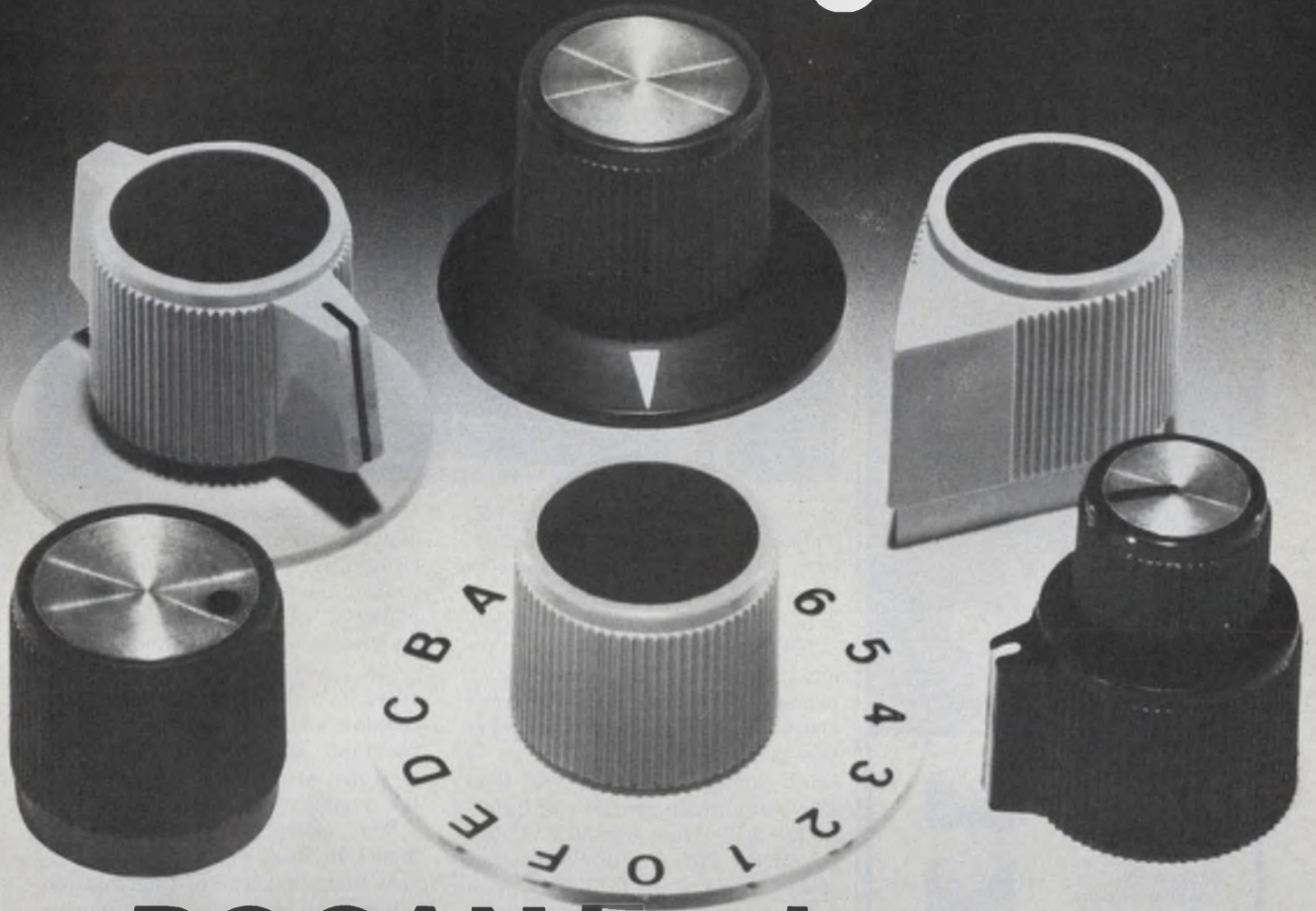

ROGAN knobs and dials do.

Today's market is aesthetics-conscious. An attractive front panel adds to the acceptance of your product. Front panel components, including control knobs and dials, must contribute to the overall design. Some knobs and dials simply look better than others. We think that the Rogan line illustrates superior styling details, while offering the largest selection of functional shapes and sizes available. Obtain a copy of our catalog by contacting Rogan . . . the control knob and custom dial company.

ROGAN
CORPORATION

3455 Woodhead Drive, Northbrook, Illinois 60062
Phone: (312) 498-2300 • TWX: 910-686-0008

from Grayhill

the different DIP Switch

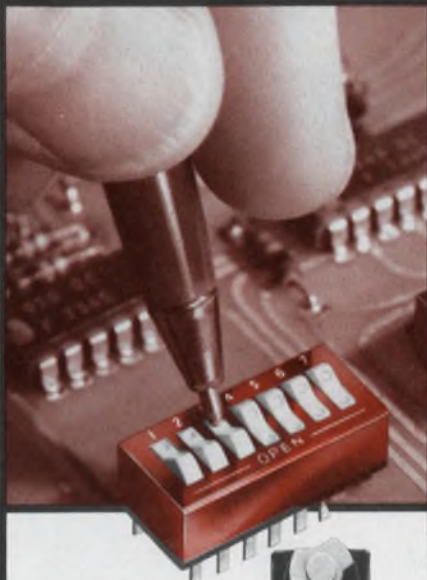

- Exclusive sliding ball contact system for positive wiping action



- Life tested to 50,000 mechanical operations, with commensurate electrical life

- Available in 9 sizes, even a hard-to-find 2 rocker version, on up to 10 rockers

- All SPST, each switch independent, rocker actuated

Of course, the different DIP Switch—Grayhill's Series 76—also offers the standard DIP benefits of easy PC board mounting, compact high density design and a multitude of cost savings. Get the full story, including detailed specifications and prices, in Grayhill Engineering Bulletin # 238, available free on request.



561 Hillgrove Avenue • La Grange, Illinois 60525
Phone (312) 354-1040

INSTRUMENTATION

3-3/4-digit panel meter is accurate to within 0.25%



Newport Laboratories, 630 E. Young St., Santa Ana, CA 92705. (714) 540-4686. See text; stock to 30 day.

Laboratory-instrument accuracy is being approached in temperature measurement at digital-panel-meter prices. Newport Laboratories claims the only digital temperature-measuring instrument at a small-quantity price of less than \$300 with maximum error of 0.25% of full scale from 0 to 50 C. Called the Model 267 Digital Pyrometer, it can measure up to 3200 F with 1-degree resolution. LED displays, 0.5-in. high, are used and reach a maximum count of 3999.

An analog linearization scheme is employed, as opposed to the digital read-only memory linearization techniques on instruments that cost more. Conformity to National Bureau of Standards requirements is better than 0.2% over the full span.

Nonisolated BCD data outputs are a standard feature, as are out-of-range and broken-thermocouple indications. Options include buffered BCD data outputs that are optically isolated—up to 300 V—from thermocouple inputs, power line or earth ground. Also available are an analog output to drive a strip-chart recorder and an internal single-limit set point. Set-point selection may be made by permanent hard-wire jumpers on

the rear connector for dedicated applications, by remote switches or by direct computer control.

The panel meter comes with plug-in circuit boards, each matched to a different temperature sensor. Available are plug-ins for types T, J, K, E, R and S thermocouples and for three ranges of platinum resistance devices. The plug-ins are sold as options for the panel-meter mainframe.

The closest competitor, the Model 70 from Ircon (Skokie, IL), uses a similar type of linearization scheme and plug-in concept. Whereas the Ircon unit costs \$485 in small quantities with a single plug-in (additional plug-ins cost \$75 each), the 267 from Newport costs only \$150 in small quantities as a bare mainframe with no plug-ins. Plug-ins for J, K and E thermocouples and two of the platinum resistance devices cost \$75 each in small quantities, and plug-ins for the type R, S and T thermocouples and one of the platinum devices cost \$120 each.

With a single low-cost plug-in, the 100-unit price for the Newport 267 is \$146.25. With the more expensive plug-in, the 100-unit price is \$175.50.

The meter is housed in a Lexan case, 1.68 × 3.92 × 5 in.

Booth No. 2122-2124

For Newport Circle No. 303

For Ircon Circle No. 304

SEE US AT INTERCON BOOTH #1625-27-29

INFORMATION RETRIEVAL NUMBER 34

Signal has the answer...

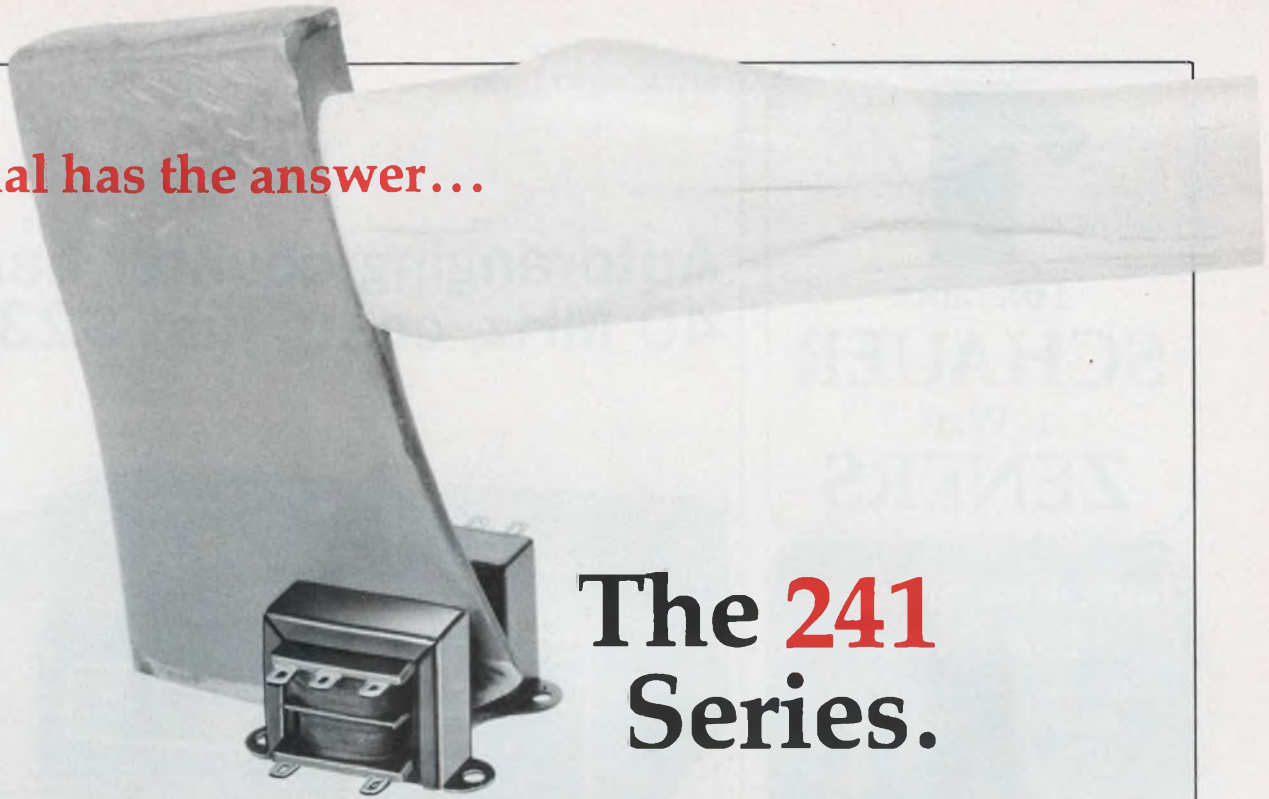

The 241 Series.

Cuts transformer weight, size and cost almost in half!

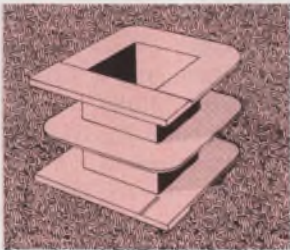

Special "split" bobbin (secondary wound alongside primary rather than over it) effectively isolates primary and secondary and reduces inter-winding capacitance. An electro-static shield

is not required in all but the most sensitive applications. Hipot rating of 2500V RMS is standard. Bobbin winding technique affords a 40-50% savings in winding space over conventional layer winding. "Split" bobbin eliminates the need for inter-winding insulation and cross-over of primary and secondary leads.

Grain-oriented steel core is used at higher saturation flux densities and results in about a 40% reduction in turns required. Although the cost per lb. of grain-oriented steel is higher than that

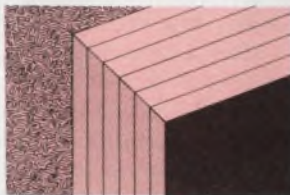

for ordinary silicon steels, the net cost is less, since less core weight is required and a significant reduction is made in copper weight.

Terminals, which are wedged into the bobbin wall, are designed so that they can be used as solder lugs or as 0.187" quick-connect types. Lead slots are incorporated in the bobbin wall leading to the terminals. It is not necessary to tape the start lead since it comes to the top of the coil through the slot and is thus separated from the winding. Separate lead wires or terminal boards and the extra assembly time to use them are eliminated.

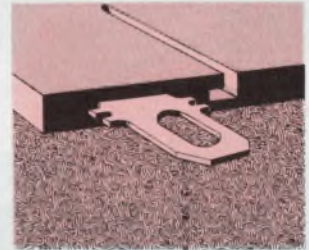

Fresh thinking in engineering design and material selection has reduced material and labor cost and results in a series of small power transformers which cut weight, size, and cost almost in half. Therefore, we named them the "2-for-1" series...



signal transformer co., inc.

1 Junius Street, Brooklyn, N.Y. 11212
Tel: (212) 498-5111 • Telex 12-5709

-and Signal has it in Stock!

AMERICAN **1** MADE

Tolerance
SCHAUER
 1-Watt
ZENERS

**Immediate Shipment
 Low Prices**

ANY voltage from 2.0 to 16.0

Quantity	Price each
1-99	\$1.07
100-499	.97
500-999	.91
1000-4999	.86
5000 up	.82

All welded and
 brazed assembly

No fragile
 nail heads

Gold
 plated
 leads

Write for complete
 rating data and other
 tolerance prices.

**Buy the kit-
 Save
 a lot**



Kit contains a 51-piece assortment of SCHAUER 1% tolerance 1-watt zeners covering the voltage range of 2.7 to 16.0. Three diodes of each voltage packaged in reusable poly bags. Stored in a handy file box. Contact your distributor or order direct.

A \$54.57 value for
ONLY \$24⁵⁰

Semiconductor Division

SCHAUER
 Manufacturing Corp.

4511 Alpine Ave. Cincinnati, Ohio 45242
 Telephone: 513/791-3030

Autoranging counter handles 40 MHz, costs just \$230



B&K Precision, 1801 W. Belle Plaine, Chicago, IL 60613. (312) 327-7270. \$230.

Almost a contradiction in today's inflationary economy, frequency counters have been plunging in price, yet soaring in performance. B&K Precision's Model 1801 typifies the trend. For \$230, the instrument gives automatic ranging from 20 Hz to 40 MHz, 1-Hz resolution and a 6-digit LED display of frequency in either kilohertz or megahertz.

TTL circuitry automatically updates the reading at a rate of up to five times per second. And when you set the function switch to AUTO, the 1801 fills all the display positions, suppresses the least significant digits, if necessary, and shows the range on kHz/MHz indicator lights.

To get the maximum resolution of 1 Hz, you switch the function knob to the 1-sec mode. In this position the kHz display lights up and the decimal point moves left to show the least-significant digits.

If, for example, you're checking the color carrier frequency of 3.579545 MHz and want the best resolution, you'd use the 1-sec mode. The LEDs would then show 579.545 kHz—if the carrier was

right on target. Here, the most significant digit (MSD) is traded off for the least, and a LED over-range indicator blinks to tell you this. But go back to AUTO and the MSD is restored.

Gate periods in AUTO are 10, 100 or 1000 ms. The B&K Precision unit selects from these three for best accuracy and fastest reading. The input is ac-coupled and can vary over a fairly wide range with no level adjustment normally needed.

Sensitivity of the 1801 is guaranteed at 30-mV rms, with the maximum input (peak ac + dc) listed as 200 V to 500 Hz, linearly derated to 100 V at 1 kHz to 5 MHz, and again linearly dropping off to 50 V at 40 MHz.

Stability of the 1801 stems from the 10-MHz internal time base. At 25 C, after a 30-m warmup, you can expect scettability of ± 0.1 ppm and variation of less than 1 ppm for $\pm 10\%$ line variations. Tempco from 0 to 50 C is no worse than ± 10 ppm. And the crystal aging rate is specified at 1 ppm/month over the short term and 10 ppm/year for the long haul. If you'd like greater accuracy, you can hook up your own external time base.

Booth No. 2718-20 Circle No. 302

OEM buyers:

Ask Control Data

about a family of mini computer
peripherals you would be proud
to call your own.

We've got it.

Call (612) 853-3111 or return coupon.

- Rotating Memories Card Readers Printers
 Core and Semiconductor Memories
 Tape Transports Terminals OCR

21 OEM offices, in 11 countries,
specializing in service to the mini OEM

Bill Droll, OEM National Sales Manager
Control Data Corporation, Dept. ED-45
P.O. Box 0 Minneapolis, MN 55440

Please send information (checked above)

NAME

TITLE

COMPANY

ADDRESS

CITY

STATE

ZIP

PHONE



The Total Services Company

INFORMATION RETRIEVAL NUMBER 37

How high is the REL in a high REL Hybrid?

Ask Raytheon/Quincy

We'll give you the answer. Easily. Because high-reliability hybrids are the only hybrids we make. And 98% of them go into military and medical electronics applications. So our hybrids have to be high in technology and performance as well as reliability. That's why we call them "highbrids."

Beam lead or chip-and-wire configurations, all our hybrids are custom engineered to meet the most rugged reliability specs imaginable. Maybe that's why our customers are so high on our hybrids. If you want to know how high our reliability really is, ask a reliable source. Contact Mr. K. Singh at Raytheon Company, Industrial Components Operation, 465 Centre Street, Quincy, Mass. 02169. (617) 479-5300.



INSTRUMENTATION

Calculating scope programs with keyboard



Norland Instruments, Fort Atkinson, WI 53538. (414) 563-8456. \$13,400 with monitor and two single-channel plug-ins; start May 31.

A smart oscilloscope—the NI 2001—combines all the capabilities of a digital scope and a micro-processor in a single mainframe. The unit requires no computer instructions or programming experience. Preprogrammed, fixed-function buttons on the keyboard allow you to calculate rise times, integrals, differentials, peak areas, rms values, peak-to-peak measurements, n-point averaging, frequency and square root.

The Norland instrument uses plug-in data-acquisition units with controls similar to those of a standard scope and provides a CRT display of signals and alphanumeric. The unit also features high-speed real-time data storage and it has an interactive keyboard to calculate, convert units, and program for automatic signal processing.

The data memory consists of a 4 k × 12-bit, 900-ns RAM and a program memory of 200 keystrokes. The 2001 accepts two plug-ins for up to four channels of data with 8, 10 or 12-bit resolution at a sample rate up to 1 MHz. Either signal-acquisition or calculating plug-ins can be used.

Booth No. 2732-34 Circle No. 301

5 amp high voltage fast switching power Darlingtontons



SDM 22301-03
SDM 22311-13

Solitron's new fast switching NPN Darlington transistors are high voltage units offering gain ratings at collector currents of 2 to 5 amps and voltages from 150 to 350. And they don't come any more rugged, packaged in an all steel TO-3 case. The result? Whatever you build will switch faster and offer more reliability than comparable units now on the market.

These Darlingtontons were designed for power switching, hammer drivers, audio amplifiers, series and shunt regulators. Available in quantity, they're competitively priced — and waiting for you right now. Write Solitron today for specification sheets and more information.

TYPE NO.	$h_{FE}(typ)$	$V_{CEO}(sus)$	$V_{CE}(sat)$	$V_{BE}(sat)$	$f_T(typ)$
	@ $I_C = 2A, V_{CE} = 5V$		@ $I_C = 2A, I_B = 0.02A$		
SDM22301	150	150V	1.6V	2.4V	10MHz
SDM22302	150	250V	1.6V	2.4V	10MHz
SDM22303	150	350V	1.6V	2.4V	10MHz
	@ $I_C = 5A, V_{CE} = 5V$		@ $I_C = 5A, I_B = 0.2A$		
SDM22311	70	150V	2.6V	3.5V	10MHz
SDM22312	70	250V	2.6V	3.5V	10MHz
SDM22313	70	350V	2.6V	3.5V	10MHz

Solitron
DEVICES, INC.

1177 Blue Heron Blvd., Riviera Beach, Florida, 33404 • (305) 848-4311 • TWX: (510) 952-7610

Keithley's newest μ volt DMM is...

sensitive . . (to 1 μ V, 10pA, 1m Ω),
stable (0.2 μ V/ $^{\circ}$ C),
versatile . . . (26 dc ranges),
economical (\$525)



The Model 160B. It's the epitome of a DMM for scientific and engineering labs. Sensitivities down to 1 microvolt, 10 picoamps, and 1 milliohm are founded on Keithley's lifetime of expertise in designing and building low-level instrumentation.

But the 160B isn't just for super-sensitive measurements... it's a rugged, all-around Multimeter too. It measures voltages to 2000 volts, currents to 2 amps and resistances to 2000 megs. Floating measurements to 2000 volts off ground are routine for the 160B which also has Keithley's traditional analog output. And there's a full complement of accessories to enhance the DMM's versatility—rechargeable battery operation, digital output, rf probe, carrying case and many more.

Punishing overloads won't impair the performance of this reliable DMM either. Its overload protection combines with rugged mechanical design to result in a Multimeter capable of handling the abuse that a lab DMM experiences.

The new Keithley Model 160B Digital Multimeter has it all: sensitivity, stability, versatility, economy. Find out what it can do for you. Send for complete literature or phone (216) 248-0400.



**KEITHLEY
INSTRUMENTS**
U.S.A.: 28775 AURORA ROAD, CLEVELAND, OHIO 44139
EUROPE: 14, AVENUE VILLARDIN, 1009 PULLY, SUISSE

520-MHz sig gen offers calibrated, metered FM



Hewlett-Packard, 1501 Page Mill Rd., Palo Alto, CA 94304. (415) 493-1501. \$2400.

Calibrated and metered frequency modulation over the full range of 10 to 520 MHz are featured by the Model 8654B rf signal generator. Four FM peak-deviation ranges are available to the user—0 to 3 kHz, 10 kHz and 30 kHz over the full range of the unit, and 0 to 100 kHz over 100 MHz. Distortion is below 1%. AM specs of the earlier 8654A are preserved in this "B" version by Hewlett-Packard.

The combination of 520-MHz range, amplitude and frequency modulation, wide output range (+10 to -120 dBm), and light weight (16 lb 5 oz.) make the unit an attractive general-purpose signal generator to test and align narrowband FM receivers.

The frequency settability of the unit has been improved with a fine-frequency vernier that can tune to 5 ppm of the carrier; this is a necessity to align receivers with channel spacings of 12.5 and 25 kHz. The instrument's solid-state oscillator drifts less than 10 ppm per 10 minutes after warmup.

The 8654B's internal AM at 400 and 1000 Hz modulates 0 to 90%, with less than 1% distortion at 50% AM. And the new internal FM holds distortion below 1%, except at highest ranges, where it's specified as less than 2%. A multi-function meter reads AM, FM and output level. Deliveries start in June.

Booth No. 2518-2531

Circle No. 307

Thinking wirewound?

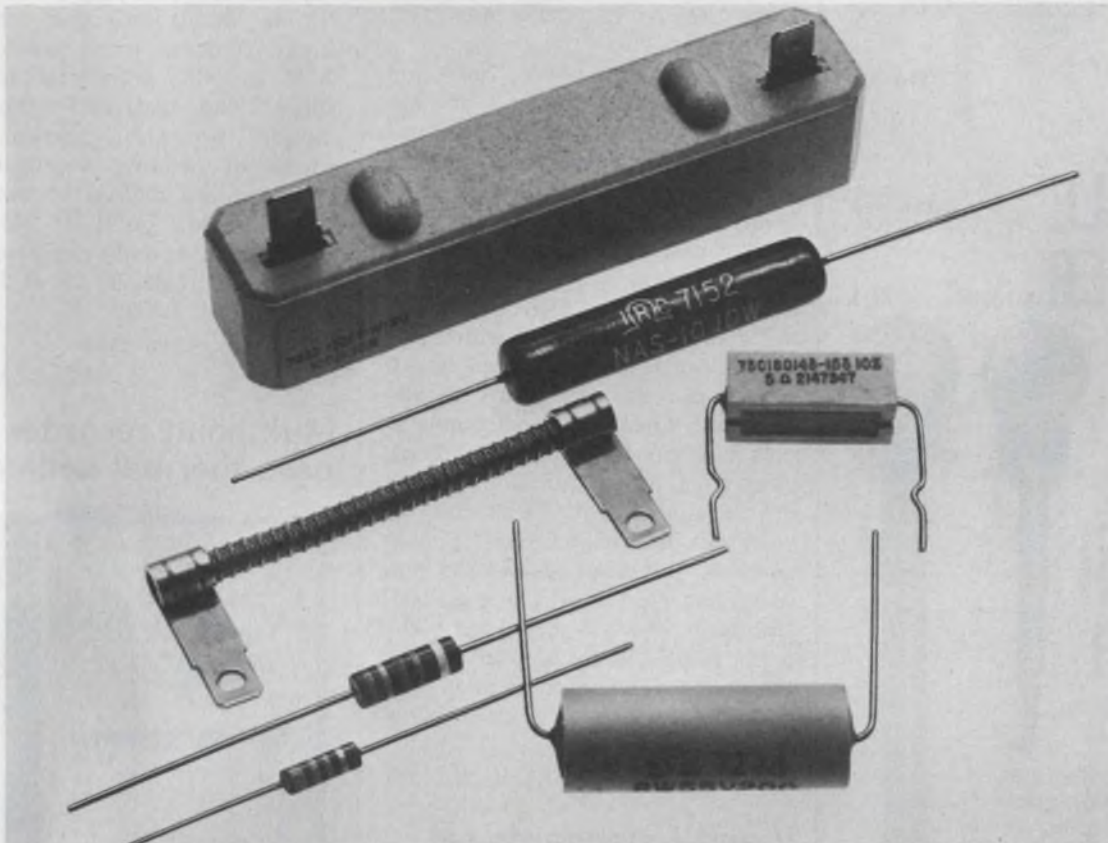

For optimum cost/performance ratios,
see TRW/IRC—at the design stage.

Why? Because we offer just about every type wirewound that's commercially feasible. So we can help you find the most for your money. Or more for less money. For example:

Watts/Inch consumer types. For appliance, automotive, heater circuitry. To 6 w/in. Terminal options.

Machine Insertable molded units. Often a carbon comp. replacement. Offer smaller size, lower resistance range, lower cost.

Ceramic insulated power. The standard for general purpose power—2 to 50 w. Fusing capabilities, special TC's available.

Fusible/flameproof units. Rated at 2 w., but won't burn or burn board under faults of 4x to 1000x rated power (or 1000 v, whichever is smaller). Special fusing characteristics if you wish.

Axial and radial power. ½ to 250 w., fixed or adjustable. Unmatched for power density/precision. Broad special design capability here.

Complete resistor choice. Understand, TRW isn't locked in to wirewounds. If we think your design will fly better with, say, precision film, we'll suggest it. In fact, TRW offers a total resistor capability—carbon comp., thin-film, Metal Glaze™, wirewound, networks.

For specs and application data on *wirewounds*, contact your local TRW sales representative. Or write TRW/IRC Resistors, an Electronic Components Division of TRW, Inc., 401 N. Broad St., Philadelphia, Pa. 19108.

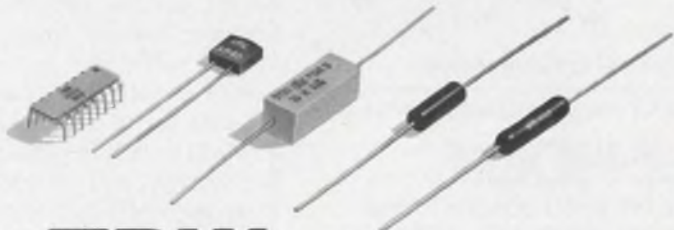

TRW[®] IRC RESISTORS

INFORMATION RETRIEVAL NUMBER 42



**THE
NEW
MICRO
TROUBLE
SHOOTER
ADDS
A
LITTLE
LENGTH
TO OUR
LINE**

X-100W

XL-1

HOOKS
ILLUSTRATED
ACTUAL
SIZE

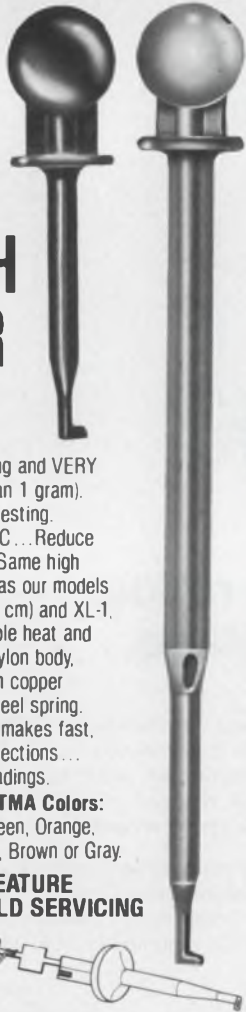

(1.75" - 4.45 cm) long and VERY little weight (less than 1 gram). Ideal for difficult IC testing. Connect DIRECT to IC... Reduce resistance build-up. Same high quality construction as our models X-100W, (2.25" - 5.7 cm) and XL-1, (5" - 12.7 cm): Durable heat and chemical resistant nylon body, Gold-plated Beryllium copper contact, Stainless steel spring. Single contact point makes fast, safe, short-free connections... assures accurate readings.

Available in 10 RETMA Colors: Red, Black, Blue, Green, Orange, Yellow, White, Violet, Brown or Gray.

ALL MODELS FEATURE EXCLUSIVE FIELD SERVICING



Damaged lead wire easily replaced.

Send for complete catalog & price list.

E-Z-HOOK

114 EAST SAINT JOSEPH STREET
ARCADIA, CALIFORNIA 91006
(213) 446-6175 / TWX 910 582 1614

INSTRUMENTATION

LED analog panel meter has 5-in. linear scale



Simpson Electric, 853 Dundee Ave., Elgin, IL 60120. (312) 695-1121. \$130.

The AnaLed Models 7527 and 7527SM combine the best of analog and digital displays. Advantages of this indicator include a bright, high visibility, 5-in. long, direct-reading LED scale; a virtually instantaneous response (15 ms maximum) with no overshoot; a dc sensitivity of 1- μ A full scale; a full-scale ac reading, which can be obtained with as little as 10 mV pk-pk; and the ability to display both linear and nonlinear signals (square-law, log, dB, ohms, etc.) as a linear function. Models are available for horizontal or vertical indication. The dimensions of the AnaLed are 200 mm \times 50 mm (the latest proposed IEC standard 7.87 \times 1.97 in.). The front panel depth is 0.75 in. for the surface mounted version and 0.5 in. for the through panel model.

Booth No. 2218 Circle No. 347

V and I standards set to high accuracies

Zi-Tech Division, Aikenwood Company, 223 Forest Avenue, Box 26, Palo, Alto, CA 94302. (415) 326-2151.

TE2004 dc voltage standard offers high precision and a stable built-in reference. Accuracy is 0.005% and a calibrated sensitive null detector is included. Output voltages in four ranges from 11 mV to 11 V fs can be set with better than 1-ppm resolution. The unit has the convenience of a line power/battery unit. TE609S current calibrator can supply accurate dc currents from nanoampere levels up to 100 mA. Five thumb-wheel switch decades permit precise selection and display of current on each of five ranges. Accuracies of 0.05% and 0.02% are available.

Booth No. 2223 Circle No. 342

Automatic counter covers 20 Hz to 18 GHz



Systron-Donner, One Systron Drive, Concord, CA 94518. (415) 682-6161.

Model 6054A automatic microwave counter spans 0.02 to 18 GHz in one band with one connector input. Dynamic input range covers -15 to +30 dBm with no dead zones. The instrument boasts a unique protection system that warns of pending overloads, and provides two measuring modes—a narrow mode for 1-Hz resolution in 1 s and a wide mode to track drifting signals. Readout is with an 11-digit LED.

Booth No. 2426-2431

Circle No. 346

Multipoint recorder uses thermal writing



Gould, 3631 Perkins Ave., Cleveland, OH 44114. (216) 361-3315.

A thermal writing multipoint recorder, the Brush 816, is designed for general-purpose recording in the laboratory, shop or field. The unit records up to eight channels of analog information on fan-fold chart paper at sampling rates of up to 16 points per second. The maximum channel span of 4.5 in. provides good display resolution. The multiplexed, overlapping traces with positive channel identification are ideal for data comparison, quick look readout and data reduction.

Booth No. 2513-2517

Circle No. 348

NOW... FOR THE BURROUGHS SELF-SCAN[®] BAR GRAPH DISPLAY

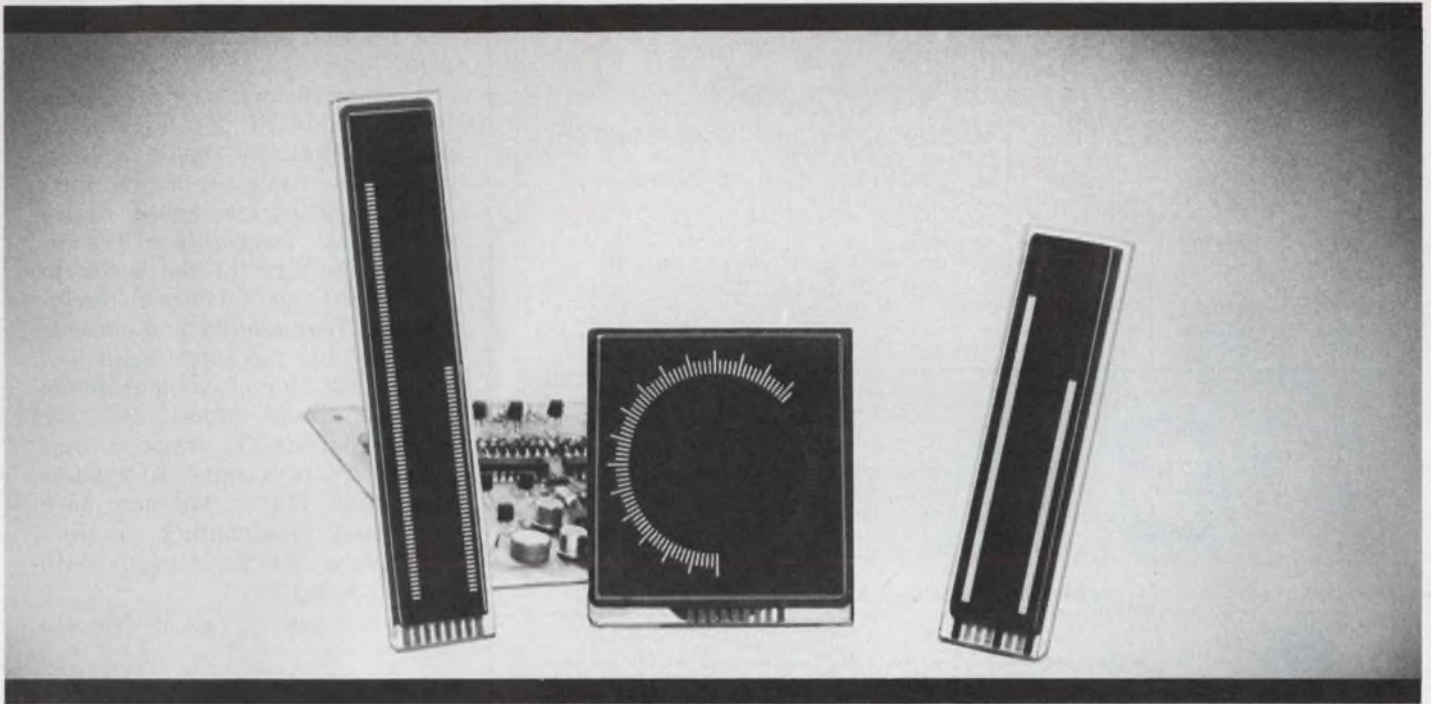

A DO-IT-YOURSELF CREATIVITY KIT— WE SUPPLY THE PARTS — YOU DO THE ASSEMBLY

PUT IT ALL TOGETHER . . . and you have a functional BURROUGHS bar graph display that's ideal for experiments, development, evaluation, and demonstration.

Here's an easy and inexpensive way to see what Burroughs bar graph displays can do for you. These breadboard kits are supplied with printed circuit board, all necessary active and passive components, and a SELF-SCAN bar graph display unit.

There are three standard bar graph displays currently available: dual 200- and 100-element bar graph displays with 1/2% and 1% resolution in each channel with only 8 connections to the display; and a full circle 120-element bar graph with 3-degree resolution with only 9 connections to the display.

We've worked out the electronics for you so you can put it together quickly. Then, all you have to do is tie in your analog inputs (any signal up to 30V), connect +5V and +250V power supplies, and your bar graph display is in operation!

Your choice of 3 kits: Kit K-1, a dual 100-element linear bar graph at \$79.95; Kit K-2, a dual 200-element linear bar graph at \$99.95; or Kit K-3, a 120-element circular bar graph at \$109.95; each contains the display, the proper drive circuit, components, and instructions for assembly. The +5V and +250V power supply, Kit K-4, is available at \$29.50.

Available from stock from all Burroughs distributors: Hamilton/Avnet Electronics, Cramer Electronics, Arnold Barnes Associates, and Jack Weiss Company, Ltd.

For further information, write or call Burroughs Corporation,
Electronic Components Division, P. O. Box 1226, Plainfield, N. J. 07061,
or call 201-757-3400 or 714-835-7335 in California.

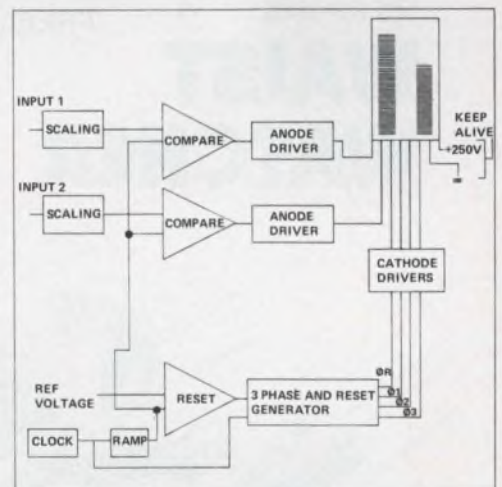

This block diagram for a dual linear bar graph shows you how simple the operation really is.

Burroughs 

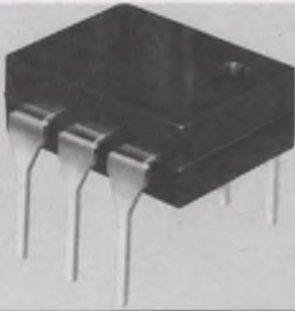

New High Voltage Opto Couplers in 6-pin DIP's!

Part	CTR Typ. Min.	Isolation Voltage (Min.)	Replaces
SPX-35	150%/100%	3500	4N35
SPX-36	150%/100%	2500	H11A1, 4N36, TIL-114, IL-15, CLI-3, IL-5, CM4-5010, CM4-5020
SPX-37	150%/100%	1500	4N37, MOC-100, OP12151, OP2152
SPX-6	150%/100%	1500	
SPX-2E	80%/30%	2500	MOC-2E, MCT-2E, M25, H11A1, H11A3, TIL-114, TIL-115, MOC-100, MOC-811, ISO-LIT1
SPX-2	80%/30%	2500	MCT-2, M26, H11A2, TIL-111, FCD-820, FPLA-820, CLI-2, CLI-5
SPX-26	30%/10%	1500	CM4-5010, CM4-5020
SPX-5	80%/30%	1500	MOC-100, MOC-811, ISO-LIT1
SPX-4	30%/30%	500	MOC-1000, MOC-1002, FCD-810, FPLA-810, IL-12, IL-15, IL-16, IL-74, ISO-LIT12, ISO-LIT16
SPX-28	30%/10%	500	H11A5
			4N28, MOC-1003



Spectronics
INCORPORATED

830 E. Arapaho Rd., Richardson, Texas 75080 (214) 234-4271

INFORMATION RETRIEVAL NUMBER 45



electrocube capacitors

...in metallized Mylar* feature packages nearly 40% smaller than comparable conventional units, with no compromise in performance and price. Choose from 900 Series 230 models in wrap and fill, epoxy and metal cases, in round, oval and rectangular configurations. Capacitances from 0.0010 to 50.0 mfd, and voltages of 100, 200, 400 and 600 VDC are available. For more information, write or call Electrocube, 1710 So. Del Mar Ave., San Gabriel, CA 91776, (213) 283-0511; TWX 910-589-1609.

FREE....application bulletin series available on request

WAIST WATCHER

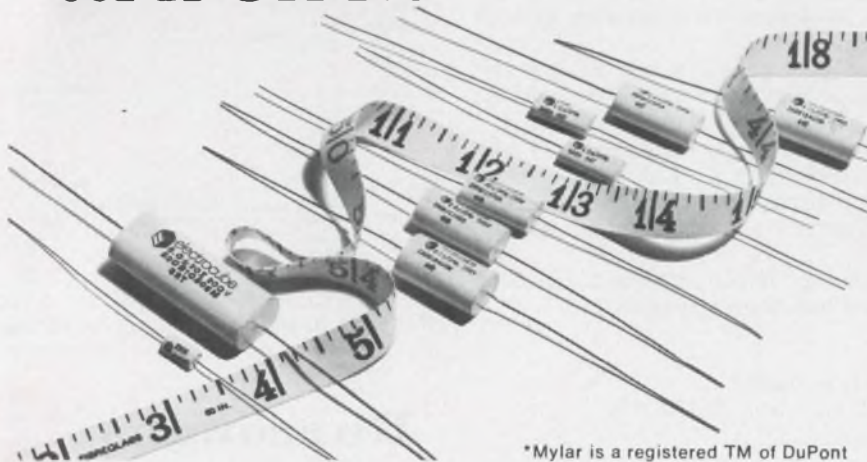
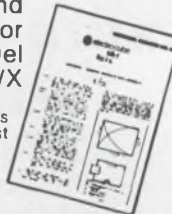

*Mylar is a registered TM of DuPont

INFORMATION RETRIEVAL NUMBER 46

INSTRUMENTATION

Temperature indicators offer high reliability



Doric Scientific, 3883 Ruffin Rd., San Diego, CA 92123. (714) 565-4415. Start at \$300.

A proprietary ion-implanted PMOS LSI chip that does practically everything—analogue and digital—is the basis for a new family of instruments, called Series 400 Digital Temperature Trendicators. The first of the series to be released has 1.0-degree resolution and repeatability and consists of Model 400 for single-input TC, Model 402 for five-input/single TC type; and Model 403 for single-input/six-TC types. All models are in a small DIN package, 72 × 144 × 173 mm, have low power consumption (1 to 3 W), and a low parts count with 100,000 h MTBF.

Booth No. 203 Circle No. 340

High-speed synthesizer also boasts low noise



Ailtech, 815 Broad Hollow Rd., Farmingdale, NY 11735. (516) 595-6471. \$8995; 60 days.

The first in a new line of direct frequency synthesizers, series 360, covers 10 kHz to 180 MHz and offers low noise and high switching speed. Discrete spurious outputs are 100-dB down (to 60 MHz) and the noise floor is 138-dB below the output level in a 1-Hz bw. Harmonics are typically 35-dB down. Switching speed is 20 μs. Frequency selection is by 11 pushbutton digits or by remote programming. The line will eventually extend to 1.4 GHz.

Booth No. 2324, 2326

Circle No. 337

Four-channel CRT has built-in chart recorder



Mirvalle Electrics, Manor Way, Old Woking, Surrey GUZZ 9JU, England.

The Instagraph, a high-speed four channel X, Y, T and Z direct-recording system, uses an inertia-less recording method. The unit produces dry 100-mm wide records in seconds. It uses recording techniques perfected by the company in the field of medical instrumentation and is a general-purpose recording oscilloscope for research and industry. Other Instagraphs available include models without monitoring CRT (useful in OEM applications) and models with 200-mm wide recording paper.

Booth No. 2308 Circle No. 349

Linear IC tester handles quad devices

Teradyne, 183 Essex St., Boston, MA 02111. (617) 482-2700.

The J149 is a bench-top test instrument for inspection of industrial linear ICs. It performs dc parametric tests on op amps, comparators, and voltage regulators. The tester will repeat test sequences for dual, triple, and quad devices. Test results are indicated on a single "reject" lamp, with other displays indicating the reason for rejection. The J149 uses two programming boards to test each device: a family board for each major class of component (such as op amp); and a device board for each unique device within a family (e.g., 741). Limits can be programmed through a keyboard entry or, optionally, through preprogrammed ROM modules that plug into the test deck. Socketing accommodates DIPs, cans, and flat packs.

Booth No. 2532-2537

Circle No. 336

SLIM-MOX

NOW VICTOREEN
QUALITY COSTS LESS
THAN A DOLLAR.

Victoreen announces SLIM-MOX, our new, thick-film, flat substrate resistor.

Compact in design, it carries with it all the quality and dependable performance you have come to expect from Victoreen.

SLIM-MOX, right now, is available from stock in a wide range of standard resistance values. More important, SLIM-MOX will deliver the same proven performance in high-voltage applications that you find in more expensive resistors with more bulk.

Specify SLIM-MOX in any standard resistance value and your unit cost will be less than one dollar in OEM quantities. Truly a major cost breakthrough for resistors designed for miniaturized

electronic networks and equipment, or other critical applications that demand stability and reliability.



Standard tolerance is $\pm 15\%$ for all standard resistance values which include 1, 2, 5, 10, 20, 50, 100, 200, 500, 1000, 2000, and 5000 megohm. All in stock. With a voltage coefficient of better than 5 ppm/volt, full-load drift typically less than 0.5% in 1000 hr at 70° C, and 250 ppm TCR or less to 5000 megohm, SLIM-MOX is a little, big performer. For less than a buck.

From a name you know you can count on. Victoreen.

Victoreen Instrument Division,
Sheller-Globe Corporation,



SHELLER-GLOBE CORPORATION

10101
Woodland
Avenue,
Cleveland,
Ohio 44104

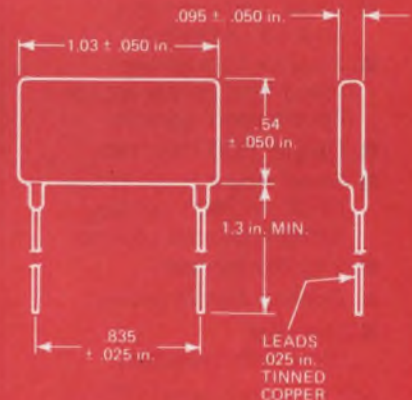

SLIM-MOX SPECIFICATIONS

Resistance Range	1M-5,000M
Power Rating @ 70°C	2W
Maximum Operating Volts (Applicable above critical resistance)	10,000V
Available Tolerance	15%
Critical Resistance	50M
Max. Service Temperature	150°C

Large Lens LED's

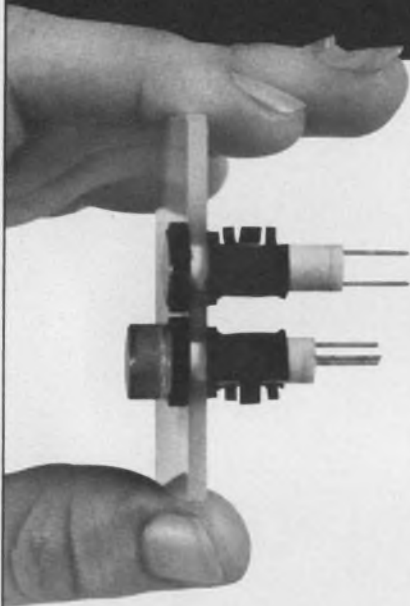

Green, Yellow, Amber, Red

- With or without built-in resistors.
- Large, bright viewing area (.4" diameter).
- Ideal for backlighting (dead front panels etc.) or hot stamped legends.
- Can be PCB mounted.
- Small mounting diameters (.250" or .290") for easy wiring and close spacing.
- 2 to 28V models.
- Optional built-in drivers.
- Low cost, immediate availability.

And we've got more! LED, Incandescent and Neon sub-miniature panel lights . . . PCB lights. We're your "one-stop-shop" for indicator lights.

The "original" little light people!

DATA DISPLAY PRODUCTS

5428 W. 104th St., Los Angeles, Ca. 90045
(213) 641-1232

INFORMATION RETRIEVAL NUMBER 48

Fast settling op amp delivers up to 100 mA

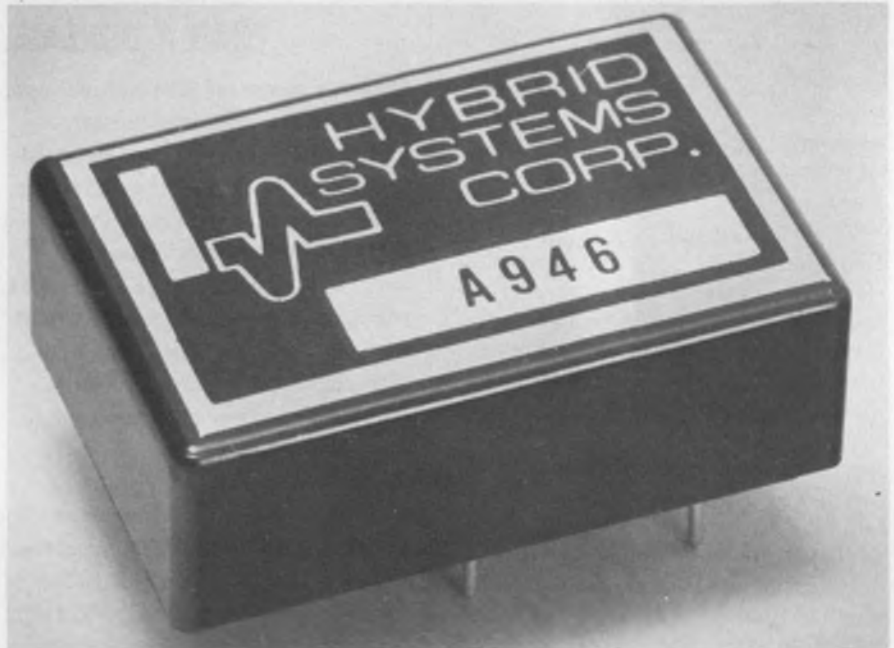

Hybrid Systems, 87 Second Ave., Northwest Park, Burlington, MA 01803. (617) 272-1522. P&A: See text.

A fast-settling modular op amp, the A946, can slew at 1000 V/ μ s typical and deliver 100 mA. It thus fills many needs, such as in fast converters, video pulse transmission and CRT deflection systems.

Two versions are available from Hybrid Systems: the A946A and A946B. The A model has an offset voltage drift of 100 μ V/ $^{\circ}$ C, while the B has a drift of 25 μ V/ $^{\circ}$ C.

Both models have many common specs—for instance, settling time to 0.01% is 250 ns, max, in the inverting mode and 300 ns, max, in the noninverting mode. The slew rate for either operating mode stays at a high 750 V/ μ s, minimum, and 1000 V/ μ s, typical.

Frequency response for either amplifier is guaranteed at 25 MHz, minimum, for unity gain and 10 MHz, minimum, for full power.

The amplifier input circuits have an impedance of 10^{11} Ω and a bias current of only 200 pA, max, or 40 pA, typical. Offset current is even lower—only 40 pA, max, and 10

pA, typical.

Amplifier voltage noise over a 0.01-to-1-Hz bandwidth is typically 10 μ V, pk-pk. Over a 5-Hz-to-2-MHz bandwidth it increases to 40 μ V rms. Current noise over the 0.01-to-1-Hz bandwidth is a low 0.1 pA, pk-pk.

In the differential operating mode the A946 amplifiers can handle ± 15 -V differential signals and ± 10 -V common-mode signals. The common-mode rejection ratio of 60 dB, min., and 80 dB typ., is measured at ± 5 V and 10 Hz.

The power-supply operating requirements are ± 15 V with a 55 mA quiescent current.

The output circuit of the op amp handles loads up to 100 mA and load capacitances as high as 400 pF in the inverting mode and 100 pF in the noninverting. The amplifier has a minimum gain of 25,000 and a typical gain of 50,000.

A 1.8 \times 1.2 \times 0.6 in. encapsulated package houses the op amp. The A946A is priced at \$62 and the A946B at \$85, when purchased in 1-to-9 lots. The units are available from stock.

Booth No. 2226 Circle No. 305

hinged standoffs for terminal boards

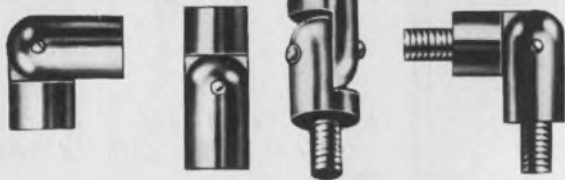
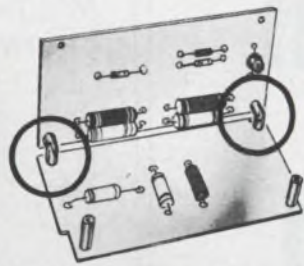

A TYPE FOR EVERY APPLICATION

- Faster Maintenance
- Interconnects Circuits
- Wiring Exposed for Testing
- Space Saver

Manufacturers of Standardized Hardware for Electronics

NEW FREE CATALOG ON REQUEST



KEYSTONE

ELECTRONICS CORP.

49 Bleecker Street • New York, N.Y. 10012

INFORMATION RETRIEVAL NUMBER 54

New! Simple, low-cost way to monitor equipment usage time!

Install these new, low cost electrochemical elapsed time indicators in the equipment you design to measure use time of equipment and its components. They are small in size... the size of an ordinary automotive fuse... and easy to install. A snap-in type that fits a standard 3AG fuse clip—or a solder type—are available. They are inexpensive enough to be used in quantity on a single piece of equipment.

The indicator employs a simple coulometry principle. When a controlled DC current is applied across the indicator's terminals, there is a precise buildup of a copper column in the unit's glass tube. The tube, calibrated in hourly increments, provides a direct scale non-reversible readout. Models are available for 1000, 2000, 5000 and 10,000 hours.

**Keeps accurate
time records for
warranty validation,
preventive
maintenance.**



Actual
Size

Send for information now!

A. W. HAYDON CO. PRODUCTS

NORTH AMERICAN PHILIPS CONTROLS CORP.

Cheshire, Conn. 06410 • (203) 272-0301

INFORMATION RETRIEVAL NUMBER 49

ELECTRONIC DESIGN 7, April 1, 1975

good product design is a MICROTEMP. on your "hot-spot".

Reliable, thermal overload
protection completes a
product design.

(Actual Size .457")



MICROTEMP® Thermal Cutoff



Typical
"hot-spot,"
protected by a
MICROTEMP Thermal Cutoff.

A MICROTEMP Thermal Cutoff, engineered into your product's design will end your "hot-spot" worries. Accurate to $\pm 1.5^\circ\text{C}$ and unaffected by aging or environment, these Thermal Cutoffs remain reliable throughout the life of the product. Their miniature size and disregard for position, enable them to be placed almost anywhere. Protect your "hot-spots" with MICROTEMP. Contact a representative or call us for details and engineering assistance.

**MICRO
DEVICES CORP.**

1881 Southtown Blvd. Dayton, Ohio 45439
Ph. (513) 294-0581 Telex: 28-8087

INFORMATION RETRIEVAL NUMBER 50

The Precision metal film resistor with 90% greater stability.



Available to S failure rate level

Wagner metal film resistors exceed MIL-R-55182 specs by 90% or more. When subjected to thermal shock (-65° to +150°C), humidity or overload (2.25 to 5 times rated wattage), average changes in resistance are in hundredths of a percent, not tenths.

Their exceptional long-term stability is due to unique construction: nickel-chromium film, vacuum deposited over an inner glazed surface of Steatite ceramic tube.

Two types: Hermetically-sealed (seal without an outer sleeve) and Non-hermetic. Both types are contamination-free, conformally coated with non-flammable epoxy, exceed MIL specs, give high heat dissipation and ensure highest reliability.

Mil types available from 1/10 watt to 1 watt and from 24.9 ohms to 2 megohms. Commercial equivalents to MIL types available to 2 watts and 6 megohms. Tolerances: 1%, 0.5%, 0.25% and 0.1%.

Write for Wagner Metal Film Resistor Catalog: WAGNER ELECTRIC CORPORATION, 630 West Mount Pleasant Avenue, Livingston, New Jersey 07039.

WAGNER®

We've got a lot more riding for you.

Check your Wagner distributor:

ARROW ELECTRONICS
4801 Benson Ave.
Baltimore, Md. 21227
301-247-5200

COMMAND ELECTRONICS
114 Allen Blvd.
Farmingdale, NY 11735
516-293-1212

L&S ELECTRONICS
139 N. Central Ave.
Valley Stream, NY 11380
516-561-2474

NRC
4151 State Rd. 84
Fort Lauderdale, Fla. 33314
305-792-3610

TEX-TRONICS
1108 E. Lancaster
Fort Worth, Texas 76102
817-335-8111

MIL-COMM
1616 Cotner
Los Angeles, Ca 90025
213-478-0525

®Trademark Wagner, Vamistor, U.S. Pat. Off. & Marcas Registradas

INFORMATION RETRIEVAL NUMBER 51

MODULES & SUBASSEMBLIES

Magnetic sensors cased in low-cost plastic

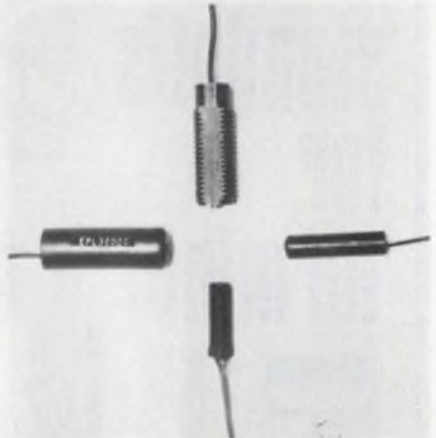

Electro Corp., 1845 57 St., Sarasota, FL 33580. (813) 355-8411. Stock.

A series of low-cost, molded-plastic magnetic sensors is designed for the computer peripheral market. The reduced size of these noncontact sensing units makes them ideal for limited-space applications. Four models are available for use in synchronization applications in high-speed printers and disc drives. Two 0.25 in. dia. models, one threaded and one with a smooth barrel, have 12 V pk-pk outputs; and two 0.4725 in. dia. models, one threaded and one with a smooth barrel, can generate higher voltages.

Booth No. 2611 Circle No. 350

Voltage references have 0.02% initial accuracy

Micro Networks, 324 Clark St., Worcester, MA 01606. (617) 852-5400. From \$50; 2 to 4 wk.

A family of 10-V precision reference sources is available in miniature, 14-pin DIPs. Four models are offered: The MN2000 and MN2001 are positive 10-V reference units, and the MN2002 and MN2003 are negative 10-V references. All units are laser trimmed for initial accuracy of better than 0.02% at 25 C. The MN2000 and MN2002 guarantee accuracy of 0.05% over the operating range of 0 to 70 C. For full MIL range applications, the MN2000H and MN2002H guarantee 0.5% accuracy over the range of -55 to +125 C. Models MN2001 and MN2003 guarantee accuracy of 0.1%.

Booth No. 1426 Circle No. 351

±15 VOLT POWER MINI'S FOR OP AMPS

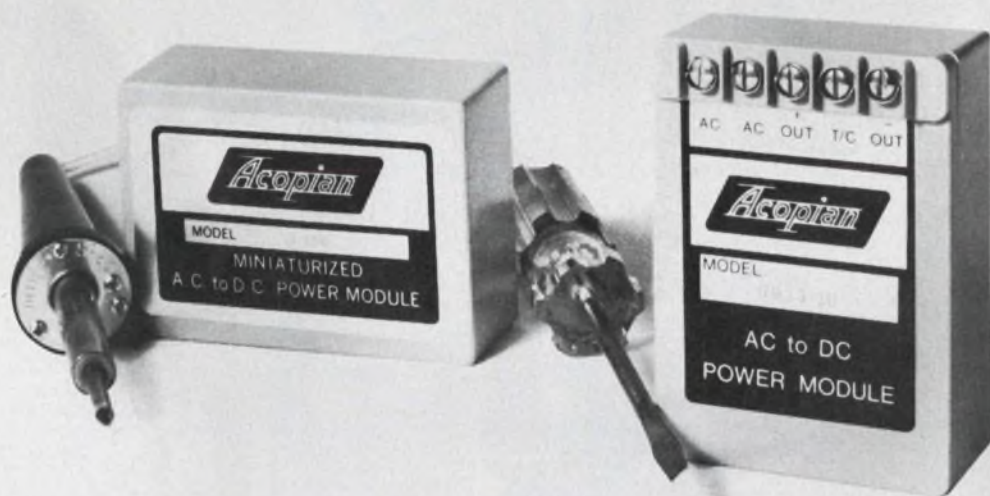

ALL MODELS U.L. RECOGNIZED

PC-BOARD MOUNTING

OUTPUT CURRENT MA	SIZE INCHES	PRICE	MODEL
25	2.3 x 1.8 x 1.00	\$24	D15-03
50	2.3 x 1.8 x 1.00	39	D15-05
100	3.5 x 2.5 x 1.00	49	D15-10A
200	3.5 x 2.5 x 1.00	69	D15-20
300	3.5 x 2.5 x 1.25	105	D15-30
500	3.5 x 2.5 x 2.00	130	D15-50

CHASSIS MOUNTING

OUTPUT CURRENT MA	SIZE INCHES	PRICE	MODEL
100	3.5 x 2.5 x 1.38	\$55	DB15-10
150	3.5 x 2.5 x 1.38	65	DB15-15
200	3.5 x 2.5 x 1.38	75	DB15-20
300	3.5 x 2.5 x 1.63	105	DB15-30
350	3.5 x 2.5 x 1.63	110	DB15-35
500	3.5 x 2.5 x 2.38	135	DB15-50

Line/load regulation, $\pm 0.1\%$ or better; ripple, 1 mv; input, 105-125 VAC. Other single and multiple output models from 1 to 75 volts, to 2.5 amps. Liberal quantity discounts. Three-day shipment guaranteed.

Complete details on these plus a comprehensive line of other power supplies and systems are included in the Acopian 74-75 catalog. Request a copy.



Corp., Easton, Pa. 18042. Telephone (215) 258-5441.

INFORMATION RETRIEVAL NUMBER 52

**Reliability is 756 little dents
and one big one.**





The big squeeze.

The heelpiece and frame are the backbone of our Class H relay. The slightest squiggle or shimmy out of either and the whole relay is out of whack.

756 tiny dents on the heelpiece, plus one big one on the frame, make sure this'll never happen.

They're the result of planishing, a big squeeze. Planishing is an extra step we go through in forming the pieces to add strength and stability by relieving surface strain. It also makes the parts extra flat.

This takes the biggest press in the industry and the biggest squeeze. Both exclusively ours.

A different kind of coil.

The heart of a relay is the coil. If ours looks different, it's because we build it around a glass-filled nylon bobbin. It costs us more, but you know how most plastic tends to chip and crack.

Also, moisture and humidity have no effect on glass-filled nylon. No effect means no malfunctions for you to worry about. No current leakage, either.

The coil is wound on the bobbin automatically. No chance of human error here.

Springs and other things.

We don't take any chances with our contact assembly, either. Our contact springs are phosphor-bronze. Others use nickel-silver. Our lab gave this stuff a thorough check, but found nickel-silver too prone to stress-corrosion. Atmospheric conditions which cause tarnish and ultimately stress corrosion have almost no effect on phosphor-bronze.

Even things like the pileup insulators (those little black rectangles) get special attention. We precision mold them.

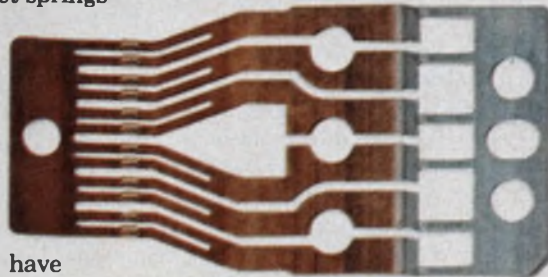

Other manufacturers just punch them out.

It makes a lot of difference. They're stronger, for one thing; and because they're molded, there's no chance of the insulators absorbing even a droplet of harmful moisture. Finally, they'll withstand the high temperatures that knock out punched insulators.

Two are better than one.

Our next step was to make sure our contacts give a completed circuit every time. So we bifurcate both the make and break springs.

Each contact works independently to give you a completed circuit every time. Contact material is pure palladium with a gold overlay because no alloy works as well.

Edge-tinned contact springs save you the job of solder tinning them later. Also, edge-tinning enables you to safely use the same relay with sockets or mounted directly to a printed circuit board. A simple thing, but it takes a big chunk out of the inventory you have to stock.

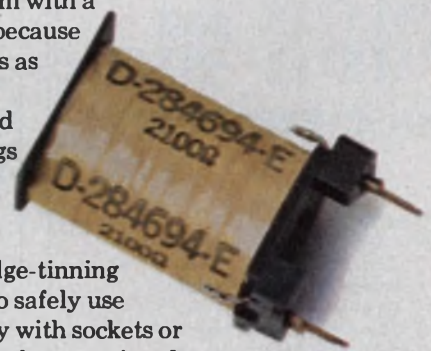

Finally, superior protection.

Out of the dozens of plastics to choose from for our dust cover, we picked a durable polycarbonate. The same material used for plastic windshields and special vehicle bodies. It's strong, resists high temperatures, and is unaffected by most cleaning solvents.

Then, for extra safety, we put a disposable cap over the cover's open end. This seals out dirt and dust while preventing damage to the terminals during shipping and handling.

Etc. Etc. Etc.

There's a lot more to tell about what makes our Class H relay reliable. Now we're waiting to hear from you.

GTE Automatic Electric,
Industrial Sales Division, Northlake,
Illinois 60164.

GTE AUTOMATIC ELECTRIC

PHILIPS



Simplify testing of ECL and TTL components with PHILIPS PM5715 and PM5712 · 50MHz pulse generators

The PHILIPS PM5715:

- 1 Hz to 50 MHz frequency range
 - Up to 10V into 50 Ohms
 - Rise, fall time ≤ 6 ns to 500 msec
 - 10 ns to 100 msec pulse delay/duration
 - Baseline offset ± 2.5 V for PM5715
 - Baseline offset -5 V to $+2$ V for PM5712
 - Auxiliary TTL output
 - Synchronized gating from external signal
 - Single pulse, double pulse, square wave modes
 - Compact and lightweight
- The PHILIPS PM5712:
- Basically the same unit as the PM5715 with the main difference in the fixed risetime of ≤ 4 ns.

For additional information, contact Philips Test & Measuring Instruments, Inc.
400 Crossways Park Drive
Woodbury, New York 11797

SPECIAL APPLICATIONS
INFORMATION 'HOT LINE'
DIAL TOLL FREE NUMBER
(800) 645-3043
NEW YORK STATE, CALL
COLLECT (516) 921-8880

Philips Test & Measuring Instruments, Inc.

PACKAGING & MATERIALS

Modular IC board offers layout flexibility

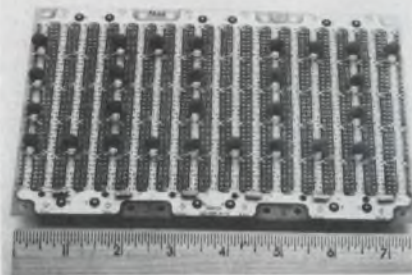

Garry Manufacturing Co., 1010 Jersey Ave., New Brunswick, NJ 08902. (201) 545-2424.

New boards, Series MD, offer more ground and voltage plane area per square inch than any other known comparable units, according to Garry Manufacturing. The boards are available with or without decoupling capacitors, and either wrap-wired and ready for assembly or blank and ready for prototype production. Options available include committed or noncommitted power and ground planes, laminated bus bars for noise suppression and contact pins in a variety of lengths for one, two or three-level wire wrapping. Pins are available in various thicknesses of gold plating over ductile nickel.

Booth No. 1526-1528

Circle No. 331

Triaxial cable connector designed for video use

Kings Electronics, 40 Marbledale Rd., Tuckahoe, NY 10707. (914) 793-5000. From \$31 to \$53 (100-up).

The Tri-Loc connector series, for television broadcast equipment, is designed for use with triaxial cable. The quick disconnect rf connectors terminate 0.375 and 0.5 in. diameter triaxial cables. When mated, the connectors are completely weatherproof. This rugged construction and the company's durable TR-5 weather-resistant finish, make the connectors suited for outdoor use. The connectors have an interface retention greater than 100 lb. and cable retention greater than 200 lb. The contacts can be either crimped or soldered.

Booth No. 1515-1517

Circle No. 352

DIP headers and covers house components

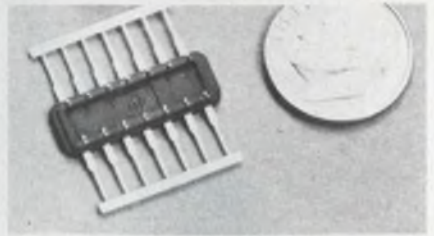

Moldtronics, Inc., 703 Rogers St., Downers Grove, IL 60515. (312) 968-7000.

A family of DIP headers and covers for 14, 16, 20 and 24-lead configurations is available with tin or gold-plated leads. Over-all width is 0.270 in. and lengths vary from 0.770 to 1.270 in. according to the number of leads. These packages can house such components as ICs, transformers, resistor networks and custom circuits.

Booth No. 1621-27-29

Circle No. 333

Enclosures made from slide-together panels

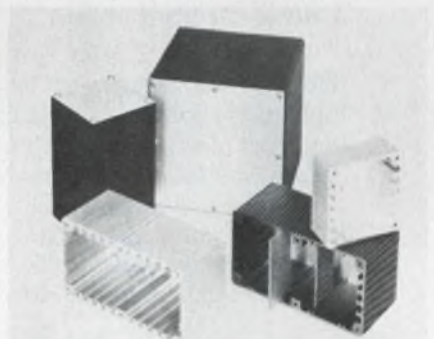

Vero Electronics, Inc., 171 Bridge Road, Hauppauge, NY 11787. (516) 234-0400.

A series of low-cost extruded enclosures in six sizes from $4 \times 2 \times 2$ to $4 \times 4 \times 8$ in. is supplied in kit form with black-anodized side walls and clear-anodized end panels. Simple slide-together construction keeps assembly time to a minimum. Finned exterior walls enhance the heat-sinking properties of the enclosures and parallel interior walls facilitate component mounting and machining. Guide slots are provided in each section to accommodate PC boards or metal deck plates.

Booth No. 1718-1720

Circle No. 328

New test chamber holds 20 ft³ of equipment

Tenney Engineering, Inc., 1090F Springfield Road, Union, NJ 07083. (201) 686-7870. From \$4000.

A new temperature-humidity environmental test chamber, TH-20, simulates temperatures and humidities in the intermediate range. The chamber features a new ceiling-mounted conditioner and machinery compartment for efficient conditioning and easy service. Outside width and depth are 33-1/2 in. to allow it to pass through standard laboratory doors. Inside capacity is 20 ft³. Electronic-bridge temperature controllers for dry and wet bulbs hold conditions to close limits. The unit operates on 115 V ac.

Booth No. 2717 Circle No. 334

Line of sockets includes large variety of styles

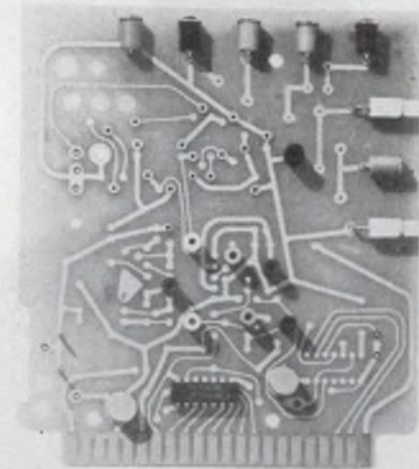

Sealectro Corp., Mamaroneck, NY 10543. (914) 698-5600.

A complete line of sockets fits PC boards, multilayer and flex circuitry and metal chassis. Non-insulated sockets can be press-fitted or swaged and feature beryllium-copper contacts in precision-machined brass sheets. Insulated sockets are offered in floating and nonfloating styles. Both styles are designed for metal-chassis applications. Press-fit Teflon insulators force flow through mounting holes to automatically lock the socket in place.

Booth No. 1215-1221

Circle No. 330

PHILIPS

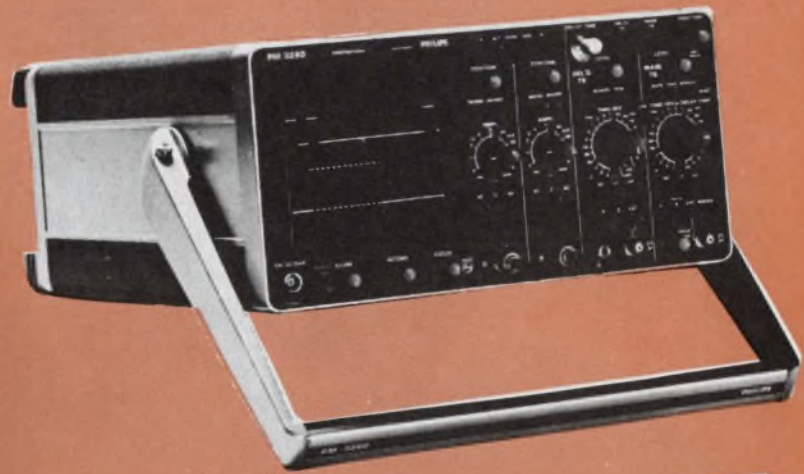

You get a "FREE EDUCATION" - when we give a DEMONSTRATION!

INFORMATION OR DEMO APPOINTMENT
HOT LINE, DIAL TOLL FREE NUMBER -
(800) 645-3043 NEW YORK STATE, CALL
COLLECT (516) 921-8880



Give us the opportunity to demonstrate our 120 MHz or 50 MHz oscilloscope side by side with whatever you're now using or with what you're accustomed to buying (TEK 465, H.P. 1707, or other), and we'll make you a free subscriber to the Philips Digital Instrument Course, an in-depth understanding of digital circuits and the mathematical theory behind them. Divided into five soft covered books and starting with a detailed instruction of number theory and Boolean algebra, the course progresses through digital blocks and circuitry right up to data communications and control. The first two books, *Basic Binary Theory and Logic Circuits*, and *Digital Timers and Counters* are available now. This offer is good for a limited time only; so ACT NOW! Call our toll free number today and make sure you don't miss out on this special offer!

PM3240 - 50 MHz

- Dual trace/delaying sweep
- Light weight: 18.5 lbs.
- Bright 10KV 8 x 10 cm display
- Low 23 Watt power consumption
- X-Y capability
- Easy to use delayed sweep
- PM3240 . . . \$ 1470.00

PM3260E - 120 MHz

- Dual trace/delaying sweep
- Light weight: 19.5 lbs.
- Bright 20KV 8 x 10 cm display
- Low 45 Watt power consumption
- X-Y capability
- Easy to use delayed sweep
- PM3260E . . . \$ 1850.00

WHETHER OR NOT YOU'RE CONVINCED THAT OUR SCOPES ARE THE BEST VALUE FOR YOUR PARTICULAR APPLICATION . . . YOU'LL JUST BE A LITTLE WISER FOR THE EXPERIENCE!

Philips Test & Measuring Instruments, Inc.

A NORTH AMERICAN PHILIPS COMPANY

400 Crossways Park Drive Woodbury, New York 11797

INFORMATION RETRIEVAL NUMBER 57
FOR DEMONSTRATION, 183

Thirteen



just became your lucky number!



Three new 10 amp relays give you 13 small enclosed relays from which to choose.

Your Guardian Angel calls them the 1300 series, of course.

Amazing. Versatile. Small. Enclosed. Multi-pole. These five words sum up Guardian's 1300 line of 13 basic models . . . in hundreds of variations. Each relay in a choice of AC or DC, solder lug or printed circuit termination. Each with its own mating socket. Each your ideal spec for any application requiring uncompromising high quality at low, affordable price.

NEW! 1345DC relay in your choice of SPST-NO, SPST-NC or SPDT. Small in size but built to take hard knocks. Just over a cubic inch small, yet specifically designed for a minimum of 50,000 miles of maintenance free operation in automotive controls . . . or an equally amazing trouble-free life anywhere you need small size, long life and low, competitive price.



NEW 1390 and 1395 DPDT

NEW! 1390AC and 1395DC relays, DPDT with 10 amp rating in a space-saving, compact new design. To give you large control capacity in a package about half the size of competitive relays that do the same job. The cost? Just about the same as competitive units . . . in many cases quite a few cents less.

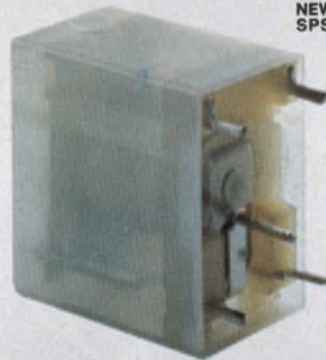

NEW 1345 SPST-NO, SPST-NC, SPDT

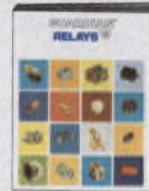

SEND FOR THE BOOK THAT TELLS IT ALL:

Guardian's 48 page relays catalog. Full of facts and specs to make selecting a relay a snap. Yours free for the asking.



GUARDIAN®

GUARDIAN ELECTRIC MANUFACTURING CO. • 1572 West Carroll Ave., Chicago, Illinois 60607

INFORMATION RETRIEVAL NUMBER 58

Compare TI's NEW SR-51....

- Mean, variance and standard deviation.
- Automatic linear regression. ● 20 programmed conversions. ● Percent and percent difference.
- Random number generator.
- 3 accessible memories. And much more for only

\$224.⁹⁵



More math power for the money. More than log and trig and hyperbolics and functions of x . . . the SR-51 has these and also has statistical functions... like mean, variance and standard deviation, random numbers, factorials, permutations, slope and intercept, and trend line analysis. Check the chart above—compare it. With the HP-45 or any other quality calculator. Then try it—at no risk. We're sure you'll agree that the SR-51 offers extraordinary value.

FUNCTION	SR-51	HP-45
Log, ln	yes	yes
Trig (sin, cos, tan, Inv)	yes	yes
Hyperbolic (sinh, cosh, tanh, Inv)	yes	no
Degree-radian conversion	yes	yes
Deg/rad mode selection	yes	yes
Decimal degrees — deg-min-sec	yes	yes
Polar-rectangular conversion	yes	yes
y^x	yes	yes
e^x	yes	yes
10^x	yes	yes
x^2	yes	yes
\sqrt{x}	yes	yes
$\sqrt[y]{x}$	yes	no
$1/x$	yes	yes
$x!$	yes	yes
Exchange x with y	yes	yes
Metric conversion constants	13	3
% and Δ %	yes	yes
Mean and standard deviation	yes	yes
Linear regression	yes	no
Trend line analysis	yes	no
Slope and intercept	yes	no
Store and recall	yes	yes
Σ to memory	yes	yes
Product to memory	yes	yes
Random number generator	yes	no
Automatic permutation	yes	no
Preprogrammed conversions	20	7
Digits accuracy	13	10
Algebraic notation (sum of products)	yes	no
Memory (other than stack)	3	9
Fixed decimal option	yes	yes
Keys	40	35
Second function key	yes	yes
Constant mode operation	yes	no

Test the SR-51 at no risk. Full refund if not satisfied. Master Charge or BankAmericard accepted.



TO: Texas Instruments Incorporated
 P.O. Box 22013, M/S 358, Dallas, Texas 75221

Try it 15 days. Return with all accessories if not satisfied.

Enclosed is my check, money order, company purchase order for \$ _____ for the purchase of _____ SR-51(s).

Please add state and local taxes where applicable. *

Please charge this order to my Master Charge. Or, BankAmericard

My Card Number is:

With the expiration date: _____

ED4

If Master Charge is used indicate 4-digit Bank Number appearing on card just above your name:

Name _____

Street _____

City _____ State _____ ZIP _____

Authorizing Signature (If billed to Credit Card Must be signed by card holder) _____

*AL, AZ, CA, CO, CT, FL, GA, IA, IL, IN, KY, MA, MD, MI, MN, MO, NC, NM, NJ, NY, PA, TN, TX, UT, VA, WA, WI. Offer good only in U.S.

© 1975 Texas Instruments Incorporated
 13500 North Central Expressway
 Dallas, Texas

TEXAS INSTRUMENTS
 INCORPORATED

**TWTs transmit
at 6 and 14 GHz**

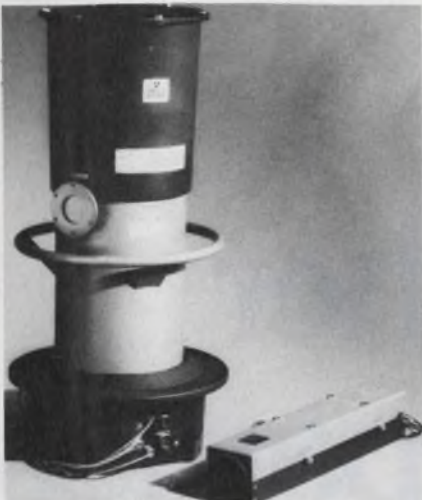

Thomson-CSF, Groupement Tubes Electroniques, 8 rue Chasseloup-Laubat, 75737 Paris Cedex 15, France.

The company's line of 6-GHz earth-station TWTs now includes five models that reportedly have been proven in the field. Among these are the TOP 1487, a 1.2-kW power unit, and the TH 3508, a 250-W unit that can transmit a 24-telephone-channel carrier. Also, the company has developed these 14-GHz transmitters: a 20-W model, 100-W helix tube and a 2-kW coupled-cavity TWT employing forced-air cooling.

Island A Circle No. 353

**Tuners handle
mismatches**

Alford Manufacturing Co., 120 Cross St., Winchester, MA 01890. (617) 729-8050. \$550 to \$650; 30 days.

Types 5135 and 5059 twinsleeve tuners are adjustable tuning networks that can match devices mismatched by as much as 10:1 at 10 GHz. At the band edges, 7.5 and 12.4 GHz, the maximum SWR that can be matched is 8:1. The tuning sleeves, made of a dielectric material, do not provide a dc path between the inner and outer conductors. Thus, a bias injected through the coaxial transmission line will not be short circuited as it would with, say, double stub tuners.

Booth No. 2432 Circle No. 354

**SERVO-TEK Quality...
Take It For Granted
Because We Don't!**



The superior quality of the complete line of Servo-Tek's **precision measurement and control products** doesn't just happen. It begins right at the design stage where our total dedication to providing industry with a product engineered to give versatility, accuracy and reliability first becomes evident. When we are satisfied that our rigid testing standards for our designs have been met, then and only then do they reach the manufacturing stage, to be produced by the most modern and efficient means available and to be monitored continually to assure control of quality.

The result is an economical, ruggedly powerful, virtually maintenance-free product, which satisfies all your needs for precision measurement and control. It is a product whose quality of performance you can take for granted, because it's pretty obvious that at Servo-Tek we don't.

*Shown: DC Tachometer Generators,
Speed Indicating System, Torque Unit
We also manufacture: Servomotors, BI-Mode Servos,
Adjustable-Speed Drives, Control Meter Relay Systems*



A Free Catalog of rotating components is available. For even faster service, phone one of our sales engineers at:

SERVO-TEK
PRODUCTS COMPANY

1086 Goffle Road
Hawthorne, NJ 07506
201-427-3100

Servo-Tek of California, Inc.
8155 Van Nuys Blvd.
Van Nuys, CA 91402
213-786-0690

Why are other computer companies refusing to run benchmarks against the Eclipse?

Apparently, they've seen some of the results.

Eclipse has been running Fortran benchmarks faster than an IBM 370/155.

And more than twice as fast as the PDP-11/45.

It's even beaten out a Xerox Sigma 9.

And those benchmarks were not ones we designed to make Eclipse look good. We only ran programs that prospects asked us to run.

Not only that, the Eclipse they were run on was using core memory. If we had used semiconductor memory with cache, you can imagine what would have happened.

Eclipse may have caught the competition off guard, but that's just what we expected it to do.

That's why we built Eclipse around a new microprogrammed architecture and an instruction set designed for high level languages and real time operating systems.

And that's why we gave it the fastest Floating Point Processor in the industry.

But making a computer fast is one thing. Getting all that speed out of it is another.

So we also came up with a sophisticated new set of Eclipse software: A Fortran 5 package, and a new Mapped Real Time Disc Operating System with features like virtual overlays and window mapping. (Which you may not have heard about because we just invented them.)

Which means if you don't want to end up with a computer that's been eclipsed, you're going to have to do something about it.

Call (617) 485-5467.

DataGeneral

The computer company you can understand.

• Data General Corporation Southboro, Massachusetts 01772. (617) 485-9100.

INFORMATION RETRIEVAL NUMBER 60

Two New DIP SOLID STATE RELAYS from CLARE

If you have pcb designs that need fast, long-life switching for DC loads to 250 Volts—or AC/DC loads to 50 Volts—check these new solid-state relays from C. P. Clare & Company.

They're DTL/TTL compatible, packaged in full-molded epoxy cases with a standard DIP footprint, and sized to fit 0.5" pcb centers. Rugged...reliable...versatile.

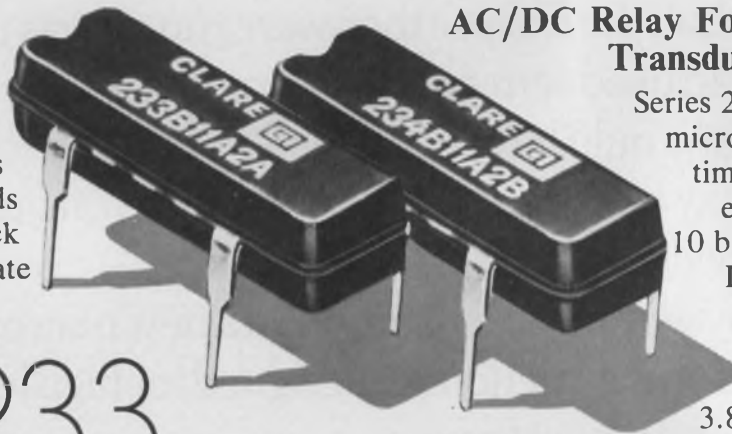

233

234

Two Choices For DC Load Switching

Series 233 relays feature a 1-microsecond response time plus a long life extending beyond 10 billion operations. They give you a choice of 60 Vdc/400 mA or 250 Vdc/100 mA peak outputs, both controlled by 3.8 to 10 Vdc input. They're ideal for solenoid, motor and lamp drivers in process controls, automatic test equipment and peripherals... or data couplers and line drivers in digital communications transmission networks.

AC/DC Relay For Analog And Transducer Switching

Series 234 features a 1-microsecond response time plus a long life extending beyond 10 billion operations.

It offers 50 V/80 mA peak output with input ranging from 3.8 Vdc to 10 Vdc.

A natural choice for analog and transducer switching, choppers, A-to-D converters, multiplexers, scanners and other sensing/input circuits for automatic process control and test equipment... or for line drivers between computers and their peripherals.

Want To Know More?

All Series 233 and 234 models are SPST (N.O.) devices, rated for dielectric withstanding voltage of 1500 Vac and insulation resistance of 10^9 ohms. Operating and storage temperatures range from -20° C to $+100^{\circ}$ C. All models are in stock for immediate shipment. For specification data, contact your nearest Clare sales office or distributor. For more comprehensive application information, contact Rick Prieto, C. P. Clare & Company, 3101 W. Pratt Avenue, Chicago, Illinois 60645. Or Phone (312) 262-7700.

QUALITY, SERVICE, RELIABILITY

C. P. CLARE & COMPANY a subsidiary of
GENERAL INSTRUMENT CORPORATION



Jobs

It's beginning to look better out there. Business seems to be picking up and the bottom of the recession may be behind us. But the pickup isn't uniform. Some companies are still hurting. And when companies hurt, their engineers hurt, too.

While most of us who have survived the recession will probably ride out its last period unscathed, some of us won't. Some of us may soon be unemployed.

Electronic Design would like to help. We're not running an employment agency; we'd probably be awful at it. Yet we might be able to connect some companies needing good engineers with some engineers needing good companies. We may be groping at this, so if you have any better ideas, please let us know. But here's what I propose.

If you expect to need a different engineering job soon, send me a letter enclosing several resumes that I can forward to possible employers. If you know some engineers who have already lost their jobs, have them send me several resumes, too.

On the other hand, if you're looking for engineers, send me a letter describing the qualifications you'd like to find. I'll try to match resumes with available jobs.

I can't guarantee success. It's quite possible I may never find good matches. But I'll try. Further, I probably won't be able to answer your letters either, and that's going to hurt because I like to answer any reader who takes time to write to me. In this case, however, the volume of mail might outstrip my capacity to reply. Please forgive me for that.

This is, of course, a free service of Electronic Design. But I hope you won't need it.



A handwritten signature in dark ink that reads "George Rostky". The signature is written in a cursive, slightly slanted style.

GEORGE ROSTKY
Editor-in-Chief

Think Large. Think Small. Think Ise

Think our three jolly green giants for desk-top electronics. Our two pint-size pigmies for carry-in-the-pocket display designs. But don't stop there. Think low operating voltages, low power consumption, wafer-thin thickness and dip clip pins for fast glass encapsulation all around, and efficient mounting.

itron

FG-159A2

ec = eb = 35Vp-p
ic = 4.5mA_{p-p}
ib = 3.5mA_{p-p}



Wd. 138mm
Lg. 40mm
Segment 9.5mm

FG-139A2

ec = eb = 30Vp-p
ic = 3.6mA_{p-p}
ib = 2.8mA_{p-p}

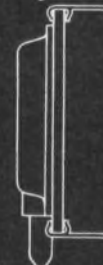

Wd. 138mm
Lg. 40mm
Segment 9.5mm

Our jolly
green giants

FG-99A2

ec = eb = 24Vp-p
ic = 3.5mA_{p-p}
ib = 2.5mA_{p-p}

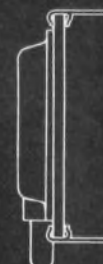

Wd. 100mm
Lg. 40mm
Segment 9.5mm

FG-125A2

ec = eb = 24Vp-p
ic = 2.0mA_{p-p}
ib = 2.0mA_{p-p}



Wd. 75mm
Lg. 26mm
Segment 5mm

Our pint-size
pigmies

FG-95A

ec = eb = 24Vp-p
ic = 2.0mA_{p-p}
ib = 1.5mA_{p-p}

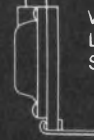

Wd. 65mm
Lg. 24mm
Segment 5mm

Something else to think about

Think Ise for digital readouts for instruments, clocks and other products, too.

The Brighter Side of Electronics

ISE ELECTRONICS CORP.

Main Office:

P.O. Box 46, Ise City, Mie Pref., Japan
Tel: (05963) 5-2121 to 4. Telex: "4969523"

Tokyo Office:

2-7-7 Shigashi Shinbashi, Minato-ku, Tokyo, Japan
Tel: (03) 433-6616 to 9. Telex: "J26546"

Noritake Electronics Office:

22410 Hawthorne Blvd. Torrance California 90505. U.S.A.
Tel: (213) 373-6704. Telex: "230674910"

ECL design just became a three-layer piece of cake.

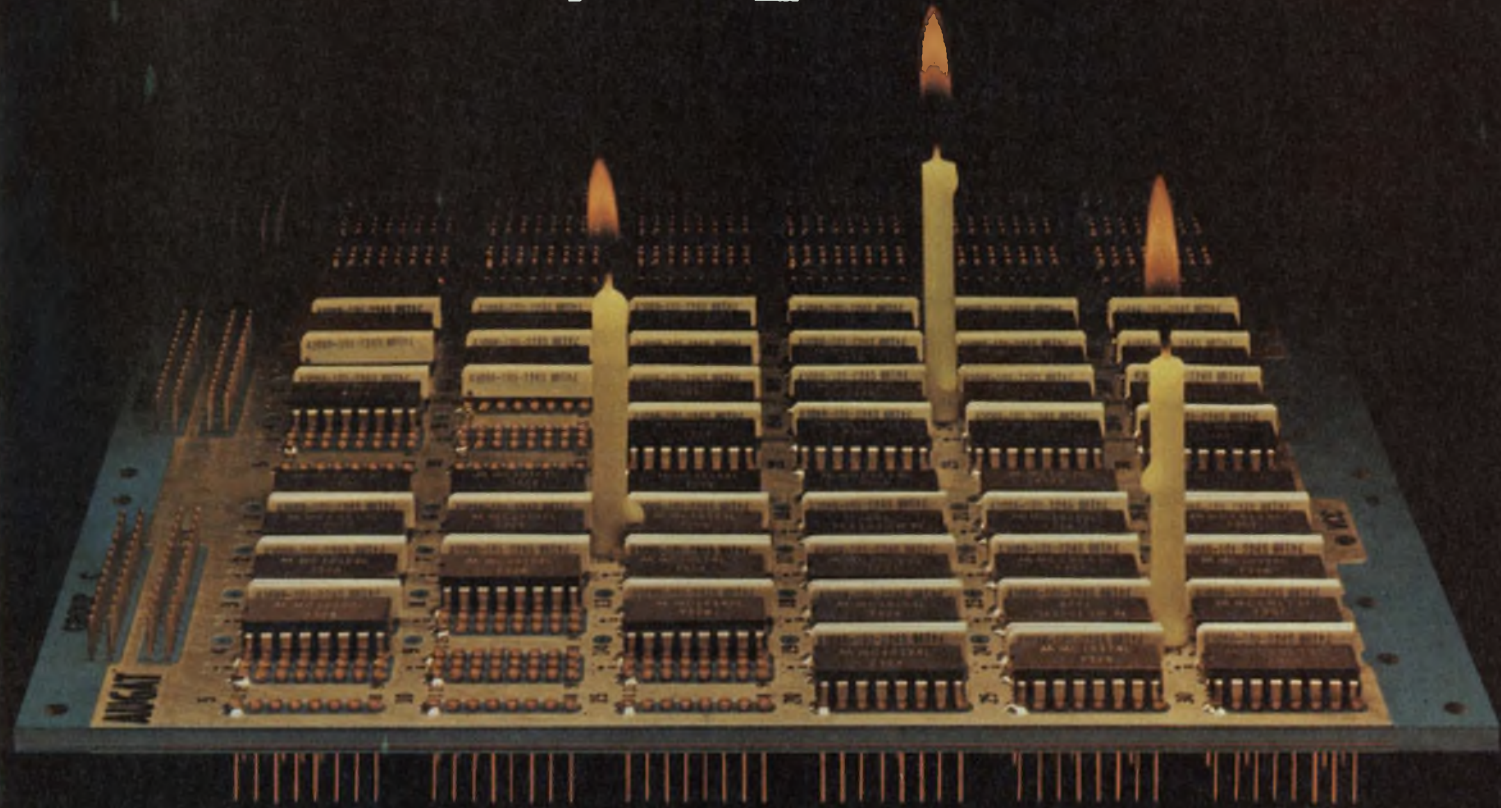

Augat ECL Board with -2 volt bus for terminating single in-line package (SIP) resistor network.

Compared to methods of the past, the Augat series of socket, Wire-Wrap® ECL boards makes ECL design a piece of cake. Even for circuits in the 125 to 500+ MHz range.

They can save you 90 percent or more in breadboarding and prototyping time. Tens of thousands of dollars in start-up costs. And many costly hours in field maintainability.

With this proven advance in three-layer interconnection technology you don't have to design in controlled impedance interconnections, mess around with transmission lines, or commit power connections for different ECL logic modules. All of which frees you to concentrate on the partitioning of logic functions and the preparation of a wiring list.

And unlike a multi-layer P.C. board, there is no loss in planar density. Two 16-pin ECL and associated pull down and decoupling components fit into one square inch on every Augat ECL board.

The nice thing, too, is that Augat ECL boards are standard catalog items available in any quantity at any time from Augat distributors around the world. You can contact them directly or write Augat, Inc., 33 Perry Avenue, Attleboro, Mass. 02703. Tel. 617-222-2202. TWX 710-391-0644.

AUGAT®

Registered TM of Gardner-Denver Company

Europe — Augat N.V., Boulevard A. Reyers, 103, 1040 Brussels, Belgium, Tel. (02) 7369399.

Japan — Kyokuro Boeki Kaisha Ltd., New Otemachi Bldg., 2-1, 2-Chome Otemachi, Chiyoda-Ku, Tokyo 100-91, Japan Tel. (03) 244-3788

FOCUS

on
**Semiconductor
memories**

It's best to be a pessimist when you consider delivery promises and product specifications for IC memories. Unfortunately young technologies don't lend themselves to early standardization. And vendors, continuously under pressure to introduce new memories, may announce ICs before they are fully characterized—or even manufactured.

In the heat of competition, a vendor may circulate a data sheet that seems to guarantee "min/max" specs. But the sheet may bear the legend "tentative," "preliminary" or some other variant of "we hope we can make the part." "Tentative" specs, like "projected" prices for a new circuit, often are more attractive than firm specs and market prices for an established unit.

Prices rate as much attention as the specs. If the price is low, it may be because the vendor has yet to make the memory, or he has built a single chip and hopes that production quantities will drop the cost.

Moreover, the IC-memory business has some peculiarities: In many cases the laws of supply and demand are completely abandoned in both good and down times. Prices can plummet for a memory that everybody wants and nobody can make.

Specs are interdependent

Because memory specs are closely linked to one another, it's a formidable task to characterize a circuit fully—even for a conscientious vendor and even for a well-established memory. You have to be aware of your own requirements and prepared to ask a lot of questions.

When a vendor writes, for example, that a memory is available in different speed ranges, it would be prudent to ask, "What else changes?"

Edward A. Torrero
Associate Editor

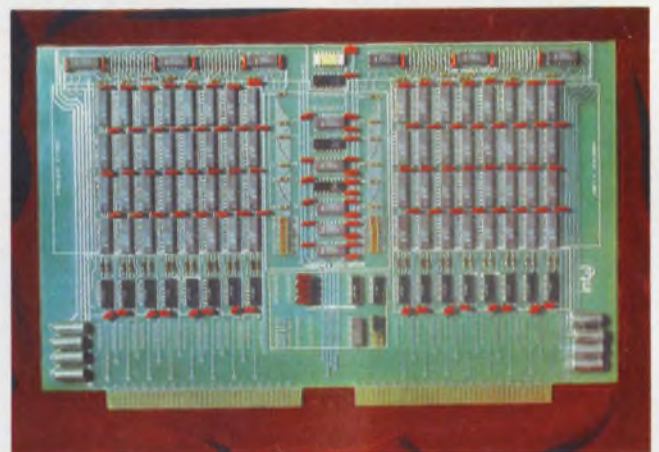

16-k bit CCD memory chips—Intel's 2416—are the main element of a 1-Mbit prototype board. Of all the packages, 30% provide support circuits.

This question must be raised often. Vendors are always pushing the state of the art. Often they advance one or more specs, but not all. You have to know what sacrifices were made, what trade-offs to get the new spec.

It's necessary, too, to determine if a particular advance is useful in your application. A new memory designed to work with the company's LSI microprocessor, for example, would be fine—in a microcomputer that uses the vendor's processor. It could easily be out of place in a mainframe application.

A vendor may emphasize that a RAM or ROM features full decoding on the chip. But you might cut costs and save nanoseconds in your system by having undecoded storage chips share a decoder/driver.

A vendor may hail the TTL compatibility of his MOS memory, perhaps forgetting its need for external pullup resistors. Though they're

cheap, resistors may take up precious board space. Another memory might not need the external components, but your system could benefit from the use of level translators external to the MOS chip.

Programmable ROMs (PROMs) introduce additional problems. Many dc and most ac characteristics—including speed—can't be readily obtained. As supplied by the vendor, a PROM isn't a finished product. Thus a spec sheet for a new PROM is often based more on preliminary data than on final characteristics.

Be guided by worst-case specs

As with most electronic products you buy, your selection of an IC memory will eventually be based on comparison of data sheets. Bear in mind that some key specifications might be in-

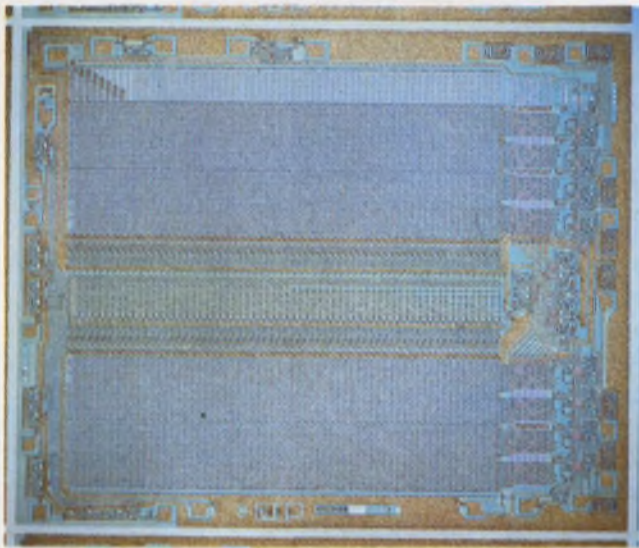

Bipolar PROMs reach 4-k bit densities. Here is Monolithic Memories' 5340, the first 4-k bipolar PROM. The IC has a typical programming time of 5 ms/bit.

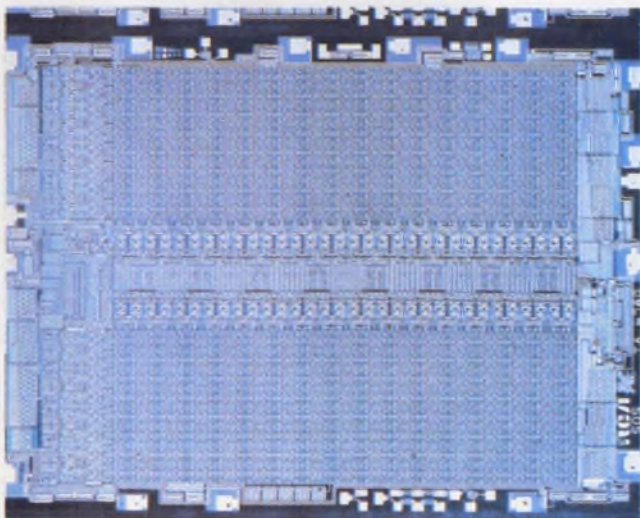

complete, others might mislead if taken too literally and still others may not be given. Check for absolute worst-case values for all specs. After selecting a memory, you'll want to design around these values.

Access times, for example, are widely favored specs to indicate the prowess of memory circuits. But "maximum" access times are often specified only for room-temperature and nominal supply-voltage conditions. Over the full temperature range and supply tolerances, the memory can be a lot slower than you first thought.

Different vendors may quote different access times for equivalent devices. They may have different definitions. MOS RAMs, especially early versions, sometimes emphasize chip-enable access—input-to-output delay, with the address present, when the chip-enable signal is applied. This chip-enable access time can be much shorter than the more commonly specified address access, in which chip enable comes after the address. Memory systems use both access modes. However, the difference is wide enough to mask some of the speed advantages of a bipolar memory over a MOS circuit, in the same application.

And "access" times don't measure a memory's system speed as well as "cycle" time, which tells you the speed for repetitive addressing. Typically read or write cycle times can vary markedly for different circuits that have the same access and internal architecture. Also, bipolar RAMs, which are static, have roughly equal access and cycle times, while MOS versions have cycle times that can be two to three times greater than the access spec.

Moreover access times aren't always guaranteed or consistent with such critical timing parameters as address hold time and write pulse width. And a specified access can depend on the characteristics of external control signals—like sharp rise and fall times from clock drivers. As a result, system operating speeds may have to be reduced from those indicated, because of requirements that are difficult to meet.

Other problems can arise with specifications for refresh, which is needed by dynamic memories to replenish data on internal storage capacitors. Here again, the data sheets frequently specify refresh periods only at room temperature. But at the maximum operating temperature, refresh is needed more often, and you can't always project the refresh requirements to the higher temperature.

In addition, refresh power constitutes a significant portion of the total standby power in many dynamic RAMs. But listed standby-power

By combining CMOS and silicon-on-sapphire techniques, RCA obtains a 1-k bit static RAM. The package pinout is that of popular bipolar memories.

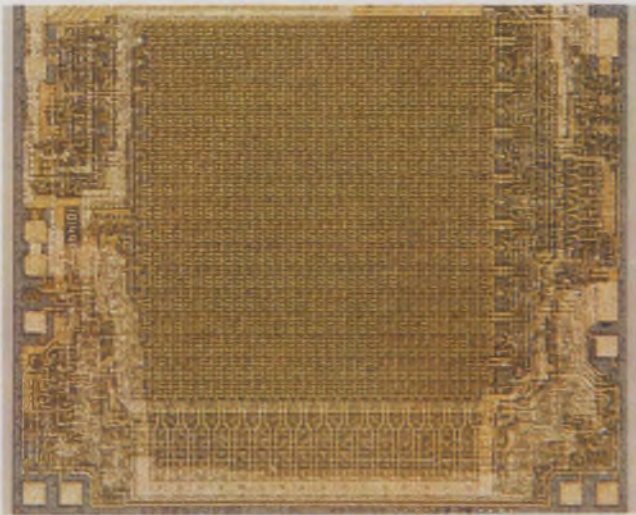

The largest ECL-10,000 PROM—Motorola's MCM 10149—has 256×4 -bit organization and maximum access of 25 ns. The bipolar PROM employs fusible links.

specs don't always include the refresh increment. If they don't, you can be way off in power estimates for a backup supply system.

The standby, or power-down, feature of static and dynamic memories lets you maintain data when not reading or writing. This feature can substantially reduce over-all power requirements. But some data sheets don't guarantee what supply levels you can safely reduce to. The omission can be serious. At relatively low supply levels, system noise may lead to loss of data.

Specs reflect test methods

Manufacturers establish specifications around the test procedures they use, and measurements are almost always automated to keep costs low. But chances are that your system won't duplicate the conditions on the manufacturers' test equipment.

A memory's listed speed and drive capability,

for example, often assume a fixed load connected right next to a memory's output. In any practical design that load could be a distributed variable. Hence you'll probably be able to achieve either the specified fanout or input-to-output delay—but not necessarily both at the same time.

More important, manufacturers don't test all operating-mode combinations, which would reveal so-called pattern sensitivities. In the worst case, these sensitivities show that some data can be lost unintentionally. Usually, though, so-called soft-bit errors are revealed—operational characteristics change with timing or data conditions.

Most manufacturers use special test patterns—which differ from one vendor to another—to keep testing time down and presumably to check for worst conditions. But don't expect to find sensitivity information on the data sheet. Manufacturers rarely publish this.

The problem of pattern sensitivities decreases when you operate the memory well within its specification limits. And it's less of a problem for a static circuit than for a dynamic one. In any case, you may have to check for specific patterns that occur in your system.

The inability of manufacturers to test PROMs fully poses special problems for the unwary user. A PROM user takes over some of the manufacturer's functions—and some of his yield problems. Only about 70 to 95% of the PROMs you purchase can be programmed successfully. Moreover newer high-density memories tend to give the lowest yields, while the smallest—256-bit—have the highest.

Thus to obtain, say, 100 good PROMs, you have to order 110 or 120. Of course, you can expect the manufacturer to replace rejects. But if you didn't purchase the extra units ahead of time, the additional time lag could neutralize the advantage of quick turn-around ROMs.

One solution is to have a distributor or pos-

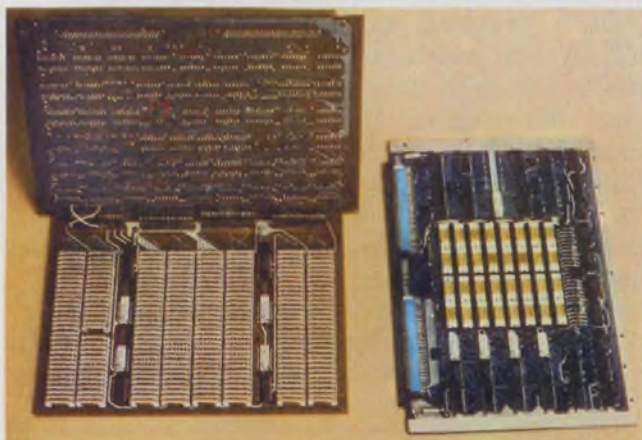

Memory boards employ 512-bit CMOS static RAMs—American Microsystems' S2222. The boards are used in Rolm's Rugged Nova system.

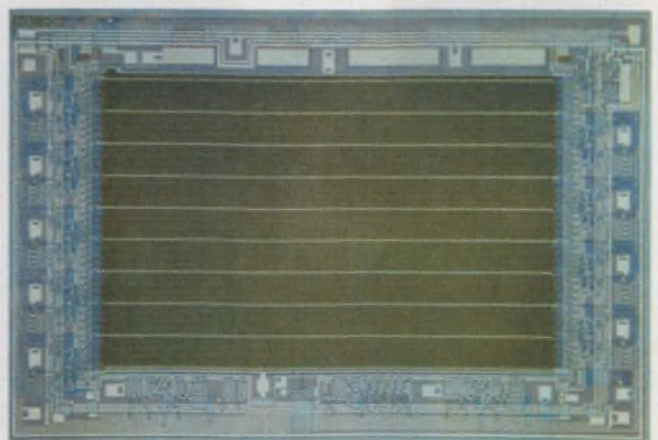

The first CCD memory chip—Fairchild's 9-k-bit circuit—employs nine 1024-bit registers that are shifted in parallel. The operating frequency is specified at 3 MHz.

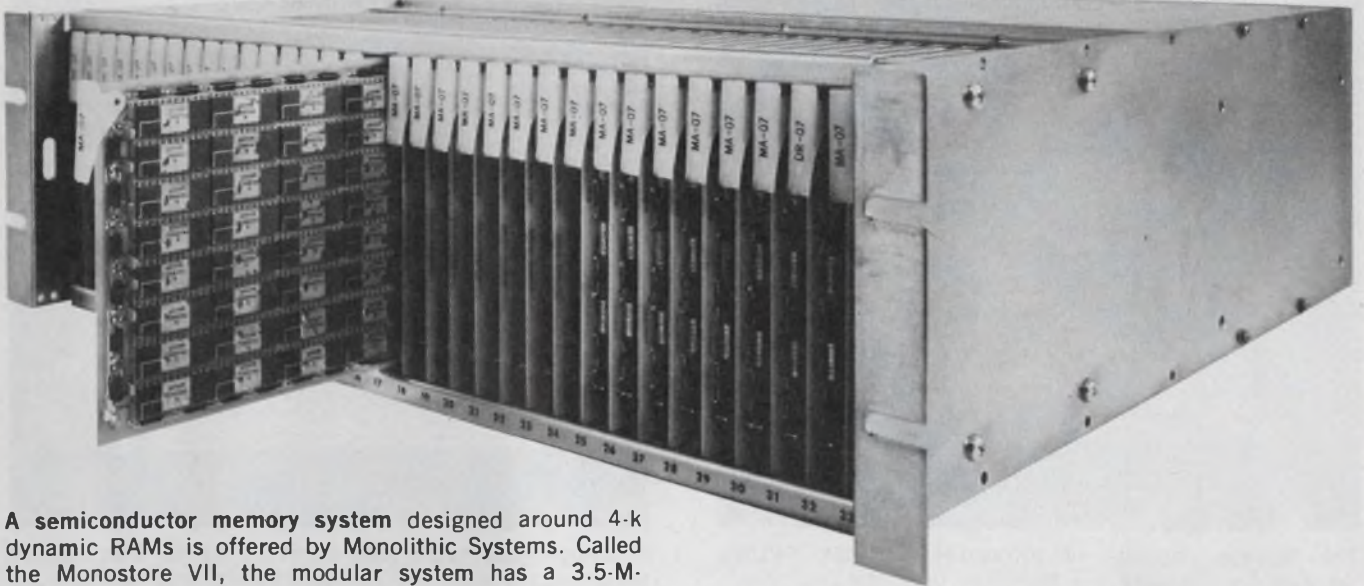

A semiconductor memory system designed around 4-k dynamic RAMs is offered by Monolithic Systems. Called the Monostore VII, the modular system has a 3.5-M-bit capacity, and it contains the peripheral circuitry needed by the RAM chips.

sibly the manufacturer program the memory. Post-programming tests weed out rejects prior to shipment. However, the increased cost of this approach usually precludes its use in low-volume applications.

Also, total costs can be higher than expected if you choose to use PROMs from different vendors. No two vendors' PROMs will program in exactly the same way, though they may have the same post-programming electrical characteristics and the same pinouts. Furthermore PROMs from the same vendor can have different programming requirements, too. Hence you can't simply program a company's new high-density PROM with the same equipment, and equipment settings, that you used for the vendor's pin-compatible, lower density PROM.

Programming equipment doesn't come cheaply. In addition to the basic mainframe, or chassis, you need a special module that tailors the equipment to a specific PROM. The module costs a few hundred dollars, while the chassis can set you back several thousand. Some equipment can handle a wide range of PROMs, but these programmers cost much more.

Some of the benefits

In spite of their many problems, available memories are getting cheaper, faster and bigger. And despite predictions that 1975 will be a down year, manufacturers are moving ahead with plans for even better memories.

As with other components, the cost of IC memories falls as market demand increases, and this year is no exception. Though a bad year for the industry, it's shaping up as a good one for semiconductor memories. Thus volume quantities

of bipolar RAMs now selling at 0.7 to 0.9 cent per bit are expected to drop to less than 0.5 cent next year. And MOS memories, which are generally cheaper than their bipolar cousins, are heading down in price, too.

In addition a whole crop of new memories is emerging for LSI-microprocessor applications. Besides tailoring memory specs to the needs of processor chips, these new memories are organized to reduce the number of packages needed.

The newest, primarily microprocessor-oriented, memories are yielding the highest densities yet. Already a 16-k bit bipolar ROM has emerged, and 4-k—even 8-k—erasable MOS PROMs have been announced. In the wings and due for introduction shortly are MOS ROMs with bit capacities of 32 k and possibly 64 k.

MOS RAMs move up to 4-k bit level

Meanwhile steady improvements in the design of memory chips have simplified the use of recent memories, such as the new 4096-bit MOS RAMs. In previous models dynamic memories offered higher speeds with less dissipation than static types. The tradeoff, however, was increased support circuitry because of critical timing specs and the need for several clocks or large voltage swings. The newest dynamic RAMs relax some of these conditions without sacrificing speed.

The latest entries in the suddenly crowded 4-k MOS RAM race are shifting the spotlight from basic performance toward system savings. Though faster, the newest versions also emphasize smaller packages for heightened PC-board densities. And one new 4-k RAM (from EMM Semi) features static operation—all others are dynamic. The result is an automatic reduction in

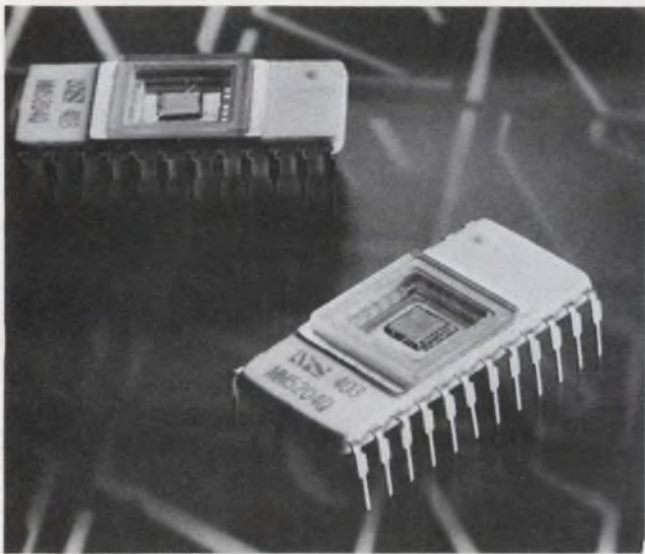

The storage capacity of ultraviolet erasable PROMs reaches 4-k bits with the MM5204 from National Semiconductor. The listed programming time is 30 sec.

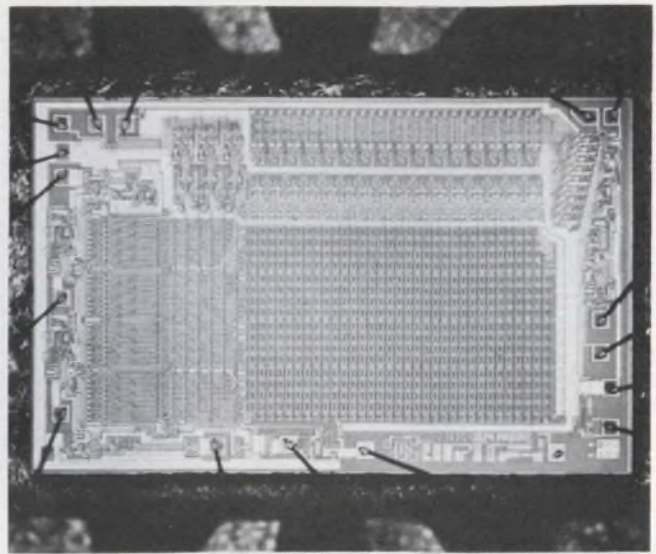

A field-programmable ROM from Harris Semiconductor, the company that introduced PROMs, has a 1024-bit capacity. The PROM features access time of 50 ns.

support circuitry and external components.

Most of the earliest 4-k RAMs, which surfaced about a year ago, are similar in fabrication, performance and packaging. Generally they are n-channel, silicon-gate circuits with maximum access times of about 300 ns and maximum cycle times of about 500 ns. And except for Mostek's MK 4096, which comes in a 16-pin DIP, all others—including the Microsystems International 7112, the first on the market—are offered in a 22-pin DIP. However, the various units differ in external-component requirements, refresh cycles, pinouts and alternate sources.

American Microsystems and Motorola obtained alternate sources the easy way: They developed the 6605 jointly. Among available 4-k dynamic RAMs, this unit has one of the lowest refresh requirements: only 32 cycles of refresh every 2 ms, compared with 64 every 2 ms for most other RAMs. (Western Digital's RM1701 needs a lower refresh: 16 cycles every 2 ms.) Reduced refresh lessens the read/write "down" times. And the 6605 also has low standby power of 2.6 mW (including refresh) and short access, 230 ns.

Ever shorter access times are being sought by several manufacturers. AMI and Motorola, for example, plan to develop an upgraded version of the 6605 that will guarantee a maximum access of 150 ns or less.

Starting with different chip designs and different pinouts, Intel and Texas Instruments got together on a common pin arrangement for their 4-k RAMs—the 2107 and the TMS 4030, respectively. The Intel/TI pinout, like Mostek's, has become a standard. Most new 4-k RAMs in 22-pin DIPs are using this pinout, just as new 4-k RAMs in 16-pin DIPs (such as Fairchild's) are adopting the Mostek pattern.

The most recent version of the Intel/TI RAM—TMS 4060/2107B—offers maximum access of 200 ns. This is the fastest yet specified for recent 4-k dynamic silicon-gate RAMs, and Intel and TI share this top speed with newer versions announced by Mostek, National Semiconductor and Western Digital among others. Many of these high-speed versions also list the top cycle time of 400 ns.

While Intel and TI use the same 22-pin pattern, they have gone in different directions on a smaller package. Intel plans to offer a version of the Mostek 16-pin RAM, while TI has its own 18-pin RAM, the TM 4050, which has the same speed ratings as its high-speed TMS 4060.

The 18-pin TMS 4050 multiplexes input and output data on a single terminal. The feature has the benefit of simplified interfacing to bussed systems. But in contrast with the Mostek unit, which requires multiplexed addressing, the TMS 4060 provides a full 12-line address. Also, the TI RAM eliminates the chip-select terminal by having the chip-enable clock and read/write-mode control perform the enable function.

A different arrangement is used in the only other 4-k RAM in an 18-pin DIP—National Semiconductor's MM5270. With a technique the company calls Tri-Share, the National RAM replaces three leads with one that serves the functions of read/write, logic chip select and V_{CC} .

Proving that static memories don't have to be slower and consume more power than their dynamic cousins, EMM Semi recently announced the first 4-k static NMOS RAM with specified access of 150 ns and a cycle of 300 ns (Model 4402). However, the static memory requires an external sense amplifier.

The sense amp can be eliminated by use of a

modified version (the 4401) which provides TTL outputs directly. However, this adds about 30 ns to the access time, bringing it up to 180 ns. The 4401 and 4402 dissipate about 60 mW in the standby mode and 300 mW when accessed. The chips come in 22-pin DIPs that use the Intel/TI pinout.

1-k MOS RAMs: Industry workhorses

Compared with 4-k RAMs, which have yet to undergo a shakeout, 1024-bit MOS RAMs present a more stable picture. Product improvements continue, to be sure, but the industry has settled on some workhorses: the 1103 dynamic RAM and the 2012 static RAM, both introduced by Intel, and the 7001, an "in-between" RAM introduced by Advanced Memory Systems. These ICs and upgraded versions from original and alternate sources are used in the great bulk of memory applications.

With the introduction of the 1103 and other 1-k RAMs in 1970, computer manufacturers began to consider semiconductor memories seriously in their designs. Though power dissipation was on a high side and the IC needed external components to make it work, the 1103's over-all specs and price were attractive.

One problem of the original 1103 was its critical overlap timing spec. The memory's timing involved a short, moving "window," or overlap, between precharge and chip-enable signals. For too short an overlap, the read-data lines could not discharge properly; for too large an overlap, the read lines could discharge prematurely. Hence carefully designed timing circuits were needed to ensure fast rise and fall times and accurate sequencing.

Later versions from Intel and other manufacturers have eliminated this problem and brought other improvements. Synertek, for example, recently announced the SY 1103A-1, which eliminates the precharge clock altogether. The silicon-gate RAM uses ion-implantation techniques to achieve worst-case access times of 145 ns. Chip-enable capacitance reduces to 18 pF, so that clock dissipation, as well as the number of system clock drivers, can be decreased.

For a host of applications, however, the performance of fast 1103-type memories isn't needed. Designers are willing to trade off speed for reduced support circuitry and increased TTL compatibility. For these reasons and more, the static NMOS 2102 has become the most widely alternate-sourced memory, either MOS or bipolar.

Manufacturers and designers alike agree on the 2102's ease of use. It operates from the same 5-V supply as TTL, and it can provide TTL interface characteristics without the need for external components. They say you can replace

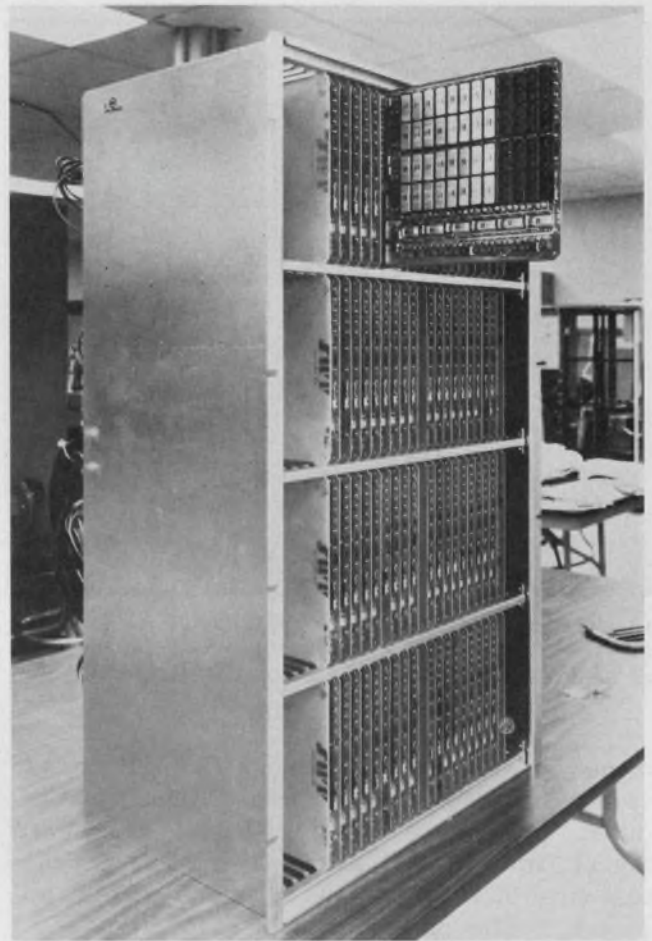

In addition to manufacturing chips, Advanced Memory Systems offers complete memory systems. The memory chips include 4-k dynamic RAMs and 1-k SOS arrays.

an equivalent TTL circuit with a 2102, and the system won't know the difference.

Standard 2102s have access times of 1000, 600 and 400 ns, and power dissipations that are somewhat less than those of comparable, though higher-speed, bipolar units. However, 2102s with higher speeds and lower dissipations are available. Advanced Micro Devices, for example, combines access of 300 ns with dissipation of 140 mW in the 9100 series—the company's version of the 2102. A triple ion-implantation process is used to create depletion loads, rather than the usual enhancement loads, in the memory's cells. The depletion load, which is normally on, doesn't need the half volt required by an enhancement type. This small saving produces much of the improvement.

Top speeds in the 9100 series reach 225 ns, but with some increase in dissipated power. Also, the series has a fanout of two TTL loads, compared with one for typical 2102s, and the logic levels are guaranteed to be identical to TTL levels.

Filling some of the gap between the 2102 and 1103 memories, the 7001 and similar versions combine the features of static and dynamic

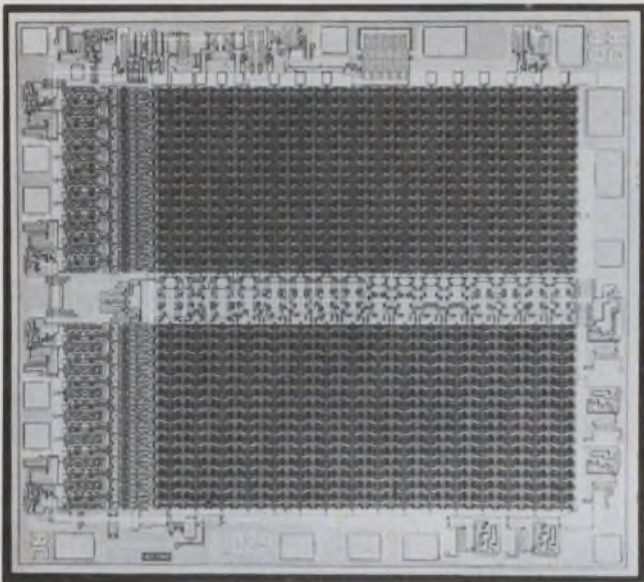

One of the most popular memories is the 2102, introduced by Intel. The 1-k NMOS static RAM can be used as a direct replacement for comparable bipolar ICs.

memories. Like a static memory, the 7001 doesn't require refresh, so peripheral circuitry is reduced. But like a dynamic RAM, speeds are higher. In fact, 7001 memories, with typical access time of 60 ns and cycle time of 180 ns, approach bipolar memories in speed.

Externally the 7001 appears static, although the internal cells operate dynamically. A so-called charge pump, external to the RAM, compensates for internal storage-capacitor losses caused by leakage. The replenishing doesn't require any power-down time, and the pump signal can be a simple sine wave with a frequency of about 1 MHz.

Advanced Memory Systems has come out with an improved version of the 7001 that simplifies the memory's interface to TTL circuits. Called the 7001I, it doesn't require the input pullup resistors that the original circuit does, since the input levels are now those of TTL. And for the chip-select input, current-drive requirements have been reduced from 20 to 8 mA. The select input can be driven by an emitter follower rather than a complementary pair.

The redesigned chip maintains the fast access and cycle times of the original memory. In addition standby power is now spec'd at $0.5 \mu\text{W}/\text{bit}$, down from $60 \mu\text{W}/\text{bit}$. The spec on maximum power dissipation remains the same at $640 \mu\text{W}/\text{bit}$. The 7001I is also being offered by RCA.

Bipolar RAMs race ahead

On the bipolar side of the RAM picture, 1024-bit memories have been introduced by Fairchild, Intersil, Monolithic Memories, Raytheon and Signetics, among others. The most widely dis-

cussed and probably most widely sold—Fairchild's 93415—uses the company's Isoplanar process. It employs silicon-nitride masking to permit oxide isolation instead of diode isolation, allowing substantial reduction in cell size. Raytheon's V-ATE process achieves much the same effect by using an air notch, which also cuts the empty spaces between devices.

Several Signetics' RAMs prove that 1-k bipolar memories don't necessarily need an advanced form of passive isolation. However the company does employ Schottky processing with such refinements as dual-layer metallization. Using the same pinout as the 93415, the company says its versions can directly replace the Fairchild unit without change in system circuitry. For much larger storage than 1 k, though, Signetics plans to turn to special density-enhancing techniques.

Fairchild's first Isoplanar 1-k RAM, introduced in 1972, measured about 130×150 mils and had an average speed of 60 to 65 ns. This version was reduced in two stages to 104×109 mils, with an increase in speed of 20 ns. And by the middle of this year, Fairchild expects to have an even smaller chip—the 93415A—with typical speeds of 30 to 35 ns. Besides speed, the bipolar memory has a power advantage. Dissipation decreases as temperature increases. Typically the standard 93415 dissipates about $1/2 \text{ W}$ at room temperature.

For systems using ECL-10,000 logic, Fairchild has a 1024-bit ECL RAM, the 10415. Motorola, which introduced ECL-10,000, is preparing to introduce a similar version, the MCM 10146. Both versions feature compatibility with the popular high-speed logic family.

While 1-k ECL RAMs will be able to reduce package count, much smaller memories still provide the fastest speeds. A 64-bit RAM in the ECL-10,000 family has access times of about 10 ns. Assuming that you interconnect 16 packages—for 1024 words—within a 1-ft radius, you lose only a few nanoseconds in the wiring. But you gain about 30 to 40 ns over a 1-k RAM package.

SOS/CMOS challenges bipolar

Meanwhile a new challenger to 1-k bipolar RAMs is emerging in the form of an SOS/CMOS chip. This 1024×1 -bit static memory from RCA and Advanced Memory Systems is called the TA6780 (preliminary numbering) and the AMS-5001, respectively. It provides speeds comparable to those of the 93415. And the less power-hungry SOS/CMOS RAM has 93415 pinouts, too. (RCA and Advanced Memory Systems also may come out with a 256×4 -bit version aimed at bulk CMOS sockets.)

The new SOS/CMOS memory (RCA calls it COSMOS) consumes about 20 mW of active dis-

sipation and 1 mW of standby power at 10 V (compared with about 1/2 W for the 93415 at 5 V). Access time at 10 V is about 120 ns in the initial version. RCA expects later versions to achieve access of 80 ns, and by year's end, 60 ns—the level of the 93415s. The circuit operates down to 4 V, and it has an upper limit of 12 V. Also, it can hold data with standby supplies at just 1.2 V.

An unusual feature of the chip's fabrication is the use of both silicon-gate and ion-implantation techniques in addition to silicon-on-sapphire. In the past most manufacturers have used one, or perhaps two, of these techniques. RCA says the combination boosts speed, reliability and yield.

In bulk CMOS memories, the industry has moved up to 1024-bit static RAMs, with products announced by several companies, including Intel, Intersil and Siltek. In its 1501, Intel provides a 256×4 -bit configuration, rather than the more common 1024×1 . And the first CMOS content-addressable memory, or CAM, has been built by Solid-State Scientific, another company that plans to introduce SOS/CMOS memories.

For high speed and low power, a CMOS RAM with a somewhat unusual organization— 512×1 —surpasses most of its CMOS RAM competition not only at the 1-k level but also for 256-bit units. The 512-bit unit, American Microsystems' S2222, has the top access time, 400 ns, and cycle time, 940 ns. Moreover it has the low power drain of 20 nW/bit (standby) and 15 μ W/bit (operating). The static RAM operates from a single 10-V supply and has a single read/write control line.

Memories for LSI microprocessors

Many of the latest RAMs, ROMs and PROMs—both bipolar and MOS—have emerged as parts of LSI-microprocessor chip sets from such manufacturers as Intel, Motorola, National Semiconductor and Rockwell. In some cases the memories have been extensions of popular circuits, like the 2102; in others, they represent major departures.

In Motorola's M6800 MPU microprocessor set, for example, the 6810 RAM can be described as a 2102 with eight outputs, rather than one. The 6810, with an organization of 128×8 bits, is intended to work with the company's 8-bit microprocessor. And since the chip set's ROM, the 6830, also provides 8-bit words (up to 1024), a minimum system can include the 8-bit microprocessor and only one RAM and one ROM. All three ICs employ n-channel MOS technology, and they operate from a single 5-V supply.

Similarly Intel has provided special memories for the company's popular MOS microprocessors: the p-channel 8008, the first 8-bit processor chip, and the n-channel 8080, described as the "first

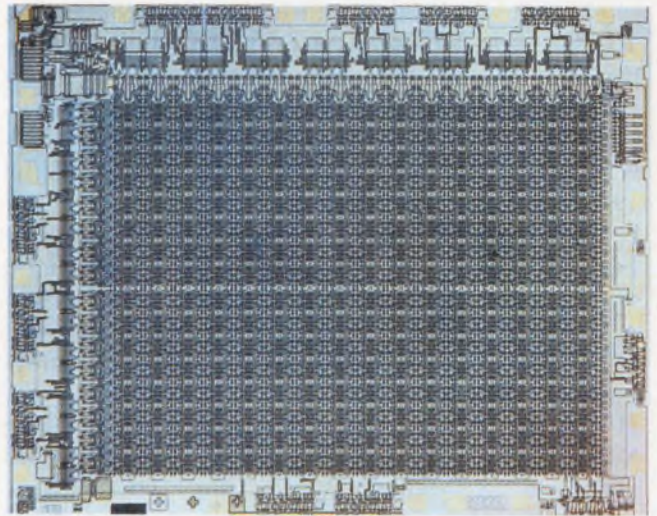

A 1024-bit CMOS static RAM, Intersil's IM6508, offers 250-ns access time over the full temperature range with a 5-V supply. Access drops to 100 ns at 10 V.

second-generation CPU chip." Like the Motorola units the Intel memories provide the logic levels, timing and speed required, while keeping the number of packages down.

Rockwell goes one step farther with its memories for the PPS-4 and PPS-8 systems—4 and 8-bit microprocessor systems, respectively. For example, you can get a combination ROM/RAM chip for additional convenience. The A08 memory includes a 704×8 -bit ROM and a 76×4 -bit RAM. By the middle of the year, Rockwell expects to have a 256×8 -bit electrically erasable ROM (the 10443).

A 42-pin DIP is the standard package for Rockwell's PPS circuits, including the memories. The large package accommodates additional circuitry that simplifies interfacing to the processor and special peripheral ICs, such as CRT and floppy-disc controllers. But because the memories are so closely linked to the company's microprocessors, applications other than for microcomputers tend to be limited.

ROMs find growing use

As microprocessors expand their applications, manufacturers are developing ever larger mask-programmable and precoded ROMs. In various forms—such as code converters, character generators and lookup tables—the precoded ROMs offer designers one way to beat mask charges, short of high-volume buying. For similar reasons, manufacturers are now precoding microprocessor software routines into their ROMs, and they are looking down the road toward more ambitious developments.

A debug program for Motorola's MPU system, for example, comes in two 6830 packages. Called Mikebug, the program can exercise each function

of the microprocessor and its peripheral circuits. The two 8-k ROMs may be replaced with a single package when Motorola introduces its 16-k NMOS ROM, the 6832. It is organized as 2-k \times 8 bits. Other manufacturers developing 16-k NMOS ROMs include Electronic Arrays, Intel and Microsystems International.

Moreover, with even larger ROMs, it's possible that even Fortran compilers will be offered on one or a few precoded chips. These would greatly simplify program development. Manufacturers report that NMOS ROMs reaching 64-k bit storage could be available by the end of the year. Motorola, for one, may have an 8-k \times 8-bit NMOS ROM with access times of about 600 ns—about the upper limit needed for NMOS microprocessors. According to the company, package dissipation, rather than chip technology, is the major barrier.

Meanwhile the largest ROM has just been announced by MOS Technology. The p-channel MOS memory, called the MCS 2029, allows 32-k bits of storage. Its access time is 800 ns, and it features TTL compatibility.

By comparison, the largest bipolar ROM is National Semiconductor's recently introduced 16-k bit memories, DM 8531/8581. The two versions have typical access time of 300 ns, latched inputs and Tri-State outputs. But they differ in organization and packaging. The DM 8531 provides 2-k words, each 8 bits long, and it comes in a 24-pin DIP. The DM 8581, in a 40-pin DIP, has a 1-k \times 16-bit organization. The DM 8531 can be used with the company's 8-bit microprocessors, and the DM 8581 with 16-bit processors.

PROMs handle 4-k bits

The largest bipolar PROMs provide 4-k bits of storage, and chips are being offered by several manufacturers, including Signetics and Intel. The first 4-k PROM available was Monolithic Memories' 5340. It features maximum access time of 90 ns. And maximum times for enable access and enable recovery are guaranteed to be 40 ns.

The Monolithic Memories' PROM uses fusible nichrome links, and its speed is achieved with Schottky-TTL processing. Programming can be attained at the typical rate of 5 ms/bit, or less than 25 seconds per PROM. The 5340 operates from a 5-V supply and has a dissipation of about 170 μ W per bit.

Fusible nichrome links are used by several bipolar-PROM vendors. Beside Monolithic Memories, other manufacturers of this type of PROM include Fairchild, Harris Semiconductor, National Semiconductor and Signetics. Other types of PROMs are offered by additional vendors. Intersil uses AIM, or avalanche-induced migration,

while Intel and Advanced Micro Devices stress polysilicon fuses. And Texas Instruments emphasizes titanium-tungsten. Each technique provides a different tradeoff for programming power needs vs long-term reliability.

More recently, several manufacturers are seeking to upgrade the testing of PROMs. With additional circuitry built into the PROM chip, for example, Monolithic Memories expects to achieve improved ac and dc measurements. Among other features, the new testing techniques can provide enhanced correlation between programmed and unprogrammed circuits.

Similarly Harris Semiconductor—the company that introduced PROMs—plans to offer a new family of products called Generic PROMs. In addition to improved measurement capabilities, each member of the family will have the same programming requirements and the same input and output characteristics. Generic PROMs, which will have standard bit capacities, are slated to offer guaranteed access times over operating temperature and voltage-supply ranges.

On the MOS side of PROMs, ultraviolet erasable memories with increased storage are emerging from National Semiconductor and Intel. The National unit, the MM5204, is a 4-k PROM with a programming time of 30 sec. The Intel PROM, the 2708, has a capacity of 8-k bits and an access of about 500 ns. Its chip design resembles that of the company's popular 1702A ultraviolet-erasable PROM, which has a 2-k bit storage capacity.

Another approach to a reversible PROM electrically alters the program. And a process that allows this is MNOS—short for metal-nitride oxide semiconductor. Compared with Intel's FAMOS (floating-gate avalanche-injection metal oxide semiconductor) erasable ROMs, memories using MNOS generally specify faster write and erase times but slower read times. However, the acceptance of MNOS memories may be on the upswing. In addition to NCR and Nitron, the major suppliers to date, Fairchild says it plans to enter the field.

From Energy Conversion Devices comes yet another way to achieve electrically alterable PROMs. The company's memories employ a matrix of amorphous glass and silicon diodes. A switch at each matrix cross-point can be changed from a relatively high resistance to a low one and back again; so a program is easily changed.

Enter CCD memories

However, the memory technology currently in the spotlight is the charge-coupled device (CCD). With the introduction of the first 16-bit CCD memory chip—Intel's 2416—charge-coupled-device ICs have become serious contenders for many mass-storage applications now filled by

discs and drums.

The new memory combines a maximum serial-data rate of 2 Mbits/sec with an average access time to any bit of less than 100 μ s. And compared with electromechanical storage, the CCD memory requires a fraction of the space and power.

However, Intel's CCD memory may face stiff competition from another 16-k bit chip expected from Fairchild. Recently, the latter announced the first CCD memory, a 9-k bit chip, and described a 16-k CCD now being readied for introduction. According to preliminary data, the 16-k bit CCD is expected to have shorter access times and higher data rates than the Intel version.

CCD memories combine features of conventional shift registers and RAMs. Like a RAM, the Intel 2416 uses a 6-bit address input to select an internal memory region. But the memory regions accessed on the CCD chip are organized as shift registers.

A total of 64 shift registers divides the memory's over-all capacity of 16,384 bits into equal

lengths. Hence each of the randomly addressable registers is 256 bits long. And a specific bit location can be accessed with only 128 shift operations, on the average—corresponding to half the total length of a register. (Were the 2416 built as a continuous register, 8192 shift operations would be needed, on the average, to access a specific bit.)

External four-phase clocks determine the data-shift rate, which can be any frequency from about 125 kHz to more than 1 MHz, over a 0-to-70-C temperature range. Depending on the shift rate, the average access time to any bit ranges from less than 100 μ s to 1 ms. The shift registers recirculate data automatically, so long as the four-phase clocks are applied continuously and no write command is given.

Data rates can be increased to more than 2 MHz by the sequential addressing of several registers between successive shift operations. This mode has the advantage of decreasing the clock-driver power, which always exceeds the dissipation of the memory chip. ■■

Need more information?

The companies and products cited in the report don't represent the manufacturer's full lines. For additional details circle the information retrieval number. For data sheets, consult ELECTRONIC DESIGN's GOLD BOOK.

Advanced Memory Systems, 1275 Hammerwood Ave., Sunnyvale, CA 94086. (408) 734-4330. **Circle No. 401**
Advanced Micro Devices, 901 Thompson Pl., Sunnyvale, CA 94086. (408) 732-2400. **Circle No. 402**
American Microsystems Inc., 3800 Homestead Rd., Santa Clara, CA 95051. (408) 246-0330. **Circle No. 403**
Amperex Elec Corp., Providence Pike, Slatersville, RI 02876. (401) 762-9000. **Circle No. 404**
Cambridge Memories, Inc., 12 Crosby Dr., Bedford, MA 01730. (617) 271-6300. **Circle No. 405**
Electronic Arrays Inc., 550 Middlefield Rd., Mountain View, CA 94043. (415) 964-4321. **Circle No. 406**
EMM Semi, a division of Electronic Memories and Magnetics, 3883 N. 28 Ave., Phoenix, AZ 85017. (602) 263-0202. **Circle No. 407**
Energy Conversion Devices Inc., 1675 W. Maple Rd., Troy, MI 48084. (313) 549-7300. **Circle No. 408**
Fairchild Semiconductor, 464 Ellis St., Mountain View, CA 94042. (415) 962-5011. **Circle No. 409**
Fujitsu Ltd., 2-chome 6-1 Chiyoda-Ku, Tokyo, Japan. **Circle No. 410**
General Instrument Corp., 600 W. John St., Hicksville, NY 11802. (516) 733-3333. **Circle No. 411**
Harris Semiconductor P.O. Box 883, Melbourne, FL 32901. (305) 727-5407. **Circle No. 412**
Hughes Aircraft Co., Microelectronic Products Div., Superior Ave., Newport Beach, CA 92663. (714) 548-0671. **Circle No. 413**
Intel Corp., 3065 Bowers Ave., Santa Clara, CA 95051. (408) 246-7501. **Circle No. 414**
Intersil Inc., 10900 N. Tantau Ave., Cupertino, CA 95014. (408) 257-5450. **Circle No. 415**
ITT Semiconductors, 3301 Electronics Way, West Palm Beach, FL 33407. (305) 842-2411. **Circle No. 416**
Microsystems International Ltd., P.O. Box 3529, Station C, Ottawa, Canada K1Y 4J1. (613) 828-9191. **Circle No. 417**
Monolithic Memories Inc., 1165 E. Arques Ave., Sunnyvale, CA 94086. (408) 739-3535. **Circle No. 418**
Monolithic Systems Corp., 14 Inverness Dr. E., Englewood, CO 80110. (303) 770-7400. **Circle No. 419**

MOS Technology Inc., Valley Forge, PA 19481. (215) 666-7950. **Circle No. 420**
Mostek Corp., 1215 W. Crosby Rd., Carrollton, TX 75006. (214) 242-0444. **Circle No. 421**
Motorola Semiconductor Products Inc., 5005 E. McDowell Rd., Phoenix, AZ 85036. (602) 244-3465. **Circle No. 422**
National Semiconductor Corp., 2900 Semiconductor Dr., Santa Clara, CA 95051. (408) 732-5000. **Inquire Direct**
NCR Microelectronics Div., Miamisburg, OH 45342. (513) 866-7471. **Circle No. 423**
Nitron Corp., 10420 Bubb Rd., Cupertino, CA 95014. (408) 255-7550. **Circle No. 424**
OKI Electronics of America, Inc., 4031 N.E. 12th Terrace, Fort Lauderdale, FL 33307. (305) 563-6234. **Circle No. 425**
Plessey Semiconductors, 1674 McGaw Ave., Santa Ana, CA 92705. (714) 540-9979. **Circle No. 426**
Ragen Semiconductor Inc., 53 S. Jefferson Rd., Whippany, NJ 07981. (201) 887-4142. **Circle No. 427**
Raytheon Co., Semiconductor Div., 350 Ellis St., Mountain View, CA 94040. (415) 968-9211. **Circle No. 428**
RCA Solid State Div., Route 202, Somerville, NJ 08876. (201) 722-3200. **Circle No. 429**
Rockwell Microelectronics Div., P.O. Box 3669, Anaheim, CA 92803. (714) 632-2321. **Circle No. 430**
Siemens Corp., 186 Wood Ave. S., Iselin, NJ 08830. (201) 494-1000. **Circle No. 431**
Signetics Corp., 811 E. Arques Ave., Sunnyvale, CA 94086. (408) 739-7700. **Inquire Direct**
Siliconix Inc., 2201 Laurelwood Rd., Santa Clara, CA 95054. (408) 246-8000. **Circle No. 432**
Silek International Ltd., Airport Industrial Park, Bromont, Quebec. (514) 372-0201. **Circle No. 433**
Solid State Scientific Inc., Montgomeryville Industrial Center, Montgomeryville, PA 18936. (215) 855-8400. **Circle No. 434**
Solitron Devices, Inc., 8808 Balboa Ave., San Diego, CA 92123. (714) 278-8780. **Circle No. 435**
Standard Logic Inc., 2215 S. Standard Ave., Santa Ana, CA 92707. (714) 979-4770. **Circle No. 436**
Standard Microsystems Corp., 35 Marcus Blvd., Hauppauge, NY 11787. (516) 231-5151. **Circle No. 437**
Synertek, 3050 Coronado Dr., Santa Clara, CA 95051. (408) 241-4300. **Circle No. 438**
Teledyne Semiconductor, 1300 Terra Bella Ave., Mountain View, CA 94040. (415) 968-9241. **Circle No. 439**
Texas Instruments, P.O. Box 5012, Mail Station 914, Dallas, TX 75222. (214) 238-4625. **Circle No. 440**
Transitron Electronic Corp., 168 Albion St., Wakefield, MA 01880. (617) 245-4500. **Circle No. 441**
Western Digital Corp., 19242 Red Hill Ave., Box 2180, Newport Beach, CA 92663. (714) 557-3550. **Circle No. 442**

**Your education represents
an important
personal investment---**



What have you done with it so far?

"Got a job" isn't quite the full answer, is it? You're you. And there's more to life than just "a job"—or should be.

What could you expect if you joined us? A quality of life that means the difference between "a job" and a way of living.

We design and manufacture complete electronic systems of various kinds for business, industry and government. It is our practice to hire very able people and then put them to work doing what they most like to do.

Because we are a large company, we offer a total career growth-potential that is as big as we are. And because we work in relatively small product-oriented divisions, your abilities and contributions are highly visible from the time you join us, with prompt recognition of superior performance.

Whether you work for us in California, New York, Ohio, Florida, Kansas or Delaware, you'll find yourself looking forward to coming to

work in the morning. And your technology won't become obsolescent in 5 or 10 years, because, to remain a leader, we must continue to work on the leading edge of the current state of the art.

Professional involvement . . . continuing development as an engineer . . . an environment of individual responsibility that encourages new ideas and rewards initiative. These are good dividends on the personal investment you've already made on your education!

If you're not realizing them now, write:

**Mr. Thomas A. Payne, Dept. ED-4
Corporate Executive &
Professional Recruitment
NCR Corporation
Dayton, Ohio 45479**

NCR

An Equal Opportunity Employer

HAYDEN BOOK COMPANY, INC.

50 Essex Street, Rochelle Park, New Jersey 07662



An Open Letter To Manufacturing Managers.

Are you putting off reliable and promising systems innovations because of the money involved? Or the time? Or maybe because of the painful "people problems" you can foresee?

You probably face these problems constantly because as systems technology expands, it demands radically new talents and skills from management.

Recently, professionals from industry, education and government met for the 10th annual symposium co-sponsored by Informatics and UCLA. Their goal? To bring *clarity* and *profitability* to today's new manufacturing methods—for you, the manager.

Now we have compiled the proceedings into a compact management handbook, called **MANUFACTURING MANAGEMENT SYSTEMS: New Challenges and Profit Opportunities**. As a manager, you couldn't ask for anything more.

This handbook is the symposium and *more*. We've cut away all the extras—the repetitions, the mumblers and the chit-chat—leaving you with the clear and uninterrupted essentials.

The result is an unparalleled, personalized handbook of guidelines, solutions and solid information from some of the nation's most successful industrial leaders.

You'll hear the vice-president in charge of technical affairs at Ford Motor Company tell how an American institution computerized its vast and complex production lines (and battled equally monstrous supplier foul-ups, record problems, etc. along the way).

An executive from a major R & D firm outlines what he has discovered to be the vital managerial skills and essentials for directing progressive operations.

One of Informatic's key men spells out some of the latest and most worthwhile computerized tools available to manufacturers.

The president of a manufacturing firm offers 16 pages of realistic guidelines for handling the sensitive problems of system implementation (without any of the current psycho-social jargon).

There's one corporation president whose share of this handbook is frankly titled "Making Sure You Really Get a Payoff From Your Manufacturing System." It amounts to nothing less than a proven master plan for doing just that.

There are ten sections in all, each one more helpful and informative than the next. Every page is sharp and direct, yet conversational, as if it were being spoken. For the manager, there's a perfect balance of technical information and the wisdom and common sense for using it.

You can now examine, read and use the handbook free, for 15 days, just by circling the information retrieval number shown below. At the end of that time, just send in a check for \$10.50, plus postage and handling, or return the book with no further obligation.

You won't run across many opportunities to hear this kind of straight talk. Try to imagine a symposium where you sit right up front and write down every single word because you know you can use it all.

P.S. Remember—it's easy to order. Just circle the *Information Retrieval No.* shown below!



TO ORDER, CIRCLE 98

Use v/f converters for analog data transmission.

Here are four circuits that provide conversion accuracies from 0.4% to 0.01% and dynamic ranges of 10,000:1.

Analog-to-digital conversion can be simplified with low-cost voltage-to-frequency converters. These produce output frequencies that are directly proportional to an input voltage.^{1,2} And v/f converters with accuracies of 0.01% and frequency ranges of 10 kHz can be built for as little as \$30. Applications include remote data acquisition, digital voltmeters and medical instruments.

V/f converters usually require less complex wiring for data transmission than conventional a/d converters. In many cases the a/d's parallel digital output must be converted into serial form for transmission over a limited number of cables. And even with the parallel-to-serial conversion, an extra line is required to couple the clock pulse from the data-acquisition system to the a/d.

A v/f needs only a single line for a serial pulse train. A clock signal and a counter at the receiving end of the system decode the pulse train.

The typical v/f output signal is a pulse train, which can be encoded by a digital counter. This approach yields an a/d converter (Fig. 1). For an a/d converter, the technique provides a monotonic response. But the need for a counting interval that is at least as long as the period of the lowest frequency signal results in slow conversion. Thus for v/f output frequencies down to about 1 Hz, the counting interval must be at least 1 s. Such conversion times are compatible with many remote data-acquisition and instrument requirements.

Faster conversion, as well as improved accuracy, can be attained with input ranging schemes such as those used in digital voltmeters and other instruments. Input ranging reduces the required v/f dynamic range, and it restricts operation to the higher frequencies, where shorter counting intervals are possible. To add input ranging, you need only use switchable summing resistors on the input amplifier.

Common-mode line-voltage drops can be removed from the v/f signal with simple isolation techniques. The pulse-train signal can be transmitted easily through isolating transformers or

optical couplers. This makes v/f's particularly useful for medical monitoring, where even small ground differences represent a hazard.

Which v/f converter?

Accuracy and conversion-time requirements determine which voltage-to-frequency converter is right for an application. Accuracy is governed by the errors and thermal drifts of the offset, gain and linearity of the v/f.

The greater the circuit accuracy, the wider its useful dynamic range. If only the upper portion of a v/f's dynamic range is used, shorter conversion times are possible than if the entire range is used. Conversion time can also be reduced by modification of the circuits for high-frequency operation—provided, of course, that larger errors can be tolerated.

Let's look at some low-precision circuits, with total errors of 0.4% and 0.1%, and some high-precision circuits, with errors of 0.03% and 0.01%.

For applications that can tolerate full-scale accuracies of 0.4% or worse, you can build a v/f with an op amp and some transistors (Fig. 2). The circuit is basically a zener-controlled relaxation oscillator formed with an integrator and level-detecting reset switch. A constant, negative, voltage input to the integrator causes the output to increase linearly until the reset switch is triggered.

Triggering occurs when the output voltage forward-biases the zener and the emitter-base junction of Q_1 . Then Q_1 drives Q_2 on, and positive feedback between these transistors rapidly increases their currents. As a result, Q_1 generates a voltage pulse at its emitter to turn on another positive-feedback coupled pair, Q_2 and Q_3 . Current from Q_2 and Q_3 overrides the signal current, i_1 , and discharges the capacitor for reset. Discharge continues until the capacitor voltage drops below a level equal to the emitter-base voltage of Q_2 and the saturation voltage of Q_3 . When this happens, Q_2 and Q_3 turn off, and the capacitor begins recharging to repeat the cycle.

During each cycle the change in capacitor voltage, ΔV , equals $V_z + V_{sat}$. The cycle time, Δt , is determined by the rate at which the input

Jerald Graeme, Manager of Monolithic Engineering, Burr-Brown, International Airport Industrial Park, Tucson, AZ 85734.

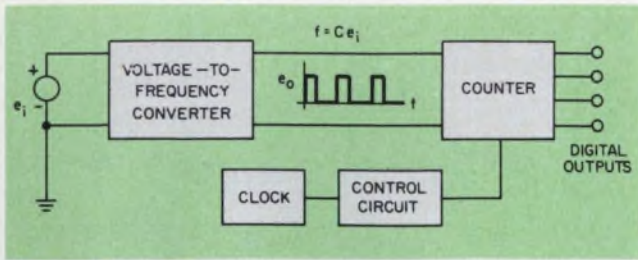

1. The output of a v/f converter can be encoded by a digital counter to simulate an a/d converter.

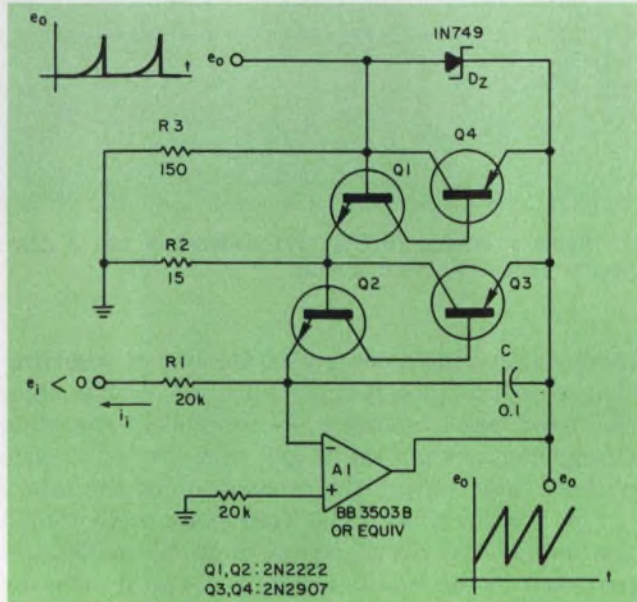

2. A low-precision (0.4%) v/f converter uses an integrator and a voltage-sensing reset switch.

current, i_i , can charge the capacitor by ΔV , as long as the reset time is negligible. If the input signal remains constant during the cycle, the capacitor charges linearly, and $\Delta t = C \Delta V / i_i$. From this, the output signal frequency is theoretically

$$f = \frac{1}{\Delta t} = \frac{-e_i}{R_1 C (V_Z + V_{sat})}$$

For this equation to hold, the input signal frequency must always be much less than that of the output signal. The output frequency will vary from 1 Hz to 1 kHz in response to input voltages from -10 mV to -10 V for the component values shown.

The actual response deviates from that expressed above because of offset, linearity and gain errors. The converter output zero is offset by the op-amp input offset voltage and current:

$$\Delta f_0 = \frac{V_{OS} + I_{OS} R_1}{R_1 C (V_Z + V_{sat})}$$

Note that the amplifier offset voltage, V_{OS} can be adjusted to null this error, and for the circuit shown, it can be reduced to 0.01 Hz.

The reset discharge time and amplifier-gain error govern the response linearity. While the discharge time, t_D , is negligible for low frequencies, it becomes significant as the frequency in-

creases, creating an error of $f^2 t_D$. Discharge time, t_D , which is generally limited by the amplifier slew rate, S_r , equals $(V_Z + V_{sat}) / S_r$. The integrator gain error, important at low frequencies, is approximated by $f(V_Z + V_{sat}) / A_{0e_i}$. Together, the two nonlinearities produce a frequency error of

$$\Delta f_N = f(V_Z + V_{sat}) (f/S_r + 1/A_{0e_i})$$

With the components shown in Fig. 2, this error reaches -0.2% of full scale.

Tolerance variations of R_1 , C , D_Z , Q_1 and Q_2 cause gain errors in the circuit. By adjusting R_1 , you force the initial gain error low. But high gain-error drift, caused by thermal sensitivity of switch thresholds, limits improvements.

The principal causes of sensitivity are the thermal variations of the emitter-base voltage of Q_1 and Q_2 . If you match these transistors, you can counteract most thermal variations. But their vastly different currents, and the pulse operation, limit the improvement that can be achieved. Thus gain drift remains about $0.05\%/^{\circ}\text{C}$. The total circuit error under limited temperature excursion is about 0.4% of full scale.

Improve v/f converter accuracy

If you use a comparator to define the thresholds of the reset switch more precisely, you can improve v/f accuracy (Fig. 3). Once again, an integrator converts the input voltage to a ramp that increases with time in proportion to the input voltage magnitude. The comparator uses a zener diode to control the high threshold and has hysteresis to provide a low switching threshold.

The circuit operation is similar to that of Fig. 2. Negative input voltages cause the integrator output to increase to $e_i = nV_Z + (n+1)V_f$. At this point the comparator output swings positive, turning on the reset switch Q_1 , to discharge C . Discharging continues until e_i reaches the low comparator threshold. This threshold equals V_f , since R_2 supplies no feedback. Diode D_2 blocks any positive feedback during the reset mode as long as the comparator output is positive. Because of D_1 , the low threshold stays above zero. This is necessary since Q_1 cannot discharge C below the transistor saturation voltage.

The change in capacitor voltage during each cycle between the two comparator switching points is $n(V_Z + V_f)$. The time required for this change determines the operating frequency. The charging time—if i_i remains constant during the charging cycle, $\Delta t = C \Delta e_i / i_i$ —helps determine the frequency:

$$f = \frac{1}{\Delta t} = \frac{-e_i}{nCR_1 (V_Z + V_f)}$$

For the component values of Fig. 3, the frequency changes from 1 Hz to 1 kHz as the input voltage varies from -10 mV to -10 V.

The error performance of this v/f depends on offset, linearity and gain. Offset, produced by A_1 ,

$$\Delta f_o = \frac{V_{OS1} + I_{OS1} R_1}{nCR_1 (V_z + V_r)}$$

By adjusting V_{OS1} , you can reduce the offset error to about 0.02 Hz.

Nonlinearities, introduced by t_D and by the limited gain of A_1 , become significant at opposite ends of the frequency range where t_D and the gain produce increasing deviations from the ideal response. Expressions for these errors result in a linearity error of

$$\Delta f_N = f \left[ft_D + \frac{n(V_z + V_r)}{A_o e_1} \right]$$

The slew rate of the op amps or the maximum current of discharge switch Q_1 , whichever is more limiting, determines the reset time, t_D . With the high-speed op amps shown the slew rate doesn't limit t_D . As a result, nonlinearity is held to $\pm 0.04\%$ of full scale.

Again, gain error stems from the tolerance variations of the R_1 , C , R_2 , nR_2 , D_1 and D_2 . A compensating adjustment of R_1 reduces this error to a level limited only by the thermal gain drift. And the gain drift of this v/f is much lower than that of the v/f in Fig. 2, since a comparator sets the switching thresholds. Threshold drift becomes mainly that of V_z and V_r . If you choose a zener diode with a drift that counteracts that of V_r , the gain drift can be reduced to $0.01\%/^{\circ}\text{C}$. The total error for operation under limited temperature excursion will be less than 0.1% of FS.

Higher accuracy with higher frequency

V/f converters with still better precision generally require a correspondingly wider dynamic range for increased resolution. As we have seen, for 0.1% accuracy, a 1000:1 dynamic range is needed. Smaller dynamic ranges are possible only when you use input range switching, but this usually can't be done in remote monitoring.

Conversion time places a limit on the minimum operating frequency. And for practical conversion times not exceeding 1 s, the minimum usable converter frequency is 1 Hz. Thus you must extend the high-frequency end of the operating band to get greater dynamic range.

However, the time required for resetting the integrator capacitor limits the high-frequency operation of these circuits. To reduce the nonlinearity error introduced by the reset time to 0.01% , the reset time must be no more than 0.01% of the minimum signal period, or 10 ns. Such short reset intervals are difficult to achieve, and they produce similarly short output pulses that are absorbed by long line capacitance.

Thus extended dynamic range for improved precision requires capacitor reset by some means that does not introduce timing error. You can do

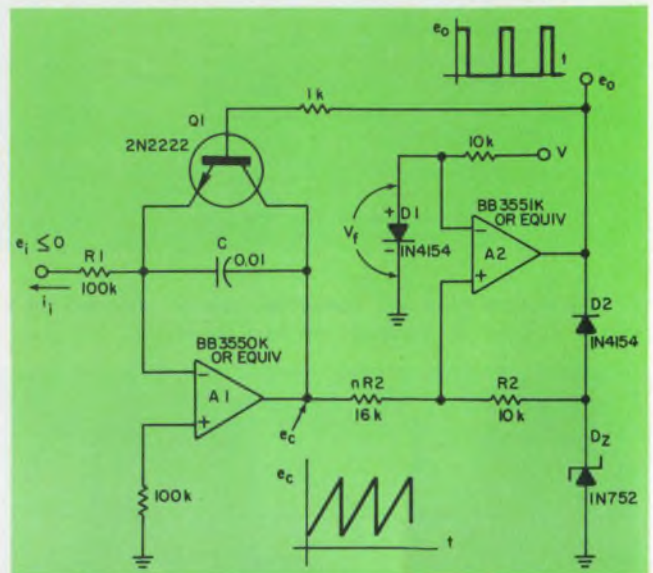

3. Higher precision (0.1%) v/f converters use a comparator-controlled reset circuit.

this by supplying a controlled amount of resetting charge to the integrating capacitor rather than the fixed reset voltage. A controlled resetting charge can be supplied at any time during a cycle without interrupting the integration of the input.

For v/f operation, the frequency with which you supply the reset charge must be made proportional to the input signal. You can do this by supplying the reset charge each time the input signal charges the integrating capacitor to a reference voltage. This operation uses an integrator whose output rises to a reference level, E_R , at a rate determined by the current i_i , from an input signal (Fig. 4). At the reference level, a discharge current, I_D , discharges the capacitor for a period, t_D . As this process repeats for a given i_i , the charging and discharging voltages are equal, and charges are equal and opposite:

$$Q_C = i_i t_C = -Q_D = I_D t_D$$

The frequency of oscillation can be calculated

$$f = \frac{1}{t_C} = \frac{i_i}{I_D t_D} = \frac{-e_i}{R I_D t_D}$$

If I_D and t_D are constants, the frequency is proportional to the input signal.

Let's look at a circuit

One circuit that uses this reset-charge scheme has an integrator and a resetting comparator (Fig. 5). While these two elements of the circuit are similar to those in Fig. 3, the comparator now provides a controlled discharge current, I_D , and a fixed discharge time, t_D . This ensures a constant reset charge of $Q_D = -I_D t_D$. You can derive the controlled discharge current by driving the integrator summing resistor, R_{2a} , with a fixed voltage from a zener diode. To produce a fixed discharge time, rather than a fixed voltage, couple the input

signal to the comparator.

Application of a negative input signal starts the v/f oscillation. The negative signal drives the comparator A_2 to its positive output state, where it conducts a current through D_4 , D_z and D_6 . This establishes a voltage of $V_z + V_{t6} - V_{t1}$ on R_{2b} and creates a discharge current of

$$I_D = \frac{V_z}{R_{2b}}, \text{ for } V_{t6} = V_{t1}.$$

Since this current is greater in magnitude than i_1 , the integrator output is a negative-going ramp. The ramp continues to the first comparator trip point. Only e_1 controls this trip point because D_2 disconnects the comparator positive feedback for positive values of e_0 . As a result, the first trip point is at $e_c = e_1/K_2$, where $K_2 = R_4/(R_3 + R_1)$.

When the voltage reaches the trip point, the circuit switches to the charging mode. The comparator output switches to its negative state, reverse-biasing D_1 to disconnect the discharging current. Current i_1 then charges the capacitor until it reaches the second trip point.

Both e_1 and the positive feedback of the comparator control the second trip point. In this negative output state, D_2 connects the positive feedback, caused by forward bias, to the comparator, and the diode bridge inverts the voltage presented by the zener diode. Thus the same zener diode establishes the second trip point and the discharge current. This ensures the matching required for good linearity. The zener creates a voltage of $-V_z - V_{t5} + V_{t2}$ on the comparator feedback resistor, R_{2b} . Together the voltage and input signal define the second comparator trip point at

$$e_c = K_1 (V_z + e_1/K_2) + e_1/K_2, \text{ for } V_{t5} = V_{t2}.$$

The difference in trip points fixes the change in e_c at

$$\Delta e_c = K_1 (V_z + e_1/K_2).$$

Note that the reset voltage, Δe_c , is a function of e_1 rather than a constant. This makes the discharge time, t_D , a constant, as required for the response $f = e_1/RI_D t_D$. The discharge time is

$$t_D = \frac{\Delta e_c C}{I_D - i_1} = \frac{\Delta e_c C}{V_z/R_{2b} + e_1/R_1}.$$

If Δe_c was a constant, t_D would vary with e_1 . But Δe_c in this case has a compensating variation with e_1 , and

$$t_D = \frac{K_1 (V_z + e_1/K_2) C}{V_z/R_{2b} + e_1/R_1} = K_1 R_{2b} C \text{ for } R_1 = K_2 R_{2a}.$$

With t_D a constant, the converter response relates linearly to e_1 :

$$f = \frac{-e_1}{R_1 C K_1 V_z}, \text{ for } R_1 = K_2 R_{2a}.$$

The performance of the v/f in Fig. 5 is determined by component selection and the resulting offset, gain and linearity errors. For the components shown, a 1-Hz-to-10-kHz output range is developed by an input signal range of -1 mV to

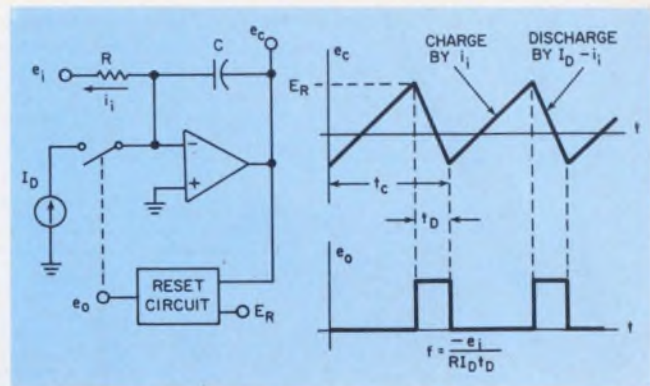

4. Controlled-charge reset circuits eliminate the linearity error caused by a separate reset interval.

-10 V. While this converter provides 0.01% resolution, accuracy is limited to about 0.03% of full scale by the error factors.

Minimize errors for best performance

The offset error for this circuit is

$$\Delta f_0 = \frac{V_{OS1} + I_{OS1} R_1}{R_1 C K_1 V_z}.$$

There is a value of V_{OS1} for which Δf_0 is zero. The offset control of A_1 can be adjusted to reduce the frequency offset to about 0.1 Hz. Gain error results from the tolerances and drifts of R_1 , C , D_z , D_1 , D_5 , D_6 , R_{2a} , R_{2b} and $K_1 R_{2b}$. These errors are compensated by adjustment of the gain-trim potentiometer and reduced to about 0.003%.

Linearity depends upon the open-loop gain of A_1 , the switching time of A_2 , the $R_1 = K_2 R_{2a}$ ratio, and the frequency sensitivity of two matched-diode pairs. Limited open-loop gain in A_1 causes an input error signal that introduces nonlinearity at low frequencies.¹ At low frequencies, the input signals are at their smallest and are sensitive to amplifier input error signals. Thus a high-gain op amp should be used.

At the high end of the frequency range, the comparator switching time and error in the resistance ratio introduce nonlinearity. Increasing frequency also degrades the diode voltage matches. An increasing frequency is associated with an increasingly frequent supply of reset charge. This requires a greater duty cycle for matched diodes D_1 and D_6 and a lesser duty cycle for the matched pair D_2 and D_5 .

As a result, the diode temperatures vary, disturbing the match needed in forward voltage drops to maintain constant I_D and t_D . Best results are achieved if monolithic dual devices are used. The combined nonlinearity can be reduced to 0.02% of full scale by the linearity trim potentiometer. Added to this trimmed error is thermal drift of typically 0.006%/°C.

You can improve the v/f accuracy further by using clock control of the discharge time. The

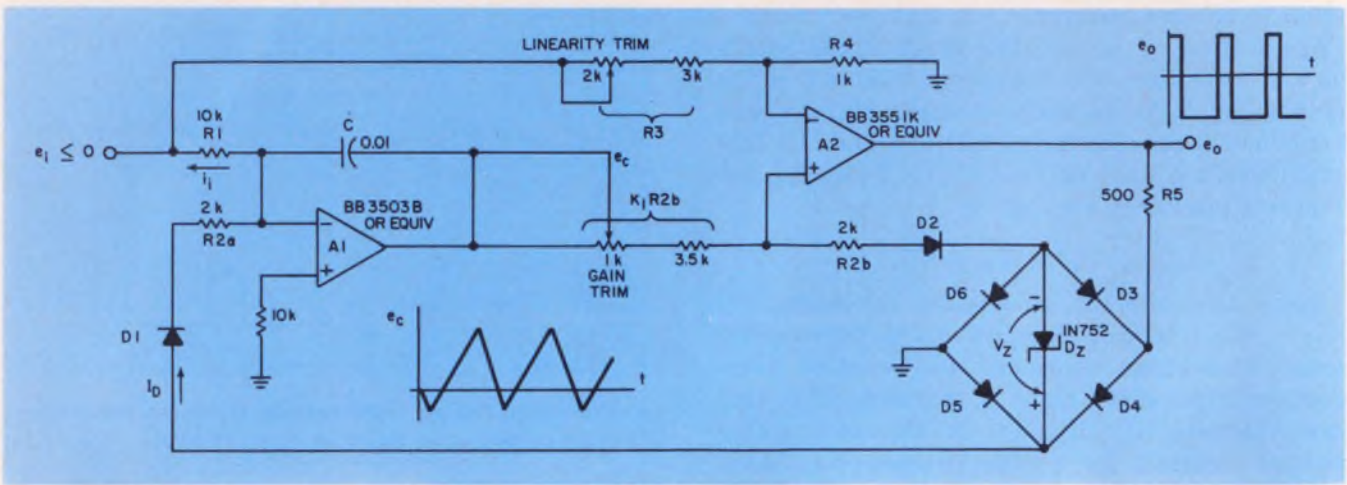

5. A 10,000:1 dynamic range and accuracy of 0.04% are obtained when controlled-charge reset is used.

price you pay is that of an external clock supply and extra wiring. As in Fig. 4, the controlled charge reset is applied for a response of $f = e_i / R_1 I_D t_D$ to provide a 1-Hz-to-10-kHz frequency range. The clock signal control permits 0.01% accuracy. The reset circuitry, controlled by the clock, permits the discharge current to flow for one period of a precision clock signal (Fig. 6).

The integrator capacitor is charged by the input signal until the integrator output reaches a reference level. In this case the reference level is the threshold voltage of a flip-flop. While this reference is not precise, it need only be constant during each cycle to ensure linear response. When the integrator output reaches the flip-flop threshold, it keys the flip-flop for switching at the next clock pulse. And the next clock pulse causes the Q output to switch to its low state while the \bar{Q} output switches to high state.

In this mode Q_1 turns on and supplies discharging current, and Q_2 turns off and provides a low output state. By appropriate choice of I_D , the integrator output will be discharged beyond the flip-flop threshold before the next clock pulse arrives, and the circuit will then be switched back to its charging state. This operation fixes the discharge time at the precise period of the clock pulse. For a constant reset charge, you also need a constant discharge current. This current is supplied by a precision current source formed by A_2 and Q_3 , and $I_D = V_Z / R_5$.² The v/f response is then

$$f = \frac{R_5 e_i}{R_1 t_D V_Z}$$

As with the previous circuits, the performance limitations are specified in terms of offset, gain and linearity errors. Offset error is once more determined by the dc input errors of the integrator, and it will be

$$\Delta f_0 = \frac{R_5 (V_{OS1} + I_{OS1} R_1)}{R_1 t_D V_Z}$$

By means of the A_1 offset control, this error can

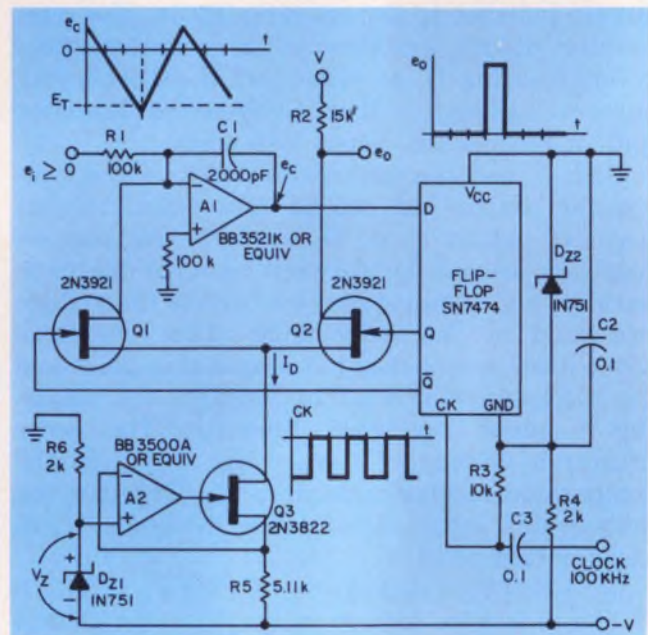

6. If clocked control of the discharge time is used, accuracies to within 0.01% are obtainable.

be reduced to 0.1 Hz. Gain errors are produced by the tolerances and drifts of R_1 , C , D_{Z1} , R_5 and the clock pulse period. To adjust gain, trim R_1 . Nonlinearity is all but removed as a source of error. Variation in the discharge time only produces a slight gain error.

The only other error that varies with frequency to introduce nonlinearity is the gain error of the integrator. As long as this amplifier has high gain, nonlinearity is controlled to permit over-all circuit accuracy of 0.01% of full scale. ■■

References

1. Tobey, G. Graeme, J., Huelsman, L., "Operational Amplifiers: Design and Applications." McGraw-Hill, 1971.
2. Graeme, J., "Applications of Operational Amplifiers—Third Generation Techniques," McGraw-Hill, 1973.
3. Connors, S., "Voltage-to-Frequency Converters: A/Ds With Advantages," *EDN*, June 5, 1974.

DO-IT-YOURSELF grabber



- Simplified Assembly
- Versatile
- Comfortable Finger Grip Action
- Completely Field Serviceable
- Molded of Tough Lexan*

**Model 3925
Mini Test Clip**
Shown Actual Size

This test clip with gold plated hook is excellent for rapid testing of components and Wire Wrap† pins. Clip is completely insulated to point of connection. Build any combination of test leads with wire up to .090 dia. Easy and comfortable to operate. Molded of rugged Lexan to resist melting when soldering. Write for literature and prices.



MODEL 3925

hooks onto components or slips over square Wire-Wrap pins

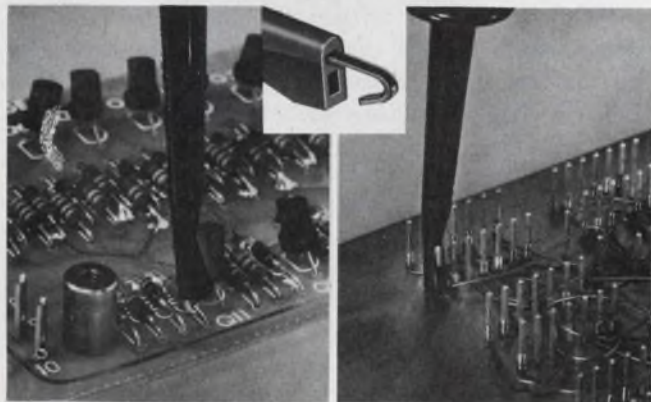

*Lexan is a General Electric trade-mark. †Registered trade-mark of Gardner-Denver Co.



POMONA ELECTRONICS

A Division of ITT

1500 East Ninth St., Pomona, Calif. 91766
Telephone (714) 623-3463

INFORMATION RETRIEVAL NUMBER 70

ELECTRONIC DESIGN 7, April 1, 1975

Dialight sees a need:

(Need: The widest choice for your every application.)

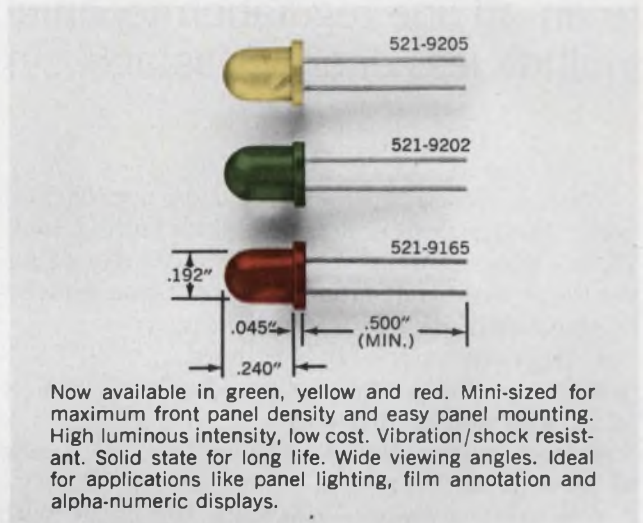

Now available in green, yellow and red. Mini-sized for maximum front panel density and easy panel mounting. High luminous intensity, low cost. Vibration/shock resistant. Solid state for long life. Wide viewing angles. Ideal for applications like panel lighting, film annotation and alpha-numeric displays.

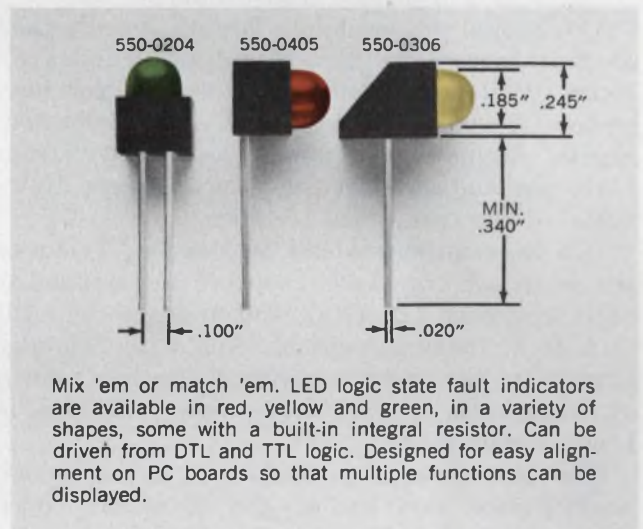

Mix 'em or match 'em. LED logic state fault indicators are available in red, yellow and green, in a variety of shapes, some with a built-in integral resistor. Can be driven from DTL and TTL logic. Designed for easy alignment on PC boards so that multiple functions can be displayed.



Dialight, the company with the widest choice in switches, LEDs, indicator lights and readouts, looks for needs . . . your needs . . . and then they develop solutions for your every application. No other company offers you one-stop shopping in all these product areas. And no other company has more experience in the visual display field. Dialight helps you do more

with these products than any other company in the business, because we are specialists that have done more with them. Talk to the specialists at Dialight first.

You won't have to talk to anyone else. Send for your free new copy of Dialight's current catalog.

DIALIGHT

Dialight, A North American Philips Company
203 Harrison Place, Brooklyn, N. Y. 11237
(212) 497-7600

See Dialight.

INFORMATION RETRIEVAL NUMBER 71

Switch your high-power supply design to an off-line regulation technique. The benefits include less energy wastage, simpler designs and lower cost.

With a direct, off-line regulation approach to power-supply design, it's possible to build a 1000-W, 5-V power supply that boasts a number of advantages over conventional units. Some benefits of the supply include:

- High efficiency—80% or more.
- Compactness—the design occupies $6 \times 6 \times 12$ in. and weighs just 6 lb.
- Dual input voltages—115 or 230 V ac, single or three phase.
- Simplified design—less than 100 parts, with no need for a front-end transformer.

Traditional power-supply designs usually take the transformer-rectifier-low-voltage-regulator route. While this method is adequate for low-power (< 200 W) designs with single-frequency inputs, higher-power applications suffer from high cost and low efficiency—two serious drawbacks of the traditional method.

But these problems can be avoided. The way out is to use transistor choppers to regulate at high frequency (20 kHz), and to design with all TTL to simplify the circuit. And with Schottky diodes in the output rectifier—to hold down switching and forward-drop losses—efficiency is boosted even more.

The power switching circuit is a half-bridge configuration that has several advantages over the usual push-pull approach to off-line regulation: The output transformer primary gets 100% use—as opposed to 50% in push-pull circuits—and the output transistors have just half as much voltage stress. This means that the unregulated bus voltage can be double that of a comparable push-pull circuit but with the same current and voltage stress at the transistors. Note that a doubling of the bus voltage also doubles output power.

The single-phase ac input can be 95 to 130 V, or 190 to 260 V, at frequencies from 50 to 400 Hz (or higher). Or the input can be 190 to 260 V three-phase over the same frequency range. Output is 5 V at 200 A, with a ripple and regulation

envelope of 50 mV. Overload protection is to 250 A.

Taking the place of a front-end transformer is an off-line rectifier that delivers unregulated, 300-V dc bus power, which is first chopped at 20 kHz by transistor switches, then transformed down to the secondary voltage required to feed the output rectifiers (Fig. 1). To achieve regulation, the conduction time of the high-voltage switching transistors is controlled at the 20-kHz rate.

Smooth dc is generated at the output terminals by integration of the pulse train after rectification. A dc regulator senses the output voltage and current and supplies a feedback error signal to the pulse-width control circuit.

To accommodate both 115 and 230-V inputs, a voltage doubler is used in conjunction with a conventional bridge rectifier. Self-heating thermistors are needed to limit the turn-on line inrush current caused by the low impedance of the filter capacitors (Fig. 2). The rectifier shown is a three-phase bridge with a peak-reverse voltage of 600 V minimum and a current capability of 8 A.

Because of the fast response of the switching regulator, input-line variations—including line ripple—are, in effect, filtered by the pulse-width-modulation action. It is, however, still necessary to keep the dc bus within the voltage regulation range of the control circuit, and this requires the use of bus filter capacitors. In actual operation from 50-Hz, 95-V lines (worst case), the dc bus will have about 20-V peak-to-peak ripple at full load with 2500- μ F filter capacitors.

The peak line currents at the input terminals depend on the line impedance, as does the rectified bus voltage. The surge limiting thermistors prevent excessive peak line currents at the expense of about a 5-V drop on the dc rectified bus under full-load conditions.

Power Darlington forms switch

Darlington transistors, connected as a bridge, switch the unregulated bus at the 20-kHz rate (Fig. 3). Drive signals are applied at the bases

Peter N. Wood, Senior Applications Engineer, TRW Power Semiconductors, 14520 Aviation Blvd., Lawndale, CA 90260.

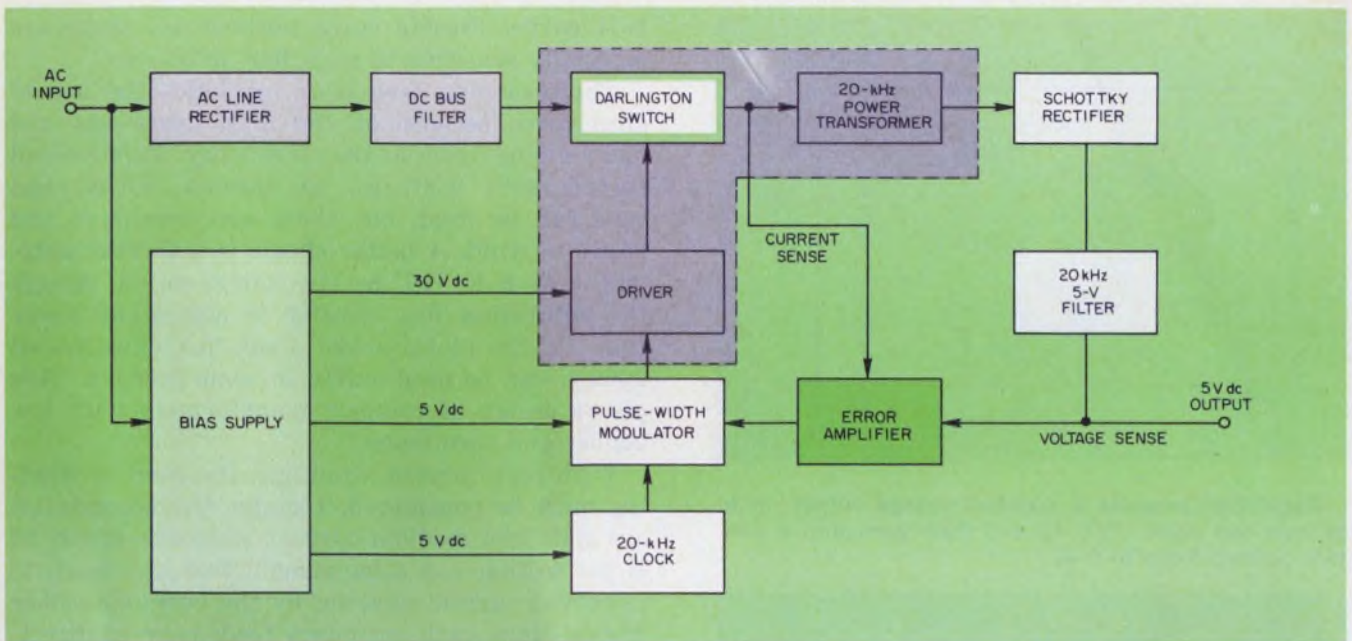

1. In an unusual approach to power-supply design, the ac input is first converted to a 300-V unregulated dc bus. The high voltage is then chopped at 20 kHz by

a Darlington switch and transformed to a lower, secondary level. Regulation is obtained by pulse-width modulation of the switched waveform.

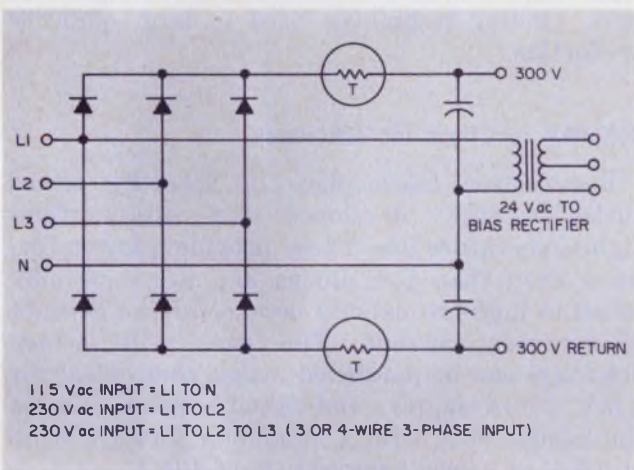

2. A three-phase bridge rectifies the input, which can be 115 or 230 V, single or three-phase. The thermistors limit line-inrush current.

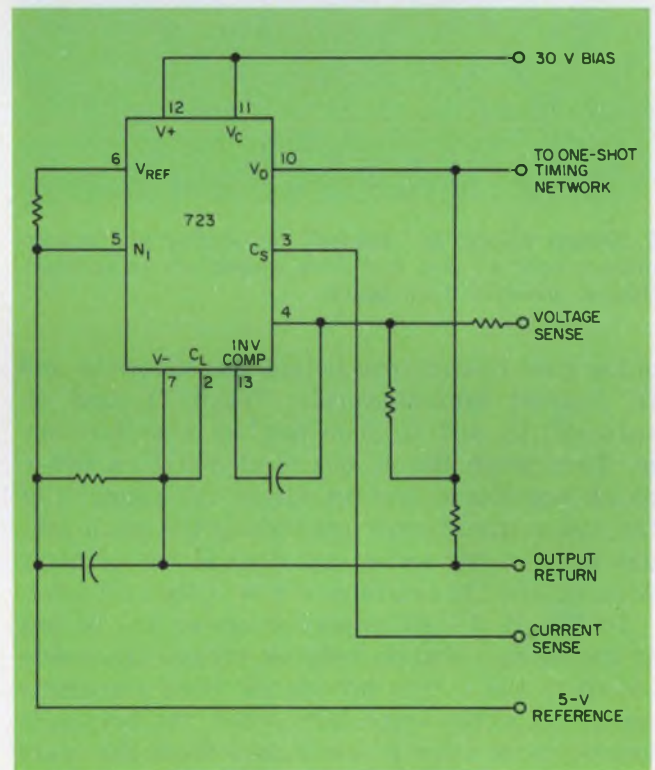

4. Both output voltage and current are sampled and generate an error signal in a 723 regulator. The error signal modulates the pulse width of a one-shot multivibrator to provide the voltage regulation.

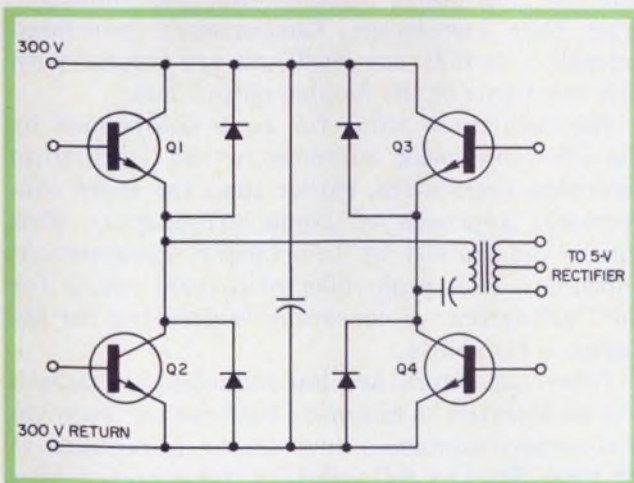

3. Darlington transistors in a bridge arrangement switch the 300-V bus. Transistors Q_1 and Q_3 conduct simultaneously for half the cycle, while Q_2 and Q_4 are cut off. The situation reverses on the second half cycle.

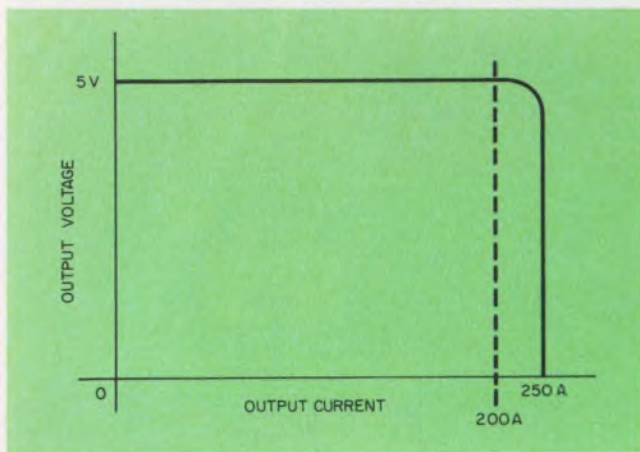

5. Regulation provides a constant-voltage output up to the overload point (250 A) and then goes into a constant-current mode to 0 V.

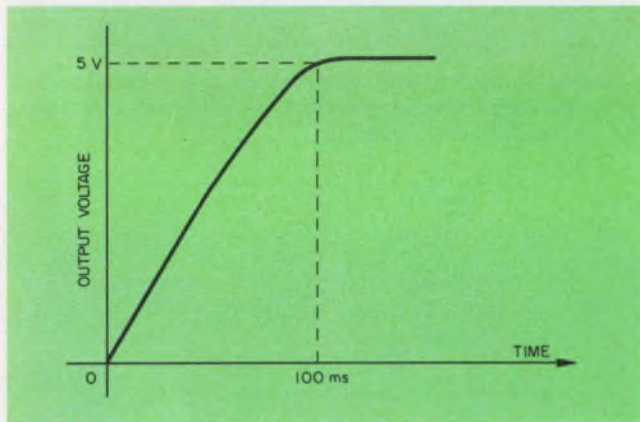

6. Output voltage is "delayed" by limiting of the thermistors until all bias and drive signals are established. Normal operation then begins.

of the four Darlington's so that transistors Q_1 and Q_2 conduct simultaneously. When Q_1 and Q_2 turn off, Q_3 and Q_4 then conduct simultaneously. Thus when the dc bus is at 300 V, a 600-V pk-pk waveform appears across the primary of the power transformer (neglecting the small voltage drop in the series capacitor at the primary winding and the saturated drops of the switches).

In Fig. 3, a $2\text{-}\mu\text{F}$ capacitor across the dc bus at the bridge location reduces voltage transients traced to the dc bus impedance. Such transients can be expected—especially when the bridge is located more than a few inches from the main filter capacitors. The capacitor is usually polycarbonate but must have low-loss characteristics to handle adequately the 20-kHz ripple currents.

Another $2\text{-}\mu\text{F}$ polycarbonate capacitor in series with the transformer primary blocks dc and thereby prevents possible saturation of the core by small imbalances in the volt-second product applied at each half cycle. There are always some differences in switching times and transistor saturation voltages that cause the core flux excursions to "walk" to one of the saturation regions of the

B-H curve. Ferrite cores without air gaps are especially sensitive to such flux imbalance.

The operating frequency precludes the use of steel cores because of the high hysteresis and magnetizing losses at that frequency. Tape-wound toroids with 0.001 in., or thinner, nickel-steel tape can be used, but these are expensive and costly to wind. A better choice is a ferrite material in an E-E, U-U or U-I configuration, though the saturation flux density is somewhat lower than for the nickel steels. Peak flux densities of 2000 G can be used safely in some ferrites. This allows design of compact transformers with low copper and core losses.

With high-current windings, the ease of winding must be considered. Usually, the secondaries are split into medium-current sections—about 50 A per section—an arrangement that also leads to improved current sharing by the output rectifier diodes. Here, each secondary feeds current directly to just one output-rectifier anode. Thus current sharing is optimized, and there are no secondary terminals to cause power losses.

The primary winding is layer wound in the usual way. This lends itself to the multiple-coil, stick winding techniques used in large-quantity production.

Schottky rectifiers for efficiency

Rectification takes place in Schottky power diodes—recently developed for high-current, high-temperature use. These provide a lower forward drop than p-n diodes and are especially suited to high-frequencies because of the absence of recovery current. The ease with which Schottkys can be paralleled makes them ideal for a 5-V, 200-A supply: Individual Schottky diodes can handle 50 A with a maximum forward drop of 0.6 V at a case temperature of 125 C.

Because of the regulation method, the rectified output is a pulse train that must be transformed into the smooth dc required at the output. Conventional L-C filter techniques are used to do this. But like the power transformer, the inductors must have low losses. Consequently powdered permalloy toroids are used and are wound with just two turns of the flexible output bus.

The inductance value for L_1 is determined by the allowable peak currents in the Darlington switching transistors, rather than the more conventional approach of ripple attenuation. This can be determined by breadboard measurement allowing a 10-A peak collector-current rating for the Darlington's—a conservative derating for acceptable reliability.

Filter capacitors are low-inductance, stacked-foil electrolytics to minimize both the esr (equivalent series resistance) and the ac impedance at 20 kHz. Stacked foil exhibits inductance values

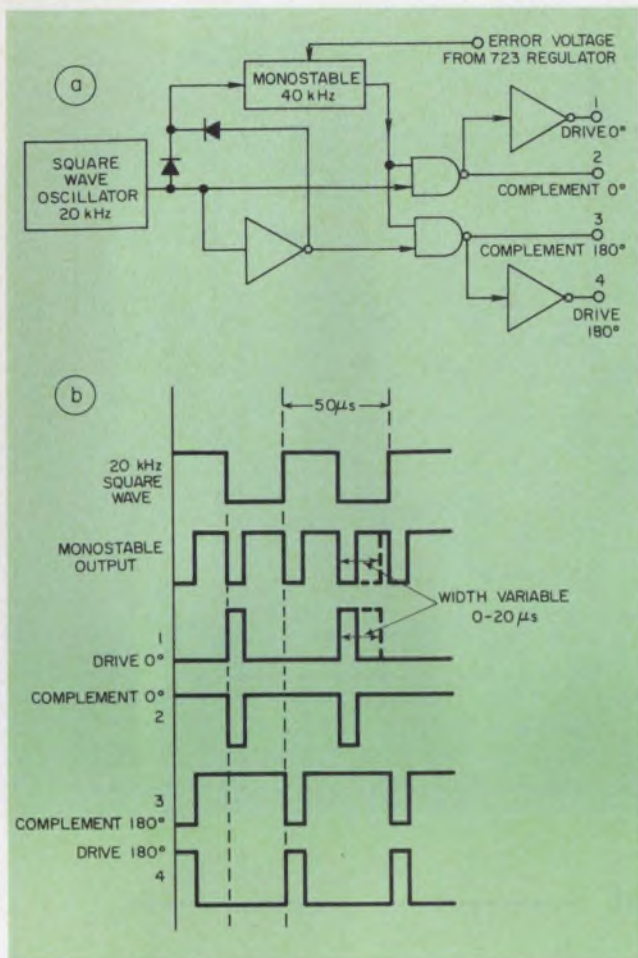

7. To derive the four signals to drive the Darlington bridge, the one-shot output is "mixed" with the 20-kHz clock in two NAND gates (a). The resulting waveforms consist of two out-of-phase signals and their complements (b).

as low as 2 nH and provides superior ripple-current ratings. Small series inductors (T_5) are formed between the capacitor sections of the filter by passage of the dc bus bars through powdered permalloy toroids. With C_{11} —a low-impedance capacitor located directly across the output— T_5 forms a second section of the output filter. This technique further reduces the common-mode ripple voltage at the output.

ICs simplify design

Two functions are performed by the error-amplifier circuit: voltage regulation and current limiting. A 723-type regulator generates the error signal needed for regulation (Fig. 4). By rectification of the output voltage of a current transformer in series with the power-transformer primary, a voltage proportional to the primary current can be generated. This signal is also applied to the 723 regulator, and in such a way that the error signal becomes current-dependent above a predetermined load current. Thus the regulation envelope exhibits constant voltage up

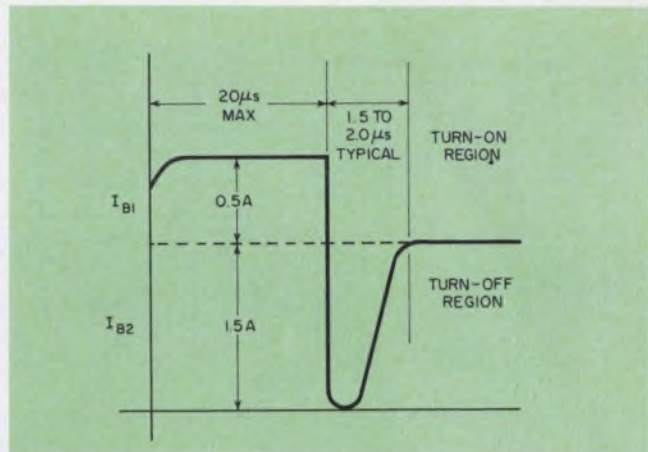

8. Critical to proper operation is the Darlington base-drive current, which must have fast transitions.

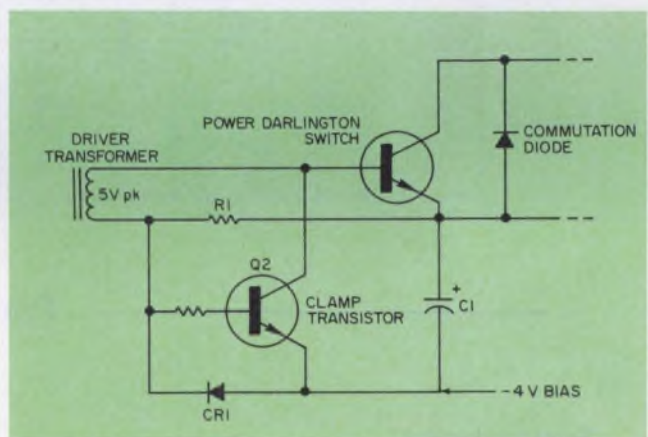

9. Turn-off current, I_{B2} , is provided by a transistor clamp arrangement at the base of the Darlington.

to the overload point, and then constant current down to zero voltage (Fig. 5).

During start-up, the dc bus voltage is delayed to ensure that all bias voltages are established and drive signals are applied to the Darlington power stage before power is switched. This delay is performed by the inrush limiting thermistors in the input filter. At the end of this delay time the dc bus falls within the regulation limits and normal regulation is established (Fig. 6).

To form the pulse-width modulator, a free-running TTL multivibrator (MC4024) generates a 20-kHz square wave, which triggers a monostable multivibrator (8601) on the leading and trailing edges. The output of the monostable is a pulse train of 20- μ s width and a 40-kHz repetition rate.

Four signals generated

By use of the 723's error signal to vary the monostable's R-C time constant, the pulse width can be varied proportionately from 0 to 20 μ s. The resultant one-shot pulse is applied to one in-

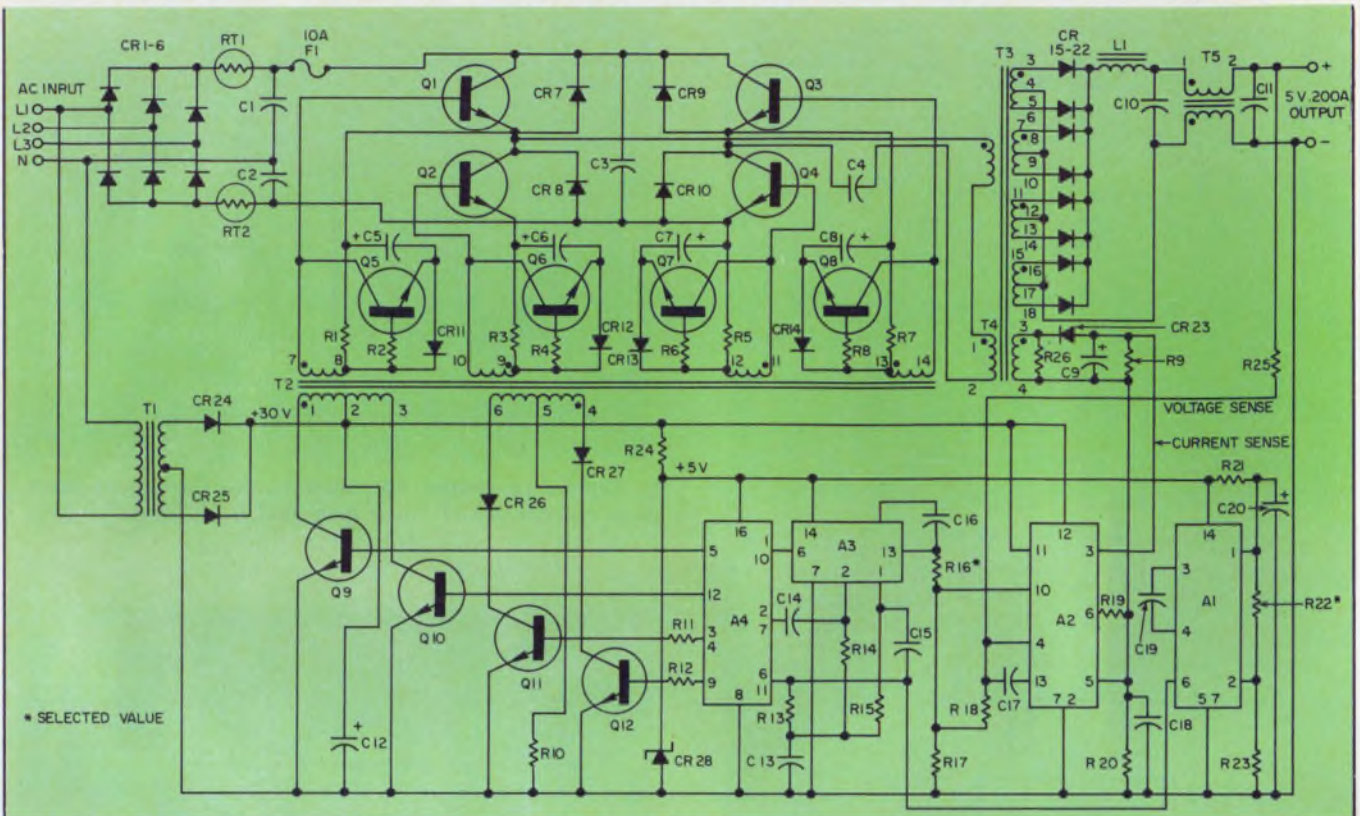

Parts list

Semiconductors

Q _{1,2,3,4}	TRW SVT6001	
Q _{5,6,7,8,9,10}	TRW SVT60-5	
Q _{11,12}	2N2222	
CR _{1,2,3,4,5,6}	1N1204	
CR _{7,8,9,10}	TRW SVD400-12	
CR _{11,12,13,14,23}	TRW DSR3051	
CR _{15,16,17,18}	TRW SD-51	
CR _{19,20,21,22}	TRW SD-51	
CR _{24,25}	1N4002	
CR _{26,28}	TRW DSR3051	
CR ₂₉	TRW LVA-51A	
A ₁	MOTOROLA MC4024	Voltage-Controlled multivibrator
A ₂	NATIONAL LM723C	Voltage regulator
A ₃	NATIONAL DM8601	Monostable multivibrator
A ₄	NATIONAL DM8090	Dual NAND, Quad Inverter

Resistors

RT _{1,2}	5Ω	Thermistor, 5DA5R0 (Rodan Industries)
R _{1,3,5,7}	10Ω, 5W	
R _{2,4,6,8}	51Ω, 1/2W	
R _{9,14,18,28}	1K, 1/2W	
R ₁₀	10Ω, 1/2W	
R _{11,12}	270Ω, 1/2W	
R _{13,23}	10K, 1/2W	
R ₁₆	100K, 1/2W(selected)	
R ₁₇	1.5K, 1/2W	

R ₁₄	470K, 1/2W
R ₁₉	2K, 1/2W
R ₂₀	5.1K, 1/2W
R ₂₁	100Ω, 1/2W
R ₂₂	6.8K, 1/2W(selected)
R ₂₃	270Ω, 2W
R ₂₄	39Ω, 1/2W

Capacitors

C _{1,2}	2500μF, 200V	Sprague type 36D
C _{3,4}	2μF, 400V	
C _{5,6,7,8,13,20}	22μF, 6V	
C ₉	56μF, 6V	
C ₁₀	47000μF, 7.5V	Sprague type 432-D
C ₁₁	10μF, 50V	
C ₁₂	1100μF, 50V	Sprague type 39D
C _{14,16,18}	0.001μF, 50V	
C ₁₇	100pF, 300V	Elmenco type DM
C ₁₈	0.1μF, 50V	
C ₁₉	0.01μF, 50V	

Transformers

T ₁	FT-14	TRW/UTC Transformers
T ₂	Special Driver	TRW/UTC Transformers
T ₃	Special Power	TRW/UTC Transformers
T ₄	Special Current	TRW/UTC Transformers
L ₁	Special Filter	TRW/UTC Transformers
T ₅	Special Balun	TRW/UTC Transformers

Fuses

F ₁	10A fast blow	Bussman type 3AG
----------------	---------------	------------------

10. The complete power-supply schematic. Ferrite transformer cores keep losses down and provide a compact design. Paralleled Schottky diodes perform the final

rectification, and also keep switching and forward-drop losses down. An L-C filter at the output smooths the pulse train into the 5-V dc output.

put of two NAND gates and the 20-kHz square wave—and its inverse—are applied to the other inputs (Fig. 7a).

The gate outputs are therefore pulse-width-regulated signals, one in phase and the other 180 degrees out of phase with the 20-kHz clock signal. An inverter connected to each of the NAND-gate outputs provides drive signals that are also 180 degrees out of phase with each other, but are complements of the NAND-gate outputs (Fig. 7b).

Thus four pulse-width-modulated signals—from the NAND gates and the inverters—are generated and constitute the base drives for the power Darlington switches. As shown in the figure, the single driver transformer has two center-tapped primaries. One primary connects with a pair of push-pull driver transistors; the other short circuits the core flux during those periods when zero drive is required at all the Darlington switches. This short-circuiting technique ensures that noise pulses or other spurious signals cannot falsely trigger the power switches during periods of no conduction.

A factor in the successful operation of high-voltage switching regulators lies in the base-drive

Transformer winding data

DRIVER TRANSFORMER (T₂)

Core:

TDK, part number H6A-P18/14-52H, pot core.

Windings:

(1-2)(2-3) 60T Bifilar, #32 single sodereze.

(4-5)(5-6) 30T Bifilar, #36 single sodereze.

(7-8)(9-10) 10T Quad, #26 single sodereze.

(11-12)(13-14)

Terminations:

Self leads to 14 pin header mounted to core.

POWER TRANSFORMER (T₃)

Core:

Stackpole, part number 50-631, ceramag 24B, 0244.

Windings:

(1-2) 32T, #14 Teflon covered flex.

(3-4) thru (17-18) 1T, #8 PVC covered solid core.

Terminations:

Self leads, length as required.

CURRENT SENSE TRANSFORMER (T₁)

Core:

Magnetics Inc., part number 52056-1D.

Windings:

(1-2) Bar primary formed by passing T₃ primary lead thru core.

(3-4) 34T, #30HF

Terminations:

Self leads, length as required.

BALUN TRANSFORMER (T₅)

Formed by passing output bus bars through Magnetics, Inc., core part number 55436-A2, 1 turn each bus bar.

FILTER INDUCTOR (L₁)

Formed by winding 2 turns of positive bus bar through 2 Magnetics, Inc., cores part number 55436-A2.

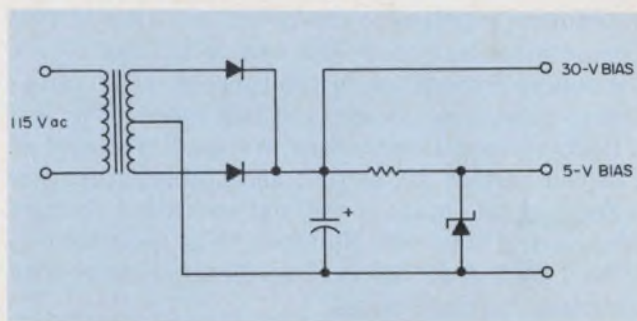

11. Bias power for the TTL and driver circuitry is provided by a simple auxiliary supply.

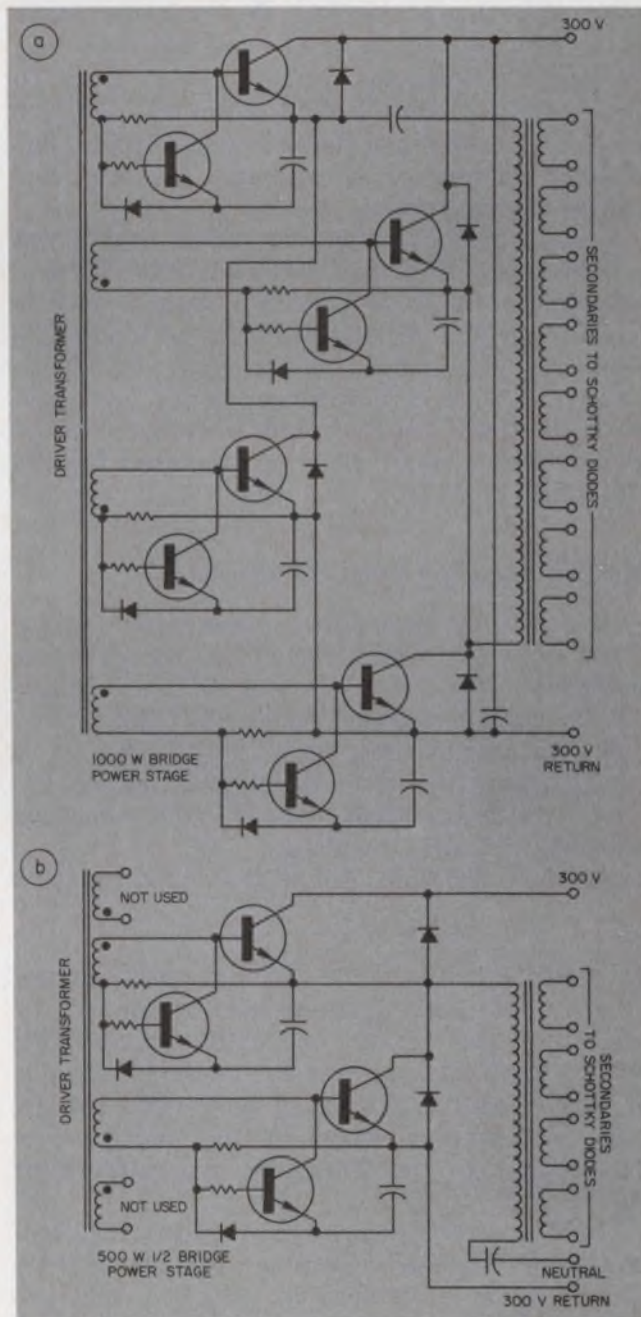

12. Power stage for a 1000-W output (a). Commutating diodes and other circuitry shunt the output-transformer inductive currents to ensure proper turn-off. If only 500 W are needed, a half-bridge connection can be used (b).

waveforms supplied to the power switches. Drive signals must have fast rise and fall times plus a low source impedance in the turn-off (I_{B2}) direction to minimize storage and fall times (Fig. 8).

High-voltage Darlington transistors are used typically at a forced gain of 20, so that acceptable saturation losses can be obtained without excessive storage time during turn off. However, it is necessary to drive 1 to 2 A in the reverse direction to ensure minimum turn-off times.

Base current, I_{B2} , is supplied by a clamp circuit (Fig. 9). During the forward-drive condition of the Darlington, voltage is dropped across R_1 , limiting I_{B1} . At the same time, the drop across this resistor charges C_1 to approximately 4 V dc. The clamp transistor, Q_2 , is reverse biased by the forward voltage of CR_1 and therefore does not conduct. When the winding voltage drops to zero, because of the shorting action of the driver circuit, Q_2 is forward driven to saturation. The collector current of Q_2 supplies I_{B2} —the Darlington reverse current.

A small amount of dc bias power is required to operate the TTL and driver circuits. To provide this, a 115-to-24-V, 0.25-A, transformer is driven from line to neutral of the ac input. The secondary is rectified full-wave and filtered to give about 30 V at 1 A. Since the 5-V logic load is substantially constant, only a dropping resistor and a 5-V zener diode are required for the TTL bits (Fig. 11).

Constant frequency offers advantages

In switching regulators, pulse-width regulation may be performed with any of the following methods:

- Constant frequency, variable ON time.
- Constant ON time, variable OFF time.
- Constant OFF time, variable ON time.
- Variable ON time, variable OFF time—or random-switching—regulator.

All these methods follow the basic equation

$$V_{out} = V_{in} \frac{t_{on}}{t_{on} + t_{off}}$$

Of the four methods, the constant-frequency approach—used here—is preferable because of the predictable performance of magnetic components and the simpler rfi suppression methods available at constant carrier frequency. By varying the ON time, the regulator modulates the output power in response to the internally generated error signal.

For the power stage and driver, the bridge connection of four Darlington transistors can provide 1000 W. If less power is required (< 500 W), only two transistors are needed. In this case, the transistors are connected in a half-bridge circuit and, of course, the transformer primary ac voltage is then half as much as for the full bridge. With

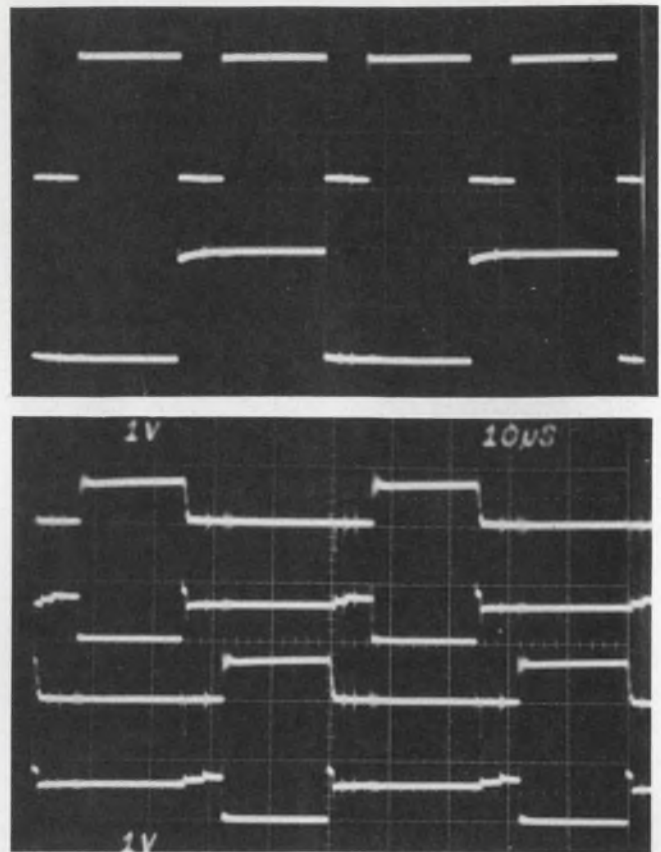

Signal and phase relationships (top to bottom): DM8601, MC4024 and DM 8090 outputs at full load, nominal line.

either circuit, the same driver and TTL logic are required, but the half-bridge uses only two of the driver secondary windings.

Figure 12 shows the power stages with the necessary turn-off circuits and commutating diodes that provide paths for inductive currents in the power transformer (Fig. 8 illustrates the typical base-current waveform, generated by the turn-off clamp circuits of Fig. 12). Base current, I_{B2} , is limited by the impedance of the clamp transistor at saturation, the esr of the bias capacitor and the impedance at turn off of the Darlington. Values of 1.5 to 2.0 A are typical of I_{B2} .

For the power transformer, a low-loss ferrite core material is chosen with an E-E configuration to minimize winding costs. Stackpole 24B Cera-mag material has a saturation density of 5.1 kG at 9.0 Oe. The core loss is approximately 3 W/lb at 20 kHz and 1 kG. With a duty cycle of 80% (corresponding to a low ac input condition), the secondary voltage must be 6 V on the average. This allows 0.6 V to be dropped in the Schottky diodes, and another 0.4 V in the choke and output busses, to give 5 V at the output.

Calculations show that to develop and support 6 V for 25 μ s would require approximately 1600 G with one turn or 750 G with two turns at 3 V per turn. The transformer is designed therefore at a flux density of 1500 G. The complete supply schematic is given in Fig. 10. ■■

THE NEWEST ADVANCE IN RESISTOR TECHNOLOGY

RNC-90Y

VISHAY'S S444

• ESTABLISHED RELIABILITY PER MIL R 55182/9

BULK METAL® BREAKTHROUGH

now outpaces all other resistor technologies
... it even surpasses existing Vishay
'state-of-the-art' leadership.

• SURPASSING ALL TECHNOLOGIES

Bulk Metal® S444 resistors have . . .

- ΔR 200ppm after 10,000 hours
- Tightest tolerances: to $\pm 0.005\%$
- TCR: 1ppm/ $^{\circ}C$ (0-60 $^{\circ}C$)
- TCR tracking: to $\frac{1}{2}$ ppm/ $^{\circ}C$
- High speed: 1 Nanosecond rise time
- Super stability: 50ppm after 10 years
- Negligible noise: Non measurable by MIL-Std-202
- Negligible voltage coefficient: 0.0005% /V max.
- Small size: 0.100" x 0.300" Board space
- Non Inductive: 0.08 MicroHenry max.
- High Temp. Exposure: 175 $^{\circ}C$ max.
- Power Rating: 0.3 W @ 125 $^{\circ}C$

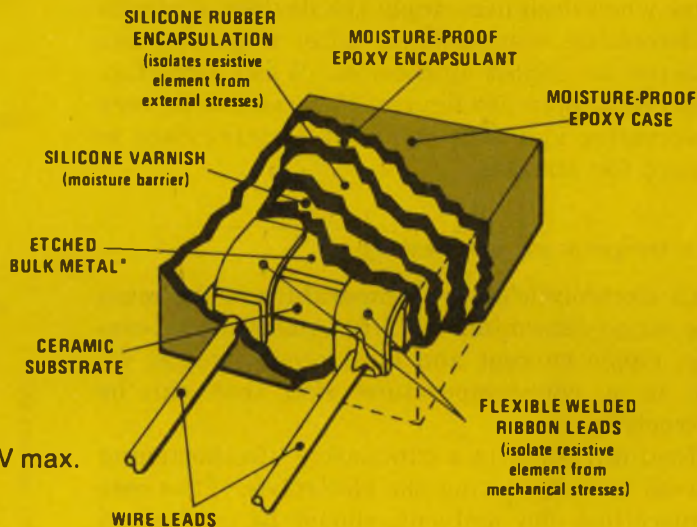

THE END OF COMPROMISE!!!

Call immediately for further information



VISHAY RESISTIVE SYSTEMS GROUP

OF VISHAY INTERTECHNOLOGY, INC.

63 LINCOLN HIGHWAY, MALVERN, PA. 19355 • PHONE: (215) 644-1300 • TWX: 510-668-8944

INFORMATION RETRIEVAL NUMBER 72

Stretch electrolytic capacitor life

by avoiding six deadly no-no's. And use core temperature, not ambient, when interpreting manufacturer specs.

An aluminum electrolytic capacitor eventually fails. The only question is, when?

Stresses that can shorten electrolytic capacitor life include:

- High temperature.
- Excess dc leakage current.
- Ripple current above 80% of rated value.
- Operating voltages above 80% of rated value.
- Excessive transients.
- Improper venting of internally generated gases.

Capacitor manufacturers only reluctantly specify or guarantee life, because of a history of abuse when designers apply the devices. Analysis to determine responsibility after a failure has occurred is almost impossible. When manufacturers do supply life figures, they tend to be very conservative and to hedge with derating data to account for stresses.

Core temperature can destroy

An electrolytic's core temperature is the main long-range determinant of life. Ambient temperature, ripple current and most other stresses result in a core-temperature rise that can be destructive.

Heating results in a cumulative life-shortening process by evaporating the electrolyte. Thus core temperature, not ambient, should be used when manufacturers' data are interpreted. For an aqueous electrolyte, the core-temperature limit of an 85-C ambient-rated aluminum electrolytic capacitor is 93 to 95 C.

Warning: Manufacturers' test data are usually measured with ripple-free dc voltages only.

Ambient and core temperatures are then about equal, because no ripple current flows and dc leakage in a good capacitor is low. However, when a capacitor is used in a dc power-supply filter or like application, ripple currents can be high and core temperatures may rise to 55 C or



Core temperature is easy to measure with a thermocouple attached to the capacitor's positive terminal.

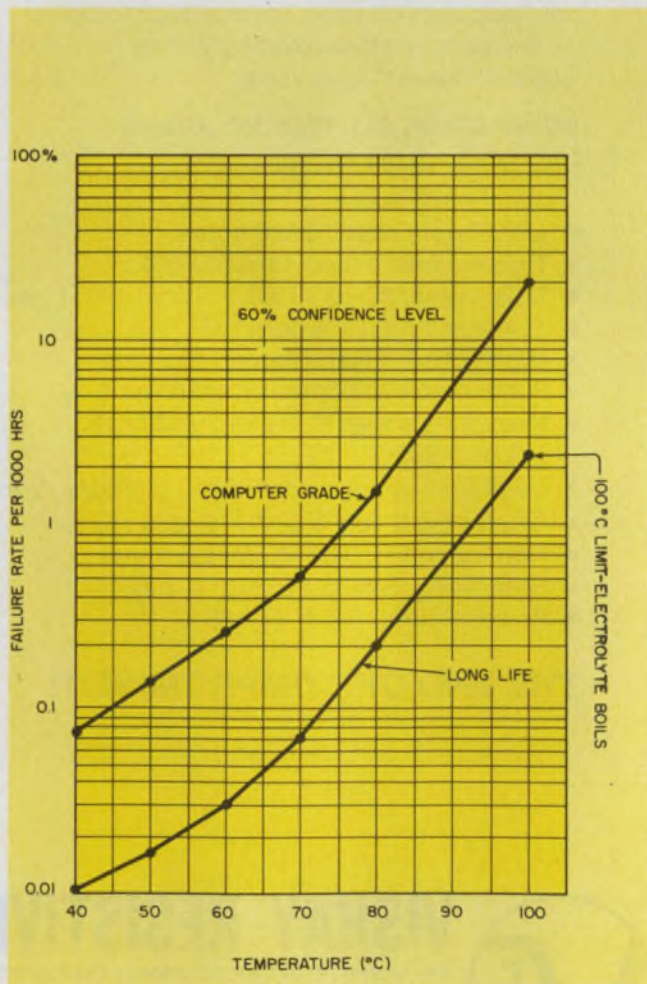

1. An electrolytic capacitor's core temperature strongly affects its failure rate. Core temperature can be much higher than ambient, when ripple current flows.

Bob Eimar, Vice President of Engineering, ACDC Electronics, Inc., 401 Jones Rd., Oceanside, CA 92054.

more above ambient.

The failure rate-vs-temperature data in Fig. 1 were derived with the use of ripple-free dc voltage; ambient and core temperatures are nearly equal. Note the dramatic increase in failure rate—more than tenfold—as the temperature rises only 20 C, from about 75 to 95 C. A typical computer-grade capacitor can have a 20-year life at a core temperature of 45 C, but life is only one year at 85 C.

The core temperature can be measured without cutting into the capacitor's case. A thermocouple or other sensor, if installed carefully on the capacitor's positive terminal, can provide a close approximation to this internal temperature.

Calculating ripple current

Ripple current is very difficult to calculate in filter applications, because of nonsinusoidal-current waveforms, difficult-to-define transformer and rectifier impedances and the nonlinearity of rectifier voltage-current characteristics. In measuring the ripple current's true rms, be sure the current meter and all connections and terminations have very low series impedance, so the capacitor's own low equivalent-series resistance (ESR) is not masked.¹

Ripple current can also be determined if you measure the true rms ripple voltage and divide this value by the impedance of the capacitor at the ripple frequency. This impedance is

$$\sqrt{(ESR)^2 + (1/2 \pi f C)^2}$$

The rms ripple voltage can be measured with a true-rms voltmeter, or the value can be approximated from the peak value of its waveshape (Fig. 2).

The ripple current, in flowing through the ESR, heats the capacitor's core, and the core's temperature rise depends upon the thermal resistance of the core to the ambient. The thermal resistance is determined by the size of the capacitor's case, the details of the device's construction and the materials used for the housing and internal filler. If a capacitor has a maximum allowable core temperature of, say, 95 C, its thermal resistance can be calculated if the ESR and maximum rms ripple current is known for corresponding allowable case temperatures.

For example, a particular 16,000- μ F, 15-V capacitor has an ESR of 0.07 Ω and ripple-current ratings of 4.4 A at 85 C and 7.9 A at 45 C. When the core temperature is 95 C and the ambient 85 C, the thermal resistance for this 10-C rise is

$$\Delta T/I^2(ESR) = 10/[(4.4)^2 \times 0.07] = 7.35^\circ\text{C/W}$$

At a case temperature of 45 C, the maximum allowed ripple current would be

$$I = \sqrt{(95 - 45)/(0.07 \times 7.35)} = 9.85 \text{ A}$$

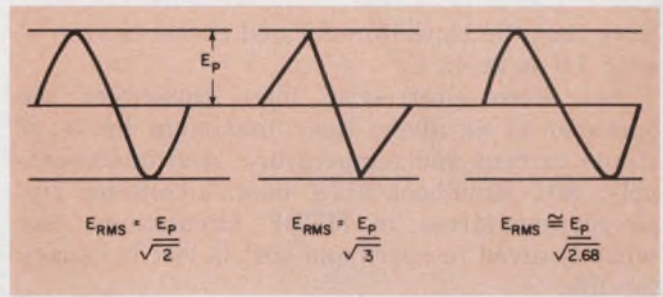

2. The approximate rms value of ripple current can be calculated from the current's peak value and a constant determined from the waveshape.

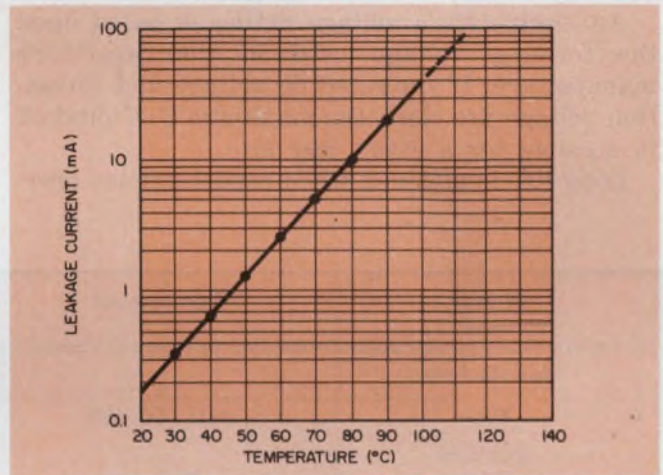

3. Leakage current doubles every time the core temperature rises about 10 C.

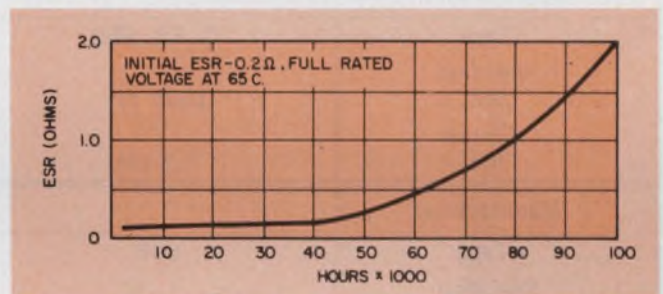

4. A capacitor's ESR increases with the unit's age, mostly because of loss of electrolyte.

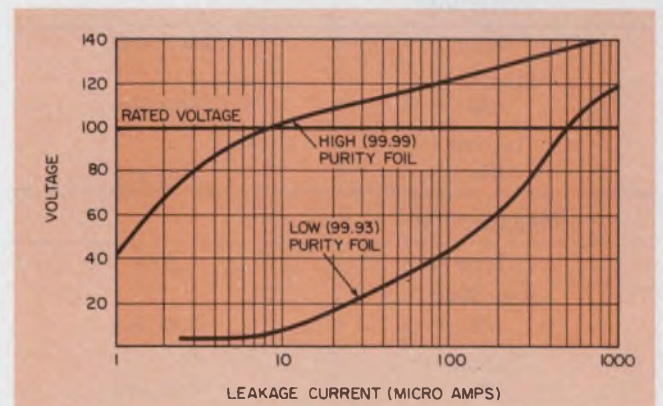

5. Leakage current is strongly affected by the purity of the aluminum foil used in manufacture.

Note that the capacitor is rated conservatively—only 7.9 A at 45 C.

Too often electrolytic filter capacitors are operated at or above their maximum limits of ripple current and temperature. And unaccountably, MIL-Handbook 217A doesn't consider ripple-current stress in MTBF calculations. But what is saved in space and cost is lost in capacitor life.

Be cautious of high C·V capacitors that are operated at or very near rated voltage and temperature. This is particularly true for bargain-basement units of obscure origins.

An electrolytic's voltage rating is based upon the forming voltage used in the capacitor's manufacture. If the rated dc voltage and formation voltage are close, the maximum C·V product is possible for a given case size.

Long life is attained when capacitors are oper-

ated at derated levels of voltage and ripple current. But most manufacturers agree that voltage derated to less than 80% of the rated value does not appreciably improve life. In fact, if a capacitor operates at 50% of its rating for prolonged periods, the aluminum foil's oxide film deteriorates and reforms to a lower voltage rating.

The two aluminum foil strips of an electrolytic capacitor have an aluminum-diode dielectric on one or both strips.² The oxide-film thickness is a function of the forming voltage. A paper spacer acts as a reservoir for the electrolyte and as a mechanical separator for the strips. The electrolyte is the capacitor's true cathode and the medium that carries charge to the dielectric surface. The electrolyte also provides oxygen to maintain the oxide film throughout the capacitor's life.

ESR and leakage depend mainly upon the com-

Quality level	Commercial	Computer grade	Long life
Manufacturer	Sprague		
Type	43D, 60-68D	39D, 36D	34D, 32D
Specified life	500 hrs	750 hrs @ 65 C	1500 hrs
Typical life	3-5 yrs	5-10 yrs	10-20 yrs
Manufacturer	Mallory		
Type	TC, FP, PFP	TCW, CGS	TCG, CG
Specified life	1000 hrs	1000 hrs	1500 hrs
Typical life	3-5 yrs	10 yrs	10 yrs
Manufacturer	Sangamo		
Type	505	DCM	500
Specified life	500 hrs	1000 hrs	1500 hrs
Typical life	10 yrs	10 yrs	10 yrs
Manufacturer	STM		
Type	14C, 41C	39C, 91C	71C
Specified life	500 hrs	1500 hrs	2000 hrs
Typical life	3-5 yrs	10 yrs	10 yrs
Manufacturer	General Electric		
Type	87F	84F, 86F	88F
Specified life	500 hrs	500 hrs	1500 hrs
Typical life	3-5 yrs	5-10 yrs	10-20 yrs

6. For industrial applications, manufacturers offer three grades of aluminum electrolytic capacitors—commercial,

computer and long-life. Entertainment-grade units are generally not reliable enough.

position, quality and amount of electrolyte. Oxide thickness and foil length also affect ESR and leakage.

High temperature accelerates loss of electrolyte, which increases leakage (Fig. 3) and ESR. High leakage and ESR, in turn, mean still higher temperatures and further electrolyte loss, or even thermal runaway. Overheating raises internal pressure high enough to leak electrolyte through the vent or even to rupture the capacitor's vent seal and destroy the capacitor. To allow normal venting, capacitors should never be mounted in an inverted position. And keep them away from heat sources and as cool as possible. Provide airflow where possible.

Temperatures below about 25 C cause a rapid ESR increase, but the ESR decreases only slightly with a temperature rise.

And ESR increases with time. The life of a capacitor (Fig. 4) may extend to 100,000 h, because the data were derived with ripple-free dc. The same capacitor at its rated ripple current would probably fail in less than 50,000 h.

Quality is hard to measure

What determines capacitor quality? One factor, of course, is the material used. Manufacturing details associated with good quality include:

- High foil purity.

- Use of uncontaminated, highly absorptive separator paper to hold the electrolyte.
- High ratio between the formation voltage and specified operating voltage.
- No skimping on the quantity of electrolyte.
- Careful, continuous quality control of materials and processes.
- 100% testing.

Purity of the foil material is particularly important. It has great influence on leakage, ESR, capacitance stability and life (Fig. 5). Metallic contaminants occluded or alloyed into the aluminum provide parasitic leakage paths and cause galvanic couples. Couples break down the electrolyte and generate gases that can rupture the vent or even the case.

Manufacturers offer four grades of electrolytic capacitors: entertainment, commercial, computer and long-life (Fig. 6). Except in low-cost TV and radio sets, entertainment grades do not meet the needs of most industrial-control or instrumentation applications.

Of course, the quality of any product is a reflection of the manufacturer. He must have a proven reputation for quality and reliability. ■■

References

1. Bowling, E. L., "Look Out! All Electrolytic Capacitors Are Not Alike," *Electronic Design*, Jan. 4, 1974, pp. 138-140.
2. Forssander, P. H., "Aluminum Electrolytics Are Hard to Beat," *Electronic Design*, Oct. 11, 1974, pp. 78-82.



Capability in Design and Production of Customized Power Transformers

Whatever your requirements for custom transformers INELCO can simplify your purchase.

Within 10 days from receipt of your specifications, a Prototype Transformer is on its way for your approval. It will further assure you of the perfection in the mass-produced units. Limited production runs are available to Test Market your prototype.

Our Engineering Department is always available for consultation on design or production needs. Because your requirements change, INELCO can organize flexibility in production scheduling. Another big plus for our ever growing list of customers.

Write today for our brochure, "Taking the confusion out of specifying power transformers".

INGLOT ELECTRONICS CORPORATION

4878 NORTH ELSTON AVENUE • CHICAGO, ILLINOIS 60630
phone 312/286-5881



INFORMATION RETRIEVAL NUMBER 73

Active filter improves tracking and capture ranges of PLL

An active low-pass filter can be inserted into many phase-locked-loop (PLL) circuits to provide additional loop gain, convenient control, extended tracking and capture range. The tracking and capture ranges can be increased by as much as 10 times, when compared with passive-filter circuits.

Consider a linear model of a PLL (Fig. 1). The dc loop gain is $K_d K_o F(0)$ and it determines the tracking range, Δf_t . $F(0)$ is the current gain of the external low-pass filter at dc, and K_d and K_o are the transfer characteristics of the phase detector (PD) and current-controlled oscillator (CCO), respectively. The tracking range can be empirically related to the dc loop gain (Fig. 2), as follows:

$$\Delta f_t = \pm \sqrt{\pi} K_d K_o F(0) \quad (\text{Hertz}). \quad (1)$$

If a passive low-pass filter is used in the loop, then $F(0)$ is less than unity, and thus the tracking range can't be increased over that set by the PLL's $K_d K_o$ product. However, with an active filter, $F(0)$ can be made greater than one, and with only a single gain adjustment, R_3 (Fig. 3).

The active low-pass filter is also a current amplifier that drives the CCO of an HA-2825 PLL IC. The dc current gain of the active filter is

$$A_i = \frac{i_2}{i_1} \cong - \frac{e_o/R_3}{e_o/R_2}, \quad (2)$$

when the impedance at CCO input, pin 9, is considered to be small compared with R_3 . Thus the gain is

$$A_i \cong - \frac{R_2}{R_3}, \quad (3)$$

and the tracking range of the PLL can be controlled easily by adjustment of R_3 :

$$\Delta f_t = \pm \frac{\sqrt{\pi} K_d K_o R_2}{R_3} \text{ Hz}. \quad (4)$$

It is better to adjust R_3 than R_2 , because R_2 and C_1 determine the -3 dB cut-off frequency, f_1 , for the filter and thus the capture range, Δf_c . In Fig. 2

$$f_1 = \frac{1}{2\pi R_2 C_1} \text{ Hz}. \quad (5)$$

And the capture range is empirically given by

$$\Delta f_c = \pm \left(\sqrt{f_1 \frac{K_d K_o}{\sqrt{\pi}}} A_i + \frac{K_d K_o}{\sqrt{\pi}} \right) \text{ Hz}. \quad (6)$$

To obtain K_o in dimensionally correct form from the usual specification in percent, the ratio $\Delta f/\mu\text{A}$ must be multiplied by the desired CCO

free-running frequency. For example, K_o for an HA-2825 PLL has a specification $\Delta f/\mu\text{A}$ of 1%. For a free-running CCO frequency of 10 kHz, K_o becomes $(0.01) \cdot (10^4)$ rad/sec/ μA .

Experimental data (Fig. 2) show that the empirical Eqs. 4 and 6 are correct to 5% for gain values between 1 and 10. For $|A_i| > 10$, the CCO input stage begins to saturate, and the linear model no longer applies.

To prevent the input impedance of the active

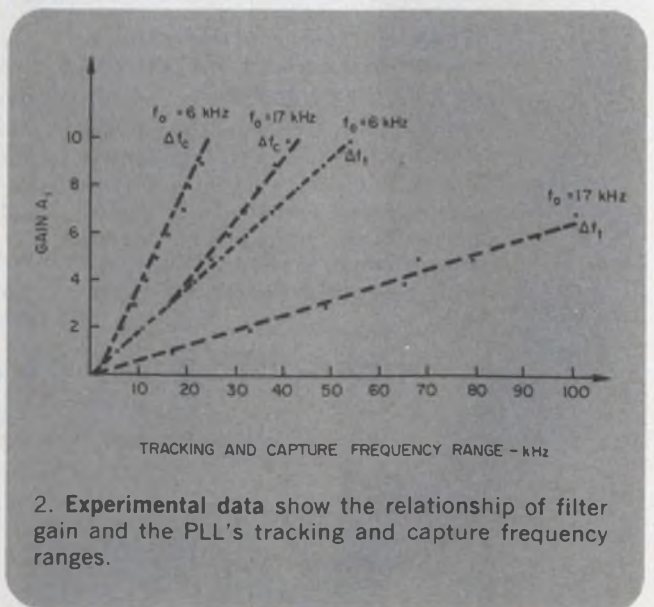
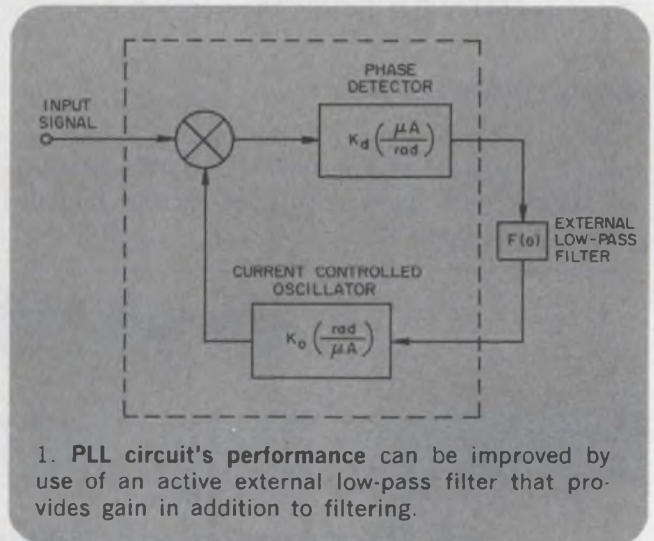

If you need
a tester
with **special**
scales, ranges,
accessories
or any
combination...

Buy a
Triplett tester
custom-designed
for you

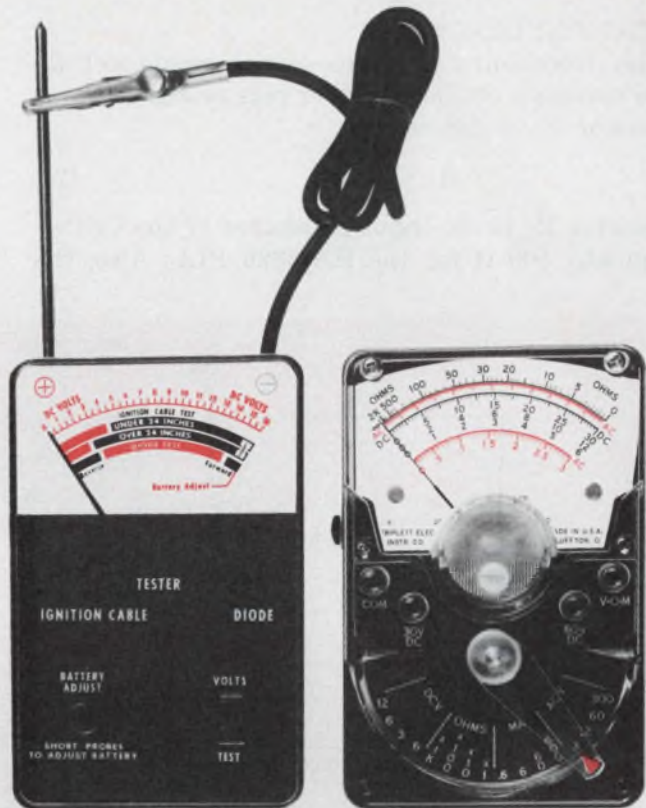

A

B

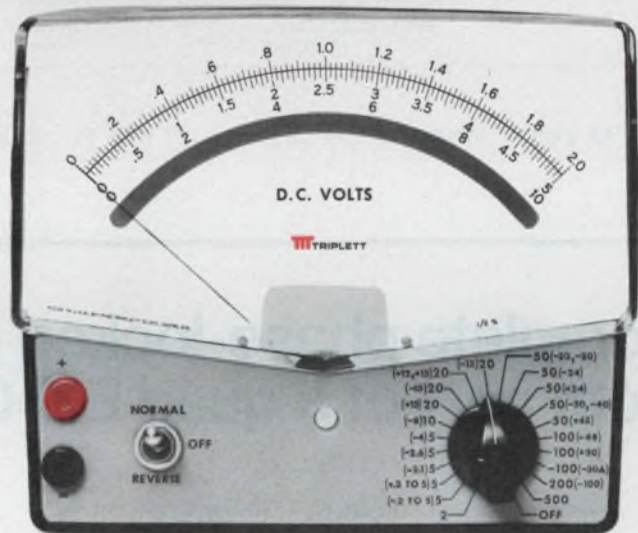

C

Triplett, manufacturer of the World's most complete line of V-O-M's, is ready, willing and able to design and manufacture special testers of virtually any size, style or type to meet your specifications.

Tester A (above) was designed to give auto mechanics a simple, rugged tester for "go/no go" tests that would otherwise be measured in electrical units unfamiliar to them.

Tester B is a modification of a

standard Triplett tester incorporating only the specific ranges needed by the field service engineers for whom it was designed.

Tester C has special ranges and special input connectors and cables to permit a single-point connection for trouble-shooting and servicing all the circuits of a complex business machine.

Several other buyers of standard Triplett test equipment request their company name on the dial to personalize their testers.

INFORMATION RETRIEVAL NUMBER 74

If you think a custom tester may solve some problems for you, contact your Triplett representative. He'll put you in touch with the Tester Designers and Engineers at Triplett who'll help you analyze the problem and suggest the optimum cost/result solution. Triplett Corporation, Bluffton, Ohio 45817

TRIPLETT
BLUFFTON, OHIO 45817

Manufacturers of the World's
most complete line of V-O-M's

IDEAS FOR DESIGN

filter from going negative—which would lock up the op-amp's output at either plus or minus V_{cc} —resistor R_1 is chosen as

$$R_1 > \frac{R_2}{R_3} R_L \quad (7)$$

Resistor R_1 is the input resistance of the CCO—typically 500 Ω for the HA-2825 PLL. Also, the

op-amp input offset voltage must be nulled carefully, since a dc offset would be amplified and shift f_o .

J. A. Connelly, Associate Professor of Electrical Engineering, and Glenn Prescott, Georgia Institute of Technology, Atlanta, GA 30332.

CIRCLE NO. 311

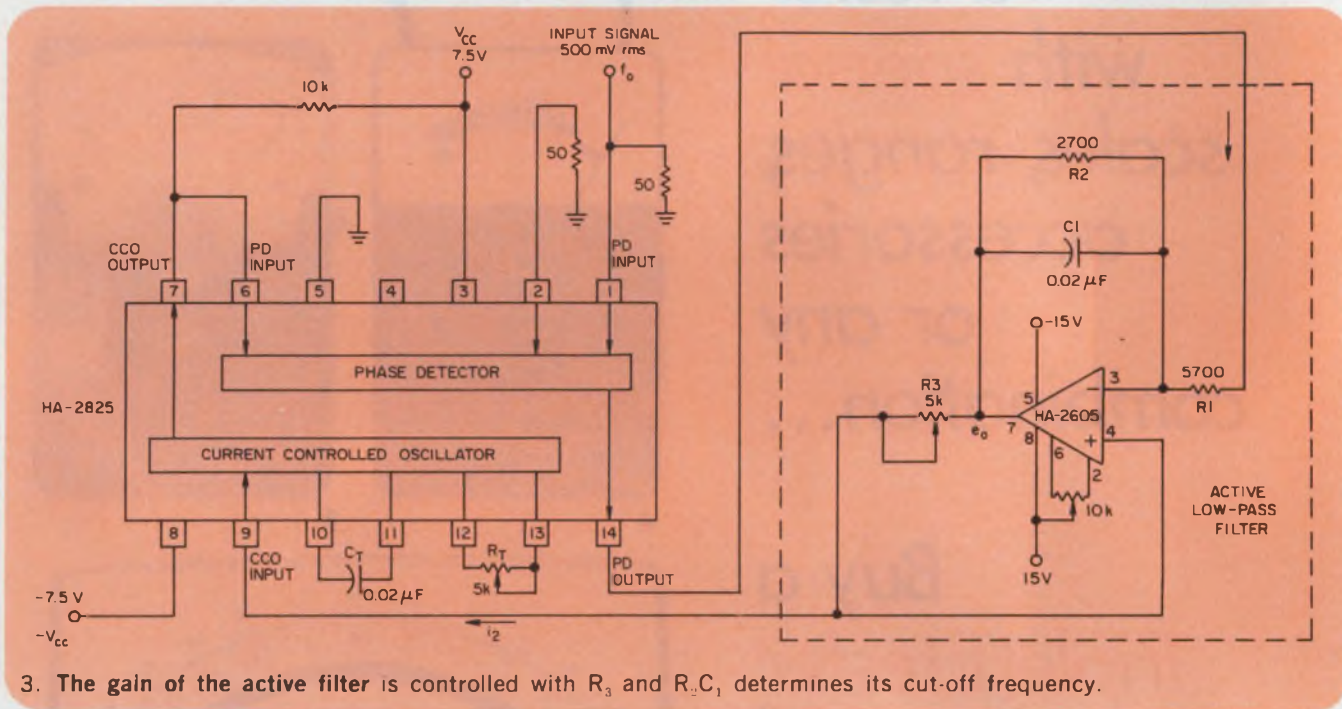

Complete phase-locked loop made from part of a quad EX-OR gate

A complete phase-locked loop circuit, which includes a VCO, phase comparator and filter, can be made from three-quarters of a CMOS quad EXCLUSIVE-OR gate.

The circuit operates on 5 V and produces a square-wave output in quadrature with the input signal. The lock and capture ranges are determined by the values of the filter, R_1 , R_2 and C_1 . For the circuit shown, the center frequency is nominally 10 kHz. The loop can capture the input frequency over better than a 1.5:1 range and track over about a 4:1 range.

As with most phase-locked loops, the loop also will lock to input signals that are multiples of the VCO frequency.

William Hearn, Electronic Engineer, Lawrence Berkeley Laboratory, Bldg. 71, Berkeley, CA 94720.

CIRCLE NO. 312

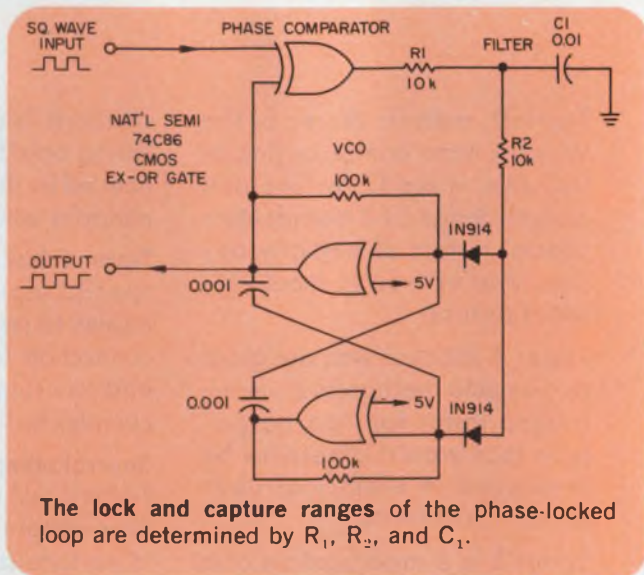

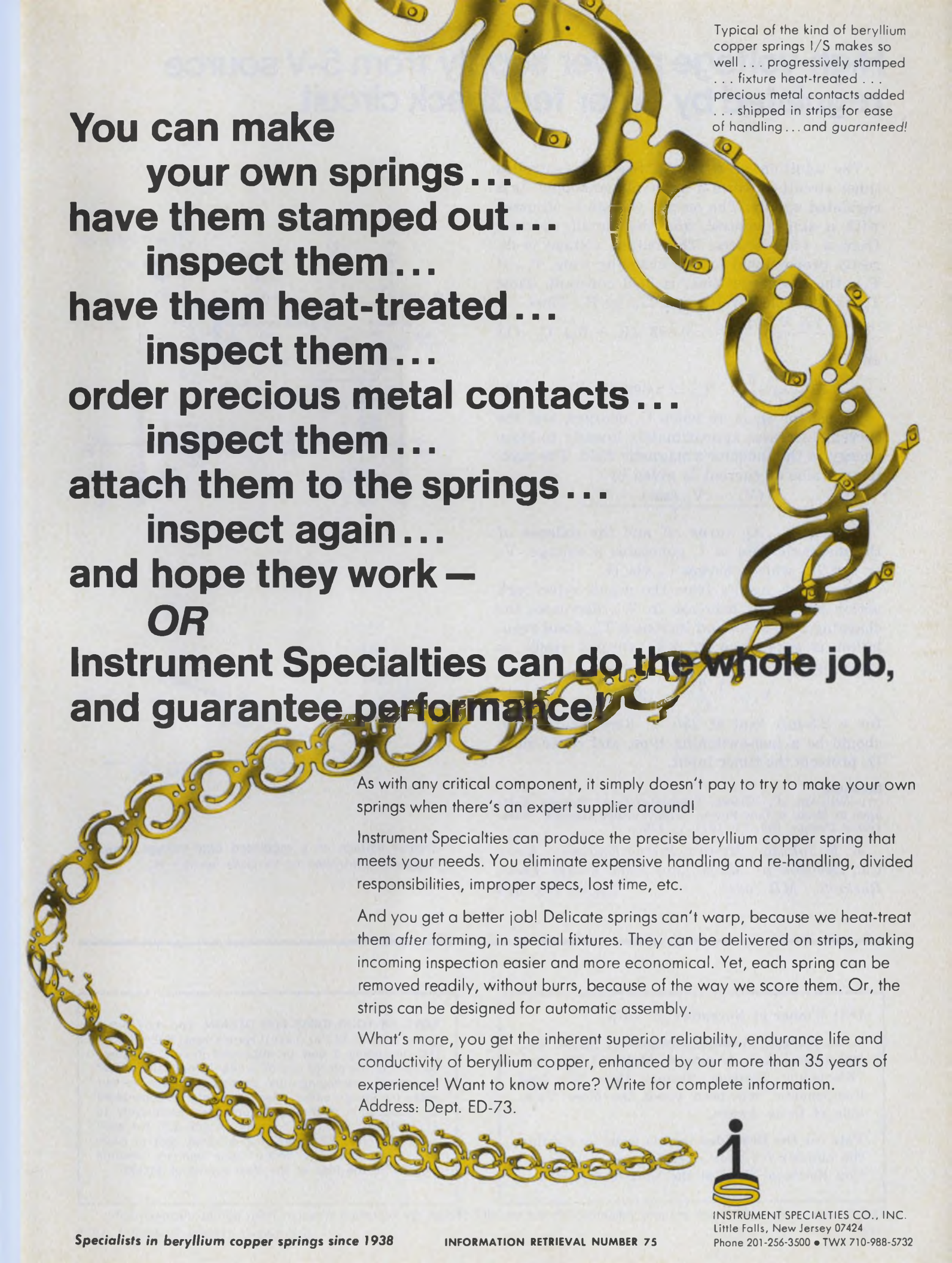

Typical of the kind of beryllium copper springs I/S makes so well . . . progressively stamped . . . fixture heat-treated . . . precious metal contacts added . . . shipped in strips for ease of handling . . . and guaranteed!

**You can make
your own springs . . .
have them stamped out . . .
inspect them . . .
have them heat-treated . . .
inspect them . . .
order precious metal contacts . . .
inspect them . . .
attach them to the springs . . .
inspect again . . .
and hope they work —**

OR

**Instrument Specialties can do the whole job,
and guarantee performance!**

As with any critical component, it simply doesn't pay to try to make your own springs when there's an expert supplier around!

Instrument Specialties can produce the precise beryllium copper spring that meets your needs. You eliminate expensive handling and re-handling, divided responsibilities, improper specs, lost time, etc.

And you get a better job! Delicate springs can't warp, because we heat-treat them *after* forming, in special fixtures. They can be delivered on strips, making incoming inspection easier and more economical. Yet, each spring can be removed readily, without burrs, because of the way we score them. Or, the strips can be designed for automatic assembly.

What's more, you get the inherent superior reliability, endurance life and conductivity of beryllium copper, enhanced by our more than 35 years of experience! Want to know more? Write for complete information.

Address: Dept. ED-73.



INSTRUMENT SPECIALTIES CO., INC.
Little Falls, New Jersey 07424
Phone 201-256-3500 • TWX 710-988-5732

High-voltage power supply from 5-V source regulated by timer feedback circuit

The addition of a simple feedback-controlled timer circuit converts a high-voltage supply to a regulated supply. The output voltage is adjusted with a single control, and the circuit operates from a +5-V source. The output voltage is directly proportional to C_1 's charging time, T_{on} , if T_{off} , the discharge time, is held constant. Time T_{on} is controlled by R_1 , and T_{off} by R_2 . Thus

$$T_{on} \cong \frac{1.5 V_{out} L I_L}{V_c^2} = 0.693 (R_1 + R_2) C_1 \quad (1)$$

and

$$T_{off} \cong \frac{V_c}{V_{out}} \cdot T_{on} = 0.693 R_2 C_1 \quad (2)$$

Transistor Q_1 is on when C_1 charges, and the current increases approximately linearly to store energy in the inductor's magnetic field. The maximum value of current is given by

$$I_L \cong \frac{(V_c - V_{ce(sat)}) \cdot T_{on}}{L}$$

During T_{off} , Q_1 turns off and the collapse of the magnetic field of L generates a voltage, $V_L = L di/dt$, which charges C_2 via D_1 .

Regulation results from the negative-feedback action of V_{out} . A decrease in V_{out} decreases the charging rate of C_1 and increases T_{on} . Load regulation is approximately 2%. Output ripple is given by

$$V_r = \frac{I_L T_{on}}{C_2} = 12 \text{ mV},$$

for a 2.5-mA load at 250 V. Rectifier-diode D_1 should be a fast-switching type, and zener-diode D_2 protects the timer input.

Reference

1. William, J., "Boost Transistor-Level Supply Voltages to Make a Low-Power, High-Voltage Supply," *Electronic Design*, Oct. 11, 1974, p. 126.

K. R. Johnson, *Manufacturing Engineer*, Ames Co., Division of Miles Lab, 5635 Fisher Lane, Rockville, MD 20852. CIRCLE No. 313

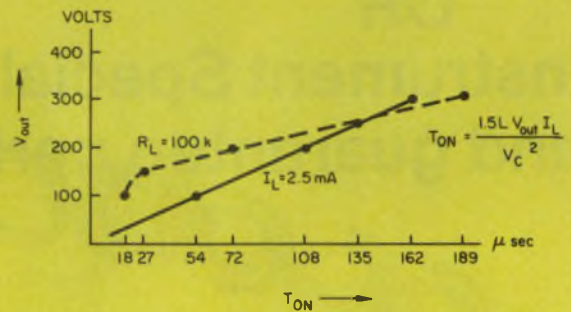
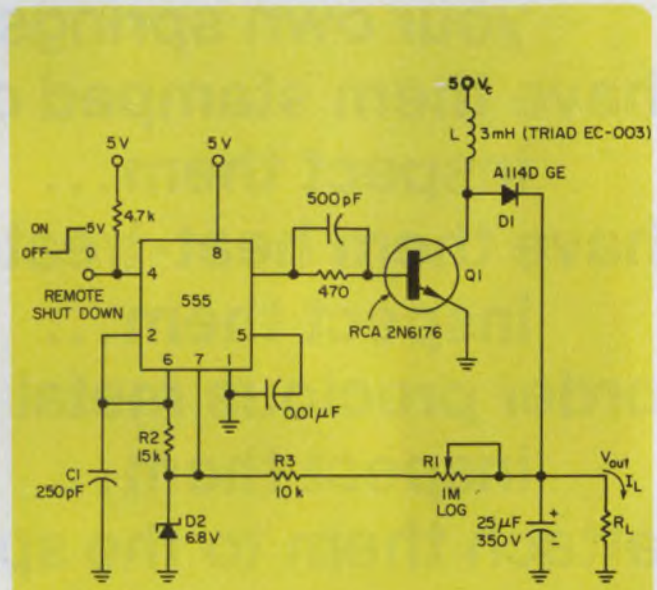

Output voltage of a regulated high-voltage power supply is controlled by variable-resistor R_1 .

IFD Winner of November 22, 1974

L. G. Morgan, Associate Engineer, Singer Co., 833 Sonora Ave., Glendale, CA 91201. His idea "Electronic Ignition System Uses Standard Components" has been voted the Most Valuable of Issue Award.

Vote for the Best Idea in this issue by circling the number for your selection on the Information Retrieval Card at the back of this issue.

SEND US YOUR IDEAS FOR DESIGN. You may win a grand total of \$1050 (cash)! Here's how. Submit your IFD describing a new or important circuit or design technique, the clever use of a new component or test equipment, packaging tips, cost-saving ideas to our Ideas for Design editor. Ideas can only be considered for publication if they are submitted exclusively to ELECTRONIC DESIGN. You will receive \$20 for each published idea, \$30 more if it is voted best of issue by our readers. The best-of-issue winners become eligible for the Idea of the Year award of \$1000.

It's 4K! It's fast! It's static! It's a whole RAM system!



It's all of those and more, much more. It's our new Microram 3400N — a 32K x 16 or 18 bit memory system using our own SEMI 4402, 4K STATIC RAM components . . . the only production 4K STATIC RAM's available today. The 4402 is fast, with a worst case access time of 200 nsec. And . . . it's second-sourced, of course!

The Microram 3400N is form, fit, and functionally compatible with all core and NMOS members of the Micromemory family, and is completely contained on a single printed circuit card. Optional features include chassis and power supply. The Microram 3400N is immediately available with a worst case access time of 275 nsec.

Call your nearest EMM sales office and discover how "The Memory Company" can give you system building block flexibility, 4K to 32K, core or NMOS.

EMM SEMI

A division of Electronic Memories & Magnetics Corporation • 3883 North 28th Avenue, Phoenix, Arizona 85017
(602) 263-0202

EMM OFFICES: WESTERN REGION, Regional Office, San Francisco, (408) 247-9711, Los Angeles Area, (213) 644-9881, Orange County Area (714) 839-5811, Minneapolis Area, (612) 941-2404, Phoenix Area (602) 968-2492, Dallas Area (214) 231-7207, EASTERN REGION, Regional Office, Boston, (617) 861-9650, Chicago Area, (312) 297-7090, Washington, D.C. Area (703) 941-2100, New York Area (516) 423-5800, Cleveland Area (216) 842-8920 INTERNATIONAL OFFICES, European Headquarters, Belgium (031) 76.69.75, United Kingdom (01) 751-1213, West Germany (089) 714.30.40.

REPRESENTATIVES: Gentry Associates; Orlando (305) 894-4401, Huntsville (205) 534-9771, Burlington, N.C. (919) 227-3639, In Canada: Magatronics, Ltd., Toronto (416) 742-8015, Montreal (514) 488-0404, Ottawa (613) 729-4004, Vancouver (604) 526-3312, In Japan: Nissho Electronics (03) 542-2351.

INFORMATION RETRIEVAL NUMBER 76

Image-sensor array enhanced by JFETs

An experimental image-sensor array that uses photosensitive junction field-effect transistors (JFETs) has been constructed at Philips Research Laboratories, Eindhoven, the Netherlands.

Undesirable differences in element sensitivity, caused by inherent variations in individual element threshold voltages, have been overcome by a new resetting method, Philips reports. And the JFET photosensitive elements have the advantages of gain and non-destructive readout.

To solve the threshold-voltage problem, the n-channel JFET has a buried photosensitive floating gate and an annular surface control gate. In this configuration the

FET threshold voltage is about equal to the punch-through voltage between the control and the floating gates.

When a sufficiently high negative pulse is applied to all control gates, two subsequent punch-throughs are produced in opposite directions between the control and floating gates. Each element is then set automatically at its individual threshold voltage. As a result, the response to a given light level becomes identical for all elements, in spite of threshold-voltage differences.

Possible applications of the new array may be a photo-detection matrix for a holographic memory and in character recognition.

Filter circuit controls amplitude and frequency

A surface-wave filter circuit that can electrically control amplitude and frequency response has been designed at the Faculty of Physics of Sofia University in Bulgaria. A control voltage in the circuit is applied to the gate of a field-effect transistor, which is connected to an acoustic surface-wave filter (see figure). The input is a high-frequency signal that reaches the transducer via a capacitor and the FET.

The filter output voltage is dependent on both control and bias voltages. The emission of acoustic energy in the filter is controlled by the FET gate voltage. The output-vs-control-voltage curves for various bias voltages show substantial linear portions.

Control of frequency response is

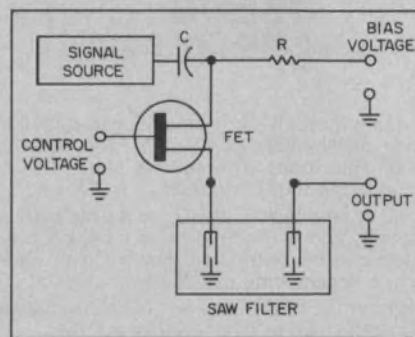

achieved by use of a system made up of several transducers, each of which receives the input signal via a separate FET. The frequency response is shaped by adjustment of the phase relationships of control voltages applied to the transistor gates. A single wideband trans-

ducer receives the acoustic wave for output.

The designers envision program-controlled filters and delay lines based on this circuit.

Electro-optics employed in new a/d converter

An experimental electro-optic a/d converter, based on a diffraction modulator, has been designed at University College in London. Design advantages include reduction of conversion delay time and of comparator components. The inventors see it as an interface between wideband analog and high-speed digital subsystems.

The diffraction modulator is a thin crystal of lithium niobate carrying an interdigitated electrode structure (see drawing). Applica-

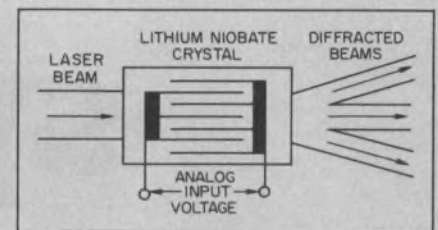

tion of voltage to the electrode system terminals produces spatially periodic variations in the refractive index of the crystal. As a result, a laser beam passing through the crystal is modulated in intensity, as different orders of power are diffracted in controlled directions.

Diffracted low-order beams are directed onto an array of photodiode detectors. The analog signal applied to the crystal electrode system is digitized as threshold detectors, in series with the diodes, pass on their outputs to NAND gates. A total output in the form of a Gray code is obtained.

The response time can be reduced to the order of a nanosecond if the input capacitance of the modulator and the optical transit time through the crystal are lowered. The drive level can be minimized by use of a very thin crystal. It may be possible, the researchers say, to use a LED and a pinhole instead of a laser.

Check the specs on this one

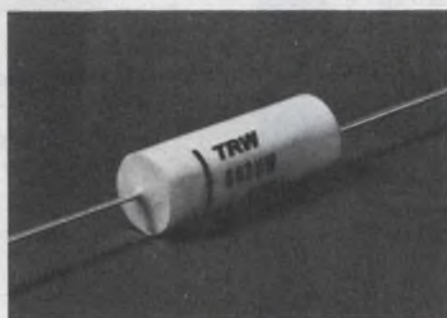

...when you need a subminiature capacitor offering "instrument" quality

With its skin-tight plastic case, TRW's Type 663UW Mylar* dielectric capacitors offer you major space savings with *no* compromise on life or reliability.

Use these TRW 663UW capacitors for high-density circuitry in computers, instruments, MIL applications. *Conservatively* rated to assure trouble-free performance in your equipment.

Complete specs on 663UW capacitors—along with a look at TRW's overall Mylar/foil capability—available on request. Write TRW Capacitors, an Electronic Components Division of TRW, Inc., Box 1000, Ogallala, Neb. 69153. (308) 284-3611.

DF: less than 1.0% at 1000 \pm 20 Hz

IR: greater than 70,000 megohm-microfarads at 25°C (5X paper dielectric capacitors)

Dielectric strength: twice rated voltage for one min.

Temp. range: -55°C to +85°C (to +125°C with derating)

Stability: easily pass 10,000 hr. test with negligible drift in capacitance and DF

Tolerances: to \pm 1%

*Du Pont T.M. for polyester film.

TRW[®] CAPACITORS

Get CUSTOM MOS in any quantity

(and we mean **ANY** quantity
—starting from 1 piece)

LSI Computer Systems, an experienced MOS company, will supply your custom MOS circuits in any process using the latest design techniques for highest reliability at the lowest cost. MOS circuits can be supplied to commercial or military specifications.

PARTIAL LIST OF CUSTOM CIRCUITS SUPPLIED

- Industrial Controls
- Juke Box Logic
- Digital Instrument Controls and Display
- Electronic Organs
- Data Communications
- Counter/Display
- Crystal Oscillator/Dividers
- Editing Typewriter
- Computers





MULTI PROCESS CAPABILITY for

HIGH SPEED • LOW POWER • LOW VOLTAGE
HIGH DENSITY • NOISE IMMUNITY
SINGLE POWER SUPPLY

LSI computer systems, inc.
22 Cain Drive, Plainview, N.Y. 11803
(516) 293-3850

Ⓛ SUBMINIATURE LAMP SPECIALISTS

Lamps for European Equipments Get them quickly from OSHINO

T-1 Bi-Pin		3V to 28V 0.100 inch pin spacing
T-1 3/4 Midg. Bayonet		3V to 28V Smallest bayonet base
T-4.6 Telephone slide		6V to 48V Smallest slide base
T-5.5K Telephone slide		6V to 60V Shortest slide base
T-5.5 Telephone slide		6V to 72V German standard DIN 49838-B

Other European type subminiature lamps also stocked for quick delivery.

• Ask informations to:

WAMCO Technical Sales, Inc.
705 W. 16th Street, Costa Mesa, California 92627
TEL: (714) 642-5100 TELEX: 678459

Mid-West 12 states only

CIMCO International, Inc.
9037 Kenton Ave., Skokie, Illinois 60078
TEL: (312) 673-0262 TELEX: 724426

OSHINO ELECTRIC LAMP WORKS, LTD.
TOKYO, JAPAN

INFORMATION RETRIEVAL NUMBER 79

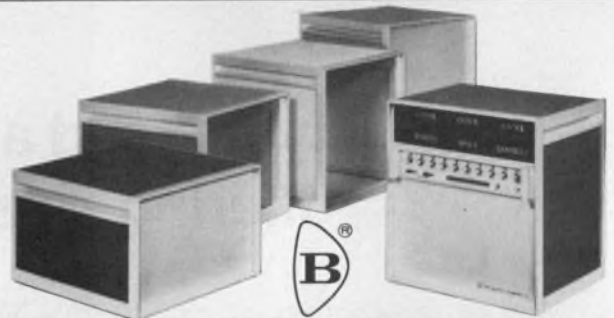

BUCKEYE CABINETS

Buckeye's classic cabinetry line of aluminum enclosures is colorful, strong and budget priced. Universal 19" front panels, with heights from 12.25" to 28". You can also depend on Buckeye for other instrument-packaging needs: Designer Cases of all types and sizes — Patented card guide, modules — PCB racks — Retractable, locking tilt-stands — and the recognized high quality matching instrument knob line.

the **BUCKEYE stamping co.** Write today for
555 Marion Rd., Columbus, Ohio 43207 free colorful
literature!

"QUALITY PRODUCTS SINCE 1902"



GUIDES • CASES • KNOBS • RACKS

See Us at the IEEE Show Booth # 1117
INFORMATION RETRIEVAL NUMBER 80

ELECTRONIC DESIGN 7, April 1, 1975

new products

Microcomputer has PDP 11/05 performance

Digital Equipment Corp., Components Group, One Iron Way, Marlborough, MA 01752. (617) 481-7400.

A microcomputer backed by memories and I/O boards dubbed the LSI-11 offers mini-level performance at low cost. The microprogrammed NMOS processor (KD11-F) has the 400 instruction PDP-11 repertoire and optional floating or fixed point arithmetic. The processor uses four chips: data, control and two control ROMs, and offers PDP-11/05 execution speed as well as vectored interrupt logic. The processor with 4 k memory mounted on an 8.5 × 10 in. board costs less than \$1000. Support products include, on 8.5 × 5-in. boards, the DLV-11 serial data interface (50 to 9600 baud); the DRV-11 parallel I/O module plus PROM and RAM. Core is also available in units of 4 k words on an 8.5 × 10 in. board. Memory is expandable to 64 k bytes; the computer handles DMA rates to 833 kHz. A typical system which includes CPU, two parallel I/O units, serial unit, PROM board and backplane sells for \$1616 (qty. 100).

Booth No. 2202, 4, 6

Circle No. 323

Dot-matrix printer includes case and supply

Victor Comptometer, Business Products Group, 3900 N. Rockwell St., Chicago, IL 60618. (312) 539-8200.

Model 5005, a dot-matrix printer includes case, power supply printer (plus associated circuits). Space is available for the user to install keyboard, microprocessor and associated circuitry. Print capacity is 34 char/line at rates up to 4 line/s. A 7-dot column is used; the font is user supplied, usually 5 × 7 or 9 × 7. Unit price is \$611 with substantial discounts for quantity orders.

Booth No. 2423 Circle No. 320

Voice synthesizer acts as computer output



Vocal Interface Div., Federal Screw Works, 500 Stephenson Hwy., Troy, MI 48084. (313) 588-2050. Under \$2000 (prod. qty.); 60 to 90 day.

The Votrax electronic voice system is an information output device that provides output messages in verbal form. Votrax has unlimited vocabulary capability so that any message can be spoken. In addition, the unit is small and completely solid state, thus allowing flexibility and ruggedness. Data requirements are held to a minimum. Votrax can produce continuous speech with a data input rate of as low as 150 b/s. In addition, the electronic voice system is available in a wide range of interface options.

Booth No. 2710 Circle No. 355

Versatile buffer can also change data mode



International Communications Corp., 8600 N.W. 41 St., Miami, FL 33166. (305) 592-7654. \$3105 (small qty).

Comstore 1032 is a versatile buffer that can also act as a speed changer and converter between synchronous and asynchronous line operation. An internal MOS memory holds up to 40,000 characters. The unit accepts or outputs asynchronous or synchronous data at any rate to 9600 bit/s. In addition, data can be inputted and outputted simultaneously at combined speeds up to 9600 bit/s.

CIRCLE NO. 356

Hand-held computer thrives on statistics

Litton Monroe, 550 Central Ave., Orange, NJ 07051. (201) 673-6600. \$795; stock.

A hand-held microcomputer offers the statistician computer power at a fraction of the cost. Preprogrammed into the Monroe 344 is a set of commonly used statistical functions that include: standard deviation (grouped or ungrouped), linear regression, Z-score, t-dependent and independent, logs and anti-logs, coefficient of correlation, expected y from regression coefficients, slope and intercept, square root, reciprocal, and integer-fraction separation. Ten independent storage registers with full arithmetic support the store, recall and exchange control. Other features include: large 10-digit display plus 2-digit exponent; automatic lighted commas for punctuation; zero suppression and separate error and overflow indication. The arithmetic and function sequence (including constants and data points) are stored automatically when calculation is performed in load mode and automatically executed when the program switch is in Run. Program step numbers are displayed when program switch is in Load position.

Booth No. 2503-2507

Circle No. 321

Pair of printers offer speed at low cost

General Electric Co., Data Communications Products Dept., Waynesboro, VA 22980. (703) 942-8161. See text; stock.

In addition to a 120 char/s printer, General Electric offers a low-cost 30 char/s unit called the TermiNet 30. The slower unit, a keyboard-printer configuration, sells for \$1200 (qty), prints 7 × 9 dot-matrix characters, 80 to the line, and uses 9-in. paper forms. A ribbon cartridge makes for clean ribbon replacement. The keyboard, a Hall-effect unit, provides ECMS, ANSI and APL character sets among others. The 120 char/s printer designated the TermiNet 120 offers LED diagnostics and uses a print belt to provide increased speed.

CIRCLE NO. 357

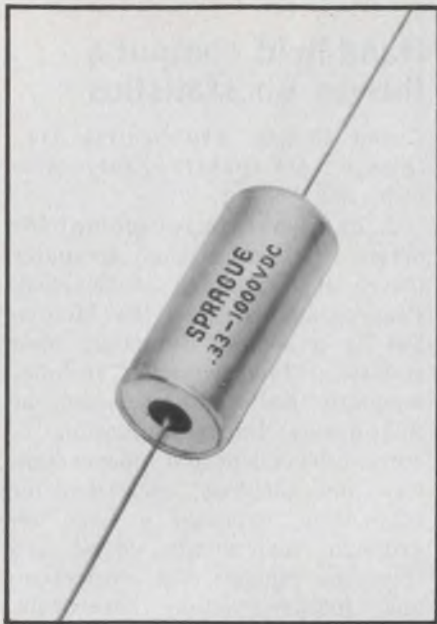

this capacitor is a natural for SCR snubber applications

Sprague Type 196P Vitamin Q[®] metal-clad paper capacitors, impregnated with an exclusive inert synthetic polymer, are well-qualified for high-current, high-voltage, high-repetition-rate a-c applications.

Conventional dry-construction film capacitors can't stand up to the 600-to-800 volts peak a-c generally encountered in SCR snubber applications. However, Type 196P hermetically-sealed capacitors are built to take even greater extremes, assuring exceptional performance and outstanding reliability.

For complete technical data, write for Engineering Bulletin 2110D to: Technical Literature Service, Sprague Electric Company, 347 Marshall Street, North Adams, Mass. 01247.



Sprague and *®* are registered trademarks of the Sprague Electric Co.

INFORMATION RETRIEVAL NUMBER 81

DATA PROCESSING

Data logger with μ P is easy to program



Doric Scientific Corp., 3883 Ruffin Rd., San Diego, CA 92123. (714) 565-4415. From \$4000; 60 days.

A wide range of data acquisition capability coupled with user-oriented programming are offered by a digital multipoint recorder called the Digitrend 220. The unit uses an Intel 8008 CPU microprocessor and will scan 20 to 1000 points at speeds to 20 point/s. Standard range/functions offered are: Four ranges of linear dc voltages with resolution to 1 μ V and automatic ranging, with thermocouple compensation; two ranges of current transmitter inputs to handle process signals of 4-20 mA and 10-50 mA. Nine interface circuit cards are available as options to couple to a variety of peripheral equipment such as computer random access ports with parallel BCD output, 7-track or 9-track incremental magnetic tape recorders, TTYs and modems.

Booth No. 203 Circle No. 324

Disc packs can store up to 80 Mbytes

AmpeX Corp., 401 Broadway, Redwood City, CA 94063. (415) 367-4151. See text; third quarter '75.

A family of disc drive devices for small and medium-sized computer systems is available. The DM-940 single density module offers 40 Mbytes of storage. The DM-980 offers 80 Mbytes. And a single DM-940 will replace several cartridge disc units. The DM-940 and DM-980 are designed to meet large capacity requirements through use of a five-high removable disc pack, which is equivalent to the CDC Models 9876 and 9877. Quantity prices are \$5000 and \$6500, respectively.

CIRCLE NO. 358

Voice response unit uses simple logic decoding

Master Specialties Co., 1640 Monrovia Ave., Costa Mesa, CA 92627. (714) 642-2427. \$1695; 12-14 wks.

EVA is the name of an expandable voice system, with whole-words stored in ROM, that outputs limited word-size messages. Whole-word storage helps produce a synthesized voice that is difficult to distinguish from the original yet uses simple logic decoding. All voice inflections and natural qualities are there. And it's a simple matter to access each ROM and call up the words one at a time in the required sequence. The unit is modularly expandable from 10 to 30 words. In the standard model, the first 10 words are the numeric words zero to nine with additional words added as specified. EVA accepts either binary address or 10 mutually exclusive switch closures for the numeric words. Additional words, after the first 10, require binary address only.

Booth No. 2708 Circle No. 325

Smart calculators aided by peripheral storage

Litton Monroe, 550 Central Ave., Orange, NJ 07051. (201) 673-6600. See text; stock.

A series of programmable calculators dubbed 324 Micro Scientist, Beta 326 and Alpha 325 ranges from hand-held portables to desktop printing units. The Model 324 for \$645 can be handheld yet offers 13 digit accuracy, 20 functions and dual 80-step storage. Ten registers with automatic capability hold results which are displayed with a 10-digit mantissa and 2-digit exponent. The 326, also handheld, features over 100 functions, 13-digit accuracy, has program capacity of 160 steps. Other features include TTL and CRT terminal compatibility plus program editing capability. The desktop 325, price \$1795, has all the capabilities of the 326, boasts a 416-step memory and has a built-in printer. Model 92, an optional cassette storage, holds up to 50,000 instructions or 9000 data items for the 325 and 326 and costs \$995.

Booth No. 2503-07 Circle No. 322

NEW PROGRAMMABLE TIME DELAY RELAYS

For R&D, low volume & production requirements.

Featuring CMOS digital circuitry; DPDT contacts—10 amps resistive; no "false" operation on delay on make function; competitive pricing; low inventory requirements.

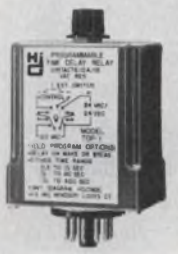

Model TDP-1: Each unit easily field selected for delay on make or break; for 24VDC, 24VAC, or 120VAC; and for delay ranges of 0.3 to 10, 3 to 80, or 10 to 300 seconds—adjustable to min/max of each range.

Low cost conventional, adjustable and fixed, single mode timers also available.



for further information contact
Hi-G, Inc./Windsor Locks, CT 06096
Area Code (203) 623-2481
see complete Hi-G line in EEM

INFORMATION RETRIEVAL NUMBER 82

FOR THE UTMOST IN RELIABILITY

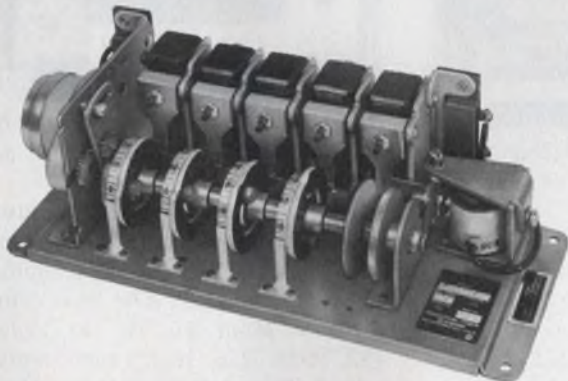

RECYCLING TIMERS Series RC

This multi-cam timer is one of a family of very versatile recycling timers that are available in single or recycling types with up to 20 control circuits. Control cams are independently adjustable from 2% to 98% of the total time cycles enabling the timer to be used as a programming device. And with supplied interchangeable gear and rack assemblies you can select from 700 time cycles ranging from 2/3 second up to 72 hours. All our timers are made to give you service far beyond what you'd reason-

ably expect. Our line consists of 17 basic types, each available in various mountings, voltages, cycles, circuits and load ratings . . . and with whatever special wrinkles you may need. Bulletin #206 tells all about our line of reliable Recycling Timers. Write for it or a catalogue of our entire line. If you have an immediate timer requirement, send us your specifications. Or for fastest service, call (201) 887-2200.



INDUSTRIAL TIMER

A UNIT OF ESTERLINE CORPORATION

INFORMATION RETRIEVAL NUMBER 83

ELECTRONIC DESIGN 7, April 1, 1975

**PROVEN RELIABILITY—
SOLID-STATE POWER INVERTERS,
over 260,000 logged operational hours—
voltage-regulated, frequency-controlled,
for missile, telemeter, ground support,
135°C all-silicon units available now—**

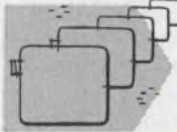
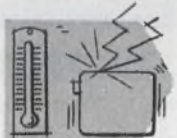
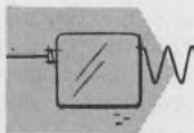
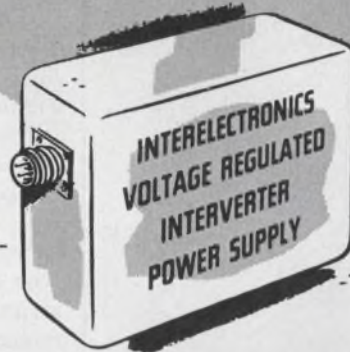

Interelectronics all-silicon thyatron-like gating elements and cubic-grain toroidal magnetic components convert DC to any desired number of AC or DC outputs from 1 to 10,000 watts.

Ultra-reliable in operation (over 260,000 logged hours), no moving parts, unharmed by shorting output or reversing input polarity. High conversion efficiency (to 92%, including voltage regulation by Interelectronics patented reflex high-efficiency magnetic amplifier circuitry.)

Light weight (to 6 watts/oz.), compact (to 8 watts/cu. in.), low ripple (to 0.01 mv. p-p), excellent voltage regulation (to 0.1%), precise frequency control (to 0.2% with Interelectronics extreme environment magnetostrictive standards or to 0.0001% with fork or piezoelectric standards.)

Complies with MIL specs. for shock (100G 11 msec.), acceleration (100G 15 min.), vibration (100G 5 to 5,000 cps.), temperature (to 150 degrees C), RF noise (I-26600).

AC single and polyphase units supply sine waveform output (to 2% harmonics), will deliver up to ten times rated line current into a short circuit or actuate MIL type magnetic circuit breakers or fuses, will start gyros and motors with starting current surges up to ten times normal operating line current.

Now in use in major missiles, powering telemeter transmitters, radar beacons, electronic equipment. Single and polyphase units now power airborne and marine missile gyros, synchros, servos, magnetic amplifiers.

Interelectronics—first and most experienced in the solid-state power supply field produces its own all-silicon solid-state gating elements, all high flux density magnetic components, high temperature ultra-reliable film capacitors and components, has complete facilities and know how—has designed and delivered more working KVA than any other firm!

**INTERELECTRONICS CORPORATION
550 U. S. Route 303, Congers, N. Y.
Telephone: 914 Elmwood 8-8000**

INFORMATION RETRIEVAL NUMBER 84



**our products
are more fully
developed...**

Standard Condenser capacitors are indeed fully developed to produce the optimum in performance and durability. Standard is in one business only, the design and manufacture of the world's finest capacitors. We have designed and delivered thousands of specialized capacitors for industry. In fact, what you think of as "special" may be among the many designs already available from stock at Standard. However, if you require capacitors of unusual shape, size, value and material, our engineering department will help you design and produce them to your exact specifications at stock prices. For immediate action, send us a sketch and complete details.

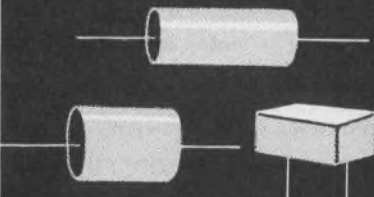

Write or phone for catalog and details.

Standard

CONDENSER CORPORATION

Dept. ED-1 1065 West Addison Street
Chicago, Illinois 60613 • (312) 327-5440

INFORMATION RETRIEVAL NUMBER 85

INSTRUMENTATION

**Portable scope also has
built-in DMM**



Tektronix, P.O. Box 500, Beaverton, OR 97005. (503) 644-0161. \$1200; stock.

The Model 213 is a DMM and a 1-MHz oscilloscope housed in one compact instrument. The lightweight (3.7 lb) unit can easily be carried anywhere in a briefcase, tool kit or on a convenient neck strap. The built-in battery charger recharges the batteries any time the 213 is connected to line voltage, but you get 3.5 h of operation from the batteries. The DMM and scope share a common power supply, built-in voltage probe, current input jacks and input attenuators.

Readout for both devices is on the 6×10 division CRT (0.5 cm/div). In DMM mode true rms reading capability makes the 213 especially convenient for nonsinusoidal ac measurement applications. Full scale dc and ac voltage ranges extend from 0.1 to 1000 V. Dc and ac current ranges are 0.1 mA to 1 A and resistance ranges span 1 k Ω to 10 M Ω . For easy readability, the 3-1/2-digit-plus-sign readout occupies a 1×4 cm area on the CRT. In the oscilloscope mode the 213 has a dc-to-1-MHz voltage bandwidth with calibrated deflection factors from 20 mV/div to 100 V/div (extends to 5 mV/div at 400-kHz bandwidth). Current waveforms are displayed with deflection factors ranging from 5 μ A/div to 100 mA/div. Horizontal sweep rates range from 2 μ s/div to 500 ms/div, and a variable sweep magnifier provides up to 0.4 μ s/div. Both internal and external triggering provide stable displays over the entire bandwidth.
Booth No. 2302-2307 Circle No. 359

**Digital multimeter
resolves to 4-1/2 digits**



Data Precision, Audubon Rd., Wakefield, MA 01880. (617) 246-1600. \$325; stock.

The Model 1450 digital multimeter is a full function bench instrument with a 0.5-in.-high, 4-1/2-digit display. The unit has 100% overranging and 21 function-range operation. Dc volts are measured from 100 μ V to 1000 V; ac volts from 100 μ V to 500 V rms; resistance from 100 m Ω to 20 M Ω ; and current, both ac and dc, from 1 μ A to 2 A. Frequency response for ac current and voltage is from 30 Hz to 50 kHz. Accuracy on dc volts is $\pm 0.02\%$ of reading $\pm 0.01\%$ of f.s., ± 1 digit. The 1450 measures 8.5 \times 3.5 \times 7.25 in. and comes with its own test leads and a combination carrying handle/tilt stand.

Booth No. 2719-2721 Circle No. 360

**512-MHz counter
works fast**



Ballantine Laboratories, P.O. Box 97, Boonton, NJ 07005. (201) 335-0900. \$745; stock.

Model 5755A frequency counter is said to give full, 6-digit resolution in half the time of similar competing models. The unit counts directly from 10 Hz to beyond 512 MHz. The instrument weighs only 5 lb. and is housed in a high-impact plastic case. Truly portable, the unit can be operated from ac or an 11 to 18-V battery. The unit measures through two input ports: Its high-impedance input (1 M Ω shunted by approximately 25 pF) covers the range from 10 Hz to 100 MHz with a sensitivity of 35 mV rms up to 40 MHz, increasing to 50 mV rms at 100 MHz. Its 50- Ω input is used for frequencies from 10 to 512 MHz.

Booth No. 2632 Circle No. 339

NEW!

CATALOG MT-40A
JUST OFF PRESS

For your copy:

1 stop off at our
IEEE Booth #2318
(and get free samples)

or

2 Circle the
Information
Retrieval No.

or

3 Call us, or your
nearest J-B-T Rep.
as listed in EEM
Gold Book, or EBG

J-B-T

SUB-MINIATURE SWITCHES



TOGGLES

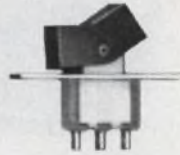

ROCKERS

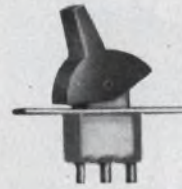

PADDLES



PUSHBUTTONS

Full 5 amp rating @ 125 VAC, or dry circuit (low current) types.

1-, 2-, 3-, and 4-Pole, double throw.

Lever, bushing, terminal, finish and mounting options
and combinations including printed circuit board types.

For J-B-T standard-size general purpose, industrial and
military toggles — Catalog TS-7.

J-B-T INSTRUMENTS, INC.

424 CHAPEL STREET • NEW HAVEN, CONNECTICUT 06508

INFORMATION RETRIEVAL NUMBER 86

LOOKING FOR A DISTRIBUTOR NEAR YOU?

Electronic Design's GOLD BOOK lists 5,700 distributors with access both **alphabetic**, by distributor name, and **geographic** by location.

When you need
information . . .

**Electronic Design's
GOLD BOOK
IS THE PLACE
TO LOOK**



shigoto cables and cord sets

... we go to any lengths.
... we go to any ends.

That's why Shigoto can help make your ends meet. From hundreds of standard combinations to unusual characteristics that meet your own requirements. Even U.L. and C.S.A. approved. Our volume production for O.E.M.'s in electronics, communications, automotive, appliances, and practically every other industry, takes all the variables out of price-performance differences. Shigoto's ability to consistently produce top quality assemblies, when combined with large quantities, always brings in the prices you need. Unmatched quality has become our standard, our reliability and delivery schedules will become yours. Call, write, or wire your specs. At Shigoto, you'll find we'll go to any ends, to any lengths, to satisfy you.

Shigoto Industries Ltd.

350 Fifth Ave., N.Y., N.Y. 10001/(212) 695-0200/Telex 224219
One of the World's Largest Manufacturing Importers

INFORMATION RETRIEVAL NUMBER 88

convert 3V logic to 15V logic

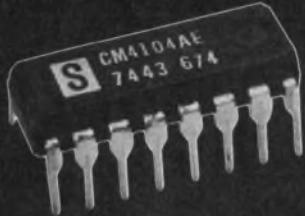

with this new Solitron CMOS chip

TTL TO CMOS LOGIC
LEVEL CONVERSION
CMOS TO CMOS INTERFACE
CMOS TO PMOS INTERFACE

Our new CM 4104A consists of 4 low-to-high voltage level translators, with an output enable control pin. All inputs are level translated, and any input may be driven more positive than V_{LO} , up to a level equal to V_{HI} . True and complement outputs are simultaneously available. When the Enable input is "low", all outputs become a high impedance. Price, \$3.62 (100 pieces).

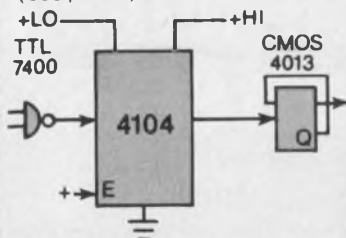

WATCH FOR NEW
DEVELOPMENTS IN OUR OVER
70 "4000 SERIES" DEVICES

Solitron

8808 BALBOA AVENUE
SAN DIEGO, CALIFORNIA 92123
TELEPHONE (714) 278-8780

INSTRUMENTATION

DPM offers 13-mm LED 2-year warranty, low \$



Newport Laboratories, 630 East Young St., Santa Ana, CA 92705. (714) 540-4914. \$81. (100); stock-2 wks.

Model 203 3-1/2-digit DPM is the first in a new series of high-reliability meters featuring low component count and a low-voltage, 13-mm (0.51 in.) LED display with an estimated life expectancy of over 11 years in continuous operation. The series features a 2-year warranty, voltage, current and ratio measurements, automatic polarity, automatic zeroing and standard BCD output. Full-scale input voltage ranges are 200 mV, 2, 20 and 200 V with instantaneous warm-up to full rated accuracy and total error of $\pm 0.05\%$ of reading $\pm 1-1/2$ counts.

Booth No. 2122-2124

Circle No. 338

350-MHz analyzer grabs spectra easily

Hewlett-Packard, 1501 Page Mill Road, Palo Alto, CA 94304. (415) 493-1501. \$4650 (includes mainframe); 30 days.

A new 350-MHz fully calibrated spectrum analyzer, Model 8557A, emphasizes ease of use with lab-grade performance. Most measurements can be made with just three controls. Frequency response is ± 0.75 dB, over-all absolute amplitude-measuring accuracy is ± 2.25 dB, and frequency readings are correct to ± 3 MHz. Dynamic display range exceeds 70 dB. The new instrument is a plug-in for the company's 180-series scope mainframes.

Booth No. 2518 to 2531

Circle No. 343

Notch filter eliminates line interference



Xetron Corp., 11079 Reading Rd., Cincinnati, OH 45241. (513) 563-4880. \$1500 to \$3000.

This digital comb notch filter, the LINX, eliminates all interfering 60-Hz harmonics throughout the entire audio band by provision of almost 200 distinct, equally spaced, notches. The unit is also available for 400-Hz power sources. A special feature is the ability to lock onto the power-line frequency and track it when any drift occurs. This keeps the interference frequency automatically held at the center of the notches and eliminates manual adjustments.

CIRCLE NO. 361

Sweep generator covers 200 kHz to 1000 MHz

Telonic Altair, Box 277, Laguna Beach, CA 92652. (714) 494-9401. \$1695; 30 day.

The Model 1210 solid-state sweep generator covers 1 to 1000 MHz in a single sweep. The unit uses a patented electronic switching technique that couples two sweep sources. The instrument provides a continuous band of frequencies from 200 kHz to the full 1000 MHz. The Autoplex switching system eliminates any need for manual switching from one range to another and gives the user a complete response curve of the unit under test. For accurate determination of frequencies, the instrument can be equipped with harmonic and single frequency markers of the Birdy bypass type. Individual marker frequencies are determined by the particular application of the instrument, which will accept up to seven marker plug-in cards. The generator is available in a 50- Ω version, Model 1210, and a 75- Ω version, Model 1240. Both have the 1000-MHz sweep range, 200-kHz-to-1000-MHz sweep width, 0.5-V-rms output, ± 0.5 -dB flatness and 1% linearity.

Booth No. 2322

Circle No. 362

Precision Is The Name Of The Game

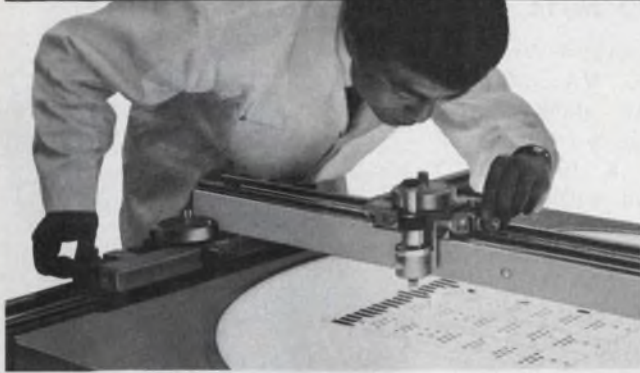

The MICRO/PLOTTER Coordinatograph by MUTOH is a "certified" winner.

The MUTOH MICRO/PLOTTER drafts, plots and digitizes to 0.001". In fact, MUTOH is the only leading manufacturer of drafting equipment offering written certification guaranteeing drafting accuracy to 0.001".

There is also another name to the game: "VERSATILITY." MUTOH believes it's equally important because they are engineers like you. Take for instance tools. THE MICRO/PLOTTER has a complete line of quick change drafting, measuring and plotting tools to adapt to every conceivable function. Both rectangular and rotary work tables are available, equipped with back-lit translucent glass work surfaces.

Scales available in English or Metric or both.

Ask about Mutoh Drafting Machines.

For more detailed information contact:



Manufacturer—Mutoh Industry, Ltd., Tokyo, Japan
U.S. Agent—

OWEN JONES EQUIPMENT SALES

535 Pennsylvania Avenue

Fort Washington Industrial Park, PA, 19034, (215) 643-1655

INFORMATION RETRIEVAL NUMBER 90

NO ONE

Customizes Switches Like CDI
Nor Has a More Complete Line

THUMBWHEEL SWITCHES



Completely sealed against hostile environments.

ROTARY SWITCHES

Snap-in, snap-out modules in seconds, eliminating downtime.



Patent Pat.
2841660,
2971066,
3015000,
2956131,
2988607.

PUSHBUTTON SWITCHES



Miniature add/subtract units retrofit most minithumbwheel switch panel openings.

Mounts on 1/2" centers, retrofits most panel openings for miniature thumbwheel switches.

CDI earns its reputation every day for Consistently High Quality, Consistently Good Delivery.

CHICAGO DYNAMIC INDUSTRIES, INC.

PRECISION PRODUCTS DIVISION
1725 Diversey Blvd., Chicago, Illinois 60614
Phone: 312, 935-4600

INFORMATION RETRIEVAL NUMBER 91
ELECTRONIC DESIGN 7, April 1, 1975

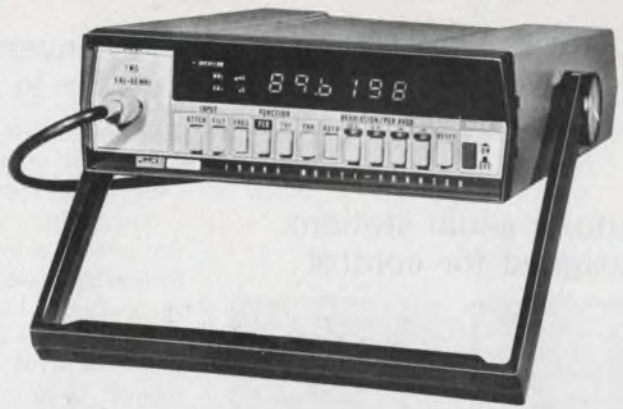

This may look like a multimeter... but it's really an autoranging multi-function counter

We've had a lot of comments that our new 1900A multi-function counter looks like our 8000A multimeter. We agree. In fact we planned it that way. Both are attractively styled and designed for user convenience. But inside they're vastly different instruments.

The 1900A is an advanced LSI/MOS multi-function counter with . . . autoranging in both frequency and period mode . . . 5 Hz to 80 MHz range with 25 mV sensitivity . . . event counting to 10⁶ . . . automatic overflow . . . six digit LED display with automatic annunciation . . . all for the unbelievably low price of \$349.*

Plus you can order a rechargeable battery option, or a data output option that lets you use the 1900A in systems applications.

And just in case you're wondering - here is what the 26 range, 5 function 8000A multimeter looks like.

Phone your local Fluke distributor to-day for a demonstration, or contact us direct.



*U.S. price F.O.B. Buffalo, N.Y.

FLUKE

COUNTER DIVISION

John Fluke Mfg. Co. Ltd.
Counter Division
P.O. Box 1094 Station D
Buffalo, N.Y. 14210
Phone (716) 842-0311
TWX 610-492-3214

INFORMATION RETRIEVAL NUMBER 92
FOR DEMONSTRATION 184

Auto/manual stations designed for control

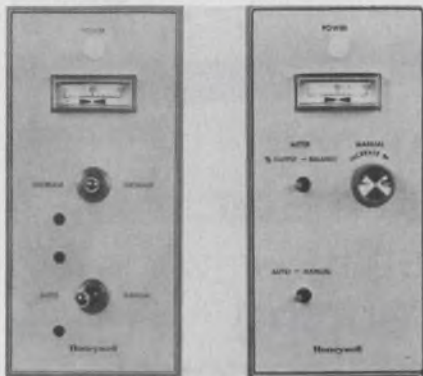

Honeywell, 1100 Virginia Dr., Fort Washington, PA 19034. (215) 643-1300. From \$140; 6 to 8 wk.

Two automatic/manual transfer stations are designed for use on manual process startup or for standby service if the control instrument is removed from service. One model is for use with current-proportioning controllers that have 4-to-20-mA outputs. The other unit is used with position-proportioning controllers to provide continuous indication of the operator position and to manually position the operator when in the manual mode. The auto/manual stations also can be used with controllers of other manufacturers, the color and size of the instruments, however, match the company's DialaTrol line. Both models have power-on lights and continue to operate in the manual mode if the controller is unplugged.

CIRCLE NO. 363

V/f converter covers 100 Hz to 5.05 MHz

Teledyne Philbrick, Allied Dr. at Rte. 128, Dedham, MA 02026. (617) 329-1600. \$149; stock.

The 4707 voltage-to-frequency converter provides a 100-Hz-to-5.05-MHz pulse-train output that is a direct linear function of a +1 mV to +10 V dc input signal. The 4707 has a linearity of 0.004%, a drift of 44 ppm/°C and a differential linearity of 14 to 16 bits. The converter is housed in a 3 × 2 × 0.4 in. case and operates over 0 to 50 C. Derated operation is possible over -25 to +85 C.

CIRCLE NO. 364

Wideband amplifier spans 5 to 500 MHz

Watkins-Johnson, 3333 Hillview Ave., Palo Alto, CA 94304. (415) 493-4141. \$125 (1 to 9); stock.

The WJ-A9 is a high-dynamic-range rf amplifier designed to deliver 11 dB of gain over the frequency range of 5 to 500 MHz. The amplifier is assembled in a hermetic four-pin TO-8 package and operates with supply voltages from +15 to +24 V dc (the supply voltage is internally decoupled). At +24 V dc the third-order two-tone intercept point is typically +35 dBm, output power at 1 dB gain compression is +22 dBm and gain is 11 dB. Most performance parameters remain constant with changing supply voltages with the output power dropping to +21 dBm at 20 V and +18 dBm at 15 V.

CIRCLE NO. 365

Programmable timer controls 10 circuits

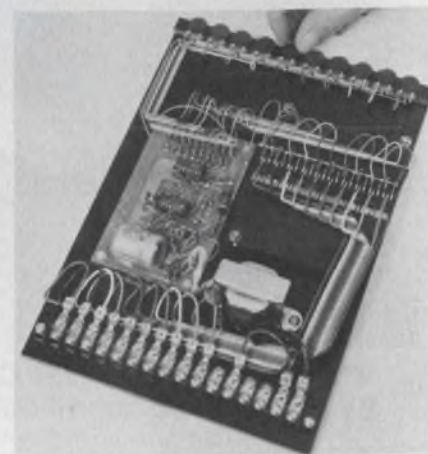

Bayside Timers, 43-69 162 St., Flushing, NY 11358. (212) 463-8935. \$180 (uncased); 1 wk to 10 days.

The Varistep timer-stepper can control 10 circuits with each having a different ON period duration. Each ON period can be adjusted independently of the other nine. The Varistep timer-stepper also provides the user with the option of using only the number of circuits needed between two and the full 10 by moving a jumper from one terminal post to another. Each circuit has its own control potentiometer, providing a minimum-to-maximum time range of approximately 1 to 3000. Options include triacs for switching heavy loads (the standard model has 10-A triacs rated for 600-W tungsten filaments), a pushbutton for single-cycle operation, a toggle switch for single-cycle/repeat-cycle operation, and precision potentiometers for high accuracy and repeatability of time interval settings.

CIRCLE NO. 366



ANALOGY
STAY IN CONTROL WITH INTECH'S INDUSTRIAL CONTROL IC'S THE 3050 AC DETECTOR DIFFERENTIAL OR SINGLE ENDED TO 1MHZ. 3040 QUAD MONITOR ALARM DRIVES EXTERNAL SPEAKER DIRECTLY. 3030 TEMPERATURE ALARM SETS OFF BELLS AND WHISTLES. EXCELLENT REPEATABILITY. THE 3020 TRI-STAGE ALERT/ALARM AND 3010 TONE ALARM DRIVE LEDs OR LAMPS. ALL 14-PIN DIP TTL COMPATIBLE. STOCK DELIVERY. LOW PRICES. WRITE US!

intech INCORPORATED
(408) 244-0500
1220 COLEMAN, SANTA CLARA CA 95050

Crystal clocks operate at Schottky speeds

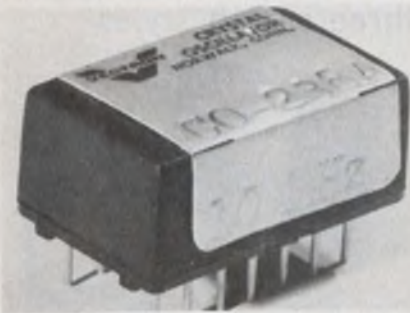

Vectron Laboratories, 121 Water St., Norwalk, CT 06854. (203) 853-4433. 4 to 6 wk.

The CO-238 DIP-compatible crystal oscillator is available at frequencies up to 100 MHz to drive Schottky TTL logic. The oscillator operates from 5 V dc, drives 10 TTL loads and plugs into a 14-pin DIP socket. The standard CO-238 provides stability of $\pm 0.0025\%$ over 0 to 70 C. Options include the MIL range CO-238-2 with stability of $\pm 0.005\%$ over -55 to $+125$ C and the high stability CO-238-3 with stability of $\pm 0.0003\%$ over 0 to 50 C.

Booth No. 2322 Circle No. 367

LVDT signal conditioner uses only two wires

Schaevitz Engineering, P.O. Box 505, Camden, NJ 08101. (609) 662-8000. \$272.90; stock.

The CTM-401 is a fully encapsulated two-wire LVDT signal conditioning module which delivers a 4-to-20-mA dc signal. This signal is directly proportional to any change in LVDT core position. The CTM module does not require any additional external power since it operates on dc current from existing process controllers, recorders or readout devices. It delivers a nominal 1-V-rms excitation to an LVDT and converts the LVDT output to 4 to 20 mA dc with zero to full range change in LVDT core position. The CTM is an intrinsically safe design because the current can be limited to 50 mA even with accidental overvoltage or internal short-circuiting. Performance includes a frequency response of dc to 100 Hz (within ± 1 dB), nonlinearity and hysteresis of less than 0.1% full scale and stability (after 15 min.) of 0.25% of full scale.

CIRCLE NO. 368

Image sensing module uses 1024-element array



Cromemco, 26655 Laurel, Los Altos, CA 94022. (415) 497-2642. \$90 (kit), \$150 (assembled).

An image sensing module that uses a 1024-element IC array is designed for digital camera appli-

cations. The IC image sensor and support circuitry are contained on a single printed-circuit board that measures 5.5×2 in. Grey-scale information and position information are digitally encoded for complete compatibility with digital systems. Outputs are also provided to permit the direct display of a picture on an oscilloscope screen. Applications include pattern recognition systems, security systems and automated control systems.

CIRCLE NO. 369

39.999999 MHz



MODEL 5500

BEST FREQUENCY SYNTHESIZER

- 10 KHz to 39.999999 MHz Range
- 1 Hz Resolution throughout range
- LED Display of Programmed Frequency
- Full Programmability & Fast Switching
- High Spectral Purity
- High Stability
- 1 v RMS Output (+13 dBm)
- Amplitude Modulation
- Auxiliary TTL Square-wave Output
- ASCII, Calculator, Minicomputer Interface Options

SOME APPLICATIONS:

- Communication systems alignment and calibration.
- Precision sweep testing of High Q networks.
- Frequency agile automatic systems.
- Programmable local oscillator.

ROCKLAND

Rockland Systems Corporation 230 W. Nyack Road, West Nyack, N.Y. 10994
(914) 623-6666 • TWX 710-575-2631

"See Us At Booth # 2221, IEEE Intercom 75"

INFORMATION RETRIEVAL NUMBER 100

SHAPE FOIL INTO MAGNETIC SHIELDS

in minutes... with scissors... low cost

No waiting. Solves many shielding problems. Use a single formula (ask us) to determine thickness and number of layers. Combine this with practical trial and error. After cutting, hand trim AD-MU foil to the correct outline and fit it around the component to be shielded.

If you need relatively few shields, or are experimenting, that's it. You've eliminated designing, tooling and manufacturing costs for prefabricated shields.

Especially good also for hard-to-get-at places and to make assemblies more compact by placing magnetically reacting components closer together without performance degradation.



Comprehensive 18-page magnetic shielding catalog with 4-page reprint from Electronic Design on request.



AD-VANCE MAGNETICS, INC.

226 E SEVENTH ST. ROCHESTER, IND 46975
(219) 223-3158 TWX 810 290 0294

Our 3rd Decade of Magnetic Shielding Leadership

INFORMATION RETRIEVAL NUMBER 101

cut costs 40% on parts like this

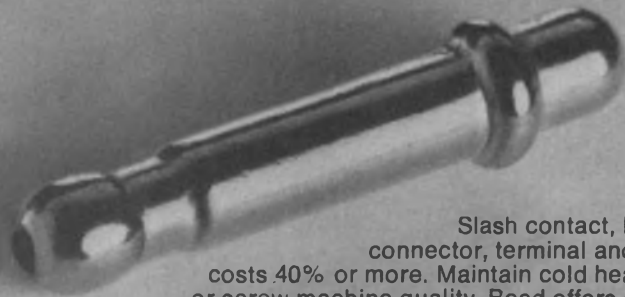

Slash contact, lead, connector, terminal and pin costs 40% or more. Maintain cold headed or screw machine quality. Bead offers a full line of standard products. Formed by our fast, accurate virtually waste free multi-swaging process to give you fast delivery, low prices. We provide custom engineering to meet your special requirements. Write or call for our new catalog.



bead electronics

A Division of Bead Chain Mfg. Co.
58 Mountain Grove St., Bridgeport, Conn. 06605
Phone: (203) 334-4124

INFORMATION RETRIEVAL NUMBER 102

PACKAGING & MATERIALS

LED lamps snap into three switch styles

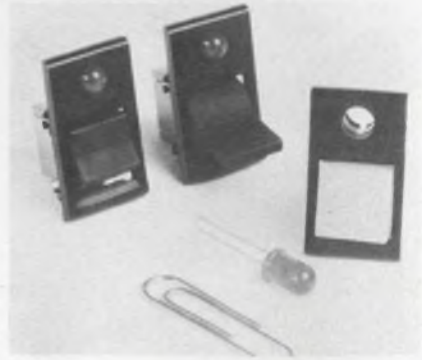

C & K Components, Inc., 103 Morse St., Watertown, MA 02172.
(617) 926-0800.

LED indicator lamp bezels have been added to three switches in C & K's family of products: 8100 Series snap-in-momentary push-button, J-50 snap-in rocker switch and J-60 snap-in paddle switch. The LED lamp can be snapped in to the bezel either before or after the switch and bezel have been installed in the panel. The switches are normally supplied without LEDs, but they are designed to accommodate lamp models supplied by Monsanto, Texas Instruments, Chicago Miniature and others.

Booth No. 1315 Circle No. 332

Selective plating saves gold

Dynatech Corp., 1255 E. Wakeham, P.O. Box 1019, Santa Clara, CA 92702. (714) 558-8755.

A new selective-plating technique called ZIP process for cantilever PC connector contacts is said to save gold use by 25 to 90% over tip-plated and welded gold-bead methods. Hard 24-K gold-plating is applied in thicknesses from 10 to 100 millionths of an inch only on the surfaces where it's needed. Also, the process eliminates underplate requirements, when the base material contains less than 88% copper. And since the deposit is of globular, rather than a columnar-grain type found in conventional processes, the plated area produces a dense, non-porous surface that has hardness levels of approximately 140 Knoop, despite purity levels near 24 K. Sample plated contacts are available free.

CIRCLE NO. 370

ELECTRONIC DESIGN 7, April 1, 1975

Flat cable terminated without preparation



Elco Corp., Willow Grove, PA 19090. (215) 659-7000.

Without preliminary cable preparation, such as stripping, plating, soldering, welding or indenting, the Flattac Series system can terminate up to 35 insulation-displacing contact crimps on flat-multi-conductor cable, simultaneously, in one cycle of a semi-automatic applicator. The terminated cable snaps into the insulator to provide a completed cable assembly in seconds. The manufacturer can provide any combination of parts of the system—from a complete cable assembly to individual components for customer termination with leased application equipment.

CIRCLE NO. 394

Ionized-air blower reduces static charges



3M Co., 3M Center, St. Paul, MN 55101. (617) 733-8830.

A tabletop ionized-air blower minimizes destructive static electricity during the manufacture and assembly stages of MOS/FET ICs. The 909 ionized-air blower increases production yields and reduces field rejects. Placed on a workbench, the unit continually bathes the area to continually discharge static buildup.

CIRCLE NO. 395

CUSTOM DESIGNED power supplies to your specs

- Small size • Lightweight • High efficiency • Low output noise • High reliability • Short and overload protection • Plug-in modular construction

TerraCom has developed high performance power supplies for use in critical applications. If your requirement is for a high frequency, low noise, lightweight and small power source, a TerraCom supply is the solution. TerraCom specializes in supplies for use in extreme environments where high reliability and excellent performance are important. Contact TerraCom for successful custom designs of the right supply for your requirement.

WRITE OR PHONE:
for data sheets on
typical power supplies
TerraCom
9020 Balboa Ave.
San Diego, CA 92123
(714) 278-4100

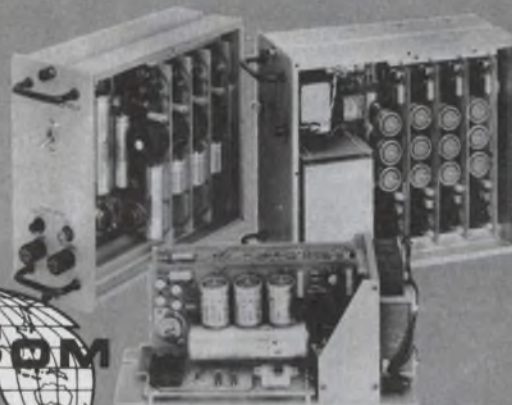

INFORMATION RETRIEVAL NUMBER 103

KNOW THE TRADE NAME BUT NOT THE MANUFACTURER?

Almost 5,000 trade names are identified for you in Electronic Design's GOLD BOOK. When you need information FAST . . .

Electronic Design's GOLD BOOK IS THE PLACE TO LOOK

SOLDERING +
DESOLDERING +
RESOLDERING =

SOLDER Ability

A NEW AND UNIQUE METHOD OF
VISUAL EDUCATION - IT'S FUN TO LEARN!

VISUAL APPLICATIONS OF THE *World's*
Most Practical SOLDER HANDLING TOOLS

SOLDAPULL™
DESOLDERING TOOLS

UNIVERSAL
US140

ATMOSCOPE™
VACUUM TIP
AV125

LONER™
SOLDERING INSTRUMENT Model 950
ENERGY SAVER!
Idle-rest.
HOLDER IR089

SOLDAVAC™
DESOLDERING TOOLS
STANDARD SVO26

TWP™
SOLDER AND WICK
AT FINGER TIPS
TW108

Triple Mate™
PERFECT SOLDERING TIPS
Work Rated

ERSA™
INDUSTRIAL SOLDERING TOOL
ER140
TIP 16

VACUUM PUMP
SN104

SNORT™
MINI VACUUM PUMP
MV124

SOLDASIP™
RESOLDERING WICK
SW091

NEW... Covered by U.S. and foreign patents and pending applications
144 PAGE TRAINING MANUAL
OVER 1,000 ILLUSTRATIONS

EDSYN pioneer in SolderABILITY, presents
FANOVISION - graphic motion in a training
manual designed to stimulate the mind to
SAVE TIME on the line. Available at \$7.95

AT PARTICIPATING DISTRIBUTORS ONLY

Send FREE Information on EDSYN Products
 Send FANOVISION Manual (\$7.95)*

*NOTE: FANOVISION Manual will be sent FREE with purchase of \$7.95 (or more) of any EDSYN Products. Limit one FREE MANUAL to a customer.

Name _____

Address _____

City _____ State _____ Zip _____

SEND TO: EDSYN, Inc.
15958 ARMINTA STREET, VAN NUYS, CALIFORNIA 91406

PACKAGING & MATERIALS

**Screwdriver system
operated by computer**



Optimized Devices, Inc., 220 Marble
Ave., Pleasantville, NY 10570.
(914) 769-6100.

A computer-operated screwdriver acts as an automatic tool for fast, accurate setting of calibration pots, tuning screws, zero adjustments, phase alignments, etc., without operator judgment. Two modes are available. In the servo mode, the computer sets a reference value and a control unit drives the screwdriver until the circuit parameter is equal to the reference. In the iterative mode, the computer measures the circuit parameter, compares it with a reference value, and drives the screwdriver a computed increment to bring the circuit parameter close to the reference. The computer repeats this process a few times until balance is achieved. The screwdriver system is available with interface and software for PDP/8 computers.

CIRCLE NO. 371

**Teflon tubing shrinks
50% under low heat**

Alpha Wire Corp., 711 Lidgerwood
Ave., Elizabeth, NJ 07207. (201)
925-8000.

A new heat-shrinkable tubing combines the properties of Teflon with low shrinkage temperature. For application to heat-sensitive components. FIT-400 FEP Teflon-tubing shrinks at a 2 to 1 ratio at only 200 to 350 F and has a 400-C operating temperature. The tubing features all of the outstanding electrical, chemical and mechanical advantages of Teflon. The tubing is available in 18 sizes from 0 to 24 AWG, and in packaged assortments of 6-in. lengths.

CIRCLE NO. 372

CONNOR-WINFIELD's

NEW
LOW PROFILE
DIP CRYSTAL
OSCILLATOR

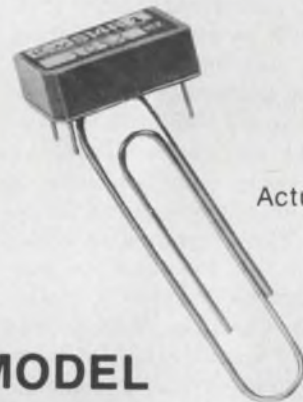

Actual Size

MODEL
S14R-2

FREQUENCY TOLERANCE:
±.01% from -25°C to +75°C

FREQUENCY RANGE: Available
4 MHz to 20 MHz

OUTPUT WAVEFORM:
Squarewave
85% of supply voltage
into a 10k Ω load
Duty Cycle 30/70 or better

SUPPLY CURRENT: 1 ma to 5 ma
TERMINATION: 14 pin DIP socket
pin diameter .02"

SUPPLY VOLTAGE: 5Vdc to 15Vdc

DIMENSIONS:
0.3" H x 0.5" W x 0.8" L

- * SMALL SIZE
- * LOW COST
- * HIGH FREQUENCY

CONNOR-WINFIELD CORP.



West Chicago,
Illinois 60185
Phone: (312) 231-5270

INFORMATION RETRIEVAL NUMBER 107
ELECTRONIC DESIGN 7, April 1, 1975

DIP test handler adapts easily to changes



Daymarc Corp., 301 Second Ave., Waltham, MA 02154. (617) 890-2345.

Type 952/3 provides automatic DIP test handling from stick to stick for 6-to-22-pin DIPs. Test rate is 6000/h with 100 ms test time. Input station and all output stations are fitted with tandem stick holders so that operation continues during stick change. Tested devices are stored on output track during stick change. Change of stick types is easily accomplished. Also adaptation to different IC body dimensions is easily done with convenient thumb-screw adjustments.

Booth No. 2333 Circle No. 329

Chamber shields against magnetic environment

Ad-Vance Magnetics Inc., 226 E. Seventh St., Rochester, IN 46975. (219) 223-3158. 30-60 days.

A new, large, movable multi-layer cylindrical AD-MU shielding system, Model MEC-125, provides a repeatable controlled magnetic environment for determining response characteristics, sensitivity, and orientation direction of magnetic sensor devices. Such devices are used for signature recognition proximity sensing, etc., in industrial, military and commercial applications. Dimensions of 36 OD x 34 ID x 40 L in. are sufficient to avoid severe anomaly distortions caused by proximity of the shielding structure. Other shields can be constructed in accordance with any specific dimensional requirements.

CIRCLE NO. 375

Terminal strips unplug from PC boards

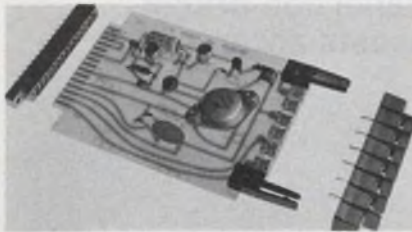

Magnum Electric Corp., 6385 Dixie Hwy., Erie, MI 48133. (313) 848-2555.

Magnum's new RS 100 line of single-row terminal strips allows the removal of all field wiring from a circuit board by simply unplugging the complete strip. The strips are rated at 120 A, 300 V. They have 3/8 and 7/16-in. center spacing and up to 30 contact positions. Plastic guide posts provide strip alignment during insertion and removal. Spring locking fingers in the guide posts hold strips when fully inserted.

CIRCLE NO. 376

New SCRs FOR YOUR DESIGNS

NEW NL-C601



1200 amperes rms
800-1700 volts

NEW NL-C602



950 amperes rms
1700-2500 volts

NEW NL-F701



1600 amperes rms
500-1700 volts

POINT THE WAY TO PROFITS

- Power and inverter SCRs available in assembled Heat Exchangers.
- Other SCRs available from 16 amps and 25 volts.
- Call or write for full details



NATIONAL ELECTRONICS

a varian division

geneva, illinois 60134 (312) 232-4300

INFORMATION RETRIEVAL NUMBER 108



use pressure sensitive
TEMP-R-TAPE of fiberglass
for quick relief.

Excellent electrical properties plus most anything else you want in fiberglass tapes like high tensile and tear strength, dimensional stability, good conformability, thermal endurance, abrasion resistance, non-corrosiveness, Temperature to 180°C. Available with several adhesive systems. Low unit cost.

Find your nearest Distributor in the Yellow Pages under "Tapes, Industrial" or in Industrial Directories or write for complete specification kit and sample offer. The Connecticut Hard Rubber Company, New Haven, Conn. 06509

CHR

an ARMCO company

MICROWAVES & LASERS

Reflection bridge boosts accuracy

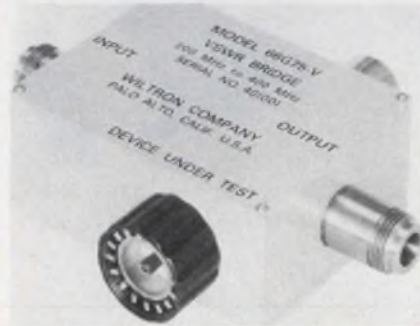

Wiltron Co., 930 E. Meadow Dr., Palo Alto, CA 94303. (415) 321-7428.

A line of 75- Ω reflection bridges—the 66G75 series—covers the 5-to-2000-MHz frequency range with directivity of 60 dB. The bridges make it possible to measure SWRs as low as 1.006 with increased accuracies. For example, a typical SWR of 1.02 can be measured with a total uncertainty of ± 0.002 . This accuracy is made possible by the special GR900 precision connector on the test port, the internal balance of the bridge and the termination.

Booth No. 2618-2620 Circle No. 377

Rotary joints provide several channels

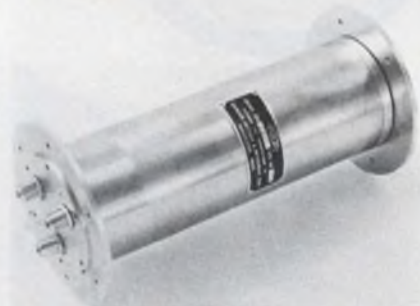

Diamond Antenna & Microwave Corp., 35 River St., Winchester, MA 01890. (617) 729-5500.

A series of multichannel IFF rotary joints is available in dual, three or four-channel configurations with a choice of coaxial connectors. Typical specifications are a VSWR of 1.2:1 maximum, isolation of 50 dB, peak power of 5 kW and phase tracking between channels of ± 5.0 degrees. Encoder drive shafts for azimuth pulse generators are also available.

Booth No. 1125-1127 Circle No. 378

Unit tests insertion loss



Weinschel Engineering, Gaithersburg, MD 20760. (301) 948-3434. \$2175 to \$2495.

Model 1872 insertion-loss test unit permits fixed and swept-frequency insertion-loss measurements from 50 MHz to 18.0 GHz. Designed as an accessory to the company's Model 1810A stabilized rf ratio meter, the test unit incorporates two tracking and low VSWR square-law detectors and a precision 50- Ω resistive power splitter. The Model 1872 has an insertion point VSWR of less than 1.07 to 2 GHz and less than 1.15 to 18 GHz (source and load). Dynamic range exceeds 30 dB when used with a 10-mW output source.

1-to-4-GHz YIG osc outputs 85 mW

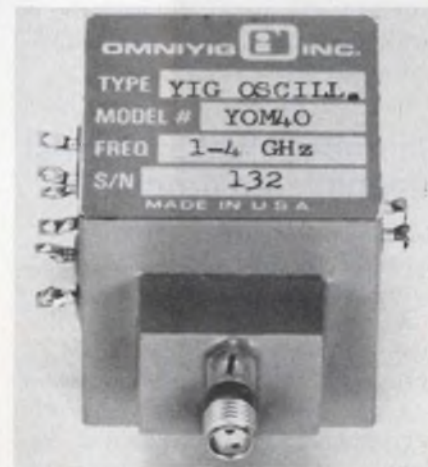

Omniyig Inc., 2325 De La Cruz Blvd., Santa Clara, CA 95050. (408) 241-1226. \$1145; 45 days.

The YOM40 1-to-4-GHz fundamental YIG oscillator permits a continuous sweep over its band with spurious responses at least -60-dB. The oscillator occupies a 1.4-in. cube. It has a typical output range of 40 to 85 mW, operating temperature range of 0 to -55 C and tuning sensitivity of 11 MHz per mA.

CIRCLE NO. 380

Filters keep distortion low

Allen Avionics Inc., 224 E. 2nd St., Mineola, NY 11501. (516) 248-8080. 3 days (prototypes).

Gaussian-type linear phase band-pass filters, offering fast cut-off and low delay-variation characteristics, are available in the frequency range from 1 kHz to 25 MHz with impedances from 50 to 10-k Ω in 30%-to-70% bandwidths. Maximum phase distortion over 3-dB passband is $\pm 3^\circ$, with typical delay variation of 5%. The filters are epoxy encapsulated or sealed in metal cans, in sizes ranging from 2 \times 1-5/8 \times 1-1/8 in. to 4-1/2 \times 2-1/2 \times 1-3/8 in.

Booth No. 1115 Circle No. 381

Mate or unmate connectors fast

Sealectro Corp., Mamaroneck, NY 10543. (914) 698-5600.

A line of Kwick-Konnect rf coaxial connectors combines fast connect and disconnect with a VSWR of less than 1.30:1. These units can be used over the frequency spectrum of dc to 18 GHz, and they can replace BNC types in front panels.

Booth No. 1215-1221 Circle No. 382

Sig gen spans 6.95 to 12.2 GHz

Polarad Electronic Instruments, 5 Delaware Dr., Lake Success, NY 11040. (516) 328-1100. \$3720; 30 to 45 days.

The Model 1108A-C compact wideband microwave signal generator has a single frequency range of 6.95 to 12.20 GHz (optionally to 12.40 GHz). The expanded coverage of the unit includes the 10.7-to-11.7-GHz communications common-carrier band and the 11.1-to-12.2-GHz broadcast, mobile and satellite communications bands. Previously, two generators were required because available X-band modular signal generators have had an 11.0-GHz upper limit. Frequencies are read directly on a four-digit readout with 0.5% accuracy. Output levels are calibrated directly from at least 0 dBm down to -127 dBm.

Booth No. 2316 Circle No. 383

A complete line of CUSTOMIZED ROTARY CERAMIC SWITCHES ...

For RF and POWER APPLICATIONS

RSC switches are available in a variety of switching models. RSC high precision, quality built units are designed for applications requiring long life maintenance-free service. Types include shorting and non-shorting, single and multi-deck, up to 18 pole positions. Features include, 10 to 100 amp current carrying capacity, 20° to 90° detents, 2000 to 24000 volts flashover and corrosion-proof construction.

Write for catalog no. 960 and complete information.

RADIO SWITCH CORPORATION

Rt. 79, Marlboro, N. J. 07746

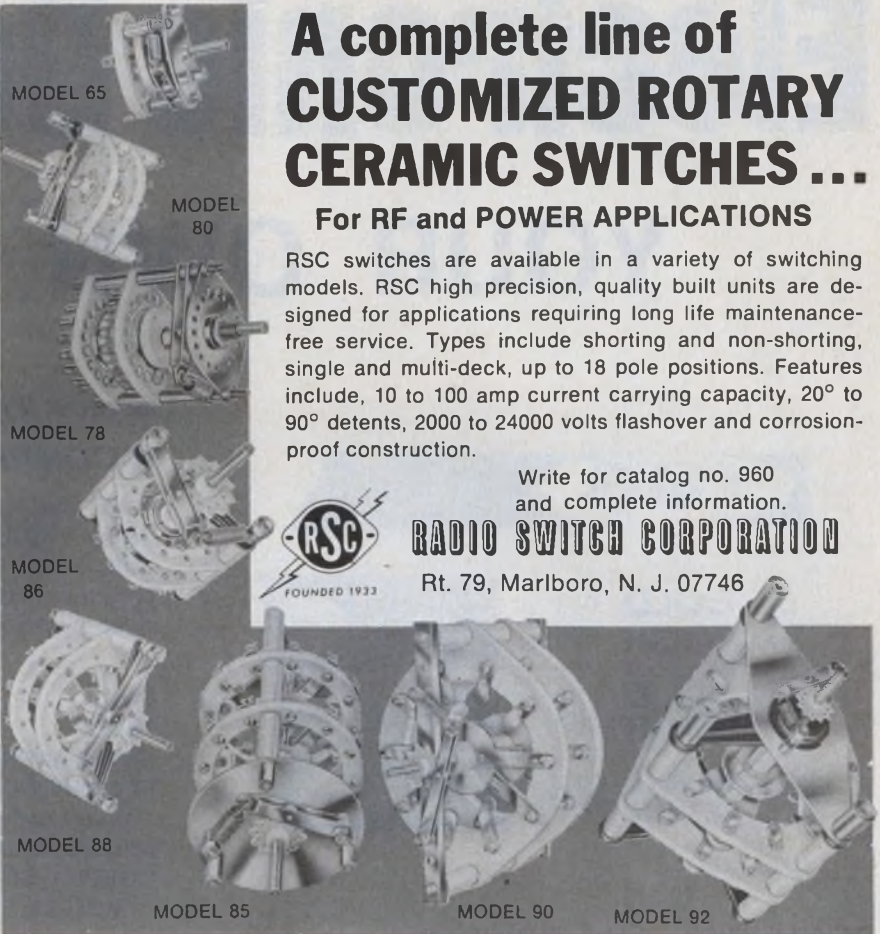

INFORMATION RETRIEVAL NUMBER 111

Why Decitek's low cost 100 cps Sam tape reader is so accurate and reliable.

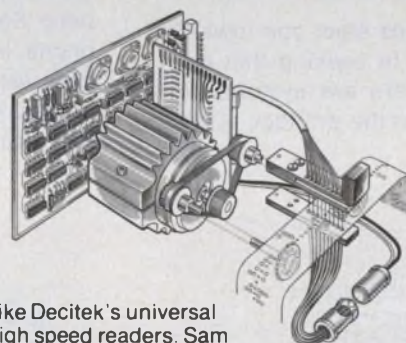

Like Decitek's universal high speed readers, Sam has our patented dual sprocket drive that starts, steps and stops accurately every time, eliminates tape wear. A highly stable fiber optic-photo transistor array reads 5, 6, 7, and 8 level advanced and center feed hole tapes interchangeably without adjustment. For more features that make Sam more than a match for any other low cost reader, write for our brochure.

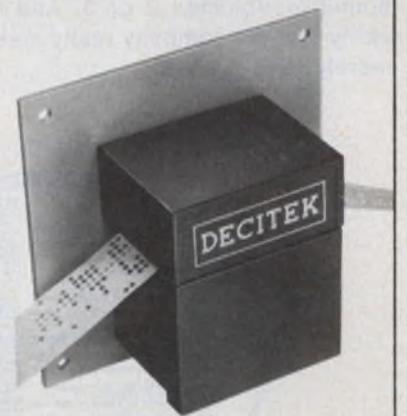

When reading matters

DECITEK

A DIVISION OF JAMESBURY CORPORATION

250 CHANDLER STREET, WORCESTER, MASSACHUSETTS 01602, U.S.A. (617) 798-8731

INFORMATION RETRIEVAL NUMBER 112

Electronic Design's YOUR OWN INSTANT

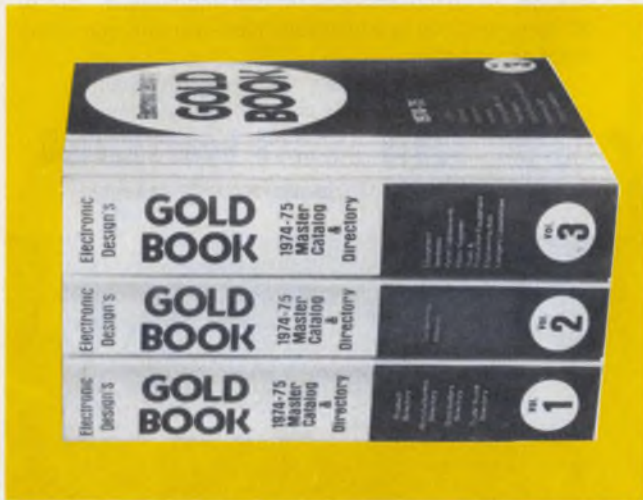

SIMPLIFIES AND SPEEDS PRODUCT SEARCH

Want to know who makes what? Just turn to the GOLD BOOK's *Product Directory*. Each manufacturer's complete street address, State, zip, and phone is given every time it's listed. Contact is simplified . . . you (or your secretary) don't have to go to any other directory to get missing address information—a big help if you're contacting many suppliers at the same time.

Boldface type and page references steer you toward catalog pages on the products you're seeking that are bound in Volumes 2 or 3. And there are symbols to verify that the company really makes the product — not merely says it does.



WANT TO KNOW MORE ABOUT A COMPANY?

You'll find 7,528 manufacturers listed in *Electronic Design's* GOLD BOOK — more than twice the number contained in EEM. But there's more, too. In addition to complete address and phone number, whenever provided by the company you'll find:

TWX
TELEX
CABLE ADDRESS
FACSIMILE EQUIPMENT
(make and call number)
QPL DESIGNATION
FEDERAL STOCK CODE
NUMBER

NUMBER OF ENGINEERS
NUMBER OF EMPLOYEES
DOLLAR VOLUME
KEY OFFICIALS
SALES OFFICES
FOREIGN OFFICES
U.S. & FOREIGN REPS
U.S. DISTRIBUTORS

LOOKING FOR A DISTRIBUTOR NEAR YOU?

Check the Geographical Section of the GOLD BOOK's *Distributors Directories*. You enter the section by state, then find your city — or one nearby — and the distributors located in that city. You can then go to the Alphabetical Section to find the complete address, zip, and phone. In most cases annual sales volume or net worth, year established, and names of key officials are included. (Distributors are also listed after the companies they represent in the *Manufacturers Directory*.)

LOOKING FOR A FOREIGN REPRESENTATIVE?

A good rep nowadays is hard to find. It's even harder to know where to start, especially if your company is looking for a rep overseas. Do your sales manager a favor and tell him that foreign reps are listed after each company in the *Manufacturers Directory*. (If you are an overseas subscriber, chances are you've already found this section very useful.)

GOLD BOOK

INFORMATION SYSTEM

**KNOW THE TRADE NAME BUT
NOT THE MANUFACTURER?**

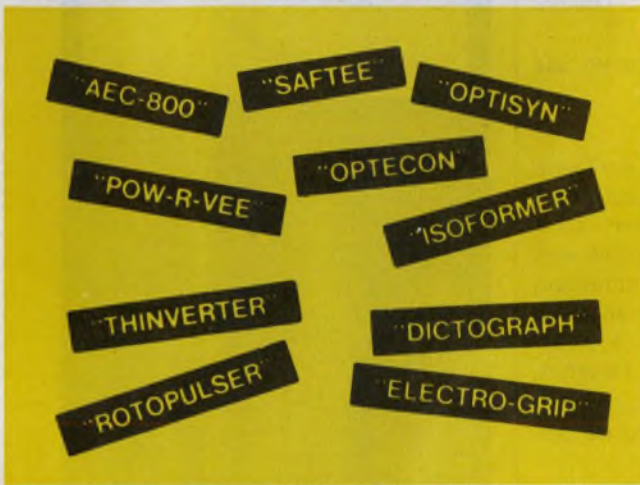

If you've always thought of a product in terms of its trade name, there's an easy way to find out what it is and who makes it. Check the GOLD BOOK's *Trade Names Directory*. Over 4,600 trade names are included from "A. P. Bondeze" to "Zoomator." You can then turn to the *Manufacturers Directory* for more information.

DID WE MISS SOMETHING? LET US KNOW ABOUT IT

The 1975-76 GOLD BOOK directories will be even more complete; more useful than our first edition. Has your company changed its address, phone, product lines or reps? Be sure your ad manager up-dates your listings. Better yet, if you know of any changes that should be made, drop a note to:

George Weingarten, Editor
Electronic Design's GOLD BOOK
50 Essex Street, Rochelle Park,
New Jersey 07662



CATALOG DATA FOR IMMEDIATE ACTION

Before you contact a supplier, check the catalog pages in the GOLD BOOK. The product information you need may already be at your fingertips. There are 2,820 catalog pages in all—more than any other industry directory. In some cases the specification data included in these pages may be sufficient to enable you to place your order. In others, the information can shorten the time required for you to discuss your specific needs.

WHEN YOU HAVE THE GOLD BOOK YOU DON'T NEED ANY OTHER INDUSTRY DIRECTORY

Research studies show that 99% of your fellow engineers rate the GOLD BOOK equal or *superior* to other industry directories. It's the "in" directory—the one that's being used and referred to. It's clearly the choice of engineers throughout the U.S. and overseas.

LOOK FIRST IN ELECTRONIC DESIGN'S GOLD BOOK

**BIGGEST, MOST COMPREHENSIVE
ELECTRONICS MASTER CATALOG
& DIRECTORY IN THE WORLD**

about
5¢/yr.*
 buys a lot
 of reliability
 with
 Angstrom's
 new
SAR,
 20 year
 end-of-life
 precision
 metal film
 resistors!



*Based on a typical
 cost of \$1.00 each



**angstrom
 precision, inc.**

one precision place
 hagerstown, maryland 21740
 telephone: 301-739-8722
 twx: 710-853-6834

application notes

Temperature measurement

"1975 Temperature Measurement Handbook and Catalog" lists over 6000 temperature measurement products. Over 25% of its 160 pages are devoted to basic temperature measurement data, including the latest NBS tables for thermocouples in 1° increments, in both C and F. Omega Engineering, Stamford, CT

CIRCLE NO. 384

Acoustic coupling

Application ideas for performing automatic polling and message exchange, computer time sharing, terminal-to-terminal and terminal-to-computer communications using an automatic acoustic coupler are outlined in a four-page brochure. Omnitec, Phoenix, AZ

CIRCLE NO. 385

Voltage testing

"Basic Facts About Voltage Testing" covers the whys and hows of high voltage testing, as well as information on leakage testing. Slaughter Co., Ardmore, OK

CIRCLE NO. 386

SCRs

Parameters, specifications, ratings and characteristics of SCRs are discussed in an application note. International Rectifier, Semiconductor Div., El Segundo, CA

CIRCLE NO. 387

Characterize logic circuits

Newly developed digital simulation software for the Model 9830A desktop calculator reduces the time it takes an engineer to verify logic behavior. This digital simulation pac is described in a six-page brochure. Each pac includes magnetic cassettes of ready-to-use prerecorded programs, a keyboard template and an instruction manual. Hewlett-Packard, Palo Alto, CA

CIRCLE NO. 388

HOW TO SOLVE DIP REED RELAY PROBLEMS FOR UNDER A BUCK!



High contact resistances, changing resistances and excessive contact bounce are usually traceable to the high molding pressures and temperatures used in making DIP reed relays. High unit costs and long delivery times are inherent in the DIP reed relay molding processing itself.

Electronic Application's new Low Profile Reed Relays solve all of these problems. Fully encapsulated and vacuum impregnated, the bubbles often found in DIP reed relays are also eliminated so now you can get an honest -55° to +85° operating temperature range. Only .28" high, they're ideal for close to the board spacing. Order them with 5 volt coil operation with a 500 ohm resistance for TTL requirements or in 1 and 3 volt versions for new CMOS requirements. Contacts in both versions are capable of up to 10 watts, ½ amp and 30 volt switching.

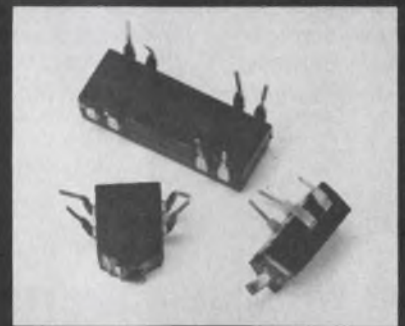

DIP REED RELAY PROBLEMS SOLVED

FROM STOCK — .97¢ ea.
 (250,000 level)

FREE

5 Volt samples to
 letterhead requests



ELECTRONIC APPLICATIONS CO.
 2213 Edwards Avenue
 So. El Monte, CA 91733 • (213)442-3212

EAGLE

SINCE



1843

PICHER

Carefree[®]
RECHARGEABLES

LEAD-ACID BATTERIES

- SEALED ● RUGGED
- NO MAINTENANCE
- SAFE ● SPILL-PROOF
- WIDE TEMPERATURE OPERATING RANGE
- LONG LIFE



RELIABLE ECONOMICAL
RECHARGEABLE POWER
for

- Alarm Systems
- Emergency Lighting
- Electromedical Apparatus
- Telephone Carrier Equipment
- Portable Television
- Communication Equipment
- Portable Instrumentation
- Computer Standby Systems
- And Many More

To Find Out How to Make
Your Battery System

Carefree[®]

Call or Write

EAGLE-PICHER INDUSTRIES, INC.
Commercial Products Dept. ED
P.O. Box 130, Seneca, Mo. 64865
Telephone (417) 776-2258

new literature

Panel meters

Specifications, photos and schematics highlight a four-page panel meter catalog. Imtronics, Ronkonkoma, NY

CIRCLE NO. 389

110 & 125-A-rms SCRs

A series of 110 and 125-A-rms silicon controlled rectifiers is described in a data sheet. The literature contains 27 graphs, two dimensional drawings and a photograph. Ratings and specifications are provided. International Rectifier, El Segundo, CA

CIRCLE NO. 390

Motors and gearmotors

Fractional horsepower motors and gearmotors are covered in a 36-page catalog. Detailed rating tables, performance curves, specifications, application data, dimensional drawings and ordering information are provided. Howard Industries, Milford, IL

CIRCLE NO. 391

pH instruments

A 28-page illustrated catalog includes two recently introduced products—the Model 119 digital pH meter with pushbutton calibration and a low-cost laboratory reference electrode. Divided into four sections, the catalog provides physical and performance specifications for 11 pH meters and 77 electrodes. Five strip chart recorders and accessories for pH meters, electrodes and recorders are described. Corning Glass Works, Corning, NY

CIRCLE NO. 392

Charge-coupled devices

Basic operation and uses of the CD100, a 100-element linear CCD, are featured in a 12-page booklet and supplemental data sheets. Schematic diagrams accompany the text. Prices are included. GEC Semiconductors, Middlesex, England

CIRCLE NO. 393

CUSTOM POWER SUPPLIES FROM OFF-THE-SHELF SUB-MODULES



Over 1200
configurations of
miniaturized, high efficiency
AC-DC & DC-DC Regulated
Power Converters using stan-
dard sub-modules . . . only from
Arnold Magnetics!

Our exclusive off-the-shelf thin-mods let you design your own custom power conversion systems as you order. There's no engineering cost, no lost design time, and no long delivery schedules.

All this, plus super performance. AC (115 VAC, 50-500 Hz) and DC (12, 28, 48 and 115 VDC) inputs . . . multiple isolated and regulated (to .1%) outputs . . . up to 120 watts per output . . . 3.9 watts delivered per cubic inch . . . efficiencies to 85% . . . short circuit and transient protection.



Your complete Power
Conversion System
is provided in a
tested and encap-
sulated miniatur-
ized, conduction
cooled package.

Call us collect . . . ask for Mark Warren.
We'll have our easy-to-use Specification
Form and our new Catalog in the mail to
you today!



ARNOLD MAGNETICS
CORPORATION

11520 W. Jefferson Blvd.
Culver City, Ca. 90230 ● (213) 870-7014

"THE HOW AND WHY OF REAL-TIME SPECTRUM ANALYSIS OF NOISE AND VIBRATION"

500-line UBIQUITOUS real-time SPECTRUM ANALYZER CALCULATOR with built-in dual memory averager



New 16-page brochure on latest Ubiquitous® 500-line Real-Time Spectrum Analyzer/Calculator UA-500A-1 contains complete application data & a "how to" section. The "why" explains the need for resolution, real time, & averaging. The "how to" section solves typical analysis problems: "how to be sure correct data is being analyzed," "how to analyze transients," "how to interface to a computer," "how to cancel background noise," "how to analyze rotating machinery."

Model UA-500A-1 is specifically designed to simplify machine diagnosis, rotating machine analysis, noise source identification, mechanical signature comparisons, underwater signal analysis, & noise reduction. Includes such features as automatic harmonic identification, direct digital readout in RPM, & the ability to make relative amplitude & frequency measurements digitally.

Demo, circle 121
Lit., circle 122

Nicolet Scientific Corp. (formerly Federal Scientific)
245 Livingston Street, Northvale, New Jersey 07647
(201) 767-7100. TWX: 710-991-9619

Share in the nation's top managerial policies, strategies, techniques . . . MANUFACTURING MANAGEMENT SYSTEMS

New Challenges and Opportunities Edited by Fred Gruenberger



By crystallizing the results of the 1973 Informatics/UCLA Symposium, this book offers a powerful blend of technical and managerial expertise for enhancing the overall success and profitability of today's manufacturing management systems. Some of the nation's top industrial and technical leaders speak freely and in depth of their organization's objectives and specific operations, as well as their personal strategies and methods. You'll find the newest computerized tools available to manufacturers . . . crucial managerial skills for directing progressive systems . . . the tact and care needed for the sensitive human problems of system implementation, and more. #5940-x, 160 pages, \$10.50. Circle the Info Retrieval No. to order a 15-day exam copy. When billed, remit or return book. No obligation.

CIRCLE NO. 175

Hayden Book Company, 50 Essex St., Rochelle Pk, N.J. 07662

VERSATILE VECTOR VOLTMETER



The Princeton Applied Research Model 129A Two Phase Lock-in/Vector Voltmeter permits simultaneous measurement of magnitude and phase angle even if the signal is masked by background noise. Flip a switch and measure the I and Q components of the vector; independent output expansion, offsetting, and filtering of each component are also provided. Full scale sensitivity ranges from 1 microvolt to 0.25 volts and is extendable to 25 volts with the optional compensated attenuator. Model 186/41. The Model 129A reference channel has fully automatic reference tracking capability and is phase matched to the signal channel over the operating range 0.5 Hz to 100 kHz. Complete specifications are contained in our Lock-in Amplifier Catalog No. T218.

CIRCLE NO. 173

Princeton Applied Research Corporation

P.O. Box 2565, Princeton, New Jersey 08540
609/452-2111.

See us at the IEEE Show - Booth #2509

ELECTRONIC DESIGN's function is:

- To aid progress in the electronics manufacturing industry by promoting good design.
- To give the electronic design engineer concepts and ideas that make his job easier and more productive.
- To provide a central source of timely electronics information.
- To promote communication among members of the electronics engineering community.

Want a subscription? ELECTRONIC DESIGN is sent free to qualified engineers and engineering managers doing design work, supervising design or setting standards in the United States and Western Europe. For a free subscription, use the application form bound in the magazine. If none is included, write to us direct for an application form.

If you do not qualify, you may take out a paid subscription for \$30 a year in the U.S.A., \$40 a year elsewhere. Single copies are \$1.50 each.

If you change your address, send us an old mailing label and your new address; there is generally a postcard for this bound in the magazine. You will have to requalify to continue receiving ELECTRONIC DESIGN free.

The accuracy policy of ELECTRONIC DESIGN is:

- To make diligent efforts to ensure the accuracy of editorial matter.
- To publish prompt corrections whenever inaccuracies are brought to our attention. Corrections appear in "Across the Desk."
- To encourage our readers as responsible members of our business community to report to us misleading or fraudulent advertising.
- To refuse any advertisement deemed to be misleading or fraudulent.

Microfilm copies are available of complete volumes of ELECTRONIC DESIGN at \$19 per volume, beginning with Volume 1, 1952 through Volume 20. Reprints of individual articles may be obtained for \$3.00 each, prepaid (\$.50 for each additional copy of the same article) no matter how long the article. For further details and to place orders, contact the Customer Services Department, University Microfilms, 300 North Zeeb Road, Ann Arbor, Michigan 48106 telephone (313) 761-4700.

Want to contact us? If you have any comments or wish to submit a manuscript or article outline, address your correspondence to:

Editor
ELECTRONIC DESIGN
50 Essex Street
Rochelle Park, N.J. 07662

classified ads

BUY SELL MODULES CARDS BOARDS MICRO PACS IBM - UNIVAC DEC - CDC - HISI

617-261-1100
AMERICAN USED COMPUTER CORP.
P.O. Box 68, Kenmore Sta., Boston, MA 02215
member COMPUTER DEALERS ASSOCIATION

CIRCLE NO. 291

NEW SERIES OF LIQUID CRYSTAL WORKSHOPS

2-DAY CHOLESTERIC
May 6-7, 1975

2-DAY NEMATIC TECHNOLOGY
May 13-14, 1975

1-DAY LIQUID CRYSTAL DISPLAYS
May 15, 1975

CONDUCTED IN PITTSBURGH, PA.
BY JAMES FERGASON AND STAFF

FOR FURTHER INFORMATION OR BROCHURE:
THE PENNSYLVANIA STATE UNIVERSITY
CONTINUING EDUCATION
3550 SEVENTH STREET ROAD
NEW KENSINGTON, PA. 15068
412-362-1012

CIRCLE NO. 292

FREE ALARM CATALOG

Full line of professional burglar and
fire alarm systems and supplies. 96
pages, 450 items. Off the shelf delivery,
quantity prices.



mountain west alarm
4215 n. 16th st., phoenix, az. 85016

CIRCLE NO. 293

STRETCH YOUR BUDGET!

Reconditioned Scopes, SS Power
Supplies, Freq. Counters & Gener-
ators - Many others. Send for our:
"Bargain Bulletin"

Lawrence Instruments, Sunbury PA

CIRCLE NO. 294

ELECTRONIC DESIGN 7, April 1, 1975

Electronic Design

Advertising Sales Staff

Tom W. Carr, Sales Director

Rochelle Park, NJ 07662

Robert W. Gascoigne
Daniel J. Rowland

(Recruitment, Quick Ads, Classified)

50 Essex Street
(201) 843-0550
TWX: 710-990-5071

Philadelphia

Thomas P. Barth
50 Essex Street
Rochelle Park, NJ 07662
(201) 843-0550

Boston 02178

Gene Pritchard
P.O. Box 379
Belmont, MA 02178
(617) 489-2340

Chicago 60611

Thomas P. Kavooras
Berry Conner, Jr.
200 East Ontario
(312) 337-0588

Cleveland

Thomas P. Kavooras
(Chicago)
(312) 337-0588

Los Angeles 90045

Stanley I. Ehrenclou
Burt Underwood
8939 S. Sepulveda Boulevard
Suite 510

Los Angeles, CA
(213) 641-6544

San Francisco 94022

Jerry D. Latta
P.O. Box 1248
Los Altos, CA
(415) 965-2636

London, Amsterdam, Tokyo, Seoul

John Ashcraft
12, Bear St.
Leicester Square
London WC2H 7AS England
Phone: 01-930-0525

W. J. M. Sanders
John Ashcraft & Co.
Herengracht 365
Amsterdam C., Holland
Phone: 020-24-09-08

Haruki Hirayama
Electronic Media Service
5th Floor, Lila Bldg.,
4-9-8 Roppongi
Minato-ku, Tokyo, Japan
Phone: 402-4556

Cable: Electronicmedia, Tokyo

Mr. O-kyu Park, President

Dongbo Int'l Corp.—
World Marketing
C.P.O. Box 4010
Seoul, Korea
Tel: 76-3910/3911
Cable: DONGBO SEOUL
Telex: EBKOREA K27286

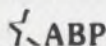

The Ultimate in Ignition Systems!

★ **ELIMINATES BREAKER POINTS.**
Perfect Timing and Dwell never change!

★ **Eliminates Tune-ups.**
Never wears out or needs any Maintenance.



★ The Most Advanced "OPTO-ELECTRIC SYSTEM"

● The Allison Breakerless System eliminates the Points and Condenser, replacing them with an Opto-Electronic Trigger, using a Light-Emitting Diode and Phototransistor. Also completely eliminates wiper-arm "friction" wear. The only "TRUE" Electronic Ignition... that you can install for under \$100. Gives 40-times more Timing Accuracy than ANY system using mechanical Breaker-Points! Unlimited RPM. Smoother running. (No timing fluctuation as with Magnetic units). Unaffected by Temperature, Moisture, or Vibration! All Solid-State Components. Easier Starting under any condition! Increased Horsepower. Sparkplugs last longer. Perfect timing increases engine Efficiency and Gas Mileage up to 30%!

● **Quick and Easy Installation!**

★ **Tested and Proven reliability.**

Only **\$49.95** ● **SATISFACTION GUARANTEED!**

● Complete. ● **1-YEAR FACTORY WARRANTY.**

(State Make, Year, Engine Size). (Calif. Res. add Tax).

● **CONVERT YOUR "C-D" UNIT TO BREAKERLESS!**
"TRIGGER-UNIT" ONLY \$34.95

★ **Send Postcard for FREE BROCHURE Today.**

ALLISON AUTOMOTIVE CO.

P.O. Box 881-F, TEMPLE CITY, CAL. 91780

INFORMATION RETRIEVAL NUMBER 117

DIGITAL DISPLAY

WHEN THE BLOCK READS "DIGITAL DISPLAY" ...don't get involved!

Let us fill the block for you.

When your lead time is short, our off-the-shelf PDC series display modules can save you time and money on moderate volume or prototype applications. We have modules in a wide range of digit sizes. They include LED, incandescent, and seven-segment numeric as well as dot-matrix alphanumeric. They're pre-wired for BCD logic and are ready to mount to your panel with just two screws. Ask for our catalog.

In fact, contact us whatever the requirements of that digital display block may be: we also design and produce custom systems. We are digital display specialists and thrive on involvement.

Precision Dynamics Corporation
3031 Thornton Ave. • Burbank, CA. 91504
(213) 845-7606

INFORMATION RETRIEVAL NUMBER 118



Thin-Trim variable capacitors provide a reliable means of adjusting capacitance without abrasive trimming or interchange of fixed capacitors. Series 9401 has high Q's and a range of capacitance values from 0.2-0.6 pf to 3.0-12.0 pf and 250 WVDC working voltage. Johanson Manufacturing Corporation, Boonton, New Jersey (201) 334-2676.

INFORMATION RETRIEVAL NUMBER 601

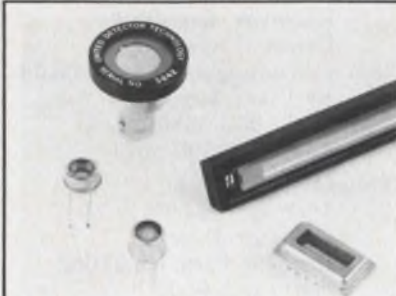

UDT offers a complete line of silicon photodiodes. Schottky for large area and enhanced UV responsivity, planar diffused for low noise and extended responsivity, photops (detector/amplifier combinations), special arrays and detectors to customer specifications. United Detector Technology, 2644 30th St., Santa Monica, Ca. 90405 (213) 396-3175.

INFORMATION RETRIEVAL NUMBER 604



Atomic Frequency Standard Model FRT for Lab/Field. Output 10-5-1 0.1 MHz, Short Term Stability $< 1 \times 10^{-11}$, $\tau = 1s$, $< 1 \times 10^{-12}$ $\tau = 100s$. Drift typ $1 \times 10^{-11}/M$. Coupled with Receiver-Controller EFR. Sync to Standard Freq absolute freq parts in 10^{12} . Efratom Calif., Inc., 3303 Harbor Blvd., E1, Costa Mesa, Ca. 92626 (714-556-1620)

INFORMATION RETRIEVAL NUMBER 607



Unique New Programmable Generator features multiple function capability. Program as digital pulse or word generator. Programmable time from 50ns to .999 sec. External trigger, 8 or 16 output channels, ROM option, computer interface, expandable memory. Interface Technology, 627 Fremont Ave, South Pasadena, CA 91030 (213) 682-3705

INFORMATION RETRIEVAL NUMBER 602



Introduction To Defense Radar Systems Engineering. Excellent introduction and practical reference to radar systems design and applications. #9194, 260 pp., \$22.95. Circle the Info Retrieval No. to order 15-day exam copy. When billed, remit or return book with no obligation. Hayden Book Co. 50 Essex St. Rochelle Park, N.J. 07662

INFORMATION RETRIEVAL NUMBER 605



IM-LITE Lamp Assembly THE LOWEST COST LAMP ASSEMBLY IN THE INDUSTRY

- 10,000 Hour Life
- UL/CSA Leads
- Wide Range of Voltage and Current
- Incandescent and Neon
- No Tools Required for Installation
- Lens Press Fits in Panel
- Lenses in Full Range of Colors
- Tamper Proof Housings

INTRONICS INDUSTRIES, LTD.
813 2nd St., Ronkonkoma, N.Y. 11779
(516) 981-3434

INFORMATION RETRIEVAL NUMBER 608



S190/S410 Switchlights. Low cost 2 Form C Mom. & Alt. action; Dual wiping contacts. Rating 100,000 cycles @ 2 amp res., 0.5 amp ind., 30 VDC & 125 VAC. Quick connect & solder terminals. Snap-in & rear panel mount. 10-amp power switch UL listed. Varied lens shapes. Clarendar Co., Box 785, Post Falls, ID (208) 773-4541

INFORMATION RETRIEVAL NUMBER 603

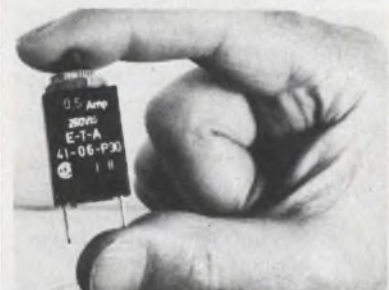

Overcurrent Protector, manual reset eliminates fuse replacement. Convenient panel mounting. 15 fractional ratings from 0.1 to 3 amp. Other models up to 400 amp. Trip-free and fool-proof, UL and CSA approved. High quality, low cost \$1.29 ea. in 1000 lots. E-T-A Products Co. of America, 7400 N. Crounse Rd., Chicago, Ill. 60648. Tel: (312) 647-8303. Telex: 253780.

INFORMATION RETRIEVAL NUMBER 606

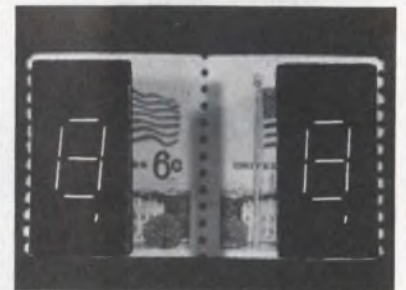

The Proven Incandescent Readout Standard 16 Pin DIP Flat Pack. All units 5 Volt 100,000 hrs. plus 3015F-BM 08ma/seg 700 ft/lam 3015F-BM10 10ma/seg 1700 ft/lam 3015F-BM15 15ma/seg 4500 ft/lam Field tested over 4 years in many applications. READOUTS, INC. P.O. Box 149, Del Mar, Ca. 92014 Tel. 714-755-2641 Telex 69-7992.

INFORMATION RETRIEVAL NUMBER 609



Contact United States Crystal Corporation for our new quartz crystal catalogue. It gives you the most up to date specifications on military CR numbers and information for designing and specifying crystals. Free engineering assistance on your crystal requirements. 3605 McCart St., Fort Worth, Texas 76110. (817) 921-3014.

INFORMATION RETRIEVAL NUMBER 610



MEMODYNE Incremental Digital Cassette recorders read, write, store alpha-numeric data at 50 cps in ASCII or 8-bit parallel. 72,000 character capacity. Low power (CMOS) for data logging, off-line terminals, microprocessors. Interfaces w/wide variety. Lit. avail. Memodyne Corporation, 369 Elliot St. Newton, Mass. 02164 617/527-6600 telex 922537

INFORMATION RETRIEVAL NUMBER 613

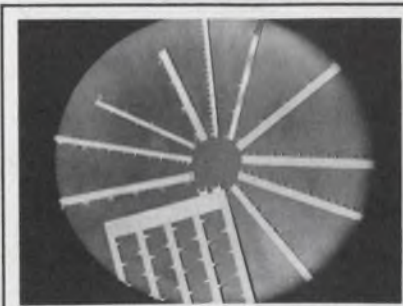

Mini/Bus® Evaluation Kit, \$25, in stock. Lets you try Rogers' low-cost, noise attenuating, high packaging density power distribution system for PC boards. Millions in use. Standard parts on 2 weeks delivery, or less! Customer parts 4 to 6 weeks delivery. Rogers Corporation, Chandler, Ariz. 85224. Phone (602) 963-4584

INFORMATION RETRIEVAL NUMBER 616



The "75WS15T" provides $\pm 15\text{Vdc}$ @ 150mA and an isolated 15Vdc @ 200mA with rem. sense. Sense current 200 μA ; Tempco 0.002%/°C; 1500V isolation; current foldback on all outputs, O.V.P. on X-Ducer supply; Price \$196.00; Del 2 wks. Other models avail—contact Semiconductor Circuits, Inc., 306 River Street, Haverhill, MA 01830, (617) 373-9104

INFORMATION RETRIEVAL NUMBER 611

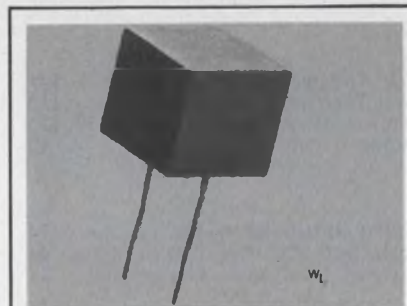

THE WL 451-T IS A HIGHLY LINEAR THERMISTOR. Using special semiconductor construction, the positive coefficient unit changes $+4.93 \Omega/\text{C}^\circ$. Special features include 1% tolerance, linearity $\pm 1\%$ from -25 to $+150^\circ\text{C}$. Epoxy-cast in a .435" cube. \$9.50 (1-9) Western Laboratories 728 S. Marengo, Pasadena, CA 91106 213-793-0148

INFORMATION RETRIEVAL NUMBER 614



Free catalog of 34,500 power supplies from the worlds largest manufacturer of quality Power Supplies. New '74 catalog covers over 34,500 D.C. Power Supplies for every application. All units are UL approved, and meet most military and commercial specs for industrial and computer uses. Power Mate Corp. (201) 343-6294.

INFORMATION RETRIEVAL NUMBER 617

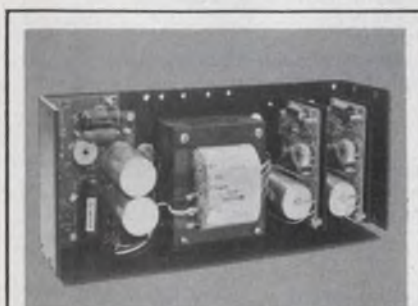

OPEN FRAME POWER SUPPLIES in single, dual or triple output feature IC control, copper shield in transformer, teflon wiring, and computer grade electrolytics. Options include 230 vac input, remote sense, and built-in OV protection. Dynage, Inc., 1331 Blue Hills Avenue, Bloomfield, Conn. 06002 203-243-0315

INFORMATION RETRIEVAL NUMBER 612



MODULAR DC/DC CONVERTERS offer 5 and 10 W dual output and 15 W single output with eff. from 55 to 68%. Regulation is 5 mv. Dual units allow rated power from one output. L/C filtering on both input and output for low noise. (1-9) from \$78.60. B. H. INDUSTRIES, 5784 Venice Bl., Los Angeles, CA 90019 (213) 937-4763

INFORMATION RETRIEVAL NUMBER 615



FREE PANEL METER CATALOG. Panel meters, stock or special. Available in a variety of sizes, 1-1/2" to 6", and styles... round, square, rectangular and edgewise. Special application meters also featured: Elapsed Time, VU Meters and Null Indicators. Jewell Electrical Instruments, Inc., Manchester, NH 03105, (603) 669-6400.

INFORMATION RETRIEVAL NUMBER 618



Complete Functions Offered on a Chip. High density monolithic thin film processing offers exceptional resistive performance for hybrid assembly. 250 standard variations available to .01% accuracy, tracking to 0.5ppm/°C. Analog Devices, Inc., Route 1 Industrial Park, P.O. Box 280, Norwood, Massachusetts 02062. Telephone: 617/329-4700.

INFORMATION RETRIEVAL NUMBER 619



Engineers! Stay Sharp The Easy Way. 10 problems and their solutions every month in an easily folded and carried pamphlet. Send \$20 for 12 monthly issues, or circle Info Retrieval No. for 15 day examination of current issue. When billed remit or return pamphlet with no obligation. Professional Exercises in Engineering, Box 2299, Sunnyvale, CA 94087

INFORMATION RETRIEVAL NUMBER 622

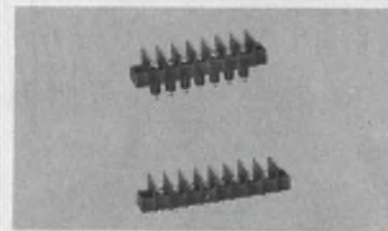

Compact Curtis Terminal Blocks of Unbreakable Thermo-Setting Plastic feature ultrasonically welded terminal inserts and full mechanical thread system. High-barrier CB/CFT blocks are rated 15 amp/300 volt with 5,500 volt breakdown. Feed-thru and surface-mount designs available. Curtis Industries, Inc., 8000 West Tower Avenue, Milwaukee, Wisconsin 53223, (414) 354-1500 or toll free (800) 645-9200 — New York call collect (516) 294-0990.

INFORMATION RETRIEVAL NUMBER 625



Custom made cases, cabinets and enclosures. Exceptionally rugged construction, laminated Formica-wood-Formica. Internally reinforced corners. Attractive wood grain or solid color exteriors. Superb workmanship, competitive prices, small or quantity lots. W. A. Miller Co., Inc., 306 Mingo Loop, Oquossoc, Maine 04964. Telephone: 207/864-3344.

INFORMATION RETRIEVAL NUMBER 620



Manufacturing Management Systems. Technical and managerial expertise to handle today's progressive manufacturing systems. #5940-X, 160 pp., \$10.50. Circle the Info Retrieval No. to order 15-day exam copy. When billed, remit or return book. No obligation. Hayden Book Company, 50 Essex St., Rochelle Pk. N.J. 07662.

INFORMATION RETRIEVAL NUMBER 623



SYNCHRO TO BCD CONVERTERS: 3 or 4 decade, unipolar or bipolar output adjustable scale factor, ± 6 or ± 30 minute accuracy, 60 or 400 Hz input, zero offset adjustment, module 2.6 x 3.1 x .82" H. Unit price from \$395/ea. Computer Conversions Corp. East Northport, N.Y. 11731 (516) 261-3300

INFORMATION RETRIEVAL NUMBER 626



Basic Engineering Sciences & Structural Engineering for E-I-T Exams. Sampling for test problems makes the best preparation yet for exams. #5712-1, 424 pp., \$17.20. Circle the Info Retrieval No. to order 15-day exam copy. When billed, remit or return book with no obligation. Hayden Book Co., 50 Essex St., Rochelle Pk., N.J. 07662

INFORMATION RETRIEVAL NUMBER 621



IMTRONICS METERS

Imtronics is a leading manufacturer of meters offering the electrical and electronics industry a wide selection of meters featuring high quality at minimum cost.

- LEVEL METERS
- BALANCE METERS
- BATTERY CHECKERS
- TUNING METERS
- S METERS
- DC CURRENT & VOLTAGE METERS

IMTRONICS INDUSTRIES, LTD.
813 2nd St., Ronkonkoma, N.Y. 11779
(516) 981-3434

INFORMATION RETRIEVAL NUMBER 624

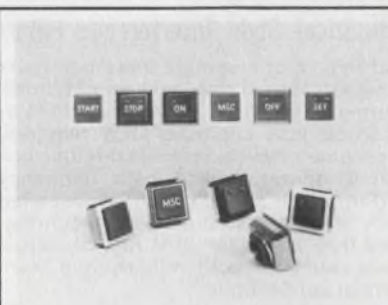

Touch Activators for solid-state switch circuits eliminate pushing, pulling, or flipping of switches. No moving parts; high reliability. A mere touch of finger activates switch circuit. Interface with CMOS, TTL, DTL, and HTL. Snap-in panel mounting. Lighted or unlighted. Master Specialties, 1640 Monrovia, Costa Mesa, Calif. 92627.

INFORMATION RETRIEVAL NUMBER 627



unwanted

noise or signals
effectively reduced
or eliminated
with



Rtron

Cylindrical Style Interference Filters

that reduce or eliminate unwanted noise or signals. Small size, light weight, maximum attenuation. Voltage current or insertion loss characteristics required, determine physical size. Maximum isolation of terminals and high frequency performance are assured by threaded neck design for bulkhead mounting. Feed-thru capacitor circuitry conservatively rated for both military and commercial applications.

See us at Booth 1226

IEEE Show or write.

Rtron corporation
P.O. Box 743 Skokie, Illinois 60076
Phone 312 • 679-7180

INFORMATION RETRIEVAL NUMBER 119

product index

Information Retrieval Service. New Products, Evaluation Samples (ES), Design Aids (DA), Application Notes (AN), and New Literature (NL) in this issue are listed here with page and Information Retrieval numbers. Reader requests will be promptly processed by computer and mailed to the manufacturer within three days.

Category	Page	IRN	Category	Page	IRN
Components			VOMs	129	74
capacitors	32	271	voltage calibrator	76	342
capacitors	78	46	Integrated Circuits		
capacitors	133	76	op amps	IV	264
capacitors	138	81	Microwaves & Lasers		
capacitors	140	85	bridge, reflection	150	377
power transformers	127	73	connectors	151	382
reed relays	154	114	filters	151	381
relays	85	53	oscillator, YIG	150	380
relays	89	57	rotary joints	150	378
resistors	79	47	signal generator	151	383
resistors, discrete film	II	262	TWTs	91	353
switch, DIP	68	34	test unit	150	379
switch, toggle	III	263	tuners	91	354
switches	143	91	Modules & Subassemblies		
switches	151	111	amplifier, wideband	144	365
thermal cutoffs	81	50	conditioner, signal	145	368
timers	139	83	converter, v/f	144	364
transformers	69	35	hybrids	72	38
Data Processing			ignition systems	157	117
buffer, data	137	356	image sensing	145	369
calculator, prog	137	321	measurement and control products	91	59
calculator, prog	138	322	op amp, modular	80	305
computer	93	62	oscillator, clock	145	367
data logger	138	324	reference, voltage	82	351
memory, disc	138	358	sensors, motion	82	350
microcomputer	137	323	stations, auto/manual	144	363
plotter	141	87	timer, programmable	144	366
printer, column	137	320	Packaging & Materials		
printer, serial	137	357	beryllium springs	131	75
synthesizer, speech	137	355	cabinets	136	80
tape reader	151	112	chamber, magnetic	149	375
voice-response unit	138	325	connector, triaxial	88	352
Discrete Semiconductors			enclosures	33	15
isolators	7	6	enclosures, electronic	88	328
optocouplers	78	45	fiberglass tapes	150	109
power Darlingtons	73	39	filters	162	119
SCRs	149	108	hooks	76	43
zeners	70	36	IC board, wire-wrapping	88	331
Instrumentation			knobs and dials	67	33
calculating scope	72	301	magnetic shields	146	101
counter	70	302	PC boards	97	64
counter	140	339	pins	146	102
DMM	140	360	plating process, gold	146	370
DPM	142	338	screwdriver, automatic	148	371
digital filter	142	361	shrink tubing, Teflon	148	372
function generator	30	13	sockets	65	32
generator, sweep	142	362	sockets	89	330
IC tester	79	336	soldering tools	148	106
meter, analog-digital	76	347	terminal strip, PC	149	376
meter, panel	68	303	test chamber	89	334
microwave counter	76	346	test clip	70	115
oscilloscope, digital	25	10	test handler, DIPs	149	329
recorder, chart	76	348	Power Sources		
scope & DMM, portable	140	359	power inverters	139	84
scope, recorder	79	349	power supplies	6	5
signal generator	74	307	power supplies	83	52
spectrum analyzer	66	306			
spectrum analyzer	142	343			
synthesizer	78	337			
temp. indicator	78	340			

The first color-capped industrial toggle.

Introducing our new heavy-duty Designer Line switches with up to 20 amp, 2 hp, A-c and D-c ratings. Now you can color-code almost any function or simply use color to improve overall equipment appearance.

Select from nine distinctive lever styles, nine standard colors, two bushing lengths, as well as eleven color-coordinated decorator facenuts in two types.

You also choose from five switch bases, screw or plug-in terminals, single and double poles, plus a variety of circuit configurations.

The first color-capped industrial toggle switch gives you the new colorful choice for your heavy-duty applications. Contact your Cutler-Hammer Sales Office or Switch Distributor.



Designer Line—the broadest line of commercial toggle switches, ratings up to 8 amps, A-c and D-c, and 15 amps A-c. A rainbow of colors! Virtually unlimited combinations of toggle styles, circuits, colors.



CUTLER-HAMMER

SPECIALTY PRODUCTS DIVISION, Milwaukee, Wis. 53201

INFORMATION RETRIEVAL NUMBER 263



MOS/FET, bipolar and CMOS on the same chip...

The RCA CA3130 is ready to meet MIL-38510/883.

This highly versatile op amp is now available in High-Rel versions. Just a few months after commercial announcement.

So anyone involved with aerospace, military and critical industrial applications can take advantage of this major breakthrough.

Because of the CMOS output stage, a voltage swing to within 10 millivolts of either rail on a single power supply is now possible for the first time. Other principal features are: high open loop voltage gain: 110dB; low input offset voltage: 8mV; low input current: 5pA; very high input impedance: $1.5 T\Omega$ ($1.5 \times 10^{12}\Omega$); high slew rate: $10V/\mu s$; 2.5mW at 5V supply voltage; 22mA output.

The speed with which RCA converted this breakthrough technology into a High-Rel device illustrates our commitment to High-Rel Linear

ICs. Further evidence of this is the separate organization devoted exclusively to High-Reliability ICs; by our MIL-M-38510 approved production facility in Findlay, Ohio; by the full Class A, B and C processing to MIL-M-38510 and MIL STD. 883.

For the CA3130 High-Rel 8-page spec sheet, and a High-Reliability IC brochure, call your RCA Solid State distributor. Or RCA.

Write: RCA Solid State, Box 3200, Somerville, New Jersey 08876; Ste. Anne de Bellevue 810, Canada; Sunbury-on-Thames, U.K.; Fuji Bldg., Tokyo, Japan.

RCA



RCA. A full house in Linear ICs.