

The first 16-k bit CCD memory chip launches a new generation of increased-density storage ICs. Charge-coupled-device memories threaten electromechanical types

with obsolescence. In contrast with discs and drums, the CCDs need less power, work at higher speeds and require a fraction of the space. For more, see p. 100.

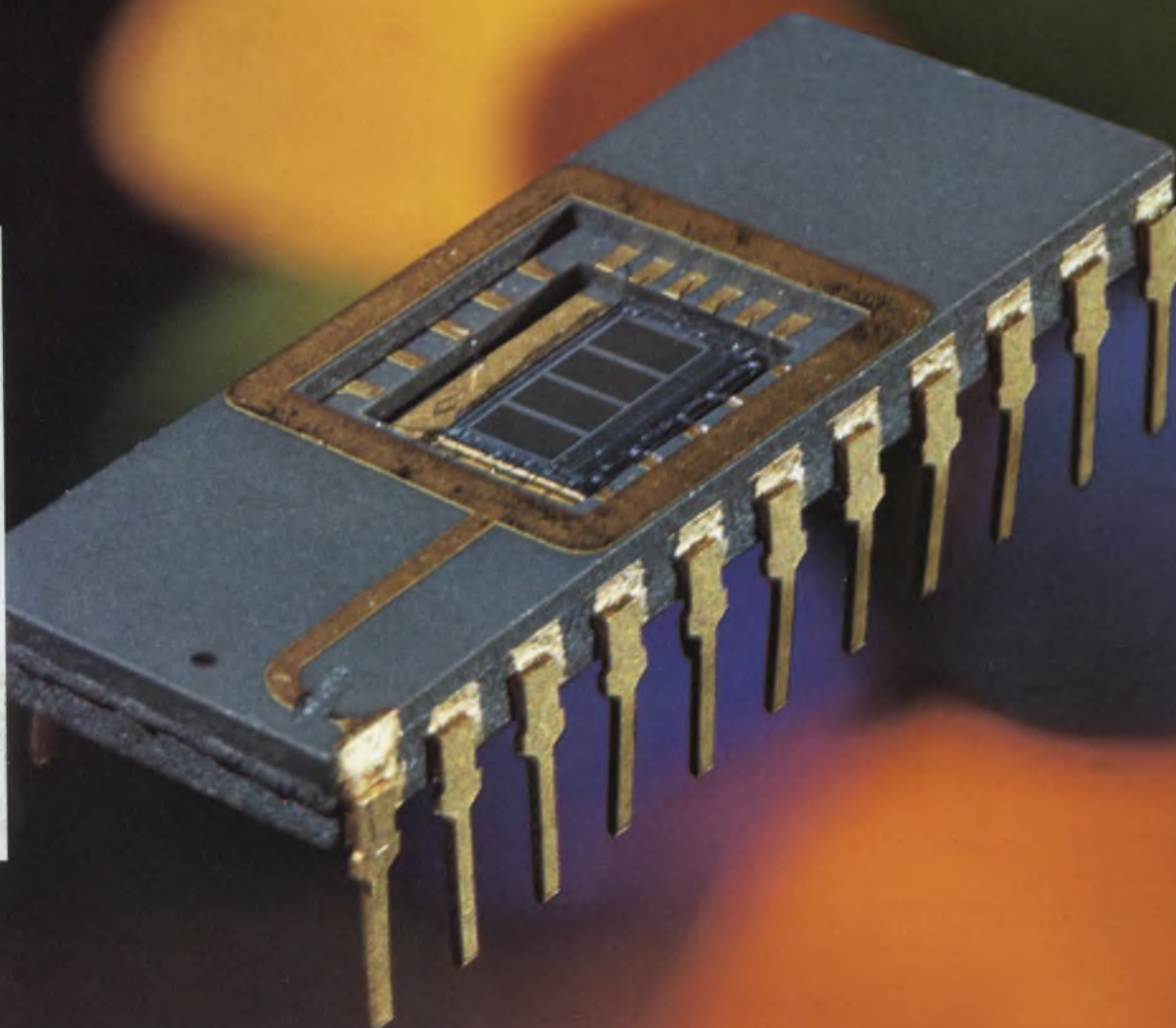

ultra-miniature transformers

1/4" X 1/4"

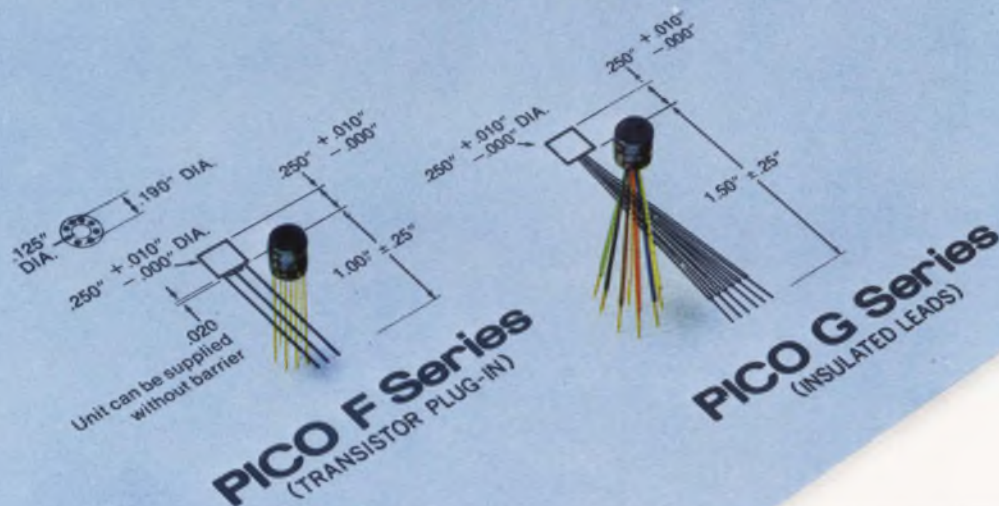

SPECIFICATIONS

- MIL-T-27D:** All Units Are Designed to MIL-T-27D and Are Hermetically Sealed in a Metal Case. PICO is a QPL source.
- Frequency Response:** ±3 db, 400 Hz-250 KHz at 1.0 milliwatt.
- Maximum Distortion:** 5% With Rated Power Level at 1 KHz.
- Dielectric Strength:** All Units Tested at 200 V RMS.
- Insulation Resistance:** Greater than 10,000 Megohms at 300 V DC.
- Weight:** 1.1 GRAMS.
- Operating Temperature:** -55°C to 105°C (All Units Can Be Supplied to Class S Requirements 130°C maximum).
- Terminals:** .012 Diameter Gold Plated Dumet Wire In Accordance With MIL-STD-1276 Type D. Leads May Be Welded or Soldered.
- Thermal Shock:** 25 Cycles, Method 107C, MIL-STD-202D, Test Condition A-1

PICO PART NUMBER F Series	PICO PART NUMBER G Series	PRIMARY IMPEDANCE OHMS	SECONDARY IMPEDANCE OHMS	POWER MILLIWATTS at 1 KHz	PRIMARY UNBALANCED DC CURRENT ma	PRIMARY DC RESISTANCE OHMS	SECONDARY DC RESISTANCE OHMS	MILITARY DESIGNATION
F5705	G6005	50	50	100	5.0	7.5	9.0	TF5RX17ZZ
F5710	G6010	100	100	100	5.0	15	18	TF5RX17ZZ
F5715	G6015	120 ct	3 2	100	4.5	15	0.75	TF5RX17ZZ
F5720	G6020	150 ct	12 split	100	4.0	20	2 4	TF5RX17ZZ
F5725	G6025	300 ct	600 split	100	3.0	40	90	TF5RX17ZZ
F5730	G6030	400 ct	400 split	100	2.5	54	58	TF5RX17ZZ
F5735	G6035	500 ct	50 split	100	2.0	62	10	TF5RX17ZZ
F5740	G6040	500	600	100	2.0	62	90	TF5RX17ZZ
F5745	G6045	600 ct	600 split	100	2.0	70	90	TF5RX17ZZ
F5750	G6050	900 ct	600	100	1.5	130	90	TF5RX17ZZ
F5755	G6055	1K ct	1K split	100	1.5	110	140	TF5RX17ZZ
F5760	G6060	1.5K ct	600 split	100	1.2	175	69	TF5RX17ZZ
F5765	G6065	2K ct	8K split	80	1.0	200	1000	TF5RX12ZZ
F5770	G6070	10K ct	500 split	80	0.5	1000	60	TF5RX12ZZ
F5775	G6075	10K	500	80	0.5	1000	60	TF5RX12ZZ
F5780	G6080	10K ct	1 2K split	80	0.5	1100	160	TF5RX12ZZ
F5785	G6085	10K	1 2K	80	0.5	1100	130	TF5RX12ZZ
F5790	G6090	10K ct	2K split	80	0.5	1100	250	TF5RX12ZZ
F5795	G6095	10K ct	10K ct	80	0.5	1100	1100	TF5RX12ZZ
F5800	G6100	10K	10K	80	0.5	1100	1100	TF5RX12ZZ
F5805	G6105	10K ct	10K split	80	0.5	1100	1100	TF5RX12ZZ
F5810	G6110	25K ct	1K split	50	0.3	2100	130	TF5RX12ZZ
F5815	G6115	25K	1K	50	0.3	2100	130	TF5RX12ZZ
F5820	G6120	30K ct	1.2K	50	0.3	2300	180	TF5RX12ZZ

Send today for PICO's Designers Kit!

PICO now offers a Designer's Kit containing ten (10) representational 1/4" x 1/4" transformers. The kit contains PICO's F5710 and G6025; F5730 and G6045; F5755 and G6065; F5770 and G6090; F5795 and G6110.

PICO's Designers Kit No. FG-100 . . . \$50.00 each

In addition to the 1/4" Series PICO offers over 600 other standard transformers to choose from.

Delivery - stock to one week . . . specials take a little longer - 9 days.

Send for free 36 page catalog.

INDUCTORS

PICO PART NUMBER F Series	PICO PART NUMBER G Series	INDUCTANCE HENRIES	DC CURRENT ma	DC RESISTANCE OHMS	MILITARY DESIGNATION
F5825	G6125	SERIES	10.0	0	2250
		PARALLEL	2.75	2	
			2.5	0	
F5830	G6130	PARALLEL	65	4	250
			SERIES	5.5	
		PARALLEL	1.5	2	
F5835	G6135	PARALLEL	1.3	0	60
			1.40	4	
		SERIES	85	1	
F5840	G6140	PARALLEL	25	6	144
			21	2	
		SERIES	6	0	
PARALLEL	15	0	15	36	
	04	10			

PICO Electronics, Inc.

50 South MacQuesten Pkwy., Mt. Vernon, New York 10551 • Telephone 914-699-5514

For immediate pricing and engineering information— call collect



For \$1,975 you have no right to expect a signal generator like this.

For \$1,975 you should have to settle for tubes, or for a non-phase-locked generator.

But here's the Wavetek 3000, so you can toss your expectations out the window. This solid state signal generator is not only phase-locked and accurate ($\pm 0.001\%$), it's programmable as well. And it covers the entire range from 1 to 520 MHz in a single band. Yet once we've

received your order, you can expect a signal generator like this one right away... for just \$1,975.

That may not be right, but it sure is reasonable.

SPECIFICATIONS

Frequency Range: 1-520 MHz
 Frequency Accuracy: $\pm 0.001\%$
 Resolution: 1 kHz
 Stability: Less than 0.2 ppm per hour
 Output Range: +13 dBm to -137 dBm
 Flatness: ± 0.75 dB

AM Modulation Range: 0-90%
 FM Deviation: 0-5 kHz and 0-500 kHz
 Internal Modulation Rates:
 400 Hz and 1 kHz

Dimensions:

12" wide x 5½" high x 13¼" deep
 Price: \$1,975

WAVETEK®

INDIANA INCORPORATED
 P.O. Box 190, 66 North First Avenue
 Beech Grove, Indiana 46107
 Tel. (317) 783-3221 TWX 810-341-3226

Resistor networks: we deliver through thick and thin.

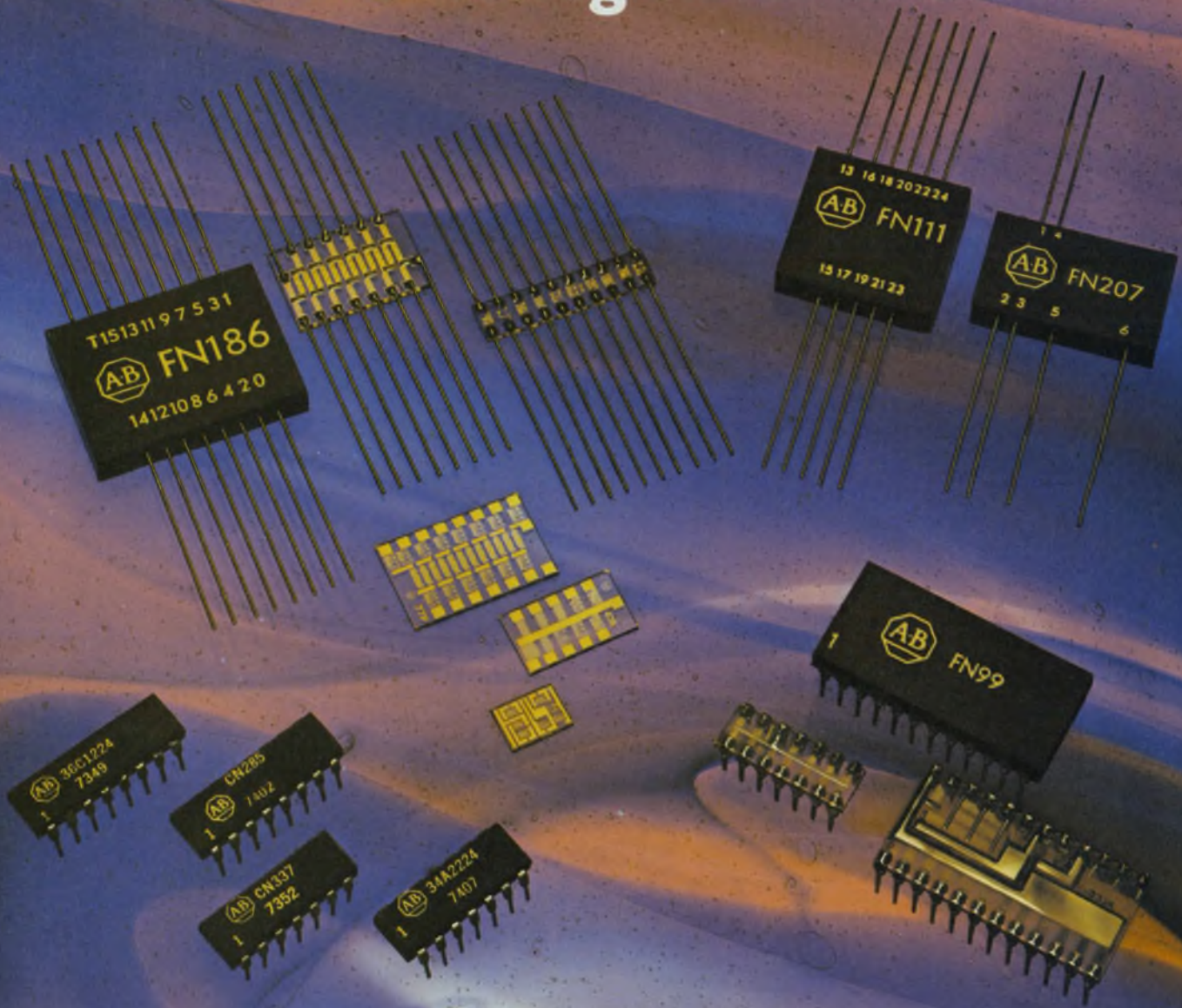

Seventeen years of film resistor experience combined with quality production capabilities give you prompt solutions to your network needs. Whether you require precision thin film or semi-precision thick film in prototype or mass production quantities. Thin film in chip, conformal coat, flat pack and DIP. Thick film in standard 14 and 16 pin DIPs with resistor or resistor/capacitor configurations. Popular pull-ups and terminators off-the-shelf. Contact your local A-B sales office or write for our 5800 series publications. Standard items are available through your appointed Allen-Bradley Electronics Distributor. Allen-Bradley Electronics Division, 1201 South Second Street, Milwaukee, WI 53204. International Division, Milwaukee, WI 53204. Canada: Allen-Bradley Canada Limited, Cambridge, Ontario. United Kingdom: Allen-Bradley Electronics, Limited, Jarrow, County Durham NE32 3EN.

SELECTED SPECIFICATIONS

	Thin Film	Thick Film
TCR	± 10 to ± 25 ppm/ $^{\circ}\text{C}$	± 100 and ± 250 ppm/ $^{\circ}\text{C}$
TCR tracking	± 5 ppm/ $^{\circ}\text{C}$	± 50 and ± 100 ppm/ $^{\circ}\text{C}$
Absolute tolerance	as low as $\pm 0.1\%$	as low as $\pm 1.0\%$
Matching or ratio tolerance	as low as $\pm 0.05\%$	as low as $\pm 2.0\%$
Resistance range	1K to 10 Megs (special 10 ohms to 50 Megs)	10 ohms to 1 Meg

If you're really serious about cost, be serious about quality.



ALLEN-BRADLEY

Milwaukee, Wisconsin 53204

INFORMATION RETRIEVAL NUMBER 3

EC85B

NEWS

- 19 **News Scope**
- 24 **That dazzling, dizzy Disney World** is run by computer.
- 26 **Electronic Music**—produced without conventional instruments and electro-mechanical devices—is incorporating the high notes of IC technology.
- 39 **Washington Report**

TECHNOLOGY

- 48 **FOCUS on component sockets:** A special report on sockets for a wide variety of electronics components, with a look at the problems faced by a designer who wants long-term, reliable circuit operation.
- 62 **Prevent low-level amplifier problems.** Commonplace components and assembly techniques can wreck performance. Here's how to maintain the precision you need.
- 70 **Design maintainability into equipment.** Here are some practical ways you can keep the servicing time low without increasing design or manufacturing costs.
- 76 **Cram data through voice-grade lines** with multilevel modulation and adaptive equalization. These techniques achieve modem data rates of 4800 bit/s or more.
- 82 **Select pin drivers cautiously** and you'll get an automatic tester that's both accurate and ready to meet future device needs.
- 86 **When phase-downs and layoffs come,** a company needs good engineer-management communications, judicious reassignments and after-hours training programs.
- 92 **Ideas for Design:** LED used as voltage reference provides self-compensating temp coefficient . . . Easy-to-build FM signal generator uses a phase-locked loop and an AM input . . . Convert 7-segment numerical code to decimal or BCD outputs.
- 98 **International Technology**

PRODUCTS

- 100 **Integrated Circuits:** CCD serial-memory capacity climbs to 16-k bits.
- 104 **Integrated Circuits:** Programmable voltage regulators handle high power in a miniature, 4-pin, package.
- 106 **Instrumentation:** 3-digit DPM reads rms of complex waveforms.
- 111 **Instrumentation:** Controller converts monitor to strip-chart 'recorder.'
- 118 **Discrete Semiconductors:** Gate turn-off SCRs handle up to 8.5 A.
- 112 Data Processing
- 116 Modules & Subassemblies
- 122 Packaging & Materials
- 126 Components

DEPARTMENTS

- 45 **Editorial:** The foreign engineer
- 7 Across the Desk
- 128 Application Notes
- 130 New Literature
- 135 Bulletin Board
- 140 Advertisers' Index
- 142 Product Index
- 144 Information Retrieval Card

Cover: Photo by Frank Melgar, courtesy of Intel, Santa Clara, CA

Build faster systems Intel's microcomp

Now you can build a limitless variety of high speed, high performance logic systems at low cost with a handful of Intel's new Schottky LSI microprogrammable computing elements. This is the first bipolar family with a total systems concept built into every part. Your system will be faster and far

INTEL'S SERIES 3000 SCHOTTKY LSI	
3001	MICROPROGRAM CONTROL UNIT
3002	CENTRAL PROCESSING ELEMENT
3003	LOOK-AHEAD CARRY GENERATOR
3212	MULTI-MODE LATCH BUFFER
3214	INTERRUPT CONTROL UNIT
3226	BIDIRECTIONAL BUS DRIVER
3601	1024-BIT BIPOLAR PROM (256X4)
3604	4096-BIT BIPOLAR PROM (512X8)
3301A	ROM (COMPATIBLE WITH 3601)
3304A	ROM (COMPATIBLE WITH 3604)
3106A	256-BIT RAM (THREE STATE)
3107A	256-BIT RAM (OPEN COLLECTOR)

more universal than hard-wired TTL, when you choose the right Series 3000 configuration for your product line. Our flexible, microprogrammable architecture lets you tailor system speed, size, logic functions, bus structures and data paths to your own needs.

And your design will cost much less than hard-wired TTL. Series 3000 LSI computing elements inexpensively replace 60 to 80 percent of the MSI/SSI components previously required in peripheral controllers, DMA channel controllers, mini-computer and midcomputer central processors, data communications concentrators and processors, industrial machines and process controllers, and other high-speed systems.

Each Central Processing Element is a complete 2-bit data processing slice with built-in functions that simplify system operation. The Microprogram Control Unit is a powerful state sequencer, used to select microinstruction sequences from microprogram memory.

More than 6.5 million microinstructions per second can be executed by the typical 16-bit central processor shown here. To further enhance throughput, multiple-bit data shifts, masking and bit testing, macroinstruction program counter maintenance, and basic register-to-accumulator operations have all been reduced to one microcycle.

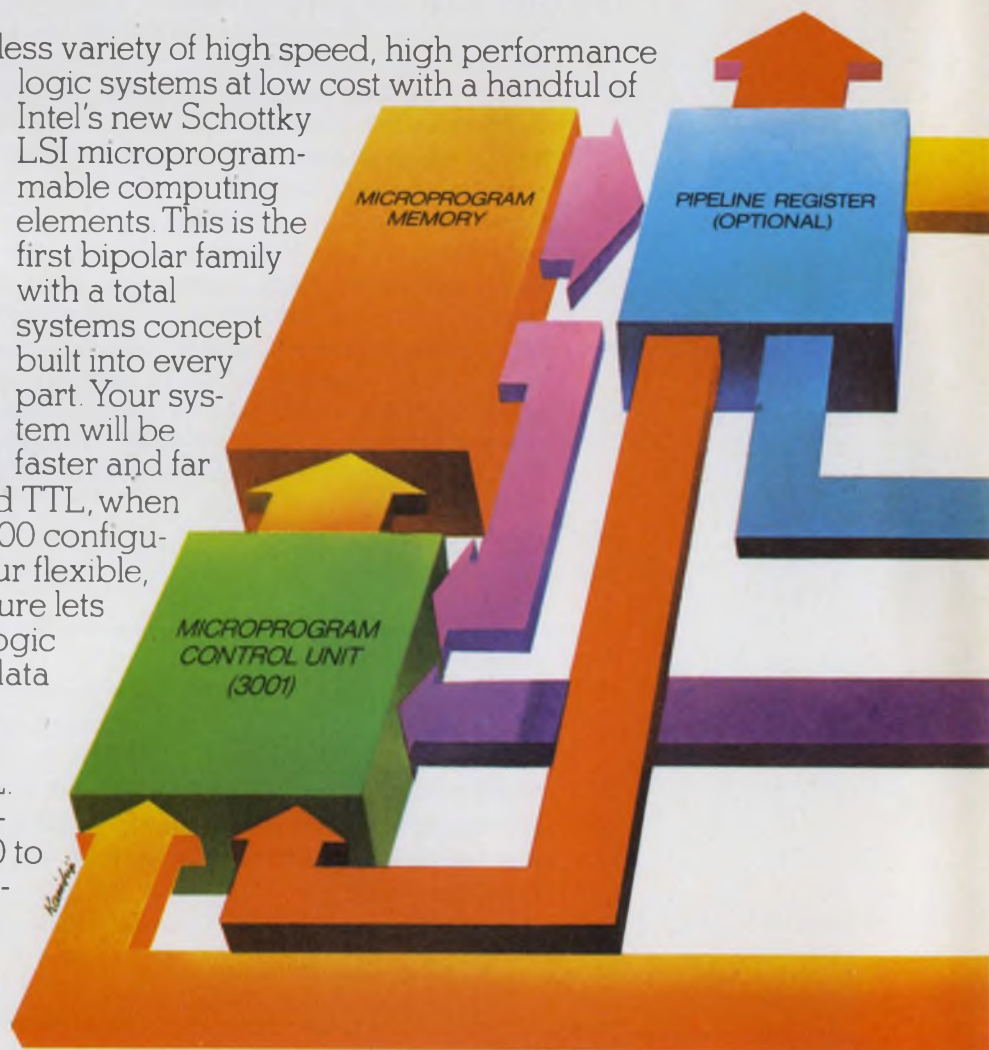

at half the cost with using bipolar LSI.

No external buffers or multiplexers are shown in the data bus structure because none are needed. The bus structure is variable and the Central Processing Array, microprogram memory, interrupt and I/O structure can be tailored to suit the application.

Start exploring your own logic universe with Intel's WF 3000 Bipolar System Development Kit.

It contains design aids, two Microprogram Control Units, ten Central Processing Elements and ten 3601 PROMs—more than enough Schottky LSI building blocks for a typical system. Our kit updating program also entitles you to receive without further charge, selected samples of new Series 3000 family members as they are announced in 1975 and priority mailings of additional design aids. The kit is available from your local Intel distributor for only \$570. We'll send you a Look-ahead Carry Generator, Interrupt Control Unit, Multi-mode Latch Buffer and Bidirectional Bus Driver directly and follow up with more samples later. Or, you can buy our Series 3000 computing elements in production volume and build high

performance systems for as little as half the cost of TTL. All elements are in stock.

For more information on Series 3000 Computing Elements, write Intel Corporation, 3065 Bowers Avenue, Santa Clara, California 95051.



intel® Microcomputers. First from the beginning.

FLAT INTERCONNECTS YOUR COMPLETE SOURCE

Ribbon Cable / IC Interconnects / Custom Harnesses

You're sold on flat cable, now buy it at its best. Precise, compact cable packages to fit your specifications perfectly, computer-loomed for unmatched versatility by Woven Electronics.

Handling ease of independent non-bonded leads speeds production, cuts cost, while technical characteristics outrank other flat cable forms.

Make Woven your source for jumpers, continuous rolls, special harnesses, all your interconnect needs.

WOVEN ELECTRONICS

P.O. Box 189 Mauldin, South Carolina 29622
803/963-5131



Vice President, Publisher

Peter Coley

Editors

Editorial Offices

50 Essex St.

Rochelle Park, NJ 07662

(201) 843-0550

TWX: 710-990 5071

Cable: Haydenpubs Rochellepark

Editor-in-Chief George Rostky

Managing Editors:

Ralph Dobriner

Michael Elphick

Associate Editors:

Dave Bursky

Jules H. Gilder

Morris Grossman

Seymour T. Levine

John F. Mason

Stanley Runyon

Edward A. Torrero

Richard L. Turmail

Contributing Editors:

Peter N. Budzilovich

Alberto Socolovsky

Nathan Sussman

Editorial Field Offices

East

Jim McDermott, Eastern Editor

P.O. Box 272

Easthampton, MA 01027

(413) 527-3632

West

David N. Kaye, Senior Western Editor

8939 S. Sepulveda Blvd.,

Suite 510

Los Angeles, CA 90045

(213) 641-6544

Northe K. Osbrink, Western Editor

112 Coloma St.

Santa Cruz, CA 95060

(408) 426-3211

Editorial Production

Marjorie A. Duffy

Art

Art Director, William Kelly

Richard Luce

Anthony J. Fischetto

Production

Manager, Dollie S. Viebig

Helen De Polo

Anne Molfetas

Christopher G. Hill

Circulation

Manager, Evan Phoutrides

Information Retrieval

Peggy Long

Promotion

Manager, Walter G. Salm

Karen Kerrigan (Reprints)

across the desk

APL language is alive and well

In your Oct. 25, 1974 issue, I was very interested in the large article on time sharing in engineering applications—and, in particular, network analysis ("Time Sharing: For Engineers Who Need Computing Punch Beyond That of the Calculator," ED No. 22, p. 56). I was surprised that I saw no mention of the programs for circuit analysis, which are up and running, alive and well, in the only programming language that is truly interactive. It allows the user to take output data, select what he wants, save selected portions, rows and columns to compare with previous runs, and so on.

The programs I refer to are MARTHA, copyrighted by MIT, and APLADDER, copyrighted by Scientific Time Sharing Corp.

The language, of course, is APL. And let me offer one subjective opinion: No engineer who has learned APL will ever again write a program in FORTRAN or BASIC.

For further information, and a side-by-side comparison, call on me anytime.

William B. Lurie

Independent Consultant

4909 Banyan Lane
Fort Lauderdale, FL 33319

A further suggestion on network design

Readers who found potential use in the excellent graphical technique described by James E. McKay in his Idea for Design suggestion "Simple Serial/Parallel Transformations Aid Network

Analysis and Synthesis" (ED No. 22, Oct. 25, 1974, p. 144) may also be interested in "Draw Your Network's Impedance," ED No. 1, Jan. 4, 1968, pp. 102-103, which describes this technique and some other useful geometrical relationships as well.

R. E. Johnson

GTE Sylvania Inc.
Parts Div.
816 Lexington Ave.
Warren, PA 16365

Don't kill the kilos

A typographical error in a New Product item on "High-Voltage Packs Have Simple Controls" (ED No. 21, Oct. 11, 1974, p. 158) gave the output of these Hipotronics (Brewster, NY) units as 60 V. The correct value is 60 kV.

Reader feedback uncovers a blooper

Two comments on articles in ED No. 20, Sept. 27, 1974:

First, the Ideas for Design section features what the author, M. Barry Greenberg, calls a divide-by-five synchronous counter with symmetric output ("Counter Has Symmetrical Output Though the Input Signal Is Asymmetrical," p. 118). The logic circuit and timing diagram shown are actually a divide-by-four. Mr. Greenberg's technique works only for even pulse-counter circuits.

Second, it is worth pointing out a limitation in the techniques given in "Look to Asynchronous Sequential Logic" (by Michael J. Charland, pp. 98-103). If these tech-

(continued on page 10)

Thin-Trim[®] capacitors



Tucked in the corner of this Pulsar Watch is a miniature capacitor which is used to trim the crystal. This Thin-Trim capacitor is one of our 9410 series, has an adjustment range of 7 to 45 pf., and is .200" x .200" x .050" thick. The Thin-Trim concept provides a variable device to replace fixed tuning techniques and cut-and-try methods of adjustment. Thin-Trim capacitors are available in a variety of lead configurations making them very easy to mount.

A smaller version of the 9410 is the 9402 series with a maximum capacitance value of 25 pf. These are perfect for applications in sub-miniature circuits such as ladies electronic wrist watches and phased array MIC's.

Johanson Manufacturing Corporation,
Rockaway Valley Road., Boonton, N.J.
07005. Phone (201) 334-2676, TWX 710-987-8367.

Johanson

Electronic Design welcomes the opinions of its readers on the issues raised in the magazine's editorial columns. Address letters to Managing Editor, Electronic Design, 50 Essex St. Rochelle Park, N.J. 07662. Try to keep letters under 200 words. Letters must be signed. Names will be withheld on request.



**Commercial gold—
lowest price**

20 microinches of gold. Amphenol has a full line of 225 Series edgeboard connectors. Some manufacturers offer a similar connector with a 10 or 15 microinch gold flash at comparable prices. But if you need gold, make sure you get at least 20 microinches of gold plate. Amphenol's got it.

**Industrial gold—
medium price**

30 microinches of gold. More critical industrial applications may need a heavier gold plating on the contacts and a stronger dielectric material, like our industrial grade 225 Series connectors. Gold plated beryllium copper contacts and a glass fiber reinforced diallyl phthalate body make this the connector for all but your toughest jobs.

Strike gold

Amphenol has a printed board connector priced for your application. That's because we offer the same connector line with 20, 30 or 50 microinches of gold plating. Our 225 Series bellows contact edgeboard connectors let you design to the price level that best suits your needs.

Whether your application calls for a cost-saving commercial connector, or the very best connector money can buy, we've got you covered. From six to 100 contacts. In five different

contact configurations. Four mounting types. And seven tail styles for solder or wrapped terminations. Taper pin and Crimp Poke Home® terminations give you additional versatility where you need it.

Amphenol 225 Series connectors are available in more places than any other brand, too. Because Amphenol has the largest network of stocking distributors in the industry. There's one nearby waiting for your call. Delivery is now.



**Military gold—
premium**

50 microinches of gold. Your toughest jobs may require a connector qualified to MIL-C-21097 C/21—like our military grade 225 Series connector line. A full 50 microinch gold plating over beryllium copper contacts and our best dielectric means this connector will stand up to the most severe operating conditions. It's our best connector for your toughest jobs.

at your price.

Or strike bright tin/lead.

If economy is most important, find out about our bright tin/lead contact plating. Performance compares favorably with light gold, but the price is lower. Eliminating gold plating on your printed boards will cut costs even further.

Find all the options. Write or call for our 36-page catalog (PC-6). Amphenol Industrial Division, 1830 S. 54th Ave., Chicago, Ill. 60650—312/242-1000.



**BUNKER
RAMO**

AMPHENOL

THE WORLD'S FIRST CIRCULAR IMAGE SENSOR.

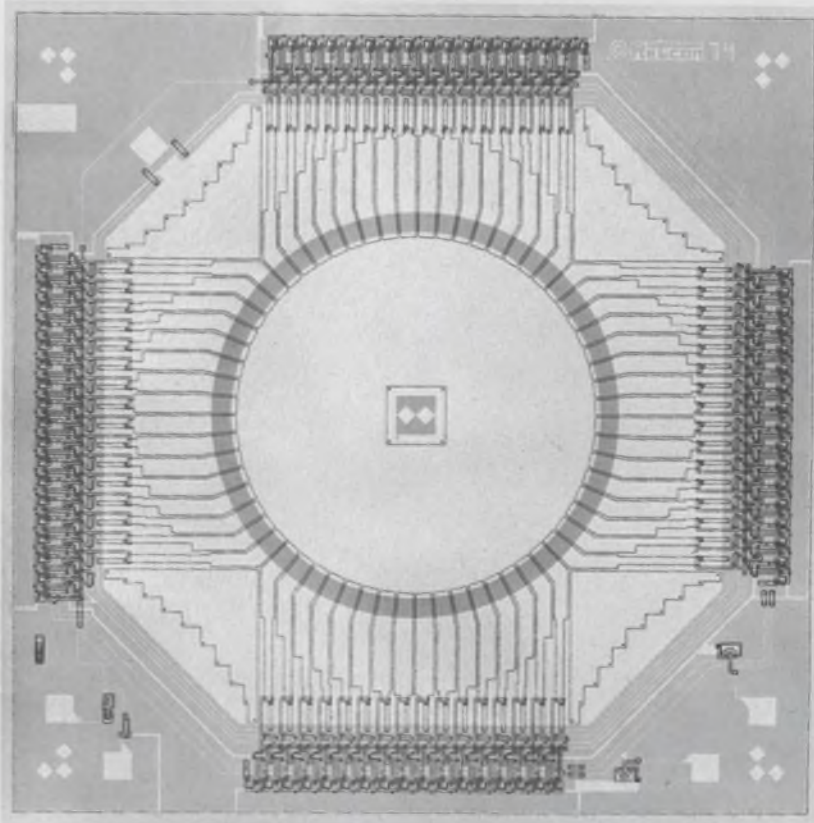

CIRCULAR?

YES. And with on-chip scanning to provide serial output on a single pin. The 64 sensors of the RO-64 are each 0.1 mm x 0.1 mm in size and are uniformly spaced on a 2 mm diameter circle. The array can be operated at scan rates as low as 30 scans per second or as high as 40,000 scans per second. The device is packaged in a 16 lead ceramic DIP and sealed with an optical quality quartz window. The RO-64 is designed for applications in tracking, automatic alignment, automatic focusing, pattern recognition and many others.

RETICON also continues to offer the most complete line of standard linear and matrix arrays in the industry. Our "C" series linear arrays provide from 128 through 1024 elements of resolution on a single monolithic chip and are considered the standard in facsimile, OCR, and industrial control applications.

Custom devices have been developed for a wide variety of applications from point-of-sale to spectroscopy.

In solid state image sensing, our technical leadership backed by over 60 salesmen and 14 distributors over the world makes RETICON the most viable source.

RETICON®

910 BENICIA AVENUE • SUNNYVALE, CA 94086
PHONE: (408) 738-4266 • TWX: 910-339-9343

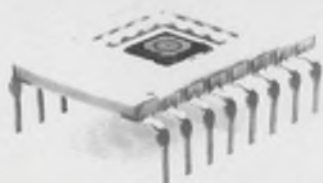

INFORMATION RETRIEVAL NUMBER 8

ACROSS THE DESK

(continued from page 6)

niques are used to design a controller for multiple autonomous asynchronous devices (multiple independent processors contending for memory; multiple peripherals contending for a priority interrupt; etc.) then the value of d —the maximum time difference between input changes in Eqs. 1 through 8—must be set to infinity, resulting in an incredibly slow controller.

Jerry Burchfiel
Computer Scientist

Bolt Beranek and Newman Inc.
50 Moulton St.
Cambridge, MA 02138

The authors reply

A re-evaluation of my article "Counter Has Symmetrical Output Though the Input Signal Is Asymmetrical" yields a divide-by-four synchronous counter rather than a divide-by-five, as claimed. The outputs of the circuit shown can be used as three subclock sources for edge-triggered logic. My sincere apologies to the readers of ED for my error.

M. Barry Greenberg
Project Engineer

G B Instruments
2030 Coolidge St.
Hollywood, FL 33020

In response to the comment of Mr. Burchfiel concerning the techniques discussed in "Look to Asynchronous Sequential Logic," it is true that the design of any asynchronous controller would present this type of problem. To alleviate the uncertainty of the maximum time difference d , due to multiple autonomous asynchronous inputs, a buffer register can be added to synchronize input changes to each other. Obviously the register clock can be asynchronous, and for best speed optimization, the period should be equal to Δ , the total cycle time of the controller.

Michael J. Charland
Development Engineer

Canberra Industries
45 Gracey Ave.
Meriden, CT 06450

(continued on page 14)

There's more behind a carbon film resistor than carbon

Particularly if the resistor comes from Piher. There's 25 years experience for a start. Which is why we are one of the world's leaders in the carbon film resistor field.

With an output of 10 million resistors *per day*, they are obviously in demand. Everywhere.

Which is why we have opened a manufacturing plant in the USA to help satisfy North American



needs, quickly, and help give a bigger share of European production to European markets.

Find out about the Piher resistor range

— and all the other products that have made us a leader in component technology.

Fill in the magazines reader reply card, or write direct to the office in your area for our technical literature. We're worth knowing.



USA – PIHER Corporation, 399 Washington Street, Woburn, Massachusetts 01801. Tel: 617 935 8750

Germany – PIHER International GmbH, 85 Nurnberg, Tuchergartenstrasse 4, Tel: 0911 533 051

France – PIHER International SARL, 83 Rue Etienne Dolet, 94230, Cachan, Tel: 656 8484

Italy – PIHER International SPA, Via Cenisio 34, 20154 Milan, Tel: 314 532/316 213

UK – PIHER International LTD, Romar House, The Causeway, Staines, Middlesex, Tel: Staines 56157

Spain – PIHER SA, Riera Canado, s/n. Apartado de Correos, 53 Badalona (Barcelona), Tel: 389 03 00

surround it
with something special





Safety. Reliability. Long-haul performance. Cost. They all have an effect on your product's design parameters and capabilities.

Belden has a custom design capability in wire, cable, and cord that can help you meet the most demanding performance for your products. We've helped solve some extraordinary problems. Can provide definitive data and answers on flex life, oil resistance, electrical characteristics, aging that can cope with practically any environment your specific job criteria calls for.

Talk to your Belden specialist about it. He understands design requirements. Can give you straight answers on cable or cord design feasibility. What modifications are possible. What the trade-offs are. The costs involved. We haven't perfected that "fancy" jacketing yet, but can improve the wire, cable, or cord package you need to meet the most challenging electrical, physical and thermal applications you might be faced with.

If you need answers right now, phone:
(312) 887-1800, Transportation Division
(312) 681-8920, Electrical Division
(317) 966-6681, Electronic Division
Or write Belden Corporation, P. O. Box 386, Geneva, Illinois 60134.

H-2-3



INFORMATION RETRIEVAL NUMBER 234



Only Sprague bantam 4-pin DIP capacitors can give you these advantages . . .



guaranteed max. high frequency impedance



**low inductance and low ESR . . .
4-terminal connection mode option**



**preferred capacitance values to
optimize performance when tantalum
and ceramic capacitors are paralleled**



automatic insertion capability



**your choice of layer-built ceramic
or solid-electrolyte tantalum**

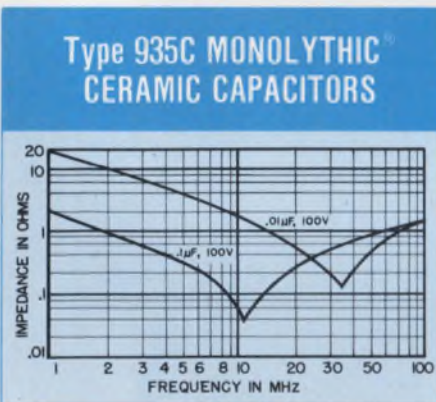

Proven multi-layer construction. COG(NP0) and X7R temperature characteristics. Preferred ratings are .01, .047, and .1 μF @ 100 WVDC. Operating temperature range, -55C to $+85\text{C}$.

INFORMATION RETRIEVAL NUMBER 271

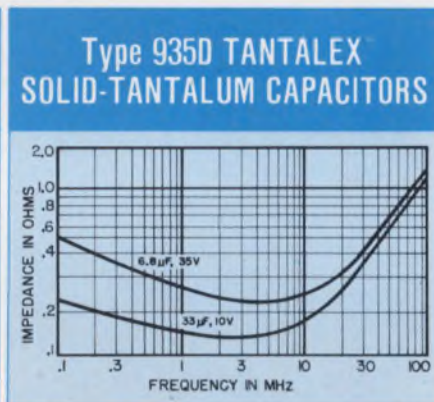

Dual in-line plastic package for mechanical protection and increased reliability. Preferred ratings are 6.8 μF @ 35 V, 15 μF @ 20 V, 22 μF @ 15 V, and 33 μF @ 10 V. Operating temperature range, -55C to $+85\text{C}$.

INFORMATION RETRIEVAL NUMBER 272

For complete technical data on Type 935C or 935D Capacitors, write for Engineering Bulletins 6242.3 or 3542.3, respectively, to: Technical Literature Service, Sprague Electric Company, 347 Marshall St., North Adams, Mass. 01247.



THE BROAD-LINE PRODUCER OF ELECTRONIC PARTS

ACROSS THE DESK

(continued from page 10)

A 'very well done' for pulse-gen article

The pulse-generator article in ED No. 24 was very well done. ("IC Applications Demand New Highs in Instrument Accuracy," Nov. 22, 1974, p. 90). It did an outstanding job of linking this product line to the logic testing market. I thought your coverage of the parametric and functional applications of pulse generators was very clear. This has been a point of confusion for many customers.

Jerry Murphy
Product Manager, Pulse Generators
Hewlett-Packard
1900 Garden Of The Gods Rd.
Colorado Springs, CO 80907

Simple test suggested for RTV in moisture

I would like to commend Morris Grossman on his excellent summary of potting and casting materials ("Today's Resins Provide a Cure for Almost Every Embedding Ill," ED No. 25, Dec. 6, 1974, p. 28). The portion devoted to RTV (room-temperature vulcanization) materials brought to mind a potential risk and proof test that an associate acquainted me with several years ago.

It seems that all RTV systems are not alike, and at least one can cause potentially serious metal-corrosion problems in an enclosed, moisture-laden atmosphere—as in marine electronics. Not wishing to become embroiled in a competitive product battle, I only suggest that designers contemplating the use of RTV make the following simple brand-comparison test:

Place a small plated steel part in a jar, add a dab or two of RTV, a couple of drops of water on absorbent paper, and cap the jar. Review the result daily.

This may sound like a non-scientific test, but at least one vendor's RTV will produce dramatic rusting within a day or two.

Bill Rich
Plant Manager

Sonagua Cientifica
P.O. Box 1253
Douglas, AZ 85607

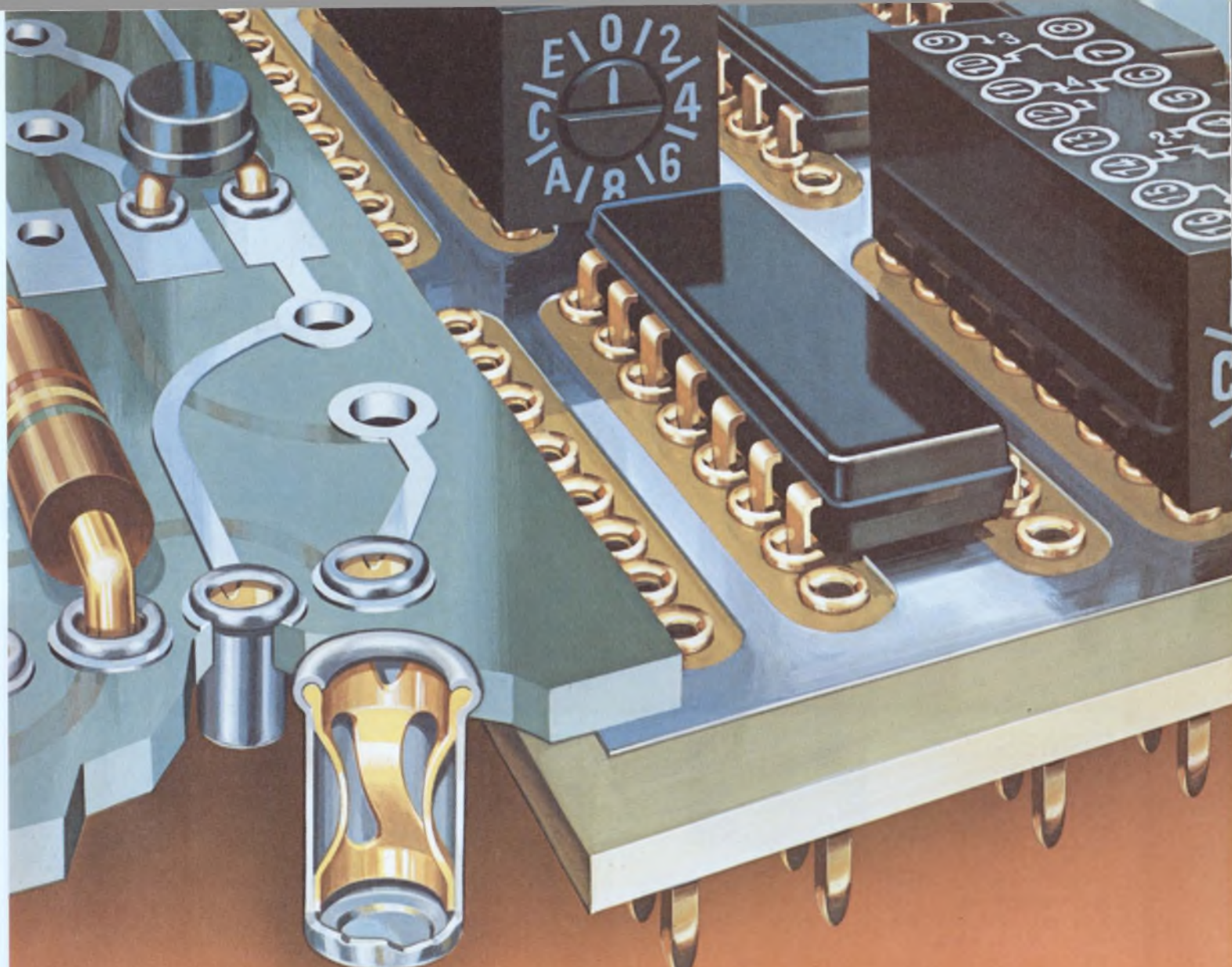

AMP gives you 60 minutes to put 3,000 sockets in their place.

Because that's all the time you need with our high-speed socket applicator. The sockets themselves give you easy pluggability.

And easy mounting of leaded devices such as transistors, crystals, plug-in relays and integrated circuit packages.

AMP sockets have closed or knockout bottoms, plus posted versions. They can take round or rectangular leads. And their low profile offers high packaging density. Gold- and tin-plated sockets are available, and all have excellent solderability.

So if you want quick, reliable loading of miniature spring sockets into dielectric panels, at low applied cost, call (717) 564-0100. Or write AMP Incorporated, Harrisburg, Pa. 17105.

AMP is a trademark of AMP Incorporated.



AMP

INCORPORATED

INFORMATION RETRIEVAL NUMBER 11

THE INFLATION FIGHTERS



SERIES 23000 SNAP-IN SLIMSWITCH



- Costs less to buy, assemble, install.
- 10 dial positions
- Prices start at \$2.50 per switch module. (25¢ per switch function for 10 positions).
- No tools needed for assembly or mounting.
- Only .315" (8mm) wide, greater panel density, easier readability.
- Lots of output code options.
- Life of a million detent operations or more.
- Stock parts and build assemblies yourself or we'll build them at no added cost.

SERIES 29000 ECONOMY MINISWITCH®



- A high quality economy switch for industrial environments...it's sealed against dust and fluids.
- 10, 11, 12 or 16 positions
- Prices start at \$3.00 per module (25¢ per switch function for a 12 position switch).
- No tools needed for assembly.
- Back panel mounted.
- Lots of output code options.
- A million detent operations or more.
- Stock parts and build assemblies yourself or we'll build them at no added cost.

SERIES 8000 MINISWITCH®



- The first miniature digital switch made
- Prices start at \$4.50 per switch module (45¢ per switch function for 10 positions)
- 8, 10, 12 or 16 positions
- Dozens of output codes available
- For general purpose use where panel space is limited and where high quality and reliability are needed.

SERIES 28000 MINILEVER®



- A miniswitch operated by a lever. . . .
- Prices start at \$5.00 per switch module (50¢ per switch function for 10 positions)
- 8, 10 or 12 dial positions
- Lever moves only 90° to rotate dial 360°
- Best for positive, quick set/reset uses

There is a Digitran authorized distributor and a sales engineering group in your area. Just dial EEM (800) 645-9200 (toll free) to find out who they are.

See pages 2-800 thru 2-803 in the 1974-75 EEM Directory for more Digitran products.

MORE SWITCHES FROM THE DIGITRAN® COMPANY

Division of Becton, Dickinson and Company [80]
855 South Arroyo Parkway / Pasadena, Ca. 91105
Phone: (213) 449-3110 TWX 910-588-3794

Send for details and quantity-prices for our "INFLATION FIGHTERS". You'll be delighted to find you can buy a DIGITRAN "INFLATION FIGHTER" for less per switch function than most toggle, pushbutton, lever, slide or rotary switches.

DO YOU WANT MORE INFORMATION?

Dear Reader, please note: for more information about the products advertised on the opposite page, please return this card to The Digitran Company.

UNLESS OTHERWISE SPECIFIED YOU WILL RECEIVE MORE INFORMATION ABOUT THE ADVERTISED PRODUCT ONLY.

1. DO YOU WANT MORE INFORMATION? Yes, send... a salesman to see me Digital Switch Catalog Short Form Catalog Digivider/Digidecade Catalog Codes Wall Chart Series 12000 Minibutton information Series 23000 Slimswitch Series 24000 Bi-Directional Digilever Information Series 25000 Economy Snap-In Thumbwheel Switch Information Series 28000 Lever Switch Information Series 29000 Economy Switch Information QPL Switches Other: _____
2. Is the purchase of this type product anticipated? Yes No
If yes, what is the application? _____
3. Is your requirement: current 1-3 months 3-6 months longer
4. Estimated annual usage Under 100 100-500 500-1000 1000 or more
5. Are you currently on our permanent mailing list? Yes No
6. Do you want to be on our permanent mailing list? Yes No
7. Are you responsible for: Design Specification Purchasing
8. What is/are the end product(s) of your company, division, department?
 Instruments Computers/peripherals Communications (Non-digital)
 Industrial controls Medical electronics Avionics
 Transportation/Automotive Digital communication
Other: _____
9. Have you purchased or specified switches of the type made by Digitran in the past? Yes No If yes, who's? Digitran Other

Name _____ Title _____
Company _____
Address _____
City _____ State _____ Zip _____
Phone (_____) _____

ED2/75 IF D5 1-B

Thanks for your interest

The Digitran Company

FIRST CLASS
PERMIT NUMBER
2342
PASADENA, CALIF.

BUSINESS REPLY CARD

No postage stamp necessary if mailed in the United States

Postage will be paid by:

THE **DIGITRAN**[®] COMPANY
855 SOUTH ARROYO PARKWAY
PASADENA, CALIFORNIA 91105



HI PERFORMANCE / LO COST



Model 452 rolloff: 24dB/octave/channel
Model 852 rolloff: 48dB/octave/channel

BEST

DUAL HI/LO ANALOG FILTERS

- **Frequency Range: 0.01 Hz to 111 KHz**
- **Frequency Selection:**
Digital, with 3 Digit Resolution
- **Cutoff Frequency Accuracy: $\pm 2\%$**
- **Responses: Butterworth and Linear Phase**
- **Functions: Low Pass, High Pass,
Band Pass, Band Reject**
- **Dynamic Range: 90 dB**
- **Passband Gains: 0, and 20 dB**
- **Low Noise**

SOME APPLICATIONS:

- **Band-limiting analog signals prior to A/D conversion**
- **Signal Conditioning**
- **Waveform Analysis**
- **Noise Studies**
- **Data Recording/Playback**
- **Distortion measurements**
- **Digital Signal Processing**

ROCKLAND

Rockland Systems Corporation 230 W. Nyack Road, West Nyack, N.Y. 10994 • (914) 623-6666 • TWX 710-575-2631

INFORMATION RETRIEVAL NUMBER 93

FOR PEOPLE WHO WANT TO READ ALL ABOUT IT!



We have nothing less than a fully illustrated, systematic, easy-to-use survey of the entire field of data management as it exists today. It covers it all, from A to Z, so it's for everybody. The programmer tightening up his files. The analyst working out a workable timesharing program. Top management needing industry-wide perspective on competitive system designs.

It's a rare publication that takes a unique "blueprint approach" to current know-how. Beginning with the single data item as the first building block in total system design. And progressing through specific techniques for data structures, streams, files . . . total hardware and operating system control . . . the latest advances in timesharing and multiprogramming . . . system modeling and simulation . . . complete

designs for various types of commercial accounting and document-oriented storage and retrieval systems. It all adds up to a vast and impressive "top to bottom" view.

And it does it all in fresh, jargon-free language, with scores of illustrations and diagrams for a rapid, visual grasp.

Whether you use it as an on-the-job manual, as a desk-top reference, or as a conference room companion with all the answers, it's an indispensable tool guaranteed to broaden your perspective and practical skill in a field that knows no limits to growth and progress. And generally give you the professional confidence that comes from knowing just about everything that's going on.

#5100-X, 6 x 9, 300 pages, cloth \$14.95

To Order:

Circle the **Information Retrieval Number** to order your 15-day free examination copy of **Data Management for On-Line Systems** by **David Lefkowitz**. At the end of that time please remit payment or return the book with no further obligation.



Hayden Book Company, Inc., 50 Essex Street, Rochelle Park, N. J. 07662

TO ORDER, CIRCLE 96

These ideas for cooling board-mounted semis could improve your circuit's performance

Thermal management is a highly versatile and valuable circuit design tool that can be used to increase semiconductor power, increase circuit density (or reduce the number of semiconductors), improve switching

and temperature-related rise and fall characteristics, increase small signal gain and DC beta, match operating characteristics of two or more devices, improve reliability and cut costs. Here are some ways circuit de-

signers have used IERC heat sinks/dissipators to beat printed circuit board-mounted semiconductor heat problems in order to improve their circuits, ideas that may be of help to you.

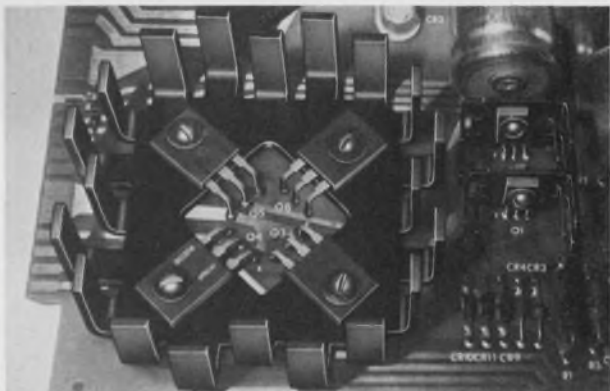

Four times the power from four power plastics took just one IERC dissipator. Bare transistors were capable of only 2 watts with 102°C substrate rise above ambient so designer used modified HP3 dissipator and got 8 watts from each at the same temperature rise. Or you could improve transistor life — roughly 7 times — by operating the devices at 2 watts and letting the same dissipator keep the substrate temperature rise to 32°.

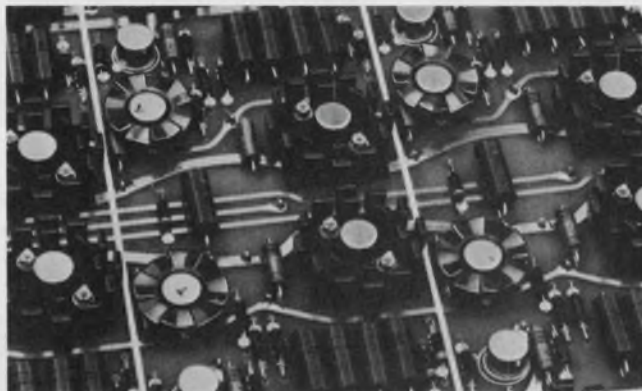

Temperature matching at varying power levels is easy with the wide variety of IERC dissipators. On this board problem was to keep TO-5s at approximately equal case temperatures although some were operated at 2.2 watts and others at 1 watt. Press-on Fan Tops costing pennies kept 1 watters at 55°C case rise above ambient while LP dissipators held 2.2-watt devices at nearly identical case temperatures. IERC Insulube® coating permits mounting LPs directly on printed circuit lines.

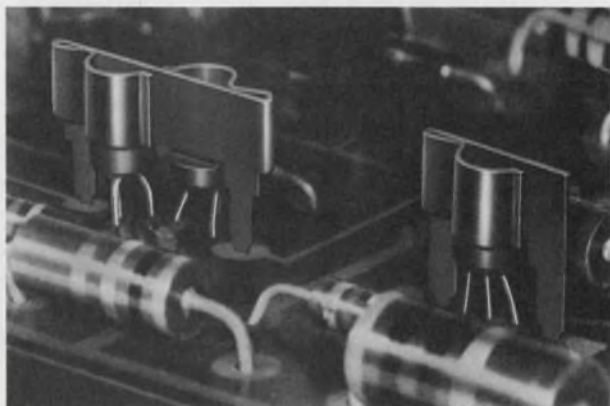

Dissipators protect circuit — Designer of this TV circuit made sure dissipators would stay when D-case devices needed replacing. He designed dissipators as a part of the circuit, making it impossible to fire the circuit without them. In addition to this circuit protection the dual "Universals" gave him some other benefits: excellent retention in shock/vibration environments, good heat sinking during solder operations, and they cost just pennies.

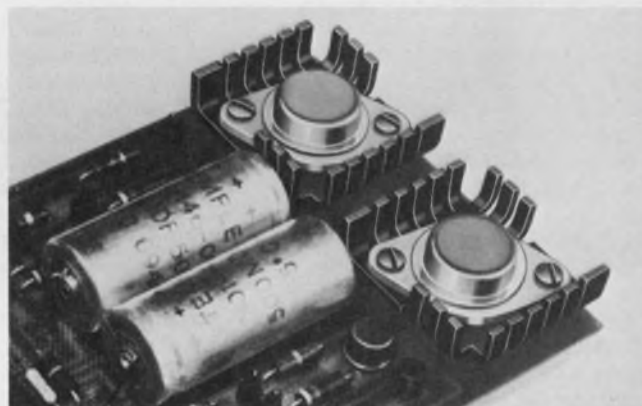

Lower cost per unit was result of replacing four TO-3s used in this 10-watt power supply with two TO-3s in UP3 dissipators. Dissipators allow two TO-3s to operate at 5 watts each with same 65°C case rise above ambient as four devices operated at 2.5 watts each. Low profile dissipators plus TO-3s were assembled in less space allotted to four transistors. New design saved money, improved reliability.



For more information

on heat sinks and dissipators for milliwatts to kilowatts, send for the IERC Short Form Catalog today. It covers the most complete line of thermal problem solving devices available anywhere.



Heat Sinks/Dissipators

INTERNATIONAL ELECTRONIC RESEARCH CORPORATION / A SUBSIDIARY OF DYNAMICS CORPORATION OF AMERICA / 135 WEST MAGNOLIA AVENUE, BURBANK, CALIFORNIA 91502

INFORMATION RETRIEVAL NUMBER 13



\$1,099 says no other 5½ digit DMM can perform as well.

We put our money where our mouth is.

For years people have been calling us "The Voltmeter House."

Today, we hope to convince you that this is no idle chatter.

To the first manufacturer who can show that his 5½ digit bench multimeter selling for \$1099 or less has better all-around specs and performance than ours, we'll pay \$1099 to his favorite charity.

\$1099 is the price of our Model 8800A 5½ digit full auto-ranging multimeter.

If you're ready... we'll begin.

AC input voltage: Measures four ranges of AC from 2V to 1200V. Most other 5½ digit DMM's are limited to 700V maximum and some to as low as 500V.

DC input voltage: Measures five ranges of DC volts from $\pm 200\text{mV}$ to $\pm 1200\text{V}$.

True 4-wire ohm measurements on all ranges: Useful for measuring low value resistance without error caused by lead resistance. Measures six ranges from 200 ohms to 20 megohms.

Accuracy and resolution: 1 μV resolution with 0.01% accuracy for 90 days over a temperature span of 18° to 28° C.

High DC input impedance: 1000 megohms through the 20 volt range. (Computer techs: you can measure any voltage up to 20 volts without loading by the multimeter.)

Offset current: Less than 15 pA on all ranges. Essential when measuring high source impedance voltages. Most other 5½ digit multimeters don't even spec it.

Maximum open circuit ohms voltage, 3.3V: Most DMM's fall into the 9 to 18 volt range. That's not good enough for measuring IC's



when specs say that the measuring voltage cannot exceed 5 volts.

Overload protection: It's the best overall protection in the industry. 1200V on any AC or DC range. 250V RMS or DC on any ohms range.

Mean Time Between Failure: 10,000 hours, calculated and demonstrated. (unique)

Unusually low power consumption: Just 8 watts. One reason why the 8800A is so reliable.

Size: Our 8800A is one of the lightest and smallest 5½ digit multimeters around. With bench space at a premium, our box will be appreciated by all technicians.

Wide range of accessories: Includes high frequency probes, high voltage probe, clamp-on AC current probe.

It goes on. Our data sheet has the full details.

If you have any doubts whether the 8800A is typical of our line, just check *Electronics Product Preference Poll* (© 1974 by McGraw-Hill, Inc.). Fluke's squarely in the Number 1 spot for "Digital Voltmeters, including Multimeters"!

For data out today dial our toll-free number, 800-426-0361

John Fluke Mfg. Co., Inc., P. O. Box 7428, Seattle, WA 98133

For a demo circle . For literature only, circle

For information on the rest of the Fluke line see our ad in EEM or the Gold Book.

INFORMATION RETRIEVAL NUMBER 141

FOR DEMONSTRATION 142

FLUKE

TV-compatible CCD camera ready to make the scene

A TV-compatible, charge-coupled-device camera, expected for more than a year, is finally ready for market. It is made by RCA and is scheduled to be available in April in two models, TC1150 and TC1155.

The first commercially available CCD camera was announced by Fairchild Semiconductor about a year ago, but it only has 10,000 picture elements and requires modification to be used with the standard home TV receiver.

Both the RCA TC1150 and TC-1155 use a 512-by-320 element CCD imager sensor. Their capabilities include a standard 525-line video output that is compatible with commonly available monitors and accessories without modification; solid-state life and reliability; sensitivity and spectral response comparable to that of silicon-target vidicon cameras and antiblooming characteristics that control highlight overloads. The new cameras are destined to replace 2/3-inch vidicons as soon as the price comes down, RCA says.

The difference between the two CCD cameras is in the lens systems. The TC1150 has a built-in lens that is part of an automatic light-control system. Its focal length is adjustable from 14 to 88 mm. The TC1155 will accept interchangeable standard C-mount lenses.

In addition to the cameras, RCA is also offering a 163,840-element CCD image array. The array is designated SID51232 and is available in two grades: SID51232BD and SID51232AD, with the former the higher-grade device.

Either sensor may be specified when ordering a camera. If the higher-quality SID51232BD device is selected, the cameras cost \$3800 each. With the SID51232AD, the price drops to \$3000 each.

For OEMs who want to put to-

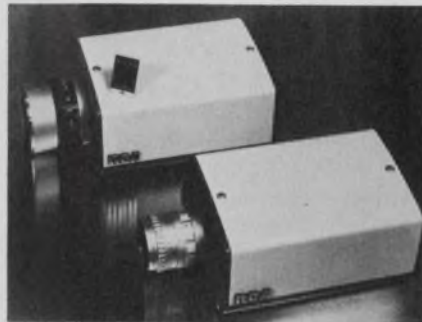

Two commercial CCD TV cameras that are compatible with standard 525-line television receivers are available from RCA. A 512-by-320 CCD array (top) replaces vidicons generally used in cameras.

gether their own imaging systems, RCA is offering the chips at \$2300 for the BD version and \$1500 for the AD. While this is high, compared with \$260 for a 2/3-inch vidicon, RCA projections indicate that by the early 1980s the sensor price could drop to \$30.

According to Dr. Ralph E. Simon, manager of the company's electro-optics product operations, the CCD imaging array is of the frame-transfer variety. In this type of device, half of the array is exposed to the optical imaging signal and half is used to store the signal while it is being processed into a sequential output.

Simon notes that the CCD chip is also suitable for use in a color camera. The camera can be built, he explains, with a conventional beam splitter, which divides light into its three spectral components. Each component is then directed to its own CCD image array. Signals from the three arrays are then combined to form a color video signal. Combination of the signals is made easy by the fixed geometry of the CCD arrays, which eliminates the registration problems sometimes found in tubes.

To make the CCD array easy to

use RCA engineers have developed a CMOS chip that will produce all the voltage pulses to drive the imager. These include signals to control blooming and to produce the 2:1 interlace required for standard TV receivers.

While RCA has not yet announced plans for a color CCD camera, the company indicates that it has built experimental models. In addition, Simon notes that the auxiliary CMOS chip can drive three image arrays simultaneously.

CIRCLE NO. 315

Wraps come off a Naked Milli

What falls between a microcomputer and a minicomputer? The Naked Milli just introduced by Computer Automation, Irvine, CA. It is priced at \$295 in single quantities, with no memory. With 8 k bytes of MOS semiconductor memory, the single-quantity price is \$1060. The machine, which is contained on a 7 x 15-in. card, is a full 16-bit computer, with eight addressing modes, bit and byte processing and direct memory access.

4-k static RAM bids for memory-chip lead

The changing 4-k RAM market is about to receive a new entry: the first 4-k static RAM.

Until now, all contenders for the lion's share of the 4-k memory market have been small, dynamic memory devices that operate at high speed. But EMM Semi has announced two new devices, the 4401 and 4402, that promise to give dynamic competitors some stiff competition.

Unlike conventional static RAMs, which are generally larger and slower than their dynamic equivalents, the new 4-k devices are about the same size and a little faster than available dynamic units.

EMM Semi says the small size and low speed have resulted from use of polysilicon resistors instead of the load resistors generally used in static memory cells.

The 4402, which is the faster of the two devices, has an access time

of 150 ns and cycle time of 300 ns. To get this speed, however, it is necessary to use an external sense amplifier.

The amplifier can be eliminated by the 4401 device. But this adds another 30 ns to the access time, bringing it up to 180 ns.

Power consumption of the new memory chips are 60 mW for standby operation and 300 mW when the chips are accessed.

The chips come in a 22-pin package that has the same pin-out configuration as the 4-k RAMs from Texas Instruments and Intel.

CIRCLE NO. 316

DEC develops a micro and an expanded mini

A minicomputer with midi architecture and a 16-bit microcomputer that can perform floating-point operations have been announced by Digital Equipment Corp.

The enlarged mini, the PDP-11/70, uses bipolar cache memory, independent peripheral controllers and 32-bit internal data paths to give more throughput than the next highest model, the PDP-11/45. Both the independent cache and separate data path are new to the PDP-11 line.

The microcomputer, the LSI-11, is made up of four NMOS LSI chips. It executes the PDP 11/40 instruction set faster than the 11/05 does, and it has a 16-bit parallel I/O bus.

I/O architecture similar to that in the IBM/360 line has been used to develop the PDP-11/70 from the PDP-11/45. A 2-kbyte, 240-ns bipolar cache acts as a switch and buffer between main memory and CPU. Simultaneously a separate 32-bit bus carries data between the controllers (up to four) through the 32-bit path between core and cache.

But the standard Unibus carries only commands from the CPU to the controllers, and it services only slow speed devices. Thus the controllers resemble IBM Selector channels, while the Unibus resembles the byte multiplexer channel on the PDP-11/45. The Unibus also carries data from fast peripherals.

With its TTL-Schottky logic, the processor cycles at 300 ns, and the

controllers can transfer 32 bits (4 bytes) in 4 μ s. The 11/70 can handle up to 63 time-sharing users under RSTS/E. With the new IAS (Interactive Application System), the computer will do concurrent batch, real-time and time-sharing.

Integral memory management allows up to 2 Mbytes of main memory (the 11/70 uses core). And the user can add up to 800 Mbytes of disc. Virtual memory is the norm on RSTS/E.

Other 11/70 features include asynchronous double-precision floating point (9 μ s to divide two 60-bit numbers) as well as address the data parity check.

The LSI-11 processor consists of a data chip, control chip and two control ROMs (all custom units from Western Digital). The ROMs provide a console control program, bootstrapping and the instruction set. An optional ROM offers floating-point or communication protocol. The LSI-11's minimum instruction time is 3.6 μ s (register-to-register). The unit runs PDP-11 software, is housed on a 8.5 \times 10-in. board and will sell for less than \$1000 equipped with a 4-k RAM.

The data bus is not a full Unibus, since data and address are multiplexed on the same 16 lines. However, the unit achieves a healthy 833-kHz DMA rate, can address 32 k words directly and provides complete interrupt vectoring (polling is not necessary to identify the interrupting device). MOS memory using Mostek's 4-k RAM, is available in units of 4 k.

CIRCLE NO. 317

2 new calculator chips offered by Rockwell

Keeping pace with the calculator industry race to pack more computing power and display circuitry into smaller space at lower cost, the Rockwell International Microelectronics Div. has developed two one-chip scientific calculator circuits.

These MOS circuits provide full scientific functions—trigonometric, logarithmic, exponential, factorial, roots and powers—which formerly required two or more chips to obtain. To minimize assembly cost, the circuits contain such internal features as direct drive of LED

segments, clock and power-on circuitry. The chip consumes less than 125 mW.

One chip—the A4800—is designed for a 35-key, single-function keyboard. It has a 10-digit mantissa plus a two-digit exponent for scientific notation.

The calculator also has hyperbolic capabilities, a gradian switch as well as a radian/degree and an accumulating memory.

The second Rockwell chip—the A4802—is designed for a 25-key, double function board. Additional features include two-level nested parenthesis, a factorial key, degree/radian keys and an eight-function memory.

CIRCLE NO. 318

Bucket brigade aids word processing

A new word-processing system uses bucket-brigade devices to ensure that voice-activated recorders do not clip off the beginnings or endings of words.

Called Thought Tank System 193 by its developer, Dictaphone Corp. of Rye, NY, the dictation equipment automatically distributes the work load to speed the output of typed copy.

According to Richard Allen, an engineer at the company's plant in Norwalk, CT, the input to the system uses a charge-transfer device to provide an 82-ms analog delay.

When voice-actuated switches are used in recording systems, a delay is necessary to avoid misinterpretation of information. Most phrases, Allen says, start with consonants. Since consonants have very little energy associated with them, any voice-actuated switching system is usually inactive until a vowel, which has a high energy content, comes along. When a system switches on a vowel, however, it clips part of the word.

This is avoided in the System 193, which feeds audio information into both a 1536-bit bucket-brigade analog shift register and the transistor switch at the same time. The transistor switch waits for a vowel before it turns on. Once it does, it allows information that has been delayed 82 ms in the bucket brigade to go to the record head of the tape recorder.

HP's New 5 Volt 100 Amp Switching Supply is Ready For the Most Important Test in the World...

YOURS

We designed the Model 62605M Switching Supply to give the top performance and reliability demanded by today's OEMs. But, more importantly, you want to know exactly how it will perform for you, in your system. So check designs, examine the modular construction, put it through your own tests. We think you'll find the kind of conservative, sophisticated design and careful attention to detail that adds up to lasting product value.

Of course, the 62605M offers all the benefits of a technologically advanced 20KHz switching supply — high efficiency — small size — low heat dissipation. And, we've added important "standard" features like a soft-start circuit to hold down in-rush current, plus overvoltage and overcurrent protection.

The 62605M operates from 120/220/240 Vac, 48-63Hz, with 70% conversion efficiency. Regulation is 0.1%, with ripple and noise of 20mV rms, 40mV p-p ripple. The supply measures 5"H x 8"W x 12"D, and weighs only 14 pounds.

There's a lot more, so get the complete story including the generous OEM and quantity discounts from your local HP Field Engineer.

HEWLETT  PACKARD

Sales and service from 172 offices in 65 countries.
1501 Page Mill Road, Palo Alto, California 94304

21501



New Old Faithful

MICROMEMORY 3000QD...32K x 20

Old Faithful. That's what you've been calling the whole MICRO-MEMORY 3000 family. Fast. Trouble-free. Dependable. Flexible — easy to build on or design around. Either core or NMOS.

Now we have a new Old Faithful to add to the line . . . the MICRO-MEMORY 3000QD. 32K x 16, 18, or 20 (alterable to 64K x 8, 9, or 10). A 3-wire, 3D core system with the same fast 300 nanosecond access. Same single card convenience. Same building block flexibility. Same day-in, day-out dependability. And it's form, fit, and functionally compatible with all core or NMOS MICRO-MEMORY 3000 systems.

Now more than ever MICRO-MEMORY 3000 makes an ideal transition between core and NMOS systems. You can design for all core, mix core and NMOS in the same chassis, or go completely NMOS — whatever suits your needs — without costly equipment modifications. You

can build from an 8K single card memory up to high density mass storage (up to 512K in a single standard chassis).

Let us show you how MICRO-MEMORY 3000 can meet your memory needs whatever they are. Call or write your local EMM office today.

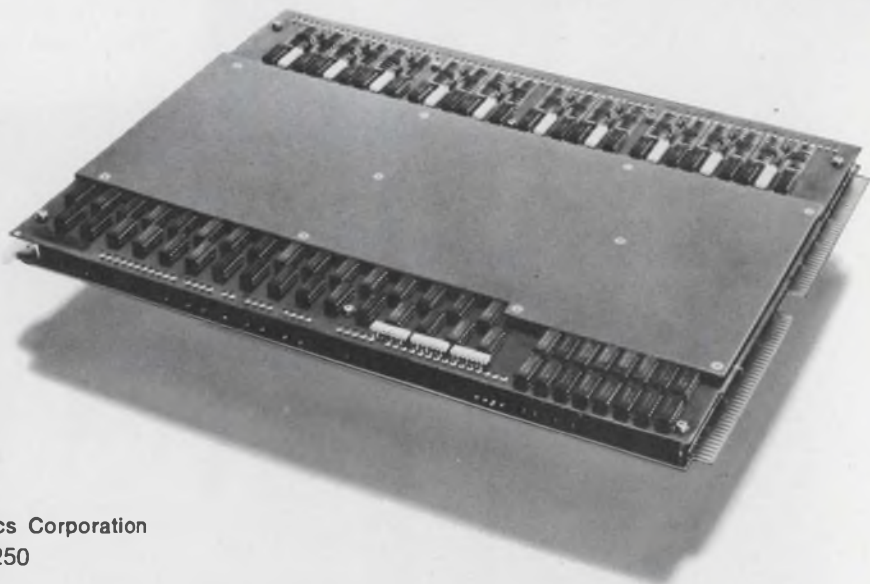

EMM ELECTRONIC
MEMORIES
COMMERCIAL MEMORY PRODUCTS

A Division of Electronic Memories & Magnetics Corporation
12621 Chadron Ave., Hawthorne, Calif. 90250

EMM OFFICES: WESTERN REGION, Regional Office, San Francisco (408) 247-9711, Los Angeles Area (213) 644-9881, Orange County Area (714) 639-5811, Minneapolis Area (612) 941-2404, Phoenix Area (602) 968-2492, Dallas Area (214) 231-7207, EASTERN REGION, Regional Office, Boston (617) 861-9650, Chicago Area (312) 297-7090, Washington, D.C. Area (703) 941-2100, New York Area (516) 423-5800, Akron Area (216) 867-5435, INTERNATIONAL OFFICES, European Headquarters, Belgium (031) 76.69.75, United Kingdom (01) 751-1213, West Germany (089) 714.30.40, Far East Headquarters, Japan (03) 404-8520.

REPRESENTATIVES: Gentry Associates; Orlando (305) 894-4401, Huntsville (205) 534-9771, Burlington, N.C. (919) 227-3639. In Canada: Megatronix, Ltd.: Toronto (416) 742-8015, Montreal (514) 488-0404, Ottawa (613) 729-4004, Burnaby (604) 526-3312.

INFORMATION RETRIEVAL NUMBER 16

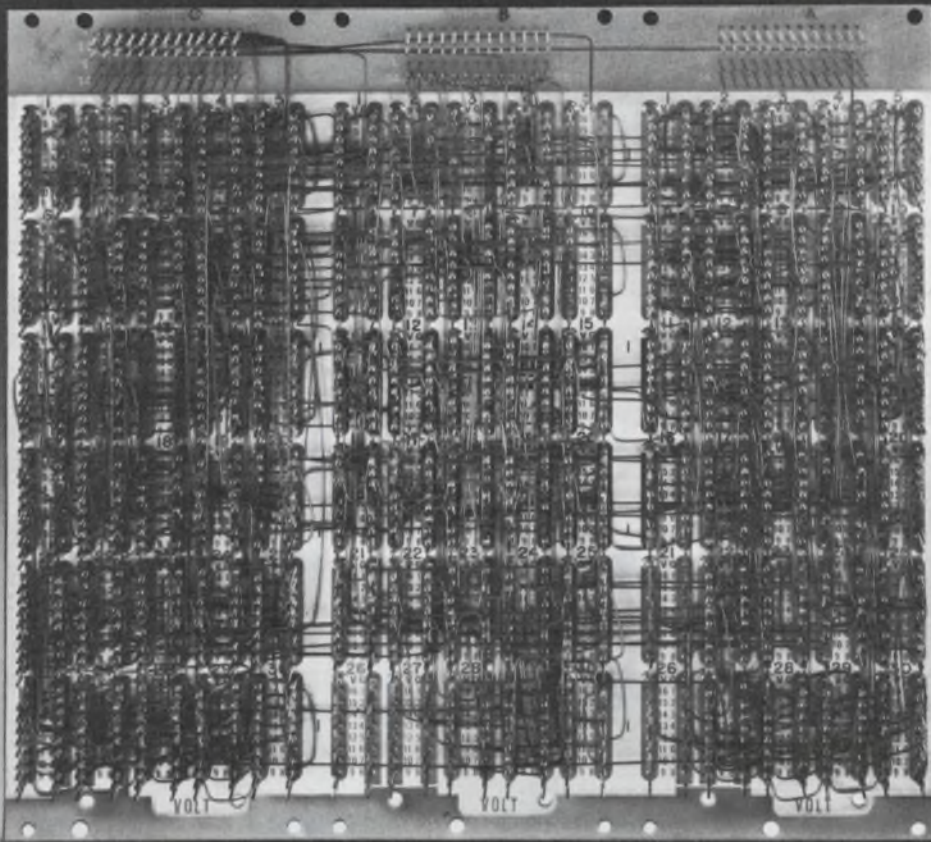

**Our packaging panels
are completely interchangeable.
Our quality, price
and delivery are the best.**

Garry offers a complete line of standard, off-the-shelf packaging panels. All of which are completely interchangeable—in form, fit and function—with panels from any other manufacturer. Including the ones you're using now. But that's where the similarities end. Garry offers you faster delivery, better price and higher quality.

And if that isn't enough consider the following.

- Our pins have squareness of .025" and are the straightest in the industry.
- Our sockets offer the most reliable retention in the industry and retains even the new short I.C. leads (down to .090").
- Our gold plating on the contact is .000040" guaranteed.
- And our recently enlarged wire wrapping department features new 14FV Vertical Gardner-Denver machines.
- Engineering assistance to convert your logic diagrams to packaging hardware.

Which means you can get a better product, at a better price, in far less time from Garry than from anybody else.

All from Garry. Where our service is unique.

Garry Manufacturing Co., 1010 Jersey Avenue, P.O. Box 94, New Brunswick, NJ 08902 (201) 545-2424.

Garry
Manufacturing Co.

We won't pin a bum wrap on you.

That dazzling, dizzy Disney World is run by computer

Cinderella's castle is a hotbed of computers and tapes that control every move any animated attraction in Disney World makes—from dancing ghosts to space meteors.

Visitors to Disney World are filing through the portals of Space Mountain, a brand new "attraction," as such man-made phenomena are called, in the still growing fantasy world of Walt Disney, just outside Orlando, FL. They smile and even laugh. Ten minutes or so later, the same people file out, a wiser and soberer crowd.

They have taken a hair-raising ride "through space," barely missing meteors and other space vehicles. And afterwards they have a look at the home of the future as envisioned by RCA.

"THE ULTIMATE THRILL RIDE," the sign outside says. "A TRIP THROUGH SPACE."

John F. Mason
Associate Editor



Photos by John F. Mason

"Tighten up that seat belt!"

All for psychological effects, you smile to yourself, yet you allow the pretty young girl to fasten you in.

"Remove earrings and glasses!"

Come on! Don't overdo it!

And your vehicle begins to move. You climb slowly for awhile and pause above a gaping black hole. Then, on the first of many devilish instructions from a computer, you plunge into the hole, bending, twisting and banking, up and down. The seat belt is no psychological ploy. Your vehicle zooms past other glowing capsules, through meteoric showers, special stellar and planetary effects and finally into a 75-foot-long, 10-foot-diameter tube. This is your re-entry into the earth's atmosphere.

Lights flash. Blast-off noises

roar through the tube, and you are finally out. Ashen-faced, perhaps. But you are out!

How do they do it, those special effects?

Six million people a year are expected to ask that question, according to RCA officials and to Disney engineers.

Controlling the ride and assuring its safety is a Data General Nova 2 digital computer with 16-k memory. The cars race over the tortuous track at up to 28 miles an hour—fast when you're barreling into a steeply banked horseshoe curve. And although you can't see this, because it's dark, you're shooting up and down through space six stories high. For safety, the cars must stay at least 18 seconds apart. If one car begins to



The control room for the Space Mountain thrill ride keeps tabs on the position of every car through magnets along the track and a Nova 2 computer. If cars begin to tailgate dangerously, the whole ride can be shut down.



gain on the one ahead, the tailgater is braked. And if necessary, the Nova can shut down the ride.

The Nova keeps tabs on each car's location by a block zone system of magnets using relay logic. When a metal fin extending beneath each car breaks the magnetic field of a magnet alongside the track, the information is fed to the computer. This information is gathered in parallel from the magnetic sensors, from the brakes, from the solenoids that operate the brakes and from the contactors that are used to confirm that the electrical machinery is running as it's programmed to run. The information is gathered in the relay system and sent to the computer.

The special effects are all operated from a digital animation con-

trol center, hidden away and off limits to everyone but a select few in Cinderella's castle.

The special computers in the control center were designed by Disney engineers and built by the now defunct Astrodata Corp. These are the computers that send instructions to the audio devices in Space Mountain. They release the blast-off roar in the final tunnel of the ride. They control the 40 projectors in Space Mountain that create the Milky Way, meteors and stars. And they control every movement—even the fluttering of an eyelash—of every animated creature in Disney World.

For each animated performer, an elaborate software program has been developed for its entire performance and stored on magnetic



In RCA's Home of the Future, video discs are commonplace, as are two-way closed-circuit television channels for business conferences, which can be held without having to leave home with people anywhere in the world.



Space Mountain, a new thrill ride at Disney World, is assured safety by a Nova 2 computer. Meteors, a Milky Way and re-entry sounds are provided by projectors and loudspeakers controlled by computers and tapes in Cinderella's castle.

tape. These programs were made with the aid of Honeywell computers. Each creature's performance is then permanently fixed and coordinated with its fellow performers. The tapes are played over and over again, sending digital instructions by wire to the performer involved.

The actual instructions are received by a proportionate servo-control mechanism in the base of the animated figure. The control converts the digital information into linear motion. Slight movements, such as eyes closing or the movement of a finger, result when the servo control triggers a magnetic device. The movement of a leg or head, or Lincoln standing up to deliver a speech, is done by a hydraulic double-action piston. ■■

Electronic music incorporating the high notes of IC technology

Electronic music, which got its start in the early vacuum-tube era, is maturing rapidly today by keeping in tune with IC development.

The two major types of electronic-music generators, electronic organs and synthesizers, are being upgraded with more features and less complex circuitry. And although the dollar volume of solid-state components used by these manufacturers is small by industry standards, they are taking advantage of virtually everything the IC producers offer.

Organs and synthesizers are using components that include the following:

- Silicon transistors—both small signal and power types.
- Linear ICs—op amps and other circuits being used in mixers, oscillators, modulators and active filters.
- Digital ICs—TTL and MOS used as counters, switches, frequency dividers, control circuits and even shift registers, ROMs and RAMs.
- Custom LSI—used by practically every new organ, with at least one custom circuit as a keyboard interface, rhythm generator or frequency divider.

Even the large-scale computer is being used to generate music of virtually unlimited scope. The Oberlin College Conservatory of Music in Oberlin, OH, is taking advantage of the college's IBM 360-based computer center and expects even better results with a



With this installation, Walter Carlos, an ex-studio recording engineer, produced the "Switched-On Bach" record in 1968—the first commercially successful synthesized recording. To the left is an eight-track recorder and to the right is his custom Moog synthesizer and mixing panel.

Xerox Sigma 9 system that should go into operation this year.

Waveforms describe sound

Gary Nelson, assistant professor of music and digital music project leader at Oberlin, explains: "If you translate music into its essential parts—time, frequency, and wave-envelope information—these can be inputted into a computer and manipulated, using a programming language such as Fortran. Every sound—whether produced by a single instrument or a symphony orchestra—can be described by its waveform and essentially repro-

duced by programming the eventual movement of a loudspeaker."

The only limitations, Nelson says, are the size and speed of the computer system and the skill of the composer—related to his musical knowledge, understanding of acoustics and his ability to use his computer "instrument."

Don Mittleman, director of the Ervin E. Houck Computing Center at Oberlin, observes: "It really does take a large computer to provide a flexible music generator. Not only is music complex with fundamentals, overtones and timing information, but the composer wants it divided into practically

If you could cut your switching loss by 80%, how would you celebrate?

By eliminating a heat sink, maybe? Saving a bit of board space? Improving your circuit's operating characteristics?

Do it with our power darlington. Unlike other darlington, ours offer access to the output transistor base, and have no internal resistors. So they'll give you greater design flexibility, higher temperature stability, and faster switching time.

Because you can vary the bias on the output transistor, you can speed up your switching time or slow it down, give your circuit more gain, less gain, whatever you want.

Using our darlington, you can cut heat loss to one-third or one-fifth, and cut the size of your heat sink proportionately. Most heat dissipation occurs during fall time, so when you speed up

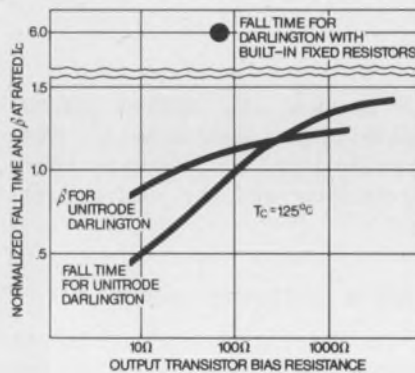

your switching time, you automatically reduce dissipation. And thanks to external resistors, our darlington are much less sensitive to temperature than ordinary darlington.

Send for our free designer's guide. It's the industry's only reference document on darlington, and it'll tell you all about them — what they are, how they work, where to use them. And it includes a dozen application examples for our special darlington.

To get your copy, just circle our number on the reader service card.

Our darlington are available in currents up to 10A and voltages up to 400V.

Unitrode Corporation, 580 Pleasant Street, Watertown, Mass. 02172.



UNITRODE

INFORMATION RETRIEVAL NUMBER 18

Nonconventional music

Electronic music can be defined broadly as music produced without conventional musical instruments or electromechanical devices.

It includes such experiments as "Music Concrete" of the 1940s, which used tape-recording techniques to modify natural sounds into music. It includes such instruments as a 200-ton synthesizer built in 1906, and the Theremin—which is played by motion of the hands near capacitive antennas.

In the past many electronic organs were not "purely" electronic, electromechanical devices, such as toothed disks with magnetic pickups or even vibrating reeds, to produce the fundamental tones. Others used vacuum-tube oscillators, and these led to today's solid-state organs.

The modern electronic synthesizer and the digital computer both use sophisticated technology, although each is quite different, to produce electronic music. This can range from duplicating the sounds of music played on conventional instruments to sounds limited only by the imagination and skill of the operator. ■■

infinitesimal time and amplitude segments, so that he can have a full range of manipulation."

The final step in computer music production is to feed the digital output to a d/a converter—but not necessarily in real time. The output from the computer can be recorded and then replayed at a lower speed. There may be a time expansion of 20 to 60 during the digital processing; music played in 1 s may have taken 20 to 60 s to be outputted from the computer.

The other major method of generating music electronically is through "synthesis"—modification of the output of an audio oscillator or white noise generator with a combination of mixing, modulation, amplification and filtration

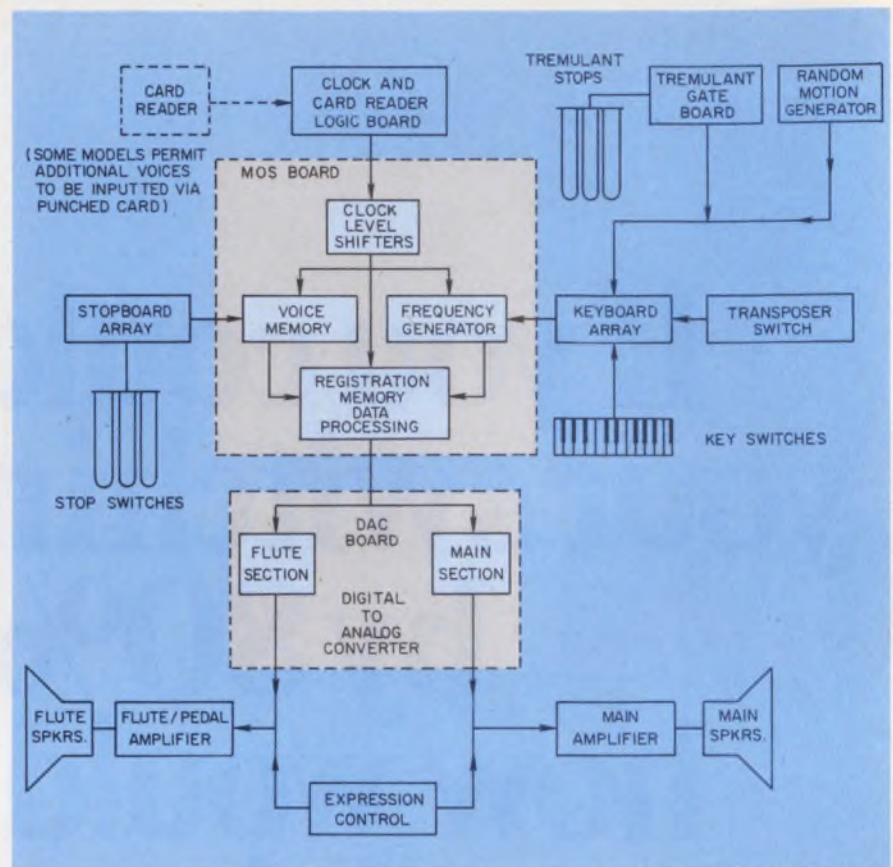

To reproduce the sound quality of a musical instrument, its harmonic structure is analyzed and stored in a ROM in this Allen Digital Computer Organ. As the organ is played, the digital word representing harmonic structure is transferred to a RAM to permit two or more instrument voices to be combined. With added attack and decay information, the data are converted to an audio signal in a d/a converter.

to produce the desired effects. Many of the techniques are common to both the electronic music synthesizer and the electronic organ.

How a synthesizer works

In operation, a synthesizer makes use of a voltage-controlled oscillator with wide frequency range that can produce a variety of waveforms, such as sine, rectangular, triangular and pulse. Next the oscillator signal is passed through a series of high, low and band-pass filters, with voltage-variable frequency response to reshape the waveform and modify the harmonic content. The signal may also be mixed, modulated and otherwise acted upon—but whenever possible, the functions are controlled by the same range of dc voltage.

These control voltages can be programmed via a set of keyboard

contacts, a linear control, a potentiometer or combination of potentiometers, such as a ball or joystick. The voltage levels can also be controlled by function generators, low-frequency oscillators and even signals generated within the other circuits. The oscillator may be replaced with a source of white noise, which can be similarly modified.

An example of a professional studio synthesizer is the Moog 55A from Moog Music Inc., Williamsville, N.Y. The complement of circuitry for this system includes one VCO capable of generating sine, sawtooth, triangular and rectangular waveforms of from 0.01 Hz to 40 KHz; seven 1 Hz-to-40 KHz VCOs and a random-noise generator. These are followed by voltage-controlled low and high-pass filters, voltage-controlled amplifiers, envelope generators (to control the rise and fall times of waveforms), mixers, signal routing and dc control facilities. The modules are con-

There's Plenty More Where These Came From...

DIP'S BY PYROFILM

Thick Film Networks . . . Hundreds of Values . . .
Hundreds of Thousands In Stock . . . 14 and 16 Pin
. . . Standard and Custom Circuits . . . Available Now

Setting New Standards in Reliability

PYROFILM

60 S. Jefferson Road • Whippany, N. J. 07981 • (201) 887-8100

INFORMATION RETRIEVAL NUMBER 19

nected via patch cords, with commonly used functions internally selectable by switches.

In operation, the keyboard generates a different voltage level for each key depressed and is commonly used to control the pitch of one or more oscillators. The envelope generator produces a voltage contour that is commonly applied to the amplifiers to create patterns of amplitude and rise and decay times. The sequencer produces a variety of programmed voltage steps at a rate determined either by an internal clock or external signal—a single output with up to 24 steps or three outputs of eight steps each.

Any of these signals can be used to control loudness, timbre (sound quality) or pitch, and any of the oscillators can modulate the outputs of the others to produce vibrato, trills or sirens.

The other major category of synthesizers is the preset portable type, used primarily with other instruments in a "live" performance. An example is the Pro Soloist made by ARP Instruments, Newton MA. It has preset tabs to create 30 musical effects that are identified, like an organ, by the sounds they resemble. In addition slider controls vary volume, brilliance and portamento (or slide from note to note). Although the keyboard is used primarily to select the frequency of the note to be played, it is touch-sensitive. Added pressure on a key will activate one of six effects, such as volume level or vibrato.

Most synthesizers are still primarily one-note-at-a-time devices. Musical chords and multipart compositions are usually produced when individual notes are recorded on multiple-track tapes and the tracks are combined. There is continuing development of "polyphonic" synthesizers, which can produce many notes at a time, thereby permitting live performances.

Compatible voltage control

In the early 1960s an important development in synthesis was compatible voltage control for all the oscillators, filters, amplifiers and special effects. A pioneer in this application was Dr. Robert Moog, who says today:

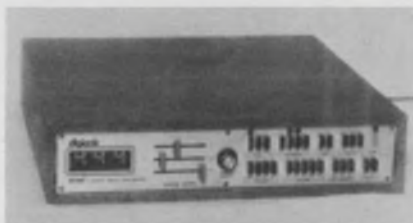

Digionic digital sequencer from Ionic Industries can memorize musical sequences up to 146 notes and modify them, as desired.

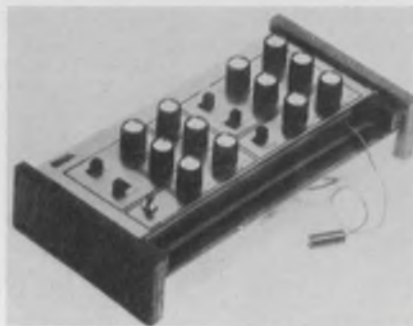

Gnome preset electronic synthesizer from PAIA Electronics, although small and limited, uses the voltage-controlled functions common to all larger synthesizers.

"Perhaps the biggest boost to the use of voltage control in synthesizers was the introduction of the silicon planar transistor. Our favorite was the 2N2926, which was inexpensive, operated over a wide voltage range and was predictable and quiet. We started doing things that were practically unfeasible with germanium transistors and tubes."

In certain circuits common to synthesizers, discrete transistors are still the rule, because of cost or performance considerations. In some cases the designer needs a discrete transistor to produce a wide-range VCO, or he uses a non-linear portion of a transistor curve that is balanced out inside an IC.

"We are making use of ICs in nearly every part of our newest units," Dr. Moog reports. "For instance, a voltage-controlled amplifier is based on the operational amplifier—now one IC rather than five transistors, a dozen resistors and several capacitors."

Circuitry in synthesizers has become virtually standardized among manufacturers. John S. Simonton Jr., president of PAIA Electronics, Oklahoma City, OK, a manufactur-

er of small synthesizers and modules, explains why:

"By now, practically all synthesizers, from the simplest to the most complex, are using many of the same circuits. After all, there is usually one most cost-effective technique for designing a voltage-controlled filter using available technology. What the manufacturer wants is a way to produce an effect with ease of control, reproducibility, minimum complications and least expense."

Some digital sequencing

Although the synthesizer technology is largely analog, digital interface techniques are appearing. An example is the Digionic digital music sequencer from Ionic Industries, Inc., Morristown, NJ. The device is connected to a synthesizer and receives and records the sequences of control voltages produced by the keyboard and voicing controls.

The control levels can then be sent back to the VCOs, VCAs and filter circuits—in effect, "playing" the synthesizer.

Using shift registers, the Digionic can memorize sequences of up to 146 combinations of four control levels. This is equivalent to 146 notes with three voicing voltages per note. An add-on is available to lengthen the sequences to 246 notes. An additional output is also available to drive a rhythm generator, and the unit can be programmed from the synthesizer keyboard or with digital inputs from magnetic or paper tape.

Once the sequence is stored, it can be modified at the will of the operator. The sequence speed can be increased or reduced without affecting pitch, voicing can be changed or the high and low notes can be transposed. The entire composition can be inverted.

In many cases the circuit technology of modern organs is becoming more and more synthesizer-like. The major difference is that an organ is polyphonic and preset. Each key or pedal controls its own set of frequencies and waveforms. Each of the "voices" can be selected and added to other voices, but no continuous adjustments are available to the player.

Organs are carefully designed so

The Schottky sandwich.



The Augat Schottky board is something you can really sink your teeth into.

On the outside there are two ground planes, top and bottom, instead of just one.

On the inside there's a special voltage plane that's made of a generous slice of copper.

Laminated together, it makes a very neat sandwich that goes perfectly with Schottky TTL design.

For example, it increases distributed capacitance by as much as 400 percent. And at the same time, it greatly reduces high frequency noise.

It has ground embraced socket and I.O. connections that enhance isolation of signal interconnections.

Individual DIP decoupling capacitor zones and electrolytic-type decouplers at every power entry point.

And voltage and ground socket pins that are soldered directly to their planes to drastically lower impedance.

All in all, the Augat Schottky board can save you up to 90 percent in breadboarding and prototyping time. Tens of thousands of dollars in start-up costs. And many expensive hours in field maintenance.

The Augat Schottky boards are standard catalog items available right now in any quantity and in any multiple of patterns, from 30 up to 180.

If you'd like a taste of what it's all about, contact any of our world-wide distributors or Augat, Inc.,

33 Perry Avenue, Attleboro, Mass. 02703.

Tel. 617-222-2202. TWX 710-391-0644.

AUGAT[®]

From **RCL**,
The World's
Largest
Manufacturer
Of
Precision/Power
Wire-Wound
Resistors

FREE
ENGINEERING
HANDBOOK,
1975
EDITION

- △ Military style cross-reference chart
- △ Heat distribution curves
- △ Special T.C.'s
- △ Typical circuitry
- △ Resistance temperature characteristics
- △ Networks - (DIPs)
- △ Established reliability resistors
- △ Low cost commercial styles
- △ Computer and fast rise time applications
- △ Vitreous enamel resistors
- ...and much more

Call our hotline for prompt
service and delivery.
(201) 374-3311

AMF

RCL Electronics

General Sales Office:
700 So. 21st Street
Irvington, N. J. 07111

the master oscillators do not vary in frequency. This keeps the organ in tune. Although the frequency of the notes may be varied for such effects as vibrato, they usually cannot be shifted at will.

Electronic organs use LSI

As the "big boys" of the electronic music field, the organ manufacturers have been using an increasing number of custom LSI circuits. The latest organ models generally have at least one custom circuit to interface the keyboard and stops to the internal circuitry. Other units have IC countdown networks for frequency division, and they are using ICs to generate such special effects as rhythm.

Wurlitzer Corp. in DeKalb, IL, uses about five different custom ICs in its latest organs, as well as a number of off-the-shelf circuits. In the pedal board, a circuit known as the priority latching network plays the highest note if two pedals are depressed at once. A custom keying circuit interfaces the keyboard contacts to the frequency dividers, so that the three "ranks of pipes" can be controlled with a single contact. This replaces a much more complicated set of three contacts per key.

Other custom ICs in the master frequency generator derive the organ frequencies by counting down from a discrete component master oscillator. All timing information needed in the rhythm generator comes from a single IC, although the sound of a marimba or blocks is produced with analog filters.

Finally, a custom chip is used to provide automatic chords and chord progressions, as well as to allow chords to be pulsed with rhythm signals.

Off-the-shelf ICs in Wurlitzer organs include op amps—used throughout the audio system as mixers and preamps, MOS dividers, IC voltage and current regulators—and LEDs with light-dependent resistors for envelope shaping.

Organ uses digital technology

A series of organs introduced about three years ago by the Allen Organ Co., Macungie, PA still appear to be the most technologically

advanced of contemporary products. The Allen Digital Computer Organs use a read-only "specification" memory to store the harmonic structure of desired voices—information which is read out at any keyboard related frequency (see diagram).

To program the memories, a desired organ voice is recorded and analyzed for its harmonic content, so its envelope can be constructed. The harmonic information is expressed as 16 words of 7 bits each; these correspond to the amplitude at 16 points along the positive half cycle of the waveform.

The negative half cycle is a mirror image, and the specification memory is divided into blocks, corresponding to the voices on the organ. Each block holds the 16 words of a positive half cycle. The blocks and each of the amplitude words are assigned a numerical address to allow the information to be retrieved on demand.

When the organ is being played and voices are selected, they are transferred to a random-access "registration" memory. This allows two or more voices to be combined digitally. As keys are played, the 16 sample points are successively read out at the correct audio rate.

The readout function is performed on a board that contains MOS circuitry. One circuit is the keyboard decoder and multiplexer, which provides an output pulse for each key depressed. These pulses are applied to the frequency generator—an action that causes the address generator to address each of the 16 sample points, then reverse and count backward for the inverted 16 points that make up the negative half cycle of the tone.

From the registration memory, the data go to a multiplication circuit, where the voice data are multiplied by the attack and decay functions retrieved from another ROM. Finally the data are converted to a conventional audio signal in a digital-to-analog converter and fed to the amplifiers and speakers. The over-all frequency of each note, as well as all the timing functions for the digital circuitry, come from a clock board with a 4-MHz master clock and counting circuitry that provides the timing pulse trains. ■■

Radar energy absorber eliminates 'ghosts'

Using a new electromagnetic energy absorbing material, engineers at Rockwell International's Tulsa Div., OK, have eliminated ghosting—a problem that often plagues radar operators.

Ghosting occurs when radar signals returning from an aircraft bounce off of another object before they are reflected back to the radar antenna. This causes the radar scope to display a weaker, false image of the same aircraft.

By placing panels made of RIGEL (Rockwell International Ghost Eliminator) on the particular structure reflecting the signals, ghosting is eliminated since the panels absorb rather than reflect the signal.

The RIGEL panels contain a thin polymer film of the energy absorbing material, a honeycombed shape support structure and a wire mesh. By changing the depth of the honeycomb structure and the pattern of the energy absorbing material printed onto the thin polymer film, the absorption frequency of the ghost eliminator can be changed.

The RIGEL panels were installed at the Tulsa International Airport on the north wall of the control tower. The installation represents the first commercial use of this classified material originally developed for the Government.

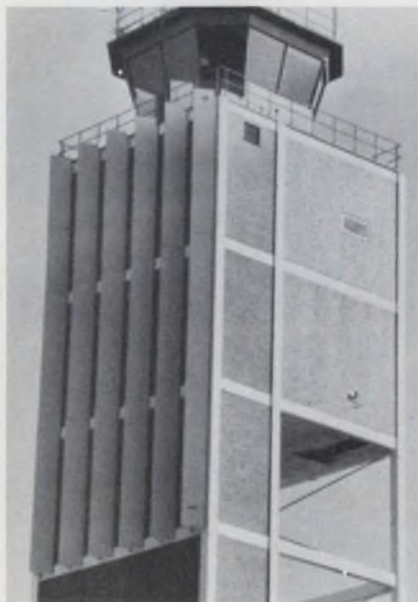

Energy absorbing panels made from a new material eliminate radar ghosts.

Meet Shelly's LED-EYE

Industry's first complete line of LED indicators in standard T1 packages.



Wide range of colors



Another first for Shelly. Industry's first T1 LED package. They're bright! In red/2.5 MCD @ 20 ma; green, orange & yellow/2.0 @ 20 ma. Also a current regulated LED which provides constant intensity from 4.5V to 11V. And a voltage sensing LED for battery status indication.

Just snap into panel

Easiest to use too. Just insert into 0.191" hole and press into position. LED-EYES are ideal for modern panels where space is at



a premium. Mounting on 0.225" centers they offer clean design and high illumination.

Digi-caps, too

Cap styles include Ball End and our unique Digi-cap, a LED-EYE imprinted with 1 or 2 letters, numerals or symbols to give added dimension to a display.



Shelly — The T1 specialists

With Brite-Eyes — T1 incandescents in 7 cap styles & 7 colors. Front relampable without tools.

With Trans-Eyes — A Brite-Eye with built-in hybrid amplifier. Eight base/circuit configurations.

With LED-Eyes — The first LED in a standard T1 package. 4 colors and 2 cap styles.



Send for our free "How To Order" brochure or phone 800-645-9200 EEM Dial-A-Source.

shelly associates

A Subsidiary of Datatron, Inc.

1562 REYNOLDS AVENUE, SANTA ANA, CALIFORNIA 92705
PHONE (714) 540-9330 • TWX 910-595-1859
MAILING ADDRESS: P.O. BOX 11427, SANTA ANA, CALIFORNIA 92711
INDICATORS • MULTI MESSAGE DISPLAYS • FIBER OPTICS • ANNUNCIATORS

Digital introduces a pair of minis for the price of micros.

**8/A-400 with
8K core. \$1845.**

**8/A-200 with
4K MOS. \$1317.**

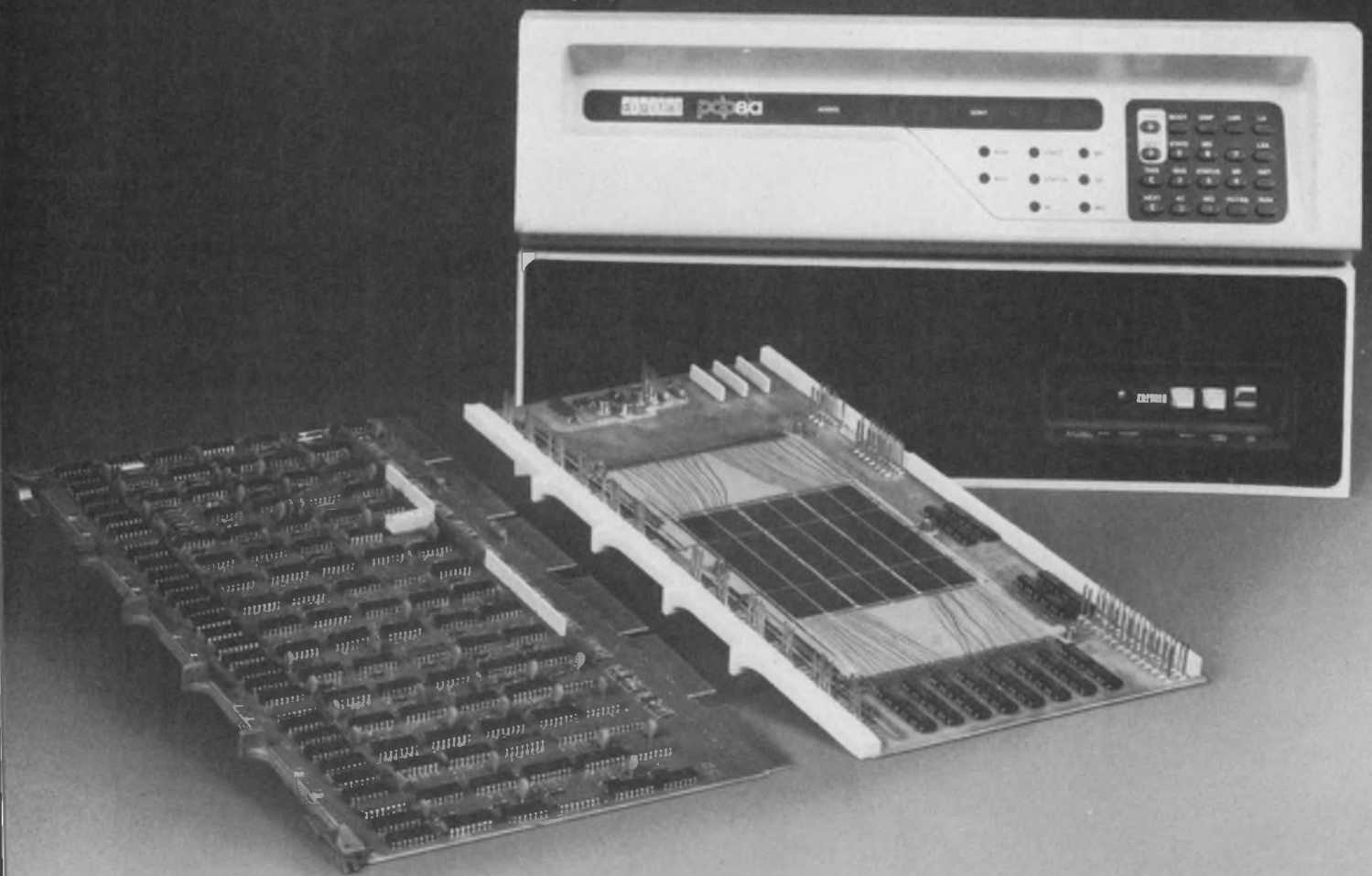

Two new small computers.
Two new bottom-busting prices.

The 8/A, with central processor, 4K of MOS (RAM) memory, chassis, power supply, operator's console, and battery backup. Just \$1317 in quantity 50.

The 8/A-400, with central processor, 8K of core memory, chassis, power supply, and operator's console. Only \$1845 in quantity 50.

Now take a look at the quantity prices in the table below. And while you're at it, take a close look at the competition's prices.

What you learn may surprise you.

But price is only half the story.

As part of the largest computer family in the world (over 25,000 PDP-8's installed), both these new computers are backed by 10 years of PDP-8 software development.

Dozens of PDP-8 peripherals. And a complete range of interfaces.

We've become the world's leading supplier of small computers by helping you make the most of computers.

Now prices are going to

keep us there.

For more information on these new computers, write Digital Equipment Corporation, Maynard, MA 01754.

(617) 897-5111. European headquarters: 81 route de l'Aire, 1211 Geneva 26. Tel: 42 79 50. Digital Equipment of Canada, Ltd., P.O. Box 11500, Ottawa, Ontario K2H 8K8. (613) 592-5111.

digital

		CPU & 1K RAM Boards Only	CPU & 4K RAM Package	CPU & 8K CORE Package	CPU & 16K CORE Package
Digital Equipment	PDP-8/A	\$ 591	\$1317	\$1845	\$2505
Computer Automation	LSI 2/10	\$1050	\$2135	\$2459	\$3491
Data General	Nova 2/4	Not Available	\$2112 (CORE)	\$2432	\$3456
General Automation	LSI 12/16	\$ 635 (Qty. 100)	\$2000 (Qty. 100)	\$2300 (Qty. 100) (RAM)	\$3100 (Qty. 100) (RAM)
National Semiconductor	IMP-16L	\$ 713	\$2660	\$3510 (RAM)	\$5210 (RAM)

Based upon current published prices for discount level of 50 units.

Prices apply to U.S.A. and Canada only.



MOS·CMOS, TTL·HTL, HP pulser solutions for

Before you choose your next pulse generator, look into THE broad line...from HP. We'll give you a choice of several instruments for your particular logic family...whether it's high-speed bipolar, MOS, high-threshold, or general-purpose bipolar logic.

Need to test above 200 MHz? Our newest pulse generator gives you a rep rate to 250 MHz for testing high-speed bipolar logic at operational frequency limits. And its UNMATCHED variable transition time down to 1 nsec lets you meet manufacturers' conditions for propagation-delay

tests...or degrade transition times for worst-case testing.

Maybe you need high output levels for MOS. We have instruments with outputs up to 16V (30V swing on dual outputs) and rep rates to 50 MHz for the most advanced MOS circuits. Other units handle lower rep rates with outputs to 100V.

TTL?...HTL? We offer a variety of instruments with single or dual outputs, selectable output impedance levels, fixed or variable transition times and pulse-burst options.

We even have a plug-in series that lets you



ECL·S/TTL... your IC problems

put together your own logic-testing system to include programming, word generation, pseudorandom sequences, multiphase clock generation, and more.

In this family, there's a pulse generator to satisfy your particular testing requirements. And you'll find human-engineered instruments to simplify your setups and reduce testing errors.

So if you're thinking digital testing, find out what HP has to offer. Give your local HP field sales engineer a call today. Or, write for a free copy of our new pulse generator brochure.

HEWLETT  PACKARD

Sales and service from 172 offices in 65 countries
1501 Page Mill Road, Palo Alto, California 94304

INFORMATION RETRIEVAL NUMBER 28

Power Splitters/Combiners

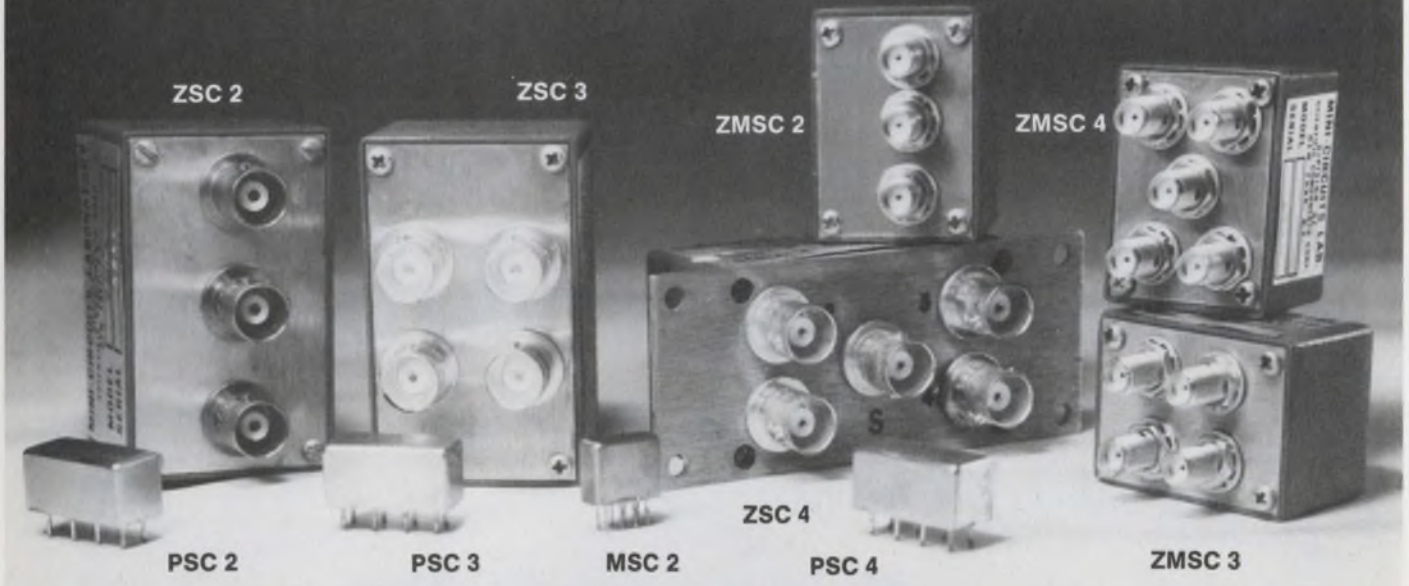

- **Broad Bandwidth** — The frequency range of any splitter/combiner is wider than any comparable competitive units.
- **High Isolation** — Typical; 40 dB @ 30 MHz — 30 dB @ 100 MHz.

- **Closely Matched Outputs**—Typical 0.05 dB amplitude unbalance at ports.
- **Low Insertion Loss** — Less than 0.5 dB over most of the bandwidth.
- **Small Board Area** — only 0.2"

- x 0.5" (0.1 sq. in.) P. C. Board area required for MSC series.
- **Price** — from 1/3 to 1/2 the price of competitive units (see below).
- **Delivery** — from stock — one week maximum.

TWO-WAY, THREE-WAY AND FOUR-WAY POWER SPLITTER/COMBINERS

Model No.	Freq. range (MHz)	Isolation between outputs (dB) typical	Insertion loss (dB) (typical)	Unbalance		Price (Quantity)
				ψ (deg)	Amp. (dB)	
PSC 2-1 ZSC 2-1 ZMSC 2-1	0.1-400	25	0.4 above 3dB split	1	0.05	\$ 9.95 (6-49) \$24.95 (4-24) \$34.95 (4-24)
MSC 2-1	0.1-450	30	0.4 above 3dB split	1	0.05	\$15.95 (6-24)
PSC 2-2 ZSC 2-2 ZMSC 2-2	0.002-60	40	0.3 above 3dB split	1	0.05	\$19.95 (6-49) \$34.95 (4-24) \$44.95 (4-24)
*PSC 2-1-75 *ZSC 2-1-75	0.25-300	25	0.4 above 3dB split	1	0.05	\$ 9.95 (6-49) \$24.95 (4-24)
PSC 3-1 ZSC 3-1 ZMSC 3-1	1-200	40	0.4 above 4.8 split	2	0.05	\$19.95 (6-49) \$34.95 (4-24) \$44.95 (4-24)

Model No.	Freq. range (MHz)	Isolation between outputs (dB) typical	Insertion loss (dB) (typical)	Unbalance		Price (Quantity)
				ψ (deg)	Amp. (dB)	
PSC 3-2 ZSC 3-2 ZMSC 3-2	0.01-30	40	0.25 above 4.8 split	2	0.1	\$29.95 (6-49) \$44.95 (4-24) \$54.95 (4-24)
PSC 4-1 ZSC 4-1 ZMSC 4-1	0.1-200	30	0.5 above 6dB split	2	0.1	\$24.95 (6-49) \$39.95 (4-24) \$49.95 (4-24)
ZSC 4-2 ZMSC 4-2	0.002-20	33	0.45 above 6dB split	2	0.1	\$64.95 (4-24) \$74.95 (4-24)
PSC 4-3 ZSC 4-3 ZMSC 4-3	0.25-250	30	0.5 above 6dB split	2	0.1	\$23.95 (6-49) \$38.95 (4-24) \$48.95 (4-24)
**PSCJ 2-1 **ZSCJ 2-1	1-200	35	0.6 above 3dB split	Phase deviation from 180° 2.5	.15	\$19.95 (5-49) \$34.95 (5-49)

COMMON SPECIFICATIONS FOR ALL MODELS: Impedance all ports, 50 ohms, *Except 75 suffix denotes 75 ohms VSWR: 1.1-1.2 typical
Nominal phase difference between output ports; 0°**Except J suffix denotes 180° Delivery from stock, One week max.

MCL
Mini-Circuits Laboratory
A Division Scientific Components Corp.

OUR NEW ADDRESS IS: 837-843 Utica Avenue,
Brooklyn, NY 11203 (212) 342-2500
Int'l Telex 620156

Foreign Sales Representatives: AUSTRALIA General Electronic Services, 99 Alexander Street, New South Wales, Australia 2065; ENGLAND Dale Electronics, Dale House, Wharf Road, Frimley Green, Camberley Surrey; FRANCE S. C. I. E. - D. I. M. E. S., 31 Rue George - Sand, 91120 Palaiseau, France; GERMANY, AUSTRIA, SWITZERLAND Industrial Electronics GMBH, Klüberstrasse 14, 6000 Frankfurt/Main, Germany; ISRAEL Vectronics, Ltd., 69 Gordon Street, Tel-Aviv, Israel; JAPAN Densho Kaisha, Ltd., Eguchi Building, 8-1-1 Chome Hamamatsucho Minato-ku, Tokyo; EASTERN CANADA B. D. Hummel, 2224 Maynard Avenue, Utica, NY 13502 (315) 736-7821; ITALY Microel Italia s. r. l., via M. Loria 50, 20144 Milano & via Senafe 27, 00199 Roma; NETHERLANDS Co:mex, Veldweg 11, Hattem, Holland

US Distributors: NORTHERN CALIFORNIA Cain-White & Co., Foothill Office Center, 105 Fremont Avenue, Los Altos, CA 94022 (415) 948-6533; SOUTHERN CALIFORNIA, ARIZONA Crown Electronics, 11440 Collins Street, No. Hollywood, CA 91601 (213) 877-3550

For complete U.S. Rep listing and product line see MicroWaves' Product Data Directory

washington report

F-16 fighter shapes up as a plum for electronics makers

While it's too early yet to come up with a firm figure, the Air Force F-16 fighter selection holds promise of a possible \$2.85-billion market for the avionics and electronics that will go into the lightweight aircraft. Much of the avionics will be off-the-shelf, but the radar will be new. The plane will be built by General Dynamics. Hughes and Westinghouse have contracts to develop the avionics, and a flyoff on these subsystems is likely this summer.

The initial Air Force purchase of 650 aircraft will include around \$490-million for the avionics. This is based on a flyaway price of \$4.6-million per aircraft.

Besides the Air Force, the NATO nations are possible customers. They could buy some 350 aircraft, adding perhaps \$262-million in avionics.

All told, there are possible lifetime purchases of between 3300 and 3800 aircraft. The total potential for the avionics market, in today's dollars, appears to be in the vicinity of \$2.85-billion for original equipment alone—and there is always retrofitting. The F-16 program is being heralded as the plum of the century.

NASA plans for fiscal 1975 available

The National Aeronautics and Space Administration's compilation of research and technology activity for fiscal 1975 is now available as the NASA Research and Technology Operating Plan Summary (RTOP-75). Included are summary portions that spell out objectives and identify installations of primary interest. NASA officials predict the plan will be particularly helpful to small R&D companies. A copy costs \$3 and can be obtained from the National Technical Information Service, Springfield, VA 22151.

U.S. moves to end procurement favoritism

New rules on Federal Government procurement by formal advertising should make it easier for sellers, tougher on buyers and stamp out favoritism. The General Services Administration says future descriptions must not specify a product that has features peculiar to a product made by one manufacturer, producer or distributor, unless the Government buyer can show the features are essential.

Nor can the specifications include either minimum or maximum restrictive dimensions, weights, materials or other salient characteristics that would tend to eliminate competition by products that are only marginally

outside the restrictions—unless such restrictions are determined by the user, in writing, to be essential to the Government's requirements.

Further, descriptions must clearly and accurately describe the salient technical requirements or desired performance characteristics without including restrictions that do not significantly affect the technological requirements or performance. And, when appropriate, the buyer must describe the testing procedures that will be used to determine if the requirements or characteristics are met.

Bye-bye ERTS, hello LANDSAT

ERTS—the Earth Resources Technology Satellite—has a new and simpler name: LANDSAT. And someday it may have a companion named SEASAT. The new names were announced unexpectedly by the National Aeronautics and Space Administration. LANDSAT stands for land satellite and SEASAT—right, for sea satellite.

SEASATS are scheduled for launching in 1978, with the 2100-lb satellites circling the earth 14 times a day on a north-south orbit and sending back information on the oceans, like the LANDSATs do for land surfaces. The SEASATs will carry a compressed-pulse radar altimeter, a coherent synthetic-aperture imaging radar, a microwave wind scatterometer and an infrared radiometer. Sensors will determine wave heights, current directions, surface-wind direction and temperatures. An envisioned network would give ships sea maps of their routes twice daily.

Capital Capsules: A comprehensive review of the status of the metric system conversion program is due in mid-February. The "Report to the Nation on the Management of Metric Implementation" will be the first annual report of the private American National Metric Council, which holds its first annual conference in Washington, March 17-19. . . . Hart, Mich., a town of 2,500 will be studied by Michigan State University to determine if wind energy can be used economically to support the electric power needs of a small municipal utility. Funds for the study are from a \$93,400 grant from the National Science Foundation. . . . Concern in some countries with the potential environmental hazard posed by polychlorinated biphenyl (PCB), a chemical used in the manufacture of capacitor dielectrics, has prompted the Electronic Industries Association to develop a new supplemental standard for capacitors using non-PCB oil-impregnated paper dielectrics. The EIA says concern has led Japan and other countries to ban the manufacture, import and use of electronic equipment containing any PCB. . . . The Air Force's Avionics Laboratory has announced a need for a radio-metric microstrip receiver. Performance goals are 34-36 GHz, instantaneous bandwidth of 500 MHz and a noise figure of 5.5 dB (DSB). USAF says the receiver must be developed with hybrid microwave integrated-circuit techniques and include a self-calibrating capability. . . . A Directory of Defense Electronic Products is available from the Electronic Industries Association. Prime use will be to brief potential foreign customers on the capability of U.S. defense and related high technology electronic products. . . . On the horizon is a study to verify thermal characterization models of beam-lead microcircuits. The contractor selected by the Army will focus on microcircuits comparable in chip size, number of beams and power dissipation to MSI circuits of the 54TTL series. The power dissipation of the devices will be in the 200-to-800 mW range.

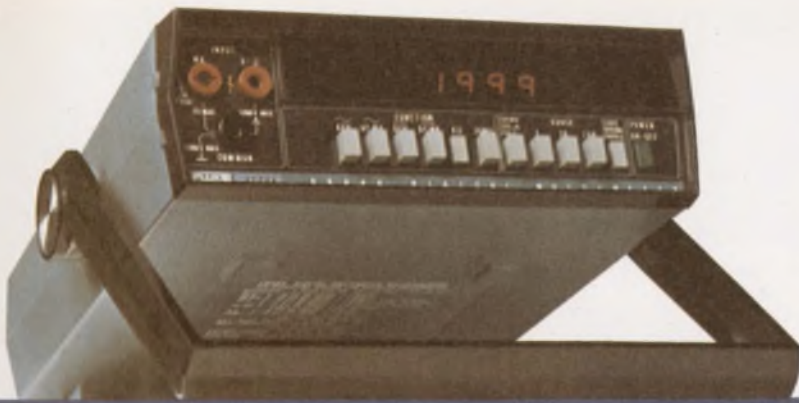

Over 50,000 people now own our 8000A.
It's the best selling DMM in the world.

Read why:

The average DMM lets you down in one performance area or another. By contrast, the Fluke 8000A 3½ digit multimeter offers you the industry's broadest and best combination of outstanding specs, including some that are unmatched anywhere.

■ **Best accuracy statement** of any 3½ digit DMM: 0.1% accuracy \pm 1 digit; one year accuracy time span; 25 C \pm 10°C accuracy temperature span.

■ **Outstanding normal mode rejection:** 60 dB at 50 and 60 Hz.

■ **Outstanding common mode rejection:** 120 dB with an unbalance resistance of one kilohm.

■ **Overload protection** specified for all ranges, not just some.

■ **26 ranges** of volts, amps and ohms.

■ **More option power** than any other DMM. Includes 2 ohm and 20 ohm range option. 20 amp current capability. BCD output. Built-in, self-contained, rechargeable battery pack.

■ **More accessories** than any other DMM. Includes 600 amp AC clamp-on current probe. 40 KV high voltage probe. 100 and 500 MHz rf probes. 3 types of rack mounts.

■ **Auto zero.** Automatically sets zero reference, eliminating the need for front panel manual adjustment.

■ **One year unconditional warranty.** Forty-eight hour local service.

■ **The incomparable Fluke reputation.** Just ask anybody.

■ **Price still only \$299.** (domestic only)

For data out today dial our toll free hotline 800-426-0361.

For a demo circle 260. For literature only circle 261.

For info on the rest of the Fluke line see our ad in EEM or the Gold Book.

John Fluke Mfg. Co., Inc.,
P.O. Box 7428, Seattle, WA 98133.





THE END OF THE ARGUMENT... THE CHOICE IS YOURS!



ALGEBRA

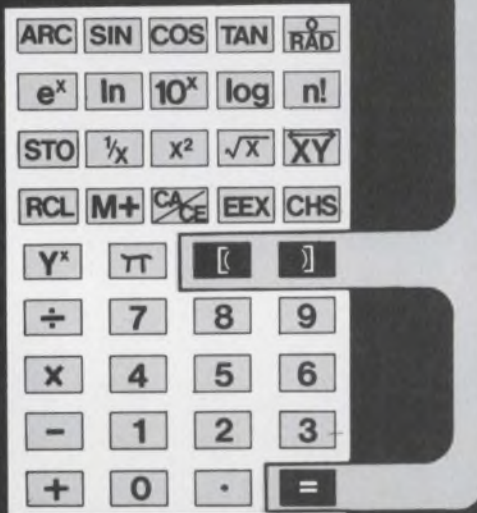

- Algebraic Entry
- Two Parenthesis Levels

or

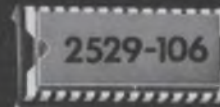

RPN*

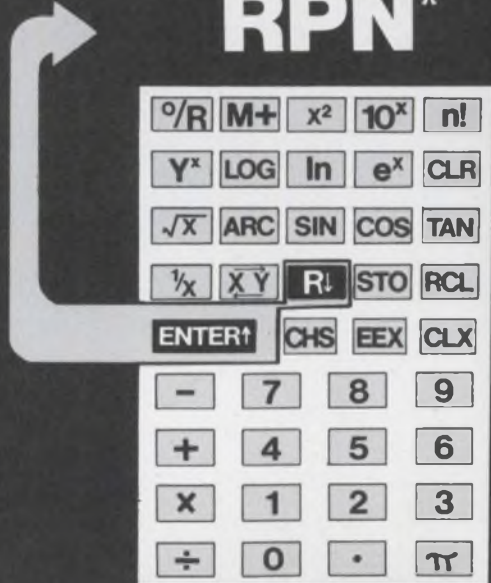

- * Reverse Polish Notation
- 4 High Operational Stack

Both With

- Full Scientific Functions • Full Scientific Notations • Full Feature Memory • Twelve Digit Display

HEADQUARTERS—
Product Mgr., Mr. Julius Hermch: MOS Technology, Inc.,
950 Rittenhouse Rd., Norristown, Pa. 19401 (215) 666-7960
EASTERN REGION—
Mr. William Whitehead, Suite 107—88 Sunnyside Blvd.,
Plainview, N.Y. 11803 (516) 822-4240
WESTERN REGION—
MOS Technology, Inc., 2172 DuPont Dr., Suite 221
Patio Bldg. Newport Beach, Calif. 92660 (714) 833-1600



MOS TECHNOLOGY, INC.
VALLEY FORGE CORPORATE CENTER, NORRISTOWN, PA. 19401 (215) 666-7950

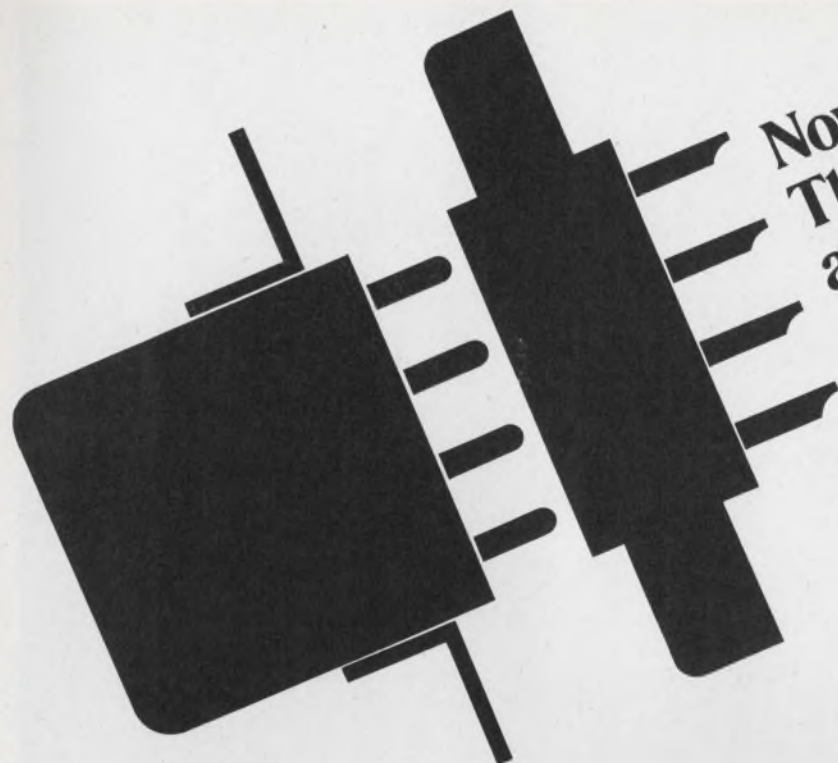

**Now!
There's one simple
answer to all of
your relay socket
needs.**

Us.

We have sockets for just about every crystal can relay made, including those by:

Babcock
C. P. Clare
Deutsch
Electronic Specialty
Hi-G
Leach
Struthers-Dunn
Wabco

and more. We have them for relays meeting MIL-R-5757, MIL-R-6106, MS, Buweps, Buord, Navair, BAC... and other specifications in Electronics, Aerospace, and the Military.

Fact is, you'd have to use a very rare relay to miss our line.

How to order.

Our distributor nearest to you has on his shelf the popular sockets that mate with relays of the leading relay manufacturers. Tell him the relay you're using — he'll know the Viking socket that fits.

Quality is tops, of course. So is delivery time. So, call him. And make your life a little easier.

Or send for our detailed 16 page brochure. A copy is yours for the asking.

O.K. Send me your brochure on Viking Relay Sockets.

NAME _____

TITLE _____

COMPANY _____ M/S _____

ADDRESS _____

CITY _____

STATE _____ ZIP _____

TELEPHONE _____

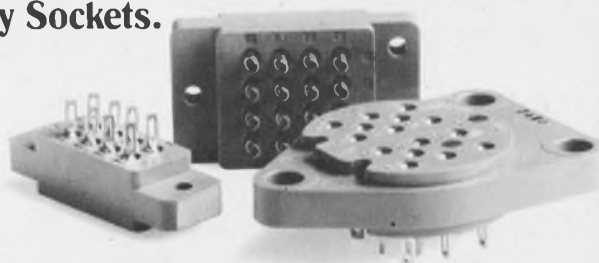

 **Viking**
CONNECTORS

Viking Industries, Inc. /MilCom Division/9324 Topanga Canyon Boulevard/Chatsworth, Ca 91311, U.S.A. / (213) 882-6275

INFORMATION RETRIEVAL NUMBER 32

If you're considering flexible circuitry, here are three good reasons why you should consider Buckbee-Mears first.

EXPERIENCE: Nobody has designed or manufactured more kinds of flexible circuitry, for different types of applications, to more rigid specifications, than Buckbee-Mears.

ENGINEERING SUPPORT: As much or as little as you require, from initial concept through design assistance, testing, evaluation and final product application.

SOPHISTICATED TECHNOLOGY: Another way of saying BMC uses both new techniques and conventional techniques in new ways to *make the "unmakeable."* Through-hole plating in multi-layer circuits with unsupported leads . . . shaped conductors in specially formulated dielectric material . . . precisely positioned connector holes in two dielectric films over the entire length of an etched harness . . . to mention just a few.

For information on how Buckbee-Mears can help solve your own flexible circuitry problem, write or call Circuits Division, Buckbee-Mears Co., 245 E. Sixth, St. Paul, MN 55101. (612) 228-6371.

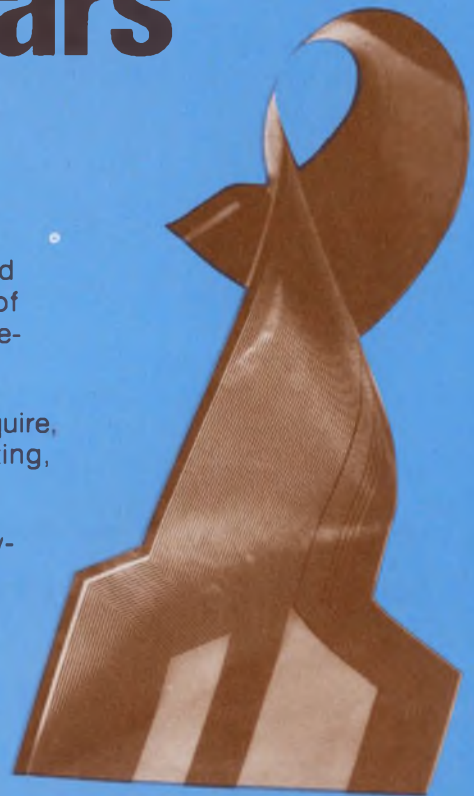

245 EAST 6TH STREET
ST. PAUL, MN 55101
612-228-6371

BUCKBEE-MEARS COMPANY

bmc

The foreign engineer

There's an old joke in Europe about the American fellow who had to buy a gift for his girlfriend. When someone suggested that he buy her a book, he rejected the idea with: "No, that won't do. She already has a book."

I know how that girl must have felt if she ever heard the story. Toward the conclusion of my visit with a semiconductor company in Paris, my host turned to me with: "By the way, our offices here are in the former home of a French writer of some repute." And in a tone one might use to ask a fellow if he's familiar with spoken Sanskrit, he asked, "Have you ever heard of Guy de Maupassant?" When I started quoting from some of de Maupassant's brilliant stories, my host was startled. He found it hard to believe that an American—an American engineer, at that—might have read de Maupassant, though that man ranked with the world's greatest short story writers. That's rather sad.

European engineers have great respect for American engineers—as *engineers*. But they find it hard to believe that an American engineer might read a book without equations. They can't picture an American engineer reading great literature, listening to great music or admiring great art.

Thanks largely to the efforts of electronics engineers, we've made great strides in shrinking the world with transoceanic cables, international radio and telephone, and round-the-world satellite communications, not to mention high-speed, jet aircraft. We have brought the world's people closer together. But not close enough.

We still don't know each other. It's not too many years since Europeans, thanks to the influence of the movies, thought all Americans were millionaires or gangsters. Today many Europeans think American engineers are great engineers, but they wouldn't want to be stuck in a conversation with one. And American engineers have distinct stereotypes for French, Italian, British, German and Dutch engineers. That's unfortunate but it may point to our next step.

We have to shrink the world further. We have to make it small enough so that international communications and travel are cheap enough, quick enough and easy enough so that people of the world—not just engineers—can get to know each other better. We may find we're not shooting at each other so much.



A handwritten signature in dark ink, which appears to read "George Rostky". The signature is fluid and cursive, written in a professional style.

GEORGE ROSTKY
Editor-in-Chief

tic-tac-toe

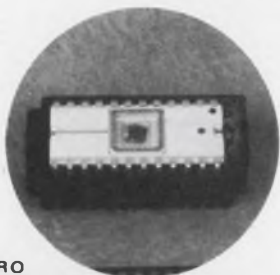

ZERO INSERTION FORCE SOCKET

40, 36, 28, and 24-position versions. Self-ejection of LSI, positive lock in the loaded position. LSI will not be damaged by repeated insertions.



LOW PROFILE BOSS™

Our newest Boss (binary option selection switch) family member. Just .360" high for 500" board spacings. And it offers the same butting/wiping contact design.



A-C RECEPTACLE

A three-pronged a-c receptacle with crimp snap-in contacts offers the lowest installed cost in the industry today. It also has a repairability feature not available on other a-c receptacles.



KK-100 PCB CONNECTOR

Right-angle, bottom-entry, and straight versions expand the possible combinations for Molex' 100" interconnection systems. Reliability, low cost, and popular density are key features.



LAMP SOCKETS

A socket from which a wedge-based bulb can be easily removed. It also withstands vibration and shock. Two popular sockets that use T-3-1/4, T-5, or T-1-3/4 wedge-base lamps are now available.

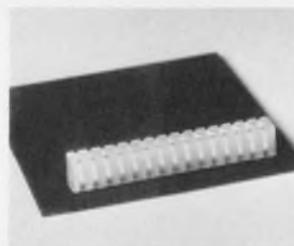

CALCULATOR KEYBOARD CONNECTOR

Currently designed as a 22-circuit version, this product can be developed to connect the main logic board to the keyboard on any calculator.



MOLEX-A-MATIC

How do you make the Molex plug-in socket connector series a better buy? You assemble the terminals by machine! We are the only company that has successfully automated this operation.

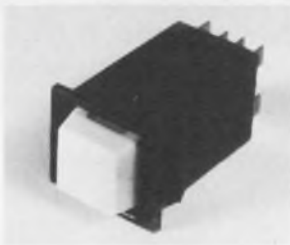

NEW LIGHTED PUSHBUTTON SWITCH

This cost-effective switch was developed to provide customers with a double-pole capability. It's part of our continual product line expansion program... and it's priced right.



COMMONING CONNECTOR

Provides inexpensive power distribution capability from single inputs to replace distribution blocks. Fewer parts, hand loading of contacts, crimp snap-in technology, and single or multiple-row stacking capability.

It's no game at Molex. It's serious business. In the past few months, we've developed many new products for many industries... computers, peripherals, radio and TV, appliances, calculators, communications, and office equipment. The nine products displayed here are the latest new products just released. There are more on the way.

Call your Molex sales representative for an update of our expanding product line. Our products are new, our prices competitive. Ask Molex to quote your next project package.



Molex Incorporated, Dept. ED275, 2222 Wellington Court, Lisle, Illinois 60532

This calculator design uses several Molex components.

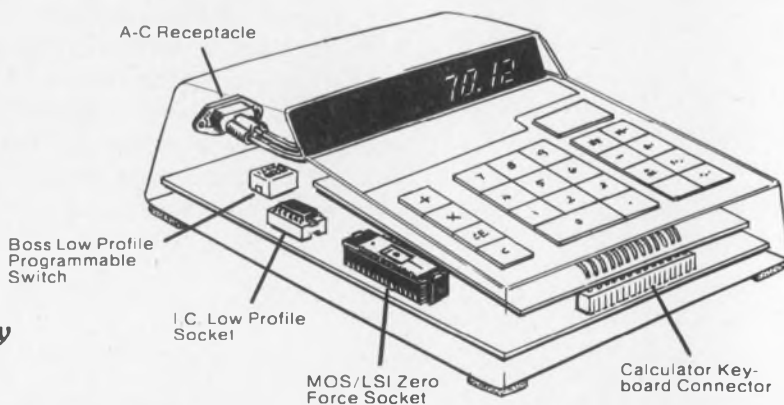

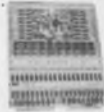

This is not a semiconductor memory.

But then, semiconductor memory isn't always the answer. What you're looking at is our new 16K X 20 core memory board. It's the newest addition to our fine family of compatible memory products. (We reduced it just to get your attention).

We call this board the Harris 3800. You'll call it reliable. Reliable because they meet the exacting demands of our own computer systems. And, they'll meet the unpredictable demands of your unpredictable needs.

Harris memories. Another source when you need economy in quantity purchases. When you need field proven memories. When you need custom design. Or when you expect reliability.

- 250 ns access time
- Size: 11½ X 13¾
- Power required: +15 vdc, +5 vdc
- cycle time 650 ns
- random access
- no field adjustments

Write for the newest in 16K memory boards... the newest non-semiconductor that is. But if your need is semiconductor... we'll be pleased to discuss pin compatible HARRIS semiconductor memory systems.

HARRIS



**COMMUNICATIONS AND
INFORMATION HANDLING**

1200 Gateway Drive, Fort Lauderdale, Florida 33309 (305) 974-1700



FOCUS

on
Component
sockets

Why use sockets? For the obvious reasons: You'll simplify component assembly and replacement, and you'll avoid damaging costly components with hot solder.

But, to use them, you must know something about contact reliability, allowable heat dissipation, dielectric breakdown and mechanical strength and a few new troubles before you buy.

One of the biggest socket problems, today, is posed by the ubiquitous DIP (dual-in-line package), whose skinny little leads were never meant for a socket. Add to that a very broad EIA spec on lead size, and it's a miracle that the sockets work sometimes.

However, the conventional IC DIP does use leads that have some definition of shape—the lead's cross-section is rectangular. The situation is much worse with LED displays that sport round pins mounted on DIP cases. Plug the round pin into a socket designed for rectangular leads, and the spring material deforms permanently.

To compound the confusion, there is the Occupational Health and Safety Act (OSHA), which, for component sockets, translates to an Underwriters' Laboratories spec on material flammability. Any design that involves handling at a job station—for example, CRT terminals or computer peripherals—must comply with OSHA. And the UL spec also applies to consumer equipment.

The old spec game

Naturally the manufacturer may play down these problems or introduce his own confusion. The catalogs will inundate you with contact shapes, elaborate mechanical drawings of sockets and a new language, with terms like "insertion/withdrawal force ratio" and "low profile." Speci-

fied contact resistance often is valid only on the first insertion. And words like "UL recognized" rather than the rating itself may be given when you really need something like UL 94VE2, a spec for self-extinguishing capability, or its older equivalent, SE-2. The 94VE2 spec is essential to meet OSHA requirements for work-station equipment.

Although flame retardance is just becoming an issue, the gold-tin controversy permeates almost every manufacturer's brochure. With gold hovering around \$175 an ounce, most manufacturers either try to eliminate the metal or find ways to skimp on its use.

When gold prices were fixed, the military had no qualms in specifying 50 μ in. of hard gold plating for reliable connections. And many computer manufacturers followed this spec rigidly. Even today, they want gold everywhere, even though tin-plated IC leads enter the socket.

Although gold-to-gold contacts offer outstanding reliability, the search for cheaper substitutes has made users think more about the real issue—good electrical contact and exactly how it should be defined.

Most manufacturers—if they supply the spec at all—give just one value of contact resistance, usually that for the first insertion. But what happens as time passes or the insertions increase? Normal force is a key parameter. If the contact material deforms, you lose force. Without force, surface films are not penetrated—poor contact results. And no one agrees on how much force is enough. With some manufacturers, the more force the better. Be sure to ask them: How do you plug in a 40-pin RAM? The answer is apt to be: "Very gingerly."

Even when the manufacturer lists such performance parameters as force and contact re-

Seymour T. Levine
Associate Editor

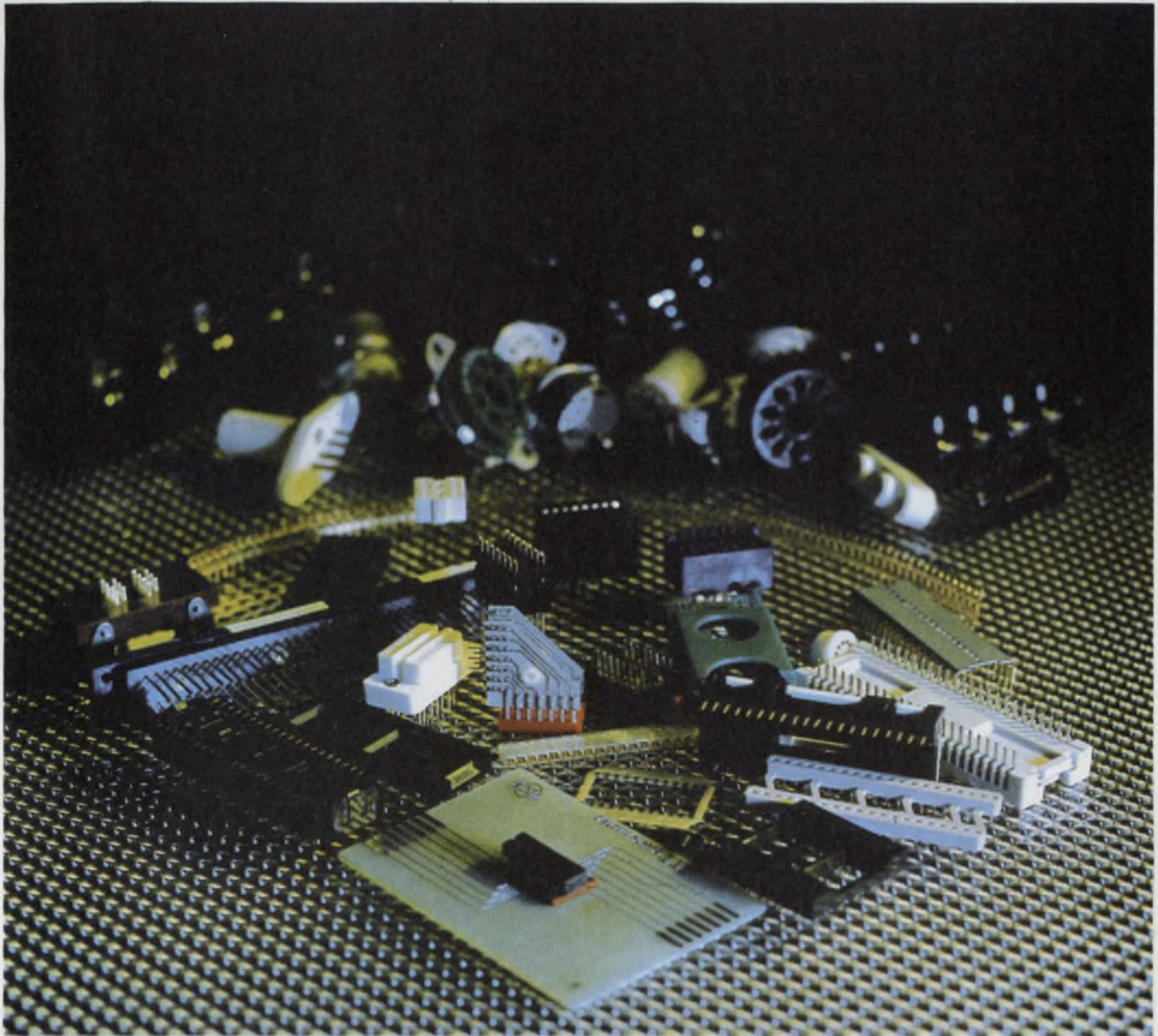

Component sockets run the gamut from a power relay to a leadless substrate. Contact problems once found in large relay and tube sockets can now turn up in IC

units. Manufacturers such as Amphenol and H. H. Eby use large firm contacts for the bigger sockets. And the same technique is used in smaller units.

sistance, you still don't know if he tests for them, or how much they vary from unit to unit. Therefore you might ask a few questions about quality control. If your vendor acts scared, you should be too.

The EIA specifies that contact has been made if the resistance is less than 50 m Ω . But what if your vendor's socket samples have 3- σ limits between 4 and 50 m Ω , or 10 to 500? Chances are that his manufacturing process is out of control, and so is your equipment reliability. The same principle holds true on normal force. The vendor should be able to hold the force to within ± 20 gm for a specific pin size and with the spring lengths used in conventional sockets.

Uncontrolled force variations should warn of IC interchangeability problems. Although various

manufacturers second-source ROMs, RAMs and even microprocessor ICs, their DIP pin widths vary between 0.015 and 0.021 in. And the thickness can vary between 0.07 to 0.014 in. Different manufacturers use different mean dimensions and stick pretty close to them.

The normal force on a spring is a cubic function of its deflection (and, hence, of component pin thickness). For components from three different sources, one package may be fine, the other may fall out at the slightest provocation and the third may either bend the spring open or be cracked by excessive spring force.

Some manufacturers advise you to specify normal and withdrawal forces. Watch out. Withdrawal is a game that can be played with a roughened test pin.

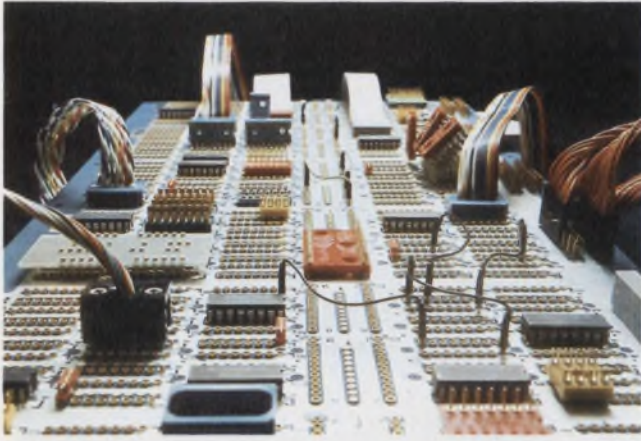

A new ECL packaging board offers pluggable terminating components (left). A single in-line package (SIP) holds the components and is plugged-in between the ICs. Like

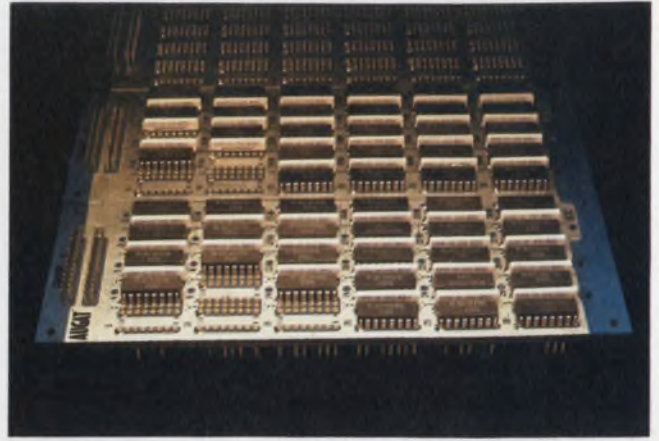

Augat's older ECL boards (right) the company's new boards have three voltage planes. Note the variety of component carriers and plugs available.

Advocates of gold contacts sometimes say that this metal is chemically inert; it does not react to form halides or sulfides. Therefore really heavy force is not needed. Perhaps 200 years ago zero contact force was possible, but pollution has changed things. First, oily films and dust accumulate on gold. Also, commercial-grade gold plate has pores in which halides and sulfide films form slowly. Thus at least 15 to 29 gm of normal force is required. With tin, the force is more than 50 gm. Of course, in addition to providing poor contact, a normal force that is too low will provide poor DIP retention.

Trouble with low voltage

Early users of IC sockets found that oxide films and dry (low-voltage) circuits didn't mix. Tubes or appliance plugs worked fine—even though films were present—because the high-voltage levels broke the films down. But IC signal voltages were often on the order of millivolts. Consequently the films were not punctured, and the circuit was stopped in its tracks.

Since ICs were usually cheaper than sockets, the manufacturers soldered the DIPs directly to the board. But now sockets cost less than most LSI chips and the trend has reversed.

But with more sockets per board, the unit price of a socket becomes important. Tin plating can help reduce cost, but not without problems. The first problem is shelf life. If your tin sockets have been around for a year or more, the chances are that the leads are too corroded for good solder joints. The second problem is that you won't know how long the contact lasts once an IC is inserted.

Tin oxides are easily punctured by mechanical friction. With enough normal force, electrical contact will occur. Recent studies at Texas Instruments in Attleboro, MA, show that tin-to-

tin contacts provide stable resistance at 100 C, but they show accelerating resistance change, versus time, at 125 C. In addition tin-to-tin connections with a combined plating thickness (DIP and socket contact) of 200 $\mu\text{in.}$ show only slight increases in resistance from initial value at 100 C. Of course, the pitfalls here are straightforward; How well do your IC and socket manufacturers control the plating thickness? Are there areas, especially near the contact points, where the plating is too thin? When base-metal corrosion sets in, it's too late.

Silver-plated DIPs and gold sockets perform remarkably well, according to TI's test results, which were based on 550 to 750 $\mu\text{in.}$ of silver. Even when mated to bright acid tin socket contacts, the silver DIPs performed well, but they failed when plugged into unplated sockets. Apparently the silver plate provides lubricity that reduces contact erosion.

In an SO_2 environment of 25 ± 5 ppm, silver plated DIPs mated to gold sockets showed a maximum resistance stability of 10 to 12% (deviation from initial value). And at elevated temperatures (125 C), the combination showed resistance value changes that were well within those measured for a gold-to-gold bond.

Watch the number of insertions

Another factor to consider is the number of insertion-withdrawal cycles. Production sockets are not test jigs for components. So don't expect hundreds of insertion/withdrawal cycles: 10 to 20 is a fair number. In fact, some manufacturers can tell you the amount of resistance change to expect after a given number of cycles. Try to specify the range of resistance you can accept and see if your vendor is willing to meet the range.

The alert reader of socket specs will soon spot

subtle pitfalls in plating specs. One is the omission of nickel plating under the gold. To be effective, the gold plating must be free of pores and thick enough to prevent the diffusion of base metal. An underplate of nickel also helps prevent diffusion. Also, there are at least two types of gold—hard and soft. Soft gold can be easily galled off by rough edges, whereas hard gold cannot. Check the one used by your vendor. And too little gold is as bad as none. The porosity of the thin surface almost ensures unwanted diffusion.

The desire to accommodate a wide variety of pin types leads to two types of DIP socket contacts: face grip and edge-grip. Actually both types perform well unless the manufacturer chooses shortcuts; then face-grip may be less risky.

Edge-grip units made with the edge of the DIP lead. Since these leads are formed with a stamping process, they are also quite ragged. Hence galling and scraping of the plating is possible. Clearly, hard gold is in order (if gold is used). A better choice is wrought gold inlay. The inlay is metallurgically bonded to the contact and is also more resistant to galling than a plated surface. In addition the gold is only where you need it; in volume, the price is competitive with tin-plated sockets. The leading advocate of this approach, Texas Instruments, is now being joined by others, such as Vector Electronic Co.

Face-grip advocates point out that they have at least one smooth face for contact (a consequence of the aforesaid stamping process) plus a redundant contact with the other face. And the universally desired contact wipe is automatic. One consequence of a face-wipe contact is slightly larger socket width, which could be a factor on tightly packed boards. Edge-grip contacts, on the other hand, expand sideways. If this expansion can break the insulation, then adjacent contacts can touch. However, most manufacturers use sufficient insulation to prevent this.

Lack of attention to plane geometry—aided and abetted by manufacturer advertising slogans—can lead to some comical configurations. The much touted slogan is “low profile,” an undefined term that means sockets that allow IC DIPs to lie as close as possible to the circuit board. The “lowest” profile height above the board is determined by the lead length and where these leads attach to the package. Not infrequently the IC leads are longer than the socket height, and the IC floats well above the socket face after plug-in.

In addition to sockets that “float” ICs, “iceberg” sockets can also hamper minimum separation between boards. Some sockets that use push-in mating contacts have exceptionally low board height on one side but protrude far out on the



The elastomeric socket has such a low profile that the young woman can scarcely see it. The “Pintrap” socket from ITT Cannon Electric is a resilient part that presses the IC pins against the internal diameter of the plated-through holes. The IC rests only 0.05-in. above the board. The socket also has lead-in chamfers; many low-profile units do not.

other side, like the underwater part of an iceberg. The extra contact length is needed to provide a good spring lever.

And there's the matter of spring material. Usually the choice is between phosphor bronze and beryllium copper. Beryllium copper is more expensive and has a higher yield point. Hardening and crystallization with age are low. This material is almost always needed for low-profile sockets to avoid permanent spring deformation. Phosphor bronze, on the other hand, costs about one fourth less and has good spring quality. Sometimes a third material, brass is used because it's fabricated easily. But its spring characteristics are not as good as the other two.

Ceramic LSI packages, such as those for some ROMs, require extra care in mounting. Most of their heat dissipation occurs on the underside of the part. Too close proximity to the board (low profile) will reduce airflow around the package and may lead to excessive operating temperatures. As a rule, low-profile sockets are those with heights of less than 0.15 in. above the component side of the PC board.

Test fixtures call for special sockets

Low-profile sockets are practically never used for IC test devices where hundreds of insertion-withdrawal cycles are anticipated. The sockets used here must have long gold-plated springs to ensure that the spring doesn't bend out of shape and to get adequate normal force without galling. As a rule, avoid calling test sockets “commercial sockets”—manufacturers often interpret this as a requirement for five to 20 insertion-withdrawal cycles.

Also, many manufacturers offer zero-insertion force (ZIF) sockets. The contacts engage the

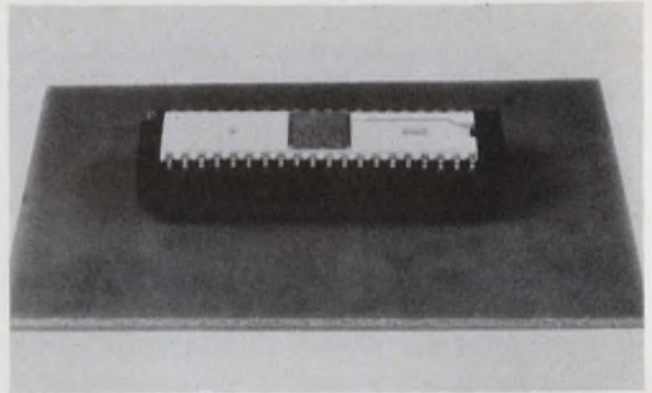
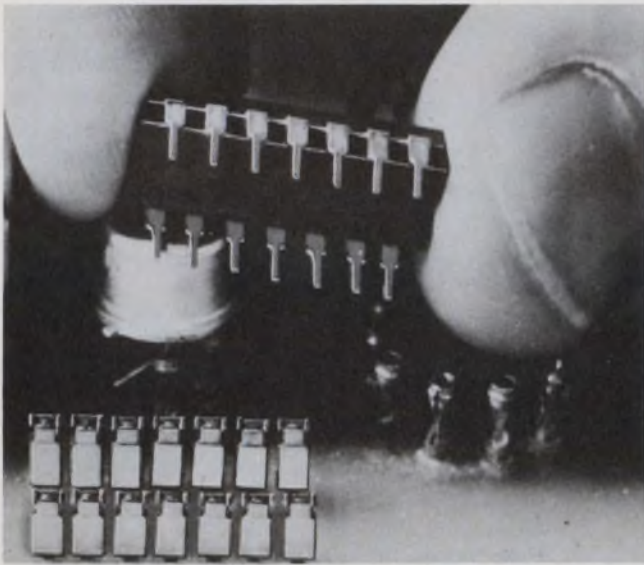

IC sockets can be as simple as precut strips, such as Molex Soldercon units (left) or complicated enough to protect delicate packages (above). The large socket, also from Molex, does not apply force on the leads until the package is pressed into position. To remove the package, simply release locking tabs on the sides.

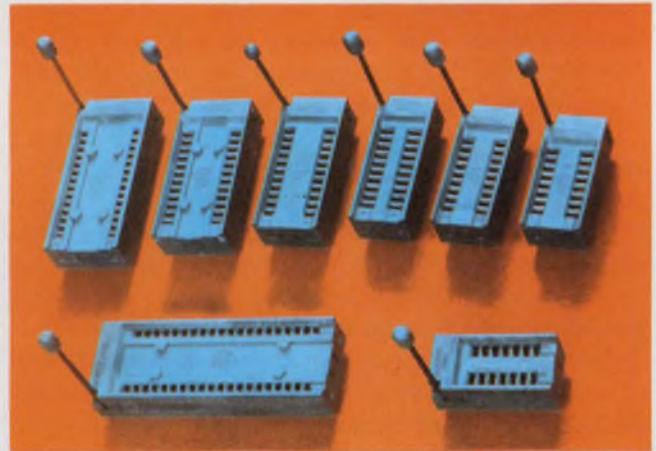
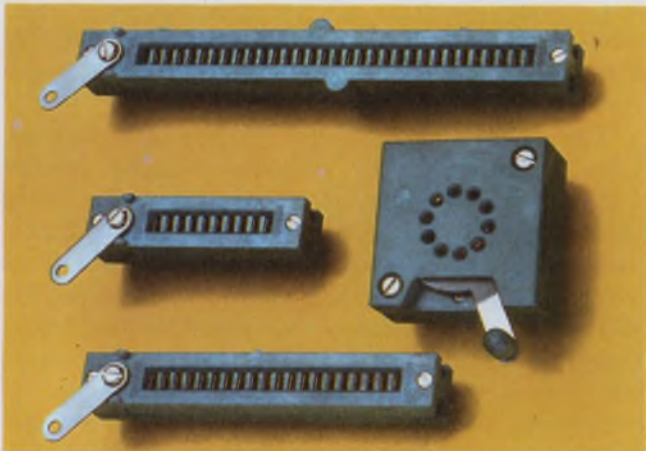

Textool's broad line of zero-insertion-force sockets handles TO-style devices (left) as well as DIPs (right).

part when cams or screws close them mechanically. These are large, expensive sockets designed for use in testers and similar gear.

Socket installation (and removal) can pose problems for the user—though removal should seldom be necessary. Incidentally, cracking occurs on most socket removals.

Wicking is a term that describes the inadvertent flow of solder into the contact area. To prevent this, many manufacturers offer a wafer protector that can be placed onto the socket pins, or they mold the socket so that body material seals off the pin area.

Sockets without such protection, and in which the contacts do not press tightly against the body, can draw up solder by capillary action. If hand resoldering is attempted, bear in mind that the sockets are vulnerable to wicking.

Once you've socketed the IC, watch out for vibration effects. Many sockets only grip the IC lead on a single face; the other face rests against the plastic base. Given the right vibration fre-

quency, contact bounce may occur where there aren't any pushbuttons.

Wrapped wire boards can reduce costs

The increased cost of PC board fabrication for complex devices has led to widespread use of wrapped-wire boards. Since practically no IC or display device is wrappable, extensive use is made of sockets with wrapped-wire tails. And to keep size down, manufacturers like Cambridge Thermionic, EECO, Augat Robinson-Nugent and Texas Instruments—to name a few—offer socket boards or high-density subassemblies. With many of these, discrete components are soldered to small plug-in carriers, which are later inserted into the socket rows.

Wrapped-termination boards have some stumbling blocks for designers. First, many engineers tend to specify gold for use on the wrapped-wire tails. Unless called for by contract, this gold is an unnecessary expense. Termination-wrapping

Socket-insulator characteristics

Group * comparison	Thermosets			Thermoplastics					
	Hard; brittle but mar resistant; stiff (flexure may break thin walls); resistant to heat distortion.			Wide range of impact strengths; resilient; flexible (permits snap fits); wide color spectrum					
Subgroup *	Not applicable			Crystalline			Amorphous		
Subgroup comparison				Denser, waxy feel; more prone to warpage; more resistant to solvents.			Less deterioration of physical properties under load or elevated temperature.		
Family † properties	Epoxy	Phenolic	Diallyl (DAP)	Nylon	PTMT or PTBT**	Teflon	Polycarbonate	Poly-styrene	Poly-sulfone
Dielectric strength	350	350	400	400	590	400	350	700	450
Thermal exposure (°Cat 1000h)	225	200	170	120	120	260	250	87	130
Tensile strength (lb/in ²)	8000	10,000	6000	7-13,000	8000	2-5000	13,000	6-8000	8-9500
Low-temp exposure	Good	Good	Good	Good	Good	Good	Good	Good	Fair
Fluid exposure	Good	Good	Good	Good	Exc.	Exc.	Good	Exc.	Good
Insulation resistance	Good	Good	Exc.	Good	Exc.	Exc.	Good	Exc.	Good

* Classifications and group properties courtesy of General Electric Plastics, Selkirk, NY

** Thermoplastic polyesters

† The properties of plastic vary with exact mix and treatment

machines produce sufficient pressure at the pins to provide gas-tight seals. However, this advantage is undercut if a hollow-formed pin, rather than a solid one, is provided. After a while the pin collapses under pressure from the wire joint, and the gas-tight seal fails.

A less common defect is bent pins. The wrapping machine stops whenever the pin center drifts out of alignment with the position of the chuck on the wrapping machine; operator intervention is needed then. If your board is assembled on an index table, try to use tough socket materials (avoid cheap phenolics). The large accelerations can sometimes crack the socket housing or even cause pins to pop out.

The increasing drive to miniaturization, which often leads to modularization, is being felt in component sockets for displays. Even miniature incandescent lamps have shrunk to T-1 size (0.125-in. diameter) and come with wire leads. In fact, there has been a proliferation of sizes, from T-3/4 at 0.93 in. to T-4 at 0.5-in. The numeral portion of the code is based on 1/8-in. as a standard diameter. Most engineers have little knowledge about lamp-holder size; lamp holders are not talled sockets. (See accompanying table on p. 55 for a guide.)

Many engineers spec the lamp holder for ac or dc current—hardly important for incandescent

types. LEDs are almost always dc. But you should spell out the minimum breakdown voltage to ground, usually ac.

In addition to bulb dimensions, keep in mind UL standards and possibly those of the Canadian Standards Association. For example, UL specifies double the line voltage plus 1000 V, which gives 1250 V as the breakdown voltage.

For bayonet-based bulbs, which have orientation pins, make sure the filament is properly oriented when the bulb is seated in the socket. And if you need wire leads, specify the gauge, type (stranded, bonded, solid), the temperature rating of the insulation and whether the end is to be tinned. You can also use MIL-L-3661B, written especially for lamp holders and indicator lights. But lamp holders built to MIL, UL or CSA specs cost more. Holders for lamps in the "miniature" category are usually the least expensive. Larger or smaller sizes drive up the price.

And don't forget temperature requirements and temperature rating (especially with high-intensity halogen units). The high range is 200 to 250 C, where the steel should be nickel-plated and insulation ceramic, the springs of stainless steel and the wire insulation of Teflon or glass braid over silicone.

You'll encounter some difficulty in the re-

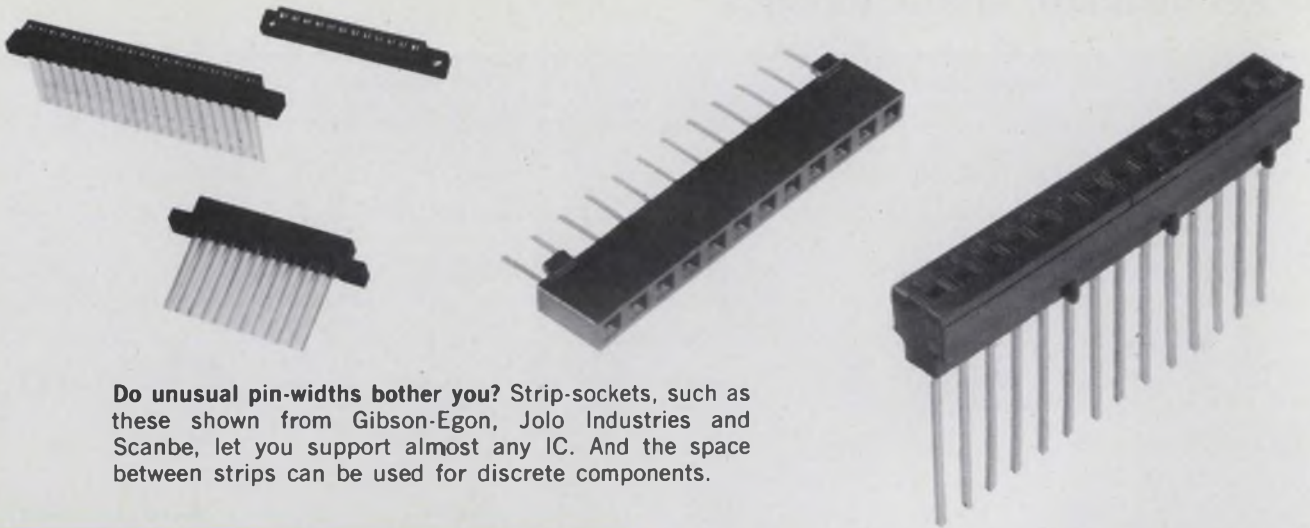

Do unusual pin-widths bother you? Strip-sockets, such as these shown from Gibson-Egon, Jolo Industries and Scanbe, let you support almost any IC. And the space between strips can be used for discrete components.

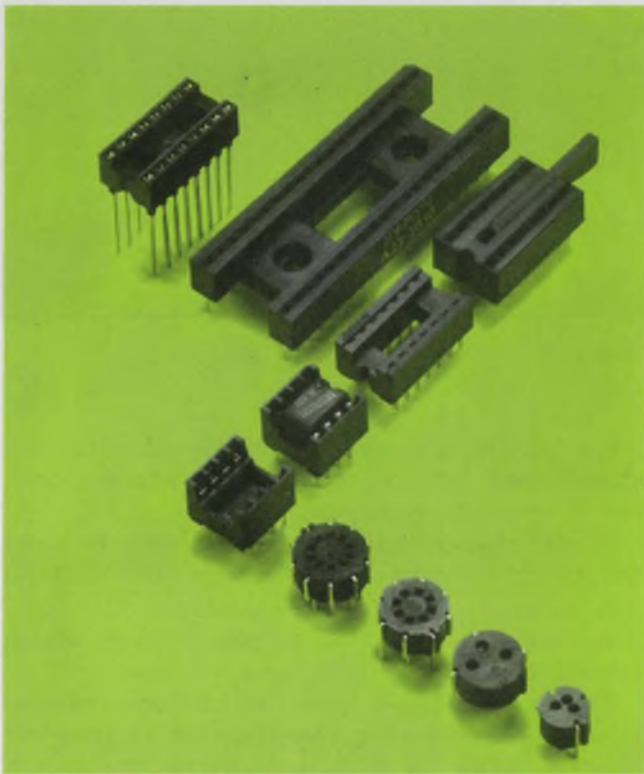

Jermyn's broad product range covers eight to 50-pin DIP sockets as well as TO-5 style IC sockets. The 16-pin DIP socket has a built-in ejector pin, which is useful for IC test purposes.

removal of midget-grooved lens-end lamps, often used in card readers and photo sensors. The sockets are designed to provide a secure grip for good optical alignment.

Sockets designed for bi-pin lamps should have contacts that are firmly fixed in the holder. Complaints of bent pins are often the result of "floating" contacts.

A number of lamp holders designed for dead (opaque) front-panel lighting require additional attention to human factors. These use midget flange-based bulbs and are very economical—about 11 cents a lamp. The lamps must have a

single common bus to all bases, and you must also have access to the rear of the panel to remove the bulbs.

Most manufacturers of DIP LED displays agree that the DIP sockets present no additional problems beyond those for the usual ICs. Lead lengths may vary from manufacturer to manufacturer, but 0.5-in. is the one most often supplied. On large orders (say, 10,000 pieces) companies like Litronix will clip the leads to a specified length. This avoids the need for specific socket heights to get the proper viewing geometry. Newer displays also have larger spacing between rows of pins—0.6-in. instead of 0.3. Circuit Assembly Corp. now provides low-cost sockets for these larger displays, for \$1 or less. Previous price levels ranged from \$3 to \$4. IEE's Atlas series holds as many as eight display digits and snaps into a front panel.

Some users of sockets for LED displays complain of cracked pins. This happens because the body width of the display often exceeds the row spacing of the pins, and the assembler loses sight of the socket when he inserts the pins.

Liquid-crystal displays resemble circuit boards rather than DIPs, even to the terminals that are often vacuum-deposited on the edges of a glass enclosure. Insertion into PC-style connectors can chip or crack the glass, especially when the applied pressure is high. One type of mounting that bypasses the problem uses elastomeric connectors. These are layered strips of rubber filled with carbon or silver in sections alternating with plain insulators. Pressure between the display contact pads and circuit pads completes the circuit.

One of the largest suppliers, Technical Wire Products, calls this type of connector Zebra and can offer 25- Ω minimum contact resistance. AMP Corp. supplies the Elastomate connector—an elastomeric rod with parallel lines of micro-metallized film. These systems are experimental

but have proved very reliable in liquid-crystal watch displays and the well-known Danameter, a palm-sized DMM manufactured by Dana Labs, Irvine, CA. The main precaution is care in manufacture of the elastomer. Conductivity is quite sensitive to the fillers used, to storage time, fabrication technique and so forth. But once installed, the material shows a resistance drop (20% for Zebra), then stabilizes. There is also a nominal 20% drop in stress after installation, a decrease that then remains constant. Since pressure is needed for contact, the mounting device should provide adequate force.

Traditional components have 'enemies'

Heat, dielectric loss and voltage breakdown assume greater importance with some of the more traditional electronic components—namely, crystals, transistors, relays and tubes.

Crystal sockets have been used for about 35 years and conform to a spacing based on odd multiples of 64ths. But moisture is one of the crystal's arch enemies. It reduces the Q of the circuit and therefore the frequency stability.

Ceramics, which include steatite and porcelain, perform well. They have low rf loss, and the upper surface can be glazed and the lower surface dunked in silicone to reduce moisture effects. Nylon or other hygroscopic materials are not recommended.

Also, watch out for modular units. Many devices use a number of crystals, and it's common practice to mold an economical receptacle to hold all of them. The materials used, however, often have greater rf loss than the materials for single units.

Mechanical relays introduce arc-over problems at points other than just the contacts. Switching of reactive loads can result in sizable spikes—often two to 10 times those of the nominal supply voltage. And sockets should be rated for ac to cover the contingency. Furthermore if inadvertent arcing occurs, the flashover leaves a conductive carbon track on most phenolic materials. Diallyl phthalate (DAP) offers greater resistance to arc-over.

Another common user mistake reported by many vendors is amperage "gluttony." Engineers send ampere after ampere through a socketed relay but forget about the socketed contact ratings. Everything works fine, except that the heat that is generated produces permanent deformation of the contact springs. And it's the last time you can plug in another relay.

Small transistors generally are not a problem, except that leads may be rough enough to gall contact surfaces. But high power transistors can literally rot certain socket materials. The high-power units require sizable heat radiators,

Approximate lamp sizes

Size term used	Lamp base diameter (approx)
Sub midget	1/8 in.
Midget (Subminiature)	1/4
Miniature	3/8
Candelabra	15/32
Bayonet	19/32
Intermediate	21/32
Medium	1-1/32
Admedium	1-5/32
Mogul	1-1/2

Courtesy Drake Manufacturing Co.



Sockets for 100-kW vhf tubes do not have low profiles. The sockets are designed to direct air past the tube's filament terminals and through the anode cooling fins. Low contact resistance is required because of high rf currents. Beryllium copper, silver-plated for rf conductivity, is used. Either Teflon or Alsingmag 665 ceramic is the insulation most frequently used by EIMAC.

and temperatures of 100 to 150 C are not uncommon. With lower-cost phenolics, organic dissociation occurs, in which volatile materials, such as fillers, are driven out. When this happens, you won't get the rated socket lives of five to six years. Fluorocarbons such as Teflon (not molded but sintered) can outlast DAP or phenolics. Being less brittle than phenolics, these sockets won't crack when bolted to rigid frames.

Vacuum-tube sockets share a number of contact problems with DIP sockets and some with fast IC families, such as Schottky TTL and ECL. High-power transmitter tubes are sensitive to capacitance between contacts—a factor that is

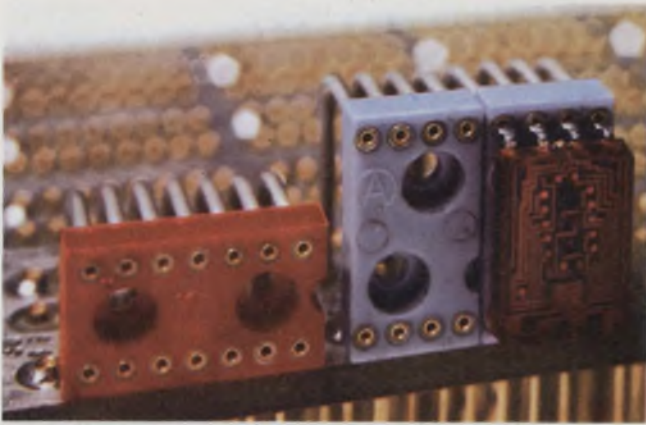

Sockets for LED displays handle practically any pattern, including different row spaces. The Augat units mount at right angles to the PC board.



No soldering and little drilling are characteristics that describe ITT Cannon's Popit socket. C-shaped contacts apply pressure to the IC and connect to PC traces when the socket is forced into the board. Two metal staples hold the socket.

controlled by the insulator material. For ECL logic, the important parameter is transmission-line impedance. Some companies, for example, Texas Instruments, use time-domain reflectometry to find the upper frequency limits.

In low-level amplifier circuits the finish for grid-pin contacts is as critical as it is for ICs—signal voltages in the μV region mean dry contacts. But pin forces are very high; a removal force of 25 pounds is not unusual. Accumulated data show that gold plate gives the best contact, followed by silver. But silver has been discarded in favor of nickel, because silver tarnish is more visible. But silver works best, even on low-level signals, possibly because it smears and forms a

gas-tight joint—which incidentally is also the idea behind Burndy's gas-tight connection for tin-to-tin mating contacts. Once a gas-tight joint occurs, circuit integrity is ensured.

Manufacturers offer innovative products

With a little patience, the designer can buy a socket to cope with just about any design problem. Versatility and modularity are keynotes of today's products.

ITT Cannon provides the lowest possible profiles for DIPs. Its Pintrap unit has an elastomer base that forces DIP pins against plated holes. The base is a mere 0.052-in. high, yet gives 250 gms of normal force and has the all-important lead-in chamfer. EPIS Corp. plans to offer conductive elastomer buttons as IC connectors. These buttons, mounted in the PC board, would eliminate the need for plated holes.

If you want to save hole-drilling charges, ITT Cannon's Popit socket seats on PC pads with the use of a simple arbor press—the board needs only two prepunched holes. The spring resembles a curled bellows that allows for wide pin-size variations and increase the effective spring length.

The wide availability of off-the-shelf sockets for up to 40-pin ICs allows low-cost mountings for most LSI and MSI components. For large numbers of pins—say, 42, 48 or 64—you can use socket strips butted end to end. These cost some 5 to 10% more per pin than fully formed sockets. TRW-Cinch provides closed-entry contact receptacles for use with socket wafers as thin as 0.113-in. The pins can be inserted in an appropriate size wafer to form sockets for just about any device, say from a TO-5 transistor case to a 44-pin LSI package.

There is another choice: You can use simple pins that let you build any contact configuration. One well-known supplier, Molex, offers the Soldercon terminal for this purpose. Berg Electronics recently introduced its version, called the Minisert socket. An elastomeric seal keeps foreign matter out and remains in place for the life of the socket.

For larger ICs, there are sockets with hollow space between the pin rows. That space in the middle (if heat is not a problem). Jermyn, for example, provides such sockets for DIPs with up to 50 pins and offers strip sockets as well.

A very reliable contact, but also among the costliest, is the screw-machine pin, for which Augat is the market leader. The unit consists of a tight-tolerance pin socket with a machined, four-contact clip forced into the socket. The outside sleeve can be of tin or gold, and the inside fingers are of gold. According to Dick Grubb,

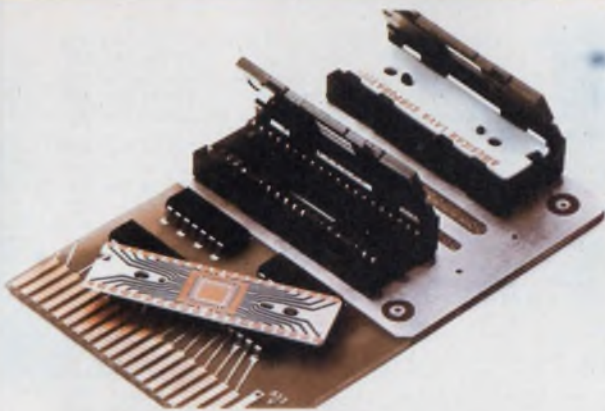
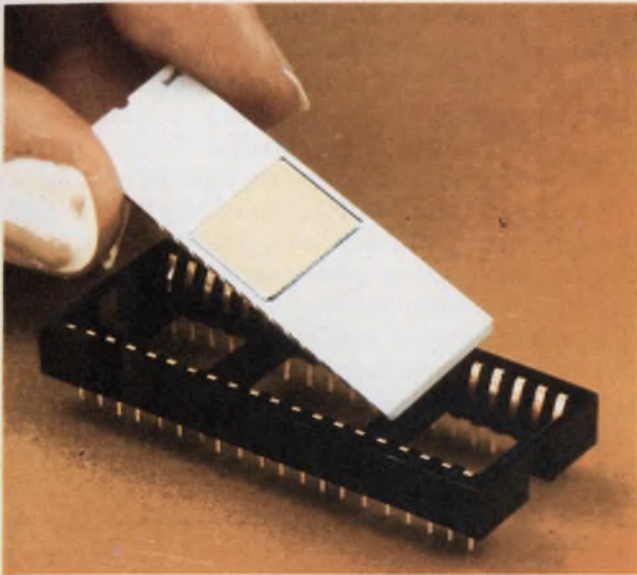

Leadless packages are plugged into this AMP receptacle (top) by someone placing the ceramic between contact rows and pressing down. The package clicks into position. A hinged plastic lid clamps the LSI package on Amphe-nol's PPI socket (bottom). The IC's side metalization is supposed to increase the available space for active chips.

marketing manager of Augat, the machined sleeve is needed to provide pressure and intimate contact with the post.

The machined posts lend themselves to an al-most infinite variety of contact configurations. One of Augat's products consists of these pins mounted on a disposable carrier. After the pins are soldered in, you remove the carrier, and there's your socket.

To keep packaging densities high, for wrapped-wire systems, manufacturers like Augat, MCI, Cambridge Thermionic (Cambion) and Robinson-Nugent offer DIP plugs to carry discrete components.

ECL logic has been rendered wire-wrappable as well. And increased use is forecast for high-speed computer logic—especially for arithmetic logic. ECL packaging panels with standard wrapped-wire pins allow rise times as fast as 1.5 ns with terminating resistors. Resistance value is not critical and clock rates to 100 MHz can be supported. Augat recently introduced a

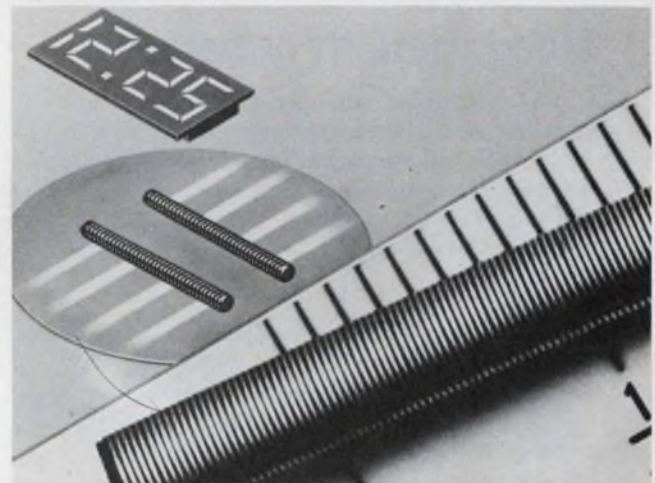
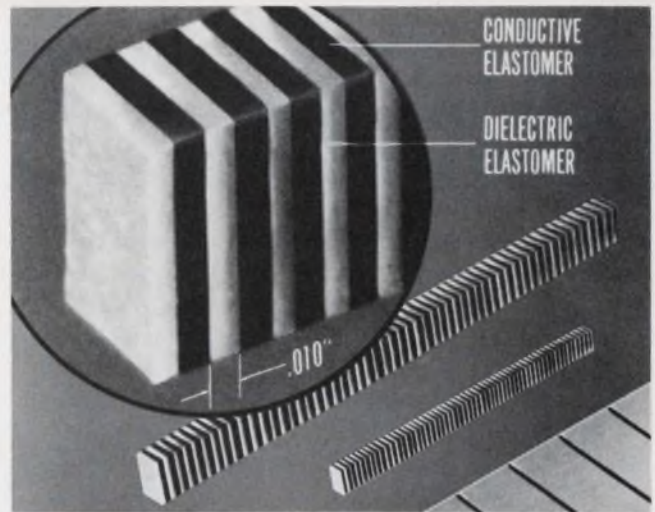

Elastomeric devices provide reliable contact for micro-miniature devices when compressed. And delicate sur-faces, such as on LCD displays, are not damaged. Technit's Zebra (top) accommodates contact spacings of 0.02-in. AMP's Elastomate (bottom) handles 0.025-in. spacing. These connectors also tolerate misalignment.

pluggable carrier for the terminating resistors; these resistors were formerly wrapped to posts on the board's backplane. Garry Corp. also sup-plies ECL boards for wrapped-wire terminations.

Even large relay sockets have quick-mounting facilities. Rundel Corp. lets you stack sockets onto a track with plastic clips as do Reed Devices Inc. and Curtis to name a few. The screw ter-minals on Rundel's units have wire clips that clamp the bare wire, eliminating the need for crimp-on terminals.

DIP sockets are now the subject of two spec-ifications: the EIA RS-415 (April, 1974), and MIL-S-83734, prepared by the Defense Elec-tronics Supply Command (DESC) at Dayton, OH. The latter spec is now awaiting approval. Both specs cover similar design areas like in-sertion and withdrawal force, contact retention, dimensions, contact resistance (both high and low level) and mechanical construction. The EIA standard recognizes most contact finishes where-as the MIL spec requires gold. However, the

usual 50- μ m. plating for MIL work has been reduced to 30- μ m, except at contact engagement, where it's 50- μ m.

The MIL spec is the more stringent: A flammability test is mandatory; the parts must be subjected to a corrosive sulfur atmosphere and retested for low-level resistance; the pins must withstand more bends. In addition the MIL spec requires 50 insertion-withdrawal cycles; in contrast with the 10 for EIA. For wrappable wire terminations, the MIL spec calls for solid pin cross sections. Wicking is also mentioned.

A word of advice: The MIL spec is not in-

tended for airborne requirements.

According to the spec's author, Herman Anderson, sockets that meet the spec are a good buy for commercial users. And a number of manufacturers, including Augat, Texas Instruments, Cambion and Sealectro, plan to comply.

At present leadless ICs, especially of the LSI type, are comparatively rare. And the debate on side-face-mounted or edge-mounted contacts continues. When sales volume increases, you can bet that manufacturers will respond. In fact, AMP, Burndy and Amphenol, among others, have leadless-IC sockets in production. ■■

Need more information?

The companies and products cited in this report do not represent the manufacturer's full lines nor all manufacturers of a particular product. For additional details circle the information retrieval numbers. For data sheets and more vendors consult ELECTRONIC DESIGN'S GOLD BOOK.

Accessories For Electronics Inc., 23-25 Bell Blvd., Bayside, NY 11360, (212) 939-5474. (P. Johnson). Circle No. 401

Aeronautical Electric Co. Inc., 5656 N. W. Hwy, Chicago, IL 60646. (312) 774-5200. (W. Youngstrom). Circle No. 402

Alden Products Co., 117 N. Main St., Brockton, MA 02403. (617) 583-0160. (D. J. Paul). Circle No. 403

Amatom Electronic Hardware, Div. of Mite, 450 Blake St., New Haven, CT 06515. (203) 397-3311. (R. Mazzulli). Circle No. 404

Amphenol Industrial Div., Bunker Ramo Corp., 1830 S. 54 Ave., Chicago, IL 60650. (412) 242-1000. (E. R. Lehmann). Circle No. 405

AMP, Inc., 449 Eisenhower Blvd., Harrisburg, PA 17105. (717) 564-0100. (J. Pletcher). Circle No. 406

AP Products Inc., P.O. Box 110, Painesville, OH 44077. (216) 354-2101. (R. J. Gabor). Circle No. 407

Arcoelectric Switch Corp., P.O. Box 348, N. Hollywood, CA 91603. (213) 985-3130. (L. Lewis). Circle No. 408

Aries Electronics Inc., P.O. Box 231, Frenchtown, NJ 08825. (201) 996-4096. (W. Y. Sinclair). Circle No. 409

Aristo-Craft Miniatures, 314 5 Ave., New York, NY 10001. (212) 279-9034. (G. Rose). Circle No. 410

Armel Electronics, 1601-75 St., N. Bergen, NJ 07047. (201) 869-4300. (W. Johnson). Circle No. 411

Augat Inc., 34 Perry Ave., Attleboro, MA 02703. (617) 222-2202. (R. M. Grubb). Circle No. 412

Automech Associates Inc., 157 Washington Ave., North Haven, CT 06473. (203) 239-2233. (A. C. Statkum). Circle No. 413

Auto-Swage Products Inc., 726 River Rd., Shelton, CT 06484. (203) 929-1401. (R. Mikulsky). Circle No. 414

Azimuth Electronics, 2377 S. El Camino Real, San Clemente, CA 92672. (714) 492-6481. (K. G. Johnsen). Circle No. 415

Berg Electronics, York Expressway, New Cumberland, PA 17070. (717) 938-6711. (F. L. Morris). Circle No. 416

Winfred M. Berg Inc., 501 Ocean Ave., East Rockaway, NY 11518. (516) 599-5010. (C. Keenan). Circle No. 417

British Aircraft USA, 399 Jefferson Davis Hwy, Arlington, VA 22202. (703) 979-1400. (G. J. McCallum). Circle No. 418

Burndy Corp., Richards Ave., Norwalk, CT 06856. (203) 838-4444. (T. Michalic). Circle No. 419

Cal Data Processors, 2019 S. Ritchey St., Santa Ana, CA 92705. (714) 558-8211. (R. Ball). Circle No. 420

Cambridge Thermanic Corp., 445 Concord Ave., Cambridge, MA 02138. (617) 491-5400. (W. G. Nowlin). Circle No. 421

CAM-LOK Div., Empire Products Inc., 10540 Chester Rd., Cincinnati, OH 45215. (513) 771-3171. (D. L. Schmitt). Circle No. 422

Cardinal Control Company Inc., 32 Kensington Rd., Kensington, CT 06037. (203) 828-6379. (L. E. Beatman). Circle No. 423

Chicago Miniature Lamp Works, 4433 N. Ravenswood Ave., Chicago, IL 60640. (312) 784-1020. (D. Wallach). Circle No. 424

Christina Industrial Corp., 6500 N. Clark St., Chicago, IL 60626. (312) 465-6330. (R. C. Ferris). Circle No. 425

Christiansen Radio Inc., 3034 Nestall, Laguna Beach, CA 92651. (714) 497-1506. (A. D. Christiansen). Circle No. 426

Chronomite Laboratories, 21011 S. Figueroa, Carson, CA 90745. (213) 320-9452. (R. Russell). Circle No. 427

Circuit Assembly Corp., 3169 Red Hill Ave., Costa Mesa, CA 92626. (714) 540-5490. (R. Forringer). Circle No. 428

Circuit-Stik Inc., Centron Engineering Inc., 24015 Garnier St., Torrance, CA 90510. (213) 530-5530. (D. E. Harper). Circle No. 429

Cole-Hersee Co., 20 Old Colony Ave., S. Boston, MA 02127. (617) 268-2190. (F. J. Wandyses). Circle No. 430

Compu-Lite Corp., 17795 Sky Park Circle, Irvine, CA 92707. (714) 546-9045. (S. A. Rasmussen). Circle No. 431

Connector Corp., 6025 N. Keystone, Chicago, IL 60646. (312) 539-3108. (E. M. Paradise). Circle No. 432

Continental Connector, 34-63 56 St., Woodside, NY 11377. (212) 899-4422. (G. Palmquist). Circle No. 433

Cosmic Voice Inc., P.O. Box 11A, Jackson, MI 49204. (517) 784-8920. (W. H. Matteson). Circle No. 434

Curtis Industries Inc., 8000 W. Tower Ave., Milwaukee, WI 53223. (414) 354-1500. (R. Van Der Elsen). Circle No. 435

Custom Connector Corp., 1738 E. 30 St., Cleveland, OH 44114. (216) 241-1679. (D. G. Harper). Circle No. 436

Dan-L Inc., 229 Laurel Rd., E. Northport, NY 11731. (516) 757-8000. (D. Eltermann). Circle No. 437

Data Display Products, 5428 W. 104 St., Los Angeles, CA 90009. (213) 641-1232. (P. Lodhie). Circle No. 438

Datatec Corp., 10935 S. Wilcrest Dr., Houston, TX 77072. (713) 774-9741. (C. W. Bentley). Circle No. 439

Digiac Corp., 175 Engineers Rd., Smithtown, NY 11787. (516) 273-8600. (V. Randazzo). Circle No. 440

Display Devices Inc., 130 W E St., Encinitas, CA 92024. (714) 753-0113. (R. C. Ross Jr.). Circle No. 441

Diversified Electronics, Box 6231, Evansville, IN 47712. (812) 426-2806. (J. R. Erickson). Circle No. 442

Douglas Electronics, 718 Marina Blvd., San Leandro, CA 94577. (415) 483-8770. (C. D. Murdoch). Circle No. 443

Drake Manufacturing Co., A General Instrument Co., 4626 N. Olcott Ave., Harwood Heights, IL 60656. (312) 867-7227. (W. Bokhoven). Circle No. 444

Dupree Inc., 9835 Dupree St., S El Monte, CA 91733. (213) 442-4700. (J. D. Pon). Circle No. 445

Dynatech Corp., 1225 E. Wakeman Ave., Santa Ana, CA 92702. (714) 558-8755. (E. L. Krause). Circle No. 446

Eagle Electric Manufacturing Co., 45-31 Court Sq., LI City, NY 11101. (212) 937-8000. (E. Ullman). Circle No. 447

Hugh H. Eby Co., 4701 Germantown Ave., Philadelphia, PA 19144. (215) 842-3000. (J. A. Viale). Circle No. 448

Electronic Energy Products Corp., 6060 Manchester Ave., Los Angeles, CA 90045. (213) 670-7880. (E. Bacher). Circle No. 449

Eimac Div., Varian Associates, 301 Industrial Way, San Carlos, CA 94070. (415) 592-1221. (W. I. Orr). Circle No. 450

Electro Mech Components, 1826 N. Flordale, S. El Monte, CA 91733. (213) 442-7180. (W. H. Trumbull Jr.). Circle No. 451

Electronic Engineering Co. of California (EECO) 1441 E. Chestnut Ave., Santa Ana, CA 92701. (714) 835-6000. (W. O. Fordiani). Circle No. 452

Electronic Molding Corp., 96 Mill St., Woonsocket, RI 02895. (401) 769-3800. (A. C. Klepper). Circle No. 453

ElecData Controls Corp., 715 N. Cherry St., Winston-Salem, NC 27101. (919) 722-6156. (J. D. Mundell Jr.). Circle No. 454

Elec Essentials Inc., 210 Elizabeth St., New York, NY 10012. (212) 226-5080. (R. David). Circle No. 455

EPIS Corp., 45 Nutmeg La., Glastonbury, CT 06033. (203) 633-8339. (E. Avakian). Circle No. 456

Erie Technical Products, 644 W. 12 St., Erie, PA 16512. (814) 453-5611. (E. C. Schmid). Circle No. 457

Excel Products Co. Inc., 700 Joyce Kilmer Ave., New Brunswick, NJ 08903. (201) 249-6600. (L. Eige). **Circle No. 458**

E-Z-Hook Div., Tektest Inc., 114 E. Saint Joseph St., Arcadia, CA 91006. (213) 446-6175. **Circle No. 459**

Flex Link Products Inc., 1923 First St., San Fernando, CA 91340. (213) 365-9355. (R. C. Carter). **Circle No. 460**

Garry Manufacturing Co., 1010 Jersey Ave., New Brunswick, NJ 08902. (201) 545-2424. (T. Malek). **Circle No. 461**

GC Electronics, 400 S. Wyman St., Rockford, IL 61101. (815) 968-9661. (H. J. Lackner Jr.). **Circle No. 462**

Gencom, Div. Emitterics Inc., 80 Express St., Plainview, NY 11803. (516) 433-5900. **Circle No. 463**

General Electronics Associates Inc., P.O. Box 285, Northfield, OH 44067. (216) 467-9622. (T. W. Duffy). **Circle No. 464**

Genisco Technology Corp., 18435 Susana Rd., Compton, CA 90221. (213) 537-4750. (W. R. Esser). **Circle No. 465**

GE Wiring Devices, 95 Hathaway St., Providence, RI 02904. (401) 781-1800. **Circle No. 466**

Gibson-Egan Co., 21 Flower St., Arcadia, CA 91006. (213) 446-5259. (G. Gibson). **Circle No. 467**

GTE Sylvania Miniature Lighting Products Inc., 526 Elm St., Kearny, NJ 07032. (201) 997-1850. (P. S. Rust). **Circle No. 468**

HMW Enterprise Inc., 15 Walnut St., Harrisburg, PA 17113. (717) 939-9313. (H. M. Wutz). **Circle No. 469**

Hunter Engineering Co., 150 Werimus Ln., Hillsdale, NJ 07642. (201) 248-7125. **Circle No. 470**

Hypertronics Corp., 50 Hunt St., Watertown, MA 02172. (617) 924-1822. (D. Downey). **Circle No. 471**

Industrial Electronic Engineers, Inc. (IEE), 7740 Lemona Ave., Van Nuys, CA 91405. (213) 787-0311. (W. E. Hartman). **Circle No. 472**

IFE Division, Plastic Mold & Engineering Co., 25 Tripps La., E. Providence, RI 02914. (401) 438-3315. (D. G. Barrett). **Circle No. 473**

ITT Cannon Electric, 666 E. Dyer Rd., Santa Ana, CA 92702. (714) 557-4700. (R. L. Harmon). **Circle No. 474**

Industrial Devices, 5 Hudson Ave., Edgewater, NJ 07020. (201) 224-4700. (B. Schnoll). **Circle No. 475**

Injectorall Electronics Corp., 98-100 Glen St., Glen Cove, NY 11542. (516) 671-6010. (E. Wollman). **Circle No. 476**

Instant Instruments Inc., 306 River St., Haverhill, MA 01830. (617) 373-9260. (J. Bonfiglio). **Circle No. 477**

InterDyne Co., 1476 Califa St., Van Nuys, CA 91401. (213) 787-6800. (R. R. Lindstrand). **Circle No. 478**

International Electro Exchange Corp., 8081 Wallace Rd., Eden Prairie, MN 55343. (612) 944-1820. (D. Kinney). **Circle No. 479**

International Rectifier, Semiconductor Div., 233 Kansas St., El Segundo, CA 90245. (213) 678-6281. (F. Schulze). **Circle No. 480**

Isolantite Manufacturing Co., 337 Warren Ave., Stirling, NJ 07980. (201) 647-3333. (G. W. Lumpe). **Circle No. 482**

Jermyn, 712 Montgomery St., San Francisco, CA 94111. (415) 362-7431. (G. Hall). **Circle No. 483**

Jettron Products Inc., 56 Route 10, E. Hanover, NJ 07936. (201) 887-0571. (J. M. Schill). **Circle No. 484**

Jolo Industries Inc., 11861 Cardinal Circle, Garden Grove, CA 92643. (714) 636-4940. (J. S. Giampiccolo). **Circle No. 485**

Keystone Electronics Corp., 43-49 Bleecker St., New York, NY 10012. (212) 475-4600. (R. David). **Circle No. 486**

Korry Manufacturing Co., 223 8 Ave. N., Seattle, WA 98109. (206) 624-4066. (D. Miksch). **Circle No. 487**

Leach Corp., Relay Div., 5915 Avalon, Los Angeles, CA 90003. (213) 232-8221. (J. E. McElligott). **Circle No. 488**

Ledex Inc., 123 Webster St., Dayton, OH 45401. (513) 224-9891. (E. Brauner). **Circle No. 489**

Loranger Manufacturing Corp., 2715 Pennsylvania Ave. W., Warren, PA 16365. (814) 723-2250. (J. A. Loranger Jr.). **Circle No. 490**

LVC Industries Inc., 135-25 37 Ave., Flushing, NY 11354. (212) 939-9777. (N. Marino). **Circle No. 491**

Magnecraft Electric Co., 5575 N. Lynch, Chicago, IL 60630. (312) 282-5500. (A. Maag). **Circle No. 492**

MALCO A Microdot Co., 5150 W. Roosevelt Rd., Chicago, IL 60650. (312) 287-6700. (F. Racy). **Circle No. 493**

Master Electronic Controls, 1553 17 St., Santa Monica, CA 90404. (213) 393-3177. (I. Nizam). **Circle No. 494**

Methode Manufacturing Corp., 1700 Hicks Rd., Rolling Meadows, IL 60008. (312) 392-9600. (L. J. Stellmach). **Circle No. 495**

James Millen Manufacturing Co., 150 Exchange St., Malden, MA 02148. (617) 324-4108. (R. W. Caywood). **Circle No. 496**

3M Company Headquarters, Product Information Center, 3M Center, St. Paul, MN 55101. (612) 733-1110. (R. H. Herzog). **Circle No. 497**

Modular Circuitry Inc., 115 W. Bidwell St., Tecumseh, MI 49286. (313) 423-8336. (J. Cramer). **Circle No. 498**

Module Components (MCi), 115 W. Bidwell St., Tecumseh, MI 49286. (313) 423-2494. (J. Cramer). **Circle No. 499**

Waldom Molex Inc., 4625 W. 53 St., Chicago, IL 60632. (312) 585-1212. (M. Halley). **Circle No. 500**

FW Morse Co., 44 Lincoln St., Box 94, Saco, ME 04072. (207) 284-4166. (R. W. Morse). **Circle No. 501**

Mupac Corp., 646 Summer St., Brockton, MA 02402. (617) 588-6110. (A. M. Largey Jr.). **Circle No. 502**

Mycom Media Corp., 2175 Greenspring Dr., Timonium, MD 21093. (301) 252-6120. (R. W. Stow). **Circle No. 503**

North American Philips Controls Corp., Box 768, Cheshire Industrial Park, Cheshire, CT 06410. (203) 272-0301. (R. Rock). **Circle No. 504**

Omni Spectra Inc., 24600 Hallwood Ct., Farmington, MI 48024. (313) 477-1234. (R. Borden). **Circle No. 505**

Oshino Electric Lamp Works Ltd., 2-5-2 Minami-Shinagawa, Shinagawa-Ku, Tokyo, Japan 03-47 1-8548. (T. Shigemori). **Circle No. 506**

Pic Design Div., Benrus Corp., Box 335, Benrus Center, Ridgefield, CT 06877. (203) 438-0345. (C. T. Wellman). **Circle No. 507**

Pylon Company Inc., 51 Newcomb St., Attleboro, MA 02703. (617) 222-3726. (R. Pozzo). **Circle No. 508**

Qualco, 1 First St., Los Altos, CA 94022. (415) 964-7666. (M. T. Ralston). **Circle No. 509**

Reed Devices Inc., 21 W. Hill Ave., Glen Ellyn, IL 60137. (312) 858-2050. (H. J. Roeser). **Circle No. 510**

Robinson-Nugent Inc., 800 E. Eighth St., New Albany, IN 47150. (812) 945-0211. (S. M. Shine). **Circle No. 511**

Milton Ross Co., 511 Second St., Pike, Southampton, PA 18966. (215) 355-0200. (J. M. Tosta). **Circle No. 512**

Rundel Idec, 950 Charter St., Redwood City, CA 94063. (415) 365-8111. (B. Theberge). **Circle No. 513**

Scanbe Canoga Industries, 3445 Fletcher Ave., El Monte, CA 91731. (213) 579-2300. (L. Cooper). **Circle No. 514**

Schoeffel Instrument Corp., 24 Booker St., Westwood, NJ 07675. (201) 664-7263. (W. Allen). **Circle No. 515**

Sealco Corp., 225 Hoyt St., Mamaroneck, NY 10543. (914) 698-5600. (S. A. Lescarboura). **Circle No. 516**

Shigoto Industries Ltd., 350 5 Ave., New York, NY 10001. (212) 615-0200. (M. Rubin). **Circle No. 517**

Showa Musen Kogyo Co. Ltd., No 5-5 6-chome, Togoshi Shinagawa-ku, Japan 03785 1111. (J. Takahara). **Circle No. 518**

Sigma Instruments Inc., 170 Pearl St., Braintree, MA 02185. (617) 843-5000. (J. Seppala). **Circle No. 519**

Sloan Co., 7704 San Fernando Rd., Sun Valley, CA 91352. (213) 875-1123. (G. M. Elsner). **Circle No. 520**

Herman H. Smith Inc., 812 Snediker Ave., Bklyn, NY 11207. (212) 272-9400. (S. Fleishman). **Circle No. 521**

Soderberg Manufacturing Co., 20821 Currier Rd., Walnut, CA 91789. (714) 595-1291. (L. P. Appelman). **Circle No. 522**

Spectra Strip Corp., 7100 Lampson, Garden Grove, CA 92640. (714) 892-3361. (B. Brachman). **Circle No. 523**

Standard Logic Inc., 2215 S. Standard Ave., Santa Ana, CA 92707. (714) 979-4770. (B. L. Billington). **Circle No. 524**

Stanford Applied Engineering, 340 Martin, Santa Clara, CA 95050. (408) 243-9200. (K. Dever). **Circle No. 525**

Sterling Instrument Co., 55 S. Denton Ave., New Hyde Park, NY 11040. (516) 328-3300. (H. R. Arum). **Circle No. 526**

Struthers-Dunn Inc., Lambs Rd., Pitman, NJ 08071. (609) 589-7500. (L. R. Davis). **Circle No. 527**

Sullins Electronic Corp., Rhea La., San Marcos, CA 92069. (714) 744-0125. (S. Sullins). **Circle No. 528**

Superior Electric Co., 3000 Middle St., Bristol, CT 06010. (203) 582-9561. (R. H. Bond). **Circle No. 529**

Sys Electronics Inc., 1935 W. 96 St., Cleveland, OH 44102. (216) 651-8208. (E. Bedford). **Circle No. 530**

Technical Wire Products Inc. (Tecknit), 129 Dermody St., Cranford, NJ 07016. (201) 272-5500. (R. A. Ventimiglia). **Circle No. 531**

Teradyne Components Inc., 900 Lawrence St., Lowell, MA 01852. (617) 454-9195. (H. T. Neavitt). **Circle No. 532**

Teatron Inc., P.O. Box 48237, Chicago, IL 60648. (312) 775-2477. (D. Derr). **Circle No. 533**

Texas Instruments Inc., 34 Forest St., Attleboro, MA 02703. (617) 222-2800. (B. Spence). **Circle No. 534**

Textool Products Inc., 1410 Pioneer Dr., Irving, TX 75061. (214) 259-2676. (E. C. Karnavas). **Circle No. 535**

Thermalloy Inc., 2021 W. Valley View La., P. O. Box 34829, Dallas, TX 75234. (214) 243-4321. (R. Alpert). **Circle No. 536**

TRW Cinch Connectors, 1501 Morse Ave., Elk Grove Village, IL 60007. (312) 439-8800. (F. Apple). **Circle No. 537**

UID Electronics, Div. AMF Inc., 4105 Pembroke Rd., Hollywood, FL 33021. (305) 981-1211. (R. J. Stanish). **Circle No. 538**

Underwriters Safety Device Co., 7300 W. Wilson Ave., Chicago, IL 60656. (312) 867-4600. (H. R. Ege). **Circle No. 539**

UNEX Laboratories Inc., 321 Newbury St., Hathorne, MA 01937. (617) 774-3300. (J. O. Woodbridge). **Circle No. 540**

United Mineral & Chemical Corp., 129 Hudson St., New York, NY 10013. (212) 966-4330. (H. M. Rosenthal). **Circle No. 541**

Universal Relay Corp., 42 White St., New York, NY 10013. (212) 925-6900. (D. Lesser). **Circle No. 542**

Varian Associates, Electron Tube & Device Group, 611 Hansen Way, Palo Alto, CA 94303. (415) 493-4000. (C. G. Rockwood). **Circle No. 543**

Vector Electronic Co., 12460 Gladstone Ave., Sylmar, CA 91342. (213) 365-9661. (F. L. Hill). **Circle No. 544**

Vero Electronics Inc., 171 Bridge Rd., Hauppauge, NY 11787. (516) 234-0400. (B. Freifeld). **Circle No. 545**

Viking Industries Inc., Standard Products Div., 21001 Nordhoff St., Chatsworth, CA 91311. (213) 341-4330. (J. J. Shields). **Circle No. 546**

Waldom Electronic Inc., 4637 W. 53 St., Chicago, IL 60632. (312) 585-1212. (M. C. Vescovi). **Circle No. 547**

Wamco Technical Sales, 705 W. 16, Costa Mesa, CA 92627. (714) 833-9361. (J. M. Koyama). **Circle No. 548**

Western Indicator Co., Div. Dupree Inc., 9835 Dupree Street S., El Monte, CA 91733. (213) 442-4700. (J. D. Pon). **Circle No. 549**

Workman Electronic Products Inc., 75 Packinghouse Rd., Sarasota, FL 33578. (813) 955-4242. (J. M. Price). **Circle No. 550**

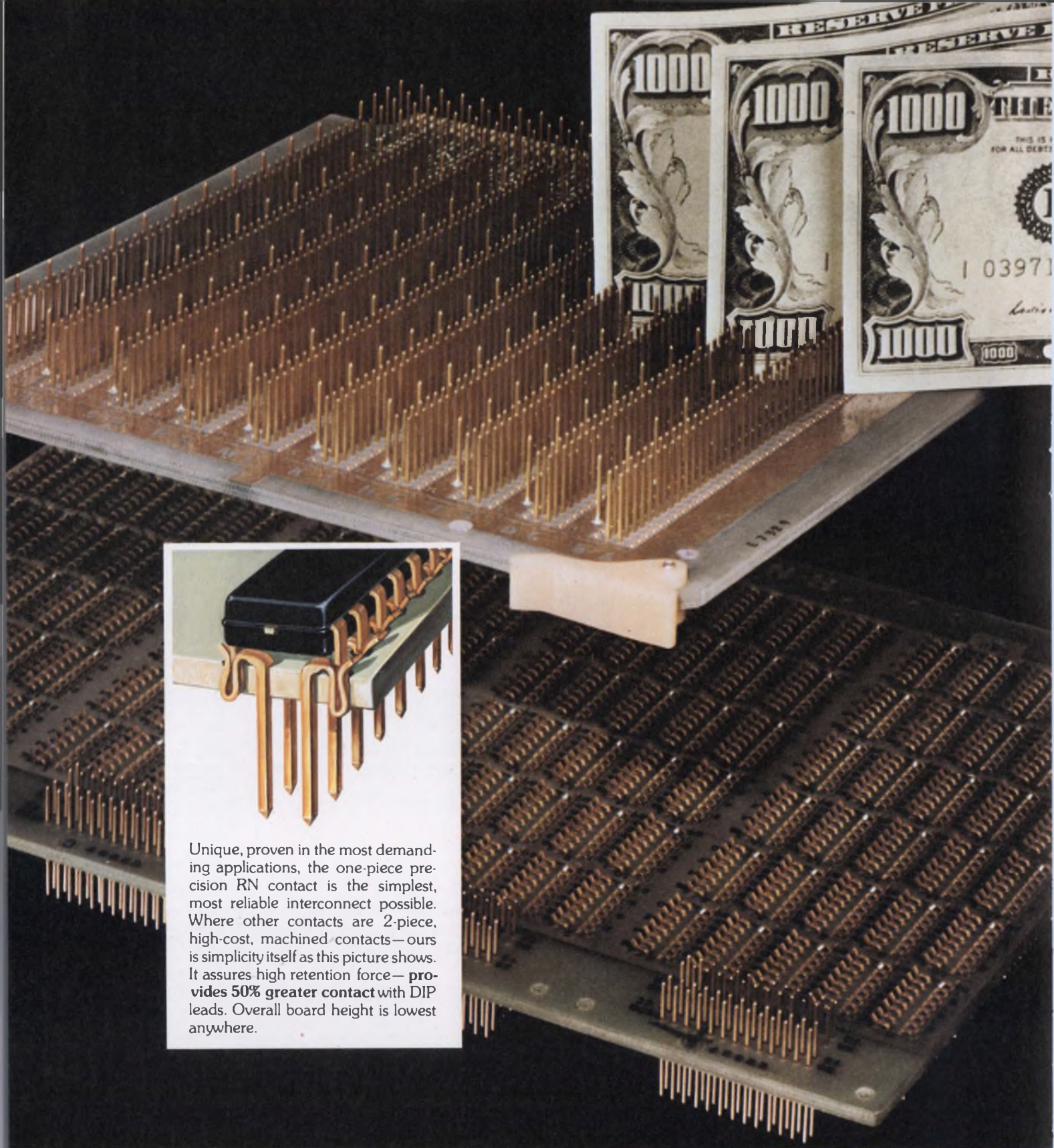

Unique, proven in the most demanding applications, the one-piece precision RN contact is the simplest, most reliable interconnect possible. Where other contacts are 2-piece, high-cost, machined contacts—ours is simplicity itself as this picture shows. It assures high retention force— **provides 50% greater contact** with DIP leads. Overall board height is lowest anywhere.

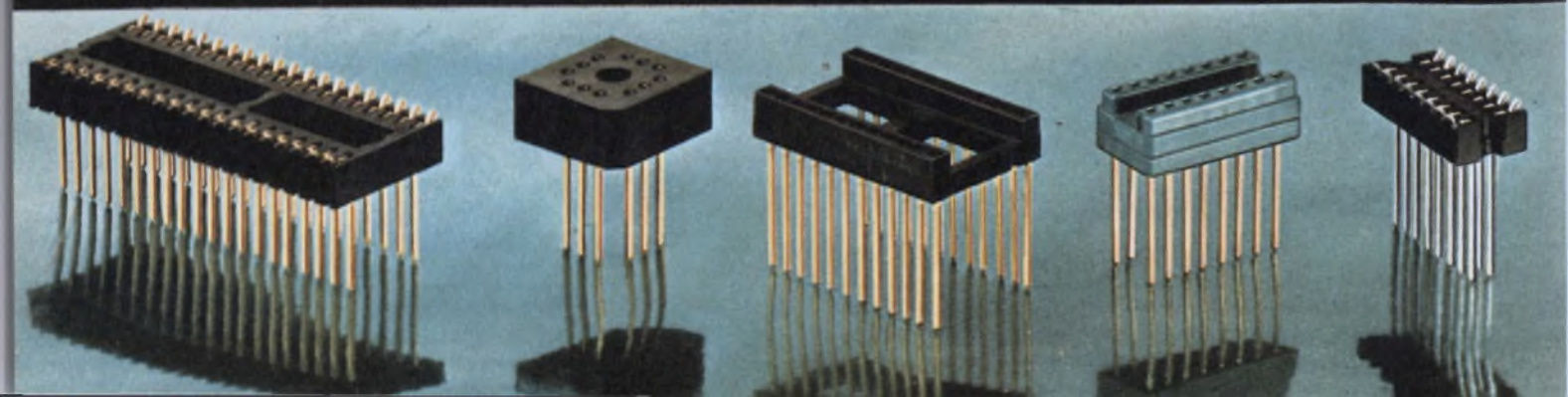

Save \$3,000... get 10-day delivery

Switch to Robinson-Nugent Wire-wrap* Socket Boards

Save 30%! By specifying RN high reliability Wire-wrap Socket Boards—your \$10,000 production order will cost only \$7,000! Sound impossible? More and more quality, cost-conscious firms are discovering that the same simple RN one-piece contact construction that reduces the cost by 30%—also brings added reliability, higher contact retention. Many say that RN Wire-wrap Socket Boards provide the most reliable, rugged solderless interconnect system available.

"Environmental Test Program" done by independent test lab reveals RN Wire-wrap Socket Boards meet or surpass the toughest MIL-specs. Summary of tests in latest RN catalog. Write for it today.

On production-size orders we'll pay for the reprogramming of your Wire-wrap tapes. What could be easier than switching to RN?

These cost-conscious firms are saving with RN high reliability Wire-wrap Socket Boards

Texas Instruments	Bendix Aerospace
Motorola	Hughes Aircraft
NCR	RCA
Airborne Instruments	Sandia Labs
Lockheed Electronics	General Dynamics



Send today for catalog with full details and specifications. Start now to save 30% on your Wire-wrap Socket Boards.

RN ROBINSON NUGENT, INC.

800 East Eighth Street • New Albany, Indiana 47150 • Phone: (812) 945-0211

INFORMATION RETRIEVAL NUMBER 36

*Trademark of Gardener-Denver Co.

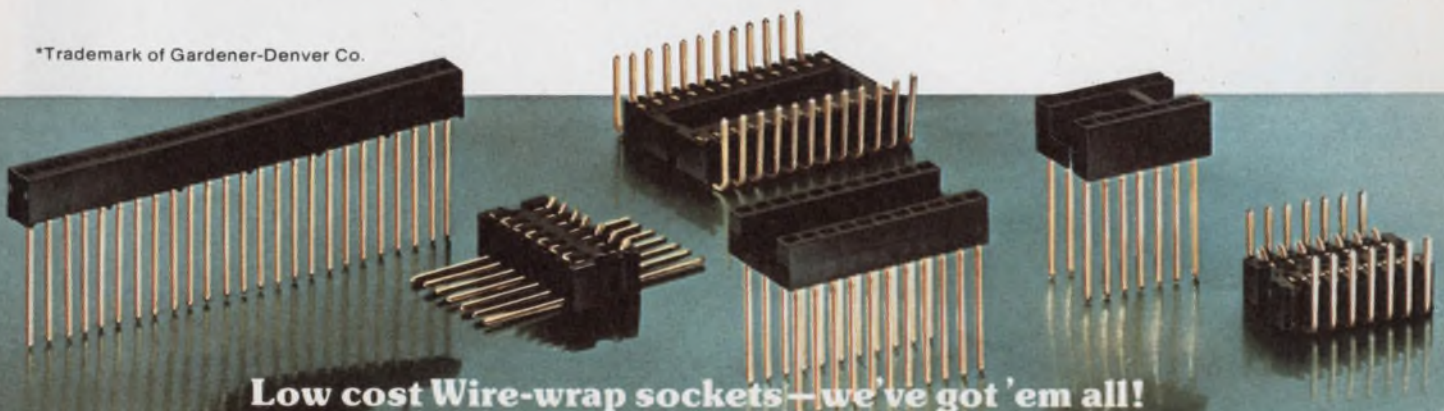

Low cost Wire-wrap sockets—we've got 'em all!

Prevent low-level amplifier problems.

Commonplace components and assembly techniques can wreck performance. Here's how to maintain the precision you need.

Even though much progress in performance has been made in low-level circuit design for instrumentation and servo control, many problems cannot be countered without making careful tradeoffs. Aside from selecting the best amplifier, you must also consider the power supplies, grounding, shielding, bypassing and even the external components used.

Carefully designed amplifiers provide microvolt offset voltages, drifts down to 100 nV/°C and input bias currents of less than 1 pA. But even with first-rate specs like these, there are many ways you can unwittingly cripple performance. Among the things you must guard against:

- Haphazard selection of the power supply.
- Improper grounding of the circuit.
- Unprotected input signals.
- Poor choice of external resistors, capacitors

and wiring techniques.

If you avoid these traps, performance can meet or surpass the manufacturer's data.

The high-stability amplifiers used in low-level circuit design are available from many manufacturers. But the variety of amplifiers presents some selection problems and calls for tradeoffs. For instance, most low-level amplifiers are limited in frequency response to a bandwidth below several kilohertz, compared with typical operational amplifiers that have responses into the megahertz region. Bandwidth vs sensitivity must be evaluated.

Two major types of low-error amplifiers are available: chopper-stabilized and varactor-bridge. Both use a carrier-modulation technique that either controls an electronic switch or excites a bridge.

A chopper-stabilized amplifier (Fig. 1a) can be built from two basic operational amplifiers. One amplifier, usually stabilized, is ac-coupled through a capacitor to the input signal to isolate the input dc offsets from an internal summing junction. The stabilized amplifier is, in turn, connected to a modulated switch that feeds the

James Williams, Senior Engineer, Instrumentation Lab, Dept of Nutrition and Food Science, Massachusetts Institute of Technology, Cambridge, MA 02139.

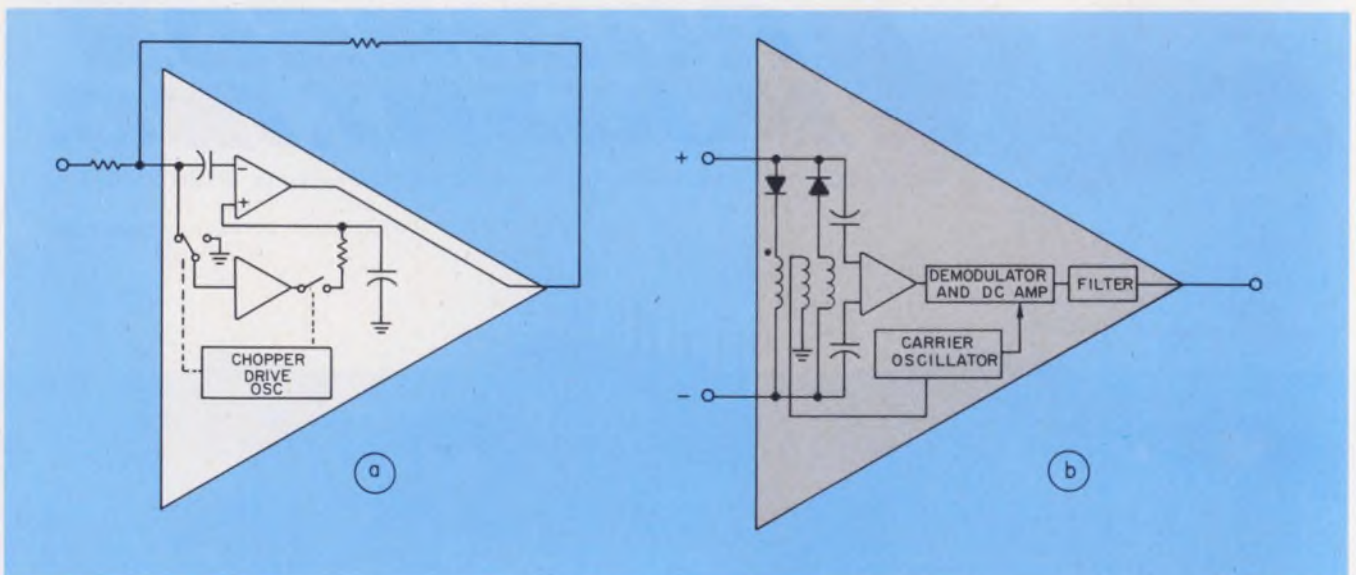

1. The basic chopper-stabilized amplifier (a) contains two separate amplifiers in a servo loop that nulls any

drift. The varactor-bridge amplifier (b) has a modulated bridge input that allows extremely low bias currents.

input of the second amplifier. This switch, driven by an internal oscillator, samples the offset at the summing junction and, by use of a synchronous demodulator, drives the positive input of the stabilized amplifier, thus counteracting the amplifier's dc drift. The feedback for this servo type of action is to the chopper circuit through an external feedback resistor.

The varactor-bridge amplifier, although not chopped, uses a carrier-modulation scheme (Fig. 1b). The varactor diodes have a junction capacitance that depends upon the applied voltage. With no voltage applied, they have a high resistance in the off state. The amplifier input circuit is a floating bridge, constructed from two diodes and a modulating signal. If the inputs are precisely balanced, the diodes are equally biased and the bridge has no output. An ac input unbalance will change the diode capacitances, which in turn produces an rf output from the bridge. This signal is then amplified, synchronously demodulated and filtered to obtain a dc output signal.

Even when you have high-quality circuits, they can easily perform poorly if the components con-

nected to them have been incorrectly selected. For instance, make sure you choose a well-regulated, low-output-impedance power supply. And watch out for these problems: Does the output of the supply overshoot when power is applied or when transients occur? Does the regulation spec include immunity to fast transients on the ac line, or do the transients feed through to the output?

Power supplies cause problems

Series-pass, linear-regulated, power supplies are the safest choice for precision circuits; however, there are some good switching supplies. Switchers offer high efficiency and small size, but beware of the high-frequency transformer radiation—this can wreck the amplifier's input. Some switching manufacturers have solved this problem; others have not even bothered to look into it.

Some amplifier modules are equipped with internal bypass capacitors. If in doubt about the unit you have, check with the manufacturer or bypass the power-supply lines at the amplifier

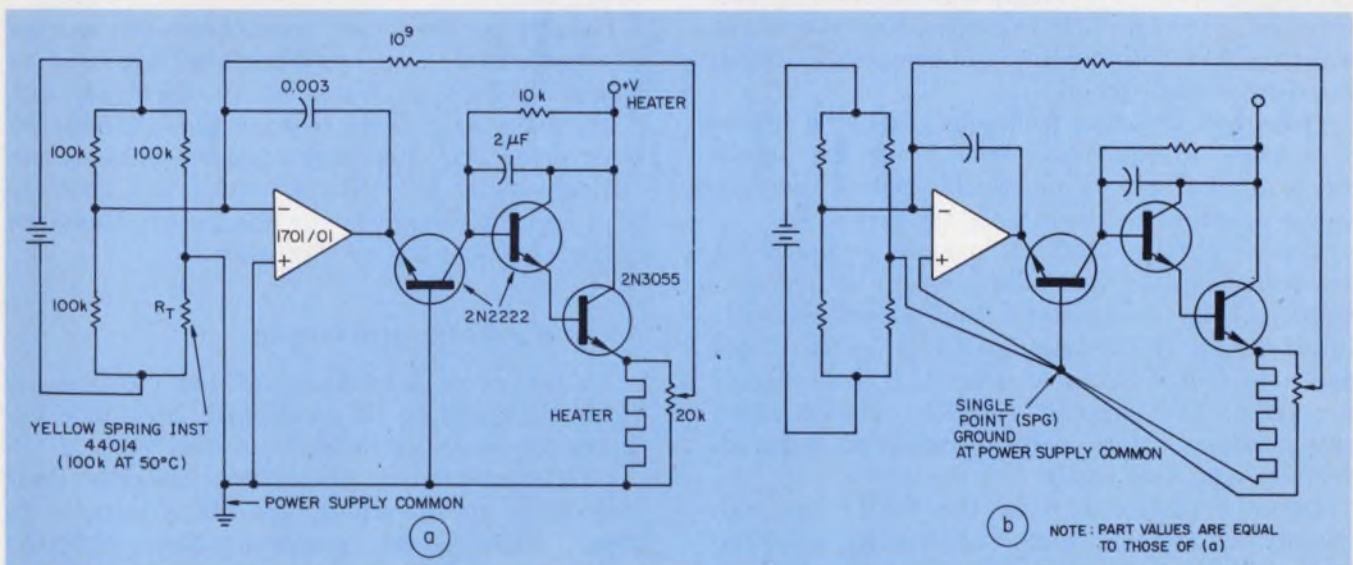

2. A precision temperature-control circuit that has ground problems (a) uses a chopper-stabilized amplifier to provide microdegree accuracy over a predetermined

range. By rearranging the ground circuit you can eliminate noise and ground loop problems (b) that can cause poor circuit operation.

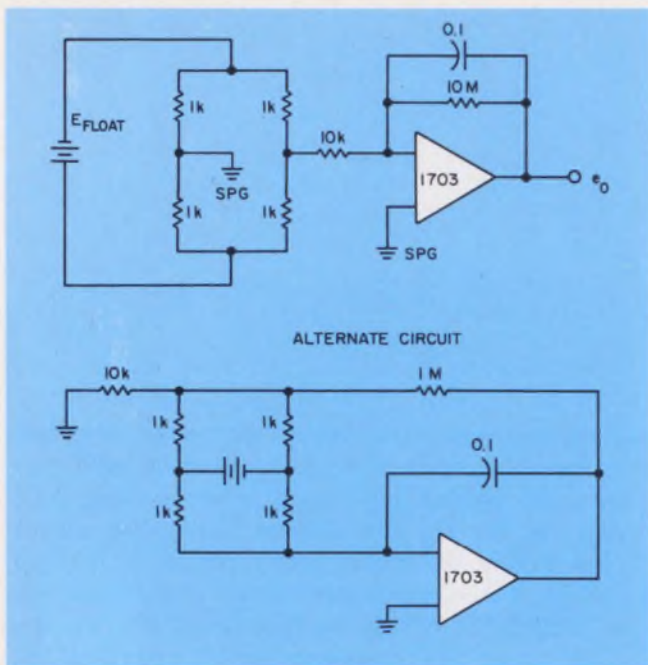

3. Single-ended chopper-stabilized amplifiers can be connected by use of a floating-bridge circuit to perform as if they had a differential input.

with solid tantalum capacitors. Aluminum electrolytics simply do not see fast transients.

Good grounding techniques are always a must. As an example, look at the temperature-control circuit of Fig. 2. Erratic operation of this circuit can be caused by a ground bus, even when the latter is only 3 in. long and made from 12-gauge wire. Large heater currents returning through the pass transistor combined with small bridge and amplifier currents set the stage for real trouble. If heater drive comes from a separate supply, the problems become even more complex. Ground lines that have large switching currents are very noisy and usually full of fast current spiking. A nondegrading common ground must be arranged, and in some cases you might want to float both circuits and completely isolate them from each other.

One good isolation technique might be to use a voltage-to-frequency converter at the amplifier's output and then optically isolate the converter's output to the rest of the circuitry.

The amplifiers used are usually designed for low-level signals and thus must be shielded against both electrostatic and electromagnetic interference. Power-supply transformer fields are notorious sources of seemingly inexplicable problems. The simplest solution: Use shielded transformers. More careful layout is also effective—and less costly.

Other emanations from the 60-Hz line can usually be brought under control by shielding and deliberate limiting of circuit bandwidth. Battery-powered circuits, despite their "line isolation," are susceptible to 60-Hz pickup. A

few picofarads of ground capacitance can seriously degrade the performance of a circuit like that in Fig. 6.

Components add unwanted headaches

Although not generally considered components, wire, solder and insulation must be considered. Certain combinations of solder, wire and binding posts can generate thermal emf's. For example, a junction of stranded wires from two different manufacturers can easily produce an emf of 200 nV/°C, or twice the input drift of an amplifier like the Teledyne Philbrick 1701/01. Amplifier sockets are fine, but a poor one can introduce contact resistance, thermal potentials or both.

With varactor amplifiers the socket choice is highly critical— $10^{15}\text{-}\Omega$ leakage from the power-supply pins to the input can provide almost 10 times the required bias current. Teflon sockets are the best choice for minimal leakage. On the circuit board, critical circuit paths should be guarded.

Precision metal-film resistors are good, but some are better than others. Certain types use "end cap" terminations and can produce pronounced thermocouple effects that swamp out a good amplifier's drift spec. High-grade wire-wound resistors offer the ultimate in low-noise performance, but they are also expensive and relatively large; save them for applications where absolute accuracy, high stability or very low temperature coefficients are musts. For example, the circuit in Fig. 2 can maintain very good stability without wire-wound resistors if you select metal-film resistors that have a 5-ppm tracking temperature coefficient.

Even mixing resistor brands is an invitation to trouble.

Capacitors are often overlooked as sources of trouble in dc circuits. When they are used as bandwidth-limiting elements in feedback circuits, make sure their leakage doesn't add another error. An integrator's leakage is obviously critical—but so is "soakage," which is a measure of a capacitor's ability to charge or discharge without voltage lag or "leftovers."

A look at amplifier performance

So far we've seen many of the troublesome items that tend to be overlooked. Now let's examine the amplifier itself.

Carrier-modulated amplifiers, despite their impressive specifications, are not a solution to every measurement problem. Most chopper-stabilized amplifiers, for example, are limited in application because of their single-ended input; high-stability, differential-input op amps can

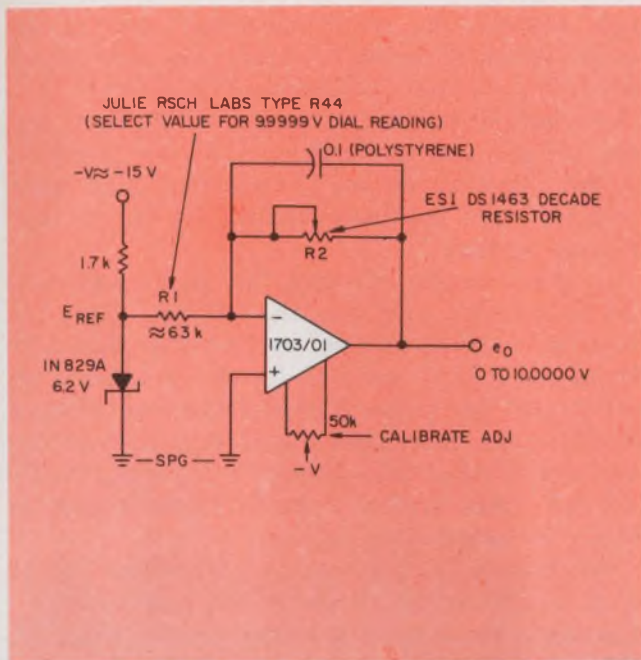

4. Chopper-stabilized amplifiers also form very stable voltage references. These are as stable as the zener diode used for the reference source.

more readily perform differential measurements. However, the common-mode rejection-ratio error can swamp out the amplifier's low drift. For applications where common-mode voltages are low, the differential-input amplifier is a good choice, but when common-mode voltages are high, use a chopper-stabilized amplifier with a pseudo-differential input (Fig. 3).

Chopper amplifiers have initial offset voltages down in the 10-to-20- μV region, while most premium FET or bipolar op amps have offsets in the hundreds of microvolts. And, unlike other amplifiers, choppers can be trimmed for offset without affecting $V_{os}/\Delta T_c$. This permits the amplifier's offset adjustment to be used as a calibration tweak (Fig. 4) or bucking adjustment.

High-performance op amps can come close to matching a chopper's offset temperature drift but not to equaling the chopper's power-supply rejection or time drift. All amplifiers take a "random walk" when it comes to offset voltage vs time. A differential amp may drift a few microvolts a month, but a chopper can achieve a low 5- μV -a-year offset drift. With unattended equipment, time drift can be critical.

Chopper-amplifier input bias current is usually about 50 pA, while FET input amplifiers go down to 1 pA and still maintain a 1 $\mu\text{V}/^\circ\text{C}$ offset tempo. Some FET op amps can even bias down to 0.1 pA, but at this low current you trade away offset stability. Remember, FET bias current doubles with every 10-C increase.

When bias current is the critical spec, look into the varactor-input amplifier with its femto-

ampere bias currents. Varactors also have high common-mode rejection—even at 100 V. Their dc drifts (10 $\mu\text{V}/^\circ\text{C}$) are relatively poor, and their bandwidth is low (typically 40 Hz or so).

When you make a choice, don't forget to consider possible interference from residual noise in chopper-amplifier outputs, open-loop gain (choppers have typical gains of 10^7 to 10^8 vs 10^6 for differential amplifiers), power consumption and price. Generally chopped amplifiers cost a bit more than differential-input units, and FET input differentials usually cost more than bipolar-input amplifiers.

Measure some key specifications

Some of the key specifications of carrier-modulated amplifiers—or any amplifier—can be verified by a few simple tests. Measure the offset voltage and its drift vs temperature. The test set in Fig. 5a allows these measurements to be taken. Set the amplifier up for a gain of 10,000, ground the input (with S_1 open), and you get the following offset vs output relationship:

$$E_{os} = \frac{E_o}{1 + R_2/R_1}$$

The gain of 10,000 allows most instrumentation to display the 10-to-20- μV offset voltage of the amplifier without any problem. If S_1 is closed and the potentiometer is adjusted to null the offset, $V_{os}/\Delta T$ can be established. With the initial offset nulled at 25 C, place the amplifier in a controlled 70-C environment and allow enough time for the amplifier to settle. Now measure the output voltage. Next, place the amplifier in a 0-C environment and measure the settled output voltage.

The offset-vs-temperature characteristic can be calculated from the standard "butterfly" equation:

$$E_{os}/T = \frac{E_{os}/70\text{ C}}{70 - 25\text{ C}} \text{ or } \frac{E_{os}/0\text{ C}}{0 - 25\text{ C}}$$

Stable resistors and a well-constructed test jig (good grounding, shielding, etc.) will ensure accurate results.

Time drift, measured in microvolts/year, can also be extrapolated from the same test circuit, if the amplifier is held at a constant temperature (about $\pm 0.1\text{ C}$) for one day. The long-term error can then be calculated from

$$\Delta_{os} (1\text{ year}) = \Delta_{os} (1\text{ day}) (\sqrt{365\text{ days/year}})$$

Another circuit (Fig. 5b) can be used to determine the amplifier's input bias current. With S_1 or S_2 closed, the output voltage is related to the bias current at the appropriate input by

$$I_b = E_o/10\text{ M}\Omega$$

Temperature dependence can be measured in the same way as for offset voltage.

Once you have narrowed the choice to a specific

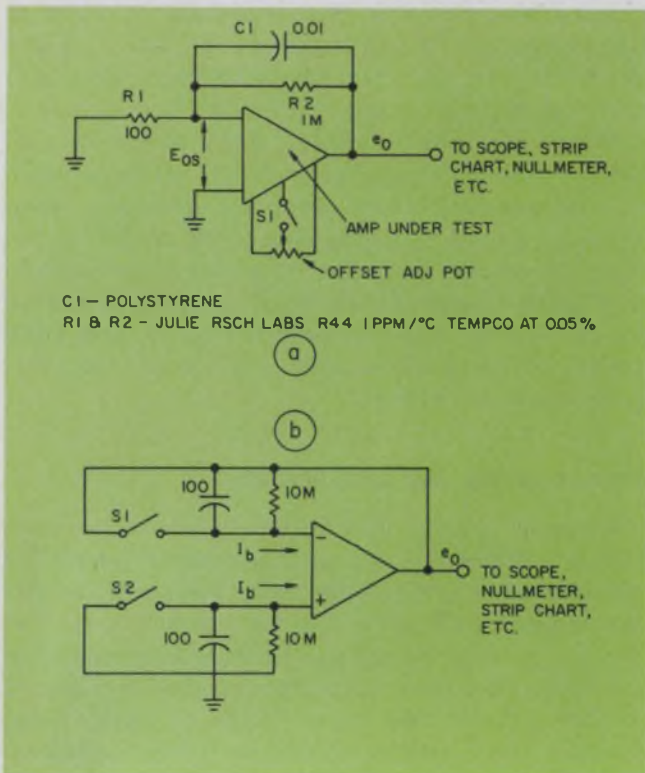

5. A simple test jig to check the amplifier for offset drift (a) or input bias current (b) doesn't require too many extra components.

amplifier type, the worst is over. Let's take a look at some applications of high-stability amplifiers.

Look at some circuit examples

A null voltmeter/data amplifier with a 5- μ V full scale sensitivity can be built with a bandwidth limited to only a few hertz if you place a 0.1- μ F capacitor across the input and output terminals of the amplifier (Fig. 6). An external resistor switching circuit lets the modular amplifier cover many gain ranges. On the four lower-

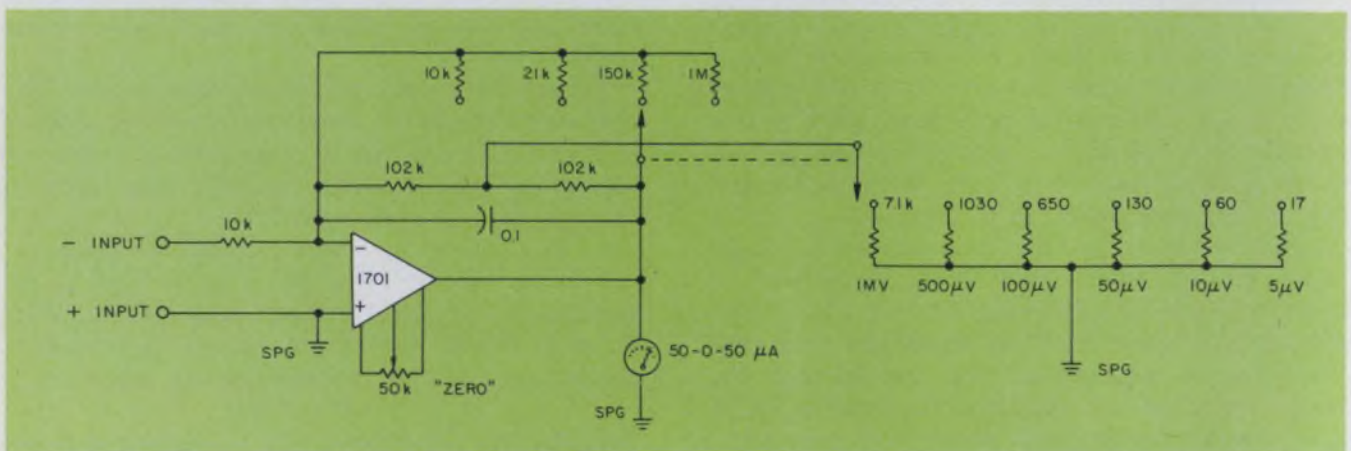

6. Band-limiting of a null voltmeter is easily accomplished if a 0.1- μ F capacitor is placed across the input and

gain ranges, two 102-k Ω resistors parallel the switch-selected feedback values. On the higher sensitivity ranges, the feedback is divided by a ratio determined by the range switch value and the 102-k Ω resistor connected to the amplifier output. This compound T provides high gain without large feedback values, which in turn reduces leakage.

In this example the amplifier delivers an output to a meter, and thus the gain accuracy (as opposed to stability) need not be better than 1%. Metal-film RN60C resistors provide both good accuracy and low noise at reasonable cost. Since a typical meter movement might require only 100 μ A, worst case, total quiescent current is only ± 3 mA from typical supplies. This circuit is handy for portable equipment.

Single-ended instrumentation amplifiers can be used in differential measurement applications—just float the input in a bridge circuit (Fig. 3). This type of circuit not only permits the amplifier to extract the offset signal but, more significantly, completely eliminates the common-mode error of the differential amplifier. Even when an amplifier has a CMRR of 120 dB, the common-mode error can overshadow the input drift characteristics of a good differential amplifier. This capability is exploited by the temperature servo circuit of Fig. 2.

In this circuit the chopper's low bias current, low drift and high loop gain combine in a temperature-control system with very high performance. The true differential signal, derived from the bridge, is amplified to drive a Darlington-connected transistor pair. Thermal feedback from the heater and bridge thermistor produced a changing signal that the amplifier conditions. The potentiometer, in parallel with the heater element, should be adjusted to provide just enough feedback to prevent the main (thermal) loop from oscillating due to thermal delay.

This type of temperature-control circuit can

output terminals to pass the high frequencies. This circuit has a 5 μ V sensitivity.

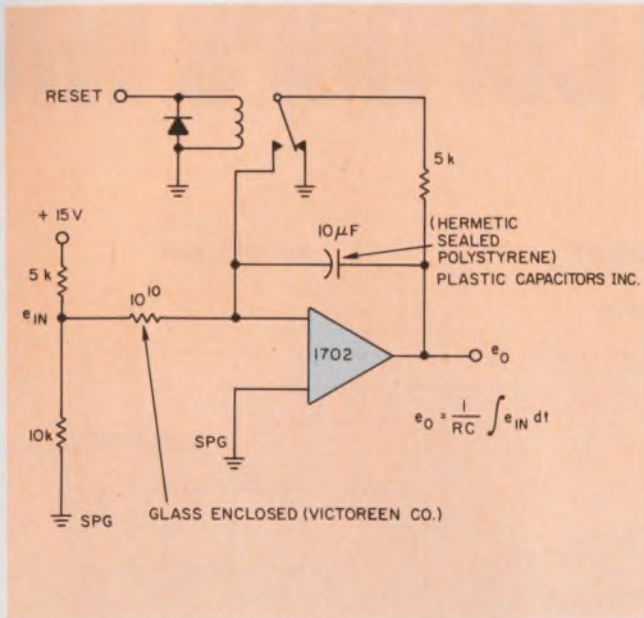

7. A long-time-constant integrator can be formed if a high-quality capacitor is placed across a varactor input amplifier. In this case the time constant is extremely long—100,000 seconds.

hold to within microdegrees at a 50-C set point. And two such controlled ovens, one inside the other, can provide stability limited only by the thermal noise of the inner oven control thermistor.

Generate precision voltages, too

High-stability chopper amplifiers can also be used to generate precision output voltages that span six decades (Fig. 4). The output voltage from the circuit is based upon the stability of an external reference that feeds the inverting amplifier. The simple op-amp gain equation details the operation:

$$E_o = -(R_2/R_1) e_{ref}$$

From this, you can see that if R_1 is carefully selected, the output voltage will be numerically identical to R_2 . Thus if a multidecade precision potentiometer is used as R_2 , any output voltage from 0 to 10 V can be dialed in.

Unlike direct coupled designs, a chopper-stabilized amplifier's offset tempco is independent of the offset voltage. Thus the offset potentiometer can be used as a calibration adjustment instead of a trim. The zener diode used should have a low tempco—typically $30 \mu\text{V}/^\circ\text{C}$ or lower, since it directly determines the output stability.

The total worst-case error over a year's time under lab conditions (20 to 30 C) can be found from the following:

$$\begin{aligned} \text{Diode thermal error} \\ &= (30 \mu\text{V}/^\circ\text{C}) (1.6 \text{ amp gain}) (\pm 5 \text{ C}) = 240 \mu\text{V} \\ \text{Diode time error} \\ &= (60 \mu\text{V}/\text{year}) (1.6 \text{ amp gain}) = 96 \mu\text{V} \end{aligned}$$

$$\text{total} = 336 \mu\text{V}$$

Amp thermal error

$$= (0.25 \mu\text{V}) (1.6 \text{ amp gain}) (\pm 5 \text{ C}) = 2 \mu\text{V}$$

Amp time error

$$\begin{aligned} &= (5 \mu\text{V}/\text{year}) (1.6 \text{ amp gain}) = 8 \mu\text{V} \\ \text{total} &= 10 \mu\text{V} \end{aligned}$$

Resistor error = 1 ppm/year

$$= 10 \mu\text{V}$$

$$\text{total circuit error} = 356 \mu\text{V}$$

At 10 V full scale, that represents about a 36-ppm error, of which only 1 ppm comes from the amplifier. Zener drifts can be reduced, but the diode would still be the main error source. Thus you can reasonably expect one-year calibration intervals on an instrument that has a five-decade range.

Varactor bridge amplifiers, although not chopped, have many precision uses because of their low input bias current—about 2 fA. Only 20,000 electrons per second flow through the input of varactor amplifiers. A typical application is shown in Fig. 7, a circuit for a geophysics experiment in which a linear ramp must be generated over a 24-hour period with a maximum of 10 V.

On the ramp there are not to be any discontinuities or steps—which rules out the use of a digital-to-analog converter to form the output. The circuit acts as an integrator with a 100,000-second time constant and an accuracy that approaches 0.2%. Since the integrating resistor is $10^{10} \Omega$, the current available to charge the capacitor, bias the amplifier and deal with the capacitor's leakage current is given by

$$I = 10/10^{10} = 1 \text{ nA}$$

If the capacitor has a leakage resistance of $10^{12} \Omega$, it will steal 10 pA of current from the input bias.

This leaves 990 pA to charge the capacitor and bias the amplifier. Since the current required by the amplifier is only 2 fA, its current drain doesn't really affect any error calculation. The capacitor's leakage, though, is the dominant error source. Humidity, radio waves, leakage paths and other interference can easily subvert the operation of this sensitive circuit.

To protect the amplifier and keep the accuracy high, the following precautions should be taken: Use a Teflon circuit board. Guard the input paths. Employ point-grounding techniques. And set up a sealed, shielded enclosure. ■■

Bibliography

Graeme, J. G., Tobey, G. E., Huelsman, L. P., "Operational Amplifiers: Design and Application," McGraw-Hill, 1972.

Patstone, Walter, "Designing Femtoampere Circuits Requires Special Considerations," *EDN*, July 1, 1972, pp. 34 to 36.

Williams, James, "Temperature Control to Microdegrees," October, 1971, paper available from MIT, Dept. of Nutrition and Food Science, Cambridge, MA.

Williams, James, "Split a Temperature Degree to 10 $\mu^\circ\text{C}$," *Electronic Design*, No. 10, May 10, 1974, pp. 110 to 113.

How to cut corners with

Cut out the corner coupon.

Linears from the Harris linear family can lower your instrumentation systems costs substantially. Improve performance, lower parts count, reduce design time, and increase system reliability. In the past, the speed and accuracy of most of these linears could only be approached with discrete devices, hybrids, or modules.

Excellent applications for Harris linears include: data acquisition, test equipment, telemetry, medical instruments, and process control.

If you're a systems engineer who's looking for a way to cut corners, without sacrificing quality, speed and reliability, then start cutting with the corner coupon. For immediate action, call your nearest Harris sales office or representative.

TRANSDUCERS

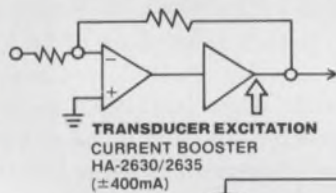

LOW LEVEL/PRECISION

HIGH IMPEDANCE

WIDE BAND

FAST RISE TIME

NOISE CRITICAL

LOW POWER

SIGNAL CONDITIONERS

PRECISE!

HIGH GAIN, LOWEST DRIFT Op AMP:
HA-2900/2905 ($A_v = 5 \times 10^6$)
VOS DRIFT = 0.2uV/°C
IOS DRIFT = 1pA/°C

NO LOAD!

FET INPUT Op AMPS
HA-2050/2055 ($I_{BIAS} = 1pA$,
SLEW RATE = 120V/uS)
HA-2060/2065 ($I_{BIAS} = 1pA$,
GAIN BANDWIDTH = 100MHz)

BROADBAND!

WIDE BAND, HIGH IMPEDANCE Op AMPS
HA-2620/2625 (GAIN BANDWIDTH = 100MHz,
 $I_{BIAS} = 1nA$)

FAST!

HIGH SLEW RATE Op AMPS
HA-2500/2505 (S.R. = 30V/uS)
HA-2510/2515 (S.R. = 60V/uS)
HA-2520/2525 (S.R. = 120V/uS)
HA-2530/2535 (S.R. = 320V/uS)

QUIET!

LOW NOISE Op AMPS
HA-909/911 (NOISE = 1uV RMS,
BANDWIDTH = 7.5MHz)

COOL!

LOW POWER Op AMPS
HA-2700/2705 ($I_{SUPPLY} = 75uA$, S.R. = 20uV/uS)
HA-2720/2725 ($I_{SUPPLY} = 15uA$ [PROGRAMMABLE])
HA-2730/2735 (DUAL HA-2720)

MULTIPLEXER

FAIL SAFE!

CMOS ANALOG MULTIPLEXERS
(LATCH UP PROOF!)

- * HI-506A (16 CHANNEL)
- * HI-507A (DUAL 8 CHANNEL)
- * 508A (8 CHANNEL)
- * HI-509A (DUAL 4 CHANNEL)
- HI-1818A (8 CHANNEL)
- HI-1828A (DUAL 4 CHANNEL)
- * INPUT OVERVOLTAGE PROTECTED

VERSATILE!

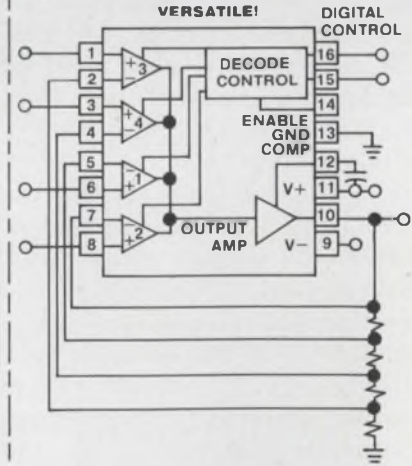

SUBMULTIPLEXING,
MULTIPLEXING, OR
PROGRAMMABLE GAIN AMP
HA-2400/2405 PRAM™

WHERE TO BUY THEM: OEM SALES OFFICES: ARIZONA: Scottsdale, (602) 946-3556 **CALIFORNIA:** Long Beach, (213) 426-7687; Palo Alto, (415) 964-6443 **FLORIDA:** Melbourne, (305) 727-5826 **ILLINOIS:** Hinsdale, (312) 325-4242; Schaumburg, (312) 894-8824 **MASSACHUSETTS:** Wellesley Hills, (617) 237-5430 **MINNESOTA:** Burnsville, (612) 432-6111; Minneapolis, (612) 835-2505 **NEW YORK:** Endwell, (607) 754-5464; Melville, L.I., (516) 249-4500 **OHIO:** Dayton, (513) 226-0636 **PENNSYLVANIA:** Wayne, (215) 687-6680 **TEXAS:** Richardson, (214) 231-9031

SALES REPRESENTATIVES: CALIFORNIA: San Diego, (714) 279-7961 **COLORADO:** Denver, (303) 771-4920 **KANSAS:** Olathe, (913) 782-1177 **MARYLAND:** Randallstown, (301) 922-1248 **NORTH CAROLINA:** Raleigh, (919) 828-0575 **OREGON:** Beaverton, (503) 643-1644 **TENNESSEE:** Shelbyville, (615) 684-4544 **VIRGINIA:** Falls Church, (703) 534-1673; Troutville, (703) 345-3283; Virginia Beach, (804) 481-7200 **WASHINGTON:** Bellevue, (206) 454-0300

the leading line of linears.

ANALOG-TO-DIGITAL

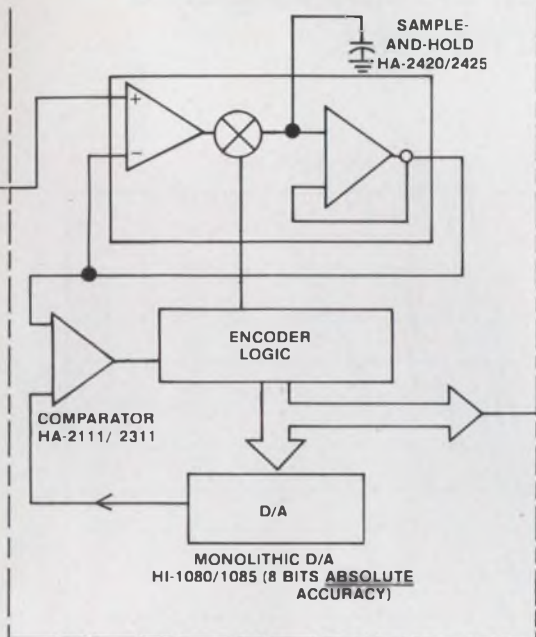

CMOS ANALOG SWITCHES (NO LATCHUP OR SCR EFFECT!)

HI-200	DUAL SPST	70Ω
HI-201	QUAD SPST	80Ω
HI-1800	DUAL DPST	200Ω
HI-5040	SPST	75Ω
HI-5041	DUAL SPST	75Ω
HI-5042	SPDT	75Ω
HI-5043	DUAL SPDT	75Ω
HI-5044	DPST	75Ω
HI-5045	DUAL DPST	75Ω
HI-5046	DPDT	75Ω
HI-5047	4PST	75Ω
HI-5048	DUAL SPST	30Ω
HI-5049	DUAL DPST	30Ω
HI-5050	SPDT	30Ω
HI-5051	DUAL SPDT	30Ω

INTERFACE

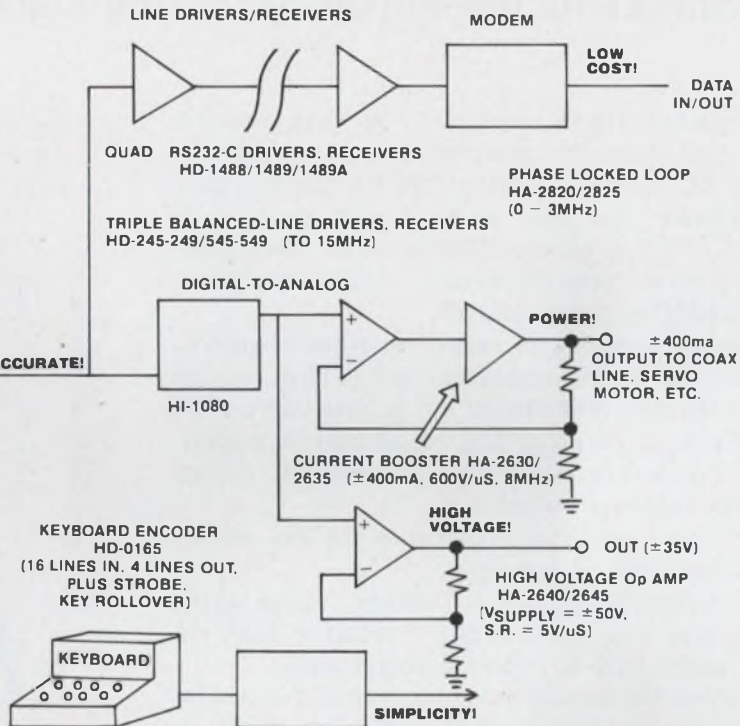

HARRIS
SEMICONDUCTOR
A DIVISION OF HARRIS CORPORATION

P.O. Box 883, Melbourne, Florida 32901 (305) 727-5430

Harris Semiconductor
P.O. Box 883
Melbourne, FL. 32901

Tell me more about cutting corners with Harris Linears. I would like more information on the devices checked.

Name _____

Title _____

Company _____

Address _____

City _____

State _____ Zip _____

OP AMPS

- High gain, low drift
- FET input
- Wide Band, High Impedance
- High Slew Rate
- High Voltage
- Low Noise
- Low Power

MULTIPLEXERS

- CMOS Analog
- Programmable gain amp

- Sample & Hold, gated op amp
- Comparator
- Monolithic D/A
- Line drivers/receivers
- Phase locked loop
- Current booster
- Keyboard Encoder
- CMOS Analog Switches

INFORMATION RETRIEVAL NUMBER 37

Design maintainability into equipment.

Here are some practical ways you can keep the servicing time low without increasing design or manufacturing costs.

Equipment that's designed for easy maintenance will help the customer save on repairs. And, with care and proper timing, the designer can achieve this goal without cost penalty to himself. This is especially important since most of today's contracts for electronic equipment have maintainability requirements.

The specifications, in regard to what is quantified and the terms employed, are varied enough to require the knowledge of a specialist. The analysis must be done first to prepare a responsive bid and then to produce an adequate design after the contract award.

Here are some basic guidelines for the design of maintainable equipment:

1. Use quick disconnect latches, steep angle screws and any other type of retainer that reduces access time to internal components.

2. Break the circuitry up into small functional building blocks, and position test points to allow for branching.

3. Place the subsections that are most likely to fail closest to the repair openings.

4. Prefer simpler packaging to allow easy access to circuit boards, mechanical assemblies and test points.

Removing the access covers to equipment may sound like a simple job. But consider this: To remove and replace a screw takes about a minute and a half. Now add up the time to do eight or 10 screws! You can easily see that conventional screws are big time wasters.

Time is of the essence

Try using quick fasteners—like quarter-turn screws, steep-pitch screws, snaps, slides, shackles. Hardware like this can cut removal and replacement time by a factor of 10.

How about sliding or hinged covers? They require only a few fasteners.

These time factors are important when you consider some contract specifications that require a mean-time-to-repair (MTTR) of only 15 min-

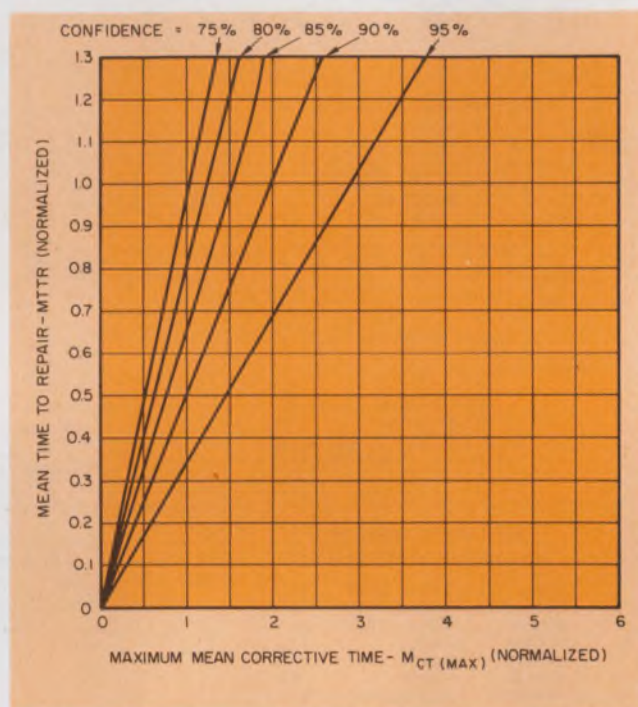

1. Both MTTR and $M_{ct(max)}$ are commonly used quantitative maintainability requirements. Thus if $M_{ct(max)}$ is 30 minutes and a 95% confidence level is needed, the MTTR read from the chart is 10.3 minutes.

utes. Fig. 1 translates the maximum time to repair, $M_{ct(max)}$ (another often used term) into MTTR for various equipment confidence levels. A requirement for a 95% confidence level is not uncommon today.

After the equipment is opened, troubleshooting is the next most time-consuming job. It may involve taking measurements, checking gear trains or inspecting mechanical linkages. Typical measurements require about one minute each, two minutes if a scope is used. Automatic test equipment also takes considerable time to set up. To save time, hold down the number of test points, and be sure the test information leads to easy fault isolation.

With strictly functional packaging, few test points, other than input and output, are needed to isolate the faulty assembly. In some instances, however, functional packaging requires large sub-assemblies. If it does, define some subfunctions

Siegfried Goldstein, Section Head, AIL Div. of Cutler-Hammer, Deer Park, NY 11729.

Maintainability: We talk about it, but what is it?

Maintainability consists of many calculations, lots of statistics, and time-consuming failure-modes analysis. But, there is still some confusion about what maintainability is. It's a design consideration: to optimize equipment design so it can be repaired within the operating and support constraints specified by the customer when it fails.

An increasing number of maintainability specialists are being trained to help cope with new design and support restrictions. Unfortunately these specialists are not the engineers designing the hardware. The actual design engineers comply with the increasing complexity of hardware, greater packaging density, more stringent environmental constraints, as well as weight limitations. Yet it is the design engineer's efforts that will eventually determine the maintenance ease of the end-item.

The designer also prepares the major portion of the contract quotation. He must be concerned with time constraints, built-in test equipment, throw-away philosophy and degree of modularization.

There is rarely enough time allotted to do the analysis and prediction for a quotation, nor time to translate the contract requirements into design constraints. This leaves the designer three approaches: hope the design quoted will meet the maintainability requirements adequately, perform a quick cycle of prediction and re-evaluation, or arrive intuitively at a design.

Ideally, the design engineer should develop the major design constraints imposed by the maintainability requirements at the time of the quotation. The level of detail depends on the depth required by the quote but should, as a minimum, define: the need for built-in test circuits, whether manual or automatic; the need for peculiar test equipment compatibility; a rough idea of the quantity and type of test points; and the level of fault isolation. Most quotes don't

require discussion of these points but you'll have flexibility for further detailing in the design phase.

Similarly the mechanical engineer should come up with packaging schemes that allow for special hardware or handling devices.

Changes become increasingly expensive as progress is made towards final drawings, and yet specifications are often so complex that designers put off interpreting them. The interpretation, done by specialists—which usually can't be funded before contract award—is a translation of the maintainability requirements into design constraints. This translation, when made by someone other than a designer, is usually biased in favor of maintainability.

Unfortunately maintainability has no immediate apparent trading value in most contracts (for example, cost incentives). For this reason the art of maintainability has to be developed in design engineers.

It costs no more to design maintainability into equipment with good access and useful test points than it does to have poor access and useless test points. This can be done, and the trade-off battle eliminated, if the design engineer has developed a "feel" for maintainability.

There are ways, other than experience, to develop this feeling: a course in principles, the use of design checklists, and the use of analogies to experiences with familiar equipment such as cars or televisions. There are also many texts available. Unfortunately the time and the will to study them aren't always there.

No matter what terms are used to specify maintainability, the repair time plays the major role. This time can be divided into tasks peculiar to the failure and tasks required no matter what goes wrong. These latter tasks are common to all repairs and must be added to repair times for any fault, thus making it imperative to reduce these basic times.

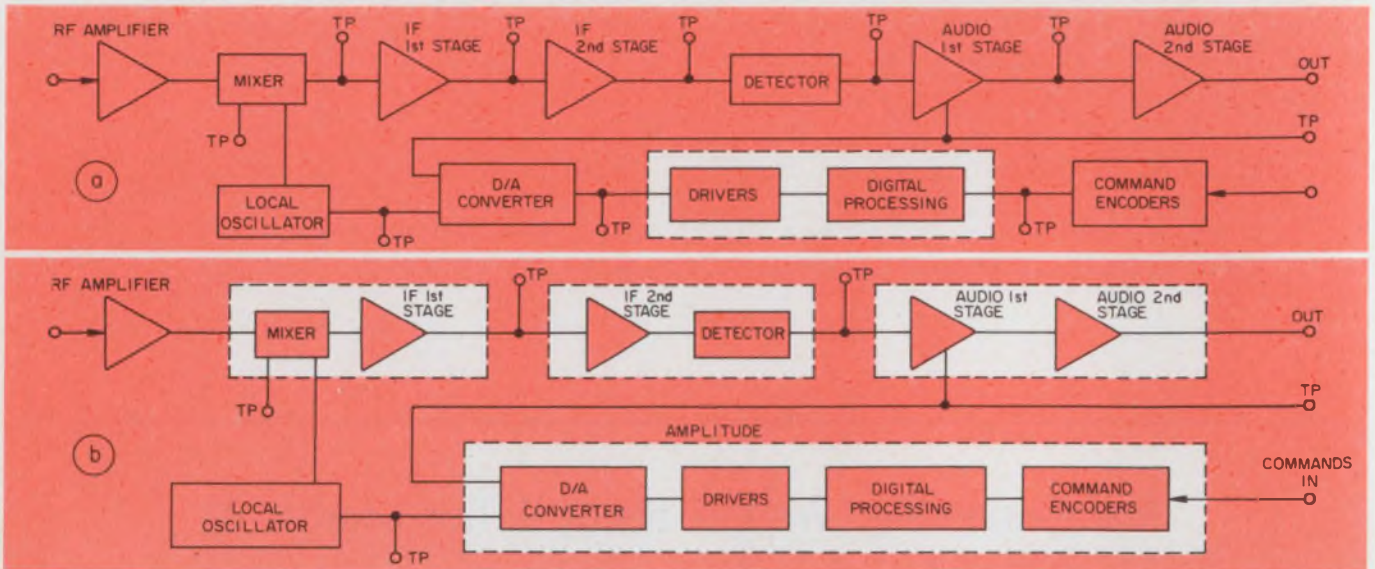

2. A hypothetical digitally tuned receiver (a) has been set up with 10 test points. Some of these points would require special buffering to prevent false readings. A

redesigned receiver circuit (b) eliminates some of the test points and combines some of the small circuits into larger functional blocks.

3. Maintainability was considered (a) when this piece of equipment was designed (right). The internal subfunctions are modularized (b) to simplify servicing (bottom). The odd shape of the unit was dictated by the space available.

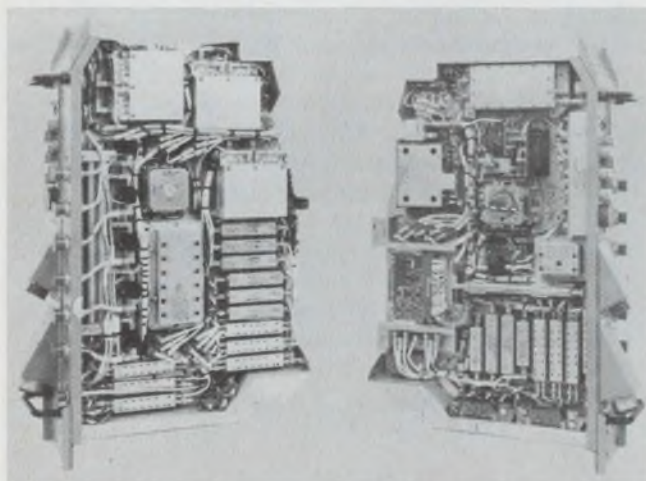
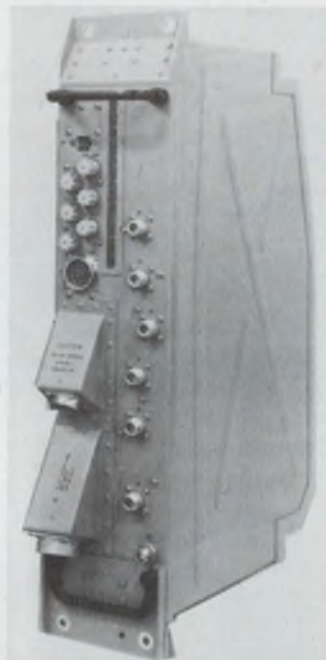

and interpose test points within each assembly. For example, Fig. 2 compares the test-point requirements for functional and random packaging.

If a function is split between two or more sub-assemblies, this can cause troubleshooting nightmares. Such a split is more common with digital than with analog circuitry. It is not uncommon to find a single gate function split between two boards, or to discover the digital-to-analog converter on one board and its drive circuitry on another.

Though splitting of functions might allow you to standardize subassemblies and reduce circuit cost, you'll be penalized in the long run because more test points will be required. Of course, if the contract permits, these smaller, multi-use circuits can be mounted in a larger subassembly or grouped into the next larger function. The larger function can then be replaced and repaired at a later date. Built-in test equipment (BITE) can also help in fault isolation. But this is usually not done unless required by the contract, since it adds weight, volume and cost.

Accessing faulty subassemblies for interchange or adjustment wastes time. Clever packaging can provide ready access to all the components, with none stacked or buried. Where this can't be done, the subassemblies most likely to fail or those requiring some adjustment should be the most readily accessible.

Think functional, think simple

Everybody is familiar with cars that seem to be built around the radio or those that appear to have had the engine or air-conditioner installed after the spark plugs were. Many people

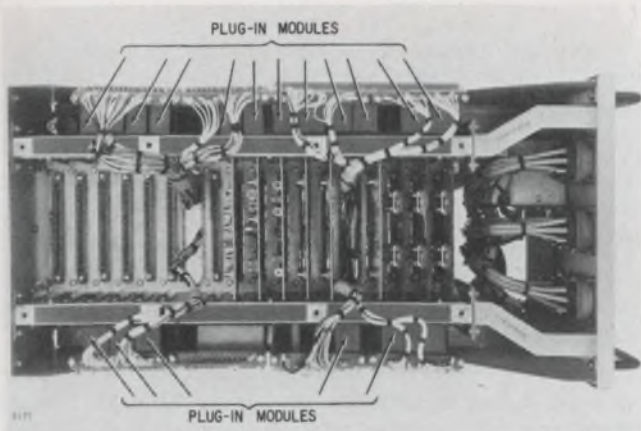

4. By packaging subfunctions into removable modules you can increase the ease of servicing a complex piece of electronic equipment.

are capable of the hindsight to correct these annoyances, but few have the foresight to prevent them.

Just such foresight has produced electronic designs that have exceeded maintenance requirements with no compromise in performance. In one example of this (Fig. 3a), the odd shape of the case was dictated by the available space, whereas the connector angle was provided for ease of manipulation. The equipment cover is made in one piece, and it permits the chassis to be withdrawn like a drawer. The cover is held to the chassis by several screws in the rear and a peripheral lip in the front plate.

For this example, EMI shielding was a design requirement; a gasket mounted in the front panel lip provides a "foolproof" seal when the cover is fastened to the chassis.

Functional packaging of the circuits at the block-diagram phase of this design minimized the number of test points. Consequently smaller connectors and less wiring were required (Fig. 3b). Functional flow grouping and the use of a central chassis also minimized cable runs, and

thus cut crosstalk and weight, while the available space inside the case increased.

In another example (Fig. 4), functional packaging was used and the functions or subfunctions contained within the subassemblies. In this case additional cost savings resulted, since smaller subdivisions were repeated and duplicated. These smaller subfunctions were mounted on small plug-in modules that, in turn, plugged into a larger subassembly.

In the unit of Fig. 4, heat was a major problem—the density of components dictated by the space available made for minimal heat transfer. The frame that holds the circuit-board mounting slides is a heat exchanger made from honey-combed material. One side of the frame cools the slides, which, in turn, conduct heat away from the circuit boards. The other side of the frame is in contact with the circuit modules and cools them sufficiently. Again, more than adequate ease of maintenance resulted from this design.

Another piece of equipment, typical of avionics packaging, crammed even more equipment into a smaller space (Fig. 5a). Note that the wire dress in this case was arranged so that it did not interfere with the removal of any subassembly. Even with this care in packaging, removal and replacement of the subassemblies is difficult. In addition the access time to the subassemblies is restricted by a conventional cover that uses many sealing screws. A redesign of the unit (Fig. 5b) used shackles so that covers could be rapidly removed to access the subassemblies.

Total equipment redesign isn't needed

Another type of design problem (Fig. 6) had some complex constraints. One unit (Fig. 6a) had a connector plane for the circuit cards and opened like a book for access to the cards and power supply. Many identical boards were used in this unit, and fault-isolation was planned to

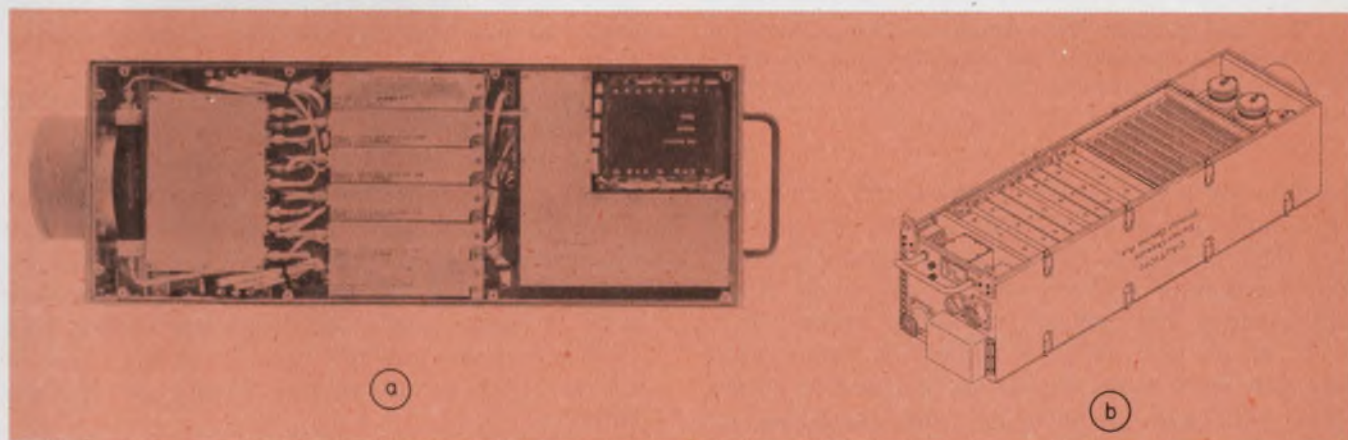

5. A densely packed piece of avionics equipment uses rigid coaxial wires to connect subfunction blocks (a). A redesigned version of the unit (b) uses shackles instead

of mounting screws to hold the individual modules in the case. The shackles help reduce the interchange time considerably.

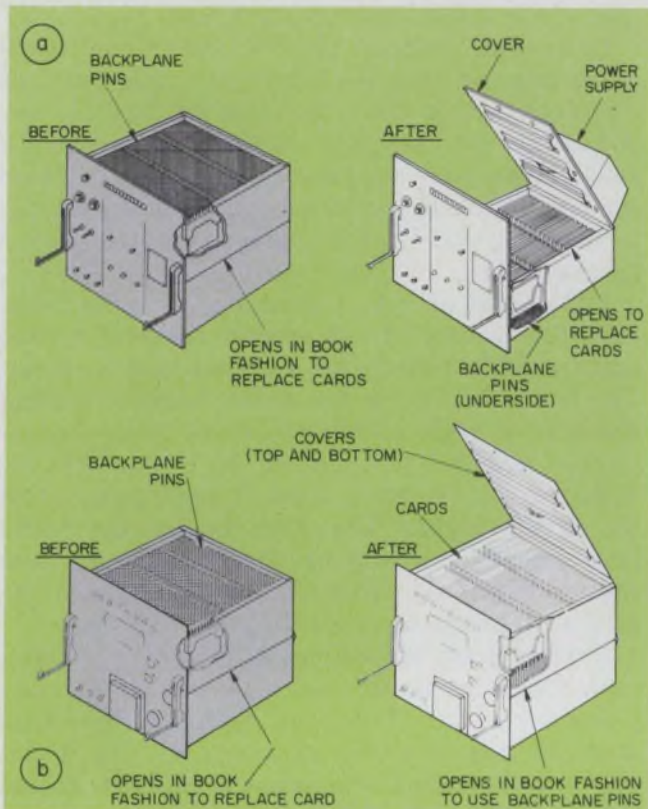

6. By placing the circuit cards in the lower half of the equipment case, you can reduce the amount of work needed to service this unit (a). If you flip the wiring trays, the cards are easier to reach, and you still have access to the wire terminals for measurements (b).

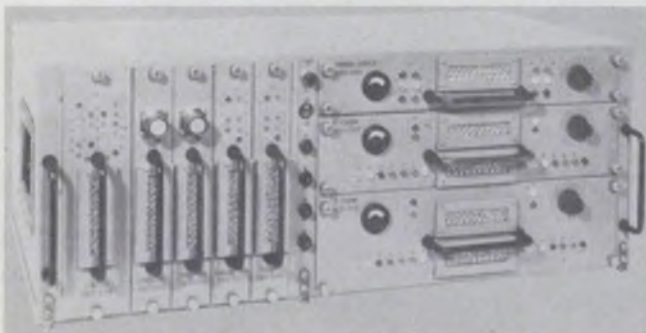

7. The final product that represents the ultimate in maintenance philosophy for in-place servicing has front-panel replaceable modules. No covers must be opened.

be done by a BITE circuit which tracked a specific fault to a group of cards. The wire terminals are then probed to determine the specific fault. The remaining problem was to access the cards and remove and replace the faulty units.

A second unit (Fig. 6b) had the same problem, but with about double the number of cards. This unit, also planned its wire terminals as test points. Good design of BITE circuits eliminates the need to use the wire terminals as test points. It thus permitted redesign during the

conceptual phase of equipment development. As the figures show, the packaging that exposed the underside of the mother boards was changed so that the user could remove the small circuit boards just by opening the cover and lifting them out. A possible heat problem in the unit of Fig. 6a was solved when the power supply was moved from the bottom layer to the top. Tiltable slide mountings permitted the drawers to be extended and tilted in two directions for easy servicing.

Some avionics maintenance requirements specify that the equipment be replaceable in flight. Here you can't really open covers or disassemble equipment, so front-panel replaceable subassemblies are used. All you do is unfasten several quick disconnect screws, pull out the bad unit and plug in another (Fig. 7).

Mechanical systems can also be built for efficient maintenance. Although you may not visualize mechanical test points, items such as flow meters, temperature gauges, strain gauges, counters, etc., yield data for fault location. Functional packaging is probably the only way mechanical devices can be sectioned off for ease of assembly and test.

Access, however, is as big a problem in mechanical systems as in the complex electronic systems. It might even be more pronounced, since the subassemblies may be large and fixed. With large equipment, the need for mechanical strength and resistance to shock vibration and temperature changes may rule out the use of quick disconnect fasteners, but huge shackles may fill the bill.

Successful design of these and other black boxes sparks out enthusiasm. Unlike many other design parameters, good maintainability is apparent immediately, not at some later date when you no longer get any feedback. It can be analyzed instantly and it can be appreciated immediately when problems arise in manufacturing, testing, or debugging phases. It also pays off, since items that are maintained easily are also easier to manufacture and test, thereby cutting costs.

Clever use of slides, pins, hinges and dovetails can greatly minimize interchange time for mechanical equipment. You can probably draw upon some everyday experiences for extra insight. Chances are you've struggled with a bolt that had no wrench access or an item that couldn't be removed after it was unfastened. Have you ever tried to pour a can of oil into a car engine only to find that you couldn't because of the angle of the fill port or obstruction caused by the air filter?

All of these everyday trials, and many more, are examples you can draw from to come up with a better way. ■■



NEW Simpson 360 Digital VOM

Handy and rugged enough for the field — accurate and versatile enough for the lab. And its simplicity and readability make it perfect for production line testing.

- 3-1/2" digit, non-blinking, auto-polarity 0.33" LED display
- AC line or battery operation
- 29 popular ranges including "low-power" ohms
- Analog indicator for scanning nulls and peaks
- Analog output signal permits interfacing with recorders and other instruments
- Up-down integration analog/digital conversion assures superior stability, accuracy and noise immunity

Supplied with test leads, AC line cord, operator's manual, without batteries **\$325**



SIMPSON ELECTRIC COMPANY

853 Dundee Avenue, Elgin, Illinois 60120 • (312) 697-2260
 CABLE: SIMELCO • Telex: 72-2416
 IN CANADA: Bach-Simpson, Ltd., London Ontario
 IN ENGLAND: Bach-Simpson (U.K.) Ltd., Wadebridge, Cornwall
 IN INDIA: Ruttonsha-Simpson Private, Ltd., Vikhroli, Bombay

ORDER NOW FROM YOUR LOCAL ELECTRONICS DISTRIBUTOR OR WRITE FOR NEW CATALOG 4400
 INFORMATION RETRIEVAL NUMBER 38

Cram data through voice-grade lines

with multilevel modulation and adaptive equalization. These techniques achieve modem data rates of 4800 bit/s or more.

To design high-speed modems for voice-grade phone lines, you must reduce the source-signal bandwidth and equalize the line for amplitude attenuation and phase delay encountered over a wide frequency range. Two basic techniques are essential: Multilevel modulation will compress the transmitted-signal bandwidth. And adaptive equalization will provide the necessary reduction of phase distortion.

These design problems arise because most phone circuits offer a bandwidth of barely 2100 Hz, do not pass dc and introduce considerable phase distortion. Such factors hamper data transmission at rates above 4800 bit/s.

Fast data are clocked

Modem is an acronym for modulator-demodulator. And most modems resemble a radio transceiver. Fast modems, however, depend on data-bit timing from either an internal or external clock. With the former, the external device controls a built-in clock in the modem. With the latter, the external device supplies a clock that controls the modulation process.

Bit-serial data arrive at the modulator (equivalent to the transmitter) through an interface circuit designed to meet EIA Spec RS-232-C (Fig. 1).

Clock signals, applied to an input shift register, control the reading rate of data into the register. The clock signal also controls the entire digital-to-analog conversion process even through carrier modulation.

A bit randomizer encodes the serial data, then furnishes an encoded bit stream to the analog modulator. Random encoding serves these two purposes:

- It eliminates modem code sensitivity to a string comprised of a particular digit.
- It provides a learning sequence to set the adaptive equalizer at the distant receiver during initial synchronization.

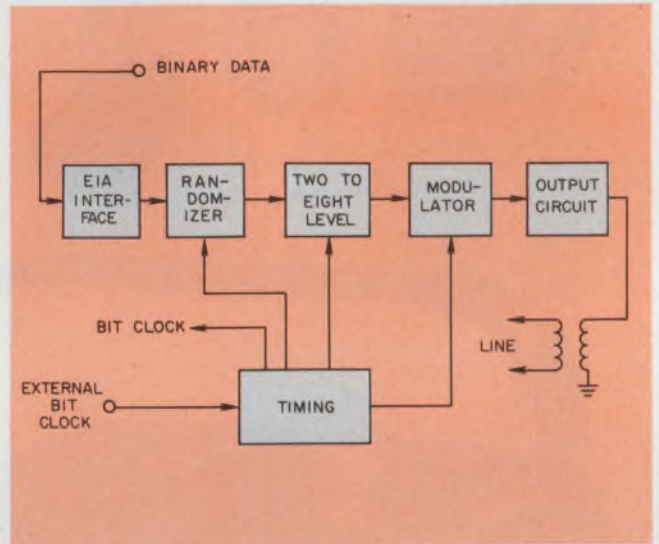

1. Modems convert digital data to analog form for transmission over voice-grade circuits. Clock signals time the modulation process.

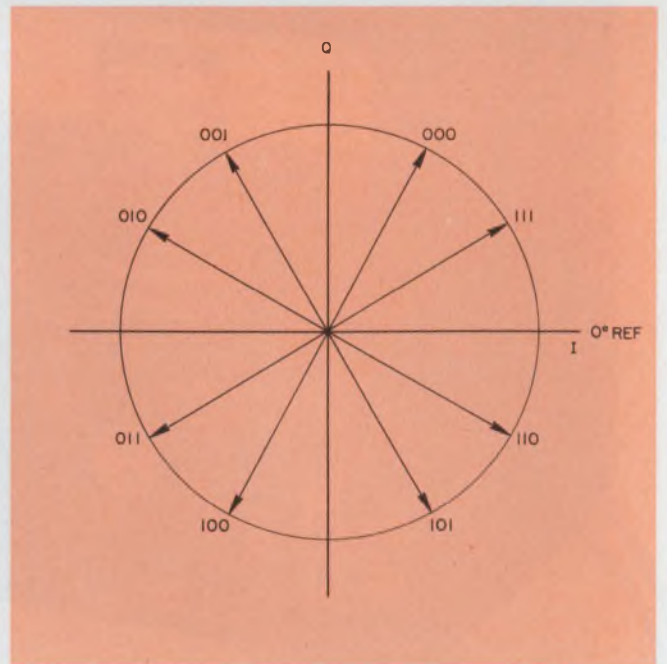

2. Multilevel transmission conserves precious bandwidth. The output of the 4800-bit/s modem is a phase-modulated waveform, which assumes one of eight phases during each baud time. One phase angle encodes three consecutive data bits.

John Jurenko, Manager, Data Communication Products, Tele-Dynamics, Div. of Ambac, 525 Virginia Drive, Fort Washington, PA 19034.

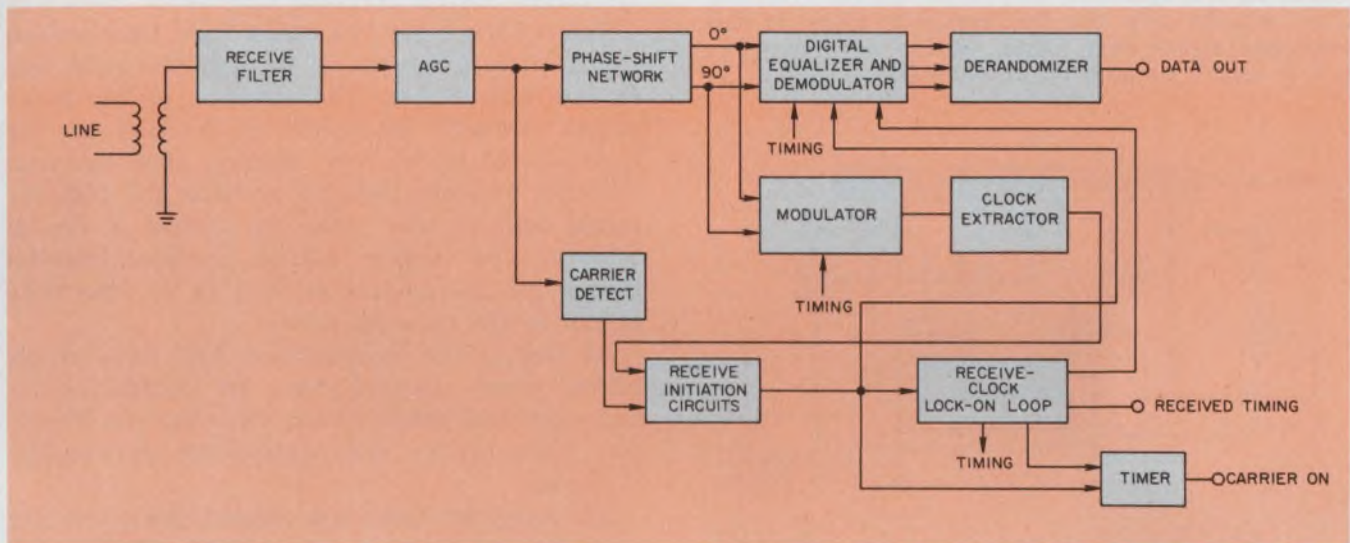

3. **Automatic gain control** levels the received signal before demodulation. The phase-shift network furnishes in-phase and quadrature signals to the demodulator-equal-

izer section. Clock signals are derived from the received signal by a separate circuit, which extracts the 1600-baud signalling rate from the envelope.

Most high-speed modems use some form of phase modulation to transmit large quantities of information over a narrow bandwidth. With differential phase modulation (used here), each transmitted phase shift is referenced to the previous shift. The receiver recovers the data by storing the previous phase and comparing (or subtracting) it to (from) the current phase.

To conserve bandwidth, several discrete phases are used. Each of the eight phase angles represents a particular pattern of three bits (Fig. 2). Multilevel modulation occupies the same bandwidth as simple binary modulation (two possible phases). But the number of bits transmitted in a given time interval is increased. Groups of three data bits determine the phase shifts in the modem discussed here.

Multilevel schemes are also more vulnerable to noise than binary methods. Fortunately most communication lines provide ample s/n ratios and the error rate still remains low.

Successive groups of three bits from the randomizer are converted to parallel form and applied to the phase modulator. The output from the phase modulator is either four-phase or eight-

phase, depending on whether the modem is transmitting a synchronization sequence or data. The symbol or baud rate of the modulator is 1600 Hz, or 1/3 the bit rate.

During the initialization (the first modem mode), an idle code of 12 symbols that lasts for 7.5 ms is sent. This is followed by a training sequence of 52 symbols for 32.5 ms.

A scrambled mark signal is sent then (from the randomizer) for 13 symbol periods, or 8.1 ms followed by data to be transmitted.

The idle code and training sequence are sent on four-phase modulation to improve the reliability of sync acquisition and to allow the receiver equalizer to train accurately and rapidly.

Delay distortion can degrade seriously the modem's transmitted signal by the time it reaches the receiver. Since phase shift is not a linear function of frequency, transmission delay (the derivation of phase with respect to frequency) is nonlinear. Inductors and capacitors used on the line are the main contributors to the distortion. Reflections due to impedance mismatches within the channel are secondary.

Low-speed modems (up to 2400 bit/s) can

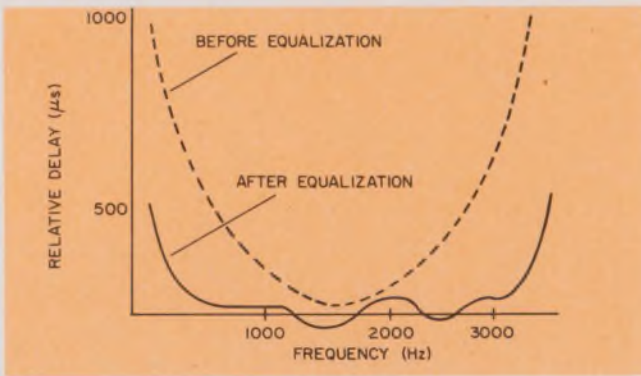

4. Factory-set equalizers cannot compensate for line characteristics over the full frequency range of the modulated signal. Delay ripple remains. Such equalization is useful, however, up to 2400-bit/s.

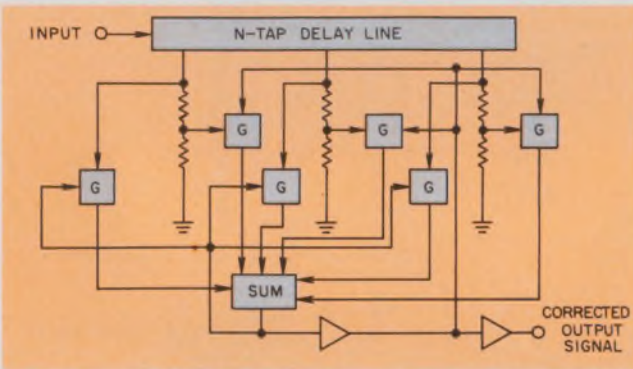

5. An adaptive transversal filter is needed for 4800-bit/s transmission. Additional circuits (not shown) set the tap gains by cross-correlation of the median channel characteristics with symbol error. This algorithm minimizes the combined effects of noise and intersymbol interference of the channel.

operate with narrow-band analog signals, fixed equalizers or a combination of the two. But a fixed, or compromise, equalizer cannot cope with the equalization accuracy required at 4800 bit/s. Hence some form of adjustable equalization is necessary ultimately at the receiver.

Receiver unscrambles the modulation

The input signal to the receiver is filtered and sent to an automatic gain control (AGC) circuit which maintains almost constant output level for 50-dB signal variations (Fig. 3). A carrier-detect circuit, driven by the AGC output, initiates receiver action when a valid input signal occurs.

The output of the AGC circuit also drives a phase-shift network that provides 0 and 90° representations of the signal to the equalizer-demodulator section.

Analog or digital circuit techniques can demodulate the phase-modulated signal. With the analog approach, a VCO provides quadrature signals to two balanced modulators. Once the

loop locks, the modulators provide the I and Q amplitude channels of the original phase-modulated signal, which is represented by

$$e(t) = I(t) \sin \omega_c t + Q(t) \cos \omega_c t.$$

In this equation

$$[I^2(t) + Q^2(t)]^{1/2} = K,$$

and the phase angle sent is given by the formula $\phi = \arctan (I/Q)$.

For digital demodulators, the input signal is first hard-limited and converted to a square wave. The sampled signal is demodulated then through algebraic multiplication with appropriate values from a digitized sine wave.

The clock is recovered easily from the received signal after it has passed through the relatively narrow input filter. The envelope of the filter output contains amplitude modulation at the baud rate of the modem; namely, 1600 Hz. And a simple envelope detector extracts the 1600-Hz signal that is used then to control a digital counter. The counter output provides internal timing for the modem as well as for the data output to the external device.

At best, fixed equalization will have ripple points where unequal delay of signals occurs and individual pulses spread out (Fig. 4). Therefore more precise and controllable equalization is needed.

The equalizer used is a tapped delay line (or its digital equivalent), gain-control units for each tap and a summer (Fig. 5). These three sections form a transversal filter.

The tap gains are set automatically in accordance with a suitable algorithm.

One of the previous algorithms used for phase modulation is called zero-forcing.¹ This algorithm attempts to get gain settings that constrain the channel impulse response to be zero at all sampling instants such as $-2T, -T, T, 2T$, etc. The response resembles the classical $\sin x/x$ waveform which is unity for X or $T = 0$.

The mean-square algorithm minimizes the sum of the square of errors rather than values at the sample points.² One advantage is that the adjustment process will always converge. In addition the algorithm will permit operation over marginal circuits that cause the zero-forcing algorithm to fail. Rather than force certain samples to be zero, the mean-square method requires that the circuitry examine the entire waveform on an average basis. As a result, the circuitry tends to compensate for the combined effects of noise and nonideal channel response. ■■

References:

1. Lucky, R. W., "Automatic Equalization for Digital Communications," *Bell System Technical Journal*, Vol. 44, April, 1965, pp. 447-489.
2. Chang, R. W., "Joint Equalization, Carrier Acquisition and Timing Recovery for Data Communications," *Proceedings of the 1970 IEEE International Conference on Communications*, June, 1970, pp. 28-34 to 28-43.

SIEMENS

When you think Zeners, think Siemens

From low-cost commercial to highly sophisticated, ultra-reliable applications, Siemens has the voltage regulating (Zener) diodes and the voltage reference (TC) diodes you need. And, even if you use one of our 11¢ devices, you have the assurance that every Siemens Zener has a built-in quality that can only come from the leader in hi-rel Zeners.

Siemens offers 48 popular JEDEC series, plus thousands of custom and proprietary devices in one of the most extensive lines of commercial and military Zeners. With this product breadth, available from our specialized Zener production facilities in Arizona, it's no wonder Siemens is looked upon as the preferred Zener source by thousands of major equipment and systems manufacturers worldwide.

When you need Zener diodes, consider the extra quality and the fast service benefits you'll receive from "the Zener specialists" . . . Siemens. For the name of your nearest Siemens U.S. sales office, PHONE TOLL FREE (800) 645-9200 (call collect in New York (516) 294-0990).

Siemens: Where Quality And Resources Make The Difference.

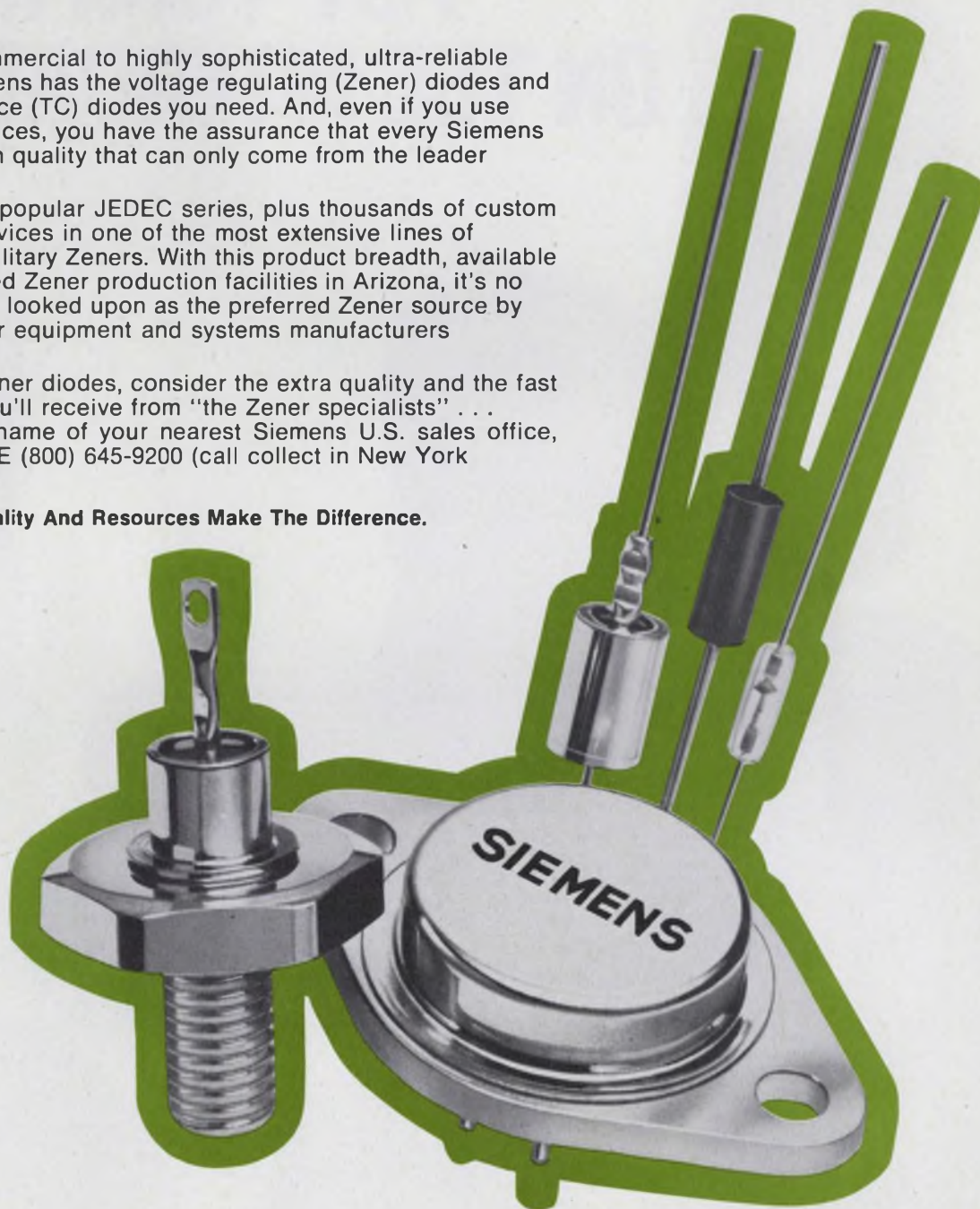

Siemens Corporation
Components Group

P.O. Box 1390, Scottsdale, Arizona 85252
(602) 947-2231 TWX 910-950-1292 Telex 667-406

INFORMATION RETRIEVAL NUMBER 39

**WHEN THE CHIPS ARE DOWN
ON MINICOMPUTERS,
PUT YOUR MONEY
ON THE INTERDATA 7/16.**

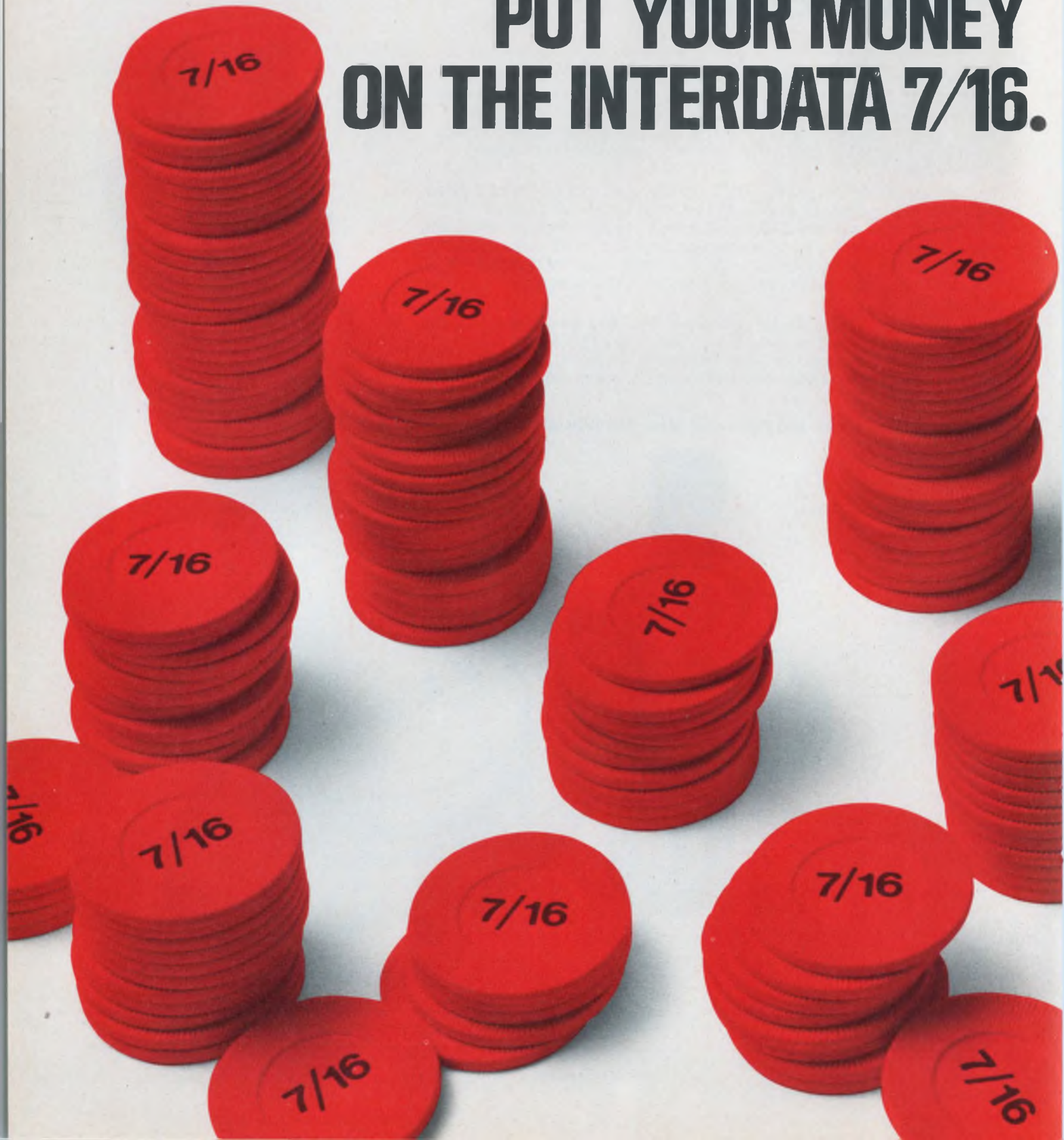

WHY GAMBLE YOUR RESOURCES ON UNPROVEN SYSTEMS?

You don't have to. The Interdata 7/16 mini-computer is here now. We've been delivering them, and a lot of them, for a long time. And our experience in high-volume manufacturing assures you a steady flow of quality mini's — when and where you need them. Delivered in 30 days.

One of the main reasons for this continuing success is the 7/16's price. It's less than \$2,000 in OEM quantities. And for this price you get field-proven benefits that translate into lower costs and increased profits for your company.

We're talking about performance-oriented features like 16 general registers. Directly addressable core memory. Automatic vectoring of interrupts. And over 100 powerful instructions that simplify design coding and debugging to reduce programming implementation costs.

In addition, with the 7/16 you get off-the-shelf, field-proven software tools which enable users to implement applications software simply and efficiently. Programs available — to name a few — are FORTRAN, EDITORS, ASSEMBLERS, DEBUG ROUTINE and a complete family of operating systems — from the simple batch-oriented to the comprehensive multi-programming, multi-tasking. And, because these systems are compact, well-documented, and do what the spec's say they'll do, you save development dollars.

Also, with the 7/16, if you want to spend more, you can get more. You have a wide choice of field-installable options to increase performance as your application grows. These include multiply/divide. Programmer's console with hexadecimal display. Power fail/auto restart. Memory protect. A high-speed Arithmetic Logic Unit that includes floating point hardware. And list processing capability.

As if all of this isn't enough, the 7/16 is part of the Interdata family of minicomputers. It's software—and interface-compatible with all other Interdata minicomputers. With the 7/16 you can write programs in Common Assembly Language so they'll execute on either 16-bit or 32-bit machines. So these programs and interfaces will work on our 32-bit machines when the time comes — and not cost you a penny more.

Unique for a 16-bit minicomputer? You bet. That's how we designed it. The 7/16's upward compatibility with 32-bits will save users a lot of software dollars in the long run.

So when the chips are down on mini's, let them fall where they may. Consider them all, then put your money on a sure thing — the dependable, here-today, Interdata 7/16. And be a winner.

For more information, just send us the coupon.

HOW TO BEAT THE ODDS ON MINICOMPUTERS.

Interdata, Inc., Oceanport, N. J. 07757

Gentlemen: I want to know more about the winning Interdata system.
 Send more information about the 7/16.
 I'm ready to win. Have an Interdata representative contact me.

Name _____ Title _____

Company _____

Address _____

City _____ State _____ Zip _____

Telephone _____



The Interdata 7/16 minicomputer.

INTERDATA[®]
Subsidiary of Perkin-Elmer

Oceanport, N.J. 07757. (201) 229-4040.
6486 Viscount Road, Mississauga, Ontario,
Canada L4V 1H3. (416) 677-8990.
Arundel Road, Uxbridge, Middlesex, England.
Uxbridge S2441.
8032 Grafelfing bei Munchen,
Waldstrabe 31, West Germany. 854-20-34-38.
92 Chandos Street, St. Leonards,
Sydney, Australia 2065. 439-8400.

Select pin drivers cautiously and you'll get an automatic tester that's both accurate and ready to meet future device needs.

When you evaluate an automatic tester, don't stop with the software and architecture. Take a detailed look at the system's clock-rate pin drivers. With the right decision on certain driver performance characteristics, such as output impedance, you can avoid serious problems and expense later on.

Everyone looks at architecture and software to get an over-all feel for the tester's ability to meet the requirements for the speed and scope of test. But the interface between the tester and device under test—the pin driver—represents a significant percentage of the tester's circuitry and is critical to performance. Thus it shouldn't be overlooked.

Even when the driver is evaluated, fuzzy specs often steer you to the wrong choice. Insist on the right driver, however, and you'll have confidence that you are testing fully and accurately all your devices. You'll also avoid the need for special tuning and you won't have to modify—and subsequently debug—your programs to adjust for driver inaccuracies.

And with the right driver, you'll be ready for years of testing. Many engineers were caught short because their drivers couldn't handle both bipolar and MOS devices. With a carefully selected driver, this can't happen.

Pinning down performance

The purpose of the clock-rate pin driver, of course, is to provide accurate inputs to the devices under test at clock rates. To make accurate, time-related measurements, you need consistent, repeatable waveforms free of such perturbations as overshoot and backswing. How can you tell whether a given clock-rate pin driver can deliver this performance? It takes some analysis. But as a minimum you should satisfy these questions:

What is the output impedance of the driver? Are the rise and fall slopes linear throughout the entire range? What is the static dc current

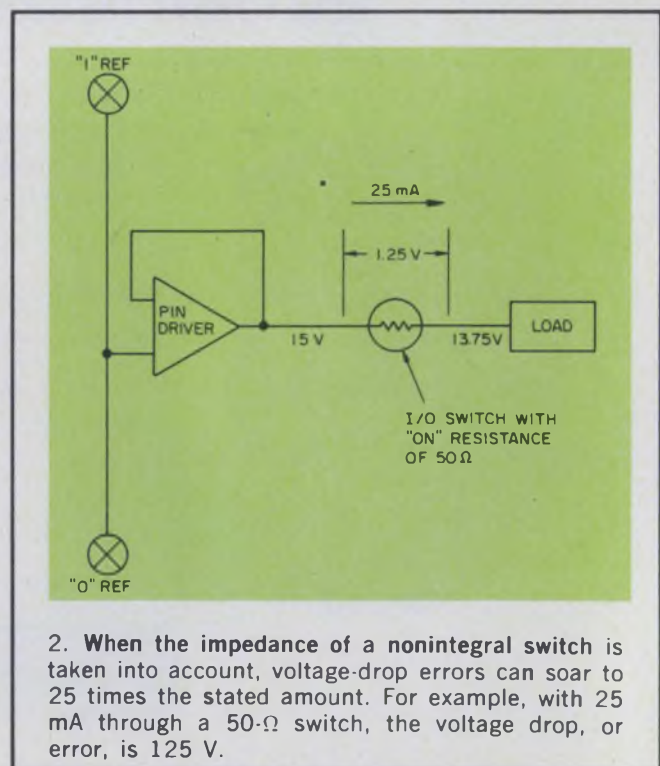
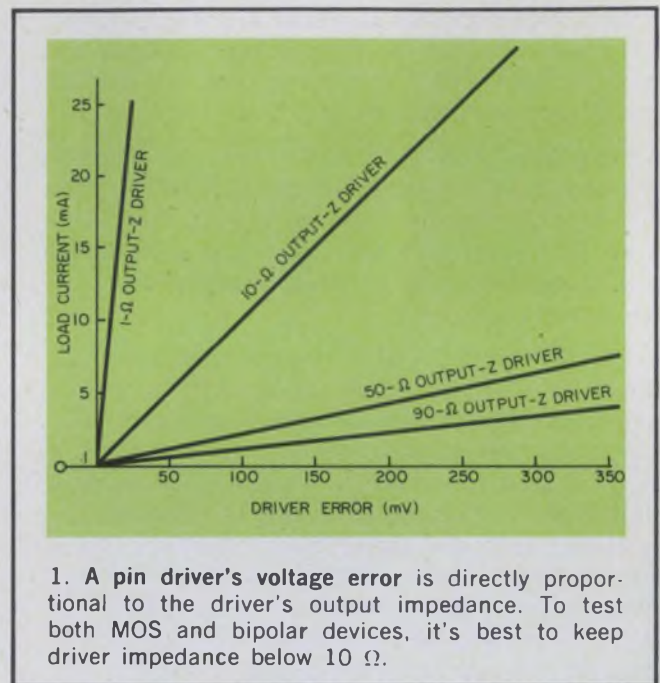

Earl Patterson, Sales Manager, Test Systems Division, Datatron Inc., 1562 Reynolds Ave., Santa Ana, CA 92707.

as applied to my application? What driver amplitude accuracy can I achieve? Is the slew rate fast enough for my test requirement?

Is the slew rate too fast? Is the input capacitance of an I/O pin too high? What crosstalk can I expect? What do the dc current ratings really mean? What is the edge current?

Frequently the answers won't be given in the manufacturer's specifications; you'll have to ask.

Perhaps the most important consideration is the output impedance of the pin driver. On the market today are drivers with output impedances of less than $1\ \Omega$, those with output impedances of $90\ \Omega$, and a variety of impedances in between. Since the voltage error is related directly to the impedance of the driver, it is important to select the right output impedance for your application.

If you want to test bipolar as well as MOS devices, insist upon a driver whose output impedance is no more than $10\ \Omega$. A look at Fig. 1 will make the reason clear. For a given device and a given forcing voltage, the voltage error increases directly with the output impedance.

If the requirement is to test devices that source or sink as little as $5\ \text{mA}$, significant errors will be incurred if the output impedance of the driver is greater than $10\ \Omega$. Output impedances higher than this would create errors of sufficient magnitude to invalidate the test. Another incentive

to keep impedance down: Low-impedance drivers are much less sensitive to load changes.

Another set of specs you'll have to sift through is the current rating of the driver. Most specs provide a value for the dc static current, but it usually isn't clear what the value really means. Does the rated dc static current imply that the driver can maintain that value at the device under test? Or does it mean that the value was measured at the output of the driver? Fig. 2 illustrates why this is important.

Degraded accuracy specs

Typically a driver does not have an integral switch; the switch is added to the line between the driver and the device under test. Suppose that the addition of the switch results in a $50\text{-}\Omega$ resistance in the line. With a current of $25\ \text{mA}$ through $50\ \Omega$, the 15-V level at the driver deteriorates to $13.75\ \text{V}$ at the device under test. In other words, the error will be $1.25\ \text{V}$, so a stated accuracy of ± 10 to $\pm 50\ \text{mV}$ is meaningless.

Of course, it is preferable that the switch be integral to the driver. In any case you should obtain at least a definition of the net voltage that will be applied to the device under test.

Another parameter that should be defined is

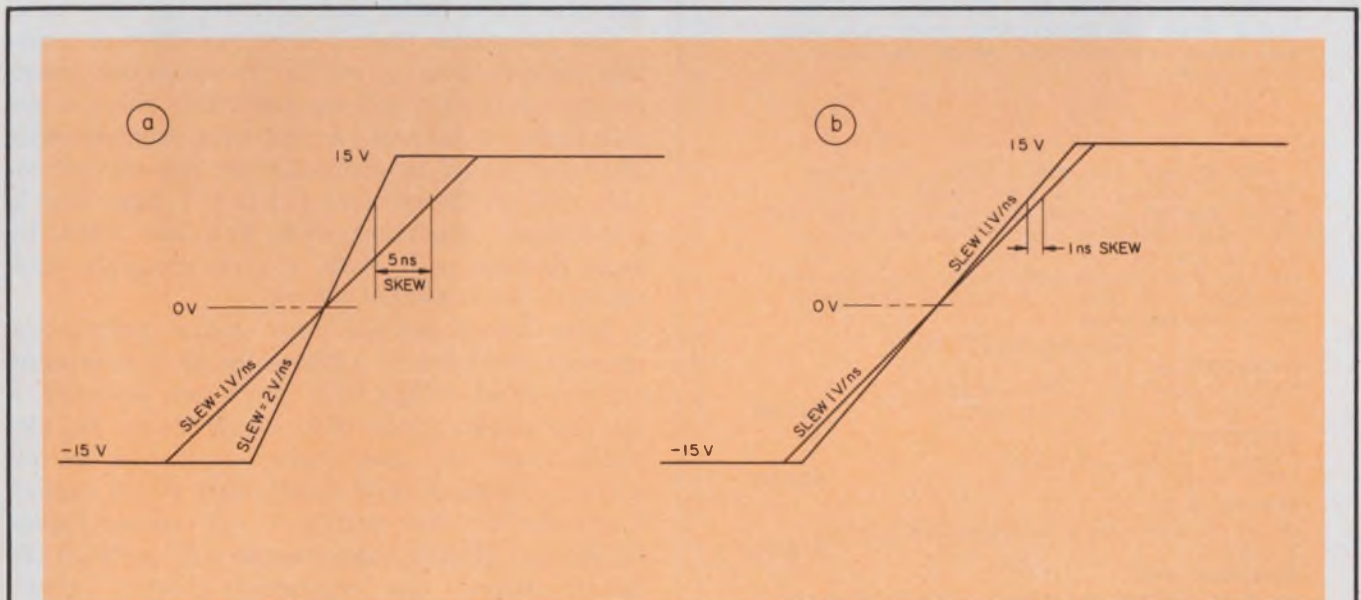

3. To make meaningful propagation delay measurements, the various drivers within a system should have similar slew rates. Two dissimilar drivers with no skew at $0\ \text{V}$ have no error at that

point, but show a larger error ($> 5\ \text{ns}$) at, say, $10\ \text{V}$. However, with the slew rates kept within 10% of each other, the error at $10\ \text{V}$ drops to $1\ \text{ns}$. Skew is often undefined on spec sheets.

These fingers can FEEL!

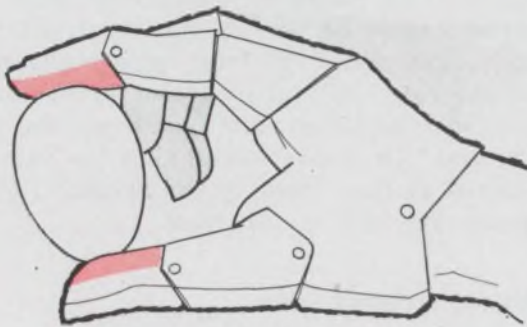

What if you had a mechanical hand that could pick up an egg or an anvil with equal ease?

DYNACON

What if you had a soft plastic sheet that changed from an insulator (10 megohm) to a conductor (10 ohm) under slight pressure? What about a sheet of such material that can handle up to 24 volts and one amp?

DYNACON

What about a flat interconnector sheet 6 x 6 inches square, with room for 200 separate terminals? A connector sheet that conducts only where squeezed vertically with no side to side conductivity? No plugs!

DYNACON

What about a floor mat 50 foot square that would detect the lightest foot print? How would you like a tiny one-piece switch that works under water?

DYNACON

Perhaps you can use a highly conductive brush-on coating that joins small terminals better than silver paste at a fraction of the cost? How about shielding against EMI and RFI that can be applied on an enclosure or as a dip coat on small components? All of the above are applications of DYNACON, a break through in conductive technique.

Promotional Prices

DYNACON A: Highly conductive (.2 ohms/square) .030 thick — Per square foot	\$20.00
DYNACON C: Pressure Conductive Sheet .030" x 10" x 10"	\$20.00
DYNACON E: Brush on shielding and Conductive Cement 2 ounces	\$ 6.00
DYNACON KIT: Samples of Pressure Conductive, Conductive and Switchable Sheet	\$12.00

DYNACON INDUSTRIES, INC.

117 Fort Lee Road
Leonia, New Jersey 07605
201 947-0106

the available, or edge, current. You'll need between 200 and 300 mA of current to drive the edge at 1 V/ns. Anything less is questionable; anything much higher will result in overshoot.

Unfortunately few data sheets include edge current, so you may have to get the information another way: From a look at the slew rate into a capacitance load, you can calculate whether you can achieve 1 V/ns into 50 to 100 pF.

Another essential item is the linearity of the rise and fall times; that is, the skew across the full voltage swing. Usually you'll want a slew rate that's fast enough to test devices in the 5-to-10-MHz range—around 1 V/ns. Higher slew rates generally lead to problems—overshoot, for example. However, the absolute slew rate by itself is not the only important parameter: The variation in rates between drivers is also critical.

Watch for consistency

Since the measurements of a clock-rate tester are time-related, it is essential that the various drivers have consistent slew rates (Fig. 3). If there is a significant discrepancy (and there often is), propagation-time measurements become meaningless. At the very least, you'll have to compromise your test specification by relaxation of your timing requirements. This kind of compromise runs the risk of bad devices being allowed to pass the test.

Unfortunately few tester specs include a definition of skew, so you'll have to ask for the information. Look for a commitment such as "less than ± 3 -ns skew measured at any point with the same voltage swing on all pins." Just to be sure, ask also if the tester can calibrate the slew rate.

One parameter that is never specified is crosstalk between pins. A pin in the receiving (monitoring) condition will see inevitably some crosstalk from the adjacent driver pins. Consequently the level should be controlled so that the crosstalk seen on the receiver pin is 1 V less. This is particularly important when you test MOS devices because with MOS, a high crosstalk level can give an unwanted signal.

Since tester designs vary, many parameters must be evaluated on a system basis to determine the net effect on the test. There are, however, a few threshold values that should never be violated. There are two important values in addition to those already mentioned: First, capacitance should never exceed 40 pF on an input/output pin. Higher capacitances will overload the device. Second, the comparator's input impedance should be at least 10 M Ω over the full input voltage range—not just at one point.

These requirements for drivers aren't esoteric; they are readily available and should be insisted on. ■■

If your counter looks this good...

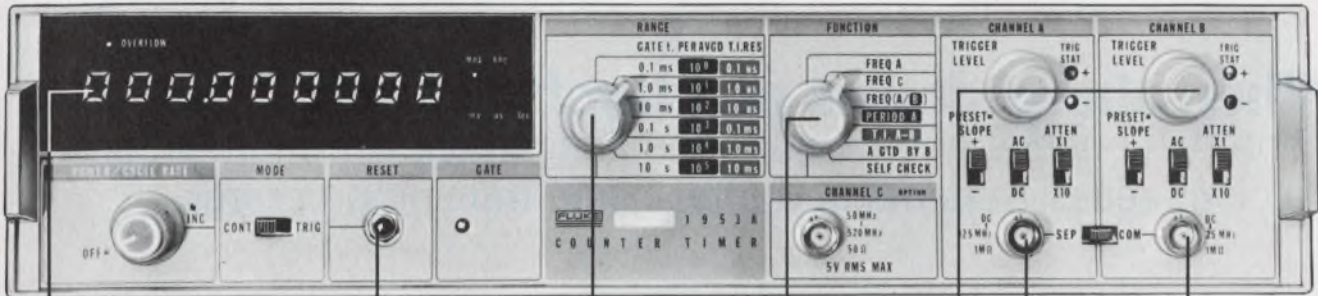

EASY TO READ
9-digit LED display
Large 7-segment characters
Full leading zero suppression
Automatic annunciation and overflow

DISPLAY CHECK
Pressing reset button when counter is in self check mode lights all digit segments

WIDE RANGING
Six choices of:
• Gate times
• Period averages
• Time interval resolution

VERSATILE
Measures:
• Frequencies
• Frequency ratios
• Period and period averages
• Time intervals
• Gateable totals
• Self check

FULL TRIGGERING CONTROL
Preset or variable trigger level controls with status indicators
Slope, coupling, and attenuation switches

TWO INPUT CHANNELS
Direct coupled amplifiers with 30 mV sensitivity

and gives you these options...

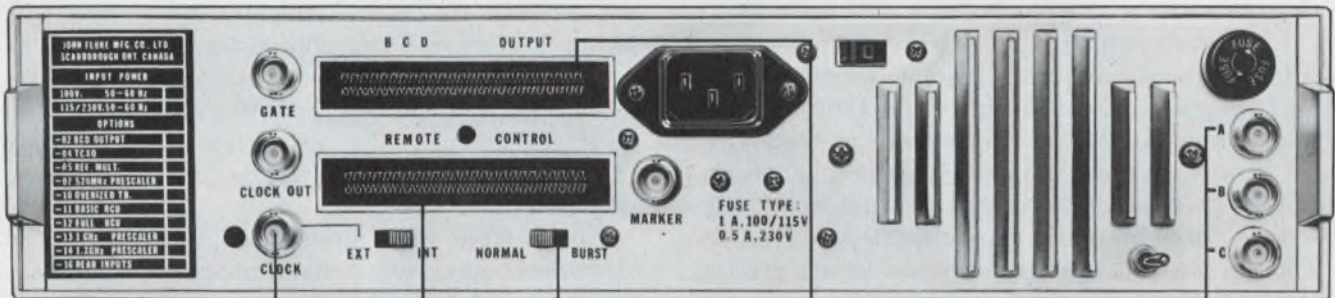

HIGHER ACCURACY
Higher stability timebase
Options 04 and 10

PRESCALERS
520 MHz prescaler, Option 07
1000 MHz prescaler, Option 13
1250 MHz prescaler, Option 14

TIMEBASE MULTIPLIER
For operation from 1 or 5 MHz in addition to standard 10 MHz external reference clock
Option 05.

REMOTE PROGRAMMING
Basic remote programming, Option 11.
Full remote programming, Option 12.

BURST MEASUREMENTS
Select normal or burst measurements
Burst measurements made on Freq A or Freq C modes
Option 05.

DIGITAL OUTPUT
Parallel BCD output, Option 02

REAR INPUTS
Three rear panel mounted BNC jacks for A, B and C input channels, A and B are in parallel with front panel inputs.
Option 16

it must be a Fluke
1953A Programmable Universal Counter/Timer
\$849.00*

*U.S. price F.O.B. Buffalo, N.Y.
Remote programming and other options extra.



COUNTER DIVISION

**John Fluke Mfg. Co. Ltd.
Counter Division**

P.O. Box 1094 Station D Buffalo, N.Y. 14210, Phone (716) 842-0311, TWX 610-492-3214

FOR A DEMONSTRATION, CIRCLE 161

FOR MORE INFORMATION CIRCLE 162

When phase-downs and layoffs come, a company needs good engineer-management communications, judicious reassignments and after-hours training programs.

The replacement of one or two large projects with a number of small ones has many implications for the engineering staff—from cutbacks and downgrades to the need for different capabilities.

For years, the primary business base for the Strategic Systems Div. of Rockwell International was the guidance and control system for the Minuteman ICBM and avionics for the F-111 aircraft. We phased down those projects gradually, from a total of 30,000 employees in 1964 to 7000 today.

Organization of the phase-down was more haphazard than we would have liked, mainly because we didn't know how many people we'd have to lay off. There was some optimism in 1969, for example, when, at 21,000 employees, we thought we'd have to reduce personnel by only another 10%. In 1970 we realized that we had to reduce the work force by much more than that.

Though we had to play the phase-down pretty much by ear, we were able to find cures for most of our managerial migraines caused mainly by the following four challenges:

- Convincing engineering specialists to become generalists.
- Assisting supervisors to tighten their control of project budgets.
- Training supervisors and managers to write new-business proposals.
- Coping with the over-all morale problem.

Of course, the worst problem for me was having to tell some old friends that I had to demote them or that I didn't have a job for them. I've been able to rehire only about 5% of them.

Specifying the generalists

Because there is a great need for special engineering work in large programs like Minuteman and F-111, many of our engineers spent several years working on very specific jobs. When

we transitioned them from the large programs to smaller ones, I told them that they were going to have to work in broader areas of activity than they'd been used to, that they'd have to resurrect some of the engineering talent that they hadn't used in some time.

I try to structure this job change so that it's as painless as possible for the employee.

When we need someone with knowledge about a small project, often we've found an engineer who has experience in that area. We bring in other people from the larger project who are not experts in this particular work, but who have a history of being able to learn quickly. The knowledgeable lead engineer teaches them the new technology in a special class after working hours, leading them past the theoretical point of view so they can understand what's key to the new project.

For example, we've brought engineers from the Minuteman program, which relies on a conventional gyro technology, to our micro program, which relies on electrostatic suspended gyro technology. We've scheduled an after-hours course on electrostatically suspended gyros that's taught by the lead engineer, who's been active in that field for several years.

We've also conducted a series of courses on MOS LSI technology. We've managed to convert our design engineers from integrated-circuit technology to the large-scale-integration technology that MOS requires.

How do engineers react to shifting from one program to another and to learning a new technology? Once they stop hanging onto the feeling of security that a very large program offers, most have reacted very favorably. They find it challenging to use the skills they've never used or haven't used for a long time.

Getting a handle on the budget

Another challenge that the phase-down creates for supervisors and their lead engineers is controlling the budget in smaller projects. Since the supervisor no longer has the flexibility that a

Thomas K. Shuler, Vice President and General Manager, Strategic Systems Div., Rockwell International, Anaheim, CA 92803.

Thomas K. Shuler and the Strategic Systems Division of Rockwell International

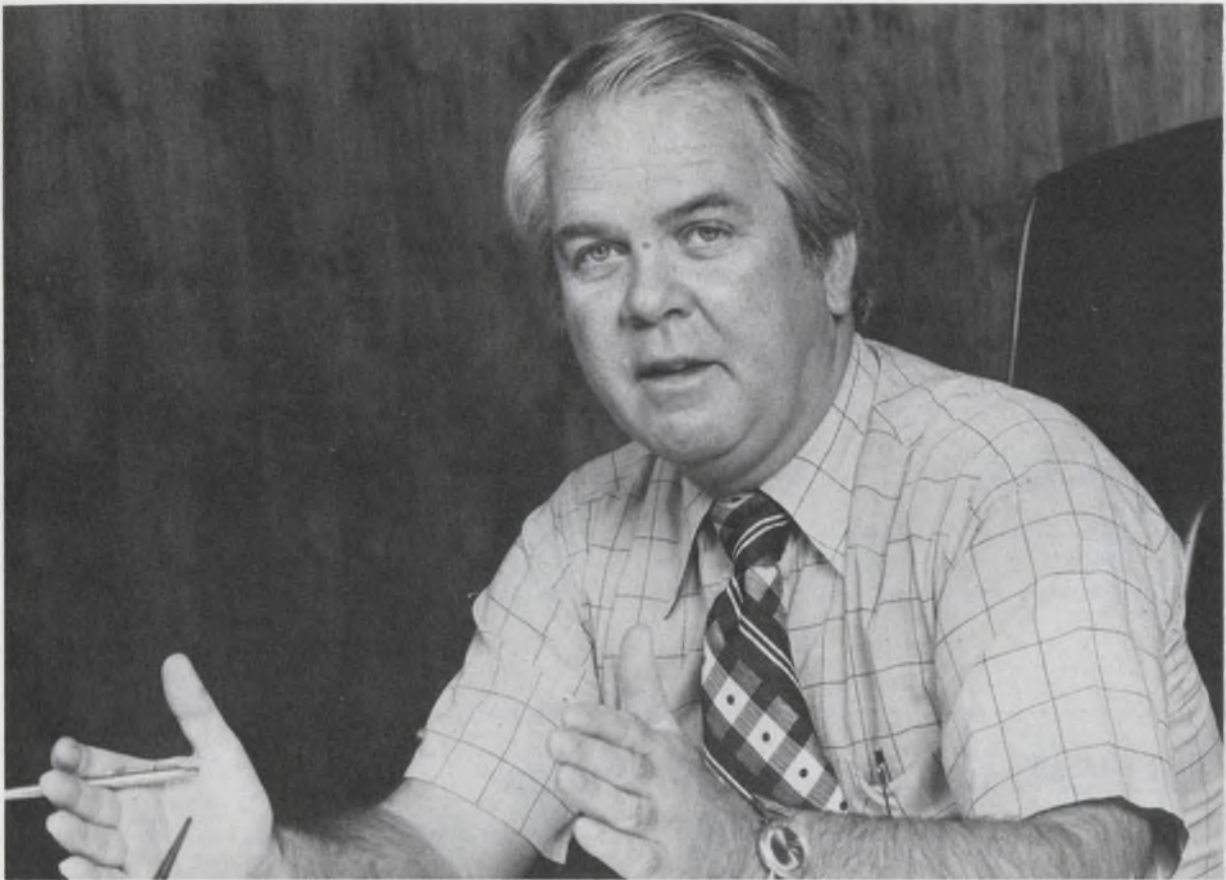

Thomas K. Shuler became vice president and general manager of the Strategic Systems Division in April, 1974. He has responsibilities for all activities from new-business proposals through design, production and logistics support of operational equipment.

Programs under his direction include guidance and control equipment for Minuteman ballistic missiles, avionics for FB-111 and F-111D aircraft and the master computer for the Short Range Attack Missiles (SRAM). In addition, he is responsible for numerous advanced studies and related hardware production with both government and commercial customers. Previously,

Shuler was vice president, Strategic Systems and Special Programs for the Autonetics Division.

Shuler joined the company in 1951 as a member of the Systems Analysis unit autopilot group. Since then he has held a variety of management and engineering positions.

Before joining Rockwell he was an instructor and assistant professor of electrical engineering at Iowa State College. He received his BSEE degree from the University of Notre Dame and his MSEE degree from Iowa State.

Shuler and his wife reside in Newport Beach, California. They have three children.

large budget might have given him on a larger program, he must make sure that his entire smaller job can be done with the funds he does have. This calls for the first-line supervisor and the lead engineer to become businessmen.

In the large projects a specific group is responsible for the scheduling and the tracking of the man hours and the dollars that are being

spent. On smaller programs the supervisors have to learn about accounting systems and planning and control systems.

We've assisted our supervisors through a series of training courses that explain how these business skills can apply to a whole program instead of just a part, as they'd been used to. Instructors for this series are from administration

and from our program-planning and control group. The series is funded on a burden budget against each of the 793 contracts we presently have.

And then, of course, all of these programs have to be reviewed.

Management reviews in a large program are regularly scheduled and conducted by the program manager. Line supervisors do not ordinarily participate in the review. For the small programs, though, we try to conduct status reviews on a regular basis, and we require each supervisor to report his own status to management—cost, schedule and performance against the requirements. Many supervisors have probably never had the responsibility of defending their actions and reporting their goals. Their inexperience in reviewing has taken a great amount of management's time, but it has been worth it.

Writing winning proposals

The more programs there are, the greater the need for preparing new-business proposals. Periodically some of our people are taken from

their regular spot on a program and asked to write these proposals. A few are natural writers; most are not. We try to train them to write better proposals by giving them direct feedback on why certain proposals have been rejected by the customer. Regularly, we tell our people what our proposal wins and losses are, in the hope that these examples will assist them in their work.

We knew the large-program customer very well. We'd dealt with him for many years, and we were able to tell him when he was wrong, without losing his business. Now we're dealing with people we don't know as well—they don't like to be told they're wrong, particularly during the proposal and contract phase.

Because of this new environment, we tell our people that we have to be more responsive to the ideas of a new customer, on how the program is run. It may not be the way we ran the old large program, but we have to build mutual trust, and that takes time.

If necessary, we put on our best salesman's suit and try to get our customer to agree to our way of thinking, or if that's not possible, we try to learn to agree with his way of thinking. We feel that if we can build more mutual trust and

Dial MGMT for company information

As vice president and general manager of Rockwell International's Strategic Systems Div., Tom Shuler finds communication is a big part of the solution to problems caused by project phase-downs. Besides scheduling monthly conferences to keep his staff abreast of events, he encourages his people to use Rockwell International's employee communication system—Dial MGMT. Following is a four-point description of that system:

1. Any employee can dial "MGMT" (which stands for "management") and dictate his question into a tape recorder that is in the public-relations office of the Autonetics Group. Public relations is the central information agency for calls from the public. Since it accumulates knowledge of company organization and management-employee interface, it can readily refer questions or suggestions to the appropriate department. The agency can also promulgate answers by publishing the questions in the in-house organ or management newsletter, particularly if the questions and answers affect a substantial number of employees.

2. Questions are transcribed each workday morning. Normally they are typed onto a transmittal form, which is then addressed to the department or departments with responsibility

over the subject. Exceptions are the occasional nonsense questions or comments received. Most anonymous questions, for example, are really not questions but instead pranks or comments made to "blow off steam."

3. Most employees asking a question give their name, phone extension and department identification. A number of questions are answered immediately, because they've been asked before. If there will be some delay in the reply, the public-relations department notifies the caller that his question has been received and when to expect the reply.

4. Questions are usually answered in writing. Whenever there is some doubt about the intent of a question, it is clarified by a supervisor in a personal visit to the employee seeking information.

One benefit of the MGMT system is that it encourages frank communicating. Oral communications are more spontaneous than written ones, since the caller can react on the spur of the moment and express his true feelings on an immediate problem, idea or situation. Another benefit is that the caller knows he will be heard and that someone cares, because (a) he gets a return phone call or visit and (b) the answer goes to him individually.

respect, we can be a little more blunt with him in the future.

Dealing with legitimate worries

When the company's two large programs were phased down, our engineers and managers worried about being laid off, demoted or dislocated. Today, to combat rumors about layoffs, I conduct one conference a month for 150 salaried employees at a time and present our annual operating plan.

This plan tells them where we really stand, what our outlook for business is and what contracts we'll be bidding on in the future. I want the 2000 people in my division to know first-hand what I think of the future, what I think is important, and what contracts I think we can win.

The only way I've ever found to deal with the morale problem during a layoff is to tell the people directly why we're doing what we are. Each man we lay off is told by his immediate supervisor, and often by the next manager up, why the action was taken. He is told what his shortcomings are and how he can improve in the future.

I took advantage of the phase-down to replace people who really should have been replaced even when there wasn't a phase-down. Our organization is stronger today than it was when we had 21,000 people. The people in key positions are more qualified now.

Demotions are decided by a committee made up of me, the managers who report to me, and their subordinate managers. We rate engineers and managers once a year. Ratings are based on past performance, productivity, business-like approach and success. When things get tough, like cutting back from 115 first-line supervisors to 100, we consult our rating charts, and the bottom 15 are dropped.

Job dislocation is the least of the three personnel problems. When people were losing their jobs, others were actually relieved when they were told that they weren't being let go, just being reassigned. If the reassignment means that the engineer must perform totally different work, it does present a challenge to his new manager. We don't let it become a hardship.

We haven't had any serious disorientation. My impression is that the people who are left behind on the large programs often envy the ones who are moved, because they don't get a chance to work on a new program. They worry when they're not selected. They feel that when the old program phases down, they'll be left without a job. But most of them realize that they are retained on their assignment because of special competence, and we don't intend to lose those abilities. ■■

A CAMBION® Double "QQ" Product Line

Socketing IC's?

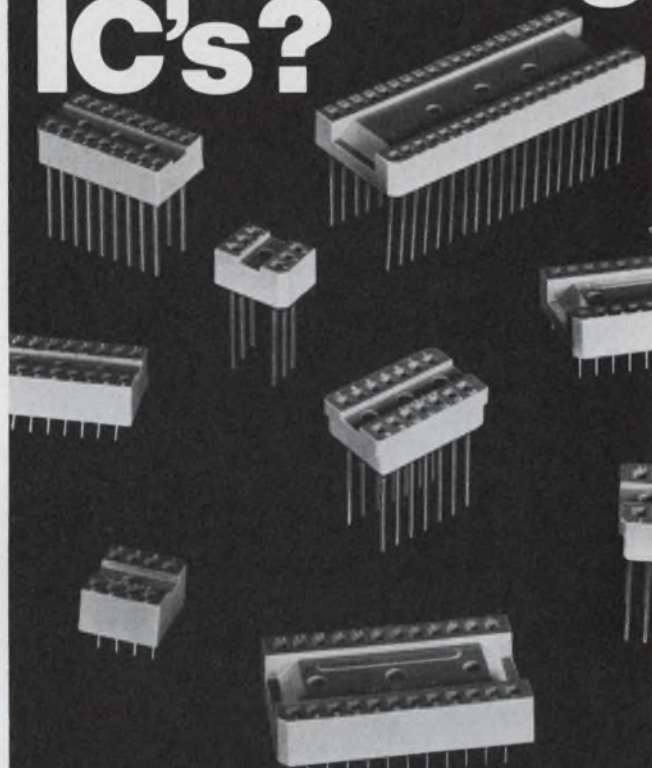

Trust CAMBION for three good reasons.

Engineers more and more are putting IC's in separate sockets. What's the reason? There are three.

First, reliability. True pin positioning and precisely formed contacts are required for hand or automatic wire-wrapping.

Second, serviceability. Replacement and servicing of IC's is quick. Equipment downtime is minimal.

Third, protection. A DIP should not be subjected to the elevated temperatures of pin soldering. Or, if wrapped, needs a positive, long-life connection.

Those are the reasons for socketing. The reasons for trusting CAMBION?

First, quality. Each CAMBION socket has controlled body design and materials, finest contact plating, excellent retention, true durability.

Second, quantity. In either wrappable or solderable types, in variety and body design, CAMBION has 6, 8, 14, 16, 18, 22, 24, 28, 36 and 40 pin sockets available in whatever quantity you require. We sell millions annually.

Third, reliability. So far, customer rejects have been less than .1 of 1% (our QC man says that's infinitesimal).

So take CAMBION Double "QQ" approach to socketing and order the quality you want - in any quantity. We've a catalog full of them so you can make your own selection. Cambridge Thermionic Corporation, 445 ED Concord Avenue, Cambridge, Massachusetts 02138. Phone: 617-491-5400. In Los Angeles, 8703 La Tijera Blvd. 90045. Phone: 213-776-0472.

Standardize on

CAMBION®

The Guaranteed Electronic Components

INFORMATION RETRIEVAL NUMBER 44

OUR CMOS 201 MODEM IS A CARD!

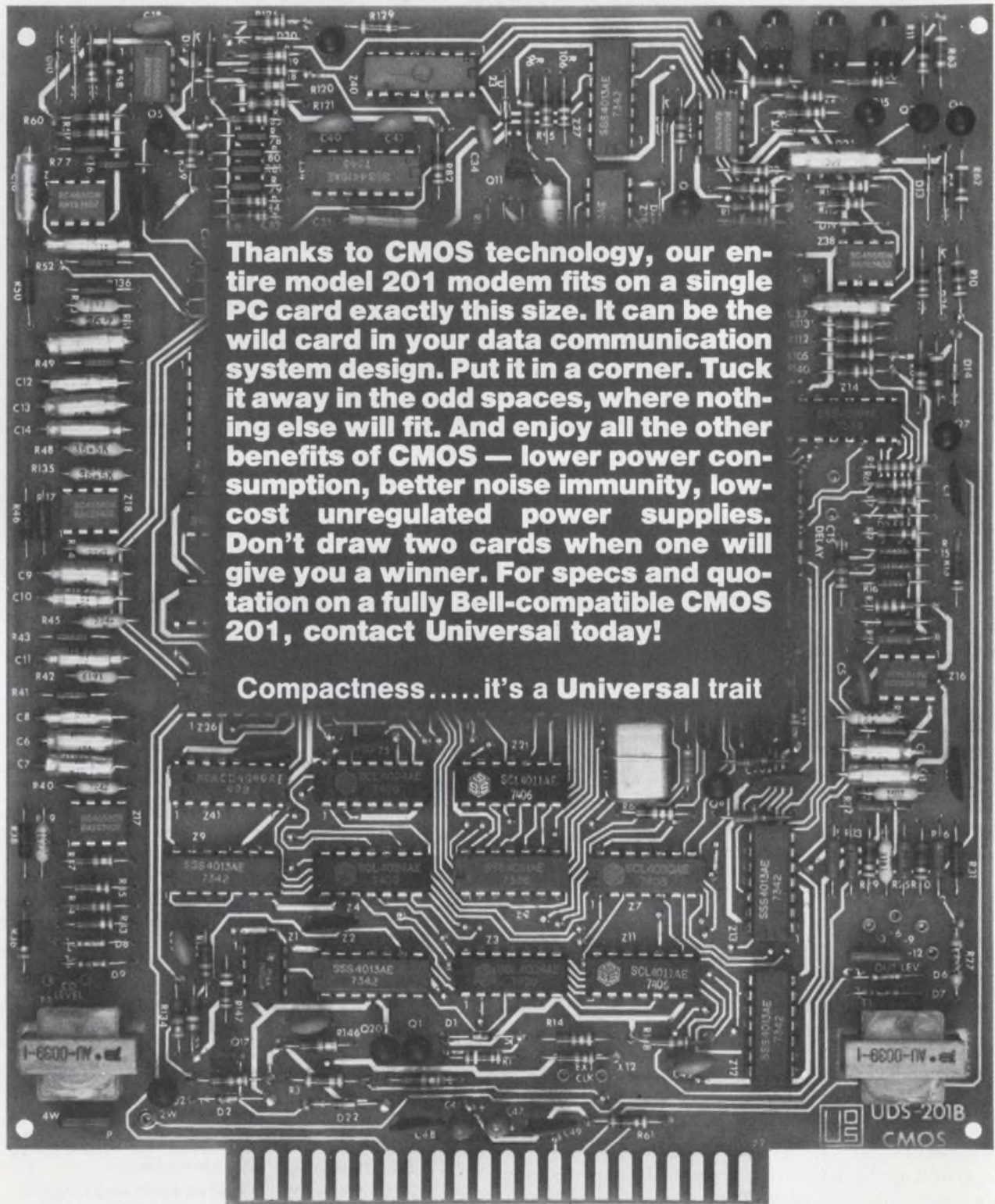

Thanks to CMOS technology, our entire model 201 modem fits on a single PC card exactly this size. It can be the wild card in your data communication system design. Put it in a corner. Tuck it away in the odd spaces, where nothing else will fit. And enjoy all the other benefits of CMOS — lower power consumption, better noise immunity, low-cost unregulated power supplies. Don't draw two cards when one will give you a winner. For specs and quotation on a fully Bell-compatible CMOS 201, contact Universal today!

Compactness.....it's a Universal trait

ACTUAL SIZE... LESS THAN 50 SQUARE INCHES



universal data systems

2611 Leeman Ferry Road • Huntsville, Alabama 35805 • Telephone (205) 533-4500 • TWX 810 - 726-2100

Created by Hall & McKenzie Advertising, Winter Park, Florida

INFORMATION RETRIEVAL NUMBER 45

The newest advance in resistor technology.

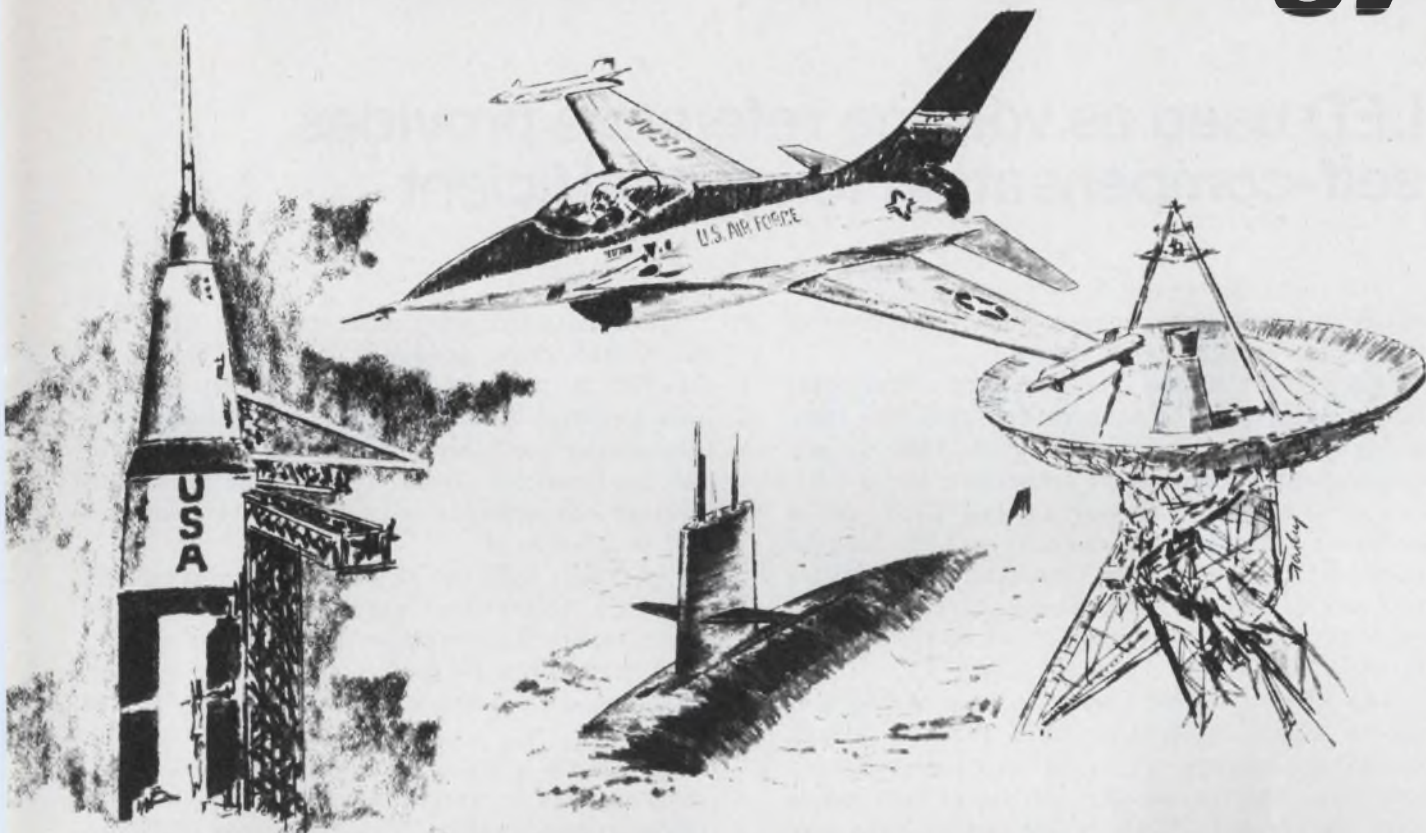

Vishay's S444

Established reliability per Mil R 55182/9

BULK METAL® BREAKTHROUGH now outpaces even further all other resistor technologies and surpasses even existing Vishay 'state-of-the-art' leadership.

SURPASSING ALL TECHNOLOGIES

Bulk Metal® S444 resistors continue . . .

- Tightest tolerances: to $\pm .005\%$
- TC: 1ppm/ $^{\circ}\text{C}$ (0-60 $^{\circ}\text{C}$)
- TC tracking: to 1/2ppm/ $^{\circ}\text{C}$
- High speed: 1 Nanosecond rise time
- Super stability: 25ppm per year
- Negligible noise: Non measurable by MIL-Std-202
- Negligible voltage coefficient: 0.0005%/V max.
- Small size: .100" x .300" Board space
- Non Inductive: 0.08 MicroHenry max.
- High Temp. Exposure: 175 $^{\circ}\text{C}$ max.
- Power Rating: .3 w @ 125 $^{\circ}\text{C}$

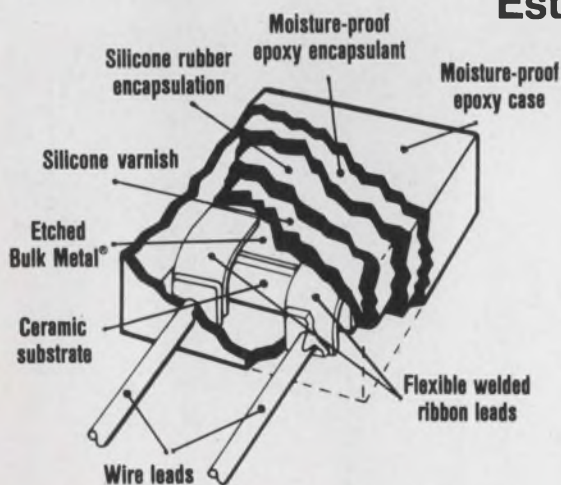

VISHAY RESISTIVE SYSTEMS GROUP

OF VISHAY INTERTECHNOLOGY, INC.

63 LINCOLN HWY., MALVERN, PA. 19355 (215) 644-1300

The end of compromise.

INFORMATION RETRIEVAL NUMBER 46

LED used as voltage reference provides self-compensating temp coefficient

Low-cost LEDs, when used as voltage references, can overcome some serious limitations of temperature-stable zener diodes.

When zener diodes are used with a transistor buffer or as part of a current source, the transistor's V_{be} must be compensated. This usually requires an extra diode or transistor. But a LED can serve as a voltage source below 5.1 V, and it needs no compensation, because a LED has the same drift as a typical transistor base-emitter junction already built in. At low currents a typical LED has a voltage drop of 1.4 to 1.7 V and a junction coefficient of about $-2 \text{ mV}/^\circ\text{C}$.

The LED-stabilized current source in Fig. 1 is shown with some typical loads. Without adjustments, the voltage across the emitter resistor—and hence the current through it—is very stable with temperature. Tests of the circuit have provided better than $\pm 1/2\%$ stability over the -55 -to- 100 -C range—usually much better than needed for the type of loads shown. Other applications include coulometers, ramp generators, LED assemblies, bridges and special thermistors and

other sensors.

The results will vary with the LED and transistor used. Some trimming of stability can be obtained by adjustment of the $10\text{-k}\Omega$ resistor. Also, a change in the $301\text{-}\Omega$ resistor will affect the temperature coefficient. The change in coefficients can be predicted from known semiconductor-junction characteristics. In Fig. 1 the load current is 2.5 mA.

Fig. 2 shows the use of a LED-transistor reference in a voltage-regulated power supply. The power supply can provide over 1-A output. With a 4-V change in the unregulated input, the output changes 4% when set to 1 V and only 2% at 5 V.

The LM395 is an integrated transistor that includes circuits for internal overcurrent and over-temperature protection. This transistor should be mounted on a heat sink for 1-A loads.

Peter A. Lefferts, National Semiconductor Corp., A.L.I.C. Dept. Bldg. C, 2900 Semiconductor Dr., Santa Clara, CA 95051.

CIRCLE NO. 311

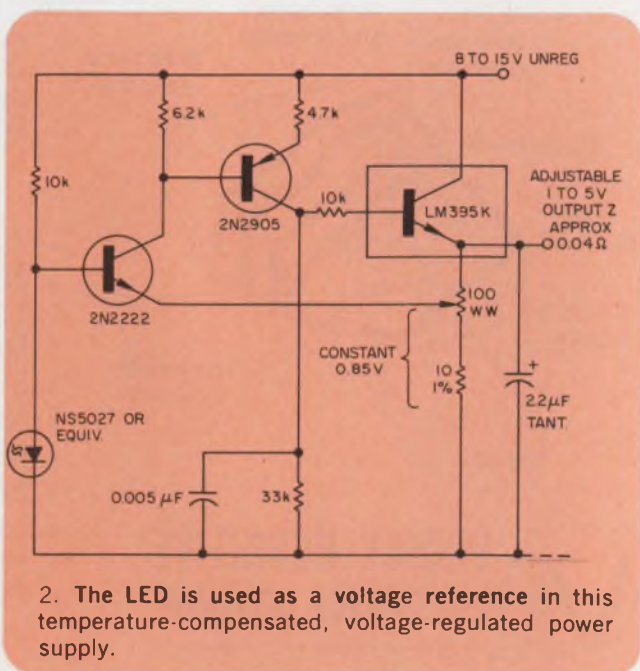
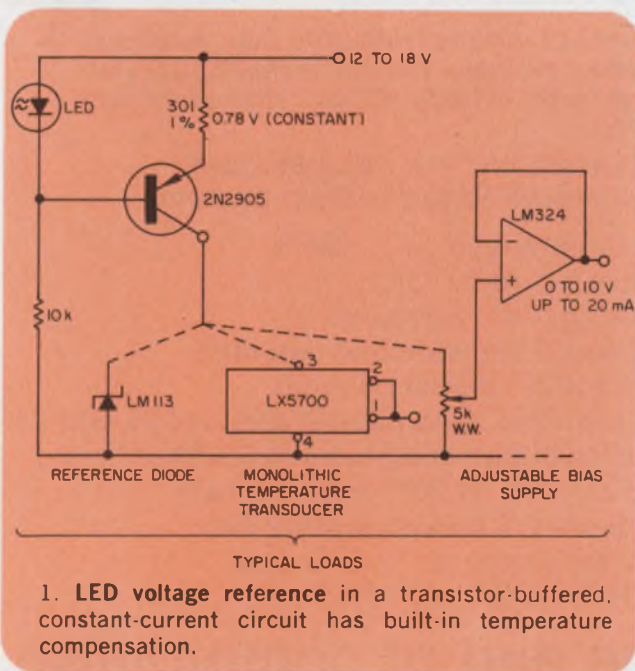

How to order a Card-Pak.



When we say we can ship Card-Pak instantly, you can see from our picture why. Each of those boxes contains a knocked down Card-Pak assembly, ready to go. And this is only one of our stockrooms for Card-Pak.

To order one or all of our Card-Paks, just dial (714) 835-6000 collect.

But why should you want what we've so obviously got so much of?

Because Card-Pak is the newest circuit card filing system on the market. And, we modestly think, the best.

It will take up to 56 cards in 19 inches of width. It will take any card between 2x4 and 8x9 inches. It will space those cards any way you like

And why.

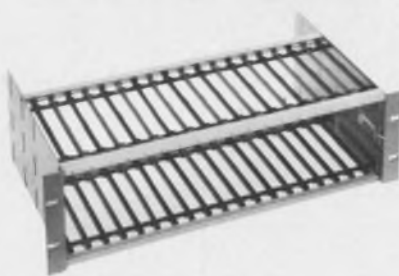

from 3/10 inch up (in .05 inch increments).

It offers a variety of tier arrangements and sizes. As well as versatile provision for connectors. And card handles, card ejectors, and an assortment of identification techniques.

Card-Pak is not cheaply made. It uses parts of precision-molded Noryl, anodized aluminum end plates, and extruded aluminum rails.

And last but not least you can put most Card-Paks together with eight screws. You furnish the screwdriver, we furnish the screws.

We alertly await your call.

EECO FOR PACKAGING

1441 East Chestnut Avenue, Santa Ana, California 92701
Phone 714/835-6000

Also available from G. S. Marshall nationwide.

INFORMATION RETRIEVAL NUMBER 47

Easy-to-build FM signal generator uses a phase-locked loop and an AM input

Need a simple FM signal generator that can be built fast? Try the Signetics 562 phase-locked loop (PLL) and modulate its timing-circuit voltage with an AM signal. This combination provides an FM generator with wide frequency capability and low distortion.

In the circuit, capacitor C_{10} determines the free-running frequency of the PLL's internal voltage-controlled oscillator (VCO). Audio-voltage input to point A modulates this frequency, which appears at pin 4. The values shown were chosen for FM receiver alignment at 10.7 MHz. Resistor R_{11} provides fine frequency-tuning adjustment of up to $\pm 10\%$ of the center frequency.

The change in the VCO free-running frequency, f_o , is a function of the voltage at point A, and the value of R_7 and R_8 . This deviation can be calculated from

$$\Delta f \approx \frac{6.4 - V}{1300 R} f_o,$$

where V is the voltage at point A and R is the resistance of R_7 in ohms.

The best waveform linearity results when R_7 and R_8 are matched to within 1%. For high sensitivity or very wide frequency deviations, R_7 and R_8 can be reduced to as low as 20 k Ω .

If a range switch is used to change the values of C_{10} , a span of center frequencies from 50 kHz to 30 MHz can be obtained, although the output amplitude will vary somewhat, increasing at lower frequencies. Distortion of the output signal is typically less than 0.5% throughout the entire audio band (for a ± 75 -kHz deviation).

All unused inputs are taken to ac ground to ensure loop stability and low noise. If necessary, the PLL can be locked to an incoming reference signal. This reference signal can be injected into pin 12, and the resulting output signal will be as stable as the input. Since the PLL has a built-in VCO, and signal stability is voltage dependent, a well-regulated power supply should be used.

R. Marshall Jr., Sustaining Engineer, Signetics, 811 E. Arques Ave., Sunnyvale, CA 94086.

CIRCLE NO. 312

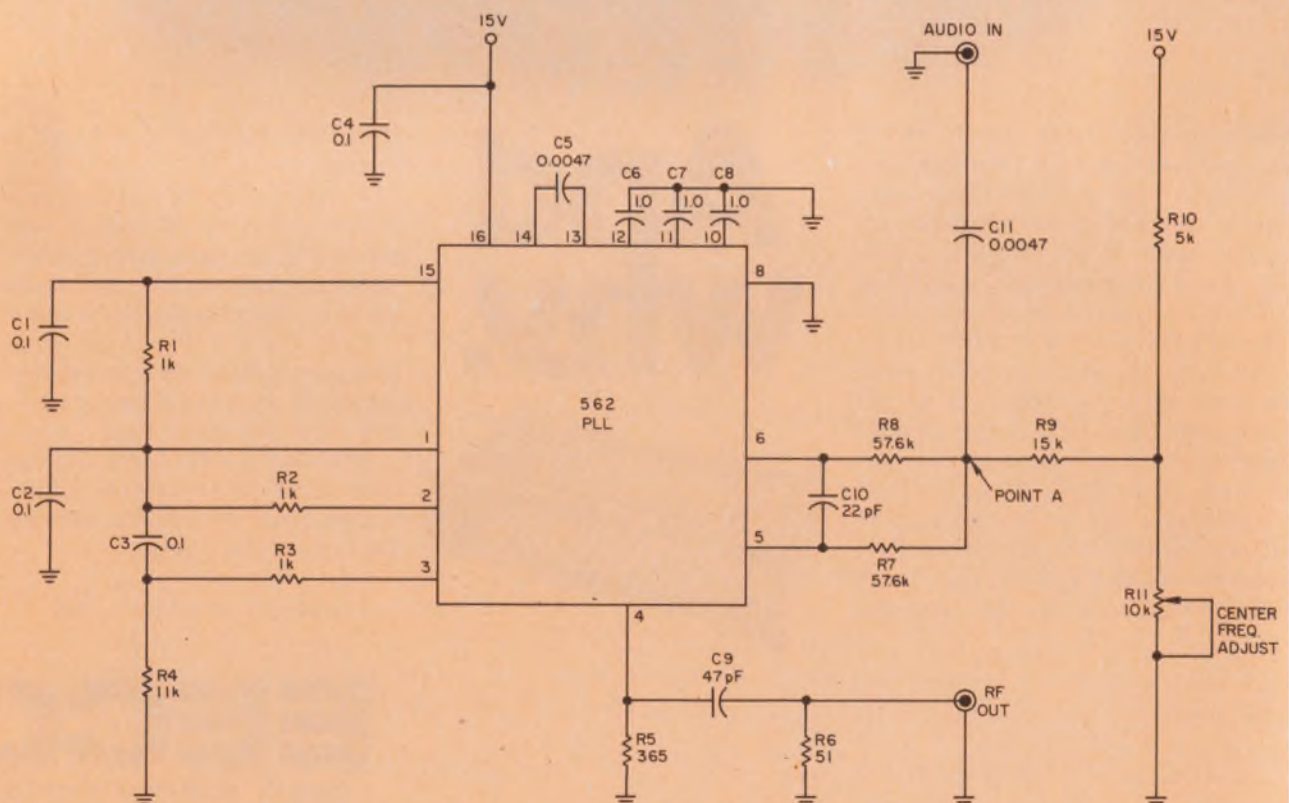

The 562 PLL can be modulated by an AM signal to deliver a frequency-modulated, low-distortion output.

Introducing the incredible Nitron EAROM memories...



Won't
blow their
minds in a
blackout.

Erase in
one second...
up to a
million times.

Our non-volatile, electrically alterable, read-only memories (EAROMs) are the tiny memory devices that do it all:

1. They can store data for years without power.
2. They're non-destructive and immune to external power interruptions.
3. They let you erase stored information in just one second, without ultraviolet irradiation.
4. They let you alter the memory as often as needed — up to a million times.
5. They're particularly useful for communications, computer peripherals, and very low power applications.
6. Standard products and custom capability.

Part Number	Description	Power Supplies (Volts)	Package	Notes
NC7001	64 x 1	±15	18 DIP	ROM Organization
NC7002	1024 x 1 512 x 2	±15	40 DIP	ROM Organization
NC7010	1024 x 1 512 x 2	±15	28 DIP	ROM Organization
NC7030	8 x 16	±15	18 DIP	Shift Register Stack
NIT-80C	1K x 8	±15	PC Board	8K Memory Module
NIT-80T	1K x 8	±15, +5	PC Board	8K Memory Module

Before you forget, call us at (408) 255-7550.
Or send the coupon for the full NITRON story.

NITRON A division of **MCDONNELL DOUGLAS** 

NITRON, 10420 Bubb Road, Cupertino, CA 95014

Before I forget, please tell me more about NITRON memories.

name

company

title

address

Convert 7-segment numerical code to decimal or BCD outputs

While many many MSI and LSI circuits have seven-segment numerical outputs, the designer often has a need for BCD or decimal outputs. And though BCD-to-seven-segment converters and decimal-to-seven-segment are common, those that can do the reverse are not. (A new chip that can do the job is available from Scarpa Laboratories, 46 Liberty St., Metuchen, NJ 08840.) The recoder shown converts seven-segment outputs to BCD or decimal. It requires no clocking circuitry, and the conversion time is limited only by the propagation delay of the circuit.

In the accompanying, specially arranged truth table for seven-segment numeric characters, the numbers at the bottom of each column represent the bit positions, or "priority number," of each character's equivalent word. The equivalent word feeds into a 74147 priority encoder to determine the position of the word's least-significant ONE

bit. The 74147 output is an octal code, which then is translated into a 1-of-7 output from the 74138 decoder.

Note that the so-called priority numbers column in the table contains duplicates for 3, 4, 5 and 6. In these cases, it is also necessary to look at the state of the next least-significant bit to uniquely determine the number at the input to the circuit.

A decimal equivalent of the seven-segment input word is available at section AA' of the figure. A second 74147 and inverters convert the decimal equivalents to positive-logic BCD.

The circuit interprets a blank at the input as a zero. And it is designed to work on codes where the numbers 6 and 9 use only five segments.

David L. Howells, Western Electric, 2400 Reynolds Rd., Winston-Salem, NC 27106.

CIRCLE NO. 313

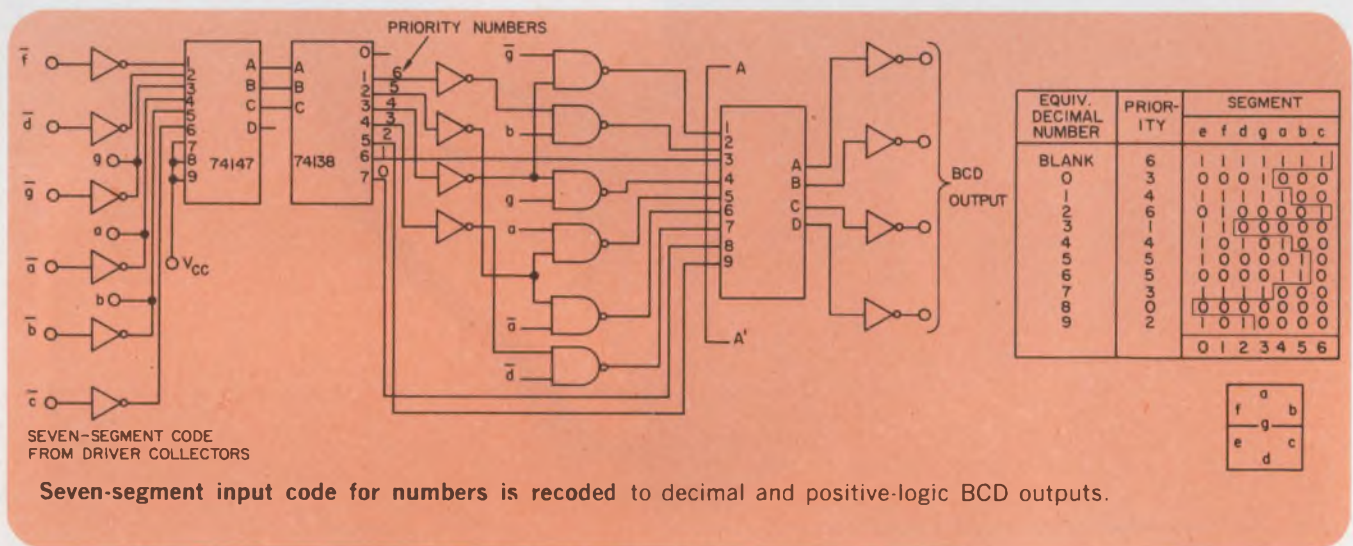

IFD Winner of October 11, 1974

Martin Mann, Chartered Engineer, 45 Old School Lane, Milton, Cambridge, England CB4 4BS. His idea "Inductance Calculation Simplified for Small Air-Wound Coils" has been voted the Most Valuable of Issue Award.

Vote for the Best Idea in this issue by circling the number for your selection on the Information Retrieval Card at the back of this issue.

SEND US YOUR IDEAS FOR DESIGN. You may win a grand total of \$1050 (cash)! Here's how. Submit your IFD describing a new or important circuit or design technique, the clever use of a new component or test equipment, packaging tips, cost-saving ideas to our Ideas for Design editor. Ideas can only be considered for publication if they are submitted exclusively to ELECTRONIC DESIGN. You will receive \$20 for each published idea, \$30 more if it is voted best of issue by our readers. The best-of-issue winners become eligible for the Idea of the Year award of \$1000.

ELECTRONIC DESIGN cannot assume responsibility for circuits shown nor represent freedom from patent infringement.

YOU'VE JUST BEEN TOLD THE MICRO COMPUTER YOU SPECIFIED HAS BEEN DISCONTINUED.

Don't worry. Help is here.

While other OEM suppliers are discontinuing their micro computer models because of the unavailability of LSI CPU chips, Microdata is delivering the MICRO-ONE.

Smart system designers will use the Microdata computer-on-a-board to open up new market areas while lowering component and assembly costs and increasing profit margins and reliability.

The MICRO-ONE is a high-speed microprogrammed micro

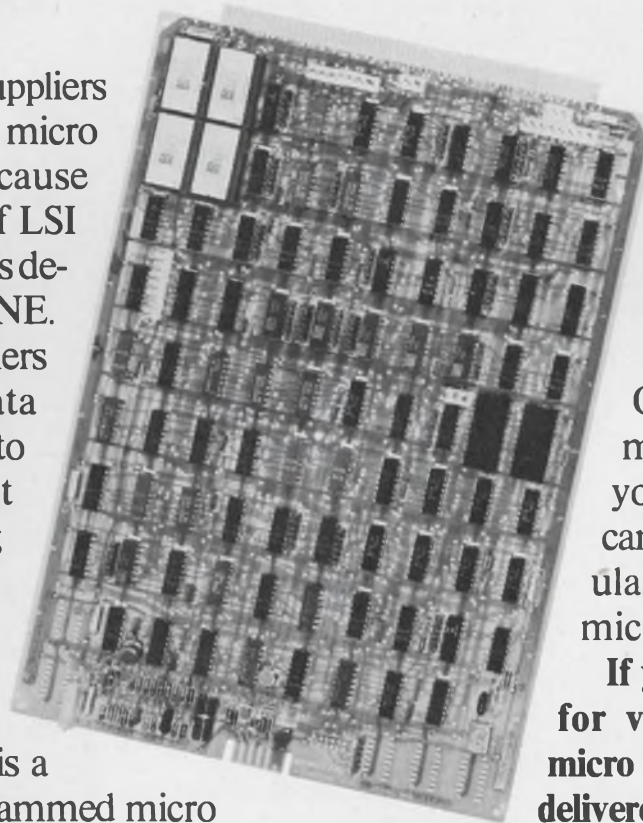

computer whose flexibility and functional modularity make it ideally suited for dedicated volume applications.

Because the MICRO-ONE is microprogrammable, that software you've already written can be saved. We'll emulate the discontinued micro computer.

If your requirements are for volume quantities of micro computers that *can be* delivered, write or call:

Microdata

17481 RED HILL AVENUE • IRVINE, CALIFORNIA 92705
TELEPHONE 714/540-6730 - TWX 910-595-1764

INFORMATION RETRIEVAL NUMBER 49

Microprocessor race intensifies on Continent

European computer manufacturers are racing to get their own microprocessors on the market. Olympia Werke, a West German electronics and business-machine company, has announced what it calls Europe's first microprocessor system. The 8-bit system consists of a computing/control unit, a program control unit, memory and program data unit.

Three European-based semiconductor companies cooperated in developing the microprocessor. AEG-Telefunken, General Instrument and SGS-Ates each provided a different process approach for the 15 MOS-LSI chips of the microprocessor system.

Telefunken used a metal-gate double ion-implantation technique. General Instrument relied upon a

metal-gate nitride configuration. Italy's SGS-Ates used silicon-gate.

Much of the chip line is interchangeable; therefore there are no second or third-source supply problems.

Close on the heels of this announcement, Nixdorf Computer AG presented what is said to be the first European n-channel microprocessor. This is an 8-bit CPU with an integrated 32-by-8-bit RAM. The unit uses 4600 transistors on a silicon chip measuring about 0.18×0.16 in. and is housed in a 40-lead package. The microprocessor is TTL-compatible, requires no special clock and has separate input-output (no special circuits are necessary for microprogrammed ROMs or additional RAMs). Total delay time is $1.5 \mu\text{s}$.

Heat shock slices optical fibers smoothly

A new method of cutting optical (glass) fibers by heat shock is reported to provide highly clean and smooth cutting surfaces. Siemens Laboratories, Munich, West Germany, is the developer.

Conventional mechanical cutting and breaking processes produce irregular fiber surfaces at the cutting plane. This results in transmission losses at interfaces between laser source or detector and optical fibers. Keeping these interface losses low is a crucial problem in optical signal-transmission systems.

The temperature-shock process uses point heating of the fiber plus light axial pull or pressure.

Tiny laser requires less pump energy

A miniature crystal laser that requires only a tenth of the pump energy previously needed while yielding the same output has been announced by the Max Planck Institute of Solid-State Physics, West Germany. The laser uses a neodymium pentaphosphate crystal measuring only fractions of a millimeter long.

The over-all length of the laser system is only a few centimeters, mirrors included. The low power requirements are a result of the relatively long life of neodymium ions in the excited state—as long as 0.1 ms. This, in turn, makes it possible to reduce the exciting

energy to less than 1 mW. The researchers are aiming at an eventual exciting energy level of "about $100 \mu\text{W}$." The light amplification efficiency of the synthetic laser crystal is now about 30%.

Other advantages cited by the developers are high temperature stability (up to 400 C), resistance to high radiation and relatively simple production. The mini laser is expected to find use in optical transmission-line repeaters.

DF system developed for small airfields

A miniature doppler direction finder for small airfields has been developed by Rhode & Schwarz, Munich, West Germany. The system operates from a 12-V battery, weighs about 67 lb and uses a frequency range of 117.5 to 136.5 MHz. Accuracy is reported better than ± 2 degrees.

Air-pollution network relies on computers

A network of 14 air-pollution monitoring stations has been put into operation in Bavaria, West Germany. The net will be completed by the end of 1976 and will then have a total of 80 stations. Signals from the stations' sensors are fed into a PDP-11/10 computer, which sends the digital signals via telephone line to a central PDP-11/45. Here the incoming data are processed for continuous evaluation.

Laser diodes may find gas-spectrometry use

Laser diodes emitting at 5 to 8 μm and that may be useful in gas-spectrometry applications have been developed at AEG-Telefunken's Research Laboratories, Ulm, West Germany. Diodes of the PbS-PbSe type, measuring $500 \times 200 \times 250 \mu\text{m}$, are mounted on a copper cooling substrate. The trigger current density is about 60 A/cm at 10 K or 1000 A/cm at 77 K. CW operation was achieved at 30 K. The devices may be fine-tuned by changes in the current that vary the diode's temperature.

Greater RFI/EMI shielding in new, narrow-width contact strips from Instrument Specialties

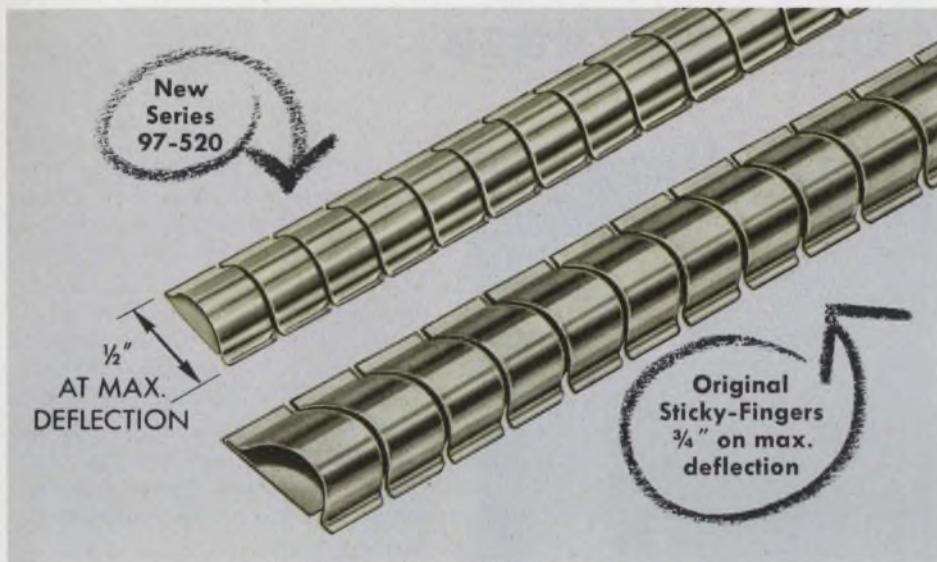

Latest addition to **sticky fingers**® line!

Instrument Specialties now offers Sticky-Fingers self-adhesive, beryllium copper contact strips in three variations to solve your most critical RFI/EMI problems.

Comparable to the shielding effectiveness of the original Sticky-Fingers, our newest series 97-520* offers shielding effectiveness of 92 dB at 10 GHz plane wave or greater than 92 dB at 1 MHz magnetic, and has a dynamic range of 0.10". Yet, it measures a scant 3/8" wide, and 1/2" at maximum deflection.

Supplied in standard 16" lengths, series 97-520 is ideal for metal cabinets and electronic enclosures where variations exist in the space to be shielded, and where high shielding effectiveness must be maintained in narrow spaces, even with frequent opening and closing of the cabinet.

Select the exact series that fits your application best. Write today for a complete catalog, list of finishes available, and our latest Independent Shielding Evaluation Report. Address: Dept. ED-68.

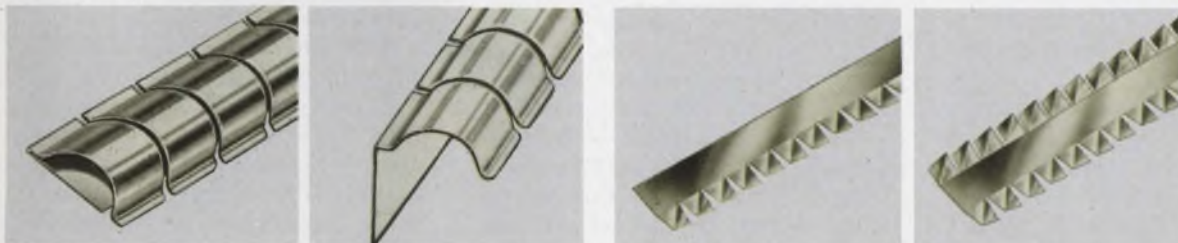

Series 97-500*—the original 3/4" wide Sticky Fingers. For greatest possible shielding and where space permits. Also available: Series 97-505—90° configuration of Series 97-500; same shielding effectiveness.

For those all-purpose applications where economy and space are both factors, specify the 3/8" wide single-twist series 97-555, or 1/2" wide double-twist series 97-560 Sticky-Fingers.

Specialists in beryllium copper springs since 1938

*Patented

INFORMATION RETRIEVAL NUMBER 50

ELECTRONIC DESIGN 4, February 15, 1975

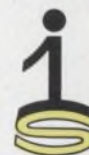

INSTRUMENT SPECIALTIES CO., INC.
Little Falls, New Jersey
Phone 201-256-3500

CCD serial-memory capacity climbs to 16-k bits of storage

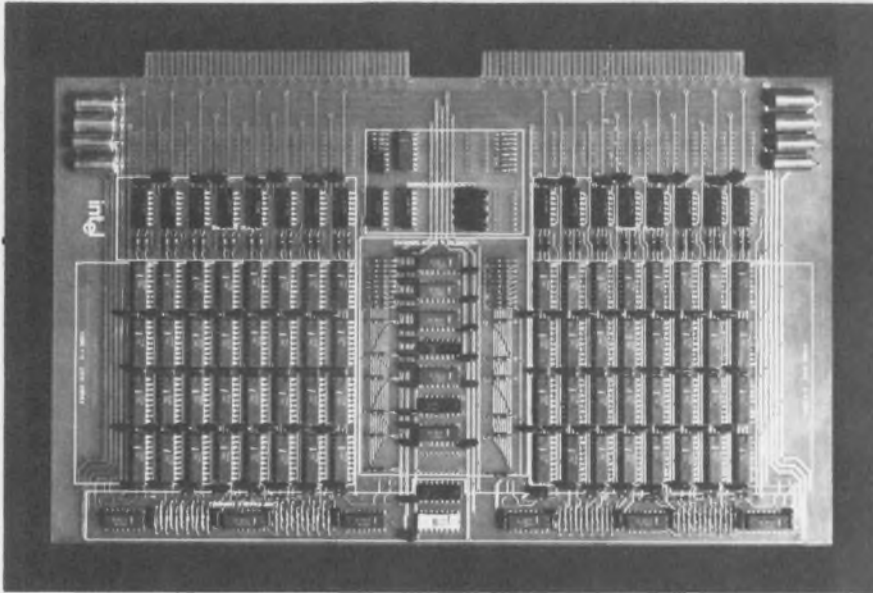

Intel, 3065 Bowers Ave., Santa Clara, CA 95051. (408) 246-7501. P&A: See text.

With the introduction of the first 16-k bit CCD memory chip—Intel's 2416—charge-coupled-device ICs become serious contenders for many mass-storage applications now filled by discs and drums.

The new memory combines a maximum serial-data rate of 2 Mb/Sec with an average access time to any bit of less than 100 μ s. And compared with electromechanical storage, the CCD memory requires a fraction of the space and power.

However, Intel's CCD memory may face stiff competition from another 16-k bit chip expected shortly from Fairchild (464 Ellis St., Mountain View, CA 94042). Recently the latter company announced the first CCD memory, a 9-k bit chip, and described a 16-k CCD now being readied for introduction (see "9216-bit CCD Memory a Market Trail Blazer," ED 3, Feb. 1, 1975, p. 22). According to preliminary data, the Fairchild 16-k bit CCD is expected to have

shorter access times and higher data rates than the Intel version.

CCD memories combine features of conventional shift registers and RAMs. Like a RAM, the Intel 2416 uses a 6-bit address input to select an internal memory region. However the memory region accessed on the CCD chip is organized as a shift register.

A total of 64 shift registers divide the memory's over-all capacity of 16,384 bits into equal lengths. Hence each of the randomly addressable registers is 256 bits long. And a specific bit location can be accessed, on the average, with only 128 shift operations—half the total length of a register. (Were the 2416 built as a continuous register, 8192 shift operations would be needed on the average, to access a specific bit).

Externally the silicon-gate, n-channel MOS memory requires +12 and -5-V power supplies, four-phase clock signals, address drivers, and control signals for input and output data and to provide chip enable and select.

The four-phase clocks determine

the data-shift rate, which varies from about 125 kHz to over 1 MHz over the 0-to-70-C temperature range. Depending on the shift rate, the average access time to any bit ranges from less than 100 μ s to 1 ms. (By comparison, rotating memories have an access of over 2/ms to more than 100/ms.) The shift registers recirculate data automatically as long as the four-phase clocks are applied continuously and no write command is applied.

Data rates can be increased to more than 2 MHz by sequential addressing of several registers between successive shift operations. This mode of operation has the advantage of decreased clock-driver power—which always exceeds the dissipation of the memory chip.

At 1-MHz, for example, the chip dissipates about 150 mW, compared with about 400 to 450 mW of capacitive dissipation for the clock drivers.

A 9 \times 15-in. developmental board has a storage capacity of 1,048,576 bits, organized as 128 kilobytes (see photo). Of the total number of packages, 30% provide support circuits for the CCD memory chips. The company points out that only eight are needed for a 1-megabyte system.

With interleaving or multiplexing techniques, a board's data rates can reach a maximum of 8 megabytes per second. Maximum access time to read or write data to any location is then 128 μ s.

The Intel 2416 comes in two versions. In an 18-pin plastic DIP (prefix P), the chip sells for \$55 in quantities of 100 to 999. In a 22-pin ceramic DIP (prefix C), the CCD memory costs \$58 at the same quantity level. Delivery is from stock.

Intel
Fairchild

CIRCLE NO. 305
CIRCLE NO. 306

Nowadays, you can't buy immediate delivery.

But you can rent it.

When you order electronic test equipment, you could wait weeks or even months for delivery.

Or, you could rent from REI, and have what you want within hours. With the largest inventory in the business, it's a safe bet that your local REI Instant Inventory Center has exactly what you need. And it's just a phone call away.

Immediate delivery is just one reason for renting from REI. Saving money is another. You pay only for the period you have your instruments, and you can return them anytime... so you get more mileage from your equipment budget.

REI stocks 8,137 fully checked-out test instruments. And they're ready whenever you are. For the full story on renting, as well as prices, send in the coupon for prompt delivery of our free illustrated catalog. Or, call us now for your immediate requirements.

Burlington, MA (617) 273-2770 • Gaithersburg, MD (301) 948-0620 • Oakland, NJ (201) 337-3757 • Ft. Lauderdale, FL (305) 771-3500 • Des Plaines, IL (312) 827-6670 • Dallas, TX (214) 661-8082 • Mountain View, CA (415) 968-8845 • Anaheim, CA (714) 879-0561 • Rexdale, Ontario (PLC Leasing Ltd.) (416) 677-7513



Rental Electronics, Inc.
99 Hartwell Avenue, Lexington, Mass. 02173
Please send me your free, 78-page rental
equipment catalog:

Name _____ Title _____
Company _____
Address _____
City _____ State _____ Zip _____

Rental Electronics, Inc.

A PEPSICO LEASING COMPANY



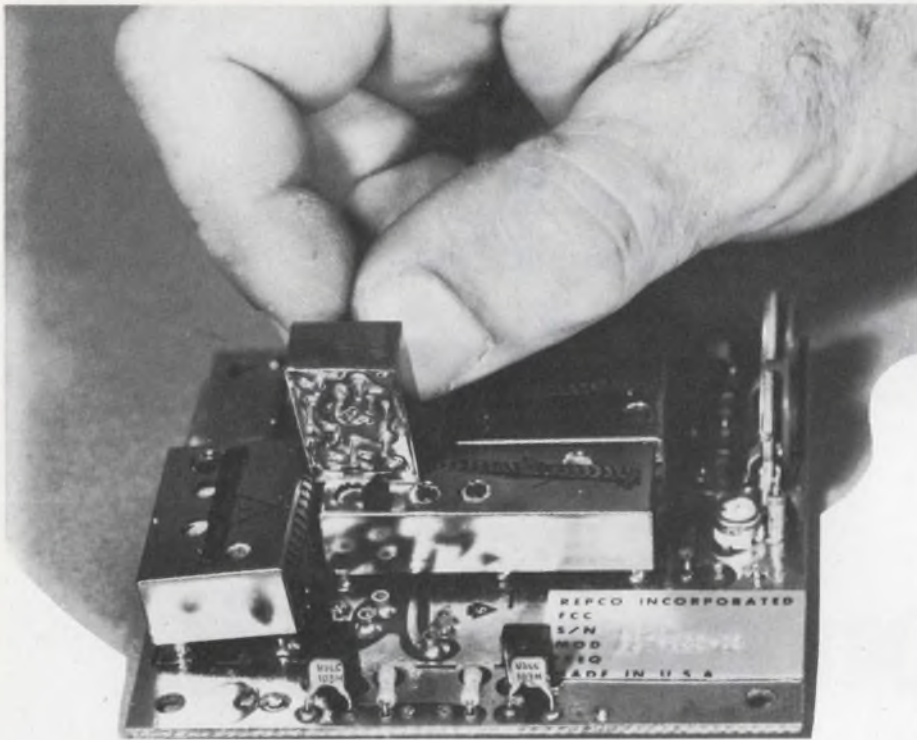

ACTUAL SIZE

Link up

with Reppo RF transmitters and receivers

Reppo's FCC type accepted RF links give you design flexibility with proven reliability (actual cases report systems in use for years with no RF failure), excellent MTBF, rapid MTTR (with low cost, off-the-shelf PBC modules). Suitable for voice, low-speed digital, or tone. 25-50 Mhz, 66-88 Mhz, 132-174 Mhz; and our new UHF 450-470 Mhz ranges. Reppo's delivery, production capacity, and volume pricing will warm your heart! Write today for our free specs brochure and special evaluation unit price.

----- Special evaluation offer! -----

Reppo, Incorporated
 Special Products Department
 P. O. Box 7065, Orlando, Florida 32804
 (305) 843-8498 TWX 810-850-0120

Please send me free specs brochure and special low unit price available for evaluation of your RF links.



Name _____ Title _____

Company _____ Address _____

City _____ State _____ Zip _____

ED2

Reppo World's leading manufacturer of modular handheld portable radios.

INFORMATION RETRIEVAL NUMBER 52

INTEGRATED CIRCUITS

9-digit LED drivers boost densities

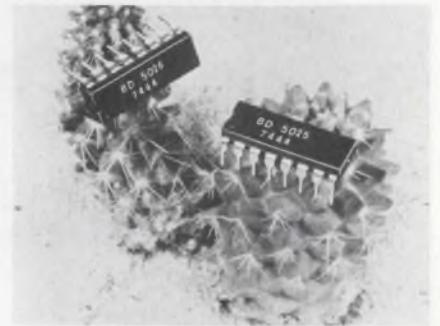

Boumar Arizona, Inc., 2355 W. Williams Field Rd., Chandler, AZ 85224. (602) 963-7361. \$1.55 (1000); stock.

Two LED digit drivers, designed primarily for nine-digit hand-held calculators or other multidigit display applications, provide nine MOS-compatible LED digit drivers in a single 16-pin DIP. And each driver can replace two six-digit packages in most calculator applications. Called the BD5025 and 5026, the new bipolar circuits employ a five-input sequential addressing scheme. With a sequential pulsing of the five address inputs, internal logic sequentially multiplexes through all nine outputs. Hence four input lines are eliminated and the circuit is compatible with most of the industry's single-chip calculators. The two circuits are functionally identical, with the design of the BD5025 optimized for 3-to-6-V operation, and the BD5026 for 6 to 9 V. Each driver sinks up to 160 mA.

CIRCLE NO. 307

NOR functions come in CMOS gates

Signetics, 811 E. Arques Ave., Sunnyvale, CA 94086. (408) 739-7700. 47¢ (1000).

Four CMOS NOR-gate circuits are interchangeable with like-numbered RCA models. The new circuits are the N4000A dual three-input NOR gate with inverter, the N40001A quad two-input NOR gate, the N4002A dual four-input NOR gate, and the N4025A triple three-input NOR gate. Input resistance is greater than $10^{12} \Omega$, and input current is less than 10 pA. Fan-out to low-power TTL logic gates is two.

INQUIRE DIRECT

Zero Centurion™ cases. 59 better ways to protect your portable equipment.

Zero's rugged aluminum carrying cases provide complete protection for the most delicate portable equipment in virtually any environment. And there's a wide choice of styles, sizes and prices in the extensive Zero line.

Zero Centurion Elite offers the ultimate in distinctive styling, quality and reliability, plus two-week delivery. Valu-Line offers the same kind of reliability at a lower price. And the Economy Series puts Zero's high quality within the reach of any budget.

If you can't find exactly what you need in our 59 standard models, Zero can provide full custom modification capability. Aluminum carrying cases—one of the many ways Zero supports your world.

Write for your free catalog today.



Zero Manufacturing Co.

777 FRONT STREET · BURBANK, CALIFORNIA 91503

Design and Manufacturing Facilities | ZERO WEST · BURBANK, CALIFORNIA · 213/846-4191
ZERO EAST · MONSON, MASSACHUSETTS · 413/267-5561
ZERO SOUTH · CLEARWATER, FLORIDA · 813/531-8991



FOR IMMEDIATE NEED, CIRCLE 207

FOR INFORMATION, CIRCLE 208

3' x 4' on the floor. Tenney gives you more!

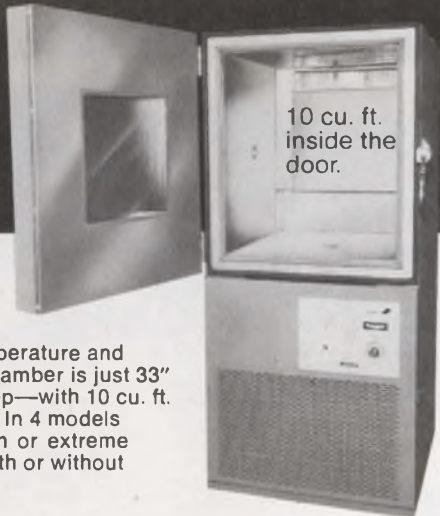

TenneyTen temperature and humidity test chamber is just 33" wide by 49" deep—with 10 cu. ft. inside capacity. In 4 models offering medium or extreme temperature, with or without humidity.

Model TTRS: -40°F to 350°F with humidity
Model TTTC: -100°F to 350°F with humidity
Model TTS: -40°F to 350°F
Model TTC: -100°F to 350°F

Write or call for details.

Tenney
ENGINEERING, INC.

1090 Springfield Rd., Union, New Jersey 07083 • (201) 686-7870
N.Y. Phone (212) 962-0332

700A

Rogan knobs look better and are built better,



and we'll prove it with a free sample.

After you receive our catalog, send us a note outlining your specific requirement and the quantity involved.

Or furnish us with our competitor's part number and we will cross-reference it.

Our samples and quotation will be returned promptly.

ROGAN
CORPORATION

3455 Woodhead Drive, Northbrook, Illinois 60062 (312) 498-2300

INFORMATION RETRIEVAL NUMBER 54

INFORMATION RETRIEVAL NUMBER 55

Programmable voltage regulators handle high power in a mini, 4-pin package

Fairchild Semiconductor, 464 Ellis St., Mountain View, CA 94049. (415) 962-2361. 100-up prices: \$1.25 (78MG), \$1.35 (79MG); stock.

A pair of programmable, four-terminal voltage regulators from Fairchild Semiconductor allow the simple design of fixed or variable regulators. They take advantage of a new packaging scheme that permits efficient heat transfer and easy installation.

The 78MG positive and 79MG negative regulators can be programmed, with a pair of resistors connected to a single pin, to regulate voltages from V_{ref} (5 V for the 78MG and 2.23 V for the 79MG) to approximately 35 V. Both regulators are short-circuit-proof, have thermal-overload protection

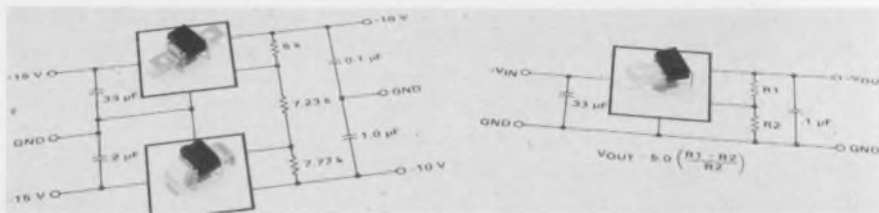

and are designed for safe-area-limiting of the output transistors. They have 500-mA output current capability, with 1% line and 2% load regulation.

The package consists of a mini-DIP epoxy case with four pins and tinned wings. The wings are 0.24 in. wide and extend from 0.19 to 0.215 in. from the sides of the DIP, depending on bend. The wings can be bent downward (71MG2IC) or bent parallel to the package (71MG2C). The V style is also available with a single wing.

The package is made from a proprietary epoxy material. Thermally, $\theta_{jc} = 8 \text{ C/W}$ and $\theta_{ja} = 70 \text{ C/W}$. Power dissipation is internally limited to 6 W, operating temp is 0 to 125 C and storage temp is -55 to +125 C.

Other specifications for the 78MG include an I_{ref} of 1 μA and an $I_{quiescent}$ of 2.5 nA. For the 79MG, the corresponding specs are 0.3 μA and 0.5 nA. Output impedance is 200 m Ω and temp coefficient 0.5 mV/ $^{\circ}\text{C}$.

CIRCLE NO. 302

dB Multimeter...

Full function digital multimeter with 120 dB range operates on battery or line.



Six functions, 31 ranges, AC-DC Volts, AC-DC Current, Ohms plus dB, integral battery charger standard. Basic DC accuracy 0.1%, 100uV resolution, dB accuracy, .5dB, 3 1/2 digit LED display. Compact and rugged enough to stand on! Only...

\$395.

Call your nearest United Systems representative for complete specifications.

\$295.

Don't need dB? Compare the Model 2120; identical to the 2180 less dB with five functions, 26 ranges.

Don't need dB or current? The Model 2110 offers three functions, 15 ranges.

\$245.

All Models Delivery from stock.

Digitec

UNITED SYSTEMS CORPORATION

a subsidiary of

Monsanto

918 Woodley Road • Dayton, Ohio 45403 • Ph: (513) 254-6251 • TWX: (810) 459-1728

**SPECIAL OFFER
TO ELECTRONIC DESIGN
SUBSCRIBERS**

Now \$49.95

The scientific calculator that has just solved your biggest problem--price

The Sinclair Scientific was originally introduced at \$119.95 and was recently advertised at \$99.95. Now under a special arrangement, the same calculator is available in limited quantities to ELECTRONIC DESIGN subscribers at \$49.95. This is half the cost of most other scientific calculators. Additionally, each purchase of a \$49.95 calculator brings you a \$5 bonus certificate good toward the purchase of any other Sinclair calculator.

The Sinclair performs logarithmic and trigonometric functions, as well as displaying scientific notation on all calculations.

What's more, the Sinclair Scientific isn't just portable. It's pocketable.

Less than 3/4 inch thin. And 3 3/4 ounces light. It's the world's thinnest, lightest scientific calculator.

Just look at some of its essential functions, and you may never use your slide rule or log tables again:

- | | |
|-------------------------------|----------------------------------------------------------------------------|
| log and anti-log
(base 10) | automatic doubling
x ² , including square
and other roots |
| sin and arcsin | plus the four
basic arithmetic
functions |
| cos and arccos | |
| tan and arctan | |
| automatic squaring | |

What makes a scientific calculator scientific?

There are many calculators that call themselves "scientific." But most, frankly, don't measure up.

To be a really valuable tool for engineers, scientists, technicians and students, a calculator must provide *all* of the following: Log functions. And trig functions. And scientific notation (10⁻⁹⁹ to 10⁺⁹⁹).

Specifications

- | | |
|-----------------------------------------------------------------------------------------------------------------------------------|--------------------------------------------------------------------------------------------------------------------------------|
| Functions:
4 arithmetic
2 logarithmic
6 trigonometric | Logic:
Reverse Polish with
post-fixed operators
for full flow chain
calculations |
| Keyboard:
16 key format with
4 "triple-action"
function keys using
standard, upper and
lower case operation | Power Source:
Battery operated with
4 inexpensive AAA
penlight batteries,
providing over 25
hours of use |
| Display:
5-digit matrix
2-digit exponent
(both signable) | Size:
4 1/2" high,
3" wide, 11/16" thick |
| Exponent:
200-decade range,
from 10 ⁻⁹⁹ to
10 ⁺⁹⁹ | Weight:
8 1/2 oz.
Warranty:
1 year |

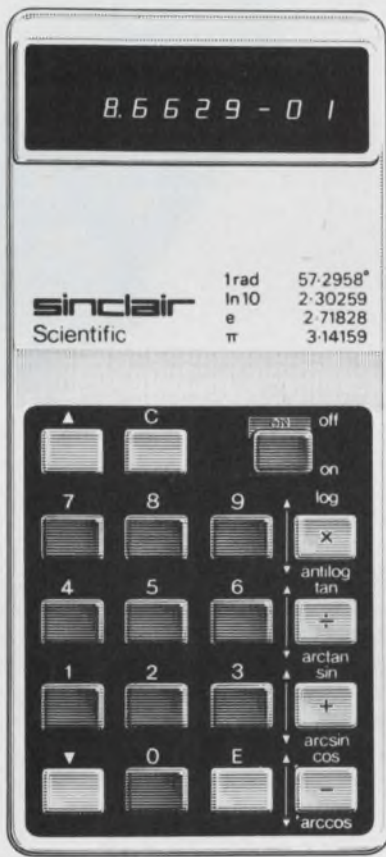

actual size

Clearly, a scientific calculator without scientific notation severely limits the size of numbers with which you can work easily. And scientific notation without transcendental functions is little more than window dressing on an arithmetic calculator.

What it all adds up to is this: Only Sinclair provides truly scientific capacity at a truly afforded price.

What makes the Sinclair Scientific so inexpensive?

Two important technological breakthroughs.

First, the British-built Sinclair Scientific has a *single* integrated circuit. Engineered by Sinclair. And exclusive to Sinclair. (Competitive units require more than one chip. Their chips are larger. And also more expensive.)

Second, Sinclair's exclusive keyboard has only four function keys, which provide "triple-action" by changing from standard to upper or lower case mode.

Extra keys mean extra cost. (Not to mention size and weight.) And fewer keys mean a simpler format to memorize—for increased speed and fewer entry errors.

Old hands at small miracles.

Sinclair has been an innovator in calculator miniaturization right from the start. And it's now Europe's largest manufacturer of pocket calculators.

Naturally, Sinclair maintains a service-by-return mail operation in the U.S. (and everywhere else in the world) to handle any product problems, should they develop. And the Sinclair Scientific is backed by an unconditional one year replacement warranty.

How to get your Sinclair Scientific.

To order your Sinclair Scientific today, just fill out the coupon below.

sinclair™
SCIENTIFIC
The logical choice.

ORDER FORM

To: **Hayden Mail Order**
50 Essex St., Rochelle Park, N.J. 07662

Individual Orders must be accompanied by check or money order.

Please send me _____ Sinclair Scientific(s) at \$49.95 (plus \$3.50 per unit, shipping and handling) including batteries, carrying case, instruction booklet and warranty. (New Jersey residents add sales tax.)

Enclosed is my check or money order for _____

Signature _____

Name _____

Company _____

Address _____

City _____ State _____ Zip _____

Company Purchase Orders for 6 or more calculators are accepted for D&B rated accounts.

a little A-300 goes a long way.



In high frequency transmission. RF power generation for industrial and research processes. RFI/EMI and general laboratory applications, too.

The Model A-300 is a totally solid state power amplifier, covering the frequency range of 0.3 to 35MHz with a gain of 55dB. Capable of delivering 300 watts of linear Class A power and up to 500 watts in the CW and pulse mode, the A-300 is the ultimate in reliability.

Although the unit is perfectly matched to a 50 ohm load, it will deliver its full output power to any load (from an open to a short circuit) without oscillation or damage.

Complete with power supply, RF output meter and rack mount, the A-300 weighs a mere 89 pounds and operates from ordinary single phase power.

High power portability goes a long way for \$5350.

For further information or a demonstration, contact ENI, 3000 Winton Road South, Rochester, New York 14623. Call 716-473-6900 or TELEX 97-8283 E N I ROC

ENI

The World's Leader
in Solid State
Power Amplifiers

SEE
Electronic Design's
GOLD BOOK
FOR COMPLETE
PURCHASING
INFORMATION

INSTRUMENTATION

3-digit DPM reads rms of complex waveforms

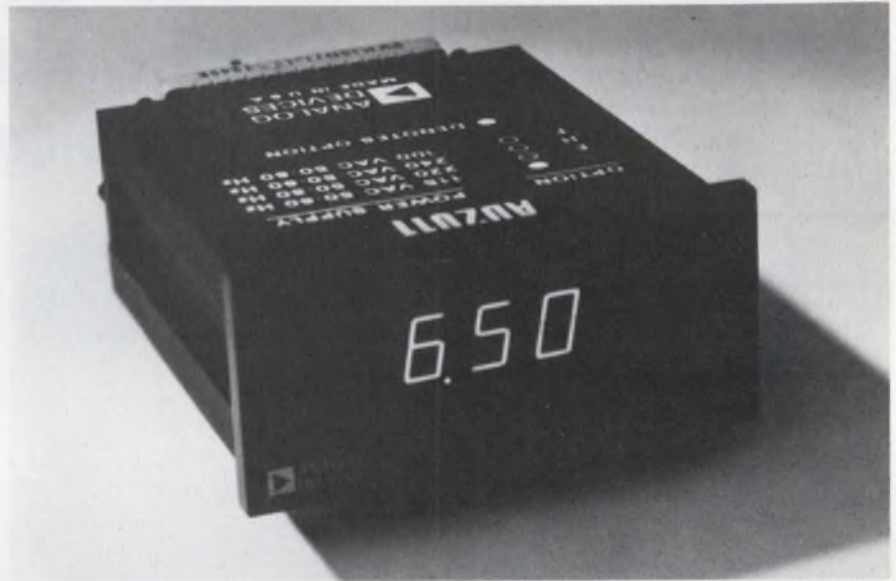

Analog Devices, P. O. Box 280, Route 1 Industrial Park, Norwood, MA 02062. (617) 329-4700. \$295; stock.

Truth—like beauty—frequently is in the eye of the beholder. So when Analog Devices points to its 2011 DPM as the industry's first to measure the "true" rms of any ac waveform, you may well ask: Which "true"?

While the line-powered AD2011 does indeed measure and display the rms of a complex waveform, it uses a computing technique to derive the figure—rather than a thermal-input device that responds directly to the rms value. Which technique is more valid depends on whom you talk to.

Philosophical discussions aside, however, the 3-digit Analog Devices unit, which sells for \$295, won't wince at pulse trains, triangles, gaussian noise, SCR-chopped sinusoids and the like—provided the crest factor, input-voltage and other limitations aren't ignored.

These limitations, and other specs, vary with the input range. To avoid use of ac attenuators, the 2011 provides four separate full-scale ranges: 1, 10, 100 and 1000 V.

On the 1-V and 10-V scales, the crest factor—the ratio of rms to average value—shouldn't exceed 7 at 100% of full scale, and 10 at 25%. The numbers drop to 1.4 and 5, respectively, on the 999-V range.

The maximum safely sustained input varies from 240 V rms (340 V pk) on the lowest scale, to 1100 V rms (1555 V pk) on the highest. Common-mode voltage is limited on all ranges to 300 V rms at 60 Hz.

Since the 2011 is dc-coupled, the unit will include in the measurement any dc levels riding along with the ac waveform. How accurately the meter reads such waveforms is another story.

While the unit's 3-dB frequency response extends from 30 Hz to 300 kHz (10 kHz on the 1000-V scale), accuracy is specified for dc or for sinusoids from 45 to 1 kHz. For these, you can expect $\pm 0.1\%$ of reading $\pm 0.1\%$ fs ± 1 digit on the 1-V range. The percentage-of-reading figure deteriorates to $\pm 0.3\%$ on the two middle scales and to $\pm 1\%$ on the highest.

But if you need only one range, that range can be calibrated to keep accuracy at the $\pm 0.1\%$ value. "Typical" errors vary from $\pm 0.5\%$

(continued on page 108)

**RF Microwattmeters—
Analog and Digital—
FS Sensitivities from
10 nW to 10 mW**



MODEL
42B/42BD

Boonton rf microwattmeters offer unrivalled sensitivity: 10 nW fs to 10 mW fs; from 200 kHz to 18 GHz, at highest stability ever attained at these sensitivities. Analog (42 B) or digital (42 BD) versions, both with linear DC outputs and logic-level programmability. BCD outputs are standard on digital version, autoranging and dB display (0.01 dB resolution) optional. Boonton Electronics, Parsippany, N.J. 07054

INFORMATION RETRIEVAL NUMBER 255

**Wide-Range
Programmable
Capacitance Meters**



MODEL
72B/72BD

Boonton analog (72B) and digital (72BD) provide rapid, accurate, 3-terminal and differential measurements, at 1 MHz, from 1 pF fs. Measures semiconductor-junction capacitance at low (15 mV) test level, with provision for external DC bias. Phase-sensitive detector measures accurately even at Q=1. Logic-level range programmability and fast-tracking DC output are ideal for ATE. Model 72BD has standard BCD output and autoranging. Boonton Electronics, Parsippany, N.J. 07054

INFORMATION RETRIEVAL NUMBER 256

**Direct Capacitance Bridge
0.00005 to 1000 pF
and 0.01 to 1000 mho**



MODEL
75D

Boonton Model 75D Direct Capacitance Bridge is designed for 1 MHz capacitance and loss measurement. Capacitance range, 0.00005 pF to 1000 pF; basic accuracy, 0.25%. Conductance range: 0.01 mho to 1,000 mho, basic accuracy, $\pm 5\%$. Internal bias from -6 V to +150 V. Adjustable test level, 1 mV to 250 mV, at 1 MHz. Two modes of operation allow either conventional capacitance and loss measurements or one-control balance for capacitance only. 3-terminal input configuration. Boonton Electronics, Parsippany, N.J. 07054

INFORMATION RETRIEVAL NUMBER 257

INFORMATION RETRIEVAL NUMBER 258 ▶

Happy birthday, price-less.

Introduced just one year ago, our 102A FM/AM Signal Generator is celebrating a well-earned sales success against the HP8640B that once had the market sewn up. It's no wonder when you can save thousands of dollars and still get all you really need.

With our generator you get a well shielded, low noise source from 4.3 to 520 MHz that is both stable in frequency and accurate in level. We've shrunk warmup to 15 minutes and weight to 30 lbs.

We have the best residual FM spec around: 100 Hz resolution with a 6-digit display, individual metering of modulation and RF output, true peak monitoring, and 0-300 kHz internal FM deviation on all bands—external FM deviation can be as wide as 2 MHz peak-to-peak even at the lowest frequencies.

The 102A is engineered for your convenience. That's why we've designed a front panel that is easy-to-use and understand, why we have the specifications decaled on the top of the instrument in plain view, why we've added a unique adjustable "feel" main drive mechanism for easy narrow-band receiver setting, and why we have a full list of optional goodies—like a detected AM output to verify our negligible phase-shift for VHF omnitemesting, fused RF output with replaceable elements, and external clock input.

Call or write today for data and/or a demo and you'll call the 102A price-less, too. Boonton Electronics Corp., Rt. 287 at Smith Rd., Parsippany, N. J. 07054; (201) 887-5110.

Price \$3575.

BOONTON

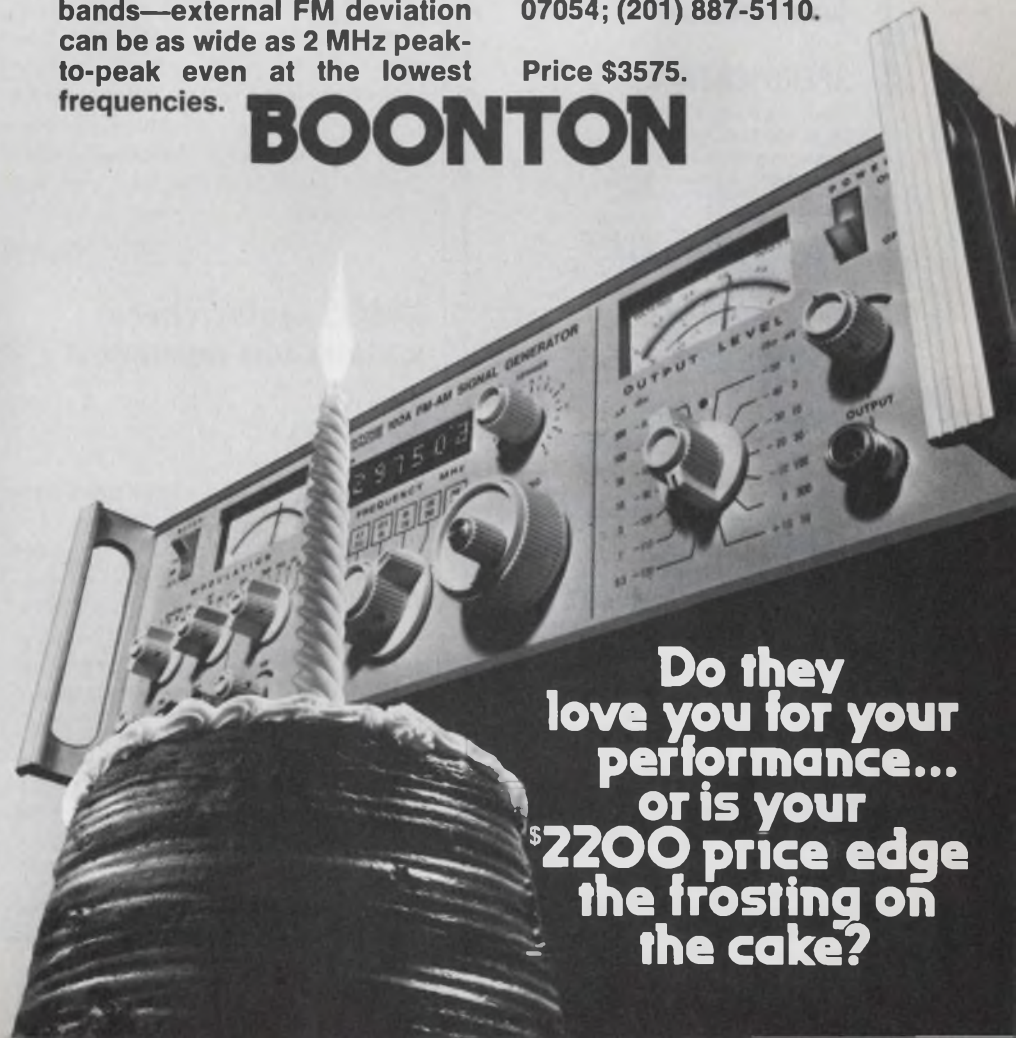

Do they
love you for your
performance...
or is your
\$2200 price edge
the frosting on
the cake?

DIRECT FROM STOCK

5V3A

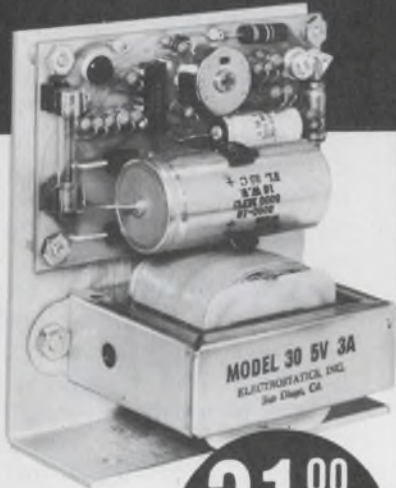

31⁰⁰ (1-9)

\$23.70 - 100 pcs.

Excellent regulation and ripple.

SPECIFICATIONS

Size: 4 x 4.5 x 2.75 overall
 Input: 105-125V, 47-420 Hz
 Output: Any DC voltage 3 to 30
 Regulation: Line — 0.005%
 Load — 0.05%
 Ripple: Less than 250 Microvolts
 Temp: Operative —40 to +71°C
 Storage —65 to +85°C
 Coefficient —0.01%/°C Max.
 Current Limiting: Fixed Foldback Type
 Overvoltage: Optional

MODEL	VOLTAGE	AMPS
30-5	5.0	3.0
30-10	10.0	1.8
30-12	12.0	1.5
30-15	15.0	1.2
30-24	24.0	1.0
30-28	28.0	1.0

ORDERING INFORMATION

QUANTITY	PRICE	WITH O.V.
1-9	\$31.00	\$36.00
10-24	29.20	33.70
25-49	26.60	29.90
50-99	25.10	28.20
100-	23.70	26.90

CALL (714) 279-1414 FOR DELIVERY

Electrostatics, inc.
7718 CLAIREMONT MESA BLVD. • SAN DIEGO, CA 92111

INSTRUMENTATION

(continued from page 106)

for a symmetrical square wave to $\pm 0.9\%$ for pulse trains with 10% duty cycle and SCR-controlled waveforms fired at 90 degrees. In any case, a voltage-frequency limit of 10^6 V-Hz must be observed (10^7 V-Hz on the 1000-V scale).

Other features of the 2011 include a Beckman gas-discharge display and a floating, opto-isolated input.

CIRCLE NO. 301

Pulse/delay gen offers ± 30 -V offset/ ± 30 -V out

Instrument Research Co., Box 231, Lincoln, MA 01773. (617) 897-7647. \$1255; 30 days.

Model 910 is a modular, multi-channel pulse-delay generator that can directly drive all presently used logic families, including MOS and HTL, without interface converters. The 910 does this by providing a ± 30 -V offset range coupled with a ± 30 -V amplitude. The unit's channels (four) can operate either as delay or pulse generators, and this feature permits generation of multiphase outputs, double pulses, pulse bursts and complex waveforms.

CIRCLE NO. 308

CMOS tester checks wafers and packages

Teradyne, 183 Essex St., Boston, MA 02111. (617) 482-2700. \$90,000; 20 weeks.

The J295 computer-operated system performs functional and dc parametric tests on CMOS devices at both the wafer level and in final packaged form. Two clock pulse generators are included in the basic system for use during functional testing. The pulses are programmable in amplitude, delay and width. For parametric testing, the J295 can force voltage while measuring current or force current while measuring voltage. A differential-voltage measurement capability is included.

CIRCLE NO. 309

MONOLITHIC CRYSTAL FILTERS



TELLING vs. SELLING

The purpose of this column is to disseminate information. Or, to be absolutely honest, to sell by informing. As a responsible engineering or procurement person, you're quite capable of making your own decisions, given the facts. So that's what we give you. We think that the more facts about monolithic crystal filters we present, the more likely you are to buy ours. That's our "let the buyer be aware" theory.

ON SPECIFICATIONS

Writing a component specification is a lot like writing a legal contract. Both can be precise and complete, or vague and ambiguous. Or misleading.

In specifying monolithic crystal filters, one simple method—the boundary method—guarantees desired selectivity—precisely, under specified conditions, without ambiguity. That's why all of PTI's standard specifications are boundary specs. While other methods of specification may make the filter appear in a more favorable light, we feel that this kind of "specmanship" is not in your best interest and hence not in ours.

And boundary specifications—since they are usually intimately related to system requirements—represent a "natural" for the equipment designer preparing a filter spec. One pitfall: in writing boundary specs don't try to include filter manufacturing tolerances. We'll take care of that. Specifying selectivity is only one part of the story. If you need guidance in any aspect of writing specifications for monolithic crystal filters, we may be able to help.



Piezo Technology Inc.

2400 Diversified Way Orlando Florida 32804
305-425-1574

The Standard in monolithic crystal filters.

INFORMATION RETRIEVAL NUMBER 59

ELECTRONIC DESIGN 4, February 15, 1975

INFORMATION RETRIEVAL NUMBER 58

Temperature indicator handles 6 TC types



Doric Scientific, 3883 Ruffin Rd., San Diego, CA 92123. (714) 565-4415. \$799; 45 to 90 days.

The 402 digital temperature Trendicator is the third model of the company's Series 400 family. It will accept any of six thermocouple (TC) types (J, K, T, R, S or B) and will display in degrees F or C. The 1-degree-resolution unit uses six interlocking push-buttons to select TC type and provides a 0.6-in.-high planar display in a panel mounting DIN package, 72 x 144 x 173 mm. It can be used with grounded or floating TCs. Included are dual-slope integration, auto-zero, digital linearization, and noninterfering TC break detection.

CIRCLE NO. 320

Ergonomic scope is No. 2 in new line



Philips, P. O. Box 523, Eindhoven, the Netherlands. \$1470 w/o probes.

PM 3240 dual-beam scope offers a sensitivity of 5 mV and a bandwidth of 50 MHz. The unit belongs to the same family as the recently introduced PM 3260, a scope that stresses ergonomic design. Like the PM 3260, the new instrument has an 8 x 10-cm screen and bright trace at the highest sweep speeds. And at only 8 kg (18 lb) it weighs even less than its companion instrument. The front-panel layout is very logical, with the controls split into four vertical sections—Ya, Yb, delayed and main time base, with all the main controls on exactly the same level.

CIRCLE NO. 321

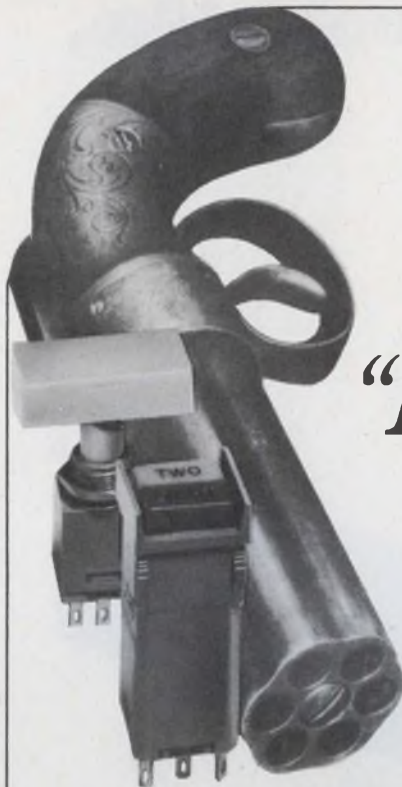

Before you order switchlights, we challenge you to compare our low cost

"Persuader Line"

feature for feature with other leading brands

We're the kind of firm that believes in more than one gun barrel and plenty of ammunition. So when you add our familiar S410* series to our new S190* series, you'll find we have a very convincing line of general purpose switchlights indeed. It's "The Persuader"—the line we invite you to compare for low cost, quality and versatility with that of any other manufacturer. Just check the list below, then get in touch with your local distributor for exact specifications. And we're easy to find . . . located in major cities world wide.

Standard Features	Clare-Pendar "Persuader"	Micro	Diallight	Other
1. Low Cost	YES			
2. Distributor Stock	YES			
3. U.L. Listed	YES			
4. 2 Form C	YES			
5. Wiping Contacts	YES			
6. Snap Action Contacts	YES			
7. 10 amp Rated	YES			
8. 2 amp Rated	YES			
9. 100,000 Cycle Life	YES			
10. 6 Lens Shapes	YES			
11. Split Lens Displays	YES			
12. Solid/Proj. Displays	YES			
13. 5 Adapter Shapes	YES			
14. Barrier Adapters	YES			
15. Snap-In Mount	YES			
16. Rear Panel Mount	YES			
17. Gang Frame Mount	YES			
18. Quick Connect Trmls.	YES			
19. Engraved Legends	YES			
20. Alt. Remain-In	YES			
21. Mom./Alt./Indicator	YES			

*S190 \$1.62 in quantities of 1000

See distributor listing Vol 1/568

*S410 \$2.53 in quantities of 1000



CLARE-PENDAR



CLARE-PENDAR
a GENERAL INSTRUMENT CO.
Box 785, Post Falls, Idaho 83854
(208) 773-4541

All sockets look alike, but.....

While some socket manufacturers include some of the features and advantages of a Scanbe socket some of the time, no manufacturer can include all the features all of the time...except us.

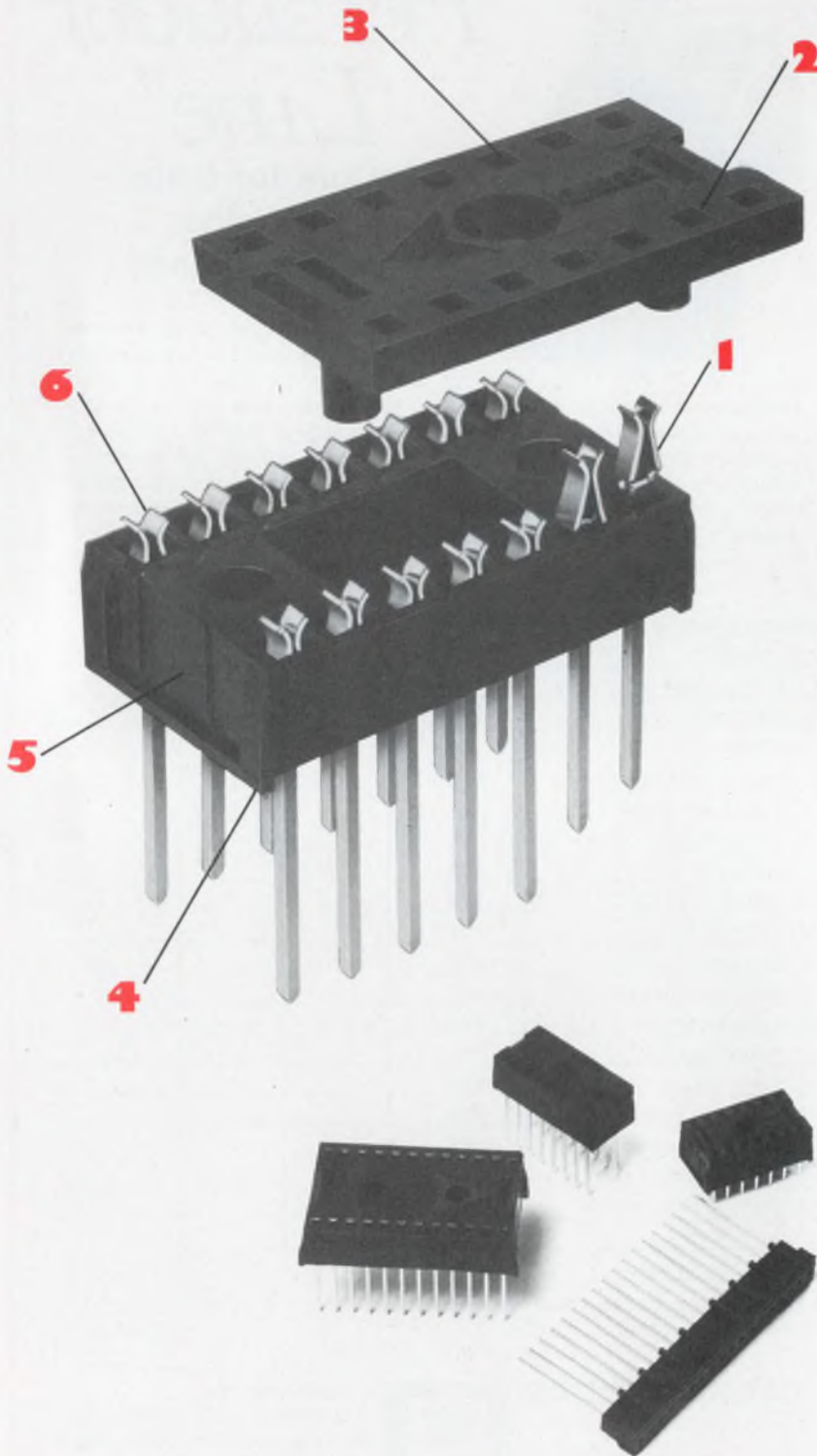

1 EDGE GRIPPING CONTACTS

provide greater contact pressure.

2 CLOSED ENTRY DESIGN

accurately guides I.C. leads into contacts.

3 TAPERED ENTRY CHANNELS

insure that I.C. leads enter contacts in perfect alignment.

4 SOLDER RELIEF

keeps solder from wicking into contacts.

5 PRECISION MOLDED

cap and body assures accurately positioned and aligned pins.

6 MATERIAL

U.L. approved glass filled nylon with gold over nickel or tin contacts.

Scanbe produces 14, 16 and 24 pin Sockets...11, 12, 14, 18 and 20 pin Pin Strips...and Scanbe includes all the features all the time.

Give us a call or write today for our latest Socket information. You'll be glad you did.

Scanbe Manufacturing Corp.
3445 Fletcher Avenue
El Monte, California 91731
Tel: (213) 579-2300

 **SCANBE**
CANOGA INDUSTRIES

SCANBE DISTRIBUTORS

WESTERN

Aimac/Stroom, Seattle, WA
(206) 763-2300

Aimac/Stroom, Portland, OR
(503) 292-3534

Electronic Parts, Denver, CO
(303) 744-1992

Moltronics of Arizona, Phoenix, AZ
(602) 272-7951

Moltronics, San Diego, CA
(714) 278-5020

Moltronics, Santa Clara, CA
(408) 244-7600

Moltronics, South Gate, CA
(213) 773-6521

Rose Electronics, Burlingame, CA
(415) 697-0224

EASTERN

Car-Lac, Bohemia, NY
(516) 567-4200

Garden State Electronics, Roselle, NJ
(201) 241-9000

Pytronics, Montgomeryville, PA
(215) 643-2850

QPL Electronics, Waltham, MA
(617) 891-0460

Summit Distributors, Buffalo, NY
(716) 884-3450

Summit Distributors, Rochester, NY
(716) 334-8110

Time Electronics, Woburn, MA
(617) 935-8080

Treeko Sales, Beltsville, MD
(301) 937-8260

CENTRAL

Hall-Mark Electronics, Elk Grove Village, IL
(312) 437-8800

Hall-Mark Electronics, Houston, TX
(713) 781-6100

Hughes-Peters, Inc., Columbus, OH
(614) 294-5351

Hughes-Peters, Inc., Cincinnati, OH
(513) 351-2000

Industrial Components, Minneapolis, MN
(612) 831-2666

Marsh Radio Supply, West Allis, WI
(414) 545-6500

Olive Electronics, St. Louis, MO
(314) 863-7800

Pioneer-Cleveland, Cleveland, OH
(216) 587-3600

Pioneer Michigan, Livonia, MI
(313) 525-1800

Specialized Products, Dallas, TX
(214) 358-4663

SOUTHERN

Hall-Mark Electronics, Orlando, FL
(305) 855-4020

Powell Electronics, Huntsville, AL
(205) 539-2731

SCANBE MANUFACTURING CORP.

3445 Fletcher Av. / El Monte, CA 91731
(213) 579-2300 / TWX: (910) 587-3437

Controller converts monitor to strip-chart 'recorder'



Ann Arbor Terminals, Inc., 6107 Jackson Rd., Ann Arbor, MI 48103. (313) 769-0926. \$1895 (single trace); 45-60 days.

Imagine a strip-chart "recorder" with no chart paper, no pen, no ink and no moving parts. Sounds impossible?

Your daydream can be realized if you change the word "recorder" to "display" and design an interface controller that sits between a computer and a standard 525-line TV monitor—as Ann Arbor Terminals did.

The company's Series 200 CRT strip-display controller converts 15-bit data to a composite video signal that produces a continuously moving, strip-chart-like trace on the CRT. The trace enters at the top of the field and spills off at the bottom, so that the vertical axis represents time; and the horizontal, amplitude.

Single trace is standard on the controller, with dual trace optional. Since amplitude excursions and "chart" speeds are under program control, speed changes are automatic and practically instantaneous. This means that there's no information loss between speeds, or error build-up to worry about over long "chart" runs.

With a graphic field (which occupies 80% of the screen) of 192 sample points and a maximum sample rate of 60 Hz, the fastest trace covers top to bottom in 3.2 s. And unlike galvanometer recorders—which restrict pen movement—traces can roam over the full field at will, and adjacent traces can overlap.

One feature that few recorders can boast—but which the Ann Arbor controller can—is alphanumeric: 64 upper-case ASCII characters in a format of 16 lines with 80 characters per line. Also under program control, the alphanumeric can indicate chart speeds, scales and other information. In some instances, Ann Arbor says, you can get a numerical readout of a bipolar signal level, similar to that of a DPM.

Both the graphic and alphanumeric fields are centered and superimposed. While both fields occupy the same height—16 character spaces, or 192 sample points—the graphic width is 4/5 that of the alphanumeric.

On top of both fields is still another: eight vertical grid lines at half brilliance that extend the full screen height. These, of course, are analogous to the X-Y grid of standard chart paper, with the X lines missing.

A programmable "window," which consists of two separated horizontal line segments, appears on the 128th sample line. The position along the horizontal and the length of the segments and gap are controllable so that a limit, or excursion, indicator can be set up.

Why buy a recorder that doesn't record? Many applications are ones of monitoring and don't need hard copy. Or perhaps you can store data more conveniently on tape rather than on stacks of paper.

But the Series 200 offers a number of advantages over electromechanical recorders: no wear, no hysteresis, operation at analog input frequencies to 30 Hz (computer-input signal), an amplitude resolution of about 0.4%, a rise time of 16.6 ms and a power drain of only 30 W.

The Ann Arbor controller is also available as a plug-in board set for OEM applications. Multidrop expansion to 16 individually addressable controllers is standard.

CIRCLE NO. 303

Kiss Noise Good- bye

The higher a counter's sensitivity and the wider the frequency measuring range, the more noise is superimposed on signals, right? Wrong. Not with high-input sensitivity/wide frequency range counters from T.R.I. You get noise-free measurement of even weak signals.

Model:5108
Frequency Counter \$950



550MHz measuring capability for \$950

Model 5108. Measures up to 550MHz. 10 mVrms input sensitivity. Built-in automatic noise suppression. And a clear 9-digit display. Plus 5×10^{-8} /day stability. All for \$950. How's that for economy? And how's this for flexibility, it's size-right for field use. Also a good choice for bench and systems applications.

Model:5104
Universal Counter \$519



60MHz measuring capability for \$519

Model 5104. A money-saver. Has a low-pass filter in the input to suppress noise. Measures up to 60MHz. 50 mVrms input sensitivity. In addition to frequency, use it also to measure time intervals, frequency ratios, and to totalize. Weighs a carry-around 9.3 lbs. No other counter offers so much so economically.



T.R.I. Corporation

505 West Olive Avenue Sunnyvale, CA 94086
(408) 733-9080

INFORMATION RETRIEVAL NUMBER 63

DATA PROCESSING

Microprogrammed minis are 32-bit machines



Systems Engineering Labs, 6901 W. Sunrise Blvd., Fort Lauderdale, FL 33313. (305) 587-2900. See text; stock.

The SEL 32/50 and 32/55 mini-computers mark the beginning of a 32-bit series dubbed SEL 32. Designed for OEM use, the 32/50 (about \$18,000) features separate microprocessor I/O controllers that simplify interfacing. The 32/55 for end users (prices start at \$25,000) has a complement of equipment that includes two floating-point processors, mass-storage and shared memory. All members of the SEL 32 Series use microprogrammed firmware and use single bus structure with throughput rates up to 26.6 Mbyte/s. All members of this series can directly address 16 Mbytes; initial models can use up to 1 Mbyte of memory.

CIRCLE NO. 322

Printer uses monorail for 600 line/min speed

Data Printer Corp., 600 Memorial Dr., Cambridge, MA 02139. (617) 354-4700. \$9675.

Character-links that ride on a monorail track help the CT-6644 printer provide good copy at 600 line/min. The unit prints any of 64 characters with 132-character line length. The price includes a sound-deadening enclosure plus a single-line buffer memory.

CIRCLE NO. 323

CMOS memory module meets Mil temp range

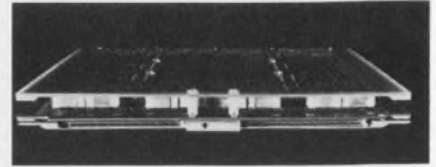

Rolm Corp., 18922 Forge Dr., Cupertino, CA 95014. (408) 257-6440. \$11,000; 150 days.

An 8-k CMOS memory module is available that operates over the Mil temperature range of -55 to 95 C. The Model 2032 RAM is up to 60% faster than conventional core memory yet requires only 30% as much operating power as the same amount of core. The unit features static memory that does not need refreshing, an extremely low standby current requirement (less than $25 \mu\text{W}$ at 3 V), and plug-in installation in the Rolm computer chassis.

CIRCLE NO. 324

Software driver helps upgrade to disc OS

Sykes Datatronics, 375 Orchard St., Rochester, NY 14606. (716) 458-8000. See text; stock.

Software drivers can now interface the manufacturer's flexible disc memory with two DEC PDP-8 operating systems—the 4K Disc Monitor System and OS/8. As the system disc, the unit can handle all support programs such as BASIC, Fortran, assemblers, editors and utility routines. Users with 4K PDP-8 systems that have limited I/O can be upgraded to become disc operating systems. The drivers are available at a nominal cost of \$50 along with the purchase of the flexible disc memory called the SYKES disc. Diskettes written on the Sykes drive are compatible and directly interchangeable at all levels with IBM 3740 systems. The disc controller automatically performs the following functions: sector search, track sequencing, record blocking, generation and check of IBM sync and CRC characters, address verification prior to reading and writing every sector, head unload, and bootstrap. The storage units are available in single and dual drive systems and a typical system sells for \$3700.

CIRCLE NO. 325

OUR 5V POWER MINI'S STACK UP LIKE THIS



OUTPUT VOLTAGE	OUTPUT CURRENT AMPS.	REGULATION LOAD $\pm\%$	REGULATION LINE $\pm\%$	RIPPLE MV RMS	PRICE	MODEL	SIZE INCHES
5	.250	.05	.05	0.5	\$39.00	5E25	2.3 x 1.8 x 1.00
5	.500	.1	.05	1	49.00	5E50A	3.5 x 2.5 x 1.00
5	1.0	.2	.05	1	69.00	5E100	3.5 x 2.5 x 1.25
5	1.5	.3	.1	1	98.00	5E150	3.5 x 2.5 x 1.25
5	2.0	.15	.05	1	110.00	5E200	3.5 x 2.5 x 2.00
5	2.5	.15	.05	1	125.00	5E250	3.5 x 2.5 x 2.00

... and the model you choose will be shipped 3 days after Acopian receives your order. With a 105-125 VAC input, use it at full rated load to 71° C. Short circuits won't damage it. These mini-modules can be mounted on a printed circuit

board in a space of only a few square inches. Generous quantity discounts are available. Or, if you're working with other voltages, choose from hundreds of other models. Single outputs from 1 to 75 volts.

Duals for op-amps with output currents from 25 to 500 ma. Even triple outputs. Complete details on these plus a comprehensive line of other power supplies and systems are included in the Acopian 73-74 catalog. Request a copy.



Corp., Easton, Pa. 18042. Telephone: (215) 258-5441.

QUALITY IN VOLUME

When you achieve it, you can offer true competitive value. That's just what we're doing at USCC/Centralab for 1975. MONO-KAP™ radial, and MONO-GLASS axial monolithic ceramic capacitors are now available to volume users *from stock* to eight weeks. Our investment and "learning curves" last year guarantee competitive responsiveness — USCC will welcome your specials and non-stock orders. Here's an offer you haven't heard lately — your money is going to buy more at USCC. Cash in on the best values in monolithic ceramic capacitors.

DISCRETE ASSEMBLY

MONO-KAP™ radial-leaded epoxy coated capacitors are reliable performers; they're rugged enough to work in MIL environments. 4.7 pF to 10 Mfd., 50 to 200 WVDC in 4 dielectrics, including Z5U, in a variety of case sizes featuring meniscus control to 0.032 inches. Large quantity orders from stock.

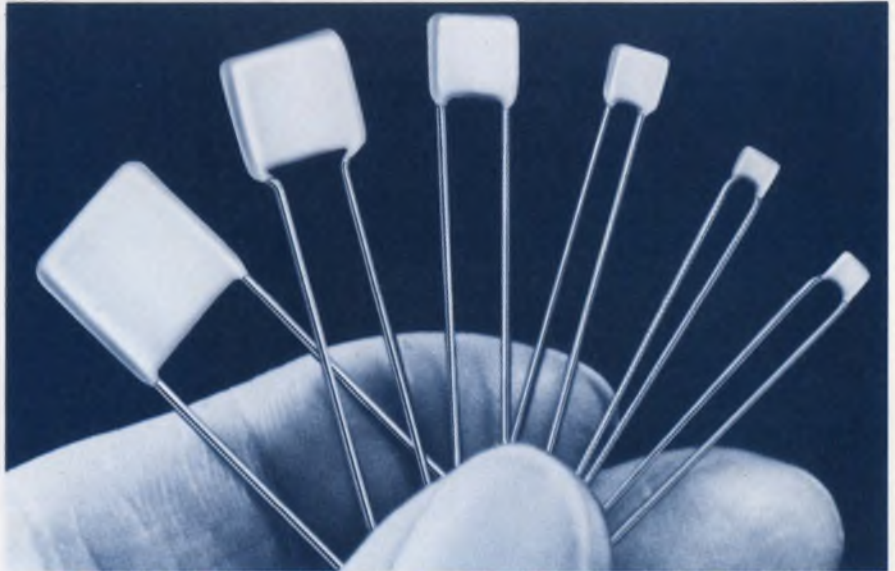

AUTOMATIC INSERTION

MONO-GLASS axials are glass encapsulated, designed for automatic PCB insertion; furnished reel-packed for high volume applications. They're available in 50 and 100 WVDC from 1 pF to 1.0 Mfd.; four dielectrics: COG, X7R, Z5U and Y5V.

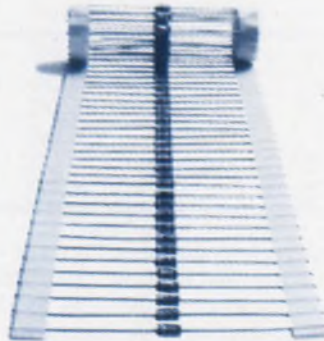

CUSTOM DESIGN

We're responsive to your design requirements; get USCC's new expanded 1975 catalog.



If you need a special call (213) 843-4222 or your nearest overseas location for assistance or evaluation samples.

Remember. USCC/Centralab. Value.

FOR QUICK REFERENCE, SEE OUR PRODUCTS IN YOUR EEM, GOLD BOOK OR EBG PAGES.

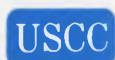

USCC/Centralab

Electronics Division • Globe-Union Inc.

2151 North Lincoln Street • Burbank, California 91504

(213) 843-4222 • TWX: 910-498-2222



INFORMATION RETRIEVAL NUMBER 65

Calculator gains versatility with PROM



Sharp Electronics Corp., 10 Keystone Place, Paramus, NJ 07652. (201) 265-5600. \$645.

A scientific calculator, the Model PC-1002, performs 15 scientific functions and has 10 built-in programs. The calculator has a special-application PROM with 256 programming steps. These can be divided into four separate program groups operated by an independent set of keys. There are four models. Each has a PROM that is programmed for different applications: statistics (providing mean, standard deviation, standard error, linear regression); mathematics (law of sines and cosines, perimeter and area); and surveying. The 15 functions of the PC-1002 include trigonometric, inverse trigonometric, hyperbolic, exponential, logarithmic, factorial, power, azimuth, and area calculations. An operator can also program the unit with up to 64 steps, apart from the PROM. The calculator has a 10-digit mantissa, two-digit exponent, and eight memory registers.

CIRCLE NO. 326

Prototyping boards now available for PPS-8

Microelectronics Div., Rockwell International, P.O. Box 3669, 3430 Miraloma Ave., Anaheim, CA 92803. (714) 632-3279. See text.

Samples of Rockwell's PPS-8 microcomputer system are now available as prototype boards. The first system, priced at \$600, includes CPU, two RAMs and two general-purpose I/O chips. The second unit, priced at \$700, includes CPU, two RAMs, a parallel data controller and direct-memory access unit.

CIRCLE NO. 327

Graphics CRT designed for multi-user systems

Digital Equipment Corp., 146 Main St., Maynard, MA 01754. (617) 897-5111. \$10,000; 90 days.

An interactive graphics terminal, designated the EG-11, with its 17-in. display, operates with PDP-11/40 and PDP-11/45 computer systems. It provides Fortran-IV compatible graphics capability when used with Digital's multi-user RSX-11 software. A typical RSX-11 system with 24k words of memory, can accommodate a single EG-11 terminal. A PDP-11 with 64k words of memory, 40 Mwords of disc storage and an RSX-11D or M operating system can support up to four graphics terminals along with other peripherals and consoles.

CIRCLE NO. 328

Low-cost mini added to V-70 series



Varian Data Machines, 2722 Michelson Dr., Irvine, CA 92664 (714) 833-2400. \$8000; March.

A low-cost systems computer, designated V-71, offers up to 32 kwords of memory at a cost of \$8000 (qty 12). Basic V-71 computers include 16 kwords of 1200ns core memory, I/O bus with DMA, chassis, power supply and programmer console. The V-71 is the fourth unit of the V-70 series and is priced to be the least expensive. The V-71 can be selectively expanded in terms of processor options, I/O structure and memory size. With options, the V-71 handles a comprehensive blend of hardware, systems software (including the VORTEX operating system) and extensive peripherals. Options on the V-71 include a writable control store, power fail/restart, TTY controller, automatic bootstrap loader for TTYs and a real-time clock.

CIRCLE NO. 329

Serial printer operates at 330 characters/s



Centronics, 1 Wall St., Hudson, NH 03051. (603) 883-0111. \$4675; 60 days.

The Model 102AL is a 132-column serial impact printer, which uses LSI (Large Scale Integration) electronics and has a printing speed of 330 characters per second (125 lines per minute). Modular design of the electronics package on one PC board increases maintainability by minimizing parts and provides for flexible interfacing. The 102AL will produce an original plus up to four carbon copies. The last printed line is visible for immediate reading. The standard mode produces a line of elongated bold-face characters on command. The printer uses the dot matrix technique for generating characters in a 9 x 7 pattern. Popular computer and communications (up to 9600 baud) interfaces are available as options.

CIRCLE NO. 330

Low-cost couplers have 450 baud data rates



Omnitec Corp., 2405 S. 20th St., Phoenix, AZ 85034. (602) 258-8246. See text.

Priced well under \$250 (qty), the 400 Series acoustic couplers offer 450 baud rates, RS232 (EIA) interfacing, full or half duplex operation and good sensitivity. These units are also offered as coupler kits for built-in installation.

CIRCLE NO. 331

MODULES & SUBASSEMBLIES
Amplifier provides 5-kV
input/output isolation



Intronics, 57 Chapel St., Newton, MA 02158. (617) 332-7350. From \$125; 2 to 4 wk.

The IA100 series of isolation amplifiers provides high input impedances, good input-output isolation, high common-mode rejection rates, and good linearities. There are four models in the series, with minor component changes to optimize each in a particular area. The IA101 is a unity gain buffer; the IA102, a low drift adjustable gain model; and the IA103/104s are low input current adjustable gain amplifiers. All units have accuracies of $\pm 0.01\%$ and input-output isolation capability of 5000 V. The input impedance is $10^9 \Omega$ shunted by no more than 10 pF. An additional feature of the IA100 series is a floating ± 15 -V supply, which is isolated from the output and can be used to power transducers that feed the amplifier. The units are packaged in $2.5 \times 3.5 \times 0.9$ in. cases with gold-plated pins suitable for either socket or printed circuit board mounting.

CIRCLE NO. 332

Sample/hold amplifier
has auto-zero feature



Validyne Engineering, 19414 Londelius St., Northridge, CA 91324. (213) 886-8488. \$250; 4 wk.

The AD136 peak-hold/auto-zero plug-in sample-and-hold circuit is designed for use in the company's MC1 module case system. The unit has a digital counter and a digital-to-analog converter, which combined, provide extended hold times without the leakage of voltages usually associated with analog s/h circuits. In the auto-zero mode, the AD136 accepts signals from 0 to +10 V with a resolution of 0.01 V. In the peak-hold mode, the AD136 tracks any signal from 0 to +10 V, and can hold that input until a larger signal is applied, or until reset to zero. The output voltage will be within ± 0.01 V of the input voltage. The peak-hold circuit will track input signals with slew rates up to 0.4 V/ms. For recurrent signals with higher slew rates, the AD136 will advance on successive cycles until the peak value is reached.

CIRCLE NO. 333

Liquid level controller
has no moving parts



Lisle-Metrix Ltd., 49 Sheffield St., Toronto, Ontario, Canada. M6M-3E5. (416) 249-9151. \$45 (U.S.) (unit qty.); stock.

The LL liquid level controller uses a probe to electrically sense the liquid level. This eliminates mechanical problems inherent in float type units. The unit uses very low ac voltage applied to the probe and is completely safe for use with all types of liquids in any environment. Sensitivity of the LL can be adjusted in the field, thus permitting the unit to be used with a wide variety of fluids. Internal circuitry and terminal connections have been arranged so that two models are required to perform all normally required functions, including high or low level alarm, lock-in, lock-out, or cut-off service as well as differential level pump-up or pump-down control. The controllers are housed in a chemically resistant ABS plastic enclosure.

CIRCLE NO. 334



ANALOGY

INTECH'S 3020 TRIPLE LED/LAMP FLASHER IC TO THE RESCUE. THREE INDEPENDENT LAMP DRIVERS, EACH WITH 100 mA CAPABILITY. EACH DRIVER HAS TWO TTL-COMPATIBLE INPUTS. VARIABLE FLASHING AND DUTY CYCLE 5 TO 15V SUPPLY AND LOW STANDBY.

intech INCORPORATED
 (408) 244-0500
 1220 COLEMAN, SANTA CLARA CA 95050

Sine wave oscillator has 10:1 tuning range

Kinetic Technology, 3393 De La Cruz Blvd., Santa Clara, CA 95050. (408) 296-9305. \$19.50 (100-up); 4 to 6 wk.

The OS-550 double-DIP hybrid modules are solid-state sine wave oscillators. Frequencies to a 1% tolerance can be provided between 100 and 3000 Hz. The DIP case measures $0.82 \times 0.7 \times 0.225$ in. The oscillator requires from ± 6 to ± 18 V for operation. At ± 12 V, current is approximately 5 mA and output levels to 7 V rms are obtainable. No external components are required but frequency tuning over a 10 to 1 range can be achieved with an external potentiometer.

CIRCLE NO. 335

Digital delay available in 11 different times

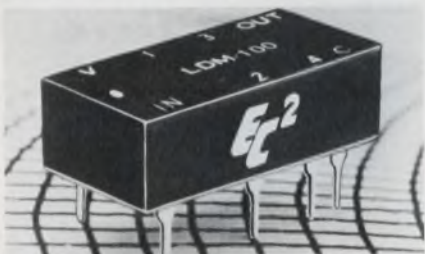

Engineered Components Co., 3580 Sacramento Dr., San Luis Obispo, CA 93401. (805) 544-3800. Under \$20 (small qty.); stock.

The LDM logic delay module provides precise tapped delays with required driving and pick-off circuitry in a single DIP package. The LDM is available in 11 delays from 25 to 250 ns. Each module has taps at the 20% increment point of total delay. Tap tolerance is maintained at ± 3 ns or $\pm 5\%$ (whichever is greater) of nominal tap delay. Tolerance on total delay is maintained at $\pm 5\%$. Temperature coefficient of delay is approximately $+500$ ppm/ $^{\circ}$ C over the operating temperature range of 0 to 70 C. Rise time for all modules is 4 ns maximum, when measured from 0.75 to 2.4 V. The DIP series of modules is packaged in a molded, flame-proof Diallyl Phthalate case per MIL-M-14, type SDG-F, and is fully encapsulated in epoxy resin. Package size is $0.4 \times 0.8 \times 0.25$ in.

CIRCLE NO. 336

datum inc



Number one

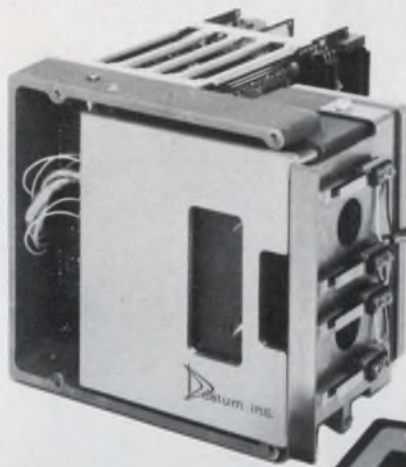

Model
4200
Cassette



in tape cassette performance!

- Reel-driven speed control
- Reference-edge tape guidance
- Two-Track Read-After-Write heads
- Recording speeds from 15 IPS to **75 IPS**
- NRZ or phase-encoded (up to 1600 BPI)
- Torque feedback tension servo
- Infrared EOT and BOT sensors
- 120 IPS rewind speed
- Bi-directional operation
- $\pm .001$ -inch tracking

Datum Model 4200 digital tape cassettes are particularly suitable as minicomputer peripherals or for use in key-to-cassette systems, instrumentation systems and data logging systems. Standard features include dual-gap read-after-write heads.

Offered with a wide range of accessories, including software. Can be packaged in multiples: typically, three drives with associated controller and computer interface.

Write for brochure
and prices.

Peripheral Dynamics Corporation

Datum inc

1363 S. State College Boulevard, Anaheim, California 92806 ■ 714/533-6333

INFORMATION RETRIEVAL NUMBER 67

Isotronics has ~~504~~ 512 varieties of flatpacks



We wanted to tell you exactly how many varieties of flat packages we have...but we found out the number keeps going up so rapidly that we can't keep the ad up to date. By the time you read this ad the "512" will already be too low.

We have a lot of flatpacks... sizes from $\frac{1}{4}$ " x $\frac{3}{8}$ " to 2" square in production tooling... smaller and larger in preproduction...number of leads from 2 to 160...leads on 1, 2, 3 or 4 sides... and sometimes on 2 levels... flat leads or round, insulated or grounded...any type of plating, including gold, electro tin, nickel, etc....and you can seal them by soldering or welding.

What it amounts to is this: When you need a flat package, call Isotronics.

the microcircuit
packaging specialists



Isotronics

Isotronics, Inc.
12 Coffin Ave.
New Bedford, Mass. 02746
(617) 997-4575 TWX 710 344 1961
Cable—ISOTRONICS

Gate turn-off SCRs handle up to 8.5 A

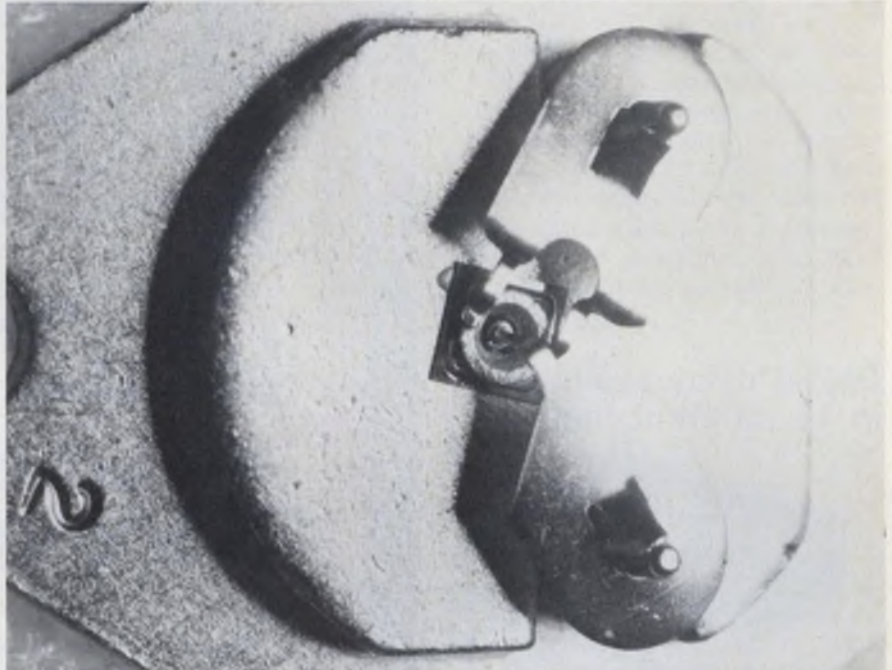

RCA Solid State Div., Route 202, Somerville, NJ 08876. (201) 722-3200. P&A: See text.

Can you get an SCR that doesn't need any extra turn-off circuitry? Until recently you couldn't. Now the TAG5000 series of gate turn-off (GTO) SCRs from RCA eliminates the extra circuitry. All that's required is a positive pulse on the gate for turn-on and a negative pulse for turn-off.

There are 12 SCRs in the TAG-5000 series, as shown in the table. All of them have a maximum forward dc current of 8.5 A and can operate at case temperatures of 75 C. Larger currents of up to 15 A can be controlled if the case temperature can be kept to 25 C.

For the device suffix classifications—A, B, D and M—the repetitive peak off-state voltages are 100, 200, 400 and 600 V, respectively. As a tradeoff for the high blocking voltages, you pay the price of low, repetitive-peak-reverse voltages of 70, 50 or 30 V for the 5001, 5002 and 5003 SCRs, respectively.

To turn on these SCRs, you need a positive-going, 0.7-to-1-A current pulse applied to the gate for about 3 μ s or longer. The forward gate curve looks like that of a forward conduction diode with a voltage drop of about 1 V.

The GTO can be turned off by a negative-going voltage pulse applied to the gate. No reduction of the anode current is necessary to produce turn-off. The TAG5001 offers the fastest switching speed but requires a negative pulse of -70 V. Similarly, the 5002 and 5003 require -50 and -30 V, respectively, for turn-off.

The gate controlled turn-on time

100-to-999 prices for the GTO series SCRs

Type Number	Suffix			
	A	B	D	M
TAG5001	\$4.80	\$5.76	\$6.90	\$8.34
TAG5002	\$4.20	\$5.05	\$6.12	\$7.44
TAG5003	\$3.00	\$3.60	\$4.50	\$6.54

ranges from 2 μ s for the 5001 to 3 μ s for the 5003. Turn-off times, though, range from a low of 2 μ s for the 5001 to a high of 20 μ s for the 5003. Test conditions for these results are as follows: for turn-on time measurements, $V_D = 100$ V, $I_T = 5$ A, $I_k = 1$ A and $T_C = 25$ C; for turn-off time, $V_D = 100$ V for all A types and 200 V for all others, $I_T = 5$ A, $Z_{GS} = 1$ Ω , and $T_C = 125$ C.

All of the devices are available in sample quantities from stock with TO-3 metal packages. Large production quantities will be available in late 1975. The prices for the 12 models are shown in the table for 100-to-999 quantities.

CIRCLE NO. 304

LED numeric assemblies have driver options



Dialight, 203 Harrison Pl., Brooklyn, NY 11237. (212) 497-7600. \$37.85/3 digits (100-up); 4 to 6 wk.

The 749 series numeric LED readout assembly is available with or without decoder/drivers in a black bezel, for simplified panel mounting or multidigit groupings. The display has a character height of 0.27 in. When supplied with decoder/drivers, or latch and counter options, all components are mounted on a printed-circuit board, with terminations for automatic blanking of leading and/or trailing edge zeros, and intensity control. The user has the option of hard wiring to the board or using edge card connectors. All digits include a left-hand decimal point. A polarity overflow module is also available. The decoder/drivers, one for each character, require an 8421 BCD code. The unit also contains a lamp-test input that overrides all other inputs and can check for a possible display malfunction.

CIRCLE NO. 337

New low cost power converters

for portable instrumentation

(total output up to 15 watts)

Powercube[®] has now added high-reliability, low-cost DC to DC Converters to our menu of off-the-shelf Cirkitblock[®] modules.

Like all Powercube products, our new DC-DC Converters offer great flexibility in custom power module configurations with total output power up to 15 watts. You can specify up to four isolated, regulated, short circuit and overvoltage protected outputs and a DC-AC inverter input, all in one encapsulated 2" x 2" x 1" package weighing six ounces at most!

These Cirkitblock modules are ideal for powering railroad signaling equipment, automotive testing systems, computer-controlled heavy equipment, aircraft on-board electronic systems, oil and land surveying equipment, and other portable instrumentation. Ruggedly constructed, the modules assure unmatched reliability in hostile environments from -20 to +85°C.

Powercube can dish up a wide range of Cirkitblock pre-regulators, power generators, and output modules which offer the highest ratio of power/control density to unit cost of any micro-miniature power device. Outputs to meet your requirements available for all standard battery input voltages, all for less than it would cost you to make them yourselves. Request your free power module application handbook today.

Prices range from \$75-\$150 in small quantities.

Typical Powercube DC to DC Converter

±15 V at ¼ amp*
+5 V at 1 amp
200 V at 10-15 mA
11-14 V input*
*Other input/output voltages available



POWERCUBE CORPORATION
214 CALVARY STREET, WALTHAM, MASS. 02154 (617) 891-1830
SUBSIDIARY OF UNITRODE CORPORATION

INFORMATION RETRIEVAL NUMBER 69



When it comes to telephone coupling transformers TRIAD is plugging away!

Triad has plug-in transformers specifically designed and built to interconnect remote data entry and display terminals to computers over voice-grade telephone lines. They are used for impedance matching, isolation, line balance, bridging, hybrid and holding coil applications. All of them meet telephone company requirements for voice/data use on leased private lines or through the dial-up switched telephone network.

If you're wrestling with a design problem in the interconnecting of data modem terminals, write for more data.

Triad also makes many standard plug-in power transformers for transistorized control and instrumentation with 115-volt and 115/230-volt primaries. They provide a voltage step-down and isolation from power line at relatively low power levels at 4 to 38 volts when connected in parallel, and 8 to 76 volts when series-connected. Plug-in printed circuit audio transformers with 100 MW output and various primary and secondary impedances are also in stock. See your Triad industrial electronic distributor today for a catalog—or write Triad Distributor Services, 305 N. Briant Street, Huntington, Indiana 46750.



TRIAD-UTRAD
Litton Distributor Services

INFORMATION RETRIEVAL NUMBER 70

DISCRETE SEMICONDUCTORS

Bridge rectifiers made to handle 0.75 A

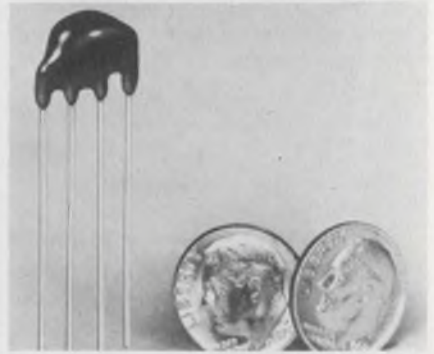

General Instrument, 600 W. John St., Hicksville, NY 11802. (800) 645-1247. 75 KBD02: \$0.20 (25,000-up); 3 to 4 wk.

The 75 KBD series single-phase bridge rectifiers are miniature 0.75-A silicon units rated from 50 to 1000 V PRV. All units in the series have a peak surge overload rating of 30 A and an operating temperature range of -55 to $+125$ C. The miniature bridge rectifiers have a colored dot to identify the positive output lead for double-checking of unit orientation in production-line assembly operations.

CIRCLE NO. 338

Transient suppressors dissipate up to 1500 W

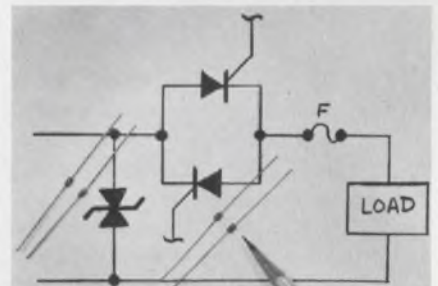

Microsemiconductor Corp., 2830 S. Fairview St., Santa Ana, CA 92704. (714) 979-8220. From \$3.55 (100-up); stock to 30 day.

A line of silicon transient suppressors provides either symmetrical or unidirectional circuit protection from voltage transients. The devices dissipate peak-pulse power surges of 500 W (1 ms) in DO-35 packages or 150 W (1 ms) in DO-41 packages. Breakdown voltages range from 6 to 200 V $\pm 10\%$. Dynamic impedance spans 1.5 to 175 Ω , depending on breakdown voltage.

CIRCLE NO. 339

High-voltage rectifier stacks custom designed

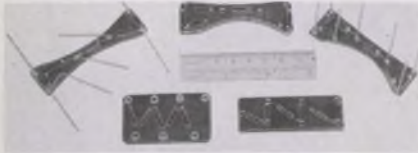

Electronic Devices, 21 Gray Oaks Ave., Yonkers, NY 10710. (914) 965-4400. \$375 for 1000 pcs; 4 to 6 wk.

Custom tailored diode matrices facilitate the assembly of high voltage multipliers for color television and similar applications. These assemblies consist of five or six high voltage diodes cast in an epoxy with through-hole or wire lead terminations at each interconnection. Capacitors, resistors, terminals and lead wire can be easily attached.

CIRCLE NO. 340

Disc power diodes handle currents to 850 A

AEG Telefunken, D 6000 Frankfurt 70, AEG Hochhaus, West Germany.

Disc power diodes, types D280 and D480, have effective forward current ratings of 620 and 850 A, respectively. Model D280 has a maximum cyclic PIV of 1800 V and the D480 has a max of 2800 V. Pulse currents of 5300 and 7300 A can be withstood by the D280 or D480, respectively.

CIRCLE NO. 341

Optical isolator handles voltages up to 10 kV

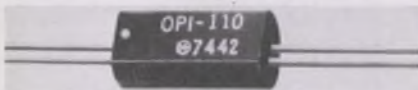

Optron, 1201 Tappan Circle, Carrollton, TX 75006. (214) 242-6571. \$2.90 (1000-up); stock.

The OPI 110 high voltage optoisolator consists of an npn phototransistor coupled with a GaAs infrared emitter mounted in a plastic package. The isolator has an input-to-output isolation voltage of 10 kV, a typical current transfer ratio of 40% and an input current of 10 mA. Typical switching time of the OPI 110 is 4 μ s. The OPI 110 is housed in a cylindrical package that has a 0.3 in. diameter and is 0.5 in. long.

CIRCLE NO. 342

Choose your bandwidth.... TAKE YOUR CHOICE!

120 MHz/5 mV

- Dual trace/Delaying sweep
- Lightweight: 19.5 lbs
- Bright 20 KV 8 x 10 cm display
- Low 45 Watt power consumption
- X - Y capability
- Easy to use delayed sweep

PM3260E \$ 1850.00



50 MHz/ 5 mV

- Dual trace/Delaying sweep
- Lightweight: 18.5 lbs.
- Bright 10 KV 8 x 10 cm display
- Low 23 Watt power consumption
- X - Y capability
- Easy to use delayed sweep

PM3240 \$ 1470.00



10 MHz/2 mV

- Dual beam to avoid chop/alternate problems
- Brilliant 10 KV 8 x 10 cm display
- Lightweight: 21 lbs.
- TV sync
- X - Y capability

PM3232 \$ 875.00

PM3233 \$ 925.00



FREE DIGITAL INSTRUMENT COURSE

In-depth information on digital circuits and the mathematical theory behind them. Number theory, Boolean algebra. The course progresses through digital block, data communication and control. This digital instrument course is yours **FREE**, if you allow one of our Sales Engineers to demonstrate Philips equipment to you. Ask our Field Engineer about your complimentary gift during your demonstration.

For further information, contact:

Philips Test & Measuring Instruments, Inc.
A NORTH AMERICAN PHILIPS COMPANY

400 Crossways Park Drive Woodbury, New York 11797
Telephone: (516) 921-8880 Twx: 510 221 2120

SPECIAL APPLICATIONS INFORMATION 'HOT LINE'
DIAL TOLL FREE NUMBER (800) 645-3043 NEW YORK STATE, CALL COLLECT (516) 921-8880



PHILIPS

DO YOU HAVE AN electronic display light measurement problem?



A work horse when it comes to measuring the output characteristics of electronic displays; that's the Gamma Scientific Model 2900MR Scanning Microphotometer System.

Its versatility gives it the capability of measuring any type of display; CRT, LED, liquid crystal, gaseous discharge, large screen projection, photochromic, hard copy.

Specific measurements include: contrast, resolution, line width, spot size, persistence, phosphor noise, flare, halation, modulation transfer, radiance, illuminance, candlepower, spectral radiance, specular or diffuse reflectance, chromaticity, correlated color temperature, luminance profiling, integrated luminance, screen brightness, ambient light level, effects of polarizers, filters, etc.

Dynamic or static measurement. Two-slit technique, single-slit, square or circular apertures.

You can tailor the system to your needs simply by selecting the optimum lens-aperture combination.

Spatial or spectral scan capabilities added with either scanning eyepiece or monochromator, both motor driven. Dual channel digital interfacing with computers.

Give us your problem. We're sure we can help.

Call collect.



**GAMMA
SCIENTIFIC
INCORPORATED**

3777 Ruffin Road, San Diego, Calif. 92123
(714) 279-8034 Cable: GAMSIG SDG TELEX: 69 7938

PACKAGING & MATERIALS

Connector terminates cable ends en masse

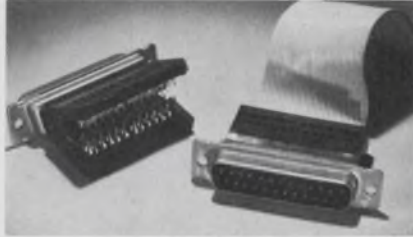

AMP Inc., Harrisburg, PA 17105.
(717) 564-0101. See text.

A fast, economical means of mass-terminating flat, round-conductor cable to pin and socket contacts is now available in the HD-F series of Amplimite connectors on a sample basis from AMP. Production is scheduled for early 1975. This series mates with AMP's standard HD-M and HD-P high density subminiature rectangular connectors. The insulation-piercing contacts are pre-loaded in the housing and use a special two-fork crimp design that penetrates the cable from opposite sides, interlocks and traps the conductor. The connector accommodates cable with solid or stranded conductors on 0.050-in. centers without any cable preparation other than cutting the end square. A 25-position version is now available with a 37 position to follow. Housings are thermoplastic and have integral cable guides and strain relief. Only a simple arbor press is needed to close the housing and terminate all contacts simultaneously. The current rating is 1 A and dielectric strength is 500 V. Contact life is 500 cycles.

CIRCLE NO. 343

Tool nimbly handles wafers and chips

Unitool Corp., 3740 Skypark Dr.,
Torrance, CA 90505. (213) 378-
2323.

Chips can be picked up and aligned with Unitool's vacuum-type Roto-Pic. Wafers can be lifted from trays and boats for inspection. The tool reduces manual handling and provides positive hold and release characteristics. The unit operates on standard shop air. Easily replaced tips come in various sizes. A kit that includes a vacuum pump and hoses is available.

CIRCLE NO. 344

dependable power

custom designed



to suit your application

silvercel[®] by yardney

Silvercel rechargeable batteries pack the most useable power into the smallest and lightest weight modular package available today. In fact, this compact, rechargeable power source delivers 3 to 4 times the energy of common rechargeable batteries and does it with flat, non-tapering discharge voltage characteristics.

Silvercel batteries have been custom designed as essential components in aircraft, missiles, torpedoes, submersibles, medical equipment, communications equipment and many other applications where a portable power source is required.

When it comes to dependability and performance, Silvercel produces. And if, by chance, one of our standard sizes doesn't suit your application, we'll design a battery for you. Silvercel is really all you have to know in batteries.

Yardney
ELECTRIC CORPORATION

82 MECHANIC STREET,
PAWCATUCK, CONNECTICUT 02891

INFORMATION RETRIEVAL NUMBER 73
ELECTRONIC DESIGN 4, February 15, 1975

Wrought-gold contacts use little gold

Vector Electronics Co., Inc., 12460 Gladstone Ave., Sylmar, CA 91342. (213) 365-9661. R724: \$1.50; R724-2: \$0.88; (100-500) stock.

Vector's R724 and R724-2, 24-pin LSI sockets provide the low-contact resistance of gold-plating with a price approaching conventional nickel-plated units. The sockets use wrought-gold strips that are metallurgically bonded to copper-nickel alloy contacts. Since the gold strips are placed only where device leads contact the terminal, the amount of gold required is reduced. The smooth surface of the 50-microinch wrought inlay provides lower contact resistance than the porous surface of a conventional gold plate. The R724 sockets are standard 0.280-in. height units with 0.690-in. leads for wrapped-wire termination. The R724-2 is a low profile, 0.150-in. socket with 0.150-in. leads for solder interconnections.

CIRCLE NO. 345

Ceramic substrates in 3-week delivery



Comco Inc., 9421 Telfair Ave., Sun Valley, CA 91352. (213) 768-5450. See text.

Comco offers 3-wk deliveries for both black and white custom ceramic substrates. There is no tooling charge for square or rectangular substrates and extremely low tooling costs for other designs, according to Comco. Product capabilities include 96% alumina and microsurface 99.5%, Al_2O_3 substrates. The microsurface substrates provide surface finishes of 4 micro-in., or better, as fired. All types are available in an almost infinite variety of custom sizes, shapes and hole patterns. Scored True-Snap substrates provide exceptionally clean breaks regardless of the number of firing cycles.

CIRCLE NO. 346

How high is the REL in a high REL Hybrid?

Ask Raytheon/Quincy

We'll give you the answer. Easily. Because high-reliability hybrids are the only hybrids we make. And 98% of them go into military and medical electronics applications. So our hybrids have to be high in technology and performance as well as reliability. That's why we call them "highbrids."

Beam lead or chip-and-wire configurations, all our hybrids are custom engineered to meet the most rugged reliability specs imaginable. Maybe that's why our customers are so high on our hybrids. If you want to know how high our reliability really is, ask a reliable source. Contact Mr. K. Singh at Raytheon Company, Industrial Components Operation, 465 Centre Street, Quincy, Mass. 02169. (617) 479-5300.



Label printer makes king-sized labels



Diamond Engineering Corp., 3655 150th N.E., Redmond, WA 98052. (206) 883-1071.

An automatic label printer produces king-sized labels with variable-sized letters and numerals. The labels are fed from a perforated, continuous roll. Label width can be 4-3/8 to 14-7/8 in. A variety of adhesives, including self-adhesive stock, can be employed in the printer. The printer can produce four-lines of characters in about 15 s. Input methods can vary from a simple typewriter keyboard to on-line computer inputs.

CIRCLE NO. 347

Grounding clip cuts through wire insulation

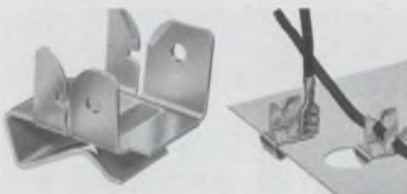

Fastex, Div. of Illinois Tool Works Inc., 195 Algonquin Rd., Des Plaines, IL 60016. (312) 292-2222.

The Blade grounding clip cuts grounding wire insulation and costs. The clip eliminates the need to measure wires, cut them to length, strip insulation and attach terminals. The clip slips easily over a panel edge or the edge of any hole having a 1/2-in. minimum diameter. There are two sizes available: one accommodates a panel thickness range from 0.020 to 0.078 in. and the other from 0.078 to 0.125 in. The Blade clip accepts wires from 18 through 12 gauge. It can also serve as a male contact for either 3/16 or 1/4-in. female quick-connect wire terminals.

CIRCLE NO. 348

Nylon cover protects TO-3 devices



Thermalloy Inc., 2021 W. Valley View Ln., P.O. Box 34829, Dallas, TX 75234. (214) 243-4321. \$0.12 (100 up); stock.

A molded cover for TO-3 devices in black or white nylon eliminates the possibility of short circuits to an exposed TO-3 case. The cover provides for electrical connection of the collector case to the mounting screws with two No. 6 lock washers and at the same time protects against contact with the screws themselves. Breakaway insulating covers for the screws are shipped attached to the cover, so that they are readily available on the production line. A hole in the center of the cover allows access for a test probe.

CIRCLE NO. 349

RELIABLE HIGH-VOLTAGE INTERCONNECTIONS FROM **ROWE INDUSTRIES**

**WORLD'S LEADER IN
HIGH-VOLTAGE, CORONA-
FREE CONNECTORS**

We design, develop and manufacture the hard ones. Over 600 Rowe designs are tooled. PHONE US TODAY.

**ROWE SUBMINIATURE
COAXIAL CONNECTORS
& CABLE ASSEMBLIES**

Ideally suited for use where space is at a premium.

APPLICATIONS:

- Airborne
- X-Ray
- Radar
- Displays
- Laser
- Power Supplies
- ECM

15 KVDC. Silicone rubber insulation. Temp. -55°C to 200°C.

CALL OR WRITE ROWE INDUSTRIES TODAY
(419) 729-9761 • 6233 BENDORE ROAD • TOLEDO, OHIO 43612

FOR THE UTMOST IN RELIABILITY



INTERVAL TIMERS Series PAB.

This is an automatic reset interval timer with an extremely accurate timing mechanism built to stand up under hard usage in modern manufacturing processes. Due to the simplicity and reliability of its special clutch we can offer it in a range of time intervals from 1 second (1/60" dial divisions) to 3 hours (3' dial divisions), twelve in all. It is also available in a panel mount model PAF.

All of our timers are made to give you service far beyond what you'd reasonably expect. Our line consists of 17 basic types, each avail-

able in various mountings, voltages, cycles, circuits and load ratings... and with whatever special wrinkles you may need.

Bulletin #403 tells all about our line of reliable Interval Timers. Write for it or a catalogue of the entire line. If you have an immediate timer requirement, send us your specifications. Or for fastest service, give us a ring at (201) 887-2200.



Industrial Timer Corporation, U.S. Highway 287, Parsippany, N.J. 07054

Two new adjustable 4-terminal voltage regulators.

Fairchild's unique new *adjustable* 0.5 A voltage regulators are available either way you want them:

Positive (78MG Series).
Or, *negative* (79MG Series).

They both come in our unique power mini-DIP with integral heat sinks.

And talk about versatile. These adjustable devices are ideal for applications requiring:

1. Continuously adjustable output.
2. Constant output with 4% (worst case) tolerances.

3. Output levels unavailable from standard fixed devices.

Of course, adjustable or fixed, no one gives you a selection of voltage regulators like Fairchild with our broad line of 100mA-to-5A positive 7800 Series fixed devices.

Plus, our new negative 7900 Series for complementary applications.

Five extra reasons Fairchild 7800/7900 Series Voltage Regulators can be a lot easier to use.

No matter which Fairchild device you choose, remember:

1. They're *all* there. Variable or fixed — one resource for every application.
2. They're *complete*. Self-contained. One chip in one package. So you can use them where you want them — with no expensive design time.
3. They're *reliable*. Featuring thermal shutdown, short circuit protection, safe area compensation and automatic recovery when the fault condition's relieved.
4. They're *inexpensive*. Because low-labor,

single-unit installation simply costs a lot less.

5. And of course, they're *in stock* now.

For samples and data sheets complete with application information, call your Fairchild Distributor or Sales Office today.

Semiconductor Components Group,
Fairchild Camera & Instrument Corp.,
464 Ellis St., Mountain View, CA 94040.
Tel. (415) 962-5011. TWX: 910-379-6435.

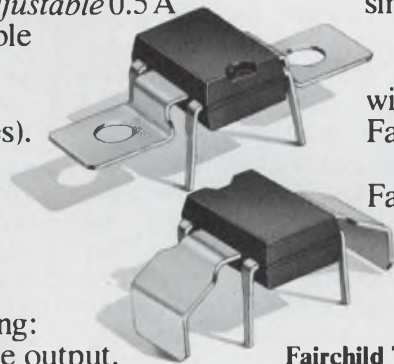

Fairchild 7800/7900 Series Voltage Regulators

OUTPUT VOLTAGE	FIXED				ADJUSTABLE	
	5A TO-3 & TO-220	1A TO-39 & TO-220	500 mA TO-39 & TO-220	100 mA TO-92 & TO-39		
P O S I T I V E	2.5			78L02	NEW 78MG POS 500 mA	
	5	78H05	7805	78M05		
	6		7806	78M06		78L06 (6.2V)
	8		7808	78M08		78L08
	12		7812	78M12		78L12
	15		7815	78M15		78L15
	18		7818			
	20			78M20		
N E G A T I V E	24		7824	78M24	NEW 79MG NEG 500 mA	
	5			79M05		
	6			79M06		
	8			79M08		
	12			79M12		
	15			79M15		
	18					
	20			79M20		
24			79M24			

Note: μ A723 is also available in positive or negative.

**MADE IN
FAIRCHILD**

THE WIDEST SELECTION OF MIL-QUALIFIED POWER SUPPLIES

Specified into the most sophisticated systems requiring extreme environmental applications

- Shipboard
- Airborne
- Ground Support
- Communications

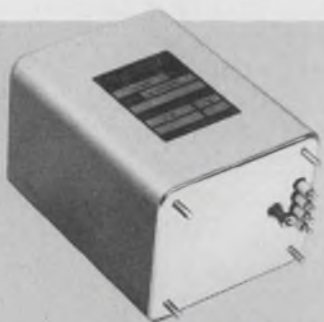

QUALIFIED FOR EXTREME MIL ENVIRONMENTS

TECHNIPOWER PM-95 and F/FD-115
AC-DC SERIES

3 to 325 VDC, up to 800W
Base temperatures to 115°C

Qualified for:

MIL-STD-810	MIL-STD-202
MIL-E-5400	MIL-E-4970
MIL-E-16400	MIL-E-5272
MIL-S-901	MIL-STD-461/462

Backed By 5-Year Warranty

SEND FOR FREE 66-PAGE
DESIGN/DATA CATALOG

TECHNIPOWER, INC. 
A BENRUS SUBSIDIARY

Benrus Center
Ridgefield, CT 06877
(203) 431-1300

COMPONENTS

Pushbuttons provide split-legend displays



Illuminated Products Inc., 207 S. Helena St., P.O. Box 4011, Anaheim, CA 92803. (714) 535-6037.

A line of five standard illuminated pushbutton switches, the Presslite 700 and 800 Series, offers panel designers a choice between a split-legend design with two lamps and a single-legend model that accommodates one or two lamps. A variety of colors is available for different ambient-light environments. The lamps are T-1-3/4 midget-flange types. They are replaceable from the front of the panel. Momentary and alternate-action switches are available. Contact rating is 10.5 A at 125/250 V ac or 28 V dc.

CIRCLE NO. 350

Alarm unit yelps 85-dB sound at 10 ft



Kolin Industries Inc., Box 357, Bronxville, NY 10708. (914) 561-5056.

The Kolin Mini Earsplitter, Model ES-250, emits a yelping sound, similar to emergency vehicles, which demand attention instantly. The unit is weatherproof for outdoor use. It is completely transistorized and has no moving parts to wear out. The ES-250 works on from 6 to 12 V dc and draws 100 mA at 6 V and 175 mA at 12 V.

CIRCLE NO. 351

Optically coupled relays made for PC mounting

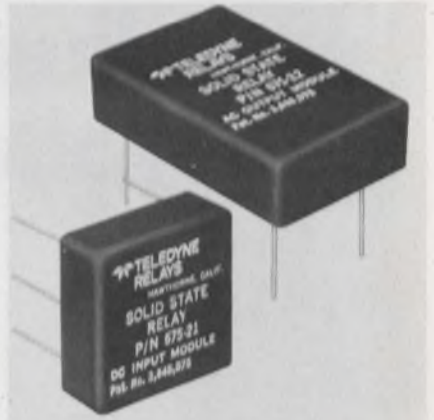

Teledyne Relays, 3155 W. El Segundo Blvd., Hawthorne, CA 90250. (213) 973-4545. From \$9.90 (1000-up); stock to 6 wk.

The series 675 optically isolated relays are designed for direct PC board mounting. There are five models in the series and all offer 1500 V rms isolation and different input/output capabilities. The 675-1 accepts ac inputs from 95 to 130 V and can control logic-level voltages (5 V dc). The 675-4 and 675-5 relays control ac load voltages of 20 to 250 V under input control signals of 4 to 10 or 10 to 32 V dc, respectively. Model 765-21 accepts 10 to 55 V dc control signals and controls logic voltage levels (5 V). And, the 675-22 operates under control signals of 4 to 10 V dc and can control heavy duty loads of 4 to 55 V dc. The three dc output models 675-1, -21 and -22 handle currents of 16 mA, 16 mA and 3 A, respectively. The two ac output units can handle 3 A rms. All units are housed in 0.5 in. high epoxy cases. The other case measurements are 1.25 x 1.25 in. for all units except the 675-22 which measures 1.25 x 2 in.

CIRCLE NO. 352

Snap-action switch sealed against moisture

Cherry Electrical Products Corp., P.O. Box 718, Waukegan, IL 60085. (312) 689-7702. \$1.36 (2000 up).

A new sealed snap-action switch, the E72-40A, is immune to moisture or even immersion in water. The switch is UL listed and CSA approved for ac use. It is rated at 10 A, 1/4 hp at 115/250 V ac. Operating force is 230-g maximum.

CIRCLE NO. 353

Full Circle Surge Protection

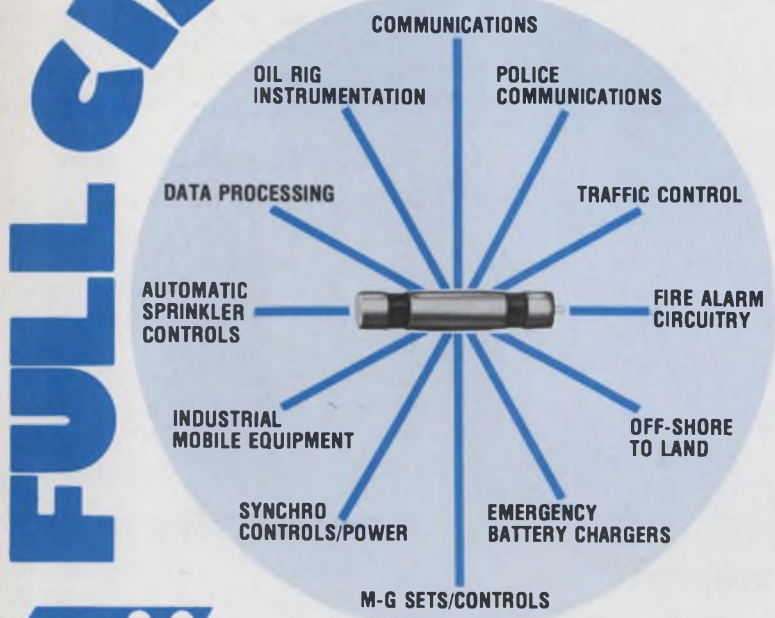

Protect your solid state equipment from junction damage caused by high-current surges due to power switching and lightning transient induction. Ordinary protective devices ground only one wire, allowing currents to reach your equipment through the "other" wire. TII 3-Electrode Gas Tube Surge Arresters simultaneously ground both wires of a signal or power pair. TII protection can end unnecessary service calls and customer complaints. To learn more about surge and how to



protect against it, write for your free copy of "Surge Protection for Solid State Circuitry" or circle the appropriate reader reply number.

Worldwide Patents
U.S. Pat. 3,810,000; 3,810,001; 3,810,002;
3,810,003; 3,810,004; 3,810,005;
3,810,006; 3,810,007; 3,810,008;
3,810,009; 3,810,010; 3,810,011;
U.S. Patent and
TII Accepted
Masters Available

Licensed by M-O Valve Co., Ltd.,
and by Western Electric Co.
Made in U.S.A.



TELECOMMUNICATIONS INDUSTRIES, INC.
More than 2,000,000 TII Gas Tube Surge Arresters in Service.

1375 Akron Street
Copiague, New York 11726
(516) 842-5000 • Telex: 144631

INFORMATION RETRIEVAL NUMBER 78



FREE Fiber Optics Catalog

Features the complete AO line of fiber optics products—from Inspection Fiberscopes and Light Guides to Illuminators, Image Conduits, Faceplates and Custom Components. Includes the four newest remote inspection fiberscopes now available.

Describes the principle, technology and techniques used to make flexible light and image transmissions a proven, practical fact. Write today for your FREE copy of the AO Fiber Optics catalog to American Optical Corporation, Fiber Optics Division, Southbridge, Mass. 01550.



INFORMATION RETRIEVAL NUMBER 79

ELECTRONIC DESIGN 4, February 15, 1975

Whatever brand of switchlight you've been using . . .

We call and raise!

Our bet is that you will decide on our "Persuader Line" once you compare what we have to offer with that of any other leading manufacturer. See page 109 for our 21-point check list, then call your local distributor or Clare-Pendar, Box 785, Post Falls, Idaho 83854 (208) 773-4541.

CLARE-PENDAR

INFORMATION RETRIEVAL NUMBER 80

127

YOUR NEW STALWART RUBBER MATERIALS GUIDE IS READY.

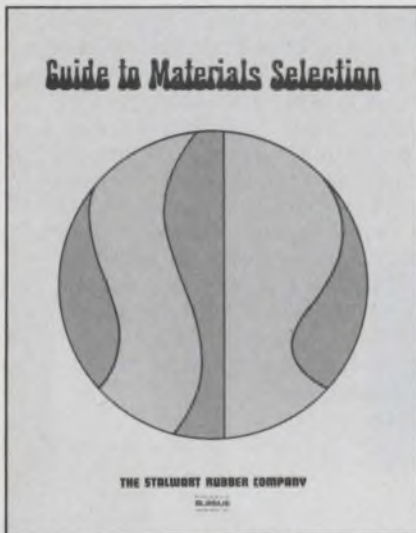

Your complimentary copy of our 14-page Stalwart Rubber "Guide To Materials Selection" is hot off the presses and waiting for you.

The Guide lists today's 18 most commonly used elastomers with hundreds of characteristics suitable for thousands of industrial uses. It's full of ideas to fit your designs and save you money.

Every day over 20,000 copies of past editions make buying rubber parts easier for designers and engineers all over the country. Our latest edition makes it easier still.

So clip and send the coupon today. It's free.



THE STALWART RUBBER COMPANY
160 Northfield Road Bedford, Ohio 44146

Subsidiary of
BLASIUS
INDUSTRIES, INC.

Send a free copy of your newest
"Guide To Materials Selection" to:

Name _____
Title _____
Company _____
Address _____
City _____ State _____
Zip _____

INFORMATION RETRIEVAL NUMBER 81

application notes



Crystal oscillators

"How to Specify Crystal Oscillators" covers clock oscillators, TCXOs and oven-controlled oscillators. A comparison of these types and a discussion specifically for timing applications are included. Vectron Laboratories, Norwalk, CT

CIRCLE NO. 354

Etching substrates

Procedures for etching thin-film coated substrates are outlined in a four-page application note. These procedures apply to three-film ni-chrome-nickel-gold and two-film nichrome-gold substrates. Analog Devices, Norwood, MA

CIRCLE NO. 355

Gunn-effect devices

Theory and practical circuit design of Gunn-effect devices can be found in a 28-page booklet. Ampere Electronic, Hicksville, NY

CIRCLE NO. 356

Thermistor curve manual

A 20-page Thermistor Curve Manual presents a complete story on the use of thermistors in the self-heat mode and is complemented with detailed graphs, charts, working tables and practical problems with solutions and/or answers. Fenwal Electronics, Framingham, MA

CIRCLE NO. 357

Power supplies

Application data for single-output power supplies include schematics, parts list and outline and mounting drawings. A troubleshooting guide is included along with rating tables, series/parallel operation and resistor values. Power-One, Camarillo, CA

CIRCLE NO. 358

Phase and gain matching

Specifying phase and gain matched microwave and i-f components is covered in a two-page bulletin. A composite block diagram illustrates a two-channel monopulse receiver, using phase and gain matched mixer preamps and i-f limiters. RHG Electronics Laboratory, Deer Park, NY

CIRCLE NO. 359

High-voltage power supplies

"Standard Test Procedures for High-Voltage Power Supplies" describes loading methods for both constant and changing load; test setups and procedures for voltage calibration; and test setups and methods for both static and dynamic output voltage regulation. It also contains instructions for checking output current regulation, ripple, tempo and stability. Spellman High Voltage Electronics, Bronx, NY

CIRCLE NO. 360

Linear power amplifiers

"Add Power to Your Network Analyzer" demonstrates how linear power amplifiers permit network analyzers to measure complex impedance of high power components over the 100-MHz-to-12-GHz frequency range. Microwave Power Devices, Plainview, NY

CIRCLE NO. 361

Extend sig gen freq range

With a do-it-yourself circuit, described in an application note, the Model 8640A and 8640B signal generators' frequency range may be extended downward to dc. The instruments' standard range is 450 kHz to 1100 MHz. The note shows how to build a simple external heterodyne circuit with common stock parts to do the job. Hewlett-Packard, Palo Alto, CA

CIRCLE NO. 362

**SOUTH BAY CABLE
SOLVES
TOUGH
CABLE
PROBLEMS!**



For computer applications, business machines... or a custom design to fit your particular requirement. Write for catalog or send details of your needs.

Manufacturers of cable for electronic use both military and commercial.



Idyllwild, California 92349 • Tel. (714) 659-2183

INFORMATION RETRIEVAL NUMBER 82

**The New Brush 2400:
the best performing, most versatile
wide channel recorder you can buy.**

It is available in 2, 3 and 4 channel configurations utilizing combinations of 50 mm and 100 mm channels totalling 200 mm. It had a 99.65% linearity over the full 100 mm channel. Its frequency response is an outstanding 30 Hz at 100 mm, 50 Hz at 50 mm and up to 125 Hz less than 3dB down. It has a full range of plug-in signal conditioners for just about any industrial-scientific-medical application.

For full details on why the new Gould 2400 is the best performing direct writing recorder you can buy, write Gould Inc., Instrument Systems Division, 3631 Perkins Avenue, Cleveland, Ohio 44114. Or Kouterveldstraat 13, B 1920 Diegem, Belgium.



 **GOULD**

INFORMATION RETRIEVAL NUMBER 83

ELECTRONIC DESIGN 4, February 15, 1975

**You buy
more
when you buy
Data Precision**

Today, more than ever before, Data Precision instruments are the smartest buy in the industry. Model for model they offer performance, flexibility and reliability at appreciably less cost than comparable competitive instruments.



Model 245 \$295

Model 245 is the only truly portable 4-1/2 digit full function multimeter available. With a basic accuracy of $\pm 0.05\%$ its performance far exceeds other alternative portables. Compare its cost and 4-1/2 digit performance with any 3-1/2 digit instrument.



Model 2440 \$675

By far the most accurate autoranging full function 4-1/2 digit multimeter available. It has DCV accuracy of $\pm 0.007\%$ rdg. ± 1 LSD/6 months, autoranging and autozeroing, remote ranging and triggering and isolated BCD output, all included in one basic price.



Model 1450 \$325

Our newest 4-1/2 digit full function, 21 range multimeter features a basic accuracy of $\pm 0.02\%$ of rdg. $\pm 0.01\%$ f.s., big bright 1/2 inch planar display and 100% overranging.

Contact your Data Precision representative or Data Precision directly. You may be surprised just how much more instrument you can buy, when you buy Data Precision.

 **DATA PRECISION**
...years ahead

Data Precision Corporation, Audubon Road, Wakefield, MA 01880
Phone (617) 246-1600

INFORMATION RETRIEVAL NUMBER 84

~~443~~ 683!

LOW COST VIDEO ALTERNATIVES FOR INDUSTRY...

Plus Keyboards, Video Monitors, & Accessories

APPLICATIONS: Data Entry/Retrieval • Data Readout/Display • Industrial Monitoring/Control • TV/Video Tape Titling • TTY Replacement • Printer Add-On • Multi-Drop.

TYPES: • RO(Read Only) • KSR(Keyboard Send/Receive) • ASR(Automatic Send/Receive).

DISPLAYS: 7 Formats, 256 to 3200 Characters.

AVAILABLE FEATURES: Alphanumerics, Graphics, Video Overlay • Selectable Data Rates to 9600 Baud • RS232-C, Current Loop, TTL Interfaces • I/O Multiplexing • Upper/Lower Case & Special Character Sets • Switchable Characters • Blinking, Dual Intensity, Reverse Video • New Line, Hold at EOL, Auto LF on CR • Protected Format, Compressed Transmission, Error Detection.

DESIGN III Display Terminals



BAREBONES Display Terminal PC Module Sets



SERIES 200 Display Controllers

Styling to match every application, configuration, and budget requirement. Engineering assistance for the toughest application. And immediate availability.



... creating new ways to communicate

6107 JACKSON RD • ANN ARBOR, MI 48103 • TEL: 313-769-0926 • TWX: 810-223-6933

INFORMATION RETRIEVAL NUMBER 85

SWITCH DEPENDABILITY BEGINS ON THE INSIDE

LOOK INSIDE ONE OF OURS!

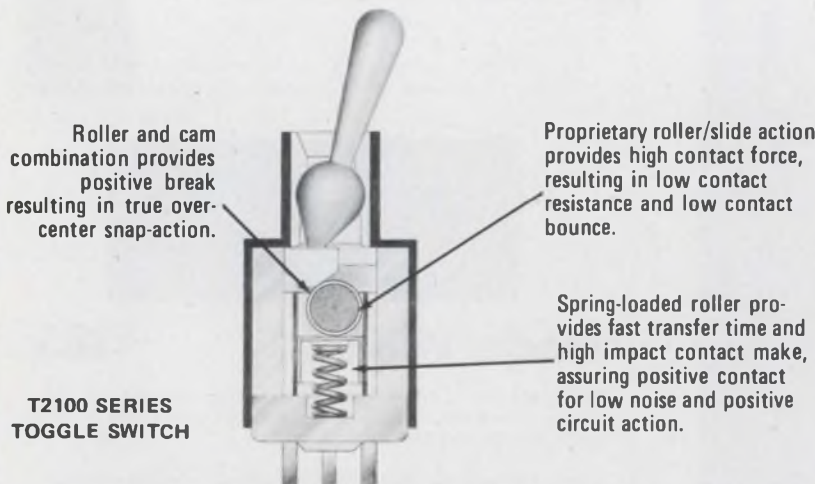

T2100 SERIES TOGGLE SWITCH

Control Switch's T2100 Series of miniature toggle switches features a unique roller/slide design resulting in a low noise switch with bounce less than 1 ms, less than 25 milliohm contact resistance... and they are available with load capability to 10 amps.

SEND FOR PORTFOLIO OF TECHNICAL BULLETINS.

CONTROL SWITCH

A CUTLER-HAMMER COMPANY

1420 DELMAR DRIVE, FOLCROFT, PA. 19032 215/586-7500



I-2

INFORMATION RETRIEVAL NUMBER 86

new literature



Vibration and Shock Measurement and Analysis

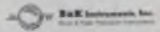

Vibration measurement

A 24-page brochure explains how to characterize and measure vibration using amplitude measurement, frequency analysis and motion analysis. Features and application suggestions are given for force and acceleration sensors, vibration preamplifiers, real-time frequency analyzers, portable analyzers and tape recorders. B&K Instruments, Cleveland, OH

CIRCLE NO. 363

Solid-state switch drivers

High-speed solid-state switch drivers are covered in a six-page bulletin. LRC, Hudson, NH

CIRCLE NO. 364

5-1/2-digit multimeter

An eight-page brochure describes the Model 3500 5-1/2-digit multimeter, which uses a Tri-Phasic a/d conversion technique, Isopolar reference system and Ratiohm resistance measuring. Data Precision, Wakefield, MA

CIRCLE NO. 365

Lab Coat Courier

The aim of this newspaper is to disseminate information in technical fields related to data handling, temperature control, dielectric analysis and laboratory presses. Tetrahedron Associates, San Diego, CA

CIRCLE NO. 366

Molded plastic parts

Power transistor mounts and covers, capacitor mounts, machine screw insulators, finishing washers and beaded ties are described in a catalog. The catalog includes part numbers, materials, dimensions and prices. Micro Plastics, Arlington Heights, IL

CIRCLE NO. 367

PC connectors

An 84-page printed board connector catalog covers printed circuit and tape cable applications. Complete electrical and mechanical specifications, illustrations, outline drawings and ordering information are included. Continental Connector, Woodside, NY

CIRCLE NO. 368

Pots and switches

A two-color, 12-page catalog pictures and describes the capabilities of 53 types of cermet, carbon and wirewound trimmers and pots, 36 choices of rotary selector switches and an additional 20 miniature selector switches. It also covers six or eight-lead single-in-line resistor networks, 14 or 16-lead DIP resistor networks and seven DIP programmable switches. CTS Corp., Elkhart, IN

CIRCLE NO. 369

Monolithic ICs

Monolithic integrated circuits for gas discharge displays and power interfaces in dual in-line packages are illustrated in a short-form catalog. The catalog lists 14 display/interface and transistor arrays for the digital decade. Sprague Electric, North Adams, MA

CIRCLE NO. 370

Optical encyclopedia

Volume I of the 1975 Optical Industry & Systems Directory contains over 900 categories of products and services, which are completely indexed. Volume II contains a series of short tutorial articles describing the principles and applications of optical/electro-optical/laser technology. The cost of both volumes is \$32. The Optical Publishing Co., Seven North St., Pittsfield, MA 01201

INQUIRE DIRECT

New, easy-action swivel cord.

Smooth, reliable 360° rotation.

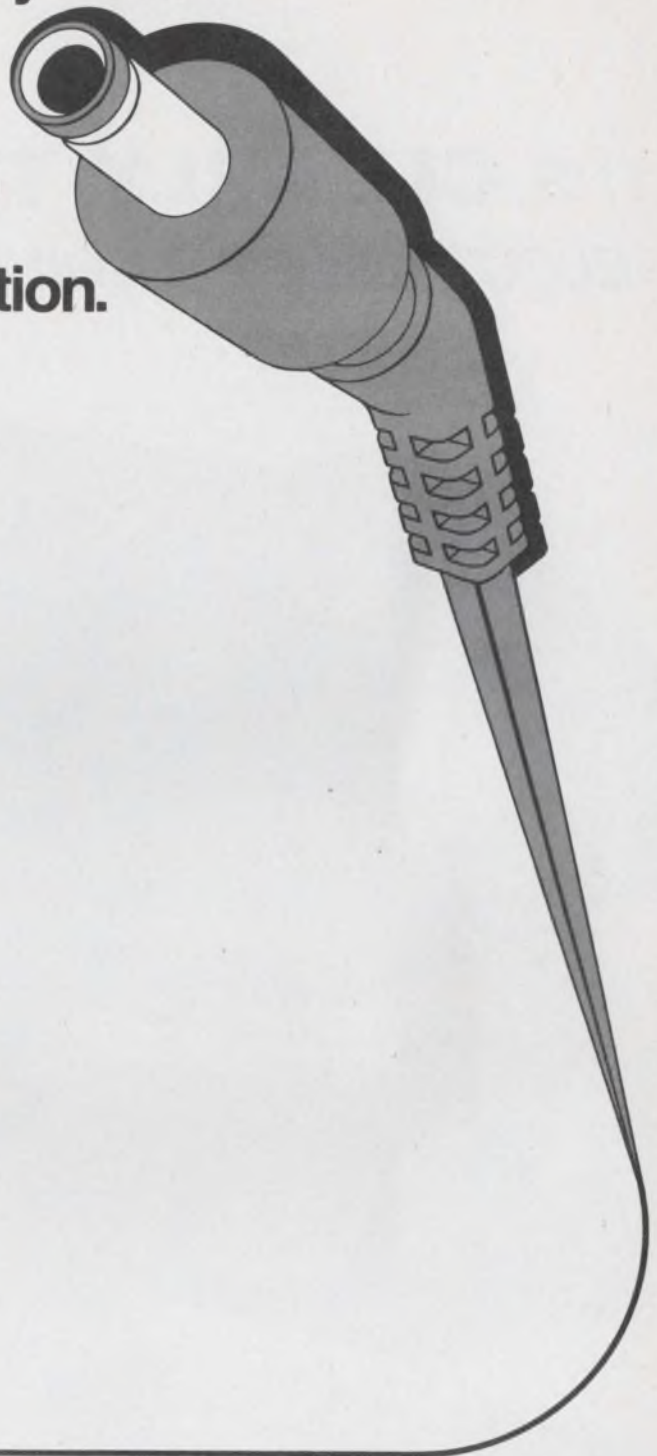

Victor offers you a high quality swivel cord with outstanding flexibility and ease of handling. Its advanced-design 360° rotation effectively eliminates kinking and snarling. Ideal for personal care equipment and similar small appliances. Standard cords available, but our engineers can provide you custom designs for your special application. Units are easy to assemble and

provide remarkably trouble-free performance.

Write or phone for details, and find out why Victor has become the standard of quality in cord sets and other wire specialty items.

Victor Electric Wire & Cable Corp.
618 Main St., West Warwick, R.I. 02893
Telephone: 401 821-1700

INFORMATION RETRIEVAL NUMBER 87

IT'S CLEARLY THE CHOICE OF ELECTRONICS ENGINEERS – WORLDWIDE

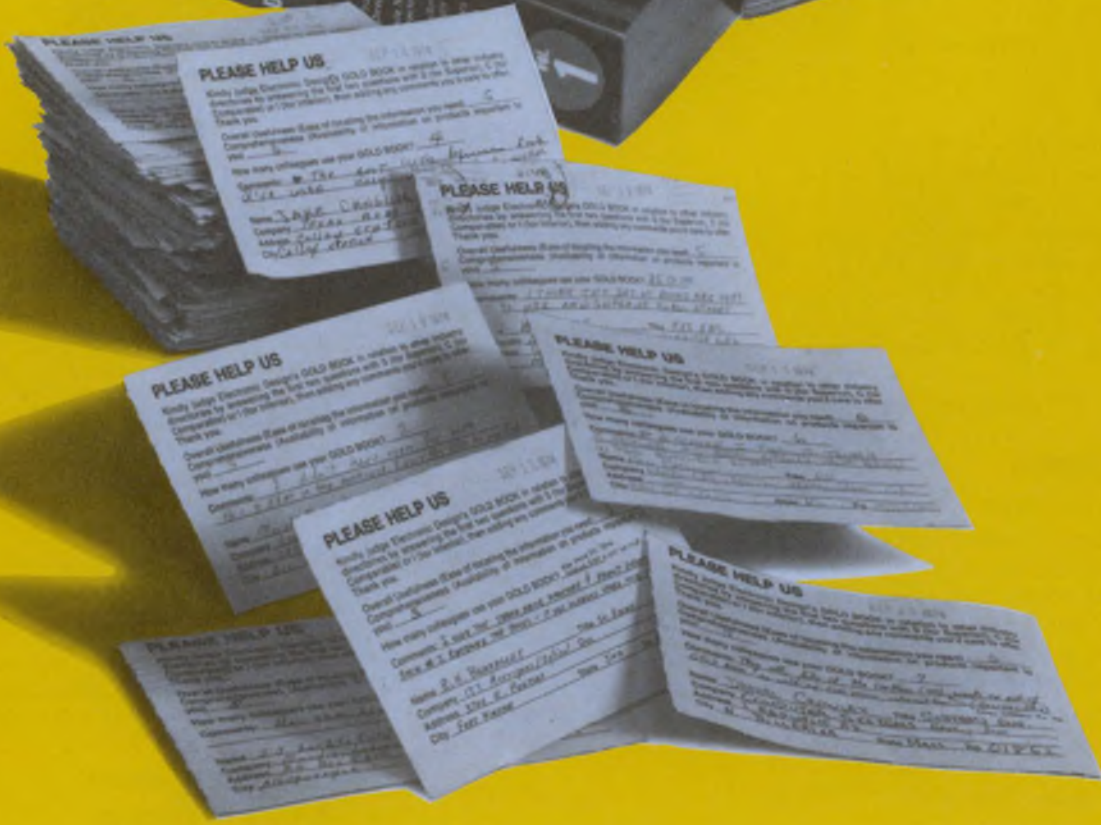

WHEN YOU HAVE Electronic Design's GOLD BOOK YOU DON'T NEED ANY OTHER INDUSTRY DIRECTORY

In just a few months, the first issue of *Electronic Design's* GOLD BOOK has become the leader among all directories used in this industry. Engineers have responded enthusiastically throughout the U.S. and from all over the world — especially in Europe where they've never seen anything like it before. The GOLD BOOK has become number one almost overnight.

HERE'S HOW YOUR FELLOW ENGINEERS RATE THE INDUSTRY ANNUALS

	Annals Consulted Within Past Month	Annals Preferred
Electronic Design's GOLD BOOK	85%	60%
Electronic Engineer Master (EEM)	63%	42%
Electronic Buyer's Guide (EBG)	32%	8%
Thomas Register	16%	7%
Conover-Mast Purchasing Directory	2%	1%

SOURCE: Study by Dr. Eugene D. Jaffe, Associate Professor of Marketing, St. John's University, Nov. 1974. Base: respondents using directories. Totals exceed 100% due to multiple mentions

The GOLD BOOK has revolutionized directory use patterns in this industry. Here's why: The GOLD BOOK is by far the largest, most complete one-step electronics purchasing and reference tool ever produced. And it's far easier to use. Look at these comparisons:

COMPARISON OF ELECTRONICS INDUSTRY DIRECTORIES (1974-75 editions)

	EBG ELECTRONICS BUYERS' GUIDE	EEM ELECTRONIC ENGINEERS MASTER	ELECTRONIC DESIGN'S GOLD BOOK
Number of manufacturers listed	5,800	3,165	7,528
Total number of products listed	4,267	3,235	4,799
Number of direct products listed	2,479	2,250	2,925
Number of cross-reference products listed	1,788	985	1,874
Number of distributors listed in Distributors Directory — Alphabetic	0	1,720	5,780
Number of distributors listed in Distributors Directory — Geographic	0	1,720	5,780
Is complete mailing address given each time a company is listed in product directory?	No	No	Yes
Is telephone number given for each company listed in product directory?	No	No	Yes
Are distributors listed for each manufacturer?	No	Partial ¹	Yes
Does manufacturers listing include FSCM numbers?	No	No	Yes
Does manufacturers listing include facsimile equipment by make and call number?	No	No	Yes
Total Circulation	30,017 ¹	89,169 ¹	Over 90,000
Overseas Circulation ²	1,339 ³	0 ³	13,200
Number of ad pages	590 ⁴	2,752	2,820

¹ Paid listings only
² Includes Canada

³ Standard Rate & Data; Oct. 24, 1974
⁴ Includes fractionals

**MOST THOROUGH, MOST COMPLETE, EASIEST-TO-USE
ELECTRONICS INDUSTRY DIRECTORY IN THE WORLD**

ACTUAL SIZE



Our 5-volt AD2010. The 3½-digit DPM small enough for any application. Only ¾" deep and \$94 in 100's. No wonder we've sold so many. For details, call 617-329-4700 (East coast), 312-894-3300 (Midwest), 213-595-1783 (West coast). Analog Devices, Inc., Norwood, Mass. 02062.

INFORMATION RETRIEVAL NUMBER 88



Many Options for Most Applications

New CR-2000 Series utilizes the popular 1" x .100" grid pattern, with 1 to 6 poles and a variety of options and contact forms for almost any application. Reliable low-level switches may be conditioned by special run-in and dynamic testing. Models can be epoxy-encapsulated or simply encased for added economy. Ask for Bulletin MR 11.1 for full details.



COTO-COIL COMPANY, INC.
59 Pavilion Ave.
Providence, R. I. 02905
Tel: (401) 467-4777

INFORMATION RETRIEVAL NUMBER 89

SUBSCRIBER SERVICE For prompt service include the addressed label when writing about your subscription.

CHANGE OF ADDRESS

city	company address	division/department	company	name	NEW ADDRESS
state				title	
zip					

If you're moving, please let us know six weeks before changing your address. If you have a question, place your magazine address label here and clip this form to your letter.

MAIL TO: ELECTRONIC DESIGN Circulation Dept. Hayden Publishing Co., Inc., 50 Essex Street, Rochelle Park, NJ 07662

NEW LITERATURE

IC chip

The CD-4 demodulator system, which allows demodulation of discrete disc recordings manufactured in this format, is described in a six-page data sheet. Matsushita Industrial Div., New York, NY

CIRCLE NO. 371

Linear modules

Oscillators, f/v and v/f converters, panel frequency meters, expanded scale frequency meters, frequency transducers, log amplifiers, pressure-to-frequency converters, tone encoders and decoders, choppers, transformers and telemeters are covered in a 32-page catalog. Solid State Electronics, Sepulveda, CA

CIRCLE NO. 372

Optocomponents

Optoelectronic components are covered in a catalog. It includes three infrared diodes, three photo-transistors, one photo-Darlington, four optocouplers, two gap detectors and one reflex detector. ASE-A-HAFO, Fack, Sweden

CIRCLE NO. 373

Components

A 530-page catalog contains one of the largest selections of electro-mechanical components. Designed as a quick-reference handbook, it details parts with schematic drawings, specifications and prices for each stock number. Allied Devices, Baldwin, NY

CIRCLE NO. 374

Mil-Spec components

A bulletin lists specifications for basic, hermetic, interlock, pushbutton and toggle switches, indicators and switchlites. Control Switch, Folcroft, PA

CIRCLE NO. 375

Electronic enclosures

A colorful 16-page catalog features electronic enclosures. Ample photographs, dimensional drawings, specifications and a color selector chart fill out the book. Premier Metal Products, Bronx, NY

CIRCLE NO. 376

bulletin board

Practically any type of technical drawing can be produced with the aid of a new **British computer software package** based on plain English or, alternatively, on any other international language. The package is **EUCLID II** (Easily Used Computer Language for Illustrations and Drawings), developed by **D-A Computer Services** from a grant by the British National Computer Center under the British Government Software Development Scheme.

CIRCLE NO. 377

A computer-aided software test program (**Fairtest**) for digital logic subassemblies is available from the **Systems Technology Div. of Fairchild**. With an IBM 360 or 370 computer, Fairtest can simulate digital networks with up to 10,000 nodes, generate test programs in **Factor** (Fairchild's Sentry test system language) and provide a fault isolation dictionary. A compiler is available for use on the computer that assembles the Factor program and translates it to Sentry 600 code.

CIRCLE NO. 378

Applied Materials has announced a 10% across-the-board increase on all **CVD reactor systems**, except the recently introduced Series 6000.

CIRCLE NO. 379

The **Singer Co.'s Kearfott Div.** is now marketing **vortex-type, single-stage blowers**. Pressures or vacuums of up to 34 inches of water are possible with free deliveries of 60 cfm. This performance is achieved at 3350 rpm without positive displacement of the air.

CIRCLE NO. 380

MRI Systems has released a **CDC version of the report writer feature** for data management **SYSTEM 2000**. The report writer, which operates in either a batch or interactive mode, allows the user to generate highly detailed reports in a sophisticated format without having to use a procedural language.

CIRCLE NO. 381

You get a lot in a little package with General Electric Reed Switches

GE Reed Switches feature rugged design, fast operation, long life. For complete information, use the reader service card, or write GE, 316 E. 9th St., Owensboro, Ky. 42301

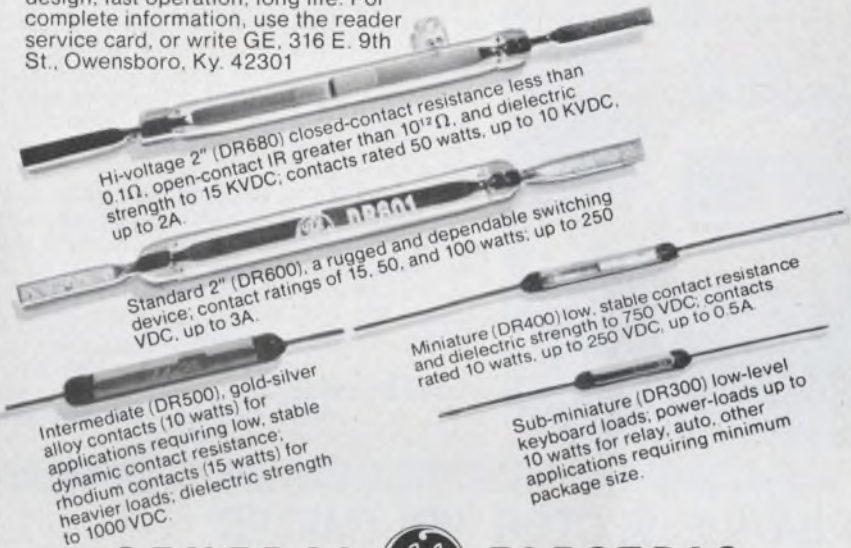

364-01

GENERAL  ELECTRIC

INFORMATION RETRIEVAL NUMBER 90



electrocube capacitors

...are now available in multiple-unit **Dual In-Line Packages (DIP)**. These unique 14 and 16-pin units will accommodate up to 8 capacitors, in various dielectric and capacitance combinations, for use in either automatic inserting or standard plug-in sockets. The packages save PC board space, inventory and handling time, and assembly costs. Get complete information today on these **Skinny DIP's** from Electrocube, 1710 So. Del Mar Ave., San Gabriel, CA 91776, (213) 283-0511; TWX 910-589-1609.

FREE...data file on request

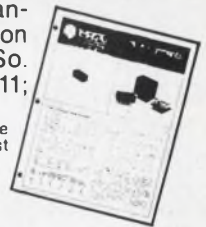

SKINNY DIP'S

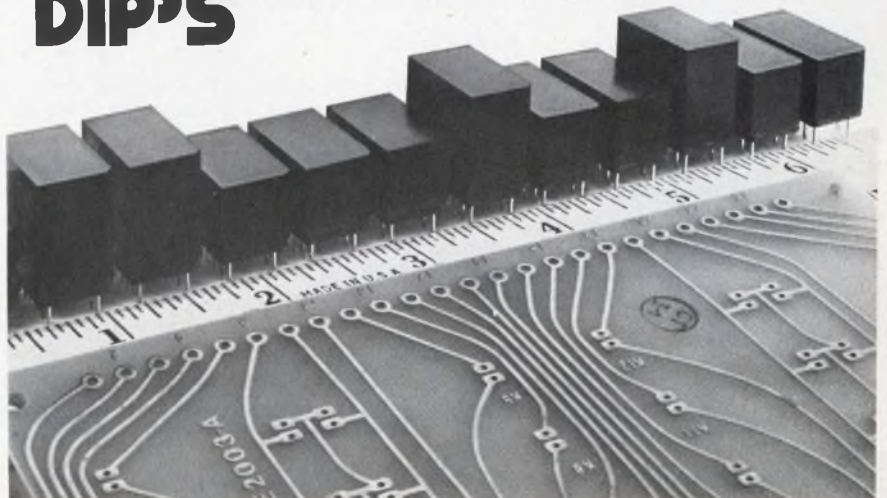

INFORMATION RETRIEVAL NUMBER 91

Design Data from Manufacturers

Advertisements of booklets, brochures, catalogs and data sheets. To order use Reader-Service Card (Advertisement)

Electronic Design

ELECTRONIC DESIGN's function is:

- To aid progress in the electronics manufacturing industry by promoting good design.
- To give the electronic design engineer concepts and ideas that make his job easier and more productive.
- To provide a central source of timely electronics information.
- To promote communication among members of the electronics engineering community.

Want a subscription? ELECTRONIC DESIGN is sent free to qualified engineers and engineering managers doing design work, supervising design or setting standards in the United States and Western Europe. For a free subscription, use the application form bound in the magazine. If none is included, write to us direct for an application form.

If you do not qualify, you may take out a paid subscription for \$30 a year in the U.S.A., \$40 a year elsewhere. Single copies are \$1.50 each.

If you change your address, send us an old mailing label and your new address; there is generally a postcard for this bound in the magazine. You will have to requalify to continue receiving ELECTRONIC DESIGN free.

The accuracy policy of ELECTRONIC DESIGN is:

- To make diligent efforts to ensure the accuracy of editorial matter.
- To publish prompt corrections whenever inaccuracies are brought to our attention. Corrections appear in "Across the Desk."
- To encourage our readers as responsible members of our business community to report to us misleading or fraudulent advertising.
- To refuse any advertisement deemed to be misleading or fraudulent.

Microfilm copies are available of complete volumes of ELECTRONIC DESIGN at \$19 per volume, beginning with Volume 1, 1952 through Volume 20. Reprints of individual articles may be obtained for \$2.00 each, prepaid (\$5.00 for each additional copy of the same article) no matter how long the article. For further details and to place orders, contact the Customer Services Department, University Microfilms, 300 North Zeeb Road, Ann Arbor, Michigan 48106 telephone (313) 761-4700.

Want to contact us? If you have any comments or wish to submit a manuscript or article outline, address your correspondence to:

Editor
ELECTRONIC DESIGN
50 Essex Street
Rochelle Park, N.J. 07662

"THE HOW AND WHY OF REAL-TIME SPECTRUM ANALYSIS OF NOISE AND VIBRATION"



New 16-page brochure on latest Ubiquitous® 500-line Real-Time Spectrum Analyzer/Calculator UA-500A-1 contains complete application data & a "how to" section. The "why" explains the need for resolution, real time, & averaging. The "how to" section solves typical analysis problems: "how to be sure correct data is being analyzed," "how to analyze transients," "how to interface to a computer," "how to cancel background noise," "how to analyze rotating machinery."

Model UA-500A-1 is specifically designed to simplify machine diagnosis, rotating machine analysis, noise source identification, mechanical signature comparisons, underwater signal analysis, & noise reduction. Includes such features as automatic harmonic identification, direct digital readout in RPM, & the ability to make relative amplitude & frequency measurements digitally.

Demo, circle 171
Lit., circle 172

Nicolet Scientific Corp. (formerly Federal Scientific)
245 Livingston Street, Northvale, New Jersey 07647
(201) 767-7100. TWX: 710-991-9619

VERSATILE VECTOR VOLTMETER



The Princeton Applied Research Model 129A Two Phase Lock-in/Vector Voltmeter permits simultaneous measurement of magnitude and phase angle even if the signal is masked by background noise. Flip a switch and measure the I and Q components of the vector; independent output expansion, offsetting, and filtering of each component are also provided. Full scale sensitivity ranges from 1 microvolt to 0.25 volts and is extendable to 25 volts with the optional compensated attenuator. Model 186/41. The Model 129A reference channel has fully automatic reference tracking capability and is phase matched to the signal channel over the operating range 0.5 Hz to 100 kHz. Complete specifications are contained in our Lock-in Amplifier Catalog No. T218.

CIRCLE NO. 173

Princeton Applied Research Corporation

P.O. Box 2565, Princeton, New Jersey 08540
609/452-2111.

MATERIALS FOR MAGNETIC FUNCTIONS

by Fennimore N. Bradley

This valuable reference provides a thorough background as well as practical design techniques for the materials needed for magnetic functions. Included in its exhaustive coverage is detailed treatment of key parameters of about 30 classes of ferrite materials relating processing to costs and design trade-offs . . . and equally thorough coverage of about 40 classes of both conventional and exotic magnetic metals and processes. The book focuses on design problems encountered in a wide range of permanent-magnet applications . . . pinpoints design problems in nearly 30 categories of electromagnetic devices . . . and concludes with coverage of environmental influences such as corrosion, magnetic field, temperature, stress, etc. 360 pp., 6 x 9, illus., cloth, \$17.20. Circle the reader-service number to order a 15-day examination copy.

CIRCLE NO. 174

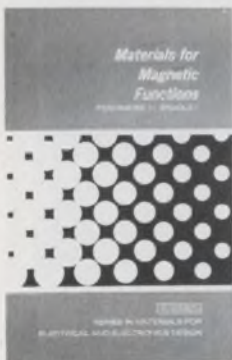

HAYDEN BOOK COMPANY, INC., 50 Essex St., Rochelle Park, N.J. 07662

recruitment
and
classified ads

RENT a MINI

1 DAY DELIVERY
DEC PDP 8I (4K)
DEC PDP 8L (8K)
ASR 33

FOR SALE

MINIS DEC • DG • CAI • GTE
HP • HIS • IBM • INT
LOCK • MICRO • SEL
VARIAN • XLO.

PRINTERS MOS 4330\$3950
CDC 9322\$2500
DP 2440\$7500

CARD DOC M200\$950
READERS GDI 100, 110\$750

PAPER DIGITRONICS 2500\$350
TAPE CHALCO • BRPEII\$250

MAG PERTEC • WANGCO
TAPE POTTER • AMPEX

617-261-1100

AMERICAN USED COMPUTER CORP.

P.O. Box 68, Kenmore Sta., Boston, MA 02215
member COMPUTER DEALERS ASSOCIATION

CIRCLE NO. 296

DIGITAL DESIGN ENGINEER

Experience with design and development of digital subsystems. Familiar with TTL, MOS, MSI and control applications of PROM, RAM, and microprocessors. Head of Scientific Services, Geophysical Institute, Univ. Alaska, Fairbanks AK 99701. An equal opportunity employer.

HERMETIC SEALING

Connectors • Headers • Relay Bases
Terminals • Custom Seals • Testing
Glass/Ceramic To Metal • Since 1959

DETORONICS CORPORATION

10660 E. Rush • S. El Monte, CA 91733
(213) 579-7130 • TWX 910-587-3436

CIRCLE NO. 297

Electronic Design

(Advertisement)

Advertising Sales Staff

Tom W. Carr, Sales Director

Rochelle Park, NJ 07662

Robert W. Gascoigne
Daniel J. Rowland

(Recruitment, Quick Ads, Classified)

50 Essex Street
(201) 843-0550
TWX: 710-990-5071

Philadelphia

Thomas P. Barth
50 Essex Street
Rochelle Park, NJ 07662
(201) 843-0550

Boston 02178

Gene Prichard
P.O. Box 379
Belmont, MA 02178
(617) 489-2340

Chicago 60611

Thomas P. Kavooras
Berry Conner, Jr.
200 East Ontario
(312) 337-0588

Cleveland

Thomas P. Kavooras
(Chicago)
(312) 337-0588

Los Angeles 90045

Stanley I. Ehrenclou
Burt Underwood
8939 S. Sepulveda Boulevard
Suite 510
Los Angeles, CA
(213) 641-6544

San Francisco 94022

Jerry D. Latta
P.O. Box 1248
Los Altos, CA
(415) 965-2636

London, Amsterdam, Tokyo, Seoul

John Ashcraft
12, Bear St.
Leicester Square
London WC2H 7AS England
Phone: 01-930-0525

W. J. M. Sanders
John Ashcraft & Co.
Herengracht 365
Amsterdam C., Holland
Phone: 020-24-09-08

Haruki Hirayama

Electronic Media Service
5th Floor, Lila Bldg.,
4-9-8 Roppongi
Minato-ku, Tokyo, Japan
Phone: 402-4556
Cable: Electronicmedia, Tokyo

Mr. O-kyn Park, President

Dongbo International
Corporation
1.P. O. Box 4010
Seoul, Korea
Phone: 28-1911
Cable: Dongbo Seoul

ABP

BPA

**GUIDE TO
DIELECTRIC MATERIALS**



Short form catalog is a useful illustrated guide to product lines and literature. Eighteen different product lines are described. Useful applications and outstanding properties are listed. The catalog contains a reader service card for requesting more detailed information on specific product lines.

INFORMATION RETRIEVAL NUMBER 273

**ECCOSORB®
ANECHOIC CHAMBERS**



The most advanced anechoic and shielded chambers . . . used worldwide for antenna pattern, radar cross-section, VSWR and RF compatibility measurements. Send for data.

INFORMATION RETRIEVAL NUMBER 274

**FREE SAMPLE
RFI GASKET
ECCOSHIELD® SV**

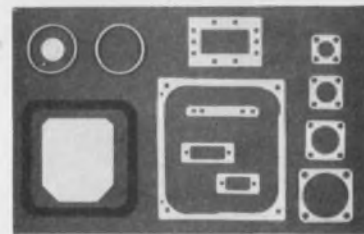

Eccoshield® SV is the flexible, compressible plastic with the conductivity of metal—available in many physical forms—for RF and hermetic seals. Insertion loss has exceeded 100 db.

INFORMATION RETRIEVAL NUMBER 275

Emerson & Cuming, Inc.



CANTON, MASS.

GARDENA, CALIF.

NORTHBROOK, ILL.

Sales Offices
in Principal Cities

EMERSON & CUMING EUROPE N.V., Devel. Belgium

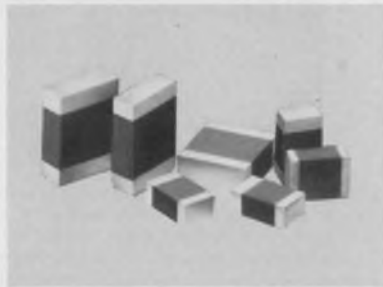

HIGH Q MULTILAYER CAPACITORS feature very high quality factors at microwave frequencies. Offered in three standard sizes: .050 x .040, .080 x .050, .125 x .095. Capacitance values from 0.1 pf to 1000 pf with close tolerance and voltages to 1000 VDCW. Johanson/Monolithic Dielectrics Div., Box 6456, Burbank, Ca. 91510, (213) 848-4465.

INFORMATION RETRIEVAL NUMBER 601

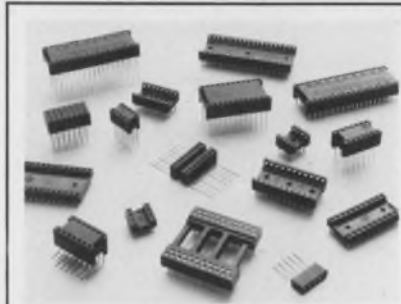

DIP Sockets—New, full color Catalog describes CA's extensive DIP Socket line: 8 thru 42-pins; .200", .300" & .400" centers; four different contact lengths; gold over nickel or bright tin plating; high density; low profile; flat pack calculator chip types. Circuit Assembly Corp. 3169 Red Hill Ave., Costa Mesa, Calif. 92626. Ph (714) 540-5490.

INFORMATION RETRIEVAL NUMBER 604

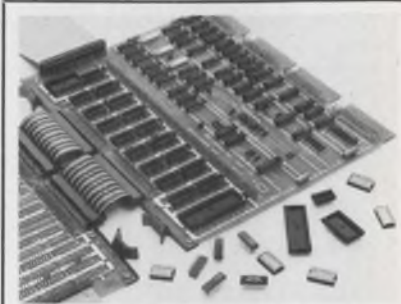

PDP-11 General Purpose Interface. The MDB-11C provides all features of a DEC DR11C plus additional 16 bit register, 4 selectable interrupt control levels, 16 decoded device addresses, takes only one quad slot, has maximum Unibus load of 1. Also, 20 wirewrap positions are provided. \$390. MDB Systems, Inc., 981 N. Main Street, Orange, CA 92667.

INFORMATION RETRIEVAL NUMBER 607

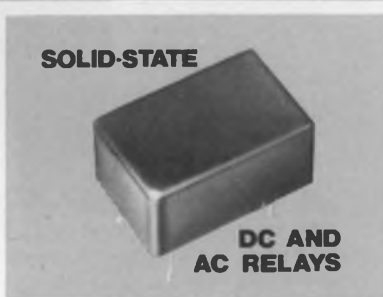

SOLID-STATE

DC AND AC RELAYS

For computer peripherals and other high-speed, high-reliability switching jobs, with either DC or AC loads up to 6 amp, these transformer-coupled Heinemann relays offer highest sensitivity, isolation, accuracy for TTL and other low-level control signals. Heinemann Electric Company, Trenton, NJ 08602.

INFORMATION RETRIEVAL NUMBER 602



Basic Engineering Sciences & Structural Engineering for E-I-T Exams. Sampling for test problems makes the best preparation yet for exams. #5712-1, 424 pp., \$17.20. Circle the Info Retrieval No. to order 15-day exam copy. When billed, remit or return book with no obligation. Hayden Book Co., 50 Essex St., Rochelle Pk., N.J. 07662

INFORMATION RETRIEVAL NUMBER 605



IMTRONICS METERS

Imtronics is a leading manufacturer of meters offering the electrical and electronics industry a wide selection of meters featuring high quality at minimum cost.

- LEVEL METERS
- BALANCE METERS
- BATTERY CHECKERS
- TUNING METERS
- S METERS
- DC CURRENT & VOLTAGE METERS

IMTRONICS INDUSTRIES, LTD.
813 2nd St., Ronkonkoma, N.Y. 11779
(516) 981-3434

INFORMATION RETRIEVAL NUMBER 608



Silicon photodiodes for high resolution position sensing. UDT offers a wide variety of single and dual axis silicon photodiodes for light spot position sensing. Continuous lengths to 9" and areas to 1.4" in diameter with precision resolution to better than 10⁻⁵ inches. United Detector Technology, 2644 30th St., Santa Monica, CA 90405 (213) 396-3175.

INFORMATION RETRIEVAL NUMBER 603



MICRO-MINIATURE DC/DC CONVERTERS

1.35 Watt DC/DC Converters in 24 pin dip: 1.245" x .795" x .375" from 5Vdc input with 3 std outputs: 5, ±12 or ±15Vdc. Effie, up to 90%, power foldback & no derating thru 71°C. The "UD" Series offers isolated power for logic op-amps etc. Del. stk - 2 wks priced 1-9 from \$26.95. Semiconductor Circuits Inc 306 River St. Haverhill MA 01830 617-373-9104

INFORMATION RETRIEVAL NUMBER 606



Comstron's 1013 costs only \$1595. It's a 5 digit, 0.1Hz to 13MHz Frequency Synthesizer for bench & systems applications. A metered, leveled output, up to 3V RMS, with a precision output attenuator adjustable in 10db steps with continuous level control, low phase noise & low harmonic distortion ensures signal purity. Comstron Corp, 120-30 Jamaica Ave, Richmond Hill, NY 11418 (212) 441-3200.

INFORMATION RETRIEVAL NUMBER 609



Free catalog of 34,500 power supplies from the worlds largest manufacturer of quality Power Supplies. New '74 catalog covers over 34,500 D.C. Power Supplies for every application. All units are UL approved, and meet most military and commercial specs for industrial and computer uses. Power Mate Corp. (201) 343-6294.

INFORMATION RETRIEVAL NUMBER 610

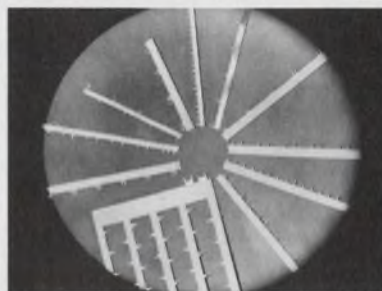

Mini/Bus® Evaluation Kit, \$25, in stock. Lets you try Rogers' low-cost, noise attenuating, high packaging density power distribution system for PC boards. Millions in use. Standard parts on 2 weeks delivery, or less! Customer parts 4 to 6 weeks delivery. Rogers Corporation, Chandler, Ariz. 85224. Phone (602) 963-4584

INFORMATION RETRIEVAL NUMBER 613



Free Applications Booklet—"Group Delay Equalization In Communications Systems". This comprehensive manual, prepared by SEG's Equalizer Design Dept., features useful applications information as well as a tutorial look at the design of equalizers and their functions. SEG Electronics Corp. 120-30 Jamaica Ave., Richmond Hill, N.Y. 11418 (212) 441-3200.

INFORMATION RETRIEVAL NUMBER 611



Free—Short-Form Catalog Describes Circuit Assembly Corp.'s major product lines in full color. This new catalog shows CA's extensive DIP Socket line, Plugs, Modules, and Interconnects plus Contact Stampings, Signal Transmission Interfaces, and Custom Components. Circuit Assembly Corp., 3169 Red Hill Ave., Costa Mesa, Ca 92626. Ph (714) 540-5490.

INFORMATION RETRIEVAL NUMBER 614

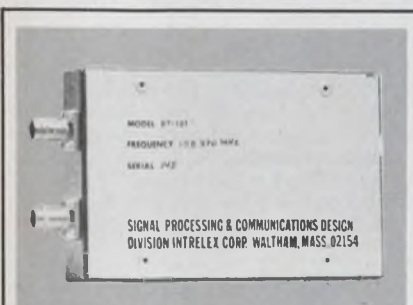

Wideband 145-175 MHz 1W/2W Transmitter for use in FM, voice or digital data transmission (ICW keying to 10 KHz). 10ppm stability over -30°C to +60°C and +12.5 ±2.5 volts supply variation. Features high DC to RF conversion efficiency, RF output leveling, and up to 5 remotely switched channels. Inrelex Corp. 34 Middlesex Circle, Waltham, MA 02154

INFORMATION RETRIEVAL NUMBER 612

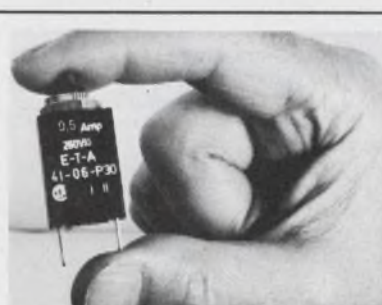

Overcurrent Protector, manual reset eliminates fuse replacement. Convenient panel mounting. 15 fractional ratings from 0.1 to 3 amp. Other models up to 400 amp. Trip-free and fool-proof, UL and CSA approved. High quality, low cost \$1.29 ea. in 1000 lots. E-T-A Products Co. of America, 7400 N. Croname Rd., Chicago, Ill. 60648. Tel: (312) 647-8303. Telex: 253780.

INFORMATION RETRIEVAL NUMBER 615

Advertisers wishing to reserve Quick Ad units should note the following mechanical requirements: Specs—Supply glossy photo of product and approximately 40 words which will set no more than 10 lines of 34 characters each. AFTER SUBMISSION NO COPY CHANGES CAN BE ACCEPTED. Quick Ads cost only \$300 per insertion, less for frequency advertisers.

RATES:

1x
\$325

7x
\$300

13x
\$275

19x
\$270

26x
\$265

39x
\$260

52x
\$255

104x
\$250

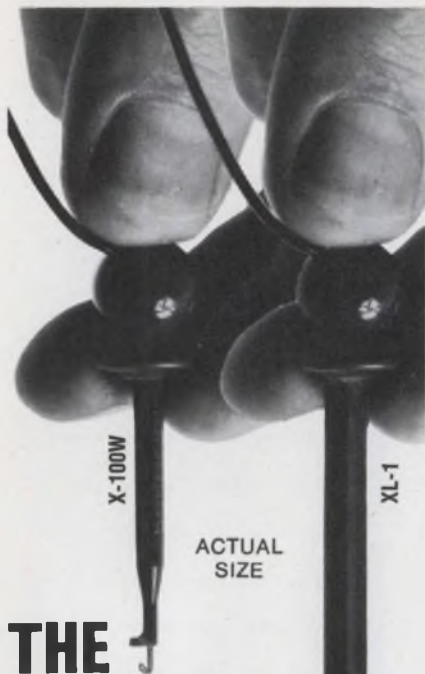

THE TROUBLE SHOOTERS

E-Z-Mini Hook 2.25" (5.7cm) long and E-Z-Mini Hook XL-5" (12.7cm) long reach through wiring nests to make fast, safe, short-free connections... horizontally or up to three vertical connections on a single pin even with three wraps. Single contact point assures true readings. Constructed of durable heat and chemical resistant nylon, Beryllium Copper, Gold-Plated contact, stainless steel spring.

Available in 10 RETMA Colors

Red, Black, Blue, Green, Orange, Yellow, White, Violet, Brown or Gray.

EACH SIZE AVAILABLE IN TWO TIP STYLES



X-100W (2 1/4" long)
XL-1 (5" long)
Square Hole Tip

For lateral or vertical hookups to square wire wrapped pins, or component leads.



X-100W2 (2 1/4" long)
XL-2 (5" long)
Rectangular Hole Tip

For lateral or vertical hookups to rectangular wire wrapped pins or component leads.

EXCLUSIVE FIELD SERVICEABLE FEATURE

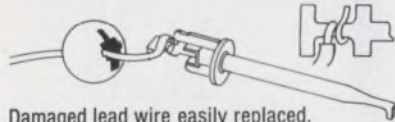

Damaged lead wire easily replaced.

Send for complete catalog & price list.

E-Z-HOOK®

114 EAST SAINT JOSEPH STREET
ARCADIA, CALIFORNIA 91006
(213) 446-6175 / TWX 910 582 1614

advertiser's index

Advertiser	Page
AMP, Incorporated	15
Acopian Corp.	113
Alco Electronic Products, Inc.	141
Allen Bradley Co.	2
American Optical Corporation	127
Amphenol Industrial Division, Bunker-Ramo Corp.	8, 9
Analog Devices, Inc.	134
Ann Arbor Terminals Inc.	130
Arrow-M Corp.	141
Augat, Inc.	31
Belden Corp.	12, 13
Bodine Electric Company	141
Boonton Electronics Corporation	107
Buckbee-Mears Company	44
Cambridge Thermionic Corporation	89
Cincinnati Sub-Zero Products, Inc.	141
Circuit Assembly Corp.	138, 139
Clare-Pendar	109, 127
Comstron Corp.	138
Control Switch, A Cutler-Hammer Company	130
Coto Coil Company, Inc.	134
Data Precision Corporation	129
Datum, Inc.	117
Digital Equipment Corporation	34, 35
Digitran Company, The	16, 16A, 16B
Dynacon Industries Inc.	84
EEOC	93
E-T-A Products Co. of America	139
E-Z Hook	140
Edmund Scientific Company	144
Electrocube	135
*Electronic Design	96B
Electronic Memories, Commercial Memory Products	22
Electronic Navigation Industries	106
Electrostatics, Inc.	108
Emerson & Cumming, Inc.	137
Esterline Angus Instrument Corporation	143
Fairchild Semiconductor, A Division of Fairchild Camera and Instrument Corporation	125
Fluke Counter Division	85, 143
Fluke, Mfg. Co., Inc., John	18, 41
French Trade Shows	143
Gamma Scientific Incorporated	122
Garrett Corporation, The	Cover III
Garry Manufacturing Co.	23
General Electric Company	135
Gold Book, The	132, 133
Gould Inc.	129
Harris Communications and Information Handling	47
Harris Semiconductor, A Division of Harris Corporation	68, 69
Hayden Book Co.	16D, *101, 136, 138
Hayden Mail Order	105
Heinemann Electric Company	138
Hewlett-Packard	21, 36, 37
Imtronics Industries Ltd.	138
Industrial Timer, A Unit of Esterline Corporation	124
Instrument Specialties Company, Inc.	99
Intech, Incorporated	116
Intel Corporation	4, 5
Interdata	80, 81
International Electronic Research Corporation	17
Interlex Corp.	139
Isotronics, Inc.	118
Jensen Tools & Alloys	144
Johanson Manufacturing Corp.	7
Johanson/Monolithic Dielectrics Division	138

Advertiser	Page
Litton Triad-Utrad	120
MDB Systems, Inc.	138
*Marconi Instruments Limited	113
Microdata Corporation	97
Mini-Circuits Laboratory, A Division of Scientific Components Corp.	38
Molex, Incorporated	46
Monsanto, United Systems Corporation subsidiary	104
Mos Technology, Inc.	42
Newport Laboratories, Inc.	142
Nicolet Scientific Corp.	136
Nitron, A Division of McDonnell Douglas	95
Oshino Electric Lamp Works, Ltd.	144
*Philips Electronic Components and Materials	96D
*Philips Industries, Test and Measuring Instruments Dept.	96A
Philips Test & Measuring Instruments, Inc.	121
Pico Electronics, Inc.	Cover II
Piezo Technology, Inc.	108
Piher International Corp.	11
Power Cube Corporation	119
Power/Mate Corp.	139
Princeton Applied Research Corp.	136
Pyrofilm Corporation	29
RCA Solid State	Cover IV
RCL Electronics, Inc.	32
Raytheon Company, Industrial Components Operation	123
Rental Electronics, Inc.	101
Repro. Incorporated	102
Reticon	10
Robinson Nugent, Incorporated	60, 61
Rockland Systems Corporation	16C
Rogan Corporation	103
Rogers Corporation	139
Rowe Industries	124
S.E.G. Electronics	139
Scanbe Canoga Industries	110, 111
Semiconductor Circuits, Inc.	138
Shelley Associates	33
Siemens Corporation	79
Simpson Electric Company	75
Sinclair Scientific	105
*Sodeco	96C
South Bay Cable Corp.	129
Sprague Electric Company	14
Stalwart Rubber Company, The	128
Systron-Donner	144
T.R.I. Corporation	112
Technipower, Inc.	126
Telecommunications Industries, Inc.	127
Tenney Engineering, Inc.	103
USCC/Centralab Electronics Division, Globe-Union, Inc.	114, *115
United Detector Technology, Inc.	138
United Systems Corporation, A Subsidiary of Monsanto	104
Unitrode Corporation	27
Universal Data Systems	90
Victor Electric Wire & Cable Corp.	131
Viking Industries, Inc.	43
Vishay Resistive Systems Group	91
Wavetek Indiana Incorporated	1
Woven Electronics	6
Yardney Electric Corporation	122
Zero Manufacturing Co.	103

*Advertisers in non-U.S. Edition.

Motors • Gearmotors
SCR Speed Controls

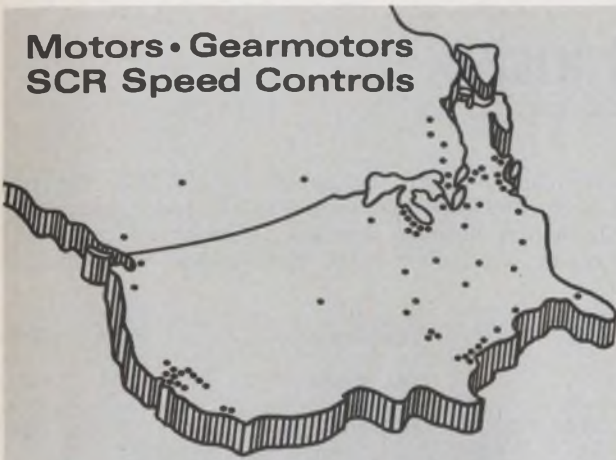

Bodine Distributors ...68 in U.S. and Canada

There's a Bodine Distributor near you . . . 59 in the U.S. and 9 in Canada to give you prompt delivery • On a broad line of 1/2000 to 1/4 Hp A-C and D-C motors and gearmotors • On SCR speed controls, encased or chassis. Over 340 items normally stocked. Send for catalog S for all shelf-stocked Bodine products and the distributor nearest you.

**BODINE
ELECTRIC
COMPANY**

Bodine Electric Co., 2528 West Bradley Pl., Chicago, Ill. 60618
INFORMATION RETRIEVAL NUMBER 99

EVEN AN OIL BATH WON'T STOP THIS FLATPACK.

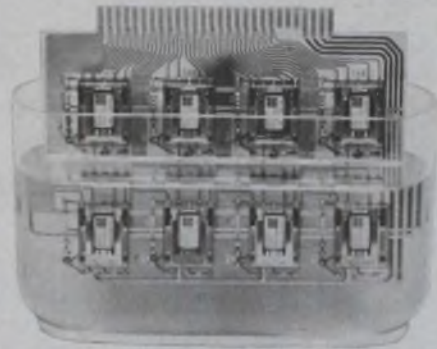

This NFE relay will mechanically switch 10^8 times under the worst operating conditions and live for 5×10^6 at 1 A, 30 VDC resistive and 10^4 at 2 A, 30 VDC. Life expectancies that double those of standard flatpacks used under hostile conditions. NFE relays come in 2 Form C and 4 Form C types with coil

voltages of 6, 12, 24, 48, or 60 V. They measure .425" H x .772" (2C) or .953" (4C) W x 1.165" L. Great for dense P/C board mounting. Operate power: 300 mW for the 2C; 480 mW for the 4C. That's half the power needed for comparable flatpacks. There are no other flatpacks like them. Send for full NFE relay specs.

Relays for advanced technology.



Arrow-M Corp. 250 Sheffield St., Mountainside, N.J. 07092 U.S.A.
Telephone: 201-232-4260

INFORMATION RETRIEVAL NUMBER 101

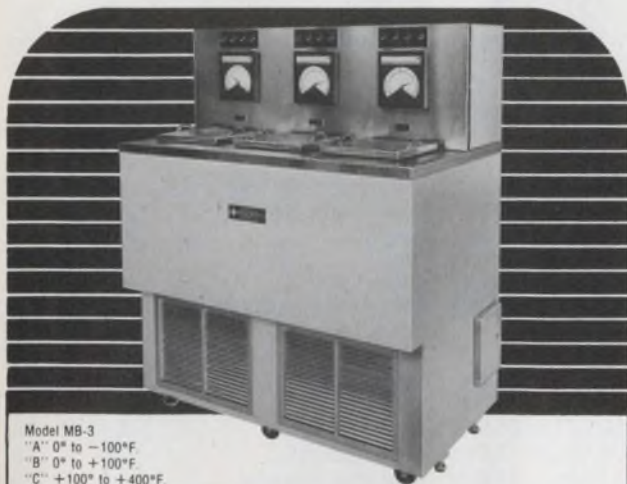

Model MB-3
"A" 0° to -100°F
"B" 0° to +100°F
"C" +100° to +400°F

Multi-Bath Test Stand for efficient production line testing

For chilling charpy specimens, calibration, shock testing and other special test requirements, rely on CSZ Multi-Bath test stands. Stainless steel chambers, liquid agitators, immersion heaters for high temperature operation, mechanical refrigeration systems for low temperature operation. Eye level indicating controllers and switches for each chamber. Caster mounted units for portability.

Write for literature kit

**CINCINNATI
SUBZERO**
PRODUCTS INC.

2612 Gilbert Ave., Cincinnati, Ohio 45206
Phone: (513) 751-8810

INFORMATION RETRIEVAL NUMBER 100

Finest quality ALUMINUM KNOBS with pointers and indicators you won't find anywhere else. Brilliantly anodized in Natural, Black or 2-tone for enhanced appearance.

Mating sizes available in 1/2", 3/4" or 1". Completely machined, including the knurl.



KPN
SERIES

Call (617) 686-0126 today for samples and quotations on this and other series.

ALCO ELECTRONIC PRODUCTS, INC.
1551 Osgood St., No. Andover, Mass. 01845

INFORMATION RETRIEVAL NUMBER 102

Miniature CYLINDRICAL TOGGLE switches have a high U.L. Listed 10 amp rating. All metal case construction and high impact insulation makes this a

great environmental switch. Over 250,000 On-Off operations. Silver terminals and contacts. Available as SPDT and DPDT.



MCTG
SERIES

For complete information, call us today at (617) 686-0126.

ALCO ELECTRONIC PRODUCTS, INC.
1551 Osgood St., No. Andover, Mass. 01845

INFORMATION RETRIEVAL NUMBER 103

NEW DPVM's FROM NEWPORT



BRIGHT 13MM LED DISPLAY, BCD OUTPUT, RATIO AND 2-YR WARRANTY

\$8100*

FOR **\$81** 3½ DIGIT MODEL 203

- Four full scale ranges
- Auto-Polarity \pm 1999 counts
- Voltage, Current and Ratio measurements
- Automatic Zero-Front panel F.S. adjust

(Model 2003, 4½ digit \$139*)

Whether you need 3½ or 4½ digits, Newport will deliver the most reliable and versatile Digital Panel Volt Meter (DPVM) available. With a great reduction in parts and the addition of the new ½-inch LED display, we can now increase our warranty to a full 2 years. The life expectancy of the display is greater than 11 years. Full scale ranges are 200 millivolts, 2, 20, and 200 volts... and BCD output comes free.

Newport now has worldwide stocking representatives providing off-the-shelf deliveries and local support. For complete data, call or write: Newport Laboratories, Inc., 630 East Young Street, Santa Ana, CA 92705.

For immediate response, CALL COLLECT
(714) 540-4686
(In Europe-Tele. Amsterdam [20] 45-20-52)

*Quantities of 100

NEWPORT

INFORMATION RETRIEVAL NUMBER 104

product index

Information Retrieval Service. New Products, Evaluation Samples (ES), Design Aids (DA), Application Notes (AN), and New Literature (NL) in this issue are listed here with page and Information Retrieval numbers. Reader requests will be promptly processed by computer and mailed to the manufacturer within three days.

Category	Page	IRN	Category	Page	IRN
Components			test stand	141	100
capacitors	7	6	tool kits	144	109
capacitors	14	212	VOM, digital	75	38
capacitors, ceramic	114	65	Integrated Circuits		
electronic catalog	144	110	EAROM memories	95	48
filters, crystal	108	59	image sensor	10	8
amps, subminiature	144	111	memory, CCD	100	305
motors	141	99	modem, CMOS	93	47
reed relays	134	89	regulator, voltage	104	302
relays, opto-coupled	126	352	voltage regulators	125	240
resistor networks	23	17	Modules & Subassemblies		
resistors	11	9	amplifier, isolation	116	332
resistors, wire-wound	32	21	delay, digital	117	336
surge arresters	127	78	hybrid microcircuits	III	244
switch, snap-action	126	353	hybrids	123	74
switches, reed	135	90	lamp drivers	116	66
switches, toggle	130	86	oscillator, sinewave	117	335
switches, toggle	141	103	Microwaves & Lasers		
switchlights	127	80	fiber optics catalog	127	79
thin-film networks	29	19	rf links	102	52
transformers, plug-in	120	70	Packaging & Materials		
Data Processing			anechoic chambers	137	274
computer on a board	97	49	cable	6	5
display terminals	130	85	cable	129	82
memory, CMOS	112	324	card racks	91	46
minicomputer	112	322	cases	103	53
minicomputers	35	24	connectors	122	343
printer, line	112	323	connectors	124	75
software, disc	112	325	copper contact strips	99	50
tape cassette	117	67	cover, TO-3		
terminal, graphics	115	328	dielectric material guide	137	273
Discrete Semiconductors			dual inline packages	135	91
diodes, high power	121	341	flatpacks	118	68
display, numeric	119	337	flexibile circuits	44	35
LED indicators	33	22	gaskets, RFI	137	275
rectifiers, bridge	120	338	heat sinks & dissipators	16	12
SCRs, gate-turn-off	118	304	hooks	140	98
zeners	79	39	knobs	103	55
Instrumentation			knobs, aluminum	141	102
CRT display control	111	303	label printer	124	347
capacitance, bridge	107	257	relay sockets	43	34
capacitance meters	107	256	rubber parts	128	81
counter	143	107	Schottky boards	31	20
counter/timer	85	162	socket boards	61	36
DMM	144	108	sockets	15	11
DPM	106	301	sockets	89	44
DPM	134	88	sockets	110	61
DPMs	142	104	sockets, LSI	123	345
French trade show	143	106	swivel cord	131	87
interval timers	124	76	test chamber	103	54
microwatt meters	107	255	tin/lead contact plating	9	7
multimeter	104	56	tool, chip pick-up	122	344
multimeters	129	84	wire, cable and cord	13	234
oscilloscopes	121	71	Power Sources		
recorder	129	83	batteries	122	73
recorders	143	105	power supplies	113	64
rental equipment	101	51	power supplies	126	77
scanning micro-photometer	122	72	power supply	108	58
scope	109	321	switching supply	21	15
signal generator	1	2			
signal generator	107	258			

Build recorders into your products?

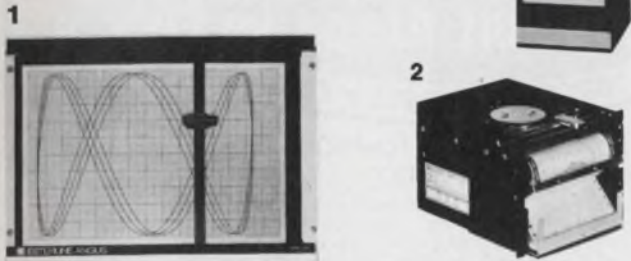

OEM recorders easy to apply, adapt, and customize. Esterline Angus units fit easily into your design, enhance your product's reputation for reliability. Our own service network, OEM experience, and big discounts support, too. Look into these and other recorders:

1. Spartan X-Y recorders. New, clean, simple. Single or multi-range 1MV/in. through 10V/in. Troublefree throughout. 11" x 17". Many options.

2. Miniservo® recorders. 10 cm wide, Z-fold or roll. Sensitivities from 1 mV to 1V, 8 speeds to 300 cm/hr.

3. Minigraph recorders. 2½" wide, inkless. Single or 2-channel, time-share, temperature, and event. 70 speeds. Request OEM PAK. Esterline Angus Instrument Corporation, Box 24000, Indianapolis, IN 46224. Telephone 317/244-7611.



INFORMATION RETRIEVAL NUMBER 105



8291 users of electronic components for aeronautics and space in 1974.

Salon international des
composants électroniques 75

Paris
2-8 April

For you, this year again, Paris is a must

French Trade Shows
1350 Av. of the Americas
New York N.Y. 10019
☎ (212) 582.49.60



57077 visitors from 88 countries in 1974

Salon international des
composants électroniques 75

Paris
2-8 April

For you, this year again, Paris is a must

French Trade Shows
1350 Av. of the Americas
New York N.Y. 10019
☎ (212) 582.49.60

INFORMATION RETRIEVAL NUMBER 106



This may look like a multimeter... but it's really an autoranging multi-function counter

We've had a lot of comments that our new 1900A multi-function counter looks like our 8000A multimeter. We agree. In fact we planned it that way. Both are attractively styled and designed for user convenience. But inside they're vastly different instruments.

The 1900A is an advanced LSI/MOS multi-function counter with . . . autoranging in both frequency and period mode . . . 5 Hz to 80 MHz range with 25 mV sensitivity . . . event counting to 10⁶ . . . automatic overflow . . . six digit LED display with automatic annunciation . . . all for the unbelievably low price of \$349.*

Plus you can order a rechargeable battery option, or a data output option that lets you use the 1900A in systems applications.

And just in case you're wondering - here is what the 26 range, 5 function 8000A multimeter looks like.

Phone your local Fluke distributor to-day for a demonstration, or contact us direct.

*U.S. price F.O.B. Buffalo, N.Y.

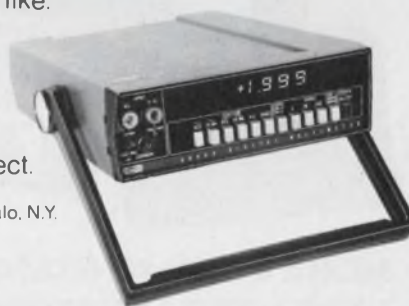

FLUKE
COUNTER DIVISION

John Fluke Mfg. Co. Ltd.
Counter Division
P.O. Box 1094 Station D
Buffalo, N.Y. 14210
Phone (716) 842-0311
TWX 610-492-3214

INFORMATION RETRIEVAL NUMBER 107
FOR DEMONSTRATION 206

At last! TRUE RMS in a low cost DMM.



Buy it now...or add it later

What's so great about TRUE RMS? Well, did you ever have to measure distorted sinewaves? Triangles? Squarewaves? Pulses? Don't bet you won't have to tomorrow. TRUE RMS is the only accurate way to do it. And only Systron-Donner's Model 7224 lets you buy it now or add it later. Model 7224 is a 20,000 count multimeter featuring:

- choice of TRUE RMS or AC averaging
- 0.001 ohm resolution
- autoranging
- large in-line/in-plane display
- DC/DC ratio option
- 5 ranges DC volts, 7 ranges ohms standard
- optically isolated BCD output
- FAST and SLOW sample rate. For details, call your Scientific Devices office or Systron-Donner at 1 Systron Drive, Concord, CA 94518. Phone (415) 676-5000.



INFORMATION RETRIEVAL NUMBER 108

FIELD ENGINEER TOOL KITS

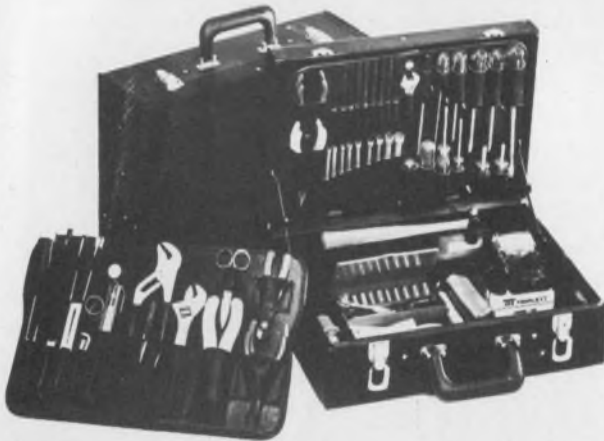

MORE THAN 40 STANDARD KITS UNLIMITED CUSTOM DESIGNS

Jensen leads the way in precision tool kits for field engineers, electronic technicians, scientists, instrument mechanics. Each kit engineered to do a specific job. The JTK-17D illustrated above, for example, contains more than 100 tools. Most mounted on two removable pallets. Available with optional VOM meter. Deluxe attache case features hardwood construction, scuff-proof llama-grain cover, brass hardware. Roomy compartments hold spare parts, additional tools. Document pouch inside cover holds schematics, service manuals, etc.

Free Catalog. Write for new 112-page catalog detailing other kits, hard-to-find precision tools, and prices.



JENSEN TOOLS and ALLOYS
4117 N. 44th Street, Phoenix, Arizona 85018

A BLISS & LAUGHLIN industry

INFORMATION RETRIEVAL NUMBER 109

FREE CATALOG CHOOSE FROM OVER 4,500 UNUSUAL BARGAINS

OPTICS • SCIENCE • ELECTRONICS



1,000's OF HARD-TO-FIND BUYS FOR INDUSTRY

Brand new 180-page easy-to-read edition packed with new products, charts, diagrams, illustrations. On-the-job helps; quality control aids, unique, exclusive items to speed your work, improve quality, cut development and production costs! Loaded with optical, scientific and electronic equipment available from stock for industry, research labs, design engineers, experimenters, hobbyists.

ONE SOURCE FOR ALL YOUR NEEDS

Tremendous variety. Terrific savings. Countless hard-to-get surplus bargains. Many "one-of-a-kinds" nowhere else. Ingenious scientific tools. Thousands of components: lenses, prisms, wedges, mirrors, mounts, all types of accessories. Hundreds of instruments: pollution testing equipment, lasers, comparators, magnifiers, microscopes, projectors, telescopes, binoculars, photo attachments, ecological items, black light equipment and America's largest collection of unique lighting products.

BUY DIRECT WITH MONEY-BACK GUARANTEE

Edmund ships over 5,000 orders monthly to America's largest industrial — every item guaranteed! You must be satisfied, or return your purchase in 30 days for your money back. Shop the catalog of America's largest Science-Optics-Electronics Mart with confidence! Get your FREE copy without obligation. No salesman will call. Write now for free catalog. DA



EDMUND SCIENTIFIC CO.
300 EDSCORP BUILDING
BARRINGTON, NEW JERSEY 08007
TELEPHONE: 609-547-3488



INFORMATION RETRIEVAL NUMBER 110

Ⓢ SUBMINIATURE LAMP SPECIALISTS

Complete line of PC board Bi-Pin lamps and sockets

INCANDESCENT—SOLID STATE

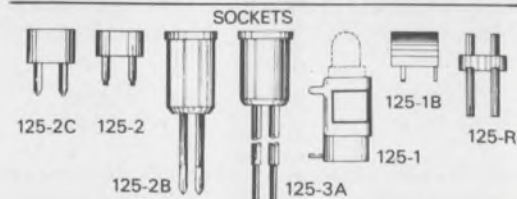
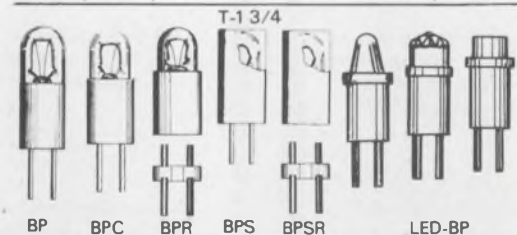
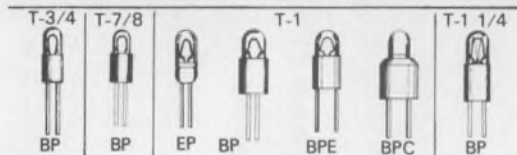

15 sizes, hundreds of electrical specifications.

• Ask information to:

WAMCO Technical Sales, Inc.

705 W. 16th Street, Costa Mesa, California 92627
TEL: (714) 642-5100 TELEX: 678459

Mid-West 12 states only

CIMCO International, Inc.

201 North Wells St. (Rm. 1920) Chicago, Illinois 60606
TEL: (312) 782-5621 TELEX: 724426

OSHINO ELECTRIC LAMP WORKS, LTD.
TOKYO, JAPAN

INFORMATION RETRIEVAL NUMBER 111

ELECTRONIC DESIGN 4, February 15, 1975

What's your design problem...
Unit-size? Complexity? Reliability?
Packaging? Field service?
Multi-component handling?

**Garrett hybrid
microcircuits are
the solution.**

Garrett custom engineering can meet your requirements with hybrid microelectronic technology, performance-proved in consumer, industrial, and military products.

Our high-volume production capability, which encompasses thick film, thin film, component attach of discretes or chips, and automated testing, allows you to order just one micro device instead of many separate components. Reduces your material-handling and labor costs. And increases efficiency.

Whatever your hybrid microcircuit requirements, contact the one reliable source that offers maximum performance at minimum cost. Garrett. Send us your design specs for fast response on price quote and delivery. Contact: Manager, Microelectronic Sales, Garrett Manufacturing Ltd., 40 Voyager Court North, Rexdale, Ontario, Canada. M9W 4Y3. Tel. (416) 677-9790.



The Garrett Corporation One of The Signal Companies

GARRETT
MICROCIRCUITS
They solve the problem

Digital IC news from RCA...

High Rel COS/MOS is winning over T²L logic users.

The chart below is merely a partial representation of the broad variety of military and aerospace programs where RCA High-Rel COS/MOS circuits are being used, instead of T²L and other logic. It shows both wide acceptance and confidence. Not only in RCA technology. But in the COS/MOS devices that technology has produced.

If your digital system can be improved by taking advantage of the performance characteristics of CMOS, you can now start incorporating RCA COS/MOS with confidence. All RCA COS/MOS circuits are available in High-Rel Mil-38510/883 specs from a Mil-M-38510 approved production facility in Findlay, Ohio. And all are available through your local RCA distributor. The fact is,

we already have a most comprehensive line of High-Rel COS/MOS ICs and, as new RCA COS/MOS products are developed, they'll become available in High-Rel versions soon after commercial announcement.

To order your High-Rel COS/MOS devices and the free High-Reliability Integrated Circuit brochure, contact your local RCA Solid State distributor. Or RCA.

Write: RCA Solid State, Box 3200, Somerville, New Jersey 08876; Ste. Anne de Bellevue 810, Canada; Sunbury-on-Thames, U.K.; Fuji Bldg., Tokyo, Japan.

RCA

PROGRAMS USING HIGH REL COS/MOS

GENERAL GOVERNMENT

TOW COBRA
S 3A AIRCRAFT
LANS PROGRAM
D-106S COMMUNICATIONS
AIRS
ARC-150
ARC-164
PRC-85
STINGER
AN/ALE 139
DMD/PLARS
AFSCS
FAA VOICE SWITCH
MULTI ROLE COMBAT
AIRCRAFT (EUROPE)
AN-TPN-19
AN-ASQ-119
ARTIC
AWA

MK 46
CAPTOR
MANPACK
SKIRU
NYVO
BISS

ARMING DEVICES

XM-56
SM-70
ADAM
FMU
FM

SATELLITES, AEROSPACE

ATMOSPHERIC EXPLORER
HEAO
SPACE SHUTTLE
ITOS
B-SAT
SAT COM
NIMBUS
HELIOS
OSCAR-6
PIONEER F
ATS
IMP SATELLITES
MJS-77
(MARINER) (PITON-SATURN)
CTS
VELA

INFORMATION RETRIEVAL NUMBER 245

RCA. The first house in CMOS.