

Electronic Design.25

VOL. 22 NO.

FOR ENGINEERS AND ENGINEERING MANAGERS

DEC. 6, 1974

Cure potting problems with new materials. Epoxies still are used most. But silicones can take the heat, polyurethanes adhere well, polyesters lower costs and

fillers improve heat conductivity. Some are opaque, others clear; some rubbery, others hard. And for weight reductions, foams fill the bill. Find a remedy on page 28.



Need E-Rel Components?

We helped write the book!

Don't spin your wheels when you shift to established reliability from standard military specifications. Dale has the QPLs and the finished goods stock to save you valuable time. We're offering fast delivery on many established reliability part numbers for both wirewound and metal film resistors and wirewound trimmers. And we can deliver something else, too: *Experience*. Our work in the Minuteman program led to the formulation of the first specifications for established reliability resistors. Since then our materials improvement and failure rate documentation programs have become models in the industry. Today our AGS resistors have a proven failure rate of .000032% per 1,000 hours. *That's established reliability*. Put it to work for you now. Call 402-564-3131 (wirewound styles) or 402-371-0080 (film styles) or dial 800-645-9200 for the name of your Dale representative.

Fast delivery on many styles

★
ESTABLISHED RELIABILITY

★ ★ ★ ★ ★
ESTABLISHED RELIABILITY

MIL-R-39007, MIL-R-39009
MIL-R-39015, MIL-R-39017

MIL-R-55182



MIL-R-39007
MIL-R-39009
MIL-R-39015
MIL-R-39017
MIL-R-55182



DALE ELECTRONICS, INC.
Columbus, Nebr. 68601
A subsidiary of The Lionel Corporation
In Canada: Dale Electronics Canada Ltd.
In Europe: Dale Electronics GMBH,
8Munchen 60, Falkweg 51, West Germany

INFORMATION RETRIEVAL NUMBER 246



The quickness of the eye never deceives the hand

Keeping up with the display is no problem on this new 50 MHz oscilloscope.

Every control falls naturally and quickly to the hand because we designed it that way. Ya, Yb, delayed and main time bases are all clearly separated with the main controls on exactly the same level. So you find what you want, when you want it, without the eye leaving the screen. Separating the two time bases also eliminates confusion and a

possible source of error.

As well as being easy to use the new PM 3240 is also light to carry - 8 kg light to be precise. So it's ideal for service applications, on computers and communications equipment, as well as for general laboratory use.

Neither does the eye get confused by difficult-to-see signals. The screen is a large 8 x 10 cm and 10 kV bright, enabling low duty cycles at high

sweep speeds to be displayed clearly.

Get your hands on this new instrument and you'll appreciate the difference that Philips' ergonomics can make. And if you need a higher bandwidth, there's an equally ergonomic 120 MHz model available.

For more information contact : Philips Test & Measuring Instruments Inc., 400 Crossways Park Drive, Woodbury, New York 11797.



Special Applications Information "HOT LINE"
Dial Toll Free Number (800) 645-3043
New York State, Call Collect (516) 921-8860

PHILIPS

Solid state dip relays... make good cents

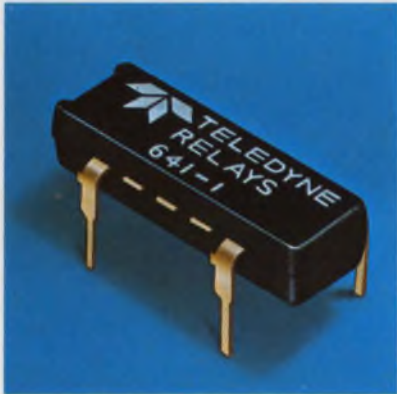

And dollars too, when you're designing point of sale terminals and other business machines. Teledyne's Seren-DIP® relays are totally silent, reliable, long life components that can replace a surprising amount of expensive discrete circuits. Our 641 is a low profile TO-116 DIP; one small PC board holds all you need for control and switching a POS terminal or medium size business machine. But small size can mean big

performance. The 641 is a small AC powerhouse: 1 AMP triac output with a 10 AMP surge rating; 140 or 280 volts, AC. It'll easily drive lamps, solenoids, stepping motors, transformers, or any inductive load – without noise or misfire errors. The Teledyne 641 is U.L. recognized. We also make high level DC and Bi-polar Seren-DIPs.

Seren-DIP solid-state DIP relays – they make design sense and their dependability and cost effectiveness may help you make POS sales, too. Ask your distributor or call our applications engineers. Call your nearest Teledyne Relays office for location of your local representative or distributor.

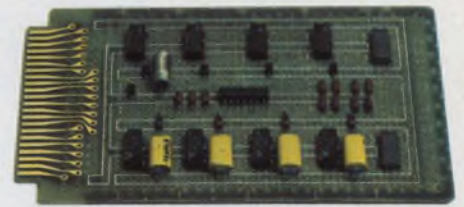

TELEDYNE RELAYS

3155 West El Segundo Boulevard, Hawthorne, California 90250
Telephone (213) 973-4545

Burgstrasse 6-8, 62 Wiesbaden, West Germany
Telephone: 06121-30231/2 Telex: 04-186851 (Trel-D)

Heathrow House, Bath Road, Cranford, Hounslow, Middlesex, U.K.
Telephone: 01-8972501 Telex: 935008

INFORMATION RETRIEVAL NUMBER 272

NEWS

- 23 **News Scope**
- 28 **There's a cure for almost every potting or embedding ill**, with today's wide selection of resins.
- 36 **A new generation of iron-core transformers** is getting tiny; Now only the price must shrink.
- 40 **Your voice tells when you're lying** with small, solid-state analyzer.
- 45 **Washington Report**

TECHNOLOGY

- 54 **Which dc/ac inverter?** At least eight different circuit schemes are used. Learn what these increasingly important units can do and know their limitations.
- 62 **Avoid wiring-inductance problems.** Properly configured wiring can reduce unwanted coupling, troublesome feedback and noise pickup.
- 68 **Predict wideband amplifier response** with a simple graphical procedure. Spec sheets provide the basic data needed to compute closed-loop response.
- 74 **Printer control:** a minor task for a fast microprocessor. An interrupt-driven approach frees the processor for other tasks and saves hardware.
- 86 **Meet the applicant before talking to him.** Prepare for those in-depth job interviews by learning how to study the engineer through his resume.
- 92 **Ideas for Design:** Circuit adds BCD numbers with binary 4-bit full adders . . . Up/down counter controls pulse width of a one-shot . . . Voltage-tunable active filter features low, high and bandpass modes.
- 100 **International Technology**

PRODUCTS

- 105 **Integrated Circuits:** Single monolithic chip holds 16-bit microprocessor.
- 114 **Instrumentation:** 4-1/2-digit DPM fits standard panel cutout.
- | | |
|-----------------------------|-----------------------------|
| 110 Modules & Subassemblies | 124 Discrete Semiconductors |
| 116 Microwaves & Lasers | 128 Data Processing |
| 120 Packaging & Materials | 132 Components |

Departments

- 51 **Editorial:** Nice young girls and consultants
- | | |
|--------------------|--------------------------------|
| 7 Across the Desk | 144 Product Index |
| 134 New Literature | 146 Information Retrieval Card |
- 142 **Advertisers' Index**

Cover: Photo by Tom Bassett, courtesy of Dow Corning Corp., Midland, MI

Put a complete your system for less

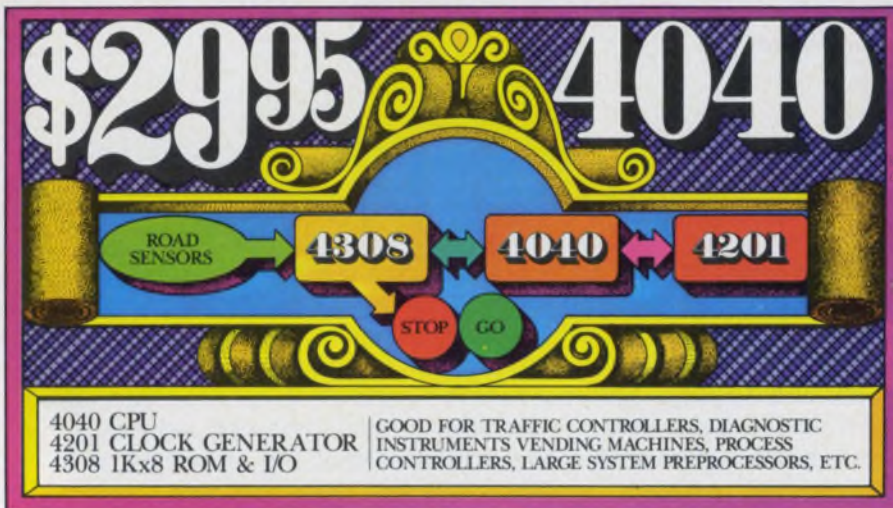

Cash in on the demand for economical intelligent products with Intel's inexpensive new 4040 CPU, 4201 integrated system clock, 4308 high density, low cost program memory and three new I/O components. Faster and more versatile than any other MOS 4-bit microprocessor unit, the 4040 can totally automate a smaller system or large portions of a big system. Yet an MCS-40 micro-

computer system with CPU, clock, memory and I/O costs as little as \$29.95.

Many equipment manufacturers are replacing hardwired logic and bulky electromechanical assemblies with MCS-40 systems. Most moderate speed control logic built with TTL can be replaced. The savings certificates show only a few 4040 applications. MCS-40 devices can be used with our 4004 central processor unit, too. The 4004, in production since June 1971, can lower system costs even more.

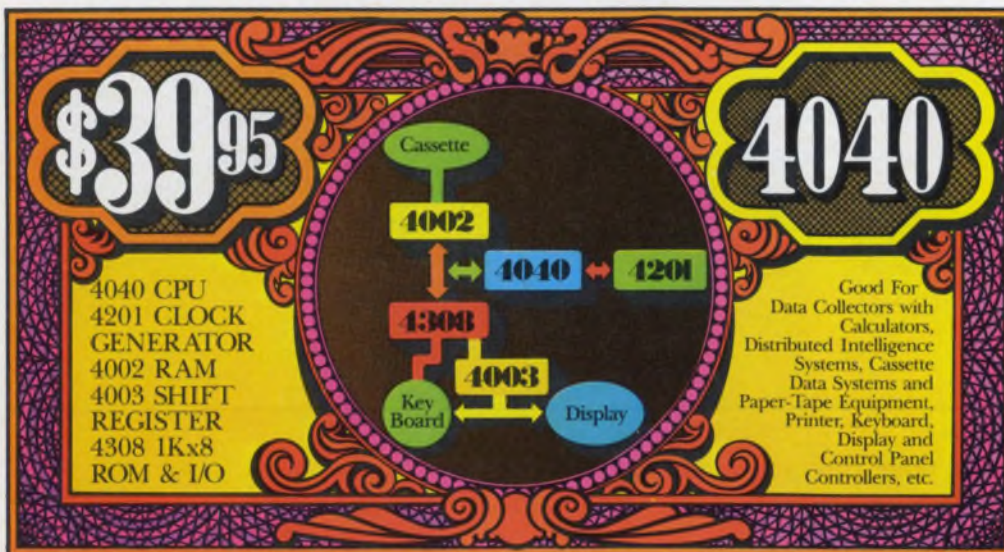

With either CPU, you'll save development time, lower component count and reduce assembly costs. You'll save even more as microcomputer costs decline while other system costs rise. And you'll gain valuable insurance against product obsolescence. Any design is easy to program and update

with Intel's total development support, assemblers and Intellec 4/MOD 40 development systems. Our training centers will even teach you how to use Intel microcomputers.

microcomputer in than \$30.



MCS-40 4040

| | |
|---|--|
| <ul style="list-style-type: none"> 4040 4-BIT PARALLEL CPU 4201 SYSTEM CLOCK 4001 2K ROM AND I/O 4308 8K ROM AND QUAD I/O 4316 16K ROM (2Kx8) 4702A 2K PROM (ERASABLE) 4289 MEMORY INTERFACE | <ul style="list-style-type: none"> 4002 320-BIT RAM AND I/O 4101 1K STATIC RAM (256x4) 4003 SHIFT REGISTER 4207 GP BYTE OUTPUT 4209 GP BYTE INPUT 4211 GENERAL PURPOSE BYTE INPUT AND OUTPUT |
|---|--|

In high volume for just \$29.95, you can buy an MCS-40 system with the 4040 CPU, 4308 1Kx8 ROM with four independent I/O ports, and 4201 system clock generator. The 4040 itself has 60 instructions, 7-level subroutine

nesting, 24 index registers, interrupt processing, memory and index register bank switching, single-step operation and a low power standby mode.

A few dollars more buys extra computation flexibility. Use our 4289 interface, for example, to attach standard memory or I/O devices. And, at only \$99.95 in quantity of one, the system with the 4702 erasable PROM is ideal for prototypes and low volume production.

At these prices, you can even use several microcomputers in large systems. Knowledgeable designers are putting 4040 intelligence into new products at less cost than simple-minded electro-mechanical parts and single-minded logic cards.

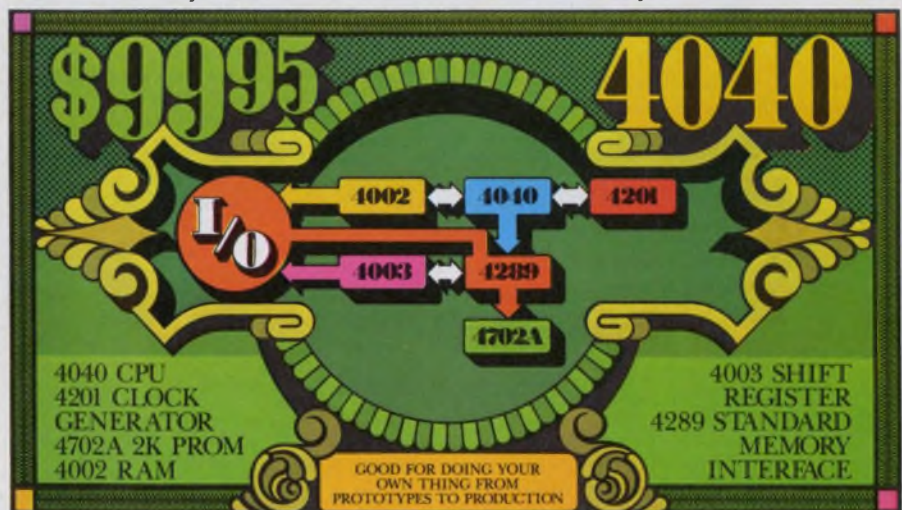

Write for details on the MCS-40 family and the industry's most extensive software support. Or call any Intel office for an appointment with our applications engineers.

Intel Corporation, 3065 Bowers Ave., Santa Clara, Calif. 95051 (408) 246-7501.

intel® Microcomputers. First from the beginning.

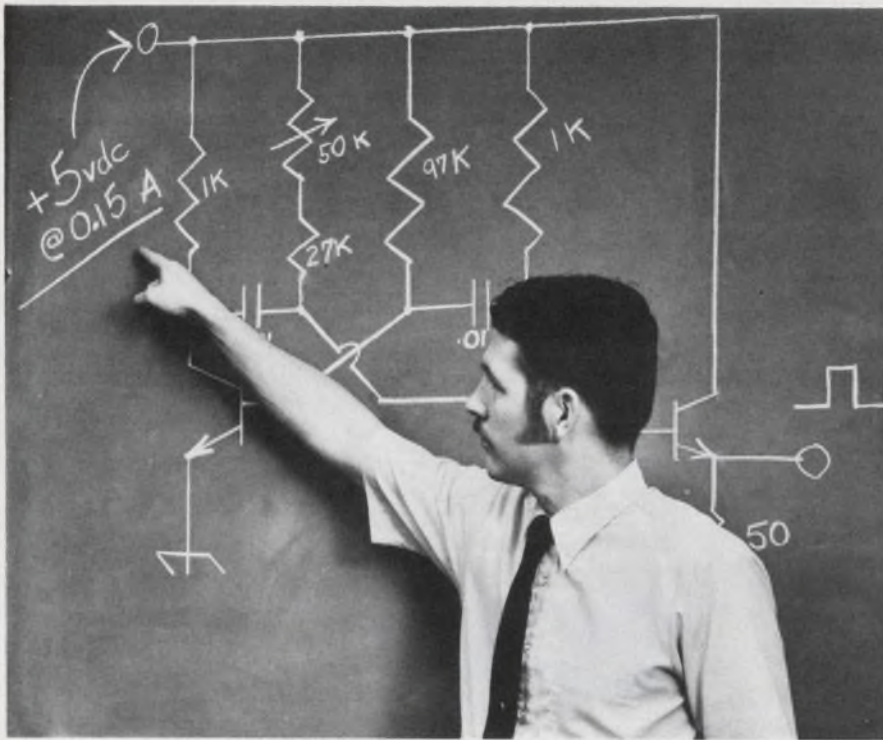

How to Design Your Power Supply for \$72

You get the **complete schematic diagram, and parts list** with operating and installation instructions when you spend \$72 for an Abbott Model "RN" power supply. Two years in development, this model represents the latest state of the art in power module design. It features close regulation (0.1%), low ripple (0.02%), automatic short circuit and complimentary overvoltage protection and continuous operation in a 160°F ambient.

Abbott Engineers followed specific design criteria in engineering these modules. First, the electrical design was carefully engineered to insure that all components operate well within their limits, under "worst case" operating conditions. Second, the thermal design, including case construction, was carefully made to insure that the maximum temperature limits of all components are never exceeded. Then the size and weight of these modules were controlled to a minimum, without sacrificing reliability. Finally these units were thoroughly tested to make certain that all design and performance specifications were met.

So, you can build your own power supply using our schematic diagram if you want to—but we think we can build it more

Please see pages 307-317 Volume 1 of your 1974-75 EEM (ELECTRONIC ENGINEERS MASTER Catalog) or pages 853-860 Volume 3 of your 1974-75 GOLD BOOK for complete information on Abbott Modules.

Send for our new 60 page FREE catalog.

reliably and for less cost, simply because we have been doing it for ten years. Put our power supply in your system first and try it. Examine its performance. We think you will be pleasantly surprised at the quality, adherence to specifications, and the reliability you find in the Abbott Model "RN".

Any output voltage from 5 to 100 volts DC with current from 0.15 to 20 amperes is available. *Many of the popular voltages are carried in stock for immediate delivery.* Please call us for attractive O.E.M. discount prices.

Abbott also manufactures 3,000 other models of power supplies with output voltages from 5.0 to 740 volts DC and with output currents from 2 milliamperes to 20 amperes. They are all listed with prices in the new Abbott catalog with various inputs:

60 A to DC
 400 A to DC
 28 VDC to DC
 28 VDC to 400 A
 12-38 VDC to 60 A

Vice President, Publisher
 Peter Coley

Editors

Editorial Offices
 50 Essex St.
 Rochelle Park, NJ 07662
 (201) 843-0550
 TWX: 710-990 5071
 Cable: Haydenpubs Rochellepark

Editor-in-Chief George Rostky

Managing Editors:

Ralph Dobriner
 Michael Elphick

Associate Editors:

Dave Bursky
 Jules H. Gilder
 Morris Grossman
 Seymour T. Levine
 John F. Mason
 Stanley Runyon
 Edward A. Torrero
 Richard L. Turmail

Contributing Editors:

Peter N. Budzilovich
 Alberto Socolovsky
 Nathan Sussman

Editorial Field Offices

East

Jim McDermott, Eastern Editor
 P.O. Box 272
 Easthampton, MA 01027
 (413) 527-3632

West

David N. Kaye, Senior Western Editor
 8939 S. Sepulveda Blvd.
 Suite 510
 Los Angeles, CA 90045
 (213) 641-6544
 Northe K. Osbrink, Western Editor
 112 Coloma St.
 Santa Cruz, CA 95060
 (408) 426-3211

Editorial Production

Marjorie A. Duffy

Art

Art Director, William Kelly
 Richard Luce
 Anthony J. Fischetto

Production

Manager, Dollie S. Viebig
 Helen De Polo
 Anne Molfetas
 Christopher G. Hill

Circulation

Manager, Evan Phoutrides

Information Retrieval

Peggy Long

Promotion

Manager, Walter G. Salm
 Karen Kerrigan (Reprints)

abbott transistor

LABORATORIES, INCORPORATED
 general offices eastern office

5200 W. Jefferson Blvd./Los Angeles 90016
 (213) 936-8185 Telex: 69-1398

1224 Anderson Ave./Fort Lee, N.J. 07024
 (201) 224-6900 Telex: 13-5332

INFORMATION RETRIEVAL NUMBER 5

CMOS circuits called a cinch to interface

CMOS circuits are extremely easy to interface with switches—more so than the article "Interface CMOS Logic With Switches" shows (ED No. 17, Aug. 16, 1974, p. 80).

verters would provide complimentary outputs.

Ward Spaniol
Engineer

Jet Propulsion Laboratory
Pasadena, CA

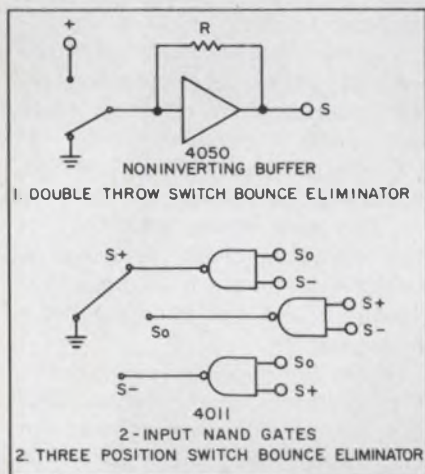

A completely bounce-free circuit is shown in my Fig. 1, in contrast with the author's Fig. 1. Note that six circuits can be constructed from one dual-in-line package, with $R = 0$.

The author refers to his Fig. 2 as the fastest possible transition through the logic decision band. This is not so, since the signal S will have slower rise and fall times than \bar{S} . Fortunately CMOS is not too edge-sensitive.

The circuit the author uses in Fig. 4 is a bounce minimizer, not a bounce eliminator. A true bounce eliminator can be configured as in my Fig. 2. Three additional in-

The author replies

I would like to thank Mr. Spaniol for his comments, which uncover several points lacking in clarity. But I would remind him not to get carried away with the task of simplifying the interface. The latches of my Fig. 1 were presented as classic textbook latches used as debouncers; as Mr. Spaniol points out, they are not necessarily the simplest circuits. I would not, however, recommend general use of the circuit Mr. Spaniol shows with $R = 0$, since output transistors are shorted to the opposite supply voltage for one gate delay with each switch throw. Although at 10 V and room temperature the maximum delay ($t_{PD} + 1/2 t_{TRANS}$) is only 105 ns, I doubt that the manufacturer's reliability figures apply to devices with this designed-in short. This is a good debouncer, though, if used as the Schmitt trigger of Fig. 3, with the input resistor around 390 Ω to provide source impedance similar to that of another gate.

Mr. Spaniol's second objection is perhaps one of misunderstanding. When the single-throw switch of my Fig. 2 is thrown, the two times of definite input signal po-

(continued on page 8)

Electronic Design welcomes the opinions of its readers on the issues raised in the magazine's editorial columns. Address letters to Managing Editor, Electronic Design, 50 Essex St. Rochelle Park, N.J. 07662. Try to keep letters under 200 words. Letters must be signed. Names will be withheld on request.



OPTRON OPTOELECTRONIC ASSEMBLIES

LOW PRICED
IMMEDIATE DELIVERY
CUSTOM DESIGNS AVAILABLE

OPTRON transmissive optical switch and reflective transducer assemblies consist of infrared LED's coupled with silicon phototransistors or photodarlington. Both use discrete hermetically sealed devices for maximum reliability and sensitivity. The assemblies feature non-contact switching, TTL compatibility and fast switching speeds. Low priced standard assemblies are immediately available and custom designed versions for special applications are available on request.



OPB 120 TRANSMISSIVE OPTICAL SWITCH uses an infrared LED aligned across a gap with a silicon phototransistor. The

OPB 120 replaces mechanical switching elements with solid state dependability. Typical applications include rotary encoders, tachometers and motion sensors. Standard gap widths are 0.125 and 0.200 inches.



OPB 125 OPTOELECTRONIC REFLECTIVE TRANSDUCER consists of a gallium arsenide infrared LED coupled with a silicon phototransistor in compact low-

cost molded plastic housing. It has extremely high sensitivity and is ideal for such applications as EOT/BOT sensing, line finding, and edge and flaw detection.

Detailed technical information on these and other OPTRON optoelectronic products . . . chips, components and PC board arrays . . . is available from your nearest OPTRON sales representative or the factory direct.



OPTRON, INC.

1201 Tappan Circle
Carrollton, Texas 75006
214/242-6571

(continued from page 7)

larity are separated by a period of noise (bounce). The idea presented was to select the $R_i C_i$ constant, with the constraints of too short a constant not filtering the bounce and too long a constant inserting undue delay.

The circuit of Fig. 4 might be described as a bounce suppressor, but if, as pointed out in the text, the Schmitt feedback resistor is included, the circuit latches and becomes a bounce eliminator. This eliminator uses far fewer gates for N position switches than Mr. Spaniol's circuit, which requires N gates of N-1 inputs each and also suffers from output shorting problems (two gate delays = 200 ns max at 10 V 25 C, by RCA spec).

Mike Stiglianese
Electronic Engineer

Cincinnati Electronics
2630 Glendale-Milford Rd.
Cincinnati, OH 45241

Heated objections to oven design

I expected to find much useful information on oven and oven-control design in your article "Split a Temperature Degree to 10 $\mu^\circ\text{C}$ " (ED No. 10, May 10, 1974, pp. 102-107). I however, was most disappointed.

My specific criticisms are as follows:

1. Dr. Williams' patronizing writing style is quite unsuited for a technical magazine.

2. The article states that sensors in the 1-k Ω range should be avoided in preference to higher resistance sensors, but only a Yellow Springs Instrument Co. (YSI) part number is given. In addition, the oven's operating temperature is never mentioned, so I couldn't figure out the resistance at temperature—even if I did have a YSI catalog.

3. The hints on oven design (p. 107) are so vague that even Sherlock Holmes would have to work for hours to make any use of them. Cylindrical ovens are quite useful. It would be very helpful if one didn't have to research thermo books to figure out how to wind

heater windings. It's not entirely obvious that atmospheric-pressure changes will cause temperature change, even if PV does equal NRT.

4. Most important, the article leaves many things unsaid. Take the following examples:

If you change dc gain of the controller to return the closed loop poles to the left-hand plane ("tuning" the controller) changes in the temperature control point occur. A better method would be to have an open-loop zero with a time constant longer than the thermal delay between the sensor and the heater (which should be wound right on top of the sensor).

Also, the method of measurement of small temperature changes, which presumably was used to produce the photos on p. 104 and the 10- $\mu^\circ\text{C}$ spec, is not explained.

Nor is the 10- $\mu^\circ\text{C}$ spec fully explained. Is this value the random peak-to-peak deviation at a constant (controlled) ambient, the peak deviation due to a step-function change in the ambient, or the change in the average temperature caused by changes in the ambient (due to finite servo gain)?

This article only hints at the work (I presume) Dr. Williams did. Much of the work will have to be duplicated by those who wish to build a similar oven to suit their own needs. In all deference to my learned colleague at MIT, if I had written an article such as this while I was at Caltech, my professors would not have considered it suitable for ELECTRONIC DESIGN.

Craig W. McCluskey,
1st Lt., USAF

Sacramento ALC/MMEER
McClellan AFB, CA 95652

The author replies

I am sorry that Lt. McCluskey did not find my article worthwhile. Perhaps I can clear up some of the points he has raised.

1. The article was written in collaboration with an ELECTRONIC DESIGN editor. I assume that he applied the same standards of writing style to my article as any other he works on. Therefore if Lt. McCluskey finds this style odious, perhaps he should cancel his subscription to avoid future pain.

2. As was clearly stated on p.

105, "The sensor bridge uses a Kelvin-Varley divider in one of its arms to provide a linear resistance scale and to enable the bridge to match a wide range of temperatures and sensors." Plainly, the controller was intended to accommodate a wide variety of sensors (hence temperature setpoints.) The YSI part number was only one example of a usable sensor.

The hints on oven design were meant to alert the reader to the necessity for careful thought in this area. In a six-page article, I cannot possibly cover a subject as complex as ovens in a rigorous manner. In addition your comment on cylindrical ovens indicates an unwillingness to work. The winding scheme we employ for cylindrical ovens was originated by a first-team freshman on an aging PDP-7 computer in about two hours.

I agree wholeheartedly with the remarks about atmospheric-pressure changes. The effect is small (not really offensive above 30 $\mu^\circ\text{C}$) but decidedly there, especially when a quick storm front moves in. The only other possibility is that my strip-chart recorder is sensitive to pressure changes, but I couldn't find any such reference in the manual.

In Lt. McCluskey's fourth point, it is certainly clear that a feedback change will cause a change in temperature setpoint. Also, the change will be quite small (the feedback potentiometer looks into a 10⁹- Ω resistor)—so small that it will be completely swamped by even the best thermistor calibration curve (1%). The stability of the setpoint, however, will remain unaffected. Your solution is unwarranted, though it will work.

Next, the photographs had nothing to do with temperature measurement. They are, as stated, "... heater voltage oscillations ..." The 10- $\mu^\circ\text{C}$ spec was vague. It was produced when the oven was monitored with a separate thermistor and a primary standard resistance bridge (Julie Research Labs PRB 205S). This spec refers to the total temperature shift within the oven for a 1-C ambient shift (settling times are long).

Lt. McCluskey's last remark is the most interesting, if not re-

(continued on page 19)



MEASUREMENT COMPUTATION

innovations from Hewlett-Packard

NEWS

DECEMBER, 1974

in this issue

Versatile new
spectrum analyzer

Take the work out
of word generation

Not one, but *five*
new systems

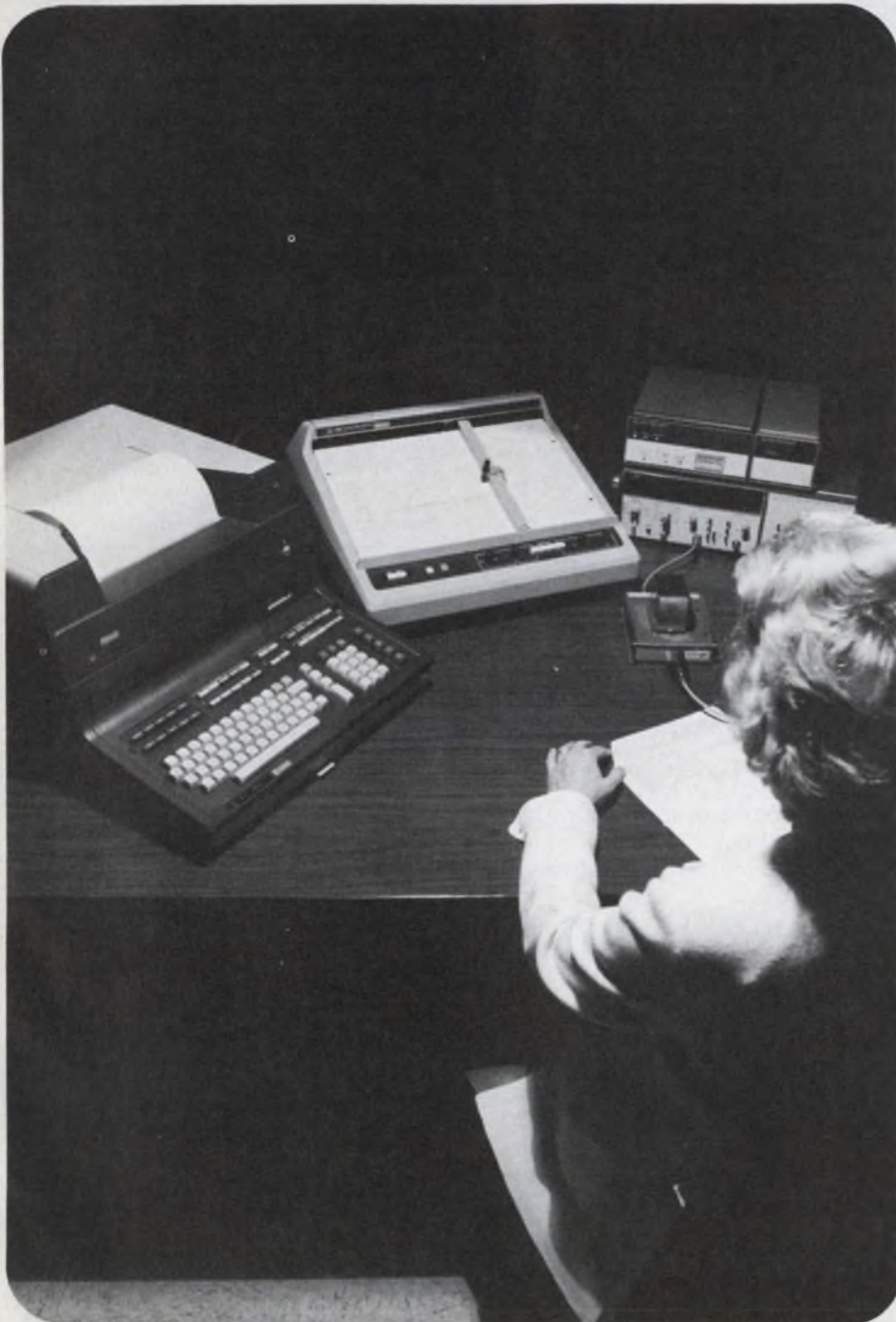

New HP interface bus links instruments

A new approach has been adopted as a major interface standard for HP products. It means you can conveniently interconnect a wide range of HP instruments, calculators, and other devices having stimulus, response, display, control or computational capabilities. Indeed, you can now assemble relatively low-cost systems with minimum engineering effort.

Called the Hewlett-Packard Interface Bus (HP-IB), it accommodates high and low-speed devices in the same system. You can interconnect as many as 15 devices—voltmeter, printer, signal source, calculator, digital clock, etc.—over a total distance of up to 20 meters. Devices are linked via a passive cable network having 16 signal lines. These signal lines carry all information (addresses, commands, program data and

(continued on page 3)

New combinations of counters and calculators solve difficult measurement problems

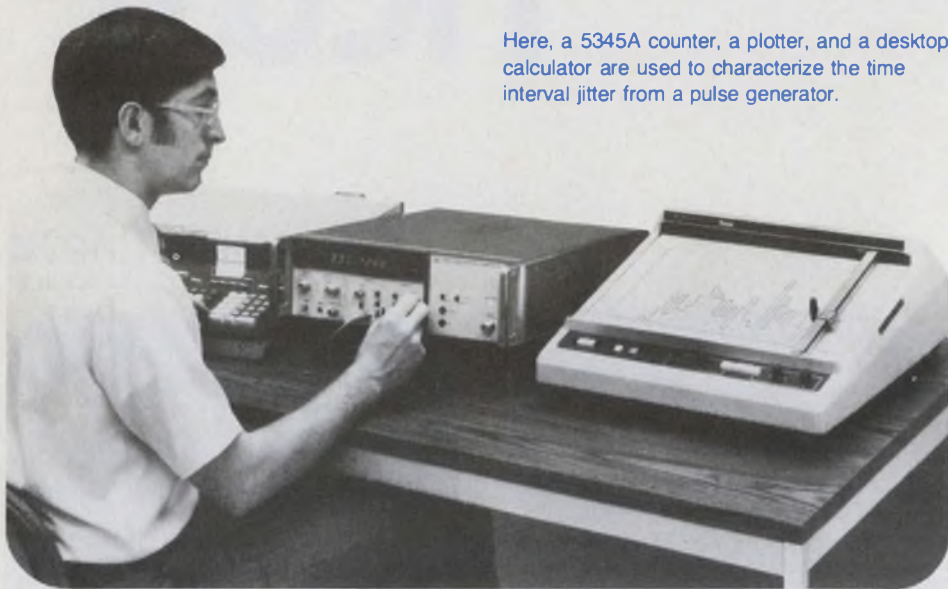

Here, a 5345A counter, a plotter, and a desktop calculator are used to characterize the time interval jitter from a pulse generator.

Thanks to the new HP interface bus, you can couple the speed and computational power of an HP calculator with the measurement capability of HP electronic counters and state-of-the-art accessories. Several new application notes describe how these versatile low-cost combinations solve difficult measurement problems.

AN 174, a new series of 13 application notes, describes HP interface bus systems configured around the 5345A counter and a 9820A, 9821A or 9830A calculator. These systems are used to:

- Spec VCOs with respect to tuning step transient response and post-tuning drift,
- Characterize digital receiver performance as a function of S/N by measuring the statistical variation in receiver delay time,
- Match the delays through two lengths of cable to within a few picoseconds for antenna feed systems.

The 174 series covers a wide variety of applications from phase measurements to complete VCO linearity testing. We'll be glad to send you an index so that you can order specific notes of interest.

You can also combine the 5340A microwave counter with a calculator to measure the linearity of VCOs operating at frequencies up to 23 GHz. Application note 181-1 describes how this synergistic counter/calculator combination

Low-cost data acquisition: three counters (with snap-on interface modules) send time interval, frequency, and voltage information to a thermal printer that also acts as a controller.

measures, computes and plots the transfer characteristic, differential, non-linearity, and integral nonlinearity of the VCO under test.

Application note 181-2 provides an example of a simple data acquisition system using HP low-cost counter modules, an interface, and a 9820A or 9821A calculator. A multimeter/counter measures frequency, ac volts, dc volts, or resistance and outputs these measurements to the calculator. The calculator computes the mean, standard deviation, and peak-to-peak deviation of the data and even plots a histogram.

For the two 181 application notes and 174 series index, check 5 on the HP Reply Card.

Two new timing instrument accessories

A timing generator and a digital clock are HP's newest ASCII-programmable instrument accessories. The two modules are compatible with the HP interface bus and, as such, can be linked to counters, digital voltmeters, and other HP instruments.

The 59308A timing generator provides precision time intervals from 1 μ s to greater than a day. These time intervals are defined by start/end pulses and HP interface bus start/end "flags." This flexible way of defining time intervals permits use in a wide variety of hardware and software applications. For example, the 59308A can be used to provide delayed gating pulses to counters or digital voltmeters to obtain frequency or voltage vs. time information. It can also be used to schedule subroutine execution in computer/calculator programs or to measure the time between events with μ s resolution.

The 59309A digital clock displays calendar and time data (month, day, hour, minute, second) and can be used for time logging to printers and calculators.

To learn more, check 1 on the HP Reply Card.



For digital timing applications that require precise intervals from μ s to days, use HP's new timing generator and digital clock.

Now, take the work out of word generation

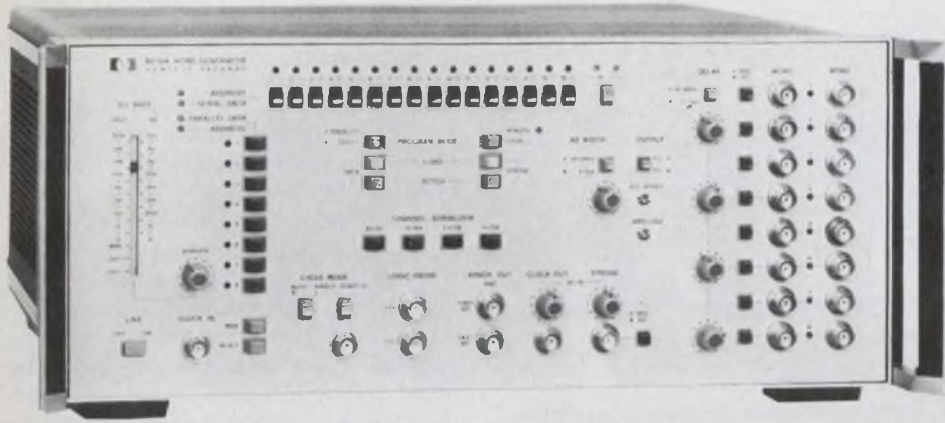

HP's new 8016A 50-MHz word generator is also fully compatible with the new HP interface bus.

High speed, high capacity, stability, bit pattern programmability, and competitive price put the new 8016A word generator at the top of its class. It's ideal for testing ICs, circuit boards, and data communication systems.

Freely-programmable bit patterns and high capacity produce a flexible output, both in content and format. Data output can be parallel (32 bytes each 8 bits wide) or serial (8 words each 32 bits long) at rates up to 50 megabits/second. The 8016A also has a strobe output (that can function as a ninth data channel or floating trigger), selectable ECL and TTL

output levels, and six independent delay circuits.

Unlike the confusing front panels of complex word generators, the 8016A front panel is simple and easy to use. Data can be loaded in either parallel or serial form. As an option, you can also load bit patterns via a card reader, at the rate of 256 data bits in 2 seconds.

The 8016A is especially effective for determining worst-case conditions in IC testing.

For specifications and details, check L on the HP Reply Card.

Interface links instruments

(continued from page 1)

status data) at data rates up to 1 megabyte/sec.

Simple HP interface bus configurations do not require the use of a controller such as a calculator or computer (although HP-IB is compatible with both). In most cases, HP programmable calculators are the ideal controllers for customer-assembled systems whenever some degree of data manipulation is required. Our HP-IB calculator interface package provides everything necessary for interconnecting your HP 9820A, 9821A or 9830A calculator with up to 14 other HP-IB instruments and accessories.

Several popular measurement solutions are available in the form of complete, pre-assembled HP-IB systems. (See the 3050B data acquisition system in this issue.) They are fully integrated and documented from a hardware and software point of view, and HP takes full responsibility for overall performance of these pre-assembled systems.

Check Q on the HP Reply Card for details on the new HP interface bus and a list of currently available HP-IB products.

Two HP scopes for digital design, testing, and field service

If you work with digital systems, two HP oscilloscopes can make your job easier: the 1710B is a 200 MHz dual-channel scope for field servicing, while the 1720A is a 275 MHz dual-channel scope for digital logic design and testing.

Both have tight accuracy specs for those critical measurements—for example, calibrated sweep to 10 ns/cm (1 ns magnified times 10) and accurate to 3% over the full 10 cm of horizontal deflection. Differential time measurements are accurate to 1% for most applications. Both scopes offer delayed sweep, stable triggering, and selectable input impedance (50Ω or 1MΩ). And both scopes maintain specified performance from 0° to 55°C.

The 1710B with deflection factors to 5 mV/cm is ideal for servicing computers that use ECL 10K or TTL logic.

The precision 1720A has deflection factors to 10 mV/cm. It's used in the design, manufacture, and testing of fast logic systems—computers, peripherals, logic components, and communications equipment.

For the full scoop on these handy scopes, check C on the HP Reply Card.



Accuracy and environmental specifications make either the 1710B scope (shown here) or the 1720A model equally suitable for bench use or field service.

Now, simulate logic designs directly from your schematic

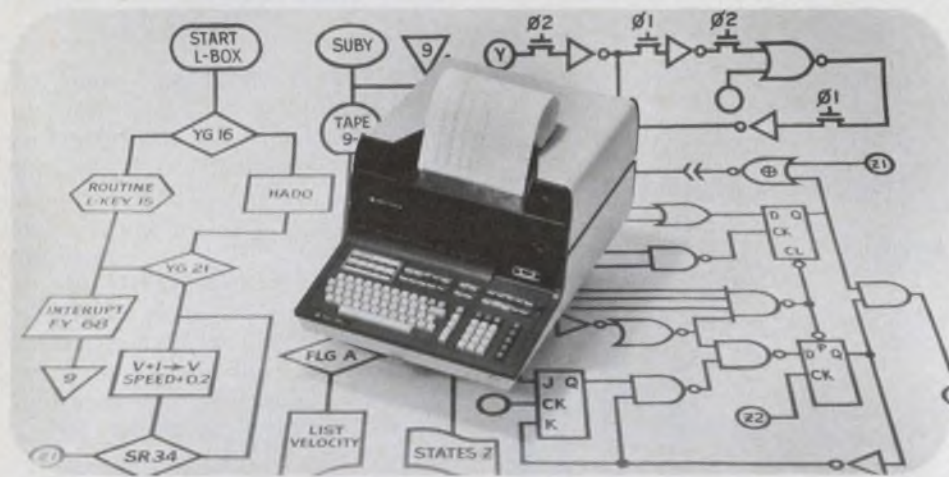

Digital simulation cuts design time and improves accuracy.

HP's new approach to logic circuit design provides a self-contained digital simulation technique that 1) improves the accuracy of complex designs, and 2) reduces the time engineers spend verifying logic behavior. The system uses an HP 9830A programmable calculator and newly available digital simulation software. Four programs handle:

- Combinational networks for all logic families,
- Synchronous one-clock networks for DTL/TTL/ECL families,
- Synchronous two-phase networks for

MOS/LSI families,

- Timing analysis including propagation delays.

You can use the new digital simulation system to generate truth tables, analyze sequential logic circuits, generate state-time maps, document designs, analyze MOS/LSI circuits, and generate timing diagrams.

A basic system consists of the calculator with 4K memory, a string-variables read-only-memory, and a thermal printer.

For more information, check R on the HP Reply Card.

Multiprogrammer provides flexible computer access

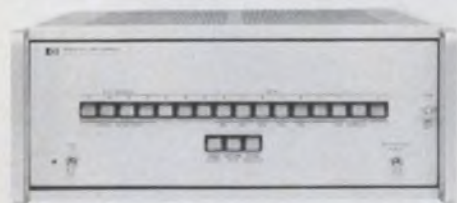

Attach HP's multiprogrammer to your computer and you can add up to 240 more I/O channels.

Now you can build your own control or data acquisition system—economically—with an HP 6940A multiprogrammer.

You need just one computer input/output channel to interface with the multiprogrammer. The 6940A itself holds up to 15 plug-in analog and digital I/O cards, mixed in any combination. Some plug-ins convert programmed

output into signals to drive stepping motors, control transducers, close contacts, or to stimulate units under test. Other cards convert responses from process instruments into digital data for computer input.

If you need more than 15 input/output channels, simply add the 6941A extender mainframes. Each extender holds 15 plug-ins, and you can add up to 15 extenders—giving you a total of 240 channels controlled from one computer I/O slot.

For details, check J on the HP Reply Card.

New automatic spectrum analyzer delivers spectral, distortion and wave analysis

Now, you can perform spectral analysis, distortion analysis, and wave analysis quickly, automatically with the same system—the new 3045A automatic spectrum analyzer. Using the new HP interface bus, we combined the accuracy of a digital display in a spectrum analyzer with the high resolution of a synthesizer and the computational and control capability of a desktop calculator. The result: a fast, fully programmable, automatic system for production testing, quality control, and lab work.

Frequency ranges from 10 Hz to 13 MHz. Amplitude is displayed in dB on a digital display—to 0.01 dB resolution. It's easy to use: HP provides all the software for general measurements and programming instructions for more specific measurements.

The interface bus accommodates up to 15 devices, so you can easily add a plotter to graph relationships—for example, distortion vs. frequency or gain vs. frequency for audio amplifiers.

To learn more about automatic, low-cost analysis, check D on the HP Reply Card.



Eliminate tedious frequency tuning. The new 3045A system is the automatic and accurate way to test consumer electronic products.

New digital pattern analyzer works with any scope

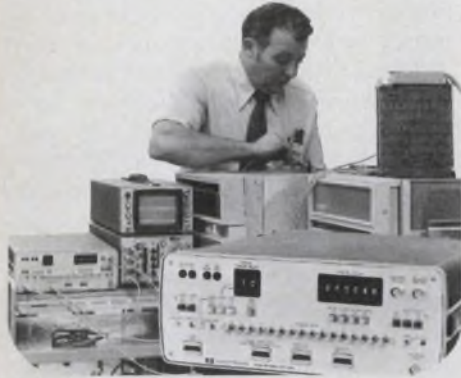

Troubleshooting a disc is a typical application for the new 1620A digital analyzer that scans parallel or serial bit patterns at rates up to 20 MHz.

The new 1620A digital pattern analyzer is a versatile trigger source compatible with any oscilloscope. The unit scans digital patterns up to 16 bits, serial or parallel, synchronous or asynchronous; and when it recognizes a preset pattern, it produces a trigger signal (2V, 25 ns). Essentially, the 1620A provides a dynamic window for checking your digital circuitry—using your existing oscilloscope, regardless of the manufacturer.

Use the front panel control to set the trigger word, i.e., the pattern that the analyzer will search for in the passing data stream. The trigger word can be simple (any pulse) or complex (a unique combination of ones and zeros).

Unlike a trigger that depends on a time delay, the pattern-recognition triggering technique eliminates accumulated timing error. If you want to examine the contents of a disc track or any long digital record step by step, the 1620A does have digital delay. You can move the measurement window up to 999,999 clock periods after pattern recognition.

Also to eliminate errors in asynchronous systems, a special filter ignores "glitches" of short duration that could cause spurious triggers.

For more information, check B on the HP Reply Card.

New precision power splitter aids swept measurements

A remarkably versatile and useful device for swept-frequency measurement applications is the new HP 11667A power splitter. Its dc to 18 GHz frequency range makes it an ideal companion for the HP 8755 frequency response test set and the new HP 86290A/8620A broadband (2-18 GHz) solid-state sweep oscillator.

Tracking between output arms is within .25 dB over the full range. When the splitter is used to level a sweeper or to divide signals in ratio measurements, this close tracking has the equivalent effect of improving output source match and frequency response tracking. Thus, your measurements are more accurate.

Some important uses for the new power splitter are described in the data sheet.

For your copy, check O on the HP Reply Card.

Wideband swept measurements to 18 GHz become easier and more accurate using the new HP 11667A power splitter.



Add a tracking generator to HP's RF spectrum analyzer

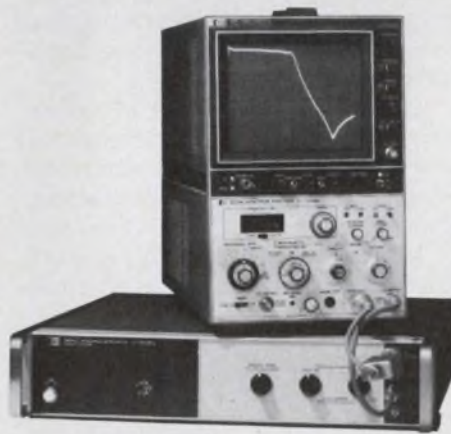

The HP 8558B RF spectrum analyzer now has a companion tracking generator for making swept-frequency response measurements from 500 kHz to 1300 MHz. The HP 8444A option 058 tracking generator's output signal is always the same frequency as the spectrum analyzer, making it possible to achieve more than 90 dB dynamic range in swept transmission and reflection measurements. The generator provides 0 dBm calibrated output with ± 0.5 dB full band flatness.

For precise frequency measurements, add a counter to the analyzer/generator combination, and you can selectively determine the frequency of any and all displayed signals.

Make wide dynamic range swept measurements with HP's 8558B spectrum analyzer and new tracking generator.

For more information check M on the HP Reply Card.

New low-cost system helps you gather data, make decisions and control instruments



Sitting at a calculator, you can monitor and act upon data being gathered at a remote location.

Automatic data gathering and reduction need not be expensive—if you choose HP's new 3050B automatic data acquisition system. This compact low-cost system scans up to 520 channels under calculator control; measures dc, ac and ohms at up to 4 readings/second; then calculates results either on-line or off-line.

Basically, we've used the new HP interface bus to team a multimeter and a scanner with a programmable calculator. The system measures:

- dc in 5 ranges from 100 mV to 200V with 1 μ V resolution
- ac in 4 ranges from 1V to 200V with 10 μ V resolution over a frequency range of 20 Hz to 100 kHz
- resistance from 100 Ω to 10 M Ω with 1 m Ω resolution

With the appropriate transducer, you can also measure pressure, torque, velocity, acceleration, and weight. The

calculator controls data logging and, at the same time, performs other required calculations, such as transducer linearization or statistical analysis.

You can easily use the 3050B to measure multiple physical parameters and to monitor devices. It's also suited for research work, as well as production testing. Now, you can test 100% of your pc boards or other electronic devices, at a fraction of the cost of a computerized system.

If you need to obtain or send data elsewhere from your test site, HP offers an optional common carrier interface, and arrangements can be rented from the phone company for remote transmission.

For full details, check E on the HP Reply Card.

New lab computer also handles data management

The new Scientific/310 data system provides multiprogramming, real time, and networking capabilities to give you more than just data from your laboratory.

The S/310's versatile multiprogramming lets you develop programs concurrently in FORTRAN, ALGOL, and assembly language; and we provide both an easy-to-use and efficient editor (EDIT II) and a powerful file manager.

The real-time executive software lets you sense and respond to time-critical events right away. To its already reliable system, HP has added fail-safe mechanisms that keep the S/310 operating even if the primary power is removed for as long as 2-1/2 cycles. And power fail/auto restart is provided to save operational status.

A number of options are available. User microprogrammability and batch processing with spooling can help reduce operator time by speeding up slow routines and spooling input and output for processing.

To learn more, check A on the HP Reply Card.



The S/310 can be linked to an HP S/250 data management system, HP 3000 computer systems, or an IBM/360 to share data and management information.

Two new compact recorders for end users and OEMs

HP announces two new compact X-Y recorders (8.5 in. by 11 in. or 20.3 cm by 28 cm DIN A4)—the 7010A OEM model and the 7015A laboratory version. Both models have mechanical pen lift, electrostatic paper holddown, continuous duty dc servo motors, and a universal pen holder that accepts most commercial fiber pens.

Slewing speed is 20 in./sec. (50.8 cm/sec.). Peak acceleration is 500 in./sec. (1270 cm/sec.) on the X axis and 1000 in./sec. (2540 cm/sec.) on the Y axis. Common mode rejection is 130 dB dc and 90 dB ac.

The 7010A OEM version has 100 mV/div. sensitivity. The 7015A is a general-purpose recorder for schools and laboratories and, as such, has three ranges: either 0.01 V/in., 0.1 V/in., and 1 V/in. or 0.01 V/cm, 0.1 V/cm, and 1 V/cm. Several options are available for both models.

To learn more, check K on the HP Reply Card.

The 7010A is a compact, durable OEM recorder with a reasonable price tag.

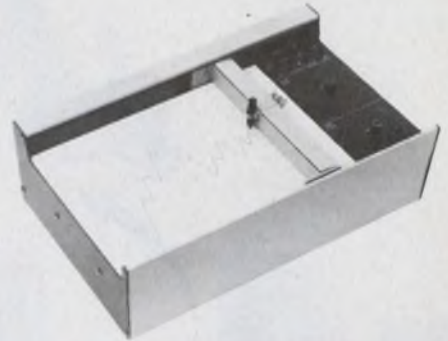

New polarity and overflow display expands LED family



The new 5082-7750 series displays provide a high contrast ratio and wide viewing angle.

HP introduces the 5082-7752 "±1" overflow LED display. It's ideal for instrumentation such as digital voltmeters and digital multimeters. Designed for use with HP's 5082-7750 series of .43 in. (11 mm) display, it's bright enough to be viewed up to 20 feet away.

These common anode devices are IC compatible and come in a standard 0.3 in. (0.8 cm) DIP lead configuration. Contact any franchised HP distributor for immediate delivery.

For more information, check G on the HP Reply Card.

New calculator LED displays

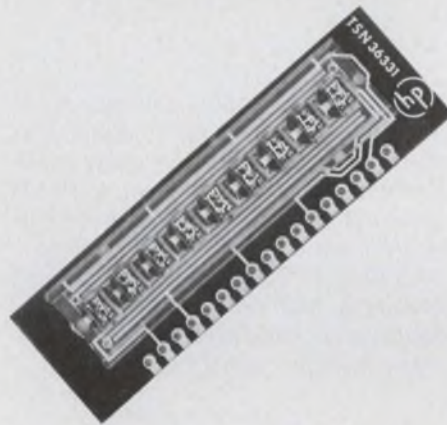

Nine digits, matched for brightness, are mounted on a single pc board.

Now, you can buy calculator displays, 0.1 in. or 2.67 mm high, in eight or nine-digit clusters on a printed circuit board. The new 5082-7440 series red LED displays have right-hand decimal points, are MOS compatible, and require low power (only 250 μ A average per segment). Mounted on 200 mil (5.08 mm) centers, they have a magnifying plastic lens for excellent readability. Use them in handheld calculators or any product that requires small, low-power, low-cost, long-life indicators.

For specifications, check F on the HP Reply Card.

New panel-mount microwave step-attenuators

OEM users of microwave turret attenuators now have an attractive alternative: a choice of four new step-attenuators covering dc to 4 GHz or dc to 18 GHz and available in either 70 dB or 110 dB models.

Typically, turret models must switch both center and outer conductors of the attenuating element so contact repeatability is a problem. The new HP 33320 series uses a new "edge-line" switching design with the attenuating pads connected in cascade. Only the center conductor is switched. Repeatability is within 0.02 dB even after 100,000 complete 11-step rotations.

Required panel space is less than 1 in. by 2 in. (2.5 cm by 5 cm). Bench models with type N or APC-7 connectors and a heavy base are also available.

For more information, check P on the HP Reply Card.

HP's new step-attenuators provide high accuracy, inherent stability, and excellent repeatability at microwave frequencies.

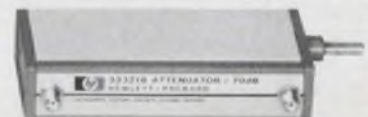
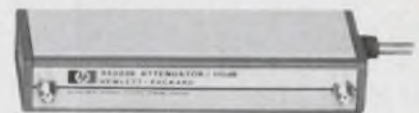

Five new measurement/control systems have MOS memory



HP measurement/control systems operate independently or share workloads in a distributed systems network.

Now, HP introduces five new systems, all using our latest computer with semiconductor memory.

The new HP 9611A industrial measurement and control system features new analog and digital I/O capabilities: analog current input signal conditioning, event counter, programmable timer, stepping motor controller, stall alarm, and signal conditioning for 50 Vdc and

117 Vac digital inputs and outputs. It includes screw-type terminations and all other capabilities previously available with the HP 9610 system. All 9611A measurement/control capabilities can be remoted over serial cables up to 10,000 feet. (You avoid the installation problems, high costs and signal degradation associated with long runs of many multiple signal lines.)

A lower-cost system without screw terminations and signal conditioning, the new HP 9603A offers both the local and remote measurement/control capabilities of the HP 9611A. (Another low-cost system, the 9604A, is a single-task dedicated system without time-scheduling capability.)

A high-accuracy system, the new HP 9602A, provides an integrating A-to-D subsystem for maximum noise rejection. This system measures dc with optional digital I/O and ac, resistance, and frequency measurement capabilities.

The 9611A, 9603A, and 9602A offer a choice of 3 different real-time operating systems for time and event scheduling of multiple tasks—one of these in HP real-time BASIC. The other two are CPU memory-based and disc-based real-time executive systems. The disc-based system, built around the new RTE-II executive, provides two multi-user swapping partitions.

These new systems can be operated together as satellites in a distributed systems network coordinated by the new HP 9700A distributed systems central system. Thus, they can share workloads and benefit from the centralized program development, data storage, and file management facilities of the HP 9700A central system.

To learn more, check N on the HP Reply Card.

HEWLETT  PACKARD

East-20010 Century Blvd., Germantown, MD 20767, Ph. (301) 428-0700.

South-P.O. Box 2834, Atlanta, Ga. 30328, Ph. (404) 436-6181.

Midwest-5500 Howard Street, Skokie, Ill. 60076, Ph. (312) 677-0400.

West-3939 Lankershim Boulevard, North Hollywood, Calif. 91604, Ph. (213) 877-1282.

Europe-Post Office Box 85, CH-1217 Meyrin 2, Geneva, Switzerland, Ph. (022) 41 54 00.

Canada-6877 Goreway Drive, Mississauga, Toronto, L4V 1L9, Ph. (416) 678-9430.

Japan-Yokogawa-Hewlett-Packard, 1-59-1, Yoyogi, Shibuya-ku, Tokyo, 151.

(continued from page 8)

vealing. While the rest of his letter might be interpreted as constructive criticism, this section's purpose is plainly singular. It falls somewhere between a cheap shot and rhetoric. The parenthetical comment and the last sentence are baseless venom, obviously chosen to promote an aura of ridicule (which thus magically validates all previous criticism). and indicates a possible need for professional consultation.

James Williams

MIT

Dept. of Nutrition and
Food Science
Cambridge, MA 02139

Yet another use for microfiche

I find the comment by Scott Campbell on the paper shortage (see "No Shortage of Solutions to the Paper Shortage," ED No. 15, July 19, 1974, p. 7) to be interesting. Like most engineers, I have cabinets, drawers and folders full of articles and ideas, which I can rarely find when needed. A microfiche version with one detailed, easily filed, readable index of the contents would not only save paper but would also drastically reduce the storage space needed for copies of the magazine.

Craig Emigh

Army Electronics Command
Fort Monmouth, NJ 07703

A few numbers needed in gain-control circuits

The following errors appeared in my article "Get Gain Control of 80 to 100 dB" (ED No. 13, June 21, 1974, pp. 94-99):

1. Fig. 1— R_7 is X OFFSET; 50 k.
2. Fig. 2—the value for R_{1A} is 20 k.
3. Fig. 4— R_i is 9.53 k.
4. Figs. 5 and 6—pin 2 is the inverting input; pin 5 is the amplifier bias input.

Walter G. Jung

1946 Pleasantville Rd.
Forest Hill, MD 21050

Bell Labs also makes versatile active filters

I was interested to read your survey "The Rise of Active Filters: They're Running Strong in Two Major Fields" (ED No. 13, June 21, 1974, pp. 34-44).

The list of commercial manufacturers was quite complete. However, you failed to report on active-filter progress at Bell and Western Electric, and implied (on p. 40) that we do not make active filters for use with our equipment. This failure denies the reader knowledge of the status of the work of perhaps the largest producer of active filters in the world.

Readers can obtain information on our STAR active-filter, building-block design if they write to us.

Another report on an active filter being produced in very large volume can be found in the *Bell Labs Record*, Vol. 51, No. 4, April, 1973, entitled "Active Filters Make It Small in the D3 Channel Bank" by R. A. Friedenson.

Economical discrete and thin-film active filters have been produced in high volume by Western Electric for the past few years, and their usefulness and cost competitiveness are continuing to grow.

J. J. Friend,
Supervisor
Circuits and
Technology Group

Bell Laboratories
Holmdel, NJ 07733

Ed. Note: We're aware that Bell is doing work in active filters. The laboratory was, however, reluctant to disclose the full details of this work.

Correction

In a listing of packaged-oscillator manufacturers for a Focus article in the Sept. 13 issue, Precision Dynamics Corp. was inadvertently included. The company, which is at 3031 Thorton, Burbank, CA 91504, makes digital displays. For information on these products, circle No. 319 on the Information Retrieval Card.

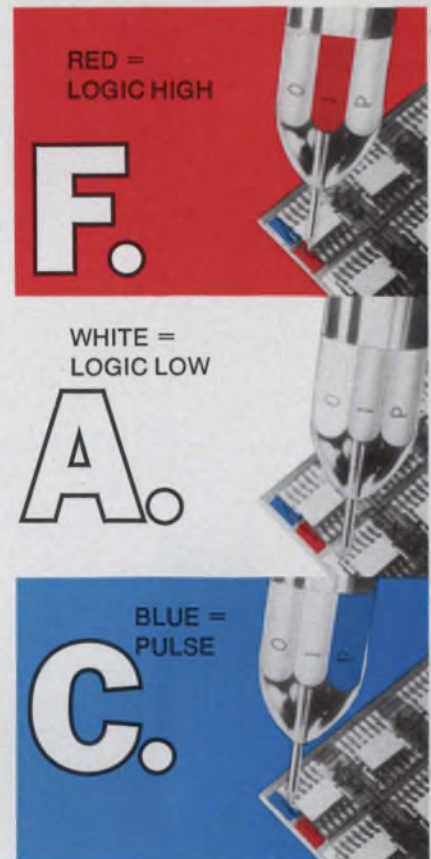

T. a new,
faster,
low cost, digital
system that cuts
troubleshooting
time to minutes
...or seconds.

You'll reduce setup time, increase field service cost efficiency, reduce training time, relieve documentation worries, and best of all speed analysis time, with the new F.A.C.T. system for digital troubleshooting.

Failure Analysis by Color Tracing is an exclusive Kurz-Kasch system. By comparing the color observed on a logic probe with the color marked on a print, schematic or overlay, anyone can troubleshoot digital logic. No decision making is needed. F.A.C.T. does it all. F.A.C.T. is faster than scopes, clips, meters or comparators and displays more information. Its low cost... \$149.50, includes a Kurz-Kasch logic probe and pulser, a protective pocket pouch and a F.A.C.T. software documenting procedure. For FREE literature, 30 day FREE TRIAL probes, or special F.A.C.T. information, telephone Tom Barth, General Manager, (513) 296-0330, 2876 Culver Avenue, Dayton, Ohio 45401.



Kurz-Kasch, Inc.
ELECTRONICS DIVISION

INFORMATION RETRIEVAL NUMBER 7

decoding the codes

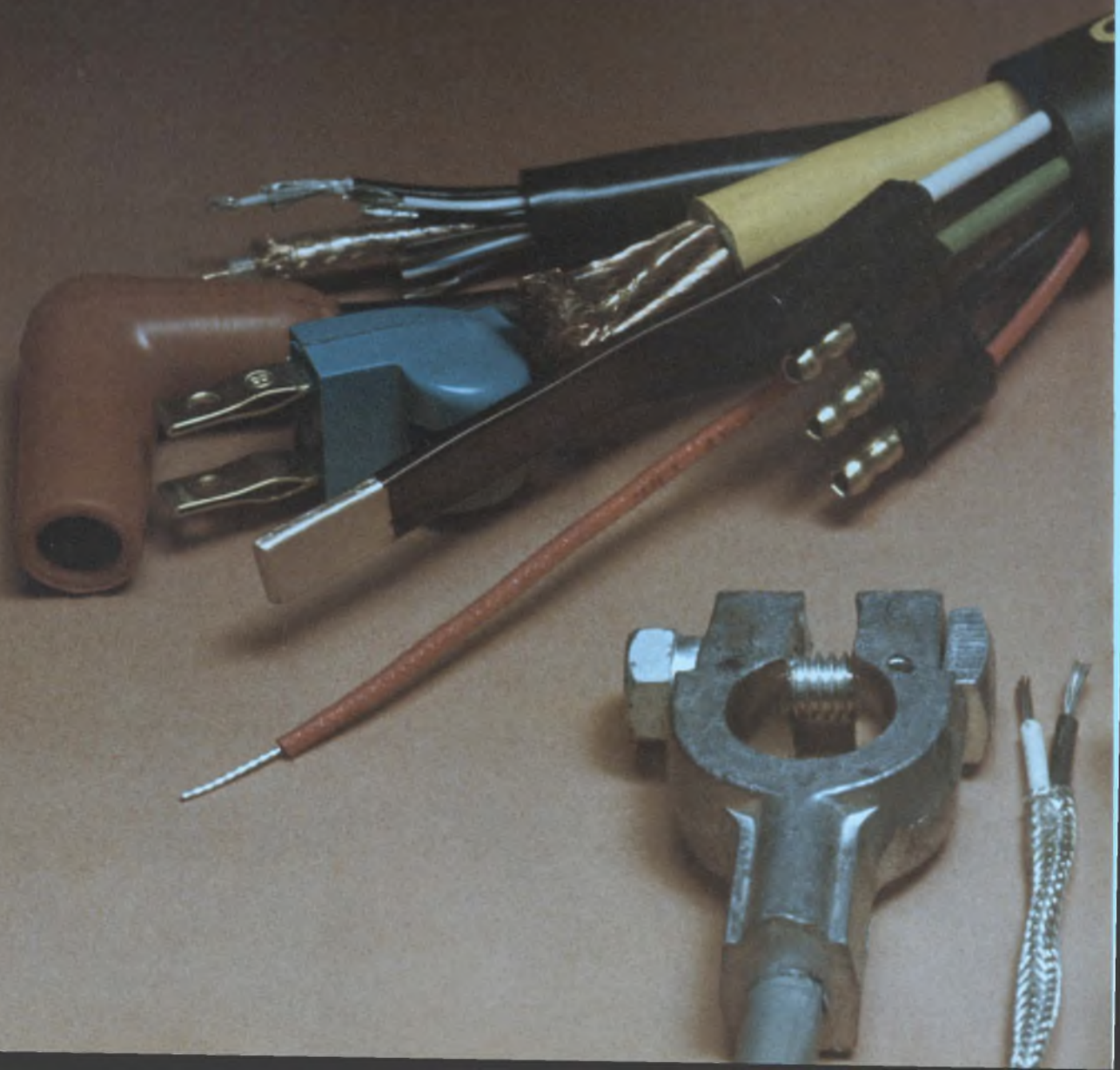

With ever-changing technology and increasing demands for innovative products, more precise safety guidelines are a must.

Belden knows the codes, standards, requirements and limits of acceptability in the wide world of industrial wire, cable and cord. As supplier of thousands of standard items for electrical, electronic and automotive needs we can readily help you select the right product for the job. Belden products meet or exceed industry code needs. And we can custom design and manufacture complex cable configurations to meet the most demanding specifications. If a code is puzzling you, or you have an application where you're not sure what the standards are, check with Belden. We cope with codes every day.

If you want answers right now, phone:

(312) 887-1800, Transportation Division

(312) 681-8920, Electrical Division

(317) 966-6681, Electronic Division

Or write Belden Corporation, 2000 South Batavia Avenue,
Geneva, Illinois 60134.

H-3-3

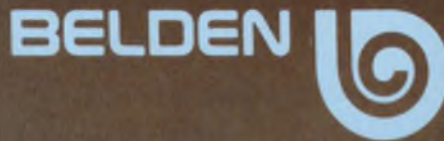
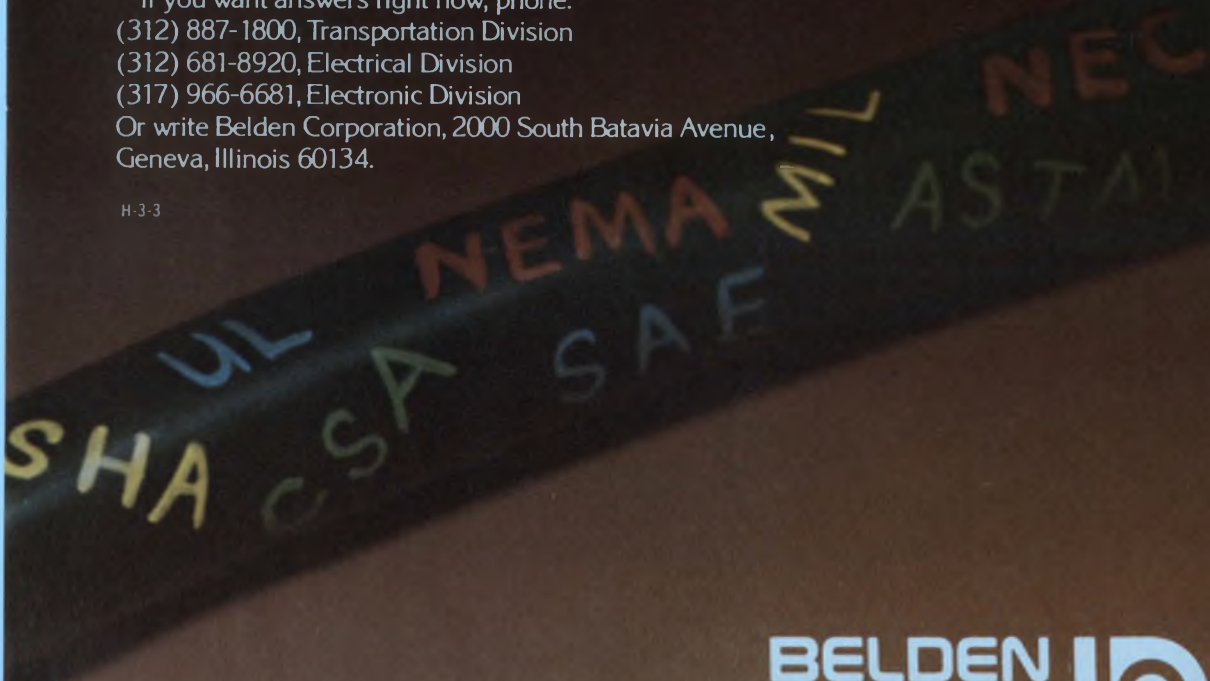

INFORMATION RETRIEVAL NUMBER 234



Watts New



Sorensen introduces the new, higher power density DCR-B series lab/system dc power supplies. Designed specifically as an extension of the popular single-phase DCR-A series. Minimum panel height is 3½". Power output is up to 2700 watts. Noise and ripple are 50% lower than in previous models.

Other DCR-B advantages: low cost-per-watt; fast response time; choice of 32 new versatile models to cover a broad range of applications; exceptional efficiency and dependability; and new, less expensive overvoltage protection option that can be installed at the factory or in the field. For complete data, contact the Marketing Manager at Sorensen Company, a unit of Raytheon Company, Manchester, N.H. 03103. (603) 668-4500.

Representative Specifications – DCR-B

| Voltage Ranges: 0-10, 20, 40, 60, 80, 150, 300, 600 volts DC | | | |
|--|------------|------------------------------|-------------|
| Efficiency: Up to 86% typical | | | |
| Panel Height | Cooling | Nominal Output Power (watts) | Price Range |
| 3½" | convection | 500 | \$400-475 |
| 5¼" | convection | 1000 | 575-690 |
| 7" | convection | 1800 | 775-975 |
| 7" | fan | 2700 | 1075-1150 |

Sorensen
POWER SUPPLIES

Bipolar IC microcomputer claims a number of 'firsts'

Employing "bit manipulation, as opposed to number crunching," a new microcomputer system is said to have an architecture that is unique for control and communications.

The system—the SMS MicroController by Scientific Micro Systems, Mountain View, CA—also has such "firsts" as these, according to James Geers, vice president of marketing:

- The most extensive use of high-speed, bipolar/LSI technology in a microcomputer to date.

- Execution of control sequences at speeds up to 100 times faster than available microcomputers.

- Direct processing of I/O variables at the same speed at which the internal registers operate—300 ns.

- A low cost of \$370 in 100 quantities.

The SMS MicroController is a complete microcomputer, Geers says. It contains a microprocessor, an integrated I/O structure, ROM/PROM program storage and RAM data storage. The machine is designed to handle most minicomputer applications where extensive data processing is not required.

I/O efficiency is achieved Geers says, with an integrated structure, expandable from 32 to 224 individually addressable I/O connection points. As a result, control, status and data lines of user devices are instantly accessible by the MicroController program.

Another feature, Geers points out, is direct variable-field addressing, which gives access to any 1-to-8-bit I/O field of the array of 224 I/O points. Testing and branching on a 1-to-8-bit I/O field is performed in a single 300-ns instruction.

Transferring a single preselected data field from an I/O source to an I/O destination requires two instructions (600 ns). Any register

or I/O field can be conditionally tested for a specific bit pattern in 900 ns, Geers says.

Design support for the SMS system is provided for both hardware and software. A MicroComputer simulator, a real-time, on-line replica of the SMS machine, is available with front-panel controls for program modification and control during debugging.

A MicroController machine compiler, a symbolic programming language, allows the user to program with an assembler-level instruction set. With the compiler, the manufacturing information for producing the firmware is generated.

CMOS parking meter eliminates dead time

A popular sport of the urban motorist—finding a parking meter with some time left on it—will become a thing of the past if an electronic parking meter comes into widespread use.

Developed by Applied Technology Systems, Inc., of Lewisburg, TN, the new meter uses programmable CMOS logic, throwaway or rechargeable batteries and an optional Hall Effect electromagnetic sensor.

The meter has several options. The most interesting, from the buyer's point of view, is that the Hall Effect sensor, which can be included for only \$5 or \$10 can detect when a car leaves the space controlled by the meter. Once the car leaves, the sensor automatically resets the timer in the meter to zero.

This feature makes it possible to increase the revenue of the meter. Instead of being limited by a number of time periods in a day, the money taken in reflects the

number of cars that use the space.

Readout options are also available. An analog readout of time can make the meter look exactly like present mechanical meters. Or a liquid-crystal digital display can be used. A third possibility that several municipalities are looking at is a go/no-go display that indicates time is left but not how much.

According to Dr R. B. Rubenstein, executive director of Applied Technology Systems, the new meter has many advantages over present mechanical devices. The mechanical meters, he notes, require removal and preventive maintenance twice a year. This work requires two hours per meter, he says, and if the maximum time period of the meter has to be changed, another two hours per meter are needed. Many of the mechanical meters must also be wound by hand once every two weeks.

The electronic meter is made from solid-state components; no preventive maintenance is required. If the maximum time period of the meter has to be changed, it can be done on location by the flipping of a switch.

The new meters are being marketed at costs comparable to those for mechanical units, Rubenstein says.

Army vehicles to get intelligent terminal

A rugged, powerful intelligent terminal will ride in the Army's armored field vehicles before long. Called a Query Control Station, the terminal will be used for computation, data entry, message composition, validation, storage and display printout of digital and voice messages.

The terminal, to be developed by Singer Librascope, Glendale, CA, consists of a processor, plasma panel display with keyboard, 1200-lpm line printer and communication interface.

A 1602, 16-bit microprogrammed minicomputer from Rolm Corp., Cupertino, CA, is the heart of the system. It has 64-k words of core memory. Four of these minis can be interconnected for multiprocessor applications in an expanded system.

The communications interface is

expandable to handle 64 channels of data and voice.

Henry Pinczower, program manager at Singer, emphasizes: "This system is rugged, compact, lightweight and modular in construction. It is meant for use on the field of battle."

It will be part of the Army Tactical Data System. Development is supported by the U.S. Army Electronics Command at Fort Monmouth, NJ.

Delivery of the two systems under the current contract is due in 28 months.

Cooled alloy promises better magnetic circuits

Cooling a molten amorphous alloy to normal ambient temperatures at the fantastic rate of a million degrees a second produces a glass-like alloy that, under stress, is reported to have substantially better magnetic properties than today's best available soft magnetic materials. The superior properties of the magnetic amorphous alloy, termed Metglas 2806 by Allied Chemical Corp., Morristown, NJ, promises significant performance improvements in magnetic components and circuits.

Metglas 2806 is one of a family of low-cost amorphous alloys produced by an Allied Chemical process in which quenching from the liquid state occurs so rapidly that the random atomic structure of the liquid phase is retained in the solid at normal ambient temperatures.

The unique atomic structure gives these materials exceptional strength combined with good ductility, superior corrosion resistance, high hardness and low acoustic attenuation.

An independent investigation of the properties of Metglas 2806, was headed by Prof. C. D. Graham Jr. at the University of Pennsylvania. The researchers determined that when a 0.002-in-thick \times 0.070-in.-wide ribbon of the alloy is stressed to 25 kg/mm², its magnetic properties are far better than those of one of the best soft magnetic materials, 80-20 Permalloy. The Metglas is better in the following ways:

- It has an almost perfect,

square-loop hysteresis characteristic compared with the rather broad loop of the 80-20 Permalloy.

- The Allied Chemical alloy can be magnetized more easily to higher saturation levels. The Metglas reaches a saturated level of 8600 G with a small coercive field of 0.03 Oe compared with the 0.015 Oe required to saturate the Permalloy at about 8000 G.

- Upon the removal of the coercive field, the Metglas retains a substantially higher percentage of its magnetism—about 96% of its saturated value, or 8-k G, compared with 75% of the 80-20 material's saturated value of about 6-k G.

- The Metglas is substantially harder and stronger than Permalloy and similar magnetic materials.

Metglas 2806 has an electrical resistivity of about 180 $\mu\Omega$ -cm, which is three times greater than that of 80-20 Permalloy. As a result, the hysteresis losses of Metglas are substantially less. This means that Metglas can be used as transformer cores for high-frequency power devices such as inverters and converters. Permalloy and similar materials are not used now in these applications because of the excessive losses.

While the magnetic properties of the Metglas material are at their best when the material is stressed, the unstressed-material properties are still good. They are about equal to those of 8020 Permalloy, Allied Chemical reports.

CIRCLE NO. 318

Mini systems grab attention at Interkama

An IBM plant terminal—a ruggedized minicomputer that operates with a host computer in steel, chemical and other industrial plants—drew more than a passing glance at the recent Interkama '74 exhibition.

The exhibition, the largest trade fair in the world dedicated to instrumentation and automation, attracted 90,000 visitors to a new display center outside of Dusseldorf, West Germany. A total of 841 companies exhibited products for eight days.

The IBM prototype plant terminal—designated the 5937—has a

gas-panel display rather than a CRT. It can accommodate 240 character lines or six 40-character lines.

The terminal was developed by IBM Stockholm and is to be sold first in Europe and then, in a year or so, in the U.S.

Among the other attractive exhibits was one by Siemens, the largest company in Europe, with 200,000 workers. It showed its 300 Series minicomputer, which according to Dr. Karl Heinz Kaske, program manager, should be competitive with Digital Equipment Corp.'s PDP series.

DEC displayed its PDP-11 at the show, with a VT30 color mimic diagram display, which allows any part of the screen, or the whole screen to flash in color under software control.

Siemens also displayed a gas chromatograph for monitoring air pollution. It measures pollution particles per billion.

An American company, Hybrid Systems of Burlington, Mass., showed for the first time its Delta Verta system, a digital transmitter that features low cost and ease of multiplexing (see "The Low-Cost Way to Send Digital Data," ED No. 2, Jan. 18, 1974, p. 68).

Of the 841 exhibits at Interkama, 616 were by West German companies. And although the United States accounted for only 16, the American displays covered 8% of the floor space.

From the Communist bloc, East Germany sent three exhibitors, Yugoslavia one, Poland two, Czechoslovakia one and Hungary one.

A cross-section of visitor views at the show indicated the following:

- They were interested in low cost, but not at the expense of quality. They wanted reliability, ease of maintenance and flexibility.

- Software must be part of a hardware package. Buyers have learned that it's too expensive to fashion their own software. They want their programs flexible enough to use for future projects. And they want language compatibility.

- Users are systems-oriented. They don't want to put things together themselves.

- Low power requirements are important, which makes components such as CMOS attractive.

Dialight sees a need:

(Need: The widest choice for your every application.)



730 SERIES Your choice . . . a red or green LED readout with large 0.625" characters . . . low power, operates with standard IC power supply levels. Comes in plus-minus module. Display uses standard or high brightness LEDs for maximum light output arranged in a seven-segment format. Available with or without on-board decoder/driver. Unique lens design generates bright, highly legible characters.



739 SERIES Save design time and installation costs . . . this LED display assembly is attractively designed in a convenient package with bezel and is ready for instant panel mounting. Available in groups of one or more characters, with or without decoder/driver . . . characters are 0.625" and come with either green or red LEDs in seven-segment format. Readout offers lowest cost per character for comparable size.

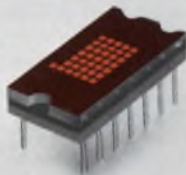

745-0005 Dot matrix LED readout display produces a bright 0.300" high character or symbol display. Has wide angle visibility and is compatible with USASCII and EBCDIC codes. Low power requirements. Mounts into standard 14-pin DIP socket. The display is also available in bezel assemblies with or without code generator.

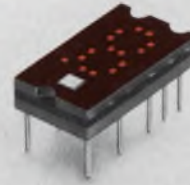

745-0007 LED hexadecimal display with on-board logic operates from 5 to 6 volt supply, low power consumption. Integral TTL MSI chip provides latch, decoder and drive functions. 0.270" character display has wide angle visibility and mounts into standard 14-pin DIP socket.



755 SERIES High brightness planar gas discharge displays in a 0.550" character. Orange color gives high contrast ratio and allows readability to 40 feet even in high ambient lighting. Designed for interfacing with MOS/LSI, displays have an expected life of 100,000 hours or more.

Dialight, the company with the widest choice in switches, LEDs, indicator lights and readouts, looks for needs . . . your needs . . . and then they develop solutions for your every application. No other company offers you one-stop shopping in all these product areas. And no other company has more experience in the visual display field. Dialight helps you do more with these products than any other company in the business, because we are specialists that have done more with them. Talk to the specialists at Dialight first. You won't have to talk to anyone else.

DIALIGHT

Dialight, A North American Philips Company
203 Harrison Place, Brooklyn, N. Y. 11237
(212) 497-7600

See Dialight.

That's our price for our new 3660J IC Instrumentation Amplifier. Now, if you are building your own, do you know what yours is really costing you? Take a few minutes to add up your costs. Just to match the performance of our new IA's, it would take a well matched pair of op amps, four matched and tracking precision resistors, and at least three more resistors to hook your unit into a circuit. After you design yours, you still have to purchase the parts. Calculate your design and purchasing time, plus all the paperwork. Now, add in your production and testing time, and a little bit for overhead. You might even have to rework your design, and chances are that you'll have to do some tweaking, too. By the time you get through, your costs could be two or three times as high as our price of

\$10.70 in 100's. Then, your parts will probably be spread out all over a PC board that you'll have to make fit somewhere in your system. That's a lot of trouble and money, especially if you need one amplifier per channel. And, what about your performance? Although our 3660J is the lightweight of the new 3660 series, just look at what it has to offer. It lets you adjust the gain from 1 to 1000V/V with a single resistor. At a gain of 1000, it has a guaranteed voltage drift of less than 10 $\mu\text{V}/^\circ\text{C}$, a CMR of 96dB, and an input impedance of 20 Megohms. It also offers nonlinearity of 0.1%, a bias current drift of $-2\text{nA}/^\circ\text{C}$, and of course, IC reliability. It's especially useful in applications where size, accuracy, reliability, and economy are your primary considerations. And, just in

case you have an application that demands a lower bias current and a higher impedance, we also have the 3670 FET IC series. These amplifiers guarantee a bias current of -10pA , and an input impedance of $10^{13} \Omega$. The price tag is a little higher than the 3660, but not that much.

Why build your own Instrumentation Amplifiers when the 3660 and 3670 are here now? Try a few of ours and go home on time at night. Burr-Brown, International Airport Industrial Park, Tucson, Arizona 85734. Telephone (602) 294-1431.



You can build your own Instrumentation Amplifiers, but can you do it for less than \$10.70?

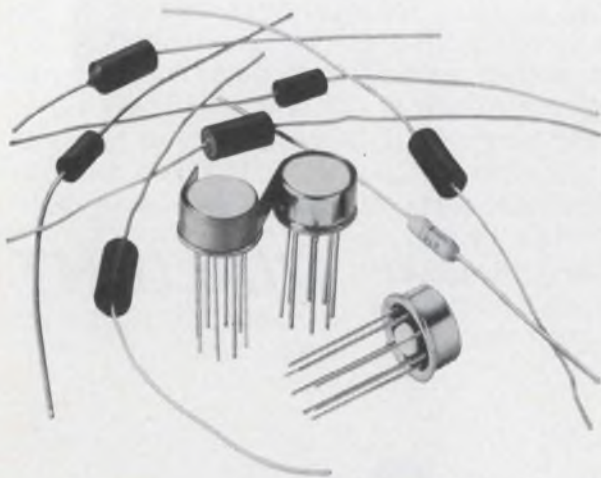

With yours, you start with this.



The 3660 (Low Drift) and the 3670 (FET)... IC Instrumentation Amps from Burr-Brown!

With ours, you start with this.

"The end" had a fantastic beginning.

Never before has a laboratory tape recorder gained acceptance as rapidly as the Model Ninety-Six. It was recognized as the industry leader within a year after we introduced it as "the end" . . .

. . . **The end of head wear worries.** Superb, trouble-free performance in dozens of labs has proven how right we were, how reliable our patented solid ferrite heads really are.

. . . **The end of spectral pollution.** The Model Ninety-Six gives you super-clean data. A wideband servo produces absolute minimum TBE and virtually eliminates recorded flutter.

. . . **The end of configuration problems.** Users have told us omniband electronics make sense. Only six plug-in assemblies support any configuration.

Users have also told us about other great Model Ninety-Six features: selective track recording capability, 100% digital electronic shuttle, and non-contacting, optic-free end-of-tape sensing system. You can learn about these and other superior features when you talk to a man who's used the Model Ninety-Six. Or call or write our expert, Ed Haines, (303) 771-4700. Honeywell Test Instruments Division, P.O. Box 5227, Denver, Colorado 80217.

INFORMATION RETRIEVAL NUMBER 11
For Demonstration, Number 196

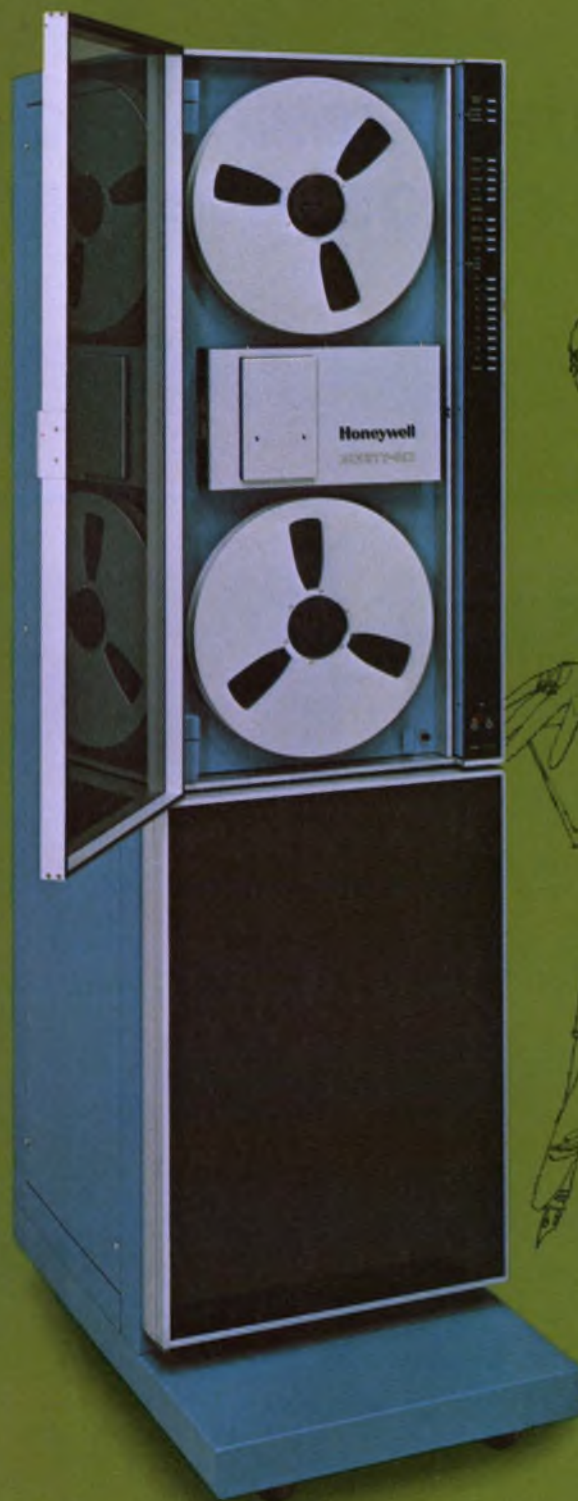

Honeywell

TEST INSTRUMENTS DIVISION

Today's resins provide a cure for almost every embedding ill

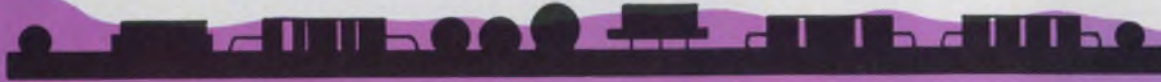

With new developments in potting and embedding, the designer who goofs in packaging has only himself to blame. It's becoming hard to miss with progress like this:

- High viscosity in early epoxy resins made it tough to process the material. Today there are resins with almost any viscosity.

- Costs used to be high. Now fillers hold down the costs and improve the product as well.

- Materials once were toxic and smelly. Newer compounds have largely overcome these health problems.

- Flame resistance formerly was poor. New materials can meet the most stringent safety standards.

- Large castings used to be hard to make, because of the speed and magnitude of exothermic (self-heating) reactions. Today there are many resin systems specifically designed for large-volume parts.

This is not to say that the engineer can't go wrong. He can if he doesn't know his materials. Without such knowledge, materials designed to protect can cause more damage than the environmental hazards they are intended to protect against, according to Harold M. Lester, vice president and research director of Sigma Plastronics of Dearborn, MI. He believes that specialized potting compounds should be selected for



There is a potting compound for almost any purpose. Emerson & Cuming's extensive Stycast line contains compounds that feature a variety of desirable properties—from low cost to low viscosity.

each application.

"The trend is away from one kind of slop that can do all jobs," he notes. "The all-purpose compound is like aspirin. It can't cure serious problems."

For example, when hard epoxies are used to protect thick-film re-

sistors, the expansion and contraction during temperature cycling can cause the resistor to delaminate from the substrate. It is essential to match the thermal coefficients of the protective material and the circuit assembly. Another solution is to cover the substrate with a resilient conformal coating, or encapsulant—such as silicone or urethane—and then embed the circuit in rigid material.

A very similar problem occurs when metal containers are used for potting. The relatively high thermal coefficient of expansion of the metal, unless matched by the potting compound, results in the separation of the embedment material from the walls of the container and thus poor thermal contact and overheating. In addition cracks can appear around leads and sharp corners and allow seepage of moisture, with subsequent circuit failures.

In potting, a rigid shell forms the outer surface of the final product, and the embedding material should fill the entire space not occupied by the electronic assembly within the shell. But in casting, a mold, which is removed after the embedding material hardens, gives the proper dimensions to the finished product. Thus casting eliminates the problem of the embedment separating from the shell; there is no shell.

In both methods, the potting or casting material is poured slowly into the shell or mold. The process may be done in a vacuum to avoid air entrapment. The assembly is

Morris Grossman
Associate Editor

then cured, either at room temperature by its own exothermic heat or in an oven.

Another problem—one that may arise with potting in a metal shell but not with a cast assembly—is electrical shorts to the case. A sheet of insulating material between the assembly and the shell is often needed, especially at high voltages.

Emerson & Cuming of Sharon, MA, has more than 50 epoxy resins for casting in its Stycast series. Stycast 2850, for example, features high thermal conductivity; Stycast 1090, light weight, Stycast 2651, low cost, and Sty-

pour. And even very viscous thixotropic epoxies, which don't flow unless stirred, are made for dip-coating components and assemblies.

- Ease of curing. Temperatures for curing can be tailored from about 50 to 150 C, depending on the curing agent. And epoxies cure quickly.

- Good electrical properties. Volume resistivities range from 10^{12} to over 10^{16} Ω -cm. Dielectric constants less than 4 are readily obtained and dielectric strength is about 250 to 400 V/mil.

- Excellent mechanical properties. Low shrinkage. Good adhesive and mechanical strength.

can be obtained. One is its recent Lab 0853 formula, which has a low dielectric constant of 2.18 at 1 to 10 MHz; Teflon has 2.10.

(Note: Most tabulations of dielectric constant list measurements at 1 kHz. Dielectric constant changes with frequency and should be measured at the frequency used.)

In addition to low dielectric constant, the 0853 formula bonds better than Teflon, which is often used in microwave devices, and it can flow around corners or into cavities where a Teflon insert cannot be placed, according to Lester of Sigma Plastronics. The formula's coefficient of thermal expansion is also much lower than that of Teflon's.

These properties, Lester says, make the epoxy excellent for radar and other microwave devices.

Another Sigma Plastronics epoxy has quite different characteristics: The Barrier Grades I, II and III are extremely "hydrophobic," according to the manufacturer. The material resists the passage of water vapor or liquid. When properly cured, these epoxy resins are said to exhibit extraordinary adhesion to aluminum.

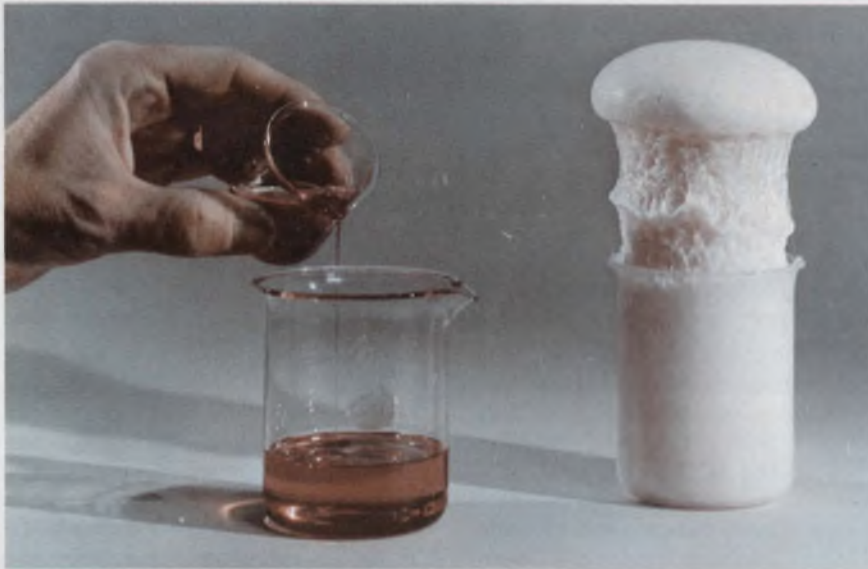

Foams can be formed with most potting materials. Light weight, though, is offset by lowered mechanical strength.

cast 1467, fire-retardant properties.

The ubiquitous epoxy

Epoxies owe their success to their extensive range of properties. Among the more important ones are these:

- Wide range of viscosities. The viscosity of epoxies ranges from an extreme low of about 100 centipoises to the more common 1000 to 5000 cp and paste-thick 40,000 cp. (Water is about 1 cp at room temperature.) Low viscosity is very important to ease the penetration of small openings and to avoid air cavities. Low-viscous material is also easier to mix and

- Outstanding chemical resistance. Most resins have very high resistance to caustic agents and good-to-excellent acid resistance.

Use of an epoxy should be considered when these factors are indicated:

- The cost of the compound is not a primary consideration.

- A close dimensional control is required.

- Adherence to components is important, as in sealing against moisture around terminals.

- Packaging is for MIL-spec systems.

Sigma Plastronics offers a wide range of epoxy resins that illustrate amply the versatility of epoxies and some of the "specials" that

Diluents reduce viscosity

In general, the viscosity of liquid resins must be reduced to facilitate handling. Usually heat is used. But when the material must be dispensed at room temperature, diluents are added—like styrene oxide, xylene and allyl glycidyl ether. Heat is preferred, because the diluents can permanently impair the resin's electrical properties, whereas heat has only a temporary effect.

But a very recent development by Dow Chemical, Freeport, TX—an experimental epoxy resin, XD-7818—has low viscosity at room temperature and contains no diluents. The viscosity at 25 C is 3500 cp. Its low viscosity allows excellent bubble release and high filler loading, according to Robert M. Bercaw, the company's technical development manager.

Fillers help

Low viscosity and high thermal conductivity generally don't go to-



Fillers such as sand can lower costs and improve the thermal and other properties of potting compounds. An automotive electronic ignition system, shown before and

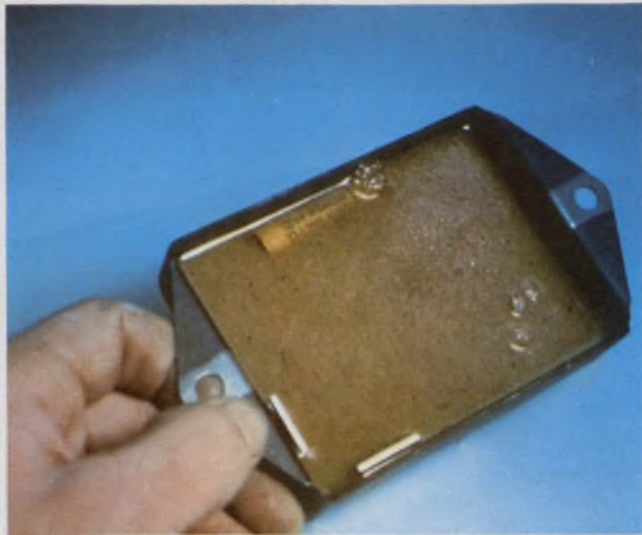

after embedment in Hysol's ES0269 sand-casting resin, is a high-volume application. Special dispensing methods limit equipment wear.

gether in most potting compounds. However, a filler-like silica, or sand, can increase thermal conductivity two to 12 times in a low-viscosity resin.

And fillers can have other favorable features. They generally reduce the exotherm of a resin during curing and shrinkage after cure.

The Hysol Div. of Dexter Corp., situated in Industry, CA, has developed a low-cost, sand-filler potting system, ES0269, which is being used to embed automotive electronic ignition systems. The cost is low, because only one part of ES0269 is used to five parts of sand. Thus the potting system figures out only to 20 to 30¢ a pound.

The filler is not in the resin when poured, but mixes directly in the system. Thus the usual abrasive wear in the dispensing equipment is minimized.

Some epoxies have bounce

Flexibilizers lessen the basic hardness of epoxies. They reduce internal strains during curing, and this makes possible castings of large volume and complexity. Also, they improve adherence, peel strength, low-temperature performance and crack resistance during temperature cycling.

But offsetting these mechanical advantages, flexibilized epoxies lose some of their desired electrical properties. As the rubber-like qualities increase, dielectric loss

factor and dielectric constant increase, and resistivity decreases. Moreover the material loses some strength and softens at elevated temperatures.

Thus manufacturers recommend that designers use the most rigid, cured resin that will provide the needed mechanical properties. Flexible epoxies are especially deficient in high-frequency, high-temperature applications.

Examples of flexible epoxy compounds include two recently developed by the 3M Co., St. Paul, MN: Nos. 280 and 281 liquid-epoxy resins. These compounds cure relatively fast and feature a semi-flexible, shock-resistant consistency. The flexibility is said to remain even with long-term, high-temperature aging.

And the Novalac epoxy formulation, Isochemerez 448—made by Isochem, Lincoln, RI—can be cured into a rigid, semi-flexible or flexible form with the proper curing agent.

There are many flexibilizer agents and flexibilized epoxies on the market. But designers are advised to ask suppliers for the latest, since the field is very active and new compounds continually become available.

Other resins important, too

Though epoxies probably fill 85% of the embedment market, silicones, polyurethanes, polyesters, some thermosetting hydro-

carbons and even acrylics also find a place. In addition the foams of all the resins are used when weight reduction is important.

Though the silicones are technically not organic, they are loosely classed as resins because their properties are similar to those of organic compounds. Silicone embedment materials fall into three categories:

1. RTV (room-temperature vulcanized) silicone flexible resins. With excellent thermal-shock resistance and low internal curing stresses, they come colored or clear, and they have excellent stability in a vacuum. Thus they can be used in deep-space applications.

2. Silicone gels. Very tough, they withstand considerable breaking forces and heal themselves when punctured for testing.

3. Rigid solventless silicones. Though little used because of poor crack and thermal-shock resistance and the need for elevated temperatures for curing, they do find applications because of other desirable silicone properties.

The strong points of silicones include these:

- Wide temperature stability from about -65 to 300 C, with only moderate variations in properties.

- Excellent electrical properties, with low loss factors.

- Ease of handling.

Silicones come in a wide range of viscosities, and most varieties can be cured at or near room tem-

1975 CERAMIC CAPS...NOW

MONO-KAP™. MONO-GLASS. Radial. Axial. USCC/Centralab has taken the lead for '75. You can be confident now of short delivery, plentiful supply and competitive pricing on reliable ceramic capacitors from the leader in monolithic technology.

DISCRETE ASSEMBLY

MONO-KAP™ radial-leaded epoxy coated capacitors are reliable performers; they're rugged enough to work in MIL environments. 4.7pF to 10Mfd., 50 to 200 WVDC in a variety of dielectrics and case sizes. Immediate delivery from stock; large volume production orders in *eight weeks* . . . and price competitive.



AUTOMATIC HIGH VOLUME INSERTION

MONO-GLASS axials are glass encapsulated, designed for automatic



PCB insertion; furnished reel-packed for high volume applications. They're available in 50 and 100 WVDC from .01 to 1.0Mfd.; three dielectrics: COG, X7R and Y5V.

Our basic materials research gives you the best in monolithic technology; our productivity engineering guarantees competitive prices and best delivery.

You can design confidently with USCC in 1975 for: calculators, computers, business machines, communications or any volume application using discrete or automatic assembly.

Some manufacturers are still solving problems; we can produce 25 million pieces per month and we're still expanding; at USCC we've got 1975's

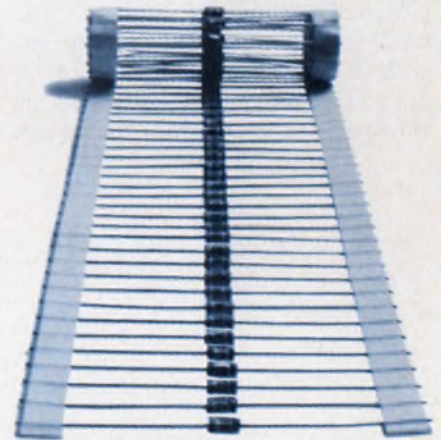

capacitors NOW. Write or call for large quantity quotations or evaluation samples.

Remember, USCC/Centralab.



USCC/Centralab

Electronics Division • Globe-Union Inc.

2151 North Lincoln Street • Burbank, California 91504

(213) 843-4222 • TWX: 910-498-2222

INFORMATION RETRIEVAL NUMBER 12

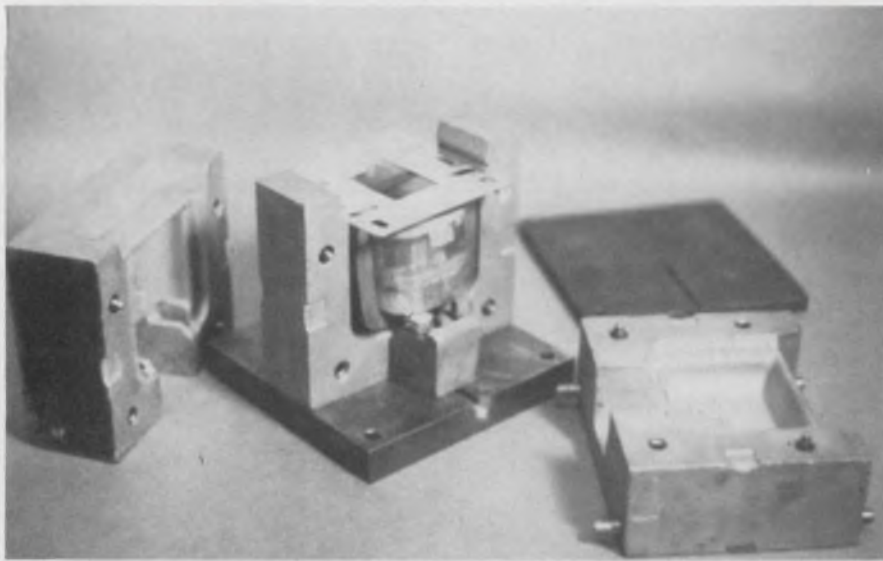

Unlike potting, casting requires no outer case. Typical is this five-piece mold, which is removed after the embedding material cures. The component, protected by the resin, needs no other housing.

peratures with little if any exothermic action.

The new 3102 RTV silicone rubber from Dow Corning, Midland, MI, illustrates many of the advantages of silicones. It is rated to be thermally stable from 54 to 250 C, and it has a viscosity of 8000 cp, as supplied. The material bonds to metals, glass, other silicones and organic resin laminates or moldings, and to vulcanized silicone rubber. And it cures in deep sections.

And Dow Corning's Sylgard line covers a wide range of different properties. One variety is a clear resilient material that can be cut with a knife for fast access to repair circuits. Voids can then be refilled with fresh resin that cures

at room temperature.

General Electric, Waterford, NY, also offers a silicone-rubber potting compound, designated RTV-627. GE believes that silicones are replacing epoxies and other conventional compounds—many of which, it says, are becoming scarce because of material shortages. RTV-627 can be cured in minutes at 150 to 350 F. At room temperature, the potting compound sets in less than 24 hours. The color of the cured compound is black.

Polyurethanes

Moca is DuPont's trade name for 4,4'-Methylene(bis) 2-chloroaniline, a compound used until recently in polyurethane resins. Now

the compound is restricted by Federal regulations because of toxicity.

But non-Moca polyurethanes, or urethanes, are available. Examples include Emerson & Cuming's Sty-cast CPC-18 and the RF-1730 compounds made by the Resin Formulators Co.'s Evra Div., Culver City, CA.

RF-1730 is derived from castor-bean oil and thus not dependent on petroleum supplies. The hard, semi-flexible material costs substantially less than silicone resins and about 10% less than epoxies, according to the manufacturer. Also, because of its extremely low exothermic properties, it can be cast in large volumes.

Echo gel is another polyurethane. Made by Communications Technology Corp., Los Angeles, it's low in toxicity, free flowing, non-expanding and sets in about 15 minutes. Mixing and handling is simplified by premeasured packaging in sealed plastic bags. After a separator between two parts of the package is removed and the mixture kneaded until uniformly mixed, the material is ready to pour.

But Dail de Villeneuve, development manager of Communications Technology, warns that misapplications of some two-part compounds can result in a real mess. Frequently unknown to the novice is the fact that some compounds set up properly only in large volumes. An attempt to coat a PC board with such a compound can decrease the exotherm to the point where the compound may not cure

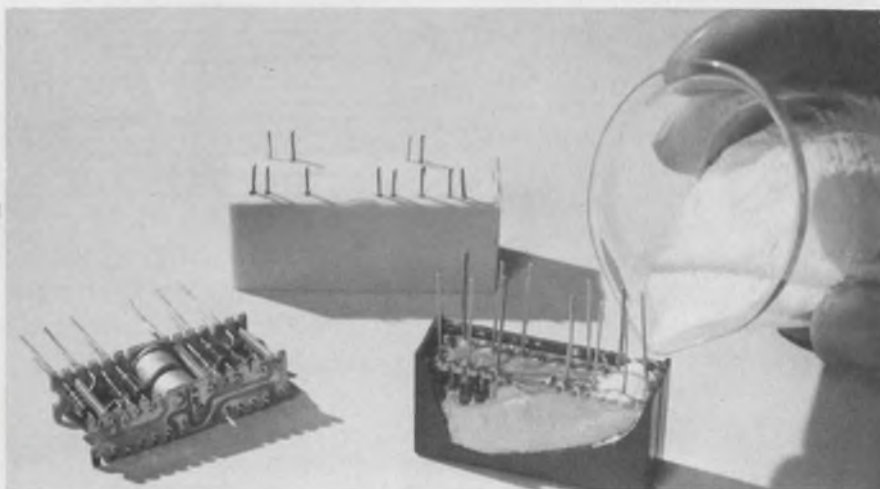

Some epoxies come in powder form, such as this one-part Eccofoam EFF-14 from Emerson & Cuming. The material is vibrated into place and cures to a fine-structured foam with a density of about 15 lb/ft³.

Cinch adds sum logic to I.C. logic board logistics

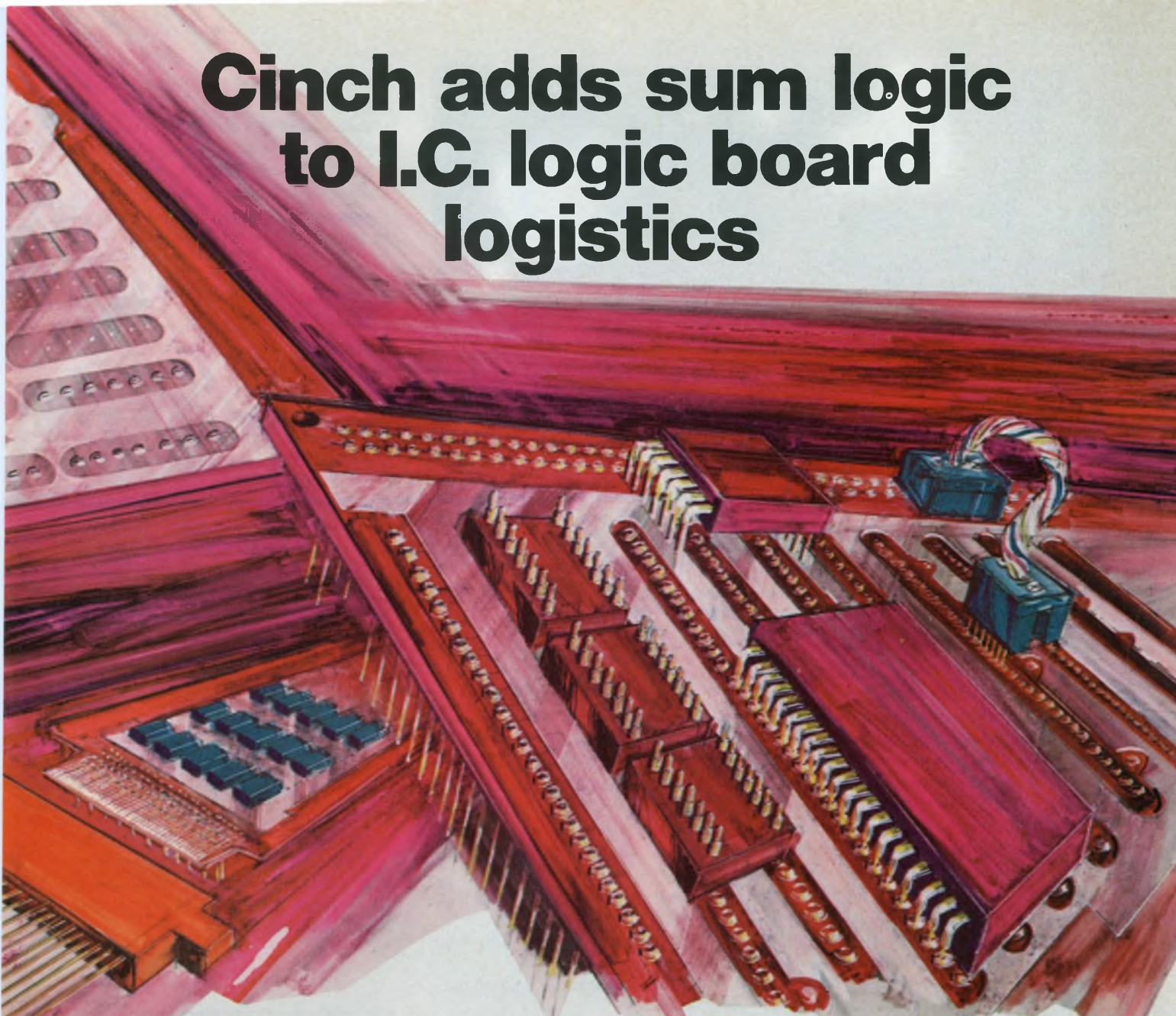

Some people stop half way. Sum people get it all together, like TRW/Cinch Connectors does with its new integrated circuit logic boards.

Working from the logic of a national distribution network to assure fast, off-the-shelf delivery on popular board configurations, Cinch assembled the features and flexibility that facilitate prototyping and short production runs:

1. Universal boards accommodating 14 to 40-lead plug-in IC's and high density DIP boards in 14 and 16-pin patterns (in 30-pattern multiples up to 180).
2. Socket terminals that accept varying sizes of DIP leads and round pins, with a choice of two and three-level wire wrap* terminals for high wiring density and flexibility in circuit changes.
3. A full line of accessories—adapter plug-input/output plugs, board interconnectors, and edge connectors.
4. FR-4 epoxy glass boards, 1/8 or 1/16 in., with power and ground planes on each side connected to each pattern.

For special requirements, our application engineers are available to assist in developing custom boards. These can be produced with minimum turn-around time at our extensive manufacturing facilities.

To sum up: design flexibility, distributor stocking, and custom board availability point to Cinch Connectors as your logical source for IC logic boards.

Available nationwide through these distributor networks

Pioneer-Standard Electronics
Rampart Components
RESCO Electronics
Sterling Electronics
Wilshire Electronics

Dial toll-free (800) 645-9201 for the name and phone of your nearest facility.

For additional information see listings in EEM Vol. 4 or contact your TRW/Cinch logic board distributor or TRW/Cinch Connectors, An Electronic Components Division of TRW Inc., 1501 Morse Ave., Elk Grove Village, Illinois 60007; (312) 439-8800. CC-7311

*T.M. Gardner-Denver

TRW CINCH CONNECTORS

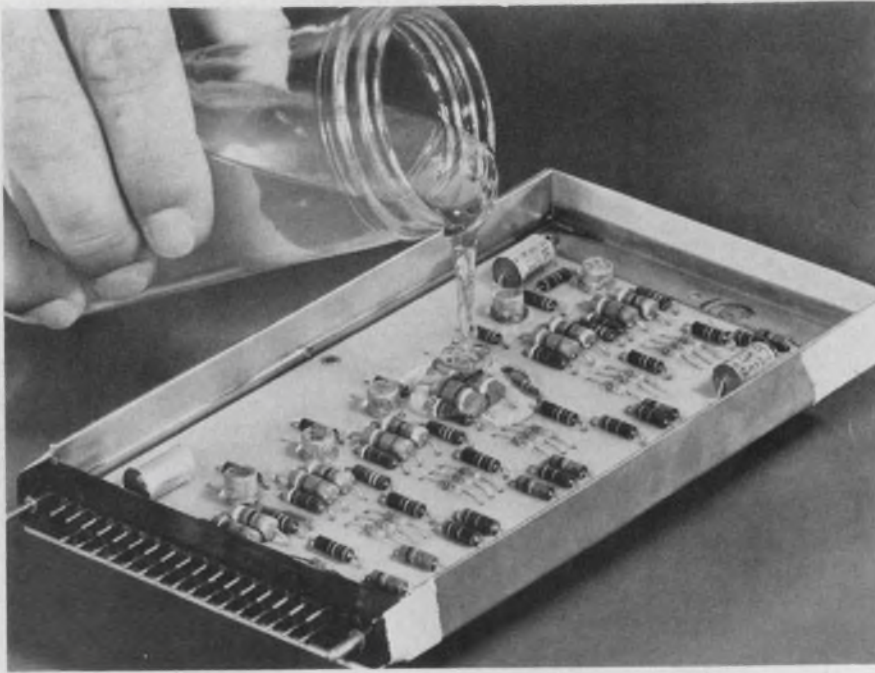

Only materials that can cure in shallow layers—don't depend on their exothermic heat—should be used on large-surfaced PC boards.

because of the large surface.

Like silicones, polyurethanes can cure at or near room temperature. However, the silicones are far superior in withstanding high temperatures. Polyurethanes are generally limited to operating below 150 C, as compared with the common silicone rating of 250 C. And polyurethane reacts with moisture, so components must be carefully dried before embedment to prevent the formation of bubbles. On the other hand, polyurethanes adhere better and to more materials than silicone resins do.

Polyesters are economical

Polyester cost is low compared with that of most other embedding materials, and polyester handles easily. But it has higher shrinkage and poorer adhesive qualities than the epoxies. Also, its resistance to extreme environments is not as good.

Other materials also find limited uses in potting. They include thermosetting hydrocarbons—like Buton, made by Enjay Chemical Co., NY—thermosetting acrylics and polysulfides.

And most liquid resins can be made into foams to cut package weight. The polyurethane foams are the most popular, though epoxy and silicone foams are also used.

The price paid for light weight is lower mechanical strength and lower thermal conductivity, but dielectric strength and electrical losses usually improve.

Though fillers have a dramatic effect upon a compound's thermal properties, there are other benefits. Fillers can:

- Reduce exothermic heat during curing.
- Reduce weight loss with heat aging.
- Reduce shrinkage and expansion.
- Improve fire resistance.
- Extend pot life.
- Cut costs.

Certain electrical properties can be improved with fillers, but the designer is advised to watch out for degradations, too. Dielectric strength, for example, is usually adversely affected, especially if the filler has absorbed moisture or another contaminant. The dissipation factor and dielectric constant can be varied, up or down, by a change in the filler.

Fillers are often classified as reinforcing, or fibrous, and bulk, or nonreinforcing. Some bulk fillers are sand, talc, clay and calcium carbonate. Typical reinforcing fillers are mica, asbestos and chopped glass.

Filler materials are generally cheaper than unadulterated embed-

ment materials of the same volume. Hardness is usually increased and machinability reduced by bulk fillers, especially with abrasive materials like sand. Impact and tensile strengths are increased by reinforcing fillers, but bulk fillers tend to decrease these strengths.

Stripping an embedment

When a company has made an investment in a successful new electronic device and wishes to protect the device's secrecy, the unit often is sold in potted form. However, a competitor's curious engineer has a counterweapon—the stripper.

Sigma Plastronics says that there are few epoxies that can resist its XMIS-408-100 epoxy stripper. "A competing powerful stripper," according to a Sigma spokesman, "took four hours at 125 C to strip Emerson & Cuming's ARC-138-S epoxy-molding compound. But the -100 stripper did the same job in six minutes at room temperature."

And to escalate the intrigue, Sigma Plastronics has developed a "nonstrippable" resin, its "No. 1 Secrecy Resin," an unusually high-density cross-linked epoxy.

"In addition," the Sigma spokesman says, "the resin can be filled with small sheets of lead to foil X-ray snoopers." ■■

For more information

For a list of manufacturers of potting compounds, refer to the following sections in the Product Directory of ELECTRONIC DESIGN's Gold Book:

| | |
|--|----------------|
| Potting Compounds, Epoxy | Vol. 1, p. 312 |
| Potting Compounds, Foam-in-place | Vol. 1, p. 313 |
| Potting Compounds, High Temperature Cements | Vol. 1, p. 313 |
| Potting Compounds, Polyester | Vol. 1, p. 313 |
| Potting Compounds, Silicone | Vol. 1, p. 313 |
| Potting Compounds, Urethane and Polyurethane (except foam) | Vol. 1, p. 313 |
| Cleaners & Solvents | Vol. 1, p. 83 |

Thinking wirewound?

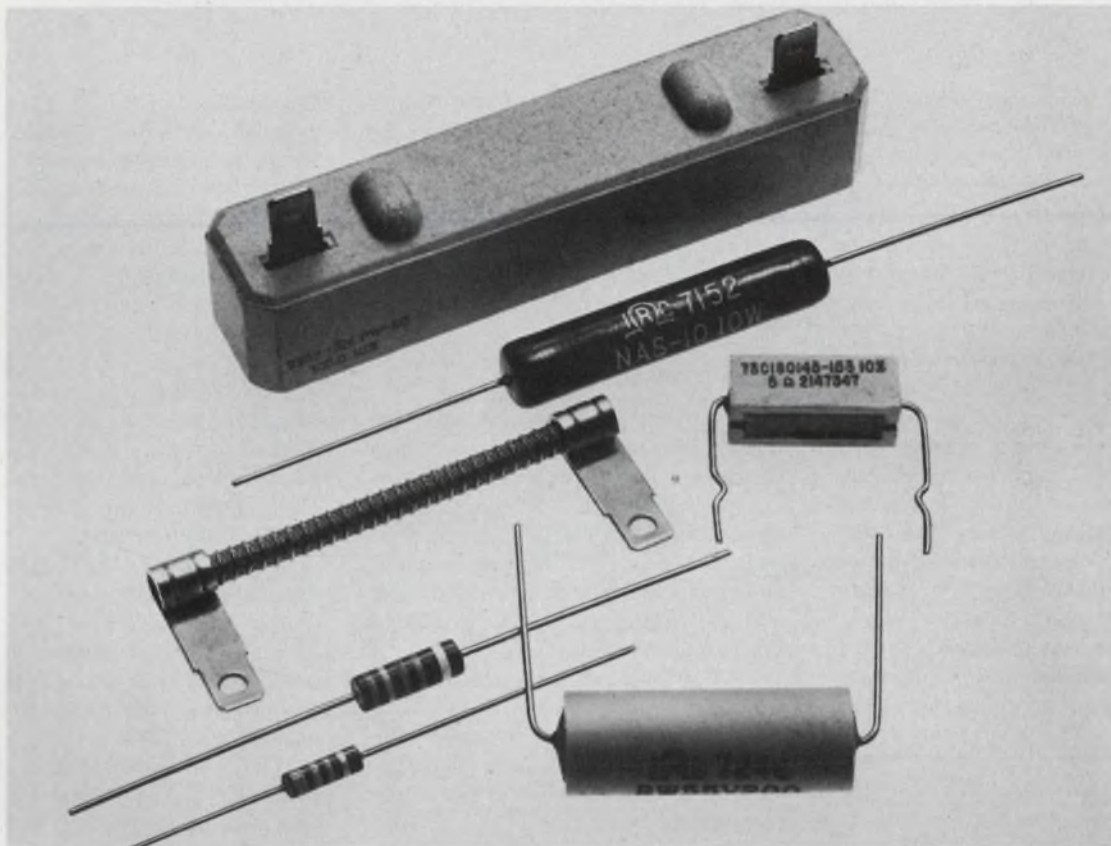

**For optimum cost/performance ratios,
see TRW/IRC—at the design stage.**

Why? Because we offer just about every type wirewound that's commercially feasible. So we can help you find the most for your money. Or more for less money. For example:

Watts/Inch consumer types. For appliance, automotive, heater circuitry. To 6 w/in. Terminal options.

Machine Insertable molded units. Often a carbon comp. replacement. Offer smaller size, lower resistance range, lower cost.

Ceramic Insulated power. The standard for general purpose power—2 to 50 w. Fusing capabilities, special TC's available.

Fusible/flameproof units. Rated at 2 w., but won't burn or burn board under faults of 4x to 1000x rated power (or 1000 v, whichever is smaller). Special fusing characteristics if you wish.

Axial and radial power. ½ to 250 w., fixed or adjustable. Unmatched for power density/precision. Broad special design capability here.

Complete resistor choice. Understand, TRW isn't locked in to wirewounds. If we think your design will fly better with, say, precision film, we'll suggest it. In fact, TRW offers a total resistor capability—carbon comp., thin-film, Metal Glaze™, wirewound, networks.

For specs and application data on *wirewounds*, contact your local TRW sales representative. Or write TRW/IRC Resistors, an Electronic Components Division of TRW, Inc., 401 N. Broad St., Philadelphia, Pa. 19108.

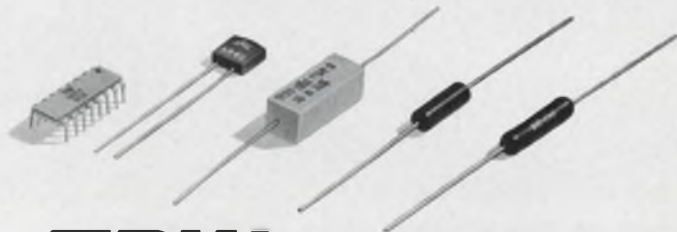

TRW[®] IRC RESISTORS

INFORMATION RETRIEVAL NUMBER 14

Iron-core transformers get tiny; Now only the price must shrink

Iron-core transformers, traditionally bulky components, are catching up—or, rather, down—in size with other microsized elements in electronic packages.

A new generation of miniature iron-core microtransformers has many desirable characteristics for use in signal-processing circuitry. And the smaller transformers are available from several sources. Cost is holding down use of the units, however, even where they could provide superior performance. Each unit must be hand-fabricated (see photo). Many designers are using less-expensive but also less-effective solid-state circuitry and components.

At present the principal use of microtransformers is in aerospace and military applications. But

manufacturers see improvements in production processes lowering costs eventually. One expert believes that these microsized structures may revive the use of magnetic amplifiers, which were outmoded by the growth of solid-state technology.

Excellent isolation given

"Magnetic devices are still required in some applications," says Octavio Forte, group section chief at the Charles Stark Draper Laboratory, Cambridge, MA. "The excellent isolation of transformers is valuable in circuits such as line drivers and in signal-processing in modulators and demodulators.

"We're using microsized, 1/4-in.-cube transformers in synchronous demodulator circuits for telemetering applications in military systems. These devices are compatible with the 1/4-by-1/4-in.

flat-packs used in the NAFI [Naval Avionics Facilities, Indianapolis] standard module.

"In the NAFI package, two small PC boards are mounted back-to-back. We have a very high-density packaging format. The transformers are placed so that they efficiently fill the available volume."

Transformers have no equal in signal-processing applications, Forte asserts. For example, he says, optical couplers can be used for isolation, but they are not suitable equivalents.

"First of all, they're very lossy and they require a lot of power to drive them," Forte points out. "Also optical couplers have low bandwidth. In addition they have to be biased, which leads to offset-voltage problems."

With the development of micro-magnetics, Forte sees the reappearance of magnetic amplifiers.

Jim McDermott
Eastern Editor



Iron-core microtransformers require detailed hand assembly and fabrication. Joining of heavy leads to wires between 0.001 and 0.0005-in. thick is a critical opera-



tion. Here skilled operators, using microscopes of 10 to 30 power magnification, are stacking tiny laminations in the bobbin of a Bourns 1/4-in.-cube transformer.

Resistor networks: we deliver through thick and thin.

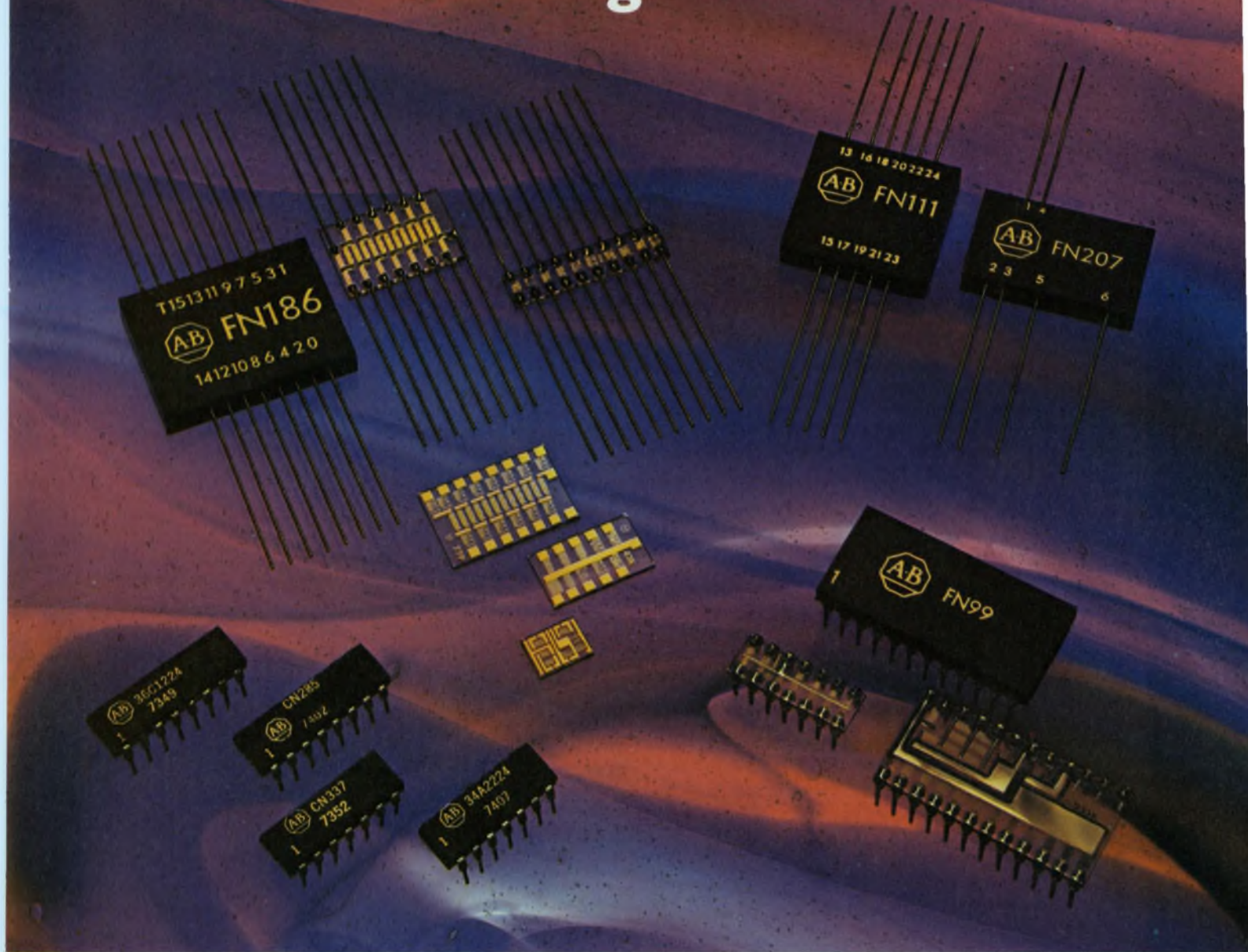

Seventeen years of film resistor experience combined with quality production capabilities give you prompt solutions to your network needs. Whether you require precision thin film or semi-precision thick film in prototype or mass production quantities. Thin film in chip, conformal coat, flat pack and DIP. Thick film in standard 14 and 16 pin DIPs with resistor or resistor/capacitor configurations. Popular pull-ups and terminators off-the-shelf. Contact your local A-B sales office or write for our 5800 series publications. Allen-Bradley Electronics Division, 1201 South Second Street, Milwaukee, WI 53204. International Division, Milwaukee, WI 53204. Canada: Allen-Bradley Canada Limited, Cambridge, Ontario. United Kingdom: Allen-Bradley Electronics, Limited, Jarrow, County Durham NE32 3EN.

SELECTED SPECIFICATIONS

| | Thin Film | Thick Film |
|-----------------------------|---|---|
| TCR | ± 10 to ± 25 ppm/ $^{\circ}\text{C}$ | ± 100 and ± 250 ppm/ $^{\circ}\text{C}$ |
| TCR tracking | ± 5 ppm/ $^{\circ}\text{C}$ | ± 50 and ± 100 ppm/ $^{\circ}\text{C}$ |
| Absolute tolerance | as low as $\pm 0.1\%$ | as low as $\pm 1.0\%$ |
| Matching or ratio tolerance | as low as $\pm 0.05\%$ | as low as $\pm 2.0\%$ |
| Resistance range | 1K to 10 Megs (special 10 ohms to 50 Megs) | 10 ohms to 1 Meg |

If you're really serious about cost, be serious about quality.



ALLEN-BRADLEY

Milwaukee Wisconsin 53204

INFORMATION RETRIEVAL NUMBER 15

EC85

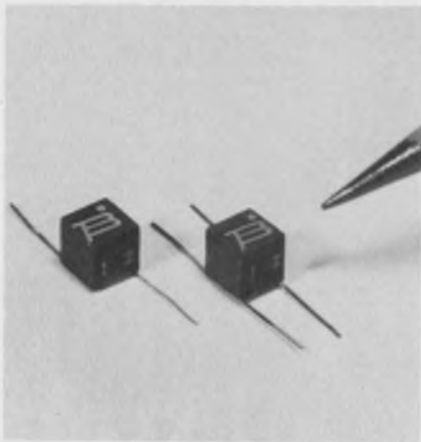

Microminiature 1/8-in.-cube transformer, by Bourns, is used in a 19.2-kHz accelerometer circuit.

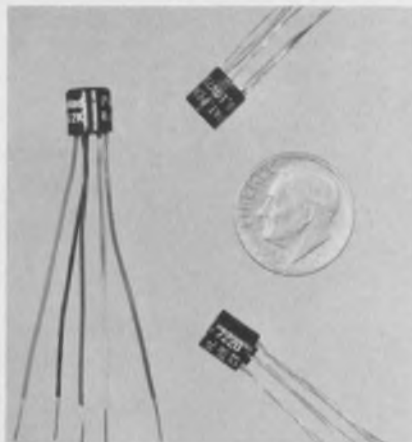

Leads for these microsized Pico Electronics transformers are suitable for cordwood or PC-boards.

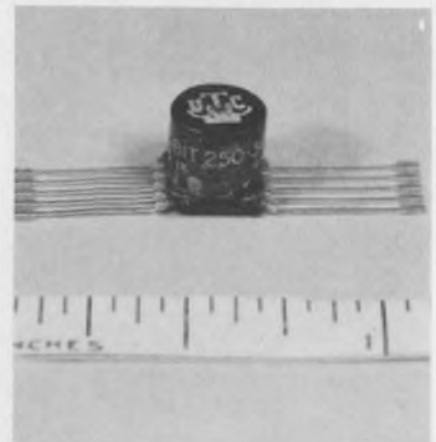

Terminations for flat-pack mounting are provided on this micro-unit by TRW/UTC Transformer.

"Magnetic amplifiers still have a place," he insists. "They are simple, reliable, don't drift and don't require power. In addition, for some military applications, they are resistant to radiation."

A penalty in reducing iron-core transformers to miniscule dimensions is the need to reduce the linear power-handling capability to milliwatts. For example, micro-transformers used by Draper Laboratory in the NAFI application—units by Bourns Pacific Magnetics Corp., Romoland, CA—have a flat output from 400 Hz to 250 kHz, with a rating of 5 mW at 400 Hz and 200 mW at 2 kHz.

The smallest Bourns unit is a 1/8th-in. cube with a rating of 24 mW at 10 kHz and a flat response from 2 kHz to 500 kHz.

Similar units of essentially the same size, but differing magnetic design, are produced by Pico Electronics, Inc., Mt. Vernon, NY, and TRW/UTC Transformers, New York City.

A Pico Electronics unit, the PG603, handles 65 mW with 5% distortion at 400 Hz and 200 mW at 1.6% distortion at 1 kHz, according to Joseph Sweeney, a co-inventor of the Pico design.

The UTC microsized package—the Bit 250 series—has a frequency response of ± 2 dB between 300 Hz and 250 kHz. The typical power levels, for 5% maximum distortion at 1 kHz, is 80 mW, according to Burton Yudin, UTC design engineer.

Construction of the microtransformers differs among companies, but the objective is to pack the

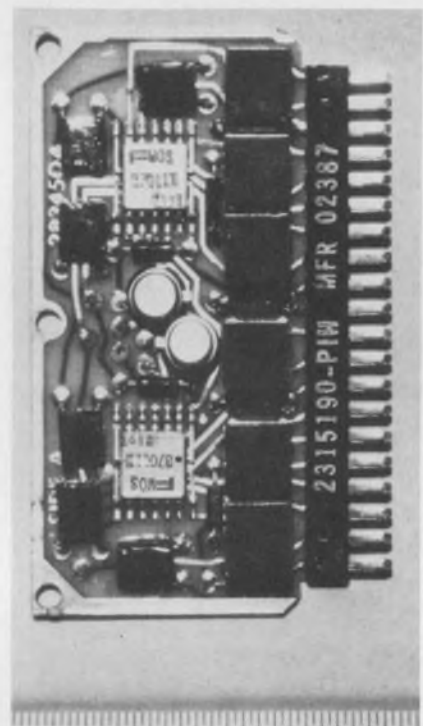

Twelve microtransformers are mounted on this 1-in. NAFI board. Six units are stacked on each side.

most copper and core material within a given space. Bourns uses magnetic laminations that are inserted into coils wound on a bobbin.

Pico Electronics and UTC enclose their transformer-coil structures within a tiny can of highly permeable material, which forms the outside magnetic circuit. Variations of this design are patented by both companies.

Lead termination critical

The most time-consuming and critical part of microtransformer

fabrication is the lead termination. The transformer wires are less than 0.001-in. in diameter. Special solder is used by most fabricators, but Piconics, Inc., of Tyngaboro, MA, a manufacturer of microchip inductors, welds some of its leads.

"We weld the leads on our more expensive units," says Steven Slenker, president. "Although this required development of special equipment, we find it gives us the highest reliability."

In recent thermal-shock tests—with the units cycled between 125 and -65 C—100 of the welded-lead units survived 1300 temperature cycles with only one failure, according to Slenker.

"Usually," he notes, "after 50 cycles, 50% of most components fail. The military requires but five cycles."

There are two ways to reduce the size and cost of present micro-transformers, says Dr. Guenter Finke, director of R&D for Magnetic Metals, Camden, NJ. One is to improve materials and design, the other way is to improve production methods.

"Today's materials are good," Finke notes, "and designs of lamination shapes with higher inductance can be expected."

The handling of tiny laminations and components can be improved, he says.

"We have considered making this type of core lamination by photo-etching rather than stamping," Finke reports. "In that case, the laminations could be stacked many at a time and simply dropped into a fixture to speed assembly." ■■

Only Fluke digital thermometers give you error less temperature measurement

Let's face it, we're all stuck with thermocouple error, but Fluke's new digital thermometers introduce less error than any other available instruments.

Here's how we do it.

1. Digital linearization with a 64-segment ROM.
2. 0.1° resolution, 40,000 counts in one range.
3. Ultrastable A-to-D converter with temperature coefficient less than $1 \mu V / ^\circ C$, noise less than $\frac{1}{2} \mu V$ peak-to-peak.
4. Internal isothermal reference (no external ice-point reference required.)

Other features include compatibility with all common thermocouple types, light weight, rugged portability, ability to operate from either 12V dc or 115V ac standard and an optional battery pack allows complete flexibility of operation.

Here are instruments using the latest "Large-Scale-Integration" technology so you get high reliability, lowest component count, extraordinary versatility, and they are rated for a minimum 10,000 hour MTBF.

There are three instruments and a multi-point switch unit in the Fluke digital thermometer group. At \$749, the Fluke 2100A-03 reads the complete range of any one thermocouple type without range changing.

Model 2100A-06 lets you choose via pushbutton any of six thermocouple types and two voltage ranges. Price \$995.

The 2100A-10 gives the user choice of ten thermocouples of one type in a single unit for \$895.

The 2150A, 10, 20, or 30 point selector unit extends measuring capability up to 100 thermocouples when used with either the 2100A-06 or the 2100A-10. Prices from \$250.

Options are battery pack or digital output at \$150 each.

Don't be left out in the heat or cold without a Fluke digital thermometer. Ask for our free temperature wall chart with all the details.

Dial our toll free hotline, 800-426-0361, write us or circle the appropriate response number below.



Circle No. 123 for a demonstration

Circle No. 124 for literature

John Fluke Mfg. Co., Inc.
P. O. Box 7428
Seattle, Washington 98133.



Your voice tells when you're lying with small, solid-state analyzer

You're on the phone talking to the mechanic who has towed your car in and is giving you an estimate for repair work. You ask him if it's a minor problem that requires a simple adjustment. He says no, the starter has to be replaced, and that will cost well over \$50. You know he's probably lying. A small instrument in your attaché case tells you so.

The briefcase-sized instrument is the Mark II voice analyzer from Law Enforcement Associates, Inc., Belleville, NJ. It acts as an emotional stress detector—just as the more familiar polygraph does—to help detect lies. But unlike the polygraph, it requires no electrical connection to the person being questioned. It detects changes in the rapid, involuntary and inaudible variations—known as tremolo—in the voice.

Fred Fuller, president of Technical Planning Inc., the Bethesda, MD, research company that originally developed the Mark II, notes that the voice analyzer can be operated in the presence of the subject or via a remote microphone, tape recorder or telephone pickup coil.

The voice analyzer does not "detect" lies, Fuller stresses. What it does uncover, he explains, is the emotional stress created when the average person lies. By asking a few "neutral" questions—such as, "Is this the XYZ Garage?" "With whom am I talking?"—the examiner can establish a base line that takes into account any inherent nervousness on the part of the subject. When a subject departs from this base line, Fuller notes, the examiner may infer that he is lying.

In describing how the solid-state circuitry works, Fuller says that the incoming audio signal is first rectified and filtered. The filtered waveform contains spikes that are



By detecting the emotional stress in a person's voice, the voice analyzer can help determine whether someone is lying.

related to the spoken words. These spikes are then differentiated and fed back to the input, through a low-pass filter, to eliminate the audio carrier. The resulting signal is then fed to a Schmitt trigger, whose output pulses are accumulated in shift registers. The pulses are counted and either read out on a digital display or recorded on a built-in strip chart recorder.

The normal digital value for emotional stress varies from between 10 to 100. The absolute value is not important, says Fuller. "What is important," he emphasizes, "is the variation from each individual's base line."

Comparative studies conducted in cooperation with nationally recognized polygraph-test concerns have produced matches of over 95% in the assessment of guilt or innocence for specific crimes and a 90% match in pre-employment examinations, Fuller reports.

A big advantage of the voice analyzer over the polygraph, Fuller says, is that no extensive training is required to use it. Polygraph outputs must be interpreted by skilled operators, and the results may vary from operator to operator. The Mark II voice analyzer's digital readout gives objective findings, the developer points out. ■■

KEYPUNCH OPERATOR
 112 A. UNIVERSITY OF ARIZONA
 112 A. UNIVERSITY OF ARIZONA
 112 A. UNIVERSITY OF ARIZONA

SECRETARY TRAINEES
 NO PREVIOUS WORK EXPERIENCE
 112 A. UNIVERSITY OF ARIZONA
 112 A. UNIVERSITY OF ARIZONA

EXPERIENCED P.T. TELLERS
 112 A. UNIVERSITY OF ARIZONA
 112 A. UNIVERSITY OF ARIZONA

APPLY TO DATA PROCESSING
 15 E. MONROE ST.
 (2ND FLOOR PHOENIX)
 8:30 - 10:30 DAILY
 261-2442

PAYROLL CLERK
 112 A. UNIVERSITY OF ARIZONA
 112 A. UNIVERSITY OF ARIZONA

PERSONNEL * CLERK
 112 A. UNIVERSITY OF ARIZONA
 112 A. UNIVERSITY OF ARIZONA

SECRETARY TO \$650
 112 A. UNIVERSITY OF ARIZONA
 112 A. UNIVERSITY OF ARIZONA

SECRETARY
 112 A. UNIVERSITY OF ARIZONA
 112 A. UNIVERSITY OF ARIZONA

*** TYPIST ***
 EARN & LEARN
 LARGE OPC \$400
 112 A. UNIVERSITY OF ARIZONA
 112 A. UNIVERSITY OF ARIZONA

ACCOUNTANTS RECEIVABLE
 112 A. UNIVERSITY OF ARIZONA
 112 A. UNIVERSITY OF ARIZONA

REC/TYPIST
 112 A. UNIVERSITY OF ARIZONA
 112 A. UNIVERSITY OF ARIZONA

KEYPUNCH OPERATOR
 112 A. UNIVERSITY OF ARIZONA
 112 A. UNIVERSITY OF ARIZONA

CLERK TYPIST
 112 A. UNIVERSITY OF ARIZONA
 112 A. UNIVERSITY OF ARIZONA

TRUST ADMINISTRATOR
 112 A. UNIVERSITY OF ARIZONA
 112 A. UNIVERSITY OF ARIZONA

WESTERN PERSONNEL
 TEMPE 968-8661
 64 E. Duffey at Mill/108 Bldg
 MESA 833-4601
 137 S. Maryland/Suite C
 SPECIALIZING IN:
 * SECRETARIES/STENO
 * EMPLOY/ACCT. CLKS
 * GEN. OFF. RECEPTIONISTS
 ALL THE WESTERN LISTINGS
 AT OUR CONVENIENT OFFICES
 P/R SECY - FEE NEW
 CLAIMS PROCESSOR
 SECRETARY PLUS
 SECRETARY
 ADMINISTRATIVE SECRETARY
 EXECUTIVE SECRETARY
 PERSONNEL CLERK

ACCTS PAY
 112 A. UNIVERSITY OF ARIZONA
 112 A. UNIVERSITY OF ARIZONA

PUBLIC CONTACT WOW
 112 A. UNIVERSITY OF ARIZONA
 112 A. UNIVERSITY OF ARIZONA

ACCTS. RECEIVABLE TO \$3.50 HOUR
 112 A. UNIVERSITY OF ARIZONA
 112 A. UNIVERSITY OF ARIZONA

BOOKKEEPER
 112 A. UNIVERSITY OF ARIZONA
 112 A. UNIVERSITY OF ARIZONA

SECY/BKPR TO \$650
 112 A. UNIVERSITY OF ARIZONA
 112 A. UNIVERSITY OF ARIZONA

PERSONNEL CLERK TO \$2.60 HOUR
 112 A. UNIVERSITY OF ARIZONA
 112 A. UNIVERSITY OF ARIZONA

RECEPTIONIST
 112 A. UNIVERSITY OF ARIZONA
 112 A. UNIVERSITY OF ARIZONA

DATA PROCESSING TERMINAL OPERATOR
 112 A. UNIVERSITY OF ARIZONA
 112 A. UNIVERSITY OF ARIZONA

RECEPTIONIST
 112 A. UNIVERSITY OF ARIZONA
 112 A. UNIVERSITY OF ARIZONA

OFFICE RETAIL CLERK
 112 A. UNIVERSITY OF ARIZONA
 112 A. UNIVERSITY OF ARIZONA

SECRETARY PLUS
 112 A. UNIVERSITY OF ARIZONA
 112 A. UNIVERSITY OF ARIZONA

SECRETARY
 112 A. UNIVERSITY OF ARIZONA
 112 A. UNIVERSITY OF ARIZONA

ADMINISTRATIVE SECRETARY
 112 A. UNIVERSITY OF ARIZONA
 112 A. UNIVERSITY OF ARIZONA

EXECUTIVE SECRETARY
 112 A. UNIVERSITY OF ARIZONA
 112 A. UNIVERSITY OF ARIZONA

PERSONNEL CLERK
 112 A. UNIVERSITY OF ARIZONA
 112 A. UNIVERSITY OF ARIZONA

MULTILITH
 112 A. UNIVERSITY OF ARIZONA
 112 A. UNIVERSITY OF ARIZONA

Positions Wanted

QUAD OP AMP WITH COMPLETE SPEC BACKGROUND SEEKS AMPLIFIER GAIN FUNCTION

You'll find it difficult to top the qualifications of the new MC3403 quad differential input op amp. Its resume includes 38 different parameters with 26 of these sporting min and/or max values. So now you don't have to put up with the uncertainties of the common "typical" spec.

The new quad although electrically similar to the industry standard 741 boasts several advantages over such standard op amps. For instance, the MC3403 can operate at single supply voltages starting at 3.0 V and going all the way up to 36 V with about one-fifth the quiescent power supply currents of the MC1741 (per amplifier). Or choose split supply. Either way, you can design confidently with the MC3403 as performance min/max is specified for both.

Also, we've reduced crossover distortion to a mere 1% (typ) using a class AB output stage.

Price? Quoted at \$2.60 (100-up). But that's only the surface of the savings. In most cases, each MC3403 can replace four industry standard 741's. That affords you much greater economy than the already low price implies.

So interview the MC3403 quad op amp today. Use the coupon below or the reader service number to retrieve the comprehensive MC3403 data sheet.

CIRCLE NO. 121

FREE LINEAR "THEM-TO-US" CROSS REFERENCE

We'd like to familiarize you not only with the MC3403 quad op amp but with all the linear "professionals" from Motorola. So we're offering a new "Linear IC Cross Reference" which tells you at a glance what Motorola linear IC to use in place of whosever else's you were thinking of using!

As far as we know, it's the most complete linear IC cross reference in the industry today. Fast and easy to use. Handy, fileable format. Free for the asking.

If you have anything to do with linear ICs, you should have Motorola's "Linear IC Cross Reference". Send for it today via coupon or reader service number.

From quad op amps to interface, we'll handle your linear IC job.

CIRCLE NO. 122

HIRE MOTOROLA LINEAR TODAY



MOTOROLA LINEAR
-practical innovations for systems design!

Snip Out and Attach to Company Letterhead.

Show me your qualifications:

Send: _____ MC3403 quad op amp data sheet

_____ Motorola Linear Cross Reference Guide

Name _____

Title _____

Mail Drop _____

Mail to: Motorola "Quad"
 P. O. Box 20912
 Phoenix, Arizona 85036



The Nova 830. A little less of a good thing.

It has come to our attention that there are people who don't need all the speed of our 840.

So we've come up with a computer that goes a little slower. And costs a lot less.

The Nova 830.

The 830 uses our low-cost 32K byte memory boards.

But aside from that, you can't tell an 830 from an 840.

The 830 comes with the 840's Memory Management and Protection Unit that lets you expand up to 256K bytes, all of which are fully supported.

And it has the 840's Mapped Real Time Disc Operating System that helps you develop programs as much as it helps run them. (MDROS is one of Data General's family of compatible operating systems. So it can handle all our high level languages and all our peripherals.)

Like the 840, the 830 is a natural for dual operations: Timesharing and Batch, Remote Job Entry and Batch, Timesharing and Remote Job Entry, or if you're so inclined, Batch and Batch.

And like the 840, you can get an 830 in 45 days. Or less.

Unlike the 840, you can get an 830 with 128K bytes of memory for \$23,150.

Data General

The computer company you can understand.

• Data General Corporation, Southboro, Massachusetts 01772, (617) 485-9100.
Datagen of Canada Ltd., Hull, Quebec (819) 770-2030/Data General Europe, Paris, France 504-23-44.

INFORMATION RETRIEVAL NUMBER 18

Another technical knockout

the first plastic, low-noise GHz transistor

Look out, expensive metal and ceramic types — here comes the MRF901 in a microwave plastic package: a 1 GHz small-signal device with 2 dB NF at an applications-unlimited price!

The die is fabricated using unique arsenic-ion-implant process technology to gain higher performance for state-of-the-art designs — and it's available in metal-ceramic packages for high reliability applications.

Now you can improve communication system performance by gaining low-cost dB's in receiver sensitivity.

And... increase receiver

range with an MRF901 in front of your diode mixer for a 3-5 dB improvement in front end NF at UHF.

And... build a better 900 MHz front end for less \$.

And... design low-cost, HF pre-selectors for counters up to 1500 MHz.

And... achieve low-noise at high current (up to 20 mA) for low-distortion, UHF/VHF MATV amplifiers.

And... do it for a unit price of just \$9.00.

It's available now from an RF supplier who believes OEM needs are first priority. See your distributor. Design it in. Be first with the first...

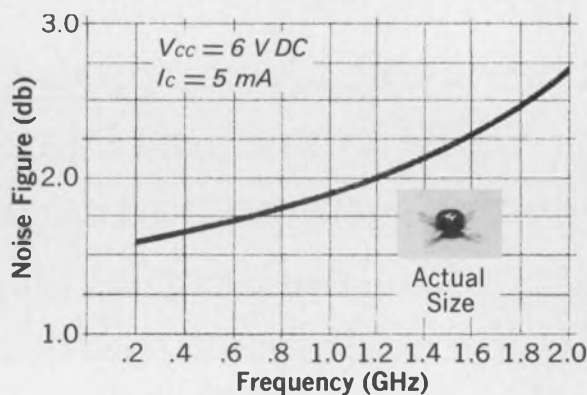

heavyweight
from Motorola, the RF producer.

washington report

Commerce Dept. bullish on electronics sales

Predicting that 1974 will go down in the records as a good year for the electronics industry—especially the computer segment—the Dept. of Commerce is bullish on the future. In a new industrial outlook report, the department sees industry shipments of electronic components up 11% over 1973, commercial, military and industrial equipment up 3% and computer-industry shipments up 22%.

In a projection to 1980, the Government outlook is for all electronics sales to increase at an annual rate of 5.5%, reaching \$35-billion by 1980. The highest growth rate, the department says, will be in electronic systems and equipment—8.9%. Electronic components are seen growing at an estimated 3.3% and consumer electronics at 2.6%.

Computer industry growth is estimated at 14% in 1975, with a five-year average somewhat lower—10%. Software is expected to be the major emphasis in this field during the remainder of this decade. An average annual growth of 21% through 1980 is predicted for calculator sales.

U.S. and Soviet pushing joint technical efforts

A bright spot in the international outlook is the progress being made in scientific and technical cooperation between this country and the Soviet Union.

Some efforts, started last year by the formation of a U.S.—Soviet Joint Commission on Scientific and Technical Cooperation, are now moving from the planning stages to joint research. Four chemical-catalysis projects and two projects applying computers to management are the first to make this transition. Projects in electrometallurgy, such as solid-state joining, are also reported ready. The joint commission, following its recent meeting in Washington, requested that the U.S. National Academy of Sciences and the Soviet Academy of Sciences select experts to carry out work on solid-state theory.

Rising unemployment making engineers wary

With unemployment rising, a U.S. Labor Dept. monograph, "Labor Market Experience of Engineers During Periods of Changing Demand," may enjoy a healthy sale. Should the unemployment rate of engineers rise as dramatically as it did in the last recession, the defunct Technology Mobilization and Re-employment Program may also be revived. This was a national effort to find jobs for engineers, primarily those in the hard-hit aerospace industry.

The national unemployment rate for all workers was up to 6% in October, for all professionals and technicians, it was 2.3%. Among professionals, engineers have had the highest unemployment rate in recent years. In 1967 it was 0.7%, and by 1971 it had climbed to 2.9%. The Bureau of Labor Statistics doesn't classify engineers as a group; they are lumped with scientists and technicians. In 1973 when the national unemployment rate for all workers was 4.9%, the bureau's scientist-technician category stood at 3.4%.

The monograph may be purchased for \$1.05 from the Superintendent of Documents, U.S. Government Printing Office, Washington, DC 20402.

Private processing of nuclear fuel backed

While the nuclear-power industry's most visible problems are posed by the environmentalists, one equally serious for it and the electronics industry is the future supply of fuel for the reactors. Unless something is done, by 1982 U.S. uranium-enrichment facilities will not be able to satisfy demand here and abroad. At present nuclear fuel is enriched at three gaseous-diffusion plants owned by the Atomic Energy Commission. Even if they are upgraded, as planned, they won't be able to accept new customers. A bill introduced in the House would create a quasi-governmental corporation to stimulate nuclear-fuel processing by private industry.

Called the United States Enrichment Corp., it would be self-supporting and would take over the AEC's plants. The corporation would expand production, probably through encouragement of private industry to build plants and development of the centrifuge process, which is less power-consuming and water-consuming than the gaseous-diffusion process.

To ensure a market for private industry, the corporation would not construct competing facilities and eventually would turn all enrichment processing over to commercially operated plants. It's estimated that an annual investment of \$2-billion would be required to provide the added production facilities.

Capital Capsules: The Air Force is looking for sources to develop varactor diodes for ECM voltage-controlled oscillators, with emphasis on minimizing post-tuning drift and settling time. . . . NASA is interested in demonstrating the feasibility of automating solar-cell-array fabrication with use of production wrap-around cells and FEP plastic films. The agency is also seeking a contractor to develop standard specifications for silicon solar cells. . . . Fairchild Industries has delivered to the Army a system that will electronically identify shipping containers, trucks and other vehicles, even when they are whizzing by an interrogator at speeds up to 85 mph. The device, which is triggered by a label on a box or vehicle, records the serial number. The system is to be tested. . . . NASA reports that flat conductor electrical cable, a spinoff of the space program, is being installed in private housing for the first time. Developed originally for wiring in satellites, the flat wire will be used to make a surface-mounted, snap-on baseboard electrical system in six apartments in Yonkers, NY.

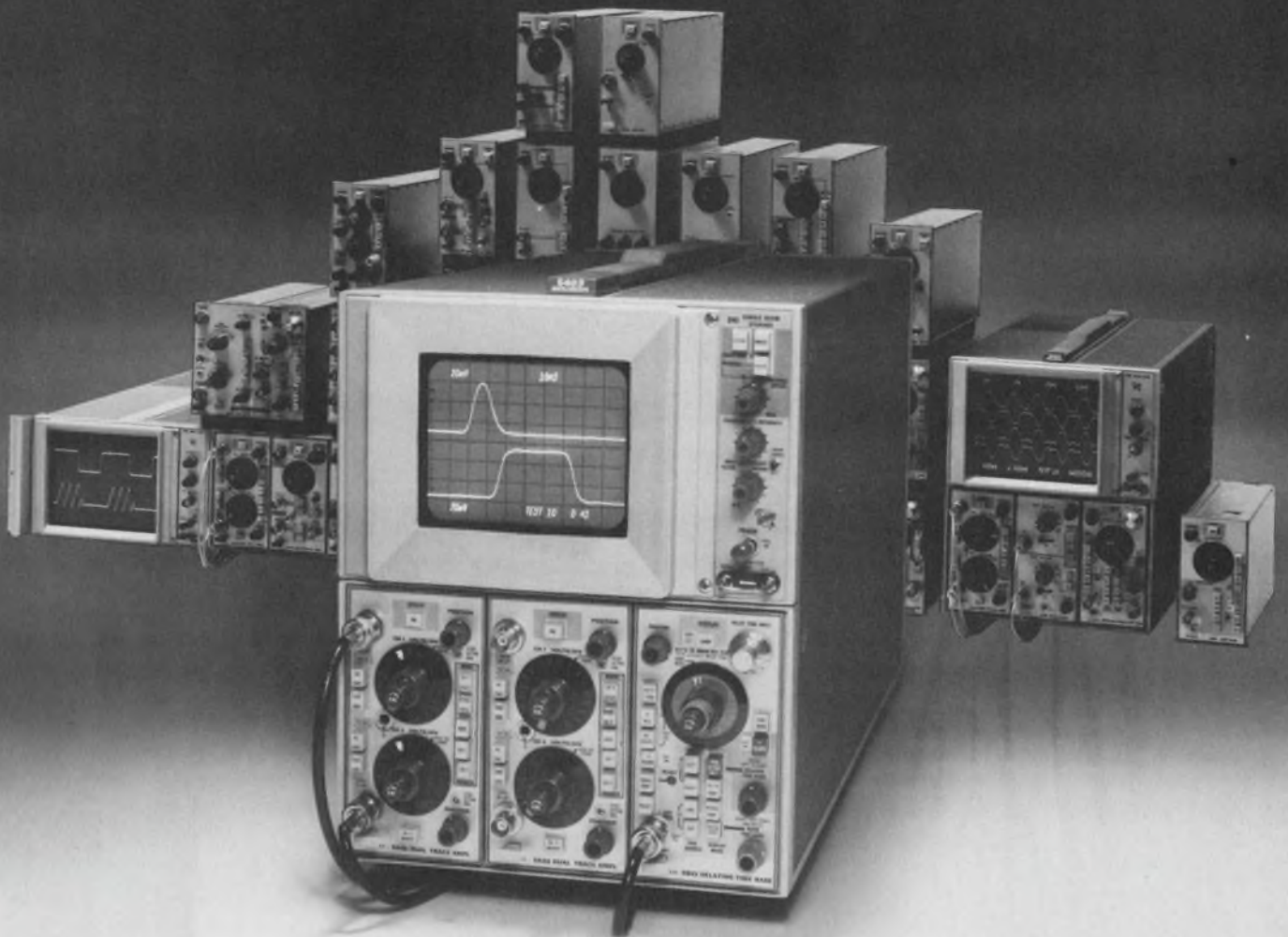

Capture Those Hard to View Signals at Low Cost

Single shot events; high speed, low repetition rate signals; changes in successive sweeps, very slow signals; repetitive signals obscured by random noise—all of those hard to display waveforms are easy to view using the new 5403/D41 Variable Persistence Storage Oscilloscope from Tektronix.

You vary waveform storage time for the 5403/D41 simply by turning a dial. Normal intensity viewing time ranges from milliseconds up to 5 minutes and a waveform can be saved for up to an hour by simply pushing a button.

With a writing speed of 5 div/ μ s, 60 MHz bandwidth and the added convenience of a 3 plug-in mainframe, the 5403/D41 saves you hundreds of dollars over the price of other variable persistence storage oscilloscopes. Complete with 60 MHz vertical amplifier and 10 ns/div time base, the 5403/D41 is priced from only \$2,560. What's more; with the flexible, easy-to-use 5403/D41 you can add unique

convenience features: CRT readout of deflection factors, and user programmable CRT readout of test identification data.

Versatile, Modular Family. The 5403/D41 Variable Persistence Storage Oscilloscope is the latest addition to the versatile, modular 5000 Series. With this flexible family you can tailor the oscilloscope best suited to your measurement needs by choosing from 2 mainframes (60 MHz or 2 MHz bandwidth), 7 display modules, and 21 diverse plug-ins. 5000 Series measurement flexibility includes a 60 MHz dual trace amplifier, a 10 ns/div sweep rate delayed time base, an easy-to-use dc to 1 GHz sampler, a dc to 100 kHz spectrum analyzer, a 10 μ V/div differential amplifier, a differential comparator accurate to 0.20%, a four trace amplifier (8 traces with two amplifiers), and a semiconductor curve tracer.

The flexible 5000 Series is designed to handle your present measurements and is expanding to meet your future needs.

To learn more about the new 5403/D41 Variable Persistence Storage Oscilloscope and how this low cost instrument can make difficult signals easy to measure, contact your local Tektronix Field Engineer or write Tektronix, Inc., P.O. Box 500, Beaverton, Oregon 97077. In Europe write Tektronix Ltd., P.O. Box 36, St. Peter Port, Guernsey, C.I., United Kingdom.



TEKTRONIX®
committed to
technical excellence

“Scotchflex” Flat Cable Connector System makes 50 connections at a time.

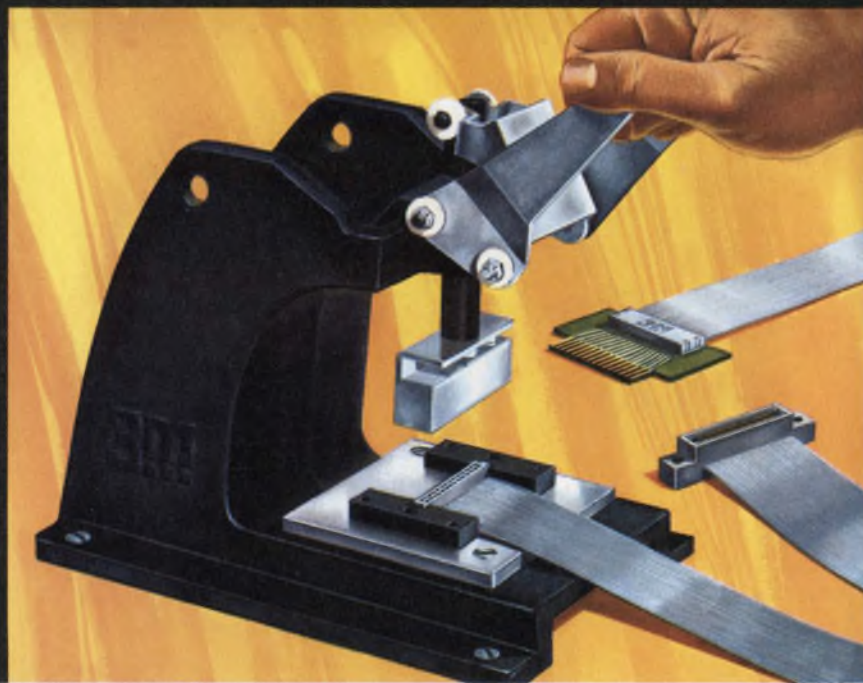

“SCOTCHFLEX” IS A REGISTERED TRADEMARK OF 3M CO.

Build assembly cost savings into your electronics package with “Scotchflex” flat cable and connectors. These fast, simple systems make simultaneous multiple connections in seconds without stripping or soldering. Equipment investment is minimal; there’s no need for special training. The inexpensive assembly press, shown above, crimps connections tightly, operates easily and assures error free wiring.

Reliability is built in, too, with “Scotchflex” interconnects. Inside of connector bodies, unique U-contacts strip through flat cable insulation, grip each conductor for dependable gas-tight connections.

“Scotchflex” offers you design freedom, with a wide choice of cable and connectors. From off-the-shelf stock you can choose: 14 to 50-conductor cables. Connectors to interface with standard DIP sockets, wrap posts on standard grid patterns, printed circuit boards Headers for de-pluggable connection between cable jumpers and PCB. Custom assemblies are also available on request.

For more information, write Dept. EAH-1, 3M Center, St. Paul, Minn. 55101.

“Scotchflex” Your systems approach to circuitry.



Ferrite transformers cost less, increase reliability and eliminate scrap. Broad Band-Rated™ ferrites replace laminations to 16,000 perm.

New design solutions

If you're using metal laminations to get high permeability transformers and inductors, take another look at ferrite technology. Our ferrite components now eliminate the high cost of lamination assembly in critical bandwidth applications from 100 Hz to above 250 MHz.

Increased reliability and guaranteed circuit performance of our components end design guesswork and production rework. You design with known circuit parameters and our pretesting program assures that our components will continue to meet your circuit requirements.

Highest permeability available

Toroidal perm over 16,000 and

effective permeability over 5,000 allows you to use Broad Band-Rated ferrites in a wide variety of new applications. Our full range of shapes includes mated parts in pot core, RM6 and E core configurations to extend your design flexibility.

Some help from your friends

We'd like to help you apply the latest ferrite technology to your broad band requirements. Our new design guide outlines the improved characteristics of our components and gives you guaranteed specs that make sense. Shunt resistance and reactance per turn squared, temperature coefficient, disaccommodation and hysteresis core constant.

The applications section covers

design of both high and low frequency transformers and shows you how our circuit specifications make your design task easier, more precise.

Circle the Bingo card for your copy of the design guide or call (201) 826-5100 and talk to the engineers who wrote it.

Either way, if you're still gluing laminations to get high permeability, talk to the ferrite experts.

That's us.

Indiana General
Keasby, NJ 08832

National distribution through Permag in Atlanta, Boston, Chicago, Dallas, Detroit-Toledo, Los Angeles, New York and San Francisco.

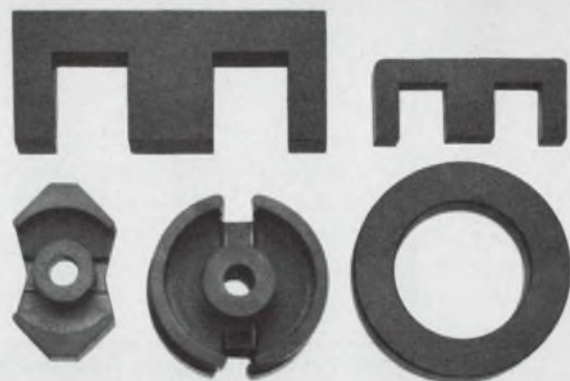
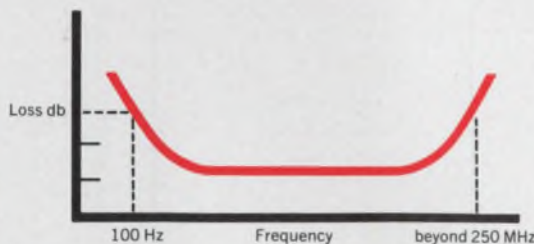

indiana general

a division of Electronic Memories & Magnetics Corporation

INFORMATION RETRIEVAL NUMBER 22

There's nothing new about a 2N3055 but there's a **powerful** difference in this one.

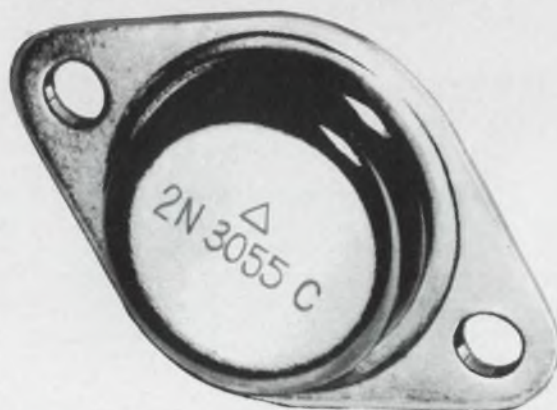

**That's why we call ours the 2N3055C*
*"C" designates it as the Cadillac of power transistors.**

Compare the specs below and see at a glance why Sensitron's up-graded version of the workhorse 2N3055 . . . the 2N3055C . . . is your best bet for a wide range of power transistor applications.

| Parameter | Conventional 2N3055 | RSM Sensitron "Cadillac" 2N3055C |
|-----------------------|--------------------------|--|
| Chip size | 140-175 mil ² | 210 mil ² |
| P _D | 115 W @ 25° C case temp. | 150 W @ 25° C case temp. |
| I _{Cmax} | 15 A | 30 A |
| BV _{EBO} | 7V | 10V |
| BV _{CEO} | 60 V | 120 V |
| BV _{CER} | 70 V | 130 V |
| I _{CEX} | @ 100 V < 5 mA | @ 120 V < 1 mA |
| h _{FE} | 20 @ 4 A | 25 @ 4 A |
| h _{FE} | 5 @ 10 A | 10 @ 8 A |
| V _{CE (sat)} | 1.1 V @ 4 A | 0.75 V @ 4 A |
| V _{CE (sat)} | 8.0 V @ 10 A | 3.0 V @ 10 A |
| SOAR | 60 V @ 1.9 A | 70 V @ 2.15 A |

Write or call for more information or applications assistance on the 2N3055C and other RSM Sensitron single diffused power transistors.



Sensitron Semiconductor

A DIVISION OF RSM ELECTRON POWER, INC.
221 West Industry Court • Deer Park, N.Y. 11729
Telephone 516-586-7600 • Telex 96-7737

INFORMATION RETRIEVAL NUMBER 23

ELECTRONIC DESIGN 25, December 6, 1974

Nice young girls and consultants

Walking the streets of Hong Kong a few weeks ago, I was stopped on several occasions by individuals brushing past me and whispering an offer, "Nice young girl?" I wondered why they selected me and a few others among the thousands working their way down the crowded streets. And why, "Nice young girls"?

Was that the only "merchandise" they had available? Or did they spot me as the type who might prefer "nice young girls" to "nice old girls," "not nice young girls," "not nice old girls," or a similar choice among boys. At any rate, I was a customer for none of the above, so their message was wasted on me.

In Tokyo, a few days later, I had a somewhat similar encounter when a charming young lady stopped me on the way to my hotel room, engaged me in an intellectual discussion, asked about my line of business, then volunteered that she was a consultant. Now, by a common definition of a consultant—one who lives more than 100 miles from the office—she may have qualified.

But in other respects she differed from most consultants I've met. At any rate, like other consultants, she tried to convince me that I was in urgent need of her consulting services. When she saw that I was not to be a client, and that precious minutes of her professional time were being wasted, she left in search of those more desperate for consulting services.

If we can ignore the moral, religious and sociological considerations involved in these transactions, we can take a dispassionate look at the business approach. Recognizing that the purveyors, in these cases, couldn't influence the basic design of the product, we can wonder if they merchandised it effectively. Did they not waste a call? Could they have used their time more effectively by selecting more likely clients? Should they have promoted a different feature of the product?

I think the lessons from my experiences in Hong Kong and Tokyo are the same: (1) Know your customer. (2) Learn to find your customer efficiently; don't waste your efforts with unlikely prospects. (3) Learn your customer's needs. (4) Design the product to meet your customer's needs—if possible.



George Rostky

GEORGE ROSTKY
Editor-in-Chief

Hughes heat pipes. Order 'em hot off the shelf.

Now you can order heat pipes just like you order nuts and bolts. Because now Hughes stocks heat pipes in a variety of standard, off-the-shelf sizes and thermal capacities. (If you have a heat transfer problem that calls for a custom solution, we solve those, too.)

1333H STAINLESS STEEL AND AMMONIA

Thermal transport capacity: 50 watts with evaporator 90° below condenser, 15 watts horizontal operation, 7 watts with evaporator 90° above condenser. Recommended operating range: -80° to +90°C. Weight: 8 grams. Active Length: 5.69 inches. Diameter: 3/16". \$37.00.

1370H COPPER AND WATER

Available in diameters of 1/4", 1/2", and 1" at \$37.00, \$40.00 and \$50.00, respectively, with thermal transport capacities of 345, 750, and 6000 watts with the evaporator 90° below condenser; 115, 250 and 2000 watts horizontal operation; 38, 60, and 500 watts with evaporator 90° above condenser. Recommended operating range: +50° to +150°C. Weight: 21, 70, 550 grams. Standard Active Length: 6, 6, 12 inches.

1350H STAINLESS STEEL AND METHANOL

Available in diameters of 3/16" and 1/4" at \$37.00 each and 1/2" at \$40.00. Thermal transport capacities are 55, 75, and 180 watts with evaporator 90° below condenser, 17, 25, and 60 watts horizontal operation, and 6, 10, and 20 watts with evaporator 90° above condenser. Recommended operating range: -40° to +120°C. Weight: 8, 11, and 38 grams. Standard Active Length: 6 inches.

1361H FLEXIBLE STAINLESS STEEL AND METHANOL

Available in active lengths of 7" and 8" at \$75.00 each, with thermal transport capacities of 20 watts with the evaporator 90° below condenser, 7.5 watts horizontal operation, 2.5 watts with evaporator 90° above condenser. Recommended operating range: -40° to +120°C. Weight: 20 grams. Diameter: 1/4".



For detailed information, or if you have a hot requirement and want one now, just fill out and send in the coupon. Hughes Electron Dynamics Division, 3100 W. Lomita Blvd., Mail Station 2124, Torrance, California. (213) 534-2121.

PLEASE PRINT

SEND INFORMATION.

SEND QUICK ORDER FORM.

NAME _____ COMPANY _____

ADDRESS _____ CITY _____

STATE _____ ZIP _____ TELEPHONE _____

All prices shown are effective in U.S.A. and Canada

ED-12

TRW connects with Celanex. At 1/3 the cost of DAP

Based on a very thorough material comparison, Cinch Division of TRW Electronic Components now molds these printed circuit edge connectors, shown below, in flame-retardant Celanex SE-O—replacing DAP and glass-filled phenolics. Why? Celanex cuts molded insulator costs by a whopping ⅓. And insulator properties in Celanex are equivalent or better.

Fact is, for electrical/electronic connectors, glass-filled Celanex thermoplastic polyester combines all the advantages of DAP and phenolics. With none of their disadvantages.

Celanex is faster cycling than all thermosets. By far. Easier to mold in thin-walled sections. And Celanex scrap can be re-ground and reused. Another cost-saving.

Celanex is rigid, for support of the printed circuit board. It will withstand severe shocks to thin-wall parts. It's dimensionally and electrically stable at elevated temperature and humidity. And it resists strong chemical solvents and cleaning solutions.

Maybe Celanex has so much going for it because Celanese was the first to market a thermoplastic polyester. We have more ex-



perience and far greater depth of data to offer you. It's yours for the asking. Celanese Plastics Company, Dept. X-602, 550 Broad Street, Newark, New Jersey 07102.

Celanese Plastics Company is a division of Celanese Corporation. Canadian Affiliate: Celanese Resources, Ltd. Export: Amcel Co., Inc., and Pan Amcel Co., Inc., 522 Fifth Ave., New York 10036.

Celanex: the original thermoplastic polyester

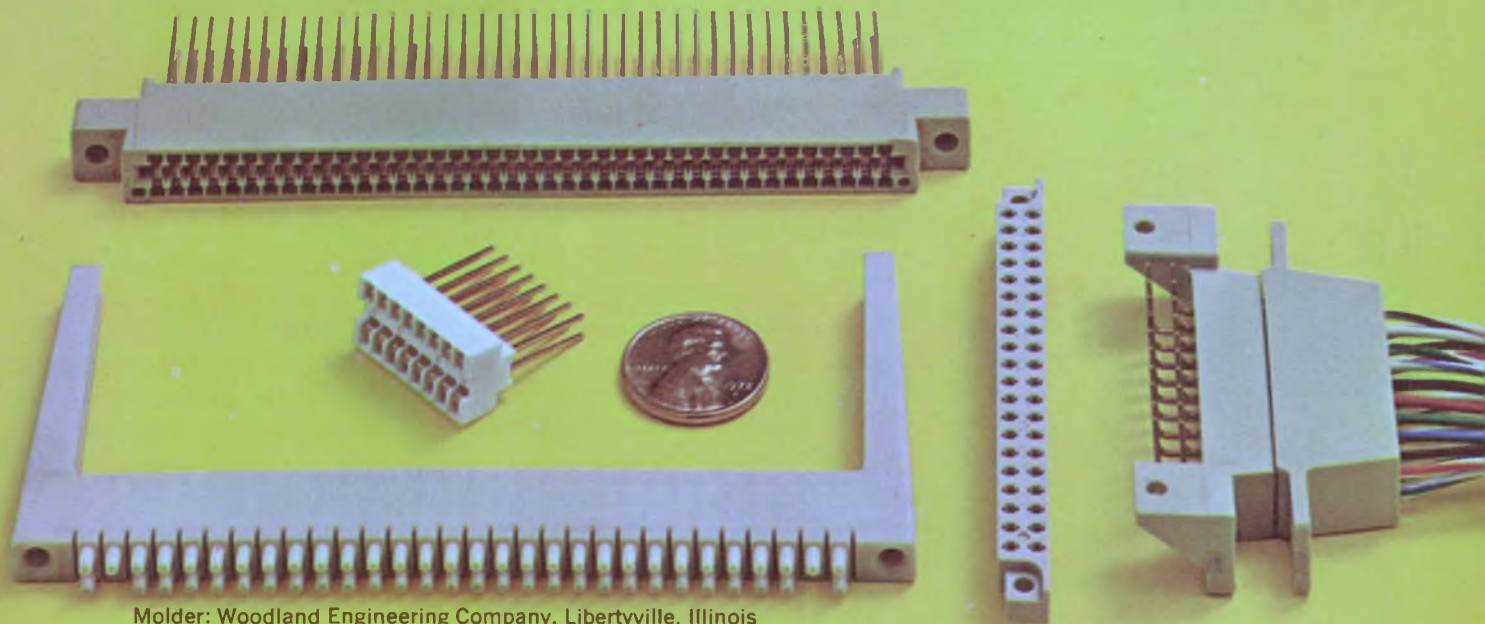

Molder: Woodland Engineering Company, Libertyville, Illinois

INFORMATION RETRIEVAL NUMBER 26

Which dc/ac inverter? At least eight different circuit schemes are used. Learn what these increasingly important units can do and know their limitations.

With the rapidly growing use of dc/ac inverters in uninterruptible power systems (UPS), portable equipment and power frequency converters, it has become imperative for a specifying engineer to understand the capabilities and limitations of the many inverter types available today. Eight types of commercial inverter designs are presently popular, with each trading off one set of performance characteristics for another.

But whatever the type, the emphasis in recent applications increasingly bears on such factors as efficiency, weight, reliability, EMI and safe operation—as well as on the more traditional areas of frequency stability, harmonic content, regulation and transient performance. Today's inverter frequently encounters—and must be able to handle—nonlinear loads, such as those of the ubiquitous computer peripheral.

The first decision in comparing design techniques starts with the needed power level. By and large, inverters can be split into two groups based on power: the low-power, transistor-based design and the high-power SCR-based system.

Transistors vs SCRs

Limited to low-power designs because of its dissipation, the power transistor can nevertheless be found today in 3- ϕ systems with apparent powers up to 15 kVA. Above that level, the SCR can handle the power; SCR versions go as high as 1 MW in a large UPS arranged in a complex, power sharing array.

Each type—the transistor and the SCR—has its problems. For instance, for an SCR to turn completely off, its anode-to-cathode current must be reduced to zero for about 30 μ s. This isn't easy to do when the prime power source is dc. Dozens of "solutions" to the turn-off, or commutation, problem have been applied—much to a specifier's dismay.

On top of the turn-off problem, SCR designs are sensitive to noise and EMI so that a specifier must worry about these too.

George A. O'Sullivan, President, Abacus Controls Inc., 65 Fourth St., Somerville, NJ 08876.

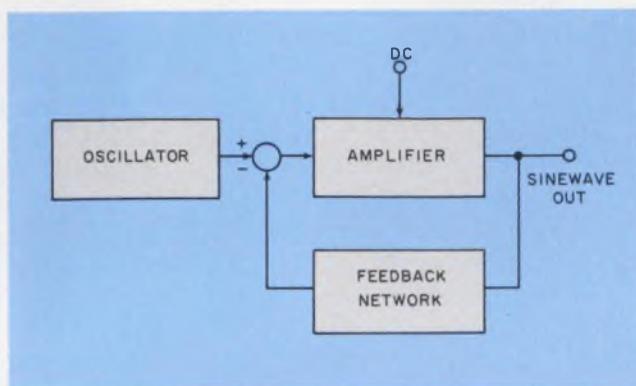

1. **Low efficiency (30%)** mars the otherwise excellent performance of one of the first dc/ac inverters: a Wien-bridge oscillator coupled to a power amplifier.

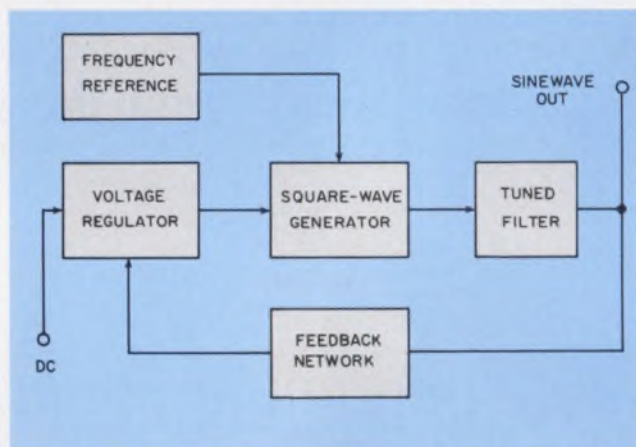

2. **Square-wave generators** form the basis of many inverters. Filtering is necessary to remove harmonics. In this scheme, a voltage regulator controls the output level.

One of the earliest inverters—used mostly in military applications to convert 60 to 400 Hz—couples a Wien-bridge oscillator to a class AB power amplifier (Fig. 1). The oscillator/amplifier technique is still alive in lab power supplies, but with the older vacuum tube now replaced by transistors.

The transistorized versions retain their forbears' characteristics of high accuracy, low harmonics, good voltage regulation and excellent load transient response. And both variable volt-

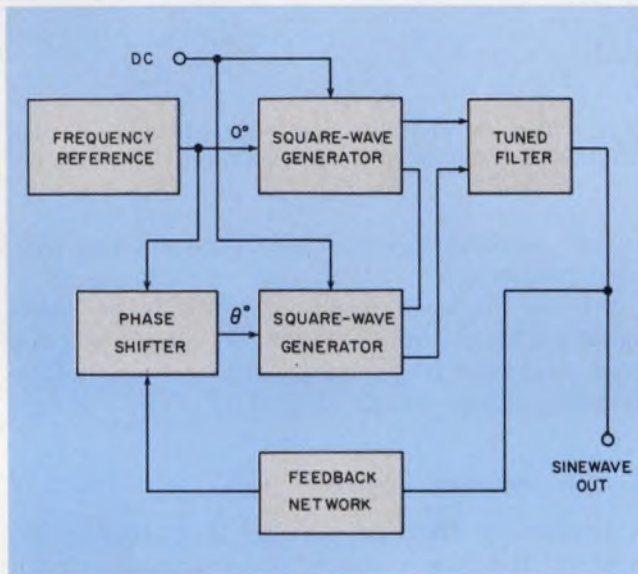

3. To avoid the poor response and low efficiency of the voltage regulator, phase-shift voltage control can be used. But clean sinusoids are hard to get.

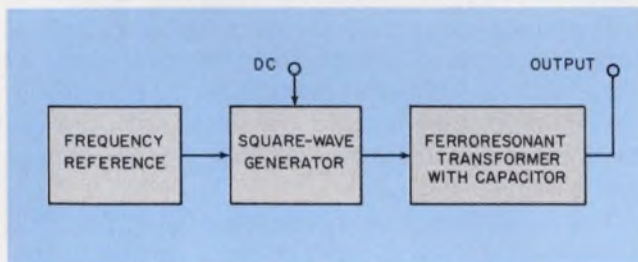

4. The simplest inverter is the ferroresonant-transformer type, which inherently provides regulation, filtering and overload protection, but not variable voltage.

age and frequency are easily incorporated into the design. Unfortunately, they have also inherited poor efficiency (30 to 40%), high weight-to-power ratio and relatively high cost.

The classic Royer oscillator—a two-transistor, square-wave dc/ac converter—appeared in the mid-fifties and became the basic building block in both dc/ac and dc/dc units for more than a decade.

The square-wave generator is efficient and reliable, and the switching transistor can control

power 10 to 20 times greater than its dissipation rating. But to obtain a low-harmonic sine wave requires substantial filtering: A square wave contains all odd harmonics in inverse proportion to the number of the harmonic. That is, the ratio of the third harmonic to the fundamental is 0.333; the fifth is 0.20; and the seventh is 0.143.

Harmonics are a problem

To remove harmonics close to the fundamental, without attenuation of the fundamental frequency, requires massive filters. Most commonly used is a series-tuned LC network, followed by a parallel-tuned LC circuit across the load. Tuning is critical, and loads with power factors other than unity upset the harmonic rejection of the filter.

Two modes of voltage control are popular in square-wave units. The first precedes the square-wave generator with an independent voltage regulator (Fig. 2). The voltage is sensed at the output of the inverter and returned to the regulator through a feedback network. Response to load transients is extremely poor because the closed-loop response must be much slower than that of the four-pole series and parallel-tuned filters located inside the feedback loop.

And since full power is handled twice—once in the voltage regulator and again in the square-wave generator—efficiency plunges and cost and weight soar. To avoid this problem, two square waves can be added with a controlled phase shift (Fig. 3). Each square-wave generator can supply half the power. When the two square waves are in phase, maximum load is delivered. Out-of-phase operation provides zero power to the load.

However, the filtering problem with two square-wave generators becomes more severe. This is because at some relative phase angles, the harmonics of the two generators add in-phase and become a much higher percentage of the fundamental frequency.

Note that poor response to load transients is inherent in all square wave/tuned-filter inverters. Variable voltage may be incorporated in

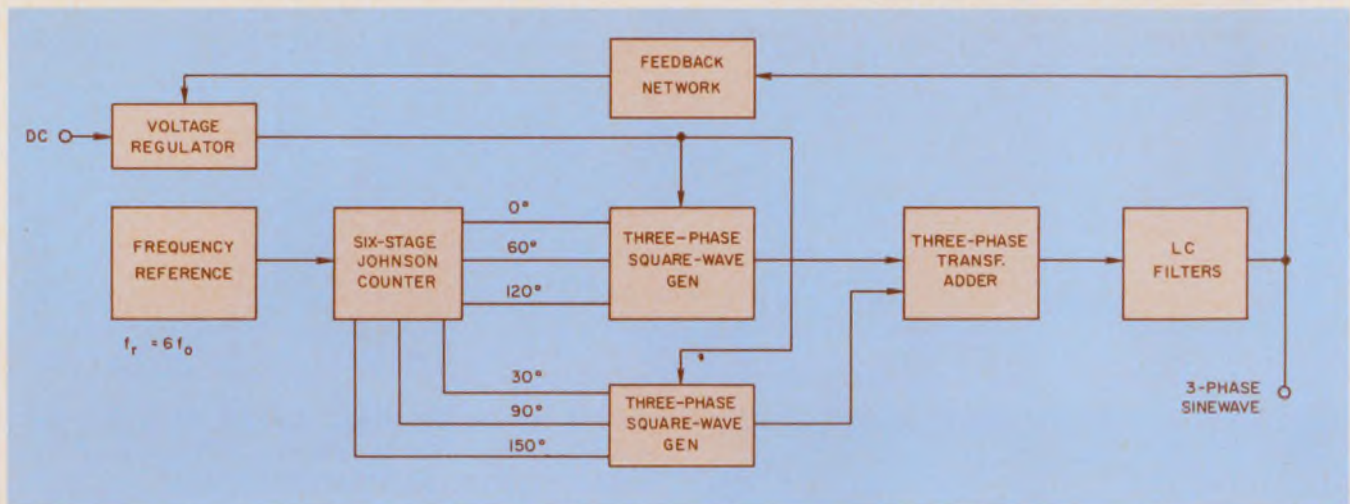

5. One of the purest sine waves is delivered by the step approach, in which a number of square waves—con-

trolled in phase and amplitude—are added. Harmonics are related to the number of steps.

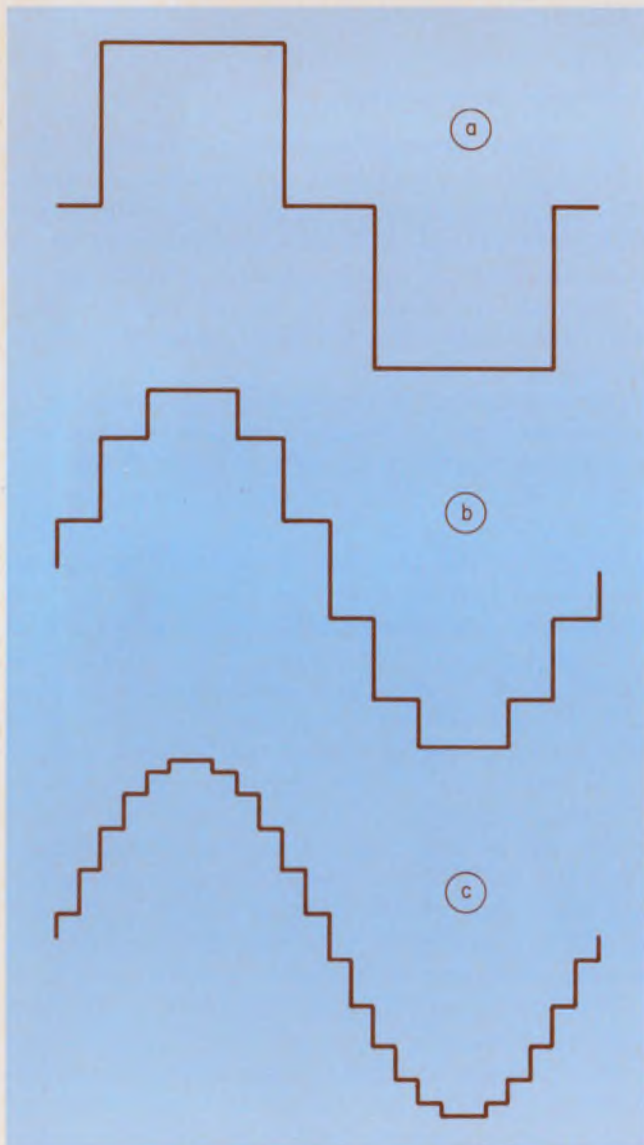

6. In the stepped-waveform approach to inversion, output harmonics depend on the number of steps and the step height. Step number is usually a multiple of three: 6 (a), 12 (b) and 24 (c) are commonly used.

square wave/tuned-filter inverters, but not variable frequency.

By far the least complex inverter—the ferroresonant transformer—provides voltage regulation, harmonic suppression, and overload protection in a simple circuit (Fig. 4).

The ferroresonant inverter

Because of the transformer's large leakage reactance, the square wave in the primary circuit is not transformed into the secondary. Instead, the impulse from the primary activates a tuned, saturating magnetic circuit and ac-capacitor combination. At a constant frequency, this tuned circuit provides a constant voltage to the load.

Harmonic content of the ferroresonant transformer's output is satisfactory for most applications. But a further reduction in harmonics is possible with the addition (in series with the capacitor) of an inductor selected for third-harmonic suppression.

The square-wave ferroresonant-filter inverter provides a constant voltage and constant frequency that are not adjustable in the field. Efficiency of the system runs 70 to 85%, depending upon power level.

Three-phase inverters require three square-wave/ferroresonant-filter inverters that can be synchronized and controlled at 120-degree phase shift. In this configuration, the basic simplicity of the ferroresonant transformer is lost. The square-wave/ferroresonant-filter inverter is a low-cost solution to low and medium-power single-phase applications that operate from batteries with outputs of 12, 24, 28, 48, and 120 V. To get variable voltage, line synchronization or a more perfect sinusoid, however, other approaches are needed.

The oscillator/amplifier provides a clean sine

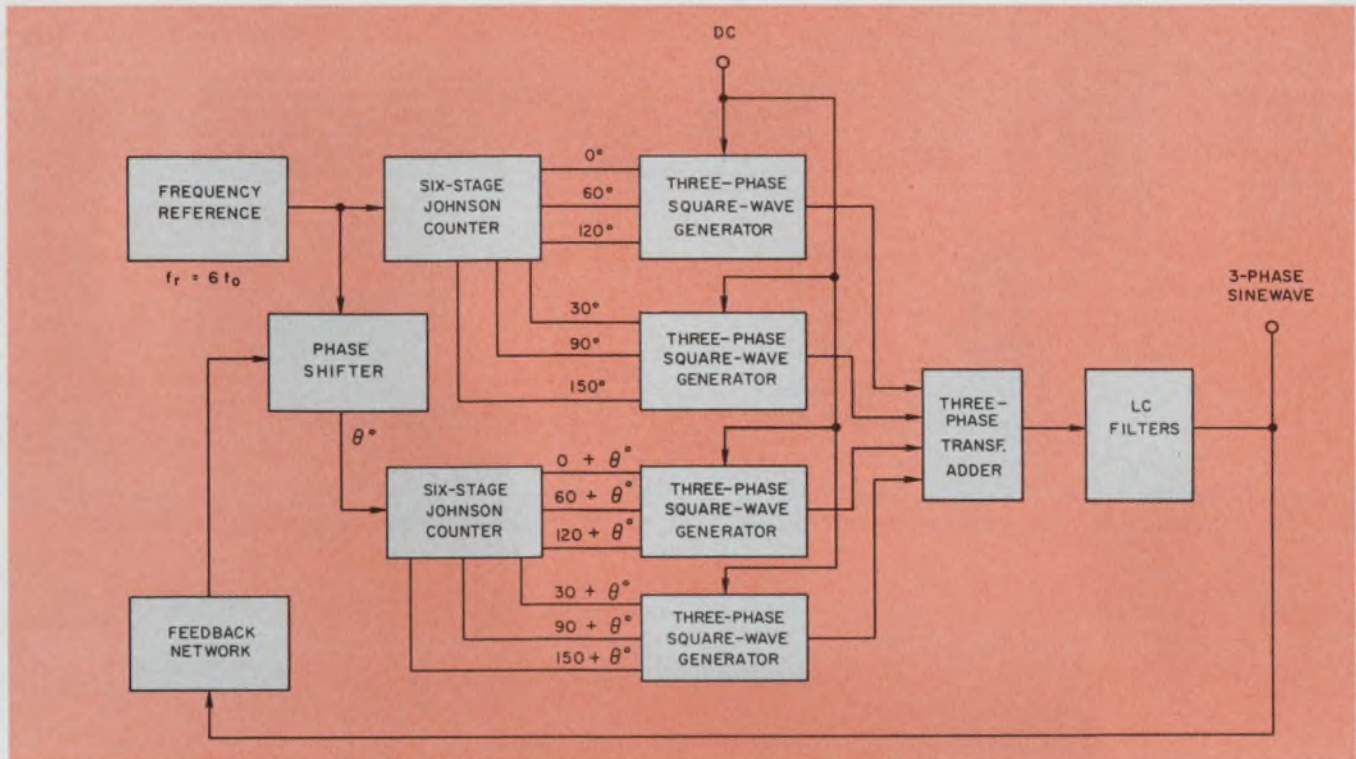

7. Phase shifters or voltage regulators can also be used to control voltage in the step technique. Regulators are

the least efficient. But phase shifters—which need two complete sets of steps—are the most complex.

wave but at a sacrifice in efficiency; the square-wave generator is efficient but can't give a good approximation of a sine wave. In the search for an inverter that yields a clean sine wave, the step wave emerges (Fig. 5).

In the step technique, several square-wave generators are controlled in phase and amplitude to make a step wave. Usually, the steps are evenly spaced across 360 degrees and the height of each step is selected to eliminate low-order harmonics.

The general relationship between the number of steps and the retained harmonics is:

$$\text{Harmonic number} = \sum_{N=1}^{\infty} MN \pm 1,$$

where M includes all positive integers and N is the number of steps. A 12-step wave thus contains the 11th, 13th, 23rd, 25th and succeeding harmonics, and the amplitude of each retained harmonic is inversely proportional to the number of the harmonic—the same relationship as that of the square wave.

Theoretically, the number of steps can be any integer. But in practice only even multiples of three are chosen. These provide positive and negative half-cycle symmetry and generate three phases with a single set of components. The amount of hardware needed to generate a step wave is substantial, and the technique is practical only for large three-phase systems in which power sharing between components is required.

Most popular are 12 and 24-step waves (Fig. 6). The three-phase square-wave generator con-

sists of six power-switching circuits arranged in a three-leg bridge, with a delta-connected transformer joining the centers of each pair of power-switching circuits.

Voltage control with the step approach is similar to that of the square wave. A separate voltage regulator (with its inefficient double handling of power) is one approach. A phase shifter that moves a second complete set of steps with respect to the first is most often used in a large SCR UPS (Fig. 7).

Variable voltage and variable frequency over a limited range are possible. Harmonic control is simple: With an LC filter tuned at about the fourth harmonic, the speed of response to load transients is reasonably good—about 3 cycles of the line frequency. Efficiency at full power is about 85% but, at partial power, losses are significant and efficiency falls off with decreasing power.

The latest inverter: digital synthesis

The step-wave inverter provides an efficient low-harmonic sine wave. But the high parts count makes it impractical at low and intermediate power levels. With the introduction of large-scale integrated circuits, especially the programmable read only memory (pROM), the hardware required to build a digital equivalent of the step wave becomes practical.

To synthesize a sine wave digitally, a pROM is

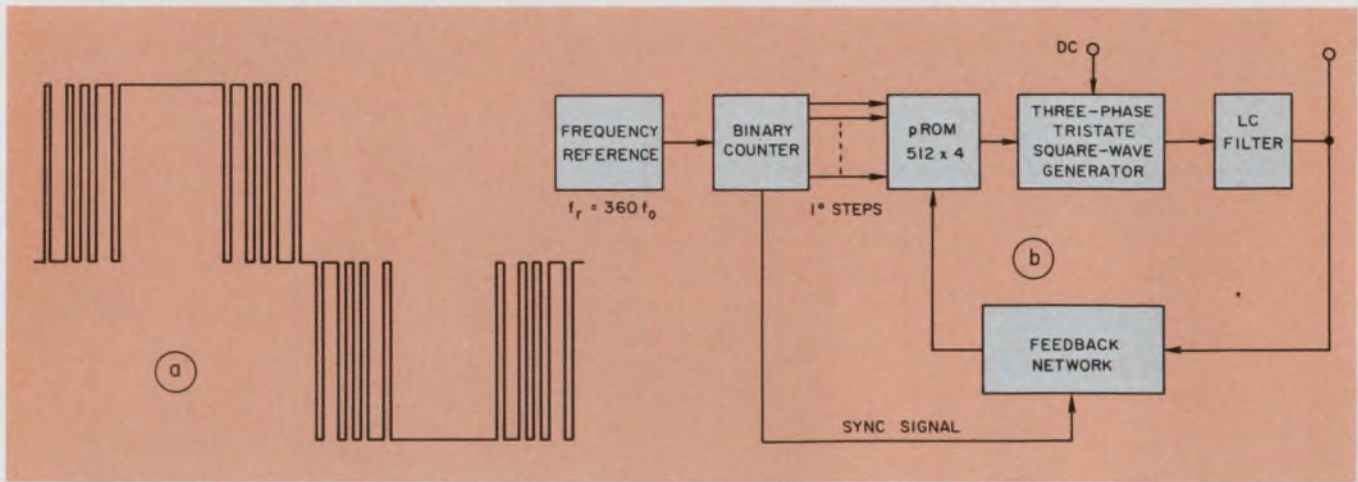

8. Digitally synthesized sine waves (a) are made possible by programmable, read-only memories (pROMs)

which store patterns of pulses (b). Outputs from the pROM provide switching signals to a 3- ϕ bridge.

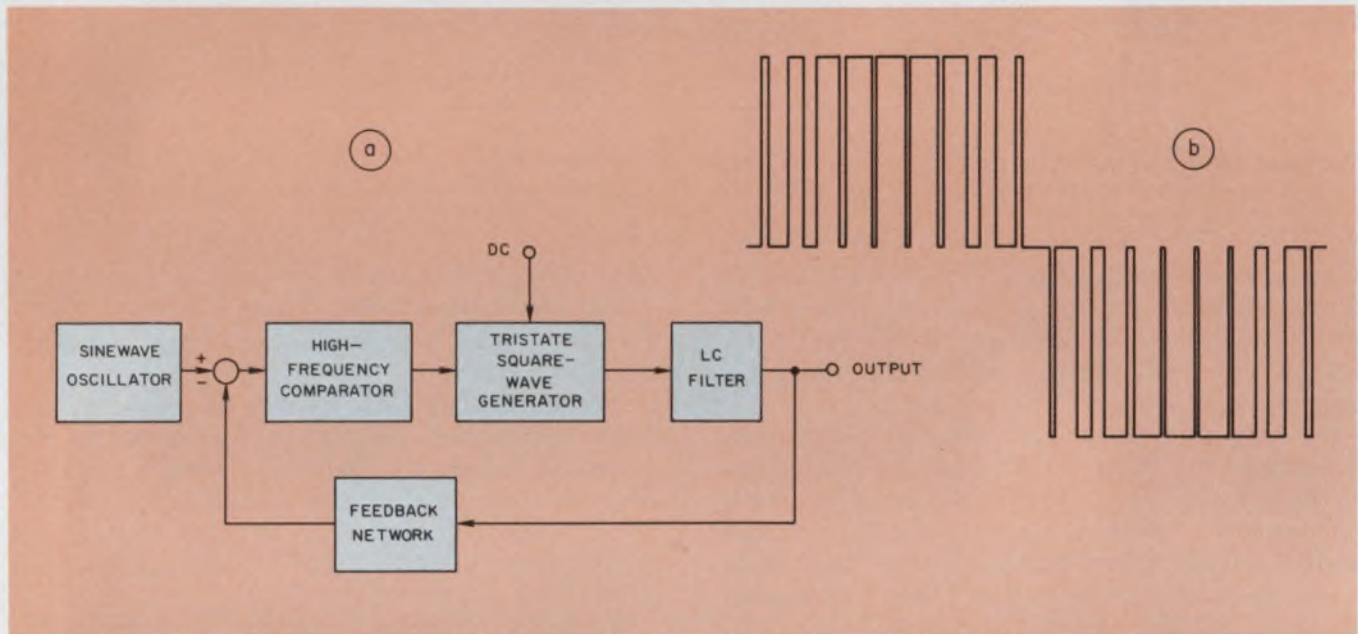

9. To get the best efficiency (80%), the switching-regulator technique (a) is used to control, or modulate,

the width of pulses in a train (b). Harmonics are kept down by use of high switching frequencies.

used to store a pattern of pulses, both positive and negative, that are selected to eliminate low-order harmonics. A simple LC filter reduces the higher order harmonics; these are more prevalent than in the step-wave approach.

The digital synthesizer regulates voltage by increasing the amount of time the pulse pattern stays at zero as the dc voltage increases. Overload and short-circuit conditions are automatically compensated by operation in a current-limit mode. Since harmonic rejection and voltage regulation are combined in one set of switching instructions stored in a pROM, the power stage contains the minimum number of switching components.

A three-phase system requires six switching circuits arranged in a three-phase bridge. A

single-phase system requires four switching circuits arranged in a bridge. The power-to-weight ratio is high, as is the efficiency over the entire operating range from no load to full load.

One method of digital synthesis is shown in Fig. 8. A reference frequency 360 times higher than the operating frequency yields a one-degree resolution in the pulse pattern. A nine-step binary counter provides the cyclical information to a 512×4 pROM. Three of the pROM outputs provide switching instructions to each leg of the three-phase bridge. The fourth output resets the binary counter.

Digital synthesis is practical from 500 W, single phase, to 15 kW, three phase. At low powers, the cost of the digital controller becomes significant. The upper power limit is set by the

limited power dissipation of available transistors (With SCRs, the upper limit can go as high as 100 kW.) Speed of response and purity of the sine wave are similar to those of the step wave. Variable voltage and frequency are available simultaneously. In a UPS application, synchronization with the line voltage is readily accomplished with a phase-locked loop.

High-frequency switches emerge

With the rapid evolution in power handling ability and switching speeds of power-transistors and SCRs, and with the development of dc switching power supplies, it was natural to look for ways to apply high-frequency switching technology to the dc/ac inverter. Several workable techniques have been developed. The most popular uses a sine-wave oscillator and a switching amplifier with positive and negative output capability, much like the original oscillator/amplifier combination (Fig. 9).

In the switching-amplifier—or pulse-width-modulation—method, before the output is filtered it resembles a two-polarity "picket fence." To get voltage regulation and control, the picket fence is made narrower or broader as required to decrease or increase the output voltage. When the switching frequency is high compared with the generated frequency (by a factor of 20, or more), the harmonic content is low.

The modulated inverter's response to load transients is good, and efficiencies greater than 80% are achievable. Variable voltage and frequency over a broad range (45 to 450 Hz) are available and the weight-to-power ratio is attractive. However, pulse-width-modulated inverters are relatively expensive because of the high price of very fast switching power transistors.

When a single transistor is used in each switching position, the inverter is limited to a few kilowatts. Higher power units have been built with transistors operating in parallel, but the circuitry becomes very complex: It is impossible to force transistors in parallel to share the load during the inactive switch-off mode of operation, and it is risky to count on load sharing when dynamic characteristics—which are subject to aging—are matched.

The combination of high response speed and high efficiency makes the pulse-width-modulated inverter a poor performer for short circuits and overloads. Most designs turn the inverter off when an overload exists, rather than limiting the current (because current can't be limited fast enough to save the power devices). But to turn an inverter off in the face of an overload is clearly contrary to the requirements of a UPS. ■■

OSCILLATORS

1 Hz to 250 MHz

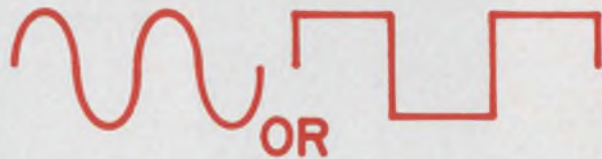

ANALOG

DIGITAL

ANALOG ENGINEERS — We haven't forgotten you. Accutronics has not devoted all its engineering talents to digital devices which are compatible with TTL, ECL, MECL and COS/MOS logic. In our standard product line we carry a complete line of SINE WAVE oscillators from 1 Hz to 250 MHz. Take for example our Series 110 which is neatly packaged in a 1.5 x 1.5 x 1.5 hermetically sealed can and available from 10 MHz to 250 MHz with +10dbm out into 50Ω. GREAT for your analog application.

INTERESTING? Call Gerry DeWar (312) 232-2600, and he will be glad to fill you in on all the details and send you our new catalog.



Series 110

FREQUENCY: 10 MHz to 250 MHz
 FREQUENCY TOLERANCE: $\pm 0.001\%$ from 0°C to 60°C

SUPPLY VOLTAGE: +12V DC
 OUTPUT VOLTAGE: +10dbm $\pm 3\text{db}$ into 50Ω
 SPURIOUS RESPONSE: >70db down
 HARMONICS: >20 db down
 SIZE: 1.5 x 1.5 x 1.5" typical with OSM connector

See Gold Book, Vol. 2 pg. 936-937

Please write or call for

NEW 1975 CATALOG

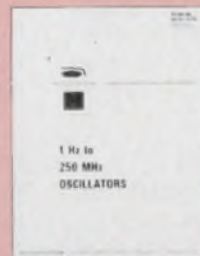

Our new catalog covers various types of oscillators: VCXO, LCVCO, RCVCO, high stability, computer clocks, high output power, Navy standard hardware modules and low current drain oscillators from 1 Hz to 250 MHz. We'll even send you three neat conversion charts (3) to hang on your wall and impress your friends.

accutronics

A HAMMOND CORPORATION COMPANY

628 NORTH STREET • GENEVA, ILLINOIS 60134

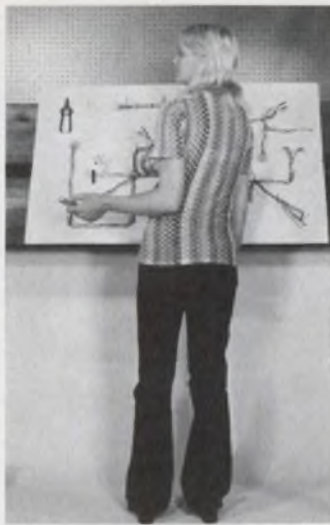

What's a Gudebrod?



Many of the new-today company names and images are dreamed up in public relations and advertising agency offices. The company and its product names will have an interesting ring to them, will be catchy, quick on the tongue and easy to remember, which in turn helps to sell the product.

The Gudebrod Brothers formed this company in 1870 B.P.R.H. (Before Public Relations Hoopla!). But even with this time honored image . . . our name sure takes a beating!

Chances are, one of our **GOOD BOARD** Salesman is teaching a young apprentice in the harness room, the proper way to tie the no-lost motion knot . . . *we often do that* you know! Chances are somewhere in the world, there is an electronics show where the **GUDIE BROD** (as they say in Denmark) products such as lacing tapes, cable lacers, harness pins, WHO clips, swivel tilt board mounts, snips and cutters are on display.



As for the **GOOD BROAD** lacing tapes . . .

Why, they're of the highest quality and we

offer you a complete range from which to choose. Nylon*, Dacron*, Teflon*, Nomex*, Glass. All have a definite purpose. Many meet and exceed military specifications, and if none meet your requirements . . . we'll research for one that does.

Good Guide's been thru it!

We've been all through those vibrations, extreme heat and cold, fungus, chemical reactions and self-extinguishing problems. We know how to tie it up, hold it down or cut it off! Knots won't slip, harnesses stay tied, assemblies remain firm and secure . . . and it's a lot faster and less expensive than you think. Give one of our 6 branch offices a call today and we'll talk about it. Don't be alarmed if our switchboard operator also pronounces the name wrong . . . she's been doing that for the better part of the last 103 successful years!



By the way . . . **GUDEBROD** is pronounced **GOOD BROD** but of course, those of you buying our products may continue to call us whatever you like!

Send for the Gudebrod Facts today!

Burbank, Cal. Chicago, Ill. Charlotte, N. C. New York, N. Y. Boston, Mass.
 (213) 848-3962 (312) 337-3025 (704) 333-9591 (212) 524-5858 (617) 426-5347

G
Gudebrod Executive Office
 Dept. S121, 12 South 12th Street
 Philadelphia, Pa. 19107 (215) 922-1122

*DuPont Trademark

INFORMATION RETRIEVAL NUMBER 28



made in Georgia, U.S.A.!

Combine Murata's 30-year-old world renowned reputation as the leader in ceramic capacitors with its new "Made in Georgia, U.S.A." label and you'll find unexcelled quality, delivery and service. Discs, dipped, molded and chip monolithic multilayers, reduced titanates—Murata has a complete line of everything in the ceramic capacitor field. Write, call or circle the number below. We'll let you know how Murata can solve your ceramic capacitor problems.

muRata

CORPORATION
OF AMERICA

Rockmart, Georgia 30153 • Phone: 404-684-7143 • Telex: 54-2999

INFORMATION RETRIEVAL NUMBER 236

Avoid wiring-inductance problems.

Properly configured wiring can reduce unwanted coupling, troublesome feedback and noise pickup.

Do you know that there are 465 nH in just one foot of 30-AWG wire? And that a 10-ns current pulse of 10 mA produces a 0.5-V noise spike? But place the wire over a ground plane, and you reduce the inductance to 100 nH and the noise spike to 0.1 V.

Wiring inductance is often overlooked in the design of PC boards, back panels and cables. And many of the less obvious characteristics of inductance are not accounted for, even when an attempt is made to consider inductive effects. The result of this neglect is noise pickup, unwanted coupling and troublesome feedback.

You can calculate wiring inductances, however, and alleviate problems from this source. Let's see how.

What is inductance?

Inductance, L , can be defined by the equation

$$L = \frac{N\phi}{I}$$

Magnetic flux "lines" ϕ , or linkages represented by the quantity $N\phi$ (turns \times flux), accompany all current flow, I . Flux lines occur both internally and externally to the conductor. Inductance also is considered the parameter that represents how well flux lines can oppose changes in the flow of current in a circuit. The opposition to the change in flow of current, or self-inductance, is manifested by a back voltage, e , that develops in the circuit,

$$e = -L di/dt.$$

When the flux lines "cut" across, or couple, with other nearby conductors, voltage is induced in these conductors. The amount of induced voltage is determined by the degree of coupling, called mutual inductance.

Most engineers know how to calculate the self-inductance of an isolated wire, but they often overlook the mutual-inductance effect of a nearby return-current conductor. This neglect can lead to serious errors. If the return conductor is

near, which is the usual case, the effect of the mutual inductance subtracts from the isolated self-inductance value and lowers the over-all self-inductance, L_s .

Fundamental formulas reviewed

The over-all self-inductance of two mutually coupled conductors in series (Fig. 1a) is given by the equation

$$L_s = L_1 + L_2 \pm 2L_m,$$

where

L_s = over-all self-inductance;

L_1 = self-inductance of one wire, if isolated;

L_2 = self-inductance of the other wire, if isolated;

L_m = mutual inductance between inductors.

If L_2 is a current-return conductor of the same length and diameter as L_1 , then $L_1 = L_2$ and

$$L_s = 2(L_1 - L_m).$$

Usually, a load, Z_L , connects between the ends of a feed wire and its return (Fig. 1b). The ef-

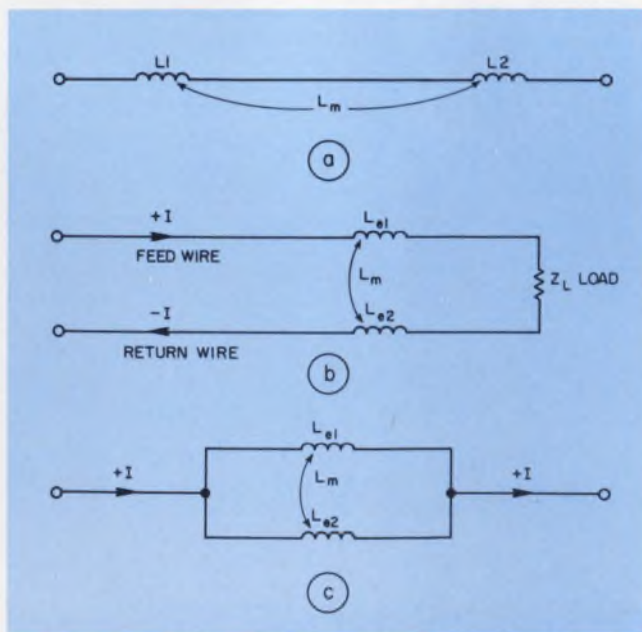

1. In calculating the inductance between wired points in a circuit, you must take into account the mutual inductance (a) to nearby current paths, such as a return path (b) or between parallel feed paths (c).

Paul M. Rostek, Senior Circuit Design Engineer, NCR Corp., San Diego, CA 92127.

fective inductance, L_s , of each separate lead—feed or return wire—if the inductances are considered equal, is one-half of the over-all inductance, L_s . Thus

$$L_{e1} = L_{e2} = (1/2) L_s = (L_1 - L_m) \text{ or } (L_2 - L_m).$$

Note that the effective inductance of each wire, L_{e1} , is a lower value than the self-inductance of each wire when isolated.

The over-all self-inductance of two conductors in parallel (Fig. 1c) is given by

$$L_s = \frac{L_1 L_2 - L_m^2}{L_1 + L_2 - 2L_m}.$$

If the current in both conductors is in the same direction, and the conductors are equal in size and parallel, then L_m is positive. And since $L_1 = L_2$, then

$$L_s = \frac{L_1 + L_m}{2},$$

and

$$L_{e1} = L_{e2} = (L_1 + L_m) \text{ or } (L_2 + L_m).$$

Since the current flows in the same direction in both wiring legs, the mutual inductance, L_m , limits the reduction in over-all inductance. At large distances between the conductors, L_m approaches zero and L_s attains a maximum reduction of 50% in inductance.

Inductance changes with frequency

Magnetic flux traverses both the outside and inside of a wire that carries current. The self-inductance is thus composed of both the internal and external flux linkages. Since more total flux encloses, or links, the inside of a wire than its surface, a filament of the wire near the wire's center has greater inductance than a filament near its surface. Thus at high frequency, less current flows in the wire's interior. This phenomenon is known as the "skin effect," because the current concentrates at the wire's surface. Since the center of the wire carries less current,

Table of sample inductance calculations

Self-inductance of 12 in. of 30-AWG circular wires at low frequencies

| | SINGLE WIRE | PARALLEL CURRENTS | PARALLEL OPPOSING CURRENTS | RETURN CURRENT PLANE |
|------------|-------------|-------------------|----------------------------|----------------------|
| SEPARATION | ISOLATED | $d = 0.02$ in. | $d = 0.02$ in. | $h = 0.02$ in. |
| INDUCTANCE | 465 nH | 415 nH | 98 nH | 140 nH |
| SEPARATION | | $d = 0.2$ in. | $d = 0.2$ in. | $h = 0.2$ in. |
| INDUCTANCE | | 346 nH | 236 nH | 278 nH |

Self-inductance of 12 in. of flat conductors at low frequencies

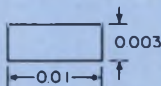
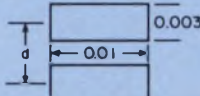
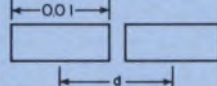
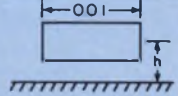
| | SINGLE BUS | PARALLEL BUS | FLAT CABLE | BUS OVER GND PLANE |
|---------------|---|---|--|---|
| CONFIGURATION |  |  |  |  |
| SEPARATION | ISOLATED | $d = 0.02$ in. | $d = 0.02$ in. | $h = 0.02$ in. |
| INDUCTANCE | 482 nH | 116 nH | 116 nH | 158 nH |

Inductances for common wiring configurations

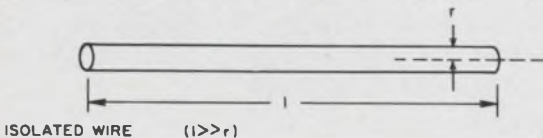
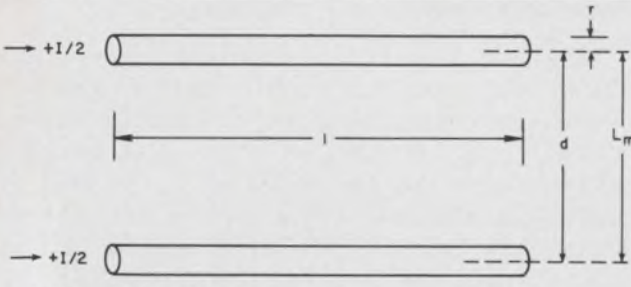
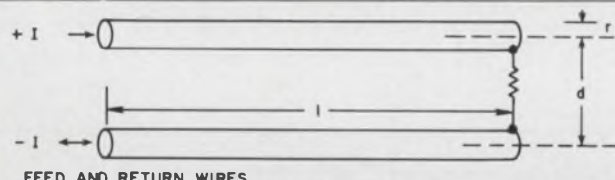
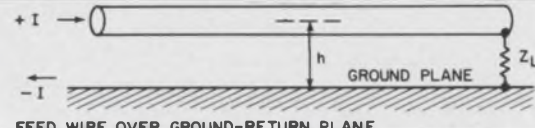
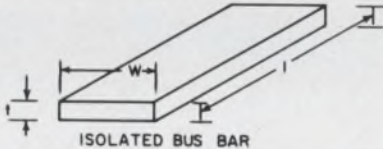
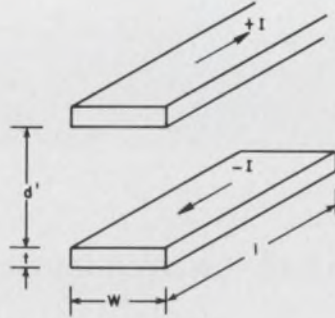
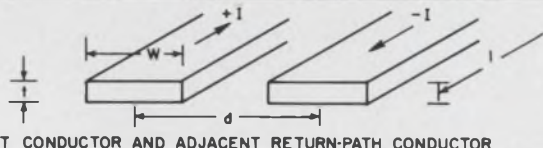
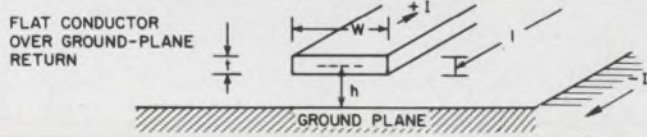
| Configuration | Formulas All dimensions in inches, inductance is in nH |
|--|--|
|  <p>ISOLATED WIRE ($l \gg r$)</p> | $L_s = 5l \left[\ln \frac{2l}{r} - 3/4 \right] \dots \text{Low frequency, } l \gg r, \delta = 1/4$ $L_s = 5l \left[\ln \frac{2l}{r} - 1 \right] \dots \text{high frequency } l \gg r, \text{ limit as } f \rightarrow \infty, \delta \rightarrow 0,$ |
|  <p>FEED WIRES IN PARALLEL</p> | $L_m = 5l \left[\ln \frac{2l}{d} - 1 + \frac{d}{l} \right]$ <p>Mutual inductance between thin parallel wires.</p> $L_s = \frac{L_1 + L_m}{2} \text{ or } \frac{L_2 + L_m}{2}$ $L_s = 5l \left[\ln \frac{2l}{\sqrt{rd}} - 1 + \frac{\mu \delta}{2} \right] l \gg d$ <p>Over-all self-inductance of two parallel wires, as used in distribution cables, or bus bars, where current is in the same direction.</p> |
|  <p>FEED AND RETURN WIRES</p> | $L_e = L_s - L_m$ $L_e = 5l \left[\ln \frac{d}{r} + \mu \delta - \frac{d}{l} \right]$ <p>Inductance of each of two wires in close proximity to each other, with current in each in opposite directions.</p> |
|  <p>FEED WIRE OVER GROUND-RETURN PLANE</p> | $L_e = 5l \left[\ln \frac{2h}{r} + \mu \delta \right]$ <p>Self-inductance of a wire only, when current return is via a ground plane.</p> |
|  <p>ISOLATED BUS BAR</p> | $L_s = 5l \left[\ln \left(\frac{2l}{W+t} \right) + \frac{1}{2} + \frac{2}{9} \left(\frac{w+t}{l} \right) \right]$ <p>Self-inductance of a flat etched conductor, bus bar or ground plane when isolated from a return path at low frequency.</p> |
|  <p>BUS BAR AND ADJACENT RETURN BUS</p> | <p>for low frequencies:</p> $L_e = 5l \left[\ln \left(\frac{W}{W+t} \right) + 2.75 \frac{d}{W} \right], \text{ for } W > d, W > t$ $L_e = 5l \left[\ln \left(\frac{d}{W+t} \right) + 1.5 - \frac{d}{l} + \frac{2}{9} \frac{W+t}{l} \right], \text{ for } d > W, W > t$ <p>for high frequencies and $W \gg t$:</p> $L_e = \frac{14l}{W} \left[d' + \Delta \right], \Delta = \frac{2.6}{\sqrt{f}}, \text{ skin depth for copper}$ <p>Self-inductance of each conductor. Total inductance is the sum of inductances of the feed and return bus bar.</p> |
|  <p>FLAT CONDUCTOR AND ADJACENT RETURN-PATH CONDUCTOR</p> | $L_e = 5l \left[\ln \frac{d}{W+t} + \frac{3}{2} \right] \text{ for low frequencies}$ <p>Self-inductance of each conductor. If feed conductor (+I) is flanked by two return flat conductors, the feed conductor's inductance remains the same.</p> |
|  <p>FLAT CONDUCTOR OVER GROUND-PLANE RETURN</p> | $L_e = 5l \left[\ln \frac{6h}{t + .8W} \right] + \mu \delta$ <p>Self-inductance of flat conductor only, when current return is via a ground plane.</p> |

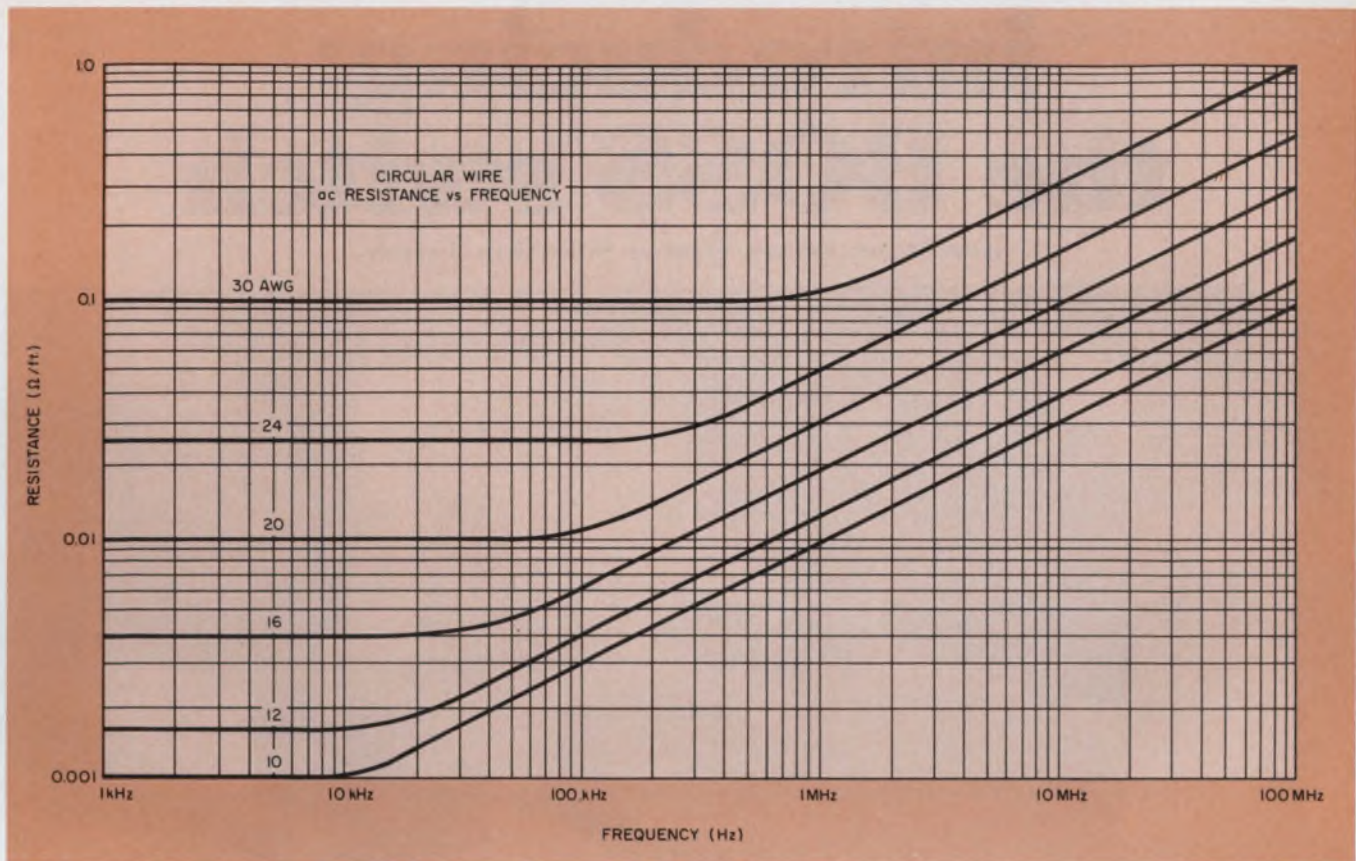

2. Skin effect causes an increase in the resistance of a wire as the frequency increases.

the effective cross-section area is less and the wire's ac resistance is higher (Fig. 2). In addition the inductance is reduced by a skin-depth factor,¹ as follows for an isolated circular wire:

$$L_s = 5.08 l \left[L_n \frac{2l}{r} + \mu \delta - 1 + \frac{r}{l} \right],$$

where

- L_s = wire self-inductance in nanohenrys;
- r = wire radius in inches;
- l = wire length in inches;
- μ = relative magnetic permeability (copper = 1.0);
- δ = skin depth factor = $K/r \sqrt{\rho/\mu f}$ ($0 < \delta < 0.25$);
- ρ = volume resistivity in ohms-in. = 0.68×10^{-6} for copper;
- K = conversion constant = 3168.

The change in inductance with frequency is small for a circular wire. Skin effect at very high frequencies decreases inductance by roughly 6% in short wires and about 2% in long wires. However, in parallel conductors, especially flat bus bars, the skin effect has greater influence and should not be neglected.

Lowering the self-inductance

The diameter of a wire does not have a major influence on its self-inductance (see table of

sample calculations). For example, the self-inductance of a 2-AWG isolated wire with a diameter of 0.26 in. is approximately half the inductance of a 30-AWG wire with a diameter of 0.01 in. An increase of the wire size can provide a reduction of about 50% in self-inductance.

If the current is divided between two parallel conductors and flows in the same direction in each, the self-inductance can also be reduced to half if the wires are spaced far apart. For example, two 30-AWG wires, separated by 0.02 in., will reduce the over-all self-inductance only 18%; and for 0.2-in. separations, by 32%. A separation of several inches between wires reduces the over-all inductance approximately 50% of the self-inductance.

The most effective way to reduce inductance is to place the forward and return-current conductors in very close proximity. Two 30-AWG wires separated by 0.02 in., reduce the over-all self-inductance to one-fifth of a single isolated wire. Laminated bus bars or multilayer boards with closely spaced ground and voltage layers can reduce wiring inductance to one-tenth or less that of conductors isolated far from their return, or ground, plane. ■■

Reference

1. Grover, Frederick W., PhD., "Inductance Calculations," D. Van Nostrand Co., Inc., 1946.

introducing: the BOSS™ switch

new Molex Binary Option Selection Switch

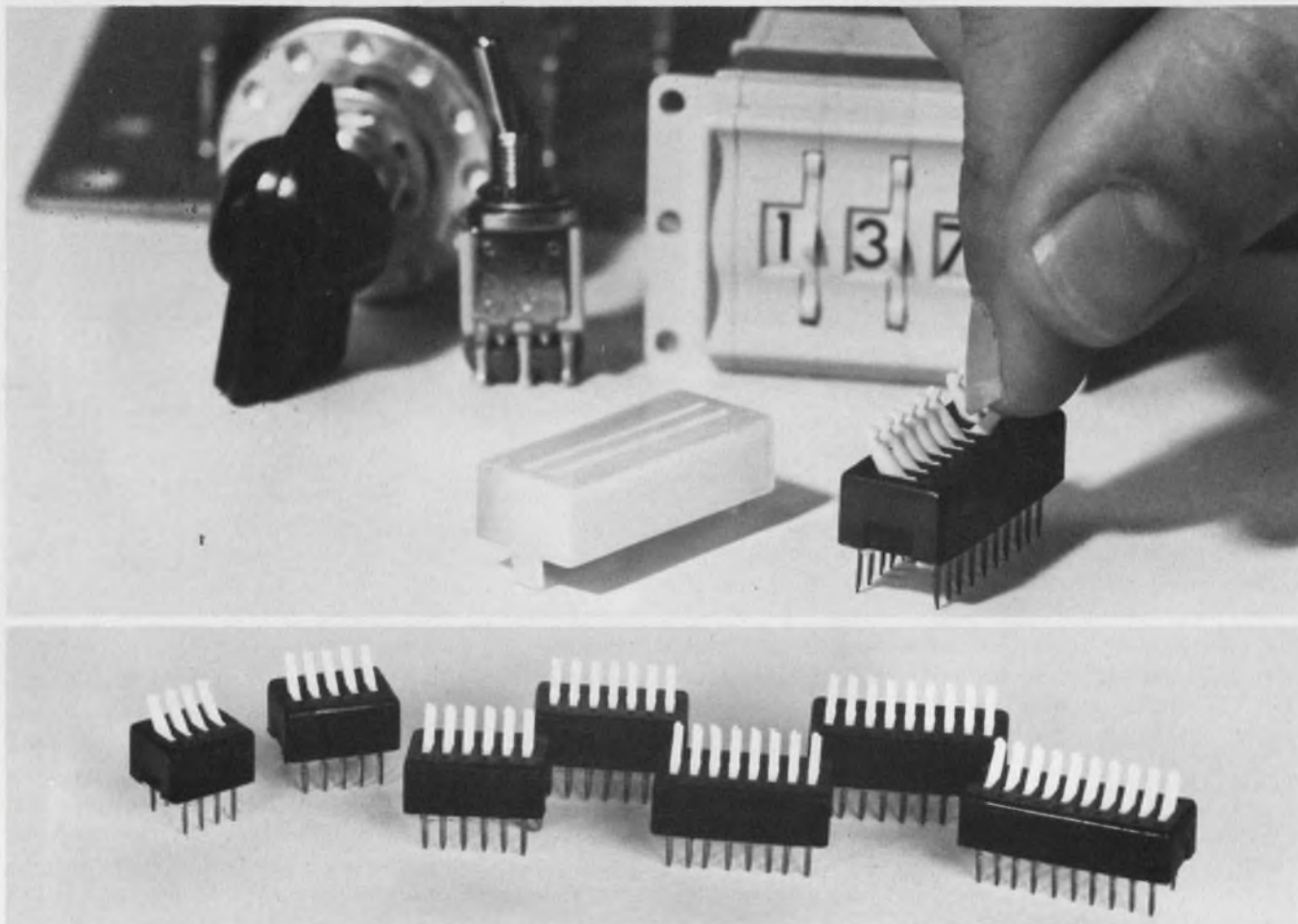

It's the BOSS because butting and wiping contacts make it better.

You need both butting *and* wiping contacts for *positive* logic function programming. The new BOSS switch gives you both—plus gold-over-phosphor bronze contacts for reliable “dry circuit” applications. And easy manual operation means you don't need special tools to program the BOSS.

We make the BOSS in a choice of four to 10 single-throw, single-pole switches with a polyester housing. Enclosed design protects against dust, dirt, and other environ-

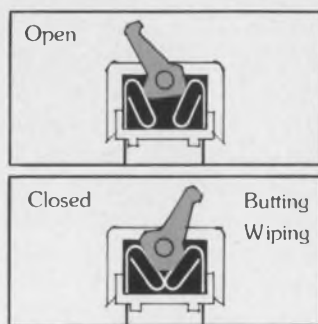

mental hazards and makes the BOSS fully cleanable after soldering.

Solder-tail leads on .100 x .300 centers let you mount the BOSS through a DIP header or directly to the P.C. board eliminating the cost of interconnection wiring to perform the switching function.

BOSS is rated for 50 ma at 30 v, d-c and it programs savings up to 50% into computer, computer peripheral, communications, testing equipment, and related applications.

molex ... Affordable Technology

Molex Incorporated, Dept. ED1274, 2222 Wellington Court, Lisle, Illinois 60532

New GE-MOV[®] Varistors

...Voltage transient protection - 25¢*

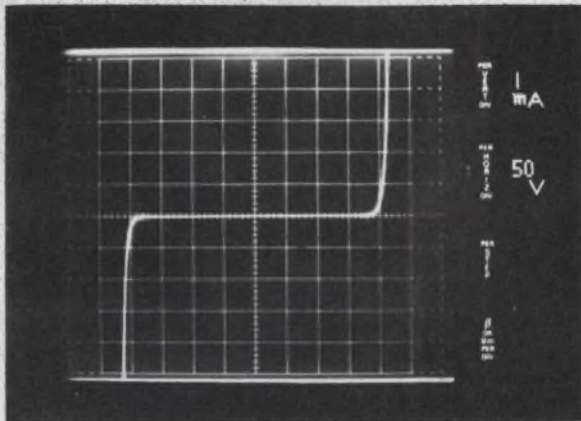

Actual photograph of V220MA2A characteristic

New axial lead "MA" series GE-MOV[®] Varistors offer both low cost, compatibility with automatic insertion.....and better voltage transient protection than back-to-back zener diodes because of 4-7 times better peak pulse current rating (20A @ 75°C).

■ 14 types in the "MA" series GE-MOV[®] Varistors offer ratings of - 88-264V RMS - 121-365V DC

| Type | Voltage RMS DC |
|----------|-------------------|
| V150MA1A | 88 121* |
| V220MA2A | 132 181 |
| V220MA4B | 138 191 |
| V430MA3A | 253 349 |
| V430MA7B | 264 365 |

■ Over 110 companion GE-MOV[®] Varistors in 5 different packages offer transient protection 12-100V RMS, 16 - 780 V DC, peak current ratings up to 2000A.

*Suggested resale price 10,000 lots, 25¢

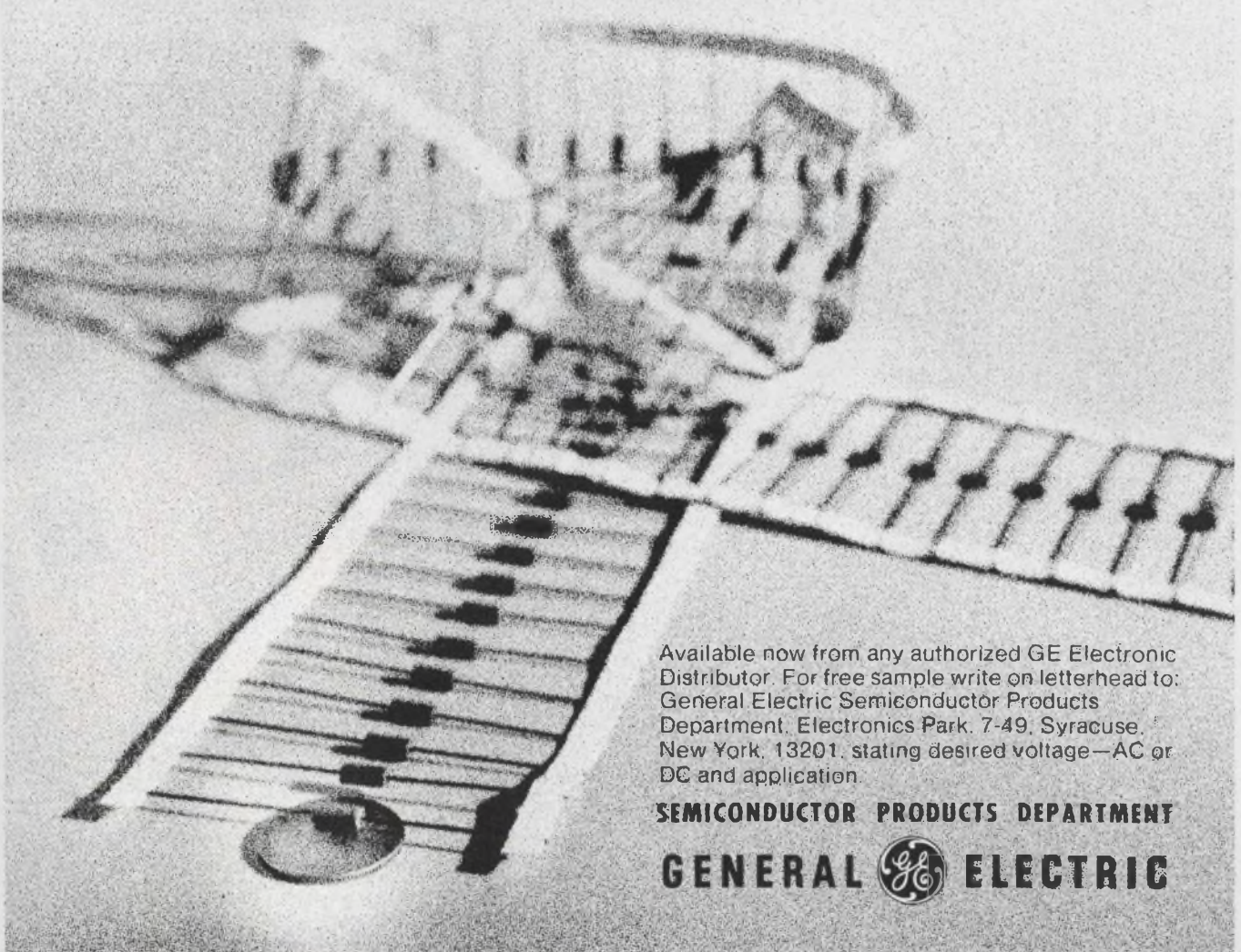

Available now from any authorized GE Electronic Distributor. For free sample write on letterhead to: General Electric Semiconductor Products Department, Electronics Park, 7-49, Syracuse, New York, 13201, stating desired voltage—AC or DC and application.

SEMICONDUCTOR PRODUCTS DEPARTMENT

GENERAL  ELECTRIC

MIL-STD-883 is Intersil's normal production standard.

Now there's i38510. It's three ways better than 883.

1. Scanning Electron Microscope analysis.



Intersil's high-resolution SEM inspects metal deposition and coverage of i38510 high-rel wafers. Normal wafer with perfectly deposited metal appears in circle at left. Cracks and faults, right, are easily identified and rejected.

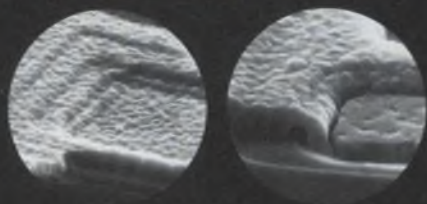

2. Off-the-shelf delivery from bonded inventory.

After final QA acceptance, i38510 product is placed in bonded inventory and held for immediate delivery.



3. Positive product traceability.

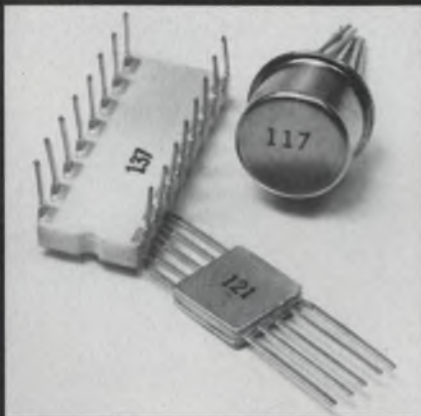

Each i38510 device is marked with its wafer-lot number and delivered with process documentation.

What is the i38510 Reliability Program?

It's Intersil's exclusive in-house program for military hi-rel products. These devices are made with MIL-M-38510A processing and MIL-STD-883 test methods, plus scanning electron microscope analysis and positive wafer traceability. They are delivered off-the-shelf with no minimum quantity required. In addition, Intersil will process to custom reliability specs; call Francis Azariah, (408) 257-5450 for details.

How does i38510 compare to MIL-M-38510A?

The object of i38510 is to provide microcircuits made to the exacting requirements of MIL-M-38510A, but not covered by specific MIL-M-38510A performance specifications. The i38510 program complies with all the requirements for systems, procedures and processing of MIL-M-38510A, except that electrical test conditions and limits are guaranteed to Intersil i38510 internal specifications.

Military Hi-Rel's an old story to us.

In June we received Manufacturer Certification under MIL-M-38510A for linear ICs. We've been qualified under MIL-S-19500 for 3 JAN-TX devices.

But more than that: At Intersil everything we make is processed to MIL-STD-883, Method 5004.1, Class B visual and environmental screening. It's been the production standard for all our products for years. All the more reason to talk to us for whatever you need in High-Rel. Intersil, 10900 North Tantau Ave., Cupertino, CA 95014.

Intersil



Here's where to get i38510 delivery.

Intersil stocking distributors.

Elmar/Liberty Electronics.
Schweber Electronics.
Semiconductor Specialists.
Weatherford.

Intersil area sales offices.

Boston (617) 273-2055.
Chicago (312) 371-1440.
Dallas (214) 387-0539.
Los Angeles (213) 532-3544.
Minneapolis (612) 925-1844.
New York (201) 567-5585.
San Diego (714) 278-6053.
San Francisco Bay Area
(home office) (408) 257-5450.
Upstate New York/Canada
(315) 463-3368.

Representatives in all major cities.

**Introducing the
third generation PDP-11.
For only \$1647***

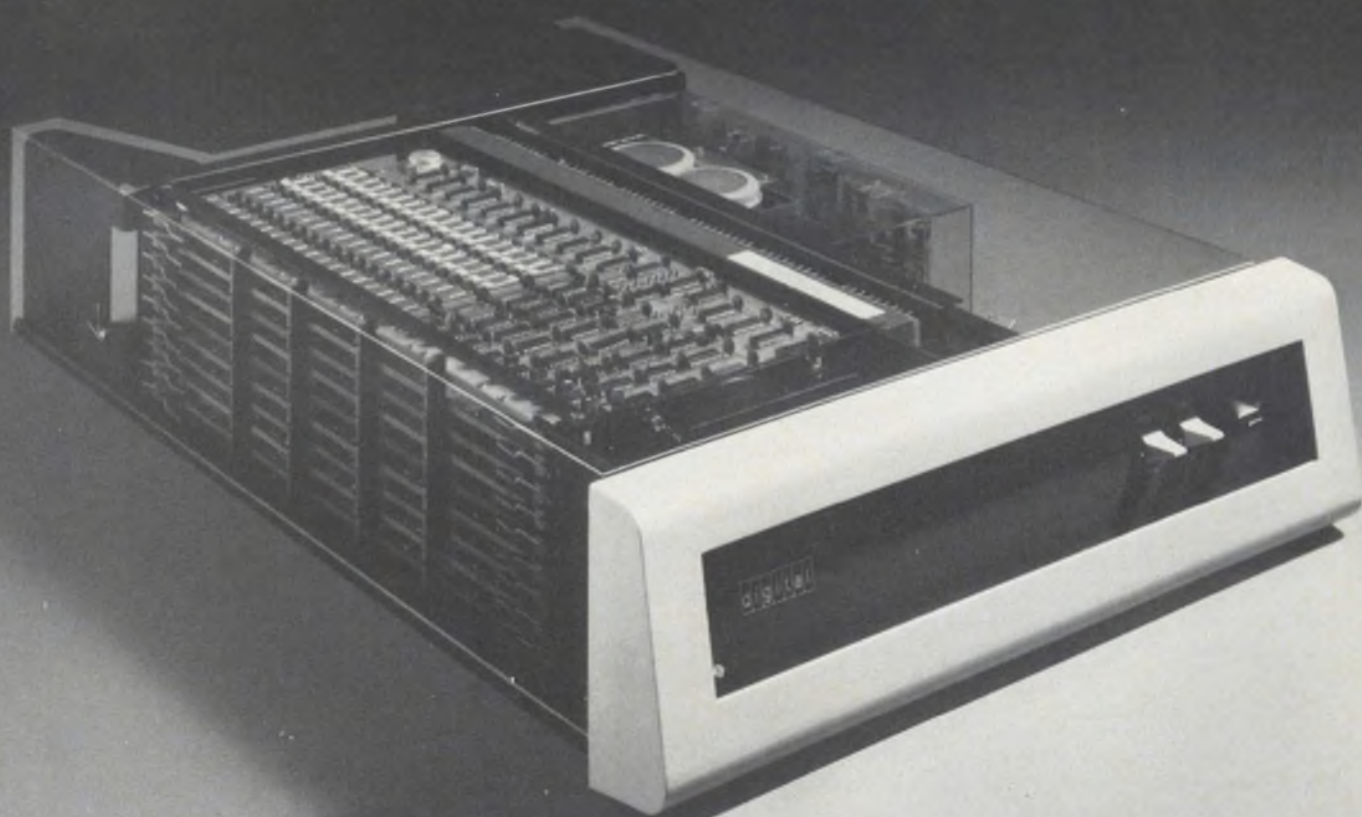

The incredibly successful PDP-11/05 has just taken a giant step forward into the third generation.

And a giant step backward in price.

Introducing the PDP-11/04. For OEM's who couldn't afford a PDP-11 before.

At \$1647* it's got more going for it than any other computer in its class:

MOS memory using 4K semiconductor chips.

The easiest-to-operate operator's console ever designed.

A single high-speed data bus — UNIBUS™ — through which all system components and peripherals communicate.

Direct memory addressing.

Automatic hardware stack.

Automatic priority

interrupts (vectored).

Unique self test feature.

PDP-11/05 instruction set.

And it'll be ready for delivery in July of '75.

The PDP-11/04.

It's just what you've been waiting for. And now you can get it. Just contact any of the

Digital offices below, or call or write Digital Equipment Corporation, Maynard, MA 01754. (617) 897-5111. European headquarters: 81 route de l'Aire, 1211 Geneva 26. Tel: 42 79 50. Digital Equipment of Canada Ltd., PO Box 11500 Ottawa, Ontario K2H 8K8. (613) 592-5111.

digital

| Single Unit Prices ** | | | |
|-----------------------|----|-----------|--------|
| Digital Equipment | 4K | PDP-11/04 | \$2495 |
| Computer Automation | 4K | LSII | \$2765 |
| Data General | 4K | Nova 2/4 | \$3200 |
| General Automation | 4K | SPC-16/45 | \$3950 |
| Hewlett Packard | 4K | 21M/10 | \$5950 |
| Interdata | 4K | 7/16 | \$3200 |

*50-unit quantities. Prices apply to U.S.A. and Canada only.

**Most recently published prices.

USA

ALABAMA

Huntsville (205) 881-7730

ARIZONA

Phoenix (602) 268-3488

Tucson (602) 793-7881

CALIFORNIA

Mountain View (415) 964-6200

Los Angeles (213) 479-3791

Santa Ana (714) 979-2460,

(213) 628-0191

San Diego (714) 280-7880

Sunnyvale (408) 735-9200

COLORADO

Englewood (303) 770-6150

CONNECTICUT

Fairfield (203) 255-5991

FLORIDA

Fort Lauderdale (305) 739-0530

Orlando (305) 851-4450

GEORGIA

Atlanta (404) 451-7411

HAWAII

Kailua, Oahu (808) 261-3182

ILLINOIS

Chicago (312) 498-2500

INDIANA

Indianapolis (317) 243-8341

IOWA

Bettendorf (319) 359-7444

LOUISIANA

New Orleans (504) 837-0257

MAINE

Portland (207) 774-6822

MARYLAND

Washington, D.C. (301) 459-7900

Baltimore (301) 752-8797

MASSACHUSETTS

Maynard — Corporate

Headquarters (617) 897-5111

Waltham —

Regional Office (617) 890-0330

Westfield (413) 568-9511

MICHIGAN

Ann Arbor (313) 761-1150

Southfield (313) 559-6565

MINNESOTA

Minneapolis (612) 854-6562

MISSOURI

Independence (816) 252-2300

St. Louis (314) 872-8540

NEW HAMPSHIRE

Nashua (603) 224-6629

NEW JERSEY

Fairfield (201) 227-9280

NEW MEXICO

Albuquerque (505) 296-5411

NEW YORK

Albany (518) 869-3506

New York City (212) 582-1300

NORTH CAROLINA

Durham (919) 489-3347

OHIO

Cleveland (216) 289-9000

Dayton (513) 294-3323

OKLAHOMA

Tulsa (918) 749-4476

OREGON

Portland (503) 687-2260

PENNSYLVANIA

Philadelphia (215) 825-4200

Pittsburgh (412) 243-8500

SOUTH CAROLINA

Columbia (803) 252-4645

TENNESSEE

Knoxville (615) 588-6571

Nashville (615) 889-5908

TEXAS

Austin (512) 454-3660

Dallas (214) 620-2051

Houston (713) 777-3471

UTAH

Salt Lake City (801) 467-4669

VERMONT

Montpelier (802) 229-0424

VIRGINIA

Richmond (804) 233-6935

WASHINGTON

Seattle (206) 641-0070

WISCONSIN

Milwaukee (414) 463-9110

CANADA

ONTARIO (613) 592-5111

EUROPE

SWITZERLAND

Geneva (022) 42-79-50

Unique packages don't come along every day.

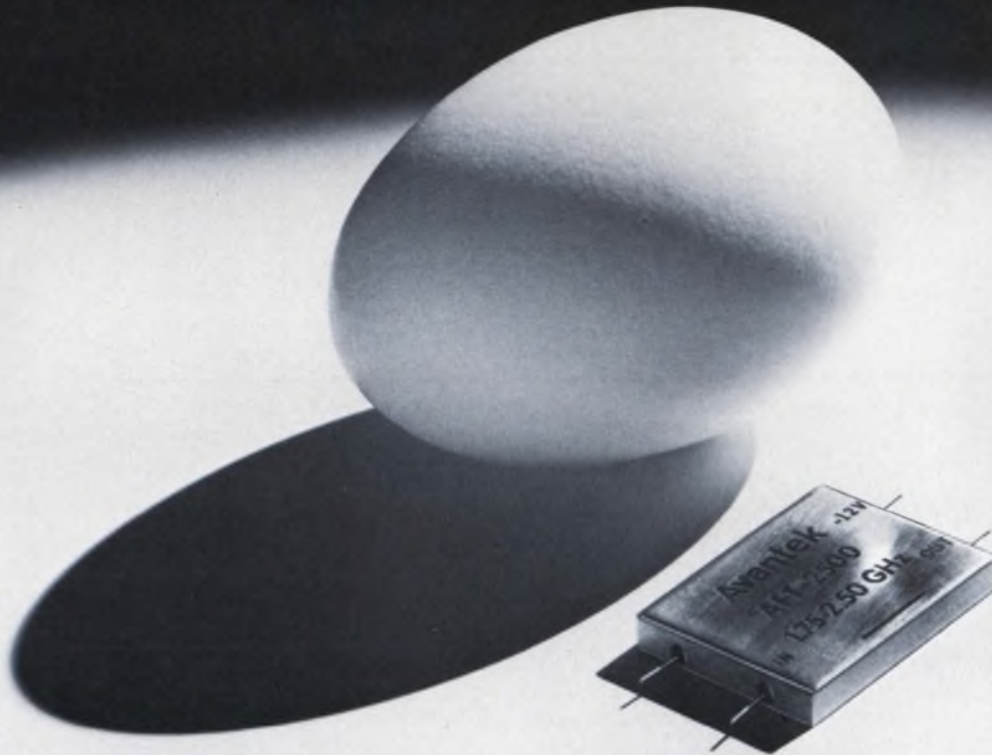

Connectorless packages have been around a long time, but, to the designer of modern communications systems, few satisfy present day requirements.

Avantek has changed all this with its new connectorless flat-pack amplifier, the AFT-2500. Avantek arsenic emitter transistors and thin film substrates were united to meet the low noise, high dynamic range and low return loss requirements of microwave communications systems. The result — an amplifier offering extremely high performance characteristics in a versatile package at an extremely attractive price.

AFT-2500 Typical Specifications

| | |
|------------------|---------------|
| Frequency Range: | 1.7-2.5 GHz |
| Noise Figure: | 3.5 dB, max. |
| Gain: | 20 dB, min. |
| Intercept Point: | +22 dBm |
| Power Output: | +10 dBm, min. |
| VSWR, In and Out | 1.25, max. |

This unique modular package, precision formed of Kovar and Monel, is ideal for 2 GHz systems where “drop-in” to printed circuit boards is required. For complete flexibility, the AFT-2500 is available with an optional connector package when improvement of an existing system is desired.

If maximizing your system receiver sensitivity with a versatile, low noise amplifier appeals to you, call or write Avantek for more information on the new AFT-2500. Avantek, Inc., 3175 Bowers Avenue, Santa Clara, CA 95051 (408) 249-0700.

Avantek... *years ahead today*

Join 'em... the growing crowd using MOSTEK's 16-pin 4K RAM!

The crowd of MOSTEK's 4K RAM users continues to grow. Why this preference for MOSTEK's 16-pin MK4096 over 22-pin alternates? Let's review a few of the reasons:

MOSTEK saves you memory board space. You can pack over twice the memory in the same board space as the 22-pin designer, without increasing power dissipation. The result is a more compact and efficient system.

MOSTEK leads in 4K performance. Check the comparative performance table for proof!

MOSTEK gives you direct compatibility with TTL, DTL, ECL and CMOS. The MK4096 will interface

directly with these popular logic families *without* the special high-voltage clock drivers required by 22-pin RAMs. Fewer address drivers are required also.

COMPARATIVE PERFORMANCE—16-PIN VS 22-PIN RAMs

| PARAMETER | MOSTEK | 2107 | 4030 |
|------------------|-------------------------|---------------------------|---------------------------|
| Power Diss | 375 mW | 425 mW | 690 mW |
| Input Levels | | | |
| Input 0 (Max) | 0.8 | 0.8 | 0.6 |
| Input 1 (Min) | 2.4 | 3.0 | 2.2 |
| Output Levels | | | |
| Output 0 (Max) | 0.4 at 2 mA | 0.45 at 1.8 mA | 0.4 at 3.2 mA |
| Output 1 (Min) | 2.4 at 5 mA | 2.4 at 100 μ A | 2.4 at 2 mA |
| Access Time | 300 ns | 300 ns | 300 ns |
| Read Cycle Time | 425 ns | 500 ns | 470 ns |
| Write Cycle Time | 425 ns | 700 ns | 470 ns |
| Output Data | | | |
| Hold Time | 260 ns | 40 ns | 30 ns |
| Clock | | | |
| Characteristics | 2 TTL Clocks 7 pF | One 12V Clock 21 pF | One 12V Clock 27 pF |

MOSTEK's 4K RAM is easy to use. You can use readily available automatic handlers both for incoming test operations and in circuit board assembly. Not so with 22-pin versions!

Want still more reasons to join the MOSTEK 4K RAM team? Then contact MOSTEK at 1215 West Crosby Road, Carrollton, Texas 75006, (214) 242-0444—or your local MOSTEK distributor or representative. In Europe contact MOSTEK GmbH, TALSTR 172, 7024 Bernhausen, West Germany, Tel. (0711) 70 10 96.

MOSTEK

INFORMATION RETRIEVAL NUMBER 134

MOSTEK moves forward...in memories.

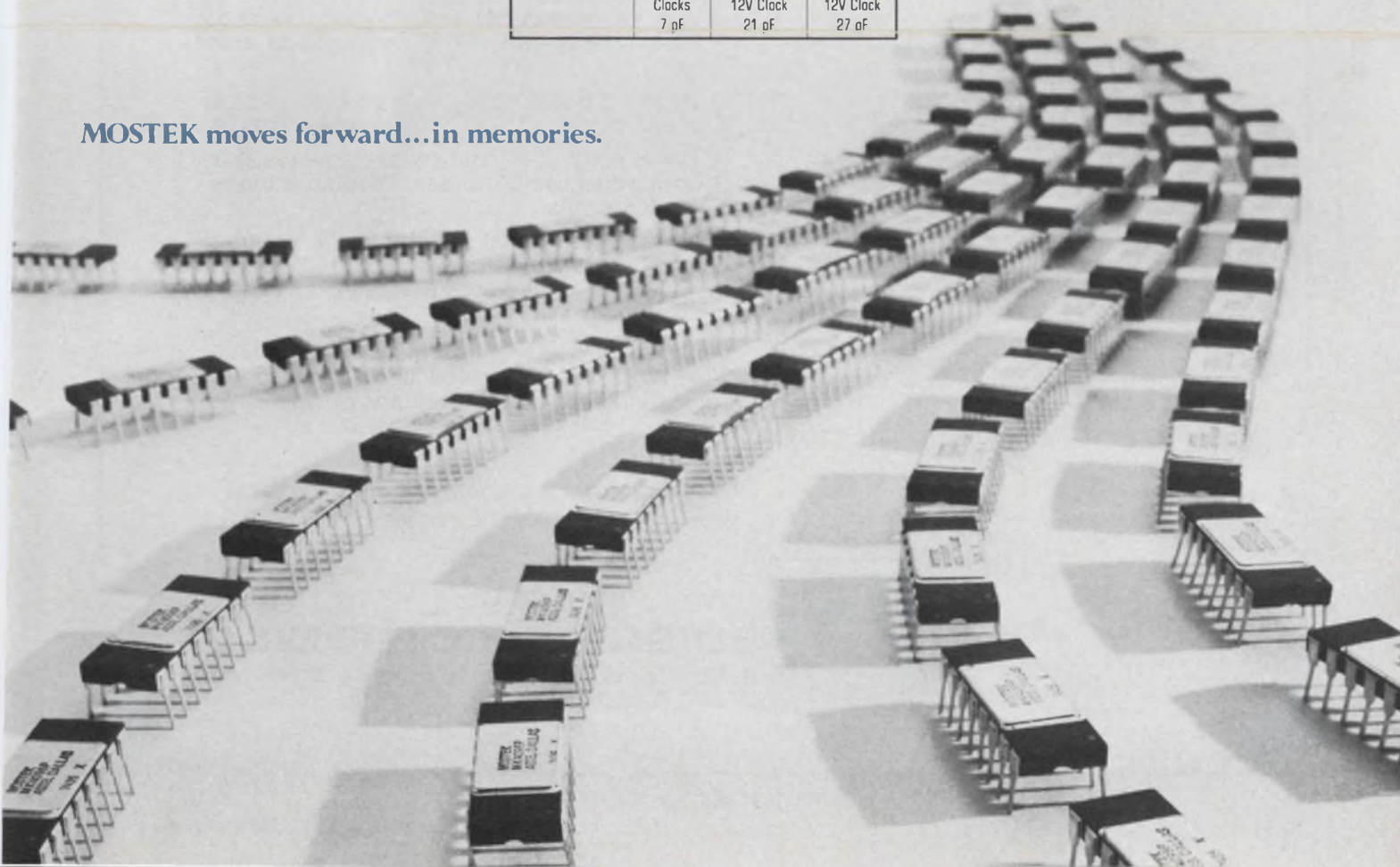

4 SWITCHED ON 4 ADVANTAGES!

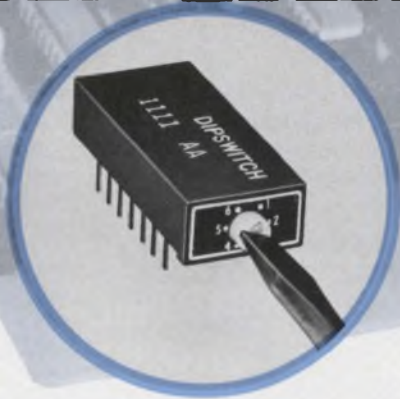

DIPSWITCH was the industry's first rotary switch for DIP sockets. It offers the designer the versatility and reliability only experience can bring.

Here are four reasons you should consider **DIPSWITCH** for your switching needs.

- 1** if multilayered boards are part of your design, **DIPSWITCH**'s .230" profile is about half anybody else's. You can stack as close as 1/4".
- 2** if saving board space is important, you can piggyback an IC right onto **DIPSWITCH**.
- 3** if you need additional switch closures, **DIPSWITCH** can be tandem coupled using extended shafts.
- 4** if you need special switch closure programming, **DIPSWITCH**'s six independent cams can be factory assembled to perform your programming.

If you have a switching problem, why not let us help? We have factory consultants ready to help you design your switch program and pick your options.

DIPSWITCH® is a Registered Trademark of the McGraw-Edison Company. Pat. No. 3621157



EDISON ELECTRONICS
a McGraw-Edison Company Division

Grenier Field Municipal Airport, Manchester, New Hampshire 03103 • (603) 669-0940

you can see why...



the time is right with **PANAPLEX™** clock panel displays

PANAPLEX clock panels are designed to be read. These large, bright, easy-to-see, pleasing numerals are easily read in any light — even bright sunlight.

These four- and six-digit clock panels are compatible with MOS clock chips, and have the high reliability and quality that has made the PANAPLEX family of displays the choice of calculator manufacturers.

PANAPLEX clock panels can display either 12- or 24-hour time systems and have integral AM/PM indicators and colons.

Available in two standard sizes (0.5 and 0.7 inch), these thin panels (0.2 inch excluding tubulation) offer design flexibility that's hard to beat.

The soft, neon-orange color is easy to read at a glance: — no magnifier

needed, no eyestrain, no LED-red fatigue factor.

For additional information on the PANAPLEX clock panels, write Burroughs Corporation, Electronic Components Division, P. O. Box 1226, Plainfield, New Jersey 07061, or call (201) 757-3400 or (714) 835-7335.

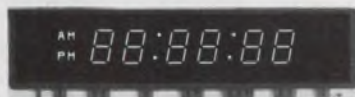
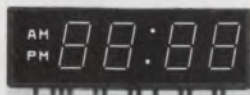

You can see the difference

Burroughs



DISTRIBUTORS: Hamilton Electro Sales/Culver City, Cal.; Hamilton/Avnet Electronics/San Diego, Seattle, Mountain View, Cal., Phoenix, Denver, Salt Lake City, Albuquerque, Houston, Dallas, Prairie Village, Kan., Hazelwood, Mo., Schiller Park, Ill., Livonia, Mich., Minneapolis; Arnold Barnes Associates, Inc./Richardson, Tex.; Cramer Electronics/Syracuse, N.Y., Newton, Mass.

DC Volts and Current



SERIES 200AS

For resolution of 0.05%, counts to ± 1999 in four voltage and six current ranges. Up to 60 readings/second. Low-cost. Sperry display. From \$159.



SERIES 200BS

Single polarity low cost OEM meter with BCD outputs. 1.999 volts full scale; 0.05% resolution. Up to 60 readings/second. Sperry display. From \$139.



SERIES 253

Small, 5 VDC powered ± 1999 counts with $10\mu\text{V}$ basic sensitivity. 12 voltage and current ranges selected by plug-in range change module. LED display. From \$120.

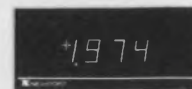

SERIES 257

Small size. Line powered. ± 1999 counts with $10\mu\text{V}$ basic sensitivity. 12 voltage and current ranges selected by plug-in range module. Sperry display. From \$145.



SERIES 400AS

Low-cost unit counts to ± 3999 in four voltage and five current ranges. Gated and buffered BCD outputs provide easy multiplexing. High common-mode rejection. Sperry display. ± 4999 counts optional. From \$189.

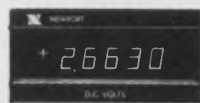

SERIES 2000AS

Top performer counts to ± 39999 for high resolution. Externally controlled storage for BCD data, overload, and polarity bits. 3-pole active input filter. Easily interfaces into data systems. Sperry display. From \$385.



SERIES 2000BS

Versatile low-cost $4\frac{1}{2}$ digit DPM covers four voltage and four current ranges. Resolution to 0.005%. Priced for OEMs. Compact size. Sperry display. ± 39999 counts optional. From \$280.

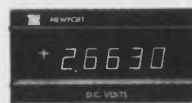

MODEL 2400AS

High-performance micro-voltmeter has ± 39.999 mv range, $1\mu\text{V}/\text{digit}$ sensitivity. Stabilized input and multipole active filter. Optional DC excitation supply drives strain gage transducers. Sperry display. From \$585.

Temperature Measurements



SERIES 260

Measure and display temperature in standard NBS thermocouple ranges. Four digits (to ± 3999 counts) give 1° resolution. Excellent conformity. Reading rates to 60/second. 0.1° resolution for RTD models. From \$500.



SERIES 2600

Best available conformity and accuracy. Five digits (to ± 38000 counts) for 0.1° resolution. Accuracy limited only by thermocouple itself. Fast response. Easy-to-integrate data system interface. From \$750.



MODEL 6110

Industrial tachometer-counter, for accurate indications of RPM and other industrial frequency and rotational measurements. Optically-coupled, isolated input. To 999,999 counts. Sperry display. Liberal O.E.M. discounts all models. From \$250.



MODEL 6210

Industrial accumulator with exceptional radiated and conducted noise immunity. Optically-coupled, isolated input with 50 mV sensitivity. Sperry display, to 999,999 counts. Buffered, isolated and gated BCD data outputs. From \$210.

Time and Event Measurement

Compatible Accessories



MODEL 810

The 810 is a basic 9 column printer expandable to 18 columns. It records in two colors at rates to 3.7 lines per second. New formats can be quickly made by rearranging the internal format patchboard. From \$495.



SERIES 270

Used with any digital panel instrument with BCD output, digital comparators provide instant alarm or control outputs whenever an input digital number exceeds a preset limit. From \$135.



MODEL 6151

Remote Storage and Display receives parallel digital data, octal or BCD. Up to six digits are stored and displayed while source instrument is encoding a new reading. From \$175.



MODEL 6700S

Digital clock displays days, hours, minutes or hours, minutes, and seconds, and provides gated and buffered BCD time-of-day output. Optional internal oscillator gives accuracy of up to $3 \times 10^{-7}/\text{mo}$. Sperry display. From \$275.

Newport Digital Panel Instruments

NEWPORT LABORATORIES, INC. 630 EAST YOUNG STREET ■ SANTA ANA, CALIFORNIA 92705 ■ 714/540-4914

INFORMATION RETRIEVAL NUMBER 137

Need an unusual cable? You've come to the right place!

TIMES WIRE & CABLE PROTOTYPE GROUP

**PLEASE
DISTURB**

Most cable companies would just as soon duck small prototype jobs.

Not Times Wire & Cable.

Working with customers in the design and development phase is the best way we know to stay technically sharp and ahead of our competitors. That's what our special prototype group is all about.

Just tell us what you need. High strength or low strength? Extra stiffness or extra flexibility? High or low radiation? Short or long time delay? High or low loss? Water blocked or fluid transmitting?

We'll come up with a cable to fit the bill. We'll also recommend connectors . . . even do the assembly if you desire.

Camera cables, data transmission cables, underwater cables, down hole cables, tamper proof cables . . . we've produced them all. You may have a requirement we've already solved. We've solved quite a few.

Maybe the only thing that's unusual about your application is the length of the run. But that's not unusual for us. We're interested in orders as low as \$1,300.

If you've got an application coming up, call Joe Lanoue, head of our Prototype Group (203) 265-2361. It won't cost you a cent for an application analysis.



TIMES
WIRE & CABLE CO.
Wallingford, Conn. 06492

PRODUCTS FROM H·S·I

... A Concise Listing



HIGH SPEED DIGITAL PULSE COUNTERS

with 4, 6, 8 digits; 12, 24 VDC, 115 VAC, 60 Hz; response rates of 0-100 pps; 2 or 3 wire stepper or synchronous motor. Extremely long life and extraordinary reliability. Available with BCD readout capability.

CIRCLE NO. 161

HIGH SPEED DIGITAL STOP CLOCKS

with 4, 6, 8 digits; 12, 20, 115 VAC, 50 or 60 Hz; 1.5 watt max.; readout in sec., min. or hrs.; increments of 1/10 or 1/100 of a sec. or a min. or an hour; manual or electric reset. Quiet, dependable and accurate. Available with BCD readout capability.

CIRCLE NO. 162

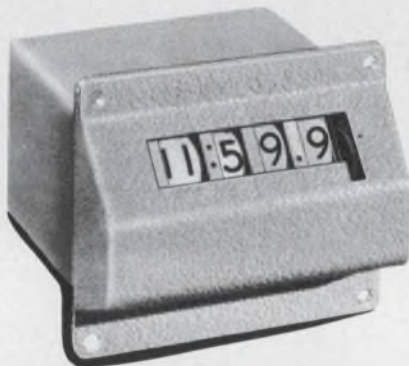

DIGITAL PANEL MOUNT CLOCKS

with readout in 12 or 24 hours, mins., 1/10 min. or 0-55 sec.; calendar (Gregorian month/day/hour/min./sec. or Julian 1-366 day/hour/min./sec.); 12, 20, 115 VAC, 50 or 60 Hz; driven by BIG INCH synchronous motors. Rapid transfer, reliable, long life, extremely accurate. Available with BCD readout capability.

CIRCLE NO. 163

PRECISION SWITCHES

Resilient or hermetic seal, high and low temperature switches and switch assemblies for applications where optimum performance is the criteria. SPST, SPDT, DPDT, etc. Push button, plunger, roller, toggle actuated. Many types, styles, sizes.

CIRCLE NO. 164



BIG INCH® PRECISION MINI-MOTORS

One watt synchronous, 2-wire and 3-wire stepper, step-servo, brushless DC; uni-directional, bi-directional; 1-1/16" dia.; instant (1/100 sec.) stop/start/reverse; integral gear train. Powerful, efficient, dependable.

CIRCLE NO. 165



HAYDON SWITCH & INSTRUMENT, INC.

500 Meriden Road, Waterbury, Conn. 06705
(203) 756-7441

SEND FOR LITERATURE ON ANY OF THE ABOVE PRODUCTS

MICROPAC 80. THE FIRST COMPLETE MICRO-COMPUTER DEVELOPMENT SYSTEM. Here it is: all it takes to prototype, develop or support a microcomputer-based system.

All the hardware. Logic (incorporating the Intel 8080 micro CPU), memory and communications interfacing, of course. But you also can order all the process interfacing you'll need for any application.

And all the software. So that you can develop your microcomputer program on the microcomputer. You don't need any other computers at all.



Once you've completed your development programs, you can put your MicroPac 80 to work in production, using the programs you developed.

We'd like to tell you more. A whole lot more. Write PCS, 5467 Hill 23 Drive, Flint, Michigan 48507.

Suddenly, the whole business of industrial control has changed.



Predict wideband amplifier response

with a simple graphical procedure. Spec sheets provide the basic data needed to compute closed-loop response.

A high-frequency operational amplifier's performance can be predicted with high accuracy in any number of closed-loop configurations if you use the Nichols Chart.¹ Employed widely by control-system engineers, the chart helps evaluate an op amp's closed-loop response by using the op-amp manufacturer's open-loop gain and phase-response curve. Once some points are plotted on the chart, it's easy to pick off op-amp peaking, phase margin and bandwidth data.

A brief review of control-system fundamentals shows how closed-loop performance is calculated for a high-frequency amplifier. In most wideband systems the general amplifier configuration in Fig. 1a is drawn. The control system representation of this circuit (Fig. 1b) can then be modeled, where

- G' is the feed-forward transfer function;
- G is the amplifier open-loop transfer function;
- H is the feedback transfer function.

The closed-loop expression is

$$\frac{E_o}{E_i} = \frac{-G'G}{1 + GH} \quad (1)$$

The functions G' and H are derived if we assume an ideal operational amplifier and use the principle of superposition. To calculate G' , mentally disconnect the amplifier summing point from the rest of the circuit and solve for voltage, e_i , using an ideal voltage source, E_i (Fig. 1c). Solving for G' , we get:

$$G' = \frac{e_i}{E_i} = \frac{Z_C Z_F}{Z_1 Z_C + Z_1 Z_F + Z_C Z_F} \quad (2)$$

The feedback-transfer function (Fig. 1d) is similarly calculated when we solve for e_o with E_o impressed:

$$H = \frac{e_o}{E_o} = \frac{Z_F Z_1}{Z_F Z_1 + Z_F Z_C + Z_C Z_1} \quad (3)$$

When G' is compared with H , we see that

$$G' = (Z_F/Z_1) H. \quad (4)$$

The closed-loop expression (Eq. 1) can now be expressed in a form suitable for graphic manipu-

lation on the Nichols Chart,

$$\frac{E_o}{E_i} = \frac{-Z_F}{Z_1} \left(\frac{GH}{1 + GH} \right). \quad (5)$$

Using the chart

We can see how the chart works by using the example of a very-high-frequency amplifier. Since most high-frequency amplifiers use the feed-forward technique to achieve high-frequency performance, consider a typical inverting amplifier, the Harris HA-2530. The open-loop response of

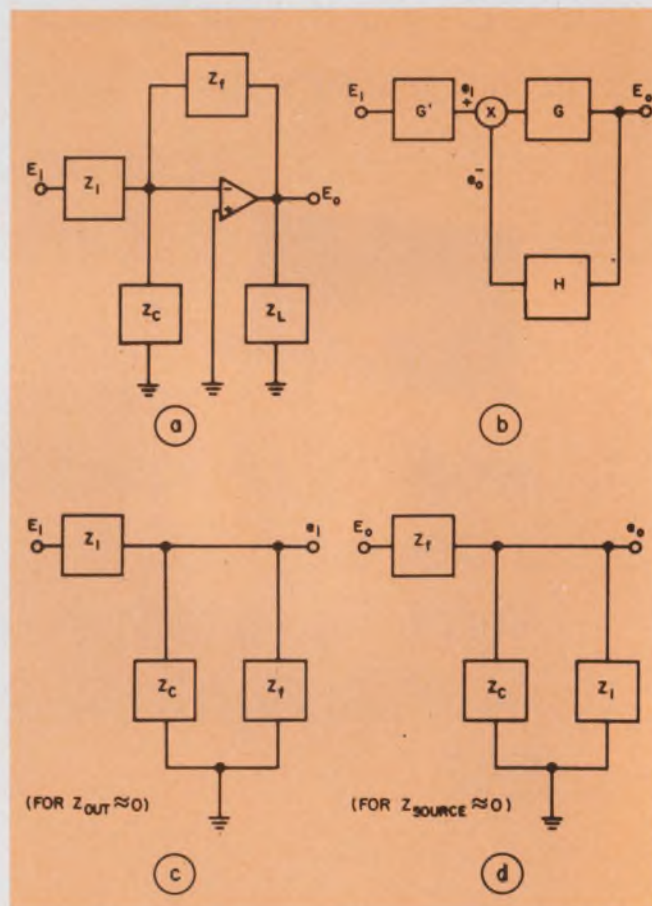

1. Control system basics. Any wideband amplifier (a) can be represented by control-system blocks (b). When solving e_i for a given E_i , use the circuit in c. Solve the feedback-transfer function by calculating e_o with E_o impressed (d).

Ernie Thibodeaux, Linear Applications Engineer, Harris Semiconductor, P. O. Box 883, Melbourne, FL 32901.

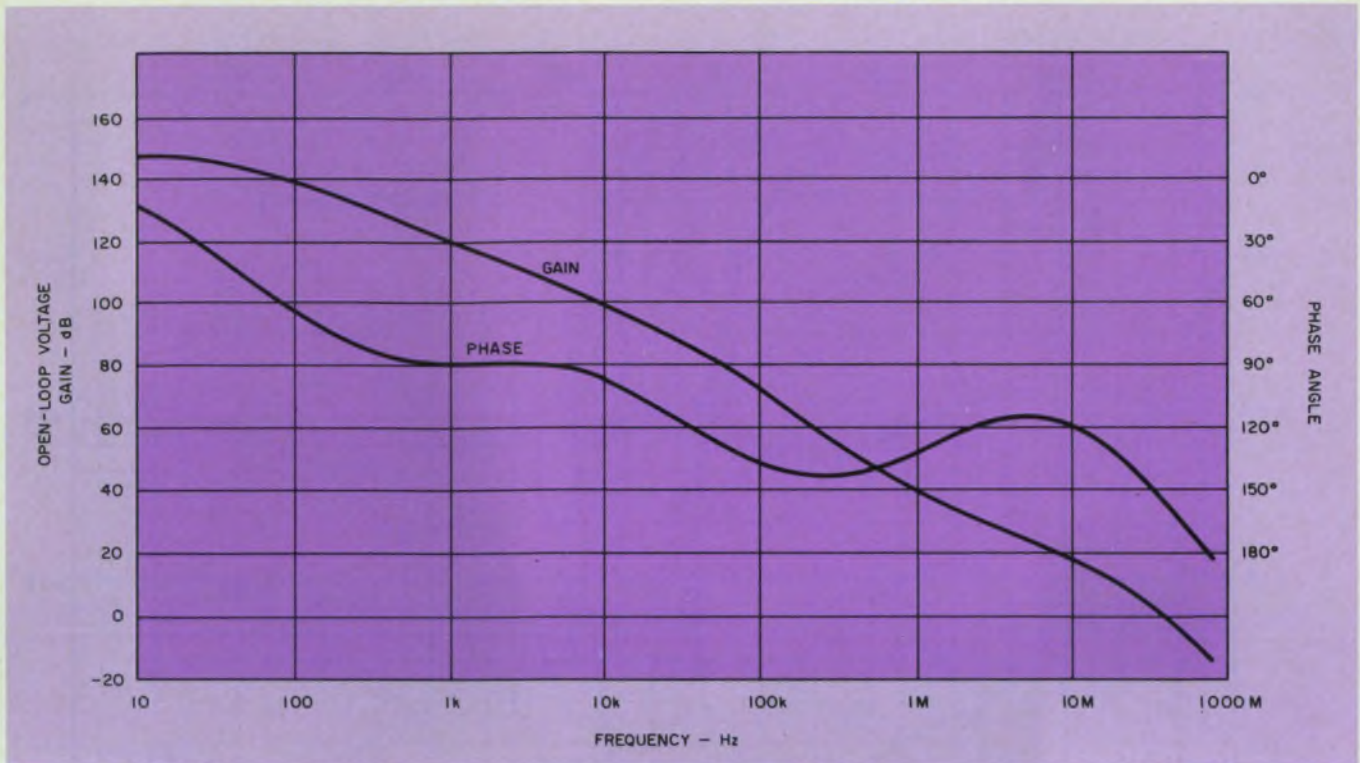

2. Typical operational amplifier open-loop response curve is shown for Harris' high-frequency HA-2530 op amp.

this op amp (Fig. 2) is representative. Using the open-loop response curve, together with the feedback factor, we determine the closed-loop response with the Nichols Chart (Fig. 3).

Using the amplifier configuration in Fig. 4, we'll first predict closed-loop response for unity gain, compare the results with actual lab data, and show how the results can be used to predict performance for virtually any gain configuration.

In any high-frequency application, resistors R_1 and R_F should be chosen so their interaction with stray and input capacitance occurs well beyond the bandwidth of the amplifier. In our example, $R_1 = R_F = 500 \Omega$ and $C_F = 10 \text{ pF}$ (to cancel the

effects of input capacitance). This results in a purely resistive feedback factor, as defined by Eq. 3. From Eq. 3, a solution for H yields a figure of $1/2$, or -6 dB . The loop gain (GH) can be derived from Fig. 2 if we adjust the open-loop gain curve (G) by -6 dB .

The graph is plotted as follows:

1. Plot both gain and phase of the GH function on semi-log paper. Add the poles and zeros of H to the manufacturer's open-loop gain and phase curves. In our example, the feedback factor is resistive; when the open-loop gain curve is adjusted downward by -6 dB , the values in Table 1 result.

Table 1. Basic gain and phase

| f(MHz) | GH (dB) | GH (degrees) |
|--------|---------|--------------|
| 1 | 33 | -132 |
| 2 | 26 | -120 |
| 4 | 21 | -114 |
| 6 | 17 | -114 |
| 10 | 12 | -120 |
| 15 | 6 | -128 |
| 17 | 5 | -132 |
| 20 | 3 | -137 |
| 25 | 0 | -142 |
| 30 | -2 | -148 |
| 38 | -5 | -155 |
| 42 | -7 | -160 |

Table 2. Gain and phase from the chart

| f(MHz) | $\frac{GH}{1+GH}$ (dB) | $\frac{GH}{1+GH}$ (degrees) |
|--------|------------------------|-----------------------------|
| 1 | 0.14 | -1 |
| 2 | 0.22 | -2.5 |
| 4 | 0.3 | -5 |
| 6 | 0.45 | -8 |
| 10 | 0.7 | -15 |
| 15 | 2 | -30 |
| 17 | 2.3 | -35 |
| 20 | 3.2 | -45 |
| 25 | 4.0 | -70 |
| 30 | 3.5 | -75 |
| 38 | 0 | -130 |
| 42 | -2.5 | -145 |

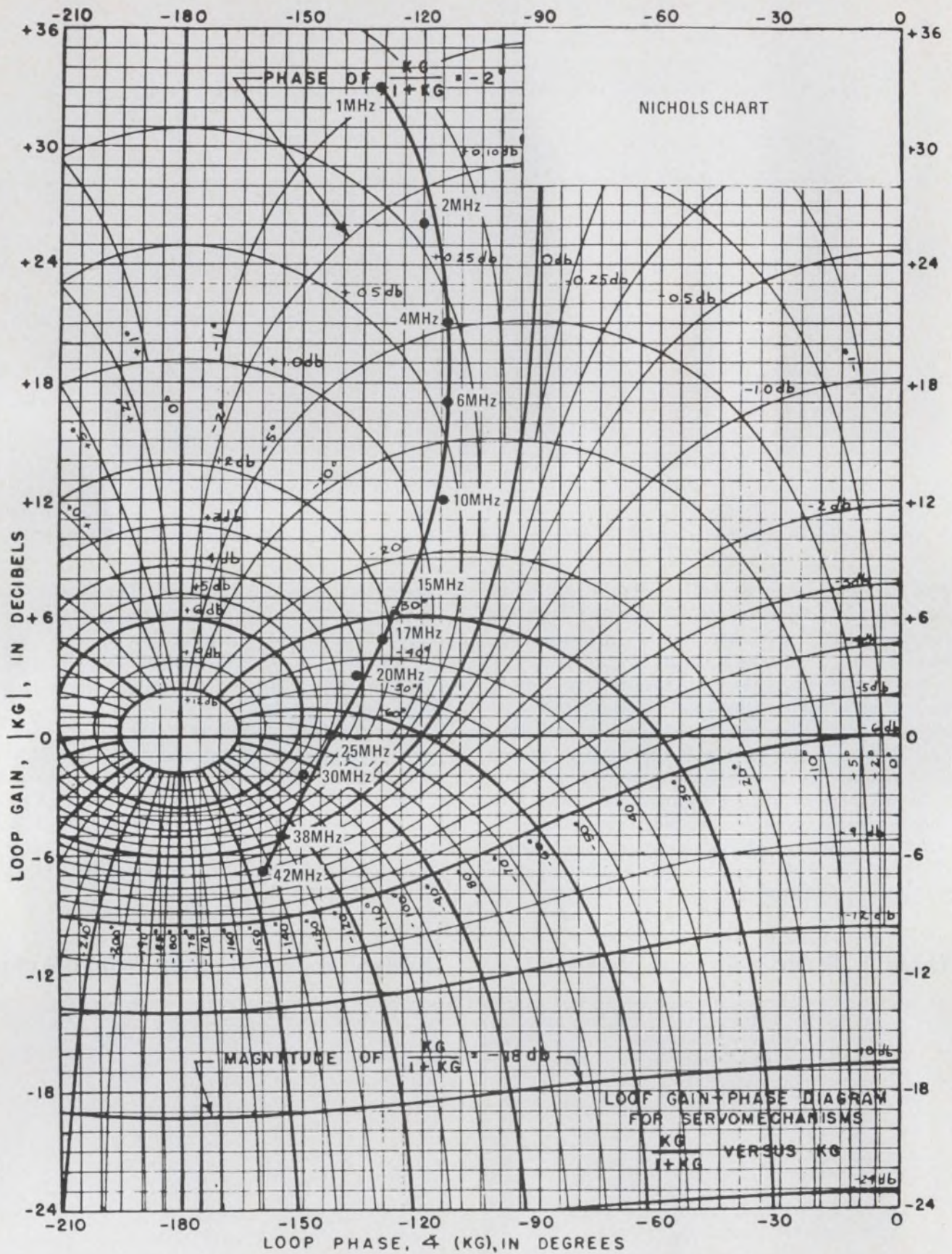

3. A plot of function $GH/(1+GH)$ on the Nichols Chart. The curve defines performance of the amplifier under

unity-gain, maximum-bandwidth conditions. The amplifier used is Harris' HA-2530 op amp.

Table 3. Predicted vs actual response

| | Actual | Calculated |
|-------------------------------|--------|------------|
| Bandwidth (0 dB)—MHz | 29 | 31 |
| Closed-loop phase margin—deg. | 39 | 42 |
| Peaking—dB | 2.3 | 2 |

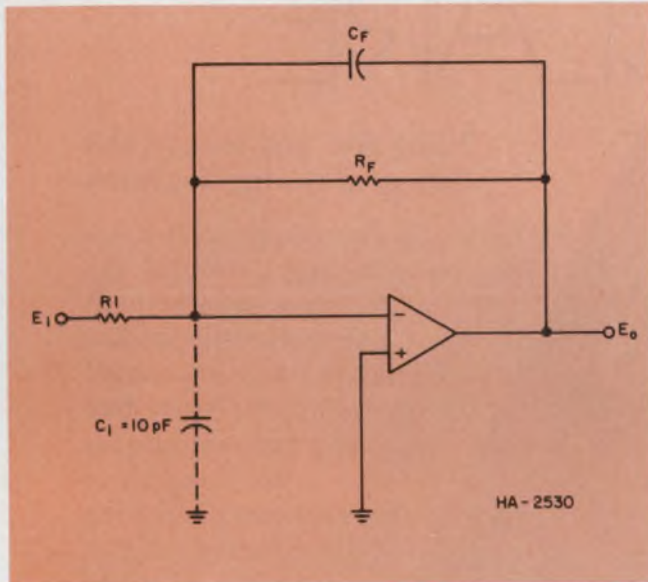

4. Closed-loop response at unity gain is plotted for an op amp with this feedback configuration. Note that feedback is considered resistive.

2. Transfer gain and phase points to the rectangular coordinates of the Nichols Chart.

3. Pick gain and phase of the function $GH/(1+GH)$ at the selected data points from the chart. The results are shown in Table 2.

4. Transfer these points to semi-log paper and construct the $GH/(1+GH)$ curve as shown in Fig. 5.

5. Add Z_F/Z_1 or the pole defined by $1/(1+SR_F C_F)$ in this case. At this point, the complete closed-loop expression (Eq. 5) has been graphically determined and is shown as $(E_o/E_i)_{CALC}$ in Fig. 5.

6. Read bandwidth, peaking and closed-loop phase margin directly from Fig. 5.

A comparison of lab data with the calculated results reveals very close agreement (Table 3).

Though the results define the performance of the amplifier under unity gain, maximum-bandwidth conditions, performance at other gains can be interpolated from the Nichols Chart. Construct a tracing paper template of the unity curve already drawn on the chart. Gain change is determined by shifting this curve up or down the vertical axis. Increased gain corresponds to moving the curve down an amount proportional

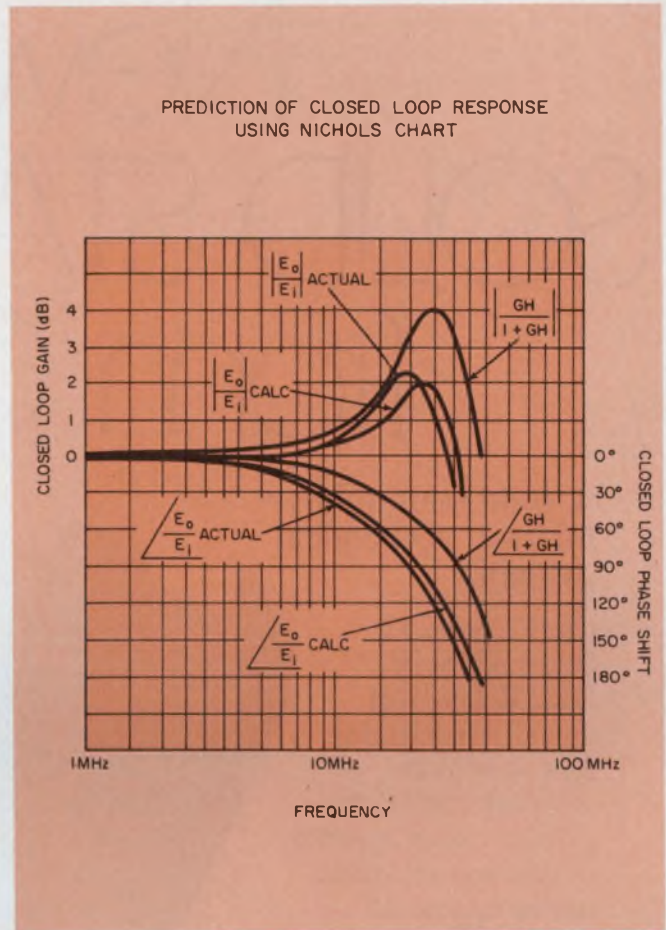

5. Actual vs calculated values for a typical wideband op amp indicate how close to actual values the predicted values come.

to H in decibels.

The technique works for inverting op amps, too. Move the template curve by an amount equal to $20 \log [R_1/(R_1 + R_F)] + 6$ dB. Note that for inverting op amps, the curve is already shifted by 6 dB due to the equal voltage division of feedback and input resistors. For example, to read out a 20-dB gain, shift the curve by approximately -14 dB; the $GH/(1+GH)$ data points are obtained directly.

For the complete closed-loop response (Eq. 5), remember to add the poles and zeros of Z_F/Z_1 as a final step. In our example, C_F equals $0.1 C_i$, or 1 pF for pole-zero cancellation of the feedback factor. But with $R_F = 500 \Omega$, the pole frequency ($s = 1/R_F C_F$) or Z_F/Z_1 occurs well beyond the amplifier bandwidth and would not contribute to any degradation in frequency response. Therefore, for computing gains of 10 or more, the procedure is simplified. Correct each $GH/(1+GH)$ point by $20 \log (R_F/R_1)$ to get complete closed-loop information directly from the chart. ■

Reference

1. James, H., Nichols, N., and Phillips, R., "Theory of Servomechanisms," MIT Radiation Laboratory Series, Vol. 25, p. 181.

New AC SOLID STATE RELAY from CLARE

A solid state relay for fast, economical assembly

Clare's new 212 Series AC Solid State Relay gives you all needed relay functions at an affordable price. No printed circuit assembly or electromechanical device can match the 212 Series Relay for assembly speed and convenience on your production line. Two screws through the molded-in, standard-spaced holes mount it. The combination terminals accept lugs, bare wires or quick-connects without additional hardware being needed.

A highly sensitive yet extremely versatile solid state relay

Clare's new 212 Series Relay features zero-crossing synchronous switching, and has heavy duty switching capabilities, with a choice of 10 or 25 amp ratings at 140 or 250 Vac. The opto-isolator provides total input/output isolation, and the sensitive input is fully compatible with DTL/TTL inputs. The 212 Series relay also provides transient dv/dt protection for the output, and it is designed to handle both resistive and inductive loads.



Long life and safety are integral design features

This tough, dependable relay has a one-cycle surge current rating of 1,000%. Recessed terminals and molded-in dividers eliminate externally caused short circuits. Its arc-free switching makes it safe for use in explosive atmospheres. Operating temperature range is from -40°C . to $+80^{\circ}\text{C}$. With no moving parts, the 212 Series Relay has an almost indefinite life under normal operating conditions.

Applicable for use in many industries

The 212 Series AC Solid State Relay will reliably, conveniently and economically fill switching needs for lamps, motor starters and solenoids. It is ideal for computer peripheral, process control system and inductive load applications.

Available now!

For full technical data, contact your nearest Clare sales office or distributor. For more comprehensive application information, contact George Neeno, C.P. Clare & Company, 3101 W. Pratt Avenue, Chicago, Illinois 60645. Or Phone (312) 262-7700.

QUALITY, SERVICE, RELIABILITY

C. P. CLARE & COMPANY a subsidiary of
GENERAL INSTRUMENT CORPORATION





Availability is one of the most important factors in selecting trimmers. Amphenol can promise immediate off-the-shelf delivery, from its network of strategically located distributors—plus a price that's trimmed to boost *your* profits.

Whether you need a 3/4" rectangular cermet or wirewound trimmer, "Just Ask and You Shall Receive" our Series 6034 or 3810.

These 3/4" sealed trimmers are available in all pin spacings and styles. The 6034 cermet is an industry standard of excellence. Specifications of the 6034 cermet are: resistance values of 10Ω to $1\text{ meg.}\Omega \pm 10\%$; infinite resolution; the CRV is 3% of total resistance or 20Ω , whichever is greater; temperature coefficient is $100\text{ ppm}/^\circ\text{C}$ nominal.



The 3810 wirewound features the unique Vista-Trim top that allows you to see the adjustments you make. Specifications of the 3810 wirewound are: resistance values of 10Ω to $20,000\Omega \pm 10\%$; resolution 1.78% to 0.22% respectively; temperature coefficient is $50\text{ ppm}/^\circ\text{C}$ nominal; ENR 100Ω max.

Let us show you how these trimmers can fulfill your specific requirements. For additional information and immediate action, contact the Amphenol sales office in your area or local Amphenol distributor by dialing our toll-free hotline (800) 645-9200. (In New York State) dial collect (516) 294-0990.

There's a reason to ask for us by name.



AMPHENOL

AMPHENOL CONNECTOR DIVISION
2801 South 25th Ave., Broadview, Ill. 60153 Tel: 312-345-9000

INFORMATION RETRIEVAL NUMBER 102

Printer control: a minor task for a fast microprocessor. An interrupt-driven approach frees the processor for other tasks and saves hardware.

The second generation of fast microprocessor units (MPUs) easily controls high-speed printers. And with lower-speed printers—such as those used for terminals—microprocessors can perform additional tasks: They can operate displays, store information on tape or disc and do arithmetic calculations.

An interrupt-driven approach frees the processor for other jobs and saves hardware. In applications like transaction terminals, control of the printer involves a small percentage of the processor's time (Fig. 1). Use of a microprocessor also allows a designer to reduce a relatively complex system to a few manageable tasks. Service routines can be developed for the various peripherals, and a suitable executive control program can tie the system together.

Define the problem

A specific microprocessor system that includes a simple drum printer will show how to define and tackle the tasks associated with the printer. The printer selected, a Seiko AN-101F, uses a continuously rotating drum (Fig. 2a). Actuation of the trigger magnet causes the hammer to strike the paper through the inked ribbon and to print a character.

Any of 42 alphanumeric characters plus the special characters *, \$, ", -, . and / can be printed in 21-column format. Each column position has a complete character set spaced evenly around the drum. A given character appears once during every revolution of the drum and is the same for all column positions. The hammers operate in parallel. All column positions that have the same letter must therefore have the corresponding lines (trigger magnets) armed simultaneously.

The control circuitry must also actuate the hammers at the right instant if printing is to occur. Timing signals are generated by detec-

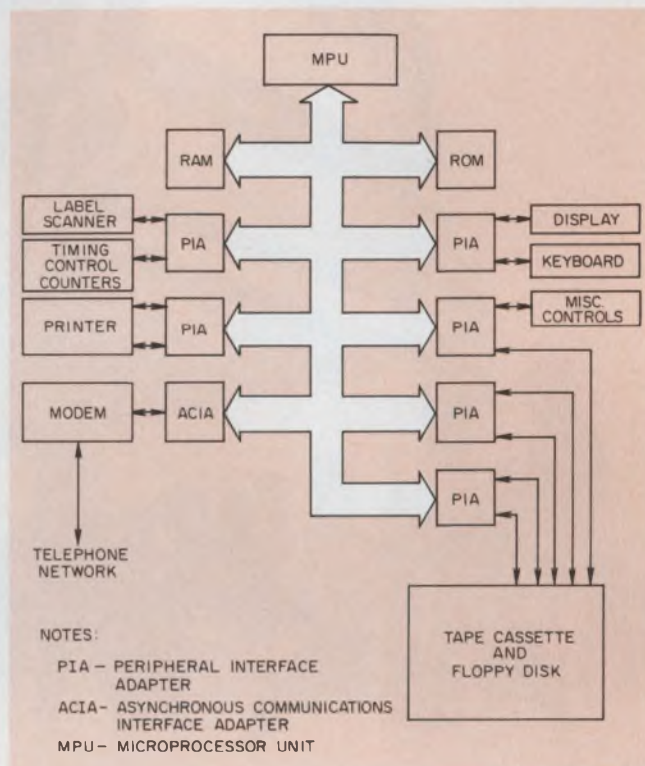

1. Microprocessors can operate a broad range of devices simultaneously. Interface adapters link the unit's address and data busses with external peripherals to form a system like an intelligent terminal.

tion heads and ferrite magnets associated with the ratchet shaft and drum.

The ratchet shaft rotates 42 times to each rotation of the drum and generates signals TP and TL for each character (Fig. 2b). TP defines the time for energization of the trigger magnets and TL the de-energization. The reset signal R is generated on a separate line, once for each rotation of the drum, and denotes completion of the line (Fig. 2c).

The designer must decide on an optimal trade-off between external circuitry and MPU use.

In this case, the printer manufacturer provides a suggested controller design that can be implemented with 16 to 20 SSI and MSI circuits (without magnet-drive circuitry). With this approach the processor only monitors status and

Al Moore, Manager Microprocessor Applications and Mark Eidson, Applications Engineer, Motorola Semiconductor Products, 5005 E. McDowell Rd., Phoenix, AZ 85008.

transfers bytes of data at the proper time.

At the other extreme, the processor could assume as much of the control function as possible and eliminate external circuits. If over-all system timing allows, this is usually the most cost-effective approach.

An alternate approach is to use interface circuits provided by the microprocessor manufacturer. Sometimes these devices let you handle a wide variety of equipment with minimal additional logic and simple programming. For ex-

lines and determine which registers can be selected by the processor. Bit b_0 in either register A or B masks (blocks) interrupt signals IRQA and IRQB, respectively. Bit b_1 determines which transition (high-to-low or low-to-high) of CA1 (CB1) sets the interrupt flag and generates an interrupt request (IRQ) to the processor.

The register has two interrupt request flags or bits that can be set by transitions on the CA1 (CB1) and CA2 (CB2) control lines and read by an MPU Read Control Register opera-

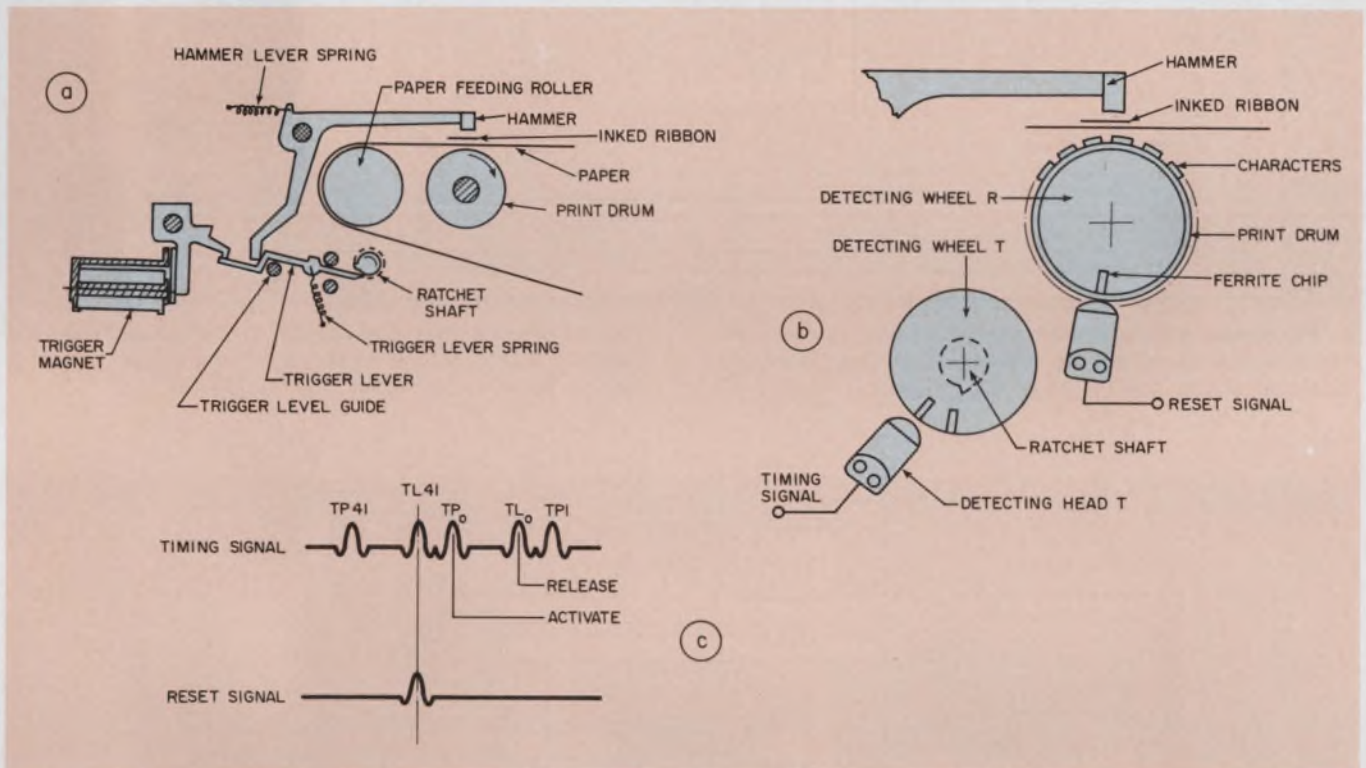

2. Column printers provide inexpensive hard copy. A drum printer requires timed signals to a trigger magnet (a). And magnetic pickups supply timing information to the controlling device (b). The timing signals indi-

cate the character available. The reset signal occurs once in each drum revolution and indicates the completion of a print line as well as the need to advance paper and ribbon (c).

ample, Motorola's MC6820 peripheral interface adapter (PIA) mediates between the processor and various external devices. To the processor, the unit appears as six memory locations that can be addressed in the same manner as main memory (Fig. 3). To the external devices, the unit provides a separate 8-bit bidirectional data bus along with two control lines for each of two peripherals.

Internally the PIA is divided into two symmetrical but independent register configurations. Each half contains an output register, control register and data-direction register (Fig. 4).

Individual bits in the data direction registers set the corresponding peripheral data lines to be either input or output. The control registers affect the operation of the four peripheral control

tion. The status of the interrupt flags cannot be altered by an MPU write instruction. They are reset indirectly to zero each time the MPU reads the corresponding Output Register or can be cleared with the hardware $\overline{\text{Reset}}$.

When $b_5 = 0$, b_3 and b_1 of the Control Register perform similar functions to b_0 and b_1 for control of the interrupt bits via the CA2 (CB2) input. When enabled, the IRQA (B) external interrupt responds to either b_3 or b_1 . Bits b_3 and b_1 are set, respectively, by lines CA1 (CB1) and CA2 (CB2), and the bits are also named IRQA1 (IRQB1) and IRQA2 (IRQB2).

If $b_5 = 1$, CA2 (CB2) acts as an output and will function in one of three modes. If b_1 is also equal to 1, CA2 (CB2) serves as a program-controlled set/reset output to the peripheral and follows b_3

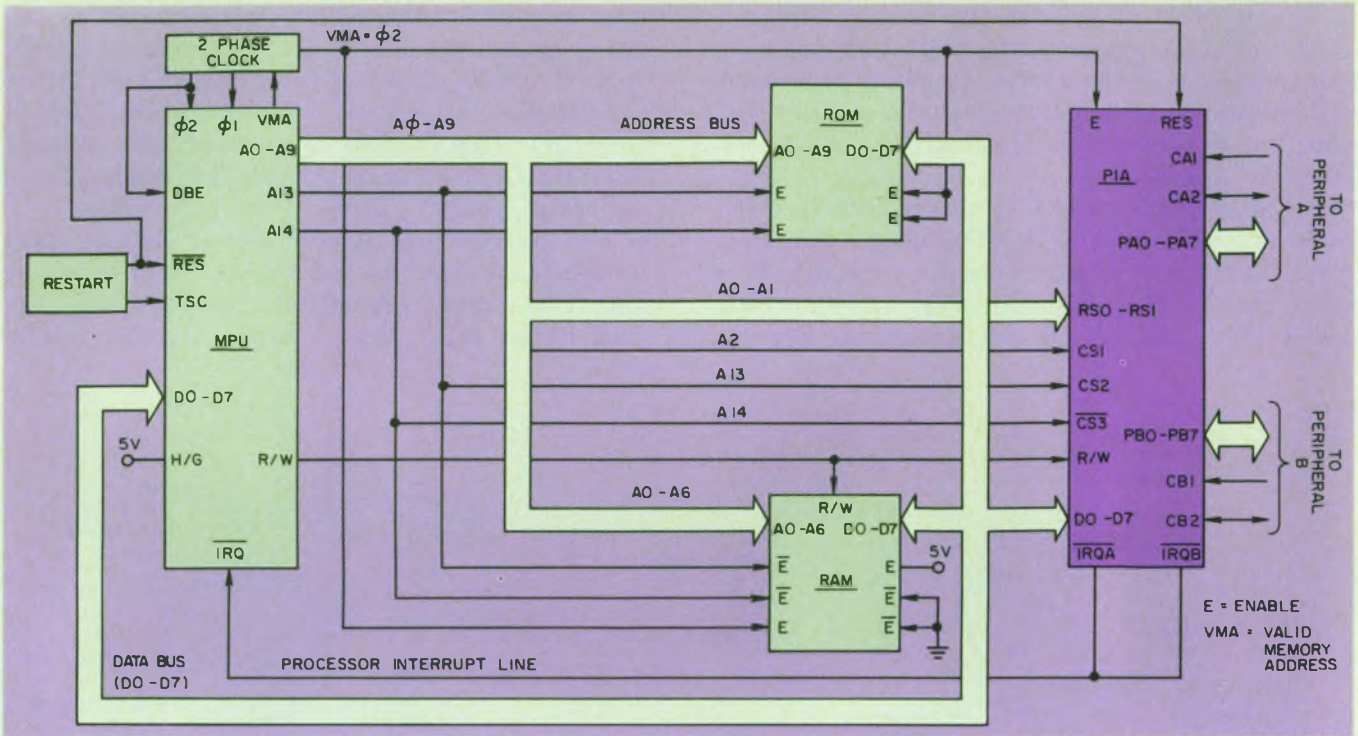

3. Peripheral interface units are addressed by the processor in the same way as memory locations. They provide convenient control and data signals for use with

the peripherals and can signal the processor via the common interrupt line when asynchronous operation is needed between processor and peripheral.

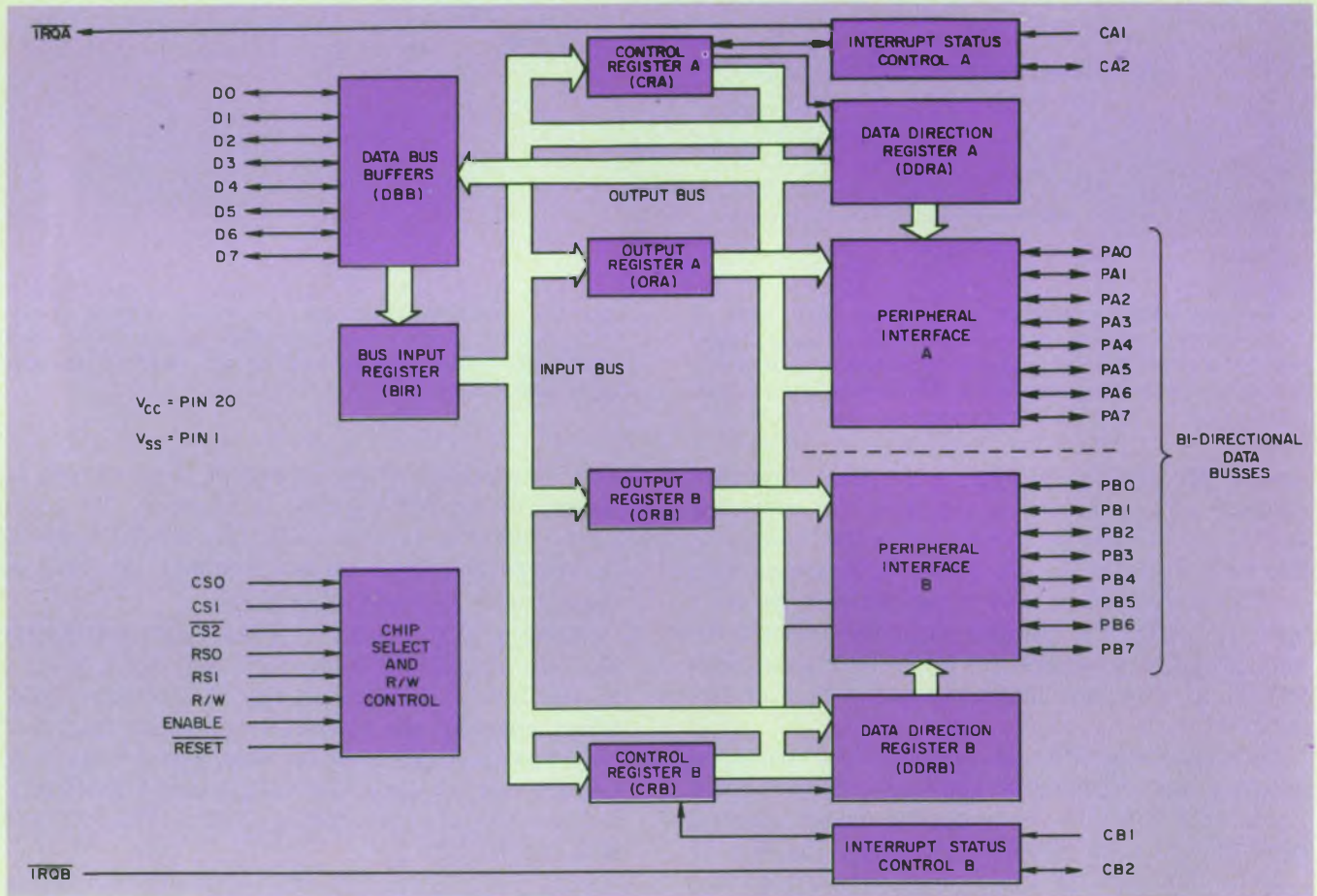

4. The peripheral side of the PIA includes two 8-bit bidirectional data busses and four interrupt/control lines. The PIA permits data transfer between the proc-

essor bus and peripheral data busses. And the processor can read or write into either set of registers. The PIA also provides handshake control logic.

as it is changed by the MPU Write Control Register operations.

If $b_3 = 0$ when $b_5 = 1$, CA2 (CB2) can be used in either a pulse-strobed or handshake mode. Operation of the two sections differs slightly for these two operating modes.

In the handshake mode ($b_3 = 0$), CA2 is taken low by the negative transition of the MPU Enable Pulse after an MPU Read Output Register operation. And CA2 returns high when IRQA1 is set next by CA1. This, in effect, "tells" the peripheral that it has been read and allows it to acknowledge via CA1. The "B" side operation is similar, except that CB2 is taken low after an MPU Write Output Register operation and returned high by the next CB1 transition. This tells the peripheral that data have been written into it and that it can respond via CB1.

In the pulse-strobed mode ($b_3 = 1$), CA2 is set low again by a Read Output Register command but is now returned high by the next MPU-originated Enable Pulse. The CB2 operation is similar, except that an MPU Write Operation initiates the pulse. The Enable pulse is generated by ANDing the Valid Memory Address signal (labeled VMA) line with phase two of the clock.

The output registers, when addressed, store data present on the processor data bus during a write operation. These data will also appear on the peripheral lines that have been programmed as outputs. If a peripheral line is serving as an input, the corresponding bit position of the output register can be written into by the processor. However, the data will not appear on the peripheral data line. During a processor Read operation, the data present on the peripheral lines are transferred directly to the processor's data bus.

The data-direction registers and control registers are programmable from the processor. Lines RS0 and RS1 (connected to the processor's address bus) select the register, and data are transferred through the 8-bit data bus (D0 to D7).

With this scheme, control registers A and B are selected unequivocally; and the interface registers are selected in accordance with the data on RS0 and RS1, as well as the contents of control-register bit two.

Assign one line to a print column

Use of the PIA still requires some hardware judgments. If—as in this sample case—you want to print 16 columns, you could build an external 1-of-16 decoder and use four PIA data lines.

However, since you have all 16 data lines, you can assign one to each print column. If there had been only four spare lines in the system, the decoder approach might warrant further consideration.

As a further tradeoff, consider what happens

if you use all 21 columns of the AN-101F. Then the designer might choose between five extra PIA lines as opposed to an external 5-bit shift register.

The final design objectives are these:

- To minimize use of external electronics (other than the PIA).
- To use only timing signals from the printer without modifications other than pulse shaping.
- To reduce the time in which the MPU must be involved with printer control activity.

Each hammer driver is controlled by one of the PIA's 16 data lines. These lines are the outputs of registers ORA and ORB in the PIA, which are regarded as memory locations by the MPU. Hence the MPU can enable the activation of a particular column hammer by setting the appropriate bit position in the memory locations assigned to ORA and ORB (Fig. 5).

During initialization, CB2 is established as an output and is used by the MPU to strobe the enabled hammer drivers at the proper time. At the end of a print cycle, the printer's paper and ribbon must be advanced. This requires a 36-ms pulse. A control program generates the pulse and applies it through CA2, which has been established as an output during initialization.

After being shaped and inverted by the MC3302 comparators, the printer timing and reset pulses are applied to the CB1 and CA1 inputs, respectively. By means of these signals and the MC6800 interrupt structure, the printer "tells" the MPU that it requires servicing. Part of the printer control program's function is to establish suitable interrupt modes through use of the PIA Control Registers.

For example, in the following control sequence, negative transitions on the CB1 timing input during a print cycle must initiate service to the printer by the MPU. The MPU sets this up by writing $b_0 = 1$ and $b_1 = 0$ into Control Register B during processing. For subsequent timing transitions, the PIA issues an Interrupt Request to the MPU via the system IRQ line.

The MPU responds by interrupting its current activity (the MPU's internal registers are saved on a "stack" so that the task may be resumed later). The processor fetches the starting address of an executive service routine from a memory location permanently assigned to the Interrupt Request. The service routine directs the MPU to poll its peripherals: it tests the flag bits in the PIA Control Registers to see which needs servicing. Flag bit b_7 of the printer PIA's control register is set by the same transition that caused the interrupt. When the MPU finds this flag set, it jumps out of the polling routine to an appropriate printer control program.

The basic task, or algorithm, of the control program is to examine the text of the message to

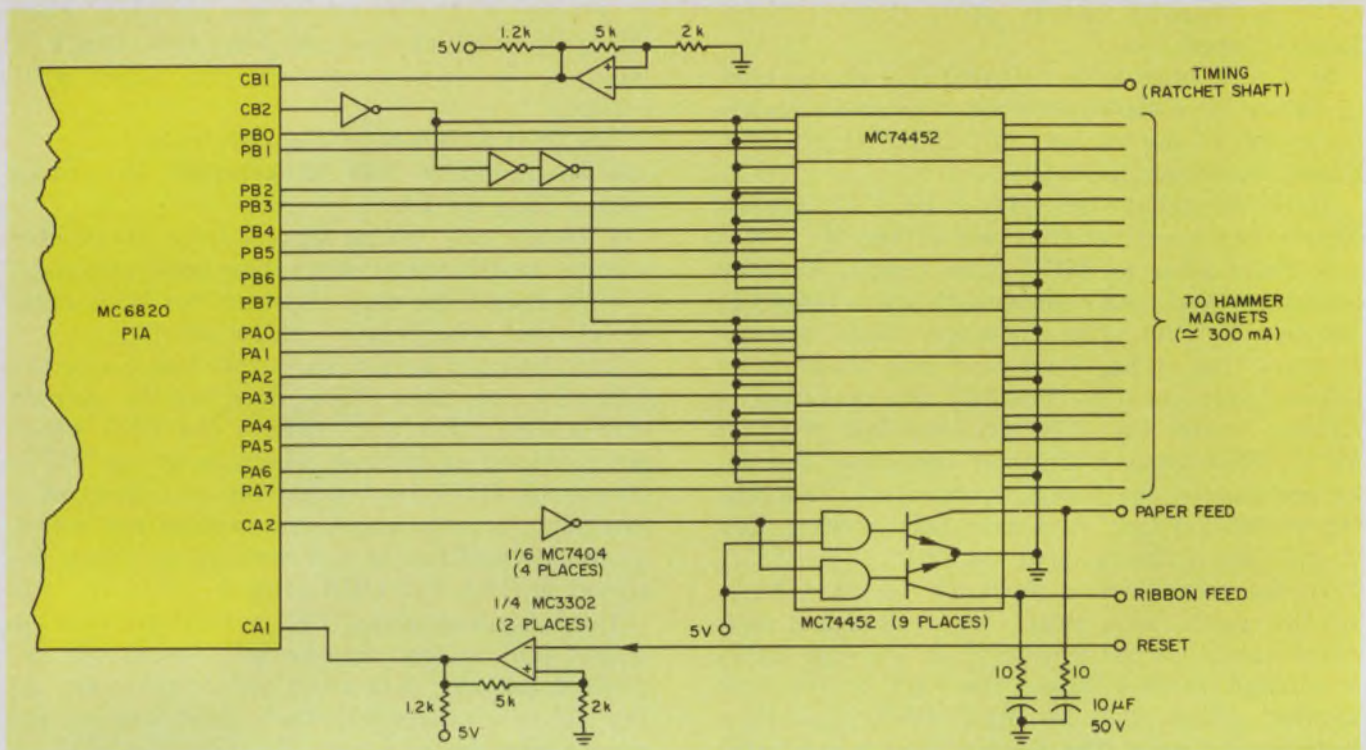

5. Both data busses of the PIA are used and 16-column messages can be outputted. Each PIA wire drives a single magnet through a peripheral driver. The timing

signal of the printer interrupts the processor for each character position on the drum. The reset signal indicates completion of a line.

be printed and make sure that the appropriate bits in the PIA's output registers, ORA and ORB, are set at the proper time.

Inform the MPU of the character position

The time for one print-drum rotation is divided into 42 intervals, t_0 through t_{41} . All similar characters in the text are printed simultaneously; that is, all 0s are printed during t_0 ; all 1s during t_1 , etc. For example, if the text requires the letter C in columns 3 and 9, column hammers 3 and 9 must be engaged during the time interval t_{12} in which all Cs are under the hammers.

After each TL interrupt, the MPU examines the entire message to see if there are any characters to be printed during the next time interval. The text to be printed may be either a "canned" message stored in ROM or variable information generated by the executive program and stored in RAM. Messages are stored in memory in 16-byte blocks, with each memory position corresponding to a printer column position. Prior to calling the printer, the executive program loads the starting address of the message to be printed into a buffer. The printer routine then uses this address in conjunction with the MPU's indexed addressing mode to locate the desired message. This technique permits use of the same subroutine for all of the system printer requirements.

A 42-byte Character File, corresponding to the

printer's character set, is stored in a ROM in the same sequence as it appears on the printer drum. As each TL interrupt is serviced, the Character File pointer is incremented and points to the address of the next character on the drum.

The MPU then compares every character of the text with the current Character File character and keeps a running column count. Each bit position in the PIA Output Registers is set or cleared, depending on whether or not the respective the text with the current Character File character.

The flow charts and control programs that result are shown in Figs. 6 and 7. The control problem is divided into four tasks: (1) Initialization; (2) Printer Enable; (3) Reset Service Routine; (4) Print Service Routine.

The Initialization routine, PKIPRT, defines the housekeeping tasks that are done routinely by the executive program during system power-up.

Lines 300 and 310 (see program listing) clear CRA and CRB (XPICRA, XPICRB) and set $b_2 = 0$, so DDRA and DDRB can be addressed. Lines 320 to 350 store ones in all of the DDR bits that define the 16 data lines of ORA and ORB as outputs. Lines 360 to 380 load the control registers with the hexadecimal (HEX) value 3C, which gives them the bit configuration shown:

| | | | | | | | | |
|---------|-------|-------|-------|-------|-------|-------|-------|-------|
| CRA (B) | b_7 | b_6 | b_5 | b_4 | b_3 | b_2 | b_1 | b_0 |
| | 0 | 0 | 1 | 1 | 1 | 1 | 0 | 0 |
| | 3 | | | C | | | | |

where

- $b_0 = 0$ IRQ interrupts are disabled.
- $b_1 = 0$ CA1, CB1 are established as negative edge-sensitive inputs.
- $b_2 = 1$ ORA, ORB are now selected.
- $b_3 = 1$ CA2, CB2 are established as outputs
- $b_4 = 1$ that follow b_3 ; they are now high.
- $b_5 = 1$

With CA2 and CB2 high, all the driver circuits are disabled, since one input of each driver AND gate is held low (Fig. 5). CA2 and CB2 are inverted before they reach the AND gates.

Lines 390 and 400 are "dummy reads" of ORA and ORB, which clear the IRQ flags that may have been set and ensure that the IRQA (B) lines are high; that is, inactive. Line 410 returns control to the executive program.

The Printer Enable routine, PKNTRL, is called by the executive program whenever a line of text is to be printed (Fig. 6b).

Since the printer drum continuously generates reset pulses at CA1, the IRQA flag will be set. But the IRQA line will be inactive (it was disabled during initialization when the MPU set $b_0 = 0$). To ensure that the next reset pulse starts the print cycle instead of the CA1 interrupt enable, the IRQA flag is cleared by a dummy read of ORA (XPICRA) before CA1 is enabled (lines 490 to 510).

The "printer done" flag (#\$29) is cleared by another service routine before it returns to the main program. Subsequent interrupts generated by the printer will cause the line of text to be printed, and further control by the executive program is unnecessary.

When the CA1 input is triggered by the printer reset pulse, the MPU interrupt sequence directs processing control to the PRNTIR routine (Figure 6c). Since the IRQ flag and line are active, they must be disabled before the processor exits from the routine, to allow further interrupts. Line 590 reads ORA (XP1ORA) to accomplish this as the first instruction.

Lines 600 to 620 test b_1 of CRA to determine whether the CA1 input was positive or negative edge sensitive:

- If $b_1 = 0$, then the CA1 input was a negative transition, and the program branches to PKSCN1. Lines 780 and 790 set CRA to 3C, as in the Initialization routine, to disable the CA1 interrupt input. The starting address of the printer character file PKCF00 is stored by lines 800 to 810 for use during the first scan loop. Lines 820 to 840 clear the previous timing interrupts and set CRB to allow the next negative CB1 transition to interrupt the MPU. The RTI instruction at line 850 returns the MPU to the status at the time the interrupt occurred and the program execution resumes.

- If $b_1 = 1$, CA1 was positive, signaling the

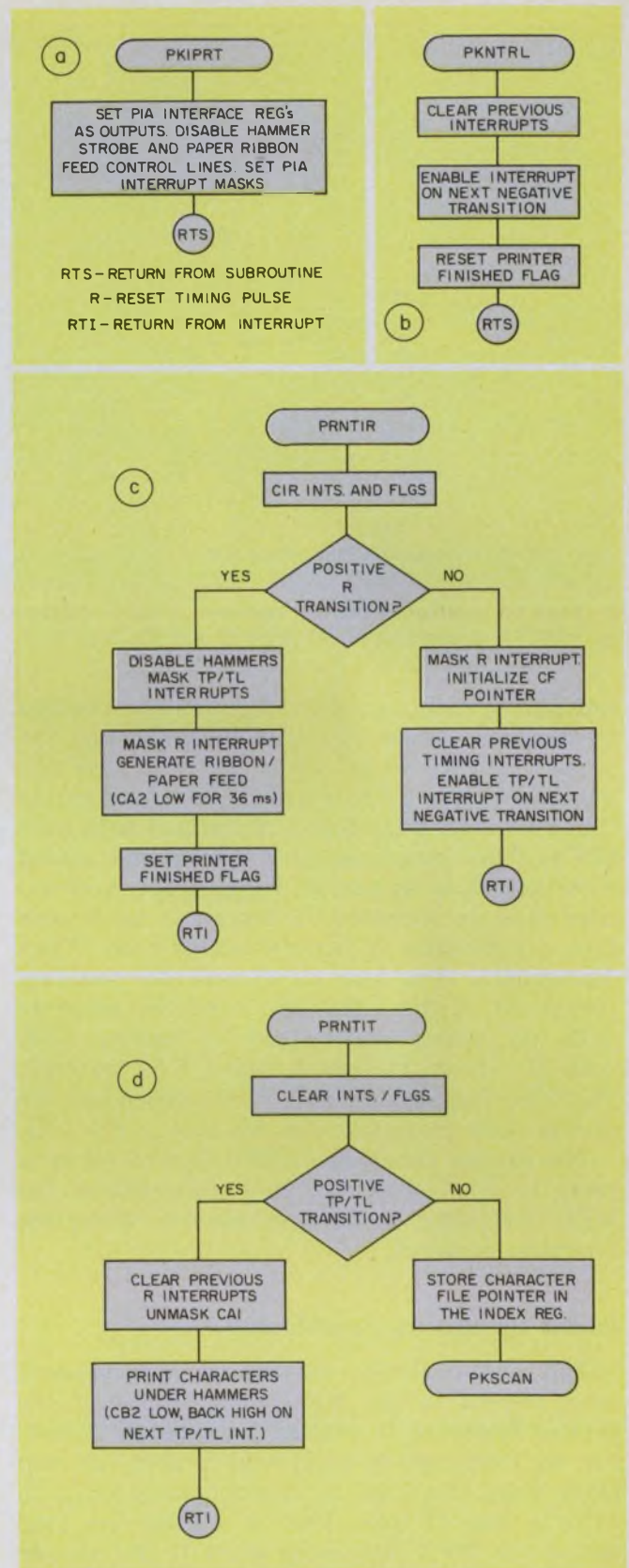

6. The control problem is broken into four tasks: Initialization (a), Printer Enable (b), Reset Service (c) and Print Service (d). The initialization routine defines house-keeping tasks. PKNTRL is called by the executive when a line is to be printed and enables reset interrupts from the printer PIA. PRNTIR is used at the beginning and end of a print cycle (line print and paper feed). PRNTIT selects the proper hammers.

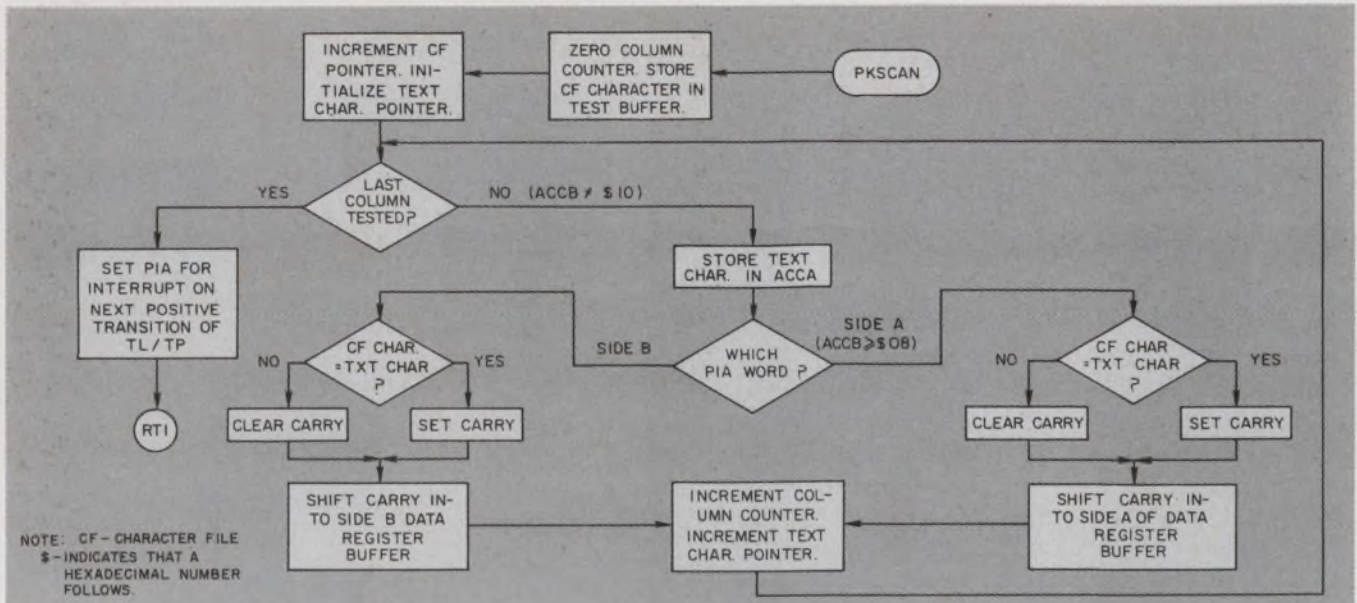

7. Each bit position in the PIA registers is set or cleared by PKSCAN depending on whether or not the text char-

acters match those of the character file. The subroutine is called by PRNTIT.

end of the printing cycle. The routine disables the hammer stroke CB2 with lines 630 and 640 by setting CRB to 3C ($b_3 = 1$). The next two lines store 34 in CRA, which clears b_3 and makes CA2 go low. A delay loop is generated with lines 670 to 720. Accumulators A and B are loaded with the values 48 and 92, respectively. Accumulator B is decremented 92 times (to zero) each time Accumulator A is decremented once. When Accumulator A is zero (≈ 36 ms), the program jumps out of the delay loop. And the program stops the paper ribbon feed by loading CRA with 3C ($b_3 = 1$), which makes CA2 go high. The delay-loop accumulator values depend on the system clock frequency—in this case ≈ 875 kHz.

The printer done flag (#\$29) is then set by a jump to another service subroutine before the MPU is returned to the program flow where the interrupt occurred.

Printer operation is asynchronous

The printer timing signals are asynchronous with respect to the MPU clock. Hence if the printer interrupt is enabled immediately following an interrupt, it could take nearly two full print drum rotations, or approximately 1.5 s, to print a line of text. This is a relatively long period for MPU processing time. If the printer requires continuous control during this period, it would be impractical in many applications. Fortunately the printer signals may be used to interrupt the MPU briefly while it is performing other tasks. This interrupt-driven approach will be clarified as more of the control program is described.

The printer-interrupt service routines are de-

signed for the MPU to resume other system tasks shortly after each printer interrupt is serviced. The relationship between the printer signals and MPU activity is shown in Fig. 8. The approximate time during which the MPU is busy servicing the printer is indicated by the cross-hatched area that follows each allowed interrupt. Use of this interrupt-driven approach involves intervention by the MPU for less than 30 ms out of each 850 ms print cycle.

Program loop selects the hammers

The majority of the time is used during the Print Service routine, PRNTIT. Printer operation requires that the selected print hammers be engaged only during the time between TP_n and TL_n . The PRNTIT routine selects the hammers that are required during a given interval and causes them to engage and disengage at the required times. Most of the processor time (approximately 0.6 ms following each TL pulse) is spent determining which hammers should be engaged during the next interval.

In Fig. 8, $TL_{4,1}$ will be the first CB1 transition after PRNTIR has enabled CB1 to be negative-edge sensitive. $TL_{4,1}$ will cause the IRQB line to go low and therefore interrupt the MPU in the same way as before. The exception, this time, is that the IRQB flag is set by CB1. The interrupt sequence will jump to PRNTIT (Fig. 6c) instead of PRNTIR.

Again, the first thing is to have the processor clear the IRQB flag and the IRQ line by reading ORB (XPIDRB). Then lines 910 to 940 test b_1 of register CRB to determine whether the CB1 input to the PIA was positive or negative-edge

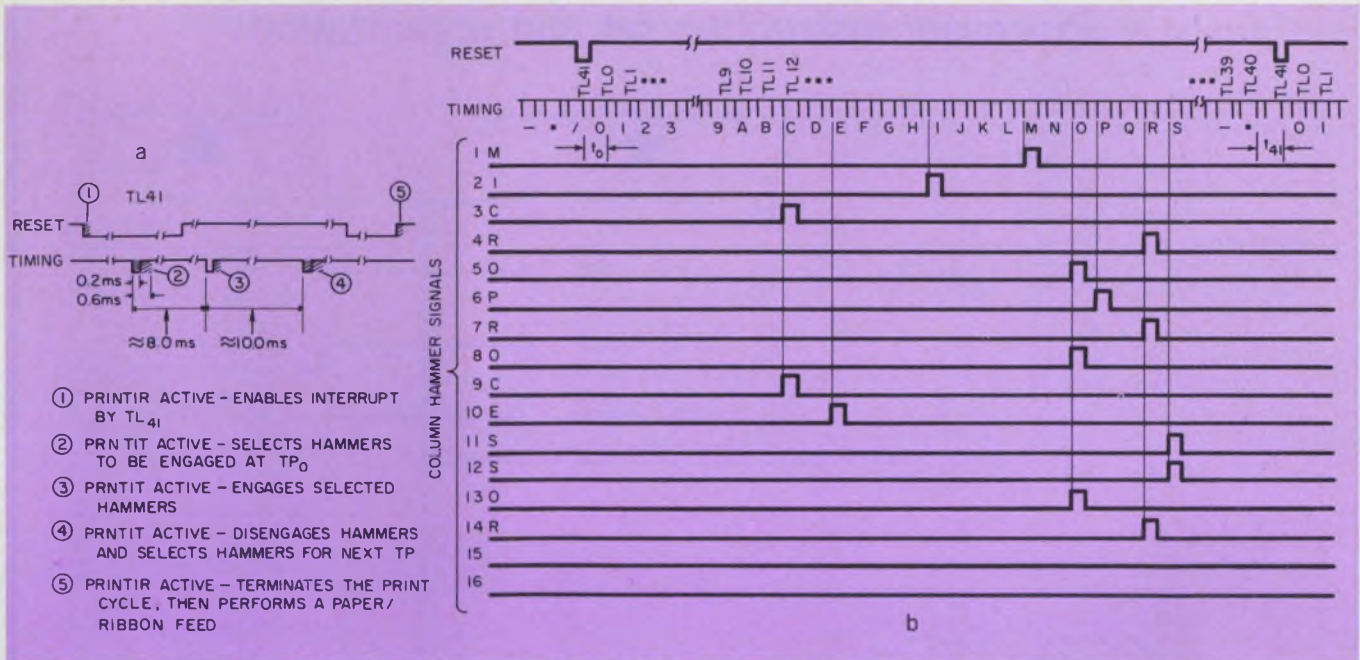

8. The printer routines operate asynchronously with the printer. Interrupts from the RESET and TIMING lines provide the necessary activation (a). A complete print

cycle takes 850 ms but consumes less than 4% (30 ms) of MPU time. Print cycle timing for the word "micro-processor" is shown in b.

sensitive, as follows:

- If $b_1 = 0$, CB1 was a negative transition. And the program branches to PKSCN2 (line 1030), which loads the index register with the current character file (CF) address pointer. The scan loop follows and will be described further on (Fig. 7).

- If $b_1 = 1$, CB1 was a positive transition; namely, a TP timing pulse. This means that the hammers must now be strobed. Before this is done, the CA1 is enabled (lines 950 to 970) to allow the next positive reset transition at CA1 to signal the end of the print cycle. The hammer strobe is then armed to be set low on the next Write in ORB by having the processor store $\#\$25$ in CRB (lines 980 and 990). This combination of b_3 , b_1 and b_5 also returns CB2 high on the next CB1 interrupt at TL. The eight data bits set by the previous scan loop for the B side outputs are then stored in ORB (lines 1000 and 1010), causing CB2 to go low. The strobe inputs on the driver AND gates go high and activate the hammer whose data lines have been set high. Line 1020 returns control to where the interrupt occurred.

The scan loop, PKSCAN, is the actual data-processing section of the program. The column counter (Accumulator B) is cleared and the current character-file character stored in the test buffer (lines 1080 to 1100). The next character-file character address is then stored (lines 1110 to 1120) to initialize the next loop. The first text character address is loaded into the index register before the start of the scanning process.

The first instruction (see table) in the actual loop (line 1140) compares the column count with $\#\$10$ (decimal 16) to see if the last character of text has been checked. If it has, the program enables an interrupt by the next positive timing-pulse transition (lines 1160 to 1170) and returns control to the executive program. If the last text character has not been tested, the program branches to PVNXT1. Line 1190 loads accumulator A (ACCA) with the text character corresponding to the present column counter value. The next two lines determine which output register is to be written into. If the column count is ≥ 8 , it will be ORA; if < 8 , ORB. The text character previously stored in ACCA is compared with the current character file (CF) character (lines 1220 to 1280 for ORB; lines 1290 to 1340 for ORA). The carry bit is set if both are equal; it is cleared if they are not. The carry is then shifted into the ORA or the ORB buffer with the ROL instructions on line 1270 for side B and line 1340 for side A (since a Write into ORB is required to activate CB2, the data are stored in a buffer until the time for hammer activation).

When the shift has been completed, the column counter and text address pointers are incremented (lines 1350 and 1360). Then a branch is executed to the start of the loop.

This control operation might appear slow and cumbersome. However, during an actual print operation, less than 4% (30 ms out of 850 ms) of the MPU's capability is really used.

Combined with the fact that only 20 conven-

Processor instruction set and organization

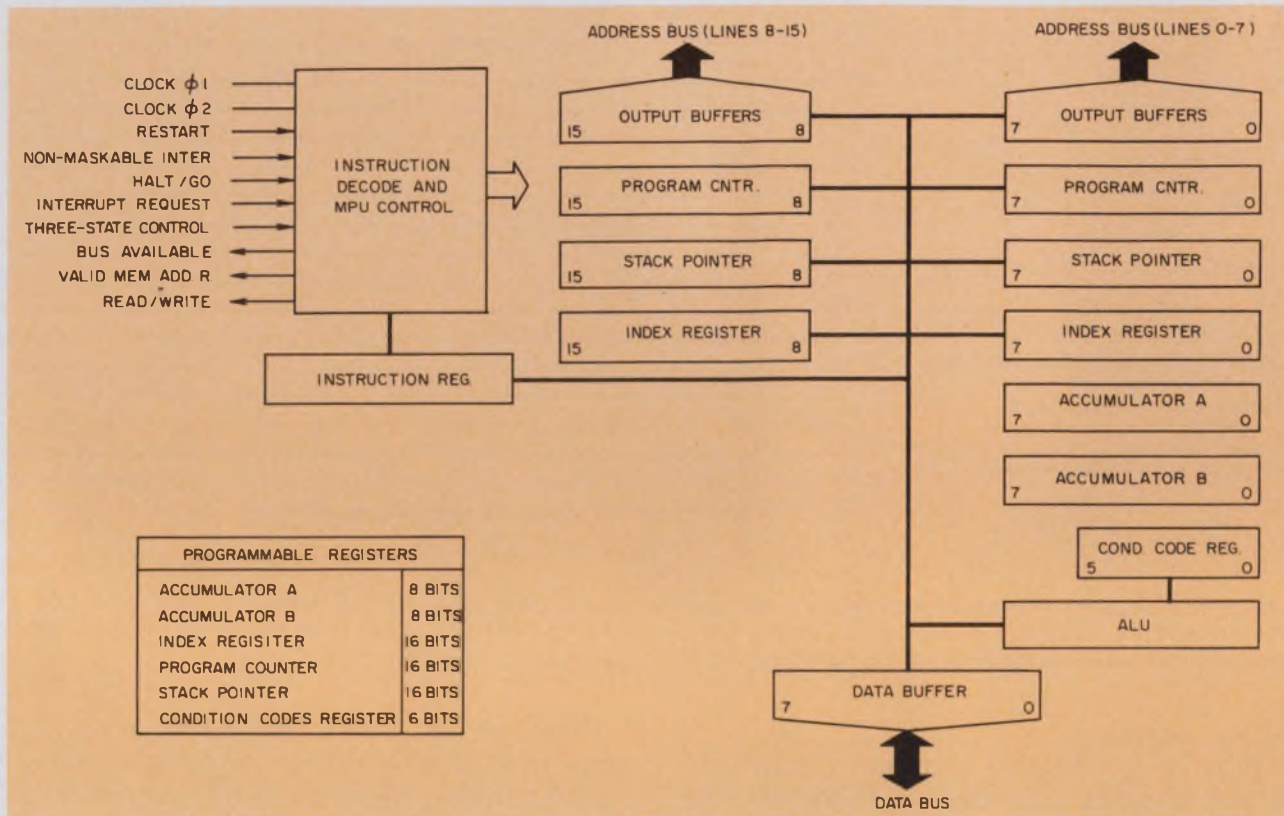

| | | | |
|-----|---------------------------------|-----|--|
| ABA | Add accumulators | INC | Increment |
| ADC | Add with carry | INS | Increment stack pointer |
| ADD | Add | INX | Increment index register |
| AND | Logical and | JMP | Jump |
| ASL | Arithmetic shift left | JSR | Jump to subroutine |
| ASR | Arithmetic shift right | LDA | Load accumulator |
| BCC | Branch if carry clear | LDS | Load stack pointer |
| BCS | Branch if carry set | LDX | Load index register |
| BEQ | Branch if equal to zero | LSR | Logical shift right |
| BGE | Branch if greater or equal zero | NEG | Negate |
| BGT | Branch if greater than zero | NOP | No operation |
| BHI | Branch if higher | ORA | Inclusive or accumulator |
| BIT | Bit test | PSH | Push data |
| BLE | Branch if less or equal | PUL | Pull data |
| BLS | Branch if lower or same | ROL | Rotate left |
| BLT | Branch if less than zero | ROR | Rotate right |
| BMI | Branch if minus | RTI | Return from interrupt |
| BNE | Branch if not equal to zero | RTS | Return from subroutine |
| BPL | Branch if plus | SBA | Subtract accumulators |
| BRA | Branch always | SBC | Subtract with carry |
| BSR | Branch to subroutine | SEC | Set carry |
| BVC | Branch if overflow clear | SEI | Set interrupt mask |
| BVS | Branch if overflow set | SEV | Set overflow |
| CBA | Compare accumulators | STA | Store accumulator |
| CLC | Clear carry | STS | Store stack register |
| CLI | Clear interrupt mask | STX | Store index register |
| CLR | Clear | SUB | Subtract |
| CLV | Clear overflow | SWI | Software interrupt |
| CMP | Compare | TAB | Transfer accumulators |
| COM | Complement | TAP | Transfer accumulators to condition code reg. |
| CPX | Compare index register | TBA | Transfer accumulators |
| DAA | Decimal adjust | TPA | Transfer condition code reg. to accumulator |
| DEC | Decrement | TST | Test |
| DES | Decrement stack pointer | TSX | Transfer stack pointer to index register |
| DEX | Decrement index register | TXS | Transfer index register to stack pointer |
| EOR | Exclusive or | WAI | Wait for interrupt |

tional ICs are being replaced, this seems to indicate that the control of such printers is a trivial task for high-performance microprocessors. But the MPU controls seven to 10 other peripheral devices while it performs the executive function. And control of the printer is accomplished with

a minimum of additional expense in hardware (200 bytes of ROM) and engineering development time. In addition many of the chips in the example are alternate-sourced. American Microsystems (Santa Clara, CA) plans to alternate-source Motorola's MC6800 family by early 1975. ■■

Microprocessor coding for printer control

Assembly listing fields

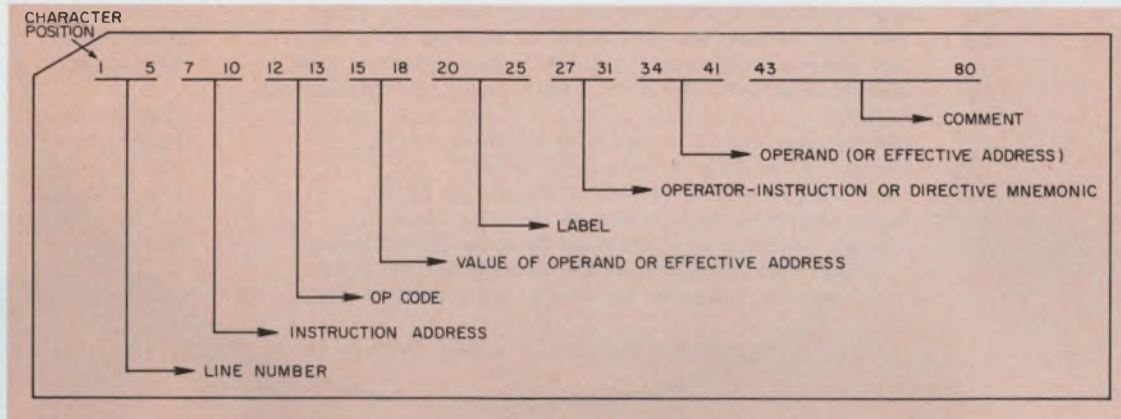

Assembly listing

```

PKIPRT
00280
00300 7C4C 7F 8009  ** INITIALIZE PRINTER PIA
00310 7C4F 7F 800B  PKIPRT CLR  XPICRA
00320 7C52 4F      CLR  A
00330 7C53 43      COM  A
00340 7C54 B7 800B  STA  A  XP1DRA  SET PIA DATA LINES AS OUT
00350 7C57 B7 800A  STA  A  XP1DRB
00360 7C5A 86 3C    LDA  A  #30C    SET PIA CONTROL REGSTRS TO
00370 7C5C B7 8009  STA  A  XP1CRA  DISABLE OUTPUTS
00380 7C5F B7 800B  STA  A  XP1CRB  AND SET INTRPT MASKS
00390 7C62 B6 800B  LDA  A  XP1DRA  READ DATA RGSTRS TO CLEAR
00400 7C65 F6 800A  LDA  B  XP1DRB  INTRPTS AND FLAGS
00410 7C68 39      RTS

00070 7CA5 CE 7E8B  LDX  #PKCF00  INT'L CF POINTER
00080 7CAB DF D7    STX  PVX&FR
00090 7CAB F6 800A  LDA  B  XP1DRB  CLR PPREV TIMING INTRPTS
00100 7CAD C6 3D    LDA  B  #33D    SET CB1 TO INTRPT ON NEXT
00110 7CAF F7 800B  STA  B  XP1CRB  NEG TIMING PULSE
00120 7CB2 3B      RTI

PRNTIT
00280
00300 7C63 F6 800A  PRNTIT LDA B XP1DRB CLR INTRPT AND FLAG
00310 7C66 F6 800B  LDA B XP1CRB TEST IF CB1 IS A POS
00320 7C69 C5 02    BIT B #302    OR NEG INTRPT
00330 7C6B 27 13    BEQ  PKSCN2   NEG, GO SCAN
00340 7C6D B6 800B  LDA A XP1DRA POSITIVE, PRINT
00350 7C6E 86 3F    LDA A #33F   CLR PPREV RESET INTRPT
00360 7C6F 87 8009  STA A XP1CRA SET CA1 TO INTRPT ON NEXT
00370 7C70 C6 25    LDA B #325   POS TRANS OF RESET PULSE
00380 7C71 F7 800B  STA B XP1CRB PRINT CHAR NOW UNDER HAMMERS
00390 7C72 D6 DA    LDA B #F1DRB CB2 LOW, HI NEXT NEG CB1
00400 7C73 F7 800A  STA B XP1DRB GET SIDE B OUTPUT INFO
00410 7C74 3B 800A  RTI          STORE IT AND START PRINT
00420 7C75 DE D7    PKSCN2 LDX  PVX&FR  RETURN - WAIT FOR NEXT SCAN
00430 7C76 39      LOAD CURRENT CF POINTER

PKNTRL
00430
00440
00450
00460
00470
00490 7C69 B6 800B  PKNTRL LDA A XP1DRA CLR PREV. RESET INTRPTS
00500 7C6C 86 3D    LDA A #33D   SET CA1 TO INTRPT ON NEXT
00510 7C6E B7 8009  STA A XP1CRA NEG TRANS OF RESET
00520 7C71 01 29    LDA A #29    RETURN - WAIT FOR START INT
00530 7C73 BD 6309  JSR  XKRSTF  CLEAR PRINTER DONE FLAG
00540 7C76 39      RTS

PRNTIR
560
570
590 7C77 B6 800B  PRNTIR LDA A XP1DRA CLR INTRPT AND FLAG
600 7C7A B6 8009  LDA A XP1CRA TEST IF CA1 POS OR NEG
610 7C7D 85 02    BIT A #302   INTRPT
620 7C7F 27 1F    BEQ  PKSCN1  NEG, GO INT'L SCAN LOOP
630 7C81 C6 3C    LDA B #33C   TRUE, PPR/RBN FEED
640 7C83 F7 800B  STA B XP1CRB DISABLE HAMMERS;INTRPT MASKED
650 7C86 86 34    LDA A #334   START PPR/RBN FEED;INTRPT M
660 7C88 B7 8009  STA A XP1CRA DELAY LOOP = 36 MILLISECOND
670 7C8B 86 48    LDA A #338   #CYCLES=ACCA*(ACCB)3+5
680 7C8D C6 92    PKTG01 LDA B #392 FOR A 1MHZ CLOCK
690 7C8F 5A      PKTG02 DEC B
700 7C90 26 FD    DEC A  PKTG02 LET ACCA = $48
710 7C92 4A      BNE A ACCB = $48
720 7C93 26 F8    BNE  PKTG01  LOOP
730 7C95 86 3C    LDA A #33C   STOP PPR/RBN FEED;INTRPT MSKD
740 7C97 B7 8009  STA A XP1CRA
750 7C9A 86 29    LDA A #329   SET PRINTER DONE FLAG 29
760 7C9C BD 6303  JSR  XKSETF  RETURN
770 7C9F 3B      RTI
780 7CA0 86 3C    PKSCN1 LDA A #33C MSAK CA1 INTRPT
790 7CA2 B7 8009  STA A XP1CRA

```

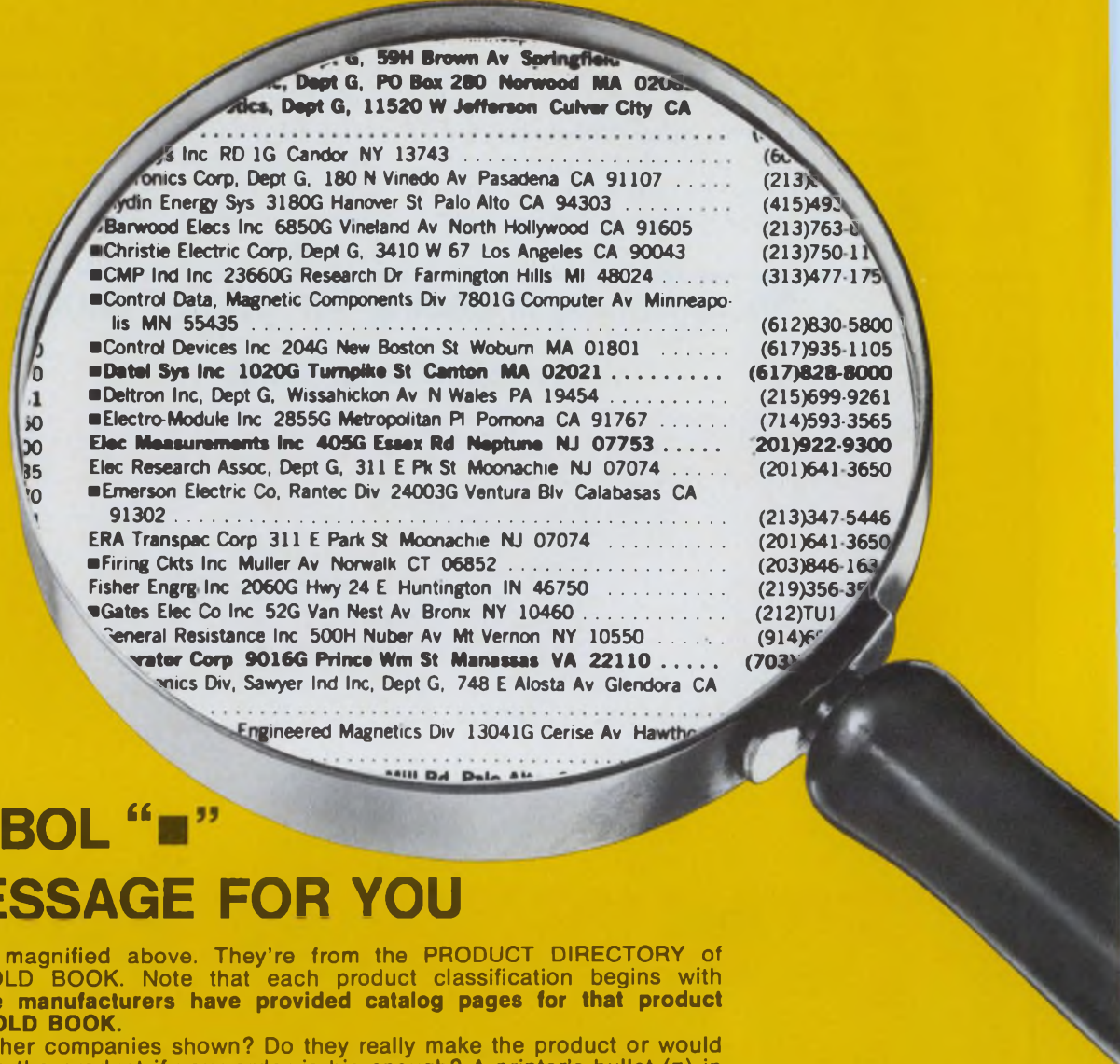

THIS SYMBOL "■" HAS A MESSAGE FOR YOU

Look at the listings magnified above. They're from the **PRODUCT DIRECTORY** of *Electronic Design's* **GOLD BOOK**. Note that each product classification begins with boldface listings. **These manufacturers have provided catalog pages for that product in vols. 2 or 3 of the GOLD BOOK.**

But what about the other companies shown? Do they really make the product or would they merely *like* to make the product if your order is big enough? A printer's bullet (■) in front of its name means that the company has submitted printed literature on that product to the editors of the **GOLD BOOK**. It's reasonable to assume that these suppliers actually make the product, for its not likely that a supplier would prepare literature for a product he can't ship. The bullet ■ gives you a measure of verification.

Manufacturers listed in boldface in the second sub-group have provided catalog pages, but not for the specific product heading the list.

In a constantly moving industry, these measures of verification are of course subject to change. Yet they can be helpful guides as you seek out potential suppliers.



Electronic Design's **GOLD BOOK** BIGGEST AND BEST ELECTRONICS MASTER CATALOG & DIRECTORY IN THE WORLD

King; 94107; (415)986-
 SUPPLY CO ; (415)431-6300
 SIS ; (415)391-8776
 MARKING EQPT CO 533 Mission St; (415)397-
 ELECS 1444G Market St; 94102; (415)626-1444;VN
 Zachariah president

SAN JOSE
 AMFAC ELEC SUPPLY CO ; (408)298-5800
 ASTRONICS 560G Hyde Pk Dr; 95136; (408)578-6223;M
 Hecht president
 Dr; CALVERT ELECS INTL PO Box 5066; 95150; (408)247-
 4700
 (714) CB SLS F CALIFORNIA 1275 Bryan Av; 95118; (408)265-
 6096
 CONSOLIDATED PARTS INC ; (408)294-2302
 DUNLAP ELECS, DEPT G, 970 S Bascom Av; 95128;(408)
 287-2627;B Hill br mgr
 WW GRAINGER INC, DEPT G, 1260 N 13 St; 95112;(408)
 288-9160
 GRAYBAR ELECTRIC CO, DEPT G, 1376 N 10 St; 95103;
 (408)292-9090
 ITT JENNINGS 970 Mc Laughlin; 95116; (408)292-4025
 92123; JAMES ELEC TOOL CO ; (408)272-1818
 MILLERS ELEC SUPPLY 522 S Bascom Av; 95128; (408)
 295-6818
 PENINSULA LEC SUPPLY INC 980 S 1 St; 95110; (408)
 294-3594
 QUEMENT ELECS, DEPT G, 1000 S Bascom Av; 95128;
 (408)998-5900;B Quement president
 WALSH ELEC 1419 A Foyworthy Ave; 95118; (408)265-
 0340

SAN LEANDRO
 ASSOC ; (415)483-9616
 CON INC 14302 Wicks Blv; 94577; (415)351-2716
 SUPPLY CO ; (415)357-2211
 ENGRG 2081 Edison Ave; (415)635-3831

SANTA FE
 (805)528-1598

BELL ELECTRIC
 BROWNELL ELEC INC
 CALVERT ELECS INC 290
 4700
 COMPUMECH 2938G Scott Blv; 951
 Richards president
 FISHER SWITCHES INC ; (408)244-6182
 MOLTRONICS 337 Mathews St; (910)338-0036
 NOVA TRONIX ; (408)243-9530
 SOLID STATE TECHNOLOGY 3650 Charles; 950-
 247-8620
 STRUCTURAL TECHNOLOGY 2550 Scott Blvd; 92-
 (408)241-5102

SANTA CRUZ
 SANTA CRUZ ELECS INC 718 Frederick; 95060; (408)423
 1140

SANTA FE SPRINGS
 DYNAMICS ELEC PRODS INC ; (213)945-2493
 HY CAL ENGRG 12105 Los Nietos; 90670; (213)698-7785
 MCMASTER CARR SUPPLY ; (213)945-1311

SANTA MARIA
 VALLEY ELECTRIC CO 901 S Blosser Rd; 93454; (805)
 Wa5-9585

SANTA MONICA
 AIR SUPPLY CO ; (213)829-1781
 ALVARADIO IND INC 2105 Colorado St; 90404; (213)828-
 0385
 DISTRIBUTOR SPECIALISTS ; (213)829-5401
 IFR AVIONICS 2701 Airport Av; 90405; (213)390-3409
 MASTER DISTRIBUTORS, DEPT G, 1553 17 St; 90
 (213)395-2637;K Nizam president
 SHELLEY FRANK ELEC ; (213)392-3913
 TEXAS INSTRUMENTS SUP CO 1651 10Th; 90
 393-6731
 TRANS TEL IND LTD 2180 Colorado Av
 828-6808

SANTA ROSA
 F PLANTE ELEC INC 423 47

SAUSALITO
 PHILIP

LOOKING FOR A DISTRIBUTOR NEAR YOU?

Distributors are listed 3 ways in *Electronic Design's GOLD BOOK*:

1. IF YOU KNOW THE MANUFACTURER, you will find his U.S. distributors included under his listing in the MANUFACTURERS DIRECTORY. Name, city, and phone numbers are provided.
2. IF YOU KNOW THE DISTRIBUTOR'S NAME, you can find his complete address, zip, and phone number in the *alphabetic section* of the DISTRIBUTORS DIRECTORY. In most cases annual sales volume or net worth, year established, and names of key officials are included.
3. IF YOU WANT TO FIND OUT WHICH DISTRIBUTORS ARE LOCATED NEAR YOU, check the *geographical section* of the DISTRIBUTORS DIRECTORY. You enter the section by state, then find your city — or one nearby — and the distributors located in that city. You can then go back to the *alphabetic section* to learn more about them.

Electronic Design's GOLD BOOK

BIGGEST AND BEST ELECTRONICS MASTER CATALOG
 & DIRECTORY IN THE WORLD

'Meet' the applicant before talking to him.

Prepare for those in-depth job interviews by learning how to study the engineer through his resume.

Hiring an engineer happens to be one of the most important and difficult challenges a manager is likely to face; yet few managers know how to interview applicants in the depth that's required to get qualified staffers.

In selecting many engineers over a period of years, I've learned that the future isn't in the job, unless it's in the man. This means that the interviewer must not only study the candidate during the interview, but also through his resume and get to know him as well as possible before interviewing him in person.

Getting to know you

Questions I ask myself when I look at a resume are:

- *What is the applicant's relevant experience?* I remember one time I hired an engineer with a Ph.D. in electronic engineering to design circuits, and he was useless. He had eight years of schooling and four years of theoretical engineering, and he just couldn't make anything work. Moral? Pay particular attention to the theoretical-vs-practical experience ratio; this ratio must be compatible with the requirements of the position. The only exception is hiring someone with long-term potential.

- *Is his current salary compatible with his experience level?* If I talk to an engineer who has been out of school four years and who's making \$22,000, I tend to think that he has missed his calling; maybe he's a better politician than he is an engineer. It could be he worked for a company with a fat Government contract that needed a high-priced guy to fulfill the contract and they jacked up his salary to fill the breach. I think a graduate designer pulls down about \$12 k in a small company and about \$13 k in a large company. A good circuit designer with eight years of experience should get between \$18,000 and \$20,000 a year.

- *Does the resume reflect an ability to com-*

municate ideas? When I read a resume that says that Joe Engineer "was instrumental in helping the engineering department achieve growth quotas," I still don't know what he did. A good resume is the one that makes me feel I've actually talked to the guy after I've read it.

- *Is the resume too "slick"?* Does it look like it may have been prepared by a professional resume writer or that the candidate is attempting to oversell himself? If the typing is perfect and the English is flawless and full of industry cliches, I suspect that the applicant hired a professional to write his resume. If the engineer is a good prospect, I'll call him and talk to him for awhile. If he can write that well, he should be able to articulate as well verbally. Even if he didn't write his own resume, I wouldn't reject him automatically. Engineers, like everyone else, can accept poor advice.

- *What is the average length of time of his employment with current and former employers?* According to a Government manpower study, the ideal length of service is two to seven years. A shorter period than two years tends to indicate a lack of ability to identify with an organization and its objectives. Periods in excess of seven years show a lack of ambition and drive. The average tenure for electronic engineers is about three years nationwide.

This rule of two to seven years should be used with great care; many a good engineer has changed positions more often than every two years because of circumstances beyond his control. One could say, I suppose, that if the engineer repeatedly falls into situations that don't work out, that his judgment is suspect.

- *Is the applicant's educational background commensurate with experience and the new position?* A Ph.D. in theoretical physics is about as unrelated to circuit design as is a Ph.D. in history. There are exceptions to this rule; the best circuit designer I ever met was self-taught.

The protocol of buying and selling

A well-conducted personal interview is the clincher in the successful acquisition of engineers.

Alan J. Rider, Engineering Consultant, Reston Consulting Group, Reston, VA 22091.

Alan J. Rider



Alan Rider is one of those engineers who has involved himself in more than engineering during his career. He has spent much of his time designing and inventing, but he has also been a manager, a manufacturer's rep and a company founder—twice.

Before he came out of his engineering cocoon, he'd spent five years at a Naval research laboratory designing instrumentation for basic underwater sound studies, and another two years developing and producing optical character readers at Control Data. Then he went into management working as an engineering supervisor at NAVCOR, where he was responsible for the development of special proposals of analog and digital systems, plus product development of analog and digital systems, and product development of analog-to-digital converters and function modules. Later, Acuity Systems Corp. hired him as V.P. of Engineering and there he co-

invented and developed an automatic eye refraction device to aid doctors in preparing eye glass prescriptions. At one point along the line, Rider also worked as a manufacturer's representative. For three years he sold electronic system components, magnetic tapes and core memories.

To develop low-cost optical recognition terminal equipment he founded Recognition Terminals, Inc. Now he has formed the Reston Consulting Group that specializes in engineering management consulting, management training, management studies, documentation systems and production engineering.

Rider is married, has two children, and when asked if he has a hobby, answers, "any man who owns a house these days can keep himself busy mowing the grass, fixing the plumbing, and so on, without looking for any other extracurricular activity."

The objective, of course, is to gain enough information about the candidate to ensure an accurate prediction of his ability to fulfill the requirements of the position.

Many people conducting an interview don't act in a manner consistent with that objective. The protocol of the employee-selection process calls for the potential employer to assume first the role of seller and the candidates that of buyer. This is the advertising and initial contact phase. Upon selection of one or more potential candidates, the roles reverse; the candidates become the sellers, and they must sell themselves. When a candidate is chosen, the roles reverse again; the company must sell him on joining the staff.

A thorough understanding of this protocol is important. Too often the interviewer is impressed with the applicant's credentials, or he has an urgent engineering need and assumes the seller's role during the interview. The end result is that the interviewer has not learned enough about the applicant to make a wise prediction.

If you have done a super job of interviewing the candidates and then made a wise choice, you probably won't have to sell your choice on joining you—your competence will already have done the job.

Let the applicant do the talking

I always make it clear to the applicant that the purpose of the interview is to learn a great deal about him and that he is to do 80% of the talking. The interviewer is not learning anything about the candidate while he himself is talking. Usually in this situation, he is selling when he shouldn't be.

Having an interview is a traumatic experience for most people, and as we are discussing the hiring of engineers, and not politicians, who must be able to react quickly under pressure, some effort must be made to relax the applicant. I generally provide him with a soft drink or a cup of coffee and engage him in small talk for a few minutes.

In addition I explain that it is our policy to have all likely candidates visit the company at least twice. This helps relieve some of the pressure on both parties. The applicant knows that the one interview is not an all-or-nothing affair, and the interviewer has a longer time to choose his candidate.

Next, I explain to the applicant that I consider his knowledge to be a set of "N" vectors and that I am interested in the magnitude of those pertinent to the position to be filled. A list of pertinent vectors and their relative magnitudes must

be prepared beforehand and used as a guide throughout the interview. Obviously the basis for this list is the position description.

Every engineer must understand thoroughly and use with facility the basic tools of his trade. Logic designers must know Boolean algebra, minimization methods, NAND logic and asynchronous circuits. Circuit designers must know time-and-frequency-domain analysis and passive-and-active-circuit analysis. Each must be familiar with the basic components used by his specialty and also with device parameters and what companies manufacture them.

In search of knowledge

I conduct interviews with the "N" vectors concept in mind. To learn the magnitude of the knowledge vector, I start off by querying at a level that I believe anyone with the applicant's experience should be able to cope with. Then I ask increasingly difficult questions in search of the magnitude of his knowledge.

With a little skill in this technique, you will find that there need not be a progression of increasingly difficult questions. Rather, depending upon the ease with which the first question was answered, you can often jump ahead. Occasionally you will go too far and then you have to backtrack. The object is to determine the magnitude of the candidate's knowledge.

Some attempt to determine the applicant's relevant aptitudes should be made. Unfortunately engineering schools graduate many men and women who have little aptitude for engineering and who will never be successful engineers.

Most engineers generally do some maintenance on their cars and home appliances. They are not satisfied with the workmanship performed by tradesmen. In addition the engineer interested in his profession will faithfully read trade journals in depth.

Two of the major reasons why engineers turn down job offers are these: (1) Lack of understanding of the responsibilities, and (2) Lack of understanding of exactly what will be expected of them. Both of these unknowns generate a subconscious fear.

To help ensure that the good candidate will join your company, give him a copy of the job description and a professional critique of his knowledge vectors as they relate to the position. Emphasize the strong points he will bring to the position and how the job will help him on his weak points. The critique enables the applicant to understand your expectation level as he relates to the position. ■■

WORLD FAMOUS SIMPSON 260

OVER 2,000,000 SOLD

The pace-setting VOM for over 30 years

The finest **260**[®] SERIES 6

NOW... with special Amp-Clamp dial ranges for easy AC current measurements up to 250 amps.

New Amp-Clamp, Model 150 Adaptor. Measures AC current without breaking the circuit being tested. Plugs into the 260—reads directly on the new Amp-Clamp scales. Use with any 250, 260 (Series 3 thru 6) or 270.

Ranges: 0-5, 25, 50, 100, 250 amperes.



260-6, Complete with batteries, test leads and manual **\$74.50**

260-6P (overload protected), complete with batteries, test leads and manual **\$112.00**

260 CARRYING CASES:

Vinyl, DeLuxe #00805 **\$19.35**

Vinyl, standard #01818 **\$16.05**

AMP-CLAMP, Model 150 Adaptor with test lead **\$27.60**

Many other 260 models and accessories to choose from.

GET "OFF THE SHELF" DELIVERY FROM YOUR LOCAL ELECTRONIC DISTRIBUTOR . . . AND WRITE TODAY FOR CATALOG 4300.

KATY INDUSTRIES



SIMPSON ELECTRIC COMPANY

853 Dundee Avenue, Elgin, Illinois 60120
(312) 695-1121 • Cable: SIMELCO • Telex: 72-2416

IN CANADA: Bach-Simpson, Ltd., London, Ontario

IN ENGLAND: Bach-Simpson (U.K.) Limited, Wadebridge, Cornwall

IN INDIA: Ruttonsha-Simpson Private, Ltd., Vikhroli, Bombay



ELECTRICAL EQUIPMENT GROUP

Introducing the V-71. 32K for 8 grand.

Incredible. Getting 32K out of an off-the-shelf mini. Plus the option of a power fail/restart, teletype controller, automatic bootstrap loader for TTY's and real-time clock for only \$800 more*.

It gives us the distinction of being the cheapest computer in the world delivering 32K. And gives you the chance to get a lot more power for your money.

But the V-71 is more than just another piece of bare metal selling at a rock-bottom price (we leave that specialty to others). It—like the entire Varian V-70 family—has been elegantly designed by Varian engineers who think in terms of systems and total concepts.

With additions, the V-71 is capable of a powerful blend of hardware, systems software (the VORTEX operating system), and extensive peripherals. And Writable Control Store if that's what you need.

How much of a system you want to make out of the V-71 is up to you. The raw power is there. And Varian's open-ended architecture makes it easy to add whatever building blocks you need.

If you want more power for less money, check out the new V-71. For further information, write Varian Data Machines, 2722 Michelson Drive, Irvine, CA 92664. Or call 833-2400.

*V-71 price and options based on orders of a dozen.

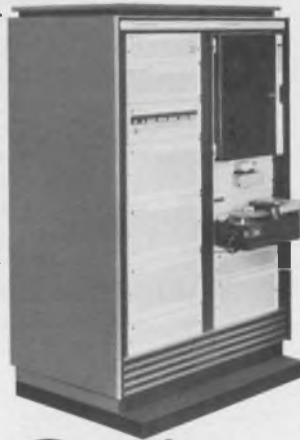

Ferrites from Ferroxcube ...

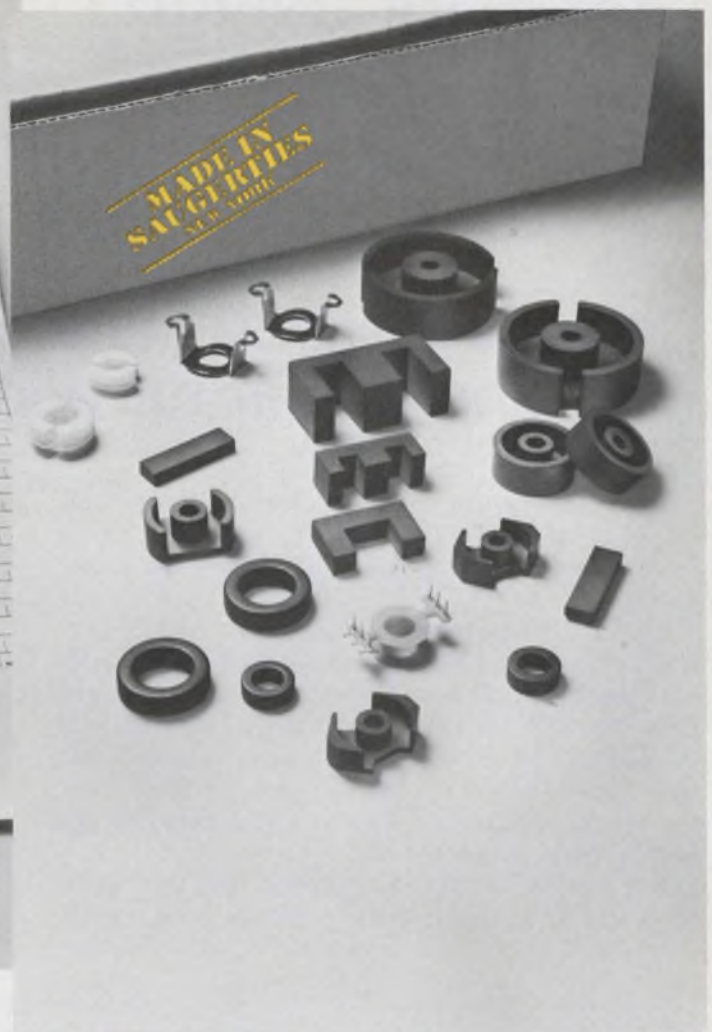
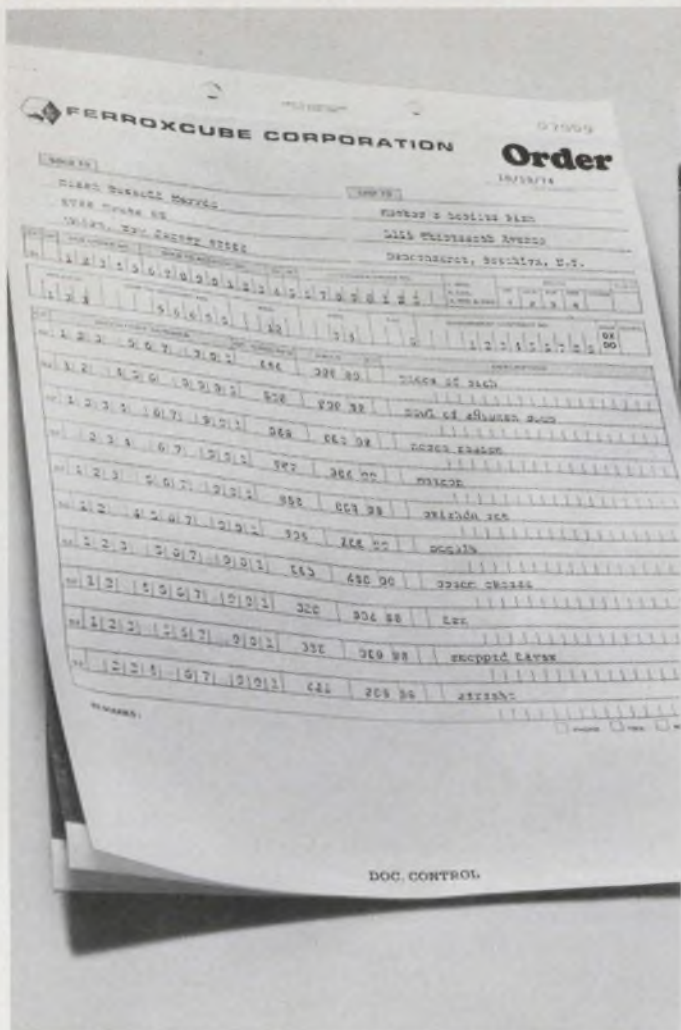

24 hour turnaround

Everything you need in ferrites. All sizes and shapes—pot cores, square cores, toroids, E's, U's, I's, and specials, too—in a variety of performance proved materials including new 3C8 for high flux density applications.

Made in Saugerties. Ferroxcube ferrites are made of the finest materials, in the most modern facilities, to the most rigid specifications, right here in Saugerties, New York. So there are none of the uncertainties of quality and delivery often associated with overseas supply.

Stocked nationwide. Six strategically located distribution points across the nation—in Boston, Saugerties, New York, Philadelphia, Chicago, and San Diego—keep over 50,000,000 ferrites ready and waiting for your order. Almost like having your own on-site supply.

Delivered immediately. With such a complete line of quality product, made domestically, and stocked strategically, your only worry when you order Ferroxcube ferrites may be whether you can get the receiving area open in time. See for yourself.



FERROXCUBE CORPORATION, SAUGERTIES, N. Y. 12477
A NORTH AMERICAN PHILIPS COMPANY

914•246-2811

Distributed through North American Philips Electronic Components Corporation with warehouses in Boston, 617•899-7100; New York, 516•538-2300; Saugerties, 914•246-5861; Philadelphia, 215•836-1616; Chicago, 312•593-8220; San Diego, 714•453-5440

17791

Circuit adds BCD numbers with binary 4-bit full adders

BCD adders are not available in many logic families. A simple BCD adder, however, can be constructed with two 4-bit full adders and a few gates.

Two BCD numbers are added in IC₁, as if they were binary, and the sum is checked by the add-six circuit. If the sum is less than 10, the output from the add-six circuit is a ZERO. If the sum is greater than or equal to 10, a six is added into IC₂. Thus, for sums that are greater than nine, the result is advanced by six, and a carry to the next decade is produced.

For example, if BCD numbers 0101 and 0111, or 5 and 7, are added, the result is 1100, or 12.

Since this result is greater than nine, a six is added, and the resulting 10010, or 18 in binary, becomes a one carry with a weight of 10 and 0010, or 2. This translates to 12 in BCD.

The basic circuit is shown in Fig. 1a. A variation of the add-six gating circuit is in Fig. 1b. Other such gating circuits can be devised from the available gates to achieve the necessary logic.

This circuit can also be used to convert a 4-bit binary number to BCD. In this case the first 4-bit adder, IC₁, is not needed, and the C₀ input to the add-six circuit also is eliminated.

Peter Shkabara, 1320 Oberlin Dr., Glendale, CA 91205.

CIRCLE No. 311

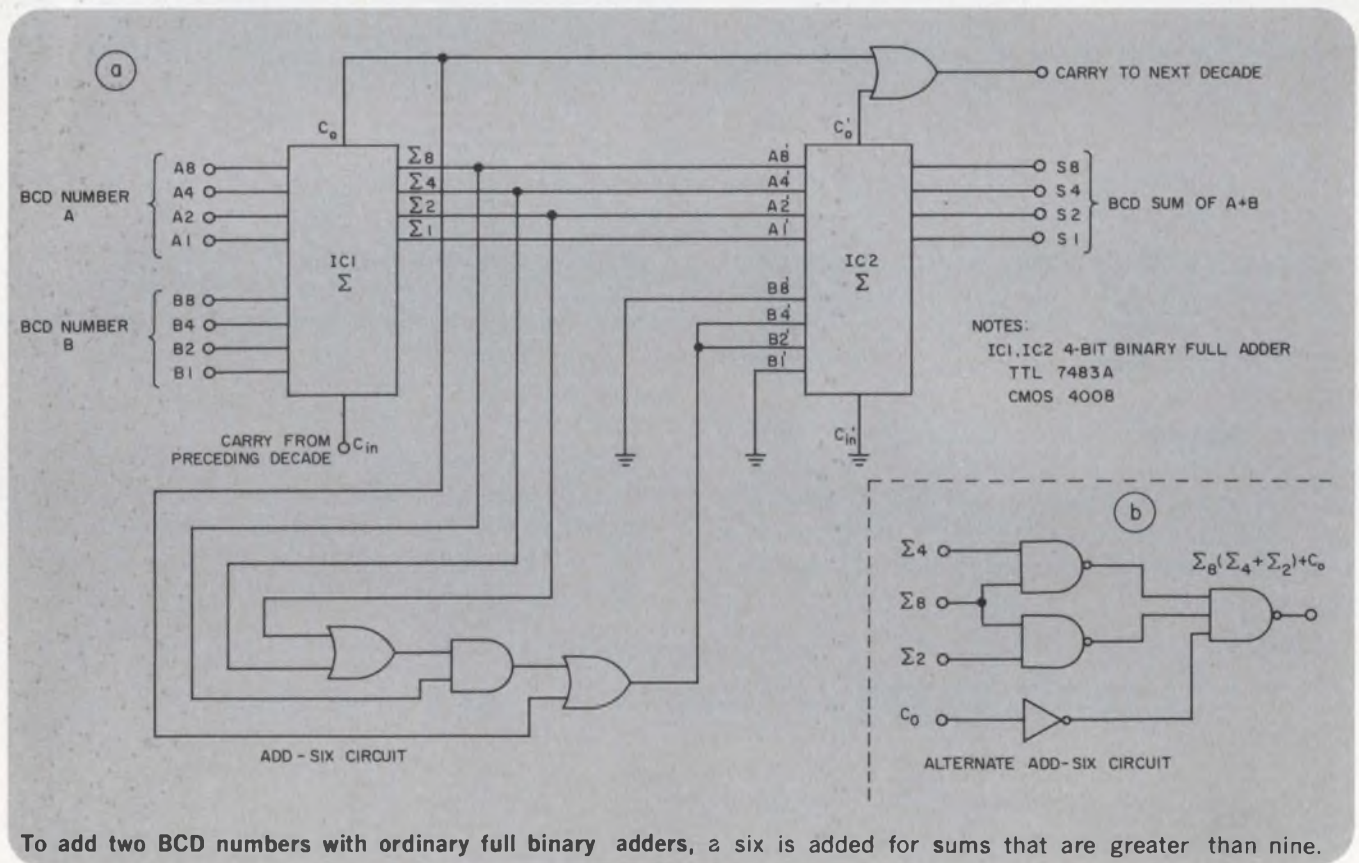

POWER MINI'S FOR CHASSIS MOUNTING

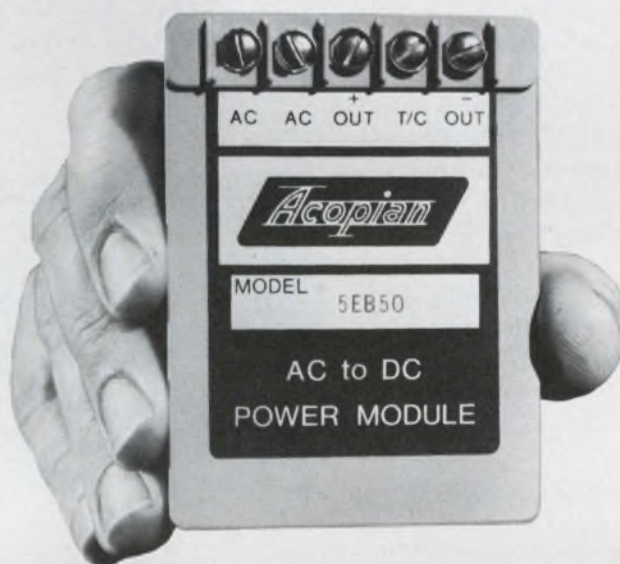

ALL MODELS U.L. RECOGNIZED

| OUTPUT VOLTAGE | OUTPUT CURRENT AMPS. | REGULATION LOAD $\pm\%$ | REGULATION LINE $\pm\%$ | RIPPLE MV RMS | SIZE INCHES LxWxH | PRICE | MODEL |
|----------------|----------------------|-------------------------|-------------------------|---------------|-------------------|----------|---------|
| 5 | .500 | .15 | .05 | 1 | 3.5x2.5x1.38 | \$ 55.00 | 5EB50 |
| 5 | 1.0 | .25 | .05 | 1 | 3.5x2.5x1.63 | 75.00 | 5EB100 |
| 5 | 1.5 | .35 | .1 | 1 | 3.5x2.5x1.63 | 105.00 | 5EB150 |
| 5 | 2.0 | .25 | .05 | 1 | 3.5x2.5x2.38 | 115.00 | 5EB200 |
| 5 | 2.5 | .25 | .05 | 1 | 3.5x2.5x2.38 | 130.00 | 5EB250 |
| ± 15 | .100 | .05 | .05 | 1 | 3.5x2.5x1.38 | 55.00 | DB15-10 |
| ± 15 | .150 | .05 | .05 | 1 | 3.5x2.5x1.38 | 65.00 | DB15-15 |
| ± 15 | .200 | .05 | .05 | 1 | 3.5x2.5x1.38 | 75.00 | DB15-20 |
| ± 15 | .300 | .05 | .05 | 1 | 3.5x2.5x1.63 | 105.00 | DB15-30 |
| ± 15 | .350 | .05 | .05 | 1 | 3.5x2.5x1.63 | 110.00 | DB15-35 |
| ± 15 | .500 | .1 | .05 | 1 | 3.5x2.5x2.38 | 135.00 | DB15-50 |

Input, 105-125 VAC. Other mini power supplies from 1 to 75 volts. Three day shipment guaranteed. Complete details on these plus a comprehensive line of other power supplies and systems are included in the Acopian 1974-75 catalog. Request a copy.



Corp., Easton, Pa. 18042. Telephone: (215) 258-5441.

Up/down counter controls pulse width of a one-shot

The pulse width of a monostable multivibrator can be controlled by numerical data. Applications for such a circuit include the following:

- Variable time delay.
- Display intensity modulator.
- PCM generator.
- Sample-and-hold gate time modulator.

Let's examine a conventional TTL one-shot (Fig. 1). If gate G_2 turns ON when V_2 decreases below 1.6 V, the circuit's pulse width is $T = 0.66 RC$. Thus the period of the monostable can be changed by a variation of resistance R .

However, the allowed change in resistance of R , and hence the change in pulse width, is small. Resistor R must be greater than 200Ω to prevent the overloading of G_1 , and less than 1000Ω to keep G_2 OFF when no trigger input is present. The low resistance limit can be reduced to below 20Ω by the addition of an emitter follower to the output of G_1 (Fig. 2).

Control of the multivibrator's pulse width is achieved by use of a 7442 decoder, which selects one-out-of-10 diode-resistor pairs. The pulse width is then a function of the BCD input to the decoder. This BCD number is derived from the number stored in the counter.

The pulse width, after second-order effects are

taken into account, is given by

$$T = 0.59 [(n+1)R - 30] C,$$

where n equals the number stored in the counter. The 74192 counter allows you to parallel load this BCD number to select the desired pulse width. The counter can count up or down in single steps via its clock input.

The addition of a second emitter follower at the input of G_2 would allow an increase of the upper resistance limit to well beyond 1000Ω and thus a much wider range of pulse-width control.

Dr. Robert Mauro, Assistant Professor of Electrical Engineering, Electrical Engineering Dept., Manhattan College, Bronx, NY 10471.

CIRCLE NO. 312

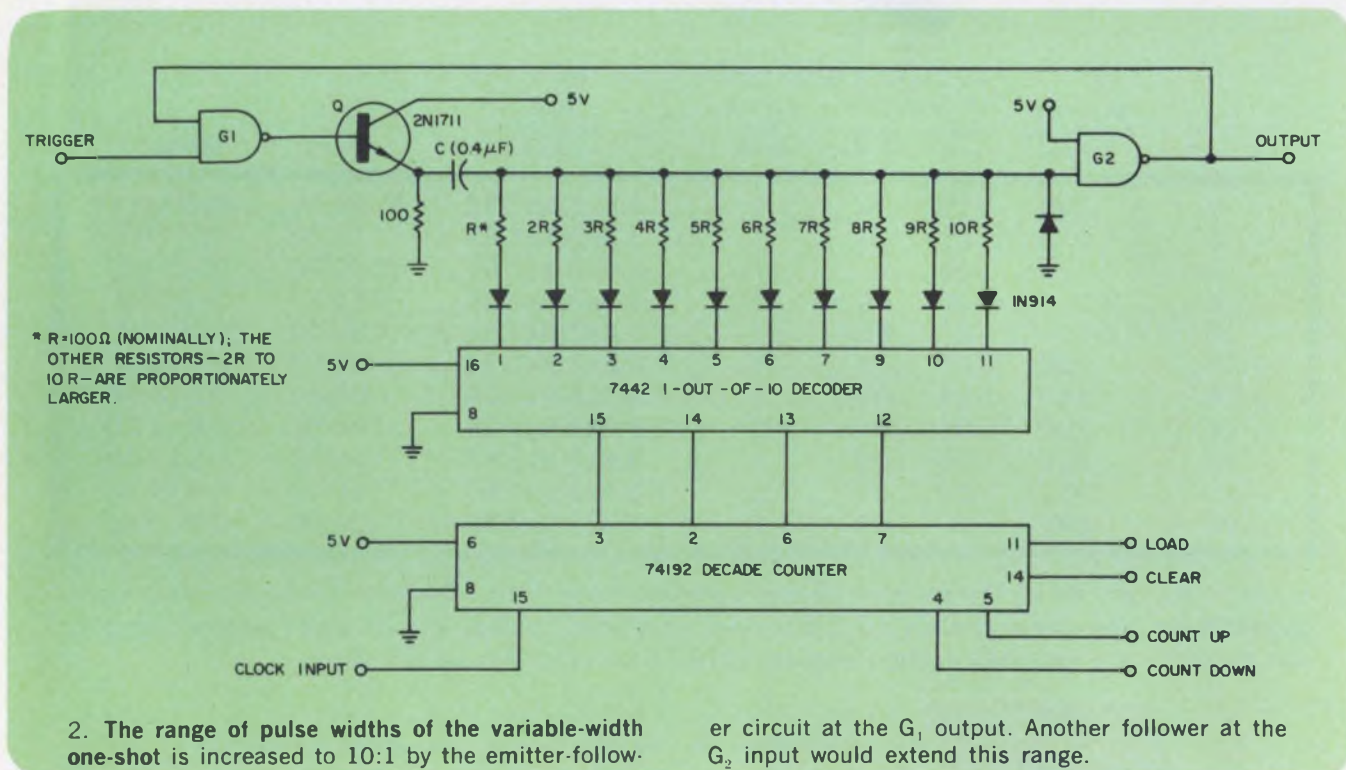
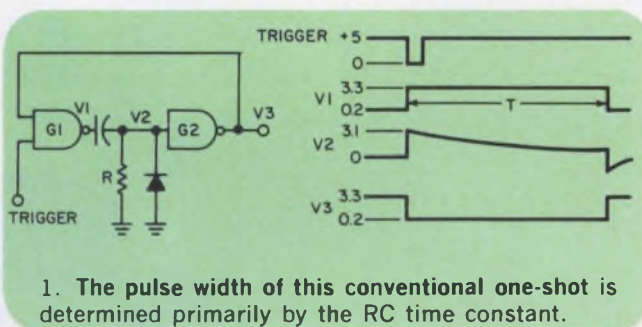

CHOPPER AMP PERFORMANCE AT BIPOLAR PRICES... *it's easy!*

$$V_{OS} - 10 \mu V$$

$$TC V_{OS} - 0.2 \mu V/^{\circ}C$$

$$V_{OS}/Time - 0.2 \mu V/Month$$

$$e_n - 0.35 \mu V p-p$$



NO EXTERNAL COMPONENTS - NO CHOPPER PROBLEMS!

Freedom at last! Freedom from zeroing potentiometers and periodic system recalibrations. Freedom from noisy, expensive chopper amplifiers. Freedom from bulky external components.

New monoOP-07 Ultra-Low Offset Voltage Op Amps combine ultra-low noise, ultra-stable performance

with applications ease and flexibility — at unbelievably low prices. Upgrade system performance, reduce design time, improve MTBF while saving money. The monoOP-07 is a direct replacement for 725, 108A/308A, 741 and most other op amps — they're off-the-shelf at your Precision Monolithics distributor now!

GUARANTEED MIN/MAX SPECIFICATIONS

| | monoOP-07AJ | monoOP-07J | monoOP-07EJ | monoOP-07CJ | |
|-----------------------------|-------------|------------|-------------|-------------|-------------------|
| Temp. Range | -55/ +125 | -55/ +125 | 0/+70 | 0/+70 | $^{\circ}C$ |
| V_{OS} @ 25 $^{\circ}C$ | 25 | 75 | 75 | 150 | μV |
| V_{OS} @ Full Temp. | 60 | 200 | 130 | 250 | μV |
| TCV_{OS} | 0.6 | 1.3 | 1.3 | 1.8 | $\mu V/^{\circ}C$ |
| Long Term Drift | 1.0 | 1.0 | 1.5 | 2.0 | $\mu V/Month$ |
| Noise Voltage (.1 to 10 Hz) | 0.6 | 0.6 | 0.6 | 0.65 | $\mu Vp-p$ |
| CMRR ($V_{IN} = \pm 13V$) | 110 | 110 | 106 | 100 | dB |
| Price @ 100 Pcs. (TO-99) | \$60.00 | \$25.00 | \$15.00 | \$9.95 | • |



1500 SPACE PARK DRIVE, SANTA CLARA, CALIF. 95050
TEL. (408) 246-9222 • TWX 910-338-0528 • CABLE MONO

AUTHORIZED DISTRIBUTORS:

NEW YORK METROPOLITAN AREA Harvey Radio, Westbury, N.Y.: (516) 921-8700 • NEW ENGLAND AREA Gerber Electronics, Dedham, Mass.: (617) 329-2400 • UPSTATE NEW YORK Harvey Federal Electronics, Binghamton, N.Y.: (607) 748-8211 • NORTHEAST Newark Electronics, Woburn, Mass.: (617) 935-8350 • BALTIMORE-WASHINGTON Whitney Distributors, Baltimore, Md.: (301) 944-8080 • PENNSYLVANIA Hallmark Electronics, Huntingdon Valley, Pa.: (215) 355-7300 • Pioneer/Pittsburgh: (412) 391-4846 • MICHIGAN RS Electronics, Detroit, Mich.: (313) 491-1000 • SOUTHEAST Kirkman Electronics, Winston-Salem, N.C.: (919) 724-0541 • EAST CENTRAL Pioneer/Cleveland, Cleveland, Ohio: (216) 587-3600 • Pioneer/Dayton, Dayton, Ohio: (513) 236-9900 • CENTRAL Hallmark Electronics, Elk Grove Village, Ill.: (312) 437-8800 • Minneapolis, Minn.: (612) 884-9056 • St. Louis, Mo.: (314) 291-5350 • TEXAS-OKLAHOMA Sterling Electronics, Houston, Texas: (713) 623-6600 • Dallas, Texas: (214) 357-9131 • SOUTHWEST Sterling Electronics, Albuquerque, N.M.: (505) 345-6601 • Phoenix, Ariz.: (602) 258-4531 • WEST Westates Electronics Corp., Chatsworth, Calif.: (213) 341-4411 • Sunnyvale, Calif.: (408) 733-8383 • Intermark Electronics, Sunnyvale, Calif.: (408) 738-1111 • Denver, Colo.: (303) 936-8284 • Salt Lake City, Utah: (801) 486-3411 • San Diego, Calif.: (714) 279-5200 • Santa Ana, Calif.: (714) 540-1322 • Almac-Stroum, Seattle, Wash.: (206) 763-2300 • Portland, Ore. (503) 292-3534 • CANADA Intek Electronics, Vancouver, B.C.: (604) 324-8831.

INFORMATION RETRIEVAL NUMBER 36

Voltage-tunable active filter features low, high and bandpass modes

You can build a voltage-tunable filter with low-pass, high-pass or bandpass characteristics and variable Q. Just four discrete general-purpose transistors and a few other discrete components are required. The circuit can tune across the whole audio spectrum (20 Hz to 20 kHz) without the need for range switching. The design is particularly suited for electronic-music synthesis.

The circuit uses a standard, noninverting amplifier configuration, as in the simplified diagram of Fig. 1. The three-modes are obtained by the introduction of the signal into three different points of the circuit. An increase in the gain of the amplifier increases the filter's Q. The Q remains almost constant as the filter's cutoff frequency is tuned across the audio spectrum. Cutoff frequency is changed when R_1 and R_2 are varied simultaneously.

In the actual circuit, silicon diodes replace R_1 and R_2 (Fig. 2). The diodes change resistance when their forward bias voltages are changed. The differential-amplifier transistors Q_1 and Q_2 apply the bias voltage in opposing phase to the two RC diode networks in parallel. The opposing phases cancel the control voltage so that the control voltage doesn't appear at the signal output terminal.

The bias effect of the input signal on the diodes is also cancelled, when the signal level across each diode pair is kept below 50 mV.

The noninverting amplifier's transistors, Q_3 and Q_4 , and potentiometer R_3 control the ampli-

fier's gain, and consequently, the Q of the filter. But excessive gain can cause the circuit to oscillate. An op amp can also be used for the non-inverting amplifier.

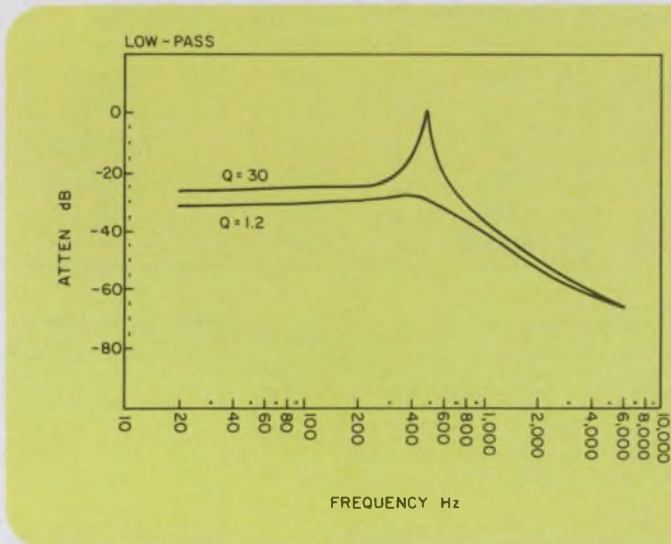
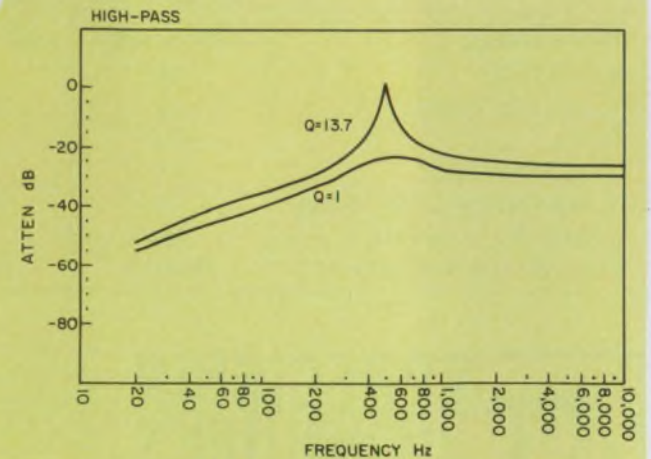
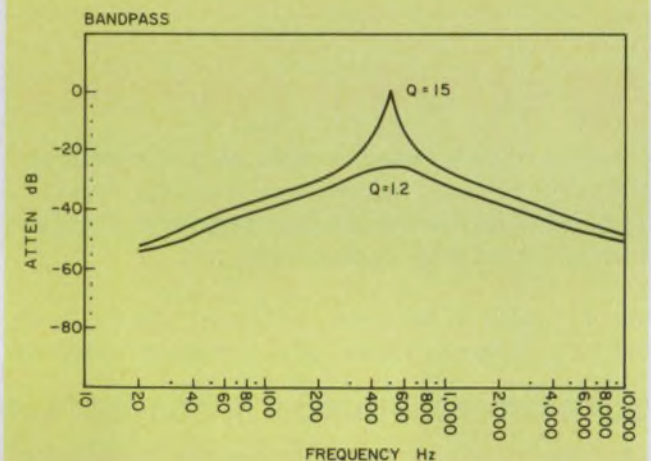
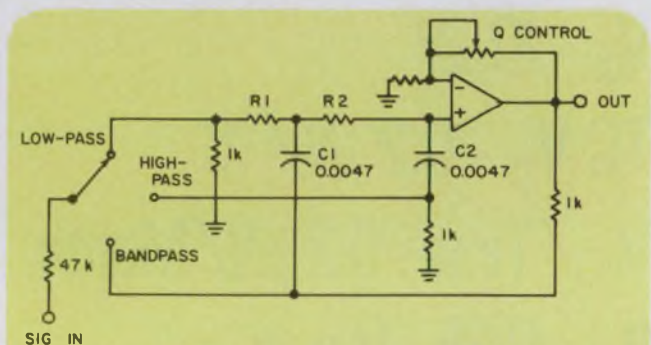

1. To select the filter's frequency-response mode, the signal is applied to one of three different input points, as shown in this simplified diagram.

6 ways you can get design flexibility with Panasonic miniature aluminum electrolytics.

1. Panasonic L Series gives you a complete range of standard miniature electrolytics for commercial, industrial and entertainment use. Wide range, from .47 μ fd to 10,000 μ fd. 6.3 through 100 volts. Available in axial and radial design, with temperature range of -40°C to +85°C. Panasonic L series mini's can be ordered in standard capacitor tolerances of $\pm 10\%$; $\pm 20\%$; or -10%, +75%.

2. Panasonic MS Series can be used to replace larger, more costly mylar capacitors. Their small size reduces space and weight on your PC boards. And because of their extremely low leakage and ESR ratings the MS series can be used to replace dipped tantalums at considerable cost savings. Panasonic MS electrolytics have a capacitance range of .1 μ fd through 100 μ fd, 6.3 to 100 WVDC.

3. Panasonic 2H Series gives you top performance under wide temperature conditions. Temperature characteristics from -55°C to +105°C. They have long product life and are available in radial and axial types. These electrolytics can be ordered in a choice of tolerances; $\pm 10\%$ and $\pm 20\%$.

4. Panasonic 3H Series incorporates very wide temperature range (-55°C to +125°C) and attractive low temperature stability characteristics. The 3H Series can also meet most stringent environmental conditions. Available in axial and radial lead configurations with a choice of tolerances; $\pm 10\%$, $\pm 20\%$.

5. Panasonic Z Series are designed specifically for high stability over a temperature range of -40°C to

+85°C. These miniature electrolytics have exceptionally smooth performance curves for temperature vs. capacitance, temperature vs. impedance and D.F. vs. temperature. Both in radial and axial type.

6. Panasonic High Voltage Electrolytics rated up to 500 volts (axial type) and up to 350 volts (radial type). Temperature range from -25°C to +85°C. Panasonic High Voltage Electrolytics are available in capacitance tolerances from -10%, +100%; -10%, +75% or $\pm 20\%$.

Panasonic miniature electrolytics can meet most tough design specifications that call for very close tolerances, demanding ESR and leakage specs. We invite your special requirements. Panasonic's wide range of miniature electrolytics may be the answer to that special application problem you are trying to solve.

Matsushita Electric Corp. of America
Industrial Division
200 Park Avenue, New York, N.Y. 10017

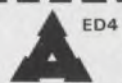

- Have a representative call.
 Send more information on aluminum electrolytics.

Name _____

Title _____

Company _____

Address _____

Phone _____

Panasonic Electronic Components

our technology is all around you

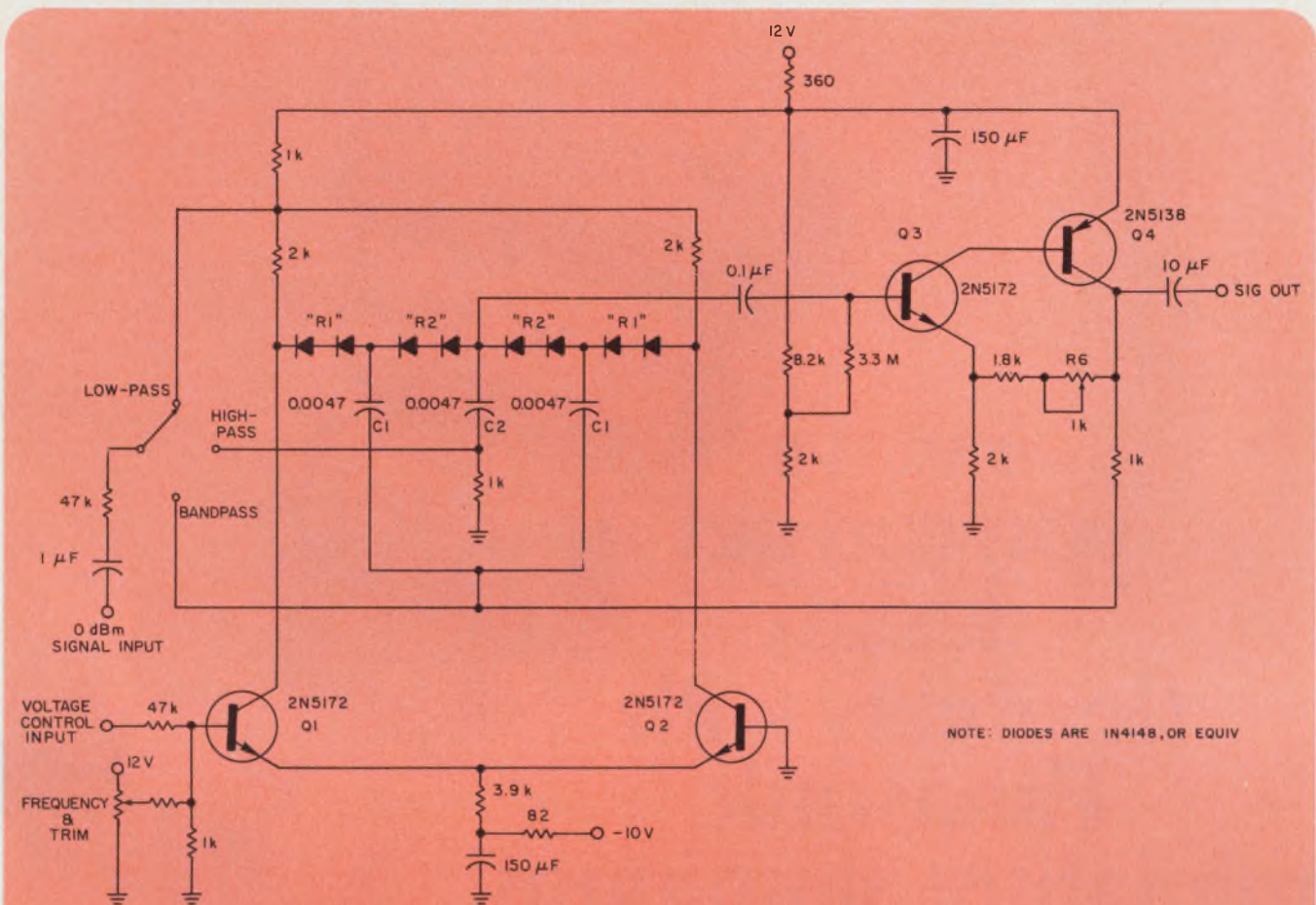

2. The Q of the voltage-tuned active filter is adjusted by R_6 . The Q remains almost constant over

the complete frequency range. At high Q s the input signal level should be limited to -10 dBm.

The plots shown were made with the center frequency set arbitrarily at 500 Hz. Pass characteristics and Q remain essentially the same as the center frequency is changed. The output amplitudes in the pass portions of the curves are approximately -25 dB from the input signal. The circuit operates well with an input signal

level of 0 dBm (0.77 V rms) at low Q . However, with a Q of 10 or higher, the input signal should be limited to about -10 dB to prevent the circuit from being overdriven. Plots were made with an HP-650A oscillator and an HP-400-L ac voltmeter.

Nyle A. Steiner, 334 "L" St., Salt Lake City, UT 84103. CIRCLE NO. 313

IFD Winner of August 2, 1974

Michael O. Paiva, McIntosh Laboratory Inc., 2 Chambers St., Binghamton, NY 13903. His idea "Start a Logic Circuit in the Proper Mode When Power Is Turned On Or Interrupted" has been voted the most valuable of Issue Award.

Vote for the Best Idea in this issue by circling the number of your selection on the Information Retrieval Card at the back of this issue.

SEND US YOUR IDEAS FOR DESIGN. You may win a grand total of \$1050 (cash)! Here's how. Submit your IFD describing a new or important circuit or design technique, the clever use of a new component or test equipment, packaging tips, cost-saving ideas to our Ideas for Design editor. Ideas can only be considered for publication if they are submitted exclusively to ELECTRONIC DESIGN. You will receive \$20 for each published idea, \$30 more if it is voted best of issue by our readers. The best-of-issue winners become eligible for the Idea of the Year award of \$1000.

ELECTRONIC DESIGN cannot assume responsibility for circuits shown nor represent freedom from patent infringement.

TI can fill any keyboard opening.

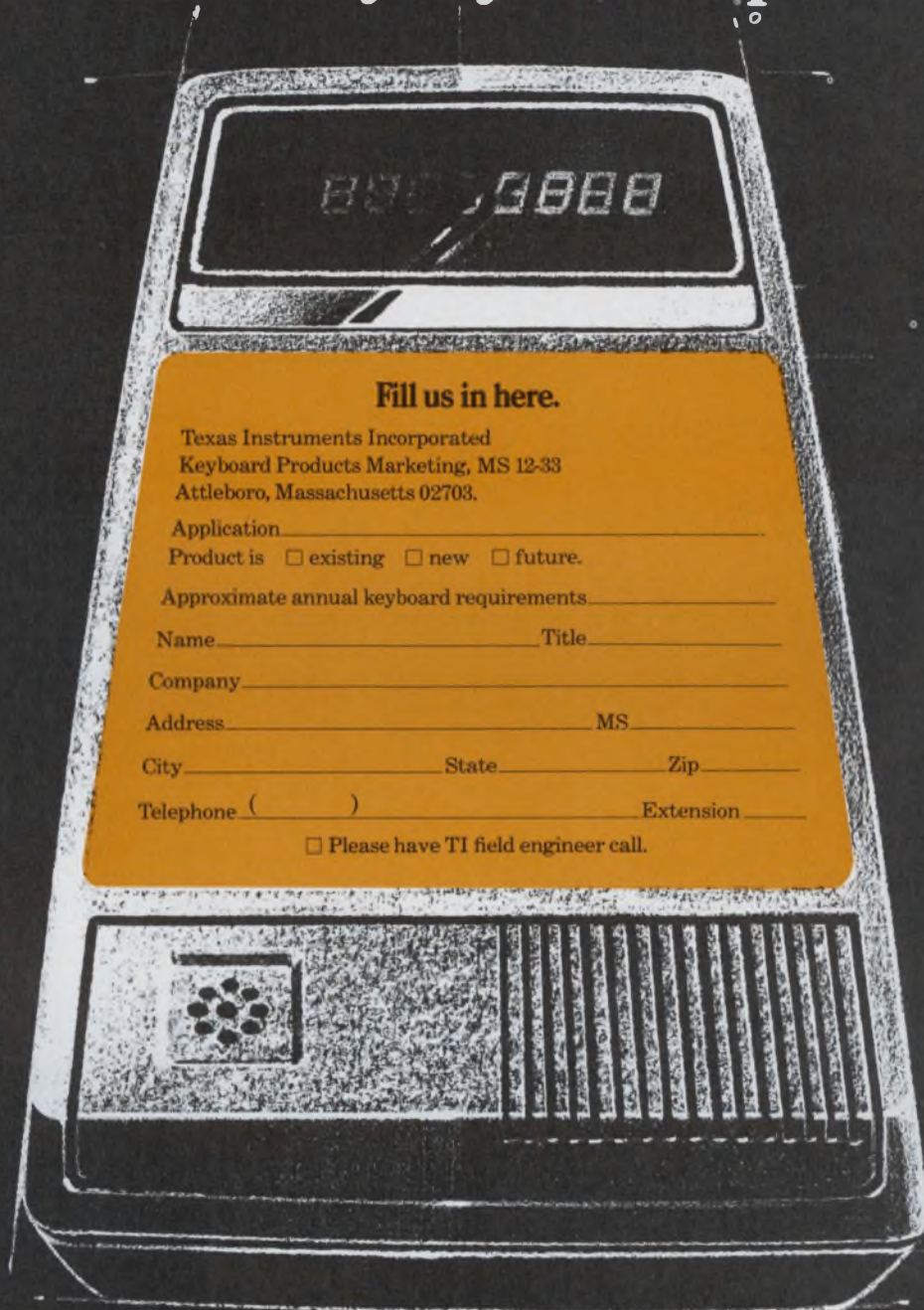

Fill us in here.

Texas Instruments Incorporated
Keyboard Products Marketing, MS 12-33
Attleboro, Massachusetts 02703.

Application _____

Product is existing new future.

Approximate annual keyboard requirements _____

Name _____ Title _____

Company _____

Address _____ MS _____

City _____ State _____ Zip _____

Telephone () _____ Extension _____

Please have TI field engineer call.

At Texas Instruments, we know keyboards. We should. We've delivered over 10,000,000. For hand-held devices, desktop devices and data terminals, too.

We've engineered some important advances in low profile keyboards. Like snap-action Klixon[®] disc contacts to give the reassuring tactile and audible feedback that users prefer. And a seal to protect the contacts against dust and moisture. Even a 2-pole switch when ordinary keyswitches won't do.

We've learned how to save precious space inside and outside the package — so "low profile" means

what it says. Like .345" high complete with keytops and retaining bezel. And more functions per square inch of keyboard.

We've also made significant advances in keyboards for desktop and data terminal applications. Like a modular building block approach to travel keyboard design that holds down tooling expense. And a library of available cluster modules to put your keyswitches where you want them at no extra charge. And snap-in solderless key modules to simplify field modification and maintenance of data terminals.

That's why it makes sense to check

with TI whenever you're designing a keyboard application.

Chances are we can give you a better keyboard in less time and at a more favorable price/performance figure than anyone else in the business. Standard or custom. Prettested to save you the assembly and yield expenses of doing the job yourself.

For a quick quote on your current requirements, call Keyboard Products Marketing in Attleboro, Mass., (617) 222-2800, Extension 6222. For complete technical information, send in the coupon.

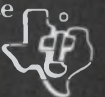

TEXAS INSTRUMENTS
INCORPORATED

Milliwatt calorimeter used to sense waveguide heat

A milliwatt calorimeter for waveguide measurements in the 90-to-140-GHz band has been developed at the Max Planck Institut für Radioastronomie in Bonn, West Germany. The calorimeter has a short time constant and compensates for losses in its own waveguide section by sensing the heat generated in the waveguide. The operating range is 1 to 100 mW. Accuracy is within 4% between 10 mW to 100 mW and 6% from 1 to 10 mW.

A length of silver waveguide in the calorimeter connects a flange and a brass-heater mount with an absorbent filmohm termination (see figure). Microwave power applied to the calorimeter is converted into heat, which is conducted back along the waveguide to the flange.

The waveguide walls are very thin, to keep the time constant to a

minimum. Consequently the termination temperature rise is rapid. The load is maintained at a constant temperature above ambient by a heater in the brass mount for the load. The small amount of power that passes through the termination is reflected by a copper disc back along the waveguide to be absorbed by the load.

The calorimeter is enclosed in a cylindrical copper shield that is protected from air currents by a plastic-foam cover. Variations in the heater current maintain a thermistor-bridge balance and keep the load at constant temperature. Heater resistance is constant for powers up to 200 mW, and the small voltage changes obtained in power measurement are identified when the heater voltage is compared with the output of an adjustable, precision voltage source.

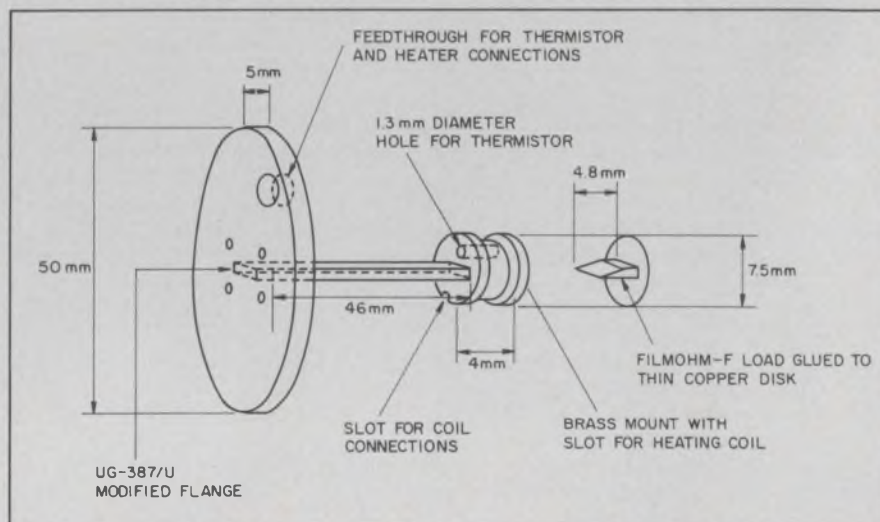

Microwave exposure monitored by Ge films

A small, personal monitor to protect against excessive exposure to microwave energy makes use of the absorption of rf power in germanium films. As the radiation is absorbed, the film temperature increases and its resistance changes.

The instrument was developed at the University of Newcastle-upon-Tyne in England. Studies with animals show that a safe exposure level is 10 mW/cm² for five minutes at frequencies above 10 GHz. Exposing the animals to radiated power of 100 mW/cm² for 100 minutes killed them.

Germanium films 3 μm thick with a conductivity of 1.75 × 10³/Ω/m have been obtained for the monitor by deposition of the germanium on a heated glass surface. The electrical (ohmic) contacts are formed by deposition of aluminum films on the substrate. The tempo of the germanium-film resistance is 0.3%/°C.

This type of germanium sensor can reliably monitor power levels from 1 mW/cm² to 1 W/cm². For display of the level, light-emitting diodes are used. They are driven by the outputs of a decade counter that can be switched on or activated automatically when a danger level is reached.

To show the accumulated radiation over a week, an integrated exposure-level indicator is used. It can be either a silver cell at the input to the counter or a piece of photographic film adjacent to the LEDs. CMOS logic is used throughout the instrument.

High-impedance probe cuts off below 3 Hz

A high-impedance, ac-coupled oscilloscope probe with an unusually low cutoff frequency of less than 3 Hz has been designed by the Dept. of Electronic and Electrical Engineering at the University of Sheffield in England. The input impedance is maximized by use of a matched pair of junction FETs, operating as a self-biased, source-follower circuit. The source follower is bootstrapped by an operational amplifier.

Zero Centurion™ cases protect the world of portable equipment.

Zero's rugged aluminum carrying cases provide complete protection for the most delicate portable equipment in virtually any environment. And there's a wide choice of styles, sizes and prices in the extensive Zero line.



Zero Centurion (Elite) offers the ultimate in distinctive styling, quality and reliability, plus **two-week delivery**. Valu-Line offers the same kind of reliability at a lower price. And the Economy Series puts Zero's high quality within the reach of any budget.

If you can't find exactly what you need in our 59 standard models, Zero can provide full custom modification capability. Write for your free Zero catalog and discover how well we support your world.

Aluminum carrying cases. One of the many ways Zero supports your world.

Zero Manufacturing Co.

777 FRONT STREET · BURBANK, CALIFORNIA 91503
 Design and | ZERO-WEST · BURBANK, CALIFORNIA
 Manufacturing | ZERO-EAST · MONSON, MASSACHUSETTS
 Facilities | ZERO-SOUTH · ST. PETERSBURG, FLORIDA



INFORMATION RETRIEVAL NUMBER 39

Flux, Flux, Flux?

**"COBRUSH" AWAY
 EVEN HARD BUILDUP
 IN SECONDS**

MS-190 or Heavy Duty MS-190HD Flux Removers, combined with the new "Cobra" Solvent Brush, guarantee fast, efficient removal of the most difficult flux accumulation.

SEND FOR TRIAL UNIT:
 One 16 oz. can of MS-190, one
 16 oz. can of MS-190HD plus
 "Cobra" Solvent Brush.



Money Back if not satisfied. You've nothing to lose but your Flux Problems.

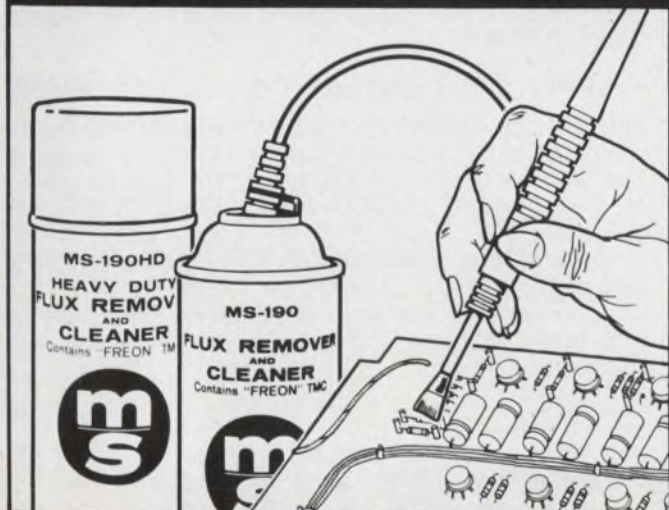

m miller-stephenson
s chemical co., inc.

Box 628, Danbury, Conn. 06810 / Area Code (203) 743-4447 ED

- Enclosed is my check. Please send Trial Unit.
- Please send me data and prices on MS-190 — MS-190HD and MS-226 "Cobra" Extension Solvent Brush.

Name _____ Title/Dept. _____
 Company _____
 Address _____
 City _____ State _____ Zip _____

CHICAGO • LOS ANGELES • TORONTO Dist. in ITALY • GERMANY •
 FRANCE • ENGLAND • SCOTLAND • SPAIN • NETHERLANDS • LEBANON

INFORMATION RETRIEVAL NUMBER 40

WHO SAYS ENGINEERS ARE SQUARES?



WIN A FREE CARIBBEAN WINDJAMMER CRUISE PLUS \$1,000 CASH

Once again, by reader demand, a week's Windjammer Cruise for two in the fabulous blue Caribbean is waiting for the lucky winner of *Electronic Design's* TOP TEN CONTEST. And that's not all! The first prize winner gets \$1,000 in cash, round-trip air transportation for two, plus a free ad re-run worth thousands of dollars for his company.

Think of it . . . warm sun . . . bright blue water . . . easy carefree days cruising among the Bahama Out-Islands, the Virgin Islands, or the exotic Windward/Leewards. Visit foreign ports. Swim . . . snorkel, or just relax.

IT'S EASY TO ENTER. Nothing to write, nothing to buy, no slogans, no gimmicks. All you have to do is select the TOP TEN ads in the January 4 issue, as measured by *Reader Recall* (*Electronic Design's* method of gaging readership). It's a

*Free reruns awarded only if the company has an advertisement in the January 4 issue.

once-a-year chance to test your skill as well as win valuable prizes for yourself and for your company.

100 PRIZES IN ALL. Portable color TV; Bulova electronic timepieces and technical books broaden your chance to win, make it even more worthwhile to enter.

SEPARATE CONTEST FOR ADVERTISERS

Advertisers, marketing men and advertising agencies can enter too. Duplicate awards are given to the top three winners (Windjammer Cruise, cash, air transportation, free ad re-run; Color TV; Bulova timepiece).

Remind your advertising people that it's the issue of the year for readership . . . the issue of the year for prizes. Put your hard-earned degrees or just plain common sense to work. This year you can be the winner!

THIS YEAR TRY YOUR LUCK!

(Who says engineers are squares?)

**WAKE UP AND JOIN THE
FUN AND EXCITEMENT!**

100 VALUABLE PRIZES!

**ENTER Electronic Design's
1975 TOP TEN CONTEST**



"We enjoyed every minute we were there," writes Paul R. Saunders, winner of last year's Top Ten Contest. "The islands, the people of those islands and the cruise are wonderful . . . the hardest part of the whole trip was returning to reality." Paul and his wife are shown, left, at the end of their trip at English Harbour, Antigua. Paul also won \$1,000 cash and round-trip air tickets for two to the Windjammer Cruise home port. At the time of the contest Paul was associated with Varisystems Corporation, Long Island, N.Y.

**WATCH FOR COMPLETE RULES AND ENTRY BLANKS IN
ELECTRONIC DESIGN'S JANUARY 4, 1975 ISSUE**

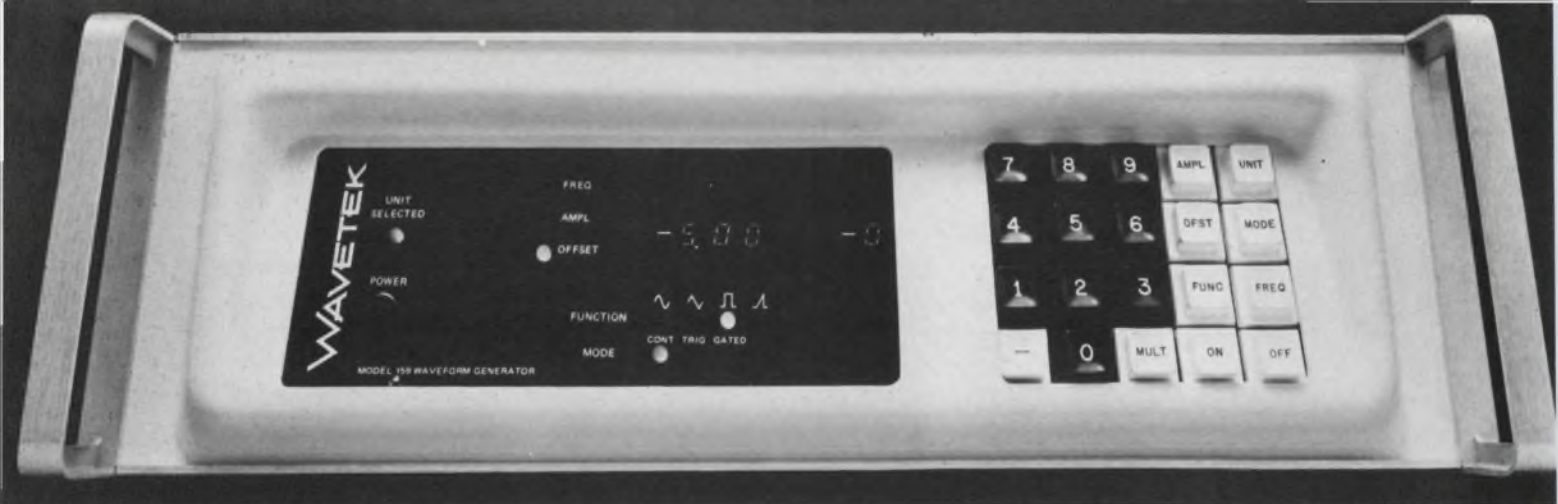

Program waveforms with or without lifting a finger.

With. Your finger, and Model 159's keyboard, can generate sines, squares, triangles, and ramps. Control frequency, amplitude, and offset to three digits. Reverse phase, polarity, activate triggered and gated modes at the touch of a button. A bright L.E.D. display shows



each command as you enter it on the keyboard.

Without. Model 159 and its remote-control-only version, Model 158, can be programmed by all types of remote ASCII sources, including computers, TTYs, even other Model 159



keyboards. Model 158/159 ranges: frequency—1 Hz to 3 MHz; amplitude—20 mV to 10 V; DC offset—up to ± 5 V. Model 158, \$1,245; Model 159, \$1,495.

For more information, circle our reader service number or contact Wavetek direct.

WAVETEK®

P.O. Box 651 San Diego, CA 92112
Tel. (714) 279-2200 TWX 910-335-2007

Single monolithic chip holds 16-bit microprocessor

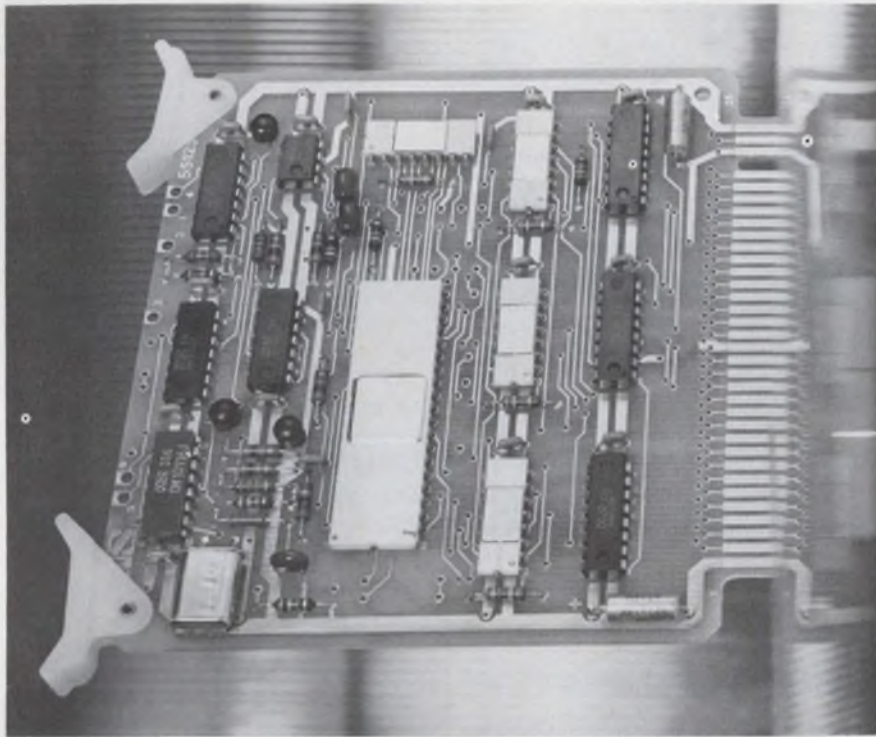

National Semiconductor, 2900 Semiconductor Dr., Santa Clara, CA 95051. (408) 732-5000. P&A: See text.

The first 16-bit microprocessor on a single chip—National Semiconductor's processing and control element (PACE)—offers all the basic features of the company's multichip model. Though not as fast nor as flexible as the older version, PACE provides the convenience and cost savings of single-DIP packaging. And it can be used for either 8 or 16-bit data processing.

The PACE chip permits a sizable reduction in components for an equivalent IMP-16—National's earlier multichip, 16-bit microprocessor on a card. Excluding memory, only six ICs are needed when PACE is used, compared with 20 to 25 for the IMP-16. When special circuits become available, PACE and just 10 other ICs will consti-

tute a microcomputer with 1-k words (each 16 bits) of ROM and 256 words (also 16 bits each) of read/write memory.

But PACE won't necessarily replace the IMP-16. While the two are software-compatible, the new chip has a longer instruction-execution time of, typically, 10 μ s. For the same algorithm, PACE yields a throughput of 1/2 to 2/3 that possible with the IMP-16. Alternately, common software and common peripheral hardware for the two suggest the use of PACE as a low-level processor with IMP-16 as the host processor.

In addition designers can't expand or change the 45-instruction set provided with PACE, as they can with the IMP-16. The earlier unit's 43-instruction set can be extended with a special CROM (control read-only memory). Moreover microprogramming techniques can tailor the IMP-16's instructions to

specific applications.

A single PACE chip incorporates the single CROM and four RALUs (register and arithmetic logic unit) that the IMP-16 uses as the central processor. Hence PACE contains the microprogram storage, registers, accumulators and stack for a 16-bit processor.

Furthermore PACE incorporates a number of support circuits found on the IMP-16 board. Internal to the chip, for example, are interrupt-control circuitry, an eight-phase clock generator, control flags and a jump-condition multiplexer. As a result, support components for PACE reduce to a simple clock driver, and input and output buffering circuits. (To keep the PACE chip's power dissipation down, National has reduced the IC's output-drive capability, so it is lower than that available from the multichip processor.)

A data-processing controller using PACE can be built on a 4-1/2 \times 4-1/2-in. PC board (see photo). Besides the PACE chip, the board contains four hex MOS sense amplifiers, three hex buffers, a crystal oscillator and clock drivers.

The PACE circuitry can respond to six different interrupt levels, each of which can handle a number of peripheral devices. If, say, three interrupts occur, PACE selects the ones with the highest priorities. And any interrupt results in a vectored branch to a specific memory location.

PACE's ability to handle 8 or 16-bit data simplifies designs that employ either of the data word lengths. Double-precision software operations or hardware changes aren't required when going from one data word length to another. At the same time PACE offers the advantage of a 16-bit instruction set and 16-bit addressing.

(continued on page 106)

E-Z-HOOK SCOPE CABLES LET YOU CUSTOMIZE

The best way to fully extend the use of your scope. Simple spring-loaded hook attaches with a single contact point. Frees your hands, while making a safe, short-free connection. Inner terminal board comes connected as a direct probe with a removable link for the addition of circuitry, permitting customizing of probe to your specific needs. Strain relief adds to life of cable or lead.

Cable shown: No. 5420. Specify probe color and cable length. When ordering

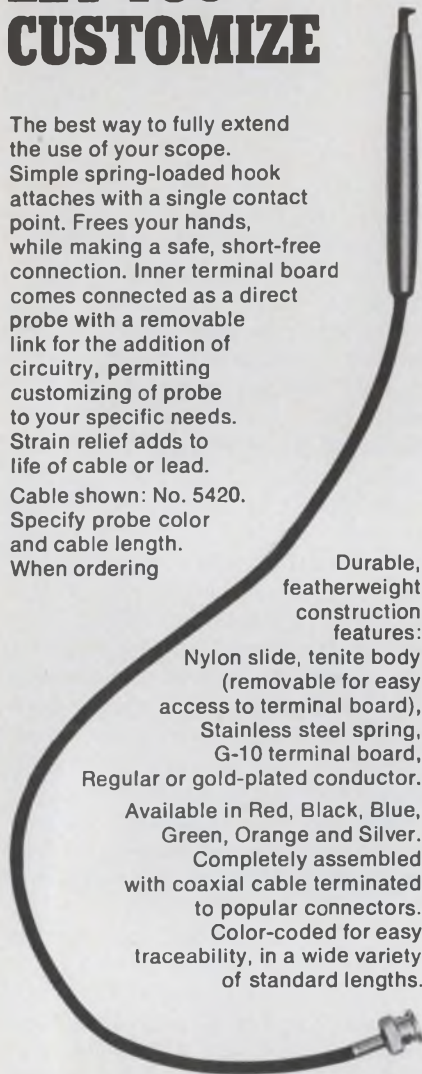

Durable, featherweight construction features:

Nylon slide, tenite body (removable for easy access to terminal board), Stainless steel spring, G-10 terminal board, Regular or gold-plated conductor.

Available in Red, Black, Blue, Green, Orange and Silver. Completely assembled with coaxial cable terminated to popular connectors. Color-coded for easy traceability, in a wide variety of standard lengths.

EXCLUSIVE FIELD SERVICEABLE FEATURE

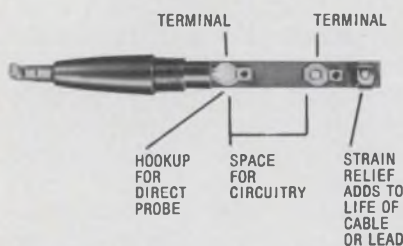

Send for complete catalog & price list.

E-Z-HOOK

114 EAST SAINT JOSEPH STREET
ARCADIA, CALIFORNIA 91006
(213) 446-6175 / TWX 910 582 1614

INTEGRATED CIRCUITS (continued from page 105)

Designers using PACE can employ the same software development aids offered by National for the IMP-16. For example, a slightly modified version of the earlier unit's prototype system (IMP-16P) comes with a PACE processor card and with programs in pROMs geared for PACE. And an application program already written for the IMP-16 can be converted directly to one for PACE with a special translator program.

Like the IMP-16, PACE employs established p-channel MOS, silicon-gate technology. PACE requires supplies of +5 and -12 V, and the chip comes in a 40-pin DIP.

Tentative prices for PACE are under \$400 in single quantities and below \$100 in very high volume. The manufacturer plans to sample PACE in next year's first quarter and to begin shipments by the second quarter.

INQUIRE DIRECT

16-k ROMs have 450-ns access

Motorola Semiconductor, P.O. Box 20924, Phoenix, AZ 85036. (602) 244-3466. \$23.95 (100-999); stock to 8 wk.

A 16-k mask-programmable ROM employs n-channel MOS, metal-gate technology to achieve address access times of 800 ns maximum, and 450 ns typical. Called the MCM6590L, the ROM has a 2048-bytes \times 8-bit organization. A pre-programmed version, the MCM-6591L, contains six conversion codes: ASCII to Selectric, to EBCDIC and to a modified 8-bit Hollerith; Selectric to ASCII, EBCDIC to ASCII and a modified Hollerith to ASCII. Also stored are 128 USASCII characters using mixed character fonts of 5 \times 7 and 7 \times 7 dot matrices with extra check bits. Also featured are three-state outputs and compatibility with TTL and CMOS. Power dissipation is less than 500 mW, and the ICs come in 24-pin packages.

CIRCLE NO. 302

Dual IC boasts broad uses

Philips, P.O. Box 523, Eindhoven, the Netherlands.

The general-purpose TCA240 monolithic IC contains two entirely separate but identical long-tailed pairs. Each consists of four transistors, two resistors and a diode. The supply voltage range of the IC is 0 to 16 V. Total power dissipation is 500 mW at 25 C. Applications extend from modulators, mixers and switches/choppers to AM synchronous demodulators, FM quadrature detectors and phase comparators. The TCA240 comes in a 16-pin DIL housing.

CIRCLE NO. 303

LED-driver chips aim for watches

Dionics Inc., 65 Rushmore St., Westbury, NY 11590. (516) 997-7474. 40¢ to \$1.10 (100,000).

Four monolithic bipolar ICs can be used as LED drivers in digital wristwatch applications. Two of the chips, the S 913N and DI 913P, are nine-position LED segment drivers using npn common-collector and pnp common-emitter designs, respectively. The DI 413N and DI 413P are four-line digit drivers, using npn common-emitter and pnp common-collector designs, respectively. All circuits are glass-passivated with aluminum bonding pads and are gold backed for eutectic or epoxy die bonding.

CIRCLE NO. 304

1-k NMOS RAM has 60-ns access

Nortec Electronics Corp., 3697 Tahoe Way, Santa Clara, CA 95051. (408) 732-2204. \$22 (100-999).

The 7001, a 1024 \times 1-bit MOS RAM, offers 60-ns access and 180-ns cycle times. Moreover, it uses one-tenth the power of similar speed bipolar memories. The n-channel, metal-gate RAM has a special internal refresh mechanism that enables static operation without the need for synchronous periodic refresh cycles. Power dissipation is 60 μ W standby and 640 μ W under maximum operating conditions. The 7001 has internal address-input latches, and it accepts TTL levels at all inputs, except Chip Select.

CIRCLE NO. 305

Clean up your act!

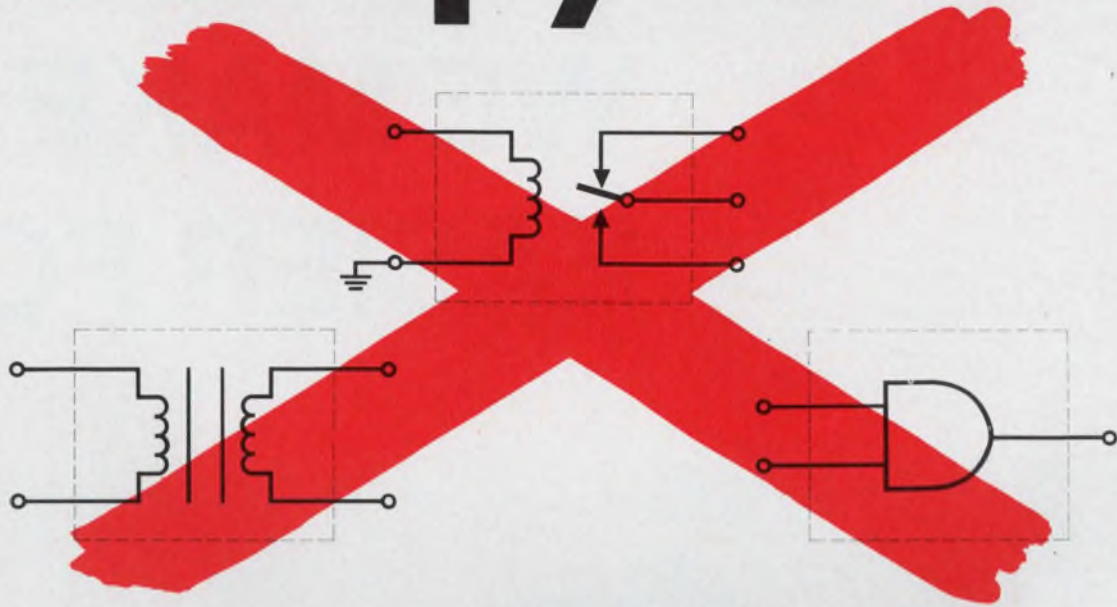

Opto-isolate your critical circuits with Monsanto's MCT2's.

Here's a cost-effective way to get top signal transfer (50% CTR for MCT2's, 250% for MCA 230's), yet isolate critical components against transients of 1.5 to 2.5kV: Put an opto-isolator in the circuit. Switching speeds range from 150kHz (MCT2) to 10kHz (MCA230). Millions of them are in daily use in industrial controls, telephone interfaces, computer mainframes and peripherals. Cleaning the noise out of critical paths.

System interface problems?

We've put together App Notes on sixteen of the thorniest design problems that O/I's can help solve. Includes:

- Input drive circuits.
- Solid-state 125 MA relay.
- Low-cost AC relay.
- O/I's in linear coupling.



- Gated amplifier functions.
- Phone line coupler isolator.
- Logic isolation, line receiver.
- Interfacing Darlington O/I's to TTL logic . . . and more!

We'll be glad to send you a copy of this 64-page applications book. Simply ask for it on your letterhead. And give us an idea of your application, will you please?

And now . . . more!

We've increased our production of these widely accepted components during the past six months and can now deliver the quantities you specify when you need them. Call your Monsanto distributor or **Monsanto Commercial Products Company**, Electronics Division, 3400 Hillview Avenue, Palo Alto, CA. 94304. Phone: (415) 493-3300

Putting innovation to work.

Monsanto

INFORMATION RETRIEVAL NUMBER 43

ICS, READ-ONLY MEMORY (ROM)

SHAPER—SEE ICS, MULTIVIBRATOR

RANDOM ACCESS MEMORY (RAM)

Microsystems Inc 3800 GB Homestead Rd Santa Clara CA (408)246-0330
 Vol 2/590,592,593
 Sys Inc 550G Middlefield Rd Mt View CA 94043 (415)964-4321
 7613-617
 Semiconductor 464 Ellis Ct Mountain View CA 94042 (415)962-5011
 2/642-548
 Instru Corp, Dept G, 600 West John St Hicksville NY (516)733-3333
 802 Vol 2/655 (609)452-2222
 tek Inc 743G Alexander Rd Princeton NJ 08540 Vol 2/749,
 750 (408)246-7501
 tel Corp 3065G Bowers Av Santa Clara CA 95051 (516)293-3850
 Vol 2/683-688,696-708,716-745
 LSI Computer Sys Inc 22G Cain Dr Plainview NY 11803 (408)739-3535
 Vol 2/759
 Monolithic Memories Inc, Dept G, 1165 E Argues Av Sunnyvale CA (214)242-0444
 94086 Vol 2/760,761,765 (602)244-6900
 Mostek Corp, Dept G, 1215 W Crosby Rd Carrollton TX 75006 (408)732-5000
 Vol 2/766-768
 Motorola Semiconductor Prod Inc, Dept G, 5005 E McDowell Rd (201)722-3200
 Phoenix AZ 85008 Vol 2/787,792
 National Semiconductor Corp 2900G Semiconductor Dr Santa Clara (408)739-7700
 CA 95051 Vol 2/807,808
 RCA Solid State Div, Dept G, Box 3200 Somerville NJ 08876 (214)238-2011
 Vol 2/847,849-852 (408)734-4330
 Signetics Corp, Sub Corning Glass, Dept G, 811 E Arques Av Sunny- (408)732-2400
 vale CA 94086 Vol 2/860,861 (516)483-5185
 Texas Instrus Inc, Dept G, PO Box 5012 Mail Station 84 Dallas TX
 75222 Vol 2/887,889,893
 Adv Memory Sys 1275 Hammerwood Sunnyvale CA 94086 (212)679-1340
 Adv Micro Devices 901G Thompson Pl Sunnyvale CA 94086 (213)644-9881
 Automata Sys Corp 592G Maude St South Hempstead NY 11550
 Calvert Elecs Intl, Semiconductor Div, Dept G, 220 E 23Rd St New York
 NY 10010
 EM & M 12621G Chadron Av Hawthorne CA 90250
 Energy Conversion Devices Inc, Dept G, 1675 W
 48084
 Harris Semiconductor, Dept G, PO
 Hughes Aircraft Co Centinela & Teale St Culver City CA 90230
 Hughes Aircraft Co, Microelectronic Prods Div 500G Superior Av Newport
 Beach CA 92663
 Intersil Inc 10900G Tantau Av Cupertino CA 95014
 Monolithic Sys Corp 2700G S Shoshone Englewood CO 80110
 Raytheon Co Semiconductor Div 350G Ellis St Mountain View CA
 94040
 Solid State Scientific Inc, Dept G, Commerce Montgomeryville PA 18936
 Standard Logic Inc, Dept G, 2215 S Standard Av Santa Ana CA 92707
 Standard Microsystems Corp 35G Marcus Blv Hauppauge NY 11787
 Semiconductor 1300G Terra Bella Av Mountain View CA

HERE'S HOW WE MAKE IT EASIER FOR



Corp 2900G Semiconductor
 State Div, Dept G, Box 3200 Somerville NJ 08876
 2/847,849-852
 netics Corp, Sub Corning Glass, Dept G, 811 E Arques Av Sunny-
 vale CA 94086 Vol 2/860,861
 Texas Instrus Inc, Dept G, PO Box 5012 Mail Station 84 Dallas TX (408)733-3333
 75222 Vol 2/887,889,893
 Adv Memory Sys 1275 Hammerwood Sunnyvale CA 94086 (214)238-2011
 Adv Micro Devices 901G Thompson Pl Sunnyvale CA 94086 (408)734-4330
 Automata Sys Corp 592G Maude St South Hempstead NY 11550 (408)732-2400
 Calvert Elecs Intl, Semiconductor Div, Dept G, 220 E 23Rd St New York (516)483-5185
 NY 10010 (212)679-1340
 EM & M 12621G Chadron Av Hawthorne CA 90250 (213)644-9881
 Energy Conversion Devices Inc, Dept G, 1675 W
 48084
 Harris Semiconductor, Dept G, PO Bx 883 Melbourne FL 32901 (313)549-7300
 Hughes Aircraft Co Centinela & Teale St Culver City CA 90230 (305)727-5407
 Hughes Aircraft Co, Microelectronic Prods Div 500G Superior Av Newport (213)391-0711
 Beach CA 92663
 Intersil Inc 10900G Tantau Av Cupertino CA 95014 (714)548-0671
 Monolithic Sys Corp 2700G S Shoshone Englewood CO 80110 (408)257-5450
 Raytheon Co Semiconductor Div 350G Ellis St Mountain View CA (303)761-2275
 94040
 Solid State Scientific Inc, Dept G, Commerce Montgomeryville PA 18936 (415)968-9271
 Standard Logic Inc, Dept G, 2215 S Standard Av Santa Ana CA 92707 (215)855-
 Standard Microsystems Corp 35G Marcus Blv Hauppauge NY 11787 (714)97-
 Semiconductor 1300G Terra Bella Av Mountain View CA (516-
 1-17 2-Chome Higashi-Yukigaya Ohta-Ku To

Manufacturers Directory for local offices.

YOU TO CONTACT SUPPLIERS

COMPLETE STREET ADDRESS, STATE, ZIP AND PHONE FOR EACH LISTING SAVES TIME

Knowing only a name and city isn't much help if you or your secretary want to contact several manufacturers at once for information or a quote. That's why *Electronic Design's* GOLD BOOK repeats each manufacturer's full name, street address, city, state, zip and phone number every time the manufacturer is listed in our PRODUCT DIRECTORY. It's all there. You don't have to leaf through other directories to find the missing information.

IT'S ANOTHER REASON TO REACH FIRST FOR ELECTRONIC DESIGN'S GOLD BOOK.



Electronic Design's **GOLD BOOK**

**BIGGEST AND BEST ELECTRONICS MASTER CATALOG
& DIRECTORY IN THE WORLD**

from Grayhill

the different DIP switch

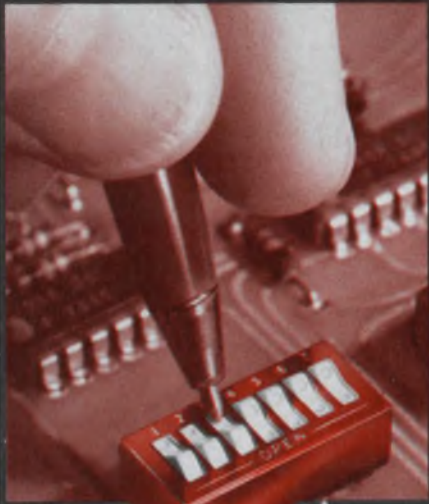

- Exclusive sliding ball contact system for positive wiping action



- Life tested to 50,000 mechanical operations, with commensurate electrical life
- Available in 9 sizes, even a hard-to-find 2 rocker version, on up to 10 rockers
- All SPST, each switch independent, rocker actuated

Of course, the different DIP Switch—Grayhill's Series 76—also offers the standard DIP benefits of easy PC board mounting, compact high density design and a multitude of cost savings. Get the full story, including detailed specifications and prices, in Grayhill Engineering Bulletin # 238, available free on request.



561 Hillgrove Avenue • La Grange, Illinois 60525
Phone (312) 354-1040

INFORMATION RETRIEVAL NUMBER 44

MODULES & SUBASSEMBLIES

Crystal clock oscillator has DIP-sized case

Conner-Winfield Corp., West Chicago, IL 60185. (312) 231-5270. \$38; stock to 5 wk.

The S14R DIP crystal TTL oscillator measures only 0.3 × 0.49 × 0.78 in. It can plug into an IC socket, and is available at any frequency from 4 to 20 MHz. The oscillator has a frequency tolerance of ±0.01% from -25 to +75 C, a fanout of 10 TTL loads and a duty cycle of 30/70 or better.

CIRCLE NO. 306

Audio amplifiers made for studio applications



Modular Audio Products, 1385 Lakeland Ave., Airport International Plaza, Bohemia, NY 11716. (516) 567-9620. AM-37: \$113, ABL-27: \$105.50, AL-27A: \$88.25 (1 to 9); stock.

Three PC-card amplifiers include the AM-27 microphone pre-amplifier, the ABL-27 bridging line amplifier and the AL-27A line amplifier. All three use the company's MAP 1731A audio operational amplifier as its active element. Model AM-27 is a general purpose audio module that has transformer coupled inputs and outputs and an adjustable gain from 25 to 65 dB. Model ABL-27 is designed for amplification of medium to high level (+20 dB) signals. It has an adjustable gain from -7 to +33 dB. Model AL-27A has a transformer coupled output, adjustable gain/loss up to +47 dB and low noise of -125 dBm.

CIRCLE NO. 307

THE LEMO QUICK-LOK MULTICONTACT CONNECTOR.



Easily engaged and disengaged
—Rugged, all metal machined shell
Positive strain relief accepts
cables from .070 to .410 O.D.
Polarized with hermaphroditic insert—
Easy to assemble

Miniature design saves panel space
Quality appearance
complements any front panel
Available with 2 through 18 contacts

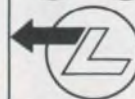
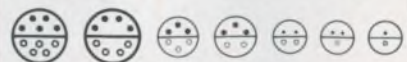

LEMO U.S.A. INC.
2015 SECOND STREET • BERKELEY, CA 94710
(415) 548-1966 • TELEX 335-393

INFORMATION RETRIEVAL NUMBER 45

S/d converter operates at rates up to 3600°/s

Control Sciences, Inc., 10315 Woodley Ave., Granada Hills, CA 91344. (213) 342-3067. \$5500 (unit qty); stock to 45 day.

The Series 168B synchro (and resolver) to digital converters function at both 60 and 400 Hz. They work with both 26 and 115-V references and with 11.8 and 90-V stator inputs. Models may be selected to provide error-free tracking rates to 10 rps (3600°/s). Typical of tracking-type converters, analog synchro (and resolver) input data are accurately and continuously converted into binary digital format. Data are always available, except when a digital transition occurs. This condition is indicated by a logic 1 on the converter busy line. During readout, data may be prevented from changing by pulling the inhibit line to logic 0. All units are completely trimmed and adjustable free. Typical electrical specifications include: accuracy, ± 4 min ± 0.9 LSB at 25 C; resolution, 14 bits (0.022°); and digital output, parallel natural binary angle positive logic, DTL/TTL levels, one inhibit and one converter busy.

CIRCLE NO. 308

Programmable controller includes pROM storage



Barber-Colman, 1309 Rock St., Rockford, IL 61101. (815) 877-0241. From \$1189; 6 wk.

The Maco III programmable control system includes a 256 word pROM memory (expandable to 2048 words, eight 115-V-ac input functions and eight output functions (expandable to 256 functions in any combination). Analog and high accuracy digital timing functions are also available. A separate programmer, which uses simple relay ladder symbology, and a diagnostic card for easy machine and control troubleshooting are available options to the system.

CIRCLE NO. 309

Did You Know Dearborn Makes 31 Styles of Film Capacitors?

HERMETICALLY-SEALED METAL CASE TUBULAR CAPACITORS

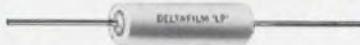

BARE METAL CASE

Style LP8, metallized polycarbonate film
Style MPF, metallized PETP-polyester film
Style AP8, polycarbonate film
Style AM8, PETP-polyester film
Style AS8, polystyrene film
Style AF8, PTFE-fluorocarbon film

METAL CASE WITH INSULATING SLEEVE

Style LP9, metallized polycarbonate film
Style MPIF, metallized PETP-polyester film
Style AP9, polycarbonate film
Style AM9, PETP-polyester film
Style AS9, polystyrene film
Style AF9, PTFE-fluorocarbon film

WRAP-AND-FILL ROUND TUBULAR CAPACITORS



Style LP66, metallized polycarbonate film
Style AP66, polycarbonate film
Style AS66, polystyrene film

HERMETICALLY-SEALED CERAMIC CASE TUBULAR CAPACITORS

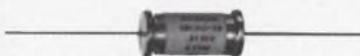

Style SML, high voltage paper/PETP-polyester film, inserted tab construction.
Style SMLE, high voltage paper/PETP-polyester film, extended foil construction.

EPOXY-CASE RECTANGULAR CAPACITORS



AXIAL-LEAD

Style LP7A, metallized polycarbonate film
Style LM7A, metallized PETP-polyester film
Style AP7A, polycarbonate film
Style AM7A, PETP-polyester film
Style AS7A, polystyrene film

RADIAL-LEAD

Style LP7S, metallized polycarbonate film
Style LM7S, metallized PETP-polyester film
Style AP7S, polycarbonate film
Style AM7S, PETP-polyester film
Style AS7S, polystyrene film



WRAP-AND-FILL OVAL TUBULAR CAPACITORS

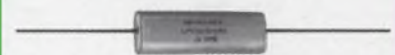

Style LP77, metallized polycarbonate film

HERMETICALLY-SEALED GLASS CASE TUBULAR CAPACITORS



Style GML, high voltage paper/PETP-polyester film, 85 C
Style GTL, high voltage paper/PETP-polyester film, 125 C

EPOXY CASE RECTANGULAR CAPACITORS



Style EFX, high voltage paper/PETP-polyester film.

Write for engineering bulletins on those capacitor styles in which you are interested.

SPRAGUE ELECTRIC COMPANY
Dearborn electronics division
P.O. BOX 1076, LONGWOOD, FLORIDA 32750

450-4129
SPRAGUE
THE MARK OF RELIABILITY

Multicircuit timers adjust for 0.01 to 30 s

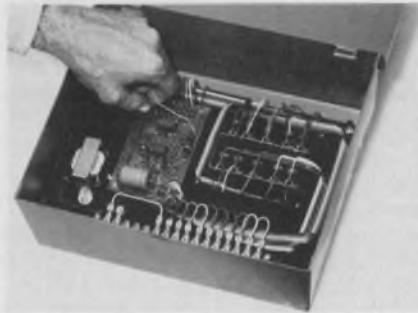

Bayside Timers, 43-69 162 St., Flushing, NY 11358. (212) 463-8935. \$160; 1 wk to 10 day.

A 10-circuit solid state timer-stepper can be adjusted from 0.01 to 30 s per step. No tools are needed for the 10140 circuit board to change both the step program and the duration of the steps. Other field changes can be made with simple tools. The standard model is available with up to 10 circuits. Starting with this form and size, the user can utilize any number of circuits less than 10 simply by moving a jumper to any one of nine terminals. The standard 10140 timer-stepper has 10-A triacs rated for 600-W tungsten-filament lamps but can drive triacs as large as 40 A for 2000-W loads. The complete 10140 board, with time interval control potentiometer, ten 10-A triacs, and cable and plug for connection to a 60-Hz ac power supply, is cased in a 12 x 10 x 4 in. standard NEMA box. Options include pushbutton start and toggle switch with single-cycle and repeat-cycle position.

CIRCLE NO. 321

Bandpass/reject filter spans 1 Hz to 20 kHz

Frequency Devices, Inc., 25 Locust St. Haverhill, MA 01830. (617) 374-0761. \$40 (100-up); 2 to 4 wk.

The 781R1Q2 bandpass/band reject active filters cover the frequency range from 1 Hz to 20 kHz. The Q is externally adjustable from 0.5 to more than 100. The notch depth is typically 50 dB and trimmable to 60 to 80 dB. Both bandpass and band-reject outputs are simultaneously available and a $\pm 5\%$ fine frequency adjust is also provided. Power requirements are ± 5 to ± 18 V at 48 mA. The filter can handle input voltages swings of ± 10 V ($V_{supply} = \pm 15$ V). The input impedance is 20 k Ω while the output is less than 10 Ω .

CIRCLE NO. 322

Get many functions from liquid level controller

Cambridge Scientific, 101 Virginia Ave., Cambridge, MD 21613. (301) 228-5111. From \$105.

The Level-Matic solid state liquid level controller can function as a low level alarm, a high level alarm, a "pump-up" device to maintain a high level in a container or a "pump-down" device to prevent overflow conditions. The unit will control the water level in cooling tower sump when two probes are used. Also, it can open a make-up valve to fill the sump and at the same time, open a bleed-off valve and turn on a chemical feed pump during the fill time. The controller requires 115 V, 60 Hz at 0.5 A, and the probe voltage is 24 V ac.

CIRCLE NO. 323

See through opto-control has range of 150 ft

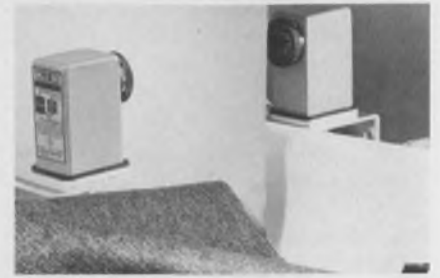

Honeywell, 11 W. Spring St., Freeport, IL 61032. (815) 232-1122. \$150 (large qty.).

The MLS5 high-intensity photoelectric unit produces a pulsed infrared beam that will sense through canvas, denim, rubber, multiple sheets of paper, cardboard or even wood. The emitter and receiver units, less than 3.5 in. high, are designed to scan farther than 150 ft. even in direct sunlight. The photoelectric control is said to be able to sense an object as small as 1 in. wide at any scanning distance up to 150 ft. The units can also be used for machine-control operations and traditional speed counting and sorting operations. The control can be used in either direct or reflective scan applications. The MLS5 may be interfaced directly with various logic circuits or wired to a 12 V dc relay. Input voltage is 12 V dc min and 18 V dc max., with a 20% maximum power supply ripple. The light emitter draws a current of 70 mA max.; the receiver needs 40 mA max. Response time is 15 ms for both on and off states when operated at a maximum rate of 33 operations/s within a temperature range of -40 to 70 C.

CIRCLE NO. 324



ANALOGY

GOTTA GET UP EARLY IN THE A.M. TO BEAT THE 3010 IC TONE ALARM. EXCEED ITS DC REFERENCE BY 5mV, AND IT TURNS ON BOTH AC AND DC. DC OUTPUT DRIVES TTL, LED OR LAMP LOADS. AC OUTPUT DRIVES A SPEAKER, LIGHT OR TONE. 5 TO 15V SUPPLY. LOW STANDBY CURRENT.

intech INCORPORATED
(408) 244-0500
1220 COLEMAN, SANTA CLARA CA 95050

Here are 10 more good reasons to turn to Amperex...

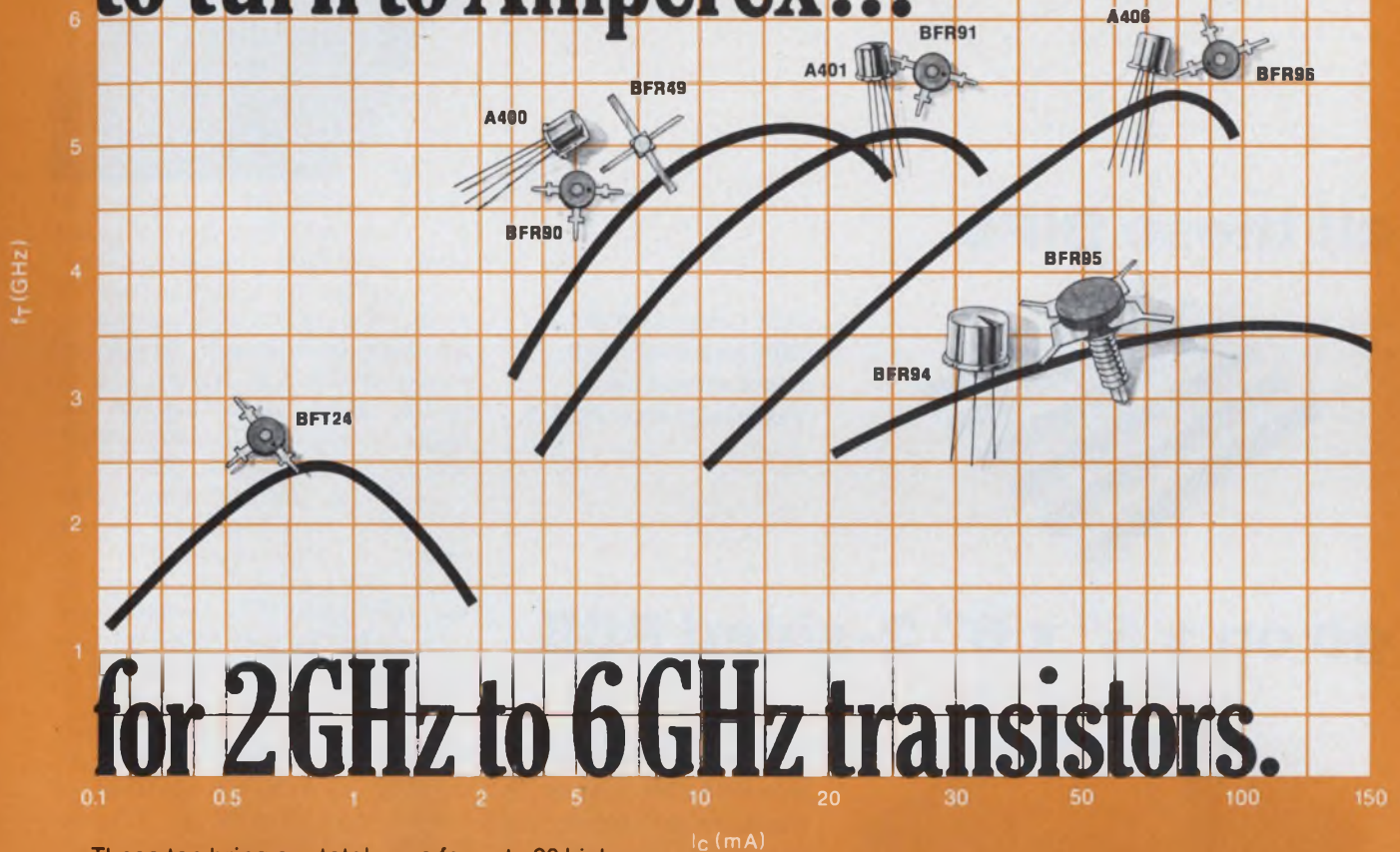

for 2 GHz to 6 GHz transistors.

These ten bring our total... so far... to 23 high-performance, small-signal RF transistors with gain-bandwidth products from 1 to 6 GHz... covering the operating current range from 100 μ A to 150 mA. There's an Amperex GHz transistor to fill virtually any small-signal application up to 2 GHz... CATV/MATV amplifiers, portable pagers and transceivers, high bit-rate communications equipment, frequency counters and high frequency oscilloscopes, to name but a few.

World leadership in shallow diffusion technology and unsurpassed packaging skills come together at Amperex to produce the industry's best combination of GHz transistor specifications, packages and prices.

- Gain-bandwidth products from 1 to 6 GHz at collector currents from 100 μ A to 150 mA
- Noise figures as low as 1.9 dB at 500 MHz
- Low intermodulation and cross-modulation distortion types for wide band and other sophisticated linear applications
- Package-Versatility: plastic Micro-T, ceramic Micro-T, Stud-mounted stripline and JEDEC TO39 and TO72 metal cans
- An entire line priced so low that only two of the 23 devices cost more than \$3.95 in quantities of 1,000... and most are priced between \$2.00 and \$3.00

For further information on the Amperex line of high-performance, GHz-range transistors, write Amperex Electronic Corp., Solid State and Active Devices Div., Slatersville, R. I., 02876, or phone (401) 762-9000.

A GHz Transistor-Line Sampler

| TYPE NUMBER | CASE STYLE | f_t (GHz) @ | I_c (mA) | PRICE EACH* |
|-------------|-----------------|---------------|------------|-------------|
| BFT24 | Plastic Micro-T | 2.3 | 1 | \$2.10 |
| A400 | TO-72 metal | 5.0 | 14 | \$2.38 |
| BFR90† | Plastic Micro-T | | | \$2.70 |
| A401 | TO-72 metal | 5.0 | 30 | \$2.62 |
| BFR91 | Plastic Micro-T | | | \$2.95 |
| A406 | TO-72 metal | 5.0 | 50 | \$3.15 |
| BFR96 | Plastic Micro-T | | | \$3.85 |
| BFR94 | Stripline Stud | 3.5 | 100 | \$7.25 |
| BFR95 | TO-39 Metal | | | \$3.95 |

*In 1000 piece quantities

†Also available as type BFR49 in special high-reliability ceramic stripline package. Price each: \$15.25

Amperex®

TOMORROW'S THINKING IN TODAY'S PRODUCTS

Sold through
North American Philips Electronic Component Corporation

With MINI BUS[®]

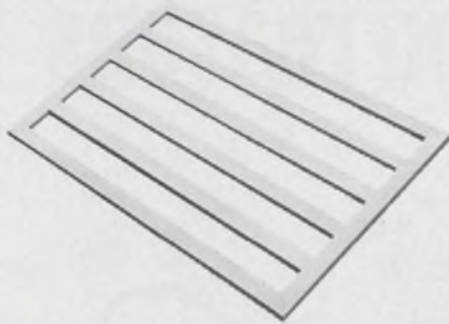

It's the PC card bus bar that saves space on a PCB. Saves money too. Makes board design and layout easier.

all these DIPs



How can you put 36 DIPs on a 30 sq. inch board without using costly multi-layer PCBs?

go on a 5" x 6" 2-sided PCB

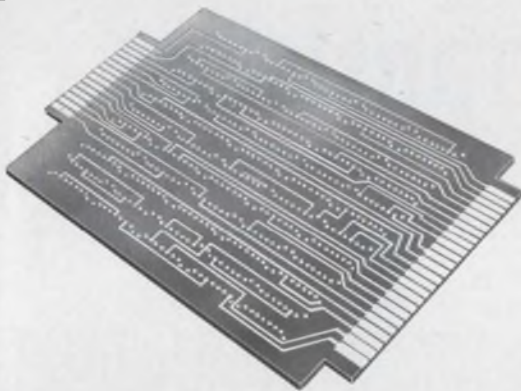

Take Voltages and Grounds **off the board** with MINI/BUS. Use all the board geometry for interconnecting DIPs.

like this

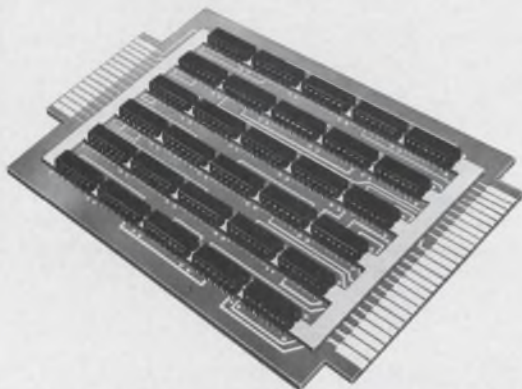

With MINI/BUS, you'll save design and layout time. You'll save space on the board. And **you'll save money** — up to half the cost of a typical 4-layer PCB.



Rogers Corporation Chandler, Arizona 85224 Phone: (602) 963-4584

Represented in Canada by LLOYD A. MEREDITH,
1560 Watersedge Road, Clarkson, Ontario L5J 1A4 Phone: (416) 533-2367

INFORMATION RETRIEVAL NUMBER 47

INSTRUMENTATION

4-1/2-digit DPM fits standard panel cutout

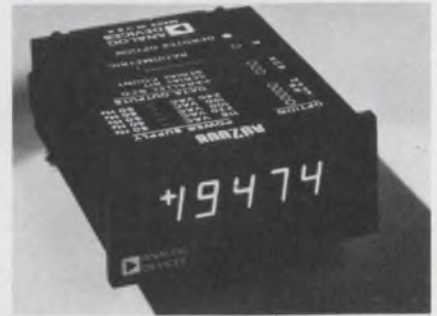

Analog Devices, Route 1 Industrial Pk., P. O. Box 280, Norwood, MA 02062. (617) 329-4700. \$295; stock.

This 4-1/2-digit, ac line-powered DPM, the AD2008, features a Beckman gas-discharge display and a case designed to fit the 1.68 × 3.93-in. panel cutout that has virtually become an industry standard for ac-powered DPMs.

To mount, the user simply slips the DPM into the panel cutout, snaps in two nylon mounting blocks and tightens two screws on the rear plate. The snap-on lens comes with an anti-reflective surface and two color choices: red or amber.

The AD2008 measures bipolar voltages over a full-scale range of ±1.9999 V with an accuracy of 0.005% reading ±50 μV ±1 digit. The unit's gain tempco is 15 ppm/°C; automatic circuitry corrects for zero offsets. Gain stability is 100 ppm per 1000 h and zero stability is 10 μV per 1000 h.

A fully floating opto-isolated input section allows measurements to be made with common-mode voltages up to 300 V rms, and provides more than 100 dB of common-mode noise rejection, even with control signals and optional data outputs connected. Normal-mode rejection is over 60 dB.

In its ratiometric version, available at no extra cost, the Analog Devices unit accepts external reference voltages over the range of 600 mV to 1.3 V at full specified accuracy. Power consumption of the AD4008 is 4 W.

The unit offers two optional data output formats: full parallel latched BCD for 4-1/2 digits, polarity, and overload lines; or a pulse-train output, which can be counted externally to the DPM.

CIRCLE NO. 301

Scope computes and displays results

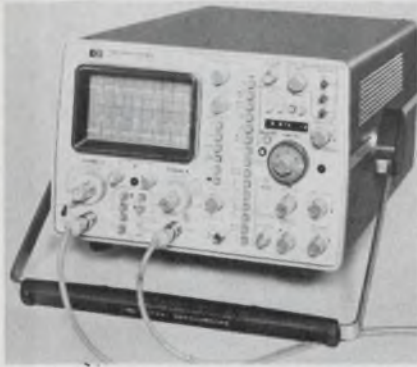

Hewlett-Packard, 1501 Page Mill Rd., Palo Alto, CA 94304. (415) 493-1501. \$4500.

Using the microprocessor from the company's familiar HP-35 calculator, a new dual-channel, 275-MHz scope, Model 1722A, provides digital LED readout of time interval, frequency, dc voltage, peak or instantaneous voltage, and percent difference between amplitudes. All these and the scope display are taken from a single probe to the circuit under test. For time intervals, such measurements as clock phase, rise time, pulse width, period or propagation delay can be made with resolution as great as 20 ps. When the 1722A is set to the 1/TIME mode, the microprocessor computes the reciprocal of whatever was set in the TIME mode and displays the answer on the LEDs. The unit may also be set to digitally indicate the average (dc) voltage at the input of Channel A. It functions then as an autoscaling 3-1/2-digit DVM. Scope performance characteristics are similar to those of the HP Model 1720A.

CIRCLE NO. 325

10-MHz pulser sells for just \$159

The Pal Kit Co., P. O. Box 1056, Minnetonka, MN 55343. \$159 assembled; 2 wks.

Model BP2 pulse generator offers a repetition rate of 1 Hz to 10 MHz and a variable width of 50 ns to 1 s. Output level varies from 0.5 to 10 V, no load, and 0.25 to 5 V into 50 Ω . Max rise and fall times are 20 ns. A 4-V (no load) sync pulse is also provided. Output modes include normal, invert and square wave.

CIRCLE NO. 326

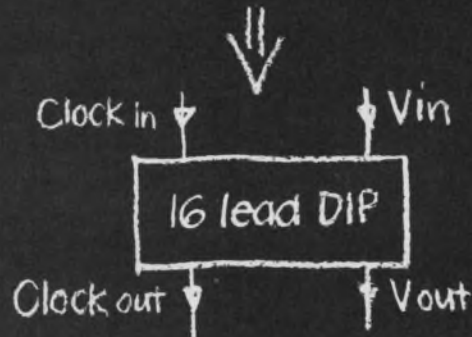

Analog Memory
70 DB S/N

Sample rate: 12 MHz
1 μ sec - 40 msec delay

IN PRODUCTION!

Reticon Corporation, a pioneer in solid state image sensing, has now applied its technological leadership to the field of analog memories.

These devices are large scale integrated circuits which sequentially time sample an analog input signal and store each sample as an analog voltage level on one of a series of storage capacitors. The stored samples are then read-out in sequence to reconstruct the original input signal with a new time base. Several device types are available from inventory with up to 128 elements of storage.

Applications include time base correction (expansion or compression), tapped delay lines, correlation, digital filtering, real time Fourier transforms, chirp radars and many others.

Write or call for further information including detailed peripheral circuits.

There are over 60 salesmen and 14 distributors to serve you worldwide.

RETICON®

910 Benicia Avenue,
Sunnyvale, California 94086
Phone: (408) RET-ICON TWX: 910-339-9343

Multicoupler serves 12 receivers



Watkins Johnson Co., 3333 Hillview Ave., Palo Alto, CA 94304. (415) 493-4141.

The WJ-9310 multicoupler can couple a single antenna to as many as 12 receivers operating in the 20-to-1000-MHz frequency range. The unit offers a nominal gain of 2 dB, and it has a noise figure of 6.5 dB from 20 to 300 MHz and 8.5 dB from 300 to 1000 MHz. Third-order intermodulation intercept point is +12 dBm, referenced to the input. Isolation between outputs is 25 dB minimum.

CIRCLE NO. 327

Oscillator slashes phase noise

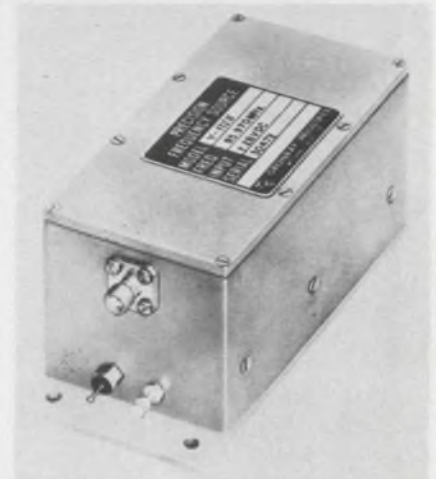

Greenray Industries Inc., 840 W. Church Rd., Mechanicsburg, PA 17055. (717) 766-0223.

Model Y-1128 crystal oscillator has a typical phase noise of only 150 dB/Hz at 10 kHz from carrier and typical short-term stability of just three parts in 10^{-10} per second. The available center frequency range is 1 to 100 MHz with two units. Input voltage requirement is +28 V dc $\pm 2\%$ and output power is 10 mW into 50 Ω . Other features include EMI filtering in the dc-input line, stability of $\pm 0.005\%$ from 0 to 50 C and 40-dB minimum harmonic suppression.

CIRCLE NO. 328

This Christmas give your car a Mark Ten B Capacitive Discharge Ignition. You and your car will enjoy it all year.



The Mark Ten B keeps your car in tune. That means increased mileage, less maintenance and a better running car. A well-tuned car also decreases emission contaminants. All this adds up to more driving enjoyment for you. Mark Ten B, the perfect gift—for cars—and their owners.

DELTA PRODUCTS, INC.

P.O. Box 1147, Dept. ED
Grand Junction, Colo. 81501
(303) 242-9000

Here's my Christmas order. Please rush!

Please send me free literature.

Enclosed is \$ _____ Ship ppd. Ship C.O.D.

Please send: _____ Mark Ten B assembled @ \$64.95 ppd. _____ Mark Ten B Kit @ \$49.95 ppd. 12 volt negative ground only • _____ Standard Mark Ten, assembled, @ \$49.95 ppd.

_____ 6 Volt: Neg. Ground Only _____ 12 Volt: Specify _____ Pos. Ground _____ Neg. Ground • _____ Standard Mark Ten Deltakit* @ \$34.95 ppd. (12 Volt Positive or Negative Ground Only)

Car Year _____ Make _____

Name _____

Address _____

City/State _____ Zip _____

1.8-GHz class C amp delivers 132 W



Microwave Power Devices, Inc., Adams Ct., Plainview, LI, NY 11803. (516) 433-1400. 60-90 days.

Model PWA 1718-12 cw solid-state class-C amplifier delivers 132-W saturated power output over the frequency band of 1750 to 1850 MHz. Other features include 50-dB gain, output circulator for protection against load mismatches and stripline and MIC construction. The unit employs field-replaceable modules.

CIRCLE NO. 329

Advantages of the Slo-Syn[®] AC synchronous motor.

Slo-Syn AC constant speed, brushless motors have extremely rapid starting, stopping and reversing characteristics.

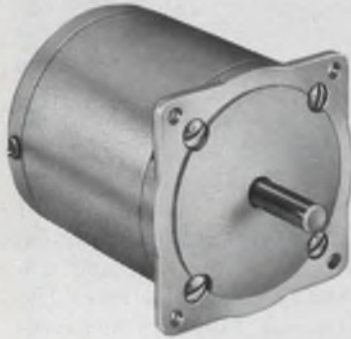

Their operation is simple, requiring only single-pole, three position switches to provide forward, reverse and "off" control.

And, because of the low shaft speeds, 28.8 to 200 rpm, Slo-Syn synchronous AC motors are uniquely dependable as control components.

Motor runs directly off incoming line voltage. Low speed allows direct load coupling without gearing. Clutching and braking can be eliminated because of instant start, stop and reverse. Torque being proportional to voltage, the increase or decrease of voltage controls torque directly.

The Slo-Syn AC motor we're describing is bi-directional, synchronous, brushless with permanent magnet construction and most models are UL listed.

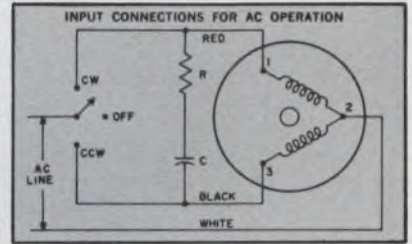

Only two moving parts—Bearing contact points are the only two moving parts. There is no connection between rotor and stator and unlike conventional AC motors, Slo-Syn brushless AC motors will not overload or overheat.

Neither will they try to overcome a stalled condition by drawing more power causing overheating and resulting motor failure. Running torque does not increase when stalled.

This is the first of a series of ads dealing with the basics of AC synchronous and DC stepping motor design and application.

Send for Superior Motor Catalog—60 pages packed with design opportunities.

Write, wire or telephone Jack Wallace, The Superior Electric Company, Bristol, Conn. 06010. 203/582/9561

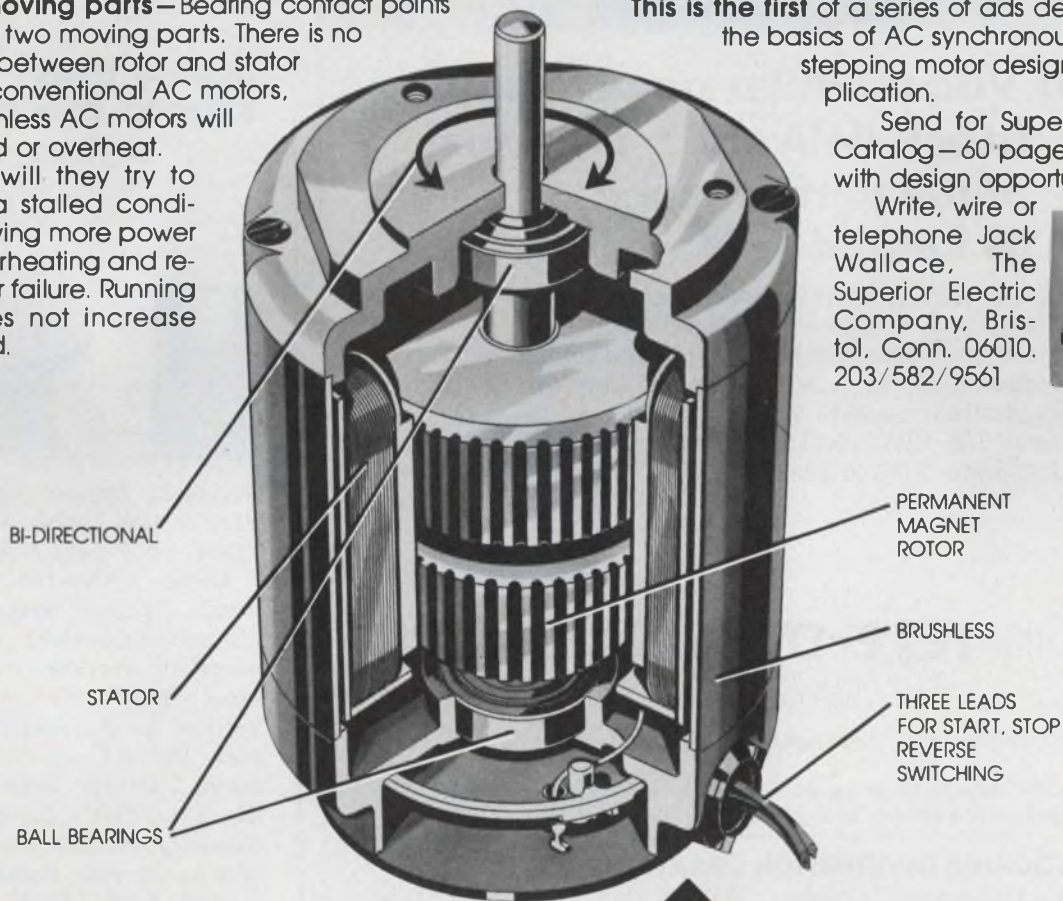

The Superior Electric Company

We always live up to our name

INFORMATION RETRIEVAL NUMBER 50

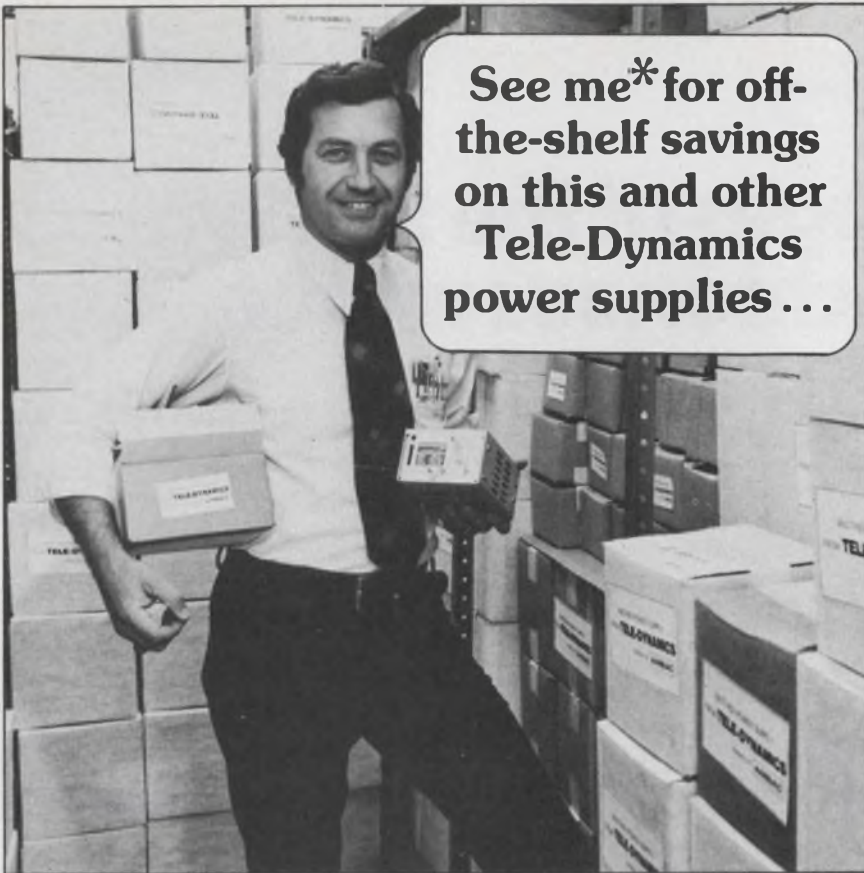

See me* for off-the-shelf savings on this and other Tele-Dynamics power supplies...

5-28 Vdc modular power supplies

- Stock delivery • Low cost
- Same performance as Lambda LM

Tele-Dynamics Series HR modular supplies are offered in 30 models in 5 case sizes, all interchangeable with Lambda LM and similar units.
Output: 5-28 Vdc, 1.3-20 A. **Ripple:** 1 mV rms.
Regulation: $\pm 0.05\%$ line, $\pm 0.05\%$ load.
Input: 105-125/210-250 V, 47-63 Hz.
Unit price: \$113 to \$256.



TELE-DYNAMICS DIVISION OF AMBAC
 WANLASS POWER SUPPLIES AND LINE CONDITIONERS

525 Virginia Drive, Fort Washington, PA 19034 • (215) 643-3900

Career opportunities for power supply engineers—an equal opportunity employer M/F

*110 STOCKING DISTRIBUTOR LOCATIONS

- Allied • Arrow-Angus • Cramer • Newark • Olive Radio • Philadelphia Electronics • Pioneer Standard • RPS Electronics • Ralph's • Stark • Sterling (Calif.) • Summit • Testco • T. I. Supply • Zack • Texas Instruments, Ltd. (Europe) • Tisco (Europe)

Call toll-free (800) 645-9200 for the one nearest you. In N.Y. State, call collect (516) 294-0990.

© TELE-DYNAMICS

6050 A

MICROWAVES & LASERS

3-way S-band divider has low price tag

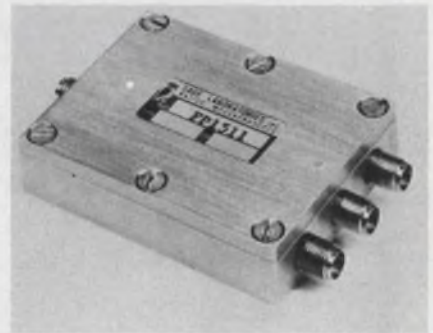

Sage Laboratories Inc., 3 Huron Dr., Natick, MA 01760. (617) 653-0844. P: See below; 60 days.

Over the 2-to-4-GHz frequency range, the FP1511 three-way divider/combiner features 1.5:1 maximum VSWR, 18-dB minimum isolation between outputs and 0.5-dB maximum insertion loss. The unit costs only \$150 and measures 1.85 × 2.28 × 0.50 in.

CIRCLE NO. 330

System finds antenna directions

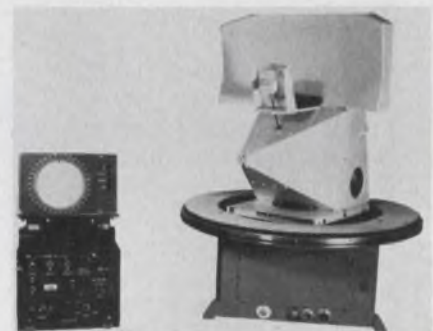

Aeroflex Laboratories, Inc., S. Service Rd., Plainview, LI, NY 11803. (516) 694-6700.

Model ARAS-100 antenna direction-finding system features compatibility with many current electronic-warfare receiving systems. The new system provides vertical or horizontal polarization over the 0.7-to-2-GHz frequency range, circular polarization over the 2-to-18-GHz band and a continuously variable rotational speed of 0 to 350 rpm. Pointing accuracy is 1/2 degree with a servo-controlled manual mode. A CRT with 4-in. diameter polar-signal presentation provides the display and video dynamic range extends from 0.1 to 3.0 V.

CIRCLE NO. 331

Attenuator has flat characteristics

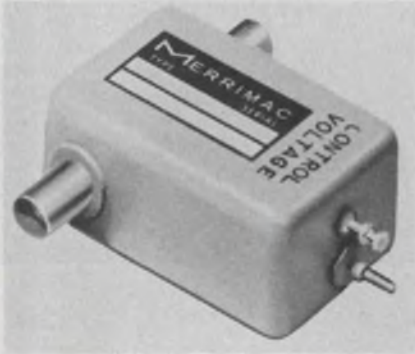

Merrimac Industries Inc., 41 Fairfield Pl., West Caldwell, NJ 07006. (201) 228-3890. \$165; stock to 45 days.

The Model ARE-1 electronic attenuator features flat attenuation characteristics of ± 0.5 dB in the 0-to-20-dB range and over the 2-to-100-MHz frequency band. Other characteristics include intermod intercept point of +43 dBm (two-tone, third-order); maximum insertion loss of 1.3 dB; maximum VSWR of 1.5:1 with impedance of 50Ω ; bias voltage/current of 15 V at 5 mA and control voltage/current of 0 to 15 V at 0 to 30 mA. Maximum input power is +10 dBm.

CIRCLE NO. 332

2-to-4-GHz VCO has 200 ppm/°C stability



Teledyne Microwave, 1290 Terra Bella Ave., Mountain View, CA 94040. (415) 968-2211.

Operating from 2 to 4 GHz, the Model VTS-621 voltage-controlled oscillator provides 50-mW rf power with a stability of 200 ppm/°C. Harmonics are down 20 dBc minimum and spurious signals are down 60 dBc minimum. The unit operates over a temperature range of -54 to $+85$ C and gives a linearity of $\pm 3\%$ BSL. The unit measures $2.0 \times 1.5 \times 1.0$ in.

CIRCLE NO. 333

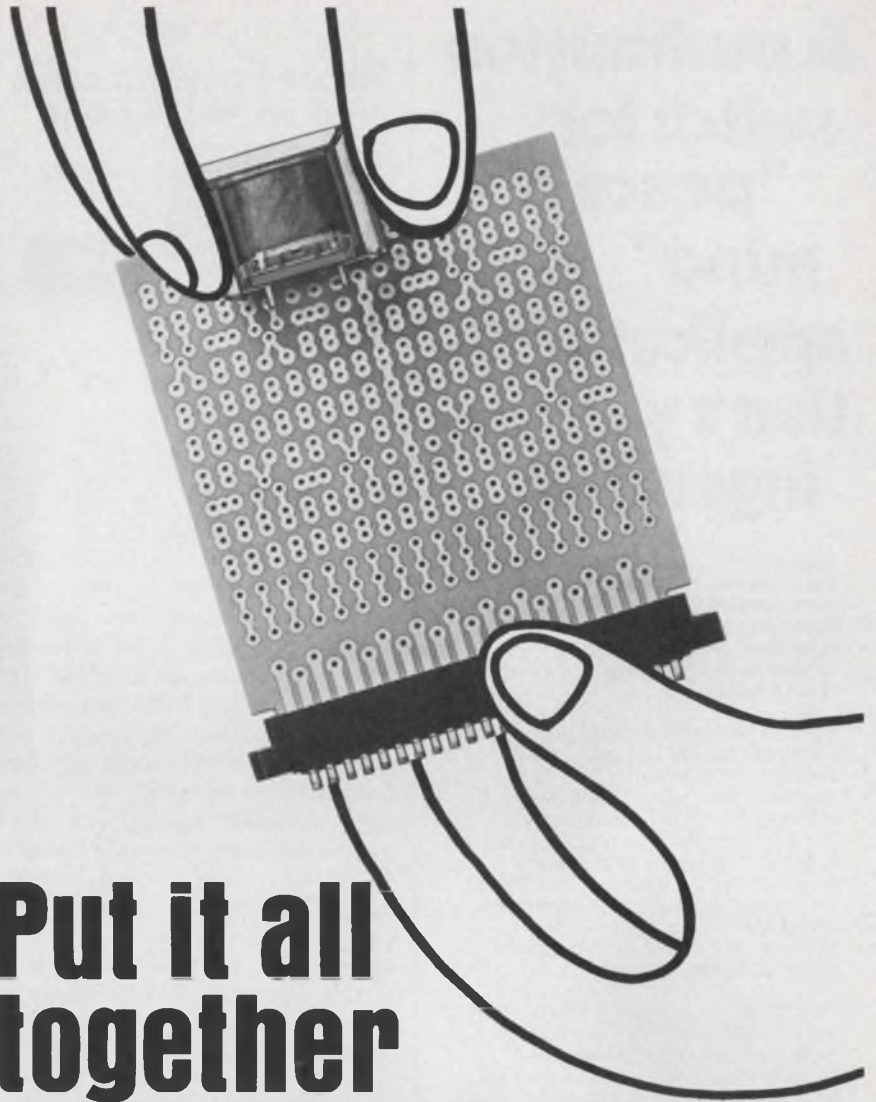

Put it all together with TRIAD

Who else but Triad has the printed circuit cards, the plug-in transformers and inductors, and the right connectors in stock at your industrial electronic distributors—ready for you to use? Triad's new standard series of plug-in telephone coupling transformers are designed particularly to interconnect remote data entry and display terminals to computers over voice grade telephone lines. Useful for impedance matching, isolation, line balance, bridging, hybrid and holding coil applications. Other plug-ins for transistorized control and instrumentation include units for both power and audio use.

All Triad plug-ins fit precisely into standard grid patterns on our versatile line of integrated and universal circuit cards. And—when you put a "CO" prefix ahead of the card number, you'll get the applicable Winchester connector in the same package with the card—ready for you to put together. Call your distributor for Triad's latest catalog. Triad Distributor Services, 305 North Briant Street, Huntington, Indiana 46750.



TRIAD-UTRAD
Litton Distributor Services

INFORMATION RETRIEVAL NUMBER 52

A pushbutton switch for "peace of mind" applications--that's yankee ingenuity.

Switchcraft's ORCON pushbutton switches are designed and manufactured specifically for applications where economy is measured only by maximum reliability. Where "peace of mind" is mandatory.

ORCON Series OA lighted pushbutton switches provide you with 2PDT through 6PDT circuitry in a 3/4" diameter package. ORCON Series OB offers SPDT, DPDT switching in a 23/32" diameter housing. Both offer features that give you that extra peace of mind. Consider ORCON's exclusive snap-slide migration-free lifting and wiping action of the self-cleaning cobalt-gold contacts which eliminates arcing.

ORCON switches accept single lamp, redundant-lamp pushbuttons in a variety of colors and shapes—square, round, rectangular. And we have them all. You can specify momentary silent, momentary positive, alternate action or push lock/push release functions.

When you want to specify a little extra peace of mind, see what ORCON—and a little yankee ingenuity—can do for you. Contact your Switchcraft Representative, or Switchcraft Inc., 5555 N. Elston Avenue, Chicago, Illinois 60630. Or phone (312) 792-2700.

SWITCHCRAFT



PACKAGING & MATERIALS

Silicon-iron strip cores need no impregnant

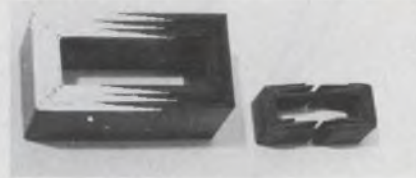

Inter-Technical Corp., Inc., P.O. Box 23, Irvington, NY 10533. (914) 591-8822.

A new method of manufacture produces distributed-gap transformer cores in very small sizes. Made from silicon-iron strip, the new cores offer the full magnetic qualities of silicon iron, unimpaired by impregnation and the cutting operation after annealing. The cores can be as small as H121 cut cores or EE 24-25 laminations. At 400 Hz, they can readily substitute for 4-mil cores or 6-mil laminations. In some cases, they can be used instead of costly nickel-iron laminations or toroids. Often they offer the only solution when the gapped VA rating of cut cores is unacceptable. Since no impregnant is used, there is no lamination movement when the operating temperature rises. The usual resultant increase of exciting current with increase in temperature is thus limited. New LL (Low Loss) distributed-gap cores are available in strip widths up to 1-1/2 in. and build-ups to 3/8 in. Minimum window length and width are 1/2 and 1/4 in., respectively. Maximum window length and outside periphery are 2 and 8-1/4 in.

CIRCLE NO. 334

Soldering-iron holder saves solder tips

Plato Products Inc., 4357 N. Rowland Ave., El Monte, CA 91731. (213) 283-0466. \$9.99 (1-9); stock.

Plato soldering-iron holders with tip saver, TWH-905, solve the problem of tip detinning. The tip saver is a solder dispenser attached to the soldering-iron holder. After soldering, the tip is touched to the tip-saver solder before placing in the holder. This procedure prevents oxidization of the solder tip, because the 0.062-in. diameter solder provides an abundance of flux and solder to keep the tip tinned.

CIRCLE NO. 335

Part holder adapts to perforated boards

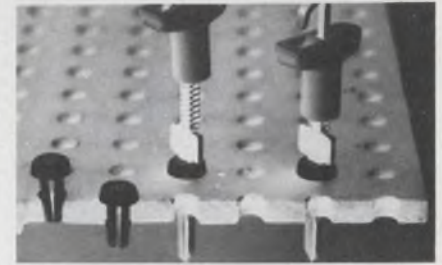

E-Z-Hook, 114 E. Saint Joseph St., Arcadia, CA 91006. (213) 446-6175.

Perf-board adaptors in E-Z-Hook's NailClip line provide an economical way to breadboard or pretest components and circuits prior to assembly. The adaptors are constructed of natural nylon. The Perf-Eze, Model PE-93, insert adaptor snaps into 0.093-in. dia perf-board holes. Any of the four NailClip models, available in 10 colors, may then be pressed into the adaptors. Insert and NailClip may be removed and reused. Solder connections may be made on the back plane to interface with automated checkout systems.

CIRCLE NO. 336

Degreaser system recycles solvents



Avanel Industries, Inc., 1827 Gilford Ave., New Hyde Park, NY 11040. (516) 746-6710.

A degreaser/cleaner system, Micro-Clean 300, reuses solvents by recirculating them through a replaceable micron filter. Large filters are easily replaced. They come in ratings of 5, 10, 25, 50 and 100 microns. The system is set at bench height and provides a recessed work area for retention of the solvent.

CIRCLE NO. 337

Why settle for less than Preston's "Balanced Precision" Amplifiers?

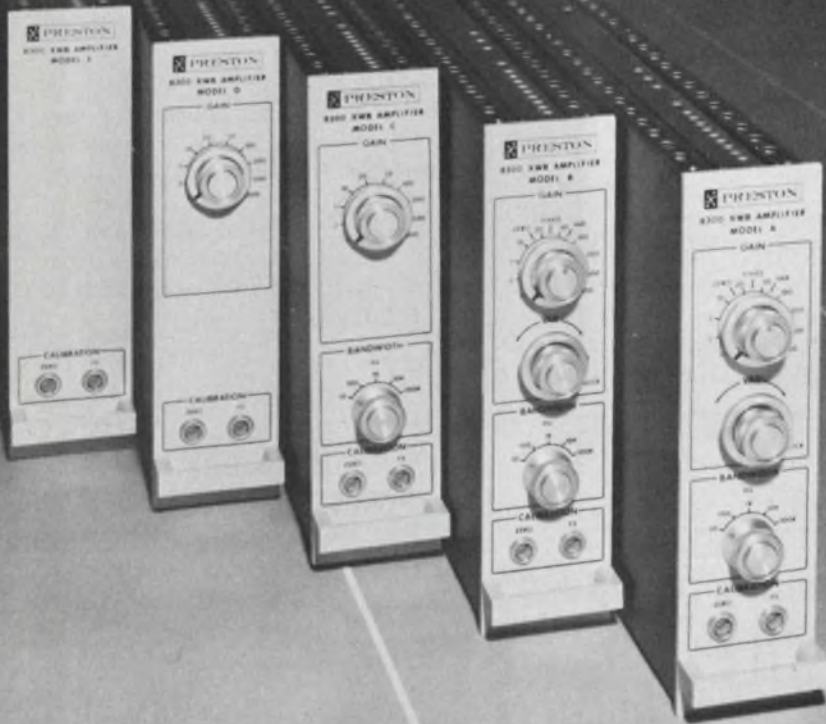

**Preston's Amplifiers
Deliver Precision
Many Times
Better Than
Any Other
Amplifier!**

Here's how Preston's 8300 XWB Series compare with the "next best" amplifiers at overcoming the FOUR major sources of instrumentation system errors:

COMMON MODE REJECTION—3 to 5 times better! Preston's amplifiers deliver the highest CMR available: *150 db at DC, 130 db at 60 Hz!*

TEMPERATURE STABILITY—2 to 5 times better! Gain Temperature Coefficient is an outstanding *10 parts/million/°C*, and Zero Shift is a super-small *0.1 $\mu\text{V}/^\circ\text{C RTI}$!*

PUMPOUT CURRENT—10 times better! Every model in the 8300 XWB Series stays under *1/2 nanoamp* over the entire temperature range!

OVERLOAD RECOVERY—10 times as fast! Recovers to within *0.01%* of the overload signal in only *30 microseconds!*

And Preston's 8300 XWB Series deliver the accuracy and versatility to meet every instrumentation system requirement:

ACCURACY—from 0.1% to 0.005%!

GAIN SELECTION—10 manual or remotely controlled steps!

BANDWIDTH SELECTION—Five steps from 10 Hz to 100 kHz with full output power over the entire bandwidth!

PROGRAMMABLE GAIN AND BANDWIDTH—for direct control from computers and controllers at standard digital logic levels.

TEN NEW OPTIONS—including triple outputs, three- and four-pole Bessel filters, and remote calibrate relays.

Get all the details in our 12 page "Balanced Precision" brochure that shows how to determine your instrumentation system's true accuracy! Write to Preston Scientific, Inc., 805 East Cerritos Avenue, Anaheim, California 92805, or call us at (714) 776-6400.

We'll put all our years of experience on the line!



 **PRESTON**

NEW NEW NEW

IMC introduces fan for cooling sandwiched areas

IMC's new, high performance FULMAR fan features maximum efficiency for cooling high power density enclosures and rows of printed circuit board arrays. Unique design of this fan allows for convenience of "Side by Side" mountings for maximum airflow distribution and stable motor performance under low voltage (brown out conditions). Fulmar's low noise level is a natural for computer room use.



4-3/4" diameter by 5-29/32"

FEATURES

- A compact 2" in depth
- Meets U.L. recognition requirements
- Automatic reset overload protector is standard
- Capacitor supplied with unit

50/60 HZ AIRMOVER



Circle the "Bingo" for details! For immediate service please call Fred Taylor, Sales Manager at (603) 332-5300 or write:

IMC MAGNETICS CORP.

NEW HAMPSHIRE DIVISION

ROUTE 16B, ROCHESTER, NEW HAMPSHIRE 03867

INFORMATION RETRIEVAL NUMBER 55

PACKAGING & MATERIALS

Breadboarding kit allows easy rf design

Christiansen Radio, Inc., 3034 Nestall, Laguna Beach, CA 92651. (714) 497-1506. \$60 (unit qty); stock.

Christiansen Radio's new rf breadboarding kit is the latest addition to the Mini-Mount line of breadboarding equipment. Designed around the company's adhesive-backed circuit pads and specially designed movable rf partitions, the kit allows the circuit designer to mount components interwire stages and distribute power without drilling. The kit includes 100 assorted Mini-Mounts, a 4 x 8-in. double-sided solder-plated G-10 ground plane and 10 rf partitions.

CIRCLE NO. 338

DIP receptacle features low profile, easy insert

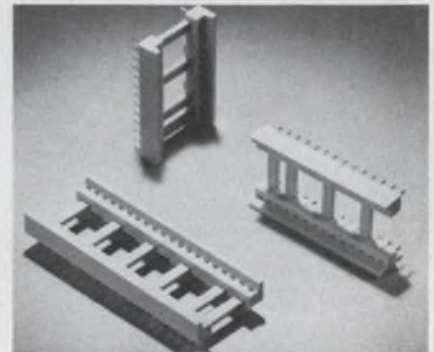

Amp Inc., Harrisburg, PA 17105. (717) 564-0101.

A new series of 0.600-in. wide low-profile DIP receptacles is available in 24, 28 and 40-position versions. These solder-to-board receptacles feature closed contact entry with large lead-in ramps for easy insertion of the circuit package. The receptacles are less than 0.160-in. high, excluding the ramp, and the housings are of flame-retardant, glass-reinforced nylon with anti-bridging, easy-cleaning standoffs. Contacts are beryllium copper and may be ordered with tin or gold plate. Contact current rating is 1.5 A and dielectric withstanding voltage is 1000 V rms. Individual contact engagement force is 0.9 oz min. Contact durability is 25 cycles.

CIRCLE NO. 339



Versatile 1" x .100" GRID Reed Relays

Many Options for Most Applications

New CR-2000 Series utilizes the popular 1" x .100" grid pattern, with 1 to 6 poles and a variety of options and contact forms for almost any application. Reliable low-level switches may be conditioned by special run-in and dynamic testing. Models can be epoxy-encapsulated or simply encased for added economy. Ask for Bulletin MR 11.1 for full details.



COTO-COIL COMPANY, INC.
59 Pavilion Ave.
Providence, R. I. 02905
Tel: (401) 467-4777

INFORMATION RETRIEVAL NUMBER 82

Circuit Savers

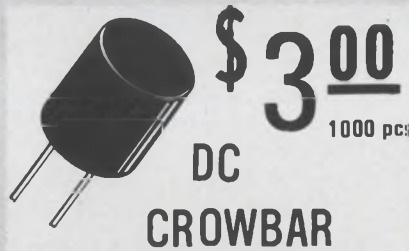

\$3⁰⁰
1000 pcs

DC CROWBAR

Here's positive low cost protection for your IC's, transistors, power supplies and pc cards.

The LVC-1A crowbar switches to a short circuit whenever the voltage across it exceeds a specified level.

Any trip voltage level between 4.7V and 200V \pm 10% can be selected. The unit will handle a peak current of 50 Amps (8ms) and 3A continuously. MIL Temperature range. Call Mike Coyle for applications assistance.

Full line of protection modules for every hi-lo voltage/current requirement. Write or call for Catalog 749.

279 Skidmore Road
Deer Park, New York 11729
Telephone: 516 - 586-5125

MCG Electronics

See Gold Book vol 2. p. 1277.

INFORMATION RETRIEVAL NUMBER 83

A bench and system use innovator from T.R.I.

Model: 6141
Programmable DC V/I Generator



Model: 6120 Programmable DC Standard



Two DC V/I Generators for all new applications

1. A stimulus to auto testing equipment...Programmable functions for OEM use.

Two DC V/I generators can control externally the functions you need for OEM applications. These units have a pulse-width modulation system, so switching output noise is far less than that of conventional products.

2. Includes a 14-step memory and flip switch for newer, wider bench uses.

Model 6120 includes a 14-step memory so it can be used as a simple testing device for storage of the desired output. Model 6141 has a new flip switch enabling quick setting of the output.

3. High accuracy and very small step advantages permitting use as a standard device.

Both models have very small step advantages, continuously variable, and highly stabilized output for adequate use as standard device.

4. Continuous function highly suited for instrumentation checks and maintenance.

Both models can vary the output level both stepwise and continuously, making them highly suited for checking and maintenance.

| | Model 6141 | Model 6120 |
|-------|-----------------------------|-----------------------------|
| DCV | 0 ~ ±12V (1μV step) | 0 ~ ±1200V (1μV step) |
| DCI | 0 ~ ±120 mA (0.1μA step) | 0 ~ ±120 mA (0.1μA step) |
| Price | \$890 | \$2995 |



T.R.I. Corporation

505 West Olive Avenue Sunnyvale, CA 94086
(408) 733-9080

INFORMATION RETRIEVAL NUMBER 57

ELECTRONIC DESIGN 25, December 6, 1974

Gaskets made with wires embedded in silicone

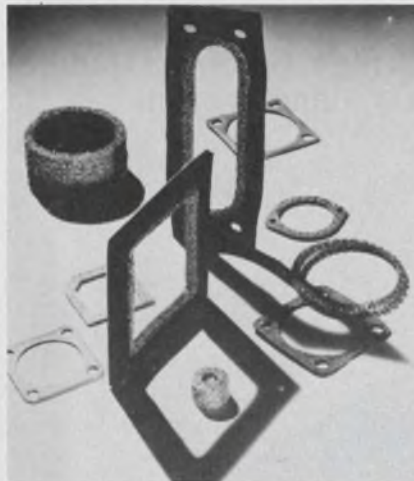

Radcon Corp., 246 Columbus Ave., Roselle, NJ 07203. (201) 241-5550. \$0.07 per in.²; stock to 6 wks.

Radcon's series 1550 rf gasketing material has a conductivity of approximately 0.003 Ω cm. The resistivity, though, varies with the type of conductive material dispersed through the material's silicone-rubber base. The material is made in sheets and in custom shapes ranging from 0.002 to 0.125-in. thickness. Other thicknesses also are available. The series 1547 material is made conductive by running wires through the silicone rubber. Those wires are usually monel, but almost any conductive wire can be used. The 1547 material comes in 25-durometer solid silicone with a minimum thickness of 0.062 in. and in sponge silicone of medium density with a minimum thickness of 0.093 in.

CIRCLE NO. 340

Kit of ferrite cores for wide-band xformers

Fair-Rite Corp., Wallkill, NY 12589. (914) 895-2055. \$10; stock.

A sample kit contains 18 different core shapes of nickel-zinc and new high-permeability manganese-zinc ferrites for winding wideband transformers. The cores are specially selected for effectiveness at frequencies above 2 MHz. The core shapes are provided in three different materials each, with application data that include characteristics curves. The data also describe how to choose the right material and core size for a particular application.

CIRCLE NO. 341

low cost ceramic trimmer capacitors

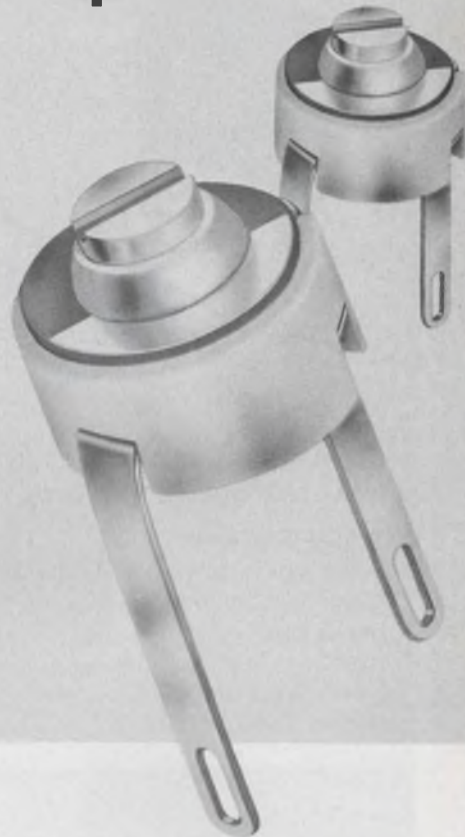

These ceramic trimmer capacitors are designed for broadband application, from audio to 500 MHz and afford an ideal *low cost* means of "trimming" circuitry such as crystal oscillators, CATV amplifiers and all varieties of communication and test equipment.

FEATURES

- Capacitance values from 1-3 to 5-25 pf
- Low profile - .208 above board height
- Low cost - 75c in 1000 quantities
- Delivery from stock



MANUFACTURING CORPORATION

BOONTON, NEW JERSEY 07005

201 / 334-2676

TWX 710-987-8367

INFORMATION RETRIEVAL NUMBER 58

POWER SUPPLIES

analog



DUAL OP - AMP SUPPLIES from $\pm 25\text{mA}$ to $\pm 500\text{mA}$

SPECIFICATIONS:

INPUT VOLTAGE AND FREQUENCY:

105 to 125 Vac 50 to 440Hz

OPERATING TEMPERATURE

-25°C to +71°C No Derating

RIPPLE AND NOISE

1mVrms typical

| MODEL NO | REGULATION | | PACKAGE SIZE (INCHES) | LIST PRICE (19) |
|--|------------|--------|-----------------------|-----------------|
| | LINE % | LOAD % | | |
| $\pm 15\text{Vdc}$ @ 25mA | | | | |
| SQ 2.15.30 | 0.25 | 0.25 | 2.0x2.0x0.875 | \$19.95 |
| LCD 2.15.25 | 0.20 | 0.20 | 2.5x3.5x0.875 | 19.95 |
| P 2.15.25 | 0.20 | 0.20 | 2.5x3.5x0.875 | 21.50 |
| $\pm 15\text{Vdc}$ @ 50mA | | | | |
| SQ 2.15.50 | 0.25 | 0.25 | 2.0x2.0x0.875 | 28.95 |
| LCD 2.15.50 | 0.20 | 0.20 | 2.5x3.5x0.875 | 35.00 |
| P 2.15.60 | 0.01 | 0.05 | 2.5x3.5x0.875 | 37.00 |
| 2.15.50 | 0.01 | 0.05 | 3.0x4.5x1.50 | 29.95 |
| $\pm 15\text{Vdc}$ @ 100mA | | | | |
| P741-1015 | 0.20 | 0.20 | 2.25x2.5x1.25 | 33.95 |
| LCD 2.15.100 | 0.20 | 0.20 | 2.5x3.5x0.875 | 45.00 |
| P 2.15.100 | 0.01 | 0.05 | 2.5x3.5x0.875 | 46.50 |
| 2.15.100 | 0.01 | 0.05 | 3.0x4.5x1.50 | 48.00 |
| $\pm 15\text{Vdc}$ @ 200mA | | | | |
| LCD 2.15.200 | 0.20 | 0.20 | 2.5x3.5x1.25 | 59.95 |
| P 2.15.200 | 0.01 | 0.05 | 2.5x3.5x1.25 | 66.00 |
| 2.15.200 | 0.01 | 0.05 | 3.0x4.5x1.50 | 59.00 |
| $\pm 15\text{Vdc}$ @ 300mA | | | | |
| P 2.15.300 | 0.01 | 0.05 | 2.5x3.5x1.56 | 98.00 |
| C 2.15.300 | 0.01 | 0.05 | 3.5x3.5x3.5 | 85.00 |
| $\pm 15\text{Vdc}$ @ 500mA | | | | |
| OF 2.15.500 | 0.01 | 0.10 | 3.5x3.5x3.5 | 65.00 |
| C 2.15.500 | 0.01 | 0.05 | 3.5x3.5x3.5 | 89.00 |

Other voltages are available
for both ANALOG
and DIGITAL applications



306 RIVER STREET • HAVERHILL, MA 01830
(617) 373-9104 • TWX 710 347 0269

INFORMATION RETRIEVAL NUMBER 59

DISCRETE SEMICONDUCTORS

Bridge rectifiers handle 10 A and are tiny

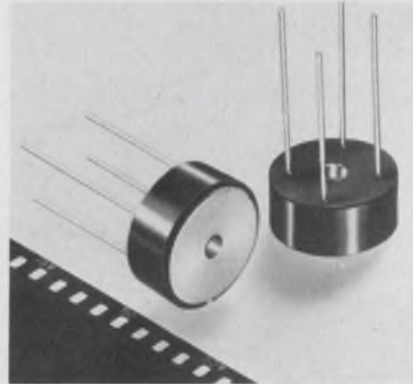

Sarkes Tarzian, 415 N. College Ave., Bloomington, IN 47401. (812) 332-1435. From \$1.98 (100-up).

The H-FB series of bridge rectifiers, with 10 A ratings, is available with PIVs from 100 to 1000 V. The devices are housed in a 0.75 in. diameter machined aluminum case with plastic insulation on all sides except where the built-in heat sink is exposed. Maximum case temperature is 150 C, and maximum one-cycle surge current is 240 A. Maximum heat dissipation at 10 A is 21 W. The H-FB series is normally available with standard silicon avalanche devices, 0.04-in. diameter wire leads and a 0.156-in. mounting hole for a #6 screw. They can also be supplied with 200-ns fast recovery devices or with special polarization and terminal configurations.

CIRCLE NO. 342

Dual monolithic JFETs have epoxy packages

Siliconix Inc., 2201 Laurelwood Rd., Santa Clara, CA 95054. (408) 246-8000. From \$0.99 (100-up); stock.

A series of monolithic matched dual FETs is available in epoxy packages. The E410 family of n-channel dual JFETs is intended for low and medium frequency small-signal differential amplifiers. Characteristics of the E410 family include offset voltage of 10 mV max, CMRR of 70 dB min, offset tempco of 10 $\mu\text{V}/^\circ\text{C}$ and g_{oss} of 5 μmho max at an I_D of 200 μA .

CIRCLE NO. 343

Rf power transistors deliver 150 W

Communications Transistor, 301 Industrial Way, San Carlos, CA 94070. (415) 591-8921. \$40 (1000-up); stock.

The S150-50 rf power transistor can deliver 150 W and is available in a rugged 1/4-28 stud-mounted package as well as in the 0.5-in. flanged package. S150-50 is designed specifically for operation (from a 50-V supply) in broad-band linear power amplifier applications in the 1.6-to-30-MHz range. It is capable of operation in Class A, AB or C amplifiers.

CIRCLE NO. 344

LED displays claim largest size available

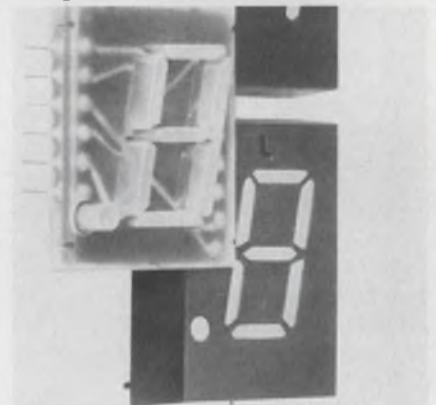

Litronix, 19000 Homestead Rd., Cupertino, CA 95014. (408) 257-7910. \$2.90 (1000 up).

Three 0.6-inch high red LED displays complete the DL-747 series of jumbo digits. The DL-750 seven-segment display has a left-hand decimal and common cathode connection, the DL-749 polarity/overflow display has a common-cathode connection and the DL-746 polarity/overflow display has a common-anode connection. All three displays are 44% larger in area than 0.5 in. high displays, the largest the company claims is available from other major LED manufacturers. Light pipes spread illumination evenly over broad segments. Black plastic surrounds the segments, providing excellent contrast. The displays have a typical luminance of 5 mcd at 20 mA per segment. Forward voltage per segment is 3.4 V typical and 4 V maximum when operated at 20 mA. All the displays are packaged in standard 18-pin DIPs.

CIRCLE NO. 345

Pretrigger recording

The Biomation demonstration

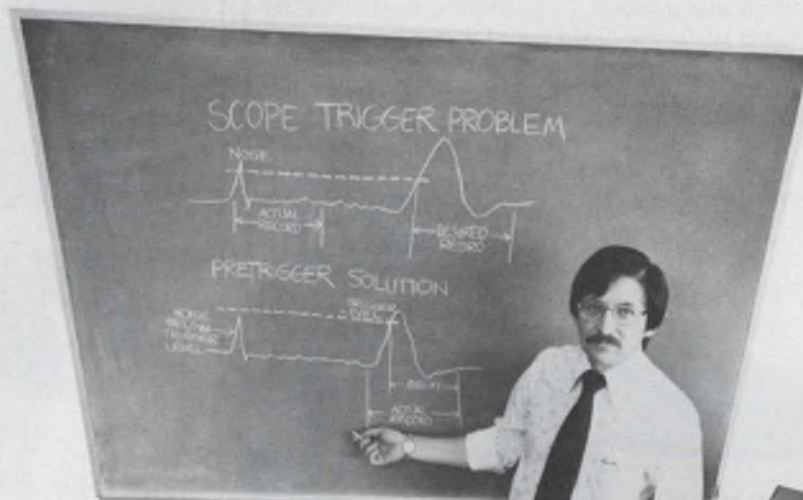

Pretrigger recording is a simple concept. And it is the most powerful recording method for short-lived signals. But Roy Tottingham, Biomation Product Manager, has found that almost no one grasps its usefulness until shown a demonstration. So here's his demo.

"Let's start with the familiar, then move to the unfamiliar. You work with scopes now, right?"

"Right."

"Good. And scopes do a fine job catching repetitive signals for analysis."

"No sweat. But my signal is a unique waveform—once per test shot."

"Exactly—A classic job for one of our waveform recorders with pretrigger recording—this Model 8100, for instance. Its 25 MHz bandwidth is ideal for a wide range of waveforms. Let's connect your signal and I'll show you why."

"O.K."

"Set the input coupling and sensitivity and select the timebase for the signals' duration. Next choose the trigger coupling, polarity and internal source."

"Say, that's just like a scope setup."

"You're right! But if this was a typical scope/camera or storage scope capture, we would now face what I call the trigger level dilemma."

"What's that?"

"Set the trigger level low and we risk triggering on noise or signal echoes. Or set the level high and the scope loses most of the leading edge. Here, like this upper trace on the chalkboard."

"Arrgh! That gets me where I live! I tried solving that problem with a special trigger detector and trigger path to externally trigger my scope, but that was a pain to set up and only worked about half the time."

"M-hmm, twice the cost and half the reliability... nobody wins."



"You mean... this Biomation box gets around all that hassle?"

"With the waveform recorder in pretrigger mode, we can't miss. Let's set the 8100's trigger level high and its trigger delay to about 80% of the record length. Now I'll reset the trigger circuit and you can trip your test anytime you want!"

"O.K. Here goes."

"And there you have it!—on the CRT monitor output of the 8100!"

"Wow! Look at that leading edge trigger point! 20% from the left end of the trace. What do you have in that 8100? A superfast disc or tape loop?"

"No way! The 8100, like all of our waveform recorders, uses a superfast A/D converter and semiconductor memory for recording."

"But how does that give me pretrigger data?"

"In pretrigger mode, the delayed trigger is used to stop recording, not start it. So the memory can be continually updated with the newest data from the A/D—in real time—until the trigger is detected. Then it's stopped after the trigger delay. Here, I'll illustrate this effect on the board. The stored signal is then repetitively reproduced through a D/A for display on a scope or CRT as you see here. Or you can output it slowly onto a chart recorder."

"Hey! That's a clean deal! Does it have digital output too?"

"Of course, and we also have models with digital input for recording digital signals. One of our units is sure to fit your need."

So there's the demo. Now if you want data sheets or applications ideas, drop us a line, Biomation, 10411 Bubb Road, Cupertino, CA 95014. (408) 255-9500.

biomation

INFORMATION RETRIEVAL NUMBER 60

AUTOMATIC TORQUE CONTROL

ADJUSTABLE UPPER AND LOWER TORQUE LEVELS

The Series CT-400 Automatic Torque Control Systems are the most complete and versatile, industrial line available from off the shelf today for electrical control and inspections of torque directly on the production line.

The electrical output signal permits control either on site or remotely. Available in one to five channels, these units feature a wide range of torques of less than 1 ft-lb to more than 100,000 ft-lbs.

Adjustable lower and upper dimensional relay trip levels, provide automatic selective rejection of under and over torqued components to meet automotive and other safety requirements.

DISTRIBUTOR
INQUIRIES
INVITED

Call or Write:
COLUMBIA RESEARCH LABS.
Woodlyn, Pennsylvania 19094
Telephone: (215) 532-9464

 **columbia** first for
transducers and control



INFORMATION RETRIEVAL NUMBER 61

Decitek gives you accurate, reliable tape reading whatever your reader requirements.

Regardless of what reader you select from the Decitek line, you will be assured of proven reliable performance. A patented dual sprocket drive gives consistently accurate character registration

up to 600 cps without tape wear.

The fiber optic-photo transistor read system provides highly stable error-free reading.

Write for brochure giving details on the full

Decitek line of high performance punched tape readers.

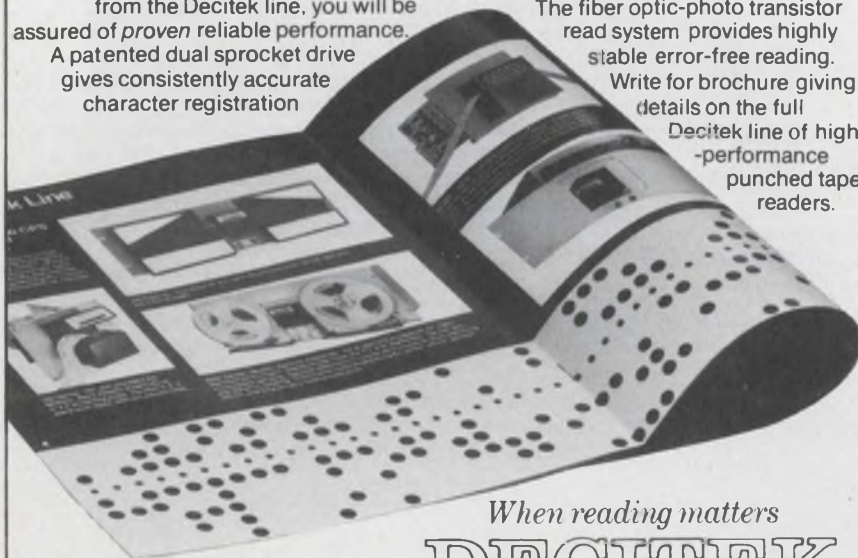

When reading matters

DECITEK

A DIVISION OF JAMESBURY CORPORATION
250 CHANDLER STREET, WORCESTER, MASSACHUSETTS 01602, U.S.A. (617) 798-8731

INFORMATION RETRIEVAL NUMBER 62

DISCRETE SEMICONDUCTORS

LED numeric displays designed for watches



Litronix, 19000 Homestead Rd., Cupertino, CA 95014. (408) 257-7910. From \$7.05 (1000-up).

The DL-5175 series of 4-digit LED displays is available in four different types, each with a colon between second and third digits. The DL-5175 is a 4-digit display of continuous-line monolithic digits 0.1 in. high, the DL-5176, a 3-1/2-digit display 0.115 in. high, the DL-5177, a 4-digit display in a monolithic package with magnified digits 0.1 in. high and the DL-5178, a 4-digit version of the DL-5176 for 24-hour timepieces. The pin-out configuration of the DL-5175 series has been optimized to allow close spacing of associated integrated circuits, such as the company's LBC-1060 and LBC-1070 bipolar drivers, without the need for jump bonds or multilevel interconnect schemes.

CIRCLE NO. 346

Photodiode array has support electronics

Integrated Photomatrix, 1101 Bristol Rd., Mountainside, NJ 07092. (201) 233-7200. \$195; stock.

A module in the company's 4000 series is designed for optical scanning. It consists of a printed-circuit board and a self-scanned linear array of 64 photodiodes. The printed-circuit board contains all necessary driving and processing electronics to provide an electrical video output when supplied with dc voltages.

CIRCLE NO. 347

Bridge rectifiers have 300-ns recovery time

Electronic Devices, 21 Gray Oaks Ave., Yonkers, NY 10710. (914) 965-4400. From \$4.40.

The PBR and PBRL series of rectifier bridges handle currents of 15 A and have PRVs that span 50 to 1000 V. The bridges have maximum reverse recovery times of 300 ns. All units have a max range current of 200 A and a max peak repetitive current of 50 A. Both bridge models measure 1.125 × 1.125 × 0.438 in., not including terminal height.

CIRCLE NO. 348

LED lamps available in orange, yellow or green



Monsanto, 3400 Hillview Ave., Palo Alto, CA 94304. (415) 493-3300. \$0.70 (1000-up); stock.

A line of LEDs is available in green, yellow and orange. The series is mechanically identical to the company's MV5050 series of red lamps. The lamps use a unique reflector assembly, seated behind the LED, to collect the available light and project it along the central axis. Two lenses are available for each of the new colors. The MV5153 is an orange LED, encapsulated in orange diffused epoxy and projects a wide (65°) beam angle. The MV5154 is a similar device with a narrow (24°) beam angle. The other models in the series follow the same pattern: MV5253—green LED, green epoxy package, narrow beam; MV5353—yellow LED, yellow epoxy package, wide beam angle; MV5354—yellow LED, yellow epoxy package, narrow beam angle. All of the lamps have a maximum power dissipation of 105 mW, with a maximum continuous forward current rating of 35 mA at 25 C. In addition, they can be pulsed at a maximum of 5 A.

CIRCLE NO. 349

At Last.

A Data Acquisition System In a Single Module.

Save time and money . . . translating analog data into digital words. Data Translation's DATAX™ is a line of fully integrated data acquisition system modules that outperforms clusters of modules . . . and all at lower cost.

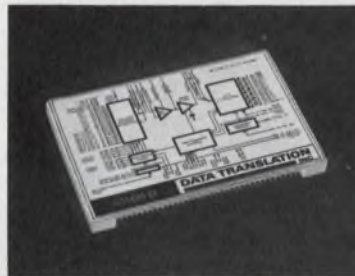

Imagine, for \$395 in 100's you get a complete system that includes:

- 16 Channel Multiplexer
- High Performance Differential Amplifier
- High Speed Sample/Hold Amplifier
- 12-Bit A/D Converter
- All Control and Programming Logic

**DATA TRANSLATION
INC**

109 CONCORD STREET, FRAMINGHAM, MA 01701

Call us at 617/879-3595 for a complete set of applications data. Or call your local representative below.

| | | | | | | |
|--------------|--------------|--------------|--------------|--------------|--------------|--------------|
| 205-539-4411 | 303-934-5505 | 904-243-6424 | 504-366-5766 | 215-925-8711 | 919-489-1546 | 713-688-9971 |
| 602-947-7841 | 305-425-5505 | 305-723-0766 | 301-953-3724 | 505-299-7658 | 216-585-8421 | 214-231-2573 |
| 213-938-2833 | 305-776-4800 | 404-939-1674 | 314-997-1515 | 201-569-2230 | 615-584-2614 | 703-527-3262 |
| 415-941-4410 | | 913-649-4000 | | 716-334-2445 | | 206-454-0900 |

INFORMATION RETRIEVAL NUMBER 63

BULL'S-EYE!

Hit the target everytime ... with subminiature monolithic ceramic capacitors from Centre Engineering. A complete line of high quality subminiature monolithic ceramic capacitors are available including; multi-layer chip capacitors, polymer coated leaded devices, multiple capacitor banks, and glass sealed devices. Over 40 different formulations.

Technological advancements in engineering and manufacturing ceramic capacitors in volume have made Centre Engineering an excellent source of supply.

Hit the bull's-eye with Centre Engineering.

Write for additional information.

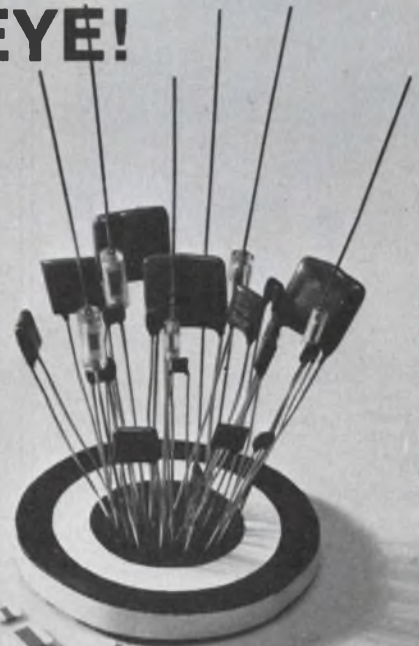

CENTRE ENGINEERING
2820 E. COLLEGE AVE., STATE COLLEGE, PA. 16801
814-237-0321 • TWX 510-691-2634

INFORMATION RETRIEVAL NUMBER 64

**FROM
BREADBOARD
TO FINAL
PACKAGING
HARDWARE...**

**ALL AVAILABLE
FROM ONE SOURCE**



★ **ADHESIVE BACKED
CIRCUIT SUB-ELEMENTS**
(Over 200 Pre-Drilled component mounting
patterns available "off-the-shelf.")

★ **EPOXY GLASS BOARD
MATERIALS**

- 76 Standard "Off-the-Shelf" Boards.
- Including Unclad, Copper Clad, Cut & Peel
Copper Clad, Pre-etched "X-Y" Pattern and
Plated thru Hole Copper Clad.
- 100" Grid Hole Pattern or Undrilled.



★ **GP CIRCUIT BOARDS and ACCESSORIES**

- Highest Quality — Choose from 74
"Off-the-Shelf" Boards.
- Sockets — Low & Standard Profile, P.C. and
Wire Wrap. • Highest Quality Gold Contacts.
- Adapter plugs • Connectors
- Card Pull Handles.



**CIRCUIT-STIK'S
NEW CUT &
PEEL BOARDS**

SEND FOR OUR NEW CATALOGS #502 & #801

circuit-stik

P.O. BOX 3396 • Torrance, California 90510
Phone (213) 530-5530

DATA PROCESSING

**Small computer systems
added to Honeywell line**

*Honeywell Information Systems,
200 Smith St., Waltham, MA
02154. (617) 237-4100. See text.*

Honeywell has introduced to U.S. markets two small computers in the \$1400 to \$4000 monthly rental range. The Level 61 models, smallest in Honeywell's recently announced Series 60 computers, are designed to meet the growing data processing requirements of firms or departments currently using service bureaus, and to provide a growth path for Honeywell's Model 58 users. The Model 61/58 batch and multistation versions and the Model 61/60 transaction processing system compete with such equipment as IBM's System/3 Models 6, 8, and 10; Burroughs' 700 and 1700 and Singer's System Ten. The Model 61/58 can be leased at prices ranging from about \$1400 to \$3000 per month and will be available for delivery in the fourth quarter of this year. The Model 61/60 can be leased at prices ranging from about \$2900 to more than \$4000 and will be available in the second quarter of 1975. Both models can function as independent systems in a small or medium-sized company or as a satellite system, processing and transmitting information to a large central computer. The main processing memory has a complement of 78 hardware instructions and a cycle time of 1.2 μ s. A 350-ns read-only memory, peripheral simultaneity and a no-sort disc file structure contribute to low storage requirements and reduce total processing time. An optional 800-ns MOS extended-memory store, ranging from 16K to 64K bytes, enhances the 5k or 10k main memory. Peripherals include mass storage subsystems with capacities ranging from 3456 megabytes, printers with operating speeds of from 100 to 650 lines per minute, and various input devices including card readers and punches and an optical mark reader.

CIRCLE NO. 350

**Process monitor replays
channels for fault study**

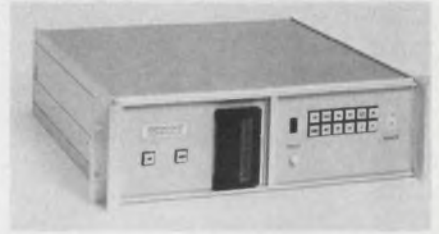

*Metra Instruments, 1340 Space
Park Way, Mountain View, CA
94043. (415) 961-7249. From \$10,-
500; 3 mo.*

An 0.25-in. tape cartridge in the Metracorder holds up to 76 Mbits (40 min) of data. A CRT bargraph display presents the data visually and at the same time, the data are made available for channel monitoring and alarms. The unit can monitor up to 80 process variables and replay them for use in visual diagnosis of failures if they occur. The data are presented to auxiliary equipment in 11-bit ASCII code.

CIRCLE NO. 351

**Intelligent terminals
are IBM-compatible**

*Sanders Associates, Daniel Webster
Highway, Nashua, NH 03060.
(603) 885-2810. \$29,925; March.*

The Sanders Series 8171 and 8172 terminals are compatible with the IBM 3270 operating specifications and include features such as dual intensity, key click, audible alarm, coaxial cable and Photopen. The 8171 represents an extension of the 8170 remote systems while the 8172 is a new product directed towards the local environment market. Designed to meet a variety of on-line alphanumeric requirements, such as inquiry/response, data entry, and order distribution, the 8171 and 8172 can be placed in 3270 application systems without change. The standard IBM 3270 terminal control function, performed with the display and keyboard, plus the binary synchronous communication line control is provided by control programs in the controller memory of the 8171 and 8172. Each system consists of a 12k microprocessor, two CRT displays with keyboards, and emulation software. Configurations ranging up to 32 CRT terminals and eight printers are available.

CIRCLE NO. 352

CHECK THIS NEW ECTRON SYSTEM FOR HIGH SPEED DATA ACQUISITION

6000 Series Systems combine per-channel low level amplifiers with a high level multiplexer and a programmable gain amplifier to provide complete multi-channel signal processing in a small, rugged package. Outstanding performance is provided by the transformer coupled, chopper stabilized design which offers extremely low drift and noise and accommodates common mode voltages up to 300 volts. The standard systems are capable of scan rates of 20,000 channels per second (higher on special order). Integral A-D converters are optional.

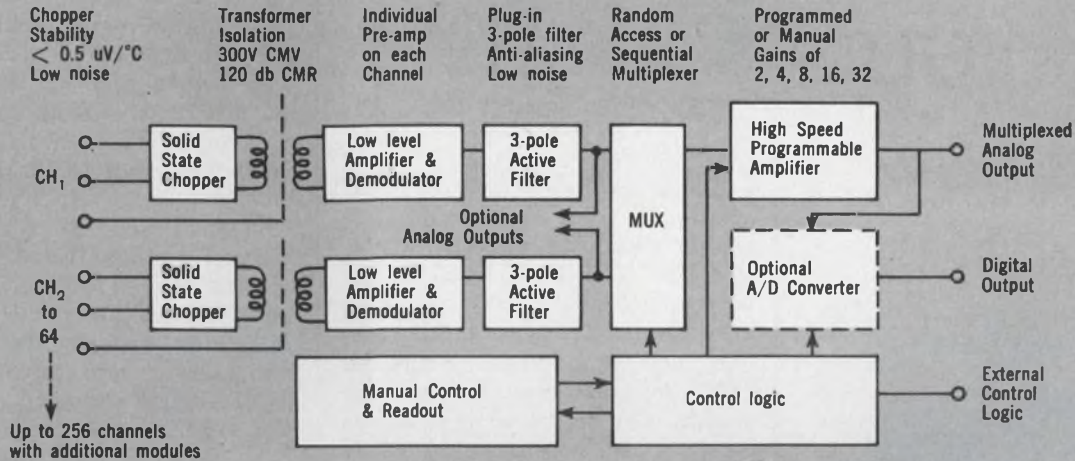

**SPECIALISTS IN DC AMPLIFIERS AND
SIGNAL CONDITIONING FOR STRAIN
GAGES AND THERMOCOUPLES**



For additional information, call Jack JaQuay at 714/278-0600

• 8159 Engineer Road, San Diego, California 92111

INFORMATION RETRIEVAL NUMBER 66

ABSOLUTELY

the world's most accurate rulings using vacuum deposit chrome, etch and fill or emulsion processes. They're produced on the world's largest 1 micro inch numerically controlled ruling engine with interferometric feedback controls. Need precision scales, grids, slits, reticles, Ronchis numbers, letters, circles, dots, or nickel mesh? We stock many items for immediate delivery. Send for brochure No. 38-36.

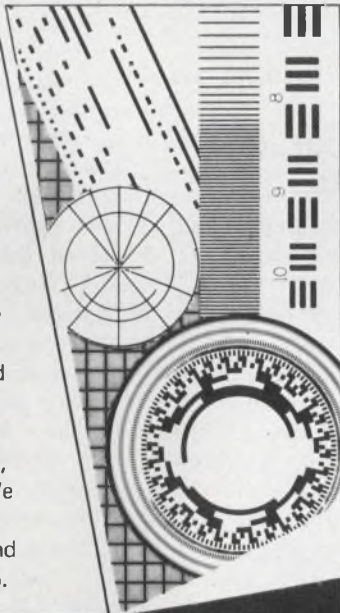

**SCALES RULINGS RETICLES
& GRIDS FROM THE WORLD'S
LEADING SCALE MAKERS.**

MICRO-LINE
DIVISION OF
BAUSCH & LOMB

JAMESTOWN, NY 14701 716/488-1958

INFORMATION RETRIEVAL NUMBER 67

ELECTRONIC DESIGN 25, December 6, 1974

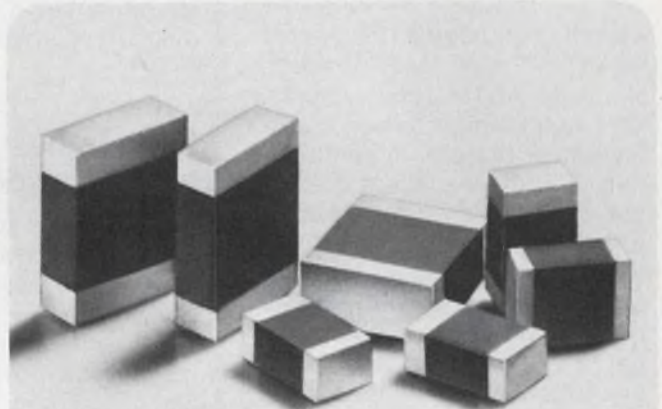

HIGH Q CHIP CAPACITORS

High Q multilayer capacitors feature very high quality factors at microwave frequencies. Superior dielectric properties and structure permit operation at high voltage and high current at microwave frequencies through the full temperature range with minimum dielectric loss. Offered in 4 standard sizes from .040" x .030" to .125" x .095". Applications include UHF-microwave hybrids and MIC's.

Johanson

Monolithic Dielectrics

Box 6456 / Burbank, California 91505
(213) 848-4465 / TWX 910-498-2735

INFORMATION RETRIEVAL NUMBER 68



flame
out

Flame retardant, polyester TEMP-R-TAPE M67 passes U/L and ASTM requirements. This outstanding flame retardant safety feature, in combination with the excellent electrical and physical properties of polyester film backing provides you with a self-adhering tape for use in a wide variety of coil winding, coil holding, harness wrapping and other electrical/mechanical applications. It is especially valuable for radio and tv appliances to reduce fire and electrical shock hazards.

Find your nearest distributor in the "Yellow Pages" or in industrial directories. Or write The Connecticut Hard Rubber Company, New Haven, Connecticut 06509.

CHR

an ARMCO company

INFORMATION RETRIEVAL NUMBER 69

DATA PROCESSING

Typewriter attachment enhances CRT terminals



Tycom Corp., 26 Just Rd., Fairfield, NJ 07006 (201) 227-4141. \$2350; 30 to 45 days.

A high-print quality typewriter attachment for intelligent terminals with CRT displays is now available. The Model KSR-38 can be used with CRT terminals that have an RS-232 output. The system includes a customer-supplied IBM Selectric and Tycom electronics. The depressed keys of the Selectric are converted to ASCII code and the data are then transmitted at a rate of 15 characters per second. Copy can be prepared on the Tycom or CRT terminal keyboards or obtained directly from a computer and edited on the CRT display. The revised copy can then be printed in hard-copy form on the Selectric or stored in the computer for later use.

CIRCLE NO. 353

Logger has separate alarm set-points

Austron Inc., 1915 Kramer Lane, Austin, TX 78758. (512) 836-3523. \$3600 (typ); 90 days.

The DL-1200R logs data from 10 analog channels on an 18-column drum printer. The unit displays data value and channel ID and can scan for alarms in the time between periodic loggings. The alarm option provides independent set points for high and low values. Input impedance is 20 M Ω and source impedance must be 10 k Ω or less. Full scale readings are from 10 mV to 10 V with 0.1% FS or 5 μ V resolution (whichever is greater). The DL-1200R response is settable from one reading/s to one every 10 s. Input isolation is provided (90 dB CMR at 60 Hz) and the number of channels is expandable to 50. In addition open circuits are noted automatically.

CIRCLE NO. 354

Instrument coupler has flexible output format

Data Works, 18752 Bryant Ave., Northridge, CA 91324. (214) 885-8985. See text; stock to 30 days.

A dual instrument coupler, the Model 1700, accepts up to 40 parallel inputs per channel and formats them to serial or 8-bit parallel characters. Program modules establish the type of conversion which can include BCD to ASCII, octal to ASCII or binary to all eight data bits. The output drives modems, TTYs or CPUs to form a complete data acquisition system. One suggested use for the two-channel version includes a multiplexing DVM (for nine analog inputs) and a digital clock to form a logging system. The maximum serial baud rate is 9600. Model 17X1 (single channel) costs \$895; the 17X2 (double channel) \$1195.

CIRCLE NO. 355

Electronic unit checks entry by fingerprint

Calspan Technology Products, P.O. Box 235, Buffalo, NY 14221 (716) 632-7500. From \$29,500, ea. terminal \$2950; 2 to 3 mo.

Equipment capable of verifying an individual's identity within two seconds, by "reading" his or her fingerprint is now available. Designated Fingerscan, the system consists of one or more access terminals connected to a specialized central station in which are stored the identification numbers and fingerprints of persons authorized to enter the controlled area or use controlled equipment. The individual activates the system by entering his identification number into the access terminal and pressing his finger onto a template. Within two seconds, the Fingerscan system will read the fingerprint, compare it with the one registered, and signal back either Access Permitted or Access Denied. Some of the technology used in Fingerscan was developed by the company for the Finder automatic fingerprint reader system, which has been in operation for more than 1-1/2 years at the F.B.I. Finder includes substantial innovations in digital image processing technology, and patents have been applied for.

CIRCLE NO. 356

CUT
PRODUCTION
TIME WITH
THESE
**LOW COST
COMPONENT
LEAD BENDERS**

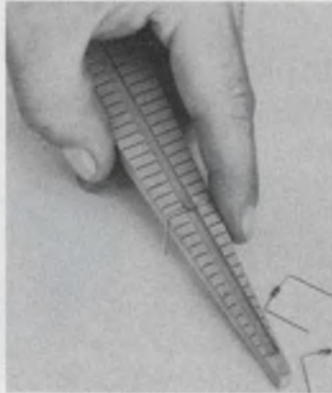

Up to 1200 component leads per hour may be formed with these simple, precise units. They cut production time and eliminate damage to components and leads. Designed primarily for resistors and diodes, MARK Series Component Lead Benders produce perfect bends. Tantalum capacitors, axial lead components, jumper wires, and other similar parts may also be formed easily and efficiently. Ideal for both prototype and production situations.

Bends are made rapidly with gentle finger pressure and meet N.A.S.A. Specification MSFC-PROC-256. No other tools are required. The aggravation and component damage associated with the long-nose plier "free bending" technique is completely eliminated. Industry proven since 1959, the MARK Series offers 5 models for forming 1/8 watt, 1/4 watt, 1/2 watt, 1 watt, and 2 watt size component leads. Priced under \$5.00, these quality tools are available for off-the-shelf delivery. For complete information write or call:

RG ENTERPRISES, INC.

P.O. BOX 667
SCOTTSDALE, ARIZONA 85252
TELEPHONE (602) 948-9888

INFORMATION RETRIEVAL NUMBER 70

**The New Brush 2400:
the best performing, most versatile
wide channel recorder you can buy.**

It is available in 2, 3 and 4 channel configurations utilizing combinations of 50 mm and 100 mm channels totalling 200 mm. It had a 99.65% linearity over the full 100 mm channel. Its frequency response is an outstanding 30 Hz at 100 mm, 50 Hz at 50 mm and up to 125 Hz less the 3dB down. It has a full range of plug-in signal conditioners for just about any industrial-scientific-medical application.

For full details on why the new Gould 2400 is the best performing direct writing recorder you can buy, write Gould Inc., Instrument Systems Division, 3631 Perkins Avenue, Cleveland, Ohio 44114. Or Kouterveldstraat Z/N, B 1920 Diegem, Belgium.



 **GOULD**

INFORMATION RETRIEVAL NUMBER 71

ELECTRONIC DESIGN 25, December 6, 1974



**0.1 Hz to 1 MHz
for only \$140.00***

This new function generator from Heath offers sine, square & triangle waveforms, wide frequency range, 10 V output, 70 dB attenuation for only \$99.95* kit, \$140* assembled

Every lab needs a good function generator. And now Heath offers a true function generator at a price everyone can afford. Our 1271 provides sine, square or triangle waveforms from 0.1 Hz to 1 MHz with a 10 volt peak-to-peak output into a 50-ohm load. The calibrated attenuator provides 0 to 50 dB attenuation in 10 dB steps with up to 20 dB additional variable attenuation for each step, for a total of 70 dB. Triangle waveform nonlinearity is 5% maximum, with waveform symmetry within 10%. Sine wave harmonic distortion is 3% maximum from 5 Hz to 100 kHz. Square wave rise and fall times are 100 ns max. Its light weight and small size allow it to be placed almost anywhere. The adjustable tilting handle provides easy carrying and positioning for best access to the front panel controls. For \$140*, you can have the SG-1271, completely factory assembled and calibrated. Or buy the kit-form IG-1271 for only \$99.95* and save by building it yourself — a triggered scope is all that's needed for alignment.



Our latest catalogs contain complete description & specs for the 1271 and many other high-performance, low cost instrument values from Heath. Send for your free copies and see how you can get more value for your instrument dollar.

HEATH COMPANY
Dept. 531-261
Benton Harbor, Michigan 49022

HEATH

Schlumberger

- Please send the 1975 Heathkit Catalog.
 Please send the latest Assembled Instruments Catalog.

Name _____

Company/Institution _____

Address _____

City _____ State _____ Zip _____

*Mail order prices; F.O.B. factory. Prices & specifications subject to change without notice.

EK-445

INFORMATION RETRIEVAL NUMBER 72

MONOLITHIC CRYSTAL FILTERS

the
State
of the
Art

TELLING vs. SELLING

The purpose of this column is to disseminate information. Or, to be absolutely honest, to sell by informing. As a responsible engineering or procurement person, you're quite capable of making your own decisions, given the facts. So that's what we give you. We think that the more facts about monolithic crystal filters we present, the more likely you are to buy ours. That's our "let the buyer be aware" theory.

ON SPECIFICATIONS

Writing a component specification is a lot like writing a legal contract. Both can be precise and complete, or vague and ambiguous. Or misleading.

In specifying monolithic crystal filters, one simple method—the boundary method—guarantees desired selectivity—precisely, under specified conditions, without ambiguity. That's why all of PTI's standard specifications are boundary specs. While other methods of specification may make the filter appear in a more favorable light, we feel that this kind of "specmanship" is not in your best interest and hence not in ours.

And boundary specifications—since they are usually intimately related to system requirements—represent a "natural" for the equipment designer preparing a filter spec. One pitfall: in writing boundary specs don't try to include filter manufacturing tolerances. We'll take care of that. Specifying selectivity is only one part of the story. If you need guidance in any aspect of writing specifications for monolithic crystal filters, we may be able to help.

Pti

Piezo Technology Inc.

2400 Diversified Way Orlando, Florida 32804
305 425-1574

The Standard in monolithic crystal filters.

COMPONENTS

Gas-discharge display provides high contrast



Cherry Electrical Products Corp.,
3600 Sunset Ave., Waukegan, IL
60085. (312) 689-7600.

Digital readouts, called Plasma-Lux, are gas-discharge display panels that are totally interchangeable with other similar panels. According to Cherry, an advanced thick and thin-film technology produces the high contrast and brightness, uniformity of each of the seven segments, low power consumption, high reliability and long life. A halo-effect back light gives the appearance of a continuous line for greater visibility, clarity and sharpness. The neon orange color is easy on the eyes and may be readily filtered. The 0.40-in-high digit size is easily read from distances up to 25 ft.

CIRCLE NO. 357

Flashlight standby life guaranteed for 10 years



Power Conversion, Inc., 70 Mac-
Questen Pkwy. S., Mount Vernon,
NY 10550. (914) 699-7333. \$7.95
+ \$0.50 for handling (unit qty).

A compact single-cell flashlight powered by one Eternacell, lithium-organic electrolyte "D" cell offers a guaranteed standby-life of 10 yr. Its brightness is greater than an ordinary two-cell flashlight; it can operate at sub-freezing temperatures; and it has a rotary-switch mechanism, a high-impact plastic head and leakproof construction. The battery is replaceable and a standard PR2 bulb is used.

CIRCLE NO. 358

Replace indicator lamps without tools

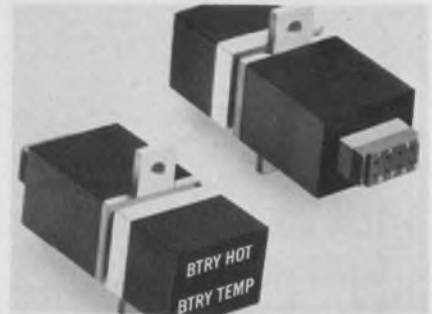

Aerospace Optics Inc., 7112 Burns
St., Fort Worth, TX 76118. (817)
284-2293.

Standard T-1 flange-base lamps are easily replaced from the front of this new indicator without any tools. The indicator connector mates with the Standard MIL-C-390-29/1-16-20 pin. Indicator messages are readable in sunlight and come in four illuminated colors—red, amber, green and white. Two separate messages can be displayed in each module.

CIRCLE NO. 359

Four DPDT switches housed in 24-pin DIP



Amp Inc., Harrisburg, PA 17105.
(717) 564-0101.

Four separate DPDT switches are housed in this DIP. Each screw-driver actuated switch is bi-directional with a center-off position. Over-all body dimensions are 1.344 L x 0.428 W x 0.312 H in. Lead spacing is the standard 0.100 x 0.300 in. DIP pattern. Contact resistance is typically 30 mΩ max. The nonswitching rating is 50 V at 100 mA and the switching rating is 5 V at 100 mA. Dielectric breakdown voltage between adjacent switches is 500 V dc minimum. Contacts and terminals are phosphor-bronze, plated-gold over nickel with an electrical life of 2000 switching cycles.

CIRCLE NO. 360

IMPROVE YOUR GOLD BOOK

Several errors crept into Electronic Design's **GOLD BOOK**. You might find it handy to clip out the following corrections and attach it to your copy of **THE GOLD BOOK**.



The 1974/75 edition of the **GOLD BOOK** is the most comprehensive electronics directory in the world.

Volume 1 required 13-million input keystrokes. Its Product Directory, in 469 pages, lists suppliers of 2925 products and services (and 1874 additional cross references). The Manufacturers Directory, in 341 pages, lists 7528 manufacturers. The same volume includes 28 pages in the Trade Name Directory, 39 pages in the alphabetic Distributors Directory and 40 pages in the geographic Distributors Directory.

Volumes 2 and 3 include 2820 catalog pages, organized within 52 basic product categories. So the three volumes include a massive amount of data and, as the errors show, the **GOLD BOOK** is not perfect. So we're not happy.

We want to make next year's edition as perfect and complete as humanly possible. We'd appreciate your help. If your company offers products or services to the electronics industry, help us make certain your company is listed. Take a few moments to fill out the card following page 114.

Acopian Corp., 131 Loomis St., Easton, PA 18042 Tel: (215) 258-5441

The company's catalog pages were not listed completely in all the appropriate product categories in the Product Directory. The complete listing of product categories that should carry catalog page references, and the associated catalog page references are as follows: Power Supplies, A-C Input, 0 to 100 VDC Output (Vol 3/875-900); Power Supplies, A-C Input, 101 to 1000 VDC Output (Vol 3/876,877, 880-891,893,897-900); Power Supplies, A-C to D-C, Modular (Vol 1/Inside Front Cover, Vol 3/875-900); Power Supplies, A-C to D-C, Unregulated (Vol 3/890,891); Power Supplies, High D-C Current, Low Voltage (Vol 3/888,889); Power Supplies, Isolated (Vol 3/896); and Power Supplies, Operational Amplifier (Vol 3/878-881,892).

Artisan Electronics, 5 Eastmans Rd., Parsippany, NJ 07054 Tel: (201) 887-7100

The company does not make Generators, Impulse, for which it was listed.

Clarke-Hess Com Research Corp., 46 W. 16th St., New York, NY 10011 Tel: (212) 255-2940

The company was listed as Com (Communication) Research Corp, with a cross reference from Clarke-Hess Com Research Corp. The company prefers its primary listing as Clarke-Hess Com Research Corp.

Further, in the Index of Catalog Pages in Volumes 2 and 3, the company was listed as Clarke-Hess, Research Corp with a cross reference to Research Corp. (This error resulted from a telephone order, in which a typesetter mistook "Com" for a comma.)

Computer Labs, 1109 S Chapman St, Greensboro, NC 27403 Tel: (919) 292-6427

The company's listing under Converters, Analog-to-Digital (Except IC) should reference Catalog Page Vol 3/1289.

Del Electronics Corp., 250 E. Sandford, Mount Vernon, NY 10550 Tel: (914) 699-2000

The company feels that it deserves a printer's bullet (indicating that literature was supplied for verification) for each of its products. The **GOLD BOOK** staff, unfortunately, did not receive the literature.

Dow Corning Corp., South Saginaw Rd, Midland, MI 48640 Tel: (517) 636-8000

All of the company's listings in the Product Directory should be boldfaced.

GTE Automatic Electric, 400 N. Wolf Rd., Northlake, IL 60164 Tel: (312) 562-7100

The company was listed in the Index of Catalog Pages, the Product Directory and the Manufacturers Directory as GTE Sylvania Automatic Electric. GTE Sylvania and GTE Automatic Electric are, in fact, separate companies, though both are wholly owned subsidiaries of General Telephone & Electronics Corp.

EF Johnson Co., 2999 Tenth SW, Waseca, MN 56093 Tel: (507) 835-2050

The company's catalog pages (Vol 2/925-929) appeared in Section 1100 (Function Modules) instead of Section 3100 (Connector Products & Terminal Boards). Further, the company's city was listed as Waseck, MN instead of Waseca, MN.

Superior Electric Co., 3000 Middle St., Bristol, CT 06010 Tel: (203) 582-9561

Catalog pages Vol 2/1375 and 1376 should have been facing pages (with Page 1376 on the left), instead of back-to-back.

Tech Wire Prods Inc, 129 Dermody St, Cranford, NJ 07061 Tel: (201) 272-5500

All of the company's listings in the Product Directory should be boldfaced.

TRAK Microwave Corp., 4724 Eisenhower Blvd., Tampa, FL 33614 Tel: (813) 884-1411

Catalog pages Vol 3/1384 and 1385, referenced from Geo Space Sys Div of TRAK Microwave Corp, also at 4724 Eisenhower Blvd, Tampa, FL 33614, should instead have been referenced from TRAK Microwave Corp in the Index of Catalog Pages.

Further, TRAK should be listed, with a cross-reference to the indicated catalog pages, in the Manufacturers Directory and under the following product headings in the Product Directory: Ampifiers, I-F (Vol 3/1384); Amplifiers, Microwave (Vol 3/1385); Microwave Circulators & Gytrators (Vol 3/1385); Microwave Isolators (Vol 3/1385); Oscillators, Microwave (except Klystron & Magnetron) (Vol 3/1384,1385); Oscillators, Pulse (Vol 3/1384); Oscillators, R-F (Vol 3/1384); and Preselectors (Vol 3/1385).

Union Carbide/Components, Box 5928, Greenville, SC 29606 Tel: (803) 963-7421

The trade name KEMET, for the company's components, was omitted from the Trade Name Directory.

Vectrol Inc., 1010 Westmore Av., Rockville, MD 20853 Tel: (301) 424-6900

The company's listing under Controls, SCR in the Product Directory should have referenced Catalog Page Vol 3/1418. This page was referenced erroneously in the listing for Vectrol under Power Converters, A-C to A-C, Solid State.

Wabash Relay & Elecs, First & Webster St., Wabash, IN 46992 Tel: (219) 563-2191

Catalog page Vol 2/1224 instead of Vol 2/1244 was referenced for this company's data page in the Index of Catalog Pages, and in the Product and Manufacturers Directories.

Dual visual recognition switches with versatility and economy—that's yankee ingenuity.

Switchcraft's unique and highly versatile DVR Switches give you the advantage of advanced DUAL VISUAL RECOGNITION. When the pushbutton is "out," the black color band contrasts with the recognition cap; in the "in" position, only the colored recognition cap shows. It means we've made it easier to see the switch position, eliminating false indications.

This kind of advanced "human engineering"—plus its low cost—makes DVR ideal for applications in EDP, computer systems and peripheral equipment, sound and communications equipment, and telephone equipment. You get reliability and economy in one little package.

DVR Switches in either momentary or push-lock/push-release functions offer up to 4-C switching. Standard silver-plated, U-shaped bifurcated sliders are rated at 0.5 amp D.C., or 3 amps A.C., 125 V non-inductive load are ideal for dry circuit use. An 11 amp power module is offered with 1-C switching (depth: 1½"), plus additional 1-C or 2-C of standard bifurcated switching (depth: 2½"). Solder lug terminals are standard; P.C. or wire wrapping terminals are available. DVR switches mount in a single 1½" hole and offer a variety of colors, styles, mounting hardware and legends.

Only Switchcraft—and a little Yankee Ingenuity—gives you all this for so little. Contact your Switchcraft Representative or Switchcraft, 5555 N. Elston Avenue, Chicago, Illinois 60630.

SWITCHCRAFT

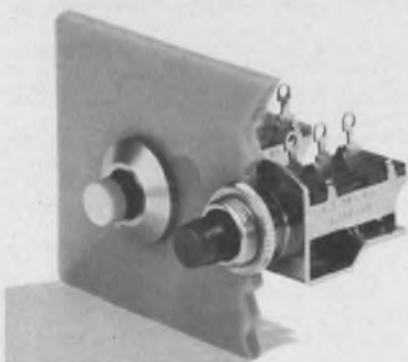

INFORMATION RETRIEVAL NUMBER 77

new literature

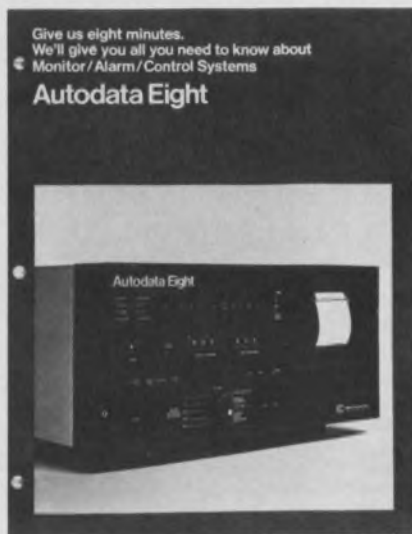

Control system

A four-color brochure describes the company's microprocessor-based Autodata Eight monitor/alarm/control system. Vidar Autodata, Mountain View, CA

CIRCLE NO. 361

Op amps

The second edition of "Operational Amplifiers" contains the theory of op amps, construction of circuits and is complete with schematics. But have your French-English dictionary handy, you'll have to translate it. Thomson CSF, Paris, Cedex, France.

CIRCLE NO. 362

Instrument catalog

A 164-page catalog describes and illustrates thousands of unusual and hard-to-find bargains for design engineers, research labs, safety specialists, experimenters and hobbyists. Edmund Scientific, Barrington, NJ

CIRCLE NO. 363

Metalized substrates

"Processing of Micaply Conductor Metalized Substrates for Hybrid Microcircuits" describes the preparation of this substrate material for various chip and wire bonding techniques. Also included are processing sequences suitable for fabricating several types of conductor networks. The Mica Corp., Culver City, CA

CIRCLE NO. 364

Picture tubes

A 24-page guide includes an interchangeability directory that lists RCA replacements for 975 picture tubes including 85 foreign types. The guide includes basing diagrams, pictorial views illustrating safety feature considerations and keys to tube sizes in the old, new and foreign type designation systems. RCA Commercial Engineering, Harrison, NJ

CIRCLE NO. 365

Rubber parts

A four-page technical bulletin covers fire-retardant rubber parts. The Stalwart Rubber Co., Bedford, OH

CIRCLE NO. 366

Bayonet terminals

A bulletin describes a bayonet terminal for use with both 1/16 and 1/32-in. PC boards. Dimensional outline drawings and a photograph of the unit attached to a PC board are included. Malco, Chicago, IL

CIRCLE NO. 367

Epoxy powders

A four-page brochure contains information on epoxy powders, one of which pre-coats and cures at temperatures as low as 85 C. A graph depicts a method of application for each of the nine epoxy powders, along with temperatures, cure time and other characteristics such as shelf life, etc. Amicon, Polymer Products Div., Lexington, MA

CIRCLE NO. 368

Transducers

A 160-page book, "Transducers: Pressure and Temperature," details the theory of transduction in general as well as the theory of operation of IC transducers in particular. It discusses their construction, includes a glossary of terms, discusses reliability, custom design and future products, and it includes design tables. National Semiconductor, 2900 Semiconductor Dr., Santa Clara, CA 95051

INQUIRE DIRECT



FREE CATALOG

CHOOSE FROM OVER 4,500 UNUSUAL BARGAINS

OPTICS • SCIENCE • ELECTRONICS

1,000's OF HARD-TO-FIND BUYS FOR INDUSTRY

Brand new 164-page easy-to-read edition packed with new products, charts, diagrams, illustrations. On-the-job helps; quality control aids, unique, exclusive items to speed your work, improve quality, cut development and production costs! Loaded with optical, scientific and electronic equipment available from stock for industry, research labs, design engineers, experimenters, hobbyists.

ONE SOURCE FOR ALL YOUR NEEDS

Tremendous variety. Terrific savings. Countless hard-to-get surplus bargains. Many "one-of-a-kinds" nowhere else. Ingenious scientific tools. Thousands of components: lenses, prisms, wedges, mirrors, mounts, all types of accessories. Hundreds of instruments: pollution testing equipment, lasers, comparators, magnifiers, microscopes, projectors, telescopes, binoculars, photo attachments, ecological items, black light equipment and America's largest collection of unique lighting products.

BUY DIRECT WITH MONEY-BACK GUARANTEE
Edmund ships over 5,000 orders monthly to America's largest industrial — every item guaranteed! You must be satisfied, or return your purchase in 30 days for your money back. Shop the catalog of America's largest Science-Optics-Electronics Mart with confidence! Get your FREE copy without obligation. No salesman will call. Write now for free catalog. DA



EDMUND SCIENTIFIC CO.
300 EDSCORP BUILDING
BARRINGTON, NEW JERSEY 08007
TELEPHONE: 609-547-3488

INFORMATION RETRIEVAL NUMBER 78

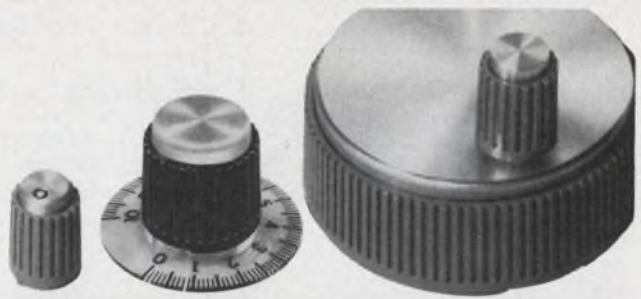

BUCKEYE KNOBS

Supplementing Buckeye's full-line of matching instrument series knobs with unique facilities for fine markings of all types are complete instrument-packaging products crafted by experts and recognized for high quality. Labor-saving P.C.B. guide modules — Front-loading, rackable or portable cases — Full size-range of colorful cabinets — Four sizes of Bord-pak racks — and safe-locking, retractable tilt-stands.

Write today for free colorful literature!

the **BUCKEYE** stamping co.

555 Marion Rd., Columbus, Ohio 43207

"QUALITY PRODUCTS SINCE 1902"

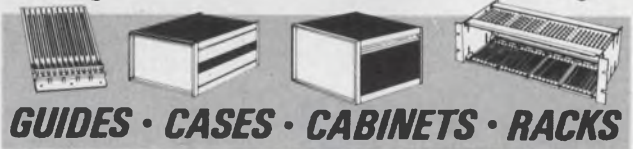

GUIDES • CASES • CABINETS • RACKS

INFORMATION RETRIEVAL NUMBER 79

A **CAMBION®** Double "QQ" Product Line

Unwind with Cambion's complete line of micro-miniature coils.



Cambion coils with repeated known design characteristics have done it again. It's the new micro-miniature series of thick-film, bondable, fixed inductors in a wide range of 0.1 to 100,000uH with immediate availability. These electronically shielded coils offer higher Q values than ever before. And with Cambion's complete engineering capabilities and manufacturing facilities coils are custom wound to fit your specifications. For complete facts on the micro-miniature series write for our Catalog 501. Cambridge Thermionic Corporation, 445 Concord Avenue, Cambridge, Massachusetts 02167.

Standardise on

CAMBION®

The Guaranteed Electronic Components

INFORMATION RETRIEVAL NUMBER 80

ELECTRONIC DESIGN 25, December 6, 1974

An autoranging DMM for only \$299?

Yes. And it's a KEITHLEY—no less. The new Model 168 is a full-function DMM. It measures ac/dc volts, ac/dc amps and ohms too. Autoranging, optional battery operation, two-terminal input, push-button operation and lighted function indicators are only a few of its added features. Send for full details now.

1-year accuracy guarantee, too!



KEITHLEY INSTRUMENTS
U.S.A.: 28775 AURORA ROAD, CLEVELAND, OHIO 44139
EUROPE: 14, AVENUE VILLARDIN, 1009 PULLY, SUISSE

INFORMATION RETRIEVAL NUMBER 81

135

SWITCHES

ROCKER AND SLIDE

Available 1 to 3 positions and 1 to 6 poles. U.L. listed 1 to 10 amps, 125v and TV ratings.

Slides as low as **6c**

Rockers as low as **17c**



AMF
UID Electronics

UID Electronics Division
AMF Incorporated
4105 Pembroke Rd.
Hollywood, Florida 33021
Phone (305) 981-1211
TWX 510-954-9810

INFORMATION RETRIEVAL NUMBER 84

NEW LITERATURE

Software

"The Evolution of Software" includes sections on early programming trends, computer languages and operating systems. Computer Sciences Corp., Los Angeles, CA

CIRCLE NO. 369

Microcomputer system

High performance n-channel microcomputer components and systems are described in a 12-page bulletin. The 15 support components described include four RAMs, six ROMs and pROMs and five peripheral circuits. Intel, Santa Clara, CA

CIRCLE NO. 370

Pushbutton switches

The Series 12000 minibutton pushbutton switch is described in a data sheet. Mechanical, electrical and environmental specifications, materials list, available codes list and price list and quantity discount are included. The Digitran Co., Pasadena, CA

CIRCLE NO. 371

SUBSCRIBER SERVICE For prompt service include the addressed label when writing about your subscription.

CHANGE OF ADDRESS

| | | | | | |
|-------------|------|---------|---------------------|-----------------|------|
| | | | | | |
| NEW ADDRESS | name | company | division/department | company address | city |

If you're moving, please let us know six weeks before changing your address. If you have a question, place your magazine address label here and clip this form to your letter.

MAIL TO: ELECTRONIC DESIGN Circulation Dept. Hayden Publishing Co., Inc., 50 Essex Street, Rochelle Park, NJ 07662

recruitment and classified ads

SAME DAY SHIPMENT Minis & Peripherals PRINTERS Some "BRAND NEW" DATA PRODUCTS

2440—700 LPM
2470—1250 LPM \$9500
MOHAWK DATA SCIENCES
4320—300 LPM
4330—380 LPM
CONTROL DATA CORP.
9322—200 LPM \$2500
9352—600 LPM

ALSO CENTRONICS, POTTER,
A. B. DICK, IBM, HIS, UNIVAC
617-261-1100

Send for Free Report
"Maintenance of Computers"

AMERICAN USED
COMPUTER CORP.
P. O. Box 68, Kenmore Sta.,
Boston, MA 02215

member
COMPUTER DEALERS ASSOCIATION

INFORMATION RETRIEVAL NUMBER 201

Custom Active Filter Design Thick and thin film process development

James Estep, Consultant
213-889-4414

INFORMATION RETRIEVAL NUMBER 202

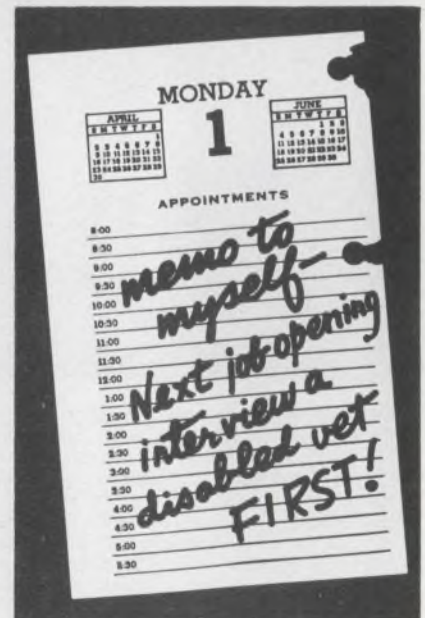

The President's Committee
on Employment of the Handicapped
Washington, D.C. 20210

The Ultimate in Ignition Systems!

★ **ELIMINATES BREAKER POINTS.**
Perfect Timing and Dwell never change!

★ **Eliminates Tune-ups.**
Never wears out or needs any Maintenance.



★ **The Most Advanced
"OPTO-ELECTRIC SYSTEM"**

● The Allison Breakerless System eliminates the Points and Condenser, replacing them with an Opto-Electronic Trigger, using a Light-Emitting Diode and Phototransistor. Also completely eliminates wiper-arm "friction" wear. The only "TRUE" Electronic Ignition that you can install for under \$100. Gives 40-times more Timing Accuracy than ANY system using mechanical Breaker-Points! Unlimited RPM Smoother running (No timing fluctuation as with Magnetic units) Unaffected by Temperature, Moisture, or Vibration! All Solid-State Components Easier Starting under any condition! Increased Horsepower. Sparkplugs last longer. Perfect timing increases engine Efficiency and Gas Mileage up to 30%!

● **Quick and Easy Installation!**

★ **Tested and Proven reliability.**

Only **\$49⁹⁵** ● **SATISFACTION GUARANTEED!**

● Complete. ● **1-YEAR FACTORY WARRANTY.**

(State Make, Year, Engine Size). (Calif. Res. add Tax).

● **CONVERT YOUR "C-D" UNIT TO BREAKERLESS!**
"TRIGGER-UNIT" ONLY \$34.95

★ **Send Postcard for FREE BROCHURE Today.**

ALLISON AUTOMOTIVE CO.

P. O. Box 881-F, TEMPLE CITY, CAL. 91780

INFORMATION RETRIEVAL NUMBER 85

KEEP

Electronic Design's

GOLD BOOK

HANDY



When You Call

Save time when you contact suppliers. Check their catalog pages first in *Electronic Design's* GOLD BOOK. Maybe the information you need is right at your fingertips.

Electronic Design

Advertising Sales Staff

Tom W. Carr, Sales Director

Rochelle Park, N.J. 07662

Robert W. Gascoigne

Daniel J. Rowland

(Recruitment, Quick Ads, Classified)

50 Essex Street

(201) 843-0550

TWX: 710-990-5071

Philadelphia

Thomas P. Barth

50 Essex Street

Rochelle Park, N.J. 07662

(201) 843-0550

Boston 02178

Gene Pritchard

P.O. Box 379

Belmont, Mass. 02178

(617) 489-2340

Chicago 60611

Thomas P. Kavooras

Berry Conner, Jr.

200 East Ontario

(312) 337-0588

Cleveland

Thomas P. Kavooras

(Chicago)

(312) 337-0588

Los Angeles 90045

Stanley I. Ehrenclou

Burt Underwood

8939 S. Sepulveda Boulevard

Suite 510

Los Angeles, Calif.

(213) 641-6544

San Francisco 94022

Jerry D. Latta

P.O. Box 1248

Los Altos, Calif.

(415) 965-2636

London, Amsterdam, Tokyo, Seoul

John Ashcraft

12, Bear St.

Leicester Square

London WC2H 7AS England

Phone: 01-930-0525

W. J. M. Sanders

John Ashcraft & Co.

Herengracht 365

Amsterdam C., Holland

Phone: 020-24-09-08

Haruki Hirayama

Electronic Media Service

5th Floor, Lila Bldg.,

4-9-8 Roppongi

Minato-ku, Tokyo, Japan

Phone: 402-4556

Cable: Electronicmedia, Tokyo

Mr. O-kyn Park, President

Dongbo International

Corporation

1.P. O. Box 4010

Seoul, Korea

Phone: 28-1911

Cable: Dongbo Seoul

free The "NEW LOOK"
1975
LAFAYETTE
ELECTRONICS
CATALOG



NEW! Larger Page Size
NEW! More Full Color
NEW! Easy-Read Type

SAVE ON LAFAYETTE
PRODUCTS PLUS BEST
MAJOR BRAND NAMES

The catalog you **NEED** if you're interested in electronics! Filled with colorful, accurate, interesting descriptions of all the latest electronics products, plus the "bits and pieces" you need to keep everything in top shape. It's the "energy saving" way to shop too—order by mail from your easy chair!

Lafayette

Listen to us, you can't go wrong.

Mail this coupon today **FREE!**

DEPT. 45124

Lafayette Radio Electronics

111 Jericho Tpk., Syosset, LI, NY

Send me your **FREE** 1975 Catalog

Name Apt.

Street

City State

Zip

Send a 1975 Catalog to my friend

Name Apt.

Street

City State

Zip



Design Data from Manufacturers

Advertisements of booklets, brochures, catalogs and data sheets. To order use Reader-Service Card
(Advertisement)

UBIQUITOUS[®]

- Spectrum Analyzers
- Correlators

OMNIFEROUS[™]

- Dual Hi-Speed FFT Processor



REAL-TIME SIGNAL PROCESSORS CONDENSED CATALOG. FREE.

For instant diagnosis of noise & vibration in real time, new 8-pg. catalog describes well-known...

- UBIQUITOUS[®] 500-line combined Real-Time Spectrum Analyzer-Calculator that automatically computes digitally
- UBIQUITOUS[®] 256-point & 512-point real-time Correlators
- OMNIFEROUS[™] Dual Channel Hi-Speed instrument-type FFT Processor
- Memory & non-storage large-screen displays for real-time spectrum analyzers
- Range Translators
- Rotating Machinery Order Normalizers
- Digital Recorders & Post-Processors

Immediate, circle No. 170
Routine circle No. 171

Nicolet Scientific Corp. (formerly Federal Scientific Corp.)

245 Livingston St., Northvale, New Jersey 07647 (201) 767-7100. TWX: 710-991-9619

ENGINEERING PRODUCT HANDBOOK A/D and D/A Converters

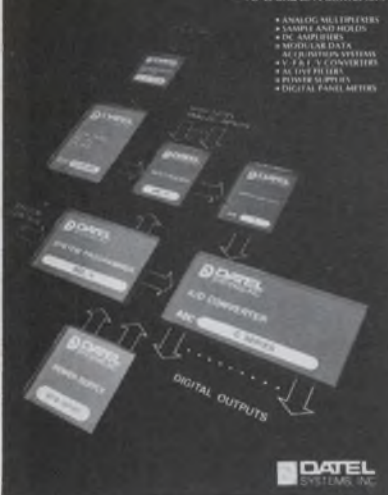

70 page A/D-D/A Engineering Product Handbook

A new 70 page product handbook contains detailed electrical and mechanical information on A/D—D/A Converters, Sample/Hold Amplifiers, Wide Band DC Amplifiers, Instrumentation Amplifiers, Analog Multiplexers, DC-DC Converters and Data Acquisition Systems. Also included are typical applications for Data Conversion Devices.



1020 Turnpike St., Canton, Mass. 02021/(617) 828-8000

CIRCLE NO. 172

PRACTICAL RELAY CIRCUITS

By Frank J. Oliver

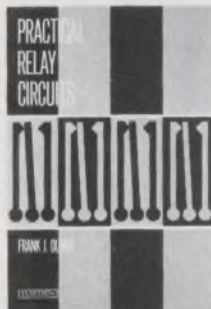

Uniquely groups various relay circuits according to the functions they perform, enabling the systems designer to quickly select the best circuit for his specific purposes. Includes arc and RFI suppression systems; time delay function; audio tone control and resonant-reed relays; sequential relays; protective functions of relays against overload overvoltage, and overcurrent, pulse generation and detection; logic circuits; and more. Particularly important is coverage of pulse-operated relay systems now extensively used with automated control systems. Illustrated with many circuit diagrams using the latest American National Standard graphical symbols. 363 pp., 6 x 9 1/4, illus., cloth, \$17.20 Circle the reader-service number to order a 15-day examination copy.

CIRCLE NO. 173



HAYDEN BOOK COMPANY, INC., 50 Essex St., Rochelle Park, N.J. 07662

Electronic Design

ELECTRONIC DESIGN's function is:

- To aid progress in the electronics manufacturing industry by promoting good design.
- To give the electronic design engineer concepts and ideas that make his job easier and more productive.
- To provide a central source of timely electronics information.
- To promote communication among members of the electronics engineering community.

Want a subscription? ELECTRONIC DESIGN is sent free to qualified engineers and engineering managers doing design work, supervising design or setting standards in the United States and Western Europe. For a free subscription, use the application form bound in the magazine. If none is included, write to us direct for an application form.

If you do not qualify, you may take out a paid subscription for \$30 a year in the U.S.A., \$40 a year elsewhere. Single copies are \$1.50 each.

If you change your address, send us an old mailing label and your new address; there is generally a postcard for this bound in the magazine. You will have to requalify to continue receiving ELECTRONIC DESIGN free.

The accuracy policy of ELECTRONIC DESIGN is:

- To make diligent efforts to ensure the accuracy of editorial matter.
- To publish prompt corrections whenever inaccuracies are brought to our attention. Corrections appear in "Across the Desk."
- To encourage our readers as responsible members of our business community to report to us misleading or fraudulent advertising.
- To refuse any advertisement deemed to be misleading or fraudulent.

Microfilm copies are available of complete volumes of ELECTRONIC DESIGN at \$19 per volume, beginning with Volume 1, 1961 through Volume 20. Reprints of individual articles may be obtained for \$2.00 each, prepaid (\$5.00 for each additional copy of the same article) no matter how long the article. For further details and to place orders, contact the Customer Services Department, University Microfilms, 300 North Zeeb Road, Ann Arbor, Michigan 48106 telephone (313) 761-4700.

Want to contact us? If you have any comments or wish to submit a manuscript or article outline, address your correspondence to:

Editor
ELECTRONIC DESIGN
50 Essex Street
Rochelle Park, N.J. 07662

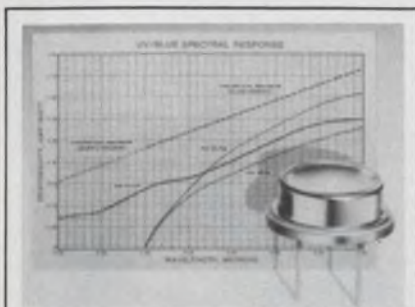

UV Blue Response Photodiode: United Detector Technology now offers blue, super blue, and UV enhanced silicon photodiodes with near theoretical responsivity in the range from 200 to 550 nanometers. Available in both the Pin-5 .5 cm² and the Pin-10 1 cm² configuration. United Detector Technology, 2644 30th St., Santa Monica, Ca. 213 396-3175.

INFORMATION RETRIEVAL NUMBER 601



Contact United States Crystal Corporation for our new quartz crystal catalogue. It gives you the most up to date specifications on military CR numbers and information for designing and specifying crystals. Free engineering assistance on your crystal requirements. 3605 McCart St., Fort Worth, Texas 76110. (817) 921-3014.

INFORMATION RETRIEVAL NUMBER 604

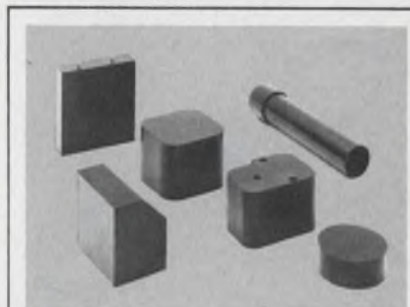

Glass laminated epoxy 155°C cases for component and circuit packaging are available in thousands of sizes. Thin wall tubes and headers offer optimum protection in all applications. Literature and samples available. Stevens Tubing Corp., 128 North Park Street, East Orange, New Jersey 07019. Telephone 201-672-2140.

INFORMATION RETRIEVAL NUMBER 607

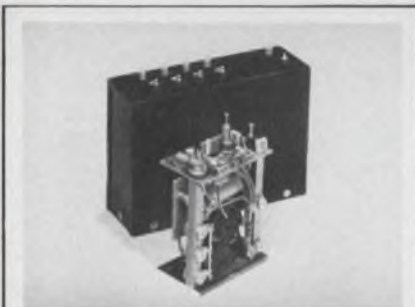

Modular DC-DC power converters. Designed to meet military/aerospace specs... priced for industrial applications. 12, 28, 48, 115 VDC inputs. 1-6 isolated, regulated (1% & 0.1%) outputs. 1-500 watts. Efficiencies to 85%. 1200 design-as-you-order configurations using standard modules. Arnold Magnetics, Culver City, Ca. (213) 870-7014.

INFORMATION RETRIEVAL NUMBER 602

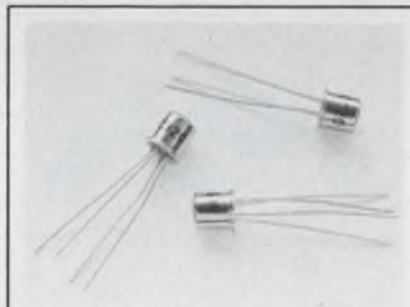

Low noise IF transistors. Type NC-921 and NC 920 have maximum 70 MHz noise figures of 1.2 dB and 1.5 dB respectively when measured in an untuned, broadband amplifier. The NC921 noise figure is typically 1 dB in a tuned amplifier. TO-72 package. California Eastern Laboratories, Inc. One Edwards Court, Burlingame, California. (415) 342-7744.

INFORMATION RETRIEVAL NUMBER 605

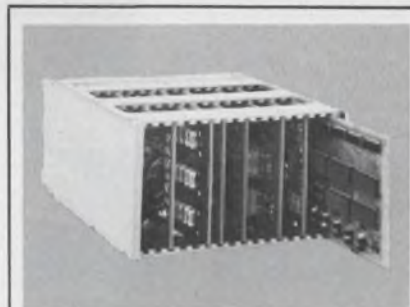

Solid-State Voice Systems for audio readout of numbers and words. Whole-words are stored in ROMs with natural sounding voice reproduction. Standard models offer 10 numeric words (0 - 9). Master Specialties, 1640 Monrovia, Costa Mesa, Calif. 92627. (714) 642-2427.

INFORMATION RETRIEVAL NUMBER 608



The new Computer Labs RDA Series D/A's eliminate harmonic distortion and produce clean "glitchless" pictures for reconstructed TV or other video signals. Input word rate for all models is 15 MHz with accuracies to ±0.05%. Min. settling time to either 8-bit or 10-bit accuracies. Computer Labs, 1109 S. Chapman St., Greensboro, N.C. 27403.

INFORMATION RETRIEVAL NUMBER 603



Atomic Frequency Standard Model FRT for Lab/Field. Output 10-5-1-0.1 MHz, short term stability < 2 x 10⁻¹¹ τ 1 sec, < 1 x 10⁻¹² τ 100 sec; Drift < 3 x 10⁻¹¹/M. Coupled with Receiver-Controller EFR, synchronized to natl frequency. Absolute frequency few parts in 10¹². Efratom California Inc., 3303 Harbor, E1, Costa Mesa, CA 92626. 714-556-1620.

INFORMATION RETRIEVAL NUMBER 606

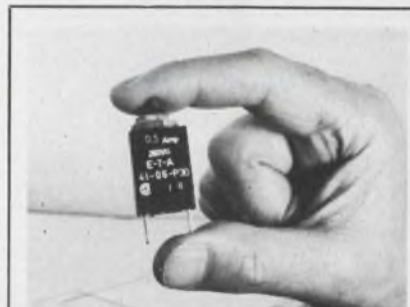

Overcurrent Protector, manual reset eliminates fuse replacement. Convenient panel mounting. 15 fractional ratings from 0.1 to 3 amp. Other models up to 400 amp. Trip-free and fool-proof, UL and CSA approved. High quality, low cost \$1.20 ea. in 1000 lots. E-T-A Products Co. of America, 7400 N. Croname Rd., Chicago, Ill. 60648. Tel: (312) 647-8303. Telex: 253780.

INFORMATION RETRIEVAL NUMBER 609

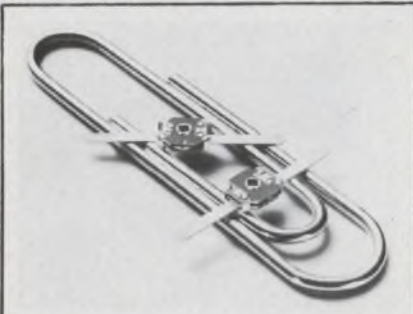

Thin-Trim variable capacitors provide a reliable means of adjusting capacitance without abrasive trimming or interchange of fixed capacitors. Series 9401 has high Q's and a range of capacitance values from 0.2-0.6 pf to 3.0-12.0 pf and 250 WVDC working voltage. Johanson Manufacturing Corporation, Boonton, New Jersey (201) 334-2676.

INFORMATION RETRIEVAL NUMBER 610

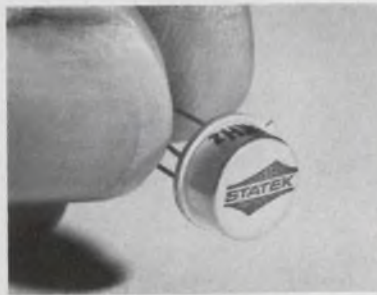

Crystal Oscillators in TO-5's Model SQXO-2 • 10 kHz, to 250 kHz, • 1000 g shock and 50 g random vibration • TTL and CMOS compatible • \$19.50 in 100 qty's. • Write or call for data on SQXO-2 or other oscillators • STATEK CORP., 1233 Alvarez Ave., Orange, CA 92668, (714) 639-7810, Telex 65-5430.

INFORMATION RETRIEVAL NUMBER 613



"Great Case" For Enclosures. All new, rugged ABS plastic 2-piece assembly accommodates PC boards up to 7-1/16" x 6-15/16", requires only 4 hidden screws. Package your product with style and save tooling costs. Prototype samples available at \$10.00 each. Call Kurz-Kasch, Inc., 2876 Culver Ave., Dayton, Ohio 45401. (513) 296-0330.

INFORMATION RETRIEVAL NUMBER 616

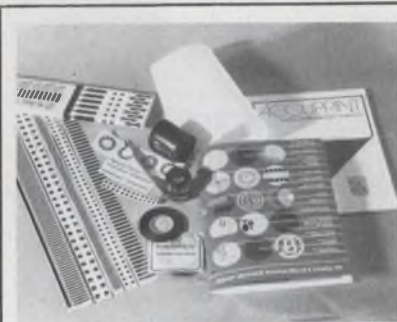

Free 84-page Printed Circuit Drafting Aids Technical Manual & Catalog contains hundreds of time & money-saving tips, plus details on over 15,000 component symbols & tapes, film, vellum, grids. Bishop Graphics, Inc., 20450 Plummer St., Chatsworth, California, 91311, (213) 993-1000.

INFORMATION RETRIEVAL NUMBER 611

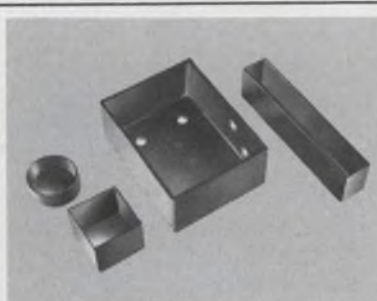

As the World's largest supplier of precision molded Encapsulation Shells and Headers, we offer over 2,000 standard sizes, in Square, Round, Oblong, and Module styles. Write or Call Today for FREE 32-page Illustrated Catalog! Robison Electronics, Inc., 3580 Sacramento Drive, San Luis Obispo, Calif. 93401 (805) 544-8000.

INFORMATION RETRIEVAL NUMBER 614



Free catalog of 34,500 power supplies from the worlds largest manufacturer of quality Power Supplies. New '74 catalog covers over 34,500 D.C. Power Supplies for every application. All units are UL approved, and meet most military and commercial specs for industrial and computer uses. Power Mate Corp. (201) 343-6294.

INFORMATION RETRIEVAL NUMBER 617

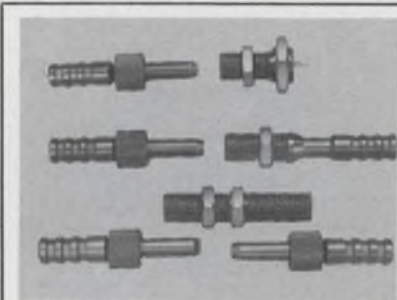

Need high-voltage commercial lead assemblies and receptacles? For all types of environment? Then find out about CAPITRON's LGH Line. Miniature and lightweight. Safe, too. Highly reliable. Even at peak performance. AMP Incorporated, Capित्रon Division, Elizabethtown, Pa. 17022. Phone: 717-367-1105.

INFORMATION RETRIEVAL NUMBER 612



FLEXIBLE CIRCUITS BY ROGERS. We have the people, experience, plant, equipment and know-how! Write for information or phone Herman Gordon for action. ROGERS CORPORATION, P.O. Box 700, Chandler, Arizona 85224, Phone (602) 963-4584

INFORMATION RETRIEVAL NUMBER 615

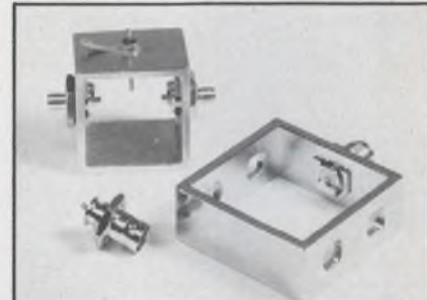

MODPAK™ electronics packaging system provides everything required (except customer's PC board). Choice of RF connectors. Standard and Custom packages available on "off-the-shelf" basis. Prices as low as \$9.75 per unit. MODPAK, 31A Green St., Waltham, Ma. 02154 (Tel.) (617) 891-7048.

INFORMATION RETRIEVAL NUMBER 618

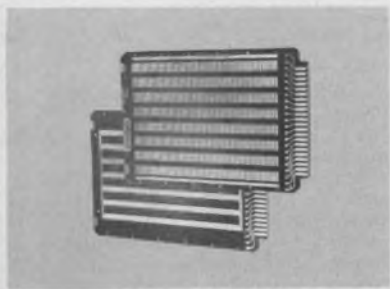

Special 2 for 1 GP board offer. For all DIP's with .300" to .600" lead spacing. Solder I.C.'s directly or plug into sockets. Computer drilled blue FR4 epoxy-glass features high quality gold/nickel plated connector fingers and bright tin plated circuitry. \$15.95 for two GP Boards through Feb. '75. Circuit-Stik, Inc. 24015 Garnier St. Torr., CA 90510.

INFORMATION RETRIEVAL NUMBER 619



Save time! Use Circuit-Stik's Desk Supply Kit to make prototype circuit boards. Keep Circuit-Stik adhesive backed subelements, interconnecting tapes, etched donut pads, and .100" grid drilled epoxy-glass at your desk for use "When you need it". #8963 Kit price of \$49.00 save \$7.00. Circuit-Stik, Inc. Box 3396, Torrance, CA 90510 (213) 530-5530.

INFORMATION RETRIEVAL NUMBER 622

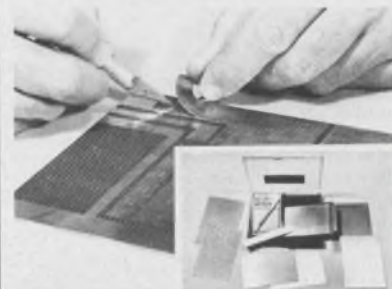

Cut & Peel Circuit Board Kit. Cut prototype boards or ground planes. Assortment of 7 includes one and two sided Cut & Peel Boards on .100" grid drilled and plain epoxy-glass, "X" and "X-Y" Board, a plug-in Cut & Peel GP Board with etched gold/nickel edge connector, and a special knife. Kit #8964 is \$37.00. Circuit-Stik, Inc. Box 3396, Torr., CA 90510.

INFORMATION RETRIEVAL NUMBER 625



Rugged and low-cost 36-pin connector. Suberly designed and produced with simplified construction. Cut your costs up to 50%. Moisture-resistant glass-filled nylon insulator Recessed contacts in both male and female housings. Hood provides positive cable strain relief. Interchangeable. E. F. Johnson Co., Waseca, MN. (507) 835-2050.

INFORMATION RETRIEVAL NUMBER 620



New Constant Temperature/Humidity Cabinet with extended -38°C . to $+93^{\circ}\text{C}$. ($+200^{\circ}\text{F}$.) range typifies complete line of these and Thermal Shock Test Chambers described in brochures giving design and performance data. Invaluable for evaluating and selecting such sophisticated equipment. Blue M Electric Company, Blue Island, Illinois 60406.

INFORMATION RETRIEVAL NUMBER 623

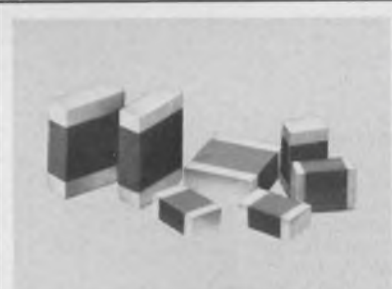

HIGH Q MULTILAYER CAPACITORS feature very high quality factors at microwave frequencies. Offered in three standard sizes: .050 x .040, .080 x .050, .125 x .095. Capacitance values from 0.1 pf to 1000 pf with close tolerance and voltages to 1000 VDCW. Johanson/Monolithic Dielectrics Div., Box 6456, Burbank, Ca. 91510, (213) 848-4465.

INFORMATION RETRIEVAL NUMBER 626

SOLID-STATE



DC AND AC RELAYS

For computer peripherals and other high-speed, high-reliability switching jobs, with either DC or AC loads up to 6 amp, these transformer-coupled Heinemann relays offer highest sensitivity, isolation, accuracy for TTL and other low-level control signals. Heinemann Electric Company, Trenton, NJ 08602.

INFORMATION RETRIEVAL NUMBER 621

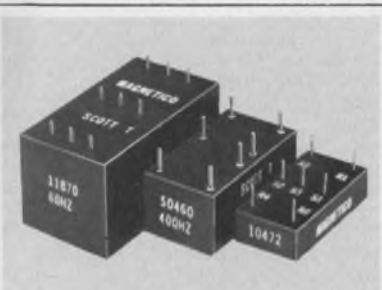

Scott T Transformer. 11870: 60HZ, 90v, L-L in. 1.1x2.1x1.1. 50460: 400HZ, 90v, L-L in. 7/8x1-5/8 x11/16. 50642: 400HZ, 11.8v, L-L in. 7/8x1-5/8-11/16. 10472: 400HZ, 11.8v, L-L in. 3/4x1-1/2x3/8. All with 6v RMS sine & cosine output. MAGNETICO, INC., 182 Morris Ave, Holtsville, N.Y. 11742 516-654-1166.

INFORMATION RETRIEVAL NUMBER 624

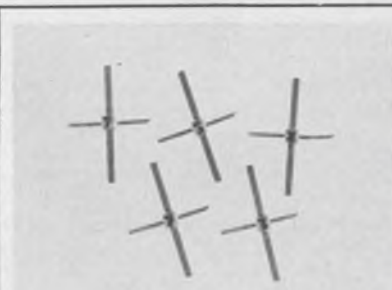

The NEC VO21 is now available in the popular ML-3 100 mil-square package. The VO21M has an FT of 4.5 GHz and a maximum current of 70 mA. Noise figure at 2 GHz is 3.6 dB and less than 2 dB at 500 MHz providing an inexpensive transistor for low noise amplifiers. California Eastern Labs, Inc. One Edwards Ct., Burlingame, Ca. 415 342-7744.

INFORMATION RETRIEVAL NUMBER 627

advertiser's index

| Advertiser | Page | Advertiser | Page | Advertiser | Page |
|--|----------------|---|--------------------------------------|---|------------|
| AMP, Incorporated | 140 | General Electric Company | 144 | PCS | 67 |
| Abbott Transistor Laboratories, Inc. | 6 | General Electric Company, Semiconductor Products Dept. | 66A | Panasonic Electronic Components | 97 |
| Accutronics, Inc. | 59 | Gold Book, The | 84, 85, 108, 109, 115AB, 133, 137 | *Philips Electronic Components and Materials | 114A |
| Acopian Corp. | 93 | Gould, Inc., Instrument Systems Div. | 131 | Philips Industries, Test and Measuring Instruments Dept. | 1 |
| Allen Bradley Co. | 37 | Grayhill, Inc. | 110 | Piezo Technology, Inc. | 132 |
| Allison Automotive Company | 137 | Gudebrod Bros. Silk Co., Inc. | 60 | Power/Mate Corp. | 140 |
| Amperex Electronics Corporation | 113 | | | Precision Monolithics Incorporated | 95 |
| Amphenol Connector Division, Bunker-Ramo Corp. | 73 | | | Preston Scientific | 121 |
| Arnold Magnetics Corp. | 139 | | | Projects Unlimited | 145 |
| Avantek, Inc. | 66F | | | | |
| | | Hayden Book Company, Inc. | 138 | | |
| | | Haydon Switch & Instrument, Inc. | 66L | RG Enterprises Inc. | 131 |
| | | Heath Company | 131 | RCA Solid State Division | Cover IV |
| Bafco, Inc. | 146 | Hecon Corporation | 146 | RSM Sensitron | 50 |
| Belden Corporation | 20, 21 | Heinemann Electric Company | 141 | Readers Service Card | 146A, 146B |
| Bell Industries/Electronic Components Division | 143 | Hewlett-Packard | 9 thru 18 | Reticon | 115 |
| Biomation | 125 | Honeywell Test Instruments Division | 27 | Robison Electronics, Inc. | 140 |
| Bishop Graphics, Inc. | 140 | Hughes Aircraft Company, Electron Dynamics Division | 52 | Rogan Corporation | 143 |
| Blue M Electric | 141 | | | Rogers Corporation | 114, 140 |
| Bodine Electric Company | 143 | | | | |
| Buckeye Stamping Company, Inc. | 135 | IMC Magnetics Corporation | 122 | | |
| Burr-Brown Research Corporation | 26 | Indiana General | 49 | Sealed Air Corporation | 143 |
| Burroughs Corporation | 66I | Industrial Timer, A Unit of Esterline Corporation | 145 | Semiconductor Circuits, Inc. | 124 |
| | | Intech, Incorporated | 112 | Simpson Electric Company | 89 |
| | | Intel Corporation | 4, 5 | Sorenson Company, A Unit of Raytheon Company | 22 |
| | | Intersil | 66B, 66C | Spectrum Technology Inc. | 145 |
| California Eastern Laboratories Inc. | 139, 141 | | | Sprague Electric Company, Dearborn Electronics Division | 111 |
| Cambridge Thermionic Corporation | 135 | Johanson Manufacturing Corp. | 123, 140 | Statek Corp. | 140 |
| Centre Engineering | 127 | Johanson/Monolithics | 129, 141 | Stevens Tubing Corp. | 139 |
| Celanese Plastics Company | 53 | Johnson Company, E. F. | 141 | Superior Electric Company | 117 |
| Circuit Stik, Inc. | 128, 141 | | | Switchcraft, Inc. | 120, 134 |
| Clare & Co., C. P. | 72 | | | | |
| Columbia Research Labs Inc. | 126 | Keithley Instruments, Inc. | 135 | T.R.I. Corporation | 123 |
| Computer Labs, Inc. | 139 | Kurz-Kasch, Inc. | 19, 140 | TRW Cinch Connectors, an Electronic Component Division of TRW, Inc. | 33 |
| Connecticut Hard Rubber Co., The | 130 | | | TRW/IRC Resistors, an Electronic Components Division of TRW, Inc. | 35 |
| Control Switch, Inc. | 146 | Lafayette Radio Electronics | 137 | Tektronix, Inc. | 47 |
| Coto Coil Company, Inc. | 122 | Lemo USA | 110 | Tele-Dynamics/Wanlass Division of Ambac | 118 |
| | | Litton Triad-Utrad | 119 | Teledyne Relays, A Teledyne Company | 2 |
| Dale Electronics, Inc. | Cover II | | | Texas Instruments, Incorporated | 99 |
| Data General Corporation | 42, 43 | 3M Company | 48 | Times Tire & Cable Company | 66K |
| Data Translation, Inc. | 127 | M C G Electronics | 122 | | |
| Datel Systems, Inc. | 138, Cover III | Magnético, Inc. | 141 | UID Electronics | 136 |
| Decitek, A Division of Jamesbury Corp. | 126 | Master Specialties | 139 | USCC/Centralab Electronics Division, Globe-Union, Inc. | 31 |
| Delta Products, Inc. | 116 | Micro-Line, Division of Bausch & Lomb | 129 | United Detector Technology, Inc. | 139 |
| Dialight Corporation | 25 | Miller-Stephenson Chemical Co. Inc. | 101 | United States Crystal Corporation | 139 |
| Digital Equipment Corporation | 66D, 66E | Modpak | 140 | | |
| Dynage Inc. | 146 | Molex, Incorporated | 66 | Varian Data Machines | 90 |
| | | Monsanto Commercial Products Co. | 107 | Vectrol, Inc. | 145 |
| | | Mostek Corporation | 66G | | |
| E-T-A Products Co. of America | 139 | Motorola Semiconductor Products, Inc. | 41, 44 | Wavetek | 104 |
| E-Z Hook | 106 | MuRata Corporation of America | 61 | | |
| Ectron, Inc. | 129 | | | Zero Manufacturing Co. | 101 |
| Edison Electronics, A McGraw- Edison Company division | 66H | Newport Laboratories Inc. | 66J | | |
| Edmund Scientific Company | 135 | Nicolet Scientific Corp. | 138 | | |
| Efratom California, Inc. | 139 | | | | |
| Electronic Design | 102, 103 | Ohto Co., Ltd. | 133 | | |
| *Electronic Design | 114B | Optron, Inc. | 7 | | |
| | | | | | |
| Ferroxcube Corporation | 91 | | | | |
| Fluke Mfg. Co., Inc., John | 39 | | | | |

*Advertisers in non-U.S. edition.

Now Leaded Ceramic Capacitors
Radial/Axial Leads = 1 pf to 10 uf

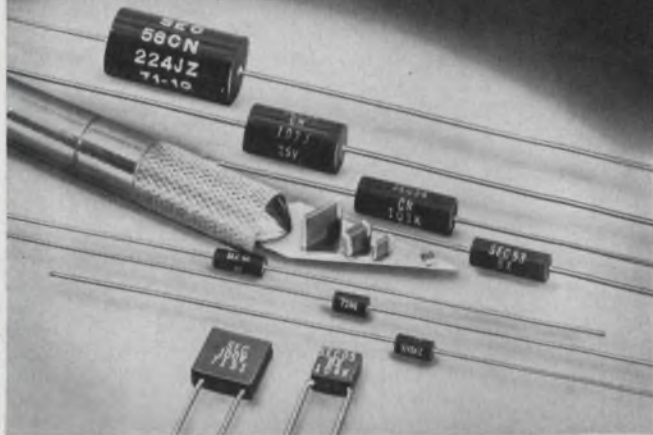

Many values off the shelf, other deliveries 6-8 weeks . . . Axial Tubular NPO from 1 pf through .027 uf . . . Axial Tubular K1200 from 1 pf through 10 uf . . . Radial NPO from 1 pf through .10 uf . . . Radial K1200 from 1 pf through 3.3 uf.

Write for full line ceramic capacitor catalog.

BELL INDUSTRIES / Electronic Components Division
150 WEST CYPRESS AVE. • BURBANK, CALIFORNIA 91505
(213) 846-9302 • TWX 910-498-2207

INFORMATION RETRIEVAL NUMBER 88

**Rogan knobs
look better
and are built better,**

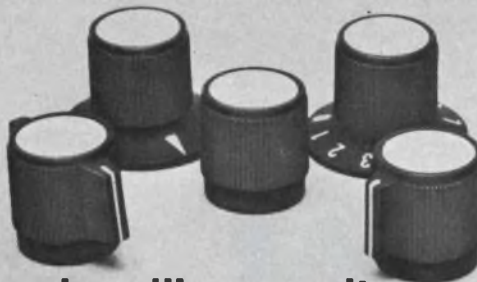

**and we'll prove it
with a free sample.**

After you receive our catalog, send us a note outlining your specific requirement and the quantity involved.

Or furnish us with our competitor's part number and we will cross-reference it.

Our samples and quotation will be returned promptly.



3455 Woodhead Drive, Northbrook, Illinois 60062 (312) 498-2300

INFORMATION RETRIEVAL NUMBER 89

**i'm
free**



**I'M A
MAIL-LITE[®]
SHIPPER**

**1 CASE of Mail-Lite FREE when you buy my
\$50 table model heat sealer.**

**2 CASES of Mail-Lite FREE when you buy my
\$100 floor model heat sealer.**



*Labor Savings: Can be heat sealed closed in 2 seconds
Postal Savings • Waterproof • Pufferproof • Lightweight • Clean*



WRITE TODAY FOR INFORMATION ON OUR
MAIL-LITE SHIPPERS AND THE SPECIAL
HEAT SEALER OFFER.

Sealed Air Corporation

19-01 State Highway 208, Fair Lawn, New Jersey 07410

INFORMATION RETRIEVAL NUMBER 91

ELECTRONIC DESIGN 25, December 6, 1974

for design
engineers

**new
fhp motor
...and control
catalog**

Just published! An expanded catalog covering more than 325 stock Bodine fractional horsepower motors, gearmotors, plus controls. Helps you select and match the right motor and control for your application.

Twenty pages, 75 illustrations, tables and drawings (all drawings decimalized). Includes 14 new gearmotors, adjustable speed/torque drive systems. Optional and accessory parts for motor controls fully tabulated. Also a performance chart on K-2 motors . . . covers normal slip, high slip and synchronous motors. Ask for Catalog S-5.



Bodine Electric Co., 2528 West Bradley Pl., Chicago, Ill. 60618

INFORMATION RETRIEVAL NUMBER 90

GENERAL ELECTRIC'S TYPE 75F BLACK HAWK CAPACITOR

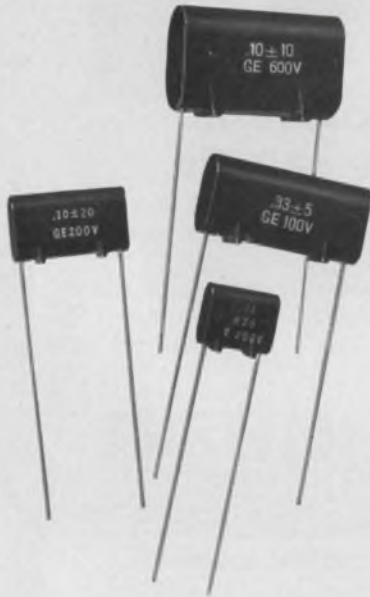

Black Hawk polyester film capacitors offer you these most sought after features:

- Molded epoxy encapsulation, precise dimensions, mounting feet and welded leads for "damage resistance" to vibration and shock.
- Top utilization of circuit board space with precise dimensions in case and lead location.
- Elevated mounting feet for greater stability and protection during dipping.
- Low dissipation factor with an exceptionally strong welded lead connection.

For more information on these, or any of General Electric's wide range of capacitors, call your nearest GE sales office today, or write Section 430-55, Schenectady, N. Y. 12345

MAKE SOMETHING OUT OF IT!

GENERAL  ELECTRIC

INFORMATION RETRIEVAL NUMBER 92

product index

Information Retrieval Service. New Products, Evaluation Samples (ES), Design Aids (DA), Application Notes (AN), and New Literature (NL) in this issue are listed here with page and Information Retrieval numbers. Reader requests will be promptly processed by computer and mailed to the manufacturer within three days.

| Category | Page | IRN | Category | Page | IRN |
|--------------------------------|------|-----|------------------------------------|------|-----|
| Components | | | VOM | 89 | 32 |
| capacitors | 145 | 93 | waveform generator | 104 | 41 |
| capacitors, ceramic | 31 | 12 | Integrated Circuits | | |
| capacitors, ceramic | 61 | 236 | analog memories | 115 | 48 |
| capacitors, ceramic | 143 | 88 | dual IC | 106 | 303 |
| capacitors, ceramic | 123 | 58 | IC reference catalog | 41 | 122 |
| capacitors, ceramic | 127 | 64 | op amps | 95 | 36 |
| capacitors, polyester film | 144 | 92 | op amps | IV | 248 |
| coils | 135 | 80 | quad op amps | 41 | 121 |
| crowbars, dc | 136 | 82 | RAM | 106 | 305 |
| digital display | 132 | 357 | ROM | 106 | 302 |
| electronics catalog | 137 | 87 | tone alarm | 112 | 46 |
| fans | 122 | 55 | Microwaves & Lasers | | |
| ferrite transformers | 66 | 30 | amplifier, class C | 116 | 329 |
| filters, crystal | 132 | 73 | attenuator | 119 | 332 |
| flashlight | 132 | 358 | direction finder | 118 | 331 |
| ignition system | 116 | 49 | multicoupler | 116 | 327 |
| ignition system | 137 | 85 | oscillator | 116 | 328 |
| motor catalog | 143 | 90 | VCO | 119 | 333 |
| resistors, film | 37 | 15 | Modules & Subassemblies | | |
| resistors, wirewound | 60 | 28 | control, opto | 112 | 324 |
| switch, PB | 120 | 53 | controller, level | 112 | 323 |
| switches | 125 | 60 | controller, program- | | |
| switches | 134 | 77 | mable | 111 | 309 |
| switches, DIP | 110 | 44 | converter, s/d | 111 | 308 |
| switches, DIP | 132 | 360 | filter, active | 112 | 322 |
| switches and relays | 124 | 59 | instrumentation amplifier | 26 | 10 |
| switches, toggle | 146 | 97 | oscillator, clock | 110 | 306 |
| timers, recycling | 145 | 95 | oscillators | 59 | 27 |
| trimmers | II | 246 | SCR power controller | 145 | 94 |
| Data Processing | | | timers, 10-circuit | 112 | 321 |
| access control | 130 | 356 | torque control system | 126 | 61 |
| computer | 128 | 350 | Packaging & Materials | | |
| data-acquisition system | 126 | 62 | breadboard kit, rf | 122 | 338 |
| data logger | 130 | 354 | busses | 114 | 47 |
| interface, Selectric | 130 | 353 | circuit boards, gp | 128 | 65 |
| keyboards | 99 | 38 | component holder | 120 | 336 |
| minicomputer | 90 | 33 | connector | 110 | 45 |
| monitor, process | 128 | 351 | connectors | 33 | 13 |
| tape reader | 127 | 63 | containers | 135 | 78 |
| terminal, intelligent | 128 | 352 | degreaser system | 120 | 337 |
| Discrete Semiconductors | | | enclosures | 101 | 39 |
| array, photodiode | 126 | 347 | ferrite cores | 123 | 341 |
| displays, LED | 124 | 345 | flat cable connector | 66A | 21 |
| displays, LED | 126 | 346 | gaskets, rf | 123 | 340 |
| LEDs | 25 | 9 | heat pipes | 52 | 25 |
| lamps, LED | 127 | 349 | knobs | 135 | 79 |
| optoelectronic assemblies | 7 | 6 | knobs | 143 | 89 |
| opto-isolators | 107 | 43 | lead benders | 146 | 98 |
| rectifiers, bridge | 124 | 342 | PC cards | 118 | 52 |
| transistor, GHz | 44 | 19 | polyester tapes | 130 | 69 |
| transistor, rf power | 124 | 344 | receptacle, DIP | 122 | 339 |
| transistors, dual | 124 | 343 | scope cables | 106 | 42 |
| Instrumentation | | | solder-iron holder | 120 | 335 |
| DMM, autoranging | 133 | 76 | solvent brush | 101 | 40 |
| DPM | 114 | 301 | tape | 35 | 14 |
| DPM counters | III | 247 | thermoplastic polyester | 53 | 26 |
| digital thermometer | 39 | 124 | wire, cable and cord | 21 | 234 |
| digital troubleshooting | 19 | 7 | Power Sources | | |
| function generator | 131 | 72 | power supplies | 6 | 5 |
| generators | 123 | 57 | power supplies | 93 | 35 |
| instrument catalog | 133 | 75 | power supplies | 118 | 51 |
| oscilloscope | 115 | 325 | power supplies | 146 | 99 |
| recorder | 131 | 71 | power supplies, dc | 22 | 8 |
| scales | 129 | 67 | | | |

THE COMPATIBLES

Spectrum Technology is your one source for frequency control devices that are compatible with the high technology logic of the Seventies. Standard, modified or custom designs include subminiature hybrid circuit crystal oscillators, dual in-line low profile hybrid circuit logic clocks, low cost crystal oscillator IC logic clocks, and TCXO's. Write or call for details.

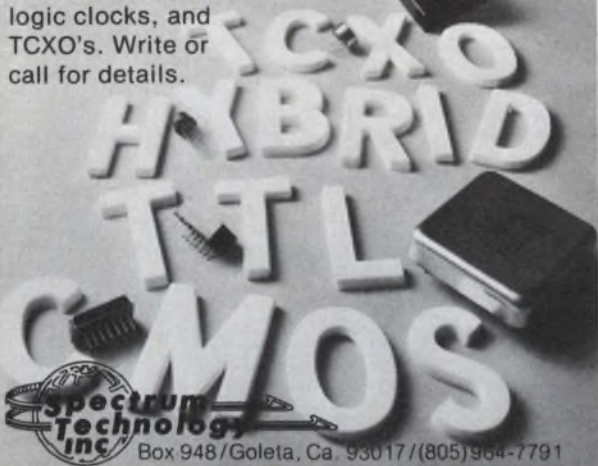

Spectrum Technology Inc.
Box 948/Goleta, Ca. 93017/(805)964-7791

Frequency Control & Timing Systems Products
Crystal Oscillators • Logic Clocks • TCXO's.

INFORMATION RETRIEVAL NUMBER 93

FOR THE UTMOST IN RELIABILITY

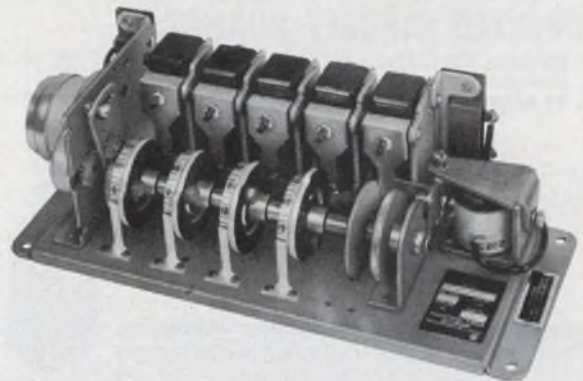

RECYCLING TIMERS Series RC

This multi-cam timer is one of a family of very versatile recycling timers that are available in single or recycling types with up to 20 control circuits. Control cams are independently adjustable from 2% to 98% of the total time cycles enabling the timer to be used as a programming device. And with supplied interchangeable gear and rack assemblies you can select from 700 time cycles ranging from 2/3 second up to 72 hours. All our timers are made to give you service far beyond what you'd reason-

ably expect. Our line consists of 17 basic types, each available in various mountings, voltages, cycles, circuits and load ratings . . . and with whatever special wrinkles you may need. Bulletin #206 tells all about our line of reliable Recycling Timers. Write for it or a catalogue of our entire line. If you have an immediate timer requirement, send us your specifications. Or for fastest service, call (201) 887-2200.

INDUSTRIAL TIMER
A UNIT OF ESTERLINE CORPORATION

INFORMATION RETRIEVAL NUMBER 95

FREE!

8-PAGE SECOND EDITION

SCR POWER CONTROLLER APPLICATIONS GUIDE



The purpose of this guide is to assist the design engineer in selecting the proper SCR Power Controller for a specific application. It contains five pages of technical details including SCR firing, a comparison of on-off and proportional control modes, general design features, application consideration, performance options and a list of major parameters that must be considered when selecting a controller. Also included is an informative discussion on six-SCR versus three-SCR Hybrid models for three-phase systems. Vectrol power controllers are offered in 30 to 400 amp models.

SEND FOR YOUR FREE COPY TODAY



VECTROL INC.
1010 WESTMORE AVE., ROCKVILLE,
MD. 20850, U.S.A. (301) 424-6900

INFORMATION RETRIEVAL NUMBER 94

ELECTRONIC DESIGN 25, December 6, 1974

Audio Indicator "Systems"

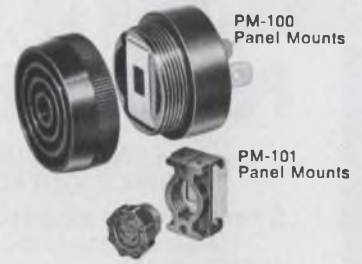

Speed Up Installation... add versatility, too!

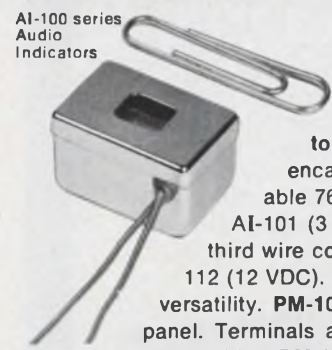

Take your choice. Components . . . or systems.

AI-100 Series Audio Indicators: Rugged, reliable, steel encased. Rated at a very noticeable 76 dB at 400 Hz. Four models: AI-101 (3 VDC); AI-103w (3 VDC with third wire collector); AI-105 (5 VDC); AI-112 (12 VDC). Use panel mounts for added versatility. **PM-100:** fits 1 1/8" opening in 1/8" panel. Terminals accept .250" female disconnects, screws, or solder. **PM-101:** for 1/2" openings in 1/8" panels. Bezel, self tap screws, or adhesive mounting. Special mounts made for OEM. What are your needs?



projects unlimited
3680 Wyse Road
Dayton, Ohio 45414
Tel. 513-890-1918
TWX 810-450-2523

IN EUROPE
projects unlimited/
Europe B.P. 15:
6100 Mont Sur
Marchienne
Belgium. Telex 51-390
Tel (07) 36 84 86

D.I.A.L. 800-645-9200 for the name of your nearest representative. In New York call 516-294-0990 collect.

INFORMATION RETRIEVAL NUMBER 96

NEW SUB-MINIATURE TOGGLE SWITCH* FOR PRINTED CIRCUIT BOARDS

- IDEAL FOR SUB-CHASSIS CHECKOUT, INTERLOCK CIRCUITS AND FIELD SERVICE
- NO MOUNTING HARDWARE REQUIRED

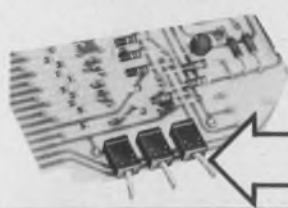

2 & 3
Position
Toggle
(Actual Size)



PCB TOGGLE SWITCH SPECIFICATIONS

(Available in 2 position or 3 position momentary and/or maintained)

| Volts | Load | Life (ops., min.) |
|---------------------------|------------------|-------------------|
| 6 VDC | 0.01 amp, res. | 500,000 |
| 6 & 12 VDC | 1 amp, res. | 100,000 |
| 28 VDC, 120 VAC | 0.5 amp, res. | 100,000 |
| Contact Resistance | 0.025 ohms, max. | |
| Ambient Temperature Range | -20°C. to +70°C. | |
| Weight | 0.06 ounce | |

* Pushbutton style also available in momentary action or latch-down, screwdriver-slot or snap-on button.

Send for technical bulletins

CONTROL SWITCH INC.

A SUBSIDIARY OF CUTLER-HAMMER INC.
1420 Delmar Drive • Folcroft, Pa. 19032 • (215) LU-6-7500
Representatives and Stocking Distributors Throughout the United States, Canada, and Europe

INFORMATION RETRIEVAL NUMBER 97

Electronic preset controller offers easy interface and industrial reliability.

- **High noise immunity**
New CMOS circuitry
- **Design flexibility**
Preset up to 6 digits
Presignal up to 6 digits
With or without display
Panel mount & table top versions
- **Input versatility**
Switch closure or electronic all in one
- **Compact package**
More features per square inch of panel than any other industrial controller.

HECON CORPORATION
P.O. Box 247
Eatontown, N.J. 07724
Phone (201) 542-9200
HECON OF CANADA, LTD.
80 Galaxy Blvd.
Rexdale, Ontario M9W-4Y8
Phone: (416) 678-2441



Write for complete information today.



INFORMATION RETRIEVAL NUMBER 99

OPEN FRAME POWER SUPPLIES

IN SINGLE, DUAL &
TRIPLE OUTPUTS

Check Dynage against Powertec,
Powermate or anyone!

Check these standard features:

- Transformer-shielded, and with 180°C insulation
- Teflon wiring
- Plated through PC board holes (component strength)
- Better temperature derating for safer operation over total range
- Pulse fired overvoltage protector with nuisance trip prevention
- Temperature stable foldback — no 'walking' under continuous short.

Send for Cross Reference Chart showing the interchangeability of our parts with Powertec and Powermate.

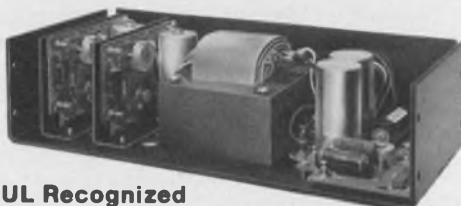

UL Recognized

For faster service call (203) 243-0315

DYNAGE inc.
1331 Blue Hills Avenue, Bloomfield, CT 06002

INFORMATION RETRIEVAL NUMBER 98

TWO CHANNEL SWEEP FREQUENCY RESPONSE ANALYZER

TWO COMPLETE CHANNELS OF
FREQUENCY RESPONSE MEASUREMENT

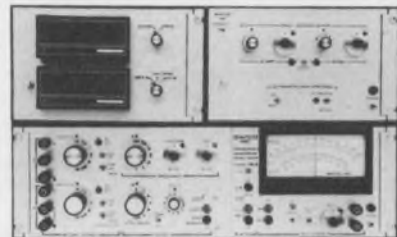

MODEL 913-72

TO GIVE: Open-loop measurement across any block in the system while in closed loop operation. Direct reading of amplitude ratio (DB) & phase shift.

AC coupled inputs (automatic rejection of up to 200 volts DC).

Automatic gain control over 80 DB dynamic range in each channel.
Automatic high noise and harmonic rejection.

SWEEP: Continuous log sweep from any start frequency to any stop frequency in the 6 1/2 decade frequency range.

FREQUENCY RANGE

MODEL 913-72 — .005 thru 10,000 Hz.

MODEL 913H-72 — .025 thru 50,000 Hz.

SEND FOR COMPLETE CATALOG OF ALL MODELS

BAFCO, INC.

717 MEARNS ROAD
WARMINSTER, PENNSYLVANIA 18974
TEL: (215) 674-1700 • TWX No. 510-665-6860

INFORMATION RETRIEVAL NUMBER 100

ELECTRONIC DESIGN 25, December 6, 1974

Another Datel
Two-for-One
Sale

Whose Digital Panel Meter
can you count on?

DATEL'S



\$99 DPM/Counter

We've put them together. A 3-digit panel meter and high speed counter. And much more, all for \$99.00, single quantity. This compact, 2-card, low parts-count DPM has easy-to-read .43" High LED digits. A counter input and gate with 0's reset not found on other DPM's lets you create frequency and period meters and tachometers. A wealth of special controls and full BCD outputs makes the DM-3000 ideal for systems use.

ALL FOR \$99 !!!!

QUICK SPECS

Input:
0 to +999mV
Drift:
100 ppm/°C max.
Power:
+5VDC
Output:
Full parallel BCD
Speed:
0 to 250 samples/second
using internal or
external clock
Counter:
0 to 10MHz count rate
Display:
Red 0.43" High LED 7-bar
Built-in-5V at 5mA short-proof
supply for external circuitry.
Selectable leading zero
suppress, display blank,
short cycle.
Optional 500kHz \pm 0.2% crystal
oscillator for accurate
frequency and period
measurement.

Use the DM-3000 as:
• 3-digit DPM
• 4-wire slaved display
• Tach. period or
frequency meter
• 0 to 10MHz general
purpose counter with
selectable full count

DATEL
SYSTEMS, INC.

1020 Turnpike Street, Canton, Mass. 02021
• TEL. (617) 828-8000 • TELEX 924461
• TWX 710-348-0135

Direct Offices

Santa Ana, Calif. (714) 835-2751
Sunnyvale, Calif. (408) 733-2424
Munich, W. Germany 089/78 40 45
Paris, France 603-06-74
Basingstoke, U. K. (0256) 66721
Tokyo, Japan 499-0631

A major breakthrough in op amps...

MOS/FET, Bipolar and CMOS on the same chip.

It's the low-cost CA3130 from RCA. An accurate, easy-to-work-with op amp from the people who first combined PMOS and bipolar technologies in the CA3100T.

Even with three technologies on a single chip, the new CA3130 is simplicity itself. Which is why it costs only \$0.75 at 1K (premium versions are also available). Among its principal features (values shown are typical):

General Purpose

High open loop voltage gain: 110 dB
Low input offset voltage: 8mV
Low input current: 5pA
Input offset current: 0.5pA

FET input

Very high input impedance: 1500 M Ω

Wideband

Unity gain crossover frequency: 15 MHz
High slew rate: 10 V/ μ s
Fast settling time: 1.2 μ s

Micropower

2.5 mW at 5V supply voltage

High current

22 mA output

A voltage swing to within 10 millivolts of either rail on a single power supply is now possible for the first time because of the CMOS output stage.

Available in 8-lead TO-5 ("T") or 8-lead dual in-line ("S") packages off the shelf from your RCA Solid State distributor. Call him or write RCA Solid State, Box 3200, Somerville, N.J. 08876. Phone (201) 722-3200, Ext. 3142.

RCA Solid State
A full house in Linear ICs

