

Electronic Design[®] 17

VOL. 22 NO.

AUG. 16, 1974

FOR ENGINEERS AND ENGINEERING MANAGERS

Microwave integrated circuits that can operate from a few kHz to nearly 30 GHz are appearing as amplifiers, mixers, passive circuits, oscillators and whole

subsystems. To discover what MIC technology means to the designer and learn how these circuits are being designed, built, packaged and used, see p. 44.

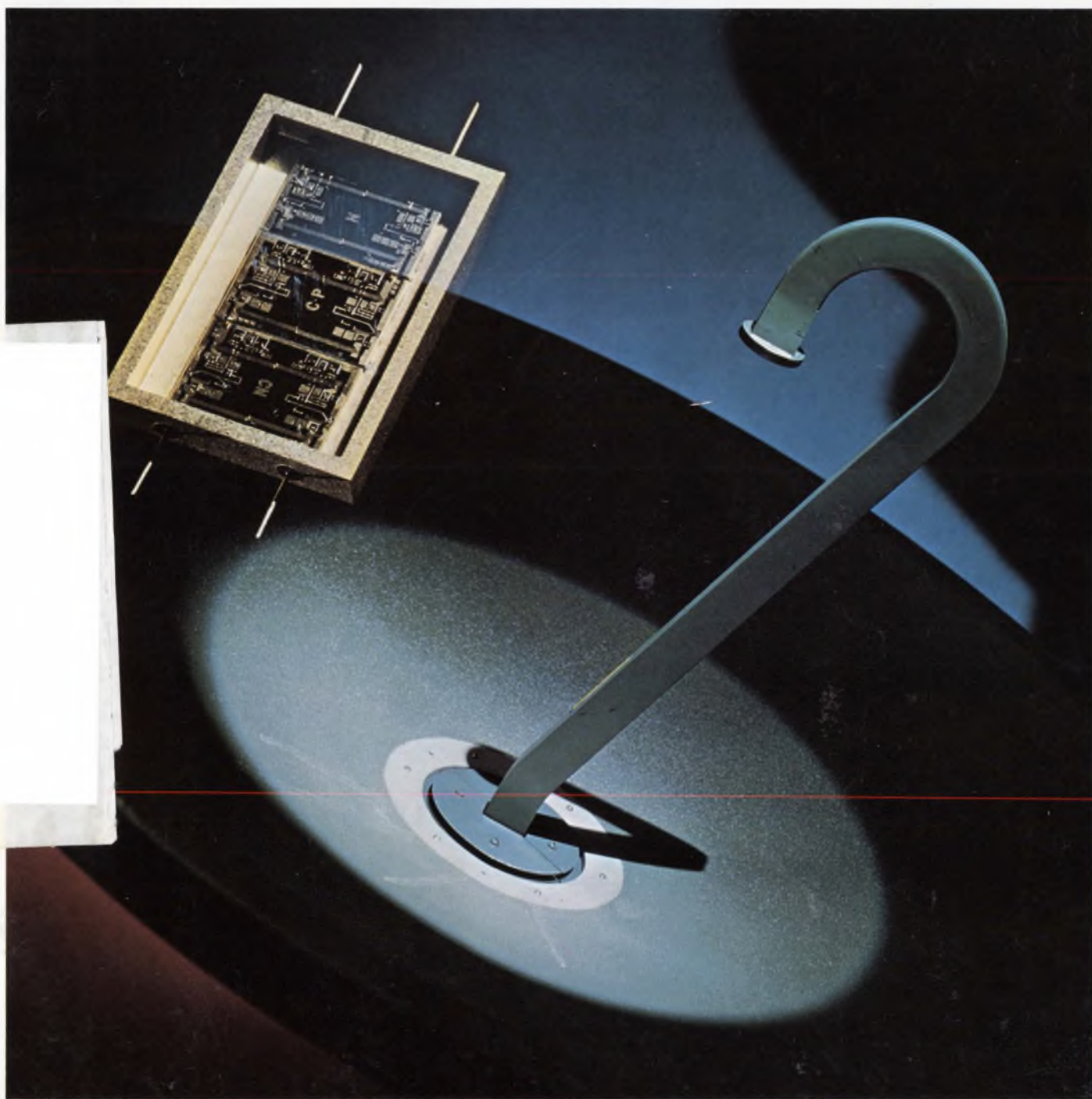

Need E-Rel Components?

We helped write the book!

Don't spin your wheels when you shift to established reliability from standard military specifications. Dale has the QPLs and the finished goods stock to save you valuable time. We're offering fast delivery on many established reliability part

Fast delivery on many styles

numbers for both wirewound and metal film resistors and wirewound trimmers. And we can deliver something else, too: *Experience*. Our work in the Minuteman program led to the formulation of the first specifications for established reliability resistors. Since then our materials improvement and failure rate documentation programs have become models in the industry. Today our AGS resistors have a proven failure rate of .000032% per 1,000 hours. *That's established reliability*. Put it to work for you now. Call 402-564-3131 (wirewound styles) or 402-371-0080 (film styles) or dial 800-645-9200 for the name of your Dale representative.



DALE ELECTRONICS, INC.
Columbus, Nebr. 68601
A subsidiary of The Lionel Corporation
In Canada: Dale Electronics Canada Ltd.
In Europe: Dale Electronics GMBH,
8Munchen 60, Falkweg 51, West Germany

★
ESTABLISHED RELIABILITY

★ ★ ★ ★ ★
ESTABLISHED
RELIABILITY

MIL-R-39007, MIL-R-39009
MIL-R-39015, MIL-R-39017
MIL-R-55182



MIL-R-39007
MIL-R-39009
MIL-R-39015
MIL-R-39017
MIL-R-55182

SURPRISE!

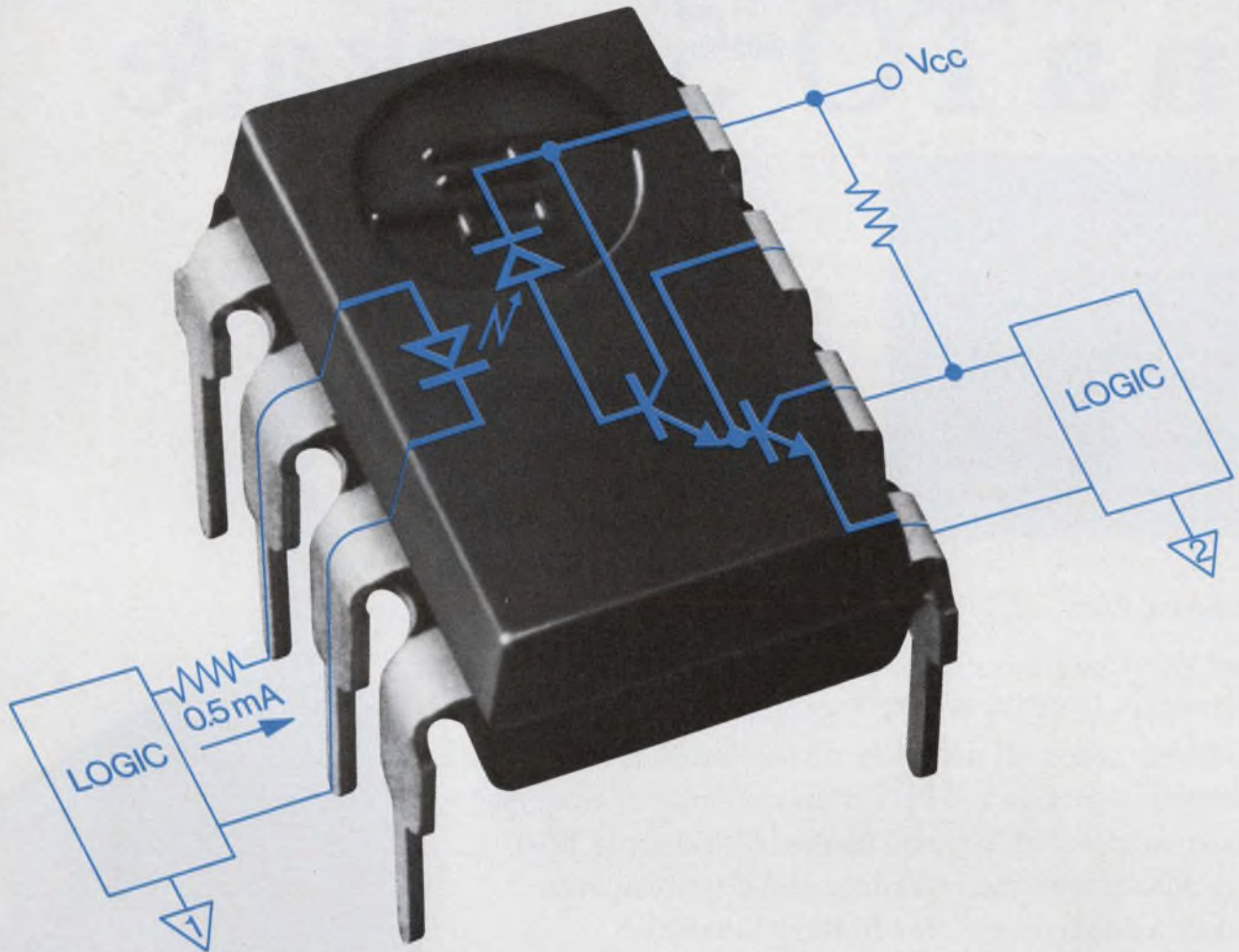

Optical isolation at 0.5 mA input

Now there is a new series of opto couplers from HP that will interface with most logic families. HP's 5082-4370 series isolators can be driven directly from CMOS, MOS, LTTL or TTL.

The unique construction of the 5082-4370 series offers a TTL compatible output voltage with speeds 50 times greater than conventional photodarlington isolators. Current transfer ratio of the 5082-4371 is typically 800% at 0.5mA input current and current transfer ratio of the 5082-4370 is typically 600% at 1.6mA input current.

Select the 5082-4370 for logic and TTL applications; 5082-4371 for CMOS, LTTL and other lower current uses. Performance of both models is guaranteed from 0°C to 70°C.

In 100 quantities, price for the 5082-4370 series starts at \$1.80* each.

For a complete design package on our new 5082-4370, hermetic, dual and high speed isolators contact Hall-Mark, Schweber, Wilshire or the Wyle Distribution Group.

Or write us, we're sensitive to your needs.

HEWLETT  PACKARD

Sales and service from 172 offices in 65 countries.
1501 Page Mill Road, Palo Alto, California 94304

01407

*Domestic USA price only.

INFORMATION RETRIEVAL NUMBER 2

ELECTRONIC DESIGN 17, August 16, 1974

1

RF switching to 500 MHz in a TO-5 package



RF circuit and packaging engineers are discovering that Teledyne TO-5 relays make excellent subminiature rf switches for frequency ranges up through UHF. Their reasons are: inherently low inter-contact capacitance and low loss contact circuit geometry. Typical rf performance: Isolation — 45db at 100 MHz, 35db at 500 MHz;

Insertion Loss — 0.2db at 100 MHz, 0.4db at 500 MHz.

And Teledyne Relays offer the widest possible selection: MIL relays in SPDT & DPDT standard, sensitive, and maglatch types, all available with internal diodes; commercial models in DPDT standard and sensitive types, also available with internal diodes. All Teledyne TO-5 relays feature hermetic sealing, gold plated contacts, and all welded construction for high reliability.

For Transmit/receive switching in hand-held transceivers or any low power remote band switching application, Teledyne TO-5 relays are an excellent choice. No other relay offers this combination of rf performance, low coil power dissipation, and small package size.

And they're **in stock** at your local Teledyne Relays distributor.



 **TELEDYNE RELAYS**

3155 West El Segundo Boulevard, Hawthorne, California 90250
Telephone (213) 973-4545

NEWS

- 39 **News Scope**
- 44 **The MIC invasion**—Vhf, uhf and microwave systems reap cost and efficiency benefits.
- 56 **Newer electronics hardware is helping police departments** short-circuit crime at the source.
- 65 **Washington Report**

TECHNOLOGY

- 80 **Interface CMOS logic with switches** using standard ICs. You can debounce mechanical devices with analog or digital filtering techniques.
- 86 **Double multiplexer logic capability** by using one of the input variables to drive some data lines. A modified Karnaugh map helps you choose the right ones.
- 92 **Thick or thin-film resistors?** For high power and resistance at low cost, thick films are best, but when high precision and tracking are important, use thin films.
- 98 **Prevent op-amp output instability.** Adding one or two passive components to the load gets rid of oscillations that cripple the output.
- 102 **Plot your voltage divider designs.** You'll get a quick overview of the effects of tolerances, limits and adjustments. The method can even handle nonlinear devices.
- 110 **Designs that sell require compromise,** follow-up and coordination with manufacturing, sales and the customer, says this engineering head.
- 116 **Ideas for Design:** Build a low-cost ECL logic probe that also has an overrange indicator . . . Four-input EXCLUSIVE-NOR gate made from a BCD-to-decimal converter . . . Successive approximation a/d converter uses three ICs and costs under \$25 . . . Differential amplifier will allow low-distortion output from mixer . . . Paul Brokaw of Analog Devices Semiconductor Wins Annual 'Ideas for Design' Award.
- 126 **International Technology**

PRODUCTS

- 131 **Instrumentation:** Analyzer picks out patterns in long digital data streams.
- 136 **Microwaves & Lasers:** 2-GHz low-noise amplifier features new package style.
- 142 Integrated Circuits
- 144 Data Processing
- 152 Modules & Subassemblies
- 158 Packaging & Materials
- 162 Discrete Semiconductors
- 166 Components
- 168 Power Sources

Departments

- 69 **Editorial:** A ray of hope
- 7 Across the Desk
- 170 Design Aids
- 170 Application Notes
- 172 New Literature
- 180 Advertisers' Index
- 182 Product Index
- 184 Information Retrieval Card

Cover: Photo by Gary Traviss, courtesy of Avantek, Inc.

The 2401 overhead in half.

Intel's 2401 n-channel 2048-bit shift register does much more than chop register board area and assembly cost in half.

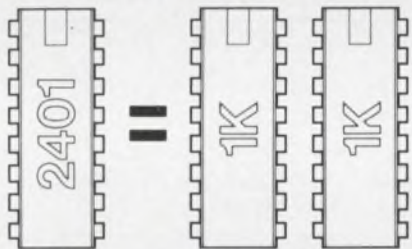

It is also a remarkably efficient, easy to drive, TTL compatible register

that cuts all your other overhead costs in half, too. Maybe more.

All inputs and outputs operate at TTL logic levels, including the single clock input and the single +5 volts V_{CC} supply pin on the corner of the 16-pin plastic DIP. That lets you trim off the high voltage sections of your power

supply and eliminate MOS/TTL interfaces.

The maximum capacitance of all inputs, including the single-phase clock input, is only 7 pF and the outputs only 14 pF. Clock capacitance is about 1/80th of the total presented by a pair of two-phase 1K p-channel regis-

ters. Other capacitances are reduced about 50%. So, remove drivers, simplify the clocking logic, and pare down the power supply some more.

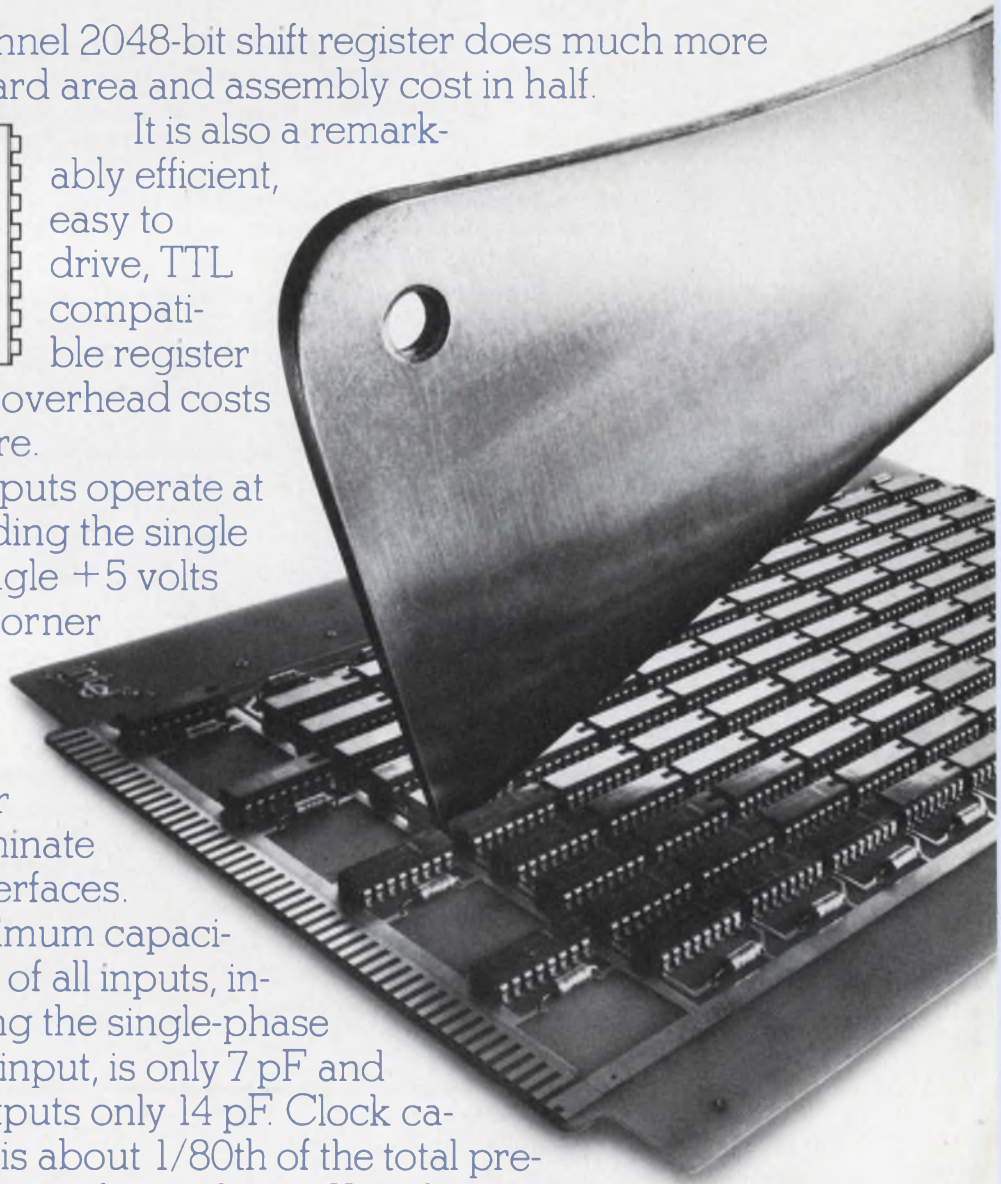

cuts shift register Maybe more.

Furthermore, the 2401 has on-chip X-Y chip select controls

TODAY'S SPECIAL

**n-Channel
2K**

and separate write/recirculate controls in each 1024-bit section. That minimizes external logic for OR-tied arrays and gives you the flexibility of single 2K or dual 1K operation.

In other words, the 2401 has advantages in serial storage designs like the 2102 (the world's most

popular static 1K RAM) has in random access designs. And the 2401 is as easy to buy as the 2102 because both are made with the same high volume, silicon gate n-channel technology.

We hope all this makes you think twice about

using expensive static registers or lesser dynamic registers in buffer, CRT refresh, key to tape, signal sampler and other serial memories.

Think instead about cutting system overhead in half (maybe more) with our big, efficient, completely TTL compatible 2401.

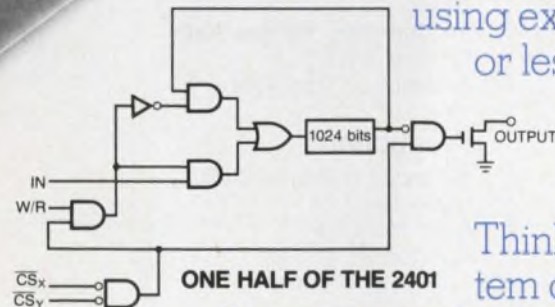

MSI DATA CORP.
PORTABLE TERMINAL

Intel Corporation, 3065 Bowers Avenue, Santa Clara, California 95051.
(408) 246-7501.

intel® delivers.

INFORMATION RETRIEVAL NUMBER 4

A Smart Way to Beat Your Power Supply Size Problem



$1\frac{1}{2}$ " thin, $2\frac{3}{4}$ " narrow, $2\frac{3}{4}$ " short

yet this converter produces 1000 volts DC, regulated, from a battery input of 28 VDC! It weighs less than 15 ounces. This is only one of our wide variety of many small light weight converters, inverters and power supplies — there are over 3000 models listed in our newest catalog, including size, weight and prices. If you have a size problem, why not send for an Abbott catalog?

MIL SPEC ENVIRONMENT — All of the power modules listed in our new catalog have been designed to meet the severe environmental conditions required by modern aerospace systems, including MIL-E-5272C and MIL-E-5400K. They are hermetically sealed and encapsulated in heavy steel containers. New all silicon units will operate at 100°C.

Please see pages 581-593 of your 1973-74 EEM (ELECTRONIC ENGINEERS MASTER Catalog) for complete information on Abbott Modules.

Send for our new 68 page FREE catalog.

RELIABLE — Highest quality components are used in Abbott power modules to yield the high MTBF (mean time between failure) as calculated in the MIL-HDBK-217 handbook. Typical power modules have over 100,000 hours MTBF — proving that the quality was built in from the beginning.

WIDE RANGE OF OUTPUTS — Any voltage from 5 volts DC to 3,650 VDC is available by selecting the correct model you need from our catalog with any of a variety of inputs including:

- 60 Ω to DC, Regulated
- 400 Ω to DC, Regulated
- 28 VDC to DC, Regulated
- 28 VDC to 400 Ω , 1 ϕ or 3 ϕ
- 24 VDC to 60 Ω , 1 ϕ

Vice President, Publisher
Peter Coley

Editors

Editorial Offices
50 Essex St.
Rochelle Park, N.J. 07662
(201) 843-0550
TWX: 710-990 5071
Cable: Haydenpubs Rochellepark

Editor-in-Chief George Rostky

Managing Editors:

Ralph Dobriner
Michael Elphick

Associate Editors:

Dave Bursky
Jules H. Gilder
Morris Grossman
Seymour T. Levine
John F. Mason
Stanley Runyon
Edward A. Torrero
Richard L. Turmail

Contributing Editors:

Peter N. Budzilovich
Robert Wollins

Editorial Field Offices

East

Jim McDermott, Eastern Editor
P.O. Box 272
Easthampton, Mass. 01027
(413) 527-3632

West

David N. Kaye, Senior Western Editor
2930 West Imperial Highway
Inglewood, Calif. 90303
(213) 757-0183
Northe K. Osbrink, Western Editor
112 Coloma St.
Santa Cruz, Calif. 95060
(408) 426-3211

Editorial Production

Marjorie A. Duffy

Art

Art Director, William Kelly
Richard Luce
Anthony J. Fischetto

Production

Manager, Dollie S. Vieblg
Helen De Polo
Anne Molfetas
Christopher G. Hill

Circulation

Manager, Evan Phourides

Information Retrieval

Peggy Long

Promotion

Manager, Walter G. Salm
Karen Kerrigan (Reprints)

abbott transistor

LABORATORIES, INCORPORATED

5200 W. Jefferson Blvd./Los Angeles 90016
(213) 936-8185 Cable ABTLABS

1224 Anderson Ave./Fort Lee, N.J. 07024
(201) 224-6900

INFORMATION RETRIEVAL NUMBER 5

Coordinate engineers, don't 'manage' them

For years, I thought I was a loner in my methods of not managing, but trying to coordinate creative engineering. If I had worked for Alexander V. d'Arbeloff, I might never have started Automation Systems (see "Let the Engineers Run the Company, ED No. 10, May 10, 1974, p. 124).

Mr. d'Arbeloff, however, did not point out in the article that coordinating such a group as he suggests is much more difficult and time-consuming (from the manager's standpoint) than usual management methods. I find they apply not only to engineering but to all phases of business, including sales and production.

I think what this article really says is that there is more to management than books; there is always the art of application, which is a concept of creative management.

I agree with Mr. d'Arbeloff that the rewards of a productive organization are well worth the extra effort.

Peter G. Bartlett
President

Automation Systems, Inc.
Lancer Park
Eldridge, Iowa 52748

Wrong connection

The schematic for my article "Tester Built for Less Than \$10 Gives GO/NO GO Check of Timer ICs" (ED No. 11, May 24, 1974, p. 106) was printed incorrectly, as follows:

1. There should be no connection between pin 1 (ground) of IC₃

and pins 4 and 8 (5 V dc) of IC₂.

2. IC₃, the timer unit under test, should show plug-in connections for pins 4 and 8 (5 V dc), pin 1 (ground) and pin 3 (connection to G₁).

John Predescu

Assistant Research Engineer
Buchler Instruments
1327 16th St.
Fort Lee, N.J., 07024.

3-state or Tri-State, it's not exactly new

In the article "Heed the Limitations of MOS I/O Circuitry" (ED No. 10, May 10, 1974, p. 82), the authors refer to a "three-state output" structure for an MOS shift register as a proprietary Signetics Circuit. National Semiconductor has been using a Tri-State (registered trademark) output structure on several dynamic shift-register products (MM4012, MM5012, MM4013, MM5013) for a least three years. In addition an application note has been available for two years (AN-65), which explains the timing and drive consideration tradeoffs involved in use of Tri-State MOS devices.

I agree with the authors that the Tri-State technique offers significant performance improvements in many shift-register systems, but the technique is by no means a new one. Many two and three-year-old systems have been designed that take full advantage of the Tri-State output of MOS shift registers.

Michael Riley

Field Applications Engineer
National Semiconductor

(continued on page 16)

Electronic Design welcomes the opinions of its readers on the issues raised in the magazine's editorial columns. Address letters to Managing Editor, Electronic Design, 50 Essex St. Rochelle Park, N.J. 07662. Try to keep letters under 200 words. Letters must be signed. Names will be withheld on request.



OPTRON OPTICALLY COUPLED ISOLATORS

LOW COST "DIP" SERIES FURTHER EXPANDS ISOLATOR LINE

OPTRON's addition of a new, low cost 6-pin plastic dual in-line isolator series further broadens its line to provide a coupler for every application.

The new "DIP" series includes six models offering complete interchangeability with popular industry types. It offers a wide range of capabilities to allow you to choose a device most suited to your circuit requirements at the best possible price. The "DIP" series has isolation voltages of 1500 or 2500 volts with a current transfer ratio of 2.0 to 50%.

OPTRON's broad selection of "DIP" and other packages with isolation voltages to 50 Kv now provides the versatility required for maximum electrical and mechanical design flexibility.

1.5 Kv isolation with 60% current transfer ratio. Phototransistor base lead available. Hermetic TO-5 package.

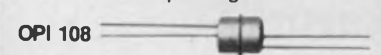

1 Kv isolation and 20% current transfer ratio. 5 μsec switching time in a welded axial lead hermetic package.

Detailed technical information on these and other OPTRON optoelectronic products... chips, discrete components, assemblies, and PC board arrays... is available from your nearest OPTRON sales representative or the factory direct.



OPTRON, INC.

1201 Tappan Circle
Carrollton, Texas 75006
214/242-6571

Do you face
a make or buy
decision on
power supplies?

BUY LAMBDA'S LZ SERIES MOUNTABLE POWER SUPPLY.

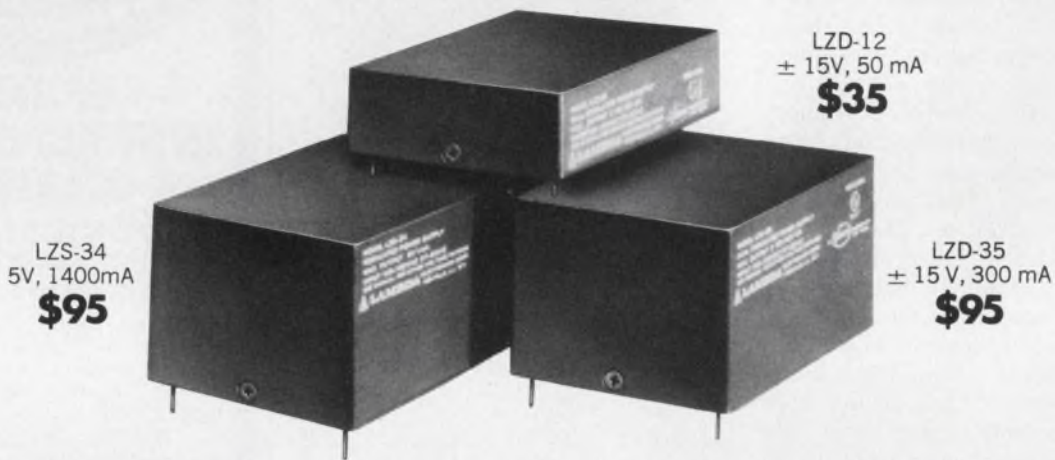

LZ-10 SERIES SINGLE OUTPUT

2½" x 3½" x 7/8"

MODEL	VOLTAGE ⁽¹⁾ VDC	CURRENT mA	PRICE ⁽²⁾
LZS-10	3	317	\$35
LZS-10	4	384	35
LZS-10	5	450	35
LZS-11	10	225	35
LZS-11	12	195	35
LZS-11	15	150	35

LZ-10 SERIES DUAL TRACKING OUTPUT

2½" x 3½" x 7/8"

MODEL	VOLTAGE ⁽¹⁾ VDC	CURRENT mA	PRICE ⁽²⁾
LZD-12	±15V	50	\$35

LZ-20 SERIES SINGLE OUTPUT

2½" x 3½" x 1¼"

MODEL	VOLTAGE ⁽¹⁾ VDC	CURRENT mA	PRICE ⁽²⁾
LZS-20	10	247	\$55
LZS-20	12	268	55
LZS-20	15	300	55
*LZD-22	24	73	40
*LZD-23	24	129	55
*LZD-22	28	84	40
*LZD-23	28	143	55

*Single output ratings for dual output models connected in series

LZ-20 SERIES DUAL TRACKING OUTPUT

2½" x 3½" x 1¼"

MODEL	VOLTAGE ⁽¹⁾ VDC	CURRENT mA	PRICE ⁽²⁾
LZD-21	± 3	217	\$55
LZD-21	± 4	258	55
LZD-21	± 5	300	55
LZD-22	±10	61	40
LZD-23	±10	114	55
LZD-22	±12	73	40
LZD-23	±12	129	55
LZD-22	±15	90	40
LZD-23	±15	150	55

LZ-30 SERIES SINGLE OUTPUT

2½" x 3½" x 1¼"

MODEL	VOLTAGE ⁽¹⁾ VDC	CURRENT mA	PRICE ⁽²⁾
LZS-30	3	633	\$65
LZS-30	4	767	65
LZS-30	5	900	65
LZS-33	10	293	65
LZS-33	12	336	65
LZS-33	15	400	65
LZS-34	3	950	95
LZS-34	4	1180	95
LZS-34	5	1400	95
*LZD-32	24	186	65
*LZD-32	28	208	65
*LZD-35	24	240	95
*LZD-35	28	280	95

*Single output ratings for dual output models connected in series

...PRINTED-CIRCUIT BOARD

LZ-30 SERIES DUAL TRACKING OUTPUT

MODEL	2½" x 3½" x 1⅞"		
	VOLTAGE ⁽¹⁾ VDC	CURRENT mA	PRICE ⁽²⁾
LZD-31	± 3	333	\$65
LZD-31	± 4	417	65
LZD-31	± 5	500	65
LZD-32	±10	163	65
LZD-32	±12	186	65
LZD-32	±15	220	65
LZD-35	±10	200	95
LZD-35	±12	240	95
LZD-35	±15	300	95

LZ-30 SERIES TRIPLE OUTPUT

MODEL	2½" x 3½" x 1⅞"		
	VOLTAGE ⁽¹⁾ VDC	CURRENT mA	PRICE ⁽²⁾
LZT-36	5	500	\$70
	±15	50	

NOTES: (1) LZ models are adjustable between the following limits: LZS-10 2.5 to 6V LZS-11 8 to 15V LZS-20 8 to 15V LZS-30 2.5 to 6V LZS-33 8 to 15V LZS-34 2.5 to 6V LZD-12 ± 14.5 to ± 15.5V LZD-21 ± 2.5 to ± 6V LZD-22 ± 8 to ± 15V LZD-23 ± 8 to ± 15V LZD-31 ± 2.5 to ± 6V LZD-32 ± 8 to ± 15V LZD-35 ± 8 to ± 15V LZT-36 2.5V-6V for + 5V output only, ± 14.5 to ± 15.5 for ± 15V output only. Contact factory for current ratings at voltage settings not indicated in the tables. (2) All prices and specifications are subject to change without notice.

SPECIFICATIONS FOR LZ SERIES

Regulation

0.15%—line or load; models LZS-10, LZS-30, LZS-34, LZD-21 and LZD-31 have load regulation of 0.15% + 5mV; model LZD-12 has line or load regulation of 0.25%; LZT-36 line regulation 0.15% (+5V) 0.25% (±15V); load regulation 0.15% + 10mV (+5V), 0.25% (±15V).

Ripple and noise

1.5mV RMS, 5mV, pk-pk

Temperature coefficient

0.03%/°C

Overshoot

no overshoot on turn-on, turn-off, or power failure

Tracking accuracy

2% absolute voltage difference for dual output models only and only for the ±15V output in LZT-36; 0.2% change for all conditions of line, load and temperature

Ambient operating temperature range

continuous duty from 0°C to + 50°C

Wide AC input voltage range

105 to 132 Vac, 57-63 Hz

Storage temperature range

-25°C to +85°C

Overload protection

fixed automatic electronic current limiting circuit

Input & output connections

printed circuit solder pins on lower surface of unit. For model LZT-36 the ± 15V outputs are independent from the 5V output.

Controls

screwdriver voltage adjustment over entire voltage range.

Mounting

tapped holes on lower surface

Physical data

Size

see tables

Weight

LZ-10 series 10 oz. net 18 oz. ship.

LZ-20 series 17 oz. net 25 oz. ship.

LZ-30 series 24 oz. net 32 oz. ship.

60-day guarantee

60-day guarantee includes labor as well as parts

LZ SERIES NOW AVAILABLE IN NEW TRIPLE OUTPUT MODEL



MODEL	VOLTAGE ⁽¹⁾ VDC	CURRENT mA	PRICE ⁽²⁾
LZT-36	5V	500	\$70
	±15V	50	

**1 DAY DELIVERY
60 DAY GUARANTEE**



**LAMBDA
ELECTRONICS CORP.**

A  Company

MELVILLE, NEW YORK 11746 515 Broad Hollow Road Tel. 516-694-4200 ARLINGTON HEIGHTS, ILL. 60005 2420 East Oakton St., Unit Q Tel. 312-593-2550 NORTH HOLLYWOOD, CALIF. 91605 7316 Varna Ave. Tel. 213-875-2744 MONTREAL, QUEBEC 100C Hymus Blvd., Pointe Claire, Quebec 730 Tel. 514-697-6520 HIGH WYCOMBE, BUCKS, ENG. Abbey Barn Road, Wycombe Marsh Tel. High Wycombe 36386/7/8 ORSAY, FRANCE 91 Gometz le Chatel. ACHERN-FAUTENBACH, W. GERMANY 1m. Holzbosch 14 Tel. 078-41-5527

**Reliability is 756 little dents
and one big one.**



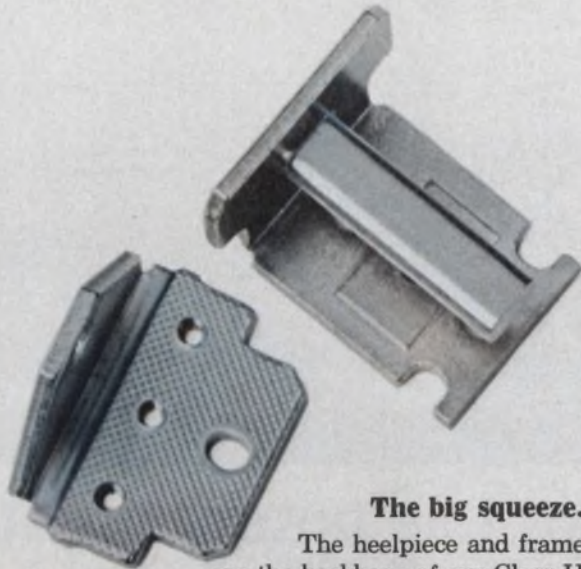

The big squeeze.

The heelpiece and frame are the backbone of our Class H relay. The slightest squiggle or shimmy out of either and the whole relay is out of whack.

756 tiny dents on the heelpiece, plus one big one on the frame, make sure this'll never happen.

They're the result of planishing, a big squeeze. Planishing is an extra step we go through in forming the pieces to add strength and stability by relieving surface strain. It also makes the parts extra flat.

This takes the biggest press in the industry and the biggest squeeze. Both exclusively ours.

A different kind of coil.

The heart of a relay is the coil. If ours looks different, it's because we build it around a glass-filled nylon bobbin. It costs us more, but you know how most plastic tends to chip and crack.

Also, moisture and humidity have no effect on glass-filled nylon. No effect means no malfunctions for you to worry about. No current leakage, either.

The coil is wound on the bobbin automatically. No chance of human error here.

Springs and other things.

We don't take any chances with our contact assembly, either. Our contact springs are phosphor-bronze. Others use nickel-silver. Our lab gave this stuff a thorough check, but found nickel-silver too prone to stress-corrosion. Atmospheric conditions which cause tarnish and ultimately stress corrosion have almost no effect on phosphor-bronze.

Even things like the pileup insulators (those little black rectangles) get special attention. We precision mold them.



Other manufacturers just punch them out.

It makes a lot of difference. They're stronger, for one thing; and because they're molded, there's no chance of the insulators absorbing even a droplet of harmful moisture. Finally, they'll withstand the high temperatures that knock out punched insulators.

Two are better than one.

Our next step was to make sure our contacts give a completed circuit every time. So we bifurcate both the make and break springs.

Each contact works independently to give you a completed circuit every time. Contact material is pure palladium with a gold overlay because no alloy works as well.

Edge-tinned contact springs save you the job of solder tinning them later. Also, edge-tinning enables you to safely use the same relay with sockets or mounted directly to a printed circuit board. A simple thing, but it takes a big chunk out of the inventory you have to stock.



Finally, superior protection.

Out of the dozens of plastics to choose from for our dust cover, we picked a durable polycarbonate. The same material used for plastic windshields and special vehicle bodies. It's strong, resists high temperatures, and is unaffected by most cleaning solvents.

Then, for extra safety, we put a disposable cap over the cover's open end. This seals out dirt and dust while preventing damage to the terminals during shipping and handling.

Etc. Etc. Etc.

There's a lot more to tell about what makes our Class H relay reliable. Now we're waiting to hear from you.

GTE Automatic Electric,
Industrial Sales Division, Northlake,
Illinois 60164.

GTE AUTOMATIC ELECTRIC

INFORMATION RETRIEVAL NUMBER 8

Centralab perspectives

FOR USERS OF ELECTRONIC COMPONENTS



CENTRALAB

Electronics Division
GLOBE-UNION INC.

5757 NORTH GREEN BAY AVENUE
MILWAUKEE, WISCONSIN 53201

One million cycles make this potentiometer the right choice for any application requiring high rotational life.

Meeting the demands of continuous motion or other extreme service, the Ultralife™ potentiometer finds use where extra life, reliability, smooth action and low noise are required.

Design and application engineers specifying potentiometers for high rotational life requirements, now have another choice with substantial savings in cost. From the extensive line of Centralab potentiometers comes the ULTRALIFE—a 2¼ watt hot molded carbon control.

The ULTRALIFE incorporates a specially developed Lifelon bearing that prevents the shaft from contacting the bushing. The bearing is self lubricating to guarantee rotational life exceeding one million cycles with smooth feel, uniform operating torque and an extremely low mechanical noise. Low contact resistance variation (CRV) throughout the long life



Available in up to four sections, Ultralife offers resistance values from 10 ohms to 5 megohms. Standard tolerances are ±20% to 499K ohms, ±30% to 5 megohms.

of the potentiometer is assured by the use of a hot molded resistor track and contact brush. In addition, wear-resistant plating applied to the collector ring further maintains minimal CRV.

Today, ULTRALIFE potentiometers are being used in many industrial and commercial applications. Musical instruments like electronic organs and guitars. For servo-systems and motor drives. And in high temperature applications. With stainless steel cover and shaft, they meet salt-spray environmental requirements as well.

For full information on ULTRALIFE, write Centralab for Bulletin 1374P.

Unit No.	Initial Resistance	After 100,000 Cycles		After 250,000 Cycles		After 500,000 Cycles		After 1,000,000 Cycles	
		Resistance	% Ch.	Resistance	% Ch.	Resistance	% Ch.	Resistance	% Ch.
1	99.319 K ohm	97.998 K ohm	-1.33	98.079 K ohm	-1.25	96.839 K ohm	-2.50	94.979 K ohm	-4.37
2	105.350 K ohm	104.600 K ohm	-.712	105.190 K ohm	-.152	104.080 K ohm	-1.21	101.810 K ohm	-3.36
3	95.289 K ohm	94.629 K ohm	-.693	94.619 K ohm	-.703	94.089 K ohm	-1.26	91.849 K ohm	-3.61
4	108.360 K ohm	107.010 K ohm	-1.25	107.240 K ohm	-1.03	106.900 K ohm	-1.35	104.300 K ohm	-3.75
5	101.090 K ohm	101.060 K ohm	-.030	101.630 K ohm	+.534	101.660 K ohm	+.564	101.040 K ohm	-.049
6	99.059 K ohm	99.049 K ohm	-.010	100.020 K ohm	+.970	99.709 K ohm	+.656	97.839 K ohm	-1.23
			Av.-.670		Av.-.272		Av.-.850		Av.-2.73

Testing proves the reliability of Centralab's Ultralife potentiometer. After 1,000,000 cycles at 3,000 cycles per hour, resistance change averaged 2.73% for six tested units.

Centralab
perspective:

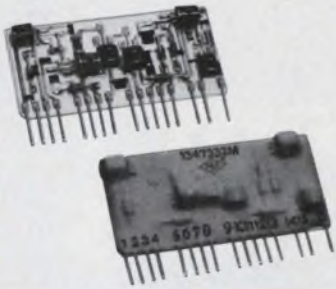

Two thick film hybrid systems. PEC and MEC.

Centralab offers the flexibility to design and fabricate thick film modules to fit virtually any application and cost parameter.

Low-cost silver/carbon or  systems for consumer applications:

- Resistor Range.....10 ohms to 10 megohms
- Resistor Tolerance...±10% preferred minimum
- Ratio Matching.....±5% minimum
- Capacitor Types.....Ceramic and tantalum
- Active Devices.....Diodes, transistors & IC's
- Operating Temp. Range....-55° C to +85° C

Noble metal/cermet or MEC systems for commercial and industrial uses:

- Resistor Range.....3 ohms to 3 megohms
- Resistor Tolerance.....±.5% minimum
- Ratio Matching.....±1% minimum
- Capacitor Types.....Ceramic and tantalum
- Active Devices.....Diodes, transistors & IC's
- Operating Temp. Range....-55° C to +150° C

For Bulletin 1547 write
A.R. Wartchow, Manager,
Electroceramic Marketing.
Outside U.S.A. contact
J.H. Meunier, Manager,
International Sales.



Centralab
perspective:

Transmitter Capacitors

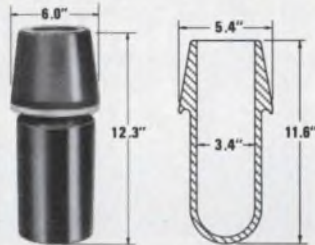

Ceramic dielectric insert.

Meet Specs For Extra Reliability and Save 50%.

When selecting capacitors for transmitter equipment, Centralab can help. Example: one ceramic dielectric type can replace two vacuum types — increase reliability — yet reduce both weight and cost by 50% or more. The cup type shown, meets specs calling for 6000 pf, 10 kV and current ratings of 100 amps at 500 kHz.

Centralab's line of special capacitors includes header, feed-thru, tubular, slug and water-cooled types — plus custom designs to meet any spec.

All it takes is a call to
Marty Hedrich at
414/228-2033.



CENTRALAB
Electronics Division
GLOBE-UNION INC.

5757 NORTH GREEN BAY AVENUE
MILWAUKEE, WISCONSIN 53201

Centralab
perspective:

CERAMOLITHIC® FILTERS HAVE EVOLVED WITH USE OF EVER HIGHER FREQUENCIES.



MSI and LSI technology have been shrinking the world of electronics, dictating higher, faster frequencies/speeds. With active circuit elements in intimate relationship, electromagnetic fields are straying into unwanted places; sharp filtering has to be an important design consideration.

U.S. Capacitor Corporation, the world's leading innovator of monolithic ceramic capacitors and filters, has tracked circuit speed developments with one idea in mind: improved attenuation at increasingly higher frequencies, in state of the art sizes and at *affordable prices*. Ceramic Filter evolution happens at USCC/Centralab by basic research in dielectric materials and new manufacturing techniques.

Today's products of this evolution are CERAMOLITHIC® subminiature EMI/RFI filters like our 9900 series feed-thru's giving better than 70 db at 10GHZ in only a .110" x .156" diameter case size — for use in medical electronics and CATV. Write for our new 1974 filter catalog or call Don Thommen direct, (213) 843-4222.

USCC/Centralab
2151 N. Lincoln Street
Burbank, California 91504



“Scotchflex” Flat Cable Connector System makes 50 connections at a time.

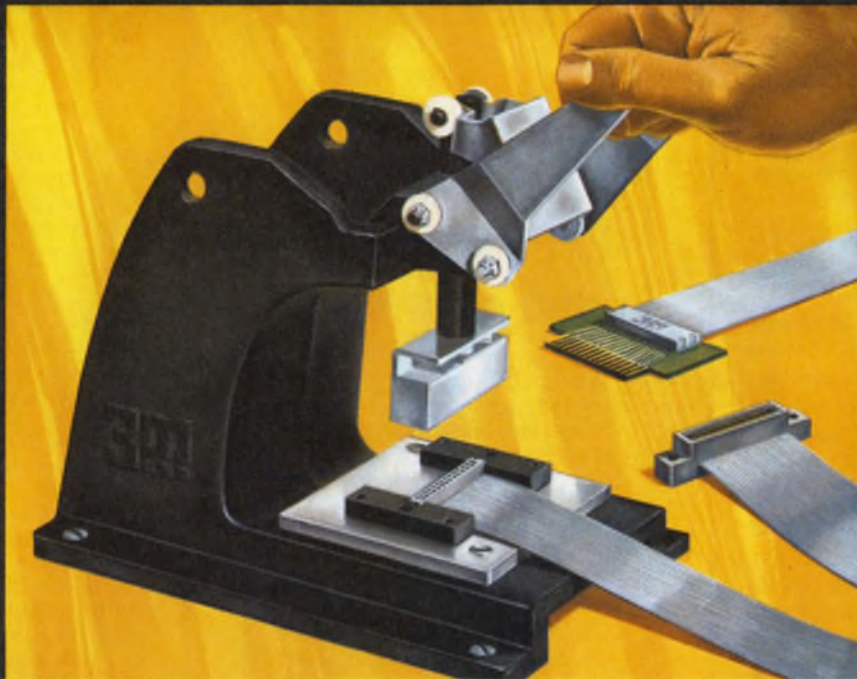

SCOTCHFLEX IS A REGISTERED TRADEMARK OF 3M CO.

Build assembly cost savings into your electronics package with “Scotchflex” flat cable and connectors. These fast, simple systems make simultaneous multiple connections in seconds without stripping or soldering. Equipment investment is minimal; there’s no need for special training. The inexpensive assembly press, shown above, crimps connections tightly, operates easily and assures error free wiring.

Reliability is built in, too, with “Scotchflex” interconnects. Inside of connector bodies, unique U-contacts strip through flat cable insulation, grip each conductor for dependable gas-tight connections.

“Scotchflex” offers you design freedom, with a wide choice of cable and connectors. From off-the-shelf stock you can choose: 14 to 50-conductor cables. Connectors to interface with standard DIP sockets, wrap posts on standard grid patterns, printed circuit boards Headers for de-pluggable connection between cable jumpers and PCB. Custom assemblies are also available on request.

For more information, write Dept. EAH-1, 3M Center, St. Paul, Minn. 55101.

“Scotchflex” Your systems approach to circuitry.



CONSOLES • CABINETS • CASES

by **PREMIER**

THE TRIMLINE SERIES
backed by over 28 years
of service to the industry

- Tasteful Designs • Optional Trims & Finishes • Modular for Console Configuration • Rugged Mechanical Strength*
- Variety of Shapes & Sizes • Full Line of Accessories*
- Moderately Priced.*

An ideal choice for systems in varied environmental locations from factory floor to well appointed offices.

Modifications are readily accommodated through our systems of staging stock parts ready for any additional fabrication and completion on short interval scheduling.

Send for our complete catalog of over 1300 products in the category of cabinets, consoles, racks, cases, blowers, fans, slides, chassis, boxes, hardware and other accessory items used for electronic system housing.



PREMIER METAL PRODUCTS CO.
337 Manida Street, Bronx, N.Y. 10474
Phone: (212) 991-6600

The widest selection of analog CMOS switches and multiplexers.

Available now.



Get them all from one source. And get them fast. 4-, 8- and 16-channel multiplexers. Quad and dual SPDT switches.

Some of our designs you've never seen before. They'll give you specs, functions, and package options you can't order anywhere else.

And we've got other designs you'll recognize right away. You probably ordered them from someone else a while ago — and you're still waiting for delivery.

Check them out. They'll give you the design benefits of CMOS — and the lowest power dissipation you can get.

The multiplexers:

AD7501 8-channel
AD7502 differential 4-channel.
AD7503 8-channel.

AD7506 16-channel.
AD7507 differential 8-channel.

The switches:

AD7510/AD7511/AD7519 quads.
AD7512 dual SPDT.
AD7513 dual.
AD7516 quad.

Get it only from us. Again, only from us.

A replacement for HI1818.
Replaces DG506.
Replaces DG507.

You can't get them anywhere else. Another that's ours alone.
Use it instead of DG200.
Instead of CD4016A.

The price is right.

So give us a call — to order or to ask for our new catalog. It'll tell you everything you need to know about our entire line of analog CMOS switches and multiplexers.

East Coast: (617) 329-4700.

Midwest: (312) 297-8710.

West Coast: (213) 595-1783.

Our analog CMOS switches and multiplexers, like our AD7520 CMOS DAC, are more innovative uses of advanced technology — to keep you (and us) a step ahead of everyone else.

Analog Devices, Inc., Norwood, Mass. 02062.



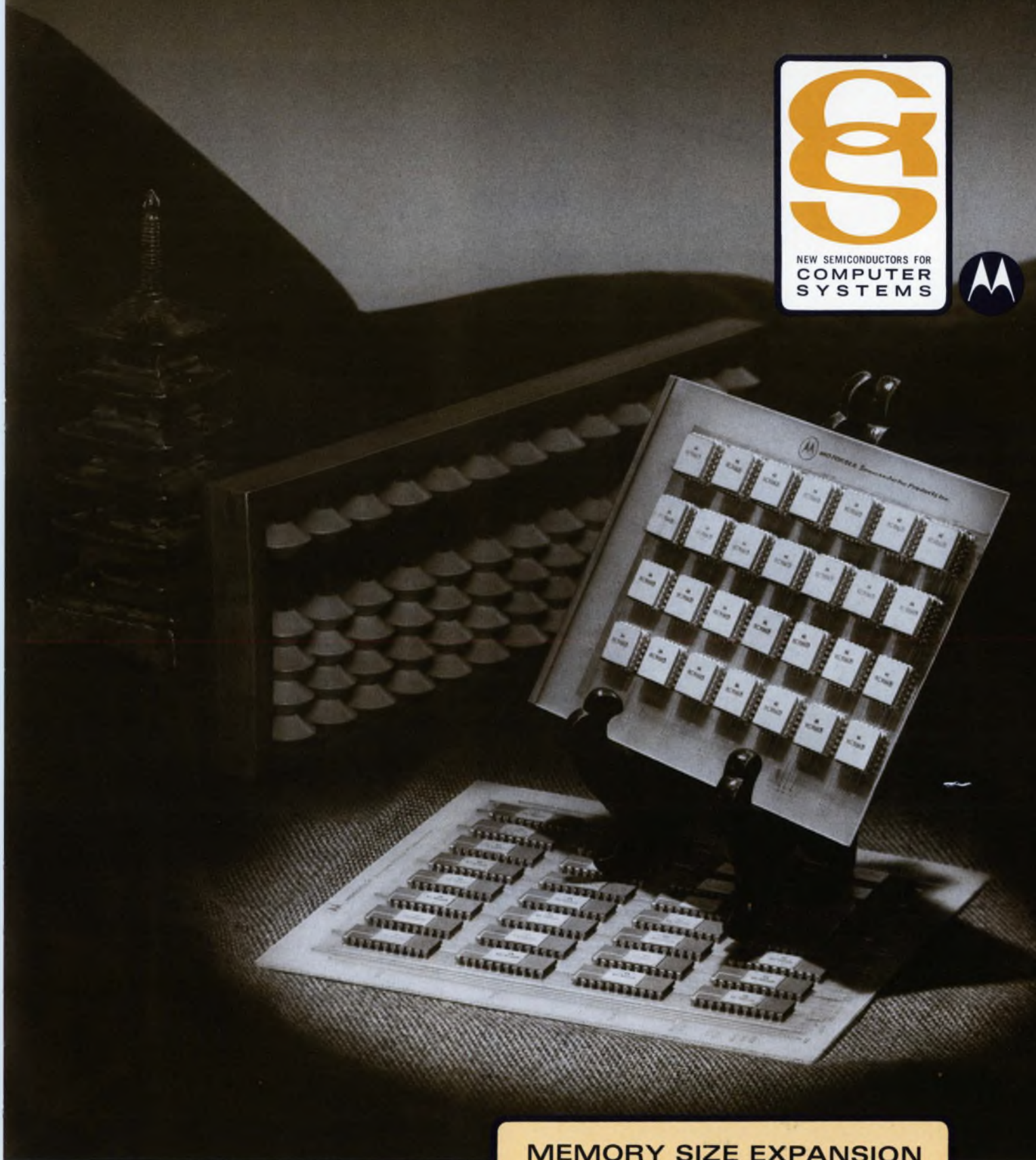

MEMORY SIZE EXPANSION MAY CHANGE PACKAGE TECHNOLOGY

ALSO FEATURING:

- LSI Deskew Register Means System Savings
- MECL MSI Simplifies Memory System Design
- MECL 10,000 Builds System Performance
- Serial Data Error Control Simplified

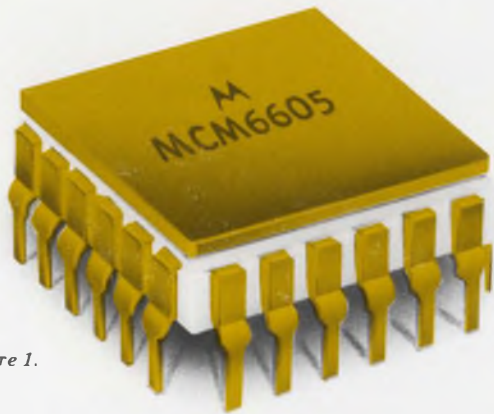

Figure 1.

Packaging Evaluations:

Semiconductor Memory Density Expansion Through Evolutionary Changes

BY: Bill Lattin and Bud Broeker

As the relentless expansion of N-channel MOS semiconductor memory size applies pressure to existing packaging technology, package change becomes a near certainty. Although the nature of that change is still not totally in focus, decisions influencing it must be based on the careful analysis of the real world.

In the real world, at present, there exists no revolutionary new packaging techniques that are available and acceptable. So, practicality then, is the foremost consideration in any technological approach to solving this high density packaging need. And a square 24-pin package, recently developed by Fujitsu of Japan, appears to be on the right track.

Why new packages

The most obvious of several important motivations for finding a new package is improvement in density over that currently available with standard dual in-line packages. In typical semiconductor memory systems, the costs of peripheral circuitry and printed circuit boards account for a significant percentage of total system costs. An increase in the packing density of the semiconductor memory elements themselves can, therefore, reduce the board cost and, to a lesser extent, the cost of peripheral drive components.

The ideal high density package would be one in which the total memory package is occupied by active silicon circuit area. A package with pins on the entire bottom would be optimum, but since no such commercial package is available for general usage, we will restrict our consideration here to packages with side mounted pins.

To help put this active area idea in perspective, with the standard 22-pin DIP, the actual chip area is only 7% of the package area — assuming a 168 mil x 195 mil 4K RAM. And, on a typical printed circuit board, this active area goes down to about 4%. Any new package, then, should increase this percentage to power dissipation limitations. Fortunately for memory package development, the power problem is greatly reduced with the design of NMOS

dynamic RAMs, since most dynamic RAMs have very low power dissipation when unselected. For example, the MCM6605 4K NMOS RAM dissipates only 3 mW when unselected, compared to 330 mW when selected. Logically then, organizing memory arrays so that most chips are unselected — except possibly during a low duty cycle refresh — the overall board power density can be kept low despite high memory device density. Accordingly, power dissipation is not a deterrent to denser packing of NMOS memory chips, essentially removing that limitation from new package design.

Additional valid reasons influencing the need for a new packaging technology include the desire for more than 22 pins in a space saving design, and the attractiveness of reduced package power supply lead lengths. A standard 24-pin package, 65% larger than the 22-pin, is just too cumbersome to be practical in large memory systems. And, too, semiconductor RAM supply connections are on the corner pins to improve power supply decoupling. Unfortunately, on the standard package, these are the farthest pins from the die bonding area. Any new package should attempt to reduce the physical length of power supply leads without affecting the easy decoupling of the power supplies.

The 24-pin square package

The 24-pin square package shown in Figure 1 was developed in Japan by Fujitsu specifically to address the above noted problems. The package uses a conventional metal seal die cavity with side brazed leads. This is clearly an evolutionary change from present packages and requires little new technology. The pin spacing is on 75 mil centers instead of the conventional 100 mil centers. This spacing is probably too close for random logic applications, but the

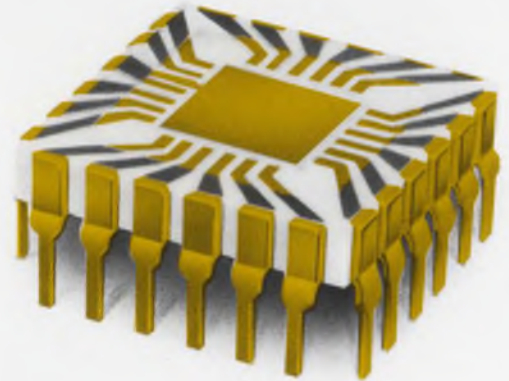

New Semiconductors for COMPUTER SYSTEMS

Motorola Semiconductor Products Inc., P.O. Box 20912, Phoenix, Arizona © Motorola Inc. 1974

The semiconductor systems described herein are intended only to illustrate typical applications. The information is believed reliable; however, no responsibility is assumed for inaccuracies. This advertisement does not alter Motorola's standard product warranty; nor, does the information convey any license under the patent rights of Motorola Inc. or others.

MECL and MECL 10,000 are trademarks of Motorola Inc.

All information and prices are believed to be accurate at time of publication. They are subject to change without notice.

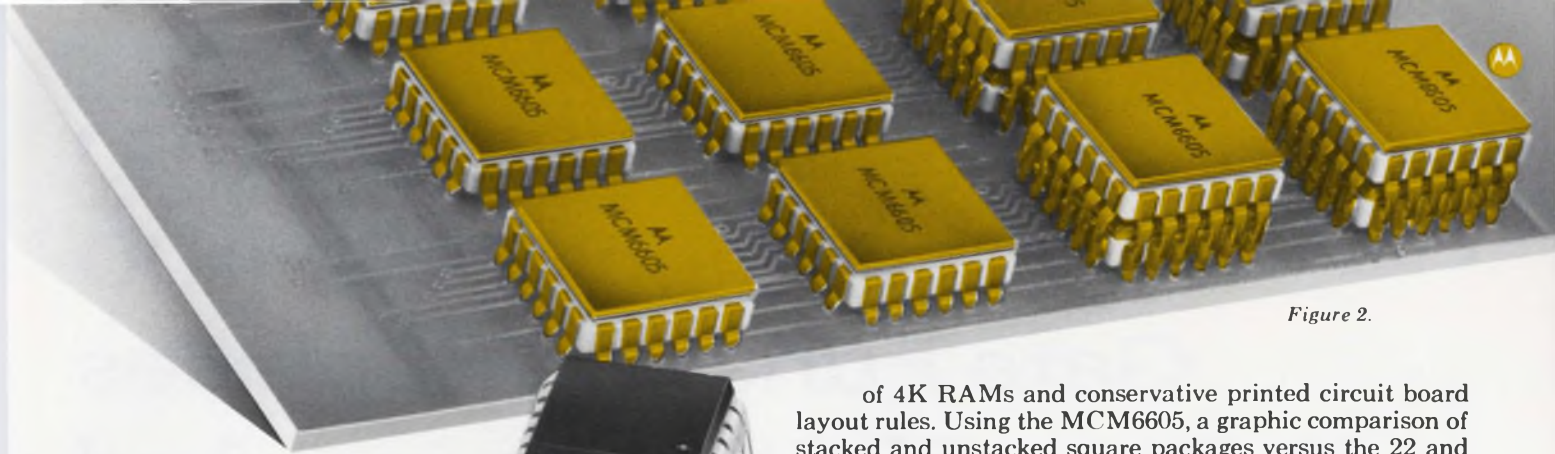

Figure 2.

of 4K RAMs and conservative printed circuit board layout rules. Using the MCM6605, a graphic comparison of stacked and unstacked square packages versus the 22 and 24-pin standards is shown below.

Package	% Chip Size to Package	% Chip to Board	Board Size (sq. in.) 16K Byte Array
22 pin .400" wide	7	4	25.9
24 pin .600" wide	4.5	3	37.2
24 pin square	12	8	12.5
24 pin square stacked	24	17	6.3

Stacking can also be useful for purposes other than density improvements. One such use would be to utilize partially good memory devices. Using stacking, two 2K partials could be combined to give one "4K" memory package. Since the use of partials is not yet fully accepted by the industry, combining partials and stacking may require too much of a psychological jump.

Final considerations

The major obstacles to acceptance of this square package appear to revolve around automatic insertion equipment and mass production soldering techniques. At present, there is no known equipment on the market for automatically inserting this package, and the practicality of changing over present equipment is unexplored. The difficulty of wave soldering boards, which have signal lines between 75 mil center pins, is also unknown.

The Fujitsu package does appear capable of achieving appreciable increases in semiconductor memory system density with a small evolution of present packaging technology. It also appears capable of easing the density crunch with RAMs of both the present 1K and 4K bit sizes and future 8K and 16K bit sizes. Initial system usage indicates it is cost effective compared with more esoteric techniques such as flip-chip and beam lead.

In the final analysis, however, further development and usage of the 24-pin square package seems to depend on the acceptance of, and commitment to this approach by system manufacturers, and not on the enthusiasm of semiconductor memory manufacturers.

Motorola is interested in your opinion about this pertinent and timely subject and would like to hear from you. If you are interested in expressing your thoughts on various memory packaging techniques, circle the number below and we'll send you a brief questionnaire to complete and return. Significant findings will be discussed in a future issue of COMPUTER SYSTEMS.

For details, circle No. 131

Bill Lattin is P/N Channel MOS Memory Operations Manager and has been with Motorola since August, 1969.

Bud Broeker joined the Company in June, 1969 and currently is Section Manager, Memory Technology Development, Computer Applications Engineering.

array format of printed circuit boards for memory systems will probably never require more than one line between package pins. Since some manufacturers presently run two leads between 100 mil center pins, one lead between 75 mil center pins should present little problem for conventional double sided boards. This approach gives a 4:1 density improvement over the industry standard 22-pin (.4 inch wide) dual in-line package and a 6:1 improvement over the 24-pin (.6 inch wide) package. Used with present 4K RAMs, the technique allows expansion into the next generation of larger (8K and 16K) NMOS dynamic RAMs.

Figure 3.

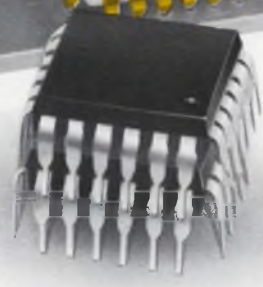

The overall board size reduction using this package is quite dramatic. Using the same conservative printed circuit decoupling rules, the small 16K byte system partially shown in Figure 2 requires 25.9 square inches for the standard 22-pin package and only 12.5 square inches for the 24-pin square package. Excellent bypassing and signal routing is possible because of the ease of orthogonal wiring, with all pins readily accessible to a low impedance power bus.

This package size and configuration has also been implemented in plastic as shown in Figure 3. Parameters are similar to the metal seal ceramic device. The plastic device uses less plastic material than its 22-pin counterpart and, as a result, is potentially less expensive.

Stacking packages

The Fujitsu 24-pin square package is also designed to allow the stacking of one package on top of another. Leads on the ceramic version are indented to allow the top package to slip over the bottom one (as shown in Figure 1). The plastic version uses a modified lead frame with notches in the leads. These notches accept the leads from the top package for soldering. Separation of the two packages is possible when necessary for replacement or repair. If stacking is used to increase the density of a 4K memory system, only two part types would be required. These two types would have chip selects and chip enables (clocks) on different pins, with the corresponding pins on the other type unused. The combination of the two parts in a stack would look like a single 8K chip with a separate chip select and chip enable for each of two 4K sections. Actually, only different chip enables would suffice for memory selection, but chip select also would be separated for maximum flexibility. Thermal problems are minimal since only one chip at a time would be powered (except for a low duty cycle refresh). In the case of Motorola's MCM6605 4K RAM, the enable chip would dissipate 335 mW and the unenabled chip 3 mW for a total of 338 mW.

The density of a memory system using stacked packages is over 20,000 bits per square inch based on the use



LSI at work!

A Bipolar LSI 400 Gate Function Replaces 50 Deskewing And Queueing Circuits

by: Vin Khanna,
Applications Engineer, Computer Applications

System designers in the magnetic tape peripheral area are discovering that Large Scale Integration can lead to significant system savings — in cost, size, power — and an increase in reliability. Motorola's new Bipolar LSI MC-8520, an example of the savings that can result, is designed for Deskewing and Queueing applications in multichannel digital tape recording systems. The 400 gate function replaces approximately 50 SSI/MSI devices in a typical phase encoded or Non-Return-to-Zero Inverted (NRZI) system.

The need for a Deskew Register arises because the data appearing on a number of channels (as in parallel 7 or 9 channel digital recording systems) rarely occurs simultaneously. Each channel is accompanied by its own clock recovery system (input clock to the MC8520) and may differ somewhat in phase from the other channel clocks, but occur at the same frequency. The data bits on the different channels are said to have "skew." This is illus-

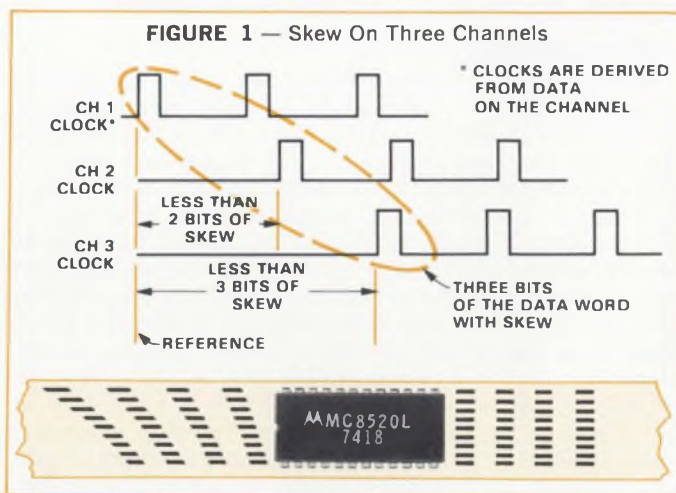

trated in Figure 1 which shows three channel clocks which are derived from the data on the respective channels. The skew is caused because the magnetic tape is not precisely parallel to the recording or read heads, either due to mechanical tolerances, or due to the fact that a tape may be written on one transport and read on another with a different alignment between tape and read head.

Lining up the bits

A data byte should be read out only after all bits of that input data byte have arrived. The Deskew Register accepts data appearing on the different channels at different times and realigns them using buffer storage, so that the data bits may be shifted out simultaneously as a parallel byte. The MC8520 Deskew/Queue Register provides 3 channels of 4-bit deskewing in a single 24 pin

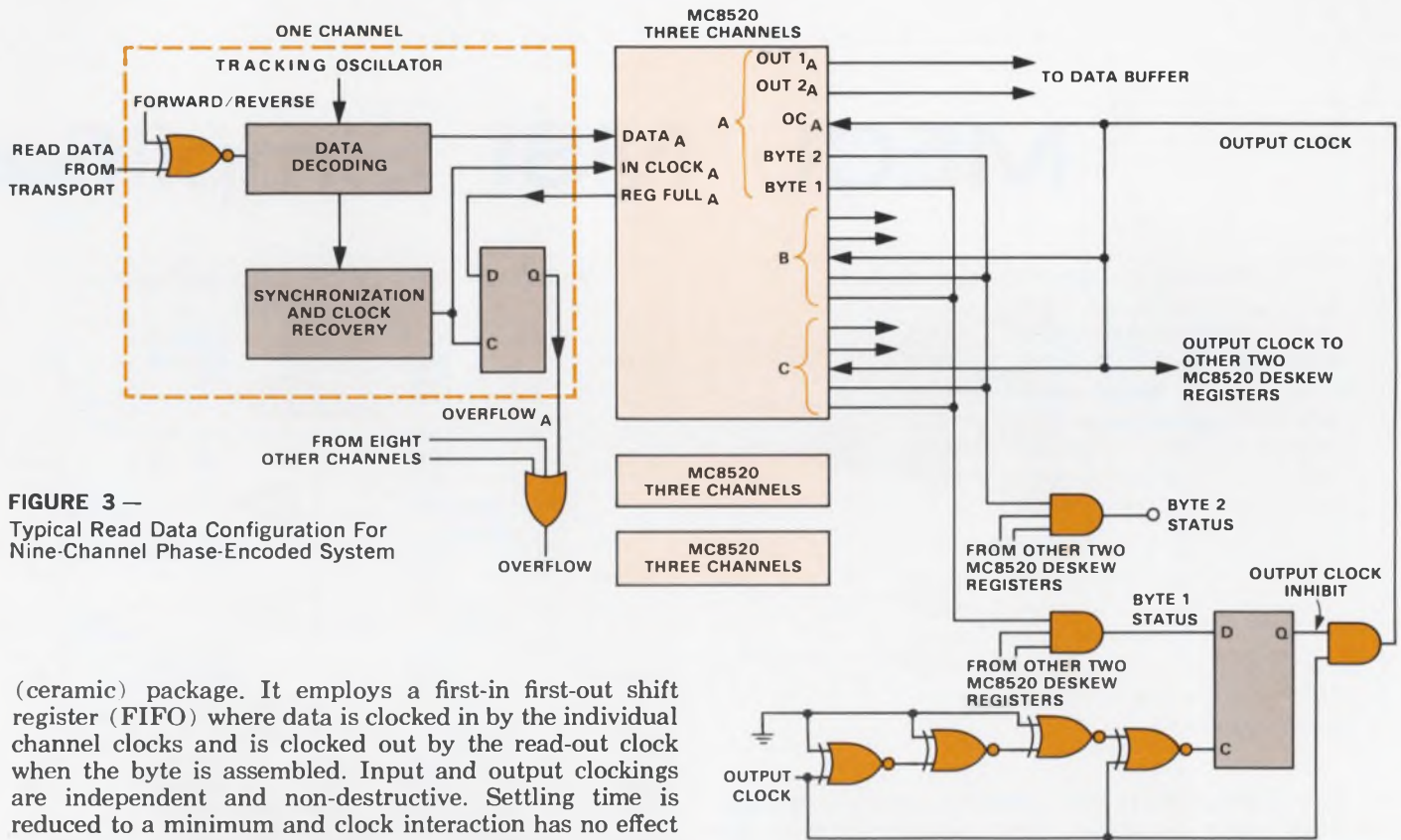
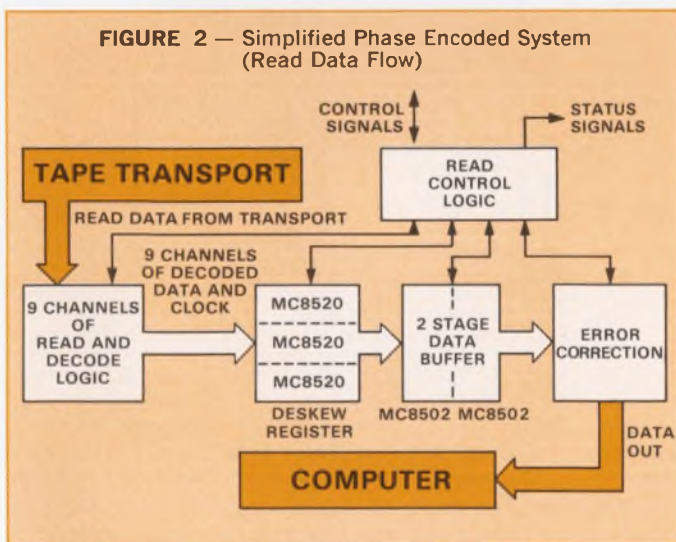

FIGURE 3 —
Typical Read Data Configuration For
Nine-Channel Phase-Encoded System

(ceramic) package. It employs a first-in first-out shift register (FIFO) where data is clocked in by the individual channel clocks and is clocked out by the read-out clock when the byte is assembled. Input and output clockings are independent and non-destructive. Settling time is reduced to a minimum and clock interaction has no effect on the storage function. Four bits of storage is provided for removal of skew from data.



The raw data from the transport is used to generate the separate data and clock signals for each of the nine channels (Read and decode logic). When a bit is clocked in on a channel, the "Byte 1" signal associated with that channel goes high. Byte 1 status signals from the same

package are wire-tied and are then fed to an "and" gate that provides a Byte 1 status signal. When this signal is high, indicating that an assembled byte is ready, the output clocks shifts the byte into a two-stage data buffer. The data buffer is used in conjunction with error-correction circuitry to correct single channel errors. In electromechanical systems having less than two bits of skew, the last two bits of the MC8520 may be used for the data buffering required for error correction. This eliminates the need for the additional two-stage data buffer (Figure 2). The Register full signal, when high, indicates that all four storage locations are full, and this signal may be used as a measure of marginal system operation due to skew.

Flexibility a plus

In another important application, the MC8520 is used to transfer data asynchronously from the processor to the write amplifier in either a phase encoded or NRZI write format. This format flexibility is desirable in many tape systems.

The MC8520 is now available for evaluation. Unit price is \$38.40 (100-up). Evaluate this LSI approach and realize a big step up in system efficiency and savings.

For details, circle No. 132



FIGURE 1 — "H" Matrix For Modified Hamming SEC-DED Pattern

BYTE 0								BYTE 1								BYTE 2								BYTE 3								BYTE 4							
0	1	2	3	4	5	6	7	8	9	10	11	12	13	14	15	16	17	18	19	20	21	22	23	24	25	26	27	28	29	30	31	32	33	34	35	36	37	38	39
	x		x		x		x	x		x		x		x		x		x		x		x		x		x		x		x		x		x		x		x	
		x	x			x	x			x	x			x	x			x	x			x	x			x	x			x	x			x	x			x	x
	x	x		x		x			x	x		x		x			x	x		x		x			x	x		x		x									
x	x	x	x	x	x	x	x	x	x	x	x	x	x	x	x	x	x	x	x	x	x	x	x																
x	x	x	x	x	x	x	x	x	x	x	x	x	x	x	x	x	x	x	x	x	x	x	x																
x	x	x	x	x	x	x	x	x	x	x	x	x	x	x	x	x	x	x	x	x	x	x	x																

MECL MSI Simplifies

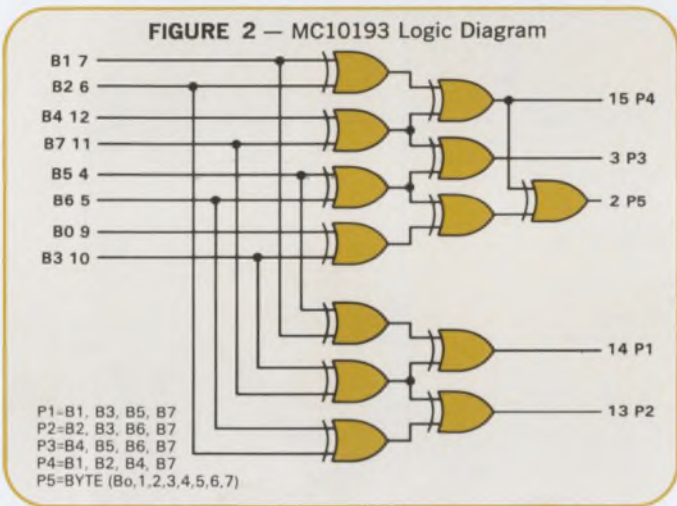

Two recent MECL 10K additions, the MC10163 and MC10193 error correction blocks, greatly simplify the design and construction of error correction hardware for memory systems. Besides simplification, the 10K MSI approach significantly reduces part count and accomplishes the operation faster than previous techniques. Both parts are building blocks for generating modified Hamming Single Error Correction — Double Error Detection (SEC-DED) codes. The modified Hamming SEC-DED codes allow correction of single errors in data words 64 bits long with the addition of only 8 check bits making a stored memory word of 72 bits. Longer or shorter data words could also be used if desired, except that the number of check bits required will be greater or fewer accordingly.

The MC10163 is designed for generating the specific code used in the IBM 370/145 series machines, but can also be used for other SEC-DED codes. The MC10193 is configured for H matrix patterns which are made up of 8 bit long segments repeated every byte. One such pattern, shown in Figure 1, was designed for speed of operation and ease of decoding the error location. The H matrix is a map showing how to generate the 8 check bits which are stored with the 64 data bits. The check bits (numbered bits 64 through 71) are determined by the odd parity of those data bits (numbered 0 through 63) which have an "x" in the appropriate check bit row. Thus, check bit number 1 (bit 64) is the odd parity of data bits 1, 3, 5, 7, 9, 11, 13, 15, 17, 19, 21, 23, 25, 27, 29 and 31 through 55. The eight check bits would be stored with the 64 data bits in the same memory location. Upon retrieval, new check bits

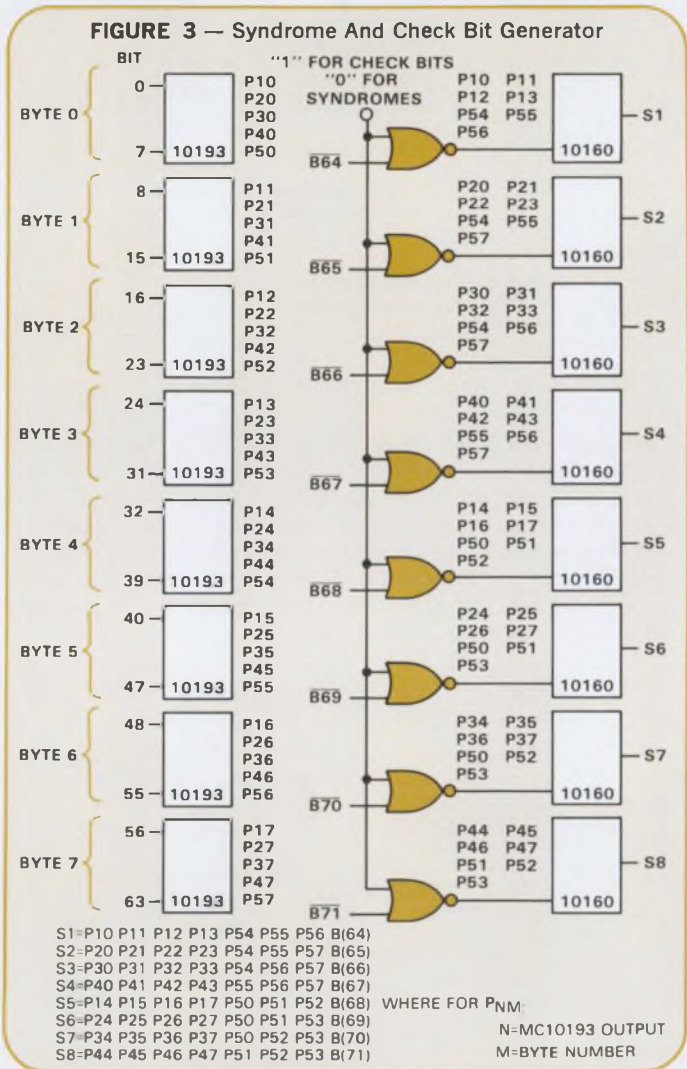

would be generated and compared with the old check bits. The comparison forms eight syndrome bits (S_1 through S_8) which can be decoded to show the type and location of any error. The syndrome bits are physically generated by the odd parity of data bits and old check bits in the appropriate column.

The pattern makes the difference

The pattern of Figure 1 is chosen so that any single bit in error will change an odd number of syndromes. Thus,

MECL 10,000 Adds 12 New Ways To Improve System Performance

System innovations are possible through the addition of four gates, two counters, two latches, two memories, and two error detection/correction circuits. The MECL 10,000 line now offers a total of 66 devices with 18 new developments scheduled for release in the coming months. Here's a brief description of the new offerings including 100-up unit prices.

Gates lead the way

MC10100L Quad NOR Gate w/Strobe; each gate has 3 inputs, two of which are independent and one of which is tied common to all four gates. Price \$.99. MC10103L is a quad 2-input OR gate, with one of the gates having both OR and NOR outputs. Price \$.99.

You'll find a lot of applications for the MC10113L Quad Exclusive OR Gate which has an enable common to all four gates. For instance, all four outputs may be wire-ORed together to perform a 4-bit comparison function ($A=B$). Price \$1.24. And, for time-critical logic paths, consider the MC10212L, a high speed (typ. prop. delay 1.5 ns) 3-input 2-NOR/1-OR Gate. Price \$2.26.

Low-cost counting

MC10138L Bi-Quinary Counter is a 4-bit counter capable of divide by two, five or ten functions. The MC10178L Binary Counter offers divide by two, four, eight, or 16 functions. Both devices feature set or reset inputs to override the clock, allowing asynchronous "set" or "clear." Individual set and common reset inputs are provided, as well as complementary outputs for the first and fourth bits. Unit prices MC10138L, \$5.28; MC10178L, \$4.78.

Quad latches add design flexibility

The new MC10153L Quad Latch consists of four bistable latch circuits with D type inputs and gated Q outputs. Latch outputs are gated, allowing direct wiring to a bus.

The MC10168L Quad Latch offers common clocking to all four latches. Separate output enabling gates are provided for each latch. Unit prices for each, \$5.10.

Fast memories accomplish more work

The MCM10142AL 64-bit RAM is similar in many respects to the MCM10148AL. However, the former offers one decided difference . . . it's 50% faster (10 ns max. access time)! Organization is 64 one-bit words and it offers full binary decoding, two chip enable inputs for easy memory expansion, and separate data input and data output pins. The MCM10142AL is specified for driving 50 ohm loads and is ideal for buffer, cache, register file and scratch pad applications. Price \$30.40.

For register file applications, take a look at the LSI MC10143L 8 x 2 Multiport Register File capable of storing 16 bits of data. Any two words may be read-out simultaneously while writing-in one word. Older designs required large numbers of separately packaged flip-flops and latches to construct an 8 x 2 fast register file. Now the MC10143L, equivalent to 110 logic gates, puts it all into one package. Result: Reduced parts count, lower assembly costs, smaller PC boards. Price \$29.00.

Aids to error detection/correction

The MC10163L and MC10193L Error Detection/Correction circuits are handy building blocks for economical error detection/correction in memory systems. The MC10163L uses the IBM method of error correction. Designers wishing to innovate will appreciate the MC10193L which offers an advantage with its byte parity check. Note the preceding article which describes the devices further. Unit prices for each, \$5.71.

Take a look at the line

Circle the number below on the reply card and get full details on these new devices. And, we'll include a complete listing of the MECL 10,000 family — now totaling 66 devices — and growing.

For details, circle No. 134



Now Available: Three New High-Speed Design Tools

MECL 10,000 or . . . Schottky TTL?

Which logic offers the best performance per dollar — MECL 10,000 or Schottky TTL? While there is no simple method for deciding which logic family to employ in a given design, the task has been simplified by an objective study which defines and evaluates many of the points of comparison to consider when selecting a logic for use in a high speed system.

The comparison study is contained in a comprehensive design file titled MECL Design File No. 4. Also included are application notes outlining MECL 10,000 10K design rules and an "Update" lists all 10K devices now available plus circuits soon to be announced.

Order your file now. Evaluate and compare. Learn firsthand why more MECL 10K is being specified for new designs . . . and upgrading of present systems.

For details, circle No. 135

Plastic MECL 10,000 — the fast answer to economy conscious designs

Plastic 10K is now stocked in depth and costs run 20% lower than ceramic package prices. And, the same reliable chip used in the ceramic package is in the new improved plastic case. Performance-proven with a reputation for flexibility and system savings, plastic MECL 10,000 offers top performance per dollar.

Get the facts! Check below for MECL Design File No. 5, which includes latest reliability figures, applications information, and latest circuit testing techniques. Start economizing now by calling your distributor for plastic 10K. An evaluation will prove what you can achieve.

For details, circle No. 136

Translate / match / optimize

Optimized systems usually require the use of several logic families. The challenge is to translate and match different logic levels, maintain a minimum part count, and still operate at maximum speed.

Now, MECL 10K offers a comprehensive selection of interfacing devices meeting various input and output system requirements. MECL translators, drivers, receivers, and comparators open up new methods for efficient coupling of non-compatible signals.

If interfacing has been your problem, we have a new design file that will provide some answers. MECL Design File No. 6 is loaded with interfacing techniques, line driving/receiving tips, bus line interfacing, operating from common power supplies, and latest methods of driving LED displays.

For details, circle No. 137

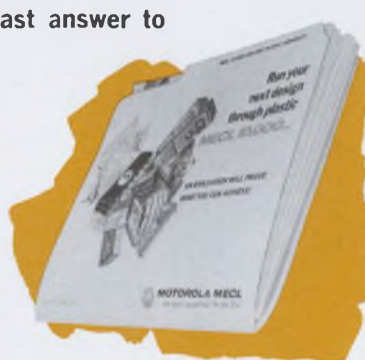

Tear along perforated line and drop in mail (no postage required). If coupon is missing, use the regular magazine readership card.

FOLD HERE

FIRST CLASS
PERMIT NO. 2565
PHOENIX, ARIZONA



BUSINESS REPLY MAIL
No Postage Necessary if Mailed in the United States.

POSTAGE WILL BE PAID BY

MOTOROLA Semiconductor Products Inc.
P.O. Box 20924
Phoenix, Arizona 85036

FOLD HERE

Couple Lightly With New Brochure



Sometimes the need for a new idea can be real heavy. If you're struggling to come up with a coupling or isolation solution, here might be a quick way to lighten your load. Send for a copy of our new Opto-Couplers At Work Brochure.

Mostly it's a broad cross-section of applications in which our line of low-cost general purpose plastic transistor and Darlington output couplers play a prominent role. But there's also a handy selection guide and a cross reference to competitor's devices. Plus a list of application notes in which opto devices are used.

To get your copy, just circle the number below on the reply card. Do it today!

For details, circle No. 138

SEAL HERE (Please use tape — Do not staple)



LITERATURE REQUEST FORM

NOTICE: Requests for literature on items described in this ad cannot be honored after October 16, 1974.

Please circle the Reader Service Number for item(s) you wish to receive:

ED-CS1-74

131 132 133 134 135 136
137 138 139 140 141 142

List (by number) the Application Notes you wish to receive:

Check here if you wish a Motorola representative to contact you:

<input type="checkbox"/> VISIT	[AREA CODE]	PHONE NUMBER
<input type="checkbox"/> PHONE	[]	

PLEASE PRINT CLEARLY—THIS WILL SERVE AS YOUR MAILING LABEL

NAME

TITLE

DIVISION DEPT.

COMPANY

COMPANY ADDRESS (STREET OR P.O. BOX)

CITY

STATE ZIP CODE

ENCLOSED LITERATURE HAS BEEN REQUESTED BY ADDRESSEE

LATEST COMPUTER-RELATED APPLICATION NOTES

AN-706 — A CRT Display System Using NMOS Memories — New NMOS Memory devices used for both storage and character generation are demonstrated in a typical CRT display system. The 128-character system design features full TTL compatibility of the NMOS memories and design simplicity.

AN-708 — Line Driver and Receiver Considerations — This report discusses many line driver and receiver design considerations such as system description, definition of terms, important parameter measurements, design procedures and application examples. An extensive line of devices is available from Motorola to provide the designer with the tools to implement the data transmission requirements necessary for almost every type of transmission system.

AN-709 — MECL 10,000 Arithmetic Elements MC10179, MC10180, MC10181 — The MECL 10,000 arithmetic functions include a 4-bit arithmetic unit, a dual adder/subtractor, and a lookahead carry block. This application note describes the devices and shows their operation in large system configurations.

AN-715 — Introduction to CMOS IC's with 3-State Outputs — This note describes a wide variety of standard CMOS integrated circuits incorporating transmission gates with standard logic. Design rules and applications of these devices include the areas

of analog switching and multiplexing, digital multiplexing, and data transmission.

AN-719 — A New Approach to Switch Regulators — This article describes a 24-Volt, 3-Ampere switching mode supply. It operates at 20 kHz from a 120 Vac line with an overall efficiency of 70%. New techniques are used to shape the load line. The control portion uses a quad comparator and an opto coupler and features short circuit protection.

AN-720 — Interfacing with MECL 10,000 — This article describes some of the MECL circuits used to interface with signals not meeting MECL input or output requirements. The characteristics of these circuits such as: Input impedance, output drive, gain, and bandwidth allow the system designer to use these parts to optimize his system. MECL interface circuits overcome a problem area of many system designs, which is the efficient coupling on non-compatible signals.

AN-726 — Bussing with MECL 10,000 Integrated Circuits — High speed data bus lines are an important part of modern computer systems. Features of the MECL 10,000 family allow construction of data busses in a transmission line environment. This application note describes some of the guidelines to consider when designing high speed bus lines and shows how the MC10123 can be used for maximum bus performance.

Plug In 3 New LEDs And Watch Your Face Light Up



If you're looking for clear-cut indications your circuit's operating on the up-and-up, but haven't found quite the right combination of indicator light reliability, package and price — plug in the MLED440, 445 or 850.

They're all new offerings from Motorola's broad line of red, green and yellow LEDs.

The miniature 440 and 445 are packaged alike — but don't look alike . . . at least in hue (a technical term for gradation of color). The 445 is a rich scarlet red, robust like wine. The 440 is a lighter fleshy pink by reason of its diffused white plastic lens. The plug-in packages measure 0.2" high.

Both offer great specs: 2.2 mcd brightness at 20 mA and a 40° field of view for the 445 and 1.2 mcd and 90° for the 440.

Evergreenness can be had with the MLED850 — furnishing 0.5 mcd brightness at 25 mA and a 90° viewing angle. It comes in the standard, 0.350"-high panel mount package.

What's best of all — they're all available in quantity. Any quantity. That means you can light up any number of faces — the one on your computer maintenance panel, the one on your instrument, your data link, your terminal, etc. — with red and green reliability.

Other bright LEDs are available for a broad range of face-lighting. Send for the comprehensive Selector/Cross-Reference brochure and watch ours light up.

For details, circle No. 139



Single Package Simplicity Offers A New Way To Drive



With the MC75452, 3, and 4 dual peripheral drivers, you can replace two gates and two discrete transistors with a single, low-cost device. That means simplicity.

And, with simplicity comes versatility. Versatility for applications such as relay and lamp drivers, power drivers, and MOS memory drivers. From large computer systems to recreational games. Anywhere you need a general purpose interface circuit in DTL and TTL type systems.

Each device is a pair of TTL gates internally connected to the bases of two high-current, high-voltage NPN transistors. The gate type is up to you. NAND, OR, or NOR; take your pick for an economical 80¢ apiece (100-up). Each comes packaged in the 8-pin plastic case 626.

If these 30V $V_{CE(R)}$ drivers don't take you where you need to go, check our MC75462, 3 and 4 35V version.

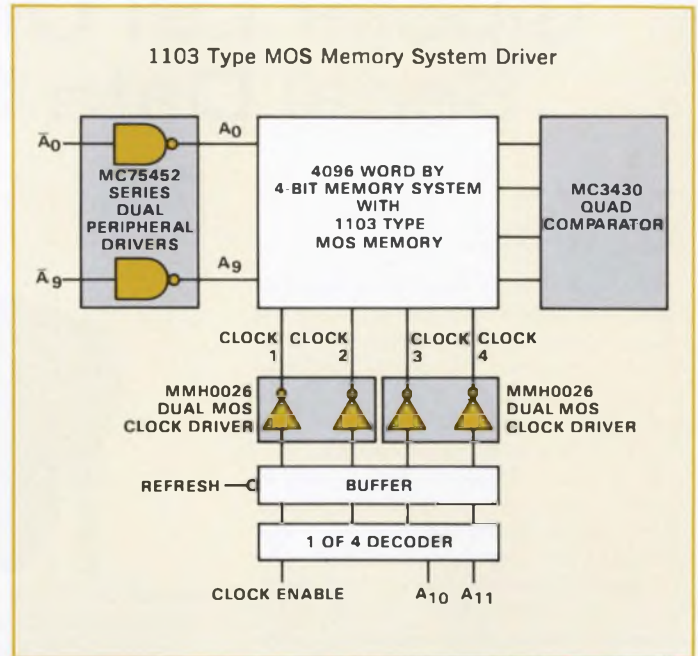

So map out your schematic. But leave the driving to our economical MC75452 series dual peripheral drivers.

For details, circle No. 140

New Hammer Drivers Pound Away At Fast Switching Requirements

These days, the trick is getting solid delivery *and* the right price. Get both from Motorola and enjoy selecting from a complete line as well.

Two new hammer drivers — MM5189 and MM5262 — broaden our line to 26 high current, high speed switches. The line provides 1/2 and 1 A collector current, 30 to 60 V BV_{CEO} devices in four popular metal cases. No need to look elsewhere, one is right for your system.

The new drivers are 1.0 amp devices. Both offer typical switching times of $t_{on} = 16$ ns and $t_{off} = 28$ ns @ $I_C = 1.0$ Adc. MM5189 matches all characteristics of the JEDEC registered 2N5189 but exceeds the H_{fe} and BV_{CEO} requirements. MM5262 equals the JEDEC 2N5262 specs but meets the switching requirements using a switching circuit simpler than that of the registered device.

The entire hammer driver line provides the f_T and low C_{in} you need for fast switching. Check the chart and select the exact BV_{CEO} and package you want to cope with the inductive environment in your application. Then we'll deliver.

For details, circle No. 141



1974 MOTOROLA HIGH CURRENT — HIGH SPEED SWITCHES

NPN				
Switching @ $I_C = 500$ mAdc			Switching @ $I_C = 1.0$ Adc	
BV_{CEO}	TO39	TO18	TO39	TO46
60 V	Specials		Specials	
50 V	2N3444JAN 2N5861 2N3725	2N4014	2N3735S MM3735 MM5262	2N3737 MM3737
40 V	2N3253JAN 2N5859		MM5189	
30 V	2N3252 2N3724	2N4013	2N3303* 2N3734S MM3734	MM3736

PNP				
Switching @ $I_C = 500$ mAdc			Switching @ $I_C = 1.0$ Adc	
BV_{CEO}	TO39	TO18	TO39	TO46
60 V	Specials		2N3763S	
50 V	2N3468S			2N3765
40 V	2N3467S		2N3762S	2N3764

* $BV_{CEO} = 12$ V; special available with 25 V, slower switching

Bipolar LSI Offers Simplified Serial Data Error Control

by: Vin Khanna,
Applications Engineer
Computer Applications

In most digital data handling systems, undetected and uncorrected errors cause varying degrees of system failure. To improve the fidelity of communicated data, a number of coding schemes are used to provide the required degree of error control.

For serial data streams, such as those occurring in cassettes, floppy discs, data transmission to CRT displays or over phone lines, the MC8503 Universal Polynomial Generator provides four of the more commonly used error checking polynomials (Figure 1). The MC8503 is compatible with TTL, operates at up

FIGURE 1
Available Polynomials

CODE SELECT			POLYNOMIAL	
X	Y	Z		
0	0	0	CRCC-16 (Fwd)	$X^{16} + X^{15} + X^2 + 1$
0	0	1	CRCC-16 (Bkwd)	$X^{16} + X^{14} + X + 1$
1	1	0	CRCC-CCITT (Fwd)	$X^{16} + X^{12} + X^5 + 1$
1	1	1	CRCC-CCITT (Bkwd)	$X^{16} + X^{11} + X^4 + 1$
0	1	0	LRCC-16	$X^8 + 1$
1	0	1	LRCC-8	$X^8 + 1$

to 3.5 MHz, and typically replaces 5-9 TTL IC's, providing system cost savings.

The check characters are generated by "dividing" the data by the encoding polynomial. The remainder resulting from the division is then appended to the message stream as a check character. During reception of the data, the message and its appended check character is again divided by the same polynomial. If no errors have occurred in transmission the result of this division should be "zero" since adding the check character (remainder) to the message has the effect of making the received message evenly divisible by the code polynomial.

The MC8503 generates the check characters by entering each bit of the data stream into the Serial Data In terminal (Figure 2). This process effectively divides the data stream by the code selected by means of control lines X, Y, and Z as indicated in Figure 1. After the last data bit is entered, the check character is stored in the MC8503; it is then added to the data

FIGURE 2 —
Generation Of CRCC-16 ($X^{16} + X^{15} + X^2 + 1$)
Check Character

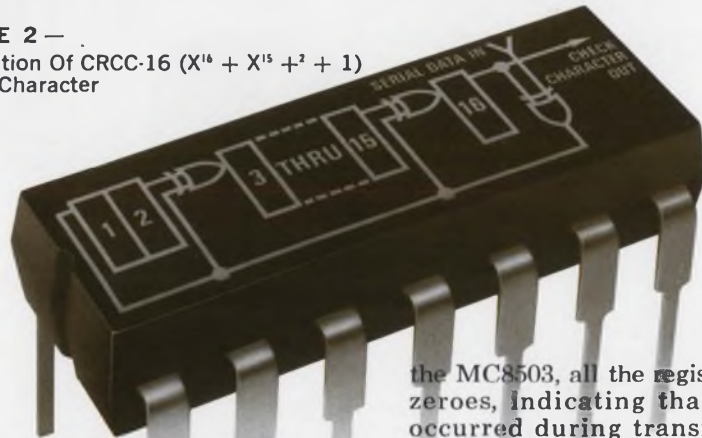

stream by taking the Shift Right control low and clocking the generator.

During reception, the data is passed through an identical circuit and if no errors have occurred, the internal All Zeros detector provides an indication that the data was correctly received. While the encoding techniques used provide some capability for error correction, the most common procedure is to request a re-transmission if errors have been detected.

Starting from a reset condition, the CRC character is shown after a 32 bit data stream. This is added to the message stream. Then during reception, after the message stream and CRC character have passed through

the MC8503, all the registers contain zeroes, indicating that no errors occurred during transmission.

Tape Rewinding Eliminated

In cassette tape systems, when an error has been detected, re-reading the data would require rewinding the tape to return to the beginning of the data block. The MC8503 eliminates this problem by providing the read backward mode.

Use our reply card for application-oriented data illustrating the various ways MC8503 can solve your error detection problems. The MC8503P is now available in the 14-pin dual in-line plastic package; \$18.00 (100-up price). Evaluate the value to your system now!

For details, circle No. 142

FIGURE 3 — Generation Of CRCC-16 ($X^{16} + X^{15} + X^2 + 1$) Check Character

Shift n	Input Data on nth Shift	Feed-back on nth Shift	Register Contents After nth Shift																
			1	2	3	4	5	6	7	8	9	0	1	2	3	4	5	6	
0			0	0	0	0	0	0	0	0	0	0	0	0	0	0	0	0	
1	0	0	0	0	0	0	0	0	0	0	0	0	0	0	0	0	0	0	
2	1	1	1	0	1	0	0	0	0	0	0	0	0	0	0	0	0	1	
3	0	1	1	1	1	0	0	0	0	0	0	0	0	0	0	0	0	1	
4	0	1	1	1	0	1	1	0	0	0	0	0	0	0	0	0	0	1	
5	1	0	0	1	1	0	1	1	0	0	0	0	0	0	0	0	0	0	
6	1	1	1	0	0	1	0	1	1	0	0	0	0	0	0	0	0	1	
7	0	1	1	1	0	1	0	1	0	1	0	0	0	0	0	0	0	1	
8	1	0	0	1	1	0	1	0	1	0	1	1	0	0	0	0	0	0	
31	1	0	0	0	0	1	1	0	0	0	1	0	1	1	0	1	1	0	
32	1	1	1	0	1	0	1	1	0	0	0	1	0	1	1	0	1	0	
			M.S.B.								L.S.B.								
			2nd Byte of Check Character								1st Byte of Check Character								
			CRCC Character																
33	0	0	0	1	0	1	0	1	1	0	0	0	0	1	0	1	1	0	1
34	1	0	0	0	1	0	1	0	1	1	0	0	0	0	1	0	1	1	0
47	0	0	0	0	0	0	0	0	0	0	0	0	0	0	0	0	0	0	1
48	1	0	0	0	0	0	0	0	0	0	0	0	0	0	0	0	0	0	0

(All zeros indicate no errors occurred.)

ACDC ANNOUNCES THE GRAND OPENING OF OUR NEW HIGH EFFICIENCY POWER SUPPLY.

We've opened it up to give you an inside look at things like the modular construction that adds to reliability and simplifies circuit check out...the low voltage drop, high speed rectifiers that combine the best elements of reliability, speed and low forward voltage drop...the low impedance output capacitors that reduce high frequency ripple to about 5mV peak-to-peak...and the sealed input EMI filter that minimizes conducted RFI.

These 20KHz inaudible switchers operate from 115/230VAC, 47-63Hz or from 150VDC with 70% efficiency and 0.1% regulation. (100VAC also available).

Overvoltage and overload protection is standard and EMI is minimized by shielding and filtering. (We even offer an optional built-in filter for compliance with Mil-Std 461, CE03). You get low inrush on turn on for soft start and can parallel up to six switchers in master-slave configuration.

There are 10 models in this new series. Five 300 watt models range from 5V at 60A to 24V at 14A. Five 500 watt models range from 5V at 100A to 24V at 23A. They're all in our new brochure. Just circle number and we'll get a copy to you right away. However, if you would like a copy of our 64-page catalog containing technical data on our complete line, fill out the coupon or write to us on your company letter-



Name _____

Company Name _____

Address _____

City _____

State _____

Zip Code _____

acdc electronics inc

Oceanside Industrial Center Oceanside, CA 92054 (714) 757-1880

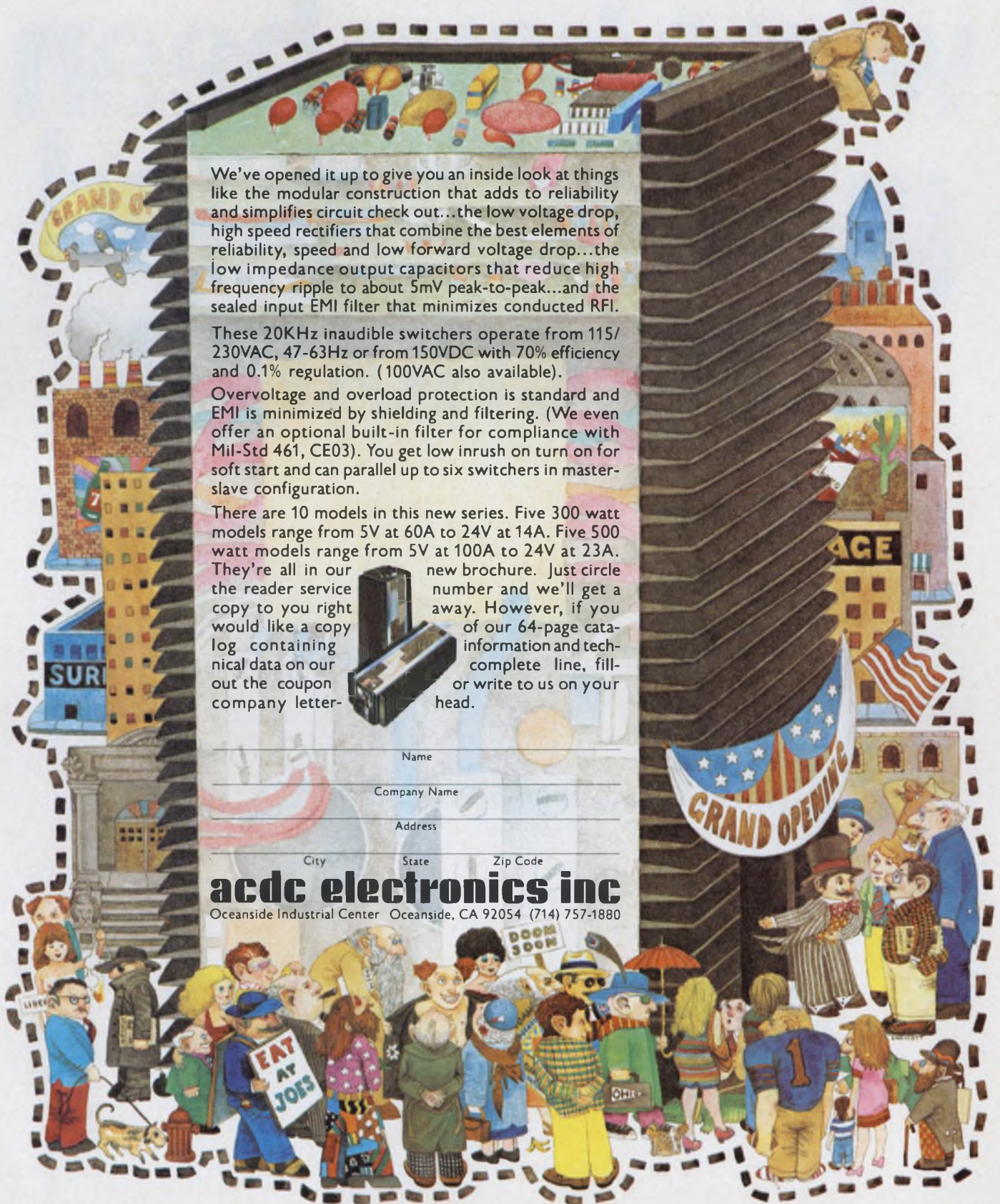

**All those little
wires have been
pushed around
long enough.**



Until now, all those wires have been at the mercy of packaging materials that expand when things get hot.

So we developed new Dow Corning® 480 semiconductor molding compound.

Dow Corning 480 has a low coefficient of thermal expansion.

So it virtually eliminates the hot intermittent open. And moisture penetration.

Which means that an integrated circuit stays integrated. Through all sorts of temperature and atmospheric extremes.

But that's not all that's different about 480 molding compound.

Its resistance to salt spray is excellent.

And it reduces your packaging costs because it saves time. Molding times are short—less than one minute for some components. Post curing is unnecessary.

Of course, Dow Corning 480 molding compound also has the advantages of our other silicones. Consistency. Long shelf life. Less cleaning downtime because there's no buildup. Non-flammability. And, because it doesn't irritate skin, there's no need for special handling.

Dow Corning 480 semiconductor molding compound is the kind of improved product you can expect to keep getting from Dow Corning. Our Technical Service and Development Department has more manpower and greater technical facilities than any other in the industry.

If you want to know more about 480, call us at 517 636-8000, or write Dow Corning Corporation, Dept. A-4334, Midland, Michigan 48640. **DOW CORNING**

DOW CORNING

PLC

FROM ALLEN-BRADLEY A New Bulletin 1774 Programmable Logic Controller

PLC: Understandable. Expandable. Easier to program and install. Made for the industrial environment. A solid state logic control system that delivers greater flexibility and operational ease. Look here:

Modular Concept

You can add, subtract or modify functional capabilities to fit control parameters of your system at any time. Meet the challenge of change without long time delays or wasting control dollars.



New programming simplicity

Allen-Bradley Program Panel uses simple symbolic keyboard to translate ladder diagrams into functional capabilities. Display screen shows program in ladder form, intensifies true program condition. You can load, dump and document a program using teleprinter or other compatible devices.



You can load, dump and document a program using teleprinter or other compatible devices.

2-level fault detection system

Built-in fault detection is at work during system operation. A self-checking system that minimizes guesswork and saves time. Processor, input/output system, module faults, etc. are detected and can shut system down automatically.



Test mode for logic checking

You can test the PLC program in the Test/Monitor mode and monitor system operation in both Run and Test modes.

Easier to install

Unique, compact design makes installation faster and easier all down the line. Modules lock solidly in rugged rack. Wiring is covered. Pivoting cableway provides easy module accessibility, 3-way terminals make wiring a snap.



Controller capabilities

1024 input/output functions
—eight modules per rack
—expandable up to eight racks.

Easier to maintain

Output status lights indicate on/off condition; processor displays indicate location of system problems. Program panel can be used for monitoring of system operation and checking for circuit functioning.

Processor capacity

Processor system with 4K memory standard; expandable to 8K.

Read/Write memory gives you optimum system flexibility with 16 bit words.

Up to 63 programmable timers/counters. Unused timers/counters may be converted to storage outputs, up to a maximum of 1024.

2-level, self-checking fault detection built into the system.



Program Panel/System Monitor

Allen-Bradley exclusive design with program display.

9 series elements and 5 parallel branches to any output function.

8 basic functions, 11 special functions.

Weighs only 35 lbs.



Other basic system specs

- System Scan time: less than 20 milliseconds, with the largest system. (Averages 2.5 milliseconds per 1K of memory.)
- AC/DC voltage handling.
- Computer interface conforms to EIA RS232C.
- Hardware processor.
- Completely solid state for exceptional reliability within the industrial environment.
- Allen-Bradley system assistance and service available worldwide.

The PLC Controller is another new addition to the ever growing line of Allen-Bradley's control capabilities. Whatever your needs, large or small, Allen-Bradley's control systems can satisfy your productivity requirements. Write for details today.

SD51



ALLEN-BRADLEY

SYSTEMS DIVISION • Highland Heights, Ohio 44143

(continued from page 7)

Valley Freeway Center Bldg.
15300 Ventura Blvd.
Sherman Oaks, Calif. 91403

A slipped digit

In my article "Customize Your Audio Filter," (ED No. 11, May 24, 1974, p. 94) Fig. 3 has an error. The capacitors connected to IC203 should be 8200 pF, not 3200 pF.

Robert Mauro
Assistant Professor
of Electrical Engineering

Manhattan College
Manhattan College Parkway
Bronx, N.Y. 10471

Some questions on calculator usage

With reference to "The Four-Function 'Scientific' Calculator" (ED No. 8, April 12, 1974, p. 102), I found the following two errors:

1. On p. 102 the answer to the sum of products example should read 1499 instead of 1449.

2. On p. 105 the voltage ratio that corresponds to 13 dBs should simply be $2^{13/3}$ without the need to square root.

Even though I succeeded in proving that $10^{15/10} \approx 2^{15/3}$ and that $10^{13/10} \approx 2^{13/3}$, I was not able to see Mr. Ayer's reason for changing the base from 10 to 2.

Furthermore could Mr. Ayer explain the note at the bottom of p. 106 (describing exponential calculations); it does not seem to be mathematically sound.

G. N. Abouyannis

Ferranti Ltd.
Electronic Components Div.
Simonsway
Wythenshawe
Manchester M22 5LA
England

The author replies

Apart from the printer's mistake (Point 1 of Mr. Abouyannis' letter), I do not think that the article contains any mathematical errors. Mr. Abouyannis will find—in most textbooks on electronics—that

(continued on page 24)

There's a world of difference between Dow Corning and the other semiconductor packaging-materials suppliers.

The difference is that only Dow Corning has available worldwide a complete line of silicone molding compounds, an accomplished technical service and development team, the advantage of a completely compatible product line, and the convenience of worldwide delivery and service. If you want to give your packaging operation a competitive advantage, just call or write. One of our representatives is nearby.

NORTH & SOUTH AMERICA

Resins and Chemicals Marketing
DOW CORNING CORPORATION
Midland, MI 48640
Telephone: 517 636-8682

EUROPE

R. Hediger
DOW CORNING INTERNATIONAL LTD.
Chaussée de La Hulpe 177
1170 Brussels, Belgium
Telephone: 73 80 60

B. Sneddon
DOW CORNING LTD.
Reading Bridge House
Reading RG1 8PW
Berkshire, England
Telephone: Reading 57251

R. Jones
DOW CORNING GmbH
1150 Vienna
Mariahilferstrasse 180/4
Austria
Telephone: 83 85 38

S. Haberer
DOW CORNING GmbH
8000 Munchen 50
Pelkovenstrasse 152
West Germany
Telephone: 14 861

J. Guillot
DOW CORNING S A R L
140, Avenue Paul Doumer
92500 Rueil Malmaison
France
Telephone: 977.00 40

M. Tedone
DOW CORNING SpA
Viale Restelli 3/7
20124 Milan, Italy
Telephone: 688.2458

ASIA

H. Takahashi
DOW CORNING ASIA LTD.
P&O Building, 9th Floor
21 Des Voeux Road, C.
Hong Kong
Telephone: 5-258035

H. Hotta
DOW CORNING ASIA LTD.
Room 803, Cathay Building
Mount Sophia
Singapore - 9
Republic of Singapore
Telephone: 321213-5

AUSTRALASIA

H. Tuijnman
DOW CORNING AUSTRALIA PTY. LTD.
36 O'Dea Avenue
Waterloo, N S W 2017
Sydney
Telephone: 699 8055

P. Winter
DOW CORNING AUSTRALIA PTY. LTD.
103 High Street
Prahran, Vic. 3181
Telephone: 51 5450

Dow Corning semiconductor molding compounds...quality and dependability worldwide.

A-4335

DOW CORNING



The R10: our compact, multi-purpose relay.

You might say we designed it to be many things to many people.

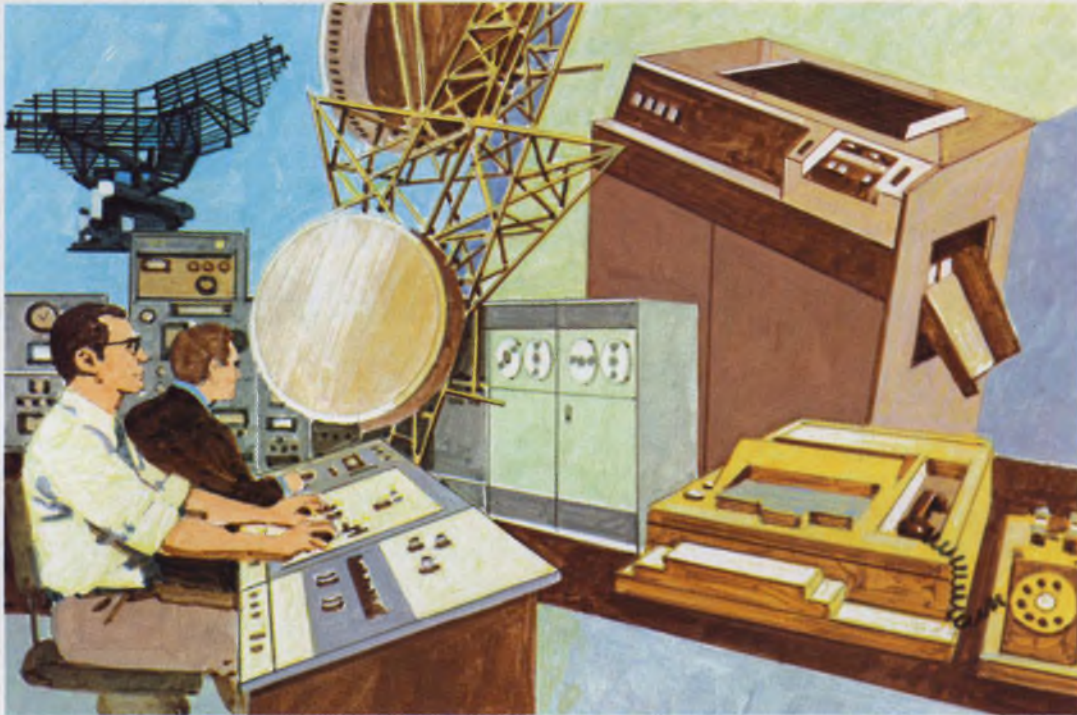

Copiers, computer peripherals, communication equipment, business machines, precision instruments—you'll find our R10 in a multitude of applications requiring a compact, reliable, multi-pole relay. That's because it probably gives you more design options than any other single relay.

Consider these choices: Contact arrangements to 8PDT. Ratings from dry circuit to 10 amperes. Six styles of contacts, including bifurcated. Sockets with solder or printed circuit terminals, including one for mounting the relay horizontal to a printed circuit board—and all with or without grounding provisions.

R10 relays have U/L Compo-

nent Recognition. Models to 6PDT have C.S.A. Component Recognition. Life expectancy is to 100 million operations, depending on contacts and load. The R10 is available with a voltage- or current-sensitive coil. Pick-up ranges from 2.25 to 86 VDC, 5 to 86 VAC, or 0.85 to 45 milliamp, with proper power supply. Depending on the number of contacts, the R10 weighs from 22 to 40 grams.

R10 relays are in stock at your leading electronic parts distributor;

or call your P&B representative. For your copy of the 226-page catalog showing the complete P&B line write Potter & Brumfield Division of AMF Incorporated, Princeton, Indiana 47670; or phone 812 385 5251.



Solving Switching Problems
is what we're all about.



NAME **3** PRODUCERS OF HIGH VOLTAGE CERAMIC CAPACITORS

If you name ERIE first, you're right on target. For we produce a full line of quality High Voltage Ceramic Capacitors ... 3kV to more than 30kV ... in the capacitance value and temperature characteristic to suit your circuit needs. We have all sizes and shapes with the terminal arrangement you want. In fact, you name the application ... chances are ERIE has a standard unit available. If not, let's talk about it.

You'll find ERIE HV Capacitors in electric utility transformers. Miniature power supplies. CRT displays. Lasers. Lightning arrestors. TV power supplies. Image intensifiers for night vision apparatus. Just about any application where high voltage is involved.

So look to ERIE first. When it comes to High Voltage Ceramic Capacitors, ERIE continues to lead the way. Your letterhead request will get you our new catalog HV/SC-200 ... or call Customer Engineering at our State College, Pa. plant — 814/237-1431.

ERIE TECHNOLOGICAL PRODUCTS, INC.
Erie, Pennsylvania 16512



INFORMATION RETRIEVAL NUMBER 19

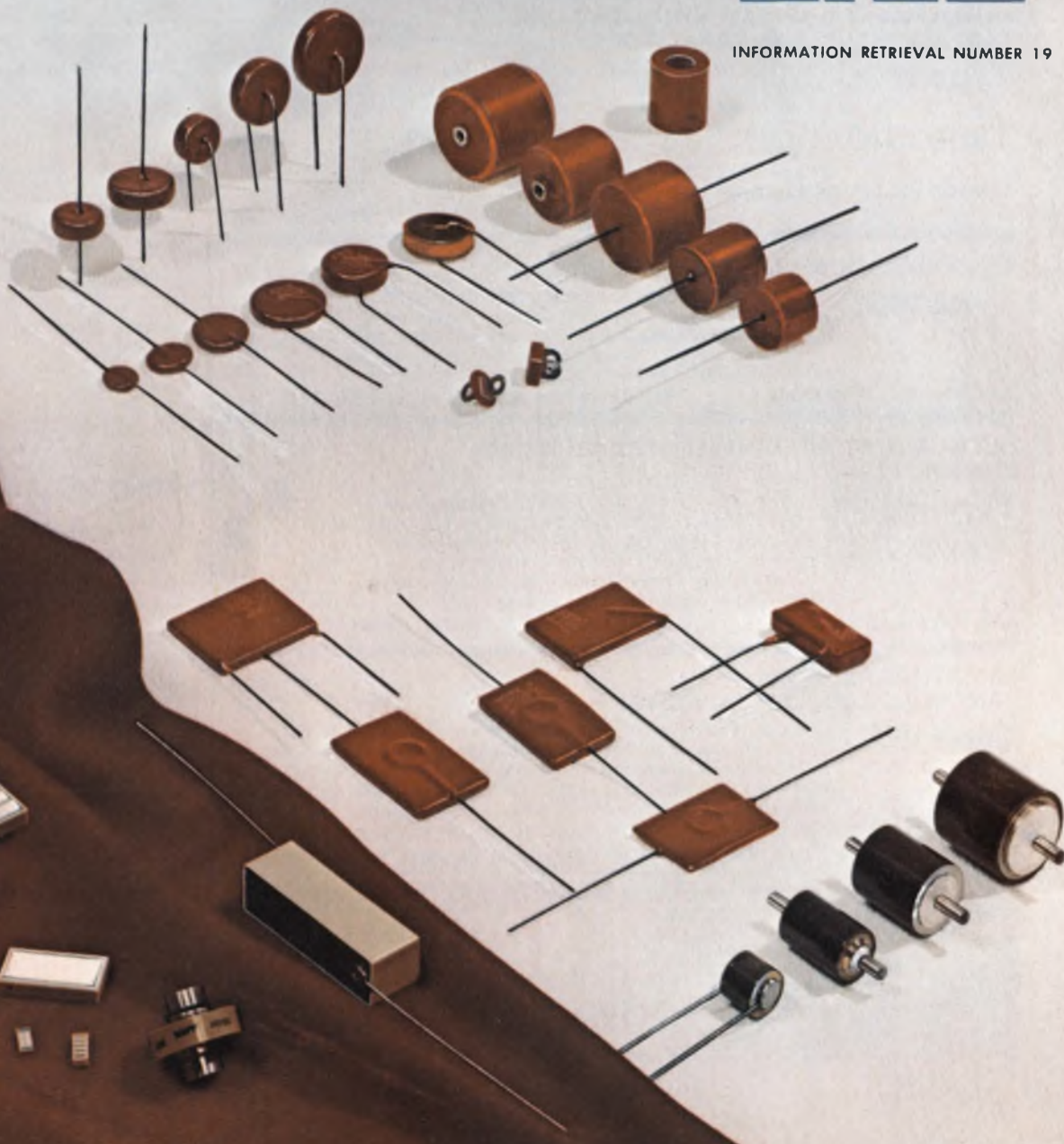

Solid Tantalums for Solid Performance

MOLDED, PLASTIC-ENCASED ECONOLINE™ TANTALEX® CAPACITORS

Type 198D Economically priced. Flame-retardant case has flatted section and polarity indicator for easy-to-read marking and error-free insertion. High volume production-oriented design for efficient assembly. Molded straight-wall case eliminates cracking as well as soldering problems associated with epoxy rundown.



ASK FOR BULLETIN 3546 INFORMATION RETRIEVAL NUMBER 161

EPOXY-DIPPED TANTALEX® CAPACITORS

Type 196D Low-cost capacitors that utilize high-quality tantalum pellet construction. Dipped coating is hard insulating resin highly resistant to moisture and mechanical damage. Designed for printed circuit board applications. Wide range of capacitance values with voltage ratings from 4 to 50 VDC.



ASK FOR BULLETIN 3545B INFORMATION RETRIEVAL NUMBER 162

HERMETICALLY-SEALED METAL-ENCASED TANTALEX® TUBULAR CAPACITORS

Type 150D Polarized units offer high capacitance, long life, low leakage current, low dissipation factor, and high stability. Also available to Spec. MIL-C-39003 as CSR09, CSR13, and CSR23.

Type 151D Non-polarized capacitors with the same outstanding characteristics as Type 150D units. Also available to Spec. MIL-C-39003 as CSR91.



ASK FOR BULLETINS 3520G, 3520.2A, 3521B, 3521.7
INFORMATION RETRIEVAL NUMBER 163

MOLDED DOMINO® TANTALEX® CAPACITORS

Type 193D For hybrid circuit and low-profile printed circuit board applications. Offer superior mechanical protection as well as excellent stability in severe operating and storage environments. Can be attached to substrates or circuit boards by conventional methods.



ASK FOR BULLETIN 3532A INFORMATION RETRIEVAL NUMBER 164

ULTRA-MINIATURE TANTALEX® CAPACITORS FOR MINIATURE CIRCUITS

Types 182D and 183D Cylindrical-shaped Type 182D and rectangular-shaped Type 183D capacitors, ideal for subminiature assemblies requiring the ultimate in component density, offer high volumetric efficiency. Housed in polyester-film sleeving with epoxy resin end seals, ensuring excellent moisture resistance.



ASK FOR BULLETIN 3517 INFORMATION RETRIEVAL NUMBER 165

MINIATURE RED TOP® TANTALEX® TUBULAR CAPACITORS

Type 162D Capacitors in resin-sealed cases offer excellent stability. For use on printed wiring boards, in packaged circuit modules, and in applications where space is at a premium. Priced competitively with axial lead molded case units. Available on reels, with taped leads, for automatic machine insertion on PC boards.

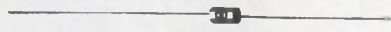

ASK FOR BULLETIN 3536B INFORMATION RETRIEVAL NUMBER 166

For complete technical data on any of these Sprague solid tantalum capacitor types, write for the applicable Engineering Bulletin(s) to Technical Literature Service, Sprague Electric Company, 347 Marshall Street, North Adams, Mass. 01247.



(continued from page 21)

when you convert to dBs, the power ratio is $\times 10 \log_{10}$ and V or I ratio by $20 \log_{10}$. Square rooting must be carried out in the example shown to obtain the correct answer! Further it can be shown by simple arithmetic that a power ratio of 2 corresponds to dividing by 3 dB. Expressing power ratio in powers of 2; namely, 2, 4, 8, 16, represents dividing by 3, 6, 9 and 12 dB, respectively. Further, an increase of $2 \times$ the V or I ratio is equivalent to a 6-dB increase. Therefore the V or I ratio 2, 4, 6, 8, 16 times represents 6, 12, 18, 34 dB respectively. Also a 2-dB decrease in the V or I ratio, or a 1-dB decrease in power ratio represents a multiplying factor of 0.8. These should be adequate reasons for use of the simpler powers of 2 rather than those of 10.

Finally the note on p. 106 is mathematically sound if Mr. Abouyannis follows carefully the example shown on the same page.

J. B. Ayer

Applied Cybernetics
2013 Deerhurst Ctr.
Ottawa K1J8H2-Ont.

Ed. Note: The first point in Mr. Abouyannis' letter was a printer's error. The second point and additional discussion are answered by Mr. Ayer.

Help we don't need

We appreciate all the help we can get: But we weren't happy when we saw that our printer had "corrected" our cover-photo credit for the August 2nd issue. The cover shot was prepared by Weston Instruments, Inc., of Newark, N.J. —NOT Western Instruments Inc.

About that Fox

We already pointed out that the photo on page 119 of the April 26th issue is of a Fox 1 computer, not a DEC PDP-8. We failed to point out that the Fox 1 is made by the Foxboro Co., located in Foxboro, Mass.

HOW TWO MOS RAMS STACK UP AGAINST EIGHT.

It's a rout: compare two 256 x 4, five-volt ion-implanted, N-channel silicon gate static MOS RAMS. With 16 pins and bus-structuring. Against eight 1024 x 1's. It's no contest, no two ways about it. The 256 x 4 is the greatest savings device to come across the board in read/write organization. And here's the byte. You get an eight-bit word with only two IC's instead of eight. Why pay for more than you need? The 256 x 4 organization gives you no wasted bits. And an industry standard package saves you board space, design time and money.

Presenting the 2606 static MOS RAM. The first one out had to be fast. The 2606 gets it done in 750 ns access time. Its bus structuring means simpler input/outputs, and no interface and support logic. And this RAM fits right into the scheme of new bus-oriented systems to come. Throw in total TTL compatibility with no clocks required, and your 256 x 4 package is complete.

The 2606. Your distributor has inventory now. Buy some today. And while you're at it, send us the coupon. We'll get you more information on our new 256 x 4's—and other MOS memories. From Signetics, first again.

**ADD IT UP.
NOW TWO IS MORE
THAN EIGHT.**



signetics

Signetics MOS
P.O. Box 3004-39
Menlo Park, California 94025 (408) 739-7700

Let's have the complete specs and technical data on your new 256 x 4 N-channel: The 2606

Name _____

Title _____

Company _____

Address _____

City _____ State _____ Zip _____

Telephone _____

Signetics Corporation, a subsidiary of Corning Glass Works, 811 East Arques Avenue, Sunnyvale, California 94086 (408) 739-7700.

INFORMATION RETRIEVAL NUMBER 211

Our family of high the broadest and fas

Here's proof.

Compare the performance characteristics of these monolithic high slew rate op amps. Device for device, ours offer more. Even the slower slew rates are fast. And nobody tops our fastest. What's more, the slew rates are guaranteed and tested. And where bandwidth limits are critical and you need wide bandwidths at high output levels, these are the op amps for you.

Other advantages are better settling times; space savings because of fewer external components; the best possible DC performance at the highest speeds; and availability in chip form. So, wherever you need high speeds and greater reliability in op amps, look to Harris. For details see your Harris distributor or representative.

comparative diagram

PRECISION
NON-COMPENSATED
5V/V GAIN STABLE

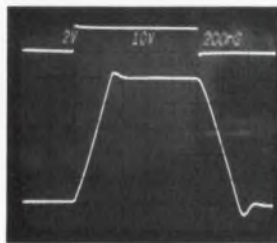

INTERNALLY COMPENSATED
UNITY GAIN STABLE

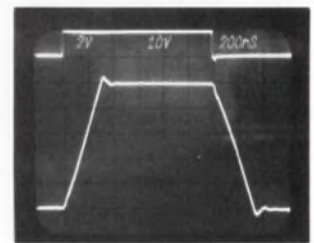

PARAMETERS	LOW SLEW RATE			LOW SLEW RATE		
	HA-2620	HA-2622	HA-2625	HA-2500	HA-2502	HA-2505
Slew Rate	± 25	± 20	± 20	± 25	± 20	± 20
Full Power Bandwidth	400	320	320	350	300	300
Gain Bandwidth Product	100	100	100	12	12	12
Settling Time	1000	1000	1000	330	330	330
Voltage Gain	100k	80k	80k	20k	15k	15k
Bias Current	15	25	25	200	250	250
Offset Current	15	25	25	50	50	100
Offset Voltage	4	5	5	5	8	8
100-999 Units	\$14.95	\$8.95	\$5.95	\$18.50	\$12.95	\$7.50

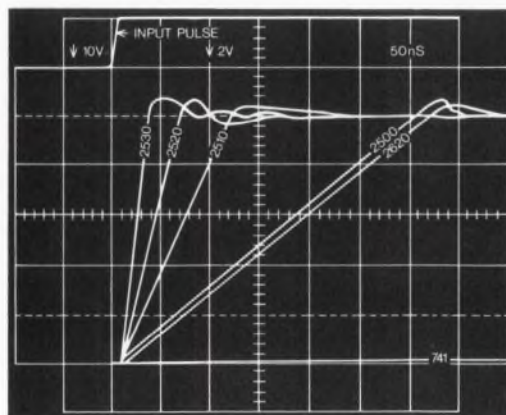

slew rate op amps is best in the industry.

**NON-COMPENSATED
3V/V GAIN STABLE**

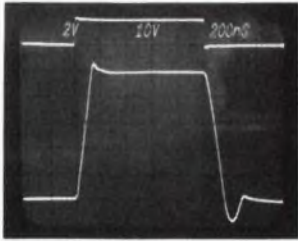

**NON-COMPENSATED
3V/V GAIN STABLE**

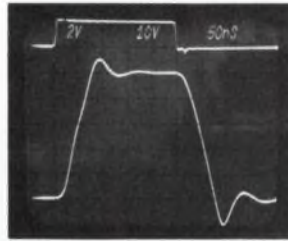

**NON-COMPENSATED
10V/V GAIN STABLE
INVERTING ONLY**

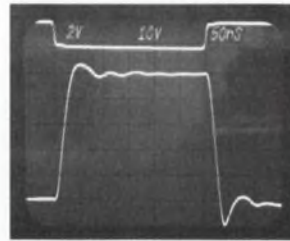

MEDIUM SLEW RATE

HIGH SLEW RATE

VERY HIGH SLEW RATE

MEDIUM SLEW RATE			HIGH SLEW RATE			VERY HIGH SLEW RATE			UNITS
HA-2510	HA-2512	HA-2515	HA-2520	HA-2522	HA-2525	HA-2530	HA-2535		
±50	±40	±40	±100	±80	±80	±280	±250	V/μS (MIN)	
750	600	600	1500	1200	1200	4000	4000	kHz (MIN)	
12	12	12	20	20	12	70	70	MHz (TYP)	
250	250	250	200	200	200	500	500	ns (TYP)	
10k	7.5k	7.5k	10k	7.5k	7.5k	100k	100k	V/V (MIN)	
200	250	250	200	250	250	100	200	nA (MAX)	
50	50	100	25	50	50	20	20	nA (MAX)	
8	10	10	8	10	10	3	5	mV (MAX)	
\$18.50	\$12.95	\$7.50	\$18.50	\$12.95	\$7.50	\$33.00	\$14.30		



HARRIS
SEMICONDUCTOR
A DIVISION OF HARRIS CORPORATION

P.O. Box 883, Melbourne, Florida 32901 (305) 727-5430

WHERE TO BUY THEM: ARIZONA: Phoenix - Hamilton, Liberty, Weatherford, Scottsdale - HAR (602) 946-3556 CALIFORNIA: Anaheim - Weatherford, El Segundo - Liberty, Glendale - Weatherford, Long Beach - HAR (213) 426-7687, Mountain View - Elmar, Palo Alto - Weatherford, HAR (415) 964-6443, Pomona - Weatherford, San Diego - Liberty, Weatherford, COLORADO: Commerce City - Elmar, Denver - Hamilton, Englewood - Weatherford, CONNECTICUT: Danbury - Schweber, Norwalk - Harvey, FLORIDA: Hollywood - Hamilton, Schweber, Melbourne - HAR (305) 727-5430, GEORGIA: Atlanta - Schweber, Norcross - Hamilton, ILLINOIS: Elk Grove Village - Schweber, Schaumburg - HAR (312) 894-8824, Schiller Park - Hamilton, INDIANA: Indianapolis - Pioneer, KANSAS: Lenexa - Hamilton, MARYLAND: Baltimore - Hamilton, Rockville - Schweber, MASSACHUSETTS: Burlington - Hamilton, Lexington - Harvey, Wellesley - HAR (617) 237-5430, MICHIGAN: Livonia - Hamilton, Troy - Schweber, MINNESOTA: Edina - Hamilton, Schweber, Minneapolis - HAR (612) 432-6111, MISSOURI: Hazelwood - Hamilton, NEW JERSEY: Cedar Grove - Hamilton, Mt. Laurel - Hamilton, Somerset - Schweber, NEW MEXICO: Albuquerque - Hamilton, Weatherford, NEW YORK: East Syracuse - Hamilton, Melville - HAR (516) 249-4500, Syracuse - HAR (315) 463-3373, Rochester - Schweber, Westbury - Schweber, Woodbury - Harvey, NORTH CAROLINA: Raleigh - Schweber, OHIO: Beachwood - Schweber, Cleveland - Pioneer, Dayton - Pioneer, HAR (513) 226-0636, PENNSYLVANIA: Wayne - HAR (215) 687-6680, TEXAS: Dallas - Hamilton, Weatherford, HAR (214) 231-9031, Houston - Hamilton, Weatherford, UTAH: Salt Lake City - Hamilton, WASHINGTON: Seattle - Liberty, Weatherford, WASHINGTON, D.C.: HAR (202) 337-3170, CANADA: Mississauga, Ontario - Hamilton, Montreal, Quebec - Hamilton, Ottawa, Ontario - Hamilton

LEGEND FOR HARRIS SALES OFFICES & DISTRIBUTORS: Elmar Electronics (Elmar), Hamilton Avnet Electronics (Hamilton), Harris Semiconductor (HAR), Harvey Electronics (Harvey), Liberty Electronics (Liberty), Pioneer Standard Electronics (Pioneer), Schweber Electronics (Schweber), R. V. Weatherford Co. (Weatherford).

INFORMATION RETRIEVAL NUMBER 212

Typical
Performance
(25°C)

	A3/A4	A5/A6	A7/A8	A9	A13	A15	A25
Frequency	5-500 MHz	5-500 MHz	5-500 MHz	5-500 MHz	5-1000 MHz	5-1000 MHz	5-1500 MHz
Package	TO-8/ Flatpack	TO-8/ Flatpack	TO-8/ Flatpack	TO-8	TO-8	TO-8	TO-8
Gain	15 dB	15 dB	15 dB	11 dB	14.5 dB	14.5 dB	10 dB
Gain Flatness	± 25 dB	± 25 dB	± 25 dB	± 4 dB	± 5 dB	± 5 dB	± 4 dB
Noise Figure	3.5 dB	4.5 dB	5.5 dB	8.5 dB	4.0 dB	4.5 dB	6.0 dB
VSWR	1.3:1	1.3:1	1.3:1	1.5:1	1.5:1	1.5:1	1.3:1
Output Power	+1 dBm	+9 dBm	+14 dBm	+22 dBm	0 dBm	+8 dBm	+7 dBm
Intercept Point	+11 dBm	+22 dBm	+26 dBm	+32 dBm	+11 dBm	+21 dBm	+19 dBm
Price (1-9)	\$112/ea	\$99/ea	\$109/ea	\$125/ea	\$129/ea	\$119/ea	\$129/ea

WJ-A3/A4
Low Noise: 3.5 dB

WJ-A5/A6
Wide Power Supply Range
8-20 Volts

WJ-A7/A8
High Output Power: +14 dBm

WJ-A9
Higher Output Power: +22 dBm

WJ-A13
Wide Frequency Range: 5-1000 MHz
Low Noise: 4.0 dB

WJ-A15
Wide Frequency Range: 5-1000 MHz
Medium Power

WJ-A25
Wider Frequency Range: 5-1500 MHz
Medium Power

**any way
you roll them,
they come up
high performance!**



Watkins-Johnson—U.S.A.: 3333 Hillview Ave., Palo Alto, CA 94304 • (415) 493-4141 • TWX: 910-373-1253 • Telex: 34-8415 • Cable: WJPLA • 700 Quince Orchard Rd., Gaithersburg, MD 20760 • (301) 948-7550 • TWX: 710-828-0546 • Telex: 89-8402 • Cable: WJCEI • United Kingdom: Shirley Ave., Windsor, Berkshire SL4 5JU, England • Tel: Windsor 69241 • Cable: WJUKW-WINDSOR • Telex: 847578 • West Germany: 8033 Planegg, Muenchenerstr. 17 • Tel: (089) 859-9441 • Cable: WJDBM-Muenchen • Telex: 529401 • Italy: Piazza G. Marconi, 25 00144 Roma-EUR • Tel: 59 45 54 • Cable: WJROM-ROMA • Telex: 60117

INFORMATION RETRIEVAL NUMBER 213

Circle 41 for DECscope, 42 for TU60, 43 for MPS,
44 for PDP-8/A, 45 for RT01, 46 for RT02, 47 for Modules ▶

**For the past 15 years,
we've been supplying
peripherals and component
equipment to the world's
largest manufacturer of
minicomputers.**

**And now we can supply
them to you.**

The Components Group of Digital Equipment Corporation.

We're unbundling the world's most popular minicomputers.

The Components Group will supply proven, reliable computer components to the volume buyer at the lowest possible prices.

Our products are all used by Digital as components and peripherals in the PDP-8 and PDP-11 minicomputer systems, the most popular minis in the world.

But until now, if you wanted Digital components, you had to buy an entire system.

Not any more.

Now, if you order fifty pieces or more, you can buy any of these components completely unbundled. Volume buying will get you price breaks you won't believe — just check out the prices on the next couple of pages.

And you can have our components off the shelf. As our nationwide network of warehouse/depots comes on-line this fall, volume deliveries will be made as fast as we can process your order.



Behind our commitment to deliver stands the entire Digital manufacturing capability — over two million square feet of manufacturing space in the United States, Puerto Rico, Canada and other countries overseas. These are the same facilities that have produced more minicomputers than anyone else, the facilities that manufacture and test the peripherals that support these computers.

To deliver these components quickly and to maintain our high standard of reliability, the Components Group is planning a nationwide network of warehouses. At these depots, products meeting our rigid specifications will be stocked for off-the-shelf delivery.

Our warranty is simple: all hardware is fully warranted for a specified time. If, during this period, any product should prove defective, you simply return it to the nearest depot for fast repair or exchange.

Over the next few years, we expect the cost of computer hardware — especially the cost of the computer itself — to keep going down. Entirely new applications will open up. Volume production of proven components and peripherals enables us to sell at greatly reduced prices. Our low-cost, high-quality products will provide our customers with an opportunity for enhanced profits and a competitive edge in an increasingly price-conscious market.



Even our newest components are proven products.



Like our computers, our components are designed to deliver maximum performance and reliability.

They are all members of traditional Digital product families, designed to support or complement our well-known computers. And they're all

easy to interface to any other commonly used minicomputer. (If you wish, we'll even design and manufacture your interface in volume.)

Some Components Group products, like our cassette system, remote terminals, and logic modules, are products that we have been manufacturing for a number of years, in quantities to support only our own systems.

Other products, like the PDP-8/A, the DECscope, and the Microprocessor Series of modules are recent price/performance breakthroughs that employ proven, readily available technologies. These products, of course, are also closely related to our traditional computer, terminal, and module products.

All our components and peripherals have been designed for reliability and ease of maintenance, features that are especially important to the volume buyer. Reliability is ensured by pretested quality components





and a minimum of sensitive or moving parts. Maintenance, when necessary, is accomplished by plug-in replacement of modular subsystems.

To provide you with a range of capabilities, product families are being developed. Additional component computers, video terminals, and printers will be introduced in the near future, and will be available in volume from the Components Group.

The component products and peripherals described on the next couple of pages, our introductory line of products, have been selected for reliability and performance. Look them over. They could be the start of a beautiful relationship.



A display terminal for the price of a teletypewriter.

Video has a lot of advantages. It's fast. It's quiet. And non-computer people find it easy to work with.

But until now, video was pretty expensive.

Now there's DECscope. The world's most inexpensive display terminal.

The keyboard is typewriter-style, so it's easy to use. The scope displays ASCII-standard uppercase characters, each on a 5x7-dot matrix for readability. After displaying 12 lines, the page scrolls upward from the bottom; its speed can be adjusted by the user.

After you've found the information you want, you can take it with you, too. Our optional low-cost copier will deliver hardcopy in 18 seconds; it fits right into the DECscope's desktop cabinet.

Interfacing is with a standard 20mA current loop, or with an inexpensive EIA option for access to the computer over standard



Under \$950 in quantities of 100.

telephone lines. Baud rates are switch-selectable up to 9600, for most efficient use of lines.

Installation is easy, just plug it in. The DECscope has few moving parts, so maintenance is simple. And its low heat output means no fans, less noise, and low power consumption.

At such an incredibly low price, the DECscope makes desktop video available to a lot of people who may never have talked with a computer before.

A reliable cassette system that's cheaper than paper tape.



Under \$1600 in quantities of 100.

The TU60 cassette mag tape system was designed for accuracy and reliability. It reads even very low data levels, yet rides right over any noise between the data blocks.

Compared to paper tape, the TU60 is easier to handle, less messy, and a lot more versatile. (Ever try to erase a hole?)

And the TU60 is tough. Its extra-heavy 1 mil tape resists stretching and edge wear, and is spec'd for a minimum of 1000 passes. Reel-to-

reel drive and servo-controlled motors give smooth, easy starts and stops, with no capstans, pulleys or pinch rollers that could damage tape.

With an error rate ten times better than most other cassette systems, the TU60 is a machine you can count on. The read electronics adapt to the tape speed, so power variation or mechanical difficulty won't cause mistakes on the tape.

Other error reducing features include automatic leader detection, single-track low-density recording, and 16-bit cyclic redundancy checking.

Maintenance is rarely necessary. When it is, it's no problem. The top flips open, everything is accessible, and the two main modules can be replaced in minutes.

And look at the price.

So how come you're still using paper tape?

A low-cost, easy-to-use microprocessor that you can have right now.

Our MPS microprocessor series of modules: the least expensive microprocessor on the market.

We designed the MPS using only standardly-available components with a proven track record. The CPU employs reliable P-channel MOS/LSI silicon-gate technology. We can get it to you now, and we can get it to you without the quirks and bugs that plague a too-new technology.

You can get it on-line fast, too: the MPS interfaces easily. Since its external circuitry is TTL-compatible, you can use it with Digital's broad line of logic modules.

Software development is easier. Control programs are prepared on a small, low-cost PDP-8 minicomputer, using the MPS software-development kit of six basic programs.

Physically, the MPS is a series of four building-block modules and an optional control panel. A basic, fully-operational processor can be assembled from as few as two modules: the CPU and a memory module.

The 8-bit parallel processor can directly address up to 16K words of memory; cycle time is $12.5\mu\text{sec}$. Reprogrammable memory (PROM)

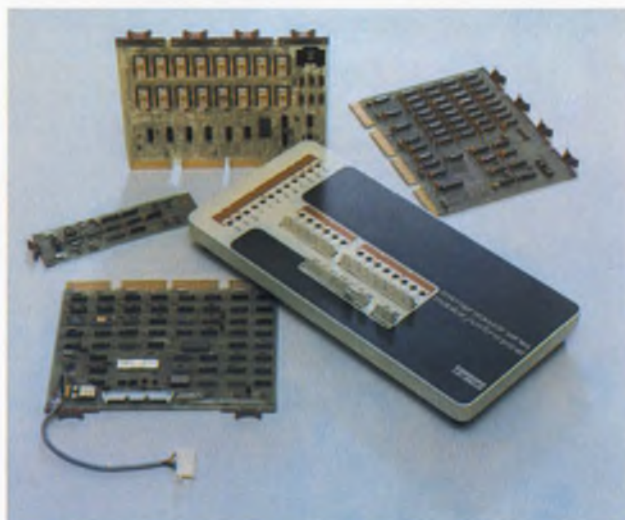

**\$476 in quantities of 100.
(CPU & 1K RAM.)**

is available in 256-word increments. Read-write memory (RAM) is available in 1K-word increments. An external-event-detection module implements nine levels of priority-arbitration. These include application-defined six-level priority interrupt schemes, AC and DC power-failure detection capability, and the processor-controlled functions of Halt and Restart.

The MPS gives you the convenience of building-block modularity and a design development package that allows you to customize to your application. It's an intelligent solution to low-end processing and control problems.

The PDP-8/A component computer.

A no-nonsense, no-compromise computer-on-a-board.



**\$572 in quantities of 100.
(CPU & 1K RAM.)**

To give you speed and performance at an extremely low price, we've put the world's most experienced mini-computer, the PDP-8, on a single board.

And we've done it using only proven, readily-available, multi-source, MSI semiconductor technology.

The 12-bit PDP-8/A has a cycle time of $1.5\mu\text{sec}$, a huge, healthy software library, and the same powerful instruction set as the PDP-8/E. It's fully compatible with most PDP-8 family hardware, operating systems, and high-level

programming languages like BASIC, FORTRAN IV, and FOCAL.

The Omnibus™ backplane makes it easy to interface the PDP-8/A directly to more than 60 PDP-8 options and peripherals. To make your life even easier, we've made the seven most-requested options available on two option boards: serial-line interface, 12-bit parallel I/O, front-panel control, and real-time clock on one board; power-fail/auto-restart, memory extension, and bootstrap loader on the other.

We've employed expandable semiconductor memory to enable you to tailor your memory capacity to your needs, from 1K to 32K words. Choose ROM, RAM, PROM, or ROM/RAM combinations — mix and match to suit your application.

The PDP-8/A will give you minicomputer power at micro-processor prices. We start delivering in quantity in late 1974. We're accepting volume orders now; talk to us.

Remote terminals for people who think they can't afford remote terminals.

The RT01 and RT02 interactive terminals get around. To the warehouse, the textile mill, the stockroom, the factory floor, and a lot of other places where you might not expect to find the long arm of the EDP department.

Even non-computer people can use them to enter all kinds of data — crane positions, vat levels, logged time, part numbers, whatever — into a remote computer. There's no need for confusing, numerically-coded instructions. RT02 models will prompt the inexperienced operator, spelling out on the display what information is needed next.

The RT01 displays up to 12 digits of data in a numeric Nixie™ display. For non-numeric response, it has programmable status indicators. The 16-key pad will output 30 ASCII characters.

The RT02 costs more and gives you more. A 64-character gas-discharge alphanumeric readout that



Starting at less than \$600.

displays up to 32 characters at once. 16-key or 58-key input. Interactive display prompting.

Both terminals are ASCII-compatible, so you can interface them to any computer with a Teletype™ port. EIA modem interface is also standard.

Both have simple displays and few moving parts for built-in reliability and ease of maintenance.

And look at their down-to-earth prices. These are remote terminals that you can get close to.

Logic modules and custom interfacing to get it all together.

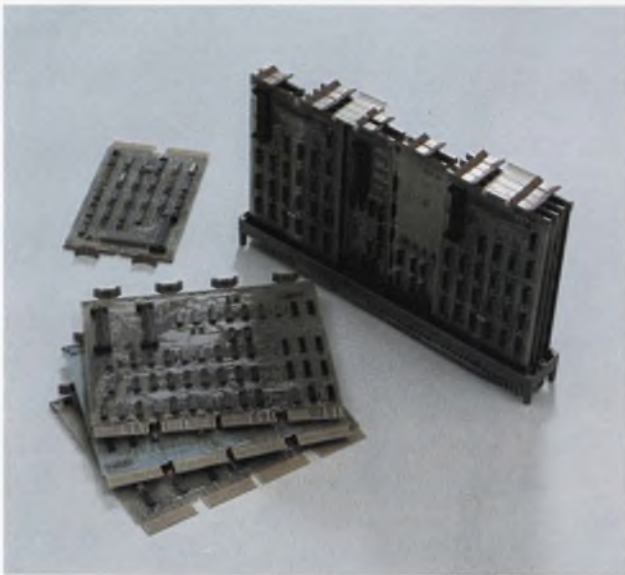

Digital, the world's largest seller of solid-state modules, gives you the widest choice on the market: over 400 pre-tested modules.

M Series modules. These high-speed logic modules give you high fanout, large capacitive drive capability and excellent noise margins. In frequencies up to 6MHz.

K Series modules. These noise-resistant modules are designed for easy system check-out in industrial control situations where noise-resistance is more important than speed. Though frequencies from DC to 100KHz are typical, we can give you frequencies as low as 5 KHz.

A Series modules. For communication between your computer and the outside world, our analog modules give you 10-bit and 12-bit performance in a family of mutually compatible functions — multiplexers, operational amplifiers, sample-and-hold circuits, A/D and D/A converters, reference voltage sources, and multiplying A/D converters.

DECKit interfaces. Our DECKits offer you pre-tested, fully-documented interfaces for a number of common interfacing situations. Basically just a few modules and a prewired systems unit, they eliminate design time, breadboarding, and wirewrapping.

And more. The Components Group will also supply you, in volume, with custom interfaces, custom modules, and custom variations of our standard terminals. Our Logic Products Handbook and Logic Systems Design Handbook can provide general support and solutions to specific standard problems. We also carry a full line of compatible hardware, power supplies, plug-in-boards, cabinets, racks and related equipment.

digital
COMPONENTS
GROUP

**Unbundling the world's
most popular minicomputers.**

Meet the Components Group now
— we've got a lot to talk about. Call us direct at

800-225-9480

Toll-free from 8:30AM to 5:00PM your time.
US only. Massachusetts residents, please dial (617) 481-7400.

Digital Equipment Corporation, Components
Group, One Iron Way, Marlborough,
Massachusetts 01752.

In Canada: Digital Equipment of Canada
Limited, P.O. Box 11500, Ottawa, Ontario,
K2H8K8, (613) 592-5111.

Prices quoted are in US dollars and will vary outside
the United States.

SIZZLE...OR...SWIZZLE OUR CAPACITORS CAN TAKE IT!!!



We're celebrating! TENSOR, the high-technology capacitor company, has joined GTI Corporation . . . which means that a much broader market can now have 6 to 8 week delivery on the most stable glass-sealed ceramic capacitors around. Take our type C150 for instance, a 0.065-inch diameter by 0.150-inch long capacitor with a range of 100 pf to 22,000 pf at 25V in an environment ranging from -55° to $+125^{\circ}\text{C}$ (X7R characteristic).

TENSOR capacitors can take it because they're processed with some very unique and proprietary techniques (patents pending). It took 24 years of combined monolithic capacitor experience to come up with TENSOR's advanced technology. **So we're not really the new kids in town . . .**

For cold facts and hot delivery on the ultrastable, small-package capacitor that can really take it, call TENSOR:

(714) 453-7262



tensor electronics

A SUBSIDIARY OF GTI CORPORATION

11404 Sorrento Valley Road
San Diego, California 92121

INFORMATION RETRIEVAL NUMBER 21

a

SELF-SCAN[®] PANEL

says it all...

**ENGLISH • FRENCH • GERMAN • HEBREW • RUSSIAN
JAPANESE • SYMBOLS • GRAPHICS • and other languages**

No matter what you have to say or how you say it, a SELF-SCAN panel display provides the economical and practical solution to your readout problem. The only commercially available dot matrix pattern with five years of proven customer performance plus the following features:

- Low Cost
- Compact Packaging
- Few Connections
- Distinctive Appearance

The 5 x 7 dot matrix format of SELF-SCAN panels and our variety of MOS character generators allow you to communicate with maximum legibility and flexibility. Simultaneous bi-lingual display is also possible on certain models. SELF-SCAN panels are simple to interface to computers.

Single register displays of 16, 32, and 80 characters, and multi-register displays of 256 (8 x 32) characters are available. 0.2", 0.3", 0.4" characters with soft neon-orange glow are visible up to 25 feet.

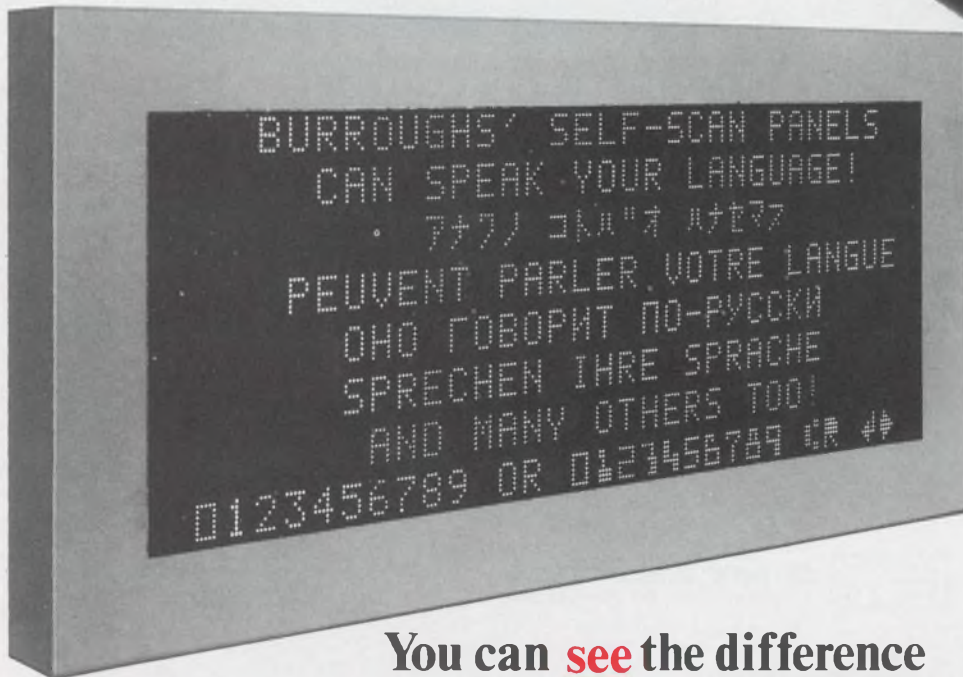

Call your Burroughs representative for a "briefcase" demonstration, or get in touch with Burroughs Corporation, Electronic Components Division, P.O. Box 1226, Plainfield, New Jersey 07061. Tel. (201) 757-3400 or (714) 835-7335.

You can see the difference **Burroughs**



See us at Wescon, Booth No 1003 to 1006

INFORMATION RETRIEVAL NUMBER 22

Nerem to focus on radars: limited-scan and CCD aids

Limited-scan radars and the use of charge-coupled devices with radar signal processing—both are considered promising enough to rate discussion at the IEEE's Nerem '74 this fall.

The limited-scan radars are hybrids—part phased array and part reflector or lens—and L. J. Ricardi, chairman of a Nerem seminar on radar systems and their components, says they have a good future.

The hybrid combines the flexibility of a phased array and the low cost of a reflector, notes Ricardi, a professor at the Massachusetts Institute of Technology. The reflector cuts down on scan angle—a possible limit of 20 degrees vertically and the same horizontally. But it substitutes for a lot of phased-array elements. The reflector enables the designer to get by with a tenth the elements he'd normally have to use in a pure phased-array system, Ricardi says.

Limited scan is excellent for airport landing systems, satellite docking radars, shipboard use and weapon guidance and control, the MIT professor continues.

"The only thing it's not good for," he adds, "is for surveillance over a wide expanse."

An even newer development to be described at Nerem is the use of charged-coupled devices with radar signal processing. According to three engineers at Texas Instruments who are preparing the paper, there's no reason to operate in the digital world at all. The whole signal-processing operation can be accomplished in analog form, they say, thereby eliminating the need for a/d and d/a converters.

CCDs are analog in nature anyway, says W. H. Bailey, one of the authors, and by applying the CCD through a Chirp-Z transform algorithm, the designer need not go to

the digital world to take the Fourier transform.

Typically radars have had discrete Fourier transform processors on them, Bailey explains. They have a discrete Fourier transform box that converts the analog signal to a digital one, processes it and reconverts it to an analog mode. This box is time-shared between the range bands in the radar system.

"If done digitally, you need a whole lot of digital hardware or some very fast digital hardware, particularly fast switching, Bailey says. "But we think we can eliminate a lot of digital hardware by using a single chip that combines CCDs and analog MOS circuitry.

"We haven't demonstrated everything yet, but we have demonstrated a number of components we need."

The Nerem seminar will be held Oct. 29-31 in the Sheraton-Boston Hotel.

Written data converted to ASCII code by pen

"What the Polaroid camera was to photography, the Alphabec-70 is to data entry."

Ken Scott, product manager of Xebec Systems, Inc., Sunnyvale, Calif., so describes his company's latest data-entry device—a computerized ballpoint pen that automatically translates hand-printed data into ASCII-coded data. Once coded, the data are entered into a computer system for further processing.

According to Scott, the system—which consists of the data-entry pen, processing electronics and display—is designed to replace many of approximately 700,000 keyboard entry devices now in use.

"Since we are currently limited



Computerized pen automatically translates hand-printed data into ASCII-coded data. The pen is designed to replace keyboard entry devices now used.

to recognition of 16 characters—10 digits and six control symbols—we expect the device to be useful in only 2 to 5% of the keyboard applications," Scott says.

The character-recognition capability of the system can be doubled, he says, by addition of a switch to the pen, but that's still a ways off.

The new device is said to eliminate all labor costs and human sources that follow origination of source documents. The Alphabec-70 system dispenses with the conventional data-entry methods of initial recording, editing, coding, the setting up of batch controls, verification and correction. Instead data are recorded, entered into the computer and verified all at once by one person.

In describing how the system works, Scott notes that transducers in the head of the pen sense the direction of movement. This information is sent to the unit's pattern-recognition circuitry, where the symbol being drawn is defined. Both a visual and aural display of the information is then fed back to the user, who can check to see if the character entered into the system was correctly recognized. If it wasn't, he merely draws a line from right to left to erase the character and re-enter the correct one.

Once the data are recognized, they are displayed on a 32-character, gas-discharged panel.

With a disc memory added to the system, Scott reports, it is possible to get an audio reponse in which the name of the character is spoken. The first Alphabec-70, to be delivered by the end of the year, will not have this capability. But if there is enough interest in the audio response, systems with this feature could be delivered by the end of 1975, Scott says.

Seiko down-plays the digital watch

Seiko, one of the world's largest watch manufacturers, apparently isn't going to jump aboard the digital-watch bandwagon.

In announcing a major expansion of its analog quartz line in the U.S., Masahiro Sekimoto, executive vice president of Seiko Time Corp., concedes that there is a place in the market for digital quartz types—namely liquid-crystal-display and LED timepieces.

"However," he emphasizes, "we believe that sales of those watches will reach a plateau, level off and eventually occupy a smaller segment of industry sales than analogs."

Digital watches, Sekimoto observes, do not lend themselves as readily as analogs to the wide varieties of shapes needed for costume jewelry.

"Besides," he notes, "analog offers the great advantage of indicating both elapsed time and remaining time—which digitals cannot show."

Seiko has been marketing a line of liquid-crystal digital watches in Japan since last year and plans to introduce them in the U.S. next year.

I²L microprocessor reported being built

What may be the industry's first bipolar microprocessor using integrated injection logic (I²L) is reported under development at Transitron Electronics Corp., Wakefield, Mass.

If the new processor does use injection logic—and Transitron will neither confirm or deny that it does—a significant increase in chip density would result. A meas-

ure of the density increase is indicated by the fact that the Transitron bipolar processor will be on four chips, while a bipolar processor soon to be announced by Raytheon will consist of seven.

According to Martin Gordon, manager of Transitron's Central Processing Div., the unit will contain four 4-bit RALUs (register and arithmetic units) and a control read-only memory (CROM). Unlike the CROMs used in other microprocessors, Gordon says, this one will not be user-accessible.

"It's not necessary because the microprocessor comes with a firm microprogrammed instruction set," he explains. "National Semiconductor tried a microprogrammable machine, and we don't think it's been successful."

The Transitron processor will come with a complete software support package, Gordon reports. Just what that means he wouldn't spell out, but industry sources say that the processor will be Fortran programmable. This would make it a lot easier to use than many, because most engineers are familiar with Fortran.

Reports in the industry are that, barring unforeseen difficulties, the microprocessor will be finished by next March. Gordon would say only that the company hoped it would be ready by early next summer.

Microprocessor runs a facsimile machine

The ubiquitous microprocessor is even finding a niche for itself in the copying business.

A microprocessor-controlled facsimile machine under development at Rapifax Corp., White Plains, N.Y., promises to cut the cost of hard-copy transmission by up to 90%, according to Robert Ayling, the company's marketing vice president.

Under programmed instructions, the unit converts hard copy into digital data and stores the data on magnetic tape until after the usual working hours. It then automatically dials up the desired location, establishes a link with another machine on the other end to varyify a connection and transmits the copy at any one of three speeds—35, 50 or 90 seconds, depending

upon the needed resolution.

According to Bob Hoffman, engineering director at Rapifax, "The microprocessor will perform all supervisory functions in the machine and log all data transmitted."

If the programmed number cannot be reached on the first try, the machine will continue on its program, dialing other programmed numbers, going back up to nine times during the evening to try and reach the unanswering location. In the morning an operator can request a printout of all the data transmitted.

The machine doesn't require specially conditioned lines—standard unconditioned, 3-kHz, voice-grade lines are used.

The facsimile machine uses an electrostatic printing process and a continuous roll of paper.

Monolithic switch array developed for phones

What is said to be the largest monolithic crosspoint switching array—a 4 × 4 × 2 matrix capable of switching up to 16 balanced, 600-Ω telephone lines—is being manufactured for a military telephone system.

The complete array, which is designed to replace reed switches in telephone systems, is produced on a 117 × 129-mil chip, according to its manufacturer, Raytheon Semiconductor, Mountain View, Calif.

The actual switching is performed by SCRs that require a 3.8-mA holding current to remain on. The current is provided by a FET for each pair of switches that latch on with a 4-mA, 3-μsec TTL pulse. The switch input capacitance is less than 2 pf, OFF resistance greater than 10 MΩ, and ON resistance better than 12 Ω, max, with good matching between line pairs. The unit is packaged in a large, 24-pin DIP and is designed to operate from -35 C to +85 C.

According to Charles M. Smaltz of the linear/interface advance products group at Raytheon: "We are now getting reasonable process yields for a chip this size and feel ready to go into commercial production of this array as well as some smaller balanced and single-ended units."

Nothing can loosen our new connector.



Nothing but an easy pull straight up.

The secret's in the "Chinese finger" design of the receptacle contacts. The more you vibrate them or the harder you pull on their terminated wires, the greater their grasp on the mated posts.

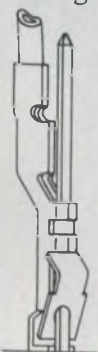

So the only way to unmate our new Locking Clip Connector is to give the housing a gentle pull straight up.

Retention is excellent, with average insertion and withdrawal forces.

Unique contact design principle provides maximum retention, with minimum insertion and withdrawal forces.



The Locking Clip Connector mates with .025" posts on a true grid. Receptacle contacts are tin-over-nickel plated by a unique process which makes them approach the performance of gold. The connector is available in 4-, 10- and 20-position configurations and will accept #26 to #30 AWG wire. Contacts can be terminated by high-speed, automated machines for uniform reliability at low applied cost.

For more information on the

AMP Locking Clip Connector, circle bingo number 35, or write AMP Industrial Division, Harrisburg, Pa. 17105.

AMP
INCORPORATED

Dialight sees a need:

(Need: The widest choice for your every application.)

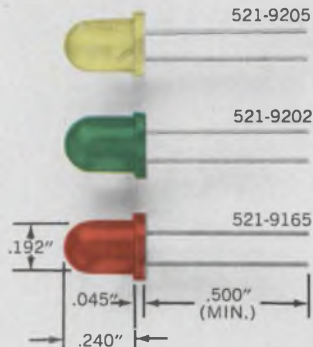

Now available in green, yellow and red. Mini-sized for maximum front panel density and easy panel mounting. High luminous intensity, low cost. Vibration/shock resistant. Solid state for long life. Wide viewing angles. Ideal for applications like panel lighting, film annotation and alpha-numeric displays.

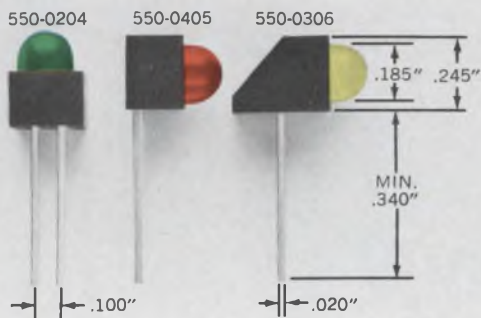

Mix 'em or match 'em. LED logic state fault indicators are available in red, yellow and green, in a variety of shapes, some with a built-in integral resistor. Can be driven from DTL and TTL logic. Designed for easy alignment on PC boards so that multiple functions can be displayed.

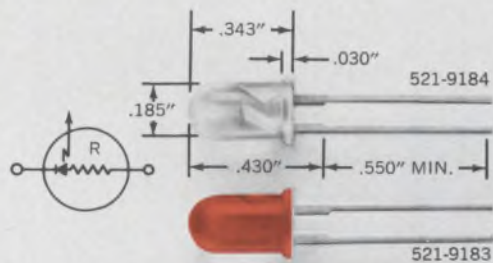

Available in red or clear LED packages with or without a built-in current limiting resistor. Red LED is also made without resistor. Suitable for circuit status indication, alpha-numeric displays and visual indicators. Features long wire-wrappable leads. IC compatible with solid state reliability. High luminous intensity, low power consumption, low cost.

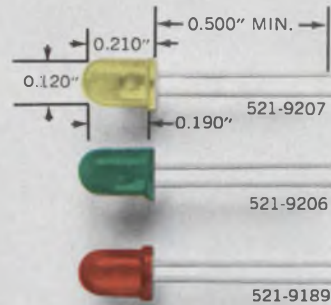

Your choice of green, yellow and red, with axial leads for dense packaging requirements. Wide viewing angle for easy readability. Low power consumption, low cost, IC compatible. 10mA operation for typical brightness. Size is identical to the most popular red LEDs.

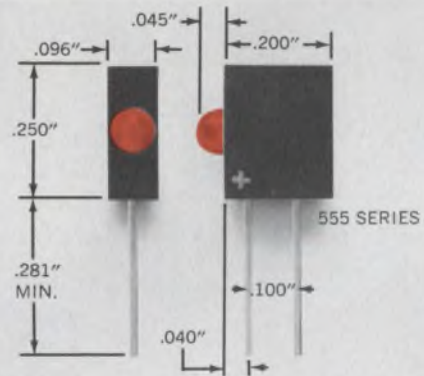

LED logic state fault indicators available in 14 models with voltage ratings from 1.7 to 14. Suitable for dense packaging on printed circuit boards—up to 10 units to the inch—IC compatible. With built-in series resistor. Polarity identified. Low power consumption.

Dialight, the company with the widest choice in switches, LEDs, indicator lights and readouts, looks for needs . . . your needs . . . and then they develop solutions for your every application. No other company offers you one-stop shopping in all these product areas. And no other company has more experience in the visual display field. Dialight helps you do more with these products than any other company in the business, because we are specialists that have done more with them. Talk to the specialists at Dialight first. **DIALIGHT** You won't have to talk to anyone else.

Dialight, A North American Philips Company
203 Harrison Place, Brooklyn, N. Y. 11237
(212) 497-7600

See Dialight.

SUPER CHIPS!

Look to Varadyne for the best ceramic chip capacitors in the business . . . they're super!



Complete Ceramic Chip Capacitor Capability!

RANGE — Our chips are offered in capacitances from 1.0 pF to 4.7 mFd.

SIZE — We offer nine standard sizes, 30 special sizes, plus micro-miniature chips for integrated circuits.

MIL APPROVAL — We have MIL approved chips qualified to MIL C-55681.

FORMULATIONS — Our four ceramic formulations range from K 30 to over K 7,000 — Type BN (Frequency Stable) NPO, Type BP (Ultra Stable) NPO, Type BX (Stable) X7R and Type GM (General Purpose) X5V/Z5U — one of which can solve your capacitor problems.

Super Chip!

We'll perform where it counts! In planning, production and quality control.

We've set records with innovative packaging and volumetric efficiency since the introduction of the ceramic chip!

Big order?

Hand it to us. We'll cut it down to size.

Our expanded production lines move out even the largest orders with ease!



Super Specs?



Lay 'em on Varadyne! We'll come back, in no time at all, with super chips that meet or exceed the standards you set. Our Q/C people won't settle for anything less.



Fast Delivery!

We've made long lead times obsolete. Does six weeks sound good? Four weeks? Two weeks? In stock? If we agree on a date, we'll meet it!

Need more data?

We'll send you technical literature on our chip line — both capacitors and resistors. We'll even include our leaded capacitor literature if you like; axial "G2-Cap" or radial "Clover Cap."

OVER 350 MILLION SOLD



We're on the move!

VARADYNE

Varadyne Industries, Inc.
Capacitor Division
2110 Broadway, Santa Monica, California 90404
Phone (213) 829-2984 • TWX (910) 343-6856



We've learned a lot!

INFORMATION RETRIEVAL NUMBER 25

THE MIC INVASION

Vhf, uhf and microwave systems reap cost and efficiency benefits

A cable-television line amplifier, a 400-MHz power amplifier, a 2-to-4 GHz low-noise amplifier and a 10-GHz parametric amplifier—each is an example of the ever-growing application of Microwave Integrated Circuits (MICs).

MICs are appearing throughout the uhf, vhf and microwave field, reducing circuit size, improving performance and cutting costs in amplifiers, oscillators, passive components and entire systems.

MIC technology is hybrid—not monolithic—it is likely to remain so for some time. The circuits require far larger substrates than digital circuits, since they use transmission lines, and the substrate materials are not suitable for “growing” transistors. In any case, the quantities of MICs needed for the foreseeable future fall far short of the numbers that make monolithic-circuit production efficient.

Practically all MICs are built with microstrip transmission lines. The lines are fabricated on a substrate—most commonly, high-alumina ceramic or sapphire, but also on ferrites, quartz, beryllia and “soft” plastics or fiberglass compositions. Transistors and diodes used in the circuits may be in packages or naked chip form, and resistors and capacitors can be either chips or deposited.

Wide variety of packages

The types of MICs being made extend across the rf spectrum from under 100 MHz to over 16 GHz. At



The wide variety of packages used for MICs is shown in this array of products from AvanteK. They include a 5 to 500 MHz amplifier and a varactor-tuned oscillator each in a TO-5 can. Amplifiers operating from 100 kHz through 4 GHz are also shown in various forms.

the lower end of the spectrum, up to about 1 or 2 GHz, several manufacturers produce “gain block,” wideband, low-noise amplifiers in TO-3, TO-8 and modified dual-in-line packages (DIPs) with wire leads. One example is the line produced by Fairchild Microwave Products, Palo Alto, Calif. George Bechtel, manager of microwave products, explains:

“We buy fairly conventional, high-quality TO packages that have room inside for one small substrate. Within the space limitation, we have parts with up to 14 dB gain in a TO-8 and 20 dB in a TO-3 4-lead can. The TO and modified DIPs are useful up to about 2 GHz with a typical VSWR of 1.5.”

These amplifiers are designed to be inserted on the top of a microstrip mother board and, according to the various manufacturers, are easy to interface and can often be cascaded in twos or threes for higher gain.

Above 1 or 2 GHz simple IC packages become lossy and exhibit high VSWR. Traditional packages above that frequency are gold-plated boxes—rectangular packages large enough to take several substrates, with sufficient room inside to prevent spurious resonances. Such boxes are generally equipped with coaxial connectors, such as the widely used SMA, and are interconnected with semi-rigid coaxial cable.

The present design trend is away from systems requiring several interconnected boxes and towards eliminating connectors and cables, where possible. This is not because of a performance problem with the SMA connector—the VSWR of a high-quality SMA is less than 1.2 max for dc through 18 GHz—but because of the expense of the connectors and problems with making up cable assemblies.

Donald R. Chambers, senior re-

Microstrip in MICs: The what and why

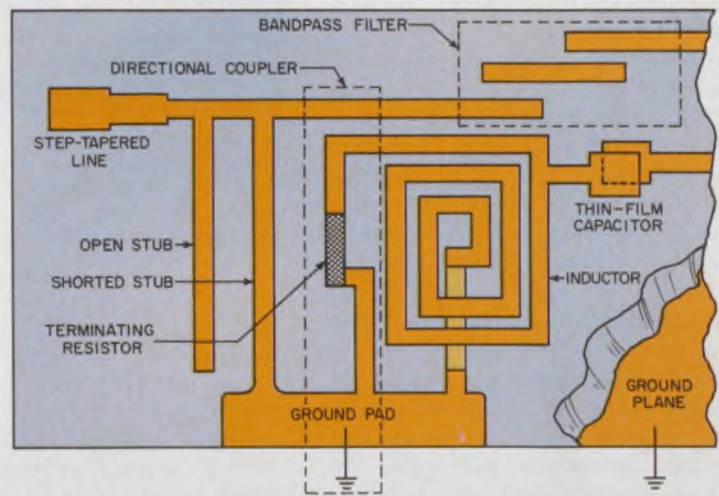
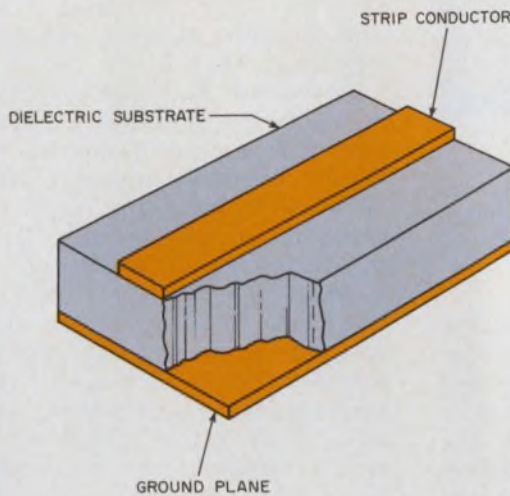

The basic current element in most MICs is the microstrip transmission line. A conductive strip is fabricated on one side of a flat dielectric substrate and a ground plane on the back side. Most of the rf energy is propagated along the line in the TEM mode, and the electric field is confined to the dielectric directly below the strip conductor.

The impedance of the line is controlled by the width of the strip and the dielectric constant of the substrate. Losses are influenced by the quality of the conductive strip, the loss tangent of the substrate and edge effects.

Since all circuit definition is done on the upper (strip-line)

side of a microstrip circuit, it is relatively simple to design and fabricate distributed-circuit elements like open and shorted stubs, directional couplers and other transmission-line components.

In most MICs, the transmission line is combined with lumped components, such as capacitors and inductors. Other components, such as transistors, diodes and resistive biasing networks, are found in MIC oscillators, amplifiers and mixers. All these components are placed on the upper side of the substrate, and they require no drilling or cutting of the substrate to install.

If the MIC is made with thick

film, inductors and resistors can be printed along with the microstrip. With thin film, inductors, resistors and capacitors can be deposited, lithographed and etched with the microstrip.

More commonly, the capacitors are installed as chips along with the cased or uncased diodes and transistors. Isolators and circulators can be installed in the same way or fabricated directly on a MIC if a ferrite substrate is used.

Other circuit technologies are used for MICs—notably slotted line, coplanar waveguide and fin line. Each of these shares with microstrip the advantages of having circuit elements defined on one side of a substrate.

search engineer with the Stanford Research Institute, Menlo Park, Calif., explains: "It is vital that a connector be fitted to a cable 'just right.' If not, there is a big lumped-impedance mismatch at the connector-cable junction. Many firms go to an outside job shop to have cables made up, which is an expensive proposition. After the cables are checked with a reflectometer, many have to be sent back for rework."

Manufacturers are eliminating

the cable and connector problems and expenses by putting individual MIC building blocks together in one box to make up a complete sub-assembly, such as an entire receiver front end. Watkins-Johnson Co.'s Solid State Div., Palo Alto, Calif., has developed a MIC sub-assembly technique that it is using for many systems.

Ceramic substrates are gold-plated on the bottom and brazed to the gold-plated Kovar carriers. The carriers are then bolted to an

aluminum plate that becomes part of the case for the completed sub-system. Interconnections between substrates are made with flat gold ribbons.

Some of the reasons for this assembly technique are given by Dr. James Crescenzi, head of the components R&D section at Watkins-Johnson. He says: "Since the backplanes of the substrates are actually brazed to metal carriers, there is no possibility of poor or intermittent backplane grounding. We

can also make nonplanar devices, like mixers, in compatible metal packages that can also bolt to the same plate."

Another manufacturer that is mounting substrates on a plate and doing it with clamps is Hewlett-Packard's Microwave Components Group, also in Palo Alto. Douglas A. Gray, engineering manager, explains:

"The only other way to get a subsystem to go together without internal connectors is to put the entire subsystem on one big substrate. We tried that and learned a lesson—it was just too difficult to repair or modify one part of the circuit without damaging the rest."

Several companies have had good results with the MIC-on-a-plate method up to about 8 GHz, as long as the substrates are carefully butted together and the jumpers properly designed.

Other ways are being perfected to eliminate connectors from within systems, including a mother-board assembly with MICs in special low-loss packages. AvanteK, Santa Clara, Calif., is producing an all-metal package, made of Kovar. Power and signal leads are brought through the side of the



A wide-band, low-noise cable television amplifier, the Motorola MHW 526, produces 16 dB of gain from 40 to 300 MHz. Input and output impedance is 75 Ω.

1.16 × .82 × .17-in.-high package to minimize the lead lengths between the internal substrate and the mother board. The package is dropped into a cutout on the mother board, and the package leads lay on top of the board's microstrip conductors. The package is held on the board by strapping.

Another example is a package from Bendix Electrical Components Div., Sidney, N.Y. It is a glass-and-metal rectangular package that will accept a substrate up to 1 by 1 in. The package sits on a glass substrate, with microstrip conductors bringing the power and signal

out, and after being dropped into a hole cut in the mother board, it is interfaced with jumpers to the board's microstrip circuitry. The maximum tested frequency of the Bendix package is about 2 GHz, and the AvanteK package is designed to go to above 6 GHz or higher with modified internal structure and domed lid.

To indicate the factors required in the design of a high-performance MIC package, Lawrence R. Thielen, AvanteK's president, says: "We had to make the inside dimensions of the package large enough to take up to three of our standard 0.33 × 0.5-in. substrates to provide 24-to-25-dB gain at 4 GHz. The rf feedthroughs had to provide a low VSWR (about 1.15), good impedance matching at 50 Ω and a coefficient of expansion the same as Kovar to maintain hermeticity. The package is expensive but pays for itself above 1.5 GHz by eliminating connector interfaces."

Substrates: Performance vs cost

Most MIC designers agree that their substrate of choice would be sapphire or other single-crystal material. Such material can be

Characteristics of MIC substrate materials

Material	Dielectric constant (type)	Dielectric loss tan. (A)	Surface finish (best side)	Used for:
Alumina 94-96%	9.7	0.0004	AF-5-25 μin.	Thick-film MIC
Alumina 99+%	10.1	0.0002	AF 1-10 μin. AP 1 μin.	Thick and Thin-film MIC
Beryllia	6.6-6.8	0.0001-0.0003	AF 5-10 μin. AP 2-5 μin.	Power MICs (C)
Ferrite (YIG)	15	0.002	AP 1-5 μin.	Thin-film MIC (D)
Ferrite (other)	11.3-13	0.002	AP 3-5 μin.	Thin-film MIC (D)
Quartz (fused)	3.75	0.0001	OPTICAL (B)	Thin-film MIC (B)
Sapphire (90°)	9.39	0.0001	OPTICAL (B)	Thin-film MIC
Soft	MICs are being produced with fiberglass compositions and other soft materials—characteristics vary widely.			

AF — As-fired surface (as it comes from the furnace, without polishing).

AP — As-polished surface.

A — Loss tangent (dissipation factor) varies with frequency—typical values shown.

B — Usually optical finish on one side (lapped to better than 250 Å and scratch and pit-free), better than 1 μin. on back side, parallel to a few seconds of arc, and 1 wavelength flatness or better.

C — Used either as heat conductive pad under power transistor or as substrate for entire power MIC.

D — Used as substrates to eliminate the need for separate ferrite isolators and circulators. The MIC circuit and ferrite parts are fabricated in one step.

E — Used at millimeter wavelengths because the lower dielectric constant permits thicker substrates and wider conductors. It has also been used for substrates for precision oscillators, because its thermal expansion is lower than that of sapphire.

CERAMOLITHIC[®] EVOLUTION

U.S. Capacitor Corporations' monolithic ceramic EMI/RFI filters have evolved in phase with solid state technology. Increasingly higher frequencies in tiny LSI environments make tough demands on designers: better attenuation, in state-of-the-art sizes and at affordable prices.

We've met these challenges at USCC/Centralab by accelerating the filter evolution through research in dielectrics and high-productivity manufacturing techniques.

Here's what today and tomorrow look like.

The latest and smallest filters available from USCC — 9900 Series feed-throughs. Better than 70db insertion loss at 10 GHz. Used all the way from medical electronics to CATV.

Also today, MIL-STD-461 filters — the smallest ever offered for this use. For any relatively low source and load impedance job, the highest insertion loss at low frequencies.

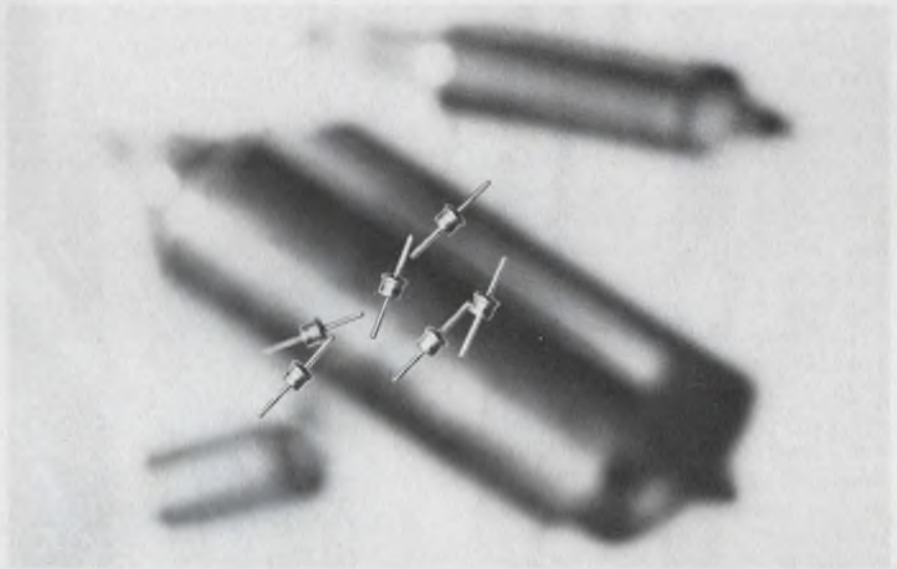

Above is USCC's smallest filter product — the 9900 series feed-thru pictured over larger more costly conventional types.

Buttons. High efficiency low pass "buttons" for data processing and MIL-F-15733 missile use. The best EMI/RFI filter job for the least money.

— a dielectric that serves as its own outer case — with obvious economics. Make the ceramolitic evolution work for you; contact us early in your design cycle.

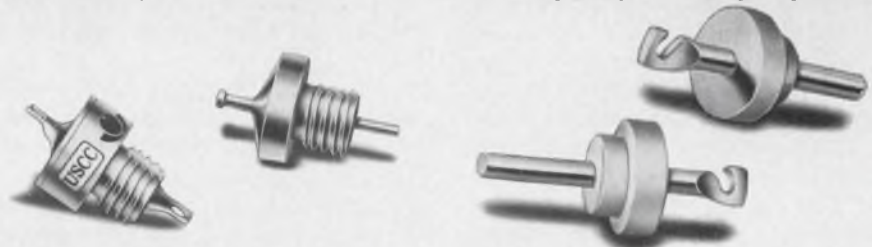

Tomorrow?
CASELESS FILTERS. U.S. Capacitor has reached the next step in CERAMOLITHIC[®] evolution

Write or call Don Thommen (213) 843-4222 for evaluation samples or help with your filter application.



USCC/Centralab

Electronics Division • Globe-Union, Inc.



2151 North Lincoln Street ■ Burbank, California 91504
(213) 843-4222 ■ TWX: 910-498-2222

INFORMATION RETRIEVAL NUMBER 26

given an optical finish, has consistent electrical characteristics and an impermeable surface that won't trap chemicals during processing.

Unfortunately sapphire substrates are expensive—\$5 to \$7, compared with about \$3 for the best 1- μ in alumina. Although the current work in silicon-on-sapphire may lead to a larger production of sapphire substrates, it may not help lower MIC substrate prices too much. Dr. Fedia R. Charvat, general manager of the Crystal Products Dept. of Union Carbide Corp., San Diego, explains:

"A MIC substrate must have the same dielectric characteristics across its entire surface, be thin—25 mils is fairly typical—and have an excellent surface finish and flatness. It requires better surface finish and different axis alignment than an SOS substrate, and is more expensive to produce. The MIC substrate will remain a premium-priced sapphire product for a long time to come."

For Union Carbide and other companies growing crystals with the Czochralski process, making a substrate entails aligning the axis of the sapphire boule with X-ray diffraction, slicing wafers, then finishing and polishing the substrate.

Another way to produce substrates, developed by Tyco Laboratories, Waltham, Mass., is through the growth of thin ribbons directly from a sapphire melt. In this process a molybdenum rectangular rod with a central capillary tube is mounted vertically in a crucible. Capillary action causes molten sapphire to rise through the tube and spread across the upper face of the rod. The shape of this surface determines the cross-sectional shape of the crystal. When a sapphire "seed rod" is brought into contact with the molten material and slowly pulled upward, a sapphire crystal ribbon is formed of any desired length. The ribbon is then cut and polished to form the MIC substrate.

The main alternative to sapphire—which is used for all thick-film work and the majority of thin-film circuits—is a high-purity alumina ceramic. Making a fine-grained substrate that doesn't re-

quire extensive polishing means that the producer must use an expensive fine-grain alumina powder as raw material. Powders are now available with particle size smaller than 1 μ .

According to Dean Heil, principal development engineer with Coors Porcelain Co., Golden, Colo., the MIC market is putting a strain on the ceramics houses, which are trying to produce fine alumina ceramics at a price MIC houses will pay. Heil explains:

"First, we have to contend with customers who measure the surface finish using various methods—sometimes producing a 100% difference in measured surface between their figures and ours. We also have to deal with variations in particle size and characteristics

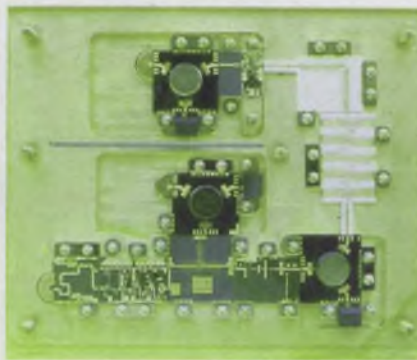

A microwave frequency down-converter from Hewlett-Packard combines ferrite, ceramic and sapphire substrates on an aluminum carrier plate.

from our powder suppliers—which determine what our ceramic will be."

The initial surface is very important, since ceramics are more difficult to polish than single crystals. As Heil points out: "It is really a problem to polish ceramics. Since the material is polycrystalline, finishing is really a ripping-and-tearing process at the microscopic level."

Available alumina ceramics are getting better, with more consistent electrical characteristics and finer surfaces. The 3M Electronic Products Div. (formerly American Lava), Chattanooga, Tenn., produces its ALSiMag 805 ceramic with an unpolished 1 μ in. surface finish.

Research has been done to achieve a finer finish on alumina with the use of glazes, but the results have been variable. Jim Wade, marketing manager for 3M notes: "Glazed substrates suffer from meniscus at edges and holes, reduced thermal conductivity and variations in glaze thickness, causing a variable dielectric constant."

Most MIC designers overspecify the surface finish on substrates, according to Dr. Crescenzi of Watkins-Johnson. He says: "As long as there are no gross surface defects—such as scratches or pits—a 2- μ in. finish will perform just as well as an optically polished surface, even at 8 GHz. Sapphire is still very nice to work with, from a processing point of view; it doesn't absorb and release vapors during thin-film processing. But if MIC designers would use a reasonable surface finish, they could get material at a much better price."

Conductors: Thin or thick films?

Building a MIC with thin-film technology is much like making a monolithic integrated circuit. Conductors are formed by deposition of thin films of metal—gold or copper over chromium, for example—followed by photoetching. Thin-film technology permits the manufacturer to fabricate capacitors and resistors by the addition of extra steps to the process. Conductors can be spaced as close as a mil, with line widths controlled to 0.1 mil. Thick film, on the other hand, uses screen printing to lay down conductive paths of gold paste. Thick-film conductors tend to be rougher, with line definition on the order of 10 to 20 mils and a proportionately larger minimum spacing.

Western Microwave, Sunnyvale, Calif., builds many thick-film circuits, including a variety of mixers, passive circuits and subsystems from 1 GHz to above 12.5 GHz, as well as ferrite circulators and isolators with microstrip compatible tabs. John P. Watien, staff engineer, sums up the tradeoffs between thick and thin-film circuits:

"Thick-film is well suited to high-yield production. It takes far fewer steps to screen conductors on a substrate than to deposit and



BOURNS®
New, Low-Cost
Cermet
Trimming
Potentiometer
outperforms
the other
“small-change”
models!

Bourns super cermet performance delivers again. Our new Model 3352 trimming potentiometer handles more power . . . takes more shock and vibration . . . has a lower CRV . . . and is easier to set than, for example, the “Model 91”. Naturally, Bourns super cermet performance is comparably priced. You can depend on it.

The 3352 is a 3/8" diameter, single-turn device with an easy (but stable) three-way thumbwheel adjust. It can be wave-soldered, and withstands board washing processes with minimal (1%) TR shift. The 3352 is available TODAY in a variety of pin styles to suit your requirements.

Compare performance . . . specify Bourns Model 3352. For complete details, contact your local Bourns representative . . . or the factory direct.

COMPARE PERFORMANCE

	Model 3352	Beckman Model 91
Power	.75 watts at 40°C	.5 watts at 40°C
Electrical Angle	230°	180°
Adjustability	±0.05%	±0.05%
Torque	5 oz.-in. max.	6 oz.-in.
Shock	100G's max. ±2% VRS	50G's no VRS spec.
Vibration	30G's max. ±2% VRS	10G's no VRS spec.
Contact Resistance Var.	1%	2%
Rotational Life	200 cycles	200 cycles
Temp. Range	-55°C to +125°C	-55°C to +125°C



*Nobody knows more about
trimming potentiometers than we do*



etch, and requires less equipment."

But as the frequency of the circuits increases, the economy of thick film is offset by physical limitations, he notes. "It is impossible," Watjen says, "to control the line definitions as closely with screen-printing, and the surface of the conductors is more lossy than that with thin film. For relatively simple circuits, thick film works fine through S band (5 GHz), but inside a precisely designed amplifier, its usefulness would cease long before that."

Hewlett-Packard's Microwave Components Group produces MICs for use inside HP test equipment, and it uses thin film exclusively at all frequencies. According to Douglas A. Gray, engineering manager: "We found that any cost advantage in thick film is lost by having to support two production areas. Since we do everything in thin film and use thin-film capacitors and resistors whenever possible, we find thin film just as economical as thick film, even for simple or lower-frequency circuits."

Many companies using thin film for production of MICs rely on an outside metalization service that offers specialized facilities and experience. One such company is Tek-Wave Inc., Somerville, N.J., which, in addition to metalization, also does finishing and polishing of substrates, etching, packaging and other services.

"The bulk of MIC manufacturers," says a Tek-Wave spokesman, "can save time, money and headaches by dealing with an outside service that buys, tests, polishes and deposits their substrates. Besides knowing how to deal with the suppliers, a company such as ours has specialized test equipment to assure quality control all along the line. Such equipment and knowledge are really outside the area of designing and testing microwave circuits, which the MIC houses are best equipped to do."

What makes MICs so appealing?

The basic microstrip transmission line is relatively straightforward. The problems arise in interfacing microstrip to active components, such as transistors. The parameters of a transistor vary

with dc voltage levels, signal levels, and frequency, making interface over a wide signal range far from simple.

The MIC designer solves his problems by using equipment and techniques not always available to engineers, such as automatic network analyzers and computer-aided design. Nick Jansen, engineering product line manager of MICs at Microwave Associates, Burlington, Mass., tells how the procedure is applied to a transistor amplifier:

"First, you take a transistor and put it into a carefully designed test fixture and characterize the S parameters, using a network analyzer. Then you take the para-

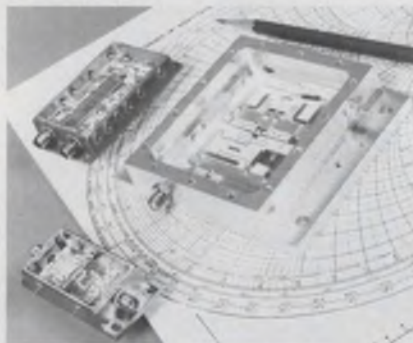

A 9.2 to 9.8 GHz parametric amplifier from AIL is fabricated on a YIG substrate. The pump oscillator is not shown in the photo.

meters and put them into a network-synthesis computer program. By setting certain parameters and letting the program minimize error functions, you arrive at a number of compromise solutions for making the part work over the necessary bandwidth."

In a typical case, matching a transistor to a circuit might entail adjusting input and output matching stubs, varying bias networks, using emitter feedback loops and sometimes even paralleling transistors to achieve the necessary gain-bandwidth product.

Although an engineer can, for perhaps \$20, buy the parts for a wideband MIC amplifier that sells for over \$100 and assemble the parts himself, he is faced with a long process of design and testing. In the MIC amplifier the costs are spread over many parts instead of a few. As Bechtel of Fairchild says:

"A good engineer can design a

narrow-band amplifier and build it cheaper than a MIC. However, if he is dealing with an octave of bandwidth and requires low noise and constant impedance and VSWR, he had better look carefully at what is available in MICs."

MICs, in their simplest sense, are simply integrated counterparts of existing microwave circuits, and are used in the same way. A directional coupler, amplifier or oscillator is replaced with a MIC. The engineering manager looking at the change generally approves for one of three reasons: reduction in size, increase in performance or cost saving.

Perhaps the greatest proportion of MICs being produced and sold are the 1-to-6-GHz amplifiers and passive components and mixers up to about 16 GHz, but the technology is being applied in a number of other interesting ways.

One important commercial use of MICs is in distribution amplifiers for cable television. Such amplifiers must not only meet stringent standards of performance set by the cable TV industry, but must be cost-competitive as well.

A typical example of MIC cable-television amplifier performance is the Motorola MHW 526. It provides about 16 dB gain from 40 to 300 MHz, with a 10-dB noise figure and a gain flatness of about 0.1 dB across the band. A "super" cable amplifier from TRW Semiconductors, Lawndale, Calif., provides 33 dB across the same band, with 0.5 dB flatness and 7.5 dB NF.

Another application of MIC technology becoming increasingly more common is in power amplifiers for telemetry and data-link microwave work and vhf-uhf mobile radio transmitters.

The simplest power MIC is a transistor with impedance matching and protective circuitry. An example is the Gigamatch line from RCA's Solid State Div., Somerville, N.J. These units are packaged in stripline-compatible, heat-dissipating cases and contain a power transistor, input-matching network and emitter ballasting for protection from overdrive and mismatch. Units in this line handle up to 30 W at 4.2 GHz with 4-



Bendix goes square and rectangular, too.

Printed circuit board connectors. Mother/daughter PCB terminations. Center connectors. Miniatures. Subminiatures. ARINC. You name it and chances are Bendix has it. Because now, Bendix is a source for a wide range of square and rectangular connectors.

You can choose from a wide range of contacts as well. Crimp-type rear removable. Solderless wrap. Solder termination. Floating. Straight or right angle.

Choose from a wide range of connector styles and contact variations.

All this means if you're in computer main frame, communications equipment, avionics or automotive electronics, Bendix probably has just the connector you need.



Fact is, we could write a book about our square and rectangular connectors so we've done precisely that. Why not send for it? It gives you over 70 pages of ways to go square and rectangular, too. Write: The Bendix Corporation, Electrical Components Division, Sidney, New York 13838.

Bendix

to-7-dB gain.

Collins Radio, Dallas, Tex., produces the Models 648U-20 and 648U-50—225-to-400-MHz power modules packaged in rectangular flange-mounted cases with SMA input and output connectors. The 648U-20 provides 20-W rf output with 30-dB power gain, and the 648U-50 offers 50-W rf output with 6-dB gain. Collins has also introduced a 100-W unit of planar construction with the substrates mounted on a plate.

Among the other companies producing power modules are RCA, TRW Semiconductors and Motorola.

Power circuits represent the main MIC application of beryllia, which serves either as a heat-conducting pad under power transistors or as a substrate for the entire power stage. X-band amplifiers have been produced with MIC techniques, too.

The AIL Div. of Cutler-Hammer, Melville, N.Y., has developed a 9.2 to 9.8-GHz parametric amplifier with a 30-GHz Gunn-diode pump oscillator. The amplifier is for Air Force use as a general replacement for more expensive parametric amplifiers (the projected price in large quantities is about \$200). It is also intended for phased-array antennas, where an amplifier can be incorporated behind each element.

The parametric-amplifier stage is fabricated on a YIG substrate, so a circulator can be formed by metalization rather than by use of a "drop-in" part. The oscillator, using a resonant cavity and a Gunn diode mounted on a Teflon-fiberglass substrate, is in a separate box. The over-all performance of the unit is 14-dB gain at the center frequency, with a bandwidth greater than 100 MHz.

Conventional MICs using microstrip circuitry are rapidly approaching their maximum operating frequency as a result of two factors. First the bipolar transistors in amplifiers are good only up to about 6 to 8 GHz; then the geometry of the transistor—the size decreasing with frequency—becomes too small to produce.

The size of the transistor's geometry—which affects the transit time within the structure—is proportional to the velocity of the

electrons. With the current state of the art, a 1- μ metalization width is possible, which creates the 6-to-8-GHz limit for silicon bipolar transistors.

Several manufacturers are planning to introduce the gallium-arsenide FET in MIC amplifiers sometime this year, and this will increase the upper useful frequency to 12 GHz and beyond. The higher operating frequency possible with the GaAs FET stems from the fact that the electron velocity in GaAs is at least twice that in silicon. With the currently practical 1- μ metalization, the op-

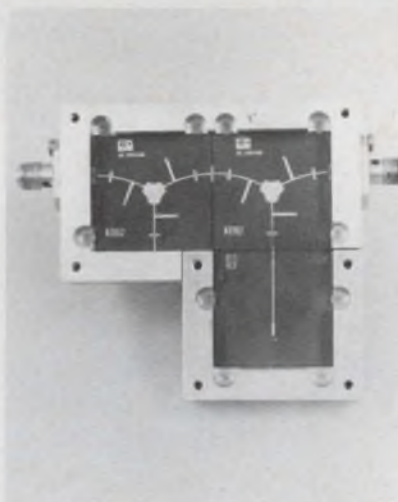

Wideband 200 to 400-MHz power amplifier modules from Collins Radio use beryllia substrates. Some newer modules are built on aluminum carrier plates.

erating frequency is about doubled, with no increase in geometries.

The other limiting factor that applies to mixers and passive MICs as well as transistor amplifiers is substrate thickness and surface finish. As the operating frequency is increased, the width of the conductor and the thickness of the dielectric must be decreased to maintain impedance and hold down dielectric losses. Even with a quartz substrate, which has a dielectric constant about two-thirds that of sapphire, above about 20 GHz the lines become too narrow and the substrate too fragile to produce circuits.

At about 20 GHz or so, the MIC technology takes new forms and

is combined with resonant cavities to become a component in waveguide systems. One example is the 30-GHz pump oscillator used in the AIL parametric amplifier, which has the Gunn diode mounted on a substrate but depends on a cavity, or "fin lines," for operation. Bell Laboratories is doing work on 40-to-100-GHz waveguide systems that use conductors on substrates to couple energy into and out of mixer diodes.

Watch those spec sheets

Most of the specifications of MIC parts are well understood by a microwave engineer. Passive components still have the same parameters of losses, front-to-back ratios, operating frequencies and VSWRs. YIG or voltage-controlled oscillators are still rated by frequency, stability, operating voltages and output levels.

The most troublesome component to specify is usually the MIC amplifier. In addition to worrying about its size and cost, a designer has to keep his eyes open when looking at the specifications; otherwise his system performance may be totally inadequate. Here are some things to watch out for in the amplifier spec sheets:

- Noise figure across the entire operating frequency range.
- Gain flatness across the band (± 1 dB is fine, ± 0.5 dB is available).
- Operating temperature range.
- Intermodulation (with changes in frequency and signal levels).
- VSWR (usually varies with frequency, sometimes worse in high-gain amps).
- Gain/phase matching with changes in frequency and temperature.

As Avantek's president, Thielen, puts it: "There is specsmanship with MIC amplifiers, just as with any complex part. It is hard to balance all the various parameters in an octave-band, low-noise amplifier—and that is exactly what the customer is paying for. Only attention to detail and care in design as well as the best possible parts and construction can produce a really good MIC circuit." ■■

Why The Danameter is selling like hotcakes.

One-Year Battery Life.

In a digital instrument, you'd expect to fool with a battery regularly, recharging it or replacing it.

Not with The Danameter. The battery will last you at least one year. And even if you find a way to wear it out, you're only talking about 69¢.

Liquid Crystal Readout.

With an analog voltmeter, accuracy depends on how well you can interpret.

With The Danameter, the liquid crystal display shows precisely the information you require in large digits. It adjusts to all light conditions. Even direct sunlight.

And it's accurate to a degree you never imagined possible in an instrument at this price.

Automatic Polarity.

You don't swap leads with The Danameter. Because the

digital display shows you instantly whether the polarity is positive or negative.

Almost Indestructible.

The Danameter has only one function selector. It's recessed behind the molded edges of its cyclac case. You can drop it on concrete. You can kick it down the hall. When you pick it up, it'll be working perfectly.

It's the first true portable instrument of its kind.

And it's only \$195.

Call your Dana sales rep toll-free at 800-645-9200. In New York, phone 516-294-0990. In Europe, call 02-41 45 50.



DANA

Others measure by us.

The first name in counters is not the counter you name first.

We aren't as well known for our counters as we are for our digital multimeters. But we should be. Because we make some of the best counters available for the money.

The nine models in our 8000B/8100 series feature measurements such as frequency, period, multiple period, time interval, time interval average and totalize modes.

A standard 8-digit display provides high resolution measurements. Models feature 10 nanosecond resolution for single shot time events along with 150 picosecond resolution for repetitive events.

ATE. For more accurate waveform parameter testing, the counters feature digitally programmed trigger-level resolution of .05 volts and trigger-level hysteresis compensation.

Communications. For low-level, high-frequency measurements, sensitivity as high as one millivolt at 500 MC is featured. Counters also employ a 150 MC direct count capability.

Yet prices start at \$1,390. So before you talk to the biggest name in counters, talk to the best. Contact your Dana sales representative by calling toll-free 800-645-9200. In New York, phone 516-294-0990. In Europe, call 02-41 45 50.



DANA

Others measure by us.

It takes a Hi-Rel supplier to deliver Hi-Rel products

If your system requires high-reliability integrated circuits, you need a real high-reliability supplier—and ITT is the logical choice. We are a leader in exact compliance with the screening requirements of MIL-STD-883. We were the first semiconductor company to fully qualify circuits under MIL-M-38510. We have one of the industry's broadest lines of MIL-M-38510 qualified devices. Inventories of these parts are available right now—at our plant and at our distributors. What's more, if MIL-M-38510 and MIL-STD-883 don't fit your idea of high reliability, tell us about your specs. We have the custom circuit capability to meet them. Get technical data and shipment dates from the place that's dedicated to hi-rel IC production. Write ITT today.

ITT...Logically

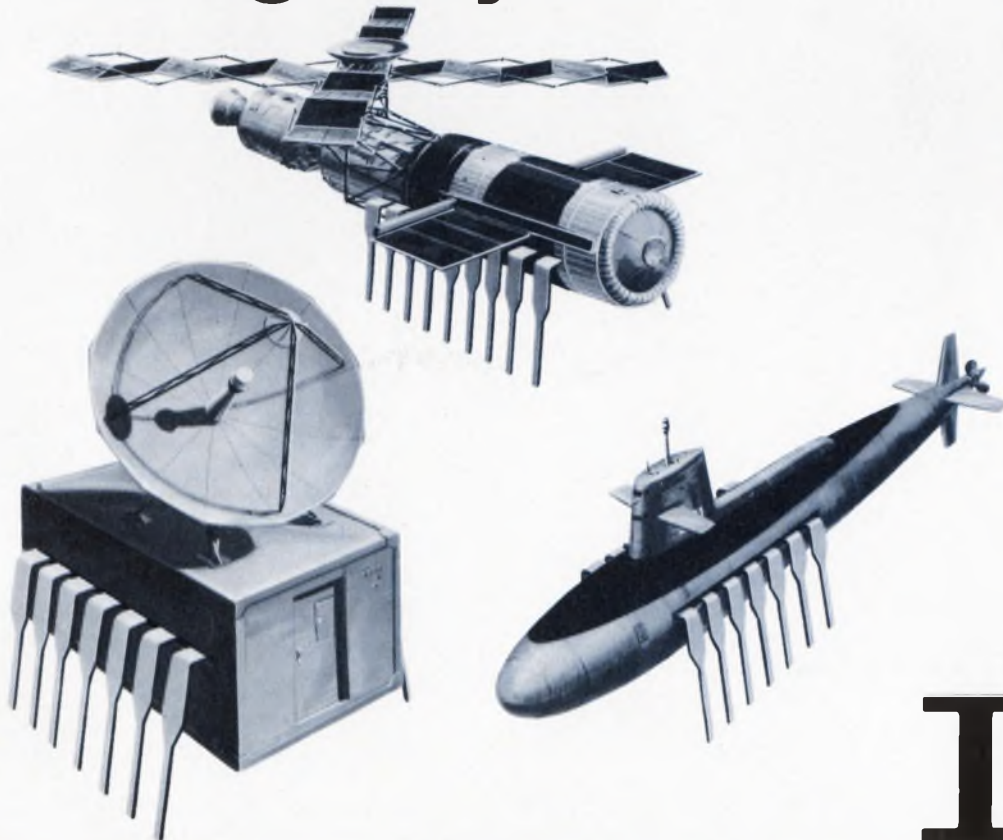

semiconductors

ITT Semiconductors is a division of International Telephone and Telegraph Corporation, 3301 Electronics Way, West Palm Beach, Florida 33407. Phone 305/842-2411. Factories in West Palm Beach, Florida • Lawrence, Massachusetts • Footscray, England • Colmar, France • Freiburg, Germany • Cascais, Portugal • Taipei, Taiwan • Sydney, Australia.

ITT

MV5050-series GaAsLITEs: Worth looking into.

Viewing angle for various devices ranges from 50 to 110 degrees. Choose from full-flooded diffused, or pinpoint lens effects, either red or clear.

High brightness GaAsP chip is eutectically bonded to header.

The virtually unbreakable "bulb" can take temperatures up to 125°C without deforming. It's made from a unique formulation of a modified bisphenol Type A epoxy system.

Bendable, solderable, wire-wrappable leads are plated copper for best heat transfer and stability characteristics. They mount easily in PC boards on 100-mil centers.

Long life and shock resistance are inherent to the GaAsLITE design. No filament or glass to break. .001"-dia. gold connecting wire is bonded by thermo-compression to die and anode lead, and encapsulated.

Automated handling becomes a possibility with a new cylindrical barrel design that makes the MV5050-series lamps fit precisely into .200-inch aperture. Flattened flange, denoting cathode, speeds handling.

Installation is a snap with our mounting grommet, supplied on request at no extra cost.

Six solid-state indicator lamps

Three solid-state illuminators

Here's our newest family of low-cost, long-life solid-state indicators and illuminators. They're all IC-compatible and use new high brightness materials. Like all our GaAsLITEs, they shine with very little power and are a snap to design into your equipment. Compact, rugged and reliable, the MV5050-series gives you the widest selection of lens effects in the industry. Pin-point. Soft diffused. Flooded. And your choice of viewing angles. All the details are on the data sheet.

For illumination, our MV5054-series GaAsLITEs use high-performance GaAsP to light up a 1/4"-dia. circle. Choice of three brightness levels. And the MV5054-1 has a *new reduced price*. For complete specs and pricing information, ask any of our distributors or write **Monsanto Commercial Products Company** Electronics Special Products 3400 Hillview Avenue Palo Alto, CA 94304 (415) 493-3300/

Putting innovation to work

Monsanto

INFORMATION RETRIEVAL NUMBER 215

30 AMP CENTER TAPPED Silicon Integrated Rectifiers



Three new series in TO-3 cases

Three New Series:

A controlled avalanche (R702, 704, 706); non-controlled avalanche (R711, 712, 714, 716) and a fast recovery time series (R711X, 712X, 714X, 716X).

Advanced Rectifier Technology:

All series feature a low (0.5°C/W) maximum thermal resistance, ($R_{\theta J-C}$). This results in greater operational reliability and longer life. The hermetically sealed TO-3 case offers ease of handling and mounting.

Specifications for a variety of applications:

Controlled avalanche versions have 200V, 400V and 600V Peak Repetitive Reverse Voltages (V_{RRM}) with 250V, 450V and 650V min. avalanche voltages (V_{BR}). The non-controlled avalanche and fast recovery (200 nsec., t_r) series have 100V, 200V, 400V and 600V (V_{RRM}). All units are rated at 15 Amps per diode (I_o) at 100°C, (T_c). Peak 1/2 cycle surge current, per diode (I_{FSM}), 250A (150A for fast recovery series).

Typical applications are: Power supplies, inverters, ultrasonic systems, choppers and low RFI systems.

Three Circuit Configurations:

Center tapped common cathode, case positive; common anode, case negative and a doubler circuit.

Typical low pricing: R711, \$0.93 ea., 1000 quantity.

AVAILABLE CIRCUITS

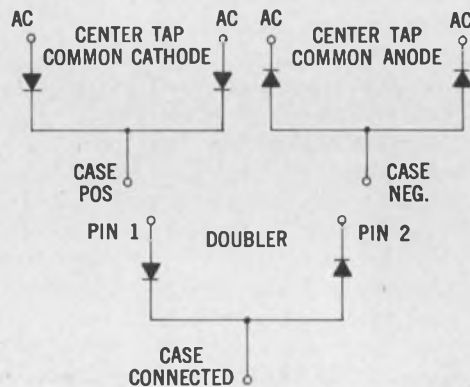

Design us in . . . we'll stay there

VARO

VARO SEMICONDUCTOR, INC.

P.O. BOX 676, 1000 N. SHILOH, GARLAND, TEX. 75040 (214) 272-4551 TWX 910-860-5178

Varo Sales Representatives

AL Buchanan & Abrams Assoc. 305-898-7444 • AZ W. W. Posey Co. 602-949-5873 • AR Whiteside Sales 214-231-9771 • CA (NO) W. W. Posey Co. 415-948-7771 • CA (SO) Corcoran Assoc. 213-823-4589 • CT Comp Rep Assoc., Inc. 203-239-9762 • DE Tom Davis Marketers 302-998-0123 • FL Buchanan & Abrams Assoc. 305-898-7444 • GA Buchanan & Abrams Assoc. 305-898-7444 • IL (NO) Varo Semiconductor Inc. 312-627-3802 • IL (SO) Beneke & McCaul 314-567-3399 • IN Technical Reps, Inc. 317-546-4967 • KS Beneke & McCaul 314-567-3399 • KY Technical Reps, Inc. 317-849-6454 • LA Whiteside Sales Co. 214-231-9771 • ME Comp Rep Assoc., Inc. 617-444-2484 • MD Tom Davis Marketers 703-591-7390 • MA Comp Rep Assoc., Inc. 617-444-2484 • MI Davis-Martensen Co. 313-474-8300 • MN Loren F. Green Assoc. 612-781-1611 • MS Buchanan & Abrams 305-898-7444 • MO Beneke & Caul, Inc. 314-567-3399 • NJ (NO) Cooper-Simon & Co. 516-487-1142 • NJ (SO) Tom Davis Marketers 302-998-0123 • NM W. W. Posey Co. 302-998-0123 • NY (METRO) Cooper-Simon & Co. 516-487-1142 • NY (UPST) Bob Dean, Inc. 607-272-2187 • NC Buchanan & Abrams Assoc. 704-332-4974 • OH (NO) J. C. Hofstetter Co. 216-241-4880 & 216-725-4477 • OH (SO) J. C. Hofstetter Co. 513-296-1010 • OK Whiteside Sales Co. 214-231-9771 • OR C. K. Shanks & Assoc. 503-292-5656 • PA (E) Tom Davis Marketers 302-998-0123 • PA (W) J. C. Hofstetter Co. 412-561-5454 • RI Comp Rep Assoc., Inc. 617-444-2484 • SC Buchanan & Abrams Assoc. 704-332-4974 • TX Whiteside Sales Co. 214-231-9771 • VA Tom Davis Marketers 703-591-7390 • WA C. K. Shanks & Assoc. 206-632-4290 • WI Varo Semiconductor, Inc. 312-627-3802 • CANADA • ONT Cantronics, Ltd. 416-661-2494 • QUE Cantronics, Inc. 514-733-0749

INFORMATION RETRIEVAL NUMBER 30

Newer electronics helping police short-circuit crime at the source

The narcotics dealer has just picked up his latest shipment of heroin. He's not too worried about getting caught. On the car seat next to him as he pulls away is a police radio receiver that he bought at a local radio store. The receiver tips him off if the cops are on his tail. It allows him to avoid any roadblocks being set up.

But today the receiver is giving off strange noises, and just ahead he sees a police roadblock. Patrol cars are closing in behind him, too. How did this happen?

It happened because the police had an electronic speech scrambler, a device that makes voice transmissions unintelligible to people without decoding equipment. It's only one of the many electronic aids law-enforcement agencies are using with increasing frequency to outwit criminals.

In the last few years significant progress has been made in applying electronic technology to law enforcement. Much of this progress is in communications, where scramblers and digital techniques have become very attractive.

Electronics is also being used to produce composite photographs of suspects, to sort and identify fingerprints and to detect explosive and narcotic substances.

But with all the advances, there are still some areas where the development of electronic equipment has not kept up with the needs of law-enforcement agencies.

For example, small, reliable, low-cost transmitters are needed for concealment on the body of undercover agents. Accurate vehicle-location systems are sought to keep tabs on available manpower or to



Hard-copy readout is provided as part of Motorola's Command and Control digital-communications system. It minimizes the chance of error in the dispatching of officers to a particular location.

track escaping criminals.

Law-enforcement agencies throughout the U.S. are finding it increasingly difficult to carry on private conversations on their radio networks. Police communications are easily intercepted by both casual eavesdroppers and lawbreakers equipped with inexpensive police-band receivers.

Low-cost scramblers sought

To overcome this problem, it is only natural for the police to turn to scramblers. But some law-enforcement officials are unhappy with the performance of present low-cost scramblers. According to Detective Owen Greenspan of the Applied Technology Unit of the New York City Police Dept., the cheaper units are generally too simple to afford a high degree of

privacy, while the complex units that do guarantee privacy are generally too expensive to be widely used.

"What we need is a cheap scrambler that offers high security," Greenspan says.

Arnold M. McCalmont, president of Technical Communications Corp., Lexington, Mass., disputes Greenspan. Low-level scramblers, McCalmont says, can be very effective in police work. He notes that while it is indeed possible to decode low-level devices fairly easily, one must have the proper equipment to do it. The average criminal, he argues, is not going to haul a truckload of decoding equipment around; he's going to carry a little monitor.

Digital-communication systems are also finding increasing support among law-enforcement agencies.

Jules H. Gilder
Associate Editor

COMPLETE

10 BIT DAC

ON A SINGLE CHIP!

SIMPLIFIED SCHEMATIC AND PIN CONNECTION DIAGRAM

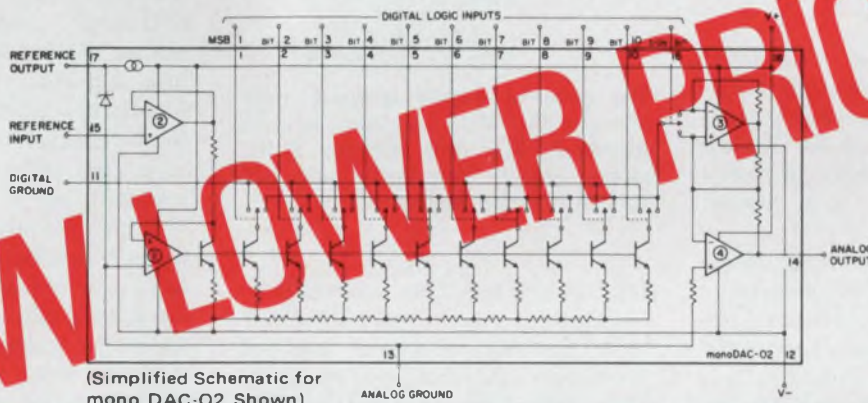

(Simplified Schematic for mono DAC-02 Shown)

A complete 10-Bit plus Sign D/A Converter on a single chip! No need to add complex external precision voltage references or output operational amplifiers . . . it's all there, tested and ready to go . . . and, every device is 100% tested for monotonicity at 0°, 25° and 70°C and receives a 72 hour high-temperature powered burn-in to insure the ultimate in quality and reliability. The monoDAC-02's flexible Sign/Magnitude coding allows use in both unipolar and bipolar applications and the

logic inputs are compatible with TTL and CMOS levels . . . external reference capability further broadens application versatility. The monoDAC-02 provides fast 1.5 usec settling, low 225mV power consumption and puts it all together in a compact 18-pin DIP . . . and the best part of the story is monoDAC-02's new, lower prices . . . they're waiting for you at your Precision Monolithics stocking distributor . . . call him today!

	Resolution	Monotonicity (Guaranteed, 0° to 70°C)	Price @ 100 pcs.
monoDAC-02DDU1	10-bits + sign	7-bits	\$15.00
monoDAC-02CCU1	10-bits + sign	8-bits	\$20.00
monoDAC-02BCU1	10-bits + sign	9-bits	\$30.00
monoDAC-02ACU1	10-bits + sign	10-bits	\$60.00



**PRECISION
MONOLITHICS
INCORPORATED**

1500 SPACE PARK DRIVE, SANTA CLARA, CALIFORNIA 95050
TEL. (408) 246-9225 • TWX 910-338-0528 • CABLE MONO

AUTHORIZED DISTRIBUTORS:

NEW YORK METROPOLITAN AREA Harvey Radio, Woodbury, N.Y.: (516) 921-8700 • NEW ENGLAND AREA Gerber Electronics, Dedham, Mass.: (617) 329-2400 • UPSTATE NEW YORK Harvey Federal Electronics, Binghamton, N.Y.: (607) 748-8211 • NORTHEAST Newark Electronics, Woburn, Mass.: (617) 935-8350 • BALTIMORE-WASHINGTON Whitney Distributors, Baltimore, Md.: (301) 944-8080 • PENNSYLVANIA Hallmark Electronics, Huntingdon Valley, Pa.: (215) 355-7300 • Pioneer/Pittsburgh: (412) 391-4846 • MICHIGAN RS Electronics, Detroit, Mich.: (313) 491-1000 • SOUTHEAST Kirkman Electronics, Winston-Salem, N.C.: (919) 724-0541 • EAST CENTRAL Pioneer/Cleveland, Cleveland, Ohio: (216) 587-3600 • Pioneer/Dayton, Dayton, Ohio: (513) 236-9900 • CENTRAL Hallmark Electronics, Elk Grove Village, Ill.: (312) 437-8800 • Minneapolis, Minn.: (612) 884-9056 • St. Louis, Mo.: (314) 521-3800 • TEXAS-OKLAHOMA Sterling Electronics, Houston, Texas: (713) 623-6600 • Dallas, Texas: (214) 357-9131 • SOUTHWEST Sterling Electronics, Albuquerque, N.M.: (505) 345-6601 • Phoenix, Ariz.: (602) 258-4531 • WEST Westates Electronics Corp., Chatsworth, Calif.: (213) 341-4411 • Sunnyvale, Calif.: (408) 733-8383 • Intermark Electronics, Sunnyvale, Calif.: (408) 738-1111 • Denver, Colo.: (303) 936-8284 • Salt Lake City, Utah: (801) 486-3411 • San Diego, Calif.: (714) 279-5200 • Santa Ana, Calif.: (714) 540-1322 • Almac-Stroum, Seattle, Wash.: (206) 763-2300 • Portland, Ore.: (503) 292-3534 • CANADA Intek Electronics, Vancouver, B.C.: (604) 324-6831.

INFORMATION RETRIEVAL NUMBER 31

These systems provide a more efficient way to communicate and can alleviate congestion, the main problem with current voice radio networks.

According to Marshall J. Treado, program manager of communications systems for the Law Enforcement Standards Laboratory of the National Bureau of Standards, congestion on voice channels is so bad that if a patrolman wants to transmit a message, he often must wait several minutes before he can get through. That's not so bad if it's just a routine message, but if the officer is in trouble and needs help, it could be a matter of life or death.

Digital radios wanted

Congestion can be eliminated with digital-communication techniques, Treado says, because information is transmitted at higher rates. Consequently more information can be handled in a digital system.

Another big plus for digital communications is its inherent security. In a recent study performed for the Law Enforcement Standards Laboratory by Urban Sciences Inc., Wellesley, Mass., 80% of those responding indicated that security was a major reason for their interest in digital systems.

Digital-communication systems offer another attraction for law-enforcement agencies, Treado reports. They can give the cop on the street direct access to local, state and Federal data banks on crime. The information can be accessed by mobile computer terminals.

Such terminals come in all shapes



The smallest mobile terminal available is the MCT-16 from Atlantic Research. The unit features a full alphanumeric keyboard plus 10 special-function keys.

and sizes. They may use cathode-ray tubes, plasma panels, light-emitting-diode arrays or printers to display incoming information. They may have one-way or two-way transmission capability, and may come with an alphanumeric keyboard and coded keys.

The smallest mobile terminal currently available is put out by Atlantic Research Corp., Alexandria, Va. Called the Arcom MCT-16, the two-way, hand-held terminal is 5.25 in. wide, 11.5 in. long, 3.625 in. deep and weighs only 4 lb. The terminal comes with a mobile radio interface that matches it

to existing radio equipment.

According to William A. Shand, marketing manager for Arcom Systems at Atlantic Research, the MCT-16 terminal has a full alphanumeric keyboard plus 10 additional function keys, which can be programmed to access any computer program that the customer requires in the state or local data bank.

The terminal, Shand says, was specifically designed for law-enforcement applications, but it can be adapted for other uses. It contains an 80-character buffer memory and a 16-character dot matrix LED display. As data are entered into the terminal, the characters are displayed on the screen. When the cumulative entry exceeds 16 characters, Shand explains, the earlier entries leave the visual display and enter into memory. Upon completion of the data entry—up to 80 characters—the entire message is transmitted when the transmit key is pressed.

Other features of the MCT-16 include automatic status reporting, automatic vehicle identification, redundant message transmission, automatic acknowledgment and message hold, voice override and an emergency key.

Suspects depicted electronically

A new electro-optical device permits the assembling of a composite photo consisting of facial features from four different sample photographs. These features are manipulated until the best likeness of the suspect is achieved. The unit helps police identify suspects more quickly.

The machine, known as a Video Identification System, eliminates cut-and-paste procedures and allows witnesses to see and correct instantly images viewed on a TV monitor.

To create a montage, the operator places four pictures in magnetic mounts that are provided with the synthesizer portion of the system. The component features of each picture can then be interchanged at will by manipulation of a series of mirrors designed for eyes, eyebrows, nose, mouth, etc.

According to a spokesman for the developers of the video identification system, GBC Closed Circuit

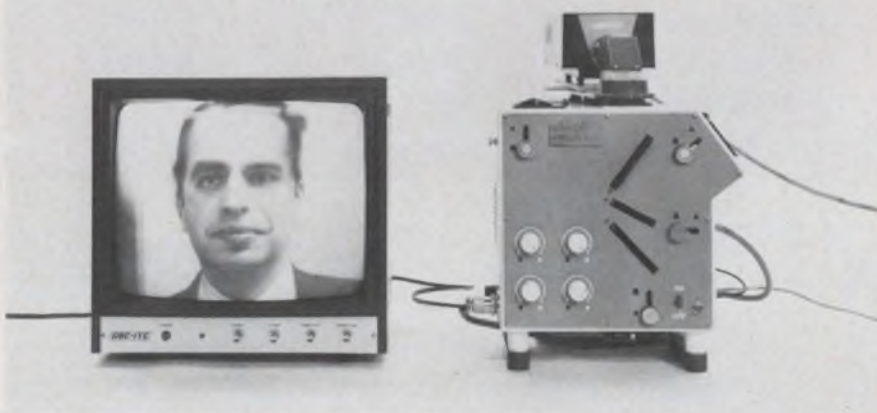

Rapid photo composition of a suspect's picture in a TV monitor is possible with the GBC Video Identification System.

THICK FILM RESISTORS COME IN MANY SHAPES!

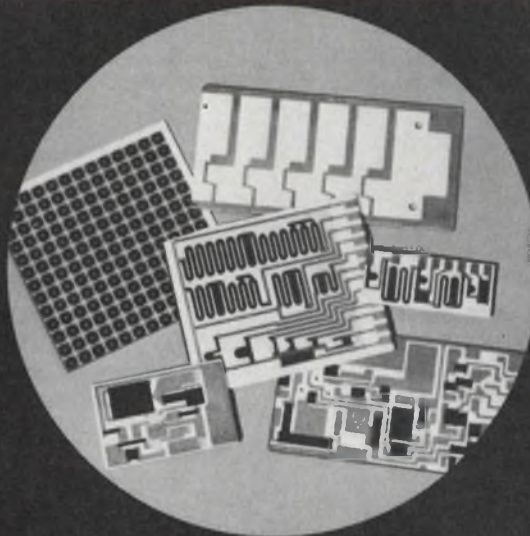
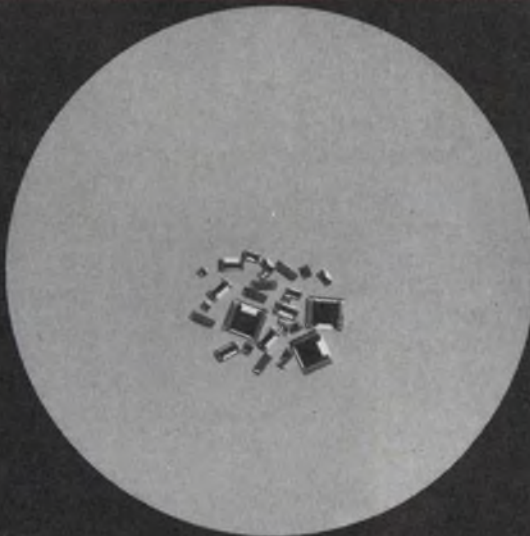
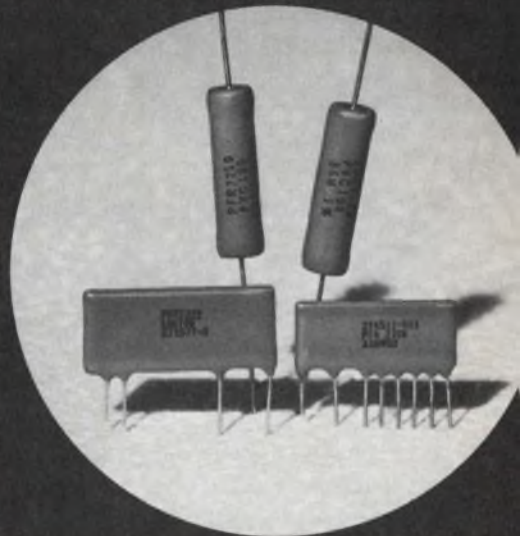
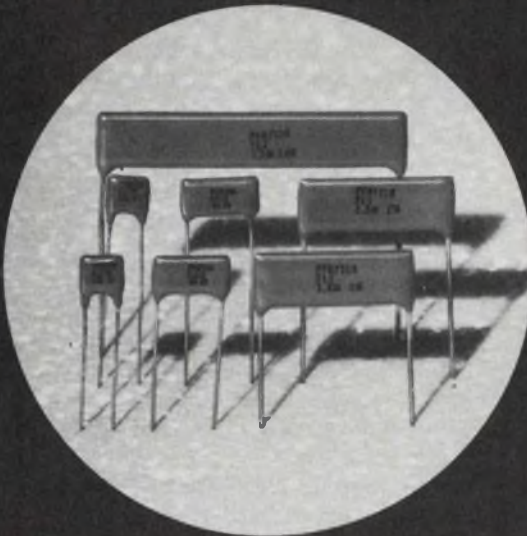
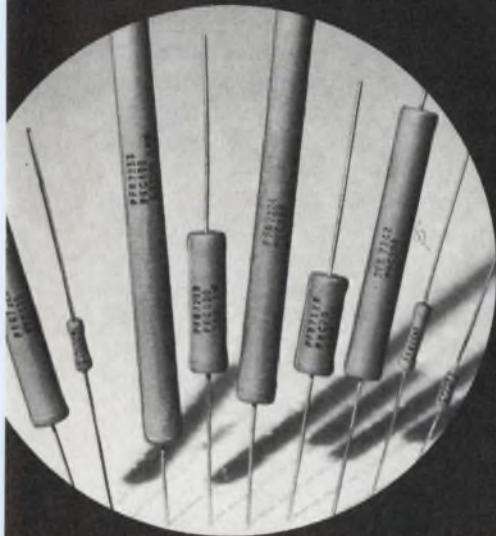

When You Specify Pyrofilm ...

PVC—High Voltage, up to 17.5 KV, up to 1000M, as low as 100 PPM/°C.

FLATSO—4 Sizes up to 10 KV, 100M. 1/2, 1/4, 1 & 2W. Tolerances: 1, 2, 5 & 10.

NETWORKS—Matched in Temp. Coefficient, Ratio and/or Tolerance.

CHIPS—6 sizes with values ranging from 10 ohms to 5 meg. ohms.

CUSTOM NETWORKS—Sure, the Pyrofilm Thick Film Resistor Line is broad...but there are times when you have a unique set of requirements. That, too, is the time to talk to the Pyrofilm people.

Setting New Standards in Reliability

PYROFILM

60 S. Jefferson Road • Whippany, N. J. 07981 • (201) 887-8100

TV Corp. of New York City, the lens system in the unit is designed to eliminate hard edges at the lines where the various elements in the montage are joined. This minimizes the need for retouching.

Special controls on the video-monitor portion of the system permit the adjustment of contrast as well as size and placement of specific details.

After the picture is composed, a photograph is made. Identifications and arrests made with this system, the police report, have shown that the final picture is often a more exact likeness of the suspect than an artist's drawing.

Computer identifies fingerprints

The use of computers to identify fingerprints is not new. The Federal Bureau of Investigation has been doing it for years. What is new is an optical computing technique that uses holograms to compare entire fingerprints, rather than the currently used discrete set of points generated from a scan of the print.

The innovation in fingerprint identification is being developed by McDonnell Douglas Electronics of St. Charles, Mo., for the New York Police Dept. According to Dr. Marvin Berkowitz, director of the Applied Technology Unit of the New York Police, the system is the first of its kind in the country and will be used to match latent fingerprints lifted from a crime scene with 130,000 fingerprints of known habitual criminals. This approach, Berkowitz says, is a significant advance over the current manual techniques used when latent prints

of only one or two fingers are recovered from a crime scene.

The automated system will be installed next month, Berkowitz adds, and it is expected to reduce the cost of matching fingerprints from about \$150 in an average case to \$75.

In describing how the system works, Berkowitz notes that the optical correlation process begins with the recording of the Fourier transform of the unknown print. This is done by production of a hologram of the lifted print. A device called a latent comparator then generates the product Fourier transform of the print and a known print on a microfilm file card. A prism is used to produce the inverse transform of the overlay of the unknown and known fingerprints. The inverse transform is proportional to the degree of similarity of the two prints, and it can be used to indicate when the known and unknown prints have a high probability of being identical.

The system, Berkowitz reports, can compare 200,000 fingerprints an hour with an accuracy of 90%. This is several times faster than manual techniques that give the same accuracy, he says.

Electronic 'nose' finds explosives

Detection of explosives is becoming an increasingly important activity for law-enforcement agencies. In the past trained dogs have been used for this work. Of late, electronic "noses," more commonly referred to as gas chromatographs, have appeared on the scene.

Gas chromatographs compare the

various vapors in air with known smells. The chromatograph samples a given amount of air, separates its various components, defines each component by type and quantity, and stores the information in memory for later comparisons.

Most chromatographs sample a relatively small amount of air, so they are not very sensitive. But a new device from Elscint Ltd., which is based in Haifa, Israel, but has offices in Palisades Park, N.J., uses a special concentrating technique. The method removes the desired vapor from several liters of sampled air, then injects the concentrated vapor into the machine for analysis.

According to Dr. Reuben Sinai, vice president of marketing for Elscint, the machine is so sensitive that suspects apprehended in an area where explosives have been planted, or where an explosion has taken place, can be examined and traces of the explosives detected hours or even days later.

Further development of the basic machine is under way, Sinai notes. An attempt is being made to develop a unit that can identify narcotics as well as provide positive personal identification by odor "fingerprints."

High on the list of equipment for which improvements are eagerly sought is the miniature radio transmitter used in undercover work.

According to Detective Gene Crimmins of the New York Police Intelligence Div. small transmitters with very high reliability are still difficult to get. Reliability is a key factor, Crimmins says, because an undercover agent's life often depends on the proper working of the transmitter. The problem, he says, is that most police officers are not technically oriented. The devices must be made user-proof. A good starting point, he suggests, is elimination of the long antenna wire.

The police also want—and fast—an accurate vehicle-tracking system. For intelligence and surveillance applications, Crimmins explains, the transmitter must be not only easily concealable on the suspect's car but must also emit directional data as well. The quality of current systems still leaves a lot to be desired, he reports.

Automatic vehicle-location sys-



Optical computing is used in this automated fingerprint-identification system from McDonnell Douglas Electronics Co.

Dramatic new product opportunities ... yours with new 3C8 ferrites

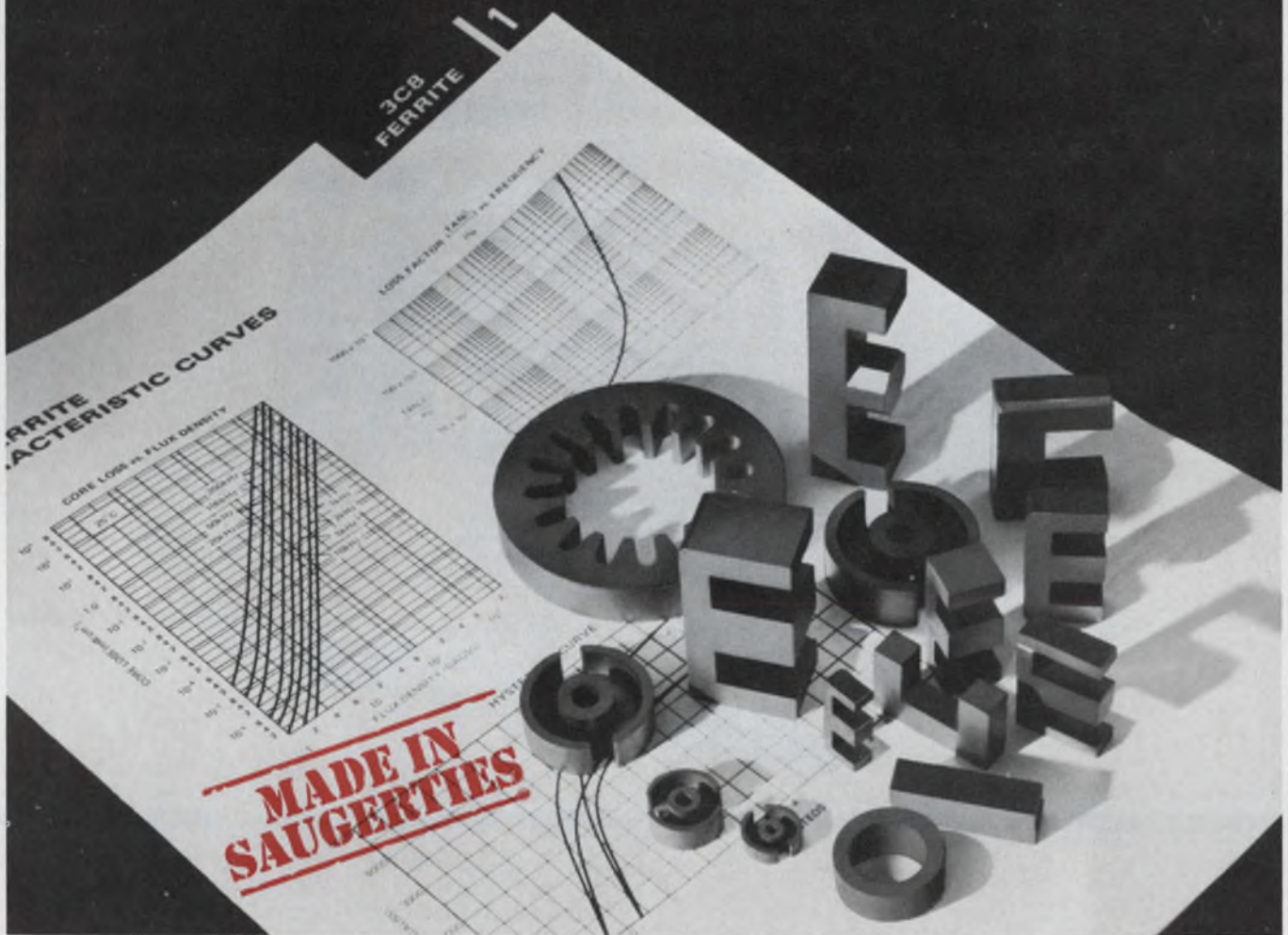

The market is ripe for product breakthroughs. Just look, for example, at the growth of such items as the handheld calculator, small camera flashguns, ultra-mini portable radios and recorders. The key to these tremendous sales successes is high frequency power conversion circuits.

And the key to still *more* efficient, high-frequency power conversion is Ferroxcube's new 3C8!

This important new ferrite material gives significantly higher flux densities at higher temperatures, and lower losses at high excitation levels than any other magnetic core material. It is available in practical size cores for use up to kilowatt power levels.

3C8 is already being used with great success in: inverters, battery chargers, fluorescent lamp ballasts,

strobe light devices for highway markers and harbor buoys, power oscillators, power amplifiers, ultrasonic generators.

In all of these circuits Ferroxcube's 3C8 material has led to greater efficiency, lower cost, less weight, and smaller sized units. In one power supply, for example, the size of the core was reduced from 13 lbs. at 60Hz to 4 lbs. at 20,000 Hz and the volume from 35 to 9 cu. inches—savings of 70 to 75%!

Can 3C8 improve your present products or suggest new products and markets for your company? If you've got the imagination, we've got the core! Call 914•246-2811, TWX 510-247-5410 or write today.

Ferroxcube linear ferrites—made in Saugerties, N. Y. and stocked in seven U. S. locations.



FERROXCUBE CORPORATION, SAUGERTIES, N. Y. 12477
A NORTH AMERICAN PHILIPS COMPANY 914-246-2811

Distributed through North American Philips Electronic Components Corporation with warehouses in Boston, 617•899-7100; New York, 516•2300; Saugerties, 914•246-5861; Philadelphia, 215•836-1616; Chicago, 312•593-8220; San Diego, 714•453-5440

INFORMATION RETRIEVAL NUMBER 33

Digital Timing Measurements The Easy Way.....

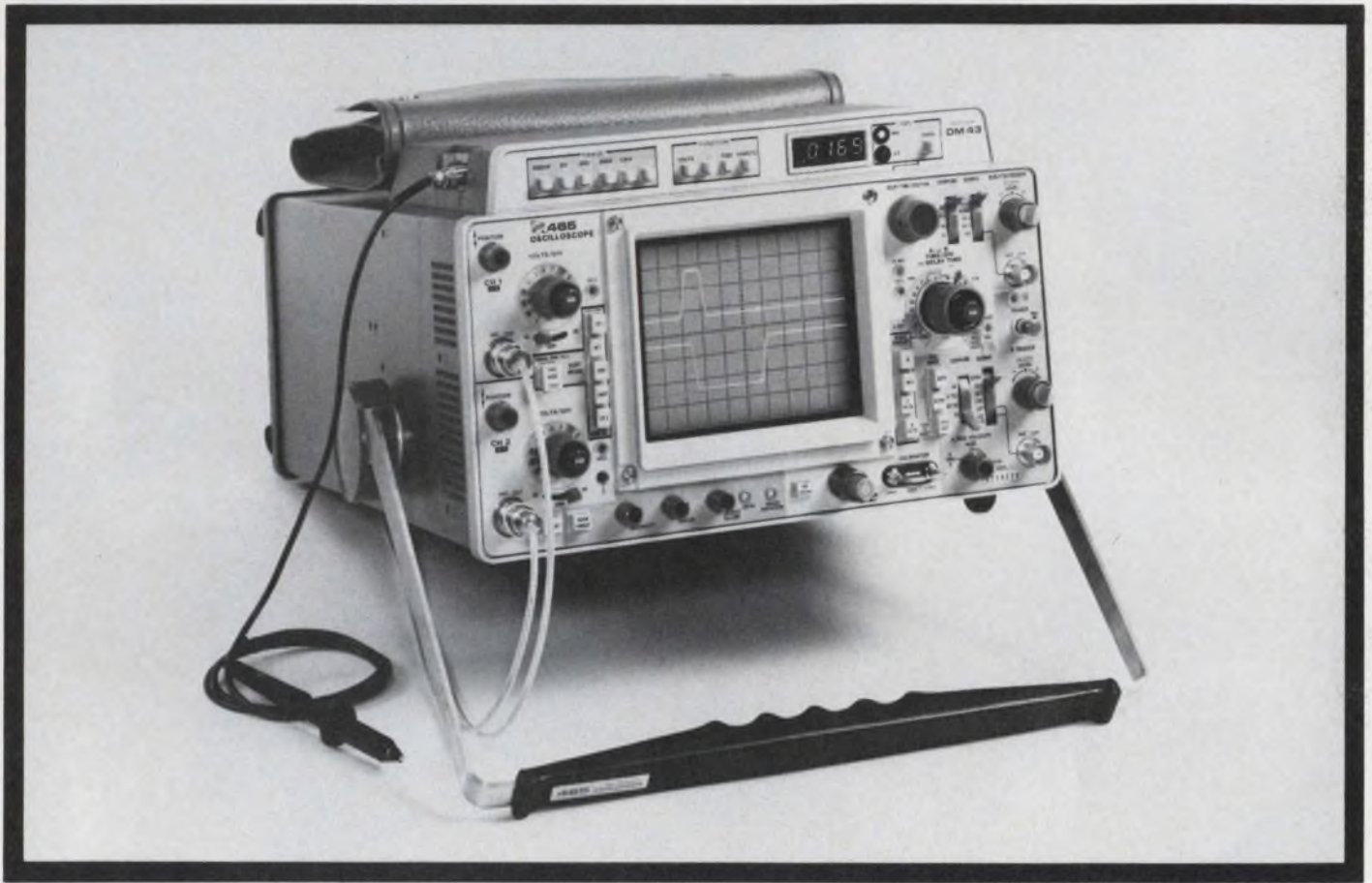

Digital timing measurement with improved resolution, 1% accuracy, increased freedom from error, faster operation, and greater operator convenience. The new TEKTRONIX DM43 with its unique direct numerical readout of time intervals adds all of these advantages to the field proven 465 and 475 oscilloscopes. What's more the DM43 includes precision digital meter capabilities as well. The DM43 is also available in the new 466 and 464 Fast Storage Portable Oscilloscopes. The DM43 provides a direct numerical readout of the time between any two points on the oscilloscope screen selected by the delay time position control. 3½ digit resolution and the 1% accuracy of the DM43/oscilloscope combination provide

convenient measurement of critical digital system timing in field servicing, in production, and in the design lab. Speed of measurement, freedom from error, and operator convenience are all improved since no dial readings or mental calculations are needed to arrive at a final reading.

Dc voltage measurement with an accuracy of 0.1% from 0 to 1200 V, resistance measurement within 0.75% over the range 0 to 20 M Ω , and the convenience of temperature measurement with a probe over the range -55°C to +125°C add still more to the versatility of the DM43. In field servicing, in production, and in design laboratory applications the DM43/Portable Oscilloscope combination provides the capability to meet almost any measurement need, and it's all in one compact package which can easily be carried wherever tests must be made.

With all of its added features the DM43/Oscilloscope combination is priced only \$475 above the price of the oscilloscope alone. A second model, the DM40, has all of the features of the DM43 except temperature measurement for only \$390.

To find out more about this unique innovation in portable instrumentation, contact your local Tektronix Field Engineer or write Tektronix, Inc., P.O. Box 500, Beaverton, Oregon 97005. In Europe write Tektronix, Ltd., P.O. Box 36, St. Peters Port, Guernsey, C.I., U.K.



TEKTRONIX®
committed to
technical excellence

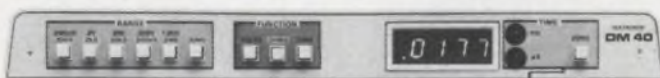

Logic Triggered Displays

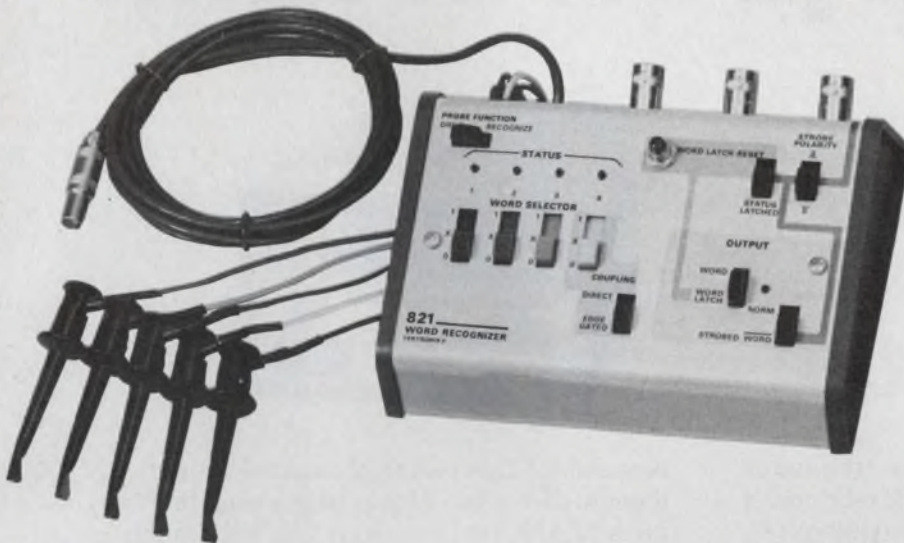

Stable oscilloscope displays of asynchronous logic sequences are easily achieved with a trigger from the TEKTRONIX 821 Word Recognizer. Or the 821 will work equally well with synchronous sequences that have no single unique sync point. As a digital trigger generator, the 821 combines your choice of four input logic signals to produce a single output pulse. Each input can be independently set to recognize a logical "1", "0", or "don't care" condition. And a different logic combination can be chosen as a trigger simply by changing these input recognition switches. Appearance of a specific op code in an instruction register, a predetermined count from a digital counter, or the occurrence

of a special set of logic levels at your system inputs can all be used for jitter-free oscilloscope triggering.

And the versatile 821 performs four additional functions. As a logic "babysitter" the 821 latches an output indicator light if the selected set of input levels is ever recognized. The absence of a selected logic combination at an external clock time can be indicated by a light or by a "fault" pulse. By simply supplying an external strobe, the 821 can be used as a four input logic probe capable of supplying timing information. In drive mode, the 821 forces operator selected logic levels at the four probe tips for troubleshooting static logic. All of these valuable logic diagnostic aids are offered in one pocket-sized unit for only \$200.

For more information on stable triggering on digital information contact your local Tektronix Field Engineer or write: Tektronix, Inc., P.O. Box 500, Beaverton, Oregon 97005. In Europe write: Tektronix, Ltd., P.O. Box 36, St. Peter Port, Guernsey, C.I., U.K.



Electronic "noses," like this gas chromatograph from Elscint, make it possible for police to detect the presence of explosives.

tems are needed by police departments to monitor their own manpower. Since these systems are not surreptitious, they can be a lot more sophisticated. But there are still problems in getting them to work accurately.

Deputy Inspector Harry F. Burns of the New York Police Communications Div. reports that the accuracy of these systems varies from about 75 to 500 feet.

"We are not satisfied with the state of the art. We are not sure that current systems can do the job," Burns says.

Detective Greenspan also has complaints about available vehicle-tracking systems. Many vendors, he says, grossly misrepresent their products.

For example, he notes that one company tried to sell the police a system that was developed to track whales. Not only did this equipment require an unwieldy 10-ft. antenna, he says; it didn't work.

Getting supporting data from manufacturers is a further problem, Greenspan reports. Because of the proprietary nature of many devices, manufacturers are unwilling to provide schematics, replacement parts and testing techniques for maintenance of the equipment, he says.

Greenspan's group is also pushing manufacturers to incorporate automatic-testing capabilities into the equipment that they sell to police. If electronic equipment could be tested automatically, repair and maintenance times would be greatly reduced, he believes.

But for some unknown reason, manufacturers, particularly those with the largest share of the market, are slow to incorporate changes, Greenspan says. ■■



Two instrument ideas that you proved right.

1. Automatic Microwave Counter



Why pay over \$5,000 for a microwave frequency counter that measures CW only? Systron-Donner's idea: one instrument that measures **everything**: FM, pulsed RF and CW. Result: Model 6057 which measures virtually any microwave signal from 20 Hz to 18 GHz. Price \$5,450. Industry response: One of our

best sellers. Don't want to measure everything? S-D thought of that too. Model 6016 measures CW only; price \$4,875. Yes, a manual T.O. system too. Model 6092 price \$3,695.

Circle No. 145

2. Microwave Frequency Synthesizer

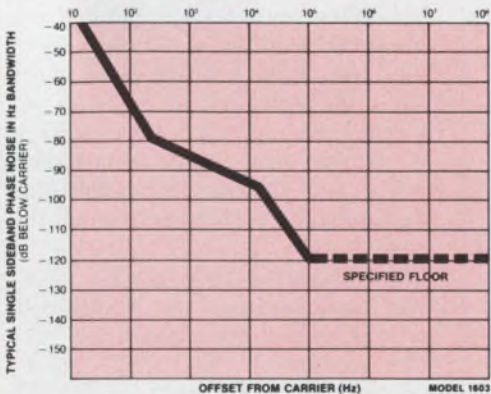

How do conventional synthesizers achieve microwave frequencies? By using multipliers. But that multiplies noise too. Systron-Donner's idea: eliminate multipliers, use **octave band** signal sources instead. Result: a family of frequency synthesizers with the highest spectral purity obtainable today. Industry response: enthusiastic. Request our new application note entitled "The Microwave Frequency Synthesizer: An Improved Standard for Microwave Research, Testing, and Applications."

Circle No. 146

For immediate details, call our Quick Reaction line (415) 682-6471 collect. Contact your Scientific Devices office or Systron-Donner at 10 Systron Drive, Concord, CA 94518. In Europe: Munich, W. Germany; Leamington Spa, U.K.; Paris (Le Port Marly) France. Australia: Melbourne.

SYSTRON  DONNER

washington report

Equipment sales to Soviet questioned

The wisdom of selling certain electronic equipment to the Soviet Union has been strongly challenged by Senator Henry M. Jackson (D-Wash.). The Senator specified equipment that could be used for repression, such as voice print analyzers, stress evaluators, holographic identification cards and other devices used in crime detection in the United States.

Meanwhile, the possibility of repression in the United States is also being eliminated in one instance. A joint computer operation between the Agriculture Dept. and the General Services Administration has been killed. GSA will stick with computer operation on its own, it says, following protests of potential invasion of privacy.

Avionics trends set for two decades NASA says

Civilian aviation electronics for the next two decades is already on the drawing boards, NASA aviation expert J. Lloyd Jones told a Senate Committee looking into advanced aeronautical concepts. The first goals are to minimize the aircraft's impact on the environment and to conserve energy.

Toward the end of the century, today's wide-body jets will give way to trunk-line and short-haul transports which will give a boost to the electronics industry. Shorter runs mean more take-offs and landings, more complex approach and landing procedures and hence more automatic electronic aids in aircraft and on the ground.

NASA is enthusiastic over organic storage

NASA considers the use of organic material from the stilbenes family of structures to be a real breakthrough in its efforts to obtain greater computer memory capacity. Using an experimental holographic technique, storage capacity has been increased from 10^9 bits to approximately 10^{11} or 10^{12} bits according to NASA's fundamental electronics chief, Dr. Bernard Rubin.

A family of organic compounds (stilbenes) has been found by scientists at Battelle Memorial Institute's Columbus Laboratories which undergo changes in the index of refraction as a result of incident laser light. The reaction can be manipulated by a low-power laser to produce phase holograms that can store as much as 100-million bits per square centimeter.

The problem with inorganic crystalline materials is their poor sensitivity to light and with organic thermoplastic materials there is gradual degradation of the information, Rubin says. On the other hand a memory system using laser holography coupled with the stilbenes organic com-

pounds affords greater reliability and reduced maintenance, than conventional mass storage systems, Rubin pointed out.

A cost savings on the order of one to two magnitudes—from 10^{-3} cents and 10^{-4} cents per bit, as opposed to 10^{-2} cents per bit for drum memory systems—is projected. Access time is faster, lead out about the same.

Organizations that require large amounts of archival storage may find the NASA development useful. The U.S. Census Bureau is said to be interested.

Government begins response to data needs

Just before Labor Day, the Federal Power Commission will respond to demands for more efficient data systems by unveiling an IBM-370-158, quadrupling its computer capacity. When operational, by the end of the year, the computer will increase processing capability forty fold.

The new facility puts the FPC well ahead of most Government agencies, which use computers only for making out payrolls. It brings the commission's computerization up to that of the Labor Dept. and Census Bureau, but leaves it still short of the degree to which NASA makes use of its data processing machines.

The push began during the energy crunch last year when the FPC had to come up with data, and couldn't make it. It had to rely on figures supplied by industry rather than generating its own.

Other Government agencies planning to update computer system capabilities include the Civil Aeronautics Board and several commissions—Federal Trade, Securities and Exchange, and Interstate Commerce.

Navstar eyed to supplant Loran

A compact global positioning system called Navstar—navigation by satellite Star—is on the horizon as a replacement for the widely used Loran system, say Pentagon officials.

A Navstar network of 24 satellites, the Pentagon says, will cover the world. It will give any ship, aircraft or even foot soldier equipped with a terminal, position data accurate within tens of feet. Loran, on the other hand, which depends on ground-based transmitters, doesn't cover the entire world or provide such accuracy.

Another advantage over Loran, the Pentagon says, is Navstar's compactness. A typical aircraft or ship installation occupies one cubic foot, and weighs less than 50 pounds. A backpack terminal weighs 12 pounds.

The first of a series of 800-pound satellites is scheduled for launch in 1977 into an 11,000 nautical mile orbit by a refurbished Atlas-F booster. By then, the improved Loran-C is also expected to be operational.

Capital Capsules: Conferees of the House and Senate Armed Services committees at press time were continuing to iron out differences in military R&D needs for the current fiscal year. Actual appropriations are dealt with by separate committees . . . Teleprompter fended off trouble with the Securities and Exchange Commission by consenting to SEC compliance without admitting charges of fraud and a false 1972 report. SEC also had charged the cable corporation with untrue and misleading press releases masking adverse conditions.

SIEMENS

Cost - Effective Solutions to Semiconductor Test Problems



GENERAL PURPOSE IC TESTER COMPUTEST 716A

Low-cost parametric and functional tester for digital and linear circuits

DIGITAL CIRCUIT TESTERS COMPUTEST 720 SERIES

Provides complete DC parametric and functional verification of digital IC's

LINEAR CIRCUIT TESTER COMPUTEST 735

Tests operational amplifiers, regulators, comparators, sense amplifiers and custom linear circuits

BENCH-TOP MEMORY TESTERS COMPUTEST 901 SERIES

Provides real-time verification of semiconductor memory performance from the device to the complete memory systems level

**FOR APPLICATIONS ASSISTANCE . . .
CALL US!**

FREE!

Send for the Computest catalog of Semiconductor Test Equipment and our Semiconductor Program Library



NAME _____

COMPANY _____

ADDRESS _____

CITY _____

STATE _____ ZIP _____

Siemens Corporation
Electronic Systems Division
Computest Products

3 Computer Drive, Cherry Hill, N.J. 08002 (609) 424-2400

THE ODD COUPLER.

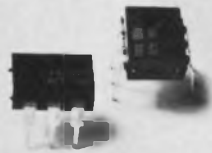

If you get a kick out of interfacing between two voltage levels, you're gonna *love* these.

The new NCT 200 and NCT 260 opto couplers from National Semiconductor provide isolation voltages of 2 KV to 3.5 KV (don't you find such a high isolation voltage odd?).

You might also be tickled to learn that the isolation capacitance is 0.5pF... and the typical current transfer ratios 80% (NCT200).

And more couplers are coming in our ever-expanding new opto-electronics line.

Speaking of opto-electronics...

Our name up in lights.

We knew we could make it in the big time of LEDs and lamps if we just kept plugging away.



Current highlights include our new NSA series arrays that meet



your 6, 7, 8, 9 (up to 14) digit needs, with or without minus sign, floating decimal and fixed decimal in all the popular combinations.

And a range of new individual single digit LEDs.

And more...with even more coming soon.

For more electrifying details give us a call or write National Semiconductor Corporation, 2900 Semiconductor Drive, Santa Clara, California 95051.

Inquiries will be processed without regard to race, creed or color.



NATIONAL

A ray of hope

I sometimes feel that everybody who works for the government is a crook. It's probably not true but I get the feeling that integrity and morality simply don't go with a government job. What's really terrible about the government corruption is that it corrupts us. A part of us—the sense of justice and ethics and morality—wither and rots.

We are no longer aghast when a vice president of the United States is pitched out of office and disbarred. We aren't outraged when people in the highest government circles go to jail—or escape with laughably light sentences that would be overly lenient for a purse-snatcher. Without emotion we quibble over the legality of a president's withholding evidence, lying to Congress and to you and me, and with a background in tax law, filing highly questionable tax returns. We split hairs over fine legal points but we hardly raise the question of whether a president should set moral and ethical standards for his country. We shrug off pious hypocrisy and outright lies and come to expect them as natural political expediency.

With this as background, the editors of ELECTRONIC DESIGN were pleasantly startled by a letter from Gerald C. Stoker of Sandia Laboratories. Mr. Stoker thanked us for publishing his Idea for Design, "A/d converter remembers signal peaks whose duration is less than 50 ns," (ED 12, June 7, 1974). But he returned our \$20 check, adding, "I am returning this check since I cannot accept payment for an idea incurred while working on tasks funded by the Atomic Energy Commission."

Now \$20 is not much these days. But in this case, it's a symbol of integrity and I'm awfully proud that this symbol comes from the engineering profession.

I've never met Mr. Stoker, and I've spoken to him only once—by telephone. I learned that his favorite charity is the Arthritis Foundation, which will receive his check and a matching one from ELECTRONIC DESIGN.

Mr. Stoker is single, but I get the feeling that if he had a daughter, he would not be the type of person to sock the taxpayers for the cost of her birthday party. If he runs for president, I think I'll vote for him.



A handwritten signature in cursive script that reads "George Rostky".

GEORGE ROSTKY
Editor-in-Chief

THE CREATIVE CHALLENGE:

exploring the universe of design possibilities of engineered metallic mesh, mazes and matrices.

NO. 2

EMI & INTERACTION SHIELDING in Computers, Process Controls, & Instruments

The understandable tendency to associate EMI (Electro-Magnetic Interference) exclusively with communications equipment—radio receivers, telephones, radar, etc., is a hangover from the days when the term "RFI" (Radio-Frequency Interference) was used; and, indeed, the earliest applications of shielding were all concerned with attempts to exclude unwanted noise from RF Circuits.

That narrow viewpoint was appropriate in 1944, when we developed the electronics industry's very first RFI gasket, but now, thirty years later, we find ourselves shielding such "high-level" devices as digital logic circuits in computers, process controls, and instruments of all kinds. *In fact, it is difficult to find a single class of electronic devices that does not require effective shielding, in some environments.*

True, the sub-microvolt front end of a communications receiver cannot function in *any* environment (except a "shielded room") without effective EMI attenuation. But anyone who has developed or applied high-density digital circuitry knows that *high-level circuitry, too, can be plagued by EMI, despite the fact that its minimum signal/noise tolerance is at least 100 times (40 dB) higher than that of communications equipment.*

It's all a matter of *environment*. The EMI source from which a communications receiver must be shielded may be a sparking commutator 8 feet away; but the back-plane wiring of a digital minicomputer may be only 8 inches away from the switching regulator in its own power supply! What is more, broadband digital circuits are sensitive to noise over a much wider spectrum than tuned receiver circuits. And digital circuits are very often used in *close proximity* to other high-speed (fast-pulse) digital devices—printers, teletype-

writers, etc. In industrial environments, it is not uncommon to find broadband noise fields that are 50-60 dB stronger than those inside a communications center. *Clearly, the 100:1 sensitivity advantage of digital circuitry can be wiped out by a 1000:1 increase in environmental noise level.*

What has all this to do with knitted wire mesh? Simply this: *knitted wire mesh is the most versatile engineered material ever developed for providing the EMI "barrier," or "seal" in a shielding assembly.* It is available in an almost unlimited range of metallic materials, and can be combined with elastomers, to form resilient, highly compressible, close-tolerance, easily installed EMI seals. Mesh can be made air-permeable, for dust filtration. It can be made transparent to light—yet *opaque* to EMI. It can be supplied in a wide range of standard and custom shapes, sizes, and forms. A few of these are shown in Figure 1—but don't let your imagination bog down there. Accept the creative challenge, work with us, and the sky's the limit.

In Figure 2, we have shown three Fourier Spectra of EMI generated by environmental and interactive EMI sources in digital process controls. Note the broad range over which the interference may exceed 1 Volt. In such an environment, *it often takes weeks to "debug" a system that worked perfectly in the lab!*

And any system may, even after costly debugging, encounter a *new source* of EMI, and go sour all over again...

Note: By now, if you are a conscientious designer, you have begun to develop "EMI Anxiety"—the neurotic fear that somewhere out there, evil men are waiting, with megawatt/gigaband/white-noise sources, all focused on your device. These feelings, we are happy to tell you, are far from fantasy. Fortunately, help is available. METEX maintains a free EMI counselling and therapy clinic, at which knitted-wire-mesh techniques are applied—analytically and effectively.

As a first step, write—*today*—for our quarterly engineering publication, "**The Creative Challenge**"—free to engineers and designers whose responsibility includes outwitting today's troubled electromagnetic environment. You'll begin to feel better immediately...and, when our free Design Kit arrives, you will find new courage to apply the samples, photos, and data it contains.

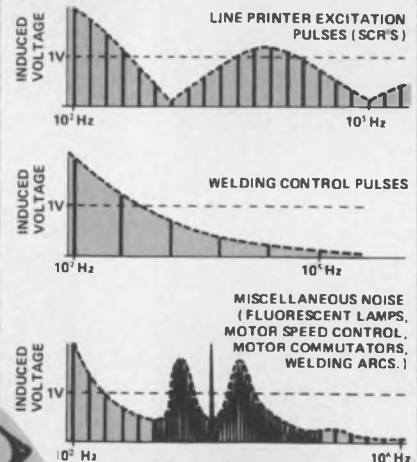

METEX
Edison, New Jersey
CAL-METEX
Inglewood, California

Engineering and Production Facilities on both coasts.

Electronic Design's

GOLD BOOK

**NOW
OFF THE
PRESS**

**AND READY
TO GO TO WORK
FOR YOU**

**OVER 85,000 DISTRIBUTION
TO ENGINEERS, ENGINEERING & PURCHASING MANAGERS
— INCLUDING 10,800 COPIES IN EUROPE**

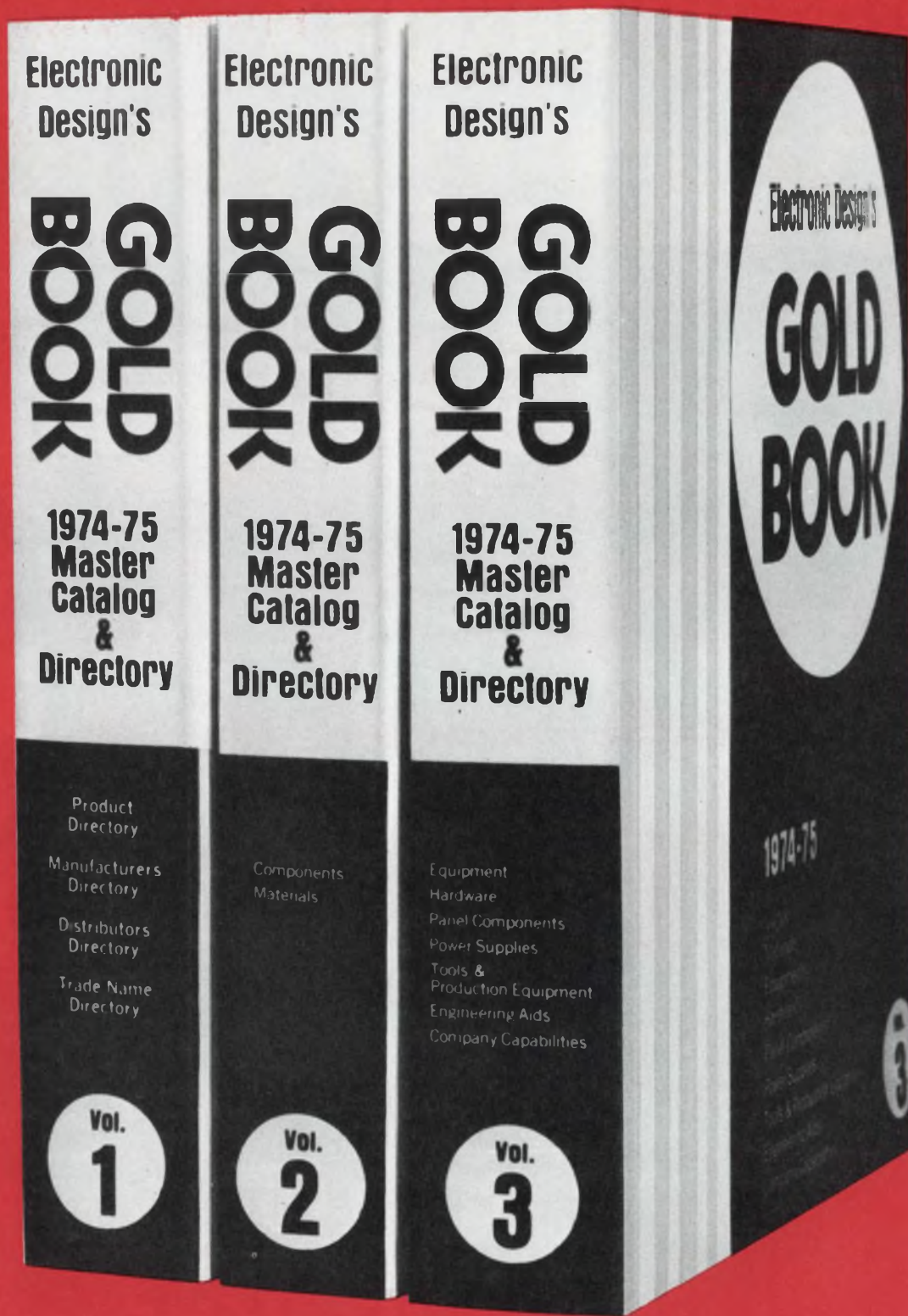

**BIGGEST IN THE FIELD - EASIEST TO USE
OVER 3,800 PAGES**

**THE MOST
USEFUL
THE MOST
COMPREHENSIVE
ELECTRONICS
INDUSTRY
DIRECTORY
EVER DEvised**



**VOLUME 1
DIRECTORIES**

PRODUCT DIRECTORY • MANUFACTURERS DIRECTORY
DISTRIBUTORS DIRECTORY (ALPHABETIC)
DISTRIBUTORS DIRECTORY (GEOGRAPHIC)
TRADE NAME DIRECTORY



**VOLUME 2
CATALOG PAGES**

COMPONENTS • MATERIALS



**VOLUME 3
CATALOG PAGES**

EQUIPMENT • HARDWARE • PANEL COMPONENTS
POWER SUPPLIES • TOOLS & PRODUCTION EQUIPMENT
ENGINEERING AIDS • COMPANY CAPABILITIES



**Electronic
Design's
GOLD
BOOK**

KEEP

Electronic Design's

GOLD BOOK

**HANDY WHEN YOU
CONTACT SUPPLIERS**

To save time in your search for product information and specs, keep *Electronic Design's* GOLD BOOK handy. It gives you names, numbers; answers many of your questions before they are asked. Helpful hints on efficient communication with vendors preface each volume.

3 VOLUMES

JAM-PACKED WITH LISTINGS AND SPECIFICATION/PURCHASE DATA

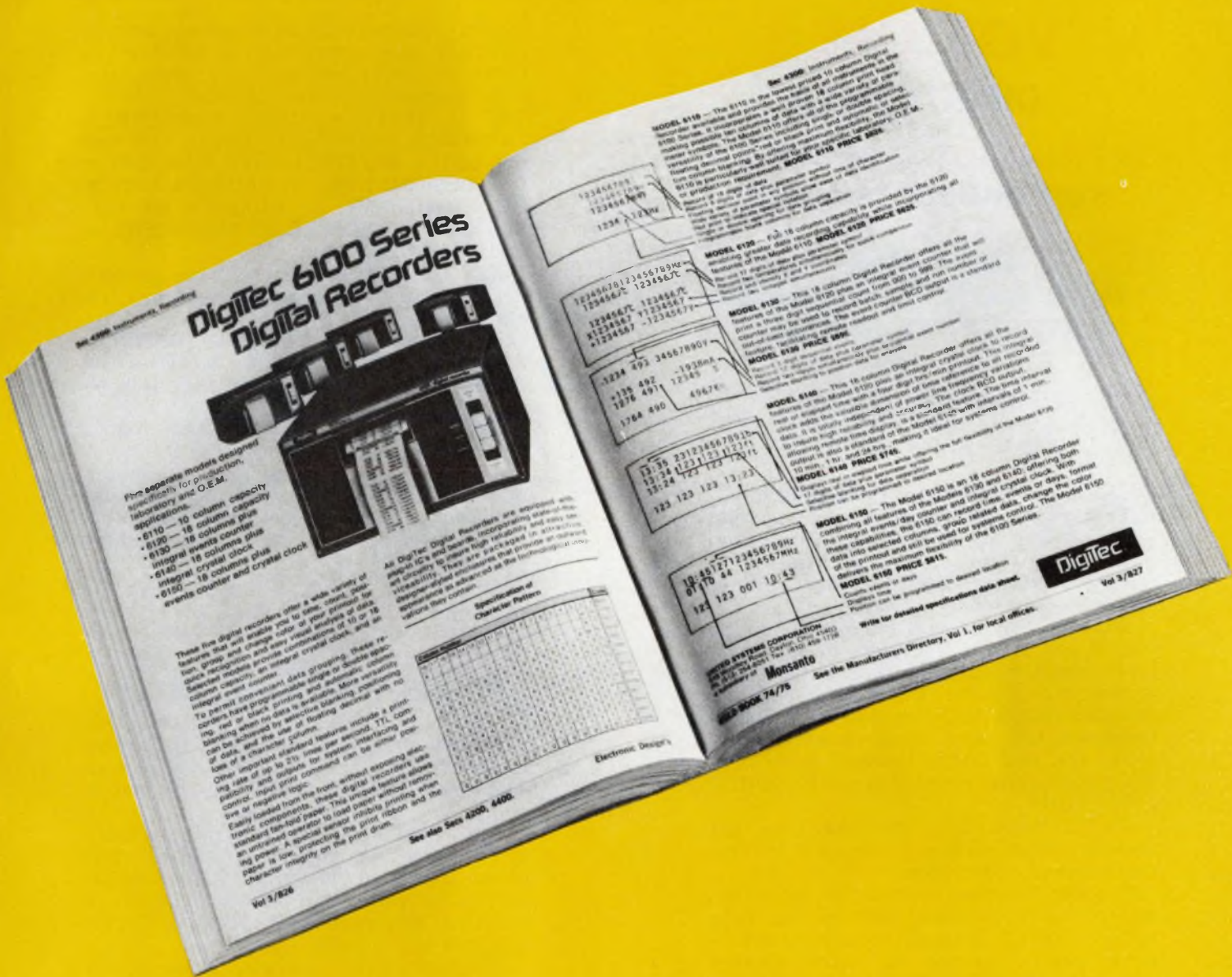

Electronic Design's

MASTER CATALOG & DIRECTORY OF SUPP

VOLUME 1

DIRECTORIES

- **PRODUCT DIRECTORY**
5,000 PRODUCTS LISTED

COMPLETE

- **MANUFACTURERS' NAMES**
 - **STREET ADDRESSES**
 - **ZIPS**
 - **PHONE NUMBERS**
- SAVE YOU TIME**

You've never seen such a complete directory. Almost 5,000 products are included — everything that an electronics manufacturer would require — components, computers, hardware, test equipment, instrumentation, systems, services.

Knowing only a name and city isn't much help if you or your secretary want to contact several manufacturers at once for information or a quote. That's why *Electronic Design's* GOLD BOOK repeats each manufacturer's full name, street address, city, state, zip, and phone number every time the manufacturer is listed in our **PRODUCT DIRECTORY**.

It's all there. You don't have to leaf through other directory sections to find the missing information.

A special symbol before the manufacturer's name indicates that he has submitted product literature to our editors — helps you to screen out manufacturers who might be doubtful or limited sources of supply.

References to manufacturers' catalog pages in Volumes 2 and 3 are highlighted among the Product Directory listings.

- **MANUFACTURERS DIRECTORY**
7,500 COMPANY LISTINGS

This directory furnishes a wealth of information about companies in the electronics

industry. It's the most thorough electronics directory ever compiled. In addition to complete street address, city, state, zip, and telephone, wherever possible it lists . . .

TWX • TELEX • CABLE ADDRESS • FACSIMILE EQUIPMENT (Make and call number) • 800 (TOLL-FREE NUMBER) • QPL DESIGNATION • FEDERAL STOCK CODE NUMBER • NUMBER OF EMPLOYEES • NUMBER OF ENGINEERS • DOLLAR VOLUME

KEY OFFICIALS. Names of key personnel are included as reported to us by each manufacturer.

SALES OFFICES, EXPORT OFFICES, FOREIGN OFFICES, U.S. & FOREIGN REPS. Representatives are reported by name, city and telephone number.

U.S. DISTRIBUTORS follow each manufacturer's listing as reported by the company. Name, city and telephone numbers are included to facilitate contact. (So that readers get the most comprehensive information, manufacturers are not charged for these listings.)

- **DIRECTORIES OF DISTRIBUTORS**
5,700 DISTRIBUTORS LISTED

In addition to the distributors listed in the *Manufacturers Directory*, two separate directories each contain 5,700 distributors with access (1) alphabetically by name, and (2) by geographical area.

The alphabetical directory gives distributors' names, complete addresses, and phone numbers. When available, dollar volume, net worth, and year established are included. Key personnel, TWX or TELEX numbers are shown.

The geographic directory is organized by state and city, with complete address and phone numbers. It's easy to find a distributor in or near your town.

- **TRADE NAME DIRECTORY**

If you've heard the trade name, but can't remember who makes it, here's the place to look. Over 4,600 industry trade names are included. Listing includes brief description of item and company name.

FAR AND AWAY THE MOST SUPERIOR ELECT

GOLD BOOK

LIERS TO ELECTRONICS MANUFACTURERS

VOLUMES 2 & 3 MANUFACTURERS' CATALOGS



- 520 PAGES ON ICs AND SEMICONDUCTORS
- 300 PAGES ON INSTRUMENTS
- 290 PAGES ON POWER SUPPLIES
- 210 PAGES ON WIRE AND CONNECTOR PRODUCTS
- 150 PAGES ON SWITCHES

Volumes 2 and 3 of *Electronic Design's* GOLD BOOK are filled with manufacturers' technical data and product catalogs — a gold mine of information for the engineers, engineering and purchasing managers of this industry. Products are classified by related families and are organized in 52 product categories.

Volume 2 contains *Components and Materials*; Volume 3 contains *Equipment, Hardware, Panel Components, Power Supplies, Tools and Production Equipment, Engineering Aids*, and *"Company Profiles and Capabilities."*

Electronic Design's GOLD BOOK is the place to look. Users will keep it handy for information on the following products:



VOLUME 2

Capacitors
Circuit Protective Devices
Cooling Products
Crystals, Oscillators,
Timing Devices
Delay Lines
Filters
Function Modules
Inductors & Transformers
Integrated Circuits, Hybrid
Integrated Circuits, Monolithic
Keyboards & Keypads
Magnetic Products

Motors & Rotating
Components
Non-magnetic Materials &
Printed Circuits
Relays & Solenoids
Resistors, Fixed
Resistors, Variable
Semiconductors, Discrete
(except LEDs)
Switches
Thermal Devices
Tubes & Related Products

VOLUME 3

Amplifiers
Audio Equipment
Books
Communications
Equipment
Company Profiles &
Capabilities
Computer Peripherals
(except Storage)
Computer Peripherals,
Storage
Computers & Data
Handling/Acquisition
Products
Connector Products &
Terminal Boards
Controls & Controllers
Displays & Readouts
Engineering Aids
Environmental Testers
& Chambers
Hardware & Panel
Components

Cabinets, Chassis,
Containers, Racks
Calculators
Instruments, Measuring &
Testing
Instruments, Recording
Instruments, Signal Source
Memory Products (except
ICs & Peripherals)
Microwave & Radar Products
Multiple Products
Optoelectronic & Laser
Products
Panel Lamps, LEDs,
Lampholders
Panel Meters
Power Supplies, Batteries
Production & Automation
Equipment
Services
Tools & Soldering Products
Transducers
Wire & Cable

RONICS INDUSTRY DIRECTORY IN THE WORLD



REACH FIRST FOR Electronic Design's

GOLD BOOK

FOR

- PRODUCT INFORMATION & CATALOG DATA
 - WHO MAKES WHAT
 - DISTRIBUTORS • REPS
- MANUFACTURERS' NAMES • TELEPHONE NUMBERS
- ADDRESSES • ZIP CODES • TWX • TELEX • CABLE ADDRESSES
- FACSIMILE EQUIPMENT • QPL AND FSCM DESIGNATIONS
- FINANCIAL DATA • KEY PERSONNEL



A HAYDEN PUBLICATION

Peter D. Coley, Vice President/Publisher

50 Essex Street, Rochelle Park, New Jersey 07662 • Tel: 201-843-0550 • TWX: 710-990-5071

WELCOME TO WESCON!

September 10-13
Los Angeles Convention Center

The nation's largest and most complete electronics show and convention this year opens in Los Angeles on September 10. And of course, you're invited.

This 23rd annual Wescon is a super week in an exceptional electronics year. There are 54,000 net square feet of product demonstrations by 300 electronics producers — that's a full house, literally.

The 540 exhibits are grouped in four product/system categories on one beautiful carpeted and air-conditioned floor of the Los Angeles Convention Center, and will be open for hands-on demonstrations for four days and one evening.

The four-day **professional program** is an escalator ride away — also in very large, carpeted and air-conditioned auditoriums. This 28-session program is both current

and choice. Four knowledgeable sessions on microprocessors; a full day on CCD applications; an expert update on medical electronics; a first-rate panel on uninterruptible power problems; sessions on component and board testing, plastic encapsulated circuits, management in periods of crisis, and taking high-technology products from lab to market.

And there's more — a keynote address by **Donn Williams**, president of Rockwell Electronics Operations, a Distributor-Manufacturer-Representative conference, an all-industry reception, and three California-colorful social events for visiting wives.

Your share of **four idea-filled days** awaits you in Los Angeles. Registration for all four days of the program and show is just

\$5, payable at the door. And if you'll assist us in a simple questionnaire-survey at the show, you'll be eligible for a very special prize drawing. On each of Wescon's four days, a drawing winner will receive an HP-45 hand-held calculator!

Better **plan right now** to join us in Los Angeles. Write directly to the Wescon Housing Bureau, P.O. Box 3669, Los Angeles, CA 90054, for accommodations. We're holding large blocks of rooms at the Regency Hyatt House, Los Angeles Hilton, Biltmore, Sheraton-West and Wilshire-Hyatt.

WESCON74

INFORMATION RETRIEVAL NUMBER 48

Western Electronic Show and Convention, 3600 Wilshire Blvd., Los Angeles, Ca 90010 (213) 381-2871

Sponsors: IEEE Los Angeles Council and San Francisco Section; Electronic Representatives Association (Southern and Northern California chapters).



Interface CMOS logic with switches using standard ICs. You can debounce mechanical devices with analog or digital filtering techniques.

The mechanical-logic interface has traditionally called for specialized discrete-component circuits to eliminate contact bounce, but IC circuits can do the job cheaper and at a saving in circuit-board real estate.

So far only one IC manufacturer—National Semiconductor—has developed such an IC interface as a standard product, but you can build your own.

Contact bounce—the settling effect, or “ringing,” that occurs due to mechanical closure—causes unwanted transitions in logic circuits. The IC interface locks out these transitions.

Since CMOS logic is undergoing rapid development at present, let's see how it can be used to interface man and machine.

Simple cures for contact bounce

The simplest CMOS circuits to eliminate contact bounce are double-throw latches (Fig. 1). These circuits can be built with NAND or NOR gates. The pull-up or pull-down resistors on the latch inputs have values that range typically from 100 kΩ to 1 MΩ. The circuit can be constructed from two gates of a quad two-input package. Although two latches can be built from a quad gate package, three latches in a 14-pin dual in-line case could help reduce wiring and package count.

A major drawback of latch bounce-suppression circuits, however, is that double-throw switch contacts are required. Since make-or-break switching is the only type usually available, switch bounce can be combatted with an input integration technique that is CMOS-compatible (Fig. 2).

The high input-impedance and symmetrically located switching of level of CMOS gates simplify the circuits needed for input integration. In Fig. 2, R_p has a value between 100 kΩ and 1 MΩ, while R_i is at most, one-tenth the value of R_p . Also, the $R_i C_i$ time constant can be selected to minimize

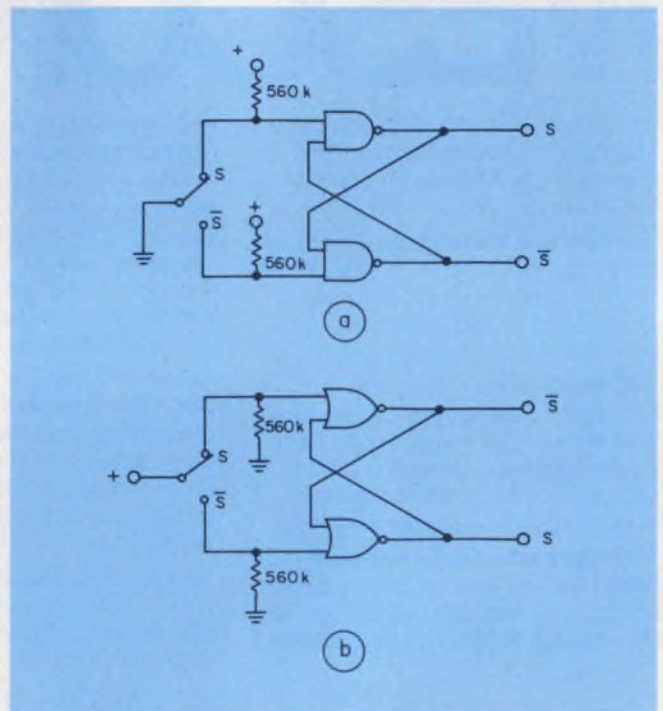

1. The basic switch debouncing circuits are the double-throw NAND latch (a) and the double-throw NOR latch (b). Each circuit uses two gates.

the effect of mechanical bounce, while it provides the fastest possible transition through the logic decision band.

The input integration scheme can be improved if a Schmitt trigger circuit is added to ensure a positive logical decision on the input level (Fig. 3). The relative resistor values specify the percentage of hysteresis.

This percentage can be defined as the difference between the two input levels required to switch the trigger, expressed as a percentage of the logic supply voltage. The following formula can then be used to calculate the percentage of hysteresis:

$$\left[\frac{R_1 + R_2}{R_2} - 1 \right] \times 100.$$

Thus if $R_2 = 200$ kΩ and $R_1 = 100$ kΩ, transfer characteristics for the circuit of Fig. 3a are as shown in Fig. 3b.

The problem of how to connect multiple-posi-

Mike Stiglianese, Electronic Engineer, Cincinnati Electronics, 2630 Glendale-Milford Rd., Cincinnati, Ohio 45241.

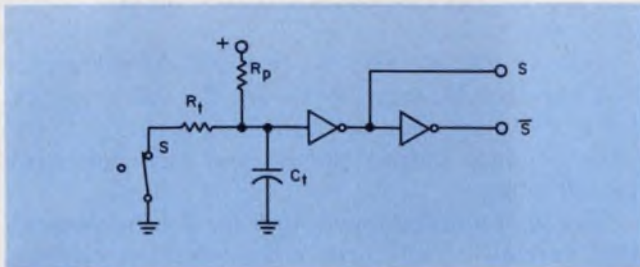

2. Two inverters, a capacitor and two resistors form an integrator that can minimize switch bounce.

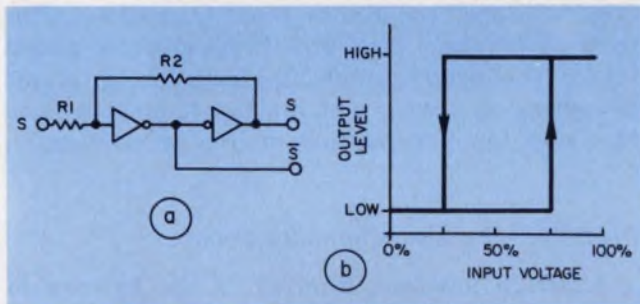

3. Two inverters and two resistors form a Schmitt trigger (a). The hysteresis loop (b) has distinct switching points at the 50% limits.

tion mechanical switch inputs can be attacked from two directions. On one side are single-pole, multiposition, nonshorting switches that pull selected signals to ground, and on the other are multipole switches that multiplex input position information and pull selected input codes to ground.

Multiple-position switches have problems

The single-pole multiposition switches have a disadvantage: A buffered input line is required for every switch position. Multipole switches also have a drawback: They require crisscrossed wiring; this reduces the system reliability.

Which method you select depends almost entirely on the application. For situations where the single-pole switch seems most promising, several logic circuits are useful. First, a data multiplexer can often be of value, since multi-

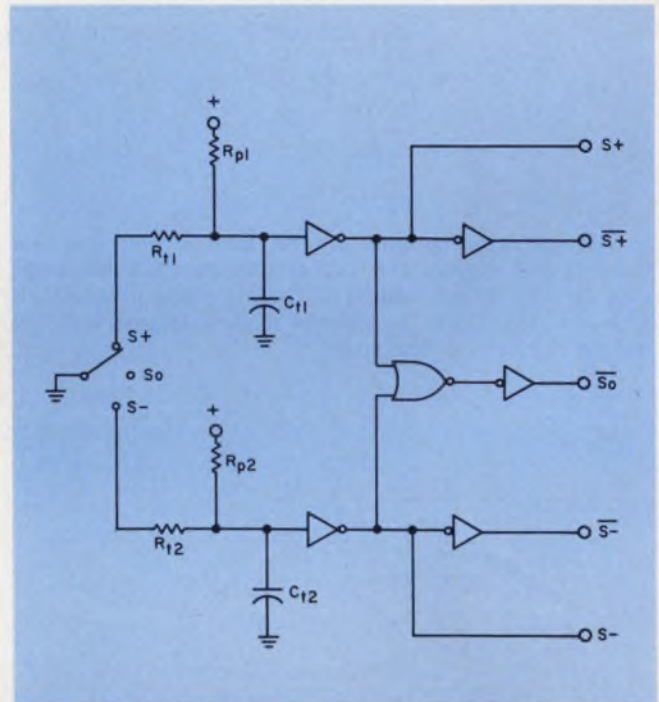

4. A three-position switch-bounce eliminator can be built with a few inverters and a NOR gate. This circuit can be expanded to cover a wide number of switch types.

plexed switch data may be desired but not a multipole switch.

The circuit of Fig. 4 is often used for multiposition switches. If a feedback resistor in the Schmitt trigger is included, circuit performance can be improved. But if the RC buffers are placed in a passive-network 14-pin DIP, the added resistor decreases the networks possible in a single package from six to four.

The reason for the OR circuit between the two inputs becomes apparent when you consider that, for an N-position switch, only $N-1$ lines need be sampled—the last position being true if all others are not true. Therefore if the logic of Fig. 4 is duplicated and the \bar{S}_0 outputs are fed to another NOR function, the output of the NOR represents the Nth switch position. Thus, the circuit of Fig. 4 can interface with a single three-position switch or two two-position switches.

Many problems arise when you are trying to

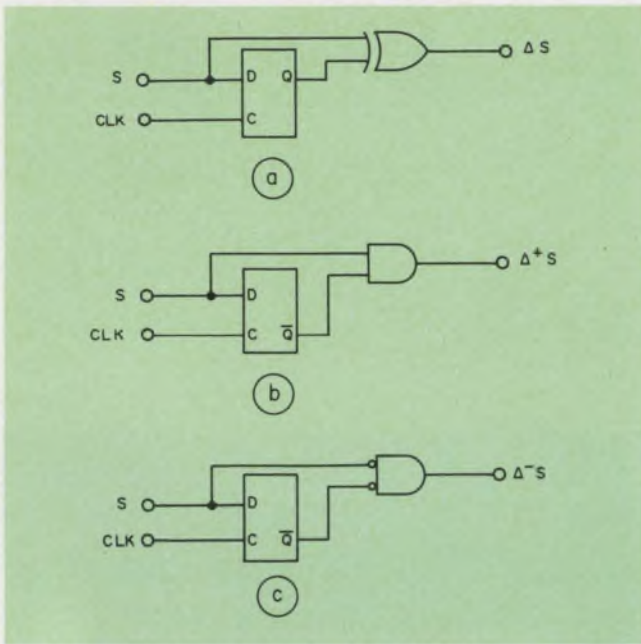

5. Edge-detector circuits can be built if you use one flip-flop and a gate. The circuit with an EXCLUSIVE-OR gate (a) can detect leading or trailing edges. The circuit with the AND gate (b) detects leading edges, and the last circuit (c) trailing edges.

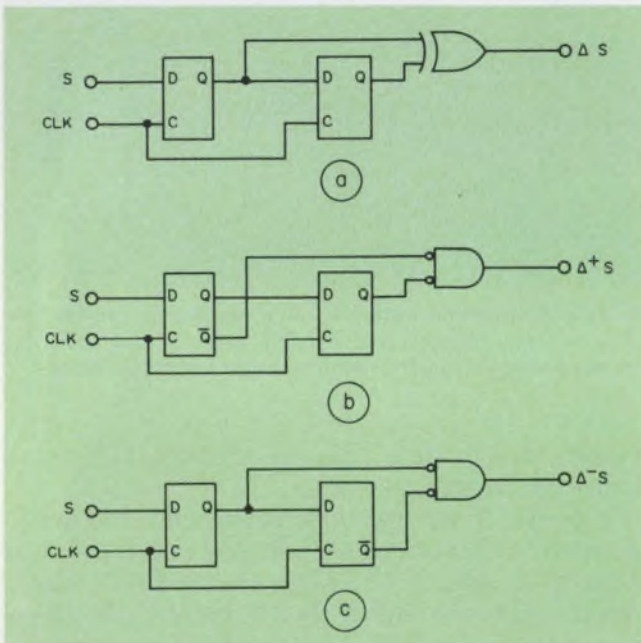

6. More reliable versions of the circuits shown in Fig. 5 result when you add an extra flip-flop.

interface a mechanical switch to logic and synchronize its signal to the system clocks. Although you can synchronize an input level simply by clocking the buffered input into a flip-flop, the need for a pulse on either input change or transitions of a specific direction may arise and with it logic timing problems.

A minimum-logic method of synchronizing input information to system clocks is shown in Fig. 5. These circuits synchronize one pulse edge,

while the other edge remains asynchronous. The delta circuit of Fig. 5a produces a pulse output for each change of input level, where input level changes occur at a rate less than one-half the clock frequency.

Note that the leading edge of the wave can shift while the trailing edge is synchronous with the edge of the clock. The action of the circuits in Figs. 5b and 5c is similar to that in 5a.

A major disadvantage of the circuits in Fig. 5 is the variation in pulse widths produced by the asynchronous front edge of the output pulse. By adding a flip-flop to each of the circuits, you can get completely clock-synchronous output pulses (Fig. 6).

The circuits of Fig. 6—positive differentiator and negative differentiator—are the static equivalents of the dynamic delta logic circuit. These circuits produce output pulses that are one clock period long.

The logic arrangement in Fig. 7 is a generalized version of all three edge-detection circuits. The designer has complete control over detection of either edge through positive-edge pulse enable and negative-edge pulse enable inputs.

Synchronous output pulses that are one clock cycle wide are produced by input transitions after the system power reset circuit releases the preset input. The preset input also prevents spurious triggering at power turn-on, but it may be used to inhibit input transitions during processing.

Digital filtering also eliminates bounce

Although low-pass filtering is the byword of contact bounce eliminators or noise-suppression circuits, analog filters do not always do the job in digital applications. The digital low-pass filter (Fig. 8) works well when the circuit must be simple and inexpensive.

The digital filter is similar to the edge-detection circuits, except for the second flip-flop, which has its own output fed back to its input, and thus doesn't change state if the input differs from the first stage output. However, if the first-stage input and output coincide, the input has remained constant at the two consecutive clock-sample times and data arrive at the output stage.

Thus input information gets accepted at the second stage only if it has remained at the input for more than one clock period. This limits the maximum frequency that the filter can pass to one-quarter that of the clock.

Since this circuit is not the ultimate in digital low-pass designs, sustained asynchronous high-frequency oscillations at the filter input can cause the circuit to hunt at a frequency less than or equal to one-quarter of the clock frequency. To eliminate some of the burst noise problems, the filter can be clocked at a frequency of 1 kHz. At

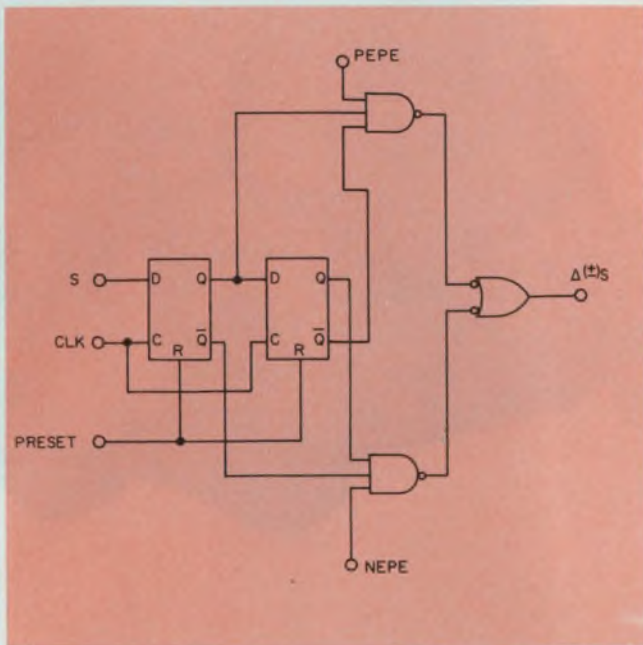

7. A gated edge-detector circuit can be controlled externally to sense leading or trailing edges.

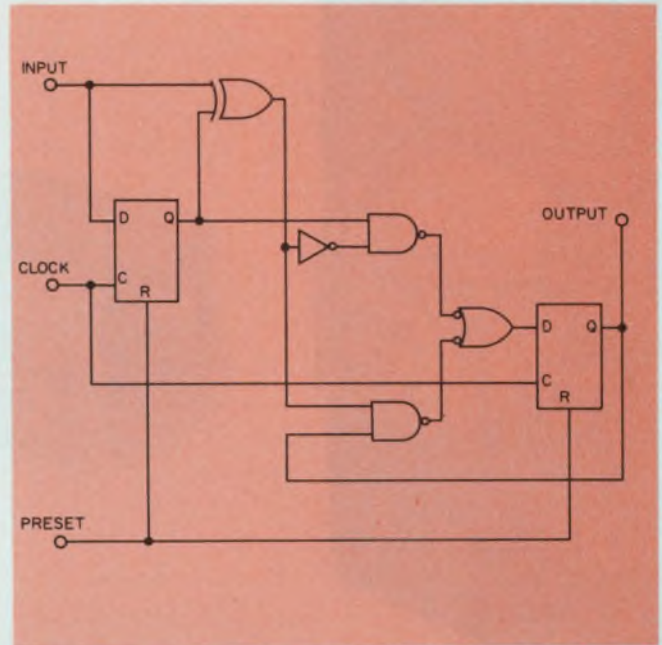

8. When analog filtering techniques don't work, a digital low-pass filter may be just the device you need.

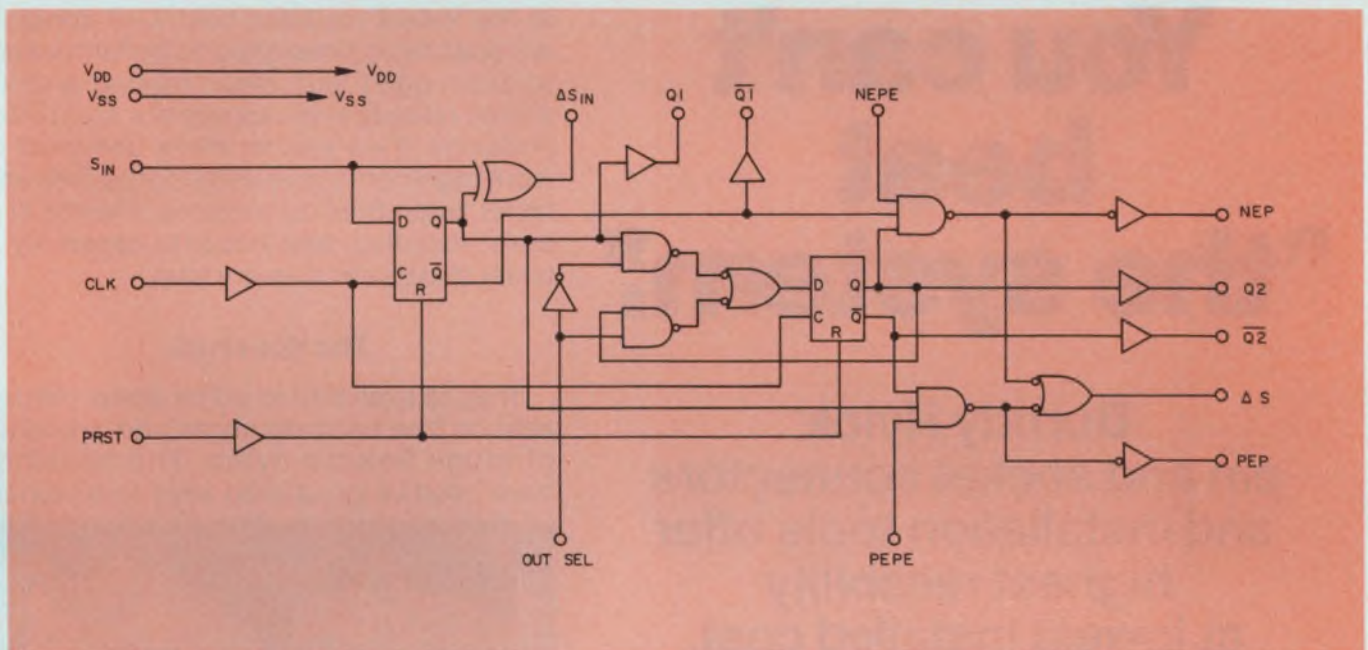

9. A generalized version of the digital filter can be made fully programmable and to fit in a 14 or 16-pin DIP.

this rate, contact-bounce noise at a data transition would have to be sustained for at least 4 ms, or line-burst noise with no intended transition for 2 ms, before an error could occur at the filter output.

A functional block, similar to the circuit of Fig. 9, could then be housed in a 16-pin DIP. This circuit can meet the requirements of either the low-pass filter or any edge detector. It can also be reduced to a 14-pin DIP if the \bar{Q} outputs aren't needed. Digital differentiation capability can be a great boon if you need a pulse, instead

of an edge, to do the processing.

For applications where improved performance of the digital filter is needed, another flip-flop can be added to control the output select line. If the D flip-flop is set by the rising clock edge and reset with the ΔS_{in} signal, its \bar{Q} output can be used to control the output select. In this way any transitions on the input between clock pulses will inhibit the low-pass output change at the subsequent clock time. This implies that an unchanging input must be present for two successive clock periods before the output can change. ■■

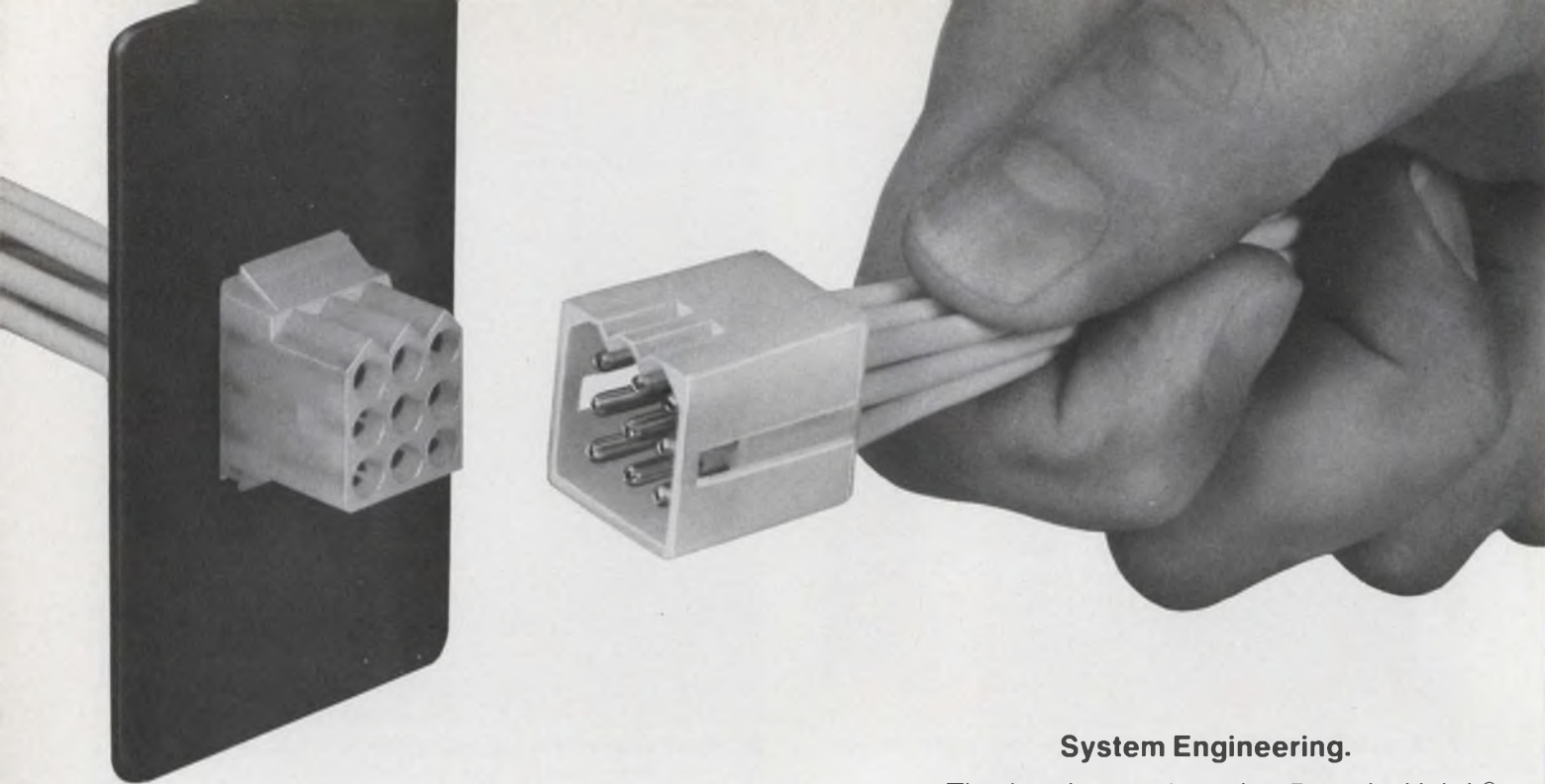

You can't beat "the system."

**Burndy Hylok[®]
pin and socket connectors
and installation tools offer
highest reliability
at lowest installed cost.**

System Engineering.

That's what makes the Burndy Hylok[®] pin and socket connector system perform at the lowest installed cost. Our contacts are specifically designed to be terminated in our rugged, automatic tooling and installed reliably and easily in our connector housings. It's a system that's designed to work together to give you trouble-free and faster assembled connectors. The result is lower installed cost because assembly is faster and easier at every step.

The Housings.

They're available in either panel mountable or free hanging styles and are made of tough flexible nylon. The housings have positive polarizing keys to eliminate

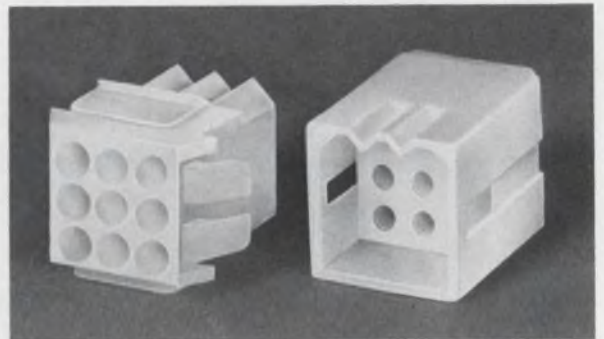

mis-mating. Low profile mounting ears make Hylok[®] fast and easy to install, and resilient take-up springs hold the housing securely over a wide range of panel thicknesses. Hylok[®] housings are available in 2,3,4,6,9,12 and 15 positions to cover virtually every application.

The Contacts.

Burndy Hylok[®] contacts feature a three point stabilizer and three positive

BURNDY CONNECTS

International Sales and Manufacturing Brussels Barcelona Paris Rotterdam Stockholm Stuttgart Turin Zurich St. Helens (Eng.) Toronto Sydney Tokyo Mexico Sao Paulo

forward stops. The result is an accurate, precise contact "float," so mating is always fast, easy and smooth. Never a contact out of alignment. Our contacts

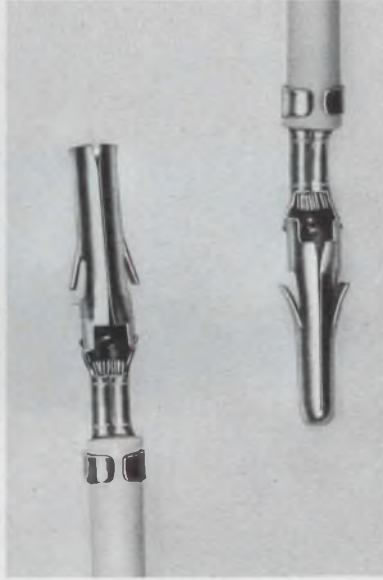

cover the full range of wire sizes. Number 24 to 16 AWG and .040" to .130" insulation diameter. They also feature serrated wire barrels to break up surface oxides and a stepped insulation barrel to keep the conductors in perfect alignment with the contacts.

The Tooling.

There's a complete line of Burndy installation tooling to match every production requirement. The Burndy UTM Universal Terminating Machine is a rugged 5-ton bench press that delivers the quietest, most consistently reliable crimps in the business. For larger runs, choose the Burndy automatic wire processing machines ADET or ASET that cut the leads to length, mark them, strip them to length and terminate one or both ends. All at speeds up to 4,000 leads per hour! Burndy installation tooling is as versatile as it is fast. Both pin and socket contacts are terminated in the same mechanisms to reduce change-over time and all



machines feature easy-to-set dial adjustments for wire size and insulation size.

Compatibility.

Burndy Hylok® pin and socket connectors are interchangeable and interchangeable with other standard pin and socket connectors.

It all adds up to the finest system of pin and socket connectors ever made. A system that can't be beat for dependability and total value. For more information on Burndy Hylok® pin and socket connectors, write Burndy Corporation, Norwalk, Connecticut 06856. And see why you can't beat our system.



BURNDY
Offices in principal cities throughout the United States

INFORMATION RETRIEVAL NUMBER 49

Double multiplexer logic capability

by using one of the input variables to drive some data lines. A modified Karnaugh map helps you choose the right ones.

A multiplexer can help cut the size of a combinational logic circuit, but the extent of the shrinkage depends on what you do with the chip's data lines.

The same IC can handle an additional logic variable if you apply logic signals to both the control and the data lines of the multiplexer. A multiplexer with three control inputs handles four variables, one with four control inputs handles five. In each case you've doubled the number of minterms handled over the number possible with the more conventional approach, in which the data lines are permanently wired as ONES or ZEROS.

Multiplexers are designed to transfer one input signal—chosen from n —to a common output. They come in different forms, but standard types are represented by the 74150 (16 inputs, one output, four control inputs) and the 74151 (eight inputs, one output, three control inputs).

The logic synthesis of a truth table is straightforward when the number of variables equals the number of inputs. You connect the n -input variables to the multiplexer control lines. For each combination of the variables, the multiplexer chooses and gates one of the 2^n input lines. If the values that describe the functions in the truth table are applied to the corresponding lines, the multiplexer output is the function (Fig. 1).

You can double the number of combinations—from eight to 16—if the data lines of the multiplexer are connected to some combination of a fourth variable, D , and its complement, \bar{D} . The circuit in Fig. 2 uses the same multiplexer and handles a function of four variables, A , B , C and D .

Mapping lets you assign the pins

The problem of how best to assign data pins to the extra input arises, along with the need to synthesize these circuits in an orderly fashion.

A truth table plus a modified Karnaugh map

Cornelis Van Holten, Senior Engineer, Delft Technical University, Dept. of Applied Physics, 1 Lorentzweg, 2208 Delft, the Netherlands.

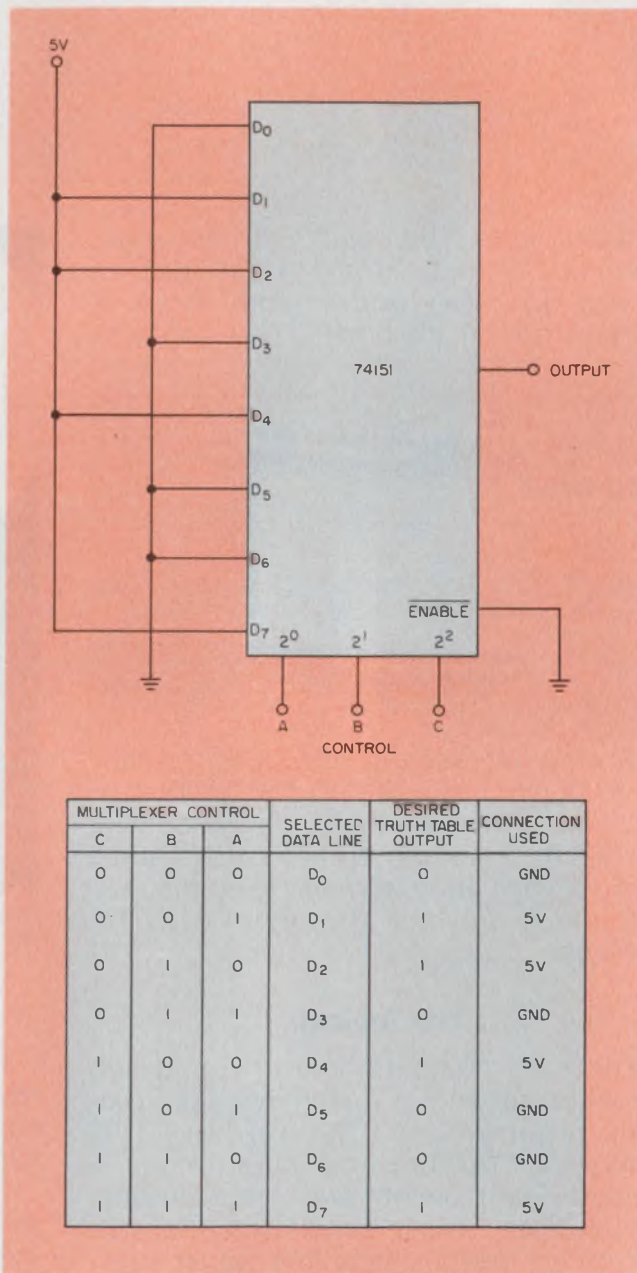

1. A digital multiplexer can generate arbitrary logic functions. In this case, the output is the odd-parity function of variables A , B and C . The inputs D_0 to D_7 are wired HIGH or LOW to correspond to the truth table. This simple technique lets you handle a number of variables equal to the number of control inputs of the multiplexer (in this case, the 74151).

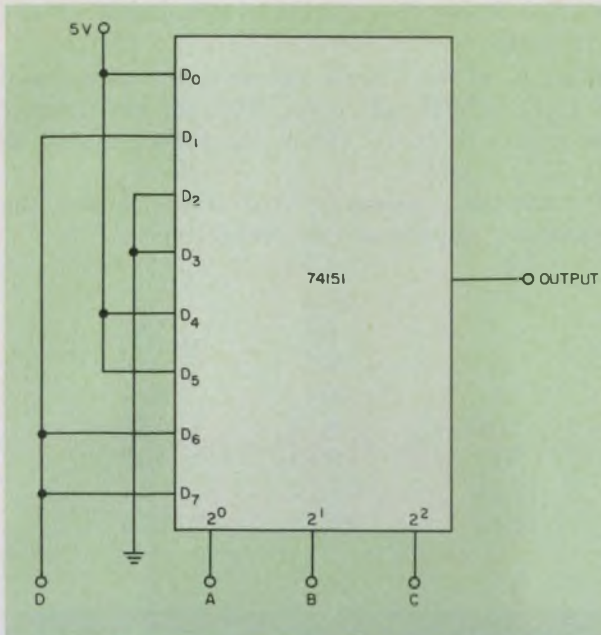

D	MULTIPLEXER CONTROL			SELECTED DATA LINE	DESIRED TRUTH TABLE OUTPUT
	A	B	C		
0	0	0	0	D ₀	1
0	0	0	1	D ₁	0
0	0	1	0	D ₂	0
0	0	1	1	D ₃	0
0	1	0	0	D ₄	d
0	1	0	1	D ₅	1
0	1	1	0	D ₆	0
0	1	1	1	D ₇	0
1	0	0	0	D ₀	1
1	0	0	1	D ₁	1
1	0	1	0	D ₂	d
1	0	1	1	D ₃	0
1	1	0	0	D ₄	1
1	1	0	1	D ₅	1
1	1	1	0	D ₆	1
1	1	1	1	D ₇	1

d = DONT CARE

2. Application of another input variable to the data lines lets the 74151 handle 16 minterms instead of eight. The

same technique can be extended so that 1-of-16 multiplexers handle five input variables.

are all it takes. The map makes use of binary weights that are ascribed to each variable. For consistency, A has a weight of 1, B a weight of 2, C a weight of 4 and D a weight of 8. Each combination can take on three values, 0, 1 and d, with the latter standing for "don't care."

The modified Karnaugh map is laid out the same way as the conventional one, except that each square receives a number equal to the decimal equivalent of the variables (Fig. 3). The horizontal and vertical lines indicate those columns (rows) for which the variable is ONE. This map is called the Mahoney map. Also, note that the 1, 0 and d entries in the squares correspond to the truth table values.

Any variable can be designated for use with the data inputs of the multiplexer. The remainder of the variables is connected to the control inputs. The general rules for assignment of data pins are as follows:

1. For the variable chosen, compare those map squares that differ in number by the binary weights of the variable.
2. For the remainder of the variables, connect the one with the lowest weight to the control input with the lowest weight. Then proceed in ascending order with the remaining variables.

As an example, suppose A is chosen for the data inputs and B, C and D for the control inputs. The weight for A is 1, and so squares (0,1), (2,3), (4,5) ... (14, 15) are compared. Each comparison has one of nine possible outcomes (see table). The choice between X and \bar{X} , which represents the chosen variable, depends on the place of the 1 or 0 in the (0,1) or (1,0) combination in the Mahoney map. If the 1 lies in the field of the

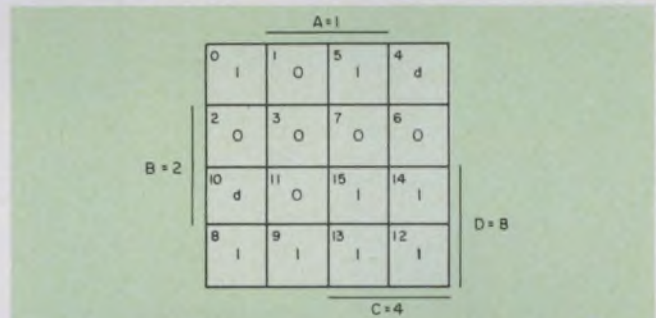

DECIMAL EQUIVALENT	8 D	4 C	2 B	1 A	TRUTH TABLE OUTPUT
0	0	0	0	0	1
1	0	0	0	1	0
2	0	0	1	0	0
3	0	0	1	1	0
4	0	1	0	0	d
5	0	1	0	1	1
6	0	1	1	0	0
7	0	1	1	1	0
8	1	0	0	0	1
9	1	0	0	1	1
10	1	0	1	0	d
11	1	0	1	1	0
12	1	1	0	0	1
13	1	1	0	1	1
14	1	1	1	0	1
15	1	1	1	1	1

d = DONT-CARE

3. You must convert the truth table to a modified Karnaugh map. The numbers in each box represent the decimal equivalent of the minterm (1 = full weight, 0 = no weight). The horizontal and vertical lines indicate the columns (rows) for which the associated variable is ONE. The 1,0 and d entries are the same as stated in the truth table below the map.

Required data-line input

Map entries	Required input
0,0	0
0,1	X or \bar{X}
0,d	0
1,0	X or \bar{X}
1,1	1
1,d	1
d,0	0
d,1	1
d,d	0 or 1

Note: For the 0,1 or 1,0 pairs, choose X if the ONE lies in the field of X.

variable, choose the variable; otherwise choose its inverse.

With A as the chosen variable, the pairs used are (0,1), (2,3) and so on. And the multiplexer data inputs D_0 to D_7 (from the table) are A, 0, 1, 0, 1, 0, 1 and 1.

For the cases where B, C or D are chosen, the comparison sequences are respectively:

B	C	D
0,2	0,4	0,8
1,3	1,5	1,9
4,6	2,6	2,10
5,7	3,7	3,11
8,10	8,12	4,12
9,11	9,13	5,13
12,14	10,14	6,14
13,15	11,15	7,15

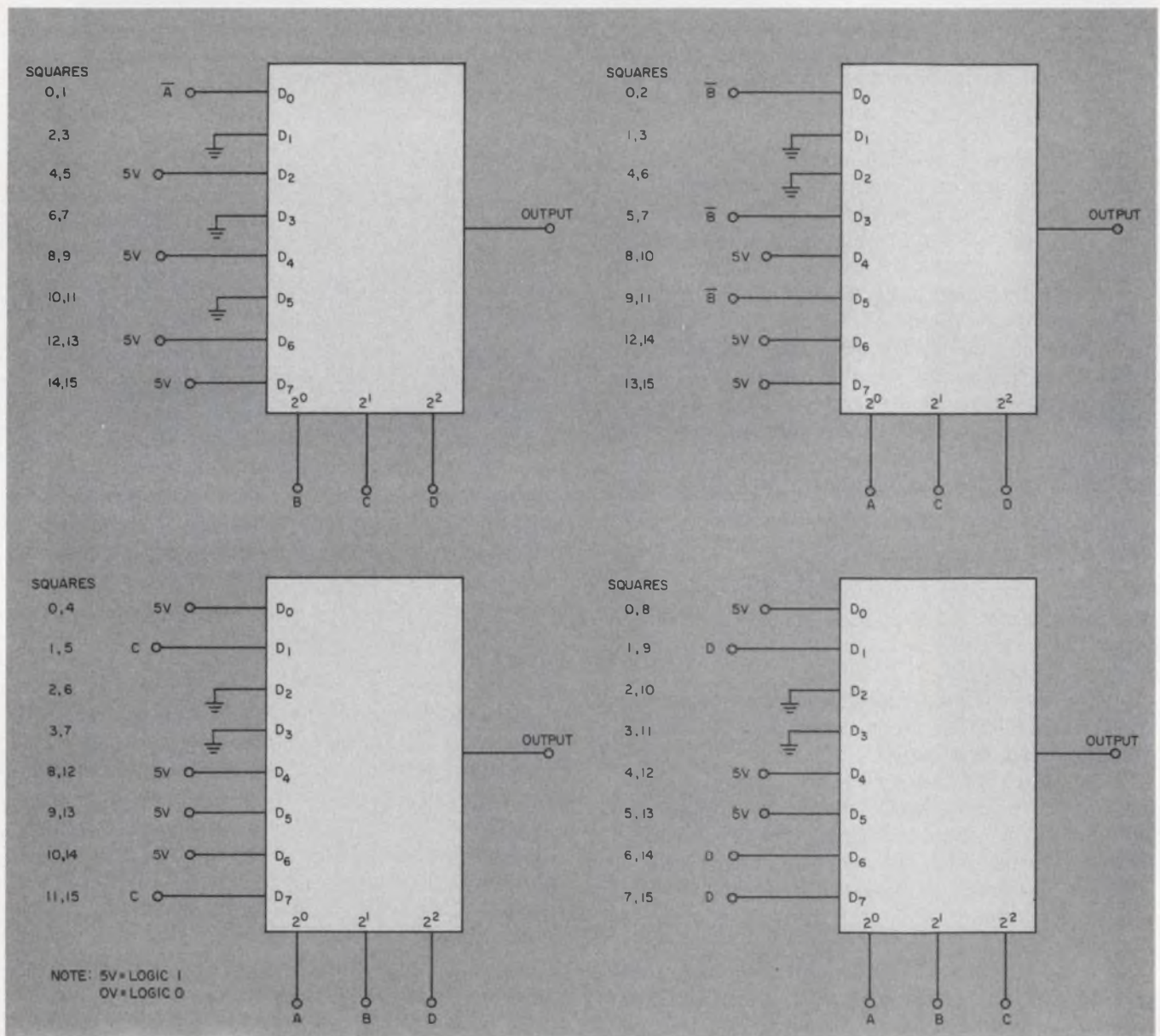

4. Comparison of squares with fixed differences of numerical weights in the modified Karnaugh map (Mahoney map) allows alternate realizations for the same

truth table. You can then select the circuit for minimum fan-in or similar criterion. The 74151 multiplexer IC can be used for all circuits shown.

From these comparisons, we obtain the four circuits in Fig. 4, all of which have the same output equation.

The best solution, or the one often preferred, has a low fan-in value (least input load) and does not require additional inverters to negate the variable. If the multiplexer used has only an inverted output, then interchange ONES with ZEROS and vice versa. Also, the variable that is the input to the data section of the multiplexer requires inversion.

The procedure to follow with five variables parallels that for four, except that a 16:1 multiplexer is used. The Mahoney map (Fig. 5a) represents an arbitrary five-variable function, and vertical lines indicate the respective columns (rows) for which the given variable is a logic ONE. The binary weights assigned to the five variables are 1, 2, 4, 8, and 16, respectively.

There are five solutions to the problem (Fig. 5b), with the comparison of squares as shown. The choice of E as input to the data lines is best; the fan-in is only 2, and no inverters are necessary. The other solutions have larger fan-ins and use negated inputs.

Invert all the inputs—as before—if you use a multiplexer such as the 74150. All ZEROS become ONES, all ONES become ZEROS, and the “don’t care” ZEROS or ONES remain the same. For the solution chosen, the inverted value of E—namely, \bar{E} —is used twice. ■■

5. A five-variable function gives a Mahoney map layout that is a direct counterpart of the five-variable Karnaugh map (a). Squares are compared as in the four-variable case, with outcomes taken from the table. Any one of the five inputs can be connected to the data lines of the multiplexer (b). The simplest circuit results if variable E is used.

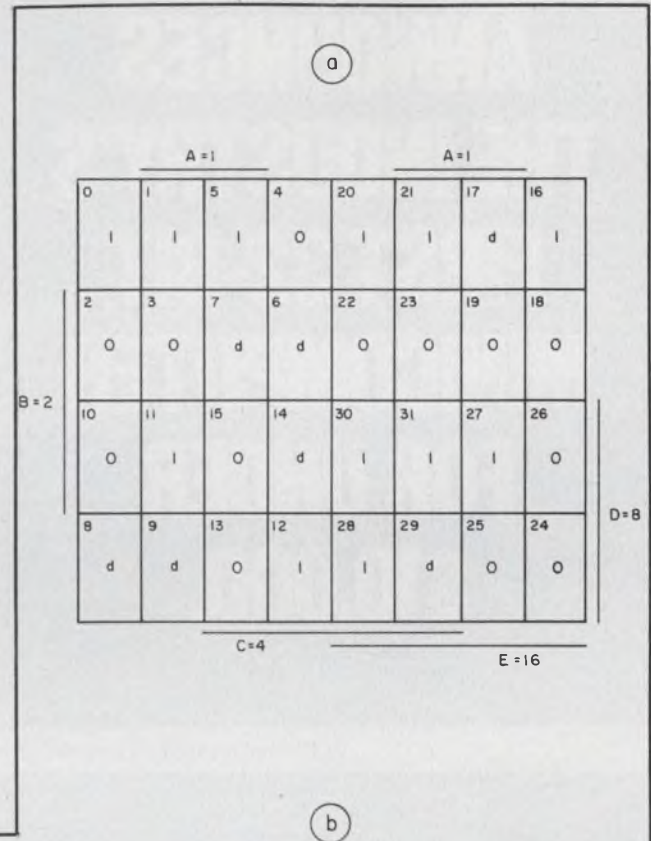

A		B		C		D		E		DATA LINE USED
SQUARES	RESULT	SQUARES	RESULT	SQUARES	RESULT	SQUARES	RESULT	SQUARES	RESULT	
0, 1	1	0, 2	\bar{B}	0, 4	\bar{C}	0, 8	1	0, 16	1	D ₀
2, 3	0	1, 3	B	1, 5	1	1, 9	1	1, 17	1	D ₁
4, 5	A	4, 6	0	2, 6	0	2, 10	0	2, 18	0	D ₂
6, 7	0/1	5, 7	1	3, 7	0	3, 11	D	3, 19	0	D ₃
8, 9	0/1	8, 10	0	8, 12	1	4, 12	D	4, 20	E	D ₄
10, 11	A	9, 11	1	9, 13	0	5, 13	\bar{D}	5, 21	1	D ₅
12, 13	A	12, 14	1	10, 14	0	6, 14	0/1	6, 22	0	D ₆
14, 15	0	13, 15	0	11, 15	\bar{C}	7, 15	0	7, 23	0	D ₇
16, 17	1	16, 18	\bar{B}	16, 20	1	16, 24	\bar{D}	8, 24	0	D ₈
18, 19	0	17, 19	0	17, 21	1	17, 25	0	9, 25	0	D ₉
20, 21	1	20, 22	\bar{B}	18, 22	0	18, 26	0	10, 26	0	D ₁₀
22, 23	0	21, 23	B	19, 23	0	19, 27	D	11, 27	1	D ₁₁
24, 25	0	24, 26	0	24, 28	C	20, 28	1	12, 28	1	D ₁₂
26, 27	A	25, 27	B	25, 29	0	21, 29	1	13, 29	0	D ₁₃
28, 29	1	28, 30	1	26, 30	C	22, 30	D	14, 30	1	D ₁₄
30, 31	1	29, 31	1	27, 31	1	23, 31	D	15, 31	E	D ₁₅

INTERDATA ANNOUNCES THE INDUSTRY'S FIRST 32-BIT MINICOMPUTER FOR UNDER \$10,000.

WITH UP TO A MILLION BYTES OF DIRECTLY ADDRESSABLE MEMORY.



Minicomputer myths you can live without:

1. There's no such thing as a 32-bit minicomputer.
2. Minicomputers have an absolute 64K addressing limit.
3. The only way to even access more is to resort to some sort of hardware kluge with a hairy software scheme that'll cost you an arm and a leg.

All wrong

Because now there's the Interdata 7/32 - a powerful new 32-bit minicomputer with main memory expandable up to a million bytes and direct addressing up to 16 million bytes.

Big it is. But hairy it isn't.

Because it's simple, straightforward and efficient. And it's the industry's first uncomplicated extended-memory software environment.

Backed up by a lot of hardware muscle like thirty-two 32-bit registers, 1024 I/O interrupts with automatic vectoring, 239 instructions. And a lot more. All of which would lead you to expect to pay a lot more money, right? Well, that's also a myth.

Performance	7/32	NOVA 840	PDP-11/40
Word length	32	16	16
Memory speed (characteristics)	750	800	900
Maximum memory capacity (bytes)	1,048,576	362,144	362,144
Addressing range (bytes)			
Direct	1,048,576	612	65,536
Indirect	1,048,576	612	65,536
Double indirect	1,048,576	Yes	Yes
General-purpose registers	32 32-bit	4 16-bit	8 16-bit
Index registers	30 32-bit	2 16-bit	8 16-bit
Virtual storage levels	Yes	No	Yes
Minimum storage (unformatted tape)	6.5	47.5	40.5

Price	7/32	NOVA 840	PDP-11/40
32 K.B. processor	8,400	\$12,800	\$15,300
64 K.B. processor	14,800	19,200	20,700
128 K.B. processor	22,400	28,800	28,700
256 K.B. processor	41,800	51,200	50,800
1 Megabyte processor	77,600	Not available	Not available

Source: Data General, Proc. List. 11/5/73. DEC PDP-11/40 Proc. List. 8/73. BEE OEM & Product Services Catalog, 1973. Amdahl Minicomputer Characteristic Digest, June 1973. "How to Use Nova Computers", 1973.

The software muscle is all there, too. A new FORTRAN V compiler. An optimizing assembler called CAL. And the first extended operating system that's both powerful and simple - OS/32. Plus all the other field-proven Interdata software - it's all compatible.

The new Interdata 7/32.

We put our muscle where their myth is.

INTERDATA

1 Phoenix Place, Hingham, Mass. 02043 (617) 531-1200
Boston - (617) 890-0311
Chicago - (312) 613-6100
Dallas - (214) 376-6100
Denver - (303) 733-6100
Detroit - (313) 578-6100
Houston - (713) 785-6100
Los Angeles - (213) 646-6100
New York - (212) 474-6100
Philadelphia - (610) 497-6100
Portland - (503) 474-6100
San Diego - (619) 545-6100
Seattle - (206) 474-6100
Tokyo - (03) 474-6100
Waltham - (617) 890-0311

7/32 minicomputers scheduled for delivery July, 1974: On Time.

INTERDATA ANNOUNCES THE INDUSTRY'S FIRST \$3200 MINICOMPUTER TO CHALLENGE THE NOVA.

PDP-11 PERFORMANCE AT A NOVA 2 PRICE.



Minicomputer myths you can live without:

1. There is no such thing as a high-performance, low-cost minicomputer.
2. You have to choose between two extremes - pay a ton for a machine like the PDP-11 and save on software costs, or buy a cheapie like the Nova 2 and pay the price later.

All wrong

Because now there's the Interdata 7/16 - an extremely flexible 16-bit OEM minicomputer that combines the best of both worlds.

It's easier to program than the PDP-11 because it has 16 hardware registers, up to 64K bytes of directly addressable main memory, 255 I/O interrupts with automatic vectoring to service routines and a comprehensive set of more than 100 instructions. That's a lot of muscle.

It's completely modular in design - plug-in options can be installed in the field to meet your specific application requirements.

Options like multiply/divide, programmers' console with hexadecimal display, power fail/auto restart, memory protect and a high-speed Arithmetic Logic Unit that includes floating point hardware. In fact, you can expand the low-cost 7/16 all the way up to the 32-bit Interdata 7/32.

Yet it costs as little as \$3200. Just like the machines that give you the barest minimum. And quantity discounts can reduce that low price by as much as 40%.

Performance	7/16	NOVA 2/4	PDP-11/05
Data word length (bits)	16, 32	16	16, 18, 16
Instruction word length (bits)	16, 32	16	16, 32, 48
General-purpose registers	16	4	8
Hardware index registers	15	2	8
Maximum memory available (K bytes)	64	64	64
Directly addressable memory (K bytes)	64	2	64
Automatic interrupt vectoring	Standard	Not available	Standard
Parity	Optional	Not available	Special order
Cycle time (microsec)	1.0 or 0.75	1.0 or 0.8	0.9
Available I/O slots	4	3	3

Price	7/16	NOVA 2/4	PDP-11/05
8 K.B. processor	\$3,300	\$1,300	\$4,700
16 K.B. processor	5,300	1,700	6,400
32 K.B. processor	5,300	3,300	10,200
Memory (2Mbit option)	\$450	\$1,600	\$1,800
Floating Point option	\$4,900	\$1,000 plus \$1,000 for 2/10 reconfiguration	Not available

Source: Data General, Proc. List. Copyright 1973, and address in direct 5/18/73. BEE OEM & Product Services Catalog, 1973. Amdahl Minicomputer Characteristic Digest, June 1973. "How to Use Nova Computers", 1973.

So you no longer have to make the painful choice between good performance and good price. Or between hardware economy and software efficiency. Now you have a minicomputer that gives you both.

The Interdata 7/16.

We put our muscle where their myth is.

INTERDATA

1 Phoenix Place, Hingham, Mass. 02043 (617) 531-1200
Boston - (617) 890-0311
Chicago - (312) 613-6100
Dallas - (214) 376-6100
Denver - (303) 733-6100
Detroit - (313) 578-6100
Houston - (713) 785-6100
Los Angeles - (213) 646-6100
New York - (212) 474-6100
Philadelphia - (610) 497-6100
Portland - (503) 474-6100
San Diego - (619) 545-6100
Seattle - (206) 474-6100
Tokyo - (03) 474-6100
Waltham - (617) 890-0311

7/16 minicomputers scheduled for delivery February, 1974: On Time.

Thick or thin-film resistors?

For high power and resistance at low cost, thick films are best, but when high precision and tracking are important, use thin films.

In hybrid microcircuits, the choice narrows to either thick or thin-film resistors. Which do you pick?

The best choice is dictated by circuit requirements; there is no clear advantage of one technology over the other in all cases (Table 1).

Thin-film resistors are used where high precision, stability and low noise are required. But thick-film resistors have better power handling capability and lower cost.

Of all circuit components, resistors are the most widely used, especially in microcircuit packages. To a large extent, this is because thick and thin-film resistors can be made inexpensively and in high density. Thus circuits like digital-to-analog converters, which are highly resistor-dependent, are a particular favorite for microcircuit hybrid packaging. And dramatic size reductions with improved characteristics become routinely attainable (Fig. 1).

Even though the average circuit designer may not be associated directly with the manufacturing of film resistors, an understanding of thick and thin-film technologies will help him evaluate the final specifications.

Thin-films are vacuum deposited

A thin-film resistor is typically 100 Å, or 10^{-6} cm, thick. Most thin-film resistors are manufactured by the evaporation or sputtering of nichrome or tantalum nitride onto prepared silicon substrates, usually through selective masks. Special deposition vacuum chambers are used (Fig. 2).

In evaporation, the material to be deposited comes from a heated source. A vacuum chamber with a high vacuum of 10^{-5} torr, or lower, is used. The material vaporizes and deposits on the cool surfaces of the substrate exposed by the mask. The material source can be a filament, a heated boat or crucible, or material vaporized by a focused electron beam.

Jim King, Staff Engineer, Hybrid Systems Corp., 87 Second Ave., Northwest Park, Burlington, Mass. 01803.

Cathodic sputtering is another form of deposition, but the deposition is made in a controlled partial vacuum. The chamber is first pumped down to about 10^{-6} torr and then backfilled with a known mixture of gases. Argon is usually used, together with some partial pressures of nitrogen or oxygen. A high dc potential between anode and cathode causes the gas to ionize and bombard the cathode. Particles are dislodged from the cathode and deposited on substrates on the anode. Ionization and deposition can also be done with use of a radio-frequency field to energize the gas.

Evaporation and sputtering deposition produce resistors in three basic ways. The first method uses metal masks in contact with or close proximity to the substrate. The various resistive materials deposit through openings in the mask onto the substrate. Masks are used mostly with evaporation methods, because masks tend to distort sputtered depositions.

A second method deposits material over the entire surface of the substrate. Photolithographic techniques then selectively etch away material to form a network of resistors. This method is used with both evaporated and sputtered films.

The third method is reverse photolithography, where the deposition is made over a previously developed photoresist. After deposition, the photoresist is washed away, and the desired pattern remains.

Table 1. Thin-film/thick-film comparison

	Thick film	Thin film
Size	small	small
Tolerance	good	best
T.C.R.	good	best
Temperature coefficient tracking	good	best
Power	high	medium
Design flexibility	good	fair
Resistance range	excellent	good
Resistivity range	widest	fair
Relative cost	low	moderate

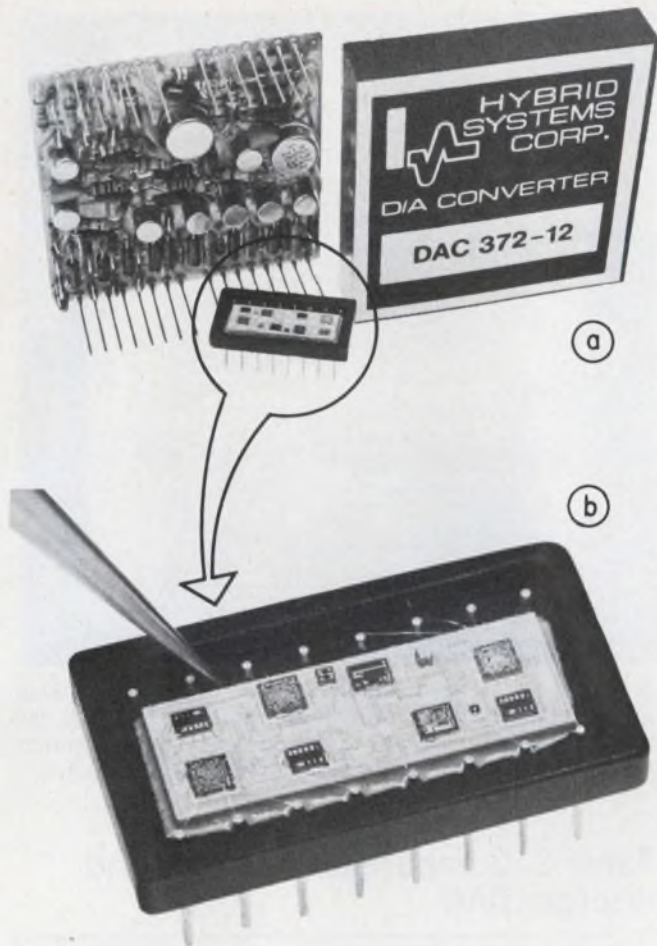

1. An example of the size reduction that is attainable with film-resistor technology is seen in this comparison of similar discrete and hybrid d/a converter designs (a). Thin films were chosen for the precision resistors in the ladder network of the hybrid design (b) because of their excellent tracking qualities over a wide temperature range. The less critical resistors are thick film.

Thin-film technology produces resistors in batches with predictable results. Film thickness, a primary variable in resistor manufacturing, can be controlled accurately from batch to batch. Then resistance can be determined solely by the type of the resistive material and its area dimensions.

The tolerances of thin-film resistors are usually within $\pm 5\%$, as deposited. They cover a wide range of resistance values— 10Ω to $10 \text{ M}\Omega$. To meet tight tolerances, resistors are then laser-trimmed to reduce cross-sectional area and increase the resistance.¹ Other trimming methods include air-abrading, oxidizing and etching with chemicals.

Thick-films are silk-screen applied

In the manufacture of thick-film resistors, a paste, or "ink," material is applied to the substrate through a silk screen, and the pattern is fired at high temperature. The substrate is commonly 96% alumina.² The resistor material is forced onto the substrate with a squeegee, and the material passes through "windows" in the mesh of the screen. The substrate is then fired at 800 to 1000 C in a conveyorized furnace, and the resistor composition adheres to the substrate surface. Conductor interconnect material is also deposited and fired in the same manner. Conductor material is usually a palladium or palladium-silver composition (Fig. 3).

Resistor inks consist of a metal or metal oxide, glass and organic binders mixed in various proportions to produce a wide range of resistance values. Thick-film resistors are typically within

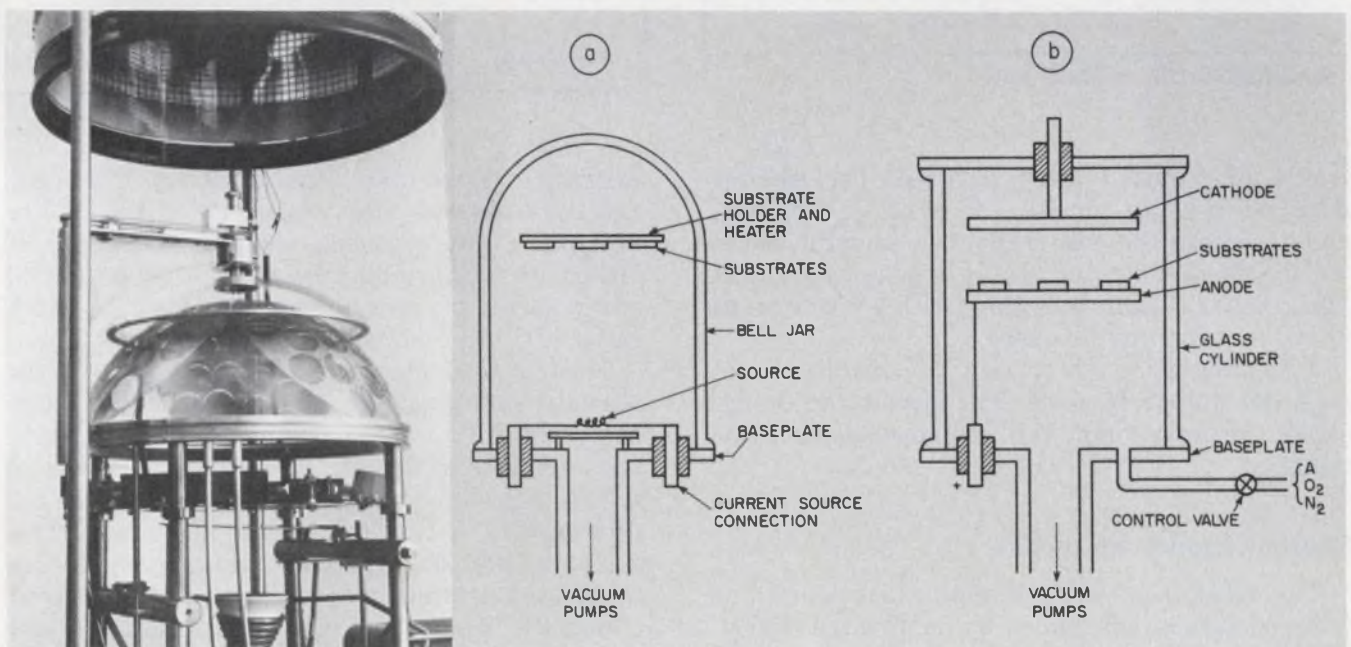

2. Either a planetary evaporation chamber (photo and a) or a sputtering system (b) are used to deposit thin-film

resistors. Evaporation is done in a vacuum, but sputtering uses a low pressure gas.

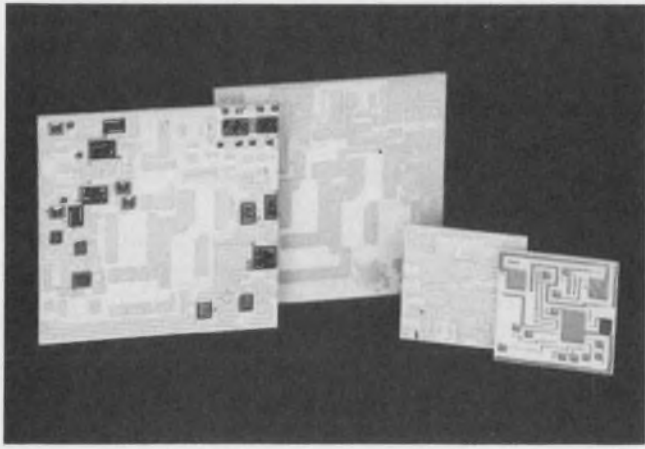

3. Thick-film resistors are deposited, together with conductors, by squeegee action through a screen mask onto a substrate that is usually 96% alumina. The substrate is then fired at 800 to 1000 C.

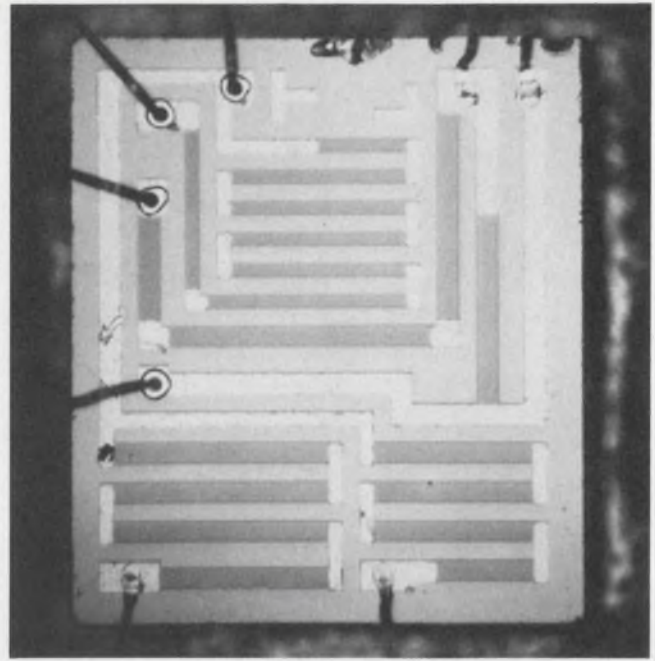

4. Thickness is held uniform, and the resistor values are determined by variations in width and length for a given material. The dark areas are nichrome thin-film resistors, and the light are aluminum conduction paths.

Table 2. Thick and thin-film parameters

Characteristic	Thick film	Thin film	Units
Resistivity Range	15 to 330 K	50 to 500	Ω/\square
Resistance Range	5 to 100 M	10 to 10 M	Ω
TC of Resistance	± 200 to ± 300	± 20 to ± 100	ppm/ $^{\circ}$ C
Tracking	± 5 to ± 50	± 1	ppm/ $^{\circ}$ C
Power Dissipation	20 to 500	25 to 100	W/sq. in.
Temperature Range	-55 to 125	-65 to 150	$^{\circ}$ C
Noise*	0 to -20	-50	dB
Resistance Tolerance	± 0.5 to ± 20	± 0.001 to ± 10	%
Resistance Matching	± 0.05 to ± 0.5	± 0.01	%

*per MIL-STD-202, method 308

$\pm 50\%$ of required value, as fired. The resistor material is quite sensitive to process variables, and therefore the final resistance usually varies widely. Thus trimming also is required for thick-film resistors. As in thin films, both laser or sand-abrasion trimming are used.

Trimming is a major cost consideration and need not always be done. The circuit can be designed so that only key components must be trimmed.

Resistance ratios are precise

The resistance value of both thick and thin-film resistors is determined by the film resistivity, specified in ohms per square. The film thickness, in both cases, is not considered a variable during layout, design and manufacturing. The re-

Table 3. Comparison of a film and discrete DAC

	Film DAC	Discrete DAC
Resolution	12 bits	12 bits
Linearity	1/2 LSB	1/2 LSB
Linearity vs. Temp.	2 ppm/ $^{\circ}$ C	30 ppm/ $^{\circ}$ C
Settling Time	1 μ s	300 ns
Size	1 x 0.5 x 0.190 in. (16-pin DIP)	2 x 2 x 0.4 in.
Price (1-9)	\$79.00	\$75.00

sistivity is based upon a uniform film of a specified thickness and sheet resistivity (Fig. 4). For example, a film material having a resistivity of 1000 Ω per square may be used to make a 3000 and a 500- Ω resistor by use of length-to-width ratios of 3 to 1 and 0.5 to 1, respectively.

Though the tolerances and stability of the absolute resistance of film resistors compares favorably with values attainable from discrete resistors, it is in the area of tracking and precise ratios that films really are superior (Fig. 5). Film-resistor networks that use the same material can provide extremely close temperature tracking, matching and initial ratio adjustment (Table 2). Though the many available thick and thin-film resistive materials provide a large range of performance tradeoffs, the use of different materials on the same substrate can cause problems.

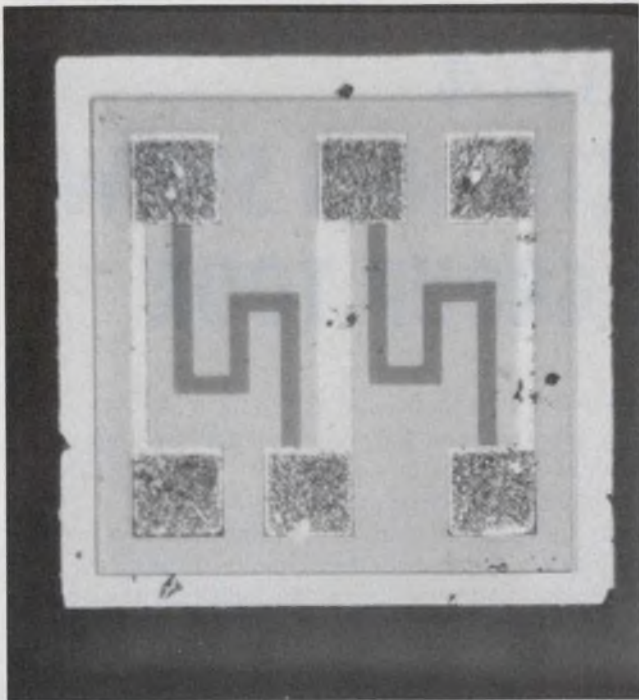

5. A center-tapped film resistor maintains a stable ratio over wide temperature ranges for a long time.

Resistive materials should all be fired at the same time, because each firing causes changes. Thus manufacturers offer a family of materials with similar composition but different resistivities.

Film resistor networks can outperform most discrete-resistor networks in establishing precise ratios between analog signals. Often the relationship must be digitally controlled, as in a digital-to-analog converter. Other uses include attenuators, gain controls and op-amp networks.

Fig. 1 illustrates the improvements that can be achieved by proper application of film technology. A 12-bit digital-to-analog (d/a) converter made from discrete resistors is compared with almost the same d/a converter made with a combination of thick and thin-film resistors. Not only is there a large reduction in size with films, but use of film technique in a hybrid package³ improves the circuit's performance in some areas, while keeping the cost of manufacturing almost the same as that of the discrete unit (Table 3).

For the less critical resistors in Fig. 1, thick films are chosen. The precision resistors in the d/a converter ladder are thin film, to take advantage of that film's excellent tracking ability. All of the converter resistors in the more significant stages were deposited on a single chip, to assure tracking over a wide range of temperature. ■■

References

1. Torrero, E. A., "Focus on Resistor Trimming Equipment," *Electronic Design*, Feb. 3, 1972, pp. 44-50.
2. Bailey, J. T., "The Case for Using Ceramics," *Electronic Design*, April 12, 1974, pp. 74-77.
3. Ruegg, F., "Why Not Use Hybrids?," *Electronic Design*, July 5, 1974, pp. 84-89.

High-Q Tunable Filter

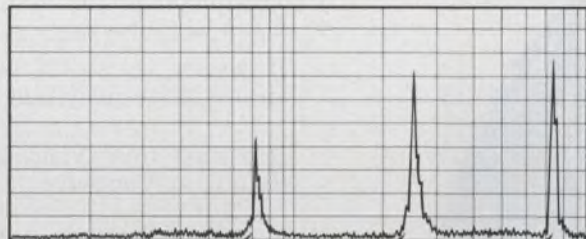

The EDMAC Hi-Q Tunable Filters are general purpose active two pole filters which can be used in either a bandpass or a bandreject mode of operation.

FEATURES

- ≡ Tunable bandwidths corresponding to circuit Q's of 1000.
- ≡ Tunable frequencies from 1 Hz. to 30,000 Hz.
- ≡ Independent controls for bandwidth and center frequency.
- ≡ Simultaneous bandpass and bandreject filter functions.
- ≡ Controlled input-output phase relationship.
- ≡ Zero phase shift at center frequency.
- ≡ Selectable automatic tracking.
- ≡ Circuit overdrive indication.
- ≡ Selectable calibration mode.

WRITE FOR COMPLETE SPECIFICATIONS

EDMAC Associates Inc.
333 West Commercial Street,
East Rochester, New York 14445
(716) 385-1440



1974 JAPAN ELECTRONICS SHOW SPECIAL GROUP TOUR

With the cooperation of ELECTRONIC DESIGN and CP AIR (CANADIAN PACIFIC AIRLINES), a special tour program has been tailored by Imperial Travel Service of New York for exhibitors and visitors to the 1974 JAPAN ELECTRONICS SHOW to be held in Tokyo, Japan, September 18-24.

This program will offer you many unique opportunities to witness at first-hand the growing Japanese electronics industry and provide free time to do business in Japan and the Orient. If you are taking your wife along, you will find this tour ideal with its many side trips and excursions.

Departure from Vancouver: Sunday, September 15, 1974 via CP Air
Return to Vancouver: Sunday, September 29, 1974 via CP Air

Tour Fare: \$1,138 per person on sharing basis
\$175 per person for single supplement

The above includes:

Air transportation from West Coast to Tokyo, round trip,
Economy on GIT fare.

Accommodation for 15 days at first class hotels.

Full American breakfasts during the tour.

Transfers by chartered motorcoaches between airports and hotels.

Sightseeing tours in Tokyo, Nikko, Kyoto and Osaka.

Special plant tours designed for the participants.

Services of tour couriers and guides.

Features: Interpreter/Secretarial services will be available
upon request.

Extension trips to Taiwan, Korea, Hong Kong and
Singapore available.

For detailed information, complete and mail coupon below,
or call collect Area Code (212) 581-6350.



To: Imperial Travel Service
680 Fifth Ave., New York, N.Y. 10019
I am interested in your Special Group Tour to
the Japan Electronics Show, Sept. 18-24, 1974.
Please send me detailed information as soon as
possible.

Name _____

Title _____

Company _____

Address _____

Good news for MOS-LSI users.

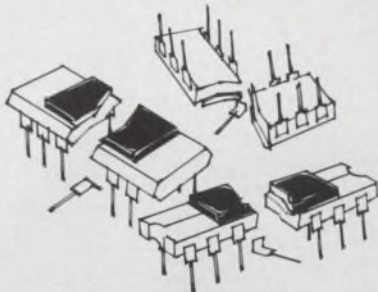

No breaks

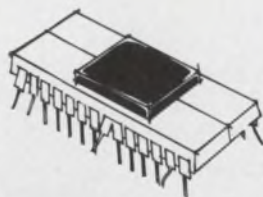

No bends

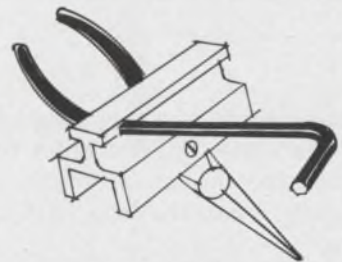

No tooling

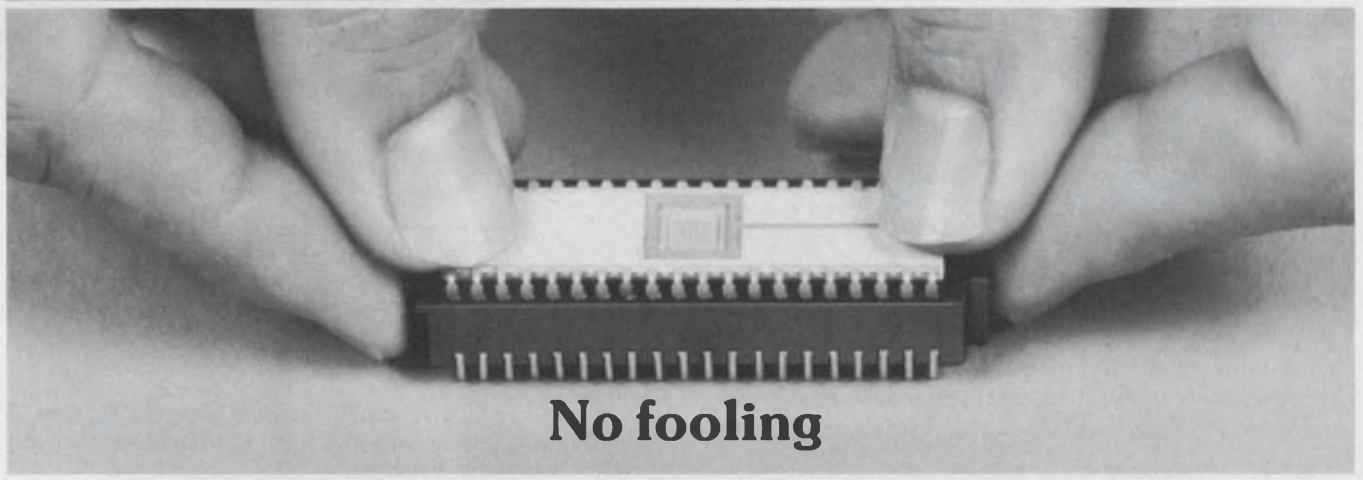

No fooling

Molex new "Zero Force" sockets take you away from all this.

Molex announces a major breakthrough in MOS-LSI socket design that lets you insert and withdraw fragile ceramic or plastic MOS-LSIs with no damage, breakage, or loss of hermeticity.

Our secret is a new patented locking principle that exerts zero force on the LSI leads until the instant the package is locked in position.

Here's how: Just as the MOS-LSI package is pressed into position (and two fingers are the only tools you need), a special contact wedge moves the spring contacts against the leads, creating a wiping action. A soft "click" tells you the package is securely seated.

Result: A securely locked, gastight connection wiped clean of resistant film. To remove the MOS-LSI, you release the locking tabs on the contact wedge and lift the package out.

The Molex Zero Force Socket has a low profile (.4 with LSI seated) and we offer it in 24, 26, 28, 36, and 40-position models.

Our price is another breakthrough. If you're paying more than 1¢ per line in OEM quantities, let Molex take you away from all that, too.

Get more factual Read all about the Zero Force Socket in our new Idea File. For your copy, write to the address below.



"Click" - it's in



"Pop" - it's out



molex ... Affordable Technology

Molex Incorporated, Dept. ED874, 2222 Wellington Court, Lisle, Illinois 60532

INFORMATION RETRIEVAL NUMBER 52

Prevent op-amp output instability.

Adding one or two passive components to the load gets rid of oscillations that cripple the output.

The addition of a few passive components to the load of an op amp eliminates oscillations that can degrade the op-amp's output. These instabilities can occur when the load is capacitive, reactive or active.

The connection of a large capacitance to an op amp's output causes the most common problem. The capacitive load might be the input capacitors of sample-and-hold and differentiator circuits. Or less obviously, it might be the distributed capacitance of cables. Either load modifies the amplifier's single-pole transfer characteristics (Fig. 1).

In combination with the output resistance, the capacitance introduces a second pole, located approximately at $-1/2\pi R_o C_L$ in the s plane. In the frequency domain, the pole causes an additional break in the gain curve that increases rolloff to -12 dB per octave and adds phase shift. If the closed-loop gain curve intersects this section of the open-loop curve, the amplifier becomes marginally stable and exhibits unacceptable transient response.

One way to solve the problem is to select an amplifier that has a lower output impedance, or to connect a current booster to the output. The change increases the frequency at which the pole occurs. Stability is improved because a greater range of gain can be tolerated before the poles become complex.

Isolate load and modify feedback

An alternative solution isolates the load and modifies the feedback loop of the amplifier (Fig. 2). The addition of R_s and C_F decouples the load, while C_F and R_F introduce a zero, z_1 , in the transfer function. The zero should be placed near load-capacitor pole p_2 to reduce its additional phase shift. In the s plane, the zero prevents the poles from becoming complex.

The required feedback capacitance can be cal-

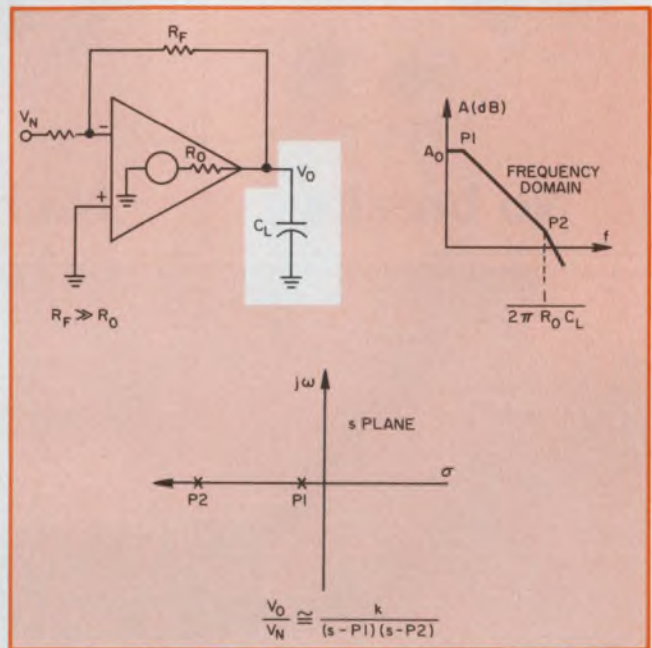

1. A large capacitive load combines with the op amp's output resistance to introduce an additional pole in the system's transfer function.

culated from C_L , R_F and R_s . Let R_s be equal to, say, 150Ω —a high-enough value to minimize the design's dependence on op-amp resistor R_o . For a capacitive load of $0.01 \mu\text{F}$ and a feedback resistance of $20 \text{ k}\Omega$,

$$C_F \approx \frac{R_s C_L}{R_F} \approx 75 \text{ pF}.$$

Reactive loads cause oscillations

Passive filters and long, discrete analog lines represent another class of problem loads. These loads can be modeled by a series inductance and capacitance (Fig. 3). The amplifier's output resistance is neglected to illustrate the condition for oscillations. This worst case can occur at dc and low frequencies, where output resistance is extremely small.

Oscillations are indicated by the circuit's transfer function:

$$\frac{V_o}{V_s} = \frac{1/LC}{s^2 + 1/LC}$$

Charles F. Wojslaw, Instrumentation Section Leader, National Semiconductor, 2900 Semiconductor Dr., Santa Clara, Calif. 95051.

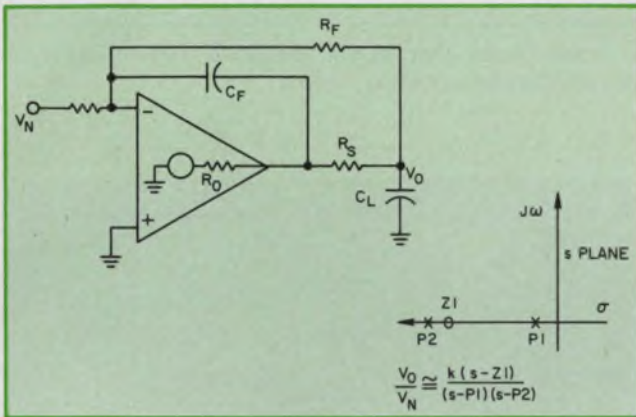

2. The addition of C_F , R_S and R_F decouples the load and introduces a zero in the transfer function.

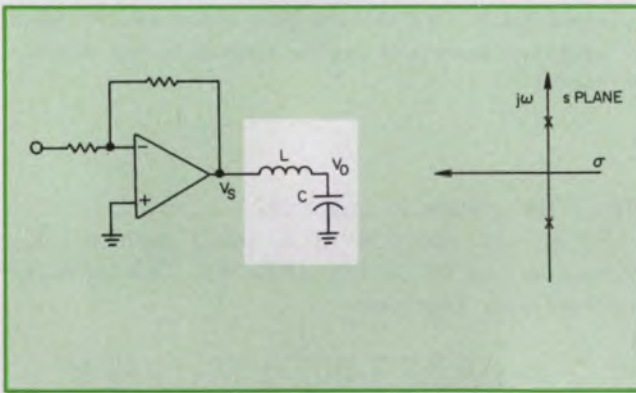

3. Reactive loads produce undamped oscillations.

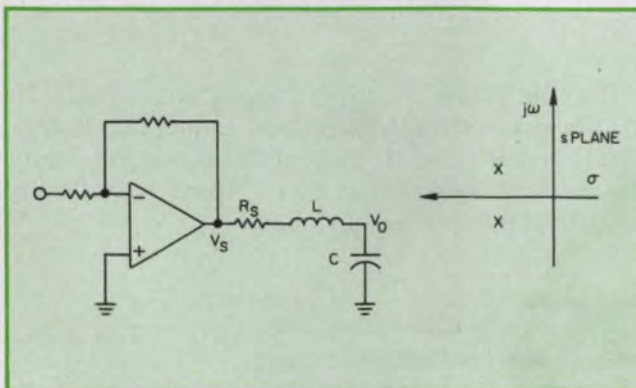

4. A small resistor, R_S , shifts the poles to the left of the $j\omega$ -axis.

The function has two poles on the $j\omega$ axis.

Oscillations can be eliminated (Fig. 4) by the addition of a small series resistor, R_S . The transfer function changes to

$$\frac{V_o}{V_s} = \frac{1/LC}{s^2 + s(R_S/L) + 1/LC}$$

which has the form of the function for the classic second-order system. That system is characterized by its damping factor, δ , and natural frequency, ω_n . The system's transfer function has the following general form:

$$\frac{V_o}{V_s} = \frac{k}{s^2 + 2\delta\omega_n s + \omega_n^2}$$

The poles are complex, and they are in the left-hand side of the s plane. For an optimum transient response, let

$$\delta = 0.7$$

and

$$R_S = 1.4 \sqrt{L/C}$$

Typical values for L and C —of, say, $10 \mu\text{H}$ and $0.01 \mu\text{F}$, respectively—result in a value for R_S of 44Ω . Generally R_S ranges from 10 to 200Ω , and the resistance can be neglected in designs, provided the next stage has a moderate input impedance.

Active loads present problems, too

Loads that include active devices can cause instabilities when a device has a current-voltage characteristic that displays a negative-resistance region. Examples include tunnel and four-layer diodes, and unijunction transistors.

Also included are some bipolar transistors, when they are forced to operate in their V_{CE0} -breakdown region. Stable operation in the breakdown region is possible if you can get there without going through a negative-resistance region. Otherwise, the transition through that negative-resistance region will cause instability.

For the simplified case of an op amp driving a tunnel diode, the load can be modeled as in Fig. 5. The transfer function,

$$\frac{V_o}{V_s} = \frac{1/LC}{s^2 - (1/RC)s + 1/LC}$$

has two poles in the righthand side of the s plane.

Design with ESSEX

for heavy-duty load control

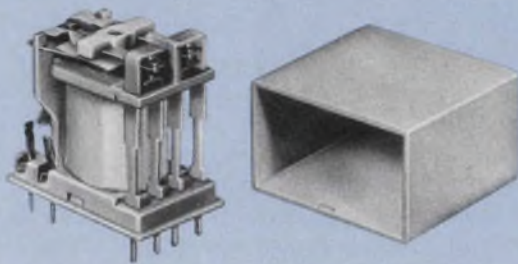

ESSEX Type 164 Double-Pole Relay

Interfacing with solid-state circuitry is the reason Essex designed this miniature, sensitive relay. Here's the answer for controlling heavy loads, or high-level signals that may be an integral part of your design.

Plug in the 164 to a PC board for computer, instrumentation, appliance, vending or home entertainment center applications, and handle up to 10 amps resistive at 125 V. AC or 28 V. DC.

ESSEX INTERNATIONAL, INC.
CONTROLS DIVISION, 131 Godfrey Street, Logansport, IN 46947.

INFORMATION RETRIEVAL NUMBER 53

"CANNON'S BURGUN-D CONNECTORS LOWERED OUR COSTS, and upped my salary."



"Burgun-D's universality and Cannon's automatic strip and crimp machine can do the same for you. Find out how in Cannon's 'Secrets of Connector Success.' And get ready to improve your life style."

Contact ITT Cannon Electric, International Telephone and Telegraph Corporation, 666 East Dyer Road, Santa Ana, CA 92702. (714) 557-4700.

CANNON ITT

INFORMATION RETRIEVAL NUMBER 54

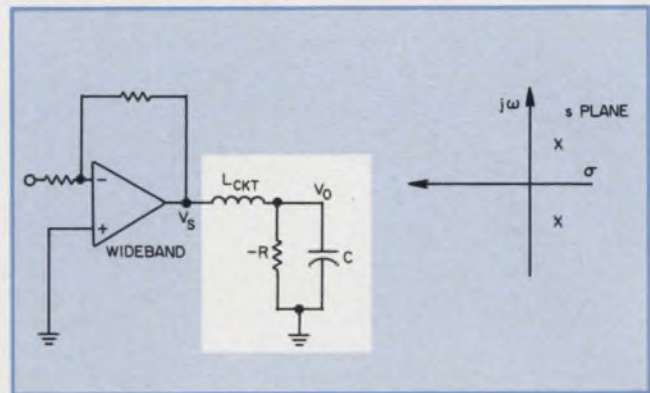

5. Active loads that exhibit negative resistances can also degrade an op amp's output.

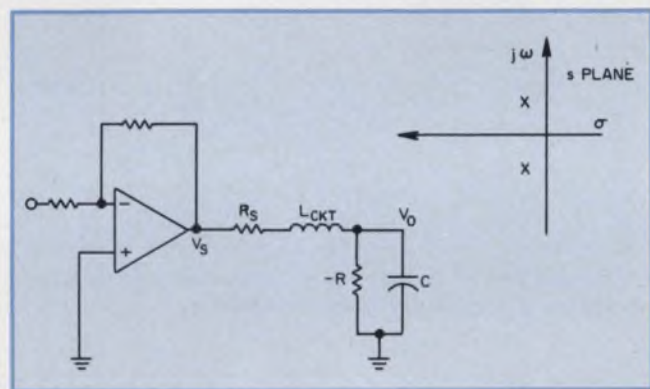

6. However, oscillations can be damped by the addition of resistor R_s .

Hence the system is unstable.

Again, the addition of a small resistor, R_s , eliminates the instability (Fig. 6). The transfer function now becomes

$$\frac{V_o}{V_s} = \frac{1/LC}{s^2 + s(R_s/L - 1/RC) + 1/LC(1 - R_s/R)}$$

For stability, both poles must be in the left-hand side of the s plane. Thus the design must meet these two conditions:

$$R_s/L - 1/RC > 0$$

and

$$1 - R_s/R > 0.$$

For the tunnel-diode circuit, L is typically 20 nH (which includes distributed inductance), C is 20 pF and R is 50 Ω . The second condition limits the value of R_s to about 50 Ω , which is sufficient to satisfy the first condition. ■■

Bibliography

Ghausi, M. S., *Principles and Design of Linear Active Circuits*, McGraw-Hill, 1965.

Graeme, J. G., *Applications of Operational Amplifiers*, McGraw-Hill, 1973.

Graeme, J. G., Tobey, G. E., Huelsman, L. P., *Operational Amplifiers*, McGraw-Hill, 1971.

Zero basic boxes cradle the world of industry.

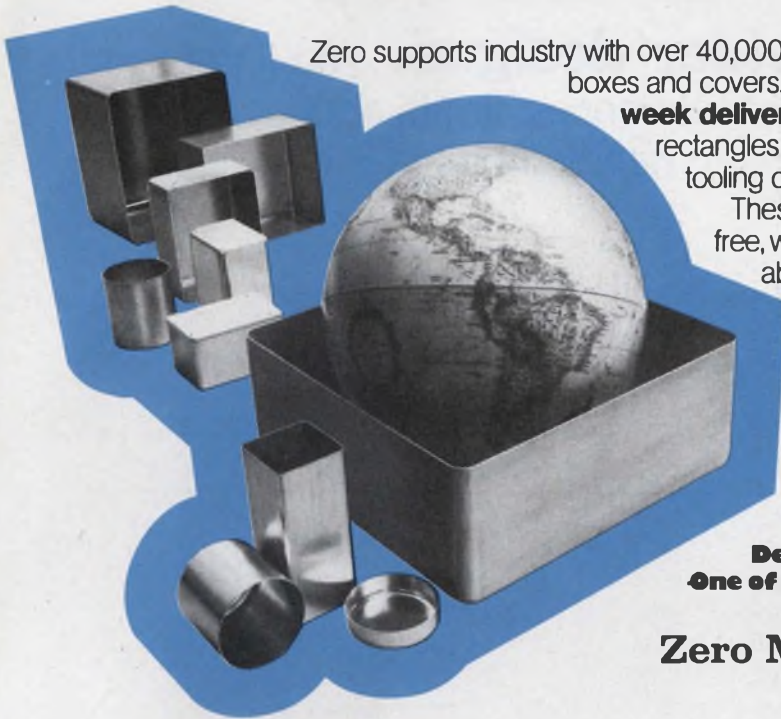

Zero supports industry with over 40,000 standard sizes of deep drawn aluminum boxes and covers. Complete facilities on both coasts mean **one week delivery** on the most complete size range of rounds, rectangles and squares anywhere. And there's never a tooling charge on standard Zero boxes!

These versatile enclosures are seamless and draft-free, with smooth, wrinkle-free surfaces. And we hold to absolute dimensional integrity, piece after piece.

Contact us in the design stage, and we can save you time and money. If a standard's not the exact answer, Zero has complete facilities for tooling and modifying to match your most exotic designs. Write for your free catalog today, and discover how well Zero supports your world.

**Deep drawn aluminum enclosures.
One of the many ways Zero supports your world.**

Zero Manufacturing Co.

777 FRONT STREET · BURBANK, CALIFORNIA 91503
 Design and Manufacturing Facilities | ZERO WEST · BURBANK, CALIFORNIA
 ZERO EAST · MONSON, MASSACHUSETTS
 ZERO SOUTH · ST. PETERSBURG, FLORIDA



INFORMATION RETRIEVAL NUMBER 55

The 80 MHz universal counter/timer that measures time interval...and a lot more too for only \$749

Now you can measure frequency, frequency ratio, single period, multiple period averages, and time interval, as well as totalize and gateable totalize - all with the 1952A universal counter/timer - a real bargain at only \$749.

Plus you get many other features, such as a dc to 80 MHz range that can be expanded, in the field, to 515 MHz, 50 mV sensitivity, and matched input channels with full control of coupling, slope and trigger level.

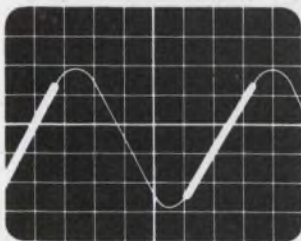

It's this trigger level control, when used in conjunction with the oscilloscope marker output which lets you easily position start and stop trigger points in time interval measurements.

The model 1952A has a seven-digit LED display incorporating leading-zero suppression and units annunciation... plus overflow, gate and trigger level status

lamps. And if you need more digits, 8 and 9 digit displays are available.

No wonder the 1952A is called "The Versatile One".

And of course you get traditional Fluke quality and a full 12-month guarantee.

Phone or write today for complete details on "The Versatile One" at \$749 from Fluke.



John Fluke Mfg. Co., Ltd.
 Counter Division
 P.O. Box 1094, Station "D"
 Buffalo, N.Y. 14210
 Phone (716) 842-0311
 TWX 610-492-3214

INFORMATION RETRIEVAL NUMBER 56

Plot your voltage-divider designs.

You'll get a quick overview of the effects of tolerances, limits and adjustments. The method can even handle nonlinear devices.

Since resistance voltage dividers make up a substantial portion of most electronic circuits, it's well worthwhile to use all the tricks you can to save time and do a better job. A graphical method shows immediately how any needed adjustment affects all the parameters. The technique enhances the application of Ohm's and Kirchoff's Laws.

The direct use of Ohm's and Kirchoff's Laws are simple enough in elementary applications. But if you try to select a working set of resistors for a two-state circuit—such as the ones found in most logic gates and flip-flops—or worse yet, if you try to confine the selection to only standard resistor values, you may find yourself blindly juggling a dozen factors simultaneously. Design limits, such as voltage, current and power ratings, can be shown on the graph to eliminate trial and error and to provide immediate answers. Even nonlinear resistors can be handled by the graphical method, and the effects of resistor tolerances and temperature coefficients can be evaluated.

A look at the general divider

Fig. 1a shows a general N-resistor voltage divider. Usually the top and bottom supply voltages are determined by the over-all system, and the circuit designer has no control over them. But the designer does select the other node voltages and currents as a first step in almost any circuit design. After he chooses suitable node voltages and currents, he must find corresponding values for the resistors R_k . Though these resistors need not be linear, a usual restriction is that the R_k be positive.

The voltage drops across the resistors (Fig. 1a) are defined as: $\Delta V_1 = V_2 - V_1$, $\Delta V_2 = V_3 - V_2$, etc. Notice that $\Delta V_1 + \Delta V_2 + \dots + \Delta V_N = V_{N+1} - V_1$, and that the arrows point along the ΔV voltage drops.

The R_k equations for the general voltage divider

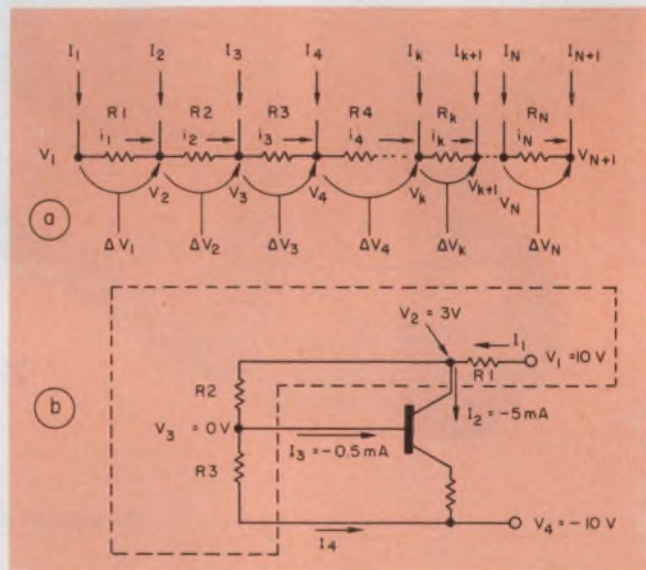

1. The generalized voltage divider circuit (a) and a three resistor divider as used for transistor biasing (b) follow the convention that currents, I_k , that flow into the divider are positive and voltage drops, ΔV_k , across the resistors are negative.

der are easily derived. Clearly the current i_k that flows in the k-th resistor R_k is, by Kirchoff's Law, the sum of all currents into the nodes higher on the string— I_1 to I_k . Thus

$$R_k = -\Delta V_k / \sum_{j=1}^k I_j.$$

A typical voltage divider, shown in Fig. 1b, biases a transistor input. The divider uses three resistors, R_1 , R_2 and R_3 . These resistors divide the 10 to -10-V drop to yield biasing voltages $V_2 = 3$ V and $V_3 = 0$ V. And biasing currents $I_C = I_2 = -5$ mA, and $I_B = I_3 = -0.5$ mA are provided. Since both currents flow out of nodes 2 and 3, respectively, they are, by the convention of Fig. 1a, negative. Also the voltage drops are $\Delta V_1 = -7$ V, $\Delta V_2 = -3$ V and $\Delta V_3 = -10$ V.

Then let's arbitrarily choose $I_1 = 10$ mA and compute the following values:

$$R_1 = -\Delta V_1 / I_1 = - (3 - 10) / 10 = 0.7 \text{ k}\Omega,$$

$$R_2 = -\Delta V_2 / (I_1 + I_2) = - (0 - 3) / (10 - 5) = 0.6 \text{ k}\Omega,$$

Ronald C. Clark, P.E., Litton Guidance & Control Systems, Inc., 5500 Canoga Ave., Woodland Hills, Calif. 91364.

$$R_3 = -\Delta V_3 / (I_1 + I_2 + I_3) = -(-10 - 0) / (10 - 5 - 0.5) = 2.22 \text{ k}\Omega.$$

Find the resistors graphically

The example in Fig. 1b is simple; thus the analytic approach is also simple. But let's repeat the solution graphically, and its advantages become apparent.

Set up a current-voltage diagram as in Fig. 2a. On the horizontal axis, draw an appropriate scale for the resistor voltage drops, $-\Delta V_k = V_k$

the upper and right edges of Fig. 2a. These scales are a handy aid and eliminate the need to calculate $1/\text{slope}$, especially when the voltage divider must use only preferred resistor values.

Fig. 2b illustrates the technique to select preferred resistors. For resistor lines that correspond to the RETMA standard, C83.2, the preferred values are shown. The values increase from value R to the next higher value, R' , according to the formula $R' = 10^{1/6} R = 1.46R$, such as 1.0, 1.5, 2.2, 3.3 k Ω , etc.

As before, draw vertical lines for voltages

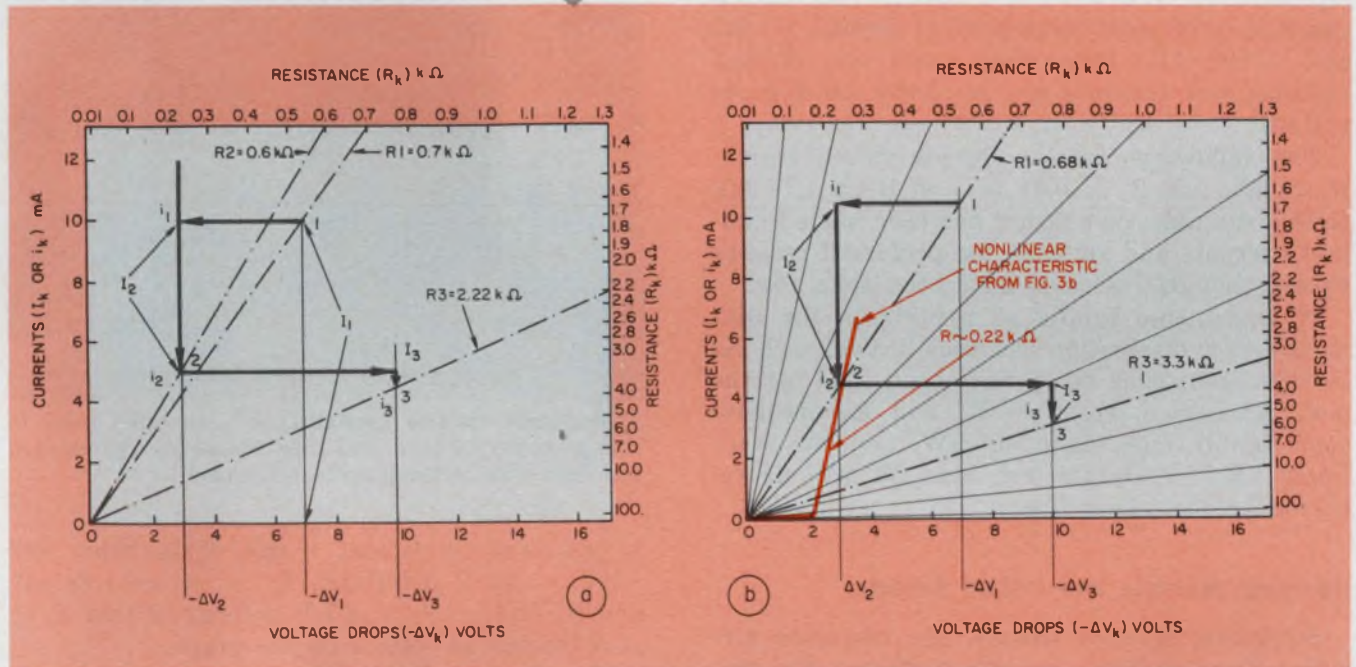

2. Both linear (a) and nonlinear (b) resistors can be handled with the graphical method.

$-V_{k+1}$. On the vertical axis, draw the node currents, I_k or resistor currents, i_k , to scale. Now plot the current and voltage points as follows: Draw vertical lines for all the $-\Delta V_k$ s— $-\Delta V_1 = 7 \text{ V}$, $-\Delta V_2 = 3 \text{ V}$ and $-\Delta V_3 = 10 \text{ V}$. Since $i_1 = I_1$, indicate this current on the $-\Delta V_1$ line as point 1 at $i_1 = 10 \text{ mA}$, and draw a line from the origin through point 1. The reciprocal of the slope of this line is $-\Delta V_1 / i_1$, which has the value of the resistor $R_1 = 0.7 \text{ k}\Omega$.

Next find the point $(i_2, -\Delta V_2)$, or point 2. Draw a horizontal line from point 1 to the vertical line $-\Delta V_2$. Then on the line $-\Delta V_2$, lay off a current I_2 with a line of 5-mA length (from 10 to 5 mA) and downward, because I_2 is negative. This defines the new point 2 at $(I_1 + I_2, -\Delta V_2)$ on the current-voltage plane. Draw the R_2 line from the origin through point 2 and measure $1/\text{slope}$ of this line to find $R_2 = 0.6 \text{ k}\Omega$.

Repeat this procedure for point 3, or $(I_1 + I_2 + I_3, -\Delta V_3)$, and the example is completed with $R_3 = 2.22 \text{ k}\Omega$.

Note the resistance scales that are drawn along

$-\Delta V_1$, $-\Delta V_2$ and $-\Delta V_3$. But now choose the first current $i_1 = I_1$, so that point 1 falls on a close preferred resistor line, say $R_1 = 0.68 \text{ k}\Omega$. Proceed to plot the points, but each point must fall on the nearest preferred resistor line. The following values result:

$$\begin{aligned} R_1 &= 0.68 \text{ k}\Omega, I_1 = 10.5 \text{ mA}, \\ R_2 &= 0.68 \text{ k}\Omega, I_2 = 6 \text{ mA}, \\ R_3 &= 3.3 \text{ k}\Omega, I_3 = 1.4 \text{ mA}. \end{aligned}$$

The graph works on nonlinears

The graphical procedure works for nonlinear as well as linear resistors. Instead of finding a resistance R_k , you may use a nonlinear characteristic like one of those in Fig. 3.

If instead of the linear resistance $R_2 = 0.68 \text{ k}\Omega$ (Fig. 1b), the nonlinear configuration shown in Fig. 3b were used, its characteristic would be plotted to intersect point 2. The nonlinear parameter, V_B , is taken equal to 2 V, and the R is taken as $0.22 \text{ k}\Omega$ for this example.

Current, voltage, power and other limits are

easily handled within the same graph. A current limit is a horizontal straight line; a voltage limit, a vertical straight line. Lines of constant power dissipation are hyperbolas.

Limits are easily handled

To illustrate the use of these and other limits, consider the simplified transistor circuit in Fig. 4a and its equivalent circuit in Fig. 4b, where the transistor becomes the resistor R_2 . The limits on the transistor are $I_L = 10$ mA, $V_L = 10$ V and $P_L = 30$ mW (Fig. 4c). Also, the transistor is to operate in its linear region, away from the lines representing saturation and cutoff. The saturation and cutoff lines correspond to slopes $1/0.1$ k Ω and $1/100$ k Ω , respectively, and the desired voltages and currents are as shown on Fig. 4a and 4b.

The following resistor design values result: $R_1 = 0.54$ k Ω , $R_2 = 0.41$ k Ω and $R_3 = 1.16$ k Ω . In this example, no attempt has been made to adjust currents and voltages for preferred resistor values, though this could have been done, too.

If a complete family of hyperbolas for constant-power dissipation had been drawn, each resistor's dissipation could have been read off the plot. As shown, resistors R_1 and R_3 dissipate considerably more than 40 mW, and the transistor (R_2) dissipates less than 30 mW as required by the power limit.

Handling two-state and k-state dividers

Switching circuits usually use two-state circuits. Some systems use three states: the two extreme states and an intermediate, or quiescent, point. The general case is the k-state circuit. And each multistate circuit usually needs resistance voltage dividers for substantial portions of its structure.

A two-state flip-flop and its divider circuit are shown in Fig. 5. The two states are labeled with unprimed and primed parameters, and the supply voltages $V_1 = 10$ V, $V_4 = -10$ V are common to both states. Corresponding primed and unprimed resistors R_1 , R_2 and R_3 have equal resistances. All of the voltage and current values, as shown, can't be chosen independently on an a-priori basis; some have to be adjusted during the design process. The desired output logic levels are zero and -5 V.

Consider transistor Q and the unprimed set of components and values to be in the high-conducting state. The desired transistor collector current is 5 mA, with a collector-emitter voltage of 2.7 V. Transistor Q' is cut off, so its collector and base currents are negligible and its collector-emitter voltage is 7.7 V.

Fig. 5c shows the graphical design of this flip-flop. The design is started with the node current

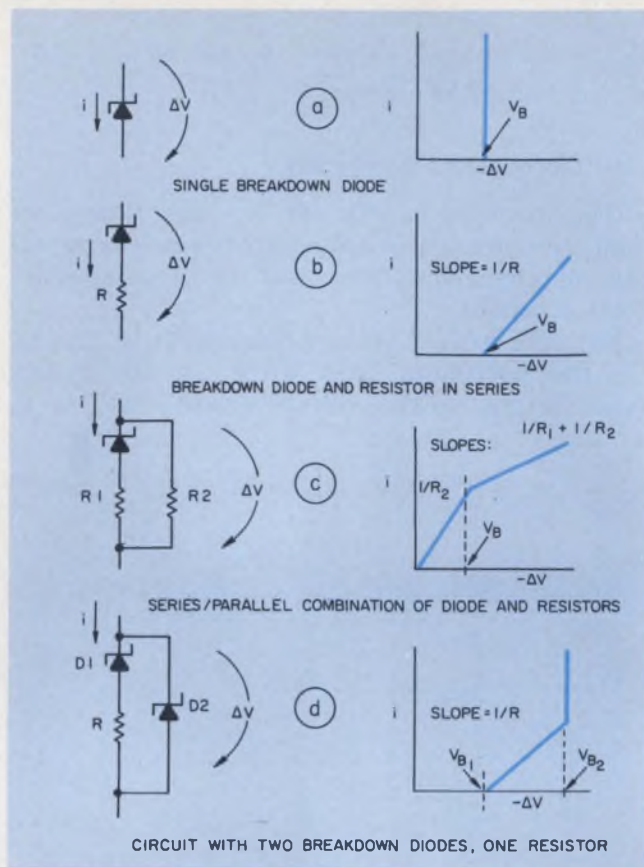

3. Nonlinear resistor configurations are often used in voltage-divider circuits and they are easily represented and dealt with in the graphical approach.

I_1' set to a convenient 8 mA. This value and $-\Delta V_1 = 15$ V determine $R_1' = R_1 = 1.88$ k Ω , and R_1 and $-\Delta V_1 = 10$ V determine that $I_1 = i_1 = 5.3$ mA at point 1 on the graph.

The Current I_2' at node 2' comes from two sources: The 2-mA output load current minus a first-trial, 5-mA collector current; thus the first-cut $I_2' = -3$ mA. The current i_2' is then found graphically as $i_2' = i_1' + I_2' = I_1' - 3$ mA = 5 mA. This locates point 2' on the $-\Delta V_2'$ line. At node 2, $I_2 = 2$ mA. Thus $i_2 = i_1 - 2$ mA = 3.3 mA and point 2 can be plotted as shown.

Note that line R_2' , which connects points 2 and 2', does not pass through the origin and has a negative slope. But we want R_2 to be equal to R_2' , and we want to use positive, linear, resistances. Therefore, some of the parameters must be adjusted to attain these conditions.

From the graph it is clear that a line through the origin and points 2 and 2' would require that I_2 equal -6.36 mA. Thus the collector current of Q must be 8.36 mA, instead of the initially selected 5 mA. With this change, $R_2 = 2.26$ k Ω .

Points 3 and 3' are now located on the $-\Delta V_3$ and $-\Delta V_3'$ lines at $I_3 = 0.167$ mA and $I_3 = 0$ mA. For both points to lie on a straight line through the origin, an adjustment was needed. The value of R_3 is then 0.79 k Ω .

Resistance voltage-divider parameters may be affected by temperature, supply voltages, com-

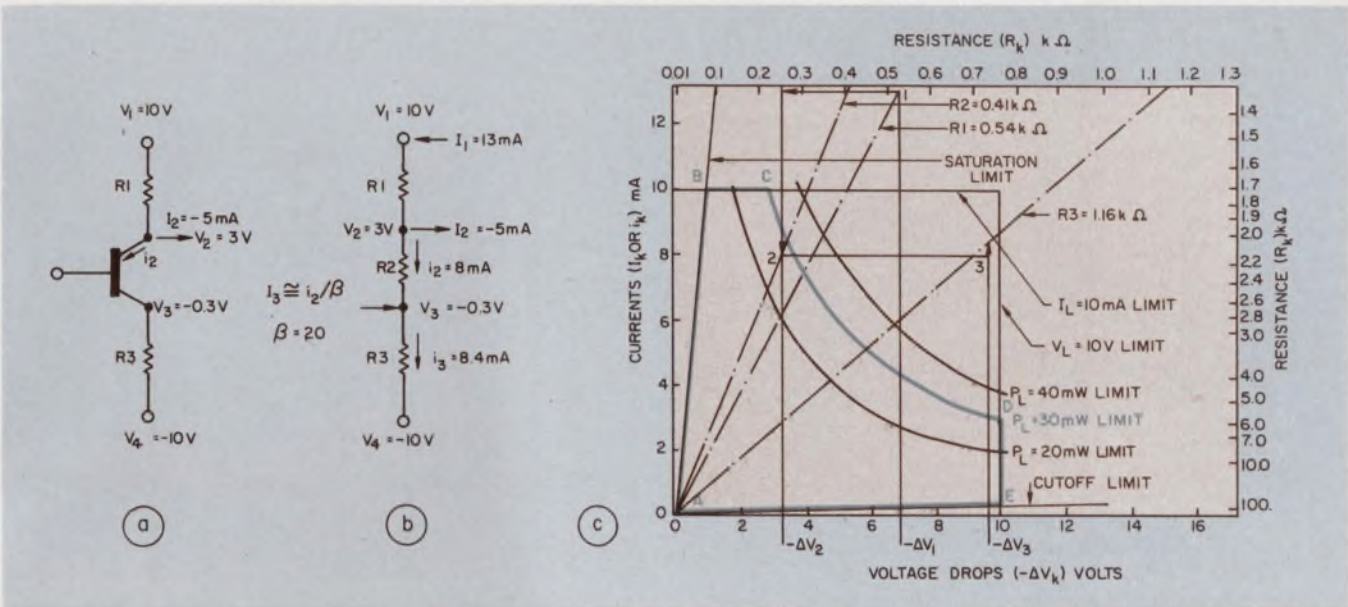

4. Voltage, current, resistance and power limits can be outlined on the voltage-divider graph as a guide.

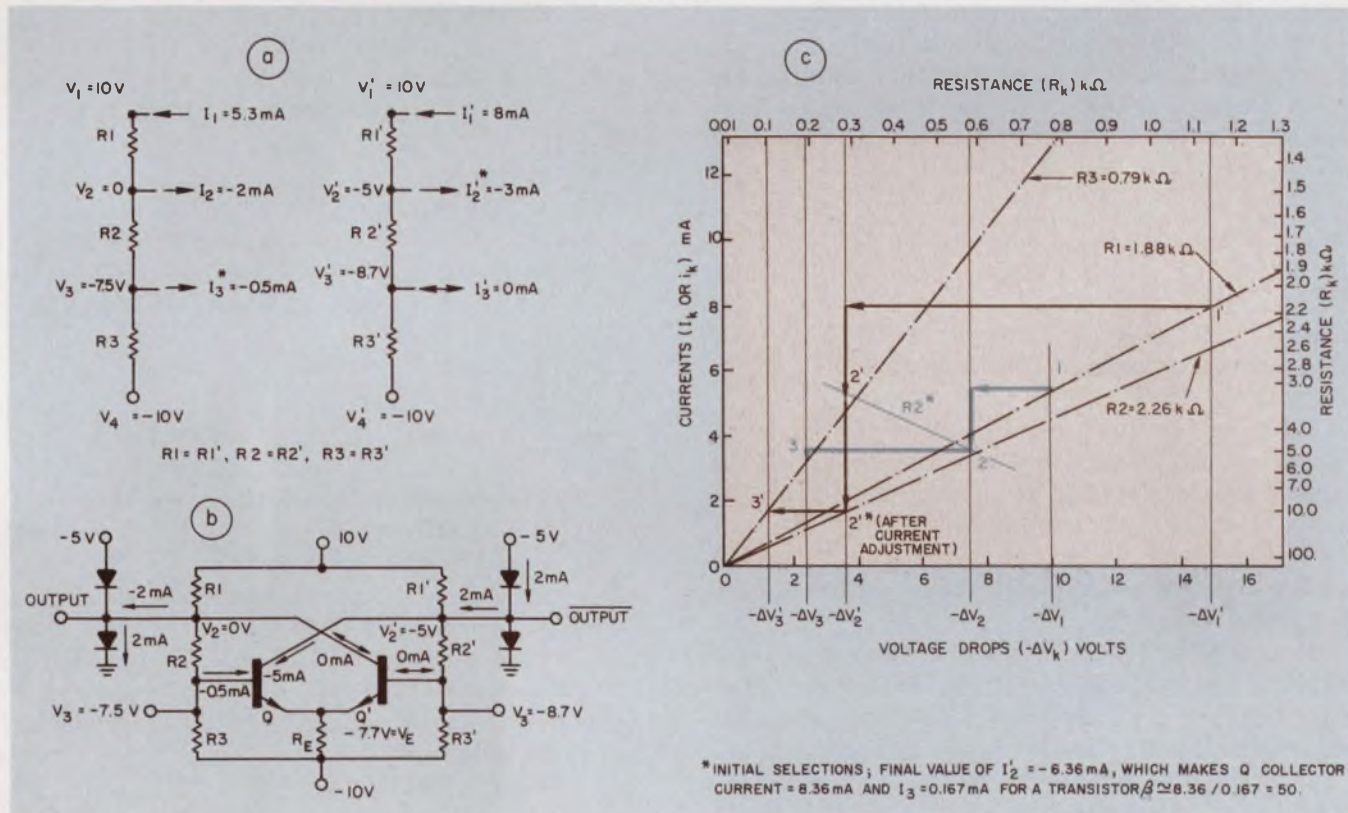

5. To design a divider for a two-state circuit, such as a flip-flop, can be a tedious trial-and-error job. However,

it becomes a rather simple exercise with the graphical method, since effects of adjustments are easy to see.

ponent tolerances and age. The effects of these conditions are easily analyzed graphically.

variations as in Fig. 6a. Follow the previously explained steps. The zone extremes establish the maximum excursions of the dependent current variables. From Fig. 6a, the results of this exercise are:

Suppose parameters vary

In a three-resistor divider (R_1 , R_2 and R_3), suppose that all voltage drops, $-\Delta V_k$, vary $\pm 10\%$, that all resistors R_k also vary $\pm 10\%$, and that the I_1 , I_2 and I_3 variations are to be found.

$$\begin{aligned}
 8.2 \text{ mA} &\leq I_1 \leq 12.5 \text{ mA}, \\
 -6.7 \text{ mA} &\leq I_2 \leq 0.2 \text{ mA}, \\
 -7.0 \text{ mA} &\leq I_3 \leq -3.2 \text{ mA}.
 \end{aligned}$$

To solve the problem, plot the $-\Delta V_k$ and R_k

Another closely related problem is to find how one or more small parameter variations affect

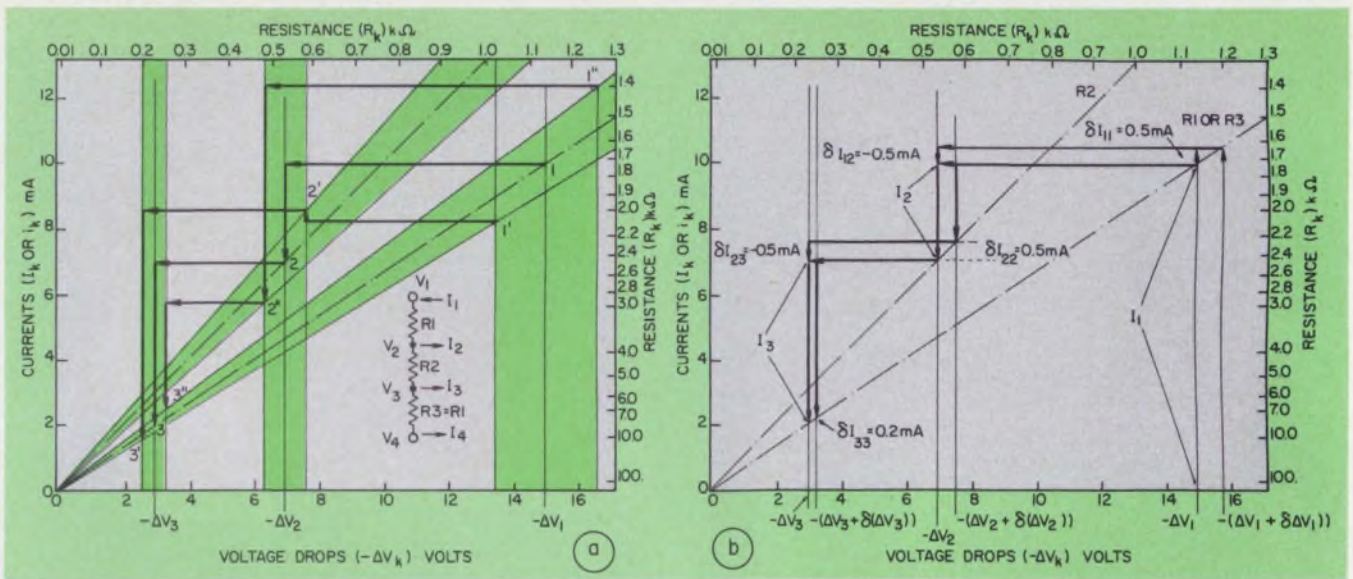

6. The effects of variations of power-supply voltage, temperature and other parameters become readily ap-

parent on a voltage-divider graph (a), and also, sensitivity coefficients can be determined, as in (b).

some other parameter. In the relationship

$$y_j = f_j(x_1, x_2, \dots, x_n), \quad (1)$$

f_j represents an unknown function relating the x to the y variables. If the x variables vary slightly by amounts δx_k , then the y_j must also vary slightly by δy_j , where:

$$\delta y_j = \sum_{k=1}^n (\partial f_j / \partial x_k) \delta x_k = \sum_{k=1}^n a_{jk} \delta x_k \text{ for } j=1, 2, \dots, N. \quad (2)$$

The a_{jk} are called sensitivity coefficients, and they can be considered constants for *small* variations in x .

To solve for them, set all but one of the small variations δx_k to zero, one at a time, until all the sensitivity coefficients are determined. Then the summation (2) will establish δy_j .

This exercise is the mathematician's way of saying that the principle of superposition applies for small variations.

To perform the procedure graphically, refer again to the example of Fig. 6a and suppose that variations in ΔV_1 , ΔV_2 and ΔV_3 occur, and that their effects on I_1 , I_2 and I_3 are to be found.

Let's analyze three cases: $\delta_0(\Delta V_1) = -0.75$ V, $\delta_0(\Delta V_2) = 0.5$ V and $\delta_0(\Delta V_3) = -0.15$ V. In each case all other deviations are set to zero and variations $\delta_0 I_1$, $\delta_0 I_2$ and $\delta_0 I_3$ are determined separately for each $\delta(\Delta V_k)$.

Fig. 6b shows the graphical solutions for the three cases. The current variations are found to be:

Case I	Case II	Case III
$\delta_0 I_{11} = 0.5$ mA	$\delta_0 I_{21} = 0$ mA	$\delta_0 I_{31} = 0$ mA
$\delta_0 I_{12} = -0.5$ mA	$\delta_0 I_{22} = 0.5$ mA	$\delta_0 I_{32} = 0$ mA
$\delta_0 I_{13} = 0$ mA	$\delta_0 I_{23} = -0.5$ mA	$\delta_0 I_{33} = 0.2$ mA

The sensitivity equations are derived from these results:

Case I

$$\delta I_{11} = (0.5 \text{ mA} / -0.75 \text{ V}) \delta(\Delta V_1) = (-0.667 \text{ mA/V}) \delta(\Delta V_1)$$

$$\delta I_{12} = (-0.5 \text{ mA} / -0.75 \text{ V}) \delta(\Delta V_1) = (0.667 \text{ mA/V}) \delta(\Delta V_1)$$

Case II

$$\delta I_{21} = 0 \text{ mA},$$

$$\delta I_{22} = (0.5 \text{ mA} / -0.5 \text{ V}) \delta(\Delta V_2) = (-1.0 \text{ mA/V}) \delta(\Delta V_2),$$

$$\delta I_{23} = (-0.5 \text{ mA} / -0.5 \text{ V}) \delta(\Delta V_2) = (1.0 \text{ mA/V}) \delta(\Delta V_2).$$

Case III

$$\delta I_{31} = 0 \text{ mA},$$

$$\delta I_{32} = 0 \text{ mA},$$

$$\delta I_{33} = (0.2 \text{ mA} / -0.15 \text{ V}) \delta(\Delta V_3) = (-1.33 \text{ mA/V}) \delta(\Delta V_3).$$

The over-all current variations are then:

$$\delta I_1 = (-0.667 \text{ mA/V}) \delta(\Delta V_1), \quad (3)$$

$$\delta I_2 = (0.667 \text{ mA/V}) \delta(\Delta V_1) - (1.0 \text{ mA/V}) \delta(\Delta V_2),$$

$$\delta I_3 = (1.0 \text{ mA/V}) \delta(\Delta V_2) + (-1.33 \text{ mA/V}) \delta(\Delta V_3).$$

Now suppose temperature, T , and pressure, P , influenced ΔV_1 , ΔV_2 and ΔV_3 of the previous example as follows:

$$\delta(\Delta V_1) = (0.1 \text{ V/}^\circ\text{C}) \delta T - (0.05 \text{ V/psi}) \delta P,$$

$$\delta(\Delta V_2) = (0.1 \text{ V/}^\circ\text{C}) \delta T, \quad (4)$$

$$\delta(\Delta V_3) = (0.05 \text{ V/}^\circ\text{C}) \delta T + (0.01 \text{ V/psi}) \delta P.$$

If you substitute Eqs. 4 into Eqs. 3, you get:

$$\delta I_1 = (-0.0667 \text{ mA/}^\circ\text{C}) \delta T + (0.0333 \text{ mA/psi}) \delta P,$$

$$\delta I_2 = (-0.0333 \text{ mA/}^\circ\text{C}) \delta T - (0.0333 \text{ mA/psi}) \delta P,$$

$$\delta I_3 = (0.0335 \text{ mA/}^\circ\text{C}) \delta T - (0.0133 \text{ mA/psi}) \delta P.$$

These new equations now govern how I_1 , I_2 and I_3 vary with respect to the variations in temperature and pressure. ■■

1974'S
BIGGEST
DESIGN-IN
NUMBER.

THE 4136
QUAD OP AMP
REPLACES FOUR
AT 40% LESS.

741's.



If there ever was a linear IC destined to become the biggest volume commodity item since the 741, it's Raytheon Semiconductor's 4136 Quad Op Amp.

The 4136 is the only quad op amp that's electrically equivalent to four 741's. The only one that requires no design changes. And it's even better than the 741. Lower input noise, better input offset voltage matching, wider input common mode voltage range, greater gain, higher slew rate, and wider bandwidth.

The 4136 costs 40% less than four 741's. And that's just the beginning. Packaged in a standard commercial or military 14-pin DIP, it requires only one mechanical assembly step. So naturally it takes up less board space. Testing is simpler too. And inventory is less of a problem. This all adds up to greater cost savings.

There's more to the big 4136 design-in number story. Get all the facts on quads.

Raytheon Semiconductor
350 Ellis Street
Mountain View, California 94042

RAYTHEON



Send me all the facts on the 4136 Quad Op Amp and your other money-saving Linear Quads.

Name _____
Title _____
Company _____
Address _____
City _____
State _____ Zip _____

4136 Quad Op Amp • 324 Ground Sensing Quad Op Amp • 3900 Single Supply Current Quad Op Amp • 339 Quad Comparator

ED

RAYTHEON SEMICONDUCTOR

Designs that sell require compromise, follow-up and coordination with manufacturing, sales and the customer, says this engineering head.

My biggest challenge has been managing designers who want to work alone in an industry where success depends on their working with others. Too often when a designer is given seven months to produce a product, he takes six and a half months to design it and then turns the design over to the manufacturer. That leaves just two weeks to ship it.

I tell my designers that good product design is the result of follow-up, coordination and compromise with sales, with the manufacturer and, of course, with the customer.

When a designer visits a customer to talk about a new product concept, he's often so concerned about losing a prospective sale that he tells the customer he'll give him anything he wants. That's a mistake, because the customer may be wrong. What the designer should do is analyze the customer's requirements and understand them well enough to know what he needs, instead of what he wants. When the designer is finished, he should know the product better than the customer does.

Keep asking questions

To reach that point, however, a designer must show his ignorance, which he's usually afraid to do. He should realize that he's there to learn what his prospective customer's business is. The customer will most probably be impressed by his candidness.

Some of the questions a designer should ask a customer about the product he wants are:

- What type of equipment is the product being designed for?
- What is the application of the equipment?
- What is the production environment?
- What level of education or background have the people who are going to maintain this equipment?
- How many variations of this equipment are there?

Designers often fail to find out how the customer is going to use his equipment. They usually ask for the specs and try to make them work. They don't ask where the equipment will be used or who the maintenance people are. Quite often the customer will ask for more than he needs; he may specify some kind of interconnection system because he read that it's the best. But it may not be the best for the way the designer intends to build it.

The designer must follow up constantly. He must make certain that the customer understands that he should supply help throughout the project. He should also constantly check the specs to see if he should drop some, add some or change some. One last word on handling customers: know the customer's product, but never try to tell him his business.

Designing by committee poses problems

Often the designer isn't the one who fails to compromise. What happens, for instance, when a company decides to produce an in-house product? Usually the company organizes a new-product committee composed of the managers—sales, production, engineering and marketing.

I remember how a product committee operates from my own experience. I'd designed a new fancy component that would have been extremely useful in a fixed-time traffic controller. However, the new-products committee determined that the company needed an actuated traffic controller, and they thought that they would incorporate my new component design as a sales gimmick. I tried to tell them that this idea was impractical, but they wrote down a set of specs and the new unit was incorporated.

Six months later they found out that the project was four times bigger and four times more expensive than the market required. Before it was over, they had lost four years of engineering time and over \$100,000 in material. There had been no coordination and no follow-up.

The point is that someone wrote down a set of specs without compromising. They sent these specs to engineering, which had been isolated

Peter G. Bartlett, President, Automation Systems, Inc., Eldridge, Iowa 52748

from the market. If the engineer doesn't know the market, he'll design his own embellishments; he'll design specs that may not be required, some of which he could even drop or modify. The product will grow beyond belief, if you don't have follow-up and coordination.

Painstaking coordination pays

So we decided to rework the traffic-controller project. This time we wrote a generalized spec for an actuated controller. We held weekly meetings for the people who were designing, selling and making this product. They were involved in the product from the beginning.

Sales asked for a product feature that would help them sell it. Engineering asked them at a later meeting if they really wanted to pay \$7 more per product for that feature. Sales dropped the idea, and because they were clued in, they didn't say later that they couldn't sell the product because it was designed improperly. This product came out of production six months after it was conceived and became the standard of the industry.

I've seen coordination efforts fail because a new-products committee tried to do the coordinating. The heads of departments get together and discuss the theory of the new product, and the product comes out with a committee design.

If a company hasn't done a product for a long time, it probably is used to living off its own fat, growing weak in management and in new-product introduction. Ironically the designer in those companies either has very little to say or he's given the whole apple without knowing what to do with it. Often management says, in effect: "Make it and don't bother me with it, because I don't know what you're talking about." They think that's why they're paying the designer.

Designing means compromising

But working alone really tests a designer, because he's confronted by many a temptation. Here are some traps that designers must consider:

- *Experimenting on the customer's product:* Should the designer use an integrated circuit that is higher priced than the old standbys because he wants to use the newer technology? Answer: Don't use it unless there's a definite need for it.

- *The "not invented here" syndrome:* Even if the designer hasn't invented it, he must let the customer know when there's an item on the market that's three-quarters of the product that the customer wants.

- *Upgrading and downgrading the customer's specs:* Maybe the guy doesn't need gold-plating, or maybe he should have it because of environmental considerations. Maybe paper circuit boards can't be used because they'd have to be repaired



Peter G. Bartlett ponders a problem in his Iowa office.

frequently, and glass epoxy would be better. The designer must use common sense and not let the specs always dictate the design.

▪ *The unique design:* The biggest problem for designers is the customer who asks for some kind of unique panel control. How do you build it when you've found after you've designed it that there's a bug in it? He has asked for a mode or front-panel control that doesn't fit the way the system naturally operates. Answer: The designer should ask if he can display the control more inexpensively and still give the same information. The customer will usually say one of two things: "I don't care as long as the information is displayed," or "No, that feature is worth the extra money to me."

Providing all the specs, even when they aren't necessary, is a challenge to a designer. Just keep reminding him to keep it simple.

Learn to lean on production

Part of the designer's success depends on his relationship with the manufacturer. He has to make production feel that it has had a hand in creating the product. When the designer has finished the design and is putting his prototype together, it's time to show it to the manufacturer.

The designer should have enough of the drawings and information so he can tell someone who's

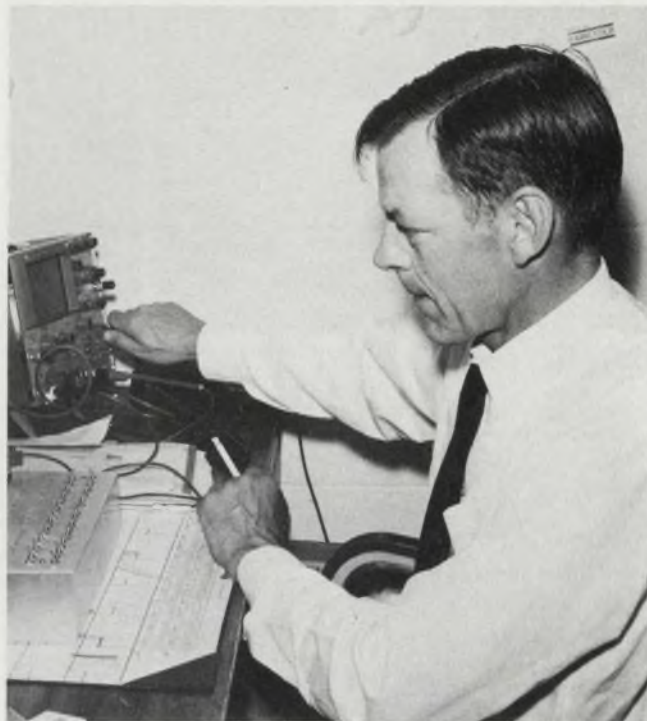

not an engineer what it's all about, particularly when he's working on a new product. He might say: "We're not doing the normal design this time; we're doing something different." Or: "We have to go through a resistor-selection process, and since you've never had to balance components before, how would you like us to present it to you

Peter G. Bartlett and ASI

Peter G. Bartlett's ability as an enterpriser came to the fore early. Before he graduated from Northwestern University, he had already worked for two employers. He began his electronics career as a technician at Cook Electric Company Research Labs where he designed operational amplifiers for shipboard fire control computers. Later he developed an electro-optical edge guide servo control system for rolling mill applications for another employer, Askania Regulator Company.

He was becoming a designer, but he was also to become an entrepreneur and a college professor. His wife and he moved on to Maryland where they took graduate work at the University of Maryland. He had no inkling then that one day his wife would hire him as a member of her management team. He joined his wife, who is a talented businesswoman, in the spring of 1973, as President of Automation Systems.

In Maryland, Bartlett worked at the Westinghouse Air Arm Division on solid state missile radar. In 1957 he joined Motorola, Inc., as a staff scientist. He set up in-house training courses in solid state circuits and also designed

and sold radar indicator displays for shipboard use. Leaving Motorola in 1960 as Manager of the Military Communications Department he formed Bartlett Laboratories, Inc., and worked on research contracts from the Navy and Air Force in atomic battery research.

In 1963, Bartlett profitably sold his company and became an Associate Professor of Electrical Engineering at the University of South Carolina.

In 1964 Professor Bartlett joined the Systems Division of Gulf and Western as Director of Research. During his tenure he developed a number of solid state controls which were applied to the industrial and vehicular traffic control fields. In 1968 he formed and managed the Systems Division of Struthers-Dunn, Inc.

The products of Automation Systems, Inc., his present company, cover all phases of solid state control of industrial automation equipment—both hard wired and programmable computer controls. Its market is aimed at automotive and related manufacturing operations.

Peter Bartlett and his wife live in Davenport, Iowa, with their five children.

for production—this way or that way?"

Once he has shown the new-product prototype to the production people, they'll often make suggestions. Too often they are belittled by engineering. But they know their business as well as the engineer knows his. They're making suggestions not because they're trying to get out of doing something, but because either they don't know how to do it or they see a faster cheaper way to do it.

If you even suspect that the design is not routine, talk to production about it. I don't think that's done more than 5% of the time, because it takes time and effort and it rocks the boat. Most new products never reach the market because those involved haven't anticipated the problems as soon as they should have.

If the designer doesn't bring the product to production soon enough, he'd better follow it through himself, because he hasn't given the production man time to absorb his knowledge. The only time the designer should actually get involved in the production is if it's a really tight schedule.

Beware of complacency

I've seen it happen time and time again—the company won't ask the customer to modify the specs that are killing it. The company sits on the

project and becomes complacent. If it isn't careful, another company will take over the contract by default.

I remember a company that had a project for four years; the product had grandiose specs. I worked for another company, and we wanted that project because the one we had was phasing out. We knew they had some problems getting the system into a small enough package to fit the application. It was an airborne product and had to fit in a limited space.

We organized a group of four people and worked together for six months to build a small prototype of the product to present to the Air Force. They gave us enough money to investigate a bit further, and in a year we had the entire contract.

So even if you have the contract for four years, you can still lose it. The original contractor had invested heavily in the program—the company had built a factory building to accommodate the project. It lost the whole thing because it didn't respond to the customer; it didn't go back and make the design compromises. We did. We said in effect: "Here, you've asked for this, and it's taking up too much room; so we've modified it slightly. We can still accomplish the same end result, but maybe not the way you intended it." We rewrote the specs and landed a \$100-million contract. ■■

Micaply Ohmega™ A different way to design without discrete resistors.

For printed circuits and microelectronics

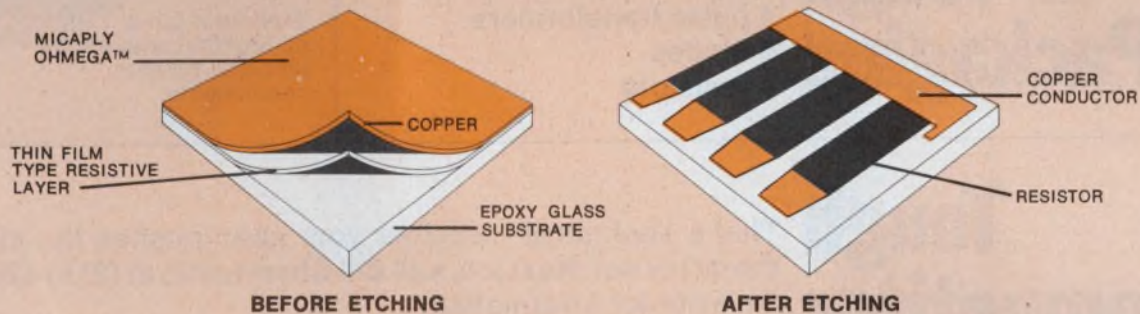

Micaply Ohmega™ can reduce costs and eliminate the need for discrete resistors. **And it's available immediately.**

It's a proven resistor-conductor laminate with a bi-layer cladding on one or both sides.

Etch integral resistors and conductors on the same surface. The entire process is subtractive.

No screening, firing or vacuum equipment is required.

- 25 and 100 ohms-per-square materials.
- Line widths consistent with thin film microelectronic techniques are possible.
- 10" x 36" sheets for processing economy.
- Design assistance and circuit

production available.

It's being used now for termination resistor networks, calculator circuits and microelectronics. Get the facts. Write today.

The **Mica** Corporation
Culver City, California
(213) 870-6861 and
Micaply International, Silloth, England

INFORMATION RETRIEVAL NUMBER 57

TECHNITROL Takes The Tough PT'S.

When it comes to pulse transformers (PT'S), Technitrol's experience leads the field. Technitrol was first with DIP transformer packaging and the H case. But, Technitrol is first where it really counts: getting the job—no matter how tough—done right. Here are two examples:

1/Tough Performance

Check these specs for a high-inductance transformer:

CMRR: 30 db @ 10 MHz
Bandwidth: 5KC to 3 MHz
Inductance: 20 mh min.

Here's
Technitrol's
answer!



2/Tough Packaging

Here's what one customer wanted in a DIL-type case:

4 pulse transformers
8 diodes
8 resistors

Technitrol put it
all together with
discrete, reliable
components.



Tough Competitor

That's Technitrol—whether your spec pushes the state-of-the-art or not. Next job, call Bill Chamberlin at (215) 426-9105. Or write for information.



Technitrol, Inc.

TECHNITROL, INC.

1952 E. Allegheny Avenue / Philadelphia, Pa. 19134.

Specialists in pulse transformers and completely transfer molded, welded DIP delay lines, under $\frac{3}{16}$ " high—to 250 ns.

INFORMATION RETRIEVAL NUMBER 58

ELECTRONIC DESIGN 17, August 16, 1974

FERRITE HEAD CORE

Look to TDK for superb hot pressed ferrite materials and precision manufacturing techniques.

TDK's hot pressed ferrites are available in both Mn-Zn ferrite and Ni-Zn ferrite. TDK offers these superb materials adding precision processing techniques in order to achieve high density recording head cores.

Please contact us about any problems you may have with head cores for industrial, audio and video applications. TDK will be most pleased to assist you.

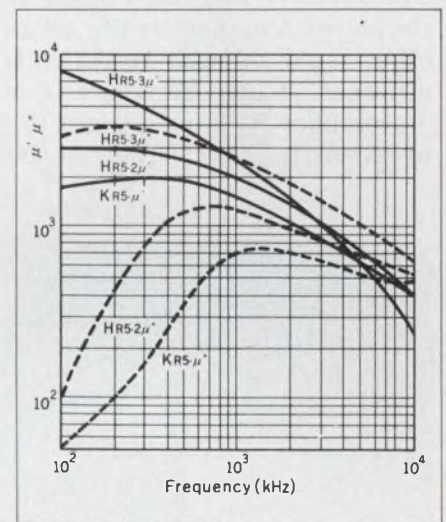
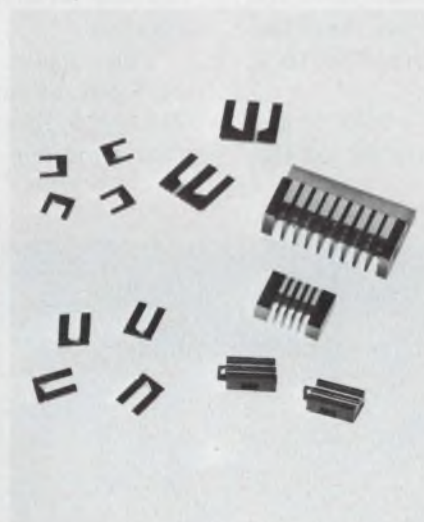
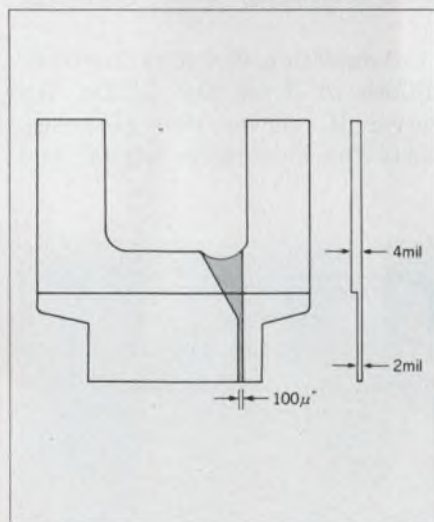

	Initial permeability	Flux density @15 Oe (gauss)	Coercive force (Oe)	Specific density (g/cm ³)	Material composition
HR3S	18,000 ± 20%	> 3,700	< 0.05	> 5.10	Mn-Zn
HR5-2	3,000 ± 15%	> 4,900	< 0.1	> 5.05	Mn-Zn (hot pressed)
HR5-3	10,000 ± 20%	> 3,700	< 0.05	> 5.10	Mn-Zn (hot pressed)
KR4	1,500 ± 15%	> 3,200	< 0.2	> 5.30	Ni-Zn
KR5	1,600 avg.	> 3,000	< 0.15	> 5.30	Ni-Zn (hot pressed)
KR6	2,000 ± 15%	> 3,200	< 0.15	> 5.30	Ni-Zn
KRZ	2 max.	—	—	> 5.30	Non-magnetic ferrite



TDK CORPORATION OF AMERICA 931 South Douglas Str, El Segundo, Ca 90245 Phone: (213) 644-8625 CHICAGO BRANCH 2906 West Peterson Av, Chicago, Ill 60659 Phone: (312) 973-1222
 NEW YORK BRANCH 755 Eastgate Blvd, Garden City, N.Y. 11530 Phone: (516) 746-0880 EL PASO BRANCH Room 6, 8201 Mantana Place, El Paso, TX 77925
 TDK ELECTRONICS CO., LTD. 14-6, 2-chome, Uchikanda, Chiyoda-ku, Tokyo 101, Japan

Build a low-cost ECL logic probe that also has an over-range indicator

A versatile and inexpensive probe for emitter-coupled logic (ECL) can be constructed easily with a few ECL integrated circuits. The probe features the novel display of the letter H for high and L for low and an over-range indicator.

ECL probes are commercially available but expensive. And TTL logic probes are not suitable for use with the threshold and logic levels encountered in the ECL logic family.

The circuit shown uses an MC10114 line receiver that contains three differential amplifiers with ECL-10,000-compatible outputs (Fig. 1). The noninverting inputs of the amplifiers are connected together to the probe input, and the other input of each amplifier is connected to a different voltage reference.

Amplifier A_1 is referenced to V_{bb} , which is approximately -1.3 V. This is the midpoint of the

ECL-10,000 logic swing. Amplifier A_2 goes to a forward-biased silicon diode to provide approximately -0.7 V. A logic level greater than this voltage causes the output of amplifier A_2 to go HIGH. The rated maximum level for ECL 10,000 is -0.81 V at 25 C. And amplifier A_3 is connected to approximately -2.0 V which is below the normal ECL-10,000 low level (-1.85 min at 25 C).

The inverting outputs of A_2 and A_3 are tied together to provide a wired-OR function. Their combined signals indicate an over-range condition via one section of an MC10116, triple, ECL line receiver.

The outputs of the detection circuitry are then buffered by amplifiers to drive the LEDs. An MC10116 line-receiver IC serves two purposes. One amplifier inverts the over-range signal and

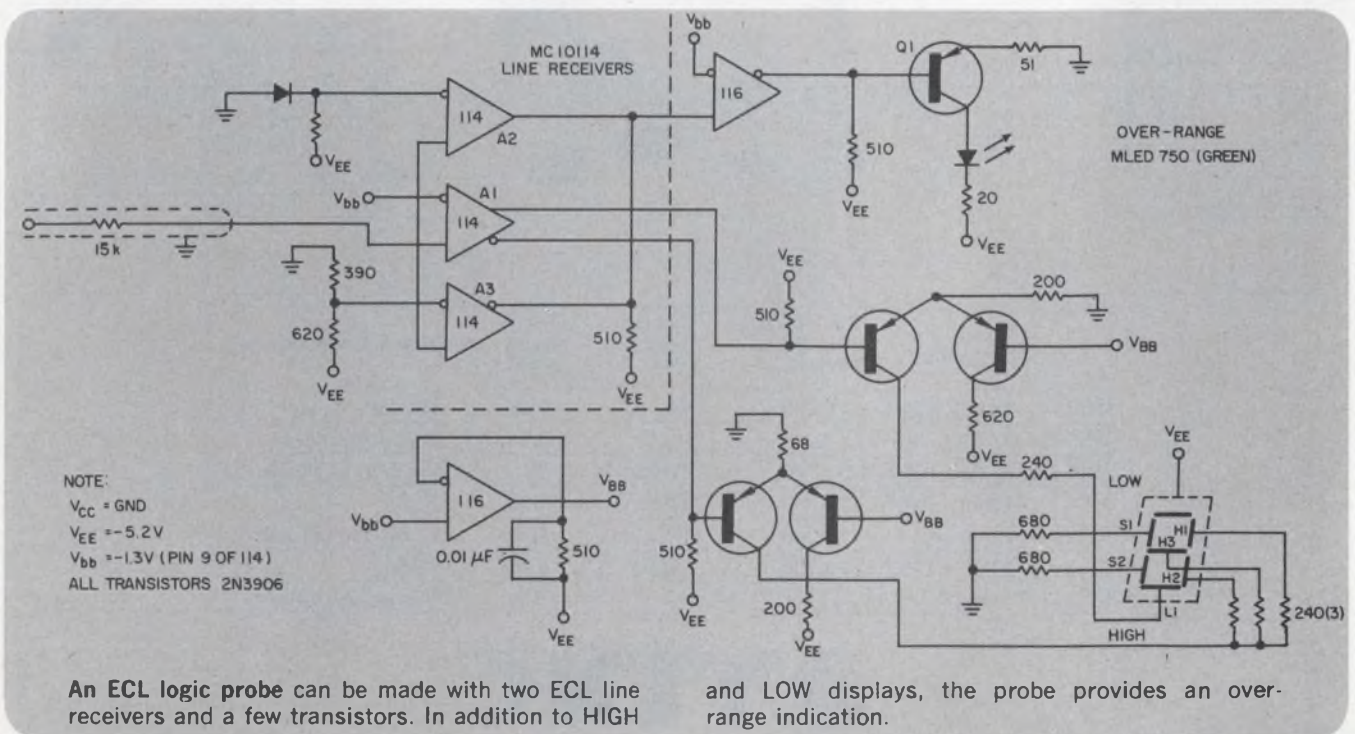

±15 VOLT POWER MINI'S FOR OP AMPS



ALL MODELS U.L. RECOGNIZED

PC-BOARD MOUNTING

OUTPUT CURRENT MA	SIZE INCHES	PRICE	MODEL
25	2.3 x 1.8 x 1.00	\$24	D15-03
50	2.3 x 1.8 x 1.00	39	D15-05
100	3.5 x 2.5 x 1.00	49	D15-10A
200	3.5 x 2.5 x 1.00	69	D15-20
300	3.5 x 2.5 x 1.25	105	D15-30
500	3.5 x 2.5 x 2.00	130	D15-50

CHASSIS MOUNTING

OUTPUT CURRENT MA	SIZE INCHES	PRICE	MODEL
100	3.5 x 2.5 x 1.38	\$55	DB15-10
150	3.5 x 2.5 x 1.38	65	DB15-15
200	3.5 x 2.5 x 1.38	75	DB15-20
300	3.5 x 2.5 x 1.63	105	DB15-30
350	3.5 x 2.5 x 1.63	110	DB15-35
500	3.5 x 2.5 x 2.38	135	DB15-50

Line/load regulation, $\pm 0.1\%$ or better; ripple, 1 mv; input, 105-125 VAC. Other single and multiple output models from 1 to 75 volts, to 2.5 amps. Liberal quantity discounts. Three-day shipment guaranteed.

Complete details on these plus a comprehensive line of other power supplies and systems are included in the Acopian 74-75 catalog. Request a copy.



Corp., Easton, Pa. 18042. Telephone (215) 258-5441.

INFORMATION RETRIEVAL NUMBER 60

drives the over-range indicator through transistor Q_1 . A second amplifier is used as a V_{bb} buffer to derive V_{BB} . Though V_{bb} is available on both line-receiver packages, only a few milliamps should be drawn from each IC voltage source. Buffered output V_{BB} is more stable for biasing of the transistor current switches that drive the LED displays.

Discrete transistor current switches drive the seven-segment LED display with segments H_1 ,

H_2 and H_3 in parallel from the HIGH output. Segment L_1 is driven by the LOW output. The anodes of segments S_1 and S_2 are tied to ground with 680- Ω resistors.

Of course, simple single LEDs like red MLED 600s, can serve also for the HIGH and LOW signals.

Tom Balph, Applications Engineer, Computer Applications, Motorola Semiconductor Products, Inc., Phoenix, Ariz. 85008. CIRCLE NO. 311

Four-input EXCLUSIVE-NOR gate made from a BCD-to-decimal converter

A substitute for an EXCLUSIVE-NOR gate can be made from the BCD-to-decimal, or a four-line to 10-line decoder, such as the 7441, 7442 or 74141. And the gate can be used with two, three or four inputs. An EXCLUSIVE-NOR gate is not too frequently used, and is sometimes difficult to find around the lab when needed.

To make the conversion, the decimal 1, 2, 4 and 8 outputs are wired together to a common output load resistor, as shown in the figure. The other output terminals are allowed to float. Inputs A, B, C and D are used in the normal way.

When all inputs are LOW, the output will be HIGH. If any one, but not more than one, of the inputs goes HIGH, the output will go LOW, since only a decimal number 1, 2, 4 or 8 is generated. This is the logic behavior required in an EXCLUSIVE-NOR gate. If more than one of the inputs goes HIGH, the output of the converter will remain HIGH, because the decimal equivalent of the input is other than a 1, 2, 4 or 8. A LOW output then appears on one of the unused output terminals.

If only a two or three-input EXCLUSIVE-NOR gate is needed, then the D input may be used separately as an inhibit. In this case, the decimal-eight output must be left floating, because an input on D would provide an output on the decimal-number eight, or greater.

If only a two-input EXCLUSIVE-NOR gate is desired, A and B inputs are used, and C and D must be tied LOW. However, they can be used also as inhibits, either together or separately.

Do not try to make more than one two-input EXCLUSIVE-NOR gate from the same decoder by use of A and B as one set of inputs, and C and D as another set. This will not work. If B is HIGH on one gate and C is HIGH on the other,

the converter will read decimal six, which is outside both gates.

The National Semiconductor version of the 7441 will not work as a four-input EXCLUSIVE-NOR gate in this scheme because it contains an overrange feature. However, it will work as a two or three-input gate, if the D input is kept low.

Jack Lambert, Lambert Associates, 5 Graham Rd., Lexington, Mass. 02173. CIRCLE NO. 312

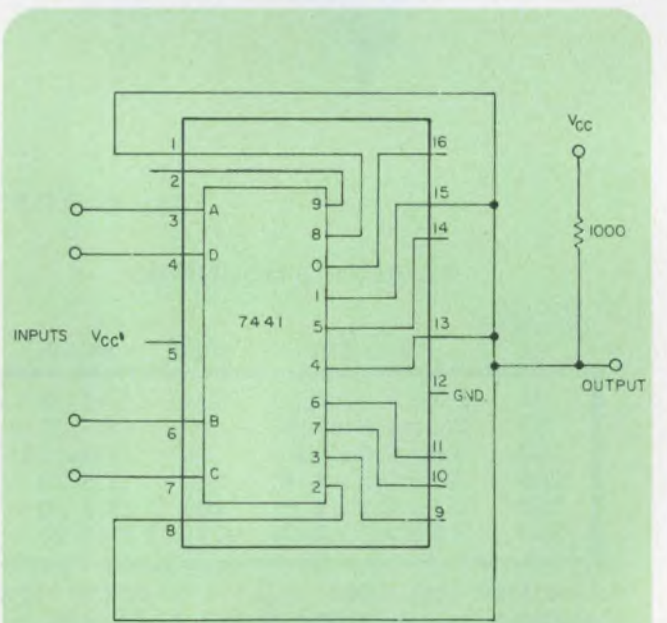

Four-input EXCLUSIVE-NOR gate logic is provided via inputs A, B, C, D. For a three-input gate, tie the D input LOW, unless you want to use the D input as an inhibit. With D as an inhibit, the decimal-eight output must be omitted from the output.



“A good general purpose signal generator should handle most of your bench needs and be cheap enough to fit every budget. That’s why we designed the HP 8654A”

Frequency range: 10-520 MHz
Calibrated
output level: +10 to -130 dBm, leveled
Modulation: AM & FM,
internal & external
Stability: 20 ppm/5min
Price: \$1700. Domestic USA price only.

But you'll want to evaluate the 8654A for yourself. A call to your local HP field engineer will put one in your hands. Or for more information just write.

HEWLETT  PACKARD

Sales and service from 172 offices in 65 countries.
1501 Page Mill Road, Palo Alto, California 94304

Successive approximation a/d converter uses three ICs and costs under \$25

For less than \$25, you can build an 8-bit analog-to-digital (a/d) converter that uses only three ICs and four discrete components.

The three ICs are an 8-bit digital-to-analog converter (DAC), a successive approximation register (SAR) and a comparator. The basic successive approximation a/d converter and its timing diagram are shown in Fig. 1.

When the start command is given, a ONE is placed in the first bit of the SAR. In turn, this sets the first latch to ONE and turns on the DAC's most significant bit. If the comparator output remains low (with an input signal to the comparator), the ONE will remain in the latch. If not, the latch will be reset to ZERO before the next bit trial begins.

The next clock cycle causes a ONE in the second-bit position, and a similar comparison

process is initiated. After the trial of the last bit, the end-of-encode output changes to indicate the parallel data are ready.

The actual circuit (Fig. 2) shows all the external connections needed to set up a complete 8-bit a/d converter. The circuit can also be expanded to 10 bits for about \$15 more.

Typical performance specs of the 8-bit a/d converter include a maximum linearity error of 0.2% over 0 to 70 C, and a full-scale tempco error of 60 ppm/°C over the same temperature range. The ZERO scale error is a low 0.2 LSB, and the conversion time is a fairly fast 6 μ s.

Donn Soderquist, Application Engineer, and Jerry Zis, Mktg. Mgr., Precision Monolithics, 1500 Space Park Dr., Santa Clara, Calif. 95050.

CIRCLE No. 313

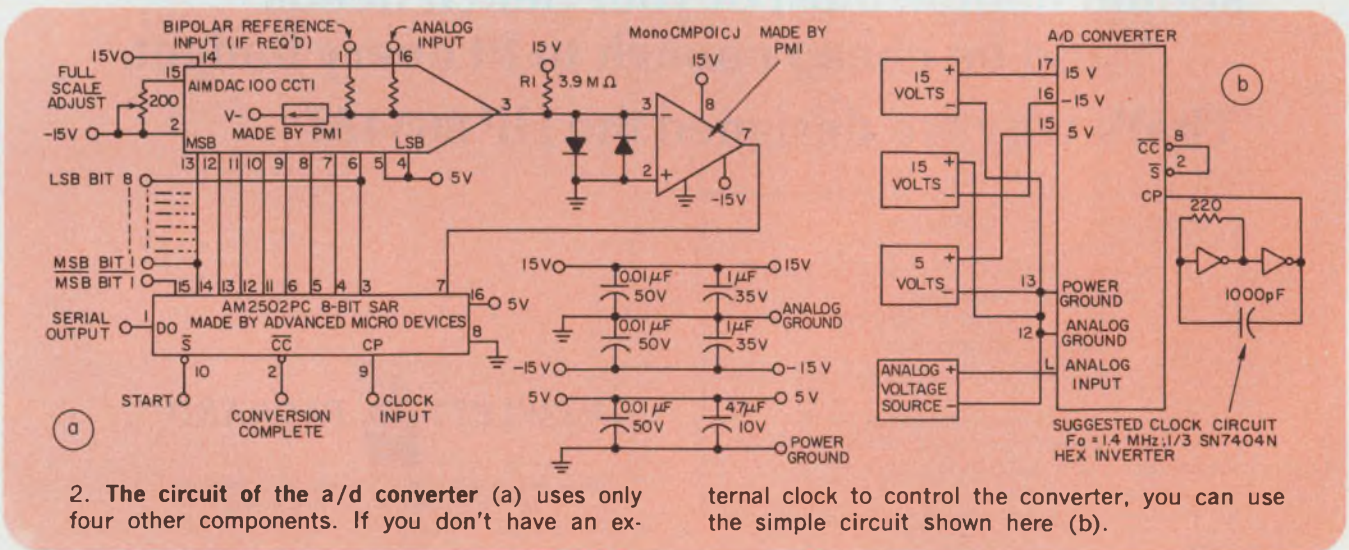
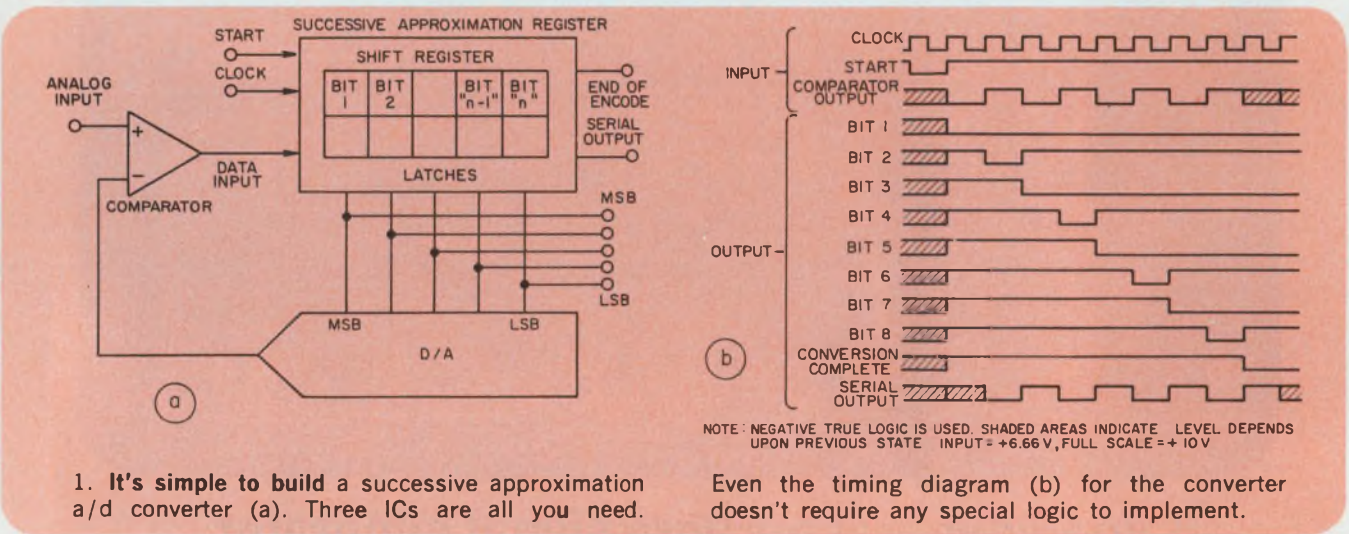

FUJI**COMPONENTS FOR CUSTOMER'S SYSTEM**

WANTED

For partners to manufacture ADD-ON memories and OEM systems with us.

FUJI memory system cards, power supplies, and drawers have a wide range of applications as OEM processor components. Large inventory assures off-the-shelf delivery. We also manufacture and design add-on memory and OEM system use interfaces and logic design incorporation with our better-half. Since we supply memory, power supplies and other components as hardware specialist, we are looking for partners to cooperate with us in the field service, maintenance.

**COMPACT MEMORY RAM SYSTEM****4K x 18 bits****Model CMS2401 · 2402**

- * Complete System _____
- TTL compatibility _____
- * Wide Temperature Range _____
0°C to +50°C
- * Modular Expandability _____
up to 65k bytes
- * Exceptional Reliability _____
70,000 hr. MTBF
- * Low Power Consumption _____
15V driving
- * 19" rack and power supply _____
optional

SYSTEM SPECIFICATIONS

- Unit capacity:
4096 words-18 bits or 8192
words-9 bits
- Access time:
CMS2401 330ns
CMS2402 300ns
- Cycle time:
CMS2401 1μs
CMS2402 750ns
- Operating Mode:
READ/RESTORE
CLEAR/WRITE
READ/MODIFY/WRITE
- Dimensions:
10" (W) x 15" (D) x 0.5" (H)

CORE MEMORY SYSTEM**MB2000 Series**

- * Stand Alone Memory System —
enclosure power supply and fan
- * Plunge Expandable _____
up to 65k bytes in standard
chassis
- * Modular Design _____
8k bytes interchangeable board
and interface card
- * Compactness _____
19" standard rack 6-1/4" height
- * Wide Temperature Range _____
0°C to +45°C

SYSTEM SPECIFICATIONS

- Capacity:
8k bytes to 65k bytes
- Operating Mode:
READ/RESTORE
CLEAR/WRITE
READ/MODIFY/WRITE
- Dimensions:
19" (W) x 20" (D) x 6-1/4" (H)
- Various Optional Devices:
Self Checking, Parity Checking,
Customer interface

DIRECT LINE SWITCHING REGULATED POWER SUPPLY

We have a complete selection of standard modules in stock awaiting customer selection. Power supplies based on customer specification can also be quickly designed, manufactured and delivered.

FUJI ELECTROCHEMICAL CO.

Head Office: Hamagomu Bldg., 5-36-11, Shinbashi, Minato-ku, Tokyo, Japan TEL: 434-1271

Overseas Office: New York, TEL: (212) 532-5630
Los Angeles, TEL: (213) 620-1640
Düsseldorf, TEL: (211) 89031

JOHNY TSUKIKAWA
SAM. YOSHINO
TAD. KOMURO

INFORMATION RETRIEVAL NUMBER 62

Paul Brokaw of Analog Devices Semi Wins Annual 'Ideas for Design' Award

Something was wrong. When Paul Brokaw walked into the conference room at Analog Devices Semiconductor, there were too many people. He saw the people he expected at the scheduled product planning meeting—Bob Peterson, president; Mitch Maidique, vice president and general manager; and Stan Harris, director of marketing. But he also saw George Rostky, editor-in-chief of Electronic Design. And Rostky certainly did not belong at this meeting.

Seating himself at the only vacant chair—next to Rostky—Brokaw promptly found himself being questioned about his new appointment as director of advanced product development. In the course of the conversation, Rostky suggested that Brokaw was a pretty good circuit designer and Brokaw admitted that he did indeed enjoy circuit design.

Some minutes later, Rostky recalled: "Oh, didn't you publish an Idea for Design last year—something about using a 723 as a switching regulator to get half an amp from a plastic TO-5 transistor?"

It was while they were discussing the circuit that Rostky interrupted with: "By the way, Paul, that circuit won Electronic Design's annual Ideas for Design award for 1973," then handed him a walnut-mounted, gold-toned brass plaque en-

graved with the inscription:

ELECTRONIC DESIGN's top award to A. Paul Brokaw of Analog Devices Semiconductor. In recognition of his important contribution to electronics engineering. The outstanding "Idea for Design" of 1973.

Rostky allowed Brokaw to gape for about a minute before he added, "Oh, I almost forgot," then handed him a check for \$1000. Later, when he became more coherent, Brokaw, a man most people at Analog Devices Semiconductor regard as being totally unflappable, said: "That completely bombed me. I had no idea. I walked in for our product planning meeting and figured there was going to be a short interruption. But Wow!"

Brokaw's award-winning idea (ED No. 12, June 7, 1973), stemmed from many years of working with switching regulators, most of which, he feels, are inadequate. Most have a big overshoot that can damage the load, he says, and most aren't protected against overshoot.

Paul and his wife Sonja live in Burlington, Mass. with their 11-year-old son, Steven. In his spare time, Paul likes to ski or swim. For an indoor sport, he likes to write technical articles and science fiction. But he's never satisfied with what he's written and, in fact, he's still working on a story he started 20 years ago.



Recovering from the shock, Paul Brokaw, director of advanced product development at Analog Devices Semi-

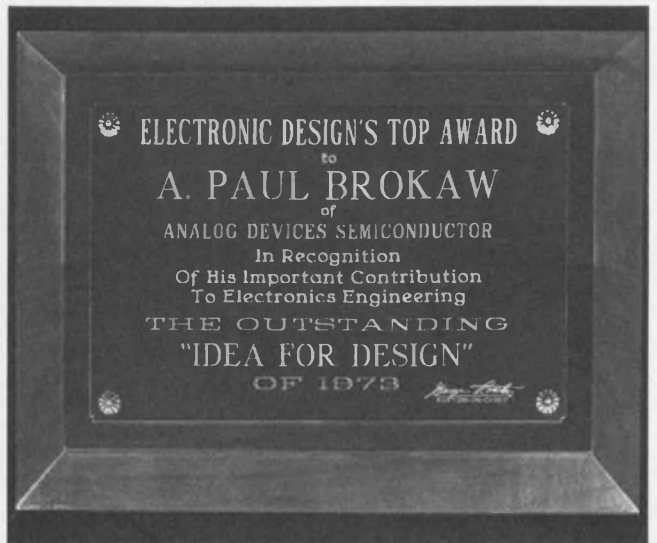

conductor, stares in disbelief at the plaque and \$1000 check he just received from George Rostky.

inverter-rated™

cool power!

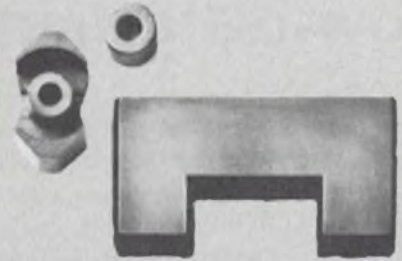

Ferramic™ components guarantee circuit performance

Typical power dissipation vs temperature curves under high drive conditions

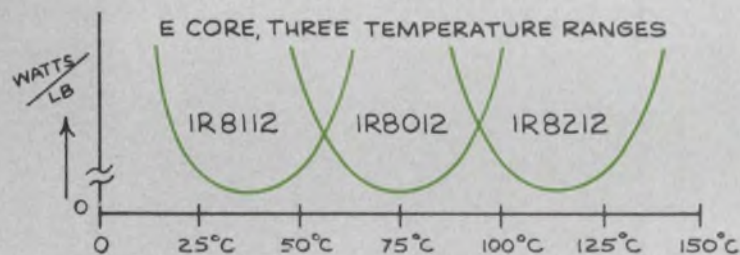

Three temperature ranges

Inverter-Rated components are now available in three temperature ranges. You can select components matched to your temperature requirements and get the highest efficiency possible in your inverter designs.

By specially processing our components for low loss at the temperature you require, we can offer you better performance under all circuit conditions. And significantly improved characteristics in high temperature applications.

Ferrite components for inverters

Our *Inverter-Rated* ferrites are designed specifically for your inverter applications. You get highest efficiency

in the full range of shapes—E Cores, U Cores, Toroids, Pot Cores and Cross Cores. And each of these *Inverter-Rated* components is tested under inverter conditions to assure performance in your circuit. So your inverter design is based on specified and guaranteed electrical characteristics—not just routine magnetic parameters.

New design data

Our new design guide gives you the facts you need to apply the latest ferrite technology to your inverter circuits. We speak your language with complete component specifications, temperature characteristics, application information. We spell out the circuit characteristics of our components and give you guaranteed circuit parameters.

To learn more about our *Inverter-Rated* components

and how they can improve your inverter designs, just check the reader service cards. Or call (201) 826-5100 and talk to the men who developed this ferrite technology. Either way, if you're talking inverters, talk to the ferrite component experts.

That's us.

Indiana General
Electronic Products
Keasbey, N.J. 08832

National distribution through Permag locations in Atlanta, Boston, Chicago, Dallas, Detroit-Toledo, Los Angeles, New York, and San Francisco.

indiana general

a division of Electronic Memories & Magnetics Corp.

INFORMATION RETRIEVAL NUMBER 63

Differential amplifier will allow low-distortion output from mixer

A 741 op amp can provide a balanced output for an MC1596 product detector, or mixer. This reduces alias frequencies (even multiple $f_o \pm$ even multiple f_s) that can cause serious in-band spurious interference. This double balancing of a mixer also tends to eliminate other alias frequencies: (odd multiple $f_o \pm$ even multiple f_s) and (even multiple $f_o \pm$ odd multiple f_s).

With a single-ended output, the MC1596 needs a symmetrical carrier to keep the alias frequen-

cies down, but the balanced output provided by the 741 reduces this requirement. Also the need for highly symmetrical switching in the mixer is reduced.

The 741, used as a differential amplifier, is more economical than a well-balanced transformer would be. The circuit easily keeps the $2f_o \pm 2f_s$ products below the -60 -dB level.

B. Priestley, Senior Engineer, EMI Ltd., Hayes, Middlesex, U.K.
CIRCLE No. 314

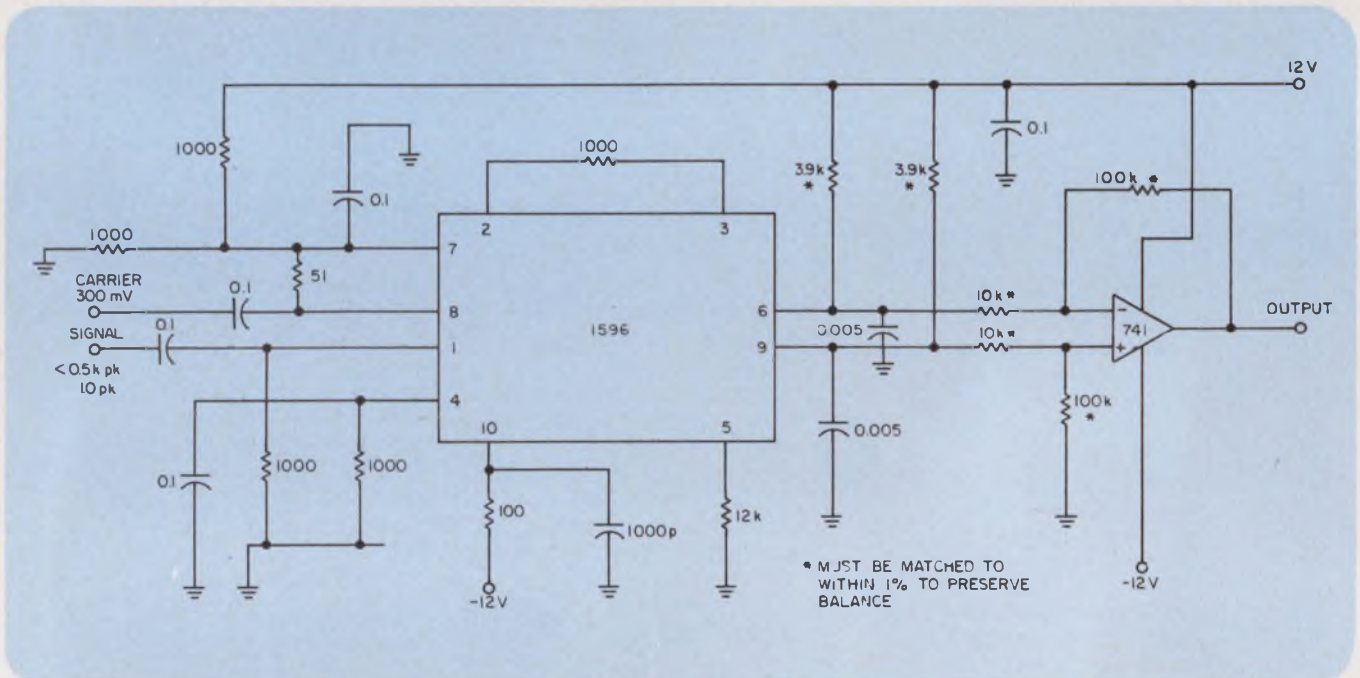

A differential amplifier can couple a balanced output from a doubly balanced mixer.

IFD Winner of April 12, 1974

David Larsen, Instructor, Chemistry Dept., Virginia Polytechnic Institute and State University, Blacksburg, Va. 24061. His idea "Modified Data-Transmission Module Can Handle ASCII and BCD" has been voted the Most Valuable of Issue Award.

Vote for the Best Idea in this issue by circling the number for your selection on the Information Retrieval Card at the back of this issue.

SEND US YOUR IDEAS FOR DESIGN. You may win a grand total of \$1050 (cash)! Here's how. Submit your IFD describing a new or important circuit or design technique, the clever use of a new component or test equipment, packaging tips, cost-saving ideas to our Ideas for Design editor. Ideas can only be considered for publication if they are submitted exclusively to ELECTRONIC DESIGN. You will receive \$20 for each published idea, \$30 more if it is voted best of issue by our readers. The best-of-issue winners become eligible for the Idea of the Year award of \$1000.

ELECTRONIC DESIGN cannot assume responsibility for circuits shown nor represent freedom from patent infringement.

MEET YOUR TOUGHEST DESIGN CRITERIA

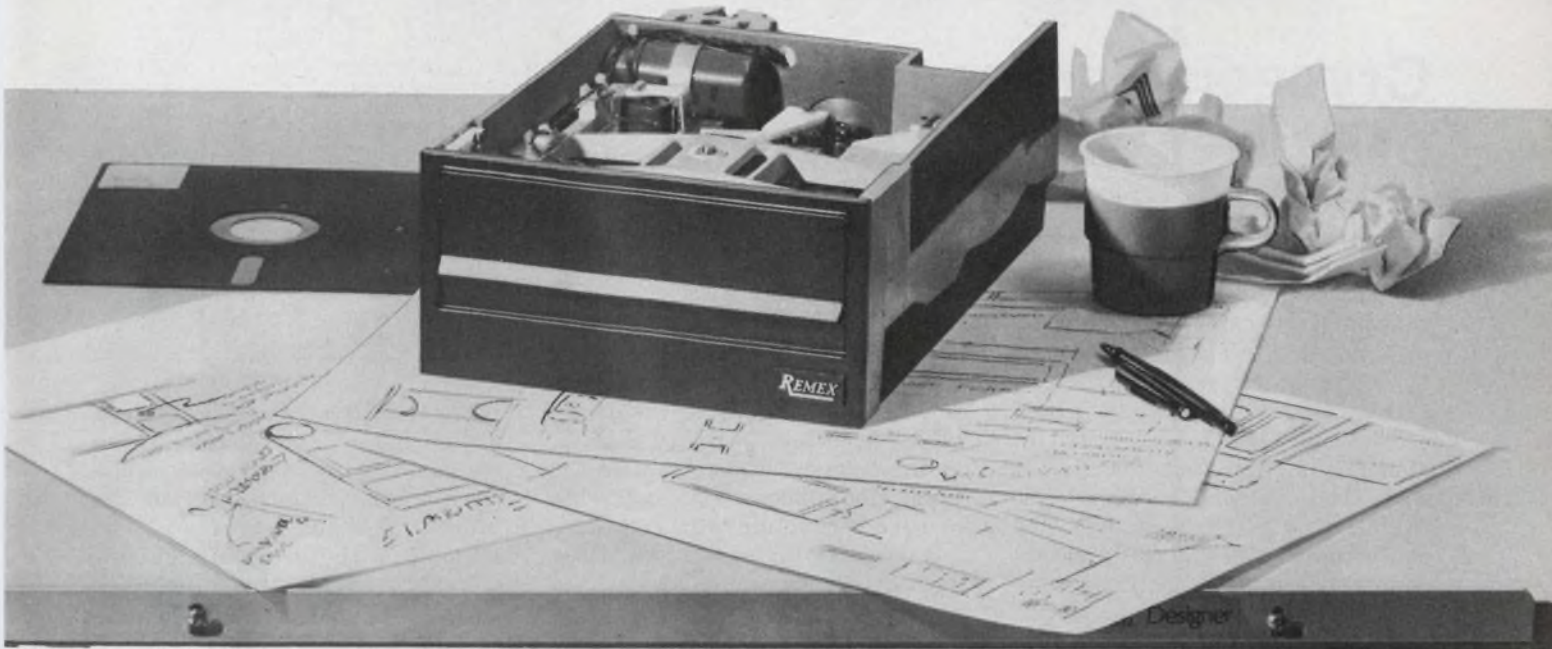

MEET THE REMEX FLOPPY DISK DRIVE

No compromise required. There is one floppy disk drive with the design flexibility to meet all your systems requirements. The REMEX RFD7400.

IBM compatibility? Remex has it. Complete media and data interchange with 3740 Series systems. Guaranteed by Remex because the RFD7400 meets every one of the 3740 floppy disk specifications. We test for them!

Standard media? The RFD7400 provides a unique write enable option that gives fool proof operation on any standard IBM media. No need to pay a premium for specially prepared media. Select from any available source.

Fail safe design features? Our floppy disk drive has Track "00" and track "76" sensing. A unique feature which prevents machine damage and loss of data at *both* ends of diskette media.

Long life? How about 15,000 hours? The RFD7400 construction provides years of reliable operation with only 12 grams of head pressure, utilizing a tungsten-carbide ball bearing stylus. The result; 50% longer life than competitive units.

Extra capacity? You bet! Up to 3.2 megabits with our special hard sectoring and data recording options. And we use standard media too.

Random average access time? The RFD7400 is more than 30% faster

than competition. Think of what this can do for your throughput.

Special configurations? The RFD-7400 can be custom designed to fit almost any application. Test us by sending your design headache to our Applications Engineering Manager. Better still, call us direct and order your evaluation unit for immediate delivery. Chances are that our standard unit already meets your requirements.

Write, Remex, a Unit of Ex-Cell-O Corporation, 1733 Alton Street, Santa Ana, California 92705 or call (714) 557-6860.

We work with you.

REMEX



**Ex-Cell-O
Corporation**

Cryogenic transmission of power being tried

Cryogenic power transmission is being tested in West Germany by collaboration between AEG-Telefunken, Kabelmetall and Linde. A prototype cryogenic cable produced by the group can carry 200 kV dc at 12.5 kA.

The cable, which is 250 mm in diameter, is in sections 200 meters long. The distance between cooling stations is 10 to 20 km. The superconducting cable core consists of interwoven niobium-tin (Nb_3Sn) ribbons, supported by polytetrafluoroethylene spacers. Impregnated paper is used for insulation.

Core, spacers and paper insulation are inside a flexible steel hose filled with helium at "overcritical" pressure and a temperature of 4.5 to 6.5 K. This hose is inside a

thermal protection system of three more coaxial hoses containing layers of thermal insulation, liquid nitrogen for intermediate cooling and thermal insulation.

Laboratory experiments have shown that the cable can carry twice the nominal current at 6 K. A dc prototype was chosen for the experiments because a closed ring of superconducting wire can carry a dc current for very long periods without application of continuous power.

After evaluation of all data from the dc experiments, a three-phase ac superconducting power line is expected to be out of the lab before year's end. The first permanent installation—probably in Munich—is scheduled for 1979.

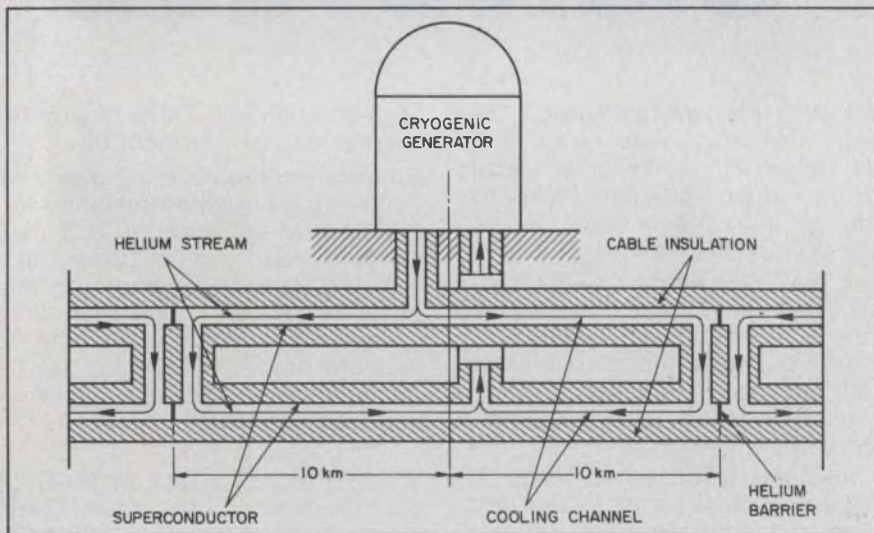

PCM circuit encodes with fewer pulses

A PCM encoder circuit that reduces drastically the number of pulses needed for quantization of a signal has been designed at the

University of Trondheim, Norway.

The rectified version of the input signal (see Figure) is first sampled by charging capacitor C

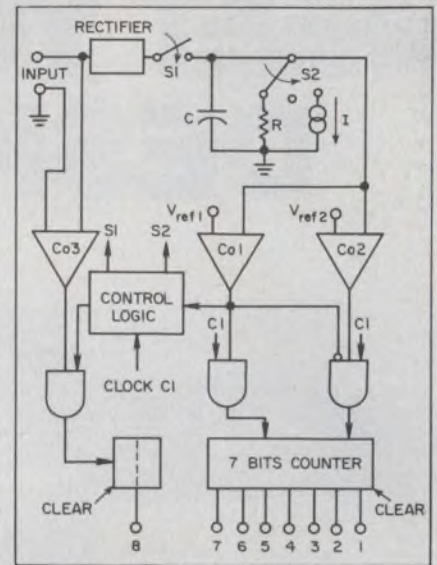

rapidly. After the opening of switch S_1 , switch S_2 closes in synchronism with the clock pulse. Each clock pulse increments the counter (initially reset to 0) by 16, as long as the decaying capacitor voltage is greater than the reference voltage of 32 V. When the capacitor voltage drops below 32 V, the comparator Co 1 changes state, which prevents further counting by 16.

In the next clock pulse, analog switch S_2 is connected to the constant-current-sink position, which results in a linearly decaying voltage. At the same time, the counter input is changed so it begins to count by ones, rather than by 16s. When capacitor-C voltage reaches 16 V, counting is terminated by the comparator Co 2. The seven digits in the counter now give a binary representation of the quantized signal. The sign information in the eighth bit is obtained from comparator Co 3.

Electronic fuel meter available for cars

A new, electronic instrument to monitor automobile fuel use has been produced by VDO, a West German manufacturer. The instrument is a speedometer with an additional analog output for a read-out of liters per 100 km. A simple computing circuit will combine the electronic speed signal with a signal from a flowmeter in the fuel line. Together these inputs will provide rate of fuel consumption.

Hughes heat pipes. Order 'em hot off the shelf.

Now you can order heat pipes just like you order nuts and bolts. Because now Hughes stocks heat pipes in a variety of standard, off-the-shelf sizes and thermal capacities. (If you have a heat transfer problem that calls for a custom solution, we solve those, too.)

1333H STAINLESS STEEL AND AMMONIA

Thermal transport capacity: 50 watts with evaporator 90° below condenser, 15 watts horizontal operation, 7 watts with evaporator 90° above condenser. Recommended operating range: -80° to +90°C. Weight: 8 grams. Active Length: 5.69 inches. Diameter: 3/16". \$37.00.

1370H COPPER AND WATER

Available in diameters of 1/4", 1/2", and 1" at \$37.00, \$40.00 and \$50.00, respectively, with thermal transport capacities of 345, 750, and 6000 watts with the evaporator 90° below condenser; 115, 250 and 2000 watts horizontal operation; 38, 60, and 500 watts with evaporator 90° above condenser. Recommended operating range: +50° to +150°C. Weight: 21, 70, 550 grams. Standard Active Length: 6, 6, 12 inches.

1350H STAINLESS STEEL AND METHANOL

Available in diameters of 3/16" and 1/4" at \$37.00 each and 1/2" at \$40.00. Thermal transport capacities are 55, 75, and 180 watts with evaporator 90° below condenser, 17, 25, and 60 watts horizontal operation, and 6, 10, and 20 watts with evaporator 90° above condenser. Recommended operating range: -40° to +120°C. Weight: 8, 11, and 38 grams. Standard Active Length: 6 inches.

1361H FLEXIBLE STAINLESS STEEL AND METHANOL

Available in active lengths of 7" and 8" at \$75.00 each, with thermal transport capacities of 20 watts with the evaporator 90° below condenser, 7.5 watts horizontal operation, 2.5 watts with evaporator 90° above condenser. Recommended operating range: -40° to +120°C. Weight: 20 grams. Diameter: 1/4".



For detailed information, or if you have a hot requirement and want one now, just fill out and send in the coupon. Hughes Electron Dynamics Division, 3100 W. Lomita Blvd., Mail Station 2124, Torrance, California. (213) 534-2121.

PLEASE PRINT

SEND INFORMATION.

SEND QUICK ORDER FORM.

NAME _____ COMPANY _____

ADDRESS _____ CITY _____

STATE _____ ZIP _____ TELEPHONE _____

All prices shown are effective in U. S. A. and Canada

ED-8

INFORMATION RETRIEVAL NUMBER 66

Crank up this high-performance machine and you'll have 30 MHz at your command. Enough frequency for about any test situation you can name.

Of course top end isn't everything. The Wavetek 164 has the sophistication to maneuver smoothly on anybody's test bench.

You can shift to any of nine

different waveforms in continuous, triggered or gated modes. Drop to 3 μ Hz and then run up the entire range in 1000 to 1 sweeps or discrete 10% steps. You can even adjust rise-and-fall times with the unique trapezoidal waveform.

The price is \$995*. A bit more than average. But a few minutes at the controls will convince you that

the Model 164 is no average function generator.

*F.O.B. San Diego, wheels optional at extra cost.

WAVETEK®

P.O. Box 651
San Diego, California 92112
Tel. (714) 279-2200, TWX 910-335-2007

INFORMATION RETRIEVAL NUMBER 67

Thirty million Hertz puts you in the driver's seat.

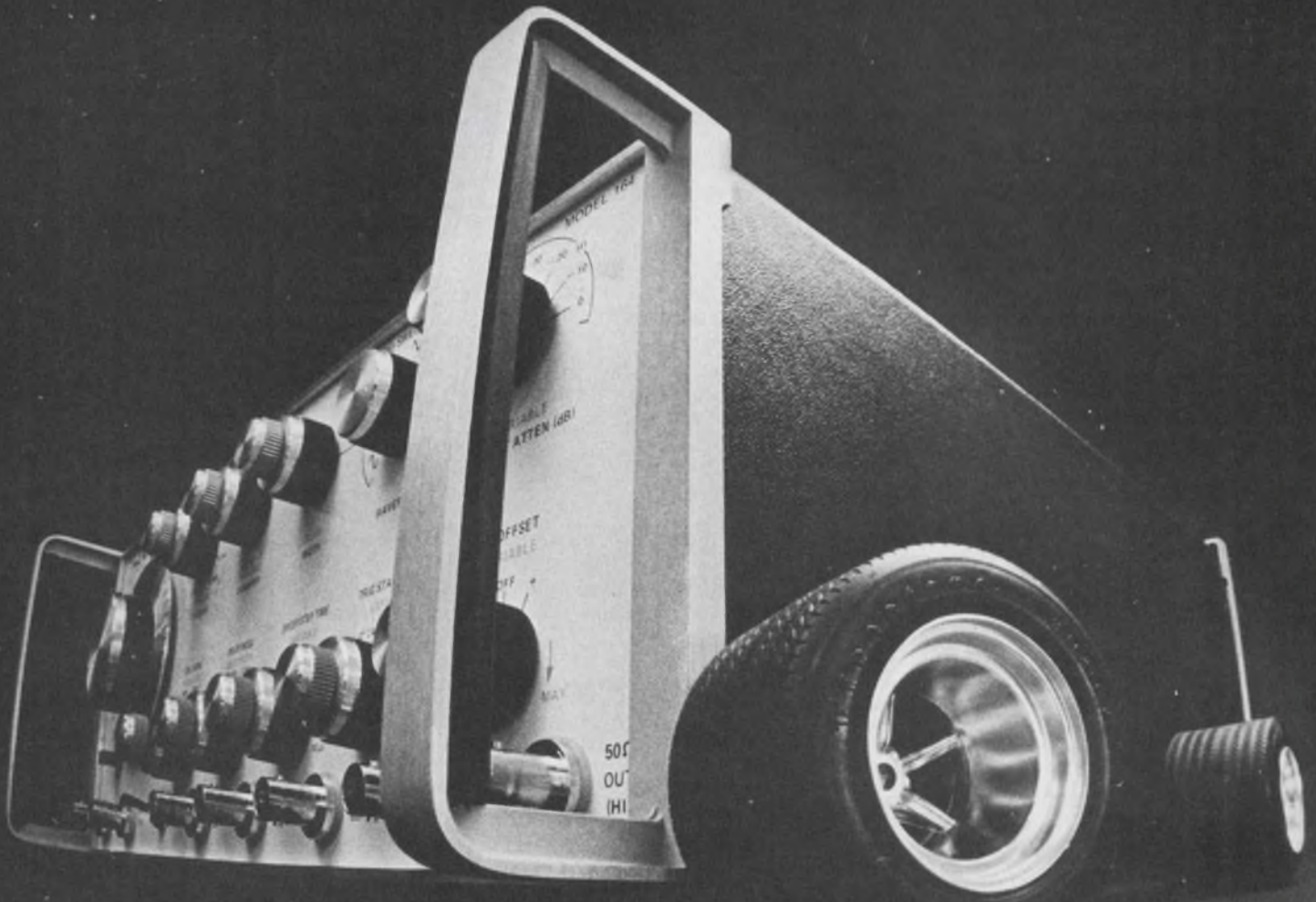

new products

Analyzer picks out patterns in long digital data streams

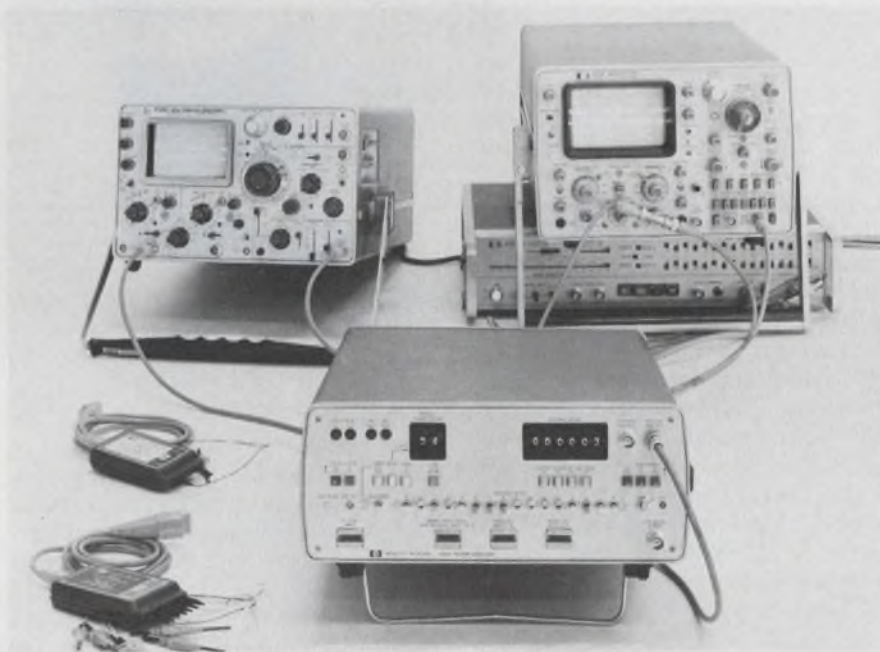

Hewlett-Packard, 1501 Page Mill Rd., Palo Alto, Calif. 94304. (415) 493-1501. \$1750 with probes; without probes (serial only), \$650. Sept.

With Hewlett-Packard's new pattern analyzer, the 1620A, you can wade into the middle of a long stream of digital bits—such as those on a disc track—and get a close look at any pattern of up to 16 bits.

When it recognizes a preset pattern in the stream, the 1620A shoots out a 2-V, 30-ns pulse, which can then trigger any scope, data analyzer or other instrument.

Actually the HP instrument is more a "recognizer" than an analyzer, since the external scope provides the display, and the engineer does the analysis of the displayed pattern. The 1620A's role is to produce a trigger pulse that is timed by the appearance of a particular data pattern. The scope will then show the data following the pattern trigger or some other events that depend on the pattern.

The data can stream into the 1620A at a 20-MHz rate and in either serial or parallel mode. In parallel, up to 16 channels—synchronous or asynchronous—can be accommodated. Serial patterns can be 16 bits long.

The input threshold can be set to TTL levels with a pushbutton. Or the threshold can be varied to accept other logic levels. In either serial or parallel mode, the trigger word is set by 16 three-position toggle switches. Thus any switch can be set to HI, OFF (don't care) or LO.

In serial, you can also set a toggle switch to engage a "qualifier" line—an input that's separate from the input data—and then use a two-digit thumbwheel to delay the trigger output up to 99 input data frames from the appearance of the qualifier. (A frame is defined as one 16-bit pattern.)

The qualifier switch can be set for an edge or a level—or the switch can be turned off, in which

case the qualifier can be ignored. (Delay, of course, is in the edge mode only.)

In either the parallel or serial mode, a six-digit thumbwheel can be used to delay the output trigger up to 999,999 clock periods after pattern recognition has occurred. And in the parallel asynchronous mode, a filter automatically engages to prevent spurious output triggers. These can result from differences in pulse timing (skew) among the various channels.

Thus the filter tells the HP 1620A to ignore glitches of duration shorter than that set by any of four pushbuttons: 10 (no value selected), 20, 50, 100 or 200 ns.

CIRCLE 251

Digital phasemeter resolves 0.01°



Dranetz Engineering Labs, 2385 South Clinton Ave., South Plainfield, N.J. 07080. (201) 755-7080. \$3200 to \$4000.

Model 305D phasemeter offers precision measurement of phase angles from 0.00° to ±180.00° and 0.00° to 360.00°, with 5-digit-plus-sign illuminated readout display, 0.01° resolution and an operating frequency range from 2 Hz to 11 MHz. The unit can accept a variety of standard plug-in modules for specific functions and applications, e.g., high-frequency operation, autoranging, remote programmability, network analysis, etc.

CIRCLE NO. 252

Frequency standard uses rubidium reference



Efratom California, Inc., 3303 Harbor Blvd., Suite E1-E2, Costa Mesa, Calif. 92626. (714) 556-1620. \$6780.

This laboratory frequency standard, Model FRT, is said to incorporate the world's smallest rubidium frequency standard, the Model FRK. Sinusoidal frequencies of 10, 5, 1 or 0.1 MHz are available on the front and back panels. Fine-frequency adjustments of 1×10^{-12} are possible within a range of $\pm 1 \times 10^{-9}$. Main features are a short-term stability of 2×10^{-11} , $\tau = 1$ s, and a long-term stability of 3×10^{-11} /month, as well as fast warm-up time: less than 10 m to reach 2×10^{-10} .

CIRCLE NO. 253

Unit generates pink or white noise



B & K, 5111 W. 164th St., Cleveland, Ohio 44142. (216) 267-4800. \$912; 3 mo.

Model 1405 generates white noise in the frequency range of 20 Hz to 100 kHz. The unit has a built-in -3 dB/octave filter which is used to produce pink noise from 20 Hz to 50 kHz. Other features include uniform spectral density of 10^{-4} V²/Hz; a built-in compressor amplifier with meter; six compressor speeds; and a signal/hum ratio better than 90 dB.

CIRCLE NO. 254

Unit tests instructions of microprocessor chip



Macrodata Co., 6203 Variel Ave., Woodland Hills, Calif. 91334. (213) 370-8551. Less than \$50,000; 60 days.

The Big "M" is said to be the first low-cost microprocessor tester. The unit tests the individual instructions on a chip in varying sequences to ascertain worst-case testing. Other techniques presently used check only the logic of the microprocessor. Intended for probe and receiving inspection use, the Big "M" can also test memories. Dc parametric capability is included in the basic system.

CIRCLE NO. 255

Sensor measures LED light output (all colors)

Photon Products, Inc., P.O. Box 1230, Cupertino, Calif. 95014. (408) 296-5226. \$375 (1-4); stock to 4 wks.

Model ISP-530 is a photometric-response integrated sensor that precisely matches the CIE luminosity spectral curve in the 530-to-680-nm (green, amber, and red) range with less than 5% point-by-point deviation. The sensor accurately measures red, green, and amber light-emitting diodes, liquid crystals and gas-discharge tubes. An adjustable balance control allows zeroing under normal ambient lighting conditions. Gain adjustments are in lumens/cm², candelas, foot-lamberts, or foot-candles.

CIRCLE NO. 256

**A PORTABLE
4½ DIGIT
MULTIMETER
FOR \$299.
A 10 MHZ
COUNTER OPTION
FOR \$50.**



**VALHALLA
SCIENTIFIC**
7707
CONVOY COURT
SAN DIEGO,
CALIF. 92111
714-277-2732
**WHAT MORE
CAN WE SAY?**

Thermal converters handle inputs to 1 GHz

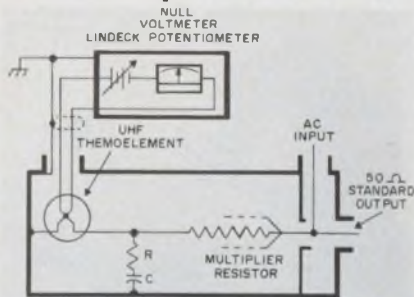

Ballantine Labs., P.O. Box 97, Boonton, N.J. 07005. (201) 335-0900. \$475 to \$530; 4 wks.

Series 1396A thermal voltage converters (TVC) have accuracies that are traceable to the NBS. Three models are available: 1396A-1, which covers 0.25 to 1.0 V; the 1396-A2.4, with a range from 1.0 to 2.4 V; and the 1396A-7, which covers from 2.4 to 7.0 V. All three units span the full frequency range from 10 Hz to 1.0 GHz and are used in a transfer mode to convert ac inputs to dc. Uncertainty in the rf-to-dc conversion is 1% maximum.

CIRCLE NO. 257

Scope offers storage plus dual beam



Philips Test & Measuring Instruments, 400 Crossways Park Dr., Woodbury, N.Y. 11797. (516) 921-8880. \$1945.

PM3234 is a new 10-MHz, 2-mV storage scope that features true dual-beam operation to eliminate the need for chopped or alternate mode displays at lower bandwidths. This ensures that the phase relationship of the signals is always correct and allows two complete waveforms to be displayed under single shot or low rep rate conditions. In addition to storage, the unit operates normally but with continuous control of persistence from 0.3 s to 10 m. Other features are an 8 × 10-div screen, 8.5-kV acceleration potential, and an auto-triggering circuit.

CIRCLE NO. 258

Rugged...versatile

New!

"The Persuader"

The S190 switchlight outguns everything its size...costs only \$1.62*

In every era, new products come along to keep the competition honest, with all the cards on the table. So we invite you to compare our S190 series with other switchlights. Check our variety of lens colors and easy mount panel adaptors...our wide terminal spacing for easy and fast wiring: solder, quick connect, PCB...our no-tool lamp replacement, long life wiping contacts, rugged molded case. Consider the low cost when you realize that the S190, with its 2 Form C action, has greater circuit flexibility than most switchlights on the market. And it's easily available at your local distributor! Call our sales office in your area for applications assistance...we're located in major cities, world wide. Clare-Pendar Co., Box 785, Post Falls, Idaho 83854, (208) 773-4541.

*In quantities of 1000



CLARE-PENDAR
Switchlights & Keyboards



Compact scope joins modular test line



Tektronix, P.O. Box 500, Beaverton, Ore. 97005. (503) 644-0161. \$650.

The SC 501 is the first plug-in module oscilloscope for the company's TM 500 Series of multi-functional test and measurement instruments. The unit weighs only 2-1/4 lb., has a bw of 5 MHz and a calibrated vertical deflection range from 10 mV/div to 1 V/div, selectable in decade steps. A variable control extends this range to at least 10 V/div. The 2.5-in. CRT displays signals from 10 mV/div at sweep rates to 200 ns/div. Calibrated sweep rates are selected by pushbutton logic in decade steps from 1 to 100 μ s/div, and from 1 to 100 ms/div.

CIRCLE NO. 259

\$995 buys 5-1/2-digit autoranging DMM



Data Precision, Audubon Rd., Wakefield, Mass. 01880. (617) 246-1600. \$995; stock to 30 days.

Model 3500 5-1/2-digit DMM features autoranging from 1 μ V and 1 m Ω through all ranges, 1/2-in. planar display, isolated BCD output and local/remote trigger control operation. Offered are 21 ranges of ac V, dc V, ohms and ratio. Basic dc accuracy is $\pm 0.007\%$ of reading $\pm 0.001\%$ of fs ± 1 LSD for six months.

CIRCLE NO. 260

Kilovoltmeter replaces electrostatic types



Zi-Tech Div., Aikenwood Co., Box 26, 233 Forest Ave., Palo Alto, Calif. 94302. (415) 326-2151. \$295.

Model 88M high-voltage meter directly measures dc voltages up to 30 kV with an accuracy better than 1% of full scale. The unit has greater than 30,000 M Ω input impedance and the maximum test current taken is less than 1 μ A. The whole instrument weighs less than five pounds, and can be supplied with a high-voltage probe. The meter also features a recorder output for checks of long-term, high-voltage stability. Power is provided by internal 9-V batteries.

CIRCLE NO. 261

Light-beam recorders offer up to 14 channels



Hathaway Industries, 11616 E. 51 St., Tulsa, Okla. 74101. (918) 663-0110. Two channels, \$1335; three channels, \$1445; 45 days.

Model 460 light-beam recorder is said to be the first true high-frequency replacement for the channel pen recorder. All of the calculation for damping resistors and series/parallel matching has been removed. The basic model is a two-channel unit with a flat frequency response of 2000 Hz. The 470 Series is the big brother of the 460, and records up to 14 channels of data. Both series offer push-button speed controls with a choice of 12 speeds from 0.1 to 80 ips.

CIRCLE NO. 262

IC testers handle TTL, CMOS and other logic

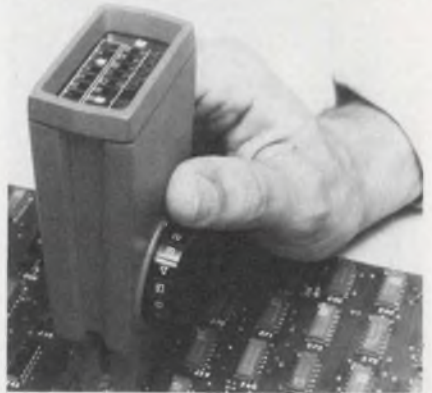

Fluke/Trendar, 500 Clyde Ave., Mountain View, Calif. 94040. (415) 965-0350. \$395; stock.

An expanded series of hand-held instruments for testing ICs in-circuit are successors to the TRENDAR 200 IC TESTCLIP. Each instrument combines three troubleshooting aides in one device: a logic probe, a logic clip and a logic comparator. The TRENDAR 200-01 is a general-purpose 5-to-10-V detection device with 400-ns failure blanking; the 200-02 is a high-speed 5-V TTL/DTL instrument that operates to 5 MHz with 100-ns failure blanking; the 200-03 is a higher-voltage unit for CMOS, HTL, and Hi-Nil logic, with 200-ns failure blanking.

CIRCLE NO. 263

Dual-trace scope boasts top-of-the-line features



Scopes Unlimited, 1928 S. Anaheim Blvd., Anaheim, Calif. 92805. (714) 557-8755. \$1150.

Model 530A is a 25-MHz, dual-trace, portable scope which offers an internal, parallax-free 6 \times 10-cm CRT graticule, 1-mV sensitivity on both vertical channels, five display modes, and a high-speed, gated trigger that can lock virtually any signal from dc to 40 MHz, including TV line and frame.

CIRCLE NO. 264

Start with our new Blue Streak™ cable

... it's loaded with features designed to lower your installed costs. For instance, every fifth conductor is color coded for quick identification and the Blue Streak immediately identifies polarity. The unique cable construction permits clean conductor separation for breakouts and easy insertion into connector assemblies. Available in 50 conductors or less — solid or stranded wire — this U/L listed self-extinguishing cable is the perfect companion for the new one-piece connectors.

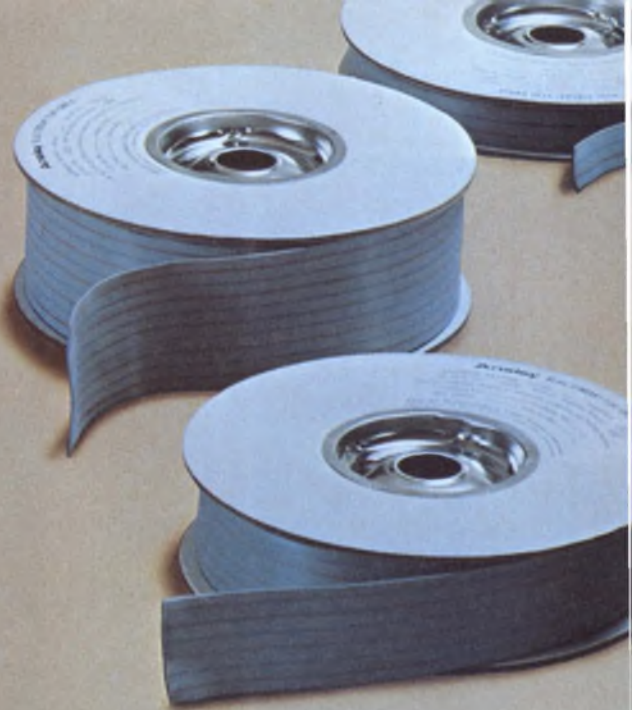

New cable connector system...It's designed to lower your installed costs.

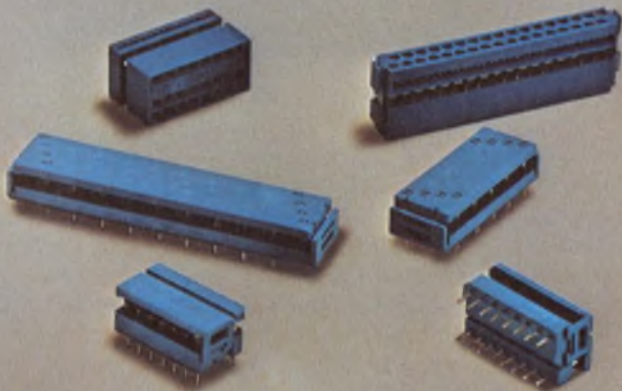

A perfect crimp every time

... because our Blue Streak hand tools feature the Shure-Stake® principle which makes the tool responsible (not the installer) for the compression connection. Your installer must complete the set compression stroke before the connector can be removed. It's as fool proof and reliable as a compression connector tool can be. A full line of bench mounted tools with interchangeable dies are also available.

The Ansley Team — One Piece Connectors — Shure Stake® Hand Tools and Blue Streak™ Cable — all combine to offer you the most reliable connection package at the lowest installed cost.

Ansley

ANSLEY ELECTRONICS CORP.
Subsidiary of Thomas & Betts Corporation

3208 Humboldt St., Los Angeles, Ca. 90031
Tel. (213) 223-2331, TWX 910-321-3938

SOLD COAST TO COAST THROUGH AUTHORIZED ANSLEY DISTRIBUTORS.

INFORMATION RETRIEVAL NUMBER 70

Our new insulation displacing flat cable connectors install in 1/3 the time

... simply because they come to you in *one* piece. Two benefits result; assembly of the connector itself is eliminated and the time consuming job of lining up the cable on the connector is no longer necessary.

To install — simply insert the cable end into the connector and crimp. It's that easy — fast — and reliable! Speaking of reliable — our new connectors feature an exclusive "tulip" contact design which provides 4 contact points per conductor. In addition, the front of the "tulip" contact is designed to act as a strain relief on the wire.

We'll be more than happy to send you a test report on contact reliability.



What
you see
is what
you get



Better yet, what you set is what you get!

When you set a DIGIVIDER voltage divider or DIGIDECAD resistance decade at a value, you get only that—value (within 1/10 of 1% accuracy). We make them with more liberal tolerances, too. But, regardless of your accuracy requirements, (1.0%, 0.5%, 0.25% or 0.1%) you get...

- In-line readout • Positive detent action
 - Absolute repeatability (no hysteresis)
- ...in less space and for less money per digit than a 10 turn precision potentiometer.

We make DIGIVIDERS or DIGIDECAD assemblies in any of our modular switch lines.

Send for our DIGIVIDER, DIGIDECAD Catalog today and see what you get.

There is a Digitran authorized distributor and a sales engineering group in your area.

See pages 1148 and 1149, Vol. 2 in the 1973-74 EEM Directory for more Digitran products.

**DIGIVIDER
DIGIDECAD**
MORE SWITCHES FROM THE
DIGITRAN
COMPANY

Division of Becton, Dickinson and Company **BD**
855 South Arroyo Parkway / Pasadena, Ca. 91105
Telephone: (213) 449-3110 / TWX 910-588-3794

INFORMATION RETRIEVAL NUMBER 71

2-GHz low-noise amplifier features new package style

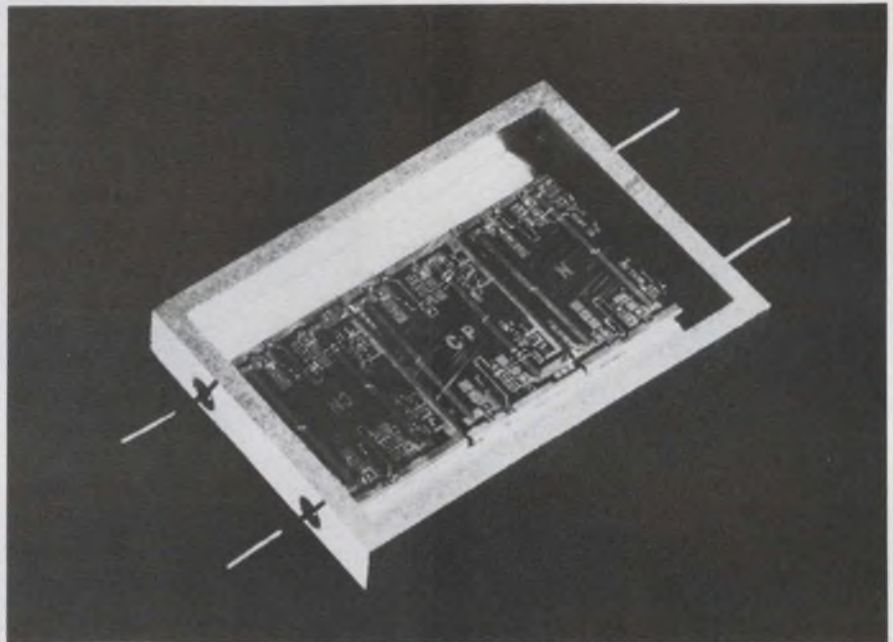

Avantek, Inc., 3175 Bowers Ave., Santa Clara, Calif. 95051. (408) 249-0700. P&A: See text.

Combining impressive performance with a unique packaging concept, the Avantek AFT-2500 hybrid amplifier is an attractive choice for front-end applications in receivers that operate in the 1.7- to 2.5-GHz communications band.

The amplifier operates with a power input of -12 V dc, 40 mA, and provides a minimum of 20-dB gain across the entire band. It has a noise figure of better than 3.5 dB, a 75-dB spurious-free dynamic range (for a 1-MHz bandwidth signal) and maintains a VSWR of 1.25 at both the input and output terminals.

The circuitry consists of two thin-film substrates, with thin-film resistor bias networks and chip capacitors. Low-noise arsenic-emitter bipolar transistors, produced by Avantek, are used.

The package for the amplifier chips shows care in design. Its dimensions are $1.16 \times 0.82 \times 0.17$ in., and it weighs about 0.75 oz. The two input and two output leads, which also carry power to the am-

plifier, emerge through glass seals on opposite narrow ends. The amplifier is designed to be inserted into a cutout rectangle on a microstrip circuit board, with the gold-plated Kovar leads soldered to the surface of the strip conductors. The bottom of the case is gold-plated and flat, to allow effective grounding by straps or bonding to a ground plate.

The package itself is fabricated from parts machined of Kovar and monel. Glass feedthroughs were chosen both for their electrical and thermal-expansion characteristics—which match those of the Kovar assuring that the package remains hermetically sealed. The unit operates over a range of -54 to $+65$ C with shock, vibration and humidity specifications suitable for missile or aircraft environments.

The price of the AFT-2500 amplifier is \$395 in quantities of 1 to 9. Delivery is immediate for small quantities. An available accessory package includes an aluminum case, a choice of rf connectors and a dc feedthrough filter for interface to nonmicrostrip circuitry.

CIRCLE NO. 250

85 amp DO-5



The ratings are back and even we're a little amazed at the fantastic results. We knew our upgraded DO-5 was a honey, but an 85 amp rating is (to say the least) a major breakthrough in power semiconductors.

Here's how it tested:

- Dimensions as per JEDEC DO-5 outline.
- Maximum Recurrent Peak Reverse Voltage . . . 100-1600 volts.
- Maximum Average Forward Current, Single Phase Half Wave Rating at 115°C. Case Temperature 85 amps.
- Maximum Surge Current (One Cycle) 1500 amps.
- (-) JC 0.6"

For detailed information, contact:
FMC Corporation
Semiconductor Products Operation
Homer City, Penna. 15748
(412) 479-8011

FMC Special
Products

4-channel Gunn osc aims for ECM uses

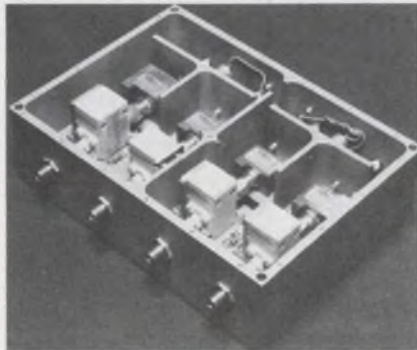

Omni Spectra Inc., 1040 W. Alameda Dr., Tempe, Ariz. 85282 (602) 966-1471. \$4500; 4 to 6 wks.

A four-channel varactor-tuned Gunn oscillator, the Model A30464, spans the 10-to-18-GHz range with simultaneous tuning in 2-GHz steps. Intended for ECM applications, the unit has an integral isolator, heater, and voltage regulator. The regulator guarantees 25-mW minimum output power and 0.2% frequency stability as a function of temperature variation and load pulling through all phases of 2:1 VSWR. Thermal runaway is avoided by use of an automatic reset switch and a proprietary circuit.

CIRCLE NO. 265

Cavity amplifier outputs 700 W pk

Trak Microwave Corp., 4726 Eisenhower Blvd., Tampa, Fla. 33614. (813) 884-1411. \$3400; 12 days.

A class-A broadband cavity amplifier can provide a peak rf output of 700 W. The amplifier has a 1-dB instantaneous bandwidth between 1245 and 1355 MHz. Called the Model 8603-1100, the new unit has a center frequency of 1300 MHz with gain flatness of ± 0.5 dB maximum in any 30-MHz band segment within the operating range. Rf pulse characteristics of the conduction-cooled unit include 15-ns rise and fall time on a 6.5- μ s pulse measured at the 3-dB points. Repetition rate is 340 pps with a duty cycle of 1% maximum. The unit measures 12 \times 7 \times 4 inches and meets MIL-STD-810B temperature and altitude specs.

CIRCLE NO. 266

MIC amplifiers yield gains up to 31 dB

Fairchild Transistor Div., 464 Ellis St., Mountain View, Calif. 94042. (415) 962-3816. \$49 up (100-999); stock.

A series of hybrid MIC amplifiers is offered for the 5-to-550-MHz range. Units available in TO-8 packages include the FMA 150, FMA 155 and FMA 160 models. The FMA 150 operates from +12 V dc and has a gain of 15 dB, typical noise figure of 2.5 dB, power output of -2 dBm and maximum VSWR of 2:1. For applications requiring lower gains—up to 10 dB—the FMA 155 is available with a typical noise figure of 5 dB, and output power of +10 dBm. The FMA 160 is similar to the FMA 155, but has a gain of 14 dB. Higher gain units are available in either a TO-3 package or a DIP. These units feature maximum gains of 20 dB (FMA 131 and 134) and 31 dB (FM 135). The FMA 134 has a minimum output of +16 dBm.

CIRCLE NO. 267

Gunn-effect osc provides 250 mW



Varian, Solid State Div., 611 Hansen Way, Palo Alto, Calif. 94303. (415) 493-4000. \$265 up; 30 to 60 days.

The VSC-9009 series of Gunn-effect oscillators delivers cw output powers ranging from 5 to 250 mW. The units are available in frequencies between 5.4 and 8.0 GHz. Standard models are tunable ± 100 MHz and special versions can be furnished with a tunability of ± 350 MHz or more. In addition, a VSC-9019 series provides varactor-tuned devices within the same power and frequency specifications.

CIRCLE NO. 268

Laser offers low noise, stable output



Hughes Electronics Dynamics Div., 3100 W. Lomita Blvd., Torrance, Calif. 90509. (213) 534-2121. Under \$6000; 60 days.

A cw argon-ion laser features a light-feedback stabilization system for low noise and long-term stability. The new 1-W TEM₀₀ laser system, called the Model 3067H, offers a noise level of less than 1% rms, and output power stability of $\pm 1\%$. The laser head incorporates the design features of the company's "Hip-Pocket" helium-neon lasers, and includes a beryllia-oxide ceramic bore, tap-water cooling system and permanently aligned optics. The head measures 28 \times 4.75 inches and weighs 30 lbs. The Model 3067H carries a one-year warranty, with the 1-W output guaranteed for the warranty period.

CIRCLE NO. 269

Antenna control has switch and selector



Daico Industries, Inc., 2351 E. Del Amo Blvd., Compton, Calif. 90220. (213) 631-1143.

Control of transmit/receive signals to upper or lower aircraft antenna or to ADF antenna is provided by a new selector-switch assembly. Designed to replace a MIL-spec SA/521A rf switch and C4808 selector, the solid-state control network provides four modes of operation including a memory for automatic antenna selection on transmission command. The switch operates over the 225-to-400-MHz range, outputs 100 W cw, has a 50- Ω impedance and provides a minimum isolation of 40 dB. Other features include 0.5-dB maximum insertion loss and 28-V operation.

CIRCLE NO. 270

“Electronic signatures – a better way to see”

“Need a better way to predict the failure of mechanical parts such as bearings? Need to add another technique to your bag-of-tricks for analyzing problems in electronic systems? I’m Dave Luttrupp, HP Product Manager for spectrum and wave analyzers. Let me show you a way.”

“When you consider that most items, from devices to systems, have a unique ‘signature’—a characteristic frequency spectra you can analyze for trouble-indicating changes—then you’ll appreciate how signatures can give you a better way to see and solve these problems.”

“Take this bearing, for example. It’s worn. Sure, the engineer responsible could have waited until his screaming motor told him, but our 3580A Spectrum Analyzer gave him some early warning signs that minimized motor damage and prevented production downtime. And he didn’t have to take it apart to know the bearing was worn... its frequency signature told him. At first, he tried to solve this problem with an oscilloscope. That didn’t work because the signature was buried in noise. What he needed was a simple way to isolate the noise so the elusive signal could be clearly seen. Spectrum analysis does just that.”

“There are engineers in other disciplines with this same basic need to separate noise from the signature. One wanted

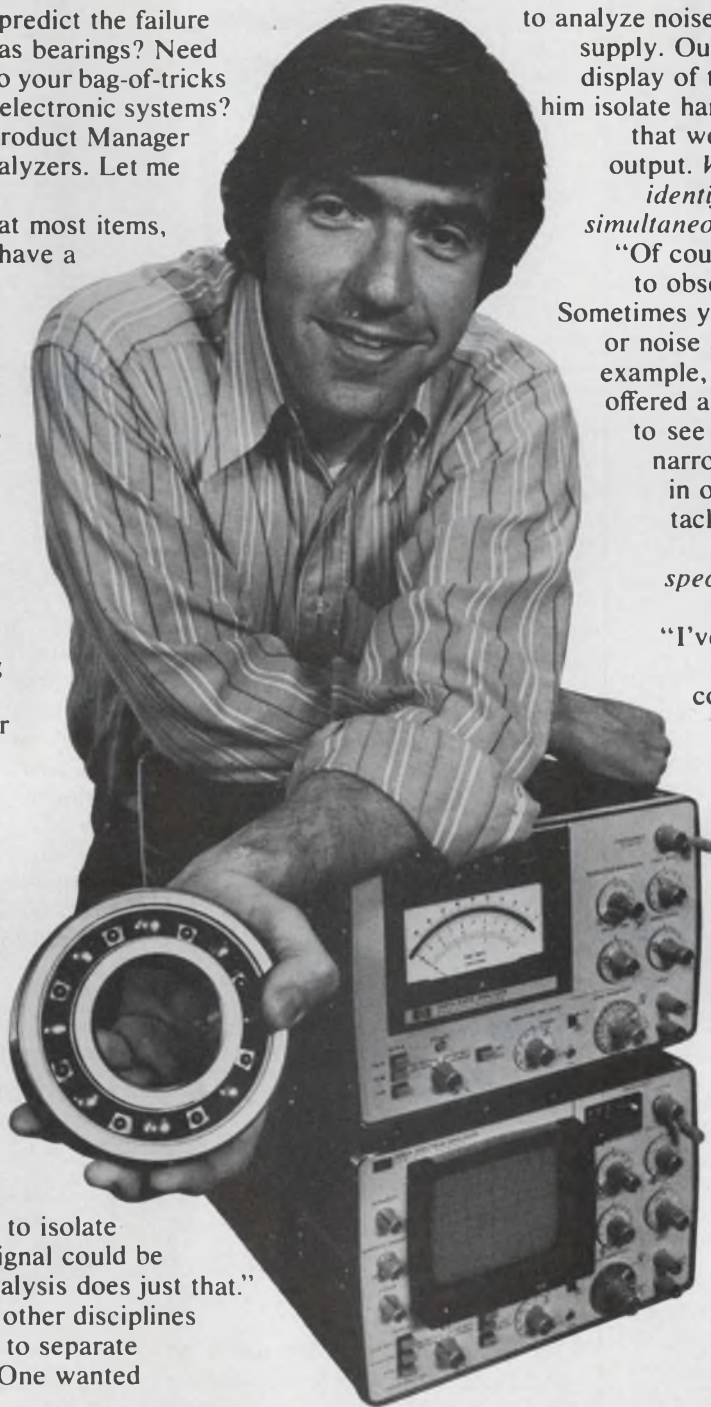

to analyze noise on the output of his power supply. Our HP 3580A, with its CRT display of the frequency spectrum, let him isolate harmonics and spurious noise that were sneaking through to the output. *When you need to view and identify a number of frequencies simultaneously, consider the 3580A.*”

“Of course, you don’t always want to observe a frequency spectrum. Sometimes you need to measure signals or noise at specific frequencies. For example, our 3581A Wave Analyzer offered a better way for an engineer to see a ground-loop problem. Its narrow bandwidth let him home in on spurious frequencies and tackle them one at a time. *For low-level measurements at specific frequencies, the 3581A Wave Analyzer is ideal.*”

“I’ve seen this type of problem in so many places that I’m convinced you too could see more with one of our analyzers. They’ve helped solve application problems ranging from space radiation studies to researching musical-instrument overtones and harmonics. If you think ‘signature analysis’ can help solve your engineering problems, call me, Dave Luttrupp at 303/667-5000. I’ll be happy to talk electronic signatures with you. Or, call your nearest HP field engineer. He, too, can show you a better way to see and solve your problems with electronic signatures.”

For New Standards in Frequency Analysis, Think HP.

HEWLETT  PACKARD

Sales and service from 172 offices in 65 countries
1501 Page Mill Road, Palo Alto, California 94306

INFORMATION RETRIEVAL NUMBER 73

"We figure payback at 18 months — even with our extremely low usage rate of 1 hour a day, 70,000 units a year."

We gave the Qualifier 901 a big build-up because we know it is the surest, least expensive way to avoid faulty IC's in your finished product.

But we had to know how the industry felt about our new system. When the phones

"From what I've seen, the 901 and its Qual Card programming works beautifully regardless of staff."

"I have technical people, but I need a test unit where I can utilize non-technical people... say someone that knows the difference between AC and DC!"

We just introduced the Fairchild Qualifier 901™

It's our new logic IC tester for incoming inspection of CMOS, DTL and TTL. We told you about unique Qual Card™ programming. We pointed out its simplicity of operation. Foolproof. There's only two things to remember: insert the Qual Card and IC — and read the results.



started ringing, we got nosy. A sampling of the most common responses is here.

The comments we received convinced us we had satisfied our design concept: "Make it easy for the user."

For example, take a look at Qualifier 901 programming. The durable plastic

Qual Card, verified by us, is immediately available from our library. When it comes back by return mail, all you do is put it in the machine. Everything is in the card. It's unbreakable. Slide the

Qual Card into the reader slot. No dials. No programmers. No operators to train. Nothing is left to chance.

Your operator can't miss.

The machine tests itself before it begins with your IC's. When the system is turned on, a comprehensive self-analysis is performed. When a program is loaded, the system checks itself. Further, an accompanying packet of diagnostic program

"Why a 901? It's simple. We'll reduce our 1½-2% IC failure, 50% board rework to an acceptable ½% IC failure, 10% board rework!"

cards verify the accuracy of the drive and measurement circuits.

And the Qualifier 901 is under \$8000 for the basic 16-pin test unit. For another \$2500 you can expand that capability to a 24-pin field. The Qual Card costs from \$20 to \$60 each.

If you'd like more information on the Qualifier 901, we'll send you a brochure, a list of representatives and a growing library catalog of 400 Qual Cards now available. Call collect or write today.

Fairchild Systems, A Division of Fairchild Camera and Instrument Corporation, 1725 Technology Drive, San Jose, California 95110. (408) 998-0123 TWX: 910-338-0558.

"We need a unit for incoming inspection with minimally qualified people at \$2.50-\$3.00 an hour!"

MADE IN
FAIRCHILD

IC kit controls TV

Texas Instruments, P.O. Box 5012, M/S 308, Dallas, Tex. 75222. (214) 238-3741. \$9.50 per kit (100); 4 wks.

Four ICs are offered for varactor-tuned TV applications. They are the SN76701 and 702 analog-voltage switches and the SN76710 and 711 logic-control circuits. These new devices provide a complete 16-channel TV control system with one SN76701, one SN76711, and three SN76702 packages. For 14-channel applications, the SN76710 is used in lieu of the SN76711. The circuits feature touch-tune or sequence operation, a tuning range of 0 to 30 V, analog input-to-output offset voltage of ± 100 mV, typically, and a clock frequency range of 0.1 Hz to 200 kHz. Analog temperature coefficient is 0.2 mV/ $^{\circ}$ C typically.

CIRCLE NO. 275

CMOS encoder picks top priorities

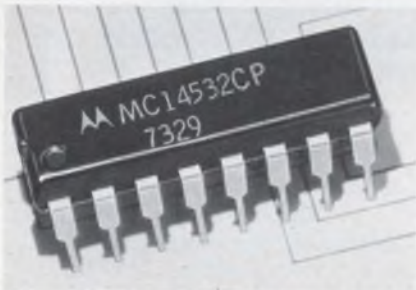

Motorola Semiconductor Products, Inc., Box 20924, Phoenix, Ariz. 85036. (602) 244-3466. \$4.05 up (100-999); stock.

An 8-bit encoder for positive logic systems selects the highest priority active input and assigns it a binary address. Called the MC14532, the new CMOS encoder has eight data inputs and a data enable. There are five outputs: one is a group select; three are binary addresses; and one is an output enable. The IC typically operates with a 25-nW quiescent power dissipation from a 5-V supply. Input capacitance averages 5.0 pF and typical noise immunity is 45% of V_{DD} .

CIRCLE NO. 276

Quad register guarantees 2 MHz

Fairchild Semiconductor, 464 Ellis St., Mountain View, Calif. 94042. (415) 962-3816. \$11.60 (100).

A quad static shift register, called the 3356, provides four individually controlled 256-bit registers in a single 16-pin DIP. The Isoplanar 3356 guarantees data rates of 2 MHz and a zero data-hold time. The 3356 has an on-chip clock generator driven by a single-phase TTL clock input. All inputs, including clock and recirculate, have a special pull-up device to provide TTL compatibility without external components.

CIRCLE NO. 277

256-bit S-TTL RAM has 20-ns access

National Semiconductor Corp., 2900 Semiconductor Dr., Santa Clara, Calif. 95051. (408) 732-5000. \$19.20 (100); stock.

A 256 \times 1-bit Schottky-TTL RAM, called the DM74S200, comes fully decoded and has three gated memory-enable inputs to simplify decoding. The memory has a maximum input current of only -0.25 mA. Access time from the memory enable inputs is typically 20 ns; it's 31 ns from the address inputs. The RAM typically dissipates 1.7 mW per bit and it offers Tri-State outputs.

INQUIRE DIRECT

Decoder handles 4 audio channels

Signetics, Consumer Products, 811 E. Arques Ave., Sunnyvale, Calif. 94086. (408) 739-7700. \$4 to \$9.

A complete four-channel hi-fi audio demodulator and preamp comes on the QSI 5022, reportedly the largest linear IC produced for consumer systems. The circuit decodes four discrete channels of sound from a single CD-4 disc recording. The IC's preamp produces two outputs that have a 180 $^{\circ}$ phase difference. Another section amplifies and limits the carrier signal, which is fed to a phase-locked loop FM demodulator and a carrier-level detector. The IC comes in a 28-lead DIP.

INQUIRE DIRECT

Function gen comes on a chip

R-OHM Corp. Exar Integrated Systems, 16931 Milliken Ave., Irvine, Calif. 92705. (714) 546-8780. \$4 (100).

Much of the circuitry needed to build precision function or signal generators is provided by the XR-2206 monolithic function generator. The XR-2206 contains a voltage-controlled oscillator, an analog multiplier and sine shaper, a unity-gain buffer amplifier, and a pair of current switches. The oscillator frequency range is 0.01 Hz to more than 1 MHz. Frequencies can be swept linearly through a 3000:1 range, typically. Amplitude modulation capability is 100% with linearity typically maintained at 95% modulation. Duty cycle is adjustable from 0.1 to 99.9%.

CIRCLE NO. 278

CMOS-switch line starts at 50¢/channel

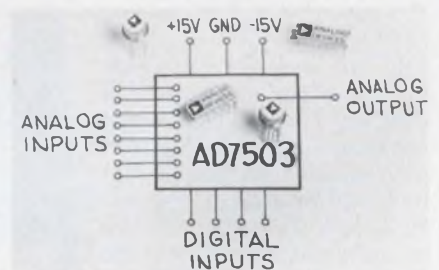

Analog Devices, Route 1 Industrial Park, P.O. Box 280, Norwood, Mass. 02062. (408) 249-2111.

A complete line of analog CMOS switches and multiplexers features plastic packaging for low costs starting at less than 50¢ per channel and high-density CMOS processing that provides 16 channels on a single chip. The multiplexers consist of the AD7503 eight-channel, the AD7506 16-channel and the AD7507 differential eight-channel devices. The AD7503 achieves 30- μ W quiescent power dissipation and 100- μ A maximum standby supply current; it uses a high-density double-layer interconnect process. The AD7503 has TTL-compatible inputs and doesn't latch up over a ± 15 -V range. The switches include the AD7511, AD7516 and AD7519 quad and the AD7512 and AD7513 dual switches.

CIRCLE NO. 279

This shiny new convertible gets 3.7854 liters per gallon.



And that's just the beginning.

The Rockwell 203 Converter also converts inches to feet, ounces to pounds, centigrade to Fahrenheit—any number that requires conversion from one measurement system to another.

In fact, the 203 Converter is pre-programmed to perform 112 *direct* conversions involving U.S., metric and Imperial constants. That's more than any other converter in the field.

- It will perform the calculations and conversions architects and engineers use in connection with site surveys, specifications and drawings.

- The 203 will speed up problem solving for the importer/exporter who works daily with measurements of volume, weight, distance, area, temperature, etc.

- The programmable conversion feature of the 203 allows travel

agents and travelers to immediately compute U.S. dollar equivalents of foreign currencies (this feature lets you program *any* constant into the 203's memory; so the number and kinds of conversions possible are virtually up to you).

Here are a few more of the 203's many features:

- Two fully-addressable memories
- Automatic constants
- Calculations with fractions and decimal numbers
- Full-floating or two-place decimal settings
- U.S. or Imperial liquid measure
- Statute or nautical miles

The capacity, the versatility and the capabilities of the Rockwell 203 Converter put it miles (and kilometers) ahead of all the rest.

For more information on the 203 Converter or the entire family of Rockwell hand-held professional calculators, call your local Rockwell dealer, or complete and mail us the following coupon.

Please send me information on the Rockwell 203. 8

Please have salesman call right away.

Name _____

Occupation _____

Company _____

Address _____

City _____ State _____

Zip _____ Phone _____

Mail to: Unicom Systems
Rockwell International, 950 DeGuigne Drive
Sunnyvale, California 94086

Our family has a mind for business.



**Unicom Systems
Rockwell International**

...where science gets down to business

INFORMATION RETRIEVAL NUMBER 76

GENERAL ELECTRIC'S TYPE 84F TUBULAR ALUMINUM CAPACITOR...



New from General Electric — an axial leaded, all welded tubular capacitor meeting the high CV small case size requirements of today's transistorized electronic equipment. Excellent for industrial and entertainment applications requiring maximum capacitance with limited space. Quality constructed for long life and high reliability, the 84F capacitor offers these features:

- All welded construction
- High volumetric efficiency
- High ripple current capacity
- 1,000 hour life rating at 85 C
- Wide range of case sizes and voltages

For more information on these, or any of General Electric's wide range of capacitors, call your nearest GE sales office today, or write Section 430-54, Schenectady, N. Y. 12345.

MAKE SOMETHING OUT OF IT!

GENERAL  ELECTRIC

INFORMATION RETRIEVAL NUMBER 77

DATA PROCESSING

Tape readers aim for medium speed uses



Electronic Engineering Company of California, 1441 E. Chestnut Ave., Santa Ana, Calif. 92701. (714) 835-6000. See text; 30 days.

EECO's line of 200 CPS Photoelectric Paper Tape Readers are designed to satisfy the lower speed range of the punched tape spectrum. Standard models will handle 1200-ft. reels, 600-ft. reels, 200-ft. fanfold loops or strips of tape. Readers come in two versions, desk top and 19-in. rack mount. All units will "stop on character" at 200 char/s. The reel models will operate at 400 char/s in the re-wind/search mode. All electronics are mounted on a single PC board for increased reliability. LEDs are used as light sources and photo-transistors as sensors. Single unit prices for the readers range from \$550 to \$895.

CIRCLE NO. 280

Keyboard-style tape punch uses no power



Data Devices International, 6325 DeSoto Ave., Woodland Hills, Calif. 91364. (213) 884-5500. \$244; stock.

The Model 58 is a keyboard style tape that can prepare five or eight-track paper and Mylar tapes. The punch is portable and operates without electrical power. It can be used anywhere—from computer room to shop floor.

CIRCLE NO. 281

Optical card readers handle 800 cards/min



True Data, 2701 S. Halladay, Santa Ana, Calif. 92705. (714) 979-4842. See text.

A family of optical card readers offers operating speeds of 200 to 800 cards/min. with 80-column cards. A proprietary mechanism handles damaged and mis-registered cards as routinely as clean ones. Either model of the ODR Series reads a mix of punched or marked cards. The Model 400 reader (\$2095) processes 200 or 400 cards/min. and the Model 800 (\$2395) handles either 300, 400, 600 or 800 cards/min. without field modification. Data output is 12-bit parallel and is serial by column. Switch selectable I/O polarity levels allow emulation of most competitive card readers. Standard TTL circuitry is used.

CIRCLE NO. 282

Local modem moves 19,200 bits a second

Codex, 15 Riverdale Ave., Newton, Mass. 02195. (617) 969-0600. \$995.

Model 8200 lets you send data at rates up to 19,200 bit/s over local loops (common carrier or private) for distances up to several miles. Four wires provide half or full-duplex operation. Two wires permit simplex or half duplex operation. Use of differential phase modulation is said to give good immunity from line parameter change and line distortion. Receive timing is derived from the data and is claimed to be insensitive to the data pattern. The modems allow local and remote loopback to isolate system failures.

CIRCLE NO. 283

SEARCHING FOR . . .
RELIABILITY AND PERFORMANCE
IN TINY WIDEBAND TRANSFORMERS?

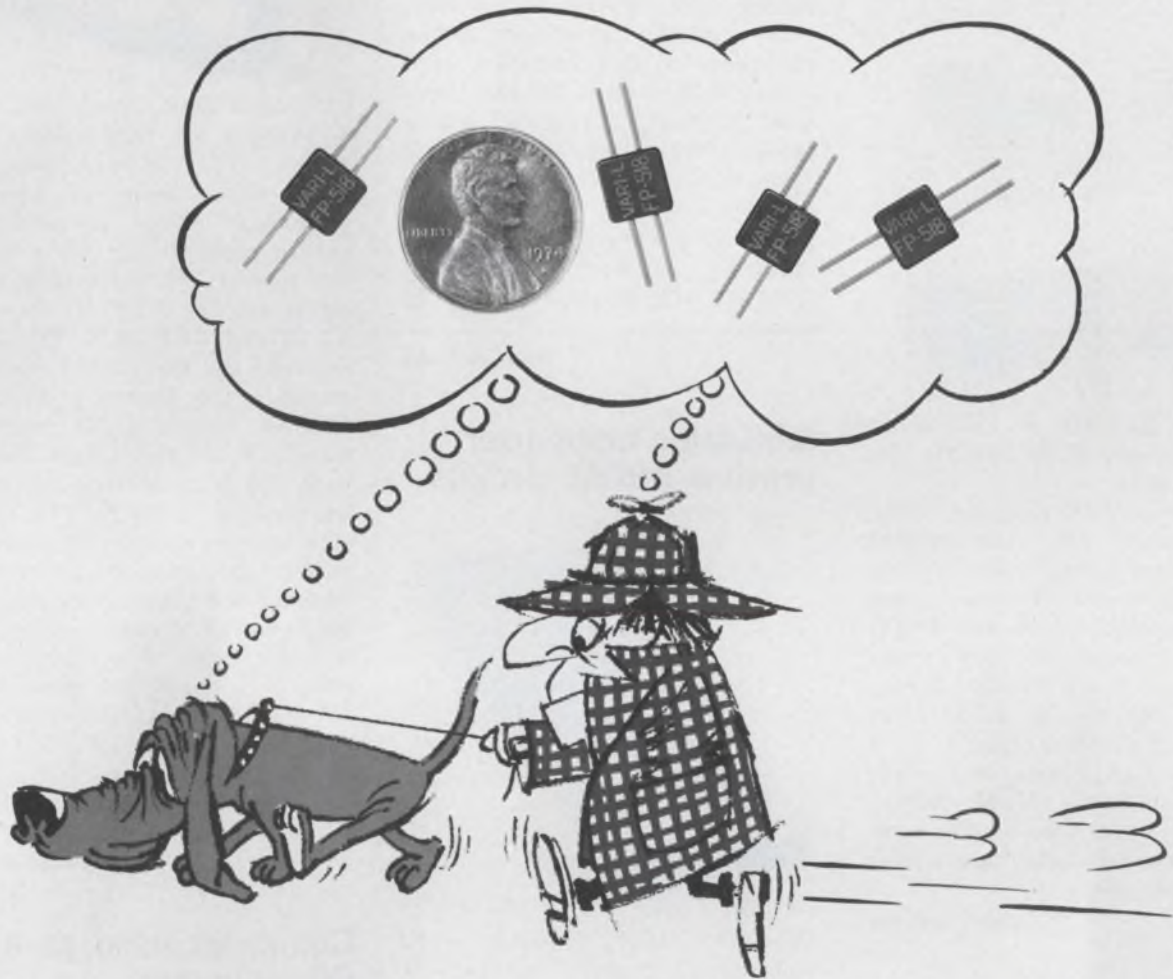

Discover Vari-L's new substrate compatible flatpack wideband transformers.

- Subminiature size — $\frac{1}{4}$ " x $\frac{1}{4}$ " x $\frac{1}{8}$ "
- 0.5 Db Insertion loss
- Ribbon leads
- 12.5 to 600 ohm impedance range
- Up to 1 GHz bandwidth
- MIC Substrate compatible
- Balanced & unbalanced configurations

Their small size, easily solderable or weldable planar ribbon leads, and high performance/high reliability design makes them ideal for MIC substrate and conventional printed circuit applications.

CALL OR WRITE FOR COMPLETE INFORMATION



VARI-L COMPANY, Inc.

3883 Monaco Parkway ■ Denver, Colorado 80207 ■ Phone: (303) 321-1511 ■ TWX: 910-931-0590

ANSI formats used in cartridge memories



Kennedy Co., 540 W. Woodbury Rd., Altadena, Calif. 91001. See text; 45 days.

The Series 4000 cartridge memories feature fully implemented ANSI record formats. The systems accept byte-oriented data, phase encode at 1600 bit/in and supply preamble, postamble and cyclic redundancy check. Total storage is 2.875 Mbytes on a cartridge and the recorders operate at a 5-kbyte/s rate. Single unit prices range from \$2495 (Model 4000-1) to \$6050 (Model 4000-4). The number of cartridge decks ranges from one to four.

CIRCLE NO. 284

Software executive helps build bigger programs

Computer Automation, 18651 Von Karman, Irvine, Calif. 92664. (714) 833-8830. \$500.

Increased productivity for Alphas and Naked Mini/LSI computers is promised by the Real Time Executive (RTX) software package. This comprehensive executive provides task control, priority scheduling interrupt service and task-to-task communication for user-written applications programs. The nucleus or core of the executive requires just 650 words of memory yet allows the user to construct modular software packages that includes data communications.

CIRCLE NO. 285

Intelligent controller handles peripherals

Harvey Hubbell Inc., Pulsecom Div., 5714 Columbia Pike, Falls Church, Va. 22041. (703) 820-0652.

The Model 400 terminal controller has the intelligence (Intel 8008 CPU) to control peripheral devices and interface them to a communications line. Terminal interface cards join the peripherals to the controller, a line interface card connects the unit to the common carrier. Firmware allows speed settings between 37.5 and 1800 baud. And the unit accommodates six cards. A skilled programmer is needed to write the necessary software; the manufacturer will do so for quantity orders.

CIRCLE NO. 286

Simulator helps user preview pROM circuits

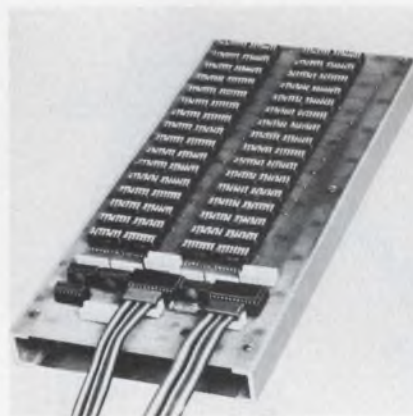

Orbitran, 11487 Woodside Ave., Lakeside, Calif. 92040. (714) 448-5075.

The Model 237 pROM simulator is electrically compatible with the Signetics 8223 and Harris 8256 in that it provides open collector TTL logic outputs. It is intended for use with two, 16-pin, 8-bit pROMs that have 37 octal address steps. The 6 × 14 × 1.75-in. device can easily be integrated into production lines where programmable pROMs are used. By the use of switches, the operator can set each of the 256 bits to be either ONE or ZERO. Ribbon cables are provided to connect the pROM socket to the simulator. The input loading (2 TTL loads) is 3.2 mA to ground. And the device will sink up to 30 mA. Typical propagation delay is 35 ns.

CIRCLE NO. 287

Microprogrammed minis are a second-source

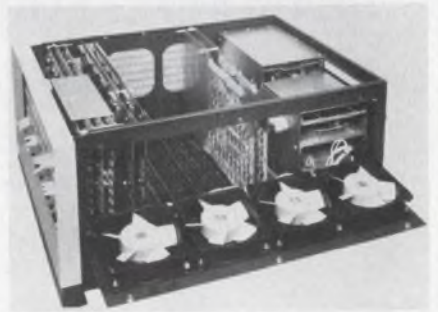

California Data Processors, 2019 S. Ritchey St., Santa Ana, Calif. 92705. (714) 558-8211. See text.

Cal Data's series of microprogrammable minis provides compatible replacements for a volume user's minis. Initial models in the series are the CDP XI/00, CDP-XI/35 and CDP-XI/I. The XI/35 emulates the PDP-11/35; the XI/I emulates the Tempo I. Processor features include 48-bit microcommands, 8 × 16-bit core memory with 675-ns cycle time and interleaved data transfers. The processors have 16 or more file registers that operate in word, byte, nibble (4-bits) and bit increments. A 16-bit parallel I/O channel gives peak transfer rates of 6 Mbyte/s. The computers handle memories of up to 128 k words. The basic machine CDP-XI/00 sells for under \$4000; the XI/35 with 32-k memory sells for less than \$13,000. An 8-k version costs \$9300.

CIRCLE NO. 288

Computer used as a QC inspector

Photo Digitizing Systems, 820 S. Mariposa St., Burbank, Calif. 91506. (213) 849-6251.

One way to boost chip yield is to let a computer check masks. With the Model 200, an image dissector camera and microscope scans a master plate and has the images stored in a minicomputer memory. The computer then inspects work plates placed under the microscope. The computer checks for pinholes, opaque spots, nicks, protrusions and scratches. Resolution is 0.0001-in., but a higher microscope magnification (100 ×) gives resolution to less than 1 μ. Similar equipment is also available to check film images, graphs, charts and other pictorial material.

CIRCLE NO. 289

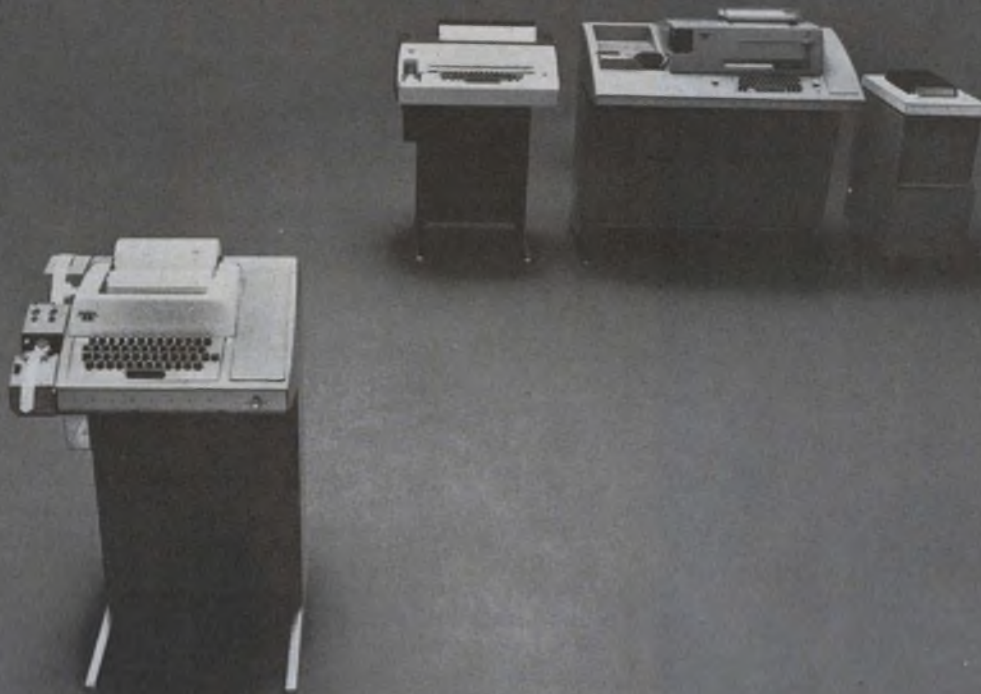

As good as the model 33 is, we're aware that for some people it's not enough.

Our model 33 is the standard of the data communications business for three very good reasons. Economy, reliability and versatility.

Yet we realize some applications require a little more. That's why the model 33 isn't an orphan.

Some of our customers want everything the model 33 offers, but they want it in a wide-platen configuration to accept standard computer fan-folded forms. For them, we make the model 38.

Some customers may have applications requiring an extremely rugged terminal. A

machine that can operate day and night for months on end with little maintenance. For them, we make our heavy-duty model 35.

Still others need a unit that can give them greater speed. For them we build our 4210 magnetic tape terminal. The 4210 is compatible with all our other terminals and can move data on-line at speeds up to 2400 wpm.

Our data terminals are offered in various configurations: models 33, 35 and 38 can be ordered as ASR, KSR and RO units.

It takes more than manufacturing facilities to build the terminals Teletype® Corporation offers. It also takes commitment. From people who think service is as important as sales. In terminals for computers and point-to-point communications.



The computercations people.

For more information about any Teletype product, write or call: TERMINAL CENTRAL, Teletype Corporation, Dept. 89R, 5555 Touhy Avenue, Skokie, Illinois 60076. Phone 312/982-2500. Teletype is a trademark registered in the United States Patent Office.

immediate prototype delivery on Grayhill rotary switches



Adjustable stop switches off-the-shelf with the form-fit-function characteristics you need

- Simple pin adjustment provides the right number of positions per pole
- Over 100,000 possible combinations
- Available now from your local Grayhill distributor

Here's the fast route to rotary switches for prototypes or small production runs. Grayhill Adjustable Stop switches, available from your local Grayhill distributor, cut procurement lead time. You no longer need to wait for even small quantities to be built to order. The Adjustable Stop feature is available in one-inch and half-inch diameter, single deck and multi-deck versions. Your distributor can supply 1-and 2-deck Adjustable Stop switches from stock (one or two poles per deck) and can quickly secure other variations from factory stock. Write for complete literature.



561 Hillgrove Avenue • LaGrange, Illinois 60525
(312) 354-1040

DATA PROCESSING

Color-display system shows up to 900 chars

Terminal Display Systems Ltd., c/o British Information Services, 845 Third Ave., New York, N.Y. 10022. (212) 752-8400.

The MRCD display controller provides 40 char/line on CRT monitors with eight colors. Red, green and blue video generators accept serial characters and store them in a MOS refresh memory. Internal logic circuitry generates three composite video signals—one for each gun. Standard 525-line monitors display the results. Each character, as well as its background, can be displayed in a different color. Two models of the system provide 16 or 24-line displays (640 or 960 characters).

CIRCLE NO. 290

Low-cost mil mini is good for severe environs



Rolm Corp., 18922 Forge Dr., Cupertino, Calif. 95014. (408) 257-6440. See text.

The Model 1603 is a military mini that costs less than ruggedized commercial machines meant for severe environs. For \$9950 (unit quan.) you get a 16-bit machine with 8-k memory that has a 1.2 μ s cycle time. Direct-memory access (DMA) is standard and you can expand storage to 32 k. An optional arithmetic card adds 7.7 μ s hardware multiply and divide. In addition the company has available 30 general-purpose interfaces for use with the 1603. These sell for \$500 to \$1250 each and connect directly to the I/O bus. The \$9950 price includes a week of software and a week of hardware training. High-level languages supported are Fortran, Basic and Algol.

CIRCLE NO. 291

Medium-speed line printer has low price

Okidata Corp., 111 Gaither Dr., Moorestown, N.J. 08057. (609) 235-2600. \$7500 (quan.); 90 days.

The LP500 Line Printer is equipped with a 64-character set, and prints 500 lines/min. With a 128-character set the unit prints 330 lines/min. A moving belt printing technique delivers sharp, even characters over the 136-column line. The swinging yoke arrangement used simplifies paper insertion and ribbon replacement. The windowed top hood and front door provide reduced operating noise levels.

CIRCLE NO. 292

Modem family gives 2400 bit/s operation

Penril Data Communications, 5520 Randolph Rd., Rockville, Md. 20852. (301) 881-8151.

A three-modems series offers 2400-bit/s data rate over direct dial facilities and 3002 leased lines (C2 or unconditioned). Model 2400-B1-A is the lowest cost and features rapid synchronization and carrier recovery as well as analog and digital loopback tests. The 2400-B1-B is identical to the "A" unit but has automatic answer. The 2400-B1-C has a remote diagnostic capability in the form of an addressable test pattern.

CIRCLE NO. 293

Software announced for distributed processing

Xerox Corp., 701 S. Aviation Blvd., El Segundo, Calif. 90245. (213) 679-4511.

The Model 530 is a 16-bit computer. With IDEN software the machine becomes part of a distributed computer system. Information entered from local terminals is processed immediately; and processed information can be retained or sent to a larger host such as the company's 560 or IBM 360/370 machines. Features of IDEN include: forms creation and validation, film management, and ability to run concurrently with real-time tasks. A complete system consists of 32-k memory disc storage, CRT network and controllers.

CIRCLE NO. 294

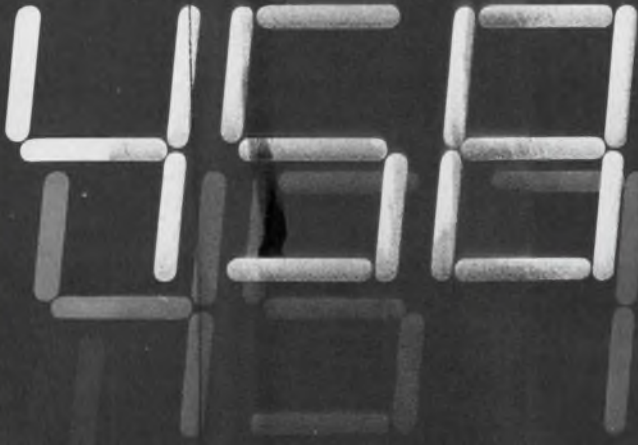

What you don't know about field effect liquid crystal display devices won't hurt your competitors!

...but one of the things you just
plain have to know is that
Roche holds the basic rights.

A lot of companies interested in numeric displays of any kind are working with field effect nematic liquid crystal arrangements. They need the advantages this basic invention has over dynamic scattering. We would like to start a dialogue with you that may put you a light year ahead of your competition.

Please talk to us about a non-exclusive licensing arrangement which will put Roche's world-wide resources at your disposal. You'll have to come to Roche sooner or later. With the kind of competition you face, later may be too late.

Please write on your company letterhead to C. J. Wiley or call him at (201) 235-3751.



Hoffmann-La Roche Inc.
Nutley, N.J. 07110.

Lab recorder stores data at 33-k bit/in.

Bell & Howell Electronics, 360 Sierra Madre Villa, Pasadena, Calif. 91109. (213) 796-9381.

Features of the laboratory-grade recorder named Starr include a 300-Hz phase-locked servo and TTL compatibility of controls and interfaces. The recorder—in the PCM mode—can provide densities of 300 kbit/in. Other record modes include direct, FM and wideband. The unit records simultaneously on 28 tracks; the ferrite heads are warranted for 3000 hours' use.

CIRCLE NO. 295

Controller mates mini to 330-type disc drives



Diva, 607 Industrial Way W., Eutontown, N.J. 07724. (201) 544-9000.

Disc storage with capacities of 116-million to 1-billion bytes is available for minicomputer users. An intelligent controller named Computroller I processes data at the appropriate rate for disc and CPU. The controller uses IBM 3330-type correction procedures yet emulates the instruction set of the manufacturer's controller, so there is complete software compatibility. Individual disc drives provide 116 Mbytes (single spindle) and 232 Mbytes (double spindle). The controller handles up to eight spindles. Average access time is 32 ms with a transfer rate of 624 kbytes/s and the recording density is 4400 bit/in. A complete 116 Mbyte memory including controller (DD-30 drive) costs \$27,100; a 232-Mbyte unit (DD-32 drive) costs \$39,200.

CIRCLE NO. 296

Intelligent terminal offered for APL use



Ontel Corp., 3 Fairchild Ct., Plainview, N.Y. 11803. (516) 822-7800. \$4360; 45 days.

A CRT terminal for APL use, Series A4000, combines an intelligent terminal with a specially designed APL keyboard and character set. The new terminal delivers a clear video display of APL and uses standard ASCII character sets. A 4-k microprocessor provides on-line and off-line operating flexibility. Advantages of the A4000 include: true APL overstrike capability; a foreground-background switch for selective display of an overstruck APL symbol; full character editing within the APL definition or execution mode. A single APL OUT key permits the user to generate the APL special function with one keystroke. The Series A4000 display terminal is a three piece modular system with a moveable keyboard and display. The keyboard is similar to the IBM 2741 Selectric with special function and transmission mode control keys.

CIRCLE NO. 297

Double-density disc stores 200 Mbytes

Ampex Corp., 401 Broadway, Redwood City, Calif. 94063. (415) 367-4151. \$20,000.

A double density disc file system with 200 Mbytes, the Model DM-331, is said to have an average access time 2 ms faster than the IBM 3330 and occupies 50% less floor space. Average access time of each drive in the DM-331 is 30 ms. The DM-331 is available with a simplified interface for non-IBM systems.

CIRCLE NO. 298

Cartridge transceiver has error checks

Three Phoenix Co., 10202 N. 19th Ave., Phoenix, Ariz. 85021. (602) 943-2311. \$1780.

Error checking capability for both media and transmission line allows for recovery and re-transmission of data and is just one feature offered in the TCT-300 cartridge drive. The unit uses a 3M DC300A tape cartridge as a storage media. It can transmit data asynchronously from 110 to 2400 baud by switch selection. The ANSI proposed standard is followed. The tape speed for record and transmit at 30 in/s and fast forward and rewind are 90 in/s. Precision alignment of head and tracks assures cartridge interchangeability. Tape storage capacity is 300-k characters recorded at 1600 bit/in. Options offered includes editing, character insertion, context search, and current loop interface.

CIRCLE NO. 299

Memory cards replace small discs and drums



Intel Memory Systems Div., 1302 N. Mathilda Ave., Sunnyvale, Calif. 94086. (408) 734-8102.

A standard semiconductor memory system is now plug-compatible with several types of small fixed-head-disc memories. Full memory capacity is 90 tracks with 5120 bits in each track. A wire-wrap interface card adapts the in-63 Memory System. The system reduces maintenance and increases reliability because most maintenance is done with a simple card substitution. A standard 19-in. rack enclosure houses the memory and contains a power supply that operates on standard line current, and/or batteries for standby power.

CIRCLE NO. 300

From the
voltmeter
house...

Here's how we tested our 42,386th multimeter.

The world's best-selling 3½ digit multimeter is virtually indestructible.

Recently, two Fluke quality control engineers wanted to know if our 8000A 3½ digit multimeter would survive a fall from a 24-foot rack. We were shipping several to a phone company.

So they tossed one out the window. Two stories up. It still worked.

But 99⁴⁴/₁₀₀% of these out-of-the-ordinary tests we **don't** instigate.

They just seem to happen.

Our president talks about the time he picked up an 8000A at a trade show without knowing it was ready for case removal. The works crashed to the floor but it still played perfectly . . . to everyone's delight and the president's relief.

One reason why our DMM is so tough: it only has 99 parts. Major analog and digital circuitry are on LSI chips.

It's also flexible. This DMM has 26 ranges, including five ranges of ac and dc volts, five ranges of ac and dc current, and six ranges of resistance. And it's the only DMM using an A-to-D converter with inherent self-zeroing to completely eliminate offset uncertainty.



But it's the ruggedness that really makes the 8000A a conversation piece. Our sales force still laughs about the Fluke salesman who was so hot to make a sale that he took his Fluke multimeter and brought it down—crash!—right on his prospect's desk.

"See," he said, "it's really tough."

And so it was, but the op amp that was hidden under a pile of papers wasn't. P.S.—our salesman didn't make the sale.

On a more positive note, a UPS truck accidentally backed over an 8000A not long ago . . . without ill effect.

So there you are. The world's largest selling 3½ digit DMM. And the toughest. And for \$299 it could be yours.

For data out today, dial our toll-free number, 800-426-0361

In the continental U.S., dial our toll free number 800-426-0361 for the name and address of your nearest local source. Abroad and in Canada, call or write the office nearest you listed below, John Fluke Mfg. Co., Inc., P.O. Box 7428, Seattle, Washington 98133. Phone (206) 774-2211. TWX: 910-449-2850. In Europe, address Fluke Nederland (B.V.), P.O. Box 5053 Ledeborstraat 27, Tilburg, The Netherlands. Phone 013-67-3973. Telex: 844-52237. In the U.K., address Fluke International Corp., Garnett Close, Watford, WD2 4TT, England. Phone 0923-33066. Telex: 934583. In Canada, address ACA, Ltd., 6427 Northam Drive, Mississauga, Ontario. Phone 416-678-1500. TWX: 610-492-2119.



Dc power amplifier has ± 75 mV deadband

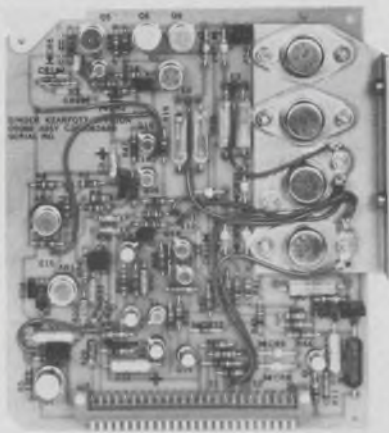

Singer, Kearfott Div., 1150 McBride Ave., Little Falls, N.J. 07424. (201) 256-4000.

The C70 3722 101 dc power amplifier is designed for pulse-width modulated operation. Its bridge output provides an average dc voltage that is proportional to a dc input signal. A deadband of ± 75 mV (nominal) is incorporated for ease of servo loop stabilization. Short-circuit protection is provided with a reset delay of approximately 2 s. Efficiencies of up to 85% at full load are typical. Nominal output voltage and current ranges are 0 to 22 V dc and 0 to ± 3 A, respectively. The amplifier is packaged on a printed circuit card approximately 4.75×5.25 in., and provisions are available on the amplifier for attaching additional heat sinks. Power requirements are 24 to 28 V dc and -6 V dc. Other package configurations are available.

CIRCLE NO. 301

Naked a/d converter has 0.0025% linearity

Function Modules, Inc., 2441 Campus Dr., Irvine, Calif. 92664. (714) 833-8314. \$98 (100-up).

The Model 109 "naked" a/d converter uses a version of the dual-slope integrating technique. It has automatic zero correction to provide linearity of better than ± 1 ppm/ $^{\circ}$ C. When combined with required counter and clock, the Model 109 becomes a complete, high performance a/d converter with resolution of up to 16-bits binary or 5-1/2 digits BCD.

CIRCLE NO. 302

Digital angle translator delivers 13 or 16 bits

Interface Engineering, Inc., 386 Lindelof Ave., Stoughton, Mass. 02072. (617) 344-7383. 127-4: \$230; 127-5: \$270.

The DD127 digital translator module can simplify data entry into position control systems. The unit accepts angle input in engineering units (degrees) and translates to natural binary angle for entry to the control system. The translators are available in 13 or 16-bit precision, and accuracies of 0.06 and 0.006° . They have a translation speed of less than 500 ns. The DD127 units are housed in $3 \times 4 \times 0.4$ in. modules and are DIP compatible. The DD127-4 accepts four digits of input BCD angle data (359.9° full scale) and delivers a 13-bit parallel binary angle with 0.06° accuracy. The DD127-5 accepts 5-digits of BCD and delivers a 16-bit binary angle accurate to 0.006° .

CIRCLE NO. 303

Digital thermometer and clock on one card

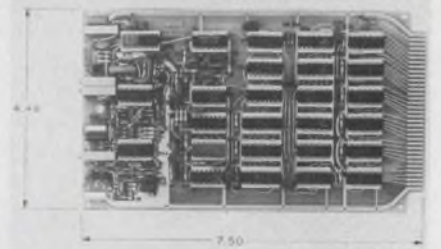

Nationwide Electronic Systems, 1536 Brandy Parkway, Streamwood, Ill. 60103. (312) 289-8820. \$250 (100-up).

A time and temperature circuit card combines a digital clock and digital thermometer on a single plug-in circuit card. The clock keeps time using the 60 Hz line frequency as a time base. Should the 60-Hz line fail, a built-in standby oscillator takes over so that the clock will continue running. The clock provides parallel BCD outputs, TTL/DTL compatibility and has built-in latches (hold capability). The outputs are three-state logic with each digit individually controllable to permit almost any variety of output bus arrangements. The thermometer accepts a three-wire precision platinum wire probe, which handles temperatures from -20 to $+140$ F with 0.6 F accuracy. The probe leads can be of any type of wire, and the circuitry automatically compensates for lead length. The thermometer data outputs are latched, and three-state buffers are provided for maximum flexibility. The 4.5×7.5 in. card has gold plating on the double-sided 35-position card edge connector, sockets for all ICs and readily accessible test points and calibration adjustments.

CIRCLE NO. 304

ANA & LOG

CHARLIE SAYS HE'LL FIRE ME UNLESS I PITCH IT HIGH AND TIGHT AT 250 NANoseconds!

OKAY, WE'LL USE THE A-862 DAC.

I'M GLAD YOU'RE NOT YOGI BERRA!

INTECH DA'S KLUGES

ANALOGY
THE A-862 IS IN THE CATCHER'S MITT BEFORE YOU KNOW IT WITH ITS 250NS 1DAC SPEED AND LINEARITY TEMP CO OF ONLY 2PPM/ $^{\circ}$ C. IF VOLTAGE TURNS YOU ON. TRY IT AS A 1.545 VD AC AT 6PPM/ $^{\circ}$ C.

intech INCORPORATED
(408) 244-0500
1220 COLEMAN, SANTA CLARA CA 95050

Optical limit switches use pulsed IR sources

Mektron, 2728 N. Jessup St., Portland, Ore. 97217. (503) 285-3681.

The 210 series of solid state optical limit switches can eliminate the major problems of standard photoelectric controls. Each switch consists of a pulsed, solid-state light source operating in the infrared region and an electronic detector which is tuned to reject all light except that from the pulsed source. Alignment is made simple with a sighting groove on the housing and self-contained indicator which illuminates when the unit is properly aligned. The standard model uses a separate light source and detector for a maximum range of 500 ft. The retro-reflective model has a lamp and detector within a single case, and has a maximum range of 40 ft. Either model is available with an operating voltage of 117 or 234 V ac, or 12 V dc. A TTL/DTL compatible output is standard with both models. Options include detector with time delay, 5 A output relay, 10 A triac, or opto-isolated output.

CIRCLE NO. 305

Line voltage monitor also checks frequency

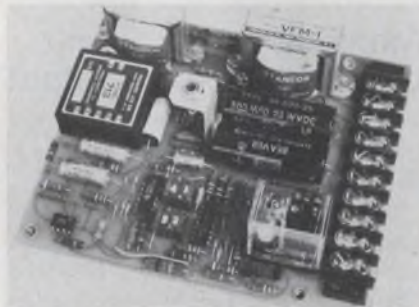

Richard Lee Co., Box 724, New Providence, N.J. 07974. (201) 655-1333. \$152 (50-up); 3 to 6 wk.

Model VFM-1 voltage and frequency monitor has four limit adjustments set by the customer to select the high and low voltage and frequency trip points. Any voltage or frequency condition that exceeds the preselected limits deactivates a dpdt relay. All contacts on this relay are available for control purposes. Self-contained on a 4.5 x 6 in. printed circuit board, the Model VFM-1 can be easily installed in existing equipment with only four mounting screws.

CIRCLE NO. 306





When it comes to telephone coupling transformers TRIAD is plugging away!

Triad has plug-in transformers specifically designed and built to interconnect remote data entry and display terminals to computers over voice-grade telephone lines. They are used for impedance matching, isolation, line balance, bridging, hybrid and holding coil applications. All of them meet telephone company requirements for voice/data use on leased private lines or through the dial-up switched telephone network.

If you're wrestling with a design problem in the interconnecting of data modem terminals, write for more data.

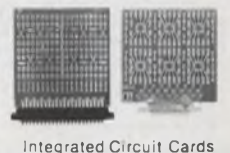
Triad also makes many standard plug-in power transformers for transistorized control and instrumentation with 115-volt and 115/230-volt primaries. They provide a voltage step-down and isolation from power line at relatively low power levels at 4 to 38 volts when connected in parallel, and 8 to 76 volts when series-connected. Plug-in printed circuit audio transformers with 100 MW output and various primary and secondary impedances are also in stock. See your Triad industrial electronic distributor today for a catalog—or write Triad Distributor Services, 305 N. Briant Street, Huntington, Indiana 46750.



 **TRIAD-UTRAD**
Litton Distributor Services

INFORMATION RETRIEVAL NUMBER 84

**FROM
BREADBOARD
TO FINAL
PACKAGING
HARDWARE...**

**ALL AVAILABLE
FROM ONE SOURCE**



**★ ADHESIVE BACKED
CIRCUIT SUB-ELEMENTS**

(Over 200 Pre-Drilled component mounting patterns available "off-the-shelf.")

**★ EPOXY GLASS BOARD
MATERIALS**

- 76 Standard "Off-the-Shelf" Boards.
- Including Unclad, Copper Clad, Cut & Peel Copper Clad, Pre-etched "X-Y" Pattern and Plated thru Hole Copper Clad.
- .100" Grid Hole Pattern or Undrilled.

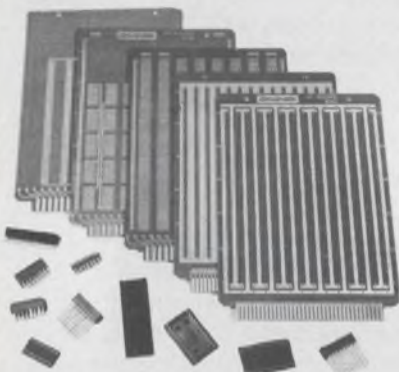

★ GP CIRCUIT BOARDS and ACCESSORIES

- Highest Quality — Choose from 74 "Off-the-Shelf" Boards.
- Sockets — Low & Standard Profile, P.C. and Wire Wrap. • Highest Quality Gold Contacts.
- Adapter plugs • Connectors
- Card Pull Handles.

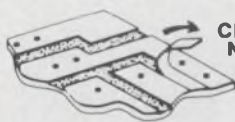

**CIRCUIT-STIK'S
NEW CUT &
PEEL BOARDS**

SEND FOR OUR NEW CATALOGS #502 & #801

circult-stik

P.O. BOX 3396 • Torrance, California 90510
Phone (213) 530-5530

MODULES & SUBASSEMBLIES

**Multiplying DACs have
4-MHz bandwidths**

Intronics, 57 Chapel St., Newton, Mass. 02158. (617) 332-7350. From \$125; 4 to 6 wk.

Series MDI 1200 multiplying d/a converters produce an analog output current proportional to the product of a variable analog input voltage and a 12-bit binary input. These units have a reference input bandwidth of 4 MHz, output settling time of 500 ns and guaranteed monotonicity over the rated operating range of 0 to +70 C. Two quadrant operation is obtained when offset binary input is used in conjunction with an internal reference offset resistor. The MDI 1201 and MDI 1202 are internally trimmed, meeting rated specs without external adjustments. The MDI 1200 series units are packaged in 2 x 3 x 0.4 in. modules.

CIRCLE NO. 307

**Proportional controllers
handle up to 200 A**

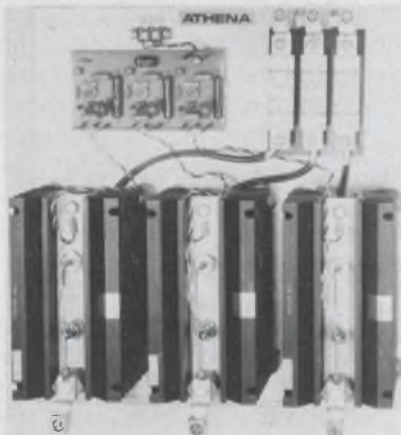

Athena Controls, 2 Union Hill Rd., West Conshohocken, Pa. 19428. (215) 828-2490. From \$140.

The Series 91 and 93 solid-state power controllers smoothly proportion ac currents to 200 A to assure setpoint temperature maintenance to ± 0.5 F accuracy. Rapid proportional action of these units can reduce energy waste up to 30% and increase heater life 2 to 7 times over on-off contactor temperature control. Units are available for phase-angle firing or zero-voltage switching with single and three-phase line inputs to 240 or 480 V ac. All input signals are optically coupled.

CIRCLE NO. 308

**True rms-to-dc converter
accepts 0 to 20 V pk-pk**

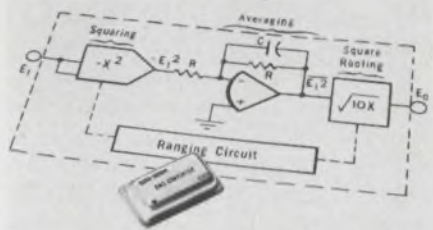

Burr-Brown, International Airport Industrial Park, Tucson, Ariz. 85734. (602) 294-1431. \$75 (1 to 9); stock.

The 4340 true rms-to-dc converter has an unadjusted accuracy of ± 2 mV $\pm 0.2\%$ of reading. By adding just two external resistors, the user can improve this performance to ± 0.3 mV $\pm 0.1\%$ of reading. The 4340 accepts input voltages from 0 to 20 V pk-pk including complex ac waveforms as well as a dc voltage level. Input and output impedances are 5 k Ω and 1 Ω , respectively. The converter can supply up to 5 mA at a voltage of +10 V dc when run from a rated power source of ± 15 V dc. The operating temperature for the 14-pin DIP unit is -25 to +85 C and it is highly stable to $\pm 0.01\%$ of reading/ $^{\circ}$ C.

CIRCLE NO. 309

**Amplitude control unit
provides constant output**

Frequency Devices, 25 Locust St., Haverhill, Mass. 01830. (617) 372-6930. \$65 (1 to 9); stock to 3 wk.

The Model 665 amplitude control module when used in conjunction with the company's Series 400 fixed frequency, and Series 440 tunable sine wave quadrature oscillators provides a very low distortion (to 0.04%), stable amplitude signal source. The 665 contains its own internal reference and offers output amplitude regulation of 100 ppm/ $^{\circ}$ C without influencing the output distortion of the oscillator. The amplitude stability of either of the quadrature outputs can be maintained even when the 440 Series oscillators are tuned over their entire 1000:1 frequency range. The filtering time constant of the 665 can be adjusted with external capacitors to minimize the response time of the control loop.

CIRCLE NO. 310

Line frequency sensor accurate to within 1%

Logitek, Inc., 42 Central Ave., Farmingdale, N.Y. 11735. (516) 694-3080.

The HZA industrial frequency sensor module de-energizes electrical systems when the frequency of single or three-phase service exceeds set limits for a predetermined time. The unit senses frequency to within 1% accuracy. Preset high and low frequency limits are programmed into the sensor. When frequency on the line returns to normal, the sensor automatically re-energizes the system. Built-in time delays of up to 10 s that can eliminate any transient tripping are standard. Other delay times are also available. Operating specifications include: Input operating voltage (nominal), up to 600 V; input frequency (nominal), 50, 60 or 400 Hz; output contact form, 3pdt; and output contact rating, 10-A resistive.

CIRCLE NO. 320

Self-contained reference junction lasts 5000 h



Omega Engineering, Box 4047, Stamford, Conn. 06907. (203) 359-1660. From \$85.

The LXCJ thermocouple reference junction is a completely portable, self-contained, electronic replacement for ice baths and ovens. The unit is color coded, hermetically sealed, and completely solid state. It is only 4 in. long and weighs less than 4 oz. It will maintain reference accuracy by as much as 0.25 C under conditions where the ambient varies by 10 C. The built-in mercury cell has a 5000 hour lifetime and a transparent window lets you know when the battery is dead. There are 15 different thermocouple calibrations.

CIRCLE NO. 321

8-bit a/d converters perform in 8 μ s

Zeltex, 1000 Chalomar Rd., Concord, Calif. 94518. (415) 686-6660. 2000: \$59; 2010: \$95.

The 2000 series of a/d converters offers high-speed, 8-bit performance. The converters use a unique successive approximation circuit design, that delivers 8 bits in 8 μ s. The Model ZAD2010 is a fully militarized configuration that provides 1/2-LSB performance over the temperature range of -55 to $+125$ C. The Model ZAD2000 is a commercial version of the ZAD-2010. Both models are packaged into a case $1.76 \times 1.98 \times 0.4$ in. The units are DIP compatible and can be mounted into sockets or onto a PC board. Four input ranges are built-in and are selected by external jumpers. Ranges of ± 10 , $+5$, 0 to $+5$ and 0 to $+10$ V are standard. Binary, offset binary and 2's complement output codes are also standard.

CIRCLE NO. 322

Best Sellers for the Best Reasons

For AF sine/square waves

1. Output from 20 Hz to 200 kHz
2. Constant 600-ohm output impedance
3. Level control up to 10 p-p volts min.
4. Low total harmonic distortion
5. Fast rise time — 150 ns typical
6. Three-line power cord for safety
7. WA-504B/44D optional price: Only \$109.50



For RF — 85 kHz to 40 MHz

1. Completely shielded including cable
2. Sweep output @ 455 kHz & 10.7 MHz
3. 400 Hz internal modulation (plus external)
4. Crystal calibrated marker circuit (less crystal)
5. Dial accuracy $\pm 2\%$
6. Three-line power cord for safety
7. WR-50B optional price \$89.90



To buy the RCA Generators, contact any one of the more than 1,000 RCA Distributors worldwide. Or write: RCA Electronic Instrument Headquarters, Harrison, N.J. 07029.

RCA Electronic Instruments

Specialists demand the best tools of their trade.

INFORMATION RETRIEVAL NUMBER 86

There's only 1 low priced 12 bit D/A...



that remains
monotonic over
it's temperature
range.

It takes precision matched ladder resistors that track to 2ppm/°C to achieve 12 bit monotonicity. And all the other low cost D/A's fail to provide sufficient linearity drift to pass the monotonicity test with temperature. In fact most don't even specify linearity drift which is the key D/A performance parameter. At \$59 (1 to 9 pieces) the 411-12 is the lowest cost for the performance.

And they're in stock!

Other 411 Models with corresponding price/performance are available...

Call or write today

FUNCTION MODULES, INC.
711B W. Seventeenth St.
Costa Mesa, CA 92627
Phone: (714) 645-6001

MODULES & SUBASSEMBLIES

Power buffer amplifier delivers ± 120 V



Intech, 1220 Coleman Ave., Santa Clara, Calif. 95050. (408) 244-0500. \$50 (1 to 9); stock.

The A-403 buffer amplifier has an output voltage of ± 120 V. Its output current is 100 mA minimum and the slew rate is 100 V/ μ s minimum. Input range is ± 50 to ± 120 V. This buffer amplifier can be used to drive a capacitive load, such as a long coaxial cable, up to 10,000 pF. Amplifier input impedance is greater than 10 k Ω , which permits the use of low-power op amps. The output is short-circuit protected with fold-back current limiting. It has a guaranteed operating temperature range of -25 to $+85$ C and is housed in a 1.6 \times 3 \times 1 in. plug-in module with heat-sinking to permit operation without special cooling requirements.

CIRCLE NO. 323

Mini servo amplifier delivers 5 W of drive

Amerton, Inc., P.O. Box 458, Melbourne, Fla. 32901. (305) 723-7308.

A miniaturized 5-W electronic servo amplifier, Model 528, is a full-range transistorized drive unit. The amplifier requires a supply voltage of 28 V dc $\pm 10\%$ and consumes 8 W at max signal and 2 W with no signal applied. Other specifications include: frequency response, 380 to 420 Hz ± 0.25 dB, 100 to 1000 Hz ± 3 dB; gain, variable up to a maximum of 2000; phase shift, 0 $\pm 6^\circ$ at 400 Hz; linearity, 5%; and size, less than 1 in.³.

CIRCLE NO. 324

Modular system monitors analog signals

Beta Products, 1201 Tappan Circle, Carrollton, Tex. 75006. (214) 242-6571.

The Betatrip Model 1500TR monitors any standard instrument control loop or other variable dc current source. It provides an output signal to alarm and/or control devices whenever preset limits are exceeded. Input impedance is 1 M Ω and each card has its own power supply for complete isolation. Repeatability is $\pm 0.1\%$ of span while the deadband is adjustable from 0.5% to 10% of the total span. Ranges include 1 to 5, 4 to 20, 10 to 50 mA dc or 0 to 5 V dc. Outputs can drive a 24 V annunciator or optionally, form C relay contacts are available.

CIRCLE NO. 325

Temperature controller offers several outputs

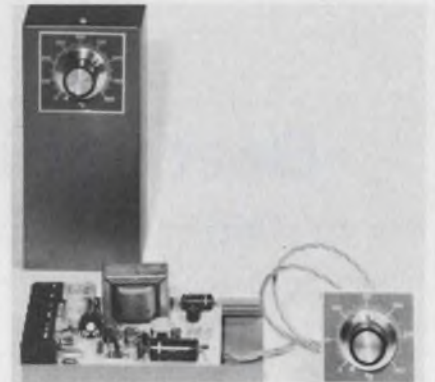

Athena Controls, 2 Union Hill Rd., West Conshohocken, Pa. 19428. (215) 828-2490. \$54.

A thermocouple sensing temperature controller is supplied on a printed circuit board complete with barrier terminals, plastic mounting track and setpoint control. Three models are available: Model 86T6 with a time proportioning relay output of 6 A at 120 V or 3 A at 240 V; Model 86Z3, fully solid state with a zero-voltage switched 3-A triac output; and Model 86G2 which supplies 10-mA pulse signals to drive solid state contactors. All models include electrical cold junction compensation and failsafe thermocouple break protection as standard features. A remote setpoint potentiometer and a 7 \times 3.375 \times 2.125 in. case are available options.

CIRCLE NO. 326

Voltage level monitor has adjustable limits



Calex, P.O. Box 555, Alamo, Calif. 94507. (415) 932-3911. \$88; 2 to 3 wk.

The Model 425-250 industrial Voltsensor is a controller/alarm system in one encapsulated package. The package contains a precision level monitor, an adjustable potentiometer, a 115-V-ac relay, a LED indicator and a 115-V-ac power supply. The unit has a single adjustable ± 14 -V-dc trip point range and an accuracy of better than 1 mV over a 28-V full-scale range. The Voltsensor can be used as an adjustable trip point for alarm circuits, a power supply voltage monitor, production testing and quality control for go no-go limits. All it takes is a screwdriver to add the unit to existing circuits.

CIRCLE NO. 327

SCR motor drive made for adverse conditions

Doerr Electric, 1201 Doerr Way, Cedarburg, Wis. 53012. (414) 377-0500.

A 1/8 to 1 hp single phase SCR control, the Stedi-Drive, meets NEMA 4 and 12 requirements for applications requiring protection from water, dust and oil. The drive package includes a 90-V-dc totally enclosed, nonventilated, permanent magnet motor in foot mount, or 56C face version. Standard control features include full-wave bridge, current limit, IR compensation, min/max speed adjust, dynamic breaking, transient voltage protection and fused overload protection. No-load to full-load speed regulation is 3% over a 30:1 speed range. A larger drive package up to 2 hp will be announced shortly.

CIRCLE NO. 328

New and improved General Electric lamps provide for increased design flexibility.

Two new sub-miniature halogen cycle lamps ideal for miniaturization.

These new T-2, 6.3V, 2.1 amps, 75 hour GE halogen cycle lamps are the smallest of their type (.265") and set industry standards for size and light output (16-20 candlepower). They are the perfect lamps for miniaturization of equipment such as reflectors, housings and optical systems, and they also save on overall cost of your equipment.

In addition, they are less than half the cost of the #1973 quartz lamp they replace. Two terminal configurations are available: #3026 (20 candlepower) has wire terminals; #3027 (16 candlepower) has a new two pin, ceramic base that plugs in to make installation and removal a snap.

These lamps have an iodine additive that creates a regenerative cycle that practically eliminates normal bulb blackening. They will produce approximately 95% light output at 75% of rated life.



An expanded line of Wedge Base Lamps for simple, low-cost circuitry.

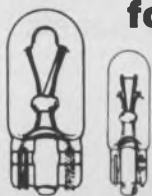

Now you can have greater design freedom than ever before with wedge base lamps. GE now offers six large lamps in its line of T-1 3/4 (.230" max.) all-glass, sub-miniature wedge base lamps. In addition to our three 14V lamps (#37, #73 and #74), we now also offer two 6.3V lamps (#84 and #86) and a 28V lamp (#85).

These lamps are ideal for applications where space is at a premium. Their wedge-based construction allows you to design for low-cost sockets and virtually ends corrosion problems because they won't freeze in the sockets. And the filament, which is always positioned in the same relation to the base, offers more uniform brightness.

Green Glow Lamp has been improved over previous lamp.



Actual Size

Now our G2B Green Glow Lamp, the only domestic green lamp on the market today, gives a more uniform, purer green light than our previous model. It's bright enough for your circuit component applications. With appropriate current limiting resistors, it can be used for 120/240 volt green indicator service. Or used together with our high-brightness C2A red/orange/yellow glow lamps to emphasize multiple functions with color.

All GE glow lamps give the benefits of small size, rugged construction and low cost — 12¢ each for the G2B, 44¢ each for the C2A in 100,000 quantities.

Send today for newest literature.

For the most up-to-date technical information on any or all of these lamps, write: General Electric, Miniature Lamp Products Department, #0748-L, Nela Park, Cleveland, Ohio 44112.

GENERAL ELECTRIC

INFORMATION RETRIEVAL NUMBER 88

Oven controller uses time proportioning



Oven Industries, Inc., P.O. Box 229, Mechanicsburg, Pa. 17055. (717) 766-0721.

A compact 200-W dc time-proportioning temperature controller, Model 4C4-200, is a solid-state on/off controller with a factory-set bandwidth of approximately 0.25 C. The power that must be dissipated by the controller is greatly reduced by the on/off action. This results in a smaller package (3.06 × 3.56 × 1.06 in.) with significantly less heat sinking than an equivalent full proportional unit. The controller has a setpoint stability of ±0.025 C/°C for ambient changes from -20 to 70 C and ±0.01 C/V for an input voltage change from 24 to 30 V dc. TP Series sensor probes are used for control over temperature ranges from -20 to 250 C.

CIRCLE NO. 329

Fluorescent ink allows discrete marking

Metron Optics, P.O. Box 690, Solana Beach, Calif. 92075. (714) 755-4477. \$13.25; five pens.

Transfluor is a transparent ink that fluoresces under exposure to ultraviolet light. It can be used for the inspection of electronic components. The ink is nearly colorless and transparent and is virtually undetectable on a shiny surface under normal light. It can be used to mark over existing color coding or for discrete marking. The ink fluoresces in a bright, highly visible color even on black surfaces. Transfluor is waterproof and flexible and can be removed by solvents normally used in electronics. It is also electrically nonconductive and will not harm surfaces nor cause contamination. It will mark on any surface, including Teflon. The ink is available in the disposable Metron Marker pens.

CIRCLE NO. 330

Packaged blower uses low panel height



McLean Engineering Laboratories, P.O. Box 127, Princeton Junction, N.J. 08550. (609) 799-0100.

The manufacturer claims that its Sidewinder blowers use less space and deliver more air, at higher pressure and at a very low noise level, than do conventional configurations. Flat blower wheels that are mounted sideways plus an airflow deflector that delivers air vertically in a broad discharge, make the difference. The resulting turbulence breaks up the hot-air shield around critical electronic components. The 3-1/2-in.-panel-height model delivers 180 cfm; the 5-1/4-in. model, 350 cfm; and the 7-in. model, 515 cfm.

CIRCLE NO. 331

DIP wrap-wiring panels have 108 pins



Mupac Corp., 646 Summer St., Brockton, Mass. 02402. (617) 588-6110. \$61.50 (10 up).

Mupac's new family of wire-wrappable panels is designed for use with dual in-line ICs that require two voltages and a ground, or three voltages, such as RAMs and ROMs. The panels feature Mupac's 108-pin, two-piece, wrap-wiring to wrap-wiring connector. The 108 pins provide a high proportion of input-output channels for the 32 IC patterns on the panels. All IC patterns are mechanically keyed to prevent improper insertion of the dual in-line devices.

CIRCLE NO. 332

Conformal coating protects film networks

Transene Co., Inc., Route One, Rowley, Mass. 01969. (617) 948-2501. \$20 per quart; stock.

Hybrisil conformal coatings protect and stabilize thick and thin-film resistor networks. The coatings are one-part systems, silicone based and easily applied. The need for high-temperature firing that is necessary with cermet encapsulation is avoided. Several compositions are offered. Hybrisil-100 cures to a flexible, translastic material in normal room humidity. Hybrisil-200 is a silicone-mica filled system which cures at a sequence of temperatures from 65 to 220 C. Hybrisil-300 also cures at these elevated temperatures and produces a cured coating that will withstand 2500 V.

CIRCLE NO. 333

PC lead cutter shears instead of bites



Plato Products Inc., 4357 N. Rowland Ave., El Monte, Calif. 91731. (213) 283-0466. \$2.80 (50 up); stock.

The Microshear 170 PC lead cutter shears rather than bites. This action significantly reduces lead-wire fly-off. The cutter requires 50% less operator effort, has a longer cutting life, is lighter, and costs much less than conventional diagonal cutters, according to Plato Products. A thin profile with 1/16-in. wide blades makes it ideal for hard-to-get-at areas in electronic assembly where conventional cutters can't reach. Other features include a permanently attached, double-coil, steel return spring and plastic-dip vinyl handles. It flush cuts round or flat leads up to 14 AWG, weighs 1.8 oz. and is 5-in. long.

CIRCLE NO. 334

**"CANNON® BACKPLANES
BROUGHT ME FAME
AND FORTUNE IN
ONLY SIX
WEEKS."**



"That's normal delivery (three weeks turnaround on prototypes). What tipped me to Cannon? Their 'Secrets of Connector Success.' It's invaluable to innovative thinkers — like you."

Contact ITT Cannon Electric, International Telephone and Telegraph Corporation, 666 East Dyer Road, Santa Ana, CA 92702. (714) 557-4700.

CANNON ITT

INFORMATION RETRIEVAL NUMBER 89

**We started a
counter revolution**

... in 1964, when we introduced the Hecon line ... every kind of electro-mechanical, electronic and pneumatic/ fluidic counter imaginable, from totalizing to predetermining to batching ... *every single one tested before it leaves our plant.*

Find out for yourself. Contact us for free catalog today.

HECON CORPORATION

P.O. Box 247
Eatontown, N.J. 07724
Phone (201) 542-9200

HECON OF CANADA, LTD.

80 Galaxy Blvd.
Rexdale, Ontario M9W-4Y8
Phone: (416) 678-2441

HECON H890

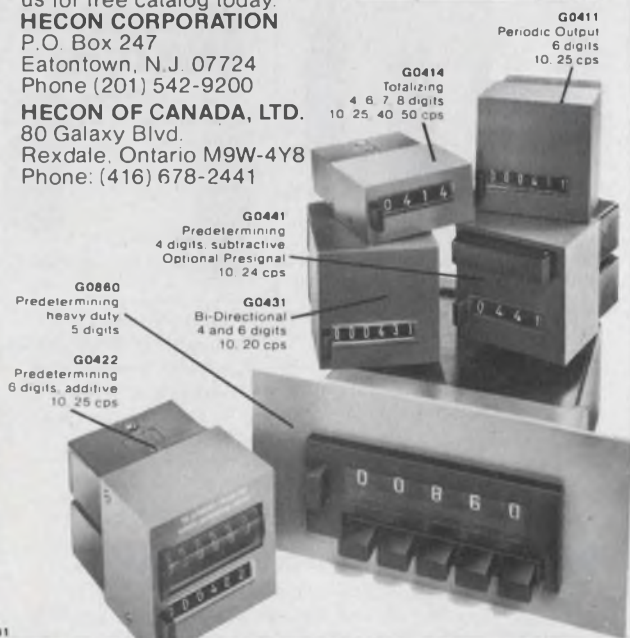

INFORMATION RETRIEVAL NUMBER 90

ELECTRONIC DESIGN 17, August 16, 1974

NCR

ACCOUNTING COMPUTER DIVISION

NCR's newest, rapidly expanding division has requirements for professionals in the following positions:

COMPUTER ENGINEERS

- MINICOMPUTERS
- COMMUNICATIONS
- BUSINESS SYSTEMS
- LOGIC DESIGN • CIRCUIT DESIGN
- SYSTEMS FORMULATION
- SYSTEMS ARCHITECTURE

SYSTEMS AND PROCEDURES ENGINEER

ELECTRICAL ENGINEERS

MECHANICAL ENGINEERS

PACKAGING ENGINEERS

PRODUCT ENGINEERS

- PERIPHERALS AND MINICOMPUTERS

SYSTEMS SOFTWARE PROGRAMMERS

- FIRMWARE DEVELOPMENT
- MINICOMPUTER OPERATING SYSTEMS
- COMMUNICATIONS
- FILE MANAGEMENT
- ASSEMBLERS • COMPILERS

MICROPROGRAMMERS

- S-LANGUAGE • EMULATORS
- VIRTUAL MEMORY
- MINICOMPUTER ARCHITECTURE

DESIGN AUTOMATION ENGINEER

Let us tell you the full story of Wichita, Clean Air Kansas, and the employment opportunities at NCR's Accounting Computer Division...where everybody is somebody!

If qualified and interested in being interviewed for any of the above positions, please send resume including present and expected salary to Don Wilde, Professional Placement, P.O. Box 1297CR Wichita, Kansas 67201.

An Equal Opportunity Employer M/F

INFORMATION RETRIEVAL NUMBER 901

Flexible heater uses adhesive backing

Electro-Flex Heat, Inc., Northwood Industrial Park, Bloomfield, Conn. 06002. (203) 242-6287.

A pressure-sensitive adhesive backs flexible silicone-rubber heating elements that operate between -100 and 300 F. After a protective tape is removed, the element is pressed or rolled onto the surface to be heated to remove any trapped air bubbles. The adhesive increases heat transfer, even to temperatures of 450 F. The cement, while it cures over time, never fully loses its pressure sensitivity. Shear strength of the cement varies from approximately 30 to 300 psi during this aging process. The pressure-sensitive adhesive is available for both wire-element and etched-foil heaters in sizes of 1 × 1 to 36 × 120 in.

CIRCLE NO. 336

Gun melts glue on demand

Adhesive Machinery Corp., Folly Mill Rd., Seabrook, N.H. 03874. (603) 474-3003.

Hipermatic 2.5, a portable hot-melt glue gun for product assembly and packaging, weighs less than 2 lb and it has twice the hot melt capacity of its closest competitor. It can be loaded in seconds with Hi-Per hot-melt cartridges that are 1-3/4-in. diameter by 2-in. long. After an initial warm-up period of only 2-1/2 min., the gun melts on demand as the trigger is depressed. And since the hot melt is in a molten state only as it is used, thermal degradation of the glue is virtually nonexistent. Delivery rate is 35% faster than other guns. If required, hot melt can be supplied on a continuous basis.

CIRCLE NO. 337

Industrial cases strong enough to stand on

Zero Manufacturing Co., 777 Front St., Burbank, Calif. 91503. (213) 846-4191. 1 wk.

A new series of high-strength industrial carrying cases, the 100X Series, is available in 13 standard sizes. The cases are completely dustproof, weather resistant and odor-proof. They are strong enough to stand on, and the heat-treated-aluminum case shells feature seamless and wrinkle-free surfaces. And even the largest model (26 × 18 × 9) weighs less than 10 lb. The cases have a satin-buffed anodized-aluminum finish and positive-locking latches. A gasketed tongue-and-groove closure extrusion, bonded to the case shells, provides sealing and case integrity. Adjustable panel-mounting brackets are easily installed.

CIRCLE NO. 338

TWO GREAT ONES

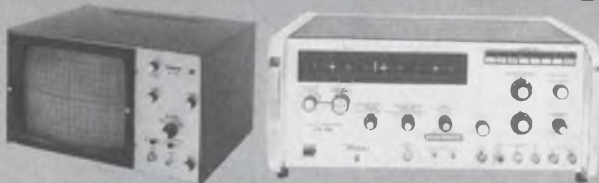

Texscan's DU-120 oscilloscope is a sensitive, large screen, solid state X-Y display unit designed to satisfy the particular needs of a production or laboratory testing system using sweep generator techniques. The DU-120 incorporates the latest circuitry, including regulation of the high voltage source and a dual packaged FET input. The VS-60 sweep generator is a completely solid state, low distortion, wide sweep instrument covering the frequency range 5 MHz to 1000 MHz with many optional features available from stock.

Texscan

A WORLD LEADER IN ELECTRONICS
"And Coming On Strong"

Texscan Corporation
2446 North Shadeland Avenue
Indianapolis, Indiana 46219
Ph: 317 357-8781
TWX: 810-341-3184 Telex: 272110



REED TYPE PUSHBUTTON SWITCHES

- Hermetically sealed contacts
- Life expectancy in the millions
- Low closed contact resistance
- Ideal for dry circuits
- Explosion proof
- Low bounce characteristics.



Momentary Action
and Mercury-Wetted Reed

KEYBOARD SWITCHES

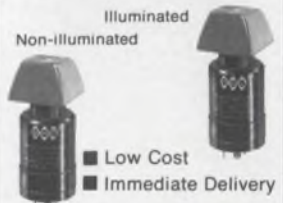

- Low Cost
- Immediate Delivery

KEYBOARDS

- Standard off-the-shelf
- Custom for O.E.M.'s
- Encoded or non-encoded
- Low cost
- Choice of "N" key rollover, 2 key rollover or 2 key lockout
- Large selection of key caps and space bars
- Any or all keys illuminated
- Fast delivery

Write or call today for delivery dates and quotations.



GEORGE RISK INDUSTRIES, INC.

G. R. I. Plaza, Kimball, Nebraska 69145
Phone: 308-235-4645 TWX: 910-620-9040

Universal DIP card has 22 bypass capacitors

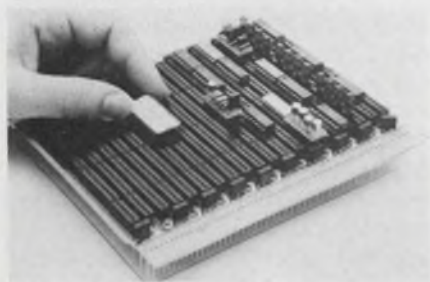

Electronic Engineering Company of California, 1441 E. Chestnut Ave., Santa Ana, Calif. 92701. (714) 835-6000. \$76.50 (unit qty); stock.

Up to 50 DIPs can be mounted on EECO's new 3D-2012/3012, two or three-level wire-wrappable, plug-in cards in any combination of 14, 16, 24, 36 or 40-pin DIPs. Discrete components and special packages having pins on 0.100-in. centers and in rows 0.3 or 0.6-in. apart can also be mounted. The cards feature 120 etched connector fingers, 22 test points and extractor handles. They are made with flame-retardant-glass epoxy. Convenient wire-loop busses can supply V_{cc} or ground to any pin. A plastic shield protects pins and wiring. Power-plane noise is reduced by 22 bypass capacitors.

CIRCLE NO. 339

Mag shield fits CRT yoke and neck

Ad-Vance Magnetics, Inc., 226 E. Seventh St., Rochester, Ind. 46975. (219) 223-3158. \$25 (OEM qty); 6 wks.

Ad-Vance Magnetics' new two-section, single-layer, 0.025-in. thick, AD-MU-78 Model L-10 magnetic shield fits a CRT's deflection yoke and neck. A larger more costly shield to cover the entire CRT is thus often not necessary. Quick access to the yoke assembly is provided by a removable slip-on-and-twist cover. Low-level magnetic field are attenuated from 45 to 50 dB. The open-ended-cylinder yoke shield measures 4 L x 3-5/8 ID in. The deflection yoke is held in place by epoxy bonding. Grounding is achieved by two tabs welded to the cylinder near the open front end.

CIRCLE NO. 340

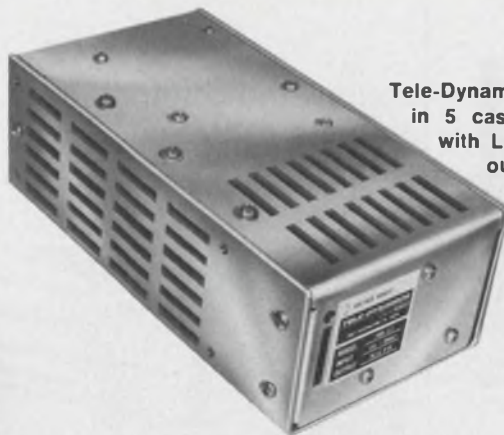

Tele-Dynamics Series HR...30 models in 5 case sizes... interchangeable with Lambda LM and similar... output 5-28 Vdc, 1.3-20 A... ripple 1 mV rms... line & load regulation each $\pm 0.05\%$... input 105-125 / 210-250 V, 47-63 Hz... unit price \$113-\$256.

Are you paying too much for modular 5-28Vdc power supplies?

If you're buying from Lambda, you are.

Tele-Dynamics HR Series supplies have same performance, lower cost, and are available at 110 stocking locations. Call toll-free (800) 645-9200* for the distributor or engineering representative nearest you.



*N.Y. state, call (516) 294-0990 collect.

Distributors • Allied • Arrow-Angus • Cramer • Intermark • Newark • Olive Radio • Philadelphia Electronics • Pioneer Standard • RPS Electronics • Ralph's • Stark • Sterling (Calif.) • Summit • Testco • T. I. Supply • Zack
Distributed in Europe by Texas Instruments, Ltd. and Tisco

WANLASS POWER SUPPLIES

TELE-DYNAMICS

DIVISION OF **AMBAC**

525 Virginia Drive, Fort Washington, PA 19034 (215) 643-3900

Career opportunities for power supply engineers—write Mr. W. Booth.
AN EQUAL OPPORTUNITY EMPLOYER M/F

©TELE-DYNAMICS

5987

INFORMATION RETRIEVAL NUMBER 195

ECCOMOLD® EPOXY MOLDING COMPOUNDS



Comparative physical, electrical and processing properties of Eccomold transfer molding compounds are in colorful chart. Typical applications are indicated.

INFORMATION RETRIEVAL NUMBER 151

NEW DATA APPLICATION GUIDE EMI/RFI GASKETS



ECCOSHIELD® folder describes the broadest line of conductive plastic gaskets, including forms and applications. All materials feature high insertion loss, hermetic seal, low closing pressures, low compression set, low maintenance. Send for FREE copy.

INFORMATION RETRIEVAL NUMBER 152

NEW TECHNICAL DATA ON EPOXY CASTING RESINS



STYCAST® Casting Resins are described and properties tabulated in this new folder/chart. Includes all significant properties of 24 high-performance resins plus notes on curing agents, cure procedures and use. Valuable reference.

INFORMATION RETRIEVAL NUMBER 153

Emerson & Cuming, Inc.



CANTON, MASS.
GARDENA, CALIF.
NORTHBROOK, ILL.
Sales Offices
in Principal Cities

EMERSON & CUMING EUROPE N.V., Oevel, Belgium

DISCRETE SEMICONDUCTORS

Calibrated photodiode detects radiation

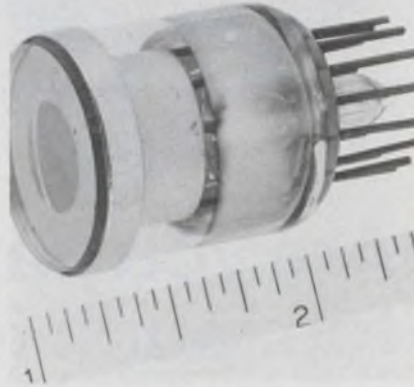

ITT Electro-Optical Products Div.,
7635 Plantation Rd., Box 7065,
Roanoke, Va. 24019. (703) 563-
0371.

A 1.5-in. dia. vacuum photodiode, Model F4096, is designed to be used as a standard radiation detector. Because of the plane-parallel close spaced anode-to-photocathode design, the F4096 can be operated linearly below the ionization potential of residual gases. Both internal and external guard rings are provided to extend the minimum detectable flux level by several orders of magnitude. The F4096 is remotely processed. The process technique allows the selection of many different combinations of photocathode materials and entrance faceplates to meet spectral response needs between 120 and 900 nm. Regardless of the spectral response selected, each F4096 is supplied with an absolute spectral response calibration traceable to the National Bureau of Standards. The responsivity of the F4096 to input radiation is almost independent of the applied operating voltage. Uniformity of integral responsivity over the sensitive photocathode area is $\pm 5\%$. With 10 to 14 V applied to the anode, the maximum dc dark current is 10 to 14 A. The maximum rise time is 0.1 μ s. When the tube is operated with 10 to 14 V applied to the anode, ion bombardment of the photocathode is prevented and thus improved stability and prolonged useful lifetime results.

CIRCLE NO. 341

Plastic Darlington transistors handle 0.5 A

Motorola Semiconductor, Box
20924, Phoenix, Ariz. 85036. (602)
244-3466. For 100 to 999; \$0.52
(2N6426), \$0.47 (2N6427); stock.

The 2N6426 and 2N6427 npn Darlington transistors are available in TO-92 plastic cases. They are rated at 40-V V_{CEO} , 500-mA I_C , and 625 mW free air dissipation. Noise figure is typically 3 dB for both devices. The 2N6426 has a minimum gain of 30,000 at 10 mA dc, and the 2N6427 has a minimum gain of 20,000.

CIRCLE NO. 342

High intensity LED delivers 125 millilumens

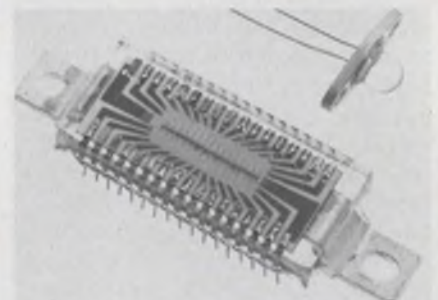

Plessey Semiconductors, 1674 Mc-
Gaw Ave., Santa Ana, Calif. 92705.
(714) 540-9945. \$14.70 (100-up).

A GaP yellow LED, Model GPL5, has a typical brightness of 10,000 ft. lamberts and a light output of 125 millilumens at 250 mA. The diode is mounted on a TO-37 header with a molded Wierstrasse sphere encapsulation that gives a cone of high-intensity light. It has a peak emission wavelength of 575 nm in the yellow part of the spectrum to minimize eyestrain. It has an operating life of at least 10,000 hours under any vibration conditions. Rise and fall times of the light output are 40 ns, and pulsed currents of up to 2 A peak give a brightness of 80,000 ft. lamberts. Custom-designed assemblies of GaP diodes in monolithic arrays of up to 32 elements and hybrid arrays of up to 200 elements emitting green, yellow or red light can also be supplied. Power drive requirements are 3 V at up to 500 mA peak per diode. Typical diode sizes are 0.015 in. square, and these are assembled and encapsulated on metallized ceramic on 0.02 in. centers.

CIRCLE NO. 343

Low leakage diode series has 4 nA I_{rev}



MSI Electronics Inc., 34-32 57th St., Woodside, N.Y. 11377. \$6 (100 to 999); 2 wk.

The low leakage SQ5461A-76A tuning diodes are identical to their JEDEC 1N5461A-76A counterparts except for the 4 nA vs the 10 μ A reverse current ratings at 30 V. Otherwise, both series cover a 6.8-to-100-pF range of capacitance values in 16 types with corresponding Q values for these glass DO-7 packages ranging from 250 to 600 at 4 V bias and 50 MHz.

CIRCLE NO. 344

Overcurrent protector reacts to heat/current



Murata Corp. of America, 2 Westchester Plaza, Elmsford, N.Y. 10523. (914) 592-9180.

A barium titanate device, Model PTH 475 A, replaces fuses for overcurrent protection. This Posistor consists of a semiconductor resistance element that is heat/current sensitive. Under normal loads the device presents a nominal resistance of 10 Ω . When the current increases beyond a predetermined threshold, self-heating causes the device to present a high resistance which limits current to a safe value. A typical unit measures approximately 1-5/8 in. long \times 7/16 in. diameter. Maximum voltage rating is 200 V rms and maximum current is 5 A peak.

CIRCLE NO. 345

Hockey-puk SCRs can handle 210 A rms

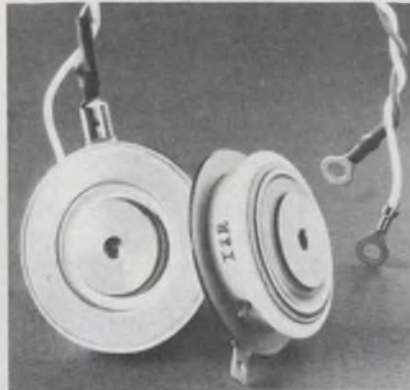

International Rectifier, 233 Kansas St., El Segundo, Calif. 90245. (213) 678-6281. \$68.27 (1 to 9); 4 wk.

The 125P series of inverter hockey puk SCRs handles 210 A rms. The series has an accelerated cathode excitation design for high frequency inverter applications. The 125PM, 125PL, 125PLB series feature blocking voltages to 1200 V, plus high di/dt and high dv/dt. Maximum turn-off time is 20 μ s for the 125PM, 30 μ s for the 125-PL and 40 μ s for the 125PLB. All units conform to the TO-200AB JEDEC outline.

CIRCLE NO. 346

IR-emitting GaAs diodes provide 6 or 8 mW



Laser Diode Laboratories, 205 Forrest St., Metuchen, N.J. 08840. (201) 549-7700. IRE-10: \$2.09, IRE-20: \$1.83 (100-up prices): stock.

The IRE-10 and IRE-20 are GaAs infrared emitting diodes. These devices will emit IR light at 940 nm and are designed for either pulsed or cw operation. At 100 mA continuous drive the IRE-10 provides a typical power output of 6 mW and the IRE-20 8 mW. In the pulsed mode over 200 mW peak optical power is typically emitted by either device at 10 A. The IRE-10 is supplied in a hermetically sealed, lensed, TO-18 package and the IRE-20 in a clear plastic encapsulated TO-18 case.

CIRCLE NO. 347

DOUBLE-BALANCED MIXERS

Great Value at

\$7.95
500 piece quantities.

\$9.95 in quantities of 1 to 49 pieces

DC-500MHz
6dB conversion loss
40dB isolation
EMI shielded case



A breakthrough in technology and high production volume enables Mini-Circuits Laboratory to offer these new products at an unprecedented low price.

In today's tough competitive market can you afford not to use these remarkably low priced and high performance units?

Ruggedness and durability are built in the SRA-1. These new units are packaged within an EMI shielded metal enclosure and hermetically sealed header. They use well matched hot-carrier diodes and uniquely designed transmission line transformers.

We invite you to convince yourself. Place your order now and check our delivery, product performance and reliability.

Mini-Circuits Laboratory

2913 Quentin Rd., Brooklyn, N.Y. 11229
(212) 252-5252, Int'l Telex 620156
A Division Scientific Components Corp.

*FRANCE: S.C.I.E., *31, rue George-Sand, Palaiseau 91, France *GERMANY, AUSTRIA, SWITZERLAND: Industrial Electronics GMBH, *Klüberstrasse 14, 6000 Frankfurt/Main, Germany *UNITS IN STOCK

ENGLAND: Dale Electronics: Dale House, Wharf Road, Frimley Green, Camberley, Surrey. JAPAN: Denisho Kaisha, Ltd.: Eguchi Building, 8-1, 1-Chrome, Hamamatsucho, Minato-Ku, Tokyo.

*UNIT IN STOCK.

INFORMATION RETRIEVAL NUMBER 96

MONOLITHIC CRYSTAL FILTERS

the
State
of the
Art

SAVING ENERGY

It's an important topic these days. Especially to the communications industry. In almost every field, better communications means energy saved. As the cost of energy increases, so does the challenge to provide more and better communications equipment and systems.

Our company is involved in only a small area of communications—monolithic and tandem monolithic crystal filters. But, we see our responsibility in the total order of things. Whether it's reliable delivery of parts or production prototypes for your next generation of equipment, we're ready to help you save energy for everyone.

SPEAKING TO THE DEAF

Our monolithics find their way into some fascinating and unusual applications. For instance—a narrow-band FM system which allows children with severely impaired hearing to participate in normal classroom activities. One of the requirements of the system was that both the students' receivers and the teacher's transmitter allow unhindered movement by the wearer. Another was freedom from interference, including interference from other systems in nearby classrooms. Cost was also an important factor. One of our standard 10.7 MHz tandem monolithic crystal filters in each receiver takes care of the interference. Its size is consistent with the needs of the wearer. Its cost is consistent with educational budgets.

What's your production application? Talk with us about it. We may be able to help. And if your interests include teaching the deaf, we'd be happy to put you in touch with the manufacturer of this equipment.

Pi

Piezo Technology Inc.

2400 Diversified Way Orlando, Florida 32804
305-425-1574

The Standard in monolithic crystal filters.

DISCRETE SEMICONDUCTORS

Opto-isolators have 2% to 50% transfer ratios

Optron, 1201 Tappan Circle, Carrollton, Tex. 75006. (214) 242-6571. From \$1.50 to \$1.95 (100-up).

DIP housed opto-isolators have current transfer ratios from 2% for the OPI 2150 and OPI 2250 to 50% for the OPI 2153 and OPI 2253. Isolation voltage of the OPI 2150 and OPI 2153 is 1500 V and of the OPI 2250 and OPI 2253 is 2500 V. The OPI 2151 and OPI 2251 isolators have a minimum current transfer ratio of 10% with isolation voltages of 1500 and 2500 V, respectively. Isolation voltage of the OPI 2152 is 1500 V, the OPI 2252 is 2500 V, and each has 20% minimum current transfer ratio.

CIRCLE NO. 348

LED design kit gives wide lamp variety

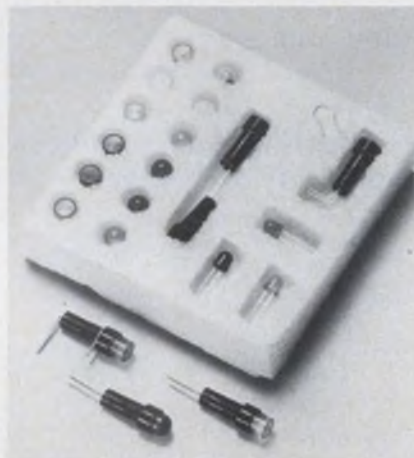

The Sloan Co., P.O. Box 367, 7704 San Fernando Rd., Sun Valley, Calif. 91352. (213) 875-1123. \$4.95; stock.

A lamp design kit, Model 175, provides all of the component parts required to build any LED indicator for either panel or printed-circuit mounting. The design kit includes 12 lenses (six domed and six flat), with fresnel rings in red, green, amber, white and clear. Also included are two body styles for panel mounting plus one body style with mounting clip for printed circuit mounting. Three replaceable LEDs in red, green and amber offer a choice of light sources.

CIRCLE NO. 349

Bridge rectifiers handle 25 or 30 A at 60 C

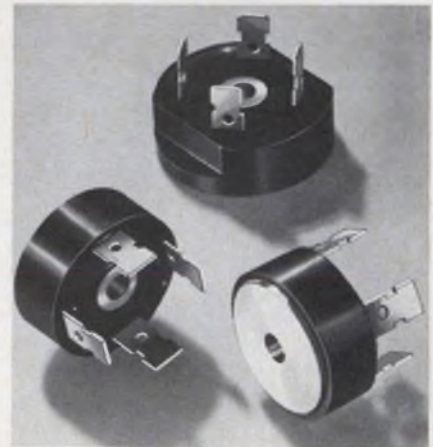

Sarkes Tarzian, Semiconductor Div., 415 N. College Ave., Bloomington, Ind. 47401. (312) 467-1326. From \$3.42 to \$5.33 (25 up).

Four series of rectifier bridge assemblies use a positive pressure system to assure rapid heat dissipation between the diodes and the thin aluminum base. Two series, rated at 30 A and two at 25 A (at 60 C case temperatures), are available with either a center through hole or a mounting stud. All four series have a 400 A surge rating and are available in seven voltage ratings from 50 to 1000 V. The two series rated at 30 A include three 0.25 in. Faston terminal configurations for soldering, wrapped wire, or 0.25 in. quick disconnect terminations. A fourth terminal configuration has 0.04 in. diameter pins. The case diameter is 1.375 in. and over-all length from heat sink to terminals is 1 in. maximum.

CIRCLE NO. 350

25-A transistor made for high power levels

Power Physics Corp., Industrial Way West, Eatontown, N.J. 07724. (201) 542-1393. \$45 (100-up).

The PP 7676, a 25 A silicon planar npn transistor, is designed for high voltage power applications. Some of the parameters include $V_{CBX} = 200$ V; $I_C = 25$ A; $P_T = 150$ W at $T_C = 100$ C; $h_{FE} = 40$ (min), 150 (max) at $I_C = 10$ A; V_{CEO} (sus) = 150 V at $I_C = 200$ mA; and V_{CE} (sat) = 0.75 V at $I_C = 10$ A. The PP 7676 is mounted in a JEDEC TO-63 case with an isolated collector.

CIRCLE NO. 351

P-i-n diode resistances vary from 5 Ω to 1 kΩ

Siemens Corp., 186 Wood Ave. S., Iselin, N.J. 08830. (201) 494-1000. \$0.31 (1000-up); stock.

Type BA 379 p-i-n diode will change its resistance from less than 5 Ω to more than 1 kΩ as the bias current varies from about 10 mA to zero. Above approximately 1 MHz, the resistance is independent of ac level for reasonable power levels. The diode comes in an epoxy package with ribbon leads. It is usable from 1 MHz to several GHz and is specifically designed for attenuation applications in vhf/uhf tuners.

CIRCLE NO. 352

Opto-electronic design kit has six devices

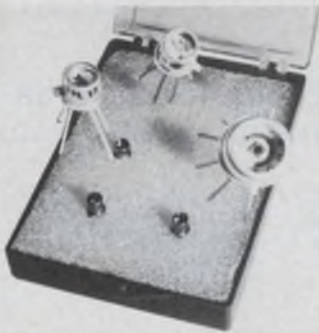

Integrated Photomatrix, 1101 Bristol Rd., Mountainside, N.J. 07092. (201) 233-7200. \$75.

The opto-electronic design kit can aid designers of devices for industrial control, instrumentation, monitoring, inspection and gauging. It consists of six of the company's opto-electronic switches and other devices, together with a 96-page circuit design handbook. The six included in the kit are: IPL-12, a light-activated switch with Schmitt trigger and buffer amp; IPL-13, a light-intensity-to-pulse-frequency converter; IPL-15, a light-activated switch with trigger, bipolar buffer and adjustable threshold control; IPL-16, a linear analog photo-detector with high-speed, adjustable-gain buffer op-amp; IPL-17, a light-activated switch with trigger, buffer, threshold/hysteresis control, plus independent strobeable and analog outputs; and the IPL-33, a linear silicon photodiode with a 0.03 in.-square detector element.

CIRCLE NO. 353

Switching transistor handles 4 A continuous

RCA Solid State Div., Box 3200, Somerville, N.J. 08876. (201) 485-3900. \$1.50 (1000-up); stock.

The 2N6500 epitaxial-base silicon npn transistor is designed for use in high-current, high-speed switching circuits. This transistor, formerly the company's developmental type No. TA8932, is a de-

rivative of the popular 2N3879. It is rated for a V_{CBO} of 120 V and a continuous collector current of 4 A. The 2N6500 also has a total saturated switching time of less than 1 μs and is housed in a TO-66 package. Typical applications for this transistor include oscillators, switching regulators, series regulators, converters and inverters.

CIRCLE NO. 354

industries' largest selection of SCR Phase Controlled Power Supplies

CALL TOLL FREE 800-631-4298



E/M has expanded its former 2.5, 5.0 and 10.0 kw SCR Models to now include 27 new models with power ratings of 600w, 1200w and 2000 watts. All models are 0.1% regulated in both the voltage and current mode of operation with automatic crossover. Remote programming and sensing are standard on all models as well as forced air cooling and automatic over-temperature protection. The three lower power ratings are all single phase input, while the three higher power ratings are all three phase input. As expected, E/M has maintained its position of providing the highest power output per mechanical volume in the industry for equipment of this type. Front panel heights being 3½" on 600w, 5¼" on 1200w, 7" on 2000w and 2500w, 8¾" on 5000w and 12¼" on 10,000w models.

	600w		1200w		2000w		2500w		5000w		10,000w	
	Amps	\$	Amps	\$	Amps	\$	Amps	\$	Amps	\$	Amps	\$
0-6									600	2200		
0-7.5	85	500	125	850	200	1000	300	1400				
0-10	60	500	100	850	150	1000	250	1400	500	2200		
0-20	30	425	50	750	90	900	125	1300	250	1800	500	2700
0-30							100	1300	200	1800		
0-40	16	425	30	750	50	900	60	1300	125	1700	250	2500
0-50											200	2700
0-60	11	425	20	750	35	900						
0-80	8	425	14	750	25	900	30	1300	60	1700		
0-100											100	2700
0-120							20	1300	40	1700		
0-150	4	425	7	750	13	900						
0-160							15	1300	30	1700	60	2500
0-250							10	1300	20	1800	40	2700
0-300	2	450	3.5	850	6	1000						
25-500							5	1600	10	2200	20	2700
10-600	1	450	1.5	850	3	1000						

SEE EEM VOL. 1-673-675 FOR ADDITIONAL PRODUCT INFORMATION

ELECTRONIC MEASUREMENTS INC.

405 ESSEX ROAD, NEPTUNE, NEW JERSEY 07753

Phone: (New Jersey) (201) 922-9300 • (Toll-Free) 800-631-4298

Specialists in Power Conversion Equipment



INFORMATION RETRIEVAL NUMBER 98

Actuator allows large overtravel on switch

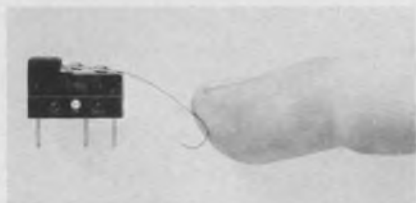

Cherry Electrical Products Corp., 3600 Sunset Ave., Waukegan, Ill. 60085. (312) 689-7600. \$0.91 (2000 up); switch and actuator.

A new spring-steel actuator provides additional overtravel to the Series E61 light-force subminiature switch. The switch with a 14-1887 actuator increases overtravel from 0.040 to 0.50 in. It also decreases operating force from 24 to 15 g. The actuator returns to its normal actuating position after each depression—even when bent well beyond the actuation point.

CIRCLE NO. 355

Precision pot features 5-W power rating



Beckman Instruments Inc., 2500 Harbor Blvd., Fullerton, Calif. 92634. (714) 871-4848. \$27 (25-99); stock.

Precision, single-turn potentiometer, Model 6273, is 1-1/16-in. diameter, and it features a power rating of 5 W at 70 C and 0.1% max. output smoothness. A new conductive-plastic resistance element provides the unit's stability, good independent linearity and resistance to adverse environmental conditions, according to Beckman. Shaft rotational life is 40-million revolutions. Total resistance change after 1000 h at rated power is 4% max.

CIRCLE NO. 356

Low-pass filters cover 300 Hz to 250 kHz



TT Electronics, Inc., 2214 S. Barry Ave., Los Angeles, Calif. 90064. (213) 478-8224. \$41 (unit qty); 3 wks.

A new series of subminiature low-pass filters, Series J655, for telemetry applications covers frequencies from 300 Hz to 250 kHz, which includes IRIG channels 1 to 21. Terminations from 1 to 10 k Ω may be specified, depending upon the frequency selected. The filters provide a minimum of 45-dB attenuation at 1.85 times the cutoff frequency. The typical passband flatness is ± 0.2 -dB maximum and the insertion loss is less than 0.5 dB. Powers up to 20 mW can be handled. The case size is 0.95 \times 0.75 \times 0.75 in.

CIRCLE NO. 357

14-pin DIP socket is temperature controlled

Jermyn, 712 Montgomery St., San Francisco, Calif. 94111. (415) 362-7431. \$5.15 (unit qty); stock.

A 14-pin DIP socket, part number 75T1-1, has a built-in semiconductor heater. The nominal control temperature is 75 C and the socket is suitable for ambient temperatures of -55 to 60 C. The stabilizer socket can control the temperature of circuits like operational amplifiers, oscillators or voltage regulators that are housed in 14-pin DIPs. Improvement in temperature coefficient of 500% is possible. Operating voltage is 24 ± 4 V dc or ac. Warm-up time at -55 C is 4 minutes maximum. Over-all dimensions are 0.89 L \times 0.498 W \times 0.281 H in.

CIRCLE NO. 358

Cermet trimmer has integral thumbwheel



Bourns, Inc., 1200 Columbia Ave., Riverside, Calif. 92507. (714) 684-1700. \$0.39 (1000 up).

The new Model 3352, 3/8-in. single-turn cermet trimmer handles 3/4 W, withstands shock and vibration to 100 G and 30 G, respectively, and has a multiwire wiper inside an integral thumbwheel rotor. An effective electrical rotation angle of 230 degrees provides $\pm 0.5\%$ voltage ratio adjustability. The trimmer is available in a variety of pin styles and in a resistance range from 10 Ω to 2 M Ω .

CIRCLE NO. 359

Capacitors handle peak currents of several amps



Electro Motive Corp., Willimantic, Conn. 06226. (203) 423-9231. \$0.08 to \$0.31 (OEM qty); 3 to 12 wks.

El-Menco polypropylene-dielectric capacitors provide improved performance in the audio to ultrasonic frequency range, according to the manufacturer. Peak currents of several amperes are easily handled and the units resist corona deterioration. Dissipation factor at 1 kHz is not greater than 0.1% and insulation resistance is greater than 10¹² Ω . Capacitance drift, after a temperature cycle from -55 to 85 C, is less than 0.5%. The temperature coefficient is -200 ± 150 ppm/ $^{\circ}$ C. The capacitors meet or exceed all EIA requirements. The capacitors are available in two series. The type PPD series covers a range of values from 0.0018 to 0.47 μ F at dc-rated voltages of 200, 400 and 600. The Type PPDS series covers a range of values from 0.001 to 0.1 μ F at dc-rated voltages of 600, 1000 and 1600. Tolerances for both types are ± 2 , ± 5 , ± 10 and $\pm 20\%$.

CIRCLE NO. 360

Speakers for headphone are waterproof



Shigoto Industries Ltd., Empire State Bldg., 350 Fifth Ave., New York, N.Y. 10001. (212) 965-0200.

A new line of speakers features Mylar cones and plastic baskets that are waterproof. The speakers are designed for headphones and application in outdoor, underwater and high-humidity environments. Standard models range in size from 1-3/4 to 2-1/4-in. dia. The line has a wide selection of specifications: frequency response from 0 to 20 kHz; resonant frequency from 200 to 400 ± 50 Hz; voice coil impedance from 3.2 to 600 Ω ; and a nominal input from 0.1 to 0.2 W.

CIRCLE NO. 361

Temperature probes use platinum elements



Thermalogic, 241 Crescent St., Waltham, Mass. 02154. (617) 891-9496. From \$15 (unit qty).

The new Ultra-Therm probes are available in a broad variety of ranges and mounting configurations. They can be used for sensing temperatures from -200 to 550 C and they are available as cartridge, threaded-fitted or spring-loaded types. The sensors have a temperature coefficient of 0.00385 or 0.003916 $\Omega/\Omega/^\circ\text{C}$. The 100- Ω sensors are available with tolerances of $\pm 0.1\%$ to $\pm 1.0\%$. The stability and repeatability of platinum enables the user to interchange or retrofit sensors without affecting system performance.

CIRCLE NO. 362

Precision resistors have TC of 2 ppm/ $^\circ\text{C}$

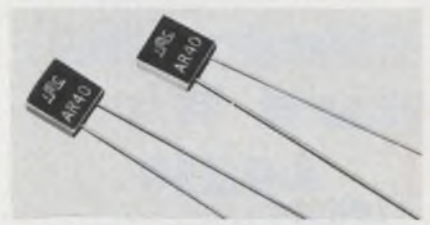

TRW/IRC Resistors, P.O. Box 887, Burlington, Iowa 52601. (319) 754-8491. \$2.40: 0.05%, 2 ppm/ $^\circ\text{C}$ (1000 up); 4 to 6 wks.

Ultra-precision, low temperature-coefficient, metal-film resistors, designated AR40, consist of two cylindrical resistor elements welded together in an epoxy case measuring $0.320 \times 0.295 \times 0.100$ in. Both resistor elements are capped at the ends, with 0.025-in. diameter tinned-copper radial leads that are welded to the caps. Resistance range is 20 Ω to 100 k Ω with standard tolerances to 0.01%. Temperature coefficient is ± 2 ppm/ $^\circ\text{C}$. Power rating is 0.3 W at 85 C.

CIRCLE NO. 363

Complete Audio Distortion and Frequency Response ... Automatically

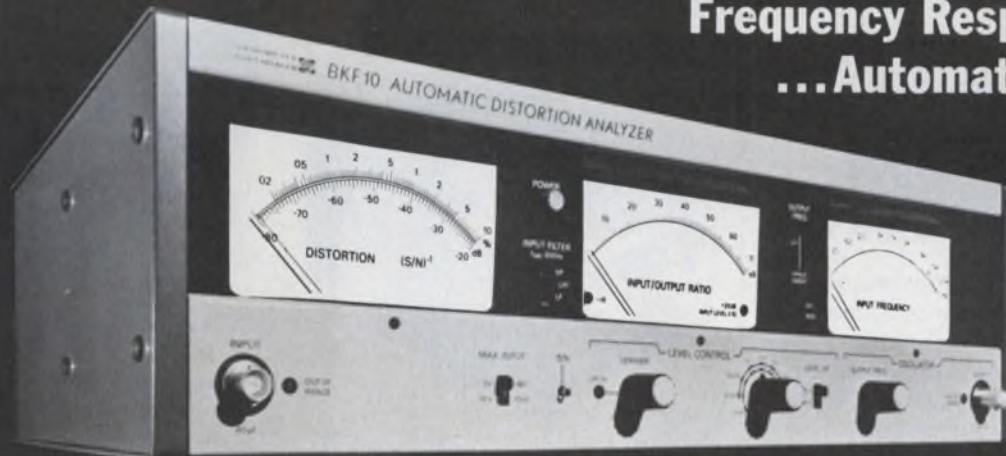

RADIOMETER
COPENHAGEN

Comprehensive distortion and frequency response measurements are easily performed with the BKF10 Automatic Distortion Analyzer. This unique instrument combines a distortion meter, a low distortion audio sweep oscillator ($<0.01\%$ t.h.d.) and an input/output ratio meter. Operation is totally automatic... No balancing, nulling or level setting is required. Addition of a recorder provides complete distortion and frequency response curves. Send for complete information.



THE LONDON COMPANY / 811 SHARON DRIVE / CLEVELAND, OHIO 44145 / (216) 871-8900

"See it at WESCON, Booth 2109."

INFORMATION RETRIEVAL NUMBER 100

Pro-Log Eliminates Hard Wired Logic

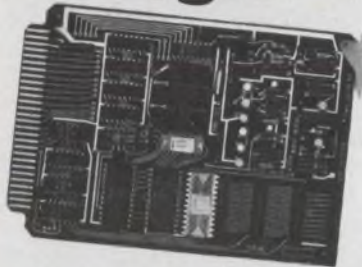

Our 4-bit microprocessor system can replace a rack full of your TTL chips. You'll save design time and production costs. No big redesign jobs for options or changes because the logic is stored in reprogrammable ROMs. Our programmed logic systems are available now, off the shelf.

Our PLS-401 microprocessor system costs less than \$400 in a quantity of one, with substantial OEM discounts. Plus we've got all the support you need: Design manuals, 2-day intensive design course, ROM Programmers, System Testors, special interface cards and support hardware to make your system go together smoothly.

and Mini Computers

Our MPS-800 microprocessor systems are modular production systems with mini-computer features such as: Expandable RAM, DMA, and 8 level priority interrupt. From under \$950 in a quantity of one with RAM. We have special interface cards and support hardware.

Micro Processor Systems from Pro-Log



852 Airport Road
Monterey, Calif. 93940
(408) 372-4593

INFORMATION RETRIEVAL NUMBER 101

POWER SOURCES

Op amp supply is rated for high MTBF

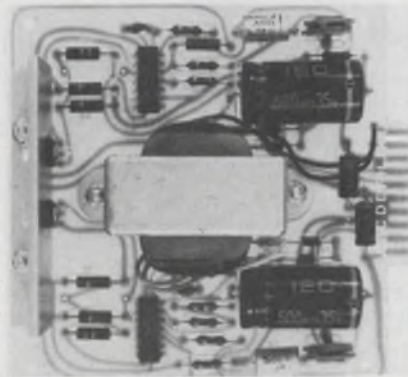

Elasco, Box 276, Bloomfield, Conn. 06002. (203) 242-0708. \$47 (1-9); stock.

Model 2Q15-250PC op amp power supply is rated at ± 15 V dc, ± 250 mA with a calculated MTBF of 49,200 hrs. The entire power supply comes on a plug-in PC card. Size is 4.5 \times 4.5 \times 1.87-in. Specs include an input of 105 to 125 V ac, 50 to 400 Hz; regulation, line and load, of 0.1%; short-circuit proof; ripple of 2 mV rms; tracking output; and an operating temperature of -20 to $+50$ C.

CIRCLE NO. 364

Modular unit delivers dual outputs at 10 W



Computer Products, 1400 N.W. 70th St., P.O. Box 23849, Fort Lauderdale, Fla. 33307. (305) 974-5500. \$99.

Model PM501 modular supply provides dc outputs of ± 15 V at 350 mA. The unit measures 3.5 \times 2.5 \times 1.62 in. and is contained in an anodized aluminum case, epoxy encapsulated. The supply is designed for PC-board mounting. Specs include a line and load regulation of $\pm 0.02\%$, maximum, and ripple and noise of 0.5 mV rms.

CIRCLE NO. 365

Open-frame units give protected outputs

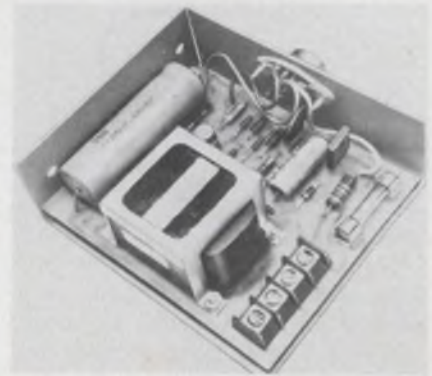

Voltex Co., 115 Marine St., Farmingdale, N.Y. 11735. (516) CH-9-2336. \$39; stock to 2 wks.

Series 400 medium-power, open-frame modules deliver output voltages and currents from 5 V dc at 1-1/2 A to 24 V dc at 400 mA. Connections are by screw type barrier terminal blocks. Foldback current limiting and SCR crowbar overvoltage protection are standard.

CIRCLE NO. 366

Power modules offer high efficiency



Abbott Transistor Labs, 5200 W. Jefferson Blvd., Los Angeles, Calif. 90016. (201) 224-6900. \$265 (1-4); stock.

High-Efficiency series of power modules converts 47 to 440 Hz ac lines to 100 W of regulated dc power. Model "VN100" series uses a new approach in switching technology to give efficiencies of up to 80%. Any output voltage between 4.7 and 50 V dc is available in a package that measures only 5-3/4 \times 6-1/4 \times 2-3/4-in. Line and load regulation are held to 0.4% and ripple to 30 mV rms maximum. Baseplate temperature range is 0 to 71 C and maximum tempco is 0.03%.

CIRCLE NO. 367

64 models offered in compact modular line

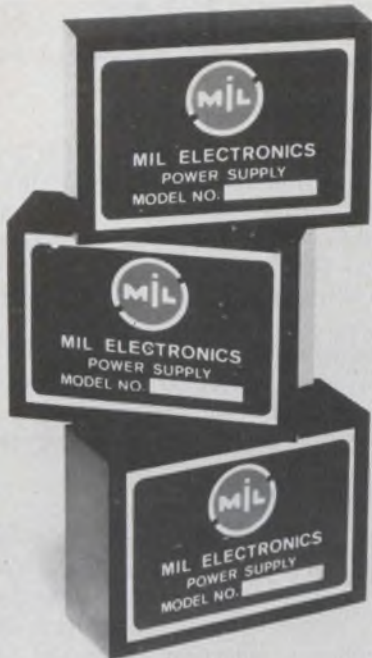

Mil Electronics, 176 Walker St., Lowell, Mass. 01854. (617) 453-4142. \$39 for ± 15 V, 100 mA (1-9); stock to 4 wks.

This line of 64 regulated power supplies—the F series—ranges from single and dual 5 V dc to 28 V dc, with current rating up to 1 A, along with several triple output supplies. All models are replaceable units for Semiconductor Circuits, Analog Devices and Computer Products. Features include small size and full encapsulation. All voltages between 5 and 28 V dc are available.

CIRCLE NO. 368

Rechargeable battery withstands shock

Globe-Union, Inc., 5757 N. Green Bay Ave., Milwaukee, Wis. 53201. (414) 228-1200. 6 V, \$77.32; 4-V, \$57.54; *immed. delivery.*

Tel/Cell GY-13 Series batteries are specifically designed for the communications industry. The units are protected against vibration and shock by tough, injection-molded polypropylene cases and molded side supports that lock cell elements tightly in position. Available in 4 and 6-V models, Tel/Cell batteries connect in series to obtain higher voltages. Or they can be arranged in parallel for capacities beyond their 100 A-h rating.

CIRCLE NO. 369

Phase-controlled units regulate to 0.1%

Electronic Measurements, 405 Essex Rd., Neptune, N.J. 07753. (201) 922-9300. \$425 to \$1000; stock to 8 wks.

Twenty-seven new models of dc power supplies use SCR phase control for a regulation of 0.1%. The SCR Series covers the range of 6 to 600 V, 1 to 200 A, in power ratings of 600, 1200 and 2000 W.

All models are 0.1% regulated in both the voltage and current modes of operation, with automatic cross-over. Input is single phase. Remote programming and sensing are standard, as are forced-air cooling with automatic over-temperature protection. Front-panel heights for the 600, 1200 and 2000-W units are 3-1/2, 5-1/4 and 7-in., respectively. Depth and width are 18 and 19 in., respectively.

CIRCLE NO. 370

Our new IC Op Amp Tester is a cheap little know-it-all.



A. Input offset voltage (Eos).

B. Bias current, inverting input (IB^-).

C. Bias current, non-inverting input (IB^+).

D. DC open loop gain.

E. DC common mode rejection ratio (CMRR).

F. Oscillation detection.

All you really need to know about our New Model 1234 IC Op Amp Tester is that it costs less than \$700 and is smart enough to do the following:

1. Test virtually all IC op amps, monolithic and hybrid, in DIP and TO-5 configurations with or without plastic carriers.

2. Perform the six most important measurements previously accomplished only by testers costing at least three times as much. These are:

Now you can't afford NOT to weed out your incoming disasters and sort your devices by accurate test results.

Write for the complete information on this new tester, our companion instrument to the Model 1248 functional tester for digital ICs.

esi
ELECTRO
SCIENTIFIC

Electro Scientific Industries
13800 N.W. Science Park
Dr., Portland, Ore. 97229,
Phone (503) 646-4141.
Telex 36-0273.

Openings: Application Engineers, Product Manager.

application notes

Miniature lamps

A 56-page Design Data Handbook is devoted to the theory and practice of designing with miniature lamps. GTE Sylvania, Kearney, N.J.

CIRCLE NO. 371

Low-current opto-isolators

Low-power applications for low-current, high-gain optically coupled isolators are detailed in an application note. It shows how 5082-4370 series isolators can be used where large common-mode signals are encountered, along with low-power requirements. Hewlett-Packard, Palo Alto, Calif.

CIRCLE NO. 372

2-to-4k RAMs

How to design an original memory around a pin-for-pin compatible pair of 2-to-4k RAMs is detailed in a seven-page application note. Concise diagrams and schematics are included. Advanced Memory Systems, Sunnyvale, Calif.

CIRCLE NO. 373

Semi thermal management

"Guidelines to Semiconductor Thermal Management," a 22-page catalog, discusses the fundamentals of heat transfer, thermal calculations for steady state, single pulse, repetitive pulse operation of semiconductors and methods of heat dissipation. Included are charts and graphs, a nomograph and a bibliography. International Electronic Research, Burbank, Calif.

CIRCLE NO. 374

Wirewound resistors

"Pulse Handling Capabilities of Wirewound Resistors" contains formulas for calculating the overload capabilities of resistors under pulse conditions ranging from less than 100 ms to 5 s. Both intermittent and equally spaced repetitive pulses are considered and the formulas apply to noninductive as well as inductive resistors. Dale Electronics, Columbus, Neb.

CIRCLE NO. 375

IC parameter evaluation

Three application notes describe how the J127 accurate circuit analyzer can be used to evaluate various IC parameters. Each note shows a sample programming worksheet and includes an illustration of the gate under test and of the normal J127 connections and programmed values for each test. Teradyne, Boston, Mass.

CIRCLE NO. 376

How to specify ADCs

A basic approach to avoiding common errors in specifying a/d converters is outlined in an eight-page primer. Starting with an analysis of error sources, the paper discusses the error budget as a design tool, the real difficulties in designing a reliable, low-cost converter, the build-or-buy problem, the speed-vs-accuracy tradeoff, ambiguities in converter specifications and a section on clues to rating the converter vendor. Analogic, Wakefield, Mass.

CIRCLE NO. 377

Digital logic guide

"Logic," a digital logic troubleshooting guide, assists engineers with specific circuit problems and keeps them informed of latest technological developments. Kurz-Kasch Electronics Div., Dayton, Ohio.

CIRCLE NO. 378

Video detectors

A 35-page application note, "Broadband Direction Finding Application of Video Detectors from 500 MHz to 20 GHz," presents aspects of DF systems techniques. The note describes video detector characteristics in depth and discusses the influence the characteristics have on system design and performance. American Electronic Laboratories, Lansdale, Pa.

CIRCLE NO. 379

Comparison study

An engineering comparison study of MECL 10,000 and Schottky TTL defines and evaluates many of the points which the user should consider when selecting a logic family for a high-speed system or subsystem. Motorola, Phoenix, Ariz.

CIRCLE NO. 380

design aids

Synchronous motors

"Permanent Magnet Synchronous Motor Selector Guide" lists in chart form comparative electrical, physical and operating characteristics for 13 models of synchronous motors offered in four different frame configurations. Formulas used in working out motor specifications are provided. North American Philips Controls.

CIRCLE NO. 381

Power supplies

A power supply selection guide contains charts and graphs. The 15 x 22-in. wall chart is divided into three categories: general information, selection guide and applications. ACDC Electronics.

CIRCLE NO. 382

Dual in-line templates

A dual in-line template is a handy aid for PC-board layout, consisting mostly of 14 or 16-lead TO-116 (DIP) packages. Circuit pad patterns can be quickly drawn on a layout without moving the template. The templates are made from 0.03-in. green tinted plastic and are priced as follows: DIP-1 (1:1) \$1.50; DIP-2 (2:1) \$2.50, and DIP-4 (4:1) \$3. Tangent Template.

CIRCLE NO. 383

Miniature hardware guide

A microhardware slide guide is a hardware catalog in a convenient 10 x 4 in. slide rule format. Specifications are read out for over 1300 sizes of hard-to-find micro-eyelets, microrivets, microwashers and micronuts. Circon.

CIRCLE NO. 384

Power tubes

A wall chart shows the company's recommendations for power tubes by power level and application. The chart catalogs the various services from 500 kHz to 1450 MHz and cross-references tube recommendations against power levels from 10 W to 250 kW. RCA.

CIRCLE NO. 385

Millions already in use

NEW KIT LETS YOU TRY IT

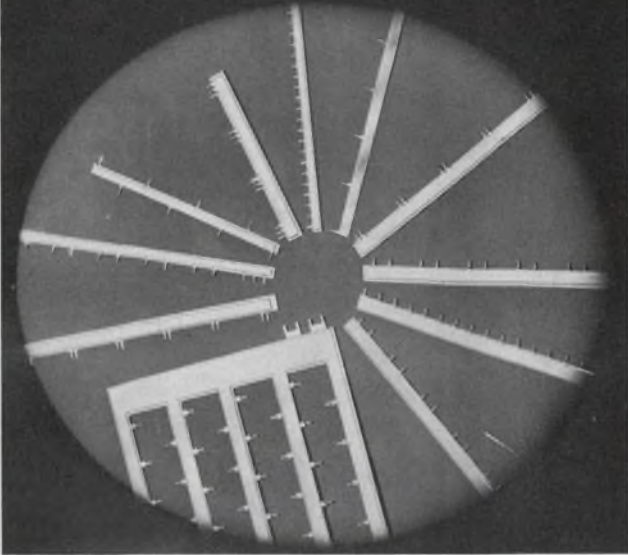

Evaluation kits @ \$25 in stock.
Standard parts on 2 weeks delivery, or less!
Custom parts 4 to 6 weeks delivery!

MINI/BUS The low-cost, noise attenuating, high packaging density, power distribution system for PC boards. Ask for data.



Rogers Corporation / Chandler, Arizona 85224
West: (602) 963-4584 East: (203) 774-9605

INFORMATION RETRIEVAL NUMBER 104

HARD FIRED GOLD.

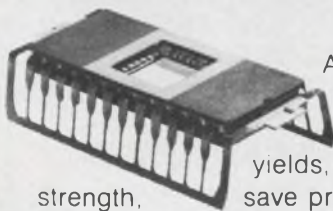

A new innovation from Diacon to improve die attach yields, increase bond strength, save preform costs. Available in 14, 16, 18 and 24 lead DiaPak. The slight premium "Hard Fired" costs will be a money-saving trade-off for consistent yield improvements. **DIACON, INC.**

4812 Kearny Mesa Road, San Diego, California 92111
(714) 279-6992

INFORMATION RETRIEVAL NUMBER 105

ELECTRONIC DESIGN 17, August 16, 1974

PULSE GENERATOR

TTL & CMOS COMPATIBLE

Why keep haywiring a test fixture every time you need pulses? Those once-used kludges can become a costly way to go. At least they are when compared to this —

The Model 101A generates TTL and CMOS (+5 V) pulses from 50 ns to 500 ms, 1 Hz to 5 Mhz, with unlimited duty cycle, 10 ns rise and fall times. It can free-run or be triggered or gated for pulses, delayed pulses, pulse bursts. Can count-down and be FM'd. Supplies +5 V at 500 ma for powering breadboards.

\$195⁰⁰ immediate delivery
satisfaction guaranteed



LOGICPULSE

18758 Bryant St., Northridge, CA. 91324 • (213) 993-0225

INFORMATION RETRIEVAL NUMBER 106

WHEN IT'S TIME FOR A SWITCH ...

It's time for Shigoto. Because every Shigoto switch is backed by solid engineering know-how. A reliable piece of equipment you can count on. To perform every time. We've got toggle and rocker, lever and leaf, push button, panel, rotary, radio, knife, slide and snap action switches. All sizes, all ratings. Leaf through our Catalog and pick the switch that's compatible with your requirements. If we haven't already made it, we can, specially for you. And while you're at it, check out our other outstanding O.E.M. components, too.



SHIGOTO. A STANDARD FOR INDUSTRY

Write or phone for our catalog and more information

Shigoto Industries Ltd.

350 Fifth Ave., N.Y., N.Y. 10001/(212) 695-0200/Telex 224219
One of the World's Largest Manufacturing Importers

INFORMATION RETRIEVAL NUMBER 107

DIRECT FROM STOCK

5V15A

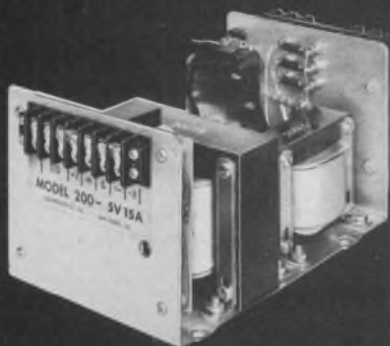

SINGLE **\$99**

\$84.00 - 100 pieces

**Singles and duals
up to 200 Watts,
3 to 50 Volts.**

SPECIFICATIONS

Size: 5 x 5.5 x 10.75 overall

Input: 105-125V, 47-420 Hz

Output: Any DC voltage 3 to 50

Regulation: Line — 0.005%
Load — 0.05%

Ripple: Less than 250 Microvolts

Temp: Operative — 40 to +71°C
Storage — 65 to +85°C

Coefficient — 0.01%/°C Max.

Current Limiting: Fixed Foldback Type

Overvoltage: Optional

MODEL	VOLTS	AMPS
200-5	4.5-5.5	15.0
200-12	11.5-12.5	10.0
200-15	14.5-15.5	9.0
200-24	23.5-24.5	7.5
200-28	27.5-28.5	7.0
200-48	47.5-48.5	4.0
200-0505	± 4.5-5.5	7.0
200-1212	± 11.5-12.5	5.0
200-1515	± 14.5-15.5	4.5
200-2424	± 23.5-24.5	3.5
200-2828	± 27.5-28.5	3.5

ORDERING INFORMATION

SINGLE			DUAL		
Qty	Price	w/O.V.	Qty	Price	w/O.V.
1-9	\$99	\$114	1-9	\$119	\$129
10-24	94	107	10-24	113	122
25-99	90	102	25-99	104	112

CALL (714) 279-1414 FOR DELIVERY

Electrostatics, Inc.

7718 CLAIREMONT MESA BLVD. • SAN DIEGO, CA 92111

new literature



Nonlinear circuits handbook

A 540-page Nonlinear Circuits Handbook is a complete reference to the principles, circuitry, specifications, testing and applications of nonlinear analog building blocks such as multipliers, dividers, squarers and rooters, log, antilog, log-ratio elements and root-mean-square to dc converters. The book contains over 325 illustrations and is written in a lucid style. Price of the handbook is \$5.95. Analog Devices, P.O. Box 796, Norwood, Mass. 02062

INQUIRE DIRECT

Industrial control relays

Descriptive details on industrial control relays with sealed contacts are contained in a four-page publication. Allen-Bradley, Milwaukee, Wis.

CIRCLE NO. 386

Custom ICs

A 12-page booklet contains a wealth of information on custom integration. Included are a description of a low-cost integration program, secrecy procedures to protect circuit design, a description of a new speakerphone designed on the Monochip, new logic schemes for custom ICs and a discussion of the reliability of ICs. Interdesign, Sunnyvale, Calif.

CIRCLE NO. 387

Wiring components

A data sheet details the company's products' acceptability to OSHA requirements. Products include cable ties, plastic wiring duct, terminals, disconnects, splices and wire joints and cable-tie installation tools. The pamphlet also contains suggestions for bringing these components into compliance with NEC requirements. Panduit, Tinley Park, Ill.

CIRCLE NO. 388

Silicon rectifiers

Silicon rectifiers such as bridges, axial lead, high-voltage packs, cartridges, OEM television and other special device rectifiers are described in a catalog. Electrical characteristics, dimensional drawings and photos are included. Electronic Devices, Yonkers, N.Y.

CIRCLE NO. 389

Eyelets

A 44-page catalog describes a full range of eyelets, classified by type and application, and eyeletting equipment. USM Corp., Eyelet Div., Shelton, Conn.

CIRCLE NO. 390

Electroconductive resins

Characteristics and potential applications of experimental electro-conductive resins are described in a bulletin. Properties, data tables, molecular structure drawings and graphic representatives of their performance on Mylar film and glass plate are included. Handling, health hazards and ecological evaluation methods are discussed. Dow Chemical USA, Midland, Mich.

CIRCLE NO. 391

Switching pwr supplies

An eight-page tutorial article, "The Principle and Facts about Switching Power Supplies," reviews the various approaches of switching and covers all of the aspects from the application and users point of view. RO Associates, Menlo Park, Calif.

CIRCLE NO. 392

Digitizing service

Details on the company's Digi-Graphics service—a full capability digitizing service bureau—are provided in a four-page brochure. Computer Equipment Corp., Rockville, Md.

CIRCLE NO. 393

Temp controllers

Theory of operation and specification data for dc proportional temperature controllers are given in a six-page foldout. Oven Industries, Mechanicsburg, Pa.

CIRCLE NO. 394

French products

A bulletin covers new products and processes that are available in France. French Embassy, Washington, D.C.

CIRCLE NO. 395

Heat-shrinkable tubing

The high-flame resistance and flexibility of Thermofit heat-shrinkable RT-876 tubing are described in a data sheet. Raychem, Menlo Park, Calif.

CIRCLE NO. 396



Thick-film compositions

Thick-film resistor, conductor, dielectric and insulating ink compositions are described in a six-page brochure. Also included are epoxy cements, solder paste and various optoelectronic materials. Electro Materials Corp. of America, Mamaroneck, N.Y.

CIRCLE NO. 397

Your source for Electronic Discharge Printers

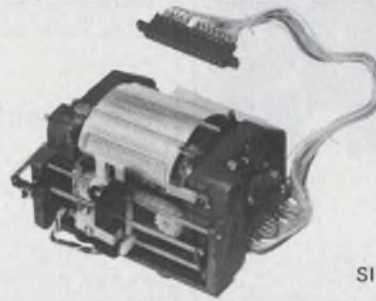

\$130

1606A
16 COLUMN

\$150

2106A
21 COLUMN

SINGLE QUANTITY PRICE
VOLUME DISCOUNTS

FAST 6 LINES PER SEC.

QUIET NON IMPACT PRINTER

SMALL 3.3" X 4.5" X 4.5"

LIGHT ONLY 1.5 POUNDS

LONG LIFE MTBF 5.5 MILLION LINES

HOOK UP WITH HYCOM. These quick, quiet and compact alphanumeric printers need no ribbons and have fewer moving parts . . . adding up to economy and reliability. Get them from the source . . .

HYCOM

16841 Armstrong Avenue, Irvine, California 92705, Telephone (714) 557-5252

Your source for Microelectronic Systems
Custom MOS/LSI • Communication Systems • Dedicated Calculators

INFORMATION RETRIEVAL NUMBER 109

MF ELECTRONICS

CRYSTAL OSCILLATORS

MF Electronics produces a broad line of temperature-compensated and clock oscillators for both DIP and PC board use. Any frequency from 4 MHz to 50 MHz may be specified in our low-profile Model 5406 oscillator with a stability of ± 50 ppm or ± 25 ppm from 0° to 65°C. Temperature ranges from -55° to 125°C are also available. Our Model 5401 temperature-compensated oscillator, in flatpack or compact form for PC board mounting, is offered with a stability of ± 1 ppm from 0° to 65°C. Frequencies can be specified from 1 KHz to 10MHz. All oscillators operate from

a 5V power source for use in standard DTL and TTL. Under MF Electronic's quality control program, every MF oscillator is individually numbered and tested to insure it meets all specifications. The complete range of test results is recorded at the factory, allowing us to guarantee each oscillator and to identify its performance parameters years after its production. Because we make them better and test them better, MF Crystal Oscillators are better for you.

Model 5406



For information and assistance on all your crystal oscillator needs, contact:

MF ELECTRONICS CORP.

118 EAST 25th STREET, NEW YORK, N.Y. 10010 • (212) 674-5360 • TWX: 710-581-4109

INFORMATION RETRIEVAL NUMBER 110

POWER CHIPS

from

GENERAL SEMICONDUCTOR

- Fast switching transistor chips
- 1 amp to 30 amps
- 40 volts to 250 volts
- Low saturation voltage
- Low leakage
- Delivery from stock

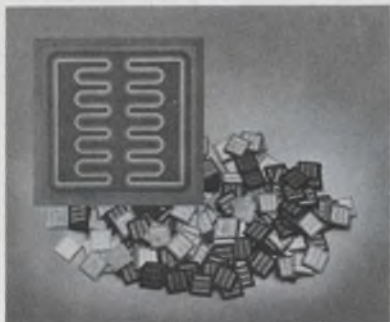

15 AMP CHIP (135 Mil. Sq.)

JEDEC NO.	CHIP NO.
2N2811	GTC2811
2N2812	GTC2812
2N2813	GTC2813
2N2814	GTC2814
2N4070	GTC4070
2N4071	GTC4071

The above partial listing of planar transistor chips available from General Semiconductor Industries, Inc. They are also available as the corresponding JEDEC part number in standard power packages. Call us for your other device requirements.



GENERAL SEMICONDUCTOR INDUSTRIES, INC.

2001 WEST TENTH PLACE • TEMPE, ARIZONA 85281
MAILING ADDRESS: P.O. BOX 3078
602-968-3101 • TWX 910-950-1942

NEW LITERATURE

Over/undervoltage devices

A four-page bulletin provides data on over and undervoltage protection devices. Heinemann Electric, Trenton, N.J.

CIRCLE NO. 398

Components

An up-to-the-minute guide covers over 200 types of components—relays, correeds, rotary stepping switches and other types of switches and accessories. GTE Automatic Electric, Northlake, Ill.

CIRCLE NO. 399

Electromechanical units

A 116-page guidebook presents hundreds of electromechanical equipment and components. Specifications and prices are given. All merchandise is new or rebuilt and is indicated as such in the catalog. American Design Components, New York, N.Y.

CIRCLE NO. 400

Rf power sources

Applications and specifications of high-power rf sources are given in a catalog. The catalog describes options and accessory products, including AM capability, FM, a phase-lock synchronizer, head-rack assemblies, etc. Ailtech, City of Industry, Calif.

CIRCLE NO. 401

Magnetic semiconductors

Magnetic semiconductor products for a wide range of measurement and control applications are featured in a six-page brochure. Hall generators, gaussmeters and power system transducers for utility, manufacturing, laboratory and computer applications are cited in the brochure. F.W. Bell, Columbus, Ohio.

CIRCLE NO. 402

High-band porta phones

Features and operation of the RF-2810 series high-band porta phones are explained in a two-page brochure. Specifications, including FCC type acceptance, frequency range, rf power output and options, are included. RF Communications, Rochester, N.Y.

CIRCLE NO. 403

Data logger

System 9400—a stand-alone data logger that can also be configured for computerized data-acquisition networks—is covered in a 16-page catalog. The brochure covers all of the basic modules, including a digital clock and internal recorder and interfaces. Monitor Labs, San Diego, Calif.

CIRCLE NO. 404

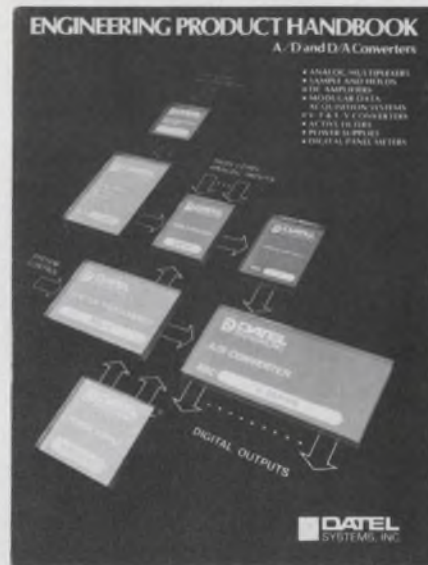

A/d and d/a converters

A 70-page handbook contains specifications and application information on the company's a/d and d/a conversion products. Eleven pages are devoted to principles of data acquisition and conversion with a large number of illustrative diagrams and tables. Datel Systems, Canton, Mass.

CIRCLE NO. 405

Oscillators

An 86-page multisection catalog describes oscillators, multiplier/amplifiers and other related components. The catalog contains performance curves, outline drawings, schematics, block diagrams, waveforms and graphs. Greenray Industries, Mechanicsburg, Pa.

CIRCLE NO. 406

Seminars

A 44-page catalog describes courses in computer, management, mathematical and statistical sciences. The Institute for Advanced Technology, Control Data, Rockville, Md.

CIRCLE NO. 407

Computer systems

Process management and control systems are described in a 16-page catalog. The Foxboro Co., Foxboro, Mass.

CIRCLE NO. 408

Bulk core storage system

Principal characteristics of the company's 4510 and 4852 bulk-storage systems are given in a four-page brochure. A chart compares the company's systems to drum storage. Fabri-Tek, Minneapolis, Minn.

CIRCLE NO. 409

Adjustable speed drives

A 24-page catalog highlights adjustable speed drives. A master selection guide aids in selecting the type of drive to best meet application requirements. Parametrics, Orange, Conn.

CIRCLE NO. 410

Panel meters

Edgewise panel meters with scale lengths of 1-1/2 and 2-1/2 in. are illustrated and described in a data sheet. Performance specifications, dimensional drawings and prices are given. Beede Electrical Instrument, Penacook, N.H.

CIRCLE NO. 411

Ribbon connectors

A four-page selection guide highlights telephone-standard format 25 pair miniature ribbon connectors. A summary of qualification testing performed for telephone industry requirements is provided. Viking Industries, Chatsworth, Calif.

CIRCLE NO. 412

Voltage regulators

A 24-page catalog features a basic explanation of line voltage fluctuations, how they're being aggravated by energy shortages and what effects they have on business and industrial machinery. A comparison chart shows how various types of regulators compare in terms of key characteristics, and an applications chart cross-references 39 groups of electrical/electronic equipment across more than 20 basic industries. Sola Electric, Elk Grove Village, Ill.

CIRCLE NO. 413

For price, delivery, quality
look to wabash

For relays and switches
look to wabash

All components in Wabash's complete line of reed relays and switches are manufactured by us, assuring complete control of each unit. We are true manufacturers, not assemblers. 3 billion daily reliability test cycles hold highest quality level; pricing is competitive because we share combined purchasing by all Wabash divisions; 3 weeks lead time is typical of fast delivery. Call now.



For all relay types
look to wabash

Wabash Relay & Electronics, Inc.
a subsidiary of Wabash Magnetics, Inc.
First and Webster Streets, Wabash, Indiana 46992
Phone 219/563-2191 TWX 810-290-2722

■ RF SWITCHING & MERCURY WETTED RELAYS ■ SUBMINIATURE REED SWITCHES
■ DIP REED RELAYS ■ SSR MODULES ■ STANDARD & MINIATURE REED RELAYS

INFORMATION RETRIEVAL NUMBER 113

SPECIAL FEATURE EDITORIAL

of interest to the

MICROWAVE COMMUNITY

- SEPTEMBER — ANTENNAS & PHASED ARRAYS
- OCTOBER — ECM — ELECTRONIC COUNTERMEASURES
- NOVEMBER — TEST EQUIPMENT

Watch for them in . . .

MICROWAVES

A HAYDEN PUBLICATION

50 Essex Street, Rochelle Park, New Jersey 07662

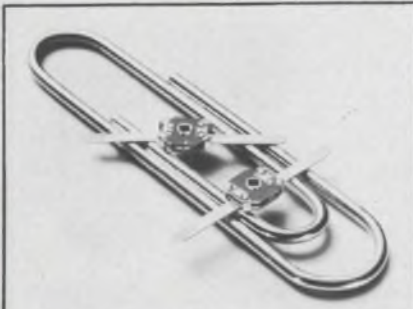

Thin-Trim variable capacitors provide a reliable means of adjusting capacitance without abrasive trimming or interchange of fixed capacitors. Series 9401 has high Q's and a range of capacitance values from 0.2-0.6 pf to 3.0-12.0 pf and 250 WVDC working voltage. Johanson Manufacturing Corporation, Boonton, New Jersey (201) 334-2676.

INFORMATION RETRIEVAL NUMBER 181



"VLF to HF ACTIVE AIRBORNE ANTENNA provides highly efficient reception for Omega, Loran C and Communication applications. Operating frequency is 10 KHz to 30 MHz with a 50 ohm constant output impedance." BAYSHORE SYSTEMS, Springfield, Va.

INFORMATION RETRIEVAL NUMBER 184

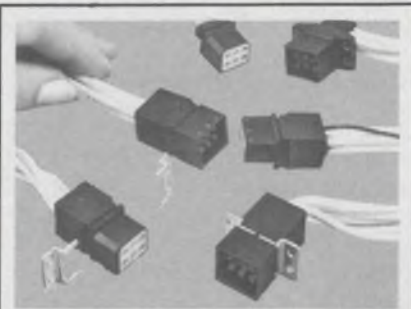

CAPITRON subminiature LGH high-voltage connectors. They're lightweight—a mated pair is less than 14 gr. And compact—requires less than .6 sq. in. of mounting surface. Operates up to 5 KVDC at 70,000 feet. And within a temperature range of -55°C to +125°C. AMP Incorporated, Capatron Division, Harrisburg, Pa. 17105. (717) 564-0100.

INFORMATION RETRIEVAL NUMBER 187

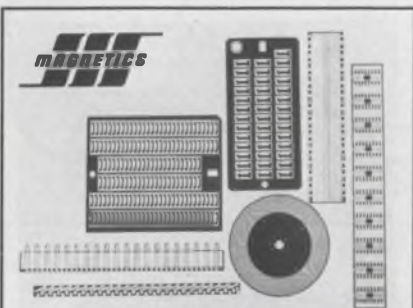

THIN METAL PARTS BY MAGNETICS' PHOTOETCH PROCESS cuts costs and lead time substantially. Photoetching eliminates die costs, assures precise tolerance and uniformity. Ideal for recording head laminations, lead frames, etc. We stock popular alloys, .000125" up. Full plating, selective plating offered. Magnetics, Butler Pa. 16001.

INFORMATION RETRIEVAL NUMBER 182



Basic Engineering Sciences & Structural Engineering for E-I-T Exams. Sampling for test problems makes the best preparation yet for exams. #5712-1, 424 pp., \$14.95. Circle the Info Retrieval No. to order 15-day exam copy. When billed, remit or return book with no obligation. Hayden Book Co., 50 Essex St., Rochelle Pk., N.J. 07662

INFORMATION RETRIEVAL NUMBER 185

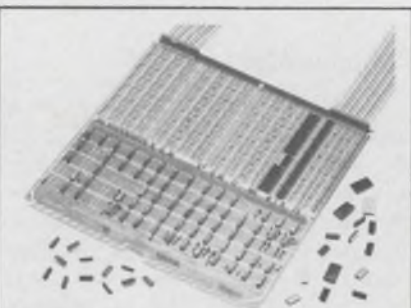

NOVA/DCC-116 general purpose interface board provides: multiple device selection, 4 I/O registers, DMA zero word count detect, 105 socket positions for 14, 16, 24 & 40 PIN IC's. Basic board (all features of data general 4040 plus multiple device select) \$350. MDB Systems, Inc., 981 N. Main St., Orange, CA. (714) 639-7238.

INFORMATION RETRIEVAL NUMBER 188



A new system for digital spectral and tristimulus analysis of light sources has been announced by Gamma Scientific. This new Model 3100 Scanning Spectroradiometer, with its 3100-5C Interface, couples to any general purpose digital computer. Gamma Scientific, 3777 Ruffin Rd., San Diego, Ca. 92123. Phone 714/279-8034.

INFORMATION RETRIEVAL NUMBER 183



The Lowest Power, Lightest, Smallest 10 1/2" Reel Digital Magnetic Tape Recorder in the World. Operates on 12 volts \pm 2 volts DC and writes 700,000 tape characters per ampere hour. Small size and low weight permit a wide variety of packaging options. Digi-Data, 8580 Dorsey Run Rd., Jessup, MD 20794. (301) 498-0200

INFORMATION RETRIEVAL NUMBER 186



Introduction To Defense Radar Systems Engineering. Excellent introduction and practical reference to radar systems design and applications. #9194, 260 pp., \$20.00. Circle the Info Retrieval No. to order 15-day exam copy. When billed, remit or return book with no obligation. Hayden Book Co. 50 Essex St. Rochelle Park, N.J. 07662

INFORMATION RETRIEVAL NUMBER 189

**FREE
10 Ways
To Use
Conductive
Paints**



Our electrically conductive paints are solving "impossible" lab problems and reducing unit production costs. One customer saves a fortune each year PAINTING on four MILLION 1000 meg resistors. Think that over. Why not request "Ten Ways To Use Conductive Paints"? Micro Circuits Co., New Buffalo, Mich. 49117. (616) 469 2727.

INFORMATION RETRIEVAL NUMBER 190



Free catalog of 34,500 power supplies from the worlds largest manufacturer of quality Power Supplies. New '74 catalog covers over 34,500 D.C. Power Supplies for every application. All units are UL approved, and meet most military and commercial specs for industrial and computer uses. Power Mate Corp. (201) 343-6294.

INFORMATION RETRIEVAL NUMBER 193

Advertisers wishing to reserve Quick Ad units should note the following mechanical requirements: Specs—Supply glossy photo of product and approximately 40 words which will set no more than 10 lines of 34 characters each. AFTER SUBMISSION NO COPY CHANGES CAN BE ACCEPTED. Quick Ads cost only \$300 per insertion, less for frequency advertisers.

RATES:

1x
\$300

7x
\$280

13x
\$255

19x
\$250

26x
\$245

39x
\$240

52x
\$235

104x
\$230



Contact United States Crystal Corporation for our new quartz crystal catalogue. It gives you the most up to date specifications on military CR numbers and information for designing and specifying crystals. Free engineering assistance on your crystal requirements. 3605 McCart St., Fort Worth, Texas 76110. (817) 921-3014.

INFORMATION RETRIEVAL NUMBER 191

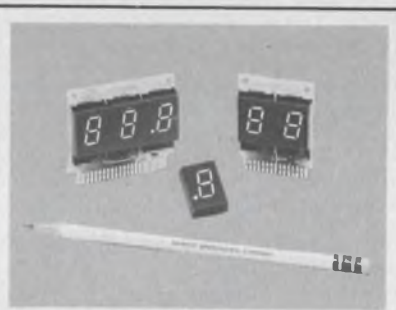

Plug-in LED Display Assemblies with decoder/driver circuits already assembled, ready to plug-in and read-out. Accepts 4-line BCD input. Operates from 5 VDC. Utilizes 0.6" high red numeric LED display. Master Specialties, 1640 Monrovia, Costa Mesa, Calif. 92627. (714) 642-2427.

INFORMATION RETRIEVAL NUMBER 194



WTD-101 ALPHA-NUMERIC TAPE PRINTER. Low cost * 110 Char./Sec. * 64 Char. Set * Small Size * High Reliability * Red/Black Printing * Point of Sale Appl. * OEM Prices start at \$975.00 * WTD INC. 2519 DeKALB PIKE NORRISTOWN, PA. 19401 (215) 277-2510.

INFORMATION RETRIEVAL NUMBER 192

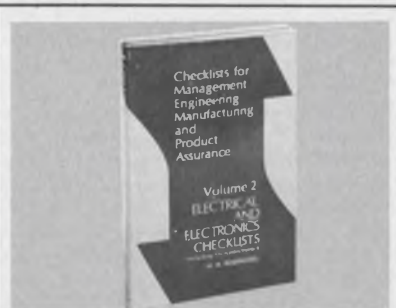

Electrical/Electronics Checklists. 22 detailed checklists to insure complete accuracy and efficiency for a broad array of designs. #9181, 190 pp., \$14.00. Circle the Info Retrieval No. to order 15-day exam copy. When billed, remit or return book with no obligation. Hayden Book Co. 50 Essex St., Rochelle Pk., N.J. 07660.

INFORMATION RETRIEVAL NUMBER 195

PIEZOELECTRIC TUNING FORK

**LOW PRICE
HIGH RELIABILITY**

TYPE : TFO 697.5Hz~1492.5Hz



$20^L \times 8.0^H \times 6.5^W$ mm

TYPE : TFA 712.5Hz~1500Hz



$33^L \times 10^H \times 9^W$ mm

 IWATA ELECTRIC CO., LTD.

Mansei Bldg. Rm. 36 1-16, 1-Chome
Soto-Kanda, Chiyoda-ku, Tokyo 101, Japan

INFORMATION RETRIEVAL NUMBER 114

KEEP

Electronic Design's

GOLD BOOK

HANDY



When You Call

Save time when you contact suppliers. Check their catalog pages first in *Electronic Design's* GOLD BOOK. Maybe the information you need is right at your fingertips.

Electronic Design

ELECTRONIC DESIGN's function is:

- To aid progress in the electronics manufacturing industry by promoting good design.
- To give the electronic design engineer concepts and ideas that make his job easier and more productive.
- To provide a central source of timely electronics information.
- To promote communication among members of the electronics engineering community.

Want a subscription? ELECTRONIC DESIGN is sent free to qualified engineers and engineering managers doing design work, supervising design or setting standards in the United States and Western Europe. For a free subscription, use the application form bound in the magazine. If none is included, write to us direct for an application form.

If you do not qualify, you may take out a paid subscription for \$30 a year in the U.S.A., \$40 a year elsewhere. Single copies are \$1.50 each.

If you change your address, send us an old mailing label and your new address; there is generally a postcard for this bound in the magazine. You will have to requalify to continue receiving ELECTRONIC DESIGN free.

The accuracy policy of ELECTRONIC DESIGN is:

- To make diligent efforts to ensure the accuracy of editorial matter.
- To publish prompt corrections whenever inaccuracies are brought to our attention. Corrections appear in "Across the Desk."
- To encourage our readers as responsible members of our business community to report to us misleading or fraudulent advertising.
- To refuse any advertisement deemed to be misleading or fraudulent.

Microfilm copies are available of complete volumes of ELECTRONIC DESIGN at \$19 per volume, beginning with Volume 1, 1961 through Volume 20. Reprints of individual articles may be obtained for \$2.00 each, prepaid (\$.50 for each additional copy of the same article) no matter how long the article. For further details and to place orders, contact the Customer Services Department, University Microfilms, 300 North Zeeb Road, Ann Arbor, Michigan 48106 telephone (313) 761-4700.

Want to contact us? If you have any comments or wish to submit a manuscript or article outline, address your correspondence to:

Editor
ELECTRONIC DESIGN
50 Essex Street
Rochelle Park, N.J. 07662

recruitment and classified ads

SAME DAY SHIPMENT

Minis & Peripherals

PRINTERS

"BRAND NEW"

DATA PRODUCTS

2440- 700LPM

2470-1250LPM

MDS 4320-300LPM

ALSO

CENTRONICS, POTTER, CDC

A. B. DICK, IBM, HIS, UNIVAC

617/261-1100

*Send for Free Report
"Maintenance of Computers"*

AMERICAN USED COMPUTER CORP.

P.O. Box 68, Kenmore Sta., Boston MA 02215
member COMPUTER DEALERS ASSOCIATION

INFORMATION RETRIEVAL NUMBER 241

FREE ALARM CATALOG

Full line of professional burglar and fire alarm systems and supplies. 96 pages, 450 items. Off the shelf delivery, quantity prices.



mountain west alarm
4215 n. 16th st., phoenix, az. 85016

INFORMATION RETRIEVAL NUMBER 242

CARIBBEAN ASSEMBLY

ELECTROFAB LTD.

Specialists in high volume hand assemblies. Experienced machinery maintenance. Electronic & telecommunications engineering back-up. Fast turn-around & daily air cargo to USA. \$1.50 hr. FOB Caribbean. Call/Write (301) 439-8890. Box 878 Hyattsville, Md. 20783

INFORMATION RETRIEVAL NUMBER 243

Protect Your Heart HAVE REGULAR MEDICAL CHECK UPS



Give Heart Fund



Electronic Design

Advertising Sales Staff

Tom W. Carr
Sales Director

Rochelle Park, N.J. 07662

Robert W. Gascoigne
Daniel J. Rowland

(Recruitment, Quick Ads, Classified)

50 Essex Street
(201) 843-0550
TWX: 710-990-5071

Philadelphia

Thomas P. Barth
50 Essex Street
Rochelle Park, N.J. 07662
(201) 843-0550

Boston 02178

Gene Pritchard
P.O. Box 379
Belmont, Mass. 02178
(617) 489-2340

Chicago 60611

Thomas P. Kavooras
Berry Conner, Jr.
200 East Ontario
(312) 337-0588

Cleveland

Thomas P. Kavooras
(Chicago)
(312) 337-0588

Los Angeles 90303

Stanley I. Ehrenclou
Burt Underwood
2930 Imperial Highway
Inglewood, Calif.
(213) 757-0183

San Francisco 94022

Jerry D. Latta
P.O. Box 1248
Los Altos, Calif.
(415) 965-2636

London, Amsterdam, Tokyo, Seoul

John Ashcraft
12, Bear St.
Leicester Square
London WC2H 7AS England
Phone: 01-930-0525
W. J. M. Sanders
John Ashcraft & Co.
Herengracht 365
Amsterdam C., Holland
Phone: 020-24-09-08
Haruki Hirayama
Electronic Media Service
5th Floor, Lila Bldg.,
4-9-8 Roppong
Minato-ku, Japan
Phone: 402-4556
Cable: Electronicmedia, Tokyo
Mr. O-kyn Park
President
Dongbo International
Corporation
1.P. O. Box 4010
Seoul, Korea
Phone: 28-1911
Cable: DONGBO SEOUL

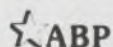

Design Data from Manufacturers

Advertisements of booklets, brochures, catalogs and data sheets. To order use Reader-Service Card (Advertisement)



REAL-TIME SIGNAL PROCESSORS CONDENSED CATALOG. FREE.

For instant diagnosis of noise & vibration in real time, new 8-pg. catalog describes well-known . . .

- UBIQUITOUS® 500-line combined Real-Time Spectrum Analyzer-Calculator that automatically computes digitally
- UBIQUITOUS® 256-point & 512-point real-time Correlators
- OMNIFEROUS™ Dual Channel Hi-Speed instrument-type FFT Processor
- Memory & non-storage large-screen displays for real-time spectrum analyzers
- Range Translators
- Rotating Machinery Order Normalizers
- Digital Recorders & Post-Processors

Immediate, circle No. 170
Routine, circle No. 171

Nicolet Scientific Corp. (formerly Federal Scientific Corp.)

245 Livingston St., Northvale, New Jersey 07647 (201) 767-7100. TWX: 710-991-9619



Power Supply Catalog Fall • 1974 FREE

Modular D.C. Power Supplies are described in this new 20 page brochure. It gives applications, specifications and features on a complete line of P.C. board mounting D.C. Power Supplies for both digital and linear integrated circuits.

Included is a selection guide which categorizes D.C. Power Supplies according to output (volts and current), regulation data, price information, and complete mechanical specifications.



1020 Turnpike St., Canton, Mass. 02021

CIRCLE NO. 172

Why Test Semi-Conductors For Noise?



Quan-Tech

Randolph Park West, Route #10
Randolph Township, N.J. 07801, Phone #201-361-3100

The **QUAN-TECH NOISE FILE** contains technical reports on the nature and origin of electrical noise in semi-conductors.

The effects of noise in terms of impaired performance have been widely recognized, and the **RELATIONSHIP BETWEEN NOISE AND COMPONENT RELIABILITY** generally accepted in the electronic industry. Thus the analysis of electrical noise generated by components is not only vital to the development and production of low-noise circuits, but also is becoming of major importance in achieving maximum reliability of instrumentation.

Instruments are available for testing noise of transistors, and thin film circuits. Applications include Incoming Inspection, Laboratory Studies, and High-Speed Production Testing.

CIRCLE NO. 173

"CANNON'S ADAPTA-CON CONNECTORS MADE A BELIEVER OUT OF MANAGEMENT,

and a hero out of me."



"Because ADAPTA-CON's the cost-conscious choice for plugging to feed-through posts, back-panel tails, as I/O connectors, and jumpers. The whole story—and how to use it—is right here in 'Secrets of Connector Success.' Get your copy today, hero."

Contact ITT Cannon Electric, International Telephone and Telegraph Corporation, 666 East Dyer Road, Santa Ana, CA 92702. (714) 557-4700.

CANNON ITT

INFORMATION RETRIEVAL NUMBER 118

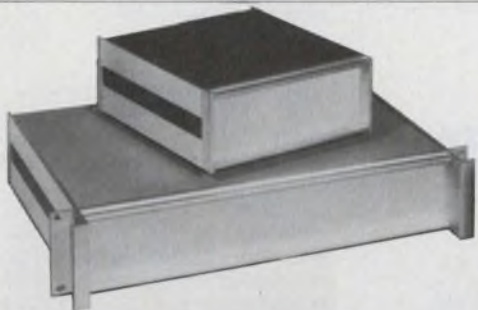

BUCKEYE CASES

Buckeye bord-pak cases are made of aluminum extrusions and available in 1/3, 1/2, 2/3 and full rack widths. Full fabricating capabilities and complete electronic packaging needs from Buckeye include: colorful cabinets, 4 sizes of adjustable P.C.B. Racks, patented card guide modules; retractable tilt-stands with feet, and a complete line of matching instrument knobs.

Write today for free colorful literature!
the BUCKEYE stamping co.

555 Marion Rd., Columbus, Ohio 43207

"QUALITY PRODUCTS SINCE 1902"



GUIDES • CABINETS • KNOBS • RACKS

"See us at Wescon '74—Booth 1145-46"

INFORMATION RETRIEVAL NUMBER 119

ELECTRONIC DESIGN 17, August 16, 1974

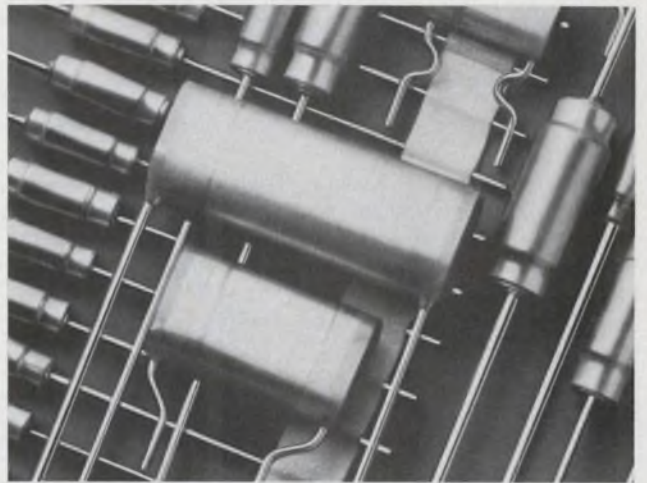

Two remarkable film capacitor types. Only from Paktron.

Axial lead polyester and polypropylene Micromatic® capacitors. Self-encased—wound on their own leads. Radial lead Filmatic® capacitors with Rippleweld® lead attach process. Modern plants in Vienna and Lynchburg, Virginia. For free catalog, write:

PAKTRON, Division Illinois Tool Works Inc.,
900 Follin Lane, S. E., Vienna, Virginia 22180.
Phone (703) 281-2810. TWX 710-833-0682.



PAKTRON
innovators in film capacitors
The Innovative Electronic Group of ITW...
PAKTRON • LICON • EMCON © ILLINOIS TOOL WORKS INC. 1974

INFORMATION RETRIEVAL NUMBER 120

Solid! Murata ceramic IF filters

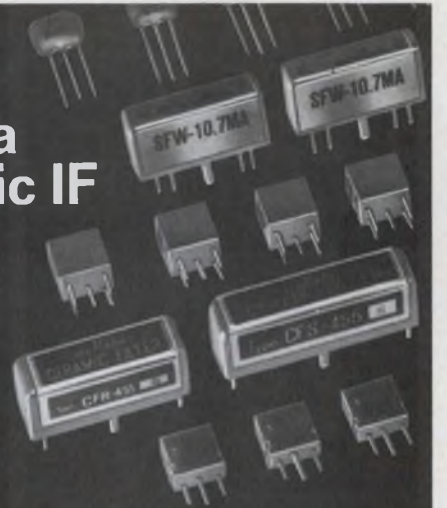

They're sharp. They're small. And, they're solid . . . for years! Murata's ceramic IF filters provide the solid-state performance in AM, FM, TV and Communications IF's that's expected by every one of our customers . . . consumer, industrial or military. Find out all there is to know about Murata's renown ceramic IF filters. Complete information is yours for the asking.

muRata MURATA CORPORATION OF AMERICA
2 Westchester Plaza, Elmsford, New York 10523
Telex: MURATA EMFD 137332 / Phone: 914/592-9180
A Subsidiary of Murata Mfg. Co., Ltd., Japan

INFORMATION RETRIEVAL NUMBER 121

product index

Information Retrieval Service. New Products, Evaluation Samples (ES), Design Aids (DA), Application Notes (AN), and New Literature (NL) in this issue are listed here with page and Information Retrieval numbers. Reader requests will be promptly processed by computer and mailed to the manufacturer within three days.

Category	Page	IRN	Category	Page	IRN	Category	Page	IRN
Components			relays	2	3	computer system	148	294
attenuators	140	74	relays	11	8	controller	146	286
capacitor, aluminum	144	77	relays and switches	175	113	controller, disc	150	296
capacitor, film	181	120	relays, double-pole	100	53	controller, display	148	290
capacitors	37	21	resistor networks	127	65	digitizer, photo	146	289
capacitors, ceramic	23	19	resistors, precision	167	363	disc drive, floppy	125	64
capacitors, chip	43	25	resistors, thick-film	59	32	memory, cartridge	146	284
capacitors, polypropylene	166	360	socket, 14-pin DIP	166	358	memory, cartridge	150	299
capacitors, tantalum	24	161	speakers, headphone	167	361	memory, disc	150	298
components	11	245	switch, snap	166	355	memory, MOS	150	300
components, ferrite	123	63	switches	171	107	microprocessor system	168	101
display	38	22	switches, reed	160	94	minicomputer	146	288
ferrite head core	115	59	switches, rotary	148	80	minicomputer	148	291
ferrites	61	33	switchlight	133	69	minicomputer, 32-bit	91	50
filters, LP	166	357	temperature probes	167	362	modem, data	144	283
indicators	42	24	transformer wideband	145	78	modem, data	148	293
lamps	157	88	transformers	153	84	printer, line	148	292
liquid crystal displays	149	81	trimmer, cermet	166	359	printers, alphanumeric	173	109
motor, mini	184	124	tuning fork	178	114	programmable logic controller	20	17
potentiometer	12	9	voltage divider	136	71	punch, tape	144	281
potentiometer	166	356	Data Processing			reader, paper tape	144	280
pulse transformers	114	58	calculator, hand-held	143	76	recorder, instrument	150	295
relay, multipurpose	22	18	card reader, optical	144	282	simulator, pROM	146	287
						software, executive	146	285
						teletypewriter	147	79
						terminal, CRT	150	297

FINALLY. A LOW NOISE GUARANTEE COMES TO IC FET OP AMPS.

The Analog Devices AD514 FET-input op amp.

The AD514 gives you an input noise voltage below $5\mu\text{V}(\text{p-p})$ max. Guaranteed. Because every one is tested for noise parameters.

You also get a low bias current of 10pA max and a low V_{os} drift of $25\mu\text{V}/^\circ\text{C}$. All for the price of only \$9.90 in hundreds for the AD514L, with other versions of the AD514 starting as low as \$5.90.

For more information, send for the data sheets. Or call Analog Devices Semiconductor, Norwood, Mass. 02062. East Coast, (617) 329-4700. Midwest, (312) 297-8710. West Coast, (213) 595-1783.



**ANALOG
DEVICES**

Discrete Semiconductors

diode, high intensity	162	343
diode, p-i-n	165	352
diodes, IR emitting	163	347
diodes, low leakage	163	344
isolators	7	6
isolators, optical	164	348
kit, lamp assembly	164	349
kit, optoelectronic	165	353
opto-couplers	1	2
photodiode, calibrated	162	341
power chips	174	111
protector, overcurrent	163	345
rectifiers, bridge	164	350
SCRs	55	30
SCRs, hockey-puk	163	346
transistor, switching	165	354
transistors, Darlington	162	342
transistors, power	164	351

Instrumentation

chip tester	132	255
counter	64	145
counter/timer	101	56
counters	159	90
DMM	134	260
distortion analyzer	167	100
frequency standard	132	253
frequency synthesizer	64	146
function generator	130	67
generators	155	86
IC op amp tester	169	102
IC tester	67	39
light sensor	132	256
logic test clip	134	263
multimeter, 4-1/2 digit	132	68
noise generator	132	254

Category	Page	IRN	Category	Page	IRN
oscillators, crystal	173	110	conformal coating	158	333
oscilloscope	62	36	connectors	41	35
oscilloscope	134	259	connectors	181	118
oscilloscope	160	93	connectors, PC board	51	28
pattern analyzer	131	251	cutter, hand tool	158	334
phasemeter	131	252	enclosures	15	13
pulse generator	171	106	flat cable connector system	14	12
rms converter	133	257	gaskets, EMI/RFI	162	152
recorders	134	262	glue gun	160	337
scope	133	258	gold, hard-fired	171	105
scope	134	264	heat pipes	129	66
signal generator	119	61	heater, flexible	160	336
voltmeter	134	261	industrial cases	160	338
wave analyzer	139	73	ink, fluorescent	158	330
word recognizer	63	37	lamine	113	57
Integrated Circuits			metallic mesh, mazes and matrices	70	40
CMOS switch	142	279	oven temp control	158	329
COS/MOS	IV	247	panels, wrapped-wire	158	332
encoder, CMOS	142	276	pin and socket connectors	85	49
function generator	142	278	resins, epoxy	162	153
register, quad	142	277	semi molding compound	19	16
semiconductor	137	72	shield, CRT	161	340
TV control kit	142	275	sockets	97	52
Microwaves & Lasers			thick-film systems	13	10
amplifier	138	266	Power Sources		
amplifier	140	272	battery	169	369
amplifier, hybrid	136	250	modular supply	168	365
amplifier, MIC	138	267	modules	169	368
antennas	140	273	op-amp supply	168	364
filter	140	274	open-frame modules	168	366
Gunn oscillator	138	265	power supplies	117	60
laser	138	269	power supplies	161	95
oscillator, Gunn	138	268	power supplies	165	98
sources, power	140	271	power supplies	172	108
switch/selector, antenna	138	270	power supply	6	5
Modules & Subassemblies			power supply	9	7
amplifier, buffer	156	323	power supply	17	15
amplifier, power	152	301	SCR supply	169	370
amplifier, servo	156	324	switching supplies	168	367
annunciator, modular	156	325	new literature		
controller, amplitude	154	310	adjustable speed drives	175	410
controller, temperature	156	326	bulk core storage system	175	409
controllers, power	154	308	components	174	399
converter, a/d	152	302	computer systems	175	408
converter, a/d	155	322	custom ICs	172	387
converter, v/f or f/v	III	246	data logger	174	404
converter, rms	154	309	digitizing service	173	393
converters, multiplying	154	307	electroconductive resins	172	391
DAC, 10-bit	57	31	electromechanical units	174	400
DAC, 12-bit	156	87	electronic components	172	386
drive, motor	157	328	eyelets	172	390
filter, high-Q tunable	95	51	French products	173	395
filters	13	11	heat-shrinkable tubing	173	396
filters, EMI/RFI	47	26	high-band porta phones	174	403
filters, ceramic r-f	181	121	magnetic semi-conductors	174	402
filters, monolithic	164	97	oscillators	174	406
junction, reference	155	321	over/undervoltage devices	174	398
monitor, voltage	153	306	rf power sources	174	401
sensor, frequency	155	320	panel meters	175	411
sensor, voltage	157	327	ribbon connectors	175	412
switches, optical	153	305	seminars	174	407
thermometer, digital	152	304	silicon rectifiers	172	389
translator, angle	152	303	switching power supplies	172	392
Packaging & Materials			temperature controllers	173	394
backplanes	159	89	thick-film composition	173	397
blower	158	331	voltage regulators	175	413
boxes and covers	101	55	wiring components	172	388
bus	171	104			
cable connector system	135	70			
cards, DIP	161	339			
cases	181	119			
circuit boards, g-p	154	85			
compounds	162	151			

MOVE IT?



NEW "V-PAC"* POWER SOURCES for PORTABLE & AUTOMOTIVE ELECTRONICS

Use your 12v DC source to operate most IC types, including MOS, linear and TTL's. Get isolation, with single or dual voltage sources, positive and/or negative polarities.

Select from sources which provide DC voltages from -6 to +15, at one watt. You can use "V-PAC" sources on the same PC card as ICs, use standard 24 pin 1C plug or solder mount. Use less than .3 cubic inch volume per unit.

Call or write now for full technical specifications. Ask for the "V-12" data.



Reliability, Inc.

5325 Glenmont
Houston, Texas 77036
713-666-3261

TWX: 910-881-1739

*Trademark, Reliability, Inc.

**Your application really
deserves a super-reliable
mini motor, but the
cost enrages the boss.
Now what do you do?**

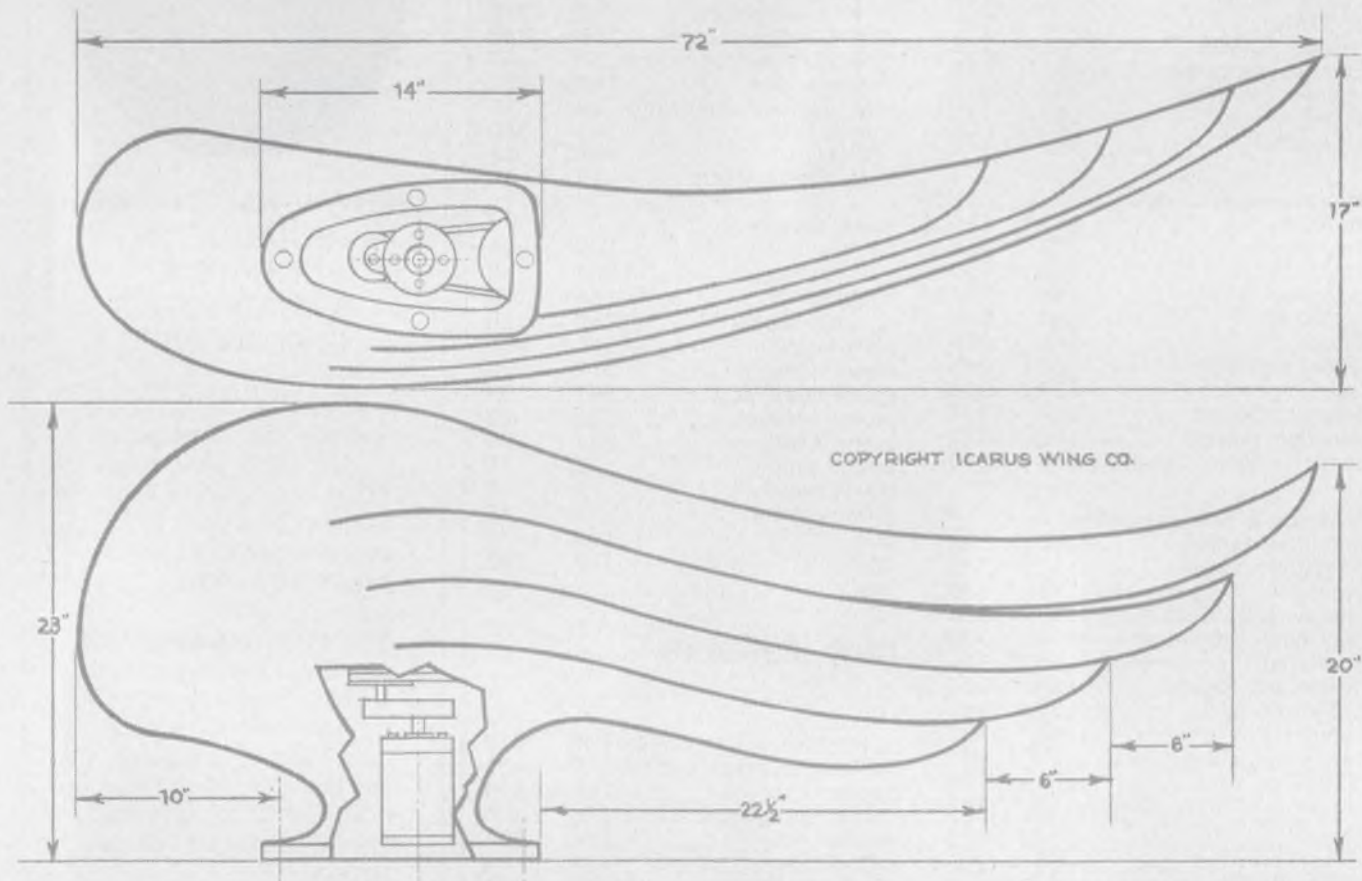

Good time to call TRW/Globe. When your product can't afford to fail (like this design for the Icarus Wing Co.), we can supply precision miniature motors that will protect you and calm the boss.

We learned about reliability the hard way, designing motors for military, aerospace, and nuclear applications.

Many commercial and industrial applications benefit from that "military" experience. They gain de-

pendable performance, superior output per cubic inch, multiple functions in small "motion packages," and minimum interfacing, assembly, and inventory costs.

To learn more about protecting your product from failure, **write for our free booklet: "Protect Yourself."** TRW/Globe Motors, an Electronic Components Division of TRW Inc., Dayton, Ohio 45404 (513-228-3171).

TRW[®] GLOBE MOTORS

INFORMATION RETRIEVAL NUMBER 124

A new winner from Datel Systems . . .

Two-for-One SALE!



Take your pick.

A voltage-to-frequency or frequency-to-voltage converter.
We've put them both together in one little module.

Our VFV-10K has a highly linear (50ppm max.) pulse train output (10kHz full scale) and is ideal for analog-to-pulse rate conversion or in data transmission applications. These fast-settling designs will change pulse rate within one cycle of the new frequency and will drive up to 1000pF of capacitive load or 12 TTL loads.

A 100kHz full scale version (VFV-100K) offers greater resolution in the same 2" x 2" x .375" modular package as its 10kHz brother.

PROGRAMMABLE I/O

Both the VFV-10K and VFV-100K include a built-in inverter stage so that positive or negative, current or voltage inputs may be used. The digital section provides DTL/TTL or CMOS compatible short-circuit-proof positive or negative pulses.

Use the VFV-10K or -100K for a multitude of signal applications such as those suggested below. At only \$59.00 and \$79.00 each, they're a bargain.

Applications

Use a VFV for:

1. Remote isolated analog V/F data transmitter using optoisolators.
2. Linearize a sine wave VCO using an F/V in the feedback loop.
3. Accurate low drift super long term integration using a V/F and a 5 or 6 decade counter. (The total area under the curve is proportional to the total accumulated counts. Wideband noise following integration).
4. Single, scalable frequency meter or tachometer using a F/V and a DPM.
5. Simple analog addition or subtraction for frequency difference or frequency sum.
6. V/F-type analog-to-digital converter and readout. Use a V/F and Datel's DM-3000 universal counter/display/DPM in its clocked-counter configuration.
7. Specified linearity all the way down to zero for wide dynamic range applications.

QUICK SPECS

Input Ranges

0 to +10V, -10V, +1mA or -1mA min.

Nonlinearity

±.005% max. (VFV-10K)
±.05% max. (VFV-100K)

Output Pulse

75 usec. wide (VFV-10K)
7.5 usec. wide (VFV-100K)
DTL/TTL or CMOS selectable logic levels
12 TTL loads

Settling Time to .01%

Within one cycle of new frequency

F/V Operation

500 usec. filter time constant (VFV-10K)

50 usec. filter time constant (VFV-100K)

Stability

Gain

20ppm/°C Max. (VFV-10K)

200ppm/°C (VFV-100K)

Zero

10uV/°C max. (both models)

Power

±15V at 25mA

Mechanical and Pinning

2" x 2" x .375" DIP spaced

Send today for
your FREE 72 page
Engineering
Product Handbook



1020 Turnpike Street, Canton, Mass. 02021
• TEL (617) 828-8000 • TELEX 924461
• TWX 710-348-0135

WESTERN REGIONAL OFFICE: SANTA ANA, CALIF.
714-835-2751

INTERNATIONAL SUBSIDIARIES

W. Germany Datelek Systems, GmbH, 8 Muenchen 71

Becker-Gundahlsr. 1

TEL. 089/784045, Telex 5212855

France Datel Systems SARL

11 Rue Ferdinand Buisson, 75016 Paris, Fr.

Tel: 603-06-74/603-05-31

United Kingdom Datel (UK) Ltd., Sealine House,

Priestley Road, Basingstoke, Hampshire RG-24 9NT

Tel: Basingstoke (0256) 66721



**The digital pocket stockbroker.
If you want to design one tomorrow,
we're ready with your CMOS devices today.**

Portability is just one of the benefits CMOS can contribute to your design.

You know the others. CMOS has opened whole new worlds to the imagination, with its high noise immunity, low power consumption, and tolerance of varying supply voltages.

And you know who made it all possible. RCA. We created the technology, developed the manufacturing expertise, and introduced

the COS/MOS CD4000 series, accepted as the industry standard. A series that is growing monthly.

That's why the logical decision for CMOS is RCA. We're also a leading producer of linear IC's. As well as a commodity supplier of power transistors; developers of liquid crystal displays; technology innovators of RF power devices; and a major supplier of thyristors.

In addition to comprehensive technical product data, RCA gives

you professional and experienced field engineering and applications support. As well as a commitment to excellence in everything from research to manufacturing.

So whatever you're into, and whatever you need, check with us first. Chances are one or more of our products anticipate your needs. A good place to start is to check our handy product line guide. Write RCA Solid State, Section 57H16, Box 3200, Somerville, N. J. 08876.

RCA Solid State