

# Electronic Design 19

VOL. 21 NO.

FOR ENGINEERS AND ENGINEERING MANAGERS

SEPT. 13, 1973

The first 4-kbit programmable ROMs are here. They double the memory size of any existing device. The access time is a fast 70 ns maximum and the

power dissipation only 97  $\mu$ W per bit. The bipolar devices offer on-chip address decoding and open-collector outputs that permit memory expansion. See P. 99.



latest at  
WESCON

# Technology Marketing Inc. asked us to prove our network capability.

## Now it's your turn.

Respected computer systems developers like Technology Marketing Incorporated are making good use of Dale's thick film network capabilities. The network above is used to set threshold voltage and provide termination for two sense windings in a P.C. layout compatible with 7500 Series memory sense amplifiers. It has been used effectively in high volume production memory and computer systems developed by Technology Marketing Inc.

Standard or Special, Dale can provide the resistance function you need...in the quantities and at the price you require. Make us prove it.

### Models immediately available for these and many other standard functions:

- MOS/ROM pull-up/pull-down
- Open collector pull-up
- "Wired OR" pull-up
- Power driver pull-up
- High speed parallel pull-up
- TTL unused gate pull-up
- TTL input pull-down
- Digital pulse squaring
- Line termination
- Long line impedance balancing
- LED current limiting
- ECL output pull-down resistors
- TTL input

**Power Rating:** 1/8 watt max./resistor; 2 watts/package (single in-line); 1-1/2 watts/package (DIP).

**Resistance Range:** 10 ohms to 1 Meg., depending on tolerance.

**Tolerance:** 1%, 2%, 5%, 10%, 20%.

**T.C.:**  $\pm 200$  ppm/ $^{\circ}$  C.

**Packaging:** Flame retardant epoxy coating or sandwich-type ceramic construction.

Double width and discrete networks also available in standard or special designs.

*For complete information, call your Dale representative or phone 402-371-0080.*



DALE ELECTRONICS, INC., 1300 28th Avenue, Columbus, Nebraska 68601  
A subsidiary of The Lionel Corporation • In Canada: Dale Electronics Canada Ltd.

INFORMATION RETRIEVAL NUMBER 242

# mighty mods...



## Now . . . High Efficiency, Switching Regulated Power Supplies

The new Switching Regulated Series is the most recent addition to the expanding line of Hewlett-Packard Modular Power Supplies. The MIGHTY MODS started with the 62000 Series — a complete line of modular power supplies with coverage from 3 to 48 volts, up to 192 watts.

The new Switching Regulated Supplies, Series 62600, feature advanced transistor switching design with up to 80% efficiency. You get more power in a smaller, cooler operating package . . . with 4 to 28 volts, up to 300 watts, 0.2% combined line and load regulation, 20mV rms/30mV p-p ripple and noise. And, HP thinks ahead to give you all the protection you need: overvoltage, overcurrent, over-temperature, reverse voltage and protected remote sensing. What it all adds up to is: selection, performance, reliability plus competitive pricing (with quantity and OEM discounts). Whether it's a modular, laboratory, or digitally programmable power supply — be confident when you specify . . . specify HP.

For detailed information, contact your local HP field engineer. Or write: Hewlett-Packard, Palo Alto, California 94304. In Europe, Post Office Box 85, Meyrin-Geneva, Switzerland.

HEWLETT  PACKARD

21303

# The smallest 5 amp general purpose relay

**MINI-T AND THE MINTED DOLLAR...  
SMALL IN SIZE BUT SOLID IN VALUE**



Teledyne's new, heavy-duty 120 volt 5 amp relay is in stock at your local distributor. The space-saving (.4 cu. in.) 2PDT Mini-T is furnished with sockets and hold down clips for P.C. board or chassis mounting. This Teledyne relay employs an unusual shaded pole design that permits direct AC operation without the need for rectifying diodes. Available with either AC or DC coils and demonstrating cost effectiveness that's hard to beat, the United States-manufactured Mini-T is truly worth its one-half ounce weight in silver. The Mini-T . . . another finely-crafted relay from Teledyne. Call our nearest distributor today.

 **TELEDYNE RELAYS**

3155 West El Segundo Boulevard Hawthorne, California 90250  
Telephone (213) 679-2205

INFORMATION RETRIEVAL NUMBER 3

---

## NEWS

- 23 **News Scope**
- 26 **Solid-state relays** are beginning to replace their electromechanical counterparts in many applications.
- 32 **System designers feel impact of semiconductor memories.**
- 34 **Display makers debate pros and cons of 4 leading types.**
- 36 **The point of sale market rings up dramatic growth.**
- 39 **'Ladar' concept proves feasible, with some advantages over radar.**
- 51 **Washington Report**

---

## TECHNOLOGY

- 60 **How to build a microcomputer:** Take an 8-bit parallel processor, add external circuitry, provide the right software and watch the timing relationships.
- 68 **BCD logic—Part 7.** BCD trig and hyperbolic functions: They're different geometrically, but related analytically. Similar circuits generate each type.
- 76 **Cut component count** and improve reliability with controlled-avalanche rectifiers. In high-transient circuits they also protect other components.
- 80 **Analyzing the dynamic accuracy** of simultaneous sample-and-hold circuits is straightforward. A wideband scope and a simple mathematical model supply the answers.
- 86 **Getting the best inside information,** says this corporate manager, depends on how well your people can filter job problems and company data.
- 90 **Ideas for Design:** Phase-locked loop helps generate waveforms with variable duty cycle or phase shift . . . Resistive bridge and op amp form a multiplying DAC . . . Nondifferential phase inverter offers balanced-output Z with 2 transistors.
- 96 **International Technology**

---

## PRODUCTS

- 99 **ICs & Semiconductors:** Largest programmable ROM stores 4096 bits and has 70-ns max access time.
- 100 **ICs & Semiconductors:** Chopper-stabilized op amp IC reduces drift to 0.2  $\mu\text{V}/^\circ\text{C}$ .
- 104 **Microwave & Lasers:** Varactor-tuned oscillators cut size, weight to new lows.
- 114 **Packaging & Materials:** Ferrite-bead specs permit precise attenuation matching.
- 110 **Modules & Subassemblies**
- 120 **Components**
- 124 **Data Processing**
- 131 **Power Sources**
- 138 **Instrumentation**

---

## Departments

- 57 **Editorial:** Open the doors to the press
- 7 **Across the Desk**
- 142 **Design Aids**
- 143 **Application Notes**
- 144 **New Literature**
- 148 **Advertisers' Index**
- 150 **Product Index**
- 152 **Information Retrieval Card**

**Cover:** Designed and photographed by ED art director Bill Kelly; pROM packages supplied by Monolithic Memories Inc., Sunnyvale, Calif.



# We make components for guys who can't stand failures.

You can't court martial a resistor or capacitor for refusing to carry out orders. But at Corning we make our resistors and capacitors for guys who are demanding enough to wish that they could.

Corning makes components that give you an extra measure of performance. Components that let you make sure your system delivers all you designed into it. Because, like you and the guys who use your equipment, we can't stand failures either.

#### Some examples:

We build extra reliability into all our components. Components like our metal film resistors—both standard and flame proofs. Components like our glass, ceramic and glass/ceramic capacitors. Like our solid tantalum capacitors—hermetic and non-hermetic, polar and non-polar, miniature and microminiature. And like our discrete component networks—available with custom combinations of discrete microminiature resistors, capacitor chips and diodes in a dual in-line package.

#### Consider our glass capacitors:

Take our high reliability glass capacitors, for example. Their fused

monolithic construction offers outstanding stability, dependability and electrical performance and is virtually immune to environmental stresses. That's why they have been designed into so many major aerospace and missile projects. And why industry has designed them into the most important EDP and instrument applications.

#### And our ceramic capacitors:

Take our miniature multilayer ceramic capacitors, which are QPL to MIL-C-11015 and MIL-C-39014. The dielectric provides high volumetric efficiency and superior reliability. The monolithic units are molded into rugged flame proof cases and are ideally suited for automatic insertion.

Or take our exclusive miniature multilayer ceramic Glass-K™ capacitors, which also meet or exceed all requirements of MIL-C-11015. The special Glass-K dielectric—fused into a compact monolithic structure and sized for automatic insertion—produces high volumetric efficiency and reliable performance. Available in three different stability characteristics, these capacitors are suitable for both military and com-

mercial applications in miniature circuitry.

Our CGC miniature multilayer ceramic capacitors provide increased volumetric efficiency and an extended range of capacitance values. This series is available in four automatically insertable case sizes.

#### We'd like to tell you more:

For all the details on all of Corning's extra reliable components, write for our new "General Design Guide" to: Corning Glass Works, Electronic Products Division, Corning, New York 14830.

And for information on availabilities, call your local authorized Corning distributor or D.I.A.L. EEM: (800) 645-9200, toll-free. Or in New York state, call collect: (516) 294-0990.

**CORNING**  
ELECTRONICS

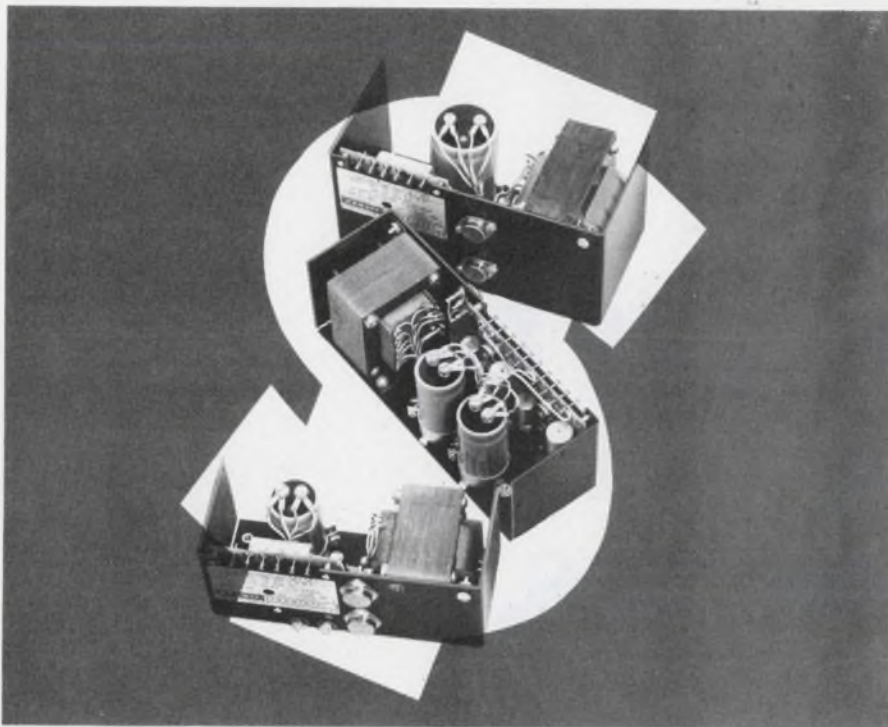

# Start Getting Your Money\$worth Out of Power Modules

Now, you can really start getting your moneysworth out of power modules with Abbott's new LOW COST series. Designed to give you 100,000 hours of trouble-free operation (that's 11½ years), these reliable units meet the needs of OEM engineers. Their purchase price is about \$7 per year of service. The model LC series feature:

- 47-420 Hz Input Frequency
- 0.1% Regulation
- +50°C. Ambient Operation
- Single and Dual Outputs
- 1 Day Stock Delivery

These units provide more quality per dollar compared to similar items on the market. See table below for prices on some of our LC models. Many other LC models are listed in our catalog.

If analyzing the many similar power supplies on the market is confusing; if you are concerned about the long-term reliability of those units, then decide on an Abbott power supply for your system. Your best buy in OEM power modules is ABBOTT.

Abbott also manufactures 3,000 other models of power supplies with output voltages from 5 to 740 VDC and with output currents from 2 milliamps to 20 amps. They are all listed with prices in the new Abbott Catalog with various inputs:

- 60 to DC
- 400 to DC
- 28 VDC to DC
- 28 VDC to 400
- 12-24 VDC to 60

5V @ 6 Amps	5V @ 10 Amps	12V @ 10 Amps	15V @ 4 Amps	28V @ 1 Amp	±12V @ 1.2 Amps	±15V @ 4 Amps
LC5T6	LC5T10	LC12T10	LC15T4	LC28T1	LLC12T1.2	LLC15T4
\$72	\$81	\$99	\$81	\$72	\$99	\$135

Please see pages 686 to 699 of your 1972-73 EEM (ELECTRONIC ENGINEERS MASTER Catalog) for complete information on Abbott modules.

Send for our new 56 page FREE catalog.

**abbott transistor**

LABORATORIES, INCORPORATED

general offices

eastern office

5200 W. Jefferson Blvd./Los Angeles 90016  
(213) 936-8185

Telex: 69-1398

1224 Anderson Ave./Fort Lee, N.J. 07024  
(201) 224-6900

Telex: 13-5332

INFORMATION RETRIEVAL NUMBER 5

## Vice President, Publisher

Peter Coley

## Editors

Editorial Offices

50 Essex St.

Rochelle Park, N.J. 07662

(201) 843-0550

TWX: 710-990 5071

Cable: Haydenpubs Rochellepark

Editor-in-Chief: George Rostky

Managing Editors:

Ralph Dobriner

Michael Elphick

Associate Editors:

Dave Bursky

Jules H. Gilder

Morris Grossman

Seymour T. Levine

John F. Mason

Stanley Runyon

Edward A. Torrero

Richard L. Turmail

Contributing Editors:

Peter N. Budzilovich

Steven A. Erenburg

## Editorial Field Offices

East

Jim McDermott, Eastern Editor

P.O. Box 272

Easthampton, Mass. 01027

(413) 527-3632

West

David N. Kaye, Senior Western Editor

2930 West Imperial Highway

Inglewood, Calif. 90303

(213) 757-0183

Northe K. Osbrink, Western Editor

112 Coloma St.

Santa Cruz, Calif. 95060

(408) 426-3211

Washington

Heather M. David, Bureau Chief

2506 Eye St., N.W.

Washington, D.C. 20037

(202) 338-3470

## Editorial Production

Marjorie A. Duffy

## Art

Art Director, William Kelly

Richard Luce

Anthony J. Fischetto

## Production

Manager, Dollie S. Vloblig

Helen De Polo

Anne Molfetas

Christopher G. Hill

## Circulation

Manager, Nancy L. Morrilt

Ron Deramo

## Information Retrieval

Peggy Long

## Promotion

Manager, Jeffrey A. Welner

Karen Kerrigan



## Psychological economics to solve fiscal problems

George Rostky's editorial, "Let's not talk our way into a recession," prompts this letter.

Being a schooled economist, and still maintaining a high interest in the subject, I have been searching for the solution of the problem of why some of the economic policies that we have tried in this country never seem to work out as planned.

After studying Adam Smith, Malthus, Keynes, Galbraith and Freeman, I found that none of these alone, or in combinations thereof, seem to solve the problems of society.

I have been whirling around in my head that a *psychological theory* of economics is the answer, rather than a fiscal and/or monetary theory. If you believe your editorial, then we should get together and bring life to this new theory which will obviously save the world. I have already coined a few names for our theory: Fernrot, Rotfern, Fernky. Do you have any other suggestions?

The psychological theory in essence holds that it is the state-of-mind of the people in a society and their actions because of their state-of-mind that brings prosperity, recession, depression, inflation or what have you; and fiscal and monetary policies do not and cannot counteract that. (It also holds that the press and news media are the main vehicles of information that allow the people to make their judgement; and their reporting methods leave one hell of a lot to be desired. For instance they make "statements of fact" on which the

average man relies heavily to reach an action decision. The collective actions of many people acting on a combination of distorted inputs and ignorance begin to make the society move in an oscillatory fashion, and from time-to-time, make it go unstable.)

I think you have the picture. Should we discuss it further at length?

*Tom Fern*

*Vice President—Sales*

Burr-Brown Research Corp.  
International Airport Industrial Park  
Tucson, Arizona 85706

## A shortcoming found in the watergate

We have subjected your recently announced active, low-level input watergate with expandable output to extensive analysis and found that it does not function properly. It appears to have a bug in it.

*A. U. Ayres*

and

*R. F. Podlesny*

Delco Electronics  
General Motors Corp.  
6767 Hollister Ave.  
Goleta, Calif. 93017

## ... And yet an earlier version of the tri-flop

Continuing the search for ever-earlier references to the tri-flop (see "And Now . . . the Tri-Flop," ED No. 23, Nov. 9, 1972, pp. 80-81), I suggest the following:

"The 'Tri-Stable' Flip-Flop Circuit: How It Works, How To De-

*(continued on page 12)*

Electronic Design welcomes the opinions of its readers on the issues raised in the magazine's editorial columns. Address letters to Managing Editor, Electronic Design, 50 Essex St. Rochelle Park, N. J. 07662. Try to keep letters under 200 words. Letters must be signed. Names will be withheld on request.

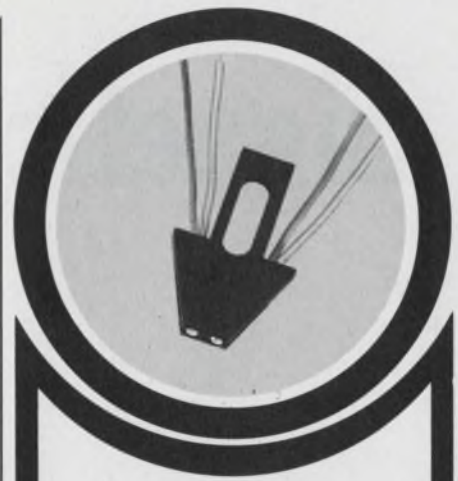

## OPTRON OPTOELECTRONIC ASSEMBLIES

LOW PRICED  
IMMEDIATE DELIVERY  
CUSTOM DESIGNS AVAILABLE

OPTRON transmissive optical switch and reflective transducer assemblies consist of infrared LED's coupled with silicon phototransistors or photodarlington. Both use discrete hermetically sealed devices for maximum reliability and sensitivity. The assemblies feature non-contact switching, TTL compatibility and fast switching speeds. Low priced standard assemblies are immediately available and custom designed versions for special applications are available on request.



**OPB 120 TRANSMISSIVE OPTICAL SWITCH** uses an infrared LED aligned across a gap with a silicon phototransistor. The

OPB 120 replaces mechanical switching elements with solid state dependability. Typical applications include rotary encoders, tachometers and motion sensors. Standard gap widths are 0.125 and 0.200 inches.



**OPB 125 OPTOELECTRONIC REFLECTIVE TRANSDUCER** consists of a gallium arsenide infrared LED coupled with a silicon phototransistor in compact low-cost molded plastic housing. It has extremely high sensitivity and is ideal for such applications as EOT/BOT sensing, line finding, and edge and flaw detection.

Detailed technical information on these and other OPTRON optoelectronic products . . . chips, components and PC board arrays . . . is available from your nearest OPTRON sales representative or the factory direct.



**OPTRON, INC.**

1201 Tappan Circle  
Carrollton, Texas 75006  
214/242-6571

# Signetics takes a back seat



## Whether you're talking designs, devices, or deliveries.

As you read this, we're shipping about 25% of all U.S. commercial orders for ECL 10k, and booking much more. And we're on contract with major computer manufacturers to design and produce new ECL 10k and CML devices for their 1975 lines. What that means to you is that Signetics is a prime for the latest, broadest, available-now line of high-technology ECL 10k.

We're talking deliverable realities — get our wall chart (see coupon) and you'll see it's dated. As of that date, everything on it is in production and available. It all adds up to many more new, Signetics-originated designs and much greater across-the-board

ECL 10k availability for you.

Case in point: the speed breakthrough to 15ns in the 10139 ECL PROM. Brand new. Unique. Obviously destined to be the heart of some of the fastest new computers and add-on memories going on the drawing boards right now. Yours, perhaps. At ECL system speeds, you now achieve non-volatile microprogramming with unprecedented ease. Delivery: from stock.

The highest gate function density around is the 10100 Quad Gate. Flexible enough to fit anyone's system. Enough designers agree, that the 10100 now has the highest usage of any quad gate —voila!

# to no one in ECL 10k.

Down have plummeted the prices, so that it's now the lowest cost unit around, too.

Delivery: from stock.

What's the fastest parity in the world? We spec 4ns on our 10170 9 + 2. Byte organized and expandable. At least a year ahead of anything else. Delivery: from stock.

And for you folks out there in add-on memory land, here are two advanced translators to keep you jiggling without Geritol while you solve add-on interface problems. The 10190 Quad Line Receiver/MST translator – a powerhouse – and the 10191 Hex ECL 10k-to-MST high-density translator with six per package. Talk directly to major CPU ECL with your ECL 10k.

Stack it all together and it reads like this. If you're going to buy ECL memory, you ought to buy from the company that specializes in ECL. If you're looking for high-technology ECL, you'll find it at the company that has gone in deliberately to develop high-technology ECL. If you want to choose from the widest line of ECL available now, then the only place to go is where that widest available line exists. Now.



That's what Signetics has become. The ECL source to go to first.

Check this partial list, for openers, and note the delivery times. Then get our chart for the full listing. And if what you want isn't on the chart, and it's a commercially feasible device – we'll build it! That's how over 80% of our Signetics-originated ECL designs got started, from customer requests.

PARTIAL LISTING OF SIGNETICS-ORIGINATED ECL 10k:

DEVICE	FUNCTION	REMARKS	DELIVERY
10139	32 x 8 PROM	Fastest PROM alive: 15 ns Only ECL PROM. Allows non-volatile microprogramming at ECL system speeds.	From Stock
10145	16 x 4 RAM	Fastest RAM alive: 9ns Scratch pad buffer memory. Ideal for register files and control stores.	From Stock
10190	Quad Line Receiver/MST Translator	Solves add-on memory interface problem. Powerful line receiver.	From Stock
10191	Hex ECL 10k-to-MST Translator	Solves add-on memory interface problem. High density	From Stock
10100	Quad Gate	Highest gate function density. Lowest price.	From Stock
10112	Clock Driver	More flexible than 10110, 10111. Optimized to drive 10133.	From Stock
10158/59	Quad 2-to-1 Multiplexers	Lower cost/function. Lower power dissipation. 10159 has powerful enable.	4-6 weeks
10171/72	Dual 1-of-4 Decoder/demultiplexer	Additional logic function. Completes demultiplexer line.	From Stock
10113	Quad ExOR	Higher density than 10107. Lower cost per gate. Powerful output enable feature.	From Stock
10170	9 + 2 Parity	Expandable. Fastest parity – 4ns. Byte organized.	From Stock

Start moving in the best circles. Get up on ECL 10k with our brand-new, dated (and frequently updated) wall chart of ECL deliverables. It's free. Clip. Write. Mail.

CLIP THIS COUPON TO YOUR LETTERHEAD FOR FAST RESPONSE.

Signetics—ECL 10k  
811 East Arques Avenue  
Sunnyvale, Calif. 94086

Hello there... I'd like a chart, please. I can't believe I read the whole ad, but I did get the point that you're coming on strong as front runner in ECL 10k.

Name \_\_\_\_\_

Title \_\_\_\_\_

The address you can get off my letterhead, which I have not forgotten to attach.

Signetics Corporation. A subsidiary of Corning Glass Works.

# decoding the codes

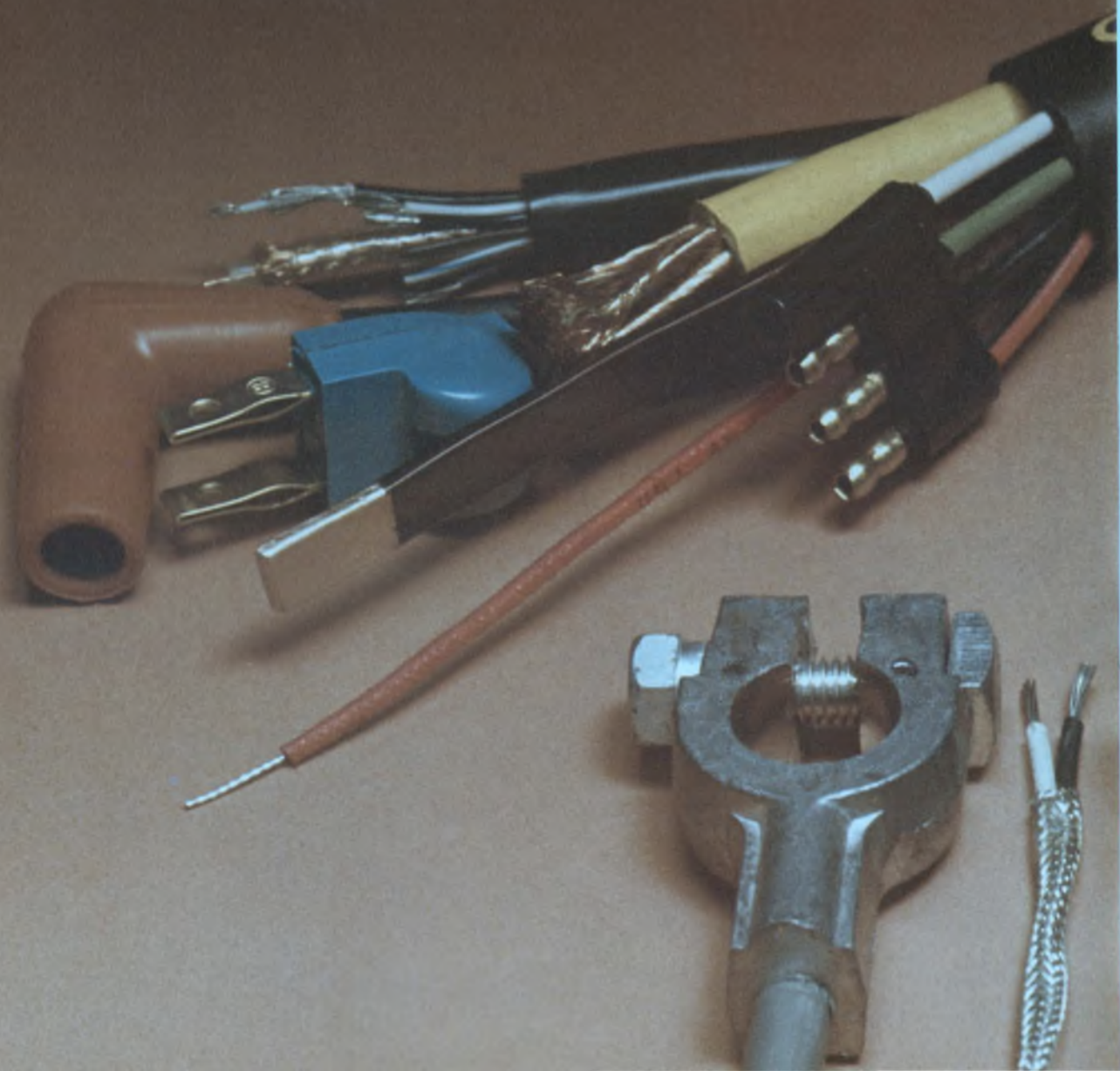

With ever-changing technology and increasing demands for innovative products, more precise safety guidelines are a must.

Belden knows the codes, standards, requirements and limits of acceptability in the wide world of industrial wire, cable and cord. As supplier of thousands of standard items for electrical, electronic and automotive needs we can readily help you select the right product for the job. Belden products meet or exceed industry code needs. And we can custom design and manufacture complex cable configurations to meet the most demanding specifications. If a code is puzzling you, or you have an application where you're not sure what the standards are, check with Belden. We cope with codes every day.

If you want answers right now, phone:  
(312) 887-1800, Transportation Division  
(312) 681-8920, Electrical Division  
(317) 966-6681, Electronic Division  
Or write Belden Corporation, 2000 South Batavia Avenue,  
Geneva, Illinois 60134.

H-3-3



INFORMATION RETRIEVAL NUMBER 234





## OTHER RESISTORS DO A SLOW BURN UNDER SPRAGUE'S TORCH TEST!

CERON® CERAMIC-INSULATED FLAME-PROOF WIREWOUND RESISTORS are a *new* development to meet the need for a *truly* non-flammable resistor in electronic equipment. Unlike some other so-called "flame-proof" resistors, which open-circuit before burning when subjected to high overloads, new and exclusive Sprague Ceron® Resistors are absolutely inert in the presence of heat or flame. They will not ignite under any degree of overload. *Actually, they will not burn even when placed directly into an open torch flame!* This is clearly indicated in the photograph above, which dramatizes the protective qualities of the flame-proof Ceron® coating as compared with that of a

conventional silicone-coated resistor.

The special coating is completely resistant to standard industrial cleaning solvents. Totally inorganic, it is also immune to attack by fungus. It provides excellent protection against thermal shock, humidity, and vibration. Dielectric strength, measured in a "V" block, is 500 volts a-c.

Series 380E (standard) and Series 400E (non-inductive) Ceron® Resistors meet moisture requirements of Specification MIL-R-26. Resistance values range from 1 to 60,000 ohms, in wattage ratings from 1 to 10 watts. Resistance tolerances as close as  $\pm 1\%$  are available. Sizes range from  $\frac{1}{8}$ " D. x  $\frac{3}{8}$ " L. for the 1-watt resistor to  $\frac{5}{16}$ " D. x  $1\frac{3}{4}$ " L. for the 10-watt unit.

For complete technical data, write for Engineering Bulletin 7250 to: Technical Literature Service, Sprague Electric Co., 347 Marshall St., North Adams, Mass. 01247.



THE BROAD-LINE PRODUCER OF ELECTRONIC PARTS

INFORMATION RETRIEVAL NUMBER 9

ACROSS THE DESK  
(continued from page 7)

sign It," by C. K. Beagle, ELECTRONIC DESIGN, Feb. 1, 1961, pp. 38-39.

In addition I have a definite recollection that my first encounter with this circuit was in late 1957 or early 1958 while I was employed at the Hughes Aircraft Communications Laboratory. One of my co-workers was sufficiently intrigued by the idea to build the circuit from published information and verify its operation. Unfortunately I do not have the specific publication reference available from my files.

J. H. McInnis Jr.  
Member, Technical Staff

Jet Propulsion Laboratory  
4800 Oak Grove Dr.  
Pasadena, Calif. 91103

## Infinite delay, at last

The father of one of the most revolutionary developments of the century—the write-only memory—has developed a new device whose implications may be even more profound. Quietly, almost shyly, Signetics introduced the Procrastitron, a startling device, smaller than a breadbox, that offers both positive and negative infinite delay, that's infinitely adjustable.

The Procrastitron, in its positive-delay mode (+P), can be used routinely by those who have been unable to delay their decisions adequately. It should thus prove valuable to every executive, as it allows one to delay any and all decisions indefinitely.

In the philosophically more stimulating negative-delay mode (−P), the device offers a mind-boggling array of possibilities, making it, perhaps, the ultimate product of our industry. For example, one can start a scope company in 1948 and name it Tektronix, or a test-equipment company in 1939 and name it Hewlett-Packard. Or one can buy IBM at 35 and Xerox at 14. Or one can marry the *other* girl. Or change one's presidential vote. The possibilities are limitless.

Unbiased observers picture a fantastically successful future—or past—for this new Signetics device.

(continued on page 16C)

INFORMATION RETRIEVAL NUMBER 10 ►

Until recently, if you wanted broadband RF power, you had to settle for bulky tube-type power amplifiers. No more. Starting at the top, we developed a full line of all-solid-state Class A power amplifiers, covering the frequency spectrum of 10 kHz to 560 MHz, with power outputs ranging from 300 milliwatts to over 1000 watts. And we're still climbing.

Driven by any signal generator, frequency synthesizer or sweeper, these compact, portable amplifiers are versatile sources of power for general laboratory work, RFI/EMI testing, signal distribution, RF transmission, laser modulation, data transmission, NMR, ENDOR, ultrasonics and more.

Completely broadband and un-

tuned, our highly linear units will amplify inputs of AM, FM, SSB, TV and pulse modulations with minimum distortion. Although all power amplifiers deliver their rated power output to a matched load, only ENI power amplifiers will deliver their rated power to any load regardless of match.

We also designed our amplifiers to be unconditionally stable and failsafe—you need never fear damage or oscillation due to severe load conditions (including open or short circuit loads).

ENI instrumentation amplifiers come complete with an integral AC power supply and an RF out-

put meter. Ruggedized amplifiers capable of operating under severe environmental conditions are available.

To find out more about our RF power amplifiers write: ENI, 3000 Winton Road South, Rochester, New York 14623. Call 716-473-6900. TELEX 97-8283 ENI ROC.

**RF Amplifiers.  
We started at the top.  
Then worked our  
way up.**



**ENI**

The world's leader in solid-state power amplifiers.

**Reliability is a single-sided frame,  
a ball and a cricket room.**

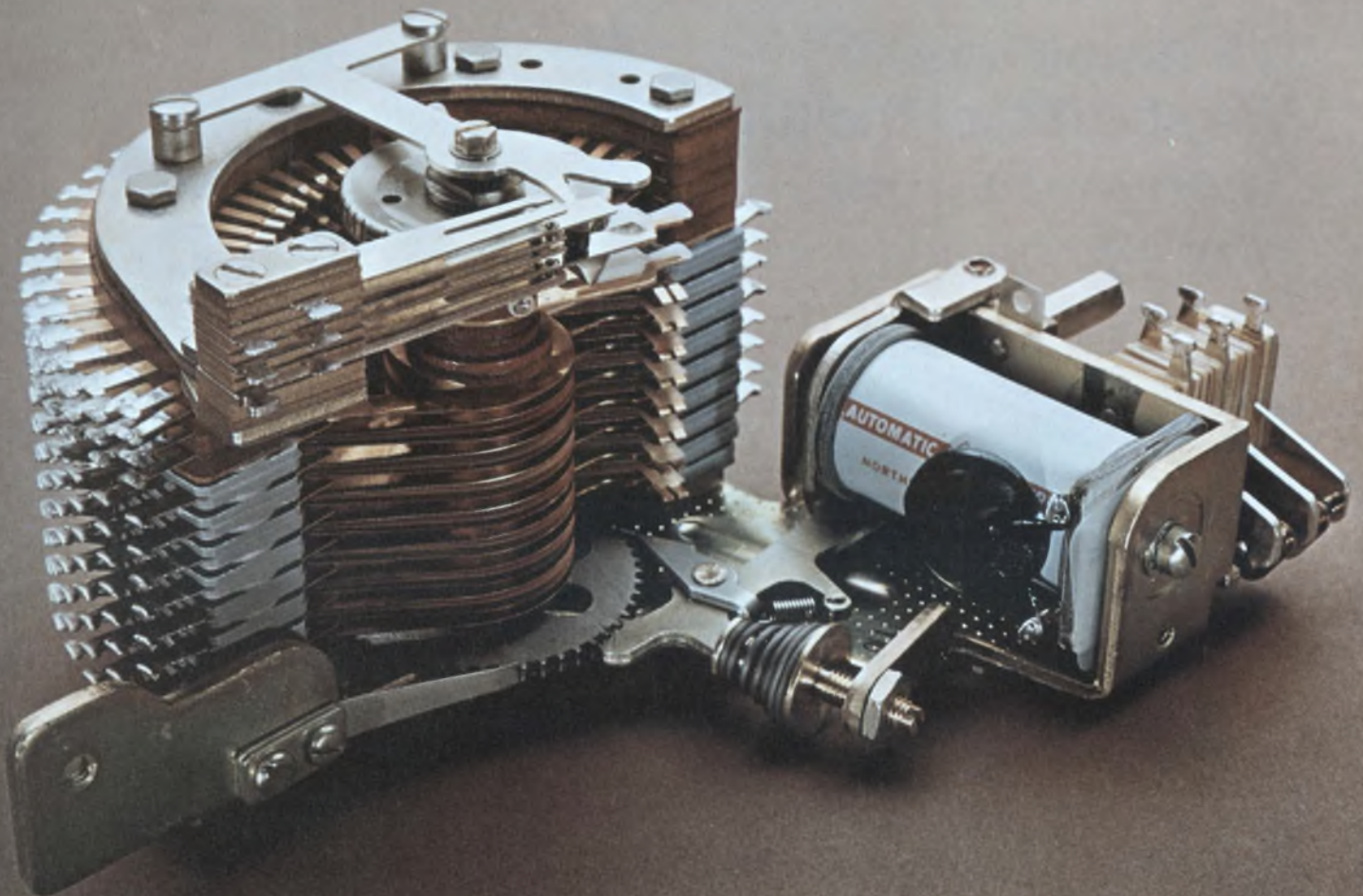



Our Type 45 rotary stepping switch is made to be forgotten. We build them to work hard, fast and long without constant fiddling or adjusting. They've got to be able to work in heat or cold, take bumps and grinds and still click-click along with close-spaced consecutive operations.

**We start out really flat** To keep everything on the level we start our assembly with an open-type, one-piece frame. Thick and really flat. Some manufacturers use two thinner frames. But we found that starting with a single thick frame eliminates problems of matching the switch parts. Everything stays in line. And a single-sided frame takes a lot less room—the switch is only as wide as need be.

**A lube job that lasts a lifetime** The entire wiper assembly rotates on a large-diameter stainless steel shaft around a full-length hub bearing. We lubricate this bearing and seal it during assembly. So throw away the oil can.

**Then we supply a pinch that's just right** Each pair of wipers is tension-adjusted during assembly. As they click around the bank levels on a flat plane, we want each pair to pinch the contact just the right amount. Too hard a pinch and the contacts will wear out quickly. Too soft a pinch will cause a poor connection. We teach our wipers to pinch just right.

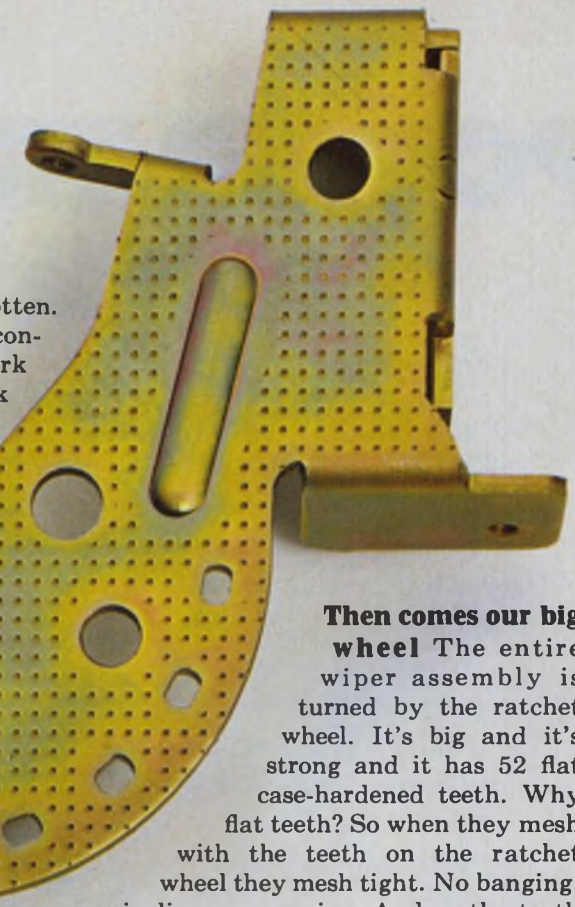
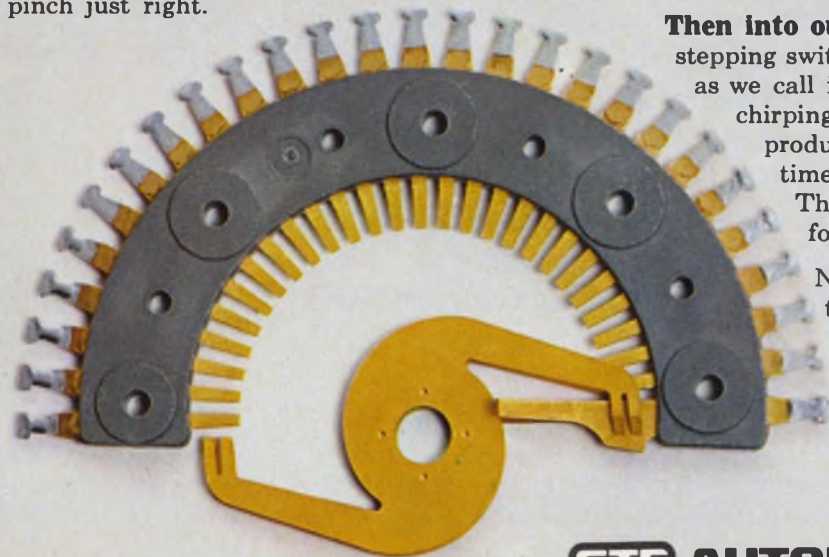

**Then comes our big wheel** The entire wiper assembly is turned by the ratchet wheel. It's big and it's strong and it has 52 flat case-hardened teeth. Why flat teeth? So when they mesh with the teeth on the ratchet wheel they mesh tight. No banging, wiggling, or scraping. And as the teeth wear, they just mesh deeper in the grooves.

**Ball bearing anchor for good measure** The armature assembly has to be securely fastened to keep it from wobbling up and down, or everything goes out of whack. So we choose a big stainless steel pin and secure it with wide bearings to the armature yoke. To make sure this pin never slips out of the yoke, we drill a hole in both ends. Then we force a steel ball bearing into these holes. This expands the walls of the pin into and against the walls of the armature and the whole assembly is anchored for life. We're the only ones that do it this way. So we're the only ones that offer a lifetime fit.

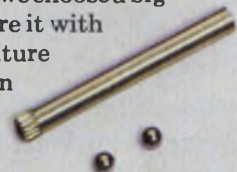

**Then into our cricket room** Every single AE stepping switch goes to the run-in test room. Or, as we call it, the cricket room, because of the chirping noise all the switches we're testing produce. Here, every switch is tested 50 times a second for 45,000 operations. Then, and only then, are they ready for delivery to our customers.

Now that we've explained all the little things we do to make our Type 45 reliable, put it through your own tests. GTE Automatic Electric, Industrial Sales Division, Northlake, Illinois 60164.

**GTE AUTOMATIC ELECTRIC**

# POWER TRANSISTORS. NO WAITING.

If you've tried to buy medium power plastic packages lately you probably know that they can be scarcer than hen's teeth. They're backlogged on delivery, and you practically have to have friends in high places to get some.

So you'll be happy to learn that National is now in the medium power transistor business.

We call ours Durawatt™

Like other power plastic packages the main use is as a replacement for TO5 sockets, because it is more economical and has better free air power dissipation.

But Durawatt has a couple of advantages over the others.

One is that you can *get* it. Ours in the hand is worth two of theirs in the bush. Quantity devices are now in distributor hands, and we can deliver additional orders in 4-6 weeks.

And another is that Durawatt has National's usual Epoxy B as the encapsulating material. Which eliminates thermal intermittent opens, and means fewer field failures.

Durawatt is compatible with General Electric's D-40 and Motorola's Uniwatt. It has a free air power dissipation of 1¾ watts-2 watts, and heat sunk rating of 7-15 watts depending on die size.

Other National power transistors are in the works. Such as the TO220 package with complementary Darlingtons.

So if you're tired of waiting in line, see your National distributor about Durawatt. Or write for details: National Semiconductor Corporation, 2900 Semiconductor Drive, Santa Clara, California 95051.

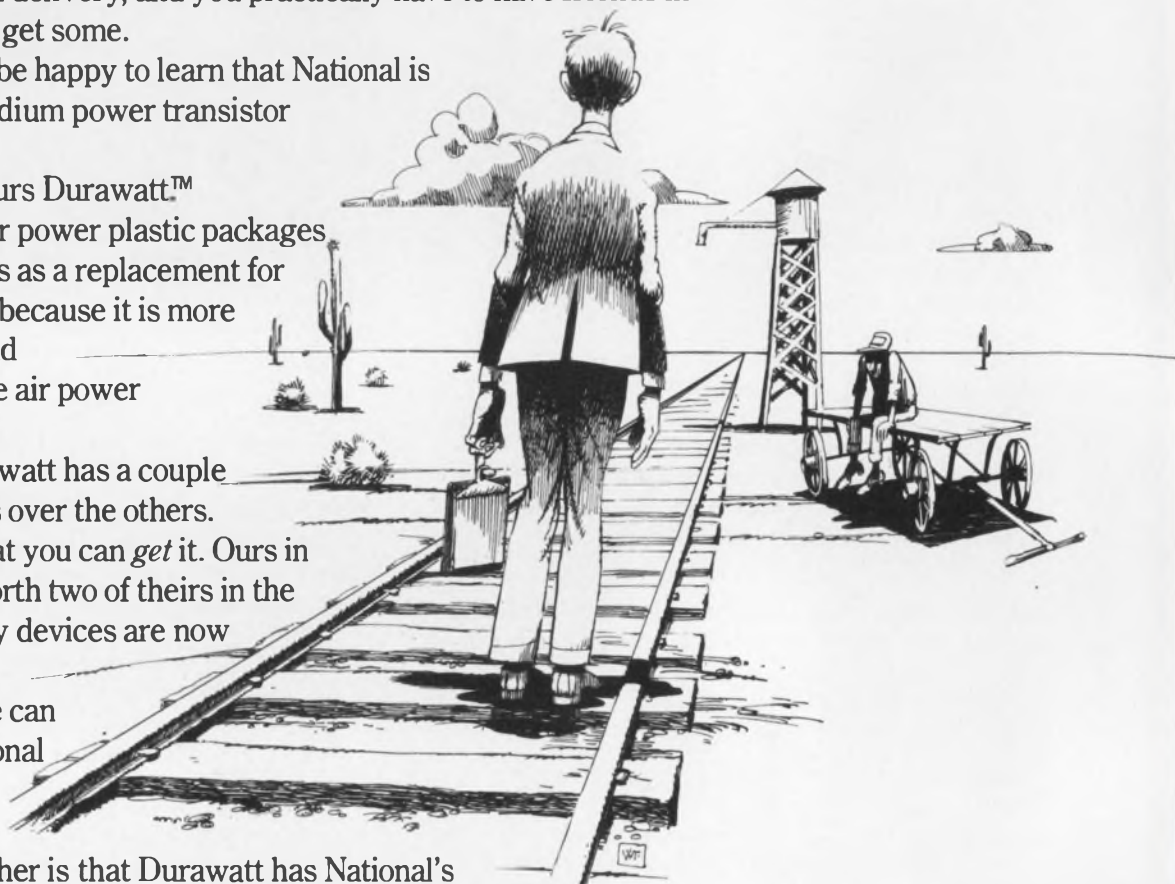

## National

Scottsdale, Ariz. (602) 945-8473 • Mountain View, Calif. (415) 961-4740 • Sherman Oaks, Calif. (213) 783-8272 • Miami, Fl. (305) 466-8309  
Chicago, Ill. (312) 693-2660 • Glen Burnie, Md. (301) 760-5220 • Burlington, Mass. (617) 273-1350 • Englewood Cliffs, N.J. (201) 871-4410  
Syracuse, N.Y. (315) 455-5858 • Dayton, Ohio (513) 434-0097 • Dallas, Texas (214) 233-6801

# Finally:

**A monolithic chopper-stabilized op amp.  
An offset voltage drift of  $0.2\mu\text{V}/^\circ\text{C}$ .  
An offset current drift of  $1\text{pA}/^\circ\text{C}$ .**

This new device is a true breakthrough—the industry's first monolithic chopper-stabilized op amp. And, in addition to its single-chip advantages, it offers the precision advantages of almost unbelievably low offset current and voltage drifts. And that's only the

beginning. The device incorporates a fully differential input, an initial offset voltage of less than  $50\mu\text{V}$ , an offset current of  $0.05\text{ nA}$ , and an open loop gain of  $5 \times 10^8$ . The gain bandwidth product is  $3\text{ MHz}$  and the slew rate is  $2.5\text{ V}/\mu\text{S}$ , while the CMRR and PSRR are both

$160\text{db}$ . Together, these features permit design applications in precision linear systems not feasible before with conventional monolithic amplifiers and hybrids.

This new device represents a major landmark in the development of Harris' expanding family of highly diversified monolithic linears. Its innovative design is the result of combining a number of advanced technologies into a standardized process, which permits volume production of a superior quality product. For more details see your Harris distributor or representative.

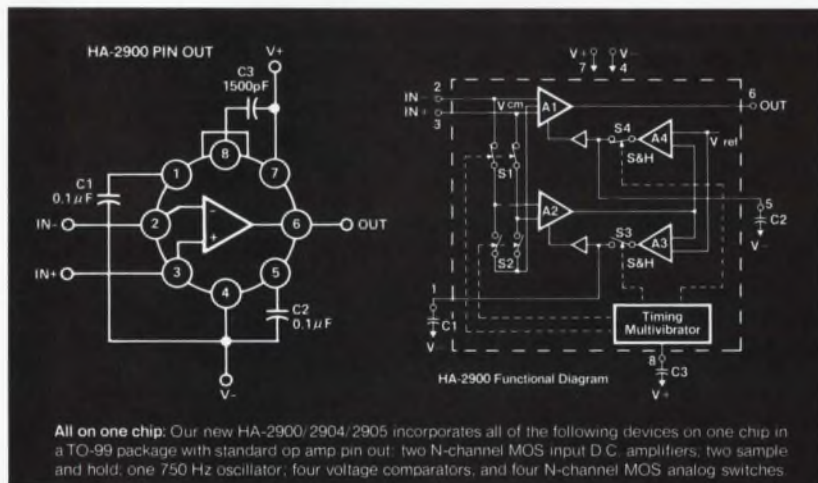

Supplied: TO-99 can with standard pin-out

	100-999 units
HA-2900 -55°C to +125°C	\$88.00
HA-2904 -25°C to +85°C	\$71.50
HA-2905 0°C to +75°C	\$55.00

# Harris



**HARRIS**  
**SEMICONDUCTOR**  
A DIVISION OF HARRIS-INTERTYPE CORPORATION

P.O. Box 883, Melbourne, Florida 32901  
(305) 727-5430

**WHERE TO BUY THEM:** ARIZONA: Phoenix—Liberty Weatherford; Scottsdale—HAR (602) 946-3556 CALIFORNIA: Anaheim—Weatherford; El Segundo—Liberty; Glendale—Weatherford; Long Beach—HAR (213) 426-7687; Mountain View—Elmar; Palo Alto—Weatherford; HAR (415) 964-6443; Pomona—Weatherford; San Diego—Weatherford; Western COLORADO: Denver—Elmar; Weatherford WASHINGTON, D.C.: HAR (202) 337-3170 FLORIDA: Hollywood—Schweber; Melbourne—HAR (305) 727-5430 GEORGIA: Atlanta—Schweber; ILLINOIS: Chicago—Schweber; Schaumburg—HAR (312) 894-8824 MARYLAND: Rockville—Schweber MASSACHUSETTS: Lexington—R&D; Waltham—Schweber; Wellestey—HAR (617) 237-5430 NEW MEXICO: Albuquerque—Weatherford NEW YORK: Melville—HAR (516) 249-4500; Syracuse—HAR (315) 463-3373; Rochester—Schweber; Westbury—Schweber OHIO: Beachwood—Schweber; Dayton—HAR (513) 226-0636 PENNSYLVANIA: Wayne—HAR (215) 687-6680 TEXAS: Dallas—Weatherford; HAR (214) 231-9031; Houston—Weatherford WASHINGTON: Seattle—Liberty; Weatherford.

**LEGEND FOR HARRIS SALES OFFICES & DISTRIBUTORS:** Harris Semiconductor (HAR); Elmar Electronics (Elmar); Harvey/R&D Electronics (R&D); Liberty Electronics (Liberty); Schweber Electronics (Schweber); R. V. Weatherford Co. (Weatherford); Western Radio (Western).

INFORMATION RETRIEVAL NUMBER 131

# SURPRISE!



## New common cathode display just \$2.70\*.

Now, the great-looking HP display is available in either common cathode and common anode configuration. Both at the new low price of just \$2.70\* in 1K quantities. Both have the same wide viewing angle and large 0.3 inch character and uniform segment illumination that assures excellent readability.

Specify either the 5082-7730 series (common anode) or -7740 (common cathode) for any commercial application. Reduce your display system costs by choosing the display that complements your drive electronics.

And get traditional HP quality.

Contact your HP distributor for immediate delivery. Or, write us for more details.

These displays are worth a closer look.

HEWLETT  PACKARD

Sales, service and support in 172 centers in 65 countries.  
Palo Alto, California 94304. Offices in principal cities throughout the U.S.

01332

\*1K quantity. Domestic USA Price Only

INFORMATION RETRIEVAL NUMBER 132

16B

ELECTRONIC DESIGN 19, September 13, 1973

# SURPRISE! SURPRISE!

Now your HP distributor  
has still another way to keep  
you looking good.

Distributor Stocking Locations:

## HALL-MARK ELECTRONICS

Huntsville, Alabama  
(205) 539-0691  
Lenexa, Kansas  
(913) 888-4747  
St. Louis, Missouri  
(314) 521-3800  
Raleigh, North Carolina  
(919) 832-4465  
Tulsa, Oklahoma  
(918) 835-8458  
Dallas, Texas  
(214) 231-6111  
Houston, Texas  
(713) 781-6100

## SCHWEBER ELECTRONICS

Toronto, Canada  
(416) 925-2471  
Hollywood, Florida  
(305) 927-0511  
Elk Grove Village, Illinois  
(312) 593-2740  
Rockville, Maryland  
(301) 881-2970  
Waltham, Massachusetts  
(617) 890-8484  
Troy, Michigan  
(313) 583-9242  
Edina, Minnesota  
(612) 941-5280  
Somerset, New Jersey  
(201) 469-6008  
Rochester, New York  
(716) 328-4180  
Westbury, New York  
(516) 334-7474  
Beachwood, Ohio  
(216) 464-2970

## WYLE DISTRIBUTION GROUP

Liberty Electronics/Arizona  
Phoenix, Arizona (602) 264-4438  
Liberty Electronics  
El Segundo, California (213) 322-8100  
Elmar Electronics  
Mt. View, California (415) 961-3611  
Western Radio  
San Diego, California (714) 235-6571  
Elmar Electronics  
Commerce City, Colorado (303) 287-9611  
Liberty Electronics/Northwest  
Seattle, Washington (206) 763-8200

## EUROPE

**Celdis Ltd.**  
37-39 Loversock Road, READING, Berks. England  
Tel.: READING 58 22 11  
**I.S.C. France**  
20, rue Gambetta, 92-Boulogne, France  
Tel.: 604.52.75  
**Ingenieurbüro Dreyer**  
238 Schleswig, Flensburger Strasse 3, Germany  
Tel.: (04621) 2 31 21  
**FBV Elektronik**  
8 Munich 2, Gabriel-Max-Strasse 90  
Tel.: (0811) 644055-8  
6 Frankfurt/Main 1, Myliusstrasse 54  
Tel.: (0611) 720416-18  
**R. V. Diode**  
Hollantlaan 22, Utrecht City, The Netherlands  
Tel.: (03088 42 14)  
**Intelko A. B.**  
Sandsborgsvagen 50, 12 233 Fnskede, Sweden  
Tel.: (08) 49 25 05

**HEWLETT**  **PACKARD**

## ACROSS THE DESK

(continued)

### Anyway they slice it . . .

I have a singular comment regarding the Engineering Manpower Commission letter by John D. Alden that opposed some of the remarks of Joel Snyder. No matter how fine a cut is claimed necessary to slice the "statistical baloney" properly, it still came out as baloney. Predictions of increasing demand for engineers simply did not materialize. Thus such incorrect predictions by Engineers Joint Council and other institutions could only have aided in worsening the conditions for all engineers.

*Malcolm Kasparian Jr.*

113 Warwick Ave.  
Waltham, Mass. 02154

### Flat back favored for op-amp symbol

When I saw those familiar flat-backed triangles, I thought, "Gee, Graeme's finally got religion!" It was therefore disappointing to find his letter, ("Round or Flat Symbol: Which for Op Amps?" ED No. 14, July 5, 1973, p. 11) disavowing them and placing them in a league with "slang" and arrowless transistors.

While curved backs—the vestige of a practice sporadically employed in the analog-computing field to distinguish open-loop amplifiers from committed amplifiers—do appear in the IEEE standard *Graphic Symbols for Analog Computers*, straight-backed triangles can be found in a more all-embracing publication of the American National Standards Institute: Y32.2, 1967, *Graphic Symbols for Electrical and Electronics Diagrams*, under Section 16: "Graphic Symbols for Composite Assemblies." In particular, 16.2.3, the familiar straight-backed triangle with two lines left, is described as "amplifier with two inputs."

It's further interesting to note that there isn't a single amplifier symbol in all of Section 16 with even a vestige of a curved spine.

Beyond this, the history of the

development of the operational amplifier as a circuit component supports the straight-backed triangle. Before Burr-Brown had even appeared on the corporate scene, George Philbrick (who is generally credited even by the Russians as the first to make productive use of *differential* operational amplifiers) had published a 28-page "Applications Manual" in 1956, the first major publication devoted to operational amplifiers and their applications. It used straight-backed, two-input amplifiers throughout. (Incidentally, in the 1947 landmark Ragazzini, Randall & Russell IEEE paper on analog computing, operational amplifiers appeared as *rectangles!*)

While the rest of the world went "straight," Burr-Brown went it alone with the curved back, which, for all we know, is still in wide use among specialists in analog computers. But I think that the universal usage of op amps in all branches of electronics calls for a more widely accepted standard. I applaud the discernment of most of the industry and of ED in sticking with the easy-to-use amplifier with two inputs.

*Dan Sheingold*  
*Analog Devices, Inc.*

### The HP5000A: Is it really 'new'?

The front cover of your April 1 issue has certainly brightened our future. As a result of the recent economic crunch, which took a big bite out of our firm, we barely had money enough to operate, let alone properly market our digital analyzers. One bright spot did appear in that period—Hewlett-Packard sought us out and took a license under our systems patent on our analyzers.

This is not to take anything away from Hewlett-Packard's product, nor is it sour grapes; but I'm sure you would want to know

(continued on page 21)

# For \$495.00

## Screen out your bad IC's before they hide out.



Plug in device.

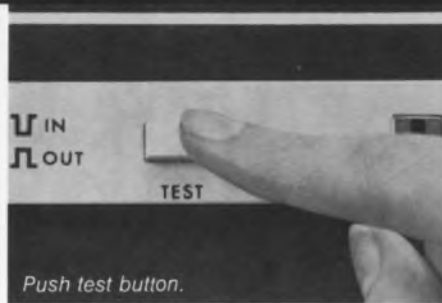

Push test button.

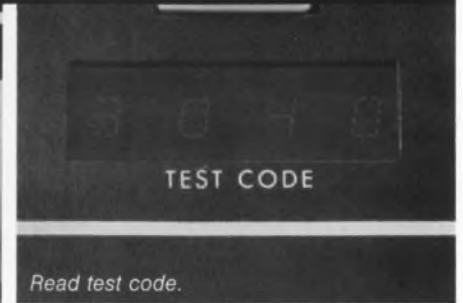

Read test code.

### Easy as one...two...three

The Model 1248 IC Functional Tester will start paying for itself on the first day of use, even low volume use. Incoming digital ICs—TTL, DTL, and CMOS—can be tested for functional failure at the rate of 10 per minute or better by a non-technical person. Plug in, push the button, and eliminate *all* your DOAs before they go into your circuit and require expensive trouble-shooting to track down.

Operation is simplicity itself.

After the switches are set to apply the proper function to each pin of the 14 or 16 pin DIP, testing is a matter of seconds—one second for TTL/DTL and five seconds for CMOS. The test result, displayed as a



highly visible four-digit test code, is absolute. No comparison with a "good" IC is necessary. Switch settings and test codes for most devices on the market come with the instrument, along with complete instructions including how to test unlisted devices.

Self-contained, rugged, and compact, this tester goes anywhere. You are invited to try it—free. No obligation if returned within 10 days. Call or write the factory for our full-color booklet on this unique IC functional tester.

Electro Scientific Industries,  
13900 N. W. Science Park Dr.  
Portland, Oregon 97229.  
Telephone 503/646-4141.  
Telex 36-0273.

**esi.**

### CHANGEOVER TO TEST ANOTHER IC IS FAST.



insert different device socket if necessary.



push proper mode button.



set switches to new positions.



check clock button for polarity. Now test as above, one, two, three!

# What this country needs is a good \$1,000 full-scale computer.



Introducing the computer for everybody. NAKED MINI™/LSI.

It's the computer for people who never thought they could afford a computer for their product.

It's also for people who have always been able to afford more, but have always gotten less computer than this.

NAKED MINI/LSI is the first OEM mini-computer designed for widespread, multi-level use. The first computer able to do more jobs than any computer could ever do before.

To do this, we had to give it an unheard of combination: extensive 16-bit computing power, large memory, and a small price tag. Specifically, NAKED MINI/LSI is the first computer powered to satisfy 90% of all potential minicomputer applications—and yet be priced as low as \$990 in OEM quantities of 200. And that price includes 4K words of memory.

Imagine it. For a price less than most hardwired circuitry or even a microcomputer,

your product can benefit from a general purpose computer having powerful arithmetic capabilities, up to 256K 16-bit words of memory, both byte and word processing, and uniquely flexible input/output.

Without going into all the jazzy widget features, let's just say that the NAKED MINI/LSI gives your product all the performance it could need to monitor, sequence, and control effectively. Which means your product will be more competitive, more flexible, and more immune to obsolescence.

And because we used LSI technology to make our new computer, you can add all this clout simply by plugging in a single card that measures 1" x 15" x 17" and weighs only 4 pounds.

For full details on the NAKED MINI/LSI (or its stand-alone counterpart, ALPHA/LSI), write Computer Automation, Inc., 18651 Von Karman, Irvine, Calif. 92664. Or call: (714) 833-8830. TWX 910-595-1767.

## The NAKED MINI™/LSI from Computer Automation.

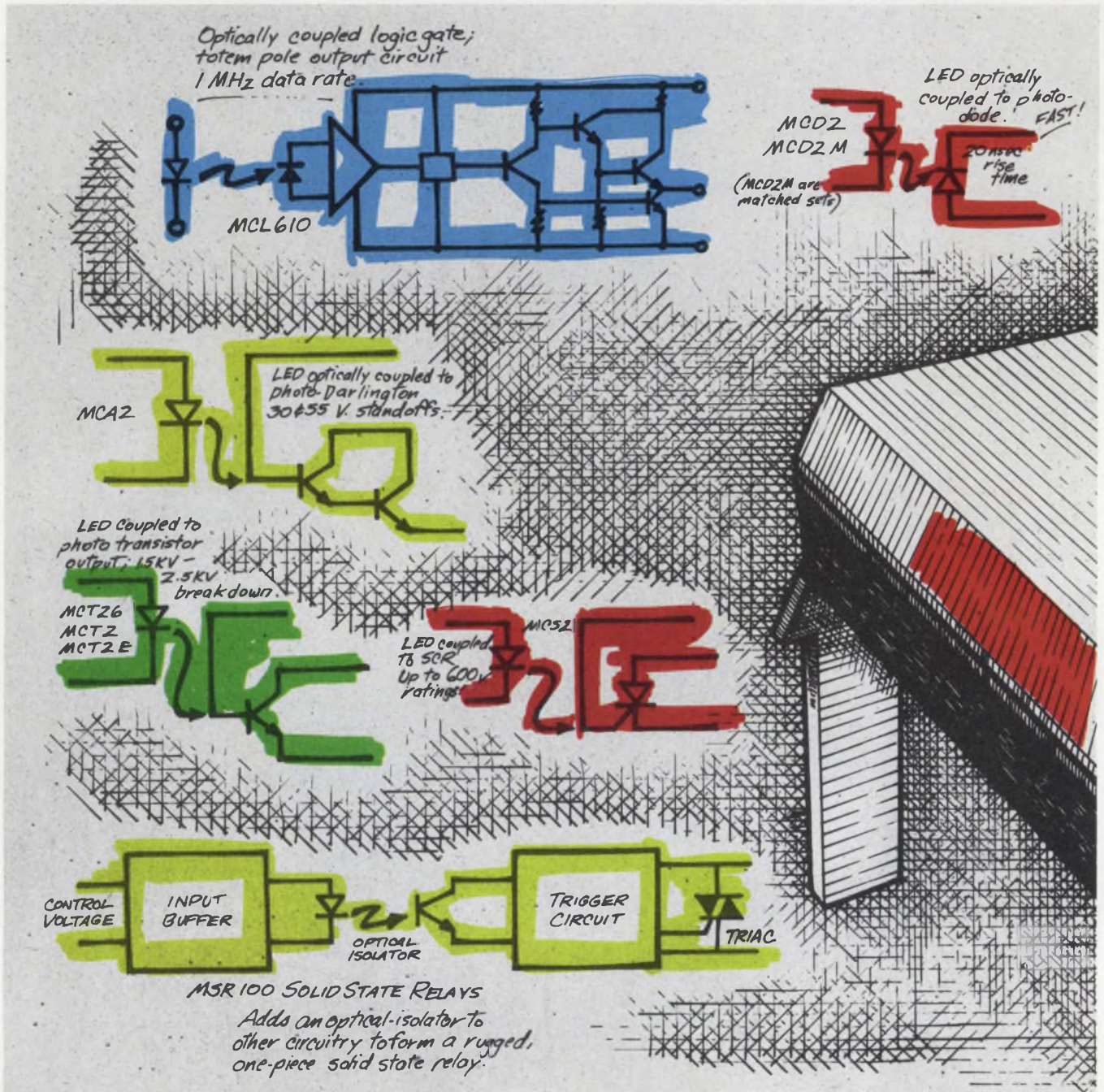

# Just a few reasons why we're

If your circuits could use a little peace and quiet, or if you're not getting delivery of the product you really need, we have a large line of opto-isolators (optical couplers) that will help solve your problems. At TTL logic levels. With isolation of  $10^{11}$  ohms. In a variety of output configurations and specifications. Blessed freedom from electromechanical switches and the inherent problems in data coupling! Not only do we give you the biggest assortment of emitters and detectors inside the package, we also give you many design ideas in a new book of applications notes. Over sixty pages of circuit designs and solutions. It's FREE to you, if you'll write us on your letterhead and simply ask.

We've also got a line of solid state relays, with AC or DC inputs, that will help with your power switching requirements.

Specify the O/I's with the reputation for outstanding quality.



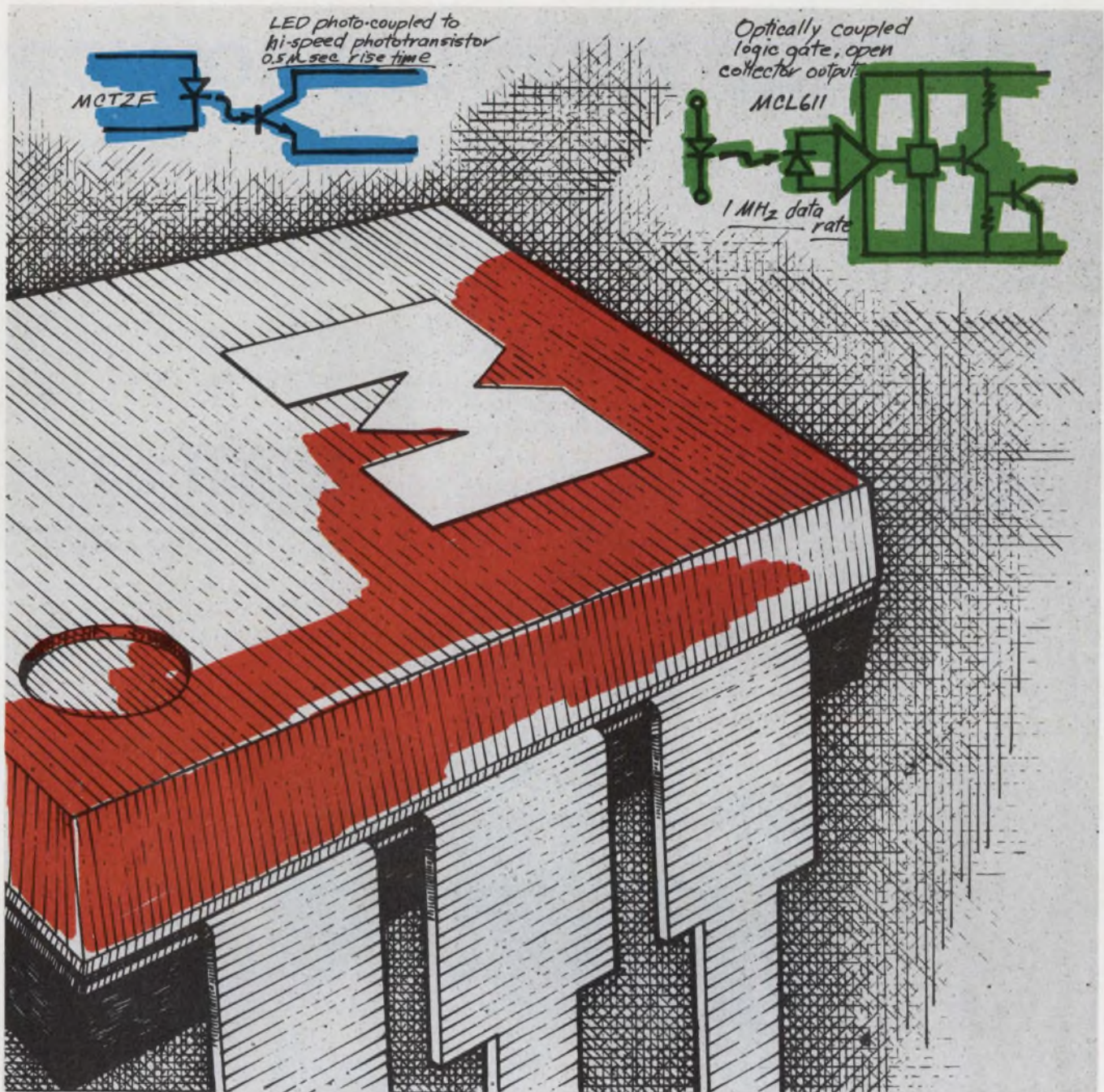

# first in Opto-Isolators.

Putting innovation to work.

Monsanto Commercial Products Co. Electronic Special Products  
10131 Bubb Road, Cupertino, CA. 95104 (408) 257-2140  
A unit of Monsanto Company

# Monsanto

EASTERN HAMILTON/AVNET, Atlanta, GA (404) 448-0800 Baltimore, MD (301) 796-5000 Boston, MA (617) 273-2120 Cedar Grove, NJ (201) 239-0800 Long Island, NY (516) 333-5800 Miami, FL (305) 925-5401 Mount Laurel, NJ (609) 234-2133 Syracuse, NY (315) 437-2642 KIERULFF ELECTRONICS, Gaithersburg, MD (301) 948-0250 Hicksville, NY (516) 433-5530 Rutherford, NJ (201) 935-2120 Paoli, PA (215) 647-2612 Needham Heights, MA (617) 449-3600 SCHWEBER ELECTRONICS, Atlanta, GA (404) 449-9170 Rockville, MD (301) 881-2970 Hollywood, FL (305) 927-0511 Raleigh, NC (919) 832-8881 Rochester, NY (716) 328-4180 Westbury, NY (516) 334-7474 Somerset, NJ (201) 469-6008 HAMMOND ELECTRONICS, Orlando, FL (305) 241-6601 SEMICONDUCTOR SPECIALISTS INC., Pittsburgh, PA (412) 781-8120 MIDWEST HAMILTON/AVNET, Chicago, IL (312) 678-6310 Dallas, TX (214) 638-2850 Detroit, MI (313) 522-4700 Houston, TX (713) 526-4661 Kansas City, MO (913) 362-3250 Minneapolis, MN (612) 854-4800 St. Louis, MO (314) 731-1144 HARRISON EQUIPMENT, Houston, TX (713) 224-9131 KIERULFF ELECTRONICS, Garland, TX (214) 271-2471 SEMICONDUCTOR SPECIALISTS INC., Dayton, OH (513) 278-9455 Chicago, IL (312) 279-1000 Detroit, MI (313) 255-0300 Indianapolis, IN (317) 243-8271 Minneapolis, MN (612) 854-8842 Kansas City, MO (816) 452-3900 St. Louis, MO (314) 428-6100 Dallas, TX (214) 358-5211 SCHWEBER ELECTRONICS, Elk Grove Village, IL (312) 593-2740 Cedar Rapids, IA (319) 366-0774 Beachwood, OH (216) 464-2970 Troy, MI (313) 583-9242 WESTERN ALTA ELECTRONICS, INC., Salt Lake City, UT (801) 486-7227 ELMAR ELECTRONICS, Mountain View, CA (415) 961-3611 Denver, CO (303) 287-9611 HAMILTON ELECTRO SALES, Culver City, CA (213) 870-7171 HAMILTON/AVNET, Denver, CO (303) 534-1212 Mountain View, CA (415) 961-7000 Phoenix, AZ (602) 269-1391 Salt Lake City, UT (801) 262-8451 San Diego, CA (714) 279-2421 Seattle, WA (206) 624-5930 KIERULFF ELECTRONICS, Palo Alto, CA (415) 968-6292 Phoenix, AZ (602) 273-7331 Denver, CO (303) 343-7090 Seattle, WA (206) 763-1550 San Diego, CA (714) 278-2112 LIBERTY ELECTRONICS, Phoenix, AZ (602) 264-4438 Seattle, WA (206) 763-8200 El Segundo, CA (213) 322-8100 WESCO ELEC., Los Angeles, CA (213) 685-9525 WESTERN RADIO, San Diego, CA (714) 235-6571 CANADA CANADIAN DYNAMICS LTD., Vancouver, B.C. (604) 325-3201 Calgary, ALB (403) 265-6500 CESCO ELECTRONICS LTD., Montreal (504) 735-5511 Ottawa (613) 729-5118 Toronto (416) 638-5250 Quebec (418) 524-4641 Vancouver (604) 433-7834 HAMILTON/AVNET, Montreal (514) 735-6393 Ottawa (613) 725-3071 Toronto (416) 677-7432 SCHWEBER ELECTRONICS, Toronto (416) 925-2471 SEMICONDUCTOR SPECIALISTS, Ontario (416) 678-1444

INFORMATION RETRIEVAL NUMBER 14

# One-stop memory source

Whatever you need in memory, chances are you'll find it here. Arrays, stacks, complete single-card memories, megabit systems. Standard or custom designs. Wide temperature core or semiconductor. EMM is the one-stop memory source.

Take our Micromemory 3000, for instance. It's a complete TTL compatible memory on a single card—up to 8K by 18 bits with a 650 ns cycle time. You can put them together to get any system capacity you want. And the Micro-Ram 3000 is a compatible 200 ns semiconductor memory on a single card. Standard multi-card chassis, including power supply and other options, are available.

Then there's the Micromemory 2000. Also a total system on one card with edge connections that allow it to be treated just like a logic circuit. Not quite as high performance. Even lower cost. It operates from plus five volts input only.

Or if your need is for large mass memories, consider the Micromemory 6000. It is a multiple board module with 16K sense. In its basic configuration of 16K by 40 or 32K by 20, it uses only two boards.

And there are more to come. But we won't talk about them now because they're still in field test. After all, we promise only what we can deliver, and we deliver only proven hardware.

If you'd like to know more about our proven hardware, and how it can fit your needs, call Phil Harding at (213) 644-9881. Or contact your local EMM sales office.

**EMM** ELECTRONIC  
MEMORIES  
**COMMERCIAL PRODUCTS**  
A Division of Electronic Memories & Magnetics Corporation  
12621 Chadron Ave., Hawthorne, Calif. 90250



EASTERN REGION: (617) 861-9650; CENTRAL REGION: (312) 297-7000; WESTERN REGION: (213) 477-3911

INFORMATION RETRIEVAL NUMBER 15

## ACROSS THE DESK

(continued)

that the HP5000A is not a "new way" to troubleshoot or "analyze" digital logic. It's been around—albeit quietly—for four years.

Our Models 4015, 4015P and 201 SPN, which were sold and successfully delivered and installed in 1969, 1970 and 1971, today constitute just one facet of our growing company's product line.

*Philip S. DiVita*  
President

Data Display Systems, Inc.  
P.O. Box 515  
Richboro, Pa. 18954

## Hewlett-Packard replies

HP's 5000A logic analyzer is "a new way to troubleshoot digital logic," as your April 1 cover story said. True, Data Display Systems did have a similar product before the 5000A, showing remarkable foresight into future digital testing needs, but, unfortunately for them, the world was not then ready for a new measurement tool. Digital troubleshooters have continued to try to adapt the analog oscilloscope to their needs, usually ignoring innovative products, such as Data Display Systems' and even logic probes selling for under \$100, that will actually solve most of the problems expensive scopes address.

Now, digital problems have overrun the conventional scopes' defenses. Digital bits are neither green traces on a CRT nor red LEDs; they're quantized representations of discrete information. How they're displayed is subordinate to whether they're even displayable. The need for a simple method to capture and hold sections of long, and often infrequent, digital data streams demands a solution now, and the new solution is the 5000A.

There are quite a few differences between our product and Data Display's. One might say ours is the 1973 version of the older product. Considering exactly what is being used today for analyzing digital logic, no one can refute your point: The 5000A is a "new way."

*Jesse Pipkin*

Hewlett-Packard  
5301 Stevens Creek Blvd.  
Santa Clara, Calif. 95050

# monoform out of the West!

**A whole family of switchlights  
that don't cost much**

It used to be you touched a spur to a horse and something happened right away. Nowadays, you lay a finger to a switch that better be even more reliable. And because you may need hundreds of them, they should be low cost and arrive in a hurry. That's the way it is with our Monoform family of switchlights.

**Monoform I** (the single lamp, momentary & alternate, rated 2 amp 120 Vac).

**Monoform II** (two independent lamps for horizontal split legends, mom. & alt., 2 amp 120 Vac).

**Monoform III** (10 amp, ¼ H.P. power switch).

There's a whole family designed by Clare-Pendar to give you more value, more flexibility than any other switchlight that costs just about two silver dollars.



**CLARE-PENDAR**  
Phone 208-773-4541

P.O. Box 785 Post Falls, Idaho 83854 Telex 32-6448

**“We wanted to go right from keyboard to disc, right? But space was critical. GP relay specs were OK, but I didn’t have any room. Besides, we had to flow solder and dip clean the assemblies to get volume up and cost down. What I needed was a new kind of relay-- and some help-- right now...”**

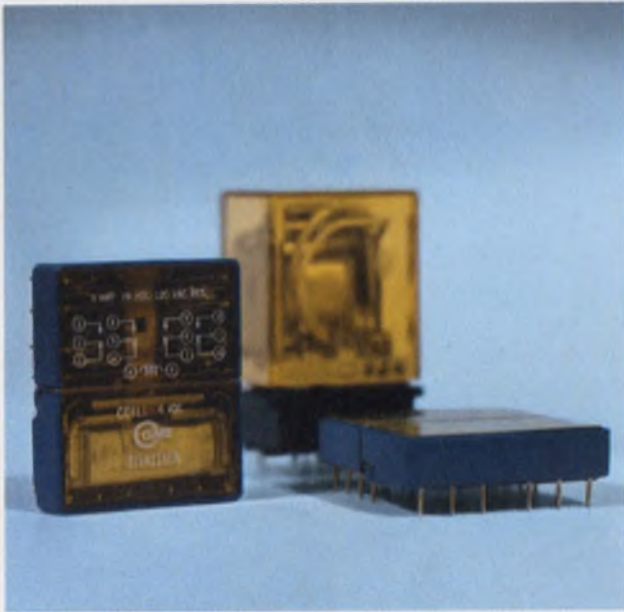

**PROBLEM:** The market for computer periphery is wide open. And equipment that takes you directly from keyboard to disc is a fantastic idea—if you can make it small enough and cheap enough to sell. And that’s tough. Relays are one problem. They’ve got to be dependable (nothing radical, something available) yet small enough to fit your P.C. design. And they’ve got to maintain reliability under the effect of high speed production. You can’t afford any weak links in your final package, but you have to make your decision fast because of competition.

**SOLUTION:** Clare’s new 311 Series General Purpose Relays saved the day.

They offer 3 amp switching in an extremely low-profile package with .5” mounting centers. They sit a mere 0.350” above the board and take up less than 0.7 cubic inch space. The Lexan® dust cover and pins molded in the base fully protect the relay during wave soldering and partial dip cleaning. And the pins are mounted on a .1” center grid, to add flexibility and save you money. The new 311 also has excellent voltage breakdown ratings and shock resistance, gold plated steel terminals, and fine silver contacts.

Clare’s expertise lies in the design and manufacture of relays. That’s why we can give you so

much in a single low-profile relay. Right now.

But our energy lies in the application of relays to help you solve specific problems. We specialize in getting down to work.

If you need help—or just some specific information about our new low-profile 311 series relay—get in touch with us. The “right now bunch” is ready to go to work for you.

Contact your local Clare Distributor or Sales Engineer. C. P. Clare & Co., 3101 Pratt Avenue, Chicago, Ill. 60645. 312/262-7700.

**QUALITY/SERVICE/RELIABILITY**

**we help. get in touch with us. CLARE the “right now” bunch.**

a GENERAL INSTRUMENT company

GENERAL PURPOSE RELAYS MERCURY-WETTED RELAYS REED RELAYS SOLID STATE RELAYS TELEPHONE RELAYS STEPPING SWITCHES

INFORMATION RETRIEVAL NUMBER 17

## Low-loss method of laser transmission discovered

An extremely low-loss method of transmitting laser pulses through the air and a concept for laser modulation that uses a microwatt liquid-crystal modulator are two papers that are expected to attract considerable interest at next week's Electro-Optics '73 Conference in New York City (Sept. 18-20). Both papers are based on studies under way at the Florida Technology University at Orlando.

"The use of ultra-short—1 ps—laser pulses should give us about 20 times greater transmission distance through the atmosphere than we can get with regular 1 ns pulses," says Roland L. Phillips, associate prof. of electrical engineering at the University and co-author of his paper: "Ultra-short Pulse Laser Modulation for Optimum Atmospheric Transmission."

"We're studying the use of a phenomenon that was observed several years ago, and has just recently been understood," Phillips explains. The phenomenon, called "self-induced transparency," permits propagation of an ultra-short pulse through the air or through an optical fiber with far lower losses than in the normal transmission modes.

"In transmitting the picosecond pulse," Phillips points out, "the front part of the pulse is absorbed in the medium and the latter part of the pulse stimulates an emission—like a laser. So we put in and also extract energy. Thus, transmission loss is effectively reduced," he says.

Means of ultra-short-pulse generation—such as mode locking, use of an external modulator or use of a saturable-dye absorber—are presently available.

"Water vapor is the medium in the atmosphere that does the lasing," Phillips points out. "But a present limitation is that none of

the absorption lines of water—the wavelengths at which water lases and wavelengths that lie in the infrared—coincide exactly with the frequency of suitable infrared lasers.

The next step in the program, according to Phillips, is the development of a picosecond-pulse laser that is tunable over the infrared band.

Researchers at Florida University are also studying the use of liquid crystals as a novel microwatt modulator. Described in a Session V paper, "Liquid Crystal Modulator for Information Display and Remote Sensing," Phillips says that the principal application that is under research is data relay from a remote point where conventional power is either absent or undesirable.

"We've looked at two effects occurring in nematic liquid crystals," Phillips says. First is the effect that causes the crystal to become opaque when a voltage is applied."

But such action is too slow for data communications. So, the second effect—a birefringence that occurs when voltage is applied—makes the crystal doubly refractive and capable of rotating the plane of polarization of light.

The latter effect is considerably faster, Phillips indicates, and has the potential of 4 kHz, which is comparable to the bandwidth of a telephone-voice circuit.

"In field use as a modulator," Phillips says, "the crystal would be stationed at some remote point, such as five miles away. The laser beam would be aimed at the modulator, behind which is a retroreflector that reflects the beam energy back to a receiver alongside the transmitter." The modulating voltage at the remote terminal changes the polarization of the reflected

beam in accordance with the data that is transmitted, Phillips explains.

"Study of this type of system" Phillips says, "was initiated by the need for data transmission from hazardous areas—such as pressure and temperature from the hydrogen and fuel-tank farm at aerospace launch centers—where the system power must be substantially below hazardous levels.

## Silicon rectifier unit can operate at 500 F

Despite doubts expressed by leading semiconductor manufacturers, a high-voltage silicon-junction rectifier assembly has been developed that is capable of operating continuously at 500 F.

The rectifier unit was built at the Bendix Electrical Components Div., in Sidney, N.Y.

David C. Baker, chief engineer of the Company's Electronic Laboratory explains that the need for the rectifier arose when a capacitor discharge system for large jet engines, like those for the SST, was required. But the rectifier assembly—operating at about 20 mA forward current and between 2 and 4 kV inverse voltage—had to be mounted on the turbine itself, hence the continuous elevated operating temperatures. Eighteen to 24 diodes are used in the capacitor-discharge high-voltage rectifier.

A study by Dr. Tugrul Yasar, member of the technical staff of Bendix Research Laboratories, Southfield, Mich., indicated that silicon junction rectifiers—using contact materials that could withstand elevated temperature cycling, and having silicon of sufficient purity—could operate up to 300 C (570 F).

An investigation of available silicon diodes indicated that the 1N648 types were suitable candidates, with this type showing the lowest inverse leakage. Endurance tests at 500 F with the rectifiers secured to beryllia heat sinks on a copper plate produced zero failures with a 12 J, two-sparks-per-second operation, for over 4000 hours.

In the production units the rectifiers are assembled on a glass-filled PC board and potted in a metal case using alumina-loaded

silicone rubber. A MTBF of 22,111 hours, at a 90% confidence level has been established with this package operating at 480 F, according to Baker.

## IEEE meeting will focus on electronic security

Electronic security systems—present and future—will be thoroughly discussed by manufacturers, users and law-enforcement officers at a symposium to be held by the Institute of Electrical and Electronics Engineers at the Statler Hilton Hotel in New York City on Sept. 25 and 26, 1973.

A device with tremendous potential, described by William Weitzen, vice president of KMS Industries, Arlington, Va., identifies individuals electronically and automatically by their fingerprints.

Without having to carry a card that could be lost or stolen, a person who seeks to prove his identity provides a machine with his identification number, then puts his right index finger on a square in the machine. The machine matches the fingerprint with one already stored on a small holographic film. If the prints match, the machine unlocks the plant door, gives the money or whatever is involved.

The machine is described as a coherent optical-matched filter correlator that computes the two-dimensional cross-correlation function between the fresh fingerprint and the encoded fingerprint on the holographic card.

A machine that performs a similar check with the human voice is described by J.R. Richards, RCA's Advance Technology Laboratories, Camden, N.J. A bomb threat called in by telephone could be taped and used later to check against the voice of suspects.

The pros and cons of screening airline passengers for concealed weapons by active or passive magnetometer systems will be discussed by Malcolm Schwartz, president of Infnetics, Inc., of Wilmington, Del.

Schwartz will point out areas where he feels that research on airline passenger search techniques is needed and for which the government should provide funds.

How to cut down on fraudulent

credit-card claims will be discussed by experts from the Addressograph/Multigraph Co. in Cleveland; TRW Data Systems in Hawthorne, Calif.; IBM, Los Gatos, Calif.; and the First National City Bank in New York.

The panelists will discuss ways to get verification of cards more quickly as well as how to do a little bookkeeping at the same time, according to session organizer Lawrence E. Shoemaker, vice president of Corporate Security, Diners Club, New York.

There exist now, Shoemaker says, experimental merchant terminals that accept a card and automatically check it out in a central computer. What's needed are terminals that will accept an entire family of credit cards—the merchant can't have a machine for each card. The machine should verify the customer's account and transmit the credit automatically to the merchant's account.

Could a fingerprint be used instead of a card? Shoemaker says that credit-card companies are certainly interested in the concept, but the problem is now a matter of being able to store so many holographic prints.

## Lithium battery uses inorganic electrolyte

A new lithium battery with eight times greater energy density and more than twice the operating voltage of standard dry cells has been developed by the General Telephone & Electronics Corp., in Stamford, Conn.

In contrast to other recently developed lithium batteries (see "The Lithium Battery: It Just Might Revolutionize Portable Power," ED No. 10, May 10, 1973, p. 44), the new unit uses an inorganic liquid as an electrolyte, and produces 250 Wh/lb of energy. This compares favorably with 30 Wh/lb produced by conventional dry cells, and 200 Wh/lb for other lithium batteries.

According to Dr. James J. Auburn, one of the developers of the new battery, the increased energy density can be attributed to use of inorganic salts. Whereas the other lithium SO<sub>2</sub> batteries require the addition of an extra solvent, he explains, the new inorganic lithium

battery uses thionyl chloride (SOCl<sub>2</sub>) for both the negative electrode and the electrolyte. This means we can pack more energy-producing material into the cell," Auburn says.

The new battery also has a higher open-circuit voltage than other lithium batteries (3.6 V compared to 2.6 V). Auburn notes that the thionyl chloride is a stronger oxidizing agent than the one used in the lithium SO<sub>2</sub> battery. Therefore a higher voltage is produced.

Another important feature of the inorganic lithium battery is its high degree of voltage stability. During the battery's lifetime, the voltage will only change from 3.6 to 3.2 V.

The estimated shelf life of GTE's inorganic lithium battery is greater than 2 years. This seems to be a striking contrast to estimates of up to 20 years for other lithium batteries. Auburn noted that there is no reason why his company's battery shouldn't last as long as the other lithium batteries. He continues, "No one has had a lithium battery for 20 years. They are only estimating its lifetime. We're simply making a conservative estimate."

## Intercon '74: The accent will be on marketing

The IEEE's 1974 convention at the New York Coliseum will differ greatly from previous shows. The theme for next year is "Getting down to business" and reflects a switch in the show's image from a purely technical convention to an out and out marketing show.

The new emphasis contrasts sharply with previous IEEE policy, and appears to stem from this year's relaxation of the no selling rule.

According to Frederick T. Van Veen exposition director for the show, Intercon's display of electronic products and systems will be aimed at the state-of-the-markets and not the state-of-the-art. The reason, he notes, is that suddenly electronics manufacturers are moving outside the industry and talking about consumer and business products, automotive electronics and medical systems.

# VACTEC optoelectronics



## New High Speed Silicon Photovoltaic Cells

Ten times faster with excellent linearity, high temperature stability, and high low-light sensitivity.

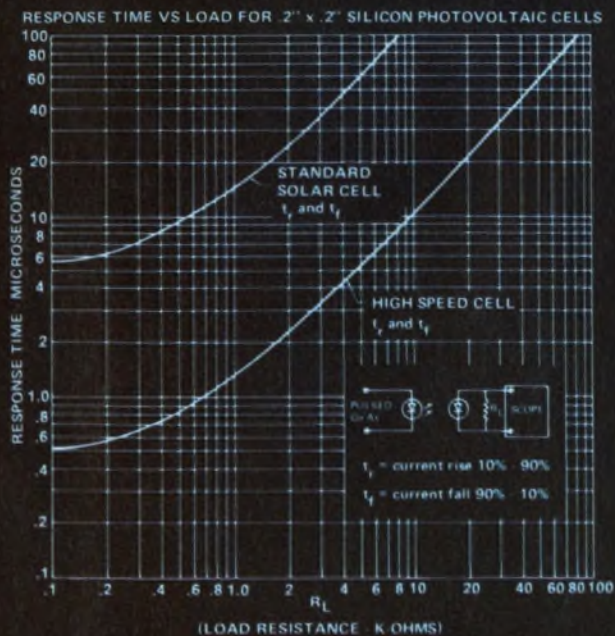

## THE INDUSTRY'S BROADEST LINE:

- A. Standard and high speed silicon photovoltaic cells.
- B. Phototransistor and photodarlington.
- C. Opto-Couplers (three types).  
LED/Photoconductor  
LED/Phototransistor  
Lamp/Photoconductor
- D. Selenium photovoltaic cells.
- E. C-MOS and Bi-polar custom I.C's.
- F. CdS and CdSe Photoconductors.

Write today for more details.

Vactec, Inc.  
2423 Northline Industrial Blvd.  
Maryland Heights, Mo. 63043  
Phone (314) 872-8300

# Solid-state relays are finding gradual acceptance—at last

The concept of a solid-state relay is probably as old as the transistor itself. Although their use hasn't increased as rapidly or dramatically as was predicted when the first ones appeared, they are nevertheless replacing their electromechanical counterparts.

The main reasons for their relatively slow acceptance is higher cost plus general customer inertia.

What is a solid-state relay? The answer to that seemingly straightforward question depends on who you ask. The variety of answers you get depends on how many engineers you choose to query.

A solid-state relay is a photocoupled triac. A solid-state relay is a reed-triggered triac. It is also a transformer-isolated triac. A solid-state relay is a transistorized switch. The more people you ask, the more confusing it becomes.

To illustrate the magnitude of this confusion, it should be pointed out that there is a MIL spec for solid-state relays—MIL-R-28750—but it doesn't have a definition.

All this results in more than a problem in semantics. It can create major headaches for the engineer. To help clarify the situation, several manufacturers were asked to categorize the different types of solid-state relays. The result is the following three categories:

- Hybrid solid-state relays that have a mechanical part in them, either at the input or at the output.
- Static solid-state relays, that have a transformer or light bulb on the input to provide isolation.
- All solid-state relays that provide isolation by light-emitting diode optical couplers. This last

category is the newest and is the one drawing the most interest.

The hybrid relay combines a mechanical switch with solid-state circuitry. The switch can be on the output, as is the case with time delay and amplifier relays, or it can be on the input, as is the case with a reed-triggered thyristor. The reed switch provides isolation and is a cheap way of solving the arcing problem when it is used to trigger a triac, but it does not eliminate the problem of mechanical wear.

There are two types of static solid-state relays, those that use a transformer for isolation, and those that use an incandescent or neon bulb for photoisolation.

With the transformer isolated device, it is necessary to add a gated oscillator to the relay, so that the control signal can be transmitted through the transformer.

The photocoupled approach that uses either an incandescent or neon

bulb has a lifetime and a switching speed that are limited to the bulb.

Light-emitting diode optically coupled relays have the charisma of solid state and have thus generated the most interest. Such solid-state relays have the advantage of high switching speeds and long life as do all solid-state devices.

## Implementation is slow

Industry experts note that one of the major factors that have hampered the growth of solid-state relays is cost. As James Seppala, applications manager for Sigma Instruments, Braintree, Mass., points out, "The average price for a solid-state relay that can switch 10 A, is \$12 in large quantities. An electromechanical relay can do the same thing for only \$1.80."

Other reasons for the slow adoption of solid-state relays include the need to provide line isolation and immunity from line transients



A whole family of solid-state relays with ratings ranging from 2.5 to 40 A, 120 to 240 V, ac and dc is available from Crydom controls. Relays feature photoisolation and zero voltage switching.



# There's more to resistors than resistance

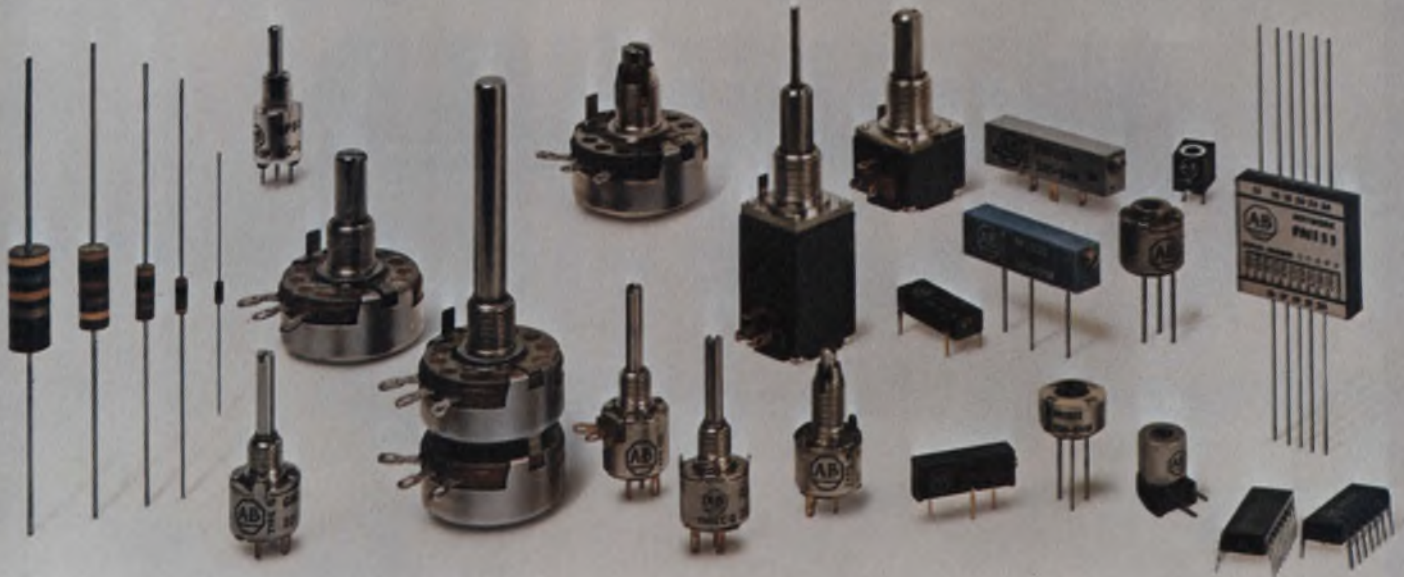

## If you're really serious about cost, be serious about quality.

If you think all resistive components are the same, listen to what these users have to say about Allen-Bradley fixed composition resistors:  
**Buyer**—"A-B has shipped nearly four million parts without a single reject or problem. The quality is superb. I've spent 12 years in production control and purchasing. I've seen the amount of down-time, rework and field retrofit caused by others:"

**President**—"We have used many millions of Allen-Bradley hot-molded resistors. The uniformity of quality from one shipment to the next is truly outstanding."

**Engineer**—"When we use A-B resistors instead of some other make, it's one less component we have to worry about."

"We learned the hard way. The subtle things make the difference. They all

add up to the top quality we want in our products."

**Purchasing Agent**—"We wish we had more Allen-Bradleys."

Write for Publication RD. Allen-Bradley Electronics Division, 1201 South Second Street, Milwaukee, WI 53204. Export: Bloomfield, NJ 07003. Canada: Allen-Bradley Canada Limited, Cambridge, Ontario. United Kingdom: Jarrow, Co. Durham NE32 3EN.



**Allen-Bradley**  
Milwaukee, Wisconsin 53204

# WHEN THE CHIPS ARE DOWN WE DELIVER!



**CAPACITORS  
THAT IS**

We said it and we meant it. We're USCC/Centralab and we said we were preparing to meet the capacitor delivery crisis by substantial commitment to automated production machinery and facilities expansion.

We did it, and we've got the chips to prove it — ELEVEN MILLION in stock, most in the following popular sizes:

- |                              |            |
|------------------------------|------------|
| • BC - .080±.010 x .050±.010 | .045 T MAX |
| • BF - .100±.010 x .050±.010 | .060 T MAX |
| • BI - .150±.010 x .050±.010 | .060 T MAX |
| • DJ - .180±.010 x .080±.010 | .065 T MAX |
| • FH - .125±.010 x .095±.010 | .065 T MAX |

We'll also deliver non stock and custom chips in not more than 8 to 12 weeks A.R.O.

Whether it's an immediate or future requirement, contact our applications engineering department now at (213) 843-4222, or our local representative.



**USCC/Centralab**

Electronics Division • Globe-Union, Inc.



2151 North Lincoln Street • Burbank, California 91504

INFORMATION RETRIEVAL NUMBER 20

# WE DELIVER!

CAPACITORS  
THAT IS

REPRESENTATIVES

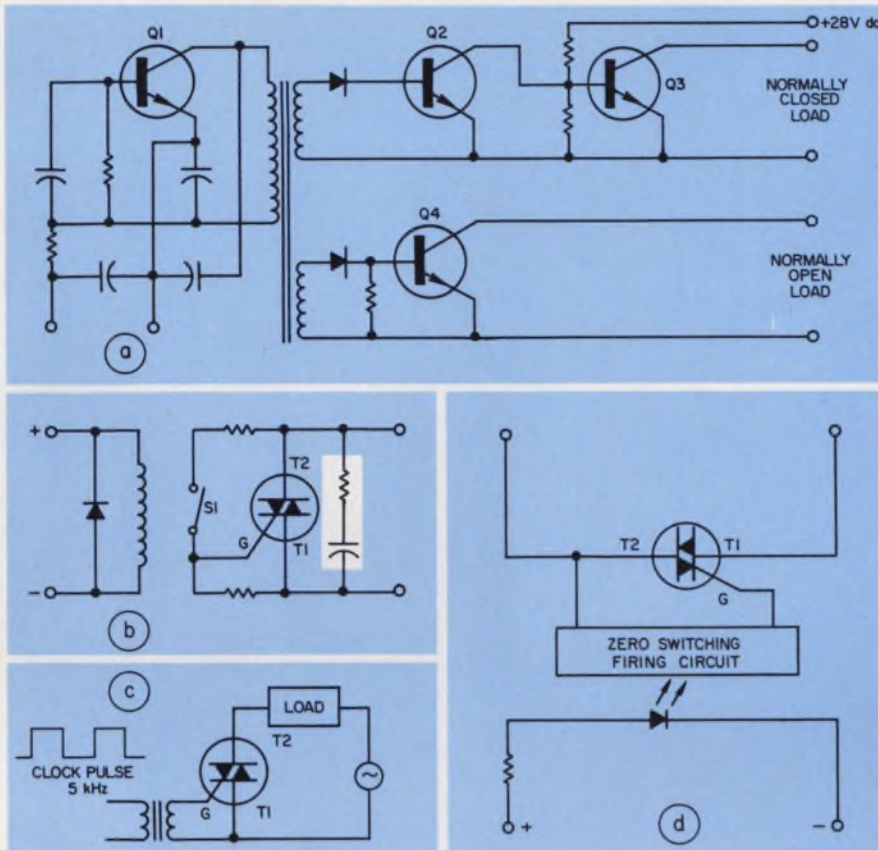

Several types of solid-state and hybrid relays are available. Potter & Brumfield use transistors and transformer isolation in one of their devices (a). Q<sub>1</sub> is a gated oscillator whose signal is rectified by diodes on secondary side of the transformer. Resultant dc voltage switches the transistors. A hybrid relay (b) uses a reed to provide isolation. This particular device contains a series RC snubber network (box). A transformer-isolated static relay (c) requires clock pulses to gate the triac, while the all solid-state relay (d) uses a LED to activate zero switching circuitry which triggers the triac.

as well as the expense of multipole arrangements, notes Thomas McNulty, manager of thyristor applications at RCA's Solid State Division, Somerville, N.J.

McNulty likens the competition between the solid state and electromechanical relay to that of the transistor and the tube. "There will not be a widespread conversion to solid-state relays," he says, "but rather a gradual adoption of the new device." This is particularly true, he continues, in those areas where increased reliability is required and shock or mechanical fatigue impose severe limitations on the electromechanical device.

Not everyone agrees that solid-state relays will eventually win out over electromechanical relays, just as the transistor beat the tube.

Hugh J. Cullin, director of engineering for Struthers-Dunn, Pitman, N.J., doesn't. "There will always be an electromechanical relay," Cullin maintains.

William Collins, executive vice president of Crydom Controls, El Segundo, Calif., notes that solid-state relays are being applied in areas where electromechanical devices have shortcomings. Solid-state relays are more expensive, Collins admits, but they are not sold on the basis of price, rather on their ability to do things—such as zero switching—that electromechanical devices cannot.

## Solid state advantages

Electromechanical relays are being replaced by solid state ones in applications where high reliability, long life and noise free interference are required. Typical of these applications are medical electronic equipment, industrial control systems and computer interfaces.

The high reliability of solid-state relays results from the fact that there are no moving parts, notes Richard Fox, a product en-

## ALASKA

USCC/Centralab  
(213) 843-4222

## ARIZONA

Jarko Associates  
(602) 966-3020

## CALIFORNIA (Northern)

Cal-Tronix  
(408) 296-1366

## CALIFORNIA (Southern)

USCC/Centralab  
(213) 843-4222

## COLORADO

Electro-Rep, Inc.  
(303) 744-2821

## HAWAII

USCC/Centralab  
(213) 843-4222

## IDAHO

H. S. Thorpe Company  
(206) 454-0667

## MONTANA

USCC/Centralab  
(213) 843-4222

## NEVADA (Clark County only)

Jarko Associates  
(602) 966-3020

## NEVADA

USCC/Centralab  
(213) 843-4222

## NEW MEXICO

Electro-Rep, Inc.  
(505) 256-1749

## OREGON

H. S. Thorpe Company  
(206) 454-0667

## UTAH

Electro-Rep, Inc.  
(303) 744-2821

## WASHINGTON

H. S. Thorpe Company  
(206) 454-0667

## WYOMING

Electro-Rep, Inc.  
(303) 744-2821

USCC USCC/Centralab  
Electronics Division • Globe-Union, Inc.  
2151 North Lincoln Street • Burbank, California 91504



## Whoosh! or “pouf”

**Our little fans and blowers deliver just the air you need . . . no more, no less.  
We guarantee it.**

The 105 cfm blast—or the 14 cfm gentle breeze—delivered by a Howard fan or blower is a matter of design. Designed to *your* performance parameters by Howard engineers who test and build these hardy little fans and blowers so carefully and to such exacting specifications that performance is guaranteed for 5 years in writing!

Air delivery tests to AMCA standards measure the air movement capabilities of each fan and blower. Dynamic and static air pressure tests assure that Howard

fans and blowers deliver just the amount of air your product needs—and continue to do so over their maximum life period.

More and more leading quality-minded firms are specifying Howard components. (Names on request). Can you afford less than the *guaranteed controlled air movement* of Howard fans and blowers?

**FREE Design Engineer's Manual and Guide** to help you design the ideal cooling systems for your products.



# HOWARD INDUSTRIES

DIVISION OF MSL INDUSTRIES, INC.

One Dixie Highway, Milford, Illinois 60953, Dept. ED

Phone: (815) 889-4105

**FHP MOTORS GEARMOTORS FANS BLOWERS**

INFORMATION RETRIEVAL NUMBER 25

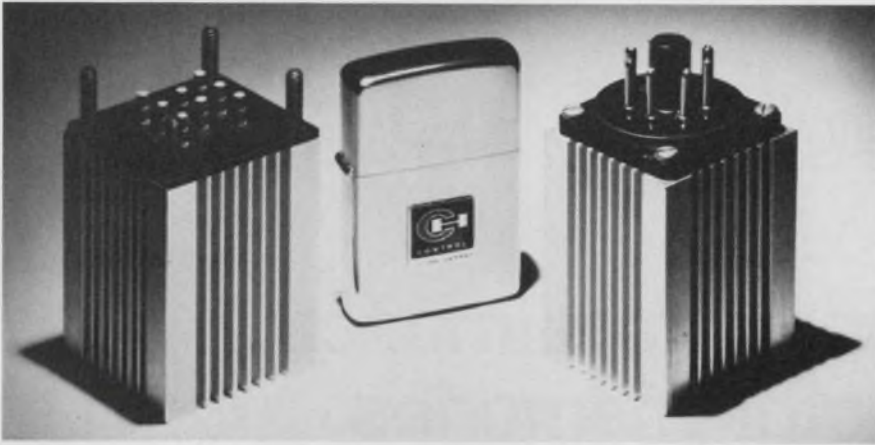

**Reed-isolated solid-state relays** from Cutler-Hammer can handle up to 8 A. A heat sink type can be used to dissipate internally generated heat.

gineer from the semiconductor products department of General Electric, Syracuse, N.Y.

Whereas electromechanical relays have a finite contact life that is largely dependent on the material used, the nature of the load and the application environment, solid-state devices have no known wearout modes. When operated within specified limits, their life is indeterminate.

The high reliability of solid-state relays, notes Albert Metzler, chief electrical design engineer for Guardian Electric, Chicago, makes them ideal for business machine applications. Sure they cost more, he goes on, but with the right kind of solid-state relay in it, you don't have to worry about servicing the equipment.

### But there are problems

Although a solid-state relay may be a direct replacement for its electromechanical counterpart—and many of these do exist—the engineer may still have some problems in substituting the solid state version for the mechanical one.

In explaining why problems might arise, GE's Fox says that some of the specs on solid-state devices differ from those on electromechanical ones. To cite an example he notes that engineers must beware of surge ratings on solid-state relays.

"These ratings are solid state ratings, not relay ratings," he emphasizes. The difference is that a semiconductor rating is a nonrepetitive one, which if exceeded could destroy the device. The surge rating on a mechanical relay how-

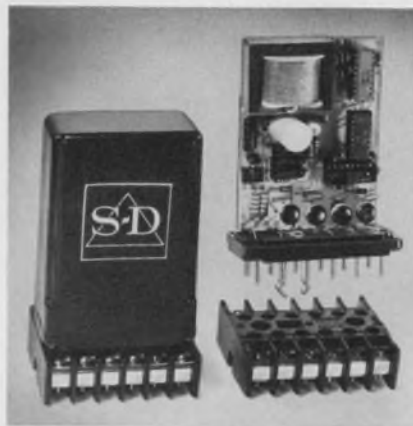

**4-pole solid-state relay** from Struthers-Dunn uses both photoisolation and transformer isolation.

ever is an inrush rating. If exceeded it just burns up the contacts a little, but the device will still work.

Another thing to watch out for in designing with solid-state relays, notes Crydom's Collins, is that high power devices require heat sinks.

"When you get to the higher currents solid-state relays with their associated heat sinks are often bulkier than the electromechanical equivalent. This is something that isn't normally expected because people normally equate solid state with miniaturization." The heat arises from the fact that there is an ON resistance of several ohms with solid-state devices compared to a couple of milliohms for electromechanical relays.

One factor that is peculiar to solid-state relays is  $dv/dt$ , notes Virgil Merkel, senior development engineer for Potter & Brumfield, Princeton, Indiana. The  $dv/dt$  rating of a solid-state relay indicates



**LED optical isolation** and synchronous zero voltage switching are featured in this solid-state relay.

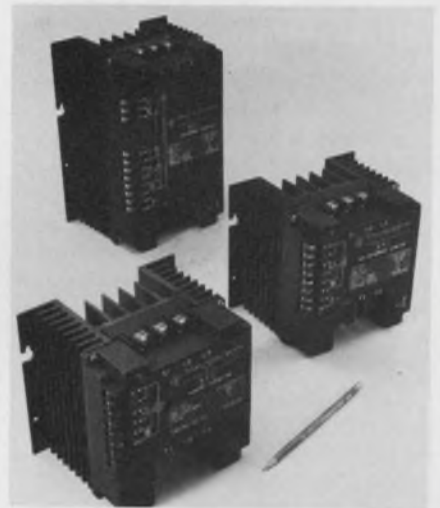

**Solid-state motor control relays** from Texas Instruments use transformer coupling to provide isolation.

that if the input voltage exceeds the rating within a specified period of time, the device may turn itself on without any gate input, resulting in loss of control.

There are two types of  $dv/dt$ , explains Merkel, static and commutating. The static  $dv/dt$  refers to voltage transients that already exist on the power line, while commutating  $dv/dt$  refers to transients resulting from an inductive load.

The  $dv/dt$  problem can be eliminated, notes Merkel, by using a suppression or snubber network. Such a network consists of a series resistor and capacitor in parallel with the thyristor.

But not all manufacturers build a snubber network into their solid-state relays, reports GE's Fox. "This is something that you really want to know," he goes on, "because a relay without a snubber network might not work in applications where a relay with one would." ■■

# System designers feel impact of semiconductor memories

Relatively inexpensive semiconductor memories are proving a boon to the designers of large and small data-processing systems.

The large-scale computer can incorporate memory capacity at various points in the system to provide efficient data management. The small-scale computer and such devices as intelligent terminals and instruments could not have been developed without the semiconductor memories.

These facts were emphasized in Session 16 at Wescon, "The Impact of New Semiconductor Memories on Systems Design."

An overview of the memory field was provided by Alan D. Marston of Hewlett-Packard, Cupertino, Calif., in his paper, "Impact of Recent Advancements of Memory Technologies on Products."

Marston noted: "Application of the new devices results in decreased costs, lower power requirements, smaller weights and volumes and, owing to fewer external connections, higher reliability. Both MOS and bipolar technologies are capable of appreciable evolution, and whether or not their relative capabilities stay the same remains to be demonstrated."

### Advantages of NMOS cited

In another paper, "N-Channel RAMs," Mike Markkula of Intel Corp., Santa Clara, Calif., stressed the advantages of the n-channel, MOS random-access memory over p-channel and bipolar units.

Markkula noted: "N-channel MOS devices have several inherent performance advantages over p-channel and bipolar circuits. Since the majority carriers are electrons rather than holes, their mobility

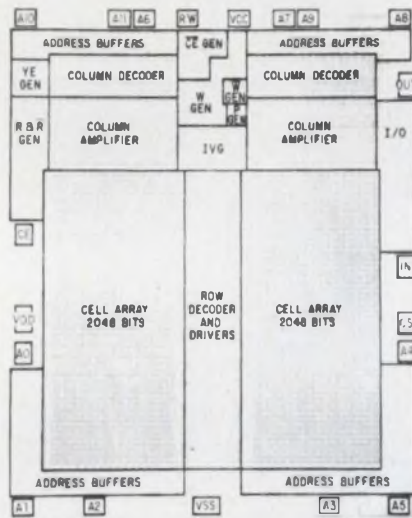

The newest standard in semiconductor memories is the 4-k, n-channel RAM. Intel's 2107 is shown here.

is increased by a factor of two, which gives a theoretical factor of two-speed improvement over p-channel MOS."

He also observed that threshold voltages were lower for n-channel, which leads to lower power consumption than bipolar and a 15% tighter packing density than p-channel MOS.

Markkula admitted that even though n-channel offered several significant advantages over other technologies, it has not been possible to realize all simultaneously in a single device. Development has taken place in three directions he pointed out, each concentrating on a particular feature:

- Low cost devices—taking advantage of the tighter packing density to put more memory in one package.
- Ease of use—using the lowered threshold voltage to make

TTL-compatible memories.

■ High-speed—optimizing the design for highest speed and taking advantage of the increased mobility of electrons over holes.

### The PLA as a logic element

Programmable logic arrays were discussed in a paper, "The Programmable Logic Array As A Design Tool," by Dale Mrazek of National Semiconductor Corp., Santa Clara, Calif. He first examined the characteristics of PLAs, then cited several applications where they are used to advantage over alternate logic forms.

He said: "A PLA is an array of logic elements in which a given input function produces a known output function. The device could be as simple as a gate or as complex as a ROM."

The major operational difference between a PLA and a rectangularly structured ROM is that the number of inputs to the PLA can be much larger.

"The application of the PLA in a digital solution is a natural evolution of design," Mrazek continued. "Several years ago digital systems were designed with gates and dual-D memory elements. Now the design of the same system-control function can be achieved through the use of a PLA."

He cited one example of an application for the PLA: a code converter where the selective decoding of the array allows it to operate with no precoding of data, such as a ROM would require. He also discussed the PLA as a decode element in a digital processor and as a sequential converter.

The speed of memory cycles was stressed in a paper, "System Ap-

# Shorten design time with the long Licon® Switch line

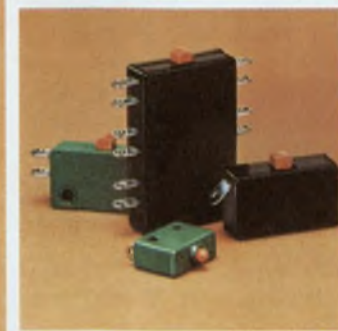
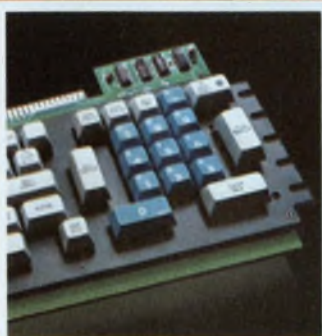
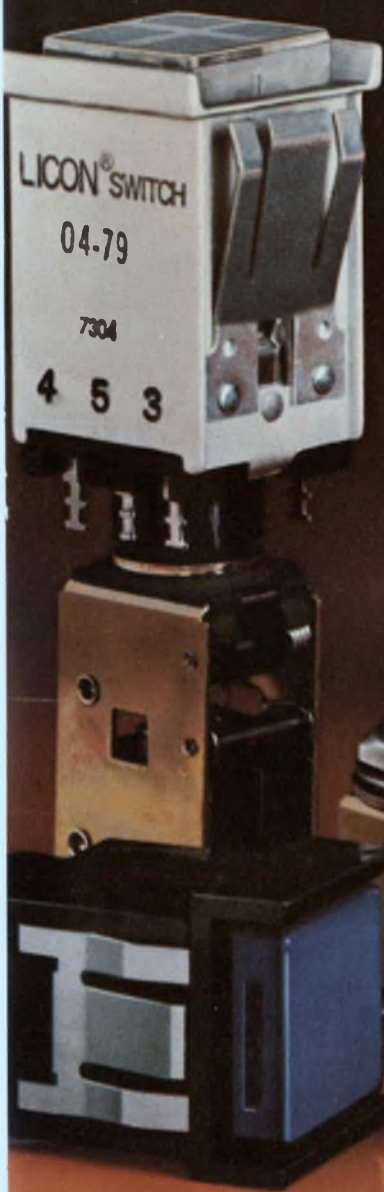

**Licon simplifies the search for the exact switch you need.** Saving design time is the whole reason for our long-line switch capability. If your requirements call for lighted or non-lighted switches, miniature snap-action Licon Butterfly® Switches . . . rugged industrial or limit switches or keyboards, Licon makes it easy to select the right switch to meet your needs.

**Long-line capability shortens design time.** Pick exactly what you need. No compromises on taking only what's available from a limited line.

**Choice is yours all the way** in shapes, sizes, number of lights, type of lights, read-out cap splits, colors, method of actuation, competitive prices and more. Long-life performance and reliability are standard with each and every long-line switch product. Add to this the switch engineering "know-how" of the ITW problem-solvers, plus Licon's full quality-controlled switch production capabilities.

**Shorten design time the easy way.** Call your local Licon Representative or distributor for a live long-line switch demonstration in your office. Or call or write for a Licon Switch Catalog.

## LICON

LICON, DIV. ILLINOIS TOOL WORKS INC.  
6615 W. Irving Park Rd, Chicago, Ill. 60634  
Phone (312) 282-4040. TWX 910-221-0275

The Electronic Group of ITW...LICON ■ ELECTRO MATERIALS ■ PAKTRON ■ CHRONOMATIC

INFORMATION RETRIEVAL NUMBER 26

plications—4-k RAMs,” by Bud Broecker of Motorola Semiconductor, Phoenix, Ariz. He described improvements in the second generation of semiconductor memories: They tend to operate at lower levels, making them TTL-compatible, and they tend to be easier to design into circuits. They are also faster.

“With the faster memory speeds now available,” Broecker noted, “in many cases circuits are slowed down by the speed of the control

logic. With a 250-ns memory, if the control logic takes 150 ns, the operation is severely slowed.”

He described the speed advantages of using ECL logic to drive the higher-speed memories and explained: “Although the gate speed may be about the same for Schottky vs ECL logic, the saturated flip-flops tend to be about three times slower.”

This wasn't much of a problem before, Broecker said, “since the

typical application of early memories, such as the 1103, was to replace core memories.

“The speed of the memory cycle was not a primary consideration,” he stressed. “With the earlier designs everybody was happy just to get a memory to work. With recent designs, such as the 4 k, we designed along with AMI; we considered how it was to be used and designed it to speed up the system operation.” ■■

## Display makers debate pros and cons of 4 leading types

Light-emitting diodes, gas discharge, liquid crystal or light-emitting film—which display is best?

Display manufacturers and digital instrumentation manufacturers presented the pros and cons in Session 2 at Wescon, “Readouts for Instrumentation and Test Equipment.”

On behalf of LEDs, Dr. Harold Allen of Monsanto, Cupertino, Calif., reported. “We are in process of reducing the cost, reducing the power consumption, increasing the number of colors and improving the aesthetics of LED readouts.”

OEM pricing is now less than \$1 a digit for many models, he noted. Some of the newest displays can be driven directly by an MOS chip with about 0.5 mA per segment drive. On a custom order, most any color on the spectrum between red and green can be provided, and in some cases even more than one color is available as a function of drive level.

Aesthetics are being improved, Allen said, by the use of magnifying lenses and diffusing light pipes to produce a bar of light per segment rather than several dots.

### The non-gappy look

Robert Kuntz of Sperry Information Displays, Phoenix, Ariz., outlined the case for planar gas-discharge displays. They are the most attractive available, he contended, since they reduce the gappy look of most other seven-segment displays. Present cost is in the \$2-

per-digit range in 1000 quantities, competitive with LEDs of comparable size.

The main disadvantage of gas-discharge displays, Kuntz conceded, is the fact that a 200-V power supply is necessary, instead of the 5 V that LEDs require.

“There is, though, an advantage to this,” he contended. “Now you can isolate your display power supply from your logic power supply. This keeps multiplex noise out of your logic circuitry.”

Liquid-crystal readouts, said Dr.

Robert Young of American Microsystems, Santa Clara, Calif., fill the bill for low-power, low-voltage and high-ambient-light applications.

“They come,” he pointed out, “in two primary types: field effect and dynamic scattering. Field effect is best when low power drain and low voltage are most important. A viewing angle of only 80 degrees and limited background color selection are the major disadvantages. Dynamic scattering displays can be provided with any color background and have about a 160-degree viewing angle.”

Field-effect displays are faster, Young noted. They can be turned off in about 20 ms, compared with 150 ms or slower with dynamic scattering. Field-effect units can also be driven off 7 to 9 V, compared with 15 to 20 for dynamic scattering.

An additional advantage of the field effect, Young said, is that they can be more readily multiplexed. He believes that lifetimes of 30,000 to 50,000 hours can now be quoted for liquid-crystal displays.

### Light-emitting films lauded

Robert Webb of Sigmatron, Santa Barbara, Calif., spoke in favor of light-emitting-film displays. “I strongly feel,” he said, “that our LEF displays are the the best looking, the most versatile and the cheapest in the market.”

They are versatile, in that any font can be provided, Webb said.



LED auto control panel conceived by Monsanto. About 1500 individual light-emitting diodes on this dashboard give information on gallons of gasoline left, miles per hour, cumulative miles driven, exact time, elapsed time, seat-belt status and door and hand-brake status.



# "We subjected the Augat plug-in socket panel to an accelerated-life test in order to induce contact failure."

## "We failed."

Dave Fillio  
Principal Engineer, Component & Materials Engineering  
Honeywell Information Systems

"We needed an interconnection system for controllers on the H716 mini-computer that could help us meet four basic requirements:

"High density to get as much as possible into a small package and still meet the increasing customer demand for a broad range of peripherals, each requiring a separate controller.

"The capability of automatically wiring, with a minimum of two-levels.

"Flexibility to permit anticipated design changes and still allow us to meet a very tight schedule.

"And finally, all these features had to be available in a standard product.

"The most logical approach seemed to be printed wiring boards. But to accommodate all our controllers could have required as many as eight boards. And we couldn't afford the room. Also, when recycling changes are taken into consideration, the design cycle of printed wiring boards becomes too long and, consequently, too costly.

"Multi-layering offered a minimum of flexibility, and it, too, was rejected.

"The only practical solution was the plug-in socket panel. And of all the vendors, Augat was the only manufacturer that could provide a completely uniform, broad range of standardized products, the lowest possible profile and maximum reliability.

"The reliability tests we



Dave Fillio

conducted on the Augat machined sockets included environmental exposures, accelerated-life, vibration, thermal shock, and durability. All tests with the Augat system were positive.

"From a field service standpoint, a key consideration with increasingly complex and flexible systems like the H716 is keeping them on the air at all times. Because of the reliability of the Augat interconnection system, we've had no reports of machine down-time associated with the Augat product since the introduction of the H716 eight months ago."

More and more companies like Honeywell are realizing that Augat socket-panels are an economical, reliable and totally flexible solution to interconnection problems, including development, production and field service requirements.

Augat's precision-machined tapered entry contact has made Augat the reliability standard for the industry. As

the world's leading manufacturer of socket panels and other IC interconnection products, Augat is ready to help you solve your interconnection problems.

Call or write today for a free brochure and complete product information. Augat, Inc., 33 Perry Avenue, Attleboro, Massachusetts 02703. Represented and distributed internationally.



The H716

## Plug into Augat®. Honeywell did.

SEE US AT WESCON, BOOTHS # 1607-1608

He quoted pricing of 75 cents a digit in 1000 quantities for 0.35-inch-high digits and 50 cents a digit in 50,000 quantities.

The major disadvantage of the light-emitting-film display, Webb said, is that a 650-V supply is needed to drive it. The high voltage can be provided by pulsing a small transformer. LEF power consumption is about 50 mW for three

to five digits, including the driver.

A display user at the session, Jim Masatsugu of Digilin in Glendale, Calif., discussed displays for industrial system use. He noted that the gas-discharge display looks like a zener diode to the driver. The LED appears resistive and the liquid-crystal display looks like a parallel resistor and capacitor with a series capacitor on each end.

Ron Guly of Data Technology, Santa Ana, Calif., another user, reported on design problems with the different types of displays. As an example, he cited the fact that the gas-discharge display sometimes oscillates at high frequencies. This becomes a problem if the display is to be used in an instrument that deals with high frequencies, such as an rf counter. ■■

## The point-of-sale market rings up dramatic growth

"The total market for point-of-sale systems is a potential 91,000 terminals per year," a Stanford Research Institute market specialist told designers at Wescon's Session 6. The session examined the field from several points of view—current market trends, historical perspective and what the user wants and needs from terminals and systems.

Noting the explosive growth in the field in the last two to three years, the specialist, Alan Purchase, cautioned that "the penetration of this market depends on the ability of the electronics industry to understand the needs and attitudes of retailers." Among the untapped markets for point-of-sale systems, he indicated, are specialty stores, restaurants and fast-food outlets.

In an allied paper, Brian Claxton of American Regitel Corp., Sudbury, Mass., outlined what a "mature" point-of-sale system should contain:

- Full interactivity between terminal and computer.
- Full alphanumeric printing capability on terminals.
- Full positive credit verification.
- Automatic central data collection.
- Intelligent terminals—to allow stand-alone operation during processor or phone-line failures.
- The ability to generate appropriate summary reports.

The term "point-of-sale system" is misleading, Purchase maintained in his paper, "The Point-of-Sale Market."

"These are really data systems



Typical of today's intelligent terminal for point-of-sale systems is Singer's Model 902.

for the retail industry," he said, "and one of the input points happens to be located where the retail transaction takes place. They could better be called inventory control systems, sales-accounting systems or credit-verification systems, depending on how they are used."

Department-store chains, Purchase noted, are motivated primarily to obtain an accurate inventory-control system that will give them faster notice of sales trends, help prevent overstocking at one store and loss of sales at another, and that will keep track of merchandise between the warehouse and the sales floor to prevent pilferage. The over-all system, the Stanford Research Institute specialist said, must include an accurate record of merchandise received at the warehouse—a terminal there could generate the tags that are attached to goods.

General-merchandise stores have a slightly different reason for being interested in inventory control,

Purchase pointed out—a minimum investment in stock without the penalty of loss of sales. A well-designed point-of-sale system would also accommodate the high turnover rate in employment of retail clerks, Purchase said, by minimizing the amount of record-keeping they would be required to do.

The major need of gasoline service stations, the speaker said, is for fast, accurate credit verification. He observed that it currently costs from 25 to 40 cents to complete each credit-verification check and that low profits on gasoline sales make such checks expensive to the retailer.

### Pioneer GE system recalled

In his paper, "Point-of-Sale—An Idea Becomes an Industry," Claxton recalled that the General Electric TRADAR system, introduced around 1964, was the first integrated point-of-sale system. It pioneered time-sharing cash-register terminals under the program control of a central processor. A major drawback, he said, was that the system was so highly centralized that it was dependent on uninterrupted telephone service for operation. The cost was high, too, ranging from \$8000 to \$10,000 for each register.

"Naturally," Claxton said, "both retailers and potential suppliers were attentive. A number of new systems began development in the late 1960s using several technical approaches, each one the natural result of the manufacturer's background." ■■

# P&B low-profile R50 Relays let you tee off on critical printed circuit board spacing problems.

New low profile R50 relays with 0.1" grid spacing are designed for switching currents where larger relays are usually required. Up to 2 amps @ 26 VDC or 1 amp @ 115 VAC, resistive.

While retaining a small package size—0.415" height—some R50 operating parameters exceed those of reeds. Special 1 Form C contacts, for example, will switch capacitive or lamp loads that normally would weld reed relay contacts.

Additional features include contact resistance of less than 50 milliohms, sensitivity to 125 mw, and

standard coil voltages from 6 to 115 VDC with operate and release times of less than 6 ms.

Enclosures are ultrasonically welded to their base making them ideal for use with production techniques requiring flow soldering and spray cleaning.

R50 relays can be used in most applications demanding high density packaging such as 0.6" center to center spacing of printed circuit cards. Other applications include: Annunciator circuits that only require a single contact and limited mounting space for switching device . . .

communication systems such as intercoms, modems, auxiliary tape devices, interfacing systems and read out devices . . . machine tool control circuits.

For complete information, contact your local P&B representative or call Potter & Brumfield Division of AMF Incorporated, Princeton, Indiana 47670. Telephone: 812 385 5251.

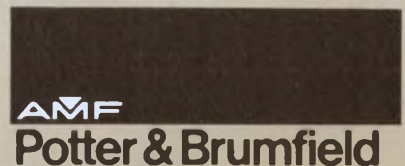

**Solving switching problems is what we're all about.**



# Dialight sees a need:

(**Need:** Single source supply for all indicator lights.)

# See Dialight.

Dialight has so many kinds of indicator lights—approximately 1,500,000 on our shelves—that we have set up a special magic eye seek-out system to help you find the one you need in a wink. Whether it's a flasher, placard, press to test, oil tight, water tight, dust tight, dimmer, or nondimmer, we have them all, some with incandescent, neon or LED lamps, from 1.35 to 220 volts. Sizes vary from small indicators (mount in 0.120" clearance holes) to large indicators (mount in 1 $\frac{3}{16}$ " clearance



holes), and are available in a variety of terminations and finishes, lens-cap shapes and colors with or without hot-stamped, engraved or film legends. We've developed a 14-digit code number that tells any of our 120 stocking distributors in the U.S. and Canada just what indicator you want for off-the-shelf prompt delivery. If you would like to see for yourself how our code works, just write for your free copy. At Dialight it's a designer's choice because we see your need.



Dialight is a company that looks for needs . . . and develops solutions. That's how we developed the industry's broadest line of indicator lights, readouts, and LED light sources. No other company offers you one-stop shopping in visual displays. And no one has more experience in the visual display field. Dialight can help you do more with indicator lights than anyone else because we have done more with them. Talk to the specialists at Dialight first. You won't have to talk to anyone else.

And also be sure to send for your free copy of our latest 56-page Indicator Light Selector Guide. It will show you how easy it is to quickly find your way to the indicator light you need. This handy guide describes in detail the many indicator light choices—shapes and colors of their lens caps, available terminations, mounting data, available finishes, and LED, incandescent and neon light sources for which they are compatible.



Please send me INDICATOR LIGHT SELECTOR GUIDE.

NAME \_\_\_\_\_  
 TITLE \_\_\_\_\_  
 COMPANY \_\_\_\_\_  
 ADDRESS \_\_\_\_\_  
 CITY \_\_\_\_\_ STATE \_\_\_\_\_

**DIALIGHT**

Dialight Corporation, A North American Philips Company  
 60 Stewart Avenue, Brooklyn, N.Y. 11237 (212) 497-7600

INFORMATION RETRIEVAL NUMBER 29

ELECTRONIC DESIGN 19, September 13, 1973

# 'Ladar' concept proved in experimental system

An experimental system has been developed that demonstrates the feasibility of a laser detecting and ranging system—a "ladar" instead of a radar.

The ladar offers potential advantages over the conventional radar unit:

- The micron wavelength of light would provide microradian target resolution with a modest antenna size, or radian resolution with a very small antenna.

- Because the frequency of light is above the resonant frequency of plasma clouds, the ladar would be able to track such targets as re-entry vehicles and missiles, now obscured by such phenomena.

The experimental ladar system, developed by Hughes, had to overcome a problem with beamwidth. The angular resolution of a radar system is a function of the width of the transmitted beam. The beamwidth is a function of the ratio of the wavelength of the transmitted signal to the wavelength size of the transmitting array. However, as Dr. William B. Bridges, senior scientist at Hughes

Research Laboratories, Malibu, Calif., explains:

"The effective beamwidth of a microwave or laser signal is limited to those portions of the beam which are phase coherent. The problem with the development of a multi-element array for laser radar was that turbulent air affects different portions of a laser beam differently, causing phase differences within the beam, which destroy the effective beamwidth and resolution."

An answer was found in the Coherent Optical Adaptive Technique (COAT). Bridges, who is manager of the COAT program, notes: "By detecting any phase differences between signals radiated by a number of elements in a laser array and correcting them automatically, this system can maintain its beamwidth over air paths sufficiently turbulent to make a laser radar otherwise usable."

In the COAT system described in a paper presented earlier this year at the IEEE/OSA Conference on Laser Engineering and Applications in Washington, the laser signals radiated over a 100-meter turbulent air path are controlled. The light from the systems source—a helium-neon laser operating at

Northe K. Osbrink  
 Western Editor

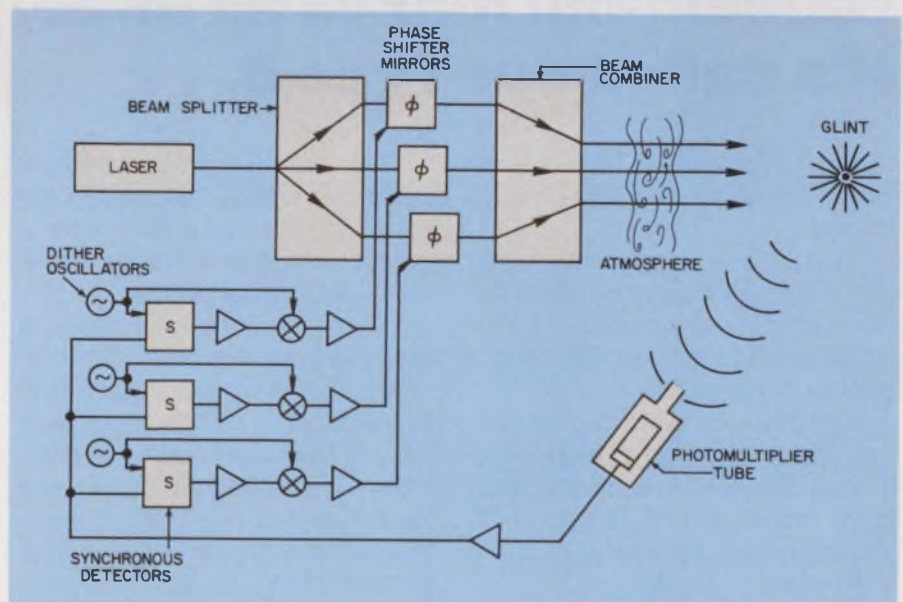

Experimental "ladar" system with a three-element array incorporates the Coherent Optical Adaptive Technique to maintain its effective beamwidth. This system has operated over a 100-meter turbulent airpath.

timing  
relay



load  
relay



low-cost  
relay



## Heinemann makes all three. It's called our Type B.

A single Heinemann Type B time-delay relay is really three relays in one.

First, it's a good delay relay, delivering all the timing accuracy and recycling speed you need for most applications within its 1/4-sec to 2-min range.

Second, its continuous-duty coil and enclosed 5-amp gold-plated fine-silver contacts often can let it carry the load it switches, saving you a separate load relay.

Third, for all the double duty it performs, and all its quality construction, its price is decidedly in the low-to-moderate range. Especially in OEM quantities.

Where else in all relaydom could you find this combination of charms? And Type B is just one of five models in our Silic-O-Netic® line of hydraulic-magnetic time-delay relays. Bulletin 5006 (send for a copy) tells all about them. Heinemann Electric Company, Brunswick Pk., Trenton, NJ 08602.

5619



# HEINEMANN

INFORMATION RETRIEVAL NUMBER 30

6358 Å—is fed through a beam-splitter mirror arrangement and separated into three beams of light. Each of the beams is reflected off a mirror mounted on a piezoelectric ceramic element.

Voltages applied to the element cause motion that is transmitted to the mirror, which can shift the beam approximately a wavelength. This allows the phase of each beam to be varied independently. The three beams are then combined in a beam-combiner mirror array. The resulting beam is aimed down the atmospheric path and reflected by a target, and the resulting glint is detected by a photomultiplier tube.

Each of the three beams maintains its identity by being phase-modulated with an identifying, or dither, frequency generated by a separate oscillator and applied to the moving mirror elements. When the output of the photomultiplier is amplified and fed to three synchronous detectors, each of which is also fed by the corresponding dither oscillator, a phase-error signal for each beam is generated. This is fed to the corresponding moving mirror, which shifts the phase of each individual beam to restore the phase relationship of the over-all radiated beam.

### Improvements expected

Bridges stresses that this is an experimental system, to demonstrate the feasibility of this technique, and that later-generation systems will employ more sophisticated methods to control the laser signals. By maintaining the phase coherence of an optical beam in the atmosphere, the beamwidth is limited only by atmospheric diffraction rather than by atmospheric turbulence.

Other features demonstrated by the COAT system are selective convergence on the stronger of two glints from a complex target and the ability to converge on a moving target.

The COAT program is a joint project of Hughes Research Laboratories and Hughes Aircraft Co. of Fullerton, Calif. The current operation is under contract from the Advanced Research Projects Agency of the Dept. of Defense through the Rome Air Development Center in New York State. ■■

# NEW SOLID STATE RELAYS

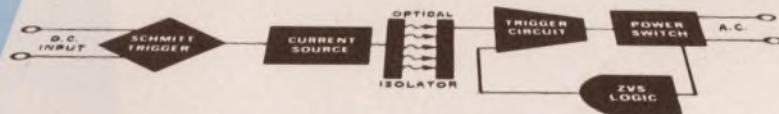
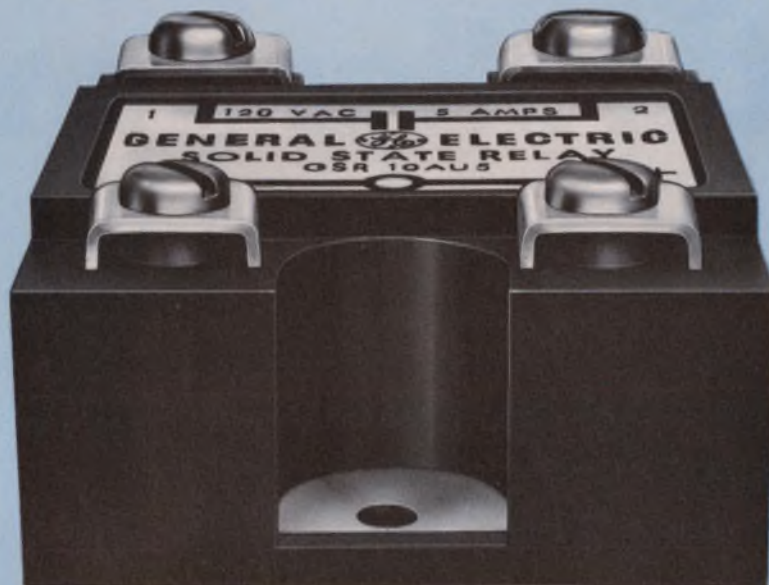

## FROM GENERAL ELECTRIC

All the technology that went into making General Electric a leader in couplers and power semiconductors is in our first solid state relay. Two models, 5 Amp. GSR10AU5 and 10 Amp. GSR10AU10, feature

- 120 V line operation
- Zero voltage switching, 5V max.
- T<sup>2</sup>L operation — 30 to 100° C
- Operates from 6.3 to 140 V RMS
- 1500 V RMS Photon Isolation

AVAILABLE NOW FROM YOUR AUTHORIZED GE DISTRIBUTOR

GENERAL  ELECTRIC

# Lighted pushbutton switches this good should cost dollars more.

## Our prices:

\$125\*

\$160†



### OAK SERIES 300.

Get premium performance—at much less than a premium price. Oak Series 300 lighted pushbutton switches give you tested-for-reliability operation and long life. The economical solution to pushbutton applications for bank terminals, calculators, copiers, and more.

Modular design simplifies panel design. Oak Series 300 switches are relampable from the front, with

replaceable lenses, legend plates, and button assemblies. The snap-on lamp holders withstand physical shock, help prolong lamp life.

Choose from single, dual, or four-lamp display, as well as indicators and non-lighted types. Specify one to twelve station banks, with momentary, interlock, alternate action, or any switching combination available on the same bank.

Colors? Your choice of any one of the following for single-leg switches (or any combination for split-leg switches): lunar white, white, red, green, amber, yellow, orange, blue.

Get the complete details. Write for our Series 300 brochure.

\* Single-leg, single-lamp, normal latch, 2P2T, glass alkyd insulation, no engraving, less lamps. OEM quantities.

† Split-leg, four-lamp, normal latch, 2P2T, glass alkyd insulation, no engraving, less lamps. OEM quantities.

**OAK Industries Inc.**

SWITCH DIVISION/CRYSTAL LAKE, ILLINOIS 60014  
TELEPHONE: 815-459-5000 ■ TWX: 910-634-3353 ■ TELEX: 72-2447

INFORMATION RETRIEVAL NUMBER 32



## Who to call for fast delivery on Oak Series 300 Switches.



Now you can order Oak Series 300 Lighted Pushbutton Switches and assemblies (single-legend/single-lamp or non-illuminated) in quantities up to 149 from your regional Oak distributor. These distributors are equipped to assemble custom units and ship within 3 days.

### DRW

MASSACHUSETTS, Watertown. (617) 923-1900  
NEW YORK, Farmingdale. . . . . (516) 249-2660\*

### EDMAR ELECTRONICS

ILLINOIS, Des Plaines. . . . . (312) 298-8580\*

### G. S. MARSHALL

CALIFORNIA, El Monte. . . . . (213) 686-1500\*  
CALIFORNIA, San Diego. . . . . (714) 278-6350  
CALIFORNIA, Sunnyvale. . . . . (408) 732-1100  
COLORADO, Arvada. . . . . (303) 427-5858  
OHIO, Dayton. . . . . (513) 278-9496

### HALL-MARK

ALABAMA, Huntsville. . . . . (205) 539-0691  
FLORIDA, Orlando. . . . . (305) 855-4020\*  
GEORGIA, Atlanta. . . . . (404) 963-9728  
ILLINOIS, Chicago. . . . . (312) 437-8800  
KANSAS, Kansas City. . . . . (913) 888-4747  
KANSAS, Wichita. . . . . (316) 682-2073  
MARYLAND, Baltimore. . . . . (301) 265-8500  
MINNESOTA, Minneapolis. . . . . (612) 925-2944  
MISSOURI, St. Louis. . . . . (314) 521-3800  
NORTH CAROLINA, Raleigh. . . . . (919) 832-4465  
NEW YORK, New York. . . . . (516) 293-7500  
OHIO, Dayton. . . . . (513) 278-6963  
OKLAHOMA, Okla. City. . . . . Enterprise 50094  
OKLAHOMA, Tulsa. . . . . (918) 835-8458  
PENNSYLVANIA, Philadelphia. (215) 355-7300  
TEXAS, Austin. . . . . (512) 454-4839  
TEXAS, Dallas. . . . . (214) 231-6111\*  
TEXAS, Houston. . . . . (713) 781-6100  
WISCONSIN, Milwaukee. . . . . (414) 476-1270

### INTERFACE ELECTRONICS

WASHINGTON, Seattle. . . . . (206) 285-3500\*

\*Assembly Locations

**DAK Industries Inc.**  
Crystal Lake, Illinois 60014

## MOS/LSI modem replaces expensive bipolar type

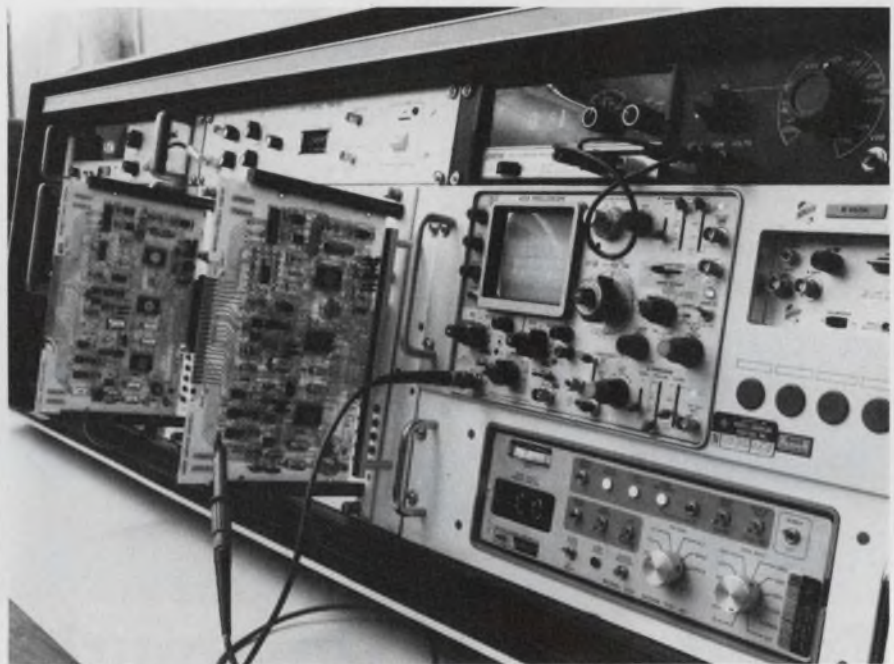

High speed MOS/LSI modem from Rockwell is contained on a single printed-circuit board and features adaptive equalization.

An MOS/LSI modem for computer terminals, composed of five chips on a single printed-circuit card, replaces circuitry that now occupies several cubic feet of space. And the price is said to be only a fraction of what its bipolar equivalent would cost.

The modem, developed by the Microelectronic Products Div. of Rockwell International, Anaheim, Calif., is a 4800 bit/s device featuring adaptive equalization.

According to James L. Thomas, manager of telecommunications for Rockwell, the five ICs used are:

- A transmitter chip, which contains a/d and d/a converters, as well as circuitry to generate the transmitted waveform.
- A receiver chip, which demodulates the received signal.
- An equalizer chip, which compensates for changes in telephone-line characteristics.
- A clock chip, which contains an oscillator and countdown chain that provides a timing reference for the rest of the modem.
- A reverse-channel chip, which is really a low-speed, frequency-shift-keyed modem.

The modem, designed a year ago

for a specific customer, is only now making its debut in the commercial market. The adaptive feature, Thomas notes, means that it can be used on a wide range of telephone channels. The automatic compensation, he continues, is accomplished by monitoring continuously the transmission of data and measuring the impulse response of the channel being used. Amplitude and delay distortion caused by the channel are compensated for automatically by changes in the coefficients of internal digital filters.

While the price for the new modem has not been announced because it is flexible, Thomas notes that it will be only "a few hundred dollars." This, he says, compares with equivalent bipolar devices that now cost \$3000 to \$6000.

"The reason we can't quote an exact price," Thomas says, "is that we are currently planning to sell modem subassemblies that plug right into a customer's product. Since interfacing with each product is different, pricing will have to be, too."

Rockwell is considering selling just the modem chips as a set, but has not yet made a decision. ■■



## Timefax® and Timemark® are the best recording papers for transmitting a picture of your plant baseball team. (Or almost anything else you can record.)

**Sonar Recorders** Timefax and Timemark electro-sensitive recording papers give instant access to the recorded information. You get an immediate dry copy. The fish won't get away or you won't run aground because you lost time processing the image.



**Photo Facsimiles and Voice Characteristic Sonagrams** Only the full range of neutral grey tones provided by Timefax and Timemark electro-sensitive recording papers will give you this recording ability.

**Facsimile Receivers** Timefax and Timemark papers give a dense black image on a white background. With Timefax and Timemark you get the highest quality copy in the industry.

**Computer Print Out** Using Timefax or Timemark papers you can record up to 60,000 characters per

second on an impactless computer printer or 30 characters per second on the simplest strip printer.

**Industrial Event Recorders** You can record a few inches per hour or hundreds of inches per second with maximum reliability because it's electro-sensitive recording.

**Non-destructive Testing** Very high resolution images will give you all the detail you need for flaw detection, surface profiling and spectrum analysis.

**Electrical Writing** Essentially that's what you do with Timefax and Timemark recording papers. You simply amplify the electrical output of your measuring transducer and this signal writes directly on our electro-sensitive recording paper. Couple this with the fact that the electro-sensitive recording process is completely dry and permanent. And it's hard to justify recording any other way.

We have a technical manual entitled "The Dry Electro-sensitive Recording Process". It was written to give design engineers a better understanding of the technical aspects of the electro-sensitive recording process. We would be happy to send you a free copy upon request.



**FITCHBURG CPI**  
Litton Box 1106, Scranton, Pa. 18501 Phone: 717-347-2035

# Plug in these mini-transformers.

# Wave solder them.

# Pocket the saving.



TRW/UTC can help you open up some refreshing solutions to your printed circuit board audio transformer problems. Our Ouncer, Subbouncer and Sub-subbouncer lines, the quality standards for years, are now available with plug-in terminals for labor- and cost-saving board mounting. Leads are designed for wave soldering.

These plug-in units offer all the quality, reliability and utility of the famous UTC ouncer line with insulated leads. Nothing has been compromised.

Special Subbouncer and Sub-subbouncer molded units can be furnished in place of any open frame model. Metal encased types to MIL Grade 4 are available from stock or can be made to your specs.

This is the transformer line that couples highest performance and reliability with plug-in economy and the shortest delivery cycles. Call or write for catalog on your letterhead. TRW/UTC Transformers, an Electronic Components Division of TRW, Inc., 150 Varick Street, New York, N.Y. 10013. Tel: (212) 255-3500.

## **TRW** UTC TRANSFORMERS

INFORMATION RETRIEVAL NUMBER 34



# Single and Dual Centrifugal Blowers Venturi Fans • Orifice and Panel Fans

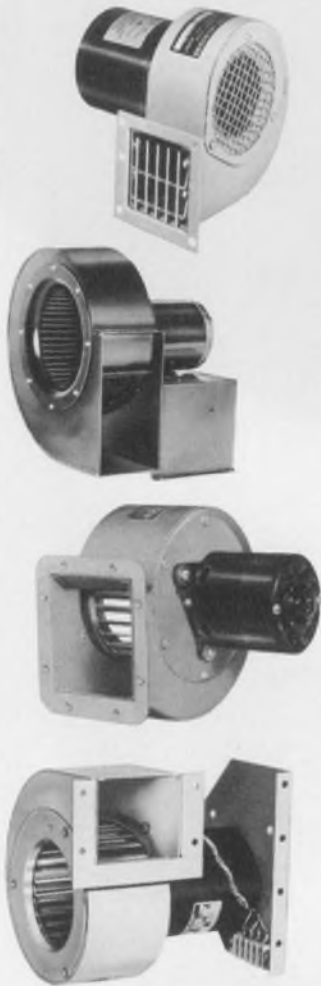

**SINGLE CENTRIFUGAL BLOWERS**—McLean does have a large selection of single centrifugal blowers engineered to meet a wide variety of CFM output and pressure characteristics. Inlet duct flanges, exhaust outlet flanges and protective screens are available. CW and CCW rotations can be supplied. Each motor has been specifically designed for the application, bearings are properly loaded, double shielded and permanently lubricated. Motor and wheels are balanced to precision tolerances assuring vibration-free operation. All motors are UL approved. These blowers may be operated in any shaft position.

CFM output ranges from 50 to 2000 CFM with static pressures from 0" to 3.0" SP. Motors can be supplied for any AC frequency or power.

**DUAL CENTRIFUGAL BLOWERS**—There is an extensive variety of McLean Dual Centrifugal Blowers offering a wide choice of static pressure and output characteristics. Wheel diameters range from 3" to 12". Motors can be supplied for any AC frequency or power, single or three phase. Each motor has been specifically designed for the application, bearings are properly loaded, double shielded and permanently lubricated. Motors and wheels are balanced to precision tolerances assuring vibration-free operation. All motors are UL approved.

Exhaust outlet flanges, inlet duct flanges, protective screens and various types of mounting flanges and supports are available.

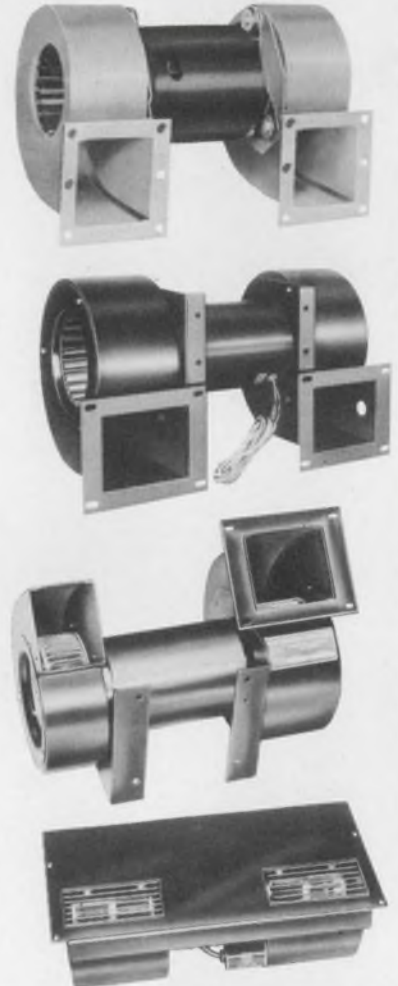

### VENTURI-MOUNTED FANS

420 CFM. Mounts top, bottom, or side of cabinet. Airflow either direction. Diameter 10½". Depth 3¾"



### PANEL FANS • ORIFICE FANS

Low-cost cooling. Up to 550 CFM. Low, quiet speeds. Mounts top, bottom, or side of cabinet with shaft in any position.



### 1973 CATALOG

The largest, smartest, most reliable line of blowers, fans, cooling equipment and precision motors.

# McLEAN ENGINEERING LABORATORIES

P.O. Box 127F Princeton Junction, N.J. 08550

PHONE: 609-799-0100 • TELEX 84-3422

"See us at Booth 1525 WESCON"

INFORMATION RETRIEVAL NUMBER 35

Woven

## An open and shut case.

The evidence is conclusive. Our **Accordion Fold** fits the back panel-to-drawer connection task to a T. Simple to connect. Free, easy movement. Strain relief tabs minimize wear.

### WOVEN ELECTRONICS

P.O. Box 189, Mauldin, South Carolina 29662

INFORMATION RETRIEVAL NUMBER 36

The Mark Ten B Capacitive Discharge Ignition System keeps your car in tune . . . and everyone knows that a well-tuned car gets better mileage, requires less maintenance, runs longer and better, and helps in the quest for cleaner air.



... Just ask Detroit and the E.P.A.

Order your Mark Ten B today! Please send me free literature.

Enclosed is \$ \_\_\_\_\_  Ship ppd.  Ship C.O.D.  
 Please Send: \_\_\_\_\_ Mark Ten B @ \$59.95 ppd. \_\_\_\_\_ Mark Ten B Kit @ \$44.95 ppd.

Car Year \_\_\_\_\_ Make \_\_\_\_\_

Name \_\_\_\_\_

Address \_\_\_\_\_

City \_\_\_\_\_

State \_\_\_\_\_ Zip \_\_\_\_\_



**DELTA PRODUCTS, INC.**

Dept. ED P.O. Box 1147 - Grand Junction,  
 Colo. 80501 (303) 242-9000

# SPECIAL GROUP TOUR



## 1973 JAPAN ELECTRONICS SHOW

With the cooperation of ELECTRONIC DESIGN and PAN AMERICAN AIRWAYS, a special tour program has been tailored by Imperial Travel Service of New York for exhibitors and visitors to the 1973 JAPAN ELECTRONICS SHOW to be held in Osaka, Japan, October 1 through 7. Far and above regular sightseeing tours, this program will offer you many opportunities to witness at first-hand the growing Japanese electronics industry and provide free time to do business in Japan and the Orient. If you are taking your wife along, you will find this tour ideal with its many side trips and excursions.

Departure from West Coast: Saturday, September 22, via Pan American  
Return to the United States: Monday, October 8, via Pan American

Tour Fare: \$945 per person on sharing basis  
\$150 per person for single supplement

The above includes:

Air transportation from West Coast to Tokyo, round trip,  
Economy on GIT fare.

Accommodations for 15 days at first class hotels.

Full American breakfasts during the tour

Transfers by chartered motorcoaches between airports and hotels.

Sightseeing tours in Tokyo, Nikko, Kyoto and Osaka.

Special plant tours designed for the participants.

Services of tour couriers and guides.

Features: Interpreter/Secretarial services will be available upon request.  
Extension trips to Taiwan, Korea and Hong Kong available.

For detailed information, complete and mail the coupon below.



To: Imperial Travel Service  
50 Essex Street, Rochelle Park, NJ 07662

I am interested in your Special Group Tour to the Japan Electronics Show, October 1-7, 1973. Please send me detailed information as soon as possible.

Name \_\_\_\_\_

Title \_\_\_\_\_

Company \_\_\_\_\_

Address \_\_\_\_\_

# New function generator programs faster— functions better, longer.

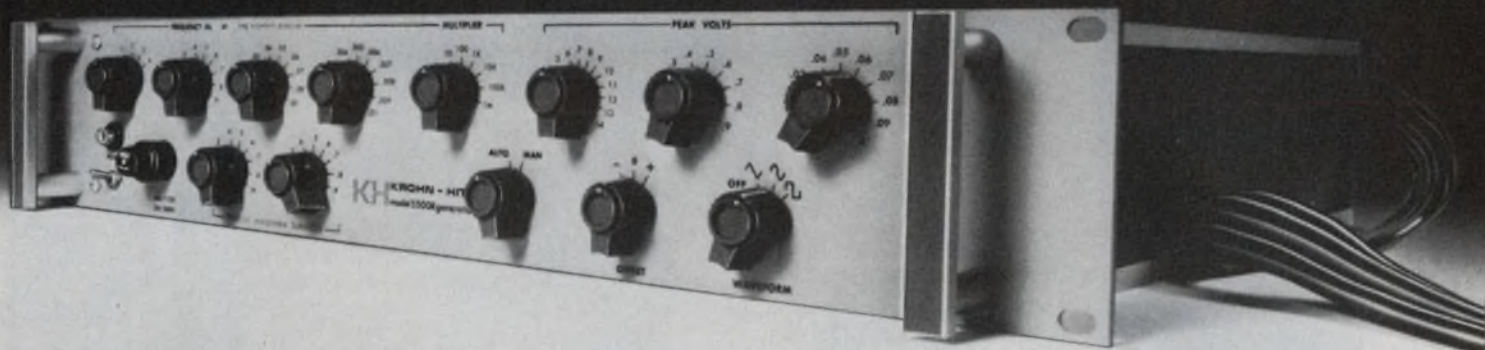

**The 5500R Programmable Function Generator utilizes high-speed FET switches for greater reliability and generates functions automatically in less than 100 $\mu$  sec.**

There are no relays to break down. And optical coupling assures high isolation between system and logic drive. Frequency range is 0.0001Hz to 5MHz. Sine, square, triangle, pulse and sawtooth waveforms, as well as frequency, amplitude, DC offset and pulse width control functions, can all be selected auto-

matically or manually. And the 5500R programming interface is compatible with DTL, RTL, TTL logic and relay closures. It's ideally suited for automatic calibration and test systems. For fast action, call (617) 491-3211, TWX 710 320 6583, or contact your local KH representative listed below.

**KH KROHN-HITE  
CORPORATION**

580 Massachusetts Avenue, Cambridge, Massachusetts 02139

SALES OFFICES: ALA., Huntsville (205) 534-9771; CAL., Santa Clara (408) 243-2891, Inglewood (213) 674-6850; COLO., Littleton (303) 795-0250; CONN., Glastonbury (203) 633-0777; FLA., Orlando (305) 894-4401; HAWAII, Honolulu (808) 941-1574; ILL., Des Plaines (312) 298-3600; IND., Indianapolis (317) 244-2456; MASS., Lexington (617) 861-8620; MICH., Detroit (313) 526-8800; MINN., Minneapolis (612) 884-4336; MO., St. Louis (314) 423-1234; N.C., Burlington (919) 227-2581; N.J., Bordertown (609) 298-6700; N.M., Albuquerque (505) 255-2440; N.Y., E. Syracuse (315) 437-6666, Rochester (716) 328-2230, Wappingers Falls (914) 297-7777, Vestal (607) 785-9947, Elmont (516) 488-2100; OHIO, Cleveland (216) 261-5440, Dayton (513) 426-5551; PA., Pittsburgh (412) 371-9449; TEX., Houston (713) 468-3877, Dallas (214) 356-3704; VA., Springfield (703) 321-8630; WASH., Seattle (206) 762-2310; CANADA, Montreal, Quebec (514) 636-4411, Toronto, Ontario (416) 444-9111, Stittsville, Ontario (613) 836-4411, Vancouver, British Columbia (604) 688-2619.

See us at WESCON, Booth 1333.

INFORMATION RETRIEVAL NUMBER 40

# Here's all it takes to make it at 900 MHz.

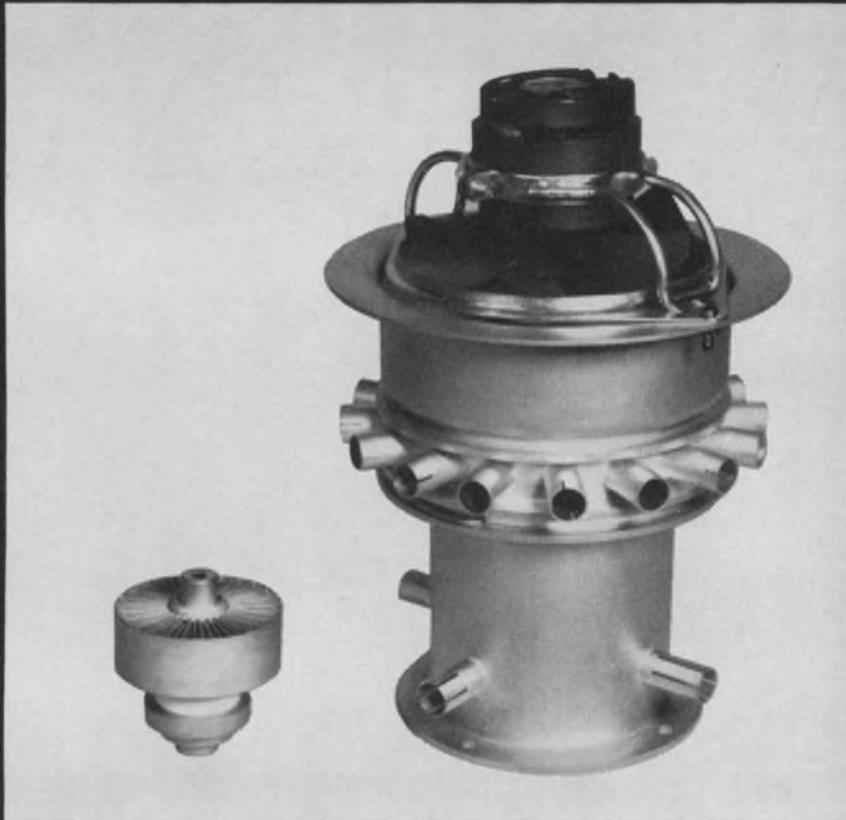

We've got the tube (A2965A) and cavity (Y1261) combination ready now for the 150 watt base station. Plus know-how and proved experience you can call on. As a result, you can move in on this burgeoning market fast, and save the time, trouble and expense of proto-

type engineering and testing.

You save because the RCA A2965A UHF power amplifier tube is specifically designed for base station transmitters. It delivers power in excess of 150 watts from 806 to 960 MHz. And its sturdy, coaxial input construction assures optimum performance at UHF with minimal tube inductances and feed-thru capacitances.

For more information on

RCA tubes, cavities and know-how for 900 MHz equipment, contact your RCA Representative. Or write Manager, Power Tube Marketing, RCA, Section ZR15, Lancaster, Pa. 17604.

**RCA** Power Devices



# washington report



Heather M. David  
Washington Bureau

## **The Soviet MIRV may boost DOD budget**

The announcement by Defense Secretary James Schlesinger that the Soviets have developed and flight tested a Multiple, Independently Targeted Reentry Vehicle (MIRV) should make things easier for proponents of a bigger Defense budget, which is now being considered by the Congress. The news is expected to forestall massive cuts in research and development, such as those contained in an amendment to the House version of the procurement bill by Rep. Les Aspin (D-Wis.). Rep. Aspin wants to slash the 1974 R&D budget by almost a billion dollars. The Senate Armed Services Committee is reported reconsidering some of its cuts and may restore some funds to the bill in the final House and Senate conference. The Soviet MIRV is also affecting Pentagon planning for the 1975 budget program, leading to thoughts of improved reentry vehicle guidance electronics and other upgrading that could be accomplished within the limitations of the Strategic Arms Limitation Talks (SALT) agreements.

## **OTP urges more competition in land mobile radio**

The Federal Communications Commission may reverse a staff decision to give the telephone common carriers the lion's share of the newly opened land mobile radio communications frequencies as a result of recommendations by both the Justice Dept. and the White House Office of Telecommunications Policy. The major recipients both agencies agreed, should, in fact, be equipment manufacturers and communications firms not affiliated with telephone companies. OTP recommended that 14 MHz of the disputed 115 MHz should go to the telephone companies, but that 40 MHz should be allocated for use by mobile radios on a nonregulated basis. The remaining 61 MHz should be held in reserve. The FCC staff group had proposed giving the telephone common carriers 75 MHz and the land mobile companies 40 MHz.

## **Navy, Air Force formulate RPV plans**

Both the Navy and Air Force have convened working committees to plan the future use of remotely piloted vehicles (RPVs) which look attractive to many military planners for their potential in taking over functions assigned to manned aircraft. Among the pluses: far lower cost, no loss of life or POW problem. The Navy has identified as many as 50 possible missions for RPVs ranging from reconnaissance to actual dog-fights with enemy fighter aircraft. The Air Force mission analysis group,

empaneled at the Aeronautical Systems Division, Wright-Patterson AFB, Ohio, has been receiving presentations from industry on drone and RPV technology, and is letting a series of short term contracts on such aspects as guidance, communications and electronic countermeasures capability to aid in arriving at recommendations for future Air Force RPV progress. Industry expects to get guidance from both groups later this fall.

## **Air Force calls fly-by-wire a success**

Initial flight tests of an electronic flight-control system, often called "fly-by-wire," has proven the concept of substituting electronic links for the conventional aircraft mechanical control system, Air Force officials report. In the new system electrical signals are used instead of hydraulics to activate the controls. Due to the fly-by-wire system's lighter weight and smaller size, a combat plane could carry as many as three control systems as backups in case of enemy attack. Besides this luxury, the system's individual components are more reliable than are mechanical components, the Air Force says. Known as the Survivable Flight Control System, the fly-by-wire unit was built by McDonnell Douglas.

## **The Navy seeks new reconnaissance techniques**

The Navy is looking for new technological approaches to the problem of getting good tactical reconnaissance imagery for its fighter and attack aircraft. Naval Air Systems Command is asking industry for imaginative technical ideas for tactical reconnaissance sensors and suggestions for new approaches for production of such systems. Navair expects to fund the development of at least two reconnaissance sensor pods costing \$500,000 to \$1.3-million each. One would carry sensors for clear weather missions, the other for fog, rain or cloud areas. The Navy expects to award one or more contracts for a prototype early in 1975, if funding is approved.

**Capital Capsules:** NASA has told industry it wants to lease a satellite system to supplement its own satellite tracking network. The new system would consist of two synchronous satellites, one over the Pacific and one over the Atlantic Ocean, that could track and communicate with NASA spacecraft in low altitude earth orbit. . . . RCA Corp. has been awarded a \$7.5-million Army Satellite Communications Agency contract to design and build transportable ground stations for use with the Defense Communications Satellite System. The contract calls for nine engineering development terminals. . . . The Institute of Electrical and Electronic Engineers (IEEE) has initiated a Technology Forecasting and Assessment Project aimed at developing a comprehensive forecast of electrotechnology and an assessment of its impact. The Air Force's Rome Air Development Center, New York, is looking for contractors to determine the most promising approach to switching optical wavelength signals between many optical fiber transmission circuits. The technique would eventually be used, in a communications system, if successful. . . . The Navy's Project Sanguine, the underground extremely-low-frequency system for communicating with submarines throughout the world, is meeting the same frosty reception in Texas it encountered in Wisconsin.

**And what a beautiful team!**

Recently Tektronix introduced to you two new time saving products, the Digital Processing Oscilloscope and the Tektronix Type 31 Programmable Calculator. Now, we have married them. Meet the Digital Processing Oscilloscope/31 Calculator (DPO/31).

How did we do it? First from our 7000 Oscilloscope family we took the 7704A 200 MHz mainframe, added a processor to digitize waveforms, and interfaced the processor with our Type 31 programmable Calculator. The complete assembly can be programmed to perform waveform calculations and measurements with the stroke of just a few keys.

Calculator programming is easy because Tektronix removed the program language barrier making it possible for you to communicate with the machine in the math language you grew up with. 24 user definable keys enable you to customize the calculator to meet your own specific needs.

Now, you can stop making waveform measurements by plotting or photographing and then doing your calculations point by point. Computations which presently take hours can be performed in just minutes.

By the way, there is no requirement to keep the DPO/31 constantly together. The calculator can be used all by itself just like any other scientific programmable calculator. Use the Digital Processing Oscilloscope as a stand alone unit to measure, store and playback waveforms. The DPO/31 adapts to you and your requirements.

Price depends on options and plug-ins chosen. A complete operating DPO/31 costs as low as \$11,745. For all the details on this versatile new package, use the reader service card, contact your field engineer or write Box 500A, Beaverton, Oregon 97005. In Europe TEKTRONIX LTD., Guernsey, C.I., U.K.



# JUST MARRIED

INFORMATION RETRIEVAL NUMBER 42

## Tektronix TM 500 Series puts it all together

Tektronix has taken a new approach to test and measurement instruments. The TM 500 Series is modular, multifunctional, synergistic, cost effective, and more. It includes the features you've been looking for.

Presently, the TM 500 Series includes 24 general purpose plug-in test instruments. All new ways to think of Tektronix. Digital counters to 550 MHz. Signal sources ranging from below 1 mHz to above 1 GHz. Pulse generators to 250 MHz. Digital multimeters with 4½ digit LED readout and temperature measurements from -55° C to +150° C. Plus signal processors, power supplies, and CRT monitors.

All the modules are interchangeable. So you can make combina-

tions of instruments to meet your particular needs. When new instruments are introduced (and many will be soon), you simply plug them into the power unit. You can use a single compartment (TM 501), a triple compartment power unit (TM 503), or two 503's combined for a standard rackmount installation.

Connections between modules and/or external equipment are made through the power unit rear interface board and optional rear panel connectors. Approximately 30 input-output lines are available in each compartment for special set-ups you might want to make. This intracompartiment interface feature also permits multifunction applications resulting in a synergistic effect. Instruments working

together perform more functions than the same instruments working independently. Many modules include serial BCD so information can be transferred directly to a computer or calculator.

The TM 500 is compact too. A three-compartment power unit is only 6"x8.7"x15.3". That means the TM 500 is two to six times smaller than comparable instruments. So you save bench space. And it's light weight, easy to carry. A package including a general purpose counter, multimeter, and power supply weighs 14 to 18 pounds!

Cost? All TM 500 plug-in modules are competitively priced with instruments of comparable capabilities. Because TM 500 instruments share the fixed costs of

**Modular, compact, synergistic,  
multifunctional, versatile,  
cost effective and more.**

power supplies, cabinets, etc., they consistently provide the lowest cost per test/measurement function. And, because the instruments are modular, cost of maintenance is lower too.

For complete details, contact your Tektronix Field Engineer. Or write or phone for our new 12 page, full color brochure and 24 data sheets. They show why the TM 500 is the finest test and measurement series available today. Tektronix, Inc. P.O. Box 500, Beaverton, Oregon 97005. In Europe, write Tektronix Ltd., Guernsey, C. I., U.K.



INFORMATION RETRIEVAL NUMBER 43

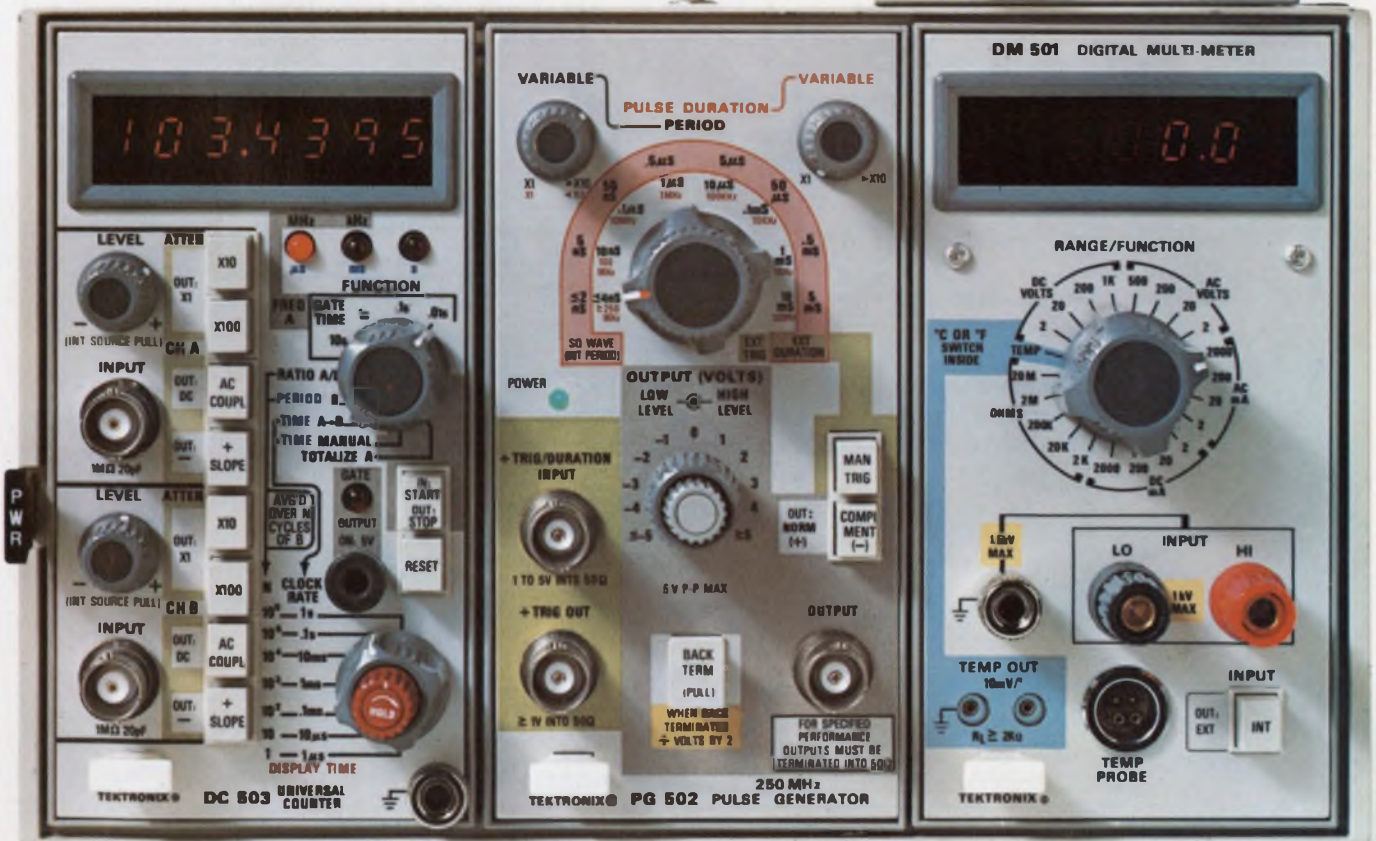

**TEKTRONIX DC 503 UNIVERSAL COUNTER**

LEVEL ATTEN X10  
 INPUT (INT SOURCE PULL) CH A  
 AC COUPL  
 SLOPE  
 X100  
 CH B  
 AC COUPL  
 SLOPE  
 X100

FUNCTION  
 GATE TIME  
 RATIO A/B  
 PERIOD B  
 TIME A-B  
 TOTALIZE A  
 GATE OUTPUT ON/OFF  
 START/STOP  
 RESET

CLOCK RATE  
 10<sup>0</sup> 10<sup>1</sup> 10<sup>2</sup> 10<sup>3</sup> 10<sup>4</sup> 10<sup>5</sup> 10<sup>6</sup> 10<sup>7</sup> 10<sup>8</sup> 10<sup>9</sup> 10<sup>10</sup> 10<sup>11</sup> 10<sup>12</sup> 10<sup>13</sup> 10<sup>14</sup> 10<sup>15</sup> 10<sup>16</sup> 10<sup>17</sup> 10<sup>18</sup> 10<sup>19</sup> 10<sup>20</sup> 10<sup>21</sup> 10<sup>22</sup> 10<sup>23</sup> 10<sup>24</sup> 10<sup>25</sup> 10<sup>26</sup> 10<sup>27</sup> 10<sup>28</sup> 10<sup>29</sup> 10<sup>30</sup> 10<sup>31</sup> 10<sup>32</sup> 10<sup>33</sup> 10<sup>34</sup> 10<sup>35</sup> 10<sup>36</sup> 10<sup>37</sup> 10<sup>38</sup> 10<sup>39</sup> 10<sup>40</sup> 10<sup>41</sup> 10<sup>42</sup> 10<sup>43</sup> 10<sup>44</sup> 10<sup>45</sup> 10<sup>46</sup> 10<sup>47</sup> 10<sup>48</sup> 10<sup>49</sup> 10<sup>50</sup> 10<sup>51</sup> 10<sup>52</sup> 10<sup>53</sup> 10<sup>54</sup> 10<sup>55</sup> 10<sup>56</sup> 10<sup>57</sup> 10<sup>58</sup> 10<sup>59</sup> 10<sup>60</sup> 10<sup>61</sup> 10<sup>62</sup> 10<sup>63</sup> 10<sup>64</sup> 10<sup>65</sup> 10<sup>66</sup> 10<sup>67</sup> 10<sup>68</sup> 10<sup>69</sup> 10<sup>70</sup> 10<sup>71</sup> 10<sup>72</sup> 10<sup>73</sup> 10<sup>74</sup> 10<sup>75</sup> 10<sup>76</sup> 10<sup>77</sup> 10<sup>78</sup> 10<sup>79</sup> 10<sup>80</sup> 10<sup>81</sup> 10<sup>82</sup> 10<sup>83</sup> 10<sup>84</sup> 10<sup>85</sup> 10<sup>86</sup> 10<sup>87</sup> 10<sup>88</sup> 10<sup>89</sup> 10<sup>90</sup> 10<sup>91</sup> 10<sup>92</sup> 10<sup>93</sup> 10<sup>94</sup> 10<sup>95</sup> 10<sup>96</sup> 10<sup>97</sup> 10<sup>98</sup> 10<sup>99</sup> 10<sup>100</sup>

103.4395

**TEKTRONIX PG 502 PULSE GENERATOR**

VARIABLE PULSE DURATION PERIOD VARIABLE

5 nS 10 nS 20 nS 50 nS 100 nS 200 nS 500 nS 1 μS 2 μS 5 μS 10 μS 20 μS 50 μS 100 μS 200 μS 500 μS 1 ms 2 ms 5 ms 10 ms 20 ms 50 ms 100 ms 200 ms 500 ms 1 s 2 s 5 s 10 s 20 s 50 s 100 s 200 s 500 s 1000 s

OUTPUT (VOLTS)  
 LOW LEVEL  
 HIGH LEVEL  
 5 V P-P MAX

TRIG/DURATION INPUT  
 1 TO 5V INTO 50Ω  
 + TRIG OUT

OUTPUT  
 1 TO 5V INTO 50Ω

MAN TRIG  
 COMP (—)

BACK TERM (PULL)  
 WHEN BRIDGE TERMINATED  
 VOLTS BY 2

FOR SPECIFIED PERFORMANCE  
 OUTPUTS MUST BE  
 TERMINATED INTO 50Ω

250 MHz

**TEKTRONIX DM 501 DIGITAL MULTI-METER**

RANGE/FUNCTION

DC VOLTS 200 1K 500 200  
 AC VOLTS 20 200 2000  
 Ω 20K 200K 2000K 20M 200M 2000M  
 TEMP 20M 200M 2000M  
 °C OR °F SWITCH INSIDE

10V MAX  
 LO INPUT HI  
 10V MAX

TEMP OUT 10mV  
 R<sub>i</sub> ≥ 20k

TEMP PROBE

0.0

# CMOS Analog Switches

TTL-controlled switches handle full  $\pm 15V$  signal swing  
with only  $\pm 15V$  supplies.

New DG200 and DG201 devices provide channel and gain selection for analog signals up to  $\pm 15V$  power supply levels without exceeding switch signal handling levels (see typical applications circuit below). Devices feature:

- Monolithic CMOS construction; drivers and gates on a single chip.
- Low  $r_{DS}$  over full temperature and signal range.  
 $< 100 \Omega$  for DG200 (dual SPST)  
 $< 250 \Omega$  for DG201 (quad SPST)
- Static protection on all terminals.
- Break-before-make switching action.
- Independent pairs of sources and drains for maximum flexibility.
- Direct TTL, DTL and CMOS compatibility.

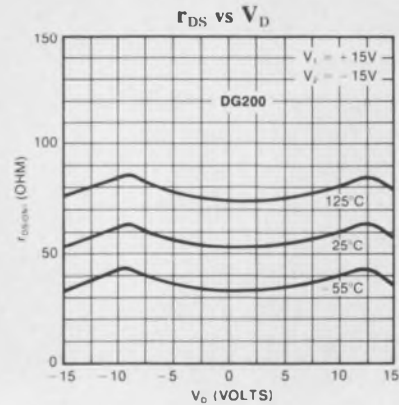

With supply voltage levels less than  $\pm 15V$ , the maximum analog signal always equals supply voltage.

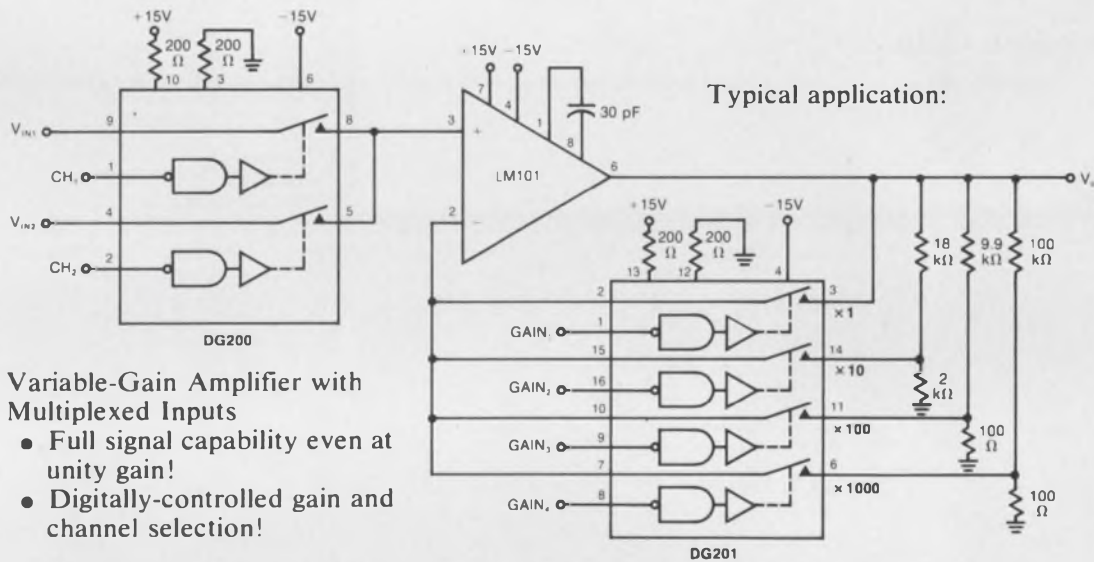

## Variable-Gain Amplifier with Multiplexed Inputs

- Full signal capability even at unity gain!
- Digitally-controlled gain and channel selection!

The DG200 and DG201 are ideal devices for digital computer interface with this analog world. If your switching problems are unique — and whose aren't — our applications people are eager to help. For complete information

## write for data

Applications Engineering: (408) 246-8000 Ext. 802



Siliconix incorporated

2201 Laurelwood Road, Santa Clara, California 95054

INFORMATION RETRIEVAL NUMBER 44

## Open the doors to the press

While working on a recent assignment, I discovered a special technical meeting had been scheduled on microprocessors—the very topic I was covering. Expected to attend were representatives of the leading manufacturers in the field, designers who had experience in this new and exciting area and interested researchers. What better opportunity to obtain at least background information—the trade euphemism meaning not-for-publication—for a forthcoming story?

That's what I thought until I discovered that I was barred from attending. Not because I was not a member of the sponsoring technical society—I am. Not because I was not an engineer—I am. But because I work for a technical publication.

I was told that the presence of press people would tend to inhibit panel members in their discussions. They could become distracted and not cover as fully the various aspects and nuances of positions they represent. In short, it was said that the meeting wouldn't be as free and open with the press present.

It's a familiar story. Each year there are several "closed" meetings, especially on topics dealing with state-of-the-art developments. These are the ones that present the kind of information you most want to know.

We think this policy doesn't make sense.

Since when do manufacturers send to meetings representatives who are easily distracted or who could seriously misrepresent basic company positions—especially when competitors are present? Often the participants are experts in their field who have frequently taken part in "open" discussions. In any case, it's hard to see how they could become seriously distracted by having an editor in the audience.

And who is being denied information on, say, a manufacturer's plans, problems and positions? Certainly not the competitor—he's already there.

You're the one who loses out when we're barred from these "closed" meetings. The vast majority of you can't attend when we can't. Even when we don't report directly on what takes place, we can gather background material that helps shape future articles that help you. What we learn, you learn.

More ominously, the existence of such "closed" meetings could create the impression that important decisions possibly affecting a whole industry are being shaped secretly by a handful of men. At a time when full and open disclosures are being asked of even our highest officials, the times seem right for meeting organizers to make a change:

Gentlemen, open the doors to the press.



*Edward A. Torrero*

EDWARD A. TORRERO  
Associate Editor





# Piher components are going places

**W**ith our exports hitting an all time high in the first quarter of 1973 – particularly carbon film resistors and trimming potentiometers – we can rightly claim that our products are going places. They are going to every country in the world where the name Piher is synonymous with product excellence in the highly competitive component business. It takes much more than a slick sales machine to build up one of Europe's biggest component companies. It takes total dedication to one end – ensuring that every customer knows that the Piher label stands for technical excellence.

And it does.

That's the major reason why we have grown to nearly 4,000 employees in six major plants achieving a \$50m annual turnover.

We design all our own production machines to ensure quality and reliability. We have no licence agreements, no sub-contract working. From start to finish we are in control of every product that goes out to a customer. And we have a lot of customers.

We produce 8 million carbon film resistors *a day* to meet world demand – and we have the largest variety of quality preformed resistors available anywhere.

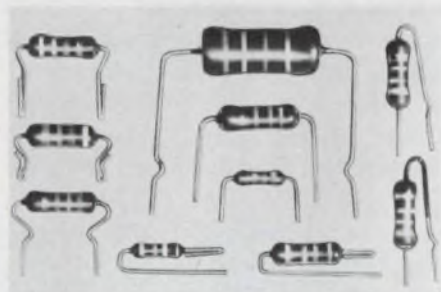

*Piher output of carbon film resistors is a staggering 8 million a day.*



*Headquarters of Piher International in Barcelona. The company employs nearly 4,000 people in six major manufacturing centres throughout Spain.*

We also provide the best range of quality, low-cost encapsulated trimmer pots – also slider and rotary versions – for every type of application, custom built to specific requirements where the need arises.

And that's only the beginning.

Our small signal and medium power transistor range is growing fast.

Our ferrites are in the forefront of magnetic ceramic technology.

And we have just laid down the most modern ceramic capacitor line in Europe.

Apart from our six manufacturing centres we have a world-wide distribution network backed by five Piher companies in the USA, Germany, Great Britain, France and Italy. They are only a 'phone call away if you need details on the best components in the business.

Or write to us for data sheets on the product area you are interested in.

Find out more about us. It pays.

*U.K.* – Piher International Ltd., Romar House, The Causeway, Staines, Middlesex, England. Tel: Staines 56157. Telex 934167

*U.S.A.* – Piher International Corp. 1239 Rand Road, Des Plaines, Illinois 60016, U.S.A. Tel: 312-297 1560. Telex 282154

*Germany* – Piher International GmbH, 85 Nuremberg, Westtorgraben, 5. Germany. Tel: 0911 260 469. Telex 623354

*France* – Piher International SARL, 83 Rue Etienne Dolet, 94230, Cachan, France. Tel: 656 26 07. Telex 27107

*Italy* – Piher International S.P.A. Via Cenisio 34, 20154 Milan, Italy. Tel: 314532/316213

*Head Office* – Riera Cañado, s/n Apartado de Correos 53 Badalona (Barcelona) Spain. Tel: 389 03 00. Telex 59521



# How to build a microcomputer:

Take an 8-bit parallel processor, add external circuitry, provide the right software and watch the timing relationships.

Second of three articles on microprocessors

The design of microcomputers—computing systems using microprocessor chips—begins with the processor chip. Internal operation, timing relationships and external circuitry are all important because, among other things, they affect the efficient use of the instruction set provided by the manufacturer.

Unlike less-complicated ICs, microprocessors cannot be completely characterized on a simple data sheet. An internal microprogram controls the complex circuitry of microprocessors. And its operation depends on software that you must provide. But you won't know how unless you carefully analyze how the chip works.

Let's look at an 8-bit parallel microprocessor—the Intel 8008, which has been second-sourced. A single-chip MOS/LSI processor, the 8008 can directly access up to 16,384 bytes of external memory using a 14-bit address. The seven 8-bit general-purpose registers on the chip can accommodate an ASCII character or two BCD digits.

Two supply voltages, +5 and -9 V dc, are required. At 25 C, the IC dissipates 1 W. All interconnecting lines are TTL-compatible, and each of the eight data lines can drive one low-power TTL load. Suitable clock-frequencies range from a minimum of about 300 kHz to a maximum of 800.

## External circuitry needed

To form a computer system, the microprocessor typically requires the external circuitry shown in Fig. 1. The 8-bit bidirectional data bus connects the microprocessor to the external memory and external registers  $I_1$  and  $I_2$ . During states  $T_1$  and  $T_2$  at phase  $\phi_{22}$ , the control logic strobes data into the external registers. It also determines which way data travel on the bus to and from the microprocessor. In addition the control

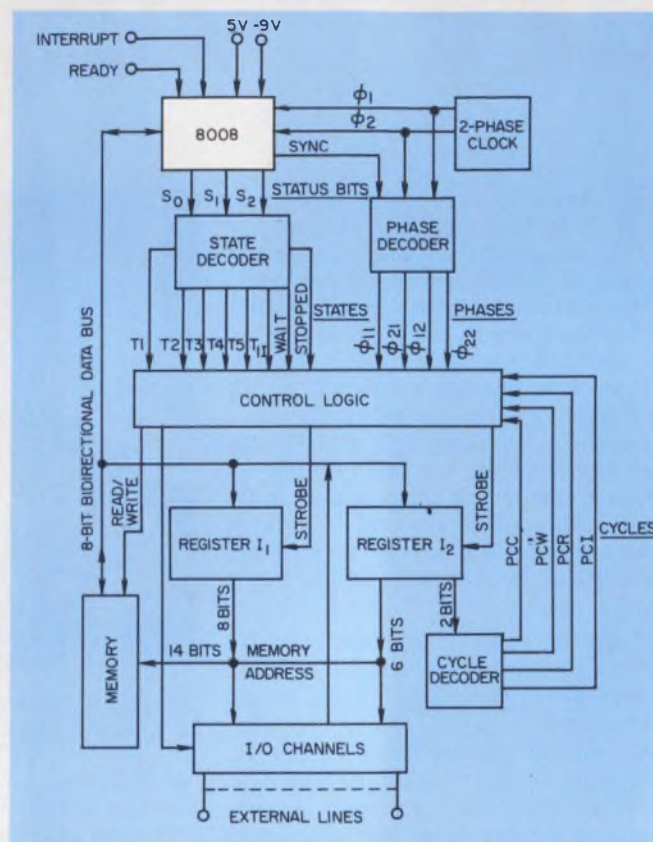

1. A computing system using the microprocessor. The external components provide the interface logic for control of the microprocessor and transfer of data to and from memory and I/O devices.

logic determines when the memory reads or writes, and it activates I/O channels.

External registers  $I_1$  and  $I_2$  supply addresses to memory as well as data bytes and pointers to the I/O channels. Data from the two most-significant-bit positions of register  $I_2$  are transferred to the cycle decoder. The decoder produces four cycles—PCI, PCR, PCW and PCC—which coordinate the internal operation of the microprocessor with the external circuitry.

When power is applied to the processor chip, 32 clock periods are needed to clear all registers and to initiate the internal microprogram. Then the processor goes into the STOPPED state—as indicated by status bits  $S_0$  through  $S_2$ —until an

Donald R. Lewis, Consultant, Lewis Associates, P.O. Box 33, Kew Gardens, N.Y. 11415.

W. Ralph Siena, Senior Principal Engineer, Litcom, 1770 Walt Whitman Rd., Melville, N.Y. 11746.

**Table 1. Nine states execute LMI instruction**

Cycle	State	Operation
PCI	T <sub>1</sub>	Low-order bits of program counter to I <sub>1</sub> . Increment program counter.
	T <sub>2</sub>	High-order bits of program counter and control bits to I <sub>2</sub> .
	T <sub>3</sub>	Fetch instruction byte from memory location addressed by I <sub>1</sub> and I <sub>2</sub> . Put into instruction register.
		Skip states T <sub>4</sub> and T <sub>5</sub> and go to the next cycle
PCR	T <sub>1</sub>	Low-order bits of program counter to I <sub>1</sub> . Increment program counter.
	T <sub>2</sub>	High-order bits of program counter and control bits to I <sub>2</sub> .
	T <sub>3</sub>	Read byte (immediate data) from memory location addressed by I <sub>1</sub> and I <sub>2</sub> . Put into auxiliary register b.
		Skip states T <sub>4</sub> and T <sub>5</sub> and go to the next cycle.
PCW	T <sub>1</sub>	Register L out to I <sub>1</sub> (low-order address)
	T <sub>2</sub>	Register H and control bits to I <sub>2</sub> (high-order address)
	T <sub>3</sub>	Register b to memory location addressed by I <sub>1</sub> and I <sub>2</sub> .
		Skip states T <sub>4</sub> and T <sub>5</sub> and go to the next cycle.
END OF EXECUTION OF INSTRUCTION		

interrupt occurs. When this happens—and during states T<sub>1</sub> and T<sub>2</sub>—the address of memory location 0 is referenced for the first instruction byte.

If the first instruction has been loaded into location 0, the instruction byte will be fetched during state T<sub>3</sub>. Otherwise the internal instruction decoder attempts to execute the instruction represented by the random-bit pattern in memory location 0. Then the microprocessor sequentially executes instructions or branches, as programmed.

Table 1 shows the execution of typical instruction LMI (Load Memory Immediate—with the next byte in memory following the instruction byte). The instruction occupies two bytes of memory, while its execution requires three cycles. At the beginning of the instruction—and during state T<sub>1</sub>—the eight low-order bits of the program counter are sent to register I<sub>1</sub>, and the program counter is incremented by one. The six high-

order bits of the program counter and the two control bits transfer to register I<sub>2</sub> during state T<sub>2</sub>.

At the end of state T<sub>2</sub> the cycle decoder sends a PCI signal to the timing logic, indicating that this is an instruction-fetch cycle. During state T<sub>3</sub> the memory location addressed by the contents of register I<sub>1</sub> and I<sub>2</sub> is read into the instruction register of the microprocessor. The instruction decoder recognizes that this is an immediate type of instruction and transfers control to the appropriate microprogram. Since states T<sub>4</sub> and T<sub>5</sub> are not required, the cycle ends with state T<sub>3</sub>.

Similarly the second-cycle and third-cycle operations are executed. Register b, in the second cycle, refers to one of two auxiliary registers (the other is called a). Both are used by the microprogram to transfer data internally. Registers H and L—in the third cycle—are two of seven 8-bit registers internal to the processor chip. The

**Table 2. Subroutine links registers H and L**

	Label	Instruction	Binary	Comment
INCREMENT REGISTERS	INCHL	INL RFZ INH RET	00110000 00001011 00101000 00xxx111	INCREMENT REGISTER L RETURN IF NOT ZERO INCREMENT REGISTER H RETURN
DECREMENT REGISTERS	DECHL	DCL CPI 377 <sub>8</sub> RFZ DCH RET	00110001 00111100 11111111 00001011 00101001 00xxx111	DECREMENT REGISTER L COMPARE AGAINST THE NEXT BYTE ALL ONEs RETURN IF NOT MATCHED DECREMENT REGISTER H RETURN

Note: x = don't care

seven are labeled A through E, H and L. They make up the accumulator (register A) and scratch-pad memory (the remaining registers).

**Registers H and L should be linked**

To execute a memory-reference instruction, the logic takes the 14-bit memory address from the contents of register H (containing the 6 most significant bits) and register L (containing the least significant 8 bits). The instructions contain no field for the memory address.

Since registers H and L can be incremented and decremented, as well as operated logically and arithmetically with register A, it's possible to scan and index all memory locations. When register L is incremented or decremented through a count of zero, register H should be incremented or decremented to continue the scan.

The internal circuitry of the microprocessor does not link registers H and L; so they must be linked by a software subroutine. Table 2 shows one subroutine for incrementing and one for decrementing through all 16k of memory. The contents of registers H and L are independent of the internal instruction address and the program counter.

**Ready line allows processor to idle**

The Ready line of the microprocessor may be activated by a logic ZERO at any time during an instruction. When it is, the microprogram proceeds normally until it reaches the end of a T<sub>2</sub> state. Then, instead of going into state T<sub>3</sub>, the microprogram enters the WAIT state; the microprocessor just marks time by repeating the four clock phases. Deactivation of the Ready line by a logic ONE and after phase  $\phi_{22}$  causes the microprocessor to resume normal operation by going into state T<sub>3</sub>.

The Interrupt line may also be activated at any time during an instruction. When this occurs, the microprogram continues to complete execution

of the remaining cycles of the instruction. Then, instead of going to the T<sub>1</sub> state of the PCI cycle, the microprocessor goes to the T<sub>11</sub> state. As a result, the external circuitry can jam an RST (restart) instruction onto the data lines during state T<sub>3</sub>. The instruction calls one of the eight locations in low-order memory that contains the subroutine that services the interrupt.

On interrupt the contents of the program counter are not incremented but are pushed down in an internal stack. Hence a RETURN instruction should be programmed at the end of the interrupt service. This instruction causes the program-counter stack to pop up the original program counter, and normal operation is resumed.

**Timing vital to processor operation**

By means of the cycles and states, the chip conveys information on what is happening internally and what should happen externally. Each instruction requires one, two or three cycles to complete its execution, and each cycle is composed of three, four or five states. In turn, each state is composed of four sequential pulses derived from the system clock.

The clock phases are called  $\phi_1$  and  $\phi_2$  (Fig. 2). The chip internally divides  $\phi_2$  by two to form a signal called SYNC, which is made available to the external circuitry. Each cycle of SYNC contains two pulses from  $\phi_1$  and two from  $\phi_2$ —one each from the two phases when SYNC is high and one each when SYNC is low. A complete cycle of SYNC is called a state, and that is made up of four sequential pulses called phases— $\phi_{11}$ ,  $\phi_{21}$ ,  $\phi_{12}$  and  $\phi_{22}$ .

Three parallel bits on the status lines define the present state from eight possible states for the chip (Table 3a). Each state begins with the completion of phase  $\phi_{22}$  of the preceding state. The states indicate time slots for functions performed by internal and external operations of the microprocessors.

Normally only three to five of the eight states are used in a cycle. The remaining states can be used for interrupt ( $T_{11}$ ), direct-memory-access conditions (WAIT) and processor halt (STOPPED).

Under normal operation 8 bits are outputted from the chip onto the external data lines during state  $T_1$ . Since memory addresses require 14 bits, two passes are needed to output the complete

memory address. The low-order part of the address is the byte transferred during state  $T_1$ .

The external circuitry does not know at this time whether the contents of register  $I_1$  is part of an I/O instruction, or the memory address of an instruction byte or a data byte.

In the case of an I/O instruction, the byte outputted during state  $T_1$  is the contents of register A rather than part of a memory address. In any event, the byte outputted during state  $T_1$  must be stored in external register  $I_1$  until the external circuitry determines the type of cycle.

During state  $T_2$  the microprocessor delivers to the external data lines the six high-order bits of the memory address (or the pointer to the I/O device) as well as two control bits. The control bits are the two most significant of the byte; they define which cycle the microprocessor is presently in. The byte outputted during state  $T_2$  must also be stored in an external register,  $I_2$ , until the cycle has been decoded (Table 3b). The cycle defined by the two control bits de-

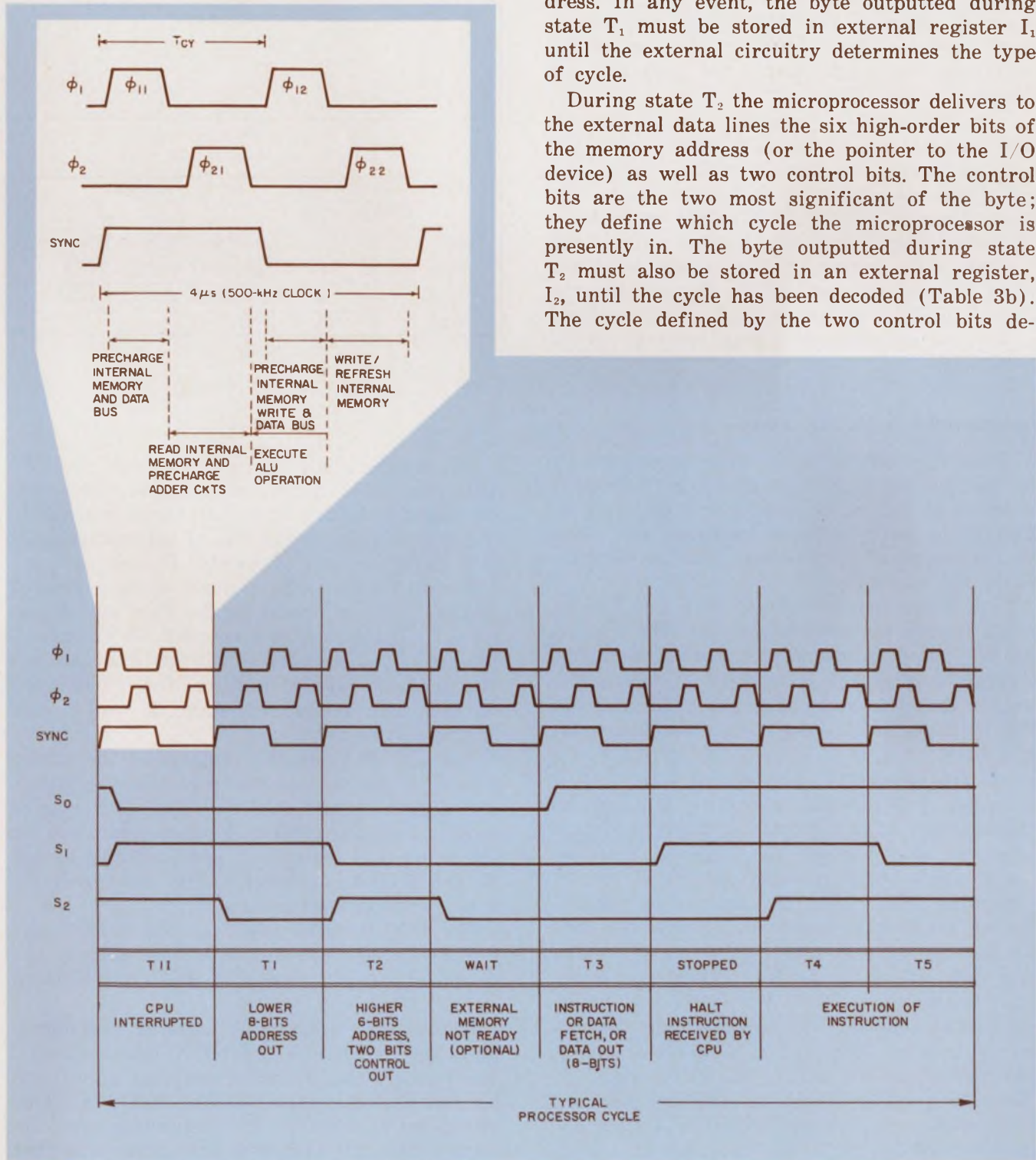

2. Internal microprogram control uses cycles and states to convey relevant internal and expected external operations to the rest of the circuitry. A typical execution

time for nonmemory instructions is  $20\mu s$  (with a 500-kHz clock), which covers states  $T_1$ ,  $T_2$ ,  $T_3$ ,  $T_4$  and  $T_5$ — or a typical processor cycle.

termines what is to be done with the contents of the two registers.

In state  $T_3$  the microprocessor either inputs a byte of data, fetches an instruction byte or outputs a byte of data. These transfers are performed via the bidirectional data bus, with the particular operation depending on the instruction being executed.

During states  $T_1$  and  $T_5$  the microprocessor executes the instruction and transfers data between its internal registers. Some instructions do not require these states. In these cases the states are either left idle or the cycle ends by skipping to state  $T_1$ .

Whenever a HALT instruction occurs, the microprocessor goes into the STOPPED state. The internal registers continue to refresh themselves periodically, maintaining the stored data. The microprocessor remains STOPPED until it receives an interrupt signal. It then goes to the  $T_{11}$  state at the beginning of the next instruction. When this is detected on the status lines, the INTERRUPT line should be put back to logic ZERO; the microprocessor then resumes normal operation.

### Two control bits identify cycles

A specific microprogram cycle is defined by the two control bits (most significant two bits) of external register  $I_2$  at the end of state  $T_2$ . Each cycle performs a particular portion of an instruction, which may require one, two or three cycles for completion.

Each instruction must begin with a PCI cycle, which fetches the next instruction. The instruction's location in memory is contained in the program counter and transferred to registers  $I_1$  and  $I_2$  during states  $T_1$  and  $T_2$ , respectively. Fig. 3 shows the processor-state transitions for each cycle.

During the fourth phase,  $\phi_{23}$ , of state  $T_2$  it is convenient to strobe the two control bits through combinatorial logic into one of four cycle flip-flops. In this manner the external circuitry knows which cycle is being performed.

For the PCI cycle the contents of the addressed memory location are put onto the data bus during the next sequential state ( $T_3$ ). The data byte enters the microprocessor and transfers via the internal data bus to the instruction register and decoder, which determines the operation to be performed. The program counter is incremented by one during the PCI cycle.

Some instructions—such as Register-Register, Register-Arithmetic-Logic, Rotate and Return—are executed internally during states  $T_1$  and  $T_5$  of the PCI cycle. For other instructions, the PCI cycle terminates with state  $T_3$ , and additional cycles are required to complete the execution.

**Table 3. Status and control bits yield states and cycles**

State	Status Bits		
	$S_0$	$S_1$	$S_2$
$T_1$	0	1	0
$T_2$	0	0	1
$T_3$	1	0	0
$T_4$	1	1	1
$T_5$	1	0	1
$T_{11}$	0	1	1
WAIT	0	0	0
STOPPED	1	1	0

3a

Cycle	Control Bits		Function
	MSB	2SB	
PCI	0	0	INSTRUCTION FETCH CYCLE
PCR	1	0	MEMORY READ CYCLE
PCW	1	1	MEMORY WRITE CYCLE
PCC	0	1	I/O CYCLE

3b

When either the PCR (memory-read) or PCW (memory-write) cycles are indicated, the external register,  $I_1$ , holds the contents of register L. The six least significant bits of external register  $I_2$  hold the contents of register H.

For a PCR cycle, the contents of the addressed memory location appear on the data bus during state  $T_3$ . The data byte is entered into the microprocessor, and transferred via the internal data bus to the designated register. Depending upon the particular instruction, states  $T_4$  and  $T_5$  may or may not be used.

For a PCW cycle, the contents of the appropriate register, as designated by the instruction, will appear on the data bus. The data byte is written into the memory location addressed by the contents of registers  $I_1$  and  $I_2$ . States  $T_4$  and  $T_5$  are skipped during a PCW cycle, and the cycle terminates with state  $T_3$ .

The PCC cycle is used only for INPUT and OUTPUT instructions. These instructions are composed only of a three-state PCI cycle followed by a PCC cycle.

At the end of state  $T_1$  external register  $I_1$  holds the contents of register A (accumulator). External register  $I_2$  holds the least significant six bits of the instruction byte that was transferred during state  $T_2$ . The instruction byte contains a field of bits that points to the particular I/O device addressed. The instruction also indicates if it is an input or an output operation.

If an output operation is called, state  $T_3$  is

idle and the microprocessor merely marks time. Meanwhile the external circuitry must transfer the contents of register  $I_1$  (contents of the accumulator) to one of 24 possible output devices, as indicated by the pointer field in register  $I_2$ . Register  $I_1$  contains the data byte placed into register A before the OUTPUT instruction was executed. The cycle ends with state  $T_3$ .

To call an input operation, the input byte must appear on the data bus prior to state  $T_3$ . During state  $T_4$ , conditional flags will appear on the data bus. These may be examined for test purposes or to show status conditions. At the end of state  $T_5$ , the inputted data byte appears in register A.

The input device may be addressed in one of two ways, depending on the external circuitry. One technique uses the pointer field in register  $I_2$ —as was done during the output operation. This allows only one of eight possible input devices to be addressed. A different instruction is required to input from each device, because of the pointer field in the instruction byte.

The second method uses the entire 8-bit byte in register  $I_1$  (instead of the pointer field of register  $I_2$ ) to address one of 256 possible input devices. Since the contents of register A are placed into external register  $I_1$  during  $T_1$ , this technique requires the device address to be placed into register A before execution of the INPUT instruction. Thus a single input instruction can address several input devices by changing the contents of register A.

### 230 instruction codes are possible

Most of the microprocessor's basic set of 48 instructions have modifiers, such as registers or condition flags, that result in a total of 230 individual instruction bytes.

Instructions that perform internal operations are one byte long. Immediate type of instructions are two bytes in length, since the data is in the byte after the instruction. Three-byte instructions are used for call and jump operations, since a two-byte address follows the instruction byte.

There are six types of basic instructions. The register operations include register-register, register-memory and increment or decrement. The arithmetic operations are addition with or without carry or subtraction with or without borrow. The logic operations include AND, OR, EXCLUSIVE-OR and COMPARE, as well as ROTATE register A left or right. Most instruction operations can have as modifiers any of the seven registers, the contents of memory (addressed by the contents of registers H and L), or immediate data (next byte). The exceptions are INCREMENT, DECREMENT and ROTATE register A.

The transfer operations cover JUMP, CALL and RETURN. These may be unconditionally

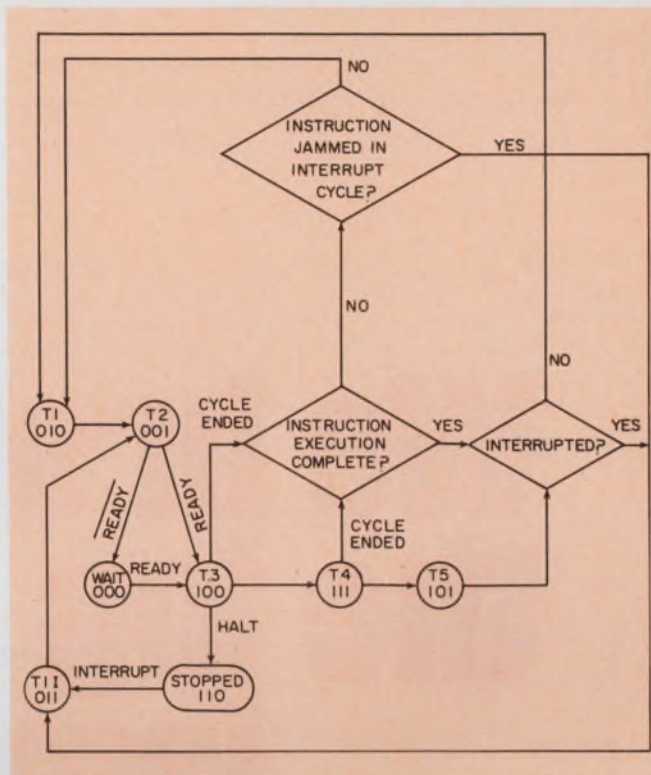

3. Each cycle causes microprocessor state transitions. A cycle begins when status lines indicate state  $T_1$ .

executed or executed on one of four conditional flags either true or false. The flags are CARRY, ZERO, SIGN and PARITY.

Using the COMPARE instruction, tests can be made for less-than, greater-than or equal conditions. The ZERO flag, when set after a COMPARE instruction, indicates an equality. If not set, the CARRY flag determines less-than or greater-than conditions.

An additional transfer instruction, RST, is a one-byte call. Normally a call requires three bytes to give the two-byte branch address following the instruction byte. But the RST instruction has embedded in its bit pattern the location of the branch. The microprocessor has eight individual low-order memory locations that the RST instruction can call.

The bit pattern of the RST instruction is derived by adding the number 5 to the address of one of the eight individual memory locations. An example of this: To call location address 0, the RST instruction would be 5, or a bit pattern of 00000101. ■■

*The first article appeared in the Sept. 1 issue and discussed the tradeoffs of microprocessors vs random logic. A concluding article in the series will deal with interface and software problems.*

#### Bibliography:

MCS-8 Micro Computer Set, Intel Users Manual, March, 1973, Revision 3.

# We broke the log jam.

**\$12.50**

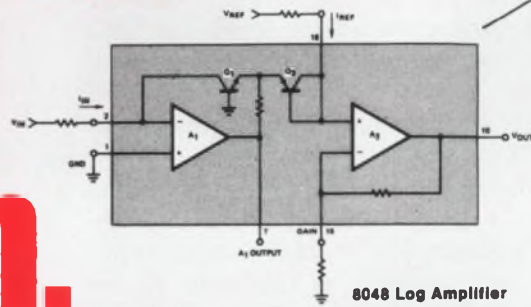

**1.**

With the monolithic 8048 logarithmic amplifier and 8049 antilogarithmic amplifier.

**2.**

Both priced from 1/3 to 1/10 the cost of modular log amplifiers.

**3.**

For use in the most cost-sensitive analog data compression and computational applications.

# Also the antilog jam.



## The first monolithic log and antilog amplifiers.

Up to now you've had to pay \$50 to \$150 for big epoxy-filled modules when you wanted a logarithmic amplifier.

No more. Now the Intersil 8048 log amp and 8049 antilog amp cost \$12.50 each in 100+ lots, available immediately.

Meaning that now it's practical to use these monolithic devices, in their 16-pin DIP packages, for signal conditioning with reliable integrity, as well as for a wide range of arithmetic computations.

### Check the specs.

Both amplifiers combine two high performance FET input op amps and a special thin film temperature-compensating resistor network. The 8048 accepts 6 decades of current input (1nA to 1mA) or 3 decades ( $\pm 10\text{mV}$  to  $\pm 10\text{V}$ ) of voltage. The 8049 accepts input voltages up to  $\pm 6\text{V}$ . In all respects, performance of these monolithic devices compares beautifully with that of the modules.

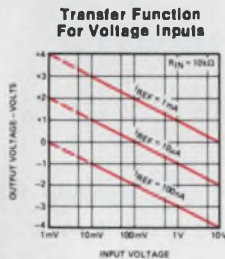
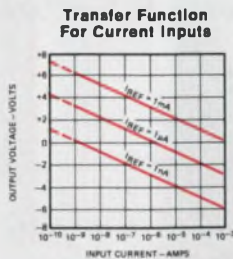

# Intersil



### Get 'em here.

Intersil stocking distributors. Elmar/Liberty Electronics. Schweber Electronics. Semiconductor Specialists. Weatherford.

Intersil area sales offices. Boston (617) 861-7380. Chicago (312) 371-1440. Los Angeles (213) 370-5766. Minneapolis (612) 925-1844. New York (201) 567-5585. San Diego (714) 278-6053. San Francisco Bay Area (home office) (408) 257-5450.

Representatives in all major cities.

	Order Number	Full Scale Accuracy (Max.)		Dynamic Range		Nominal* Output	Package	100 Pc Price
		@ 25°C	0°-70°C	Current Input	Voltage Input			
<b>8048 Log Amp</b>	ICL8048CCPE	$\pm 1.0\%$	$\pm 2.5\%$	120dB	60dB	1V/dec.	16p pla. DIP	<b>\$12.50</b>
	ICL8048CCDE	$\pm 1.0\%$	$\pm 2.5\%$	120dB	60dB	1V/dec.	16p cer. DIP	<b>15.00</b>
	ICL8048BCPE	$\pm 0.5\%$	$\pm 1.25\%$	120dB	60dB	1V/dec.	16p pla. DIP	<b>25.00</b>
	ICL8048BCDE	$\pm 0.5\%$	$\pm 1.25\%$	120dB	60dB	1V/dec.	16p cer. DIP	<b>27.50</b>
<b>8049 Antilog Amp</b>	ICL8049CCPE	$\pm 1\%$	$\pm 2\%$	—	60dB	1 dec./V	16p pla. DIP	<b>12.50</b>
	ICL8049CCDE	$\pm 1\%$	$\pm 2\%$	—	60dB	1 dec./V	16p cer. DIP	<b>15.00</b>

\*Both 8048 and 8049 adjustable from approx.  $\frac{1}{2}$  to 2 volts.

## BCD trig and hyperbolic functions:

They're different geometrically, but related analytically. Similar circuits generate each type.

*This is the last in a series of seven articles on binary-coded-decimal logic. The first six articles discussed the four basic arithmetic operations, how to handle the decimal point, extraction of the square root, and logarithms and the exponential function.*

The idea of generating a function by successive additions or subtractions of a few selected constants—the method used for logarithms and exponentials—can be used for trigonometric functions too. But first the function must be converted to a form that allows performance of the iterative process.

Consider a vector (more specifically a sinor)  $R$ , represented by its binary-coded-decimal components  $X$  and  $Y$ , and rotate it through an angle  $\theta$ . The components of the rotated vector become

$$\begin{aligned} X' &= X \cos \theta \mp Y \sin \theta \\ Y' &= Y \cos \theta \pm X \sin \theta, \end{aligned} \quad (1)$$

where the signs in the equations are plus or minus depending upon the direction of rotation. The top signs apply to a counterclockwise rotation.

Now divide both sides of these equations by  $\cos \theta$ , thus:

$$X_n = \frac{X'}{\cos \theta} = X \mp Y \tan \theta \quad (2)$$

$$Y_n = \frac{Y'}{\cos \theta} = Y \pm X \tan \theta$$

The factors  $X'/\cos \theta = X_n$  and  $Y'/\cos \theta = Y_n$  represent a new vector,  $R_n$ , whose magnitude is larger than the initial vector  $R$  by  $1/\cos \theta$ .

If the angle  $\theta$  is considered as made up of a series of additions and subtractions of angles  $\alpha_i$ ,  $\theta = \alpha_0 \pm \alpha_1 \pm \alpha_2 \pm \dots \pm \alpha_n$ ,

the trick in the iterative-constant method is to choose the values of  $\alpha_i$  so that  $\theta$  is approached rapidly and accurately with the use of a few values of  $\alpha_i$ . This is possible if the values of  $\alpha_i$  are chosen so that

$$\alpha_i = \tan^{-1} (10^{-i})$$

**Table 1. Constants for generating trigonometric functions**

i	$10^{-i}$	$\alpha_i$ in Degrees	$K_i$
0	1.0	45.0000000	1.41421356
1	0.1	5.7105931	1.00498756
2	0.01	0.5729386	1.00004999
3	0.001	0.0572957	1.00000049
4	0.0001	0.0057297	1.000000005
5	0.00001	0.0005729	1.00000000

for a calculator algorithm that works with a BCD number system (Table 1).

Since the values of  $\alpha_i$  decrease about 1/10 for each  $i$  increase— $\alpha_0 = 45^\circ$ ,  $\alpha_1 = 5.7^\circ$ ,  $\alpha_2 = 0.57^\circ$ —to cover all angles of  $\theta$  between zero and 90 degrees, a maximum of nine repeat steps may be needed with each  $\alpha_i$ . These repeat steps are given the index numbers  $j = 1$  to 9. Hence the angle through which the vector  $R$  is rotated can be expressed as

$$\theta_n = \sum_{\substack{j=1 \\ i=0}}^{j=9} \pm \alpha_{i,j}, \quad (3)$$

or, in expanded form,

$$\theta_n = \alpha_{10} \pm \alpha_{11} \pm \alpha_{12} \pm \alpha_{13} \dots \pm \alpha_{19} \pm \alpha_{21} \pm \alpha_{22} \pm \dots \pm \alpha_{29} \pm \alpha_{30}.$$

Now substitute successive values of  $\alpha_i$  for  $\theta$  in Eq. 2, starting with an initial vector position at zero degrees. Each step in such a process produces a new value of  $X$  and  $Y$  and each step is represented as follows:

$$X_{n+1} = (X_n \pm 10^{-i} Y_n) = K_n X' = K_n \cos \theta_n, \quad (4)$$

$$Y_{n+1} = (Y_n \mp 10^{-i} X_n) = K_n Y' = K_n \sin \theta_n.$$

Each step,  $n$ , has two index numbers,  $i$  and  $j$ . And each step involves multiplication by a factor  $K_i = 1/\cos \alpha_i$ . After  $n$  steps, the value of  $K$  is

$$K_n = \prod_{i=0}^{i=n} k_i = \frac{1}{\cos \alpha_0} \cdot \frac{1}{\cos \alpha_1} \cdot \frac{1}{\cos \alpha_2} \dots \frac{1}{\cos \alpha_n}. \quad (5)$$

The value of  $K_n$  thus increases with each step and approaches 1.6468 for large values of  $i$ .

To simplify the control logic for this algorithm, we use the same number of angular steps,

Hermann Schmid, General Electric Co., Box 5000 Binghamton, N.Y. 13902.

### Table 2. Computing the sine and cosine of 30°

STEP	I	J	X(I, J)	Y(I, J)	SUM ALPHA	PRODUCT K
Load	—	—	1.00000	0.00000	00.0000	—
1	0	1	1.00000	1.00000	44.9999	1.41421
2	1	1	1.00000	0.90000	39.2892	1.42126
3	1	2	1.19000	0.79000	33.5785	1.42835
4	1	3	1.26900	0.67100	27.8678	1.43547
5	1	4	1.20190	0.79790	33.5785	1.44263
6	1	5	1.28169	0.67771	27.8678	1.44983
7	1	6	1.21391	0.80587	33.5785	1.45706
8	1	7	1.29450	0.68448	27.8678	1.46433
9	1	8	1.22605	0.81393	33.5785	1.47163
10	1	9	1.30745	0.69133	27.8678	1.47897
11	2	1	1.30053	0.70440	28.4408	1.47904
12	2	2	1.29349	0.71741	29.0137	1.47912
13	2	3	1.28632	0.73034	29.5867	1.47919
14	2	4	1.27901	0.74321	30.1596	1.47927
15	2	5	1.28644	0.73041	29.5867	1.47934
16	2	6	1.27914	0.74328	30.1596	1.47941
17	2	7	1.28657	0.73049	29.5867	1.47949
18	2	8	1.27927	0.74335	30.1596	1.47956
19	2	9	1.28670	0.73056	29.5867	1.47964
20	3	1	1.28597	0.73185	29.6439	1.47964
21	3	2	1.28524	0.73313	29.7012	1.47964
22	3	3	1.28451	0.73442	29.7585	1.47964
23	3	4	1.28377	0.73570	29.8158	1.47964
24	3	5	1.28304	0.73699	29.8731	1.47964
25	3	6	1.28230	0.73827	29.9304	1.47964
26	3	7	1.28156	0.73955	29.9877	1.47964
27	3	8	1.28082	0.74083	30.0450	1.47964
28	3	9	1.28156	0.73955	29.9877	1.47964
29	4	1	1.28149	0.73968	29.9935	1.47964
30	4	2	1.28141	0.73981	29.9992	1.47964

$X_{30}/K_{30} = 0.866029$   
 Cosine  $\theta = 0.866025$   
 error =  $0.000004$

$Y_{30}/K_{30} = 0.499994$   
 sine  $\theta = 0.500000$   
 error =  $0.000006$

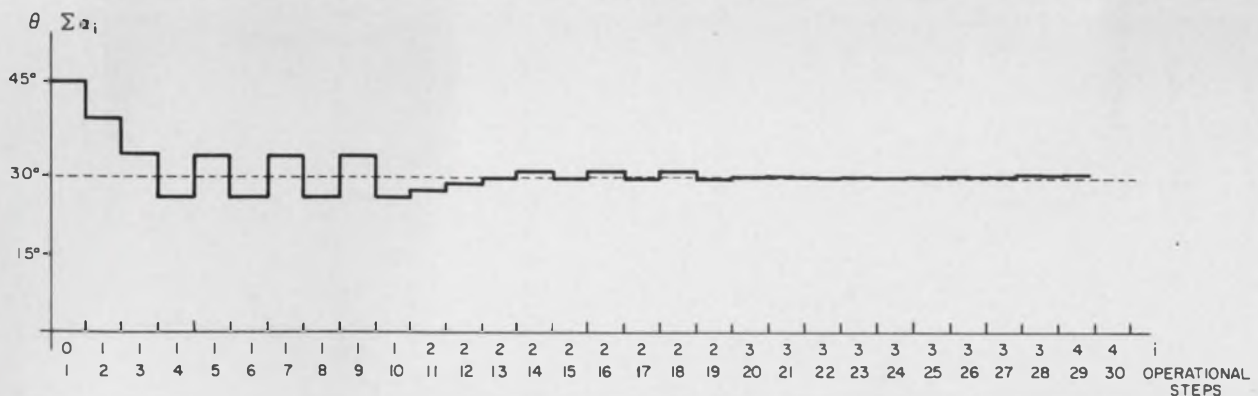

no matter what value  $\theta$  has, between zero and 90 degrees. Then the final value  $K_n$  will always be the same. Thus, as in the example for calculating functions for  $\theta = 30$  degrees (Table 2), if 30 angular steps are always used,  $K_n = K_{30} = 1.479648$  for any angle  $\theta$ , and  $1/K_{30} = 0.675836$ .

Note that the first angular step with  $i = 0$  is unique in that it is performed only once. By contrast, all other steps are repeated nine times ( $j = 1$  to 9). The final values of  $\sin \theta$  and  $\cos \theta$  are obtained by dividing  $X_{30}$  and  $Y_{30}$  by  $K_{30}$  (Eq. 3). The calculated results are compared

with known accurate values at the bottom of the table. Note the five-place accuracy with only 30 steps. Ten-place accuracy would need 60 steps.

This iterative-constants technique is based on the coordinate-rotation-digital-computer (CORDIC) method developed by J. E. Volder<sup>1</sup> about 15 years ago. His implementation was in a binary form where  $\alpha_i = \tan^{-1}(2^{-i})$ . But, as we've demonstrated, the algorithm also works for a BCD system. In fact the Hewlett-Packard HP35 and 45 electronic slide rules use this method.

Once the sine and cosine have been derived, the generation of  $\tan \theta$  merely requires the division of  $Y_n$  by  $X_n$ , or  $K_n \sin \theta$  by  $K_n \cos \theta$ . Since this division can be performed in place of the  $X_n$  and  $Y_n$  division by  $K_n$ , no extra execution time is required. From the example in Table 2,

$$\tan 30^\circ = \frac{Y_n}{X_n} = \frac{0.499993}{0.866029} = 0.577340.$$

This value differs from the true value of  $\tan 30^\circ$  by only  $5 \times 10^{-6}$ .

### Polar/cartesian conversion

Given a vector  $R/\theta$ , the algorithm to find its components, X and Y, follows the same steps as for generation of the sine and cosine (Table 2). The method differs only in the initial value assigned to  $X_1$  before the rotation process starts. In place of loading a value of  $X = 1$ , as when solving only for the sine and cosine, the initial magnitude of X is made equal to the length of the vector R. The initial value of Y remains zero. Then the final magnitudes  $X_n$  and  $Y_n$  become

$$X_n = K_n R \cos \theta,$$

$$Y_n = K_n R \sin \theta.$$

When  $X_n$  and  $Y_n$  are divided by  $K_n$  at the final step, the desired components X and Y of  $R/\theta$

**Table 3. Constants for generating hyperbolic functions**

i	$10^{-i}$	$\mu_i$	$K_i$
0	1.0	$\infty$	
1	0.10000	0.100335347	0.994987439
2	0.01000	0.010000333	0.999949999
3	0.00100	0.001000000	0.999999500
4	0.00010	0.000100000	0.999999995
5	0.00001	0.000010000	0.999999999

result. This is polar-to-cartesian conversion.

When X and Y are given, a similar approach can provide cartesian-to-polar conversion and generate  $\theta$  and R. Here the criteria for the iterative addition or subtraction of the quantities  $10^{-i} Y_n$ ,  $10^{-i} X_n$  and  $\alpha_i$  are provided by the polarity of  $Y_n$ . And the sequence of steps now makes  $Y_n$  approach zero. In this process the sum of the values of  $\alpha_i$  required to force  $Y_n$  to zero equals the angle  $\theta$ . The equations that are thus solved are

$$R = \sqrt{X^2 + Y^2},$$

$$\theta = \tan^{-1}(Y/X).$$

Based upon the constants in Table 2, Table 4 shows the steps required to carry out such a transformation. The rectangular components are chosen as  $X = 0.50000$  and  $Y = 0.86603$ . With 30 steps the method provides the magnitude  $\sqrt{X^2 + Y^2}$  to a five-digit accuracy.

Note that since the process rotates the initial vector so that  $Y_i$  approaches zero, the value of  $X_{30}/K_{30}$  approaches the value of R; thus  $R = X_{30}/K_{30} = 1$ , and the sum-alpha column approaches the angle  $\theta$ .

Consider Q as the independent variable and  $\theta$

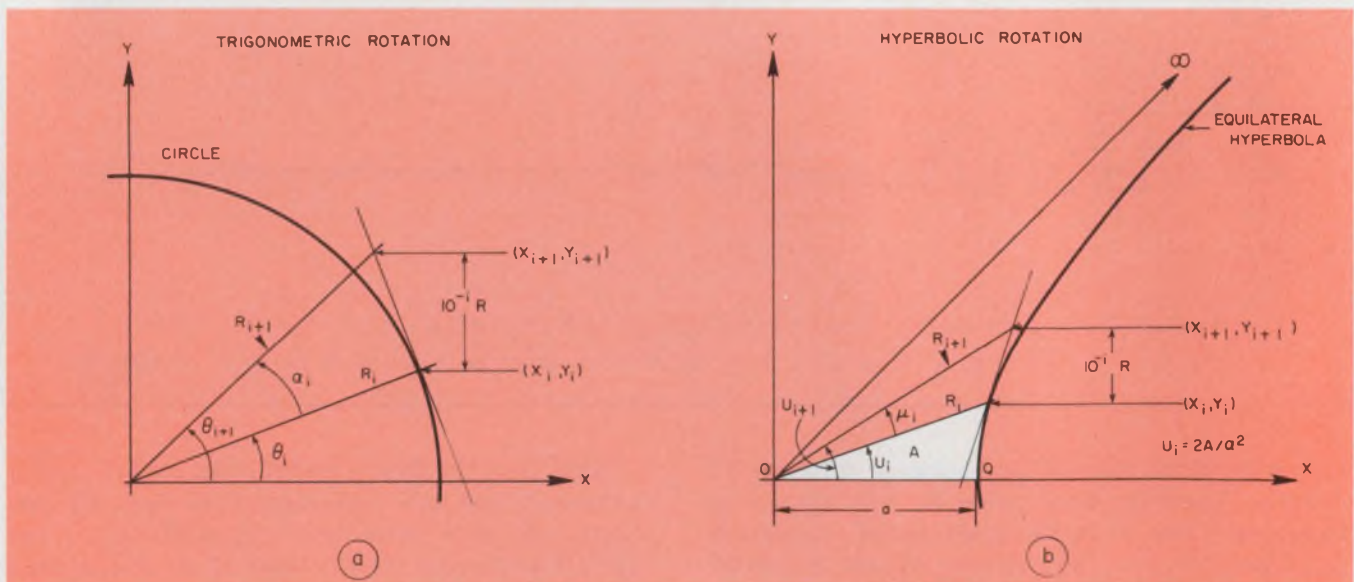

1. Although the geometry of trigonometric functions is based on the characteristics of a circle (a) and hyper-

bolic functions are based upon an equilateral hyperbola (b), the equations of both take almost identical forms.

**Table 4. Converting to polar coordinates— $X = 0.500000$ ,  $Y = 0.866025$**

STEP	I	J	X(I, J)	Y(I, J)	SUM ALPHA	PRODUCT K
Load	—	—	0.50000	0.86603	00.0000	—
1	0	1	1.36602	0.36602	44.9999	1.41421
2	1	1	1.40262	0.22942	39.2892	1.42126
3	1	2	1.42557	0.08916	33.5785	1.42835
4	1	3	1.43448	-0.05339	27.8678	1.43547
5	1	4	1.43982	0.09005	33.5785	1.44263
6	1	5	1.44883	-0.05393	27.8678	1.44983
7	1	6	1.45422	0.09095	33.5785	1.45706
8	1	7	1.46331	-0.05447	27.8678	1.46433
9	1	8	1.46876	0.09186	33.5785	1.47163
10	1	9	1.47795	-0.05501	27.8678	1.47897
11	2	1	1.47850	-0.04023	28.4408	1.47904
12	2	2	1.47890	-0.02545	29.0137	1.47912
13	2	3	1.47915	-0.01066	29.5867	1.47919
14	2	4	1.47926	0.00413	30.1596	1.47927
15	2	5	1.47930	-0.01066	29.5867	1.47934
16	2	6	1.47941	0.00413	30.1596	1.47941
17	2	7	1.47945	-0.01066	29.5867	1.47949
18	2	8	1.47956	0.00413	30.1596	1.47956
19	2	9	1.47960	-0.01066	29.5867	1.47964
20	3	1	1.47961	-0.00918	29.6439	1.47964
21	3	2	1.47962	-0.00770	29.7012	1.47964
22	3	3	1.47963	-0.00622	29.7585	1.47964
23	3	4	1.47963	-0.00474	29.8158	1.47964
24	3	5	1.47964	-0.00326	29.8731	1.47964
25	3	6	1.47964	-0.00178	29.9304	1.47964
26	3	7	1.47964	-0.00030	29.9877	1.47964
27	3	8	1.47964	0.00117	30.0450	1.47964
28	3	9	1.47964	-0.00030	29.9877	1.47964
29	4	1	1.47964	-0.00015	29.9935	1.47964
30	4	2	1.47964	-0.00001	29.9992	1.47964
True $\Theta = 30.0000$			$X_{30}/K_{30} = 1.00000 = R$			
computed $\Theta = 29.9992$			$Y_{30} \rightarrow 0$			
error = <u>0.0008</u>						

as the dependent variable. Then to solve equations

$$\theta = \cos^{-1} Q_a$$

or 
$$\theta = \sin^{-1} Q_b$$

use exactly the same steps and numbers as in Table 2. The initial conditions remain  $X = 1$  and  $Y = 0$ , but now the algorithm, instead of "looking" for passage through a given  $\theta$  in the sum-alpha column, looks at the ratio

$$\frac{X_n}{K_n} = Q_a = \cos \theta_n$$

or

$$\frac{Y_n}{K_n} = Q_b = \sin \theta_n$$

for instructions either to add or subtract the next increment,  $\alpha_{i+1}$ . The appropriate treatment of  $X_n$ ,  $Y_n$  and  $K_n$ , of course, also follows this criterion. The final sum in the sum-alpha column is the answer,  $\theta$ .

Trigonometric functions are defined by a vector  $R < \theta$ , which relates to a circle, and hyperbolic functions are defined by analogous quantities—the hyperbolic radius  $R_H$  and hyperbolic angle  $U$ , which relate to an equilateral hyperbola (Fig. 1). And although the geometry of the two classes of functions appears quite different, their algebraic forms are largely identical. This permits the same algorithms and circuits to serve both functions with very small changes.

#### Cosh and sinh with the same algorithm

Hyperbolic functions are defined by the relationships between a point with coordinates  $X$  and  $Y$  on an equilateral hyperbola, the distance  $R$  of that point from the zero axis ( $X = 0$ ,  $Y = 0$ ) and the hyperbolic angle  $U$ . The common hyperbolic functions and their inverse relation-

ships are:

$$R = \sqrt{X^2 + Y^2}$$

$$Y = \cosh U \quad U = \text{arc cosh } X$$

$$Y = \sinh U \quad U = \text{arc sinh } Y$$

$$Y/X = \tanh U \quad U = \text{arc tanh } (Y/X)$$

Fig. 2 shows plots of both the hyperbolic and trigonometric functions for comparison.

The hyperbolic angle  $U$  is defined as  $U = 2A/a^2$ , where  $A$  is the area between the hyperbola and the radius line to it (Fig. 1). Thus  $U$  is a nondimensional number between zero and infinity. At the point where the hyperbola crosses the  $X$  axis,  $U = 0$  and  $a$  is the distance from this point to the zero axis. Where the hyperbola approaches infinity,  $U$  approaches infinity.

By analogy to trigonometric functions, a rotation of  $R_H$  also can be represented by a summation of angular steps, and all the equations for generating trigonometric functions have their counterpart in hyperbolic functions:

$$U = \mu_n \pm \mu_1 \pm \mu_2 + \dots \pm \mu_n \quad (6)$$

$$U_i = \tanh^{-1} (10^{-i})$$

$$X_{n+1} = X_n \pm 10^{-i} Y_n$$

$$Y_{n+1} = Y_n \pm 10^{-i} X_n \quad (7)$$

$$\frac{R_n}{\cosh U_n} = R_{n+1} = \sqrt{X_{n+1}^2 + Y_{n+1}^2}$$

$$K_n = 1/\cosh U_n \quad (8)$$

Table 3 provides a listing of values for the hyperbolic quantities  $\mu_i$  and  $K_i$  over the range of  $i = 0$  to 5. Obviously they differ from those for the trigonometric functions. But the step-by-step procedure for generating hyperbolic functions is the same, since the equations take the same forms as trigonometric functions.

### Implementing the circuit

Three serial accumulators simultaneously solve Eqs. 3 and 4 or their hyperbolic counterparts, Eqs. 6 and 7 (Fig. 3). To handle 16-digit words each accumulator is made with a 60-bit shift register and a serial BCD adder that has an internal one-digit, or four-bit, delay. The timing, control logic and  $\alpha_i/\mu_i$  ROM make up the rest of the circuit.

In operation the system has an I/O mode, followed by an initial 45-degree step and then the execution of the nine-step  $\alpha_1$  rotations. The I/O operation and the 45-degree step each use only one circulation period, or 64 clock pulses. And they both occur during word interval  $W_0$ . Also during this period,  $i = 0$  and hence  $10^i = 1$ .

Switches  $S_{x_0}$  to  $S_{x_{15}}$  and  $S_{y_0}$  to  $S_{y_{15}}$  connect the terms  $10^{-i} X_n$  and  $10^{-i} Y_n$  to adder/subtractors 1 and 2, respectively, from taps at every fourth

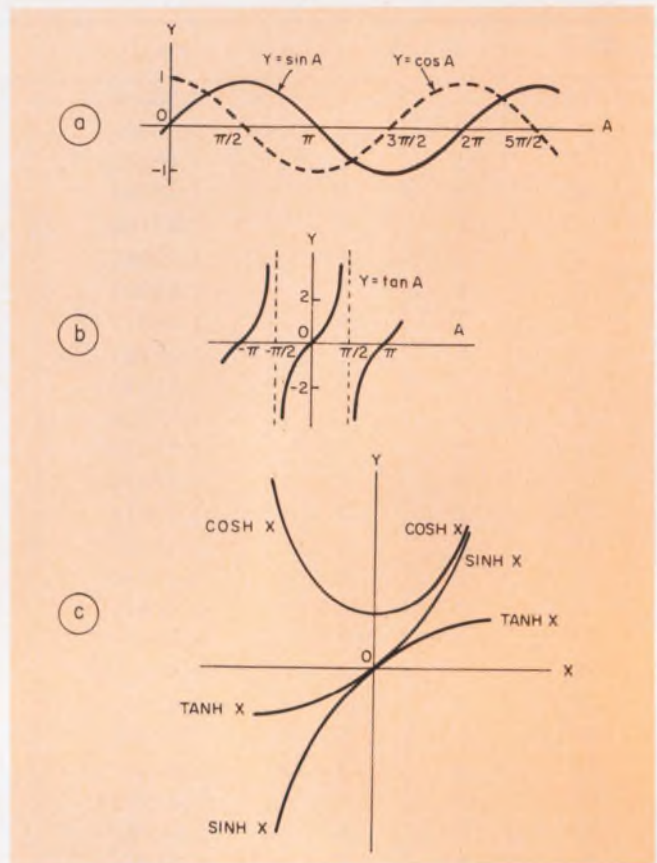

2. Plots of sines and cosines (a), tangents (b) and their hyperbolic counterparts (c), unlike their equations, bear little resemblance to one another.

stage of the registers. The last tap is the output  $X_n$  or  $Y_n$ , the second-last tap represents  $10^{-1} X_n$  or  $10^{-1} Y_n$ , the third-last tap represents  $10^{-2} X_n$  or  $10^{-2} Y_n$  and so on.

Flip-flop FF and switch  $S_1$  control the mode and function of the three adder/subtractors 1, 2 and 3. When the circuit is set to calculate functions of angles (mode R)  $S_1$  connects  $A_{i+1}$  (sums of alpha) to FF. When the circuit is set to convert coordinates (P/C mode),  $S_1$  connects  $Y_{i+1}$  to FF.

The flip-flop is clocked at bit-time  $B_0 D_0$ . It will set if a carry has been generated in either adder/subtractor 1 or 2 which, in turn, occurs after the computation of the most-significant digit. The carry, which is stored in the adder/subtractor, indicates that either  $Y_{i+1}$  and  $A_{i+1}$  has a negative value.

The flip-flop outputs  $Q$  or  $\bar{Q}$  determine the adder/subtractor's mode. A ONE makes it subtract.

The  $\alpha_i/\mu_i$  values come from a ROM that provides a bit-serial output. For a 16-digit system, 16 values of  $\alpha_i/\mu_i$  are needed. Hence a  $1024 \times 1$  ROM is required to generate the sixteen 64-bit serial words. One of the inputs to the ROM is a

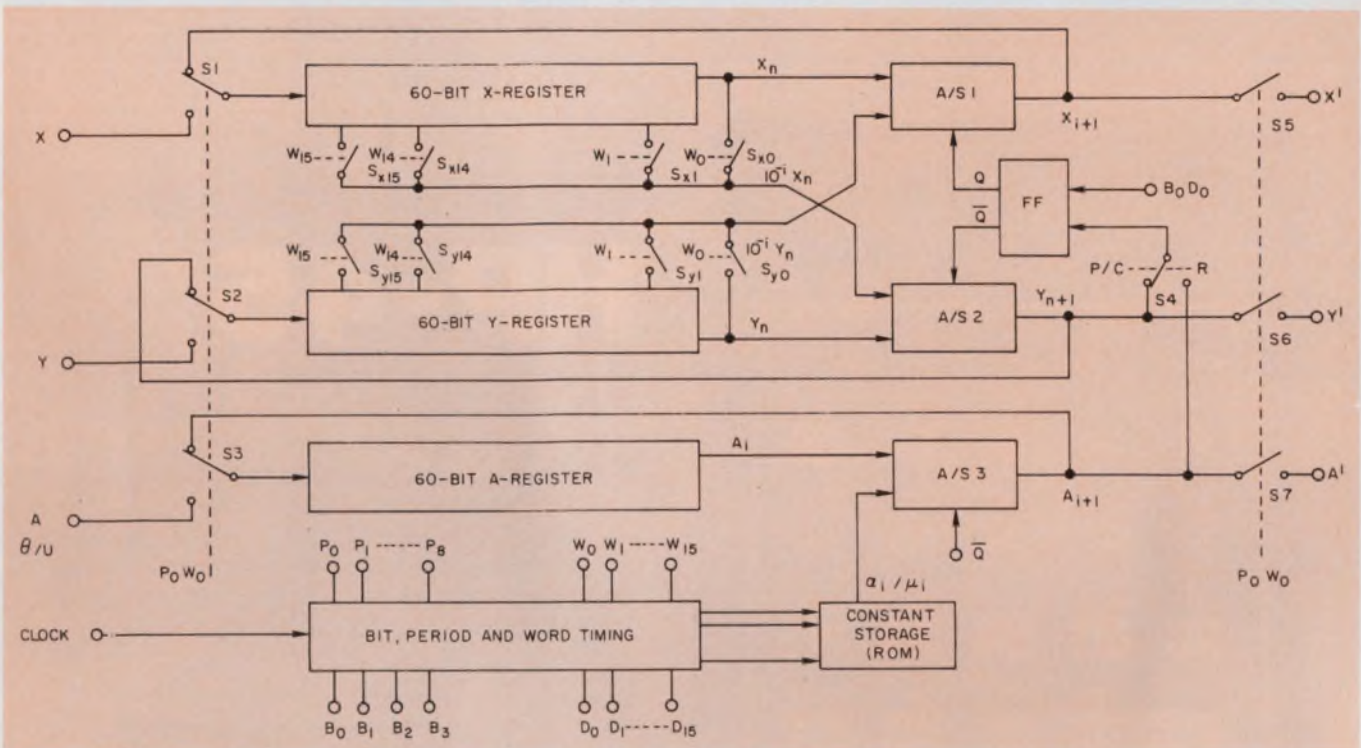

3. Except for a different set of constants in the ROM, both the trigonometric and hyperbolic functions are

generated with the identical circuit. Where  $\alpha_i$  is the trigonometric increment,  $\mu_i$  becomes the hyperbolic.

sequence of six bits derived from the clock— $f_c/2$ ,  $f_c/4$ ,  $\dots$   $f_c/64$ . Four additional bits select each of the 16 values of  $i$ —one for each of the word periods.

The timing for this circuit is organized as follows:

Bit timing	} 4- $B_1$ periods	= 1-digit period ( $D_h$ )
Digit timing		
Circulation periods	} 9- $P_1$ periods	= 1-word period ( $W_1$ )
Word timing	} 16- $W_1$ periods	= 1-calculation time

(except  $P_1 = 2$  periods)

Thus, with the first word period only two circulation periods long, the time required to perform one complete calculation requires  $[(15 \times 9) + 2] 16 \times 4 = 8768$  clock periods. This is only 87.68 ms with a 100-kHz clock frequency. To this, however, must be added the time required to multiply by  $1/K_n$ , or the time required to divide the sine by the cosine if the tangent (or hyperbolic equivalent) is being generated.

The  $S_{x_n}$  and  $S_{y_n}$  switches are actuated to connect the  $10^{-1} \cdot X_n$  and the  $10^{-1} \cdot Y_n$  to the adder/

subtractors during the following intervals:

- during  $W_0$ ,  $10^0 X_n$  via  $S_{x_0}$  and  $10^0 Y_n$  via  $S_{y_0}$ ;
- during  $W_1$ ,  $10^{-1} X_n$  via  $S_{x_1}$  and  $10^{-1} Y_n$  via  $S_{y_1}$ ;
- during  $W_2$ ,  $10^{-2} X_n$  via  $S_{x_2}$  and  $10^{-2} Y_n$  via  $S_{y_2}$ ;

etc.

And the sequence of the algorithm proceeds as follows:

- During  $P_0$  of  $W_0$ , the initial values of  $X$ ,  $Y$  and  $A$  shift into the registers. Simultaneously the results of a previous operation  $X'$ ,  $Y'$  and  $A'$  can shift out.

- During  $P_1$  of  $W_0$ , a 45-degree rotation (clockwise) is performed by subtracting  $Y_n$  from  $X_n$  via A/S-1, adding  $X_n$  to  $Y_n$  via A/S-2 and adding  $\alpha_n$  to the initial value of register  $A$  via A/S-3.

- During  $P_0$  to  $P_8$  of  $W_1$ , the nine 5.7-degree rotations are made. The values of  $10^{-1} Y_{1j}$  is subtracted or added to the contents of the X-register via A/S-1. Simultaneously  $10^{-1} X_{1j}$  is subtracted or added to the contents of the Y register via A/S-2. And,  $\alpha_1/\mu_1$  is subtracted or added to the contents of the A-register via A/S-3.

- During  $P_0$  to  $P_8$  of  $W_2$  to  $W_{15}$ , thirteen sets of nine  $\alpha_i/\mu_i$  steps are carried out in a way similar to that described for  $W_1$ . ■■

#### Reference

1. Volder, J. E., "The CORDIC Trigonometric Computing Technique," *IRE Transactions on Electronic Computers*, EC-8, September, 1959.

# Increased power at no increase

## New! Hewlett-Packard's HP-45 Advanced Scientific Pocket Calculator!

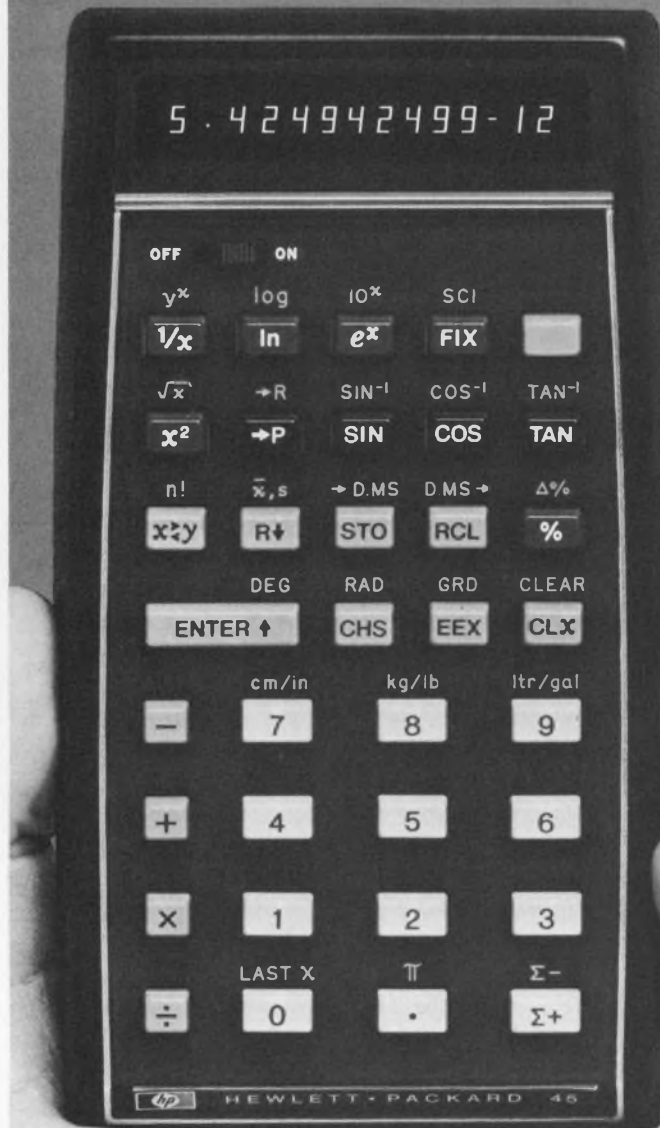

ACTUAL SIZE

In today's fast-moving world, your time is too valuable to spend solving problems the old-fashioned way with a slide rule, or waiting to use an on-line computer.

The new HP-45 lets you solve even the most complex scientific and engineering problems in seconds—anywhere, any time—just by pressing a few keys!

Identical in size to Hewlett-Packard's famous HP-35, the second-generation HP-45 features a unique Gold "Shift" Key that doubles the function of 24 keys, for increased capability . . . nine addressable memory registers (plus five others) . . . and the ability to perform register and vector arithmetic. And the HP-45 also has all the log and trig tables pre-programmed.

Only an actual on-the-job trial can show you how valuable it can be to you.

**Send for full information  
Mail the coupon today.**

**HEWLETT-PACKARD**  
Advanced Products Division  
10900 Wolfe Road • Dept. 232-C  
Cupertino, California 95014

613/6C

### Send now for FREE INFORMATION

- Please send me a brochure on the HP-45 and the HP-35.
- Please send me an HP-45. Enclosed is my check for \$395.\*
- Please send me an HP-35. Enclosed is my check for \$295.\*

\*Add state and local taxes. Domestic U.S.A. prices only. Full refund within 15 days if not satisfied!

Name \_\_\_\_\_ Dept. \_\_\_\_\_

Company \_\_\_\_\_

Address \_\_\_\_\_

City \_\_\_\_\_ State \_\_\_\_\_ Zip \_\_\_\_\_



### New reduced price on the popular HP-35 . . . \$295

The HP-35—the original scientific pocket calculator that's now the standard of the industry—is available at a new, reduced price . . . \$295. It has all the trigonometric, logarithmic, arithmetic and data manipulation capabilities that have made it the indispensable tool of more than 75,000 scientists and engineers.

The HP-45 and HP-35 come complete with: Battery pack • AC adapter/recharger  
• Leather carrying case • Safety travel case • Illustrated owner's handbook  
• Self-adhesive owner's name tags. The HP-45 also includes a Quick Reference Guide



# in size or price! Only \$395!

## Compare the HP-45's advanced features with those of *any* other scientific calculator!



**Gold "shift" key doubles the function of 24 keys** ... helps give the HP-45 increased capability with no increase in size! Primary functions are labeled on the keys, alternate functions above. Gold key lets you shift from one to the other.

SCI



**Display formatting in fixed decimal or scientific notation** ... at the press of a key. And you can round off answers to any number of digits (0 to 9) displayed after the decimal point in either mode. Full accuracy is always maintained internally.

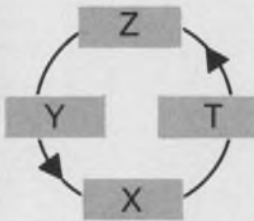

**Operational stack has 4 registers** ... for automatic storage and retrieval of intermediate solutions. The stack design permits review of stored data at any time.

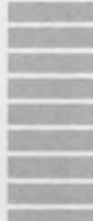

**9 additional memory registers are addressable** ... can be used for storage and retrieval of data, or to perform register arithmetic. A 10th ("Last X") register lets you recall last input argument for error correction or for multiple functions of same argument.

DEG RAD GRD



**Trig functions may be performed in any of 3 selectable angular modes** ... degrees, radians or grads. Decimal angles are calculated in whichever mode is specified. The HP-45 also computes natural and common logarithms, as well as antilogarithms.

cm/in kg/lb ltr/gal



**Permanent U.S./metric constants permit instant conversion** ... for rapid calculation of problems involving length, weight or volume. And you get 10-digit accuracy!

→ D.MS D.MS →



**Instant conversion from an angle in any angular mode to degrees/minutes/seconds** (e.g.  $45.89^\circ = 45^\circ 53' 24''$ ) ... with the answer automatically rounded to the nearest second. Or convert from D/M/S to the equivalent decimal angle.

→ R



**Instant conversion from polar to rectangular coordinates** ... or vice-versa. And vector calculations are simple when you also use the  $\Sigma+$  key to simultaneously accumulate two coordinates.

n!

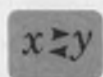

**Factorial function allows rapid calculations of combinations and permutations** ... to reduce problem-solving time to seconds. You can quickly find the factorial of positive integers.

$\Sigma-$   $\bar{x}, s$



**Statistical analysis is easier** ... because the  $\Sigma+$  key provides a running total when summing numbers, keeps track of the number of entries, and automatically computes the sum of the squares. The  $\bar{x}, s$  key calculates the arithmetic mean and the standard deviation.

Beyond the basic four functions (+ - × ÷), the HP-45 is pre-programmed to:

Perform trigonometric functions:

- Sine
- Arc sine
- Cosine
- Arc cosine
- Tangent
- Arc tangent

Perform logarithmic functions:

- Common logarithm
- Natural logarithm
- Common antilogarithm
- Natural antilogarithm

And perform:

- Serial calculations
- Mixed serial calculations
- Chain calculations
- Mixed chain calculations

Calculate:

- The square root of the number displayed
- The square of the number displayed
- The reciprocal of the number displayed
- The raising of any positive number to any power
- The factorial of positive integers
- Percentage and percent differences
- Sum of the squares
- The mean of entries made with the " $\Sigma+$ " key
- The standard deviation of entries with the " $\Sigma+$ " key

Automatically convert:

- The decimal angle in any of the angular modes in the display to degrees/minutes/seconds
- The degrees/minutes/seconds angle in the display to a decimal angle
- Polar coordinates to rectangular coordinates
- Rectangular coordinates to polar coordinates
- Centimeters to inches
- Inches to centimeters
- Kilograms to pounds
- Pounds to kilograms
- Liters to gallons
- Gallons to liters

And the HP-45 will also:

- Simultaneously accumulate two sets of entries for statistical and vector calculations
- Allow for deletion of erroneous entries
- Recall the last argument of a calculation to check for accuracy
- Display the constant Pi at the touch of a key
- Permit selective data storage and retrieval in up to 9 registers
- Operate in any of three trigonometric modes—degrees, radians or grads
- Perform register arithmetic
- Perform vector arithmetic
- Fit in your shirt pocket
- Operate on rechargeable batteries or AC

Hewlett-Packard pocket calculators ...  
If you work with numbers, you can't afford to be without one!

HEWLETT  PACKARD

Sales, service and support in 172 centers in 65 countries  
Advanced Products Division • 10900 Wolfe Road • Cupertino, California 95014

Quantity discounts available.  
Ask about the complete  
Hewlett-Packard line.

Domestic U.S.A. prices only.

## Cut component count and improve reliability with controlled-avalanche rectifiers. In high-transient circuits they also protect other components.

Has a rectifier ever failed when you bread-boarded a circuit, because of transients not anticipated in your preliminary design? Or, has a rectifier—that functioned normally in a circuit—failed when operating as part of a larger system, because of power-line transients generated elsewhere in the system?

Use of a controlled-avalanche (CA) rectifier may solve problems associated with failures caused by transients in electronic equipment. A CA rectifier benefits nearly all transient-generating circuits.

The CA rectifier offers a couple of advantages when the transient energy falls within its capability:

- 1) Almost instantaneous response when clamping a voltage transient, due to the highly-regenerative nature of the rectifier's avalanche mode.
- 2) Reduction of the number of components that have to be designed in, bought, inspected, stored and finally wired into a circuit.

Typical applications for CA rectifiers include:

- microwave ovens.
- electrostatic copiers.
- power supplies and converters.
- voltage regulators.
- TV high-voltage circuits.

Since CA rectifiers cost more than conventional rectifiers, their use must be justified before a final choice is made. To simplify that decision, let's review the characteristics and limitations of CA rectifiers; see where they can be particularly helpful; then, go through the actual selection procedure.

### What is a CA rectifier?

A controlled-avalanche junction in a silicon rectifier can absorb or dissipate—without failing—a relatively large amount of energy while in the “breakdown” or avalanche mode. Because of its construction, a “conventional” junction can

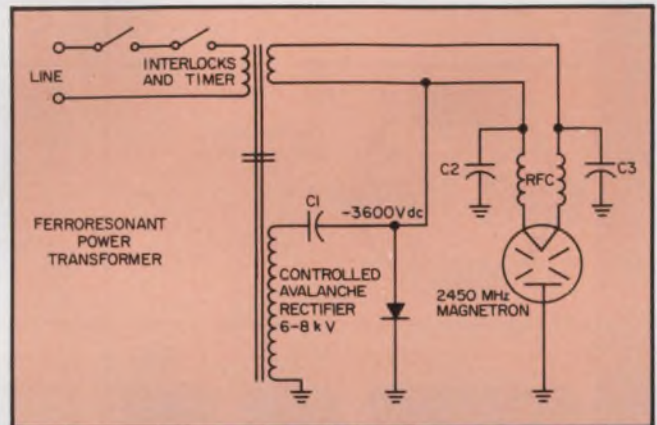

1. A controlled-avalanche rectifier eliminates the need for a separate filament transformer and delay timer in the high-voltage section of a microwave-oven magnetron power supply.

withstand only a few microamperes in the reverse direction before failure.

Controlled-avalanche means that the reverse voltage rating of a rectifier is specified to range between a minimum and maximum value at a specified avalanche current rating. The present state-of-the-art allows avalanche junctions to withstand voltages in excess of 1300 V.

With limitations, the CA rectifier can solve problems associated with failures caused by transients in a system. Energy-handling capability is the principal limitation. When the transient energy is a fraction of a joule, a silicon junction can probably be found which will absorb the energy reliably. In high-voltage circuits, several junctions in series may be needed.

To protect circuits from transients that contain more than a few joules of energy, you probably will have to use some other type of protective devices. Many types are rated for over 1000 J. But these other devices tend to be much larger than silicon rectifiers.

### Who needs one?

The microwave-oven application is a classic example of the use of a controlled-avalanche

Douglas Waltz, Product Engineer, Varo Semiconductor, Inc., 1000 N. Shiloh, Garland, Tex. 75040.

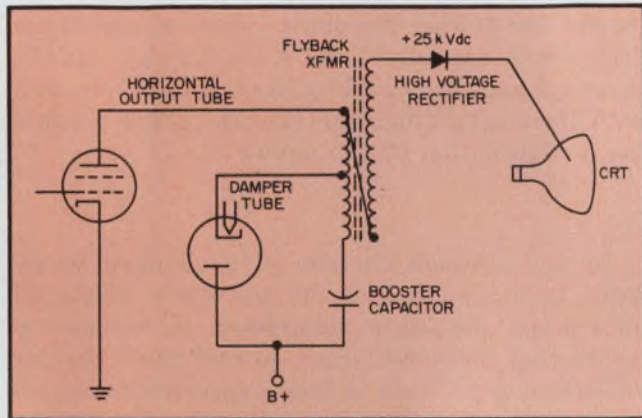

2. About 50 junctions in series are used to produce a controlled-avalanche rectifier that will withstand a repetitive reverse voltage of 32 to 36 kV in a color TV. Conventional rectifiers use about twice as many junctions.

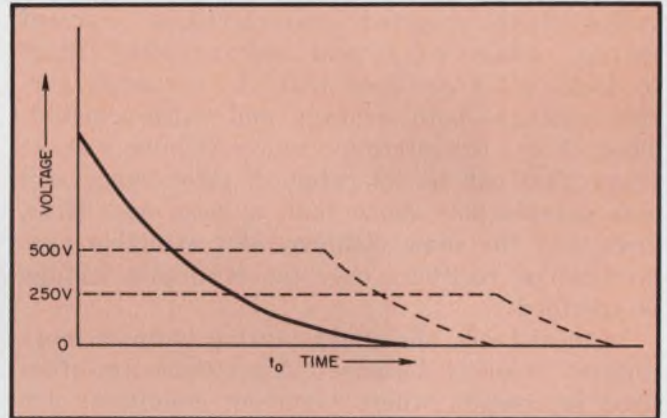

3. Controlled-avalanche rectifiers can keep transients between acceptable limits. Such transients can occur when power to an inductor is suddenly switched off, and can damage conventional rectifiers.

rectifier. Fig. 1 is the basic circuit that is gaining wide popularity with oven manufacturers. Over-all reduced cost compared to earlier circuits justifies the popularity. The circuit is a half-wave doubler with shunt rectification. It provides a negative high-voltage to power the magnetron with an input of approximately 1500 W.

A characteristic problem occurs with magnetrons when high voltage is applied while the filament is warming up. The magnetron starts to oscillate, then suddenly ceases conduction. This may happen several times during each line cycle, for several tenths of a second, until the filament warms enough to sustain oscillation in the correct mode. Each time oscillation ceases, large, transient voltages are created on the high-voltage line due to sudden unloading of the power supply.

In this application, a controlled-avalanche rectifier serves the normal, rectifying function and also protects several other components from being damaged by transients. If the transients are not clamped, the voltage can rise high enough to break down the transformer insulation, the RF filter capacitors ( $C_2$  and  $C_3$ ), or even the magnetron. The CA rectifier—using several series junctions, and selected to be within the range of

6-8 kV for this circuit—will ensure protection for these components. It will clamp the transients and absorb about 1 J of energy.

### Color TV supplies

Hybrid color TV sets are another application of CA high-voltage rectifiers. Fig. 2 shows that the high-voltage rectifier consists of about 50 junctions in series. It can withstand a normal, repetitive reverse voltage of 32 to 36 kV. However, damper tubes tend to arc over occasionally as filament material flakes off. Because of arcing within the tube, or elsewhere, a transient voltage appears across the rectifier. This may destroy the rectifier if it can't absorb the energy in the transient-generating circuit.

In this case, it seems that junction avalanche protects the junction passivation from abnormally high, reverse voltages. A full explanation involves the stray capacitance from the rectifier to ground and the extremely fast-rising transient voltages in the circuit. The junction nearest the AC end probably avalanches first; the rest then "domino" until all junctions are finally avalanched, and the voltage is clamped.

In this application, about 50 avalanche junc-

tions do a job that would, otherwise, have required about 90 conventional junctions and lots of luck. The actual breakdown level of a single conventional rectifier junction can exceed 3000 V. This voltage is impressed across the short silicon/passivation interface, and can cause passivation failure in circuits that use series junctions and have fast-rising voltage waveforms.

### Selecting the avalanche rectifier

Selection of a controlled-avalanche rectifier involves three required characteristics: current rating, voltage range and energy rating. Start by looking for rectifiers with the necessary current ratings—both average and surge current. Then choose the minimum and maximum voltage range that can be tolerated. A tight range will cost considerably more than a loose one. Note, also, that for some commercially available avalanche-type rectifiers only the minimum voltage is specified.

In most cases, the energy rating is much more difficult to select, because CA rectifiers are often used in circuits where transient conditions are difficult to repeat and measure. In such cases, trial-and-error may be the only satisfactory method of selection. Manufacturers can frequently supply devices that are similar in most characteristics except for the junction area. (Note that junction area also affects forward-surge and average-current ratings.)

When these options are available, start with the largest junction device, and work down in size to determine the smallest sized junction that will live in the circuit. Then the desired safety factor can be added, and selection is complete—except for providing the correct thermal environment.

When the transient is repeatable on demand, it can be studied for its energy content, and a more enlightened selection approach can be used. Fig. 3 shows the sort of transient waveform that might occur when power to an inductor is suddenly switched off.

Assume we need to limit the voltage to a range of 250 to 500 V. Alternately connect CA limit rectifiers of these two voltages to the circuit, and find the duration of energy within the rectifier. For this study, use the largest-junction rectifiers available.

Any energy that has to be absorbed in the time region,  $t_0 - t_1$ , (Fig. 4) is almost entirely absorbed by the thermal capacitance of the junction. In the region,  $t_1 - t_2$ , enough time has elapsed for some heat to flow into the rectifier package. Therefore, the energy rating of the rectifier will be higher if the transient extends

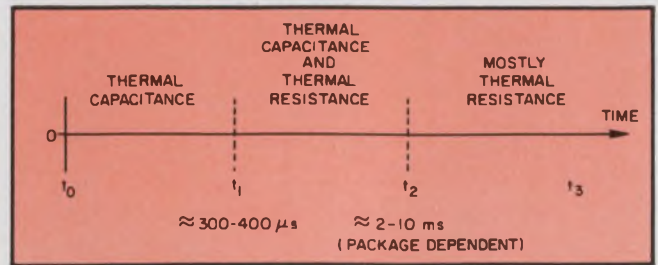

4. Transient duration determines whether the energy must be absorbed by the thermal capacitance of the junction ( $t_0 > t > t_1$ ) or by the thermal resistance of the rectifier and its package ( $t > t_2$ ).

beyond 300-400  $\mu$ s. Beyond  $t_2$ , thermal resistance determines basically how much energy can be absorbed and dissipated by the CA rectifier; and, with increasing time, the energy rating reaches the dc dissipation of the device.

To find average current in a clamped waveform, take a picture of the waveform displayed on a scope and use a planimeter (a mechanical device that measures area) to find the irregular waveform area. This is then expressed as a percentage of a square-cornered pulse having the same peak amplitude.

The peak voltage and time are also measured with an oscilloscope.

Energy is calculated from  $E = VI t$ , where

$V$  = clamped voltage level,

$I$  = average current, and

$t$  = time in seconds.

Information obtained can be used to determine the optimum sized junction area and package required to absorb safely the energy present in the circuit, and to meet all other requirements.

The energy rating for any particular rectifier type is usually given at only one pulse width (frequently at 100  $\mu$ s). As the pulse width exceeds the 300  $\mu$ s to 10 ms period, the rectifier package and heat sink play an increasingly important role in over-all energy handling.

High-energy, high-voltage rectifiers can be made, using a series of avalanche junctions. For example, the 6-8 kV rectifier used in the circuit of Fig. 1 can be made of 10 junctions, each having an energy capability of  $> 0.15$  J for a final rectifier rating guaranteed to be  $> 1.5$  J. In this particular case, the rating is specified at 400  $\mu$ s pulse width because this is the approximate energy pulse width seen in the circuit. ■■

### Bibliography:

Todd, Carl David, *Zener & Avalanche Diodes*, Wiley-Interscience, New York, 1970.

Markus, John, *Electronics and Nucleonics Dictionary*, Third Edition, McGraw-Hill, New York.

# LOW NOISE LOW DRIFT OP AMPS... *made easy!*

0.5  $\mu\text{V}/^\circ\text{C}$

0.6  $\mu\text{V}$  pk-to-pk

8.0  $\mu\text{V}/\text{Month}$

**Max!**

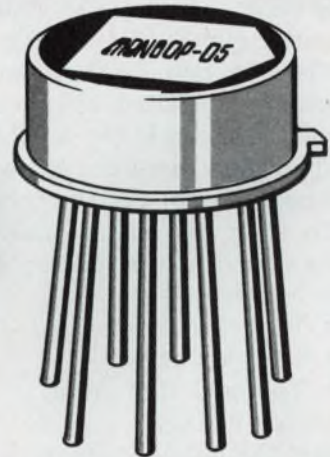

## YOUR TOUGHEST OP AMP SOCKET JUST GOT FILLED!

The new monoOP-05 series guarantees the most accurate input specs in the industry . . . and no additional components are required for frequency compensation or protection! Best of all . . . the parameters are rock-stable, month after month! With offset voltages as low as 150  $\mu\text{V}$  (Max), bias currents as low as 2.0 nA (Max), and CMRR as high as 114dB (Min), the monoOP-05 is the "ideal" op amp for all precision aerospace and industrial transducer and computation circuitry!

Try one! Discover just how easy low noise, low drift op amp designs can be! (The monoOP-05 is a direct replacement in 725, 108 and unnull 741 sockets . . . upgrade your system now!)

Units processed to MIL-STD-38510 and/or with long-term stabilities 100% tested and guaranteed to better than 5.0  $\mu\text{V}/\text{Month}$  are available . . . contact the factory or your local PMI representative. Matched dual versions in 14-pin DIP packages are also available . . . inquire about the amazing monoOP-10 series!

### GUARANTEED MIN/MAX SPECIFICATIONS

	monoOP-05A	monoOP-05	monoOP-05E	monoOP-05C	
Operating Temp. Range	-55/+125	-55/+125	0/+70	0/+70	$^\circ\text{C}$
Vos @ 25 $^\circ\text{C}$	0.15	0.5	0.5	1.3	mV
Vos vs. Temp.	0.5	1.0	0.6	1.5	$\mu\text{V}/^\circ\text{C}$
Vos vs. Time	8.0	9.0	9.0	—	$\mu\text{V}/\text{Month}$
Noise (0.1 Hz to 10 Hz)	0.6	0.6	0.6	0.65	$\mu\text{V}$ , pk-to-pk
Input Bias Current	2.0	3.0	4.0	7.0	nA
CMRR	114	114	110	100	dB
Open Loop Gain	300	200	200	120	V/mV
Price @ 100 pcs. (TO-99)	\$44.95	\$19.95	\$14.95	\$7.95	



1500 SPACE PARK DRIVE, SANTA CLARA, CALIFORNIA 95050  
TEL. (408) 246-9225 • TWX 910-338-0528 • CABLE MONO

#### AUTHORIZED DISTRIBUTORS

**NEW YORK METROPOLITAN AREA** Harvey Radio, Woodbury, N.Y.: (516) 921-8700 • **NEW ENGLAND AREA** Gerber Electronics, Dedham, Mass.: (617) 329-2400 • **UPSTATE NEW YORK** Harvey/Federal Electronics, Binghamton, N.Y.: (607) 748-8211 • **NORTHEAST** Newark Electronics, Malden, Mass.: (617) 321-3930 • **BALTIMORE-WASHINGTON** Whitney Distributors, Baltimore, Md.: (301) 944-8080 • **MICHIGAN** RS Electronics, Detroit, Mich.: (313) 491-1000 • **SOUTHEAST** Kirkman Electronics, Winston-Salem, N.C.: (919) 724-0541 • **CENTRAL** Hallmark Electronics, Elk Grove Village, Ill.: (312) 437-8800 • **MINNEAPOLIS**, Minn.: (612) 925-2944 • **ST. LOUIS**, Mo.: (314) 521-3800 • **TEXAS-OKLAHOMA** Sterling Electronics, Houston, Texas: (713) 623-6600 • **DALLAS**, Texas: (214) 357-9131 • **SOUTHWEST** Sterling Electronics, Albuquerque, N.M.: (505) 247-2496 • **PHOENIX**, Ariz.: (602) 258-4531 • **WEST** Westates Electronics Corp., Chatsworth, Calif.: (213) 341-4411 • **STERLING** Electronics, San Carlos, Calif.: (415) 592-2353 • **INTERMARK** Electronics, San Carlos, Calif.: (415) 592-1641 • **DENVER**, Colo.: (303) 936-8284 • **SEATTLE**, Wash.: (206) 767-3160 • **SALT LAKE CITY**, Utah: (801) 359-0531 • **SAN DIEGO**, Calif.: (714) 279-5200 • **SANTA ANA**, Calif.: (714) 540-1322 • **WESTERN CANADA** Intek Electronics Ltd., Vancouver, B.C.: (604) 873-2477.

INFORMATION RETRIEVAL NUMBER 48

# Analyzing the dynamic accuracy of simultaneous sample-and-hold circuits is straightforward. A wideband scope and a simple mathematical model supply the answers.

In most simultaneous data-acquisition systems a large number of analog input channels are strobed at precise time intervals and then sequentially digitized by an analog-to-digital converter. To check the multichannel sample-and-hold circuits there are some simple tests the user can perform to verify correct circuit operation.

To start the error analysis, several assumptions can safely be made: All static errors have been eliminated—

- The offset error.
- The gain error.
- The hold step error.

Input voltage,  $V_{in}$ , to the sample-and-hold equals the output voltage,  $V_{out}$ , from the sample-and-hold.  $V_{in}$  is any dc voltage between  $\pm 10$  V. The offset error is  $V_{out}$  when  $V_{in} = 0$ , while the gain error is the maximum value of the offset error divided by  $V_{in}$  maximum (10 V).

## Looking at the dynamic errors

Normally, one sample-and-hold circuit is used for each a/d converter with any multiplexing between input channels done previously. However, for a large number of channels this leads to errors due to the different conversion times of the various channels. In a simultaneous sample-and-hold configuration, a number of input analog channels are strobed at a precise time and the held voltages are sequentially converted to digital form.

At this point the most basic test that can be performed is to simultaneously apply the same voltage waveform to all inputs. Now, if we look at the output for each channel, the digital words representing each voltage should be identical. If the system fails this basic test, the user must search the specification sheets and the circuits themselves for the error sources.

The three major sources of dynamic errors can be traced to the following:

**Ralph Johnston**, Datel Systems, Inc., 1020 Turnpike St., Canton, Mass. 02021.

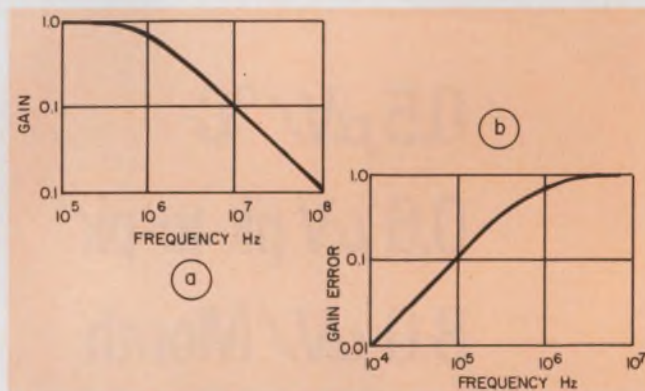

1. Plots of a single pole transfer function (a) and of the gain-error (b) are shown with a 1-MHz cutoff frequency.

- A change in the gain during the sample mode as a function of frequency.
- A nonzero hold step as a function of frequency (hold-step error).
- A shift in the effective beginning of the hold-step as a function of  $V_{out}$ ,  $dV_{out}/dt$ , or frequency (aperture-shift error).

The aperture-shift error can be caused by a slowly opening switch or by a pole at the unity-gain  $-3$  dB point ( $f_{co}$ ) of the unity-gain sample amplifier. The error advances the effective time of the switch opening to a time prior to its actually reaching open circuit. For applications of simultaneous sample-and-hold circuits both the  $f_{co}$ 's and the switch opening times, must be matched.

## The transfer function during sample

Gain in the sample stage can be represented by a linear transfer function—at least for amplitudes small enough that the amplifier slew-rate doesn't affect the results. Thus, a simple low-pass function with a pole at  $f_{co}$ , say 1 MHz, can be represented by the following:

$$\frac{V_{out}}{V_{in}} = \frac{1}{1 + j \frac{f}{10^6}}$$

The graph of this typical low-pass filter is shown in Fig. 1a. It has unity-gain transmission and a

1-MHz -3 dB point.

Usually, though, it proves more useful to plot small deviations from unity gain as shown in Fig. 1b. The formula used for this gain-error plot is

$$\text{Gain error} = \frac{V_{out}}{V_{in}} - 1 = \frac{-j \frac{f}{10^6}}{1 + j \frac{f}{10^6}}$$

While not usually seen in this form, this type of frequency-response plot is quite valid. From the equation we see, for example, that a circuit band-

width of 1 MHz, an input of 10 V at a frequency of 1 kHz results in an error of 0.001 or 10 mV.

By now finding the response of the circuit to a ramp of K V/sec, we can try to match transfer functions of all the channels of the sample-and-hold stages. The gain-error transfer function is put into the s domain using LaPlace transforms and becomes

$$\text{Gain error} = \frac{-s}{2\pi \times 10^6} \cdot \frac{1}{1 + \frac{s}{2\pi \times 10^6}}$$

The ramp is also transformed, and becomes K/s<sup>2</sup>.

## The sample-and-hold: What is it and where is it used?

A sample-and-hold (S/H) circuit holds or "freezes" a changing analog input signal voltage. Usually, the voltage thus frozen is then converted into another form, either by a voltage-controlled oscillator, an analog-to-digital (a/d) converter or some other device.

The simplified block diagram of a lossless (ideal) S/H circuit is shown in Fig. 1. Here the amplifiers are assumed to be ideal—with infinite input impedances and bandwidths, zero output impedances and unity gains. The electronic switch is also considered ideal—with infinite speed, zero impedance in the sample position and infinite impedance in the hold position. Also, the sampling capacitor, C, is assumed to have no leakage or dielectric absorption.

Depending upon cost, the user has three basic methods to choose from when setting up a multiple-signal data-acquisition system. The most basic but also the most expensive scheme is the

one shown in Fig. 2a. This circuit uses an individual S/H and a/d converter for each sensor line. Fig. 2b is a low cost alternative in which all the sensor lines are first multiplexed and then fed into a single S/H and a/d converter. Another method, falling between those of Figs. 2a and 2b in cost and performance, is shown in Fig. 2c. Here, the sensor signals are first sampled and then multiplexed and sent to a single a/d converter.

If the S/H circuits were ideal, the only significant errors would occur in the multiplexer or the a/d converters. In a real world situation, of course, the S/H circuits introduce some serious errors into the conversion circuit.

The circuits of Figs. 2a and 2c require additional qualities from the S/H circuits that are not needed for the system of Fig. 2b. Precise matching of the aperture delays and bandwidths is required.

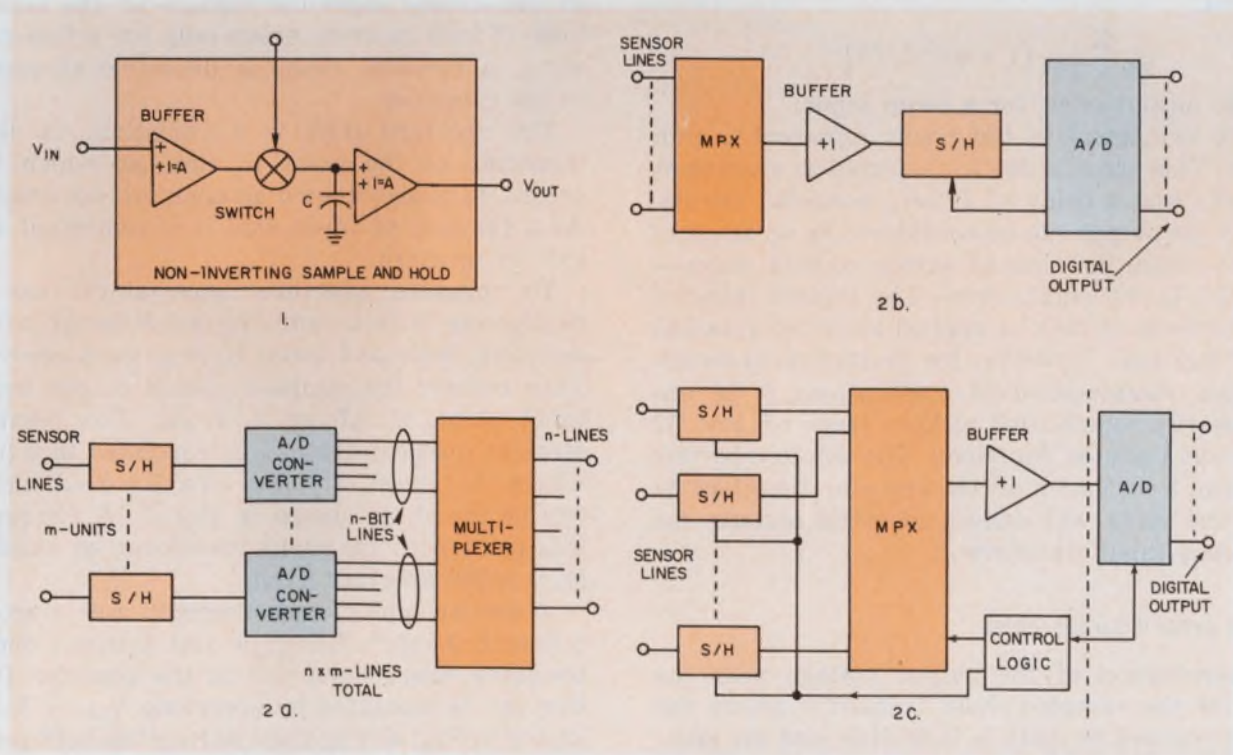

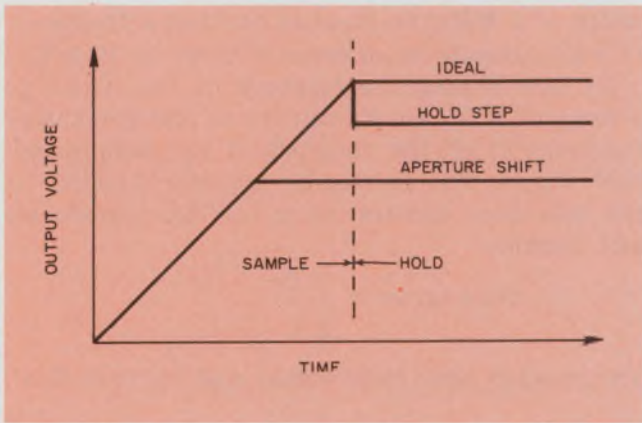

2. Dynamic errors caused by the hold step and the aperture shift are hard to distinguish.

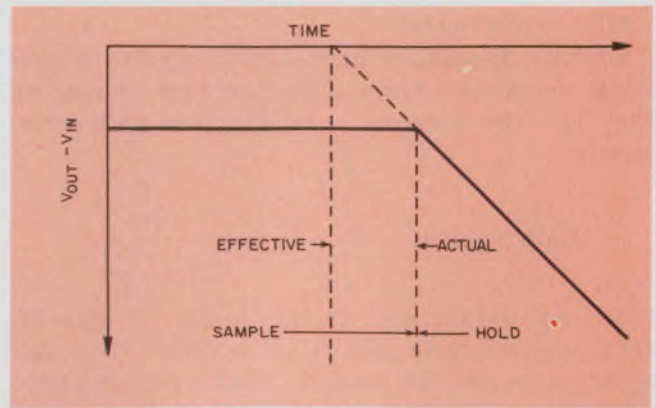

4. If you use a different scope input, the effective point of hold initiation can be found by extrapolating back to the zero point.

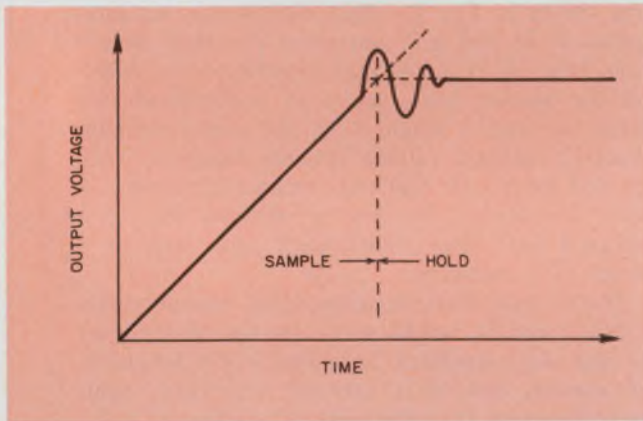

3. By extrapolating the two straight-line segments to meet each other, you can find the effective time at which the hold period starts.

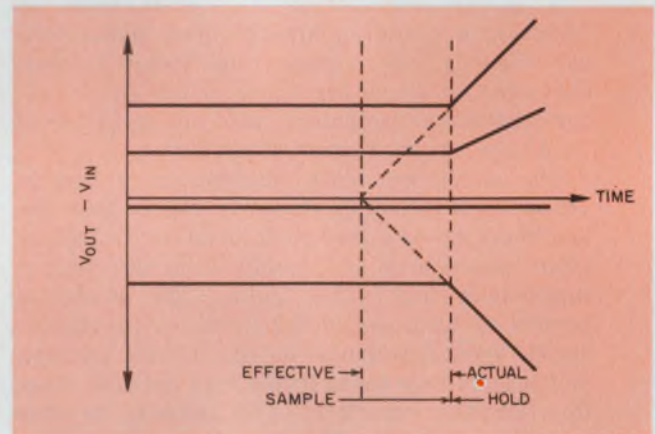

5. The effective start time for hold is not affected by the slope of the input ramp—for a first-order analysis.

Taking the inverse transform of the product we get

$$\frac{K}{2\pi \times 10^6} [1 + e^{-(2\pi \times 10^6)t}]$$

as the output error for a ramp input.

The two terms in the result represent a gain error. This error is due to the ramp as a constant  $K/2\pi f_{co}$  and a delay of  $1/2\pi f_{co}$  seconds. The delay in the output can be considered as an advance in the transition time of sample-to-hold states—but this is not usually done. The inverse transfer function can always be applied after the data has been digitized. However, for multichannel simultaneous sample-and-hold applications it is unnecessarily complicated to keep track of, say, 32 different transfer functions. The solution to this problem is to match all the transfer functions so that the units will deliver identical outputs for the same input waveform.

#### Other error sources exist

Examination of the output voltage near the time of the sample-to-hold transition shows the errors caused by both a hold step and an aperture shift (Fig. 2).

The hold-step error appears as a sudden change in the sample capacitor voltage at the time of hold. If such an error exists only for a fast ramp input, a probable cause is dielectric absorption in the capacitor.

The aperture shift is a variation, in either direction, of the point in time at which hold occurs. It is also known as aperture uncertainty. As a function of input rate it is somewhat difficult to measure.

To measure aperture uncertainty, use an oscilloscope with a sampling amplifier or with a sensitive, wideband input having good recovery. Then observe the sample-and-hold output for an input slope of 0.5 or 1 V/ $\mu$ s. The resulting straight lines can then be extrapolated to a point where they meet, and the effective hold instant can be found, as shown in Fig. 3. A change of this point with the input waveform, or randomly, is called aperture jitter.

A similar type of measurement uses a scope's differential input. All static and dynamic errors, including linear ones, due to the transfer function can be measured by observing  $V_{out} - V_{in}$  as shown in Fig. 4. The slope during the hold period can be extrapolated back to zero to find the effective



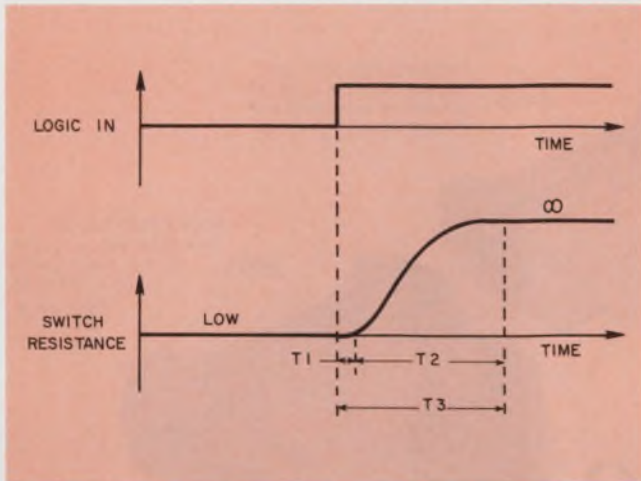

6. A typical analog switch introduces a delay in the sample-to-hold transition.

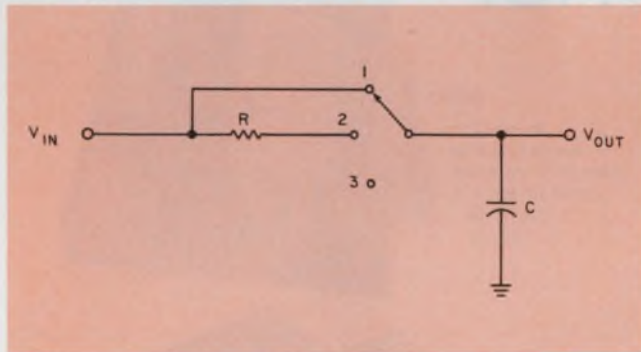

7. An ideal slow opening switch can be modeled by using a simple RC network and a three position switch.

time when hold starts. With a single-pole transfer function, the value of  $V_{out} - V_{in}$  during sample for an input ramp is proportional to the slope of the waveform. But as shown in Fig. 5, to a first-order approximation, the start of hold is unaffected.

But, there is zero aperture uncertainty with the transfer function representation, thus the effective time of hold initiation occurs before the switch opens! The amount of this shift can be determined as a function of bandwidth. A transfer function with an  $f_{co}$  of 1 MHz can be represented by an RC low-pass filter with a resistor of 159  $\Omega$  and a capacitor of 100 pF. An input ramp of 1 V/s will cause a capacitor current of 1 mA (CV/t) which in turn causes a resistor drop of 159 mV. Thus the effective time of hold occurs 159 mV/V/ $\mu$ s or 159 ns before the actual switch opening.

The two measurements described are difficult to perform without high performance test equipment. Therefore, most manufacturers' specifications of aperture delay and uncertainty tend to be primarily concerned with the variation of switch resistance after the logic input changes to the hold state. Fig. 6 shows a typical logic

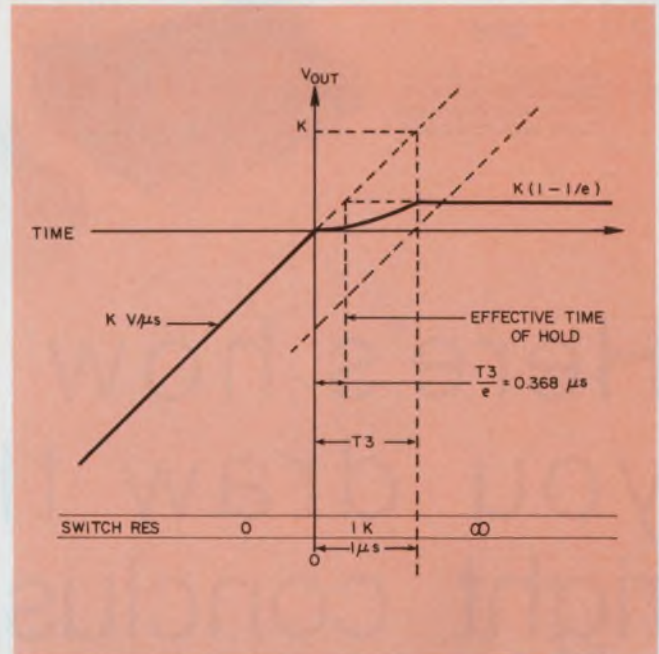

8. The effective time at which hold commences occurs before the switch is fully opened.

switch resistance change during the sample-to-hold transition.

The time  $T_1$  is known as the switching delay or aperture delay and is characteristic of any practical switch. Switching time,  $T_2$ , usually is measured from the 10 to 90% points (as for logic circuits) and is sometimes called aperture time. The total switching time,  $T_3$ , is also referred to as either the aperture time or aperture delay. If the rise time of the switch varies with the input voltage waveform, or just randomly, the change in  $T_3$  is called the aperture jitter.

To further complicate matters, some definitions do not use switch resistance. Diode-bridge switches are characterized by stored charge and not by changes in resistance. The switch must then be viewed as a black box—apply a ramp voltage to it, open the switch and determine the effective time of opening by observing  $V_{out}$  and extrapolating the straight lines as previously described. A second method relying on diode reverse-recovery measurements can be used but is not as accurate.

The example shown in Fig. 7 can demonstrate that the effective switch opening time occurs before the switch resistance reaches infinity. Let  $V_{in}$  be a ramp of  $K$  V/ $\mu$ s. If, at time  $t = 0$ , the switch goes from position 1 to 2, then 1  $\mu$ s later it goes to position 3, the effective time of hold can be seen from Fig. 8 to occur while the switch is in position 2. The aperture-time advance is fixed for an input ramp but will have jitter for waveforms that have curvature. The effective hold initiation will occur between instants  $T_1$  and  $T_3$ . This is why  $T_3 - T_1 = T_2$  is often specified as the aperture time. ■■

\$395

Model 5112-1 single pen recorder with 1, 2, 5, 10 in/min. chart speeds and 10 mv fixed input spans



\$445

Model 5110-2 single pen recorder with 2.2, 5, 10, 20 cm/min. chart speeds and 5 input spans of 10 mv up.



\$595

Model 5212-1 two pen recorder with 1, 2, 5, 10 in/min. chart speeds and 10 mv fixed input spans.



\$690

Model 5212-2 two pen recorder with 1, 2, 5, 10 in/min. chart speeds and 5 input spans of 10 mv up.



\$990

Model 5220-5 two pen recorder with electric pen lift, 2.5, 5, 10, 20 cm/min. chart speeds and 5 input spans of 1 mv up.



CIRCLE NO. 161

## **OmniScribe<sup>™</sup>** strip chart recorders

Here's the newest low cost strip chart recorder from The Recorder Company. And when you compare the costs with the performance you'll understand why it pays to buy from a company whose entire resources are devoted to building and servicing the finest laboratory recorders in the world. Mail for your copy of the OmniScribe brochure today.

**THE RECORDER COMPANY** | **houston instrument**

4950 TERMINAL AVENUE, BELLAIRE, TEXAS 77401  
(713) 667-7403 TWX 910-881-5782 CABLE HONICO

European Office Rochesterlaan 6 8240 Gistel Belgium  
Telephone 059-27445 Telex BAUSCH 19399B

# Here's how you draw the right conclusions:

## **Omniographic<sup>®</sup>** x-y and strip chart recorders

If you want one pen or two . . . for GC or spectrometry . . . for thermo-couple or strain gauge . . . the Omniographic recorder with options will give you a full range of inputs combined with operational conveniences. Consider switching to Omniographic recorders . . . built by The Recorder Company.

### 27-plug-in modules for virtually every laboratory function make this the most versatile recorder

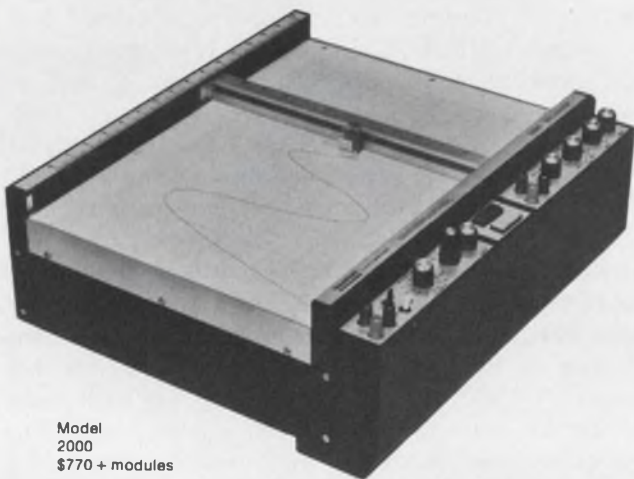

Model 2000  
\$770 + modules

OEM DISCOUNTS

CIRCLE NO. 162

SOLITRON GIVES YOU THE

# POWER

AT HALF THE

# PRICE

## 10 AMP, 200 VOLT

**HI-REL INDUSTRIAL TRANSISTORS**

Solitron's versatile 10 Amp, 200 Volt, Silicon NPN Power Transistors are available in a low-cost series which can replace many expensive hi-rel industrial devices. For half the price of other units, they provide the same performance characteristics. The transistor series is available in a wide range of TO-3 (SDT 1611-1638) and TO-66 (SDT 1641-1668) packages with multiple gain selections and  $V_{CEO}$ 's from 40 V to 200 V. Features include multiple diffused planar process for excellent reliability; excellent fast-switching characteristics, with low turn-off time; and Safe Operating Area (SOAR) specified for forward and reverse-biased operation.



### WHY PAY MORE?

When Solitron Transistors Do The Job For Less?

For complete information, write:

**Solitron**  
DEVICES, INC.

1177 BLUE HERON BLVD. / RIVIERA BEACH, FLORIDA 33404 / (305) 848-4311 / TWX: (510) 952-7610

SAN DIEGO, CALIF.  
8808 Balboa Ave.  
CMOS, PMOS Circuits  
Diodes, Rectifiers, &  
Zeners  
FET & Dual FET  
Transistors  
High Voltage Assemblies  
Linear & Monolithic IC's

RIVIERA BEACH, FLA.  
1177 Blue Heron Blvd.  
Hi-Rel Power Transistors  
SI & Ge. Power  
Transistors  
Hi-Rel Power Hybrids  
PNP-NPN Industrial  
Transistors

PORT SALERNO, FLA.  
Cove Road  
Microwave Connectors  
Plaxial (R) Cable  
Precision RF Coaxial  
Connectors

JUPITER, FLA.  
1440 W. Indiantown Rd.  
Microwave Stripline  
Components  
Microwave Diodes  
Microwave-CATV  
Transistors  
Hi-Rel Power  
Transistors

TAPPAN, N.Y.  
256 Oak Tree Road  
Diodes & Rectifiers  
Ferrite & Ferrite Devices  
High Voltage Assemblies  
Power Rectifiers  
Thick Film  
Hybrid Circuits

BEDFORD, ENGLAND  
Edison Road  
Elms Industrial Estate  
Solidev, Ltd.  
Full line of  
Solitron devices

HONG KONG  
P. O. Box K-2042  
Kowloon, Hong Kong  
Solidev/Hong Kong Ltd.  
Full line of  
Solitron devices

INFORMATION RETRIEVAL NUMBER 49

## Getting the best inside information, says this corporate manager, depends on how well your people can filter job problems and company data.

William James Durant, the American educator and writer, once noted that while Americans are not the best informed people on earth as to the events of the last 60 centuries, they are the best informed as to the events of the last 24 hours. Getting the right information to the right people at the right time has been the hallmark of most successful American companies. And for information to be useful, it must be filtered as it goes up and down the chain of command.

Filtering is simply knowing what you yourself have to know and knowing what information you have to pass along to the next level of supervision to help solve the company's every day problems.

### Protecting the filterer

A wise man once said that submerging problems in a sea of information is not the same as solving them. Computers, for example, can turn out a tremendous amount of data that can be reproduced and distributed everywhere so that everyone has a pile of it. The middle manager usually wants to know why he has to paw through all this data when his boss has the same pile.

But there's no way that the top man can inspect all his data by himself. He has to have his subordinates filter it for him. Each level of management has to digest the data by soft-pedaling the part that says the company's doing well and spotlighting the part that says it isn't.

Although the filtering of data is a prime responsibility of managers, they often feel intimidated by the computer. Some companies have thrown out the computer so their managers can return to filtering information that is a vital part of their job.

Of course, it's one thing to filter data, but it's quite another to filter the problems that

creep up on you on the job.

You can't go to your supervisor with every little problem; there are certain problems that even the lowest managerial aide handles himself. But when does he go to his supervisor and say, "Look I've got a problem I can't handle; I need some help"? The new engineer normally thinks that if it's a technical problem, he's closer to it, and he hesitates to go to a supervisor—especially if he thinks the supervisor may feel that the engineer should know the solution. One of the first things that a beginning engineer learns is that if he has a problem that's going to delay his project to any extent, he'd better go to his supervisor and find out what to do. Chances are that the supervisor has been there for a few years and may already have the solution to the problem. The same approach holds all the way up the chain of command; the individual should know when to blow the whistle for help.

### Learning how far is far enough

The time to blow the whistle is when you're jeopardizing either the cost or the schedule of a project or the performance of the product. Whistling is a matter of judgment, and it varies with the type of job. All jobs have varying degrees of complexity in regard to schedule and budget. Sometimes the budget is the toughest problem to meet. A good rule is that if you're within 10% of the budget, you're in pretty good shape, because your profit margin is within that figure. If you go over that figure, you should ask for help.

If the emphasis is on the schedule of a project, you must go to management and find out exactly how important promptness is. What are the penalties for being late?

Many young engineers graduate from school thinking that engineering calls for considerable inventiveness, and many feel that it's impossible to schedule such creativity; they believe they must wait for inspiration, that it's an intuitive thing. But after working in the field for years, I've found that you can schedule in-

---

E. W. Bush, Vice President and General Manager, Cubic Industrial Corp., San Diego, Calif.



**E.W. Bush**

**Education:** BSEE, University of Utah.

**Responsibilities:** Responsible for all operating functions of the company including marketing, product development and manufacturing.

**Experience:** Ten years in various management posts in Cubic Corp's Defense Systems Div: Four years as Reconnaissance Systems Director with management responsibility for the division's technical publications group and design drafting group; six years in program management positions including an airborne mapping system and a pseudo-random noise artillery targeting system for the U. S. army and a nine target missile tracking system produced for the Defense Atomic Support Agency.

**Publications:** "Tactical Aircraft Positioning," Navigation, Journal of the Institute of Navigation, Summer 1972, Volume 19; "Missile-borne Wideband Telemetry System," Convair Astronautics Document 2N-7-211, April 1959; "Telemetry Addition to the Azusa Tracking System," IRE Proceedings, 1959 National Symposium on Space Electronics and Telemetry, September 1959; "A New and Proven Geodetic Survey System," 1966 National Photogrammetry Conference; "Microwave Communications Systems," Electronic Industries, January 1966; "Keep Your Door Open," Line and Staff Supervisors, May 1966; "Can-Doer

Will Make Good Leader," Line and Staff Supervisors, July 1966; "Balance 3 Basics to Supervise," Line and Staff Supervisors, August 1966; "Heroes Never a Morale Problem," Line and Staff Supervisors, November 1966.

**Employer:** Cubic Industrial Corp. is a wholly owned subsidiary formed in 1972 by Cubic Corp. of San Diego, to produce non-defense products. The subsidiary designs, engineers, manufactures and markets products that serve the surveying and civil engineering fields with both long and short range automatic surveying instruments. It also has a line of Computer Output Microfilm (COM) printers that it manufactures on an OEM basis for Eastman Kodak Company. Electronic vote tallying and computer-controlled voice response systems are also a part of the product mix.

More recently, the concern began producing automatic revenue collection systems for the mass transit market, and it is working under a multi-million dollar contract from the Illinois Central Gulf Railroad to manufacture automatic ticket vendors and gates. It also produces special ticket encoding machines for the Bay Area Rapid Transit (BART) and sophisticated electronic positioning systems that are used worldwide for natural resources exploration, dredging, and other hydrographic applications.

spiration—in fact, you have to schedule it.

If the crucial factor is product performance, then the communication is with the customer. Some product parameters are more important than others, and the project engineer should know which are. You must have good rapport with the customer to be able to say, if the schedule or the budget is jeopardized: "Do you really need this?" or "Do we have any latitude?" The customer may find later that a particular spec is not right and that it's going to cause him difficulty.

If there's good communication between the contractor and his customer, it's possible to make compromises. The engineer should find his counterpart in the customer's organization and establish rapport with him. He should try to keep the problems at the lowest level, where, hopefully, it's easiest to solve them.

Top management has a problem, too, because there's information it doesn't always want passed down the chain of command—as, for example, if the business outlook is dropping and there's going to be a layoff soon. Obviously you don't want that kind of information relayed because it affects morale and besides it may never come to pass. The company may get a contract that it hadn't expected; there's no need to shake up the troops until it becomes necessary.

### The 'pick and shovel' work

Good management communication is "pick and shovel work," like checking on shipment and making sure that a product release was made. It's following up on engineering problems. Of course, a manager can't get involved in every problem all the time, but occasionally you can get down to the nitty gritty and find out what the problem is. You may find out that there isn't any problem at all, but at least you've followed it up and found out what was going on.

The engineers never know when you're going to check, so they're on their toes and know what's going on. If you ask them a question and they don't know the answer, the next time around the chances are they'll be a little better prepared. It all makes for better communication.

Management can improve the filtering of data and job problems by determining just what its employees' capabilities are and where they can best fit into the company. I don't think that there's any one kind of company organization that's necessarily right. You have to come up with an organization that best fits the people you have. When the employees change, you have to change the organization to fit them. You've got to get people who can communicate with one

another, and you've got to organize to implement that.

A lot of engineers think that because they work under a chain of command, they work under a dictatorship and have to do what they're told. The supervisor doesn't want that; he wants to get some feedback. If he has given directions that aren't right, he wants feedback before repercussions set in.

### Never say 'never'

The most important thing to remember in company communications is not to take too adamant a stand. Don't say, "This is it"; don't be too definitive. Leave some latitude for compromise. One thing I've learned in negotiating a contract is never to say, "Well, that's my last offer," because when you've said that, you've ceased to negotiate. Don't ever completely commit yourself. If you take an adamant stand that's not acceptable to the person you're talking to, you're just going to upset him, and that won't solve anything.

The most difficult thing about communication is that it's hard to realize that talking isn't necessarily communication. It's not communication until someone listens and understands and acts on it. You have to establish some method of feedback so that the direction that's given is implemented. The quickest way for a company to get into trouble is to have open-loop communication, so that there's no way to find out if anything has been done.

A lot of managers get feedback by going out for a floor check. Even though they often don't know the exact reasons for making the rounds, they're astounded at the problems that surface. There are guys out there who wouldn't volunteer information, but if you ask them for it, they'll tell you.

### Being forced into management

I went into engineering because I preferred working with objects rather than people. I think this is why most engineers go into engineering. I wasn't interested in English; I was interested in the math courses in school, the sciences.

Now what do I do? I spend all my time talking and writing reports and letters—all the things I wasn't interested in. But I had to change as I was promoted. One good piece of advice I can offer is: don't try to get into management; if you're worth a damn, you'll be forced into it. The graduate engineer is usually equipped with the technical qualifications to succeed; what he must learn is the supervisory task of knowing how and when and what to communicate. ■■



# NEW Simpson 360 Digital VOM

**Handy and rugged enough for the field — accurate and versatile enough for the lab. And its simplicity and readability make it perfect for production line testing.**

- 3-1/2" digit, non-blinking, auto-polarity 0.33" LED display
- AC line or battery operation
- 29 popular ranges including "low-power" ohms
- Analog indicator for scanning nulls and peaks
- Analog output signal permits interfacing with recorders and other instruments
- Up-down integration analog/digital conversion assures superior stability, accuracy and noise immunity

Supplied with test leads, AC line cord, operator's manual, without batteries ..... **\$275**



## **SIMPSON ELECTRIC COMPANY**

853 Dundee Avenue, Elgin, Illinois 60120 • (312) 695-1121  
 CABLE: SIMELCO • Telex: 72-2416  
 IN CANADA: Bach-Simpson, Ltd., London, Ontario  
 IN ENGLAND: Bach-Simpson (U.K.) Ltd., Wadebridge, Cornwall  
 IN INDIA: Ruttonsha-Simpson Private, Ltd., Vikhroli, Bombay

ORDER NOW FROM YOUR LOCAL ELECTRONICS DISTRIBUTOR OR WRITE FOR NEW CATALOG 4200

INFORMATION RETRIEVAL NUMBER 50

## Phase-locked loop helps generate waveforms with variable duty cycle or phase shift

A phase-locked-loop (PLL) integrated circuit provides a way to generate pulse trains with voltage-variable phase or duty cycle.

For the PLL to remain locked, the voltage at point A must remain constant. The presence of an external modulating signal at A upsets the equilibrium. And the output of the phase detector goes up or down to maintain the voltage at A. But a change in phase-detector output also means a change in phase difference between the input signal and the VCO signal. For square-wave input signals, the VCO phase shift will be proportional to the modulation voltage.

The NE 565 provides phase shifts from zero to 180 degrees. An Exclusive-OR gate, acting as a multiplier (phase detector) produces an output pulse train of twice the input frequency. Its duty cycle (0 to 100%) is proportional to the phase difference between the VCO and the input signal—and hence also to the modulation voltage.

Adjustment of  $R_3$  varies the center frequency of the VCO. Adjustment of  $R_1$  obtains the required 90° center phase shift (50% duty cycle on PWM train).

Salient performance characteristics with a 6-to-7-V supply are as follows

- Steady state linearity—1% from 5° to 175° phase shift.
- Phase jitter—less than 1%.
- Temperature drift—0.15°/C.
- Power-supply sensitivity—1.5°/V.

The circuit shown operates with input signal frequencies to 500 kHz. Other PLL integrated circuits extend operation to higher frequencies. To minimize distortion, keep the modulating frequency below a few percent of the input-signal center frequency.

Noel Calvin, Engineer, Caltronix, 2683 Buena Vista Way, Berkeley, Calif. 94708.

CIRCLE No. 311

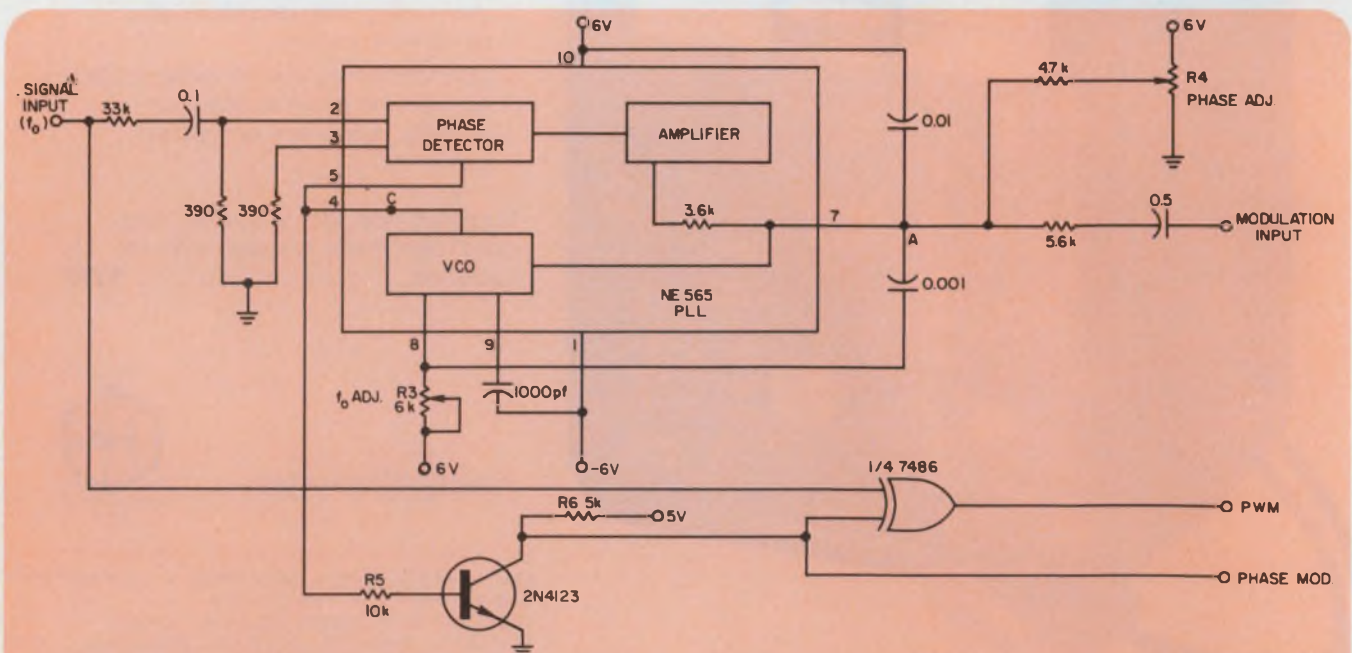

Offsetting the PLL voltage-loop with a modulating signal phase-modulates the VCO output (point C).

Exclusive-ORing of the pulse input signal with the VCO generates a double-frequency PWM signal.



**attenuator-  
rated™**

**quiet!**

**Ferramic® components  
guarantee circuit  
performance.**

*Attenuator-Rated* components are new—and they're processed specifically for highest interference suppression.

#### **End guesswork**

This new breed of slip-on Ferramic components puts an end to cut-and-try selection. Now you can choose from a full line of our *Attenuator-Rated* components and get known attenuation properties.

Our complete specifications include the data you need to get dependable attenuation characteristics matched to your circuit requirements. And we back our specs with our own testing program.

#### **Highest attenuation**

An ordered series of nine components give you total flexibility in optimizing

attenuation to your specific circuit.

With each of these components you can select the attenuation properties you require. The highest suppression in the industry from 10 KHz to 10 Mhz or maximum attenuation from 10 to 250 Mhz.

#### **New design guide**

Selection of optimum noise attenuation couldn't be easier. Our complete design guide gives you the facts you need. You get typical attenuation and impedance curves, application data and specs that relate directly to your circuit requirements.

If your circuit impedance is known, you can determine attenuation characteristics directly from our graphs. And once your problem is

solved—it stays solved. Our testing program insures that each *Attenuator-Rated* component will meet its attenuation specs.

For complete design information and the answers to your attenuation requirements, use the reader service card for your copy of our design guide. Or call (201) 826-5100 and talk to the men who wrote it. Either way, if you're talking attenuation, talk to the ferrite experts.

That's us.

Indiana General  
Electronic Products  
Keasbey, N.J. 08832

*National distribution  
through eight  
Permag locations.*

**indiana general** 

a division of Electronic Memories & Magnetics Corp.

# Resistive bridge and op amp form a multiplying DAC

A differential amplifier is the key to an economical circuit that affords digital gain control of an ac or dc reference signal.

Normally if the two op-amp inputs are tied to equal voltage inputs, zero outputs results if  $R_1$  through  $R_4$  are equal in value. Adding network  $N$  attenuates the voltage at the inverting input, thereby unbalancing the inputs of the op amp (Fig. 1). The output  $V_o$  is then noninverting, and it is given by the equation

$$V_o \approx \left( \frac{R_1}{2} Y_N \right) V_{IN},$$

where  $Y_N$  is the admittance of the shunt network, and the expression in parenthesis is the gain of the circuit.

Use of digitally switched admittances can provide binary gain control, BCD control or any desired weighting (Fig. 2). Each switch provides binary or BCD weighting of the admittance.

To design the circuit, select values for full-

scale gain (or attenuation),  $G_{FS}$ , and  $R$ . The selection of  $R$  establishes the resistance values for the shunt network (Fig. 2). Resistors  $R_1$  through  $R_4$  (Fig. 1) have equal values. The value for  $R_1$  is found by substituting the expected circuit gain and value of  $Y_N$ —at the maximum value that can be represented by the switches—in the equation

$$R_1 = \left( \frac{2 G_{MAX}}{Y_{MAX}} \right).$$

For the four-bit binary network,

$$G_{MAX} = \frac{15}{16} G_{FS}$$

and

$$Y_{MAX} = \frac{1}{R} [1 + 1/2 + 1/4 + 1/8].$$

Therefore  $R_1 = R \times G_{FS}$ . Similarly the results for the two-decade DAC are

$$G_{MAX} = \frac{99}{100} G_{FS}$$

$$Y_{MAX} = \frac{1}{R} [(1 + 1/8) + \frac{1}{10} (1 + 1/8)]$$

so that

$$R_1 = 1.6 R \times G_{FS}.$$

With all the network switches off, the feed-through is typically  $-60$  dB but can be reduced to  $-100$  dB by trimming one of the bridge resistors ( $R_3$  or  $R_1$ ). For best results with BCD weighting, all resistors should have a 0.5% tolerance with a 100-ppm tempco. If you use a third decade, divide these tolerances by 10. The attainable circuit accuracy rivals that of commercial DACs selling in the \$200 range. The main limitation of the circuit is the effect of op amp speed on the settling time.

*K. R. Johnson, Canalco, Inc., 5635 Fisher Lane, Rockville, Md. 20852. CIRCLE NO. 312*

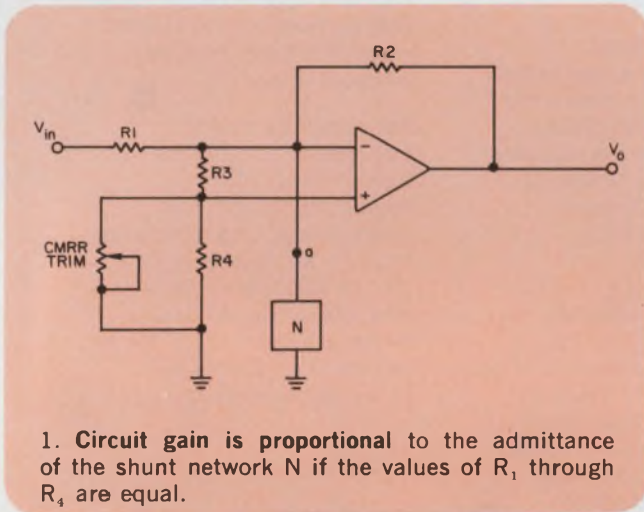

1. Circuit gain is proportional to the admittance of the shunt network  $N$  if the values of  $R_1$  through  $R_4$  are equal.

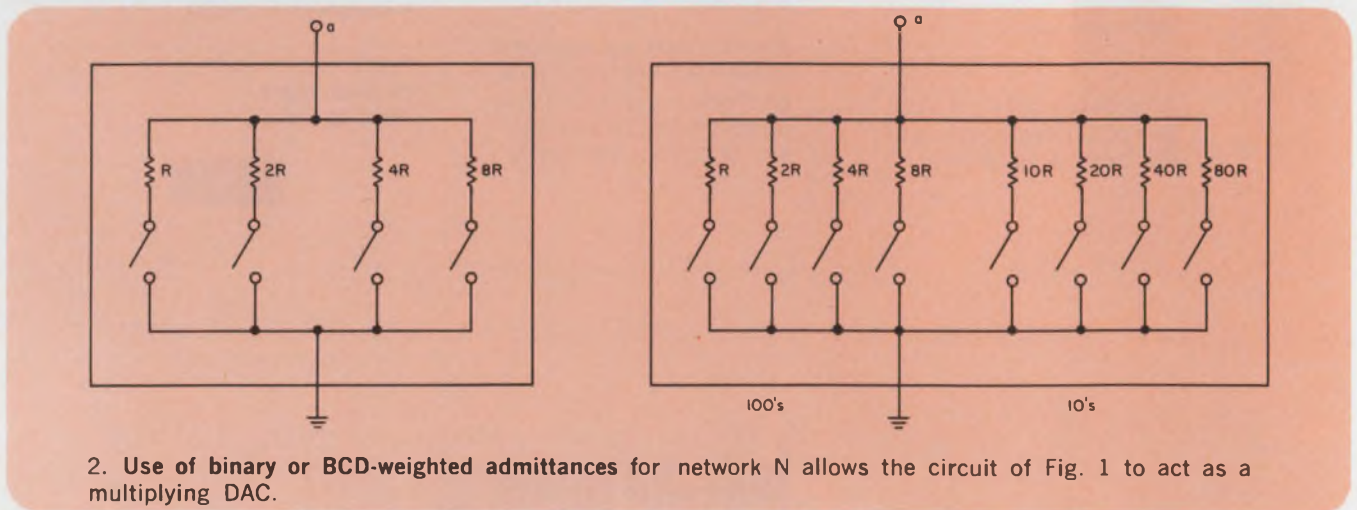

2. Use of binary or BCD-weighted admittances for network  $N$  allows the circuit of Fig. 1 to act as a multiplying DAC.

# The Rise and Fall\*

**of the 30MHz function generator.**

It's variable.

This is the first function generator that puts out a trapezoidal waveform with adjustable rise and fall time. Which makes our Model 162 very useful for such things as comparator evaluation, measuring core memory drive circuit response, measuring amplifier response time and minimizing switching transients.

But while the trapezoidal waveform was catching your eye, maybe you missed the frequency.

30MHz!

About ten million more Hertz than you ever got from a function generator before.

And the 162 will go as low as 3 $\mu$ Hz, with continuous, triggered or gated modes and a choice of 9 output waveforms.

All this, and more (which we'll gladly tell you about) for just \$845.

You **will** buy it.

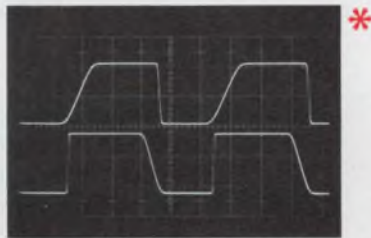

**WAVETEK®**

P.O. Box 651, San Diego, California 92112  
Telephone (714) 279-2200, TWX 910-335-2007

INFORMATION RETRIEVAL NUMBER 52

# Nondifferential phase inverter offers balanced-output Z with 2 transistors

A single-transistor phase inverter can furnish a balanced output voltage, but not the balanced impedances required in class-B audio output stages. The circuit shown provides both, yet it uses one less transistor than a differential pair (with current source).

Transistor  $Q_2$  acts as a current source. Its output impedance, when divided by  $\beta + 1$  (of transistor  $Q_1$ ), is still much greater than  $R_2$ . Therefore the output impedance of terminal 2 is approximately that of  $R_2$ . Resistor  $R_1$  determines the impedance at point 1, since the collector resistance of  $Q_1$  is much larger. Setting  $R_1$  equal to  $R_2$  provides equal output voltages and also balanced output impedances.

Resistor  $R_4$  reduces the effect of variations in  $Q_2$ 's base-emitter junction resistance with signal level—a primary cause of signal distortion. To design the circuit, choose gain  $G$ , input impedance  $Z_{in}$ , output impedance  $Z_o$  and the quiescent voltage,  $V_{o2}$ , at terminal 2. From these calculate

$$\begin{aligned} R_1 &= Z_o \\ R_2 &= Z_o \\ R_3 &\approx Z_{in} \end{aligned}$$

and

$$R_4 = \frac{\beta \cdot R_2}{G}$$

Choose  $R_5$  and  $R_6$  so that

$$\left( R_5 + \frac{R_3}{\beta_2} \right) \ll R_6.$$

Let

$$\left( R_5 + \frac{R_3}{\beta_2} \right) = \frac{R_6}{10}$$

and find

$$R_3 \approx \frac{\beta_2 (R_6 - 10 R_5)}{10}.$$

To calculate  $R_1$ , compute

$$K_2 = \frac{V_{o2}}{V_{cc}}.$$

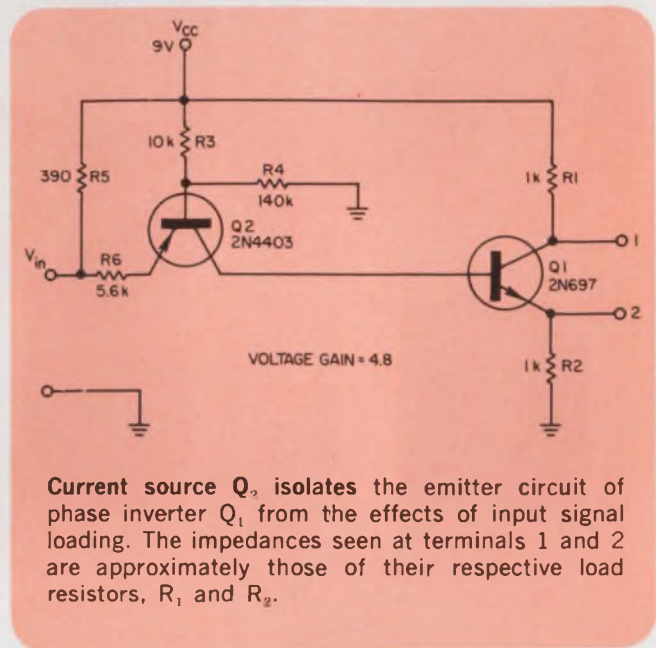

Current source  $Q_2$  isolates the emitter circuit of phase inverter  $Q_1$  from the effects of input signal loading. The impedances seen at terminals 1 and 2 are approximately those of their respective load resistors,  $R_1$  and  $R_2$ .

Then find  $R_1$  from the equation

$$R_1 = \frac{\beta_2 R_5 R_3}{R_3 (K_2^{-1} \beta_1 \beta_2 R_2 - R_3 - \beta_2 R_6)}.$$

And the quiescent voltage  $V_{o1}$  at terminal 1 is given by

$$V_{o1} = (1 - K_2) V_{cc}$$

Since the component values and gain are beta-dependent, some adjustment of the calculated values may be necessary to insure proper circuit operation. For the values shown, the circuit has a gain of 4.8, and a 4-V dynamic range, with the second harmonic 30 dB below the fundamental.

Neale C. Hightower, Research Engineer, Engineering Experiment Station, Georgia Institute of Technology, Atlanta, Ga. 30332.

CIRCLE NO. 313

## IFD Winner of May 10, 1973

Charles H. Ristad, Staff Engineer, System Products Div., IBM Corp., Endicott, N.Y. 13760. His idea "Volume compressor with 50-dB range built around single op amp" has been voted the Most Valuable of Issue Award.

Vote for the Best Idea in this issue by checking the number for your selection on the Information Retrieval Card at the back of this issue.

**SEND US YOUR IDEAS FOR DESIGN.** You may win a grand total of \$1050 (cash)! Here's how. Submit your IFD describing a new or important circuit or design technique, the clever use of a new component or test equipment, packaging tips, cost-saving ideas to our Ideas for Design editor. Ideas can only be considered for publication if they are submitted exclusively to ELECTRONIC DESIGN. You will receive \$20 for each published idea, \$30 more if it is voted best of issue by our readers. The best-of-issue winners become eligible for the Idea of the Year award of \$1000.

ELECTRONIC DESIGN cannot assume responsibility for circuits shown nor represent freedom from patent infringement.

# The CRT display isn't really obsolete. DIGIVUE® just makes it look that way.

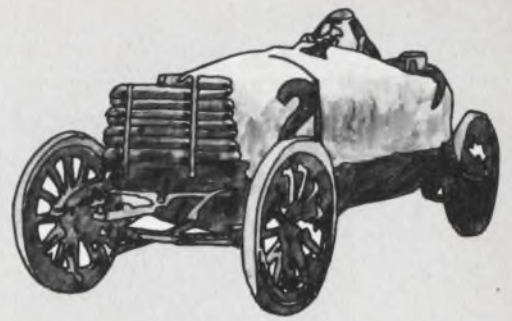

## And Design Adaptability Is One Reason Why . . .

Digivue is the plasma display device from Owens-Illinois that delivers computer-generated alpha-numeric and graphic displays at microsecond speeds. Digivue provides drift-free images, selective write/erase, inherent memory, hard copy printout potential, rear-projection capability.

Digivue units are flat panel devices with panel depth independent of display size. Depth of panel and case for the 512-60 Digivue unit is a slim 7 inches, allowing for a variety of installation possibilities—in desks, drawers, walls, and physical compatibility with a variety of drive systems.

The bulky, boxy CRT display just can't match that kind of style.

If you'd like to know more about the next generation in display systems, take a look at tomorrow—take a look at Digivue.

Call or write:  
Electro/Optical Display Business  
Owens-Illinois, Inc.  
P.O. Box 1035, Toledo, Ohio 43666  
(419) 242-6543 Ext. 66-415

INFORMATION RETRIEVAL NUMBER 53

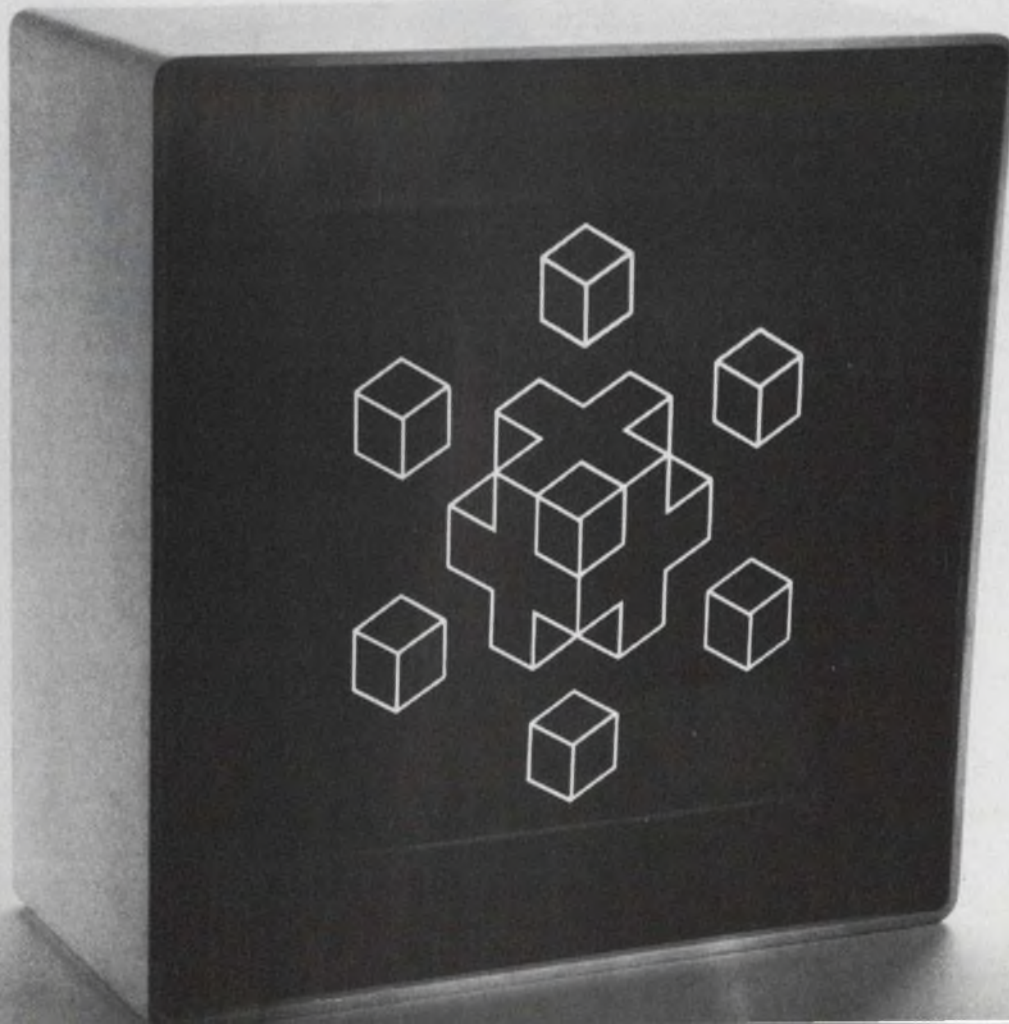

## Improved videotelephone developed in Germany

Although introduction of videotelephone service is not expected in West Germany before 1980 at the earliest, Siemens AG has announced that its latest videotelephone unit is "ready for series production."

The company's Videaset 101 is a further development of Siemens' first European videotelephone, which was introduced in 1967 and has been in trial service since 1971 between Siemens in Munich and the Deutsche Bundespost in Darmstadt.

The new unit has 1-MHz bandwidth, a 28-square-inch screen, a vertical resolution of 267 lines and capability of transmitting 500 characters per frame. Frame frequency is 60 Hz.

The Videaset 101 consists of three units: an eight-pushbutton telephone, with two contrast-and-brightness controls, a button for hands-free conversation and a volume-control switch; a rotatable picture unit that can be tilted six degrees; and an attachment box containing the power supply, video amplifier, voice-switched amplifier for hands-free operation and the associated relay assembly.

A mechanical scissors aperture in the picture unit permits the use of plumbicon and silicon-vidicon camera tubes as well as the conventional vidicon. The automatic aperture control (F 2.8 to 22), plus the gain control (factor of



Videotelephone unit has a 28 sq-in. screen and a vertical resolution of 267 lines.

16) make possible a brightness range of about 50 to 50,000 lumens/m<sup>2</sup>.

The camera is adjustable to three focal distances: 32 cm, 80 cm and 3 m.

A company spokesman says that the videotelephone will probably be used increasingly in PABXs in the next few years, with eventual introduction in the public telephone network by 1980.

tation and telecommunications (where frequency data has to be monitored and switch actions should be initiated when signal frequencies reach certain values).

Designated the FX-101, the switch accepts sine-wave or pulse-input signals and operates an integral semiconductor switch when the input frequency reaches a pre-determined value. Grounding or floating a control-input pin allows arrangement of the device to switch ON when the input frequency lies anywhere above a single-datum line (datum mode) or within a pre-set band of values (band mode). The switch set points may be varied over a very wide range of frequencies according to the values of two external resistors and two capacitors.

In addition to the datum/band option, the FX-101 has control inputs that allow a choice of auto or external switch resetting. Further options include latch to ON or latch to OFF in the external mode, expandable set point on/off differential in the datum mode, direct switch pre-set and hold pre-set, and selection of fail-safe, delayed fail-safe or ignore-switching options.

CIRCLE NO. 178

## Green LEDs reported to give higher output

Green light-emitting diodes—with output that is reported higher than that of other diodes in the same price range—have been introduced by Siemens of West Germany. The base material used is gallium phosphide. Higher efficiency has been achieved, Siemens says, through a special production method for both the monocrystalline base material and for the diodes made from it.

The wavelength of the emitted light is  $\lambda = 565$  nm; light emission is optimally matched to the eye's range of sensitivity to gain maximum subjective effect. The LEDs are marketed in a 3-mm version (designated LD 37), in a 5-mm version (LD 57) and as a linear array of up to 10 diodes (LD 47).

CIRCLE NO. 179

## Frequency-sensitive switch has MOS features

A monolithic frequency-sensitive switch that employs MOS medium-scale integration has been designed by Consumer Microcir-

cuits Ltd., a British company. The switch, which is housed in a 10-lead TO-100 can, is used in such applications as control, instrumen-

# There are some memories you'd like to forget.

## We can help.

Meet the Rangers. 3 modular systems that cover the entire field of memory testing. A new series of Sentry compatible testers, the Rangers were developed to meet the growing needs of the semiconductor memory market — RAMS, ROMS, and Shift Register memories.

Ranger I is the core unit of this new testing family. A dedicated functional pattern exerciser, it will handle any of today's memories at a 20MHz test rate. Design philosophy is independent data and sequence algorithm. Continuous, non-skip, pattern execution, with selection of up to 30 partitionable programs. Walking Patterns, Checkerboard, Spiral, Ping Pong, Star & Corner Disturb, Diagonal, Read-Modify-Write, and others.

Ranger II is an even more versatile memory tester with programmable pin electronics and timing generators. Besides the wafer testing, incoming inspection and engineering evaluation capabilities of Ranger I, Ranger II is programmable with pin and electronics timing. It's multiplexed to separate stations and can do margin testing. Parametric testing is optional.

Ranger III is a computer controlled, functional and parametric system for mass production volume testing. If you're a memory producer, Ranger III provides quality control and extensive data manipulation. It will let you know exactly where you stand at each step of the manufacturing process.

The Rangers were developed as extensions to the Sentry Line. Much of the hardware like power supplies, PMU, pin electronics, timing and computer, have been proven with other Sentry systems. Any of the Rangers can be easily added to Sentry products enabling protection of your investment. With the Rangers you can test your complex logic and memories with the most powerful system available today.

If you've got some memories you'd like to forget, now's the time. Write today for further details, or call us collect (415) 493-5011 for a demonstration. Our TWX: 910-373-1204.

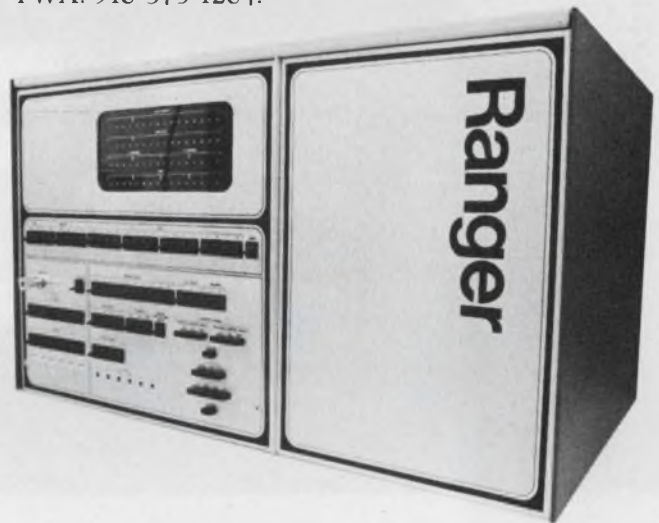

Fairchild Systems Technology  
3500 Deer Creek Road  
Palo Alto, California 94302

Please send me information on your new Ranger family of memory testers.  
I am particularly interested in Ranger I  Ranger II  Ranger III

Name \_\_\_\_\_  
Title \_\_\_\_\_  
Company \_\_\_\_\_  
Street \_\_\_\_\_ City \_\_\_\_\_  
State \_\_\_\_\_ Zip \_\_\_\_\_  
Phone \_\_\_\_\_

ED

**FAIRCHILD**  
SYSTEMS TECHNOLOGY

Fairchild Systems Technology a division of Fairchild Camera & Instrument Corporation.

INFORMATION RETRIEVAL NUMBER 54

# Introducing

\*\*\*\*\*

## THERMO-465

A totally new magnetic tape.  
It operates at

# 400° F

Or at

# 65° F

below  
zero

Thermo-465, the only product of its kind, was developed by Graham Magnetics, makers of the world's first and only permanent computer tape.



If you have a need for a magnetic tape that functions perfectly in extremely high and/or extremely low temperatures, Thermo-465 is the answer.

Tests results show Thermo-465 both meets and exceeds the stringent environmental requirements for use in systems for aircraft crash recorders.

After exposure to temperature extremes of +400°F and

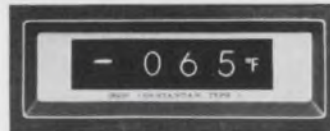

-65°F, it shows no change in its operating characteristics nor in its signal strength. Recording and playback is error-free in every instance. Data has even

been recovered after exposure to temperatures up to 800°F. Thermo-465 is available in 1000' lengths and 1/4" or 1/2" widths. Other configurations available on request.

If you'd like to place an order or would like more information concerning possible applications for this new product, write Graham Magnetics Incorporated, Dept. 465, Graham, Texas 76046, on your letterhead.



## GRAHAM MAGNETICS

Graham, Texas 76046

Another new product from the Research Center of Graham Magnetics, Inc.

INFORMATION RETRIEVAL NUMBER 55



## Largest programmable ROM stores 4096 bits and has 70-ns max access time

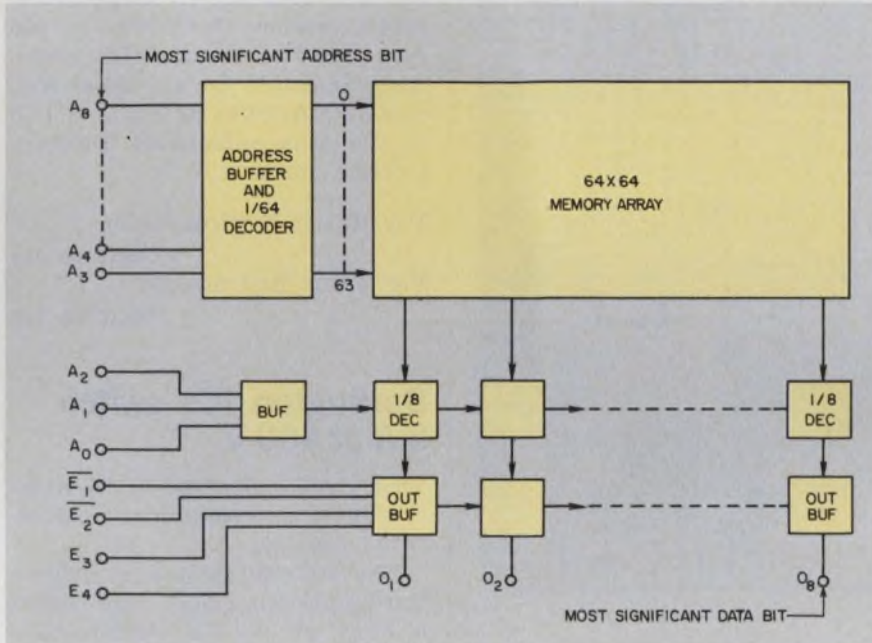

Monolithic Memories, 1165 E. Arques Ave., Sunnyvale, Calif. 94086. (408) 739-3535. P&A: See text.

Though it offers twice as many bits as the largest pROM previously available, the Monolithic Memories 5340/6340 4-k pROM gives up nothing in speed or power.

With 4096 bits (organized as  $512 \times 8$ ) the field-programmable read-only memory has a maximum access time of only 70 ns. That's the same as the maximum access of the Harris Semiconductor HPROM-2048 and the Monolithic Memories 6305, both 2048-bit ( $512 \times 4$ ) pROMs and both the largest bipolar pROMs available till now. Intel has a 2048-bit erasable MOS pROM, the 1702A, with similar power dissipation, 700-mW worst case. But its access time is a rather slow  $1 \mu\text{s}$ .

The new pROM uses only 10% more power than the earlier 2-k units, so the power per bit is substantially reduced from 300 to 170  $\mu\text{W}$ , worst case.

Speed of the 6340 is attained by

using an advanced Schottky/TTL process rather than conventional gold doping or a vertical isolation technique like the Poly-Planar process used by Harris.

The heart of the pROMs are fusible nichrome links that define the logic ONEs and ZEROs when programmed. The memories, though, are supplied with all locations initialized for high outputs.

Also guaranteed for the new chip are 40-ns max times for enable access and enable recovery. Standard loads for each output are specified as 30 pF in parallel with a 900  $\Omega$  resistor going to ground and a 450  $\Omega$  resistor connected to  $V_{cc}$ . Inputs and outputs are fully DTL/TTL compatible. The outputs have open collectors, which permit wire-ORing for memory expansion.

The pROMs are mounted in 24-pin dual-in-line packages. Eight pins are used for the output word, nine for the address, four for the enable line controls and two for power (one for ground and one for  $V_{cc}$ ). There is also one pin with no internal connection.

The 5340 and the 6340 are electrically identical. Their power-supply voltage is nominally 5 V, while the worst-case supply current is 140 mA maximum. The 5340 is guaranteed over the full military temperature range of  $-55$  to  $+125$  C, while the 6340 is specified for commercial range of 0 to 75 C.

The speed of programming is typically 10 ms/bit, or less than 25 seconds per pROM (based on a 50% ZERO pattern). Once the user fixes the logic patterns, he can order a pin-and-performance compatible, mask-programmable unit from Monolithic Memories. The interchangeability and possible side-by-side operation of the pROM and ROM offer an effective means of customizing a small portion of a system.

Programming is easily accomplished by first applying  $V_{cc}$  and then addressing the desired output word with the nine input-address lines. Then the enable line should be disabled. Next, the desired output pin is raised to an elevated voltage to supply the current needed to program the fuse. The outputs must be programmed one at a time, since the internal decoding circuits can sink only one programming pulse at a time. To ensure a fully programmed link, the user verifies that the internal devices can sink 12 mA at a  $V_{cc}$  of 4.2 V at room temperature.

In 100-to-999 quantities the price of a 6340 pROM is \$95—just about double the cost of competing 2-k units. In similar quantities the 5340 sells for \$140. Both devices are available from stock.

Monolithic Memories 53/6340	CIRCLE NO. 250
Monolithic Memories 6305	CIRCLE NO. 251
Harris Semiconductor HPROM-2048	CIRCLE NO. 252
Intel 1702A	CIRCLE NO. 253

# Chopper-stabilized op-amp IC reduces drifts to $0.2 \mu\text{V}/^\circ\text{C}$

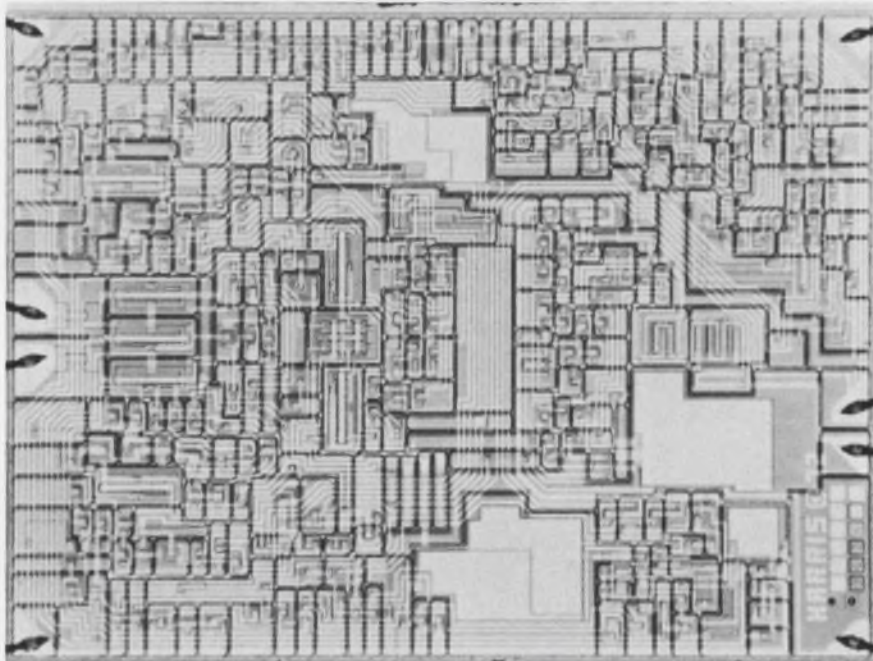

Harris Semiconductor, P.O. Box 883, Melbourne, Fla. 32901. (305) 727-5407. P&A: See below.

Long the favorite for ultra-stable systems, chopper amplifiers first emerged in IC form with Texas Instruments' two-chip version in a 14-pin DIP (ED 13, June 21, 1973, p. 136). Now close on the heels of the TI unit comes Harris Semiconductor's HA-2900 amplifier in a TO-99 can—the first single-chip IC op amp with chopper stabilization. It provides typical drifts as low as  $0.2 \mu\text{V}/^\circ\text{C}$ . And Harris Semiconductor says long-term drifts as low as  $10 \mu\text{V}$  per year can be expected.

Compared to TI's SN62088/72088 chopper amplifier, the Harris unit has lower offsets, lower offset drifts and higher open-loop gain. But by a wide margin, the TI unit beats the HA-2900 on slew rate.

Over rated temperature ranges, the two units provide the following: the HA-2900 has a maximum offset of 50 to  $80 \mu\text{V}$  vs 100 to  $200 \mu\text{V}$  for the TI unit (eliminating the need for trimmers in most

cases); typical offset drifts are  $0.2$  to  $0.3 \mu\text{V}/^\circ\text{C}$  for the Harris op amp vs  $0.6$  to  $1 \mu\text{V}/^\circ\text{C}$  for TI's op amp. The Harris unit's typical offset current drift is  $1 \text{ pA}/^\circ\text{C}$ —TI doesn't list this spec.

Both units have typical bandwidths of 3 MHz. The HA-2900 has the higher minimum gain of  $10^6$  to  $10^7$ , but the lower—by a factor of 10—typical slew rate of  $2.5 \text{ V}/\mu\text{s}$ .

One of the two chips contained in the TI unit is an MOS circuit that includes the chopper and demodulation controls. The other chip provides two FET-input differential amplifiers. In the Harris unit, dielectric-isolation techniques are used to combine npn, pnp and n-channel MOSFET elements on a single chip measuring  $93 \times 123$  mils.

The HA-2900 can operate on standard  $\pm 15\text{-V}$  op amp supplies, with a maximum rating of  $42 \text{ V}$  between terminals. The op amp requires three external capacitors: two for the sample-and-hold circuitry and one for a timing multivibrator.

Prices for the Harris unit in 100-up quantities range from \$88 for a  $-55$ -to- $125\text{-C}$  temperature-range version (HA-2900) to \$55 for a  $0$ -to- $75\text{-C}$  version (HA-2905). Also available is a  $-25$ -to- $85\text{-C}$  model (HA-2904) priced at \$71.50 in the same quantities. Delivery is from stock.

For Harris Semiconductor

CIRCLE NO. 254

For Texas Instruments

CIRCLE NO. 255

## Darlington ICs switch 5 A at 400 V

TRW Semiconductors, 14520 Aviation Blvd., Lawndale, Calif. 90260. (213) 679-4561.

The SVT6250 series of monolithic Darlington amplifiers can switch 5 A at 400 V. The devices have sustaining breakdown voltage ratings (collector to emitter) of 350 V (Type SVT6251) and 400 V (SVT6252). The  $V_{\text{CE(sat)}}$  is 1.4 V, and typical rise and fall times are 350 ns. The units are housed in a standard TO-3 package.

CIRCLE NO. 256

## Calculator IC drives display tubes

National Semiconductor, 2900 Semiconductor Dr., Santa Clara, Calif. 95051. (408) 732-5000. \$18 (100); stock.

An MOS circuit, the MM5725, contains a complete eight-digit calculator and can directly drive fluorescent display tubes. It has three registers that provide addition, subtraction, multiplication and division. The MM5725 includes a 16-place decimal-point register and an oscillator and clock driver. Timed key-bounce protection is also provided by the internal clock. The new IC operates with a  $-28$  and  $-35 \text{ V}$  supply.

INQUIRE DIRECT

## Rcvr/Xmtr IC has 3-state status buffers



Texas Instruments, P.O. Box 5012, M/S 308, Dallas, Tex. 75222. (214) 238-3741. DIP: \$7.02 (100 up); stock.

An MOS/LSI universal asynchronous receiver/transmitter (UART) IC features three-state buffers on the five status outputs. Called the TMS 6011, its buffers allow wire-ORing of the status outputs. The transmitter section accepts parallel data, converts it to serial form and generates the start, parity and stop bits. Receiver and transmitter sections are separate and the device can operate in full duplex mode. Data words may be externally selected to be 5 through 8 bits long. Baud rate is externally selected by the clock frequency, which can vary between 0 to 200 kHz.

CIRCLE NO. 257

## Dual clock driver comes in mini-DIP

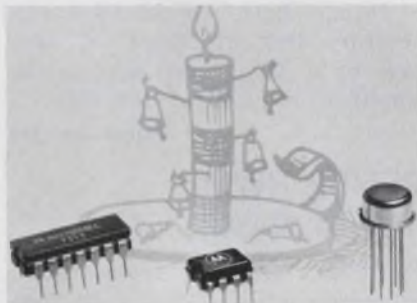

Motorola, P.O. Box 20924, Phoenix, Ariz. 85036. (602) 244-3466. MMH-0026CG: \$3.95 (100 up); stock.

A high-speed MOS dual clock-driver circuit, the MMH0026C, is available in a mini-DIP. The driver is capable of 20-ns transition times with a 1000-pF load, and can provide an output driving current of  $\pm 1.5$  A with a 20-V swing. Pulse repetition rates from 5 to 10 MHz are possible depending on loading. Power consumption in the high output state is 2 mW.

CIRCLE NO. 258

## Dual regulator IC finds alternate source



Silicon General, 7382 Bolsa Ave., Westminster, Calif. 92683. (714) 892-5531. SG1468N: \$2.80; stock.

The SG1568/1468 dual-tracking regulator ICs are electrical and pin-for-pin replacements for Motorola's MC1568/1468 regulators. They provide balanced positive and negative outputs to 100 mA and are internally set for  $\pm 15$ -V outputs. However, a single external adjustment adjusts both outputs simultaneously from 14.5 to 20 V. Input voltage range is  $\pm 30$  V and line and load regulation is 10 mV. The SG1568 military-grade version has an output voltage tolerance of  $\pm 200$  mV. Positive and negative outputs are balanced to within  $\pm 150$  mV.

CIRCLE NO. 259

## TTL comparators boast 6-ns delay

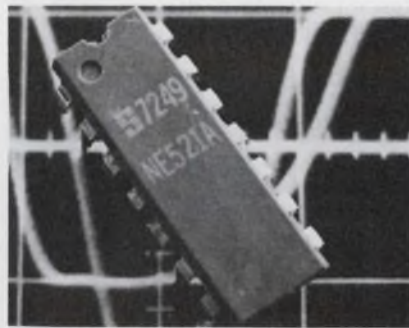

Signetics, 811 E. Arques Ave., Sunnyvale, Calif. 94086. (408) 739-7700. \$3.50 (100); stock.

Two dual high-speed voltage-regulator ICs feature a typical propagation delay as low as 6 ns. Called the 521 and 522, the new comparators maintain a  $\pm 3$ -V common-mode range, 7.5-mV input offset voltage and a 5- $\mu$ A offset current. The 521 has the 6-ns delay and TTL-compatible output levels that can source or sink up to 10 Schottky-TTL gates. The 522 has a typical delay of 10 ns and open-collector outputs that permit wired-OR connections.

INQUIRE DIRECT

intel delivers  
n-channel.

1K MOS  
RAM

WITH...

## ICs detect/correct errors in tape drives

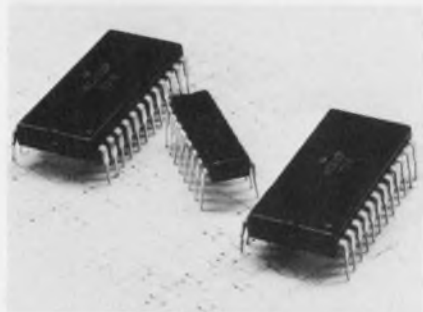

Motorola, P.O. Box 20924, Phoenix, Ariz. 85036. (602) 244-3466. \$22 (100-999); stock.

Three bipolar LSI devices can perform the complete error detection and correction function in magnetic tape drive systems and are especially useful for those systems using the NRZI format. The MC8500 cyclic redundancy check character (CRCC) generator constructs CRCC for error analysis. The MC8501 error-pattern register detects channel errors. And the MC8502 dual-mode register detects recording channel errors and provides general storage and data handling functions. Typical power dissipations for the three ICs range from 320 to 350 mW.

CIRCLE NO. 260

## Dual TTL 'one shot' boosts repeatability

Texas Instruments, P.O. Box 5012, M/S 308, Dallas, Tex. 75222. (214) 238-3741. SN74221N: \$1.44 (100); 16 wk. (prod. qty).

A monolithic dual-version of the company's SN54/74121 "one-shot"—the SN54/74221—reportedly provides improved repeatability over the original device in output pulse width from device to device. Output pulse width for 99% of the new IC is grouped within  $\pm 0.2\%$  typically of the median pulse width. The IC also features an asynchronous clear input that can be used to terminate the output pulse when desired. It incorporates full voltage and temperature compensation that reduces variations in the output pulse width to typically less than  $\pm 1\%$  for the SN-54221 and to less than  $\pm 0.6\%$  for the SN74221.

CIRCLE NO. 261

## Equipment circuits now in IC form

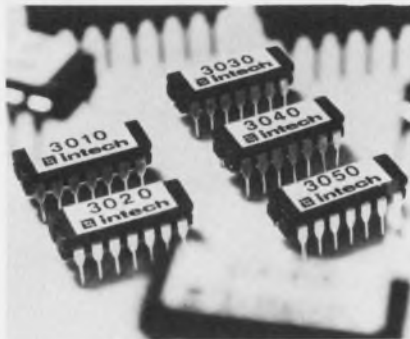

Intech, Inc., 1220 Coleman Ave., Santa Clara, Calif. 95050. (408) 244-0500. 3010: \$4.90; 3020: \$6.00 (100-999).

Five integrated circuits, previously not available in IC form, consist of the following: the 3010 tone alarm, the 3020 triple lamp and LED driver, the 3030 temperature alarm, the 3040 calibration monitor and the 3050 ac detector. These circuits use TTL compatible logic and operate with supply voltages from 4.5 to 18 V. They are inspected to MIL 883, and come in 14-pins DIPs. The 3010 compares the input signal to an adjustable reference. When the input exceeds the reference, the output generates a pulsating or constant tone. The 3020 includes three LED/lamp drivers each of which has two inputs.

CIRCLE NO. 262

## Automotive ICs include triple op amp

Fairchild Semiconductor, 464 Ellis St., Mountain View, Calif. 94040. (415) 962-3816.  $\mu A7350$ : \$3.25;  $\mu A7351$ : \$2.80 (100-999).

Two ICs—the  $\mu A7350$  tachometer subsystem and the  $\mu A7351$  triple op amp—are available for automotive applications. The  $\mu A7350$  includes a tachometer-pulse generator, an op amp and two comparators on a single chip packaged in a 16-pin DIP. The tachometer section produces fixed-width pulses at the zero crossings of a ground-referenced ac input signal. The  $\mu A7351$  triple op amp is a general-purpose circuit specifically designed for single 4 to 16-V or dual 2 to 8-V power supplies. The outputs of the op amps, which have a slew rate of 90 mV/ $\mu$ s, can be connected in the wired-OR mode.

CIRCLE NO. 263

## Wideband op amp boasts 38-MHz crossover

RCA Solid-State Div., Route 202, Somerville, N.J. 08876. (201) 722-3200. \$4.25 (100 up); stock.

The CA3100 op amp features a high unity-gain crossover frequency of 38 MHz typical and an open-loop 3-dB corner frequency of approximately 110 kHz. It can provide 18 V pk-pk and 30 mA pk-pk when operating from  $\pm 15$ -V supplies. Typical slew rates reach 70 V/ $\mu$ s in a 20-dB amplifier, and 25 V/ $\mu$ s in a unity gain amplifier. Open-loop gain is typically 42 dB at 1 MHz, and settling time is 0.6  $\mu$ s. The CA3100 is pin compatible with LM118, 748 and 101 op amps.

CIRCLE NO. 264

## Dual FET op amp uses two 8007s

Intersil, 10900 N. Tantau Ave., Cupertino, Calif. 95014. (408) 257-5450. 8043C: \$6.50 (100).

A dual FET-input op amp IC, the 8043, contains two amplifiers that are each equivalent to the company's popular 8007. Two versions are available: The 8043M operates from  $-55$  to  $+125$  C, with input current of 2 pA typical, 20 pA maximum and typical offset voltage of 10 mV. The 8043C operates from 0 to 70 C and has input current of 3 pA typical, 50 pA maximum and typical offset voltage of 20 mV. Both versions have temperature drift of 25  $\mu$ V/ $^{\circ}$ C, slew rate of 6 V/ $\mu$ s and amplifier-to-amplifier isolation of 100 dB.

CIRCLE NO. 265

## 256-bit RWMs now in plastic

Signetics, 811 E. Arques Ave., Sunnyvale, Calif. 94086. (408) 739-7700. \$15 (100); 6 wk.

Two 256-bit bipolar random-access memories, formerly available only in ceramic packages, can now be obtained in plastic. The RAMs are the N82S06B, which has tri-state outputs, and the N82S07B, an open-collector-output version. Typical access time is 30 ns for both of these TTL memories. The typical read time is 45 ns, while typical write time is 20 ns. Each model dissipates 1.5 mW per bit (typical).

INQUIRE DIRECT

# HIGHEST SPEED

80 nsec max! Intel's new 2105 n-channel silicon gate memory is the fastest 1K MOS RAM *available* today! Cycle time is only 180 nsec, while standby power is 80  $\mu$ W/bit. Other speed selections are also available. Compared to equivalent bipolar memories, the 2105 offers less than half the cost per bit and consumes less than one-eighth the power. It beats core hands-down on both cost and performance.

Organized 1024 words by 1-bit, the 2105 provides easy interfacing with on-chip decoding, TTL levels for addresses, write-enable and data-in signals. OR-tie capability is provided for ease of expansion.

Planar refresh allows all 1024 memory cells to be refreshed at once and a "hidden refresh" feature eliminates memory busy signals.

To help you cut your design time to a minimum, Intel has available a 2105 pre-production memory board, the IN-36. It is available with timing and control on one 8" x 10" board in sizes up to 4K words by 9-bits. Cycle time is 300 nsec; access is 150 nsec.

To simplify interface and minimize package count, ask about Intel's 3210 and 3211 TTL and ECL drivers coming soon. Each device contains 4 address drivers and 1 clock driver designed specifically for Intel's n-channel RAMs.

The 2105 and IN-36 are products of Intel's n-channel silicon gate technology. They're available at any Intel distributors. Intel Corporation, 3065 Bowers Avenue, Santa Clara, California 95051, (408) 246-7501.



intel delivers  
n-channel.

INFORMATION RETRIEVAL NUMBER 56

# GENERAL ELECTRIC'S TYPE 84F TUBULAR ALUMINUM CAPACITOR...



New from General Electric — an axial leaded, all welded tubular capacitor meeting the high CV small case size requirements of today's transistorized electronic equipment. Excellent for industrial and entertainment applications requiring maximum capacitance with limited space. Quality constructed for long life and high reliability, the 84F capacitor offers these features:

- All welded construction
- High volumetric efficiency
- High ripple current capacity
- 1,000 hour life rating at 85 C
- Wide range of case sizes and voltages

For more information on these, or any of General Electric's wide range of capacitors, call your nearest GE sales office today, or write Section 430-54, Schenectady, N. Y. 12345.

## MAKE SOMETHING OUT OF IT!

**GENERAL  ELECTRIC**

INFORMATION RETRIEVAL NUMBER 57

## Varactor-tuned oscillators cut size, weight to new lows

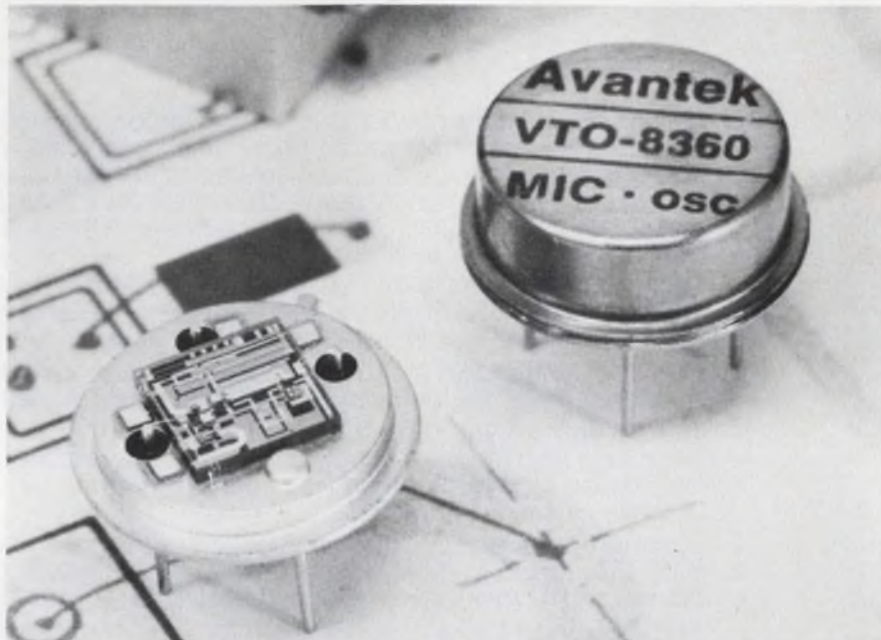

Avantek, 3175 Bowers Ave., Santa Clara, Calif. 95051. (408) 249-0700. \$116 to \$156 (100-249); 30 days.

Avantek's VTO series comprises the smallest and lightest varactor-tuned oscillators yet. Previously, such oscillators for the microwave-frequency range were generally available only in discrete-component forms—bulky assemblies with standard rf connectors that limit component packaging density. With the new Avantek series, however, thin-film-on-sapphire oscillators are now available in 4-lead TO-8 packages. And unit costs are generally less than \$150 in production quantities.

The VTO series consists of eight circuits that cover the 600-to-6600-MHz frequency range. Output powers extend from 10 mW at the upper end of the frequency band to 20 mW at the lower end. Tuning voltages are less than 30 or 60 V, depending on the specific version, and all units can operate from 15-V supplies, with a maximum current drain of 50 mA. The VTO series lists a temperature range of 0 to 65 C.

A typical unit—the VTO-8360—operates over the frequency range

of 3.6 to 4.3 GHz. Output power varies by  $\pm 1.5$  dB maximum, with a minimum value of 10 dBm at 25 C. All harmonics are typically 25 dB below the fundamental signal.

The VTO-8360 has a typical frequency drift of  $-35$  MHz over the full temperature range, a 40-MHz pk-pk "pulling" (into all phases of a 12-dB return loss) and a  $-5$  MHz/V "pushing." Tuning rates are limited by the 45-pF input capacitance.

The oscillators can be used directly with 50- $\Omega$  microstrip lines without external resonators or conventional rf connectors. An optional test fixture, with SMA rf output connectors and Conhex control-voltage input connectors, is available for initial circuit layout and design.

The availability of the VTO series permits compact system design in small spaces. For example, Avantek says the VTO-8090 can be combined with a flat-pack, double-balanced mixer, and rf and i-f gain amplifiers, as needed, to achieve a miniature telemetry front end having a 6.5-dB noise figure—all in a space of less than  $2\frac{1}{2} \times 3\frac{1}{4} \times 1\frac{1}{4}$  inches.

CIRCLE NO. 267

# 191 FLAVORS OF BECKMAN DIPS



All 191 flavors of RESNET™ DIPS offer system compatibility because we use the same packages you use for I.C.s; plus you get ceramic dependability at plastic prices.

Whether you're inserting resistors automatically or by hand — call your local Beckman/Helipot representative and ask how you can save money using RESNET DIPS. He stocks locally for immediate delivery.

If you need immediate technical literature or the telephone number of your local Beckman/Helipot representative, call H.E.L.P. (Helipot Express Literature Phone) toll-free (800) 437-4677.

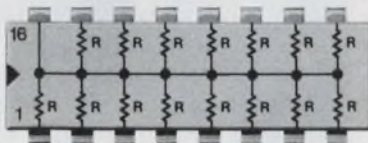

898-1 (15 resistors)  
Price (1,000-4,999) \$.85

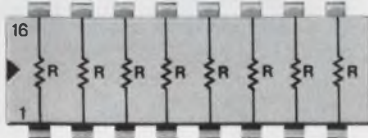

898-3 (8 resistors)  
Price (1,000-4,999) \$.76

#### STANDARD RESISTANCE VALUES (± 2% or ± 2Ω)

62*	110	330	1.0K	2.2K	6.0K	15.0K
68	160	470	1.5K	3.3K	6.8K	22.0K
100	220	680	2.0K†	4.7K	10.0K	

\*Standard in 898-3 only.  
†Standard in 898-1 only.

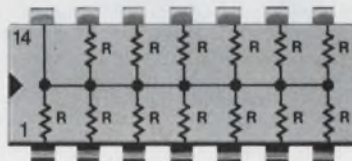

899-1 (13 resistors)  
Price (1,000-4,999) \$.81

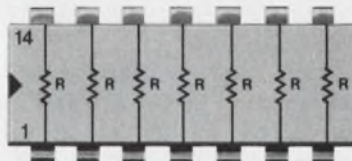

899-3 (7 resistors)  
Price (1,000-4,999) \$.72

#### STANDARD RESISTANCE VALUES (± 2% or ± 2Ω)

22	62	180	510	1.5K	4.3K	11K
24	68	200	560	1.6K	4.7K	12K
27	75	220	620	1.8K	5.1K	13K
30	82	240	680	2.0K	5.6K	15K
33	91	270	750	2.2K	6.0K	16K
36	100	300	820	2.4K	6.2K	18K
39	110	330	910	2.7K	6.8K	20K
43	120	360	1.0K	3.0K	7.5K	22K
47	130	390	1.1K	3.3K	8.2K	
51	150	430	1.2K	3.6K	9.1K	
56	160	470	1.3K	3.9K	10K	

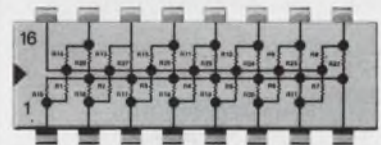

898-5-R220/330  
Pulse squaring TTL terminator.  
Price (1,000-4,999) \$1.45

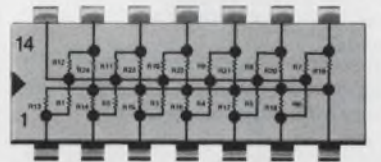

899-5-R220/330  
Pulse squaring TTL terminator.  
Price (1,000-4,999) \$1.35

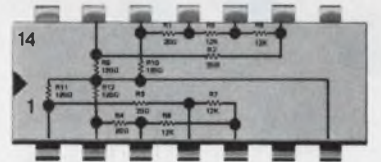

899-19  
DIP interface network providing resistors for μA711 core sense amplifier configuration.  
Price (1,000-4,999) \$1.18

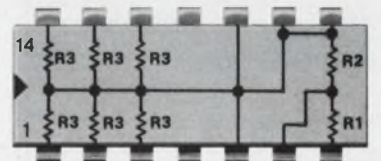

899-40  
DIP network provides six line terminators and the threshold setting divider for the Intel 3208A sense amplifier.  
Price (1,000-4,999) \$1.35

**Beckman**

HELIPOT DIVISION

INFORMATION RETRIEVAL NUMBER 58

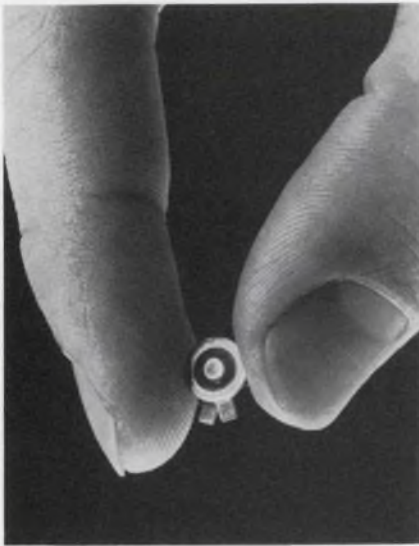

## World's Smallest Thermostats

- Tiny-Stat from TI. Extremely reliable, hermetically-sealed, snapping design.
- Extremely fast response.
- Tamperproof- calibration preset at factory.
- Ideal for remote sensing applications where size and weight are critical.

### World's Biggest Line.

TI's line of precision thermostats gives you more to choose from.

- More reliability.
- More switching cycles.
- More resistance to shock and vibration.

All are fast because they're snapping. All are custom calibrated to prevent tampering. Many are UL listed.

Write for literature.

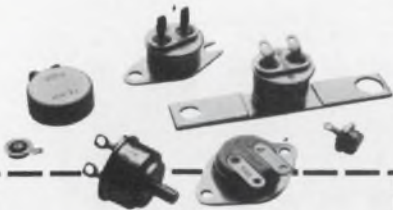

Texas Instruments Incorporated  
Control Products Division, MS 12-33  
Attleboro, Mass. 02703

Gentlemen: Please send me your product information on KLIXON® Precision Thermostats.

Name \_\_\_\_\_

Company \_\_\_\_\_

Address \_\_\_\_\_

City \_\_\_\_\_

State \_\_\_\_\_ Zip \_\_\_\_\_

**TEXAS INSTRUMENTS**  
INCORPORATED

INFORMATION RETRIEVAL NUMBER 59

## MICROWAVES & LASERS

### 70-MHz transistor produces 150-W cw

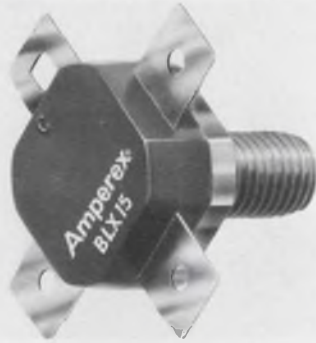

Amperex Electronic Corp., 230 Duffey Ave., Hicksville, N.Y. 11802. (516) 931-6200.

An rf power transistor offers up to 150 W in SSB, or class A, B and C operation. Called the BLX15, it can operate in cw up to 70 MHz with an IMD  $\leq -30$  dB. This new npn silicon planar device is ruggedized against mismatch failures and has a gain-bandwidth product of 300 MHz at collector currents as high as 10 A.

CIRCLE NO. 268

### 18-GHz diode switches list low 1-dB loss



Hewlett-Packard, 1501 Page Mill Rd., Palo Alto, Calif. 94304. (415) 493-1501. 33632A: \$60, 33634A: \$100 (1-9); stock.

Switch modules have a maximum insertion loss as low as 1.0 dB at 18 GHz. The low loss spec applies to the Model 33632A two diode switches that also feature 45-dB isolation. A four-diode version, Model 33634A, with 80-dB isolation has an insertion loss of 1.8 dB maximum at 18 GHz, and only 1.2 dB at 12 GHz. Both types of diodes are general-purpose p-i-n chips with a carrier lifetime of about 200 ns. Thus the switches can modulate with a bandwidth of 0.8 MHz, or achieve 10-to-90% switching in 100 ns or less.

CIRCLE NO. 269

### 4-GHz preamp offers 4-dB noise figure

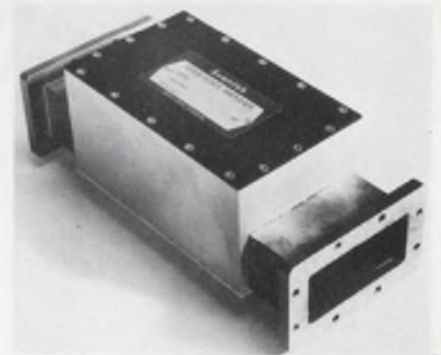

Avantek, 2981 Copper Rd., Santa Clara, Calif. 95051. (408) 739-6170.

The AW-4208 low-noise communications preamplifier covers the 3.7-to-4.2-GHz frequency band and features a noise figure of only 4.2 dB maximum, 3.8 dB typical. Gain is listed at 7 dB minimum, with a flatness of  $\pm 1$  dB guaranteed. The preamplifier contains its own built-in alarm circuit. Failure of the amplifier will result in the closure of a set of dry contacts that can be sensed by an alarm system. Meantime-between-failure of the preamp is calculated to be 166,000 hours.

CIRCLE NO. 270

### VCO delivers 500 mW with 20 dB isolation

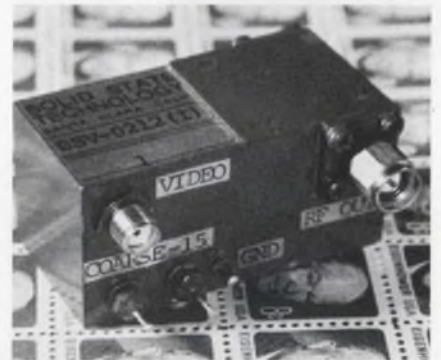

Solid-State Technology, 3650 Charles St., Santa Clara, Calif. 95050. (408) 247-8620. \$565; 30 days.

The Model SSV-0212(I) integrated VCO and isolator offers bandwidths that vary from 36% around 4 GHz to 2% around 500 MHz. Output power ranges from 50 to 500 mW. Isolation is 20 dB minimum. The VCO/isolator measures 1 x 1 x 2 inches and weighs 2.5 oz.

CIRCLE NO. 271



# Why square ferrite cores?

save up to 40% in space  
save up to 40% in assembly time  
save up to 30% in inventory

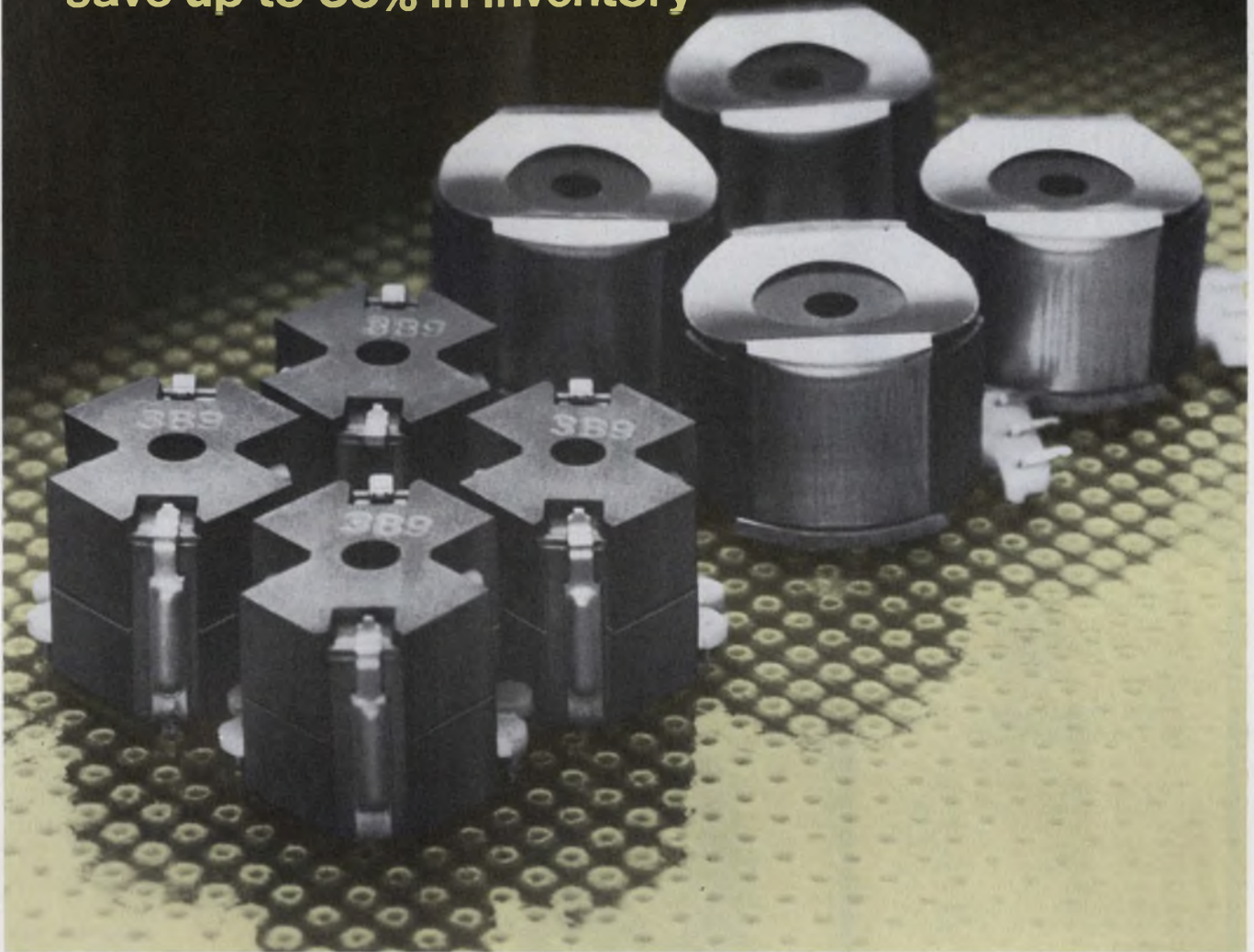

Ferroxcube's new RM Series square cores save up to 40% in pc board space over round pot cores. Furthermore, RM Series saves up to 40% in assembly and mounting time. Two simple, gold-plated clips hold them together and readily snap them into place on the pc board.

Your parts inventory is reduced since the economical mounting clips replace more expensive pot core mounting assemblies.

Ferroxcube's RM cores are available

with a choice of ferrite material: choice of ungapped, fixed-gap or adjustable-gap types, with smooth precise tuning of inductance to an accuracy of better than 0.03% in adjustable models.

RM cores now in stock. For complete information call 914-246-2811, TWX 510-247-5410 or write Ferroxcube, Saugerties, N. Y. 12477.

Ferroxcube linear ferrites—made in Saugerties, N. Y. and stocked in seven U.S. locations.

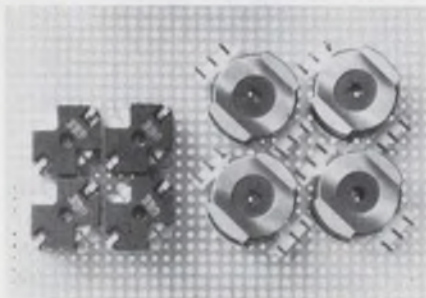

**FERROXCUBE** CORPORATION, SAUGERTIES, N. Y. 12477  
A NORTH AMERICAN PHILIPS COMPANY

Distributed through North American Philips Electronic Components Corporation with warehouses in Boston 617-449-1406, New York 516-538-2300, Saugerties 914-246-5861, Philadelphia 215-927-6262, Chicago 312-593-8220, Santa Clara 408-249-1134, San Diego 714-453-9250

INFORMATION RETRIEVAL NUMBER 60

# TRIACS & SCR's

**ELECTRICALLY  
ISOLATED  
STUD-MOUNT**



## TRIACS

6 A to 40 A ( $I_{T(RMS)}$ )  
50 V to 600 V ( $V_{DROM}$ )

## SCR's

8 A to 35 A ( $I_{T(RMS)}$ )  
50 V to 600 V ( $V_{DROM}$ )

BeO insulator provides superior thermal characteristics in dual hermetic packaging with a glass-passivated chip in an  $\frac{1}{2}$ " isolated stud-mount package. Center gate design for low switching loss — improved dv/dt ratings and di/dt characteristics.



Call or write for  
complete information

## HUTSON INDUSTRIES

BOX 34235 • 2019 W. VALLEY VIEW, DALLAS,  
TEX. 75234 (214) 241-3511 TWX 910-860-5537

### Distributed by:

In Canada: WEBER-SEMAD ELECTRONICS, Downs-  
view, Ont. 416/635-9880

### Vice-President, European Operations:

30 Rue Pierre Semard, Yverres, 91 France Tel:  
Paris 925-8258 • TELEX 21-311

### Distributed in Europe by:

Belgium: C. N. ROOD S.A. Brussels 02-352135  
Denmark: E. V. JOHANSEN A/S, Copenhagen  
(01) 295622 ■ Norway: INTELCO, Box 158,  
47 2 207451, Sentrum, Oslo ■ Spain: BELPORT,  
Madrid 234.62.62 ■ Sweden: ELEKTROFLEX, Sun-  
dyberg 08-28-9290 ■ Switzerland: D. LEITGEB,  
Dubendorf 051 85 9666 ■ UK: CLAUDE LYONS,  
LTD, Hoddeston, Hertfordshire (09924) 67161

INFORMATION RETRIEVAL NUMBER 61

## MICROWAVES & LASERS

### Spectrum analyzers have 2-GHz span



Systron-Donner Microwave Div.,  
14844 Oxnard St., Van Nuys,  
Calif. 91408. (213) 786-1760. 809-  
1: \$5245; 809-2: \$5150; 60 days.

Two wide frequency-span spectrum analyzer plug-ins feature a frequency range of 10 Hz to 12.4 GHz—the Model 809-1 tuning unit—and operation to 40 GHz with external mixers—the Model 809-2. Both units offer frequency spans to 2 GHz, 70-dB dynamic range, -115-dBm maximum sensitivity and resolution bandwidth down to 300 Hz. The units are swept front-end, super-heterodyne types. A discrete transistor is used as the first local oscillator. Electronic tuning is accomplished by a YIG resonator.

CIRCLE NO. 272

### Mirror mount for precise positioning



Oriel Corp. of America, 1 Market  
St., Stamford, Conn. 06902. (203)  
348-4247.

The 1467 adjustable mirror mount provides precision positioning for a mirror, beam splitter or other optical component. Major features of this 4-inch mount are a 0.5-second resolution, full 360-degree rotation about the vertical axis, usable aperture at 45 degrees and stable wobble-free motion.

CIRCLE NO. 273

### High-pass filter for 225-400 MHz band



Microwave Filter, 135 W. Manlius  
St., East Syracuse, N.Y. 13057.  
(315) 437-4529.

The Model 2438 uhf high-pass filter transmits frequencies in the 225-400-MHz band with a loss and VSWR below 0.5 dB and 1.5, respectively. The filter's rejection is 50 dB minimum at 150 MHz and below. The filter case measures 2.4 × 4.75 × 1 inches.

CIRCLE NO. 274

### Power amp maintains 1° linear phase

Sierra Systems, Inc., 2255 Old Middlefield Way, Mountain View, Calif. 94040. (415) 969-3056. \$295; 4-6 wk.

The 850 Series power amplifier maintains a linear phase of less than 1° across any octave band in the frequency range of 20 to 100 MHz. Power output is +27 dBm at a nominal gain of 43 dB. The noise figure for this amplifier is 6 dB max. These sets of amplifiers can also be phase matched to within ±2° and amplitude matched to within ±.5 dB. Options include a 30 dB agc control and a ±3 dB gain adjust.

CIRCLE NO. 275

### Rugged transistor rated at 120 W

Communications Transistor, 301 Industrial Way, San Carlos, Calif. 94070. (415) 591-8921. \$50; stock.

With a peak power rating of 120 W, the 150-MHz BAM120 transistor operates from a 13-V supply and has high reliability features. It incorporates nichrome-resistor stabilization and is guaranteed to withstand infinite VSWR at all phase angles when operated at rated power and supply voltage. The BAM120 comes in a low-inductance hermetic stripline package.

CIRCLE NO. 276

# FREE

## new Heath/ Schlumberger Electronic Instruments Catalog



Gives complete details and specifications on hundreds of high performance, budget-conscious instruments for research and industrial applications. Here are just a few examples:

**NEW High performance strip chart recorder...** 4 switch-selected input ranges from 10 mV to 10 V full scale... 10 chart speeds... accuracy within 1%... complete remote control capability... switchable input filtering... easy paper loading... disposable nylon-tip pen. Only \$365\*.

**NEW 110 MHz frequency counter...** 5 Hz - 110 MHz guaranteed, 2 Hz - 130 MHz typical... 15 mV input sensitivity guaranteed, 3-10 mV typical... input sensitivity control... autoranging with four automatically selected ranges... 1 MHz time base w/1 part in 10<sup>6</sup>/mo stability... 7-digit LED readout. \$325\*.

**Dual trace oscilloscope...** DC-15 MHz bandwidth w/ 24 nsec risetime... 50 mV/cm sensitivity... 200 nsec to 0.5 sec/cm sweep rates... triggered sweep... X-Y capability. \$595\*.

**For your free copy, mail coupon or use reader service number.**

<b>HEATH</b>		
<b>Schlumberger</b>		
Heath/Schlumberger Scientific Instruments		
Dept. 531-268		
Benton Harbor, Michigan 49022		
Please send new electronic instruments catalog.		
Name _____		
Title _____		
Company/Institution _____		
Address _____		
City _____	State _____	Zip _____
*Mail order prices; FOB factory.		EK-395

INFORMATION RETRIEVAL NUMBER 62

# TO-5's WE CAN COOL 'em



**1.7¢\***

1129-U Press on  
May be stacked  
Typical  $R_{\theta}$ , 56° C/W



**5.1¢\***

2226-U Press-on  
Clears adjacent compo-  
nents  
Typical  $R_{\theta}$ , 59° C/W



**8.2¢\***

2230-B5, 3/4" Press-on  
gear type, screw mount  
Typical  $R_{\theta}$ , 51° C/W



**8.5¢\***

2257-R 1/2" Press-on  
gear type  
Typical  $R_{\theta}$ , 68° C/W

Popular, easy-to-use economy coolers for PC board components. Thermalloy offers the most complete line of heat sinks in the industry: over 100 designs for cooling all types of packages including DIP's, plastics, TO-3's, TO-66's, and power transistors.

\*Prices for 5000 quantity  
 $R_{\theta}$  values for natural convection @ 1 W

**Free Samples  
and Catalog  
Write Today**



**Thermalloy Inc.**

P.O. BOX 34829  
2021 W. VALLEY VIEW LANE, DALLAS, TEXAS 75234  
PHONE 214-243-4321, TWX 910-860-5542

## MODULES & SUBASSEMBLIES

### Hybrid DAC has 24-pin hermetic can and 13 bits

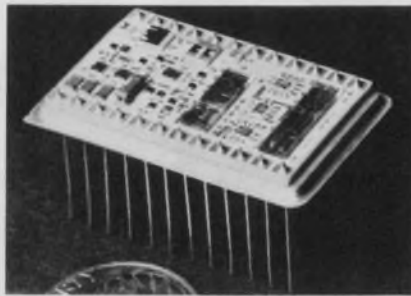

ILC Data Device Corp., 100 Tec St., Hicksville, N.Y. 11801. (516) 433-5330. \$350; 4 wk.

Model SDAC is a high speed (100 ns), 13-bit thick-film hybrid d/a converter. It is packaged in a hermetically sealed 24-pin double dual-in-line metal can (0.8 × 1.4 × 0.2 in.). It features pin programmable voltage ( $\pm 2$  mA) output and output short-circuit protection. Designed for the severe environments, the unit is processed to MIL-STD-883 level C, with level B processing also available for those applications requiring extreme reliability. A separate analog ground allows full accuracy to be obtained at the load even in the presence of ground differences and noise (CMRR = 60 dB min over  $\pm 1$  V).

CIRCLE NO. 277

### Vector generator module has a 5 V/ $\mu$ s write rate

Optical Electronics, P.O. Box 11140, Tucson, Ariz. 85706. (602) 624-8358. From \$185; stock.

The 6210 series of vector generators is a building block approach to generate one, two or three-dimensional vectors for computer displays. One module is required for a one-dimensional generator, four for a two-dimensional generator and six for a three-dimensional generator. Features of the 6210 series system include: 5 V/ $\mu$ s maximum writing rate, 20 V maximum vector length, +10 V CRT blanking voltage, minimum set up time of 2  $\mu$ s, minimum vector length of 20 mV and all commands are TTL and CMOS compatible. The units require standard supplies of  $\pm 15$  V and will operate over a temp range of  $-55$  to  $+85$  C.

CIRCLE NO. 278

### Precision oscillator has low phase-noise spec'd



Greenray Industries, 840 W. Church Rd., Mechanicsburg, Pa. 17055. (717) 766-0223. From \$385 (1 to 3); 7 to 8 wk.

The Model Y-1128 is a crystal oscillator that operates at any customer specified frequency in the range of 1 to 100 MHz. Higher frequency units are available upon request. Single-sideband phase noise reduction by 140 dB in a 1-Hz measurement bandwidth is guaranteed. Each unit has a special low noise oscillator circuit and high Q crystal to achieve this. Complete test data including noise measurements are provided with each unit. Measurements are traceable to the National Bureau of Standards. Output power is 10 mW and input voltage is +28 V dc. The unit is mounted in an aluminum housing 2 × 4 × 2 in.

CIRCLE NO. 279

### Synchro-drivers handle large loads with ease

Transmagnetics, 210 Adams Blvd., Farmingdale, N.Y. 11735. (516) 293-3100. \$325 (1 to 9); stock to 3 wk.

The B676 series of high power synchro drivers has an accuracy of 10 min of arc and will drive at least three size 11TR4A torque receivers. TR receivers tend to draw large surges at turn-on or with step changes. Due to the ac coupled design of the B676-series drivers, they deliver no dc to the load. Also they are completely protected against false angle inputs. All units are short-circuit and over-current protected. The units are packaged on a glass epoxy, plug-in, printed circuit board, 8 × 4-1/2 × 1 in.

CIRCLE NO. 280

## Eight-bit a/d guaranteed over military temp range

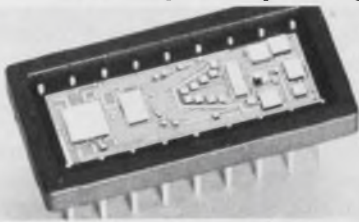

Micro Networks, 5 Barbara Lane, Worcester, Mass. 01604. (617) 753-4756. For 1 to 24 pcs.; \$225 (mil. temp.); \$150 (commer.) stock to 3 wk.

Models MN502H and MN503H are eight-bit a/d converters. They are thin-film hybrids packaged in 18-pin hermetic DIP packages. Total conversion time is 10  $\mu$ s. These a/d's are guaranteed to have a linearity of  $\pm 1/2$  LSB over the full military temp range of  $-55$  to  $+125$  C. No external adjustment or external components are required to achieve the specified guaranteed linearity. The units also provide parallel and serial outputs. The MN502H provides a unipolar output of 0 to  $-10$  V while the MN503H provides a bipolar output of  $+5$  to  $-5$  V. These a/d's also include an input buffer and provide a fanout capability of 12 TTL loads (high state) and 6 TTL loads (low state). Power supply requirements are  $\pm 15$  V and  $+5$  V.

CIRCLE NO. 400

## Dc motor speed control has selectable feedback

Extron, 5735 Lindsay St., Minneapolis, Minn. 55422. (612) 544-4197.

Series 600 full-wave dc adjustable-speed drive includes programming points to change the feedback modes and horsepower range. Models cover the range from 1/4 to 5 hp, with input voltages of 120 and 230-V ac, single phase, 50/60 Hz. Standard feedback modes, selectable via programming points, are: armature, torque, tachometer and voltage-current combinations. Speed regulation is  $\pm 2\%$  in the armature-feedback mode and  $\pm 0.5\%$  in the tachometer mode. Current regulation is  $\pm 1\%$  when control is programmed for the torque mode. All models of the 600 series can be used with either shunt-wound or permanent-magnet dc motors.

CIRCLE NO. 401

## Proportional servo amp delivers 0.1% accuracy

Jordan Controls, 5607 W. Douglas Ave., Milwaukee, Wis. 53218. (414) 461-9200.

The AD-7300 series proportional servo amplifiers offer positioning sensitivity to 0.1% while supplying power in both 90 and 180-V dc ranges. The units provide full-wave single-phase SCR static-reversing output for proportional control of

90-V dc motors of up to 1 hp and 180-V dc motors of up to 5 hp ratings. All outputs are short-circuit protected. Available options include null indication (lamp, relay, solenoid, etc.) and a motor-speed clamp circuit. Regulated  $\pm 15$  V dc supplies are included for potentiometers, lights, relays, etc. and a 500  $\Omega$  1-turn wire-wound trimpot, connected internally to  $+15$  V dc, is available for trim adjustment.

CIRCLE NO. 402



THE LIGHTEST CUSHIONED SHIPPING BAG YOU CAN BUY . . .

LIGHT because I'm lined with clean plastic bubbles of air laminated to heavy duty golden kraft. I can reduce your shipping weight by up to 8 ounces versus a mailer box and offer a postal savings of 8 cents an ounce in first class and 4 cents an ounce in third class. Compare the cost to mail:

	Weight	Postage per M First Class	Postage per M Third Class
MAIL-LITE — 14 $\frac{1}{4}$ " x 20"	2.7 ounces	\$240	\$120
Padded Bag — 14 $\frac{1}{4}$ " x 20"	9.7 ounces	\$800	\$400
Mailer Box — 10" x 16" x 2"	10.8 ounces	\$880	\$440

I'm tough, clean, waterproof and heat sealable too. Like all Sealed Air® products, my bubbles are barrier coated for better protection.

Write for **FREE MAIL-LITE SAMPLE . . .** and receive the Mail-Lite Guaranteed Postal Savings Chart.



## Sealed Air Corporation

19-01 STATE HIGHWAY 208/FAIR LAWN, NEW JERSEY 07410

### Active filters use four resistors for tuning

*Burr-Brown, International Airport Industrial Park, Tucson, Ariz. 85706. (602) 294-1431. From \$16 (100 up); stock.*

The UAF11/15 Series and the UAF21/25 Series of active filters are in dual-in-line type packages. They can be externally tuned for gain, frequency, and Q over their specified ranges by adding only four resistors. Full power-bandwidth of the UAF11/15 Series low-pass output is 10 kHz for  $\pm 10$  V signal ranges and is usable at frequencies up to 100 kHz for a  $\pm 1$  V signal range. The UAF21/25 Series has a full power-bandwidth of 100 kHz at the low-pass output for  $\pm 10$  V signal ranges and is usable up to 1 MHz for  $\pm 1$  V signal swings. A 1% or 5% frequency accuracy with  $\pm 50$  ppm/ $^{\circ}$ C frequency stability over the respective operating temperature range is available in either series. The Q range is 0.5 to 500 with stabilities from 0.01 to 0.1%/ $^{\circ}$ C, depending on the  $f_0 \cdot Q$  product. Output impedance is 2  $\Omega$  for the UAF11/15 and 10  $\Omega$  for the UAF21/25. Each series is available in a 0.46 by 0.16 by 0.25 in. epoxy, or a 0.5 by 0.88 by 0.25 in. hermetic kovar, 14-pin DIP. Epoxy units operate over a  $-25$  to  $+85$  C temperature range while the hermetic package has a  $-55$  to  $+125$  C operating temperature range.

CIRCLE NO. 281

### High speed switch driver delivers $\pm 50$ mA/output

*Sanders Associates, Microwave Div., Grenier Field, Manchester, N.H. 03013. (603) 669-4615.*

The series DC 545 switch drivers features an output circuit that is short-circuit protected. The drivers are TTL compatible, operating from  $\pm 12$  V dc at 75 mA maximum and have built-in power supply decoupling. Total switching time is 15 ns maximum from 50% TTL input gate to 90% of output current spike. Steady state output current is  $\pm 50$  mA minimum depending upon logic state. The open circuit output voltage is  $\pm 10$  V minimum, depending upon logic state. Units are available that are screened to MIL-STD-883. Unit size is  $0.5 \times 0.5 \times 0.1$  in.

CIRCLE NO. 282

### Fault monitor handles up to eight interlocks

*Extron, 5735 Lindsay St., Minneapolis, Minn. 55422. (612) 544-4197. \$150.*

The Model 800 first out indicator can monitor faults in up to eight separate limit switches or interlocks. It will indicate and hold only the first contact to open until manually or automatically reset. The unit can be added to new or existing systems without disrupting operations. Extra contacts are not required, and additional readouts can be installed. Each input to the readout positions is isolated from the others by LED opto-isolators and, therefore, can be used in different series circuits.

CIRCLE NO. 283

### Hybrid DAC has 12-bits in a DIP-like package

*Micro Networks, Barbara Lane, Worcester, Mass. 01604. (617) 756-4635. \$45 (1 to 24), \$33 (250 up); stock.*

The MN 312 R 12-bit d/a converter in a 16-pin DIP provides an output range of 0 to  $+1$  V and settles to 0.01% of its final value in less than 0.5  $\mu$ s. It offers 12-bit linearity  $\pm 1$  bit over the operating temp range of 0 to 55 C. The unit requires only a dual supply of  $\pm 15$  V for operation. No additional external components or trimming pots are required to obtain the specified initial linearity or guaranteed linearity over the operating range.

CIRCLE NO. 284

### Square-root extractor has many output ranges

*Rochester Instrument Systems, 275 N. Union St., Rochester, N.Y. 14605. (716) 325-5120.*

Designated the SC-1330, the square-root extractor produces a signal that is linearly proportional to the square of the input signal. The basic range of the SC-1330 is 1-to-5-V dc input and 4-to-20-mA dc output. However, the unit also accepts other inputs and can provide output signals in 1-to-5, 4-to-20, 10-to-50 mA range, 1-to-5-V dc range, zero-based currents from 1 to 50 mA or other voltage outputs to 10 V dc through the use of appropriate resistor shunts at the output. Accuracy is  $\pm 0.25\%$  from 1 to 100% of span. Response time is 100 ms and repeatability is  $\pm 0.1\%$  of span.

CIRCLE NO. 285



### ANALOGY

GOTTA GET UP EARLY IN THE A.M. TO BEAT THE 3010 IC TONE ALARM. EXCEED ITS DC REFERENCE BY 5mV, AND IT TURNS ON BOTH AC AND DC. DC OUTPUT DRIVES TTL, LED OR LAMP LOADS. AC OUTPUT DRIVES A SPEAKER, LIGHT OR TONE. 5 TO 15V SUPPLY. LOW STANDBY CURRENT.

**intech** INCORPORATED  
(408) 241-0500  
1220 COLEMAN, SANTA CLARA CA 95050

## Automatic dialer handles up to 40 addresses



OPT Industries, 300 Red School Lane, Phillipsburg, N.J. 08865. (201) 454-2600.

Both the pulse and tone dialers, models 4201 and 4202, respectively, are activated by contact closure. Each can automatically dial up to 40 addresses consisting of 7, 8, 10 or 11 digits. Options include automatic line seizure, redial operation, multiple address capability and dial-tone detector. They can be ordered integrally with the PC board unit or as add-ons when needed. Each dialer PC card measures 7-1/2 x 4-1/2 x 3/4 in. thick. Selectable delay, selectable interdigit time and tone interval are also incorporated. Power consumption is 300 mA at 5 V dc.

CIRCLE NO. 286

## Solid-state time delay is resistor programmed

Flight Systems, P.O. Box 25, Mechanicsburg, Pa. 17055. (717) 697-0333. From \$19.50 (1-9).

Programmable time delay modules can supply up to 100 mA output current, and operate from +5 to +16 V power supply. Series RD units have a timing accuracy of  $\pm 2\%$  typical with temperature and voltage, and a repeatability accuracy of  $\pm 0.5\%$  maximum. Rise time is 5  $\mu$ s max, duration is 10  $\mu$ s min. and amplitude is 20 V max, 3 V min. Other specifications include a 10-k $\Omega$  input impedance, a 15- $\Omega$  nominal output impedance, output rise and fall times of 500  $\mu$ s max (no load), a recycle time of 2% of maximum delay, and an operating temperature range of -20 to +70 C. Delay time is resistor programmable over a 10-to-1 range on all models. Maximum delay periods available are 50 ms to 50 s depending upon model selected.

CIRCLE NO. 287

# LAY YOUR CARDS on the table...



Don't "throw-in" a potentially winning circuit design just because you need a special timing or current switching component. Adlake offers mercury wetted contact relays, dry reed relays, and load relays . . . custom motor start-winding timers, fault grounding switches, pulse start dual time delays, and bistable AC/DC switches as standard catalog items . . . or how about a full line of hybrid timers, transfer timers, pulse latches, and power pulse latches for special applications.

You need **RELIABLE, PRACTICAL, and ECONOMICAL** special components. And Adlake's design engineers, with decades of experience, can tell you if a special current or timer device can be built reliably, practically, and at reasonable cost — 24 to 48 hour turn-around time is not unusual.

**Before you decide to "reshuffle" your circuit design ... CONTACT ADLAKE ... our innovative engineers can design and build the special component you need.**

### PULSE START DUAL TIME DELAY

Provides two preset time delay functions to a common load. A momentary "switch-closure (or pulse)" to the selected timing terminal starts the output circuit (120 VAC, 5A). At the pre-selected time, the circuit switches off.



### POWER PULSE LATCHES, SERIES HR-1000

Power Pulse Latches are designed for main power switching control of machine tools, assembly line systems, display sign flasher/control systems, and other power switching applications requiring long life, highly reliable, heavy current switching. With rated positive "gate" voltage applied to the all solid state input circuit, successive control pulses will alternately switch the load contacts "on" and "off". Output is DPST (N.O. or N.C.) high current mercury displacement switch contacts which will switch up to 100 amps per pole at 120 VAC.

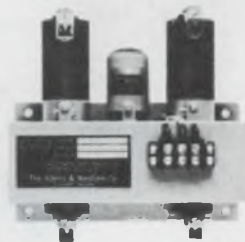

### MOTOR START WINDING TIMER

Dependable silent delay timing of start winding contactor. Same unit operates on voltage input from 120 to 460 V.A.C. Output capable of controlling up to 220 V.A.C. contactor coil. All solid state output insensitive to shock, dirt and most other environmental influences.



**ADLAKE CAN GIVE YOU AN UNBEATABLE HAND!**

**THE ADAMS & WESTLAKE COMPANY**



ELKHART INDIANA 46514  
219 - 264 1141  
TELEX 25 8458  
CABLE ADLAKE

# NEW SHORTER CASE! SCHAUER 1-WATT ZENERS



**SAME LOW PRICES FOR 1% TOLERANCE ZENERS ANY VOLTAGE FROM 2.0 TO 18.0**

Quantity	Price Each
1-99	\$1.07
100-499	.97
500-999	.91
1000-4999	.86
5000 up	.82

**IMMEDIATE SHIPMENT**  
Send for rating data and 20%, 10%, 5% and 2% tolerance prices.

Semiconductor Division

**SCHAUER**

MANUFACTURING CORP.

4511 Alpine Ave., Cincinnati, Ohio 45242  
Telephone 513/791-3030

## Ferrite-bead specs permit precise attenuation matching



Indiana General, Crows Mill Rd., Keasbey, N.J. 08832. (201) 826-5100. P&A: See below.

With the introduction of Indiana General's Attenuation-Rated Ferramic components, designers can now select directly from data sheets the right ferrite bead to meet insertion-loss requirements. Each bead comes specified for guaranteed minimum attenuations at two frequencies and with curves of ferrite-bead characteristics over a frequency bandwidth of about 250 MHz. The attenuations represent the highest available in the 10-kHz-to-10-MHz range, and they provide maximum values over the full frequency range specified.

The new components consist of nine beads in the AR-9100 series and nine beads in the higher attenuation AR-9700 series. Within a series, each component differs from the other in inside diameter, outside diameter and height; thus the beads handle a variety of circuit requirements.

For each ferrite bead, guaranteed series impedances and insertion losses are given at 50 kHz and 100 MHz. For other frequencies, curves provide information on the variation of impedance and attenu-

ation from 10 kHz up to 250 MHz. The impedance spec appears in the form of the magnitude of series impedance divided by the square of the number of turns. The inclusion of the turns factor permits designs that have more than a single wire encompassed by a bead.

The AR-9700 components, unlike those in the AR-9100 series, can be affected by dc fields. Accordingly, separate specs provide data for zero amp-turns, and also, 0.7 amp-turns.

The specs for the new ferrite beads assume 1-Ω source and load impedances in a series-insertion configuration—the most widely used since it provides higher suppression at higher frequencies. For other circuit conditions, the data given can be readily applied by means of a simple calculation.

A typical bead in the AR-9700 series—the AR-9703—measures 0.16 inch (height) by 0.075 inch (inside diameter). Minimum attenuations with zero amp-turns are 28 dB at 100 MHz, and 6.5 dB at 50 kHz. They are about 7 dB less with 0.7 amp-turns.

Prices for the AR-9100 and AR-9700 components range from 5¢ to 10¢ in quantities of 1000. Delivery is four to six weeks.

CIRCLE NO. 288



# The **MET-L-WOOD CONCEPT**

... a material  
that lasts  
longer than  
tomorrow

In tune with the world's most sophisticated computers and machines, Met-L-Wood is the material that will make them last and last . . . and last. The doors of the ILLIAC IV, one of the world's largest computers, are made of Met-L-Wood.

Met-L-Wood is a structural laminate combining the best qualities of wood and metal. It features high rigidity, strength and durability, and offers long lasting, distortion-free beauty. Met-L-Wood's advantages include ease of handling, faster erection, simplified installation and easy fabrication and a wide variety of core and facing materials.

For doors, panels, housings, floors, interior and exterior walls, anywhere beauty and super durability are required, Met-L-Wood is the first choice of materials.

For more information, write: MET-L-WOOD CORPORATION, 6755 West 65th Street, Chicago, Illinois 60638.

Photo courtesy of Burroughs Corporation



**MET-L-WOOD** Corporation  
STRUCTURAL LAMINATES SINCE 1925

## Knitted-wire tape shields cables

*Technical Wire Products, Inc., 129 Dermody St., Cranford, N.J. 07016. (201) 272-5500. \$3 for 25 ft, 1 in. tape; \$10 for 100 ft.*

EMC shielding tape is a knitted-wire mesh fabric that is produced by knitting tin-coated, copper-clad steel wire into a cylinder of inter-

locking wire loops. It is then flattened into a two-ply tape to make it convenient to handle. The tape can provide effective electrostatic and electromagnetic shielding. It readily conforms to the contour of a cable and its splices. Only 0.015 in. thick, the tape can be wrapped with an advance of one-half layer per turn. The two-ply tape thus provides four single layers of wire mesh which can be secured with solder or a conductive adhesive.

CIRCLE NO. 289

## Temperature indicator kits cover wide range



*Tempil Div., Big Three Industries, 2901 Hamilton Blvd., South Plainfield, N.J. 07080. (201) 757-8300. \$10, \$15, \$20.*

Temperature labels are available in test-kit form, with 10 different pressure-sensitive, temperature-indicating labels per kit. Each label contains four different heat-sensitive indicators (accurate to within  $\pm 1\%$ ), sealed under a transparent window. As the temperature noted is reached, the windowed indicators turn irreversibly black, creating a temperature history of the surface to which the label has been affixed. The labels are removable and can be attached to an inspection report or other record. Kits are available in three different categories: Test kit A - lower temperature range (100 to 300 F) at \$10 per kit; test kit B - full temperature range (100 to 600 F) at \$15 per kit and test kit C - upper temperature range (280 to 600 F) at \$20 per kit. A sample label for monitoring any specified temperature up to 300°F, both may be obtained free by writing.

CIRCLE NO. 290

## Now there's a big name in miniatures.

It's Raytheon. And you know with Raytheon on a miniature switch you get quality, dependability and most important — availability. Popular toggle, push-button, proximity, rotary and rocker-type designs carry the Rayswitch name and Raytheon's reputation for excellence in electronics.

Whatever your application, from test equipment to computer peripherals, there's a Rayswitch for your panel. Switch to the big name in miniatures.

Call your Raytheon representative. Or for a FREE copy of our Rayswitch catalog write Raytheon Company, Fourth Avenue, Burlington, Mass. 01803.

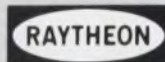

## Tape can withstand temperatures to 500 F

*Aremco Products, Inc., P.O. Box 145, Briarcliff Manor, N.Y. 10510. (914) 762-0685. \$19.50 to \$39 per roll.*

Pyro-Tape 546 is a glass-plastic tape that combines high tensile strength (18,000 lb/in<sup>2</sup>), high dielectric strength (500 V/mil) and a high temperature capability (500 F continuous and flash temperatures to 4000 F). It comes in a 0.006 in. thickness and its adhesive backing is said to have a sticking strength to 20 lb per inch of width.

CIRCLE NO. 291

## New miniature connector replaces phono plug



*Amphenol RF Div., 33 E. Franklin St., Danbury, Conn. 06810. (203) 743-9272. See text.*

Up to now, the only low-cost alternative to the use of quality rf connectors has been the familiar phono plug. However, the phono plug exhibits a poor VSWR and insertion loss, and it is not particularly dependable or long-lived. Now, the ALC-5 connector, which is specifically designed for rf communications equipment, is fully crimpable; both the outer ferrule and center contact are crimped on the cable in contrast to the time consuming soldering effort required on phono plugs. This enables the user to save on assembly and installation costs. Thus, the 45-cents per mated-pair ALC-5 cost compares favorably with 20 cents or under for a mated-pair of phono plug and jack. And, of course, the ALC-5 is a connector with a very acceptable rf performance. Tests show that the VSWR for a pair of ALC-5s with about two inches of RG-58C cable is less than 1.2 from zero to 2 GHz and less than 1.25 from 2 to 4 GHz. The dielectric breakdown voltage is 1500 V rms.

CIRCLE NO. 292

## PC-board bus handles power and ground

*Eldre Components, Inc., 1239 University Ave., Rochester, N. Y. 14607. (716) 244-2570. \$0.12 to \$2.50; stock.*

Two-Bus is a two-conductor bus for distributing power and ground to DIPs. Often, the use of Two-Bus can eliminate the need for multilayer boards. It also allows the engineer greater layout latitude. The bus has a distributed capacitance of 700 pF/in.<sup>2</sup> and comes in a large assortment of lengths.

CIRCLE NO. 293

# Three basic lamp solutions from General Electric for your design problems.

## Immediate delivery on Solid State Lamps (LED's).

GE has a complete line of competitively priced infrared and visible SSL's now ready for off-shelf delivery from your GE distributor or GE representative. The line includes a new small infrared SSL-65 with a .050" diameter. Our visible



SSL's feature high efficiency GaP pellet material and the GE-patented light reflector for bright, uniform light. GE will refund your cost or provide a replacement lamp for all lamps not meeting published specifications.

## Improve your product communications with Green Glow Lamps.

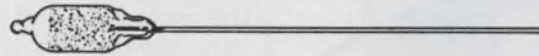

Our Green Glow Lamp (G2B) has exactly the same electrical and physical characteristics as our high-brightness C2A red/orange/yellow glow lamp. You can use the G2B alone for 120 volt green indicator service. Or together with the C2A to emphasize multiple functions with colors.

Uses include: safe-unsafe functions, dual state indications and multiple operations in up to 5 colors (with color caps). They can be operated in series with any appropriate current limiting resistor. Both the G2B and C2A can save money because of their low cost, small size and rugged construction.

## Simplify circuitry with these newest Wedge Base Lamps.

Now you can design simple, low-cost, non-complex socketry by using these GE Wedge Base Lamps. They're available in two sizes, the GE T-1 $\frac{1}{4}$  with a .240" max. diam. and the GE T-3 $\frac{1}{4}$  with a .405" max. diam. These all-glass sub-miniature



lamps are small enough to solve the space problem posed by indicator lights. Their wedge-based construction virtually ends corrosion problems because they won't freeze in the socket. And the filament is always positioned in the same relation to the base.



## Send today for information.

For free technical information on any or all of these lamps, just write: General Electric Company,

Miniature Lamp Products Department, #4454-L, Nela Park, Cleveland, Ohio 44112.

GENERAL  ELECTRIC

INFORMATION RETRIEVAL NUMBER 70

# Everything you need for adding high-speed punched tape reading to your computer.

(At significant savings, too.)



Decitek can supply a complete, ready-to-run reader-interface package to operate reliably with your particular mini-computer — at an attractive price that can add to savings you may already be gaining by buying other peripherals directly.

The Decitek package includes our universal, widely-proven photoelectric reader for 150/300/600 cps reading...PC board circuitry to plug into your mini's card rack...connecting cables...complete installation information.

For the special systems builder and computer user, here's a money-saving yet reliable way to add the capability of high-speed punched tape reading to a computer system. Come directly to Decitek. For full details, call or write Decitek, 15 Sagamore Rd., Worcester, Massachusetts 01605. Tel. (617) 757-4577.

## DECITEK

A DIVISION OF JAMESBURY CORP.

INFORMATION RETRIEVAL NUMBER 71

## PACKAGING & MATERIALS

### Conductive bag protects FETs during shipment



Custom Materials, Inc., Alpha Industrial Park, Chelmsford, Mass. 01824. (617) 256-3911.

Velostat shipping bags provide protection from static electricity discharges by creating an equalized distribution of charge over the entire surface area of the bag. Ordinary plastics can create localized static electricity through friction, which can damage components like FETs. Velostat bags can be grounded through common bonding techniques. Handling precautions and instructions are printed on the bag. Available standard sizes are in the range 5 × 8 through 8 × 12 in.

CIRCLE NO. 294

### Wrapped-wire packaging available for ECL

Augat Inc., 33 Perry Ave., Attleboro, Mass. 02703. (617) 222-2202. \$40 to \$80 (unit qty).

To date, packaging techniques for ECL 10,000 logic have been limited to two-sided PC (microstrip) and expensive multilayer (strip-line) boards. Wrapped-wire terminations were not widely used because of problems stemming from the 2-ns rise time. Augat's new ECL panel, designated 8136-ECL1, has a third voltage plane in addition to the usual ground and  $V_{cc}$  planes. The added plane allows the boards to control impedance of transmission paths while maintaining maximum logic power efficiency. This is accomplished by terminating long lines with a resistive load equal to the characteristic impedance of the line to the —2.0 V plane. The panels are available in 30 different patterns.

CIRCLE NO. 295

### Infrared thermometer tests small components

William Wahl Corp., Heat Spy Div., 12908 Panama St., Los Angeles, Calif. 90066. (213) 391-7234.

Model HSA-8 battery operated infrared thermometer provides instant noncontact surface temperature measurements of circuit board components as small as 0.1 in. diameter with an accuracy of  $\pm 1\%$ . An accessory side-mount meter plugs into the unit's 0-1 V output jack for ease of reading when precision aiming is required for small components. The target area is defined by a light beam which shines precisely on the component under observation. The temperature range is 0 to 600 F and the sensitivity is 1/2 F with a response time of one second. To operate simply aim, pull trigger and read temperature.

CIRCLE NO. 296

### Pressure adhesive holds component pads on card

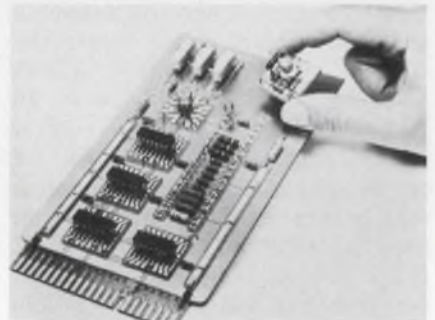

Christiansen Radio, Inc., 3034 Nestall, Laguna Beach, Calif. 92651. (714) 497-1506. \$75: Profession kit; from \$1.40: ground plane; stock.

The Mini-Mount breadboarding system now provides a ground plane card with uncommitted gold-plated fingers and doubled-sided, solder-coated surfaces. When used with Mini-Mount mounting pads, they permit rapid assembly of electronic components which can be plugged directly into a card cage. Pressure-sensitive adhesive on the back of the pads holds them in place. The mounts are easily moved about or exchanged like checkers. Mini-mounts come in different configurations to fit 14 and 16-pin DIPs, 6-12 pin TO-5 style cans, transistors, inductors, resistors, and other components.

CIRCLE NO. 297

# Alite From Victoreen

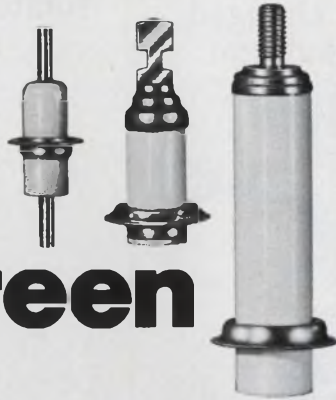

TERMINALS  
BUSHINGS  
SEALS

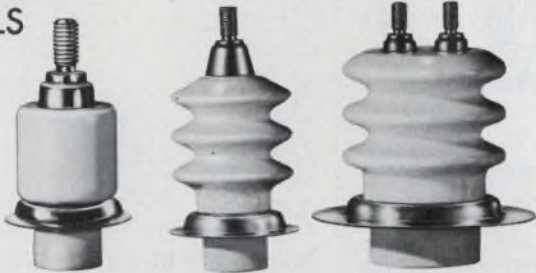

AVAILABILITY FROM STOCK ON STANDARD ITEMS

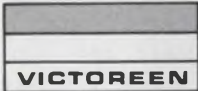

Send for free Victoreen Alite catalog. Write to  
Victoreen Instrument Div. of VLN  
10101 Woodland Avenue, Cleveland, Ohio 44104

INFORMATION RETRIEVAL NUMBER 72

Millions already in use

## NEW KIT LETS YOU TRY IT

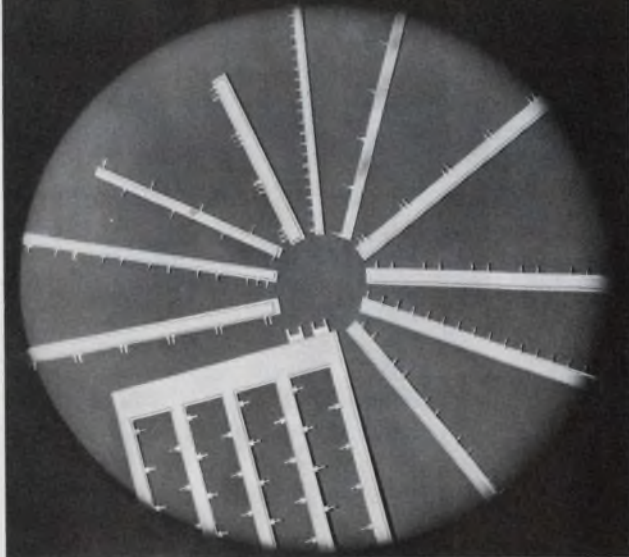

Evaluation kits @ \$25 in stock.  
Standard parts on 2 weeks delivery, or less!  
Custom parts 4 to 6 weeks delivery!

**MINI-BUS** The low-cost, noise attenuating,  
high packaging density, power distribution system for  
PC boards. Ask for data.



Rogers Corporation / Chandler, Arizona 85224  
West: (602) 963-4584 East: (203) 774-9605

INFORMATION RETRIEVAL NUMBER 73

ELECTRONIC DESIGN 19, September 13, 1973

RELIABILITY ✓

QUALIFICATION ✓

EVALUATION ✓

ENVIRONMENTAL ✓

COMPONENT  
SCREENING ✓

DYNAMICS  
TESTING:  
SHOCK AND  
VIBRATION ✓

Whether it's a whole system or a single component... whether it's intended for commercial, military or industrial use... it's vital to your customers—and your company's image—that your product works and **stays** working.

Making sure of that is ATL's business. ATL has built a nationwide reputation as an independent source for a TOTAL ELECTRONICS & AVIONICS TESTING CAPABILITY few others can match.

How? Fifteen years experience as one of industry's leading test labs... a modern facility utilizing the most up-to-date test equipment... and references in almost every product area. Testing can be performed to your specs, military specs or to your industry standards. Where required, we can even establish a program for you.

Remember: the product you engineer is only as effective as the evaluation and reliability planning that go into it. Let ATL see that it gets the best of both.



ASSOCIATED  
TESTING  
LABORATORIES, INC.

NORTHWEST INDUSTRIAL PARK, BURLINGTON, MASS. 01803, (617) 272-9050  
9 BRIGHTON ROAD, CLIFTON, N.J. 07012, (201) 473-6455

INFORMATION RETRIEVAL NUMBER 74

## There's a lot to Analog Devices.

It's all in our 1973 Product Guide. 208 pages describing digital panel meters, linear integrated circuits, A-D converters, amplifiers, dual monolithic transistors, function circuits and power supplies.

In addition to the specs you'll find guides to selection and application.

And it's free. Just check our number on the reader service card, or give us a call at 617-329-4700, and we'll send you a copy.



Analog Devices, Inc.,  
Norwood, Mass. 02062



### COMPONENTS

#### Message sets changed easily in readout unit



Major Data Corp., 1796 Monrovia Ave., Costa Mesa, Calif. 92627. (714) 646-2455. From \$49; \$8.50, per Slip-Chip; 45 days.

Three new rear-projection readouts that feature snap-in/snap-out message sets in black-and-white or color are offered in 64, 32 or 16 message units. They operate like a minislide projector. Message change time is nominally under 5 s. These units, designated the Major 64 Mark II Slip-Chip readout, provide a 1.10 in. high image. Custom versions to 8 in. high are also available. Image selection requires a six-bit input code (three-bits for the X axis and three-bits for the Y axis) and the response is obtained within 70 ms. If power is lost or removed, the last message remains until power is restored or until the next code is applied.

CIRCLE NO. 298

#### Clicker makes noise to reduce keying errors

Endicott Coil Co. Inc., 24 Charlotte St., Binghamton, N.Y. 13905. (607) 797-1263.

A clicker, which provides an audible signal for electronic keyboard operators, reduces errors on silent, soft-touch keyboards. The level and quality of the signal can be controlled by varying the duration of the applied pulse and changing the clicker's method of mounting.

CIRCLE NO. 299

#### Solid-state chopper isolates signals



Solid State Electronics Corp., 15321 Rayen St., Sepulveda, Calif. 91343. (213) 785-4473.

The Model 98 chopper relay is completely solid state and inertialess. It employs silicon semiconductors and magnetic components to achieve complete isolation between drive and signal and the input needs no transformer. It has capabilities which the company says cannot be duplicated by any electromechanical device. Its typical low noise of 25  $\mu$ V makes it particularly applicable for switching low-level signals. The dynamic range extends from  $\pm 75 \mu$ V to  $\pm 20$  V and the unit handles dc to 5 kHz.

CIRCLE NO. 300

#### Red or green LEDs replace 28 V lamps

The Sloan Co., P.O. Box 367, 7704 San Fernando Rd., Sun Valley, Calif. 91352. (213) 875-1123. \$0.96: Red, \$1.76: Green, with internal resistor (2000 up); 3-4 wk.

Sloan 28 V, T-1 3/4 based LEDs are available in red or green colors. Lens material can be either clear, colored or diffused. Light intensity typically is 2.5 mcd at 15 mA. The 28 V capability permits the LEDs to be used as direct replacement for incandescent bulbs in applications where light intensity is not critical but diode reliability is required.

CIRCLE NO. 301

# Sold on solid state? For our TWT amplifier there's still nothing like a vacuum tube!



Sure our amplifier uses solid state components —everywhere, in fact, except in the high voltage regulator and the TWT itself.

Why do we employ a vacuum tube regulator? Because our customers have experienced greater reliability with this inherently high voltage component.

It makes our TWT amplifier exceptionally well qualified for antenna pattern measurement, EMI susceptibility testing and r-f power instrument calibration.

But where contemporary concepts add to reliable performance, we employ them. Our

modular construction and plug-in boards will accommodate a variety of TWTs for example. And we can and do add VSWR protection, harmonic filtering and variable output, when required.

Octave band width 10, 20, 100 and 200 watts TWTAs from 1 GHz to 18 GHz.

One of our 26 TWT amplifiers should meet your power, frequency and gain requirements. For detailed specifications write MCL, Inc., 10 North Beach Avenue, La Grange, Illinois 60525. Or call (312) 354-4350.

**MCL**  
INC

See us in EEM-Vol. 1 pp. 551-566

INFORMATION RETRIEVAL NUMBER 76

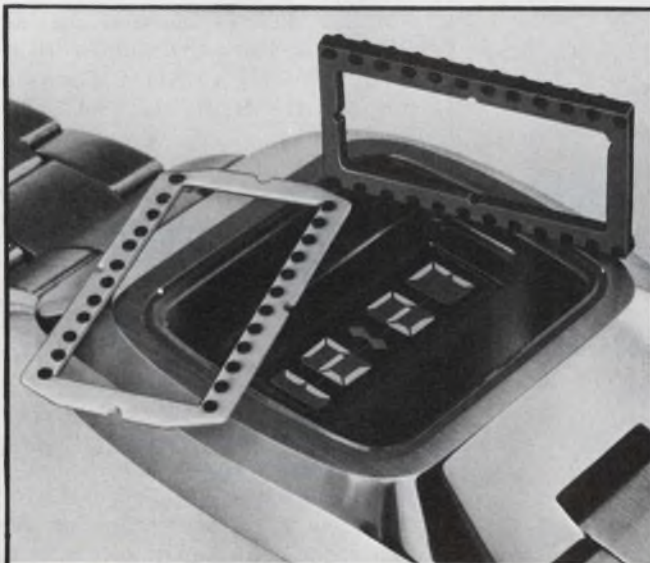

## INTERCONNECTOR CONDUCTIVE ELASTOMERIC

- Conductive and resilient elastomeric contact elements retained and positioned in a dielectric carrier • Low cost
- Reduces package volume • Seals contact surfaces • Isolates vibration • Speeds assembly

U.S. Pat. 3,680,037

**TECKNIT**® | *Technical Wire Products, Inc.*

Eastern Division • 129 Dermody St., Cranford, NJ 07016 (201) 272-5500  
Western Division • 427 Olive St., Santa Barbara, CA 93101 (805) 963-1867

INFORMATION RETRIEVAL NUMBER 77

ELECTRONIC DESIGN 19, September 13, 1973

## SECOND GENERATION ROTARY SWITCHES.

**Unprecedented  
reliability  
competitively  
priced.\***

These Series 50A and 51A rotary switches evolved from our use-tested mil spec rotary line.

The "A" Series was developed especially for customers who still prefer Grayhill reliability but who do not require military performance.

They are available with 30°, 36°, 45°, 60° or 90° angles of throw, solder lug or PC terminals, sealed or unsealed. They are available with up to four poles. Will make and break 200 milliamps at 115 VAC or 30 VDC resistive load at 10,000 cycles.

For more information on all Grayhill products write for our newest Engineering Catalog. Grayhill, Inc., 523 Hillgrove Avenue, La Grange, Illinois 60525. (312) 354-1040.

\*As low as \$3.10 for quantities of 100.



SHOWN  
ENLARGED  
4X

**Grayhill**

INFORMATION RETRIEVAL NUMBER 78

121

COMPONENTS

**Transformers provide trigonometric outputs**

*Perkin-Elmer Corp., Electronic Products Dept., Main Ave., Norwalk, Conn. 06856. (203) 762-1000. \$40-45 (100 up); 8 wks.*

Two newly designed computing transformers provide trigonometric outputs. The first is a 1 x 1 x 0.6 in. reference isolation transformer

that converts a single-channel input voltage to a sine and cosine output of some predetermined angle. In a typical application, this unit replaces a resolver with a locked shaft. The second is a series of auto-transformers that are tapped in a trigonometric progression. Typical functions include sine and tangent values. Applications lie in all areas of angular conversion and in switchable references.

CIRCLE NO. 303

**Liquid crystal display uses only 1/2 μW**



*International Liquid Crystal Co., 26101 Miles Ave., Cleveland, Ohio 44128. (216) 831-8100. Stock.*

Ilixco displays use field-effect liquid crystals to create up to 40 to 1 contrast in ambient lighting. The company says that diffused lighting does not affect the display and there is no washout in direct sunlight. Because the power requirements are only 1/2 μW or less, field-effect liquid crystals allow longer battery life. Visibility is good at a 90 degree angle with a transmissive type display—white or light-colored numbers against a dark background. Displays are CMOS compatible, they operate over a range of 0 to 70 C and can be stored at -20 to 70 C. Rise and decay time is less than 50 ms. Three standard digital clock displays are now available: the BLM 7052, for a 12-hr clock that shows AM/PM, days of the week and an alarm indicator; the simpler BLM 6035, with only an AM/PM indicator; and the BLM 6052, for a 24-hr clock.

CIRCLE NO. 304

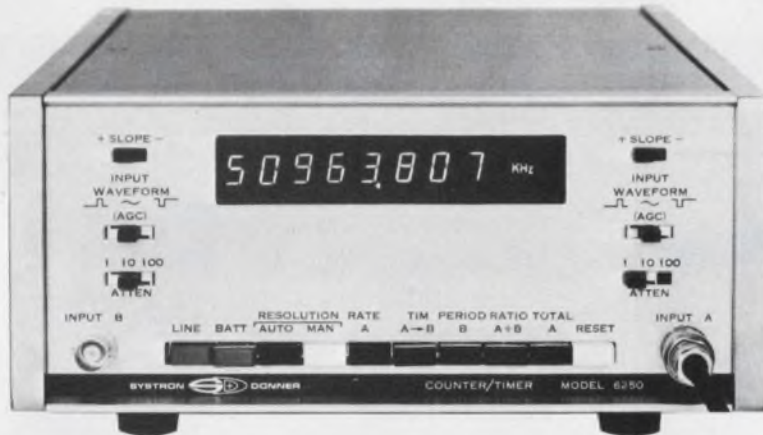

**50 MHz automatic counter/timer**

- Frequency, TIM, period, ratio, totalize
- Automatic gain control
- Autoranging
- Leading zero suppression
- 8-digit readout (standard)
- 25 mV input sensitivity
- BCD output
- Model 6250 Options include:**
- Choice of 5 higher oscillator stabilities
- Internal battery pack

Contact your Scientific Devices office or Concord Instruments Division, 10 Sysatron Drive, Concord, CA 94518. (415) 682-6161  
**Europe:** Munich, W. Germany, Leamington Spa, U.K.



INFORMATION RETRIEVAL NUMBER 79

**Cycling timer calibrated in % time ON**

*Zenith Controls, Inc., 830 W. 40th St., Chicago, Ill. 60609. (312) 247-6400.*

Zenith's series CP timers provide continuous ON-OFF cycling of electrical circuits. These single-circuit timers are dial-adjusted for ON time as a percentage of the total time. The range covers 3 to 97% for any one of twelve time ranges—4, 15, 30 or 60 s; 5, 15, 30 or 60 min; and 2, 6, 12 or 24 hr. Setting accuracy is within 2% of full scale and repeat accuracy within 1% of full scale. Electrical rating is 15 A at 250 V for a resistive load. Timer motor voltages are 120, or 240 V, 50/60 Hz. The timers are available in a standard panel mounting or a NEMA-1 enclosure.

CIRCLE NO. 305



## Module holds 18 thick-film resistors

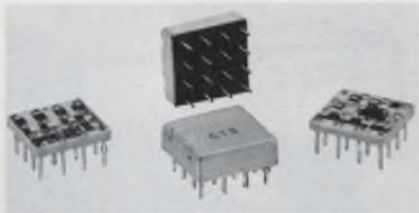

CTS Microelectronics, Inc., 1201 Cumberland Ave., Lafayette, Ind. 47902. (317) 463-2565. Typical \$0.52; (OEM qty).

The Series 780 thick-film resistor module is built on a rugged alumina substrate with 16 Amzirc copper pins that are staked and soldered into position. After the resistors are laser trimmed and any additional specified devices are attached, the assembly is sealed in an aluminum shell and backfilled with RTV encapsulant. As many as 18 resistors have already been manufactured on the single 1/2-in. square substrate. Resistor values range from 25  $\Omega$  to 10 M $\Omega$  with standard tolerances as low as  $\pm 1\%$ . Custom matching can be achieved to within  $\pm 0.58\%$ .

CIRCLE NO. 306

## Centrifugal switch operates to 20,000 rpm

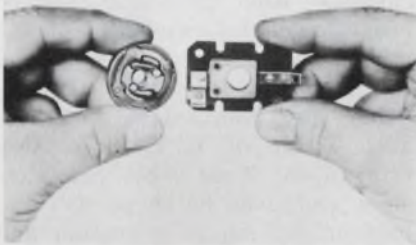

Speed Detectors, Inc., 30 W. Monroe St., Bedford Ohio 44146. (216) 232-4100. \$2 to \$20; 8 wks.

The miniaturized S-50 centrifugal switch set senses shaft overspeed or underspeed at almost any specified selected speed point up to 20,000 rpm. A rigid retaining plate is fastened to a rotating shaft. Then a conical disc spring is anchored to the retaining plate and calibrated weights are mounted on the disc. The actuating arms of the disc are attached to a free floating spool that presses against the switch contact to close the switch. Centrifugal force removes the pressure to break the circuit.

CIRCLE NO. 307

## Joystick switch has nine positions

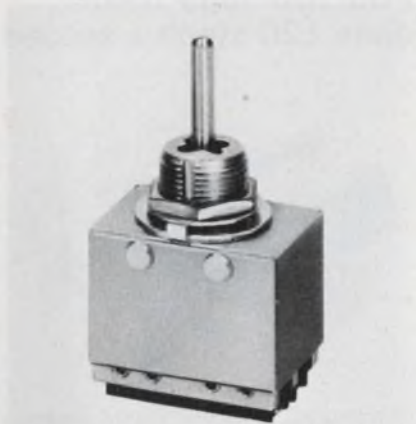

Machine Components Corp., 53 Werman Court, Plainview, L.I., N.Y. 11803. (516) 694-7222. Stock.

Joystick toggle switches provide both momentary and maintained contacts and combinations of the two. Model 91MXY is a nine-position, momentary-contact, single-pole switch with two actuating positions in each of the  $\pm X$  and  $\pm Y$  axes. The origin, or OFF, is the ninth position. Model 52MXY is a five-position, momentary, double-pole unit with single position in each axis. The units are 1.05 in. wide  $\times$  1.22 in. long.

CIRCLE NO. 308

## LED provides infrared beam of 5 mW

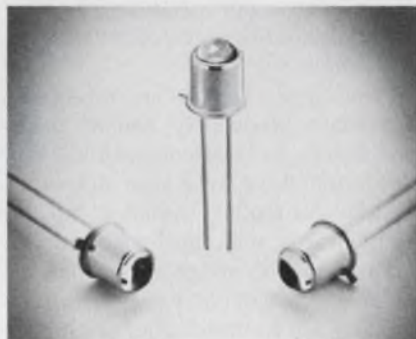

Optron, Inc., 1201 Tappan Circle, Carrollton, Tex. 75006. (214) 242-6571.

A high-power, gallium-arsenide-infrared LED, the OP 131, features a concentrated beam to provide greater on-axis intensity for longer distances than other infrared LEDs. Typical power output is 5 mW with an input current of 100 mA. The OP 131 is hermetically sealed in a TO-46 package. Its output is spectrally compatible with silicon light sensors.

CIRCLE NO. 309

# \$125



## it's so easy to take . . .

You can replace your thermopile with a SBN PYROELECTRIC DETECTOR.

- BROADBAND RESPONSE—UV to microwaves
- HIGH SENSITIVITY— $>$  to 125 V/W
- FAST RESPONSE—better than 5ns
- NO CRYOGENICS—operates from  $-40^{\circ}\text{C}$  to  $90^{\circ}\text{C}$
- RUGGED AND NONHYGROSCOPIC

This package includes a sensing element plus a integral FET and fits a standard 9 pin miniature tube socket. Available from stock for only \$125.00.

Call us at 216/248-7400 with your IR detection and measurement problems.



# HARSHAW

THE HARSHAW CHEMICAL COMPANY  
DIVISION OF KEWANEE OIL COMPANY

Crystal & Electronic Products Department  
6801 Cochran Road • Solon, Ohio 44139  
(216) 248-7400



General Electric's New  
PowerUp-15\* Battery

**RECHARGES  
IN 15 MINUTES**



**THINK  
OF THE  
POSSIBILITIES**

When charged at room temperature for 15 minutes with an approved charger, General Electric's new PowerUp-15\* battery delivers 90 percent of its rated capacity.

The battery is charged with a unique Voltage/Temperature Cutoff system which features straight forward charger control circuitry.

Ideal for portable industrial power tools, photographic equipment, portable communications devices... anywhere portable electric power is needed fast.

And you get all the advantages of time-proved GE nickel-cadmium rechargeable batteries.

For more information, write General Electric Company, Section 452-04, Schenectady, N. Y. 12345, or circle reader service card.

\*Trademark of General Electric Company

**GENERAL  ELECTRIC**

INFORMATION RETRIEVAL NUMBER 81

DATA PROCESSING

**Punched tape reader  
does 120 steps a second**

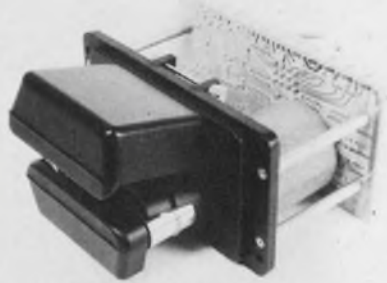

*Electronic Engineering Company of California, 1601 E. Chestnut Ave., Santa Ana, Calif. 92701. (714) 547-5651. \$299; stock to 4 wk.*

A special-purpose punched tape reader, the "Step-Mate" reads one character per command pulse at any rate up to 120 char/s. The LED/phototransistor head permits reading of tapes with up to 60% transparency without requiring external adjustments. The unit is bi-directional, TTL compatible, and handles five, six, seven or eight-level tapes made of paper, Mylar and aluminized Mylar.

CIRCLE NO. 314

**Disc-controller mates  
mini to IBM-type drives**

*Diva, Inc., 607 Industrial Way West, Eatontown, N.J. 07724. (201) 544-9000. See text.*

The disc controller interfaces Interdata Models 70 and 80 mini-computers to IBM-compatible 2310, 2311 and 2314 type disc drives. A single controller handles up to four drives and, optionally, up to eight. An "overlap seek" feature enables each drive to seek its own address simultaneously with the other drives to speed the transfer of data. The controller can be configured to derive 24 logical sectors from disc packs physically marked for 20 sectors. The unit also provides for position verification, write protection and alternate track assignment. All controller components are mounted on two boards which plug directly into the mini-computer mainframe. The price of the controller for mini format is \$7500 and for IBM-compatible format, \$10,500.

CIRCLE NO. 315

**Card-reader series  
handles marks or holes**

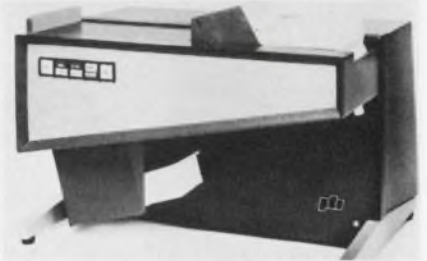

*Peripheral Dynamics, Inc., 1030 W. Germantown Pike, Norristown, Pa. 19401. (215) 539-5500. From \$1515; 60 days.*

The M series optical-mark readers read pencil marks, punched holes or a combination of the two at speeds of 300, 500 and 600 cards/min. The readers accept standard 40 or 80-column tabulating cards. Timing tracks are not required. Interface requirements for the mark/sense readers are the same as for the company's 80-column punched-card readers.

CIRCLE NO. 316

**Conversational interface  
is software-controlled**

*Digital Equipment Corp., 146 Main St., Maynard, Mass. 01754. (617) 897-5111. See text; stock.*

The DH11 interface connects PDP-11 computers to as many as 16 asynchronous communications channels, each of which may be programmed independently of the others. Data rates up to 9600 baud can be selected by the software. Other program-variable features are: Choice of 1, 1.5 or 2 stop bits; 5, 6, 7 or 8-bit character sizes, odd, even or no parity; and half or full-duplex operation and automatic echo. Additional DH11 features include a 64-character hardware buffer for received characters, direct memory access transmission for each line and split transmission and reception speeds. Options include: data set control; interface to EIA/CCITT standard modems, data sets and terminals, or to Bell System CBS or CDT data access arrangements. Up to 16 DH11s may be connected to a single PDP-11 computer. The DH-11 (without full data set control or line adapters) is priced at \$4000. A DH11 with line adapters and cable for 16 local terminals costs approximately \$318 per line.

CIRCLE NO. 317

Dear Gabby: \_\_\_\_\_

"How can I display the most messages for the least dollars?"



Shelly's Girl Gabby



Try Shelly. This is the actual size of their SR-90 multi-message module. You get a 20% larger image in a 20% smaller housing. Just imagine.

12 different messages in black & white or color from decimal or BCD inputs at only \$2.50 per message. That's one way to beat inflation.

Better send for our free brochure.

*Gabby*

**shelly/datatron**

1562 Reynolds Ave., Santa Ana, California 92711  
(714) 540-9330

INFORMATION RETRIEVAL NUMBER 82

### VERSATILITY PLUS HIGH QUALITY



RA

**IMMEDIATE DELIVERY**



RAX

The new RAX relay is an adaptation of the popular RA Type and includes plastic barriers between the movable arms, thereby enabling opposite polarity voltages to be applied to the unit without fear of arc-over.

Its rugged, compact design makes this relay ideal for commercial use, communication equipment, computers, process control applications, etc. Both the RA and RAX are miniature compact relays with 4 PDT or double make-double break action, with dust cover and pierced Faston terminals for quick connect-disconnect or soldering, or PC terminals.

The complete line of relays is U/L and CSA recognized.

Send or phone today for catalogs and complete specifications.



**SCHRACK**

ELECTRICAL SALES CORP.

1140 Broadway, New York, N.Y. 10001 (212) 683-0790

INFORMATION RETRIEVAL NUMBER 83

ELECTRONIC DESIGN 19, September 13, 1973

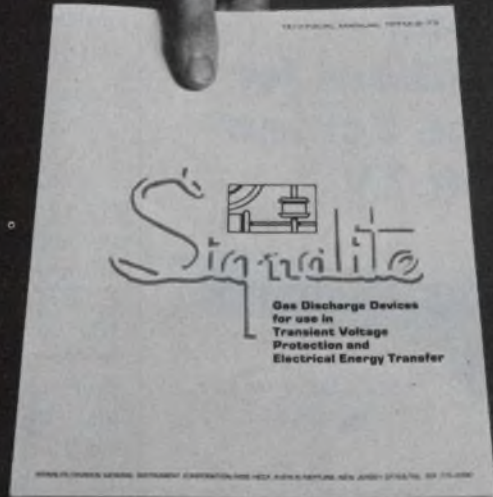

## When it comes to TRANSIENT VOLTAGE PROTECTION

*Signalite* wrote the book!

**And, It's Yours FREE!**

### It's all part of the SIGNALITE TRANSIENT VOLTAGE PROTECTION KIT!

Including a 28-page book entitled, "Gas Discharge Devices For Use In Transient Voltage Protection and Electrical Energy Transfer." Part I, Transient Voltage Protection, details sources of voltage transients, operation and construction of protectors, comparison of various transient protection devices, pulse breakdowns, V & I characteristics of protectors in AC & DC circuits, follow-on current, etc. Part II, Electrical Energy Transfer, details various devices, applications and glow-to-arc transitions. Included in the Signalite Transient Protection Kit are specification bulletins on Signalite's UNI-IMP, the fastest surge arrester in existence... COMM-GAP, a high quality, low cost protector with a wide range of applications... TWO ELECTRODE & TRIGGERED SPARK GAPS... AC/DC LINE PROTECTORS... plus an Applications Engineering Worksheet so that the Signalite Application Department can help in the design of your protection circuitry.

**Signalite**  
DIVISION OF GENERAL INSTRUMENT CORPORATION

1933 Heck Ave., Neptune, New Jersey 07753  
Area Code 201-775-2490 ■ TWX 201-775-2255

329

INFORMATION RETRIEVAL NUMBER 84

125

# High Voltage Silicon Rectifiers for Large Screen Color TV

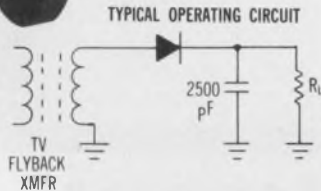

These silicon rectifiers are designed to replace the high voltage rectifier tubes in either hybrid or solid state large screen color TV.

The configuration shown, series H-431 & H-484, is designed for maximum performance. It features: a corona ring, PRV rating of 45 kV, high humidity resistance, 250 and 300 nsec.  $t_{rr}$ , and 85°C,  $T_A$ , operating temperature. A variety of mounting hardware and connections for the anode and cathode ends are available.

Other high voltage silicon rectifiers from Varo include versatile, low cost axial-lead or end-cap packages in 15 kV to 30 kV ratings for monochrome or small screen color TV.

Write for your free copy of our Applications Bulletin VSP 108, "Selecting the proper rectifier for TV high voltage circuits."



**VARO**

**VARO SEMICONDUCTOR, INC.**

P.O. BOX 676, 1000 N. SHILOH, GARLAND, TEX. 75040  
214/272-4551, TWX 910-860-5178

#### Varo Sales Representatives

AL Buchanan & Abrams Assoc. 305-423-8995 • AZ W. W. Posey Co. 505-294-8400 • AR Whiteside Sales 214-231-9771 • CA (NO) W. W. Posey Co. 415-948-7771 • CA (SO) Corcoran Assoc. 213-823-2425 • CO J. F. Hurlbut Co. 303-279-7138 • CT Comp Rep Assoc., Inc. 203-239-9762 • DE Tom Davis Marketers 302-998-0123 • FL Buchanan & Abrams Assoc. 305-423-8995 • GA Buchanan & Abrams Assoc. 305-423-8995 • IL (NO) Olson Sales Co. 312-627-3802 • IL (SO) Coombs Assoc. 314-567-3657 • IN Technical Reps, Inc. 317-546-4967 • KS Coombs Assoc. 314-567-3657 • KY Technical Reps, Inc. 317-546-4967 • LA Whiteside Sales Co. 214-231-9771 • ME Comp Rep Assoc., Inc. 617-444-2484 • MD Tom Davis Marketers 703-591-7390 • MA Comp Rep Assoc., Inc. 617-444-2484 • MI Davis-Martensen Co. 313-474-8300 • MN Loren F. Green Assoc. 612-781-1611 • MS Buchanan & Abrams 305-423-8995 • MO Coombs Assoc. 314-567-3657 • NJ (NO) Cooper-Simon & Co. 516-487-1142 • NJ (SO) Tom Davis Marketers 302-998-0123 • NM W. W. Posey Co. 505-294-8400 • NY (METRO) Cooper-Simon & Co. 516-487-1142 • NY (UPST) Bob Dean, Inc. 607-272-2187 • NC Buchanan & Abrams Assoc. 305-423-8995 • OH (NO) J. C. Hofstetter Co. 216-241-4880 & 216-725-4477 • OH (SO) J. C. Hofstetter Co. 513-298-0662 • OK Whiteside Sales Co. 214-231-9771 • OR C. K. Shanks & Assoc. 503-292-5656 • PA (E) Tom Davis Marketers 302-998-0123 • PA (W) J. C. Hofstetter Co. 412-561-5454 • RI Comp Rep Assoc., Inc. 617-444-2484 • SC Buchanan & Abrams Assoc. 305-423-8995 • TX Whiteside Sales Co. 214-231-9771 & 713-498-2551 • VA Tom Davis Marketers 703-591-7390 • WA C. K. Shanks & Assoc. 503-292-5656 • WI Olson Sales Co. 312-627-3802 • CANADA • ONT Cantronics, Ltd. 416-661-2494 • QUE Cantronics, Inc. 514-733-0749

INFORMATION RETRIEVAL NUMBER 85

## DATA PROCESSING

### Stack interface lets mini use re-entrant code

Delta Control Systems, 14 Charles St., Needham, Mass. 02194. (617) 449-4879. \$3600; 30 days.

A hardware-stack interface, the HS-101 makes possible the use of re-entrant code on the PDP-8/E minicomputer. The HS-101 acts as a temporary data register to control one or more push-pop stacks in the minicomputer's memory. A programmable 15-bit stack-pointer and 12-bit status and command register allow the user to create a variable-length data buffer, employ recursive programming and maintain a dynamic list of program activities. The HS-101 can be set for stack sizes up to 32-k words. It plugs directly into the processor's bi-directional communications bus.

CIRCLE NO. 318

### Polygamous peripheral mates with many hosts



Electronic Associates, Inc., 185 Monmouth Parkway, West Long Branch, N.J. 07764. (201) 229-1100. From \$55,000.

A single system called SPACER performs data acquisition, acts as a remote batch terminal, operates off-line, performs graphic operations (via a plotter) or performs hybrid (analog/digital) computation. And that's not all. As a remote batch terminal, the system provides access to a wide variety of computers including those of IBM, CDC, Univac, ICL, XDS and GE merely by loading the appropriate control program. The heart of the system is a 32-kword minicomputer and a 4-kbyte communications control module. The basic system which also includes a 1000 line/min printer and a 300 card/min reader costs \$55,000.

CIRCLE NO. 319

### PC board contains an entire memory system

Intel Corp., Memory Systems Div., 3065 Bowers Ave., Santa Clara, Calif. 95051. (408) 246-7501. \$750.

The in-26 NMOS memory system provides 4-k × 9-bit storage on a single PC card measuring 8.175 × 6 × 0.5 in. Memory access and cycle times are 900 ns. And up to 16-kwords are available with the use of additional cards. Each card contains the necessary logic for the read, write and modify modes of operation. Cards are also available with 4 or 6-bit word lengths and word capacities of 1 or 2-k.

CIRCLE NO. 320

### Video recorder meets all broadcast standards



International Video Corp., 990 Alhambra Ave., Sunnyvale, Calif. 94086. (408) 738-3900. \$70,000-90,000.

A broadcast video tape recorder, the IVC-9000 satisfies all three international broadcast standards NTSC, PAL and SECAM. In particular, the unit meets the higher color subcarrier requirements (9 to 12 MHz) of PAL and SECAM. The IVC-9000 uses 2-in. wide video tape. It has two record and playback heads, a writing speed of 1500 in/s and a tape speed of 8 in/s. Use of the helical scan principle provides a two-hour record/play time on a standard 4800-ft. reel. The tape format includes two audio program tracks as well as a cue track located between them. Separate control and SMPTE address tracks are also included.

CIRCLE NO. 321

Dear Gabby: \_\_\_\_\_

"How can I brighten up  
our product's  
personality?"



Shelly's Girl Gabby



Use Shelly's Brite-Eye  
microminiature indicators  
to light up your product's  
personality. 15 standard T1

lamps in 10 colors and 70 cap styles—  
including Digicaps inscribed with  
letters, numerals or symbols.

Why not send for our free brochure.

*Gabby*

**shelly/datatron**

1562 Reynolds Ave. Santa Ana, California 92711  
(714) 540-9330

INFORMATION RETRIEVAL NUMBER 86



**NEED TOP QUALITY ENCODERS?  
THEN, COME TO THE LEADER!**

Itek manufactures Digisec<sup>®</sup>, the line of optical shaft encoders. Digisec encoders are available from 1-1/2-inch synchro mount to 8-inch through hole for on axis mounting. DIGISEC encoders range in resolution from 100 counts/revolution to 21 bits/revolution—absolute and incremental models. Send for free catalog.



STANDARD FOR THE INDUSTRY

**Itek**

MEASUREMENT SYSTEMS DIVISION  
Christina Street, Newton, MA 02161  
(617)969-7300 TWX 710-335-6783

INFORMATION RETRIEVAL NUMBER 87

ELECTRONIC DESIGN 19, September 13, 1973

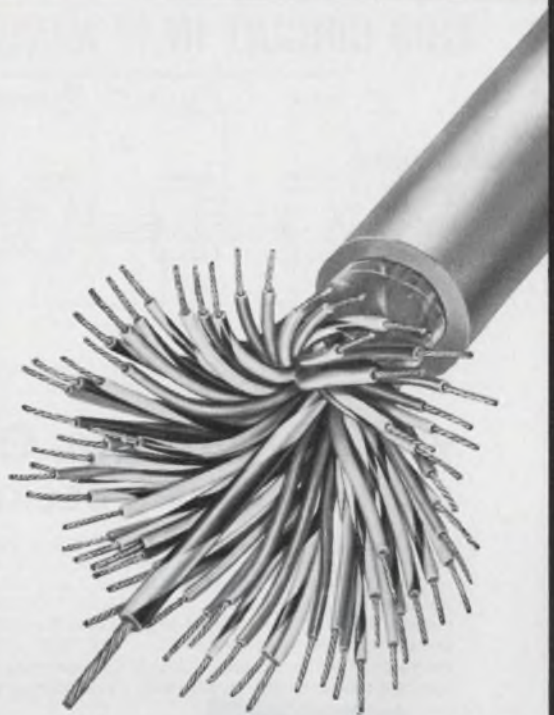

**What do you  
need in  
Multi-Conductor  
Cable?**

**Victor**

**will make it.**

Get exactly what you need in multi-conductor cable. We'll design and produce multi-conductor cable to meet just about any individual requirement.

We have the plant, the equipment, the personnel and the know-how to solve your particular problem.

**Victor**  
*Electric Wire & Cable Corp.*  
WEST WARWICK, RHODE ISLAND

INFORMATION RETRIEVAL NUMBER 88

# DO YOU THINK YOU CAN CONSTRUCT THIS CIRCUIT IN 17 MINUTES\*?

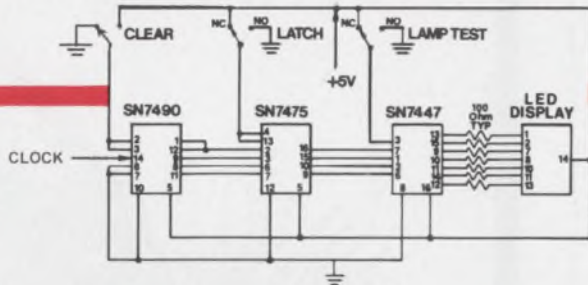

\*Circuit constructed by E&L Instruments Engineering Dept., using standard components and Elite-3, in 17 minutes, 8 seconds.

## YOU CAN WITH THE elite • 3 BREADBOARDING DESIGN SYSTEM

If time is valuable, the versatile ELITE-3 is a must for your lab. Test, design, layout any component combination, ICs, discretes, etc., *without soldering!* Eliminate expensive jumpers; use #22 gage solid wire. All components are reusable. The ELITE-3 includes independent circuit monitor logic lights, isolated toggles and pushbuttons, universal component acceptance, plus more . . . and costs only \$350.

Interested? Write or phone today for complete literature on ELITE-3 and other inexpensive, quality E&L circuit design aids.

See the Elite series, and new E&L products at WESCON Booth 1317



**E&L INSTRUMENTS, INCORPORATED**  
61 First St., Derby, Conn. 06418  
Telephone: 203/735-8774  
TWX: 96-3536 ELI DEBY

INFORMATION RETRIEVAL NUMBER 89

# OPEN-LINE REED RELAYS

Quality Engineered at Low Cost  
Broad Line . . . From Distributor Stock

An exceptionally high quality line of Form A and Form C open frame reed relays — with up to 6 contacts (Form A) and 4 contacts (Form C) per relay! Available in standard coil voltages 5 to 48 VDC . . . Capable of switching up to 1/2 amp, 250 VDC (Form A) or 1/4 amp, 28 VDC (Form C). Only .350" high by 1.125" long, with terminals on .1" or .15" grid spacing. Electrostatic and electromagnetic shielding optional. Top performance at low cost . . . Tailored to fit your cost/environmental requirements.

Phone, wire or write.

## ELEC-TROL, INC.

26477 N. Golden Valley Road  
Saugus, California 91350  
(213) 788-7292  
TWX 910-336-1556

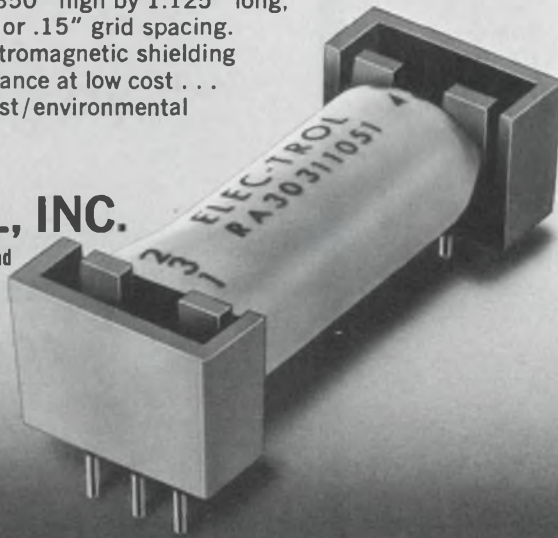

1973-74  
**eem**  
VOL. TWO

INFORMATION RETRIEVAL NUMBER 90

## DATA PROCESSING

### Front-end controller handles 40 data lines



GTE Informations Systems, Public Affairs Dept., Four Corporate Park Dr., White Plains, N.Y. 10604. (914) 694-8840. \$25,500; 60 days.

The IS/1101 communications controller consists of a communications processor, channel adapter and communications scanner. The unit accommodates up to 40 communications lines—24 asynchronous and 16 synchronous, all operating in the half-duplex mode. Model IS-1101 supports data rates from 25 to 50,000 bit/s in a variety of codes including EBCDIC, USASCII and BCD. Designed for use with the IBM system 360-370 central processors, the IS/1101 is software-compatible with existing customer applications running under BTAM, QTAM, TCAM, HASP and other access methods that support the IBM 2703 communications controller.

CIRCLE NO. 322

### TTY buffers accumulate up to 16-k characters

Fairchild Camera and Instrument, 510 N. Pastoria Ave., Sunnyvale, Calif. 94086. (415) 962-3047. See text; 60 day.

Messages typed into buffers TTB-8 or TTB-16 at 10 char/s rates may be retransmitted at speeds up to 1800 baud. The buffers act as a link between slow TTY data and high speed transmission facilities. Either unit has editing capability by character, line or file. And both models are compatible with the IBM 3704 and 3705 communications processors. The TTB-8 which stores 8000 characters costs \$1600. The TTB-16, capable of storing 16,000 characters, costs \$2200.

CIRCLE NO. 323

## Baudot-ASCII converter is also programmable

Nu Data Corp., 32 Fairview Ave., Little Silver, N.J. 07739. (201) 842-5757.

Series 701 code converters interface data links or terminals using five-bit (Baudot) code with those using eight-bit ASCII. Transmission through the converter is full duplex with serial inputs and outputs at rates between 30 to 1200 baud. The interface is compatible with EIA RS232C and can be interfaced with 20 mA telegraph loops by means of an additional coupling unit. The standard 701 provides for output of up to two Baudot characters for each ASCII character and is programmable with respect to code translations. The unit sells for \$2200 when equipped with a 1000-character buffer.

CIRCLE NO. 324

## Touch-tone generators couple acoustically



Interface Technology, 10500 Kahlmeyer Dr., St. Louis, Mo. 63132. (314) 426-6880. See text; 30 day.

These compact tone generators can be coupled automatically to any standard telephone for transmission to a computer from remote locations. Bell System tones are produced through a 12-key tone pad. Both units operate from a regular 9-V transistor battery and are completely portable. The Model 720 uses an external speaker. The Model 721 has an internal speaker and is coupled to the phone by holding the unit to the mouthpiece. The model 720 (including the external speaker) costs \$65.50; model 721 costs \$58.00.

CIRCLE NO. 325

## Low-cost CRT terminal works in buffered mode



Tec, Inc., 9800 N. Oracle Rd., Tucson, Ariz. 85704. (602) 297-1111. \$1300; Oct.

Designated the MINI-TEC, this CRT terminal provides a 960-character display (80 × 12) and operates in either a buffered or conversational mode. Sixty-three 5 × 7 dot-matrix characters can be displayed. Standard features include an RS-232C interface, switch selectable transfer rates to 9600 baud, field protect and a computer or keyboard-controlled cursor. Transmission can be either half or full-duplex.

CIRCLE NO. 326

## Drum module provides 16.9 ms access to data

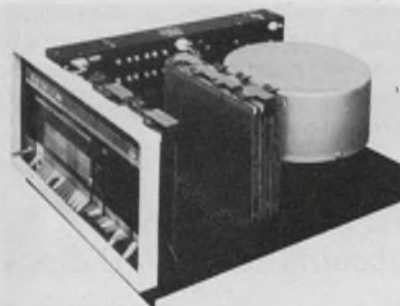

Datum, Inc., 170 E. Liberty Ave., Anaheim, Calif. 92801. (714) 879-3070. \$6570; 45 days.

Model 5100 drum memory system provides 262 k to 1 M words of on-line storage for DEC models PDP-8/e, PDP-8/f and PDP-8/m computers. Head-per-track operation gives an average access time of 16.9 ms to all data. Data transfers can vary in length from one to 4056 words. Continuous data transfers across data tracks are handled automatically. A single drum and controller mount inside the 8/e or 8/f chassis.

CIRCLE NO. 327

# a \$60 process controller?



Very much so. You can have automatic or semi-automatic control of any process that involves repetitive counting with our new predetermining counter, the Hecon Model GO 850.

After a preset number of events have taken place, the GO 850 activates a control switch. The preset number is stored in a mechanical memory and reappears when the unit is reset.

It is large (2<sup>7</sup>/<sub>8</sub>" x 5<sup>5</sup>/<sub>8</sub>" x 5<sup>3</sup>/<sub>4</sub>" ), rugged with highly visible 1/4" numbers. Preset and reset buttons are easy to operate and well-spaced to avoid troublesome setting. The counter activates a heavy-duty 4-amp switch (non-inductive, SPDT), which remains closed until the unit is reset. Resetting can be done either manually or electrically.

It has five digits and operates by subtracting the received pulse from the preset number. The counter is set by depressing the large push button beneath each digit. An interrupt feature assures accurate resetting — every time — by suppressing incoming pulses until reset is completed.

The GO 850 is available in voltages of 24, 215, 220 AC or DC with a count rate of 10 counts per second, max.

Prices range under \$60 in lots of 100. All Hecon counters are available from stocking distributors located in all major cities or from the factory.

For further information, contact: Hecon Corporation, P.O. Box 247, Eatontown, New Jersey 07724.

In Canada:  
Hecon of Canada Ltd.  
80 Galaxy Blvd.,  
Rexdale, Ontario  
Tel: (416) 678-2441



# 5 Remarkable Little Ovens from Texas Instruments, \$15.

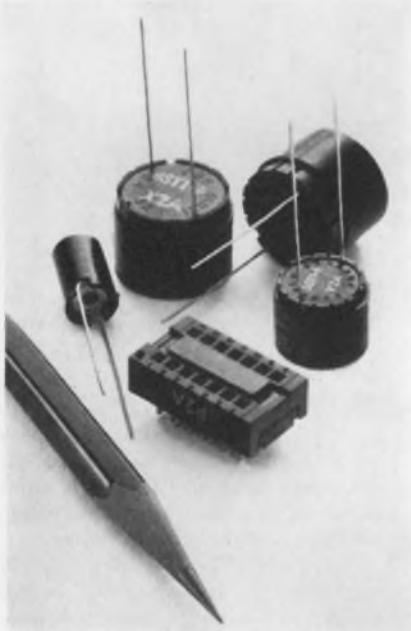

These self-regulating solid-state component temperature stabilizers provide a low cost means of controlling the environment of a wide variety of transistors, diodes, and ICs. Application of these component ovens permits the use of less expensive semiconductor devices by improving their thermal characteristics as much as 30:1. See how much less you get for your money.

**Less Bulk.** Typically 1/10th the size of conventional ovens.

**Less Headaches.** Solid state ovens have no moving parts— are more reliable— aren't handicapped by a limited cycle life.

**Less RFI.** In fact, there's no RFI since the ovens eliminate the need for thermostats and SCR's which create undesirable radio frequency interference.

**Less Money.** Costs \$3 to \$5 instead of the \$5 to \$250 you're paying now.

Send \$15 for your 5-piece Oven Sampler to Commercial Controls Marketing, MS 12-33, Attleboro, Mass. 02703. Or write for the literature.

**TEXAS INSTRUMENTS**  
INCORPORATED

INFORMATION RETRIEVAL NUMBER 92

## DATA PROCESSING

### CPU-chip simulator speeds system design



*Applied Computing Technology, Inc., 17815 Sky Park Circle, Irvine, Calif. 92664. (714) 549-3123. \$6950.*

Designed to aid manufacturers in the development of systems that use microprocessors, the Assembler simulates microprocessor programs then emulates the operation of the target microprocessor as directed by the assembled program. The unit emulates the Rockwell parallel processing system (PPS). The designer enters a listing of the program he wants the PPS to execute and runs it using a TTY for I/O. To speed debugging the Assembler provides outputs for synchronizing an oscilloscope with computer address or data lines. Satisfactory programs can be transferred directly to the pROMs used in the finished product.

CIRCLE NO. 328

### Flexible-disc drive accepts IBM 3740 discs

*Memorex Corp., San Tomas at Central Expressway, Santa Clara, Calif. 95052. (408) 987-2200. See text: Jan., 1974.*

Designed for data interchangeability with the IBM 3740 data entry system, the model 652 flexible-disc drive can write and read discs with a transfer rate of 250 kbit/s. Positioning, settling and latency times are 10 ms, 10 ms and 83 ms, respectively. The unit records 3.1 Mbits using 77 tracks at a density of 41 kbits/track. Prices for the 652 range from \$595 to \$780 depending on the quantity ordered.

CIRCLE NO. 329

### FDM system puts 22 data channels on phone line



*Lear Siegler, Inc., Electronic Instrumentation Div., 714 N. Brookhurst St., Anaheim, Calif. 92803. (714) 774-1010. See text; 30 days.*

Each channel of the frequency division multiplexer system (FDM) accepts baud rates up to 600 on all CCITT (international version of EIA 232C) and W. E. standard frequencies. Strapping options allow two-wire or four-wire operation, half or full duplex operation, EIA 232C data and high level ( $\pm 120$  V; 60 mA) input and output. Depending on the baud rate, up to 22 channels may occupy a single voice-grade line. A single channel costs \$585. The units are available in one-channel and four-channel subsets.

CIRCLE NO. 330

### Fast printer features replaceable type caps

*Data Products Corp., 6219 De Soto Ave., Woodland Hills, Calif. 91364. (213) 887-8000. See text.*

The print drive of the model 2550 line printer consists of a steel-belted polyurethane band which rides on a roller-bearing roadbed. Print slugs, permanently attached to the band, move horizontally as the band rotates. Interchangeable type caps are mounted on the end of each slug. The "Charaband" can be changed by the operator allowing the use of different character sets for different jobs. The model 2550 prints at speeds of 1250 lines/min (for OCR applications) or 1550 lines/min. for standard-quality printing. Each Charaband contains two sets of 320 characters, one set on each side. The printer will sell for \$18,000 in quantity. Pilot production models are scheduled for this fall and production units for next spring.

CIRCLE NO. 331



## POWER SOURCES

### SCR power controllers deliver up to 16 kW

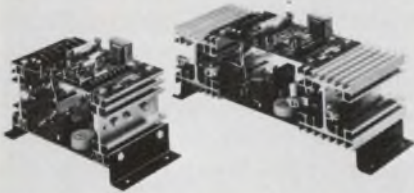

Vectrol, 1010 Westmore Ave., Rockville, Md. 20850. (301) 424-6900. From \$110.

The VPDC-500 series of SCR ac-to-dc converters provides smooth linear control from zero to 100% of the rated dc output into resistive, capacitive, inductive or dc motor loads. Standard units are available in single phase 120, 208, 240, 277 and 480 V models with ratings up to 40 A at 16 kW. All units incorporate high PIV rated SCRs, a voltage-transient suppressor network and a hard firing gate pulse as standard protection features. Units also contain a full-wave rectifier circuit consisting of two SCRs, two bridge diodes and a freewheeling diode. The SCR trigger and logic circuitry can be rewired separately from the bridge circuit if control on the secondary side of a transformer is required.

CIRCLE NO. 332

### Tracking dual-output supply has low profile

Acopian, Easton, Pa. 18042. (215) 258-5441. FD series \$115. LD series \$145; 3 day.

Models FD12-50 and FD15-50 dual output power supplies provide outputs of  $\pm 12$  and  $\pm 15$  V, respectively, at 500 mA; Models LD12-100 and LD15-100 provide the same voltages but with a 1 A rating. Overvoltage protection is optionally available. Output line and load regulation are  $\pm 0.1\%$  each. Ripple is 1.5 mV rms. Outputs are tracking and current limited and provisions for remote sensing are included. The standard input is 105 to 125 V ac, 50 to 400 Hz. All models are housed in extruded aluminum cases that are less than 1.68 in. high. Threaded mounting holes are provided on three surfaces.

CIRCLE NO. 333

### Multiple output supply has 10 minute failsafe

Rochester Instrument Systems, 275 N. Union St., Rochester, N.Y. 14605. (716) 325-5120. \$1200.

The IPS-1425 instrument power supply has four 3 A at 25 V fully-regulated dc outputs, and a chart drive output of 25 V ac. Its internal sealed-cell battery provides full load operation for a 10 min. period in case of an ac line failure. Larger

externally mounted batteries can be used when longer standby periods are required. Built-in safeguards are furnished as standard equipment. These include complete overload, overcurrent, and under-voltage protection, as well as battery protection from total discharge through a built-in under-voltage limit and a constant-current charger for maximum battery life.

CIRCLE NO. 420

## VHF Coils from 10 MHz-450 MHz

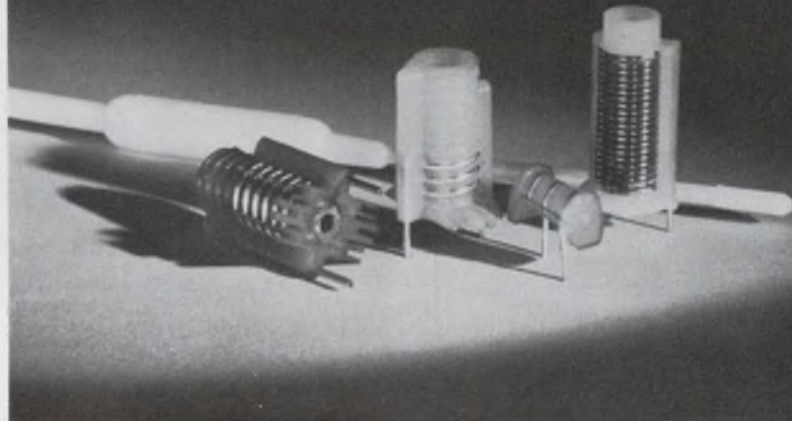

For 92-page full line catalog, please write on your company letterhead.

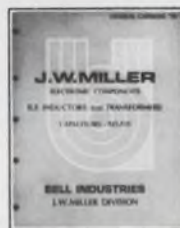

In stock for immediate delivery, Series 48A and 49A adjustable coils and Series 75A fixed coils are ideal for communications, TV and FM equipment.

The coils exhibit excellent inductance, Q and self capacitance characteristics.

Molding the plastic coil form around the winding assures accurate winding position . . . stability and uniformity of electrical parameters . . . high resistance to shock and vibration.



**BELL INDUSTRIES/J. W. Miller Division**  
19070 REYES AVENUE • P.O. BOX 5825 • COMPTON, CALIFORNIA 90224

at prices from \$50  
Hipotronics offers you  
delivery from stock  
on over 800 standard  
models of

# hv dc power supplies

... with output voltages  
from 1 to 1000 KV and  
current outputs from  
2 ma to 50 amperes.



model 860-6.5  
60 KV, 6.5 ma.

**ALSO:**

■ **Custom design units:** for wide range of applications — electrostatics, accelerators, lasers, monocyclic charging, high power radars, high voltage testing, and more.

■ **HV power packs:** wide range of compact, miniaturized power packs, with output voltages from 2.5 to 100 KV and current ratings of 2 to 10 ma. Also, standard 5-ma and 2-ma HV power packs with simplified controls.



model R-30B

Send for our 24-page catalog, "High Voltage DC Power Supplies and Components," or call our Sales Department and ask for the Power Supplies Manager.

**HIPOTRONICS**  
**HIPOTRONICS, INC.**  
Brewster, N. Y. 10509 / (914) 279-8091  
TWX: 710-574-2420

**POWER SOURCES**

## Switching regulator can operate from ac or dc

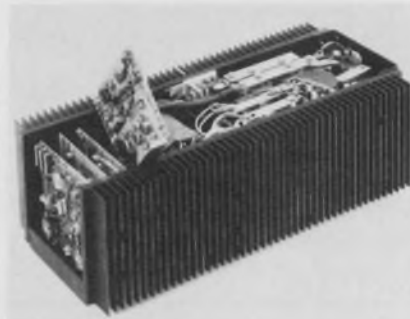

ACDC Electronics, Oceanside Industrial Center, Oceanside, Calif. 92054. (714) 757-1880. \$425 (series 300), \$550 (series 500); 4 wk.

The JP series of switching power supplies is available in 10 models (two basic case sizes). Five models in case size 300 (300 W) range from 5 V, 60 A, to 24 V, 14 A. The other models are case size 500 (500 W) and range from 5 V, 100 A, to 24 V, 23 A. All models operate from an input of 115/230 V ac, 47 to 440 Hz, or from 150 V dc with 70% to 80% efficiency and 0.1% regulation. Overvoltage and overload protection are standard. Also radiated and conducted EMI are minimized by shielding and filtering. An optional built-in input filter for compliance with MIL-STD-461, CE03 is also available. All transistors and associated circuits are in pluggable modules, which are interchangeable among power supplies of the same model.

CIRCLE NO. 334

## Modular dc supplies and converters have low cost

Frequency Devices, 25 Locust St., Haverhill, Mass. 01830. (617) 372-6930. Prices (100-pc): \$15 (supplies); \$31 (converters); stock to 2 wk.

The CV12 or H5S series of epoxy power supplies is available in 10 models. Five models are  $\pm 15$  V supplies providing current outputs of 25, 100, 200 and 300 mA. Additionally, a 5-V supply provides 1 A of current for digital logic applications. There are also four models of dc/dc converters with 5-V or 12-V inputs. They provide output voltages of  $\pm 15$  V and output currents of either 25 or 100 mA.

CIRCLE NO. 335

## Dc supply modules have 0.01% line regulation

Volteq, 115 Marine St., Farmingdale, N.Y. 11735. (516) 249-2336. \$149; stock to 4 wk.

The Series 86 rack adaptable regulated power supply modules span a range of 3.5 to 29 V. Output currents of 10 A are available at ambient temperatures of 50 C. All units include overvoltage protection and have regulation to 0.01% +1 mV line or load. Ripple is less than 1 mV rms. The size of any module is 5-7/32 by 4 by 15-7/16 in. and a rack adapter that holds up to four modules is also available.

CIRCLE NO. 336

## Regulated supply comes without transformer

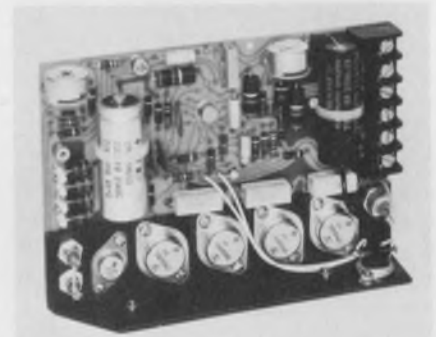

ERA Transpac Corp., 311 E. Park St., Moonachie, N.J. 07074. (201) 239-3000. From \$28.

The R-series supplies have IC control, power regulators, built-in overvoltage protection, power rectifiers, and mounting flanges. By adding an external transformer, a customized single or multiple output supply can be built. The assemblies are available in output current ratings of 3, 6, 12 or 20 A with output voltages from 4.7 to 30 V dc, depending on model. Input and output regulation is better than 0.05%, ripple is less than 1 mV rms and transient response is less than 50  $\mu$ s for 10 to 100% load change. Operating temperature is  $-20$  to  $+71$  C with a temperature coefficient of better than 0.01%/C. The outputs are ungrounded, permitting either positive or negative outputs. The built-in overcurrent and overvoltage protection is adjustable over the full operating current or voltage range of the unit.

CIRCLE NO. 337



## The Non-forgettable Memory

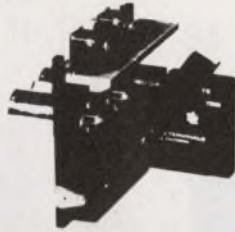

### Why is the Ross Digital Cassette Recorder the best recorder?

- Because it is the simplest
- Because it is the most rugged
- Because it is solidly built
- Because the design is versatile
- Because of patented constant speed drive
- Because there are no moving parts except the motors
- Because it is low cost

• ALL OF THE ABOVE

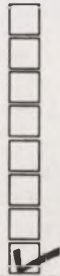

### ROSS CONTROLS CORPORATION

257 Crescent Street, Waltham, Massachusetts 02154, Tel. (617) 891-9600  
An Affiliate of American Research & Development Corp. (ARD)

INFORMATION RETRIEVAL NUMBER 95

## best buy

### 4½ digit MULTIMETER



**\$675**

No other 4½ digit DMM offers as many standard features, as much proven reliability and overall performance as the Model 2440.

100μ V to 1000 VDC (accuracy ±0.007% of reading ±1 l.s.d. for six months.) The most accurate 4½ digit meter available.

100μ V to 500 VAC

2-wire and 4-wire resistance, 100 milliohms to 12 megohms

DC/DC ratio, AC/DC ratio

Standard features include:

- Auto-Ranging
- Remote-Ranging
- Auto-Zeroing
- Remote-Trigging
- Isolated BCD output

Documented by full test data and Certificate of Conformance.



"Visit us at Wescon Booth 1334"  
INFORMATION RETRIEVAL NUMBER 96

ELECTRONIC DESIGN 19, September 13, 1973

#### CALL YOUR LOCAL OFFICE FOR A DEMONSTRATION

AL	(205)536-1941
AZ	(602)948-8410
CA/N	(415)321-7323
CA/S	(714)540-7160
CO	(303)449-5294
CT	(203)527-1245
FL/S	(305)581-6611
FL/E	(305)622-6850
FL/W	(813)726-2373
FL/N	(305)727-3205
GA	(404)252-5360
IL	(312)593-0282
IN	(317)293-9827
MA	(617)273-0198
MD	(301)552-2200
MI	(313)482-1229
MN	(612)781-1611
MO/W	(913)236-6600
MO/E	(314)731-2331
NC	(919)275-3725
NJ	(215)925-8711
NM	(505)265-6471
NY/N	(315)446-0220
NY/S	(516)482-3500
OH/N	(216)243-7430
OH/S	(513)298-3033
TX/N	(214)234-4137
TX/S	(713)461-4487
WA	(206)767-4330

Data Precision Corporation  
Audubon Road  
Wakefield, Ma. 01880  
(617)246-1600

# TEC-LITE

## YOUR COMPLETE SOURCE FOR INDICATING DEVICES

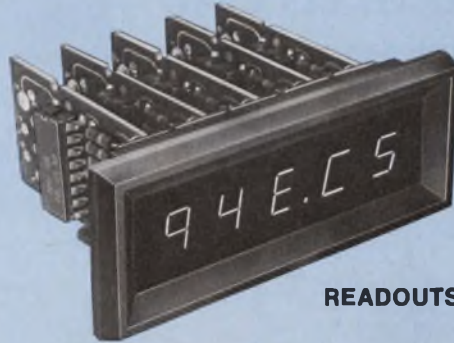

READOUTS



SWITCHES & INDICATORS

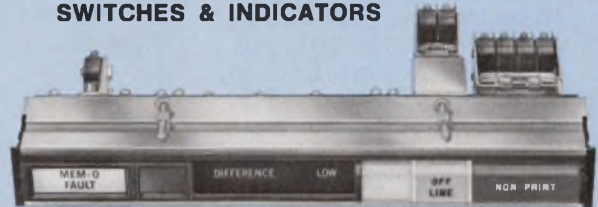

DATA-LINE DISPLAY MODULES



DISPLAY SYSTEMS

### FROM THE DISPLAY / CONTROL SPECIALIST

TEC — with over 15 years of proven performance — offers you a complete man-machine interface line of highly reliable, economically priced devices to meet your specific requirements: computers and peripherals, industrial controls, test equipment, communications, aircraft and missiles, navigation and guidance systems, and consumer products.

And if what you need isn't in our inventory we'll custom build it to your specific requirements. Many TEC-LITE devices are also available on 24-hour delivery. Get the full story in our new 8-page brochure #986, which contains our complete product line, prices, and the TEC-REP nearest you.



9800 NORTH ORACLE ROAD  
TUCSON, ARIZONA USA 85704  
(602) 297-1111  
TWX 910-952-1377

INFORMATION RETRIEVAL NUMBER 97



The U. S. Government does not pay for this advertisement. It is presented as a public service in cooperation with The Department of the Treasury and The Advertising Council.

# "We are such stuff as dreams are made on.."

W. Shakespeare



Life would be pretty dull if people couldn't dream. Take that boat you're always dreaming about. Just thinking about it makes you feel pretty good. But you won't just have to dream if you buy U.S. Savings Bonds. Because Bonds can make your dream boat a reality.

Now Bonds mature in less than six years. Which means maybe it won't take forever for your ship to come in.

Just knowing you've got the safety and security of U.S. Savings Bonds working for you can make dreaming for anything a lot more fun. Because, with Bonds, the good times and the good things can really happen.

So, don't give up dreaming. Just keep buying U.S. Savings Bonds—they're the stuff dreams are made of.



Now E Bonds pay 5 1/2% interest when held to maturity of 5 years, 10 months 14% the first year. Bonds are replaced if lost, stolen, or destroyed. When needed they can be cashed at your bank. Interest is not subject to state or local income taxes, and federal tax may be deferred until redemption.



## Take stock in America.

Now Bonds mature in less than six years.

### POWER SOURCES

#### Drive a 64-k by 18 memory with one supply

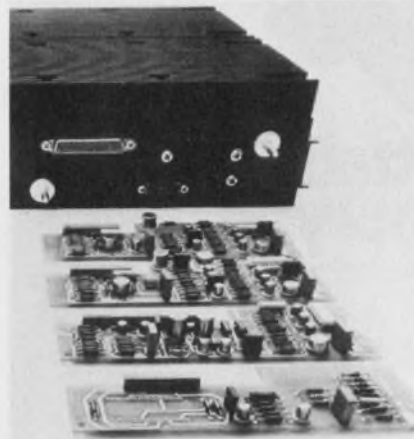

*Electronic Memories & Magnetics, 12621 Chadron Ave., Hawthorne, Calif. 90250. (213) 644-9881. From \$1760; 90 day.*

The SEPS-9 regulated supply will drive eight 8-k x 18 memory modules with two memory modules on operate and six on standby. This single modular supply measures only 10 x 6 x 2 in. and weighs 8-1/2 lb. It delivers up to 250 W.

CIRCLE NO. 338

#### Power supply for gas displays has quad output

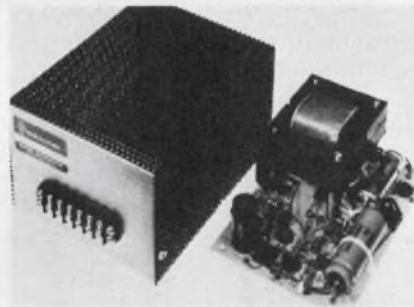

*Reacor Inc., 740 S. Sherman St., Richardson, Tex. 75080. (214) 235-1952.*

The Model DPS-206 power supply is designed for use with the Burroughs Self-Scan panel displays. Both high and low voltages are provided for digitally driven gaseous displays. The unit offers multiple outputs of -12, +5, +30 and -250 V with currents up to 3 A, time delays up to 2 s, fold-back current limiting and may be purchased with or without time-sequenced outputs to provide proper turn-on for resetting digital circuitry.

CIRCLE NO. 339

#### UPS can deliver 700-VA of standby ac power

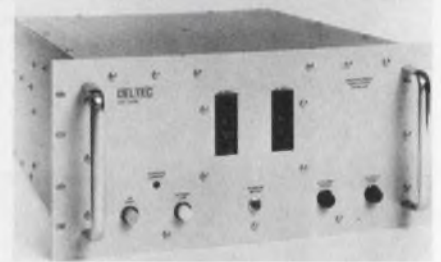

*Deltec Corp., 2775 Kurtz St., San Diego, Calif. 92110. (714) 297-4466. From \$1350.*

The DSU 710 is a 700-VA uninterruptible power source supplied with an internal power reserve sufficient to maintain ac power to a critical load during short-period utility power failures. The system is designed to supply isolated and conditioned ac power, regulated to ±5% of nominal output, with a frequency stability of 0.5%. Emergency control alarms and protection circuits are standard peripherals.

CIRCLE NO. 340

#### Regulated dc supply has short-circuit protection



*Design Products Corp., 1925 W. Maple Rd., Troy, Mich. 48084. (313) 647-1770.*

The Model 50-24-500 regulated power supply can deliver 0.5 A at 24 V dc with an input of 105 to 130 V ac, 50/60 Hz. The unit is 3-1/2 x 3-5/8 x 3-3/8 in. and plugs into a standard 15-pin printed-circuit connector. It has built-in short-circuit protection which drops the output voltage to zero if the unit is shorted. The supply is fused to protect against internal faults and has an indicator when the output is present.

CIRCLE NO. 341

We have documented proof you can **replace your oscilloscope for \$79.95**



The Kurz-Kasch logic probe is the most amazing new concept today in electronic testing. All digital logic circuitry (TTL, DTL, RTL, COS/MOS) can be tested for every condition you need to know. It actually replaces wide band pass type oscilloscopes costing \$2,000 and \$3,000. Write or call now for your free copy of that proof to: Tom Barth, Marketing Manager, Department ED



Free test data



**Kurz-Kasch, Inc.**

ELECTRONICS DIVISION  
2876 Culver Avenue  
Dayton, Ohio 45429  
Telephone 513/296-0330

INFORMATION RETRIEVAL NUMBER 99

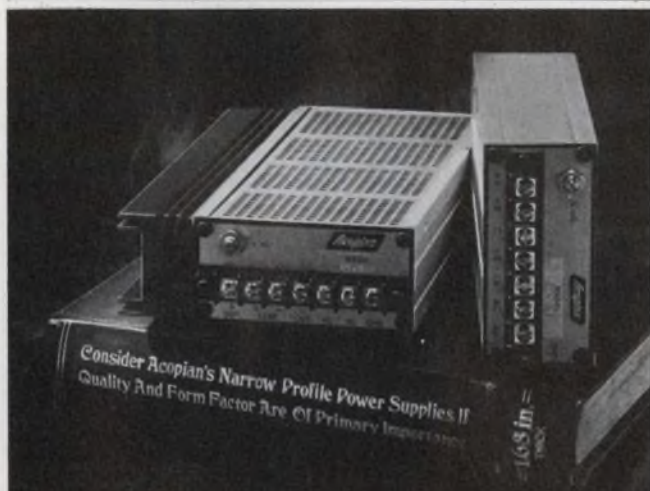

**5V @ 4 amp or ±15V @ 500 ma... in 1.68"**

The Model A5NT400 delivers 5V @ 4A with regulation of ±2 mv and ripple of 0.25 mv. Price, \$150. The FD15-50 provides tracking ±15V @ 500 ma. Regulation ±0.1%; ripple, 1.5 mv; price, \$115. Standard input, 105-125 VAC, 50-400 Hz.

Other single output models to 150 volts; ±12 and ±15 volt duals to 1 amp. All only 1.68" thick. Three day shipment guaranteed.



Acopian Corp., Easton, Pa. 18042  
Telephone: (215) 258-5441

INFORMATION RETRIEVAL NUMBER 100

ELECTRONIC DESIGN 19, September 13, 1973

# This transceiver case had to be:

Deep drawn, Shaped, Pierced, Lanced, Louvered, Debossed, Spot welded, Texture painted.

Transceiver cases are used for the installation of transmitter-receiver units in police vehicles.

AMALCO designed and engineered it, made the necessary tools and dies and produced it from blank to the finished product all in our own plant. . . . and, we delivered it on schedule.

Besides the techniques required by the transceiver case we also do:

- Testing • Hydroforming • Spinning • Stamping
  - Brake Fabrication • Heliarc, Spot and Stud Welding • Riveting • Heat Treating • Anodizing
- . . . and we have our own prototype shop, too.

If you have a fabrication problem, no matter how complex or how tight the specs, call Bill Lowry collect at (201) 233-3500.



Manufacturers of Aluminum Products  
for Industry Since 1910.

**AMALCO**

**AMERICAN ALUMINUM COMPANY**

230 SHEFFIELD ST., MOUNTAINSIDE, N. J. 07092

INFORMATION RETRIEVAL NUMBER 101

83

135

# Get it all together!

- TRUE RMS
- VOLTS, AMPS and WATTS
- 0.1% ACCURACY
- TIME-DIVISION TECHNIQUES (PATENTED)



Now, True RMS and power measurements with 0.1% accuracy are possible for general instrumentation applications. YEW's new Model 2503 provides the means. This revolutionary instrument utilizes a unique time division multiplier technique long proven in YEW's Lab Standard 0.02% Model 2885 Digital Wattmeter. Exceptional accuracy is retained over wide frequency ranges, with extreme wave form distortion AND over wide power factor variations because of this measuring technique. Wide measuring ranges from 3 volts to 600 volts, 0.1 amps to 30 amps and 300 milliwatts to 18 kilowatts combined with complete front panel control assures maximum versatility.

Send for complete technical information today!



Yokogawa Electric

For Sales and Service in the U.S.A. contact:  
Yewtec Corporation  
1995 Palmer Ave., Larchmont, N. Y. 10538  
Telephone: 914 834-3550

55 Years of Measuring  
and Recording Instrumentation.

## POWER SOURCES

### Voltage controller keeps the ac line constant



Staco Inc., 2240 E. 3 St., Dayton, Ohio 45403. (513) 253-1191.

The FRC-10 can be used with a motor-driven variable transformer to maintain constant output voltage or current, adjustable to any value within the range of the variable transformer used. The output voltage of a motor-driven variable transformer designed for 120 or 240, 40/400 Hz, single-phase service, can be regulated with the FRC-10 controller. The unit can control three-phase systems by monitoring one line-to-neutral or line-to-line voltage. The unit includes an on-off switch, pilot lamp, sensitivity control and three fuses on the panel, together with a control knob and a dual range ac/dc voltmeter which monitors either 0 to 300 or 0 to 135-V-dc output voltages.

CIRCLE NO. 342

### Ac line regulator boasts 98% minimum efficiency

Topaz Electronics, 3855 Ruffin Rd., San Diego, Calif. 92123. (714) 279-0111. From \$290.

Series LRA ac line regulators come in power ratings from 500 VA to 24 kVA, with voltage outputs of 115 V ac to 240 V ac. They operate over a line frequency of 47 to 63 Hz. The regulators have a 98% minimum efficiency. Their response time is less than 1 cycle. The output adds less than 1% total harmonic distortion. Audible noise is typically 2 dB.

CIRCLE NO. 343

### Lab power supplies have 0.02% regulation



Trygon Electronics, 1200 Shames Dr., Westbury, N.Y. 11590. (516) 997-6200. From \$400; stock.

The VPH series of power supplies is available in six models—five slot range outputs and one dual-output model. Standard ratings are 5 V/60A, 12 V/35 A, 15 V/31 A, 24 V/22 A, 28 V/19 A and dual  $\pm 15$  V/13 A. The units have 0.02% regulation, less than 1 mV ripple and less than 5 mV pk-pk ripple. The operating temperature range is  $-20$  to  $+71$  C and a patented automatic nonlinear current-foldback systems is included.

CIRCLE NO. 344

### Ac line regulator offers 0.2% voltage regulation

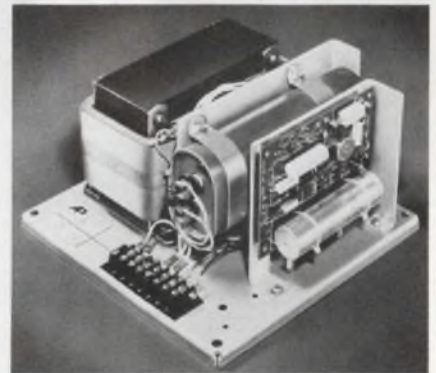

Advanced Power, Inc., 1621 S. Sinclair St., Anaheim, Calif. 92806. (714) 997-0034. From \$176; stock.

The controlled flux ac line regulator has voltage regulation of  $\pm 0.2\%$ , 100% overvoltage protection, automatic current limiting, short-circuit protection, insensitivity to multifrequency fluctuations and efficiency to 95% without heat dissipating shunt or series regulating elements. Input voltage ranges from 50 to 260 V ac with dual, simultaneous nominal outputs available of 117 and 235 V, which are adjustable over a wide range.

CIRCLE NO. 345



# CELCO makes CRT Camera Systems that will make YOU Smile!

Address inquiries to CELCO:  
70 Constantine Drive, Mahwah, NJ 07430  
1150 E. Eighth Street, Upland, CA 91786

## Introducing CELCO COF/FIC: Computer-On-Film/Film-Into-Computer

- CELCO DSC I: to 1000 TV lines, 16mm Camera • Low-Cost & Compact
- CELCO DSC II: to 2000 TV lines, 35mm Camera • Ultra-High Stability
- CELCO DSC III: to 4000 TV lines, 70mm Camera • Ultra-Low Distortion to 0.05%



CONSTANTINE ENGINEERING LABORATORIES COMPANY  
INFORMATION RETRIEVAL NUMBER 103

## FREE CATALOG

CHOOSE FROM OVER 4,500  
UNUSUAL BARGAINS  
OPTICS • SCIENCE • ELECTRONICS



### 1,000's OF HARD-TO-FIND BUYS FOR INDUSTRY

Brand new 164-page easy-to-read edition packed with new products, charts, diagrams, illustrations. On-the-job helps: quality control aids, unique, exclusive items to speed your work, improve quality, cut development and production costs! Loaded with optical, scientific and electronic equipment available from stock for industry, research labs, design engineers, experimenters, hobbyists.

#### ONE SOURCE FOR ALL YOUR NEEDS

Tremendous variety. Terrific savings. Countless hard-to-get surplus bargains. Many "one-of-a-kinds" nowhere else. Ingenious scientific tools. Thousands of components: lenses, prisms, wedges, mirrors, mounts, all types of accessories. Hundreds of instruments: pollution testing equipment, lasers, comparators, magnifiers, microscopes, projectors, telescopes, binoculars, photo attachments, ecological items, black light equipment and America's largest collection of unique lighting products.

#### BUY DIRECT WITH MONEY-BACK GUARANTEE

Edmund ships over 5,000 orders monthly to America's largest industrials — every item guaranteed! You must be satisfied, or return your purchase in 30 days for your money back. Shop the catalog of America's largest Science-Optics-Electronics Mart with confidence! Get your FREE copy without obligation. No salesman will call. Write now for free catalog "DA"



**EDMUND SCIENTIFIC CO.**  
300 ED CORP BUILDING  
BARRINGTON, NEW JERSEY 08007  
TELEPHONE: 609-547-3488

INFORMATION RETRIEVAL NUMBER 104

ELECTRONIC DESIGN 19, September 13, 1973

## LOWEST COST, COMPACT PAGE PRINTER FACIT 4553

- 15 cps
- 80 column
- 5 x 7 dot matrix for character flexibility
- Few moving parts — easy operation, quiet running
- Single print hammer
- No ribbon
- Easy paper loading
- Contains drive circuits and control electronics with character generation
- ASCII code standard
- Also same print method in a strip printer-4552
- Delivery from stock



Facit-Addo, Inc.  
501 Winsor Drive  
Secaucus, N.J.

**FACIT-ADDO, INC.**

Gentlemen: I am interested in receiving detailed data on your  4553 Page printer  4552 Strip printer

Name  Title

Phone

Company

Address

City  State  Zip

INFORMATION RETRIEVAL NUMBER 105

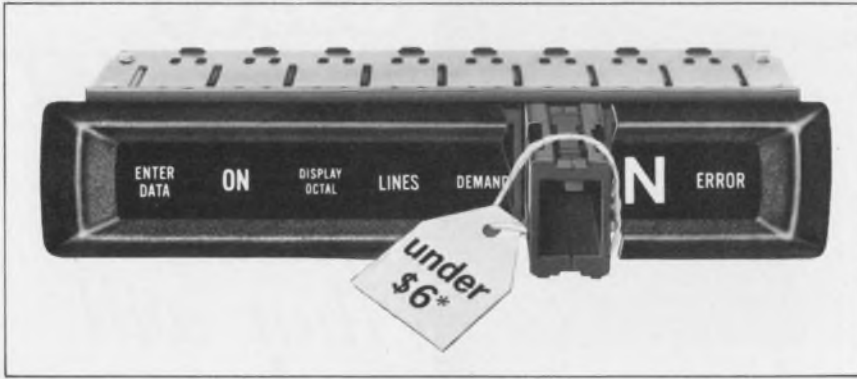

## NOW! A REAR-PROJECTION DISPLAY FOR UNDER \$6

IEE introduces the Series 1100 Readout, the first Rear-Projection display under \$6. Series 1100 costs far less than equivalent Rear-Projection models, yet packs all the similar features. We're talking of a .6" character displaying bright, crisp messages, numerals, symbols or colors, easily read from 20 feet. The total plug-in package (12 positions per readout) offers quick front panel removal for lamp and film servicing. Series 1100 accepts 5, 14 or 28 volt lamps compatible with DTL/TTL input

with a light output of 100 ft-L. Equally inexpensive is the mating Driver Decoder, the long life Series 7800. The Series 1100, low cost . . . high reliability . . . from the world leader in Rear-Projection displays. Give us a call. **Industrial Electronic Engineers, Inc., 7740 Lemona Ave., Van Nuys, Ca. 91405, Telephone: (213) 787-0311. TWX 910-495-1707.** Our European Office: 6707 Schifferstadt, Eichendorff-Allee 19, Germany, Phone: 06235-662.



\*In quantities of 1000

INFORMATION RETRIEVAL NUMBER 106

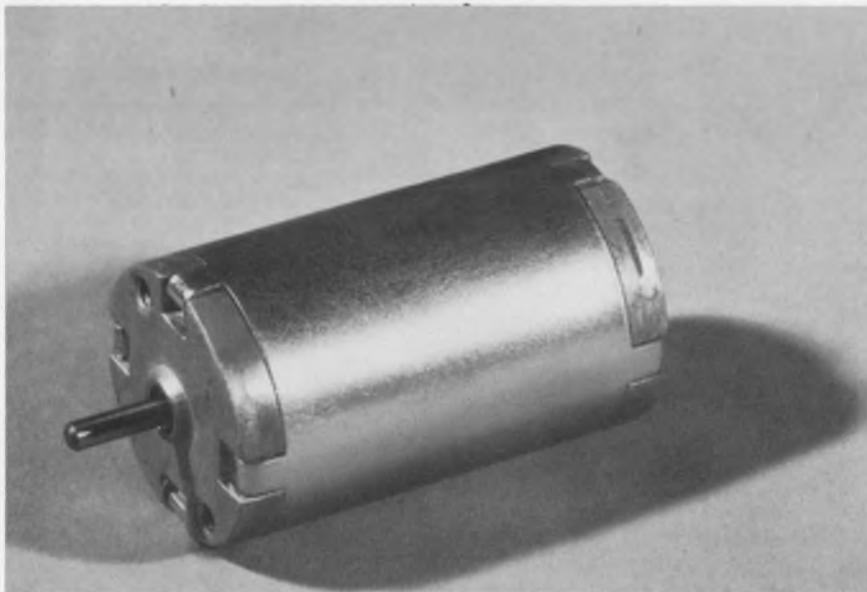

## new d-c motor speed regulated with variable-speed control

Introducing the Type FYQM, a new 1.3-inch dia, subfractional hp, commercial d-c motor. Speed control circuit board and built-in tachometer generator permit speed adjustment while motor is running, with close regulation at selected speed. Available with or without speed control. Gear-heads also available. For details, ask for Bulletin F-14652.



**BARBER-COLMAN COMPANY**  
Motor Division  
Dept. U, 12117 Rock Street, Rockford, Illinois 61101

BC-m-4

INFORMATION RETRIEVAL NUMBER 107

## INSTRUMENTATION

### Op amp tester checks six key parameters



*Electro Scientific Industries, 13900 N.W. Science Park Dr., Portland, Ore. 97229. (503) 646-4141. Less than \$700.*

Model 2134 IC Op Amp Tester performs the six most important Q/A checks on virtually all IC op amps, monolithic and hybrid. These tests are: Input offset voltage, bias current inverting input, bias current non-inverting input, dc open-loop gain, dc common-mode rejection ratio, and unity-gain closed-loop stability. Results are displayed on a 3-place digital readout, in millivolt, nanoampere, and dB units.

CIRCLE NO. 346

### Active filter offers two channels

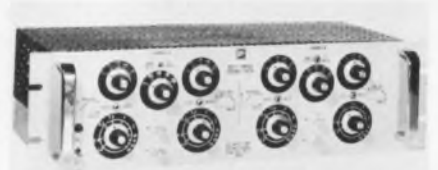

*A.P. Circuit Corp., 865 West End Ave., New York, N.Y. 10025. (212) 222-0876. \$1120 to \$1500; 2-4 wk.*

This variable-frequency, active filter operates with two simultaneous channels, yet is said to occupy half the space of conventional active filters. Cut-off frequencies are individually adjustable for each channel in five decades ranging from 0.02 to 200,000 Hz. Each channel is also independently adjustable for low-pass, high-pass, bandpass or band-reject modes of operation. The roll-off rate of 24 dB/octave can be increased to 48 dB/octave by operating the two channels in series.

CIRCLE NO. 347



## Mirror scanner controls rotation to 0.02%

General Scanning, 80 Coolidge Hill Rd., Watertown, Mass. 02172. (617) 924-6620. \$1165; 6 wk.

The CCX-100 scanner control system provides controlled rotation of mirrors up to 1 x 2-in. through an angle of 30 degrees peak-to-peak. Input is an analog voltage, usually 0 to 10 V dc from a d/a converter or signal generator. Deflection is proportional to input with a linearity of better than 0.2%. Resolution is better than one part in 5000 and step response time is better than 5 ms.

CIRCLE NO. 348

## Digital timer is accurate to .001%/year



Electronic Research Co., P.O. Box 913, Shawnee Mission, Kan. 66201. (913) 631-6700. \$249; 2 wk.

A digital timer with a timing range of 00.001 ms to 999.99 s describes the Model 220. The unit has a stated accuracy of 0.001% of the selected full-scale value, per year. Further, the instrument can be quickly configured by use of an external jumper to operate in either single-cycle or continuous cycle modes. The timer provides three parallel output signals during each timing cycle and an end-of-time signal at the termination of each cycle.

CIRCLE NO. 349

## Capacitor leakage tester checks 3600 units/hour

James G. Biddle Co., Plymouth Meeting, Pa. 19462. (215) 646-9200. \$2690.

Speed and sensitivity are the features of the 75-270 Capacitor Leakage Tester. Resistance values independent of test voltages are determined in one or two seconds. Both large and small capacitors can be handled for quality control and 100% incoming inspection at up to 3600 per hour.

CIRCLE NO. 350

## PC-board tester checks transition redundancy

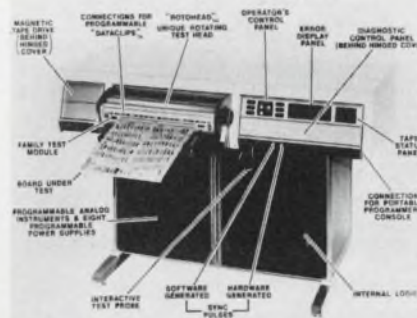

Data Test Corp., 822B Challenge Dr., Concord, Calif. 94520. (415) 689-3583. \$18,750 and up; 90 days.

Datatester 5700 series is a high-volume, PC-board automatic test system that handles large cards and features computer-enhanced testing. The standard unit has a capacity of 512 pins per board, and an optional version can handle up to 1024 pins. Testing speeds range to 2 MHz. A modular design aids users to develop the optimum system configuration.

CIRCLE NO. 351

## 860-MHz sweep gen can be set to 1%



Test & Measuring Instruments, 224 Duffy Ave., Hicksville, N.Y. 11802. (516) 433-8800. \$575.

The PM5334 HF sweep generator covers the frequency range from 3 to 860 MHz in eight panel-selected sweep ranges. Setting accuracy anywhere in the eight ranges is better than 1%. Sweep width is continuously adjustable and the sweep can be made to cover any of the eight bands or any fraction of any band. Sweep frequency is continuously adjustable from 8 to 50 Hz on any band. The unit offers fixed frequency markers at 5.5, 10.7 and 38.9 MHz, each with 0.1% stability.

CIRCLE NO. 352

For five cents, I'd start something.

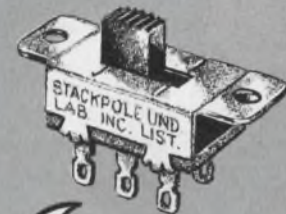
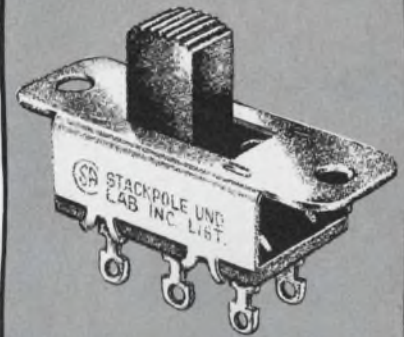

me too.

Turn on with a Stackpole slide switch. Prices start at 5¢ for this field proven standard of the industry. Available in two sizes, Regular and the new 50% smaller Miniature Series. Fully UL and CSA approved. Rated from 1 to 10 amps @ 125 and 250 volts (Miniature Series rated at 3 amps @ 125 V). Over 23 basic types, 7960 variations of slide and rocker switch adaptations. For complete details, send for Bulletin 78/79-100.



**STACKPOLE**  
COMPONENTS COMPANY  
Raleigh, N. C. 27610

INFORMATION RETRIEVAL NUMBER 108

# syntronic

## YOKE PROBLEM SOLVERS

Which deflection yoke should you use?

We constantly find new design concepts to resolve yoke problems for display engineers. Ask Syntronic for a recommendation on your application.



**SYNTRONIC  
INSTRUMENTS, INC.**

100 Industrial Rd. Addison, IL 60101  
Phone: (312) 543-6444



INFORMATION RETRIEVAL NUMBER 109

### INSTRUMENTATION

#### Nine column printer sells for \$495



Newport Labs, 630 E. Young St.,  
Santa Ana, Calif. 92705 (714)  
540-4914. \$495.

Half-rack size (4-1/2 by 8-1/2) and nine columns describe the Model 810 Data Printer. TTL-compatible rear-connector data inputs and control signals can be easily converted from positive "true" to negative "true" logic. A spare IC flip-flop, gate and inverter are pin accessible from the rear connector, as is a spare 16-pin IC DIP socket. (The printer is furnished with a DTL quad 2-input gate package installed in the DIP socket). The 810 also features programmable two-color printing, fixed or floating decimal point and uses standard adding machine paper.

CIRCLE NO. 353

#### Unit analyzes records noise components

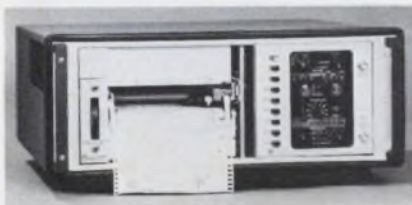

General Radio, 300 Baker Ave.,  
Concord, Mass. 01742. (617) 369-  
4400. Mainframe: \$2575; plug-in:  
\$3500.

1523-P4 wave analyzer plug-in for GR's 1523 Graphic Level Recorder is designed specifically for detailed noise-analysis studies, that is, high-resolution spectral analysis, swept-frequency analysis with a tuned detector, and amplitude-vs-time measurements at selected frequencies. Specs include bw's of 10 and 100 Hz, a dynamic range of 80 dB, and an analysis range of 10 Hz to 80 kHz. Log and linear plotting modes and tracking analyzer outputs are provided for maximum flexibility.

CIRCLE NO. 354

#### 10-MHz dual-trace scope costs just \$450



Jermyn, 712 Montgomery St., San  
Francisco, Calif. 94111. (415) 362-  
7431. \$450.

The Scopex 4D-10 Dual Trace Oscilloscope is completely solid state, with a sensitivity of 10 mV/cm and a bandwidth of dc to 10 MHz to the 3-dB point. Triggering is by means of one continuously-variable control, which sets polarity and the trigger level point. Other features include the 'bright line' auto display where the time base free runs when a trigger signal is absent; and a 'trace locate' facility, which returns a lost trace to the display area.

CIRCLE NO. 355

#### Logic probe is CMOS compatible



Kurz-Kasch Inc., Electronics Div.,  
2876 Culver Ave., Dayton, Ohio  
45429. (513) 296-0330. \$79.

C-MOS-compatible, LP-570 logic probe uses three lighted displays to indicate logic levels of 5 to 15 V dc. Logic thresholds are nominally 70% of the supply for a logic ONE, indicated by a red display, and 30% of the supply for a logic ZERO, indicated by a white display, over the range 5-15 V. The deadband between these two states is approx. equal to 40% of Vdd span and is indicated by no display. A "P" or pulse function displays pulses as fast as 100 ns. These signals are indicated by a blue display.

CIRCLE NO. 356

## 1.8-GHz analyzer resolves 30 Hz

*Tektronix, P.O. Box 500, Beaverton, Ore. 97005. (503) 644-0161. \$6500; 6 wk.*

Model 7L13 spectrum analyzer operates to 1.8 GHz. The unit is said to be so free of internal frequency modulation that it can separate close-together signals with 30-Hz resolution bandwidth, and usefully display the results. FMing is limited to less than 10 Hz. Other features are 70-dB dynamic range and less than 70-dB intermodulation products when two full-display signals are present.

CIRCLE NO. 357

## Pyroelectric radiometer spans eight decades

*Laser Precision Corp., 5 West Whitesboro St., Yorkville, N.Y. 13495. (315) 797-4449. \$1390; 60 days.*

The Rk-3240 Pyroelectric Radiometer measures laser or thermal total power or density from ultraviolet to the far infrared. Exhibiting eight decades of dynamic range, the unit is considerably more sensitive than thermal radiometers using thermocouples or thermopiles. The Rk-3240 readout features nine meter ranges from 200 nW to 10 W full scale. A choice of three sampling rates allows optimization for either speed or sensitivity. Digital readout is provided as well as auxiliary BCD and direct outputs.

CIRCLE NO. 358

## Function generators also sweep

*Ailtech, 19535 E. Walnut Dr., City of Industry, Calif. 91748. (213) 965-4911. 505: \$695; 515: \$845; 525: \$1045.*

Three function generators incorporate an independent, yet integrated, sawtooth generator. The 505, 515 and 525 generate sine waves, triangles, square waves, sawtooth waveforms, pulses, low-duty cycle pulses, tone bursts, swept sine, swept triangle, swept square waves, swept prb, haversines, mono pulses, etc. The main generator can be selected with top frequency of 5, 10 or 20 MHz. The sawtooth generator operates from 0.001 Hz to 100 kHz.

CIRCLE NO. 359

## Portable unit programs pROM in the field



*Curtis Electro Devices, Box 4090, Mountain View, Calif. 94040. (415) 964-3136. \$279.50; stock to 2 wk.*

A portable field programmer for the Signetics 10139 ECL pROM, the PR-10139, allows on-the-spot programming of the  $32 \times 8$  device by unskilled personnel. An average device takes five minutes to program. Output states are continuously indicated on eight lamps for the word address selected on an octal thumbwheel switch. Housed in a  $12 \times 6 \times 4$ -in. metal enclosure, the PR-10139 weighs 4 pounds.

CIRCLE NO. 360

## Radiometer handles nine channels simultaneously



*International Light Inc., Dexter Industrial Green, Newburyport, Mass. 01950. (617) 465-5923. \$2900.*

The IL463 Multichannel Uniformity Radiometer determines the uniformity and level of uv light reaching a photo-resist coated substrate. The system allows for control of processing parameters to ensure product repeatability and quality. Nine channels are standard. The system is accurate to  $\pm 1\%$  and is traceable to the National Bureau of Standards. A 100 to 1 dynamic range covers a multitude of irradiance levels.

CIRCLE NO. 361

You're a penny-pinching, up-tight, li'l switch with no spark.

True.

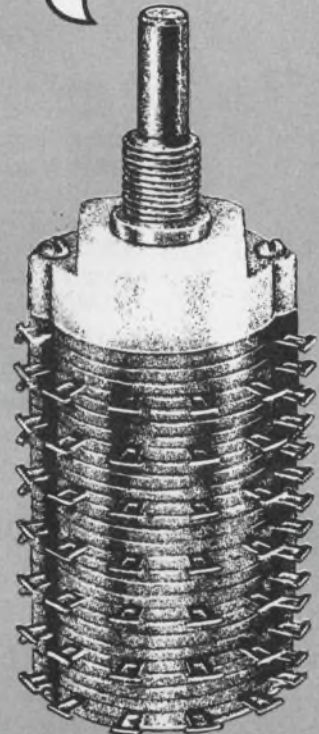

There's no better value than a Stackpole rotary switch. Fast delivery and quality features, but at a price you can afford. Unique design achieves a totally enclosed rotary, without sacrificing complex switching capability. Rigid construction and molded terminals produce a switch so tight it's explosion proof. Samples immediately. Production quantities in 1 to 2 weeks. Including switches with PC mounting. For details, send for Bulletin 73-103.

 **STACKPOLE**  
COMPONENTS COMPANY  
Raleigh, N. C. 27610

INFORMATION RETRIEVAL NUMBER 110

# When PRD makes frequency synthesizers, the performance is high...

# not the price.



**Our 7828 Frequency Synthesizer** is offered with 1 kHz phase-locked steps from 1 kHz to 80 MHz. An optional vernier provides 1 Hz resolution. It's fully programmable with contact closures, RTL, DTL, or TTL logic; 1 part in  $10^6$ /mo stability; up to 1.0 volt output into 50 ohms.

**Our 7808 Signal Generator/Frequency Synthesizer-Sweeper** has digital synthesizer performance, yet retains the manual and vernier tuning and low spurious output of conventional signal generators. Its frequency range is 0.05 to 80 MHz. Key functions are programmable.

Best of all, these synthesizers cost little more than half the price of comparable instruments. For literature, write:



PRD Electronics, Inc.  
A subsidiary of Harris-Intertype Corporation  
1200 Prospect Avenue  
Westbury, N.Y. 11590 Tel: (516) 334-7810

INFORMATION RETRIEVAL NUMBER 111

## design aids

### Chemical element table

A "Periodic Table of the Chemical Elements" shows the electronic arrangement of the elements (number of electrons in each shell); and the naturally occurring isotopes and ionization potentials for each element. Elements through 105 (Hahnium) are listed. The following information is included in the table—name, symbol, atomic number, valences, atomic weight, and boiling and melting points in degrees C. A drawing of the element's crystal structure is included. Price of the 2 × 3-foot chart is \$2. International Rectifier, Semiconductor Div., 233 Kansas St., El Segundo, Calif. 90245.

### Thermal switches

A five-color chart describes thermal parameters and operation characteristics of both rod-and-tube and leaf-type switches. Operating ranges of the switches are from below zero to over 1850 F. Control Products Inc.

CIRCLE NO. 362

### Capacitor calculators

A plastic "Microfarad Manipulator" slide rule simplifies capacitor calculations. On one side the calculator relates capacitance, reactance, resistance, frequency and dissipation factor. On the other, it relates ripple, voltage, power dissipation, impedance and resistance. It includes inches to millimeters and centigrade to fahrenheit converters and cm/mm/inches rules. Complete instructions are printed on both the calculator and its packaging envelope. The calculator is priced at \$1. Union Carbide Corp., P.O. Box 5928, Greenville, S.C. 29606.

### Ferrite core kits

Three ferrite parts kits for use in prototype design and emergency debugging applications contain a variety of standard cores (single or double hole) that are suited for wideband transformers, splitters and taps. Ferronics, Inc.

CIRCLE NO. 363

## ERIE FREQUENCY CONTROL

### The Need:

**A 1.22880 MHz CRYSTAL TO MEET  
100 G SHOCK AND +50 G VIBRATION**

**PROBLEM-  
SOLUTION  
#14**



### PROBLEM

The military demanded a miniature 1.22880 MHz crystal be designed to resist a shock of 100 G and 50 G vibration guaranteed through continuous monitoring during test, while maintaining all frequency and resistance tolerances.

### ERIE'S SOLUTION

Erie designed a special welded mount which clamped the crystal without restricting the free vibration of the piezoelectric plate, enabling it to meet this rugged performance criteria.

**CRYSTALS . . . CRYSTAL FILTERS . . . OSCILLATORS**

Write for our fully illustrated catalog and send us your Frequency Control problem for solution.



# ERIE

## ERIE FREQUENCY CONTROL

453 LINCOLN ST., CARLISLE, PA. 17013 (717) 249-2232  
DIVISION OF ERIE TECHNOLOGICAL PRODUCTS, INC.

INFORMATION RETRIEVAL NUMBER 112

# application notes

## Data communications guide

"The Communications Handbook," an illustrated 323-pager, includes fundamentals, design and implementation of data communications systems. Tables of commonly used character codes, a summary of the characteristics of Bell System data sets and abstracts from EIA standards are included. The price for this handbook is \$3 (Calif. residents add 5% sales tax). Microdata, 17481 Red Hill Ave., Irvine, Calif. 92705.

## TV-to-computer interface

Interfacing television cameras to computers for image processing is described in an eight-page application note. Colorado Video, Inc., Boulder, Colo.

CIRCLE NO. 364

## RAM technology

A monograph describes all current MOS and bipolar RAM technologies, performance, cost and manufacturing methods. All points in the brochure apply to semiconductor memory applications only and many of the general RAM technology statements do not apply to logic or analog functions. Advanced Memory Systems, Sunnyvale, Calif.

CIRCLE NO. 365

## D/a converters

Notes on fast-settling d/a converters give hints on how to choose the right converter. Computer Labs, Greensboro, N.C.

CIRCLE NO. 366

## Numerical display

"Enhancing The Visibility of The Numitron Display in Sunlight" lists a number of specific design practices that are recommended to maximize the over-all display contrast ratio. These practices include use of light shields, matte finish paints, antireflection-type filters, filter mounting and panel overhangs. RCA, Harrison, N.J.

CIRCLE NO. 367

## Surge arresters, lamps

"Gas Discharge Devices for Use in Transient Voltage Protection and Electrical Energy Transfer" is the feature piece in a technical data package. The 28-page manual is divided into two parts—transient protection and energy transfer. Supplementing the manual are specification sheets on devices produced by the company. A 12-page application manual for gas discharge circuit components and voltage regulators is included as well as an eight-page catalog on neon lamps. Signalite, Neptune, N.J.

CIRCLE NO. 368

## A Programming Language

One of the most clear and sparkingly written introductions to APL appears in a recent issue of *Tekgraphics*, a young house organ. The thoroughly human treatment of what's usually a bone-dry subject is refreshingly different. Tektronix, Beaverton, Ore.

CIRCLE NO. 369

## Rf power amplifier design

An illustrated 12-page booklet contains design charts for use in designing rf power amplifiers using high-power transistors. The booklet is indexed and includes an explanation of terminology and symbols in working with high-power, solid-state devices. CTC, San Carlos, Calif.

CIRCLE NO. 370

## Function generators

"Selecting the Function Generator to Fit Your Application" helps to identify application requirements, its environment and the price/performance decision that should be made. Cal Tek Engineering, Wayland, Mass.

CIRCLE NO. 371

## NUTRAN programming

A self-learning text describes the use of NUTRAN, a FORTRAN-like conversational language. The brochure contains in-depth descriptions of the fundamentals of the NUTRAN language, including development and use of NUTRAN statements, on-line execution and debugging of programs and solution of mathematical problems. Nuclear Data, Inc., Palatine, Ill.

CIRCLE NO. 372

Switch on NOISE,  
Switch off NOISE,  
Switch on NOISE,  
Switch off NOISE.

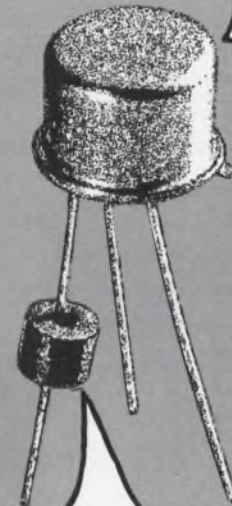

Quiet!



Ceramag® ferrite beads provide a simple, inexpensive means of obtaining RF decoupling, shielding and parasitic suppression without sacrificing low frequency power or signal level. Install beads by slipping one (or more) over appropriate conductor(s) for desired effect. Sizes from .020" ID - .038" OD - .050" L. Beads available with leads for PC boards. Send for samples.



**STACKPOLE**

Electronic Components Division

St. Marys, Pa. 15857

INFORMATION RETRIEVAL NUMBER 113

## MEMO

FROM: *Bill Wright*  
*Purchasing*  
TO: *Engineering Dept.*  
*Looks Interesting*

### 2 BILLION MODELS! 2 DAY DELIVERY "OMNI SERIES"

#### Modular Power Supplies

- 1 to 12 outputs
- 5 to 28 volts — to 635 watts
- .01% IC regulation
- competitive cost
- masterfully engineered

FREE bulletin 115A tells  
how we make it happen!

**Deltron inc.**

Wissahickon Ave.,  
North Wales, Pa. 19454



L-205

INFORMATION RETRIEVAL NUMBER 114

## NEW! DELAY LINES

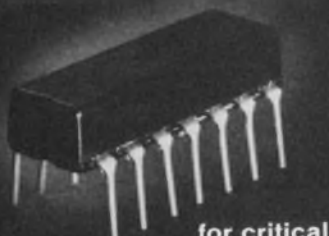

for critical  
timing applications

#### in true DIP configuration

10 NS DELAY UNIT with  $T_D/T_R > 8:1$ , tapped every NS.  
15 NS DELAY UNIT with  $T_D/T_R > 3:1$ , tapped every 3 NS.

Both units have 100 ohm Z, 10% max distortion, less than 2% attenuation and 50 VDC breakdown voltage. Delay is unaffected by DC bias. Use them singly or as a set. Available at \$15.00/unit.

**Technitrol Inc.**  
COMPONENTS DIVISION

1952 E. Allegheny Ave., Phila., Pa. 19134 (215) 426-9105

INFORMATION RETRIEVAL NUMBER 115

## new literature



### Test accessories

A 64-page catalog provides illustrations and engineering information on electronic test accessories, including schematics, specifications, features and operating ranges. Pomona Electronics, Pomona, Calif.

CIRCLE NO. 373

### Connectors, coaxial cables

A six-page brochure gives illustrated summaries of SMA, SMB and SMC-type connectors, coaxial cables and assemblies, rigid transmission lines, elliptical and rigid rectangular waveguide, miniature coaxial cables and coaxial delay lines. Cablewave Systems, North Haven, Conn.

CIRCLE NO. 377

### Low-pass filters

Over 30 standard EMI broadband low-pass filters, designed to augment the basic Maxi-Brute series, are described in a four-page catalog. The Potter Co., Wesson, Miss.

CIRCLE NO. 378

### Lampholders

Standard as well as special-purpose lampholders are described in a catalog. Applications and technical data are accompanied by drawings showing terminations, mountings, mounting requirements and electrical contacts. Kulka Electric, Mount Vernon, N.Y.

CIRCLE NO. 379

### Capacitors

A quick guide to MIL style rectangular metal-case foil Tantalex capacitors abstracts important data from MIL-C-3965 in an easy-to-use format. Sprague, North Adams, Mass.

CIRCLE NO. 381

### Front-panel knobs

Two catalogs describe front-panel knobs. Catalog PK-374 describes plastic molded knobs with illustrations, dimensions and volume pricing. Catalog K-375 covers anodized machined aluminum knobs. It is illustrated with dimensions and pricing. Alco Electronic Products, North Andover, Mass.

CIRCLE NO. 382

### Procedures for CATV

"No Loose Ends" contains a set of procedures to satisfy the proof-of-performance requirements as set down by FCC §76:605. This "cookbook" contains only procedures—no theoretical discussion—so that any technician can obtain meaningful results. Tektronix, Beaverton, Ore.

CIRCLE NO. 383

### Light measurements

Instruments for measuring radiation in the ultraviolet, visible and infrared portions of the spectrum are described in a catalog. Gamma Scientific, San Diego, Calif.

CIRCLE NO. 384

### Printer/plotters

Specifications for an electrostatic printer/plotter are described in a brochure. Gould, Inc., Newton Upper Falls, Mass.

CIRCLE NO. 385

### Thermal cutoffs

A six-page brochure cites applications, terminations, mounting techniques and safety aspects using thermal cutoffs in electrical products. Micro Devices Corp., Dayton, Ohio.

CIRCLE NO. 386

## Programmed controllers

Programmable controllers for new or existing machine tools or processes are described in a 12-page booklet. Allen-Bradley, Highland Heights, Ohio.

CIRCLE NO. 387

## Analog recorder preamps

Specifications for multichannel recorder plug-in preamps are listed in a data sheet. Gulton Industries, East Greenwich, Conn.

CIRCLE NO. 388

## Computer systems

"Solving the tough real-time problems . . ." is the title of a six-page bulletin that highlights the application versatility of 32-bit real-time computer systems—Systems 85/86. Systems Engineering Laboratories, Fort Lauderdale, Fla.

CIRCLE NO. 389

## Sensors and transducers

A selector guide describes characteristics and construction features of sensors, pressure transducers in standard ranges from 1 to 10,000 psi and digital/analog indicators. Genisco Technology Corp., Compton, Calif.

CIRCLE NO. 390

## Monolithic Darlington amps

Monolithic Darlington amplifiers, series SVT6250 capable of switching 5 A at 400 V, are described in a data sheet. Ratings and specifications, in addition to four operating curves, are shown. TRW Semiconductor, Lawndale, Calif.

CIRCLE NO. 391

## DPM

Specifications, installation and operating instructions for the model 3312 digital panel meter are included in a four-page bulletin. Data Technology Corp., Santa Ana, Calif.

CIRCLE NO. 392

## Modules

Voltsensors, power supplies, amplifiers and two new families of industrial-oriented detector packages are detailed in a 16-page catalog. Included are specifications, block diagrams, operation curves and prices. Calnex, Alamo, Calif.

CIRCLE NO. 393

## Testing digital boards

"Circuit Designers Can Make Digital Boards Easier to Test" is charmingly illustrated and is addressed to the design engineer (rather than the production engineer). It sticks to the "do-able" aspects instead of the theoretical. Teradyne, Boston, Mass.

CIRCLE NO. 394

## Electrical cord lines

Twenty new products appear in an updated 24-page catalog of appliance, power supply and extension cords. Belden Corp., Geneva, Ill.

CIRCLE NO. 395

## Analyzers

An eight-page bulletin describes model SAI-43A real-time digital correlation and probability analyzer. Standard and optional features are included. Signal Analysis Operation, Happaage, N.Y.

CHECK NO. 396

## Absolute timing systems

A handbook on the theory and application of absolute timing systems outlines techniques on how to synchronize to within microseconds to Universal Time, and describes redundancy techniques to obtain over-all system reliability of better than 100,000 hours. Data-metrics, Wilmington, Mass.

CHECK NO. 397

## Thermal instrumentation

A short-form catalog describes thermal instrumentation and contains conversion tables, charts, graphs and equations for thermocouples, RTDs and heat-flux instrumentation. Hy-Cal Engineering, Santa Fe Springs, Calif.

CHECK NO. 398

## LSI logic cards

A brochure describes the L series of LSI functional logic cards for designing general and special-purpose minicomputers. The brochure introduces the family of eleven 3 × 5 in. digital logic cards with a section on its basic architecture. Each of the cards is highlighted to include specifications and applications. Control Logic, Natick, Mass.

CHECK NO. 399

**Cut and  
formed leads  
reduce  
assembly  
costs.**

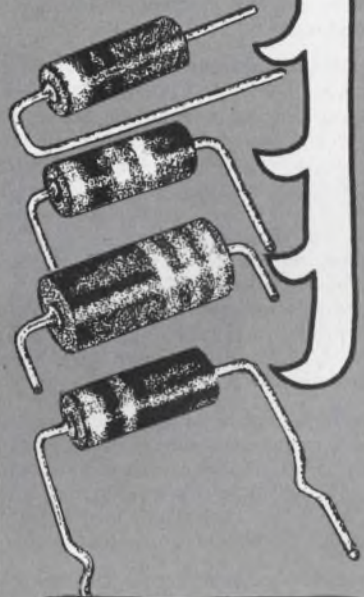

**Now that's  
a nice  
twist.**

Pre-shaped and trimmed resistor leads significantly reduce installation time. All Stackpole carbon composition resistors, 2, 1, ½, and ¼ watts are available with cut and formed leads, to your specifications. Leads are coated for easy soldering. All resistors are 100% tested. Samples available. Send for Bulletin 80-100.



**STACKPOLE**

Electronic Components Division

Kane, Pa. 16735

ELECTRONIC DESIGN's function is:

- To aid progress in the electronics manufacturing industry by promoting good design.
- To give the electronic design engineer concepts and ideas that make his job easier and more productive.
- To provide a central source of timely electronics information.
- To promote communication among members of the electronics engineering community.

**Want a subscription?** ELECTRONIC DESIGN is sent free to qualified engineers and engineering managers doing design work, supervising design or setting standards in the United States and Western Europe. For a free subscription, use the application form bound in the magazine. If none is included, write to us direct for an application form.

If you do not qualify, you may take out a paid subscription for \$30 a year in the U.S.A., \$40 a year elsewhere. Single copies are \$1.50 each.

**If you change your address,** send us an old mailing label and your new address; there is generally a postcard for this bound in the magazine. You will have to requalify to continue receiving ELECTRONIC DESIGN free.

**The accuracy policy of ELECTRONIC DESIGN is:**

- To make diligent efforts to ensure the accuracy of editorial matter.
- To publish prompt corrections whenever inaccuracies are brought to our attention. Corrections appear in "Across the Desk."
- To encourage our readers as responsible members of our business community to report to us misleading or fraudulent advertising.
- To refuse any advertisement deemed to be misleading or fraudulent.

Microfilm copies are available of complete volumes of ELECTRONIC DESIGN at \$19.00 per volume, beginning with Volume 9, 1961. Work is now in process to complete the microfilm edition of Volumes 1-8. Reprints of individual articles may be obtained for \$2.00 each, prepaid (\$.50 for each additional copy of the same article) no matter how long the article. For further details and to place orders, contact the Customer Services Department, University Microfilms, 300 North Zeeb Road, Ann Arbor, Michigan 48106 telephone (313) 761-4700.

**Want to contact us?** If you have any comments or wish to submit a manuscript or article outline, address your correspondence to:

Editor  
ELECTRONIC DESIGN  
50 Essex Street  
Rochelle Park, N.J. 07662

## The First 500-Line Real-Time Spectrum Analyzer-Averager

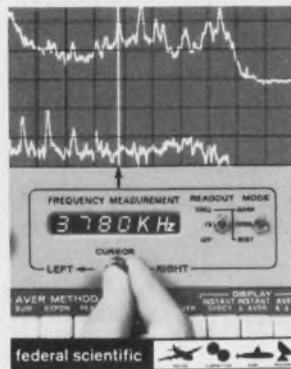

New UA-500, the most powerful analyzer of its type, offers the only standard built-in dual memory averager. Unique digital cursor reads directly in Hz. Portable, small (8-3/4"), for field and lab. **Fastest speed** minimum test time, presents flicker-free display: real-time to 10 KHz, max. range of 100 KHz, 20 sweeps/sec display rate. **Best possible resolution:** sharpest analysis filter (proprietary 24dB/octave slope) so that 500-line analyzer has effective **650 lines**. Dual memory averager allows simultaneous display of continually updated exponential average & previously stored average. To **verify quality of data**, instantaneous spectra can be viewed on the same CRT as average . . . input time function can also be displayed. Plus other standard features: transient capture, exponential & peak averaging, lin-log scales both vertical & horizontal, complete plotter set-up & recording, computer compatibility with remote sensing or control.

### Federal Scientific Corporation

An Affiliate of Nicolet Instrument  
615 West 131st St., New York, N.Y. 10027 (212) 286-4400

CIRCLE NO. 171

## Measure Vector Angle, Magnitude And Components



The new P.A.R. Corp. Model 129A Two Phase Lock-In/Vector Voltmeter, enables you to simultaneously measure the magnitude and phase angle with respect to a reference signal of virtually any low-level signal within its range of 0.5 Hz to 100 kHz—even if the signal is buried 60 dB beneath background noise. At the flip of a switch, you can also measure the in-phase and quadrature components of the vector. The Model 129A features fully automatic reference tracking, independent output expansion and filtering for each channel. Complete specifications are contained in bulletin T-314, available on request.

CIRCLE NO. 172

## PRINCETON APPLIED RESEARCH CORPORATION

P.O. Box 2565  
Princeton, New Jersey 08540 (609) 452-2111

## 400 IDEAS FOR DESIGN Volume 2

Edited by Frank Egan



A unique sourcebook of practical design techniques and approaches using the latest components, representing the best contributions to *Electronic Design's* "Ideas for Design" column. All selected for their practical value in solving the design engineer's most common, everyday problems. They have proved useful as parts of larger designs or as aids in measuring the parameters and testing the effectiveness of existing designs. 288 pp., 7 1/8 x 9 3/4, illus., cloth, \$11.95. **Circle the reader-service number to order a 15-day examination copy.**

CIRCLE NO. 173



HAYDEN BOOK COMPANY, INC., 50 Essex St., Rochelle Park, N.J. 07662



# Manufacturers

Advertisements of booklets, brochures, catalogs and data sheets. To order use Reader-Service Card.  
(Advertisement)

## Operator Can "Talk" Directly to Automatic Spectrum Processing System



Engineers without prior knowledge of computer operation "talk" directly to the SD1007D Automatic Spectrum Processing System after only brief indoctrination. Unusually flexible software allows complete operator/system interaction: changes in test procedures and data-processing input/output formats can be made as the test program requires. A single typed-in "DO" command in easily learned FOCAL language initiates an entire computer operation, complete to typed-out results. System includes a 500-line resolution Real Time Analyzer, large-screen oscilloscope, PDP 11-105 computer with 8K of core, and a Teletype for program loading, operator interaction and typing out results.

CIRCLE NO. 174

### Spectral Dynamics Corporation

P.O. Box 671, San Diego, Calif. 92112  
(714) 278-2501

## PRACTICAL RELAY CIRCUITS

By Frank J. Oliver



Uniquely groups various relay circuits according to the functions they perform, enabling the systems designer to quickly select the best circuit for his specific purposes. Includes arc and RFI suppression systems; time delay function; audio tone control and resonant-reed relays; sequential relays; protective functions of relays against overload overvoltage, and overcurrent, pulse generation and detection; logic circuits; and more. Particularly important is coverage of pulse-operated relay systems now extensively used with automated control systems. Illustrated with many circuit diagrams using the latest American National Standard graphical symbols. 363 pp., 6 x 9 1/4, illus., cloth, \$14.95. Circle the reader-service number to order a 15-day examination copy.

CIRCLE NO. 175



HAYDEN BOOK COMPANY, INC., 50 Essex St., Rochelle Park, N.J. 07662

## "PRECISION WIND TUNNEL AND VELOCITY CALIBRATOR HANDBOOK"



WILMINGTON, MASS.—Datametrics is pleased to offer our new valuable handbook for selecting the appropriate Wind Tunnel by choosing any two out of three parameters, such as Test Section Area, Max. Velocity in given Test Section Area, and required Wind Tunnel Horse power. In addition, outlines other parameters to be considered such as wind noise and turbulence level.

This handbook should prove to be extremely valuable for engineers engaged in velocity instrument calibration, fundamental flow pattern studies, scale model tests, and laboratory demonstrations.

CIRCLE NO. 176

### Datametrics

A subsidiary of ITE Imperial Corporation  
340 Fordham Rd., Wilmington, Mass. 01887 (617) 658-5410

# Electronic Design

## Advertising Sales Staff

Tom W. Carr  
Vice President &  
Sales Manager

### Rochelle Park, N.J. 07662

Robert W. Gascoigne  
Daniel J. Rowland  
50 Essex Street  
(201) 843-0550  
TWX: 710-990-5071

### Philadelphia

Thomas P. Barth  
50 Essex Street  
Rochelle Park, N.J. 07662  
(201) 843-0550

### Boston 02178

Gene Pritchard  
P.O. Box 379  
Belmont, Mass. 02178  
(617) 489-2340

### Chicago 60611

Thomas P. Kavooras  
Berry Conner, Jr.  
200 East Ontario  
(312) 337-0588

### Cleveland

Thomas P. Kavooras  
(Chicago)  
(312) 337-0588  
(call collect)

### Los Angeles 90303

Stanley I. Ehrenclou  
Burt Underwood  
2930 Imperial Highway  
Inglewood, Calif.  
(213) 757-0183

### San Francisco 94022

Jerry D. Latta  
P.O. Box 1248  
Los Altos, Calif.  
(415) 965-2636

### London W. 1

For United Kingdom and Holland  
Brayton C. Nichols

For Eastern Europe  
Peter Kehr

The American Magazine Group

9 Warwick Street  
London, W. 1, England  
Phone: 437 5462

Cable: Ammagnic, London

### Tokyo

Haruki Hirayama  
Electronic Media Service  
5th Floor, Lila Bldg.,  
4-9-8 Roppong  
Minato-ku  
Phone: 402-4556  
Cable: Electronicmedia, Tokyo

### Recruitment, Quick Ads, Classified

Allen Weinberg  
50 Essex Street  
Rochelle Park, N.J. 07662  
(201) 843-0550



# advertiser's index

Advertiser	Page	Advertiser	Page	Advertiser	Page
Abbott Transistor Laboratories, Inc.	6	GTE Automatic Electric	14, 15	PRD Electronics, Inc.	142
Acopian Corp.	135	General Electric Company	41, 104, 124	Piher International Corp.	58, 59
Adams & Westlake Company, Inc.		General Electric Company, Miniature Lamp Products Department	117	Power/Mate Corp.	151
The	113	Graham Magnetics Incorporated	98	Potter & Brumfield, Division of AMF Incorporated	37
Allen Bradley Co.	27	Grayhill, Inc.	121	Precision Monolithics Incorporated	79
American Aluminum Company	135			Princeton Applied Research Corp.	146
Analog Devices, Inc.	120				
Associated Testing Laboratories, Inc.	119	Hamamatsu Corp.	149	RCA Electronic Components	50
Augat, Inc.	35	Harris Semiconductor, A Division of Harris Intertype Corporation	16A	Raytheon Company	116
		Harshaw Chemical Company, Inc.	123	Rogers Corporation	119
Barber-Colman Company	138	Hayden Book Company, Inc.	146, 147, 151	Ross Controls Corporation	133
Beckman Instruments, Inc. Helipot Division	105	Heath/Schlumberger Scientific Instruments	109		
Belden Corporation	10, 11	Hecon Corporation	129	Schrack Electrical Sales Co.	125
Bell Industries/J. J. Miller Division	131	Heinemann Electric Company	40	Schauer Manufacturing Corp.	114
Burroughs Corporation	Cover IV	Hewlett-Packard	1, 16B, 16C, 74, 75	Sealed Air Corporation	111
		Hipotonics Inc.	132	Shelley/Datatron	125, 127
California Eastern Laboratories, Inc.	151	HiTemCo	151	Signalite, Division of General Instrument Corporation	125
CELCO (Constantine Engineering Laboratories Co.)	137	Houston Instruments	84	Signetics Corporation	8, 9
Clare & Co., C. P.	21	Howard Industries, A Division of MSL Industries, Inc.	30	Siliconix, Incorporated	56
Clare-Pendar	41	Hutson Industries	108	Simpson Electric Company	89
Computer Automation, Inc.	17			Solitron Devices, Inc.	85
Constantine Engineering Laboratories Co. (CELCO)	137	Imperial Travel Service	48	Spectral Dynamics Corporation	147
Corning Glass Works, Electronic Products Division	4, 5	Indiana General, Electronic Products	91	Sprague Electric Company	12
		Industrial Electronic Engineers, Inc.	138	Sackpole Carbon Company	143, 145
Dale Electronics, Inc.	Cover II	Intech Incorporated	112	Stackpole Components Company	139, 141
Data Precision Corporation	133, 151	Intel Corporation	101, 103	Syntronic Instruments, Inc.	140
Datametrics	147	Intersil	66, 67	Systron-Donner	122
Decitek, A Division of Jamesbury Corp.	118	Itek Measurement Systems Division	127		
Delta Products, Inc.	47			TEC, Incorporated	133
Deltron, Inc.	144	Johanson Manufacturing Corp.	151	TRW/UTC Transformers, An Electronic Components Division of TRW, Inc.	45
Dialight Corporation	42, 43			Technical Wire Products, Inc.	121
		Krohn-Hite Corporation	49	Technitrol, Inc.	144
E & L Instruments, Incorporated	128	Kurz-Kasch, Inc.	135	Tektronics, Inc.	53, 54, 55
Edmund Scientific Company	137			Teledyne Relays, A Teledyne Company	2
Electro Scientific Industries	16D	Lambda Electronics Corp.	Cover III	Texas Instruments, Incorporated	106, 130
Elec-Trol, Inc.	128	Licon, Division of Illinois Tool Works, Inc.	33	Thermalloy Company	110
Electronic Design	149				
Electronic Memories & Magnetics Corp.	20	MCL, Inc.	121	USCC/Centralab Electronics Division, Globe-Union, Inc.	28, 29
Electronic Navigation Industries	13	McLean Engineering Laboratories	46		
Erie Frequency Control	142	Marconi Instruments	96D	Vactec, Inc.	25
		Met-L-Wood Corporation	115	Varo Semiconductors, Inc.	126
Facit-Addo, Inc.	137	Monsanto Company	18, 19	Victor Electric Wire & Cable Corp.	127
Fairchild Systems Technology, A Division of Fairchild Camera and Instrument Corporation	97			Victoreen Instruments, Div. of VLN Corp.	119
Federal Scientific Corporation	146	National Semiconductor Corporation	16		
Ferroxcube Corporation	107			Wavetek	93
Fitchburg Coated Products, Division of Litton Industries	44	Oak Industries, Inc.	42, 43	Woven Electronics	47
		Optron, Inc.	7		
		Owens-Illinois, Inc.	95	Yewtec Corporation	136
				Zeltex, Inc.	152

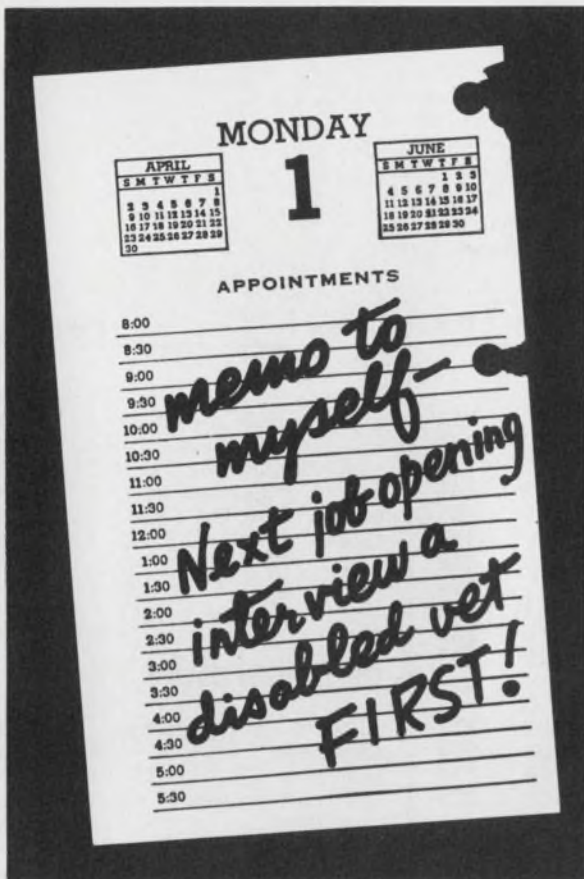

The President's Committee on Employment of the Handicapped  
Washington, D.C. 20210



INFORMATION RETRIEVAL NUMBER 117

# COMING NOV. 22

A MAJOR, IN-DEPTH ISSUE  
OF YEAR-LONG REFERENCE VALUE

# INSTRUMENTATION '73

On November 22, **Electronic Design's** editors will go all out to provide readers with an exceptional issue: INSTRUMENTATION '73. Emphasis will be both on the **design** and **use** of test and measuring instruments. The report covers both **conventional instruments**—oscilloscopes, spectrum analyzers, voltage-current-resistance measuring instruments, time and frequency measuring instruments, signal sources, recording instruments, and circuit testers, and **newer unconventional instruments**—such as logic analyzers, logic probes and clips, digital memory oscilloscopes, etc. You'll find latest state of the art information, latest advances in component and circuit design that have made new performance levels both possible and practical. New approaches to packaging are also covered.

The user will be given tips on the problems that surround buying and using test and measuring instruments. Special attention is given to systems and computer compatibility. Trade-offs, and details on manufacturers' specs are included. It's an issue that will be extremely valuable for months to come.

Note: If your company has made significant new developments in instrumentation, be sure our editors know about it. (You may also want to tip off your own ad department if you are involved in this field. It's going to be a red hot issue!)

# Electronic Design

# product index

**Information Retrieval Service.** New Products, Evaluation Samples (ES), Design Aids (DA), Application Notes (AN), and New Literature (NL) in this issue are listed here with page and Information Retrieval numbers. Reader requests will be promptly processed by computer and mailed to the manufacturer within three days.

Category	Page	IRN	Category	Page	IRN	Category	Page	IRN
<b>Components</b>			generators, function (AN)	143	371	supply, dc memory	134	338
clicker	120	299	leakage tester	139	350	supply, dual tracking	131	333
display, liquid crystal	122	304	mirror scanner	139	348	supply, instrument	131	334
LED, infrared	123	309	op amp tester	138	346	supply, mult. output, dc	134	339
LED, 28-V	120	301	PC-board tester	139	351	supply, regulated dc	132	337
readout, projection	120	298	printer	140	353	supply, switched reg.	132	334
resistor network	123	306	probe	140	356	supply, uninterrupt	134	340
surge arrestors (AN)	143	368	programmer, pROM	141	360			
switch, centrifugal	123	307	radiometer	141	358			
switch, joystick	123	308	radiometer	141	361			
switches, rocker (NL)	144	375	timer	139	349			
switches, thermal (DA)	142	362						
timer, cycling	122	305						
transformers, trig.	122	302						
<b>Data Processing</b>			<b>Microwaves &amp; Lasers</b>			<b>new literature</b>		
buffer, TTY	128	323	amp, power	108	275	absolute timing systems	145	397
controller, comm.	128	322	analyzers, spectrum	108	272	amplifiers	145	391
converter, code	129	324	filter, high-pass	108	274	analyzers	144	396
disc controller	124	315	mirror mount	108	273	CATV procedures	144	383
drive, flexible-disc	130	329	oscillators, varactor-tuned	104	267	capacitors	144	381
generator, tone	129	325	preamp	106	270	computer systems	145	389
interface, computer	124	317	rf power amp design (AN)	143	370	connectors, coaxial cables	144	377
LSI logic cards (NL)	145	399	switch modules	106	269	controllers, programmed	145	387
memory, drum	129	327	transistor	106	268	DPM	145	392
memory, semiconductor	126	320	transistor	108	276	digital boards	144	394
multiplexer, data	130	330	VCO	106	271	electrical cord lines	146	395
numerical display (AN)	143	367				filters	144	378
Nutran programming	143	372	<b>Modules &amp; Subassemblies</b>			knobs	144	382
printer, line	130	331	controller, speed	112	283	LSI logic cards	145	399
programming language (AN)	143	369	converter, hybrid d/a	110	277	lampholders	144	379
reader, incremental	124	314	converter, 12-bit, d/a	112	284	light measurements	144	384
reader, optical mark	124	316	d/a converters (AN)	143	366	modules	145	393
recorder, video	126	321	driver, switch	112	282	preamps	145	388
simulator,			extractor, square-root	112	285	printer/plotters	144	385
microprocessor	130	328	filters, active	112	281	rectifiers, bridge	144	376
stack, interface	126	318	generator, vector	110	278	sensors and transducers	145	390
TV-to-computer interface (AN)	143	364	oscillator, precision	110	279	switch applications	144	380
terminal, CRT	129	326	synchro-drivers	110	280	switches, rocker	144	375
terminal, remote job	126	319	telephone dialer	113	286	test accessories	144	373
			time delay, solid-state	113	287	thermal cutoffs	144	386
						thermal instrumentation	145	398
						wire strippers	144	374
<b>ICs &amp; Semiconductor</b>			<b>Packaging &amp; Materials</b>					
circuits, equipment	102	262	breadboard system	118	297			
clock driver	101	258	bus, PC power	117	293			
IC, dual TTL	102	261	connector, coaxial	117	292			
ICs, Darlington	100	256	connectors, coaxial cables (NL)	144	377			
LSI devices, bipolar	102	260	ferrite beads	114	288			
memory, programmable	99	250	indicator, temp.	116	290			
op amp	100	254	shipping bags	118	294			
op amp	102	264	tape, high temp.	116	291			
op amp, dual FET	102	265	tape, knitted wire	116	289			
RAM technology (AN)	143	365	thermometer, IR	118	196			
receiver/transmitter	101	257	wire strippers (NL)	144	374			
regulator ICs	101	259						
tachometer/op amp	102	263						
<b>Instrumentation</b>			<b>Power Sources</b>					
analyzer	140	354	controller, SCR power	131	332			
analyzer, spectrum	141	357	regulator, ac/dc	136	342			
dual-trace scope	140	355	regulator, ac line	136	343			
filter, active	138	347	regulator, ac line	136	345			
generator, function	141	359	supplies, lab power	136	344			
generator, sweep	139	352	supplies, modular	132	336			
			supplies, modular dc	132	335			
			supply, dc low voltage	134	341			
						<b>application notes</b>		
						numerical display	143	367
						Nutran programming	143	372
						programming language	143	369
						RAM technology	143	365
						rf power amp design	143	370
						surge arrestors	143	368
						TV-to-computer interface	143	364
						<b>design aids</b>		
						ferrite core kits	142	363
						switches, thermal	142	362

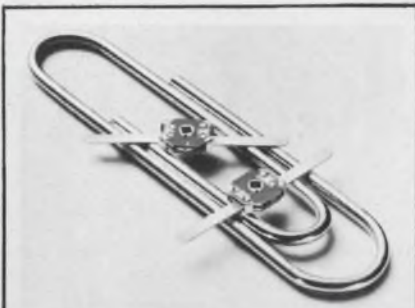

**Thin-Trim variable capacitors** provide a reliable means of adjusting capacitance without abrasive trimming or interchange of fixed capacitors. Series 9401 has high Q's and a range of capacitance values from 0.2-0.6 pf to 3.0-12.0 pf and 250 WVDC working voltage. Johanson Manufacturing Corporation, Boonton, New Jersey (201) 334-2676.

INFORMATION RETRIEVAL NUMBER 211

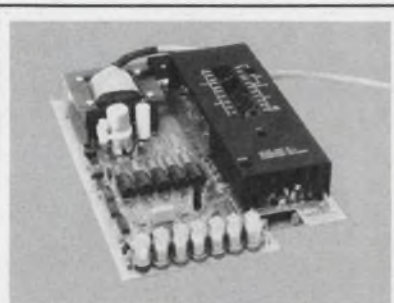

**5 1/2 digit single range DVM.** Ideal for controls, test & computing systems. 5 models, ranges of  $\pm 0.10000$ ,  $\pm 1.00000$ ,  $\pm 10.0000$ ,  $\pm 100.000$  and  $\pm 1000.00$  VDC. The  $\pm 0.001\%$  resolution; accuracy  $\pm 0.001\%$  f.s.,  $\pm 0.007\%$  reading,  $\pm 1$  l. s.d.; auto-zero; isolated BCD outputs. Data Precision Corp., Wakefield, MA 01880 (617) 246-1600

INFORMATION RETRIEVAL NUMBER 212



**400 Ideas for Design, Vol. 2**, Edited by Frank Egan. Ready to borrow, modify, or adapt, the top recent contributions to Electronic Design's popular "Ideas for Design" column range from amplifiers to switching circuits. 288 pp., illus., cloth, \$11.95. Circle below for 15-day examination copies. Hayden Book Co., New York, N.Y. 10011.

INFORMATION RETRIEVAL NUMBER 213



**Free catalog of 34,500 power supplies** from the worlds largest manufacturer of quality Power Supplies. New '73 catalog covers over 34,500 D.C. Power Supplies for every application. All units are UL approved, and meet most military and commercial specs for industrial and computer uses. Power Mate Corp. (201) 343-6294.

INFORMATION RETRIEVAL NUMBER 214

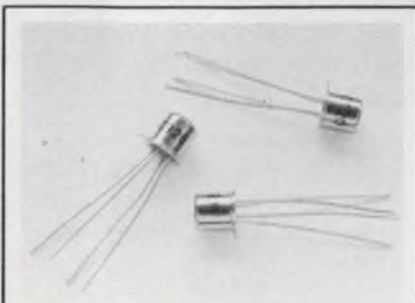

**Low noise IF transistors.** Type NC-921 and NC 920 have maximum 70 MHz noise figures of 1.2 dB and 1.5 dB respectively when measured in an untuned, broadband amplifier. The NC921 noise figure is typically 1 dB in a tuned amplifier. TO-72 package. California Eastern Laboratories, Inc. One Edwards Court, Burlingame, California. (415) 342-7744.

INFORMATION RETRIEVAL NUMBER 215



**Tungsten-coated contacts** to outlive the switch! Unique process clads custom electrical contacts with high arc resistant tungsten. Applicable to most fabricable materials. We'll supply the complete contact or clad yours. HiTemCo, 70 Cantiague Rd., Hicksville, N.Y. 11801. (516) 931-3500.

INFORMATION RETRIEVAL NUMBER 216

Advertisers wishing to reserve Quick Ad units should note the following mechanical requirements: Specs—Supply glossy photo of product and approximately 40 words which will set no more than 10 lines of 34 characters each. AFTER SUBMISSION NO COPY CHANGES CAN BE ACCEPTED. Quick Ads cost only \$300 per insertion, less for frequency advertisers.

#### RATES:

1x  
\$300

7x  
\$280

13x  
\$255

19x  
\$250

26x  
\$245

39x  
\$240

52x  
\$235

104x  
\$230

# MEET OUR NEW ZPM

## A "Super" Reliable DPM!



ACTUAL SIZE

**"Super" Reliability**—Low Power dissipation coupled with active component burn-in make these units "super" reliable. Our new ZPM's feature less than 1.5 Watts power dissipation—even with all segments lit. (They actually run cool). All active components are pre-selected and burned-in. An innovative "caged lead frame" and vented case design provide maximum component ventilation, further increasing reliability.

**"Sharp" Display**—The primary purpose of a DPM is to display "Good Looking Results", and you will agree that ours is the best looking meter around. Notice the near perfect numerals in the photo—the bright Sperry Planar display. These can be read from 20 feet away—and at wide angles up to 150°.

**"Mini" Size**—Our meters are just about the smallest ones available—a scant 12.5 cu. inches. Only 2.7 inches are required behind your panel. The total package weights less than 8 ounces and is small enough to fit nearly all existing DPM panel cut-outs.

**"Powerful" Performance**—Zeltex units operate from the AC line—and look at these specs—Accuracy 0.1% ( $\pm 1$  LSB) with Auto Zero and total Tempco of 50 ppm/°C.

**"Neat" Features**—To make your designing even simpler, 96 models are available with many "neat" features and options: hold reading control, leading zero blanking, external zero and FS adjust, two interface configurations, and decimal-point programming. And that's not all—Bipolar and Isolated BCD options are available.

Send for our complete specifications—you'll also receive our brand new Fall Catalog "Data Conversion and Linear Products". If you need a Demo—call the local Zeltex Rep. He has one for you now.



LEADERS IN DATA CONVERSION TECHNOLOGY

940 DETROIT AVENUE ■ CONCORD, CALIFORNIA 94518 ■ (415) 686-6660

SALES OFFICES: (203) 624-7800; (205) 881-3721; (206) 455-3460; (212) 539-1515; (213) 649-1232; (214) 823-5383; (216) 243-8520; (303) 423-3707; (305) 831-3355; (312) 956-0700; (314) 524-6900; (315) 689-3787; (415) 948-6533; (416) 677-1932; (505) 298-7671; (514) 331-7393; (518) 785-5032; (609) 795-1700; (612) 227-8495; (614) 457-8472; (617) 272-2606; (703) 354-1222; (713) 643-2114; (714) 832-4952; (714) 755-8668; (716) 691-8887; (816) 331-7744; (817) 738-1702; (919) 226-7177.

INTERNATIONAL SALES OFFICES: AUSTRALIA, Racal Electronics Pty. Ltd.; AUSTRIA AND EASTERN EUROPE, G. E. Electronics Ltd. and Co.; BELGIUM, C. N. Rood S. A.; DENMARK, K. Kamuk A/S; UNITED KINGDOM, Hakuto Co. Ltd.; FRANCE, Radio Television Francaise (RTF); GERMANY (WEST), Knott Elektronik GMBH; INDIA, Marketronics International; ISRAEL, I. S. Information Systems Ltd.; ITALY, 3G Electronics, s. r. l.; JAPAN, Hakuto Company Ltd.; NETHERLANDS, C. N. Rood N. V.; NORWAY, Elmatica A/S; NEW ZEALAND, Racal Electronics Pty. Ltd.; SPAIN, Aupoca, S. A.; SWEDEN, Telemetric Instruments AB; SWITZERLAND, Lacoray, S. A.

Do you face  
a make or buy  
decision on  
power supplies?

# BUY LAMBDA'S LZ SERIES THE ONLY FIELD REPAIRABLE P-C MOUNTABLE POWER SUPPLY.

Available in 3 package sizes,  
in 26 single output and 19 dual output models  
from \$35, up to 28 volts, up to 1400 mA.

## COMPETITOR COMPARISON CHART

Lambda-Pak	Com-petitors' Model	Feature	Lambda-Pak	Com-petitors' Model	Feature	Lambda-Pak	Com-petitors' Model	Feature
YES	NO	Fully repairable	YES	NO	Wide input voltage range—105-132 Vac	YES	NO	single and dual (tracking) outputs
YES	NO	Continuously adjustable voltage	YES	NO	Short-circuit proof	YES	NO	Designed for series operation
YES	NO	Multivoltage rated	YES	NO	Vacuum-impregnated transformer	YES	NO	Stocked and distributed from Los Angeles, Montreal, Chicago and New York
YES	NO	Foldback current limiting	YES	NO	Three different power packages			

### LZ SERIES SINGLE OUTPUT MODELS

MODEL	VOLTAGE VDC	CURRENT mA	PRICE
LZS-10	5	450	\$35
LZS-11	12	195	35
LZS-20	15	300	55
LZS-30	5	900	65
LZS-33	15	400	65
NEW LZS-34	5	1400	95

### LZ SERIES DUAL TRACKING OUTPUT MODELS

MODEL	VOLTAGE VDC	CURRENT mA	PRICE
NEW LZD-12	±15V	50	\$35
LZD-21	± 5	300	55
LZD-22	±15	90	40
LZD-23	±15	150	55
LZD-31	± 5	500	65
LZD-32	±15	220	65
NEW LZD-35	±15	300	95

For additional voltages, send for Lambda's 1973 catalog supplement L-3.

## LZ SERIES AVAILABLE IN 3 NEW MODELS



**Regulation** 0.15%—line or load; models LZS-10, LZS-30, LZS-34, LZD-21 and LZD-31 have load regulation of 0.15% + 5mV; model LZD-12 has line or load regulation of 0.25%.

**Ripple and noise** 1.5mV RMS.

**Temp. Coefficient** 0.03%/°C

**Tracking accuracy** 2% absolute voltage difference (dual output models only) 0.2% change for all conditions of line, load and temperature

**AC input** 105 to 132 Vac, 57-63 Hz



**WHETHER YOU MAKE OR BUY...**

**△ LAMBDA ELECTRONICS CORP.**

MELVILLE, NEW YORK 11746 515 Broad Hollow Road Tel. 516-694-4200  
ARLINGTON HEIGHTS, ILL. 60005 2420 East Oakton St., Unit Q Tel. 312 593-2550  
NORTH HOLLYWOOD, CALIF. 91605 7316 Varna Ave. Tel. 213-875-2744  
MONTREAL, QUEBEC 100C Hymus Blvd., Pointe Claire, Quebec 730 Tel. 514-697-6520  
PORTSMOUTH, HANTS, ENG. Marshlands Road, Farlington Tel. Cosham 73221  
VERSAILLES, FRANCE 64a 70 rue des Chantiers 78004 Tel. 950-2224

INFORMATION RETRIEVAL NUMBER 243

**1-DAY DELIVERY  
60-DAY GUARANTEE**

# the BEST costs LESS



SAYS IT BEST.....COST LESS

## SELF-SCAN® Alphanumeric, single register Panel Displays... under 7¢\* a dot...and the price includes all drive electronics

**ECONOMY**—SELF-SCAN Panel Displays have the lowest cost by any measure...dot, character, panel, or complete assembly. Price quoted in headline includes all panel drive electronics, character generator, bezel with mounting hardware and filter.

**LEGIBILITY**—Display characters are sharply delineated. No pincushioning, fuzzing or loss of focus.

**BRIGHTNESS**—Achieved by orange red colored dots intense enough to stand out brighter and sharper yet subtle enough to prevent possible eyestrain during long viewing periods.

**VISIBILITY**—Assured from 12 feet or 25 feet depending on character size .120° viewing angle means high visibility.

**BETTER PACKAGING**—1.34" max. depth without memory, 1.96" max. depth with memory permits installation in small space areas. SELF-SCAN Panel Displays can be mounted singly or in combinations.

Call or write Burroughs Corporation, Electronic Components Division, P.O. Box 1226, Plainfield, New Jersey 07061. Phone (201) 757-3400. A Burroughs sales engineer will stop by your office to back our claims with hard facts and figures.

\*Based on SSD 0132-0030 one thousand piece price.

# Burroughs

