

# Electronic Design 10

FOR ENGINEERS AND ENGINEERING MANAGERS

VOL. 21 NO.

MAY 10, 1973

Signal generators are closing in on synthesizers in stability and resolution, with such features as internal counters that lock and display frequency. But for rapid hopping of frequencies, you will still need a synthesizer. Either way, specification pitfalls abound —like phase noise, stability and energy leakage. See page 62.

RECEIVED  
MAY 10 1973  
CALMA CO.

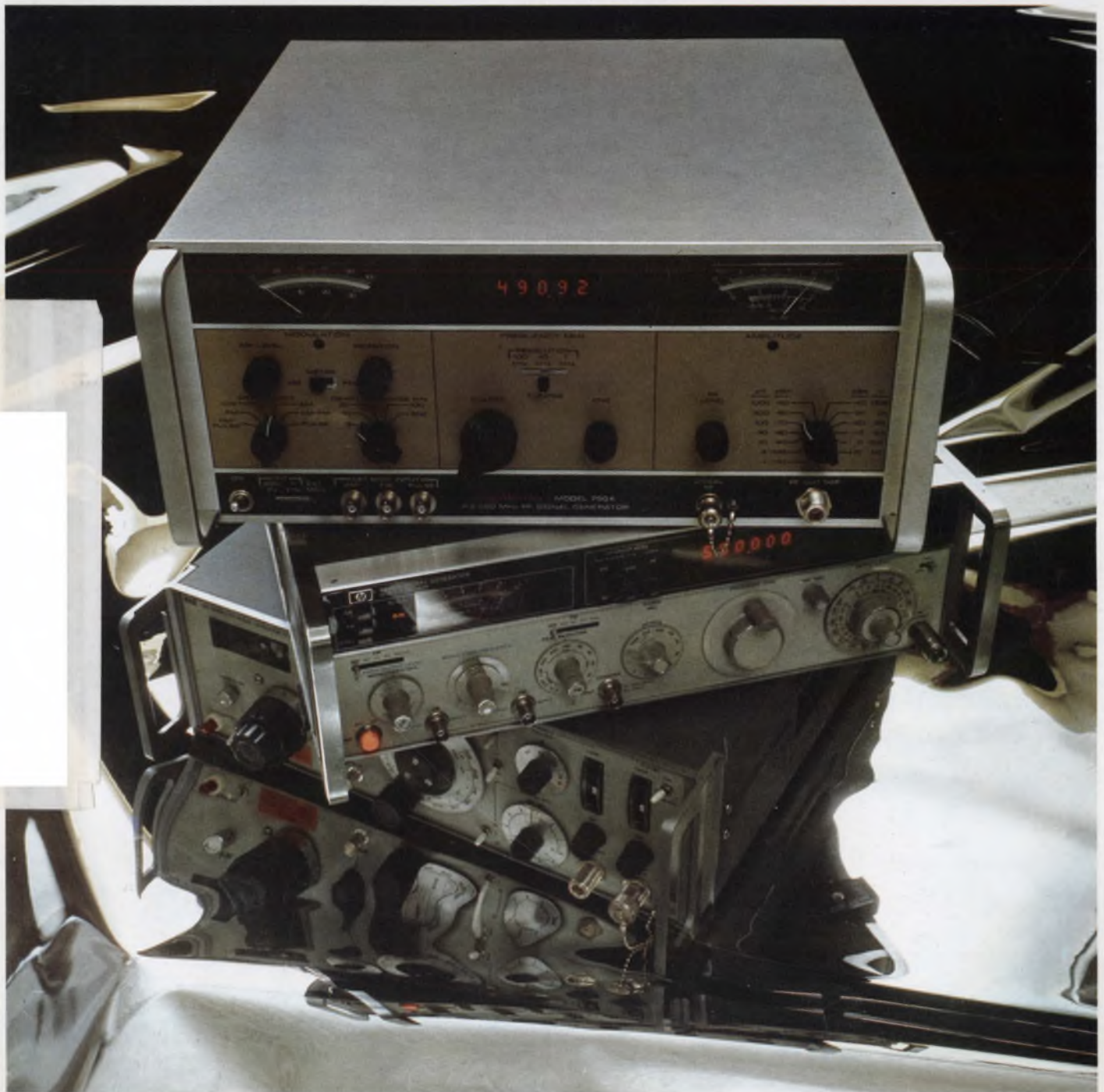

Do you face a make or buy decision on power supplies?

# BUY LAMBDA LX SERIES

Now LX series available in 54 models in 9 package sizes  
... single, dual and triple outputs

Regulation: 0.1%      Ripple: 1.5 mV RMS

Temperature Coef.: 0.03% /°C

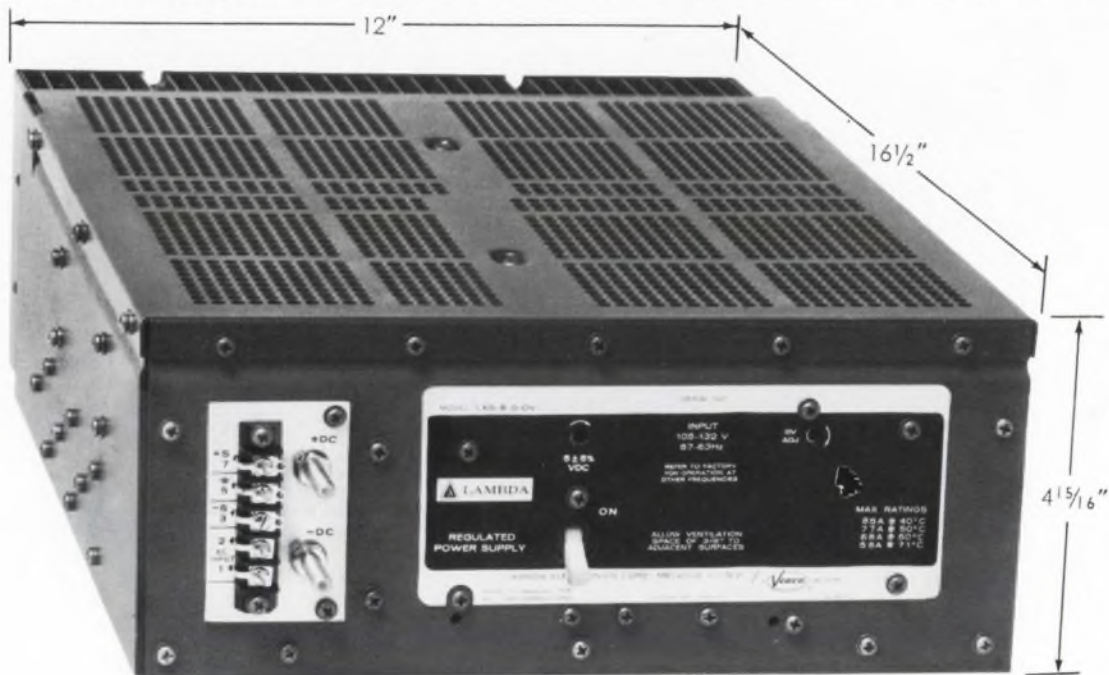

NEW  $\frac{2}{3}$  RACK, SINGLE OUTPUT "8" PACKAGE  
LXS-8-5-OV 5 VOLTS 85 AMPS (WITH OV)

**\$560**

listed in Underwriters' Recognized  
Components Index\*

designed to meet MIL environmental specifications

in stock for 1-day delivery

guaranteed 5 years

AC input: 105-132 VAC; 47-440 Hz.

LX-8 available in 7 models up to 28 volts

Send for 1973 Power Supply Catalog and Application Handbook

\* LX-8 and LX-EE models presently undergoing qualifying tests.

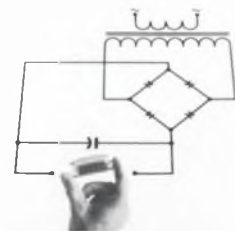

**WHETHER  
YOU MAKE  
OR BUY...**

**LAMBDA**  
ELECTRONICS CORP.

A  Company

MELVILLE, NEW YORK 11746 515 Broad Hollow Road Tel. 516-694-4200 ARLINGTON HEIGHTS, ILL. 60005 2420 East Oakton St., Unit Q Tel. 312-593-2550  
NORTH HOLLYWOOD, CALIF. 91605 7316 Varna Ave. Tel. 213-875-2744 MONTREAL, QUEBEC 100C Hymus Blvd., Pointe-Claire, Quebec-730 Tel. 514-697-6520  
PORTSMOUTH, HANTS, ENG. Marshlands Road, Farlington Tel. Cosham 73221 VERSAILLES, FRANCE 64a 70 rue des Chantiers 78004 Tel. 950-2224

INFORMATION RETRIEVAL NUMBER 201

# YOU HUM THE TUNE, EXAR PLL WILL SING IT



XR-2567



XR-210



XR-215



XR-567



XR-S200



Exar PLL

We have the broadest chorus line of Phase Lock Loop circuits available today. Take a brief look at our ever-expanding PLL line:

The XR-210 is designed for FSK Modulation and Demodulation and features a self-contained output logic driver, compatible with RS-232C requirements.

Use the XR-215 for FM or FSK demodulation, frequency synthesis and filter tracking. It has a 5V to 26V supply range and 0.5 Hz to 35 MHz frequency bandwidth. What's more, it's bipolar logic compatible.

The XR-S200 is a do-it-yourself building block. With this you design your own PLL circuits by selecting external connections and components. You get instant pro-

totypes with minimum fuss and costs.

Moving right along . . . the XR-567 PLL is designed for tone and frequency decoding. It has a bandwidth adjustable from 0 to 14%, sinks up to 100 mA of load current and has a logic compatible output. Our dual version, the XR-2567, is a real hummer with even better temperature tracking and matching characteristics. Power supply rejection is improved by an order of magnitude over the single version. The dual outputs can switch up to 100 mA at 26 volts.

All together now. We would like to send you the complete musical score on our PLL products. Our data sheets are good and they're filled with applications data. Write now, write.

## EXAR SPEAKS YOUR LANGUAGE



EXAR INTEGRATED SYSTEMS

750 Palomar Sunnyvale, California 94086 (408) 732-7970 TWX 910-339-9233

**EXAR SALES REPRESENTATIVES** Alabama, Georgia, Mississippi, North Carolina, South Carolina and Tennessee: K & E Associates, Kennesaw, Georgia (404) 974-4264  
Arkansas, Louisiana, Oklahoma and Texas: Evans-McDowell, Dallas, Texas (214) 238-7157 California: De Angelo, Rothman and Co., Culver City (213) 398-6239 Logan  
Sales Co., Redwood City (415) 369-6726 Connecticut, Maine, Massachusetts, New Hampshire, Rhode Island and Vermont: Com-Sale, Waltham, Massachusetts (617)  
890-0011, Meriden, Conn. (203) 634-0179 Indiana, Kentucky and Ohio: McFadden Sales, Columbus, Ohio (614) 221-3363 Idaho, Oregon and Washington: SD-R  
Products & Sales, Bellevue, Washington (206) 747-9424 Illinois and Wisconsin: Mar-Con Associates, Inc., Skokie, Illinois (312) 675-6450 Maryland, Virginia and  
Washington, D.C.: Rep-tron, Inc., Silver Spring, Maryland (301) 593-4844 New Jersey (South) and Pennsylvania: Harry Nash Associates, Willow Grove, Pennsylvania  
(215) 657-2213 New Jersey (North) and New York: MOS Associates, Floral Park, New York (516) 694-5923 Canada: Harvard Electronic Sales, Laval, Quebec (514) 681-1400  
**EXAR DISTRIBUTORS** California: EEP Corporation, Culver City (213) 838-1312, Intermark Electronics, San Carlos (415) 592-1641, San Diego (714) 279-5200, Santa Ana  
(714) 540-1322 Colorado: Intermark Electronics, Denver (303) 936-8284 Indiana: Graham Electronics, Indianapolis (317) 634-8202 Massachusetts: Gerber Electronics,  
Dedham (617) 329-2400 Washington: Intermark Electronics, Seattle (206) 767-3160

INFORMATION RETRIEVAL NUMBER 2

## MACHINE OR PROCESSOR CONTROL

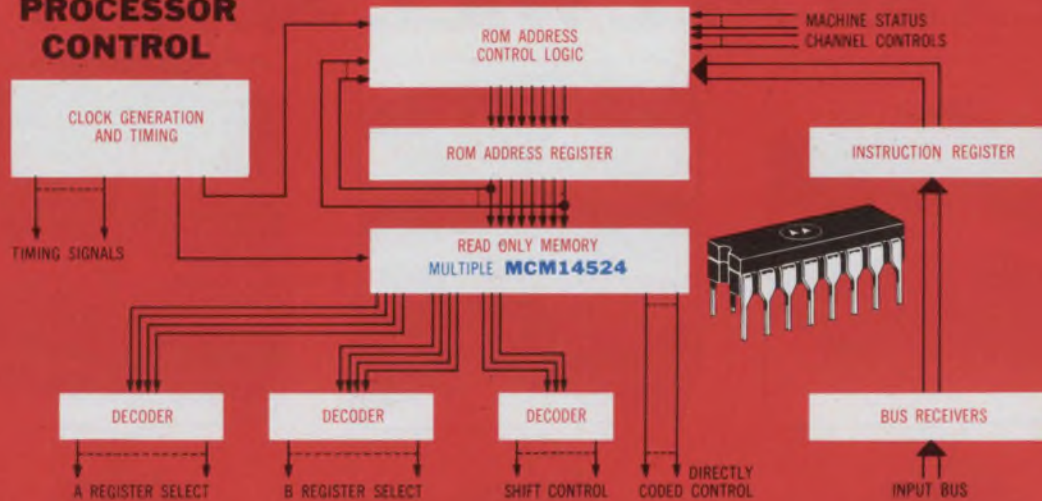

# FIRST 1K CMOS ROM

## *Creates All-CMOS System Capability-*

The interest aroused by Motorola's new MCM-14524 McMOS\* ROM was predictable. After all, it's the first 1024-bit CMOS memory. And the interest is much deeper than simple curiosity. The growing ranks of designers with requirements for low power operation and/or high noise immunity have recognized the MCM14524 as the closing link in the solution to many of their problems. The all-CMOS system.

For example, this machine or processor control section using microprogramming techniques can now take full advantage of CMOS. No need to mix in bipolar ROMs. Until the MCM14524 provided an alternative, no matter how the rest of the logic was executed, only relatively power hungry memory options were available for the ROM function. None of them offered any simple approach to noise immunity. With availability of the MCM14524, integrity of low system power use and high system noise immunity may be maintained.

Because it's a mask programmable ROM, the MCM14524 is ordered as a factory special, with the desired unique pattern for the 256 x 4 organization specified on punched computer cards, or if preferable by means of a completed truth table. The memory is

expandable by virtue of memory enable on the chip. Output latches provide a storage register, and full address decoding circuitry is on the chip, too.

Somewhat paradoxically, though the McMOS ROM is generally considered in the medium speed category, 70ns data retrieval is possible under certain conditions, i.e., in the chip enable access mode where addressing already has been established.

General McMOS family characteristics serve as a good guide to further definition of the MCM14524. Each of two versions is designed for single supply operation. The AL suffix version operates over a wide supply voltage range of +3 to +18 volts with a -55 to +125°C operating temperature range. The CL version operates over the +3 to +16 V supply range and a -40 to +85°C temperature range.

Mask charges are \$1,400.00 on orders to 24, but gradually decline to nothing when order quantities reach 500. 100-999 prices are \$24.70 and \$13.75 for the AL and CL respectively. Documentation, including programming instructions, is available from Motorola Semiconductor Products Inc., P.O. Box 20912, Phoenix, AZ, 85036. Your Motorola sales office will be pleased to entertain enquiries, too.

\*Trademark of Motorola Inc.



## MOTOROLA MOS

*Expanding Dimensions In Digital Design*

# McMOS

LOGIC OF THE 70's

## NEWS

- 25 **News Scope**
- 28 **Programmed logic array** puts 16-bit mini in economy class
- 30 **TV synch generator** designed into one-inch flatpack
- 42 **Quartz Q-switch** modulates high-power laser
- 44 **The lithium battery:** . . . It just might revolutionize portable power.
- 46 **Aneroid altimeter** gives way finally to a computerized electronic one.
- 49 **Technology Abroad**
- 51 **Washington Report**

---

## TECHNOLOGY

- 62 **Focus on Signal generators and frequency synthesizers:** A special report on the problems in specifying sig gens and synthesizers and a look at the latest commercially available units.
- 76 **The foolproof way to sequencer design.** Lockups, race conditions and unwanted states are eliminated when you follow this step-by-step approach.
- 84 **Get accurate Fast Fourier Transforms with a digital computer.** What's needed is a clear understanding of the practical limitations and tradeoffs.
- 90 **Improve fast-logic designs.** Terminated lines reduce reflections to overcome line-length and fanout limitations. Crosstalk and noise are restricted, too.
- 96 **Protect op amps from overloads.** You can avoid damage by building circuits that guard against fault conditions on the power supply, input and output lines.
- 102 **Control projects by hours, not dollars,** suggests this operations director. The approach generates accurate status reports and a way to correct mistakes fast.
- 106 **Ideas for Design:** Negative feedback gives ultra-flat filters without altering the selectivity . . . Floating voltage regulator helps build high-compliance current source . . . Volume compressor with 50-dB range built around single op amp.

---

## PRODUCTS

- 113 **Instrumentation:** A/d converter offers fastest throughput for 10-bit resolution, but it'll cost you.
- 114 **Instrumentation:** High-speed counter-timer carries a low price tag.
- 118 **Data Processing:** 16-bit minicomputer costs under \$1000.
- 130 **Modules & Subassemblies:** Control 10 A with a hybrid diode-and-SCR unit in a TO-3.
- 140 **Microwaves & Lasers:** Thermal profiler operates from ultraviolet to far IR.
- 148 **ICs & Semiconductors**
- 154 **Components**
- 158 **Packaging & Materials**

---

## Departments

- 59 **Editorial:** Fight auto pollution—but, please, no catalysts
- 7 **Across the Desk**
- 162 **New Literature**
- 168 **Bulletin Board**
- 168 **Vendors Report**
- 172 **Advertisers' Index**
- 174 **Product Index**
- 176 **Information Retrieval Card**

**Cover:** Photo by Phil Koenig, courtesy of LogiMetrics. From top to bottom, signal generators courtesy of LogiMetrics, Hewlett-Packard and Marconi.

# Now.

# CMOS analog gates for $\pm 12V$ signals ...with their problems solved.

**1.** No more "latching-up." Intersil's new Floating Body technology eliminates the problem.

**2.** No more channel-to-channel shorting. Intersil's new gates guarantee break-before-make switching.

**3.** No more costly low-reliability hybrid construction. Intersil's new CMOS gates are all monolithic.

## Floating Body technology does it.

Up to now, high level CMOS analog gates had real problems. Worst of all was the "latch-up" which occurred when a negative signal came along and the power supplies were off (Figure 1). At best, the switch just stopped operating, but all too often the whole IC was destroyed and had to be replaced.

But no more. Intersil's new IH5040 Series CMOS analog gates utilize a new technology—the "Floating Body" process—which not only eliminates latch-up but protects against over-voltages to  $\pm 25V$  without degrading ON resistance. It does this by effectively placing a diode in series with the body, isolating the entire device from the body of the chip (Figure 2).

**Figure 1.** A high current path exists when the negative supply is off and a negative input signal is present. Under these conditions, latch-up or destruction of the device will occur.

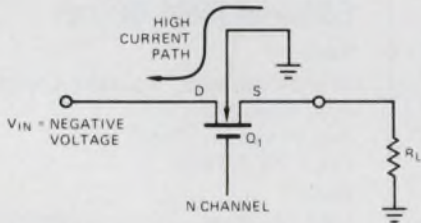

**Figure 2.** Intersil's Floating Body Process eliminates latch-up with a diode between the N-channel FET body and the positive supply.

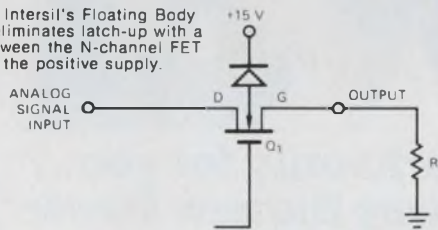

## The IH5040 Series CMOS analog gates.

These monolithic switches will handle positive or negative signals greater than 25V p-p with  $\pm 15V$  power supplies. Their ON resistance is as low as 30 ohms, quiescent current is less than  $50\mu A$ , and they can be controlled and switched in 500nS (typ.) from TTL, DTL, CMOS and PMOS circuitry.

Available in military and commercial temperature ranges, with volume prices of some models approaching \$2.00 per SPST channel, they are equivalent replacements for many more expensive hybrid analog gates.

Intersil Part No.	Type	R <sub>ON</sub>	Replaces
IH5040	SPST	75Ω	New function
IH5041	Dual SPST	75Ω	DG182A/B
DG200	Dual SPST	70Ω	DG200
IH5042	SPDT	75Ω	DG188A/B
IH5043	Dual SPDT	75Ω	DG191A/B
IH5044	DPST	75Ω	New function
IH5045	Dual DPST	75Ω	DG185A/B
IH5046	DPDT	75Ω	New function
IH5047	4PST	75Ω	New function
IH5048	Dual SPST	30Ω	DG181A/B
IH5049	Dual DPST	30Ω	DG184A/B
IH5050	SPDT	30Ω	DG187A/B
IH5051	Dual SPDT	30Ω	DG190A/B

## Get 'em here

Intersil stocking distributors. Schweber Electronics. Semiconductor Specialists. R. V. Weatherford Co.

Intersil area sales offices. Boston (617) 359-7188. Chicago (312) 371-1440. Los Angeles (213) 370-5766. Minneapolis (612) 925-1844. New York (201) 567-5585. San Diego (714) 278-6053. San Francisco Bay Area (408) 257-5450.

Overseas representatives. Copenhagen: E. V. Johanssen A/S. Helsinki: Digelius Electronics Finland OY. London: Tranchant Electronics (UK) Ltd. Milan: Auriema Italia SRL. Munich: Spezial Electronic. Paris: Tranchant Electronique. Stockholm: Elektroholm. Tel Aviv: Schweber Electronics. Tokyo: Internix. Zurich: Laser- & Electronic-Equipment.

U.S. Representatives in all major cities.

# Intersil



# Our Bill Shuart doesn't work for Power/Mate.



**He works only for you...  
and that's the way the new Power/Mate  
wants it.**

Bill is the Power/Mate Quality Assurance Manager and he has 34 supervisors and perfectionists under him.

They also work for you.

The result is unexcelled and consistent quality that we at Power/Mate are genuinely proud of.

Bill does a lot more than making sure our products are produced in accordance with his high standards of workmanship. (He wrote the book on that too.)

Bill has developed a series of courses for all our employees on soldering techniques and workmanship standards.

□ He has developed a computer failure analysis program to insure that *our* vendors also maintain the consistent high quality you should expect when you use our power supply in your product.

□ He oversees the continuing MTBF studies (by computer of course) and worst case calculations on all our power supplies to insure the long life and trouble free performance you should expect.

□ He has developed a thermally cycled burn-in rack in which we subject *all* of our power supplies for 24 hours before shipment to insure there are no premature field failures.

□ He oversees the random sampling of all production-run power supplies. These are subject to a continuous night and day life test . . . for your continued assurance of a long-lived trouble free product.

We could go on . . . but we at Power/Mate are glad he works for you. That's why we can give a five year no-holds warranty.



THE NEW  
**POWER/MATE CORP.**

514 S. River Street, Hackensack, N. J. 07601/ Phone (201) 343-6294  
TWX 710-990-5023

**Vice President, Publisher**  
Peter Coley

## Editors

Editorial Offices  
50 Essex St.  
Rochelle Park, N.J. 07662  
(201) 843-0550  
TWX: 710-990 5071  
Cable: Haydenpubs Rochellepark

**Editor-in-Chief:** George Rostky

## Managing Editors:

Ralph Dobriner  
Michael Elphick

## Associate Editors:

Dave Bursky  
Jules H. Gilder  
Morris Grossman  
Seymour T. Levine  
John F. Mason  
Stanley Runyon  
Edward A. Torrero  
Richard L. Turmail

## Contributing Editor:

Peter N. Budzilovich

## Editorial Field Offices

### East

Jim McDermott, Eastern Editor  
P.O. Box 272  
Easthampton, Mass. 01027  
(413) 527-3632

### West

David N. Kaye, Senior Western Editor  
2930 West Imperial Highway  
Inglewood, Calif. 90303  
(213) 757-0183

### Washington

Heather M. David, Bureau Chief  
2506 Eye St., N.W.  
Washington, D.C. 20037  
(202) 338-3470

## Editorial Production

Marjorie A. Duffy

## Art

**Art Director,** William Kelly  
Richard Luce  
Anthony J. Fischetto

## Production

**Manager,** Dollie S. Vieblg  
Helen De Polo  
Maxine Correal  
Anne Molfetas

## Circulation

**Manager,** Nancy L. Merritt  
Ron Deramo

## Information Retrieval

Peggy Long

## Promotion

**Manager,** Jeffrey A. Weiner  
Karen Kerrigan



## across the desk

### All the tech info, and prices, please

What do I want in ELECTRONIC DESIGN? Simple. I want the maximum amount of technical information that will aid my electronics development efforts. If this information can only come from a biased source, so be it. I simply want the source identified, so that I can mentally counter the bias.

Agreed, that you should not simply become an organ for marketing departments. But, really, that is not the question. The question is, Are you willing to supply me with the information that I need, irrespective of the source? Please let me do the fine filtering for my needs, as only I know what is wheat and what is chaff. I don't want a "big brother" to protect me from vendors and their engineers.

Another suggestion: Please beg, demand, force, etc., your advertisers to supply prices when they advertise specific products. Granted, qualifiers are necessary, but still this is a vital specification. This will also save vendors money through elimination of needless inquiries about products that are, a priori, not price-acceptable to the potential customer.

*Fred D. Campbell*

*Member of Technical Staff*

The Aerospace Corp.  
P.O. Box 95085  
Los Angeles, Calif. 90045

### Plea for price data backed by designer

Your editorial calling on manufacturers to display prices ("Price is a Vital Spec; So Why the Secrecy?" ED No. 4, Feb. 15,

1973, p. 51) is in the interest of designers. Prices should be given in the data resulting from your Information Retrieval Cards.

*John Wall Miller*

6921 Pacific Lane  
Annandale, Va. 22003.

### . . . And another view

There are many differences between marketing and engineering. Pricing is one. That's a marketing element. I would contend, contrary to your conclusion, that manufacturers who publish prices may not be around long. In components, the fact is that prices are set by the marketplace, not the price list. I would hate to have an engineer make a decision on my product without first discussing pricing with marketing.

Pricing is not black and white as many specifications are; it is negotiated and competitive. Everyone knows that the published prices are only maximums. An engineer who is frightened away by priceless data may also be frightened away by what looks like a high price. He also needs to know pricing trends, volume pricing and step pricing activities.

*Regis McKenna*

Regis McKenna, Inc.  
Communication Strategies  
348 Waverley St.  
Palo Alto, Calif. 94301.

### You, too, can be rich— Get off your gluteus!

Dr. R. S. Perloff observes in a letter to ELECTRONIC DESIGN that construction workers make up to twice what a graduate engineer

*(continued on page 10)*

Electronic Design welcomes the opinions of its readers on the issues raised in the magazine's editorial columns. Address letters to Managing Editor, Electronic Design, 50 Essex St. Rochelle Park, N. J. 07662. Try to keep letters under 200 words. Letters must be signed. Names will be withheld on request.

## low cost ceramic trimmer capacitors

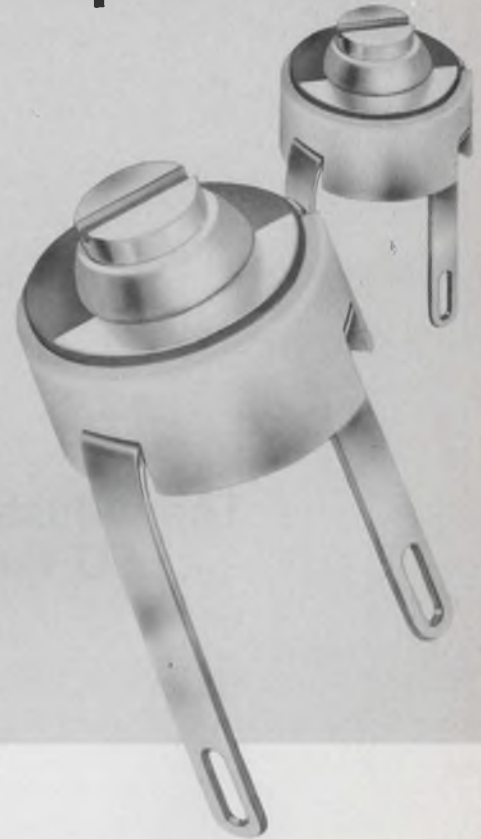

These ceramic trimmer capacitors are designed for broadband application, from audio to 500 MHz and afford an ideal *low cost* means of "trimming" circuitry such as crystal oscillators, CATV amplifiers and all varieties of communication and test equipment.

#### FEATURES

- Capacitance values from 1-3 to 5-25 pf
- Low profile - .208 above board height
- Low cost - 75c in 1000 quantities
- Delivery from stock

*Johanson*

MANUFACTURING CORPORATION

BOONTON, NEW JERSEY 07005  
201 / 334-2676  
TWX 710-987-8367

The industry's first  
LED-for-a-dime.



**10¢**  
EA.  
*@ Million*

**MLED500**  
19¢ 100-up  
17¢ 1000-up

**MLED640**  
2 mcd at 20 mils  
90° viewing angle  
Clear diffusing lens

**MLED650**  
1.4 mcd at 50 mils  
140° viewing angle  
Red diffusing lens

**MLED655**  
2 mcd at 20 mils  
90° viewing angle  
Red diffusing lens

**MLED660†**  
1 mcd at 20 mils  
90° viewing angle  
Dark red diffusing lens

**MLED665†**  
3 mcd at 10 mils  
30° viewing angle  
Red diffusing lens

†available shortly.

# The 10¢ LED. Here. There. Everywhere.

1. Panel Indicators
2. Channel Indicators
3. Battery Indicators
4. Fault Indicators
5. Cameras
6. Stereo Indicators
7. Instrumentation
8. Calculators

We're geared up. We're ready to go. And with a price of 10¢, how can you afford *not* to design lots of LEDs into your new equipment designs!

These new devices come off the same high-volume, low-cost production lines that made our transfer-molded, Uni-bloc\* plastic transistor outstanding the world over for economical, low-cost versatility. The result — the MLED500 series — now sets its own standard of leadership where price is the #1 parameter.

- High luminous intensity — 0.3 mcd typically at 20 mils
- Diffusing red lens — 110° field of view
- IC compatibility — low power consumption

You've tried LEDs produced by light guys, bright guys and innovators. *Now* try LEDs produced by a producer. Motorola Optoelectronics.

## MAKE ME AN OFFER I CAN'T REFUSE!

Quote me a price on these LEDs in the quantities I've filled in:

MLED500 \_\_\_\_\_ MLED655 \_\_\_\_\_  
MLED640 \_\_\_\_\_ MLED660 \_\_\_\_\_  
MLED650 \_\_\_\_\_ MLED665 \_\_\_\_\_

Application:  Immediate  Long-Term

Name \_\_\_\_\_

Title \_\_\_\_\_

Company \_\_\_\_\_

Address \_\_\_\_\_

City \_\_\_\_\_ State \_\_\_\_\_ Zip \_\_\_\_\_

Motorola Optoelectronics  
Box 20912, Mail Drop TB209  
Phoenix, AZ 85036

\*Trademark of Motorola, Inc.

*Semiconductor*

# From Motorola, the LED producer.

# Are these irksome insects throwing monkey wrenches into your schedule plans?



## ALLIED HAS A GUARANTEED CURE!

... We Guarantee Immediate Shipment on Thousands of Popular Items—

See the Partial List Below Featuring Parts from Bussmann, Cinch/Jones, Guardian, Pomona, Potter & Brumfield, Raytheon, Scott Instrument, and TRW/IRC

Have the promise/shortage/excuse/late-again pests ruined your production schedule plans? Allied Electronics has the sure cure for production line ills—a Guaranteed Shipment Program covering thousands of popular and often hard-to-get items. Check your open-order files, then check the list below—it's just a sample of our IN-DEPTH inventory—parts that are ready to be shipped to you today! Avoid costly downtime and unnecessary waiting—do business with the acknowledged

leader in electronics distribution—Allied. We have sales and stock facilities strategically located across the nation—ready and eager to handle your needs FAST. And, we back our Guaranteed Shipment Program with this statement: you get the parts you order from our published list or we give you a Credit Voucher for 10% of your total order (good for 90 days) to be applied to your next order. That's putting our money where our mouth is!

BUSSMANN	BUSSMANN	CINCH/JONES	CINCH/JONES	POMONA	POMONA	POTTER & BRUMFIELD	POTTER & BRUMFIELD
A/ABC 1	A/HKL X	DB-25P	12 142	B-4 Red	2811	KB17AY-120AC	PR3AY-12UAC
A/ABC 2	A/HKP	DB-25S	12 541	B-12 Black	2886	KCP11-2500 ohms	PR5AY-120AC
A/ABC 3	A/HPC	2-202-CCT	15-141	B-12 Red	3780 12 Bk	KCP11-10 000	PR7AY-24AC
A/ABC 5	A/MDL 1/8	2-302-CCT	16-141	B-18 Black	3780 24 Bk	ohms	PR11AY-120AC
A/ABC 6	A/MDL 3/8	2-303-CCT	14-DIP	B-24 Black	3780-24 Red	KHP17D11 12DC	PR11AY-120AC
A/ABC 8	A/MDL 3/16	2-304-CCT	14-DIP-1	B-24 Red	KP24 Red	KHP17D11 24DC	PR11AY-240AC
A/ABC 10	A/MDL 7/10	2-304-CCT-L	14-W-DIP	B-24 Red	3780-48 Bk	KRPSA-120AC	PR11DY-24DC
A/ABC 12	A/MDL 7/10	2-306-CCT	14-W-DIP-2	B-36 Black	3781-12 Bk	KRPSAG-120AC	9KH1
A/ABC 15	A/MDL 3/10	2-306-CCT-L	16-DIP	B-36 Red	3781-12 Red	KRP11A-6AF	9KH2
A/ABC 20	A/MDL 3/8	2-308-CCT	16-DIP-1	MDP Red	3781-24 Bk	KRP11A-12AC	9K1
A/AGC 1/32	A/MDL 1/2	2-310-CCT	16-W-DIP	MDP Yellow	3781-24 Red	KRP11A-24AC	9K16
A/AGC 1/16	A/MDL 9/10	2-302-AB	16-W-DIP-1	MDP-X	3781-48 Bk	KRP11A-120AC	9K16
A/AGC 1/8	A/MDL 3/4	2-302-CCT	16-W-DIP-2	TVS-7	3781-48 Red	KRP11A-240AC	9XR10-1
A/AGC 3/8	A/MDL 9/10	2-303-AB	16-W-DIP-3	X1-B	3782-12 Bk	KRP11AG-12AC	350013
A/AGC 1/2	A/MDL 1	2-303-CCT	50 6A 20	X1-B	3782-12 Red	KRP11AG-24AC	350070
A/AGC 3/4	A/MDL 1 1/4	2-304-AB	50 10A 20	28C-36	3782-24 Bk	KRP11AG-240AC	RAYTHEON
A/AGC 1/2	A/MDL 1 1/2	2-304-CCT	50 22A 20	28C-BNC 36	3782-24 Red	KRP11AG-120AC	DS70-3-2
A/AGC 1	A/MDL 1 1/2	2-306-AB	50 44A 30	17H	3782-48 Bk	KRP11AG-240AC	DS125-3-2
A/AGC 1 1/2	A/MDL 2	2-306-CCT		1270	3782 48 Bk	KRP11AG-120AC	KL-701
A/AGC 2	A/MDL 2 1/2	2-306-CCT		1285 Black	3782 48 Bk	KRP11D-12DC	KL-701G
A/AGC 2 1/2	A/MDL 8	2-140	GUARDIAN	1298 Black	3916	KRP11D-110DC	RS70-1-2
A/AGC 3	A/MDL 10	2-141	IR-705 12P-12DC	1325 Black	POTTER & BRUMFIELD	KRP11DG-24DC	RS70-3-2
A/AGC 5	A/MDL 15	2-140	IR-705 12P-24DC	1325 Red	BU-24AC	KRP14AG-120AC	SL1005
A/AGC 6	A/MDL 20	2-140	MER-120AC	1330 Black	BU-120AC	KRP14AG-24AC	SL16014
A/AGC 7 1/2	A/MDX 3	2-141	18-Cont-120AC	1330 Red	CB-120AC	KRP14DG-24DC	CK5879
A/AGC 10	A/MDX 3 1/2	2-140	14-Cont-120AC	1440-36 Bk	CB336-70001	KRP14DG-12DC	CK5886
A/AGC 15	A/MDX 4	2-140 Y	18-Cont-120AC	1440-36 Red	CH336-70001	KRP14DG-24DC	584GYA
A/AGC 25	A/MDX 5	2-142	18-Cont-120AC	1508	CH336-70001	KRP14DG-110DC	SCOTT INSTRUMENT
A/AGC 30	A/MDX 6 1/4	2-142	18-Cont-120AC	1614 Black	CH336-70001	KRP14DG-24DC	4508
A/AGX 1/32	A/MDX 7	2-140	660-2C 120AC	1825 Black	GAI1A-120AC	KRP14DG-24DC	TRW/IRC
A/AGX 3/8	A/MDX 4	2-141	660-4C 120AC	1825 Red	HP-11D-12DC	KRP14DG-110DC	RD 412
A/AGX 1/4	A/MDX 4	2-141	9M-120AC	2104	KASAY 120AC	KUL11A15S-120AC	RD 462
A/AGX 1/2	A/MDX 6	2-140 Y	260Q-DPDT 120AC	2249 C-12	KAI1AG-120AC	KUP11A15-120AC	8400-1K
A/AGX 1	A/MDX 8	2-141		2249 C-24	KAI1AG-6AC	KUP14A15-120AC	8400-5K
A/AGX 3	A/MDX 10	2-142		2249 C-36	KAI1AY-120AC	KUP14A55-120AC	
A/AGX 5	A/MDX 15	2-141		2249 C-48	KAI4AY-120AC	MRS-A 120AC	
A#405	A/MDX 20	2-141		2249 C-60	KAP11AG-120AC	MR11A 120AC	
A/682-14	D20418 2	2-141		2391	KAP11AY-120AC	MR14A-120AC	
A/GLH 8	D20419-0	2-140		2417	KAP11AY-120AC	PC11A-120AC	
A/HJM	DA 15P	2-140		2631	KBI7AG-120AC	PM17AY-120AC	
A/HKL	DA-15S	2-141		2708			

### PERFORMANCE SPEAKS FOR ITSELF!

ALLIED'S RECORD TO DATE ON OUR GUARANTEED SHIPMENT PROGRAM

As of March 23, 1973, 98.8% of all orders containing Merchandise covered by the Guaranteed Shipment Program were filled.

Does Your Present Supplier Guarantee Shipment or Give a 10% Credit Voucher if He Defaults? Call Your Nearest Allied Facility Today for the Parts You Were Looking for Yesterday.

Call Your Nearest Allied Facility Today!

Garden Grove, Calif. (213) 598-6605  
 Washington, D.C. (301) 345-4600  
 Chicago, Ill. (312) 421-2400  
 Boston, Mass. (617) 848 4150  
 Fort Lauderdale, Fla. (305) 772-6464  
 Fort Worth, Texas (817) 336-5401

### NEW CATALOG

1973 Edition. Write or phone for your copy today.

**ALLIED ELECTRONICS** DIVISION OF TANDY CORP.

2400 WEST WASHINGTON BLVD., CHICAGO, ILL. 60612

earns, then cites the earnings of physicians and lawyers as illustrative of an income-vs-education dichotomy ("Job Security and Pay Draw Fire and Ire," ED No. 5, March 1, 1973, p. 7). The good doctor really ought to know better.

In the first instance, yes, some construction workers do have substantial annual earnings: Those who work "high iron," who do high-pressure caisson work and who operate kidney-jolting and eardrum-shattering heavy machinery are probably in these ranks. Most of the rest earn their \$5 to \$20 an hour only when they work—not when weather prevents construction, not when there's a hiatus between one job and the next and not when their unions con them into striking. It's unfortunate, but true, that a lot of us in the electronics business would fail dismally at construction work, principally because the muscles we employ most often are the gluteus.

Which leads to the second point.

The man who chooses to become a rich physician or lawyer doesn't work for wages: He works for himself. No less than the businessman who grasps an idea and runs with it, hiring engineers along the way, the MDs and attorneys who prosper are entrepreneurs. They've invested time and money in education, precisely as have their peers in engineering. But while the emergent engineer goes to work for a company, the aspiring wealthy MD or lawyer goes to the bank for a loan to buy an electronically equipped medical suite or clinic, a law library or partnership.

In short, while the engineer looks to the sometime security of the corporate womb, these others look inward and find the confidence to make an investment and to take the risks of success or failure. The successes do get rich. The failures wind up working as staff in the offices of those who did succeed, and they earn roughly the same salaries as comparably trained engineers.

In the soul of every engineer I've ever met, there's an idea that



# THIS LOOK-ALIKE

## CUTS 20% FROM YOUR PACKAGE COSTS

Elco's Series 6064 discrete card edge connectors look like . . . and work like . . . other discrete card edge connectors. With one major exception. Ours can save you up to 20% of your total package cost. Because we'll supply our Series 6064 connectors mounted on our Variframe™ back panel which we'll custom design and build to your requirements. With connectors wired (up to three levels of wire wrapping) to your specs. And with input/output connectors and voltage and/or ground buses. To give you the best performing package at lowest cost. Fast.

Then again, if you're in a hurry for a look-alike that is, call your local Elco distributor. He has our Series 6064 connector in three sizes: 36/72, 40/80 and 50/100 contacts. With bifurcated bellows contacts on .125" grid. All with .025" square tails. And diallyl phthalate insulators that accept .062" printed circuit cards. And he's got them all on his shelf. Plus other card edge connectors at .100", .150", .156" and .200" spacings. Ready to go.

Availability. And economy. These are what distinguish our look-alikes from theirs. Just two more services in keeping with CONNECTRONICS, Elco's Total Connector Capability.



For full details and specifications on our Series 6064 connectors, contact:

Elco Corporation  
Willow Grove, Pa. 19090  
(215) 659-7000

Elco Corporation  
2200 Park Place  
El Segundo, Calif. 90245  
(213) 675-3311



# Make your circuits safer, more reliable with Dow Corning flame-retardant silicone encapsulants.

With flame-retardant Dow Corning® silicone encapsulants, every device on this board is better protected, more reliable, and safer. Why? Because these silicones supply a superior combination of electrical, physical, and thermal properties . . . *plus* flame retardancy. You can use them to increase efficiency, safety, and reliability in circuit designs for consumer, industrial, automotive, and aerospace applications.

Flame-retardant silicone molding compounds are superior packaging materials for all kinds of devices, including digital and linear ICs ①, MOS, CMOS, SCRs, and power transistors ②. They perform with reliability nearly equal to hermetics at far less cost. Years of service, and device life tests in millions, prove the superior moisture and mechanical-shock resistance, thermal life, and dimensional stability of silicones over other plastics. Resistors ③ are also packaged with these flame-retardant molding compounds, produced by low-cost transfer molding.

Flame-retardant pourable silicone encapsulating elastomer ④ adds safety and protects circuitry from moisture, dirty atmospheres, mechanical shock, and vibration. It cures to a tough, flexible rubber without exotherm or corrosive byproducts.

In addition to encapsulants, a new heat-stable, silicone heat-sink compound ⑤ meets stringent TV-set requirements, improves reliability, helps maintain device efficiency, and guards against premature device failure. It bridges the gap between devices and the heat sink to ensure high thermal conductivity.

For more reliability ideas, write for Silicones for Electronic Design, Dow Corning Corporation, Dept. C-3201, Midland, Michigan 48640. Information Retrieval Number 235. See distributor listing on following page.

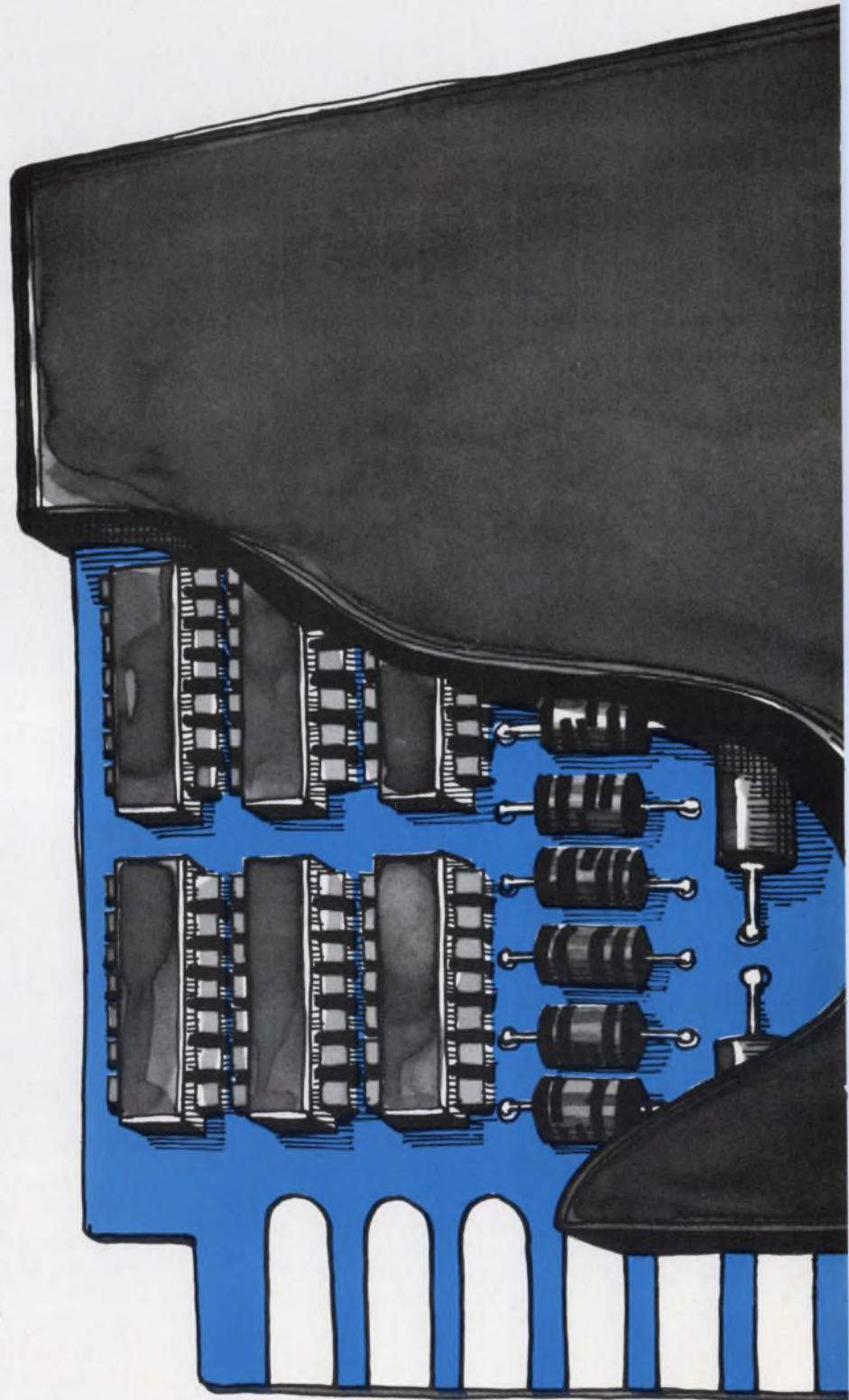
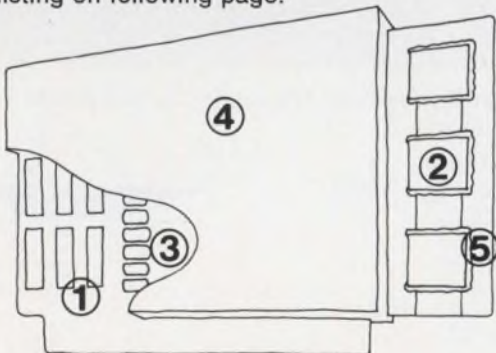

*Silicones; simply the best way  
to protect electronic circuits*

**DOW CORNING**

DOW CORNING

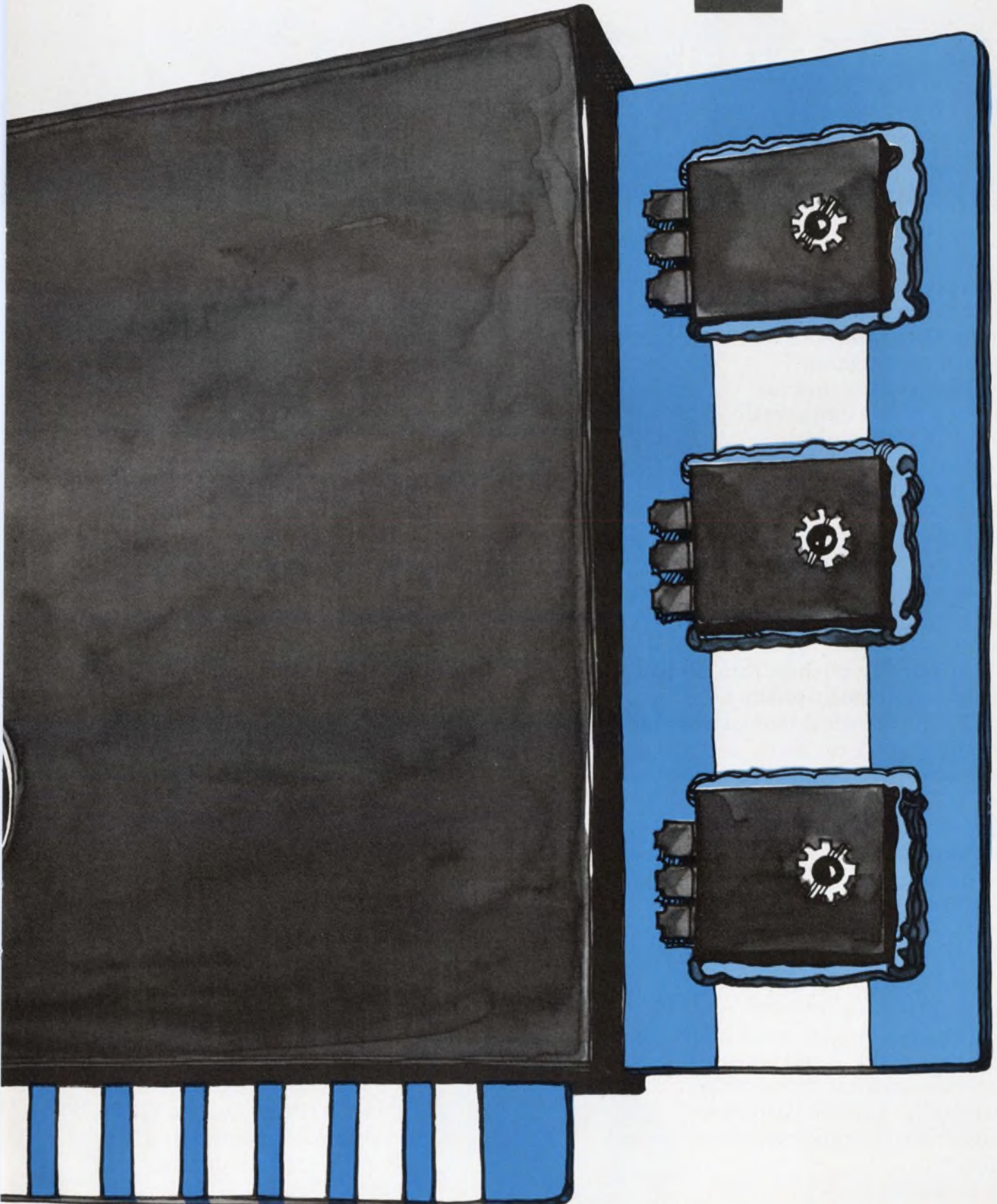

INFORMATION RETRIEVAL NUMBER 10

# "We subjected the Augat plug-in socket panel to an accelerated-life test in order to induce contact failure.

## "We failed."

Dave Fillio  
Principal Engineer, Component & Materials Engineering  
Honeywell Information Systems

"We needed an interconnection system for controllers on the H716 mini-computer that could help us meet four basic requirements:

"High density to get as much as possible into a small package and still meet the increasing customer demand for a broad range of peripherals, each requiring a separate controller.

"The capability of automatically wiring, with a minimum of two-levels.

"Flexibility to permit anticipated design changes and still allow us to meet a very tight schedule.

"And finally, all these features had to be available in a standard product.

"The most logical approach seemed to be printed wiring boards. But to accommodate all our controllers could have required as many as eight boards. And we couldn't afford the room. Also, when recycling changes are taken into consideration, the design cycle of printed wiring boards becomes too long and, consequently, too costly.

"Multi-layering offered a minimum of flexibility, and it, too, was rejected.

"The only practical solution was the plug-in socket panel. And of all the vendors, Augat was the only manufacturer that could provide a completely uniform, broad range of standardized products, the lowest possible profile and maximum reliability.

"The reliability tests we



Dave Fillio

conducted on the Augat machined sockets included environmental exposures, accelerated-life, vibration, thermal shock, and durability. All tests with the Augat system were positive.

"From a field service standpoint, a key consideration with increasingly complex and flexible systems like the H716 is keeping them on the air at all times. Because of the reliability of the Augat interconnection system, we've had no reports of machine down-time associated with the Augat product since the introduction of the H716 eight months ago."

More and more companies like Honeywell are realizing that Augat socket-panels are an economical, reliable and totally flexible solution to interconnection problems, including development, production and field service requirements.

Augat's precision-machined tapered entry contact has made Augat the reliability standard for the industry. As the world's leading manufacturer of socket panels and other IC interconnection products, Augat is ready to help you solve your interconnection problems.

Call or write today for a free brochure and complete product information. Augat, Inc., 33 Perry Avenue, Attleboro, Massachusetts 02703. Represented and distributed internationally.



The H716

## Plug into Augat. Honeywell did.



# Silicone Protectors

A full line of silicone encapsulating, insulating, sealing, coating and dielectric materials is available from Dow Corning Distributors at the following warehouse locations:

F-3205

Electrical/electronic materials  
from

## DOW CORNING

DOW CORNING

### ALABAMA

**Birmingham**  
Electrical Insulation Suppliers, Inc.  
205 252-9046

**Huntsville**  
Brownell Electro, Inc.  
205 536-2451

**Cramer/EW Huntsville**  
205 539-5722

**Mobile**  
Brownell Electro, Inc.  
205 479-5405

### ARIZONA

**Phoenix**  
Cramer/Arizona  
602 263-1112

**Essex International, Inc.—I.W.I. Div.**  
602 258-4589

**Scottsdale**  
E. V. Roberts & Associates, Inc.  
602 945-2513

### CALIFORNIA

**Berkeley**  
C. D. LaMoree Co.  
415 841-0601

**Culver City**  
E. V. Roberts & Associates, Inc.  
213 870-9561

**Irvine**  
Cramer/Los Angeles  
714 979-3000

**Los Angeles**  
Brownell Electro, Inc.  
213 532-1156

**C. D. LaMoree Co.**  
213 225-5666

**Essex International, Inc.—I.W.I. Div.**  
213 264-7000

**Mountain View**  
K. R. Anderson Company, Inc.  
415 961-6007

**Palo Alto**  
E. V. Roberts & Associates, Inc.  
415 324-1671

**Redwood City**  
Cramer/San Francisco  
415 365-4000

**San Diego**  
Cramer/San Diego  
714 565-1881

**E. V. Roberts & Associates, Inc.**  
714 565-4535

**A. E. Yale Enterprises**  
714 296-6148

**San Francisco**  
Essex International, Inc.—I.W.I. Div.  
415 626-5351

**Santa Clara**  
Brownell Electro, Inc.  
408 244-8452

### COLORADO

**Denver**  
Cramer/Denver  
303 758-2100

**Waco Electronics, Inc.**  
303 343-8474

### CONNECTICUT

**North Haven**  
Cramer/Connecticut  
203 239-5641

### FLORIDA

**Hollywood**  
Cramer/EW Hollywood  
305 923-8181

**Orlando**  
Brownell/Electro, Inc.  
305 843-6770

**Cramer/EW Orlando**  
305 894-1511

**Electrical Insulation Suppliers, Inc.**  
305 855-7100

**Tampa**  
Essex International, Inc.—I.W.I. Div.  
813 245-6821

**GEORGIA**

**Atlanta**  
Brownell/Electro, Inc.  
404 762-5181

**Cramer/Atlanta**  
404 448-9050

**Electrical Insulation Suppliers, Inc.**  
404 355-1651

**Essex International, Inc.—I.W.I. Div.**  
404 691-8520

**Chamblee**  
Prehler Electrical Insulation  
404 451-4266

### ILLINOIS

**Chicago**  
Essex Internat'l, Inc.—IMC/I.W.I. Div.  
312 254-8787

**Prehler Electrical Insulation**  
312 384-6100

**Mt. Prospect**  
Cramer/Chicago  
312 593-8230

**Magnuson Electronics, Inc.**  
312 956-0700

### INDIANA

**Fort Wayne**  
Essex International, Inc.—I.W.I. Div.  
219 742-7441

**Hammond**  
Electric Supply Corp.  
219 932-8840; 312 374-6000 (Chicago)

### IOWA

**Marion**  
EnSCO Distributing Corporation  
319 377-6313

### KANSAS

**Overland Park**  
EnSCO Distributing Corporation  
913 381-7557

### KENTUCKY

**Louisville**  
E & H Electric Supply  
502 587-0991

### LOUISIANA

**New Orleans**  
Williamson Distributing Corp.  
504 486-5584

**Shreveport**  
Williamson Distributing Corp.  
318 424-6638

### MARYLAND

**Baltimore**  
Cramer/EW Baltimore  
301 354-0100

**Essex International, Inc.—I.W.I. Div.**  
301 644-0140

**Baltimore/Washington**  
Pyttronic Industries, Inc.  
301 792-7000; 301 953-3000

**Galthersburg**  
Cramer/EW Washington  
301 948-0110

### MASSACHUSETTS

**Cambridge**  
Brownell Electro, Inc.  
617 864-7500

**Newton**  
Cramer Electronic, Inc.  
617 969-7700

**Peabody**  
Essex International, Inc.—I.W.I. Div.  
617 531-7100

### MICHIGAN

**Detroit**  
Essex Internat'l, Inc.—IMC/I.W.I. Div.  
313 925-6000

**Farmington**  
Sheridan Sales Co.  
313 377-3800

**Livonia**  
Cramer/Detroit  
313 425-7000

**Madison Heights**  
McNaughton-McKay Electric  
313 399-7500

### MINNESOTA

**Edina**  
Cramer/Bonn  
612 835-7811

**St. Paul**  
Magnuson Electronics, Inc.  
612 227-8495

**Prehler Electrical Insulation**  
612 622-1541; 612 622-1542

### MISSOURI

**Florissant**  
Sheridan Sales Co.  
314 837-5200

**Kansas City**  
Essex International, Inc.—I.W.I. Div.  
816 842-1613

**St. Louis**  
EnSCO Distributing Corp.  
314 567-3935

**Essex International, Inc.—I.W.I. Div.**  
314 371-2616

### NEW JERSEY

**Livingston**  
Robert McKeown Co  
201 992-0700; 212 267-9264 (NYC);  
516 248-2525 (L.I.)

**Moonachie**  
Cramer/New Jersey  
201 935-5600

**Essex International, Inc.—I.W.I. Div.**  
201 641-4400; 212 695-7840 (NYC)

**North Bergen**  
EISCO Plus, Inc.  
201 864-2376; 800 631-0830

**Pennsauken**  
Cramer/Pennsylvania, Inc.  
609 662-5061

### NEW MEXICO

**Albuquerque**  
Cramer/New Mexico  
505 265-5767

**Waco Electronics, Inc.**  
505 268-2409

**Williamson Distributing Corp.**  
505 344-3564

### NEW YORK

**Buffalo**  
Summit Distributors, Inc.  
716 884-3450

**East Syracuse**  
Cramer/Syracuse  
315 437-6671

**Endwell**  
Cramer/Binghamton  
607 754-6661

**Hauppauge**  
Cramer/Long Island  
516 231-5600

**New York City**  
Brownell Electro, Inc.  
212 691-7900; 212 924-6000

**Rochester**  
Cramer/Rochester  
716 275-0300

**Summit Electronics of Rochester, Inc.**  
716 334-8110

**NORTH CAROLINA**

**Charlotte**  
Brownell Electro, Inc.  
704 399-9791

**Electrical Insulation Suppliers, Inc.**  
704 392-2306

**Essex International, Inc.—I.W.I. Div.**  
704 394-1315

**Raleigh**  
Cramer/EW Raleigh  
919 876-2371

**Pyttronic Industries, Inc.**  
919 782-6370

**Winston-Salem**  
Cramer/EW Winston-Salem  
919 725-8711

### OHIO

**Cincinnati**  
Cramer/Trl States, Inc.  
513 771-6441

**Electrical Insulation Suppliers, Inc.**  
513 771-4073

**Essex Internat'l, Inc.—IMC/I.W.I. Div.**  
513 771-6500

**Sheridan Sales Co.**  
513 761-5432

**Cleveland**  
Cramer/Cleveland  
216 248-8400

**Essex Internat'l, Inc.—IMC/I.W.I. Div.**  
216 781-2310

**Prehler Electrical Insulation**  
216 267-2650

**Sheridan Sales Co.**  
216 524-8120

**Columbus**  
McGraw-Edison Co.  
National Electric Coil Division  
614 488-1151

**Dayton**  
Sheridan Sales Co.  
513 277-8911

### OKLAHOMA

**Oklahoma City**  
Essex International, Inc.—I.W.I. Div.  
405 236-5411

**Tulsa**  
Cramer/Tulsa  
918 836-3371

**Williamson Distributing Corp.**  
918 936-2749

**OREGON**

**Portland**  
Essex International, Inc.—I.W.I. Div.  
503 665-0138

**C. E. Riggs, Inc.**  
503 226-3286

### PENNSYLVANIA

**Harrisburg**  
Pyttronic Industries, Inc.  
717 233-6591; 1-800 232-0640

**Monroeville**  
Sheridan Sales Co.  
412 373-1070

**Philadelphia**  
Brownell Electro, Inc.  
215 632-3030

**Essex International, Inc.—I.W.I. Div.**  
215 236-7100

**Prehler Electrical Insulation**  
215 725-5914

**Pyttronic Industries, Inc.**  
215 643-2850; 215 242-6700

**Pittsburgh**  
Essex Internat'l, Inc.—IMC/I.W.I. Div.  
412 242-5560

**Pyttronic Industries, Inc.**  
412 276-6722; 412 923-2575

### TENNESSEE

**Memphis**  
Brownell Electro, Inc.  
901 332-9254

**Electrical Insulation Suppliers, Inc.**  
901 947-4176

### TEXAS

**Dallas**  
Cramer/Texas  
214 350-1355

**Essex International, Inc.—I.W.I. Div.**  
214 339-8346

**Specialized Products Company**  
214 358-4663

**Williamson Distributing Corp.**  
214 741-5831

**Houston**  
Essex International, Inc.—I.W.I. Div.  
713 869-3667

**Williamson Distributing Corp.**  
713 672-1715

### UTAH

**Salt Lake City**  
Cramer/Utah  
801 487-3681

### WASHINGTON

**Seattle**  
Atlas Packing & Rubber Co.  
206 623-4697

**Cramer/Seattle**  
206 762-5755

**Essex International, Inc.—I.W.I. Div.**  
206 763-8650

**C. E. Riggs, Inc.**  
206 623-5707

**WISCONSIN**

**Milwaukee**  
Cramer/Wisconsin  
414 462-8300

**Essex Internat'l, Inc.—IMC/I.W.I. Div.**  
414 475-6188

# YOUR IN-HOUSE POWER SUPPLY IS ON OUR SHELF

# 25 <sup>50</sup> WAYS

MORE POWER TO YOU!

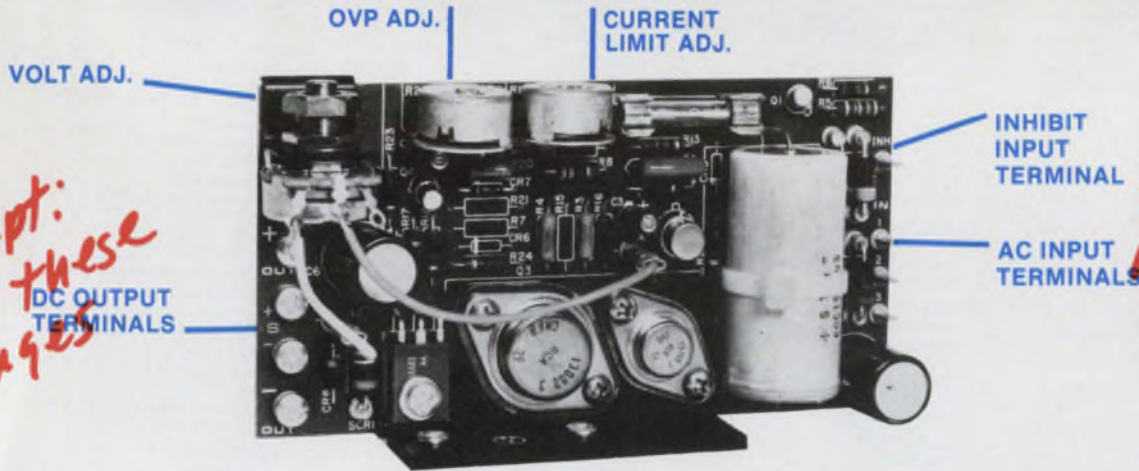

Art dept. Make these changes

Hey! Do something with the button!

ok JEP

NEW, UNIQUE LOW COST BUILDING BLOCKS WITH BUILT-IN RECTIFIER, FILTER, REGULATOR AND OVP.

50%  
10%  
75%

50 models, 5 power packages, up to 30V, up to 10A. Direct electrical connection to a transformer and mounting to a heat sink completes a quality d.c. power supply that meets your specific needs at the lowest possible cost.

**OTHER EXCLUSIVE FEATURES:**

- Regulation: Line/Load  $\pm 0.075\%$
- Logic Inhibit Function
- Hermetic Transistors
- Remote Sensing
- Computer Grade Capacitors

No need to add external components.

No bag of parts: Everything you need for In-House use is already built-in.

Write for new 40-page Powertec catalogue today.

**CUSTOM DESIGNS**

Also these new standard sub-modules are ideally suited for custom designs at low costs and fast delivery.

Custom designs are standard practice at Powertec.

**SUB-MODULES OUTPUT RATING CHART AND PRICES.**

MODEL	- 100		- 200		- 300		- 400		- 500		PRICES**
	*4.75V to 7.0V	*7.0V to 10.5V	*10.5V to 15.75V	*15.75V to 22.0V	*22.0V to 30.0V	100	PC.				
22A	1.0A	.875A	.725A	.625A	.575A	.500A	.475A	.450A	.425A	.400A	\$15.00
22B	3.0A	2.5A	2.2A	1.9A	1.7A	1.5A	1.4A	1.3A	1.2A	1.1A	20.00
22C	6.0A	5.2A	4.4A	3.8A	3.4A	3.0A	2.8A	2.6A	2.5A	2.3A	30.00
22D	12.0A	10.4A	8.8A	7.6A	6.8A	6.0A	5.6A	5.2A	5.0A	4.7A	40.00
22E	18.0A	15.6A	13.2A	11.4A	10.2A	9.0A	8.4A	7.8A	7.5A	7.1A	50.00

Typical ordering information for 5V, 1.0A, Model 22A-100; and 12V, 6.8A, Model 22D-300, etc.

\*Volt.adj. range. \*\*Consult factory for prices at other quantities.

INFORMATION RETRIEVAL NUMBER 13

POWERTEC INC. an Airtronics Subsidiary

9168 DeSoto Ave., Chatsworth, California 91311 • (213) 882-0004 • TWX (910) 494-2092

# POWERTEC

Put in New off-the-shelf Models!

22AA	.40A	.35A	.29A	.25A	.23A	.20A	.19A	.18A	.17A	.16A	\$10.00
22F	24.0A	21A	17.25A	15A	13.7A	12.2A	11.2A	10.7A	10.0A	9.4A	\$70.00
22G	36.0A	31.5A	26.0A	22.5A	20.6A	18.2A	16.8A	16.0A	15.0A	14.1A	\$95.00
22H	50.0A	43.8A	35.9A	31.5A	28.5A	25.3A	23.9A	22.3A	20.8A	19.6A	\$125.00
22T	75.0A	65.6A	53.9A	46.9A	42.8A	38.0A	35.0A	33.4A	31.5A	29.5A	\$175.00

# Six guys - ready to rap about your transformer and filter application problems



Got a transformer, filter or inductor problem you'd like to kick around with somebody who *knows*? Just pick up the phone and call the UTC Hot Line in New York. The call is on you. The rap is on us. Call and ask for:

Specialty	Bill Schulz	Burt Yudin	Bruce Gueble	Aaron Beers	Marie Fuchs	Bill Totino
Audio	•	•				
Pulse	•		•	•		
Power		•	•	•		
Ferro-Resonant			•			
Filters					•	
Inductors	•	•			•	
Q.C. MIL						•
Circuits	•					

Chances are good that we'll clue you in on a UTC standard unit to meet your needs, and already in stock at a nearby UTC distributor.

Or you may find that a standard UTC transformer, filter or inductor can be economically modified to solve your design problem. These guys have on-line computer terminals right at their desks to tap storage bank design data.

If neither of those will fly, you'll still be talking to someone who can tell you exactly what would be involved in a custom unit—and how to go about getting a prototype.

You don't have an immediate problem? Fair enough. But why not send for our current catalog — 80 pages covering some 1300 standard transformers, inductors, amplifiers and filters. Free — from TRW/UTC Transformers, an Operation of TRW Electronic Components, 150 Varick Street, New York, N.Y. 10013.

CALL THE UTC HOT LINE (212) 255-3500

## TRW<sup>®</sup> UTC TRANSFORMERS

INFORMATION RETRIEVAL NUMBER 141

# Mil spec synchro/digital converters:

## We've got 'em in cards. Or cased. For off-the-shelf delivery.

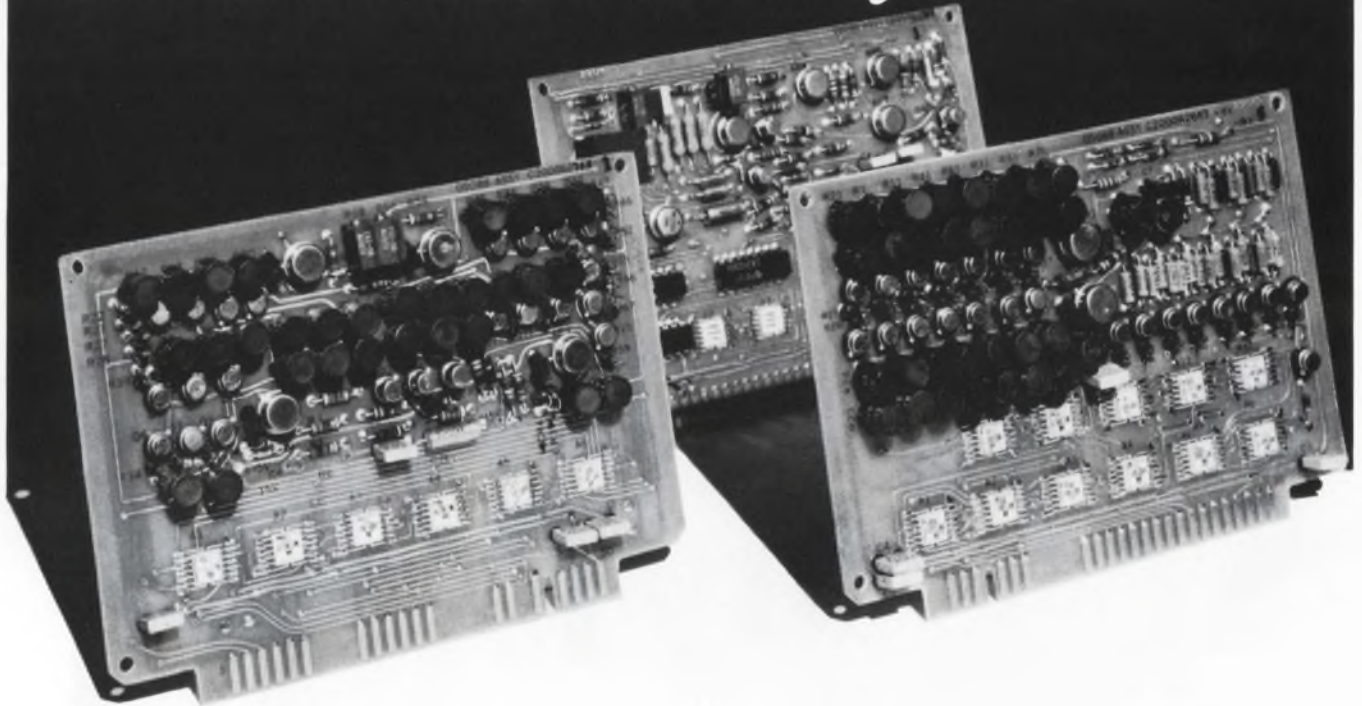

Kearfott can solve your synchro-to-digital and digital-to-synchro conversion problems with three production model solid state converters. All three meet MIL-E-5400.\*

TRIGAC I—A low cost synchro to digital converter, accurate to 12 minutes.

TRIGAC III—Synchro to digital tracking converter dynamically similar to an electro mechanical follow-up servo.

TRIGAC IV—Digital to synchro converter, accurate to four minutes.

### Typical Characteristics

		TRIGAC I		TRIGAC III	TRIGAC IV
Model Number	C70 4773 017	C70 4773 011	C70 4773 019	C70 4773 022	C70 4773 020
Package	2 P C cards	metal enclosure	2 P C cards	3 P C cards	3 P C cards
Input Signal	4 wire resolver	3 wire synchro	4 wire resolver 4 channels	4 wire resolver	12 bit parallel
Output	13 bit BCD			14 bit natural parallel	3 wire 11.8V 400Hz
Resolution	6 minutes of arc				
Accuracy	12 minutes of arc			4 minutes of arc	
Logic Levels	Logic "1" = $\pm 5V \pm 10\%$ , Logic "0" = 0-0.5V				

\*Commercial version available

We can supply any of the cards shown in corrosion-resistant metal enclosures. Write today for new catalog. The Singer Company, Kearfott Division, 1150 McBride Avenue, Little Falls, New Jersey 07424.

**SINGER**  
AEROSPACE & MARINE SYSTEMS

# 6 Reasons to look to PRD for RF instruments



## 1 The 7815 Tunable Power Amplifier

It's tunable in 6 band-switched ranges from 10 to 500 MHz. Offers high power output (8 watts) and low distortion. Unit is solid state except for final amplifier tube, and provides output metering and overload protection. Has 2.0 to 5.0 MHz bandwidth.

INFORMATION RETRIEVAL NUMBER 161



## 3 The 7828 Programmable Frequency Synthesizer

It's offered with 1 kHz phase-locked steps. An optional vernier provides 1 Hz resolution. It's fully programmable with contact closures, RTL, DTL, TTL logic. One part in  $10^6$ /mo. stability; up to 1.0 volt output into 50 ohms.

INFORMATION RETRIEVAL NUMBER 163



## 5 The NEW 7825 Wideband Power Amplifier

Designed for applications in the 10 Hz to 10 MHz range, this unit requires no tuning or adjustments and delivers 10 watts into a 50 ohm load with harmonics and intermodulation distortion down more than 40 dB. It provides over 15 watts with higher drive levels, and operates with 40 or 60 dB gain. Overdrive protection and its 3 ohm output impedance will drive any load.

INFORMATION RETRIEVAL NUMBER 165

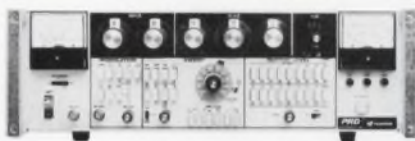

## 2 The 7808 Synthesized Signal Generator

This is three instruments in one. It has synthesizer accuracy and stability, yet retains the manual tuning and sweep capabilities of conventional signal generators. Frequency range: 0.05 to 80 MHz in 1 kHz phase-locked steps, and an optional vernier provides 1 Hz resolution. Stability: 1 part in  $10^6$ /mo. Frequency, modulation and attenuation are fully programmable.

INFORMATION RETRIEVAL NUMBER 162



## 4 The 7805 Low Distortion Power Amplifier

A solid state broadband amplifier with -30 dB harmonic and intermodulation distortion. Gain is 47 dB minimum, constant within 1 dB for full output with less than 0.1 volt at 50 ohm input. Has highly effective input and output protection so that overdriving or operation into a short or open circuit is possible without damage.

INFORMATION RETRIEVAL NUMBER 164

## 6 The PRD Quality and Reliability

Built into every PRD product, from our first microwave instrument to these five new RF instruments. They all feature the excellent design, workmanship and service that have been synonymous with PRD for three decades.

INFORMATION RETRIEVAL NUMBER 166

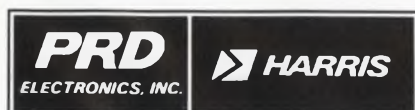

PRD Electronics, Inc. • A Division of Harris-Intertype Corporation

1200 Prospect Avenue • Westbury, New York 11590 • Tel. (516) 334-7810 • TWX 510-222-4494

# new, pocket-size Tri-Phasic<sup>TM</sup> multimeter



**MODEL 245, ACTUAL SIZE**

# Try It

**\$295.00**  
COMPLETE

You can't match Data Precision's Model 245 for price/performance, size, reliability and usability.

**PERFORMANCE:** .005% RESOLUTION, .05% BASIC ACCURACY FOR 6 MONTHS, MEASURES ACV, DCV, DC AND AC CURRENT, AND RESISTANCE WITH 100% OVERRANGING.

*DC Volts*, 1 volt to 1000 volts full scale, 100  $\mu$ V resolution.  
*AC Volts*, 1 volt to 500 volts RMS full scale, 100  $\mu$ V resolution, 30HZ-50kHz.  
*DC Current*, 1 ma to 1A f.s., 1  $\mu$ A resolution.  
*AC Current*, 1 ma to 1A f.s., 1  $\mu$ A resolution, 30HZ-50kHz.  
*Resistance*, 1 K $\Omega$ -10M $\Omega$  full scale, 100 milliohms resolution.  
Calibration guaranteed 6 months minimum.

**PRICE: \$295 COMPLETE**

Includes rechargeable battery module, line cord/recharger, fused input probes, carrying case and strap, complete software and test documentation, full Data Precision calibration Instruction Manual and separate Operator's Manual, and one year warranty.

**RELIABILITY:**

Proven LSI P-MOS and C-MOS Components plus our improved autozeroing Tri-Phasic<sup>TM</sup> conversion, Isopolar<sup>TM</sup> reference, Ratiohm<sup>TM</sup> resistance provide reliability normally found in instruments costing 3 to 4 times as much.

**USABILITY: IDEAL FOR LAB, PRODUCTION OR FIELD USE.** Truly portable, pocket size 1 $\frac{3}{4}$ " x 3 $\frac{1}{2}$ " x 5 $\frac{1}{2}$ " packaged in a rugged impact resistant case, rechargeable 6 hour battery for in-spec operation and line recharge.

To get your hands on this remarkable instrument, phone your local sales representative.

AL (205) 883-2530	IL (312) 286-6824	NJ (215) 925-8711
AZ (602) 946-7252	IN (317) 253-2087	NM (505) 265-6471
CA <sub>(M)</sub> (415) 321-7323	MA (617) 273-0198	NY <sub>(N)</sub> (315) 446-0220
CA <sub>(S)</sub> (714) 540-7160	MD (301) 588-7790	NY <sub>(S)</sub> (516) 482-3500
CO (303) 449-5294	MI (313) 482-1229	OH <sub>(M)</sub> (216) 243-7430
CT (203) 527-1245	MN (612) 781-1611	OH <sub>(S)</sub> (513) 298-3033
FL <sub>(M)</sub> (305) 241-4445	MO <sub>(E)</sub> (314) 426-2331	TX <sub>(M)</sub> (214) 234-4137
FL <sub>(S)</sub> (305) 563-8056	MO <sub>(W)</sub> (913) 236-6600	TX <sub>(S)</sub> (713) 461-4487
GA (404) 457-7117	NC (919) 787-5818	WA (206) 767-4330

Data Precision Corporation  
Audubon Road Wakefield, MA 01880  
(617) 246-1600

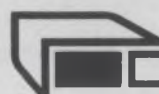
 **DATA PRECISION**  
...years ahead

## ACROSS THE DESK

(continued from page 10)

he thinks is a world-beater of an invention. Maybe Dr. Perloff's an exception, but if he's not, the American system gives him the best opportunity on earth to join the entrepreneurial ranks that will free him forever from concerns about job security and pensions; all he has to do is be willing to gamble everything he has on his conviction. If he's right, he can wind up wealthy, too.

Will Connelly  
President

U.S. Technology Export Corp.  
4165 Southwest 11th Terrace  
Fort Lauderdale, Fla. 33315.

## A word of caution on 'typical' designs

I agree fully with George Rostky's comments on "typical"-vs-"worst case" specifications ("How Exact Is Engineering," ED No. 5, March 1, 1973, p. 47). However, a few pages further on in the same issue, you present the article "CMOS Logic Elements Interface Easily," and it is full of "typical" characteristics and statements of what CMOS "can" do.

I would like to expand upon Mr. Rostky's comments with an example of how "typical" designs can cause trouble. My particular concern is with the direct connection of a CMOS gate to HTL. Yes, in most cases this will work, but not always. Worst case, a CMOS gate is generally specified as capable of sinking only 0.5 mA in the low state. HTL requires 1.2 mA and HiNIL requires 2.1 mA, worst case. So a system will probably work, with only a sacrifice of some varying and unknown amount of noise immunity. But then if a designer can sacrifice noise immunity, why is he using HTL? Proper design dictates the use of a CMOS buffer to drive HTL.

The point is, then, that while typical values may look acceptable, all parameters must be considered worst case to ensure that a system operates as designed every time.

Michael I. Wier

Product Marketing Engineer

ITT Semiconductors

Electronics Way

W. Palm Beach, Fla.



## seal of improval

*Improved reliability through the use of a glass-to-tantalum true hermetic anode seal is the prime feature of new Type 138D gelled-electrolyte sintered-anode Tantalex® Capacitors. This new construction eliminates all internal lead welds while retaining the strength of conventional internal lead-welded parts. In addition, the new construction offers outstanding resistance to extensive temperature cycling.*

Type 138D Tantalex Capacitors are designed to meet or exceed

the environmental and life test requirements of MIL-C-39006. The gelled-electrolyte employed in these new capacitors gives premium performance for all capacitor parameters with respect to frequency and temperature variations.

Originally developed for use in aerospace applications, this capacitor design is now available for general industrial and aviation use where the utmost in component performance and reliability are primary necessities.

For complete technical data, write for Engineering Bulletin 3704A to: Technical Literature Service, Sprague Electric Co., 347 Marshall St., North Adams, Mass. 01247.

THE BROAD-LINE PRODUCER OF ELECTRONIC PARTS



INFORMATION RETRIEVAL NUMBER 14



CONTROL DATA  
CYBER 70



# Think Twice:

## Control Data Did

Control Data's reputation was built on providing computers with high throughput/dollar capabilities. That capability must be protected by assuring their customers ultra-reliable computers. Therefore, when Control Data assigns a scope to a computer, that scope must be as reliable as their computer. This makes reliability equally as important a consideration as performance—In both categories, H-P's portable is a scope that meets Control Data's rigid requirements.

### It Pays To Compare.

Before choosing any scope—from the smallest portable to the most sophisticated lab model—make a careful evaluation and comparison. **If you need a portable**, remember that HP portables with self-contained batteries give you go-anywhere capability to meet your most demanding field service requirements. A sealed case with no fan or vent holes frees you from worry about dust and moisture. **For a lab system**, compare the flexibility offered by the broad range of compatible plug-ins. Then call us for a hands-on demonstration of the combination that best fits your needs.

### Look Into Price.

Analyze your total measurement

needs, then ask both manufacturers to submit prices. On currently available models, you'll find that HP can save you money—lots of it in most cases. Check carefully on all aspects of cost and performance. Whether you are comparing real-time systems with or without delayed sweep, or sampling units, you'll find that HP still offers a cost/performance advantage.

### Check Ease-of-Use.

Compare simplicity of controls, display size and error-prevention devices. Does the scope have useful, time-saving features, like selectable input impedance, variable-persistence storage and simplified sampling? Check writing speed; HP's new burn-resistant storage scopes are brighter than scopes have ever been, and write at a speed up to 400 cm/ $\mu$ sec. This means you no longer need to bury your head under a scope hood to view fast-risetime, low-rep rate signals.

### Don't Neglect Calibration And Service.

Compare calibration time needed for each manufacturer's unit. You'll find it takes less time with an HP scope. In fact, some companies bought HP scopes because of this one fact alone. You'll also

discover that HP scopes are backed by video tapes which cut the time you spend training your calibration people.

### Think Twice: Like Control Data.

You owe it to yourself to make these comparisons before you choose your next scope. To help you compose the check list for the scope that meets your personal needs, send for our "No-Nonsense Guide to Oscilloscope Selection." Or, contact your local HP field engineer for a demonstration. Think twice and check before you choose. Hewlett-Packard, Palo Alto, California 94304. In Japan: Yokogawa — Hewlett-Packard, 1-59-1, Yoyogi, Shibuya-Ku, Tokyo 151, Japan. In Europe: HPSA, P.O. Box 85, CH-1217 Meyrin 2, Geneva, Switzerland.

**Scopes Are Changing;  
Think Twice.**

083/2

HEWLETT  PACKARD

OSCILLOSCOPE SYSTEMS

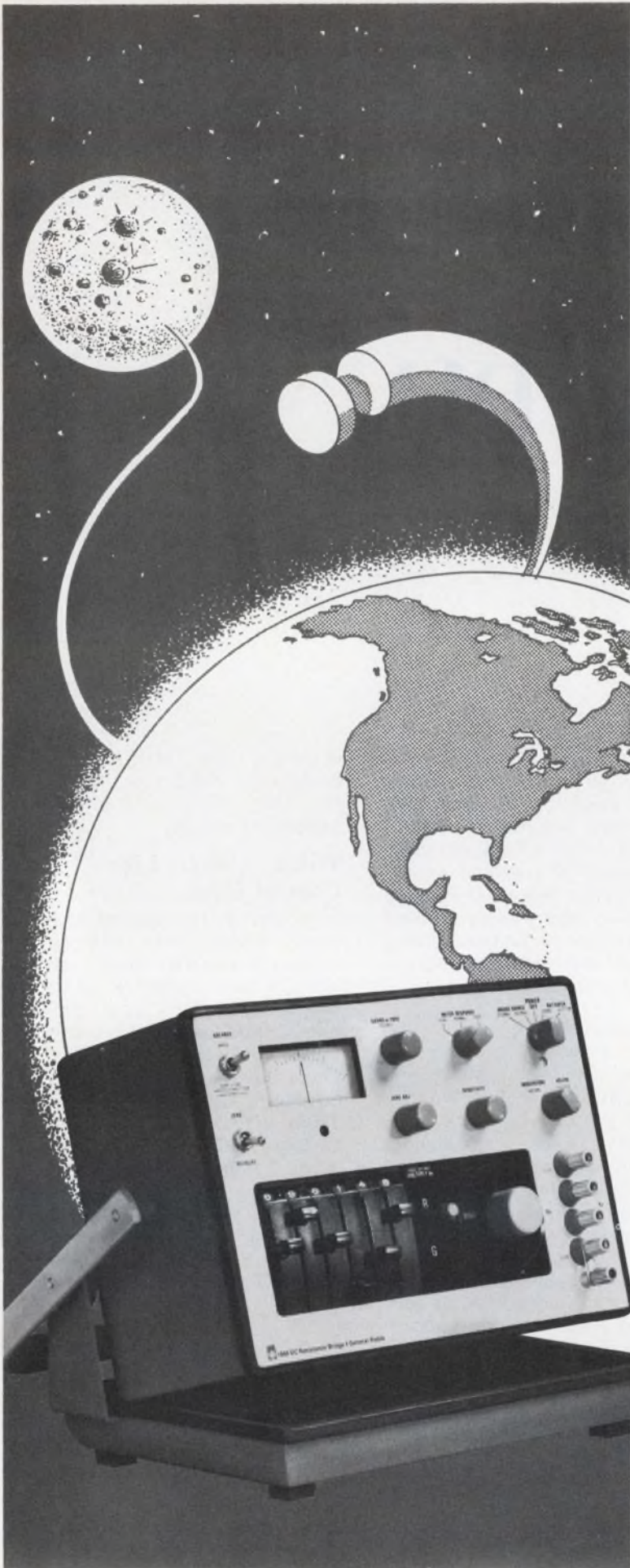

# GR's Measure- Anything Resistance Bridge

Enough #10 wire to reach the moon will total about 1 megohm. The GR 1666 DC Resistance Bridge will measure that to within  $\pm 0.01\%$ , or the equivalent of  $\pm 25$  miles. Better yet, if a piece as short as 440 yards is removed from the translunar span, the 1666 bridge will resolve the 1-ohm difference.

Most striking about the 1666 bridge is its wide measurement range. It will measure a piece of the same size wire long enough to reach from here to Neptune, 2.7 billion miles (10 gigohms), or a 1½-inch piece (100 microohms), both within  $\pm 2\%$  accuracy. And that feat doesn't really tax the 1666; it has enough resolution and detector sensitivity to distinguish between 0 and 2 microohms and between  $\infty$  and 500 gigohms (measured as 2 picomhos conductance).

Here, for \$950, is a bridge that will measure contact resistance and dielectric leakage, transformer windings and insulation, diode forward and back resistance, relays open and closed . . . and all with precision.

The 1666 has a *fast-responding* detector. The 1666 is self-contained. The 1666 has guard and Kelvin connections. The 1666 is essential if you measure resistance.

From General Radio, Concord, Mass. and, in Europe, Postfach, CH 8034 Zurich, Switzerland.



**General Radio**

300 BAKER AVENUE, CONCORD, MASS 01742

NEW YORK (N.Y.) 212 964-2722, (N.J.) 201 791-8990 • BOSTON 617 646-0550  
DAYTON 513 294-1500 • CHICAGO 312 992-0800 • WASHINGTON, D. C. 301 948-7071  
ATLANTA 404 457-2485 • DALLAS 214 234-3357 • LOS ANGELES 714 540-9830  
SAN FRANCISCO 415 948-8233 • TORONTO 416 252-3395 • ZURICH (01) 55 24 20

GR COMPANIES • Grason-Stadler • Time/Data • Techware Computing Corp.  
GR ASSOCIATE • Micronetic Systems Inc.

# 4999 counts instead of 1999.

## That's one difference between our 3½ digit DVM and their's.

If a 3-digit DVM reads to 999 and a 4-digit DVM reads to 9999, a 3½-digit DVM should read to 4999. Our's does. Their's doesn't.

Their 3½-digit DVM will read up to 1999 with 100% overrange. If your input exceeds 2000 counts you have to change ranges with loss of resolution. But Data Technology has changed all that.

Our new Model 30 has a full 1 through 5 readout in the first position. You have 4-digit accuracy for 5V and 20V logic, 20V and 30V telephone applications, 24V industrial supplies, 28V aerospace and analog applications, 36V military and 230V/440V/480V industrial voltages plus the same accuracy for 22, 27, and 47 ohm resistors. More importantly, the Model 30 provides

this capability for less money than any comparable meter: \$279 for line operation; \$299 with rechargeable batteries.

Using the bright new Sperry display, its low power requirements allow the model 30 to operate 10-12 hours without recharging the batteries. A 23-range instrument, the Model 30 has five AC and five DC voltage ranges; five resistance ranges; four AC and four DC current ranges.

The 4999 counts instead of 1999 will be the first difference you'll notice between our 3½-digit DVM and their's, but there are lots of others. Try one and see for yourself.



# the new data technology corp.

2700 S. FAIRVIEW ROAD, SANTA ANA, CALIF. 92704 (714) 546-7160 TWX: 910-595-1570



# Kurz-Kasch Digital Logic Instruments\*



... complete logic systems analysis through the Logic-Probe concept

Rugged, all solid-state, Kurz-Kasch logic probes are designed for fast, accurate testing of logic levels in all types of integrated circuit systems. A simple readout system indicates "true", "zero", or "pulse" readings precisely through color-coded visual electronic readouts in the probe tip. Absence of logic levels is indicated by all readouts remaining OFF.

**Applications** Logic levels can be accurately tested in virtually any (DTL, TTL, RTL) IC system including desk calculators, business machines, N/C devices, computers or telephone systems. Power is derived from the unit under test allowing use in the field or in the lab.

<b>Specifications</b>	High input impedance prevents loading of circuit under test.
Readout Light Red=Logic "1"	Size $\frac{3}{8}$ " dia., 6" long, 26 $\frac{3}{4}$ " leads with pin terminals
Readout Light White=Logic "0"	
No Readout Light="infinity"	

A pulse detection feature is available on most models of logic probe. A third readout is provided to display high speed pulse trains or a single cycle pulse of less than 50 nanoseconds on the standard Model LP-520. Overload protection to +50, -20 volts DC is also available.

**Standard Probes** Logic probes are presently available in five standard models. MODEL LP-500 for use in testing 4.75-5.0 V DC logic systems. MODEL LP-510 for testing 4.75-5.0 V DC systems . . . includes overload protection to +50, -20 V DC. MODEL LP-520 . . . for 4.75-5.0 V DC logic systems . . . includes overload protection and pulse detection features. MODEL LP-530 for testing of 12-15 V DC logic systems . . . includes overload protection to +50, -20 V DC. MODEL LP-540 . . . for 12-15 V DC systems . . . includes overload protection and pulse detection features.

**Add these options:** **G-S-M: Gating Feature (-G)**— 3 Channel input for timing. Pulse indicator only when probe tip and gate/gates are in coincidence. **Memory & Stretch (-M)**— Push-pull switch for selecting stretch or latch mode. Stretch mode detects high speed pulse and displays blue "P" lamp for 200 mS. Latch mode captures high speed pulse/trains and latches blue "P" on until reset. **5 Nano-second capability (-S)**— Allows detection of pulses up to 10 x faster than standard probes. Each option \$10.00.

**Special Probes** As a routine service, Kurz-Kasch will custom design logic probes to user specifications. Custom designs can include: both positive and negative logic levels from 50 to 30 volts . . . special pulse detection characteristics . . . floating or grounded cases . . . custom power supply requirements . . . power lead reversal protection . . . and your choice of logic crossover parameters.

Kurz-Kasch logic probes provide all the information you need to quickly and accurately evaluate all logic systems . . . and they are the most economical logic testing instruments available. Standard Models range in price from \$39.95 to \$69.95. Write today for complete details on all standard and special logic probes.

\*Patent #3,525,939 applies, others pending.



**Kurz-Kasch, Inc.**

Electronics Division  
1421 S. Broadway  
Dayton, Ohio 45401  
Telephone(513)223-8161

A CAMBION DOUBLE "QQ" PRODUCT LINE

# Color your IC systems Cambion.

You can let your imagination soar, and still keep your most advanced IC packaging concepts practical. With Cambion's growing line of digital products, state of the art design ideas become a reality. And we can meet your needs with repeatable Quality, no matter how great the Quantity. Our variety of components is so extensive you won't have to think "specials".

Just take a look at our new Catalog 119. It features advanced new Cambi-Cards™, card files, drawers, universal panels with and without premounted socket strips and power planes, specific logic function cards, general purpose and discrete component cards, plus strip connectors, cable assem-

blies, integrated socket strips, component socket adapters, cable cards and card extenders.

We also offer a complete NC wrapping service to speed economical production of your IC system designs.

Develop your system ideas to their fullest potential *without component restriction*. Get your own copy of the new Cambion Catalog. It has 22 more pages than its predecessor showing more new products to keep ahead of your design needs. And they all have the Cambion Double "QQ" approach: the Quality stands up as the Quantity goes on. Order your copy today. Cambridge Thermionic Corporation, 445EM Concord Avenue, Cambridge, Mass. 02138. Phone (617) 491-5400. In Los Angeles, 8703 La Tijera Blvd. 90045. Phone (213) 776-0472.

Standardize on

## **CAMBION**

... the Guaranteed Digital Products



# SPECIAL STYLES. ENDLESS CHOICE. CUTLER-HAMMER.

Cutler-Hammer has responded strongly to the new emphasis on styling in appliances and other equipment with fresh new design in switches.

Our unique rocker and paddle type switches have a new look. They're not only the finest in performance, but smartest in styling compared to traditional toggle and rotary operators.

From a simple one pole Rockette® switch to a specifically designed unit combining a variety of features, Cutler-Hammer can solve your special problem. Illuminated, snap-in-, nest-, sub-panel- or flush-mounted, sealed miniature, multi-pole, you name it. AC and DC ratings. Up to 20 amps. The choice has to be Cutler-Hammer!

And when you need an *extra special* design, we'll work with you to make just what you want.

Call your Cutler-Hammer Sales Office or Stocking Distributor. Or write for full-line catalog LD 110A.

**CUTLER-HAMMER**

SPECIALTY PRODUCTS DIVISION, MILWAUKEE, WIS. 53201

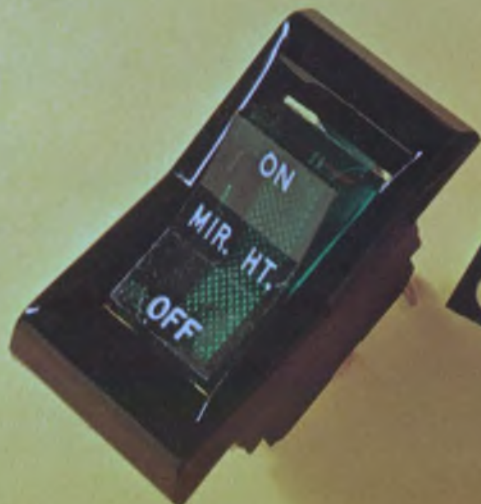

Switch  
to No.1

More than just switches,  
prompt availability,  
field help, innovation,  
quality assurance, too.

## U.S. spur to oil exploration a boost to electronics, too

President Nixon's energy message to Congress is expected to trigger a train of events that will mean more business ultimately for the electronics industry.

The President asked Congress to end Federal regulation of well-head prices for new natural gas wells—a step that “will undoubtedly stimulate new exploration,” a spokesman for the American Petroleum Institute said. And modern exploration calls for sophisticated electronic gear.

“We'd have liked it better,” the institute spokesman added, “if the President had deregulated well-head prices for producing wells, too, not just new ones.”

The Presidential message also asked that tax credits be granted for outlays for the exploration of oil. “This was a total surprise,” the institute's representative said. “And we haven't determined yet what the ramifications will be.”

Most of the new wells will be off shore, according to Gil Tausch, vice president of engineering and research at Cameco, Inc., in Houston, Tex., which develops and manufactures electronic instrumentation for producing wells and, he adds, rigs on land will be deeper.

“Off-shore wells call for more microwave communications sensors, alarms, data-gathering equipment, flow measurement devices and computer-controlled systems,” Tausch says.

More automation is needed for off-shore rigs than on land, Tausch points out, because it's difficult to find personnel who will live on a rig at sea, and it's also expensive to keep them there.

“Several companies,” the American Petroleum Institute representative says, “are designing deep-water drilling rigs—stations that are completely submerged. This, of course, requires almost total auto-

mation—a pushbutton operation.”

Deep wells on land will also require more electronic controls, because they are expensive to drill and vulnerable to costly mistakes.

Off-shore tanker terminals, which the President called for, will be needed if the 250,000-ton tankers now being built are to deliver oil to the United States. No U.S. ports can receive them.

These terminals—some 40 or 50 miles off shore—would require radar and other navigation aids, communications, flow-measurement sensors, pollution detectors, automatic alarm systems and minicomputers.

“But,” the American Petroleum Institute representative predicts, “there'll be trouble getting this terminal authority through Congress.”

The President also urged the petroleum industry to build more refineries—facilities that are heavily automated. To date there are 247 in the United States.

### FAA investigates vlf for civilian navigation

VLF—the frequency band usually reserved for submarines—is being considered by the Federal Aviation Administration as a supplement to vhf in civilian aircraft navigation systems.

“Vlf provides long-range signals useful in transcontinental flights,” says FAA's associate program manager, George Quinn. “It can be received in valleys, whereas vhf isn't. It's good at low altitude for helicopters flying out to off-shore oil rigs and in urban areas where tall buildings block vhf. And it's practical in Alaska, where there is no vhf.”

To find out how suitable vlf navigation systems—particularly

Omega—are, the FAA is carrying out five studies:

- Global Navigation, Inc., of Torrance, Calif., is testing its own Omega receiver with signals from Navy vlf communication stations.

- The FAA is testing an identical receiver at its Atlantic City, N.J. research center.

- The Naval Electronics Laboratory in San Diego is studying, from a theoretical standpoint, the feasibility of vlf for civilian aircraft.

- Bendix in Teterboro, N.J., has delivered a feasibility model of its Omega receiver to NASA's Langley Research Center in Norfolk, Va.

- Northrup is evaluating one of its Omega receivers on a trans-Atlantic run.

### Paris show attracts 121 U.S. semi makers

Any engineer who missed the semiconductor manufacturers at this year's IEEE show could have found them in abundance at the Salon International des Composants Electroniques in Paris the following week. For while there were almost no semiconductor vendors at the four-day IEEE show in New York City, with its 220 exhibitors, there were dozens at the six-day Paris components show, with 910 exhibitors, 121 of them from the United States.

And while the U.S. show played to an audience of about 28,000, the Paris show drew more than 50,000, including some 6000 from 50 countries outside France.

The April 2-7 Paris show had no exhibits of test equipment: by agreement among the sponsoring societies, these are excluded and displayed instead at the Mesucora exhibition, which this year was held April 11-18 in Paris.

But despite the popularity of the components show, there was little that was new, though some American manufacturers used the occasion to introduce to Europe products that had already been introduced in the States.

The emphasis of the semiconductor manufacturers, from the U.S. and elsewhere, lay mainly in power-control and high-voltage devices—rectifiers, rectifier stacks, SCRs, diacs, triacs—and in ICs for con-

sumer goods—radio and TV circuits, speed controllers for small motors for phonographs and tape recorders. Incidentally, selenium rectifier stacks, which have almost vanished from the U.S. market, are still popular among European manufacturers.

Radio and TV ICs were shown by Fairchild Semiconductor of Phoenix, Ariz., Sprague, North Adams, Mass., and such European suppliers as Ferranti, Manchester, England; Mullard, London; Plessey, Swindon, England, and Siemens, Munich, West Germany. Among the more outstanding devices were audio-amplifier ICs, with 10-W rms output and full short-circuit and thermal protection, from Sescosem, Paris; and SGS/ATES, Milan, Italy.

General Instrument, Hicksville, N.Y., a pioneer in MNOS ICs, didn't show any. It stressed PMOS and NMOS devices. A General Instrument engineer at the booth said that the company was not interested in "way out" technologies but rather in devices that could be sold in volume. Ferranti, by contrast, features MNOS devices as well as circuits made with its proprietary Collector Diffusion Isolation, a five-mask bipolar technology offering bipolar speeds with MOS density and power consumption. Plessey featured nonvolatile memories with capacity to 16 and 18-bit words and promised early development of a 128-by-128 MNOS memory. Inselek of Princeton, N.J., was alone in showing silicon-on-sapphire CMOS ICs. One SOS/CMOS 356-bit RAM featured 70-ns access speed, 0.3 mW/bit, full decoding and TTL compatibility.

While most of the semiconductor exhibitors followed these patterns, a few showed more unusual devices. ITT Semiconductors of Freiburg, West Germany, showed watch and clock circuits and a variety of automotive ICs, including a digital tachometer.

Most unusual was the display of a young company, Mosfet Micro Laboratories, Quakertown, Pa., which restricts itself to custom MOS wafer fabrication, especially for short runs. At \$150 to \$200 per wafer, with a minimum run of 10, the company believes it offers a unique opportunity for smaller manufacturers who want exclusive circuits.

## New monitor system for word processor

A new monitoring and control system designed for input word-processing equipment has been announced by the Dictaphone Corp., Rye, N.Y.

The system, called the Word Monitor, enables a word-processing supervisor to control and measure work flow. It is designed for use with Dictaphone's Thought Tank recorders. These recorders contain a three-hour loop of endless magnetic tape. Access is achieved through a telephone-like instrument or a hand microphone.

The monitoring and control system consists of three elements: a meter device that measures and displays the amount of dictation stored in each tank, an electronic graph monitor that makes a visual printout every time a recorder is used and shows for how long it was used, and a four-digit counter locator that measures the daily production of each secretary and enables her to find any dictated item in the bank without delay.

## Tunable laser widens its reach in IR region

A continuously tunable laser system that permits operation over a wide range of frequencies in the infrared region has been developed at IBM's Thomas J. Watson Research Center, Yorktown Heights, N.Y.

The system uses the output of two tunable dye lasers to interact with a vaporized alkali metal and to generate a coherent infrared light with a wavelength tuning range that is wider than previously possible, says James J. Wynne, a staff member who worked on the project. Previously, Wynne notes, dye lasers could be tuned only from the near-ultraviolet, across the visible spectrum and into the near-infrared to about only 1.2  $\mu$ . With the new system, however, any point in the infrared spectrum from 2 to 24  $\mu$  can be reached.

The wide range of the system can be useful in biological and medical research, where it could be used to excite vibrations and rotations in molecules, Wynne says. Another application could be

in air-pollution research. A number of pollutants, Wynne reports, show strong absorption in the tuning range covered.

The wide-range capability of the two-laser system is achieved by four-wave parametric conversion. In it, the output from one of the dye lasers is tuned so it produces Stokes radiation—a frequency-shifted radiation that results from energy scattering, in which the frequency of the energy is changed by the material it interacts with.

The second laser is then tuned so its output combines with the first two waves—those from the first dye laser and the Stokes radiation. The interaction of all three waves results in a fourth wave, the final infrared output.

## LSI circuit connector used with thin films

The new technique of making connections directly to an integrated-circuit substrate, instead of using a lead frame, is being extended to thin-film circuits. The hope is that it will offer easier maintenance and repair of the circuits.

In a paper to be presented at the Electronic Components Conference in Washington, D.C., next week, William L. Harrod, supervisor of advanced packaging and materials application at Bell Telephone's Indian Hill Laboratory, Naperville, Ill., discusses directly pluggable thin-film circuits.

In describing his work, which he calls "preliminary," Harrod notes: "We used a commercial connector, and no attempt was made to optimize the connector design." Still, the results were very good.

Whereas the LSI circuit-connector scheme is guaranteed for 100 insertions, Bell's thin-film arrangement is good for up to 500 insertions, Harrod says.

The results were surprising, he notes. "People thought that thin films would be so delicate that the connector would just strip them off the substrate," he recalls.

The processing involved is straight-forward. "We use standard thin-film material and then add a layer of rhodium and a flash of gold on top of that," Harrod reports.



# Pushbuttons that stretch your budget and your panel.

If your panel suffers from a lack of dollars or space, here's our solution: Series 3 medium-priced pushbuttons and indicators.

They offer versatility that until now was available only in much higher-priced devices. For instance, there's a choice of low-energy, electronic-duty reed switches or 5-amp, double-break power switches. Strip, matrix or individual mounting is available. As are six lighted display colors and momentary or two-level alternate action.

Buttons? Choose from four styles, including one that's similar in appearance to a keyboard button.

Added up, this makes the Series 3 perfect for jobs such as computer peripheral equipment, business machines, communications systems or most any control panel.

For more information, contact your MICRO SWITCH Branch Office or Authorized Distributor (Yellow Pages, "Switches, Electric"). They'll bend over backward to help you.



MICRO SWITCH makes your ideas work.

**MICRO SWITCH**  
FREEPORT ILLINOIS 61032  
A DIVISION OF HONEYWELL

MICRO SWITCH products are available worldwide through Honeywell International.

INFORMATION RETRIEVAL NUMBER 21

# Programmed logic array puts 16-bit mini in economy class

Using a programmed logic array (PLA) instead of read-only memories, a microprogrammed minicomputer that will sell for less than \$1000 has been designed to match the performance of minicomputers that cost twice as much.

According to Phil Kaufman, technical director at Computer Automation in Irvine, Calif., developer of the new mini: "The PLA is a circuit containing many AND and OR gates that takes 24 inputs and logically combines them to provide 20 outputs, each of which can have up to 300 partial product terms made up of the 24 input variables."

The array contains 20,400 bits of hard-wired memory in addition to the gates. Kaufman notes that if ROMs were used instead of a PLA

to implement the microprogram, it would be necessary to have 16,777,216 addresses with a total of 335,544,320 bits of storage.

The memory cycle time of the new computer is 1.6  $\mu$ s, and its add time is 7  $\mu$ s.

All control logic, including the PLA, is contained on three p-channel, silicon-gate MOS/LSI chips. Each chip is packaged in a 40-pin ceramic DIP.

Four more MOS/LSI chips make up the rest of the central processing unit. Each of the four chips is a four-bit slice of the 16-bit arithmetic logic unit and register file.

The new machine is called the Naked Mini/LSI. In comparing it with its predecessor, the Naked Mini 16, which sold for more than twice the price, Kaufman points out:

"The major specifications of the two machines are essentially the

same. However, the cost saving arises from the fact that the computer is now fabricated on only one circuit board instead of four."

The single printed-circuit board of the Naked Mini/LSI measures 15 by 16 inches. Included on it are the seven MOS/LSI circuits; memory control logic; TTL I/O bus interfacing, drivers and receivers; a clock generator to furnish the four-phase processor clock, and up to 8 k of memory. The only thing missing is the power supply.

Kaufman describes the computer's architecture as a double-bus structure. "Memory and I/O have separate addressing schemes," he notes.

"One of the unique aspects of the computer's architecture," Kaufman continues, "is the fact that the memory is self-organizing—that is, if memory modules of different sizes and types—core, MOS RAMs, ROMs and others—are mixed or rearranged on the bus, the computer will automatically assign addresses without any reference to software."

The memory can be expanded up to 256-k, 16-bit words. ■■

David N. Kaye  
Senior Western Editor

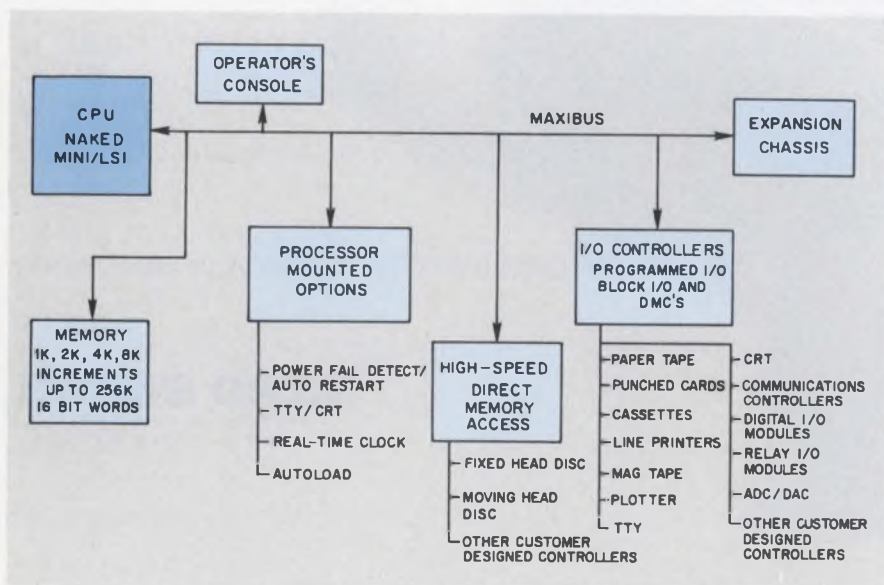

**Double-bus structure** allows different types and speeds of memory to be used together without any special software. The bus allows direct addressing of up to 248 I/O devices. The 162 element instruction set is implemented by internal microprogramming.

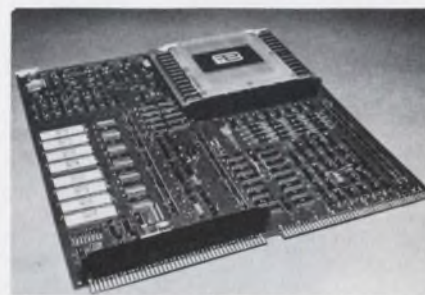

**15-by-16-inch printed-circuit board** contains an entire minicomputer, including 4-k, 16-bit words of core memory. The large packages on the left side of the board contain the central processing unit and microprogram control on silicon-gate MOS/LSI circuits.

# UHF demanded 1 GHz FETs. Signetics D-MOS does it.

FETs? From Signetics?

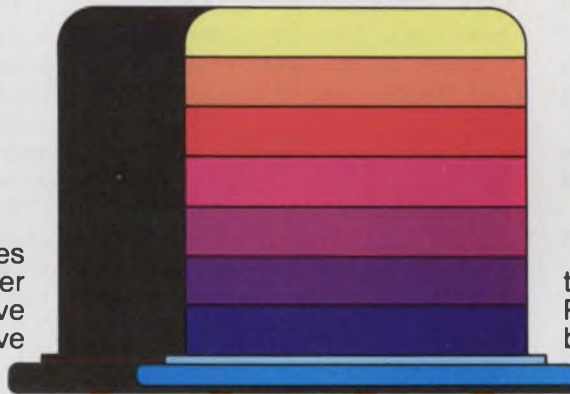

Surprise! Signetics goes discrete. With the first FETs ever produced for frequencies above 450 MHz. And everything we've poured into optimized ICs for years — ingenuity, painstaking research, user-oriented problem solving — has gone into developing these trouble-shooting UHF FETs. All double-diffused MOS devices of the N-channel enhancement mode type.

Four of them to start. Providing UHF designers unique performance that bipolar has never matched for mobile units, marine phones, TV tuners . . . and hundreds of similar applications.

Two single-gate D-MOS FETs. SD-200, unprotected by design. SD-201 with diode protection against transients. Both offer exceptionally low gate leakage. Plus unbeatable high-gain, low-noise figures.

And two dual-gate diode-protected FETs, that show excellent linearity in cross- and inter-modulation. SD-300 with AGC capacity, and ultra low noise SD-301.

Superb cross modulation characteristics at 1 GHz. Remarkably low input and feedback capacitance. Extremely high transconductance. The lowest noise figures

of any existing FETs. And simpler bias schemes.

**1 GHz**

Record-breaking low cost too. Our D-MOS FETs obviously outperform standard bipolars, hands down — for less than one-fifth the cost. Under four bucks in 100-piece quantities, instead of the \$20 or \$30 you'd expect.

Available now through your distributor in TO-46 hermetic cans, with four leads. Call for immediate delivery. Or tune in for the news behind the news, by sending for complete data sheets, technical and editorial back-up information, and of course, our application notes.



**Public notice.** Be one of the first 100 inquiries we receive, and you'll get the D-MOS FET of your choice

FREE to play around with.

N-Channel D-MOS FETs			
CHARACTERISTIC	SD-200/201	SD-300	SD-301
Gain at 1 GHz	10dB	13dB	14dB
Noise at 1 GHz	4.5dB	8dB	6dB
Fwd. Transconductance ( $\mu$ MHO)	15,000	10,000	10,000
Input Capacitance	2.0pF	2.0pF	2.0pF
Output Capacitance	1.0pF	1.0pF	0.6pF
Feedback Capacitance	0.13pF	0.02pF	0.02pF
Drain-to-Source Voltage	+30V	+30V	+30V

Signetics—D-MOS FETs  
811 E. Arques Avenue  
Sunnyvale, California 94086

Show me what a great IC supplier is up to in FETs. Send everything you've got on these discrete devices (and hopefully my FREE D-MOS FET: #SD-\_\_\_\_).

Name \_\_\_\_\_  
Title \_\_\_\_\_

in care of the letterhead address on the sheet of company stationery I have stapled, glued, clipped or otherwise appended to this coupon.

Signetics Corporation. A subsidiary of Corning Glass Works.

## Signetics

INFORMATION RETRIEVAL NUMBER 22

# Missile sync generator offers variable scan for TV systems

A variable scan-rate synchronizing generator developed originally for military missile cameras is being considered for consumer television systems.

Developed by Martin Marietta's Microelectronics Laboratory in Orlando, Fla., the generator packs the circuitry of a 19-by-5-1/2-inch TV station rack into a one-inch-square package. It is designed to be driven by crystal-controlled clock signals.

The generator incorporates these features:

- Jumpers that can adjust the device to operate at a scan rate of 525, 875, 945 or 1025 interlaced lines per frame.
- Precise crystal control of pulse timing, not only of the period but also of the pulse width.
- Internal combining of vertical and horizontal sync to give the composite sync signal, thereby minimizing the external circuitry that is needed.

■ Use of low-power T<sup>2</sup>L logic to limit power dissipation to 375 mW.

"I don't know of another sync generator that can be modified with jumpers so that it can work with different TV picture formats," says Allen Fernandez, senior engineer at the Martin laboratory and the designer of the generator.

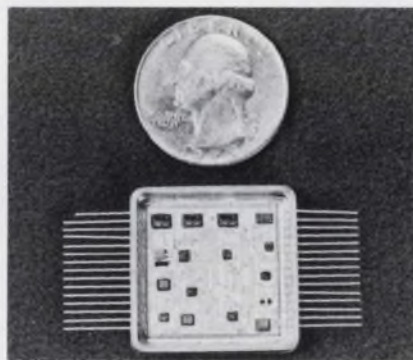

Thirty-lead flat pack contains a TV sync generator that can produce signals suitable for four standard television picture formats.

As he describes the device, it is a 30-lead package with 14 IC chips assembled on a two-layer, thick-film interconnection network. The generator uses but one standard 5-V T<sup>2</sup>L counter and three special low-power T<sup>2</sup>L counters, Fernandez points out—with the standard counter taking the clock signals.

The standard counter was necessary, he says, because its faster speed was needed at the input.

When driven by an external clock with crystal control, the generator supplies timing waveforms that are suitable for closed-circuit TV systems as well as for public TV equipment.

The 525 line-scan rate meets the performance standards for closed-circuit TV cameras with a 2:1 interlace at the 60-Hz rate.

The heart of the sync generator (see figure) is a ripple binary counter (see figure) is a ripple binary counter that can be adjusted externally to divide by any one of four numbers—33,600, 56,000, 60,480 or 65,472—for the 525, 875, 945 and 1023 line formats, respectively.

Once the ripple counter is set for a given rate, the corresponding clock input drives the system.

Fernandez notes, for example, that the 525-line system has a clock frequency of 2.0160 MHz. Dividing this by 33,600 gives a pulse that resets the counter at a 60-Hz rate. A one shot is used, the designer points out, to ensure that all the flip-flops in the counter are reset before the next clock pulse arrives at the input. The one-shot has no effect on sync generator output times.

Every time the counter is reset, exactly half of the scan lines are produced, because the horizontal period is never interrupted by the counter reset command. Thus each successive TV field is automatically interlaced at a 2:1 ratio. ■■

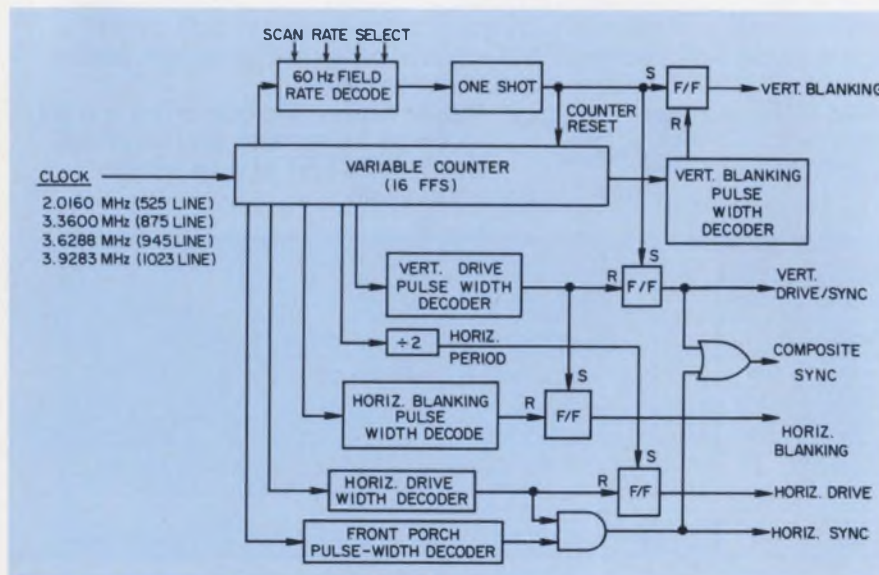

The ripple binary counter in the TV sync generator can be set to perform any one of four divisions. The clock frequency is provided by a crystal-controlled circuit that provides precise timing of sync signals.

# The GI book club



Here's a book club for capacitor guys. Almost everything you want to know about capacitors. Types. Specifications. Cross references. A real "how to" manual in an easy-to-use three ring binder. A binder we register in your name and periodically update. It's not a club for everybody, but if you're a qualified capacitor guy, membership is yours for the asking. From General Instrument . . . the people who wrote the book on capacitors. Capacitor Division, General Instrument Corporation, 165 Front Street, Chicopee, MA 01014. Phone (413) 592-7795.



**General  
Instrument**  
the capacitor company

Off the shelf delivery from Miconics/G.I. distributors coast to coast.  
Call (N.Y.) 212/361-2266 or (Calif.) 213/769-6782 for the name of the distributor nearest you.

# Lighted pushbutton switches this good should cost dollars more.

## Our prices:

\$125\*

\$160†



### OAK SERIES 300.

Get premium performance—at much less than a premium price. Oak Series 300 lighted pushbutton switches give you tested-for-reliability operation and long life. The economical solution to pushbutton applications for bank terminals, calculators, copiers, and more.

Modular design simplifies panel design. Oak Series 300 switches are relampable from the front, with

replaceable lenses, legend plates, and button assemblies. The snap-on lamp holders withstand physical shock, help prolong lamp life.

Choose from single, dual, or four-lamp display, as well as indicators and non-lighted types. Specify one to twelve station banks, with momentary, interlock, alternate action, or any switching combination available on the same bank.

Colors? Your choice of any one of the following for single-legend switches (or any combination for split-legend switches): lunar white, white, red, green, amber, yellow, orange, blue.

Get the complete details. Write for our Series 300 brochure.

\* Single-legend, single-lamp, normal latch, 2P2T, glass alkyd insulation, no engraving, less lamps. OEM quantities.

† Split-legend, four-lamp, normal latch, 2P2T, glass alkyd insulation, no engraving, less lamps. OEM quantities.

**DAK Industries Inc.**  
SWITCH DIVISION / CRYSTAL LAKE, ILLINOIS 60014  
TELEPHONE: 815-459-5000 ■ TWX: 910-634-3353 ■ TELEX: 72-2447

Remove Type 300 insert that follows for your files. If insert is missing, circle INFORMATION RETRIEVAL NO. 245 for personal copy.

For fast delivery on distributor quantities, refer to the list of distributors which follows the insert.

# Who to call for fast delivery on Oak Series 300 Switches.

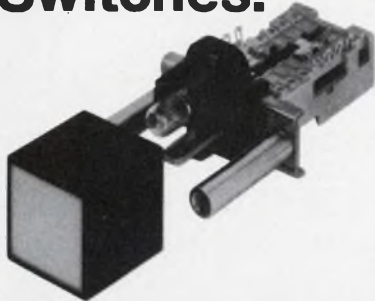

Now you can order Oak Series 300 Lighted Pushbutton Switches and assemblies (single-legend/single-lamp or non-illuminated) in quantities up to 149 from your regional Oak distributor. These distributors are equipped to assemble custom units and ship within 3 days.

## DRW

MASSACHUSETTS, Watertown. (617) 923-1900  
NEW YORK, Farmingdale. (516) 249-2660\*

## G. S. MARSHALL

CALIFORNIA, El Monte. (213) 686-1500\*  
CALIFORNIA, San Diego. (714) 278-6350  
CALIFORNIA, Sunnyvale. (408) 732-1100  
COLORADO, Arvada. (303) 427-5858  
OHIO, Dayton. (513) 278-9496

## HALL-MARK

ALABAMA, Huntsville. (205) 539-0691  
FLORIDA, Orlando. (305) 855-4020\*  
GEORGIA, Atlanta. (404) 963-9728  
ILLINOIS, Chicago. (312) 437-8800  
KANSAS, Kansas City. (913) 888-4747  
KANSAS, Wichita. (316) 682-2073  
MARYLAND, Baltimore. (301) 265-8500  
MINNESOTA, Minneapolis. (612) 925-2944  
MISSOURI, St. Louis. (314) 521-3800  
NORTH CAROLINA, Raleigh. (919) 832-4465  
NEW YORK, New York. (516) 293-7500  
OHIO, Dayton. (513) 278-6963  
OKLAHOMA, Okla. City. Enterprise 50094  
OKLAHOMA, Tulsa. (918) 835-8458  
PENNSYLVANIA, Philadelphia. (215) 355-7300  
TEXAS, Austin. (512) 454-4839  
TEXAS, Dallas. (214) 231-6111\*  
TEXAS, Houston. (713) 781-6100  
WISCONSIN, Milwaukee. (414) 476-1270

## INTERFACE ELECTRONICS

WASHINGTON, Seattle. (206) 285-3500\*

\* Assembly Locations

**OAK Industries Inc.**  
Crystal Lake, Illinois 60014

We're proud to be  
a distributor of  
**Oak**  
Series 300 Switch



**G. S. Marshall**

A Division of Marshall Industries

The component distributor  
who's fast on the draw... from stock

### Chicago

(312) 992-2128

### Colorado \*

5047 W. 64th Ave.  
Arvada, Colorado 80002  
(303) 427-5858

### Dallas

2607 Andjon St.  
Dallas, Texas 75220  
(214) 358-0161

### Dayton \*

2077 Embury Park Road  
Dayton, Ohio 45414  
(513) 278-9496  
TWX 810-449-1734

### Florida

10384 Riverside Drive  
Palm Beach Gardens  
Florida 33403  
(305) 622-8490

### Houston

(713) 643-1902

### Kansas City

(913) 648-6414

### Los Angeles \*

9674 Telstar Ave.  
El Monte, California 91731  
(213) 686-1500

### Michigan

(313) 778-5900

### New York

230 Sherwood Ave.  
Farmingdale, L.I.  
New York 11735  
(516) 293-4141

### San Diego \*

8057 Raytheon Road  
San Diego, Calif. 92111  
(714) 278-6350

### San Francisco \*

732 North Pastoria St.  
Sunnyvale, Calif. 94086  
(408) 732-1100

\* Stocking branch for Oak 300  
Switch

## NEWS

### A fivefold boost in diode speed

A new, fast ion-implantation process is reported to produce diodes that switch five to 10 times faster than any currently on the market. Typical switching times are given as 1 A in 9 ns, 3 A in 10 ns and 30 A in 25 ns. These switching times are said to hold for peak reverse voltages of 10 to 100 V.

According to Arnold Applebaum, president of Solid State Devices, Inc., Santa Fe Springs, Calif., developer of the new process:

"Speed and control are the major elements of the process. We are capable of completely processing 40 wafers in less than 10 seconds.

"This process combines a low-energy, high-density ion-implantation and deposition process under very high vacuum conditions. The process facilitates the formation of large-area, highly doped shallow semiconductor junctions and associated electrodes."

A single apparatus developed by Solid State Devices performs the process steps of pre-implantation, cleaning, ion implantation for junction formation, ohmic contact formation by kinetic contact deposition and post implantation annealing. The process is called Epion, for epitaxial ion implantation.

A unique aspect of it is that a variety of source materials can be used. "Older types of ion implanters could implant only from gaseous sources, such as boron or phosphorous," Applebaum notes. "With our system, virtually any source material can be implanted in a variety of substrates."

Another problem that the Epion process has solved is that of annealing the semiconductor target to repair lattice damage resulting from ion bombardment.

The process can also remove implanted ions from the interstitial to the substitutional positions in the semiconductor crystal lattice.

Applebaum points out that the large shallow junctions that are formed with the process are quite radiation-tolerant. And looking to the future, he says: "The process lends itself to most any type of semiconductor fabrication." ■■

# Quartz Q-switch modulates high power laser

A quartz Q-switch, with a lithium niobate transducer attached, is reported to have modulated a pulsed neodymium YAG laser having an output of 360 mJ. Modulation of such high energy levels has been impossible with present acousto-optic Q-switches.

The development is an outgrowth of a program at the Texas Instruments Central Research and Engineering Laboratory in Dallas.

The goal is to produce and modulate 1 J/pulse energy at a repetition rate of 30 to 40 pps.

Prior to the new development, a rotating mirror or prism was used as the modulating element in high-energy pulsed lasers. Acousto-optic Q-switches tend to break down above 300 mJ.

Dr. William C. Holton, head of quantum electronics at Texas Instruments, notes: "Not only do we need a different type of Q-switch to handle 1 J/pulse, but we also need a different type of laser to produce it at the rep rate we need."

Instead of YAG:Nd, Holton is working with yttrium aluminum gallium garnet ( $YAl_{1-x}Ga_xG:Nd$ ). He reports that this material easily gives 750-mJ of output and that with good laser and material design, it will put out 1 J.

Holton describes the Q-switch

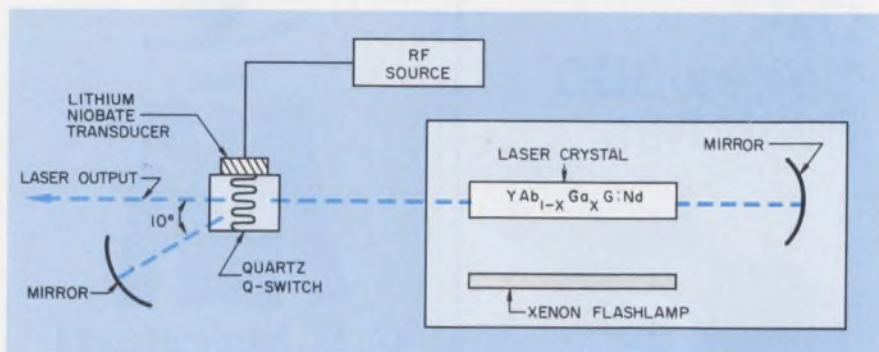

Quartz Q-switch with lithium niobate transducer is expected to allow acousto-optic modulation of 1-J/pulse laser energy.

as a piece of quartz with a lithium niobate transducer bonded to it. Modulation takes place when an rf pulse is coupled into the quartz through the transducer. The rf pulse sets up an acoustic wave in the quartz that deflects about 5% of the laser energy off at about a one-degree angle from the direction of lasing.

In the path of the deflected beam is a mirror that completes the laser cavity and allows the laser crystal to lase at a wavelength of  $1.064 \mu$ . When the rf pulse disappears, the deflection no longer takes place, and the mirror is no longer seen by the laser crystal. Therefore there is no longer a laser cavity, and the crystal ceases to lase.

Frequencies of 50 and 100 MHz have been used to trigger the Q-switch. A beam divergence of about 1.2 mrad occurs at these frequencies.

Xenon flashlamps are used to pump the laser. Since the laser is about 1% efficient, a 100-J flashlamp that can be driven at about 10 pps is required. "The 100-J flashlamps don't last too long at these rep rates," Holton points out. "Therefore a new flashlamp may also have to be developed."

He also notes that this type of laser can produce multiple Q-switched pulses out of a single flashlamp pulse and that therefore the 10 pps on the flashlamp is sufficient to produce 30 pps of laser output. ■■

## Navy miniaturizes radio mike and earphone

The bulky, highly visible handsets used with military radios may soon be replaced by a miniature and inconspicuous unit about the size of an ordinary cigarette lighter. Developed by a group of engineers at the Naval Electronics Laboratory Center's Psycho-Acoustic Group in San Diego, the unit is called the Tube Earphone and Microphone (Team) set.

The earphone consists of a



pliable plastic tube fastened to the ear by an adjustable ear-lobe clip and a sliding fastener. Since it does not obstruct the ear canal, face-to-face conversations can be carried on at the same time that the radio is in use.

Besides its convert advantage, the Team unit also offers hands-free communications for underwater swimmers, such as demolition squads. ■■



# PRICED TO FIT YOUR WALLET

## BOURNS LOW COST FAMILY

### OF INDUSTRIAL TRIMPOT® POTENTIOMETERS

**POWER:** ½ WATT (OR BETTER) AT 70°C

**TEMPCO:** CERMET— AS LOW AS 100 PPM/°C  
WIREWOUND — AS LOW AS 70 PPM/°C

**TEMPERATURE RANGE:** -55° UP TO +150°C

Join the growing population of industrial equipment designers who have discovered that *Bourns quality has never cost so little.*

Bourns LOW-COST FAMILY of industrial TRIMPOT® potentiometers was designed specifically to give cost-conscious industrial electronics equipment manufacturers superior product quality and performance . . . AT LOWER PRICES.

We invite you to compare price and specs on Bourns LOW COST FAMILY models with those of our prime competitors.

#### AVAILABILITY

The Cermet and Wirewound models shown are stocked in-depth . . . RIGHT NOW, so delivery is off-the-shelf from your local Bourns distributor or factory-direct.

Complete data, price and delivery details on all LOW-COST FAMILY models is available upon request. Just write, or call, your local Bourns Sales Office, representative, or distributor.

**AVAILABLE FOR IMMEDIATE DELIVERY  
FROM YOUR LOCAL BOURNS DISTRIBUTOR**



BOURNS, INC., TRIMPOT PRODUCTS DIVISION • 1200 COLUMBIA AVENUE, RIVERSIDE, CALIFORNIA 92507

INFORMATION RETRIEVAL NUMBER 25

# The lithium battery: It just might revolutionize portable power

The military, which depends on man-carried batteries for much of its power, is showing growing interest in the lithium organic electrolyte battery.

"It just might be the best battery the Army ever had," says a spokesman for the Army Electronics Command at Fort Monmouth, N. J.

The reason for enthusiasm is evidence that lithium produces a battery with greater energy density than that of existing types—four times as great as that for mercury zinc cells, for example. It is lighter, has greater power output, can operate over far greater temperature ranges—from  $-65$  to  $+165$  F—and has a remarkably long shelf life of up to 20 years.

Such batteries have obvious consumer applications in air-sea rescue equipment, beacons, calculators, cameras, clocks, communications, electronic watches, hearing aids, tape recorders and toys.

The Mallory Battery Co. of Tarrytown, N. Y., is in pilot production on a line of lithium batteries under a licensing agreement with American Cyanamid of Wayne, N. J., which developed the system and holds several patents. Apart from this effort, Mallory has developed a solid-state lithium battery that "could have a shelf life of 20 years," according to Bruce McDonald, the company's manager of lithium systems.

Eagle-Picher Industries, Inc., of Joplin, Mo., is developing a family of lithium batteries.

Power Conversion, Inc., Mount Vernon, N.Y., is already marketing a line of lithium batteries under the name Eternacell.

John F. Mason  
Associate Editor

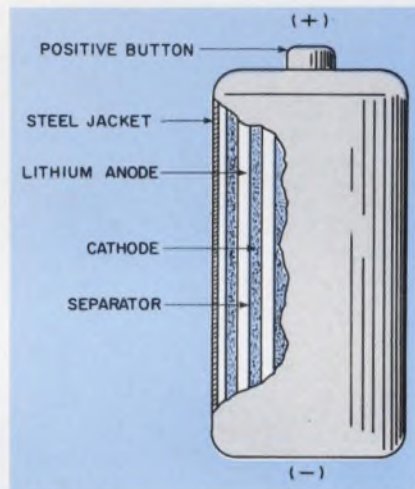

Lithium  $\text{SO}_2$  battery cells by Power Conversion are as small as 0.625 in. in diameter and 1.3 in. high.

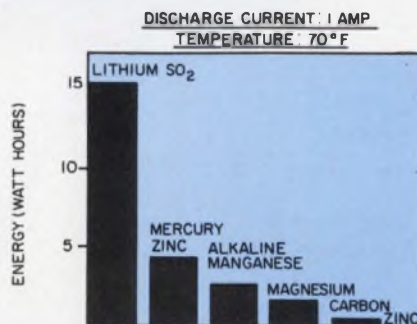

Energy from one lithium D cell at a 1-A discharge is equivalent to four mercury zinc cells, five alkaline manganese, seven magnesium and 30 carbon zinc cells.

Other companies Fort Monmouth is dealing with include: Electro Chemica, Du Pont, Honeywell and Electric Storage.

Both Mallory and Power Conversion use lithium with sulfur dioxide.

Eagle Picher's developmental system uses lithium and a general compound of carbon fluorine in

conjunction with an organic electrolyte.

Mallory's  $\text{Li}/\text{SO}_2$  cells contain a lithium anode, a carbon cathode and an organic electrolyte consisting of liquid sulfur dioxide, lithium bromine and a mixture of acetonitrile and propylene carbonate. The liquid sulfur dioxide is the depolarizer.

The cells are constructed by winding rectangular strips of anode-separator-cathode-separator stacks into a cylindrical roll, which is then placed in a nickel-plated steel can. This method increases the surface area of the electrodes and gives the cells a high current capability. The anode terminal tab is electrically connected to the steel can, and the cathode terminal is electrically connected to the aluminum cell top, which is electrically insulated from the cell can by a rubber grommet. The cell can is crimped over the rubber grommet to seal the cell.

In Mallory's solid-state battery the anode is lithium metal and the cathode a metal salt. The electrolyte is an electronically insulating solid. The electrolyte also serves as the separator between the anode and cathode. The reactive nature of the active materials with the atmosphere requires that these batteries be sealed hermetically. The absence of any liquid in the system eliminates completely any corrosion or gassing and permits the use of a truly hermetically sealed battery.

The unit cell can deliver currents of  $50 \mu\text{a}/\text{cm}^2$  or less at  $25$  C and approximately  $1 \mu\text{a}/\text{cm}^2$  at  $-40$  C without substantial IR losses.

Cells have been stored at  $105$  C for long periods with no detectable loss in capacity. The battery

## Lithium litigation

The stakes in the lithium battery market can, in part, be measured by the amount of litigation between the competing companies. American Cyanamid has sued Power Conversion, Inc., for alleged "misappropriation of trade secrets." Power Conversion, in turn, is suing American Cyanamid and Mallory for asserted violation of antitrust laws. Meanwhile the developmental and marketing plans of both companies continue full steam ahead.

should last 10 years at 70 F, Mallory says, or even 20.

Power Conversion's batteries have a shelf life of more than five years, the company's marketing manager, Stewart Chodosh, says. They can also operate at temperatures between -65 to +165 F, and they have energy densities up to 150 watt-hours per pound and an ability to operate efficiently at high rates, Chodosh adds. For example, at a 1-A drain an Eternacell D cell will operate at 2.6 V for six hours.

Energy density is one of the most important advantages of all lithium batteries, according to Eagle-Picher's project engineer, Jerry Russell. "One cell can generate 200 watt-hours per pound," he says. Prior to this, the most concentrated battery has been the silver zinc, used on the Apollo program; it achieved about 110 watt-hours per pound per cell.

Eagle-Picher also wants a five-to-10-year shelf life. "We think we already have five," Russell says. After two months at 165 F, one of the company's batteries had lost less than 5% of its capacity, he notes.

The major work now is to get a good low-temperature capability. "We're shooting for a battery with high rate capabilities at temperatures as low as -65 F," Russell reports.

Mallory's D-cell batteries range in unit price from \$11.50 to \$6.85, depending on quantity. The C cell costs from \$7.95 to \$4.75.

Power Conversion declines to discuss prices; except with customers. ■■

# Don't cost much for all they do... and we deliver fast!

A whole family of switchlights from out of the West.

monoform

Back in 1860, when you had a Colt .44 it gave you more service for the money than anything else around. Designed right for the job. Reliable. Available. And that's the way it is with the Monoform family of switchlights.

**Monoform I** (the single lamp, momentary & alternate, rated 2 amp 120 Vac).

**Monoform II** (two independent lamps for horizontal split legends, mom. & alt., 2 amp 120 Vac).

**Monoform III** (10 amp, 1/4 H.P. power switch).

A whole, low-cost range of models to fit your specifications in a thousand different ways. Cost? In the neighborhood of two bucks... and with Clare-Pendar that's a mighty good neighborhood.

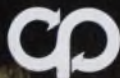

CLARE-PENDAR

Phone 208-773-4541

# Aneroid altimeter gives way finally to a computerized electronic one

The first all-electronic altimeter for aircraft uses a vibrating pressure transducer and a tiny computer to measure static air pressure instead of the conventional aneroid capsule.

The computer is an LSI chip that solves a nonlinear equation that relates altitude to static air pressure and temperature.

Developed by Hamilton Standard of Windsor Locks, Conn., as the HSA-101, the altimeter displays altitude and barometric readings electronically and provides coded altitude information automatically for use with altitude-reporting transponders.

Since the days of pioneer aviation pilots have used an altimeter that is basically an aneroid barometer with moving, clock-like hands. The altitude in the electronic altimeter is displayed from -1000 to 50,000 feet on a digital readout, and a moving bar of light sweeps



The solid-state encoding altimeter provides a digital display of altitude and barometric settings. It also provides altitude information for transponders operating in mode C.

around the face of the instrument when the altitude is increasing or decreasing. This bar simulates the 100-foot pointer of the standard aneroid altimeter. The digital readout gives altitude in increments of 100, 1000 and 10,000 feet, while the pointer display shows it in increments of 20 feet.

Jim McDermott  
Eastern Editor

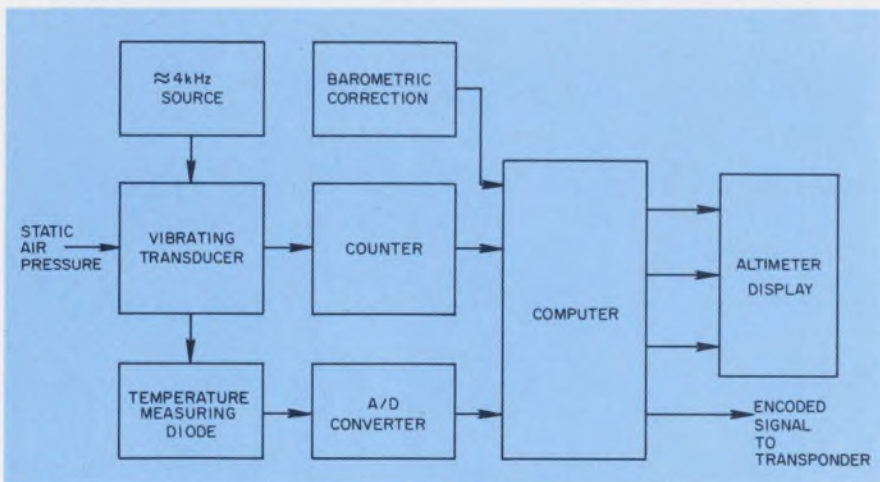

Output of vibrating transducer in new altimeter is digitized by feeding it to a counter. From the counter the signals are fed into an LSI computer that solves a pressure-temperature equation for altitude.

A prime advantage of the new altimeter, according to its designer—Michael Whittlesley, project engineer at Hamilton Standard—is that there is no hysteresis error, as with conventional altimeters. The instrument exceeds Federal Aviation Administration accuracy requirements, Whittlesley says, and also the ARINC 575 specification for air data computers.

The key to the accuracy, the designer explains, is the pressure sensor—a device that vibrates at about 4 kHz when supplied with power from a magnetic circuit. When the aircraft changes altitude, a corresponding change in static pressure forces the cylinder to vibrate at a slightly different frequency.

From a magnetic pickup, the sensor frequency is fed to a counter, and the output of the counter is applied to the LSI computer built into the instrument.

The frequency of the sensor varies not only with pressure but also with temperature, and the voltage drop across a diode secured to the sensor assembly is applied to an a/d converter. The converter output is a second input to the computer, which solves the equation that relates pressure and temperature to true altitude.

The computer output is a binary-coded decimal that is fed to the display. The digits are incandescent numerals, with the last two zeros not subject to change.

The sensor, developed originally by Hamilton Standard for use in jet fuel control, has a very fine resolution and high repeatability, Whittlesley points out. To insert a barometric correction, the pilot turns a potentiometer control. The output of the potentiometer is fed through an a/d converter to the computer, which converts the scaled pressure over a range of 28 to 31

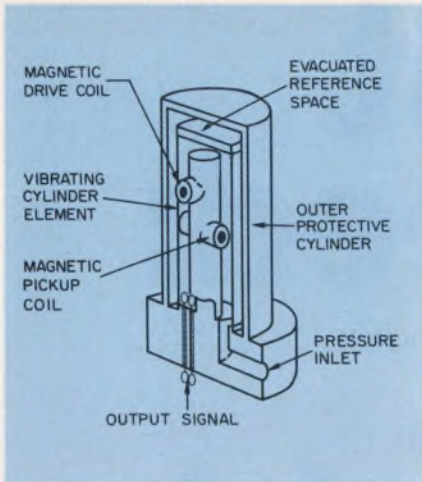

Key to the new all-electronic altimeter is Hamilton Standard's digital pressure transducer. The pressure-sensing element is a cylinder that is driven magnetically to vibrate at its natural frequency of about 4 kHz. As the static air pressure increases, internal forces increase the stiffness of the sensing element, increasing the frequency in proportion to the change in pressure.

inches of mercury.

When the barometric correction knob is turned, the altimeter reading also changes. To display millibars instead of inches of mercury, a switch at the upper righthand corner of the altimeter is operated, and the computer automatically makes the conversion.

A self-checking test feature is built into the instrument, Whittlesley explains. Pressure on the test switch in the upper lefthand corner displays all segments in the digital display as numerical eights, while the moving bar of light is sequenced around the face of the instrument.

"We're able to make the millibar-to-inches-of-mercury conversion easily," Whittlesley says, "because we have the computer in the unit."

Competing types, he points out, use aneroid capsules that energize a servo to turn the altimeter hands. This is required for altitudes of greater than 30,000 feet because the pressure change is so low that the friction of the gears and pointers becomes excessive.

The automatic altitude-reporting feature has been proposed by the FAA as a requirement for all aircraft operating in terminal control areas. ■■



If you could save up to 30% without losing anything by using this new 10mm ceramic trimmer capacitor, wouldn't you want to know it?

That's exactly what we can promise you for many applications. All the performance you need for about a third less than you've been spending.

These new trimmers have five capacity ranges from 3.0pF min. to 30.0pF max. Their operating temperature range is  $-30^{\circ}\text{C}$ . to  $+125^{\circ}\text{C}$ . And they mount interchangeably with other ceramic trimmers for PC applications. Four dielectric types available.

But check them out for yourself. Get the coupon in the mail today.

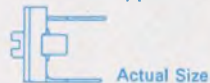

E. F. JOHNSON COMPANY/Waseca, Minnesota 56093. Dept. 3302  
You bet I'd like literature and a free test sample of your new low cost trimmer capacitor if it can do what you say!

Check capacitance (pF) range needed:

- 3.0 to 8.0       3.0 to 12.0       5.0 to 13.0  
 5.0 to 20.0       5.0 to 30.0

\_\_\_\_\_ Please send them directly.

\_\_\_\_\_ Please call me at: \_\_\_\_\_

Name \_\_\_\_\_

Firm \_\_\_\_\_ Title \_\_\_\_\_

Address \_\_\_\_\_

City \_\_\_\_\_ State \_\_\_\_\_ Zip \_\_\_\_\_



**E. F. JOHNSON COMPANY**

INFORMATION RETRIEVAL NUMBER 27

# Dialight sees a need:

(**Need:** Single source supply for all indicator lights.)

## See Dialight.

Dialight has so many kinds of indicator lights—approximately 1,500,000 on our shelves—that we have set up a special magic eye seek-out system to help you find the one you need in a wink. Whether it's a flasher, placard, press to test, oil tight, water tight, dust tight, dimmer, or nondimmer, we have them all, some with incandescent, neon or LED lamps, from 1.35 to 220 volts. Sizes vary from small indicators (mount in 0.120" clearance holes) to large indicators (mount in 1 $\frac{3}{16}$ " clearance



holes), and are available in a variety of terminations and finishes, lens-cap shapes and colors with or without hot-stamped, engraved or film legends. We've developed a 14-digit code number that tells any of our 120 stocking distributors in the U.S. and Canada just what indicator you want for off-the-shelf prompt delivery. If you would like to see for yourself how our code works, just write for your free copy. At Dialight it's a designer's choice because we see your need.



Dialight is a company that looks for needs . . . and develops solutions. That's how we developed the industry's broadest line of indicator lights, readouts, and LED light sources. No other company offers you one-stop shopping in visual displays. And no one has more experience in the visual display field. Dialight can help you do more with indicator lights than anyone else because we have done more with them. Talk to the specialists at Dialight first. You won't have to talk to anyone else.

And also be sure to send for your free copy of our latest 56-page Indicator Light Selector Guide. It will show you how easy it is to quickly find your way to the indicator light you need. This handy guide describes in detail the many indicator light choices — shapes and colors of their lens caps, available terminations, mounting data, available finishes, and LED, incandescent and neon light sources for which they are compatible.



Please send me INDICATOR LIGHT SELECTOR GUIDE.

NAME \_\_\_\_\_  
 TITLE \_\_\_\_\_  
 COMPANY \_\_\_\_\_  
 ADDRESS \_\_\_\_\_  
 CITY \_\_\_\_\_ STATE \_\_\_\_\_

**DIALIGHT**

Dialight Corporation, A North American Philips Company  
 60 Stewart Avenue, Brooklyn, N.Y. 11237 (212) 497-7600

## technology abroad

A new family of liquid crystals, with properties for display applications, has been investigated by workers at the Royal Radar Establishment in Malvern, England. The compounds are reported to be more stable at room temperatures than previous display materials. Typical of the new compounds is 4'-n-pentyl-4-cyanobiphenyl (PCB). It has been operated satisfactorily at low working voltages in two types of display

devices. One is the twisted-nematic crystal, in which control of molecular orientation at the two surfaces of a liquid-crystal layer induces a 90° rotation of linearly polarized light passing through the layer. The second is a nematic phase-change device. In this, a thin layer of cholesteric liquid crystal, with large positive dielectric anisotropy, is electrically switched to a clear pseudo-nematic state.

CHECK NO. 441

To reduce the bandwidth needed for transmission of Videophone images, research workers at the French Centre National d'Etudes des Telecommunications have developed a device that uses acoustic-surface-wave tapped delay lines to carry out a real-time double Hadamard transformation on the Videophone image. The

Hadamard transformation reduces the number of symbols required to code a picture. The Videophone signal bandwidth was 1 MHz, and a sampling frequency of 2 MHz was used. The surface-to-wave device used gold/lithium-niobate transducers, with the taps separated by 1.8 mm, which is equivalent to 0.5 μs.

CHECK NO. 442

A new telephone system for the deaf and blind is in operation in Hanover, West Germany. The phone bell is replaced with a vibrator alarm that is part of an electronic paging device carried in the individual's pocket. The analog of the telephone handset is a Thiel Braillophone, which is a

remote Braille embossing unit that is fed from conventional telephone data transmission modems. The German Deaf-Blind Center in Hanover-Kirchrode is pleased with results and predicts that the units may soon be available for home use.

CHECK NO. 443

A strain-gauge-controlled system that automatically corrects for phase error along the length of a flexible linear antenna array has been developed at the University of Birmingham in England. Phase errors can produce tilting of the main beam, loss in gain and an increase in side-lobe levels. Variable wind forces, mechanical vibrations and temperature effects cannot always be eliminated by increasing the rigidity of the ar-

ray. As a result, the Birmingham developers have devised the adaptive system, in which resistance strain gauges control ferrite-rod phase shifters in response to mechanical antenna distortion. The control signals from the strain gauges are distributed via a resistance matrix. The required corrections for the phase shifters are obtained from a simple summing circuit.

CHECK NO. 444



## Modularity lets you pick and choose for "custom" DIP assemblies off-the-shelf.

You get flexibility, lots of it, so you can start small and think bigger as you go. Choose 14, 16, 28 and 36-pin sockets, socket boards and I/O cards from the largest selection available anywhere. Allow for hybrids or discretes when and where you need them.

Choose frames in multiples to fit your particular design, for up to 1440 IC's in a plane. Choose dedicated or undedicated power routing. Get low impedance power distribution and noise-free decoupling, and eliminate

much of the post-wiring debugging of MSI based systems. Then choose connectors, plugs, clips, drawers, frame assemblies and power supplies. All from the same place.

Voila! EECO modularity and flexibility are yours for fast changes in breadboards, prototypes, and production models.

Convenience, reliability and economy are yours in a wide spectrum of packaging hardware, plus computer aided design and manufacture. From punch cards, pin list, or

logic diagram we'll furnish complete wired hardware and documentation. Single source responsibility from the house with 25 years of logic experience. For fast answers up-front, call Electronic Packaging Products (714) 835-6000. ELECTRONIC ENGINEERING COMPANY of California, 1441 E. Chestnut Ave., Santa Ana, Calif. 92701.



Dual in-line packaging • Thumbwheel switches • Punched tape readers



# washington report



Heather M. David  
Washington Bureau

## **B-1 bomber designers strive to keep costs down**

Competitive development of the avionics for the B-1 bomber's system continues, and the Air Force will decide in July whether to go with a new system or fall back on one of the conventional packages being studied by the Air Force Avionics Laboratory. Competitive design contracts for the B-1 multimode radar are due to be awarded in about a month. All B-1 avionic systems are being standardized in design, so they can also be used in other aircraft.

Meanwhile the Air Force has officially admitted that the B-1, as now designed, will be 18,000 pounds overweight, although other sources say the true figure is closer to 22,000. Too much weight, plus the attendant cost growth, could put the B-1 in an unfavorable competitive position with a stretched version of the FB-111 bomber, which has been proposed to the Air Force by its prime contractor, General Dynamics.

## **FCC may relax TV standards proposed for 1975**

The television industry may get some alleviation from a Federal Communications Commission rule that has created major problems in manufacturers' design departments. The FCC requirement states that after July 1, 1975, all TV receivers equipped with a 70-position, nonmemory, uhf detent tuning system must be equipped with automatic-frequency-control (AFC) circuitry. Also, the channel selector mechanism must have an accuracy of  $\pm 1$  MHz. Now, in response to industry complaints that compliance would drive prices up, the FCC says that it may drop the requirement for AFC on monochrome TV sets. The commission is also asking for industry comments on whether it can meet the deadline for improved accuracy on color sets and whether there is any other means of attaining equal, or superior, tuning accuracy.

## **Battle looms over offshore assembly tariffs**

Electronics companies with foreign assembly operations are putting together a massive lobbying effort to persuade Congress to retain tariff law 807 which bars duties on U.S.-produced components assembled abroad and reshipped to the United States. The apparent intention of the Administration to drop these exemptions was announced in the President's recent trade message to Congress. The Electronic Industries Association is mobilizing the lobbying effort and has enlisted the support of two former EIA members, Texas Instruments and Fairchild Semiconductor. Trade unions, on the other hand, widely support the Administration's action,

and some vehement testimony on both sides of the issue can be expected as the House Ways and Means Committee starts hearings this month.

## **Space Shuttle: Financial Trouble?**

The joint NASA-Defense Dept. space shuttle is running into heavy weather as the fiscal 1974 budget wends its way around Capitol Hill. The Senate Appropriations Committee Chairman, John L. McClellan, has announced his intention to hold up funding for the space shuttle, together with some defense and foreign-aid projects, and to transfer the money to social programs. Meanwhile the Senate Space Committee held a debate on the shuttle with top scientists—such as Dr. James Van Allen, who spoke against the project. Proponents of the shuttle, including Sen. Alan Cranston (D-Calif.), are arguing hard for putting even more money into the program as a way of increasing employment.

## **EMP simulator to be built**

The Air Force has contracted McDonnell Douglas Astronautics for the design and construction of an electromagnetic pulse simulator to be placed at Kirtland Air Force Base, New Mexico. The \$20-million facility will be used to expose various systems, including the new Advanced Airborne Command Post, to simulated nuclear-blast environments. The purpose is to determine what effects the rays may have on communications, radar, electronic warfare and other systems. The Army also is stepping up its work on EMP and is looking for industry help on a 15-month program to develop EMP-hardened cables.

**Capital Capsules:** Millimeter-wavelength communications, which some Pentagon officials feel is the only solution for the military's crowded frequency problem, will be the subject of a six-month contract by the Army Electronics Command. . . . The Defense Dept. has created a new post—Deputy Assistant Secretary of Defense for Intelligence and Warning Systems—and has named Morton Goulder to fill it. He is one of the founders of Sanders Associates, a company heavily involved in the development of surveillance equipment and electronic countermeasures systems . . . . The EIA has reactivated its engineering standards subcommittee on broadcast equipment to work toward establishing new professional color standards for TV and to update present monochrome studio facilities standards. It also plans to work on standards for color picture monitors and color studio facilities. . . . The Army is mounting a new effort to upgrade technology on mine warfare. Classified meetings were held April 24 to acquaint industry with military needs for new approaches to planting mine fields and to detecting armed mines. . . . The Navy has selected Hughes Aircraft to develop the guidance subsystem for the new Agile air-to-air missile, which will be used by both the Air Force and Navy. . . . Scientists working with NASA have put together the first closeup radar images of the moon's surface taken from the Apollo 17 Lunar Sounder. The work will eventually provide a geologic cross-section of the moon, with details to a depth of 1.3 km . . . . The FCC has given Comsat Corp. permission to develop its proposed maritime communications satellite system, to be used by commercial shipping units and the Navy, until the Navy gets its own system in 1976. Hughes Aircraft will build the satellites.

# Automated Systems Software



The TEKTEST™ III Software operating system developed for the Tektronix S-3260 Automated Test System is designed to enable **maximum device throughput** while permitting engineering studies when required. TEKTEST III is a new test language written by Tektronix Software Engineers. The language was designed to be **easily understood by systems engineers** yet **powerful** enough to control the full hardware testing capabilities of the S-3260.

The TEKTEST III Executive disc operating system permits interactive test program preparation. Other features permit *on line editing, on line debugging* and *functional test pattern editing*.

All commands are as descriptive as practical and are entered in English language format. For more information on TEKTEST III and the S-3260 contact your Tektronix Field Engineer and ask for a copy of *S3260 Automated Test System Control Through TEKTEST III Software* and the *S-3260 Brochure*.



P.O. Box 500  
Beaverton, Oregon 97005  
in Europe — TEKTRONIX LTD.  
Guernsey, C.I., U.K.

# Beware the un-opportunity

Opportunity. You've read enough employment opportunity ads and listened to enough employment personnel by now to know that they all like to discuss opportunity. But, unfortunately, they would usually rather talk about opportunity than offer it. We at Fairchild believe that if you're going to talk about something, you'd better be able to back it up. And back it up we can. First, there's the Fairchild opportunity. A chance to build a career with a company that's headed in the right direction at the right speed. Second, there's the individual opportunity. A chance to use both your brains and your

initiative in an environment that doesn't let protocol stand in the way of a good idea. We at Fairchild believe that opportunity exists within the individual, not the system. If you feel that way too, we should get together. Call or send us your resume. Employment Opportunities, Fairchild Semiconductor Components Group, Dept. 37, 465 National Avenue, Mountain View, California 94040. (415) 962-3401. An Equal Opportunity Employer M/F

**FAIRCHILD**  
CAMERA AND INSTRUMENT  
CORPORATION



**A Fairchild career... more than a pretty package**

# measurements on the move...

With TEKTRONIX you make your measurements quicker and with greater accuracy. The light-weight 465 and 475 portables combine ease-of-operation with laboratory precision to reduce your repair time at your customer's location.

Some of the functions that make the 465 and 475 value leaders are: push-button trigger view, ground reference button at probe tips, delayed and mixed sweep, CRT positioned between the vertical and horizontal controls, easy to interpret push-button mode selection, and more.

With 200 MHz at 2 mV/div, the 475 offers lasting measurement capability. A linear 8 x 10-cm display and one nanosecond sweep speed

illustrate the ability to make complex, precise time measurements.

The 465 with a bandwidth of 100 MHz at 5 mV/div and 5 ns/div qualify it for most of today's measurement needs.

A different approach to battery operation. A 12 and 24 VDC option combined with a detachable battery pack provide continuous operation under a variety of situations. Measurements can be made when power availability is restricted to 12 and 24 VDC, or when commercial power is limited, or when isolation from line or ground is desired. With the detachable battery pack you carry the weight of the batteries only when needed.

Also available are rackmount versions of both the 465 and 475.

465 Oscilloscope ..... \$1725  
(Includes delayed sweep and probes)

475 Oscilloscope ..... \$2500  
(Includes delayed sweep and probes)

DC Operation (Option 7) . Add \$75

1106 Battery Pack ..... \$250

Rackmount ..... Add \$75

Let us help you make your measurements. To see one of these scopes, call your local Tektronix field engineer, he'll be glad to demo one for you. If you prefer, for additional information write Tektronix, Inc., P.O. Box 500, Beaverton, Oregon 97005. In Europe, write Tektronix Ltd., P.O. Box 36, St. Peter Port, Guernsey, C.I., U.K.



**TEKTRONIX®**

committed to  
technical excellence

**"the value leaders"**

U.S. Sales Prices FOB Beaverton, Oregon  
INFORMATION RETRIEVAL NUMBER 33

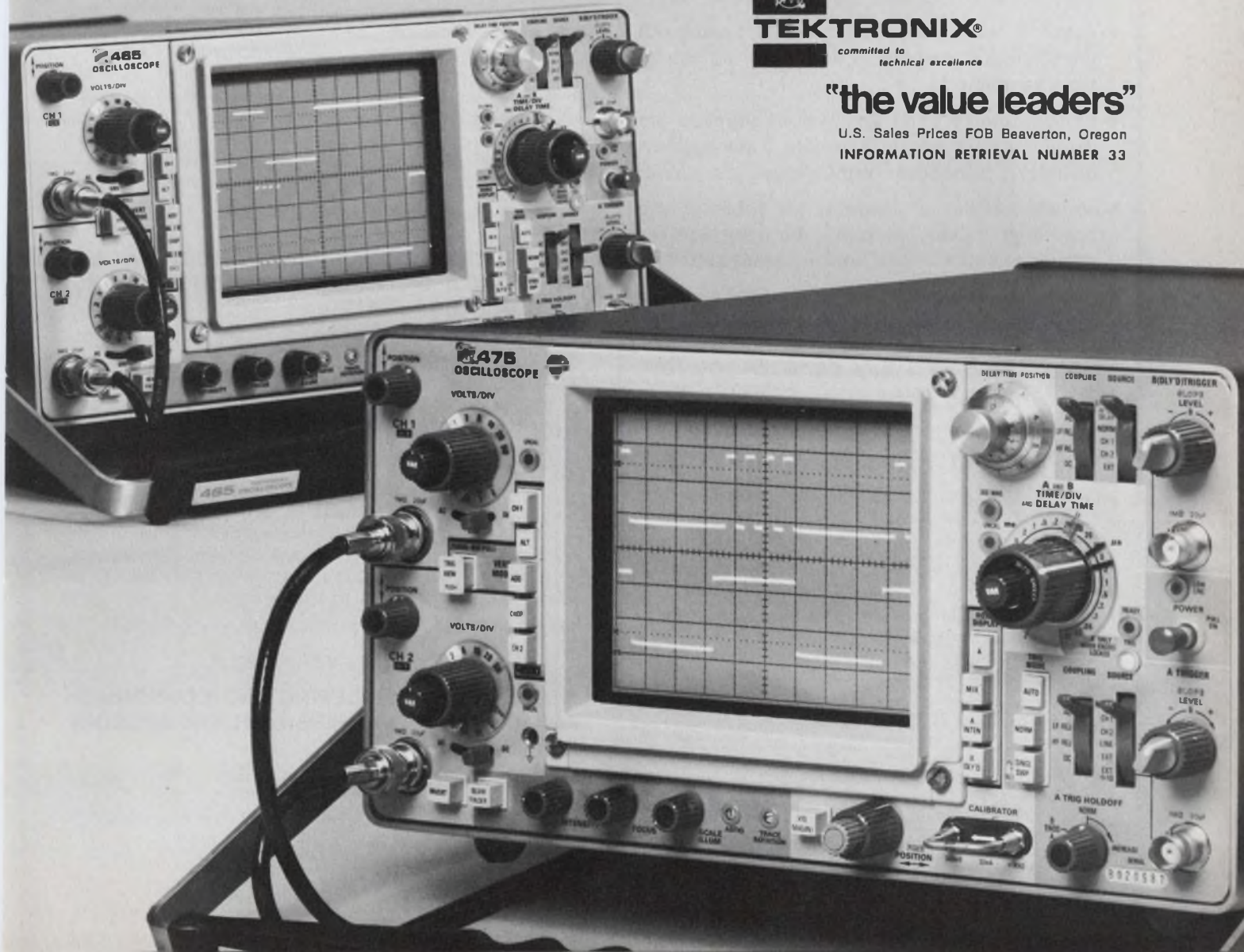

# Candidate for the PE license this year?

Use these up-to-date guides...  
specifically tailored for  
your study campaign

## HAYDEN PROFESSIONAL ENGINEERING EXAMINATION SERIES

LAWRENCE J. HOLLANDER, Editor-in-Chief,  
Professional Engineer, New York State

Written with your needs kept foremost,  
these study guides offer . . .

- a wide selection of actual, realistic problems from recent state examinations arranged by subject for convenient study
- detailed step-by-step solutions that bring out underlying principles to equip you to handle the unexpected
- concise background discussions precede the problems, presenting you with a mini-review of theory, principles, terminology
- separate tables of contents for subjects and problems quickly pinpoint the specifics for rapid review or "open book" examinations
- numerous schematic diagrams and detailed drawings to insure in-depth understanding

Review the books that concern you for  
15 full days—FREE!

### FOR 15-DAY FREE EXAMINATION

Please send the book(s) circled below on a 15-day examination basis. At the end of that time, I will remit payment, plus postage, or return the book(s) without further obligation.

5712-1      5715-6      5716-4

(For those ordering by ISBN, the Hayden Prefix is: 0-8104)

Save money! On all prepaid orders Hayden pays postage —  
same 15-day return guarantee! 72-29 ED

Name \_\_\_\_\_

Firm \_\_\_\_\_

Address \_\_\_\_\_

City/State \_\_\_\_\_ Zip \_\_\_\_\_



HAYDEN BOOK COMPANY, INC.  
50 Essex Street, Rochelle Park, N.J. 07662

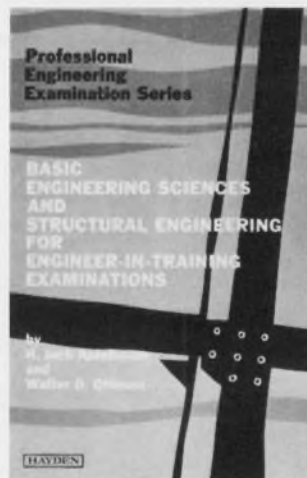

### BASIC ENGINEERING SCIENCES AND STRUCTURAL ENGINEERING FOR ENGINEER-IN-TRAINING EXAMINATIONS

H. JACK APFELBAUM, P.E., Department of Mechanical Engineering, Lowell  
Technological Institute; and WALTER O. OTTESEN, P.E., Patent Counsel

Nearly 200 solved problems selected from a nationwide survey of recent E-I-T examinations offer you a complete, well organized review of the concepts and techniques that must be understood to successfully pass the preliminary exam. Unlike other study guides that stress one aspect of the field while shortchanging others, this volume provides balanced coverage of the three broad engineering areas: *the basic sciences*: mathematics, physics, and chemistry; *the engineering sciences*: statics, dynamics, fluid mechanics, thermodynamics, electricity, and engineering economy; and *structural engineering*. More than 300 detailed illustrations pinpoint key concepts and problem-solving techniques.

408 pp., 6 x 9, illus., cloth, #5712-1, \$13.95

### ELECTRICAL ENGINEERING AND ECONOMICS AND ETHICS FOR PROFESSIONAL ENGINEERING EXAMINATIONS

JOHN S. LYONS, P.E., and STANLEY W. DUBLIN, Institute of Environmental  
Medicine, New York University Medical Center

Concentrating on the subjects and topics that form the foundation of this rapidly changing technology, this book analyzes and solves for you almost 100 problems from a nationwide sampling of recent PE examinations. Its comprehensive, up-to-date coverage includes materials and problems not found in other guides of this type, such as electrical-magnetic-thermal analogs, semiconductors, and power system short circuits. More than 170 detailed illustrations are included. The separate section devoted to economics and ethics features an unusual approach to such topics as interest, costs, valuation, and others—the summarized use of formulas in solving nearly 50 typical problems.

302 pp., 6 x 9, illus., cloth, #5715-6, \$12.95

also available

### MECHANICAL ENGINEERING AND ECONOMICS AND ETHICS FOR PROFESSIONAL ENGINEERING EXAMINATIONS

EUGENE STAMPER, P.E., and STANLEY DUBLIN

Over 200 solved problems in mechanical engineering, along with the same thorough coverage of economics and ethics.

392 pp., 6 x 9, illus., cloth, #5716-4, \$14.95

# New Low Cost AM / FM Function Generator Has Built In Modulation Source

EXACT'S NEW Model 129 AM/FM Function Generator lets you do it all with one box. AM internal or external. Simultaneous AM-FM, sweep, single shot, tone burst. The Model 129 contains two independent function generators. One provides the carrier, while the second provides AM or FM modulating signals plus trig and gating signals in the pulse and burst modes. The two generators provide Sine, Square, Triangle and pulse waveforms. The carrier generator has a frequency range of 0.1Hz to

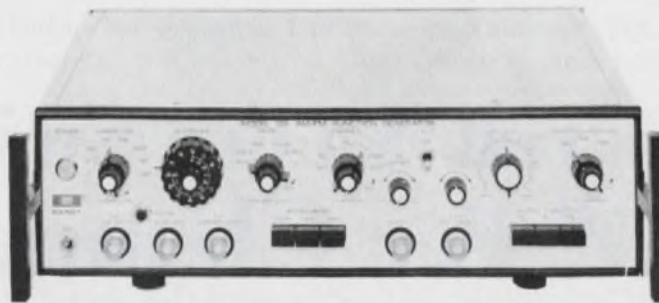

**Model 129 AM / FM Function Generator**

5MHz and the AM/FM generator 1 Hz to 1 MHz. Up to 100% modulation and double sideband suppressed carrier is provided. FM deviation up to 500:1 around a center frequency is possible. The outputs have precision attenuators, variable d-c offset and all the capabilities to make this the most versatile signal source ever offered at anywhere near the low price tag of \$795. F.O.B. Hillsboro, Oregon. Circle the bingo number and we'll send you more information, or call us collect and we'll rush a Model 129 over.



**EXACT**

Box 160 Hillsboro, Oregon  
97123 Tel. (503) 648-6661  
TWX 910-460-8811

**electronics, inc.**

A subsidiary of Danalab Inc

An Affiliate of **DANA** Laboratories, Inc.

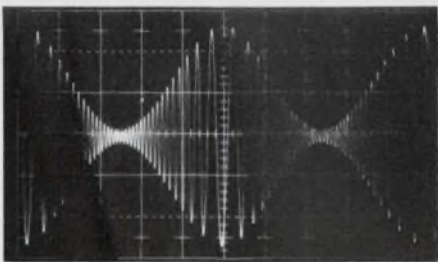

SIMULTANEOUS AM/FM MODULATION

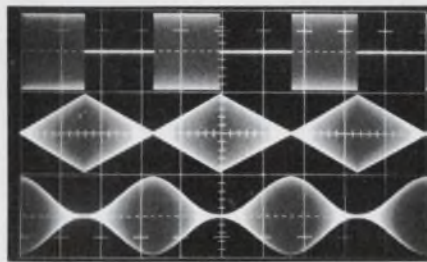

SQUARE, TRIANGLE AND SINEWAVE AM

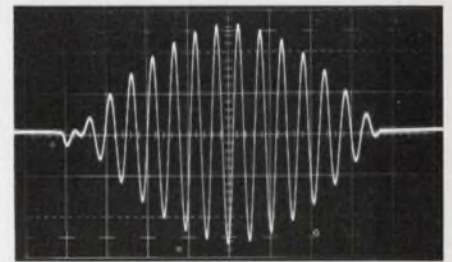

HALF SINE AM BURST

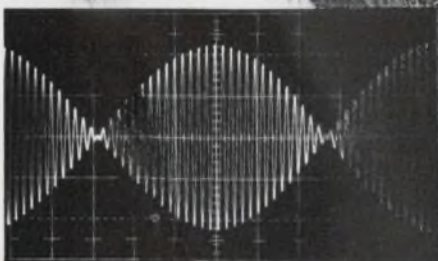

AM SUPPRESSED CARRIER

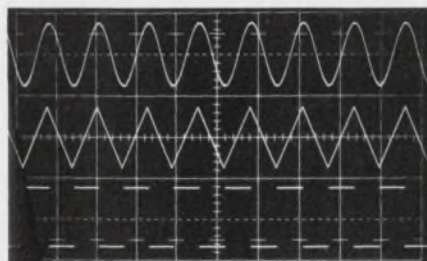

SINE, TRIANGLE AND SQUARE

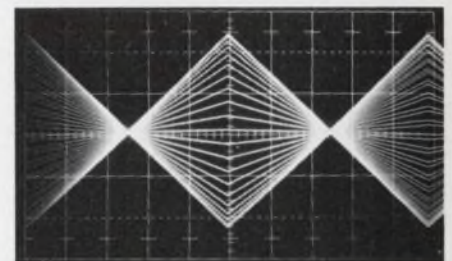

ULTRA LOW FREQUENCY AM

INFORMATION RETRIEVAL NUMBER 35



P-channel  
J FET



N-channel  
J FET

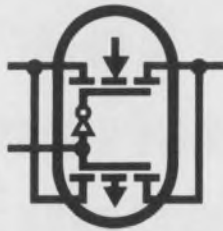

CMOS  
FETs



P-channel  
MOS FET



N-channel  
MOS FET

Since 1962, Siliconix has evolved FET technology and applied it to a complete range of singles, duals, arrays, and ICs. So what's new?

# Industrial Analog Switch: 80¢ Per Channel

Now available: analog switches specially selected for industrial control service, at per-channel prices as low as 80c (DG501CJ) and 90c (DG172CJ) in 1000-unit quantities.

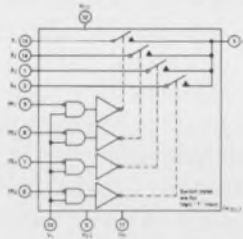

DG172CJ

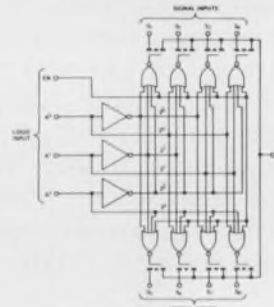

DG501CJ

You can't go wrong with our epoxy analog switches if you're a designer of industrial control circuits. Choose from a variety of switch configurations and structures:

- PMOS monolithic—DG501CJ, 8 channels, break-before-make switch action,  $\pm 5$  V analog signal range
- PMOS/bipolar—DG172, 4 channels, 20 V peak-to-peak signal capability, PMOS FETs and bipolars on a single chip

All of these FET switch/driver combinations are *off-the-shelf* and at your nearest Siliconix distributor *right now*. They're priced to compete with reed relays and other electromechanical devices—and they switch 1000 times faster, last far longer, require less drive power and associated hardware, and operate directly from industrial computer logic.

Our catalog line of FET analog switches will cover most applications. If your switching problems are unique—and whose aren't—call our applications people. They're eager to help. For complete information

## write for data

Applications Engineering (408) 246-8000, Ext. 501



### Siliconix incorporated

2201 Laurelwood Road, Santa Clara, California 95054



## Fight auto pollution but, please, no catalysts

Why is the auto industry trying to reduce auto-exhaust pollution with a "pound of cure" instead of an "ounce of prevention?" The current thinking among most manufacturers is to place a catalyst in the car's exhaust stream to neutralize the bad stuff before it hits the streets. Why not make the engine so efficient that a catalyst is not necessary?

The "cure" approach calls for a dual-catalyst system that will cost the motorist a bundle. But costs don't appear to deter the automotive industry. It only builds the cars; it doesn't buy them. Millions in R&D are being poured into perfecting a dual-catalyst system that will lean heavily on electronics to make it work. According to a report by the Committee on Motor Vehicle Emissions of the National Academy of Sciences, "The system most likely to be available in 1976 in the greatest numbers—the dual-catalyst system—is the most disadvantageous with respect to cost, fuel economy, maintainability and durability." Amen.

On the other hand, the academy committee observes, the "most promising system" is the "carbureted stratified-charge engine," in which the air-fuel mixture is preheated in a separate chamber to assure more efficient combustion. This is prevention of pollution, and the average annual cost, the committee estimates, is only a fourth that of the dual-catalyst system. Here is where the auto industry should be seeking to apply electronics—to a superior stratified-charge engine. But the prospects are, the committee says, that the engine "may not be available in very large numbers in 1976." Honda is working on a stratified-charge engine, but few other manufacturers seem interested.

Cleaning up the present conventional engine with catalysts calls for a pollution sensor in the exhaust to feed back a signal to a fuel-injection processor, so the fuel-air mixture can be modified for maximum combustion efficiency. Essential to success in the marketplace is a cheap sensor that will last at least 12,000 miles before it must be replaced. And current sensors, the National Academy of Sciences points out, last only a few hours and have problems with thermal shock, erosion of the electrodes and maintenance of good electrical contact. Can electronics perfect a dual-catalyst system? "Not likely," the academy says.

Honda's stratified-charge engine has already met the initial Environmental Protection Agency requirements. Let's tell the auto industry to make it a universal choice for breathable air.



*David N. Kaye*

DAVID N. KAYE  
Senior Western Editor

**Everyone talks  
correed reliability,**

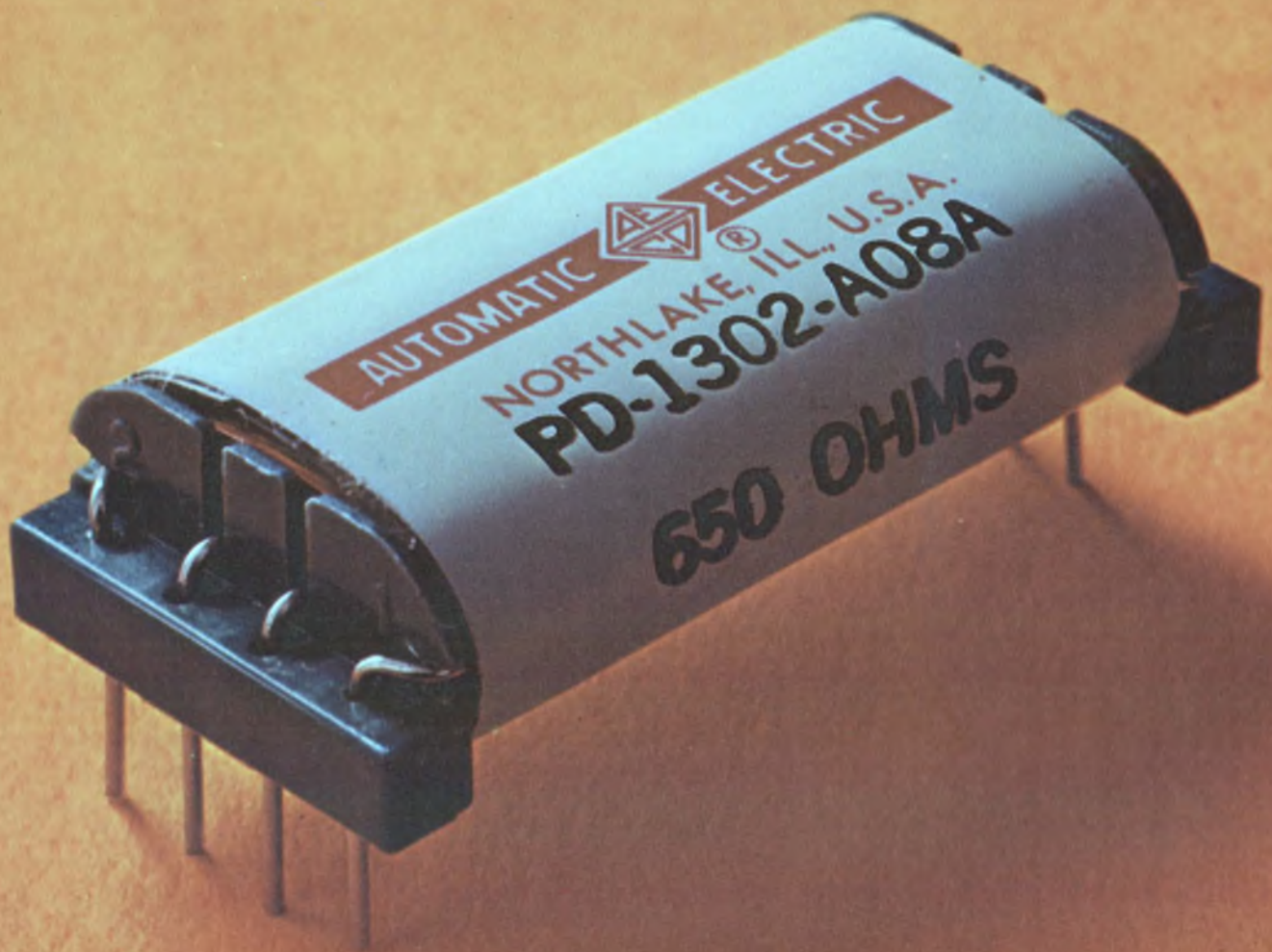

# here's the way it looks.



## Switches under glass.

The heart of every AE correed is a reed switch consisting of two overlapping blades. For protection, we seal them inside a glass capsule. But only after we pull out all the dirty air and pump in a special, pure atmosphere. That way there's no chance of contact contamination or oxidation. Ever.

Notice our terminals are one piece. A special machine delicately forms them to precision tolerances. It's a lot of work, but one-piece terminals have distinct advantages over the two- and three-piece kind.

For one thing, there's no extra joint so you're always assured of a positive contact. Also, one piece terminals are more reliable when the correed is used to switch low-level analog signals. That's because thermal EMF is reduced to practically zero.

## A different kind of bobbin.

Since we go through so much trouble with our correed capsules, we designed a special bobbin to protect them.

It's molded of glass-filled nylon. (You know how plastic chips and cracks.) Moisture and humidity have no effect on this stubborn material. No effect means no malfunctions for you to worry about. No current leakage, either.

Running the full length of the bobbin are a series of slots. They pamper the capsules and keep them from getting damaged or jarred.

And to help you remember which terminal is which, we mold the terminal numbers into the end of the bobbin. You can read them at a glance.

## Little things mean a lot.

Reliability means that we pay attention to the little things. Like the tiny pressure rods we use in every miniature correed. They're placed at

each end of the bobbin, across the one-piece terminals. What they do is prevent stresses from being transmitted from the terminals to the reed blades. This keeps the contact gap right on the button. All the time.

The contacts are normally open. To provide them normally closed, we employ another little device—a tiny magnet. It's permanently tucked into a slot next to the reedcapsule. The magnetic action keeps the contacts normally closed.

## Coiled by computer.

Once all the parts are secure in the bobbin, we cover them with protective insulation. Around this, we wind the coil. You can be sure the coil winding is correct. It was all figured out for us by computer.

Our next step is to protect the coil. We do that with more protective insulation.

## A coat of iron.

On top of the insulation goes a layer of annealed iron. It acts as a magnetic shield and minimizes interaction between coils. Also, it improves the sensitivity of the entire unit. A coat of iron is standard on all AE correeds.

## Finally comes super wrap.

To wrap it all up, we use some very special stuff. A layer of

mylar laminated material.

It's so tough we guarantee it to withstand all cleaning solvents known to man.

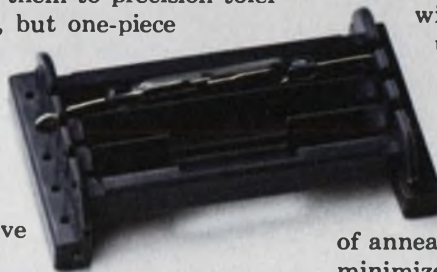

## Free Correed Handbook

This 60 page handbook explains advantages and disadvantages of correeds, describes the different types, and tells how to use and test them. To get your free copy, just write John D. Ashby, GTE Automatic Electric, Northlake, Illinois 60164.

**GTE AUTOMATIC ELECTRIC**

INFORMATION RETRIEVAL NUMBER 37

# FOCUS

on  
Signal  
generators  
and  
synthesizers

Before you study a signal-generator spec sheet, dust off your textbooks. To understand the spec sheet thoroughly and to define your needs adequately, you may need to brush up on your knowledge of noise theory, spectral analysis, time and frequency-domain theory and, possibly, switching theory as well.

Perhaps more than any other instrument, signal generators place a heavy demand on the technical background of a specifying engineer. Your first problem: deciding what is a signal generator.

The answer isn't clear-cut. A host of instru-

ments, from oscillators to function generators to frequency synthesizers, often go under that name. Let's clear this confusion right away. For our purposes, let's call a signal generator a source of accurate, stable, calibrated, variable frequency and voltage, usually offering modulation capabilities as well.

Even after you've refreshed your memory, specification pitfalls await you. Since standard definitions for sig gens don't exist, many manufacturers, in the heat of competition, define terms and perform tests to make their units look good.

On the one hand, omitted specs and scantily written spec sheets bestow a false sense of se-

**Stanley Runyon**  
Associate Editor



**Singer Instrumentation's 6201:** a 512-MHz signal generator that uses a closed loop to digitally lock the output

frequency to the reference frequency of an internal six-digit counter. Stability is 1 ppm/24 hr.



The 2006 uses Marconi's digital synchronizer to lock output frequency over the 10 to 500-MHz range.

curity; on the other, reams of specs bury the reader under figures he may not need. And always awaiting the unsuspecting is the "typical" ploy, in which the words "maximum," "minimum" and "guaranteed" are nowhere to be seen. Let's talk about specifics.

Signal-generator specifications generally fall under one of five major characteristics: frequency, spectral purity, amplitude/power, modulation and general characteristics. The relative importance of each depends, of course, on the application.

#### Is there an accurate accuracy spec?

Specs dealing with frequency usually rank high in importance. Frequency accuracy, resolution, range and stability are the ones to watch for—especially if they are missing from the spec sheet.

Generators using calibrated dials for the setting and reading of frequency generally spec accuracy as a percent of dial reading—or in terms of scale divisions, usually  $\pm$ one-half a division. And therein lies a problem.

What we're really being told here is the repeatability or resolution of the dial. This depends on the closeness of the frequency markings and on the thickness of both the markings and the pointer, as well as the often-neglected backlash in the tuning mechanism.

An accuracy spec, however, should give the maximum error we can expect at a desired frequency. With frequency synthesizers, where the user can set a frequency exactly by pushing a button or turning a knob for each digit, a small—but finite—error still exists.

The confusion resulting from the interchange of the terms "frequency accuracy" and "resolution" has reached new heights with the appear-



Remote programmability or manual control is offered by the 1061—General Radio's 160-MHz synthesizer.

ance of sig gens with built-in counters to set and read frequency. Accuracy—better termed inaccuracy or error—implies the existence of an absolute standard for frequency, to which the exactness of a numerical quantity can be traced. Resolution is strictly a measure of the fineness of a setting, without regard to the accuracy of that setting.

Thus, though a six-digit counter can resolve 1 Hz, the frequency on display may not coincide with the actual output frequency. An error exists, however small. And don't be lulled into a false sense of security by all those digits following the decimal point. Instead, check to see if the specs for resolution and accuracy are commensurate with the unit's frequency stability and residual FM: The last few digits may be useless. While you're at it, gently touch the vernier or fine tuning knob. If the count leaps, forget the last digit. Remember, too, that resolving, say, 1 Hz out of four digits, can't compare with 1 Hz out of 10 digits.

Checking—and specifying—the accuracy of counter sig gens requires new thinking on the part of those accustomed to dials. Try an experiment. Plug a frequency source into half a dozen counters. Chances are you'll get six different readings. Why? Because the accuracy of any counter is plus or minus the sum of time-base accuracy plus one count. And this quantity, of course, varies with each unit. So check out the accuracy and drift (aging) characteristics of the counter's time-base reference oscillator (usually crystal controlled). It's really the key to defining accuracy.

All quartz crystals age. The better ones vary less and in one direction, so that a maximum rate can be specified. For crystals that aren't oven-mounted, the aging rate is usually specified for a week, a month or more. Note that this is

an average frequency change, as determined from the slope of a frequency-time curve. The reason? The aging rate of room-temperature crystals can't be spec'd on a short-term basis, since temperature changes of only a few tenths of a degree can cause the equivalent of a day's aging or more.

Oven-mounted crystals, on the other hand, offer higher stability and can be spec'd for daily aging, since they are environmentally isolated.

If you're looking at locked generators with digital readout, here are some other pointed questions to ask: What frequency is displayed in the locked mode? How much can frequency drift from the setting before you get an out-of-lock indication (if any)? And what's the accuracy in both locked and unlocked modes? Don't forget to check other important specs in both modes—like residual FM and noise.

### Stability is tough to pin down

After you blow away all the smog about frequency accuracy, what's left? Stability. It determines the actual, in-use accuracy, regardless of the initial accuracy and the number of digits.

But stability specs are strangely lacking on some spec sheets. Or, if present, they are described as "excellent" or qualified by the words "after warmup," "long term" or "short term." A word like "excellent," of course, is solely the manufacturer's judgment, while the other phrases are meaningless without specification of time duration.

Even when time stability is adequately defined, manufacturers—in an apparent lapse of memory—sometimes forget that frequency can vary with temperature, line voltage and load. These should all be specified—tempco in parts per million (ppm) per degree C, line voltage for  $\pm 10\%$  variations and load for an open to a short. One other item that's often neglected: Some restabilization time may be necessary after you dial a new frequency, and especially after you change the range. This can run as high as 15 minutes or more. So look for it on the spec sheet.

Short-term stability is usually stated in ppm of frequency change over a 10-minute period. While this tells you what can happen to frequency during a test, don't forget that it assumes all other variables affecting frequency are held constant. Be especially wary of temperature fluctuations. Tempco in ppm/ $^{\circ}$ C can be much greater than the time-stability spec.

As for long-term stability, you can search a spec sheet for a long time before realizing it isn't there. When it is, "long term" can mean an hour, day or year. And a day can be eight hours or 24. Since your frequency of calibration will depend on long-term drift, it's a good idea to try



Hewlett-Packard's latest sig gen is the 8640B, a 512-MHz unit with digital locking and internal six-digit counter. Stability in the locked mode is 0.05 ppm/hr.

to pin it down.

How much stability do you need? While the answer obviously depends on your application, in some cases holding a set frequency can be more important than knowing the exact setting. Gunther Sorger, director of advanced programs for Singer Instrumentation gives this example:

In testing narrow-bandwidth communication receivers, you'll want to be centered right on the passband. If, say, the receiver operates at 400 MHz and has a passband of 3 kHz, the sig-gen carrier frequency must be stable to well within 1 kHz out of 400 MHz—or 2.5 ppm.

Even if temperature, voltage, load and the other parameters that combine to cause frequency drift don't vary, output frequency still doesn't stay constant. The reason: residual FM.

### Spectral purity can be purely subjective

Residual FM is the small, but finite wandering of the carrier frequency that stubbornly remains, even if all external sources of instability are removed. It stems from noise, power-line hum, microphonics and other effects that randomly interact to modulate the carrier frequency.

Depending on the relative frequencies of the carrier and the undesirable modulating factors, residual FM could be listed under frequency stability. Or it could be placed alongside such specs as harmonics, subharmonics, spurious outputs and noise—parameters that describe a sig gen's spectral purity. In either case residual FM is usually so small that it's important only to users who require the ultimate in stability. But finding out just what it is can be a big problem.

Because it isn't precisely defined, residual FM can't always be compared from manufacturer to manufacturer. Some spec it as a peak-to-peak deviation, some as rms. Others list it as fractional frequency deviation ( $\Delta f/f$ ) or as FM noise in terms of hertz of equivalent deviation, psophometrically weighted for telephone or broadcast applications. Still other users don't specify.



LogMetric's sig gen line ranges from the 750A, a 520-MHz unit with five-digit readout, to the 921A, an 80-MHz unit with a three-digit display.

In many cases residual FM is listed without stating the measurement bandwidths. Or, when bandwidths are stated, they vary between manufacturers such that a comparison is impossible without knowing the noise distribution. Another problem: Residual FM can change from the CW to FM mode and for various deviations within the FM mode. We aren't always told how much.

Along with the desired signal, a sig gen spits out smaller amounts of unwanted signals, including harmonics, subharmonics, noise and spurious, nonharmonically-related trash. The relative importance of the unwanted signals depends on the sig-gen application. Harmonic content, or carrier distortion, is significant when broadband equipment or devices are tested. On the other hand, spurious levels close to a carrier frequency cause trouble in receiver testing, whereas harmonics can be filtered out.

As troublesome as unwanted signals are during testing, they're twice as bothersome when you try to sort them out on the spec sheet. For

it's here that the "noise" and "communication" problems start.

For starters, check for missing purity specs. Some inexpensive sig gens don't dare list them. Next, watch for terms that don't really describe spectral purity. Fractional frequency deviation, for example, may be more appropriately applied to a discussion of stability. Then, check harmonics. Is the figure given for total harmonic distortion? Or for what?

Does the spec cover the entire frequency range or a limited range? And what happens to the distortion figure when you turn the output up to full voltage? In a quality sig gen, harmonics should be at least 30 dB down (1.5% distortion).

Noise specs probably cause the greatest confusion. And no wonder. Even when well-defined, noise is difficult to corroborate by measurement, especially when you are dealing with the low noise levels found in the latest generators.

For signal generators, noise can generally be subdivided into two major categories: broadband and close-in. Each is important for different types of tests. Watch out for a spec sheet that lists impressively low noise without stating what kind, or one that states a figure without showing the noise distribution. Both can mislead.

Close-in noise—that is, noise within a limited bandwidth around the carrier—is important in the testing of narrowband communication receivers. For this purpose, close-in noise is usually specified as single-sideband phase noise.

But there's no way of knowing from a spec sheet how the listed phase noise figure was measured or calculated. The problem is there are several different ways to define phase noise, none of which is really incorrect. Here's some background.

### Phase noise gains importance

The concept of phase-modulation (PM) noise has, until recently, been of concern mostly to those who build and use frequency synthesizers. This is because synthesizers usually derive frequencies in a way that tends to suppress amplitude (AM) noise. In this situation, therefore, PM noise, rather than AM, dominates the output trash.

PM noise results mainly from two basic processes. First, temperature changes cause a frequency-selective circuit to shift the phase of a totally stable frequency passing through the circuit. Since frequency is proportional to the time rate of change of phase, the resulting slow phase drift shows up as an error in frequency,  $\Delta f$ , which can be expressed as a fraction of the carrier,  $f$ .

On top of this slow phase drift are rapid (short-term) fluctuations in phase caused by

noise voltages that interact with the basic frequency generation process. Since this noise is essentially random, the net effect on frequency tends toward zero over the long run. Thus specs that give fractional frequency errors,  $\Delta f/f$ , can be made to look good by extending the observation, or averaging time; by listing  $\Delta f/f$  only at the higher carrier frequencies; and by limiting bandwidths of filters used to make the measurement. If no averaging time is listed, ask why.

Expressing phase drift, noise or jitter as a fractional error really describes the effects on frequency in the time domain. Perhaps more universal is the expression of phase noise in the frequency domain, in terms of sideband phase noise.

Phase noise results in FM sideband pairs spaced at each noise frequency from the carrier. Since noise is generally wideband, a spectrum, or continuum, is formed about the carrier. And since the pairs are equally spaced above and below the carrier, we have only to talk about one side of the spectrum. Hence the term "single sideband."

What we're often given in a spec sheet is the total, or integrated, sideband power in the spectrum out to some frequency above and below the carrier. It's usually expressed as the signal-to-phase noise ratio in the 30-kHz band centered on the carrier, with noise in the  $\pm 0.5$ -Hz band around the carrier excluded because it's difficult to measure.

What the spec sheet may not tell us, while boasting of a low S/N, is the noise distribution. Why do we need it? Two reasons: First, we can't compare specs or convert to other types of specs without it. Second, if our application involves one frequency or a limited range, we're interested only in the noise within that range, not the total noise. Distribution should therefore be given, and preferably as a plot of phase noise (density) vs frequency offset from the carrier.

Finally some spec sheets show impressive spectrum-analyzer displays of low harmonics and spurious frequencies. What aren't shown are the analyzer control settings and the test setup. Our advice: Ask.

#### How much power?

After a short spell to recover from your bout with frequency specs, you'll want to check out those dealing with power and voltage output. There are relatively few to watch for. The important ones are the minimum and maximum voltage levels, level stability and accuracy, leakage, impedance and VSWR.

Before you can compare sig gens for voltage outputs, or decide if the listed output range of a given unit fills your needs, you've got to figure out which volt the manufacturer is talking about.

A volt is a volt, you say? Not so.

Most U.S. manufacturers state voltage as a potential difference (pd) across a given load—usually 50  $\Omega$ . European suppliers (and some American ones), on the other hand, state outputs as emf—the open circuit voltage. To determine the voltage across your load, you've got to know its impedance and the sig gen's output (source) impedance. Then you calculate the voltage.

If you're lucky enough to have your load impedance match the generator's impedance, then all you've got to do is halve the emf to get the load voltage. And, when pd is given—and the impedances match—you're even luckier, since the pd will be the load voltage.

However, life is generally not so rosy. Chances are your load impedance not only doesn't match that of the sig gen but it also varies with frequency as well. This shouldn't cause too much worry, though, since the sig gen's output imped-



For those who don't require the ultimate in performance, Marconi offers the 2015, a 520-MHz compact unit with AM/FM capability.

ance may also vary all over the place with frequency. With any luck, they'll match up somewhere along the line. Finally, when you check output impedance, don't forget VSWR; reflections can become important at the higher frequencies.

Confusing specs can surface here, too. Watch for outputs that read, "One volt from," "after" or "behind" 50 ohms. These are all emf specs. "One volt into 50 ohms," however, is a pd spec, while "one volt out" is meaningless.

Other pitfalls: Is the voltage spec given in rms, peak-to-peak or dB above 1  $\mu V$ ? Is the output power level given in dB referred to 1 mW (dBm) or in watts and impedance? You can't compare unless all units are identical.

As for voltage range, the minimum level is important for receiver sensitivity tests, in which the input signal should be at least 10 dB below receiver sensitivity. For a receiver with a



noise figure of 10 dB—and consequently a sensitivity of  $-129$  dBm—the input signal should be  $-139$  dBm—or about  $.023 \mu\text{V}$  into  $50 \Omega$ . At this level the noise output becomes critical; so check it.

At the high end, you need enough power to measure receiver overload characteristics. Other applications may require more or less. Calibration of rf voltmeters, for example, might require 3 V, or 180 mW, into  $50 \Omega$ . But with high output levels we get another problem: leakage.

In general, the higher the output power of a sig gen, the greater the potential stray leakage. Any seam or panel opening—for a meter, dial, switch, etc.—can potentially leak electromagnetic radiation. To prevent this, a sig gen must be tightly shielded. Just how tightly depends on the application. For receiver sensitivity tests, Keith Elkins, manager of Marconi Instruments in Englewood, N.J., notes that there's no point in displaying a setting of  $0.03 \mu\text{V}$  on a dial when the radiation is far above that.

Perhaps because the leakage is high—or because it's hard to specify—many spec sheets don't list it. Or leakage is given as "negligible." The latter could mean "When the sig gen is used in a shielded room and is 20 feet from the receiver."

How should leakage be specified? Unfortunately, no general agreement exists. Some manufacturers cite compliance with MIL-I-6181 or MIL-STD-461, 462 and 463. Others give the field strength at a distance of one meter in front of the sig gen. And still others list the voltage induced in a two-turn one-inch-diameter loop placed one inch away from any surface of the sig gen, as measured by a  $50\text{-}\Omega$  receiver. It's claimed that the latter method allows receiver sensitivity measurements of at least  $0.03 \mu\text{V}$  in a shielded system.

One other point: Higher power levels generally mean more internal heat. More heat can result in greater temperature drift. Moral: Don't buy more power than you need. Try using a more sensitive meter at the output of the device under test instead of a high-power sig gen.

Finally, here are some other questions to ask when checking output: What is the accuracy of the output? Is the stated accuracy an absolute, over-all figure that holds for all frequencies and levels? Or is the listed accuracy fragmented, omitting certain individual error contributions—such as from a meter, attenuator or detector? How flat is the output level over the frequency range? Can you get the listed minimum and maximum levels at all frequencies? What's the distortion, if any, at the higher levels?

After you've set your carrier frequency and level, you may want to modulate. Many sig gens offer FM, AM, pulse modulation or a combina-

tion of the three. Usually 400-Hz and 1000-Hz internal modulating signals are provided, along with an external jack for injecting higher frequencies.

An entirely new set of specs dealing with modulation must now be investigated. They include the accuracy and stability of modulation, the depth and rate of modulation, the peak deviation for FM and the effects of modulation upon the other sig-gen specs.

### Specs can change when you modulate

The depth of modulation for AM and the deviation for FM are usually displayed on an analog meter. Consequently spec sheets list accuracies as a percent of reading or of full scale. If the latter, it's left to the user to figure his accuracy at the lower, more commonly used end of the scale. However, with scale switching, the often-used 30% AM appears at full scale.



The 8654A is HP's inexpensive AM/FM sig gen. It outputs 10 to 512-MHz and 0 to  $-120$  dBm into  $50 \Omega$ . This compact unit weighs just 16 pounds.

Watch for qualifiers on AM. They're common. It's great to get 100% AM if you need it (and few users do), but at what output levels, frequencies and waveshapes is it offered? And what happens to the carrier at heavy modulations? Severe distortion or carrier shifts are a good possibility. Perhaps more important than knowing the exact percent of modulation or peak deviation, does the set value remain set?

Peak deviation is important in the FM mode. It's usually spec'd as a percent of the carrier. With some sig gens, deviation is easily set and remains constant with frequency and band changes. With others, setting the peak deviation is not only a chore—recalibration is also required when you change frequencies. Wide deviations at low carrier frequencies are important in some applications. Not all sig gens offer it.

To modulate at high rates, you've got to supply the modulating signal. But can the sig gen handle your frequency? Read the rate specs carefully, especially those that give bandwidths. Are bandwidths defined for the 3-dB points? Or are other criteria used? Bandwidth also varies with percent of modulation and with carrier frequency. So check. Check, too, the input impedance of the modulation-input jack—you don't want to load your signal. And while you're at it, roll up a scope and check the output at that jack. There shouldn't be any.

On external modulation you should know the modulation gradient or sensitivity—that is, the deviation per volt for FM and the percent of modulation per volt for AM. Watch for qualifiers here, too. Is the volt rms or peak? Modulation linearity may also be important to you. If it is, you'll have to ask for a figure; most spec sheets don't seem to list one. Ask also how linearity is determined, whether by least squares or from the difference between the extreme deviations. The two methods can give widely divergent numbers.

Finally, modulating a signal isn't simple. Things change that shouldn't. When you amplitude modulate, you may inadvertently frequency modulate as well; when you FM, you may also AM. So check the spec sheets for incidental AM and incidental FM. Both should be small. Check also for AM and FM distortion—the former at all frequencies and at all percentage modulations, the latter at all modulating rates and at all deviations.

For pulse modulation, the important specs include minimum and maximum rep rates, pulse levels, on/off ratios, rise/fall times and minimum pulse widths. Other specs may be important to a particular application.

### Define before you buy

Defining needs involves tradeoffs. As Hewlett-Packard points out, it's unrealistic to expect high spectral purity in a sig gen and sweep capability, too—or both high-power output and microwatt levels.

When you check the specs, remember that manufacturers usually compromise, too. Performance testing is time-consuming and adds considerably to cost. Some manufacturers expect a purchaser to pay more for a generator that is comprehensively spec'd and rigorously tested.

You can narrow the choice by precisely defining your needs: Is the sig gen to be used in the laboratory, in production or in the field? Do you need a wideband, general-purpose instrument or a narrowband, dedicated unit? Specials also exist—for example, sig gens designed just to test and calibrate instrument landing sys-

tems. Perhaps one of these will do. But think ahead. An instrument suitable for a job at hand may not be suitable for a future job.

### Synthesizer or sig gen?

To make your final choice, you'll no doubt look at synthesizers and compare them with sig gens. Let's first examine synthesizers, and then see how the two types stack up.

Synthesizers can be put into two major classes: direct and indirect. A third method—direct digital synthesis—is used by at least one manufacturer. In direct-frequency synthesizers, all output frequencies are derived from one precise standard by the mathematical processes of division, multiplication, addition and subtraction.

In the indirect unit, output frequencies are produced by one or more variable oscillators, phase-locked to a frequency reference. How do direct and indirect synthesizers compare? Indirect units offer a lower parts count and consequently cost less. They're about one-third the cost of direct units that cover the same frequency range.

Direct units, on the other hand, offer finer frequency resolution (better than 1 Hz), and because all frequencies are always present, these synthesizers give faster switching times (about 20  $\mu$ s) between frequencies. As for spectral purity and stability, the comparison is not so clear-cut.

Theoretically, since both synthesizer types are referenced to a standard, each can have the same long-term stability as its standard. But over the short term, the two types can diverge. The short-term phase jitter of a direct synthesizer is related directly to that of its standard. On top of that, we've got to add phase shifts from temperature variations, line noise and other effects that occur in the networks between the standard and the output.

In indirect units short-term stability depends on additional factors: the stability of the VCO and the loop bandwidth.

Although they approach synthesizers in stability, noise and settability, signal generators are not yet ready to replace them. Synthesizers still offer the best frequency stability and phase noise.

If you need exact settability to six significant digits or more—for example, to set the 3.579545-MHz color-TV subcarrier—you've got to go with a synthesizer. Or if you need a frequency-agile, or programmable, source that is able to switch rapidly between frequencies or in fine increments—0.01 Hz, say—then only synthesizers will do the job.

But if you need modulation capabilities, a



Rockland Systems' 5100 synthesizer uses a direct digital approach to generate its 0.001-Hz to 2-MHz output

range. The technique results in high resolution plus fast, phase-coherent switching of output frequencies.

power meter or a calibrated attenuator, then synthesizers—with few exceptions—won't do.

Synthesizers have their share of problems, too. Spurious, nonharmonically related signals have plagued the synthesizer since its beginning. The unwanted signals can be removed, but with difficulty and at a price; high-priced synthesizers reduce spurious responses by at least 90 dB and medium-priced by about 60 dB. Harmonics are about the same as those of a good sig gen: 30 to 40 dB down.

If you decide that a synthesizer is your bag, you'll have to check such specs as frequency range, accuracy and stability, the number of digits, output levels and spectral purity—in the same way that you check these specs for sig gens. But there's an additional point to remember:

Some synthesizers don't have an internal frequency standard; it's offered as an option. The listed noise specs therefore may be the residual noise of the synthesizer alone and not include the noise of the optional standard—or external standard, if that is used.

One set of synthesizer specs has no sig-gen analogy—the specs dealing with programmability, especially switching speed.

### Settling the settling-time problem

For automated applications, such as in automatic test equipment, remote control and secure communications, you'll probably want full control of frequency and amplitude. You'll be looking for flexible programming and a unit that's easily interfaced. Perhaps more important, you'll be examining minimum and maximum switching times. And there is where pitfalls await.

Listing switching speed without giving a set-

tling time is the usual manufacturer ploy. Switching speed should be defined as the time elapsing between a command to a new frequency and the point at which the output frequency becomes useful—that is, the point at which the output falls—and remains—within an acceptable frequency error band.

What is acceptable, of course, depends on the application. But we can't compare spec sheets without some standard for the error band. Unfortunately, no standard exists. Some spec sheets list settling time to within a specified number of hertz, the number varying with the manufacturer. Others spec it as the point at which the new frequency is within  $\pm 0.1$  radians of its steady-state phase.

Often missing, too, are statements about other important parameters that can vary when frequency is switched. For instance, what happens to amplitude during "settling" time—does it settle too? How about phase continuity, or coherence, when frequency hopping? This is important in chirp radar applications. What switching transients can we expect? We're not often told.

Here's something else we're not always told: Switching speed is a function of the digit being switched. Lower-order decades can be switched faster than the higher orders. Thus a maximum, or worst-case, switching time should be given.

Finally, don't forget that switching times can also depend on the command signal. Check the requirements for voltage and current drive levels, source impedance and transition times. They may all be important.

### What's new in signal generators

When you're all finished with spec sheets—or vice versa—you'll want to look at some hard-

ware. The best bet is pry a unit loose from a rep and keep it awhile. Put it through its paces. Chances are you won't be able to check all the specs, but some surprises may surface, especially when you open the lid.

Less than a dozen suppliers lead the field in general-purpose, laboratory-grade sig gens. The lineup includes General Radio, Hewlett-Packard, LogiMetrics, Marconi, Rohde & Schwarz and Singer Instrumentation. Others, such as Polarad Electronic Instruments, specialize in microwave sig gens. And still others concentrate on sweepers, power generators or lower-priced generators. Some manufacturers offer many kinds, including synthesizers.

Since 1968 the trend in general-purpose sig gens has been toward all-solid-state, digital readout of frequency and extended modulation capabilities. The latest crop includes HP's 8640B, Boonton Electronics' 102A, LogiMetrics' 750A and Singer's 6201.

Hewlett-Packard's 8640B is an AM/FM unit outputting 0.45 to 512 MHz in 10 bands. Output is locked to an internal counter and displayed on a six-digit LED readout. The counter doubles as an external 550-MHz counter. Specs include resolution to 1 Hz (in 100 times expand mode); a total count accuracy of the resolution ( $\pm 1$  count), plus the reference error ( $< \pm 1$  ppm) plus aging error (2 ppm/year); and a stability in the locked mode of 0.05 ppm/hour after two-hour warm-up.

The 8640B's noise specs include an SSB phase noise, at 20 kHz from the carrier, of  $-122$  to  $-140$  dB/Hz depending on frequency; an SSB broadband noise of  $-140$  dB/Hz, and harmonics of better than 30-dB down. The output of the 8640B ranges from +19 to  $-145$  dBm, or 0.13  $\mu$ V to 2 V into 50  $\Omega$ .

Modulation includes AM, FM, pulse and simultaneous AM/FM or FM/pulse. Peak deviation ranges from 5 kHz on the 0.5-to-1-MHz band, to 2560 kHz on the 256-to-512-MHz band. The 8640B costs \$4450. A dial version, the 8640A, sells for \$3100.

Other HP developments include the 8654A—a \$1225, general-purpose AM/FM unit covering 10 to 512 MHz and offered for field checks, go/no-go tests and medium-performance lab applications—and the 8660 series, a unit with a foot in both the synthesizer and sig-gen camps. This synthesized sig gen is programmable in frequency, amplitude and modulation. It offers plug-in rf sections from 10 kHz to 1300 MHz, the highest frequency available in any synthesizer; plug-in modulation sections; a keyboard version with a 10-digit LED display, digital sweep and synthesized search. The price of the keyboard mainframe is \$6000.

LogiMetrics, the company that pioneered both



The popular Fluke 6160A indirect synthesizer offers output to 160 MHz, BCD programming with 0.5-ms switching time, and a signal-to-phase-noise ratio of 62 dB.

the locking loop using a digital counter (Model 925) and the digital display of frequency (Model 920A) offers sig gens in a wide range of prices and performance. The company's 750A FM/AM sig gen covers 4.5 to 520 MHz (continuously tuned) and has a five-digit LED display with switchable resolution of 1, 10 or 100 kHz. Accuracy is listed as plus or minus one-half the resolution plus the reference-frequency accuracy (1 ppm at room temperature). Stability is specified as typically 20 ppm plus 1 kHz for 10 minutes after a two-hour warm-up.

As for spectral purity, the 750A's FM noise is specified as typically 116 dB down at 20 kHz from the carrier, while broadband noise is typically 140 dB down. Harmonics are at least 30 dB down. The output of the 750A spans 140 dBm, or 0.1  $\mu$ V to 1 V into 50  $\Omega$ . Modulation includes AM, FM, pulse and simultaneous AM/FM or pulse/FM. Peak deviation is  $\pm 300$  kHz. The 750A sells for \$3100.

In the works at LogiMetrics is the Model 760, a 4.5-to-520-MHz unit that, the company says, will have true phase lock and, hence, phase coherence with the reference.

Singer Instrumentation's newest signal generator is the 6201. It offers an output in six bands of 7.75 to 512 MHz, locked to an internal six-digit counter. External counting to 10 MHz is possible. Readout is by a six-digit LED, with resolution of 100 Hz to 62 MHz and 1 kHz thereafter. Frequency accuracy is listed as plus or minus the last digit plus the time base accuracy ( $\pm 1$  ppm after two-hour warm-up at 25 C), while stability in locked mode is 1 ppm per 24 hours after a one-hour warm-up.

Noise specs of the 6201 include a broadband noise of at least 130 dB/Hz below the carrier, a residual FM of 0.25 ppm peak and harmonics 30 dB down. The output of the 6201 ranges from +20 to  $-146$  dBm, or 0.01  $\mu$ V to 2.2 V into 50  $\Omega$ . Modulation capability includes AM, FM, video,

**Table. Representative frequency synthesizers.**

Company and Model	Type	Frequency Specs			Amplitude	Spectral Purity			Switching Speed	Price	Remarks
		Range	Smallest Digit	Stability		Phase S/N	Spurious	Harmonics			
A.R.F. Products a) ASG 7	Indirect	93 kHz to 1 GHz		$\pm 0.001\%$	7 V rms to 11.9 MHz 3 V rms thereafter		>60 dB down	>40 dB down	<1 second	Approx. \$10,000	Binary programmable 15 bits
John Fluke a) 6160A	Indirect	1 to 160 MHz	100 Hz (to 0.1 Hz optional)	$\pm 1 \times 10^{-8}$ in 24 hr internal standard aging	3 to 13 dBm into 50 $\Omega$	>62 dB	>75 dB down	>25 dB down	<500 $\mu$ s to within 100 Hz	\$4,995	Internal standard optional (higher stability available)
	b) 645A	Direct	dc to 50 MHz	$\pm 1 \times 10^{-8}$ in 24 hr internal standard aging	0.2 to 1 V rms into 50 $\Omega$ (50 Hz to 50 MHz)	>66 dB	>100 dB down	>30 dB down	<20 $\mu$ s to within $\pm 1$ dB of amplitude and to $\pm 0.1$ radian of phase	\$11,500	Internal standard optional (higher stability available)
General Radio a) 1061	Indirect	400 kHz to 160 MHz	10 kHz (to 0.1 Hz optional)	$\pm 1 \times 10^{-9}$ per day after 1 month (internal standard)	0 to +20 dBm into 50 $\Omega$	>60 dB	>80 dB down	>27 dB down	<100 $\mu$ s	\$4,700 basic unit	Internal standard optional, control panel optional
	b) 1062	Indirect	10 kHz to 500 MHz	Same as 1061	0 to +13 dBm into 50 $\Omega$	>60 dB	>80 dB down	>27 dB down	<100 $\mu$ s	\$8,700 basic unit	
LogiMetrics a) Series 510	Indirect	Customer selects any 20% range between 50 and 300 MHz	1 kHz or 10 Hz	$2 \times 10^{-8}$ in 24 hr internal standard	0 to +10 dBm into 50 $\Omega$		>95 dB down	>40 dB down	<1 ms to within 0.01%	\$3,000 to \$8,000	Slot synthesizers
	b) Series 520	Indirect	Customer selects any 20% range between 1 and 8 GHz	$2 \times 10^{-8}$ in 24 hr internal standard	+10 to +16 dBm		>83 dB down	Second: >26 dB down Third: >36 dB down	10 ms max.	\$5,000 to \$10,000	Slot synthesizers
Hewlett-Packard a) 3330B	Indirect	0.1 Hz to 13 MHz	0.1 Hz	$\pm 1 \times 10^{-8}$ per day internal standard	+13.44 to -86.55 dBm into 50 $\Omega$	>50 dB	>70 dB down	>40 dB down	<1 ms to within 10 $\mu$ Hz (0.1 or 1 Hz digits). <1 ms to within 100 Hz (100 kHz, 1 or 10 MHz digits)	\$6,000	Internal reference included. Higher or lower stability available
	b) 5105A/5110B	Direct	100 kHz to 500 MHz	$\pm 3 \times 10^{-9}$ in 24 hr internal standard	-6 to +6 dBm into 50 $\Omega$	>40 dB	>70 dB down	25 dB down	20 $\mu$ s typical	\$14,100	Internal standard included
Rockland Systems a) 5100	Direct Digital	0.001 Hz to 2 MHz	0.001 Hz	$1 \times 10^{-8}$ per day internal reference	10 V pk-pk max. with 50 $\Omega$ source impedance		>50 dB down	>40 dB down	1.5 $\mu$ s for binary word	\$2,450	Maintains phase and amplitude coherence when switching

pulse and simultaneous AM/FM, FM/pulse or FM/video. Peak deviation is at least  $\pm 0.5\%$  of the carrier. The 6201 sells for \$4250.

Other developments at Singer include the 6106, a locked sig gen designed to calibrate VOR/ILS receivers. It covers the same frequency range as the 6201 and allows very accurate AM (0.3%) at low distortion (0.5 to 70%, AM). Phase shift between the modulation input and demodulated output at 30 Hz is less than 0.01 degree.

Marconi Instruments offers a generous choice

of sig gens. Newest are the Models 2011/2012/2013—narrowband, low-noise, low-drift units designed to test vhf and uhf mobile FM receivers. The frequency ranges are, respectively, 130 to 180, 400 to 520 and 800 to 960 MHz. All three units are claimed to measure rejection ratios that exceed 90 dB at 20 kHz offset. Output levels span 0.01  $\mu\text{V}$  to 100 mV into 50  $\Omega$ , and FM deviations range to 30 kHz. The 2011 and 2012 sell for \$3125. Check with Marconi for the 2013's cost.

The Model 2015 is Marconi's low-cost, general-

## Need more information?

The products cited in this report don't represent the manufacturers' full lines. For additional details, check the appropriate information retrieval number:

AIL, Div. of Cutler-Hammer, Inc., Deer Park, N.Y. 11729. (516) 595-6471. (G. F. McCarthy) **Check 380**  
 A.R.F. Products, Inc., Box 3226, Boulder, Colo. 80303. (303) 443-4844. (Robert P. Davidson) **Check 381**  
 American Electronic Labs, P.O. Box 552, Lansdale, Pa. 19446. (215) 822-2929. (A. Rosset) **Check 382**  
 Aul Instruments, Inc., 139-30 34th Rd., Flushing, N.Y. 11352. (212) 886-0600. **Check 383**  
 B & K Instruments, Inc., 5111 W. 164th St., Cleveland, Ohio 44142. (216) 267-4800. **Check 384**  
 Boonton Electronics Corp., Route 287 at Smith Rd., Parsippany, N.J. 07054. (201) 887-5110. (Frank R. Canning) **Check 385**  
 Clarke-Hess, 43 W. 16th St., New York, N.Y. 10011. (212) 255-2940. **Check 386**  
 Clemens Manufacturing Co., 630 S. Berry Rd., St. Louis, Mo. 63122. (314) WO-1-7228. (John F. Clemens) **Check 387**  
 Collins Radio Co., Dallas, Tex. 75207. (214) 235-9511. (T. A. Campobasso) **Check 388**  
 Dana Labs, Inc., 2401 Campus Dr., Irvine, Calif. 92664. (714) 833-1234. (James Helfrich) **Check 389**  
 Dranetz Engineering Labs, 2385 S. Clinton Ave., S. Plainfield, N.J. 07080. (201) 755-7080. **Check 390**  
 Dynascan Corp., 1801 W. Belle Plaine Ave., Chicago, Ill. 60613. (312) 327-7270. (M. E. Bond) **Check 391**  
 Edison Electronics, Div. of McGraw-Edison, Grenier Field, Manchester, N.H. 03103. (Walter Manson) **Check 392**  
 Electro/Data, Inc., 1621 Jupiter, Garland, Tex. 75042. (214) 341-2100. (F. E. Reisch) **Check 393**  
 Exact Electronics, Inc., P.O. Box 160, Hillsboro, Ore. 97123. (503) 648-6661. (Ronald T. Hill) **Check 394**  
 John Fluke Mfg. Co., Inc., 7001 220th S.W., Mountlake Terrace, Wash. 98043. (206) 774-2322. (Dale Osterud) **Check 395**  
 Frequency Engineering Labs, Div. of Harvard Industries, Inc., Box 527, Farmingdale, N.J. 07727. (201) 938-9221. (G. E. Tirone) **Check 396**  
 General Microwave Corp., 155 Marine St., Farmingdale, N.Y. 11735. (516) 694-3600. (M. Wind) **Check 397**  
 General Radio Co., 900 Baker Ave., Concord, Mass. 01742. (617) 369-4400. (David P. Friedley) **Check 398**  
 Heath Co., Benton Harbor, Mich. 49022. (616) YU-3-3961. (Earl Brohier) **Check 399**  
 Hewlett-Packard, 1501 Page Mill Rd., Palo Alto, Calif. 94304. (415) 493-501. **Check 400**  
 Hickok Electrical Instruments, 10514 Dupont, Cleveland, Ohio 44108. (216) 541-8060. **Check 401**  
 Honeywell Inc., Test Instruments Div., P.O. Box 5227, Denver, Colo. 80217. (303) 771-4700. **Check 402**  
 Hughes Aircraft Co., Industrial Electronics Group, Centinela and Teale Sts., Culver City, Calif. 90230. (213) 391-0711. **Check 403**  
 Industrial Test Equipment, 369 Lexington Ave., Clifton, N.J. 07015. (201) 546-2130. (M. Schreiber) **Check 404**  
 Instruments for Industry, Inc., 151 Toledo St., Farmingdale, N.Y. 11735. (516) 694-1414. (J. D. Fahnestock) **Check 405**  
 Jerrold Electronics Corp., 401 Walnut St., Philadelphia, Pa. 19105. (215) 925-9870. **Check 406**  
 Kay Elemetrics, 12 Maple Ave., Pine Brook, N.J. 07058. (201) 227-2000. **Check 407**  
 Krohn-Hite, 580 Massachusetts Ave., Cambridge, Mass. 02139. (617) 491-3211. **Check 408**

Lampkin Labs, P.O. Box 2048, Bradenton, Fla. 33505. (813) 746-4175. (Bill Rogers) **Check 409**  
 Leader Instruments Corp., 37-27 27th St., Long Island City, N.Y. 11101. (212) 729-7410. (J. Patanella) **Check 410**  
 LogiMetrics, 100 Forest Dr., Greenvale, N.Y. 11548. (516) 484-2222. (Frank J. Sposito) **Check 411**  
 London Co., 811 Sharon Dr., Cleveland, Ohio 44145. (216) 871-8900. **Check 412**  
 Lorch Electronics, 105 Cedar Lane, Englewood, N.J. 07631. (201) 569-8282. (Bob Felsenheld) **Check 413**  
 MCL, Inc., 10 N. Beach Ave., La Grange, Ill. 60525. (312) 354-4350. **Check 414**  
 Marconi Instruments, 111 Cedar Lane, Englewood, N.J. 07631. (201) 567-0607. (Keith Elkins) **Check 415**  
 Microdot Inc., Instrumentation Div., 19535 E. Walnut Dr., City of Industry, Calif. 91744. (213) 965-4911. (Ru S. Burkett) **Check 416**  
 Microwave Associates, Inc., Northwest Industrial Park, Burlington, Mass. 01803. (617) 272-3000. (J. Bunker) **Check 417**  
 PRD Electronics, 1200 Prospect Ave., Westbury, L.I., N.Y. 11590. (516) 334-7810. (Wally Weisman) **Check 418**  
 Pacific Measurements, Inc., 940 Industrial Ave., Palo Alto, Calif. 94303. (415) 328-0300. (D. Armann) **Check 423**  
 Polarad Electronic Instruments, 5 Delaware Dr., Lake Success, N.Y. 11040. (516) 328-1100. (Edward F. Feldman) **Check 419**  
 Resdal Engineering Corp., 300 E. Live Oak Ave., Arcadia, Calif. 91006. (213) 684-2600. (W. C. Neil, Jr.) **Check 420**  
 Robicon Corp., Plum Industrial Park, Pittsburgh, Pa. 15239. (412) 327-7000. (N. Altman) **Check 421**  
 Rockland Systems Corp., 230 W. Nyack Rd., W. Nyack, N.Y. 10994. (914) 623-6666. (Paul D. Beckwith) **Check 422**  
 Rohde & Schwarz, 111 Lexington Ave., Passaic, N.J. 07055. (201) 773-8010. (Allen Freeland) **Check 424**  
 Schlumberger Instruments and Systems, 12 Place des Etats Unis, 92120 Montrouge, France. (A. Westermann) **Check 425**  
 Servo Corp. of America, Infrared & Electro Optics Div., 111 New South Rd., Hicksville, N.Y. 11802. (516) 938-9700. (J. H. Wagner) **Check 426**  
 Siemens Corp., 186 Wood Ave. S., Iselin, N.J. 08830. (201) 494-1000. (Achim Meilenbrock) **Check 427**  
 The Singer Co., Palo Alto Operation, 3176 Porter Dr., Stanford Industrial Park, Palo Alto, Calif. 94304. (415) 493-3231. (Wally Burton) **Check 428**  
 Somerset Radiation Lab, Box 946, Arlington, Va. 22216. (703) 525-4255. (K. Schomaker) **Check 429**  
 Syntronics, Inc., 169 Millham St., Marlboro, Mass. 01752. (617) 481-7829. **Check 430**  
 Systron-Donner, One Systron Dr., Concord, Calif. 94520. (415) 682-6161. (Rudy Wagner) **Check 431**  
 Tektronix, Inc., P.O. Box 500, Beaverton, Ore. 97005. (503) 644-0161. (Earl Music) **Check 432**  
 Telonic Industries, Inc., 21282 Laguna Canyon, Laguna Beach, Calif. 92652. (714) 494-9401. (James R. Smith) **Check 433**  
 Texscan Corp., 2446 N. Shadeland Ave., Indianapolis, Ind. 46219. (317) 357-8781. **Check 434**  
 Wandel & Goltermann, 6 Great Meadow Lane, E. Hanover, N.J. 07936. (201) 887-8700. (D. E. Foreman) **Check 435**  
 Watkins Johnson Co., 3333 Hillview, Palo Alto, Calif. 94304. (415) 493-4141. (C. C. Billat) **Check 436**  
 Wavetek Indiana, Inc., 66 N. First Ave., Beech Grove, Ind. 46107. (317) 783-3221. (Ed McDonald) **Check 437**  
 Wavetek, 9045 Balboa Ave., San Diego, Calif. 92123. (714) 279-2200. (Tom Kurtz) **Check 438**  
 Weinschel Engineering, Box 577, Gaithersburg, Md. 20760. (301) 948-3434. (J. W. Spero) **Check 439**  
 Wiltron Co., 930 E. Meadow Dr., Palo Alto, Calif. 94303. (415) 321-7428. (Herman Neidhart) **Check 440**

purpose sig gen, offering 10-to-520-MHz coverage and AM/FM for "well under \$2000."

Despite Marconi's claims that its traditional units are stable without frequency lock, the company's newer units (Model 2006/1 and 2002B) combine a digital synchronizer with a fundamental generator. The synchronizer, which locks a carrier at multiples of 10 or 100 Hz, is said to be unlike an ordinary lock box, which uses a counter to lock frequency.

Finally, Marconi's 2008/1 offers an optional digital display, but with a stated noise degradation.

Many of the newer high-performance sig gens cost thousands of dollars. For less stringent jobs, you can waive accuracy, stability, purity, etc., and save money. Many companies specialize in inexpensive sig gens. Daven/Measurements, for example, offers its Model 800A FM for \$860. It



Polarad Electronic Instruments offers microwave sig gens, such as the 1105A—a 0.95 to 2.5-GHz unit.

covers 25 to 960 MHz and provides 0.1  $\mu$ V to 0.1 V. Clemens Manufacturing Co. sells its Model SG-83C for \$295. The unit outputs 50 kHz to 54 MHz and 0.6  $\mu$ V to 160 mV into 50  $\Omega$ .

#### Synthesizers are getting better

What of synthesizers? Today's units show less spurious noise and less phase noise, have better modulation and sweep capabilities, are generally less expensive than they used to be and are faster than their predecessors. The trends point toward fast, computer-controlled frequency sources for automated production and testing, and to synthesizers with improved noise characteristics for use in narrowband communications. The performance of representative synthesizers are summarized in the accompanying table. ■■

## Marco-Oak Rainbow switch



with or without  
a lamp



changes color  
changes legend



and  
latches down.

- 10.5 amps/28VDC, 125/250 VAC
- 1 or 2 pole form Z
- Contact module U.L. Listed
- Choice of on-off colors
- Ideal for high ambient light service.

Lighten your decisions  
contact . . .

**MARCO-OAK**

A Subsidiary of OAK Industries Inc.

P.O. Box 4011

207 S. Helena Street, Anaheim, Calif. 92803  
Tel. (714) 535-6037 • TWX — 910-591-1185



containing  
electrical energy  
is a little more  
complex





How a cable copes with the problems of voltage safety; frequencies; current; attenuation; capacitance; velocity of propagation; inductance; electrostatic and electromagnetic interference, depends heavily on what surrounds the conductors:

The coating, insulation, shielding, jacketing materials. And how they are applied. Belden has the ways and means. Material answers that can help you cope with both the electronic and physical environment your cable works in. The design and production know-how to give you the right combination of quality, reliability and performance your application demands.

Talk to your Belden wire specialist. He has more than 8,000 standard cable items to draw from. Knows what modifications are possible. What the tradeoffs are. The costs involved. He can give you a complete cable package tailored to your needs. You won't find a better source for know-how, understanding or results.

Write for a copy of the Belden Electronic Wire and Cable Catalog. Belden Electronic Division, P.O. Box 1100, Richmond, Indiana 47374. Phone (317) 966-6681.

8-5-2

INFORMATION RETRIEVAL NUMBER 234



We want your cable business  
and are out to prove...  
Belden covers wire with performance,  
service and ingenuity



# The foolproof way to sequencer design.

Lockups, race conditions and unwanted states are eliminated when you follow this step-by-step approach.

Logic designers often spend frustrating hours trying to make hard-wired sequential logic circuits work. Hit-and-miss design techniques lead to system lockups, race conditions and other undesirable performance.

A systematic approach to sequencer design, guarantees reliable performance. If you follow it, even a complex sequencer, with a number of branches and jumps, should present no problems. The approach is based on five broad steps before you get into the circuit design. Then, when you tackle the circuit, there are six rules to keep in mind.

Start with these steps:

1. Determine the required sequence. This depends naturally on the application.
2. Develop a flow chart for the sequence.
3. Rearrange the flow chart into a control-loop chart.
4. Prepare a Karnaugh map based on the control-loop chart.
5. Write equations for each Karnaugh state.

The flow chart in (Fig. 1a), drawn up the way a software programmer would do it, is an example of a simple sequencer. From the chart, we see that the program continues to loop until the Start/Stop switch is set to Start.

Then the program allows device No. 1 to turn on. If the Start/Stop switch is not immediately set to Stop, the program calls for turning on device No. 2. Thereafter, when the Start/Stop switch is set to Stop, the sequence returns to the beginning.

The logic designer, however, interprets the circuit's requirements as a control-loop sequence (Fig. 1b). This chart defines four discrete states that perform the sequence. The sequencer remains in State A until the Start/Stop switch is set to Start. Then the sequencer goes to State B and turns on device No. 1 and so on.

Once the control-loop chart has been drawn, the information is transferred to a Karnaugh map to show the inter-relationships of all the

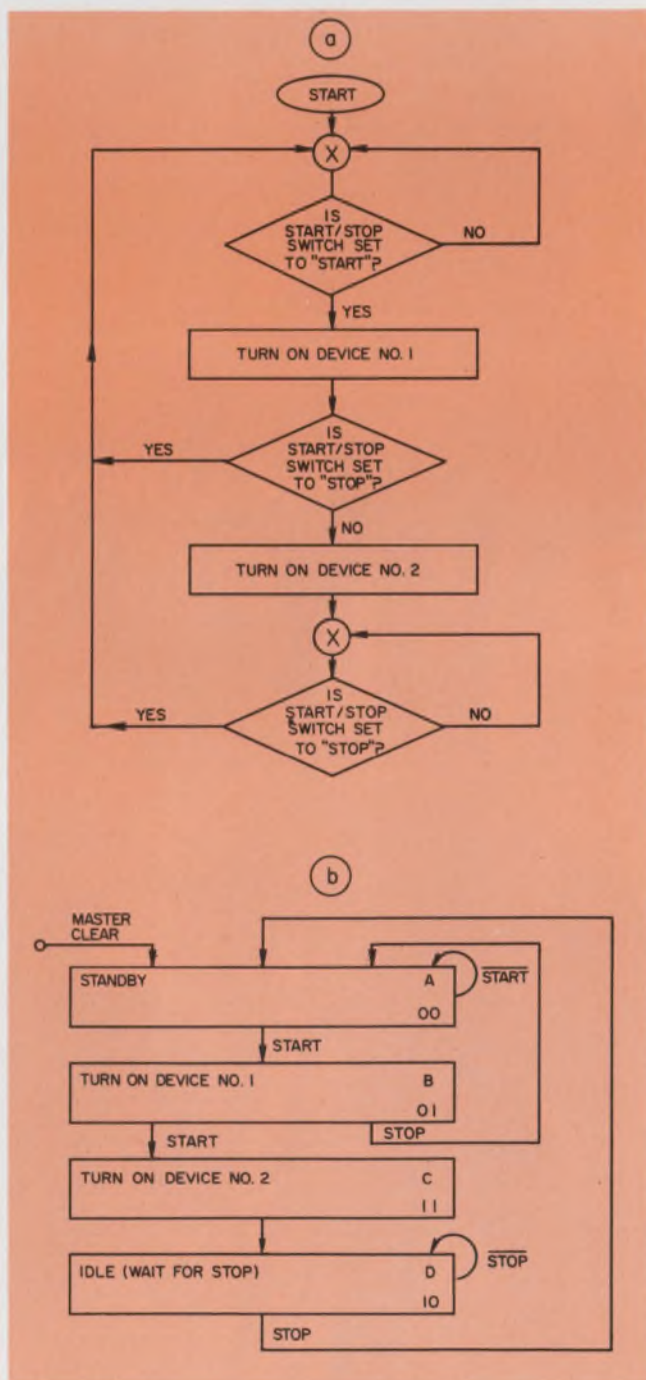

1. Sequential functional requirements, as the software programmer sees them, form a flow chart (a), and as the logic designer needs them, with the logic states defined, become a control-loop chart (b).

James H. Bentley, Principal Development Engineer, Honeywell, 600 Second St. N., Hopkins, Minn. 55343.

states. After the Karnaugh state equations are written, we are ready to draw the logic diagram.

### Follow the design rules

Here are the six rules for the circuit design:

1. Use only J-K type flip-flops to store the needed sequence-event codes. The number of codes equals  $2^n$ , with  $n$  the number of flip-flops needed.
2. Always make the standby condition an all-

ZERO event code. The Master-Clear signal must force the Sequence-Event control J-K flip-flops to standby.

3. Never permit more than one Sequence-Event flip-flop to toggle at a time when changing to the next event code.

4. Use a synchronous clock system, and strobe the Sequence-Event flip-flop changes of state with a clock pulse.

5. Store the occurrence of each external asynchronous event in any convenient type of flip-flop. Transfer the information to a D-buffer flip-flop in the time between the Sequence-Event strobe pulses. Clear both the external-store and the D-buffer flip-flops during a subsequent state time.

6. Force *completely* unused states to the standby condition. But some states, though they are not used to define a working state, may be needed to carry out Rule 3. Such unused states are called Idle states.

In the simple sequencer defined in Fig. 1 only four states are needed. Fig. 2a represents the conditions of two J-K Sequence-Event flip-flops, X and Y which are sufficient to establish four states (Design Rule 1).

State A is assigned to Standby, since the standby state must always be all-ZERO, in accordance with Rule 2. Furthermore, Rule 3 requires that states adjacent to each other in the control loop be separated by only one bit change. Thus they also are adjacent to each other on the Karnaugh map. The term "adjacent" means that as the sequence proceeds from one state to the next via an allowed path of the control loop, one—and only one—J-K flip-flop may toggle.

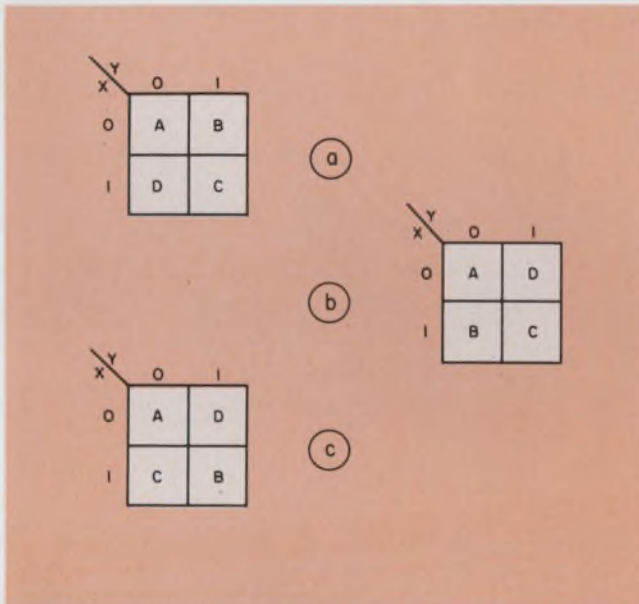

2. When the designer transfers the data to a Karnaugh map, he must strictly observe the principle of adjacency, as in maps a or b. There are four other configurations that are not permissible. One example is map c.

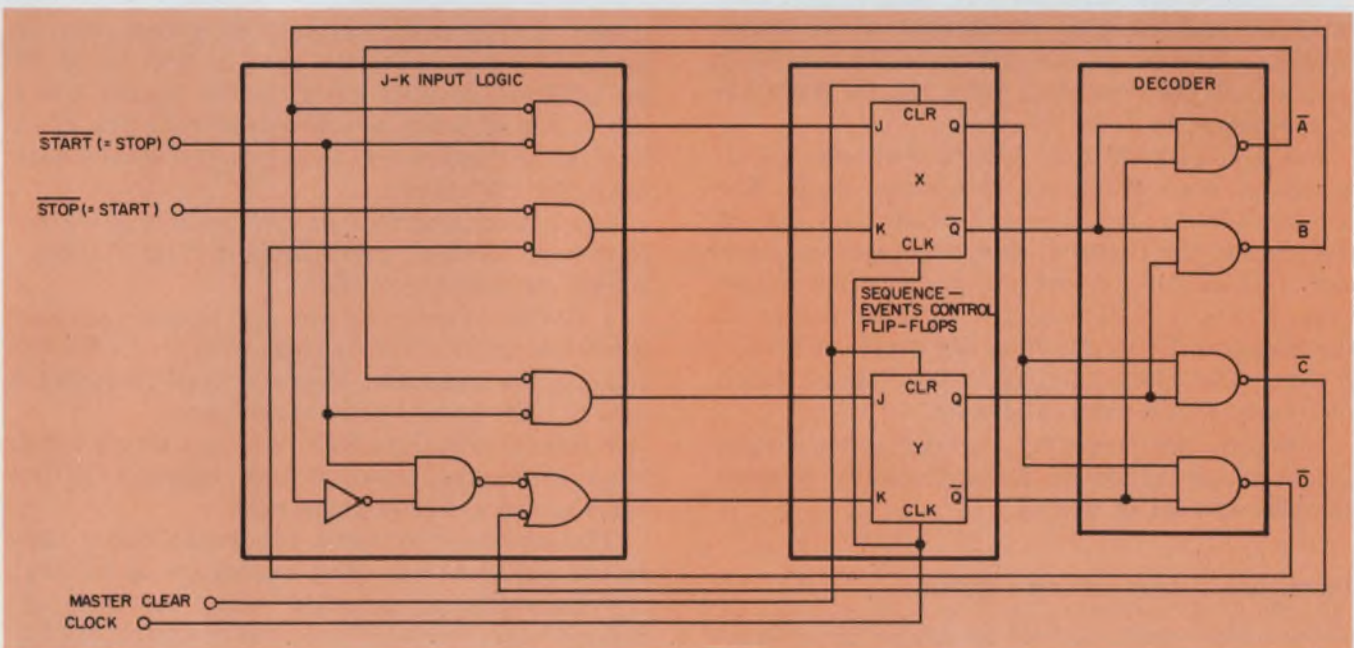

3. Three basic circuits—the J-K Input logic, the Sequencer-Event logic and the Decoder—implement the

requirements for the simple example of Fig. 1. A more complex system would need an External-Events circuit.

Fig. 2b is another acceptable Karnaugh map for the control-loop chart. All other arrangements (four more are possible) are unacceptable, since they do not comply with the adjacency rule. In the unacceptable cases two or more control flip-flops are required to simultaneously toggle to produce a change of state. Since flip-flops rarely toggle at identical speeds, even when clocked by the same clock pulse, many undesired effects can occur.

The control-loop chart and its corresponding Karnaugh map require that flip-flop Y toggles to a ONE state for the sequencer to proceed from state A to B. Therefore the steering input, J, of flip-flop Y—designated JY—must equal ONE. This happens when the sequencer is in state A and the Start/Stop switch goes to Start. The equation for this is

$$JY = A \cdot \text{Start.}$$

The subsequent state equations are

$$JX = B \cdot \text{Start.}$$

$$KY = C + B \cdot \text{Stop.}$$

$$KX = D \cdot \text{Stop.}$$

Note that in the third equation,  $KY = 1$  each time the sequencer is in state C. This results in an immediate jump to state D. However, when the sequencer is in state B, and the Start/Stop switch is set to Stop,  $KY = 1$  again. This resets the Y flip-flop, but now the system goes to state A.

The final step is to draw the logic diagram. An implementation with NAND/NOR logic is shown in Fig. 3. Note that the Master-Clear pulse sets the sequencer to the standby condition, state A.

Note also that Rule 4 requires Sequence-Event state changes to occur synchronously with a free-running clock—not at the time some external event occurs. The external occurrences must first establish and stabilize themselves or be stored between clock pulses, according to Rule 5. Only then should the next clock pulse change the state of the Sequence-Event flip-flops.

But to implement Rule 5, logic designers usually use a nonoverlapping two-phase clock. The Sequence-Event flip-flops are clocked on one of the phases, say Phase 2, after the external asynchronous events are set up at the other phase time, Phase 1. This assures that all inputs to the Sequence-Event flip-flops are stable at Phase-2 time. The clock rate, of course, must match the needs of the external events.

However, the preceding example is too simple to adequately illustrate Rules 5 and 6. A more complex system is needed.

### Examining a more complex system

Consider a mode-control sequencer for an analog-to-digital converter. The a/d converter samples inputs from an external device at a fixed fre-

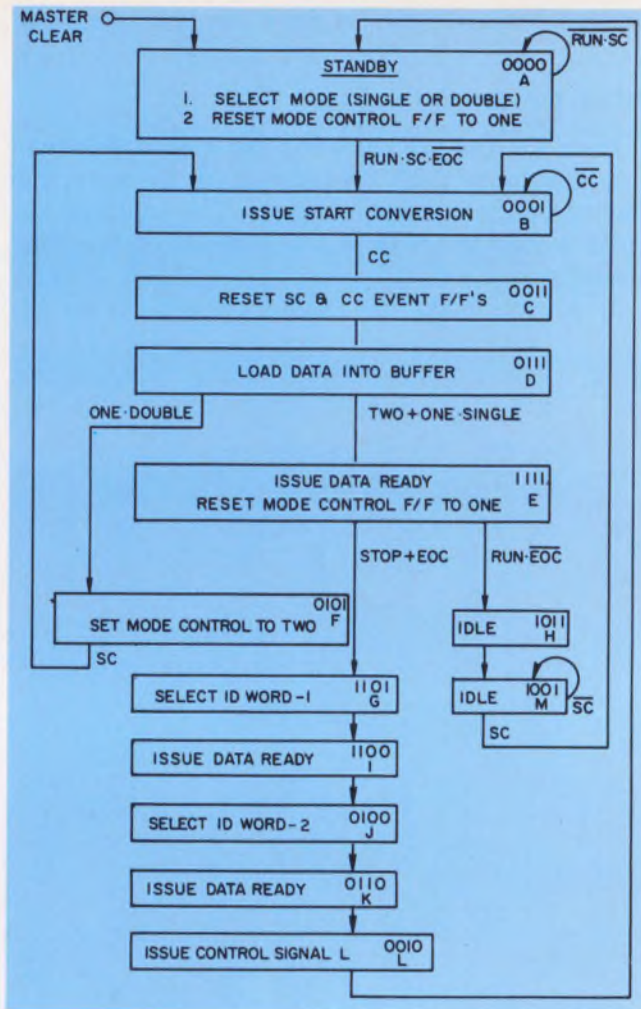

4. A control-loop chart for an a/d control system illustrates the use of idle states to attain a single-bit change at a time, when going from one state to another. Idle states, H and M, serve this function between B and E.

quency and provides outputs to a computer in bytes. The a/d-conversion rate is determined by an external device's clock, called Signal Clock (SC), which is not synchronized with the clock used by the sequencer. Fig. 4 is the control-loop chart for the system.

The system operates in two modes. Mode selection is handled, as follows, by the Double/Single control-panel switch:

- Double—Performs two a/d conversions and combines the two output bytes into one word for input to the computer. Thus the word throughput rate is half the a/d conversion rate.

- Single—Provides each byte as a single word. Thus throughput rate to the computer is the same as the a/d conversion rate.

The sequencer system's conditions under control of a manual Run/Stop switch are as follows:

- Run—Starts operating when the next SC pulse occurs, provided the End-of-Count (EOC) condition is inactive (low condition). If the EOC condition occurs before the Run/Stop switch is

set to Stop, the sequencer cycles through the shutdown routine described under Stop. EOC comes from the computer to indicate that the computer is not ready for a new set of data.

- Stop—Completes transmitting to the computer the final a/d word together with two ID words and returns to standby.

- Busy—Generates a Conversion-Complete (CC) signal when the a/d converter's Busy goes from high to low. The Busy remains high for 5  $\mu$ s after the Start-Conversion signal to the converter resets. Upon completing the CC function the sequencer resets CC prior to the next SC pulse.

- ID Word—Replaces a/d data words with ID-1 and ID-2 words after an EOC or Stop condition.

- Data Ready—Issues a Data-Ready signal to the computer when data are available on the computer input bus.

With the functions defined, charted (Fig. 4) and mapped (Fig. 5), you can now follow the six design rules. Note that this more complex example requires 13 states. But three control flip-flops are not enough, and four control flip-flops provide 16 states—more than needed. You must now apply Rule 6 to handle the unused states.

### Treating unused and idle states

If possible, unused states should be avoided. Sometimes a judicious rearrangement of the states on the Karnaugh map can reduce the number of control flip-flops needed. An optimal arrangement may require several trials. On the other hand, the need for future growth and

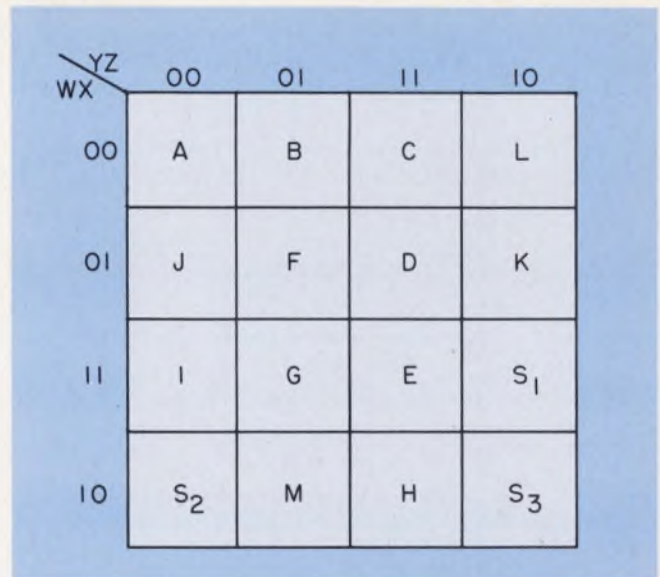

5. The Karnaugh map for the a/d controller must include the unused states, S<sub>1</sub>, S<sub>2</sub>, and S<sub>3</sub>. These states must also appear in the J-K input equations. Should the system fall into one of these unused states, the circuit must automatically transfer to Standby (state A) on the next clock pulse.

change may make providing for unused states the wiser choice.

Note that states S<sub>1</sub>, S<sub>2</sub>, and S<sub>3</sub> (Fig. 5) are completely unused. States H and M, however, are labeled Idle; they are used only to go from State E to B, in single steps as required by Rule 3. The J-K Sequence-Event flip-flop input equations must include all the states, and this means the unused states too. The complete set of input equations are:

$$JW = D \cdot (\text{TWO} + \text{ONE} \cdot \text{SINGLE})$$

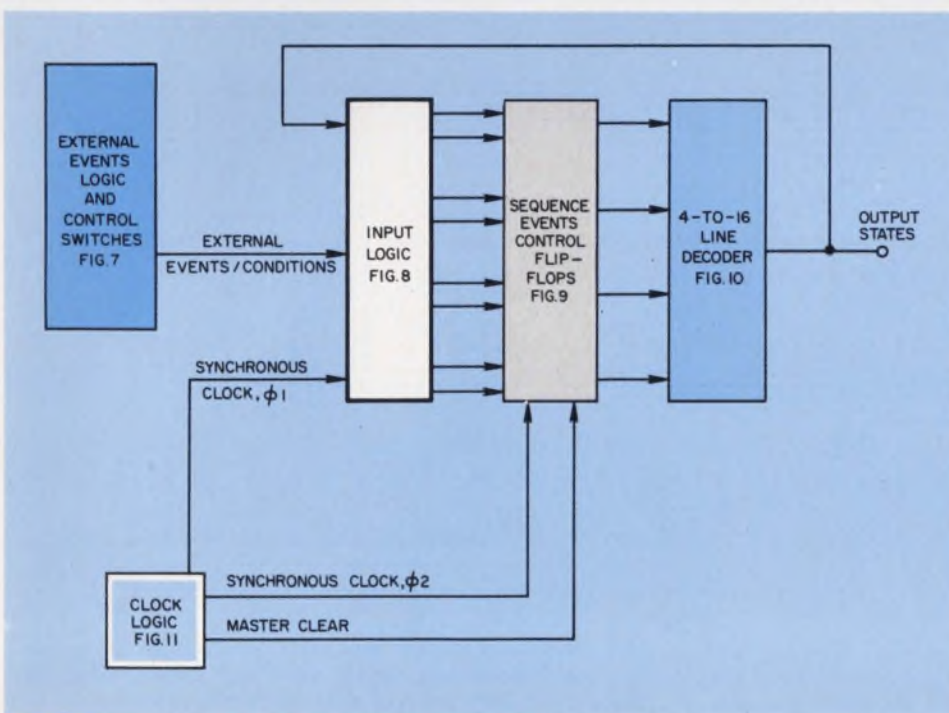

6. The a/d controller block diagram has two circuits not needed in the simple example of Fig. 3—the external-events logic and a two-phase clock.

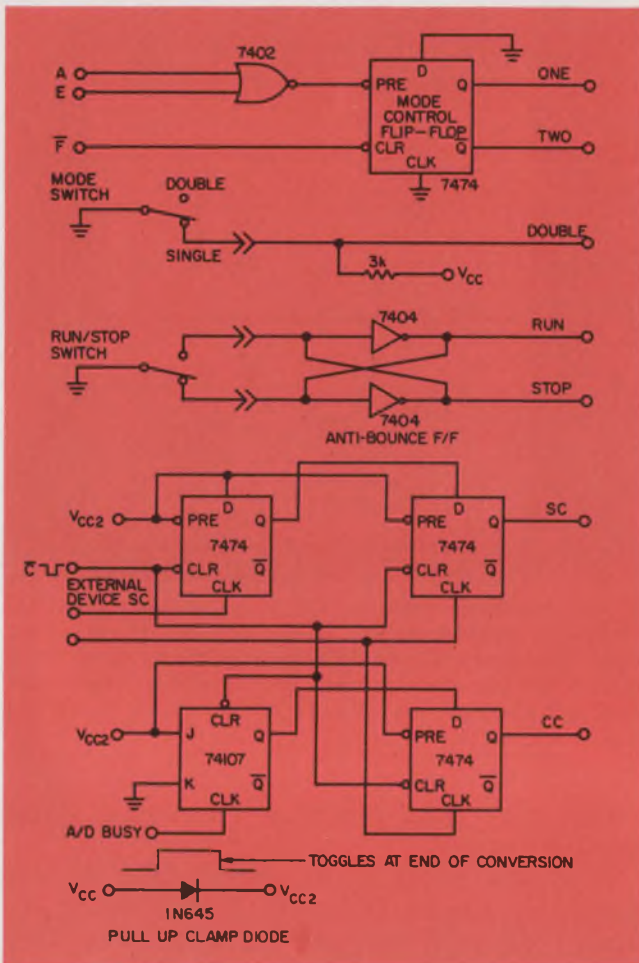

7. External events such as the external device signal clock (SC) and the a/d Busy signal, must be temporarily stored and then strobed synchronously into the sequencer by clock  $\phi_1$ . The four external-events store flip-flops are cleared when state C occurs. The external EOC signal goes directly to the input logic circuits from the computer, since it always occurs and stabilizes before it is needed by the sequencer.

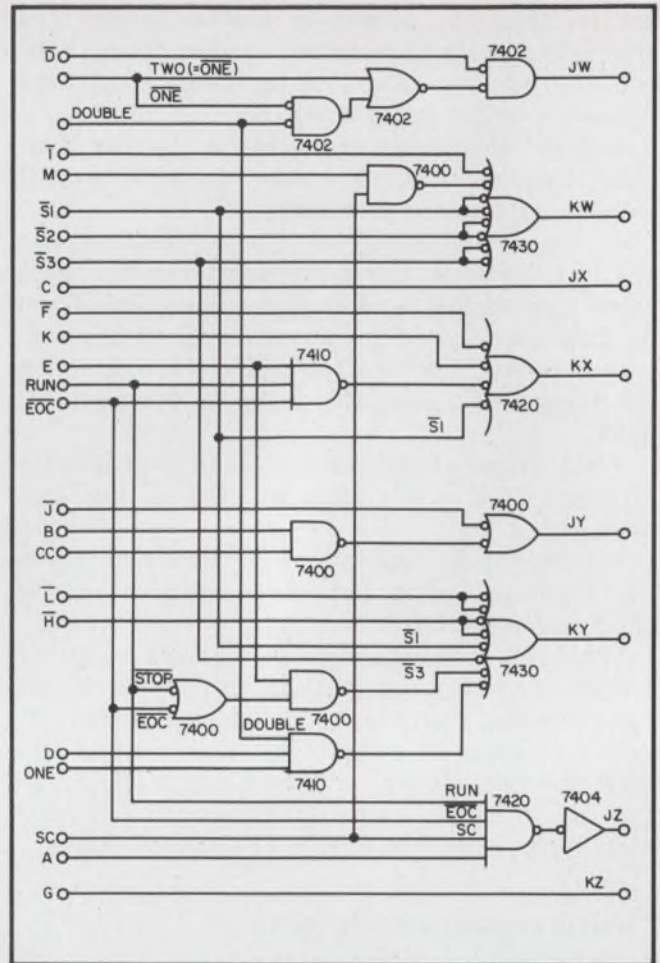

8. The Input-Logic circuit implements the equations for the J-K steering inputs of the Sequence-Events flip-flops. Note that most of the input variables to the gates come from the decoder's output, which represents the sequencer's present state. The present state, together with the signals from external events and from the control switches, determines the system's next state. Changes in the system would be made mainly in this circuit.

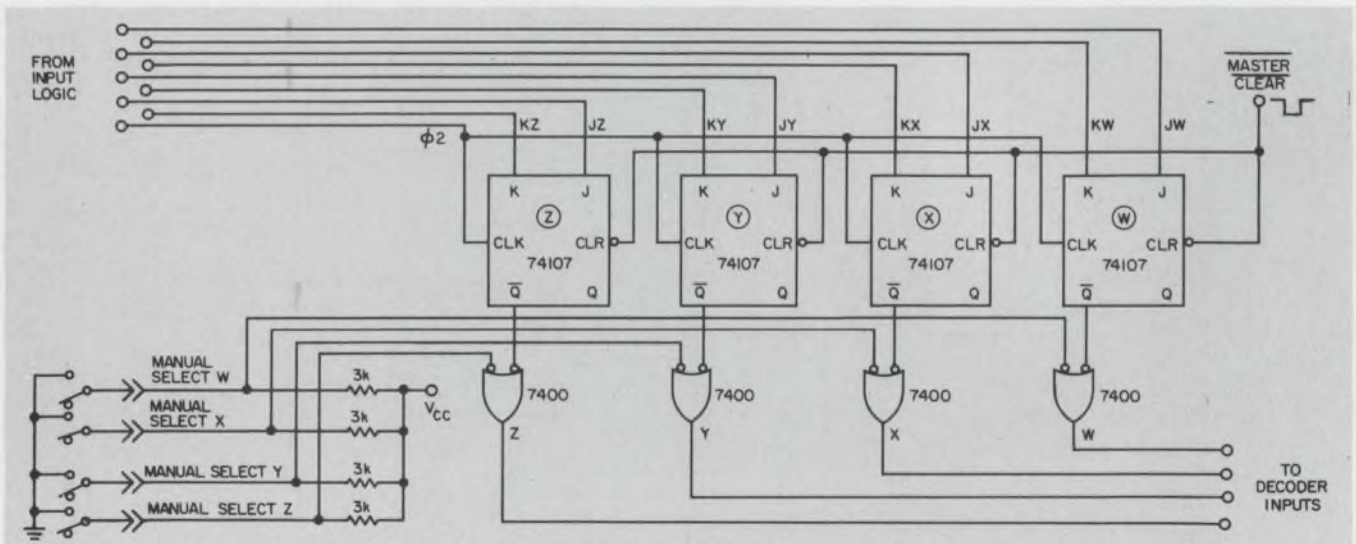

9. The Sequence-Events flip-flops derive their inputs directly from the Input-Logic circuit's outputs. Note the extra features for checkout of these flip-flops. To use

the manual checkout switches, inhibit the clock and apply a Master-Clear signal. Then any output state may be selected with the four Manual-Select switches.

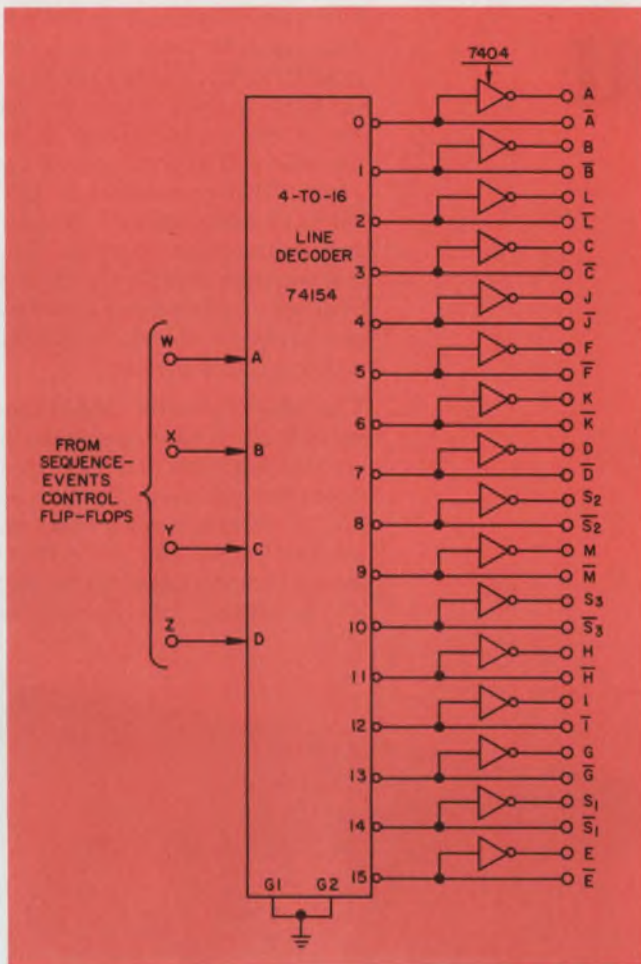

10. The simplest part of the sequencer is the decoder. Inputs A, B, C and D are tied to control flip-flop outputs W, X, Y and Z. Though all available states and their complements may not be used in an initial design, inevitable design changes make it prudent to include the full capability at the outset. Thus changes can be confined to the Input-Logic circuit. The decoded outputs are assigned from the Karnaugh map of the system.

$$\begin{aligned}
 KW &= I + M \cdot SC + S_1 + S_2 + S_3 \\
 JX &= C \\
 KX &= F \cdot SC + K + E \cdot RUN \cdot \overline{EOC} + S_1 \\
 JY &= B \cdot CC + J \\
 KY &= E \cdot (STOP + EOC) + L \\
 &\quad + D \cdot ONE \cdot DOUBLE + H \\
 &\quad + S_1 + S_3 \\
 JZ &= A \cdot RUN \cdot SC \cdot \overline{EOC} \\
 KZ &= G
 \end{aligned}$$

### Implementing the a/d control

The logic designer must not leave out any terms. To check on the number of terms, count the lines leaving each state in the control-loop chart. The total must equal the number of terms in the input equations. In this example, the count is 15. This count does not include the three unused states  $S_1$ ,  $S_2$  and  $S_3$ , since they do not appear

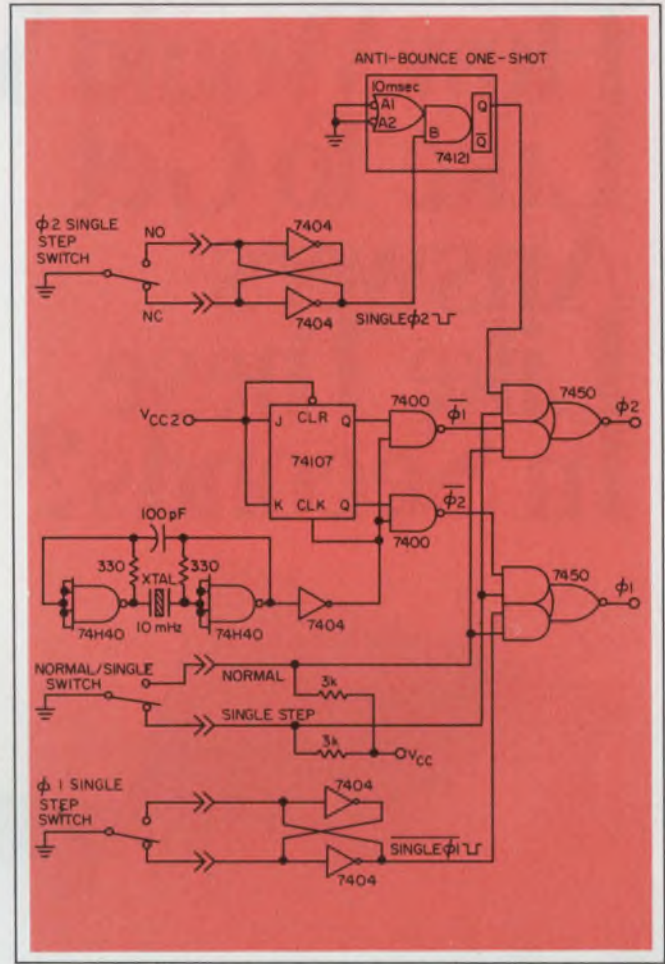

11. A two-phase clock is required for operation of the sequencer. The frequency of the master oscillator must be high enough to service the asynchronous external inputs. In this example, the clock frequency is determined by the  $5 \mu s$  conversion speed of the a/d converter. A 10 MHz frequency provides an ample margin. And for checkout purposes, three control-panel switches provide a single-step capability.

on the control-loop chart.

In accordance with Rule 6, these three unused states are forced back to state A—Standby—on the next clock pulse.

The block diagram of the a/d controller is shown in (Fig. 6). Self-explanatory circuit details are covered in Figs. 7 through 11. And beyond bare-bones requirements, the sequencer includes some refinements, such as self-checking and some peripheral device checking. Note the use of a two-phase non-overlapping clock. All the logic used in this example belongs to the TTL-7400 series.

Besides providing a fool-proof approach to sequencer design, you will find that this method is very adaptable. To make design changes, usually only the Input-Logic circuit need be altered; the remaining circuits, such as the Sequence-Event flip-flops and decoder, remain untouched. A few minutes work with a soldering iron or wrapping gun completes the changes. ■■

# How Would You Like To Get Answers Like These In Seconds?

It took only 27 seconds for HP's 3042A Automated Network Analyzer System to perform this complete low-pass elliptic filter analysis. Note the detailed plot of amplitude response as well as the tabulated printout of all the important filter characteristics. HP's 50 Hz to 13 MHz network analyzer systems are truly state-of-the-art. They can free you from countless hours of point-by-point measuring and plotting—and they're equally valuable on the production line and in the lab.

**The Most-Powerful 3042A System** not only can perform your entire testing process, but it lets you make measurements that you never could do before. It's a fully-automatic two-channel analyzer that will completely characterize any two-port linear device. Because it's automated, you get outstanding

ELLIPTIC FILTER  
TEST

FILTER NO. = 25003

INSERTION LOSS  
PASS  
0.15 DB

PASSBAND RIPPLE  
PASS  
≤ 0.3 DB

STOPBAND REJ.  
PASS  
> 50DB

1600 HZ REJ.  
-65.87 DB

2400 HZ REJ.  
-91.97 DB

3DB FREQUENCY  
1066.9 HZ

PASSBAND DELAY  
PASS  
≤ 0.4 MSEC

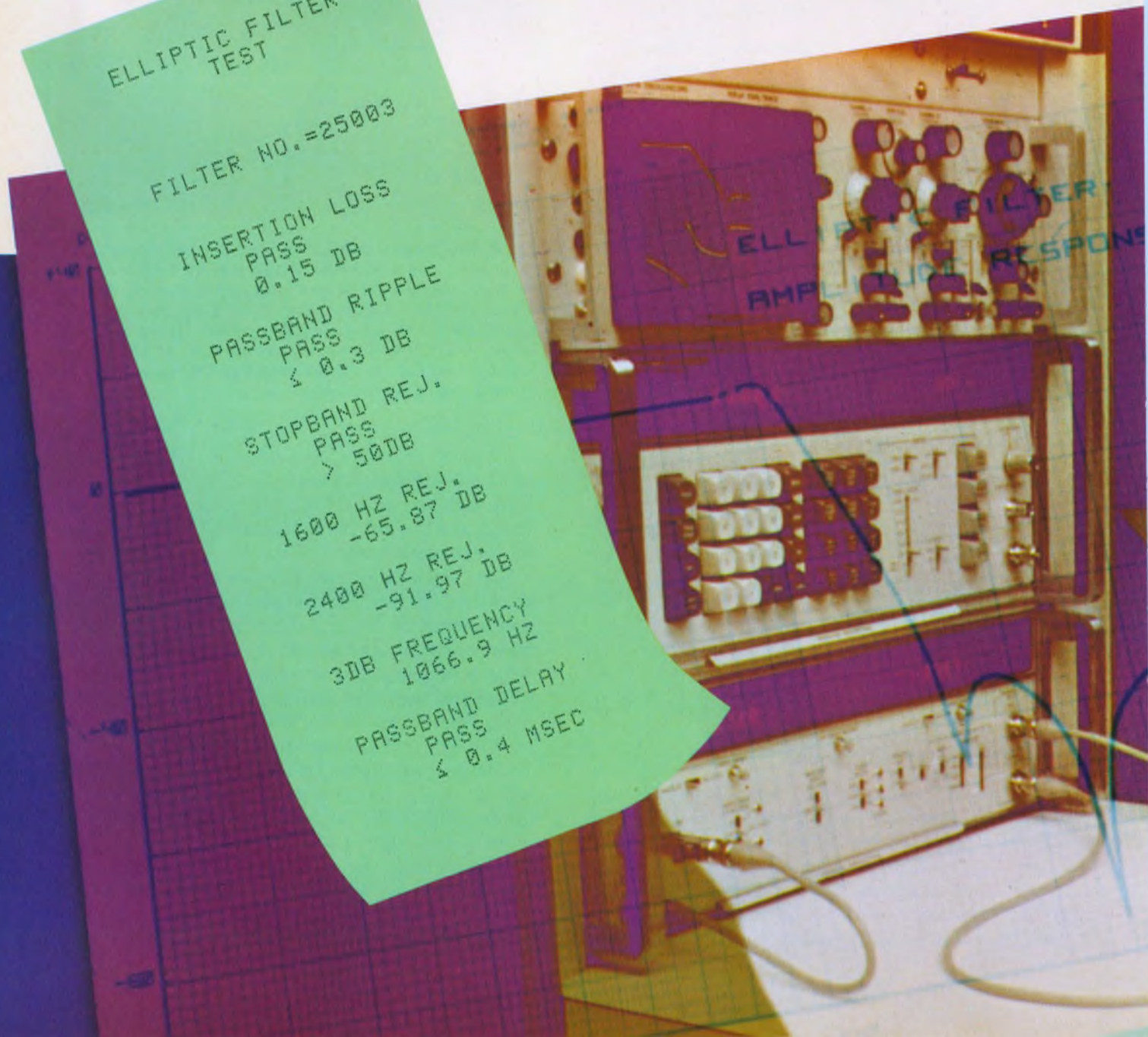



data repeatability along with the dramatic speedup in testing rate. Use it to fully test such time-takers as active filters, crystals or op amps. You can do them in seconds or minutes instead of the usual hours or days.

The system is comprised of three standard HP products—a synthesizer source, a tracking detector, and a calculator. This powerful combination applies equally to one-of-a-kind lab tests, or to repetitive production line testing. And, in addition to being able to make such tests as group delay, limit testing and offset measurements automatically, you also gain the capabilities of data reduction and decision making. You can have this fast, capable 3042A System for \$22,300—ready to operate.

**Semi-Automatic 3041A System** brings you the advantages of partial automation for significantly less money than full automation would cost. It incorporates the same synthesizer source and tracking detector used in the fully-automated system, but is controlled by a more economical marked card programmer (instead of the calculator). You can even make group delay, limit test and offset measurements with the 3041A. At \$14,000, it's modestly priced but does the work of systems costing much more.

**Basic 3040A System** teams the tracking detector with one of four automatic synthesizer sources. It's a budget-priced combination that provides you with many of the capabilities of a dedicated automated system, but at much lower cost. When you select the top-of-the-line automatic synthesizer you get a lab-in-a-box with a "brain." It combines the performance of a synthesizer, a sweeper, a marker generator, a counter, a programmable attenuator, a precision level generator, and a controller in one instrument. Depending on

the synthesizer you choose, these high-capability systems cost from \$6,900 to \$11,000.

All three of the Network Analyzer systems help you do more work in less time and with less labor. With them you can telescope what formerly took hours, or even days, into only minutes or seconds. Optional accessories let you select and pay for only the exact capability you need. For full details on these network analyzer systems call your local HP field engineer. Or, write Hewlett-Packard, Palo Alto, California 94304. In Europe: HPSA, P.O. Box 85, CH-1217 Meyrin 2, Geneva, Switzerland. In Japan: Yokogawa-Hewlett-Packard, 1-59-1, Yoyogi, Shibuya-Ku, Tokyo, 151.

093/40

**HEWLETT  PACKARD**

**NETWORK ANALYZERS**

INFORMATION RETRIEVAL NUMBER 40



# Get accurate Fast Fourier Transforms

with a digital computer. What's needed is a clear understanding of the practical limitations and tradeoffs.

Large savings in design time can be realized with Fourier transformations that permit the analysis of functions in either the time or frequency domain. Their versatility spans the design spectrum, because the frequency domain is convenient for linear analysis while the time domain is ideal for nonlinear systems. The value of Fourier transforms as a designer's tool has been further increased with the development of the Fast Fourier Transform (FFT),<sup>1-6</sup> with techniques for speeding the FFT,<sup>7</sup> and with the growing availability of computers. But digital computers, of course, can work only with *discrete* transforms, and this creates a problem.

The designer must know the precise conditions under which a computer transform is useful and reliable. Once these conditions are understood, not only will the results be reliable but the designer will also be able to specify with confidence the memory size and amount of data needed to take the transform of a given type of waveform.

## Transforms come in pairs

What is a transform? The word is often misused by engineers. When an engineer talks about a "transform," he usually means one member of a *transform pair*. But the pair consists of two functions. And when a set of data is applied to one function, a second set of data results. This second set, when applied to the second function, must reconstruct the original data precisely. For example,

$$F(i) = (1/2) [f(i) + 7]$$

and

$$f(j) = 2F(j) - 7$$

is a transform pair, although not a very useful one.

The transform pair for the Fourier series of a function  $f(t)$  of period  $T$  is

$$F(n) = (1/T) \int_{-T/2}^{T/2} f(t) e^{-jn\omega_0 t} dt$$

---

Peter K. Bice, Engineer, Hewlett-Packard, Palo Alto, Calif. 94304.

$$f(t) = \sum_{n=-\infty}^{\infty} F(n) e^{jn\omega_0 t} \quad (1)$$

That this is a transform pair can be readily verified by plugging one into the other and noting that an identity results.

Another transform pair, called the Fourier integral, is defined as follows:

$$F(\omega) = (1/2\pi) \int_{-\infty}^{\infty} f(t) e^{-j\omega t} dt \quad (2)$$

$$f(t) = \int_{-\infty}^{\infty} F(\omega) e^{j\omega t} d\omega.$$

This transform pair is also a valid expression for most cases of  $f(t)$ .

Transform pairs 1 and 2 are both well known. Furthermore we are interested in a different kind of transform pair—the one that can be handled by a computer. This is because a digital computer cannot integrate continuous functions, nor can it operate between infinite limits.

## A pair that the computer can handle

A transform pair defined as a Discrete Finite Transform (DFT) is given by

$$F(n) = (1/N) \sum_{i=0}^{N-1} f(i) e^{-j i n 2\pi/N} \quad (3)$$

$$f(i) = \sum_{n=0}^{N-1} F(n) e^{j i n 2\pi/N}.$$

First, note that the expressions do indeed form a transform pair: If one is plugged into the other, an identity results. Second, note that it is very similar in form to the expressions for the Fourier series and integral. Thus, by making certain assumptions about summing instead of integrating and by juggling the limits, we can substitute the discrete transform pair (Eqs. 3) for either Eqs. 1 or Eqs. 2.

When we turn to periodic time functions, we often want to solve equations like this with a computer:

$$F(n) = (1/T) \int_{-T/2}^{T/2} f(t) e^{jn\omega_0 t} dt. \quad (4)$$

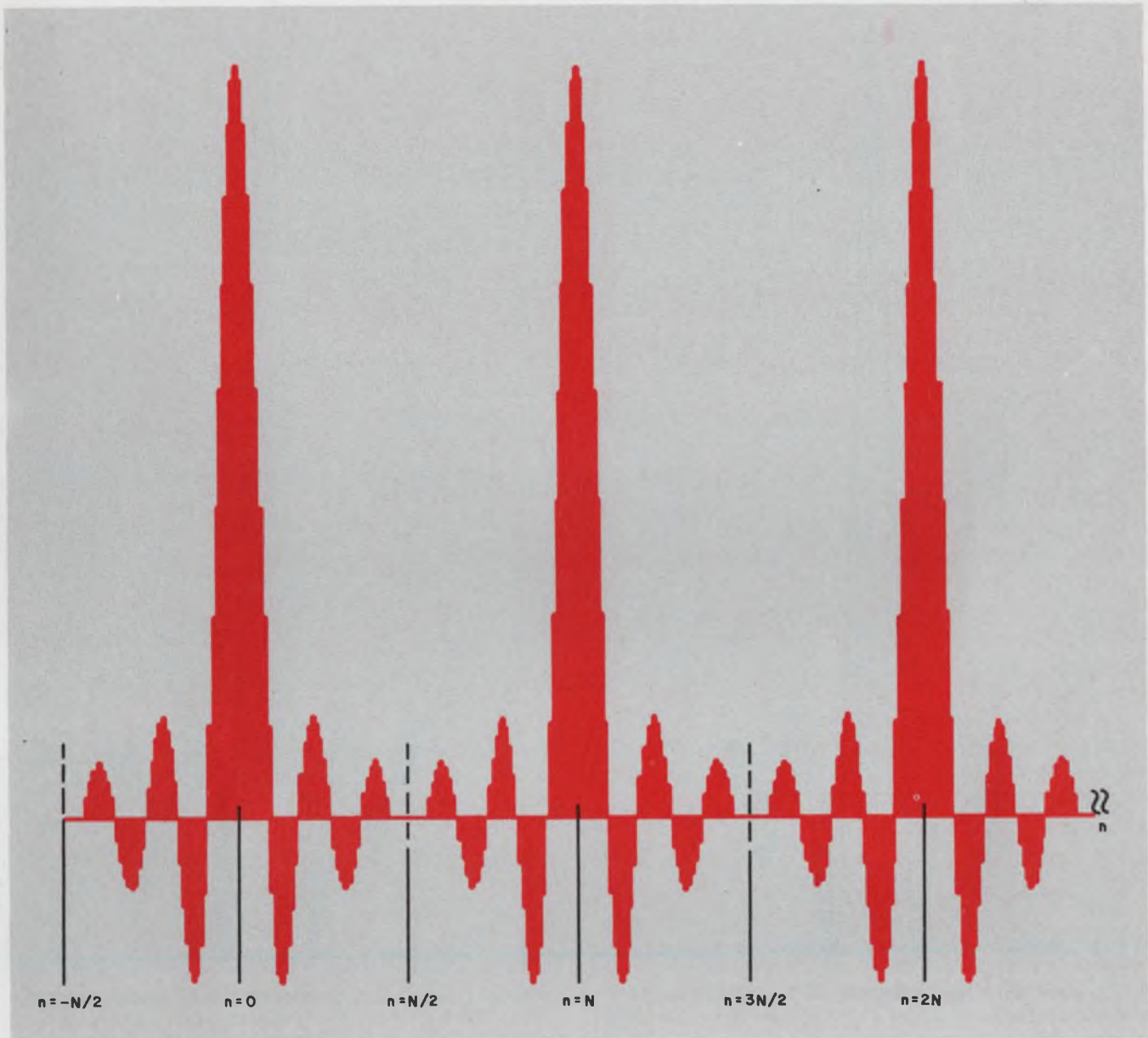

1. Waveform spectrum repeats with a "period"  $N$  the number of samples taken. Harmonics higher than  $N/2$  are misleading and must be eliminated by making the

sampling frequency higher than twice the highest harmonic frequency in the waveform. Unless this is done, the individual spectra may overlap.

The usual form of the algorithm for solving this is

$$F(n) = (1/N) \sum_{i=0}^{N-1} f(i) e^{j i n 2\pi/N} \quad (5)$$

Equations 4 and 5 are very similar. In fact, if we make a few simple substitutions, they can be made to be as nearly equal as desired.

First, let's replace the continuous integral with a sum and the continuous  $f(t)$  with a sampled version,  $f(i\Delta t)$ . This means that

$$\begin{aligned} \int_{(1 \text{ period})} &\rightarrow \sum_{(1 \text{ period})} \\ dt &\rightarrow \Delta t \\ t &\rightarrow i\Delta t, \end{aligned}$$

where  $\Delta t$  is the interval between samples of the

time function  $f(t)$  and  $i$  is the number of the sample. Assuming that the entire period consists of  $N$  samples of the time function, we obtain

$$T \rightarrow N\Delta t.$$

If we now abbreviate, for the sake of simplicity,  $f(i\Delta t)$  as  $f(i)$ —the  $i$ -th sample of the time function—and carry out all the substitutions, we get

$$F(n) = (1/N) \sum_{i=0}^{N-1} f(i) e^{j i n 2\pi/N}, \quad (6)$$

which is exactly the Discrete Finite Transform.

Note that we don't have to make such substitutions into the inverse transform of the Fourier series. Using the other half of the DFT pair is

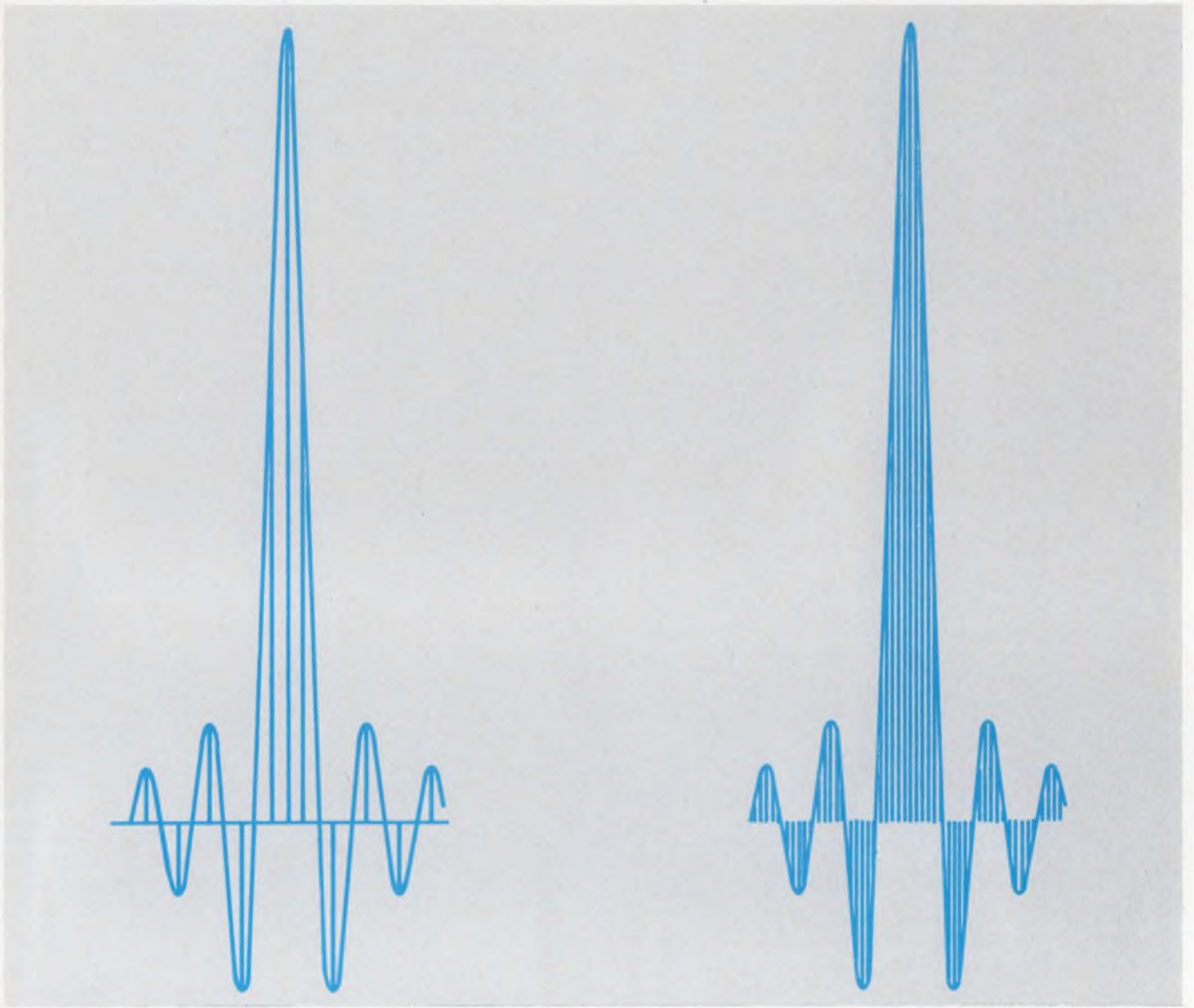

2. Envelope definition improves as the number of samples increases, as indicated in the spectra of two periodic

square pulses. The waveforms have periods of twice (left) and six times (right) the constant pulse width.

sufficient to recover the original data.

In the development of the Fourier series,  $F(n)$ , for a periodic waveform, the only compromise that was made so the series could be handled by a digital computer was to substitute a sample-and-add technique for the integration. How serious is this compromise?

#### Accuracy depends on the sampling rate

It is obvious on the surface that it makes no difference at all if the samples are spaced very close, but it can be catastrophic if they are spaced too widely. To get a feel for an appropriate sampling interval, let's substitute  $n + N$  instead of  $n$  into Eq. 6, the definition of the DFT:

$$F(n + N) = (1/N) \sum_{i=0}^{N-1} f(i) e^{-j1(n\omega\pi/N)} e^{-j12\pi}$$

which reduces to the following equation:

$$F(n + N) = (1/N) \sum_{i=0}^{N-1} f(i) e^{-j1n2\pi/N}, \quad (7)$$

because  $e^{-j12\pi}$  is always unity.

Note that the right-hand sides of Eq. 6 and Eq. 7 are identical. We therefore conclude that

$$F(n + N) = F(n). \quad (8)$$

In other words,  $F(n)$  is "periodic" (in the frequency sense) with a "period" of  $N$ . Beyond the first  $N$  values of  $F(n)$ , there is no information to be gained. In fact, that information is misleading;  $F(N)$  is always the same as  $F(0)$  in a DFT.

To understand this a little better, suppose that the waveform to be analyzed has no harmonics numbered higher than  $N/2$ . Then the DFT will result in a periodic spectrum (Fig. 1), where repetitions of the spectrum do not overlap the original. In a case such as this—where the har-

monics above  $N/2$  are zero—the amplitudes of these harmonics can be accepted as accurate.

Consider the case, however, where higher harmonics are present. Picture the righthand edge of the “primary” spectrum in Fig. 1 moving to the right beyond the  $n = N/2$  line. While this is happening, the lefthand edge of the “secondary” spectrum will be creeping leftward, eventually overlapping and adding to lines below the  $n = N/2$  line. For this reason, higher harmonics—of even lower than  $N/2$ —are not known precisely. This problem of harmonic overlap is called “aliasing.”

To cure aliasing, make sure that there are no harmonics in the input waveform that are higher than  $N/2$ , where  $N$  is the number of samples taken in the period. This requirement can be met by low-passing the input waveform or by increasing the sampling rate, thus increasing  $N$ .

Another way to define the cure for aliasing is to guarantee that the sampling frequency is at least twice the highest frequency in the input waveform (a part of Shannon’s Sampling Theorem). This is, of course, the same as saying that there’ll be no harmonics beyond  $N/2$ . Indeed, the fundamental frequency of the input waveform is  $1/(N\Delta t)$ , so that the highest allowable frequency is  $1/(2\Delta t)$ . But  $1/\Delta t$  is simply the sampling frequency, since  $\Delta t$  is the sampling interval.

### Calculating the Fourier integral on a computer

Now suppose that you want to calculate the Fourier integral of a function, rather than the Fourier series just described. Their equations are:

$$\text{Fourier series: } F(n\omega_0) = (1/T) \int_{\text{(1 period)}} f(t) e^{-jn\omega_0 t} dt. \quad (9)$$

$$\text{Fourier integral: } F(\omega) = (1/2\pi) \int_{-\infty}^{\infty} f(t) e^{-j\omega t} dt. \quad (10)$$

Since we know how to approximate the Fourier series on a computer, we can use similar techniques to approximate the Fourier integral.

As we let  $\omega_0$  get very small, the discrete values of  $n\omega_0$  approach a continuous variable,  $\omega$ . Allowing  $\omega_0$  to get small means letting the duration of the sampled waveform get very long. As this occurs, the limits on the integration approach infinity. Consequently—except for the scale factor—we can make these two equations approach each other simply by making the sampling period long.

This correlation between the Fourier series and the Fourier integral can be stated in another, more useful way. Suppose you want to find the Fourier integral of a square pulse. If you make

a periodic waveform of square pulses and measure and plot the amplitudes of the harmonics against their frequencies, these harmonics will exist at discrete frequencies, and their amplitudes will lie on a  $(\sin x)/x$  envelope (Fig. 2).

If another periodic waveform is now created for pulses of the same shape, but the repetition rate is made half that of the previous rate—so there’ll be more “dead time” between pulses—and if the amplitude is doubled, the envelope of the resulting spectrum will be exactly that of the previous envelope. But since the fundamental frequency is half what it was, the spectrum lines will be more closely spaced and the envelope defined better.

This envelope, which gets filled better and better as we increase the length of the period, is (except for the scale factor) the Fourier integral of the waveform being analyzed. You need only decide what is the desired resolution and then make the measurements accordingly.

To find the proper scale factor, note that

$$F(0) = (1/2\pi) \int_{-\infty}^{\infty} f(t) dt. \quad (11)$$

This quantity can be easily calculated and then used to scale the resulting spectrum.

### Is your computer large enough?

So far the assumption has been that we have a perfect method for finding the Fourier series. If you must rely on the DFT to approximate the series, however, you must remember its inherent limitations. You must combine a long sampling period (to get good resolution of the envelope that defines the Fourier integral) with a high sampling rate (to prevent aliasing). And since the sampling rate multiplied by the duration equals the number of samples taken, you can calculate the size of the transform that can be handled. In other words, the size of the transform that can be handled depends on the computer size and the available computer time. ■■

### References:

1. Cooley, J. W. and Tukey, J. W., “An Algorithm for the Machine Calculation of Complex Fourier Series,” *Mathematics of Computers*, Vol. XIX, April, 1965, pp. 297-301.
2. Haavind, Robert, “The FFT Computer: Designer’s Missing Link,” *Electronic Design*, Dec. 6, 1967, pp. 25-29.
3. Klahn, Richard and Shively, Richard R., “FFT-Short Cut to Fourier Analysis,” *Electronics*, April 15, 1968, pp. 124-129.
4. Bergland, G. D., “A Guided Tour of the Fast Fourier Transform,” *IEEE Spectrum*, July, 1969, pp. 41-52.
5. Singleton, Richard C., “On Computing the Fast Fourier Transform,” *Committee of the ACM*; Vol. 10, No. 10, Oct., 1967.
6. Brigham, E. O. and Morrow, R. E., “The Fast Fourier Transform,” *IEEE Spectrum*, December, 1967, pp. 63-70.
7. Bice, P. K., “Speed Up the Fast Fourier Transform,” *Electronic Design*, April 26, 1970, pp. 66-69.

# Times...the most coaxial cable



When it comes to coaxial cable nobody offers the selection we do. Flexibles, semiflexibles, high temperature, low temperature, miniatures as well as standard sizes... we've got them all. Hundreds of items from RG5 to RG404 including our own improved versions of RG cables.

Most of these cables are in stock now at our plant or our distributors throughout the country.

You'll find the whole selection in our latest "RF Transmission Line Catalog & Handbook"... the book that's become the bible of the industry. This 40-page reference is packed with all the necessary information you need to design or select cable for your application.

If you have a requirement that goes beyond what's currently available Times can still take care of you. We have the best special cable group in the business. If anybody can come up with a "prescription" for your problem, we can. We'll even make the entire assemblies for you... and probably save you money doing it.

Call us the kings of coax... or anything else you want. Just be sure to call us first when you're looking for coaxial cable, multiconductor cables or cable assemblies. We have what you want.

# complete line of in the business.



It's all in here...

Please send me a copy of your "RF Transmission Line Catalog & Handbook" with its special guide to selecting coaxial cable.

INFORMATION RETRIEVAL NUMBER 41



NAME \_\_\_\_\_ TITLE \_\_\_\_\_

COMPANY \_\_\_\_\_

ADDRESS \_\_\_\_\_

CITY \_\_\_\_\_

STATE \_\_\_\_\_ ZIP \_\_\_\_\_

PHONE \_\_\_\_\_



SUBSIDIARY OF  
Insilco

**TIMES**  
Wire & Cable Co.

358 Hall Avenue  
Wallingford, Connecticut 06492  
(203) 269-3381 TWX 710-476-0763

# Improve fast-logic designs.

Terminated lines reduce reflections to overcome line-length and fanout limitations. Crosstalk and noise are restricted, too.

Designers faced with the fairly restrictive rules on line lengths and fanouts for today's high-speed, emitter-coupled logic (ECL) families might conclude that they really can't use the speeds available—gate propagation delays of 2 ns and less. But it's possible to design a high-speed ECL digital system without restrictions on interconnection line lengths or fanout. And the same techniques can be used to restrict crosstalk and system noise to limits well below the tolerance levels of the circuits. The trick is to use transmission lines with parallel terminations that minimize reflections.

Actually every signal path connecting any two integrated circuits is already a transmission line, with such properties as characteristic impedance and propagation delay. The length of the line and propagation delay relate to the amount of ringing, or noise, that occurs on a line for a given signal rise time. Characteristic impedance is important because it appears as a load to the driving circuit and can be used to determine optimum line termination.

When the propagation delay time exceeds the signal rise time, the line appears as a resistive load to the driving circuit. The value of this load equals the characteristic impedance and is independent of the capacitive loading at the end of the line. For shorter lines, the driving circuit sees a combination of the characteristic impedance and the line load. The effect of the line impedance on the driving circuits lasts only for the duration of the initial signal and any following reflections. After the signal has stabilized to a dc level, the circuit does not see the line impedance and drives only the dc load added to the line.

## Cause of reflections

Reflections on a conductor result when the signal on the line sees a change in line impedance. The test circuit and waveforms in Fig. 1 show the effects of such reflections. In the circuit, a

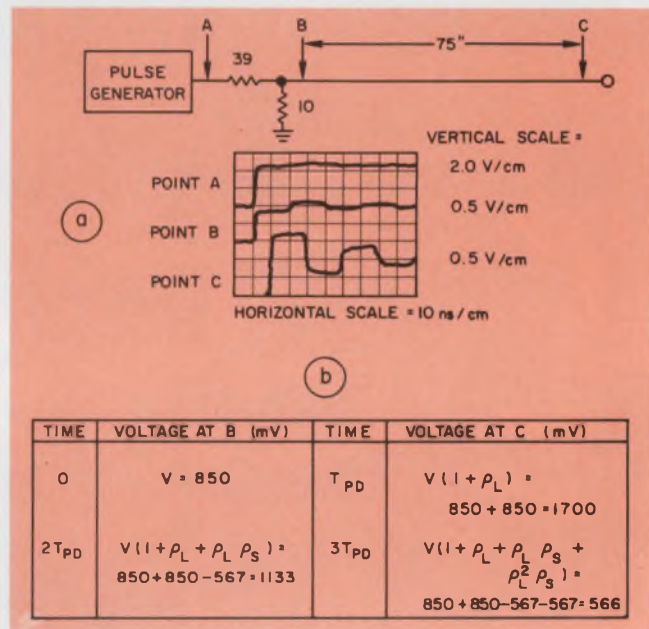

1. Changes in line impedance cause reflections that result in ringing, as seen in a simple test setup simulating an ECL gate driving a 75-inch line (a). The amplitudes of the reflections are calculated in b.

high-speed pulse generator drives a 75-inch line. The 39-ohm and 10-ohm resistors together approximate the 50-ohm load required by the pulse generator. The 10-ohm resistor simulates the low output impedance of a high-speed ECL driving circuit. A 75-inch line gives a 10-ns propagation time, so that reflections can be easily observed. Nothing happens at the receiving end of the line, point C, until one propagation time (one oscilloscope division) after the signal is sent from point B.

As the signal travels down the line, a current flows in the line equal to the signal amplitude divided by the line's characteristic impedance. When this current reaches the far end of the line, it sees an open circuit, with the result that all the current reflects back toward the sending end. This reflection causes the voltage at the receiving end of the line to double. Hence the signal at point C is twice as large as that at point B.

Two propagation delays later the reflected signal returns to point B and is seen as the small step in the point-B waveform. The step is

Bill Blood, Applications Engineering, Motorola Semiconductor Products, 5005 E. McDowell Rd., Phoenix, Ariz. 85008.



small because the 10-Ω resistance is much smaller than the 50-Ω line impedance.

A second reflection results that is equal to the difference between the small signal at point B and the initial reflection from point C. This reflection is seen at point C three propagation delays after the initial signal.

These reflections bounce back and forth, getting smaller as they progress, and cause ringing. As shown in Fig. 1, ringing consists of a series of square waves. However, it normally appears as a decreasing sine wave, because usually the driving signal has slower rise times, the line is shorter and the oscilloscope sweep speed is slower.

### Use reflection coefficients

Reflection coefficients are used to determine reflection amplitudes on a signal line. The reflection coefficient at the receiving, or load end, of the line,  $\rho_L$ , depends on the line's characteristic impedance and the load resistance at the end of the line:

$$\rho_L = \frac{R_L - Z_0}{R_L + Z_0}$$

For the example, in Fig. 1, where the open-circuit load impedance is extremely large, the reflection coefficient is approximately 1. The reflection coefficient at the sending end of the line,  $\rho_s$ , is a function of the line's characteristic impedance and the output impedance of the driving circuit. Its value is found to be  $\rho_s = (10 - 50) / (10 + 50) = -0.67$ . With these reflection coefficients, the reflection amplitudes given in Fig. 1b are calculated.

A common method to control ringing limits the length of the signal line. Reflections then occur during the rise time of the driving signal and are of reduced amplitude. For acceptable design performance, limit the line length so that propagation delay is one-half the signal rise time or less.

This technique is known as designing with short lines,<sup>1</sup> in which a short line length,  $l$ , is defined by its maximum value

$$l_{\max} \leq t_r / 2t_{PD}$$

where  $t_r$  = rise time of the logic family and  $t_{PD}$  = propagation delay per unit length.

### Fanout loads decrease line lengths

Since the propagation time of a line increases with capacitive loading, the maximum line length becomes shorter as fanout load is increased. With ECL 10,000 edge speeds—typically 3.5 ns from 10 to 90%—the maximum line length with the short-line method of design is normally between four and nine inches, depending on line impedance and fanout. Many of the recommended wiring rules suggested for high-speed logic are based on short-line design techniques.

The key to controlling reflections without line-length and fanout restrictions is the elimination of the first reflection at the load end of the line. If the reflection coefficient at the load end of the line,  $\rho_L$ , were zero, there would be no reflections and hence no waveform distortion. To achieve a reflection coefficient of zero, it's necessary to match the line's characteristic impedance with a resistance load at the end of the line. Methods for terminating a signal line when using high-speed ECL circuits are shown in Fig. 2.

All ECL 10,000 and MECL III circuits are specified with 50-Ω loads, both for dc logic levels and ac performance.<sup>2</sup> When the circuits are used in the conventional manner—positive ground on  $V_{CC}$  and  $-5.2$  V dc on  $V_{EE}$ —the 50-Ω load is terminated to a  $-2$ -V-dc supply called  $V_{TT}$  or termination voltage. When operating from a

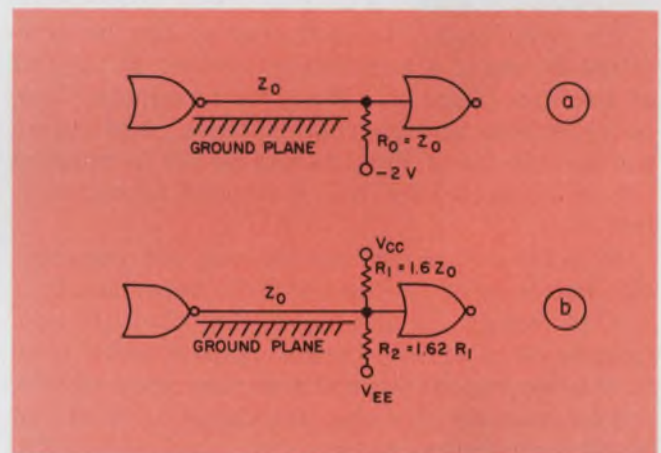

2. Terminations can eliminate reflections. The possible termination techniques include resistor  $R_0 \approx Z_0$  connected to a termination voltage (a) or the use of an equivalent resistor network (b).

$+5$ -V-dc supply,  $V_{TT}$  should be  $+3$  V dc. Or termination may be accomplished with an equivalent resistor network (Fig. 2b) if use of a separate  $V_{TT}$  supply is not practical.

The 50-Ω load specification for high-speed ECL—a worst-case specification—does not preclude using the logic with higher impedance lines. Many systems are designed in the 75-to-100-Ω impedance range for manufacturing convenience and lower system power. For such cases, improvements in waveshapes can be obtained by using proper termination-resistor values.

The results of using a ground plane and a termination are shown in Fig. 3. An ECL-10,000 gate drives an eight-inch unterminated line on a circuit board without a ground plane (Fig. 3a). The fanout is one gate at the end of the line. The upper waveform corresponds to the end of the line and the input to the receiving gate; the lower trace corresponds to the output of the receiving gate.

Because of the absence of a ground plane, the

line impedance is high ( $> 150 \Omega$ ) and somewhat undefined along the path. The waveform at the end of the line has excessive ringing, with the result seen at the output of the receiving gate. Although the circuit is functioning, the ringing significantly exceeds recommended design limits.

### Ground plane reduces ringing

With a ground plane beneath the eight-inch line (Fig. 3b), characteristic impedance becomes a well-defined  $75 \Omega$ . Thus loading has less of an effect on the line, and faster signal propagation speed can be obtained. The result: much less ringing at the end of the line, even though the line is not terminated. The amplitude of the ringing represents a conservative short-line design, and no ringing couples into the output of the receiving gate.

The eight-inch line performance can be optimized by use of a termination resistor at the end of the line (Fig. 3c). With the terminated line, no reflections and no ringing occur. And unlike the waveforms of Figs. 3a and 3b the terminated line is unaffected by line length and fanout loading.

It is the act of terminating, and not the critical matching of the line, that is important in a system design. If the exact line characteristic impedance is not known, any resistor value close to the line impedance will give very good results.

For example, if a line impedance is  $90 \Omega$  and  $100\text{-}\Omega$  termination resistors are used, only 5.3% of the signal would be reflected. This would cause a small signal overshoot that would not affect system operation and that would be much preferred to the 100% reflection of an unterminated line.

### Terminated lines increase speed

In addition to controlling ringing, the use of low-impedance transmission lines can lead to

faster system performance. The effects of fan-out loading on propagation delay time is a function of the line characteristic impedance. The amount of current flowing in a signal line determines the time it takes to charge any stray or fanout-load capacitance. And a high-impedance line conducts less current than a low-impedance line for a given signal amplitude.

The propagation delay time of a loaded line,  $T_{PD}'$ , may be expressed as

$$T_{PD}' = T_{PD} \sqrt{1 + \frac{C_D}{C_0}}$$

where  $T_{PD}$  is the unloaded line speed (about 0.15 ns per inch for a circuit-board line),  $C_D$  is the distributed load capacitance on the line (about 3 pF per ECL-10,000 fanout) and  $C_0$  is the intrinsic capacitance of the line (about  $150 L/Z_0$ , where  $L$  is the line length in inches).

Calculations of loaded line speed illustrate the performance gain when designing the low-impedance transmission lines. A six-inch,  $50\text{-}\Omega$  line on a circuit board, for example, would have a propagation delay time of 1.27 ns when loaded with a fanout of 6. A similarly loaded six-inch,  $150\text{-}\Omega$  line would have a 1.8-ns propagation delay. This small speed difference is more than one-fourth of a gate delay and represents a 30% improvement in wire-propagation delay time.

The line-propagation delay times for 12-inch microstrip lines, as functions of fanout loading and line impedance, are shown in Fig. 4. The use of low-impedance lines can have a significant effect on over-all system speed when all the line delays are added together.

In many designs the conversion to transmission-line operation is easy. Very good microstrip interconnections are formed simply by the addition of a ground plane to a standard circuit board. Added to a system backplane, the ground plane provides point-to-point interconnections with a characteristic impedance between 80 and  $130 \Omega$ , and they can be terminated. Moreover Wire-Wrap interconnections can still be used

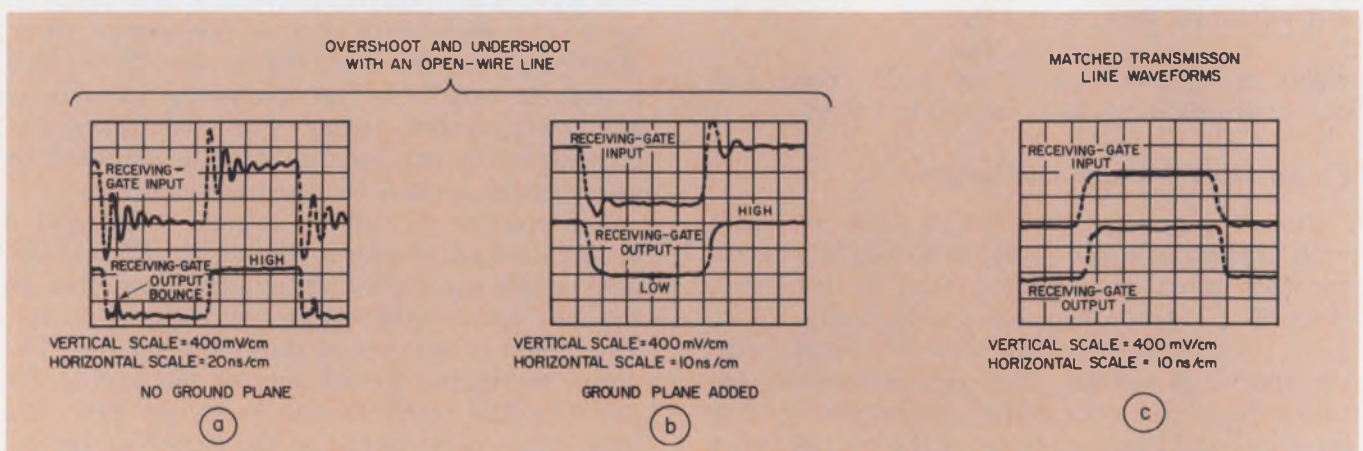

3. Waveforms show reduced ringing when a ground plane is used (a and b). Further improvements are ob-

tained when the line is terminated with a resistor (c). This case eliminates ringing as well as reflections.

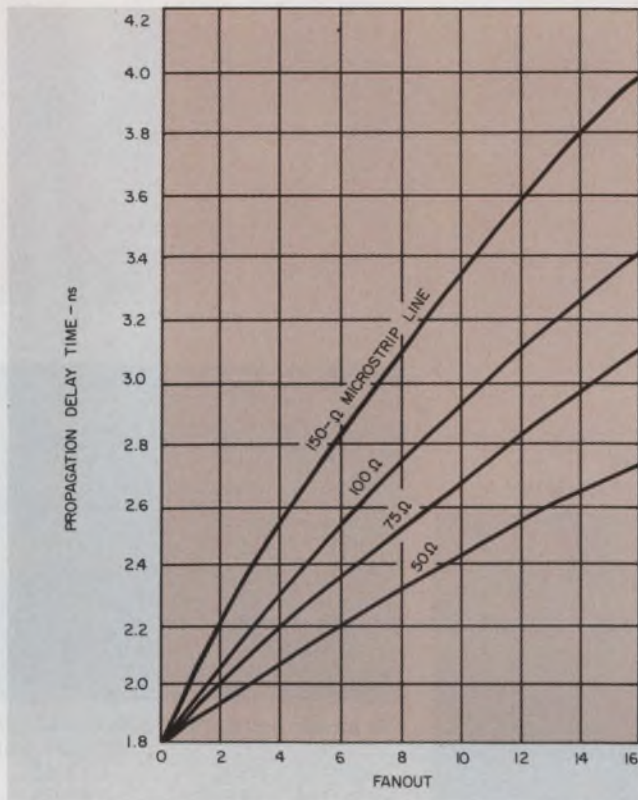

4. Low-impedance lines also result in reduced delay times, or higher speeds. Curves show the propagation time for a 12-inch lump-loaded microstrip line as a function of fanout.

with the fast edge speeds of ECL-10,000.<sup>3</sup>

For longer interconnections, ribbon cable or twisted-pair lines can be used. If every other wire in a ribbon cable is grounded or ribbon cable with a ground shield is used, the cable has a defined characteristic impedance (about 75 Ω) that can be terminated for signal integrity. Twisted-pair lines can be operated differentially with ECL gates and line receivers and have high-noise immunity over long distances.

Usually the hardware of a transmission-line system remains the same as that for a lower-speed system. But the system grounding is more carefully designed, resulting in greatly reduced crosstalk amplitudes. Crosstalk energy is coupled into the ground plane rather than into an adjacent signal line. Tests have shown that without a ground plane crosstalk on a circuit board is 2-1/2 times larger than on a similar board with a ground plane.

Finally, when designing with transmission lines, a system can be completely characterized on paper. ■■

#### References

1. *MECL System Design Handbook*, Motorola, Inc., 1971.
2. *MECL Integrated Circuits Data Book*, Motorola, Inc., 1972.
3. "Interconnection Techniques for Motorola's MECL 10,000 Series Emitter Coupled Logic," AN-556 Motorola, Inc., 1972.



Beautiful  
New Babies

# BOTH TRULY REMARKABLE

CDI's New Baby: Series SL, Linear Slide Switch (Pat. Pending)



#### REMARKABLE BECAUSE:

- 1 Up to 100 or more positions (unique).
- 2 Available with solder lugs or dip solder termination for p.c. use.
- 3 Mounts EITHER left/right OR up/down (versatile).

- 4 Single or multiple position selectors.
- 5 Over 1,000,000 detents life.

#### APPLICATIONS:

CATV channel selections.  
Column measuring.  
As an adjustable high & low limit switch, etc.

#### ELECTRICAL CHARACTERISTICS:

200 megohms min. insulation.  
1000 volts min. dielectric strength.  
2 amps @ 115 VAC current carrying capability.  
125 ma @ 115 VAC current breaking capability.

CDI earns its reputation every day for Consistently High Quality, Consistently Good Delivery, Designing to Your Needs.



## CHICAGO DYNAMIC INDUSTRIES, INC.

PRECISION PRODUCTS DIVISION

1725 Diversey Blvd., Chicago, Illinois 60614, Phone (312) 935-4600 TELEX 25-4689

# Harris CM

Here are the eight latest additions to our DI/CMOS family-- the fastest low-power logic devices on the market. And they're completely free of SCR latch-up problems.

Last fall we introduced our first eight DI/CMOS logic devices.\* Now, through our continuing development program, we've added eight more. Like the first group, these offer speeds twice as fast as any comparable IC's (typically 10ns with 10-volt power supplies) and extremely low power dissipation. Power dissipation for each of the eight new devices is typically 1nW. These units also permit a wide power supply range (3VDC to 18VDC), while providing large noise immunity—typically 45% of supply voltage. And because of our dielectric isolation process, SCR latch-up problems are completely eliminated.

Chip reliability is currently reported at more than 325,000 device hours at +125°C without failure.

The first six devices diagrammed here (HD-4000 series) are pin for pin compatible with the CD-4000A series. The last two are Harris proprietary devices (HD-4800 series). All are available in 14-pin DIP's except the HD-4814, which comes in a 16-pin package. For details see your Harris distributor or representative.

## 9

**HD-4002**  
Dual 4 NOR Gate

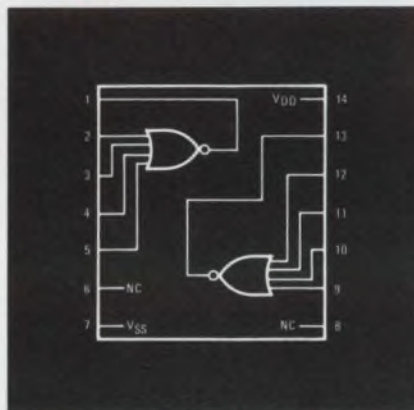

Pin for pin compatible with CD-4002A.  
100-999 units  
-40°C to +85°C \$1.00  
-55°C to +125°C \$3.40

## 10

**HD-4007**  
Dual Complementary Pair Plus Inverter

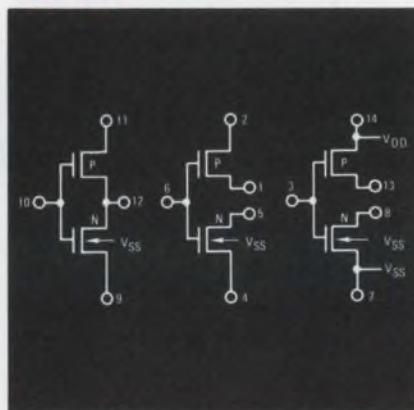

Pin for pin compatible with CD-4007A.  
100-999 units  
-40°C to +85°C \$1.00  
-55°C to +125°C \$2.65

## 11

**HD-4019**  
Quad AND/OR Gate

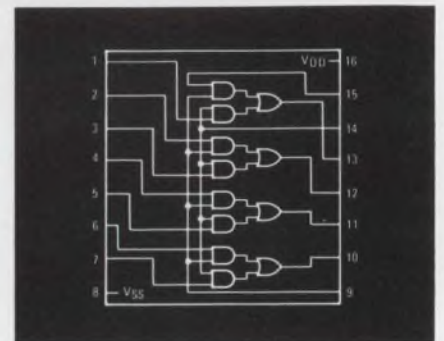

Pin for pin compatible with CD-4019A.  
100-999 units  
-40°C to +85°C \$2.45  
-55°C to +125°C \$5.05

## 12

**HD-4023†**  
Triple 3 NAND Gate

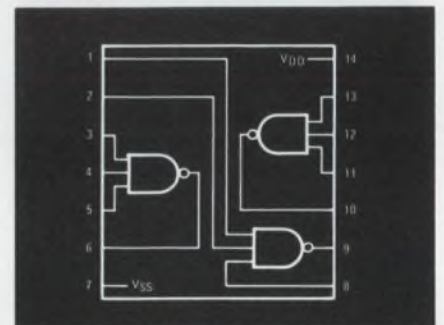

Pin for pin compatible with CD-4023A.  
100-999 units  
-40°C to +85°C \$1.00  
-55°C to +125°C \$3.40

## 13

**HD-4025**  
Triple 3 NOR Gate

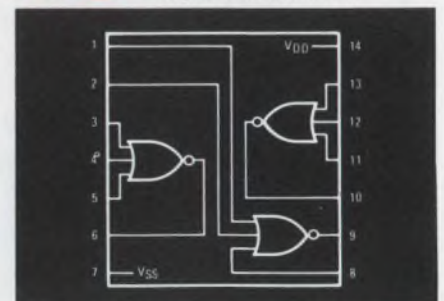

# OS cont'd:

Pin for pin compatible with CD-4025A.

100-999 units  
 -40°C to +85°C \$1.00  
 -55°C to +125°C \$3.40

**14** HD-4030†  
 Quad Exclusive OR Gate

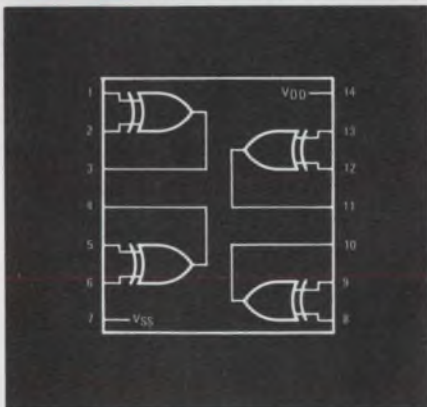

Pin for pin compatible with CD-4030A.

100-999 units  
 -40°C to +85°C \$2.10  
 -55°C to +125°C \$3.80

**15** HD-4811†  
 Quad Exclusive NOR Gate

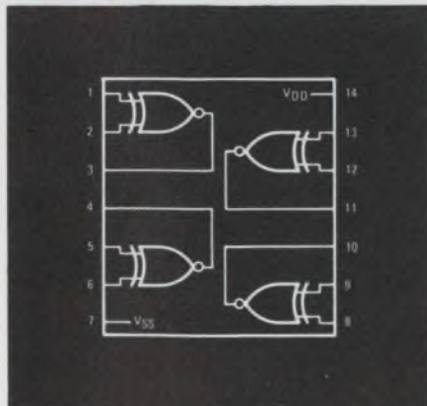

A Harris proprietary device.

100-999 units  
 -40°C to +85°C \$2.10  
 -55°C to +125°C \$3.80

† Available through distributors in late May.

**16** HD-4814  
 Hex Inverter

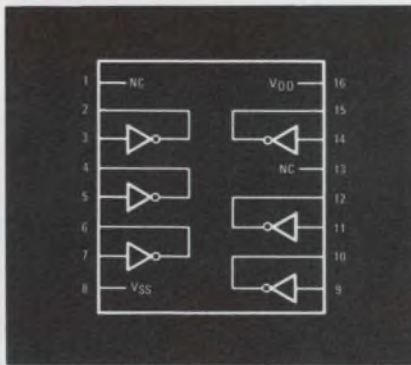

A Harris proprietary device.

Replaces HD-4009 in applications requiring only the inverting function.

100-999 units  
 -40°C to +85°C \$2.10  
 -55°C to +125°C \$3.80

## \*1 thru 8

In case you missed the ad describing our first eight CMOS devices, here they are again. All are high-speed, low-power units. The HD-4000 series is pin for pin compatible with the CD-4000A series. The HD-4809 is a Harris proprietary device.

	100-999 units	
	-40°C to +85°C	-55°C to +125°C
1. HD-4000 Dual 3 NOR Gate	\$1.00	\$3.10
2. HD-4001 Quad 2 NOR Gate	\$1.00	\$3.30
3. HD-4009 HEX Inverter	\$2.20	\$5.25
4. HD-4010 HEX Buffer	\$2.20	\$5.25
5. HD-4011 Quad 2 NAND Gate	\$1.00	\$3.30
6. HD-4012 Dual 4 NAND Gate	\$1.00	\$3.45
7. HD-4013 Dual "D" Flip Flop	\$2.10	\$4.75
8. HD-4809 Triple/True Complement Buffer	\$2.25	\$5.30



**HARRIS SEMICONDUCTOR**

A DIVISION OF HARRIS-INTERTYPE CORPORATION

P.O. Box 883, Melbourne, Fla. 32901  
 (305) 727-5430

**WHERE TO BUY THEM:** ARIZONA: Phoenix—Liberty, Weatherford; Scottsdale—HAR (602) 946-3556  
 CALIFORNIA: Anaheim—Weatherford; El Segundo—Liberty, Glendale—Weatherford; Long Beach—HAR (213) 426-7687; Mountain View—Elmar; Palo Alto—Weatherford, HAR (415) 964-6443; Pomona—Weatherford; San Diego—Weatherford, Western  
 COLORADO: Denver—Elmar, Weatherford  
 WASHINGTON, D.C.: HAR (202) 337-3170  
 FLORIDA: Hollywood—Schweber, Melbourne—HAR (305) 727-5430  
 GEORGIA: Atlanta—Schweber  
 ILLINOIS: Chicago—Semi-Specs, Schweber; Palos Heights—HAR (312) 597-7510  
 INDIANA: Indianapolis—Semi-Specs  
 MARYLAND: Rockville—Schweber  
 MASSACHUSETTS: Lexington—R&D; Waltham—Schweber, Wellesley—HAR (617) 237-5430  
 MICHIGAN: Detroit—Semi-Specs  
 MINNESOTA: Minneapolis—Semi-Specs  
 MISSOURI: Kansas City—Semi-Specs; St. Louis—Semi-Specs  
 NEW MEXICO: Albuquerque—Weatherford  
 NEW YORK: Melville—HAR (516) 249-4500; Syracuse—HAR (315) 463-3373; Rochester—Schweber; Westbury—Schweber  
 OHIO: Beachwood—Schweber; Dayton—Semi-Specs  
 PENNSYLVANIA: Pittsburgh—Semi-Specs; Wayne—HAR (215) 687-6680  
 TEXAS: Dallas—Weatherford, Semi-Specs; HAR (214) 231-9031  
 WASHINGTON: Seattle—Liberty, Weatherford  
 WISCONSIN: Wauwatosa—Semi-Specs

**LEGEND FOR HARRIS SALES OFFICES & DISTRIBUTORS:** Harris Semiconductor (HAR); Elmar Electronics (Elmar); Harvey/R&D Electronics (R&D); Liberty Electronics (Liberty); Schweber Electronics (Schweber); Semiconductor Specialists, Inc. (Semi-Specs); R. V. Weatherford Co. (Weatherford); Western Radio (Western).

# Protect op amps from overloads.

You can avoid damage by building circuits that guard against fault conditions on the power-supply, input and output lines.

Though engineers are becoming more and more aware of the subtleties of operational-amplifier characteristics, there are still far too many situations where op amps are being destroyed by voltage and current overloads. This is due, in part, to the proliferation of op amps in unusual applications.

Some overload conditions are obvious: input breakdown under excessive input voltages or output overheating under short-circuits. Most op amps are protected to some degree against these two conditions.

Other overload conditions, however, are less evident. These include voltages maintained by capacitors after the power supplies are turned off. A voltage retained at an amplifier input by a capacitor or other source can forward-bias and destroy a substrate junction when the negative supply voltage becomes less negative than the input voltage.

To help prevent op-amp failures like these, there are several protection circuits that the designer can build. They will guard op amps against power-supply faults and input and output overloads.

## Protection from power-supply faults

The most common power-supply faults in op-amp circuits are supply reversals and voltage transients. Damage from these overloads is prevented by the circuits of Fig. 1. To protect against damage by voltage reversal, a diode is added in series with each power supply to block reverse current flow (Fig. 1a). This protection also prevents forward-bias of an integrated-circuit substrate junction, since a reversed-biased diode will now disconnect the negative supply. However, for the latter protection alone, resistors can be added in series with the inputs to limit the substrate current to a few milliamperes.

Protection against transient voltages is provided by the zener diode clamps and the voltage-

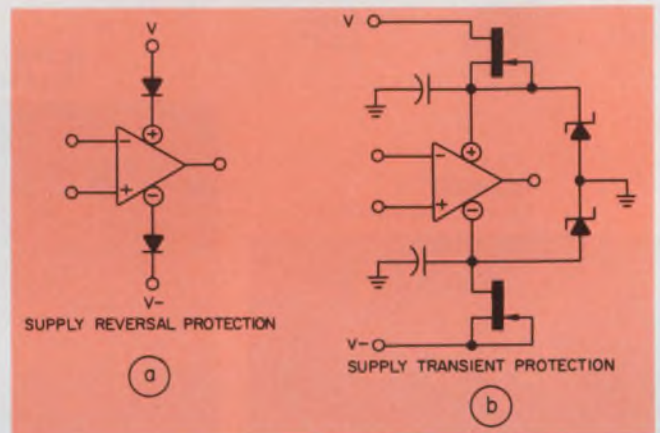

1. Damage from power-supply faults is prevented because diodes block currents during voltage reversals (a) and clamp the power-supply terminals to limit transient voltages (b).

absorbing FET current sources (Fig. 1b). The zener diodes have ON voltages that are greater than the normal supply voltages but less than the maximum supply ratings of the op amp. Thus the zener diodes will be off under normal supply voltages, and they will clamp the supply transient voltages.

The current-source-connected FETs are chosen with  $I_{DSS}$  levels above the normal current drains of the op amp. Below the  $I_{DSS}$  level, the FETs are below pinchoff and appear as small resistances in series with the supply lines. If transients appear on the supply lines, the zener diodes turn on to clamp the supply voltages, and their current drains raise the FET currents to  $I_{DSS}$ . Now the FETs are in pinchoff, and they appear as high-impedance current sources to support excess voltages. As long as the transients do not cause voltage breakdown in the FETs, the transient currents are limited to  $I_{DSS}$ .

## Keeping input voltages at safe levels

Overload conditions at op-amp inputs are essentially those of excessive common-mode and differential voltages. Either can induce a voltage breakdown that will damage or destroy the input transistors. Because of the precise match-

ing needed between the input transistors, even minor damage from breakdown can significantly degrade the dc input characteristics of the op amp. Such damage can result from quite moderate differential input voltages, since bipolar transistors typically have about a 6-V emitter-base breakdown voltage. Input stages with FETs are less vulnerable to overloads of this magnitude, but they are more sensitive to the low-energy, high-voltage discharges that are frequently encountered.

Protection from very high input voltages is

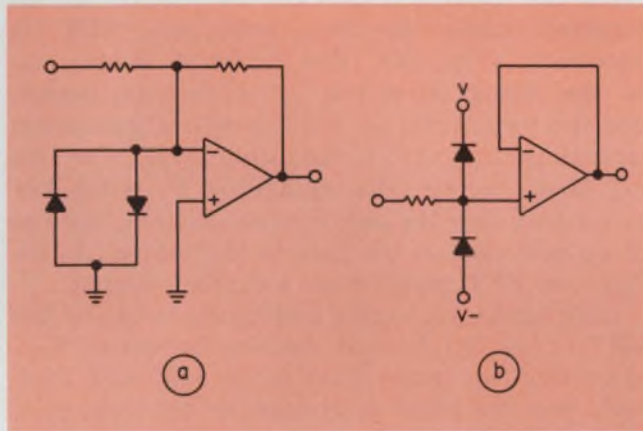

2. Input clamps protect against any level of input transient voltage that does not force excessive current through the diodes from the input resistor, in either the inverting (a) or noninverting configuration (b).

provided<sup>1</sup> by the diode clamps of Fig. 2. For both the inverting and noninverting configurations, the diodes limit the voltages reaching the amplifiers to safe levels without restricting signal swing. Input transients of thousands of volts can be withstood in this manner, so long as the diode currents are adequately limited by the input resistors. To permit amplifier common-mode swing in the noninverting configuration, the clamp diodes are connected to the power supplies rather than to ground (Fig. 2b). Here, however, diode leakages will add to the input error current.

Input protection against differential signals up to the level of power-supply voltages is usually incorporated in op amps. However, larger voltage overloads can still damage the amplifiers. Further protection against differential voltage overloads can be provided (Fig. 3a) so long as the overloads don't raise either input beyond the supply-voltage levels. Where this latter condition is possible, the supply-level clamps of Fig. 2b should be added.

Once again, diode clamps are used as in Fig. 2a, but in this case (Fig. 3a) the current-limiting resistance is divided equally between the two inputs. Thus the error-voltage drops produced with the input bias currents will tend to match

and cancel. Some error will remain, however, due to the differences in input bias currents.

Another error with this clamp circuit can result from the input current that it draws under overload. This current can be a serious error in comparator circuits, where high input resistance is needed in the overload state. To lower the overload input current, the values of input resistors can be increased, but this also increases the error voltage produced by the input offset current of the op amp.

The weaknesses of the clamp circuit in Fig.

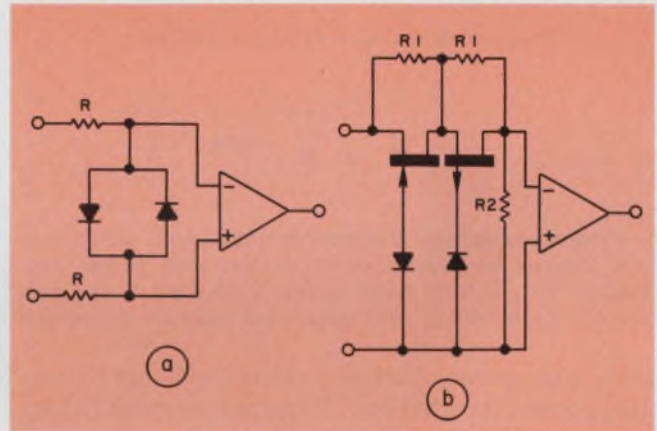

3. The effect of differential input overloads can be eliminated by one of these two protection circuits. Amplifier input voltage is reduced either by clamping (a) or by selectively dividing (b).

3a can be avoided<sup>2</sup> with a second protection circuit (Fig. 3b). In this case the differential input voltage is limited by a high-resistance divider for low current under overload. In normal operation the large resistors would develop significant error voltages, but they are shunted by low FET resistances. Specifically, dc error would be significant only at the comparator trip point, where the added voltage would produce an offset. But with the protection circuit, the differential input voltage at the trip point is zero, leaving the diodes off, and hence providing zero gate bias for the FETs.

With this bias, both FETs have a low channel resistance,  $r_{on}$ , which produces only a small error voltage because of the input bias current. When the input signal moves away from the trip point, the gate-source voltage of one FET or the other increases. This, in turn, increases the channel resistance of the FET until it reaches the megohm level of  $r_{ds}$  at pinchoff. Then the input current must flow through the resistor in parallel with this FET and through the other FET, which is zero-biased. This, in effect, leaves an input divider,  $R_2/(R_1 + R_2)$ , to reduce the input signal.

The most common types of output overloads are excess power dissipation and output-stage breakdown when the output is shorted. Most op

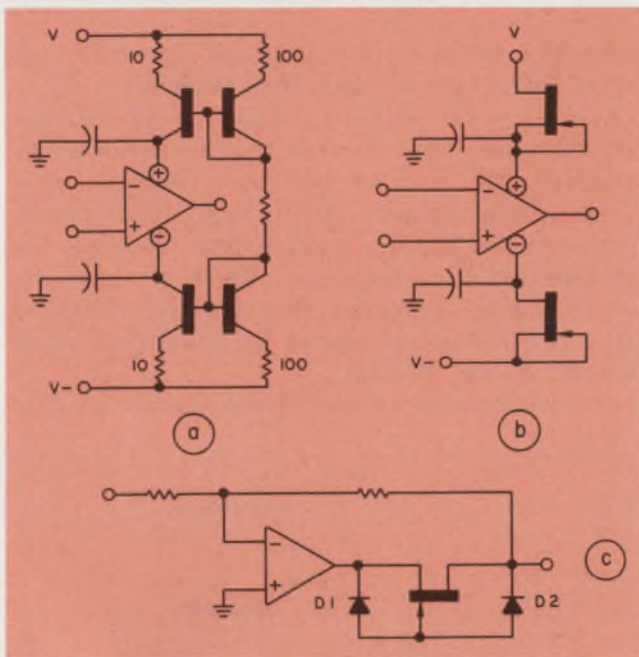

4. Precise, selectable current-limiting results when current sources are added in series with the power supplies (a, b). To limit both current polarities, a FET current source in series with the output may be added (c).

amps incorporate current-limiting circuits to control power dissipation. External current limits can be added if they are not in the op amp or if a lower level of limiting current is desired to protect a load. Also, such a reduced current limit may be needed when the output is shorted to a point above or below ground potential. In this case the added potential may increase the output-stage dissipation. And if the output is shorted to a voltage beyond the power-supply levels, voltage breakdown can result.

#### Limiting output currents

One way of providing an external current limit is to connect current sources in series with the power supplies (Fig. 4). When the supply-current drains are below the design level of the current sources, the transistors add low resistances in series with the supplies. The bipolar-transistor current sources are then in saturation, adding resistances equal to  $r_{sat}$  plus  $10\ \Omega$ , and the FETs are not yet in pinchoff, so they each add a resistance of  $r_{on}$ . Provided these small resistances are bypassed, they have little effect on performance. When the supply currents reach the predetermined operating levels of the current-sources, the transistors start to operate in their constant-current mode—with very high output resistances. Only a small additional current is then needed to develop large voltage drops across the current sources and reduce the supply voltage across the amplifier. Of course, because the voltage is also reduced, the circuit provides a power limit rather than just a current limit.

A somewhat simpler external current limit is

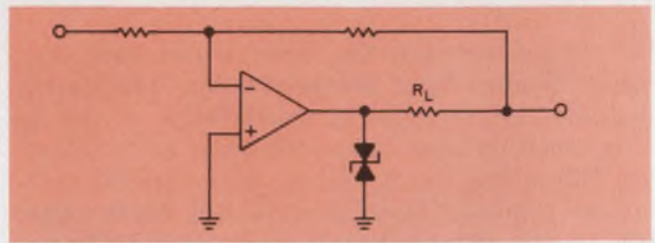

5. Protection from excessive voltages that may be connected accidentally to the output terminal is provided by zener-diode clamps.

provided if a single current source is added in series with the output. This simplicity stems from the ability of a FET to operate in an inverted mode, so that only one FET is necessary (Fig. 4c). For currents flowing into the output terminal,  $D_2$  is reverse-biased, and the voltage on the FET produces gate-drain leakage current that is conducted by  $D_1$ . For this low diode current, the voltage on  $D_1$  is too low to forward-bias the gate-source junction, but the diode does connect the gate to the source. As before, the FET operates as a current source.

Once again, the series resistance added by the FET is low ( $r_{on}$ ) until limiting occurs at  $I_{DSS}$ . Since this resistance is inside the amplifier feedback loop, its effect is divided by the loop gain. When the output current reverses and flows out of the output terminal,  $D_1$  turns off and  $D_2$  conducts the leakage current. In this way the gate is connected to the drain for an inverted FET current source. Thus the circuit works for both polarities of output current.

If an output short-circuit or an inductive load cause the output voltage to exceed one of the power-supply levels, the output stage can be damaged by voltage breakdown. Protection against such an overload can be provided by zener clamps (Fig. 5).

With the zener diodes, the op-amp output terminal cannot be pulled beyond selectable voltage levels, and the excess voltage is absorbed by  $R_L$ . The current-limiting resistor,  $R_L$ , should be made large enough to protect the zener diodes, but not so large as to develop a swing-limiting voltage in normal operation. Since  $R_L$  is in the feedback loop, its contribution to output impedance is diminished by the loop gain.

Note that a high voltage on the output terminal also raises the voltage on the inverting amplifier input through the voltage divider formed by the feedback resistors. While this voltage is reduced by the divider, it can sometimes break down the input stage. If this is a possibility, input protection should be used. ■■

#### References

1. Tobey, G., Graeme, J., Huelsman, L., *Operational Amplifiers; Design and Application*, McGraw-Hill, New York, 1971.
2. Accardi, L., "Modified 710 Maintains Accuracy at High Input Voltages," *EEE*, October, 1970.



If you need  
 a high quality **3½-digit**  
 V-O-M at your price . . .  
 buy **Triplett's** new **8035**

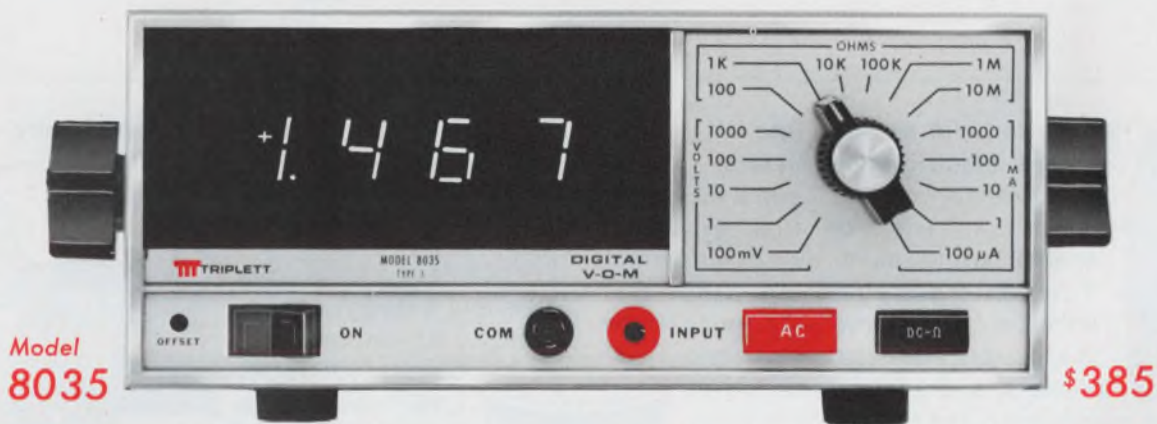

1. **EASY OPERATION** — Single polarized plug for test leads eliminates switching leads when changing functions.
2. **LOW POWER CONSUMPTION** — Less internal heating for greater stability and reliability.
3. **LOW CIRCUIT LOADING** — Greater measurement accuracy with 10 megohm input resistance for all AC and DC voltage ranges.

Designed for R&D, production, quality control, maintenance and classroom use, Triplett's new Model 8035 Digital V-O-M features an automatic polarity display, 100% overrange capability, out-of-range display blanking and high input resistance to make it nearly fool-proof.

With 26 ranges, the Model 8035 boasts accuracies from  $\pm 0.1\%$  to  $\pm 0.7\%$  of reading  $\pm 1$  digit . . . ranking it among the best on the market. Its green, polarized window and its single-plane, seven-bar, fluorescent display combine to insure bright, reflection-free readability from virtually any viewing angle.

Hardware for rack mounting is available.

See the **Model 8035**, priced at **\$385**, at your local distributor. For more information, or for a free demonstration of the convenience and accuracy of the 8035, call him or your Triplett representative. Triplett Corporation, Bluffton, Ohio 45817.

**TRIPLETT**

The World's most complete line of V-O-M's  
 choose the one that's just right for you

# All Panel Meters are not created equal.



## We try to build an edge into General Electric panel meters.

For instance, you won't see a GE panel meter turn yellow, because we use a special white paint that stays white. You won't get eyestrain either. GE panel meters come with extra-wide scales, big numerals, tapered pointers, and shadow-free cover plates for quick, sure readings. We're fussy about things like that.

## Once you've installed them, forget 'em.

GE's famous reliability just doesn't happen, we *build* it in! We designed-out a lot of extra parts that might fail, just to give you extra instrument reliability. To make sure, we added a 20% overload capability to our voltmeters and ammeters. Still not satisfied, we decided to measure instrument quality from parts to finished product in order to screen out anything marginal. Now, it's just too tough for a lemon to squeeze through.



## GE panel meters come from a good family.

They look good individually and they look good together. Choose the rounded BIG LOOK® design for unique style and wide-eyed readability. Or choose the clean HORIZON LINE® case for its behind-panel mounting flexibility (*without* the usual bezel), and its snap-off mask available in six colors. GE makes panel meters to suit you and to add snap to your application.

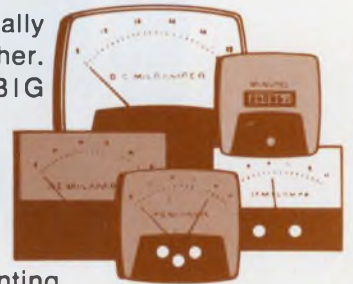

## You can count on General Electric panel meters.

They're built to help you do a better job. At GE, we're not interested in product equality. We want ours to be *better* than the rest.



For a complete catalog of competitively priced and readily available GE panel meters, see your nearby authorized GE distributor. Or write to General Electric Company, Section 592-43, One River Road, Schenectady, N. Y. 12345.

592-43

**Specify  
General Electric...  
just for good measure.**

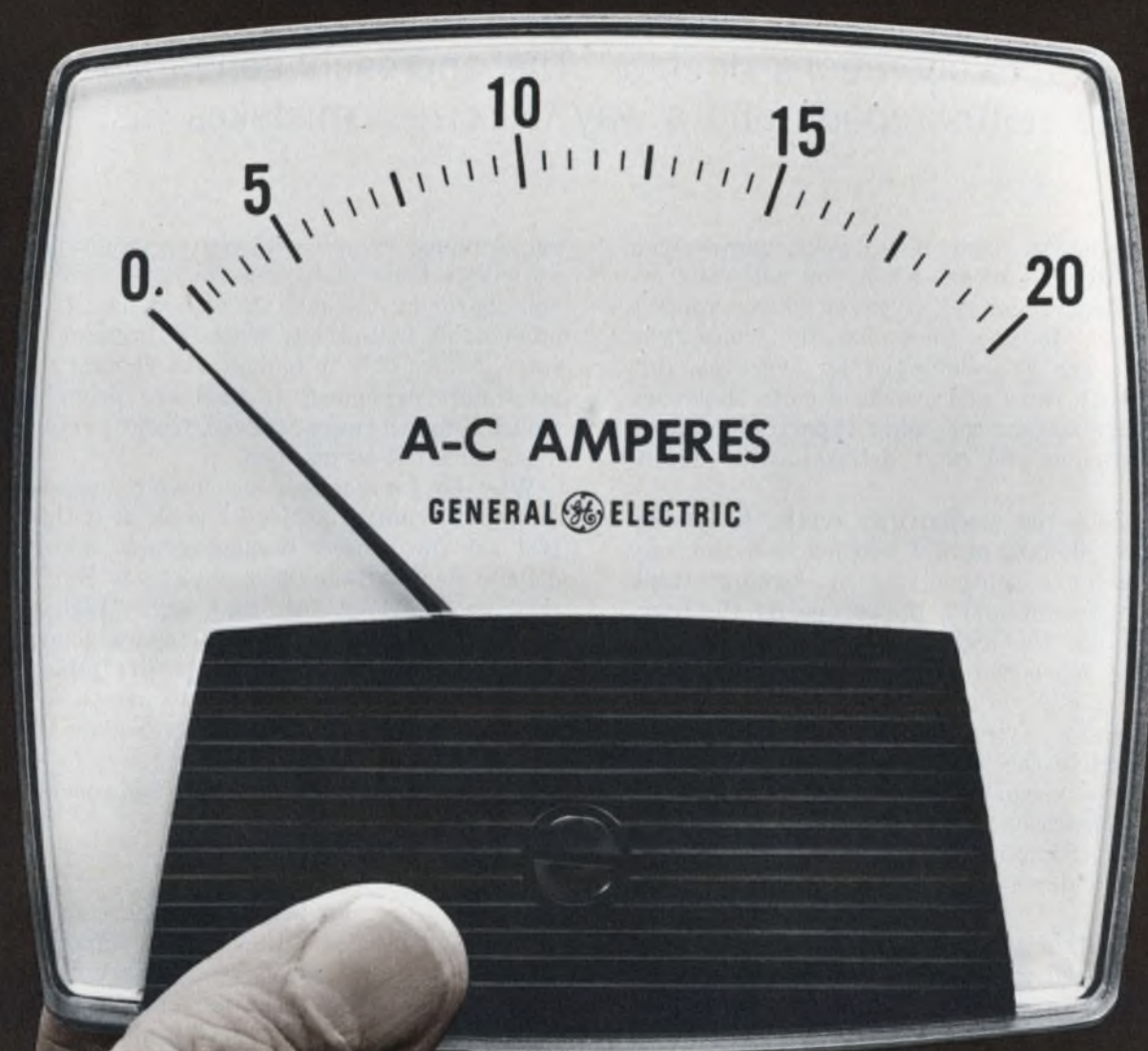

GENERAL  ELECTRIC

## Control projects by hours, not dollars,

suggests this operations director. The approach generates accurate status reports and a way to correct mistakes fast.

Have you lost control of your engineering projects lately? I mean, when you ask your accounting department to give you status reports by projects, do you know exactly where you stand? Or are you clobbered by overtime, different hourly rates and overhead costs that vary each month, so that the dollar report you receive is so confusing you can't determine its significance?

I got clobbered consistently trying to control projects by dollars until I learned that the only way to achieve control was by keeping track diligently of man-hours. If you specify the number of hours, the amount of overtime and the mix of pay levels within your department, you'll have a perfectly valid control.

Begin by specifying the number of hours needed to complete the project. In long, complicated projects it's virtually impossible to make this estimate accurately, from beginning to end, at one sitting. Simplify the estimate by breaking the project down into tasks of one to three months.

I don't authorize a task until I have one that's definable. I tell my engineers that if they can't see all the way to the end of the task, then they should define only the first pieces of it, and when they get through those, define the next level, and the next, until they reach the end. I have spent more time, money and hair on poorly defined tasks than on any other area of my job.

### Charge projects at an average rate

Let's see how the man-hour approach to project budgeting works in practice. Averaging is important. From a department standpoint, there are a certain total number of man-hours available and a certain total of wages and salaries paid for those man-hours. As long as the average hourly rate for the entire department remains relatively constant, the question of specific salaries is academic.

If I attempt to report budget or actual job

performance by job category, I inevitably wind up with a mass of figures that are very difficult and confusing to understand and use. If, on the other hand, I think and work in terms of average rates, I have only to budget and control the total man-hours expended; if they are properly controlled, then the over-all department performance must come out as planned.

Why do I no longer use dollar budgeting to attempt to control projects? Look at it this way: If I ask my project managers how many labor dollars it will take to complete a job, they'll only shuffle their feet and say, "Well, it depends on whether I have to use a senior mechanical engineer or a junior draftsman, and whether the overhead rate this month is 125% or 135%." There are too many variables to reach a decisive conclusion.

Contrast this with the hours approach.

### Manpower mix adjusted

My project managers and their supervisors are responsible for adjusting the mix of manpower needed among draftsmen, designers, technicians, junior engineers and senior engineers to get the work out. That way I don't have to keep track of the job load by job title. I track the job by figuring out if it's lagging behind or maintaining the schedule.

My secretary logs the number of man-hours for me in the engineering department—independent of the accounting department—and she can have reports, which are given to the project engineer on Wednesday, posted to the preceding Saturday. The manager who has to report exactly how much time has been charged to these projects can find out who charged what. And he has that information in time to do something about it if the man-hour budget is not being met. If an engineer or technician is off on a wrong tangent, the worker will have spent only a week of such unproductive effort before the project engineer discovers it.

Of course, no management method will work automatically; like a water pump, the man-hour control system must be primed. Besides defining

---

Richard Anderson, Vice President of Operations, Xynetics, Inc., Canoga Park, Calif. 91305.

the task, I also follow these guidelines:

- Keep progress reports simple and accurate.
- Give engineering managers complete responsibility.

Keep in mind that this type of project control works best for companies in the \$30-million-and-under range, and only for parts of projects no larger than can be visualized by the project manager. An engineer loses feel of a job larger than he can see, and he can be overwhelmed by the magnitude of what it is worth.

The tasks should usually be defined as no

larger than a man-month. When I break down a project into pieces that are this small, the definition of a task is much easier. It's usually possible to write a simple, concise paragraph about this particular segment of work that can be understood by the engineer, the engineering manager, the sales manager, the customer, and maybe even the entire accounting department. It's important that the project task be small enough to be within the engineer's ability to estimate capability, and large enough so he doesn't try to expand it too far into the future.



## Richard S. Anderson

**Education:** M.S., electrical engineering, University of Southern California, B.E.E., Georgia Institute of Technology.

**Responsibilities:** Engineering, design and development, manufacturing and quality control of all products.

**Experience:** President and Director of Computer Micro-Image Systems; Vice President, Telex Corporation; Vice President and General Manager, Systems Division, Genisco Technology Corporation; and Manager, Electronics Division, Weber Aircraft Corporation.

**Patents:** Several in the electronics field.

**Employer:** Organized in 1969 to pursue products utilizing the patented "Sawyer Principle." Motors based on this principle produce linear motion directly in one or more axes, instead of converting normal rotary motion, and therefore eliminate the need for gears, cables or lead screws. Xynetics' motors are being used in high speed, high accuracy automatic positioners and plotters in diverse applications including the apparel industry and architecture. The company recently acquired Electroglas, Menlo Park, Calif., producer of wafer probers and laser scribes.

# Dialight sees a need:

(**Need:** An opto-isolator that isolates,  
switches, and cuts noise too.)

## See Dialight.



Actual size

Dialight's opto-isolators interface between logic circuits, replacing relays and pulse transformers. They combine a light sensitive semiconductor with a light-emitting diode and the result provides: ground-loop isolation; common-mode noise rejection; fast micro-second switching speeds that are 1000 times faster than mechanical relays; wide operating temperature range with no moving contacts to stick; long life; compatibility with DTL and TTL integrated circuits; vibration and shock resistance; a small IC size for mounting on printed-circuit boards; frequency response from DC to 100 kHz. To find out how you can apply these extraordinary isolators to your electronic, control, or industrial processing applications send for your free Dialight opto-isolator data sheets.

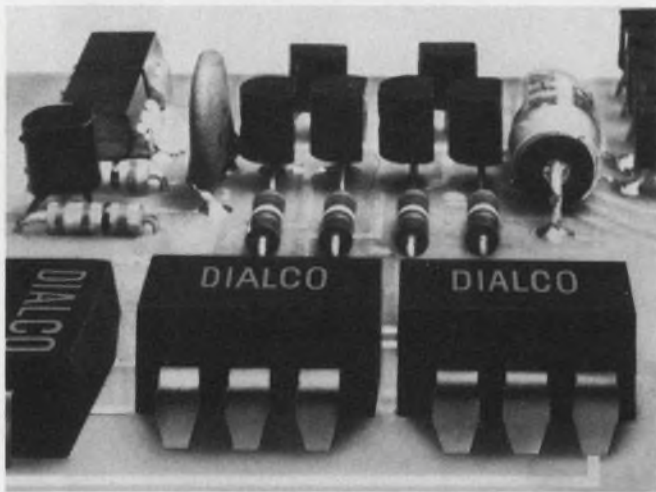

## **DIALIGHT**

Dialight Corporation, A North American Philips Company  
60 Stewart Avenue, Brooklyn, N. Y. 11237 (212) 497-7600

INFORMATION RETRIEVAL NUMBER 46

To be sure that the status of each project is reported, I hold informal weekly meetings. Each job is reviewed, with all the project engineers in attendance, to determine what has happened and what the problems are. We wind up with a report that is usually two to three sentences long for each project. It's widely circulated within the company, and it tells the project engineer that the rest of the company knows what's going on and is interested. It encourages him not to hide his head if he has project problems.

I've discovered that if I sit back and wait for the engineer to come to me with his problems, rather than generating the weekly report, he'll hope for the "good fairy" to come and take the problem away. This way we can discuss the problems person-to-person and get more out of it than we would in a regular, formal report.

Also, my project engineers are given a budget goal in dollars. I give them the authority to order materials; if the costs exceed the budget, the project managers must obtain clearance from me. To control costs, I ask the purchasing department to give me a report of commitments made by each project. If a project engineer oversteps his project budget at the commitment level, I know it within a week or two, and I can, if I wish, reverse the transaction and cancel the purchase before it's too late to correct mistakes.

### Keeping those overruns respectable

As the project manager, I don't care what the accounting department shows as the status of the material orders on the project; I do care about the commitments that have been made. Once they've been established, the question of when the material arrives, is inspected, recorded and actually paid for is incidental. All that will happen regardless of how the engineer manages the project. But by controlling the commitment point and monitoring it, I can give the project engineer freedom and still maintain the ability to correct an error before it's cast in concrete.

If I'm doing a moderately good job of managing, most of my jobs will come in fairly close to budgets—both the hours and dollars 10% to 20%, one way or the other. I make the project engineer responsible every week for reaffirming that his total job budget is still correct, so far as he is capable of estimating that week. He's responsible for rebudgeting the moment he sees a significant variation in the tasks he has to do.

Generally the jobs that burn me up are the ones with the 200, 300 or 400% overruns. You can usually account for the 20, 50 or even 100% overrun. The ones you really lose control of are the ones that go two or three times the budget. Tracking projects by man-hours gives me the control I need to keep overruns respectable. ■■

# Try any one for 10 days

# FREE!



## Your WESTON distributor is betting you'll never want to give it up.

Weston, the leader in portable test equipment, is willing to bet that once you try one of our digital DMM's, you'll never want to give it up.

So, during April, May and June, you can try any one of these compact, portable, almost indestructible multimeters for 10 days—FREE! Just pick the one that suits your needs best.

**Model 4440** Lowest cost, plus high performance. Full 3½-digits. 17 ranges, 200 mV to 1000V, 200 ohms to 2 megohms, plus AC/DC current. Blinking overrange indicator. Self-contained, re-chargeable battery gives more than 8 hours continuous operation. Or, use AC line converter.

**Model 4442** 20 ranges, plus amazing accuracy.  $\pm .05\%$  of reading  $\pm$  one digit—guaranteed! All solid-state circuitry built around MOS/SLI chip. Automatic blanking of unused digits conserves power. Battery or AC line converter.

**Model 4443** Lowest price, most precise, DC-only DMM available. 13 ranges, 200 mV to 1000V

(100  $\mu$ V res.), 200 ohms to 20 megohms (0.1 res.), plus current.  $\pm .05\%$  of reading  $\pm$  one digit—guaranteed! Battery operated. Comes complete with charger.

**Model 4444** The autoranging maximimulti-meter. Choose VAC, VDC, Ohms or DC current. The 4444 does the rest. Instant automatic range selection. Plus four full digit display including polarity. Ultimate accuracy in a portable,  $\pm .02\%$  of reading  $\pm$  one digit. No other portable offers more, does more.

So try one today. Just a note on your business letterhead will deliver a Weston Multimeter to you for a 10-day free trial. Weston Instruments, Inc., 614 Frelinghuysen Avenue, Newark, N.J., 07114.

**We're either first or best. Or both.**

**WESTON**® 

INFORMATION RETRIEVAL NUMBER 47

# ideas for design

## Negative feedback gives ultra-flat filters without altering the selectivity

By using some negative feedback and by compensating for filter group delay, you can flatten the passband response of crystal or ceramic filters considerably without altering their selectivity.

In Fig. 1 a feedback network provides 0.5 dB of gain reduction. Adjustable components add a delay of approximately  $1/2f_0$  to the existing group delay of the filter. When group delay of a filter equals  $1/2f_0$ , it exhibits a phase slope of  $180^\circ$  at mid-frequency ( $f_0$ ). At this point, therefore, the negative feedback is a maximum. Feedback will rapidly be attenuated beyond the filter's 3-dB points; thus the attenuation slopes remain unchanged.

The feedback network shown is tunable and has low Q. It is actively isolated from the filter, and its response is broad enough so it will not distort the filter response. Fig. 2 shows the relative-output responses of a filter with three different amounts of feedback.

The circuit of Fig. 1 yields a response that is three times flatter under optimum feedback conditions than a circuit without feedback. The modified filter has the advantage of retaining the desired attenuation characteristics for selectivity while increasing the linearity of the passband. Also, distortion that can result from the nonlinear loading caused by various signal levels is virtually eliminated.

The i-f amplifier has an over-all gain of 8 to 9 dB with a filter group delay of  $47 \text{ ns} \pm 20\%$  at the center frequency ( $f_0$ ).

A special transformer is required: one that has the primary tuned to 10.7 MHz with a 100-pF capacitor in parallel with it. There is also a tap at the 10% or two-turn point (whichever is greater) of the primary. The secondary is a two-turn link that is very tightly coupled to the primary at the core end. Loading the secondary are the limiter and detector sections of the tuner, in this case formed by an RCA CA3089.

Bill Everhart, Waller Corp., Box 340, Crystal Lake, Ill. 60014.

CHECK 311



2. Typical filter output response with various amounts of feedback. The range of magnitudes plotted represents 40 dB, and the fractional 3-dB bandwidth is about 2.5%.

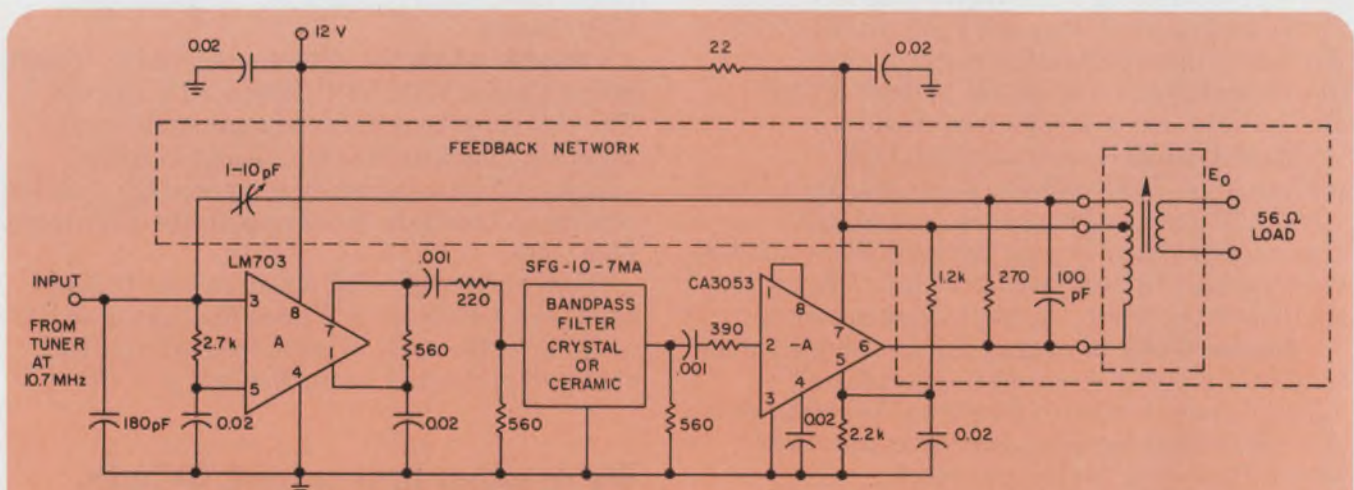

1. A 10.7-MHz i-f amplifier uses negative feedback to increase phase linearity in the passband.



# TRW's SVT Series Darlington's. All the power you need to get things moving.



**New for 220V offline power supplies!**  
SVT 6253-450 volts, 5 amps  
For information, circle 000

## TRW's Monolithic High Voltage Darlington Family

$BV_{cbo}$  to 650 Volts... Switch times typ. 300 NanoSec.

	$BV_{ce}$ (Sustaining)	$I_c$	$V_{ce}$ (Sat)
SVT 6060	300 Volts	20 Amps	2.0 Volts ( $I_c=20A, I_b=2A$ )
SVT 6061	350 Volts	20 Amps	2.0 Volts ( $I_c=20A, I_b=2A$ )
SVT 6062	400 Volts	20 Amps	2.0 Volts ( $I_c=20A, I_b=2A$ )
SVT 6000	300 Volts	10 Amps	1.4 Volts ( $I_c=10A, I_b=500mA$ )
SVT 6001	350 Volts	10 Amps	1.4 Volts ( $I_c=10A, I_b=500mA$ )
SVT 6002	400 Volts	10 Amps	1.4 Volts ( $I_c=10A, I_b=500mA$ )
SVT 6251	350 Volts	5 Amps	1.4 Volts ( $I_c=5A, I_b=500mA$ )
SVT 6252	400 Volts	5 Amps	1.4 Volts ( $I_c=5A, I_b=500mA$ )

Available in quantity—now, from your local distributor. For additional information, call Dick Seinfeld, collect, at (213) 679-4561; or write TRW Semiconductors, an Electronic Component Division of TRW Inc., 14520 Aviation Blvd., Lawndale, California 90260. In Europe, contact Mr. C. Thompson, TRW Composants, Electroniques, S.A. Rue René-Magne, Zone d'Entrepôts, 33 Bordeaux-Nord, France. Telephone (56) 297870. Telex: 842-57179.



# TRW<sup>®</sup> SEMICONDUCTORS

INFORMATION RETRIEVAL NUMBER 48

# Floating voltage regulator helps build high-compliance current source

Current sources built from IC op amps or regulators have limited voltage compliance—typically 40 V. But by use of an IC voltage regulator that floats on its own output voltage, the compliance can be made as high as desired. The limit is determined by the breakdown voltage of the series pass transistors rather than the IC breakdown voltage.

The MC 1566L regulator has separate sensing amplifiers for constant-voltage or constant-current modes of operation. Each of these amplifiers floats on the output voltage but is fed by an internally regulated supply. The regulated voltage is derived from an auxiliary supply of 25 V dc.

To supply well-regulated constant current, the functions of the current-sensing and voltage-sensing amplifiers must be reversed. In the usual connection, the 1-mA current from pin 3 flows through a resistor to ground to establish the output voltage reference. The differential voltage between pins 8 and 9 provides the error signal. When the regulator goes into constant-current (short-circuit) operation, part of the 1-mA current returns to pin 9 through a diode and produces a voltage-variable error. With this circuit, the connections are such that the functions of the amplifiers are reversed. Since the net current in sense resistor  $R_9$  is maintained at constant

value by the current-sensing amplifier (pins 8 and 9), the load current remains constant because any portion of the reference current that appears in the load must now enter the sensing resistor.

The 1- $\mu\text{F}$  capacitor, required for circuit stabilization, limits the rate of change of load voltage to a step change of load resistance. The output voltage change is exponential, with a time constant equal to that of the final load resistance multiplied by the capacitor value. The instantaneous load current equals the value of the instantaneous output voltage divided by the final value of the load resistance.

The circuit is designed for a current range of 200  $\mu\text{A}$  to 100 mA and handles input voltages to 300 V. Output compliance is 300 V, less 2.2 V to prevent saturation of the Darlington pair. Output impedance exceeds 20 M $\Omega$  at the 200- $\mu\text{A}$  and 1-mA current setting. Caution should be exercised with currents above 10 mA so as not to exceed the ratings of the MJE340 pass transistor. The operating range for the floating supply is 20 to 35 V.

*Neil Wellenstein, Applications Engineer, Motorola Semiconductor Products Div., 5005 E. McDowell Rd., Phoenix, Ariz. 85008.*

CHECK 312

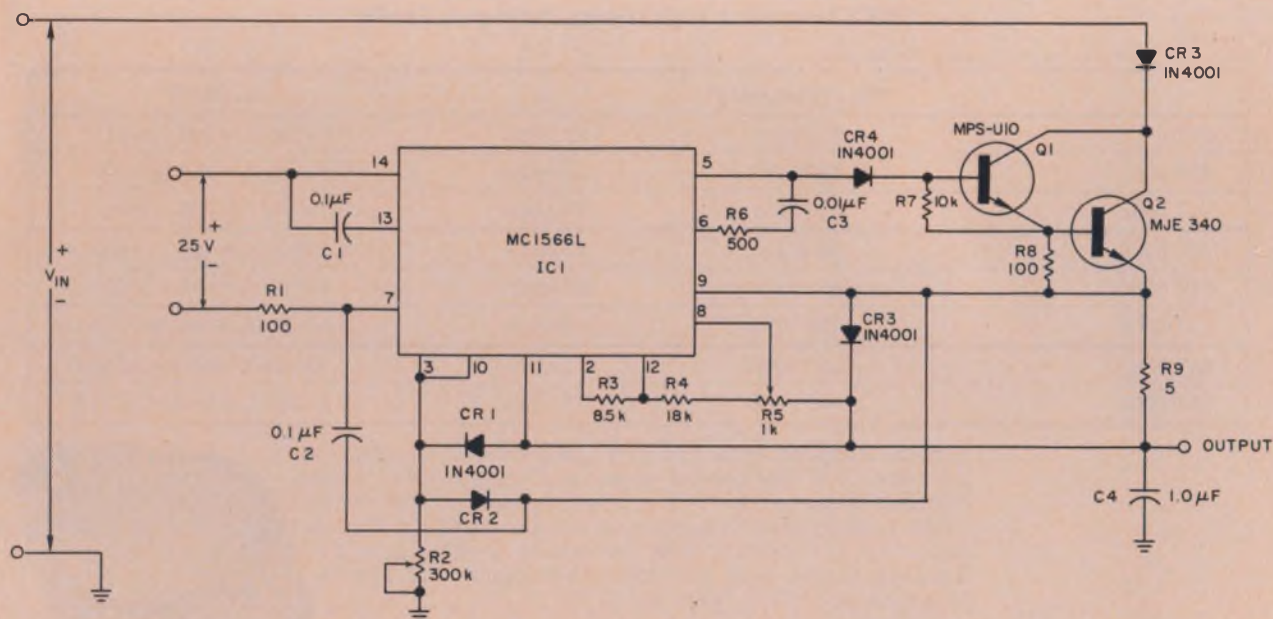

IC voltage regulator provides accurate constant currents because the voltage and current-control

functions are interchanged. The floating power source permits a voltage compliance of 300 V.

# First we souped-up super beta transistors. Then we closed the gate on FET leakage.

And as if that's not enough, we've come up with the lowest noise, lowest drift dual FET around, too.

These three are just part of the broad line of high performance dual monolithic FETs and transistors we've designed to solve more of your linear circuit problems.

Our AD815 super beta dual monolithic NPN transistor features 2000 beta at a breakdown voltage of 20V. It can reduce your input noise current by a factor of ten. Plus, you get a 0.5mV offset. Price: \$5.50 in 100's.

Our AD830 dual monolithic FET gives you an extremely low leakage current — less than 0.1pA. That's as low as they come. Price: \$11.10 in 100's.



**0.1pA  $I_g$**   
**AD830 FET**



**2000 $\beta$ @20V**  
**AD815 NPN**

And when it comes to super-low noise and drift, our AD840 dual monolithic FET has the lowest noise of any dual FET you can get anywhere: 9nV/ $\sqrt{\text{Hz}}$ . It delivers an adjusted drift of 1 $\mu\text{V}/^\circ\text{C}$ , too. Price: \$7.80 in 100's.

These designs are just right for upgrading existing circuits in low-current measurement instruments, preamplifiers, and applications involving high impedance sources. Or build them into brand new circuits; they'll make your design a lot better than anybody else's.

We've got samples and comprehensive data sheets. And our 1973 Product Guide. Just ask.

Analog Devices, Inc., Norwood, Mass. 02062.



**9nV/ $\sqrt{\text{Hz}}$**   
**1 $\mu\text{V}/^\circ\text{C}$**   
**AD840 FET**

 **ANALOG  
DEVICES**

## Call 617-329-4700

for everything you need to know about dual monolithic transistors and FETs.

INFORMATION RETRIEVAL NUMBER 49

# Volume compressor with 50-db range built around single op amp

Performance levels comparable to those of costly studio equipment can be achieved by using an op amp as the forward gain element of a volume compressor. The op amp provides forward gain without introducing excessive signal distortion. Also, the low signal levels at the op amp input permit wide gain variations with a minimum of nonlinear distortion.

A single inexpensive FET provides the gain control (Fig. 1). With no input signal, FET  $Q_1$  is pinched off by 12 V dc applied to its gate. No

agc action occurs until the output of the op amp reaches 2 V pk-pk. At this time, the forward base-emitter voltage of the Darlington pair is exceeded and the transistors conduct, thereby reducing the back-bias to  $Q_1$ . This decreases the dynamic resistance of  $Q_1$ , thus attenuating the input signal.

The high gain of the Darlington amplifier makes the 50-dB range (Fig. 2) possible. In addition the over-all circuit exhibits the fast-attack, slow-release type of agc action of a professional unit.

*Charles H. Ristad, Staff Engineer, System Products Div., IBM Corp., Endicott, N.Y. 13760.*

CHECK 313

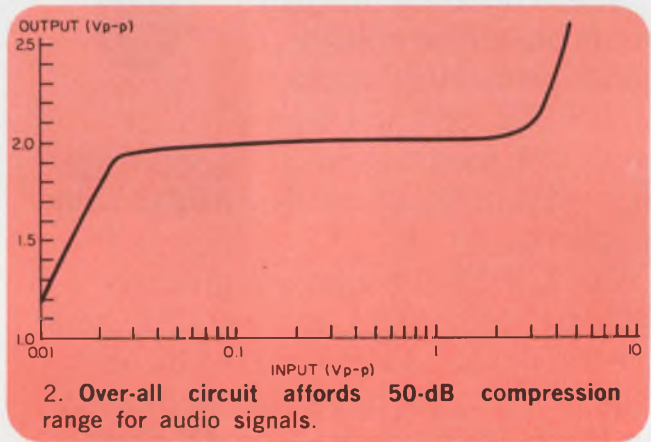
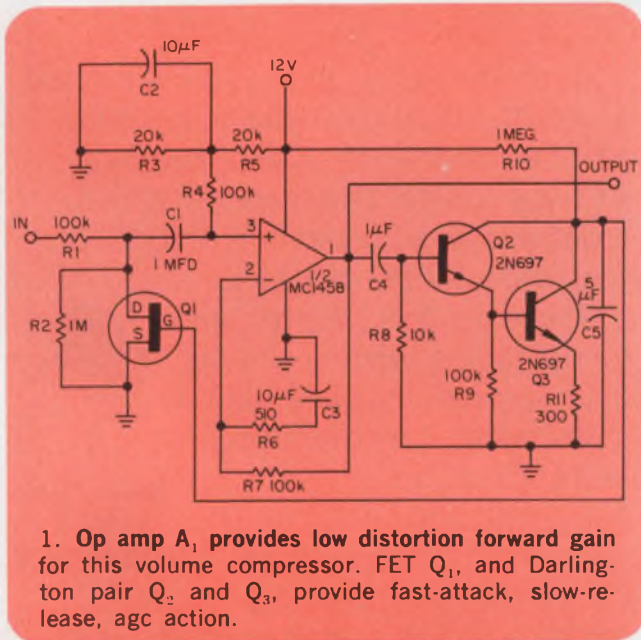

**IFD Winner of January 4, 1973**

Edward I. Levy, Dade Div., American Hospital Supply, P.O. Box 672, Miami, Fla. 33152. His idea "Retriggerable one-shot prevents false triggering of PLL tone detector" has been voted the Most Valuable of Issue Award.

Vote for the Best Idea in this issue by checking the number for your selection on the Information Retrieval Card at the back of this issue.

**SEND US YOUR IDEAS FOR DESIGN.** You may win a grand total of \$1050 (cash)! Here's how. Submit your IFD describing a new or important circuit or design technique, the clever use of a new component or test equipment, packaging tips, cost-saving ideas to our Ideas for Design editor. Ideas can only be considered for publication if they are submitted exclusively to ELECTRONIC DESIGN. You will receive \$20 for each published idea, \$30 more if it is voted best of issue by our readers. The best-of-issue winners become eligible for the Idea of the Year award of \$1000.

ELECTRONIC DESIGN cannot assume responsibility for circuits shown nor represent freedom from patent infringement.

**If Littelfuse doesn't  
have the circuit protection  
product you need,  
then chances are  
it hasn't been invented.**

**And we're working on that too.**



*John Borzoni, National Sales Manager, Industrial Electronics*

The fact is, Littelfuse has the most complete circuit protection line you'll find anywhere in the industry.

... over 8000 types of fuses, fuseholders, fuse clips, fuse blocks, and circuit breakers. Our expanding product line now includes switches and relays, too. Diversified prod-

ucts to satisfy diversified needs.

All of our standard items are readily available from any of the hundreds of authorized Littelfuse distributors throughout the country. Give them a call. They'll give you the facts. Or write Littelfuse for our "full-line" Catalog #18.

# **LITTELFUSE**

**Subsidiary of Tracor**

800 E. Northwest Highway • (312) 824-1188 • Des Plaines, Illinois 60016

INFORMATION RETRIEVAL NUMBER 50

It hasn't been a product you need  
then chances are  
it hasn't been invented.  
And we're working on that too.

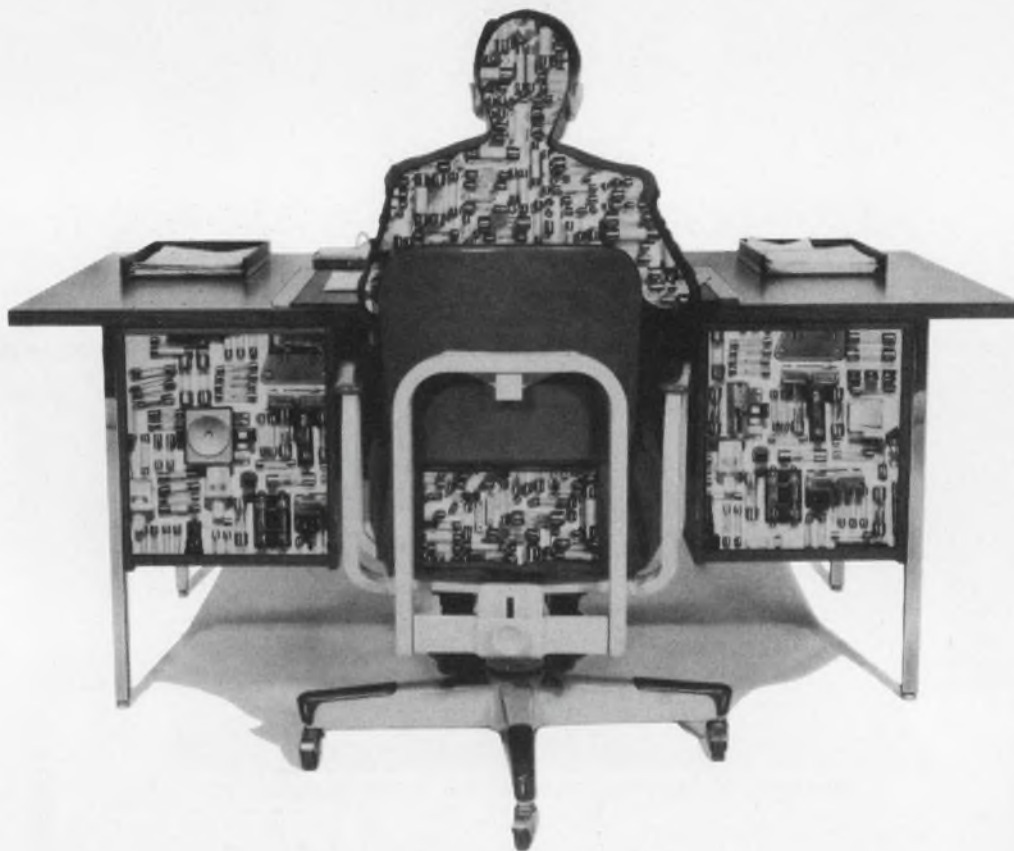

Let's face another fact. The only way to stay on top of an industry is to stay in front of it.

That's why our research and development engineers are constantly designing and testing new ideas in circuit protection, making Littelfuse "first" in design and

innovation.

So if yours is a special requirement, why not contact Littelfuse? We have a full staff of sales and research engineers who'd be happy to discuss it with you.

Just call (312) 824-1188 for more information.

# LITTELFUSE

Subsidiary of Tracor

800 E. Northwest Highway • (312) 824-1188 • Des Plaines, Illinois 60016

## new products

# A/d converter offers fastest throughput for 10-bit resolution, but it'll cost you



Computer Labs, 1109 S. Chapman St., Greensboro, N. C. 27403. (919) 292-6427. See text: 4-6 wks.

Computer Labs' 7000-series a/d converters afford conversion rates of 10 MHz—faster than any nine or 10-bit units on the market. The 10-bit versions—Models CLB 1010 or 7110—have three times the conversion rate of Preston's GMAD-series (3-1/3 MHz). Also, with a 10-MHz conversion rate in a nine-bit version, the 7000 series operates at twice the rate of Inter-Computer Electronics IAD-2209 (5 MHz)—but no faster than Preston's GMAD-01.

But the speed of the 7000 series doesn't come cheaply. The nine-bit, 10-MHz unit costs \$8000, compared with \$6800 for the Inter-Computer IAD-2209 and \$6340 for the Preston's GMAD-01. The gap widens for 10-bit units—with the cost rising to \$10,000 for Computer Labs vs \$6930 for Preston Scientific.

The new converters attain their conversion speed through a combination of a/d conversion techniques. A gray-code cascade converter furnishes the five most significant bits, and a parallel conversion circuit supplies the remaining four or five digits.

Any member of the 7000 series is available in one of two configurations—rack-mounted or stripped down ("bare bones"). Three dif-

ferent speed-bit combinations are offered: 10 bits by 10 MHz, 10 bits by 5 MHz and 9 bits by 10 MHz. The stripped-down versions lack the power supply, housing, controls and visual indicators provided with the rack-mounted versions. And they are smaller, since they consist of a basic card rack with eight circuit cards mounted inside.

All units convert analog signals to nine or 10-bit digital words in random (external command) fashion or periodically with an aperture time of less than 25 ps. Conversion accuracy depends on the number of bits, the nine-bit units offering 0.01%  $\pm 1/2$  LSB, while the 10-bit units offer 0.05%  $\pm 1/2$  LSB. The converters handle unipolar signals (zero to 2.048 V or zero to -2.048 V) and bipolar signals (-1.024 to +1.024 V), and they provide three choices of output codes: (1) Straight binary for unipolar signals, (2) Two's complement, or (3) Sign plus magnitude. An output register holds the digital output until a new binary number replaces it.

The initial delay between the leading edges (50% points) of the first Encode command pulse and the first Data Ready pulse is 250 ns  $\pm 30$  ns for the 5 MHz units and 200  $\pm 20$  ns for the 10 MHz units. Thereafter, encode com-

Bits/speed	"Bare bones"	Rack mounted
10 bits/10 MHz	CLB 1010 \$8700	Model 7110 \$10,000
10 bits/5 MHz	CLB 1005 \$6600	Model 7105 \$7600
9 bits/10 MHz	CLB 0910 \$7200	Model 7910 \$8000

mands are accepted at the stated 5 or 10 MHz rate and result in Data Ready signals of the same rate.

As a no-cost option, the user can specify an analog input impedance of 50, 75 or 93  $\Omega$  or 1 M $\Omega$ . Other input specifications include a temperature coefficient of 0.01%/°C (< 0.2 mV/°C), 30-MHz bandwidth, bias current of less than 0.1 nA and offset voltage adjustable to less than 0.5 mV.

The output data and encode command levels are TTL-compatible. Encoding occurs at the point where the external command signal (when used) crosses 1.5 V with a positive slope. Output data bits and the data-ready pulse operate with loads of 50  $\Omega$  or greater.

Pricing of the six combinations varies with configurations and speed (see table).

The user must provide forced air cooling (30 ft<sup>3</sup>/min) as well as 5% regulated voltages of  $\pm 15$  V, 5 V and -5.2 V with output currents up to 2.5 A for operation of the "bare bones" systems. These models also lack the LED display, switchable unipolar/bipolar operation and the built-in test words of the rack-mounted version.

For Computer Labs

CHECK NO. 250

For Inter-Computer Electronics

CHECK NO. 251

For Preston Scientific

CHECK NO. 252

## High-speed counter-timer carries a low price tag



Newport Laboratories, 630 E. Young St., Santa Ana, Calif. 92705. (714) 549-4914. \$695; 30 days.

The Model 700 counter-timer from Newport Laboratories continues the present trend in this instrument area toward increased performance at lower prices. In fact, the 100-MHz counting rate and \$695 price tag of the basic seven-digit version represent jumps in price and performance rather than the usual gradual changes.

Until now, universal-counter performance was typified by 50-MHz units, selling at roughly \$550 and up, and by 150-to-200-MHz units, selling for about \$1200 and up. There are 80-MHz units, too, but the higher-frequency Newport unit appears to cost less than these.

And the standard features in the seven-digit 700 make it even more attractive. For example, a proportional, oven-controlled time base, BCD outputs and remote programming of time base and function controls are all standard.

The temperature-controlled crystal oscillator has a temperature stability of one part in  $10^{-9}$  per degree C and an aging rate of one part in  $10^{-8}$  per day.

Besides frequency, the 700 measures period, period average, time interval, frequency ratio and total count. A stopwatch mode displays the elapsed time between succes-

sive operations of a start/stop pushbutton.

Readout is via a large Sperry planar display, with a LED indicating overflow. An IC ROM, replacing the usual multiwafer switches, allows automatic display of both decimal point and units.

Specifications of the Model 700 include: sensitivity of 100 mV rms, an input impedance of 1 M $\Omega$  shunted by 50 pF (50  $\Omega$  on the optional high-frequency channel), and a time interval display range of 0.1  $\mu$ s to  $10^8$  s.

Options include plug-ins that use direct-count prescaling for expanding the frequency range to either 500 MHz or 1 GHz. These options cost \$295 and \$595, respectively, making the 700 by far the least expensive 500-MHz or 1-GHz universal counter-timer available. Nine digits, plus a high-stability oscillator ( $3 \times 10^{-9}$ /day and  $1 \times 10^{-10}$ /°C tempco), are available as options.

The Model 700 belongs to a family of new low-cost counters. Other members of the family are the Model 720, a 50-MHz unit that measures frequency, period and ratio; the Model 730, a 50-MHz unit with frequency and stopwatch capability only; and the 710, a version of the 700 that offers frequency and stopwatch modes only. Both the 720 and 730 have LED six-digit displays.

CHECK NO. 253

# AMPERITE DELAYS RELAYS

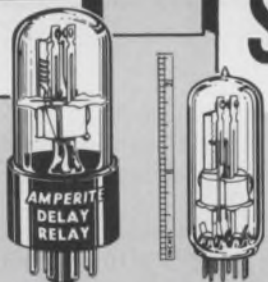

THERMOSTATIC DELAYS: 2 to 180 Sec. +

Actuated by a heater, they operate on A.C., D.C., or Pulsating Current... Being hermetically sealed, they are not affected by altitude, moisture, or climate changes... SPST only — normally open or normally closed... Compensated for ambient temperature changes from  $-55^{\circ}$  to  $+80^{\circ}$ C... Heaters consume approximately 2 W. and may be operated continuously. The units are rugged, explosion proof, long-lived, and inexpensive!

TYPES: Standard Radio Octal and 9-Pin Miniature. List Price, \$4.00

\*Miniatures Delays: 2 to 120 seconds.

All Amperite Delay Relays are recognized under component program of Underwriters' Laboratories, Inc. for all voltages up to and including 115V.

PROBLEM? Send for Bulletin No. TR-81

## AMPERITE BALLAST REGULATORS

Hermetically sealed, they are not affected by changes in altitude, ambient temperature ( $-50^{\circ}$  to  $+70^{\circ}$ C), or humidity... Rugged, light, compact, most inexpensive.

List Price, \$3.00

Write for 4-p. Bulletin No. AB-51

# AMPERITE

600 PALISADE AVE., UNION CITY, N.J. 07087

Telephone: 201 UNION 4-9503

In Canada: Atlas Radio Corp., Ltd.,  
50 Wingold Ave., Toronto 10



# More ways to go with DVM's & DMM's from DigiTec



All DigiTec instruments are available for rental or lease through Rental Electronics, Inc.

The DigiTec line of digital voltmeters offers a selection that will enable you to choose the perfect instrument for your needs. Each unit provides its own special features. You select the instrument that has the functions you require, and you'll pay for only the useful features you want.

For digital voltmeters with guarded inputs, isolated BCD outputs, LED displays and basic accuracy of .02%, you can

select from:

**the model 266**, 4 range DVM at \$525.

**the model 267**, 4 range auto-ranging DVM at \$625.

**the model 268**, 6 range DVM with  $1\mu\text{V}$  resolution at \$795.

**the model 269**, 23 range DMM at \$695.

Portability is available with either:  
**the model 261C**, a 10 range VOM at \$289.

**the model 262C**, a 25 range DMM at \$345.

Both offer .05% basic accuracy, LED displays and integral batteries as standard equipment.

All DigiTec instrumentation is backed by a one year warranty and a network of Field Service Centers in the U.S. and Canada. Contact your nearest DigiTec representative or call, United Systems Corp.

**United Systems Corporation**  
918 Woodley Road, Dayton, Ohio 45403  
Ph. (513) 254-6251 Twx: (810) 459-1728  
a subsidiary of

**Monsanto**

**DigiTec**

# The Elegant Capacitors



For elegant applications. Zero temperature coefficient  $\pm 10$  ppm/°C ( $-55$ °C to  $+85$ °C) with .01% accuracy—now 25% smaller in size.

Precise specs from precise craftsmanship. That's what you'll find in all capacitors by EAI. Polystyrene. "Mylar." Polycarbonate. Polysulfone. Polypropylene. Plain and metalized films. Hermetically sealed. RC networks, also. Matching tolerances from 5% to 0.005%.

Plus a growing list of other elegantly crafted etceteras—and fast, fast delivery.



Electronic Associates, Inc.  
185 Monmouth Parkway  
West Long Branch, New Jersey 07764  
Tel. (201) 229-1100

INFORMATION RETRIEVAL NUMBER 54

## INSTRUMENTATION

### Frequency synthesizer outputs 80 MHz

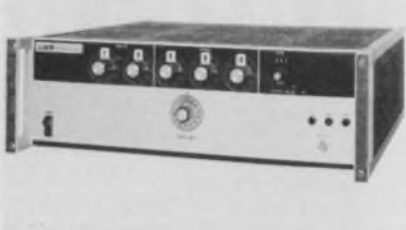

PRD Electronics, 1200 Prospect Ave., Westbury, N.Y. 11590. (516) 334-7810. \$2676; stock.

The 7828 programmable frequency synthesizer covers the range of 1 kHz to 80 MHz in 1-kHz steps. An optional vernier provides resolution of 1 Hz. Stability when locked to the internal frequency standard is 1 part in  $10^6$  per month. An optional 5 parts in  $10^9$  per day frequency standard is available. Remote programming is accomplished with a computer-compatible binary code. Other specs include phase noise of  $-60$  dB in a 10-Hz bw and at 50 Hz from carrier, and typical spurious outputs of  $-70$  dB.

CHECK NO. 254

### Analog filter system is programmable



Rockland Systems, 230 W. Nyack Rd., West Nyack, N.Y. 10994. (914) 623-6666. \$750 basic unit, plus \$650 per card; June.

System 816 programmable analog filter provides up to 16 filter channels, each mounted on a plug in a PC board. Cutoff frequencies from 10 Hz to 150 kHz with 48 dB/oct rolloff may be programmed remotely or locally by front-panel switches. The standard Butterworth low-pass of individual filters may be altered to high-pass, band-pass or band reject. Stability of cutoff frequency is  $\pm 200$  ppm/°C and the noise level is more than 80-dB down.

CHECK NO. 255

### 4-1/2-digit DMM costs \$695



Cimron Instruments, Div. of Lear Siegler, 714 N. Brookhurst St., Anaheim, Calif. 92803. (714) 774-1010. \$695; 30 days.

The DMM-40 is a four-digit multimeter with 140 percent over-range. The unit autoranges over all 20 ranges of its five functions (including ac and dc current), uses MOS/LSI circuitry and weighs only 8 pounds. Options include internal battery and BCD output.

CHECK NO. 256

### Scopes display product of two input signals

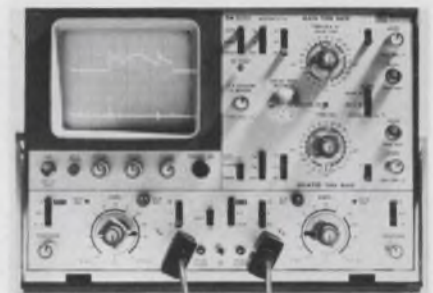

Test & Measuring Instruments, 224 Duffy Ave., Hicksville, N.Y. 11802. (516) 433-8800. PM3252: \$1995.

The ability to display the product of two input signals simultaneously with one of the original signals at a bandwidth of 25 MHz is the key feature of two new scopes. The instruments, designated PM3252 and PM3253, can also operate as sensitive (2 mV/div), wideband (50 MHz), dual-trace scopes. They can display either or both of the two input signals in a wide variety of combinations in addition to  $A \times B$ , including: A only,  $\pm B$  only, A and  $\pm B$  chopped or alternate,  $(A - B)$  only,  $(A - B)$  and  $\pm B$  chopped or alternate,  $A \times B$  and  $\pm B$  chopped or alternate, and X, Y. PM3253 displays all of these combinations and also has a variable-persistence storage CRT.

CHECK NO. 257

## 220-MHz freq counter stores prior count



United Systems Corp., 918 Woodley Rd., Dayton, Ohio 45403. (513) 254-6251. \$795; stock to 2 wks.

Model 151A, crystal-controlled frequency counter, measures from 5 Hz to 220 MHz and provides display storage—a memory circuit that will hold the prior count while a new one is being made. The unit's seven-digit, LED display, with built-in self-check, boasts a half-life reliability of 100 years. The miniature unit measures 4-1/2 × 2 × 8-1/2 in. and weighs 3.5 lb. An optional 10-hour NiCad battery pack, with charger and carrying case, is priced at \$200.

CHECK NO. 258

## Single-channel recorder is light and portable

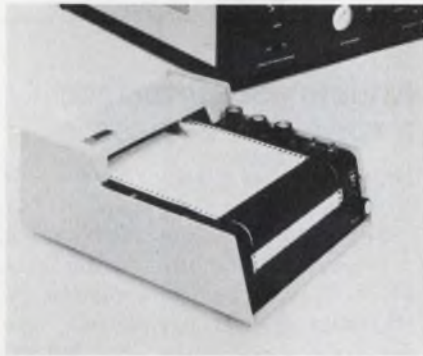

Varian, 611 Hansen Way, Palo Alto, Calif. 94303. (415) 493-4000. \$595; 2 wk.

The A-5 strip chart recorder occupies less than 1 ft<sup>2</sup> and weighs less than 7 lb. Chart speeds are 0.5, 1, 2, 5, 10 and 20 cm/min or cm/hr. Full-scale ranges are 1, 10, 100 mV and 1 V. Pen response time is 0.35 s, and accuracy is better than 0.5% of full scale. The A-5's zero is adjustable over the entire scale, and the unit operates from 115 V ac/60 Hz or 220 V ac/50 Hz. Input is single-ended and floating, input resistance is greater than 10 MΩ. The circuit is critically damped on all ranges.

CHECK NO. 259

# ...YOU'LL LIKE IT! TRUE RMS VOLTMETER RESOLVES 0.01 dB

PROGRAMMABLE ■ SENSITIVE ■ WIDE BANDWIDTH

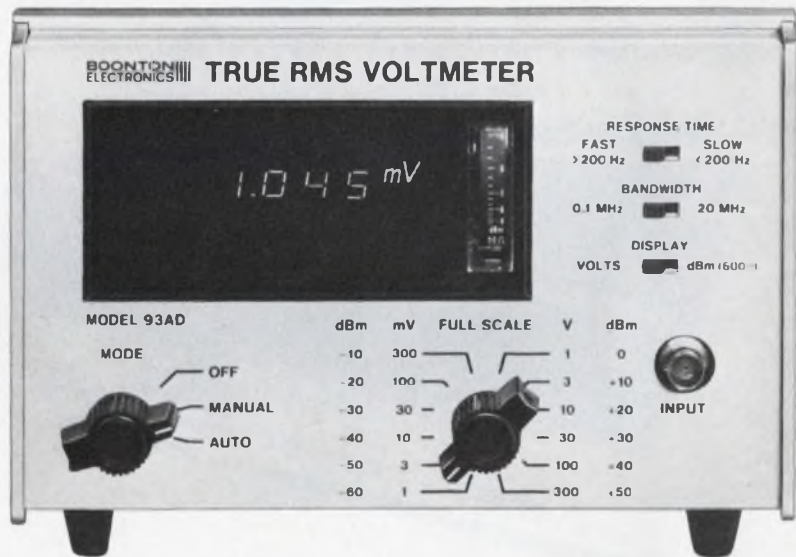

These important features, usually extra-cost or unavailable, are standard with the 3½ digit 93AD at its \$1200 base price:

- 300 μV sensitivity usable over the full 20 MHz bandwidth.
- Full remote control.
- Digital and analog outputs.
- Auxiliary analog meter.
- Selectable bandwidth and response time.

Several options and accessories are available for special requirements:

- Digital dB display and outputs.
- Automatic ranging.
- High impedance probe.

## BOONTON ELECTRONICS

ROUTE 287 AT SMITH RD.  
PARSIPPANY, N.J. 07054  
TEL.: 201-887-5110  
TWX: 710-986-8241

## 16-bit minicomputer costs under \$1000



Computer Automation, Inc., 18651 Von Karman, Irvine, Calif. 92664. (714) 833-8830. \$990 (200 units); see text.

Selling for under \$1000 in 200 quantities and contained on a single 15 × 16-in. printed-circuit board the new Naked Mini/LSI from Computer Automation ranks as the most powerful minicomputer in its price range.

Like the company's earlier Naked Mini 16, the computer includes everything but a control panel and power supplies. But its price is about half that of the Naked Mini 16, which, with 4-k of core memory, sells for \$1995 at the same quantity level. As with the older computer the Naked Mini/LSI also includes 4-k of core memory. And all other specs save one are comparable. The difference is that the new computer includes direct memory access as a standard feature. For the old computer it is a \$400 option.

The new Naked Mini has a dual bus structure—with one bus for

memory and the other for input/output (I/O). The instruction set is microprogrammed. A unique feature of the machine's architecture is that the microcode is stored in a programmed logic array rather than in read-only memory.

Memory capacity of anywhere from 1-k to 256-k 16-bit words is offered with the same cpu. 4-k is the standard size. Memory cycle time is 1.6  $\mu$ s.

An instruction set of 162 basic instructions plus optional variations makes this one of the more powerful 16-bit minicomputers around.

Up to 248 I/O devices are directly addressable in three different modes. In the direct-memory-access mode, the maximum data rate is 625-k words/s, or 1.25-M words/s with interleaved memories. In the block I/O mode, the data rate is 131,579 words/s. In the programmed I/O mode, the data rate is 34,247 words/s.

Five levels of priority interrupt are available. At least 256 inter-

rupts can be provided.

Power-supply requirements for the computer are 5 V dc at 4 A, +12 V dc at 0.75 A and -12 V dc at 4.4 A.

If the power supplies, a control panel and a case are desired, a complete boxed version, the Alpha/LSI, is available at a unit price of \$1990 in quantities of 200.

All types of memory can be used interchangeably in the computer. Therefore, either core or semiconductor memory is available regardless of the memory type already on the machine.

The computer will be available in small quantities during November and December. Volume production commences in January of 1974.

CHECK NO. 260

## Kit lets user interface a variety of devices

Digital Equipment Corp., 146 Main St., Maynard, Mass. 01754. (617) 897-5111. From \$695; stock.

Three modular interfacing kits, 11-H, F and K permit custom interfacing of user peripherals, production-control units and laboratory instruments to a PDP-11 computer. Each kit features a prewired backplane unit that accommodates from six to 18 logic modules. The user selects the necessary modules and wires the proper mating connector to a standard 40-conductor cable. The H package is capable of reading four 16-bit words from a device into the host computer and forwarding four computer-generated 16-bit words (or eight bytes) to the device. The other units have lesser capabilities. The F unit reads three and writes one word while the K unit only reads eight words. The latter unit costs \$695; the H-unit price starts at \$1165.

CHECK NO. 261

# Complete RF Network Analysis with 0.01-dB FLATNESS

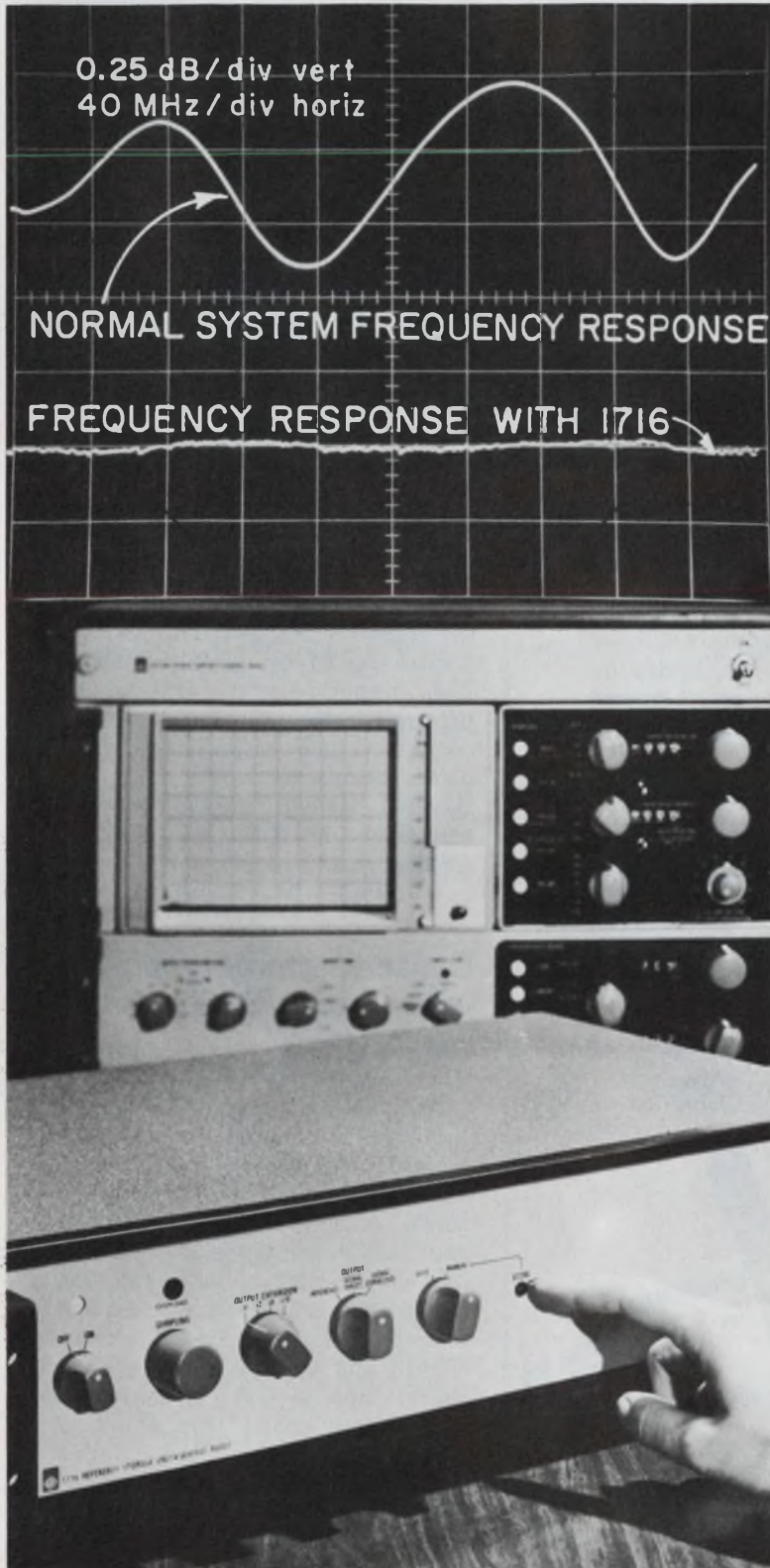

**IS** 0.01-dB flatness to from 400 kHz to 500 MHz called for?

**IS** magnitude resolution to 0.0025 dB required?

**IS** phase flatness to  $0.06^\circ$  necessary?

**IS** a means of rapid rf comparisons needed?

**IS** all this desirable — at the push of a button?

If so, it's all possible with a new instrument from General Radio — the 1716 Reference Storage Unit.

This unique instrument reduces frequency-response errors in the 1710 RF Network Analyzer by an order of magnitude, permits automatic error updating in microbellling applications, provides a rapid means of rf comparisons, and allows digital data logging of a wide variety of analog measurements. Not bad for a \$1600 investment!

The 1716 accepts the magnitude, phase, or group-delay information from the 1710, converts it to digital data, and stores the data in memory. The stored data can then be displayed directly or subtracted from a second signal and displayed as a difference. The 1716 thus provides the conversion abilities of an A/D converter and the memory and arithmetic abilities of a simple computer — with all their benefits but at a fraction of their cost.

**IS** this what you've been looking for?



**General Radio**

NEW YORK (N.Y.) 212 964-2722, (N.J.) 201 791-8990  
BOSTON 617 646-0550 • DAYTON 513 294-1500  
CHICAGO 312 992-0800 • WASHINGTON, D. C. 301 948-7071 • ATLANTA 404 457-2485  
DALLAS 214 234-3357 • LOS ANGELES 714 540-9830 • SAN FRANCISCO 415 948-8233  
TORONTO 416 252-3395 • ZURICH (01) 55 24 20

GR COMPANIES • Grason-Stadler • Time/Data • Techware Computing Corp.  
GR ASSOCIATE • Micronetic Systems Inc.

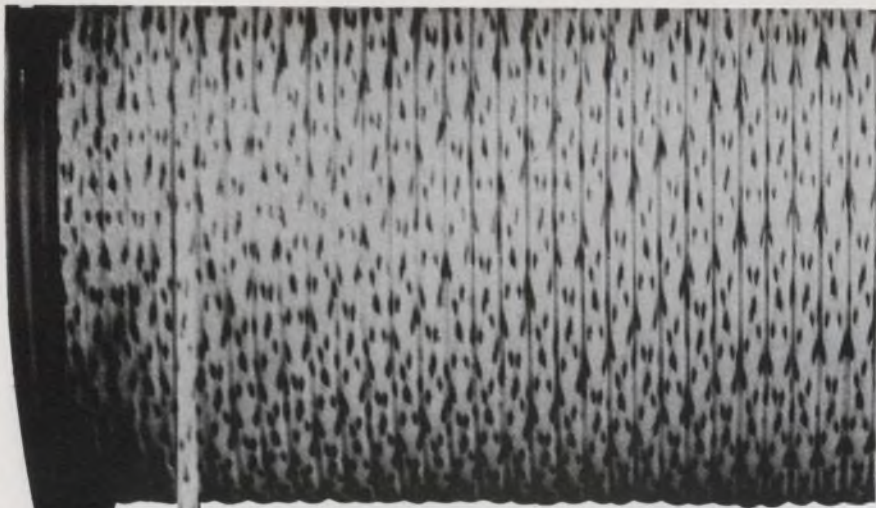

## Gudebrod's New Special Purpose Nomex\* Lacing Tapes

**H**olding a bundle of wires together sounds simple enough, but when the ties must withstand vibration, hydraulic fluid effects, even be flame resistant and still not weigh much or get in the way . . . that's something else again.

Gudebrod has developed a new series of braided Nomex\* lacing tapes that meet all these requirements and then some! These new tapes offer just the right elongation characteristics for excellent tie making. They make firm "no-slip" knots, are lightweight, non-fraying and non-flaking. If you're a "weight watcher" or work under air age restrictions, our new special series Nomex\* tapes are designed just for you.

Gudebrod manufacturers over one hundred other styles of lacing tapes and harness, room systems and accessories. . . . Ask a Gudebrod salesman about them!

Write for your Free copy of our new NOMEX\* SPECIFICATION folder. It's part of a continuing Gudebrod Fact Folder Program designed to keep you informed.

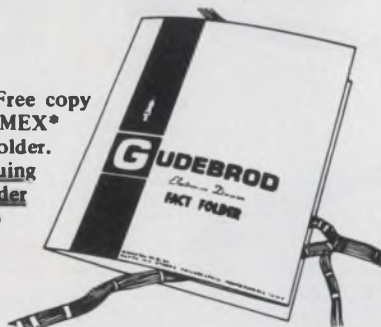

\*DuPont Registered Trademark



Gudebrod Bros. Silk Company, Inc.

Electronics Division

Dept ED2, 12 South 12th Street, Philadelphia, Pa

INFORMATION RETRIEVAL NUMBER 57

## DATA PROCESSING

### Signal monitor stores selected samples



Quantalog, Inc., Box 1523, Ann Arbor, Mich. 48106. (313) 769-4936. \$2250; stock.

The 1720 Quantalatch transforms an electrical signal into digital information and then stores it in eight-bit digital form so that it can be reproduced at will. The signal is sampled at a preselected rate, and held in a memory of 1000 sample points. New information is stored continually, while old information at the end of the memory is lost. Any signal irregularity can be arranged to start the latch process. Once the latch process starts, signal registration continues for 760 memory points. Data output from the unit can be provided in digital form (ASCII coding) to allow tape punching or direct computer input. A reconstructed analog signal is also available for X-Y recorders or oscilloscopes.

CHECK NO. 262

### Cassette memory works with phone line or mini

Dicom Industries, 715 N. Pastoria Ave., Sunnyvale, Calif. 94086. (408) 732-1060. \$3300; 60 days.

Model 345 cassette magnetic tape peripheral offers on-line and off-line operation. In the on-line mode, the unit interfaces with all major minicomputers to provide tape storage. As an off-line device, it affords serial modem-to-modem communications at transfer rates of 110 and 300 baud (10 and 30 chars). Special logic permits off-line remote control via standard ASCII control characters. On-line use is supported by a library of operating system software and "off-the-shelf" interfaces.

CHECK NO. 263

# WORLD FAMOUS SIMPSON 260

OVER

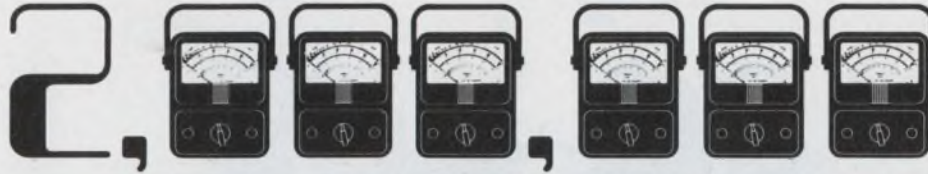

SOLD

*The pace-setting VOM for over 30 years*

The finest

# 260<sup>®</sup>

SERIES 6

NOW... with  
special Amp-Clamp dial ranges  
for easy AC current  
measurements up to 250 amps.



**New Amp-Clamp, Model 150 Adaptor.**  
Measures AC current without breaking  
the circuit being tested. Plugs into the  
260—reads directly on the new Amp-  
Clamp scales. Use with any 250, 260  
(Series 3 thru 6) or 270.

Ranges: 0-5, 25, 50, 100, 250 amperes.



**260-6**, Complete with batteries, test leads and  
manual . . . . . \$70.00

**260-6P** (overload protected), complete with bat-  
teries, test leads and manual . . . . . \$102.00

**260 CARRYING CASES:**

Vinyl, DeLuxe #00805 . . . . . \$17.50

Vinyl, standard #01818 . . . . . \$14.50

**AMP-CLAMP**, Model 150 Adaptor with test  
lead . . . . . \$25.00

*Many other 260 models and accessories to choose from.*

GET "OFF THE SHELF" DELIVERY FROM YOUR LOCAL ELECTRONIC DISTRIBUTOR . . . AND WRITE TODAY FOR CATALOG 4100A.

KATY INDUSTRIES

## SIMPSON ELECTRIC COMPANY

5200 W. Kinzie St., Chicago, Ill. 60644

(312) 379-1121 • Cable: SIMELCO • Telex: 02-53343 Chi.

IN CANADA: BACH-SIMPSON, Ltd., London, Ontario

IN ENGLAND: Bach-Simpson (U.K.) Ltd., Wadebridge, Cornwall, Eng.

IN INDIA: Ruttonsha-Simpson Private Ltd., International House, Bombay-Agra Road, Vikhroli, Bombay



INFORMATION RETRIEVAL NUMBER 58

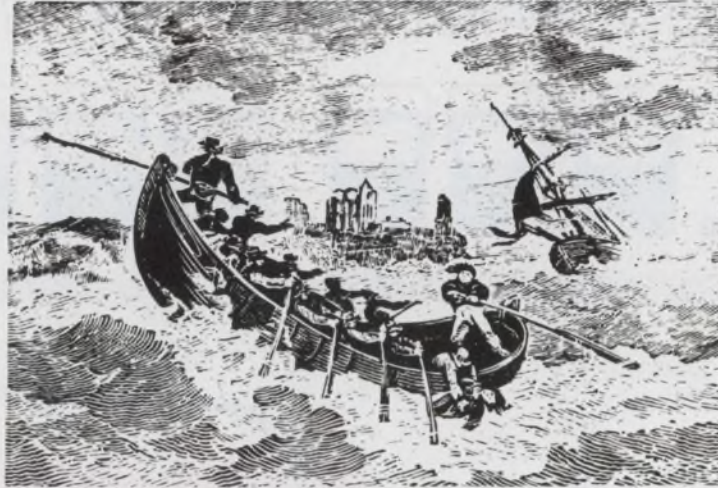

## Sometimes getting from A to D can be a struggle.

At such times it makes sense to invite in the most experienced engineers in the data conversion industry — ours — backed by the most complete line of conversion equipment in the world — also ours.

We get involved in customers' product designs all the

time — from pH meters to data acquisition systems — and the usual result is a product that goes to market sooner, with higher performance and a lower price than originally planned. In short, we help our customers compete.

It's easy to get acquainted, by sending for our free A-D/D-A Design Reference Guide and our complete catalog. Then let's talk.

**Analogic Corporation, Wakefield, Massachusetts 01880, (617) 246-0300.**

*Northeast, 617-235-2330, 203-966-2580, 315-446-0220, 201-652-7055, 212-947-0379  
Mid Atlantic, 215-272-1444, 703-534-7800  
Midwest, 412-892-2953, 216-267-0445, 513-434-7500, 313-892-2500, 913-362-0919, 314-895-4100, 312-283-0713, 414-476-1500  
South, 713-785-0581, 214-620-1551, 305-894-4401, 919-227-3639, 205-534-9771, 305-773-3411, 813-867-7820  
West, 303-744-3301, 505-523-0601, 602-946-4215, 505-296-8303, 714-540-7160, 408-374-5220, 206-762-7664, 503-646-6064  
Canada, 613-836-4411, 604-688-2619, 416-444-9111, 514-861-1375*

**ANALOGIC** ■





## For instance: Very high speed A-D converters

	Resolution	Conversion Time	Linearity	T.C.
MP2110	10 bits	5 $\mu$ sec	$\pm 0.05\%$	10 ppm/ $^{\circ}$ C
MP2112	12 bits	7 $\mu$ sec	$\pm 0.012\%$	7 ppm/ $^{\circ}$ C
MP2908	8 bits	2 $\mu$ sec	$\pm 0.1\%$	15 ppm/ $^{\circ}$ C
MP2910	10 bits	2.5 $\mu$ sec	$\pm 0.05\%$	10 ppm/ $^{\circ}$ C
MP2912	12 bits	4 $\mu$ sec	$\pm 0.012\%$	7 ppm/ $^{\circ}$ C

This is just a small sample of what you'll find in our complete catalog of over 80 conversion products. When you're going from A to D, have the catalog open. Then call us for technical support—we like to get involved: (617) 246-0300. Analogic Corporation, Wakefield, Mass. 01880.

**ANALOGIC** ■

## DATA PROCESSING

### Mini lets user program his instruction set

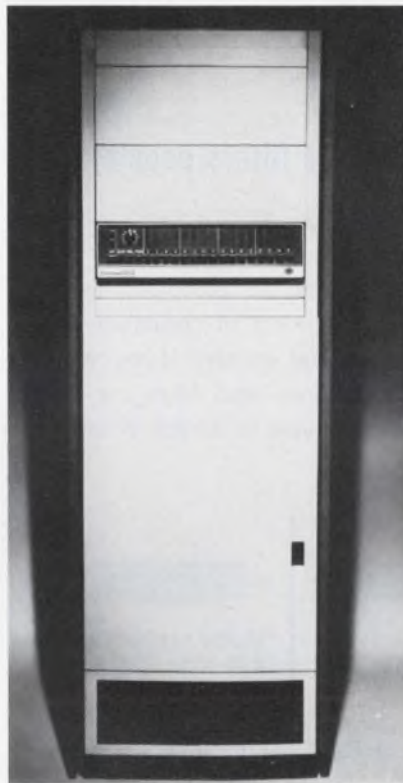

*Interdata, 2 Crescent Pl., Oceanport, N.J. 07757. (201) 229-4010. \$22,800; June.*

Now the user can tailor a mini-computer to his own needs. The Interdata Model 85 minicomputer comes with a writable control store through which the user defines his own set of tailored (microprogrammed) instructions in addition to the standard instructions. The 16-bit computer, identical to Model 80, provides a 270-ns main memory cycle with a memory capacity of 16-k bytes expandable to 64-k bytes. The dynamic store contains space for 1024-by-32 bit microinstructions for creating customized machine language. Microprogrammed routines are said to run typically three to 10 times faster than user-level software performing the same function. The manufacturer provides an assembler to simplify entry of microinstructions. Since the control store (a bipolar RAM) is writable, customized instructions can be changed with the same ease as ordinary computer software.

CHECK NO. 264

### Logic analyzer handles up to 1000 pins



*Membrain, 19 Cummings Park, Woburn, Mass. 01801. (617) 935-7960. From \$25,000; 12-16 wks.*

Model MB 1001 Logic Function Analyzer is a software controlled GO/NO GO and diagnostic test system. It is capable of testing PC boards and logic assemblies with up to 1000 pins. Pin accessing can be expanded from 10 to 1000 by addition of 10 pin modules. All interfaces can serve as inputs or outputs. Pins are monitored in parallel for logic levels in time slots as small as 10 ns. A parallel solid-state lamp display provides a visual check on pin status during all tests. Optional equipment includes dc and dynamic voltage level measurement modules, on-line CRT and auxiliary storage.

CHECK NO. 265

### Plug-in memory provides up to 28-k words

*Signal Galaxies, 6955 Hayvenhurst Ave., Van Nuys, Calif. 91406. (213) 988-1570. From \$2200; 30 days.*

According to the manufacturer, users can save 50% on plug-compatible add-on memory for the PDP-11 series computers. The self-powered semiconductor memory unit is contained in its own enclosure, cables into the main bus and is both hardware and software compatible. Memory cycle time varies from 650 to 750 ns depending on the mode of operation. The basic 4-k system costs \$2200 and is expandable in 4-k increments to 28-k (\$7300). The manufacturer also provides a one-year warranty.

CHECK NO. 266

# So you're looking for bandpass filters...

## better check Vernitron... (the ceramic filters people)

Miniature, lightweight, stable, fixed-tuned—that's ceramic filters for you. And Vernitron, innovator in piezoelectric technology, has varieties for almost any kind of communications equipment—consumer, commercial, military. If you're looking for size-reduction, cost-reduction—and high performance where it counts—it will pay you to check with Vernitron. A few examples:



**FM-4**  
10.7 MHz monolithic miniature for quality FM's. Only 0.016 cu. in.—replaces four tuned circuits 20 times its size. Bandwidth: 235 kHz @ 3 dB; 825 kHz @ 40 dB. Less than 1/2% distortion. The filter for the best in home entertainment, auto, or commercial FM's. **Data sheet 94033.**

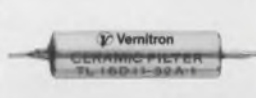

**11-DISC LADDER FILTER**  
Rugged little 455 kHz lump-filter for MIL or commercial. Rejection above 60 dB in less than 0.1 cu. in. Six standard models, 6 to 40 kHz @ 6 dB. Great for handhelds, mobile or airborne. **Data sheet 94029.**



**17-DISC LADDER FILTER**  
455 kHz. Ultimate in selective, stability and ruggedness for MIL-quality AM's or FM's. Ten standard models, shape factors 2.5:1 to 1.4:1. Rejection to above 80 dB. Highest shock and vibration resistance. **Data Sheet 94017.**



**TCF SERIES**  
Low-cost 455 kHz filter with fixed-tuned LC input, for 2-way, landmobile, aircraft, navigation or CB. Choice of standard bandwidths—6, 12, 18, 30 and 35 kHz. Highest selectivity at lowest cost. **Data sheet 94026.**



**LOW FREQUENCY (LF) SERIES**  
9 to 50 kHz. High-performance miniature for LF communications or Omega systems, selective calling, U/W sound, or command-destruct. Rejection to 40 dB. Can be cascaded for higher rejections. Cascaded assemblies available; also shock/vibration units to MIL specs. **Data Sheet 94030.**



**TRANSFILTERS®**  
Low-cost replacements for inductive or capacitive elements in IF stages or discriminators. TF's contain single resonator, 2 terminals; TO's are complete filters with 3 terminals. Excellent interstage couplers for transistor circuitry. **Data Sheets 94018-20.**

**NEED DESIGN HELP?** Computer-design facilities give us an edge in designing specials for special needs. If it's bandpass filters you're looking for, get in touch.



**Vernitron Piezoelectric Division**  
232 Forbes Road / Bedford, Ohio 44146 / (216) 232-8600

INFORMATION RETRIEVAL NUMBER 61

## DATA PROCESSING

### Receiver operation is computer controlled

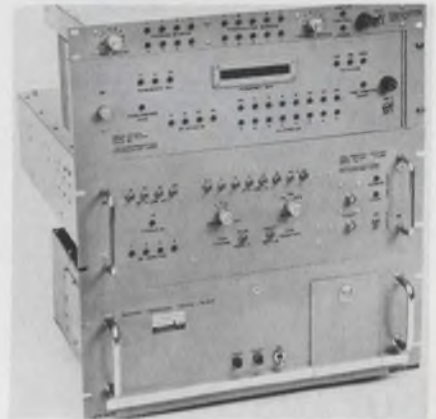

Lorch Electronics Corp., 105 Cedar Lane, Englewood, N. J. 07631. (201) 569-8282. \$28,000; 180 days.

Model HR-240NS, a computer-controlled surveillance receiver, tunes from 2 to 32 MHz in 1-Hz steps. All receiver functions can be controlled locally by panel switches or remotely with standard TTL levels. Parameters that can be varied include i-f gain (+20 dB to 115 dB in 0.5 dB steps), i-f bandwidth (2, 4 or 19 kHz) and age time constant (50 ms or 200 ms). Also selectable are type of detection (AM, FM or product) and antenna input. The receiver has a noise figure of 8 dB, corresponding to a sensitivity of -133 dBm in a 2 kHz bandwidth.

CHECK NO. 267

### Interface provides instrument control

Digital Equipment Corp., 146 Main St., Maynard, Mass. 01754. (617) 897-5111. \$150, \$125; stock.

Two logic modules permit easy interfacing of remotely programmable instruments with the PDP-11 family of minicomputers. The M1623 unit receives 8-bit bytes or 16-bit words from the computer for transfer to the instrument. A one-shot pulse generator strobes the data into the external equipment. A second module, the M1621, transfers data and status information from DVMS and similar devices under interrupt and/or programmed I/O control. The device can accept 34 bits of TTL-level information.

CHECK NO. 268

# Raytheon Semiconductor is dominant in beam leads.

## No gimmicks. Just products.

Raytheon Semiconductor's beam lead product line gives designers a choice like they've never had before. More than a hundred standard types in both military and commercial versions.

Now you can appreciate the quality, reliability, high yield and related economy of Raytheon Semiconductor beam leads. And do away with costly, low yield chip-and-wire on your hybrid modules.

We're adding to this list every week.

### Transistors

BT918	NPN UHF Amp
BT929	NPN Low-level Amp
BT930	NPN Low-level Amp
BT2221A	NPN General Purpose Amp
BT2222A	NPN General Purpose Amp
BT2369A	NPN Hi-speed Switch
BT2483	NPN Low-level Amp
BT2484	NPN Low-level Amp
BT2604	PNP Low-level Amp
BT2605	PNP Low-level Amp
BT2906A	PNP General Purpose Amp
BT2907A	PNP General Purpose Amp
BT2946	PNP Chopper
BT3906	PNP Hi-gain Amp
BT4856	N-channel FET*
BT4857	N-channel FET*
BT4858	N-channel FET*
BT5109	NPN UHF Power Amp

\* Available in second half of 1973.

### Diodes

BD914	2 Anode, 2 Cathode Leads
B2D914	1 Anode & Cathode, 2 Open Leads
BD3600	2 Anode, 2 Cathode Leads
B2D3600	1 Anode & Cathode, 2 Open Leads
BZ752	5.6V Zener
BZ758	10V Zener

BZ821T	6.2V Temp Comp Zener
BZ969	22V Zener

### Linears

RM101ABL	Op Amp
RM104BL	Negative Voltage Regulator
RM105BL	Positive Voltage Regulator
RM106BL	Voltage Comparator
RM709BL	Hi-gain Op Amp
RM710BL	Hi-speed Differential Voltage Comparator
RM711BL	Dual Differential Voltage Comparator
RM741BL	Op Amp
RM1741BL	Op Amp
RF9601BL	Monostable Multivibrator
RF8601BL	Monostable Multivibrator
RC4131BL	Hi-gain Op Amp
RM4132BL	Micropower Op Amp

### TTL

RF50BL	J-K Flip-flop (AND Inputs)
RF60BL	J-K Flip-flop (NOR Inputs)
RF100BL	Dual J-K Flip-flop (Separate Clocks)
RF110BL	Dual J-K Flip-flop (Common Clock)
RF200BL	J-K Flip-flop (AND Inputs)
RF210BL	J-K Flip-flop (OR Inputs)
RG40BL	Dual 4-input NAND Gate
RG50BL	AND-OR Inverter Quad 2-input Gate
RG80BL	Dual Pulse Shaper AND Gate
RG130BL	Dual 4-input Line Driver
RG140BL	Quad 2-input NAND Gate
RG200BL	Expandable Single 8 NAND Gate
RG220BL	Quad 2-input NAND Gate
RG231BL	Quad 2-input A01 Gate
RG240BL	Dual 4-input NAND Gate
RG250BL	Expandable Quad 2 A01 Gate
RG310BL	Expandable Dual Output 2-input A01 Gate
RG320BL	Triple 3-input NAND Gate
RG380BL	Hex Inverter
RL10BL	Fast Full Adder

RL20BL	Dependent Carry Fast Adder
RL30BL	Independent Carry Fast Adder
RL60BL	4-bit Storage Register
RL70BL	4-bit Storage Register
RG3380BL	Hex Inverter
RG3390BL	Dual 4-input AND Gate (Split Outputs)
RG3410BL	Quad 2-input NOR Gate
RR5102BL	64-bit Bipolar RAM

### Arrays

Universal 60-gate Arrays. Many MSI functions from registers to counters, both custom and standard functions.

Don't compromise your next design. Be dominant with Raytheon Semiconductor beam lead products. Contact your local Raytheon Semiconductor sales office or clip the coupon for more information.

**RAYTHEON**

Raytheon Semiconductor  
350 Ellis Street  
Mountain View, CA 94040  
Phone (415) 968-9211

Send me a copy of your Beam Lead brochure.

Send me a mechanical sample.

NAME \_\_\_\_\_

TITLE \_\_\_\_\_

COMPANY \_\_\_\_\_

ADDRESS \_\_\_\_\_

CITY/STATE/ZIP \_\_\_\_\_

ED

## Field alterable ROM works with popular minis

*Integrated Memories, Inc., 260 Fordham Road, Wilmington, Mass. 01887. (617) 658-5073. See text, 4-6 wks.*

Packaged on a single PC board, this 256-by-16 bit field-alterable ROM can be reprogrammed at the single-bit level. With this capaci-

tive type unit, the alteration is almost as simple as a pencil erasure. Any discrete bit in storage can be reprogrammed repeatedly, even while the system is operating. Larger capacity systems to 16-k bits can be accommodated on the same PC board. Model 1002G is pin-to-pin compatible with the DEC PDP-11 computer. Other models are available for most popular minis. Cost of the 16,000-bit memory is about 2¢ per bit.

CHECK NO. 269

## Solid-state programmers offer 16.5-hr. time span

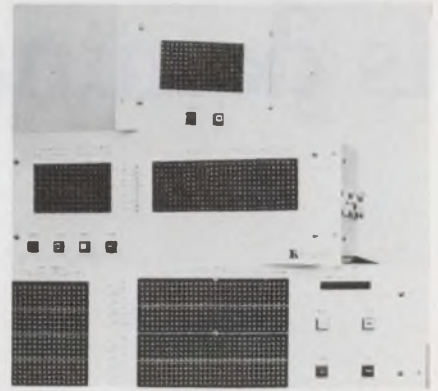

*Hugle Industries, Inc., 625 N. Pactoria Ave., Sunnyvale, Calif. 94086. (408) 738-1700. See text; 30 days.*

Originally designed to control semiconductor manufacturing processes, the RTP series programmers control from 10 to 30 operations in any sequence and provide up to 16.5 hours of unattended processing control. Timing is provided by a precision electronic clock which can select intervals as low as 1/4 second. Any time interval can be changed by removing or adding pins on the front panel without affecting any of the other time intervals. The RTP 10 × 10 real-time programmer has 10 time-interval channels and 10 output channels that are selected by diodes soldered to an internally mounted printed-circuit matrix board. Each output channel can control several functions within specified power limits. Prices for 10 × 10, 20 × 30 and 30 × 30 programmers are \$2500, \$3500 and \$4900 respectively.

CHECK NO. 270

## Tape drives offer speed and mini compatibility

*Infotec, 70 Newtown Rd., Plainview, N.Y. 11803. (516) 694-9633. See text; 30 days.*

The TDX-tape system operating at 75 in/s (800 bytes/in.) is plug compatible with most minicomputers. The system includes tape controller, interconnecting cables and all software. Prices for single-drive systems start at \$8500 (unit quantity) for most minis. The IBM 1130-compatible system starts at \$11,000 for a single drive and \$15,000 for dual drives.

CHECK NO. 271



Select  
One...

One of these tachometer generators is suited to your application. We offer them in two-bearing and single-bearing versions, no-bearing overhung versions and in sealed housings for use in environments containing oil and hydraulic fluids. Outputs range from 2.6V/1000rpm to 45V/1000rpm; brush life up to 100,000 hours—that's over ten years!

FREE CATALOG of rotating components available.

*Be Selective, Turn To...*

**SERVO-TEK**  
PRODUCTS COMPANY

1086 Goffle Road, Hawthorne, NJ 07506 · 201-427-3100

Servo-Tek of California, Inc.

8155 Van Nuys Blvd., Van Nuys, CA 91402 · 213-786-0690

# A screwdriver is all you need to hook up to most P&B relays

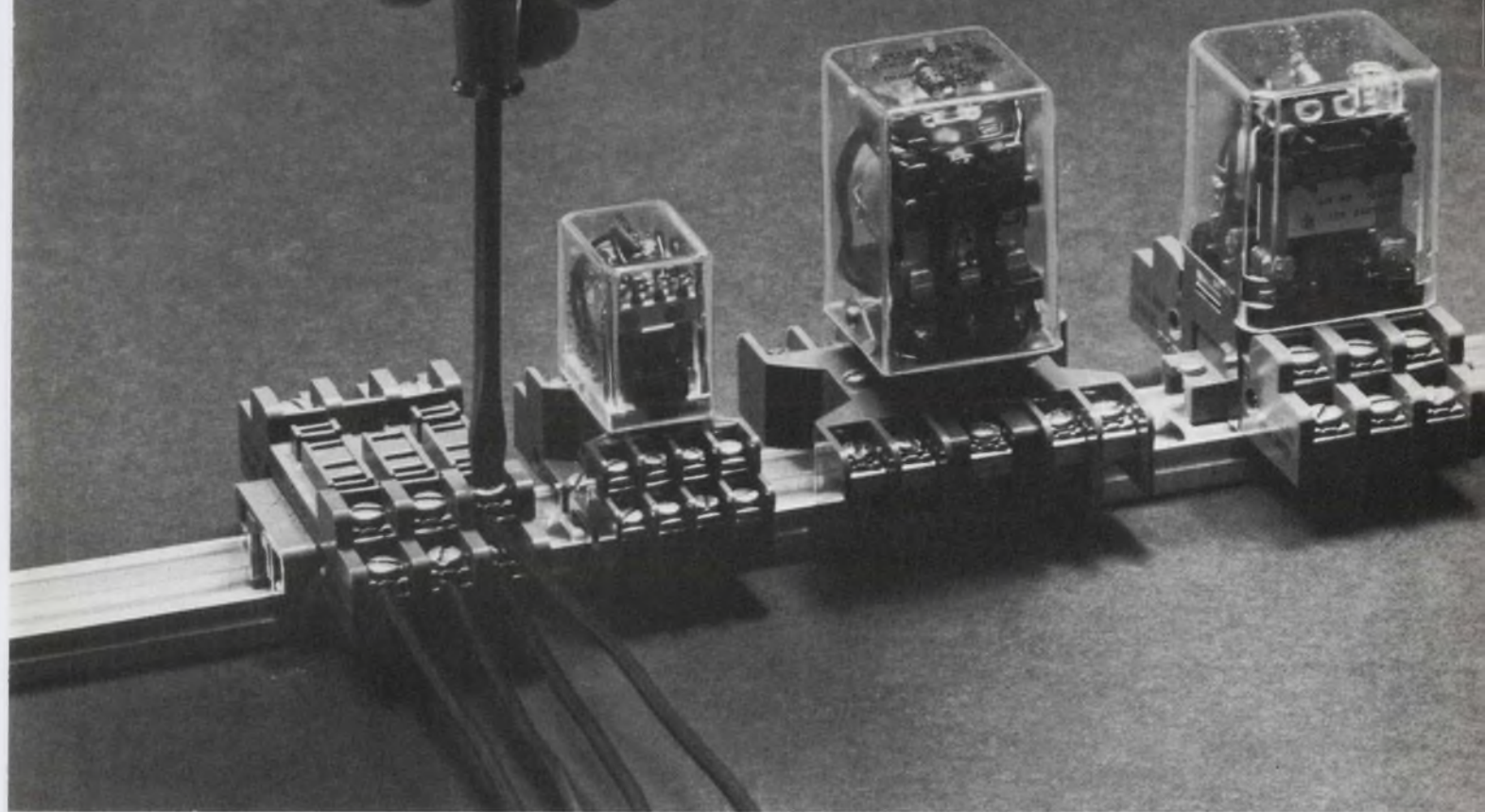

The new Potter & Brumfield socket system with screw terminals gives you a whole new world of relays to choose from.

How?

By converting octal and quick-disconnect tab termination relays to screw terminals.

Quickly. Simply.

Our system comes complete with mounting channel.

Brackets. Retainers. Spacers. And sockets made of virtually indestructible Lexan.

Think of it!

Now you can use newer, more sophisticated relays.

Just as compatible as the ones you've been using. And every bit as reliable.

But they cost less. And take up less space.



(You probably can save as much as 75 percent of the space you're now using.)

This is just part of what's possible with P&B's new socket system.

To find out more, write or call Potter & Brumfield Division, AMF Incorporated, Princeton, Indiana 47670, (812) 385-5251.

Or talk to your local P&B distributor or representative.



# 600 MHz TO 18 GHz OUTPUT FREQUENCY FROM A SINGLE YIG-TUNED MULTIPLIER!

Now you can get useable power in the 600 MHz to 18 GHz frequency range from a single solid state device. Watkins-Johnson's new YIG-tuned multiplier provides selected harmonic power over this extremely wide range with fixed-frequency inputs from 100 to 1000 MHz. And it costs much less than you would expect.



The WJ-5130-2 multiplier is one of a series of harmonic power generators created for commercial applications.

All are ideal for use in microwave counters, synthesizers and marker generators. Full details are available from our Field Sales Office/Representative or Watkins-Johnson Applications Engineering.



3333 HILLVIEW AVE., STANFORD INDUSTRIAL PARK, PALO ALTO, CALIF. 94304 • (415) 493-4141

United Kingdom: Shirley Ave., Windsor, Berkshire SL4 5JU, England • Tel: Windsor 69241 • Cable: WJUKW-WINDSOR • Telex: 847578  
West Germany: 8033 Planegg, Muenchenerstr. 17 • Tel: (0811) 71 36 57 • Cable: WJDBM-MUENCHEN • Telex: 529401  
Italy: Piazza G. Marconi, 25 00144 Rome-EUR • Tel: 59 45 54 • Cable: WJROM-ROMA • Telex: 60117

INFORMATION RETRIEVAL NUMBER 65

## DATA PROCESSING

### OCR system handles hand-written numerics



*Data Recognition, 908 Industrial Ave., Palo Alto, Calif. 94303. (415) 326-4810. \$85,000; 6 mos.*

The ADES-1 system uses proprietary software, resident in each unit's minicomputer, to provide automated data entry of hand-written numeric source documents to a computer. The system also provides the flexibility of keyboard entry by one or more operators. In this way, source numerics which are unreadable by the ADES-1, can be entered in proper sequence through the key-to-disc buffer. In addition to the minicomputer and optics, the basic unit includes a 9-in. capacity input hopper and document transport capable of processing, on an intermixed basis, documents varying in length from 4.25 to 8.75 in., in height from 2.75 to 4.25 in., and in weight from 20 lb bond to 110 lb card stock. Documents are directed to four output stackers operating under program control. Optional components of the system include: nine-track magnetic tape output, 1600 bpi, mainframe interfaces and standard OCR font recognition logic.

CHECK NO. 272

### Units send 63 channels of data over wire pair

*Dataprobe, 290 Huyler St. S., Hackensack, N. J. 07606. (201) 489-5588. See text; 4-6 wk.*

Using digital time-sharing, the Trans-coder II system sends up to 63 channels of switch closure or digital logic information over one pair of wires. The system transmits one function in 250 ms. A full system (transmitter and receiver) costs \$2500.

CHECK NO. 273

# What national semiconductor firm would you turn to to fill the op amp price/performance gap?

**Wrong!** We got it first, the LM 141/142. And we're going to second source it even if the first source isn't ready. Why? Because there's a crying need for an op amp like this from any source.

Here's why: When you're all set to design with op amps and the 741 type simply runs out of gas or the 108 type offers too much performance for the price, the LM 141/142 fills that gap.

The fully compensated 141 offers five times better input bias and offset current than the 741 and faster slew rate. The 142, with standard compensation equals the large signal performance of the 101A without feedforward compensation.

Both perform extremely well in sample and hold circuits, long interval integrators, active filters, and extended frequency range amplifiers with full output swing through the audio range.

We also have an LM 341/342 relaxed specification version priced at 99¢ in 100-999.

## Compare:

Specification	141	142	741	101A	108	
Input offset current (max.)	5	5	200	10	.2	nA @ 25°C
Input bias current (max.)	30	30	500	75	2.0	nA @ 25°C
Slew rate (min.)	1.0	1.0	.3	.3	.1	V/μs @ 25°C
Distributor list price of popular brands (100-999)	\$4.25	\$3.95	\$3.95	\$7.95*	\$12.95*	

**Then Sample Order.** We'll give you a *free* sample of the LM 141/142 or 341/342, if you tell us a little about yourself and intended use. Write on your company letterhead. Or call National and give them a nudge, we need that first source.



I'll Drink to That. (I'll Drink to Anything.)

## the challenger

# TELEDYNE SEMICONDUCTOR

1300 Terra Bella Avenue Mountain View, California 94040 (415) 968-9241 TWX: 910-379-6494 Telex: 34-8416

\*Teledyne's prices on these IC's are lower.

INFORMATION RETRIEVAL NUMBER 66

# Control 10 A with a hybrid diode-and-SCR unit in a TO-3

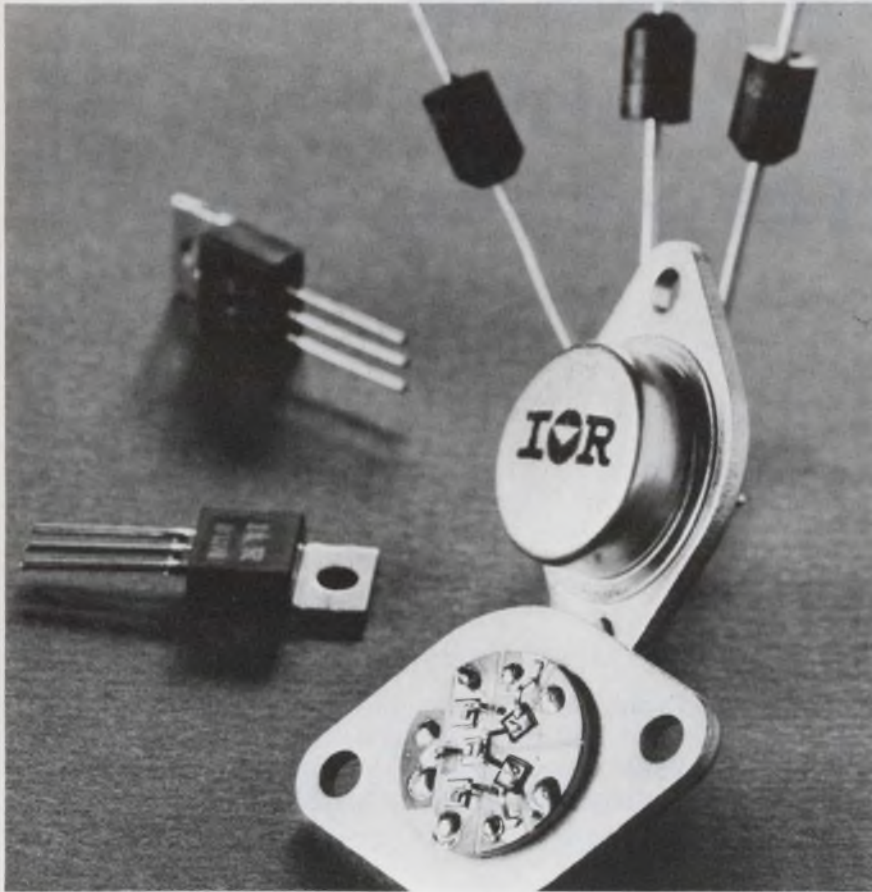

International Rectifier, 233 Kansas St., El Segundo, Calif. 90245. (213) 678-6281. From under \$6.50 (prod. quantity).

Most medium-current power supplies, battery chargers, electronic switches and fractional-horsepower motor-control circuits (under a half-hp) employ large, bulky recti-

fier assemblies. The rectifier units usually consist of multiple-diode assemblies or combinations of diodes and SCRs. Now, International Rectifiers' PH-400 series of hybrid control circuits in modified TO-3 packages can handle currents up to 10 A at 120 or 230 V ac.

The PH-400 series has seven dif-

ferent basic configurations, each of which is available for either 120 or 230 V. Models PH-401, 411, 421 and 431 are various types of bridge assemblies. Model 431 is an all-SCR bridge while the others have two SCRs and either two or three diodes (the -401 and 411 are available with or without a free-wheeling diode). The PH-441 is an all SCR ac switch, the 451 is an ac switch with one diode and one SCR, and the 481 is a controlled-center tap with two diodes and one SCR.

All units have the same maximum ratings. The nonrepetitive surge current is 100 A, thermal resistance is 1°C/W (with grease between package and heat sink), di/dt (turn-on) is 100 A/μs and the gate voltage for triggering is 1.5 V with a gate current of 25 mA. The minimum dv/dt (off-state) is 50 V/μs. All ratings apply at 25-C ambient and with a 70-C base-plate temperature at the 10-A maximum continuous output.

Because each of these units replaces up to five discrete components, they can yield substantial savings in equipment space and parts inventory. Also, they are small enough to be mounted inside or on motor casings, thus saving space and allowing the motor casing to act as a heat sink.

Small quantities are available from stock, larger quantities require 6 to 8 wks.

CHECK NO. 274



## ANALOGY

ELIMINATE THE OLD BATH AND REFERENCES WITH DIRECT-READING CONNECTION TO VIRTUALLY ANY TYPE OF THERMOCOUPLE WITH THE 601/602. REFERENCE ACCURACY OF ± 1°C, GAIN ADJUSTABLE FROM 10 TO 1000. DRIFT ERROR LESS THAN 1mV/°C, ACCEPTS CMV UP TO ± 10V. ADJUSTABLE AROUND 0°C, ± 10°C OR, SET AS YOU LIKE IT.

**intech** INCORPORATED (408) 244-0500  
1220 COLEMAN, SANTA CLARA CA 95050



# YOUR NEXT LOGICAL STEP TO HIGH SPEED CMOS —

## THE INS4000S SERIES

**INS4001S — Quad 2-Input Positive NOR**  
**INS4007S — Dual/Pair Inverter**  
**INS4009S — Hex Buffer Inverting**  
**INS4010S — Hex Buffer Non-Inverting**  
**INS4012S — Dual 4-Input Nand Gate**  
**INS4013S — Dual "D" Flip Flop With Set/Reset**  
**INS4027S — Dual J-K Flip Flop**  
**INS4030S — Quad Exclusive-or-Gate**

- CMOS that has a better power-speed product.
- CMOS that is 3 times faster than monolithic CMOS.
- CMOS that is as fast as TTL logic, but dissipates typically less than 100 nW
- CMOS that is full temperature rated from  $-55^{\circ}\text{C}$  to  $125^{\circ}\text{C}$ . That means it is ideal for industrial and military customers.
- CMOS that offers you bipolar speed with MOS power in a single package.
- CMOS that can be customized for your LSI application.
- CMOS that is price competitive.

### QUANTITIES 100-999

INS4001S	\$3.30	INS4012S	3.40
INS4007S	2.65	INS4013S	4.75
INS4009S	5.25	INS4027S	5.25
INS4010S	5.25	INS4030S	3.80



**SOS/CMOS**

**INSELEK**

For further information, call or write: Bob Heller, Dept. 6;  
University Park; 743 Alexander Road, Princeton, N. J. 08540  
Phone: (609) 452-2222; Cable: Inselek

### REGIONAL SALES OFFICES

#### EASTERN REGIONAL SALES OFFICE

JACK SCHULTZ  
REGIONAL SALES MANAGER  
191 SUDBURY RD.  
CONCORD, MASS. 01742  
(617) 369-5298

#### WESTERN REGIONAL SALES OFFICE

JOHN SPOER  
REGIONAL SALES MANAGER  
30811 MAINMAST DR.  
AGOURA, CALIF. 91301  
(213) 889-2788



## specialist or general practitioner ?

Specialist, of course . . . in the art of reducing or eliminating unwanted, troublesome signals from electronic circuits. Rtron specializes in the design and manufacture of RFI/EMI filters to cure virtually every electronic interference problem. UL Recognized data processing filters, MIL-F-15733 types and filters for every industrial application are readily available . . . from stock to custom designed, tubular, rectangular or bathtub types, in single or multi-circuit units.

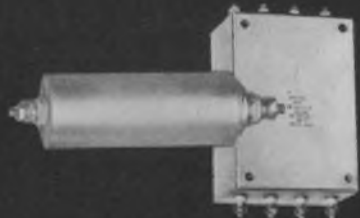

If you like our specialist, you'll like our treatment . . . phone or write . . .

# Rtron

Dept. ED-5

P.O. Box 743 Skokie, Illinois 60076

Phone 312 • 679-7180

INFORMATION RETRIEVAL NUMBER 69

### MODULES & SUBASSEMBLIES

## 0.25-in-high LED display uses plug-in decoder

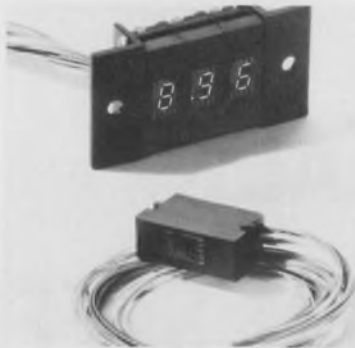

*Precision Dynamics, 3031 Thornton Ave., Burbank, Calif. 91504. (213) 845-7606. \$2150; stock to 2 wks.*

One of six new models of digital readouts in the Novalite Series, NOVA 2 is a LED that comes with current-limiting plus plug-in decoder driver, nonglare viewing screen and mounting hardware. Seven-segment LEDs feature a display character 0.25-in. high, with left-hand decimal standard. Up to 24 digits can be mounted in a common array. Individual digit package of molded thermoset plastic is  $0.4 \times 0.99 \times 0.75$ -in. Interface is prewired, with separate lines for lamp and logic  $V_{cc}$ . It accepts standard four-line BCD code, with lamp test, decimal, RBI and BI/RBO standard.

CHECK NO. 275

## Calculator display shines at 200 f-L

*Antex Industries, 1059 E. Meadow Circle, Palo Alto, Calif. 94303. (415) 326-2441.*

DA-1001 LED array is intended for calculators. The array displays numeric digits, each with its own decimal point. The type DA-1001 is a 9-digit array and the DA-1002 is an 11-digit array. A digit, located in the left-hand position, displays a minus sign "E" for error. The arrays use the standard Antex AD-1 GaAsP LED assembled on a PC board, with the anode segments of each digit and the decimal point connected in parallel for multiplexing. Specs include a brightness of 200 f-L at a forward current of 5 mA, forward voltage of 1.6 V and character height of 0.120-in. Brightness of all digits in the array is matched.

CHECK NO. 276

## Multiple-digit red LED displays are 0.6 in. dp



*OPCOA, 330 Talmadge Rd., Edison, N.J. 08817. (201) 287-0355.*

The SLB-3 series of LED numeric displays is available in three-to-eight-digit assemblies as well as to customer design. Green and yellow versions will be available shortly. The assemblies extend only 0.6 in. behind the panel and the digits are mounted on 0.8-in. centers. One connector is required for up to eight-digit assemblies, with provisions for direct wiring.

CHECK NO. 277

## D/a converter line offered on PC cards

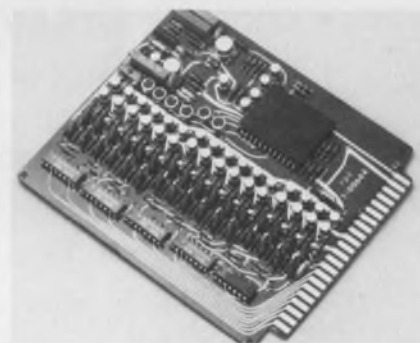

*Phoenix Data, 3384 W. Osborn Rd., Phoenix, Ariz. 85017. (602) 278-8528. \$175 to \$575; stock.*

All units in the new PDAC Series of 12 to 16-bit d/a converters include an internal precision network, control logic and output/amplifier driver. The PDAC1670R also includes a parallel-input holding register. All units in the new series operate on standard  $\pm 15$ -V and +5-V logic power supplies. Accuracy of the units is from 0.01% through 0.005% of full service range; settling time ranges to 3  $\mu$ s, linearity to  $\pm 0.0015\%$  and tempco from  $\pm 5$  ppm/ $^{\circ}$ C to an optional  $\pm 1$  ppm/ $^{\circ}$ C. All units are DTL and TTL compatible and completely repairable.

CHECK NO. 278

# The very quiet ones



Send for the "Quiet Ones" Kit,  
it's yours for the asking

- Application Book — 16 pages detailing and describing Signal Generator applications!
- Data Sheets — on the Marconi "Quiet Ones"; Models 2011, 2012, and 2013.

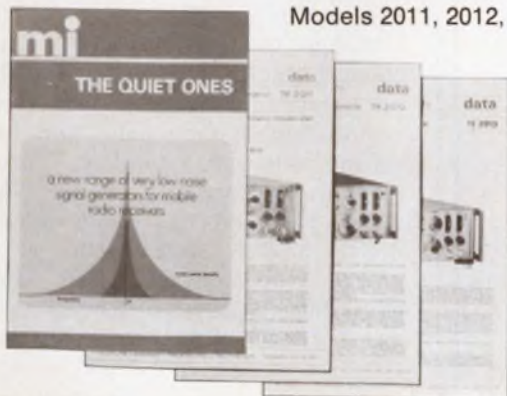

**These are the Quiet Ones. We could have said the Quietest, but this series of low noise FM Signal Generators is unique. So how can we be quieter?**

For example, our Model 2012 has less than  $-140$  dB/Hz noise, relative to the carrier, 20KHz from the carrier. It will test any of today's UHF mobile receivers to the limit of performance of their adjacent channel noise specifications.

Low noise Nuvistor® oscillators plus solid state circuits give negligible FM noise — less than 3Hz. Microphony is virtually undetectable; we had to specify it under shake table conditions. Precision piston attenuators go down to 0.03uV. And what's more, the signal goes down too, because we tightly control leakage and radiation.

OK — we don't have synthesizers or digital readout, but then we don't have any noise degradation from these "benefits" either!

All three generators are in stock including the very latest in this series — Model 2013 which covers the 800-960 MHz range. It's ready to aid your design and test tomorrow's new mobile receivers in this band.

To really appreciate these generators and their many other special features — stability, velvet smooth tuning, carrier detune facility — you must operate it. Call for a demonstration and specify Model 2011 (100-180 MHz), Model 2012 (400-520 MHz), or Model 2013 (800-960 MHz).

**mi MARCONI  
INSTRUMENTS**

111 CEDAR LANE □ ENGLEWOOD, NEW JERSEY 07631  
TELEPHONE: (201) 567-0607 731

## MODULES & SUBASSEMBLIES

### Battery monitor can send warning signals

California Manufacturing Co., P.O. Box 555, Alamo, Calif. 94507. (415) 932-3911. \$33.60 (100 up).

Model-325 voltsensor battery monitor, installed in machinery and industrial battery powered equipment, warns of low-voltage and high-current operating conditions.

The unit is powered by the source and can be used with voltages in the 9 to 50-V-dc range. Accuracy and repeatability of the adjustable trip point is 0.1% of full scale. When the unit is tripped, an output equal to approximately the battery voltage with a maximum current of 100 mA is available. The epoxy-encapsulated unit can be installed and connected with a screwdriver.

CHECK NO. 279

### Hybrid lampdriver is world's smallest

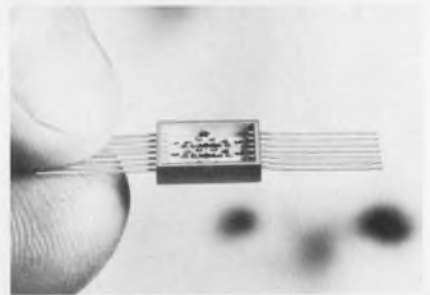

ILC Data Device, 100 Tec St., Hicksville, N.Y. 11801. (516) 433-5330. \$43 (100s); stock to 4 wks.

LD401 Series is said to be the smallest hybrid display panel lampdriver available. It is comprised of six 60-mA drivers in one flat-pack measuring just  $3/8 \times 3/8 \times 0.075$  in. The DDC hybrid package is hermetically-sealed, all metal. LD-401 can drive a wide variety of lamps up to 20 V dc. Input is DTL and TTL compatible. Power consumption is typically 50 mW from a 5-V dc power supply. On voltage is typically less than 0.2 V dc, and remains so over the unit's operating temperature range of  $-55$  to  $+125$  C.

CHECK NO. 280

# i'm heat sealable



## I'M A MAIL-LITE<sup>®</sup> SHIPPER

THE ONLY HEAT SEALABLE CUSHIONED SHIPPING BAG YOU CAN BUY . . .

I'm lined with lightweight plastic bubbles of air that can be heat sealed in two seconds. Compare that to the time-consuming wrestling match of closing a mailer box or the stapling/taping process with a padded bag.

When heat sealed I'm tough, waterproof and pilfer-proof. Like all Sealed Air<sup>®</sup> products, my bubbles are barrier coated for better protection.

Write for **FREE MAIL-LITE SAMPLE** . . . and receive the latest information on a special offer for a Mail-Lite Heat Sealer for only \$35.00.



## Sealed Air Corporation

19-01 STATE HIGHWAY 208/FAIR LAWN, NEW JERSEY 07410

### Op amps give low drift, are stable with time



Function Modules, 2441 Campus Dr., Irvine, Calif. 92664. (714) 833-8314. 370J: \$35; 370K: \$47; 370L: \$59; stock.

A new group of low-drift, non-chopper-stabilized, differential-input amplifiers feature very low input-offset voltage drift and excellent long-term stability. Three versions are available, Model 370J with  $\pm 1 \mu\text{V}/^\circ\text{C}$  input-voltage drift, Model 370K with  $\pm 0.5 \mu\text{V}/^\circ\text{C}$  input-voltage drift and 370L with  $\pm 0.2 \mu\text{V}/^\circ\text{C}$  input-voltage drift. Offset long-term drift of all three models is  $\pm 3 \mu\text{V}/\text{month}$ .

CHECK NO. 281

# BODINE

## fhp motors— gearmotors & speed controls



**42A Permanent Magnet Motor Line:** Standard TENV ratings are  $\frac{1}{8}$ ,  $\frac{1}{6}$ , and  $\frac{1}{4}$  Hp at 2500 Rpm. Only 4.3" in diameter. Available with NEMA Type C face mounting shields.



**42A-E Permanent Magnet Parallel Shaft Gearmotor Line:** Torques thru 350 Lb-in. Ratios thru 300:1. Helical steel gearing. High overhung and thrust load capabilities.



**42R Induction Motor Line:** TEFC ratings from  $\frac{1}{20}$  thru  $\frac{1}{4}$  Hp. All A-C winding types. Options include capacitor mountings, overload protectors, and special wiring provisions.



**42R-E Induction Parallel Shaft Gearmotor Line:** Torques thru 350 Lb-in. Ratios thru 300:1. Helical steel gearing. High overhung and thrust load capabilities.



**Torque Motors:** Selected K-2 and N-line motors for holding, positioning, and winding applications. Intermittent and continuous duty. Standard ratings from 7 thru 92 Oz-in.



**Encased Speed Controls:** Nine models are stocked. Several with extended speed range or adjustable torque control.



**Chassis Speed Control Kits:** Four models stocked. Unlimited adaptability. Adjustable torque control available. Permits maximum performance with matched Bodine drives.



**N-Line Motors:** Three basic sizes; 3.36", 4.50" and 5.68" in diameter. Stock ratings from  $\frac{1}{125}$  thru  $\frac{1}{4}$  Hp. All popular windings are available.



**N-1S Gearmotors:** Special purpose gearmotors for applications not requiring the ruggedness of the N-1D. Parallel in-line shaft. Only 3.41" square. 100 lot minimum order.



**K-4 Motors:** Special purpose motors for high volume applications. Standard ratings from  $\frac{1}{60}$  thru  $\frac{1}{20}$  Hp. Only 2.88" square. 500 lot minimum order upon application approval.



**K-2 Line Motors and Gearmotors:** Permanent-split capacitor instrument designs. Normal slip, high slip, and synchronous windings. Gearmotor torques thru 120 Oz-in. Only 2.405" square.



**N-1D Gearmotors:** Parallel shaft helical and spur gearing. Ratings thru 40 Lb-in. Ratios thru 900:1. Only 3.41" square.



**N-1R Gearmotors:** Single and double reduction right angle worm gearmotors. Stock ratings thru 5 Lb-in. Many ratios available for a wide range of speed selection.



**Double Reduction Right Angle Worm Gearmotors:** Provide high torques at low speeds. Stock ratings over 200 Lb-in. Ample reserves for overloads.



**Single Reduction Right Angle Worm Gearmotors:** 6 frame sizes with stock ratings over 200 Lb-in. Ratios thru 60:1. Ample reserves for overloads.

There are more than 3,500 standards in the Bodine line. From  $\frac{1}{2000}$  thru  $\frac{1}{4}$  Hp. Torques from 0.3 Oz-in. thru 350 Lb-in. Custom or specials? Yes . . . designed and built for your needs and available in small quantities, too. Over 340 STOCK motors, gearmotors, and speed/torque controls are available off-the-shelf from Bodine distributors. Call 312-478-3515 . . . or write for Catalog S: Bodine Electric Co., 2528 W. Bradley Place, Chicago, Illinois 60618.

**BODINE**

**ELECTRIC**

**COMPANY**

BODINE MOTORS  
GEARMOTORS  
SPEED CONTROLS

# You gain fundamental design advantages with General Electric infrared SSL's (LED's).

For example, General Electric guarantees\* every SSL-55B and SSL-55C infrared lamp for:

Precision beam alignment, to within 3 degrees of the mechanical axis of the lamp.

Power output of each lamp will be within the less than 2 to 1 range, as published; the SSL-55B

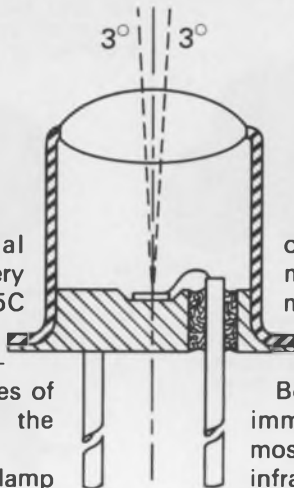

output ranges from 3.5 mW minimum to 6.0 mW maximum; the SSL-55C from 4.8 mW minimum to 7.5 mW maximum.

Both types are available for immediate delivery, as are most other General Electric infrared SSL's. For prices and complete SSL infrared data write or call today.

## Green Glow Lamp for flexibility.



Actual Size

This GE broad spectrum bright green glow lamp gives you greater design flexibility than ever before. It also emits blue, with suitable color filter.

Called the G2B, it is directly interchangeable electrically and physically with GE's high-brightness C2A red/orange/yellow glow lamp. You can use the G2B alone for 120 volt green indicator service. Or together

with the C2A to emphasize multiple functions with colors. For example: for safe/unsafe functions, for dual state indications and to show multiple operations in up to 5 colors.

They should be operated in series with an appropriate current limiting resistor. Both the G2B and C2A save money because of low cost, small size and rugged construction.

## Now Wedge Base Lamps in two sizes.

If space for indicator lights is your problem, the GE T-1 $\frac{3}{4}$  size all-glass wedge-base lamp is your solution. It measures only .240" max. diam. The wedge-base construction virtually ends corrosion problems; it won't freeze in the socket. Like



its big brother — the T-3 $\frac{3}{4}$  wedge base lamp with a .405" max. diam., the filament is always positioned in the same relation to the base. And it makes possible simplified socket design.

For free technical information on any or all of these lamps, just write: General Electric Company, Miniature Lamp Products Department, #44-54-L, Nela Park, Cleveland, Ohio 44112.

\*Lamps not meeting published specifications will be replaced or money refunded.

**GENERAL  ELECTRIC**

INFORMATION RETRIEVAL NUMBER 73

## MODULES & SUBASSEMBLIES

### Sample and hold gives 30-ns acquisition time



Optical Electronics, P.O. Box 11140, Tucson, Ariz. 85706. (602) 624-8358. \$177 (unit qty.); stock.

Model 5030 features less than a 30-ns acquisition time for a +10-V pulse or transient. It is packed in a 2.5 × 1.5 × 0.5-in. module and is fully TTL and CMOS compatible. It accepts only positive inputs. Additional specifications are: 1% maximum sensing error, 300-kHz data rate, reset time of 1  $\mu$ s, nominal supply voltages of  $\pm 15$  V, quiescent power dissipation of 240 mW, and calculated MTBF of 411,000 hours using MIL-Hdbk-217A. An internal gate allows clocking.

CHECK NO. 300

### Active C-message filter weighs less than 2 oz.

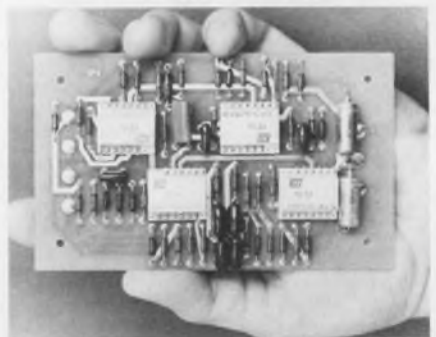

Kinetic Technology, 3393 DeLa Cruz Blvd., Santa Clara, Calif. 95050. (408) 296-9305.

The FB-194 active C-message filter meets the performance specifications referenced in Bell systems data-communications technical reference: "Transmission Parameters Affecting Voice Band Data Transmission—Measuring Techniques." It comes with a standard notch frequency of 2800 Hz (1010 Hz is optional). The FB-194 weighs less than 2 oz. and measures 3 × 5 × 1/2 in.

CHECK NO. 301

# 23 speeds for only \$675\*?

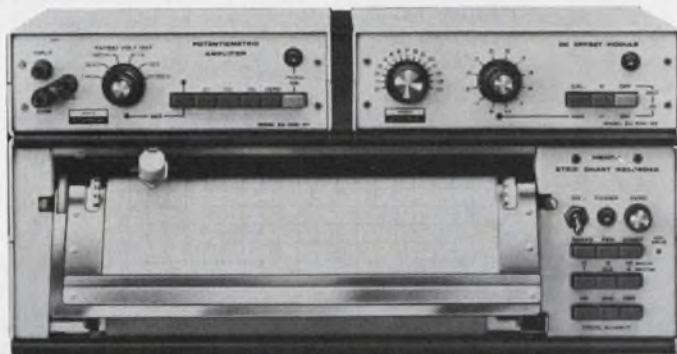

## Prove it to yourself with the Heath/Schlumberger 30-day trial offer

- 23 pushbutton-selected speeds, 30 in/min to 0.2 in/hr
- 18 calibrated spans, 1 mV to 500 V full scale
- completely programmable with TTL-levels or contact closures
- 15 full scales of calibrated suppress on all spans
- true potentiometric input
- easy conversion to metric system

Everything you'll ever need in a strip chart recorder... at less than you planned to spend. That's the Heath/Schlumberger EU-205B system. Unlike most other recorders that require a considerable investment in optional extras to get what you want, the 205B is loaded with features from the start. Enough digitally-derived speeds to satisfy the most exacting requirements... 18 calibrated spans with 15 full scales of offset available on each span... complete programmability for all functions... true potentiometric input... easy change-over to metric system work. Plus full 10" scale... writing speed less than half a second... 0.1% tracking accuracy and linearity...  $\pm 0.2\%$  accuracy... disposable pens... 3-position removable writing table... bench or rack mountable. And all solid-state design, of course.

A value? You decide. Check the details at right for our trial offer and put one in your lab for 30 days. We think you'll keep it.

Assembled EU-205B system ..... \$675.00\*



Other modules are available to permit pH and temperature measurement, digital readout, limit detection and 4-channel multiplexing. Send for our new 1973 Electronic Instruments catalog for details.

How we can sell high performance instrumentation at low cost. Heath/Schlumberger sells direct to you, through the mail. We have no salesmen or distributors. Result? Lower selling costs...

lower prices. Heath/Schlumberger is a division of the Heath Company, the world's largest manufacturer of electronic kits... and one of the world's largest buyers of electronic components. Example: Heath buys over 30 million resistors every year... and that means real purchasing power for us, and lower costs for you. And we're not a small company struggling with high overhead. We're a small division of a very large company, and we get the benefit of sharing some very important (and expensive) facilities... purchasing, engineering, production etc. Again, this means lower costs for us... and for you. We've been producing high performance electronic equipment at low cost for over 25 years. Take advantage of our 30-day trial offer (described below) and prove it to yourself.

**The Heath/Schlumberger 30-day trial offer.** We're so sure that our products can deliver on our claim of high performance and low cost that we make this offer: try this or any other Heath/Schlumberger product in your lab for 30 days. Just send us your purchase order with the statement below typed on it.

If, in *your* opinion, the product is not suitable for *any* reason, just return it to us within the 30 day limit and pay the shipping costs. After the 30 day limit we'll process your PO and bill you for the product. Send your PO now... and prove it to yourself.

**"This order is placed for 30-day evaluation. The equipment ordered may be returned within 30 days if, in the buyer's opinion, it is not suitable. The buyer agrees to pay transportation costs in both directions."**

HEATH	
<b>Schlumberger</b>	
Heath/Schlumberger Scientific Instruments	
Dept. 531-265	
Benton Harbor, Michigan 49022	
<input type="checkbox"/> Please send 1973 Electronic Instruments catalog.	
<input type="checkbox"/> Enclosed is my purchase order for a 30-day trial evaluation.	
Name _____	
Title _____	
Company/Institution _____	
Address _____	
City _____	State _____ Zip _____
*Mail order prices; FOB factory.	
EK-381	

## New line of a/d converters offered

*Sprague Electric, 347 Marshall St., N. Adams, Mass. 01247. (413) 664-4411. Eight-bit: \$230; 10-bit: \$283; 12-bit: \$346 (25 up); stock to six wks.*

These successive-approximation a/d converters, Series UHM-600, come in a small epoxy module, 2-1/8 × 4 × 3/4 in., except for

the mating dual 22-contact PC-board connector. The internal reference, clock, conversion logic, comparator, switches and laser-adjusted nickel-chromium thin-film ladder networks are individually hermetically sealed. Input voltage swings of 5, 10 and 20 V can be obtained. The digital output is 8, 10 or 12 bits binary, offset binary or BCD. The rated operating temperature range is 0 to 70 C or -25 to 85 C.

CHECK NO. 302

## Hybrid amplifiers are gain, phase matched

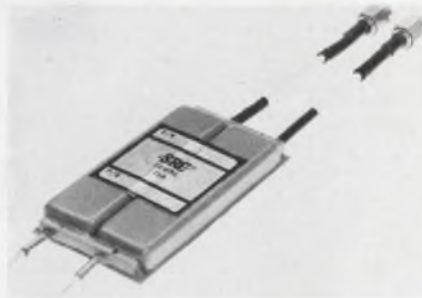

*Scientific Research Corp., 4722 Eisenhower Blvd., Tampa, Fla. 33614. (813) 844-1411. Under \$900; 12 wks.*

Model 8400-1003 are gain and phase-matched i-f-amplifier pairs. Providing high gain and large input dynamic range, the units also have gain-matched detectors and video amplifiers. Each amplifier is mounted in its own shielded enclosure and the matched pair is mounted on a common base plate. Center frequency is 60 MHz and the input dynamic range is 40 dB min. The 3-dB bw is ±5.0 MHz nominal, with a bandpass ripple less than ±0.5 dB referenced to the center frequency. Small-signal gain is 60 dB min with a noise figure of 3.0 dB max measured from a 50-Ω noise source. Age range is 50 dB min. Power required is +10 V dc at 50 mA max per amplifier.

CHECK NO. 303

# Quality you can put your finger on... a Raytheon knob.

A knob is your customer's first contact with your equipment. Make the first touch a quality one with Raytheon knobs.

Our Standard, Designer, 400 and Panel-rama Series offer a wide variety of sizes, styles and colors to match almost any application. Every knob is injection molded from impact resistant plastic. Every knob surface is clearly defined, mar-free, with no flash marks or conspicuous gate marks. Every knob features double set screws and corrosion resistant aluminum bushings.

We can also deliver knobs that meet military specifications. And for unique requirements we'll customize a knob for your application.

Quality you can put your finger on, immediate availability and Raytheon reliability... that's the kind of knob service that should turn you on! Write Raytheon Co., Fourth Ave., Burlington, MA 01803.



## Build your own power supply

*ERA Transpac, 311 E. Park St., Moonachie, N.J. 07074. (201) 641-3650. \$35 (6 A); \$55 (25 A).*

R5 series permits the user to assemble his own custom dc power supply. It comes with IC control and solid-state regulatory circuitry, ac rectification, dc filtering, built-in overcurrent and overvoltage protection, logic inhibit. Input is 47-63 Hz ac at specified level, center tapped, or 105-125 V ac with optional external transformer. Outputs cover the range from 5 to 32 V dc at 3, 6, 12 or 25 A. Regulation is better than 0.05% and ripple output is less than 1.5 mV rms. Response time is better than 50 μs. Temperature range is -20 to +71 C and tempco is better than 0.01%/°C.

CHECK NO. 304



# Here it is! Allochiral. The most rugged, reliable solderless interconnect system available. Lowest profile ever... .025" Low price, too!

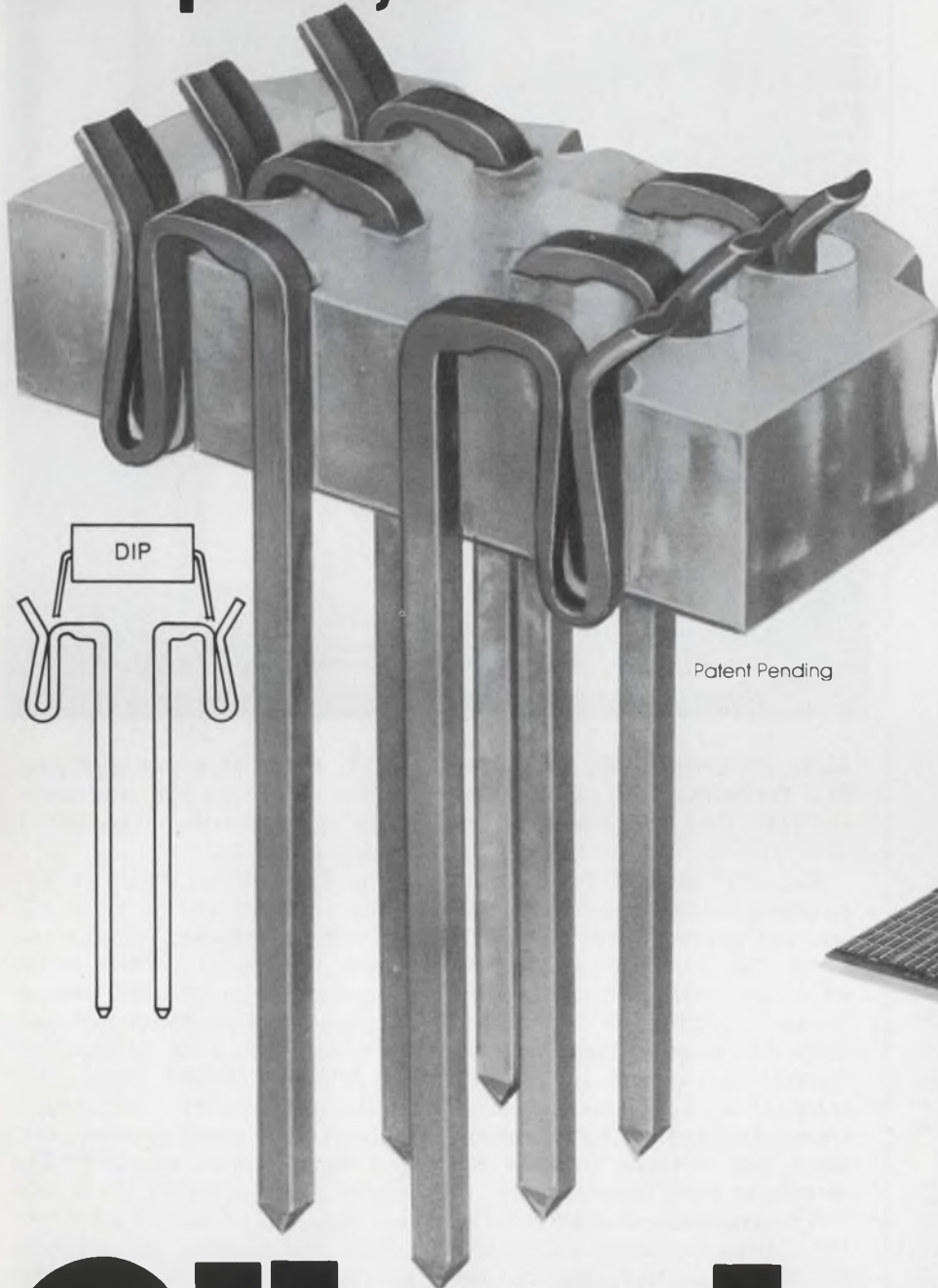

You gain...

**Super-Low Profile** for greater packaging density!

**One-piece construction** for greater reliability, production savings on each contact, board and finished assembly!

**Short IC lead lengths** - as short as .035 below device for full contact - as much as 60% of lead perimeters!

**And, more.** A complete array of associated equipment. Boards. Connectors. IC carriers. Packaging Hardware. Insertion tools (manual, semi- and full automatic)!

It's new. From Robinson-Nugent, the socket people. Push an Allochiral contact/terminal through a pre-drilled board and it becomes a properly and permanently aligned, self-supporting connector socket for ICs. Or, with its available associated equipment and hardware, a complete back panel solderless interconnect system.

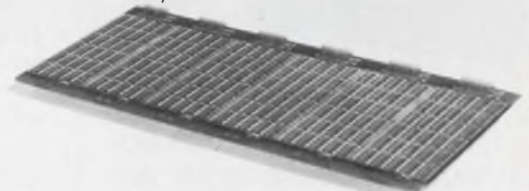

Try the new Allochiral system. From...



800 East Eighth Street  
New Albany, Indiana 47150  
(812) 945-0211  
TWX 810-540-4082

(al-o-kir'-el)

# Allochiral

INFORMATION RETRIEVAL NUMBER 76

# High Voltage Diffused Silicon Rectifiers

Six series in a wide range of minimum size packages with low leakage currents for commercial and industrial applications requiring high reliability at economical cost.

These devices feature 1kV to 40kV PRV with 5mA to 2A,  $I_o$ . All series available in fast recovery versions.

Typical applications: CRT power supplies, RF transmitters, microwave ovens, electrostatic copiers and precipitators.

Series VG; 20kV PRV. **\$1.49** (1000).

Rectifiers for medical and industrial X-Ray equipment and high voltage multipliers also available from Varo.

Write for free catalog.



Design us in —  
We'll stay there



**VARO SEMICONDUCTOR, INC.**

P.O. BOX 676, 1000 NORTH SHILOH,  
GARLAND, TEXAS 75040  
(214) 272-4551 TWX 910-860-5178

Distributed by:

ALLIED ELECTRONICS, Chicago, Ill. 312/421-2400.  
THE ALTAIR CO., Richardson, Tex. 214/231-5166.  
BELL ELECTRONICS, Menlo Park, Cal. 415/323-9431.  
BLUFF CITY DIST., Memphis, Tenn. 901/725-9500.  
BRIDGEFIELD SUPPLY, Twinsburg, Ohio, 216/425-4209.  
CRAMER ELECTRONICS, Nationwide, Newton, Mass. 617/969-7700; Rochester, N. Y. 716/275-0300.  
ELECTRONIC PARTS CO., Denver, Colo. 303/266-3755.  
FARWEST, INC., Bellevue, Wash. 206/747-115.  
MERQUIP ELECTRONICS, Skokie, Ill. 312/965-7500.  
MERRILL ELECTRONICS, Chicago, Ill. 312/286-2525.  
MILGRAY ELECTRONICS, Freeport, N. Y. 516/546-6000.  
WESTATES ELECTRONICS, Chatsworth, Calif. 213/341-4411.

In Canada:

ELECTRO SONIC, Toronto, Ont. 416/924-9301.  
PRELCO ELECTRONICS, LTD, Montreal 357. P.Q. 514/389-8051. R. A. E. IND. ELECTRONICS, Vancouver, B. C. 604/687-2621. WESTERN RADIO SUPPLY, Hamilton, Ont. 416/528-0151.

INFORMATION RETRIEVAL NUMBER 77

## Thermal profiler operates from ultraviolet to far IR

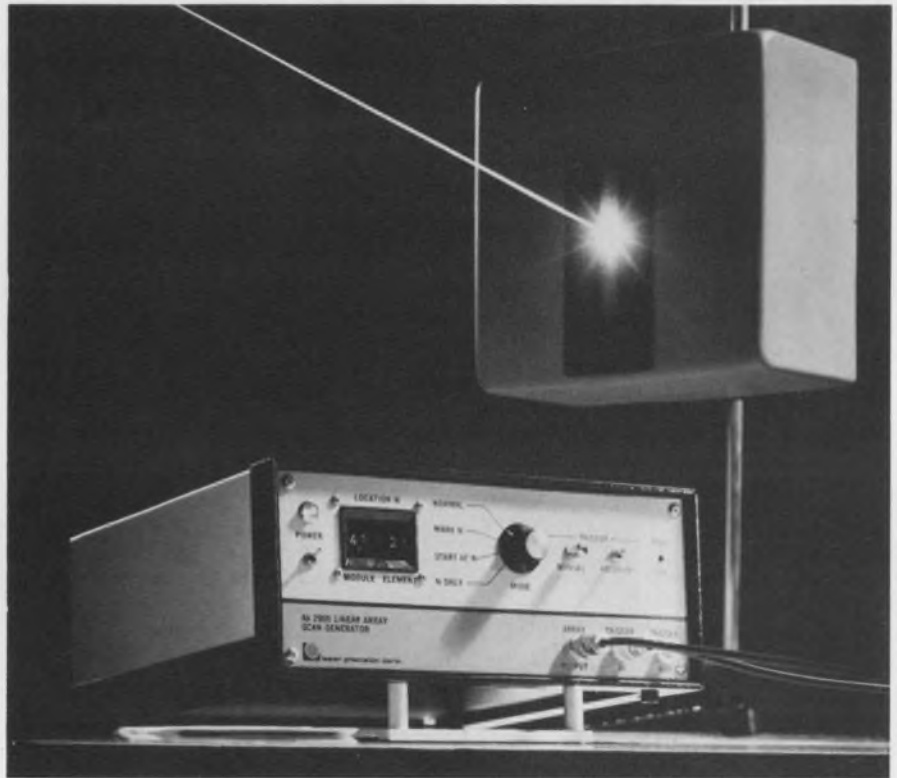

Laser Precision, 5 W. Whitesboro St., Yorkville, N.Y. 13495. (315) 797-4449. P&A: See below.

The first thermal profiling instrument using pyroelectric detectors has emerged from Laser Precision. Called the Pyroanalyzer, the solid-state instrument analyzes the spectral distribution of thermal radiation from a laser or any thermal source and can operate from the ultraviolet to the far infrared. In addition the instrument has a fast response time and can operate at room temperatures.

Nonpyroelectric-detector systems for the measurement of thermal distribution generally require some tradeoff among spectral response, response time and operating temperature. With the Pyroanalyzer, spectral response variations are held to  $\pm 2\%$  from visible wavelengths up to above  $15 \mu$ , and response times are less than  $1 \mu$ s. Operating temperatures range from

—30 to 100 C. Moreover peak powers can exceed 10 kW, and sensitivity variations per degree of C are less than 0.2%.

The Pyroanalyzer comes in different versions: 16, 32, 64 or 128 pyroelectric detector elements on 1.1-mm centers. In addition to the detectors, the instrument has an electronic scan generator and multiplexing system. In response to an external trigger pulse, the multiplex circuitry sequentially switches individual elements into a common output amplifier. The resulting analog signal has a total scan duration of about 5 ms.

The Pyroanalyzer is available also as the Ak-2930, which stores and displays the energy of single pulses, and the Ak-2950, which repetitively scans the intensity profile of a chopped cw beam.

Prices for single units start under \$2500 for a 16-detector element. Delivery is in 45 days.

CHECK NO. 305

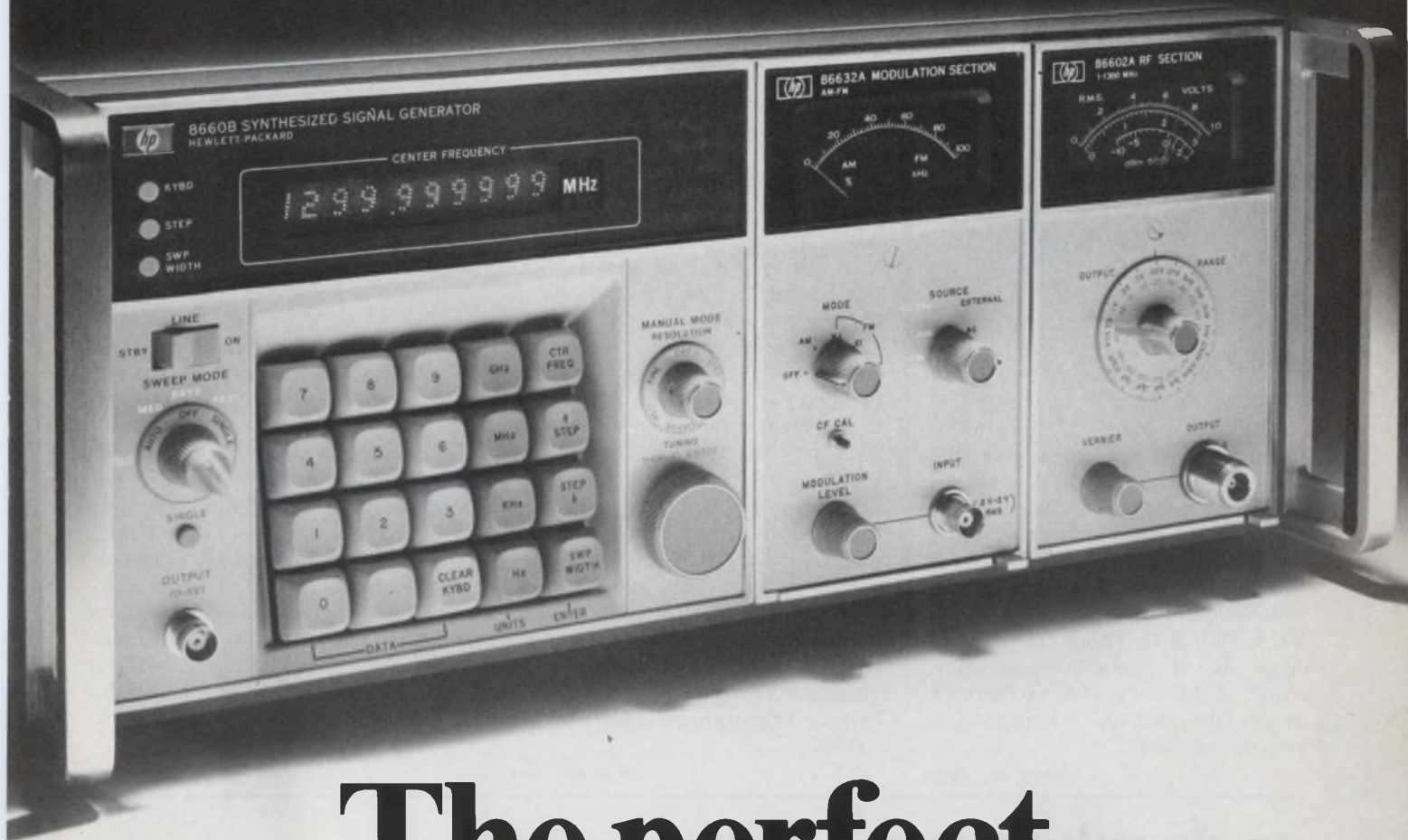

# The perfect combination.

**A synthesizer/signal generator that sets a new standard in RF performance—all the way to 1300 MHz!**

The new HP 8660B Synthesized Signal Generator has all the precision and stability you'd expect from a synthesizer. Plus performance features, operating functions and ease of operation far surpassing what you would normally find in a signal generator.

The keyboard, plus its 10-digit LED display, gives you error-free fingertip control of operating frequencies. For example, enter your center frequency and then the frequency increment corresponding to channel spacing. Now you can change the frequency up or down by that precise increment just by pushing the STEP button. Similarly you can enter sweep width for precision swept frequency testing. For total operating flexibility you can also tune the generator manually over its entire frequency

range. In all these modes you get accurate signals with synthesizer stability and spectral purity.

The instrument's modular concept allows for great flexibility in both frequency coverage and modulation. Two RF plug-in units have these outstanding characteristics: 0.01 to 110 MHz or 1 to 1300 MHz frequency coverage, settable in 1 Hz steps;  $-80$  dB spurious;  $< 1.5$  Hz residual FM;  $3 \times 10^{-8}$  /day stability;  $+10$  to  $-146$  dBm calibrated output. Precision AM and FM modulation capability, available as an option, greatly increases the 8660's versatility.

The 8660B keyboard-entry mainframe is \$6000. RF plug-ins, 0.01 to 110 MHz, \$1975; 1 to 1300 MHz, \$4800. Modulation plug-in, \$900. A lower cost unit ideally suited for remote pro-

gram applications is the 8660A mainframe. The variety of modular options makes it possible for you to "custom-tailor" a system to your exact needs, with prices for a complete system starting at \$5875.

Ask your field engineer for complete information about the immensely versatile 8660 Synthesized Signal Generators. Or write Hewlett-Packard, Palo Alto, California 94304; Europe: 1217 Meyrin-Geneva, Switzerland.

04204

HEWLETT  PACKARD  
SIGNAL GENERATORS

### Millimeter receiver limits noise to 6.5 dB

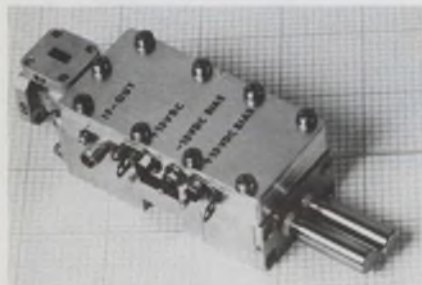

Control Data Corp., 400 Border St., E. Boston, Mass. 02128. (617) 569-2110. 90 days.

The TRG Model A9100 millimeter receiver operates over the frequency range of 35 to 39 GHz with a double sideband noise figure of 6.5 dB maximum. The i-f amplifier, which operates from 5 to 300 MHz with a gain of 40 dB, contributes a maximum of 2 dB to the noise figure. Other features include an rf instantaneous bandwidth of 1.0 GHz, rf-to-i-f gain of 30 dB minimum and i-f output impedance of 50  $\Omega$ .

CHECK NO. 306

### Telemetry transmitters deliver 10 to 20 W



Emhiser Rand Industries, 7721 Convoy Ct., San Diego, Calif. 92111. (714) 278-5080. 10-W unit: \$5000; 8 wks.

The TT 3600L series of L-band telemetry transmitters deliver 10 to 20 W of power and operate on  $28 \pm 4$  V dc power. Covering the 1435-to-1540-MHz frequency range, the transmitters have current requirements of 2.5 A maximum for the 10-W unit to 4.0 A maximum for the 20-W unit. Modulation is dc coupled FM with a standard frequency response from dc to 500 kHz. Standard peak deviation is  $\pm 500$  kHz. The units list a frequency stability of  $\pm 0.003\%$ .

CHECK NO. 307

### Multioctave mixers operate at -10 dBm

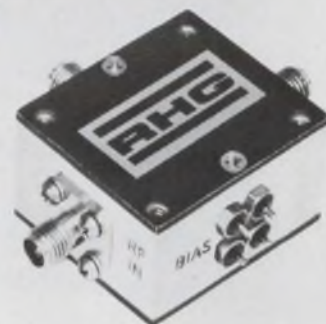

RHG Electronics Laboratory, 161 E. Industry Ct., Deer Park, N.Y. 11729. (516) 242-1100. From \$350; 30 days.

A series of mixers operates with local oscillator (LO) injection levels as low as -10 dBm while providing rf coverage of up to 1-to-12 GHz in a single assembly. The coverage of other units is 1-to-2, 2-to-4, 4-to-8 and 8-to-12 GHz. Typical LO-to-rf isolation is 18 dB, and noise figure (including 1.5-dB for the i-f) is typically 9-to-11 dB for 0-to-10 dBm LO power, respectively.

CHECK NO. 308

## ac, dc, volts, amps, ohms 25 ranges \$595 complete 5-day delivery



- New expanded AC response to 100 KHz
- New carrying case option
- New color-coded pushbuttons
- Optional battery pack with recharger (\$95) mounts internally
- 0.01% dc accuracy
- 1,000 megohm input impedance on 3 lowest ranges
- lab, field, or systems use.

For Model 7004A literature, contact your Scientific Devices office or Systron-Donner at 10 Systron Drive, Concord, CA 94518. Phone (415) 682-6161. Europe: Munich, W-Germany; Leamington Spa, U.K.; Systron-Donner S.A. Paris (Port Marly) France. In Australia: Systron-Donner Pty. Ltd. Melbourne.

**SYSTRON DONNER**

INFORMATION RETRIEVAL NUMBER 79

Response curves, performance specs, theory of operation, design considerations and applications data on size 23 and size 16 models of the Torqsyn® Remote Positioner, are all in this multi-page brochure.



The Torqsyn is a completely integrated servo system in a single package. Vernitron Corporation Control Components Division 2440 West Carson Street Torrance, California 90509 Telephone (213) 328-2504

### Free Vernitron data shows how to replace all these servo components



with one

# Torqsyn



U.S. PATENT NUMBER 3,638,000

INFORMATION RETRIEVAL NUMBER 80

# When you look inside, you won't see much-

Advanced LSI design, only \$299. For the money, no multimeter digital or otherwise gives you higher accuracy, more protection, greater sensitivity or better reliability. And no one matches Fluke's no-nonsense year long guarantee or 48-hour turnabout service in the U.S., Canada, Europe or the Far East.

In the short time since introduction, our new 8000A LSI multimeter with 26 ranges and five functions has become the standard of excellence in the low cost field. Thousands of satisfied users all over the world are using the 8000A daily to diagnose service problems and analyze design of electrical and electronic circuits.

Some like using the 8000A on the bench to make in-circuit checks on fets, diodes, and other active circuit elements. Others like the extra capability of our big 600 ampere AC current probe or 30 KV high voltage probe. Perhaps even more go for the calculated 20,000 hour reliability factor, wide choice of options or simplicity of Fluke's LSI design—our two LSI circuits are equivalent to more than 3,000 electronic com-

ponents! And the 8000A has a unique self-zero capability to eliminate offset uncertainty in your readings.

But make up your own mind about this fine new low cost multimeter from Fluke. Here's what you get: 26 ranges to measure voltage from 100  $\mu$ V to 1200 V, AC and DC, current from 0.1  $\mu$ A to 2A AC and DC and resistance from 0.1 ohm to 20 megohms. Basic DC accuracy is  $\pm 0.1\%$  of reading. Specifications carry a year's guarantee. Fluke gives you 48-hour turn-around on repairs. Wide range of low cost options include an internal rechargeable battery pack, digital printer output, high voltage probe, high AC current probe, carrying case, deluxe test leads, and rack mount adapters.

**Try one for fifteen days, with our no obligation return privilege.** We invite you to participate in our special trial offer and "ask the man who owns one" deal. For details call your local Fluke sales engineer. In the continental U.S., dial our toll free number, 800-426-0361 for his name and address. Abroad and in Canada, call or write the office nearest you listed below.

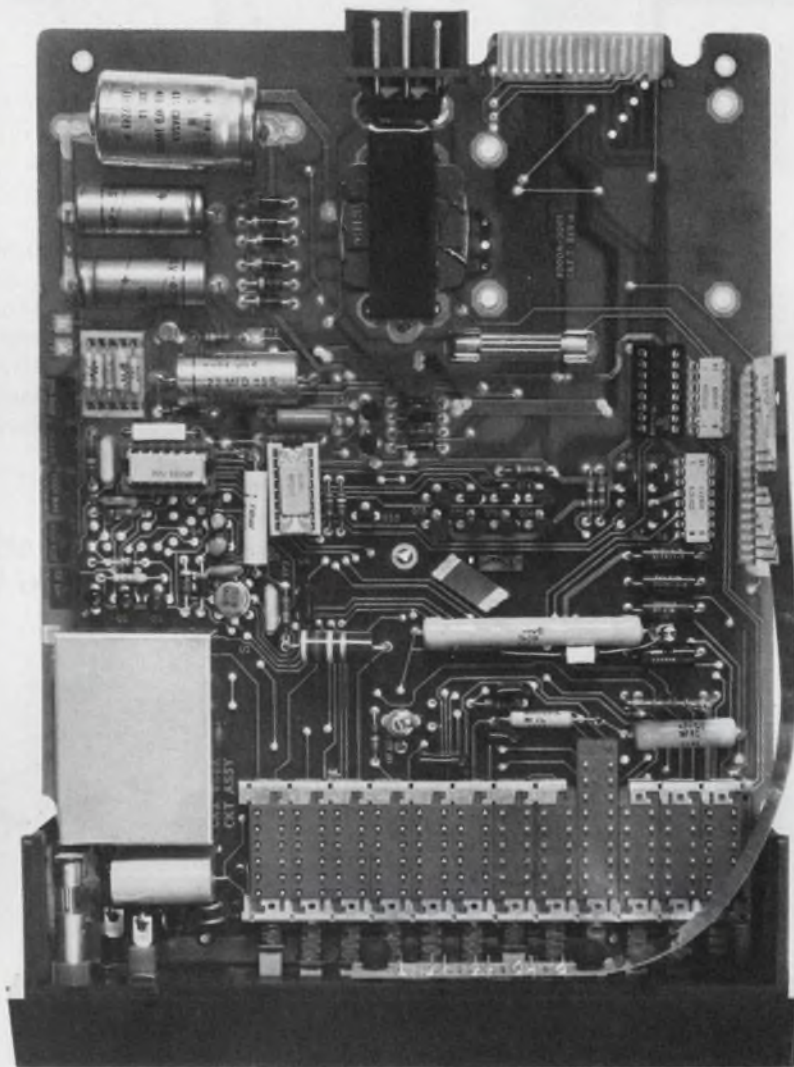

## but quality.

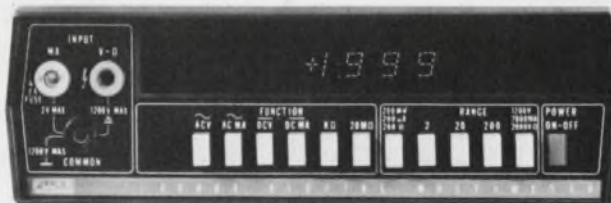

Buy it with your American Express, BankAmericard or Master Charge Card.



Fluke, P. O. Box 7428, Seattle, Washington 98133. Phone (206) 774-2211. TWX: 910-449-2850. In Europe, address Fluke Nederland (N.V.), P. O. Box 5053, Tilburg, Holland. Phone 13-670130, Telex: 884-55237. In the U.K. address Fluke International Corp., Garnett Close, Watford, WD2, 4TT. Phone, Watford, 33066. Telex: 934583. In Canada, address ACA, Ltd. 6427 Northam Drive, Missisauga, Ontario. Phone 416-678-1500.

INFORMATION RETRIEVAL NUMBER 81

## Breadboarding?

# KISS YOUR DRILL PRESS GOODBYE.



If you do much breadboarding, the chances are pretty good that you've accepted the drill press as part of the job. And you've learned to work around the inefficiencies and frustrations of drilling holes in circuit boards.

We've developed a whole new idea in solving some of the real problems in obtaining high performance breadboards. Our solution is the MINI-MOUNT™ system. These are miniature etched patterns designed so that you can mount many different kinds of components.

A pressure sensitive adhesive holds the MINI-MOUNTS in place and yet allows you to move them as the circuit develops. Virtually any type of circuit can be designed—including analog, digital, and RF circuits from DC to GHz region.

There's a lot more to the system and we'd like to send you our new brochure. While you're waiting you can make plans for your drill press's



**CHRISTIANSEN RADIO, INC.**  
3034 Nestall Road  
Laguna Beach, CA 92651

## MICROWAVES & LASERS

### Supply powers mm-wave osc tubes



*Micro-Now Instrument, 6104 N. Pulaski Rd., Chicago, Ill. 60646. (312) 478-1151. \$7350; 30 days.*

Millimeter-wave oscillator tubes for frequencies from 26.5 to 170 GHz can be powered with the Model 703 supply. The solid-state 703, designed specifically for Siemens' RWO series tubes, provides adjustable regulated voltages to 3000 V for EG2, 240 V for EG3 and 7 V for the tube heater. Internal overload protection automatically shuts the supply down when G2, G3 or cathode-current limits are exceeded or the BWO temperature becomes excessive.

CHECK NO. 309

### X4 multiplier covers broad band

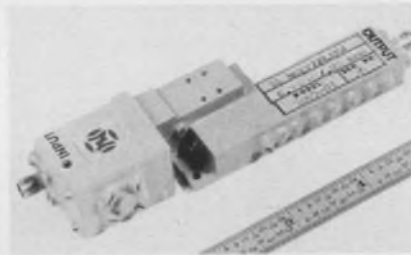

*Zeta Laboratories, Inc., 616 National Ave., Mountain View, Calif. 94040. (415) 961-9050.*

The Model 5009, a times-4 multiplier, provides an instantaneous bandwidth of 7% and output frequencies in the 6550-to-7050 MHz (suffix 01) and 7200-to-7700 MHz (suffix 02) frequency range. The conversion loss is 8 dB, within  $\pm 1$  dB across the band, and the unit is capable of handling up to 1 W of input power. This miniature frequency multiplier, only 4.5 cubic inches, includes an input ferrite isolator and output filtering to keep spurious responses down 80 dB.

CHECK NO. 310

### Video detectors handle 100 W



*American Electronic Laboratories, MS/1123, P.O. Box 552, Lansdale, Pa. 19446. (215) 822-2929. From \$175; stock to 6 wks.*

Three broadband high-power video detectors provide a power-handling capability up to 100 W peak power. The frequency ranges covered are 2-to-18 GHz (Model LD-3380) 8-to-18 GHz (LD3381) and 1-to-12.4 GHz (LD3382). The high power rating results from the use of an integral limiter within the detector.

CHECK NO. 320

### Npn overlay transistors deliver 6 W at 118 MHz



*RCA Solid State, Box 3200, Somerville, N.J. 08876. (201) 722-3200. (100-up) \$1.15 (5), \$1.80 (6), \$6.60 (7); stock.*

Three silicon npn overlay transistors that have 6-W (min.) output at 118 MHz are designated the RCA 40975, 40976 and 40977. These devices are intended for use in vhf AM transmitters operating from a 12.5-V supply. Types 40975 and 40976 are supplied in the JEDEC TO-39 package; the 40977 unit has emitter-ballasting resistors, together with a low-thermal-resistance stripline package (RCA HF-44). All 40977 units are tested at constant input power ( $f = 118$  MHz,  $V_{CC} = 25$  V) with infinite load VSWR.

CHECK NO. 321

**Distributors**

**Arizona:** Hamilton/Avnet, Phoenix (602) 269-1391  
 Kierulff, Phoenix (602) 273-7331  
 Compar, Scottsdale (602) 947-4336  
**California:** Hamilton/Avnet Mountain View (415) 961-7000  
 San Diego (714) 279-2421  
 Hamilton Electro, Culver City (213) 870-7171  
 Kierulff, Palo Alto (415) 968-6292  
 San Diego (714) 278-2112  
 Compar, Burlingame (415) 347-5411  
**Gardena** (213) 327-6550  
**Colorado:** Hamilton/Avnet, Denver (303) 534-1212  
 Kierulff, Denver (303) 343-7090  
**Florida:** Hamilton/Avnet, Hollywood (305) 925-5401  
**Georgia:** Hamilton/Avnet, Norcross (404) 448-0800  
**Illinois:** Allied, Chicago (312) 421-2400  
 Hamilton/Avnet, Schiller Park (Chicago) (312) 678-6310  
 Kierulff, Rosemont (Chicago) (312) 678-8560  
**Kansas:** Hamilton/Avnet Prairie Village (Kansas City) (913) 362-3750  
**Maryland:** Hamilton/Avnet, Hanover (Baltimore) (301) 796-5000  
 Pioneer, Rockville (301) 427-3300  
 Compar, Baltimore (301) 484-5400  
**Massachusetts:** Electrical Supply, Cambridge (617) 491-3300  
 Gerber, Dedham (617) 329-2400  
 Hamilton/Avnet, Burlington (617) 273-2120  
 Kierulff, Needham Heights (617) 449-3600  
 Compar, Newton Highlands (617) 969-7140  
**Michigan:** Hamilton/Avnet, Livonia (313) 522-4700  
**Minnesota:** Hamilton/Avnet Bloomington (612) 854-4800  
**Missouri:** Hamilton/Avnet, Hazelwood (St. Louis) (314) 731-1144  
**New Jersey:** Arrow, Totowa (201) 256-7331  
 Hamilton/Avnet, Cherry Hill (609) 662-9337  
 Cedar Grove (201) 239-0800  
 Haddonfield (609) 429-1526  
 Compar, Clifton (201) 546-3660  
**New Mexico:** Century, Albuquerque (505) 265-7837  
 Kierulff, Albuquerque (505) 247-1055  
**New York:** Semiconductor Concepts, Hauppauge (516) 273-1234  
 Hamilton/Avnet, Syracuse (315) 437-2642  
 Westbury, L.I. (516) 333-5812  
 Arrow, Farmingdale (516) 694-6800  
 Summit, Buffalo (716) 884-3450  
 Compar, Albany (518) 489-7408  
**North Carolina:** Pioneer, Greensboro (919) 273-4441  
 Compar, Winston-Salem (919) 723-1002  
**Ohio:** Arrow, Dayton (513) 253-9176  
 Kierulff, Dayton (513) 278-9411  
**Texas:** Hamilton/Avnet, Dallas (214) 638-2850  
 Houston (713) 526-4661  
 Kierulff, Garland (Dallas) (214) 271-2471  
**Utah:** Hamilton/Avnet, Salt Lake City (801) 262-8451  
**Washington:** Hamilton/Avnet Seattle (206) 624-5930  
 Kierulff, Seattle (206) 763-1550  
 Compar, Kirkland (206) 822-4191  
**Canada:** Preico, Montreal (514) 389-8051  
 Ottawa (613) 237-6150  
 Electro Sonic Ind. Sales, Toronto (416) 924-9301  
 Hamilton/Avnet, Montreal (514) 735-6393  
 Toronto (416) 677-7432  
 Ottawa (613) 725-3071  
 L. A. Varak, Vancouver, B.C. (604) 736-6411

**Representatives**

**Alabama:** Twentieth Century Marketing, Huntsville (205) 772-9237  
**Arizona:** Q. T. Wiles & Assoc., Scottsdale (602) 947-5791  
**California:** Celtec, Inc., San Diego (714) 279-7961  
 Trident Assoc., Mountain View (415) 967-7031  
 Q. T. Wiles & Assoc., Los Angeles (213) 649-1232  
**Colorado:** Parker-Webster, Denver (303) 770-1972  
**Florida:** W. M. & M. Assoc., Altamonte Springs (305) 831-4645  
 Clearwater (813) 726-8871  
 Pompano Beach (305) 943-3091  
**Illinois:** Coombs Assoc., Des Plaines (312) 824-0104  
**Indiana:** Coombs Assoc., Fort Wayne (219) 747-0402  
**Maryland:** Mechronic Sales, Inc., Rockville (301) 622-2420  
**Massachusetts:** Contact Sales, Inc., Burlington (617) 273-1520  
**Michigan:** Greiner Assoc., Grosse Pointe Park (313) 499-0198

# THIS IS NO ORDINARY DISGUISED MAN, IT'S THE SUPERMAN DIGIT.



**Replaces everything else.** The Data-Lit 707 is designed in the standard 14-pin dual in-line package. It's pin-for-pin identical with the MAN-1 and DL-10. The Data-Lit 704 is pin-for-pin identical to the MAN-4 and DL-4. And while it isn't pin-for-pin identical with tubes, the total system cost will beat them penny-for-penny.



## the bright guys litronix

**The Data-Lit 707** second generation LED display has all the qualities you would like to see in a Superman digit. Low cost, low power, full solid segments with minimum gaps, low cost, availability, standard pins, high reliability, low cost.

**It's Cheap.** Everyone wanted us to say economical. But the DL-707 is cheap compared to what you've been used to for LED displays and tube displays. The total system cost of power supplies, drivers, digits and mounting hardware is now less in the 2 to 8 digit range using LED's than any other display technology.

**ELD makes it all happen.** Encapsulated Light Diffusion (ELD) was developed in our Krypton lab. We've produced a high quality diffusing light channel in a single encapsulating step. This allows us to use 85% less GaAsP material without sacrificing brightness. The only thing it cuts is cost.



**This looks like a job for Superman DL-707.** If you're anywhere in the thriving metropolis of desk top calculators, POS equipment, digital panel meters, small instrumentation and so on, you have to see the Data-Lit 707 and get our volume prices.

Here's the first of our Superman Data-Lit 700 Series:

- DL-707 Common anode, left decimal
- DL-707R Common anode, right decimal
- DL-701 Common anode, polarity and overflow
- DL-704 Common cathode, right decimal

So step into a phone booth and call one of our distributors. The Data-Lit 700 Series is going at \$3.25 in 100-999 quantities.

**No surprises, the Bright Guys did it again.**

Litronix, Inc. • 19000 Homestead Road • Cupertino, California 95014 • (408) 257-7910 TWX: 910-338-0022

**Minnesota:** Comstrand, Inc. Minneapolis (612) 560-5300  
**Missouri:** Coombs Assoc. St. Louis (314) 567-3399  
**New Mexico:** Electronic Marketing Albuquerque (505) 265-7817

**New York:** Win-Cor Electronics, Manhasset (516) 627-9474  
 Trittech, DeWitt (315) 446-2881  
**Ohio:** E.M.A., Inc., Centerville (Dayton) (513) 433-2900  
 Aurora & Co. (Lancaster) (717) 563-6111

**Pennsylvania:** G. C. M., Ambler (215) 646-7535  
**Texas:** Semiconductor Sales, Richardson (214) 231-6181  
 Houston (713) 461-4197

**Washington:** Compar, Kirkland (206) 822-4191  
**Canada:** Contronics, Montreal (514) 733-0749  
 Downsview (416) 661-2494

**Low-pass filters handle 1 kW**

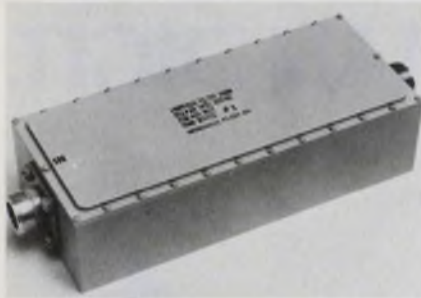

Microwave Filter Co., 135 W. Manlius St., E. Syracuse, N.Y. 13057. (315) 437-4529. \$1260; 8 wk.

Two low-pass filters—the 2998, for the 100 to 160 MHz range, and the 2999, for the 220 to 400 MHz range—are rated at 1000 W with less than 0.3-dB loss. From 200 to 1000 MHz and 440 to 1000 MHz, the 2998 and 2999, respectively, have a rejection of greater than 70 dB. The units weigh 8.5 lb. each, and measure 11 × 4-5/8 × 3 inches.

CHECK NO. 322

**Troposcatter paramp covers 1.7-2.1 GHz band**

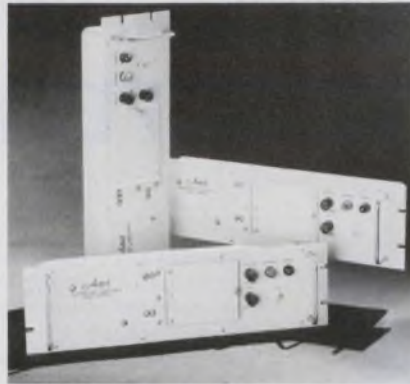

Aerotech Industries, 825 Stewart Dr., Sunnyvale, Calif. 94086. (408) 732-0880.

An L-band parametric amplifier, the AP4503, is intended for troposcatter applications in the 1700-to-2100 MHz frequency range. It has a bandwidth of 20 MHz, gain of 18 dB and noise figure of 2.0 dB. The AP4503 can operate from 117 V ac supplies and is available in either rack or pedestal-mount versions.

CHECK NO. 323

**2-4 GHz amp boasts 4.5-dB max NF**

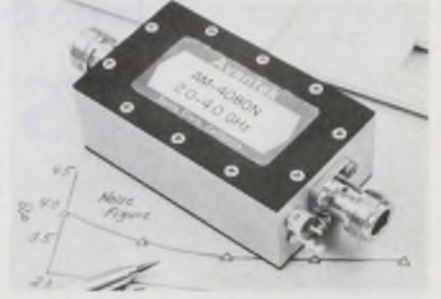

Avantek, 2981 Copper Rd., Santa Clara, Calif. 95051. (408) 739-6170. \$2000 to \$2400; 45 days.

The Model AM-4080 transistor amplifier, for the 2-to-4-GHz frequency range, offers a noise figure typically between 3.5 and 3.8 dB and guaranteed at less than 4.5 dB—reportedly the lowest figures for amplifiers of this type. Minimum gain reaches 32 dB, with a maximum variation of ±1 dB. Power output for 1-dB gain compression is +9 dBm, and intercept points for IM products are typically +20 dBm.

CHECK NO. 324

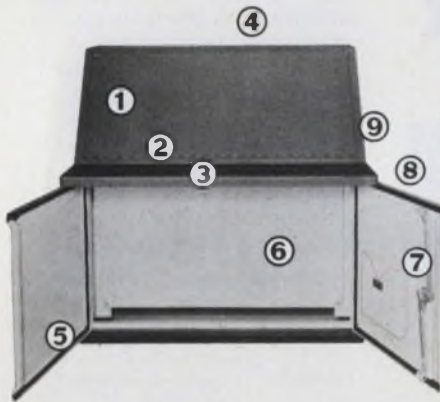

1. 24", 36", 48", or 60" width. 2. Hinged sloping control panel. 3. Optional writing desk. 4. Instrument panel top available. 5. Neoprene gaskets for complete oil tightness. 6. Accessory subpanel. 7. Three-point latches and key-locking handles. 8. Doors on both front and back. 9. All seams continuously welded. 10. NEMA-12 construction. 11. Many modifications available. Write for Bulletin C-14.

**ENCLOSURES**

**Hoffman**® **ELECTRICAL ENCLOSURES**  
 HOFFMAN ENGINEERING COMPANY  
 Division of Federal Cartridge Corporation  
 Anoka, Minnesota, Dept. ED51

INFORMATION RETRIEVAL NUMBER 84

**CUSTOM RELAY SOCKETS**

**CLOSED BACK CONSTRUCTION**

- \* Virtually indestructible. Heavy duty.
- \* Molded of Noryl Thermo Plastic Resins ("UL" listed—component-plastic materials).
- \* Terminals permanently marked.
- \* Mount directly on panel or channel without insulation.
- \* Brass inserts in all sockets.

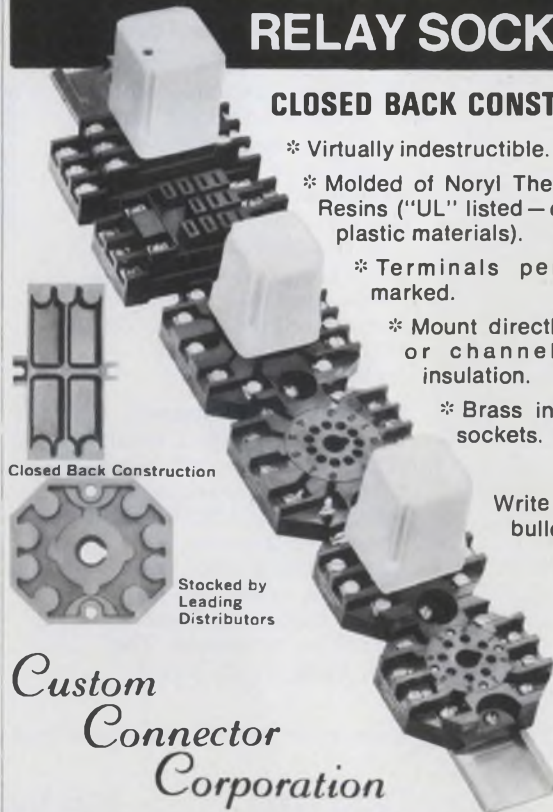

Closed Back Construction



Stocked by Leading Distributors

Write for free bulletin.

Custom Connector Corporation

1738 E. 30th STREET • CLEVELAND, OHIO 44114 • (216) 241-8064

INFORMATION RETRIEVAL NUMBER 85



# Expertise, schmexpertise. It's good old-fashioned know-how.

That's why people buy so many of our PIN diodes.

Because we make them good, we make them fast, and we make them to sell at a price you can afford.

Like less than 50¢ apiece for our glass MA-47110 in quantities of 10,000. The MA-47110 is hermetically-sealed for reliability and is ideally suited for general-purpose switching and attenuating from VHF well into the microwave range. It's the first of a whole series of other economical control devices.

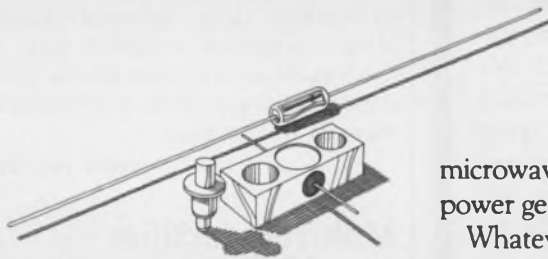

If your application requires it, we can produce PIN diodes to solve your particular power-control problem. Like our silicon-nitride passivated beam leads and hermetically sealed stripline devices. We'll make them in any quantity you want, too. Just a few. Or a whole lot, like the big batch of PIN diodes we successfully delivered for a major phased-array-radar program.

PIN diodes, Schottky barriers, Gunn and Impatt diodes, and lots of other semiconductor devices for

microwave frequency conversion, power generation, and control.

Whatever you want, when you want it, at a nice low price.

Plus the proven understanding of microwave circuits and control applications that we've developed over the years.

And that's what know-how is all about, isn't it?



**MICROWAVE  
ASSOCIATES**  
Northwest Industrial Park  
Burlington, Mass. 01803  
(617) 272-3000

**We're Microwave Associates.  
We know how.**

**YOUR PLASTIC  
PACKAGE  
DEVICES**

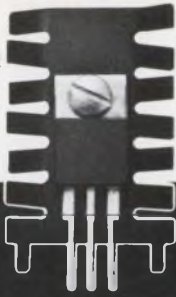

**We  
can cool  
'em for  
10¢ each\***

**No board room required**

Low-cost vertically mounted heat sinks accept all types of plastic packaged SCR's, transistors, and triacs, including center-tabbed devices. Typical  $R_{\theta}$ :  $26^{\circ}/W$ . Black anodize is standard, but also available gold chromated or nickel-plated for dip soldering to PC board. Weight only 0.07 oz.

NATURAL CONVECTION THERMAL PERFORMANCE  
P. M6025B

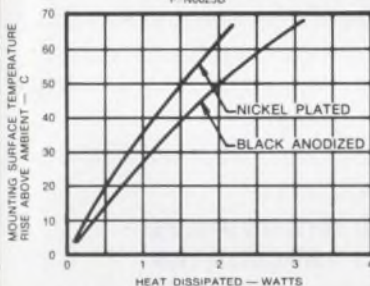

**Available from your local  
Thermalloy distributor.**

Thermalloy offers a complete line for cooling everything from TO-5's to disc compression devices.

**Write for  
FREE  
CATALOG.**



\*Chromate finish, 1000 quan.

**Thermalloy**

P.O. BOX 34829  
2021 W. VALLEY VIEW LANE / DALLAS, TEXAS 75234  
PHONE 214-243-4321 / TWX 910-860-5542

ICs & SEMICONDUCTORS

### 100-ns arithmetic unit processes serial BCD



Texas Instruments, P.O. Box 5012,  
M/S 308, Dallas, Tex. 75222.  
(214) 238-3741. \$32.11 (100 up);  
stock.

The TMS0117, a BCD arithmetic processor that handles numerical data in the serial format, can process numbers up to 10 digits in less than 100-ns main operation time. The four basic operations—add, subtract, multiply and divide—are provided. In addition, add-to-overflow and subtract-to-zero, other operations provided, may be used to set up variable delays, with digital accuracy, from a few microseconds to 200 days.

CHECK NO. 325

### Multivolt rectifier has 250-ns recovery

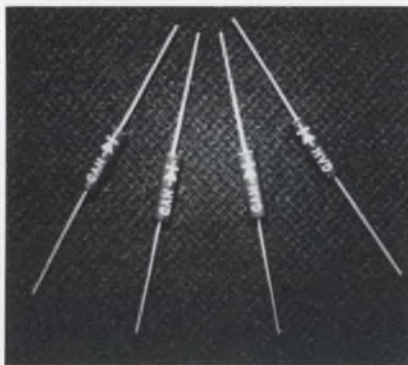

High Voltage Devices, 7485 Ave-  
nue 304, Visalia, Calif. 93277.  
(209) 733-3870.

Featuring a reverse recovery time of only 250 ns, the MX30/100 multivolt rectifier lists peak-reverse ratings of 3000 to 10,000 V. Average rectified current at 50 C is 25 A, while reverse current at 25 C is 1  $\mu$ A. Single cycle and repetitive surges are 5 and 0.25 A, respectively. The new rectifiers have forward voltage drops of 8 to 12 V.

CHECK NO. 326

### IC photoswitch outputs 20 mA

Teknis, 93 South St., Plainville,  
Mass. 02762. (617) 695-3591. \$2  
(sample qty.).

The PS12 and PS24 integrated photoswitches consist of a photo-diode, Schmitt trigger and an output-drive circuit. The output of either IC can deliver 20 mA under all light-level switching conditions. The light threshold at which the output switches is set by an external RC time constant. Nominal supply voltages are 12 V for the PS12 and 24 V for the PS24. Packaging is a four-lead glass-windowed TO-18.

CHECK NO. 327

### ECL multiplexer/latch propagates in 2.5 ns

Signetics, 811 E. Arques Ave.,  
Sunnyvale, Calif. 94086. (408) 739-  
7700. \$6.20 (100 up).

The 10173, an ECL quad clocked D-type latch with 2-to-1 data multiplexing capability, has a typical propagation delay of only 2.5 ns from data to output. From select to output, the delay is 3.7 ns typical, and from clock to output, it's 4.3 ns typical. Power dissipation is typically 325 mW per package with no load. The 10173 can drive 50- $\Omega$  lines and its open-emitter outputs allow wire-ORing and data busing. The 10173 is available in a 16-pin ceramic DIP.

INQUIRE DIRECT

### Digital clock displays 12 or 24-hour format

Antex Industries, 1059 E. Meadow  
Circle, Palo Alto, Calif. 94303.  
(415) 326-2441. MC-1001: \$11.50  
(100 up); 30 days.

The MC-1001 digital clock IC can display either hours and minutes or hours, minutes and seconds in a 12 or 24-hour format. Other features of the MC-1001 are four or six-digit display drive, 50 or 60-Hz timing and multiplexed outputs for both segments and digits. The IC can operate from a single 11-to-17 V dc power supply. The new circuit is supplied in a 24-lead ceramic package. Another version has BCD and seven-segment outputs in a 28-lead package.

CHECK NO. 328

INFORMATION RETRIEVAL NUMBER 87

**It's downright humiliating!  
Any field return is one too many!**

**Horace, you're never satisfied.  
We may have just set the industry's  
lowest return record!**

**I hate these impassioned  
technical discussions.**



## **Even a 3.1% Function Generator return rate agitates Horace. IEC has trained him well.**

It's an unwritten business rule that you don't discuss your problems with the outside world, but we're breaking tradition because we feel our F34 returns are worth talking about. This extremely low warranty repair record was established during the first year of production, even though industry statistics demonstrate that failure percentages are highest during the initial stage of product life. According to electronics manufacturers' trade association data, standard warranty returns can range from 10% for DVM's and oscilloscopes, to as much as 300% for some temperamental instruments. This is why we feel that our F34's current return rate of 3.1% is a real achievement.

Much of the credit for this reliable new function generator must go to IEC's Corporate Cal Lab, one of the few testing facilities with analysis standards one generation away from the National Bureau of Standards. The F-34 underwent the same kind of computerized error-analysis and evaluation testing that our Metrology staff developed for Polaris/Poseidon and other government programs.

With our stringent Quality Control system, we make sure that our test instruments measure up to performance standards, because we're vitally aware that downtime is a significant factor in test instrument selection. Over 300 generators were

shipped before one was ever returned, and to date, 96.9% have never required warranty maintenance. But because our QC people, like Horace, worry about that 3.1%, we'll try to do even better.

**If you would like a perfectionist like Horace on your team, specify the F-34. It generates reliable 0.03Hz - 3MHz waveforms, with Variable Width Pulse for pulse generator applications, and an outstanding combination of operating features for \$495... In a hurry to match your requirements? Call John Norburg (collect) 714/772-2811.**



**IEC INTERSTATE  
ELECTRONICS  
CORPORATION**

Subsidiary of A-T-O Inc.

Dept. 7000, Box 3117, Anaheim, Calif. 92803.

TWX 714-776-0280

TELEX 655443 & 655419



## Uninterruptible Power Systems

Compact package includes battery charger, batteries, inverter, automatic transfer switch and all required control circuitry. Back-up time can be extended by external batteries. Many optional features are available.

- Internal sealed batteries
- Proven dependability
- 95 to 130 Vac input
- High efficiency

VA	Part No.	Back-Up Time	List Price	Typical Delivery
500	3151-1	15 minutes	\$1825	2 weeks
1000	3152-1	20 minutes	2450	2 weeks
2000	2529-1	15 minutes	3950	4 weeks

Other models from 300 VA to 10,000 VA

INFORMATION RETRIEVAL NUMBER 89

# TOPAZ

ELECTRONICS

3855 Ruffin Road, San Diego, CA. 92123  
Phone (714) 279-0111 TWX: (910) 335-1526

## ICs & SEMICONDUCTORS

### 50-A bridge rectifier has 0.5°C/W resistance

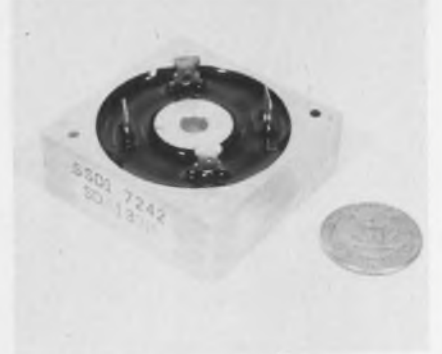

*Solid State Devices, 12741 Los Nietos Rd., Santa Fe Springs, Calif. 90670. (213) 698-3711. 50 PIV version: \$10.25 (100 up).*

A series of 50-A bridge rectifiers, called the SDA132, provide a maximum thermal resistance of only 0.5°C/W. Seven models are included in the series with PIVs ranging from 50 to 1000 V. A two-way terminal provides designers with a choice of Wire-Wrap or soldering hole mounting. Over-all size is 3/4 × 2 inches.

CHECK NO. 329

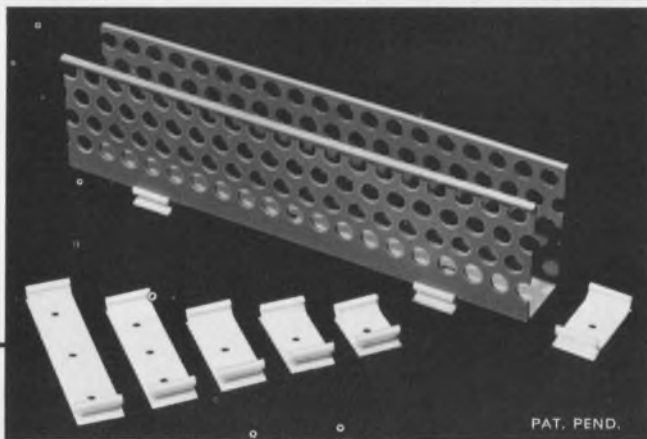

## NEW! Wiring Duct Mounting Clips

Exclusive non-conductive plastic clips simplify wiring duct mounting. Attach clips with screws, nylon rivets or pressure-sensitive adhesive provided on clip underside. Any standard Taylor duct segment—even pre-wired—snaps securely in place. Eliminates accurate mounting hole layout. Adhesive back eliminates mounting holes altogether where they would be impractical or unsightly. *Write for free samples.*



**TAYLOR INDUSTRIES, INC.**

Fisher Road/Howell, Michigan 48843

INFORMATION RETRIEVAL NUMBER 90

### SCR bridge assemblies control 20 A at 600 V

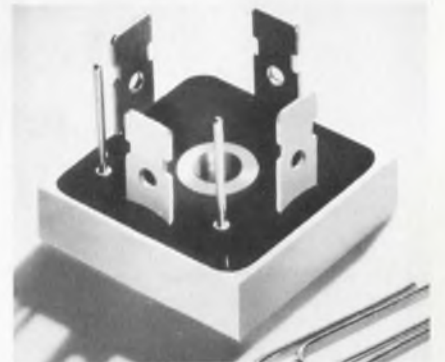

*Sarkes Tarzian, 415 N. College Ave., Bloomington, Ind. 47401. (812) 332-1435.*

Rated for 20 A max at 600 V, the 20CRBR series incorporates two rectifiers and two SCRs in an aluminum case measuring only 1.125 in. square and 0.312 in. high. The unit uses single-screw mounting through its metal center, and its terminals can be soldered or wrapped. The case is electrically isolated from the internal components. Any metal sink surface can be used as a heat sink.

CHECK NO. 330

## X-Y multiplier delivers an accuracy of 0.5%

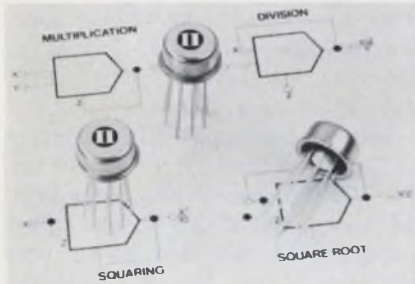

Intronics, 57 Chapel St., Newton, Mass. 02158. (617) 332-7350. (1-up) \$20 (J), \$32 (K), \$44 (L), \$44 (S); stock.

The series M530 multiplier/divider/squarer/square-rooter is a completely self-contained unit. Thin-film resistors are used instead of diffused resistors in critical locations. Models M530J, K, L are rated for multiplication errors of 2%, 1% and 0.5%, respectively, at an operating ambient temperature of +25 C; the model M530S, a MIL version, is rated for 1% accuracy at 25 C. All models have a 3-dB bandwidth of 1 MHz, and full-power output frequency of 400 kHz. The short-circuit-protected output stage delivers 5 mA max, with a  $\pm 10$ -V output swing. The M530 is in a hermetic sealed TO-100 can, and can operate at ambients from -55 to +125 C.

CHECK NO. 331

## Opto-isolator breaks down at 1500 V

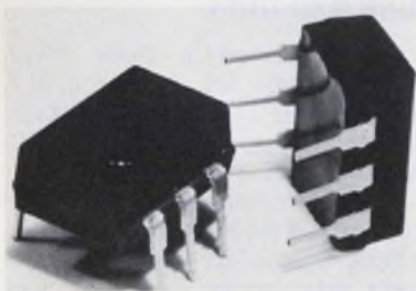

Litronix, 19000 Homestead Rd., Cupertino, Calif. 95014. (408) 257-7910. \$1.29 (1000 up); stock.

The IL-74 opto-isolator can interface directly with TTL and has a 1500-V input-to-output breakdown voltage. Typical dc transfer ratio is 35% with a minimum of 12.5%. The device comes in a six-lead DIP that contains an optically coupled GaAs infrared LED and a silicon npn phototransistor.

CHECK NO. 332

# innovation yesterday

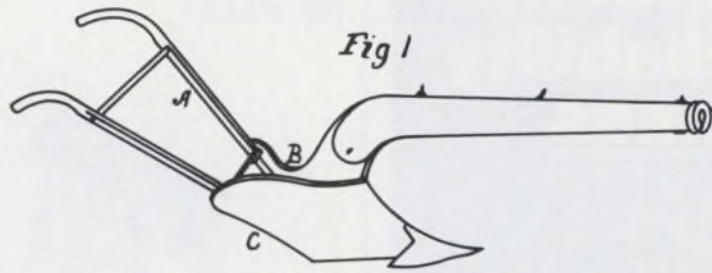

The secret weapon. This plow functions normally until the farmer is attacked, as by Indians. Then, the team is unhitched, and the plow becomes artillery, anchored by the share, "ready charged with its deadly missiles of ball or grape." U.S. Pat. 35,600 (1862)

# innovation today



**DIGIVIDER  
DIGIDECADE**

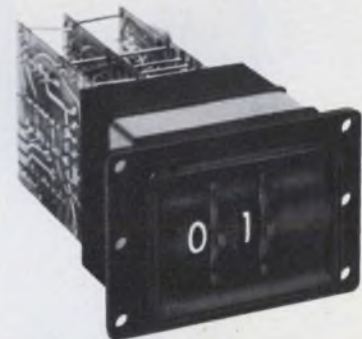

**PURE BINARY**

You might get a kick out of the 1862 plow that converted to a cannon. Taking an existing product and converting it to another use is innovative. Like our DIGIVIDER/DIGIDECADE. Or our PURE BINARY switches. We took our standard Thumbwheel switches and converted them to a new and practical use.

DIGIVIDER is a voltage divider. It acts like a ten turn potentiometer. Digitally dial the voltage or resistance you desire and that's precisely what you get.

DIGIDECADE is a resistance decade. Simply dial the resistance you want and the output will be exactly what you dialed.

Our PURE BINARY switch converts binary coded decimal input to pure binary output. Automatically. And they are compatible with TTL and DTL circuitry. So, ask for catalog. That's a good idea too.

See us in EEM 72-73  
Vol. 2 Pages 2116-2117

**THE DIGITRAN<sup>®</sup> COMPANY**

A Division of Becton, Dickinson and Company **B-D**

855 So. Arroyo Parkway / Pasadena, Ca. 91105 / Tel. (213) 449-3110 / TWX 910-588-3794

# Higher Capacitor Reliability for LESS



## **CUSTOM ELECTRONICS MICA CAPACITORS**

Your design engineers will instantly recognize the quality and reliability of reconstituted mica capacitors from Custom Electronics... where all the mica dielectric is precisely graded before production and selected for each application.

**Result:** Higher capacitor reliability for **LESS**

CMR—Wrap and Fill  
CER—Epoxy Housed  
CEM—Epoxy Molded

If your capacitor needs are **RELIABILITY** and **RAPID REACTION** (inquiry to quote; order to delivery), write or call



**CUSTOM ELECTRONICS, Inc.**  
4 Browne St., Oneonta, N. Y. 13820  
PH: 607-432-3880 TWX 510-241-8292

## ICs & SEMICONDUCTORS

### Digital mixer for PLLs

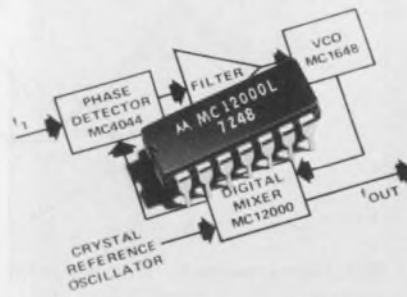

Motorola Semiconductor Products, P.O. Box 20924, Phoenix, Ariz. 85036. (602) 244-3466. \$5 (100 up).

The MC12000 digital mixer, for use in phase-locked loops, consists of a D flip-flop, together with TTL-to-ECL and ECL-to-TTL translators. In a PLL, frequencies up to 250 MHz can be generated without need for external tuned circuits. The MC12000 operates from a single power supply of either +5 or -5 V dc and comes in a 14-pin DIP.

CHECK NO. 333

### Dual JFETs have lowest noise voltage available



Analog Devices, Rt. 1, Industrial Park, P.O. Box 280, Norwood, Mass. 02262. (408) 249-2111. (1 to 99) \$9.40 (AD840), \$7.80 (AD841); stock to 4 wk.

In addition to its extremely low voltage noise of less than 15 mV/(Hz)<sup>1/2</sup> at 10 Hz, the AD840/AD841 provides an extremely low offset voltage of 5 mV maximum, and low drift of 5  $\mu$ V/ $^{\circ}$ C (AD841). The FETs are available in the TO-52, TO-71 or TO-78 package and are designed for operation over the -55 to +125 C temperature range. The AD840/AD841 are superior replacements for the 2N-5515, 2N5520 series which are hybrid dual-chip devices.

CHECK NO. 334

### Op amp features 2-nA offset, 15-nA bias

Silicon General, 7382 Bolsa Ave., Westminster, Calif. 92683. (714) 892-5531. SG1456T: \$2.25 (100 up); stock to 4 wks.

With a low input offset current of 2 nA and bias current of 15 nA, the SG1556 op amp also has a typical slew rate of 2.5 V/ $\mu$ s. Offset voltage is 4 mV and power consumption is only 45 mW maximum. Commercial versions are available with 10-mV and 10-nA offsets and 30-nA bias current (SG1456). The device comes in a TO-99 metal can, as well as in chip form, and is identical to the MC1556 series from Motorola.

CHECK NO. 335

### FM detector/limiter uses one tuning coil

Signetics, 811 E. Arques Ave., Sunnyvale, Calif. 94086. (408) 739-7700. \$1.50 (100).

The ULN2111, an FM detector and limiter IC, requires only a single winding coil for tuning. The frequency range of the IC extends from 5 kHz to 50 MHz. Outputs of 0.6 V with a total distortion of less than 1% and a limiting threshold voltage of 400  $\mu$ V rms are typical values. The new IC also has a voltage gain of 60 dB.

INQUIRE DIRECT

### CMOS/SOS line expands

Inselek, University Park Plaza, 443 Alexander Rd., Princeton, N.J. 08540. (609) 452-2222. INS 4007S: \$2.65; INS 4013S: \$4.75; INS 4027S: \$5.88 (100-999).

The only commercially available line of CMOS-logic circuits using silicon-on-sapphire technology has been extended by three ICs. The new devices consist of a dual complementary pair plus inverter (INS 4007S), dual D-type flip-flop (INS 4013S) and dual J-K flip-flop (INS 4027S). All devices in the 4000S series—now a total of five—operate over the -55 to 125 C temperature range. They are reportedly five times faster than their silicon counterparts and dissipate only one ten-millionth the power in the standby mode.

CHECK NO. 336

LED, LAMP PHOTOCELLS, M.C.  
MULTICHANNEL CdS, SILICON PHC  
SILICON PHOTOCELLS CdS, PbS, LED, L.C.

## QUALITY PHOTOCONDUCTIVE CELLS

A complete line for light meters, flame detectors, automated machinery and lighting systems.

FREE CATALOG  
call or write

**HAMAMATSU CORP.**  
120 Wood Avenue  
Middlesex, New Jersey 08846  
201 - 469-6640

INFORMATION RETRIEVAL NUMBER 93

## 3' x 4' on the floor. Tenney gives you more!



TenneyTen temperature and humidity test chamber is just 33" wide by 49" deep—with 10 cu. ft. inside capacity. In 5 models offering medium or extreme temperature, with or without humidity.

Model TTH: 0°F to 200°F with humidity  
Model TTRS: -40°F to 350°F with humidity  
Model TTRC: -100°F to 350°F with humidity  
Model TTS: -40°F to 350°F  
Model TTC: -100°F to 350°F

Write or call for details.

**Tenney**  
ENGINEERING, INC.

1090 Springfield Rd., Union, New Jersey 07083 • (201) 686-7870

Western Division: 15721 Texaco St., Paramount, Calif. 90723

700

INFORMATION RETRIEVAL NUMBER 94

ELECTRONIC DESIGN 10, May 10, 1973

# INTRODUCING OUR NEW 10 AMP ULTRA RELIABLE POWER RELAY

Our new, imported power relay has everything going for it because it is the product of an all-out effort to achieve complete reliability and durability in a more compact 10 ampere model.

Point-by-point, we have designed into it every conceivable improvement dictated by our broad engineering capabilities and extensive field testing experiences. It is interchangeable with widely used, comparable types — at a lower price. Delivery from stock. Call us or write for quotes and samples. Ask for HP. UL Component recognition No. E36213C.

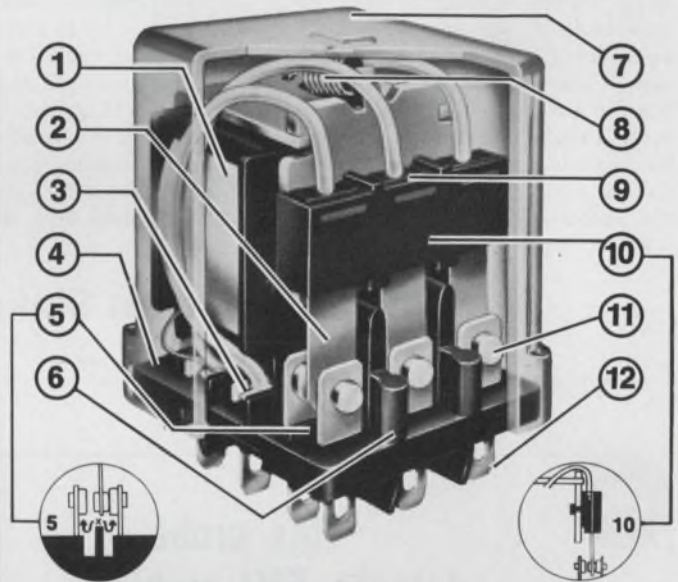

### Check these 12 Major Improvements:

- ① Polyurethane enamel-coated copper wire coil for maximum insulation and heat resistance.
- ② Beryllium copper contact spring. Best alloy for this application.
- ③ Welded leads throughout. Eliminates soldering irregularities.
- ④ Ammonia-free phenolic base. Maximum resistance against arcing and insulation deterioration.
- ⑤ Rib and groove barriers to maintain highest insulation between contacts.
- ⑥ Arc barriers to prevent pole flash-overs.
- ⑦ Clear Polycarbonate heat and shock resistant dust cover.
- ⑧ Stainless steel corrosion proof release spring.
- ⑨ Springs and wires molded into one piece with FGR #66 Nylon.
- ⑩ Plastic spring holder securely heat riveted to the armature.
- ⑪ Stabilized silver contacts for low contact resistance. Long shelf life.
- ⑫ Terminals firmly molded into the base. Choice of: plug-in, solder or 0.187" push-on wire terminations.



**LINE RELAYS**

A UNIT OF ESTERLINE CORPORATION

Line Electric Company, U.S. Highway 287, Parsippany, N.J. 07054

201/887-8200

INFORMATION RETRIEVAL NUMBER 95

153

# Quiet is the sound of our liquid cooled heat sinks for hot semi's

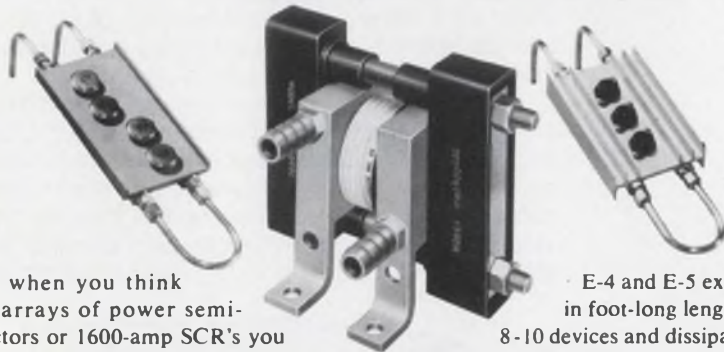

Today when you think about arrays of power semi-conductors or 1600-amp SCR's you think liquid. Otherwise you won't be able to hear yourself think. Cooling 3000 watts in a cubic foot with air makes more racket than anyone can stand. Now IERC has the building blocks for liquid cooled systems to handle that power and you can use almost any liquid. For instance, our

E-4 and E-5 extrusions in foot-long lengths hold 8-10 devices and dissipate 1000 watts. For hot shots like hockey pucks our liquid sinks dissipate 1000 watts with just 20°C case rise. Write for details and ask about our liquid cooled packaging for circuit modules, too. IERC, a subsidiary of Dynamics Corporation of America, 135 W. Magnolia Blvd., Burbank, Calif. 91502.

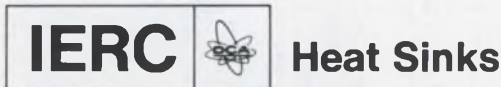

INFORMATION RETRIEVAL NUMBER 96

## COMPONENTS

### Clutch and brake series provides many styles



*Inertia Dynamics Inc., P.O. Box 295, 12 Bridge St., Collinsville, Conn. 06022. (203) 693-0203.*

Low cost (\$3 to \$9) and high torque (2.5 lb-in. static torque) are featured in this new Series-08 clutch and brake. Specifically designed for instrument and copy-machine applications, these units are equipped with sintered-bronze bearings, they are UL approved, use 22-AWG lead wire, are zinc-chromate finished and use long wear-life friction material. Standard units are available in five different design configurations, four dc voltages (90, 28, 24 and 12) and three bore sizes (1/8, 3/16 and 1/4 in.). Special designs are also available with clutch/clutch or clutch/brake combinations.

CHECK NO. 337

### Varactor diode offers leakage of only 20 nA

*Varian, Solid State East, Salem Rd., Beverly, Mass. 01915. (617) 922-6000.*

Varian's new glass-packaged, silicon varactor diodes have low leakage currents over a wide temperature range. Typical leakage is 20 nA at 25 C and 500 nA at 150 C. Capacitance-temperature coefficients are as low as 200 ppm/°C. Low losses at microwave frequencies make the varactors suitable for tuning at frequencies as high as the C band. Specifications for the capacitance-tuning-ratio range from 3.5:1 to 10:1. Available reverse breakdown voltages are 45, 60 and 120 V, and the respective minimum Q ratings are nominally 1000, 800 and 450.

CHECK NO. 338



## This probe detects EMI problems...

At least 80% of today's magnetic shield designs were developed at the Magnetic Shield Division of Perfection Mica Co. Our Netic and Co-Netic shielding materials are recognized industry standards around the world. They are cited in many military procedural documents.



Our shielding experience has resulted in the world's most comprehensive line of standardized and specialized designs like: Netic and Co-Netic foil and sheet stock - Photo-multiplier

and CRT shields - Zero gauss chambers - Transformer, relay, motor and other component shields - Shielded rooms - Field evaluator probes - Tape data preservers - Shielded conduit & cable.

We'll tackle prototype through production runs.

Check the reader service number for current literature or contact: MAGNETIC SHIELD DIVISION, Perfection Mica Company, 740 Thomas Drive, Bensenville, Illinois 60106, (312) 766-7800.

## ...and our complete line of shielding materials solves them.

INFORMATION RETRIEVAL NUMBER 97



## Thick-film resistors provide close tolerances

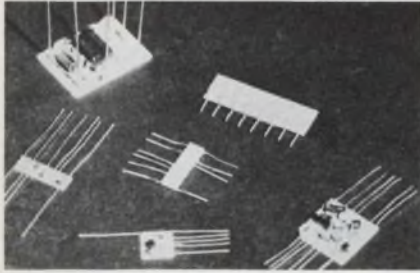

AFI Industries, 400 Warburton Pl., Long Branch, N. J. 07740. (201) 229-8300.

AFI's new line of high and low-voltage thick-film resistors, in single-inline packages, feature close-tolerance networks ( $\pm 10\%$  to  $\pm 0.1\%$ ). Designated the AF 4000 Series, the resistors have power dissipations to 5 W, resistances from 3 to  $10^8 \Omega$ , operating voltages to 50 kV, voltage coefficients to less than 5 ppm/V and noise levels of  $-3$  dB at low resistivities, to  $+15$  dB at high resistivities. This line of thick-film networks features high-density packaging and comes with 100 and 125-mil pin-terminal spacing, in a variety of circuit and mechanical configurations.

CHECK NO. 339

## Xenon arc radiates 200,000 candlepower

Varian Associates, 301 Industrial Way, San Carlos, Calif. 94070. (415) 592-1221.

An arc lamp that measures only 2 in.<sup>3</sup> puts out 200,000 cd. This Varian X6207 lamp can provide a white light that is compatible with inks and papers used in optical character reading machines. The X6207 is a short-arc xenon lamp with electrodes, reflector and lens sealed into a single, pressurized unit. The lamp's efficiency is said to be three to four times that of previous high-intensity arc lights, but the unit is only a tenth as large. It consumes 150 W and radiates over the entire spectrum of infrared, visible and ultraviolet wavelengths. Features of the X-6207 include: tungsten-alloy electrodes; a paraboloid reflector that is cast into the ceramic body of the lamp; and a window made from a sapphire crystal, thermally matched to the mating metal parts of the lamp.

CHECK NO. 340

Resolutions of 1 microvolt DC and 1 milliohm, along with 100% overranging on all functions, make the Hickok 3410 a value leader at \$695. This is a full capability instrument, measuring DC and AC voltage and current, and resistance. High level recorder output is provided. Options include an internal rechargeable battery and 300%

overranging. Send for complete specifications in 3400 Series Data Sheet.

**HICKOK**  
the value innovator

Instrumentation & Controls Division  
The Hickok Electrical Instrument Co.  
10514 Dupont Ave. • Cleveland, Ohio 44108  
(216) 541-8060 • TWX: 810-421-8286

## 4-digit microvolt multimeter for \$695



INFORMATION RETRIEVAL NUMBER 191

The new Hickok 3420 is different: it's a full 5-digit counter to 20 MHz and it also measures DC/AC voltage from 10  $\mu$ V to 1 kV, and resistance from 10 m $\Omega$  to 10 M $\Omega$  with 4-digit resolution. Frequencies are measured to 0.01-Hz resolution, accurate to  $1 \times 10^{-6}$  for 1 year. Sensitivity of 100 mV and the 20-MHz bandwidth make the 3420 useful in logic circuitry

and communications systems testing. Internal rechargeable battery is optional. Price, only \$750.

**HICKOK**  
the value innovator

Instrumentation & Controls Division  
The Hickok Electrical Instrument Co.  
10514 Dupont Ave. • Cleveland, Ohio 44108  
(216) 541-8060 • TWX: 810-421-8286

## 5-digit counter & 4-digit multimeter in one package



INFORMATION RETRIEVAL NUMBER 192



### New Low Cost Time Code

**Translator.** Advances technology of Astrodata product line acquisition. Translates all serial time code inputs into parallel BCD or binary outputs. Plug-in TTL logic modules offer compatible interface to any related equipment. Most readable 7-segment displays of days/hrs/min/sec are gas discharge type. MOXON, SRC DIV. CIRCLE 151



### New Computer Compatible, Programmable DC Power Source.

Automatic systems use. Output 100V @ 0.5A or 50V @ 1A. 16-bit binary or 8-4-2-1 BCD. Hi speed — over 10 kHz. Noise and ripple 800 uv p-p max. Load transient recovery 30  $\mu$ sec. Data circuit interface selection, programmable current limiting. Hi AC/DC isolation w/guard shield. Data line isolation. MOXON, SRC DIV. CIRCLE 152



### Versatile 480 Bit Data Generators.

New Model 916 Generator simulates digital inputs or outputs for design, development or system use with computers, peripherals and test equipment (MOS and bipolar logic levels available). Outputs; serial 1,2,8,16 channels; parallel with up to 480, 240, 60 or 30 bits per channel respectively. Rates to 15MHz. SRC/MOXON CIRCLE 153



**Moxon Inc/SRC Division**  
2222 Michelson Drive  
Irvine, California 92664  
Phone: (714) 833-2000

## COMPONENTS

### Pushbutton switch has three-position action

*Cutler-Hammer, 1420 Delmar Dr., Folcroft, Pa. 19032. (215) 586-7500. \$3 (OEM qty).*

Model B5300 is a pushbutton switch with three positions. The first, or normal position, is available as a NO or NC contact. The second position occurs after only 0.070 in. of travel. After 0.060 in. more travel, the second circuit releases and the third circuit actuates. Release the button and the operation reverses. Both the second and third positions have positive detents. The second and third switch positions are also available with NO or NC contacts. Thus combinations such as momentary OFF-ON-ON, ON-OFF-ON or ON-ON-OFF are readily obtained. The switch can be waterproof, is 1-7/16-in. high and panel mounts with a standard 1/2-in. hex nut. A wide range of colored buttons and mounting adapters are available for various front-panel designs. The switch is rated at 28 V dc and 120 V ac for 3-A resistive and 1-A inductive loads.

CHECK NO. 341

### Subminiature switch is only 0.156-in. thick

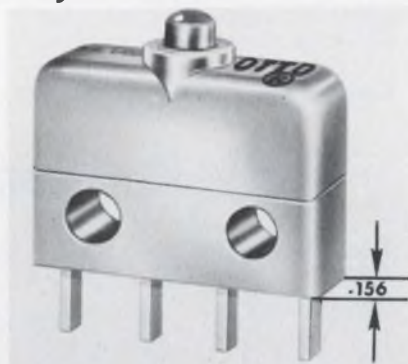

*Otto Engineering, 36 Main St., Carpentersville, Ill. 60110. (312) 428-7171. \$2.28; B3-1140, with spade terminals (100 up).*

Only 0.156 in. thick, the Otto subminiature snap-action switch, Series B3 meets the MIL-S-8805/101 spec. The length is 0.51 in. and the height is 0.35 in. An 8-A rating, double-break switching and less than 0.01- $\Omega$  contact resistance make the unit suitable for dry-circuit operation.

CHECK NO. 342

### Position transducer has built-in electronics

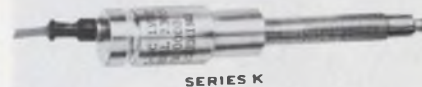

*Pickering & Co., Inc., 101 Sunnyside Blvd., Plainview, N.Y. 11803. (212) 695-3178. \$154.85 to \$190.85 (unit qty).*

The 7303 AK LVDT Series of precision linear-displacement transducers features hermetically sealed, spring-loaded core followers with replaceable tips. The required actuating force is only 10 g over the entire displacement range of 0.020 in. Nonlinearities range from  $\pm 0.05\%$  to  $\pm 3.5\%$ . Costly support equipment is not needed because of a built-in oscillator and demodulator. The units require only a 6-V dc input and they provide up to a 2-V dc output. Signals can be transmitted 200 ft. with little degradation.

CHECK NO. 343

### Small circuit breaker is MS3320 approved

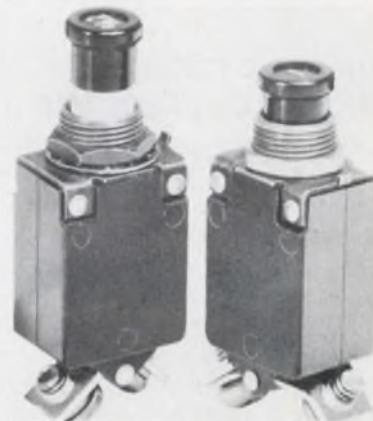

*Aiken Industries, 1824 River St., Jackson, Mich. 49204. (517) 782-0391.*

The lightweight, miniature single-phase circuit breaker, MP Series 4310, is now MS3320 approved. Circuit breakers in this series are of the push-pull, manual-reset type and have a 1 to 20-A range. The breakers feature ambient temperature compensation, vibration resistance exceeding Mil Specs, and a 6000-A interruption capacity. The housings take up only 0.553 cu. in. Calibration integrity is maintained through wide variations in temperature and altitude.

CHECK NO. 344

# a new choice in Plug-In Rotaries

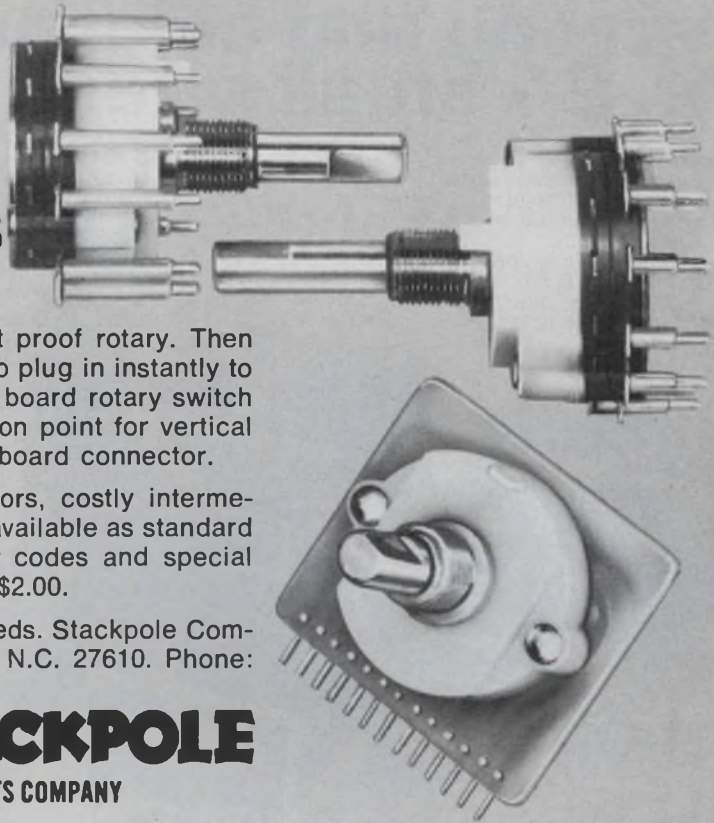

Start with Stackpole's exclusive environment proof rotary. Then add terminal pins facing front or rear, ready to plug in instantly to your PC board. Or design in a Stackpole PC board rotary switch with 12 terminals ending at a common junction point for vertical or horizontal mounting or mating to an edge-board connector.

Eliminate wiring harnesses, hand wiring errors, costly intermediate assembly. Pin termination switches are available as standard off-the-shelf switches as well as with binary codes and special switching sequences. Yet they cost less than \$2.00.

Call Stackpole. They're plugged in to your needs. Stackpole Components Company, P.O. Box 14466, Raleigh, N.C. 27610. Phone: 919-828-6201.



**STACKPOLE**  
COMPONENTS COMPANY

INFORMATION RETRIEVAL NUMBER 100

## who cares what a control knob looks like?

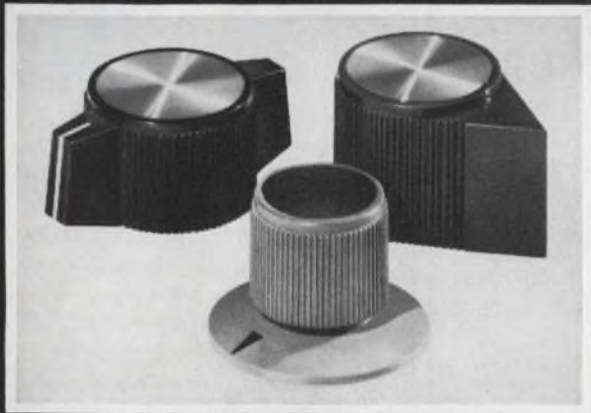

**we do.**

**ROGAN**

Outline your requirements for quotation and free knob sample. Also write for free, full-color catalog.

3455 WOODHEAD DR., NORTHBROOK, ILL. 60062, (312) 498-2300

INFORMATION RETRIEVAL NUMBER 101

ELECTRONIC DESIGN 10, May 10, 1973



**PERFECT REGISTRATION** because you position patterns first, then rub them down.

**CORRECTIONS ARE EASY** because you can lift patterns with a knife and reuse them.

**TOUGHER THAN STICK-ONS** because the ink is underneath a hard plastic over-coat.

Try the JotDraft Sampler and convince yourself. It's an assortment of 746 patterns and pads (2X scale) for \$4.50. Or write for a free sample and catalog. You'll be glad you did!

The **DATAK** Corporation

85 Highland Avenue • Passaic, New Jersey 07055

INFORMATION RETRIEVAL NUMBER 102

# How to be beautiful, strong and colorful, in 24 small sizes.

Bold design and quality construction are hallmarks of Optima Small Case enclosures. Mobile, versatile and rugged, these cases offer hundreds of two-color combinations in durable vinyl finishes, with useable inside space ranging from 133.6 to 1445.4 cubic inches. Get information on the complete Optima line. Write

Optima Enclosures, division of Scientific-Atlanta, Inc., 2166 Mountain Industrial Blvd., Tucker, Ga. 30084. Or call (404) 939-6340.

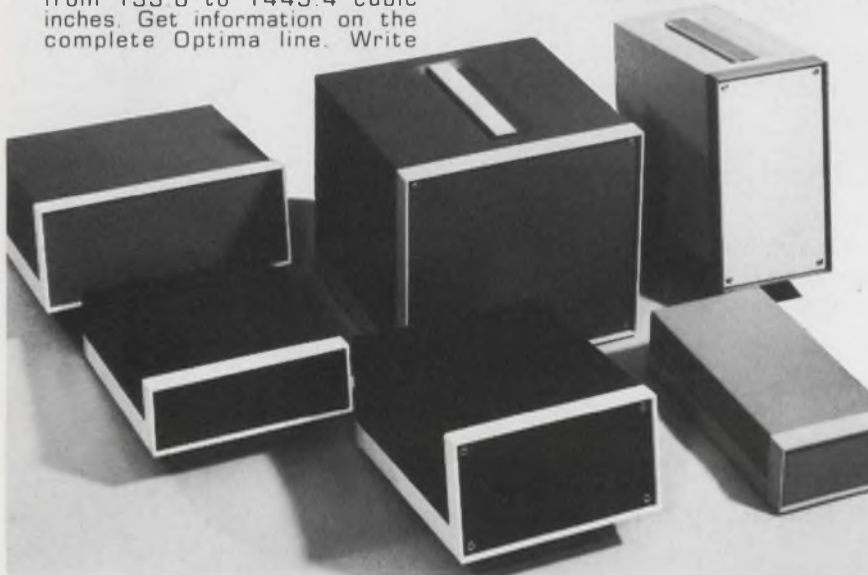

INFORMATION RETRIEVAL NUMBER 103

## Hire a veteran. Hire experience.

**A veteran electrician,  
a veteran cook,  
a veteran construction worker,  
a veteran mechanic,  
a veteran administrator,  
a veteran medical specialist,  
a veteran programmer,  
a veteran policeman.**

**Don't forget. Hire the vet.**

For help in hiring veterans, contact your local office of the State Employment Service; for on-the-job training information, see your local Veterans Administration office.



## PACKAGING & MATERIALS

### Nickel replaces noble metals at 1/10 cost



*Electro Materials Corp. of America, 605 Center Ave., Mamaroneck, N. Y. 10543. (914) 698-8434. \$6.00 per oz (OEM qty); stock.*

Nickel 6500 is a screen-printable nickel paste that can be fired in a conveyor furnace at moderate temperatures (850 to 1200 C). It is claimed to be a breakthrough in the use of a low-cost substitute for noble-metal conductors. The paste can be soldered and brazed with standard alloys; will not be leached by the solder; and costs approximately 1/10th that of Pt or Au. Standard techniques with 200 or 325 mesh screens achieve lines and spacings of 5 mils. Coverage is approximately 300 in<sup>2</sup>/oz.

CHECK NO. 345

### IC socket fights solder-wicking



*Robinson-Nugent, Inc., 800 E. 8th St., P.O. Box 470, New Albany, Ind. 47150. \$0.23 (OEM qty).*

A new series of IC sockets feature one-piece beryllium-copper contacts with terminals offset to fit larger mounting pads. This offset eliminates solder-wicking into the contacts. The TO-5 Series sockets provide 0.015-in. standoffs for PCB cleaning after soldering, yet the units stand only 0.225-in. high when mounted. The sockets' glass-nylon body has a center-through hole for hard mounting or to aid IC removal. A molded-in tab guide helps IC insertion.

CHECK NO. 346

## Avoid coating junctions before encapsulation

Emerson & Cuming, Inc., Canton, Mass. 02021. (617) 828-3300. For 2500 lb lots: \$1.70/lb (4119), \$1.94/lb (4125); 2 wk.

Encapsulate semiconductor devices without a junction coating to separate the device from the encapsulating medium. Eccomold 4119 and 4125 molding powders make this possible, due to their low ionizable extractables in water. These encapsulating materials eliminate corrosion of the semiconductor device, provide a good moisture seal, and mechanical and thermal protection. Eccomold 4119 has a higher heat deflection temperature of 175 C. Its thermal expansion coefficient is  $30 \times 10^{-6}/^{\circ}\text{C}$ . Eccomold 4125 has a heat deflection temperature of 169 C but its thermal expansion coefficient is  $22 \times 10^{-6}/^{\circ}\text{C}$ .

CHECK NO. 347

## DIP element strips help high-density designs

Circuit-Stik, 24015 Garnier St., P.O. Box 3396, Torrance, Calif. 90510. (213) 530-5530. \$6 to \$7 (pkg. of five strips); stock.

Adhesive-backed, conductive mounting pads in DIP patterns are useful for assembling high density circuit boards. Each element strip has patterns for six DIPs. Versions for either 14 or 16-lead packages are available, with or without power or ground connections, and with single or double pads. The strips have tin-plated conductors etched onto epoxy/glass substrates with an adhesive backing. Free samples are available.

CHECK NO. 465

## Tubing can shrink 50% when heated to 130 F

Daburn Electronics & Cable, 2360 Hoffman St., Bronx, N. Y. 10458. (212) 295-0050.

Daprene heat-shrinkable neoprene tubing begins to shrink at only 130 F, and if allowed full recovery, will shrink to 50% of its supplied diameter. The tubing comes in expanded-size diameters of 1/4 through 4 in. and it is packaged in 100 foot lengths. The standard color is black.

CHECK NO. 349

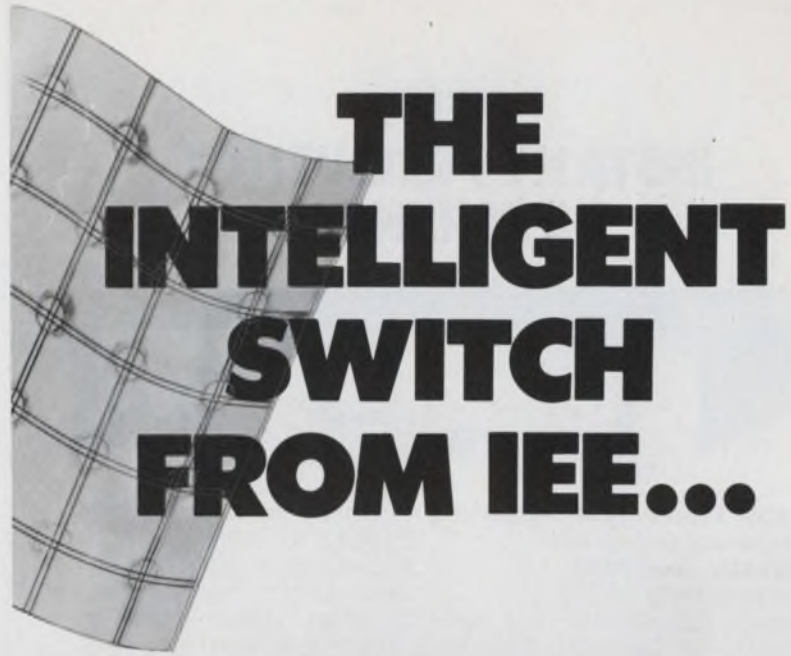

## the lite touch

Intelligent switching . . . IEE makes it happen with an ingenious completely sealed TRANSPARENT matrix switch...the "CUE-SWITCH"®. This totally reliable, light weight low-profile package is a whole new concept in man/machine interaction. Being transparent, "CUE-SWITCH" matrices can be placed over any surface yet retain the readability of printed or projected data, i.e.; silk screened panels, CRT face, calculator, indicator/annunciator lights, rear-projection graphics, etc. It's a totally sealed switch element, impervious to dust, dirt or moisture.

True fingertip pressure — 4 to 9 oz., .005" travel, actuates switching by contacting matrix-fashion wire conductors embedded in clear dielectric films. NO mechanical linkages, springs or buttons and the total switch package thickness is only .040".

How does the "CUE-SWITCH" act intelligent? The transparent switch sandwich allows direct see-through or illuminated rear projection of ANY

GRAPHIC DATA to the viewing or "touch" surface of the switch. Photo film can be used to avoid costly engravings, and there are no restrictions on data content or color.

Features of the standard product line of the "CUE-SWITCH" include:

- lighted "push button" assemblies on .8" centers
- bezel units combined with IEE's rear projection readouts
- 8 switch units wide
- 3x4 matrices with adding machine or touch-tone format

The standard product line is only the beginning . . . Inquire now about custom matrices — IEE engineers them to put intelligent switching to work for your applications. Give us a call. Industrial Electronic Engineers, Inc., 7740 Lemona Avenue, Van Nuys, California 91405.

Telephone: (213) 787-0311, TWX 910-495-1707.

Our European Office: 6707 Schifferstadt, Eichendorff-Allee 19, Germany, Phone: 06235-662.



INFORMATION RETRIEVAL NUMBER 105

# NEW! INSTANT FREQUENCY DIFFERENCE!



**Tracor Model 527A measures frequency difference instantly, precisely. For precisely \$2850.** Front-panel meter reads directly to parts per  $10^{11}$ . Allows adjustment of two oscillators to the same frequency, adjustment to a specific offset, determination of offset—all instantly. Plus both short-term and long-term stability analysis. Internal oscilloscope extends precision to  $1 \times 10^{-12}$ . Reference and signal frequencies need not be the same. Write or call for full technical and application information.

**Tracor** Industrial Instruments

6500 Tracor Lane • Austin, Texas 78721 • AC 512/926-2800

INFORMATION RETRIEVAL NUMBER 106

## Vector systems help you CUT BREADBOARDING TIME

**Vector**

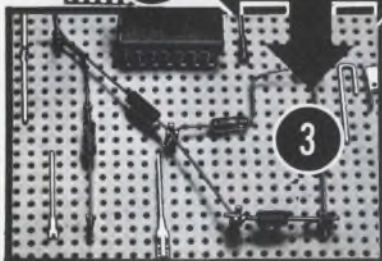
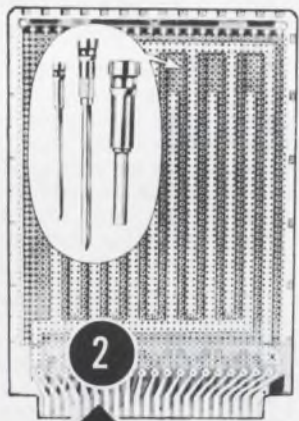

1. Finished etched circuits in your lab within an hour! Photo sensitized copper clad boards have POSITIVE ACTING resist coating which eliminates usual negative reversing step.
2. Dozens of standard off-the-shelf Plugboards in many sizes and connector styles for mounting DIPs or discrete components. New socket pins & wrappable/solderable pins, too.
3. Terminals for .025", .042", .062" and .093" holes for soldering, wire wrapping. New impact terminal staking tools speed production.
4. Versatile, adjustable Vector Strut Cage systems accommodate cards and/or modules of various sizes. Supplied completely assembled, in kits, or as separate parts for custom jobs.

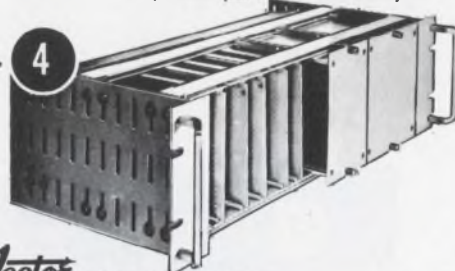

**Vector** ELECTRONIC COMPANY, INC.  
12460 GLADSTONE AVE., SYLMAR, CA. 91342  
TEL. (213) 365-9661

INFORMATION RETRIEVAL NUMBER 107

## PACKAGING & MATERIALS

### Small connector has hermetic panel mount



Microtech, 777 Henderson Blvd., Folcroft, Pa. 19032. (215) 532-3388. \$2.75 (1000 up); stock.

Ultraminiature four-contact connectors feature hermetically sealed panel mounts. The receptacles have an outer diameter of 1/4 in. and the over-all length of the plugs is less than 1/2 in. The standard bodies and pins are gold-plated brass; the sockets are gold-plated beryllium copper; and the insulators are Teflon. The hermetically sealed units have gold-plated, cold-rolled steel shells, 52-Alloy steel contacts and glass insulators.

CHECK NO. 350

### Blind fastener uses a nylon holding sleeve

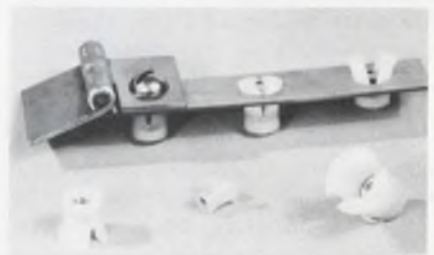

C.E.M. Co., 24 School St., Danielson, Conn. 06239. (203) 774-8571.

This blind fastener is made with a nylon outer sleeve that holds a knurled brass nut. It can be inserted quickly without special tools. You simply press it into the hole with fingers or a light hammer tap. Tight tolerances are not needed. A standard screw with either standard coarse or fine threads completes the fastening by drawing the brass nut up and creating a bulge of nylon behind the work-piece. The screw may be removed and replaced repeatedly without damage.

CHECK NO. 351

## FOR YOU TO COMPARE

CM20R \$729.00



- 5 Hz to 515 MHz
- 50 mV sensitivity
- Units Annunciation
- 5 Gate Times
- LED Display
- Leading Zero Suppression
- Optional Snap-on Battery
- High Stability TCXO's

### AND DECIDE

analog digital research

INFORMATION RETRIEVAL NUMBER 108

Here's **HOW**  
to choose the right  
**ROTARY**  
**SWITCH**  
for your needs!



**FREE!**  
11" x 17" WALL CHART

With this handy new guide, you can cross-check over 50 basic specifications against each of our 15 switch "families". In just a few minutes, you can narrow your applications down to a few possibilities...save hours of catalog search and research! Covers our Rotary Switch lines from 10A-240V to 200A-600V. Send for your free copy today.



**ELECTRO SWITCH**  
CORP.

Weymouth • Massachusetts 02188  
Telephone: 617/335/5200 TWX: 710/388/0377

INFORMATION RETRIEVAL NUMBER 109

ELECTRONIC DESIGN 10, May 10, 1973

# extra features at no extra cost...

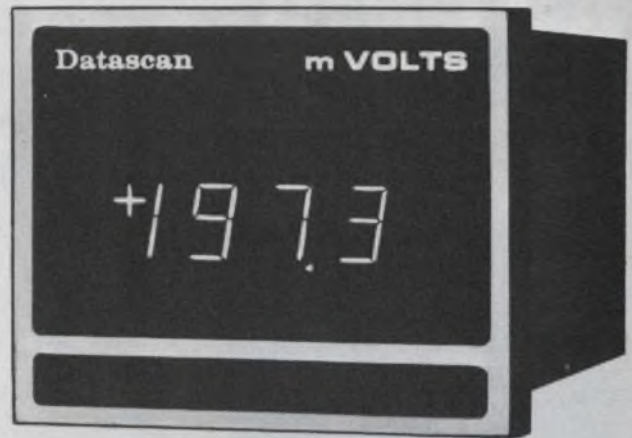

## NEW 7 SEGMENT 600 SERIES DIGITAL PANEL METERS ...from Datascan

1. **New 7 Segment Readout** — provides 0.6" high digits
2. **Die Cast Aluminum Case and Bezel**
3. **Small Compact Size** — 3.5"W x 2.9"H x 4.6"D with front mounting and adjustments
4. **High Reliability** — 100 hour minimum burn-in, 1 year warranty
5. **Low Power** — 3 Watts nominal means a small temperature rise and better performance
6. **Low Prices: Your Choice** — Models 615/625: 7 segment units and Models 610/620: Nixie tube units both available at the same low prices.
7. **Engineering Back-Up** — Our engineers are available before, during and after a sale to discuss your application and interface requirements.

Our complete line consists of 2½, 3, 3½, 4 and 4½ digit meters for voltage and current inputs with accuracies from 0.02% to 0.5%.

At Datascan, we don't just ship you a meter, we help you optimize your system (or product) so you can provide something extra to your customers... We've been helping people go digital for over a decade.

**Write or call today for our new DPM Brochure.**



Datascan  
Electronic  
Products

P.O. Box 785  
1111 Paulison Ave.  
Clifton, N.J. 07013  
Telephone: (201) 478-2800

## Datascan

INFORMATION RETRIEVAL NUMBER 110

927

161

# TRIACs & SCR's NEW ELECTRICALLY ISOLATED 1/2" press-fit series



**TRIACs:** 6A to 40A [ $I_{T(RMS)}$ ]  
50V-600V ( $V_{DROM}$ )  
**SCR's:** 8A to 35A [ $I_{T(RMS)}$ ]  
50V-600V ( $V_{DROM}$ )

Three new additions to Hutson's 1/2" press-fit series: isolated press-fit package; isolated press-fit and stud mount with Beo insulators for greatly improved thermal characteristics.

All 1/2" press-fit devices feature patented Di-Mesa construction of void-free glass-passivated center gate chips.

Write for complete information.



## HUTSON INDUSTRIES

BOX 34235 • 2019 W. VALLEY VIEW, DALLAS, TEX. 75234 (214) 241-3511 TWX 910-860-5537

Distributed by:

In Canada: WEBER-SEMAE ELECTRONICS, Downsview, Ont. 416/635-9880

Vice-President, European Operations:  
30 Rue Pierre Semard, Yerres, 91 France Tel:  
Paris 925-8258 • TELEX 21-311

Distributed in Europe by:

Belgium: C. N. ROOD S.A. Brussels 02-352135  
■ Denmark: E. V. JOHANSEN A/S, Copenhagen (01) 295622 ■ Norway: INTELCO, Box 158, 47 2 207451, Sentrum, Oslo ■ Spain: BELPORT, Madrid 234.62.62 ■ Sweden: ELEKTROFLEX, Sundbyberg 08-28-9290 ■ Switzerland: D. LEITGEB, Dubendorf 051 85 9666 ■ UK: CLAUDE LYONS, LTD, Hoddeston, Hertfordshire (09924) 67161

INFORMATION RETRIEVAL NUMBER 111

## new literature



### Clock oscillators

TTL, CMOS and ECL compatible clock oscillators ranging in frequency from 1 Hz through 200 MHz are detailed in a brochure. Vectron Laboratories, Norwalk, Conn.

CHECK NO. 352

### PC design templates

A short-form catalog gives quick reference to templates for printed-circuit design and drafting. Fourteen different templates are described and illustrated. Tangent Template, San Diego, Calif.

CHECK NO. 353

### Detectors/sensors

IR silicon detectors/pyroelectric sensors for industrial, scientific, military and commercial use are described in a four-page brochure. The Harshaw Chemical Co., Solon, Ohio.

CHECK NO. 354

### Test systems, instruments

Automatic test systems and instruments are described in a 60-page illustrated catalog. The catalog is divided into two major sections, one covering test equipment used in the manufacture of electronic equipment, the other describing testers used in the production of semiconductors and other components. Teradyne, Boston, Mass.

CHECK NO. 355

### Variable capacitors

Tubular-ceramic and film-dielectric capacitors are described in a 30-page catalog. The catalog contains an informative design data section for selecting and applying variable capacitors. Mepco/Electra, Morristown, N.J.

CHECK NO. 356

### Packaging products

Packaging products from A (aluminum rails) to V (Vectorboard) are described in an eight-page, short-form catalog. Specifications, features and prices are given. Vector Electronic Co., Sylmar, Calif.

CHECK NO. 357

### Microwave instruments

Specifications and features of microwave instruments and components are described in a 12-page illustrated catalog. Weinschel Engineering Co., Gaithersburg, Md.

CHECK NO. 358

### Snap-action switches

Quick selection charts for the company's standard line of snap-action switches are featured in a six-page foldout. Controls Co. of America, Schiller Park, Ill.

CHECK NO. 359

### Switches

Low-cost lighted and unlighted pushbutton and rocker-type switches are illustrated in a 12-page brochure. Technical specifications and order information are listed for all switch actions, color combinations, bulb types and mounting methods. Molex, Lisle, Ill.

CHECK NO. 360

### A/d systems

Three families of multichannel a/d converter systems are detailed in a six-page brochure. The brochure includes descriptions and specifications for models 7200, 7210 and model 663 multichannel a/d converter systems and models 724 and 725 low-level multiplexer, a/d converter systems. Zeltex, Concord, Calif.

CHECK NO. 361



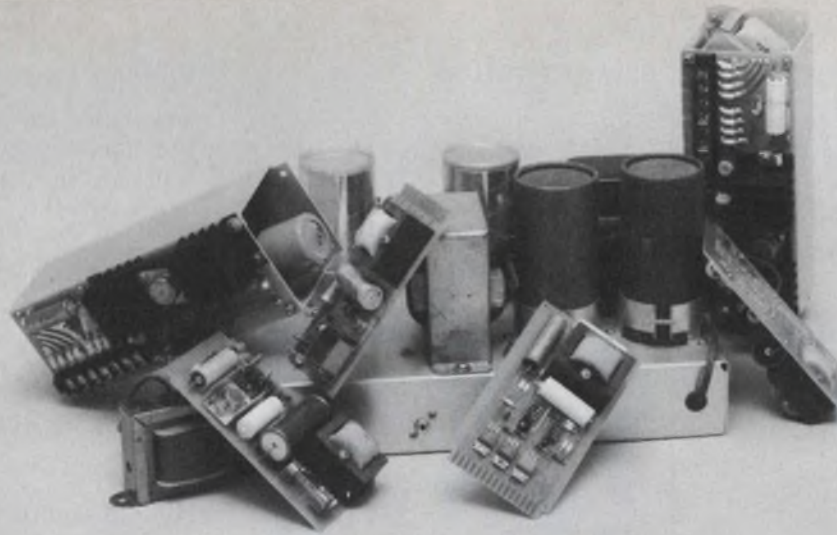

## Retire the Relics.

Unless you're going into the antique electronics business ... now's the time to replace those open-frame power supplies with today's space-saving, encapsulated power modules.

Our miniature power modules are "triple-tested" for reliability. And backed with a 2-year warranty. Because they're easy to replace, downtime is significantly reduced. And if that isn't enough ... we provide a lower cost per watt than the relics of past generations.

Delivery? Five days from receipt of order. Right from the stocking shelves of the largest manufacturer of encapsulated power supplies, Computer Products, Inc. So don't save the relics — save money, save time, and save space. Write or call

us for more information today. As for the relics, maybe the Smithsonian will take them off your hands.

STOCKING DISTRIBUTION CENTERS: Gordon V. Peck Co., Garland, Tex., (214) 341-8311; B. J. Wolfe Ent., North Hollywood, Calif., (213) 877-5518; Powermart Associates, Hartford, Conn. (203) 525-8592; and Pen-Stock, Inc., Las Altos, Calif., (415) 948-6533.



**COMPUTER PRODUCTS, INC.**

(305) 974-5500 • 1400 NW 70 ST. • FT. LAUDERDALE, FLA. 33308  
TWX (510) 956-9895

INFORMATION RETRIEVAL NUMBER 112

## Now!! Selling Direct To Public

### Big Powerful 7 H.P. Briggs & Stratton Mustang RIDING MOWER

DIRECT FROM FACTORY TO YOU.

#### 1973 Model

constructed of steel and built for constant rugged use, this powerful 7 H.P. Mower will easily cut grass and weeds 3 feet deep, pull fertilizer distributor, seeder, roller or any other lawn attachment for your lawn needs.



- ONE FULL YEAR NATIONWIDE FACTORY WARRANTY
- COMES COMPLETE WITH ILLUSTRATED PARTS LIST AND FULL OPERATING INSTRUCTIONS
- TWO DAY SERVICE ON PARTS MOST STATES
- COMES COMPLETELY ASSEMBLED IN CRATE.
- BEAUTIFUL BAKED ON RUST PROOF ENAMEL FINISH
- MADE IN U.S.A.

Compare at \$494.95

ACTUAL PHOTO OF MOWER YOU WILL RECEIVE

now **\$229.95** FULL PRICE

Tax & Freight Paid TO YOUR DOOR

TO OWN ONE RUSH CHECK OR MONEY ORDER

TO: FRANKLIN MANUFACTURING SALES  
2783 MAIN STREET  
EAST POINT, GEORGIA 30344  
PHONE (404) 768-4585

#### FEATURES

- 7 H.P. BRIGGS & STRATTON (EASY SPIN START) ENGINE
- HEAVY GAGE ALL STEEL CONSTRUCTION
- BIG 25" CUTTER AND MOWING DECK
- RUGGED 11" THREE-POSITION TRANSMISSION
- EASY HEIGHT ADJUSTMENT. VARIABLE FROM 1 1/2" to 3 1/2"
- AUTO TYPE STEERING
- BALL JOINT ADJUSTABLE TIE RODS
- TROUBLE FREE POSI-TRAC CHAIN DRIVE
- LARGE 3 x 10 TRACTOR CLEAT SURE-GRIP REAR TIRES
- ALL TIRES SEMI-NEUMATIC
- SAFETY CLUTCH
- WIND TUNNEL DESIGN VACUUM-SUCTION AUS. TEMPERED STEEL DECK.

#### — ALSO AVAILABLE: —

- STURDY, LARGE GRASSCATCHER ONLY \$20.00
- SNOW PLOW ATTACHMENT. LOW PRICE OF \$34.50. THIS PRICE ONLY APPLIES WHEN PURCHASED WITH LAWN MOWER.

A TRULY GREAT OFFER, UNBELIEVABLE, AT TODAY'S INFLATED PRICES

INFORMATION RETRIEVAL NUMBER 113

ELECTRONIC DESIGN 10, May 10, 1973



## TWO New SCRs from NATIONAL ELECTRONICS featuring

- Patented Regenerative Gate
- High di/dt with low power gate drive

F-390 850 A RMS, 500-1300 V. DC motor control and power supplies.

F-395 700 A RMS, 100-600V. Fast switching, high frequency for inverter use.



**NATIONAL ELECTRONICS**

a varian division

geneva, illinois 60134 (312) 232-4300

INFORMATION RETRIEVAL NUMBER 114

# SOLID STATE IF FILTERS FOR SOLID STATE RELIABILITY

## muRata CERAMIC IF FILTERS

Whether your application includes AM and FM entertainment receivers or communications and TV receivers, Murata has a solid state ceramic IF filter that can replace those tired, wound IF cans for increased performance and reliability with reduced size and cost. 455 KHz filters, 10.7 MHz filters, 4.5 MHz filters including bandwidths for the sharpest communications receiver specifications and bandwidths to meet the "flat-top" requirements of good FM and TV are all included in this, the industry's largest, line of ceramic IF filters.

Why not add solid state reliability to your entire IF strip? Write for complete technical information today, it's yours for the asking.

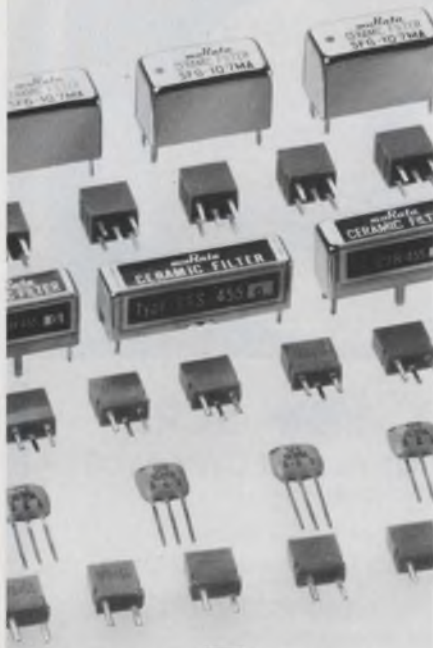

## muRata

**MURATA CORPORATION OF AMERICA**  
2 Westchester Plaza, Elmsford, New York 10523  
Telex: MURATA EMFD 137332  
Phone: 914/592-9180  
A Subsidiary of  
Murata Mfg. Co., Ltd., Japan

### NEW LITERATURE

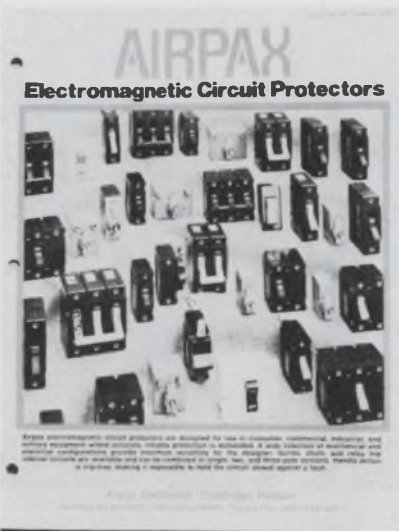

#### Circuit protectors

Bulletin 2007 covers a line of precision electromagnetic circuit protectors. The catalog serves as a reference and provides basic information on a selection of mechanical and electrical configurations. Series, shunt and relay trip internal circuits that can be combined in single, two and three-pole versions are covered. Airpax Electronics/Cambridge Div., Cambridge, Md.

CHECK NO. 362

#### Resistance coating for PCs

A graphite resistance coating for printed circuits, vacuum tubes, bleed paths, shielding, preplating nonconductors, impregnation of fibers and low-noise communication cables is described in a data sheet. Acheson Colloids Co., Port Huron, Mich.

CHECK NO. 363

#### Panels

Photographs and information on panels, accessories, enclosure and rack assemblies, sockets and hardware are included in a six-page, two-color short-form catalog. Augat, Attleboro, Mass.

CHECK NO. 364

#### Paper-tape equipment

The 4100 series paper-tape punches and readers are described in a 30-page catalog. Detailed are interface specifications, product selection guides, accessories and options. Teletype Corp., Skokie, Ill.

CHECK NO. 365

#### Voltage testers

A two-color brochure describes and illustrates Voltprobe voltage testers. Amprobe Instrument, Lynbrook, N.Y.

CHECK NO. 366

#### Slip clutches

Slip clutches with torque range of 2 to 120 oz in. are described in a catalog. PIC Design Div., Benrus Corp., Ridgefield, Conn.

CHECK NO. 367

#### Hybrid-circuit substrates

A data sheet entitled "Temperature Distributions in Hybrid-Circuit Substrates" compares thermal performance of substrate materials in various configurations and under different power input and cooling conditions. Brush Wellman, Elmore, Ohio.

CHECK NO. 368

#### Tantalum capacitors

Kemet miniature and subminiature metal-case, epoxy end filled solid-tantalum capacitors are described in a catalog. Union Carbide, Greenville, S.C.

CHECK NO. 369

#### CMOS a/d converter

A four-page data sheet describes a CMOS a/d converter designed specifically for low-power applications such as remote data logging. The data sheet contains electrical and mechanical specifications plus performance data. Datel Systems, Canton, Mass.

CHECK NO. 370

#### Motor speed control

Characteristics and features of an electronic (SCR) motor-speed control are described in a data sheet. Boston Gear, Quincy, Mass.

CHECK NO. 371

#### Strip printer

Literature details the features of the 4552 alphanumeric strip printer, including operation, design and technical data. It explains how the strip printer can be used with various types of communication systems and for recording measurements and test values. Facit-Addo Inc., Secaucus, N.J.

CHECK NO. 372

# CEM SPACERS



## FREE samples... to prove stock spacers better, cost less than specials.

Why buy specials when we have 2,152 sizes and types of *standard* spacers in stock that are far better and less expensive than anything you can make, or buy. Anywhere.

You'll save drafting time by adapting C.E.M. standards. You'll get samples for prototypes when you need them. You'll eliminate tooling costs. You'll cut inventory costs. You'll get consistent quality - square ends, better roundness, no sharp burrs. You'll get immediate delivery. And you'll save a pot of money.

How can you beat all that? You can't. So send for our free samples of *standard* C.E.M. spacers. Complete engineering specs, prices, too. (203) 774-8571

**CEM COMPANY, INC.**  
345 School St., Danielson, Ct. 06239

INFORMATION RETRIEVAL NUMBER 116

## World's smallest



## power supply for op amps...\$14

This 2.3 x 1.8 x 1-inch module has tracking outputs of  $\pm 15$  V @ 25 ma with regulation of  $\pm 0.1\%$  and ripple of 1 mv. It costs \$14.00 in 1,000 lots and only \$24.00 for one. Requisition Model D15-03. (For  $\pm 12$  V @ 25 ma, order Model D12-03.) Three-day shipment guaranteed.



Acopian Corp., Easton, Pa. 18042  
Telephone: (215) 258-5441

INFORMATION RETRIEVAL NUMBER 117

ELECTRONIC DESIGN 10, May 10, 1973

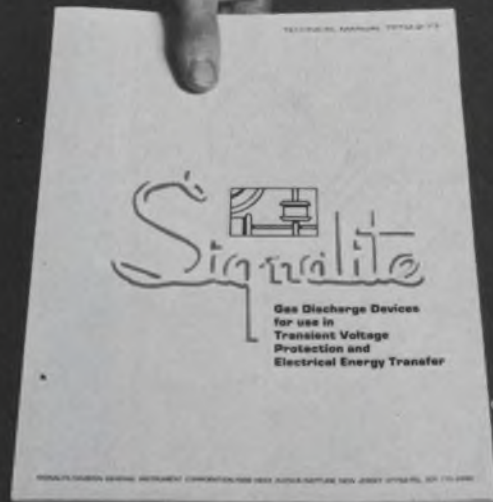

# When it comes to TRANSIENT VOLTAGE PROTECTION

## Signalite wrote the book!

### And, It's Yours FREE!

### It's all part of the SIGNALITE TRANSIENT VOLTAGE PROTECTION KIT!

Including a 28-page book entitled, "Gas Discharge Devices for Use in Transient Voltage Protection and Electrical Energy Transfer." Part I, Transient Voltage Protection, details sources of voltage transients, operation and construction of protectors, comparison of various transient protection devices, pulse breakdowns, V & I characteristics of protectors in AC & DC circuits, follow-on current, etc. Part II, Electrical Energy Transfer, details various devices, applications and glow-to-arc transitions. Included in the Signalite Transient Protection Kit are specification bulletins on Signalite's UNI-IMP, the fastest surge arrester in existence... COMM-GAP, a high quality, low cost protector with a wide range of applications... TWO ELECTRODE & TRIGGERED SPARK GAPS... AC/DC LINE PROTECTORS... plus an Applications Engineering Worksheet so that the Signalite Application Department can help in the design of your protection circuitry.



1933 Heck Ave., Neptune, New Jersey 07753  
Area Code 201-775-2490 ■ TWX 201-775-2255

329

INFORMATION RETRIEVAL NUMBER 118

165



Warning!

the DIGILAY every  
obsoletes every  
other time  
delay relay!

16 Milliseconds to 9 hours range  
1 Millisecond accuracy and repeat-  
ability at any setting  
Push button time selection  
11 Pin octal plug mounting  
\$74.00 Single quantity  
Available from stock

For more data and performance information on  
the DIGILAY write or phone  
**MICROTRONICS** Corp.  
203 Gateway Road, Bensenville, Ill. 60106  
(312) 595-9330.

## NEW LITERATURE



### Rotary switches

A 12-page catalog describes the company's Selectashaft rotary switches. The catalog contains electrical and mechanical specifications for miniature and subminiature switches in 1-in., 1.325-in. and 1.5-in. diameters. Centralab, Milwaukee, Wis.

CHECK NO. 373

### Electronic components

A 456-page catalog of electronic components and equipment contains product specification and ordering and price information. The catalog features quick-find thumb tabs, an index by product and an alphabetical index to manufacturers. Almo Electronics Corp., Roosevelt Blvd. at Bluegrass Rd., Philadelphia, Pa. 19114.

### Packaging systems

Microelectronic packaging systems and hardware are described in a 16-page brochure. Mupac Corp., Brockton, Mass.

CHECK NO. 374

### Marking products

Marking tools and dies are described and illustrated in a 20-page bulletin. Comprehensive specs on all items, marking tool and die terminology, technical engraving data, style and size chart, impact pressure chart and simplified die selection and ordering instructions are included. Ideal Engraving Co., Orange, N.J.

CHECK NO. 375

### Superconducting magnets

A full-color brochure describes compact and efficient superconducting magnets. Columbia Superconductor & Cryogenics Co., Allentown, Pa.

CHECK NO. 376

### Motor speed controls

The full range of solid-state motor speed controls for industrial, commercial and consumer products is cataloged in a quick-reference four-page guide. The catalog features a comprehensive chart which indicates the motor type to be controlled, then details ratings, dimensions, mounting, features, options and typical applications. K B Electronics, Brooklyn, N.Y.

CHECK NO. 377

### Graphics system

A 12-page illustrated brochure describes the company's COGO-8 minicomputer-based coordinate geometry system. Specific examples are provided showing how the system helps solve graphics problems involving traverse adjustments, horizontal alignment and vertical curves. Complete command summary is included. Digital Equipment Corp., Maynard, Mass.

CHECK NO. 378

### Cartridge heaters

"Firerod Cartridge Heater Application Guide" contains engineering, specification and price data on cartridge heaters. Properties, including thermal conditions and specific heat of solids, liquids and gases, are tabulated in the 28-page catalog. Illustrations show design options. Watlow Electric Manufacturing, St. Louis, Mo.

CHECK NO. 379

### Infrared thermometers

A four-page bulletin features the TempTron infrared thermometer that makes continuous noncontact temperature measurements from 500 to 4500 F. Described are features, application and performance specifications. Included is a description of display modes, control and signal-conditioning options and accessories. An outline drawing presents installation dimensions. Barnes Engineering Co., Stamford, Conn.

CHECK NO. 450

# The four most important words you will see all year.

## Miniature Inductors Available Now.

Specify fixed, variable and high frequency quality inductors. Now you can get them immediately from Pulse stock for as little as 25¢ for high frequency inductors.

- High Q at RF Frequencies
- Good temperature coefficient
- Low External magnetic field
- Small size

Catalog Number	Inductance (uhy)	Min Q	Test Freq (MHZ)	Self Res Freq (MHZ)	DCR (ohms max)
S1000	0.01	50	150	750	0.02
S1009	1.0	50	50	120	0.40
S1012	0.33	70	25	200	0.11
S1019	10	60	7.9	25	2.6
S1025	100	45	2.5	5	9.7
S1054	1.0	60	25	100	0.37
S1064	2.2	40	7.9	56	0.50
S1068	22	30	2.5	17	10.0
S3010	1.83	148	—	—	.15
S3100	28.7	61	—	—	1.75

For complete information send for Bulletin PE-61 or contact any Pulse Engineering regional office.

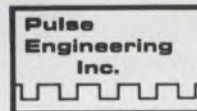

A Varian Subsidiary

**Pulse Engineering, Inc.**

P.O. Box 12235 • San Diego, Calif. 92112  
Phone 714-279-5900 • TWX 910-335-1527

INFORMATION RETRIEVAL NUMBER 120

## ALCOSWITCH

Designed for P.C. boards with optional mounting. Gold or silver contacts and terminals. Contacts have positive wiping actions, make before break. Thirty-six models to choose from in 1 to 12-pole styles. Two to 4 positions.

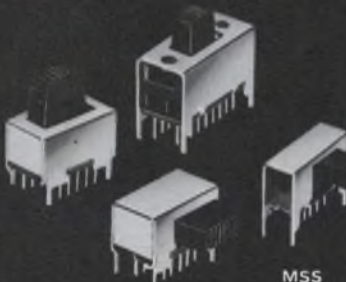

MSS SERIES

**ALCO**® ELECTRONIC PRODUCTS, INC.  
1551 OSGOOD STREET, NO. ANDOVER, MASS. 01845

INFORMATION RETRIEVAL NUMBER 121

## MULTIPLE POSITION ALCOSWITCH

High density Switch Series designed specifically for P.C. boards. No wiring errors. Actuators have ball bearing spring detent. Make Before Break action in 1, 2, 4, 6 and 8-pole circuits. 4 to 13 positions.

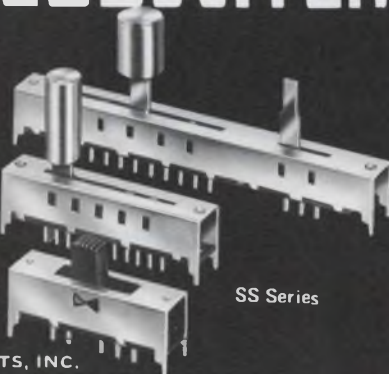

SS Series

**ALCO**® ELECTRONIC PRODUCTS, INC.  
1551 OSGOOD STREET, NORTH ANDOVER, MASS. 01845

INFORMATION RETRIEVAL NUMBER 122

ELECTRONIC DESIGN 10, May 10, 1973

## Mini Bus<sup>®</sup> by Rogers

For noise and cost reduction

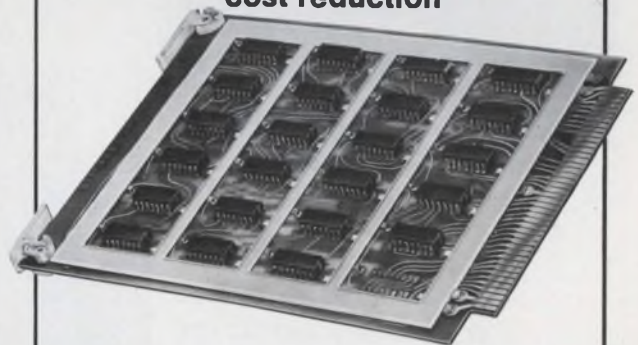

A small, voltage-distributing busbar for PC card application, each Mini/Bus gives you built-in capacitance . . . noise-cutting capacitance that means more reliable, compact circuit packaging at a fraction of multilayer prices. Write for data.



**Rogers Corporation / Rogers, Conn. 06263**

INFORMATION RETRIEVAL NUMBER 123

# For once in your life...live.

A sleek graceful sailing vessel glides across the sometimes green, sometimes blue Caribbean. The cargo: you. And an intimate group of lively, fun-loving shipmates.

Uniform of the day: Shorts and tee shirts. Or your bikini if you want. And bare feet.

Mission: A leisurely cruise to remote islands with names like Martinique, Grenada, Antigua—those are the ones you've heard of. Before the cruise ends, you'll



know the names of many more. You'll know intimately the enchanting different mood of each...and its own beauty and charm.



Life aboard your big sailing yacht is informal. Relaxed. Romantic.

There's good food. And 'grog.' And a few pleasant comforts... but any resemblance to a plush pretentious resort hotel is accidental.

Spend 10 days exploring paradise.

Spend ten nights watching the moon rise and getting to know interesting people. It could be the most meaningful experience of your life...and it's easily the best vacation you've had.



A cruise is forming now. Your share from \$245. Write Cap'n Mike for your free adventure booklet in full color.

Come on and live.



**Windjammer Cruises.**

WINDJAMMER INTERNATIONAL SUBSIDIARY • OTC

Name \_\_\_\_\_

Address \_\_\_\_\_

City \_\_\_\_\_ State \_\_\_\_\_ Zip \_\_\_\_\_

Phone \_\_\_\_\_

P.O. Box 120, Dept. Miami Beach, Florida 33139

## bulletin board

The Solid State Products Div. of Solitron Devices, Inc., has added the 2N6080 family to its line of rf power transistors. The devices provide 4, 15, 25, 30 or 40 W at 12.5 V, 150 to 175 MHz. The units are priced at \$8 (1-99).

CHECK NO. 451

National Technical Information Service can now serve the public through Telex. The NTIS Telex number is 89-9405.

CHECK NO. 452

Intersil, Inc., has reduced the price of two models of its 8013 monolithic four-quadrant analog multiplier by 50%. The 8013CC, with  $\pm 2\%$  over-all accuracy, is now \$7.50 (100-999), and the 8013BC  $\pm 1\%$  multiplier is now \$11.25 (100-999). Both operate at 0 to +70 C and are packaged in TO-99 cans.

CHECK NO. 453

Axial, vane-axial and centrifugal fans manufactured by ETRI of France are available in the U.S. for the first time through Ampheno's Component Marketing Service.

CHECK NO. 454

The National Fire Protection Assoc. has released two official interpretations of the 1969 edition of the "Standard for Intrinsically Safe Process Control Equipment for Use in Class I Hazardous Locations" (NFPA No. 493).

CHECK NO. 455

Fairchild Camera & Instrument Corp. has announced a monolithic TTL/MSI integrated circuit specifically designed to decode and drive LED seven-segment displays directly without external components. Although the device, the 9368, is optimized for use with the FND-70 1/4-in. LED display, it is compatible with other common-cathode LED digits. The 9368 and FND-70 combination is priced at \$3.60 (10,000 qty).

CHECK NO. 456

## vendors report

Annual and interim reports can provide much more than financial-position information. They often include the first public disclosure of new products, new techniques and new directions of our vendors and customers. Further, they often contain superb analyses of segments of industry that a company serves.

Selected companies with recent reports are listed here with their main electronic products or services. For a copy, circle the indicated number.

**Omni Spectra, Inc.** Microwave intrusion sensors, microwave relays, oscillators, components and connectors.

CHECK NO. 457

**Baird-Atomic.** Nuclear instruments, spectrochemical equipment, avionics and system components.

CHECK NO. 458

**Recognition Equipment.** Financial-transaction processing systems, data-entry systems and postal-automation systems.

CHECK NO. 459

**Time Brokers, Inc.** Used computers.

CHECK NO. 460

**Dynell Electronics Corp.** Underwater acoustic-detection equipment, search radars, tracking radars, digital range trackers, tracking radar antenna scanners, counter-countermeasures equipment, automatic-detection equipment, signal processors for search radars and tracking radars, Omega navigation receivers, radar video recorders, radar simulation and training equipment, special-purpose test equipment and radar conversion ("Turn-Around Program").

CHECK NO. 461

**Microwave Power Devices, Inc.** Transistorized power amplifiers.

CHECK NO. 462

**Analog Devices, Inc.** Operational amplifiers, analog multipliers, computer-interface modules, DPMs, components, d/a and a/d converters and ICs.

CHECK NO. 463

## predetermining counters ...

### step up to Hecon



If your application calls for counting a specific number of items or events, then you can count on Hecon's modular plug-in predetermining counters. Just set the quantity to be counted, and the Hecon counter does the rest—reliably and quietly. When your event-count matches the selected number, the counter activates an output switch for control purposes, such as starting or stopping machinery for production or other processes. Typical applications would be batch controlling or automated packaging. Here, the use of these predetermining counters offers reliable semi-automatic operation of production machinery and releases the operator for other tasks.

Hecon Predetermining Counters are available in 4- or 6-digit models. Digits are highly visible. Other standard features: 10 to 25 counts per second; operating voltages available from 12-220V AC or DC. Some important options are: various panel mounting configurations (including spring-clip); electrical reset units and automatic recycling units. In addition, dust covers are available to protect against lint, dust and dirt.

Step up to the best, step up to Hecon.

The predetermining counters are part of an extensive line of electro-mechanical counters from Hecon. All are available from the factory or a stocking distributor near you. For more information on the complete line, write or call for our new 36-page counter catalog: **Hecon Corporation, P.O. Box 247, Eatontown, New Jersey 07724. Phone (201) 542-9200.**

In Canada:  
Hecon of Canada, Ltd.  
80 Galaxy Blvd.  
Rexdale, Ontario  
Phone (416) 678-2441

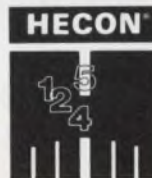

Advertisements of booklets, brochures, catalogs and data sheets. To order use Reader-Service Card (Advertisement)

ELECTRONIC DESIGN's function is:

- To aid progress in the electronics manufacturing industry by promoting good design.
- To give the electronic design engineer concepts and ideas that make his job easier and more productive.
- To provide a central source of timely electronics information.
- To promote communication among members of the electronics engineering community.

**Want a subscription?** ELECTRONIC DESIGN is sent free to qualified engineers and engineering managers doing design work, supervising design or setting standards in the United States and Western Europe. For a free subscription, use the application form bound in the magazine. If none is included, write to us direct for an application form.

If you do not qualify, you may take out a paid subscription for \$30 a year in the U.S.A., \$40 a year elsewhere. Single copies are \$1.50 each.

**If you change your address,** send us an old mailing label and your new address; there is generally a postcard for this bound in the magazine. You will have to requalify to continue receiving ELECTRONIC DESIGN free.

**The accuracy policy** of ELECTRONIC DESIGN is:

- To make diligent efforts to ensure the accuracy of editorial matter.
- To publish prompt corrections whenever inaccuracies are brought to our attention. Corrections appear in "Across the Desk."
- To encourage our readers as responsible members of our business community to report to us misleading or fraudulent advertising.
- To refuse any advertisement deemed to be misleading or fraudulent.

Microfilm copies are available of complete volumes of ELECTRONIC DESIGN at \$19.00 per volume, beginning with Volume 9, 1961. Work is now in process to complete the microfilm edition of Volumes 1-8. Reprints of individual articles may be obtained for \$2.00 each, prepaid (\$.50 for each additional copy of the same article) no matter how long the article. For further details and to place orders, contact the Customer Services Department, University Microfilms, 300 North Zeeb Road, Ann Arbor, Michigan 48106 telephone (313) 761-4700.

**Want to contact us?** If you have any comments or wish to submit a manuscript or article outline, address your correspondence to:

Editor  
ELECTRONIC DESIGN  
50 Essex Street  
Rochelle Park, N.J. 07662

## New High-Speed FFT Processor Easy to Operate



Conceived from the point of view of the operating engineer rather than the computer programmer, the new Omniferous™ FFT Analyzer operates like an instrument, calculates like a computer. This Series OF-400 Analyzer is a universal digital signal analysis system for real-time viewing of changing functions, a complete instrument with all signal conditioning and display calibration built-in. For the first time an operator can observe transfer function, cross-spectra or coherence as the signal is changing without waiting for the analyzer to perform successive laborious calculations.

Features include high speed of 68,000 samples/sec throughput, and high resolution with a 2048 transform size and extra-sharp input anti-aliasing filtering. Calculates FFT, IFFT, power spectra, auto-correlation, cross correlation, and signal enhancement (time averaging), as well as the averaging of any calculated function in sum, peak or exponential mode.

The system excels in high dynamic range, ease of use, display flexibility with two simultaneous display outputs, frequency coverage to 100 kHz, and reasonable cost. Designed by the originators of the famous Ubiquitous® family of real-time spectrum analyzers.

CIRCLE NO. 171

## Federal Scientific Corp.

An affil. of Nicolet Instrument  
615 West 131st St., New York, N.Y. 10027 (212) 286-4400

## New Bishop Mil Standard Preprinted Title Blocks



**Another First From Bishop Graphics!** Now for the first time you can get Mil Standard title blocks preprinted on both drafting film and vellum. And since they are preprinted you get immediate "off-the-shelf" delivery. The need for constantly redrawing your title block and border lines is eliminated . . . you save costly creative time. And you can choose from five mil standard formats in four sizes A through D. For oversized and non-standard formats, you can choose from Bishop's new line of preprinted pressure-sensitive mil standard title block decals and appliques called FOR-MATES™. Special preprinted formats for engineers and architects are also available. Send for free Bishop Technical Bulletin No. 1014.

## BISHOP GRAPHICS, INC.

Dept. ED-1073, 7300 Radford Ave., North Hollywood, Ca. 91605  
(213) 982-2000 Telex: 67-4672

CIRCLE NO. 172

## MATERIALS FOR SEMICONDUCTOR FUNCTIONS

By E. G. Bylander



A new handbook showing how to select materials for diodes and transistors for various applications in amplifiers, generators and multijunction devices. Defines the gamut of semiconductor types and includes a unique catalog of semiconductor materials. Also provides criteria for selecting energy-conversion materials for solar cells and thermo-electric devices. The book's treatment of electro-optical devices shows how to select materials for solid-state light sources and detectors. 220 pp., 6 x 9, illus., cloth, \$13.50. Circle the reader-service number to order a 15-day examination copy.

CIRCLE NO. 173

 HAYDEN BOOK COMPANY, INC., 50 Essex St., Rochelle Park, N.J. 07662





The U.S. Government does not pay for this advertisement. It is presented as a public service in cooperation with the Department of the Treasury and The Advertising Council.

# The Payroll Savings Plan helps you save some of your living for later.

Sure there are lots of things you want right now. Lots of things you need.

But, the sun's going to shine tomorrow, too.

That's why it's important you do something today to build a little nest egg for the future. And there's no easier way to do that than by joining the Payroll Savings Plan where you work. You sign up once and any amount you specify will be set aside from each paycheck and used to buy U.S. Savings Bonds.

The Payroll Savings Plan. The perfect way to help your good life stay that way.



Now E Bonds pay 5 1/2% interest when held to maturity of 5 years, 10 months (4% the first year). Bonds are replaced if lost, stolen, or destroyed. When needed they can be cashed at your bank. Interest is not subject to state or local income taxes, and federal tax may be deferred until redemption.

**Take stock in America.**  
Join the Payroll Savings Plan.

## Electronic Design

### Advertising Sales Staff

Tom W. Carr  
Sales Manager

**Rochelle Park, N.J. 07662**

Robert W. Gascoigne  
Daniel J. Rowland  
50 Essex Street  
(201) 843-0550  
TWX: 710-990-5071

### Philadelphia

Thomas P. Barth  
50 Essex Street  
Rochelle Park, N. J. 07662  
(201) 843-0550

### Boston 02116

Richard L. Green  
20 Columbus Avenue  
Boston, Mass.  
(617) 482-7989

### Chicago 60611

Thomas P. Kavooras  
Berry Conner, Jr.  
200 East Ontario  
(312) 337-0588

### Cleveland

Thomas P. Kavooras  
(Chicago)  
(312) 337-0588  
(call collect)

### Los Angeles 90303

Stanley I. Ehrenclou  
Burt Underwood  
2930 Imperial Highway  
Inglewood, Calif  
(213) 757-0183

### San Francisco 94022

Jerry D. Latta  
P.O. Box 1248  
Los Altos, Calif.  
(415) 965-2636

### London W. 1

For United Kingdom and Holland  
Brayton C. Nichols

For Eastern Europe

Peter Kehr

The American Magazine Group

9 Warwick Street  
London, W. 1, England  
Phone: 437 5462  
Cable: Ammagnic, London

### 4800 Verviers, Belgium

For Continental Europe  
Andre Jamar  
Rue Mallar, 1  
(087) 253.85 Telex 41563

### Tokyo

Haruki Hirayama  
Electronic Media Service  
5th Floor, Lila Bldg.,  
4-9-8 Roppongi  
Minato-ku  
Phone: 402-4556  
Cable: Electronicmedia, Tokyo



'52 POWER SUPPLIES  
STANDARD & CUSTOM

POWER SUPPLIES '55  
STANDARD & CUSTOM

'58 POWER SUPPLIES  
STANDARD & CUSTOM

POWER SUPPLIES '62  
STANDARD & CUSTOM

'65 POWER SUPPLIES  
STANDARD & CUSTOM

POWER SUPPLIES '67  
STANDARD & CUSTOM

'70 POWER SUPPLIES  
STANDARD & CUSTOM

POWER SUPPLIES '73  
STANDARD & CUSTOM

**FREE** • 32-page Standard  
Power-Supply Catalog  
• Custom Power Supplies  
and Facilities Brochure

L-203

**Deltron, inc.**  
NEMA

Wissahickon Ave., North Wales, Pa. 19454

INFORMATION RETRIEVAL NUMBER 128



The President's Committee  
on Employment of the Handicapped  
Washington, D.C. 20210

# advertiser's index

Advertiser	Page
Acopian Corporation	165
Alco Electronic Products, Inc.	167
Allied Electronics, A Division of Tandy Corp.	10
Amperite	114
Analog Devices, Inc.	109
Analog Digital Research	161
Analogic Corporation	122, 123
Arnold Magnetics	174
Augat, Inc.	14
Aztec Data Systems	174
Belden Corporation	74, 75
Bishop Graphics, Inc.	170
Bodine Electric Company	135
Boonton Electronics Corporation	117
Bourns, Inc., Trimpot Products Division	43
Cambridge Thermionic Corporation	23
CEM Company	165
Chicago Dynamics Industries, Inc.	93
Christiansen Radio, Inc.	144
Clare-Pendar	45
Computer Products	163
Custom Connector Corporation	146
Custom Electronics, Inc.	152
Cutler-Hammer	24
Data Precision Corporation	16D
Data Technology Corporation	21
Datak Corporation, The	157
Datascan Electronic Products	161
Deltron, Inc.	171
Dialight Corporation	48, 49, 104
Digitran Company, The	151
Dow Corning Corporation	12, 13, 15
E-T-A Products Co. of America	174
Elco Corporation	11
Electro Switch Corp.	161
Electronic Associates, Inc.	116
Electronic Engineering Company of California	50
Exact Electronics, Inc.	57
Exar Integrated Systems	1
Fairchild Semiconductor Components Group	54
Federal Scientific Corporation	170
Fluke Mfg. Co., Inc., John	143
Franklin Manufacturing Sales	163
GTE Automatic Electric	60, 61
General Electric Company	100, 101
General Electric Company, Miniature Lamp Products Department	136
General Instrument Corporation	31
General Radio Company	20, 119
Gudebrod Bros. Silk Company, Inc.	120

Advertiser	Page
Hamamatsu Corp.	153
Harris Semiconductor, A Division of Harris Intertype Corporation	94, 95
Hayden Book Company, Inc.	56, 60, 61, 170
Heath Company	137
Hecon Corporation	169
Hewlett-Packard	18, 19, 82, 83, 141
Hickok Instrumentation and Controls Division	155
Hoffman Engineering Company	146
Hutson Industries	162
Industrial Electronic Engineers, Inc.	159
Inselek	131
Intech Incorporated	130
Intersil	4, 5
International Electronic Research Corporation	154
Interstate Electronics Corporation	149
Johanson Manufacturing Corp.	7, 174
Johnson Company, E. F.	47
Kurz-Kasch, Inc.	22
Lambda Electronics Corp.	Cover II
Line Relays, a Unit of Esterline Corporation	153
Litronix, Inc.	145
Littlefuse	111, 112
Magnecraft Electric Company	176
Magnetic Shield Division, Perfection Mica Company	154
Magneto, Inc.	174
Marco-Oak Subsidiary of Oak Industries Inc.	73
Marconi Instruments	133
Marshall, G. S.	41
Meguro Denpa Sokki K. K.	173
MicroSwitch, A Division of Honeywell	27
Microtronics Corp.	166
Microwave Associates	147
Modpak	174
Molex, Incorporated	Cover III
Motorola Semiconductor Products, Inc.	2, 8, 9
Murata Corporation of America	164
National Connector Corporation	174
National Electronics, A Varian Division	163
Oak Industries, Inc.	32 thru 41
Optima, A Division of Scientific Atlanta, Inc.	158

Advertiser	Page
PRD Electronics Inc.	16C
Perfection Mica Company	154
Potter & Brumfield Division of AMF Incorporated	127
Powertec Inc.	16
Power/Mate Corp.	6, 174
Pulse Engineering, Inc.	167
RCA Solid State Division	Cover IV
Raytheon Co.	138
Raytheon Semiconductor	125
Rtorn Corporation	132
Robinson Nugent, Incorporated	139
Rogan Corporation	157
Rogers Corporation	167
SRC Division, Moxon, Inc.	156
Sealed Air Corporation	134
Servo-Tek Products Company	126
Signalite Division of General Instrument Corporation	165
Signetics Corporation	29
Siliconix Incorporated	58
Simpson Electric Company	121
Singer Company, The Kearfott Division	16B
Sprague Electric Company	17
Stackpole Components Company	157
Systron-Donner	142
TRW Semiconductor, An Electronic Division of TRW, Inc.	107
TRW/UTC Transformers, An Operation of TRW Electronic Components	16A
Taylor Industries, Inc.	150
Tektronix, Inc.	53, 55
Teledyne Semiconductor	129
Tenney Engineering, Inc.	153
Thermalloy Company	148
Times Wire and Cable Company	88, 89
Topaz Electronics	150
Tracor, Inc.	160
Triplett Corporation	99
United Detector Technology	174
United Systems Corporation	115
Varo Semiconductor, Inc.	140
Vector Electronic Company Inc.	160
Vernitron Corporation, Control Components Division	142
Vernitron Electrical Components	175
Vernitron Piezoelectric Division	124
Watkins-Johnson	128
Weston Instruments, Inc.	105
Windjammer Cruises	168

## "YOUR OPPORTUNITY"

WITH KNOWN DISTRIBUTOR — MANUFACTURER OF TELEPHONY EQUIPMENT SEEKING PRODUCTS TO ADD TO ITS LINE FOR NATIONAL DISTRIBUTION. ALL FACILITIES AVAILABLE FOR COMPLETE DEVELOPMENT.

in confidence reply to  
INFORMATION RETRIEVAL NUMBER 905

### INSTRUMENT DESIGN ENGINEERS

We need Electronic Circuit Designers with demonstrated, successful experience in analog and digital circuitry. Our interest is only in people with the ability to generate original ideas and apply them in our digital multimeters, amplifiers, power supplies, etc. Experience in instrument design and working knowledge of current technology essential.

If You Fit This Description  
Please Call Us Collect And  
Let Us Tell You About  
**Keithley Instruments**

If you can't call, send resume in confidence to:

Mr. Nickolas Bobick  
Personnel Manager  
28775 Aurora Road  
Cleveland, Ohio 44139  
(216) 248-0400

An Equal Opportunity Employer M/F

INFORMATION RETRIEVAL NUMBER 906

This instrument puts an end to troublesome operations such as input adjustment, frequency setting, and meter range switching. The only requirement is connection of the signal to be measured at the instrument input. Indication of signal frequency and harmonic distortion is immediate.

#### SPECIFICATIONS

**Distortion Meter Section:** • Distortion Range: 0.1%—30% (f.s.) with auto-ranging  
• Fundamental Frequency Range: 10Hz—100kHz (automatic tuning with digital readout)  
• Input Voltage: 62mV—77.5V in 6 ranges; auto-ranging and hold.  
**Level Meter Section:** • Measuring Range: -70—+48dBm (0dBm = 0.775V); auto-ranging and hold  
• Signal to Noise Ratio: 10Hz—300kHz, 0—120dB.  
**Frequency Measuring Section:** • Frequency Range: 10Hz—99.9kHz with digital readout.

# meguro's

## FULLY AUTOMATIC DISTORTION METER



MAK-600 FULL AUTOMATIC DISTORTION METER

For catalogue  
please write to.



**MEGURO DENPA SOKKI K.K.**

No. 5, 1, 2-chome, Chuo-cho, Meguro-ku, Tokyo, Japan  
TEL: 715-1211 Cables: MEGURODENPA TOKYO

INFORMATION RETRIEVAL NUMBER 129

**PERSONNEL  
RECRUITMENT  
ADVERTISING  
IN  
Electronic Design  
REACHES THE  
RIGHT PEOPLE  
AT A LOWER COST  
PER THOUSAND**

*Call the  
HOTLINE  
today  
for complete  
information:  
(201) 843-0550  
extension 209*



**Thin-Trim** variable capacitors provide a reliable means of adjusting capacitance without abrasive trimming or interchange of fixed capacitors. Series 9401 has high Q's and a range of capacitance values from 0.2-0.6 pf to 3.0-12.0 pf and 250 WVDC working voltage. Johanson Manufacturing Corporation, Boonton, New Jersey (201) 334-2676.

INFORMATION RETRIEVAL NUMBER 181

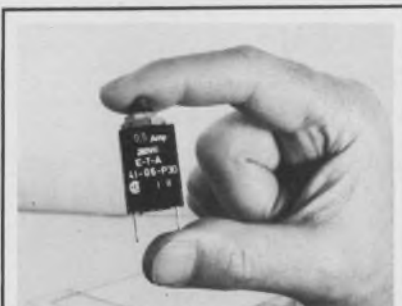

**Overcurrent protector**, manual reset eliminates fuse replacement. Convenient panel mounting. 15 fractional ratings from 0.1 to 3 amp. Other models up to 400 amp. UL and CSA approved. 93 cents ea. In 1000 lots. E-T-A Products Co. of America, 6284 N. Cicero Ave., Chicago, Ill. 60646. Tel: (312) 545-1553.

INFORMATION RETRIEVAL NUMBER 182



**Aztec Data Systems** announces its gold series DC power converters for use with gas discharge and incandescent displays. The gold series is designed primarily for battery operation where high efficiency and low cost are most important. Prices as low as \$5 in quantity. Aztec Data Systems Inc., 17805 Sky Park, Irvine, Ca. 92707. 717-540-8445.

INFORMATION RETRIEVAL NUMBER 183

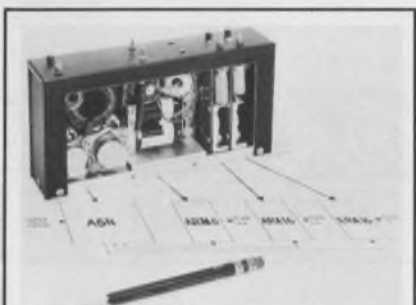

**Miniaturized/modular power supplies.** AC or DC inputs with up to 6 isolated and regulated DC outputs to 150 watts. Over 1200 "Design As You Order" configurations using standard sub-modules. Completed systems provided in pretested, encapsulated miniature packages. Immediate delivery. Arnold Magnetics, Culver City, Ca. (213) 870-7014.

INFORMATION RETRIEVAL NUMBER 184

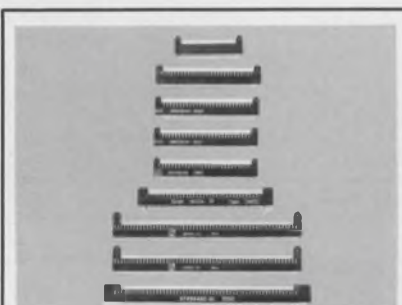

**New headers**—Here's our new top line of nine right angle molded printed circuit headers for use with 0.100" center wire wrapped plates. One 34-pin model, four 56-pins, one 70-pin and three 112-pins. Your National Connector salesman has all the details. NATIONAL CONNECTOR, 5901 So. County Rd. 18, Mpls., Mn. 55436. (612) 935-0133.

INFORMATION RETRIEVAL NUMBER 185

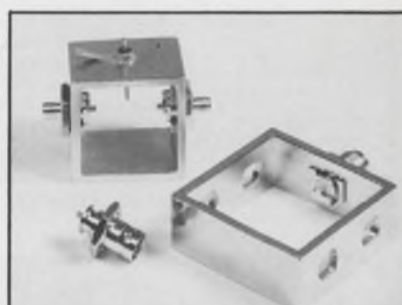

**MODPAK™** electronics packaging system provides everything required (except customer's PC board). Choice of RF connectors. Standard and Custom packages available on "off-the-shelf" basis. Prices as low as \$9.75 per unit. MODPAK, 31A Green St., Waltham, Ma. 02154 (Tel.) (617) 891-7048.

INFORMATION RETRIEVAL NUMBER 186



## UDT PHOTOPS 450

**New UDT PHOTOPS** optical detector/amplifier combinations are ideal replacements for photomultiplier tubes. These high gain, low noise, high speed devices are available with large 1cm<sup>2</sup> sensing area and latest FET circuitry. Sensitivity to 10<sup>-12</sup> watts with bandwidths to 10MHz. United Detector Technology, 1732 21st Street, Santa Monica, Ca.

INFORMATION RETRIEVAL NUMBER 187

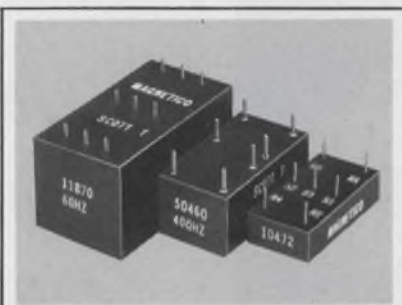

**Scott T Transformer.** 11870: 60HZ, 90v, L-L In. 1.1x2.1x1.1. 50460: 400HZ, 90v, L-L In. 7/8x1-5/8 x11/16. 50642: 400HZ, 11.8v, L-L In. 7/8x1-5/8x11/16. 10472: 400-HZ, 11.8v, L-L In. 3/4x1-1/2x3/8. All with 6v RMS sine & cosine output. MAGNETICO, INC., E. Northport, N.Y. 11731. 516-261-4502.

INFORMATION RETRIEVAL NUMBER 188



**Free catalog of 32,000 power supplies** from the worlds largest manufacturer of quality Power Supplies. New '73 catalog covers over 32,000 D.C. Power Supplies for every application. All units are UL approved, and meet most military and commercial specs for industrial and computer uses. Power Mate Corp. (201) 343-6294.

INFORMATION RETRIEVAL NUMBER 189

# product index

**Information Retrieval Service.** New Products, Evaluation Samples (ES), Design Aids (DA), Application Notes (AN), and New Literature (NL) in this issue are listed here with page and Information Retrieval numbers. Reader requests will be promptly processed by computer and mailed to the manufacturer within three days.

Category	Page	IRN	Category	Page	IRN
<b>Components</b>			profiler, thermal	140	305
arc light	155	340	telemetry transmitters	142	307
circuit breaker	156	344	video detectors	144	320
circuit protectors (NL)	164	362	<b>Modules &amp; Subassemblies</b>		
clutch and brake	154	337	a/d converters	138	302
motor speed control (NL)	164	371	d/a converter	132	278
position transducer	156	343	display	132	275
resistors, thick film	155	339	display	132	276
switch, PB	156	341	displays, LED	132	277
switch, snap-action	156	342	filter, active	136	301
varactor diode	154	338	hybrid amplifiers	138	303
<b>Data Processing</b>			lampdriver	134	280
analyzer, logic	123	265	monitor, battery	134	279
interface, computer	118	261	op amps	134	281
interface, I/O	124	268	power supply	138	304
memory, cassette	120	263	SCR bridge assembly	130	274
memory, computer	123	266	sample and hold	136	300
minicomputer	118	260	<b>Packaging &amp; Materials</b>		
minicomputer	123	264	cabinets	159	348
monitor signal	120	262	connector, miniature	160	350
multiplexer, digital	128	273	encapsulating comp.	159	347
OCR, data entry	128	272	fastener, blind	160	351
programmer, control	126	270	nickel paste	158	345
ROM, alterable	126	269	panels (NL)	164	364
receiver, remote	124	267	resistance coating (NL)	164	363
tape drive, computer	126	271	socket, IC	158	346
<b>ICs &amp; Semiconductors</b>			templates (NL)	162	353
arithmetic processor	148	325	tubing, shrink	159	349
CMOS/SOS ICs	152	336	<b>new literature</b>		
clock, digital	148	328	a/d systems	162	361
dual FETs	152	334	CMOS a/d converter	164	370
IC multiplier	151	331	capacitors, tantalum	164	369
IC photoswitch	148	327	capacitors, variable	162	356
mixer, digital	152	333	cartridge heaters	166	379
op amp	152	335	circuit protectors	164	362
opto-isolator	151	332	clutches, slip	164	367
rectifier, bridge	150	329	detectors/sensors	162	354
rectifier, bridge	150	330	graphics system	166	378
rectifier, multivolt	148	326	hybrid circuit substrates	164	368
<b>Instrumentation</b>			magnets	166	376
a/d converter	113	250	marking products	166	375
a/d converter	113	251	microwave instrument	162	358
a/d converter	113	252	motor speed control	164	371
counter-timer, universal	114	253	motor speed controls	166	377
DMM	116	256	oscillators, clock	162	352
frequency counter	117	258	packaging products	162	357
frequency synthesizer	116	254	packaging systems	166	374
programmable filter	116	255	panels	164	364
scopes	116	257	paper-tape equipment	164	365
strip chart recorder	117	259	resistance coating	164	363
voltage testers (NL)	164	366	strip printer	164	372
<b>Microwaves &amp; Lasers</b>			switches	162	360
amplifier	146	324	switches, rotary	166	373
filters, low-pass	146	322	switches, snap-action	162	359
millimeter receiver	142	306	templates	162	353
mixers, multiactive	142	308	thermometers	166	450
multiplier	144	310	test systems	162	355
pnp transistors	144	321	voltage testers	164	366
paramp, troposcatter	146	323			
power supply	144	309			

**GO RIGHT TO THE TOP WITH... BEAU BARRIER TERMINAL STRIPS**

Hey! ...an open back!

You can get closed backs too! **MMM! Molded phenolic base.**

Wow! **FAST-TAB** terminals. Real assembly cost-cutters!

...and you can get solder, wire-wrap and pc terminals too!

Perfect connections every time.

Don't forget marker/insulation strips—and covers!

Up to 26 sections!

**BEAU BARRIER TERMINAL STRIPS A MOUNTAIN OF FEATURES**

**...IN STANDARD AND CUSTOM CONFIGURATIONS**

Send for 20-page catalog on Beauplug Connectors and Terminal Strips

**BEAUPUG<sup>®</sup> CONNECTORS**

Beau Products Division

**Vernitron Electrical Components**  
117 Union Avenue, Laconia, N.H. 03246  
Tel: (603) 524-5101 TWX: 710-364-1843

In CANADA: Brimark Electronics Ltd. / Toronto 8, Ontario

# G P

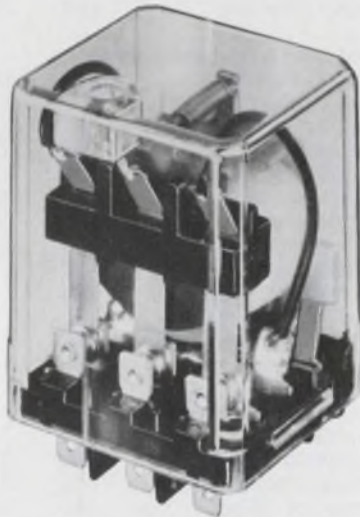

## MAGNECRAFT'S NEW CLASS 388 GENERAL PURPOSE RELAY

Magnecraft is pleased to introduce the new Class 388 General Purpose Relay. This inexpensive, high performance line of stock relays offers many quality features found only in custom built versions. Available in either a covered plug-in or open style with a wide choice of AC or DC coil voltages and SPDT, DPDT, or 3PDT 10 amp contacts.

All Class 388 relays have 3-way pierced terminals. While spaced for standard plug-in mounting, the flat terminals (0.187" x 0.020") also accept quick-connect receptacles or direct soldering. For plug-in use, three types of chassis mounted sockets are available; quick-connect, solder, or printed circuit terminals. Covered plug-in version has a tough clear polycarbonate plastic cover.

In a highly competitive business, delivery can be a deciding factor. If delivery is important to you, be aware that Magnecraft ships better than 90% of all incoming orders for stock relays, received before noon, THE SAME DAY (substantiated by an independent auditing firm). In addition to our shipping record, most stock items are available off-the-shelf from our local distributor.

# FREE!



## DESIGNER'S CATALOG

The purpose of this 36-page catalog is to assist the design engineer in specifying the proper relay for a given application. The book completely describes General Purpose, Sensitive General Purpose, and Mechanical Power Relays. New products include the complete line of Class 388 General Purpose Relays.

**Magnecraft**® ELECTRIC COMPANY

5575 NORTH LYNCH AVENUE • CHICAGO, ILLINOIS 60630 • 312 • 282-5500 • TWX 910 221 5221

INFORMATION RETRIEVAL NUMBER 131

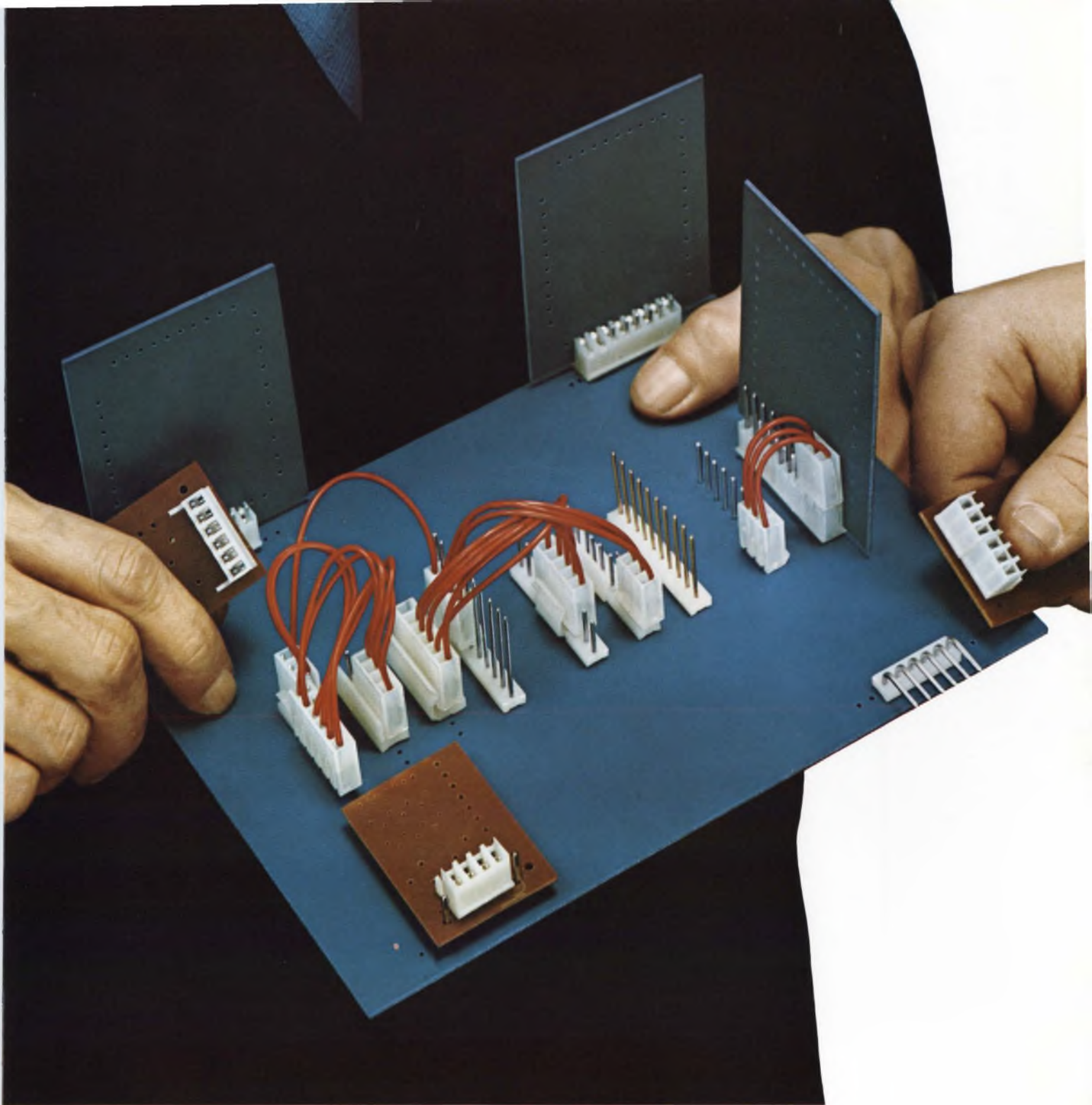

**KONEKTCON® MAKES THIS EASY!** It's the Molex system that solves the most complex board-to-board, board-to-component, chassis-to-board interconnection problems. It's economical. Reliable. Quick. Versatile. Uses only four basic connectors. Unique rigid square wire male terminals permit stacking of multiple board connections to the same circuits. Molex vibration assembly method stakes up to 300 terminals per minute for wave soldering. Preassembled round male

terminal wafers also available for 2 to 18 circuits. Three female terminal assemblies provide incomparable flexibility: cable-to-board; board-to-board, parallel; board-to-board, perpendicular; and board-to-chassis. Plus a variety of options, including a 3-circuit power transistor. For technical specs call (312) 969-4550. Or write: Molex Incorporated, Lisle, Illinois 60532.

*...creating components that  
simplify circuitry*

INFORMATION RETRIEVAL NUMBER 202



# RCA introduces its one-transistor Darlington.



No we haven't changed the Darlington circuit. We've just turned it into the Darlington transistor. By putting the whole circuit on a single monolithic chip.

In the RCA Darlington transistor design, optimum use of the silicon real estate and single level metallization provide improved performance characteristics. You get greater control over parameters and increased peak current handling capacity . . . up to 15 amps.

It's all spelled out in black and white.  $I_S/B$   $E_S/B$  and Thermal Cycle ratings are all specified . . . even the output diode is characterized.

And they don't come any more rugged. All steel (TO-3) package, controlled solder chip mounting and heavy duty clip connections make the RCA Darlington transistor a dependable workhorse in your system.

So if you're working with discrettes, you can now get higher packaging densities, lower your overall system cost and, at the same time, increase system reliability by reducing the number of external connections.

Why not give your system the advantage of all these benefits by switching from the Darlington circuit to the RCA Darlington transistor. It's at your

distributor, waiting for you right now in the following configurations:

TO-3 pkg.	$P_T@25^\circ C$	VERSAWATT plastic pkg.	$P_T@25^\circ C$	$V_{CE0(sus)}$ $V_{CER(sus)}$
2N6385	100W	2N6388	40W	80V
2N6384	100W	2N6387	40W	60V
2N6383	100W	2N6386	40W	40V

Want more data? Write RCA Solid State, Section 57E-10/UTL37, Box 3200, Somerville, N.J. 08876. Phone (201) 722-3200.

**RCA Solid State**  
products that make products pay off