

Electronic Design

FOR ENGINEERS AND ENGINEERING MANAGERS

VOL. 21 NO.

9

APRIL 26, 1973

MAY 02 1976

NMOS—higher speed and denser than PMOS. A promise of fast microprocessors and high-speed memories that use little power brings a new level of component

into a designer's grab bag. Fast 4k RAMs, 8k shift registers and microprocessors will be on the market this year. Want to learn about NMOS? See page 34.

DATA **CO.**

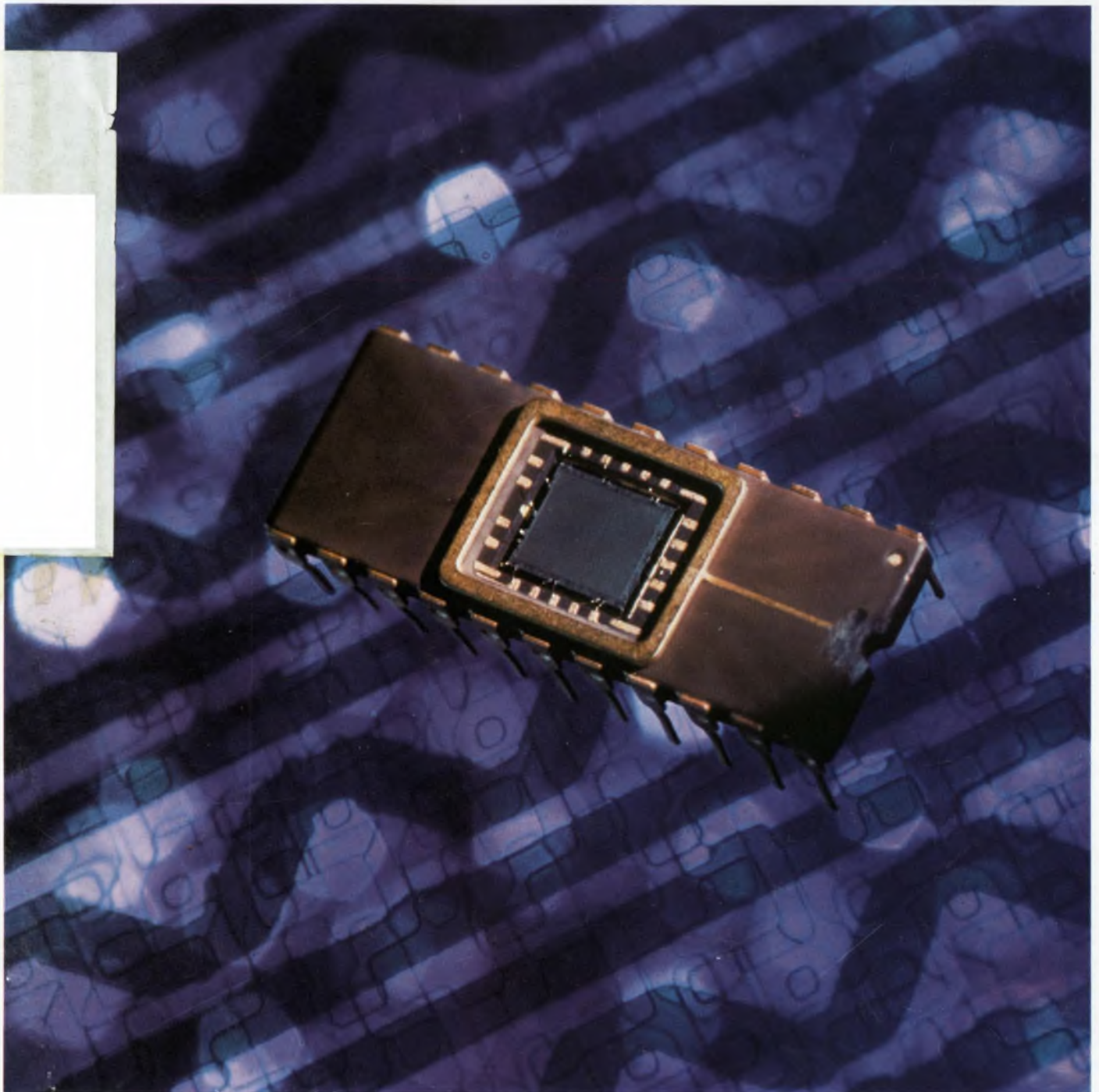

We're quicker on the trigger in Coil Country.



New Dale Trigger-Type Pulse Transformers

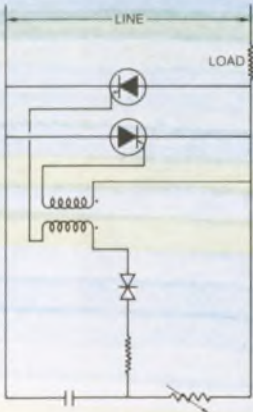

Available fast for SCR control circuits. New Dale Trigger-Type Pulse Transformers match your performance and budget requirements for industrial and commercial applications. Two styles with PC pins (PT20) or bobbin type leads (PT10) for use where trigger source isolation is employed in half or full wave SCR power control circuits. Available with turns ratio of: 1:1, 1:1:1, 2:1, 2:1:1 and 5:1. Primary inductance from 200 μ h to 5000 μ h. Interwinding capacitance as low as 400 pf. Leakage inductance as low as 3 μ h.





The price – very competitive in most any quantity. Phone today for a quote: 605-665-9301 or write:

DALE ELECTRONICS, INC.
East Highway 50, Yankton, S.D. 57078
A subsidiary of The Lionel Corporation

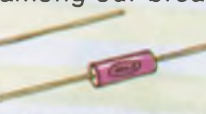

Check our expanded inductor capabilities...

Standard or special, Dale is moving up as a preferred source for inductive components. Readily available among our broadened standard lines are:

 <p>Conformal Coated Chokes Type IR-2, IR-4. Durable epoxy coating give equivalent performance, lower price than molded styles. Machine insertable. Tolerance $\pm 10\%$. Inductance: .10 μh to 1000 μh.</p>	 <p>Flame Retardant Molded Chokes Type IM-2, IM-4. Meet MIL-C-15305D, Grade 1, Class A, B. Tolerances: $\pm 5\%$, $\pm 10\%$, $\pm 20\%$. Inductance: .10 μh to 1000 μh.</p>	 <p>DIP Pulse Transformers Type PT-14, PT-16. Machine insertable, 14, 16 pin styles. Inductance: 1 μh to 2 mh. Tolerance $\pm 20\%$. Leakage inductance: As low as 0.2% of inductance. Interwinding capacitance: As low as 3 pf. ET product: Up to 10 volts/μsec.</p>	 <p>PC Mount Toroids Series TE. Meet MIL-T-27C. Type TF5SX20ZZ. Epoxy encapsulated. High Q and wide selection of Q vs. frequency ranges. Inductance: .050 mh to 20 h. Tolerances: $\pm 1\%$, $\pm 2\%$, $\pm 5\%$.</p>	 <p>Custom Chokes, Toroids, Bobbins, RF Transformers, Variable Pitch Inductors Complete facilities to design and produce everything from prototype quantities to high volume production runs.</p>
--	---	--	--	---

For a fast quote or immediate design help, phone 605-665-9301 or write Dale Electronics, Inc., East Highway 50, Yankton, S.D. 57078. Circle 80 for Inductor Catalog.



HP offers OEMs more. Like a thoroughly modern mini with Writeable Control Store.

WCS is a powerful new tool for the OEM. By microprogramming the HP 2100, you can tailor it to your customer's specific application. In manufacturing, process control, medicine, you name it. And you can add WCS anytime. Now — or in the future. Even add it to your present installations.

If you have time-critical or often-used routines, WCS lets you run them 10 times faster. And a powerful microprogramming assembler simplifies the

development of special purpose functions such as I/O handlers.

Using WCS and our new programmable ROM writer, you can also put together applications with unique instructions usable only on your equipment. This gives you real hardware security. After developing microprograms, you can write them into inexpensive programmable ROMs for your OEM production systems.

But the nicest thing about our WCS

is that it's part of our thoroughly modern mini. Why not get the full story?

For our free 80-page microprogramming guide and 2100 brochure write Hewlett-Packard, Palo Alto, California 94304.

22216

HEWLETT  **PACKARD**

Introducing the first American fuseholder to meet Europe's IEC standards.



The "shock-safe" 3AG fuseholder.

Our new fuseholder isn't really red, white and blue. Its standard color is black, just like all other fuseholders.

But there the similarity ends.

For this Littelfuse fuseholder is the only American-made holder designed to meet current International Electrotechnic Commission standards.

IEC's Publication No. 65, accepted by all European countries, requires fuseholders to offer absolute protection against electric shock, even under fault conditions.

And that's exactly what our new 3AG "Shock-Safe" fuseholder does! Several safety features have been incorporated into the fuseholder design to protect the user from any possibility of touching live parts.

In addition, our "Shock-Safe" fuseholder offers another important form of protection by

assuring your acceptance in European markets. For if the fuseholder used in your product doesn't meet IEC standards, that product could be rejected by European testing and approval boards, which refer to Publication No. 65 for the purchase of equipment.

The "Shock-Safe" fuseholder #345001 has been designed to retrofit existing panel mounting holes and is the **only** 3AG fuseholder currently available for continuous operation to **20 amperes** and **300 volts**.

"Shock-Safe" fuseholders from Littelfuse.

A basic necessity if you're selling the European market.

For more information, send for Product Bulletin #1000 or contact your local Littelfuse distributor.

LITTELFUSE

Subsidiary of Tracor

800 E. Northwest Highway • (312) 824-1188 • Des Plaines, Illinois 60016

INFORMATION RETRIEVAL NUMBER 3

NEWS

- 31 **News Scope**
- 34 **The year for n-channel MOS technology** is coming with 4096-bit RAMs and microprocessors on the way.
- 40 **Bubble memory developed in lab**, and it appears to be a success.
- 42 **U.S. prepares full-scale attack on consumer product hazards.**
- 46 **Flat-stacked tape** said to combine reel and continuous-loop benefits.
- 56 **Technology Abroad**
- 53 **Washington Report**

TECHNOLOGY

- 120 **Reject common-mode noise** with a floating data scanner. It allows you to sample low-level signals in environments plagued by electrical interference.
- 126 **Go active for sonar or radar filters.** Three input parameters specify a wide dynamic-range circuit that supplants bulky passive designs.
- 130 **Don't forget d/a converter tempco!** It's the parameter that will probably limit system accuracy. Here's what tempco is and how to calculate it.
- 134 **Four ways to motivate engineers:** Make the job clear, important and timely, and give credit for work well done, says this engineering manager. Here's how.
- 138 **Ideas for Design:** Self-correcting ring counter requires no external gates . . . Op-amp summer modifies VCO chip for clean sinewave operation . . . Intruder alarm is based on electrostatic charge detection . . . Ground lead provides inhibit function for TTL inverters.
- 146 **Design Decision:** Battery saver slashes standby power drain.

PRODUCTS

- 149 **ICs & Semiconductors:** 100-V/ μ s slew rate available in a high-voltage FET op amp.
- 154 **Microwaves & Lasers:** Ultra-broadband amplifiers deliver gain of 26 dB.
- 166 **Modules & Subassemblies:** Thermal converter raises the accuracy of rms converter over wide input range.
- 156 Data Processing
- 158 Components
- 160 Packaging & Materials
- 162 Instrumentation

Departments

- 119 **Editorial:** Ride the crest of a brain wave
- 7 Across the Desk
- 169 Evaluation Samples
- 169 Application Notes
- 170 New Literature
- 177 Bulletin Board
- 177 Vendors Report
- 178 Advertisers' Index
- 180 Product Index
- 180 Information Retrieval Card

Cover: Photo of developmental silicon-gate, n-channel, 8192-bit shift register, the world's longest, by Crombie McNeill, courtesy of Microsystems International Limited, Ottawa, Canada.

The Same Technology Instruments Makes Them

Take DVMs for example...

Today you can buy more performance for your dollar with HP's new "Self Test" 3490 and "Snap-On" 3470. Both have the features you've told us you wanted, and both were designed to make them easy on your budget. The key is HP's advanced technology. Look what your dollars will buy with these four quality members of HP's DVM family.

Self-Test 3490 makes double use of its internal ICs to bring you HP's exclusive "Self-Test" capability without extra cost. The basic 5-digit 3490, ready to measure AC, DC and Ohms sells for only \$1,650 (and at low added cost you can have isolated BCD output and isolated remote control, or the highly-useful remote control with ASCII bus). Compare the 3490 with any other multimeter in its class and you'll find an unusual blend of features and performance for the money.



Snap-On 3470 provides you with an economical 4-digit LED display unit that you can equip to meet your exact measurement needs. Get DC only for \$475 total, or AC/DC/Ohms for \$600 total. Or go to 5-digit versions for \$700 and \$825. Add on a battery pack center for \$200, BCD output center for \$175 or an exclusive HP "Self-Test" accessory for only

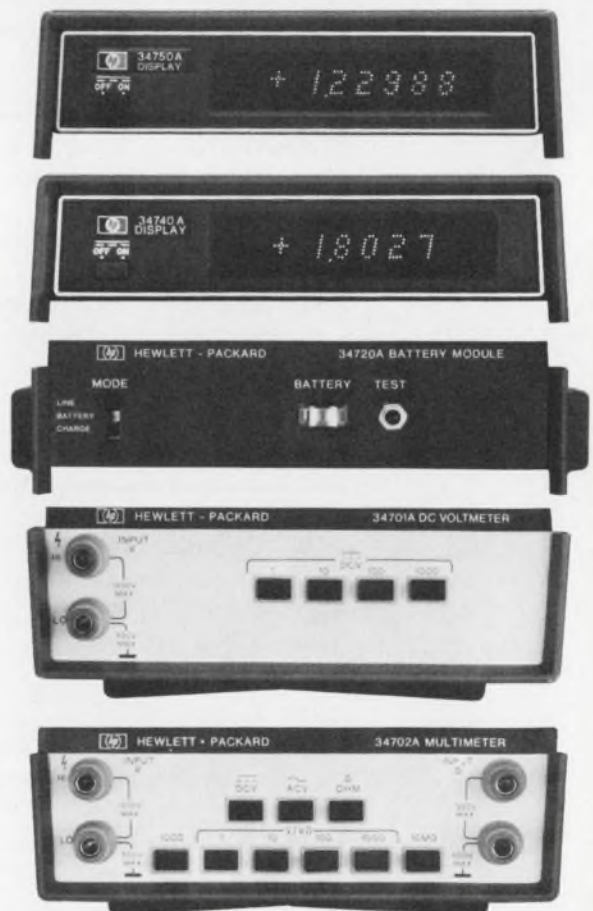

HP That Makes Better... Now Cost Less

\$50. You end up with a modern custom-tailored system for very little money.

Multi-Mode 3450 lets you add up to 12 modes of high-accuracy measurement capability to your automated system. You can have true-rms, 4-terminal ratio, 4-terminal ohms and the unique limit test in addition to the usual functions. The 3450 is both fast and accurate, with 15 readings/sec. and accuracy to (0.008% of reading +0.002% of range). Prices start at \$3,300 for the 5-digit DC volts and Ratio model, go to \$5,900 for total 12-mode capability.



Speed Star 3480 is systems oriented, but fine for the bench as well. This 4-digit, $\pm 0.01\%$ unit delivers an unmatched 1,000 readings/sec. Get the exact capability you need by selecting plug-ins. For example, you can have DC, Ohms and true-rms AC for \$2,900 (isolated BCD output and isolated remote control are low-cost options). You can even turn the 3480 into an inexpensive A-to-D converter with a sample and hold option that also lets you take peak readings or do transient analysis. Or, add data storage that stores up to 50 readings or do transient analysis. Or, add data storage that stores up to 50 readings at the 1000/sec. rate and employ a low-cost printer to output the data.



Check your DVM measurement needs. You'll find that HP can fit them closely, whether they call for state-of-the-art performance or real economy. For more information on the entire HP family of DVMs and multimeters, contact your local HP field engineer. Or, write Hewlett-Packard, Palo Alto, California 94304. In Europe: HPSA, P.O. Box 85, CH-1217 Meyrin 2, Geneva, Switzerland. In Japan: Yokogawa-Hewlett-Packard, 1-59-1, Yoyogi, Shibuya-Ku, Tokyo, 151.

Send for our 70-page Application Note 158, RS 98.

093/42

HEWLETT  PACKARD
DIGITAL VOLTMETERS

INFORMATION RETRIEVAL NUMBER 4

When You Buy a Power Supply, Why Not Get the Best?



28 VDC to DC
(55,463 Hrs.)
Model C95D

28 VDC to 400 A
(61,387 Hrs.)
Model 53D

400 A to DC
(56,148 Hrs.)
Model W5D

Abbott's New Hi-Performance Modules

are designed to operate in the stringent environment required by aerospace systems — (per MIL-E-5400K or MIL-E-5272C) and MIL-STD-461 for electromagnetic interference.

RELIABILITY — MTBF (mean time between failures) as calculated in the MIL-HDBK-217 handbook can be expected in excess of 50,000 hours at 100°C for all of these power modules. The hours listed under the photos above are the MTBF figures for each of the models shown. Additional information on typical MTBF's for our other models can be obtained by phoning or writing to us at the address below.

QUALITY CONTROL — High reliability can only be obtained through high quality control. Only the highest quality components are used in the construction of the Abbott power module. Each unit is tested no less than **41 times** as it passes through our factory during fabrication — tests which include the scrui-

tinizing of the power module and all of its component parts by our experienced inspectors.

NEW CATALOG—Useful data is contained in the new Abbott Catalog. It includes a discussion of thermal considerations using heat sinks and air convection, a description of optional features, a discussion of environmental testing, electromagnetic interference and operating hints.

WIDE RANGE OF OUTPUTS — The Abbott line of power modules includes output voltages from 5.0 volts DC to 3,650 volts DC with output currents from 2 milliamperes to 20 amperes. Over 3000 models are listed *with prices* in the new Abbott Catalog with various inputs:

- 60A to DC, Regulated
- 400A to DC, Regulated
- 28 VDC to DC, Regulated
- 28 VDC to 400A, 1ϕ or 3ϕ
- 24 VDC to 60A, 1ϕ

Please see pages 618 to 632 of your 1971-72 EEM (ELECTRONIC ENGINEERS MASTER Catalog) for complete information on Abbott modules.

Send for our new 56 page FREE catalog.



LABORATORIES, INCORPORATED
5200 W. Jefferson Blvd./Los Angeles 90016
(213) 936-8185

LABORATORIES, INCORPORATED
1224 Anderson Ave. Fort Lee, N.J. 07024
(201) 224-6900

INFORMATION RETRIEVAL NUMBER 5

Vice President, Publisher
Peter Coley

Editors

Editorial Offices
50 Essex St.
Rochelle Park, N.J. 07662
(201) 843-0550
TWX: 710-990 5071
Cable: Haydenpubs Rochellepark

Editor-in-Chief: George Rostky

Managing Editors:

Ralph Dobriner
Michael Elphick

Associate Editors:

Dave Bursky
Jules H. Gilder
Morris Grossman
Seymour T. Levine
John F. Mason
Stanley Runyon
Edward A. Torrero
Richard L. Turmail

Contributing Editor:

Peter N. Budzilovich

Editorial Field Offices

East

Jim McDermott, Eastern Editor
P.O. Box 272
Easthampton, Mass. 01027
(413) 527-3632

West

David N. Kaye, Senior Western Editor
2930 West Imperial Highway
Inglewood, Calif. 90303
(213) 757-0183

Washington

Heather M. David, Bureau Chief
2506 Eye St., N.W.
Washington, D.C. 20037
(202) 338-3470

Editorial Production

Marjorie A. Duffy

Art

Art Director, William Kelly
Richard Luce
Anthony J. Fischetto

Production

Manager, Dollie S. Viebig
Helen De Polo
Maxine Correal
Anne Molfetas

Circulation

Manager, Nancy L. Merritt
Ron Deramo

Information Retrieval

Peggy Long

Promotion

Manager, Jeffrey A. Weiner
Karen Kerrigan

across the desk

Correction suggested in encoding article

I would like to propose a correction to the article "Need to Keep Digital Data Secure?" (ED 23, Nov. 9, 1972, pp. 68-71). Referring to Table 2 on page 70, I noted an erroneous entry for clock period 12. In turn, the subsequent entries must be modified accordingly. The revised rows are:

CLOCK	DATA INPUT	FLIP FLOP STATES					
		FF 6	FF 5	FF 4	FF 3	FF 2	FF 1
12	1	0	0	0	1	0	0
13	0	0	0	0	0	1	0
14	0	0	0	0	0	0	1
15	1	1	0	0	1	0	1
16	0	1	1	0	1	1	0

Also, the correlation now becomes

$$\frac{10 - 6}{16} = 0.25.$$

The article proved interesting and informative, regardless of these minor errors.

Michael F. Smith

LTV/VAC-Avionics
P.O. Box 5907
Dallas, Tex. 75222

A crusade suggested to uncover prices

Congratulations on your editorial "Price Is a Vital Spec; So Why the Secrecy" (ED No. 4, Feb. 15, 1973, p. 51). It would also be convenient if manufacturers would date all catalogs, spec sheets, fliers, etc. This would enable the buyer to eliminate superseded material from his files and to understand why the price asked might be different from the printed price.

It would benefit the crusade if ED would give its readers blanket

authorization to send machine copies of the editorial to manufacturers who may not read your magazine.

L. M. Knapp

University of Calif., San Diego
Dept. of Physics
La Jolla, Calif. 92037.

Ed. Note: Blanket authorization granted.

A limitation noted in high-speed DAC

I should like to comment on the New Product feature on Computer Labs' eight-bit d/a ("8-Bit D/A Converter Module Settles to 0.4% Within 15 ns" (ED No. 2, Jan. 18, 1973, p. 77)). While, strictly speaking, the unit is the fastest d/a at 15 ns, it is only a current-output DAC. To fully utilize this speed, the user must have an amplifier with comparable speed—a no small task.

At the Data Device Corp. we have had such a complete DAC available as a standard product for over three years. It is our Model NDAC. It features a 5-V output range at 100-mA drive capability, sufficient to drive 50-Ω coax cable. It is available in eight or 10-bit accuracies, with max settling times of 75 and 275 ns, respectively. These are worst-case settling times for any code change. While the major carry point at half scale usually gives the worse glitch, it is not necessarily the point that has the worse settling time. That will be a function of the amplifier's ability to follow fully the code changes during the switching time. The NDAC has a temperature range of -55 to +85 C as opposed to the -20

(continued on page 10)

Electronic Design welcomes the opinions of its readers on the issues raised in the magazine's editorial columns. Address letters to Managing Editor, Electronic Design, 50 Essex St. Rochelle Park, N. J. 07662. Try to keep letters under 200 words. Letters must be signed. Names will be withheld on request.



THE LONG LINE OF ECC

Sensitive and Standard Gate
SCR's
Fast delivery and competitive prices make ECC's extensive line of SCR's your best buy.

SENSITIVE GATE SCR's

TO-5 Metal; 5/8" Hex Stud; THERMOPAK* and THERMOTAB® Packages

$I_{T(RMS)}$ 0.8 - 10 amps

I_{GT} 50, 200, 1500 μamps max

I_{TSM} 50, 100 amps min

V_{DOM} 30 - 600 volts min

STANDARD GATE SCR's

TO-5 Metal; 5/8" Hex Stud; THERMOPAK and THERMOTAB; 1/2" Press-Fit and Stud; 3/4" Press-Fit, Stud and TO-3 Packages

$I_{T(RMS)}$ 0.8 - 35 amps

I_{GT} 10, 25 ma max

I_{TSM} 50 - 325 amps min

V_{DOM} 30 - 800 volts min

5/8" Hex Stud; THERMOPAK and THERMOTAB; 3/4" Press-Fit, Stud and TO-3 Packages are electrically isolated.

All ECC SCR's feature heavily glass passivated junctions for high reliability. They are available from your nearest ECC Sales Representative or Authorized Distributor.

*trademark of ECC



New Condensed Catalog contains technical data on these and other ECC semiconductors. To receive your copy, circle No. 240.

ECC

CORPORATION

P.O. Box 669 • Euless, Texas 76039
817/267-2601

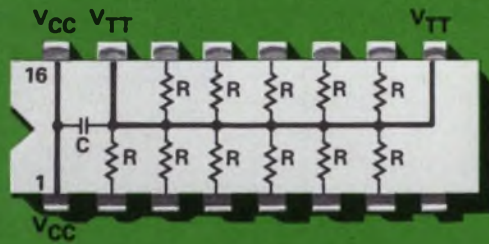

SERIES 898-41 -2.0 VOLT TERMINATORS contain eleven resistors for ECL line termination to a -2.0 volt bus. Each unit includes a 0.01 μ F decoupling capacitor to bypass the -2.0 volt bus. Standard R values of 50, 75, and 100 ohms are available and are designated 898-41-R50, 898-41-R75, and 898-41-R100.

Price (1,000-4,999) \$1.25

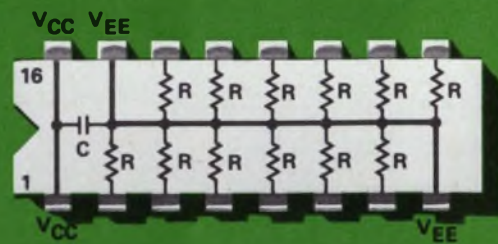

SERIES 898-42 -5.2 VOLT TERMINATORS contain twelve resistors for pull-down to the -5.2 volt bus. Each unit contains a 0.01 μ F decoupling capacitor to bypass the -5.2 volt bus.

Price (1,000-4,999) \$1.25

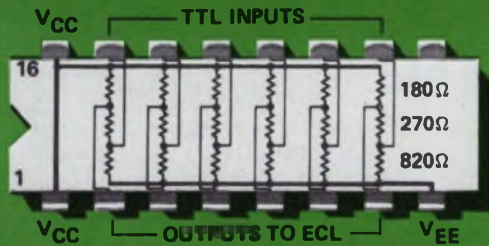

SERIES 898-45 TTL TO ECL TRANSLATOR contains six identical three-resistor sections for direct translation from TTL to ECL, both operating between a +5 volt supply and ground.

Price (1,000-4,999) \$1.25



Butterfly
Diurnal insect of the order *Lepidoptera*, characterized by clubbed antenna, a slender body, and large, broad, often conspicuously marked wings. Often found fluttering about the design engineer's stomach.

Our Bugs will get rid of your Butterflies

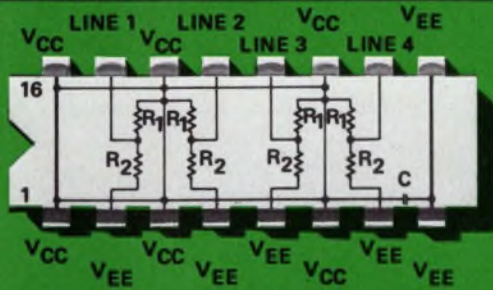

SERIES 898-43 THEVENIN EQUIVALENT TERMINATORS contain four Thevenin equivalent terminator sections. Each terminator section consists of two resistors connected as a divider from the ground bus to the -5.2 volt bus providing a Thevenin equivalent voltage of -2.0 volts. Each unit contains a $0.01 \mu\text{F}$ decoupling capacitor to bypass the -5.2 volt bus. Series 898-43 units are available with Thevenin equivalent impedances of 50, 75, and 100 ohms.

Series 898-43 R_1 and R_2 Values

Model	R_1	R_2
898-43-Z50	81 Ω	130 Ω
898-43-Z75	121 Ω	195 Ω
898-43-Z100	162 Ω	260 Ω

Price (1,000-4,999) \$1.25

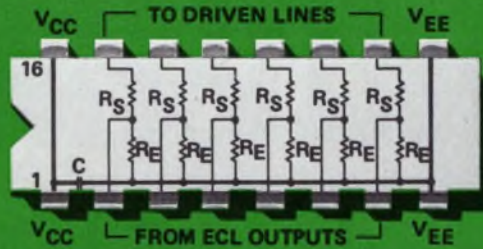

SERIES 898-44 SERIES LINE TERMINATORS contain six series terminator sections. Each section is designed for terminating a line at the driven end with a series resistor value equal to the line impedance minus the 7 ohm output impedance for 10,000 series ECL. The second resistor in each section is a pull-down resistor to the -5.2 volt bus. Each unit contains a $0.01 \mu\text{F}$ decoupling capacitor to bypass the -5.2 volt bus.

Series 898-44 R_S and R_E Values

Model	R_S	R_E
898-44-S43	43 Ω	457 Ω
898-44-S68	68 Ω	682 Ω
898-44-S93	93 Ω	907 Ω

Price (1,000-4,999) \$1.25

ECL Terminator Collection

Dependable Beckman ECL terminator networks are specifically designed for, and compatible with, the following Emitter Coupled Logic families:

- Motorola MECL 10,000 Series
- Signetics 10,000 Series ECL
- Fairchild 95K and F10K Series ECL
- Texas Instruments Series SN10000 ECL
- National Semiconductor 10,000 Series ECL

Each Beckman ECL terminator network utilizes thick film resistor materials

with layouts specifically designed for low inductance and the high speed requirements of ECL systems. Where possible, the terminator networks include $0.01 \mu\text{F}$ decoupling capacitors.

Each network is capable of operating in a $+85^\circ\text{C}$ still air environment at standard ECL voltage levels and tolerances without heat sinking.

For complete technical data, contact your local Beckman/Helipot representative or write to Beckman Instruments, Inc., Helipot Division, 2500 Harbor Blvd., Fullerton, Calif. 92634.

Beckman

HELIPOT DIVISION

INFORMATION RETRIEVAL NUMBER 7

THE INTELLIGENT SWITCH FROM IEE...

the lite touch

Intelligent switching . . . IEE makes it happen with an ingenious completely sealed TRANSPARENT matrix switch...the "CUE-SWITCH"®. This totally reliable, light weight low-profile package is a whole new concept in man/machine interaction. Being transparent, "CUE-SWITCH" matrices can be placed over any surface yet retain the readability of printed or projected data, i.e.; silk screened panels, CRT face, calculator, indicator/annunciator lights, rear-projection graphics, etc. It's a totally sealed switch element, impervious to dust, dirt or moisture.

True fingertip pressure — 4 to 9 oz., .005" travel, actuates switching by contacting matrix-fashion wire conductors embedded in clear dielectric films. NO mechanical linkages, springs or buttons and the total switch package thickness is only .040".

How does the "CUE-SWITCH" act intelligent? The transparent switch sandwich allows direct see-through or illuminated rear projection of ANY

GRAPHIC DATA to the viewing or "touch" surface of the switch. Photo film can be used to avoid costly engravings, and there are no restrictions on data content or color.

Features of the standard product line of the "CUE-SWITCH" include:

- lighted "push button" assemblies on .8" centers
- bezel units combined with IEE's rear projection readouts
- 8 switch units wide
- 3x4 matrices with adding machine or touch-tone format

The standard product line is only the beginning . . . Inquire now about custom matrices — IEE engineers them to put intelligent switching to work for your applications. Give us a call. Industrial Electronic Engineers, Inc., 7740 Lemona Avenue, Van Nuys, California 91405.

Telephone: (213) 787-0311, TWX 910-495-1707.

Our European Office: 6707 Schifferstadt, Eichendorff-Allee 19, Germany, Phone: 06235-662.

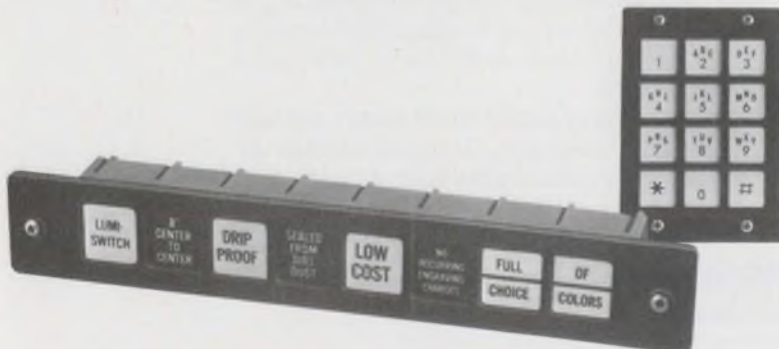

INFORMATION RETRIEVAL NUMBER 8

ACROSS THE DESK

(continued from page 7)

to +75 C of the Computer Labs' unit.

Stephen Muth

Product Manager-Data Converters
ILC Data Device Corp.
100 Tec St.
Hicksville, N.Y. 11801

Ed. Note: Although the article did state that the maximum voltage output was 1.5 V, it did not explicitly say that the MDS/MDP is a current-output d/a. It should have.

Much ado about much accuracy

Leonard Accardi's Idea for Design, "Self-Stabilized Zener Insures Constant Current in Op-Amp Voltage Reference" (ED No. 26, Dec. 21, 1972, p. 66), suggests that an IN829 with a Sprague op amp yields 150 μ V of drift vs 1000 μ V with a 741 op amp. But neither the 741 nor the Sprague op amp is guaranteed to be that good. Those are just typical data. And use of the IN829 zener diode causes a guaranteed maximum drift of 7000 μ V. So why quibble over typical values of 1000 μ V or 150 μ V.

Robert A. Pease

Teledyne Philbrick
Allied Drive at Route 128
Dedham, Mass. 02026

The author replies

Mr. Pease's comments repeat, for the most part, what was said in the article. The IN829 and IN-829A have the lowest guaranteed drift available, 5 mV (not 7 mV) at 7.5 mA over the wider temperature range of 155 C (-55 to 100 C). Since typical values are normally well below maximums, this justifies the use of the better op amp.

This circuit accomplishes what no other reference circuit has ever done, reducing the error to essentially that of the zener itself by use of a remarkably simple circuit. I invite Mr. Pease and anyone else to try to design a circuit that does

(continued on page 15)

TRW LVA diode... the sharpest knee below 10 Volts.

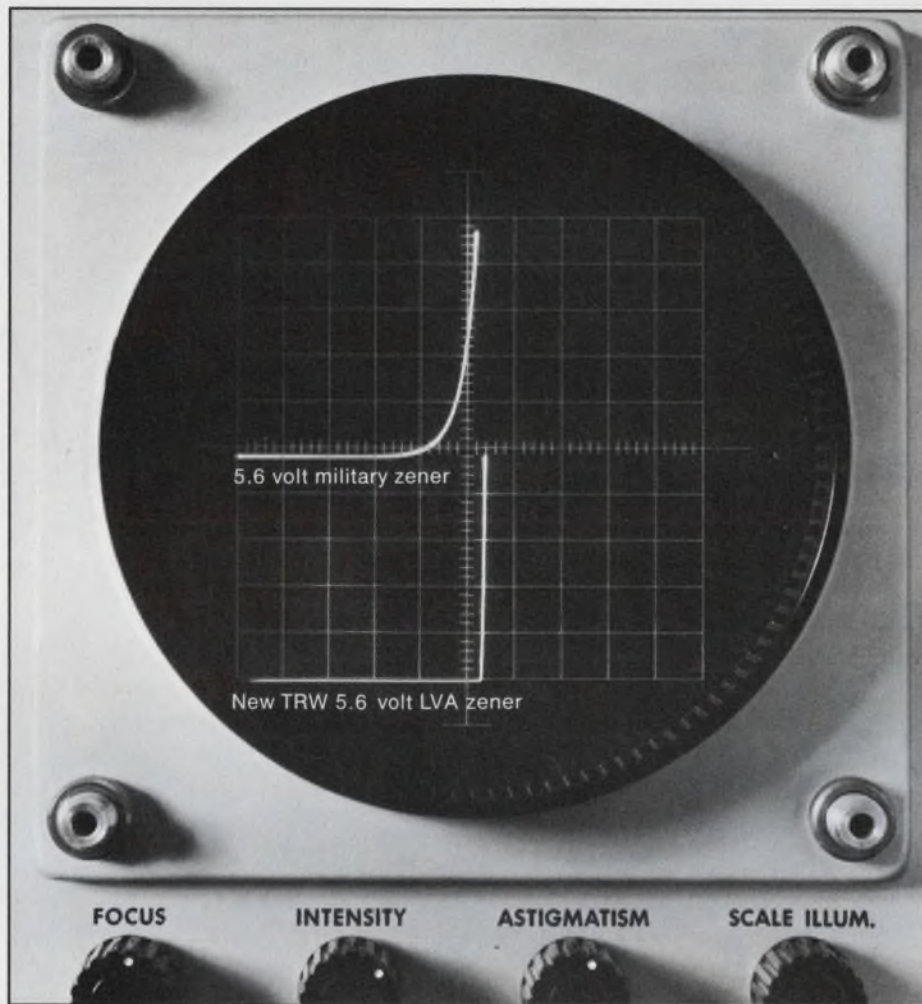

The current saver.

No other zener can approach TRW's LVA performance below 10 volts. Available for operation down to 4.3 volts, TRW LVA diodes minimize power consumption in portable-battery operated equipment. They're also ideal for instrumentation, where, as reference elements, they draw as little as 50 μ Amps.

TRW LVA's are available in various package configurations, including passivated chip form for hybrid-

compatible packages. If you have a need for a low current voltage regulator or any other product that demands low current consumption, you should check out TRW LVA zeners. When it comes to current, they're really misers!

For product information and applications assistance write TRW Semiconductors, an Electronic Component Division of TRW Inc., 14520 Aviation Boulevard, Lawndale, California 90260. Phone (213) 679-4561.

TRW[®] SEMICONDUCTORS

INFORMATION RETRIEVAL NUMBER 9

BOURNS

POTENTIOMETERS
QUALITY • DELIVERY
• PRICE •

83 DISTRIBUTOR INVENTORIES

CONTROLS AND VARIABLE RESISTORS

- CHOOSE FROM 6 POPULAR "SPACESAVER" CONTROLS
- LOWEST PROFILE IN THE INDUSTRY
- CERMET . . . FOR BETTER STABILITY AND POWER
- 3 POPULAR VARIABLE RESISTOR MODELS; HORIZONTAL AND VERTICAL MOUNT EITHER CERMET OR COMPOSITION ELEMENTS
- COMBINED FACTORY/DISTRIBUTOR CONTROLS STOCK: 167,000 PCS.
VARIABLE RESISTORS: 715,000 PCS.

TOTAL SOURCE... BUILT ON BASICS!

COMPONENTS FOR LOW-PRICED COMMERCIAL . . . TO MAN-ON-THE-MOON APPLICATIONS!

PRECISION POTENTIOMETERS

- ◊ SELECT FROM OVER 20 DIFFERENT STANDARD MODELS INCLUDING THE FAMOUS KNOBPOT® FAMILY
- ◊ 260,000 UNITS IN COMBINED FACTORY/DISTRIBUTOR STOCK
- ◊ CUSTOM PRECISIONS FOR EVERY SERVO-MOUNT APPLICATION

TRIMPOT®

ADJUSTMENT POTENTIOMETERS

- ◊ WORLD'S LARGEST LINE OF ADJUSTMENT POTENTIOMETERS!
- ◊ SELECT FROM OVER 60 MODELS . . . WIREWOUND OR CERMET!
- ◊ SINGLE-TURN . . . MULTI-TURN! ROUND, SQUARE AND RECTANGULAR!
- ◊ OVER 12,000 "MODEL/TERMINAL/RESISTANCE" COMBINATIONS!
- ◊ OVER 3,500,000 UNITS IN COMBINED FACTORY/DISTRIBUTOR STOCK

BOURNS
INC.

TRIMPOT PRODUCTS DIVISION
1200 COLUMBIA AVENUE
RIVERSIDE, CA. 92507

INFORMATION RETRIEVAL NUMBER 10



Silicone-packaged devices: The answer to a hot problem.

Within seconds after the match flame was applied to both the epoxy (left) and the silicone ICs (right), the epoxy burst into flame.

The hot issue in electronics today is flame retardancy. While epoxies and other plastics support combustion, silicone-packaged devices are virtually nonflammable. So, they don't need flame-retardant additives that alter the electrical and mechanical properties of epoxies and other materials.

And there are several other good reasons to specify silicone packaging compounds:

- excellent performance under thermal cycling
- low thermal expansion minimizes damage to components and lead wires
- basic electrical, physical, and chemical properties that remain constant over the widest temperature (-55 to 250 C), time, and frequency ranges
- uniform, lifetime electrical characteristics
- superior performance in 85 C/85% RH (biased) test
- total compatibility with all kinds of devices, including ICs, both digital and linear, MOS, CMOS, power transistors, SCRs, high-voltage rectifiers, etc.
- optimum reliability reduces manufacturing and repair/warranty costs
- safe, clean, inert, and require no special handling

Whether you are a device manufacturer or user, these advantages are important in semiconductor devices. Make the switch to nonburning silicone packaging compounds now. Write or call Jack Broser, Product Market Supervisor, Dow Corning Corporation, Department A-3312, Midland, Michigan 48640.

Silicones; simply the best way to protect electronic circuits

DOW CORNING

DOW CORNING

Six good reasons why Dow Corning should be your primary packaging-materials supplier.

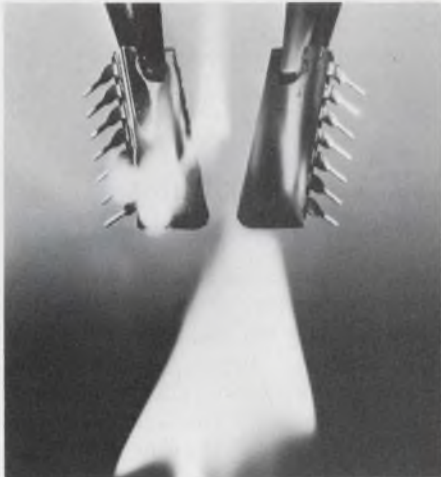

In addition to the many important advantages of silicone molding compounds, there are other good reasons why it is to your advantage to plan your growth in the electronics market with help from Dow Corning.

1. We are helping to develop the market for you. Extensive publicity, promotion, direct mail, and trade-show appearances are all educating your customers about the very substantial advantages of silicones in all kinds of harsh electronic/electrical environments.

2. Since service is extremely important in helping manufacturers in the development of advanced packaging systems, we have Technical Service & Development men strategically located worldwide to help solve your problems.

3. Your competitive advantage with Dow Corning molding compounds is a complete family of products, totally compatible with each other and with most other materials used in electronic systems, devices, or components.

4. Product-line breadth gives you the ability to design or produce the most reliable and economical packaging to protect any system, regardless of its sophistication or environment.

5. Technical leadership constantly applied in our own laboratories and with our customers results in the development of product modifications and new technologies to handle the needs and requirements of next generation devices.

6. Worldwide delivery from strategically located distribution points enables us to work with you to supply standard or special molding materials as required.

Major commitments like these indicate the kinds of things we are doing to earn your business. We'd like to discuss with you in more detail how we can grow together in this rapidly expanding area. Call or write Jack Broser, Product Market Supervisor, Dow Corning Corporation, Department A-3313, Midland, Michigan 48640.

Silicones; simply the best way to protect electronic circuits.

DOW CORNING

DOW CORNING

ACROSS THE DESK

(continued from page 10)

the job either better or simpler. I don't think it's possible.

Leonard Accardi

66-30 54th Ave.

Maspeth, New York City 11378

Correction

In the New Product article "Line Printer for Minicomputer Offers High Speed at Low Cost" (ED No. 7, April 1, 1973, p. 92) the wrong address and phone number were given for the Pertec Corp. The company is at 9600 Irondale Ave., Chatsworth, Calif. 91311. Its telephone number is (213) 882-0030.

Is that tri-flop a flip-flop-flap?

Reading the article "And Now . . . the Tri-Flop" (ED 23, Nov. 9, 1972, p. 80), I do not want to get into the discussion as to who the original inventor may be. However, your readers may be interested to know that in 1958, when we were playing with this device, it was referred to as a flip-flop-flap.

Roy Foerster

Scantlin Electronics
5454 Beethoven St.
Los Angeles, Calif. 90066

Let's engineer an end to inflation

Your editorial of Feb. 1 ("We've Got to Run Faster to Stay in Place," ED 3, p. 45) urges us all to work harder so we can now stay even in world competition. I would suggest that American engineering expertise and innovative ability are not lacking. You have missed the biggest reason for our deteriorated trade position: inflation.

Inflation of the U.S. money supply for a longer time and to a greater extent than other industrialized countries (we've had inflation for 35 of the last 38 years, and today's dollar is worth less than 30% of a 1934 dollar) has

(continued on page 16)



Type LS8 Metalized Polystyrene Capacitors are Smaller and Lighter with No Sacrifice in Performance

Dearborn® Type LS8 Metalized Polystyrene Capacitors are 1/3 the size and 1/4 the weight of their "non-metalized" foil-electrode counterparts. Yet their performance characteristics (low negative temperature coefficient of capacitance, extremely high insulation resistance, freedom from dielectric absorption) are every bit as good, making them ideally suited for applications such as low-frequency tuned circuits, an-

alog and digital computer reference, timing and integrating circuits, and high-Q tuned circuits.

Capacitance values range from .0027 μ F to 2.2 μ F. Voltage ratings are 50, 100, and 150 WVDC. Capacitance tolerances as close as $\pm 1\%$ are available. Operating temperature range is -65°C to $+85^{\circ}\text{C}$.

For complete data, write for Engineering Bulletin 401.

SPRAGUE ELECTRIC COMPANY
Dearborn electronics division
P.O. BOX 1076, LONGWOOD, FLORIDA 32750



INFORMATION RETRIEVAL NUMBER 13

ACROSS THE DESK

(continued from page 15)

caused our prices to rise much higher than equal products made in foreign countries. Rather than urging us to ever-increasing effort and greatness in engineering innovation, you ought to be urging an end to inflation in Washington.

Robert A. Lawson
Senior Engineer

56 Nob Hill Dr.
Framingham, Mass. 01701.

RCA's contributions to computers lauded

The nostalgic articles about the transistor ("The Transistor Years," ED No. 24, Nov. 23, 1972, pp. 66-131) bring to mind the graffiti that "nostalgia is not what it used to be." There were many inaccuracies in the articles, but the one that bothered me most was on p. 88. After discussing the NCR-GE 304, which was noted as first installed in November, 1959, a paragraph starts out, "about this time RCA tried to establish itself in the computer field . . ."

The author of the article apparently never heard of the RCA BIZMAC. It seems to be fashionable to disparage RCA's contributions to the computer art. Those of us in the computer field in the early days, and who were familiar with the various machines, know that RCA was an early technical leader in the computer industry. For whatever reasons RCA elected to withdraw from the general-purpose computer field, lack of early technology was not one of them.

The RCA 501 was a step forward from the BIZMAC and was the first to take advantage of transistors. Its conception predated that of the Philco 2000 and the NCR-GE 304. The first RCA 501 installed in other than an internal installation was delivered in June, 1959, several months before the November date of the NCR-GE 304, which was first installed internally at GE.

Carl M. Wright

310 Devon Rd.
Cinnaminson, N.J. 08077.

Power down:

Our new Quad Power Strobe selectively activates system components to permit reduction in standby power requirements by as much as an order of magnitude.

The HD-6600 is the industry's first monolithic, dielectrically isolated quad power strobe. Designed primarily for use with ROM and PROM systems, the device offers four power outputs which can be activated selectively, thereby

greatly reducing standby power requirements—up to as much as an order of magnitude. Each output can deliver up to 150mA simultaneously with no more than a 250mV drop from the power supply to the strobe output. Access time

from the HD-6600 input to a HPROM-1024 memory output is typically 100ns. System access time as low as 50ns can be obtained by powering the memory circuit prior to the read operation. Other applications for the new device include use in telephone relay switching, strobing of general logic circuitry, and multiplexed LED display systems. For more details see your Harris distributor or representative.

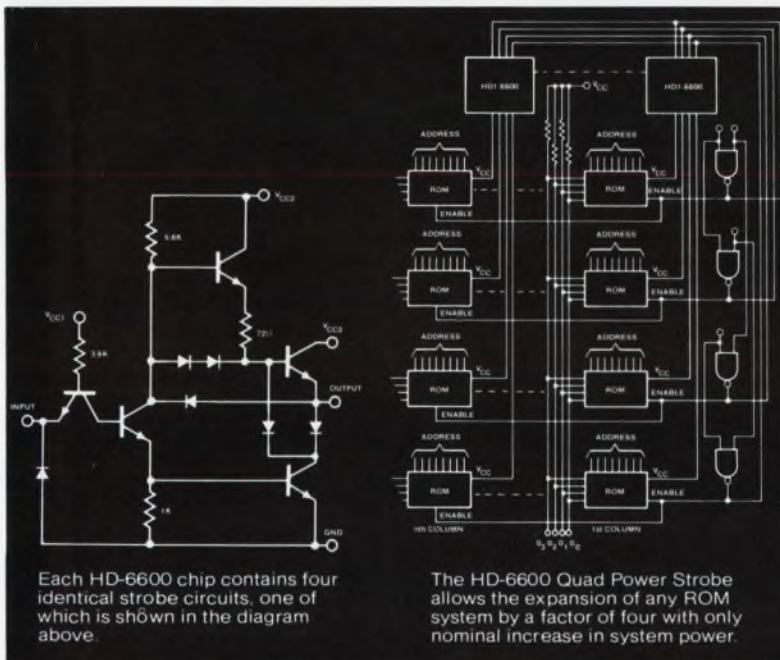

Features:

- High drive current** 200mA
- High Speed** Typically 50ns
- TTL compatible inputs**
- Quad monolithic construction**
- Inverting logic**
- Power supply flexibility**
- Low power**
 - Standby 30mW/Device
 - Active 95mW/Device
- Supplied 14-pin ceramic DIP**

	100-999 units
HD-6600-5	
0°C to + 75°C	\$5.65
HD-6600-2	
- 55°C to + 125°C	\$8.50

Harris



HARRIS
SEMICONDUCTOR
A DIVISION OF HARRIS-INTERTYPE CORPORATION

P.O. Box 883, Melbourne, Florida 32901
(305) 727-5430

WHERE TO BUY THEM: ARIZONA: Phoenix—Liberty, Weatherford, Scottsdale—HAR (602) 946-3556 CALIFORNIA: Anaheim—Weatherford; El Segundo—Liberty, Glendale—Weatherford; Long Beach—HAR (213) 426-7687; Mountain View—Elmar; Palo Alto—Weatherford, HAR (415) 964-6443; Pomona—Weatherford; San Diego—Weatherford, Western COLORADO: Denver—Elmar, Weatherford WASHINGTON, D.C.: HAR (202) 337-3170 FLORIDA: Hollywood—Schweber; Melbourne—HAR (305) 727-5430 GEORGIA: Atlanta—Schweber ILLINOIS: Chicago—Semi-Specs; Schweber; Palms Heights—HAR (312) 597-7510 INDIANA: Indianapolis—Semi-Specs MARYLAND: Rockville—Schweber MASSACHUSETTS: Lexington—R&D; Waltham—Schweber; Wellesley—HAR (617) 237-5430 MICHIGAN: Detroit—Semi-Specs MINNESOTA: Minneapolis—Semi-Specs MISSOURI: Kansas City—Semi-Specs; St. Louis—Semi-Specs NEW MEXICO: Albuquerque—Weatherford NEW YORK: Melville—HAR (516) 249-4500; Syracuse—HAR (315) 463-3373; Rochester—Schweber; Westbury—Schweber OHIO: Beachwood—Schweber; Dayton—Semi-Specs PENNSYLVANIA: Pittsburgh—Semi-Specs; Wayne—HAR (215) 687-6680 TEXAS: Dallas—Weatherford; Semi-Specs HAR (214) 231-9031 WASHINGTON: Seattle—Liberty, Weatherford WISCONSIN: Wauwatosa—Semi-Specs

LEGEND FOR HARRIS SALES OFFICES & DISTRIBUTORS: Harris Semiconductor (HAR); Elmar Electronics (Elmar); Harvey/R&D Electronics (R&D); Liberty Electronics (Liberty); Schweber Electronics (Schweber); Semiconductor Specialists, Inc. (Semi-Specs); R. V. Weatherford Co. (Weatherford); Western Radio (Western).

INFORMATION RETRIEVAL NUMBER 75

Janice.

A nice, quiet, English Girl.

Meet her any day after office hours and you'll find her reading Jane Austen, writing to her mother, listening to good music or setting off on a long country walk. With an enormous dog for bodyguard.

But up to 5 p.m. (West Coast Time) she's yours to command.

Janice runs the Jermyn sales office in San Francisco, and her working day is one long scamper to answer the phone, send off catalogs, or pack up parcels of urgent components, all despatched the day she receives the order.

She can tempt you with DIP sockets, IC mounting pads, heat sinks, and all the other semiconductor hardware made by Jermyn.

And she's making a huge success of the job, for two reasons.

The famous Jermyn same-day despatch means that when you want something in a hurry, you get it.

And the equally famous Jermyn quality means that when you get it, you won't want to change back to any other brand.

Here are a few examples, with prices and an order form, for you to try for yourself.

We'll send a complete catalog of course.

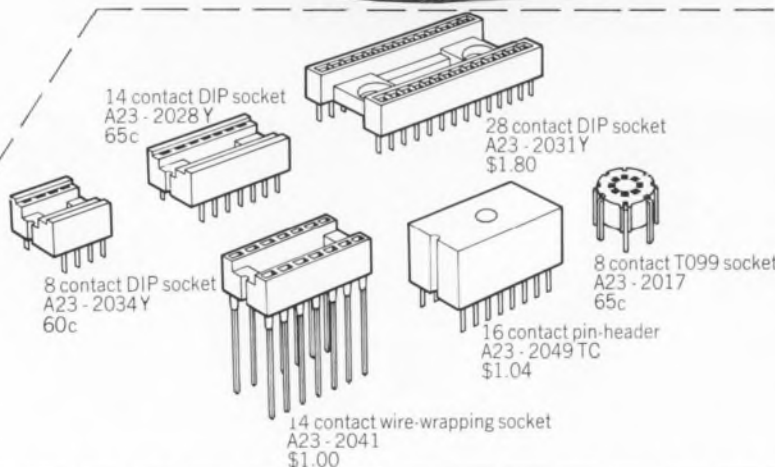

Please send me the following Jermyn components.

Type number

Quantity

I enclose check/money order \$

(Please add California sales tax where appropriate)

Name

Address

Jermyn

712 Montgomery Street San Francisco California 94111 Telephone (415) 362-7431
East Coast Sales Office Telephone (914) 634 6151

SEMICONDUCTOR NEWSBRIEFS

PUBLISHED BY MOTOROLA SEMICONDUCTOR PRODUCTS INC.

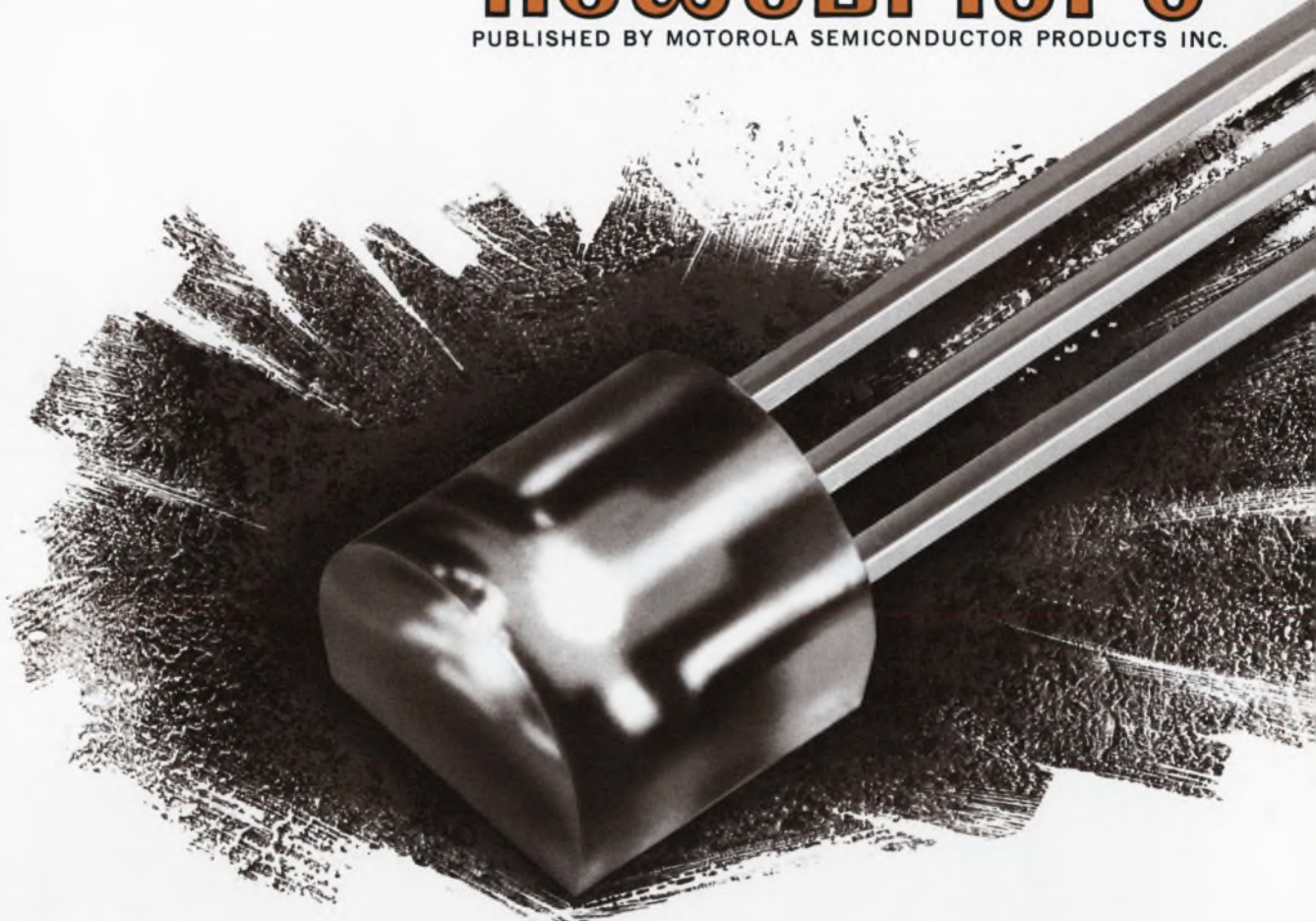

The 10¢ LED.* Here. There. Everywhere.

Two years ago, everybody said, "Can't use LEDs — too costly."

Or, "I can afford to wait 'til they're competitive with incandescents."

Or, "LEDs? Too high. Wait 'til they cost a dime."

Today they do! By the million.

Now you can dust off those shelved designs calling for displaying LEDs in status indicators, pay phones, cameras, stereo indicators, instruments and calculators — to name just a few applications

that cry for bright, solid-state indication of status or condition.

The industry's first LED-for-a-dime has adopted the same high-volume production techniques that made our injection-molded, Unibloc plastic transistor outstanding the world over for economical, low-cost versatility.

The result . . . the new MLED500 series . . . ideal for existing, automatic insertion techniques, standard throughout your industry.

High luminous intensity, 0.3 mcd typically at 20 mA — diffusing red lens with 110° field of view and IC compatibility for low power consumption are prime MLED500 advantages, but the best is its price, 19¢ 100-up, 17¢ 1000-up, *by the million-10¢.

We're geared up. We're ready to go. How can you afford not to . . . buy the million . . . display them?

Here. There. Everywhere.

For details, circle 211

Semiconductor

From Motorola, the LED producer.



Solid State Relays Enforce Electronic Apartheid

Do it optically! Segregate low and high power circuits using the new relay generation — solid state. Combining the best of two worlds, photon flux for isolation, semiconductors for everything else, the new relays provide features impossible to achieve electromechanically.

Features like higher speed, for instance. With no contact inertia to overcome, they function in microseconds. And their very speed provides a second important benefit — ac zero-crossing control. Solid-state relays can turn on at near-zero voltages minimizing electromagnetic interference (EMI).

Because there are no contacts to arc, solid state relays are safe for use in hazardous environments.

Because they have no contacts, there can be no contact bounce. You inject less noise into your system. Your designs are simpler, components cheaper.

Rugged? Solid state relays are relatively vibration and shock proof. And they come in the usual compact semiconductor packages. You can avoid the need for custom relay configurations. PC board spacings can be closer, more uniform. You save system space, cost.

The power lines in many industrial facilities supply machinery such as welders, mills, drills, lathes, etc. that are repeatedly switched. The same lines power EMI/noise susceptible test and measuring instruments. Use of ac relays with zero-crossing control can hold noise on such lines to a minimum. Let us show you what we mean.

Suppose your industrial system requires a relay capable of operating a load of moderate power at high cycling

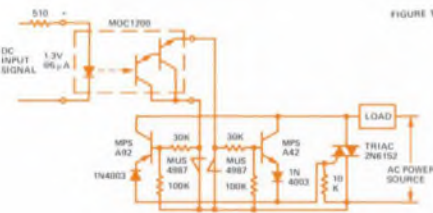

FIGURE 1

rates. Figure 1 shows an ac relay with zero-crossing actuation that will do the job. In this scheme, the load current passes through a triac. The triac is turned off by self commutation, on by a control circuit consisting of an NPN-PNP transistor pair that delivers bidirectional current to the triac gate. The zero-crossing actuation is controlled by two MUS4987 unilateral switches that provide an enabling voltage window between zero and approximately five to ten volts. 1500 volts worth of isolation between the input and load circuits is provided by the MOC1200 opto coupler. Note that the components of the relay need not be located in a particular place — they could be mounted on different PC boards, and need only about 0.2" clearance above their sockets for mounting.

The key to the superior versatility of solid state relays over the old kind is their use of photon flux rather than magnetic flux as the coupling agent between input and output circuits. When you consider that visible or IR radiation can be condensed, expanded, reflected, refracted, and even bent by using fiber optics, you begin to see how solid state relays can do formerly impossible things. Like take the coupling agent outside the relay à la the next schemes.

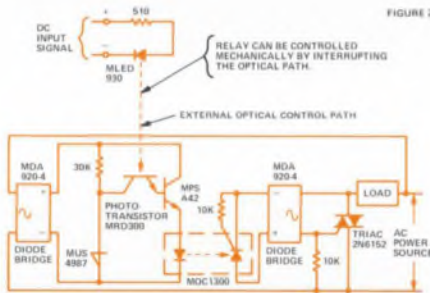

FIGURE 2

The solid state relay shown in figure 2 not only has zero-crossing actuation but provides double-barrelled control. The light beam, which can be placed anywhere it's needed, can be controlled

For details, circle 212

by varying the current to the MLED930 as well as by mechanically blocking the light transmitted to the MRD300. Result? Incomparable flexibility.

Our last circuit may give you an idea of how you can apply a solid state relay

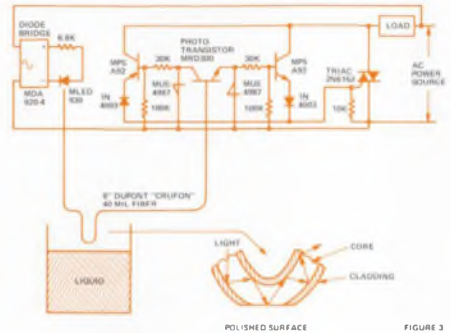

FIGURE 3

with a little ingenuity and come up with a really unique solution to a design problem. We took the zero-crossing actuated circuit of figure 1 and replaced the opto-coupler with an IR diode and a photo transistor. Then we made a sharp bend in a length of optical fiber and ground the outside radius of the bend until the core material was exposed. If the photon flux emitted by the LED is transmitted through the fiber to the photo transistor while the fiber is surrounded by air, everything is okay. But if the bend is immersed in fluid, some light is refracted out of the optical fiber and the photo transistor turns off. Voilà? A liquid level sensor is born.

As we've tried to show, the really neat thing about solid state relays is their versatility. You don't thumb through catalogues looking for a relay in a package of this maximum height or capable of that minimum current handling capability. What you do is rig up the semiconductors and optoelectronic components you need for the application in your system. On any PC board. To fit any situation. Any place.

Try a solid state relay. And enforce a little circuit segregation of your own.

SEMICONDUCTOR
NEWSBRIEFS

No. 16-73

Published by Motorola Semiconductor Products Inc., P. O. Box 20912 ♦ Phoenix, Arizona 85036
Editor: Ken Covey Art Director: John McConnell Photographer: Ed Rittershaus
The circuitry shown external to Motorola products is for illustration purposes only, and Motorola does not assume any responsibility for its use or warrant its performance or that it is free from patent infringements.

The information and prices in this issue are believed to be accurate and correct at the time of publication. However, they are subject to change without notice at any time by Motorola. MECL, MHTL, MTTL, CMOS, Unibloc, Beam-Fired and Thermopad are trademarks of Motorola Inc.

©Motorola Inc. 1973



Beam-Fired SCRs Run For Your Life

They'll run longer. The key is Beam-Fired's low switching losses, cooler operation for vastly improved reliability. Within 3 μ s, dynamic forward drop is down to 3 volts, current up to 150 amps. Initial turn-on voltage and dissipation are cut, turn-on time reduced. You get high, 1000 A/ μ s di/dt without dv/dt sacrifice.

They are fast due to state-of-the-art, patent-applied for technology: optimum cathode shunt placement, integrated gate cascade driver stages, simultaneous, large-area, multi-gate turn-on.

Fact is, they'll outrun anything else like them at the highest current, speed, frequency combination in a 110, 235, 380 or 470 amp device. But don't take our word. Take a 235 ampere Beam-Fired unit — the MCR 235A series with 10 μ s turn-off. Run it up to 30 kHz. Run it for life.

Evaluate the leading edge of SCR technology. Contact your Motorola distributor about Beam-Fired for your inverter, chopper, induction heating and cyclo-converter designs. Write for a cross-reference list and a new brochure that spells out the A-B-Cs of Beam-Fired. Box 20912, Phoenix, AZ, 85036.

Motorola's leading edge, Beam-Fired SCRs are housed in a high current, high-speed "Hockey-Puck" package developed expressly for high-power industrial applications.

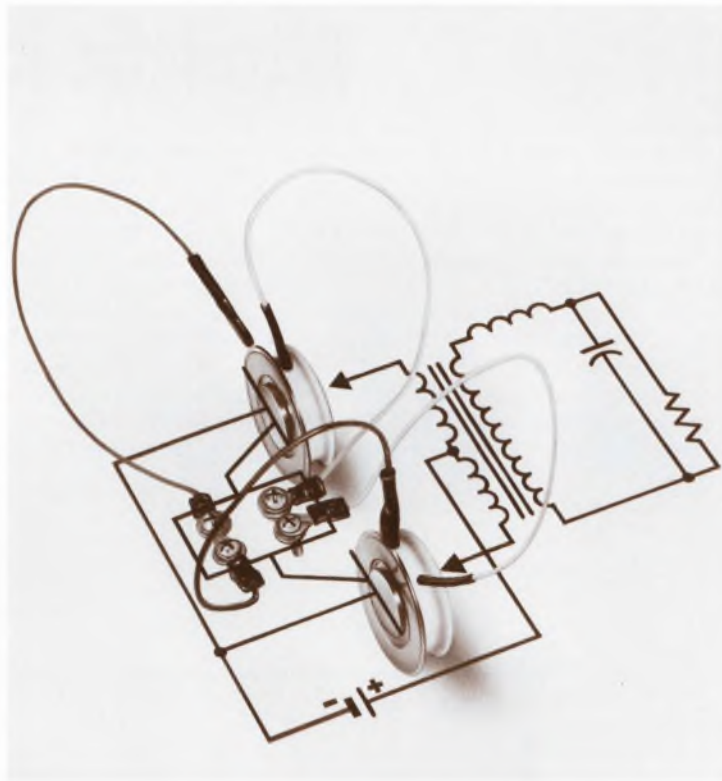

For details, circle 213

Light Up With McMOS Display Driver

Use the ultra low power MC14511 BCD-to-Seven Segment Latch/Decoder/Driver to light up seven segment LED, incandescent, fluorescent, gas discharge, or liquid crystal readouts in applications from instrument, computer, calculator, and cockpit displays to clocks, watches, and timers. It has high continuous output drive current of 25 mA per output (max), typical low McMOS power dissipation, latch code storage, lamp test provision, blanking input, and lots of other enticements. Prices (100-up) descend from \$15.00 for the AL wide temperature range series to \$7.15 and \$5.36 for the -40° to $+125^{\circ}$ C CL and CP versions.

An interesting sidelight on the MC14511 is that it combines the enhancement mode MOS devices and NPN bipolar output drivers on the same monolithic chip.

Another new McMOS function is the MC14517 Dual 64-bit static shift register. This is actually two independent 64-bit S/Rs on one chip. Each has out-

puts at bits 16, 32, and 48, so the user can get almost any combination of shift register lengths using these tap outs. Both AL and CL series ceramic versions are available at 100-999 quantity prices of \$24.00 and \$14.35 respectively.

It's worth finding out more about these — and 46 other — McMOS functions. See your Motorola distributor.

For details, circle 214

BULLETIN

McMOS Turns to Plastic

Thirty-nine McMOS functions in dual in-line plastic packages are slicing 8% to 32% from the price of commercial grade ceramic-packaged units. Since they're well below prevailing industry plastic prices, too, your typical CMOS system can now cost about 10% less. The ceramic AL and CL series boast a supply voltage range of 3 to 18V, typical noise immunity of 45% of V_{DD} , typical quiescent power dissipation of 10 nW per package for gates, diode protection

on all inputs, and more. The plastic CP versions share these features. CP McMOS even matches the wide -40° to $+85^{\circ}$ operating temperature range of the CL commercial grade series.

The rapid McMOS growth is scheduled to continue. As new functions

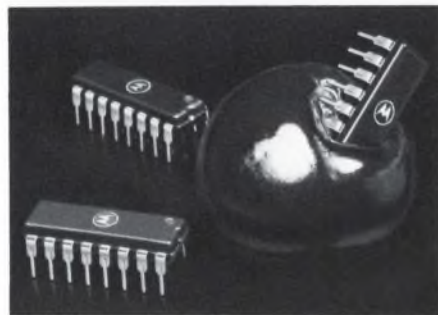

When you choose plastic McMOS over ceramic, you give up cost, but little else.

are introduced in ceramic, those that can be packaged in 14 or 16-pin plastic will be introduced concurrently.

For details, circle 215



MC7800 IC Series Brings In Altruistic Regulation

What price value? We're practically giving away seven great new three-terminal IC voltage regulators. They're the positive fixed voltage MC7800 series and they're available now, they're easy to use and they perform.

What is perform? Read on. Internal thermal over-load protection (shutdown and automatic resetting), internal current limiting, and output transistor safe-area compensation make them just about "blowout" proof. Output current goes

one amp or better — to an amp and a half with certain heat sink and input voltage conditions. Line and load regulation are excellent, and output voltage tolerance is less than $\pm 5\%$. Their package gives you TO-220 pin compatibility plus the mechanical advantages of the Motorola Case 199-04 Thermopad.

What is easy to use? The only thing easier than an MC7800 series regulator is a battery. Seven voltages are available — 5, 6, 8, 12, 15, 18 and 24 V. Just

choose the unit for your requirements, connect it, add a single capacitor (under most conditions), and that's it. And they're just as easy to use even when your requirement is for local, on-card regulation, or for low-cost systems which have traditionally ignored the need for regulation.

Practically give them away? They're only \$1.75 in 100-999 quantities. Incredible! Where does value stop and altruism begin?

For details, circle 216

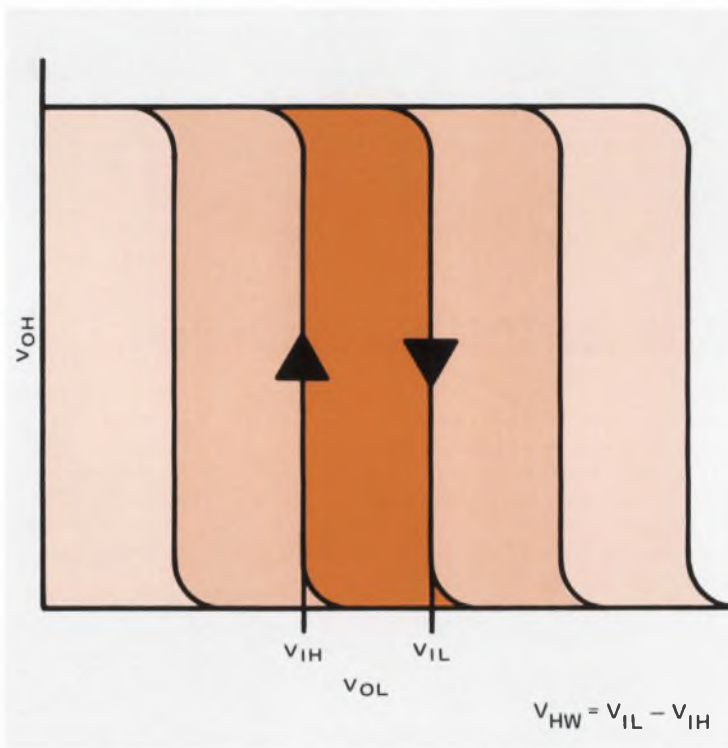

A truly universal interface device, MC696 provides hysteresis adjustable both in width and centerpoint.

Versatile MHTL Line Driver/Receiver Provides Universal Interface

The new, extremely versatile MHTL dual differential line driver/receiver/repeater — MC696 — is designed for industrial applications requiring high immunity to electrical noise.

It has a high input impedance of

$\approx 20k\Omega$ and an output impedance of $\approx 20\Omega$ in the LOW state provides current sinking sufficient to interface any logic family. An internal resistance of $\approx 1.5k\Omega$ in the HIGH state makes it virtually short-circuit proof. MC696

also features differential inputs and outputs, internal biasing, reference, and hysteresis sources, plus the ability to work over a very broad range of V_{cc} (10 to 25 V).

MC696's real forte is as an excellent line driver/receiver for differential (twisted pair) or single-ended use. Vary its hysteresis from approximately 100 mV to several volts and, with a constant loop width, center it anywhere in the common mode range.

With its ability to operate over a wide range of power supply voltages and its adjustable hysteresis capability, MC696 is an ideal logic family interface. Place it between any negative supply family (PMOS, MECL) and any positive supply family (CMOS, MHTL, TTL), adjust your switching thresholds and hysteresis and you've got ideal translation without noise immunity loss.

Data inputs in industrial environments are inherently noisy, usually from some type of contact closure like a micro-switch or a relay. Tune it out with the MC696. With any supply from 10 to 25 volts, obtain just the right amount of hysteresis with a single external resistor. Or, use MC696's internal resistor for a 3.5 V hysteresis "dead zone" from a 15 V supply.

Call your nearest Motorola sales office or distributor for evaluation samples now. 100-up prices, in 16-pin, dual in-line plastic (P) and ceramic (L) packages are \$1.25 for MC696P, and \$1.90 for MC696L.

For details, circle 217



MC1455—Your Time Is Now

Might as well say the sun is merely hot as to call Motorola's MC1455 simply a timing circuit. The MC1455 is a timer, and an oscillator as well, with a

host of readily seen applications and capable of a myriad of uses as yet unrecognized. Obvious MC1455 applications include time delay generation,

sequential timing, precision timing, pulse generation, missing pulse detection, pulse width or position modulation. You'll think of many more.

The circuit is a highly stable controller capable of producing very accurate time delays ranging from microseconds to hours. Used as a timer, it is programmed by a single resistor and a single capacitor. Used in the astable mode as an oscillator, its frequency and duty cycle are determined by two external resistors and a single capacitor. The MC1455's high current output can source or sink 200mA, sufficient to drive TTL or, say, a 4 amp SCR. Outputs are either "normally off" or "normally on".

Initially, the MC1455 is available in the compact 8-pin dual in-line plastic package for the 0 to +70°C operating temperature range.

MC1455 timing errors are very low. Typical specs are: initial accuracy — 1.0% drift with temperature — 50 PPM/°C and drift with supply voltage — 0.01%/volt.

The MC1455's supply voltage range is a wide 4.5 V to 16 V. In fact, it's functionally and pin-for-pin compatible with the Signetics 555.

See your franchised Motorola distributor or local sales office regarding the availability of the MC1455. The 100-999 quantity price is 75¢.

Although the MC1455 is barely introduced, the demand is already swelling. Clearly, its time is now.

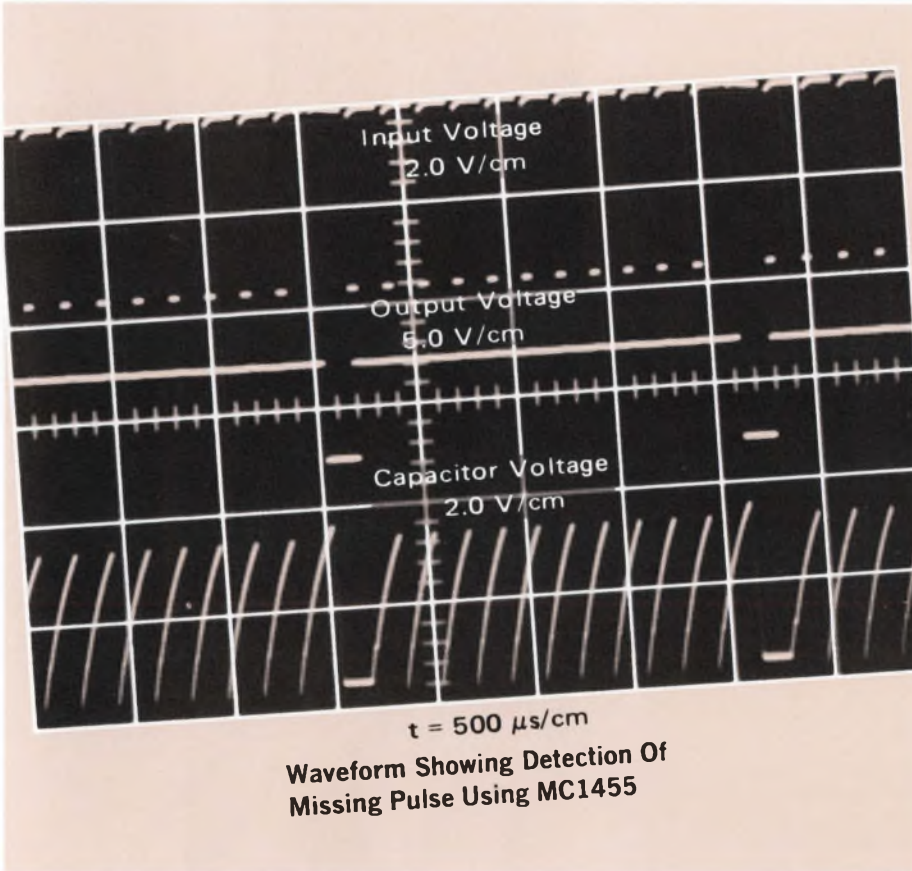

For details, circle 218

Eight-Bit MC1508 Takes Command Of DAC Revolution

Leadership of the DAC cost/performance revolution, assumed in 1972 by the 6-bit MC1506 "basic" monolithic DA converter, has passed to the new 8-bit MC1508. It leads with high performance, low cost, simplicity of use, and good delivery.

Attributes like fast settling time (300ns), excellent relative accuracy ($\pm 0.19\%$ error, max.), high-slew rate multiplying input (4.0 mA/ μ s), full 8-bit accuracy, and an extended output

voltage swing of +0.5 V to -5 V help make MC1508L-8 the leader. But second-in-command MC1408L-8 exhibits all the leader's specs except one, a 0 to +75°C operating temperature range versus MC1508L-8's -55 to 125°C.

MC1408L-7 and MC1408L-6 have seven and six-bit accuracy respectively, with full 8-bit resolution, but otherwise share MC1408L-8 performance. All four have non-inverting inputs, both TTL and CMOS-compatible.

Judge the cost of these revolutionaries in the light of greater system flexibility offered. A choice in the precision offered in the voltage reference and the speed, accuracy, and output range (and cost) of the buffer op amp are left to the designer. 100-999 prices are \$8.50 for MC1508L-8, \$5.95 for MC1408L-8 and \$3.95 for MC1406L-6, little enough for heroes.

Strange thing about this revolution, though. Supplies are plentiful.

For details, circle 219



NEW PRODUCTS BRIEFS

MC12000 DIGITAL MIXER/TRANSLATOR

— *Makes the Difference In Phase-Locked Loop Systems*

Need the difference between two frequencies? Try the MC12000, a digital mixer whose output frequency is the difference between two input frequencies. In operation, the MC12000 is an MECL Type "D" Flip-Flop with MTTL to MECL and MECL to MTTL translators to accommodate system interfacing.

Use the MC12000 as a prescaler in phase-locked loop systems where the VCO frequency is greater than 10 MHz and the tuning range is narrow. Generate frequencies (one or more) up to 250 MHz economically *without the use of tuned circuits*. Use it with mixing techniques to generate lower frequencies for economical digital processing.

Mix it up! Call your distributor for evaluation today and specify MC12000L. Prices range from \$7.50 (1-24 units) to \$5.00 (100-up). It will make the difference in your system.

For details, circle 220

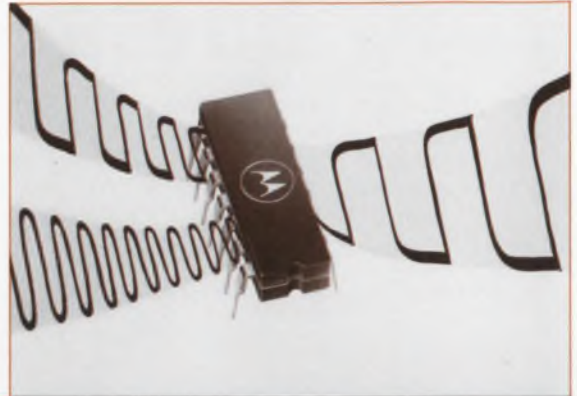

BEAM LEAD MONOLITHIC VOLTAGE REGULATOR OUTPUT

— *Adjustable From 2 To 37 Vdc*

A beam-leaded version of a popular monolithic voltage regulator is now available for your hi-rel, limited-space designs — the MCBC1723 and its TO-86 flat pack equivalent, MCB1723F.

The silicon-nitride-sealed junction linear integrated circuit will deliver an unaided load current of 150 mA_{dc}, several amps through use of one or more external pass transistors. Output voltage is adjustable from 2 to 37 Vdc.

Both the beam-lead chip and flat pack voltage regulators provide 0.01% line regulation and adjustable short-circuit protection. The beam-lead IC employs a silicon-nitride hermetic seal that eliminates the need for an external package. Its gold cantilever beam leads bond directly to a gold-metalized substrate providing the most reliable semiconductor interconnection known.

Warehouse supplies are 100-up priced at \$3.50 for MCBC1723, and \$5.60 for MCB1723F. Investigate beam-lead reliability for your system today.

For details, circle 221

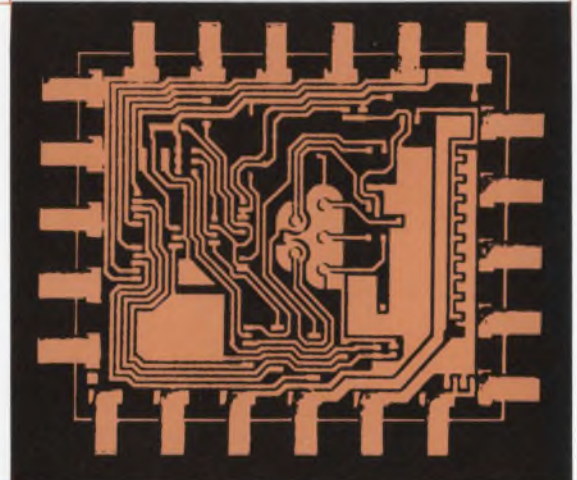

A FIRST WITH 4N's . . .

— *Affords Registered Optical Couplers*

Here are the very first 4N- numbers in EIA history . . . and the very first registered optoelectronic couplers for tight-spec use in interface and coupling systems, phase and feedback controls, solid-state relays and general purpose switching circuits. Coupling an infrared light emitting diode/phototransistor pair in an economical, compact, dual in-line package, the 4N25-28 series furnishes 500 to 2,500 V isolation voltage, 3 to 5 mA collector output current, 300 kHz frequency response and microsecond switching times. And 100-up prices that start at 99¢ — a "first-and-only" in the industry!

A new, comprehensive data sheet tells all . . . gives specs, switching time and frequency response test circuits, and typical applications like a handy isolated MTTL-to-MOS level translator, for example. Send for it - be the first with 4N's.

For details, circle 222



MOTOROLA FETHER MERCHANTS

— *Put Their Best FET Forward*

Our inveterate FET betterers have reached into their FETlocker and have come up with 3N128 — the "FET Felicific." How can an N-channel MOSFET designed for amplifier/oscillator applications be felicific? Simple. 3N128 has a pleasing faculty for assuring successful VHF receiver designs.

Power gain at 200 MHz, for example, is 13.5 dB minimum (20 typical). At the same frequency, noise figure is 5.0 dB maximum. And measured at 1 kHz, forward transadmittance is 5000 umhos; at 1.0 MHz, input capacitance is 7.0 pF. All four parameters figure strongly in your front end's performance.

To ease your design, the data sheet provides y-parameters. NF and G_p are plotted and typical third-order intermodulation distortion at 200 MHz — a great aid in determining immunity to IMD interference — is graphed.

But the most terrific felicific specific is the design economy use of the 3N128 can mean. Its price is 90¢, 100-up. Adopt the felicific philosophy — today!

For details, circle 223

THIRD ORDER INTERMODULATION DISTORTION

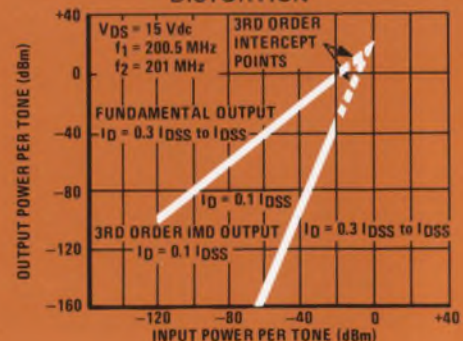

NEW LITERATURE

Please PRINT clearly (To expedite your literature we may have to use this as return mailing address)



New Guide To Thyristors Published

In about three dozen pages, we've collected most of the facts you need to select, design with and use SCRs, Triacs, UJTs, PUTs, SUSs, SBSs, Diacs and 4-Layer Diodes. And if you need a fact we didn't include, we tell you where to go to get it. Here are some of the things that are included:

- Selector guides to all the thyristors made by Motorola giving the major specifications of the most popular types.
- A bodacious cross-reference between Motorola's thyristors and those of all other major manufacturers, listing house as well as JEDEC numbers.
- Outline dimensions for all Motorola thyristor cases.
- A listing of application notes prepared to help designers use thyristors.
- A guide to definitions, symbols and terminology found in the thyristor world.

If you're in control or want to get control, this is the way. Write on your letterhead for a copy.



NAME _____

TITLE _____

COMPANY NAME _____

DIVISION _____

DEPARTMENT _____

COMPANY ADDRESS (Street or P.O. Box) _____

CITY _____

STATE _____ ZIP CODE _____

Please circle the Reader Service number of item(s) you are interested in receiving.

List Application Notes you wish to receive below (by number):

E.D.				
211	212	213	214	215
216	217	218	219	220
221	222	223		

VISIT

PHONE

Phone No. _____ Area Code _____

NOTICE: Requests for literature on items described in this ad cannot be honored after July 1, 1973.

RECTIFIER HANDBOOK ORDERING COUPON	
_____	copies at the single copy price of \$2.00 each: \$ _____
Larger quantities prices are available. For information, see your Motorola Sales Office.	

Fill in your name and address on the other side of this coupon. Tear along perforated lines and enclose in envelope with proper remittance.

FOLD HERE

FIRST CLASS
Permit No. 2565
PHOENIX
ARIZONA

BUSINESS REPLY MAIL
NO POSTAGE NECESSARY IF MAILED IN UNITED STATES

POSTAGE WILL BE PAID BY

Semiconductor NEWSBRIEFS No. 16-73
Motorola Semiconductor Products Inc.
P. O. Box 20924
Phoenix, Arizona 85036



FOLD HERE



It Costs Less To COST

That's right! It costs less in time and expense when you use Motorola's brand new COST computer program to get prices of any of our silicon power transistors.

Just provide the part numbers of the devices and zip . . . back come the \$\$\$ or ¢¢¢, as the case may be. And not only do you get instant, completely current prices, but a preferred alternate for each device.

All you need is a terminal that talks to computers, then for a station-to-station or WATS call our friendly computer will sense the cents and make like a canary.

Write for your COST brochure. It details everything you need to do. Then share in the COST!

SEAL HERE

(Please use tape — do not staple)

ORDER COUPON

Be sure to fill out both sides of this coupon, tear along perforated edge, and mail in envelope with check, money-order, or purchase-order (*) to:
Motorola Semiconductor Products Inc.
P. O. Box 20924
Phoenix, Arizona 85036

Note: (*)P.O.'s for less than \$20.00 cannot be accepted. Make checks or money-orders payable to: Motorola Inc.

NAME _____

TITLE _____

COMPANY _____

ADDRESS _____

CITY _____

STATE _____ ZIP CODE _____

LITERATURE BREAKS

Comprehensive New Silicon Rectifier Handbook Published

It's written to ease your job. Whether you're working with single or multiphase rectifier circuits, suppressing arcs in inductive circuits, wave-shaping, etc., you'll find Motorola's new Silicon Rectifier Handbook the next best thing to having your personal rectifier diode consultant. Its fourteen chapters treat the characteristics, use and selection of silicon rectifiers from every angle.

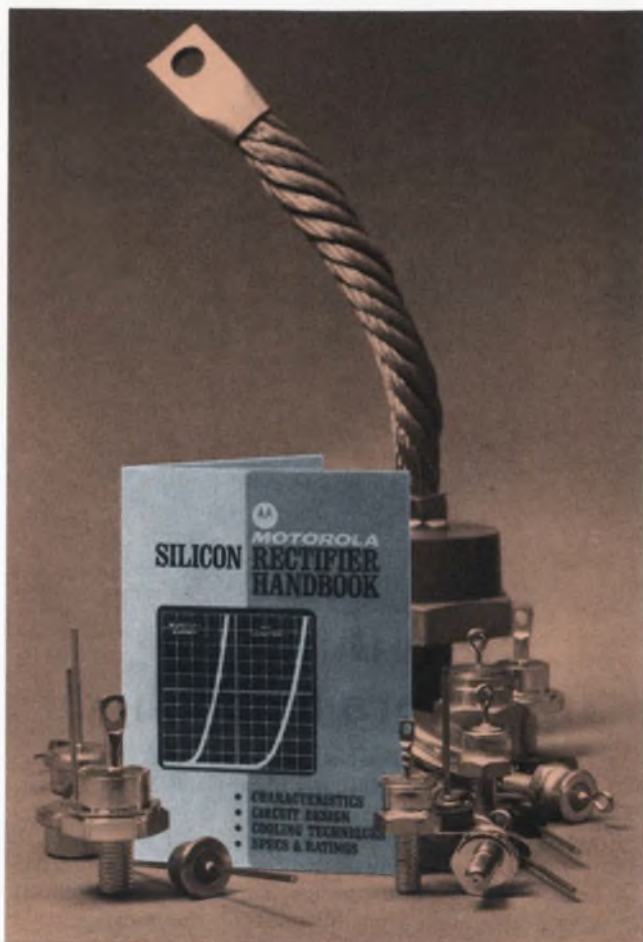

There's information on the thermal and electrical characteristics of silicon rectifiers, on their thermal properties, on cooling techniques, on protection against transients, on circuits for testing rectifiers, on the selection of rectifiers, on filter circuit design and on the design of power supplies. There are literally dozens of useful curves and charts. Little that would make your design job easier is omitted.

To get your copy of this remarkable rectifier diode design tool, use the order coupon on this page. The single copy price is \$2.00.



At last. A monolithic multiplier you don't have to trim.

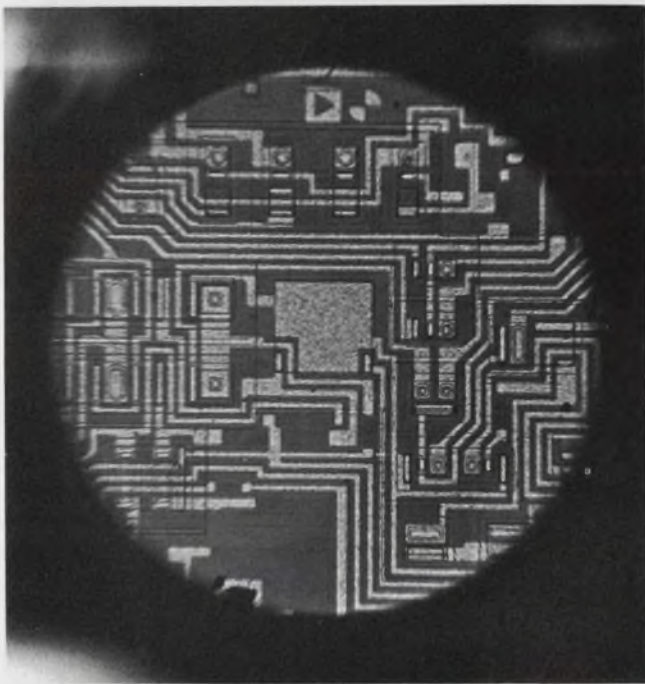

AD532. Internally laser-trimmed by us. No problems for you. \$16 in 100's.

The AD532 is the first totally self-contained monolithic multiplier/divider. Thin-film resistors are deposited directly on the chip and trimmed during production with a computer-monitored laser.

The results?

First of all, you don't have to mess around with the trimming yourself, which saves you time and money.

Plus, you can take advantage of the inherently greater reliability of a monolithic IC. We've eliminated off-the-chip trim adjustments, so there are fewer connections and less possibility that something will go wrong.

The PSRR is improved, too, because variations in the power supply have a minimal effect on trim.

In addition, you get differential X and Y inputs, because the -X and -Y inputs are no longer needed for off-the-chip trimming. This gives you two instrumentation amplifier-like inputs with 70dB of CMR.

The AD532 is a plug-in replacement for our AD530, which has been, until now, the industry standard for small size, low cost, high performance multipliers.

Other features include a maximum error of less than 1.0% and an output swing of $\pm 10V$. An output null terminal permits independent setting of the output offset. The AD532 multiplies in four quadrants with a transfer function of $(X_1 - X_2)(Y_1 - Y_2)/10$, divides in two quadrants with a $10Z/(X_1 - X_2)$ transfer function, and square roots in one quadrant with a transfer function of $\pm\sqrt{10Z}$.

All that for only \$16 in 100's. And if you'd like to see for yourself, we'll sell you five evaluation samples at the 100's price. Just give us a call.

We still make our high-accuracy AD530 multiplier, and you may also be interested in the AD531, the first programmable IC XY/Z multiplier. They're two more of the unique IC solutions we can offer to your design problems. Ask for complete specs.

Analog Devices, Inc., Norwood, Massachusetts 02062.

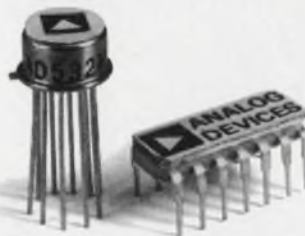

 **ANALOG
DEVICES**

Call 617-329-4700

for everything you need to know about multipliers.

INFORMATION RETRIEVAL NUMBER 14

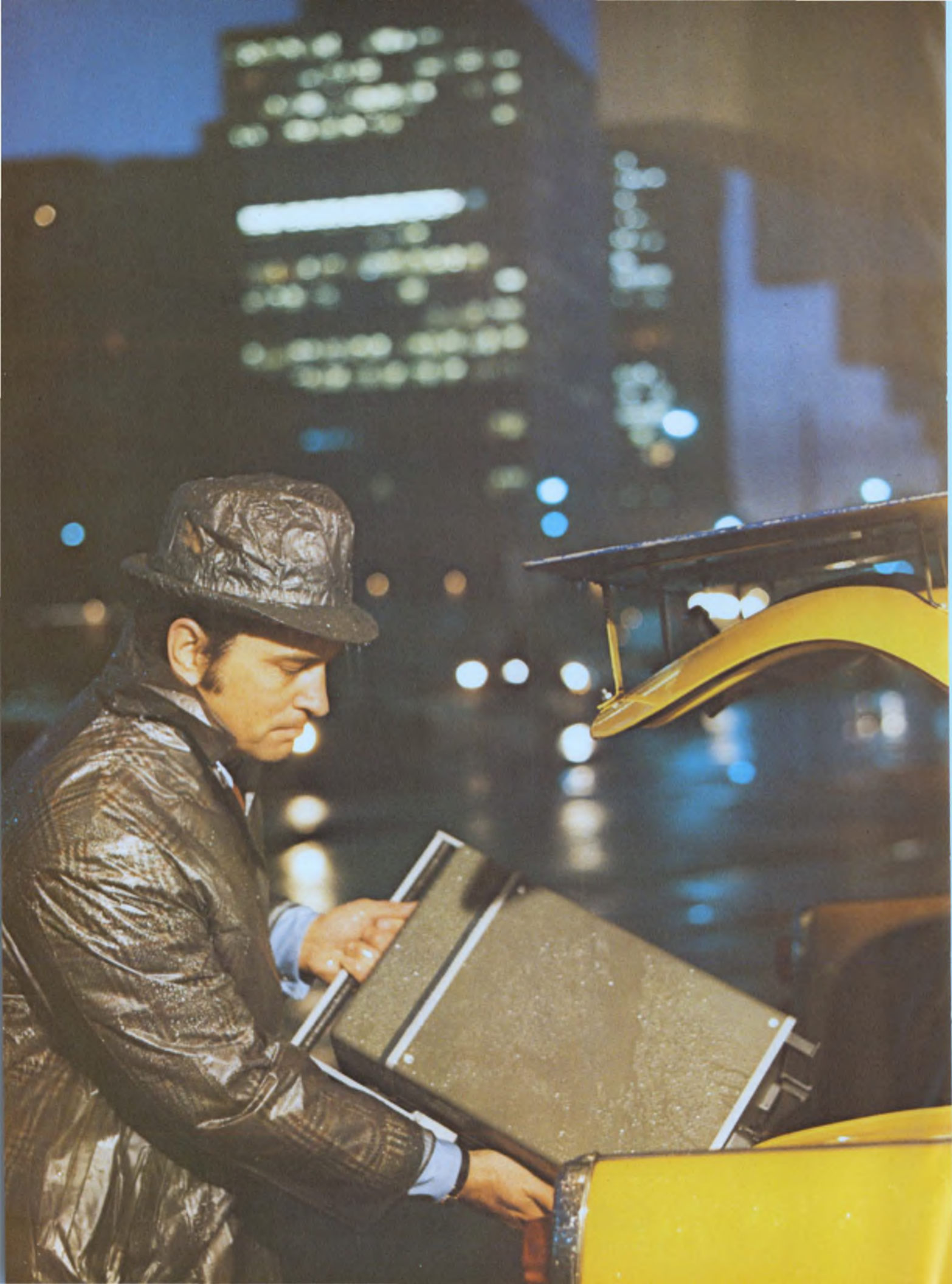

Think Twice:

When is a portable really portable?

HP's 1700 Series Portable Scopes Always Are...

They're tough go-anywhere scopes: weatherproof, dustproof, completely self-contained. Not the kind of "portable" that's gently moved from bench to bench, trailing a power cord. With a 1700 Series scope you don't worry about the rain. Or the rough ride. Or whether, when you get there, you'll find ac or dc power—or no line power.

An HP portable gives you features you'd expect only in a big lab scope. Like a large, bright CRT that lets you see even difficult signals in high ambient lighting. ECL trigger circuits and a trigger hold-off control, and sweep linearity over the full 10 divisions of horizontal display—ideal for maximum resolution in making those critical timing measurements.

But that's just the beginning. Then the 1700 Series allows you to pick the specific features you need for your field service application: conventional or variable-persistence storage CRT; bandwidths of 35, 75, or 150 MHz; sweep speeds as fast as 2 ns/div; delayed or non-delayed sweep; selectable input impedance; bright-scan viewing mode; and a built-in rechargeable bat-

tery pack for complete measurement independence.

And we're just as proud of the things you don't get with a 1700 Series portable. No heat sinks. No fans. No ventilation holes to let in dust and moisture. That's because our circuits are designed for very low power consumption—and for long, trouble-free operation. And there's no challenge in servicing our portables. In fact, you can completely recalibrate some models in an hour or less, even if all the internal adjustments are misaligned. It's not very sporting, but this ease of servicing quickly adds up to impressive savings.

So before you choose a scope, check your requirements. Then think twice about costs and benefits. Remember, Hewlett-Packard portables let you make any measurement you need—and they cost from \$100 to \$250 less than comparable scopes. These 1700 Series portables are priced from \$1475 to \$2300 for non-storage models and from \$2375 to \$2725 for models with variable-persistence storage. For help in choosing the HP portable that's best for you, send for a free copy of our "No-Nonsense Guide to Oscilloscope Selection." Or contact your local HP field engineer. Hewlett-Packard, Palo Alto, California 94304. In Japan:

Yokogawa—Hewlett-Packard, 1-59-1, Yoyogi, Shibuya-Ku, Tokyo 151, Japan. In Europe: HPSA, P.O. Box 85, CH-1217 Meyrin 2, Geneva, Switzerland.



Scopes Are Changing;
Think Twice.

083/1

HEWLETT  PACKARD

OSCILLOSCOPE SYSTEMS

PLESSEY BEATS THE MHZ'S OUT OF EVERYONE ELSE.

The SP 616 bi-polar digital divider operates at frequencies in excess of 1000 MHz. One top IC supplier declares a 500 MHz; the next best only guarantees 220 — and both only at room temperature. And so it goes — straight down the line.

The SP 600 series of DC to 1GHz frequency dividers (with guaranteed operating temperature ranges of —55 to +125 degrees centigrade) is absolutely the fastest by far.

And it includes dozens of prescalers and variable ratio counters which deliver Plessey's superior performance.

Whether you're putting together complex communications, or military systems or specialized high frequency test instruments, it pays to specify Plessey.

PLESSEY SEMICONDUCTORS

1674 McGaw Avenue, Santa Ana
California 92705 (714) 540-9945

Please send me a complete literature packet.
Now.

- I would like information only at this time.
 I would like to talk to your representative personally.

Name _____

Title _____

Firm _____

Address _____

City _____ State _____ Zip _____

Phone No. _____

Minneapolis, Minnesota
(612) 835-2717

Framingham, Massachusetts
(617) 879-7920

San Diego, California
(714) 295-2500

Farmingdale, New York
(516) 694-7377

Los Altos, California
(415) 941-4080

Houston, Texas
(713) 462-4077

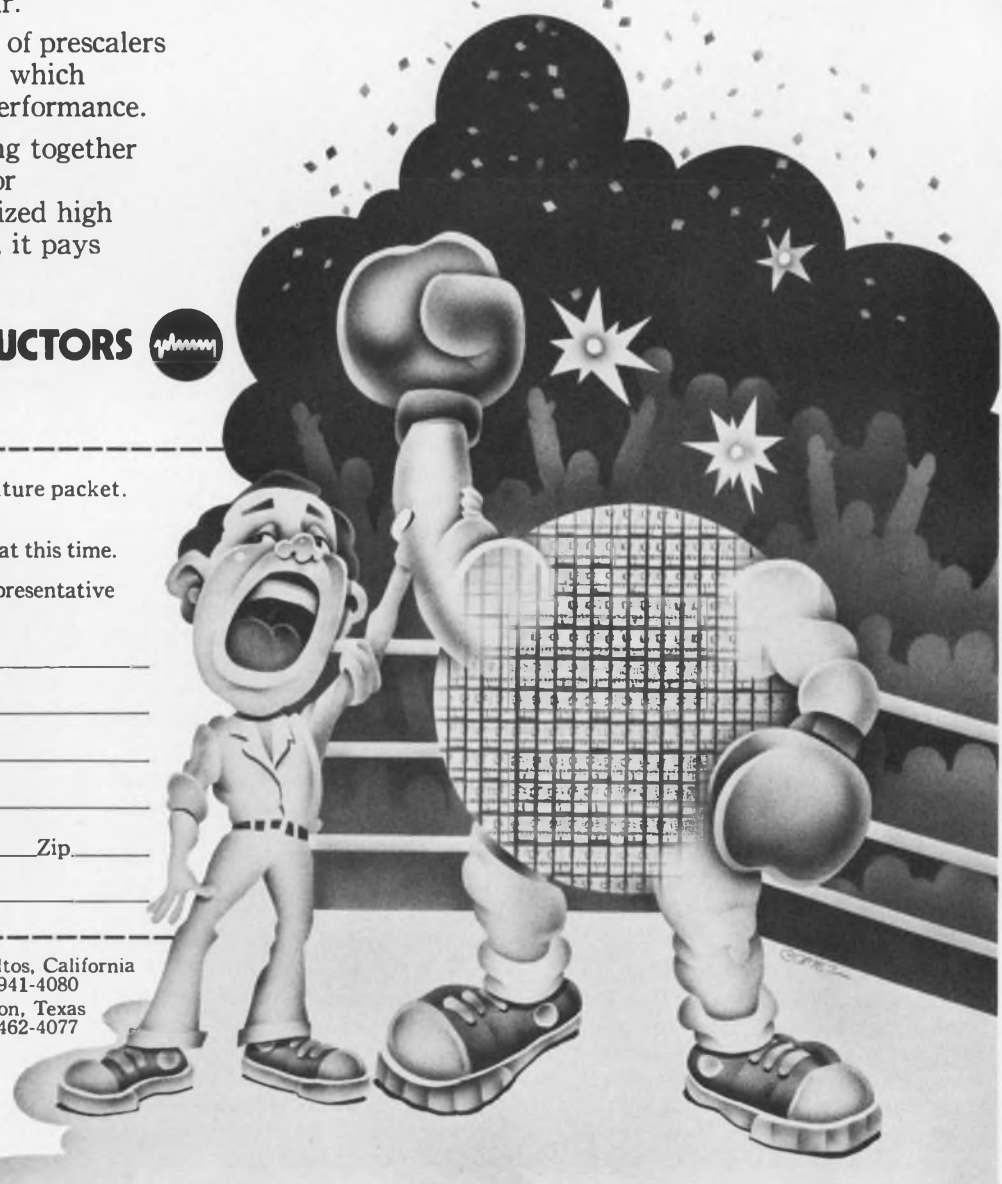

The News is

Major!



A 6" tubeaxial fan that moves more air... at higher pressures... and costs less!

It's the kind of news you expect from Rotron. An air mover with the extras built in. The Major[®] fan will deliver 150 cfm at a static pressure of .35 inches of water. That's 12% more air than the closest competitor.

The Major stays cooler, too. Its multi-slot permanent split capacitor motor draws less power than a shaded pole, and withstands line voltage variations better. An aluminum venturi and motor housing dissipate heat. And ball bearings add still further to long motor life.

The Major fan mounts interchangeably with other 6" fans. It can also be mounted on less than 6" centers.

Price? About 10% less than you used to have to pay for less performance! Get all the facts on Rotron's new Major tubeaxial fan today by sending for Catalog E2855.

Why settle for less when the best costs no more.



ROTRON INC., Woodstock, N. Y. 12498 ☐ 914 • 679-2401 ☐ TWX 510-247-9033
Pacific Div., Burbank, Cal. 91506, 213•849-7871 • Rotron B.V., Breda, Netherlands, Tel.: 49550, Telex: 844-54074

INFORMATION RETRIEVAL NUMBER 17

SPECTRA-BOTH

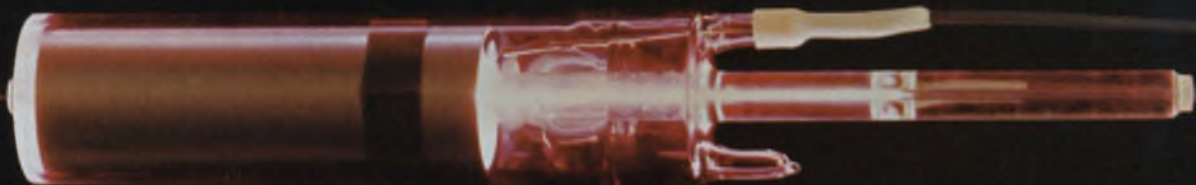

Side-Arm and Coaxial. We swing either way.

We're in two classes by ourselves. Our design capability makes us the only company that can deliver both side-arm and coaxial tubes.

If you need a tube that will go in a small package, we can provide a coaxial. If size is not a problem, we can provide a side-arm tube at considerable savings. Example: a 2.0mW, TEM₀₀, coaxial tube in quantities is \$90.00; a 2.0mW, TEM₀₀, side-arm tube in quantities is \$85.00.

Our capability gives us the broadest

line of Helium/Neon plasma tubes in the business. Over 30 different standard plasma tubes, from 0.5mW to 50mW. Most off the shelf. With internal or external mirrors. All internal mirror tubes and lasers warranted for 18 months.

Moreover, if you need a Helium/Neon laser specially designed, we can design it just for you—using the same parameters that we have tested to 26,000 hours MTTF and 15,000 hours average lifetime. We can even handle such special requests as a modulated laser

to 50 KHz, or a .01% noise laser, or you name it.

One more Both to brag about. We make more lasers than anybody, and so we have the expertise that brings you both high quality and low cost.

Home office: 1250 West Middlefield Road, Mountain View, CA 94040. 415/961-2550.



Spectra-Physics

SPECTRA-PHYSICS

Thick-film networks starting to take off

The use of thick-film resistor networks in consumer products, instead of cheap carbon-composition resistors, is reported on the increase.

Problems that have curbed the widespread use of thick-film elements—such as high cost and poor stability—appear to be close to a solution. Recent progress will be highlighted at the 23d Annual Electronic Components Conference, May 14-16, at the Statler-Hilton, Washington, D.C.

"We're seeing industry people starting to decide in favor of resistor networks, where carbon composition would previously have been the logical choice," says John Thome, manager of Micro Electronic Engineering at Allen-Bradley, Milwaukee, and co-chairman of Session VII on "Thick-Film Materials for Hybrids."

Formerly, Thome reports, "thick-film networks were used where there was a specific quality reason, such as better temperature-tracking or better tolerance." But this trend is changing, he says.

He asserts that for a network containing a dozen resistors, the cost of the network plus the labor of inserting its PC board will eventually equal that of buying and inserting a dozen carbon resistors.

John Barrington, sales manager of the Electronic Materials Div. of Du Pont, Wilmington, Del., and chairman of Session VII, sees substantial progress in lowering costs.

"Everyone's asking how we can get the cost of these materials down," he says. "I think the English have done more than most, and their approach will be described in a paper by A. S. Laurie of the Electrical Research Association, Surrey, England, on a high-quality, base-metal, thick-film resistor system."

A growing use for thick-film hy-

brids, Barrington points out, is in high-voltage divider networks for TV sets. Earlier thick-film resistor networks tended to age and change downward in value, he admits. The decrease in resistance could be as much as 20 to 50%—a damaging and permanent change. But today, Barrington continues, Du Pont and others have developed improved materials that can withstand 5000 V or more per inch, yet drift in value no more than 1 or 2%, Barrington points out.

Another way of reducing costs, Barrington points out, is by using soda-lime glass—ordinary window glass—for the resistor substrates. The method is described in a Session VII paper, "Thick-film Resistors with Glass Substrates," by Dr. Sidney J. Stein, president of Electro Science Laboratories, Pennsauken, N.J., and Cornelius Huang, the company's manager of special products research. The use of soda-lime glass hinges on a resistor material that can be fired at a relatively low temperature of 600 C. Higher firing temperatures of the usual resistor compositions—800 C and above—would melt the soda-lime glass. This type of substrate is now used for electro-optical display devices, such as readouts, instead of costly alumina ceramic.

16-bit computer smaller than a hand

A 16-bit minicomputer so small that it can be held in the palm of a hand has been developed for the nation's space program. Only 0.1-inch high and 2.5-inches in diameter, it weighs 25 grams.

The developer, Teledyne Systems of Northridge, Calif., says the mini has a 47-instruction repertoire and 1256 words of memory. Constructed on a three-layer ce-

ramic substrate, it can add two 16-bit numbers in about 10 μ s, according to Earl Kanter, vice president of Teledyne.

Kanter notes that the package, developed for NASA, contains about 35 integrated-circuit dice interconnected as a hybrid circuit. The package has 120 edge-mounted terminals and is designed to fit in a planar configuration into a larger hybrid or printed-circuit board. It will sell, Kanter says, for less than \$1000 in large quantities and will come in several models. The package is hermetically sealed and can hold a hybrid circuit with as many as 50 dice.

The present model is a parallel-processing microprocessor containing 256 words of RAM and 1000 words of ROM. The multiplication time is only 50 μ s, Kanter says, with faster speed due in other models.

The power dissipation of the computer is about 7 W, and its predicted MTBF is at least 25 years.

Coding symbol to spur grocery electronics

Long checkout lines in supermarkets may one day be only memories because of a new coding symbol adopted by the American grocery industry.

After almost three years of study, the Symbol Committee of the Uniform Grocery Product Code Council has adopted a standard accounting code symbol that will allow electronic equipment to read product information.

Charles S. Adams, vice president of Litton Industries' Retail and Revenue Systems Div. in Orange, N.J., predicts that the decision will "stimulate a new market for electronic retail point-of-sales systems that could total \$7-billion worldwide over the next 10 years."

The new code symbol, he says, when printed on each item in a store, will permit price and product identification to be registered electronically, thereby speeding the checkout process and virtually eliminating the possibility of error.

At present the prices of items are read visually by checkers and entered manually on cash-registers. With the new code symbol, optical

sensors will do the same job automatically. Product information picked up by each sensor will be sent to a computer, which will look up the prices and register and total them. All the checker will



Universal Product Code symbol for the grocery industry will be used with point of sale systems in the retail food industry.

have to do is take each item after it passes the scanner and put it into a bag.

In addition to speeding the checkout operation, the new code will give the grocery industry better control of inventory, Adams notes.

Core and wire memories facing a challenge

A thin-film variation of the ferroelectric storage cell has been developed. Like core and plated-wire memories, it offers nonvolatile storage, plus the following:

- TTL-compatible outputs.
- Present operating speeds of 1.5 μ s, with the hope of achieving 125 ns in a year.
- A present price of 0.5 cent a bit, with prospects of a drop to 0.1 cent in quantity in a year.
- A projected 8-k bits on a 200-by-200-mil substrate.

The memory system consists of a three-layer sandwich formed by a nonvolatile thin-film dielectric of KNO_3 and electrodes on the upper and lower surface. The sandwich is deposited, layer by layer, on a substrate. The electrodes are laid out in a two-dimensional grid pattern with the intersections acting as nonlinear capacitors. Storage is accomplished by the electrical hysteresis characteristic of the KNO_3 .

A 12-V, 1-mA signal reads or

writes information into each cell. Readout is destructive, as in core memory, but the output level easily drives a 7400 gate. The interface hardware is therefore minimal, consisting of X-Y selectors and ordinary hex NOR gates. The cell, according to Robert Britton, marketing director of Technovation, provides a truly nonvolatile storage mechanism, as opposed to the linear-charge storage mechanism of MOS devices.

Cell switching time varies directly with thickness and plate area, with the ultimate speed measured in fractions of a nanosecond. Present full cycle times with one-square-mil plates are about 1.5 μ s, but, Britton says, smaller plate areas will shortly provide 500-ns cycle times and, later, 125 ns.

Technovation plans to introduce a 64-bit, 1.5- μ s array at the National Computer Conference in June, to be followed by 64, 256, 1024 and 4096-bit arrays with cycle times below 100 ns.

A new portability for phones coming

With a new portable telephone, users will be able to place or receive calls by radio in any metropolitan area equipped with transceiver sites.

To make a call, the three-pound unit's keyboard is dialed. "As the portable-phone user talks, his voice is transmitted over the air much the same way a two-way radio station transmits," says Martin Cooper, vice president of Motorola's Communications Div. in Schaumburg, Ill., developer of the system.

The message is picked up by the nearest receiver, relayed to the system's central computer and fed into the regular telephone network. The central computer keeps track of each portable telephone in the system and selects the transmitter and receiver that will provide the best message quality for each call. Motorola calls the system, DYNA T.A.C.

"As the portable-telephone user moves about the city in the midst of a call," Cooper says, "the computer will switch the conversation to different transmitters and receivers, as required, to assure con-

tinued clear message quality. This happens so quickly, neither party is aware of it."

The telephone system operates in the 900-MHz band over 115 MHz of spectrum, recently allocated by the Federal Communications Commission. Channels 70 through 83 will be used.

In addition to the new spectrum allocation, advances in IC technology made the new concept possible, Cooper says. The portable unit has a miniature computer built into the two-way radio to perform the telephone functions. The computer uses large-scale, extremely-low-drain ICs.

Pending approval by the FCC, Motorola plans to install the first DYNA T.A.C. system in New York City by 1976. Initially the cost will be comparable to that of a car telephone service, the company says.

Van Allen rebuts report of microwave-oven peril

Stung by reports of microwave-oven radiation hazards, one manufacturer has opened a strong counter-attack, employing statements of rebuttal by leading scientists and a complaint filed with the Federal Trade Commission.

The manufacturer is Amana Refrigeration, Inc., of Amana, Iowa. In a seminar conducted by the company earlier this month at its plant, top radiation specialists addressed press representatives. One was James A. Van Allen, discoverer of the radiation belt that circles the earth.

"I am personally prepared to sit on top of my Amana Radarange for a solid year while it is in full operation, with no apprehension as to my safety," Van Allen told the gathering. He added: "As I stated a few years ago, in my judgment its hazard is about the same as the likelihood of getting a skin tan from moonlight."

Another specialist, Dr. Sol Michaelson of the University of Rochester, said that in 50 years of study of the effect of microwaves on biologic tissue, there was no evidence of injury to humans following exposure to radiation at levels certified for microwave ovens.

Our new model 38 series.

Even the most
expensive ASR is
a very inexpensive
\$1480.



Teletype is a trademark registered in the United States Patent Office.

Just because you need big machine features, you don't have to pay big machine prices.

Not when you've got some new alternatives: the Teletype® model 38 series terminals. They offer a lot of features. For only a little money.

Prices for an RO model 38 start as low as \$937. KSR model 38 terminals begin at \$1209. Even ASR terminals go for as low as \$1452. And for about \$200, you can equip any of them with a built-in, factory-tested modem.

Standard equipment on all model 38 terminals is a 132-character printing format on a 15-inch wide platen. Upper and lower case is also standard. So is two-color printing.

Speed? 100 words per minute. If you need more—up to 2400 wpm—the model 38 interfaces with the Teletype 4210 magnetic tape data terminal.

There's more, too. Like plug-to-plug compatibility with the model 33. So you can update your system without changing it.

The new Teletype model 38 series terminals. Where else can you get so much for so little?

It takes more than manufacturing facilities to build the machines Teletype Corporation offers. It also takes commitment. From people who think service is as important as sales. In terminals for computers and point-to-point communications.

That's why we invented a new name for who we are and what we make. The computer-cations people.



For more information about any Teletype product, write or call: **TERMINAL CENTRAL:** Teletype Corporation, Dept. 89N, 5555 Touhy Avenue, Skokie, Illinois 60076. Phone 312/982-2500

*Prices subject to change without prior notice.

The year for NMOS is coming, with 4-k-bit RAMs and more

With the promise of semiconductor memories that will finally be cheaper as well as faster than core, and with microprocessors that allow data-processing capability to be built into virtually anything, the semiconductor industry is anxiously working on its latest wunderkind: n-channel MOS technology.

NMOS allows 15 to 20% greater packing density of circuitry on a chip of silicon, 30 to 50% faster speed, lower voltage operation and potentially lower cost than the more conventional PMOS currently in use. The only real drawback to its use at present is that the technology is still very young.

David N. Kaye
Senior Western Editor

However, there is agreement in the semiconductor industry that the major hurdles have been cleared and that next year will be the year that NMOS circuits are designed into high-volume items.

In addition to memory and microprocessors, NMOS is expected to have an impact on data-communications circuits, calculator cir-

cuits, integrated charge-coupled-device systems and any other applications where 5-V operation, low cost and near-TTL speed is necessary.

First came static RAMs

NMOS circuits were first offered last year. They were 1024-bit static and dynamic RAMs. Specs for the static RAMs included access time of 500 ns, dissipation of 150 mW, single +5-V supply voltage, TTL-compatible inputs and outputs and 16-pin, plastic DIP packaging. The first RAM was from Intel Corp. of Santa Clara, Calif. It was called the 2102 and used silicon-gate technology. Shortly after this similar RAMs were introduced by Signetics of Sunnyvale, Calif., Mostek of Carrollton, Tex., Intersil of Cupertino, Calif., and several other companies. The fastest of the 1024-bit static RAMs comes from Advanced Memory Systems of Sunnyvale, Calif. Called the 7701, it has an access time of 40 to 50 ns.

After the static RAM was introduced, the next NMOS circuit to hit the market was a 2048-bit dynamic shift register—the 2401, also from Intel. It operates at 1 MHz from a single +5-V supply, with power dissipation of about 120 μ W per bit. Other manufacturers—notably American Micro-systems of Santa Clara, Calif., and Motorola Semiconductor of Phoenix, Ariz.—are expected to second-source the 2401 this year. The fastest 2048-bit shift register to be introduced is the 7111 from Micro-systems International of Ottawa, Canada. The 7111 clocks at about 8 MHz.

Most glamorous of all the NMOS circuits to date is the 4096-bit RAM. Industry sources agree

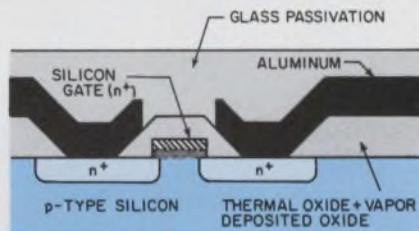

NMOS transistors using silicon-gate technology are being used by most manufacturers of NMOS large-scale integrated circuits.

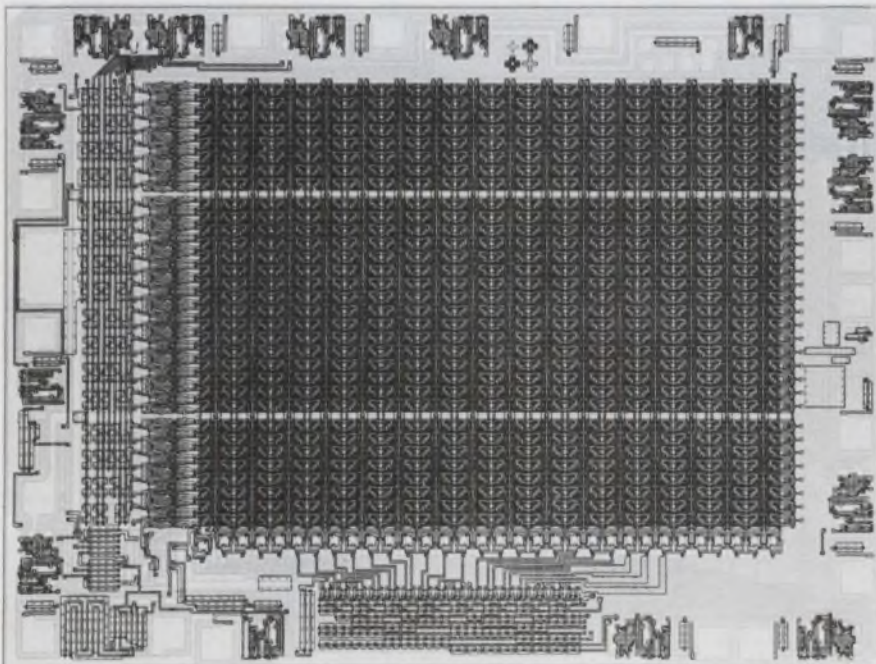

Static 1024-bit RAMs, such as the IM7552 from Intersil, are easy to use, require only a single +5-V power supply and have access times of from .5 to 1.0 μ s.

EMI FILTER CAPITAL OF THE WORLD

**FROM CERAMIC POWDER TO MIL-APPROVED TEST LAB...
ERIE HAS IT ALL, UNDER ONE ROOF**

Only one company can deliver your total EMI Ceramic Filter needs . . . ERIE. We've been applying sophisticated ceramic and related technologies to developing superior filters for 35 years. Today ERIE has, by far, the broadest line of subminiature EMI Filters in the world. From tiny high frequency filters to broad band filters to custom filter assemblies, ERIE offers the ultimate in quality. And you get single-source responsibility too, for we build the complete filter in a plant devoted exclusively to the design and manufacture of EMI Filters. So come to ERIE for your filter needs. We'll put a team to work on your particular application. Aerospace. Communications. Avionics. Industrial Equipment. Whatever the market, we can help eliminate electromagnetic "noise" and emissions. In the meantime, write for our complete catalog . . . EMI Filters or call 613/392-2581.

ERIE TECHNOLOGICAL PRODUCTS, INC.
Erie, Pennsylvania 16512

ERIE

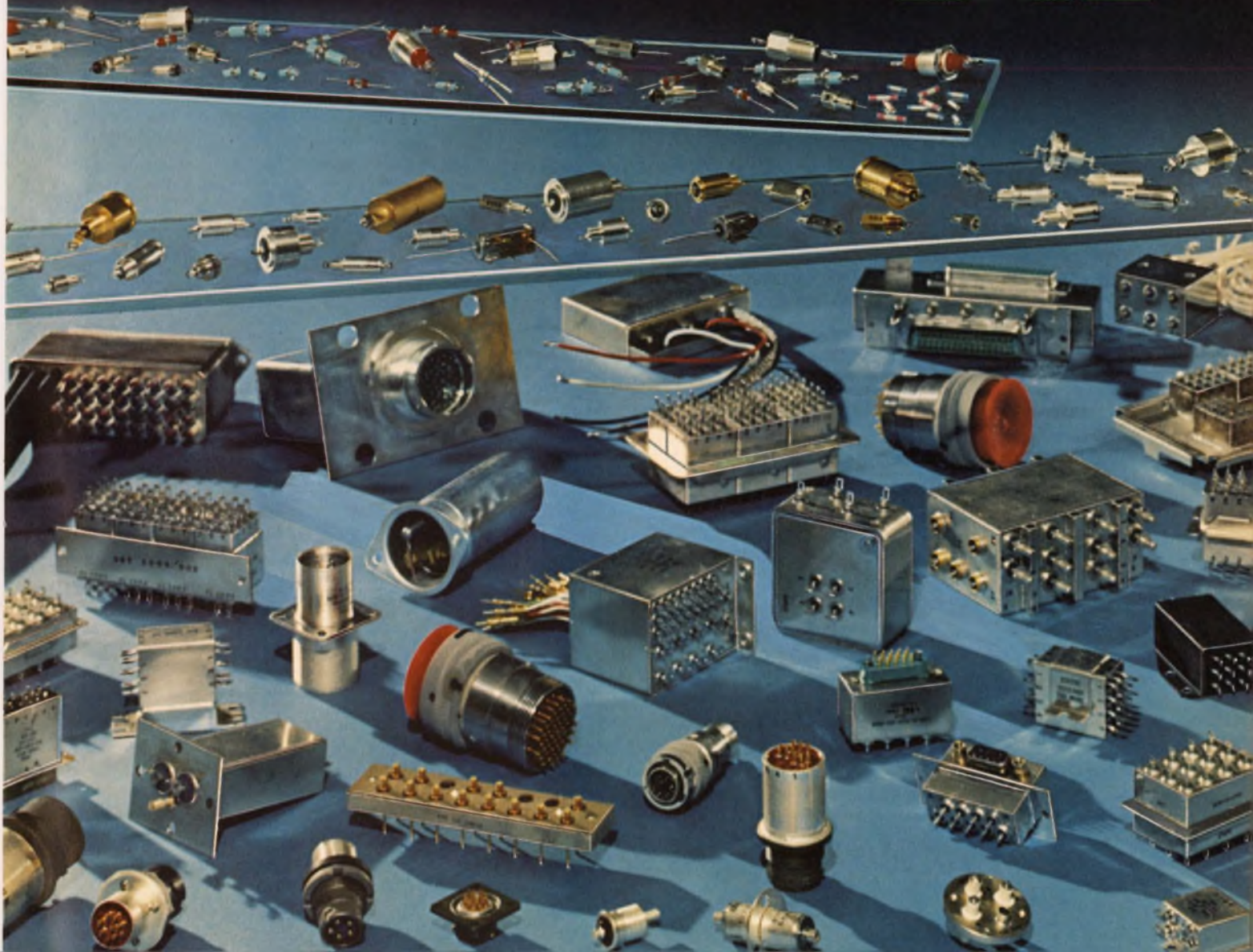

that it will be produced in volume by the second half of 1974 and that by 1975 the large-quantity price will be between 0.15 and 0.3 cents per bit. This, plus an access time of 250 to 300 ns, is expected to attract enough buyers to cut severely into the market so far monopolized by core main memory.

The first 4-k RAM

First to publicly discuss the 4096-bit RAM was Intel in a paper two years ago at the Solid State Circuits Conference. According to Mike Markkula, the company's marketing manager for North America: "We are now sampling parts and expect to be in high-volume production by late 1974. After the part is finalized, we will formerly announce it during the third quarter of this year."

Intel's RAM will require level shifting resistors on the inputs, but will be TTL-compatible on the output. Typical specs will include 400-ns access and 800-ns cycle time, 300-to-400-mW dissipation and a single clock external to the chip. The chip uses three-transistor cells that measure about 1.8 mils². Ion implantation is used for threshold setting.

First to announce a commercial 4096-bit RAM was Microsystems International, Ottawa. Called the 7112 and announced in the fourth quarter of 1972, the RAM has 400-ns access time and 500-ns cycle time. Peter English, marketing manager for computer components at Microsystems International, says: "We are now designing an improved part that will have 300-ns access time and only 400-ns cycle time."

Using silicon gate NMOS technology, the RAM requires three high-level (15-V) clocks external to the chip, but it dissipates only 300 mW of power. The inputs are TTL-compatible, but the output is a current source of 3 mA minimum. An external sense amplifier is necessary. English looks for future circuits to require only 12-V clocks instead of 15. The 7112 uses a three-transistor memory cell.

Other companies that expect to introduce 4096-bit NMOS memories with three-transistor memory cells by the third quarter of this year include Standard Microsys-

What the 4-k RAM will likely offer

Manufacturers planning to introduce a 4096-bit NMOS RAM indicate that, for the most part, the specs will be as follows:

Technology—N-channel, silicon-gate, MOS, ion-implanted.

Memory cell—Three transistor.

Access time—250 to 300 ns.

Dissipation—300 mW.

Inputs (except clock)—TTL-compatible.

Output—TTL-compatible.

Power supplies—+12 V and ± 5 V.

External clock—One 12-V clock.

Package—22-pin DIP (ceramic or plastic).

Refresh—Every 2 ms.

Decoding—On chip.

Price—0.15 to 0.3 cent per bit in large quantities (by 1975).

Availability—Samples later this year, small production in fourth quarter and large production in second half of 1974.

tems of Hauppauge, N. Y., American Micro-systems, Motorola Semiconductor, Western Digital of Newport Beach, Calif., and Signetics. American Micro-systems and Motorola are cooperating on the development of the circuit. The others are working independently.

One transistor or three?

A major area of controversy among the developers of 4096-bit RAMs is whether to use a one-transistor memory cell or a three-transistor. Manufacturers appear to be evenly divided on this. The main argument for the one-transistor cell is that ultimately smaller geometries can be achieved, thereby allowing greater packing density of cells on a chip of silicon.

One industry source says that the one-transistor cell is going to be necessary to achieve 8000-bit and 16,000-bit memories in the future. "Why not get the experience with the cell now?" he says.

Markkula of Intel counters: "We can go just as small, at this point in time, with a three-transistor cell as anyone can with a single-transistor cell. Besides, the 16,000-bit RAM may require an entirely new technology that is not yet developed."

The leader of the forces behind the one-transistor memory cell is Mostek. At the 1972 Solid State Circuits Conference, Robert S. Green, a project engineer at Mostek described such a memory cell now in the planning stage. It is designed to use metal-gate, ion-implantation NMOS technology. The

access time is to be less than 300 ns and cycle time less than 500 ns. It is to dissipate about 240 mW and to have only a single, low-level (TTL) clock external to the chip. All inputs and outputs are to be fully TTL-compatible. The memory cell size of the initial design is 2.3 mils².

Green points out that a new sense amplifier design is used on a chip that has only a 20-ns access time. "This is just as good," he says, "as having a current output and using sense amps off chip." In fact, the outputs on Mostek's chip are not only TTL but also Tri-State.

Other companies working on 4096-bit RAMs with one-transistor memory cells include Intersil; Texas Instruments of Houston, and Electronic Arrays of Mountain View, Calif. All of these expect to be sampling parts in the third quarter of 1973.

National Semiconductor of Santa Clara, Calif., and Fairchild Semiconductor of Mountain View do not expect to be introducing 4096-bit NMOS RAMs until next year. No preference in memory-cell structure has been stated by either so far.

Advanced Memory Systems has built a PMOS 4096-bit RAM with 350-ns access time. According to Thomas L. Palfi, MOS development manager: "We are designing a static 2048-bit RAM to be called the 7003 that will have 50-ns access time and will be ready by the fourth quarter of 1973. Beyond that, we may skip the 4096-bit NMOS RAM and go directly to an

To celebrate our 50th Anniversary—1923-1973



See this beauty at the Struthers-Dunn exhibit during the 1973 Design Engineering Show, Philadelphia, Pa. April 9, 10, 11, 12.

This 1923 Model T FORD as GRAND PRIZE for your most unusual relay application!

Second 50th Anniversary prize: TEN \$50.00 U.S. Savings Bonds.
Third Prize: FIVE \$50.00 U.S. Savings Bonds.

ALL entrants will receive a 9" x 12" four-color print of this photograph by contest end. Perfect for framing.

Yes! A beautifully restored Model T Ford Station Wagon from the same year the first Struthers-Dunn relays came out! It could be yours for telling us about your most unusual or interesting relay application, as detailed in the rules below. You and the car will be the talk of your town from the day it is delivered. Start writing or thinking about your application today! Note those second and third prizes, too! *Be sure to follow the rules below.*

CONTEST RULES

- (1) Entrants must give a clear and complete description of an unusual, but practical and operating, relay application or solution of a relay problem, using electromechanical or reed relays of any make or price. *Entries must contain nonconfidential matter only.* No purchase necessary.
- (2) Winning entries will be judged on basis of the most unusual applications and/or imaginative thinking of widest interest to relay specifiers.
- (3) The three judges, familiar with design and use of relays, will be from the editorial departments of technical trade publications, and their decision will be final.
- (4) Brevity, clarity and completeness will count. Be formal or informal. Schematics welcome.
- (5) No limit on entries, but keep each entry to one application.
- (6) Entries must be postmarked no later than midnight May 15, 1973. Address: 50th Anniversary Contest, Suite 1500, 1201

Chestnut Street, Philadelphia, Pa. 19107. Do not send entries to Struthers-Dunn or its distributors.

- (7) For anonymity in judging, entries will be coded and identification removed insofar as possible.
- (8) Winning entrants will be notified by July 1, 1973 and publicly announced and identified shortly thereafter.
- (9) Grand prize will be delivered to winner's home.
- (10) All entries become property of Struthers-Dunn, Inc. and none will be returned. Struthers-Dunn reserves the right to use all entries in its advertising and promotion on an anonymous basis, but entrants will be paid \$50.00 for each entry used.
- (11) Contest void where prohibited, regulated or limited by law. Winners will be responsible for taxes, if any, on prizes.
- (12) Employees of Struthers-Dunn, Inc., its sales affiliates, distributors, advertising agencies, contest judges and members of their families are not eligible.



STRUTHERS-DUNN, INC.

PITMAN, NEW JERSEY 08071

Canada: Struthers-Dunn Relay Div., Renfrew Electric Co., Ltd.

8192-bit NMOS RAM."

Fred Jenne, director of advanced products at American Micro-systems, says: "It seems that the one-transistor cell is the ultimate way to go. However, we will start with a three-transistor cell based on much more experience."

1-k dynamic RAM available

The first 1024-bit NMOS RAM was a dynamic RAM from Electronic Arrays, the EA 1500. Michael McCoy, manager of product development, notes: "The EA 1500 was introduced in March of 1972. It had an 85-ns access time and a simple refresh technique. A single write pulse automatically refreshes the entire memory. All clocks are on chip."

Other manufacturers are planning to introduce fast 1024-bit dynamic RAMs this year. Among them are Intel, Signetics, Intersil, American Micro-systems, Motorola, Fairchild and Texas Instruments. The RAMs are expected to have an access time of 50 to 120 ns, a cycle time of 200 to 300 ns and power dissipation of 250 to 300 mW. Some will have TTL outputs and some current outputs. Most will use only a single clock off chip.

Fast microprocessors emerging

NMOS microprocessors are expected to emerge this year. The first will probably come from Signetics and be announced in the third quarter. It will be an eight-bit parallel processing system with fixed instruction set. Announcements also are expected by Intel and Western Digital.

The Intel unit will be called the 8080. It will be an eight-bit parallel processing system with a 78-item instruction set. Some instructions, according to Hank Smith, Intel's manager of microcomputer systems, will be double precision. The instruction cycle time of the cpu will be 2 μ s. Input/output capability will be up to 256 input ports and up to 256 output ports. The microprocessor will also be capable of direct memory access.

The fastest of the new units is expected to be turned out by Western Digital. Although he won't quote the exact speed at present, William H. Roberts, the company's

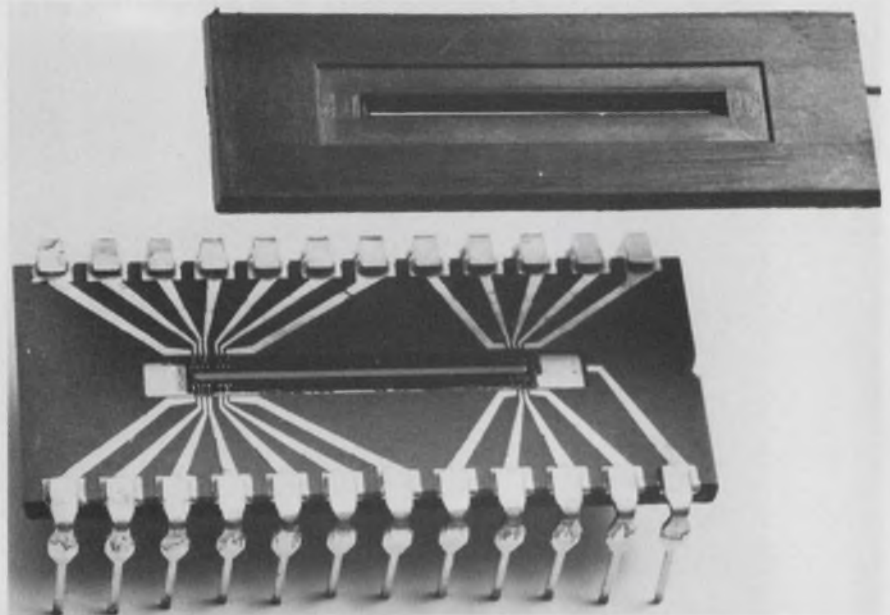

Fairchild's 500-element linear CCD imaging array is an NMOS device that has charge-transfer gates, two 250-element CCD analog shift registers, a two-element CCD selection register and an on-chip NMOS output amplifier. The sensitivity of the device is 15 microfootcandle seconds and the dynamic range 1000 to 1.

vice president of research and development, says: "Our microprocessor will be an eight-bit parallel processing system that will approach minicomputer speeds. We are not yet sure whether the user will be able to get at the instruction set. We may implement the microprogramming at the factory and not let the user change it."

Data communications, too

What other developments are expected? Roberts of Western Digital notes: "I see data-communications parts coming that are fast and require only a 5-V power supply due to NMOS."

Ronald P. Komatz, manager of MOS product development and planning at Motorola Semiconductor, also believes that data-communications hardware, such as receiver-transmitter circuits and fast modems, will be coming soon.

No major company is willing to commit itself as to when the data-communications circuits will reach the market or what the typical specs might be.

ROMs and shift registers are likely to find early use in data communications. English of Microsystems International points to an 8000-bit shift register that clocks at 5 to 10 MHz and is scheduled to be introduced in the fourth

quarter of this year. Motorola expects to introduce ROMs and keyboard encoders that use NMOS.

Standard Microsystems is about to introduce a 128-character, 7 \times 11 dot-matrix character generator with a seven-bit parallel-to-serial shift register on a chip.

NMOS also lends itself to charge-coupled-device (CCD) integrated systems. Fairchild has just introduced a 500-element linear imaging array. The monolithic n-channel device includes charge-transfer gates, two 250-element CCD analog shift registers, a 2-element CCD selection register and an on-chip NMOS output amplifier.

The device has a typical dynamic range of 1000 to 1 and a sensitivity of 15 microfootcandle-seconds. In operation, charge "packets" generated when light strikes the photosensor elements are shifted into the two 250-element CCD registers, with alternate packets shifted into each register. The charges are then transferred to the selection register, which interleaves alternate packets to restore the correct sequence of image elements before amplification by the output device. Dimensions of the chip are 60 \times 635 mils and the registers require three-phase clocking. The device is packaged in a 24-pin dual-inline package. ■■

Try our straightforward method of reducing fixed resistor costs.

Uniform manufacturing process results in consistent quality that lowers your installed cost. And cuts down unnecessary after-purchase expenses. As a result, some of our customers have been able to discontinue incoming inspection. The unique

Allen-Bradley hot-molding process minimizes the variations that make ordinary resistors noisy, thermally sensitive, and poor on power handling ability. If you think all resistors are the same, read: "7 ways to tell the difference in fixed resistors."

Free from your A-B distributor, or write to: Allen-Bradley Electronics Division, 1201 S. 2nd St. Milwaukee, WI 53204. Export: Bloomfield, NJ 07003. Canada: Allen-Bradley Canada Ltd., Cambridge, Ontario. U. K.: Jarrow, County Durham NE32 3EN.

ALLEN-BRADLEY
QUALITY ELECTRONIC COMPONENTS



INFORMATION RETRIEVAL NUMBER 22

EC72-9 © Allen-Bradley 1972

Bubble memory developed in lab, and it appears to be a success

The first bubble memory module has been built in the laboratory, and tests show that it works satisfactorily.

The design is being described this week at the International Magnetics Conference in Washington, D. C. Previous work in bubble technology has produced experimental shift-register devices.

In a paper to the conference, Paul C. Michaelis, a member of the technical staff of Bell Laboratories in Murray Hill, N. J., notes that the new bubble memory is a 1.15-megabit module.

Prototypes of the memory module have been constructed, Michaelis reports, and although they contain only a fraction of the 1.15 megabits of memory, they prove that the design works. To bring these modules up to full capacity, he says, it is only necessary to plug in more bubble chips.

Jules H. Gilder
Associate Editor

Tests on the prototype units indicate that power dissipation for the module will be 800 mW for the bubble circuitry and 3 W for the drive coils, Michaelis says. Other specs include a 1.7-second write time—time to write in 20,510 bits at a clock rate of 100 kHz—and a 5.8-ms read time.

The module uses 20-kilobit chips, although it will accept 10-kilobit chips as well, Michaelis notes.

Joseph Geusic, head of the fundamental memory group at Bell, who also is addressing the conference, says: "The 20-kilobit chips are the largest ever made in any technology." Each chip is made of epitaxial garnet material and its over-all dimensions are 5.58 by 4.94 by 0.44 mm.

Unlike earlier shift-register designs for bubble devices, Bell's new 20-k chip uses major/minor loop organization that results in on-chip decoding. This was chosen, Geusic notes, because it results in considerably better performance than shift-

registers and requires only an additional function—transfer.

A new type of transfer structure that has the shape of a dollar sign was used in the chip. Tests have shown, Geusic says, that this transfer operates with margins equal to or better than those of ordinary propagation. In the major/minor loop application, the dollar-sign transfer is used to move bubbles back and forth between the storage registers and the input-output register. An important feature of this new transfer is that it requires a very low current—less than 50 mA.

Detection of magnetic bubbles is accomplished by means of a chevron-shaped expander detector that incorporates a magnetoresistive element. This detector can expand the bubble to a long strip that is about 335 times its usual size. As a result, relatively large output signals—in excess of several millivolts—are obtained.

The bubble circuitry on the chip, Geusic says, is a hybrid type that uses both the T-bar and chevron configurations. The T-bar is used in the minor loops to achieve high density, while the chevron is used because it is compatible with the expander detector. This means that the permalloy in the magnetoresistance element in the detector can have the same thickness as the propagation structure, thereby eliminating the need for another thin permalloy metallization process and for another mask level.

The chips have 10 electrical connection pads, all of which are along one edge. This type of organization, as well as the nesting of detector and generator leads inside the transfer and annihilator leads, permits connections to be made to any number of identically oriented chips in a line without crossovers in the module. ■■

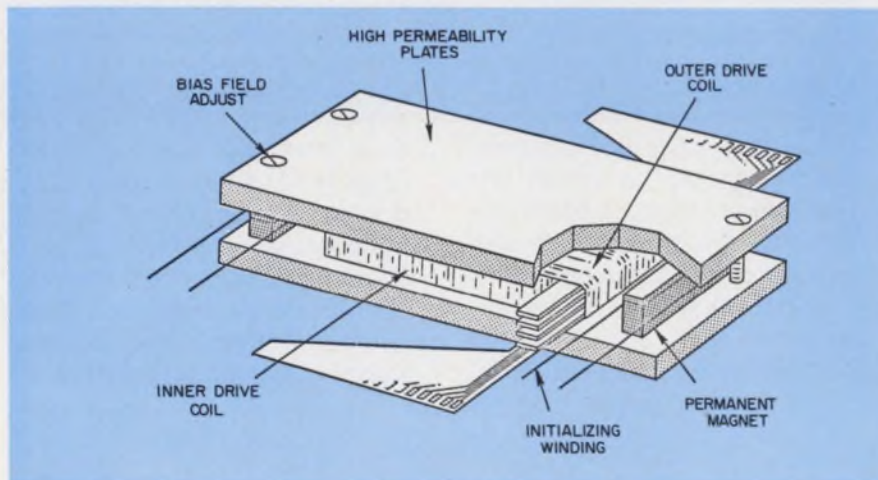

The 1.15-megabit bubble-memory module designed by Bell Laboratories consists of fifty-six 20-kilobit chips mounted on substrates and placed inside drive coils. This subassembly is then placed inside a permanent magnet that provides a bias field for the memory.

8K MOS ROMs: Delivered in four weeks flat!



(Just like every other device in Signetics MOS ROM line.)

No ifs, no buts. No gimmicks. Only Signetics guarantees 8K static MOS ROMs—masked, tested, shipped—in less than 30 days' time. A fantastic 3-to-1 improvement over any other supplier in the field. Now extended to include the high-speed, high-density capability you need so frequently today: an 8,192-bit static ROM, the new Signetics 2580.

No shot in the dark: Signetics has already proven this incredible four-week turnaround on all our MOS ROMs—1K, 2K, 4K, and now 8K.

8K of memory in 2048x4 organization. Fully optimized to give you the whole shooting match in design simplification and speed. Power supplies +5V and -12V; 700 ns access time.

8K

All 2580 inputs/outputs are totally TTL compatible. With a single TTL level clock. Fully operational to your specs within four weeks, at only 0.2¢ a bit, in 100-999 quantities—no premium for our exclusive fast delivery.

And how in the heck do we do it? We verify your coding format from cards and send confirming print-out to you in 24 hours. Masks and test programs are computer-generated. Wafers are pulled from inventory: processed, packaged, tested and shipped. You get the works—on line, on time. In just four weeks. Just the way you wanted them.

And what you want, Signetics makes sure you get. Right down the entire MOS ROM line. Maximized user-oriented circuits, in minimized user-oriented time. To push designs into production faster... and pull systems out the door for quicker profits.

SIGNETICS ROM SELECTION GUIDE					
BIT DENSITY	ORGANIZATION	POWER SUPPLIES	MAX. ACCESS TIME (NS)	COST/BIT (100-999)	TYPE
8,192	2,048 x 4	+5, -12V	700	0.20¢	2580N
5,184	64 x 9 x 9	+5, -12V	750	0.31¢	2526N
4,096	512 x 8	+5, -12V	750	0.39¢	2530N
3,072	64 x 5 x 7	+5, -5, -12V	600	0.29¢	2516N
2,560	64 x 7 x 5	+5, -5, -12V	600	0.35¢	2513N
2,048	256 x 8 512 x 4	+5, -12V	950	0.47¢	2461Y
2,048	256 x 8 512 x 4	+12, -12V	750	0.47¢	2430Y
1,024	256 x 4 128 x 8	+5, -12V	950	0.94¢	2451Y
1,024	256 x 4 128 x 8	+12, -12V	750	0.94¢	2420Y
1,024	256 x 4	+5, -12V	950	0.88¢	2441I
1,024	256 x 4	+12, -12V	750	0.88¢	2410I

Signetics Corporation
811 E. Arques Avenue
Sunnyvale, California 94086

MOS ROMs in only 4 weeks? Prove it to me.

Please send:

- delivery quotes on parts circled above.
- specs and data on your new 8K ROM, the 2580, plus your ROM selection guide and cross-reference chart.

Name

Title

Company

Address

City

State

Zip

Telephone

Signetics Corporation—A subsidiary of Corning Glass Works.

signetics

U.S. prepares full-scale attack on consumer product hazards

In legal records it's designated Public Law 92-573, and not too many engineers are aware of its existence now. But before the end of the year the designers and manufacturers of consumer products will begin to feel its impact.

The law, designed to protect the public from unsafe products, went into effect Dec. 26, 1972, and its implementation has been waiting on the appointment by President Nixon of a five-man commission to carry out the provisions. It gives the commission power to create design standards for all consumer products and the legal muscle to ensure that the standards are followed.

"The act is passed. Now we're waiting for the other shoe to drop," says Richard Sanderson, manager of product safety for Sylvania's Entertainment Div. in Batavia, N. Y., and chairman of the Electronic Industries Association's Consumer Electronics Group, Product Safety Committee.

"We're not concerned about the immediate impact of the act on the consumer electronics industry," Sanderson says. "The industry has good safety standards already. But we really don't know what's going to happen, how the act will be implemented. Eventually the new standards will probably cost us a little more than we're spending now."

The law has strong teeth. If the commission finds a consumer product that presents an unreasonable risk or injury to users, it may declare it "a banned hazardous product." It may then file an action in a U.S. District Court for seizure of the product, or an action



against its manufacturer, distributor or retailer.

The District Court may declare the product imminently dangerous and grant temporary or permanent relief to protect the public. It may require public notice of the hazards, mandate notification to purchasers and order recall, repair or replacement of the product or refunds.

A completely new requirement is the procedure involved when a manufacturer introduces a new product—"one which incorporates a design, material, or form of energy that has not been previously used substantially in consumer products and for which there exists a lack of information adequate to determine the safety of such product." The commission is empowered to require the manufacturer to furnish it with a description of the new product before its distribution.

Failure to comply with almost any of the new requirements could result in a civil penalty up to \$2000 for each violation or up

to \$500,000 for a series of violations.

The need for a tough law is set forth in the act itself as follows:

- "An unacceptable number of consumer products which present unreasonable risks of injury are distributed in commerce."

- "Product complexities result in the inability of the users to anticipate and safeguard themselves adequately."

- "The public should be protected against unreasonable risks of injury from consumer products."

- "State and local controls are inadequate."

- "Existing Federal controls are inadequate."

- "Interstate and foreign controls are needed."

The statistical sources

Congress based these statements in part on statistics from the Dept. of Health, Education and Welfare. The department's Injury Data and Control Center, Bureau of Product Safety, Bethesda, Md., keeps com-

VACTEC PHOTODETECTORS

VACTEC adds one lobster and two new detectors
(NPN phototransistors & silicon cells)
to make the broadest line of
photodetectors in the World.

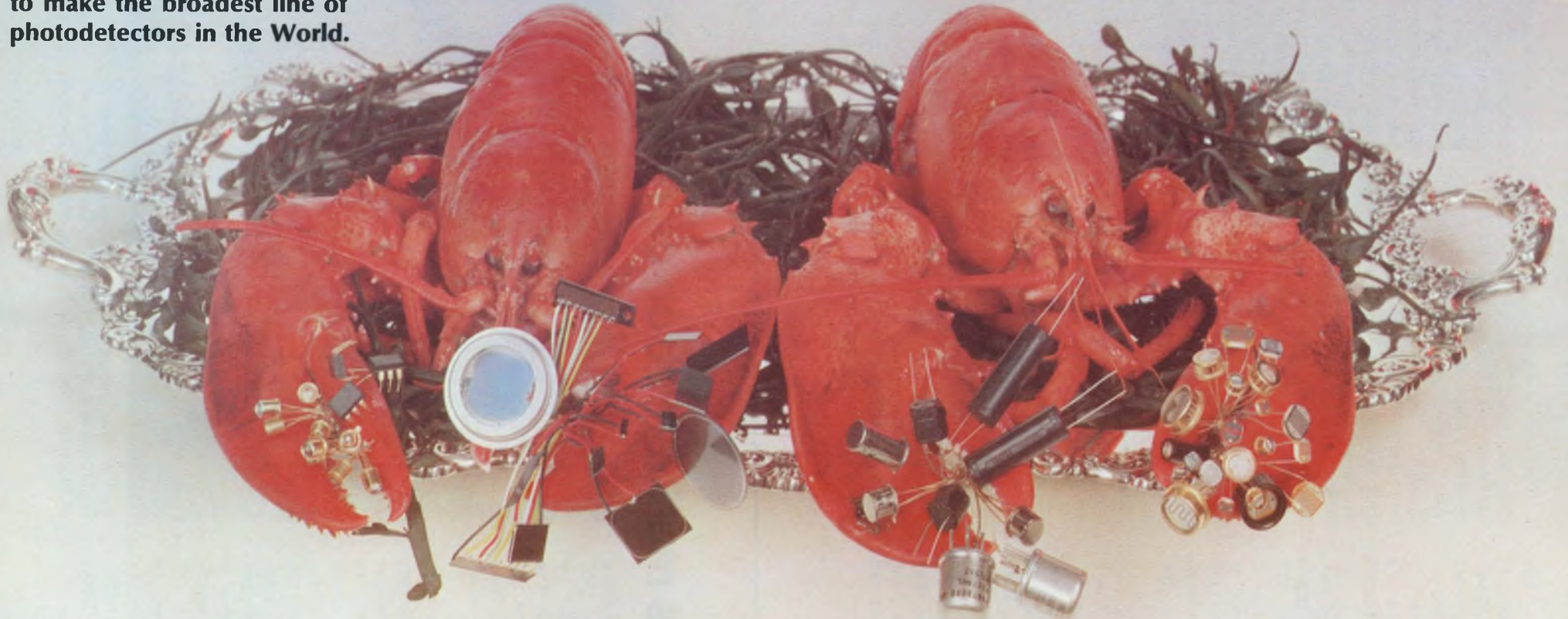

New NPN silicon phototransistors and
DIP package opto-isolators.

New complete line silicon P on N
photovoltaic (solar) cells. N on P Blue
sensitive also available.

Vactrols (opto-isolators) incandescent
or LED drivers with photoconductors
in new low cost packages.

Photoconductive Cells. Six different
materials and nine packages.

Selenium photovoltaic cells, custom detector or array designs and a portable photometer complete the line.
Contact VACTEC for any photodetector application.



VACTEC, INC.

2423 Northline Industrial Blvd.
Maryland Heights, Mo. 63043
Phone (314) 872-8300

puterized data on injuries bad enough for patients to be taken to any of 119 selected hospitals throughout the country. To project the center's figures for a nationwide count, this number may be multiplied by 10 or 12, says the center's deputy director, H. Harold Lehman.

Over an eight-month period ended last Feb. 28, hi-fi and stereo equipment in the home sent 178 people to the 119 hospitals; this is projected to a nationwide total of 1950 injuries. The injuries, Lehman says, were caused by electrical shock and burn, fires and stumbling over the equipment.

Radios put 57 people (or 600 projected nationwide) into hospitals during the eight months.

Television injured 290 in a five-month period (or a projected 3000 throughout the country). More than half of these injuries involved children under 4 years old.

Injuries from radiation are not included in the new act, since they are covered by other laws; the same is true for tobacco, food and automobiles.

The new commission will maintain an Injury Information Clearinghouse to collect, investigate, analyze and disseminate injury data associated with consumer products. Congress was particularly emphatic that information of this type should be made available to the public and to manufacturers.

No information about any consumer product may be withheld from the commission. Trade secrets which are protected by law, may be disclosed when necessary to other offices and employees of the commission.

Another commission job will be to come up with consumer product safety standards. But the commission will solicit help from interested parties.

U. S. inspections due

Once new standards are approved and published, designs and manufacturing procedures may be inspected by the commission to check on compliance.

Random inspections, as well as those for cause, can be expected.

To aid the commission, every manufacturer, private labeler or distributor will, according to the law, "establish and maintain records and make reports as the commission may deem necessary to demonstrate compliance with this act." Upon request, a manufacturer "must permit inspection by the commission of appropriate records, books and papers, regardless of whether he is or is not in compliance with the act."

Imported consumer products are to be refused admission to the United States or destroyed if they fail to comply with applicable safety rules, if they are not accompanied by a certificate of compliance or if they are not properly labeled.

IEEE says it's ready and willing to cooperate with the commission and has allocated travel funds to aid members in helping with the formation of standards, says the engineering organization's Standards Engineer, Bertram Stanleigh. IEEE's only doubts are whether or not adequate standards can be written in the 150 days the Act sets for such jobs to be done. ■■

New stamps mark electronics milestones

Four postage stamps hailing progress in electronics from 1901 to the present will be issued by the Postal Service on July 10. The design of the first stamp was unveiled at the IEEE show in New York. It is an 8-cent stamp commemorating transistors.

A 6-cent stamp will show Marconi's spark coil and spark gap, which permitted the first signals to be sent across the Atlantic in 1901. An 11-cent airmail stamp will show Lee de Forest's modifications of Marconi's invention—the audion and audion tube. And a 15-cent stamp will show an early microphone, a goosenecked speaker, a vacuum tube and a TV camera tube.

Collectors of first-day covers or first-day-of-issue cancellations can send their requests to Electronics Stamps, Postmaster, New York, N. Y. 10001. ■■



First of four postage stamps honoring progress in electronics is unveiled by Postal Service official, Edward V. Dorsey (left) with the help of the inventors of the transistor, Walter Brattain, William Shockley and John Bardeen.

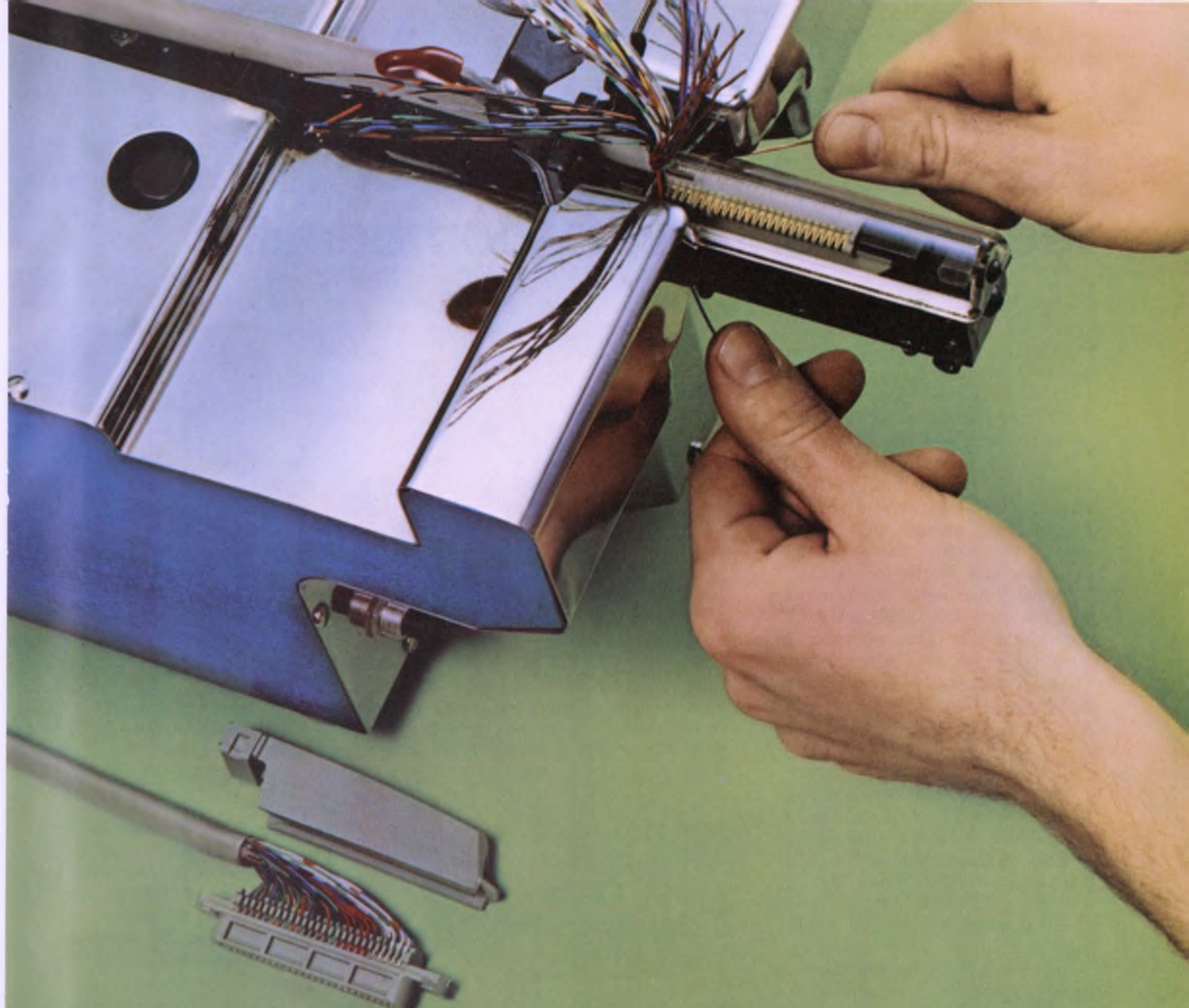

You can factory-install this 25-pair connector in less than 3 minutes. Without solder.

Impressive? Yes—especially since you can do it in your plant with our CHAMP 25-pair connector and semiautomatic application machine.

The machine automatically cuts to length and terminates 50 individual wires in highly reliable, easily replaceable, solderless contacts. In just over 2 minutes. Inter-mateable with existing connectors.

You can install the same

connector in the field—and save time and cable—with our CHAMP hand applicator tool. With it, you can terminate our 25-pair connector to a cable in just 5 minutes. Again—without the problems of solder.

Find out more about our CHAMP products for telecommunications. Call (717) 564-0101 or write for a demonstration. AMP Telecom Division, Harrisburg, Pa. 17105.



Unique design of contact provides insulation-displacing, gastight termination.

AMP

Flat-stacked tape said to combine reel and continuous-loop benefits

A tape cassette reported to blend the advantages of both reel-to-reel and continuous-loop systems has been developed in France, and its potential is being investigated by a small California company.

Instead of being wound on reels, the tape is stacked flat, one layer on top of another. Instead of being driven by a capstan with rollers, it is driven directly through notches in the side of the tape stack.

Called Helicassette, the new tape was designed for the Sodetec Co., part of the CSF-Thomson group in France. Y Square Associates of Santa Ana, Calif., is handling the development in this country.

Two tape types available

The tape comes in two configurations—S and Z (see figure). In the S version it is driven through gear notches on the outside of the stack. The tape is lifted from the top and returned to the bottom of the stack through the center of the tape reel.

In the Z version the tape is driven, again, from notches in the outside of the stack, but it is lifted from the top and returned to the bottom from the outside.

The Helicassette is said to offer these advantages:

- The drive mechanism is simple, because the tape stack itself is driven by a single drive motor. No capstan roller or other complicated take-up mechanisms are involved.

- The continuous loop of tape is reversible, unlike the tape in other continuous systems. This reversing feature cuts maximum tape access time in half.

- There is no friction between turns, and consequently no special lubricants, like graphite or silicone, are needed. Equipment reliability

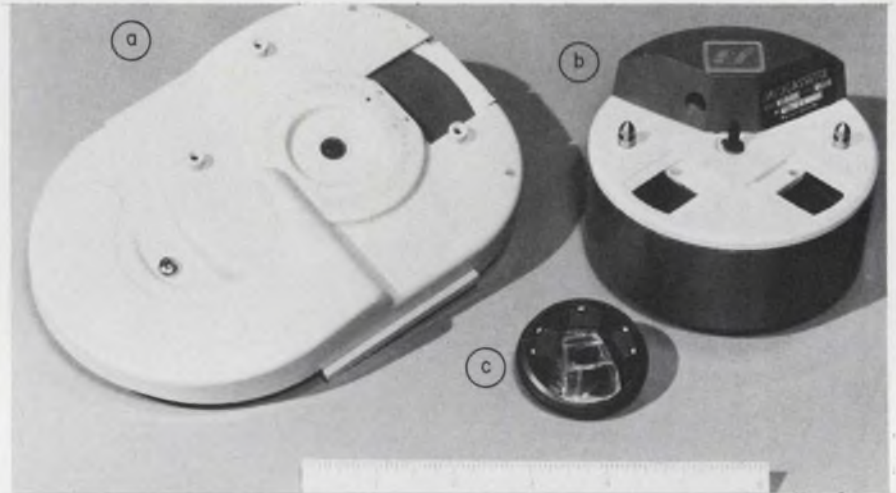

Three versions of Helicassette tape include (a) one for continuous announcements in railroad stations, (b) a unit for 31-day incremental monitoring of utility data and (c) a small unit for automobile test data.

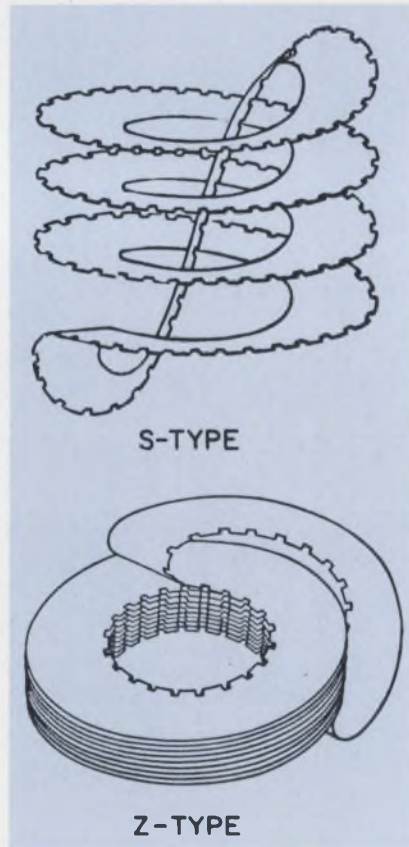

There are two basic endless-loop patterns for Helicassette tape units.

is improved.

The tape for the Helicassette is the same as for standard reel-to-reel units. Friction is negligible because the natural contour of the feedback loop forms a simple return path. Friction is further limited by the reel-driving teeth that engage the notches in the tape. By contrast, the usual endless-tape systems use graphite to reduce tape-to-tape rubbing and to prevent the destructive static build-ups that can wipe out recorded material.

The basic design of the Helicassette, according to Dr. Yujiro Yamamoto, president of Y Square Associates, is such that the width can be varied from 1/4-inch to about two inches with essentially simple scaling changes.

Tape lengths can run up to about 1200 feet with no difficulty, Yamamoto points out. Tape speeds of 120 inches per second have been used experimentally.

There is no difference in the tape performance of either the S or the Z types, Yamamoto says. Each can be used for both continuous or intermittent operation.

Three applications of the Heli-

cassette system have been demonstrated in France (see photo). These include a Z unit (a) for continuous announcements at railroad stations, and two S units, one (b) for electrical utility monitoring of voltages, currents, transients and other data and the other (c) incorporated in the test rig of an automobile to monitor transducer signals.



Tape for this S cassette is taken from the top and returned to the bottom through the center hole.

The utility-monitor that gathers data is an incremental recorder that operates for 31-day periods. At the end of this time the data are read out rapidly. The power needed for a 3-3/4-inch readout speed is about 1 W. This cassette, according to Yamamoto, is 4 inches in diameter by 3 inches high, and it contains 260 feet of 3/4-inch tape. The cassette weighs 10 ounces. Yamamoto reports that an eight-track automobile cassette that will run for about eight minutes will have 153 feet of tape.

The 3/4-inch tape can contain up to 24 tracks, Yamamoto indicates, although in the utility application only five tracks are used.

The railroad announcing cassette—the Z type—is 5-1/2 inches wide by 7-1/2 inches long by 2 inches deep. Weighing 7 ounces, it has 150 feet of one-inch tape. Because the tape is similar to the conventional type, it can store up to 2400 bpi/track, Yamamoto says.

The Helicassette tape has a 3-mil base. Production quantities of the 3/4-inch and one-inch tape used in the utility and railroad-announcing machines are available. Experimental quantities can be obtained in other widths. ■■

INFORMATION RETRIEVAL NUMBER 26 ►

Don't cost much for all they do... and we deliver fast!

A whole family of switchlights from out of the West.

monoform

Back in 1860, when you had a Colt .44 it gave you more service for the money than anything else around. Designed right for the job. Reliable. Available. And that's the way it is with the Monoform family of switchlights.

Monoform I (the single lamp, momentary & alternate, rated 2 amp 120 Vac).

Monoform II (two independent lamps for horizontal split legends, mom. & alt., 2 amp 120 Vac).

Monoform III (10 amp, 1/4 H.P. power switch).

A whole, low-cost range of models to fit your specifications in a thousand different ways. Cost? In the neighborhood of two bucks — and with Clare-Pendar that's a mighty good neighborhood.



cp CLARE-PENDAR
Phone 208-773-4541

P.O. Box 785 Post Falls, Idaho 83854 Telex 32-6448

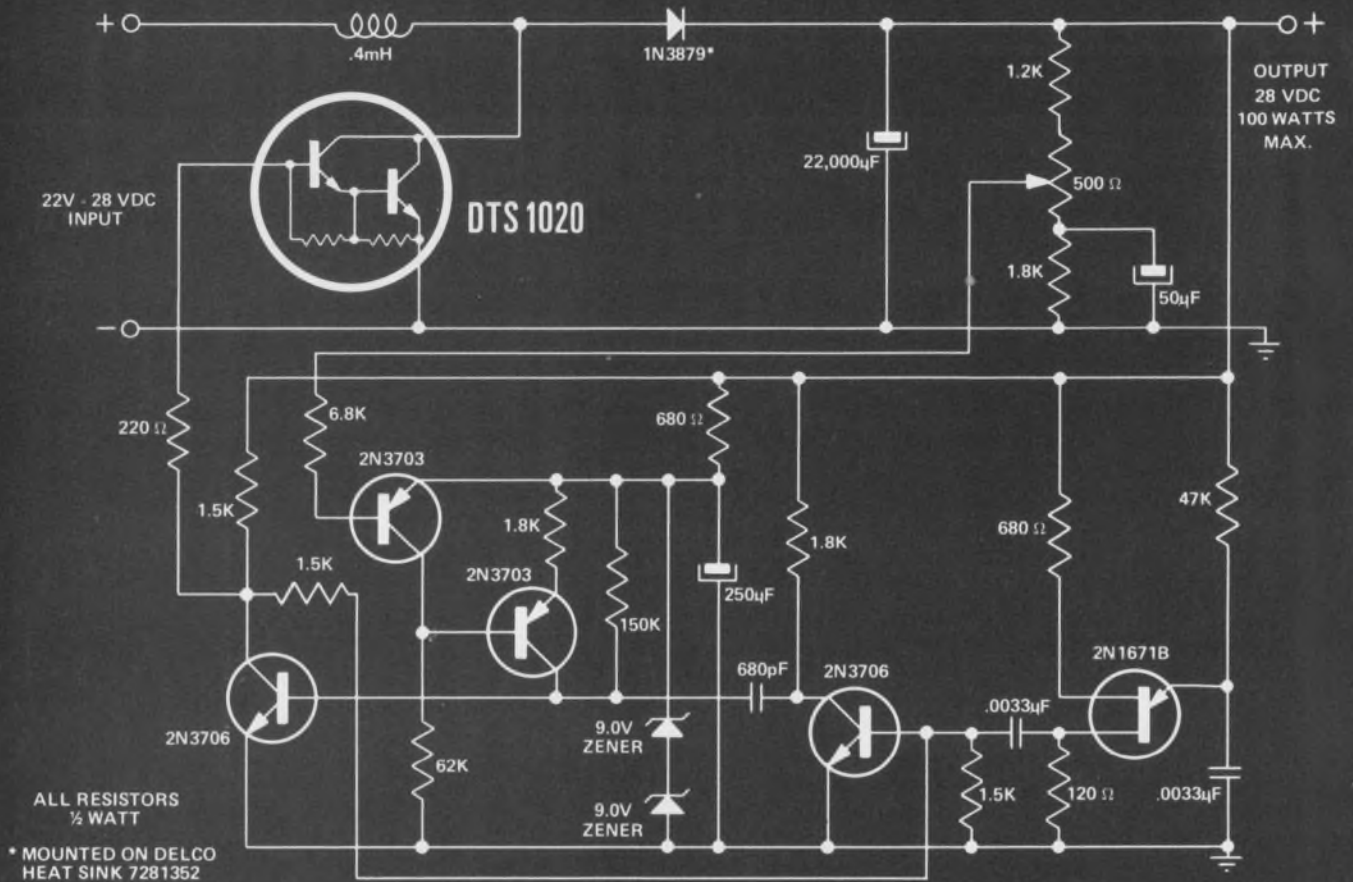

SWITCHING REGULATOR

	V_{CE0} @ 0.1 mA	V_{EBO} @ 50 mA	$V_{CE(SUS)}$ @ 500 mA	h_{fe} @ 1 MHz ($V_{CE}=10V,$ $I_C=200 mA$)	h_{FE} ($V_{CE}=5V,$ $I_C=10A$)	$V_{CE(SAT)}$ @ 5.0 A	I_C	P_T @ 75°C
DTS-1010	120V	7V	80V	12	200	1.8V	10A	100W*
DTS-1020	120V	7V	80V	12	500	1.5V	10A	100W*

*100 percent tested at 2.5A, 40V.

The Kokomoans now give you Darlington Switching Power.



Use a Darlington in place of an ordinary transistor, and you'll realize an additional magnitude of gain plus increased switching power. Use a Delco silicon power Darlington (DTS-1010 or DTS-1020) and you'll also realize a gain in dependability.

Delco's Darlington's are triple diffused mesa units housed in copper TO204MA cases and built for ruggedness. The design gives them high energy capability—the ability to handle surges of current and voltage simultaneously. They are ideal for switching inductive loads in circuits subject to transients or fault conditions.

Design a switching regulator circuit around a Delco Darlington or use it in any 60-100 volt

application to reduce circuit size, weight, and cost. In addition, the Darlington space saving feature allows you more design flexibility. Unlike an ordinary transistor, it's only energy-limited, not beta-limited. You can exploit its full energy capability in your circuit.

Call your nearest Delco distributor. He has them in stock and he's got the data on high energy switching for small spaces.

For details on the switching regulator circuit, ask for Application Note 49.



Delco Electronics

DIVISION OF GENERAL MOTORS CORPORATION.
KOKOMO, INDIANA

Now available from these distributors in production quantities.

ALA., BIRMINGHAM • Forbes Distributing Co., Inc. (205)-251-4104
ARIZ., PHOENIX • Sterling Electronics (602)-258-4531
CAL., LOS ANGELES • Kierulff Electronics, Inc. (213)-685-5511 • Radio Products Sales, Inc. (213)-748-1271
CAL., PALO ALTO • Kierulff Electronics, Inc. (415)-968-6292
CAL., SAN DIEGO • Radio Products Sales, Inc. (714)-292-5611
CAL., SAN DIEGO • Kierulff Electronics, Inc. (714)-278-2112
CAL., SUNNYVALE • Cramer/San Francisco (408)-739-3011
COLO., DENVER • Cramer/Denver (303)-758-2100
CONN., NORWALK • Harvey/Connecticut (203)-853-1515
FLA., MIAMI SPRINGS • Powell/Gulf Electronics (305)-885-8761
FLA., ORLANDO • Powell/Gulf Electronics (305)-859-1450
ILL., ROSEMONT (Chicago) • Kierulff Electronics (312)-678-8560
ILL., SKOKIE (Chicago) • Bell Industries (312)-282-5400
IND., INDIANAPOLIS • Graham Electronics Supply, Inc. (317)-634-8202
MD., BALTIMORE • Radio Electric Service Co. (301)-823-0070
MASS., NEEDHAM HEIGHTS • Kierulff Electronics, Inc. (617)-449-3600

MASS., NEWTON • The Greene-Shaw Co. Inc. (617)-969-8900
MICH., FARMINGTON • Harvey-Michigan (313)-477-1650
MINN., MINNEAPOLIS • Stark Electronics Supply Co. (612)-332-1325
MO., NO. KANSAS CITY • LCOMP-Kansas City, Inc. (816)-221-2400
MO., ST. LOUIS • LCOMP-St. Louis, Inc. (314)-647-5505
N.J., CLIFTON • Eastern Radio Corporation (201)-365-2600, (212)-244-8930
N.Y., BINGHAMTON • Harvey/Federal (607)-748-8211
N.Y., EAST SYRACUSE • Cramer/Syracuse (315)-437-6671
N.Y., ROCHESTER • Cramer/Rochester (716)-275-0300
N.Y., WOODBURY • Harvey/New York (516)-921-8700, (212)-582-2590
OHIO, CINCINNATI • United Radio, Inc. (513)-761-4030
OHIO, CLEVELAND • Pattison Supply (216)-441-3000
OHIO, DAYTON • Kierulff Electronics (513)-278-9411
PENN., PHILADELPHIA • Almo Electronics (215)-676-6000
PENN., PITTSBURGH • RPC Electronics (412)-782-3770
S.C., COLUMBIA • Dixie Radio Supply Co., Inc. (803)-253-5333

TEXAS, DALLAS • Adleta Electronics Co. (214)-741-3151
TEXAS, FORT WORTH • Adleta Electronics Co. (817)-336-7446
TEXAS, GARLAND • Kierulff Electronics, Inc. (214)-271-2471
TEXAS, HOUSTON • Harrison Equipment Co., Inc. (713)-224-9131
UTAH, SALT LAKE CITY • Cramer/Utah (801)-487-3681
VA., RICHMOND • Meridian Electronics, Inc., a Sterling Electronics Company (703)-353-6648
WASH., SEATTLE • Kierulff Electronics, Inc. (206)-763-1550
CANADA, ONT., SCARBOROUGH • Lake Engineering Co., Ltd. (416)-751-5980
ALL OVERSEAS INQUIRIES:
General Motors Overseas Operations
Power and Industrial Products Dept.
767 Fifth Avenue, New York, N.Y.
10022. Phone: (212)-486-3723.
Kokomoans' Regional Headquarters.
Union, New Jersey 07083,
Box 1018, Chestnut Station,
(201) 687-3770.
El Segundo, Calif. 90245,
354 Coral Circle, (213)
640-0443.
Kokomo, Ind. 46901, 700 E.
Firmen, (317) 459-2175
(Home Office).



THE CMOS-MADE-EASY SEMINAR STRIKES AGAIN.

A lot of water, not to mention technology, has gone under the bridge in the year-and-a-half or so since the industry's first CMOS seminar.

It's about time for another one.

A chance for you to get the full story on the latest in CMOS, plus the two-way interchange of an extended question-and-answer period.

The seminars will be held at hotels in about a dozen leading cities across the country. And cities where we don't at the moment plan to hold a seminar will get one if enough of you express an interest in attending. (By happy coincidence there's a coupon in this ad designed for just that purpose.)

Why's National doing all this?

Because we've developed a terrific logic family, 54c/74c which we believe has such an overwhelming competitive advantage that it's destined to become the standard of the industry. But the trouble is, most design engineers aren't familiar enough with CMOS yet to design it into their systems. A seminar is the best way to tell them.

Our CMOS whiz-kids.

Bob Bennett, our marketing honcho on CMOS will lead the seminars, discuss the product and its advantages, and do his bird call imitations.

Dale Mrazek and Steve Calebotta are our applications specialists. They'll talk about how CMOS can be

used, and field questions about CMOS applications.

Come pick their brains.

The world's very first CMOS Applications Contest.

But Dale and Steve aren't going to stand up there and spiel off all the applications in the world. They don't know them. They can spark you with some examples, but we hope that communication of applications ideas will be a two-way affair. That the audience will also have some applications ideas of its own.

In fact, we'll be making a contest out of it. For the best applications ideas received, either at the seminars or later by mail, there'll be lots of neat prizes.

We haven't figured out yet what the prizes will be. But some things being considered are a weekend date with Raquel Welch, a chest full (no pun intended) of ancient Roman coins



worth a million dollars, and a parrot that speaks 14 languages. But who knows? We may end up settling for a box of popcorn and two tickets to a rerun of The Sound of Music.

Here's your homework.

Here's a very basic primer on CMOS to help get you ready for the seminar.

You may take notes.

CMOS dissipates low power. Typically, the static power dissipation is 10 nW per gate, compared to a typical dissipation of one mW for an LP TTL gate. A 100 to 1 power savings will be realized when changing a system from LPTTL to CMOS, or 1000 to 1 from standard TTL to CMOS.

CMOS has a propagation delay of 25 to 50 ns through a typical gate.

CMOS has a controlled rise and fall time as opposed to TTL saturated logic, which greatly simplifies system design.

There's less noise generated. The output current spiking caused by devices switching logic state is only 2 to 3 mA by CMOS while bipolar approaches 20 to 40 mA. CMOS 54c/74c also has a higher noise margin than 7400 TTL: 1 volt instead of .5V.

CMOS can operate over a large power supply range of 3 to 15 volts. This means that lower cost power supplies can be tailored to the application and tight regulation is not necessary.

It costs more, but it's cheaper.

CMOS will show a systems cost savings when the following facts are taken into account: smaller power supply, less power supply regulation, fewer bypass capacitors, simpler design because of controlled rise and fall time, and simplified power distribution resulting in reduced cost because of low noise and low current.

Its lower power dissipation reduces costs by cutting down on fans and associated cooling equipment.

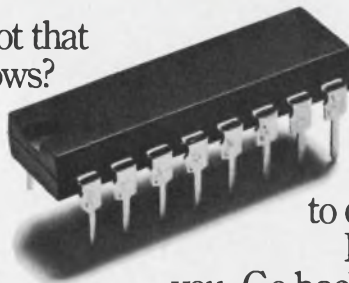

Surprise quiz.

How much power savings will typically be realized when changing a system from TTL to CMOS?

If you don't know, shame on you. Go back seven paragraphs.

The 7400 design tricks and applications you know and love.

Finally, the National 54c/74c line consists of CMOS parts which are pin and functional equivalents of many of the most popular parts of the 7400 TTL series.

The pin outs and functions are familiar to the design engineer because he's designed with the 7400 for years. With CMOS he can take full advantage of the learning curve he went through years ago because he already knows the 7400 design tricks and applications.

This is one of many important advantages of our CMOS over the competitive CMOS.

If you've got it, flaunt it.

And we've got it.

In the past ten months we've introduced twenty-seven 54c/74c products, and another 18 will be introduced by the end of 1973.

This makes a total of 45 54c/74c products that will be available to designers this year. But complete systems can now be designed with the products we have now.

Your invitation.

Our distributors will be making many of the arrangements for the seminars, but if you'd like to be sure you're invited, mail us the coupon below.

See you there.

- | | |
|--|--|
| <input type="checkbox"/> I think your CMOS seminar idea is terrific. I'd like to attend. Tell me when and where. | <input type="checkbox"/> I think your CMOS seminar idea is dumb/terrific (circle one) and/but I don't want to/can't attend but send me further details about CMOS, including data sheets and applications notes. |
| <input type="checkbox"/> I think your CMOS seminar idea is dumb, but I'd like to attend anyway. | |
| <input type="checkbox"/> None of the above. In 15 words or less. | |

NAME _____

COMPANY _____

ADDRESS _____

CITY _____ STATE _____ ZIP _____

Mail to: National Semiconductor Corporation, 2900 Semiconductor Drive, Santa Clara, California 95051.

NATIONAL.

Why square ferrite cores?

save up to 40% in space
save up to 40% in assembly time
save up to 30% in inventory



Ferroxcube's new RM Series square cores save up to 40% in pc board space over round pot cores. Furthermore, RM Series saves up to 40% in assembly and mounting time. Two simple, gold-plated clips hold them together and readily snap them into place on the pc board.

Your parts inventory is reduced since the economical mounting clips replace more expensive pot core mounting assemblies.

Ferroxcube's RM cores are available

with a choice of ferrite material: choice of ungapped, fixed-gap or adjustable-gap types, with smooth precise tuning of inductance to an accuracy of better than 0.03% in adjustable models.

RM cores now in stock. For complete information call 914-246-2811, TWX 510-247-5410 or write Ferroxcube, Saugerties, N.Y. 12477.

Ferroxcube linear ferrites—made in Saugerties, N.Y. and stocked in seven U.S. locations.

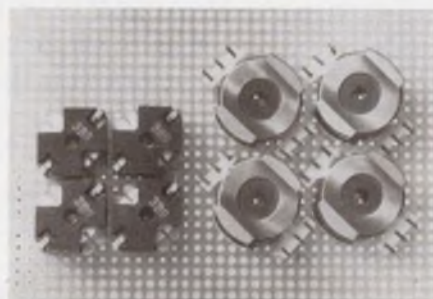

FERROXCUBE CORPORATION, SAUGERTIES, N.Y. 12477
A NORTH AMERICAN PHILIPS COMPANY

Distributed through North American Philips Electronic Components Corporation with warehouses in Boston, 617-449-1406, New York, 516-538-2300, Saugerties, 914-246-5861, Philadelphia, 215-927-6262, Chicago, 312-593-8220, Santa Clara, 408-249-1134, San Diego, 714-453-9250

INFORMATION RETRIEVAL NUMBER 29

16403

washington report



Heather M. David
Washington Bureau

Military back in manned space flight?

Look for a new push by the military to get back into the manned space-flight effort. Dr. John Foster, defense research chief, has ordered the military services to draw up plans for greatly increased participation in the NASA space-shuttle program. Studies show that the Defense Dept. could save millions by using the shuttle to orbit most of its satellites. The Pentagon also is looking at the shuttle for other military uses. It may end up being the agency to develop the space tug, a propulsion stage to be used to boost the shuttle into higher orbit. A decision on the space tug is due this fall, and with budget pressures squeezing NASA, more of the space effort could well be shifted to the military.

New Navy study of F-15 ordered

The Navy has been ordered by top defense management to restudy the possibility of buying a version of the Air Force's F-15 fighter, developed by McDonnell Douglas, instead of the costly F-14, developed by Grumman Aerospace.

The House Defense Appropriations Subcommittee ordered such a study last year but received what it termed superficial cooperation from the Navy. The results of the new study, are to be reported to Congress in a few weeks. The Navy now estimates that 313 F-14s will cost \$5.3-billion, compared with its estimate a few years ago of 710 aircraft for \$6.2-billion.

Deputy Defense Secretary William Clements also has ordered a hard look at the F-14 to see where costs can be trimmed. One item being examined is the complex fire-control system and the Phoenix missile, developed by Hughes Aircraft.

Laser safety standard still a burning issue

The Electronic Industries Association is still "optimistic" that a laser safety standard acceptable to both the Bureau of Radiological Health and industry can be worked out. The bureau has recommended a maximum 1-mW level for demonstration lasers, but industry spokesmen say this is unrealistically low. The bureau did revise its draft standard to permit a 5-mW level for surveying and alignment applications for lasers, but the beam must not exceed 2.5 mW per centimeter squared—a restriction EIA feels will make the lasers relatively useless in sunlight.

The EIA has asked that the level for all general-purpose lasers be

raised to 5 mW, with no restrictions. The association argues that no injuries have been reported to such sources as the Workmen's Compensation Boards in 50 states concerning the 100,000 or so lasers now in use. Although the bureau will publish its more stringent standards in the Federal Register, industry will have another chance to submit data to support its case.

Military pressing air-drone efforts

Remotely piloted vehicles (RPVs) will take over many functions of increasingly expensive manned military aircraft if current research efforts work out. The Defense Dept.'s Advanced Research Project Agency has earmarked \$11-million for two new efforts: (1) A low-cost RPV to perform the missions of forward observer and target designator for targets such as tanks at artillery range, and (2) A drone for battlefield surveillance and target identification. The Air Force is continuing to fund competing prototypes of its high-altitude, multipurpose vehicle call Compass Cope, one of which was successfully flight-tested in January.

New laser guidance efforts under way

As part of the Defense Dept.'s emphasis on modularization and standardization of weapons systems, the Army and Air Force are looking for a laser guidance system for missiles that they can use in common. It would be used on the Army's Hellfire airborne antitank missile and a version of the Air Force's Maverick air-to-ground missile. Hellfire will be the first Army Helicopter missile to use laser guidance, although it will also be designed to use other techniques.

Capital Capsules: The United States Export Control Office has listed restrictions on most medium-scale-integrated calculator chips and industrial circuits after meetings with semiconductor industry officials. LSI devices and some ICs still may not be sold to Soviet Bloc countries, although a new review of the restricted list will be made next spring. . . . Litton Industries has won a round in its battle with the Navy over contract costs. A U.S. District Court has ruled that Litton has the right to appeal the Navy's demand for repayment of \$55-million that the military branch paid in advance for Landing Helicopter Assault (LHA) ships. The company plans to take the Navy to court. . . . The Commerce Dept.'s Bureau of International Commerce has switched its Trade Lists of Overseas Outlets to computer format, and electronic companies already are using the service to get the names of potential overseas customers in mailing-label form. More information is available by writing Export Information Div., BIC 266 FTL, Dept. of Commerce, Washington, D.C., 20230. . . . A bill to fund development of new high-speed water and ground transportation demonstration systems as part of the Bicentennial celebration is being considered in Congress. One potential development is an 80-to-100-knot Surface Effect Ship. . . . Some 1200 NASA computer programs are now available to commercial concerns. One package, developed to design a space vehicle, is being applied by the Ford Motor Co. to design automobile frames and steering mechanisms; by Bell Helicopter for blade design; by General Electric for engineering turbine blades, and by a number of construction concerns for high-rise buildings.

need time to analyze?

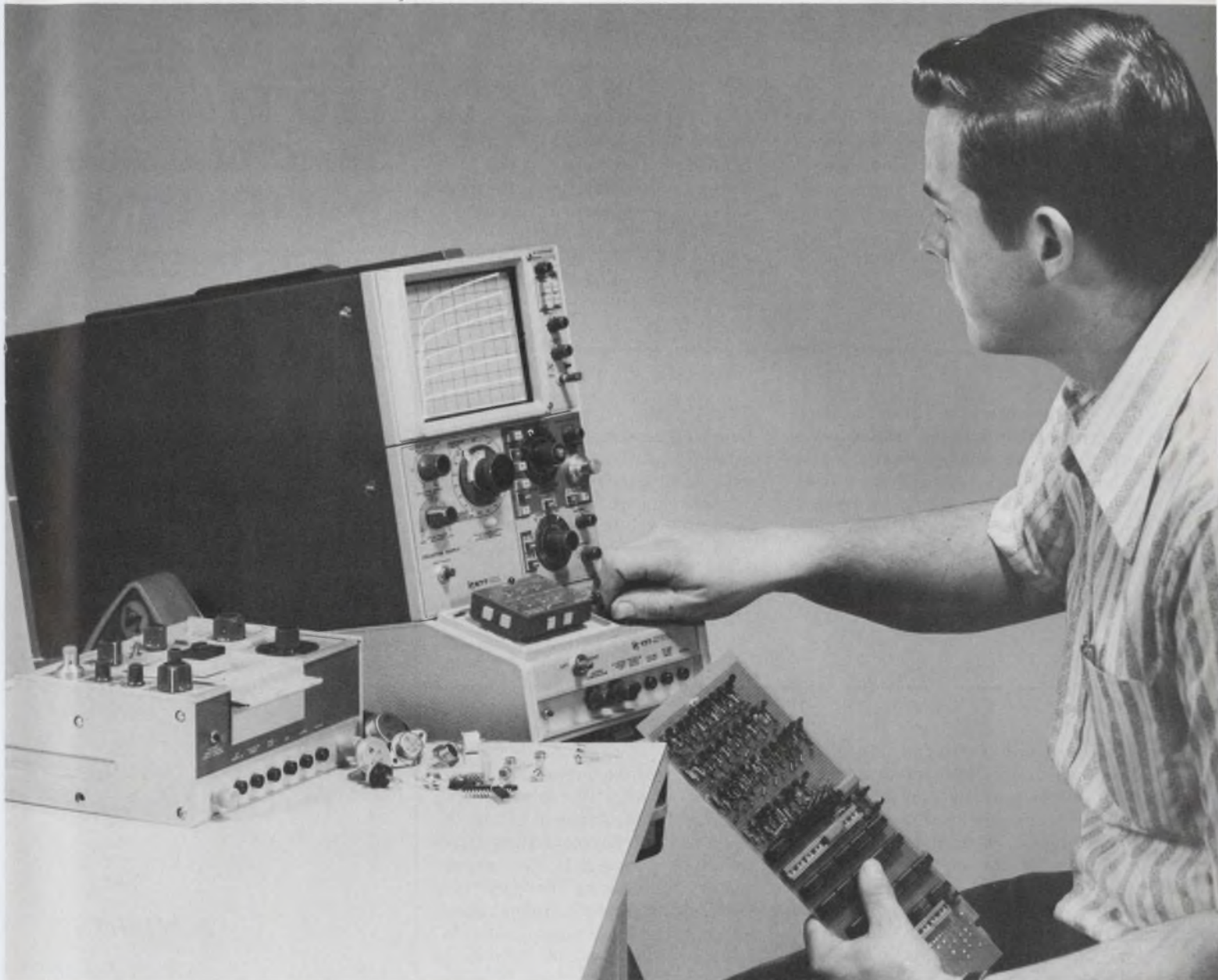

The new Tektronix 577 Curve Tracer offers a better way. Plug-in test fixtures and optional storage display module provide the type of flexibility required to keep your testing capability in stride with the ever-advancing semiconductor industry.

Storage lets you do more. You can view the characteristics of two devices simultaneously, or store variations caused by changes in operating conditions or changes in temperature. To extend measurement capability in low current or pulsed operation, you can store curves traced by a slow moving spot.

When equipped with the 177 Standard Test Fixture, the 577 displays the characteristic curves of transistors, FET's, tunnel diodes, SCR's, Zeners, or any device which current-versus-voltage plots are desired.

Measuring parameters of linear IC's such as op-amps, diff-amps, comparators and regulators becomes an inexpensive, simple task with the plug-in 178 Linear IC Test Fixture.

Depending on the type of display module and test fixture ordered, the 577 price ranges from \$1850 to \$3200.

Let us assist you in solving your measurement needs. Call your local Tektronix Field Engineer for added information and a demo, or if you prefer, write Tektronix, Inc., P.O. Box 500, Beaverton, Oregon 97005. In Europe, write Tektronix, Ltd., P.O. Box 36, St. Peter Port, Guernsey, C.I., U.K.



TEKTRONIX®
committed to
technical excellence

technology abroad

What is described as the first fully leakproof battery has been produced, says its developer—Kapsch & Soehne of Vienna, Austria—by ultrasonically bonding an external plastic coat to a negative contact embedded in a plastic

ring. The positive contact is also coated with a material that is bonded to the same battery coat. Kapsch says that the battery not only remains sealed throughout the last stages of its life but also resists high internal overpressures.

READER SERVICE NO. 441

A clutter-rejection filter for moving-target-indication radar systems, using analog shift-register bucket-brigade circuits has been developed at the Royal Radar Establishment, Malverne, England. Each of three Philips integrated-circuit, bucket-brigade delay lines provides 16 elements of delay.

This permits 16 radar range bins to be processed. Scientists at the establishment believe that the devices have a useful future, because of their capability for multiplexing, interrupted clocking and use with a staggered pulse-repetition frequency to avoid the "blind-speed" problem.

READER SERVICE NO. 442

An automobile electronic ignition system using MOS integrated circuits has been developed by Emihus Microcomponents, Ltd., in Weybridge, England. The company says its use should reduce exhaust pollution because of its close control of engine timing. Other advantages are said to include reduced engine wear and maintenance and decreased fuel consumption. Engine timing can be adjusted to within a quarter

degree at engine speeds as low as 100 rpm. An added advantage is that a negative advance can be introduced at any point in the positively advancing timing function. The company is also investigating monitoring devices (for checking lighting, brakes, etc.), antilock braking, automated servicing equipment and devices to prevent drunken drivers from operating their vehicles.

READER SERVICE NO. 443

What is described as the world's first "store and forward" service for data communication is being initiated by the British Post Office as an experimental packet-switching service for transmission of computer data. The data packets, which are sent over telephone circuits, are self-contained, addressed blocks of information. There is no direct end-to-end con-

nection between customer and computer, and each packet is routed automatically. Circuits connecting packet-switching exchanges can also be used for carrying packets sent by other customers. The system is planned for operation in late 1974, with three exchanges interconnected by 48 kbit/s circuits.

READER SERVICE NO. 444

If your
copy of the
**LED Product
Selector Guide**
from Dialight
has been
removed...

please check
the proper
number on the
reader service
card for your
copy

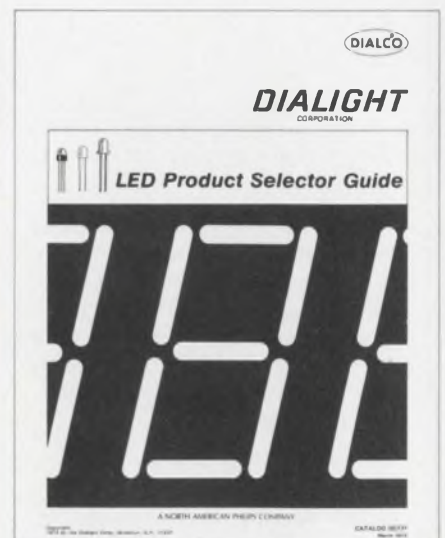

DIALIGHT

Dialight Corporation, A North American Philips Company
60 Stewart Avenue, Brooklyn, N.Y. 11237 (212) 497-7600

INFORMATION RETRIEVAL NUMBER 123

ELECTRONIC DESIGN 9, April 26, 1973

For once in your life...live.

A sleek graceful sailing vessel glides across the sometimes green, sometimes blue Caribbean. The cargo: you. And an intimate group of lively, fun-loving shipmates.

Uniform of the day: Shorts and tee shirts. Or your bikini if you want. And bare feet.

Mission: A leisurely cruise to remote islands with names like Martinique, Grenada, Antigua—those are the ones you've heard of. Before the cruise ends, you'll



know the names of many more. You'll know intimately the enchanting different mood of each...and its own beauty and charm.



Life aboard your big sailing yacht is informal. Relaxed. Romantic.

There's good food. And 'grog.' And a few pleasant comforts... but any resemblance to a plush pretentious resort hotel is accidental.

Spend 10 days exploring paradise.

Spend ten nights watching the moon rise and getting to know interesting people. It could be the most meaningful experience of your life...and it's easily the best vacation you've had.



A cruise is forming now. Your share from \$245. Write Cap'n Mike for your free adventure booklet in full color.

Come on and live.



Windjammer Cruises.
WINDJAMMER INTERNATIONAL SUBSIDIARY • OTC

Name _____

Address _____

City _____ State _____ Zip _____

Phone _____

P.O. Box 120, Dept. Miami Beach, Florida 33139



P-channel
J FET



N-channel
J FET



CMOS
FETs



P-channel
MOS FET



N-channel
MOS FET

Since 1962, Siliconix has evolved FET technology and applied it to a complete line of singles, duals, arrays, and ICs. So what's new?

Switch 10 MHz Signals with better than 60 dB OFF Isolation

The Siliconix DG181-DG191 family of FET switch/IC drivers is well-suited for processing high-frequency signals, and is directly compatible with most computer logic. FET switch/monolithic driver combinations are available in SPST, SPDT, or DPST functions.

Features include:

- Constant ON resistance with signals to ± 10 V and 100 MHz
- 60 dB OFF isolation at 10 MHz with 75 Ω load
- t_{on} and $t_{off} = 150$ ns typical
- 1 nA max (100 pA typical) leakage from signal channel in either ON or OFF state.

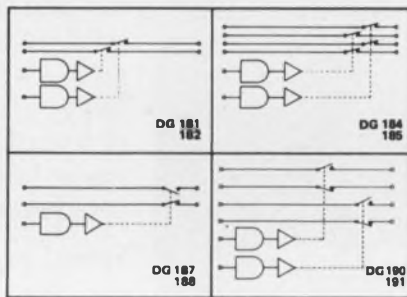

DG181-DG191 Functional Diagrams

The key to this exceptional performance is the Siliconix concept of monolithic driver design, with careful attention to critical details such as low driver output impedance. DG181-DG191 driver (switch OFF) resistance

The DG181-DG191 series of FET analog switches is an ideal solution to most switching problems. If your case is unique—and whose isn't—our applications people are eager to help. For complete information

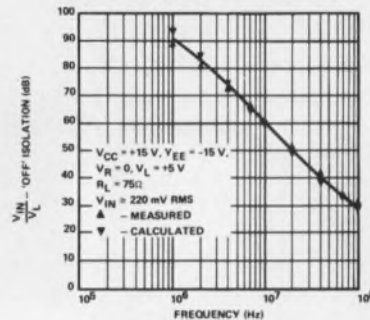

to ground is only 200 Ω , providing good a-c by-pass on the FET switch gate. Contrast this with other driver circuits with impedances as high as 26 M Ω , which adversely affect isolation characteristics.

write for data

Applications Engineering (408) 246-8000, Ext. 501



Siliconix incorporated

2201 Laurelwood Road, Santa Clara, California 95054

INFORMATION RETRIEVAL NUMBER 32

Ride the crest of a brain wave

"I had this fabulous idea. It was sensational. Really great. Just super. But I forgot it."

All of us have said words like these a thousand times. And we'll continue to, because we all get trapped by our own routines and traditions. Consciously or unconsciously, most of us fix times for the things we do. We have a time for waking, a time for washing and shaving, a time for eating, for getting to the office, for working, etc. And when we work, we generally apply ourselves to the immediate job at hand—with the next job simmering someplace in the backs of our skulls.

But the great ideas we all get once in a while can't be disciplined. We don't assign a time slot for thinking—just plain, uninterrupted thinking. If we did, we'd have no assurance that those precious ideas would come along on schedule. That wouldn't be bad, if we had some way to peak our sensitivity when the ideas did come.

A few engineers—very few, unfortunately—have cultivated the ability to tune their receivers to maximum sensitivity and maximum signal-to-noise ratio when these ideas try to surface from the recesses of their subconscious.

They learn to cut off other, stronger, signals while those faint "inspiration" signals are being transmitted. And they learn to capture those feeble transmissions and nourish them—even if other matters must wait.

And that's a lesson we all have to learn if we want to climb out of the mental ruts we tend to move in. Sure, there are plenty of fine designs that are implemented by the guy who starts with a design objective and plows ahead methodically till he finishes a job. That approach is essential, for no design comes full grown—like Minerva, the goddess of wisdom, who leaped forth from Jupiter's brain fully grown. Whatever its source, each design requires some methodical dogwork before it appears as a finished product. Without such "routine" designs, our industry would have precious little output.

But the outstanding designs—those that shake up the industry, those that elicit gasps of "elegant," "gorgeous," "beautiful," "sensational," "sneaky," "not bad, Jack, not bad at all," and other such kudos—those designs do not come from the mere application of sweat. Inspirational designs are rare. We can make them less rare if we learn to welcome those inspirations, provide soil in which they can grow and cultivate them with loving care.



A handwritten signature in cursive script that reads "George Rostky".

GEORGE ROSTKY
Editor-in-Chief

Reject common-mode noise with a floating data scanner. It allows you to sample low-level signals in environments plagued by electrical interference.

Collecting data from low-level signal sources in industrial environments poses a formidable problem: noise pickup. The solution is twofold: Control all but the common-mode noise with shielding and proper grounding. Then "float" the scanning and measuring equipment to isolate it from ground, thereby permitting rejection of the common-mode noise.

These steps are interdependent, and they result in a system that has only a single-point ground and that is balanced with respect to ground.

Sources of noise analyzed

How does noise get into the data-gathering system? Different grounded points in a plant are very often at different potentials. This usually results because unbalanced power currents flow in the ground paths, and different path resistances between the grounded points produce voltage differences between them. Ground potential differences can run well above 10 V and become prime sources for noise.

For instance, noise from ground-circulating currents is particularly troublesome in thermocouple circuits. Most thermocouple junctions make physical and electrical contact with a protective sheath, or well, that is also electrically grounded. A second ground at the recording instrument (Fig. 1a) creates a path for circulating current between the two grounds, which are usually at different potentials. This condition provides an unbalanced noise voltage at the input leads to the measuring instrument.

Inductive coupling is another source of noise. Magnetic flux lines passing through the loop formed by the thermocouple leads and the ground path induce noise voltages. This inductive noise, plus the ground-current noise, can be represented by the symbolic generator (CM voltage) in Fig. 1a.

To combat these prime sources of noise, re-

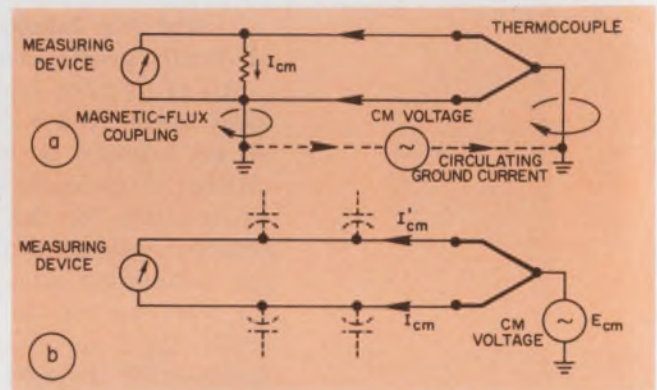

1. Data-gathering systems can pick up unbalanced noise from (a) circulating ground currents and inductive coupling in ground loops that are formed when the system has multiple grounds and (b) from capacitive coupling from power lines and electrical equipment.

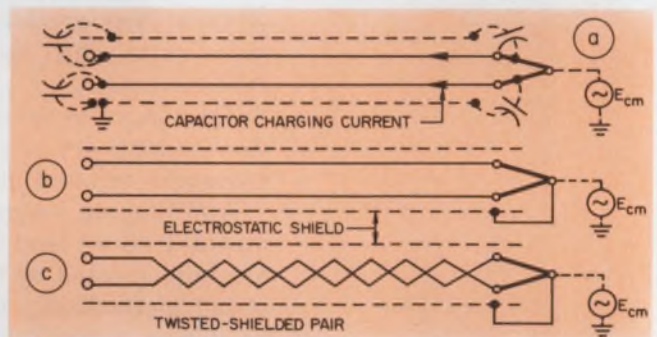

2. Shielding and single-point grounding reduces capacitive pickup. Improper grounding is shown in (a) and (b) is correctly grounded. Twisting the lead pair (c) with the shield reduces inductive pickup in the lead loop.

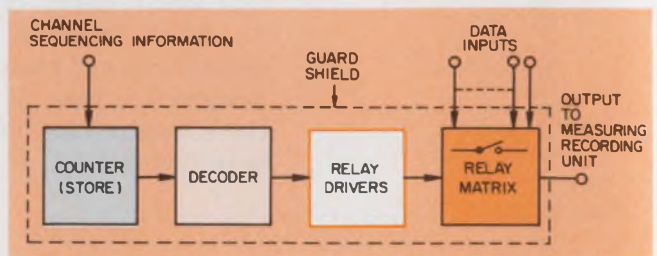

3. All control signals and the power input to every section of the scanner in this block diagram are floated above ground and the whole assembly is shielded.

Jacek H. Kollataj, SATI, Pretoria, Republic of South Africa.

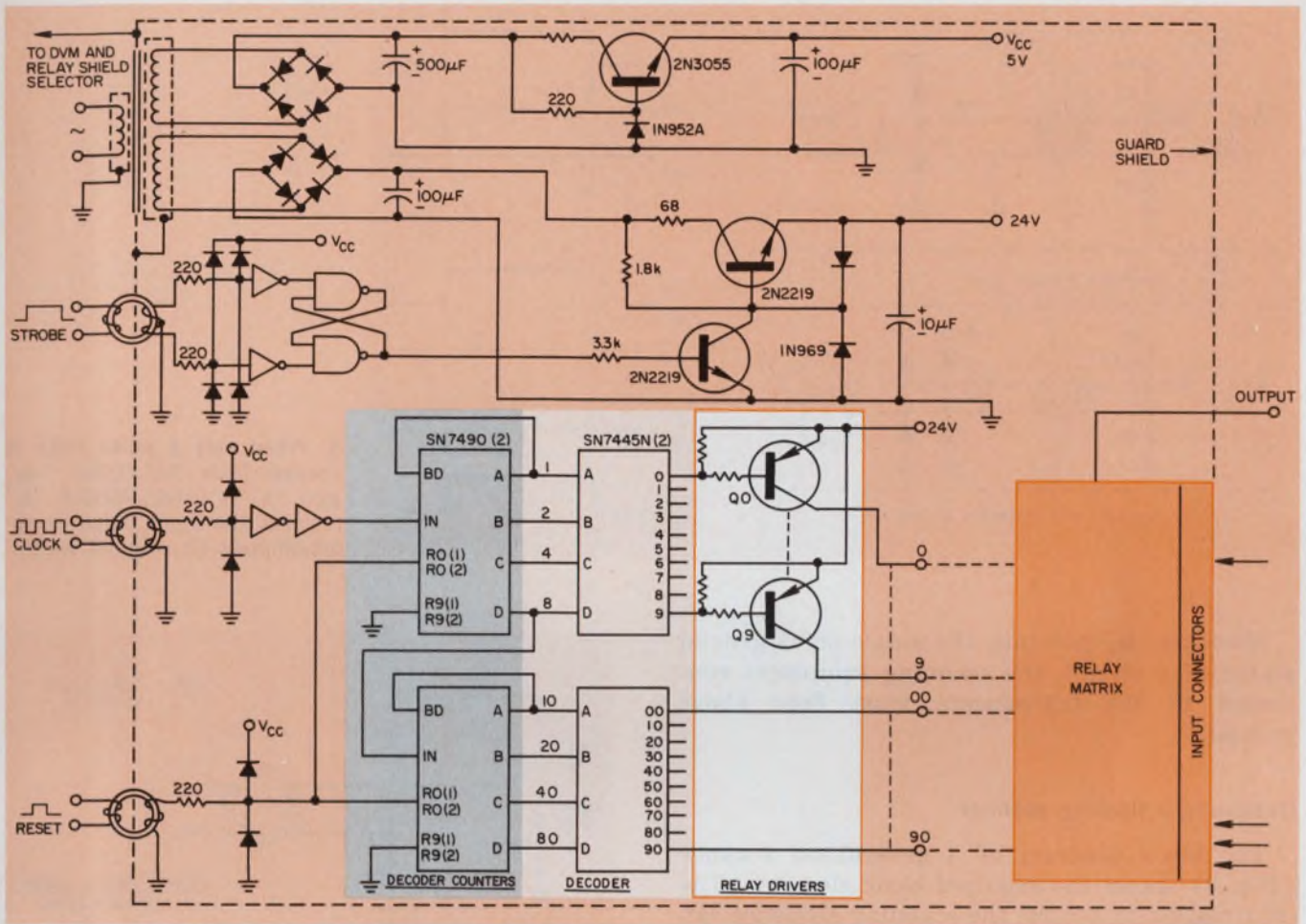

4. The power-supply transformer uses a double Faraday-box shield, and pulse transformers couple the control signals.

order and computer manufacturers use floating input systems. In these the data-scanner input terminals are not grounded, and a very high impedance is maintained between both input terminals and ground. This eliminates the conducting loops, and the remaining common-mode voltage interference can balance out at the scanner inputs.

But even in the best systems, noise can be coupled via the capacitance from each of the thermocouple conductor leads to any electrically connected object near them, such as a cable tray or power line (Fig. 1b). Differences in lead resistance and the capacitively coupled interference to each lead in the pair produce a different voltage drop in each conductor. This voltage differential, of course, can't balance itself out, as common-mode noise can.

If you attempt to balance these capacitively induced currents—by adjusting the relative resistances of the two leads from the thermocouple—any small changes in the coupling distribution, or even different loads on plant equipment, will soon upset the balance.

Shielding the leads, however, can greatly reduce capacitive noise coupling. But even when the thermocouple leads are shielded all the way

to the control room, there can be a problem. If the shield is grounded in the control room, currents must flow in the thermocouple leads to charge the capacitance between the leads and the shield (Fig. 2a). This could allow unbalanced noise to enter the instrumentation system.

Fig. 2b shows the easiest way to overcome this problem. Ground the shield at the thermocouple instead of in the control room. Since the shield is at the same potential as the couple, no charging currents flow, and no unbalanced noise is produced.

Further, twisting the pair of leads inside the shield (Fig. 2c) tends to cancel noise that is magnetically induced.

In many data-scanning systems it is necessary to transmit digital data over hundreds, or even thousands, of feet. For best noise immunity, convert the ground-referred signal at the transmission end into a differential signal, and transmit this down a balanced, shielded twisted-pair line. At the receiving end, induced noise will tend to be of equal magnitude and opposite phase on the receiver terminals. A receiver that responds only to a differential signal and has high common-mode rejection will eliminate the common-mode noise.

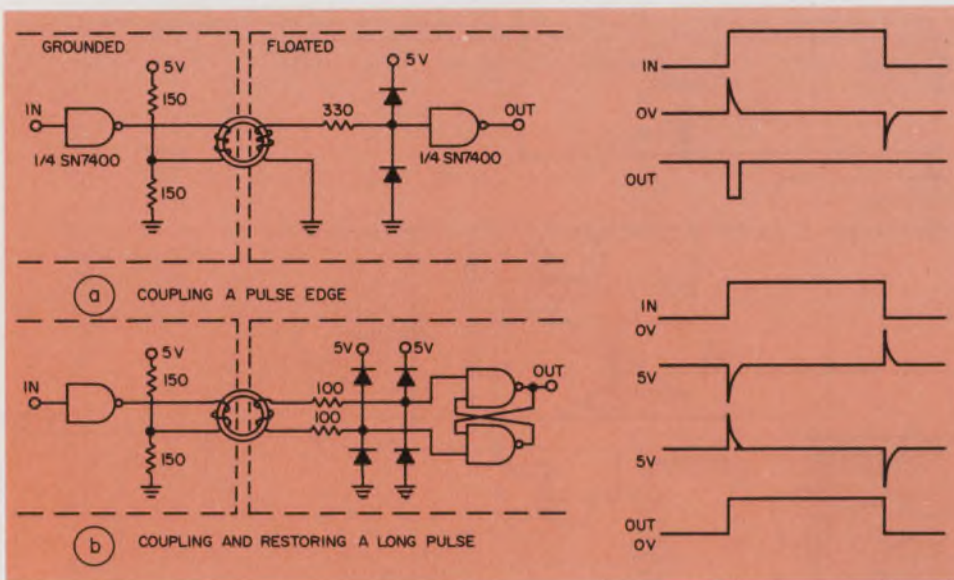

5. When only a pulse edge is needed from the circuit, version "a" is used. Version "b" restores the input pulse to approximately its original width.

However, to maintain the single-point ground status of a circuit, the scanning equipment connected to the transducers must float above ground.

Designing a floating scanner

The block diagram of a generalized scanner (Fig. 3) shows the required basic elements. The information to control the scanning sequence can be supplied to the system in either parallel or serial form. If the scanner is used with a computer, the system may require scanning of the data channels in random order, with the control information supplied in parallel form. On the other hand, ordinary data-logger systems usually scan the channels sequentially, and thus scanning information can be serial—which means the circuits can be simpler.

To achieve a floating condition, and thereby preserve the common-mode noise rejection capability, all the circuits of the scanner—counter, decoder, relay drivers, reed relays and power supply—are both floated and shielded against capacitive coupling from the environment. A special isolation transformer for the power supply shields both the primary and secondary windings inside separate electrostatic Faraday boxes (Fig. 4). And signals are transmitted from ground-referenced logic outside the scanner to the floating logic inside the scanner via pulse transformers, which have very small capacitance between primary and secondary windings.

The over-all power consumption for the 100-channel scanner described is about 1.5 W. The 5-V supply for the scanner's integrated circuits is stabilized by a simple regulator circuit that has a zener-diode reference and a single, series power transistor. The 24-V supply regulator for energizing the scanner reed relays has a series

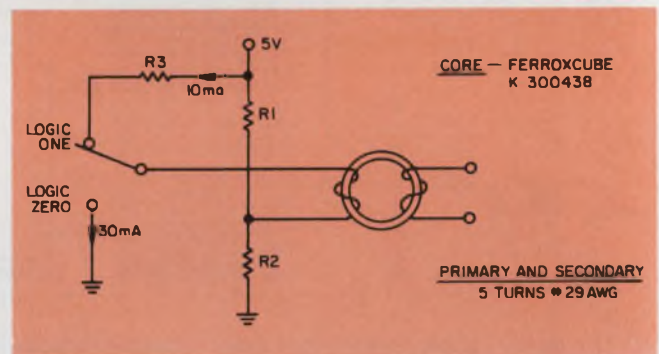

6. When the pulse transformer receives a logic ONE from its driver, its primary winding should draw about 10 mA. On a logic ZERO, the primary's current reverses and should become about 30 mA. This total primary current change of 40 mA generates a pulse of 200 ns in the secondary to drive a TTL gate.

transistor in a common-emitter configuration with a 22-V zener-diode reference. The series regulator transistor can be switched ON and OFF by a strobe signal to control all the relays simultaneously.

Reed relays (Clare MR-3MC) are used in the scanner because they fulfill most of the requirements demanded by a floating data scanner that must handle low-level signals from many dissimilar transducers. The transducers scanned may include such diverse types as thermocouples, strain gauges and pressure sensors.

The desirable reed-relay properties include the following:

- Low-contact resistance compared with that of a FET.
- No offset voltages as would occur with transistors.
- Low thermoelectric effects (with special reeds).
- Good isolation between coil and contacts. Reed relays can withstand hundreds of volts—

well beyond the capability of any FET.

- Circuit flexibility (various coil ratings, contact forms, etc.)

- Response that is fast enough to reach hundreds of scanning points per second.

However, capacitive coupling between the relay coils and their contacts can introduce noise into a scanning system. Electrostatic shields between the coil and contacts can help reduce the noise. But in the floating scanner the power supply isolates the reed coils from the ground and virtually eliminates the noise.

TTL gates can readily drive pulse transformers, and the gates are easily driven from a pulse transformer (Fig. 5a). Thus pulse transformers, with their low interwinding capacitances, are excellent isolating devices. Diodes protect the inputs of the gates by clamping positive spikes of over 5 V and all negative spikes. And the fact that pulse transformers act as differentiators in pulse circuits is easily overcome with a simple pulse-restorer circuit (Fig. 5b). Details of pulse-transformer construction and operation are shown in Fig. 6.

Sequencing the scanner

There are two ways of sequencing the floating scanner. As we have seen in Fig. 4, the scanner is a sequential type. If the two decade-counter circuits (SN7490) are replaced by two 4-bit latch circuits (SN7475; Fig. 7), a computer can select the data channels at random by addressing the latches with two parallel BCD digits, from 00 to 99.

If required, external counters or latches, synchronized with the latches or counters in the

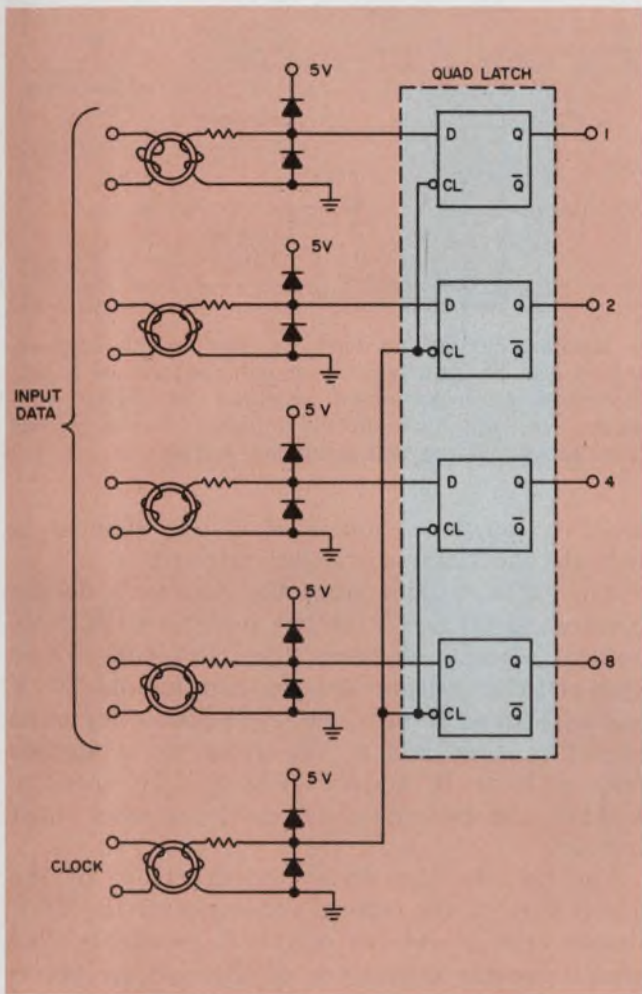

7. To handle parallel input data, the decade counters in Fig. 4 are replaced with two quad-latch circuits. The clock pulse to the latches should be shorter than the latches' D inputs. Fewer turns on the pulse-transformer windings for the clock—say, three turns each on primary and secondary—provide a shorter pulse.

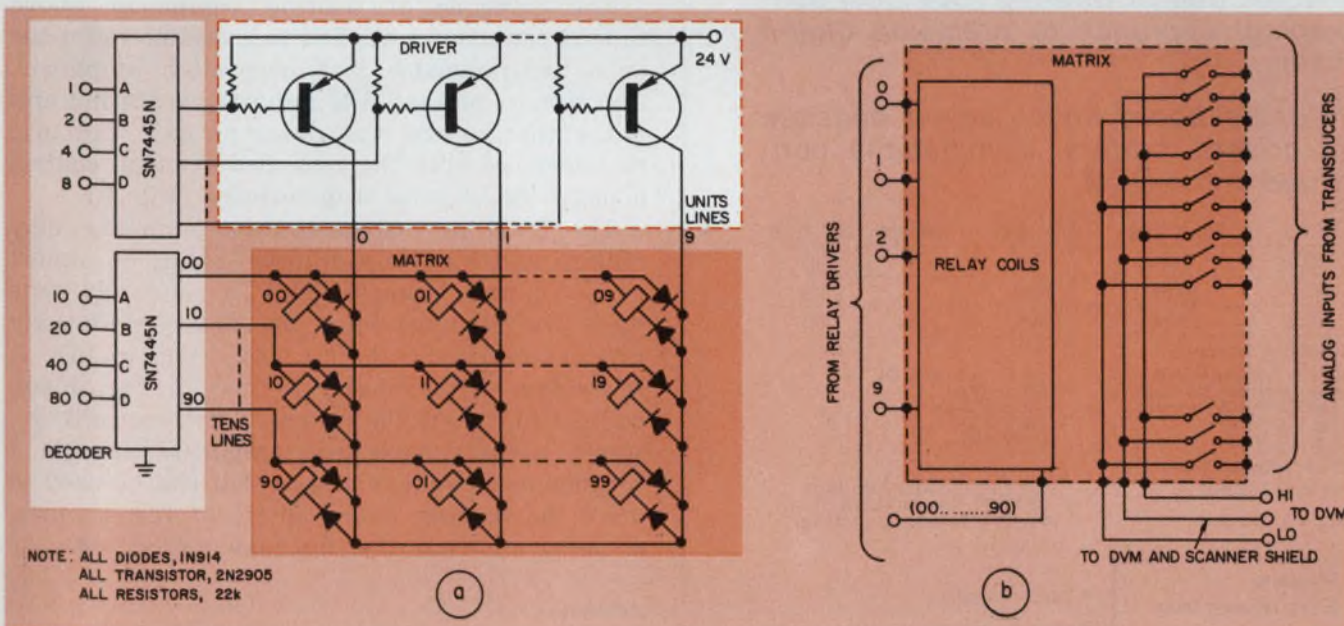

8. One hundred three-pole reed relays are driven via a matrix (a). Two poles scan data lines in (b) and the

third pole selects the isolated shield of each transducer cable and connects it to the scanner guard shield.

NOW Available Without DELAY

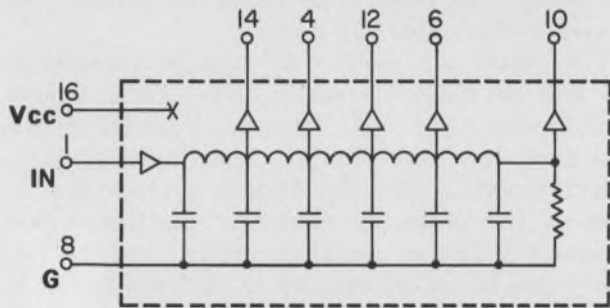

Exclusive from Pulse Engineering DIGITAL DELAY MODULE

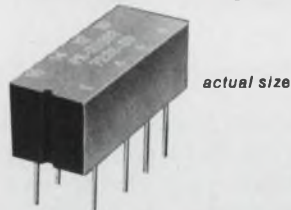

Designed specifically for TTL and DTL compatibility.

Built-in interface allows direct plug-in without additional components.

Module load incorporation reduces number of required components for specific delays, offering your most economical approach to precision digital timing.

Valuable board space saved because all drivers, buffers, terminations contained in the DDM.

PE No.	Delay Time	Delay/Tap	No/Taps	Rise Time
20330	50ns	10ns	5	4ns
20331	100ns	20ns	5	4ns
20332	250ns	50ns	5	4ns

SPECIFICATIONS

Supply Voltage Vcc +4.5 to 5.5 V DC
 Logic 1 Input Current 50 μ A Max.
 Logic 0 Input Current -2 mA Max.
 Logic 1 Vout 2.4V Min.
 Logic 0 Vout 0.4V Max.

Drive Capabilities:

Logic 0 Output 10 TTL Loads/Tap Max.
 (20 TTL Loads/Unit Max.)
 Logic 1 Output 20 TTL Loads/Unit Max.

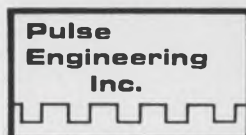

A Varian Subsidiary

Pulse Engineering, Inc.
 P.O. Box 12235 • San Diego, Calif. 92112
 Phone 714-279-5900 • TWX 910-335-1527

INFORMATION RETRIEVAL NUMBER 33

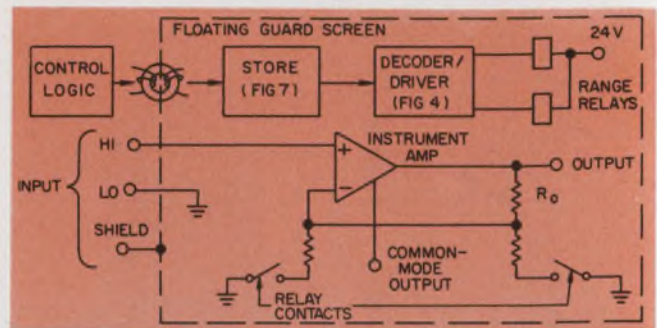

9. Isolation circuits, as they are used in the scanner, should also be employed for range selection of a programmable-gain instrument amplifier or digital voltmeter. This will maintain the integrity of the ground float throughout the data-gathering system.

scanner, can drive numerical display devices to indicate the channel number selected.

The BCD outputs from the scanner's decade counters or latches drive two integrated BCD-to-decimal decoder/drivers, the SN7445s. Their open-collector output drivers can handle 30 V and sink up to 80 mA—sufficient power for most miniature reed relays. The relay drive signals form a 10 × 10 matrix (Fig. 8). To energize a relay, the two matrix lines to a relay must conduct.

The first decoder driver energizes one of the 0-to-9 lines of the matrix and connects the 24-V supply to a line of ten relay-coil terminals. The second decoder selects one of the tens, or 00-to-90 lines, of the matrix and connects the opposite terminals of a line of ten relay coils to the power supply's zero-return line. Diodes in series with relay coils prevent the flow of reverse current and guarantee the operation of only one relay at a time. Diodes in parallel with the relay coils suppress inductive spikes.

The principle of floating equipment above ground can also be applied to a digital voltmeter or a programmable instrumentation amplifier¹. The circuits of the DVM or instrumentation amplifier that control the range or gain can also be interfaced with the grounded external control logic by use of pulse transformers (Fig. 9).

The DVM or instrumentation amplifier may require switching to a different range on almost every channel scanned. This is especially true when the readings must be converted directly into engineering units (°C, psi, rpm, in/in). A reed-relay circuit similar to that in Fig. 4 can be used to control the ranges. Some specially designed programmable-gain amplifiers provide a common-mode voltage output that can be used to drive the floating guard shield of the scanner, amplifier and recording instrumentation. ■■

Reference

1. Tobey, G. E. "Ease Multiplexing and A/D Conversion in Data Acquisition by using Programmable-gain Amplifiers," *Electronic Design*, April 12, 1973, p. 34.

Try any one for 10 days **FREE!**



Your **WESTON** distributor is betting you'll never want to give it up.

Weston, the leader in portable test equipment, is willing to bet that once you try one of our digital DMM's, you'll never want to give it up.

So, during April, May and June, you can try any one of these compact, portable, almost indestructible multimeters for 10 days—FREE! Just pick the one that suits your needs best.

Model 4440 Lowest cost, plus high performance. Full 3½-digits. 17 ranges, 200 mV to 1000V, 200 ohms to 2 megohms, plus AC/DC current. Blinking overrange indicator. Self-contained, re-chargeable battery gives more than 8 hours continuous operation. Or, use AC line converter.

Model 4442 20 ranges, plus amazing accuracy. $\pm .05\%$ of reading \pm one digit—guaranteed! All solid-state circuitry built around MOS/SLI chip. Automatic blanking of unused digits conserves power. Battery or AC line converter.

Model 4443 Lowest price, most precise, DC-only DMM available. 13 ranges, 200 mV to 1000V

(100 μ V res.), 200 ohms to 20 megohms (0.1 res.), plus current. $\pm .05\%$ of reading \pm one digit—guaranteed! Battery operated. Comes complete with charger.

Model 4444 The autoranging maximimumulti-meter. Choose VAC, VDC, Ohms or DC current. The 4444 does the rest. Instant automatic range selection. Plus four full digit display including polarity. Ultimate accuracy in a portable, $\pm .02\%$ of reading \pm one digit. No other portable offers more, does more.

So try one today. Just a note on your business letterhead will deliver a Weston Multimeter to you for a 10-day free trial. Weston Instruments, Inc., 614 Frelinghuysen Avenue, Newark, N.J., 07114.

We're either first or best. Or both.

WESTON[®] 

Go active for sonar or radar filters.

Three input parameters specify a wide dynamic-range circuit that supplants bulky passive designs.

Active filters provide a viable solution to the specialized requirements for doppler bandpass filters in radar and sonar. But the design must be chosen carefully, because the requirements include compactness, constant bandwidths approaching an octave, large input voltage swings, frequency accuracy and 12 dB/octave skirts—all at audio frequencies.

While designers have used passive RLC networks to meet these requirements—especially the need for dynamic range—stagger-tuned active bandpass stages offer several competitive advantages. Their dynamic-range performance, while not as good as for purely passive filters, nevertheless surpasses that of available gyrators. And the circuit complexity of the stagger-tuned filters is less than that of equivalent state-variable circuits.

Narrowing the choice of filter

The required maximally flat, or Butterworth, response can be achieved with passive RLC filters (Fig. 1a), active filters that use gyrators in place of the inductances (Fig. 1b) or a cascade of two op-amp bandpass filters (Fig. 2). Both the gyrator filters and the op-amp circuit provide the required 12 dB/octave skirt. But the gyrator system requires a floating voltage swing to replace L_s in the passive prototype. A complex and potentially unstable filter may result because the required differential input-signal capability equals the large, series-resonant voltage present across L_s .

The third, and most viable, alternative uses two op amps (Fig. 2), each part of a single-tuned bandpass stage. Together they realize the required transfer function:

$$T(S) = \frac{K_4 S^2}{S^4 + K_3 S^3 + K_2 S^2 + K_1 S + K_0}$$

In fact, cascades of such stages can realize Butterworth or Chebyshev polynomials or any transfer function having complex poles in the left-half

plane and zeros at the origin. And the use of such stagger-tuned filters minimizes the required output levels of the op amps for a given output signal, thus affording the maximum signal-handling capability.

Design steps for op-amp filter

A set of design equations for the two-stage doppler filter (Fig. 2) is obtained by equating coefficients of the active prototype to the passive

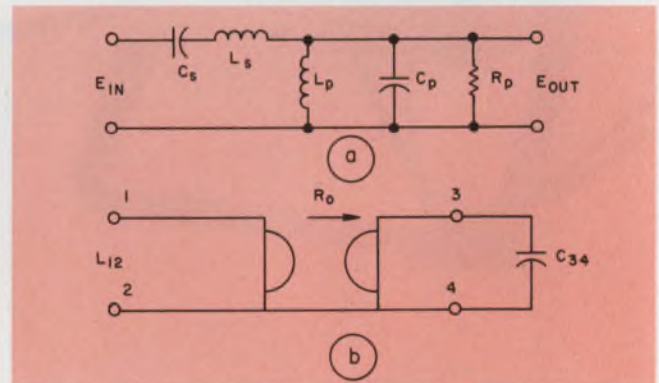

1. Passive prototype doppler filter (a) provides maximally flat 12 dB/octave (four-pole) bandpass response. Bulky inductors may be replaced by a gyrator (b), which transforms inductance to capacitance.

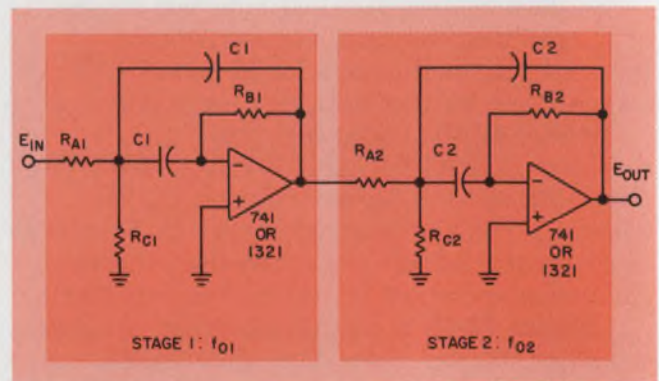

2. A Butterworth bandpass response results from the stagger tuning of two op amp active filter stages. Each stage gives a single-tuned bandpass response. The center frequency of the over-all filter is the geometric product of the center frequencies of each of the stages.

Daniel B. Talbot, Senior Engineer, Martin Marietta Aerospace, Orlando, Fla. 32805.

prototype and forcing the frequency response of the active version to have geometric symmetry. The resulting design equations are given in the accompanying table. Design inputs consist of the center frequency, f_0 , and the filter's 3-dB bandwidth, β . In addition the user must select one arbitrary value, C , for all four capacitors ($0.01 \mu\text{F}$ is suitable for center frequencies from 250 to 2000 Hz).

Now let's consider a typical design with $f_0 = 540 \text{ Hz}$; $\beta = 350 \text{ Hz}$.

Steps 1 and 2 of the table yield

$$\delta = 0.65; d = 0.44.$$

The constant, d , called the dissipation factor, is the inverse of Q for each op-amp stage. In this design procedure both stages will have the same Q and hence the same value for d . Computation of the separation constant, α , from d and δ (step 3), and then computation of the center frequency of each active section, f_{01} and f_{02} , from step 4, gives

$$\alpha = 1.25; f_{01} = 675 \text{ Hz}; f_{02} = 440 \text{ Hz}.$$

Pulsed-doppler detection—A filter problem

Target detection by a pulsed-doppler radar system (a) depends on banks of contiguous filters (b) to separate the frequency-shifted returns from the background noise. But the nature of pulsed-doppler operation imposes a number of special requirements on the filter system.

Each filter bank—one for each range cell—operates on video signals within the audio spectrum. The video signals are derived by zero-beating the incoming returns with the radar's internal STAMO, as shown. The filter requirements stem from the need to preserve the spectral shape and frequency separation of the received signals.

Skirt selectivity is important. Each of the contiguous doppler filters in the range cell must have a sufficiently narrow bandwidth to achieve a useful detection signal-to-noise ratio. The minimum number of filters required then equals the over-all bandwidth of the doppler returns divided by the noise bandwidth of the individual filter—provided the filter has an ideal rectangular bandpass characteristic. For most cases, a bank of maximally flat filters, with 12 dB/octave skirts overlapped at the 1-dB points, suffices. Approximately 40 percent more filters are needed to provide the frequency coverage. (The noise bandwidth of each filter approximately equals the 3-dB bandwidth.)

Large voltage swings must be applied to the filter bank to ensure a specified probability of detection. The large signals are needed to provide an adequate input for tripping the comparator despite the rms signal reduction (equal

to the bandwidth reduction factor) of the post-detection filters.

Finally the doppler filters must maintain constant bandwidth to match the signal return; hence the requirement for a filter that is almost an octave wide at audio frequencies.

In terms of practical filter design, the use of audio frequencies makes for very bulky passive filters, while the wide bandwidths—again, at audio frequencies—preclude mechanical and crystal filters. Active filters are attractive in that they offer adequate bandwidth and stability along with small size and reasonable cost—provided that the large signal swings can be handled.

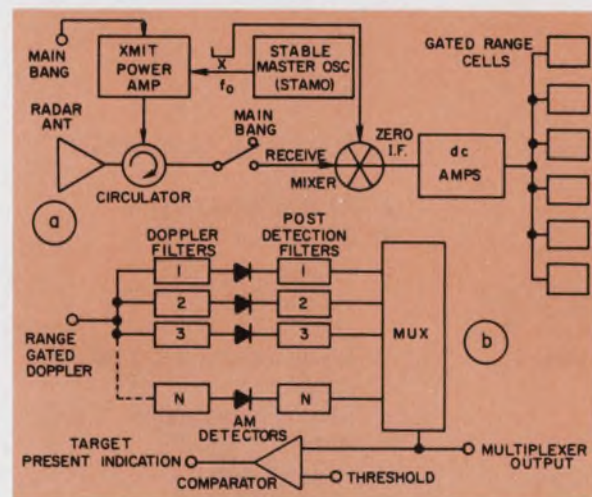

The frequencies f_{01} and f_{02} are related geometrically, since $f_{01} = f_0\alpha$ and $f_{02} = f_0/\alpha$. If desired, both α and d can be found from Fig. 3 once δ is computed.

Since C can be $0.01 \mu\text{F}$, R_A equals $45 \text{ k}\Omega$, which is the value for both op-amp filters (step 5). Inputs of C , f_{01} and f_{02} in step 6 result in values of 107 k and 164 k for R_{B1} and R_{B2} , and in step 7 values of $6 \text{ k}\Omega$ and $9.8 \text{ k}\Omega$ are found for R_{C1} and R_{C2} .

Design and adjustment guidelines

After construction of the actual circuit, trim the R_A values to adjust the gain and the R_C values to obtain the proper f_{01} and f_{02} . Use 2% tolerance capacitors with low temperature coefficients. Maximization of the dynamic output signal swing entails some sacrifice in parameter sensitivity. Sensitivity to component variation is minimal, with equal gain for both op-amp stages. Maximum dynamic range can be achieved by modifying the gain of the last stage only—but with some degradation of noise figure. To increase the gain, decrease R_A but adjust R_C so that the resistance of the parallel combination remains unchanged. Failure to do this will alter the circuit resonant frequency. The design equations yield values for R_A that result in an over-all filter gain of 0 dB in the passband. The gain is

down 1 dB at 0.7 times the 3-dB bandwidth. Op-amp types such as the 741 provide good results for center frequencies below 2 kHz; use of Model 1321 (Teledyne-Philbrick) extends operation to 100 kHz.

Almost ideal performance results when these

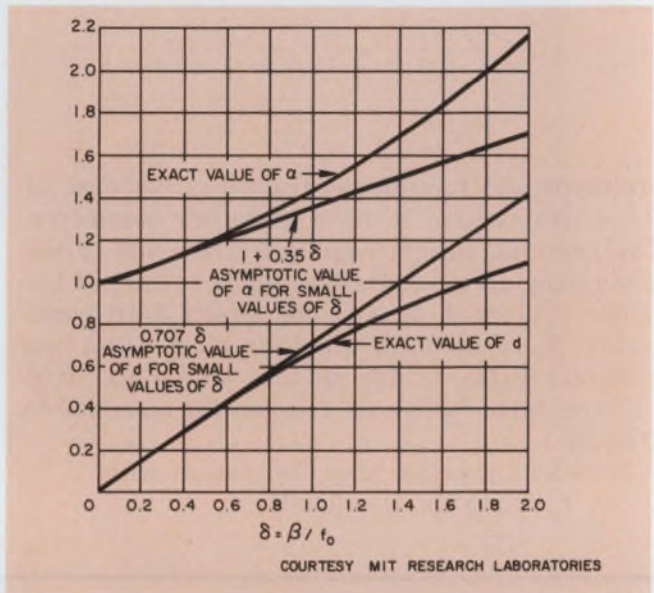

3. Specification of bandwidth divided by center frequency permits graphical determination of dissipation factor ($1/Q$) and geometrical ratio (α) of the two staggered center frequencies, $f_0\alpha$ and f_0/α .

Design steps for Butterworth active filter

$$1. \delta = \frac{\beta}{f_0}$$

where β = Bandwidth (3 dB) in Hz
 f_0 = Over-all center frequency in Hz
 δ = Dimensionless variable

$$2. d^2 = \frac{4 + \delta^2 - \sqrt{16 + \delta^4}}{2}$$

where d = Dissipation factor
 δ = Dimensionless variable in (1)

$$3. \left(\alpha - \frac{1}{\alpha}\right)^2 = \delta^2 - d^2$$

where α = Stagger or "separation" variable
 δ : As defined in (1)
 d : As defined in (2)

$$4. f_{01} = f_0\alpha$$

$$f_{02} = f_0/\alpha$$

where f_{01} = Resonant frequency of 1st stage
 f_{02} = Resonant frequency of 2nd stage
 f_0 = Over-all filter center frequency

$$5. R_A = \frac{1}{2\pi\beta C}$$

where $R_A = R_{A1} = R_{A2}$
 β = Over-all bandwidth (same as in 1)
 C = Capacitance in farads (chosen)

$$6. \frac{1}{\pi f_{01} R_{B1} C} = \frac{1}{\pi f_{02} R_{B2} C} = d$$

where R_{B1} = Feedback resistor for op amp #1
 R_{B2} = Feedback resistor for op amp #2
 f_{01} and f_{02} as in (4); d as in (2)

$$7. R_{C1} = \{R_{B1} [(2\pi f_{01} C)^2 - (R_{B1} R_A)^{-1}]\}^{-1}$$

$$R_{C2} = \{R_{B2} [(2\pi f_{02} C)^2 - (R_{B2} R_A)^{-1}]\}^{-1}$$

where R_{C1} and R_{C2} are the frequency-determining resistors for stages 1 and 2 respectively.

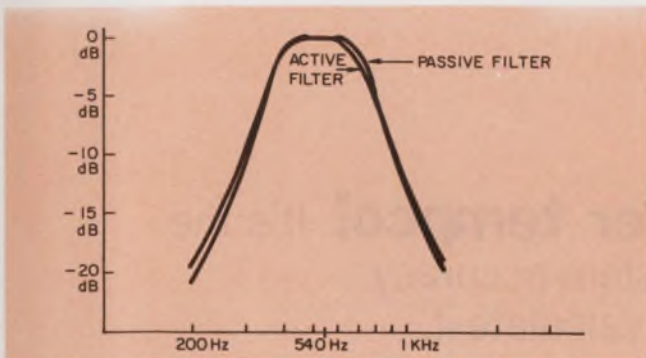

4. Active filter response compared with the original bandpass prototype, $\beta = 350$ Hz; $f_o = 540$ Hz, shows a nearly perfect Butterworth response.

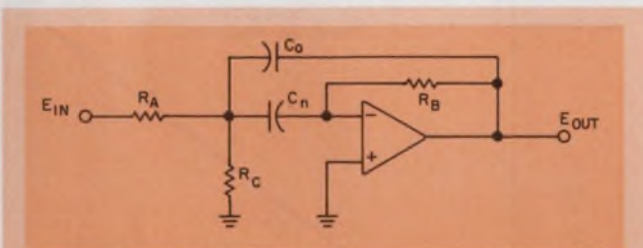

$$\frac{1}{Q} = \left(\frac{1}{R_B(R_A^{-1} + R_C^{-1})} \right)^{1/2} \times \left[\left(\frac{C_n}{C_o} \right)^{1/2} + \left(\frac{C_o}{C_n} \right)^{1/2} \right]$$

$$\left[\text{Gain at Resonance} \right] = \frac{1}{(R_A/R_B)(1 + C_o/C_n)}$$

$$\frac{E_o}{E_i}(s) = \frac{-a_1 s}{s^2 + b_1 s + b_o}$$

$$a_1 = R_A^{-1} C_o^{-1}$$

$$b_1 = R_B^{-1}(C_n^{-1} + C_o^{-1})$$

$$b_o = (R_A^{-1} + R_C^{-1}) / (R_B C_n C_o)$$

5. Each active element realizes a second-order, single-tuned bandpass response. The tabulated equations relate performance parameters to component values.

procedures are followed (Fig. 4), including perfect geometric symmetry of the skirts. Further design details and equations for the individual op-amp, second-order filters are given in Fig. 5. (See also reference.) ■■

Bibliography

Kerwin, W. J., Huelsman, L. P., and Newcomb, R. W., "State Variable Synthesis for Insensitive Integrated Circuit Transfer Functions," *Journal of Solid-State Circuits*, No. 3, Vol. SC-2, September, 1967.

Mitra, S. K., "Transfer-Function Synthesis Using a Single Operational Amplifier," *Electronics Letters*, July, 1967, Vol. 3, pp. 332-3.

Sheahan, D. F., "Gyrator-Floatation Circuit," *Electronics Letters*, Vol. 3, No. 1, January, 1967, p. 39.

Shenoi, B. A., "Practical Realization of a Gyrator Circuit and RC-Gyrator Filters," *IEEE Transactions on Circuit Theory*, Vol. CT-12, No. 3, September, 1965.

Reference

Graeme, Jerald G., Tobey, Gene E., Huelsman, Lawrence P., Editors, "Operational Amplifiers: Design and Applications,"—McGraw-Hill Book Co., 1971, pps 291-293.

TI Introduces the \$1.10 Relay.

TI has come up with a new line of snap-acting time delay relays costing only \$1.10 to \$3.00 when ordered in quantity. That's up to 25% less than conventional creep-acting blade relays—50% less than snap-acting blade relays—less than many conventional magnetic relays or contactors.

They're smaller than ordinary relays, too. They'll operate in any position, and they're resistant to shock and vibration. They also have a proven life that exceeds 100,000 switching cycles.

The secret is our Klixon® snap-acting disc and a new, low-cost electrically-heated ceramic element mounted in a compact phenolic housing.

As an OEM, you owe it to yourself to find out more. Our technical literature spells it all out.



Texas Instruments
MS 952
P.O. Box 5012
Dallas, Texas 75222

Gentlemen: Please send me literature on your new line of snap-acting time delay relays.

Name _____

Company _____

Address _____

Zip _____

TEXAS INSTRUMENTS
INCORPORATED

Don't forget d/a converter tempco! It's the parameter that will probably limit system accuracy. Here's what tempco is and how to calculate it.

Accuracy drift with temperature is one of the most overlooked specifications of d/a and a/d converters. It can also be one of the most troublesome, since system accuracy depends on converter accuracy. If you know what factors contribute to the drift, you're well on your way to calculating allowable drift or the operating temperature range for a specified error.

A converter has three components of inaccuracy at room temperature: offset, gain and linearity. These errors change when the ambient temperature changes. If you take these drifts into account during system design, you can pinpoint your allowable drift. Thus you won't overpay for an unnecessary low-drift converter—nor will you get a “bargain,” with errors that can make the system useless. Let's look at each error component.

Three-error components exist

Offset drift is the change with temperature of the all-bits-OFF voltage—that is, the drift of a d/a's output with an all-ZERO input (noncomplementary codes). Or, for an a/d, it's the change in input voltage required to produce an all-ZERO output. Offset drift introduces an error that is constant over the entire range of the transfer function (Fig. 1). This means that if an offset drift error of 2 mV is measured at 000 . . . 000, an offset drift error of 2 mV will be present at 111 . . . 111 and at every code in between.

The errors at 111 . . . 111 include gain and linearity drift as well as offset error; so measurement of the offset error is difficult at full scale. For this reason, in a typical d/a containing current switches and a binary resistor network, offset errors are measured with all bits OFF, where the only error contributors are switch-leakage currents and offset of the output op amp.

Gain drift is the change in the slope of the converter transfer function (Fig. 2). As shown, gain-drift errors are scale-factor errors that

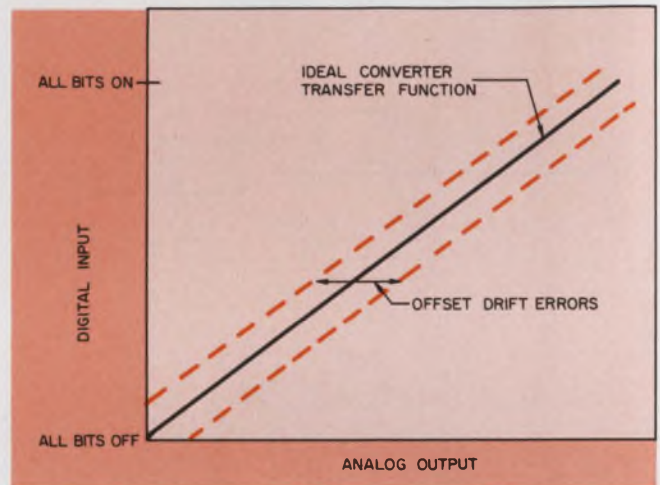

1. **D/a-converter offset error** is defined as the finite voltage or current output for an all-ZERO digital input word. For an a/d converter, offset error is the input voltage needed to produce all output ZEROS. Offset drift is the error variation with temperature.

change the gain of a converter from the nominal value, thus causing errors proportional to the output—that is, the absolute gain-drift error at one-half scale is half the error at full scale.

Gain drift is usually defined as the change with temperature of the slope of the transfer function—that is, the change in the difference between the all-bits-ON voltage and the all-bits-OFF voltage. Thus any offset-drift errors will automatically be compensated since the all-bits-OFF voltage is exactly the offset error.

Linearity error is the deviation of the actual transfer function from a straight line (Fig. 3). The figure shows, on an exaggerated scale, room-temperature linearity errors about the ideal transfer function and the additional errors of linearity drift.

Which drift errors are important depends on the application. In a unipolar data-acquisition system, for instance, one input channel may be grounded so the output of the system a/d converter for this channel is exactly the same as the offset error. Thus the output from this channel can be subtracted from other outputs to correct for offset.

C. R. Teeple, Product Specialist, Burr-Brown Research Corp., International Airport Industrial Park, Tucson, Ariz. 85706.

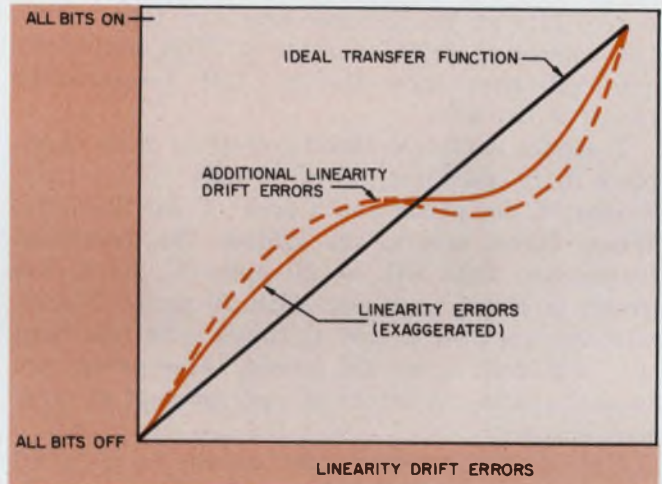
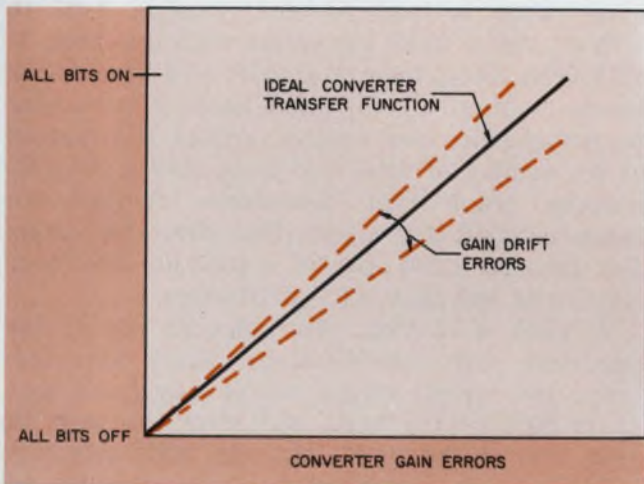

2. **Gain drift errors** are temperature-caused variations in the slope of the converter transfer function. The error is the change in the difference between the voltages corresponding to codes of all-ZEROS and all-ONES. The all bits OFF voltage is also the offset error.

3. **Linearity error** is the transfer-function deviation from an ideal straight line. Linearity drift occurs when the deviation varies with temperature. Note that the deviations shown are exaggerated. Error can be defined as the maximum deviation.

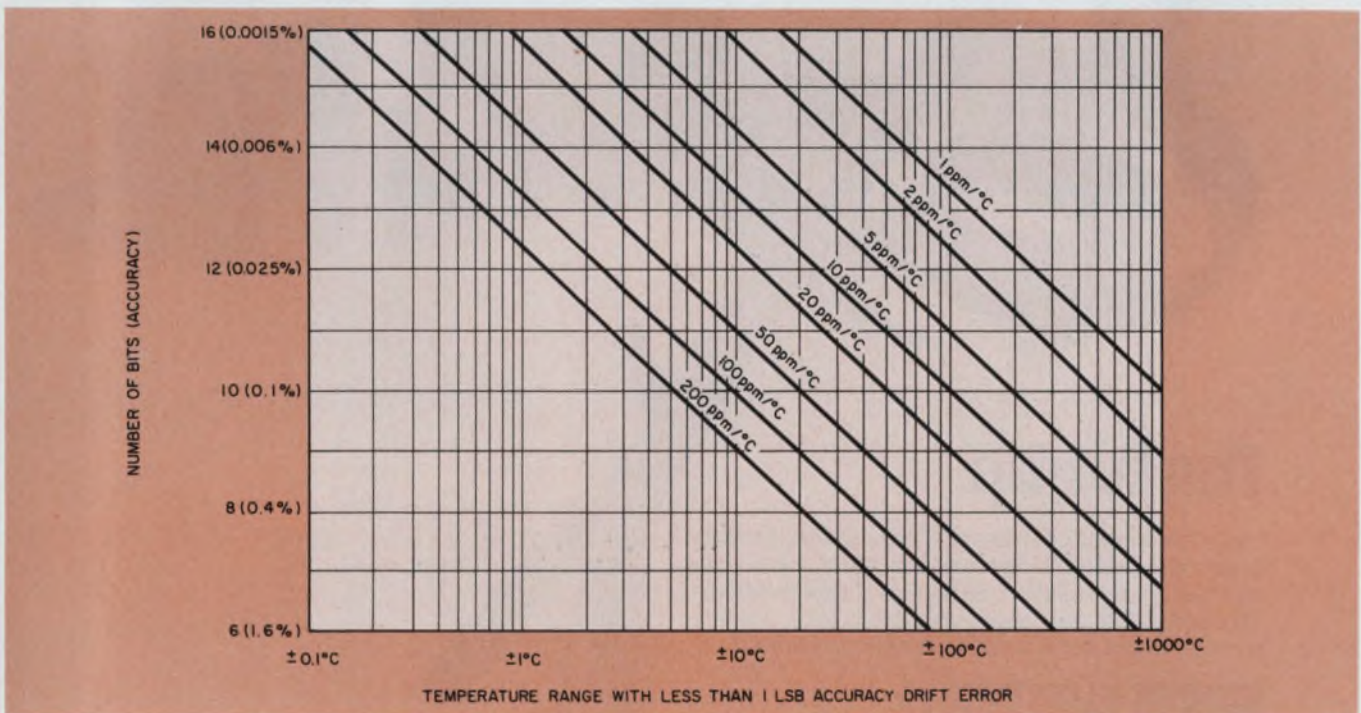

4. **Given a converter's resolution, you can quickly determine the temperature range to confine total errors to**

± 1 LSB. Or you can determine drift if you know the number of bits and the operating temperature range.

Similarly another channel can be arranged to have a full-scale input to correct gain errors. In this situation you need worry only about the linearity drift. In other applications gain or offset, or both, may be important. Other times the combined total of all three drift errors gives the worst-case limit.

Chart simplifies error calculation

A graph (Fig. 4) offers a quick way to determine the temperature range over which a converter will operate with less than ± 1 LSB drift error. For any converter, simply locate the number of bits on the vertical axis and follow it to the combined drift of interest. The horizontal axis will then show the ± 1 LSB temperature range of the unit.

Consider a typical 10-bit converter with maximum drift specifications of 10 ppm/ $^{\circ}$ C for gain, 7 ppm/ $^{\circ}$ C for offset and 3 ppm/ $^{\circ}$ C for linearity. When these errors are added, the combined worst-case drift will be 20 ppm/ $^{\circ}$ C. From the graph, a 10-bit converter with 20 ppm/ $^{\circ}$ C drift will operate over a ± 50 C range with less than ± 1 LSB drift error. Of course, these errors are in addition to the errors already present at room temperature.

Gain and offset errors can usually be adjusted to zero at room temperature. In that case the

total converter error is obtained by simple addition of the drift errors and the room-temperature linearity error. If in the given example gain and offset were adjusted to zero at room temperature, and linearity errors at 25 C were 1/2 LSB, the unit would operate over a ± 50 C range with total errors of less than $\pm 1\text{-}1/2$ LSB—that is, 1/2 LSB + 1 LSB. If the temperature range were restricted to ± 25 C, the converter would have a total error of less than ± 1 LSB—or 1/2 LSB + 1/2 LSB.

The chart may also be used to determine a converter's drift, given the number of bits and operating temperature range. If a ± 50 -C operating range is required—for example, -25 to $+75$ C—for a 12-bit converter with less than 1-LSB drift error, then total drift of 5 ppm/ $^{\circ}$ C or less is required. On the other hand, if the actual percentages are used on the vertical axis instead of the number of bits, Fig. 4 becomes a general-purpose graph that determines temperature range or drift for a specified allowable error. For instance, a 200-ppm/ $^{\circ}$ C system operates over ± 5 C with less than 0.1% drift error.

A word of caution: Any analysis should use maximum drift specifications. Many manufacturers use typical values, which may mean that 40 to 80% of the units will meet the spec. A good rule of thumb is that any drift spec not called out as a maximum is a typical value. ■■



The Cut-Up

Clip of the shears or stroke of the blade and leads are exposed to desired length for termination. No tugging and tearing of insulation. Simplicity of lead exposure offered by all of our flat woven cable is even faster and easier when you specify woven-in cut lines.

WOVEN ELECTRONICS
P.O. Box 189, Mauldin, South Carolina 29662

mighty mods...

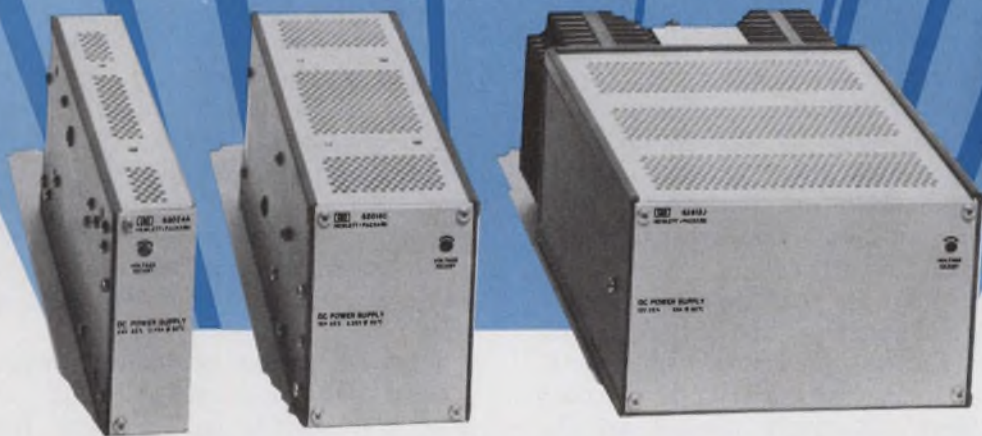

Now . . . High Efficiency, Switching Regulated Power Supplies

The new Switching Regulated Series is the most recent addition to the expanding line of Hewlett-Packard Modular Power Supplies. The MIGHTY MODS started with the 62000 Series — a complete line of modular power supplies with coverage from 3 to 48 volts, up to 192 watts.

The new Switching Regulated Supplies, Series 62600, feature advanced transistor switching design with up to 80% efficiency. You get more power in a smaller, cooler operating package . . . with 4 to 28 volts, up to 300 watts, 0.2% combined line and load regulation, 20mV rms/30mV p-p ripple and noise. And, HP thinks ahead to give you all the protection you need: overvoltage, overcurrent, over-temperature, reverse voltage and protected remote sensing. What it all adds up to is: selection, performance, reliability plus competitive pricing (with quantity and OEM discounts). Whether it's a modular, laboratory, or digitally programmable power supply — be confident when you specify . . . specify HP.

For detailed information, contact your local HP field engineer. Or write: Hewlett-Packard, Palo Alto, California 94304. In Europe, Post Office Box 85, Meyrin-Geneva, Switzerland.

HEWLETT  PACKARD

21303

Four ways to motivate engineers: Make the job clear, important and timely, and give credit for work well done, says this engineering manager. Here's how.

I've heard it said that management is the art of getting three men to do three men's work. To do that, engineering managers have appealed to shame, guilt, punishment, fear and reward. I've often wondered if any of us would resort to torture if we thought it would help us meet the project deadline. I've found that to keep people interested in their work day after day, the four most important things a manager can do are these:

- Make the job clear.
- Make the job important.
- Update the techniques required to do the job.
- Give credit for a job well done.

Why do these particular motivators work so well?

First, I assume that professionally trained people really want to do a good job, and will, if I can tell them exactly what the job is. Their longest-lasting satisfaction will always come from understanding the job and from accomplishing it, bit by bit, over a period of time. What frustrates them is confusion about a job, frequent changes in the job definition that make them think today's work isn't important because they'll just have to redo it tomorrow.

On my projects I use the least possible formalized system that will still get the job done. An informal approach saves me money and motivates my people; it also means that if I expect my people to work effectively toward an objective, I had better explain clearly and repeatedly what I want done.

To make the job important, I strive to create a successful image of the program in their minds. Since professional people don't want to waste their time on anything that isn't worthwhile, I see to it that the project has a good name and that the project members know when the various objectives and goals are reached. This builds both team and individual spirit.

Another spirit builder is to keep the same

engineers on a project from beginning to end. I've found there's no stronger motivation in developing a new design than to retain the same people who are responsible for the preliminary design. Their reputations and their ideas are at stake, and I can't excite people more than when I put them to work making their own ideas a reality. They're not about to admit that their ideas cannot be achieved in a practical and reasonable manner.

One of the most serious threats to good morale and job performance are outmoded company management systems and techniques. I examine these to see if they can't be updated. Of course, the older the system, the more additions there have been, which makes the system cumbersome and inefficient. I try to use a system that will compliment the capabilities of the engineers on the project.

Finally, professional engineering people will respond to both praise and criticism if they're offered in the proper frame of reference. Both are necessary for encouragement. Many supervisors fail to distinguish clearly between good performers and bad performers. The usual result is that everybody feels they're treated pretty much the same regardless of the quality of their work. Even a good man can lose incentive that way.

I tell every man periodically where he stands—what he's doing well and what he's not doing well, and how he can improve. Not everybody does a great job on my projects. Since there's a distribution of performance, I have to see to it that the commendations or criticisms that I issue follow some kind of a statistical bellcurve.

Management responsibility for job enrichment

Another way I help to maintain interest in a project is through discipline. For example, although I encourage talented engineers to create new designs, ideas and techniques, I have to maintain a delicate balance between creative freedom and too much freedom. The moment project members do what they want without regard for the project goals, there's a lack of moti-

R. Richard Heppie, Vice President and General Manager, Navy Programs, Lockheed California Company, Div. of Lockheed Aircraft Corp., Burbank, Calif. 91503.

R. Richard Heppe

Education: B.A., Mechanical Engineering, Stanford University; M.S., Aeronautical Engineering, Stanford University; A.E., Aeronautics, California Institute of Technology.

Responsibilities: Director of all activities in the California Company of the Lockheed Aircraft Corporation on Navy research, development, and production programs.

Experience: Active through a series of technical, engineering, and management assignments in the conception and development of every new airplane of the Lockheed-California Company during the past 25 years. These include the YC-130; XF-104; F-104A; Electra; P-3A; the rigid rotor helicopter; SST; and the S-3A. He joined Lockheed Aircraft Corporation in 1947 as an aerodynamicist, and was appointed Director of Engineering for the ASW Engineering Branch in 1969.

Affiliations: Member and chairman of numerous NACA and NASA Research Advisory Committees; past Vice Chairman of the AIAA Technical Committee on Aircraft Design and past Chairman of the Los Angeles Section of the AIAA. Elected a Fellow of the American Institute of Aeronautics & Astronautics.

Publications: Numerous papers in the fields of aerodynamics and design.

Employer: Lockheed California Company, with headquarters in Burbank, is Lockheed's center for design and production of commercial passenger transports and fighter trainer, patrol, and rotary wing aircraft. Principal activities include L-1011 TriStar commercial jet transport; advanced commercial transport studies; P-3, S-3A, F-104, and SR-71 military aircraft; AH-56A military compound helicopter; advanced fighter aircraft systems; and oceanography.



vation at one end of the project and failure at the other.

I also create and provide learning experiences and opportunities for the engineers. I try to teach them, for instance, that achieving a technical goal is not enough; the achievement is a failure unless it's done within the schedule and the cost that was allotted for the job. I offer staff members opportunities to learn about scheduling, costing and other measures of performance.

Rapid and timely decision-making is still another way I keep interest alive in the project. Nothing can expedite the performance of my organization and improve the morale of my people more than when I decide quickly what must be done. My decisions may not always be right, but they have to be made. The ones that are wrong will be corrected on almost a self-healing basis later. The important thing is that I make the decision so I don't have people standing around.

Also, I try to help the engineer understand that he has a total responsibility for the product. I get him out from behind his drafting table and into the lab and manufacturing shop, then out to where the product is being assembled and being sent to the customer. I let him see, first-hand, the good points as well as the shortcomings of what he has created.

Too many designers are led to believe that their responsibility ends after they've made a drawing, when they should be thinking in terms of creating a usable, practical machine. If the designer is shown that those are two entirely different jobs, his work will become more exciting and interesting.

Weighing in the engineers

Do managerial techniques like these work? Let me tell you about one project I was involved in—achieving the target weight of an aircraft. I had

FOR YOU TO COMPARE

CM50

\$399.00



- Frequency, Ratio, Period, Totalize
- 5 Hz to 50 MHz
- 50 mV Sensitivity
- 6 Digit LED Display
- Leading Zero Suppression
- Trigger Control Status Lamps
- Units Annunciation
- 110 Vac or 12 Vdc

AND DECIDE

analog digital research

INFORMATION RETRIEVAL NUMBER 38

ALCOSWITCH

Low profile keyboard assembly with N.O. Momentary action. Gold clad contacts give 2,000,000 operations. Basic model includes a 3 x 4 and a 1 x 4 matrix that adds to form larger systems. White key-tops have integrally molded figures. Rated 100mA @ 24 VDC.



ALCO® ELECTRONIC PRODUCTS, INC.
1551 OSGOOD STREET, NO. ANDOVER, MASS. 01845

INFORMATION RETRIEVAL NUMBER 39

ALCO
LITE

OFFERS MORE

Snapfits into 5/16" mounting hole. Equipped with high intensity neon lamp and built-in resistor for 110-125V. 6" heavy insulated leads. Withstands temperatures up to 105°C. Available in flush or truncated lenses. Colors are Red, Amber or Clear.

USES NE-2H
HIGH INTENSITY
NEON LAMP.

BIM-4E



BIM-1

ALCO® ELECTRONIC PRODUCTS, INC.
1551 OSGOOD STREET, NO. ANDOVER, MASS. 01845

INFORMATION RETRIEVAL NUMBER 40

to deliver an aircraft in four years and the weight could not exceed a prescribed value. Since many different engineers were responsible for only part of the total weight, I had to find a way to keep the weight down and the interest up.

I identified the managers of the major segments of the total design and posted on a wall outside their offices the target weight they were responsible for and their current status with respect to it. I took care to see to it that their area of responsibility and their names were prominently displayed.

Now, over a period of time, the man in each office is going to be very conscious of his performance. His comrades up and down the halls, with their own signs on display, are going to find this a topic of conversation and this ensures that they'll make their records as good as possible. I could see how the project was going just by walking down the hall. A word of caution here about fairness. When a person has been assigned a target that appears unattainable or unrealistic, relief must be given; otherwise a good man can become demotivated.

I went even further with this technique. I posted a card at each drafting board that listed what the weight for that particular part was supposed to be, what it was now and the names of the people who were responsible. We then clipped some type of red or green signal on the top of this display to indicate at a glance whether that particular element of the design was overweight or underweight. The supervisor coming through the area and the man working at the desk could see the status of the people around him. It was a visible indicator of how the total job was coming and how each person was doing.

I used another technique to recognize both good and bad performance. I was surprised when many supervisors admitted, when asked, that they had not written a commendation or a critique on any individual for years. They had no information on the performance of their people. So I let it be known that once a month copies of all commendations and criticisms would be picked up and put in a folder for their personal use, so they could identify who the good and bad performers were.

No one at the supervisory level had any objections to this. They saw their people being identified by top management, and so they did it willingly. Then I check-marked the supervisors on the organization chart, indicating whether or not each had written any commendations or criticisms that month. There was a copy of the chart lying on my desk, and as the supervisors came and went from meetings, they could see their checkmarks. It provided some very direct motivation, and they started rewarding good performance. ■■

MANY-TAPE MINI

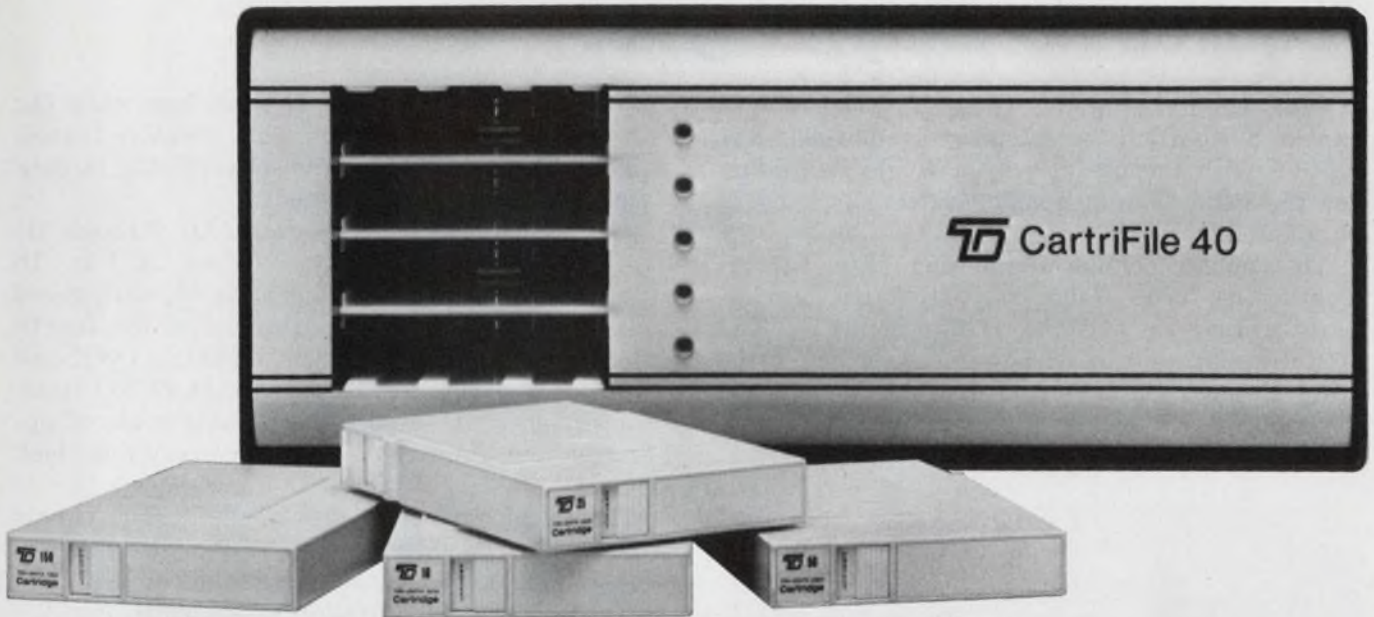

Put these FOUR mag tape drives to work and you'll add real flexibility and power to your minicomputer system. Each drive in the CartriFile® 40 is independently controllable—and reads or writes up to 18,000 bits per second. You can use each drive by itself or in combination with the others.

CartriFile 40 comes complete with electronics (read, write, and controller) plus integral power supply. Also, interfacing, cables, and basic software for all popular minicomputers.

It operates with convenient, single-tape cartridges: new Tri-Data 1000 Series. These are available in 10-, 25-, 50-, and 150-foot lengths. With four 150-foot cartridges, the system can store nearly 13 million bits.

And the price? You'll like it. Only \$4950 with interface; \$3015 in small OEM quantities (without interface).

Get all the facts on the "many-tape mini"—CartriFile 40.



TRI-DATA

800 Maude Avenue / Mountain View / CA 94040
Phone (415) 969-3700 / TWX 910-379-6978

INFORMATION RETRIEVAL NUMBER 41

Self-correcting ring counter requires no external gates

Ring counters having three or more stages can be designed to be self-starting and self-correcting with the use of only a single D flip-flop for the logic. The customary external gating is eliminated.

The counter portion of the ring (Fig. 1a) includes the type 7495 shift-right/left series-parallel register and the D flip flop FF₁. The initial application of dc power causes FF₁ to be reset through the action of R₁ and C₁, and the \bar{Q} output of FF₁ places IC₁ in the parallel mode.

With the first clock pulse, Q_A goes low while Q_B, Q_C and Q_D of IC₁ go high. This negative transition of Q_A places FF₁ in the set condition in turn placing IC₁ in the series mode.

Subsequent clock pulses cause Q_B through Q_D to undergo the transitions shown in Fig. 1b since the 7495 consists of negative edge-triggered master-slave flip flops. At the end of the fourth clock pulse, Q_D changes from ZERO to ONE and this positive edge toggles FF₁ to the ZERO state. Consequently IC₁ enters the parallel mode of operation and the cycle repeats for every five clock pulses.

The total number of bits in the system equals the number of shift register stages plus one. To obtain longer bit lengths, say seven, connect 7495 chips in serial configuration as shown in Fig. 2.

Mukta Lal Kar, Engineer, Space Science and Technology Centre, Trivandrum-22, Kerala State, India 695022.

READER SERVICE No. 311

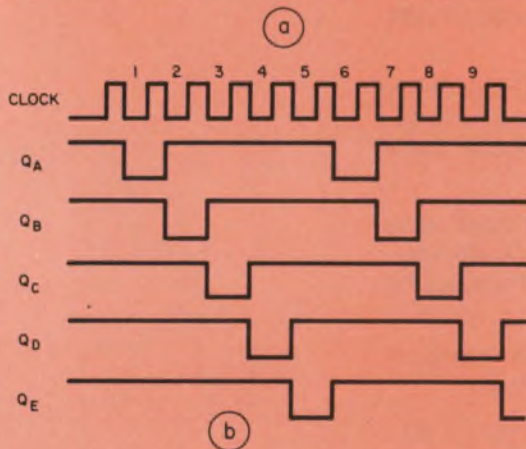
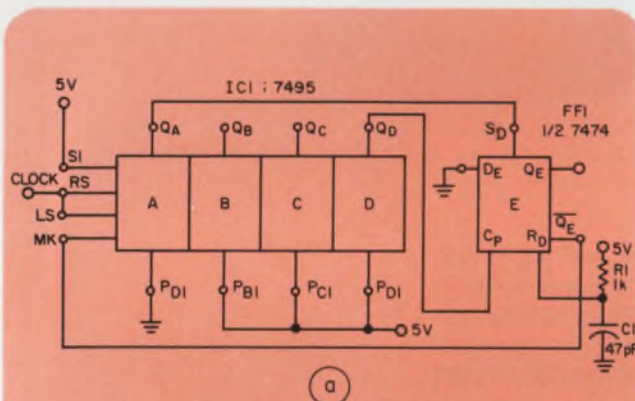

1. Five stage ring-counter includes the four shift-register stages and the D flip flop (a). Initialization and correction are provided by placing register IC₁ in the parallel mode for one clock period (b) through edge clocking of FF₁ with the Q_D bit.

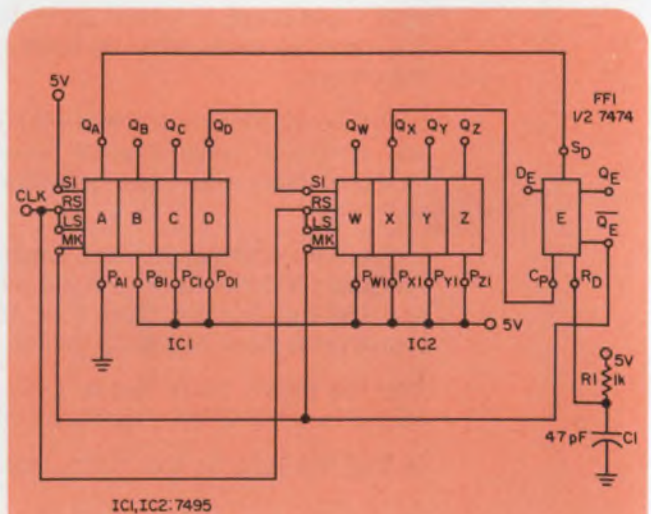

2. Length of N-bit ring counter is determined by the tap used to toggle the D flip-flop as in this seven-bit circuit. No additional gating is required.

clearly...
**CATV is on
our side.**

rf transistors

FROM SOLID STATE SCIENTIFIC

CATV Systems depend on SOLID STATE SCIENTIFIC'S power boosting transistors to go the distance! Here's gain and linearity where you need it—to keep the video crisp and clear through miles of cable. Our CATV transistors will keep your trunk amplifier, bridger amplifier and line extender output signals high and distortion free.

SOLID STATE'S CATV RF transistors—for low cross modulation, low noise figure, minimum signal distortion and fast delivery. CATV and SOLID STATE SCIENTIFIC'S RF transistors—look at it from our side—if your amplifiers use our transistors—you've got the picture.



SOLID STATE SCIENTIFIC INC.

MONTGOMERYVILLE, PA. 18936 ■ (215) 855-8400 ■ TWX-510-661-7267



Op-amp summer modifies VCO chip for clean sinewave operation

An op amp used as a summing amplifier permits economical conversion of constant-amplitude triangular waves to sinewaves without the use of critical components. Thus a commercially available integrated-circuit VCO with triangle-wave output can be modified for use as a sine-wave VCO.

Op amp A_2 sums the outputs of the diode ladder network connected to the triangle-wave output of VCO chip IC_2 . The value of R_7 equals the forward resistance of a single diode, with V_f equal to 0.4 V, while R_8 is approximately twice R_7 . With this arrangement, diodes CR_1 and CR_2 conduct sooner in the triangle-wave cycle than do CR_3 and CR_4 . As a result, the waveshape at the top of the ladder is triangular up to 0.8 V and then flattens to a maximum of 0.85 V, and the voltage across CR_1 and CR_2 is triangular to 0.4 V and flattens to a maximum of 0.45 V. These waveforms, summed in almost a one-to-one ratio, provide a good sinewave approximation at the

output of A_2 .

With the NE566V, there are voltage steps of approximately 0.05 V at the top and bottom of the triangular wave. These tend to cause discontinuities at the sinewave peaks. Negative feedback through trimmer C_6 minimizes them. The trimmer is adjusted for the best waveform at the highest output frequency, and the circuit will then produce an almost pure 1-V rms sinewave.

Input scaling and offset correction are provided by op amp A_1 . With the components shown, the circuit produces a linear frequency shift from 500 Hz to 11 kHz as the input is varied from zero to 1.05 V (scale factor = 10 kHz/V). Lack of harmonic distortion makes this circuit suitable for accurate recording of data on commercial audio-tape or cassette recorders.

Colin S. L. Keay, Associate Professor of Physics, University of Newcastle, New South Wales, Australia.

READER SERVICE No. 312

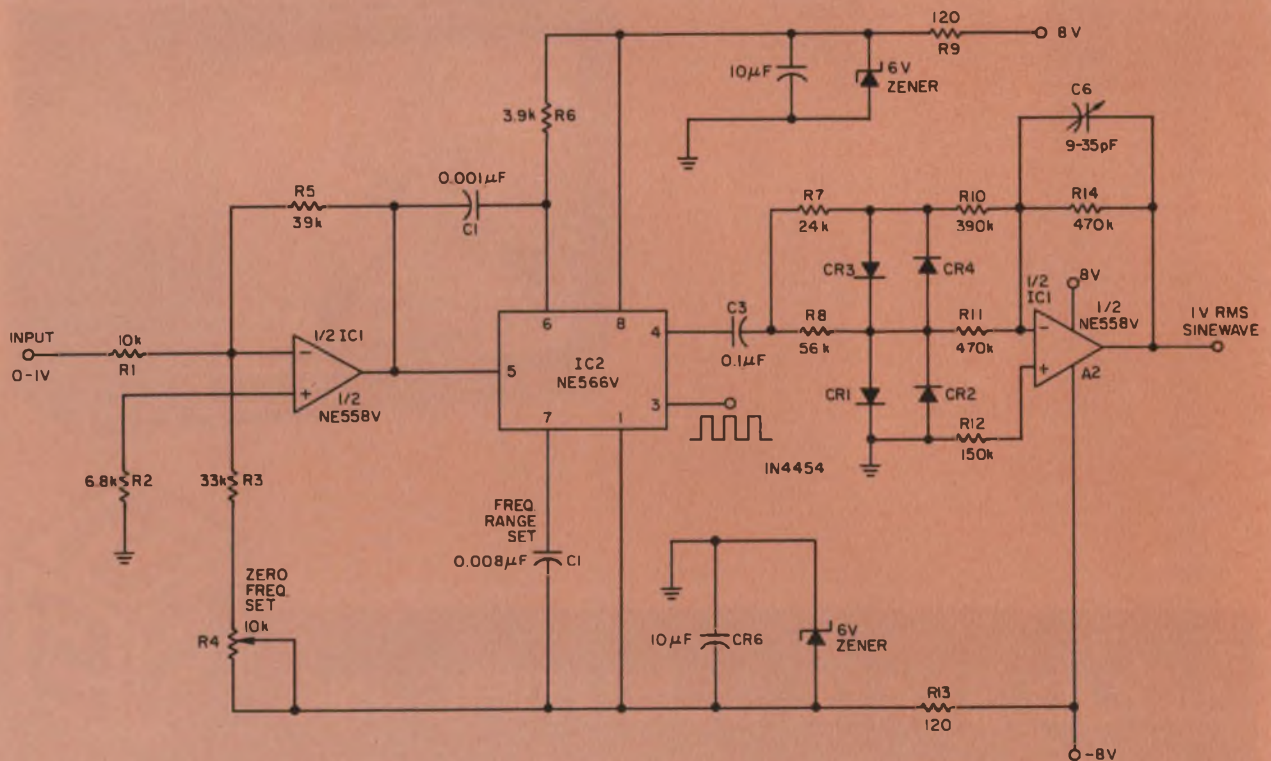

Shaping circuit uses op amp and diode ladder to convert triangular wave outputs from VCO IC to a

sinewave. Trimmer C_6 smooths discontinuities at sinewave peaks.

If you need panel instruments with **custom** dials, cases, accuracy, tracking, resistance, response time, or practically any combination of unusual specs...

Buy **Triplett's** designed-for-you **Panel Instruments**

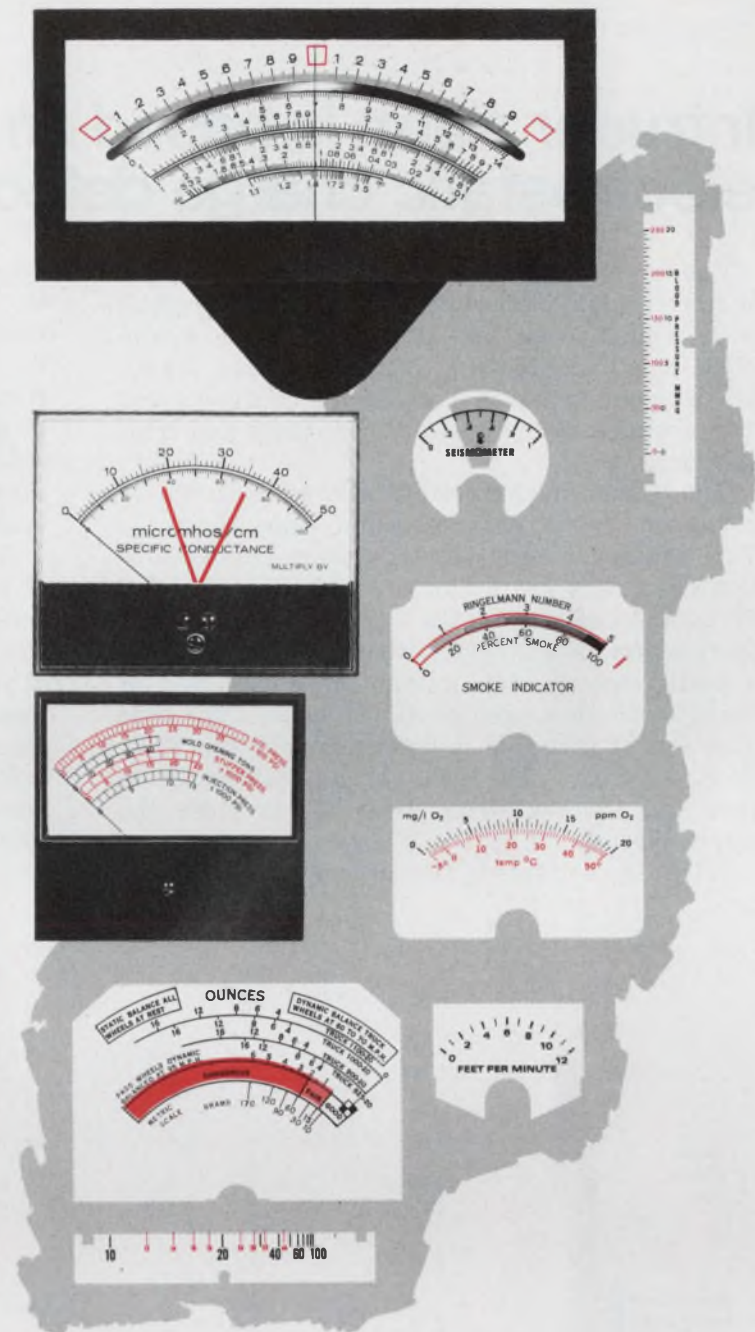

Although we stock some 1369 different styles, sizes and types of standard panel instruments, a very large proportion of our customers buy custom instruments.

Because they need:

custom dials

reading in such units as pH, roentgens, mm Hg, rpm, %, inches.

custom cases

square, round, rectangular, edge-wise (horizontal and vertical), wide, narrow, shallow.

custom accuracy

to within 1/2% with mirror scales and knife-edge pointers.

custom tracking

to match the specific needs of existing or new instrument designs.

custom resistance

for low circuit loading with tolerances as low as $\pm 1\%$.

custom damping

to meet stringent electrical and vibration requirements.

For instance, one of our customers had us design and manufacture a custom instrument to replace — in every detail of physical and electrical specifications — one which he was using on a delicate piece of medical instrumentation. Rejects from his previous source had risen to over 20%. He rejected only 3 of the first hundred we shipped—with almost negligible rejections from the many hundreds we've shipped since.

What custom panel instrument specifications do you need to make your

product more reliable, more accurate, more rugged and — in the long run — less expensive? For quick, dependable delivery of small quantities of Triplett's "designed-for-you" panel instruments, contact your Triplett Sales/Service/Modification Center. For prototypes or production quantities, contact your Triplett representative. He'll put you in touch with our Instrument Designers/Engineers who'll help you analyze the problem and suggest the optimum cost/result solution.

TRIPLETT
BLUFFTON, OHIO 45817
Manufacturers of the World's most complete line of V-O-M's

INFORMATION RETRIEVAL NUMBER 43

Intruder alarm is based on electrostatic charge detection

Use of electrostatic charge detection instead of conventional ultrasonic or rf techniques results in a tamper-proof yet simple intrusion alarm. With this technique, a high-impedance amplifier detects changes in electrostatic charge caused by movement near a metal sensor plate and trips an alarm.

The change in electrostatic charge is caused by a change in the gate-to-ground capacitance C_g . This change in electrostatic charge results in a change in Q_1 's drain current which is amplified by Q_2 and buffered by Q_3 . Transistors Q_3 , Q_4 and Q_1 function as a threshold detector that provides a positive-going step voltage when the rate of change exceeds a predetermined value. (The time duration of this step is determined by the $R_{10}C_5$ time constant.) The voltage step causes Q_3 to turn on, thereby firing triac Q_1 to close the alarm circuit.

With Q_1 activated, the dc voltage produced

across R_{16} by CR_2 , R_{19} and C_7 drops to zero. Now Q_3 is held on by the positive gate voltage developed across the divider composed of R_{15} and R_{16} . The triac conducts and the alarm circuit remains closed until reset switch S_1 is depressed to shunt the gate drive to Q_1 . Once Q_1 ceases conduction, the negative voltage developed through R_{19} and CR_2 keeps Q_3 off which in turn keeps Q_1 off.

A sensor antenna made from a six-inch length of wire is sufficient to detect the movement of a person some six feet away. However, the sensitivity of the circuit is degraded under conditions of high humidity. Also the optimum sensor-antenna configuration for a specific application should be determined empirically.

Robert D. Baird, Manager Solid State Commercial Engineering, RCA Solid State Div., Route 202, Somerville, N. J. 08876.

READER SERVICE No. 313

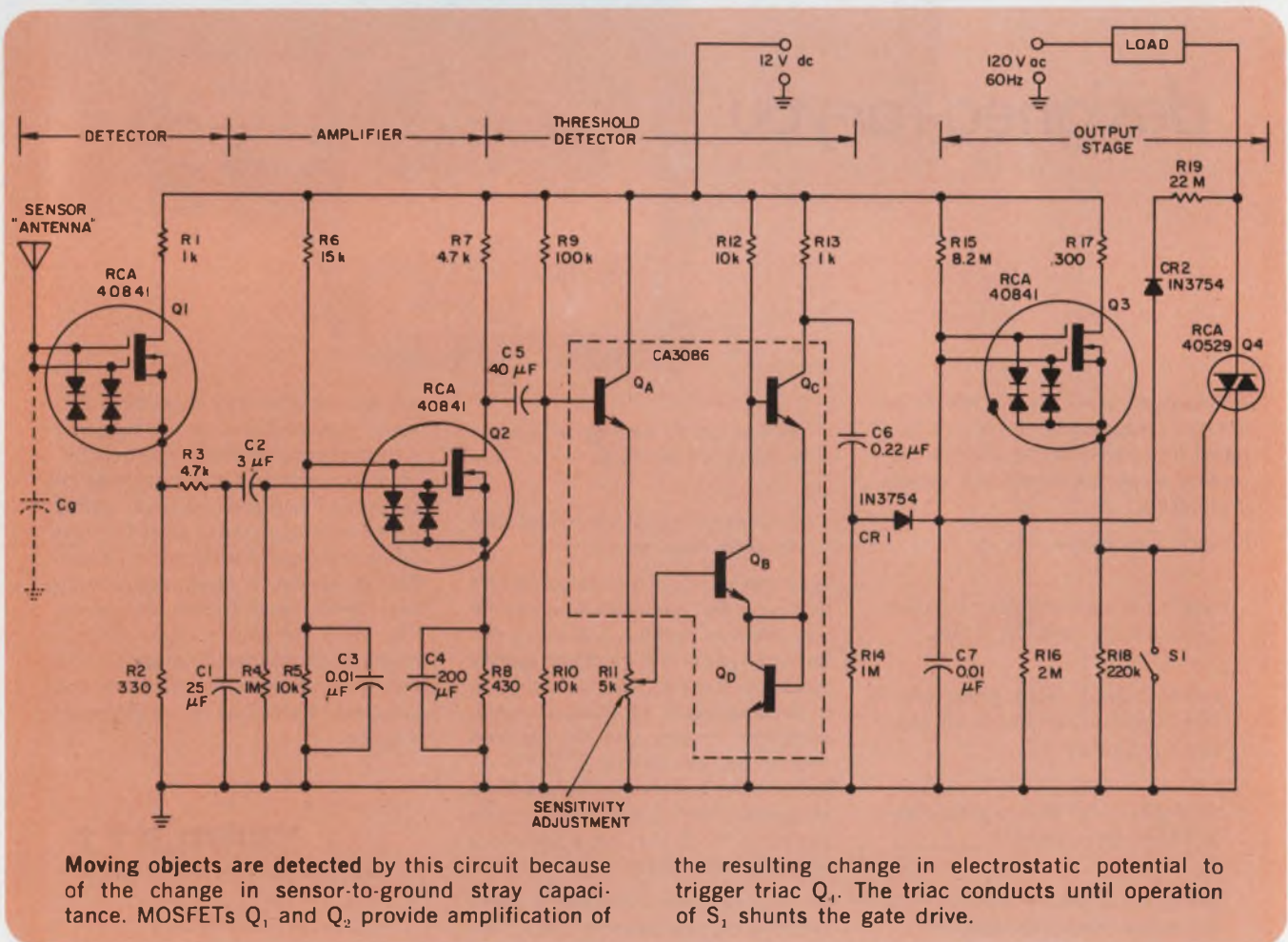

Now!! Selling Direct To Public

**Big Powerful 7 H.P. Briggs & Stratton
Mustang RIDING MOWER**

**DIRECT
FROM FACTORY
TO YOU.**

1973 Model

constructed of steel and built for constant rugged use, this powerful 7 H.P. Mower will easily cut grass and weeds 3 feet deep, pull fertilizer distributor, seeder, roller or any other lawn attachment for your lawn needs.

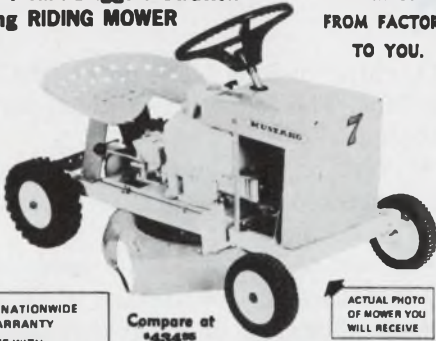

- ONE FULL YEAR NATIONWIDE FACTORY WARRANTY
- COMES COMPLETE WITH ILLUSTRATED PARTS LIST AND FULL OPERATING INSTRUCTIONS.
- TWO DAY SERVICE ON PARTS MOST STATES
- COMES COMPLETELY ASSEMBLED IN CRATE
- BEAUTIFUL BAKED ON CRUST PROOF ENAMEL FINISH
- MADE IN U.S.A.

Compare at \$454.95

ACTUAL PHOTO OF MOWER YOU WILL RECEIVE

now **\$229.95** FULL PRICE

Tax & Freight Paid TO YOUR DOOR

TO OWN ONE RUSH CHECK OR MONEY ORDER
TO: FRANKLIN MANUFACTURING SALES
2783 MAIN STREET
EAST POINT, GEORGIA 30344
PHONE (404) 768-6686

FEATURES

- 7 H.P. BRIGGS & STRATTON (EASY SPIN START) ENGINE
- HEAVY GAGE ALL STEEL CONSTRUCTION
- BIG 25" CUTTER AND MOWING DECK
- RUGGED!! THREE-POSITION TRANSMISSION
- EASY HEIGHT ADJUSTMENT. VARIABLE FROM 1 1/2" to 3 1/2"
- AUTO TYPE STEERING
- BALL JOINT ADJUSTABLE TIE RODS
- TROUBLE FREE POSI-TRAC CHAIN DRIVE
- LARGE 3 x 10 TRACTOR CLEAT SURE-GRIP REAR TIRES
- ALL TIRES SEMI-NEUMATIC
- SAFETY CLUTCH
- WIND TUNNEL DESIGN VACUUM-SUCTION AUTOTEMPERED STEEL DECK.

— ALSO AVAILABLE: —

- STURDY, LARGE GRASSCATCHER ONLY \$20.00
- SNOW PLOW ATTACHMENT LOW PRICE OF \$34.50! THIS PRICE ONLY APPLIES WHEN PURCHASED WITH LAWN MOWER.

A TRULY GREAT OFFER. UNBELIEVABLE. AT TODAY'S INFLATED PRICES

INFORMATION RETRIEVAL NUMBER 44

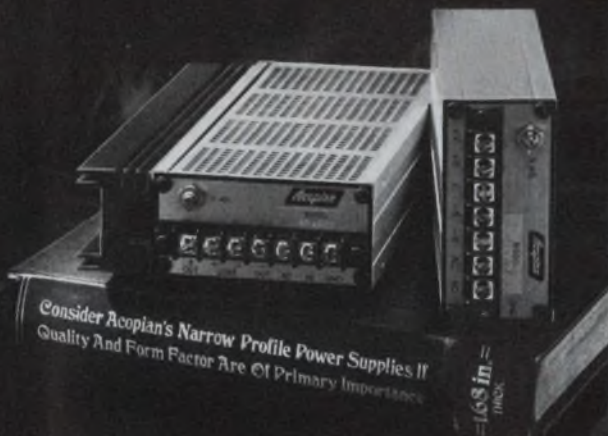

5V @ 4 amp or ±15V @ 500 ma... in 1.68"

The Model A5NT400 delivers 5V @ 4A with regulation of ±2 mv and ripple of 0.25 mv. Price, \$150. The FD15-50 provides tracking ±15V @ 500 ma. Regulation ±0.1%; ripple, 1.5 mv; price, \$115. Standard input, 105-125 VAC, 50-400 Hz.

Other single output models to 150 volts; ±12 and ±15 volt duals to 1 amp. All only 1.68" thick. Three day shipment guaranteed.



Acopian Corp., Easton, Pa. 18042
Telephone: (215) 258-5441

INFORMATION RETRIEVAL NUMBER 45

ELECTRONIC DESIGN 9, April 26, 1973

Eight



**Marco-Oak
Presslites
qualify under
MIL-S-22885**



Who says a tough switch can't be bright and beautiful?



- Listed on QPL 22885
- 3 to 15 amps, alternate and momentary
- Variety of pushbutton sizes, shapes and colors
- Complete specification catalog now available

Lighten your decisions
contact . . .

MARCO-OAK

A Subsidiary of OAK Industries Inc.

P.O. Box 4011
207 S. Helena Street, Anaheim, Calif. 92803
Tel. (714) 535-6037 • TWX — 910-591-1185

INFORMATION RETRIEVAL NUMBER 46

143

Ground lead provides inhibit function for TTL inverters

Six logical OR circuits can be implemented by a single hex inverter chip if the ground lead is used as a logic input. This method is especially useful when a single inhibit control is needed.

Each of the six relays shown is controlled by a single logic signal, A to F. A logic ONE on any line causes the corresponding relay to operate, provided X is a logic ZERO. Since an ungrounded TTL chip cannot sink current into its outputs, keeping the ground wire at logic ONE or open prevents operation of the relays. The logic function performed by an inverter with input A is $\bar{A} + X$.

The technique can be applied to other types of

TTL chips such as NOR gates, NAND gates and flip-flops. The following restrictions apply to this technique:

- Point X must be capable of sinking the supply current of the chip and the current flowing into its outputs.
- Worst-case logic ZERO levels at the outputs are increased by the voltage of X.
- All elements in a package are inhibited by X; spare inverters cannot be used elsewhere unless a "don't care" condition exists.

John C. Byrne, 50 Leduc Dr., Rexdale, Ontario, Canada M9W 2A9.

READER SERVICE No. 314

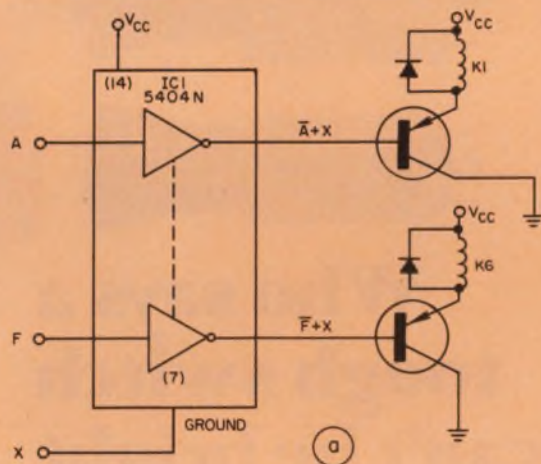

Use of the ground lead as a logic input (a) generates the function $\bar{A} + X$. Relay K₁ operates when the function of $A \cdot \bar{X}$ is true. The inhibitory effect of

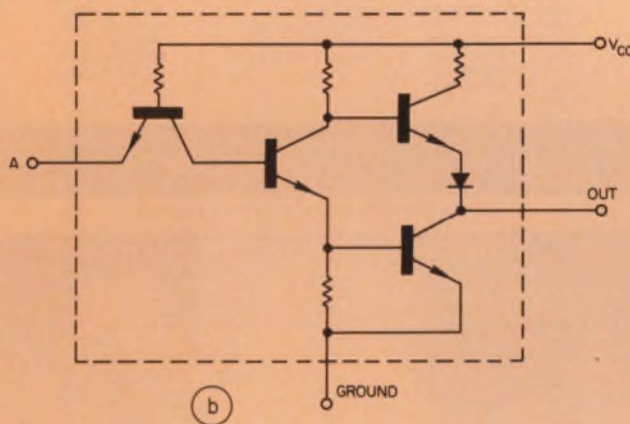

the ground lead occurs because a TTL inverter (b) cannot sink current unless grounded. Use of the ground lead affects all elements in the package.

IFD Winner of December 21, 1972

K. N. Pal, Assistant Research Engineer, Research and Development Div., TISCO, Jamshedpur, India. His idea "Transformerless voltage doubler has good output regulation" has been voted the Most Valuable of Issue Award.

Vote for the Best Idea in this issue by circling the number for your selection on the Information Retrieval Card at the back of this issue.

SEND US YOUR IDEAS FOR DESIGN. You may win a grand total of \$1050 (cash)! Here's how. Submit your IFD describing a new or important circuit or design technique, the clever use of new component or test equipment, packaging tips, cost-saving ideas to our Ideas for Design editor. Ideas can only be considered for publication if they are submitted exclusively to ELECTRONIC DESIGN. You will receive \$20 for each published idea, \$30 more if it is voted best of issue by our readers. The best-of-issue winners become eligible for the Idea of the Year award of \$1000.

TRY THIS PHILIPS MULTIMETER FOR 15 DAYS

then - return it without obligation
if it doesn't meet
your every requirement.

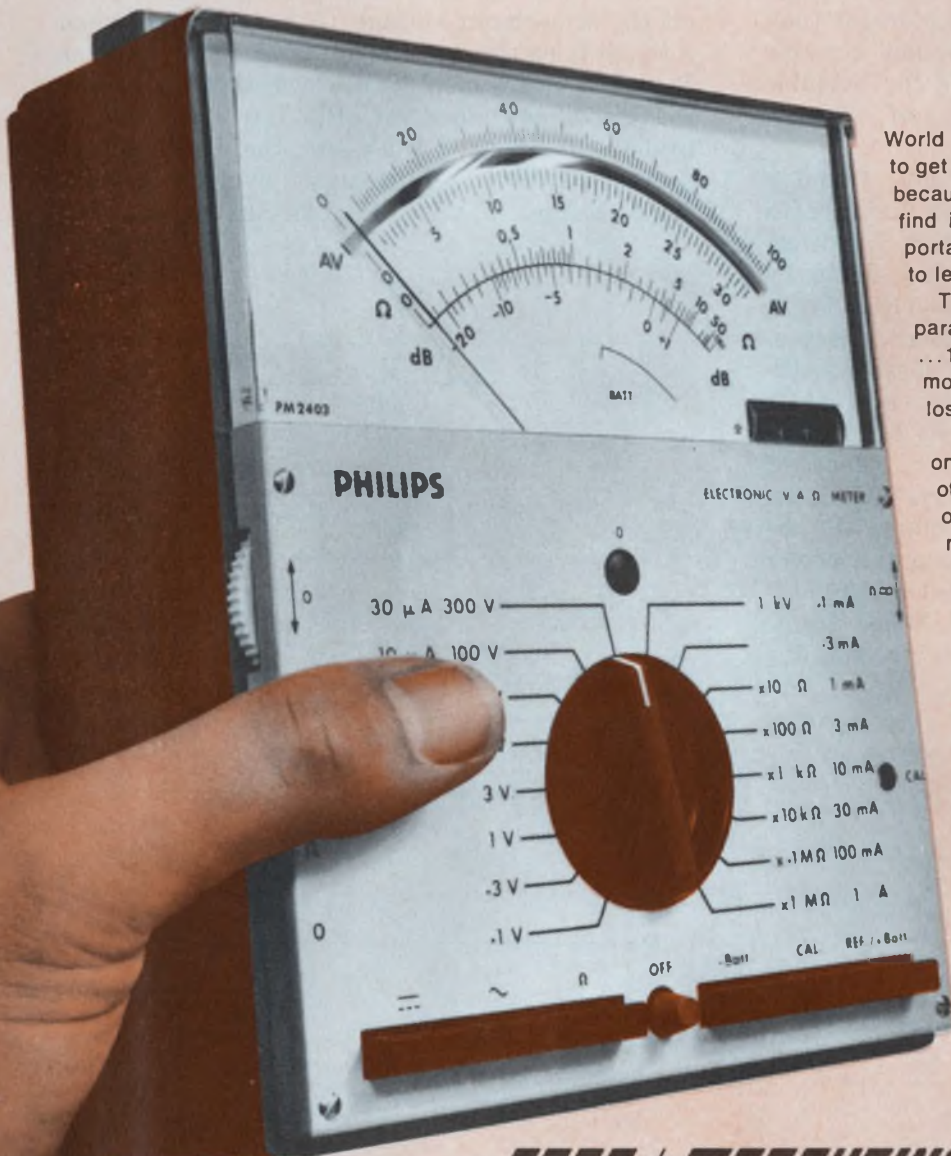

World famous Philips who makes the PM2403 is anxious to get this versatile FET-input multimeter into your hands because they're confident that once you use it, you'll find it such a unique experience in general purpose portable, electronic multimeters, that you'll never want to let go of it!

The PM2403 has input impedance of 20 MΩ in parallel with 30 pF on the 100 mV AC and DC scales ... 10 MΩ in parallel with 50 pF on other ranges. No more need to worry about circuit loading effects and loss of accuracy.

The PM2403 offers guaranteed accuracy of 2% on DC voltage ranges and 3% (guaranteed) on all other voltage and current ranges, even at 100 mV or 1 μA full scale, and flat out to 25 KHz. Resistance measurement accuracy is 5% at mid-scale readings from 10Ω to 1MΩ.

The PM2403 separates combined AC/DC signals automatically; and the reading is always up-scale, even when you've connected the leads backwards. A separate indicator shows you the polarity of every measurement and even lets you turn PM2403 into a sensitive DC null detector for voltage (100 μV) or current (1 nA).

It all adds up, we say, to a unique experience in general purpose portable electronic multimeters for the modest investment of \$130... an experience you can't afford to miss.

And that's why... if you act now... Philips is offering a 15-day free trial of the PM2403 with no obligation to buy.

For data and for details of the free trial offer, fill out and mail coupon to Test & Measuring Instruments Inc., 224 Duffy Avenue, Hicksville, New York 11802.

TEST & MEASURING INSTRUMENTS INC.
A NORTH AMERICAN PHILIPS COMPANY

- 48 ranges on only 4 scales; no-parallax mirror-scale readout.
- Pushbutton self-calibration, battery check.
- Overload protection to 3 KV.
- 6 ampere fusing on current ranges; inherent protection on resistance ranges.
- 2% guaranteed accuracy on DC voltage ranges.
- Completely shielded case and Philips ring-core meter movement for EMI isolation.
- Specifications and calibration procedure on back of case for ready reference.
- Test leads and leather case supplied.
- Full range of matching probes and shunts available.
- 1 year unconditional warranty.

TEST & MEASURING INSTRUMENTS INC.
A North American Philips Company
224 DUFFY AVENUE, HICKSVILLE, NEW YORK 11802

- Rush details of your 15-day free trial offer on the PM2403
 Send complete data on the PM2403

NAME _____

COMPANY NAME _____

COMPANY STREET ADDRESS _____

CITY _____ STATE & ZIP _____

TELEPHONE _____

Battery saver slashes standby power drain

Because they're small, integrated circuits are ideal for portable equipment. But their generally low resistances cause higher current drains than those of equivalent discrete-component circuits. And that, of course, is undesirable for portable instruments, where conservation of battery power is a major concern.

Intech, Inc., of Santa Clara, Calif., found a way to resolve this difficulty in the design of a portable, hand-held radio transceiver. A power-saver circuit reduces standby battery drain by a factor of 10. Here's how it works (Fig. 1):

Standby power to the receiver circuitry is continuously switched on and off by an astable multivibrator. The multi's time constants are set to turn power on for about 50 ms and off for 450 ms.

If a radio call comes in while the transceiver is in the pulsed standby state, a sense switch detects the transmission during the 50-ms ON interval and signals the multi to keep the power switch closed. Power is then supplied continuously, as long as a signal is received. When transmission stops, the circuit returns to standby status.

The complete schematic of the battery saver is given in Fig. 2. The transmission sensor picks off the squelch-out voltage (V_o) generated when a signal is received at the antenna. Potentiometer R_3 allows adjustment of the threshold at which the circuit switches on. R_{15} introduces slight hysteresis—about $0.4 \mu\text{V}$ —in the threshold to prevent erratic switching caused by noise or other small changes in V_o . **READER SERVICE No. 315**

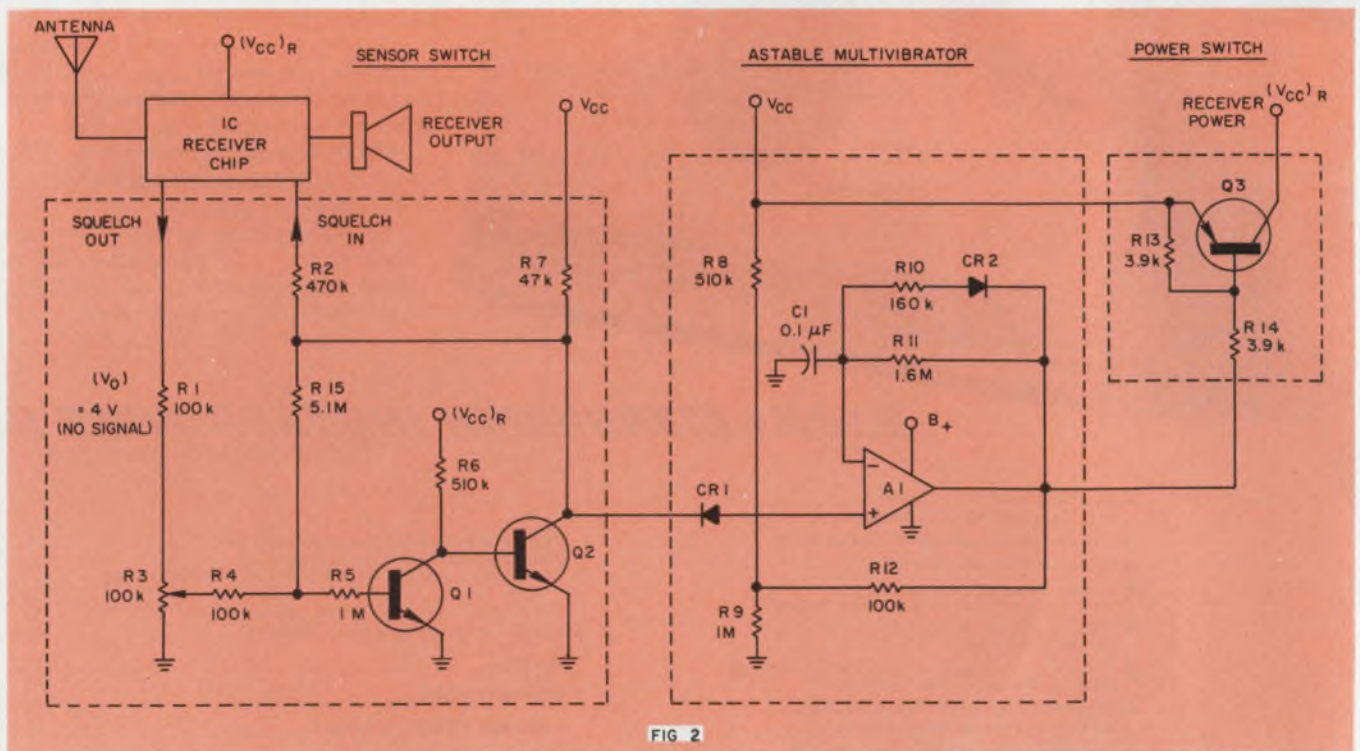
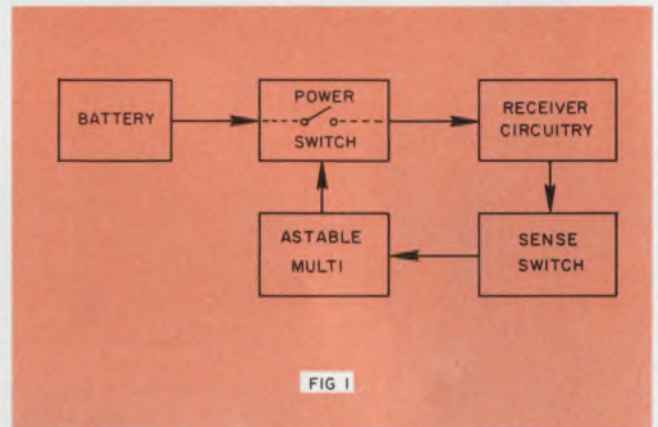

Either our drives outdrive their drives or your money back.

Plus interest.

Chances are we'll never have to pay off because our drives are the best you can buy. And we know it. We design them ourselves and build them to exceed the most demanding requirements in the industry today.

SERIES 6000 MAGNETIC TAPE UNITS. Tape speed 12.5 to 45 ips. Reel size 10.5 or 8.5 inches. Seven or nine track, half inch tape. High speed (200 ips) fast forward and rewind. All standard densities. Industry compatible interface. Simple design with few moving parts. File protect. Self seating reel hold down hubs. Controlled dynamic braking. Automatic multi-level read thresholds. Channel-by-channel electronic deskewing.

SERIES 8000 CARTRIDGE DISC SYSTEMS. 100 and 200 tracks-per-inch. 25 or 50 and 50 or 100 million bits storage capacities. Single and dual drives. IBM 5440 removable disc cartridge. Access time 10 milliseconds track to track. Data error during read or write less than 1 in 10^{12} . Disc rotation 1500 or 2400 rpm. MTBF 5000 hours. Simple design with few moving parts.

Only 8.75 inches high including power supply. Positive optical head positioning. Try us. See if you can get your money back. Write for details, or ask for a call from

one of our salesmen.
Microdata Corporation.
17481 Red Hill Avenue.
Irvine, California 92705.
(714) 540-6730.

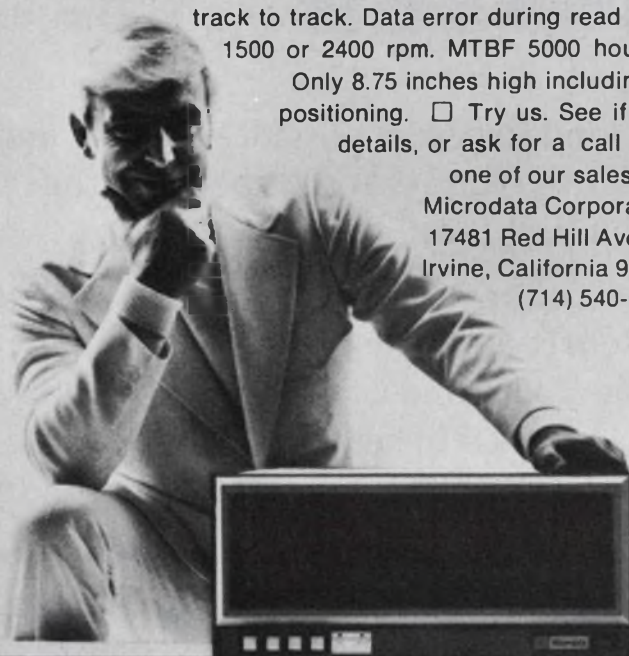

from the bold guys at

Microdata™

Support a good cause: You.

The U.S. Savings Bond Program provides an easy and safe way for you to plan for the future. And it benefits the country, too.



Robert W. Sarnoff

For the second consecutive year, Robert W. Sarnoff, RCA Chairman of the Board and Chief Executive Officer, has agreed to head the U.S. Savings Bond Program in the electronics industry.

RCA and its employees have been enthusiastic supporters of the Program since it began. Last year, 88% of RCA employees participated in this systematic method of saving.

So if you want to support a good cause, think about yourself and your country. Buy U.S. Savings Bonds.

Take stock in America.

Buy U.S. Savings Bonds

new products

100-V/ μ s slew rate available in a high-voltage FET op amp



Dynamic Measurements, 6 Lowell Ave., Winchester, Mass. 01890. (617) 729-7870. See text; stock.

Until now, FET-input operational amplifiers capable of handling and delivering high-voltage swings have offered typical slew rates of 30 V/ μ s or less. Two new models from Dynamic Measurements, the 180 and 181, offer a 100-V/ μ s minimum slew rate—the fastest available for op amps with more than a \pm 110-V output swing. The new op amps operate over a temperature range of -25 to $+85$ C.

The 180 and 181 also feature unity-gain bandwidths of 5 MHz minimum and 10 MHz typical (five times better than competing units), a full-power bandwidth of 150 kHz (three times better than any competitor) and an open-loop gain of 110 dB minimum. For both models, the output is rated at $(V_{cc}-10)$ V, where V_{cc} can range from \pm 60 to \pm 150 V, depending

upon the model, with a 10-mA supply current.

The three nearest competitors, in terms of output voltage and slew rate, are the Intech Model A301, the Teledyne-Philbrick 1022 and the Burr-Brown 3038. None can come close to the slew rate or bandwidth of the 180 and 181.

Other specifications, though, are similar for all four op amps: The input bias currents are \pm 10 pA; the common-mode-rejection ratios near 100 dB, and the maximum output voltage swings range from \pm 115 to \pm 140 V. But the settling time of the Dynamic Measurements units is a guaranteed 2 μ s maximum (to 0.1%)—at least half that of competitive units, where specified.

The 180 is an economy version of the 181 and has a common-mode voltage range of only \pm 50 V, compared with \pm 135 V for the 181. The 180 also has a maximum supply voltage of only \pm 120 V instead of \pm 150 V. Offset voltage

vs temperature is 50 μ V/ $^{\circ}$ C for the 180 and 181 "A" models and only 20 μ V/ $^{\circ}$ C for the "B" versions.

Pricing for the new op amps in unit quantities is \$75 and \$85 for the 180 A and B, respectively, and \$90 and \$120 for the 181 A and B.

For Dynamic Measurements

READER SERVICE NO. 251

For Intech

READER SERVICE NO. 252

For Teledyne-Philbrick

READER SERVICE NO. 253

For Burr-Brown

READER SERVICE NO. 254

LED coupler is priced at 90¢

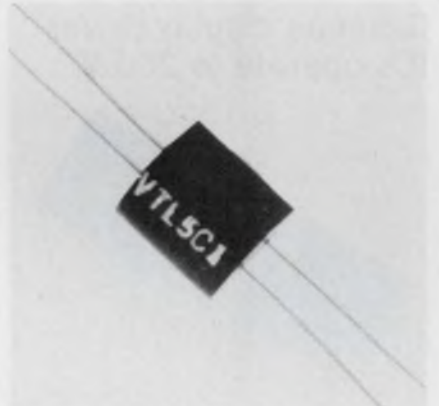

Vactec, 2423 Northline Industrial Blvd., Maryland Heights, Mo. 63043. (314) 872-8300. P: See below.

A LED/photoconductive coupler, VTL5, has the lowest cost of couplers of this type. Unit cost is as low as \$1.25 in quantities of 100 and decreases to 90¢ in quantities of 1000. The coupler is a small axial counterpart of the company's TO-5 packaged-LED/photoconductive-coupler. Applications include photochoppers, isolators and noiseless switching.

READER SERVICE NO. 257

8-k bipolar ROM has 150-ns access



Monolithic Memories, 1165 E. Arques Ave., Sunnyvale, Calif. 94086. (408) 739-3535. MM6280: \$55 (100 up); stock.

A fast-access ROM with 8192-bit storage lists an access time of 150 ns maximum. Called the MM-5280/6280, the new memory also features a power dissipation of 50 μ W per bit, fully decoded on-chip address decoding and DTL/TTL compatibility with 1/10 of standard-TTL input loading. Organized in a 1024 \times 8 format, the memory is packaged in a 24-pin ceramic DIP.

READER SERVICE NO. 258

Gaseous display-driver ICs operate to 200 V



Dionics, 65 Rushmore St., Westbury, N.Y. 11590. (516) 997-7474. DI267N: \$3.77; DI297N: \$2.57 (1-99).

A series of dielectrically isolated ICs provide constant-current drive for seven-segment gas-discharge displays. The ICs are capable of operation up to 200 V. Units in the line are also rated at 175, 150 and 125 V. Output current levels are externally programmable from 0.2 to 2.0 mA. All drivers are packaged in an 18-pin DIP.

READER SERVICE NO. 259

Power transistors offer improved specs



Soliton Devices, 1177 Blue Heron Blvd., Riviera Beach, Fla. 33404. (305) 848-4311. \$1.75 (prod. qty.); stock.

A line of 50-A, 60-V germanium DAP power transistors, the SDG-604/7, are said to offer improved specs over similar devices currently available. Intended primarily as replacements for 2N4276/83 devices, the new transistors are packaged in a TO-3 case with special 60-mil emitter leads for increased current capability. Saturation voltages are typically less than 0.9 V at 50 A. The V_{CE0} rating ranges from 20 V (for the SDG-604) up to 60 V (for the SDG-607).

READER SERVICE NO. 260

Rectifier-bridge assemblies introduced



Westcode Semiconductors, 282 Belfield Rd., Rexdale 605, Ontario, Canada. (416) 677-5881.

A series of epoxy-encapsulated silicon-rectifier bridges, type SxP, can withstand overload currents to 300 A and have an I^2t rating of 450 A² sec. Repetitive voltage ratings reach 1200 V. Single-phase units have current ratings ranging from 3 to 10 A at a case temperature of 55 C, while for three-phase units the corresponding range is 3.5 to 10 A.

READER SERVICE NO. 261

Transistor chopper handles up to ± 15 V

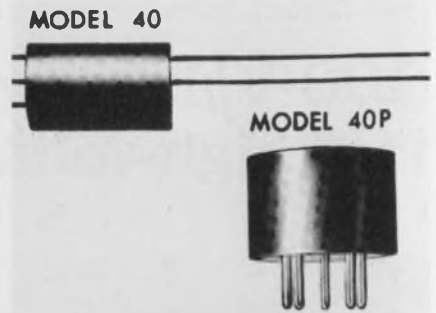

Solid State Electronics, 15321 Rayen St., Sepulveda, Calif. 91343. (213) 894-2271.

The Models 40 and 40P silicon-transistor choppers provide linear switching or chopping of voltages from a fraction of a millivolt up to ± 15 V over an operating temperature range of -55 to 150 C. Square-wave drive voltages can reach 15 V pk-pk with drive frequencies extending from dc to 50 kHz. Linear deviations are typically less than $\pm 0.5\%$ from a straight line.

READER SERVICE NO. 406

Schottky-TTL gives ICs 4-ns multiplex/select

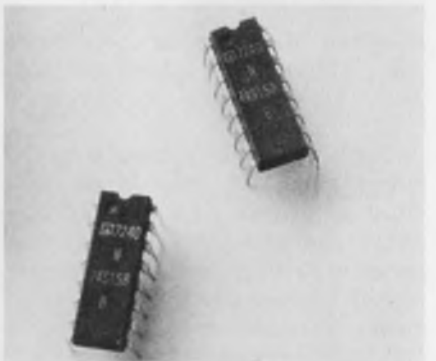

Signetics, 811 E. Arques Ave., Sunnyvale, Calif. 94086. (408) 739-7700. About \$5 (100 up).

The 157 and 158 Schottky-clamped TTL ICs select a four-bit word from one or two sources and route the data to four outputs. The selection and multiplexing can be performed with a propagation delay of only 4 ns. The 157 presents true data, while the 158 outputs inverted data. The ICs are available in military versions (prefix S54S) and commercial versions (prefix N74S).

INQUIRE DIRECT

SURPRISE!

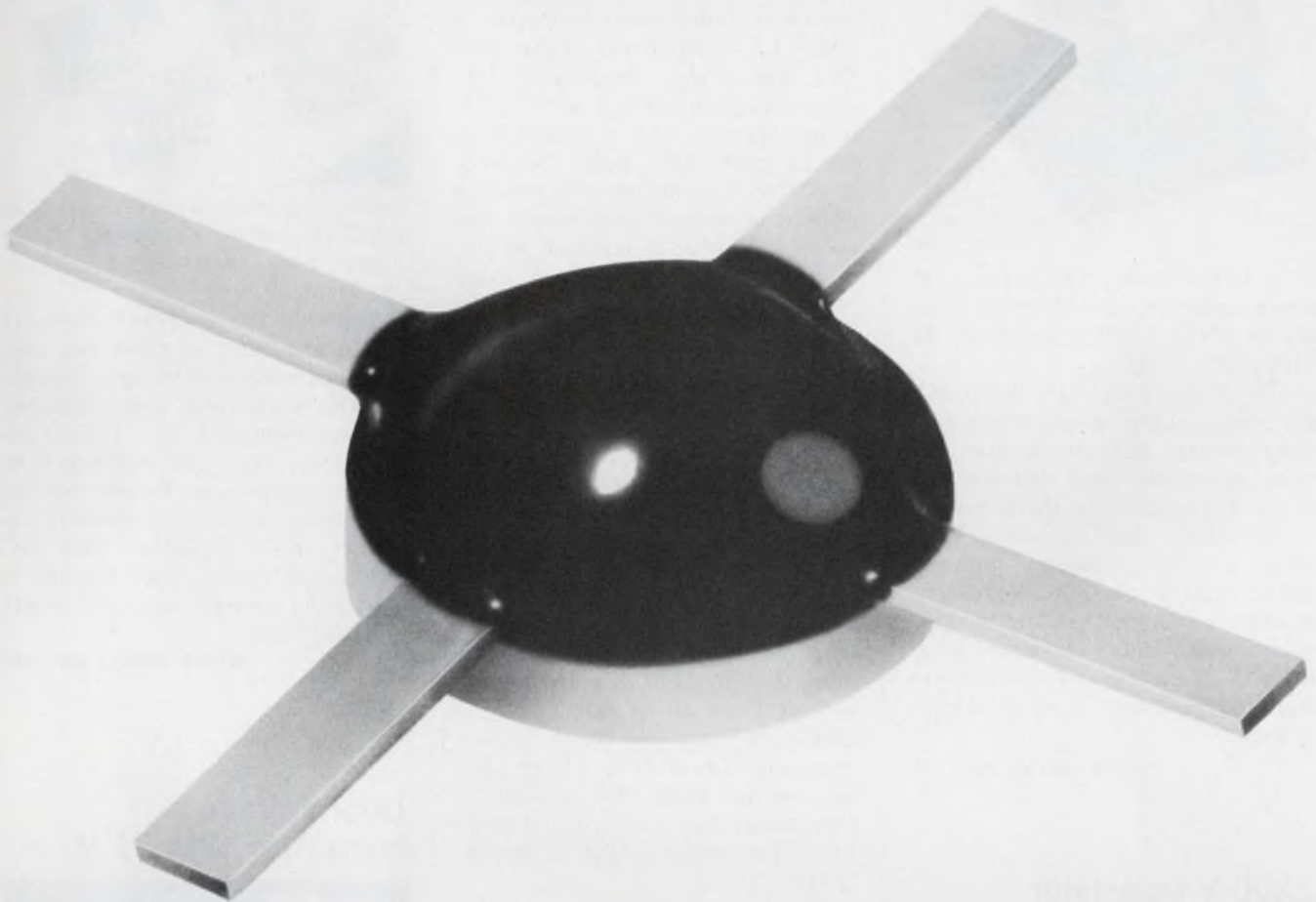

An inexpensive Schottky diode ring quad.

Only \$2.75 in 10K quantities. In stock. From Hewlett-Packard, the 5082-2830. For your money you get: Wideband operation to 2 GHz. Monolithic construction that provides extremely tight diode match and superior temperature tracking characteristics. Low conversion loss. Very low distortion. The proof is in your breadboard – and your pocketbook. For more information contact your nearby HP sales office.

01317

Domestic USA price only.

HEWLETT  PACKARD

Sales, service and support in 172 centers in 65 countries.
Palo Alto, California 94304. Offices in principal cities throughout the U.S.

INFORMATION RETRIEVAL NUMBER 50

ICs control motor speeds

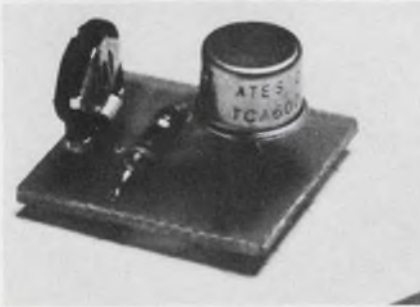

SGS-ATES Semiconductor, 435 Newtonville Ave., Newtonville, Mass. 02160. (617) 969-1610. \$2 (100-999); stock.

The TCA600 and 610, linear ICs for small-motor speed regulation, offer several advantages over the more commonly used discrete circuits. Typically only three components rather than 12 are needed. Also, a simpler design for any motor type is possible. And higher starting current at low temperatures make motor starting easier. Both the TCA600 and TCA610 are mounted in TO-39, three-lead metal cans.

READER SERVICE NO. 262

2200-V transistor delivers 2 A



Texas Instruments, P.O. Box 5012, M/S 308, Dallas, Tex. 75222. (214) 238-3741. \$12.35 (100 up); stock.

A power transistor rated at 2200-V peak collector-emitter voltage, designated the BUY71, features a continuous collector-current rating of 2 A. The BUY71 has a fast switching time of 0.7 μ s at 1.5 A. Total power dissipation at a collector-emitter voltage of 100 V and at 80-C case temperature is 10 W.

READER SERVICE NO. 263

Microprogram with 8 k-bit MOS ROM

Signetics, 811 E. Arques Ave., Sunnyvale, Calif. 94086. (408) 739-7700.

A high-speed 8192-bit MOS ROM, for microprogramming and code conversion applications, has a 2048 \times 4 bit organization and TTL-compatible inputs and outputs, and requires +5 and -12-V power supplies. Typical access time for the new ROM, called the 2580, is 625 ns. The device also features a built-in 1-of-16 chip-enable decoder and comes in a 24-pin DIP.

INQUIRE DIRECT

Power diodes handle high surges

International Rectifier, 233 Kansas St., El Segundo, Calif. 90245. (213) 678-6281.

Two lines of power diodes feature high-surge current capability. The 1N2128A series is rated for 60-A average current with a maximum I^2t of 3400 A²s in voltage ratings from 50 to 600 V. Series 70H-A is rated for 70 A with a maximum I^2t of 6000 A²s in voltage ratings from 200 to 1000 V. Maximum peak, nonrepetitive surge current is 900 and 1200 A, respectively.

READER SERVICE NO. 264

9-k bipolar ROM accesses in 120 ns

Monolithic Memories, 1165 E. Arques Ave., Sunnyvale, Calif. 94086. (408) 739-3535. MM6260: \$65 (100 up); stock.

The MM5260/6260 9216-bit ROM, organized in a 1024 \times 9 format, offers 120-ns access time and 50 μ W/bit dissipation. It may be ordered as a 7 \times 9 character generator and is DTL/TTL compatible with an input load of 1/10 that of standard TTL. Three enable inputs are provided to permit memory expansion. The new ROM has open-collector outputs and operates from 0 to 75 C (MM6260) or -55 to +125 C (MM5260). It's packaged in a 24-pin ceramic DIP.

READER SERVICE NO. 265

Multivibrator has high-input threshold

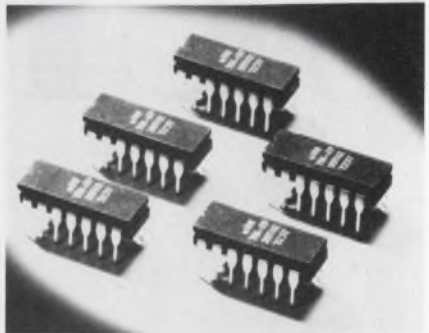

Stewart-Warner Microcircuits, 730 E. Evelyn Ave., Sunnyvale, Calif. 94086. (408) 245-9200. \$50 (10); stock.

The SW-781 special-purpose monostable multivibrator has been designed with a high-input threshold for electrically noisy automotive environments. In a typical application, as a tachometer driver, trigger pulses are tapped off the distributor using two discrete resistors and a capacitor. The SW-781 converts each input trigger to a pulse of closely controlled width and amplitude.

READER SERVICE NO. 266

Dual voltage translator lists 31 V

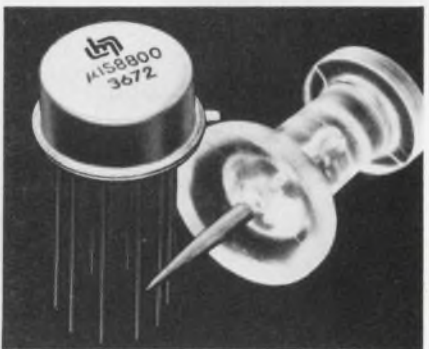

Integrated Microsystems, 16845 Hicks Rd., Los Gatos, Calif. 95050. (408) 268-2410. μ IS8800: \$6 (100 up); stock.

A dual-voltage translator, called μ IS7800/8800, provides a 31-V maximum output swing with normal power dissipation of 1 mW. The device operates from a standard 5-V supply and is compatible with all MOS devices. The μ IS7800 is rated for the -55-to-+125 C temperature range; the μ IS8800, for 0 to 70 C.

READER SERVICE NO. 267

Look what 5 volts can get you.

These five DPMs use the same 5VDC supply that powers the digital logic in your system.

This simplifies your design and improves reliability. It saves space, saves money, and reduces the amount of heat that's generated. And, because there's no line-power voltage near the DPM, internally generated noise is virtually eliminated.

So you get more reliable readings.

And here's what else you can get for 5 volts. BCD outputs. Overvoltage, polarity, and status indication. Automatic zero correction and programmable decimal points. Aluminum cases that install in a snap.

Each meter is given a seven-day burn-in before shipping. And we're shipping right now.

Our 5 volt DPMs are a whole new class of digital panel meters — a whole new way of thinking. Because now you can think of the DPM as a component, just like any other component in your system.

Take a look below. You'll find a meter that solves your particular problem. Then give us a call. Order a sample.

A low-cost 3½ digit DPM for OEM applications. An advance in price/performance capabilities for 3½ digit DPMs. LED display. Bipolar, single-ended input. Full scale range of 0 to ±199.9mV. 0.05% ±1 digit accuracy. Automatic zero and polarity. Normal mode rejection of 40dB at 60Hz or 50Hz. Common mode rejection of 60dB at ±200mV. Fully-latched DTL/TTL compatible outputs and control interface signals. Optional ratiometric input. Only ¾" deep. **\$79 in 100's. AD2010.**

CIRCLE NO. 201

A high-performance 4½ digit DPM for systems applications. Capable of performing precision measurements of floating differential voltages in noisy environments. LED display. Full scale range of 0 to ±1.9999V. 0.01% ±1 digit accuracy. Automatic zero and polarity. Normal mode rejection of 60dB at 60Hz or 50Hz. Common mode rejection of 120dB at ±300V. Optically-isolated analog section. Fully-latched DTL/TTL compatible BCD outputs and control interface signals. **\$189 in 100's. AD2004.**

CIRCLE NO. 202

A simple, reliable 3½ digit DPM for high-visibility display applications. Incandescent display. Bipolar, single-ended input. Full scale range of 0 to ±199.9mV. 0.05% ±1 digit accuracy. **\$89 in 100's. AD2001.**

CIRCLE NO. 203

A high-performance 3½ digit DPM for systems applications. The kind of performance you need for complex system interfacing and data processing. Incandescent display. True differential instrumentation amplifier input. Full scale range of 0 to ±199.9mV. 0.05% ±1 digit accuracy. Automatic zero and polarity. Normal mode rejection of 40dB at 60Hz or 50Hz. Common mode rejection of 80dB at ±2.5V. Fully-latched DTL/TTL compatible BCD outputs and control interface signals. **\$93 in 100's. AD2003.**

CIRCLE NO. 204

A low-cost 2½ digit replacement for analog meters. Incandescent display. Unipolar, single-ended input. Full scale range of 0 to +1.99V. 0.5% ±1 digit accuracy. Optional: variable reading rates, BCD outputs, and control signals. **\$50 in 100's. AD2002.**

CIRCLE NO. 205

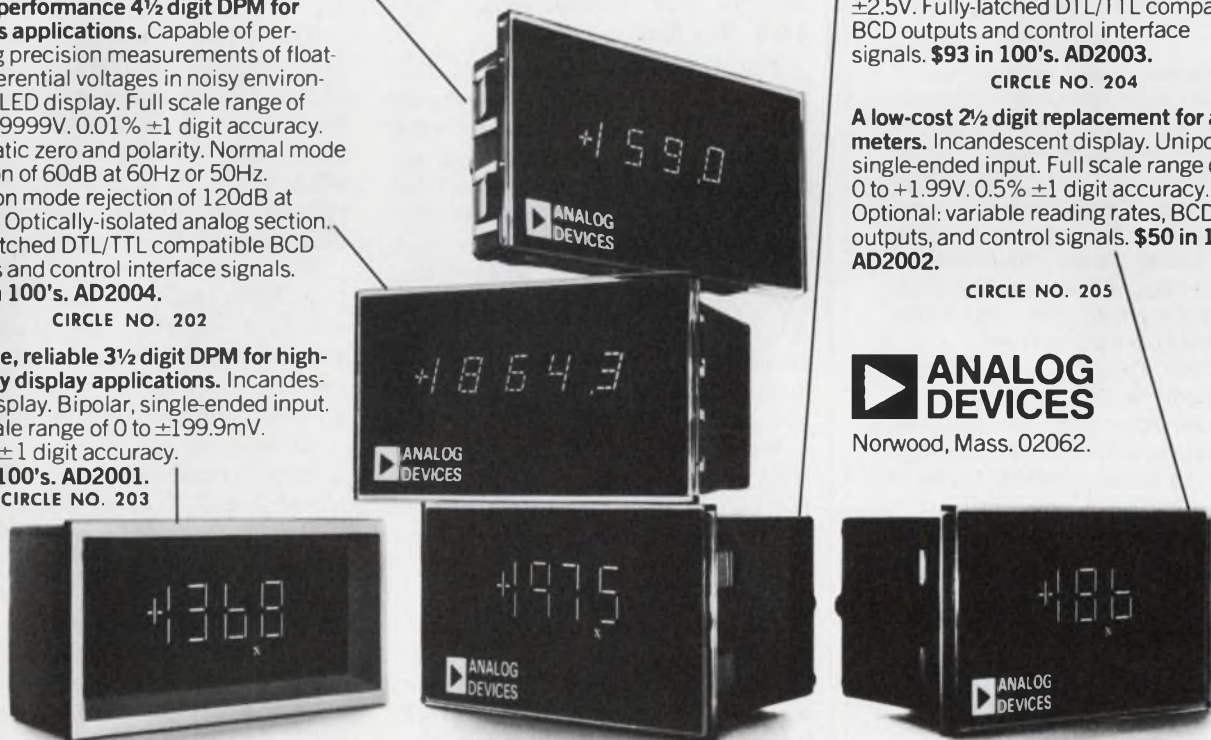

ANALOG DEVICES
Norwood, Mass. 02062.

Call 617-329-4700

for everything you need to know about 5 volt DC-powered DPMs.

DYNAMICS

LOW-PASS DC-1MHz HIGH-PASS 1Hz-1MHz

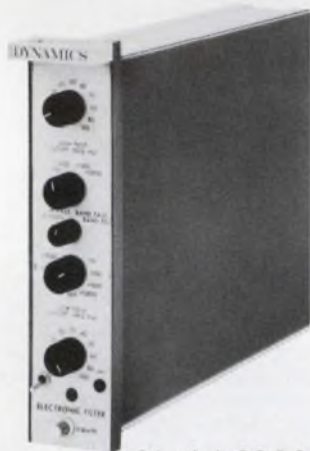

**Model 6364 A
Precision "Active"
Electronic Filters**

Designed to meet the rigid requirements of data reduction, data analysis and laboratory applications. Phase matching to within 1° is possible in the Linear Phase mode. Terminal Slopes of 36dB/Octave are standard with Butterworth and/or Linear Phase characteristics. Four different low-pass/high-pass-frequency multipliers cover the frequency band DC to 1MHz.

"Active" Filter Capabilities include custom design of Bessel, linear phase, Butterworth and Chebyshev filters up to 12 poles. Bessel filters can be phase matched 1° out to the -3dB point.

Mounting options include 8 across $8\frac{3}{4}$ "x19" rack mount or $3\frac{1}{2}$ " dual horizontal rack mount.

Contact: A. L. "Skip" White for further information.



DYNAMICS

12117 EAST SLALOUSON AVENUE • SANTA FE SPRINGS
CALIFORNIA 90670 • TELEPHONE 945-2493 AREA 213

INFORMATION RETRIEVAL NUMBER 51

MICROWAVES & LASERS

Ultra-broadband amplifiers deliver gain of 26 dB

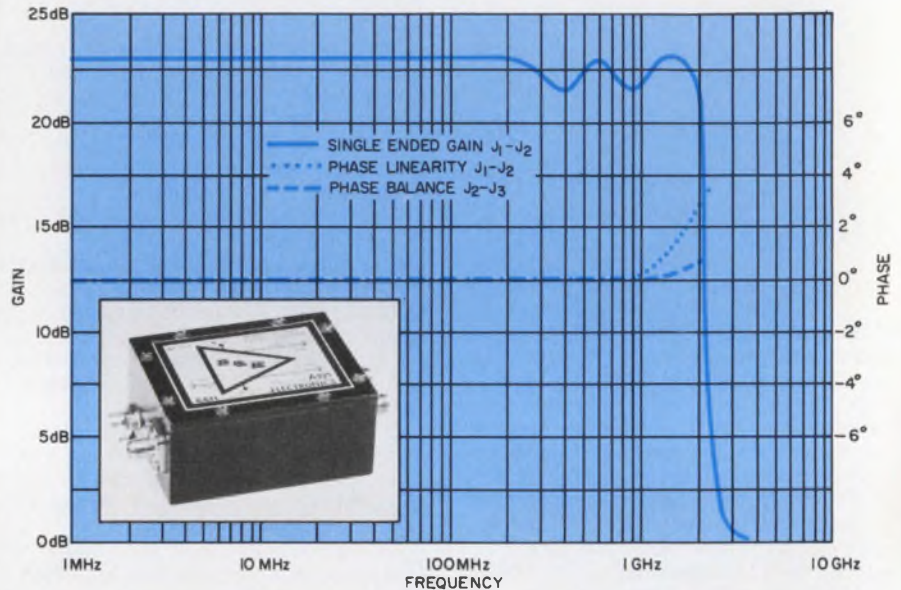

*B & H Electronics, 5 Sunny Lane,
Monroe, N.Y. 10950. (914) 783-
4988. See text.*

The DC-2002 and AC-201X linear amplifier modules, introduced by B & H Electronics, offer a gain of 26 dB and a bandwidth of almost 2 GHz, with an essentially flat response. Both types have balanced, double-ended outputs and extremely flat phase characteristics. Compared with Avantek's AMT-2000 series—the closest competitor—the B & H amplifiers have wider bandwidth, lower noise and better gain flatness.

With a response from dc to 2 GHz, the DC-2002 is believed by the manufacturer to have the widest bandwidth available for a commercial solid-state module. Gain over the frequency range is given as 20 ± 1 dB for single-ended output operation and 26 ± 1 dB for double-ended outputs. The unit has a maximum output power (1-dB compression point) of 2 dBm. Rise and fall times are 140 ps each, with a transient overshoot of only 3%. The noise figure is a low 3 dB, thus giving the amplifier a dynamic range of 85 dB. Phase linearity is within $\pm 3^\circ$ over the

entire range, and propagation delay (input to output) is 1.2 ns.

The AC-201X models have specifications that are identical to those of the DC units, except that they have low-frequency, 3-dB rolloffs. Four AC models are available: 2011, 2012, 2013 and 2014. Their rolloffs are 10 kHz, 100 kHz, 1 MHz and 10 MHz, respectively.

For double-ended outputs, all five units have a phase balance within 1° and an amplitude balance within 0.1 dB. All units offer an offset tempco of $50 \mu\text{V}/^\circ\text{C}$ and an operating temperature range of -55 to $+100$ C.

Power requirement for the DC model is ± 15 V dc at 130 and -65 mA. The four AC models require only $+18$ V dc at 100 mA.

The AC models are available from stock to four weeks, while the DC model has a 4-to-12-week delivery time. The prices for unit quantities of the five models are \$1025 (AC2011), \$1020 (AC2012), \$995 (AC2013 and 2014) and \$1225 (DC-2002).

For B & H Electronics

READER SERVICE NO. 255

For Avantek

READER SERVICE NO. 256

Laser power supply lists 5 kW, 10 kV

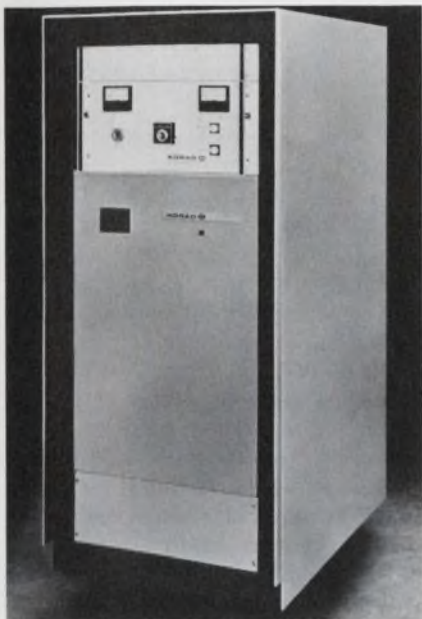

Union Carbide Corp., Korad Dept.,
2520 Colorado Ave., Santa Monica,
Calif. 90406. (213) 829-3377.
\$8950; 60 days.

The K-25 laser power supply boosts average laser output power and increases system pumping efficiency, according to Korad. The company says the new model brings into a popular priced commercial model characteristics previously reserved for special purpose types. Listing 5 kW at 10 kV, the K-25 includes a positive switching circuit to prevent accidental pre-firing of the flashlamp.

READER SERVICE NO. 268

1-to-18-GHz receiver has 20-MHz resolution

Test & Measuring Instruments,
224 Duffy Ave., Hicksville, N.Y.
11802. (516) 433-8800. \$3950.

The PM7800 receiver can display the entire frequency spectrum, or any portion of it, from 1 to 18 GHz with a resolution of 20 MHz. Sweep circuits permit displays, which may be either logarithmic or linear, on six calibrated time axes from 50 MHz to 2 GHz per division. A three-stage YIG filter provides 80-dB isolation between input and output; the over-all useful dynamic range is from -40 dBm to +20 dBm. A portable unit, the PM7800 weighs only 22 lb.

READER SERVICE NO. 269

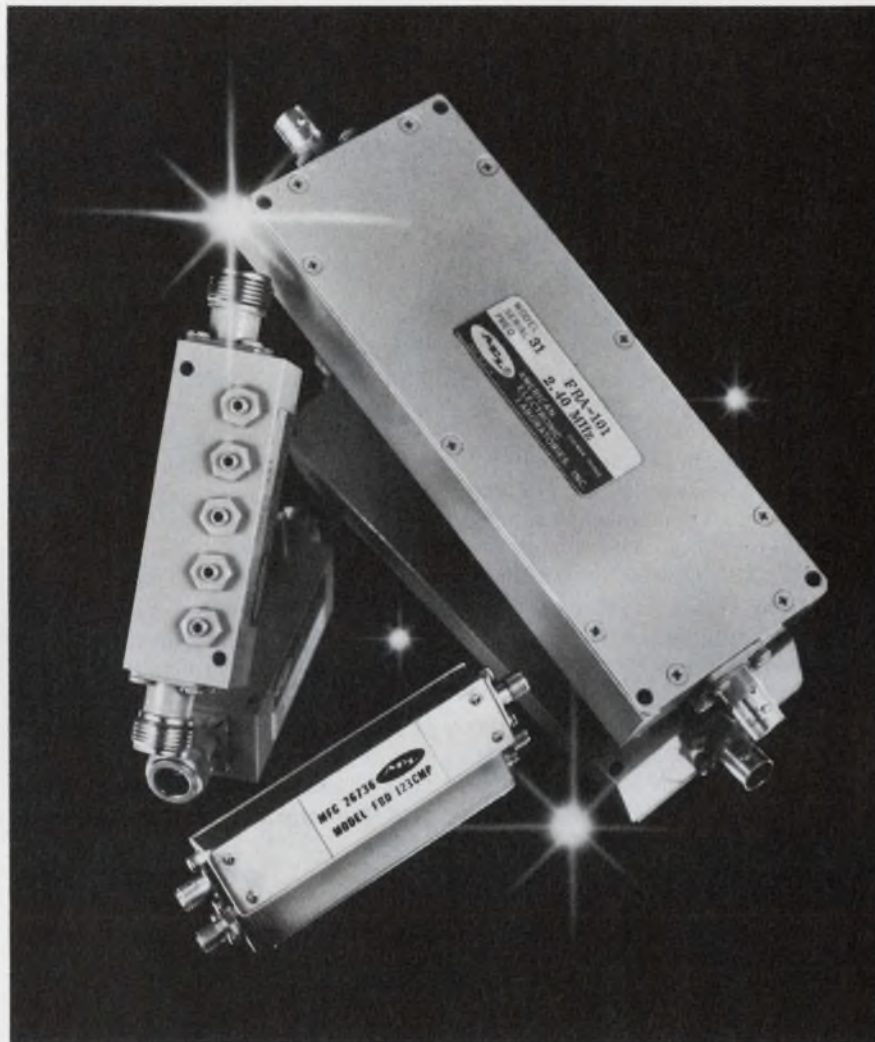

For most
filter needs—
AEL provides
off-the-shelf,
quick delivery.



For customized filter needs—AEL's computer banks have the answers. This, combined with AEL's ENGINEERING EXCELLENCE, provides filters such as:

Lumped-Constant Filters • Tubular Filters • Combine Filters • Inter-digital Filters • Low Pass Filters • High Pass Filters • Bandpass Filters • Band-reject Filters

Call or write today for more information about our filter line. Our product, as well as our ideas, are off-the-shelf.



WASHINGTON DIVISION

American Electronic Laboratories, Inc.

6629 Iron Place, Springfield, Va. 22151 • (703) 354-5700, ext. 275

INFORMATION RETRIEVAL NUMBER 52

Microprogram boosts mini language level

Microdata, 17481 Red Hill Ave., Irvine, Calif. 92705. (714) 540-6730. See text; August.

Series 3200 minicomputers comprise a three-product line that features 16-bit data words, asynchronous bus architecture and use of 32-bit microprogram instructions. All models have 300-ns main memory expandable to 128,000 words and 135-ns microprogram stores (ROMs, pROMs or RAMS). Model 3200 is the basic processor and is not supplied with any microprogrammed instructions. Model 3230 (\$8000, 8-k words) has a repertoire of 110 instructions including decimal arithmetic, character-string manipulation and stack control. Less than 20% of the allowable 4096 control-memory (microprogram store) locations are used for the basic instruction set, leaving the remainder for customized user instructions. The 3230 is architecturally compatible with the older Microdata 800 and 1600 computer series and can execute all software developed for these computers. It is also 10 times faster than the Model 821. Model 32/S is especially designed to implement PL/1-like language called MPL. This high level language affords the full range of programming capabilities previously found in assembly languages. A hardware approach to stack architecture in the Model 32/S, plus microprogrammed routines, permits efficient execution of MPL programs at speeds ranging from 0.9 to two times that obtainable with assembly language (on this manufacturer's machines). However, the execution of MPL requires use of Microdata's disc and controller system. A minimal configuration of Model 32/S including 16-k bytes of main memory costs \$10,000; with MPL, the total configuration costs about \$20,000. But the use of a high-level language such as MPL is said to afford substantial software savings to the OEM. MPL will be available in Jan., 74, the computers in late summer of 1973.

READER SERVICE NO. 270

Coupler formats data from digital instruments

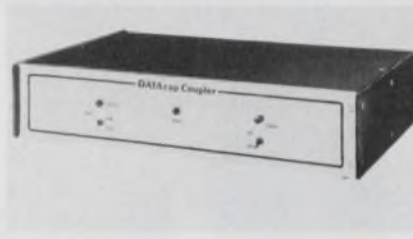

Datacap, Inc., 732 S. Federal St., Chicago, Ill. 60605. (312) 922-5366. \$420; stock.

Available in many configurations, the data coupler supplies the proper formatting and signal levels to drive teletypewriters, magnetic-tape units, paper-tape perforators and minicomputers. Source data for the unit can be supplied from various digital instruments including counters, voltmeters and a/d converters at rates up to 3000 digits/s. The unit is housed in a 3-1/2 x 19 x 12 in. cabinet and has a self-contained power supply. OEM quantity discounts are available.

READER SERVICE NO. 271

Optical reader assembles data into ASCII code

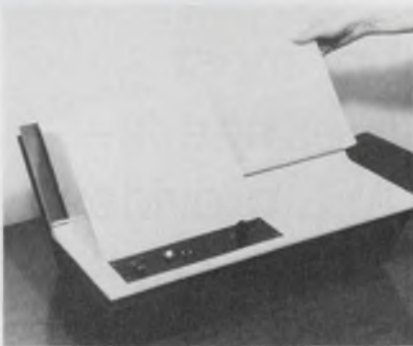

Datum, Inc., 170 E. Liberty Ave., Anaheim, Calif. 92801. (714) 879-3070. \$1795; 45 days.

Model 5098 optical-mark document reader accepts pencil-marked and preprinted data from prepared forms, tags, and page-sized documents. Each 12-bit document entry is translated into two 10-bit serial characters. Normal scan rate is 9 in./s. Transmission is asynchronous at rates of 10, 15, 60, or 120 characters/s. The signal interface conforms with EIA standard RS-232C. For error-correction purposes, retransmission may be initiated with a reverse channel signal.

READER SERVICE NO. 272

Large-scale disc storage system holds 58 Mbytes

Telefile Computer Products, 17795 Sky Park Circle, Irvine, Calif. 92664. (714) 557-6660. See text; 90 days.

A system consisting of Model DC-16-1 disc controller and up to eight Telefile Model DD-215 dual-density disc drives provides complete on-line storage for Interdata Computer Models 3, 4, 5, 50, 70, 74, and 80 and GE PAC Model 3010/2 computers. Operating features of the DC-16-1 controller include: hardware verification of track location, error checking of all data transfers, simultaneous seek operations, simple programming with only 10 commands and hardware monitoring of many subsystem status conditions. The disc drive consists of two separate and independent disc drives in a single cabinet. Each drive uses an 11-high removable disc pack. Over 58 million eight-bit bytes of data can be stored on the 20 recording surfaces of each disc pack. Access to any one of the 406 positions on the disc requires a maximum 55 MS. Data is transferred at 312,000 eight-bit bytes/s (at 2400 rpm). The DS-16-1 controller is priced at \$8200, while the dual-density disc drives cost \$22,000 each.

READER SERVICE NO. 273

Production tester evaluates disc packs

Computest Corp., Three Computer Dr., Cherry Hill, N. J. 08002. (609) 424-2400. 35-65k; 90-120 days.

Series DT-300 disc certifiers allow testing and evaluation of production samples of oxide-coated or plated discs. The series includes three models—DT-333 for 3336 type disc packs, DT-323 for 2316 or 1316 packs and model DT-313 for IBM 5440 type cartridges. A typical analysis takes about 152 seconds and includes the following information from each memory track: missing and extra bits, amplitude data, correctable/uncorrectable errors, and modulation. A comprehensive digital display of test results on a 10-column, 10-line /s printer furnishes written documentation.

READER SERVICE NO. 274

Low-priced calculator has percentage key



Berkey Photo, Inc., 842 Broadway, New York, N. Y. 10003. (212) 475-8700. \$119.95; April.

In addition to adding, subtracting, multiplying and dividing, this unit also figures percentages. The percentage of a number can be obtained then added or subtracted for a grand total. Among the other features are memory constant and selection of floating decimal or 2 place fixed point for "dollars and cents" calculations.

READER SERVICE NO. 275

Plug-compatible disc memory has controller

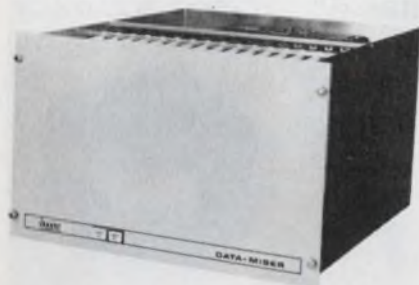

International Memory Systems, 14609 N. Scottsdale Rd., Scottsdale, Ariz. 85254. (602) 948-2120. \$4950; 60 days.

By combining I/O controller plus 1.25-million words of storage, model 110 disc memory system offers low-cost on-line storage for the PDP-11 computer. The system includes all software, controller, disc, power supplies and cabling required to plug into the computer's main data bus. Average access time is 75 ms with a 100 kHz word transfer rate. Additional 1.25 M storage units cost \$1950. The MTBF is 4000 hours and the system carries a one-year warranty.

READER SERVICE NO. 276



rotary solenoids

...practical ways to actuate and position

application simplicity

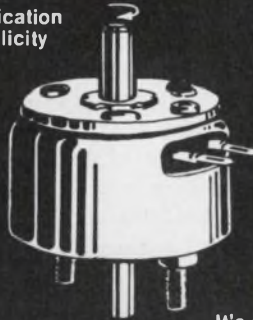

It's simple to apply. Just attach load to armature or to either shaft end, and you have direct rotary motion.

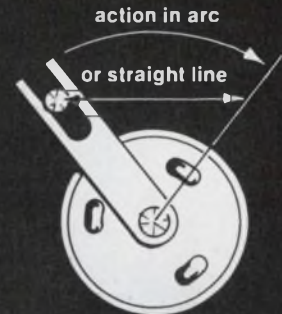

Output of a rotary solenoid is relatively uniform, so it's also a practical linear actuating solution.

long range dependability

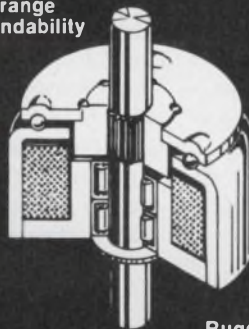

Rugged and dependable endurance engineered models give you over 100 million operations.

indexing flexibility



To increase indexing flexibility, new Ledex interface circuits let you control acceleration and deceleration, program pulses, or work from logic level sources.

What makes the Ledex rotary solenoid a practical way to actuate and position is that it's engineered to help keep your design simple and economical. It gets the job done—without the need for complex motion converters, tubing, fluids, and the like.

For a quick start on your prototype, choose from 250 shelf models—eight sizes, with torque to 117 pound-inches.

LEDEX INC.
123 Webster Street
Dayton, Ohio 45401/513-224-9891

Positioning • Switching • Interface Circuits

Toll free number for name of your nearest representative: 800-645-9200; New York firms call 316-245-0990.

INFORMATION RETRIEVAL NUMBER 53

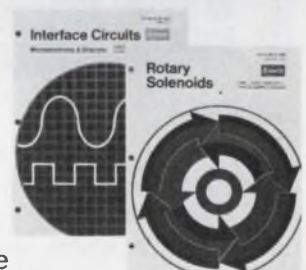

2- μ F ceramic capacitor meets MIL-spec



AVX Ceramics Corp., Myrtle Beach, S. C. 29577. (803) 448-3191. \$4.51: L-level; \$4.90: M-level (1000 up); 6-8 wks.

AVX claims that the CKR08 capacitor offers the highest capacitance available in radial-lead ceramic capacitors made to meet military specifications (MIL-C-39014). Its size is $0.3 \times 0.3 \times 0.14$ in. max—only 40% thicker than a CKR06, 1- μ F capacitor.

READER SERVICE NO. 277

Programmable timer controls 12 functions



Dynapar, 1675 Delany Rd., Gurnee, Ill. 60031. (312) 662-2666.

A new line of programmable timers can program machines to perform timed operations in each of a machine's several modes. Two machines linked by work-piece transfer equipment can be set up for coordinated operation. Front-mounted thumbwheel switches control up to twelve independently timed functions within a range from 999.99 s to 99999.0 min. Accuracy to 0.01 s is available.

READER SERVICE NO. 278

Temperature probes match within $\pm 0.15\%$

H. E. Sostman & Co., 941 Brighton St., Box F, Union, N.J. 07083. (201) 687-5700.

Sostman thermistor probes are available with resistances of 3 k, 5 k, 10 k or 30 k Ω at 25 C. When probes are replaced, the new ones match to ± 0.2 C over most of their usable temperature range of -80 to $+150$ C. The line of probes also includes dual-thermistor sensors that provide linear voltage or resistance outputs when connected via a signal conditioning network. The accuracy of the dual sensors is ± 0.15 C over their recommended range of -30 to $+100$ C.

READER SERVICE NO. 279

Drag-brake uses magnet needs no electric power

Lear Siegler, 17600 Broadway, Maple Heights, Ohio 44137. (216) 662-1000.

This magnetic-particle brake provides a constant-drag torque. The torque can be mechanically set to any point between 15 and 30 lb-in. Because the brake is energized by a permanent magnet, no electrical power is required.

READER SERVICE NO. 280

Encoder provides absolute position output

Astrosystems, Inc., 6 Nevada Dr., Lake Success, N.Y. 11040. (516) 328-1600.

Astrosystem's absolute encoder line meets NEMA-12 enclosure requirements, withstands shocks of 50 g for 11 ms, vibration of 15 g to 2000 Hz and operates over a temperature range of 0 to 70 C. The transducer weighs 2 lb. The line offers single-turn and multi-turn channels with binary or BCD outputs that range from 360 to 100,000 counts. A visual display is also available. If the power is lost, a correct reading is immediately present when power is restored. The transducers are electromagnetic devices that use no discs or light sources.

READER SERVICE NO. 281

Full-sized handles actuate small switches

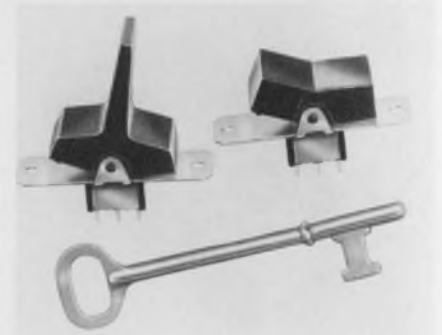

Alco Electronic Products, 1551 Os-good St., N. Andover, Mass. 01845. (617) 685-4371. \$1.00: SPDT; \$1.28: DPDT (500 up).

MST Large-Rocker and Paddle-Series switches offer a miniature body with an oversized, black, rocker or lever actuator. They are available in single and double-pole configurations with break-before-make action. Terminals are of silver and spaced to permit soldering. High-voltage barriers are located between the terminals. Contacts are solid coin silver.

READER SERVICE NO. 300

Scott-T transformer has 45 arc-sec accuracy

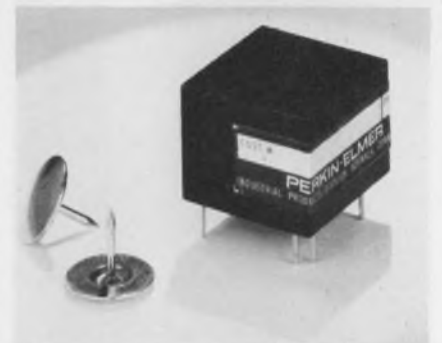

Perkin-Elmer, Main Ave., Norwalk, Conn. 06856. (203) 762-4786. \$35-\$40 (100 up); stock to 6 wks.

A line of miniaturized Scott-T transformers, which convert three-wire, synchro inputs to four-wire, resolver outputs, meet MIL-T-27, Grade 5 requirements and maintain their accuracy over the temperature range of -55 to $+125$ C. The unit measures 0.75-in. square by 0.58-in. high. They accept 11.8-V rms, 400-Hz synchro inputs with output voltages ranging to 6-V rms. Accuracies range from 45 arc-seconds.

READER SERVICE NO. 301

Electronic counters replace mechanical units

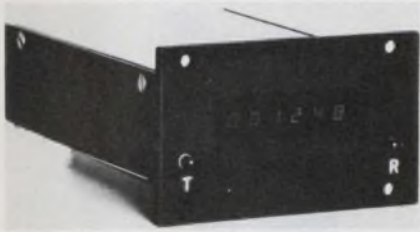

Instrument Displays, Inc., 225 Crescent St., Waltham, Mass. 02154. (617) 894-1577. \$150 (25 up); 4 wks.

This new series of electronic counters with displays provides six decades in a single unit. Readout characters have a height of 0.27 in. These units directly replace electromechanical counters and can fit in the same panel cutouts. The display can be seen from 15 ft. Front-panel, reset-to-zero and press-to-test pushbuttons provide convenient control over the unit. The entire package is less than 2-in. wide and 1-3/8-in. high. The input is TTL compatible and the unit can operate at speeds to 10 MHz.

READER SERVICE NO. 302

Rotary switch has enclosed indexing unit

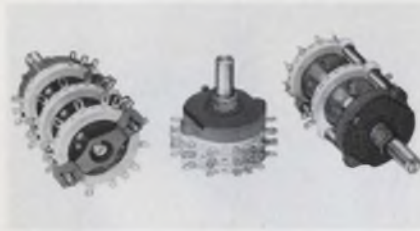

CTS Corp., 1142 W. Beardsley Ave., Elkhart, Ind. 46514. (219) 523-0210.

Series 227, 1-1/8-in. D, rotary selector switches feature a completely-enclosed, shallow index assembly with a double-bump hill and valley detent. Detent rotational life is 25,000 cycles and the stop strength is 35 in.-lb. Two-through-12-position end stops or continuous rotation are available. Design versatility results from a wide choice of shaft materials, bushing lengths, shaft style, wafer combinations and terminal lugs that include solder, PC, weld and tab push-on.

READER SERVICE NO. 303

parkermeter

ULTRA-THIN METER MOVEMENT

Revolutionary patented design features a rugged ultra-compact movement consisting of an etched-circuit wafer (12 mils thick) and a thin annular magnet between two supporting/shielding plates. Niva alloy pivots and beryllium-copper hairsprings are used.

Meter movements may be purchased separately.

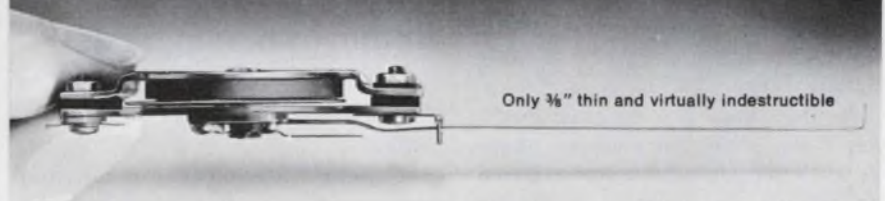

Only 3/8" thin and virtually indestructible

Used exclusively in all AIRPAX Panel and Edge-Reading Meters

The complete Airpax "parkermeter" line includes: **PANEL METERS** — Rectangular and medallion shapes (2 1/2", 3 1/2" and 4 1/2" W.) Each available in a wide variety of ac and dc ranges, voltage or current. Special scales made to order.

EDGE-READING INDICATING METERS — Available in many standard models, such as: 1 1/2", 3", 3 1/2" and 4 1/2" lengths and 1/2" and 3/4" widths. Some illuminated and some ruggedized. Many standard and special ranges available.

EDGE-READING CONTROL METERS — Available with 1 or 2 set-points. Unique "parkermeter" design provides contactless solid-state switching. Special scales and pointers available.

FEATURING:

- **TRUE FLUSH MOUNTING** — Panel meters have no protruding barrel and mount directly to panel with studs.
- **RUGGEDNESS** — All meters withstand shocks up to 240G's.
- **DEPENDABILITY** — Movements are typically unaffected by continuous electrical overloads 100 times full scale.



AIRPAX™
ELECTRONICS
Controls Division
6801 W. Sunrise Blvd.
Ft. Lauderdale, Fla. 33313



For complete specifications and prices send for our 40-page catalog . . . or call (305) 587-1100.

Receptacle handles leadless, ceramic ICs

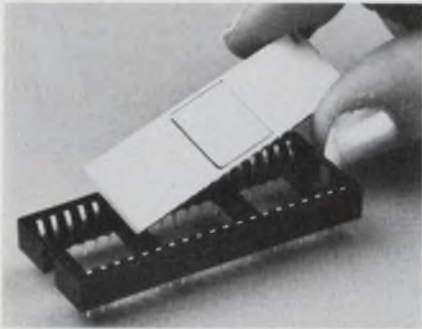

AMP, Inc., Harrisburg, Pa. 17105. (717) 564-0101.

A low-profile receptacle (0.225-in. high) accommodates the new side-metallized, leadless ceramic packages. The receptacle is only slightly larger (2.115 × 0.830 × 0.225 in.) than the ceramic package. Even with the package snapped into place, contacts are exposed for use as test points. A plastic hold-down strap is available for applications involving high shock and vibration. The high contact force (averaging 120 g) provided by leaf-type, stainless-steel contacts is, in part, responsible for the low (5 to 9 mΩ) contact resistance. Contact surfaces are protected by gold and tin-lead plating.

READER SERVICE NO. 304

Fine-adjustment slides have 0.1 μm sensitivity

Klinger Scientific Appartus, 83-45 Parsons Blvd., Jamaica, N. Y. 11432. (212) 657-0335.

Model 80.25 fine-adjustment translation slides, for manipulating IC chips and hybrid assemblies, have a 0.1 μm adjustment sensitivity provided by a differential screw and a simultaneous 1.0 μm adjustment with the main micrometer. Linear ball bearings guarantee a straight run accurate to ±1 μm. Additional guaranteed specs include: 0.2-0.4 μm flatness, zero backlash and sag less than 1 μm per 100 mm. A modular design allows many variations, such as linear-XY and XYZ motions, and also combinations of linear and rotational motions.

READER SERVICE NO. 305

Card guides come in 24 standard lengths

Bivar, Inc., 1500 S. Lyon St., Santa Ana, Calif. 92705. (714) 547-5832. 17¢ (100 up); stock.

Econ-O-Gide card guides come in 24 standard lengths, from 2-1/2 to 14 in. Each guide is made from rigid reinforced nylon with a standard, 78-mil slot for 1/16-inch PCs. Different component heights, limited board space, and needed additional air circulation suggest the use of Econ-O-Gide because of the many standard sizes and easy installation.

READER SERVICE NO. 306

Liquid rosin flux remover biodegrades

Electrovert Inc., 86 Hartford Ave., Mt. Vernon, N.Y. 10553. (914) 664-6090.

A liquid flux cleaner removes all traces of rosin flux residues without injury to the boards or components. Called Type "O" cleaner, the liquid is stable, has a reportedly low toxicity, is biodegradable and is water soluble. It is a low foamer and can be used under pressure or agitation with any cleaning equipment. Type "O" cleaner rinses off easily leaving no residue. It will not remove code paint or ink from components.

READER SERVICE NO. 307

New glass seals at reduced temp

Owens-Illinois, Levis Development Park, Perrysburg, Ohio 43551. (419) 242-6543.

CV-110 package sealant was developed to lower the sealing temperature by 60 C during electronic package assembly, such as when sealing a ceramic DIP. The sealing characteristic peaks at 440 C compared to 500 C for CV-98, the previous industry-standard sealing glass. The physical properties of the glass, which match alumina, permit sealed packages to pass military mechanical and environmental tests, such as thermal shock and cycle (+200 C to -65 C) and hermeticity, measured to 1 × 10⁻⁸ cc/sec.

READER SERVICE NO. 308

Attachment adjusts to clamp wire bundles

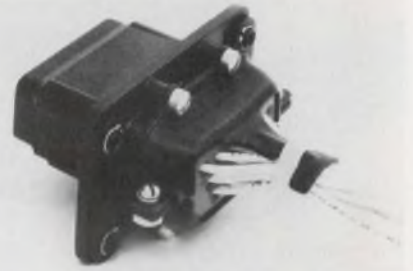

Glenair, 1211 Air Way, Glendale, Calif. 91201. (213) 247-6000. \$2 (100 up); 4-6 wks.

This clamp attachment eliminates the frequent need for wrapping a wire bundle with tape to build the bundle diameter so that clamp saddles can become effective. Most conventional clamps do not have an adequate clamping range, and thus often do not fit the bundle of wires. The Qwik-Ty design, however, adjusts to almost any bundle diameter. The clamp attachment comes with arms positioned for straight, 45 or 90-degree cable entry. A cylindrical model allows the user to orient the Qwik-Ty to any cable entry position.

READER SERVICE NO. 309

Epoxy conducts heat, insulates electricity

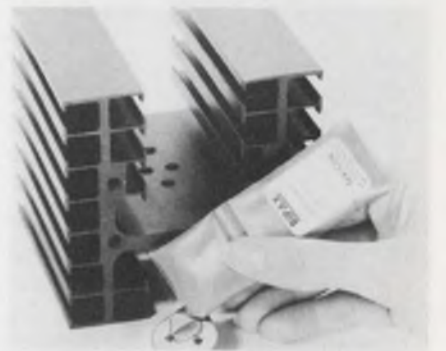

Tra-Con, 55 North St., Medford, Mass. 02155. (617) 391-5550.

Here's a two-part, thixotropic epoxy adhesive system recommended for attaching transistors, diodes and ICs to PC boards, radiators and heat sinks. Tra-Bond 2151 mixes to a buttery paste with plenty of slump-resisting body for fast assembly. It cures overnight at room temperature to form a thermally conducting and electrically insulating bond to a wide variety of electronic materials.

READER SERVICE NO. 310

Heat sinks sell for one cent each



Carbidex Corp., One Carbidex Rd., Southgate, Mich. 48195. (313) 287-8600. \$2.50 for introductory kit, TO-5 or TO-18.

A heat sink for solid-state semi-conductors sells for only one cent apiece whatever the quantity. Called the Penny Pincher, it can use as many stackable fins as needed for the heat dissipation. It is made of anodized aluminum, and it is available in TO-18 and TO-5 sizes, both with a one-square-inch of radiation surface per fin. A silicone-grease compound between the semiconductor case and the heat sink can reduce the thermal impedance.

READER SERVICE NO. 320

Test socket prevents component-lead damage



Wells Electronics, 1701 S. Main St., South Bend, Ind. 46623. (219) 287-5941. \$1 to \$3; 2 wks.

The most significant feature of the Series 602 test contactors is that they prevent overstressing component contacts during insertion. This family of sockets serves primarily for test, burn-in and aging of flatpack, TO-5 and DIP devices. Other features include: a lid that permits easy loading and removal; lid stops to prevent shorting of the lid to open contacts; and carrier braces positioned directly over contact points to prevent electrical-contact loss during operation.

READER SERVICE NO. 321

Synchro Converter Modules

to satisfy your every requirement



Synchro to DC

Convert synchro or resolver inputs to a linear DC output proportional to angle. Available for 11.8V, 400 Hz or 90V, 400Hz input. Internal reference available for external use.



Synchro to Digital

Convert synchro or resolver inputs to digital outputs; 8, 10, 12 bit binary, or 360 or 1000 BCD counts, 400 or 60Hz input.



Multi- Channel Conversions

A low cost method utilizing signal conditioning modules to multiplex many inputs through a single high speed converter. Can perform conversions at a 2ms per channel rate.



Dual- Speed Conversions

Dual-speed designs can be employed to yield low-cost high accuracy outputs to .01°. Standard models will accommodate 1:8, 1:16, 1:32, 1:36 and 1:64 speed inputs.

FREE ... Send for our 10-page Application Information Bulletin Today!

For your local Astrosystems representative call toll-free
800-645-9200

asi

Advanced Instrumentation

astrosystems, inc.

6 Nevada Drive, Lake Success, New York 11040/516/328-1600 TWX 510/223-0411
West Coast: 4301 West Commonwealth Avenue/Fullerton, Calif. 92633/714/523-0820

Pulse generators output to 50 MHz



Philips Test & Measuring Instruments, Inc., 224 Duffy Ave., Hicksville, N.Y. 11802. (516) 433-8800. PM5715: \$765; PM5712: \$575.

The PM5715 and PM5712 are economy-priced 50-MHz pulse generators. These instruments are similar in performance except that PM5715 permits operator control of pulse rise and fall time from 6 ns to 500 ms, while the PM5712 features a fixed transition time of 4 ns or less on all pulses. Both units offer pulse repetition rates from 1 to 50 MHz with output amplitude variable from 200 mV to 10 V. Dc baseline is vernier controlled in both instruments; PM5715 permits a range of ± 2.5 V and PM5712 allows settings from -5 to $+2$ V. Pulse delay and duration are independently settable via selector switches and verniers from 10 ns to 100 ms. Normal or inverted pulses are pushbutton selected on both and the PM5715 also permits pushbutton selection of pulse polarity.

READER SERVICE NO. 322

5-inch recorder is compact

Varian Instrument Div., 611 Hansen Way, Palo Alto, Calif. 94303. (415) 493-4000. \$595; 2 wks.

Model A-5 is a potentiometric recorder with a 5-in. scale. The unit occupies less than 1 ft² and weighs less than 7 lb. Chart speeds are 0.5, 1, 2, 5, 10 and 20 cm/min and cm/hr. Full scale ranges are 1, 10, 100 mV and 1 V. Pen response is 0.35 s, while accuracy is better than 0.5% fs. The A-5's zero is adjustable over full scale. Input is single ended, floating; input resistance is greater than 10 M Ω .

READER SERVICE NO. 323

\$575 buys automatic, portable DMM



Weston Instruments, 614 Frelinghuysen Ave., Newark, N.J. 07114. (201) 243-4700. \$575; stock.

Model 4444 DMM is an auto-ranging four-digit portable unit. Automatic features are: setting of the decimal point, polarity sign, proper units annunciator, over-ranging, blanking of redundant zeros and overload protection. Any input from 10 μ V to 1 kV can be applied at any time without fear of damage. The 4-1/2-digit LED display is formed on a single chip. The Model 4444 features CMR of over 130 dB for dc volts and greater than 70 dB for ac volts at 50/60 Hz $\pm 1\%$. Dc accuracy is $\pm 0.02\%$ ± 1 digit ± 10 μ V (over 90 days), and input resistance is 1000 M Ω . Sensitivity is 10 μ V.

READER SERVICE NO. 324

Analyzer measures response to 10 kHz

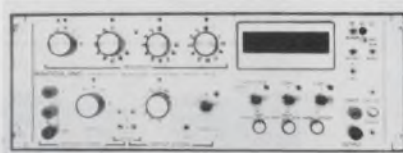

BAFCO, Inc., 717 Mearns Rd., Warminster, Pa. 18974. (215) 674-1700. \$6250; 2-4 wks.

Model 911A-DS single-channel frequency response analyzer measures amplitude ratio in dB, and phase shift in degrees from 0.005 to 10,000 Hz with over 100/1 rejection of noise and harmonics. The unit can sweep frequency and simultaneously plot the amplitude ratio and shift vs log frequency. Sweep speeds as fast as 250 sec/decade produce well-defined, accurate plots in the 0.1 to 1.0-Hz frequency range. Sweep speeds to 10,000 sec/decade cover all possible sweep conditions.

READER SERVICE NO. 325

Five-digit DMM gives 0.001% accuracy



Dana Laboratories, 2401 Campus Dr., Irvine, Calif. 92664. (714) 833-1234. \$1795; 13 wks.

Model 5900 is described by the company as, "the world's most accurate and stable five-digit multi-meter." It offers 0.001% total accuracy for 24 hours, greater than 10,000 M Ω input resistance, delayed dual slope^(R), five dc ranges, 60% overrange, and full ratio capability. In addition, it provides 0.03% ac accuracy and two measurement speeds for ac voltages, plus four-wire sensing, systems compatibility, full autoranging, and LED readout.

READER SERVICE NO. 326

Digital meter reads capacitor resistance

Clarke-Hess Communication Research Corp., 43 W. 16th St., N.Y., N.Y. 10011. (212) 255-2940. \$735; 2-6 wks.

The Model 273 E.S.R. Meter reads the equivalent series resistance of capacitors or resistors at 100 kHz. The instrument can resolve down to 1 milliohm for capacitors greater than 0.5 μ F. Two other ranges allow higher resistance measurements on smaller capacitors. The Model 273 is self-balancing and operates on a four-wire principal so that it may be used with up to 25 ft of cable between the instrument and the test jig. The 2-1/2-digit decimal display has BCD output available to drive printers or external circuitry. The unit achieves an accuracy of $\pm 2\%$ of the reading ± 3 digits within 0.5 seconds of applying the capacitor or the resistor to the instrument terminals. And the component under test is subjected to less than 500 mV dc or ac (rms). Also, the Model 273 may be used as a digital ohmmeter to read resistances (at 100 kHz) between 1 milliohm and 20 Ω .

READER SERVICE NO. 327

**Spectrum analyzer
works from 12-V battery**



Texscan, 2446 N. Shadeland Ave., Indianapolis, Ind. 46219. (317) 357-8781. \$1500; 3 to 4 wks.

Model AL-50 spectrum analyzer (field-strength meter) is designed for making rapid signal strength measurements in the 4 to 300-MHz frequency range. The unit is completely portable and can operate from its internal rechargeable batteries or from an external 12 to 20-V source. The unit will display Band A, the full 300-MHz band. Band B, C and D can be set for varying frequency ranges with front-panel controls. Dispersion is 30 kHz to 30 MHz/div, continuously variable, and 8-MHz fixed on Band A. The AL-50 displays a 40-dB dynamic range for signal-levels as low as 50 dBm. Frequencies are identified using the center frequency slide-rule dial and amplitude measurements can be made over a 110-dB range with the input attenuator and the 40-dB on-screen amplitude calibration.

READER SERVICE NO. 328

**Transmission test set
weighs just 35 pounds**

Wavetek, 9045 Balboa Ave., San Diego, Calif. 92123. (714) 279-2200. \$1995; 30-45 days.

Model 420 transmission-level test set is solid state and weighs just 35 lb. This set measures return loss (2 wire), attenuation (4 wire), impedance, frequency response and noise. Test results are clearly displayed on a built-in scope. Features include swept or single frequencies from 50 Hz to 15 kHz, stepped attenuation control on both the transmitter and receiver, lighted display grid, automatic scale selection and push-button operation, including calibration check.

READER SERVICE NO. 329

DPMs

**In 2½, 3½ and 4½-digit models.
We've got them all. Just ask us.**

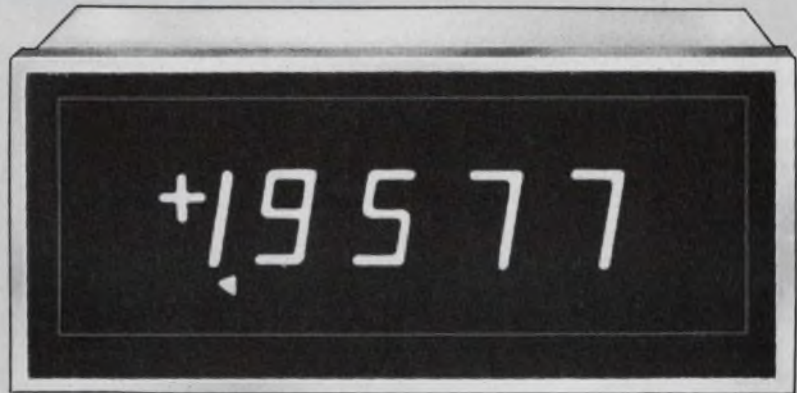

Model 45 (shown actual size)

- 4½ digits
- .01% accuracy
- 20ppm/°C stability
- Sperry planar display
- Floating differential input
- Bipolar with autopolarity

(Also available in 2½ and 3½-digit models)

**FULL
1-YEAR
WARRANTY
ON PARTS
& LABOR!**



Model 36 (shown actual size)

- 3½ digits
- .05% accuracy
- 50ppm/°C stability
- Sperry planar display
- Floating differential input
- <3.5 watts power drain

**GRALEX
INDUSTRIES**

DIVISION OF GENERAL MICROWAVE CORP.
155 MARINE ST., FARMINGDALE, N. Y. • 516-694-3607

Time-interval generator resolves 100 ns

Systron-Donner, Datapulse Div., 10150 W. Jefferson Blvd., Culver City, Calif. 90230. (213) 836-6100. \$1700 to \$3950; 12 wks.

Series 600 time-interval generators are packaged in one, two, three and four-channel models. The last digit of the model number corresponds to the number of timing channels included in the unit. Total capacity can be expanded by operating any number of instruments in serial or parallel, using a common time-base clock. Specs include time from 0.0 to 1 second, 100-ns increments, 0.001%-accuracy, optional remote digital programming, TTL-compatible inputs and outputs and multiple-mode operation. Accuracy is $\pm(0.001\%$ of setting +2 ns) and jitter is less than 2 ns (T_0 sync to any output or between any two outputs).

READER SERVICE NO. 330

Battery-powered filter has 50 cut-off points

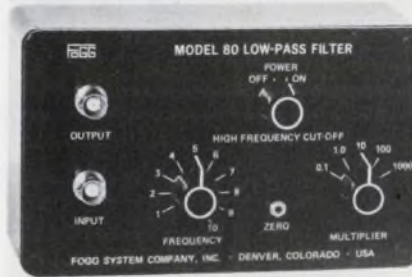

Fogg System, Box 22226, Denver, Colo. 80222. (303) 758-2979. \$196 (unit qty); 30 days.

Low-pass filter, model 80, provides 50 high frequency cut-off points from 0.1 Hz to 10 kHz. An internal battery supplies power for over 800 hours of continuous operation. The unit can filter signals from less than 1 mV to ± 3 V. Attenuation slope is 20 dB per decade and the unit has an output-current capability of 1 mA. The gain within the passband is unity, and the operating temperature range is 10 to 50 C.

READER SERVICE NO. 331

35-MHz pulse/data gen costs just \$695



Tau-Tron, 685 Lawrence St., Lowell, Mass. 01852. (617) 458-6871. \$695; 1-2 wks.

DG-7 pulse/data generator operates to 35 MHz. Specs include individual pulse and data outputs, capable of driving up to 10 V with ± 4 -V offset; 16 bits/word, both true and complement; frequency control, plus amplitude, offset and width variability on the pulse generator; rise/fall times of less than 7 ns; RZ and NRZ availability; and the DG-7 can operate from either an internal clock or an external source.

READER SERVICE NO. 332

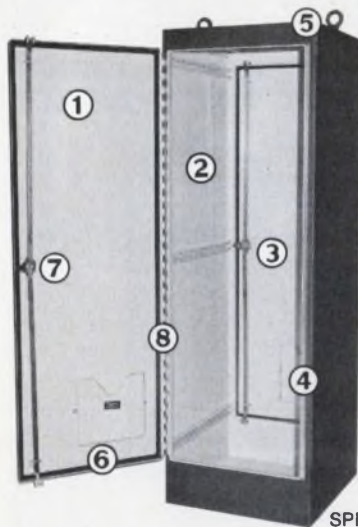

STANDARDS

MEETS NEMA 12 & 13 SPECIFICATIONS

1. Single door or double doors on front or front and back. 2. Numerous interior panels/relay rack angles available. 3. Heavy gauge steel. 4. All seams continuously welded. 5. Lifting eyes for easy handling. 6. Neoprene door gasket with oil resistant adhesive and steel retaining strips. 7. 3-point latching mechanism, oil tight key locking handle. 8. Heavy gauge continuous hinges. For detailed specifications on over thirty different sizes, write for latest bulletins.

Hoffman ELECTRICAL ENCLOSURES
 HOFFMAN ENGINEERING COMPANY
 Division of Federal Cartridge Corporation
 Anoka, Minnesota, Dept. ED-71

INFORMATION RETRIEVAL NUMBER 57

POWER SUPPLY HANDBOOK

YOUR'S

FREE



A complete reference of definitions, principles of operation, load connections and performance measurements. A working tool for the Engineer. Yours for the asking . . . and its FREE from Power/Mate.

SEND FOR YOUR FREE COPY



POWER/MATE CORP.

514 S RIVER STREET HACKENSACK N J 07601
 Phone (201) 343-6294 TWX (710) 990-5023

INFORMATION RETRIEVAL NUMBER 58

ELECTRONIC DESIGN 9, April 26, 1973

3-1/2-digit DPM occupies 48 × 48 mm

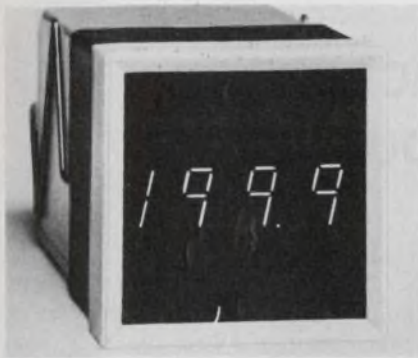

Schlumberger Instruments, 12 Place des Etats Unis, 92120 Montrouge, France. Less than \$100 (50 up).

Less than 4 square inches (48 × 48 mm) is all the panel space required by the 6520 3-1/2-digit DPM. The case size corresponds to DIN standards and allows direct replacement of existing analog meters. The plastic molded case is 4-in. deep. The 6520 features a floating input, auto polarity, 0.1% accuracy, a ±1999 display using 7-segment tubes (with a polarized green filter) and a range from 2 to 200 V. The decimal point can be preset by the user. Power required is 5 V dc ±10% (1.5 W).

READER SERVICE NO. 333

8-digit calculator comes in kit form

Heath, Benton Harbor, Mich. 49022. (616) 983-3961. \$92.50.

The Heathkit IC-2009 is a battery-powered calculator with eight-digit LED display and full floating decimal. In addition to the four arithmetic calculations, a Constant key permits chain calculations. A Clear-Entry key allows removal of an entry from the display window without disturbing prior calculations. Negative answer, entry and total overflow indicators are automatically displayed. The NC battery gives five to eight hr use between charges from the battery charger supplied with the kit. A battery indicator warns of low battery charge. The built-in battery-saver circuitry blanks each display after 15 seconds to preserve the charge. The display is instantly reactivated by pressing the Display key or entering another number or operation.

READER SERVICE NO. 334

16-bit word controls power supply output



Moxon, 2222 Michelson Dr., Irvine, Calif. 92664. (714) 833-2000. \$1495; 30 days.

Two new dc power sources feature 16-bit digital programming control of bipolar outputs to 100 V and a wide range of computer-compatible interface modules. Designated the Models 3536 and 3537, the compact rack or bench-mounted units interface with computers, data generators, TTL binary inputs, automatic controllers or similar sources. Ac-input-to-dc-output isolation is 10,000 MΩ and 10 pF. Output resolutions as fine as 500 μV are available. Also, any range of full-scale and step voltages are also available, including nonlinear step functions. Both instruments include data memory storage activated by a gate strobe pulse for programming the power source.

READER SERVICE NO. 335

5-1/2-digit DMM offered for \$1495



John Fluke Manufacturing, P.O. Box 7428, Seattle, Wash. 98133. (206) 774-2211. \$1495.

Designed specifically for high-precision bench and lab use, Model 8350A DMM offers 5-1/2 digits with autoranging, autopolarity and a measurement accuracy up to 0.005%. Dc V range is from 1 μV to 1100 V in five ranges. Ac V is from 10 μV to 1100 V rms in five ranges and resistance is from 10 milliohms to 12 MΩ in five ranges. Demonstrated MTBF is over 10,000 hours. Other features include fully-annunciated readout and rugged environmental specifications.

READER SERVICE NO. 336

Logic probes indicate levels and pulses

Alert Technology, 2910 MacArthur Blvd., Northbrook, Ill. 60062. (312) 498-0940. 520: \$32; 550: \$48; 570: \$64 (100 qty.); approx. 2 wks.

Alert 500 Series digital probes check RTL, DTL or TTL IC-logic levels, pulses and pulse trains. Two LEDs display logic levels and changes of state. One of the LEDs illuminates to indicate logic ZERO; the other illuminates to indicate a ONE. Both indicators remain off to signal a logic level that is not as high or as low as, for example, an open input gate. Input overload protection is provided up to ±250 V dc or ac continuous. All models in the 500 Series are designed to be used with any 5-V dc logic system. Additional Alert Series are available for use with other supply voltages.

READER SERVICE NO. 337

Tiny DPMs offer three-year warranty



Varian/Velonex, 560 Robert Ave., Santa Clara, Calif. 95050. (408) 244-7370. 3 digits: \$112; 4-1/2 digits: \$225; 90-120 days.

Impac DPMs come with either 3, 3-1/2, 4 or 4-1/2 digits. Dimensions of all models are identical. Front panel area is less than 1.7 in² and the behind-panel volume is less than 3 in³. Other major features include a power consumption of less than 0.3 W on standby and less than 1 W with all characters lit; automatic zeroing; LED display for all digits ± sign and decimal point; an accuracy of 0.1% of reading for 3 and 3-1/2 digit units, 0.05% of reading for 4 and 4-1/2-digit units; and tempo of 0.01%/°C from 10 to 40 C. Impac DPMs come with a 3-year warranty.

READER SERVICE NO. 338

Thermal converter raises the accuracy of rms converter over wide input range

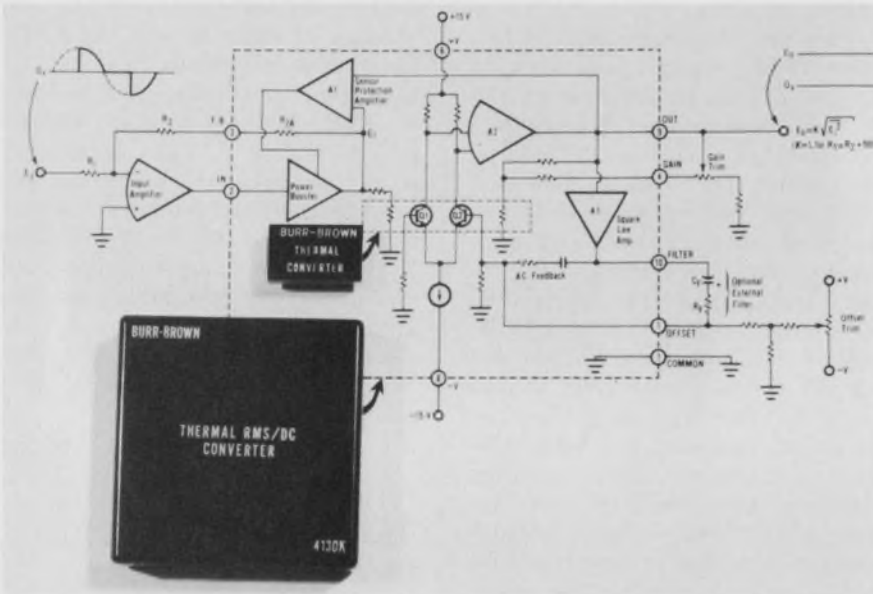

Burr-Brown, 6730 S. Tucson Blvd., Tucson, Ariz. 85706. (602) 294-1431. See text; stock (small quantity).

Most modular rms-to-dc converters use analog computing techniques to produce the dc equivalent of an rms input. Burr-Brown's new Model 4130, however, uses a patented thermal-conversion technique that avoids the accuracy limitations imposed by squaring, averaging and square-rooting operations in conventional computing converters.

The 4130 allows for external

amplification and scaling of the input signal by the addition of a user-supplied op amp. To optimize accuracy, an external offset is provided. There are two versions: The 4130K can be adjusted to a midband output accuracy of 0.05% and the 4130J to 0.1% (with the output error expressed as a percentage of the full-scale input). Nonlinearity is 0.4 mV for the 4130K and 0.1 mV for the 4130J.

Both models have minimum bandwidths of 40 Hz to 100 kHz for rated accuracy and a 10-MHz upper limit for 2% accuracy. The

maximum allowable input is 10 V pk. Therefore the units will accept input signals of 0.1 V rms at a crest factor of 100:1 and 2 V rms at 5:1. Settling time (to 0.1%) for a +20 dB step is 2 s; for a -20 dB step, it's 4 s. The dc output voltage ranges from 0 to 2 V, with 5 mA of output current available. Nominal power supply voltages are ±15 V dc at quiescent currents of +65 and -30 mA. Both units operate within specifications over a 0-to-70-C range.

The thermal converter unit of the 4130 converts the input signal into heat, measures the temperature change, converts it into a current change and produces a dc output voltage whose amplitude is equivalent to the rms value of the input signal. A matched pair of resistors and transistors on a thermally nonconductive substrate sense the temperature difference.

The 4130 also has input protection for overvoltage conditions, high input impedance (10 kΩ), wide dynamic range (26 dB) and external adjustments for gain and voltage offset. The module size is 2 × 2 × 0.6 in. (L, W, H) and is epoxy-sealed.

Prices for the 4130J and 4130K, in unit quantity, are \$115 and \$150, respectively.

READER SERVICE NO. 250

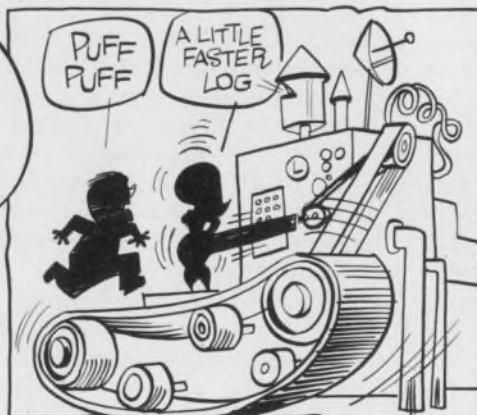

ANALOGY
 WHEN YOU WANT DIRECT CONVERSION FROM DC LEVEL TO A SERIES OF TTL COMPATIBLE PULSES ACCURATELY AND CONVENIENTLY, USE AN A-847. OUTPUT IS 0 TO 10 KHZ, INPUT IS 0 TO 10V. 0.008% LINEARITY AND 10% OVER-RANGE. ADJUSTABLE FROM 9.900 TO 10.000V AT 10 KHZ OUT. CONVERT NOW, WRITE ANA-

intech INCORPORATED
 (408) 244-0500
 1220 COLEMAN, SANTA CLARA CA 95050

LED readout has 0.77-in. characters

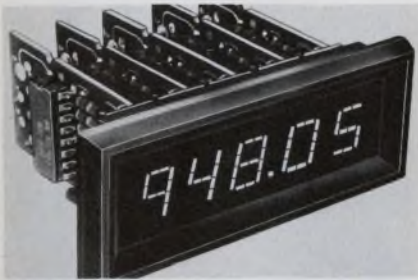

TEC, Inc., 9800 N. Oracle Rd., Tucson, Ariz. 85704. (602) 297-1111. \$25.50/digit (100s); stock.

SSR-73 Series feature 0.77-in. high characters that are sharp and easily read at distances up to 40 feet. The SSR-73 Series operates from a supply voltage of +5 V dc $\pm 5\%$ at 500-mA max. Its readout is a red-emitting LED seven-segment display (with decimal point) that produces 3 millicandellas per segment at 30 mA. Input logic levels are 0 to 0.8-V dc at -1.5 mA for logic zero and 2.5 to 5-V dc at 5 mA for logic ONE. Solid-state decoder/driver with memory accepts BCD inputs. Units include lamp test, nondriven decimal point and provision for automatic blanking of leading and/or trailing zeros.

READER SERVICE NO. 339

S/d converter modules build multiplex system

ILC Data Device, 100 Tec St., Hicksville, N.Y. 11801. (516) 433-5330. \$200-\$375; stock to 6 wks.

MSDC Series are miniature plug-in modules which can be interconnected to create a multiplexed synchro-to-digital or a resolver-to-digital converter system. Digital output is an angle format, with resolution to 13 binary bits or four BCD decades. Data conversion time is 75 μ s per channel. Binary accuracy is $\pm 3.9' \pm 1/2$ LSB; BCD accuracy is $\pm 0.07^\circ \pm 1/2$ LSB. Ratiometric conversion renders the system insensitive to input amplitude and frequency variations. In addition to the six basic building block modules, the MSDC Series is also available as a chassis expandable up to 80 channels in a single standard 19-in. rack, as well as on 5.26 \times 5.38-in. PC cards.

READER SERVICE NO. 340

10-kHz active filter sells for \$12.85



Integrated Microsystems, 16845 Hicks Rd., Los Gatos, Calif. 95030. (408) 268-2410. \$12.85 (100 up); stock.

A universal active resonator, the μ Ar2000, is designed for oscillator, timer, active filter and other applications. The unit operates from ± 12 to ± 15 -V supplies and provides an output swing of ± 10 V from dc to 10 kHz. When used as a filter, the center or corner frequency is set by the addition of two external resistors. A third resistor determines the filter Q. Operation as an oscillator also requires external parts. Packaging for the μ Ar2000 is a 16-pin ceramic and metal DIP.

READER SERVICE NO. 341

3-1/2-digit a/d unit yields 0.05% accuracy

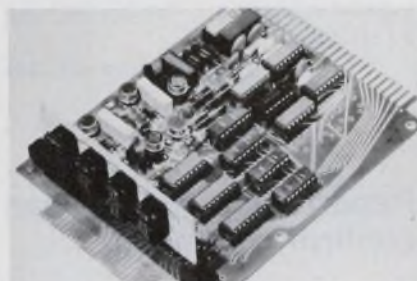

QCI, Inc., 2908 Scott Blvd., Santa Clara, Calif. 95050. (408) 247-2345. \$210.

A/d converter Model IAD 32000-00 is a 3-1/2-digit unit on a standard 4-1/2 \times 6-1/2-in. card. Accuracy of the converter is within 0.05% of the reading ± 1 digit. The display, 0.600 or 0.250-in. LEDs, plugs directly into the card or can be positioned remotely using 3M Scotchflex cable. The card can be mounted in a card cage or as part of a module (add power supply IPS-80000-00). The unit provides BCD, seven-segment and reset outputs, conversion in process, print command, overrange and polarity signals for data processing.

READER SERVICE NO. 342

syntronic

OPTIMUM CORNER FOCUS

Is a function of...

- deflection angle
- light output
- yoke impedance
- display speed
- CRT neck diameter
- CRT length
- yoke production capability

To produce one or one hundred yokes having optimum corner focus requires a thorough knowledge of system design trade-offs.

To see the difference our 25 years of experience can make, let us focus on your yoke problem.



SYNTRONIC INSTRUMENTS, INC.
100 Industrial Road, Addison, IL 60101
Phone: (312) 543-6444

INFORMATION RETRIEVAL NUMBER 61

Planning to write a book?

If you are contemplating writing a book in electrical or electronics engineering, we are most interested in hearing from you.

Hayden Book Company has active publishing and promotional programs for practical professional references and design aids, management guides, and fundamental texts and training materials.

FREE AUTHOR'S GUIDE

The 32-page **Hayden Author's Guide** is yours for the asking, and contains useful information on preparing manuscript and illustrations, styling, and publishing procedures.

For a free copy write Irving Lopatin, Editorial Director, at the address below. Please outline your book idea as fully as possible in your letter.



HAYDEN BOOK COMPANY, INC.
50 Essex Street
Rochelle Park, New Jersey 07662

MODULES & SUBASSEMBLIES

3-A power supply exhibits low ripple



RO Associates, 3705 Haven Ave., Menlo Park, Calif. 94025. (415) 322-5321. \$85 (100 up); stock.

The Model 108 is a regulated dc power supply that uses switching techniques to provide 6 to 12 V dc (adjustable) at 3-A output. Input is 115 V ac, 50 to 70 Hz. 230 V ac units are available. The unit is only 1.72 × 3.5 × 7.9-in. long. Model 108 features continuous short-circuit and overload protection as well as crowbar overvoltage protection, factory set at 14 V. Regulation is ±1 mV for a ±10% change in input line voltage, and 2 mV max for zero to full load change. Ripple is 2 mV pk-pk max. Weight is 4.5 lb. Full output is attainable up to a base plate temperature of 75 C. Remote sensing is standard.

READER SERVICE NO. 343

Report-back decoder can confirm commands

Bramco Controls, College & South Sts., Piqua, Ohio 45356. (513) 773-8271. From \$695; 6 wk.

The MD435 report-back, remote-control decoder transmits a confirmation signal in response to a command. The decoder responds to five, field-programmable, three-digit tone codes. When a relay in the decoder is activated, the relay's identification number is sent back to the control center for display and confirmation. The decoder can be used over private lines, telephone systems, radio systems, or any combination of all three. The unit is available with 19-in. rack mounting in either 12, 24, 48 V dc or 117 V ac versions. Compatible tone encoders and displays are also available.

READER SERVICE NO. 344

Frequency standard delivers stable 10 MHz



Frequency & Time Systems, 182 Conant St., Danvers, Mass. 01923. (617) 777-1255. \$5424; 4 wks.

FRK rubidium frequency standard comes in a 4 × 4 × 4-1/2-in. module, and is designed for direct use as a component in equipment or systems. The oscillator delivers a signal within a few parts in 10¹⁰ of the nominal 10-MHz frequency within 10 minutes of turn-on, and stability values considerably better than a part in 10¹⁰ are characteristic of steady-state operation. The unit operates from a 24-V dc supply and consumes only 13 W of power. It may be used as a direct replacement for precision quartz crystal oscillators.

READER SERVICE NO. 345

Instrumentation amp offers 0.25 μV/°C drift

Burr-Brown Research Corp., International Airport Industrial Park, Tucson, Ariz. 85706. (602) 294-1431. \$165; stock.

Model 3620L instrumentation amplifier can be used with signal source impedances up to 10 kΩ. Input voltage drift is a low ±0.25 μV/°C, max. Equivalent input noise is 1 μV, pk-pk and linearity is 0.01%. Common mode rejection is in excess of 100 dB at a gain of 100. The over-all gain of the 3620L can be varied from 0.1 to 10,000. Other features include an active guard-driver output, output sensing, output offsetting, and a provision for bandwidth reduction. CMR may be externally trimmed, and active low-pass filtering may be added by using a single external capacitor. Size is 2 × 2 × 0.04 in.

READER SERVICE NO. 346

evaluation samples

Resistors

Economy-priced carbon-composition and carbon-film fixed resistors are offered in all standard EIA values for 1/8, 1/4, 1/2, 1 and 2 W ratings in standard $\pm 5\%$, 10% and 20% tolerances. Providing all standard values from 1 Ω to 22 M Ω , with special values available to order, the resistors have a solid integral structure with strength and damage-resistant characteristics. The copper leads have a hot solder coating and are weldable or solderable. Shigoto Industries.

READER SERVICE NO. 347

Mylar connector fingers

High-accuracy connector master artwork features connector patterns complete on one strip and printed on a clear Mylar adhesive-backed film. The Mylar film improves the dimensional stability of these drafting aids since it will neither stretch nor shrink. It is not affected by humidity or temperature and is stronger than matte acetate. The connector fingers are opaque black and each of the ten sizes includes connectors having 22 to 36 contacts and come with a plating bar. Transparent red and blue are available. Centron Engineering.

READER SERVICE NO. 348

Spring connector

A spring connector designed for use in assembling modular racks, displays and molded housings with tubular projections, in conjunction with solid rivets, replaces threaded stand-offs and long tubular rivets. Available with or without a center stop, the latter design can be used as a friction-fit spacer or tubular clip. Seven standard diameters from 1/8 in. to 3/8 in. are available in carbon steel 1071 Rockwell "C" 46-53 or equivalent in a variety of finishes. C.E.M. Co.

READER SERVICE NO. 349

application notes

Ground fault protection

Ideafile No. 5 offers new insights into both the personnel safety hazards of ground faults and the technology of ground-fault interrupting devices, whose use is now indicated by regulatory provisions of OSHA and the NEC. The Ideafile shows how, even in a securely-grounded three-wire system, an electric equipment operator can be electrocuted by ground fault unless protection is provided. Heinemann Electric Co., Trenton, N.J.

READER SERVICE NO. 350

FETs as resistors

A 16-page application note deals with techniques to use field-effect transistors as voltage-controlled resistors. The literature discusses the characteristics of junction FETs as VCRs and draws performance comparisons between the JFET VCR and conventional fixed-value resistors. Numerous circuit applications are presented, in addition to means of reducing signal distortion via feedback techniques, and an analytical approximation of predicting FET VCR behavior. Siliconix, Santa Clara, Calif.

READER SERVICE NO. 351

Laser alignment

"Instruments and Procedures for Aligning Laser Systems" describes one of the most frequent laser maintenance problems, optical misalignment. A comprehensive list of characteristics and features that should be considered when evaluating laser alignment instruments is included. The list then compares the performance of the various types of autocollimators and He-Ne lasers that are currently used as alignment tools. The brochure describes in step-by-step fashion the use of a multipinhole autocollimator for specific procedures that ensure rapid, accurate laser alignment. American Optical Corp., Southbridge, Mass.

READER SERVICE NO. 352

DOUBLE-BALANCED MIXERS

Great Value at

\$7.95
500 piece quantities.

\$9.95 in 6-piece quantities.

DC-500MHz
6dB conversion loss
40dB isolation
EMI shielded case



A breakthrough in technology and high production volume enables Mini-Circuits Laboratory to offer these new products at an unprecedented low price.

In today's tough competitive market can you afford not to use these remarkably low priced and high performance units?

Ruggedness and durability are built in the SRA-1. These new units are packaged within an EMI shielded metal enclosure and hermetically sealed header. They use well matched hot-carrier diodes and uniquely designed transmission line transformers.

We invite you to convince yourself. Place your order now and check our delivery, product performance and reliability.

**Mini-Circuits
Laboratory**

2913 Quentin Rd., Brooklyn, N.Y. 11229
(212) 252-5252, Int'l Telex 620156
A Division Scientific Components Corp.

FRANCE: S.C.I.E., *31, rue George-Sand, Palaiseau 91, France GERMANY, AUSTRIA, SWITZERLAND: Industrial Electronics GMBH, *Klüberstrasse 14, 6000 Frankfurt/Main, Germany *UNITS IN STOCK

INFORMATION RETRIEVAL NUMBER 63

new literature



Time-code formats

A Handbook of Time-Code Formats details format data on the 22 most common time codes. The handbook graphically illustrates reference time, typical time frames, index count, index markers and other data pertinent to each specific time code. Moxon Inc./SRC Div., Irvine, Calif.

READER SERVICE NO. 353

Precision voltage dividers

Precision voltage dividers for instrument standards in calibration laboratories are described in a two-page bulletin. A selection chart for five basic models is included. Singer Instrumentation, Los Angeles, Calif.

READER SERVICE NO. 354

Thermistors

The Short Form Thermistor Catalog provides a brief, but comprehensive introduction to a broad variety of thermistor sensors and sensor assemblies. Included in this catalog are thermistors and probe assemblies, R-T curve-matched interchangeable thermistors, thermistor beads, probes, discs, washers, rods as well as fast-response glass-probe thermistors and thermistor glass encapsulated diode types. Fenwal Electronics, Framingham, Mass.

READER SERVICE NO. 355

Programmable generator

The F280A programmable waveform generator is described in a four-page bulletin. Included are specifications and data for interfacing with contact closure or DTL/TTL logic levels. Means for controlling locally and remotely are covered, as well as methods for selecting sine, square, triangle and offset operating modes. Ailtech, City of Industry, Calif.

READER SERVICE NO. 356

Adhesives

Alpha cyanoacrylate adhesives are described in a six-page bulletin. The literature gives information on four different types of the powerful, quick-setting, permanent-bond adhesives. Specifications are shown in a chart. Oneida Electronic Manufacturing Co., Meadville, Pa.

READER SERVICE NO. 357

Semiconductors

A 36-page short-form catalog gives information on linear ICs, Hall-effect ICs, functional electronic circuits, thin-film resistor arrays, thin-film hybrid circuits and digital ICs. Sprague, N. Adams, Mass.

READER SERVICE NO. 358

Dc ammeter shunts

Custom-made dc ammeter shunts are shown in a two-page bulletin. Empro Manufacturing Co., Inc., Indianapolis, Ind.

READER SERVICE NO. 359

Nickel cadmium batteries

"The Pocket Plate Nickel Cadmium Battery for Standby Service" covers ampere-hour capacity, comparative discharge performance, details of pocket plate construction and analyses of the performance characteristics. NIFE Inc., Copiague, N.Y.

READER SERVICE NO. 360

Measurement devices

Descriptions and specifications of laser calorimeters, ballistic thermopiles (with or without photodiodes), photodetectors and laser "footprint" paper are included in a 12-page catalog. The catalog lists a series of high-power French laser calorimeters and shows quantitative transmission characteristics of safety eyeshields. Hadron, Westbury, N.Y.

READER SERVICE NO. 361

Solid-state switch drivers

TTL-compatible switch drivers with total switching times less than 10 ns are described in a 44-page catalog. LRC, Inc., Hudson, N.H.

READER SERVICE NO. 362

Power supplies

A "Design As You Order" specification form for regulated power conversion systems provides the necessary instructions and technical information to design and specify custom systems from standard models. Inputs are available from 50 to 500 Hz ac and 12, 28, 48 or 115 V dc with power capability to 200 W. Complete pricing is provided. Arnold Magnetics Corp., Culver City, Calif.

READER SERVICE NO. 363

Laserscribing

A tongue-in-cheek approach to the explanation of wafer scribing using a laserscribe is presented in an easy-to-read booklet. Within its seven chapters are discussions of theory, hardware, operating costs and the results that can be achieved with a laserscribe. Quantronix, Smithtown, N.Y.

READER SERVICE NO. 364

Switches

Miniature switches, keyboard assemblies and related products are described in a 32-page illustrated catalog. Specifications, prices, dimensions, life expectancy and ordering information are included. Alco Electronic Products, North Andover, Mass.

READER SERVICE NO. 365

Light-emitting diodes

Specifications, operating voltages and prices for light-emitting-diode miniature indicator lights are highlighted in a one-page data sheet. Shelly/Datatron, Santa Ana, Calif.

READER SERVICE NO. 366

Semi memory tester

System descriptions, photographs, charts and options on the Doctor 32-II memory tester are featured in a booklet. Adar Associates, Inc., Cambridge, Mass.

READER SERVICE NO. 367

Rf and microwave devices

"Rf and Microwave Devices," a quick-selection guide, shows power-vs-frequency curves for the entire product line, with power levels to 80 W and frequencies to 3.5 GHz. The electrical characteristics of the devices are summarized by type, and the types are retabulated by application. Block diagrams illustrate typical circuit applications, and photographs show all package styles. RCA Solid State Div., Somerville, N.J.

READER SERVICE NO. 368

12-bit S/D converter

A 12-bit S/D converter is described in a two-page bulletin. Electrical and mechanical specifications are included. Clifton Precision, Drexel Hill, Pa.

READER SERVICE NO. 369

Industrial control systems

Standard modular-design digital-control systems and components are described in an eight-page catalog. FX Systems Corp., Saugerties, N.Y.

READER SERVICE NO. 370

Test instruments

More than 250 new and reconditioned test instruments are illustrated in a minibrochure which is published every other month. Tucker Electronics, Garland, Tex.

READER SERVICE NO. 371

DIP REED RELAYS

Available in all standard configurations
From distributor stock

Elec-Trol's totally encapsulated DIP REED RELAYS can be driven directly by TTL logic. Available in 1 and 2 Pole Form A, 1 Form B, 1 Form C with 5 through 24 VDC standard coil voltages. Contact ratings up to 10 watts. Available in .225" and .275" heights. Clamping diode and electrostatic shielding optional.

Phone, wire or write.

ELEC-TROL, INC.

26477 N. Golden Valley Road
Saugus, California 91350
(213) 788-7292
TWX 910-336-1556

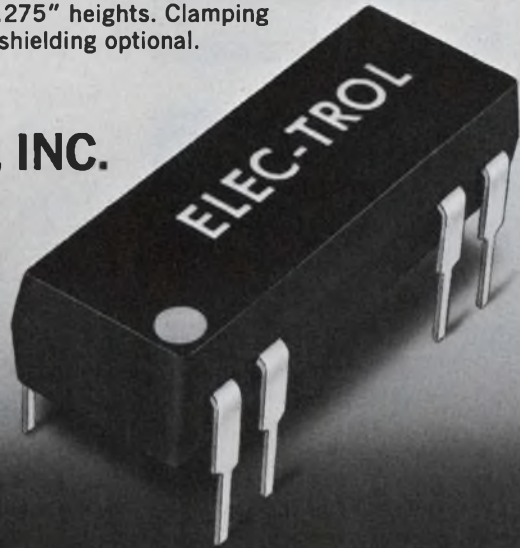

1973-74
eem
VOL. TWO

INFORMATION RETRIEVAL NUMBER 64



high current
OEM power
supplies

5 volts @ 100 amps: \$315

Volts	Amps	Size	Model No.	Price
5	65	5x11x15	HCM5N65	\$245
	100	5x15x18	HCM5N100	\$315

10 new high current power supplies: 5-, 12-, 15-, 24- and 28-volts. Current ratings from 5V @ 100 amps to 28V @ 16 amps. 0.1% regulation. Overtoltage protection available. Guaranteed forever. UL recognized. GSA listed. Stock delivery on 5V models. 4-week delivery on 12-, 15-, 24- and 28-volt models.

Write for new catalog with over 100 standard OEM power supplies.

acdc electronics inc.

Oceanside Industrial Center, Oceanside, Calif. 92054. (714) 757-1880

INFORMATION RETRIEVAL NUMBER 65



Measuring indicators

Sixteen multipoint measuring indicator panels are described in a catalog. For each panel configuration, the catalog contains outline drawings, number of points monitored, type of switching (pushbutton or toggle), mounting, point identification marking, over-all dimensions and panel cutout dimensions. Howell Instruments, Fort Worth, Tex.

READER SERVICE NO. 372

Desoldering systems

A two-page specification sheet describes the company's power desoldering systems. Pace Inc., Silver Spring, Md.

READER SERVICE NO. 373

Signal converters

Signal converters that convert flowmeter outputs to usable electrical signals linear to the flow rate are described in a four-page bulletin. Included is information on design, operation, specifications, outputs and dimensions. Brooks Instrument Div., Hatfield, Pa.

READER SERVICE NO. 374

Adhesives

Technical Bulletin No. 3023 describes Versalok structural adhesives that bond a wide variety of materials in short-cure times. A selector chart is included. Lord Corp., Erie, Pa.

READER SERVICE NO. 375

Electron tubes

Photomultiplier tubes and variants are highlighted in a 31-page catalog. A high-voltage photomultiplier power supply, magnetic focusing assemblies for dark-current reduction and tubes planned for introduction in the near future are outlined. EMI Electronics, Middlesex, U.K.

READER SERVICE NO. 376

Filters

Telegraph tone channel and speech plus filters are described in two data sheets. Descriptions, part numbers and dimensions are given. B & H Electronics, Mount Vernon, N.Y.

READER SERVICE NO. 377

Instrumentation

Digital electronic counter/timers, digital VOMs, solid-state electronic multimeters, miniature strip-chart recorders, multirange chart recorders, an RLC bridge, low-cost secondary standards, multirange precision milliohmmeters and multirange dc standards are described in a 16-page catalog. Simpson Electric, Chicago, Ill.

READER SERVICE NO. 378

Key-data terminal

A 20-page booklet describes the DT1000 key-data terminal system which provides a complete remote job entry system to a potential OEM user via a standard interface. Described in the booklet are the four basic units—two types of key-data recorders, a key station and a central recorder station—that make up the DT1000 system. Specifications and options are described. Pertec, Los Angeles, Calif.

READER SERVICE NO. 379

Electronic cabinet

A four-page catalog features the 3000-series electronic cabinet. A full selection of options permits customization to suit any specific application. Features, dimensions and specifications are included. Vent-Rak Div., General Devices Co., Indianapolis, Ind.

READER SERVICE NO. 380

Terminals

Semiassembled Teflon terminals are covered in an eight-page catalog. Information on subminiature stand-offs, feed-thrus, reverse feed-thrus and test jacks is provided. Technical data are included on electrical and chemical properties along with information on the variety of platings available to meet application requirements. Sealectro, Mamaroneck, N.Y.

READER SERVICE NO. 381

Power diodes

Two lines of power diodes featuring high-surge-current capability for a wide variety of applications are described in a data sheet. The literature provides ratings and specifications, nine rating graphs, a dimensioned outline drawing and a photograph. International Rectifier Corp., El Segundo, Calif.

READER SERVICE NO. 382

Instrumentation interface

Datos 305 which interfaces any number of instruments up to 24 digits is described in a four-page brochure. Data Graphics Corp., San Antonio, Tex.

READER SERVICE NO. 383

Thermistor chips

A data bulletin describes thermoflakes for microcircuit applications. The bulletin includes data on configurations, standard resistance values, resistance ratios and thermal properties. Nonstandard available options are noted. Thermometrics, Edison, N.J.

READER SERVICE NO. 384

Light measurements

"Systems to Solve Light Measurement Problems" features systems using standard modules which allow the user to plug together units without the requirement of building special adaptors. Fully compatible plug-in heads, accessories and attachments are shown. Gamma Scientific, Inc., San Diego, Calif.

READER SERVICE NO. 385

Dc panel meters

A series of 1-1/2 by 2-1/2-in. taut-band panel meters is described in a 16-page catalog. Jewell Electrical Instruments, Inc., Manchester, N.H.

READER SERVICE NO. 386

Silicone elastomer systems

A 10-page brochure on silicone elastomer systems used in electronic applications covers silicone potting compounds; moisture-barrier materials; transparent dielectrics; thermally conductive, fire-resistant silicones; protective silicones for PC boards; silicone heat-sink compounds and silicone mold-making materials. Transene Co., Rowley, Mass.

READER SERVICE NO. 387

Modem test equipment

Specifications and applications for the Range Rider series of communications system test equipment are described in data sheets. International Data Sciences, Providence, R.I.

READER SERVICE NO. 388

Measuring instruments

Transducer simulators, bridge amplifiers, bridge boosters, a rate/amplitude processor and a millivolt source are described in a four-page brochure. Fogg System Co., Denver, Colo.

READER SERVICE NO. 389

Materials

Several technical brochures describe products and capabilities in metals, electronic materials and parts fabrication. Plessey, Melville, N.Y.

READER SERVICE NO. 390

CATV connectors

A 12-page brochure on CATV connectors includes 33 photographs, outline drawings and specifications for seized-center-conductor series, cable-feedthrough series, adapters and miscellaneous fittings. ITT Cannon Electric, Santa Ana, Calif.

READER SERVICE NO. 391

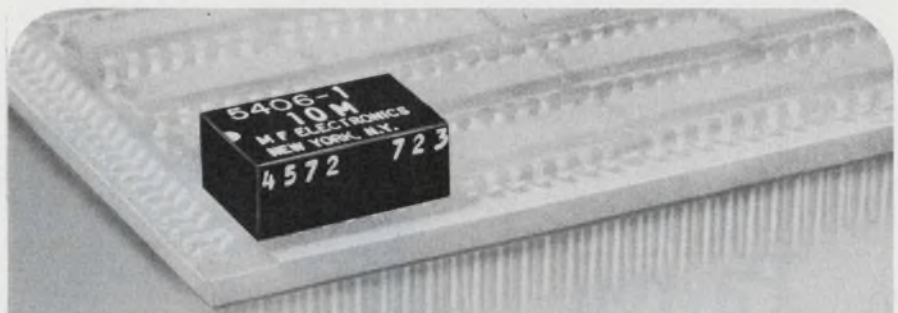

LOW PROFILE, PLUG-IN CRYSTAL OSCILLATORS FOR DIP USE

The MF Model 5406 oscillator module is designed for direct insertion into DIP sockets, or can be soldered into PC boards if desired. Only 0.3" in height when seated, it offers the advantage of allowing standard 0.5" board spacing. Any frequency from 4 MHz to 45 MHz may be specified with a stability of ± 50 ppm or ± 25 ppm from 0° to 65° C. Temperature range from -55° to +125° C is also available. Input voltage is 5v and the TTL output sinks 16 ma up to 10 MHz, and 20 ma above 10 MHz (10 TTL loads). Typical price, in quantities of 1 through 4 is \$35.00. Delivery is within four weeks, and many frequencies are available for immediate shipment. For information regarding these and other MF crystal oscillators, contact:



MF Electronics Corp.

118 East 25th Street, New York, NY 10010 • (212) 674-5360

INFORMATION RETRIEVAL NUMBER 66



dual output OEM power supplies

± 12 volts and ± 15 volts

Voltage	Current	Size	Wt. (lbs.)	10-pc. Price
± 12 & ± 15	.42 & .37	1 $\frac{3}{4}$ x 4 $\frac{1}{2}$ x 4	1 $\frac{7}{16}$	\$37.50
± 12 & ± 15	1.5 & 1.3	3 $\frac{3}{16}$ x 4 $\frac{15}{16}$ x 6 $\frac{1}{4}$	4 $\frac{1}{2}$	\$81.00
± 12 & ± 15	2.7 & 2.4	3 $\frac{3}{16}$ x 4 $\frac{15}{16}$ x 10	7 $\frac{1}{2}$	\$89.00

± 12 or ± 15 , fully adjustable voltage on OEM models, optional on pc card models. Built-in tracking and long term stability. UL recognized.
GSA listed. Guaranteed forever. Compact, low priced, available from stock.
Write for new catalog with over 100 OEM power supplies.

acdc electronics inc.

Oceanside Industrial Center, Oceanside, Calif. 92054. (714) 757-1880

INFORMATION RETRIEVAL NUMBER 67



The U. S. Government does not pay for this advertisement. It is presented as a public service in cooperation with The Department of the Treasury and The Advertising Council.

The Payroll Savings Plan helps you save some of your living for later.

Sure there are lots of things you want right now. Lots of things you need.

But, the sun's going to shine tomorrow, too.

That's why it's important you do something today to build a little nest egg for the future. And there's no easier way to do that than by joining the Payroll Savings Plan where you work. You sign up once and any amount you specify will be set aside from each paycheck and used to buy U.S. Savings Bonds.

The Payroll Savings Plan. The perfect way to help your good life stay that way.



Now E Bonds pay 5 1/4% interest when held to maturity of 5 years, 10 months (4% the first year). Bonds are replaced if lost, stolen, or destroyed. When needed they can be cashed at your bank. Interest is not subject to state or local income taxes, and federal tax may be deferred until redemption.

Take stock in America.
Join the Payroll Savings Plan.

NEW LITERATURE



Optical components

A colorful 16-page price catalog of stock optical components includes plano-parallel and wedged optical flats, Brewster angle windows, Littrow prisms, plano-concave mirror blanks, 90°-45°-45° prisms, corner cube reflectors, plano-convex quartz lenses and mirror blanks. Precision Optics, Eatontown, N.J.

READER SERVICE NO. 392

Timers

Compact, high-accuracy timers available in a wide selection—electronic, interval, continuous program, cycle, thermal—are described in a catalog. The Ripley Co., Middletown, Conn.

READER SERVICE NO. 393

TTL IC data book

"The TTL IC Data Book for Design Engineers," a 640-page hardback book, provides comprehensive specifications on the company's five families of 54/74 TTL ICs. Parameters are given for the standard, the high-speed, the low-power, the Schottky-clamped and the low-power Schottky series. Included are radiation-hardened and beam-lead circuits and TTL high-performance RAMs. Indexes are provided. MSI functions and SSI pin assignment drawings are arranged in sequence by type number. The book is priced at \$3.95. Texas Instruments, P.O.Box 5012, M/S 384, Dallas, Tex. 75222.

Electronic Design

ELECTRONIC DESIGN's function is:

- To aid progress in the electronics manufacturing industry by promoting good design.
- To give the electronic design engineer concepts and ideas that make his job easier and more productive.
- To provide a central source of timely electronics information.
- To promote communication among members of the electronics engineering community.

Want a subscription? ELECTRONIC DESIGN is sent free to qualified engineers and engineering managers doing design work, supervising design or setting standards in the United States and Western Europe. For a free subscription, use the application form bound in the magazine. If none is included, write to us direct for an application form.

If you do not qualify, you may take out a paid subscription for \$30 a year in the U.S.A., \$40 a year elsewhere. Single copies are \$1.50 each.

If you change your address, send us an old mailing label and your new address; there is generally a postcard for this bound in the magazine. You will have to requalify to continue receiving ELECTRONIC DESIGN free.

The accuracy policy of ELECTRONIC DESIGN is:

- To make diligent efforts to ensure the accuracy of editorial matter.
- To publish prompt corrections whenever inaccuracies are brought to our attention. Corrections appear in "Across the Desk."
- To encourage our readers as responsible members of our business community to report to us misleading or fraudulent advertising.
- To refuse any advertisement deemed to be misleading or fraudulent.

Microfilm copies are available of complete volumes of ELECTRONIC DESIGN at \$19.00 per volume, beginning with Volume 9, 1961. Work is now in process to complete the microfilm edition of Volumes 1-8. Reprints of individual articles may be obtained for \$2.00 each, prepaid (\$.50 for each additional copy of the same article) no matter how long the article. For further details and to place orders, contact the Customer Services Department, University Microfilms, 300 North Zeeb Road, Ann Arbor, Michigan 48106 telephone (313) 761-4700.

Want to contact us? If you have any comments or wish to submit a manuscript or article outline, address your correspondence to:

Editor
ELECTRONIC DESIGN
50 Essex Street
Rochelle Park, N.J. 07662

Electronic Design

Advertising Sales Staff

Tom W. Carr
Sales Manager

Rochelle Park, N.J. 07662

Robert W. Gascoigne
Daniel J. Rowland
50 Essex Street
(201) 843-0550
TWX: 710-990-5071

Philadelphia

Thomas P. Barth
50 Essex Street
Rochelle Park, N. J. 07662
(201) 843-0550

Boston 02116

Richard L. Green
20 Columbus Avenue
Boston, Mass.
(617) 482-7989

Chicago 60611

Thomas P. Kavooras
Berry Conner, Jr.
200 East Ontario
(312) 337-0588

Cleveland

Thomas P. Kavooras
(Chicago)
(312) 337-0588
(call collect)

Los Angeles 90303

Stanley I. Ehrenclou
Burt Underwood
2930 Imperial Highway
Inglewood, Calif
(213) 757-0183

San Francisco 94022

Jerry D. Latta
P.O. Box 1248
Los Altos, Calif.
(415) 965-2636

London W. 1

For United Kingdom and Holland
Brayton C. Nichols

For Eastern Europe
Peter Kehr

The American Magazine Group
9 Warwick Street

London, W. 1, England
Phone: 437 5462

Cable: Ammagnic, London

4800 Verviers, Belgium

For Continental Europe

Andre Jamar
Rue Mallar, 1
(087) 253.85 Telex 41563

Tokyo

Haruki Hirayama
Electronic Media Service
5th Floor, Lila Bldg.,
4-9-8 Roppongi
Minato-ku
Phone: 402-4556
Cable: Electronicmedia, Tokyo



AMERICAN BUSINESS PRESS, INC.



The President's Committee
on Employment of the Handicapped
Washington, D.C. 20210

TRUE Miles-Per-Gallon Meter

MEASURES
GAS MILEAGE
AT ALL
SPEEDS



SpaceKom's *new* mpg meter uses patented photo-electronic flow and speed sensors, and a miniature computer for instantaneous mpg readout on a 2 $\frac{1}{4}$ -inch meter. Quick and simple to install, it fits all US and most foreign cars and trucks. By monitoring gas mileage, you can detect problems, increase engine efficiency, and reduce gas consumption. *Order now or request more information from SpaceKom.*

SpaceKom P.O. Box 10
Goleta, California 93017

Please send _____ MPG meters @ \$34.50 ea.
Enclosed is \$ _____ Ship Ppd. / COD
Vehicle make/year _____

Name _____
Address _____

INFORMATION RETRIEVAL NUMBER 68

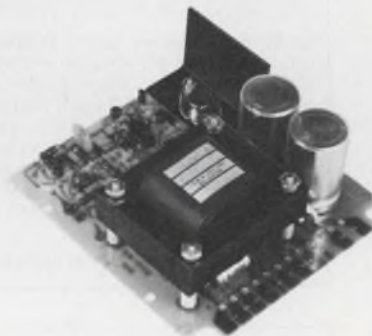

card type
OEM power
supplies

4 to 32 volts @ \$28.50

Volts	5	12	15	24	± 12	± 15
Amps	1.5	.85	.74	.51	.42	.37
10-pc. Price	\$28.50				\$37.50	

Designed for versatile mounting inside your equipment. Put the power supply where you need it. 0.1% regulation. Overvoltage protection and voltage adjustment pot available. GSA listed. Guaranteed forever.

Stock delivery on 5-, 12-, 15-, 24-, ± 12 - and ± 15 -volt models. Others in 4 weeks. Write for new catalog with over 100 standard OEM power supplies.

acdc electronics inc.

Oceanside Industrial Center, Oceanside, Calif. 92054. (714) 757-1880

INFORMATION RETRIEVAL NUMBER 69



Thin-Trim variable capacitors provide a reliable means of adjusting capacitance without abrasive trimming or interchange of fixed capacitors. Series 9401 has high Q's and a range of capacitance values from 0.2-0.6 pf to 3.0-12.0 pf and 250 WVDC working voltage. Johanson Manufacturing Corporation, Boonton, New Jersey (201) 334-2676.

INFORMATION RETRIEVAL NUMBER 181

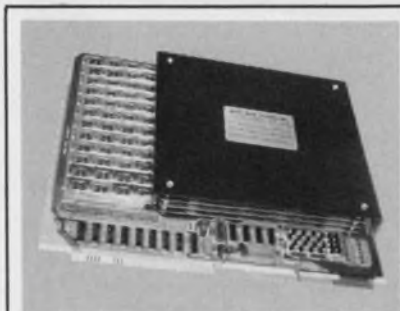

Read-only memory systems—For applications such as: data table, microprogramming and control function storage. Available with access times less than 100 ns and cycle times to 450 ns. All models available 30 days ARO. Prices as low as 1¢/bit in quantity. Aztec Data Systems, 17805E Sky Park, Irvine, Ca. 92707, 714-540-8445.

INFORMATION RETRIEVAL NUMBER 182

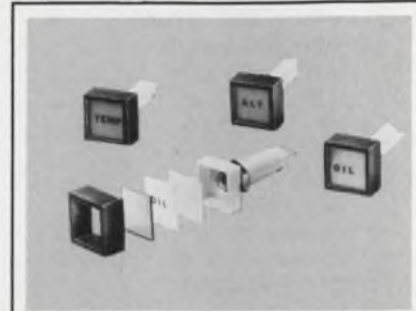

Customized legends on indicator lights—ImLec's Series BFJ offers customized legends photographically imprinted on film inserted between colored and diffuser lenses. Lens size 15/32" (12 mm.) sq. Choice of five colors. In 6, 14 or 28 volts. Pigtails available. Inter-Market, Inc., 1920 Waukegan Road., Glenview, Ill. 60025. (312) 729-5330.

INFORMATION RETRIEVAL NUMBER 183

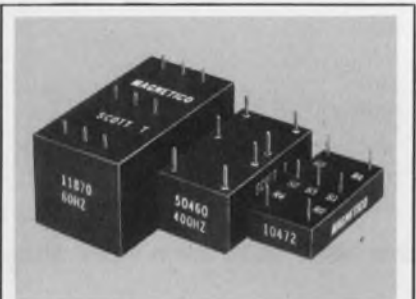

Scott T Transformer. 11870: 60HZ, 90v, L-L In. 1.1x2.1x1.1. 50460: 400HZ, 90v, L-L In. 7/8x1-5/8 x11/16. 50642: 400HZ, 11.8v, L-L In. 7/8x1-5/8x11/16. 10472: 400-HZ, 11.8v, L-L In. 3/4x1-1/2x3/8. All with 6v RMS sine & cosine output. MAGNETICO, INC., E. Northport, N.Y. 11731. 516-261-4502.

INFORMATION RETRIEVAL NUMBER 184

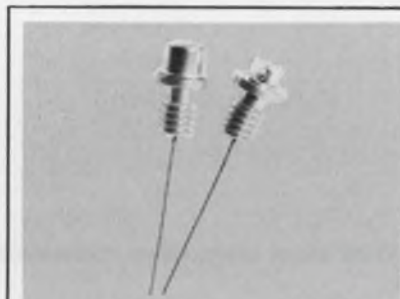

GaAs and GaAlAs Laser Diodes with diode located on rotational center of mounting stud. Wavelength selectable from 800 to 905nm; Peak power from 4 to 25 watts, Duty cycle to 0.1%. Priced from \$10.00 in hundreds. Laser Diode Laboratories, Inc., 205 Forrest Street, Metuchen, N. J. 08840. (201) 549-7700.

INFORMATION RETRIEVAL NUMBER 185

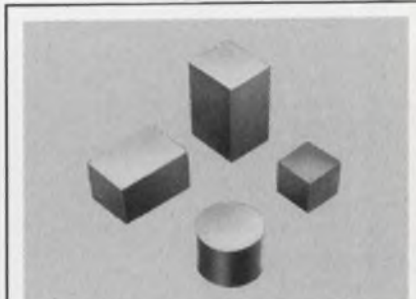

Encapsulation Shells are precision molded in flame-proof glass-fibre filled Diallyl Phthalate, conforming to MIL-M-14, Type SDG-F. Over 1600 standard shells are available in oblong, round and square styles. Robison Electronics, Inc., 2134 W. Rosecrans Ave., Gardena, Calif. 90249. Phone: (213) 321-0080.

INFORMATION RETRIEVAL NUMBER 186



Free catalog of 32,000 power supplies from the worlds largest manufacturer of quality Power Supplies. New '73 catalog covers over 32,000 D.C. Power Supplies for every application. All units are UL approved, and meet most military and commercial specs for industrial and computer uses. Power Mate Corp. (201) 343-6294.

INFORMATION RETRIEVAL NUMBER 187

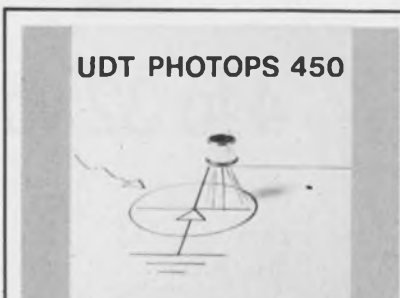

UDT PHOTOPS 450

New UDT PHOTOPS optical detector/amplifier combinations are ideal replacements for photomultiplier tubes. These high gain, low noise, high speed devices are available with large 1cm² sensing area and latest FET circuitry. Sensitivity to 10⁻¹² watts with bandwidths to 10MHz. United Detector Technology, 1732 21st Street, Santa Monica, Ca.

INFORMATION RETRIEVAL NUMBER 188



Free Dollars. Instead of a penny for your thoughts, a "dollar for your call." Just call Electronic Measurements at 201-922-9300 and ask for Bob to discuss your power supply requirements and we will send you a new dollar bill, just for talking with us. Electronic Measurements, 405 Essex Road, Neptune, New Jersey 07753. (201) 922-9300

INFORMATION RETRIEVAL NUMBER 189

Advertisers wishing to reserve Quick Ad units should note the following mechanical requirements: Specs—Supply glossy photo of product and approximately 40 words which will set no more than 10 lines of 34 characters each. AFTER SUBMISSION NO COPY CHANGES CAN BE ACCEPTED. Quick Ads cost only \$300 per insertion, less for frequency advertisers.

RATES:

1x
\$300

7x
\$280

13x
\$255

19x
\$250

26x
\$245

39x
\$240

52x
\$235

104x
\$230

bulletin board

Data Synthesis, Inc., has announced an independent contract testing service for Go/No Go, functional and diagnostic testing of digital-logic circuit cards, logic modules and assemblies. Using high-speed automatic logic function analyzers, the company claims it can test, diagnose and repair complex logic assemblies for manufacturers in a fraction of the time and at costs significantly less than present manual methods. Hard-copy diagnostic and fault-finding reporting are available.

READER SERVICE NO. 394

Solid State Scientific, Inc., has announced the addition of six devices to its line of CMOS ICs.

READER SERVICE NO. 395

Texas Instruments has introduced three n-channel dual insulated-gate FETs. Designated the 3N211, 3N212 and the 3N213, these depletion-type MOS transistors have a high-forward transconductance, y_{fs} , rating of 25 micromhos typically. Typical common-source spot noise figure is 2 dB at 200 MHz, and typical power gain is 28 dB at 200 MHz. These units have a feedback capacitance of only 0.05 pF. They are protected from excessive input voltage by integrated back-to-back diodes between gate and source.

READER SERVICE NO. 396

Motorola's Semiconductor Product Div. has introduced JEDEC registered opto-couplers. The four devices—4N25, 4N26, 4N27, 4N28—are infrared LEDs coupled to a silicon phototransistor and are intended to replace devices formerly available under the unregistered in-house type numbers MOC1001, MOC1000, MOC1002 and MOC1003. Motorola is among one of the first to use the JEDEC 4N classification.

READER SERVICE NO. 397

vendors report

Annual and interim reports can provide much more than financial-position information. They often include the first public disclosure of new products, new techniques and new directions of our vendors and customers. Further, they often contain superb analyses of segments of industry that a company serves.

Selected companies with recent reports are listed here with their main electronic products or services. For a copy, circle the indicated number.

Hermetite Corp. Hermetic seals.
READER SERVICE NO. 398

GCB Closed Circuit TV Corp. TV accessories and equipment.
READER SERVICE NO. 399

Data-Design Laboratories. Emergency lighting systems, circuit boards and microelectronic devices.
READER SERVICE NO. 400

Terminal Data Corp. Microfilm systems and microfilm camera systems.
READER SERVICE NO. 401

Data General Corp. Computers, peripheral equipment, systems, software and data communications.
READER SERVICE NO. 407

Varian Associates. Communications, medical electronics, industrial systems, pollution-control systems, data processing and digital technology.
READER SERVICE NO. 402

Wavetek. Test equipment and data communications.
READER SERVICE NO. 403

Cambridge Memories, Inc. Add-on memory systems for computers and minicomputers.
READER SERVICE NO. 404

Informatics Inc. Computers, software products and custom services.
READER SERVICE NO. 405

advertiser's index

Advertiser	Page
ACDC Electronics, Inc.....	171, 173, 175
AMP, Incorporated	45
Abbott Transistor Laboratories Incorporated	6
Acopian Corp.	143
Airpax Electronics, Controls Division	159
Alco Electronic Products, Inc.....	136
Allen-Bradley Co.	39
American Electronic Laboratories, Inc.	155
Analog Devices, Inc.....	25, 153
Analog Digital Research.....	136
Astrosystems, Inc.	161
Aztec Data Systems, Inc.....	176
Beckman Instruments, Inc., Helipot Division	8, 9
Bourns, Inc., Trimpot Products Division	12, 13
Clare-Pendar	47
Dale Electronics, Inc.....	Cover II
Delco Electronics, Division of General Motors Corporation.....	48, 49
Dialight Corporation.....	56 thru 116
Dow Corning Corporation.....	14, 15
Dynamics Electronics	154

Advertiser	Page
ECC Corporation	7
Elec-Trol, Inc.....	171
Electronic Design	179
Electronic Measurements, Inc.....	176
Erie Technological Products, Inc.....	35
Federal Scientific Corporation.....	178
Ferroxcube Corporation	52
Franklin Manufacturing Sales.....	143
Gralex Industries, Division of General Microwave Corp.....	163
Harris Semiconductor, A Division of Harris Intertype Corporation	16A
Hayden Book Company, Inc.....	168
Hewlett-Packard	1, 4, 5, 26, 27, 133, 151
Hoffman Engineering Company.....	164
Industrial Electronic Engineers, Inc... 10	
Intech, Incorporated	166
Inter-Market, Inc.	176
Jermyn Industries	16B
Johanson Manufacturing Corp.....	176

Advertiser	Page
Lambda Electronics Corp.....	Cover III
Laser Diode Laboratories, Inc.....	176
Ledex, Inc.	157
Littlefuse	2
MF Electronics Corp.....	173
Magneto, Inc.	176
Marco-Oak, A Subsidiary of Oak Industries, Inc.....	143
Microdata Corporation	147
Mini-Circuits Laboratory	169
Motorola Semiconductor Products, Inc.	17, 18, 19, 20, 21, 22, 23, 24
National Semiconductor Corporation	50, 51
Plessey Semiconductors	28
Power/Mate Corp.	164, 176
Pulse Engineering, Inc.....	124
RCA Corporate	148
RCA Solid State.....	Cover IV
Rotron, Incorporated	29
Robison Electronics Inc.	176

Schauer Manufacturing Corp.....	180
Signetics Corporation	41
Siliconix Incorporated	118
Solid State Scientific, Inc.....	139
SpaceKom, Inc.	175
Sprague Electric Company, Dearborn Electronics Division.....	16
Spectra-Physics	30
Struthers-Dunn, Inc.	37
Syntronic Instruments, Inc.....	167

TRW Semiconductor Division of TRW, Inc.	11
Tektronix, Inc.	55
Teletype Corporation	33
Test & Measuring Instruments Inc.....	145
Texas Instruments Incorporated.....	129
Tri-Data Corporation	137
Triplet Corporation	141

United Detector Technology, Inc.....	176
United Technical Publications.....	179

Vactec, Inc.	43
-------------------	----

Weston Instruments, Inc.....	125
Windjammer Cruises	117
Woven Electronics	132

Design Data from Manufacturers

Advertisements of booklets, brochures, catalogs and data sheets. To order use Reader-Service Card.
(Advertisement)

The First 500-Line Real-Time Spectrum Analyzer-Averager

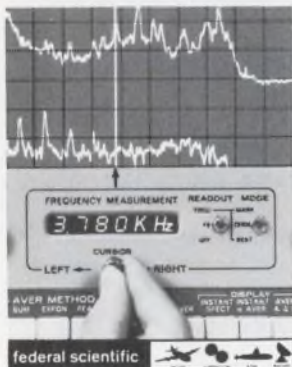

New UA-500, the most powerful analyzer of its type, offers the only standard built-in dual memory averager. Unique digital cursor reads directly in Hz. Portable, small (8-3/4"), for field and lab. Fastest speed minimizes test time, presents flicker-free display: real-time to 10 KHz, max. range of 100 KHz, 20 sweeps/sec display rate. Best possible resolution: sharpest analysis filter (proprietary 24dB/octave slope) so that 500-line analyzer has effective 650 lines. Dual memory averager allows simultaneous display of continually updated exponential average & previously stored average. To verify quality of data, instantaneous spectra can be viewed on the same CRT as average . . . input time function can also be displayed. Plus other standard features: transient capture, exponential and peak averaging, lin-log scales both vertical & horizontal, complete plotter set-up & recording, computer compatibility with remote sensing or control.

CIRCLE NO. 171

Federal Scientific Corporation

An Affiliate of Nicolet Instrument
615 West 131st St., New York, N.Y. 10027 (212) 286-4400

**"YOUR
OPPORTUNITY"**

WITH KNOWN DISTRIBUTOR — MANUFACTURER OF TELEPHONY EQUIPMENT SEEKING PRODUCTS TO ADD TO ITS LINE FOR NATIONAL DISTRIBUTION. ALL FACILITIES AVAILABLE FOR COMPLETE DEVELOPMENT.

in confidence reply to
INFORMATION RETRIEVAL NUMBER 904

**Get a jump on tomorrow,
save today.**



Take stock in America.
With higher paying U.S. Savings Bonds.

connectors

NEED INFORMATION ON
connectors?

**Who makes them?
Where to get them?**

PICK UP YOUR PHONE
AND DIAL TOLL FREE

800-645-9200

(or, in New York State, call collect (516) 294-0990)

**this service is
FREE**

use it whenever you're about to specify
any electronic product

eem

645 Stewart Ave., Garden City, N. Y. 11530

INFORMATION RETRIEVAL NUMBER 70

**PERSONNEL
RECRUITMENT
ADVERTISING
IN
Electronic Design
REACHES THE
RIGHT PEOPLE
AT A LOWER COST
PER THOUSAND**

*Call the
HOTLINE
today
for complete
information:
(201) 843-0550
extension 209*

NEW SHORTER CASE! SCHAUER 1-WATT ZENERS



**SAME LOW PRICES FOR
1% TOLERANCE ZENERS
ANY VOLTAGE
FROM 2.0 TO 18.0**

Quantity	Price Each
1-99	\$1.07
100-499	.97
500-999	.91
1000-4999	.86
5000 up	.82

IMMEDIATE SHIPMENT

Send for rating data and 20%, 10%, 5% and 2% tolerance prices.

Semiconductor Division

SCHAUER

MANUFACTURING CORP.

4511 Alpine Ave., Cincinnati, Ohio 45242
Telephone 513/791-3030

product index

Information Retrieval Service. New Products, Evaluation Samples (ES), Design Aids (DA), Application Notes (AN), and New Literature (NL) in this issue are listed here with page and Information Retrieval numbers. Reader requests will be promptly processed by computer and mailed to the manufacturer within three days.

Category	Page	IRN	Category	Page	IRN
Components			Packaging & Materials		
capacitor	158	277	card guides	160	306
counters, electronic	159	302	clamp, wire bundle	160	309
drag brake	158	280	epoxy, adhesive	160	310
encoder, position	158	281	flux remover	160	307
switch, rotary	159	303	heat sink	161	320
switches, paddle	158	300	micrometer stage	160	305
temperature probe	158	279	sealant, glass	160	308
timer, programmable	158	278	socket, leadless IC	160	304
transformer, Scott-T	158	301	socket, test	161	321
Data Processing					
analyzer, mag-disc	156	274	new literature		
calculator, pocket	157	275	adhesives	170	357
coupler, digital	156	271	ammeter shunts	170	359
memory, disc	157	276	batteries	170	360
minicomputer	156	270	CATV connectors	173	391
reader, optical mark	156	272	control systems	171	370
storage, disc	156	273	converter, S/D	171	369
ICs & Semiconductors			dc panel meters	173	386
bipolar ROM	150	258	desoldering specs	172	373
diodes	152	264	electron tubes	173	376
display driver	150	259	electronic cabinet	172	380
LED coupler	149	257	filters	172	377
linear ICs	152	262	generator	170	356
multivibrator	152	266	LEDs	171	366
op amp	149	251	laser scribing	170	364
rectifier bridge	150	261	light measurements	172	385
transistors, power	150	260	materials	173	390
translator, dual voltage	152	267	measurement devices	170	361
Instrumentation			modem test equipment	173	388
calculator	165	334	optical components	174	392
DMM	162	324	power diodes	172	382
DPMs	165	338	semi memory tester	171	367
digital ohmmeter	162	327	signal converters	172	374
generator	164	330	switch drivers	170	362
logic probe	165	337	switches	170	365
power supply, prog.	165	335	terminals	172	381
pulse generators	162	302	test instruments	171	371
recorder	162	323	thermistor chips	172	384
response analyzer	162	325	time-code formats	170	353
spectrum analyzer	163	328	timers	174	393
transmission test set	163	329	voltage dividers	170	354
tunable filter	164	331			
Microwaves & Lasers			application notes		
power supply	155	268	FETs	169	351
receiver	155	269	ground fault protection	169	350
uhf amplifiers	154	255	laser alignment	169	352
Modules & Subassemblies					
active filters	167	341	evaluation samples		
a/d converter	167	342	connector fingers	169	348
digital display	167	339	connector, spring	169	349
frequency standard	168	345	resistors	169	347
instrument amplifier	168	346			
power supply	168	343			
reporting display	168	344			
s/d converter	167	340			

Do you face a make or buy decision on power supplies?

BUY LAMBDA'S NEW LT SERIES

a 5V, 7A power supply
with overvoltage protection for \$80

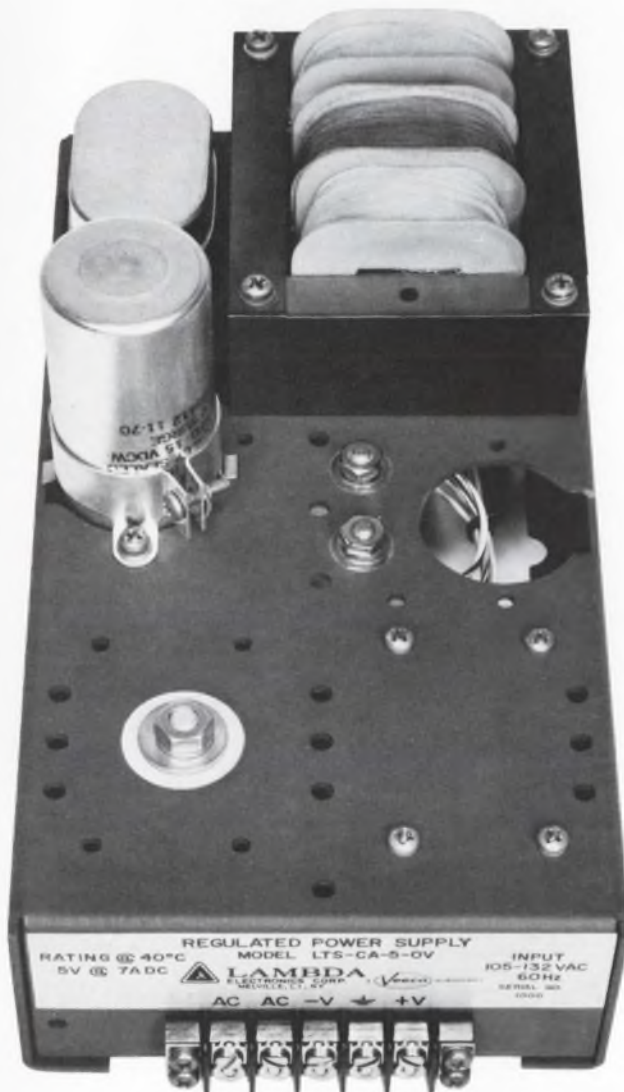

Send for 1973 Power Supply Catalog
and Application Handbook

Only 13 components
Line regulation—0.02% Load regulation—0.15%
Ripple and Noise—1.5 mV RMS
Temperature coefficient—0.01%/°C
Lambda's long life voltage regulating
ferroresonant transformer
Open construction
Lambda's 100,000 hours MTBF power hybrid
voltage regulator
MIL-R-11 composition resistors
Heavy duty barrier strip
MIL-R-26 type wire wound resistors
Convection cooled chassis
Computer grade hermetically sealed 10-year life
electrolytic capacitors
Efficiencies up to 55%
Under test for listing in Underwriters'
Laboratories recognized components index
1 Day delivery

5-YEAR GUARANTEE

LTS-CA SINGLE OUTPUT MODELS

4²⁹/₃₂" x 4¹⁵/₁₆" x 9⁵/₁₆"

MODEL	FIXED VOLT. RANGE VDC	MAX. AMPS AT AMBIENT OF: 40°C	PRICE
LTS-CA5-0V*	5±1%	7.0	\$80
LTS-CA-6	6±1%	6.6	80
LTS-CA-12	12±1%	4.4	80
LTS-CA-15	15±1%	4.0	80
LTS-CA-20	20±1%	3.1	80
LTS-CA-24	24±1%	2.6	80
LTS-CA-28	28±1%	2.2	80

*Includes fixed overvoltage protection at 6.8V±10%

LTD-CA DUAL OUTPUT MODEL

4²⁹/₃₂" x 4¹⁵/₁₆" x 9⁵/₁₆"

MODEL	FIXED VOLT. RANGE VDC	MAX. AMPS AT AMBIENT OF: 40°C	PRICE
LTD-CA-152	±15±1%	2.0	\$110
LTD-CA-122	±12±1%	2.0	110

A-C INPUT: 105-132 Vac, 59.7 to 60.3 Hz (STD. Comm'l
Line Frequency Spec.), consult factory for operation at
other frequencies.

LAMBDA ELECTRONICS CORP.

MELVILLE, NEW YORK 11746 515 Broad Hollow Road Tel. 516-694-4200 ARLINGTON HEIGHTS, ILL. 60005 2420 East Oakton St., Unit Q Tel. 312-593-2550
NORTH HOLLYWOOD, CALIF. 91605 7316 Varna Ave. Tel. 213-875-2744 MONTREAL, QUEBEC 100C Hymus Blvd., Pointe-Claire, Quebec-730 Tel. 514-697-6520
PORTSMOUTH, HANTS, ENG. Marshlands Road, Farlington Tel. Cosham 73221 VERSAILLES, FRANCE 64a 70 rue des Chantiers 78004 Tel. 950-2224

RCA introduces its one-transistor Darlington.



No we haven't changed the Darlington circuit. We've just turned it into the Darlington transistor. By putting the whole circuit on a single monolithic chip.

In the RCA Darlington transistor design, optimum use of the silicon real estate and single level metallization provide improved performance characteristics. You get greater control over parameters and increased peak current handling capacity . . . up to 15 amps.

It's all spelled out in black and white. I_S/B , E_S/B and Thermal Cycle ratings are all specified . . . even the output diode is characterized.

And they don't come any more rugged. All steel (TO-3) package, controlled solder chip mounting and heavy duty clip connections make the RCA Darlington transistor a dependable workhorse in your system.

So if you're working with discretes, you can now get higher packaging densities, lower your overall system cost and, at the same time, increase system reliability by reducing the number of external connections.

Why not give your system the advantage of all these benefits by switching from the Darlington circuit to the RCA Darlington transistor. It's at your

distributor, waiting for you right now in the following configurations:

TO 3 pkg.	$T_D@25^\circ C$	VERSAWATT plastic pkg.	$T_D@25^\circ C$	$V_{CE0(sus)}$ $V_{CEr(sus)}$
2N6385	100W	2N6388	40W	80V
2N6384	100W	2N6387	40W	60V
2N6383	100W	2N6386	40W	40V

Want more data? Write RCA Solid State, Section 57D-26/UTL37, Box 3200, Somerville, N.J. 08876. Phone (201) 722-3200.

RCA Solid State

products that make products pay off