

Electronic Design 23

VOL. 20 NO.

FOR ENGINEERS AND ENGINEERING MANAGERS

NOV. 9, 1972

Specifying keyboards? Your cup runneth over: Twelve different switching techniques are offered by 60 manufacturers. You can get low, medium and high-profile

keyboards. Encoding schemes abound, from MOS ROMs to scanners to self-encoded keys. Which do you choose? Touch the right keyboard on page 54.



Think big



50,000 Volts

For long-term continuous loading, Dale Type F film resistors provide working voltages to 14 KV, pulse voltages to 50 KV with less than 1% change after 2,000 hours. Lead and/or threaded cap terminations. Write for Bulletin M7C.



1,000,000,000 Ohms

Fill ultra-high resistance requirements with Dale Type M and MH film resistors. Miniature sleeved or glass enclosed models with values from 60 Meg. to 1,000KM. Excellent stability (0.5%/yr.). Tolerances as low as 1%. Write for Bulletin HV8C.



1,000,000 pieces
RL20...3¢

RL07 and RL20 needs can be swiftly met with a choice of two materials—metal film (Type CM) and metal oxide (Type F). Fast delivery in quantity. Call for details.

Think Dale



Save selection time... send for and use Dale's helpful and complete **Guide to Film Resistors**. Circle Reply Number for your free copy.

DALE ELECTRONICS, INC., 1300 28th Ave., Columbus, NE 68601
A subsidiary of The Lionel Corporation • In Canada Dale Electronics Canada, Ltd.

INFORMATION RETRIEVAL NUMBER 246

HP's new six pack.

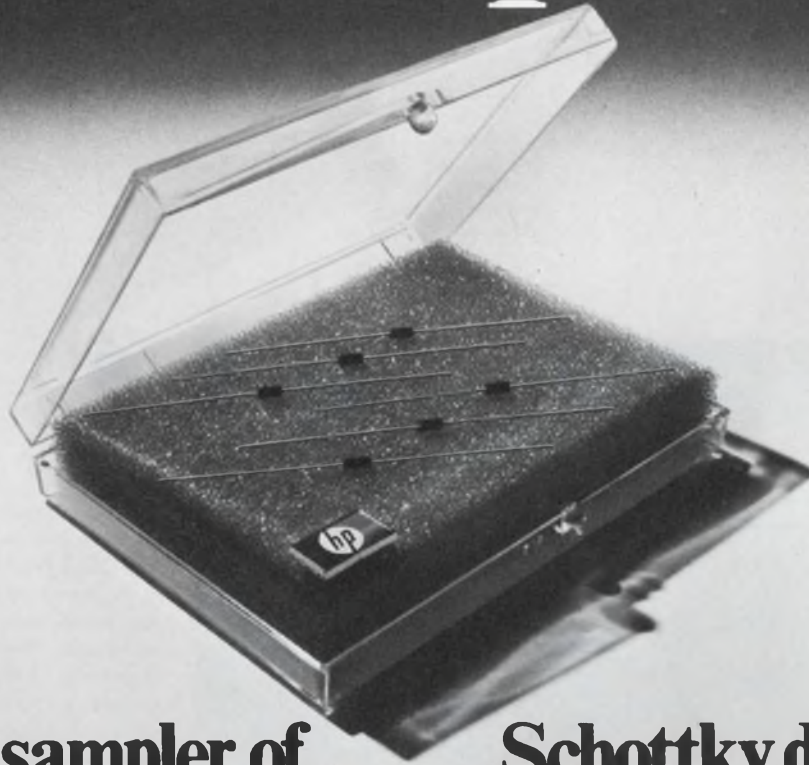

A free sampler of Schottky diodes for those who don't know they need them.

We're so sure our Schottky diodes can make your design life easier, we've put together a kit containing six samples. And we'll send it to you for nothing but the coupon and a hint as to your possible application.

You'll find Schottky diodes easier to design with than conventional PN diodes. They give better noise performance, eliminate switching transients and RFI and provide exceptional device uniformity. In addition, HP Schottky diodes are economically priced for industrial and consumer applications. HP's Schottkys are passivated silicon diodes that come in hermetically sealed subminiature glass packages.

Your free six pack will contain two high breakdown voltage, high speed Schottkys — ideal for high level detecting, clipping, clamping and sampling. Also included are four low threshold, high conductance, high speed Schottkys — for mixing, detecting and clamping where minimum offset is required.

Fill out the coupon and send it along for immediate delivery.

Please send me HP's new six-pack along with complete specifications.

Name _____ Title _____

(Company) _____ (Street) _____

(City) _____ (State) _____ (Zip) _____

It's remotely possible I could use these Schottky diodes for:

- RF Mixing Low Level Clipping RF Detecting Gating
 Balanced Modulating Clamping Frequency Doubling
 High Frequency Rectifying Sampling Power Detecting
 Analog Switching Limiting Log-Linear Element

Your free kit contains

TYPE	QUANTITY	V_F (mv) @ 1mA	V_{RR} (v)	C_j (pF)	τ (psec)
5082-2800	2	410	70	2.0	100
5082-2835	4	340	5	1.0	100

* Offer expires Dec. 31, 1972

Mail to:

Hewlett-Packard,
620 Page Mill Road,
Palo Alto, California 94304;

Europe: P.O. Box 85,
CH-1217 Meyrin 2,
Geneva, Switzerland.

HEWLETT  PACKARD

COMPONENTS

01204

THINGS THAT STAND THE TEST OF TIME



TO-5 Relay

Time and desert sands have eroded the ancient pyramids of Egypt, but like massive stone

mountains they still stand in mute testimony to man's ingenuity. The TO-5 Transistor Case Relay is a modern-day counterpart. As tiny as the pyramids are mammoth, the TO-5 is no less ingenious or durable. Originally developed to conform to the extraordinary reliability and environmental requirements of defense and aerospace needs, the TO-5 is now available for sophisticated industrial applications.

The same pioneering spirit at Teledyne that created the TO-5 Relay is breaking new ground in the field of Solid State switching devices. This advanced family of Solid State relays will also stand the test of time. Send us your requirements.

3155 West El Segundo Boulevard
Hawthorne, California 90250
Telephone (213) 679-2205



**TELEDYNE
RELAYS**



NEWS

- 23 **News Scope**
- 26 **The new telemetry**, as outlined at three-day conference: Less data, real-time analysis and adaptive control.
- 30 **At the Tokyo Show**—Japanese electronics manufacturers are keeping pace despite the recession at home.
- 32 **Pyroelectric array**, a first, has response from visible to IR regions.
- 34 **Pulse width and phase encoding** compete to be cassette standard.
- 36 **NASA's biggest solar-cell array** to power first space station in '73.
- 39 **Technology Abroad**
- 41 **Washington Report**

TECHNOLOGY

- 54 **Focus on Keyboards:** A special report on the wide range of products available—with helpful guidelines on selecting them.
- 68 **Need to keep digital data secure?** Scramble the data with pseudorandom sequences that are easily generated with ICs and that provide numerous, easily changed codes.
- 74 **Pseudorandom codes can be cracked** with just a short sequence of the text in both clear and scrambled form. Knowing the limitations is a first step to better design.
- 81 **And now . . . The Tri-Flop:** a logic block with three stable output states. It's easily implemented and offers considerable hardware savings.
- 84 **Optimize photodiode detector design** by using a graphical approach to maximize avalanche diode gain and minimize preamplifier noise.
- 88 **The ABC's of engineering management** in review, as told to us this year by eight men who made the successful transition from design bench to manager's desk.
- 94 **Ideas for Design:** Logarithmic-feedback zero-crossing detector features wide input range and TTL output . . . FSK oscillator uses twin-T network for high phase sensitivity . . . Fast ECL eliminates laser rangefinder resolution problems . . . Charge pump circuit eliminates bias supply for NMOS devices.

PRODUCTS

- 103 **ICs & Semiconductors:** Programmable transmitter is asynchronous or synchronous.
- 108 **Modules & Subassemblies:** Triple outputs in a modular DIP offered in new power-supply line.
- | | |
|---------------------|---------------------------|
| 114 Data Processing | 132 Packaging & Materials |
| 122 Instrumentation | 134 Microwaves & Lasers |
| 128 Components | |

Departments

- 51 **Editorial:** Get enriched (if not rich) with those high flyers
- 7 Across the Desk
- 136 Evaluation Samples
- 138 Application Notes
- 140 New Literature
- 146 Bulletin Board
- 146 Vendors Report
- 150 Advertisers' Index
- 152 Product Index
- 152 Information Retrieval Card

Cover: Photo by Stan Stansfield, courtesy of Cherry Electrical Products Corp., Waukegan, Ill.

ELIMINATE RESISTOR STOCKPILES

WITH... **BOURNS**

SFR™

SELECTABLE FIXED RESISTOR*

90 SELECTABLE RESISTANCE VALUES IN **1** TINY UNIT.

Model
4002

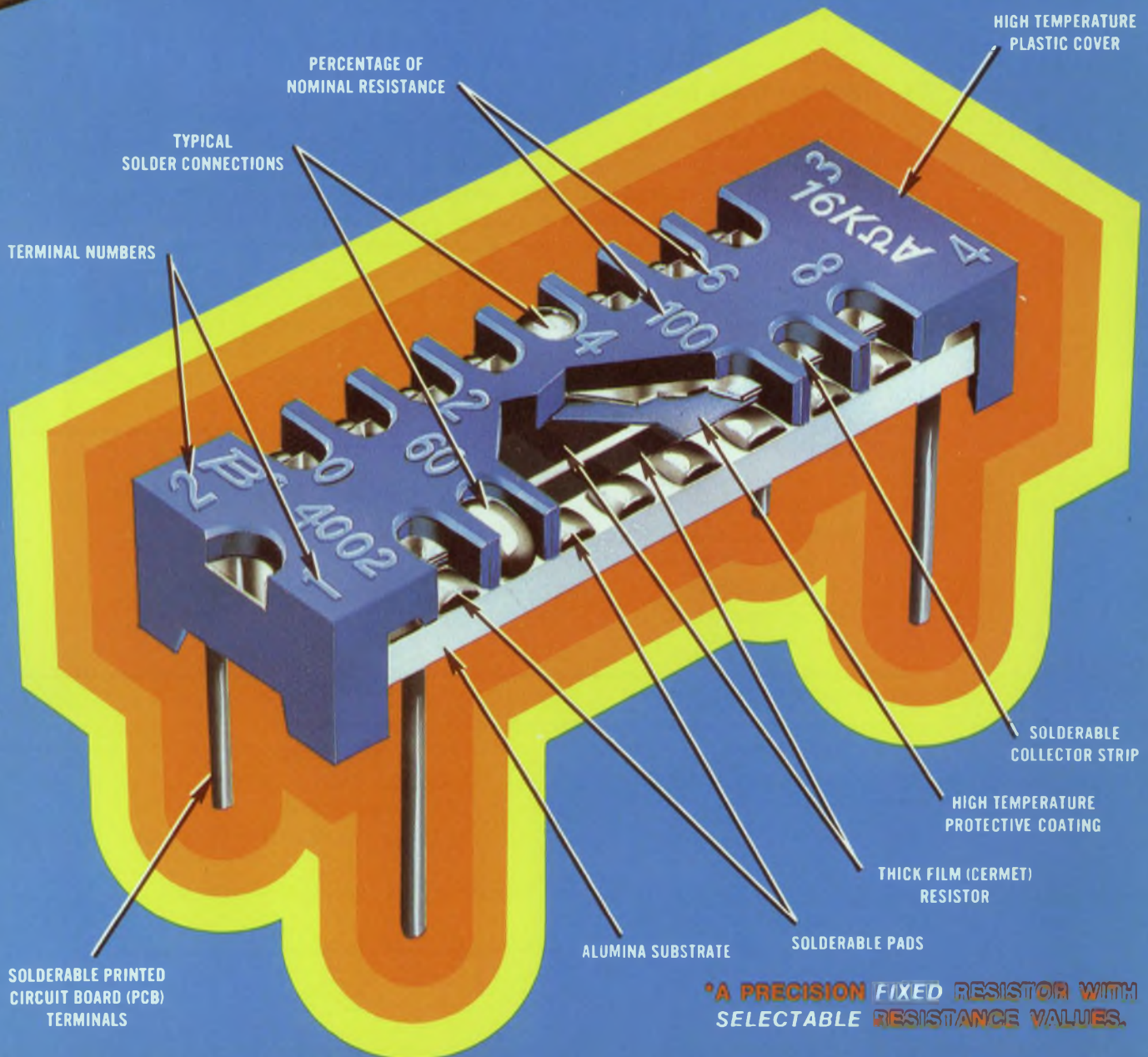

*A PRECISION FIXED RESISTOR WITH
SELECTABLE RESISTANCE VALUES.

BOURNS NEW... UNIQUE CONCEPT IN RESISTIVE COMPONENTS ALSO OFFERS

- * 33 ohm to 1.25 megohm combined resistance range over 15 units
- * Selectability within $\pm 1\%$ of required resistance value over the entire range

BOURNS
SFRTM
SELECTABLE FIXED RESISTOR

- ... IS A STABLE, THICK-FILM, FIXED RESISTOR WITH ADJUSTABILITY OF $\pm 1\%$ OR BETTER
- ... REPLACES STANDARD FIXED RESISTORS IN APPLICATIONS WHERE FINAL RESISTANCE VALUE REQUIRED CAN'T BE PRECISELY DETERMINED AT THE DESIGN STAGE
- ... REPLACES "ONE-TIME ADJUST" VARIABLE RESISTORS IN APPLICATIONS REQUIRING LONG-TERM STABILITY
- ... RESISTANCE VALUE IS SELECTED, THEN PERMANENTLY, RELIABLY SET BY SOLDERING

LOOK AT THE \$\$ YOU SAVE ON INVENTORY!!

FOR EXAMPLE: Your application requires selection of individual resistance values from 550 ohms to 1000 ohms, or 40 different resistors at 10¢ each. One Model 4002 provides the same resistance selection within $\pm 1\%$ at 76¢*.

Result: 40 different resistor values: $40 \times 10¢ = \$4.00$
One Model 4002: $1 \times 76¢ = .76$

YOU SAVE ... \$3.24!!

* 1,000 piece quantity price U.S. dollars, F.O.B., U.S.A.

it's easy to use

After mounting on PCB; probe the COARSE and FINE adjustment taps (Figures 1 and 2) to determine the precise resistance required. Solder the selected taps (Figure 3) and the SFR RESISTOR is permanently set.

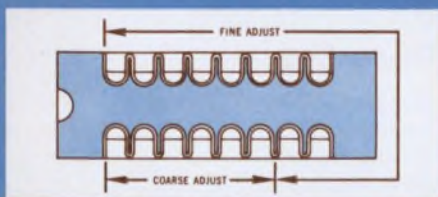

Figure 1



Figure 2



Figure 3

FOR COMPLETE DETAILS AND A BROCHURE:

- CALL SFR RESISTOR SALES COLLECT (714) 781-0270
- CONTACT YOUR LOCAL BOURNS REPRESENTATIVE.

FOR A FREE SAMPLE... write to the factory answering the following on your company letterhead.

- (a) My application for the Bourns SFR Resistor is . . .
- (b) It will replace (number) of fixed resistors in my inventory
- (c) Approximate anticipated annual quantity usage: (number)

BOURNS

"SFR" is a trademark of Bourns, Inc. Patents Pending

BOURNS, INC., TRIMPOT PRODUCTS DIVISION • 1200 COLUMBIA AVE., RIVERSIDE, CALIF. 92507

INFORMATION RETRIEVAL NUMBER 4

When You Buy a Power Supply, Why Not Get the Best?



28 VDC to DC
(55,463 Hrs.)
Model C95D

28 VDC to 400 A
(61,387 Hrs.)
Model S3D

400 A to DC
(56,148 Hrs.)
Model W5D

Abbott's New Hi-Performance Modules

are designed to operate in the stringent environment required by aerospace systems — (per MIL-E-5400K or MIL-E-5272C) and MIL-STD-461 for electromagnetic interference.

RELIABILITY — MTBF (mean time between failures) as calculated in the MIL-HDBK-217 handbook can be expected in excess of 50,000 hours at 100°C for all of these power modules. The hours listed under the photos above are the MTBF figures for each of the models shown. Additional information on typical MTBF's for our other models can be obtained by phoning or writing to us at the address below.

QUALITY CONTROL — High reliability can only be obtained through high quality control. Only the highest quality components are used in the construction of the Abbott power module. Each unit is tested no less than **41 times** as it passes through our factory during fabrication — tests which include the ser-

tinizing of the power module and all of its component parts by our experienced inspectors.

NEW CATALOG—Useful data is contained in the new Abbott Catalog. It includes a discussion of thermal considerations using heat sinks and air convection, a description of optional features, a discussion of environmental testing, electromagnetic interference and operating hints.

WIDE RANGE OF OUTPUTS — The Abbott line of power modules includes output voltages from 5.0 volts DC to 3,650 volts DC with output currents from 2 milliamperes to 20 amperes. Over 3000 models are listed *with prices* in the new Abbott Catalog with various inputs:

- 60A to DC, Regulated
- 400A to DC, Regulated
- 28 VDC to DC, Regulated
- 28 VDC to 400A, 1 ϕ or 3 ϕ
- 24 VDC to 60A, 1 ϕ

Please see pages 618 to 632 of your 1971-72 EEM (ELECTRONIC ENGINEERS MASTER Catalog) for complete information on Abbott modules.

Send for our new 56 page **FREE** catalog.



LABORATORIES, INCORPORATED
5200 W. Jefferson Blvd./Los Angeles 90016 (213) 936-8185
1224 Anderson Ave. Fort Lee, N.J. 07024 (201) 224-6900

INFORMATION RETRIEVAL NUMBER 5

Vice President, Publisher

Peter Coley

Editors

Editorial Offices
50 Essex St.
Rochelle Park, N.J. 07662
(201) 843-0550
TWX: 710-990 5071
Cable: Haydenpubs Rochellepark

Editor-in-Chief: George Rostky

Managing Editors:

Ralph Dobriner
Michael Elphick

Associate Editors:

Jules H. Gilder
Richard Lee Goldberg
Morris Grossman
John F. Mason
Stanley Runyon
Edward A. Torrero
Richard L. Turmail

Contributing Editor:

Peter N. Budzilovich

Editorial Field Offices

East

Jim McDermott, Eastern Editor
P.O. Box 272
Easthampton, Mass. 01027
(413) 527-3632

West

David N. Kaye, Senior Western Editor
2930 West Imperial Highway
Inglewood, Calif. 90303
(213) 757-0183

Editorial Production

Marjorie A. Duffy

Art

Art Director, William Kelly
Richard Luce
Anthony J. Fischetto

Production

Manager, Dollie S. Viebig
Helen De Polo
Maxine Correal
Anne Molfetas

Circulation

Manager, Nancy L. Merritt
Ron Deramo

Information Retrieval

Peggy Long

Promotion

Manager, Jeffrey A. Weiner
Karen Costa

across the desk

A paean to the muon from an early believer

What a pleasant surprise to see in News Scope that Dr. Richard C. Arnold had developed muon communications (see "Nuclear Communications Proposed as Competitive," ED 17, Aug. 17, 1972, p. 27). As an Australian with the Packard Bell Space & Systems Div., I was in a group trying to figure ways of communicating through "impenetrable" Vietnam jungle with a manpack device. All my 50-odd approaches failed dismally till I got to muons and antineutrinos.

No encouraging feedback has ever penetrated the thick security screens since nine years ago, when I submitted the theory.

My proposals to eliminate all cables, outside electromagnetic antennas and complex data transmission systems for such problems as flight-deck automatic checkout, spacecraft telephone (through walls and reactors), submarine communications or through-the-earth TV, unspoiled by solar filters or satellite failures, must have been too far out. To replace such complex radiator systems with small nuclear generators and detectors inside the control rooms must have appeared absurd.

One consequential prediction was that optical data transmission via fiber-optics or lasers would be overshadowed by the far more reliable, and possibly cheaper, free-space nuclear communications—whether to the moon or as a linkless interconnection *through* a computer.

So sincere congratulations to Dr. Arnold on opening up a whole new sophisticated field—and maybe revealing a new pollution.

Patrick Howden

Commonwealth Savings Bank of Australia
Aldwych Branch
London, England

More comments on CAD article

I would like to comment on Ralph D. Taylor's article, "Speed Computer-Aided Circuit Design" (ED 11, May 25, 1972, p. 54). Several implied generalizations in the paper are very misleading and some, to the best of my knowledge, are simply not true. The random-number method proposed is indeed a brute-force method, but it is anything but a panacea. Let me make the following points:

1. Consider the statement, "While Fletcher-Powell's results will be accurate to eight decimal places, accuracy to four decimal places should be expected when random numbers are used." This is not generally true, since one can always relax the termination criterion in any iterative process, thereby reducing computer time at the expense of less accuracy. A tradeoff between accuracy and computer time can almost always be made for most iterative minimization techniques.

2. It is true that a lot more effort is required to program a Fletcher-Powell type of routine than a simple random-number routine. However, if the former is written in a general form, it may be used over and over in conjunction with other circuit designs. In this case the effort is worthwhile. Furthermore many minimization

(continued on p. 10)

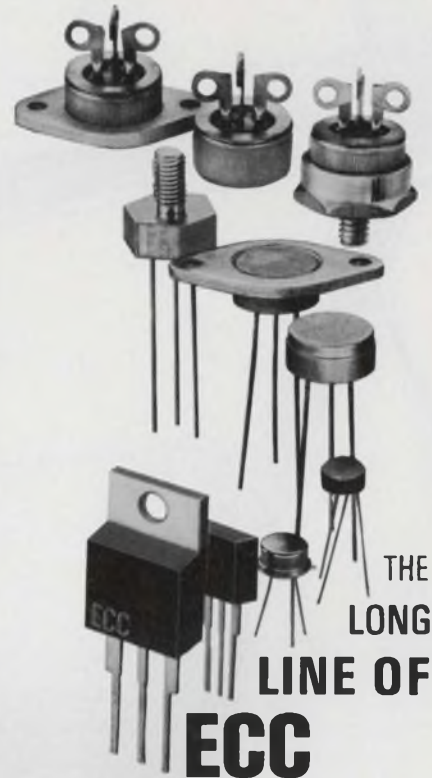

THE
LONG
LINE OF

ECC

LOW AND HIGH CURRENT

TRIACS

World's leading
Triac producer offers
fast delivery,
electrical isolation and
a variety of packages.

LOW CURRENT TRIACS

THERMOTAB® and THERMOPAK*; Swedge and TO-3; 5/8" Hex Stud, and TO-5 Metal and Plastic Packages

*trademark of ECC

$I_{T(RMS)}$ 0.8 - 16 amps

I_{gt} 1, 111 3, 10, 25, 50 ma max;
with or w/o internal trigger

I_{TSM} 20 - 150 amps

V_{DROM} 200 - 800 volts

For more information, circle No. 238

HIGH CURRENT TRIACS

3/4" Press-Fit, Stud and TO-3 Packages

$I_{T(RMS)}$ 25 - 40 amps

I_{gt} 1, 111 50 - 100 ma max

I_{TSM} 230 - 300 amps

V_{DROM} 200 - 800 volts min

For more information, circle No. 239

All packages are electrically isolated except TO-5 Metal Can. ECC triacs feature heavily glass passivated junctions for high reliability.

Contact your nearest ECC Sales Representative or Authorized Distributor for pricing and technical information.

ECC

CORPORATION

P.O. Box 669 • Euless, Texas 76039
817/267-2601

Electronic Design welcomes the opinions of its readers on the issues raised in the magazine's editorial columns. Address letters to Managing Editor, Electronic Design, 50 Essex St. Rochelle Park, N. J. 07662. Try to keep letters under 200 words. Letters must be signed. Names will be withheld on request.

THE MOTOROLA LOCALOGIC[®] DESIGN CENTER

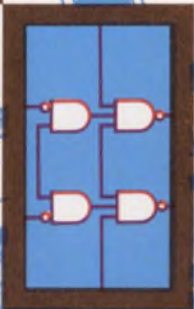
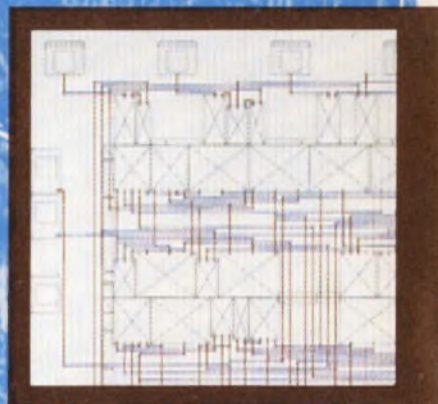
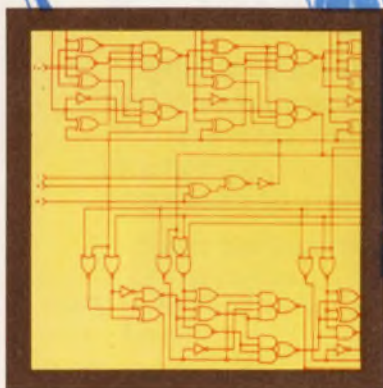

A New Concept in LSI Circuit Design

With the opening of the first LOCALOGIC Design Center in the Boston area, Motorola has brought complete LSI design capability into the field under the direct control of customer engineers. The Design Center utilizes the Polycell system . . . industry's most practical approach for designing custom LSI. The techniques are designed for use by customer (systems) designers. In this system, Polycells (proven, completely characterized logic cells, each comprised of several interconnected components) are handled as units on the computer as standard building blocks.

At the Center you are assigned an office as a base of operation during the course of your program. If you are new to the Polycell system, the Motorola design staff conducts a training program and once a design is started, the staff can help with any step in the sequence. Experience proves that, after brief familiarization, a logician or circuit designer with no prior background in semiconductor design or processing can very effectively use the system.

The LOCALOGIC Design Center is a completely self-contained operation covering the design stages between original logic definition and mask artwork generation.

Custom LSI approaches are the answer to increased system performance and lower costs. Now these custom designs can be accomplished by designers working close to their own facilities; quickly, easily, economically, with utmost design security. For complete details write to Motorola Semiconductor Products Inc., P.O. Box 20912, Phoenix, AZ 85036.

The Boston facility is the forerunner of design centers to be located throughout the United States and Free World. Investigate this new tool and make LOCALOGIC a part of your design team.

LOCALOGIC is a trademark of Motorola Inc.

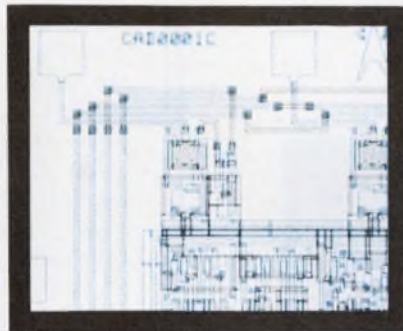

MOTOROLA LOCALOGIC

— the new concept in LSI design



ANNOUNCING THE FIRST PAGE READER ON A CHIP

or two

You can read a standard 8½" wide page at 16 mil resolution with only a single RL-512 self-scanned array. With only two of the 512 element devices aligned you can improve resolution to 8 mil on paper and still read at up to 10 MHz scan rates.

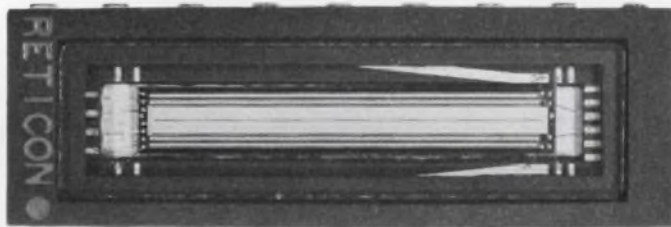

The Reticon RL-512 array offers 512 photodiodes on 1 mil centers self-scanned by on chip shift registers and multiplex switches. The device offers high sensitivity, charge storage mode operation, scan rates from 10 KHz to 10 MHz and operation on 15V supply. Optical quality quartz window seals the 18 pin standard ceramic DIP.

Other applications include OCR, facsimile, surveillance, industrial control, size and edge monitoring, laser detection and many others.

This and other devices of 16, 64, 128, 256 elements are available from inventory.

RETICON™

365 MIDDLEFIELD ROAD
MOUNTAIN VIEW, CA 94040
(415) 964-6800

ACROSS THE DESK

(continued from p. 7)

algorithms are available as packaged subroutines (see the System 360 scientific subroutine package).

3. For any iterative minimization scheme, the better the initial "guess" at the design parameters, the quicker convergence will be attained. In the logical extreme, if the initial guess corresponds to an optimal solution, the process will terminate after a single iteration. With the random-number technique, one rarely knows how close he is to an optimal solution.

4. In many situations—for example, nonlinear switching-circuit transient responses—the circuit analysis is the dominant user of computer time in any one iteration. In this case techniques that minimize the total number of iterations, and not the simplicity of each step, will prove to be far more economical. Furthermore, as the number of design variables increases, the number of combinations of variable values increases exponentially, and any random-number approach (disregarding the element of luck) will fail.

5. There is a slight error in the bibliography. The Temes and Calahan paper ("Computer-Aided Network Optimization: The State-of-the-Art") appeared in the November, 1967—not 1962—*Proceedings of the IEEE*. A more recent reference, which contains a wealth of articles in this area, is the *IEEE Transactions on Circuit Theory*, Special Issue on Computer-Aided Circuit Design (January, 1971).

Let me conclude by saying that I am not in disagreement with Mr. Taylor's results. My strong objections are to the implication that the random-number method is, in general, superior to more formal and more powerful techniques. My experience has been otherwise in four years of research on CAD and teaching of the subject at the University of California, Berkeley. Just as no single minimization technique can be claimed to be the most effective in all situations, no generalization about any one method should be based on experience with one class of relatively simple circuits. My word to any-

(continued on p. 16)

MOS ANALOG SWITCHES

Now...6 channel MEM 855P

33¢
per channel

in quantities of 1000 pcs. & up.
(Price applicable only in the continental United States)

Listed below is General Instrument's family of MOS Analog Switches (MULTIFETSM). They're all immediately available from stock in a choice of three packages: Plastic, Ceramic DIP and Flat/Pack.



Actual Size

PART NUMBER	PROCESS	NUMBER OF CHANNELS
MEM 780P, D, F	N	4
MEM 851P, D, F	P	4
MEM 853P, D, F	P	4, 6, 8, 10
MEM 855P, D, F	P	6
MEM 856P, D, F	P	6
MEM 857P, D, F	P	4 x 2, 8 x 1

When ordering specify P for Plastic, D for Ceramic DIP, F for Flat/Pack after device number to designate package desired.

For complete information call 516-733-3037 (outside N.Y. State, call toll free 800-645-1247) or write: Dept. MSFT, General Instrument Corporation, 600 West John Street, Hicksville, N.Y. 11802, or call, in New York: 516-733-3333; in Chicago: 312-338-9200; in Los Angeles: 213-641-7411. In Canada, call or write: General Instrument Canada, Ltd., 61 Industry Street, Toronto 337, Ontario, Canada, Tel: 416-763-4133. In Europe, write: General Instrument Europe S.P.A., Piazza Amendola 9, 20149 Milano, Italy. In the U.K., write General Instrument Microelectronics Ltd., 57/61 Mortimer Street, London, W1N7TD, England; In the Far East, write General Instrument of Taiwan Ltd., P.O. Box 22226, Taipei, Taiwan.



GENERAL INSTRUMENT CORPORATION • 600 WEST JOHN STREET, HICKSVILLE, L. I., NEW YORK

INFORMATION RETRIEVAL NUMBER 9

ELECTRONIC DESIGN 23, November 9, 1972



containing
electrical energy
is a little more
complex

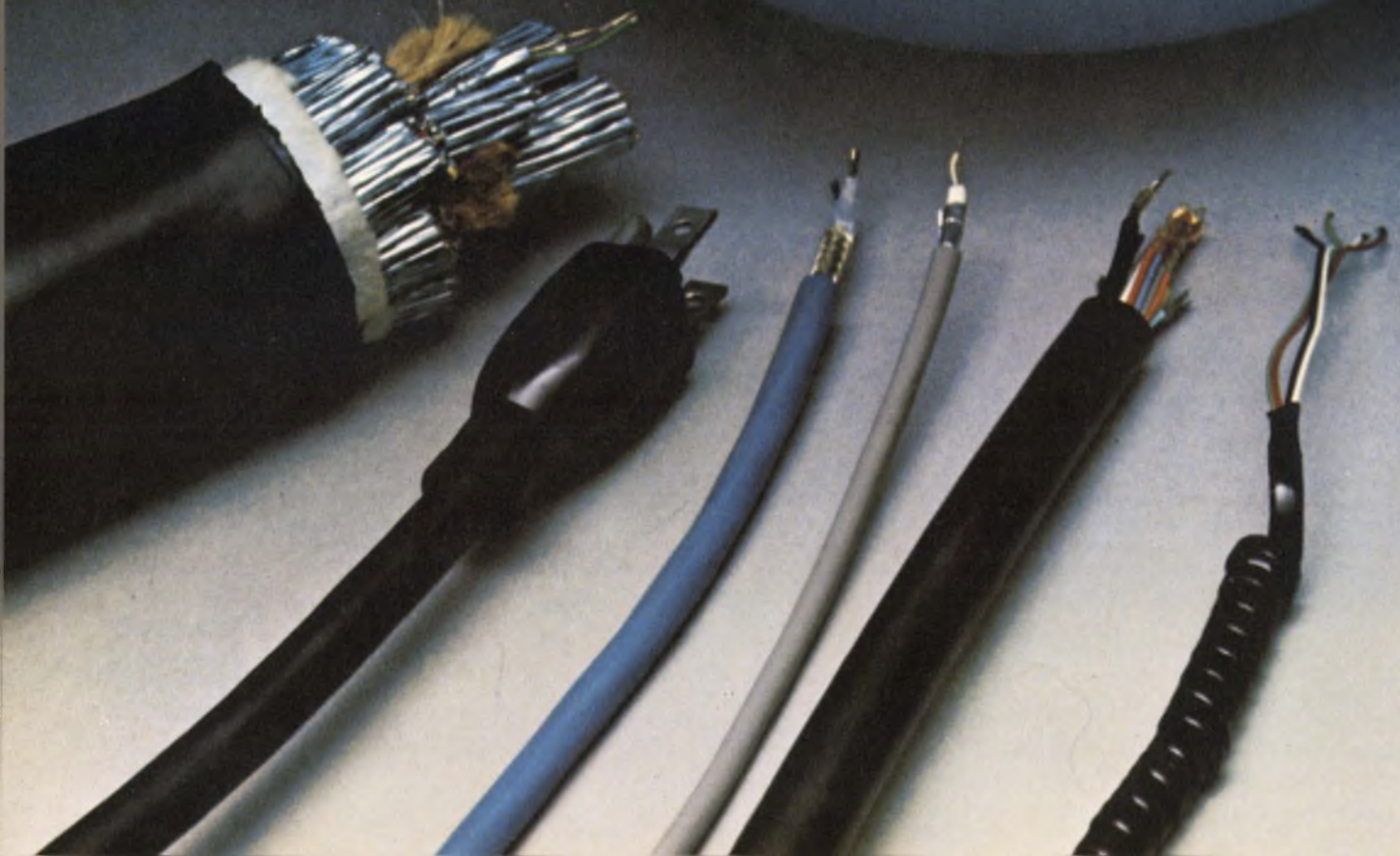

How a cable copes with the problems of voltage safety; frequencies; current; attenuation; capacitance; velocity of propagation; inductance; electrostatic and electromagnetic interference, depends heavily on what surrounds the conductors:

The coating, insulation, shielding, jacketing materials. And how they are applied. Belden has the ways and means. Material answers that can help you cope with both the electronic and physical environment your cable works in. The design and production know-how to give you the right combination of quality, reliability and performance your application demands.

Talk to your Belden wire specialist. He has more than 8,000 standard cable items to draw from. Knows what modifications are possible. What the tradeoffs are. The costs involved. He can give you a complete cable package tailored to your needs. You won't find a better source for know-how, understanding or results.

Write for a copy of the Belden Electronic Wire and Cable Catalog. Belden Electronic Division, P.O. Box 1100, Richmond, Indiana 47374. Phone (317) 966-6681.

852

INFORMATION RETRIEVAL NUMBER 234

BELDEN



We want your cable business
and are out to prove...
Belden covers wire with performance,
service and ingenuity



The end of hit-n-miss

Signetics SUPR-DIP guarantees .15% AQL.

Finally, digital circuits you can rely on. New SUPR DIP: Signetics Upgraded Plastic Reliability program. Guaranteed at .15% AQL. Already proven in the field. Available in quantity.

The first ICs you can choose and still sleep at night. And not just because they're guaranteed.

SUPR DIP saves you time, money, equipment and man power.

You achieve tremendous cost savings for a mere pennies more per part.

Your total costs go down because SUPR DIP ends any need for 100% pretesting. It ends extra preconditioning before board assembly. It screens for opens, shorts and all other anomalies at high temperature. It reduces system field failures. (Which not only saves you money on re-calls, but may save your reputation.)

SUPR DIP can cut your board reworking by a factor of 10. And can improve your standard AQL six times. We guarantee it:

0.15%

TEST	CONDITION	AQL	CUMULATIVE
Electrically Functional	25°C	0.15%	0.15%
	100°C	0.15%	
DC	25°C	0.65%	2.5%
	At Temperatures	1.0%	
AC	25°C	1.0%	
Mechanical	Major	0.25%	1.0%
	Minor	1.0%	

What's our secret? We utilize the best provisions of several user specs; plus add a few of our own.

What do you get? Top-notch standards:

- Visual die sort inspection, MIL-STD-883. Method 2010, Condition B Criteria.
- Preseal visual inspection, MIL-STD-883. Method 2010, Condition B Criteria.
- 100% thermal shock, MIL-STD-883. Method 1011, Condition A Criteria.
- 100% production electrical testing.
- 100% high temperature functional testing.

In addition, outgoing lot quality acceptance testing includes a .15% AQL for functionality; and a 1.0% to .15% AQL for mechanical and other electrical criteria.

Having tough requirements like those means we can deliver tough performance.

One EDP user, for example, didn't believe us and tested 100% of his order. Result? Instead of his usual 1+ % defects, he got .08%. Now he only does random lot acceptance testing.

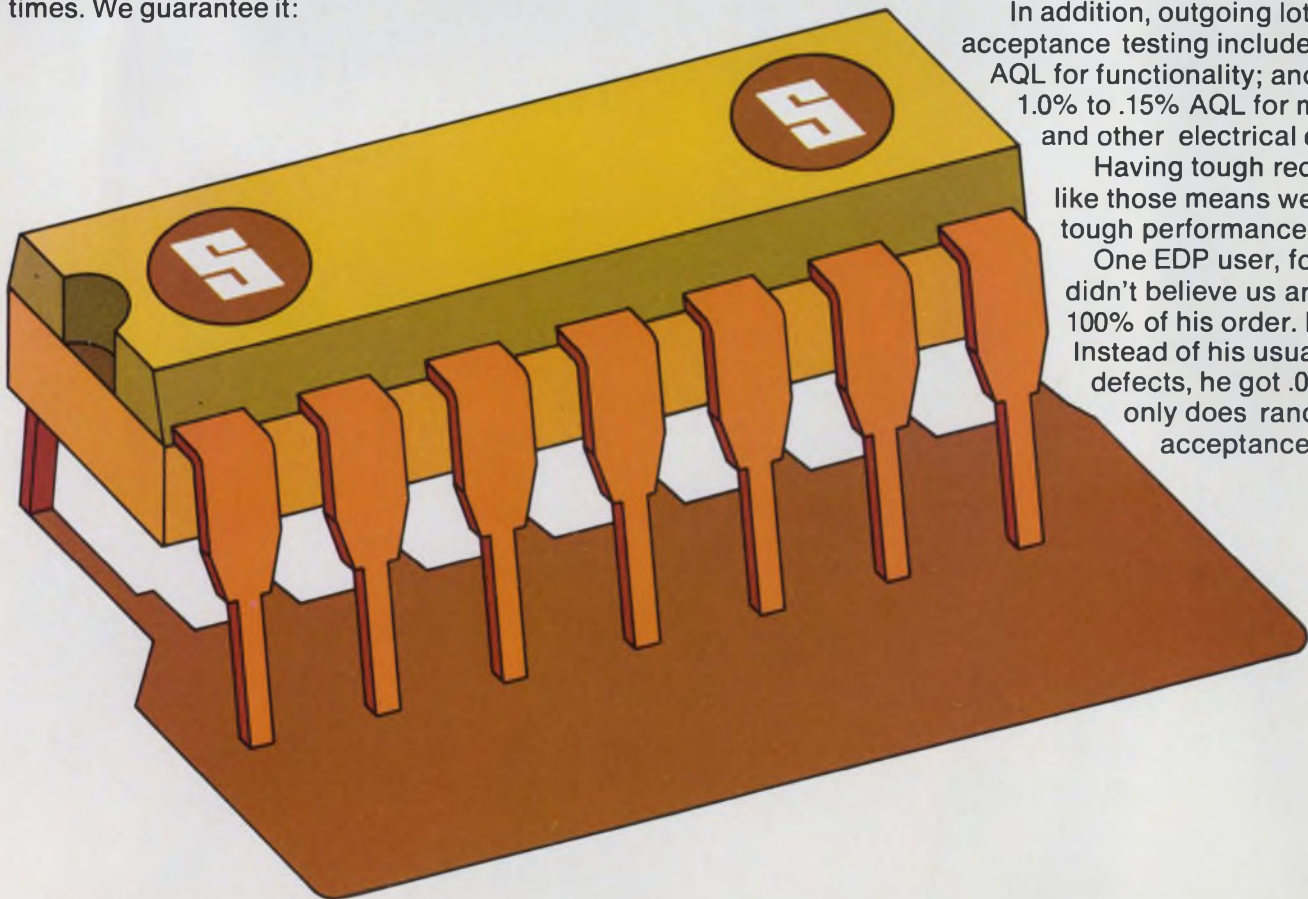

standard ICs.

Another customer concerned with board reworking bought 70,000 parts, specially identified them and inserted them into boards. After final shipment records of all systems built with SUPR DIP were collected, he added up the results. There were only .001% defects. Out of 70,000 parts! And, finally, the customer who took 4,000 SUPR DIP parts and tested them over temperature. He ran the test from zero to 100°C and back to zero again: And found that many failures — zero.

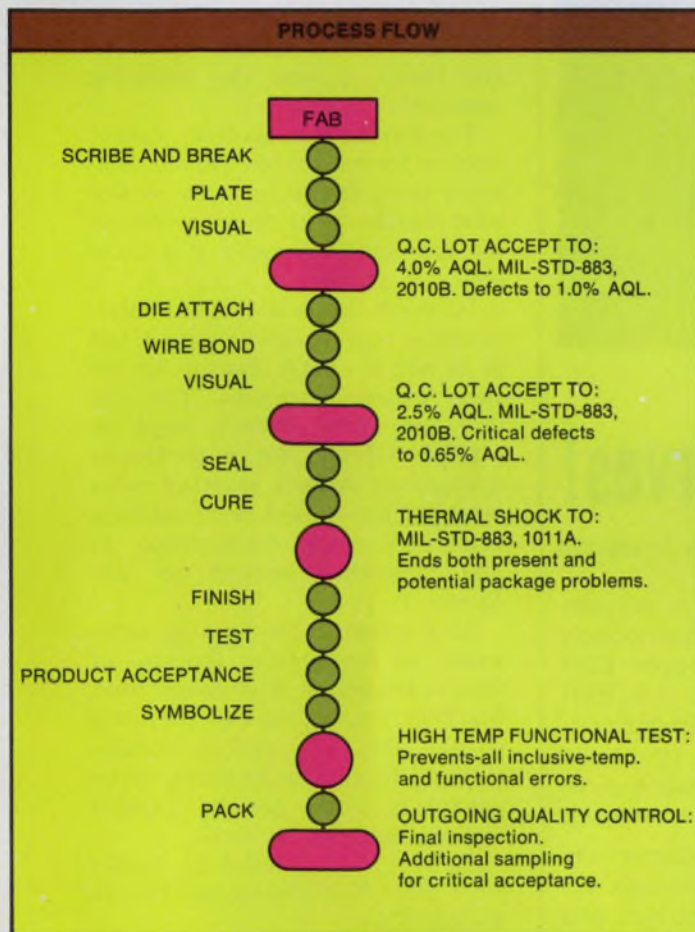

Study our Process Flow Chart and you'll understand how we can guarantee the highest quality commercial products in the business. SUPR DIPs aren't hit-n-miss devices because our work standards aren't hit-n-miss levels.

The dollars you'll save aren't hit-n-miss estimates either.

Especially on board reworking.

And we can prove it.

Or better still, you can prove it. Using your own work procedures.

Just check the number of devices per board you assemble on the chart below; then read off the percentage of board reworks at the standard AQL (point A) and at 100% pretesting (point C).

Then compare it to the dramatic savings you'll get with SUPR DIP (points B, D).

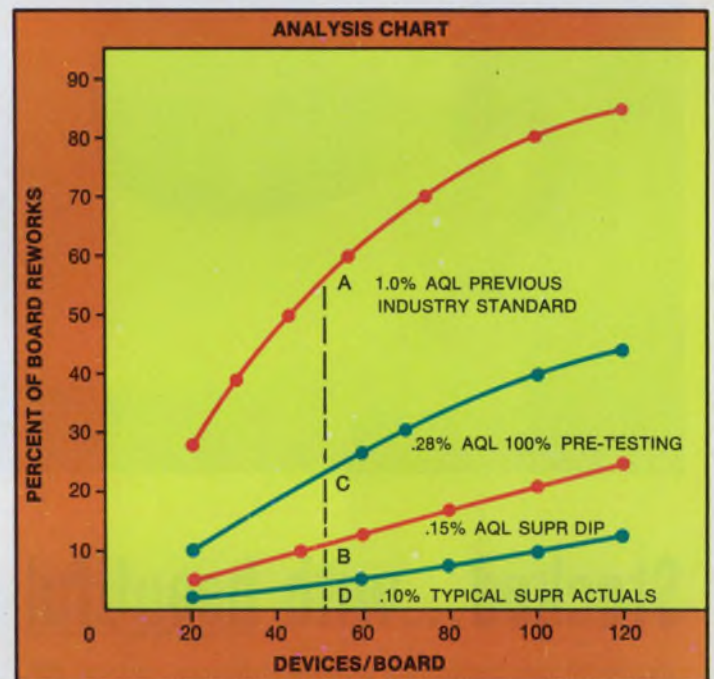

If you'd like further proof and information, just send us the coupon below. We'll tell you all about SUPR DIP. And we'll also include a pocket size AQL and LTPD Chart for handy reference.

Signetics
811 E. Arques Avenue
Sunnyvale, California 94086.

Send me all the literature, specs and data on SUPR DIP.
And don't forget my free pocket size AQL and LTPD Chart.

Name

Title

Company

Address

City

State

Zip

Telephone

Signetics Corporation—A subsidiary of Corning Glass Works.

signetics

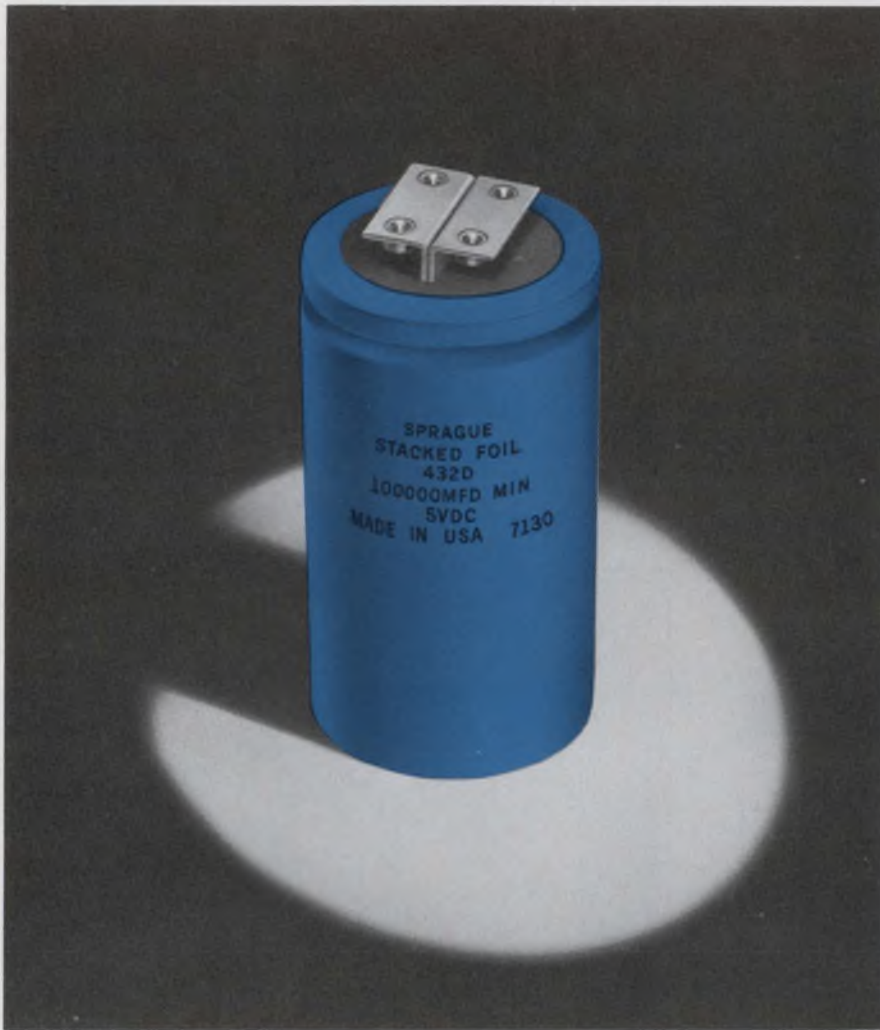

Stacked...with beautiful curves!

(stacked-foil construction with ultra-low impedance, ultra-low ESR, ultra-low inductance)

Revolutionary new Type 432D COMPULYTIC® Aluminum Electrolytic Capacitors offer capacitance values to 100,000 μ F with equivalent series resistance of typically less than 0.001 ohm and inductance of only 1 nH in a 3" x 5 $\frac{5}{8}$ " case. This same capacitor will handle 93 amperes of ripple current at 65 C and 1 kHz.

Impedance limits at 10 kHz are as low as 0.001 ohm with typical values of only half of the specified limits.

Terminals are ideal for use with laminated-bus power distribution systems found in modern EDP equipment, where the low ESR and impedance of Compulytic capacitors help insure continued operation of logic circuits even during momentary power outages.

Sprague Type 432D Capacitors are available in nine voltage ratings from 5 to 50 volts d-c, and are designed for operation over the temperature range from -40 to +85 C.

For complete technical data, write for Engineering Bulletin 3443 to: Technical Literature Service, Sprague Electric Co., 347 Marshall St., North Adams, Mass. 01247.



THE BROAD-LINE PRODUCER OF ELECTRONIC PARTS

INFORMATION RETRIEVAL NUMBER 12

ACROSS THE DESK

(continued from p. 10)

one attempting to optimize 10 to 20 parameters on an IC chip via random numbers is simply "good luck!"

Dr. Paul M. Russo

RCA
David Sarnoff Research Center
Princeton, N.J. 08540.

The author replies

In general response to Dr. Russo's letter, I hope neither he nor any other engineer believes there is a general-purpose program that will minimize an unknown function without any prior knowledge of the function or its constraints. Regarding the specific points raised by Dr. Russo, I have the following comments:

The termination accuracy cannot always be relaxed to reduce computer time, as this must be considered together with the step size of the gradient—especially if a fixed step size is used.

In many cases a general minimization routine can be reused, but it is not a simple matter to use these general programs. The step size and error criteria must be carefully chosen for a particular application. Also, a starting value must be chosen—not every starting point will cause convergence, as was somewhat implied by Dr. Russo.

As I stated in the opening paragraph of my article, the use of canned programs often takes time, but they can be used if they will do the job. The random-number method, like other methods, is no panacea; it is merely another method that can be used.

Ralph D. Taylor

Test Equipment Design

Bendix Corp.
P.O. Box 1159
Kansas City, Mo. 64141.

Ed Note: Other letters on this subject appeared in the Aug. 17 and Sept. 28 issues of ELECTRONIC DESIGN. This correspondence is now closed. Mr. Taylor says that readers who have any further questions may call him at (816) 363-3211, extension 2431.



START YOUR OWN BUG COLLECTION ...

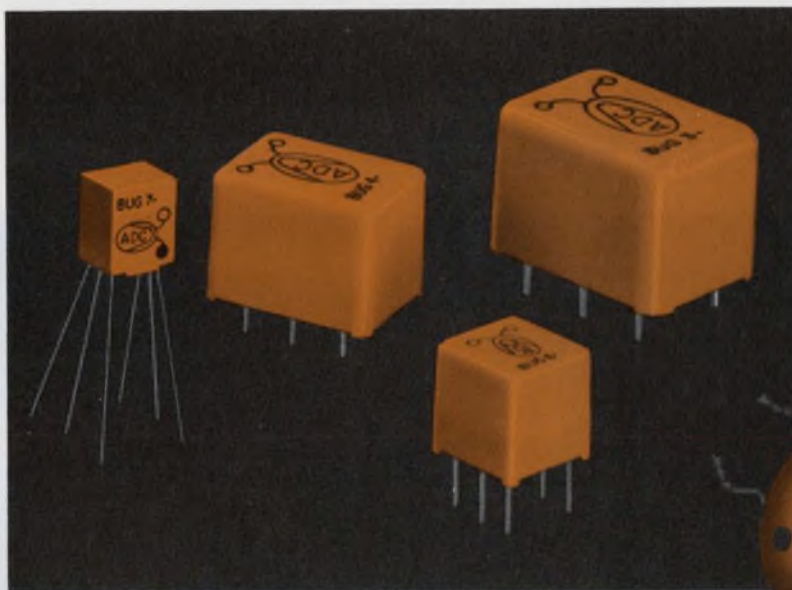

WITH A FREE LADY BUG FROM ADC!

If you've been thinking that most commercial transformers are pretty much alike, these new ADC Lady Bugs will change your mind.

We've engineered Lady Bugs to provide the kind of reliability you've come to associate only with transformers meeting military specifications. More than that, we've made sure these ADC Transformers offer something you haven't seen in a while: economy. So, beginning now, you can have the transformer performance you've always wanted, and still keep costs in line.

ADC Lady Bugs come in 46 different electrical configurations with power ratings from 50 mw to 2 watts. There are four different case sizes, with the smallest being approximately one-third cubic inch.

We don't want to bug you, but if you have a real need for miniature transformers, we will send you an evaluation sample free — no strings attached. Just tell us what your requirements are on the coupon and send it back to us. Or, if you just want more information, please circle the number on the Reader Service card.

ADC PRODUCTS, INC.

Division of Magnetic Controls Company
4900 West 78th Street
Minneapolis, Minnesota 55435
TEL: (612) 835-6800 TWX: 910-576-2832 TELEX: 29-0321

4900 West 78th Street
Minneapolis, Minnesota 55435

Yes, I would like an evaluation sample of the new Lady Bug transformer. Here's my application: _____

We anticipate using _____ units/year.

My needs are for _____ 30 days

_____ 60-120 days _____ Future

NAME _____

COMPANY _____

ADDRESS _____

CITY _____ STATE _____ ZIP _____

TELEPHONE _____



INFORMATION RETRIEVAL NUMBER 13

**Our terminal capabilities outnumber
your problems.**



The answer to your remote-computing needs is probably right on this page.

Like our model 33. Economy and reliability have made it the most popular data terminal of its kind. Or like our new wide-platen model 38. We loaded it with big machine features but we left off the big machine price tag. For high-volume operations, our model 35 is built to run day and night, year in and year out. And if your system is highly complex, our model 37 delivers the utmost in flexibility and vocabulary.

To move information on-line at speeds up to 2400 wpm, all our keyboard terminals are compatible with the Teletype® 4210 mag tape data terminal. We also manufacture paper tape senders and receivers with speeds up to 2400 wpm.

To make sure you get what you need, we sell assembled ASR, KSR and RO terminals, as well as components—printers, keyboards, readers and punches.

You can also select from three different interface options: a built-in modem; a current interface; and an EIA Standard R-232-C interface.

Platen widths range all the way up to 15 inches.

Besides alphanumeric, we can give you Greek letters, algebraic and chemical symbols, as well as special graphics.

We also cover error detection and station control with a complete group of solid-state accessories.

And our machines never have to stand alone. Our applications engineers will work with you to make sure the terminal you buy from us is exactly what you need. And our maintenance

people are ready to make sure things keep running smoothly.

So whatever data terminal problems you're up against, come to us for help. Because when it comes to flexibility, reliability and economy, you can't beat the machines that carry our name.

It takes more than manufacturing facilities to build the machines Teletype Corporation offers. It also takes commitment. From people who think service is as important as sales. In terminals for computers and point-to-point communications.

That's why we invented a new name for who we are and what we make. The computer-cations people.



INFORMATION RETRIEVAL NUMBER 14

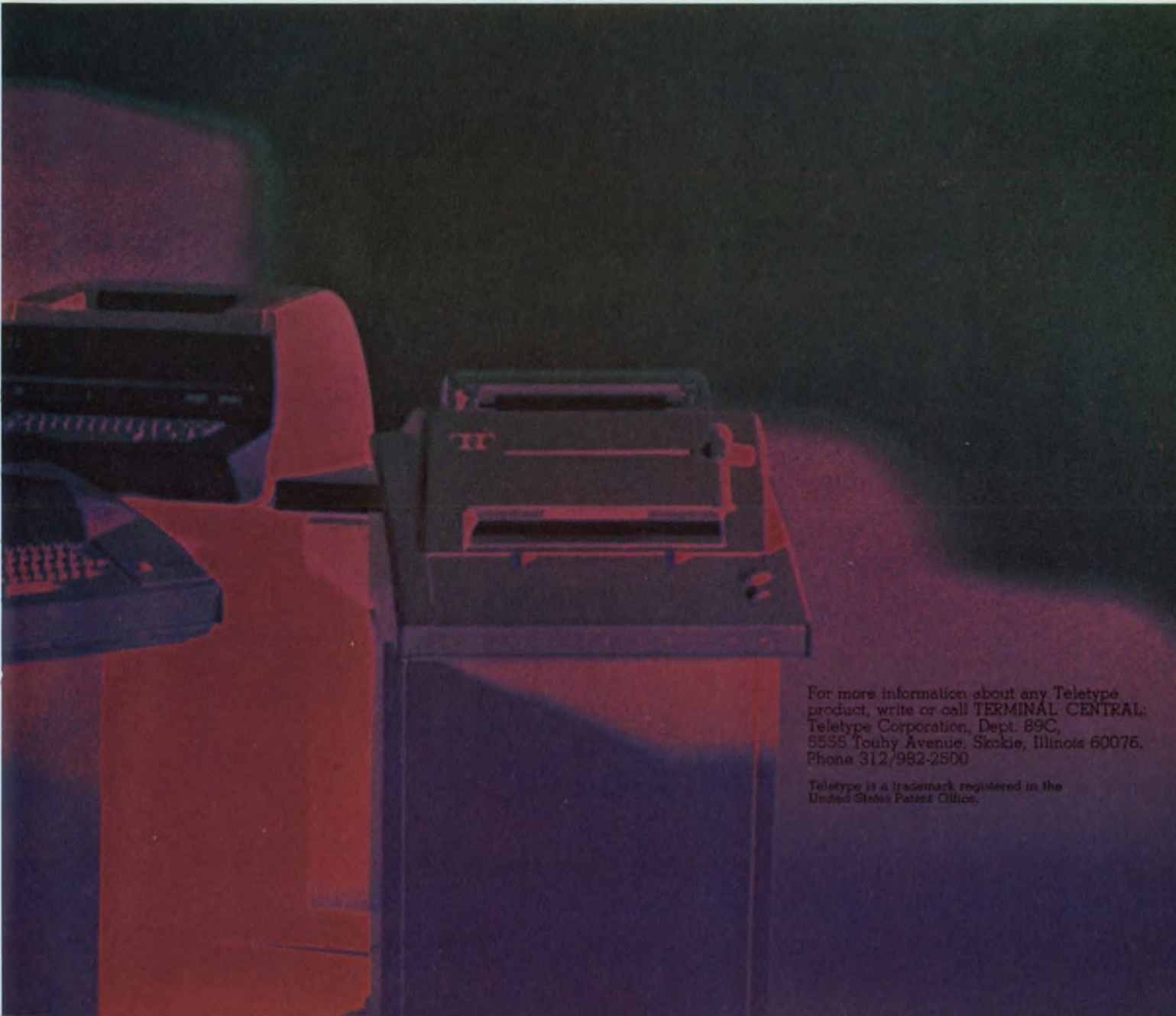

For more information about any Teletype product, write or call **TERMINAL CENTRAL**: Teletype Corporation, Dept. 89C, 5555 Touhy Avenue, Skokie, Illinois 60076, Phone 312/982-2500

Teletype is a trademark registered in the United States Patent Office.

DIGITAL SYSTEM DESIGNS

FOR INDUSTRIAL LOGIC... McMOS AND MHTL WORK TOGETHER

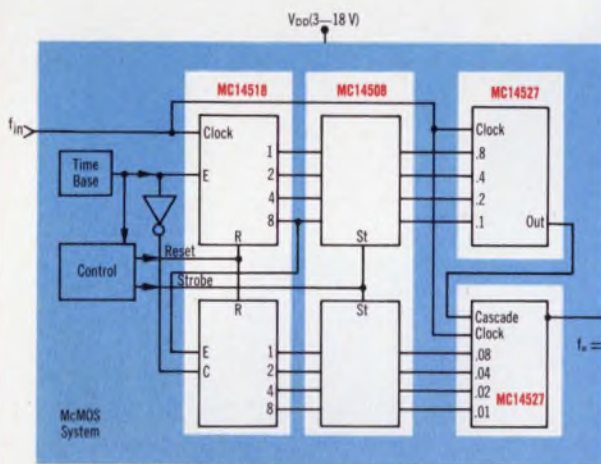

The McMOS squaring circuit illustrated could be used for direct readout of acceleration, of the stored energy of a fly-wheel, or any function where squared variable is required. Direct interface with MHTL, in this case a line driver/receiver, moves the information on for its intended use.

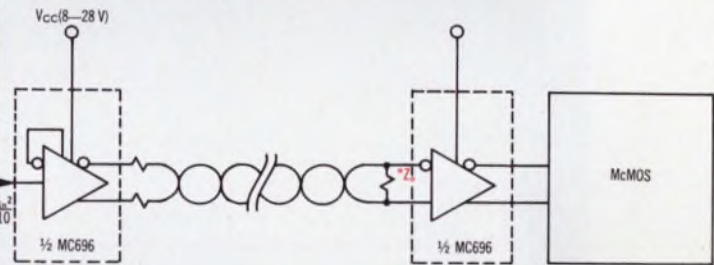

*Z₀ = Characteristic impedance of line

McMOS Squaring Circuit Interfaces With MHTL Line Driver/Receiver

WITH REDUCED POWER SUPPLY REQUIREMENTS

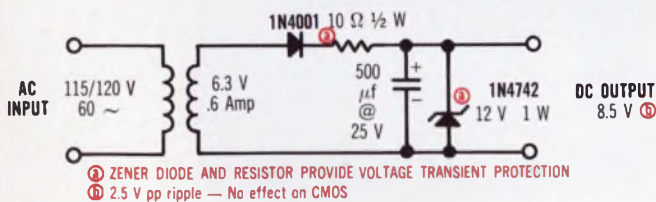

A Simple McMOS System Power Supply

WITH EASY LINEAR INTERFACING

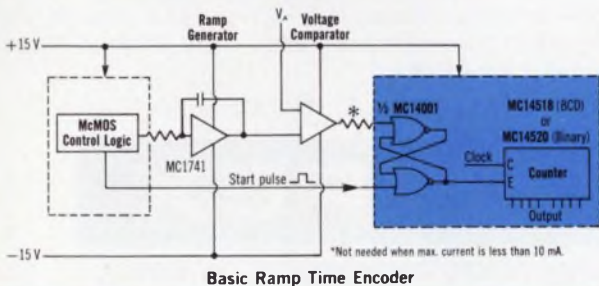

Basic Ramp Time Encoder

IN LOW POWER APPLICATIONS

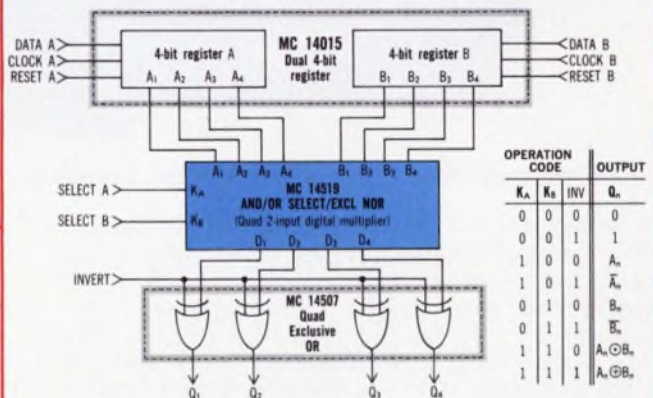

Select-Compare Data Register

Total Quiescent Power Dissipation 25 μW @ 5 V (V_{cc})

MOTOROLA MOS
Directions in digital designs

World's Smallest High-Performance Tape Drive.



25-125 ips, auto-threading, vacuum tape handling.

The Ampex TMA Tape Drive gives you top performance in the most compact package on the market. Only 19x24x18", it designs itself into your OEM system. Bargain priced, too, for more computer power.

Performance: 25 to 125 ips, 10½" reels, ANSI/ECMA 7 or 9 track standards, NRZI with 200, 556, 800 bpi or 9 track 1600 bpi. Diode and triac switching for all control circuits. Option of auto-threading or manual. Single capstan. Linear reel servo system with vacuum columns for tender loving care of your tape. A series of drives and electronics to meet your needs.

Reliable all the way. A compact performance giant.

And a super-charged buy — the best price/performance computer tape drive you can find. Special bargains

when you buy in quantity. All this backed by Ampex worldwide service, 95% interchangeable parts. Get more details on better tape drives, plus Ampex disk drives and core memories, with a call to your Ampex computer specialist.

Visit Ampex at FJCC, Booth 1056.

AMPEX

AMPEX COMPUTER PRODUCTS DIVISION
13031 West Jefferson Boulevard
Marina del Rey, CA 90291, (213) 821-8933

U.S. move to break up IBM raises hopes of competitors

The Federal Government's move in court to split up the International Business Machines Corp. to encourage competition has sent shock waves through the computer industry and produced shivers in the stock market.

Reacting to the Government's plan, competitors of IBM—organized in a newly created Computer Industries Association—have moved to voice their views. Meetings by the group have been scheduled in Los Angeles, San Francisco and New York, and the comments of the computer industry have been invited. The association is composed largely of peripheral-equipment manufacturers, but the group's counsel says it is not looking at the issues solely from that viewpoint. Many members hope to bolster the Justice Dept.'s case.

The Government made its stern stand known in briefs filed with the Federal District Court in New York in response to IBM's petition for a separate, immediate trial on the issue of how much of the market the giant computer company actually controls. The U.S. brief, filed Oct. 16, appeared to agree with IBM's contention that a survey of the market was a necessary first step to a decision on the company's future. But the Justice Dept.'s attorney, Raymond M. Carlson, said the tentative goal was to break up IBM. The brief phrased it legally this way:

"Divestiture relief designed to dissipate the enormous market power of the current IBM computer manufacturing and marketing structure by the formation of the total domestic and international computer facilities of IBM (manufacturing, marketing, research and development, capital, patents and know-how) into several discrete, separate, independent and competitively balanced entities ca-

pable of competing successfully in domestic and international markets with one another and with other domestic and foreign competitors."

The brief called for injunctive provisions to prohibit IBM from acting to frustrate the court by changing ownership or control of subsidiaries or otherwise altering its procedures except in the ordinary course of business.

Once divestiture is effected, according to the present plan, the Government would also prohibit IBM from using "bundling" in marketing systems or software or from pricing its wares in such a way as to hinder competition. It also would stop the company from announcing new products or services before they were ready to be marketed, a tactic considered an attempt to hinder competition.

The plan, the Government brief stated, "reflects plaintiff's best economic judgment as of this date, based upon an incomplete and sometimes equivocal factual record."

Meanwhile IBM is seeking to counter charges that it has monopolized the computer market, citing statistics that its business dropped from 68.4% of the EDP market in 1952 to 38.1% at the end of 1970.

Liquid-crystal display avoids flicker trouble

A laser-driven, liquid-crystal display—a new type of "wet" display that can retain an image almost indefinitely and does not have to be replenished continuously to avoid flicker problems, as conventional CRTs do—has been demonstrated as feasible.

Scientists at Bell Telephone Laboratories, Murray Hill, N.J., have shown a large-screen, black-and-white display that uses a laser

beam to draw opaque lines in a liquid-crystal film contained in a glass slide. If the crystal slide is placed in a projection system, such as an ordinary 35-mm projector, the pattern written on the slide is projected as black lines on a white background.

Through use of a special optical system, the liquid-crystal slide can be written upon while it is being illuminated by the projector's lamp system, thus providing a real-time display.

The liquid crystal is ordinarily transparent, but when the heat of a low-power laser strikes it, its molecules are disordered, and the result is a frosty or opaque region. To clear the liquid-crystal plate, an audio-frequency voltage is applied.

In Bell Laboratories' experimental system the laser beam is moved

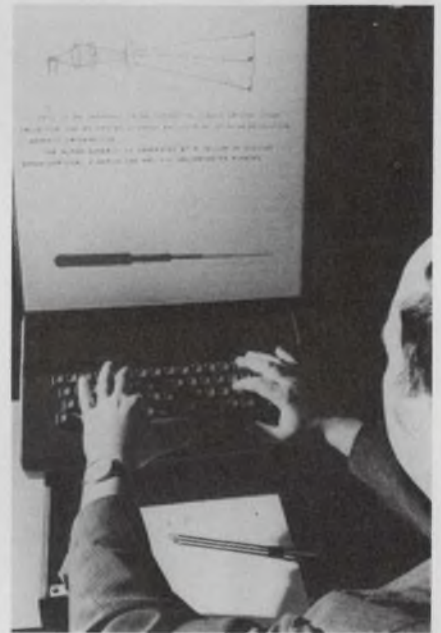

Information generated from the keyboard directs laser light over the surface of the liquid crystal slide. As the laser writes on the cell, light from an ordinary slide projector displays the information on the viewing screen.

horizontally by a galvanometer-mirror system and vertically by an acousto-optic deflector-modulator. The beam is cut off or turned on by the acousto-optic deflector-modulator.

Deflection information is stored in a memory as pulses required to produce the vertical or horizontal movements to write the various alphanumeric characters or to create

line drawings.

A liquid-crystal light valve about the size of a 35-mm slide was used in the demonstration system. The inner surfaces of the liquid-crystal glass cell were coated with a thin film of transparent metal that absorbed the heat from the laser beam.

An Nd:YAG laser with an IR wavelength of 1.06 μm was used, but Bell scientists say that He-Ne or GaAs lasers could be applied as well. Where the heat is absorbed by the metal film, the liquid-crystal material becomes disorganized, scattering visible light.

Line widths of 15 μm or more can be obtained by moving a 5-mW laser beam at speeds up to 10 cm/s across the liquid crystal cell. The laser scanning system employed is capable of writing at speeds up to several thousand characters a second.

Written images can be viewed for weeks with little loss in resolution or contrast, the scientists say. Erasure is accomplished by applying 35 V at 1.5 kHz between the transparent electrodes.

New semi processes to be tested in space

Can manufacturing and processing techniques not possible on earth be performed successfully in the zero gravity of space?

Some of the answers will be forthcoming after NASA's Skylab space vehicle goes into orbit next April. Skylab will carry a newly developed electric furnace that will allow experiments in composite casting and 10 other tests, all of keen interest to semiconductor manufacturers.

The furnace can reach and hold temperatures up to 1000 C and can achieve a variety of "cool down" rates on demand. Besides composite casting, the experiments will do the following:

- Determine how much improvement can be obtained in the perfection and chemical homogeneity of crystals grown by chemical vapor transport under weightless conditions.

- Measure self-diffusion and impurity-diffusion effects in liquid metal in space flight and characterize the distributing effects, if any,

caused by spacecraft acceleration.

- Determine the degree of microsegregation of doping impurities in germanium, caused by convectionless directional solidification.

- Grow doped germanium crystals of high chemical homogeneity and structural perfection and study their resulting physical properties in comparison with theoretical values for ideal crystals.

- Produce void-free samples of silver and aluminum reinforced with oriented silicon carbide whiskers.

- Produce doped semiconductor crystals of high chemical homogeneity and structural perfection and evaluate the influence of weightlessness in attaining these properties.

- Learn how weightlessness affects directional solidification of binary semiconductor alloys, and if single crystals are obtained, find out how their semiconducting properties depend on alloy composition.

- Produce highly continuous, controlled structures in samples of fiber-like sodium fluoride-sodium chloride and plate-like bismuth-cadmium and lead-tin eutectics, and measure their physical properties.

- Determine how pore sizes and pore shapes change in grids of fine silver wires when they are melted and resolidified in space.

- Determine the effects of weightlessness on the formation of lamellar structure in eutectic alloys when the alloys are directionally solidified.

Marine Corps to test near 'hands off' radio

A manpack radio that has "so many automatic features it's almost a hands-off radio" has been

delivered to the Marine Corps by Hughes Aircraft for test and evaluation.

In addition the set's weight is less than half that of a competitive unit.

According to Donald Q. Hall, project manager at the Hughes plant in Fullerton, Calif.: "All you have to do is to go into the transmit/receive mode, select your frequency and hit the press-to-talk switch. The antenna is tuned, the set is aligned and the transmitter comes up to full power, all automatically."

The 10-pound radio, including battery pack has been named the AN/PRC-104. The closest competitor in its frequency and range category is the AN/PRC-74C, which weighs in at 24 pounds.

Providing 280,000 channels in the 2-to-30 MHz frequency band the Hughes radio puts out 20 W of peak envelope power. This gives it a range of a few thousand yards or a few thousand miles, depending upon the type of antenna and the combination of ground and atmospheric propagation used. An eight-foot whip antenna gives about 25 miles of range. A dipole antenna will give a few hundred miles. The radio uses single sideband modulation.

Including batteries, the radio is only a foot wide, 10 inches tall and 2-1/4 inches thick. The silver-zinc battery provides at least 16 hours of service before recharging is necessary.

Hall says the transceiver consumes less than 5 W of average power. A special monitoring mode permits operation at reduced power during periods of light message traffic. This automatically cycles the receiver on and off for one second out of every 10, with a special alarm circuit alerting the operator to incoming messages.

News Briefs

A 4000-W cw carbon-dioxide laser will be installed at Ford Motor Co.'s automotive assembly div. in Allen Park, Mich., as a prototype production machine tool. Developed by Hamilton Standard of Windsor Locks, Conn., the system is designed to make deep-penetration welds on auto underbodies at a rate of 60 underbodies an hour. A solar furnace capable of focus-

ing 5000 F of thermal radiation energy from the sun onto a four-inch-diameter area of steel will be installed at the White Sands Missile Range in New Mexico. Forty-five feet high and more than 100 feet long, the solar furnace will be used to simulate sudden thermal radiation outbursts, such as would emanate from the blast of nuclear weapons.

Teradyne's L100 Automatic Circuit Board Test System speaks for itself.

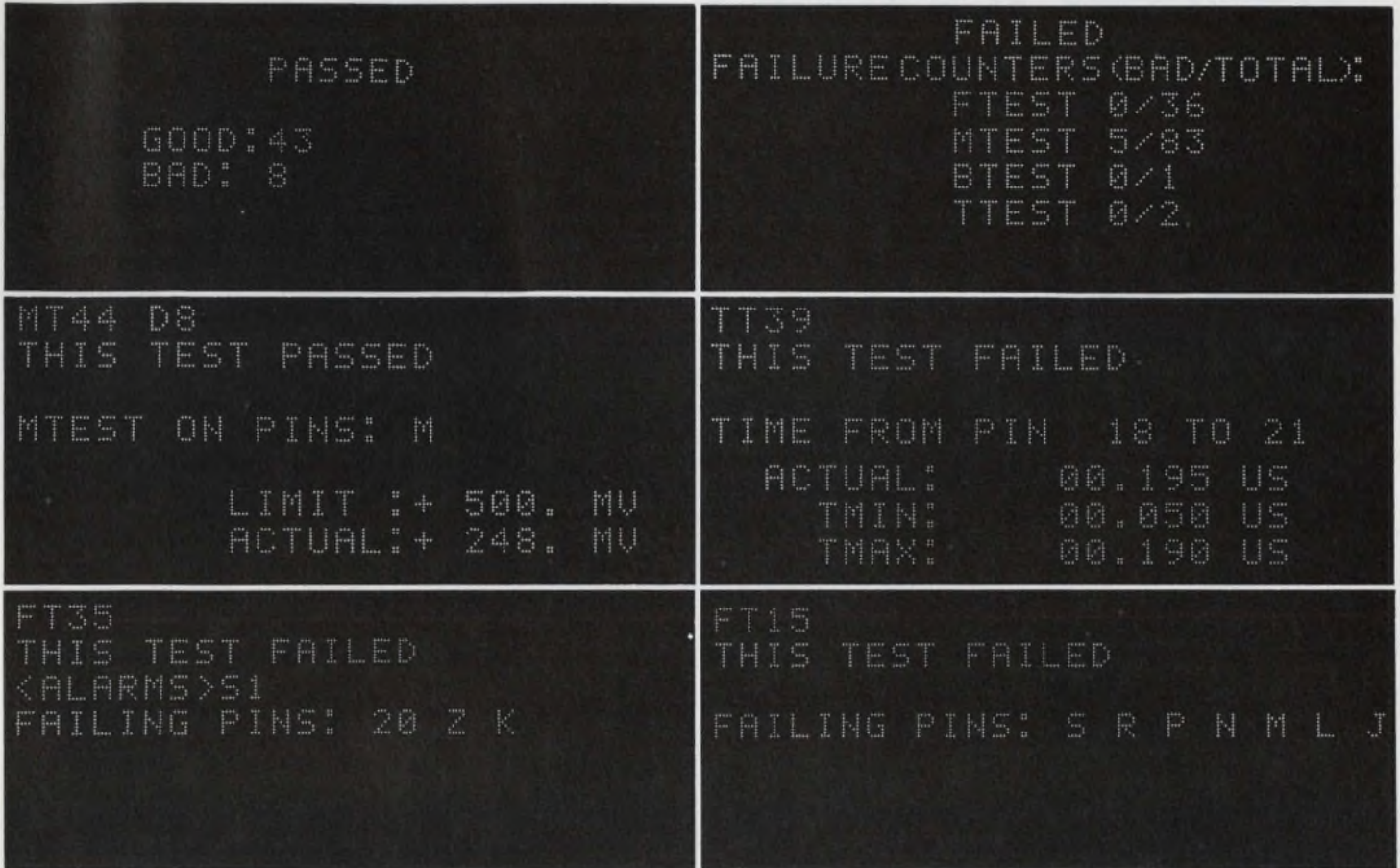

If you test circuit boards, you get the message. The L100 doesn't just tell you a bad board is bad. It helps you find out why. And in a fraction of the time you'd usually spend troubleshooting. We'd like to send you a brochureful of reasons why the L100 is the most money-saving system you can buy.

Write: Teradyne
183 Essex Street
Boston, Mass. 02111

In Europe:
Teradyne Europe
S.A., 11 bis, rue
Roquepine,
75 Paris 8^e, France.
Tel. 265 72 62.

TERADYNE



INFORMATION RETRIEVAL NUMBER 17

The new telemetry: Less data, real-time analysis and adaptive

Real-time analysis, adaptive control, less but more meaningful data and low cost are the trends for the 1970s, a panel discussion at the International Telemetry Conference concluded.

Representatives of several government agencies and industrial concerns gave their opinions at the three-day meeting in Los Angeles last month.

"Telemetry will no longer be treated as a separate system function in the space program," said William E. Miller, principal engineer for the Space Station and Sortie Laboratory at NASA headquarters in Washington, D.C. "Rather, it will be included as part of a unified data system, similar to the unified S-band system on the Apollo program."

He pointed out that K band and X band would be the main telemetry bands in the 70s, with X band used particularly on deep-

space missions. To make the data more readily accessible from deep space, he said, a data-relay satellite would be developed.

Miller believes it will be necessary to have real-time processing of telemetered data on the ground rather than bulk collection and processing.

"We may," he said, "get as much as 10^{13} bits of data per day back from a space station. Without real-time processing, we'll be lost in the flood."

Finally, Miller said, "we need new technologies for storing the data on the vehicle prior to transmission."

"Tape recorders aren't good enough," he noted, "maybe bubble memories will do the job."

But cost will be a major factor in anything NASA funds, he reminded the panel.

On to digital aircraft

Maj. William H. Hargrove of the Minuteman Program Office at Nor-

ton Air Force Base, San Bernardino, Calif., spoke of a new Air Force program aimed at developing an all-digital aircraft. Flight controls, electronic countermeasures systems, navigation and guidance systems—all will use a central-processor multiplexing system with a digital data bus architecture. The aircraft is to have digital integrated displays in the cockpit, with a capability for telemetering all data to the ground if desired. Work on digital simulation for this program is going on at Wright-Patterson Air Force Base in Ohio. The program is associated with remote pilotless aircraft programs that the Air Force is pursuing.

Maj. Hargrove stressed that cost was the major factor in future decision-making. "We have major reliability problems," he said. "Programs have been cut back to the point where we can't stand any loss of data due to malfunctions."

Cost, he went on, also has pushed the Air Force to concentrate on "operational realism" in all its testing. This means that a telemetry pod cannot ride external to a missile; no testing hardware will be allowed to affect the operational performance of the system under test.

C band for hi-g conditions

Burton E. Norman, who said he was working on instrumentation plans and programs at the Army's White Sands Missile Range in New Mexico, called for C band telemetry systems for in-barrel testing of weapons under hi-g conditions. He also said that improved telemetry systems were needed to define the environment that missiles encounter. As a general trend, he noted, "time multiplex telemetry is likely to take over a larger portion of

David N. Kaye
Senior Western Editor



DC-10 flight test data is processed in real-time at McDonnell Douglas Corp., Long Beach, Calif., while the aircraft is in the air. Flexibility of data formatting is allowed by the large-screen CRT displays.

Seven sure ways to pick the best pin and socket connector.

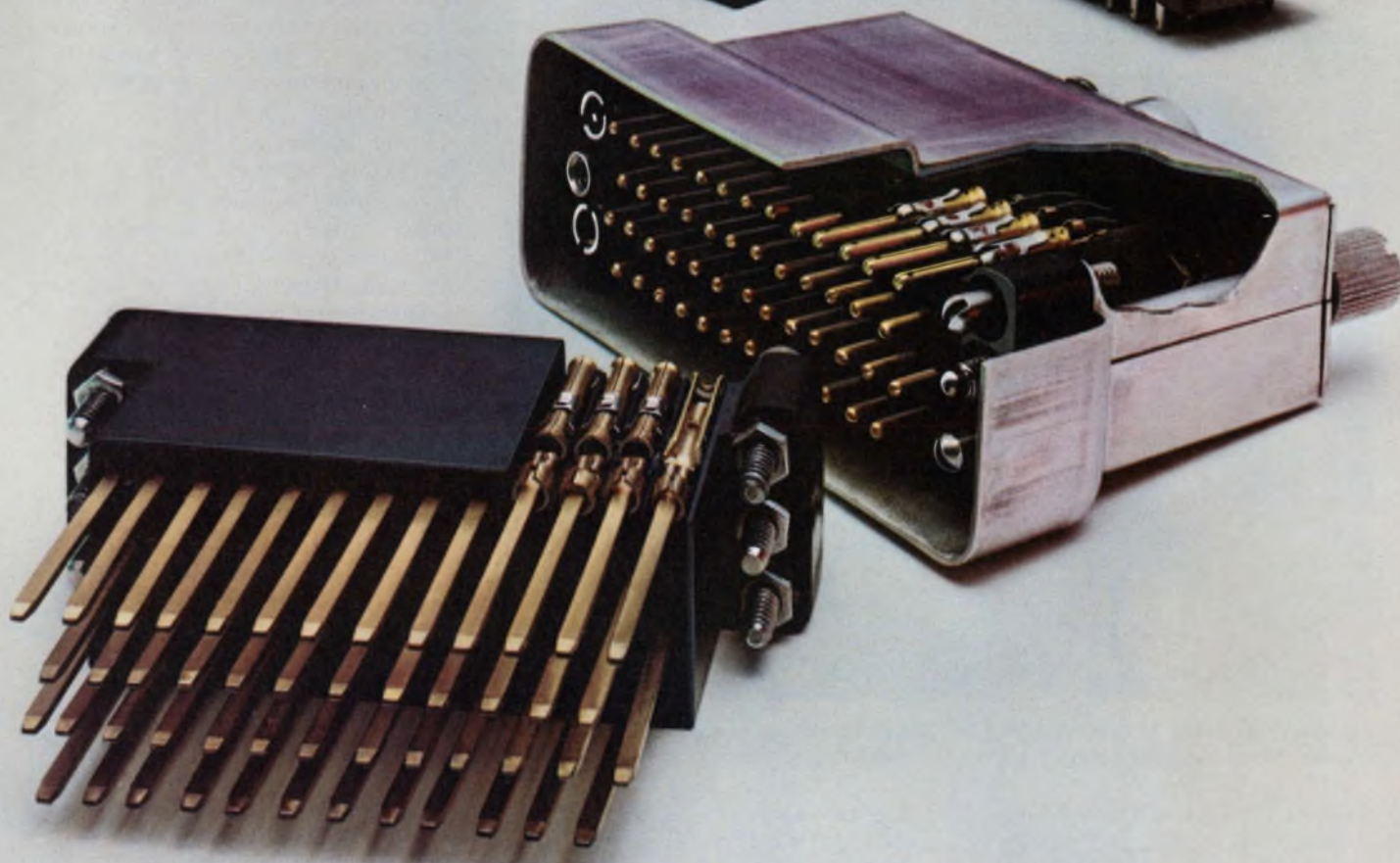

1. Pick one that's reliable, maintainable and rugged enough to withstand rough handling, hostile environments and hundreds of mating cycles.

Like our M Series.

2. Choose from the most complete line of posted or crimp-type contacts so you get the flexibility of many manual and automated terminating techniques, plus the exact size and configuration you need.

Like our M Series.

3. Be sure you get selective loading so you don't wind up paying for contacts you don't need. And look for convenient extraction so damaged contacts can be replaced.

Like our M Series.

4. Be sure stamped and formed contacts are considered so you aren't forced to pay the unnecessary high cost of machined contacts.

Like our M Series.

5. Look for a wide variety of housings including .200-inch grid or denser, staggered grid-pattern housings so you'll be certain to find the one you need.

Like our M Series.

6. Be sure contacts can be machine-terminated by high-quality, high-speed stripping, crimping and point-to-point wiring machinery so you can take advantage of the lowest applied cost in the industry.

Like our M Series.

7. Be certain it's made by AMP so you'll get the finest quality at competitive applied cost.

Like our M Series.

For more information on M Series pin and socket connectors, write **AMP Incorporated, Industrial Division, Harrisburg, Pa. 17105.**

AMP
INCORPORATED

Manufacturing and direct sales facilities worldwide: Barcelona, Brussels, Buenos Aires, Frankfurt, London, Mexico City, Paris, Puerto Rico, Sao Paulo, s'Hertogenbosch (Holland), Sydney, Stockholm, Tokyo, Toronto, Turin, Vienna.

the systems than it has now, compared to frequency multiplex telemetry."

The Coast Guard, which mailed in information to the session chairman but did not send a speaker, reported that its plans in telemetry centered on automated lighthouses and remote automated data buoys. Many of the data buoys will be used as environmental monitors, since the Coast Guard is planning to devote a large portion of its R&D budget in the 70s to pollution control and monitoring.

Test ranges plan cutbacks

Robert Pickett, Federal Electric Corp.'s manager of telemetry systems at Vandenberg Air Force



Telemetry systems at the Atlantic Fleet Weapons Range in Puerto Rico receive signals from missiles being fired by the fleet in practice drills.

Base in California, said that the Western Test Range would be eliminating telemetry ships completely and would be cutting back on instrumentation redundancy on the ground. To maintain range reliability, the move will be towards computerized preflight checkout systems. The aim is to make sure that the available equipment is all working before the missile goes down the range.

Because of budget cutbacks, fewer missiles will fly, Pickett said, adding: "We need higher data rates to handle the more concentrated instrumentation that each bird will carry."

He pointed to the need for adaptive telemetry systems. These would call for programmed data from a sensor, would transmit the data at

a desired rate and then format the data on the ground.

The European scene

Turning to Europe and its telemetry problems, Martin Deckett, a market planner for TRW Systems in Redondo Beach, Calif., pointed out that telemetry and other electronic systems projects tend to be spread over many nations. As a result, he said, Europeans must be adept at writing interface specifications.

Deckett noted that the most important telemetry project in Europe at present is the Helios spacecraft—an experimental collection station for space data. It is being built by the West Germans to have variable

data-rate transmission of from 8 to 4000 b/s. It is to have an operational range of 100 to 200 million miles, with signals from the spacecraft received by a 100-meter steerable dish at Effelsberg, West Germany.

According to Deckett, different countries have specialized in different technologies; on large systems, they all come together. Although they still require subsystems from the United States, Deckett said, the next few years will see technology expanding in Europe to eliminate such dependence.

Biotelemetry: A surge in growth

Biotelemetry, the sending of biological-data signals, had "no clear goal" in the 1960s, said Roland

Radar of the Dept. of Physiology at the University of Southern California. Neither did it have a market, he noted. The nation's space effort provided the spur for change. The current annual biotelemetry market is about \$10-million in clinical telemetry, \$3-million in commercial research and \$5-million in government research.

Among the main markets that Radar sees for biotelemetry in the 70s are these: hypertension studies; electrocardiogram and electroencephalogram transmission from ambulances, intensive-care units and progressive-care units; the study of cattle and swine in meat production; and drug testing with implant telemetry.

Loyle Baltz, an engineer with the safety testing group at the Ford Motor Co., Dearborn, Mich., spoke on the use of telemetry to test automotive safety. He pointed out that the majority of safety tests were run with hydraulic sleds and barrier crashes. "About 80 to 85% of our testing uses accelerometers and FM data recording," he told the panel. "We also measure speed, loading and pressure."

The present swing is toward the use of crash-proof, on-board telemetry equipment.

Olin King, president of SCI Systems, Inc., of Huntsville, Ala., outlined the myriad industrial applications of telemetry. He said real-time feedback for positive process control would be one of the largest markets for telemetry in the 70s. And he emphasized the growing move towards bringing the processor into the telemetry system and towards using real-time data bus technology.

"Since many telemetry systems operate in a dynamically changing environment," King said, "systems must be able to adapt."

King foresaw a large market for biotelemetry systems in the emergency treatment of accident victims. More and more communities are attempting to treat patients rapidly at the scene of an accident and on the way to the hospital to reduce fatalities. The telemetry of the patients' vital signs to a doctor at the hospital, King said, will help to save many of the 60,000 people who die each year in the U.S. because of inadequate care before reaching a hospital. ■■

state-of-the-art zeners

UNITRODE OFFERS THE HIGHEST SURGE RATINGS IN THE INDUSTRY, AT THE PRICE OF ORDINARY DEVICES.

Whatever your needs in hi-rel and military zeners from 1 watt up, Unitrode will give you more. 10 watt zeners from Unitrode will give you 600% higher surge protection than conventional 10 watt types — 35% higher than ordinary 50 watt types. And Unitrode 1.5 watt, 3 watt, 5 watt and 6 watt devices provide proportionally higher surge capabilities than their conventional counterparts.

Some series are available up to 400 volts. These unmatched capabilities are achieved through Unitrode's unique fused-in-glass construction. A silicon wafer is bonded directly between the terminal pins, eliminating the whisker. A sleeve of hard glass is then fused to the exposed



silicon surface resulting in a voidless, monolithic structure that exceeds the environmental requirements of MIL-S-19500. The 1.5 watt IN4461 series is available as JAN and JANTX devices to MIL-S-19500/406 and the 5 watt IN4954 series is available as JAN and JANTX devices to MIL-S-19500/356. And Unitrode can really service these specs. Shipment is from inventory.

Now that you know you don't have to, why settle for less than the best?

For fast action, call Sales Engineering, collect (617) 926-0404. Unitrode Corporation, 580 Pleasant St., Watertown, Mass. 02172

Unitrode Corporation

Dept. 11X, 580 Pleasant St., Watertown, Mass. 02172

Please send technical information on the following Unitrode Zeners:

- | | |
|---|---|
| <input type="checkbox"/> 1.5 watt JAN & JANTX | <input type="checkbox"/> 5 watt JAN & JANTX |
| <input type="checkbox"/> 3 watt | <input type="checkbox"/> 6 watt |
| <input type="checkbox"/> 5 watt | <input type="checkbox"/> 10 watt |

Name _____

Title _____

Co. _____

Address _____

City _____

State _____ Zip _____

See EEM Section 4800 And EBG Semiconductors Section for more complete product listing



UNITRODE



AT THE TOKYO SHOW

Japan's electronics makers keep pace despite recession at home

An air of pessimism pervaded this year's Japan Electronics Show, despite the fact there were more exhibitors and visitors than at any previous show.

A total of 415 exhibits drew over 353,000 visitors, but there were relatively few new products on display. The emphasis was on the application of existing products.

The reasons given for the pessimism: Increasing restrictions by the U.S. and European countries on the import of Japanese electronics products and a slowdown in the growth rate of the \$9.5-billion Japanese electronics industry, caused by a recent recession. Sales of Japanese products are declining both at home and abroad.

Nevertheless the products on display, though not always new, were varied, and they indicated that the Japanese are keeping pace with trends in the consumer, instrument and component areas.

A CMOS LSI circuit for a 10-digit pocket calculator was display-

ed by the Tokyo Shibaura Electric Co. (Toshiba). The chip is powered by 6 V dc and consumes 2 mW.

A silicon-gate PMOS LSI circuit was introduced by Mitsubishi Electric. It contains a crystal unit with an oscillating frequency of

16,384 Hz. The company also exhibited a CMOS LSI circuit for a quartz-crystal electronic watch with a liquid-crystal display.

And Hitachi displayed a silicon gate CMOS LSI chip, also for a quartz-crystal electronic watch. Powered by a 1.3-V mercury cell, the chip is being mass-produced by ion-implantation techniques.

As in the U.S., computer mainframe manufacturers in Japan have been debating the merits of core, semiconductor and wire memories in the last few years. However, following IBM's announcement that it will incorporate an IC memory into its 370 series, Japanese manufacturers are beginning to develop semiconductor stores.

Hitachi introduced a high-speed bipolar memory system consisting of six ICs. It has an access time of 30 ns, a cycle time of 70 ns and power consumption of 5 mW/bit.

Mitsubishi exhibited various MOS LSI memories ranging in capacity from quad 256-bit types to single 1024-bit.

On the other hand Toko, Inc.,



Industrial robot developed by Tokyo Shibaura Electric Co.

Hiroshi Arita
Japanese Correspondent

For built-in reliability, design with "Scotchflex" Flat Cable/Connector Systems.

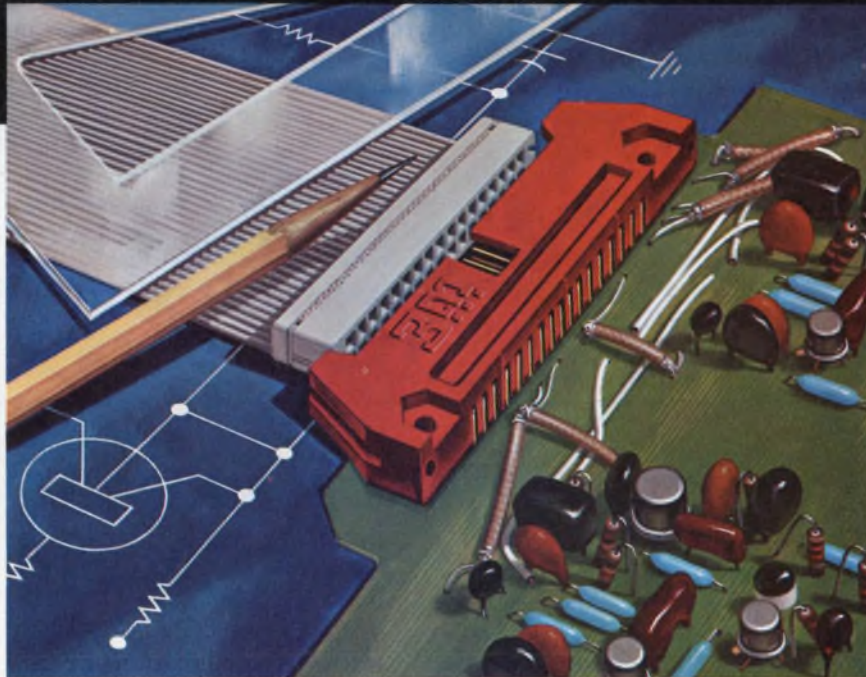

"SCOTCHFLEX" IS A REGISTERED TRADEMARK OF 3M CO.

"Scotchflex" Flat Cable and Connectors can offer you trouble-free packaging for your next generation equipment.

There's built-in reliability for your circuit inter-connects. Our flat, flexible PVC Cable has up to 50 precisely spaced conductors. The gold plated U-contacts are set into a plastic body to provide positive alignment. They strip through the insulation, capture the conductor, and provide a gas-tight pressure connection.

Assembly cost reductions are built-in, too. "Scotchflex" Connectors make up to 50 simultaneous connections without stripping or soldering. No special training or

costly assembly equipment is needed.

Off-the-shelf stock offers you flat cable in a choice of lengths and number of conductors from 14 to 50. Connector models interface with standard DIP sockets, wrap posts on .100 x .100 in. grid, or printed circuit boards. Headers are available to provide a de-pluggable inter-connection between cable jumpers and printed circuit boards (as shown). Custom assemblies are also available on request.

For full information on the "Scotchflex" systems approach to circuitry, write to Dept. EAH-1, 3M Center, St. Paul, Minn. 55101.

3M
COMPANY

a long-time manufacturer of wire memories, displayed its HS-200S wire memory, featuring 65-k to 1-Megabyte capacity, an access time of 180 ns and cycle time of 250 ns. The company says the memory is priced at 3 yen (1 cent) per bit.

Oki Electric Industry Co. introduced a new wire memory, the OPM-600/30, which will be put on the Japanese market by the end of this year. It has a capacity of 8192 words (19 bits per word), access time of 200 ns, cycle time of 400 ns and power consumption of 40 W.

Liquid crystals displayed

A variety of liquid-crystal, plasma and LED displays were shown. Most notable were the liquid-crystal watches and clocks exhibited by Matsushita Electric, Hitachi, Tamura Electric and others.

A liquid-crystal display for desktop calculators was introduced by the Asahi Glass Co. It is reported to consume 0.3 mW/cm², with a contrast ratio of up to 150 to 1 and a life of more than 10,000 hours.

Tamura announced that it was beginning to market a liquid-crys-



Wire memory from Oki Electric Industry Co. has a capacity of 8192 words, a 200-ns access time and consumes 40 W.

tal digital clock. Mitsubishi showed a 128 × 128-mm plasma display panel, consisting of 40 letters by 28 lines, for use in computer terminals. The panel emits reddish yellow with a brightness of about 300 ft-L.

As is usually the case at Japanese electronics shows, consumer electronics dominated the exhibits. There weren't too many color-TV innovations this year, a star attraction at previous shows. But Matsushita demonstrated a calculator/TV that enables the viewer to do his calculations on the TV screen; a snapshot TV that offers a viewer a glossy photo of a desired image,

and a memory TV that reproduces a scene for repeat viewing. Two similar memory sets were displayed by Hitachi and Sanyo Electric. Sanyo's set can record a TV image and reproduce it on a magnetic-sheet memory.

Other color-TV innovations included a Sanyo set with a built-in timer that automatically changes to the desired channel when the preset time has arrived. For the lazy viewer, Sharp Corp.'s "channel display" TV employs an MOS/LSI circuit that displays on the screen for 1.2 seconds the channel number of the program viewed.

Mitsumi exhibited its new semiconductor inductance element, which has opened up the possibility of fully integrating most circuits that have inductors, except possibly high-voltage ones (see "IC Device Integrates Inductors; Coil-Less Radio and TV Coming," ED 21, Oct. 12, 1972, p. 36). The company says the element-designated Semicon L is being incorporated in trap circuits for the signal carrier in color TV sets and in the i-f amplifier/detector circuit of radios.

The show, the largest electronics one in Japan, ran in Tokyo from Sept. 21 through Sept. 27. ■■

Pyroelectric array, a first, introduced

The first commercially available linear imaging array to have a response from the visible region to greater than 15 μm in the infrared has been introduced by the Laser Precision Corp., Yorkville, N.Y.

The 32-element array is a pyroelectric type. To date, says Bruce C. McIntosh, design engineer at Laser Precision, the detector arrays used in infrared imaging systems have been composed of classical sensors, such as lead sulfide, indium antimonide, thermopiles, and cryogenic detectors. Each of these types, he says, presents a compromise in spectral response, response time and operating temperature.

But the pyroelectric detectors used in the new array, McIntosh reports, have the best combination of the following: broad spectral

response, fast response to radiation and room-temperature operation. Typical characteristics of the new arrays, he says, are:

- Response time of better than 1 μs .
- Spectral response variation within $\pm 2\%$ from the visible region to greater than 15 μm .
- Sensitivity capable of detecting signals down to 4×10^{-10} W.
- Ability to withstand peak powers of greater than 10 kW.
- High thermal stability of less than 0.2% sensitivity variation per $^{\circ}\text{C}$.
- An operating temperature range from -30 to 100 C.

The pyroelectric effect, McIntosh explains, occurs in ferroelectric materials that possess a permanent electric polarization, the magnitude of which is highly dependent on

temperature. A small variation in temperature causes a finite change in the material's polarization, thus producing a change in the potential difference across the detector element.

In the array each detector is connected to an IC preamplifier. The preamps, McIntosh says, are scanned electronically by an auxiliary sweep generator that drives MOSFET switches connected to each preamplifier. For each sweep, the outputs of all the detectors are fed sequentially to an output cable and to an oscilloscope for display.

For a fairly small number of elements in an array, the scope waveform appears as a series of step functions, each representing the energy level of an individual element. The more elements in the array, the smoother the curve. ■■

Ring up more savings on keyboard switches.



As much as **50%**
(savings per key)



The new Oak Series 400.

Get Oak-engineered quality in keyboard switches with the inherent reliability of electro-mechanical operation. Ideal for peripheral data-processing equipment. Contact bounce is less than 3 milliseconds. Long life, up to 20 million operations per key. Designed with self-cleaning crossbar-wiping contacts.

Under 30¢ each.

For SPST/NO in production quantities. Other versions comparably priced. Keytop button and snap-in mounting extra.

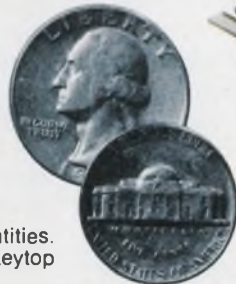

A feather touch.

We kept the operator in mind. Standard operating force is approximately 85 grams (3 oz.).



Also from Oak: Series 300 Lighted Pushbutton Switches.

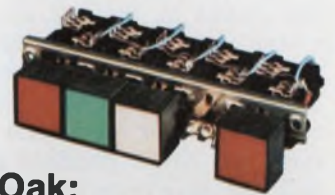

Featuring Oak's exclusive twin-lamp lighting. If one lamp goes out, the other stays on. Double-wiping contact clips. Short stroke. Smooth, quiet operation. Unlimited combinations. Request our Series 300 brochure.

The configurations you want.

The Series 400 is available in limitless arrangements, including standard 10, 12, and 16-button keyboards. And you can specify any of six different contact circuitries. Choose snap-in or plug-in P.C. mounting. Compact—only 1/2" x 1/2" x 1".

Write today for our Series 400 brochure.

OAK Industries Inc.

SWITCH DIVISION / CRYSTAL LAKE, ILLINOIS 60014
TELEPHONE: 815 • 459 • 5000 • TWX: 910 • 634-3353 • TELEX: 72 • 2447

INFORMATION RETRIEVAL NUMBER 20

Pulse width and phase encoding compete to be cassette standard

Although the digital cassette recorder industry is reported near agreement on a standard for recording of digital data on a cassette, a competing recording method is being pushed by three manufacturers. It is called pulse-width encoding. It has, its makers say, the advantage of being much less sensitive to speed variations of the tape than the phase-encoding technique incorporated in the standard developed by ANSI (American National Standards Institute).

In phase encoding, a bit cell is defined on tape. A negative-going flux reversal in the middle of the cell determines a binary ONE and a positive-going flux reversal in the middle of the cell determines a binary ZERO. This technique of recording can stand approximately $\pm 25\%$ speed variation before it starts to suffer significant bit errors. The ANSI standard requires that the long-term bit spacing or speed variation be held to a maximum of $\pm 4\%$. Thus ANSI-compatible recorders are required to be well within tolerable speed-variation limits and to operate at an effective constant speed.

In pulse-width encoding, the speed does not have to be constant over the short or long term. The technique allows for at least a 4-to-1 speed variation with no bit errors. Since there is no need to maintain a tight speed tolerance, the motor-control circuitry is less expensive.

The bit cell is divided into three portions. The cell starts with a positive-going flux reversal at the beginning of the cell and ends with a positive-going flux reversal at the end of the cell. The state of the cell is determined by the position of the negative-going flux re-

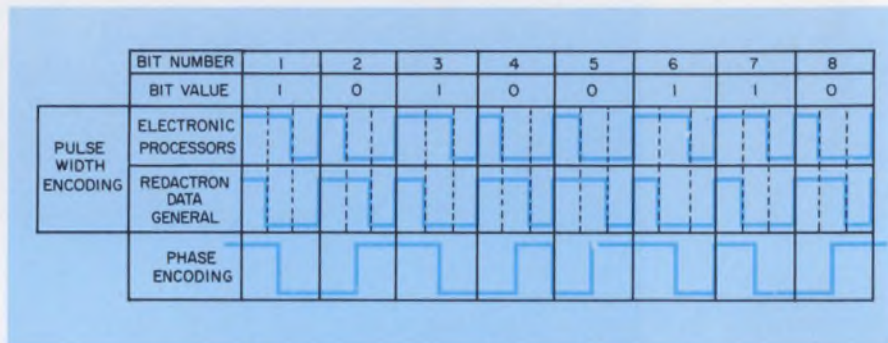

Pulse-width encoding requires that the bit cell be divided into three segments with a positive flux transition at both the beginning and the end. The position of the negative transition in between determines whether the contents of the cell are a ONE or a ZERO. Phase encoding requires a negative going flux transition in the middle of the bit cell for a ONE and a positive going flux transition in the middle of the bit cell for a ZERO.

versal. Depending upon the manufacturer, a binary ONE is either defined as the negative reversal at the one-third point or at the two-thirds point in the cell. The binary ZERO is the two-thirds point if the binary ONE is the one-third, and vice versa if the positions are reversed.

3 firms pushing technique

Three companies are pushing the pulse-width encoding technique: Redactron of Hauppauge, N.Y.; Data General of Southboro, Mass., and Electronic Processors of Englewood, Colo. Redactron and Data General choose the negative reversal at the one-third point, and Electronic Processors at the two-thirds point.

All three companies use basically the same method of reading data from the tape. According to Joseph Godbout, systems design engineer at Data General: "We use an up-down counter that is triggered by the positive flux reversal at the beginning of the cell. It starts counting up till it hits the

negative reversal; then it starts counting down. If it reaches ZERO before the next positive reversal, the negative reversal was in the first half of the cell, or at the one-third point. Therefore we read a ONE. If the counter doesn't get to ZERO before the positive reversal at the end of the cell, we read a ZERO."

The period of indecision between a ONE and a ZERO is a single count of the counter and is determined by the counter rate. The precision of the technique is determined, according to Tenny Lode, chief scientist at Electronic Processors, by the number of bit cell divisions that the counter produces.

Data General uses a TTL counter and counts at 800 kHz. This divides the cell into about 70 parts. Redactron uses an MOS counter and counts at 480 kHz. This divides the cell into about 42 parts. Electronic Processors uses a TTL counter and counts at 144 kHz.

Because of a slower tape speed in their recorder the cell is divided into 140 parts for extremely high precision. ■■

David N. Kaye
Senior Western Editor

VACTEC PHOTOCELLS

boiled to perfection

Heat, water, steam, or a combination of all three, can't penetrate Vactec's positive hermetic seals. Even the passivated plastic types are exceptionally stable. Vactec Photocells not only endure boiling water temperatures (100° C), but also other environmental extremes down to liquid nitrogen cold (-196° C).

Long term moisture like 500 to 5000 hours in a humidity chamber can be even more destructive than boiling. If you put Vactec to this test, be sure to include some competitive cells for comparison.

You simply can't buy a better photocell *anywhere*, and Vactec is competitive with import prices because of automated processing, assembling, and testing. Take advantage of Vactec engineering, research, and manufacturing in the heart of America. Because Vactec has 249 different types of cells in stock, we can ship before your order reaches an overseas supplier. Included is a complete line of visible detectors: photoconductors (CdS and CdSe); photovoltaic cells (Se and Si); couplers of LED's or lamps and photoconductors called Vactrols. Vactec also has a photometer which measures from .0002 to 10,000 fc, for as little as \$300.00.



VACTEC, INC.

2423 Northline Industrial Blvd.
Maryland Heights, Mo. 63043
Phone (314) 872-8300

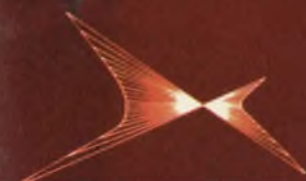

NASA's biggest solar-cell array to power first space station in '73

When the first manned orbital space station, Skylab, eases into orbit next spring, it will deploy two solar-cell arrays, each twice as large as any the National Aeronautics and Space Administration has ever flown. One array will provide power for the manned workshop and the other for the Apollo telescope.

The workshop array consists of two wings, each 28 by 30 feet. They extend straight out on either side of the workshop, making it resemble a fat aircraft with short, wide wings.

Although measuring a total of 1680 square feet, the array's solar-cell area comes to 1350 square feet. Weighing 5060 pounds, the two-wing array consists of six sections, three to a wing, each section divided into 10 active panels. Each panel contains 2464 king-size silicon cells, each 2 by 4 cm. The total number of cells comes to 147,840.

Normally solar cells measure 2

by 2 cm. The larger, rectangular cells, however, provide several advantages over the smaller square ones. They reduce the number of cells required, which in turn reduces the number of nonproductive spaces between cells and the number of connections. This in turn, improves reliability.

Consumes almost 11.5 kW

The power output requirement for the array when it first goes up will be 11.483 kW in an environment of 55 C (power increases as the temperature drops at a rate of 0.48% per 1 C). After eight months the array must provide at least 10.48 kW at 55 C. The array's energy will be channeled to eight power control groups.

The workshop array was built by the TRW Systems Group, Redondo Beach, Calif., under contract with Skylab's prime contractor, McDonnell-Douglas Astronautics, Hunt-

ington Beach, Calif.

The other array, which will power 18 Ni-Cd batteries for the Apollo telescope, consists of four undulating wings covering 1567.5 square feet, of which 1060.2 square feet are solar cells. The array contains 164,160 cells, two-thirds of which measure 2 by 2 cm and the remaining third 2 by 6 cm. The array weighs 4221 pounds.

The power requirement at the beginning of the mission will be 11.293 kW at 55 C; after eight months it will be 10.48 kW.

Power is collected from the solar panels through harnesses routed through channels in beams used to stabilize the array. The harnesses are continuous, without connectors or breaks from the panels to the junction box collector. This was done, TRW says, to increase reliability. The longest harness route is 80 feet long.

There are six harnesses in each wing, two per section. ■■

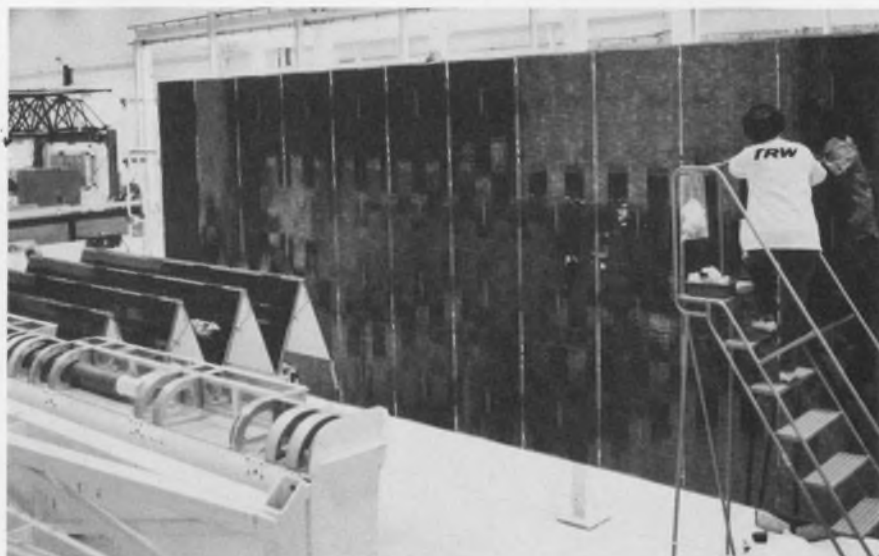

Silicon solar-cell array for Skylab is twice as large as any solar-cell array ever flown by NASA. It consists of two wings with a total solar-energy conversion area of 1350 square feet. It contains 147,840 cells.



Skylab, NASA's first manned orbital space station, will be powered by two giant solar-cell arrays.

series 1400

illuminated push button controls

a versatile concept that gives you flexibility in designing interrelated switching combinations . . . plus prototypes in 72 hours

Momentary . . . push/push . . . reciprocal release . . . master release . . . interlock . . . one assembly does the job of several.

Mount vertically or horizontally. Up to 20 stations on a single frame. Contacts are DPDT, 2 amps, 250 VAC. Single series 1400 push buttons and indicator lights to match.

For details, or to order a custom 72-hour prototype, write or call:



the total technology people

LEDEX INC.
123 Webster Street
Dayton, Ohio 45401
(513) 224-9891

POSITIONING

SWITCHING

MICROELECTRONICS

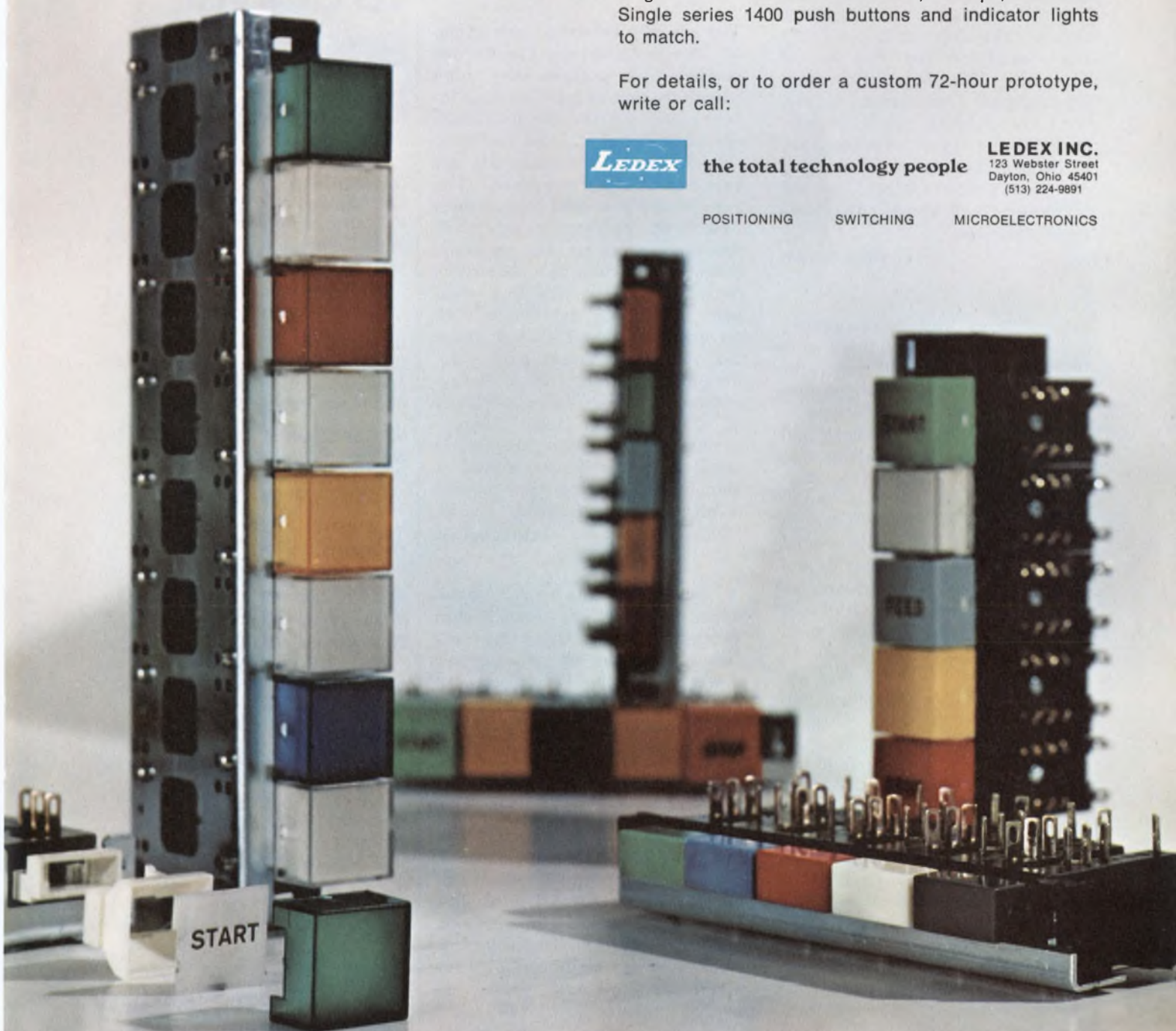

technology abroad

Replacement of an analog signal processing system in a television camera video circuit by its digital equivalent has reduced noise and distortion, improved stability and given almost error-free signals, according to engineers at EMI Electronics, Middlesex, England. An EMI 2004 monochrome camera was used in a demonstration. The camera was standard, except that an output from the head amplifier fed the digital equipment. The signal, after analog-to-digital conversion, underwent five separate digital processes: horizontal-aperture correction; black-level control and blanking insertion; gain control; gamma correction; and synchronizing-pulse insertion.

CIRCLE NO. 441

Several large superconducting coils for the field windings of a 1000-kW dc motor and generator—the heart of a new marine propulsion system—have been successfully tested by International Research and Development Co., Ltd., Newcastle upon Tyne, England. The coils have a radial depth of about 85 mm and a length of about 45 mm. They are wound with superconducting cable and impregnated with epoxy resin. To meet the stress due to rapid changes of magnetic field level, the superconductor is a twisted composite that includes a high-resistivity component and, in addition, is impregnated with a high-resistivity solder.

CIRCLE NO. 442

A radar Doppler system that gives the distance of a vessel from its berth in addition to its closing speed as it approaches is being developed by GEC-Marconi Electronics of Britain. The system, intended for use at a refinery terminal on the river Thames, consists of transmitter/receiver units operating in the 14-GHz band

together with 21-inch dish antennas that produce a 3° transmission beam. For range indication a Gunn diode is frequency modulated by a varactor diode. The frequency difference between transmitted and received signals is converted to distance.

CIRCLE NO. 443

The use of a relatively new group of intermetallic compounds for magnets of exceptionally high coercivity and energy is being investigated by the Brown-Boveri research center in Baden, Switzerland. These new materials are rare-earth/cobalt compounds. The rare earths and mixtures of them used in the program include yttrium, lanthanum, cerium, praseodymium, neodymium and samarium. Samarium cobalt (SmCo_5) magnets have been fabricated with an energy product that is twice that of conventional hard magnets and an almost linear demagnetization curve with a coercivity of 700 oersted. The energy-product of the SmCo_5 magnets is about 16×10^6 gauss-oersted. A principal use of this type magnet is in watches and clocks.

CIRCLE NO. 444

A specially constructed gold-doped silicon diode that changes junction capacitance with exposure to light has been used in two new circuits. The first is an optically tuned oscillator that has a 60-Hz frequency variation when subjected to light energies of 1 eV and 1.8 eV. It is hoped to increase this change by raising the oscillator frequency, reducing stray capacitances and back-biasing the diode. The second circuit is an optically tuned potentiometer in which resolution similar to that obtainable with precision potentiometers has been achieved. With circuit modifications, the resolution reportedly can be improved to the order of 2.10^{-6} .

CIRCLE NO. 445



a nationwide network equipped to deliver specials in a hurry.

CALIFORNIA

Los Angeles, 90022
Kierulff Electronics, Inc.
2585 Commerce Way
Mountain View, 94040
Elmar Electronics, Inc.
2288 Charleston Road

ILLINOIS

Chicago, 60624
Newark Electronics Corp.
500 North Pulaski Road

MASSACHUSETTS

Newton, 02159
Cramer Electronics, Inc.
85 Wells Avenue

NEW YORK

Westbury, 11590
Schweber Electronics
Jericho Turnpike

PENNSYLVANIA

Philadelphia, 19114
Almo Electronics Corp.
Roosevelt Blvd. at Blue Grass Rd.

TEXAS

Dallas, 75220
Solid State Electronics Co.
of Texas
P.O. Box 20299, 2643 Manana Dr.
Houston, 77004
Harrison Equipment Co., Inc.
1616 McGowen Avenue



Allen-Bradley
Milwaukee, Wisconsin 53204



MOD POT™ the most versatile potentiometer available today is suddenly more available.

It's time you got a square deal on pots. Why should you wait weeks for slight potentiometer modifications? We've got MOD POT. Hundreds of standard modules that assemble into millions of different combinations. A whole family of resistive elements, switch options and vernier drives with single or concentric shafts. Pre-engineered and pre-tested to form single, dual,

triple or quadruple section controls. To speed delivery we created a network of MOD POT Action Centers. Allen-Bradley electronics distributors are factory trained in the fine points of MOD POT assembly. They can shorten delivery time from weeks to a few days. Why wait for specials when we offer millions of standards? Contact your appointed Allen-Bradley electronics distribu-

tor or write for publication 5217. Allen-Bradley Electronics Division, 1201 South Second Street, Milwaukee, WI 53204. Export: Bloomfield, New Jersey 07003. Canada: Allen-Bradley Canada Limited, Galt, Ontario. United Kingdom: Jarrow, County Durham NE32 3EN.

Allen-Bradley

If you're really serious about cost, be serious about quality.



Look into an EMCAP.TM Surprise!

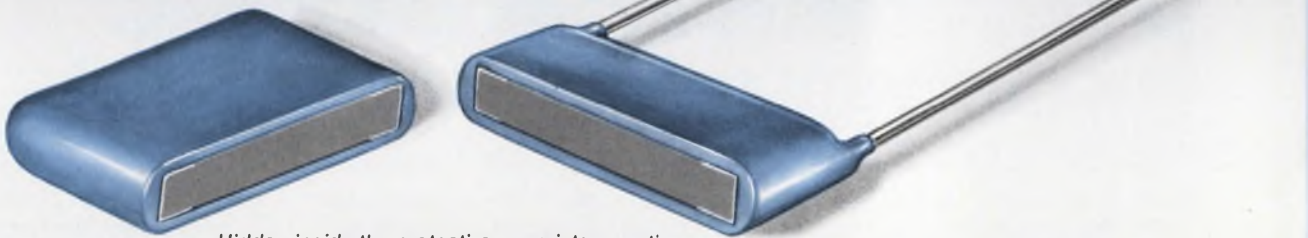

Hidden inside the protective, proprietary coating of this low-cost design is an aerospace-quality, ultra-efficient, ceramic chip capacitor.

Higher reliability at low cost. You've heard it so often it's hard to believe. But believe it. Because our EMCAP capacitors combine the proven reliability of metamorphic ceramic chips with the kind of environmentally sealed construction offered only by popular conventional capacitor types. But their low cost makes them ideal for use

throughout the computer and general communications fields. EMCAPs are available right now in sizes from 2.2pf to 4.7mf. And for optimum volumetric efficiency vs. stability, they're available in three grades: General Purpose; Stable Grade; and Ultra Stable NPO. 50V, 100V and 200V ratings. Lead spacings for 0.100 grids, or matched to ceramic discs.

For free catalog and samples, write: **Electro Materials, Division Illinois Tool Works Inc., 11620 Sorrento Valley Road, San Diego, Calif. 92121. Phone (714) 459-4355. TWX 910-322-1130.**



ELECTRO MATERIALS

The Innovating Electronic Group of ITW... ELECTRO MATERIALS ■ PAKTRON ■ LICON
INFORMATION RETRIEVAL NUMBER 24

washington report

Remember the SST we killed and buried?

Like an abandoned cat that suddenly appears on the front porch, quietly washing its face, the SST program is back. NASA has awarded three contracts "to study the technology requirements for future supersonic commercial aircraft." Boeing received \$316,415; McDonnell Douglas, \$259,000 and Lockheed, \$231,015. For the previous SST program, which lasted 10 years, prime contractor Boeing received \$1.1-billion before the SST became an emotional, political issue and was killed on Mar. 25, 1971.

The cost of killing the SST was \$100-million more than it would have cost to go on and complete the first phase of the program—fly two prototypes, William M. Magruder, SST project manager then, and special assistant to the President on technology and science now, told an Air Force Association meeting in New York on Oct. 17.

The new studies, NASA says, are focused on commercial aircraft for the 1985-1990 period. This happens to be just about the time the Soviet SST and the British-French joint venture will begin to get old.

More uhf tuner waivers granted

The Federal Communications Commission is holding fast to its decision that there be no more waivers after Dec. 31, of rules providing that tuning for uhf channels on TV receivers be comparable in accuracy to tuning for vhf channels. Two more manufacturers—the Admiral Corp. and Philco-Ford Co., using Sarkes-Tarzian 70-position detent uhf tuners—have been granted extensions of previous waivers of accuracy requirements until the end of the year. Meanwhile FCC officials say tuners made by the other major U.S. manufacturer—General Instrument's F.W. Sickles Div.—are meeting the ± 3 MHz requirement, but it is too late for TV receiver manufacturers to change their designs to accommodate different tuners.

Money at last for defense projects

The President has signed a \$74.4-billion defense appropriations bill for fiscal 1973—some \$5.2-billion less than the Pentagon requested. A final House-Senate conference compromised on differences in the two chambers' bills, resulting in these midway figures on key programs: \$69-million for two advanced airborne command-post aircraft and \$53-million for research and construction of a third; \$20-million to start development

of a new attack helicopter for the Army to replace the canceled Cheyenne; \$6-million for the Navy's submarine-launched cruise missile; and \$578-million for 35 Lockheed S-3A Viking antisubmarine warfare aircraft.

The Senate position prevailed on two programs, giving \$421-million for 30 Air Force F-15 aircraft and \$42.5-million for the Air Force's Minute-man command-data buffer electronics program.

The conference dropped a House proviso that the Trident missile and submarine contracts should be open to competition. Instead, the conference compromised: 51% of the dollar value of major components for the systems must be open to competitive bidding.

High Court to rule on software patents

The Supreme Court is expected to issue a landmark decision soon on whether computer software programs are patentable. The U.S. Patent Office has opposed the idea through lower courts and is joined in its opposition by industry leaders, such as IBM, Honeywell and Burroughs. The question arose over a 1963 patent claim by Bell Laboratories. Bell stated in a recent brief that public disclosure of processes and programs through patenting would eliminate duplication and wasted time that it felt had resulted from the secrecy now maintained by industry. Opponents predict a chaotic situation and a stifling of technology if software patents are granted.

Defense management found wanting

The Defense Dept. is reviewing its tactical communications designs after a scathing report by a House Armed Services Subcommittee just before Congress adjourned. The subcommittee charged that most tactical communications equipment was obsolete, slow-moving and badly managed. Military commanders have tended to pass up the procurement of available technology in favor of the development of sophisticated systems that take years to develop and then become obsolete rapidly, the panel said, adding: "There is little tactical communications equipment in the field today which employs technology developed later than 1962." Meanwhile the General Accounting Office has lobbed a few shells at the Pentagon's management of minor weapons systems. It reported that in a study of 15 Navy weapons that cost less than \$50-million to develop, experimental work had not been performed sufficiently on most of them before full-scale development was started.

Capital Capsules: The House of Representatives has installed a \$1-million **Control Data Corp. computerized voting system** in its chamber for use next year. It's designed to save more than 90 hours a year per member on roll-call votes. . . . The Aerospace Industries Association says **employment seems to be stabilizing**. Jobs in the year ending June, 1973, it reports, will decline mildly from 923,000 to 914,000, compared with a sharp drop in the last three years of more than 500,000. . . . The Treasury Dept. **will issue new antidumping laws shortly**, aimed particularly at foreign entries into the U.S. electronics market. . . . The Dept. of Transportation has decided to go ahead with the design of a **100% federally funded rapid transit system in Denver**. Initial investment will be \$11-million.

TEKTRONIX
committed to
technical excellence

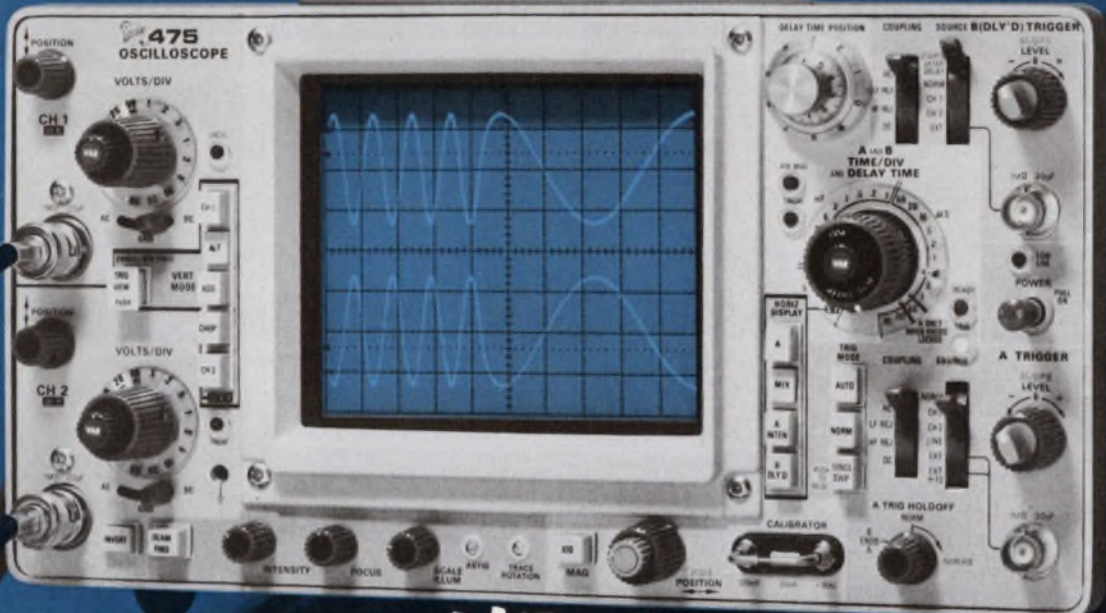

NEW

value leaders= higher bandwidths + lower prices
faster sweep speeds + new operation conveniences + better sensitivities

The **NEW** dual-trace **TEKTRONIX 475 and 465 Oscilloscopes** supersede the world's most traveled and widely used general-purpose oscilloscopes . . . the **TEKTRONIX 453A and 454A**. They have significantly more bandwidth, twice the sweep speed, a bright 25% larger (full 8 x 10 cm) display and additional user conveniences. And all of this in a shorter, thinner, lighter and much lower-priced package.

The **200 MHz TEKTRONIX 475 Oscilloscope** at 2 mV/div and 1 ns/div sweep speed contains the highest gain bandwidth and sweep speed now available in a general-purpose portable oscilloscope and for only \$2500. Add to this many user conveniences including: push-button trigger view, knob-skirt sensitivity readout, ground reference button on the probe tip, simple to interpret vertical and horizontal mode push buttons and many more . . .

The new **TEKTRONIX 465 with 100 MHz** at 5 mV/div and 5 ns/div sweep speed has all of the same user conveniences and service features as the 475 and is an outstanding price/performance package for only \$1725.

This outstanding performance and versatility with **TEKTRONIX** quality and laboratory accuracy makes these not only the finest field scopes available but also top contenders for use by development and design engineers. Optional DC or battery operation gives you a portable scope (25 lbs with panel cover and accessories) ready to travel and ready to make measurements at remote locations.

For complete information or to arrange a demonstration, contact any **TEKTRONIX** Field Office. Our offices are located in or near major cities and industrial centers — world wide. If you prefer, write Tektronix, Inc., P.O. Box 500, Beaverton, Oregon 97005.



200 MHz @ 2 mV \$2500

value leaders



100 MHz @ 5 mV \$1725

U.S. Sales Prices FOB Beaverton, Oregon

INFORMATION RETRIEVAL NUMBER 25

**Our R-10 series
offers more design
options than any other
single industrial
relay.**

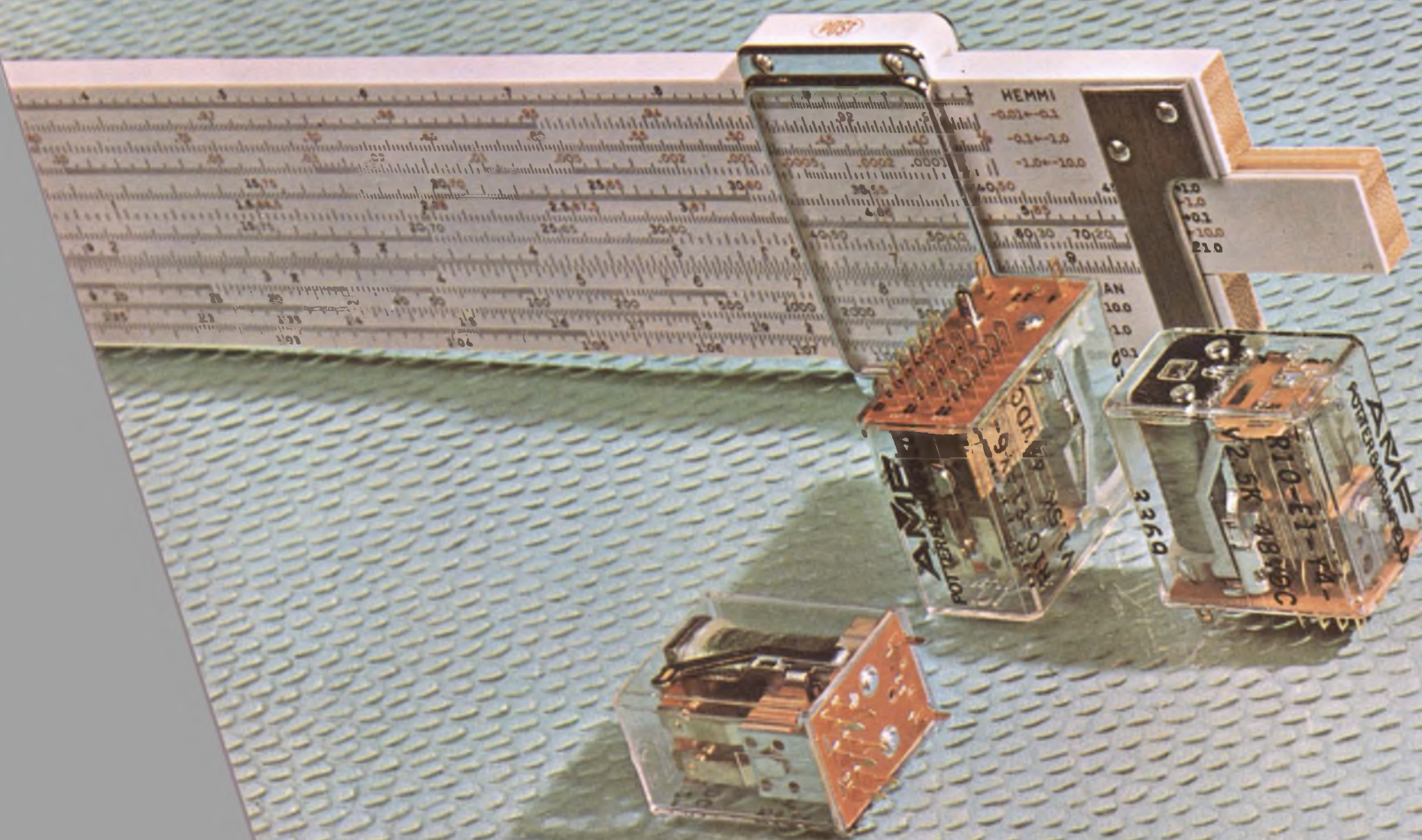

The P&B R-10 Series offers designers a whole family of AC and DC industrial relays that combine extraordinary versatility in application, the reliability of telephone-type relays, and small size (less than a cubic inch). They are widely used in copiers, computer peripherals, business machines and precision instruments.

So versatile is this series that each model is literally designed by you, to meet your special needs. You use a single family of

relays, with common mechanical dimensions and common mounting techniques, to cover the whole range of switching loads you may desire, from dry circuit to 10 amps, 28 V DC, 120 V AC. There are several terminal styles for solder or pc board mounting. Special octal plug mounting is available, and sockets multiply design options even more.

R-10's can now be ordered with Form A, B and D contacts as well as Form C, with arrangements up

to 8 Form C. Underwriters' Laboratories, Component Recognition, File 42810. DC relays have a continuous power dissipation of 2.2 watts maximum. Standard sensitivity is 125 milliwatts per pole. Mechanical life is up to 100 million operations, electrical life ranges from 100,000 to 100 million operations. Special light emitting diode (LED) indicator, a convenient check when trouble shooting a circuit is available as an option on R-10 relays.

Take just four easy steps to "design" the R-10 relay that fits your requirements perfectly.

1 Decide on the type of terminal mounting you want:

Solder terminals. Stud or plug-in mounting



Printed circuit terminals. No stud mounting



Tapped holes for mounting directly to surface

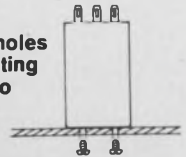

2 Select desired rating and contact form:

Rating	10 amp†		5 amp (Bifurcated)		5 amp		2 amp		Low Level (Bifurcated)		Dry Circuit (Cross Bar)	
	Poles	Forms	Poles	Forms	Poles	Forms	Poles	Forms	Poles	Forms	Poles	Forms
Contact form	2 4 6	A,B,C,D A,B,C,D A,B	2 4 6 8	A,B,C,D A,B,C,D A,B,C A,B,C	2 4 6 8	A,B,C,D A,B,C,D A,B,C A,B,C	2 4 6 8	A,B,C,D A,B,C,D A,B,C A,B,C	2 4 6 8	A,B,C,D A,B,C,D A,B,C A,B,C	2 4 6 8	A,B,C,D A,B,C,D A,B,C,D A,B,C
Contact data	.125 DIA. 		.100 DIA. 		.100 DIA. 		.078 DIA. 		.062 DIA. 		.017 DIA. 	
Resistive load* @ 28 VDC or 115 VAC	Typ. 7.5 Amps Max. 10 Amps Min. .200 Amps		Typ. 5 Amps Max. 7.5 Amps Min. .200 Amps		Typ. 5 Amps Max. 7.5 Amps Min. .050 Amps		Typ. 2.0 Amps Max. 3.0 Amps Min. 0.01 Amps		Typ. 0.1 Amp Max. 2.0 Amps Min. 0.001 Amp		Typ. 500 mA Max. 250 mA Min. Dry Circuit	

*Total load not to exceed 30 amperes per relay. †Use ungrounded frame for loads over 5 amperes.

3 Choose the proper coil resistance:

- Standard and sensitive DC voltage coils available from 3.0 to 115 volts @ 25°C.
- AC voltage coils from 12 to 115 V @ 25°C.
- DC sensitivity as high as 20 milliwatts per pole.
- Bifilar coils to protect relay drive transistors available to 48 V nominal.

4 Pick the socket that fits.



R-10 Relay Socket

Retains floating terminals of either solder or P/C pin configurations.



Printed Circuit Right Angle Socket

Allows relay to mount flat on P/C board, reduces height from 1.720" to .860" max.



Bracket Mount Socket

Allows solder terminal relay to mount flat on a chassis.

Versatile R-10 industrial relays, with their almost limitless design options and application capabilities, are available nationwide from leading electronic parts distributors. Or call your P&B representative. For a free 214 page relay catalog, write Potter & Brumfield Division AMF Incorporated, Princeton, Indiana 47670. Telephone 812 385-5251.



P&B makes more of more kinds of relays than anybody in the business.

Anybody.



Timefax® and Timemark® are the best recording papers for transmitting a picture of your plant baseball team. (Or almost anything else you can record.)

Sonar Recorders Timefax and Timemark electro-sensitive recording papers give instant access to the recorded information. You get an immediate dry copy. The fish won't get away or you won't run aground because you lost time processing the image.



Photo Facsimiles and Voice Characteristic Sonagrams Only the full range of neutral grey tones provided by Timefax and Timemark electro-sensitive recording papers will give you this recording ability.

Facsimile Receivers Timefax and Timemark papers give a dense black image on a white background. With Timefax and Timemark you get the highest quality copy in the industry.

Computer Print Out Using Timefax or Timemark papers you can record up to 60,000 characters per

second on an impactless computer printer or 30 characters per second on the simplest strip printer.

Industrial Event Recorders You can record a few inches per hour or hundreds of inches per second with maximum reliability because it's electro-sensitive recording.

Non-destructive Testing Very high resolution images will give you all the detail you need for flaw detection, surface profiling and spectrum analysis.

Electrical Writing Essentially that's what you do with Timefax and Timemark recording papers. You simply amplify the electrical output of your measuring transducer and this signal writes directly on our electro-sensitive recording paper. Couple this with the fact that the electro-sensitive recording process is completely dry and permanent. And it's hard to justify recording any other way.

We have a technical manual entitled "The Dry Electro-sensitive Recording Process". It was written to give design engineers a better understanding of the technical aspects of the electro-sensitive recording process. We would be happy to send you a free copy upon request.



FITCHBURG CPI

Litton Box 1106, Scranton, Pa. 18501 Phone: 717-347-2035

Now we can
give you the
exact shaft

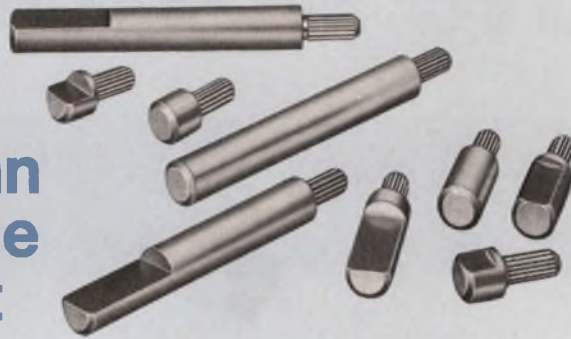

and the
exact switch
immediately

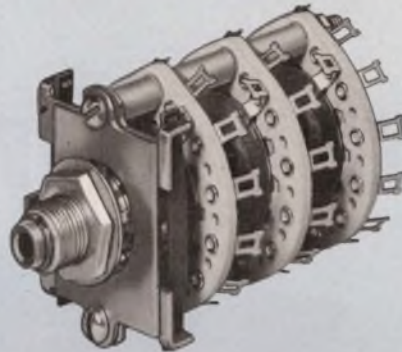

Selectashaft™ Rotary Switches Only from Centralab Distributors

Selectashaft is your Centralab Distributor's new custom assembly program that lets you mix and match rotary switches, front shafts, shaft end details and shaft flat angles. Just order the exact custom switch assembly that fits your design requirements. It takes your Centralab Selectashaft Distributor just days to deliver. No factory delays. No setup charges.

Choose from three .250 inch diameter shaft styles: plain round, .218 inch flat or .156 inch flat configurations. Select any of 24 shaft sizes from .687 inch to 2.375 inch long from the mounting surface. Shaft flat angles are available in increments of 15°.

Selectashaft switches feature a new dual-ball sidethrust mechanism for top index performance and

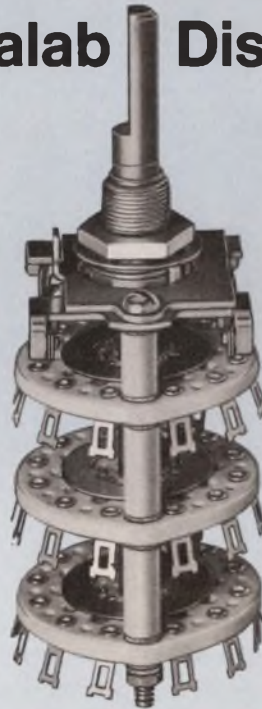

exceptionally good torque and feel. Adjustable stops allow you to easily change number of positions by varying the placement of one or two stop rings on the front plate. No disassembly or removal of stop tabs is required. To adjust torque simply remove index springs on the index mechanism. Switches are offered in miniature and sub-miniature styles with ceramic, diallyl phthalate or phenolic section material.

Don't delay. You don't have to when you order custom assembled Centralab Rotary Switches from your Centralab Selectashaft Distributor. Write Centralab Distributor Products, Department SS-1 for our complete 12 page catalog and the name of your nearest participating Distributor.

DISTRIBUTOR PRODUCTS



CENTRALAB

Electronics Division
GLOBE-UNION INC.

5757 NORTH GREEN BAY AVENUE
MILWAUKEE, WISCONSIN 53201

D-7222

INFORMATION RETRIEVAL NUMBER 28

the connector

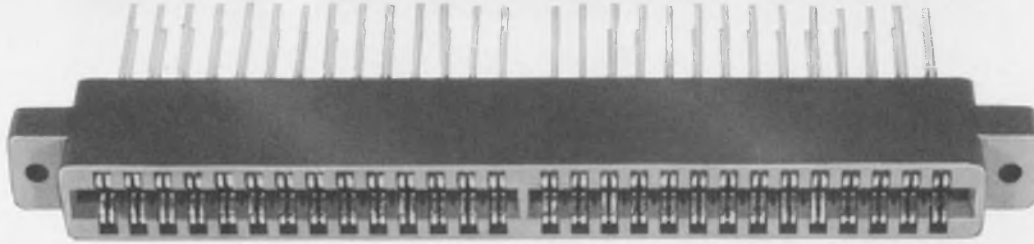

the connection

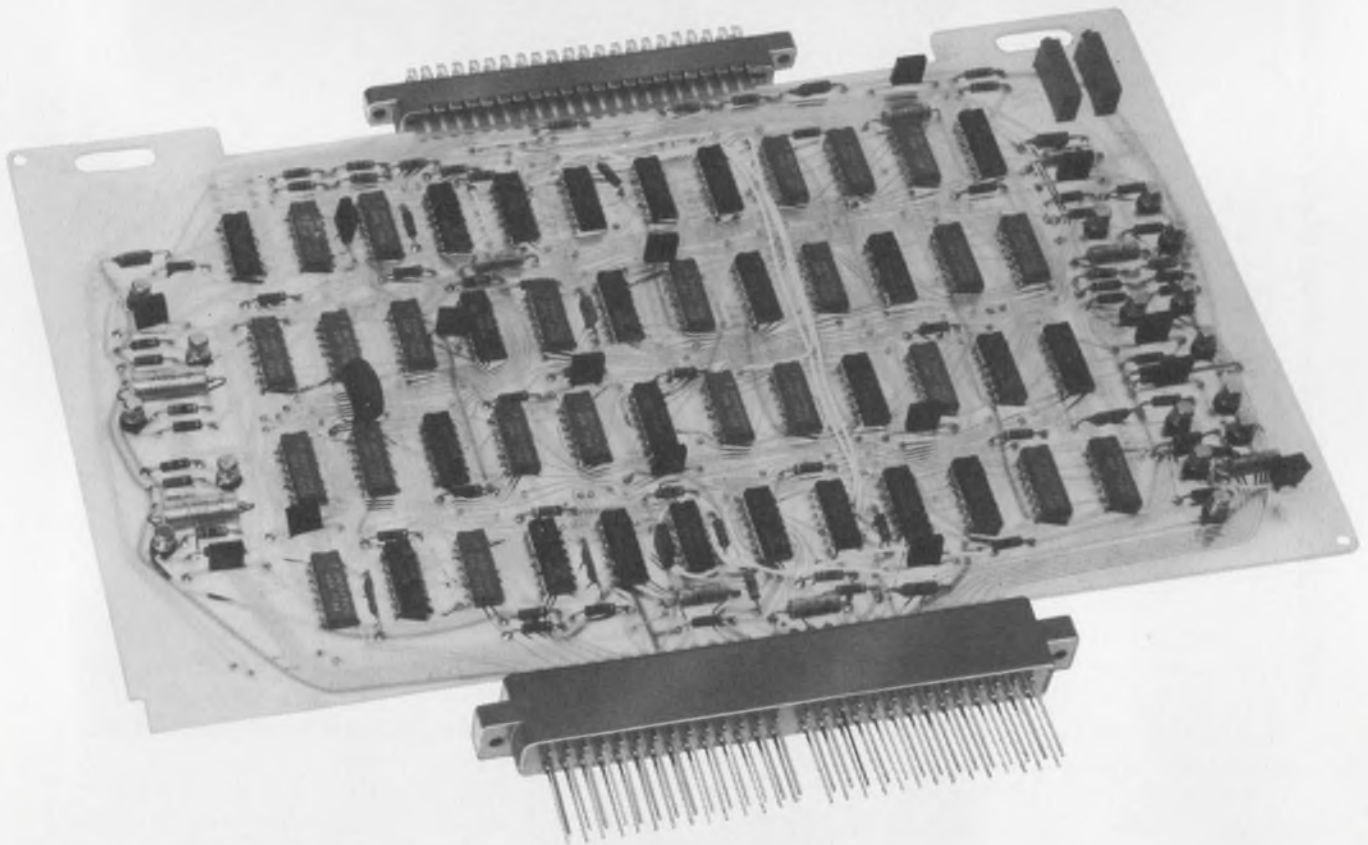

Call on Continental Connector when you need the right connection for packaging your integrated circuits in computer applications, electronic data processing, aerospace and other intricate electronic equipment. Write or phone (212-899-4422) for a free copy of our 80-page printed circuit connector technical manual.

For the Sales Representative Nearest You, See Our Listings in EEM and VSMF Directories.

CONTINENTAL CONNECTORS

CONTINENTAL CONNECTOR CORPORATION ■ WOODSIDE, NEW YORK 11377

INFORMATION RETRIEVAL NUMBER 29

EA1500 N-CHANNEL Si GATE TAKES ON BIPOLAR.



electronic
arrays,
inc.

501 ELLIS STREET
MOUNTAIN VIEW, CALIFORNIA 94040
(415) 964-4321 TWX: 910-379-6985

There's a lot of noise these days about RAMs and new super, bipolar processes. Well, we'd like to challenge all those bipolar claims. In fact, you can too. All one needs to do is pick up the data sheets and compare.

You may have heard or read that MOS is slower than bipolar. The fact is that the EA1500 N-channel silicon gate 1K RAM has an access time of 85nsec—worst case, including voltage variation, over the 0° to 70°C temperature range. Our "fair" competition also specs their 1K bipolar RAM at 85nsec—but at a nominal voltage and a junction temperature of 25°C!

OK, let's just assume it's a standoff in speed. In power dissipation, the EA1500 with a maximum, worst case, guaranteed .220mW/bit wins right out. The 93415 draws .684mW/bit at 75°C case temperature. That would take a whole bunch of air conditioning if you're going to use more than one.

Then, of course, there's price. The EA1500 sells for about one-third less than the 93415. That's 2.4¢/bit vs. 6.8¢ per bit in 100 up quantities. Just add up your bits and add up your savings. Finally, when you come to EA, you can get it. Because we don't tout it until we got it.



THE GREAT RAM CHALLENGE: N-CHANNEL VS. BIPOLAR.

INFORMATION RETRIEVAL NUMBER 30



P-Channel
JFET



N-Channel
JFET

Since 1962, Siliconix has evolved FET technology and applied it to a complete line of singles, duals, arrays, and ICs. So what's new?

Economy Epoxy FETs

Siliconix, the world's leading supplier of FETs, now brings you a full line of plastic encapsulated field-effect transistors—at economy prices as low as 32c each in 1000-unit quantities. Why be concerned over alternate sources? Call on the FET leader for quality devices at rock-bottom cost.

The Siliconix line of epoxy products includes

- FETs for general purpose amplifiers
- FETs for VHF/UHF amplifiers and mixers
- FETs for switches, choppers, and commutators
- FET pairs for differential amplifiers
- FET diodes for current limiters and regulators

Use these new epoxy FETs with the same confidence you have placed in Siliconix products in the past—they are typed, manufactured, and tested specifically for the industrial and commercial markets.

A copy of our new epoxy FET cross-reference guide and full line catalog is yours for the asking. Just circle the bingo card number or call your nearest Siliconix distributor.

Write for Data



Siliconix incorporated

2201 Laurelwood Road, Santa Clara, California 95054

INFORMATION RETRIEVAL NUMBER 31

Get enriched (if not rich) with those high flyers

Most of us take a fling, now and then, with those high-flying stocks that often come up in the electronics industry. Hoping to find another IBM or Texas Instruments, we shell out a few bucks to buy stock in a company we feel might have a brilliant future. Some of us come through such investment experiences richer, some poorer. And most of us learn nothing from the experience.

It's an entirely different matter when we are part of the high-flying company. Despite the grand intentions of ambitious founders, most small companies never grow big; many die. And if you're involved as one of the founders, or as part of the early management of a fledging company, the chances are that you will be in for plenty of heartaches.

It's likely that you'll have to work 25 hours a day, give up any dreams of a nice vacation, forget about your salary at many times, and work in many areas where you are by no means comfortable. You might find yourself saying: "Here I'm supposed to be a director of engineering, and I spend half my time doing a song and dance for investors." You might find your wife asking: "If we're owners of this damn company, how come we ain't rich?" And you might find your emotional resources strained to the limit as every day seems to offer just another struggle to stay afloat.

Eventually you might become resigned to the fact that your company will never make you a millionaire. And that even if it survives, it will always mean lots of hard work. Or your company may finally merge with another. And you become just one more guy who used to be an executive in his own company. Or your company may die as creditors finally close in and say, "Sorry, Charlie, no more."

Even if that happens, you're ahead of the game. Even if you lose some savings, even if you miss a year or two of the good and "natural" life—seeing your wife and kids on evenings and weekends and vacationing with the family—you're still ahead.

Very few people involved in startup companies wind up with 40-foot yachts and \$200,000 homes with butlers and maids strewn about. Even if their companies go bankrupt, almost all come out richer. Not in money. But in the wealth of experience they develop in a short period of time.

Let's not avoid experience. It's enriching.



A handwritten signature in cursive script that reads "George Rostky".

GEORGE ROSTKY
Editor-in-Chief

Remember the commitment we made to "883" in this '69 ad?

MACH IV

Let TI's special HI-REL Task Force take you through the turbulent sometimes uncharted universe of MIL-STD-883.

We'll keep you on course.

Scout's honor.

Others have called 883 a lot of names, a mixed bag, and some "unfortunate words". But we have tried to keep our minds clear and obedient to the mission, and our nose to the ground.

When our best minds solved the problem, TI has committed itself to 883. Where, tomorrow and hereafter.

And we're ready to deliver: "In accordance with MIL-STD-883." In fact, we've been shipping 883 tested ICs for years. Millions of them for the Microelectronics, Defense, Aerospace, P&ID and other markets.

Some of them had some light requirements (MIL-883). From this equipment, TI has designed special HI-REL Task Force to help you meet 883. A special Task Force has been organized for 883, available to help and the size provided here for 883.

The members we listed in '69 are assigned in the areas of reliability engineering, process engineering, product sales, military contracting, product planning, product manufacturing, quality control engineering, manufacturing and 883 assembly.

They're available in Dallas, St. Louis, San Jose, and Austin. But TI is full. Not just with us, but with our customers. We're committed for 883. Where, tomorrow and hereafter.

The Task Force's assignment aligns with your customer, addressing the specific test procedures and levels you'll need to satisfy 883 requirements.

For the most applicable Task Force member, call your TI Sales Office or through the number of TI personnel in local offices. If you need to be involved in your program, let the Task Force be responsible for the process.

Task Force members are also departmental liaisons, they can help and work with you if you need to be your program.

In addition, we have the industry's best test facilities going for you. At TI, from more than 2000 test facilities, we'll provide you with the test equipment, test cells and test labs to fit your needs. We'll provide 883 test equipment, test cells and test labs to fit your needs.

The thing you'll get is 883. TI's special HI-REL Task Force is committed to providing 883 test equipment, test cells and test labs to fit your needs. We'll provide 883 test equipment, test cells and test labs to fit your needs.

When the HI-REL Task Force is committed to providing 883 test equipment, test cells and test labs to fit your needs. We'll provide 883 test equipment, test cells and test labs to fit your needs.

TEXAS INSTRUMENTS



Now it's JAN ICs.

Series 54 TTL, developed by TI, has been chosen as the standard. And the same HI-REL Task Force that helped you stay on course through 883 and 38510 (with the MACH IV program) can do it again with JAN.

Scout's honor.

In 1969, TI made industry's biggest commitment to MIL-STD-883. We developed the first clear-cut procurement program—MACH IV—and established a special HI-REL Task Force to see it through. When MIL-M-38510 came along, we expanded MACH IV and kept the same Task Force on the job.

Now comes JAN-M-38510 with its new challenges and uncertainties. And the same Task Force is still on the job. This same group of managers who worked for you in '69 are still working for you today, along with some new members. Together, they bring more than 120 man-years of HI-REL experience to the task—in the areas of reliability and process engineering, product planning, product engineering, marketing, quality control, manufacturing and HI-REL assembly. The Task Force is fully committed to making JAN IC availability a reality—and TI has committed the money, facilities and manpower to support the team.

Full qualification program underway

Already you have a broad choice of JAN ICs from TI, and the list is growing rapidly under an aggressive qualification program. Our objective is to lead the industry.

It's an objective we are confident of reaching. After all, TI is the leader in developing and delivering Series 54/74 TTL—the series chosen as the JAN IC standard for TTL logic. And JAN IC qualifications are simplified by TI's extensive experience in 38510/

MACH IV processing. Incidentally, TI's 38510/MACH IV program supplements the JAN IC program, where JAN slash sheets have not been written or JAN ICs are not available.

High-volume production facilities

We've been delivering MACH IV ICs, in volume, for nearly three years—and high reliability military ICs for more than a decade. So squarely behind our new JAN effort are TI's unmatched 54/74 HI-REL domestic production facilities in Houston and Dallas. From 150,000-plus burn-in sockets to environmental shake, rattle and roll labs, to scanning electron microscopes, IR scanners, microprobes, Radifo and computer data acquisition.

You'll find our JAN ICs already on distributors' shelves. You can count on TI's production strength to maintain excellent JAN IC availability.

Send for procurement aids

We've prepared a booklet answering common questions about JAN ICs, as well as a handy pocket card which lists existing JAN IC specs, the corresponding standard TI type numbers, and explains the JAN numbering system. They're both yours by circling 242 on the Service Card. Or write Texas Instruments Incorporated, P.O. Box 5012, M/S 308, Dallas, Texas 75222.



TEXAS INSTRUMENTS
INCORPORATED

FOCUS

on
Keyboards

Keyboards are everywhere. You'll find them in such diverse products as pocket calculators and computer I/O terminals; telephones and communication terminals; and electronic cash registers and stock-quotation terminals. Their ubiquity almost guarantees that you'll use a keyboard product in the near future. And when you do, our advice is to take a closer look at the keyboard itself—some day you might have to specify one.

If you do, you're in for a tough time. Each keyboard in the wide range of products with keyboards is unique to its application—in short, customized. Not only must the designer choose from among an overabundance of suppliers—at least 60—but also from among a head-swimming selection of keyswitches, encoders, buttons, frames and options.

Which keyswitch is best?

The keyswitch is the heart of a keyboard, and every major manufacturer seems to feel that his keyswitch must be different from all others. The result: over a dozen different types to choose from. And, naturally, each manufacturer insists that his type is best. The truth is each type has advantages and disadvantages; as with most engineering problems, tradeoffs must be made.

Keyswitches can generally be sorted into two major categories: contacting and noncontacting. The former includes the reed switch, the most popular keyswitch until 1968, and a widely diverse assortment of physical-contact (alternate make and break) switches—such as the crossbar, the elastomeric (elastic diaphragm), the mercury-filled tube, the magnetic-repulsion and the coil-spring crosspoint switch, to name a few.

Stanley Runyon
Associate Editor

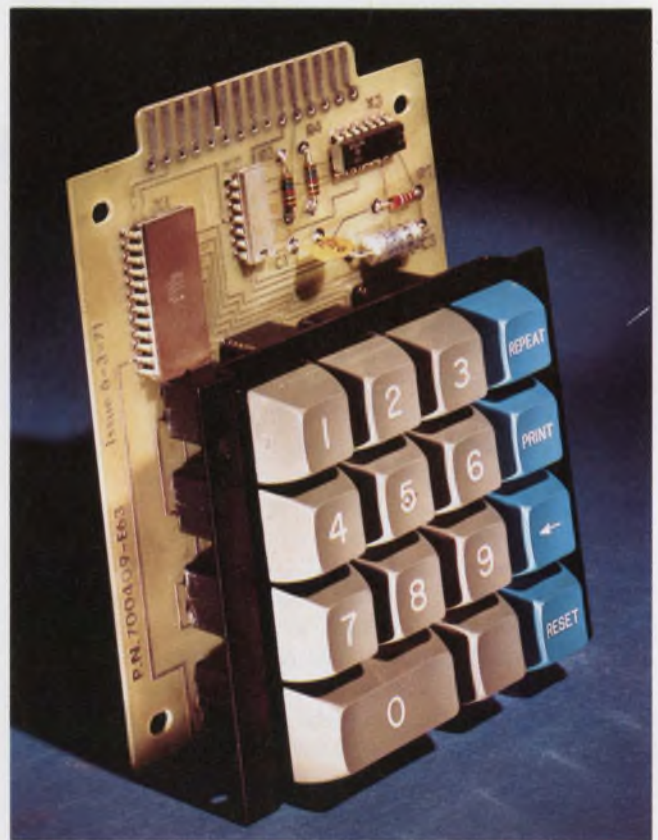

Clare-Pendar's 16-station numeric keyboard uses gold crossbar keyswitches and TTL/LSI for ASCII encoding.

The noncontact switch—sometimes mislabeled the solid-state switch—includes the Hall-effect device, the capacitive-coupled switch, the saturating magnetic core and the photoelectric switch. Of these, only the Hall-effect and the photoelectric keyswitch are truly solid state in that they use semiconductor devices to deliver their output signals.

The hard-contact, or mechanical switch, though the oldest of keyboard switches, remains popular

today for one simple reason: It's the least expensive of all the keyswitches. And while it was, for a time, eclipsed by the reed and the noncontact switch, it's making a strong comeback. Many manufacturers are expanding their mechanical switch line—and dropping their prices. Improved manufacturing techniques—plus the use of MOS circuitry, which can easily handle high-impedance closures—have led to improved mechanical switches. And they have an added attraction: multiple contacts, which allow easier coding.

The major objections to the mechanical switch have been high contact resistance, contact bounce and relatively short life compared with solid-state switches. They're also difficult, and expensive, to seal (for this reason, most enclosures function as dust covers, not as environmental seals).

However, manufacturers of mechanical switches dismiss the life/reliability and contact-bounce / high-impedance arguments as overemphasized. For example, Clare-Pendar, a manufacturer of cross-bar and reed keyswitches, states: "Since MOS encoders tolerate switch-contact enclosures of up to 200 Ω , the integrity of the contact closure has much less effect on mean cycles before failure than in the old days, when the integrity of the contact had direct impact on keyboard output. With the gold crossbar keyswitch and MOS encoding, keyboard reliability equals that of solid state—at approximately half the cost."

Bounce, it's claimed, can be easily removed with delay or filter circuitry. As for life, most mechanical switches are specified at 10-million operations, a figure that the manufacturers contend is sufficient for most applications.

But some of the newest mechanical switches are promoted as having low bounce and long lifetimes. Stacoswitch, a recent entry in the keyboard industry, says that its keyswitch has contact bounce of less than 100 μ s. Maxi-Switch is offering a bifurcated-contact switch with a bounce of less than 500 μ s. And Cherry Electrical Products has a new crosspoint switch with reported bounce of less than 300 μ s and life of at least 100-million operations. Oak Industries, an

old-line manufacturer, also offers a 100-million operation switch, one that Oak claims has never failed in a customer's test program.

Reeds are still popular

Until 1968, when the Micro Switch Div. of Honeywell introduced its Hall-effect keyswitch, the reed switch dominated the keyboard industry. The hermetically-sealed contacts—actuated by a moving permanent magnet—eliminated the corrosion and contamination problems of mechanical contacts.

The popularity of the reed stems not only from the sealed contacts, but also from the type's known characteristics: its long life—about an order of magnitude greater than that of non-sealed switches—its ease of replacement and its ability to handle fairly high loads.



Micro Switch's line is represented by these MOS and TTL-encoded data-preparation and communications keyboards. Each uses the Hall-effect keyswitch.

The major disadvantage of reeds is contact bounce. However, mercury-wetted types are available to reduce the bounce and improve dry-load (low voltage, low current) switching. One problem that's rarely mentioned, however, is that reeds can resonate when excited by vibrations of the correct frequency.

While reed switches have a longer life, they cost approximately twice as much as mechanical types, so tradeoffs must be made. Also, reed keyswitches—and reliability—vary considerably from manufacturer to manufacturer, depending on their mechanical design, such as magnet orientation and path of travel. Depending on design, reeds also can have either Form A or Form

Keyboard switching techniques



Typical contacting type is this Cherry keyswitch which uses crossed knife-edge contacts made of a gold alloy.

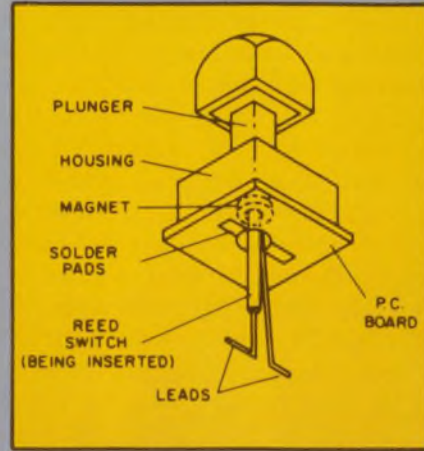

In the popular reed key-switch, the contacts close when the plunger-attached magnet comes near the reed (Key Tronic).

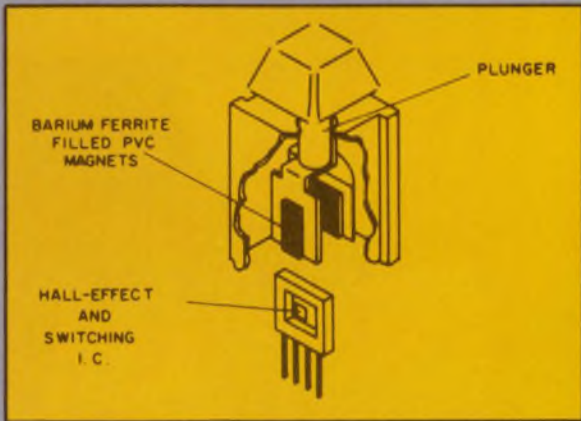

Micro Switch's Hall-effect IC chip gives a pulse output when plunger magnet passes near chip.

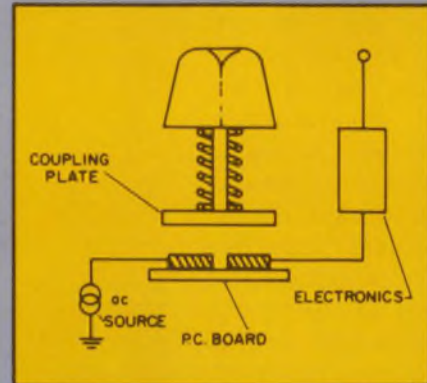

Control Devices' keyswitch couples an ac signal to switching circuitry via the coupling plates on the key.

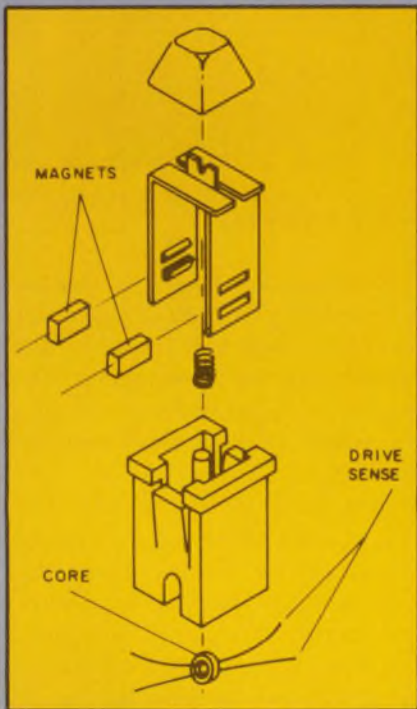

When the keyswitch is operated, the ferrite core unsaturates and transformer-couples the sense and drive wires (Licon).

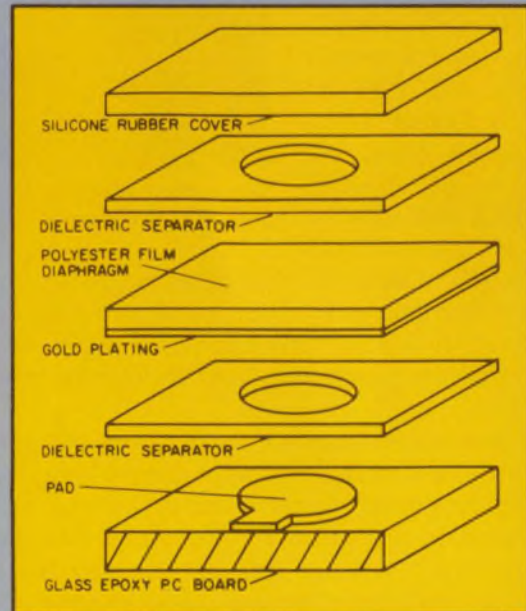

In the Datatetics elastomeric switch, a conductive-film diaphragm contacts pads on a PC board when the switch is depressed.

B contacts and both tactile and audible feedback. Reed keyswitch vendors include Key Tronic, Cherry, Controls Research, Maxi-Switch, Clare-Pendar, Alco and Dialight.

Unusual designs offered

In their quest for originality, keyswitch manufacturers have come up with some unusual designs. Stackpole Magsat, for example, markets a unique magnetic-repulsion keyswitch that pro-

vides a 1-ms pulse output and has tactile feedback and an audible click. Controls Research manufactures the BI-PAC, a switch that uses as contacts two coaxial compression springs, which are integral with the pin terminals. And Mechanical Enterprises offers its Mercurtronic switch, in which a mercury-filled, flexible tube gives bounceless closures. When the key is in the up position, the tube is pinched, breaking the continuity. Depressing the key releases the tube, allowing the mercury to flow together. The de-

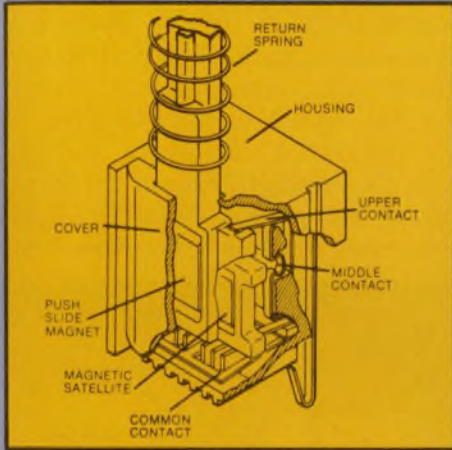

Stackpole/Magsat's flying magnet switch uses magnetic repulsion to create a pulse. The output is independent of user-caused variations in key operation.

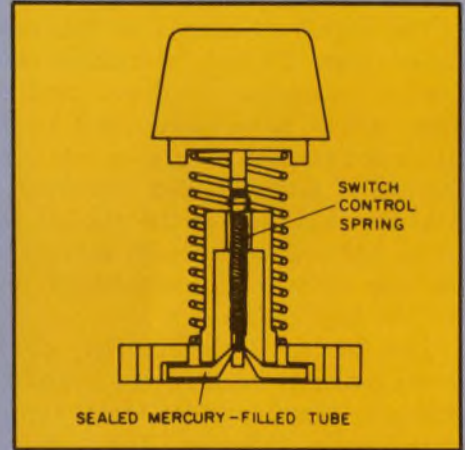

Depressing the key joins two pools of mercury in this Mechanical Enterprises' keyswitch. The mercury-filled tube is pinched off when key is released.

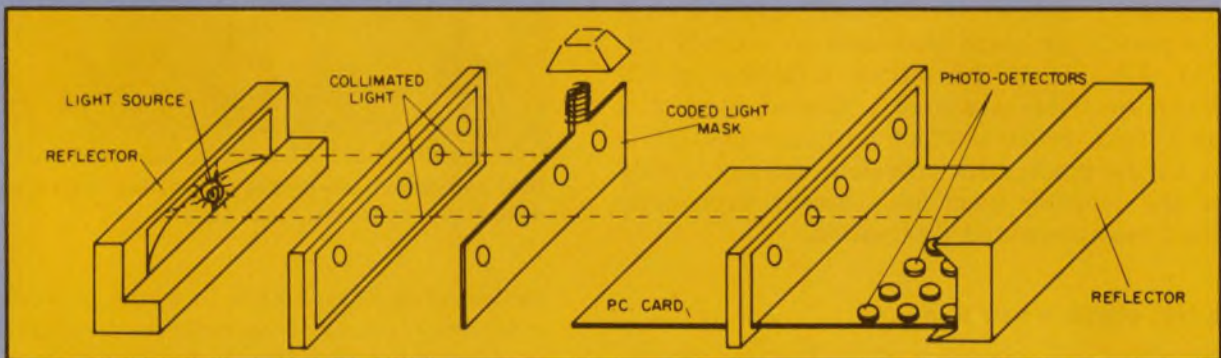

Photoelectric keyswitch uses a light source, photocells and coded masks (Western-Digital Systems).

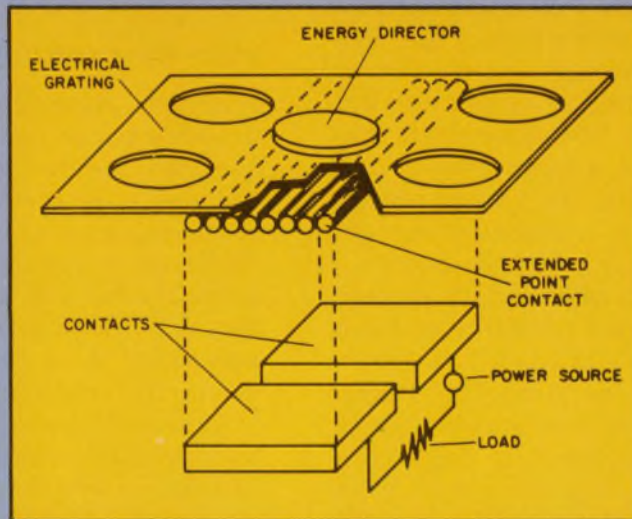

Wild Rover's thin keyboard provides a multiple-contact closure when a flexible grating contacts fixed, bottom lands on a PC board.

vice can operate in any position.

Still another type of contacting keyswitch is the elastomeric, or elastic-diaphragm, switch. Versions are offered by at least four manufacturers—Datametics, Flex Key, Donnelly Mirrors, and Chomerics—but the basic principle of each is similar. Depressing a key forces a conductive or plated elastomeric membrane against a contact grid or band on a PC board. The advantages claimed include sealed construction, little or no bounce, high reliability and life, and—because of batch fabrication—low price.

The major objections to this switch are relatively high contact resistance and a spongy touch, unfamiliar to those used to typewriter keys, which have tactile and audible feedback. However, contact resistance has been reduced by the use of a silver-filled elastomer (Chomerics). And the explosion of the market for mini-calculators has led to increased acceptance of the diaphragm switch: Its wafer-thin profile is ideal for the application.

The Control Products Div. of Texas Instruments markets its Klixon, a snap-action disc that acts as a combination contact, return spring and tactile-audio indicator. The technique allows TI to make 0.15-inch-thick keyboards.

Another company, Wild Rover, manufactures a low-profile keyboard that uses an entirely different principle. In this switch, a flexible, multi-element electrical grating is pushed against a rigid bottom contact. The multipoint contact is said to distribute the transient energy evenly over the multiple elements, thereby decreasing contact resistance and dissipation.

The Hall-effect: a new trend

Of the noncontacting keyswitches, Micro Switch's Hall-effect type is by far the most popular. Introduced in 1968, the Hall-effect switch—a true solid-state type—revolutionized the keyboard industry. The switching element, consisting of a Hall generator, trigger circuit and amplifier, is integrated on a 0.04-square-inch chip. When the key is depressed, a magnet moves past the Hall element, generating an analog voltage. The voltage is converted to a digital output and then amplified to produce a 1-ms pulse output.

The advantages of this switch include no moving contacts, no bounce, high reliability and long life, no EMI, no variations in contact resistance and, finally, no misses. The tradeoffs? Higher initial cost and the need for some standby power. However, four price reductions in four years have kept Micro Switch competitive with other manufacturers. And the company states that the quality and reliability of its keyswitch actually

reduces costs by eliminating the need for incoming inspection and by reducing service calls.

The magnetic core switch, manufactured by Licon, works by keeping a ferrite core saturated initially with a magnetic field. When the key is depressed, the field is removed and the core unsaturates and transformer-couples an ac signal to the output. The ac voltage is then rectified and used to drive IC logic. The chief advantage is the reliability associated with the ferrite core.

Both Control Devices and Raytheon offer capacitively coupled switches. In the Control Devices unit, depressing the key capacitively-couples an ac signal into signal-shaping circuitry, which converts the signal to a logic level. The Raytheon unit combines capacitive switching with a scanning technique to encode the keys.

At least three companies—Western Digital Systems, TEC and Symbolic Displays—make

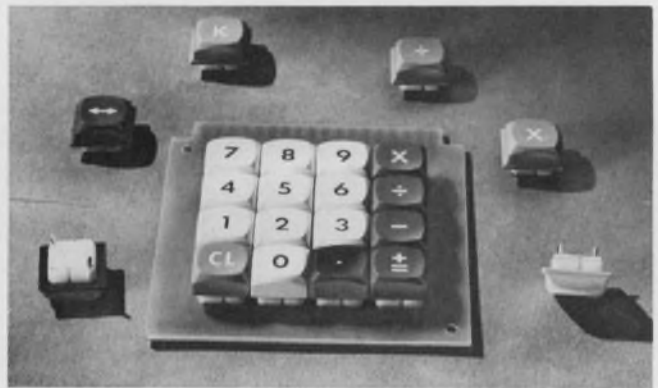

Oak Industries' low-profile contacting keyswitch is intended for calculator applications.

photoelectric keyswitches in which photodetectors sense the various light patterns produced when the keys are struck. The technique yields a unique code for each key.

Watch those switching specs

System restrictions, such as physical size, available power and coding requirements should help the designer narrow the number of keyswitches to be investigated. According to manufacturers, engineers make two major mistakes in specifying a keyboard: First, they bring in the manufacturer late in the design process; second, they don't familiarize themselves with keyboards adequately. As a result, they tend to either underspecify, or overspecify.

Important specs include force, travel, bounce, load-handling capacity, electrical noise, contact resistance, reliability, human factors and environmental factors—such as operating-temperature range, vibration and humidity. Any of these



Donnelly Mirrors evaluates the lifetimes of its flexible-diaphragm keyswitch on this test rig.

may be important, depending on the application.

For commercial keyboards, force and travel have become standardized at about 3 ounces and 3/16 of an inch, respectively—at least for typewriter and high-speed entry applications. However, for miniature calculators with low-profile keyboards, travel may be negligible.

As for bounce, the makers of contactless switches argue that little or none is desirable for two reasons: First, the keyboard electronics will be considerably simplified; second, if you start out with marginal bounce specs, you may run into reliability trouble later—despite compensating electronics.

Is there a reliable reliability spec?

Life and reliability specs, together with cost, form a major battle line between keyswitch makers—and especially between the makers of contacting and noncontacting switches. Every manufacturer claims long life and high reliability for

his product. But for the engineer—who is caught in the middle—there are no standards for failure or for keyswitch life testing. As a result, manufacturers tend to define and test for life in a way that makes their product look good.

Thus an engineer is presented with pages of statistical data that ostensibly demonstrate hundreds of millions—or even billions—of operations, cycles, etc. But these specifications are meaningless unless the manufacturer defines the failure criteria and the actual test conditions—for example, loading, environment, power levels and other factors.

When failure criteria are given, an engineer must still decide on their validity as applied to his own equipment. Thus failure can be defined as either missing or erroneous outputs, as catastrophic failure, as an arbitrary level of contact resistance or contact bounce, or by other factors.

Except for catastrophic failure, none of these constitutes absolute failure; they are relative terms that may be important to a particular application.

Micro Switch, the largest supplier of keyboards, says: "Reliability concerns the 'miss' characteristics of the keyswitch, where a 'miss' is the failure of a switch to open and close once during one complete cycle of the actuator. Mechanical contacts, regardless of the packaging or operating mechanisms, can miss from time to time."

Controls Research, a mechanical-switch maker, counters with this argument: "An occasional intermittent output may be critical in a key-to-storage device, but not to a teletypewriter communications terminal. A keyboard can fail in many ways, and even the best life-test data can't predict when or how it might fail in a customer's situation."

Running around in cycles?

The figure of 10-million operations has been generally used as an acceptable keyswitch lifetime. Of course, as Datanetics points out, it completely ignores the rest of the keyboard, which can involve considerable hardware.

However, increasing competition has led to spiraling claims for keyswitch lifetimes that leave the 10-million figure far behind.

"Many switches," says Clare-Pendar, "are rated at a hundred-million cycles; yet the probability of ever seeing a hundred-million cycles is practically nil. Reliability in meantime-before-failure or mean-cycles-before-failure—at a specified confidence level—is the most meaningful criteria."

Maxi-Switch has published statistical data for

keystroke usage ratios. Using the text of the Gettysburg Address as an example, the data show that the space bar, with 17% of the total strokes, is the key used most often. The space bar, together with the five vowels, make up 49.5% of the total strokes, Maxi-Switch says. Thus if a keyboard were operated continuously at 40 words a minute, 24 hours a day for one year, the space bar would accumulate a total of 17,870,400 operations (based on five-letter words). This, says Maxi-Switch, demonstrates that a keyboard is unlikely to have a requirement for 50-million to 100-million operations.

Don't forget the keyboard itself

With mountains of claims and counterclaims of superior switching techniques and reliability to climb over, it's easy to forget the rest of the keyboard. As Micro Switch points out, many systems are completely designed before the keyboard is considered.

Taking that approach will no doubt lead to higher costs, a marginal design, or both. This is because keyboards are not as simple as they appear but require a host of decisions. Questions that should be asked include:

Do I want a direct-wired matrix (array), a self-coded board or a fully-decoded keyboard? What physical size do I need? Does my application call for a thin keyboard or can I use a medium or high profile? Should I specify PC-board or steel-frame construction? Is weight a problem? Does the keyboard environment require oil or splash-proofing? Is mono-mode or multi-mode the way to go? What about buttons: styles, colors, arrangements? What about the human elements? Do I need tactile or audible feedback? Is N-key rollover called for, or can I use two-key rollover? Which special features, if any, are important to my application: Strobe? Data-key idle? Enable input? These, as well as other questions, can't be ignored.

Probably the first decision to be made concerns the keyboard/electronics interface. Three options are generally available: You can buy a collection of uncoded switches and build your own coding electronics; you can buy a collection of self-coded switches—such as the ferrite core, capacitor-coupled and photo-optical types—and build your own interface; or you can opt for a full keyboard system containing the keyswitch array, all coding electronics, plus circuitry for buffering, keyboard modes and other elected features. Which way to go depends on your technical expertise and the economics of building your own keyboard (as a percent of total system cost) versus buying one commercially.

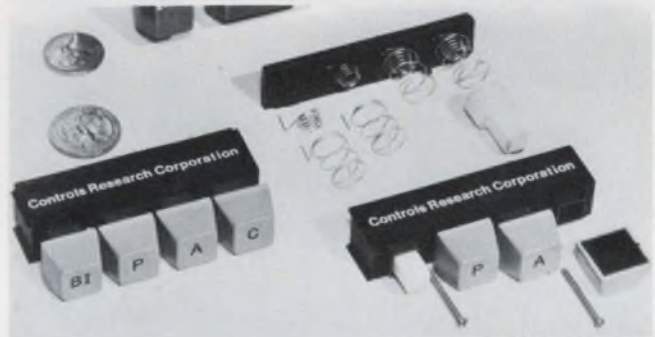

The Bi-Pac, Controls Research's coaxial-spring keyswitch, is used in the company's calculator keyboard.

Actually, most requirements don't allow selection of an off-the-shelf keyboard. Variations in mounting, output codes, key configurations and other factors usually necessitate some customizing. This is why, as Clare-Pendar points out, major keyboard manufacturers have a "boilerplate" specification, which can be used as a point of departure for a particular application. Specs can be as tight or as loose as a designer wants—but tight specs tend to increase prices.

Which code is best?

A few keyboard types have become fairly standard, at least as far as output codes and character assignments are concerned. These include the so-called data-preparation keyboard, which uses the eight-bit (plus parity) Extended Binary Coded Decimal Interchange Code (EBCDIC), and the so-called communications or data-entry keyboard, which uses the seven-bit (plus parity) American National Standard Code for Information Interchange (known as ANSI, ASCII, or USASCII).

These two types are sometimes confused: The data preparation board is used mostly for key-to-storage (tape, disc, cassette) and other key-punch applications, while the communications keyboard is popular for graphic and computer I/O terminals. As such, the key assignments for the two vary considerably—the basic communications (ANSI) keyboard separates the alpha sec-

tion from the numerals and symbols, while the data-preparation (EBCDIC) keyboard assigns numerals and symbols to the same keys as the alpha characters.

The ANSI code, now a Federal standard, is used in most of the keyboards sold today. This is because the code, when used with proper character-to-key assignments, permits key shifts—lower case to upper case, for example—by inversion of a single bit. Thus this logical-bit-pairing technique saves money, since only a simple inversion is needed to distinguish between shifted and unshifted modes.

The second most popular code, the EBCDIC, was developed to avoid nonlogical bit pairing in keypunch applications, where key assignments differ from those of the ANSI keyboard.

Other available codes include BCD, Baudot, hexadecimal and even custom types. But these are usually more expensive; so stick with the ASCII and EBCDIC, if you can.

Keyboards that assign one code for each key are said to operate in mono-mode. With more than one symbol, the keyboard operates in multi-mode—with two symbols for each key designated as dual-mode, three symbols as tri-mode and so on. For dual-mode, such as lower-case/upper-case operation, one shift key is required. For tri-mode both a shift and a control key must be operated. The shift key usually has alternate action. It may remain below the level of the unoperated keys to designate shift mode, or it may be lighted to designate a shift. Lighted keys are said to be easier to use since no key-position judgement is required.

The best operating mode (mono, dual, etc.) depends on available keyboard space, the number of characters needed and, as always, on economic considerations. For example, it may be less expensive to use a separate block of numeric keys and to operate in mono-mode than to assign the numerals to other keys and operate in dual-mode. Assigning multifunctions will save panel space, but throughput will be lowered, because an operator must press an additional control key.

As with most other keyboard characteristics, the method of producing the output code—and the output logic level as well—varies from manufacturer to manufacturer. Some manufacturers arrange the switches into an array in which an actuated switch shorts across a row and column. High-speed scanning circuitry then spots the closed switch and delivers a coded output.

Others use interim codes to address bipolar or MOS ROMs. And still other manufacturers use self-coded keys with diode matrices to connect the switches to the various bit lines. Except for logic levels, the results remain theoretically the

same for all manufacturers: A unique output code for each keyswitch. But cost tradeoffs can be made.

Clare-Pendar offers this analysis: For three or four-level keyboards, or where non-bit-compatible codes are required, the minimum cost encoder is MOS. For simple mono or dual-mode keyboards with bit-compatible shifts, TTL decoding frequently offers a cost advantage.

N-key rollover—do you really need it?

The use of MOS has thrown new fuel on a long-simmering argument over the need for N-key rollover (NKRO). NKRO, an expression coined by Micro Switch, is a technique to prevent erroneous signal transmission during burst speed typing. When a key is struck, correct information in the proper sequence will be transmitted, even though any number of previously struck keys are still depressed. The technique is an extension of 2-key rollover (2KRO) in which an electronic interlock prevents errors when two keys are simultaneously depressed.

Some manufacturers say that 2KRO is sufficient for all applications. Others contend that the 10-to-15% price differential for NKRO discourages those who want it. And still others claim that their NKRO costs nothing.

Controls Research, for example, states: "Since the cost impact, on large keyboards at least, is really zero with the right encoder chip, NKRO should be specified."

Raytheon says: "NKRO is an excellent feature in high-speed typing applications, since it substantially reduces the number of errors. However, for all other slow-speed and one-finger applications, 2KRO is quite adequate."

Studies by the Honeywell System and Research Div. for Micro Switch seem to substantiate the Raytheon statement. The studies show that about 30% fewer errors were made by high-speed typists with NKRO than with 2KRO.

Key Tronic proposes still another approach—selective N-key rollover, a combination of 2KRO and NKRO. The keyboard becomes locked after a fixed number of keys have been depressed—and they are held depressed. Key Tronic claims that this approach is less expensive than NKRO but just as advantageous.

We're all human

The NKRO debate is usually coupled with another highly controversial area—human factors. Perhaps the least understood of keyboard characteristics, such factors as tactile and audible feedback, switch and button feel and key



MOS-encoded keyboard (above) from Maxi-Switch uses a single DIP to provide any eight-bit code. Contrast this

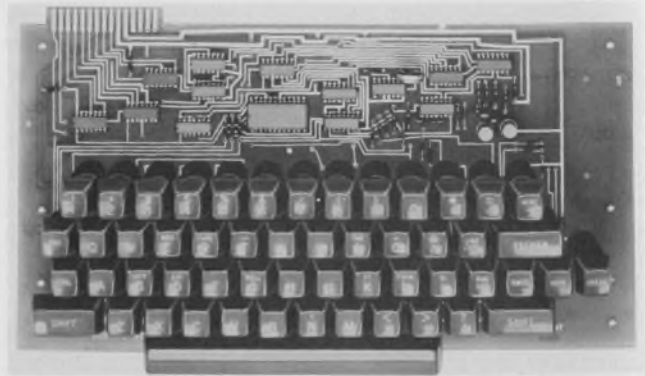

with the company's TTL scan encoded keyboard (above), which uses 14 DIPs to provide codes to 16 bits.

spacing and arrangements are the most hotly debated of all keyboard aspects. Micro Switch says that this aspect of keyboards has been of major concern for a decade.

Perhaps the most controversial parts of the Honeywell studies were these conclusions about displacement and keyboard operating characteristics:

- There is no advantage to having a snap or audible click in the keyboard operation.
- There is no difference in performance between stepped and sloped keyboards.
- Efficiency in the use of electric keyboards is greatest if force and displacement are held within the following limits: 0.9 to 5.3 ounces and 0.05 to 0.25 inches at the full travel of the keys.
- Most typists who are already familiar with electric keyboards should be able to bring their throughput to normal standards on an electronic keyboard within 10 days, usually less. (Throughput is defined as speed minus errors.)

Raytheon agrees: "If, by human factors, you mean keyswitch touch and feel, we think that causes too much concern. People will naturally feel more comfortable with a key feel that they have been accustomed to, but they also adjust rather rapidly to a different key feel, provided it doesn't have clearly objectionable characteristics."

However, Dialight states: "Human factors, next to reliability, are the most important considerations in the efficient, error-free and non-fatiguing operation of the keyboard."

Key Tronic sums up the human factor issues this way: "It seems that different segments of the market want different amounts of noise. Calculators are generally noiseless, whereas alphanumeric keyboards are produced with a small-to-moderate amount of noise. Also, key travel is continually being decreased. A number of years ago a travel of 0.187 inches was more or less an industry standard. As newer switches are being

designed, the travel is being shortened. Calculators, for example, have essentially no travel compared to alphanumeric keyboards."

The dispute over the necessity of tactile feedback has resulted in four general schools of thought. The first tries to duplicate the feel of the electric typewriter, in which the key force increases with key displacement until the moment of switch closure. At that point, the force or pressure drops suddenly, accompanied by an audible signal. The second school opts for a constant pressure, usually light for most applications (an exception is keyboards for aircraft, where key pressures are kept relatively high to avoid accidental keying). The third school takes a middle road by increasing the key force with displacement but eliminating the sharp change at closure. The fourth school just ignores the entire situation.

The old problem: Build or buy?

One question that can't be ignored and must be answered right at the beginning of any keyboard specification is: Should I build my own? As might be expected, suppliers are split on this issue. The battle line is drawn, with those who make only keyswitches lined up on one side and those who make complete keyboards on the other. Sitting on the line—with a foot in each camp—are those suppliers who make both keyswitch modules and entire keyboards.

In general, consider building your own keyboard:

- If the quantity justifies the effort economically. Oak, for example, feels that if you need only 500 to 1000 keyboards a year, you can't build your own economically. However, if you're using five to ten thousand a year, you probably can afford to hire the expertise, if you don't already have it. In contrast, Clare-Pendar feels that you should consider building your own if

you need over 50,000 units a year—or less than 100.

- If you've got both the technical people and the facilities. The latter includes PC-board and semiconductor-device fabrication capabilities.

- If "standard" designs don't suit your purpose. For example, you may have an integrated design, with all major components mounted on a single PC board to eliminate interconnect costs. Discrete keyswitches can be mounted to this master board as well, thereby avoiding connectors, mounting hardware, etc.

The don't-build-your-own arguments run this way:

- It will invariably cost more to make your own keyboard than to buy one commercially. This is because designers tend to look at material and labor costs alone and to forget the hidden costs of engineering support, scrap, transportation, tooling and the like. Also forgotten are testing costs, which can be substantial—especially for large numbers of units that require automatic or semi-automatic test equipment.

- For encoded keyboards, a keyboard vendor will negotiate a large-quantity, annual contract with an LSI-chip supplier and pass the savings on to customers who buy modest quantities of keyboards.

- Even if a keyboard requirement is unique, it is still easier and cheaper to modify an existing keyboard. For example, in the case of the integrated design, a keyboard vendor can usually supply a larger PC board, or he can build on a customer-supplied board.

If you decide to buy, then what?

Cost will probably influence your build-or-buy decision more than any other factor. And, if you decide to buy, cost will be a key factor in selection. The plethora of competing suppliers has led to mergers, shakeouts, new products—and tumbling prices. All of which means it's a buyer's market. Let's take a quick look at what's being offered.

Micro Switch, everyone agrees, is the leading supplier of keyboards, with an estimated one-third of the total market. (The No. 2 position is not so well agreed on, being contested by a half dozen or so, of the 60 remaining manufacturers.)

Micro Switch offers its Hall-effect keyboards in practically any desired alphanumeric array and electronic configuration. The choice includes communications, data preparation and numeric keyboards, two-key or N-key rollover, multimode operation and MOS, TTL or DTL encoding.

Latest developments at Micro Switch include an across-the-board price reduction (the fourth

in four years) of up to 13%; computerized quality-assurance testing, and both lighted and bi-level switches.

Controls Research offers modules or complete keyboards with either reed switches or its BI-PAC mechanism. Encoding can be either TTL/MSI scanning electronics or MOS with built-in NKRO. The former is used in the company's Model 7100, a 53-position keyboard with ANSI array and four-mode ASCII encoding. The 7100 sells for \$49 in quantities of 5000. The latter is offered in a single, 40-pin MOS chip for coding up to 64 keys.

For those who wish to build their own board, Oak offers its 400 series, a gold-alloy crossbar keyswitch that sells for less than 30 cents in large quantities (500,000). Oak will supply any spring pressure or key stem (sloped or stepped) height, as well as a choice of switch configurations: SPST and DPST, N/O or N/C, and alternate-action.

No doubt spurred on by increasing mini-calculator sales, Oak has recently introduced its 415 series, a low-profile keyswitch. The 415 stands 0.415-inches high, including the key cap, and sells for 20 cents each (with key cap and legend) in quantities of one-million.

Cherry manufactures both switch modules and complete keyboards. Both reeds and gold crosspoint switches are offered in a variety of contact forms. The low-profile gold crosspoint, Cherry's latest switch, comes with straight or angled stem, momentary or alternate action, and it's lighted, if desired. The Form A, momentary-contact version sells for 29 cents in quantities of 250,000 and is said to have extremely long life.

Cherry's standard keyboards include 66-key, tri-mode ASCII, 55-key quad-mode ASCII and 12 and 16-key numeric boards. Scanning electronics are used to encode the switches. As with most manufacturers, Cherry offers custom designs and many special features.

Raytheon's line includes plug-in reed modules and its CAPSCAN keyboard (designed to replace the reed line). The CAPSCAN combines capacitive switching with TTL-compatible scanning logic and offers 2KRO or NKRO, splash-proofing, any operating force and, as an option, lighted key caps.

Key Tronic offers a full line of reed keyswitch modules and keyboards, as well as complete customizing service. The latter includes PC-board, injection molding, electronic assembly and tool and die capabilities.

Other features offered by Key Tronic include MOS encoding with selected repeat, stepped or sloped boards by rotating the key caps 180 degrees, selective NKRO, lighted alternate action,

and pROMs to change codes in the field.

Stackpole/Magsat offers a variety of key-switches and keyboards designed around its digital switch module. The 1-ms pulse output (similar to Micro Switch's) allows Stackpole to use static encoders. Standard features include tactile/audible feedback; NKRO; shift, control and multimode keys; TTL-compatible output and strobe.

The latest Stackpole developments include a mode in which every key can be a repeat key without the need to depress a control key first and the LO-PRO, a new line of low-profile, mechanical keyswitches, designed for calculators and other low-throughput devices.

Clare-Pendar offers reed and gold crossbar keyswitches in various configurations. Individual switches are mounted on steel frames, as opposed to mounting on PC boards, so that the keyboard becomes a rigid structural member (Licon, Oak and others also use this construction). Also offered are alternate action; illuminated keytops;

MOS encoders, including NKRO; three-color key-tops; one, two or three poles, and IBM-Selectric-shape keytops.

Maxi-Switch has three different switch styles to choose from: the 1800 series keystrip, which uses a series of steel frames and glass reed contacts; the 2700 series individual glass reeds; and the 3100 series, a bifurcated gold-contact mechanical switch that sells for 21 cents in large quantities. The latter is Maxi-Switch's entry in the calculator market. Also offered are TTL or MOS encoders, multimode, two or N-key roll-over and delayed strobe.

The increasing demand for low-cost keyboards for desktop and pocket calculators has proved a boon for those manufacturers offering wafer-thin and low-profile keyboards. These include Donnelly Mirrors; Datanetics, with its elastic diaphragm switch; Stacoswitch, with its new IP Series, a modular, mechanical-contact, multistation keyboard; and Wild Rover, with its TC Series of multiple-contact switches and boards. ■■

Need more information?

The companies and products cited in this report have, of necessity, received only cursory coverage. They've been selected for their illustrative, or in some cases, unique qualities. Companies not mentioned may offer similar products. Readers may wish to consult these manufacturers for further details:

Alco Electronic Products, Inc., 1551 Osgood St., N. Andover, Mass. 01845. (617) 685-4371. (John Smerigan, Product Manager) **Circle 400**

Automatic Electric Co., 400 N. Wolf Rd., Northlake, Ill. 60164. (312) 562-7100. **Circle 401**

The Capitol Machine and Switch Co., 87 Newtown Rd., Danbury, Conn. 06810. (203) 744-3300. (Arthur E. Wilson, Sales Manager) **Circle 402**

Cherry Electrical Products Corp., 3600 Sunset Ave., Waukegan, Ill. 60085. (312) 689-7600. (Peter Barthell) **Circle 403**

Chomerics, Inc., 77 Dragon Ct., Woburn, Mass. 01801. (617) 935-4850. (A. Klepper) **Circle 404**

Clare-Pendar Co., P.O. Box 785, Post Falls, Idaho 83854. (208) 773-4541. (Stephen F. Meyer, Marketing Manager) **Circle 405**

Colorado Instruments, 1 Park St., Broomfield, Colo. 80020. (303) 466-1881. (Walter Pounds, Keyboard Marketing Manager) **Circle 406**

Control Devices, Inc., 204 New Boston St., Woburn, Mass. 01801. (617) 935-1105. (Leo Gilson, Sales Manager) **Circle 407**

Controls Research Corp., 2100 S. Fairview, Santa Ana, Calif. 92704. (714) 557-7161. (Don Schulze, Product Sales Manager) **Circle 408**

Datanetics Corp., 18065 Euclid St., Fountain Valley, Calif. 92708. (714) 549-1191. (Joseph DeClue, Engineering Vice President) **Circle 409**

Dialight Corp., 60 Stewart Ave., Brooklyn, N.Y. 11237. (212) 497-7600. **Circle 410**

Donnelly Mirrors, Inc., 49 W. Third St., Holland, Mich. 49423. (616) 396-1441. (Dick Tierney, Marketing Manager) **Circle 411**

Elec-trol, Inc., 26477 N. Golden Valley Rd., Saugus, Calif. 91350. (805) 252-8330. (Ray Freed) **Circle 412**

Hathaway Instruments, Inc., 5250 E. Evans, Denver, Colo. 80201. (303) 756-8301. **Circle 413**

Hi-Tek Corp., 2220 S. Anne St., Santa Ana, Calif. 92704. (714) 540-3520. (Russ Williams, Marketing Manager) **Circle 414**

IDM Corp., P.O. Box 954, Hanover, N.H. 03755. (603) 643-2840. (Warren Loomis) **Circle 415**

ITT Telecommunications, P.O. Box 831, Corinth, Miss. 38834. (601) 286-6921. (John Jakubik, OEM Administrator) **Circle 416**

Ikor, Inc., Second Ave., N.W. Industrial Park, Burlington, Mass. 01803. (617) 272-4400. (Tom Wilbur) **Circle 417**

Industrial Electronics Engineers, Inc., 7740 Lemona Ave., Van Nuys, Calif. 91405. (213) 787-0311. **Circle 418**

Key Tronic Corp., Bldg. 14, Spokane Industrial Park, Spokane, Wash. 99216. (509) 924-9151. (John Deichman, Vice President—Technical) **Circle 419**

Lear Siegler, Inc., 3171 S. Bundy Dr., Santa Monica, Calif. 90406. (213) 391-7211. **Circle 420**

Licon Div., Illinois Tool Works Inc., 6615 Irving Park Rd., Chicago, Ill. 60634. (312) 282-4040. **Circle 421**

Litton ABS, OEM Products Div., 600 Washington Ave., Carlstadt, N.J. 07072. (201) 935-2200. (Frank Misiewicz) **Circle 422**

The Maxi-Switch Co., P.O. Box 4404, Minneapolis, Minn. 55421. (612) 529-7601. (Craig G. Stout, Sales Manager) **Circle 423**

Mechanical Enterprises, 5249 Duke St., Alexandria, Va. 22304. (703) 751-3030. **Circle 424**

Micro Switch, Div. of Honeywell, 11 W. Spring St., Freeport, Ill. 61032. (815) 232-1122. (Edward C. Leibig, Keyboard Marketing Manager) **Circle 425**

Milli-Switch Corp., 1400 Mill Creek, Gladwyne, Pa. 19035. (215) 642-9222. **Circle 426**

National Cash Register Co., Main and K Sts., Dayton, Ohio 45401. (513) 449-2000. **Circle 427**

Oak Industries Inc., Crystal Lake, Ill. 60014. (815) 459-5000. (P. M. Hassett, Vice President, Marketing) **Circle 428**

Raven Electronics Corp., Freeport Blvd., Reno, Nev. 89501. (702) 359-3700. **Circle 429**

Raytheon Co., Industrial Components Operation, 465 Centre St., Quincy, Mass. 02169. (617) 479-5300. (Frank D. Kennedy, Manager, Keyboards and Keyswitches) **Circle 430**

George Risk Industries, Inc., 802 S. Elm, Kimball, Neb. 69145. (308) 235-4645. (Tom Kelsey, Sales Manager) **Circle 431**

Stackpole Components Co., P.O. Box 14466, Raleigh, N.C. 27610. (919) 828-6201. (Robert H. Tillack, Product Manager, Keyboards and Keyswitches) **Circle 432**

Stacoswitch, Inc., 1139 Baker St., Costa Mesa, Calif. 92626. (714) 549-3041. (John Wardlaw, Marketing Services Manager) **Circle 433**

Symbolic Displays Inc., P.O. Box 4322, Irvine, Calif. 92664. (714) 546-0601. (William J. Lang, President) **Circle 434**

TEC, Inc., 9800 N. Oracle Rd., Tucson, Ariz. 85704. (602) 297-1111. **Circle 435**

Texas Instruments Inc., Control Products Div., 34 Forest St., Attleboro, Mass. 02703. (617) 222-2800. **Circle 436**

Transducer Systems, Inc., Eastern & Wyandott Rd., Willow Grove, Pa. 19090. (215) 657-0800. **Circle 437**

Unimax, Ives Rd., Wallingford, Conn. 06492. (203) 269-8701. **Circle 438**

Western Digital Systems, 7100 Mesa Dr., Austin, Tex. 78731. (512) 453-8433. **Circle 439**

Wild Rover Corp., 97 Oak St., Norwood, N.J. 07648. (201) 768-8393. (Mike Gordon, Sales Manager) **Circle 439**

Four new linear integrated circuits worth talking about. Again.



Maybe you remember our ads which introduced some of our new integrated circuits this year.

Better yet, maybe you sent for our product information and evaluation samples.

A lot of people did because sales have been excellent.

And that's because everything we said about their performance was absolutely true.

Our AD508. No one else gives you this kind of long term drift performance.

Our AD520. The world's first and only I.C. instrumentation amplifier. A complete system all by itself.

Our AD523. It has the lowest bias current of all high performance I.C. operational amplifiers.

Our AD830 dual monolithic FETs. Their performance is so revolutionary, we gave them a new name and came up with a new way to measure them.



They're all worth talking about again so you'll get an idea of the kind of linear I.C.'s we make: multipliers, FET input op amps, high performance op amps, A/D and D/A conversion components, dual monolithic transistors.

And so you'll know what to expect from us.

We'll be using innovative FET, bipolar, and CMOS technology to give you the special and often unique performance you're looking for. At a reasonable price.

It isn't going to be all that hard to do when you look at what we've already done.

We enjoy the leadership position in analog circuitry.

We'd be happy to send you all the details on our four new integrated circuits. As well as our Product Guide which shows the rest of our

I.C. line and all the other things we make to solve more of your problems better than anyone else.

Analog Devices, Inc., Norwood, Mass. 02062 (617) 329-4700.



 **ANALOG
DEVICES**

EVERYMAN'S GUIDE TO MOS



“To MOS or not to MOS?” is a big question. Here are the answers. In a form everyone can understand. The OPTIMOS Book.

The Optimos Book is over 300 pages of comprehensive information on MOS. It's for every level of MOS interest, from non-technical top management to the working engineer at the bench. From economic philosophy to product specifications.

The Optimos Book provides an overview of the state of the art in MOS. Most specifically, the state of our art, which we call OPTIMOS: the optimum use of MOS/LSI technology, of all available cost and design options for maximum return at minimum risk. The practical use of MOS.

This book is a vital tool for management in making the basic decision

whether to go MOS or not. Once that decision has been made and the task of implementation turned over to the working engineers, they, in turn, need the data, the detailed answers to their engineering questions, the tools to do *their* job efficiently.

At this point The Optimos Book is, if you will, a cookbook. A step-by-step guide on how to design with MOS. How to get the best out for what you put in, measured in terms of time, cost, effort and objectives.

Everyman's Guide

The chapter headings tell the story:

MOS/LSI today: The coming of age of low-power

high-density MOS technology. Where MOS/LSI makes sense. Some of the risks involved.

MOS economics: An overview. How volume and die size affect costs. Selecting the optimum die size.

The critical MOS decisions: Critical cost factors. Structuring the system for MOS. Standard vs. custom MOS. Optimum partitioning. Proven MOS processes that better your odds. How to evaluate MOS vendors.

Getting the most through OPTIMOS. Fairchild's OPTIMOS approach. Its history. Planning early with us for best balance between standard and custom devices. Customer/Fairchild interface options: design and performance responsibilities, co-engineering and communications. Fine tuning

the design. Testing. Our MOS production capabilities. OPTIMOS directions for the future.

Technical appendices: More than 180 pages of specifications and application data on our standard products. More than 60 pages of specifications and design rules for our Micromosaic MOS cell library and its application in computer-aided design.

Plus reliability data, packaging, ordering information. The technical guts of a very gutsy book.

Free

Anyone interested in MOS will be interested in The Optimos Book. If you request it on your company letterhead, we'll be glad to send you a copy.

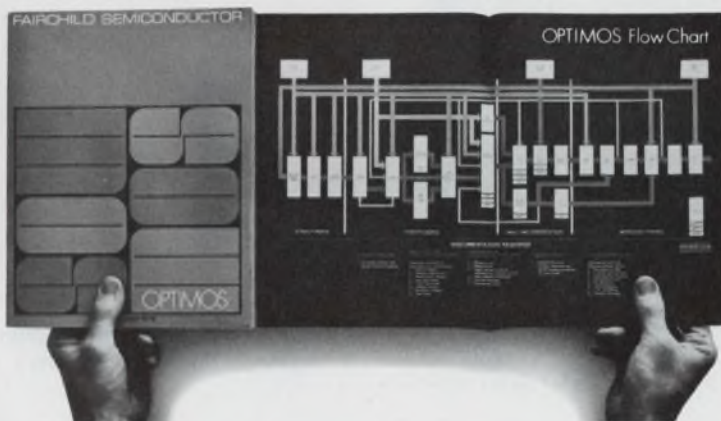

**MADE IN
FAIRCHILD**

Need to keep digital data secure? Scramble the data with pseudorandom sequences that are easily generated with ICs and that provide numerous, easily changed codes.

At one time confidential data was stored in safes and transferred by bonded couriers to keep it secure; today data is stored in unsecured computers and transferred over readily tapped telephone lines. Yet the need for security is as great as ever. One solution is to encipher the data.

Enciphering isn't a new idea, but older techniques, such as the use of manual code books, are too slow for the volume and speed with which computers can handle data. Further, frequent code changing to maintain security is cumbersome. Today's electronic enciphering systems overcome these disadvantages. Most automatic systems use pseudorandom code sequences to scramble the data. These sequences are easily generated with shift-registers and EXCLUSIVE-OR gates.

Pseudorandom enciphering/deciphering systems offer these advantages:

- They make a message appear like a random sequence.
- They can change codes easily.
- They provide a very large repertoire of different codes.
- They encipher and decipher automatically.

Bit generator provides 'random' sequences

A completely random sequence would never show any ordered pattern—all possible combinations of ONES and ZEROS are equally probable. A pseudorandom bit-stream, however, appears random for only a limited length of time. It repeats its sequence after a finite number of bits. The maximum length of the binary sequence prior to a repeat can be calculated by the expression $2^n - 1$, where n is the number of shift-register stages used in the sequence generator (Fig. 1). As n becomes large, the generated bit-stream approaches an ideally random sequence. Because n is an exponent, very long sequences are generated with modest numbers of stages— $n = 20$ provides a maximum stream of 1,048,575 bits.

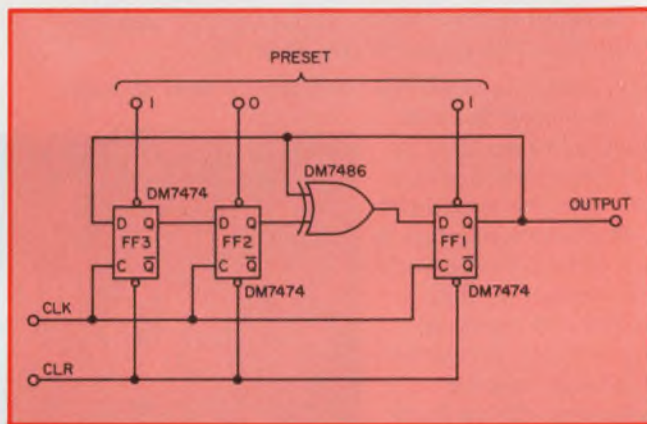

1. A three-stage, pseudorandom code generator provides a sequence that repeats every seven clock pulses.

Table 1. Three-stage word generator

CLOCK	FLIP-FLOP STATES		
	FF3	FF2	FF1
INITIAL	1	0	1
1	1	1	1
2	1	1	0
3	0	1	1
4	1	0	0
5	0	1	0
6	0	0	1
7	1	0	1
8	1	1	1
9	1	1	0
10	0	1	1
11	0	0	0
12	1	0	0
13	1	1	0
14	1	0	1
15	1	1	1

Terry Twigg, Field Applications Engineer, National Semiconductor Corp., Glen Burnie, Md. 21061.

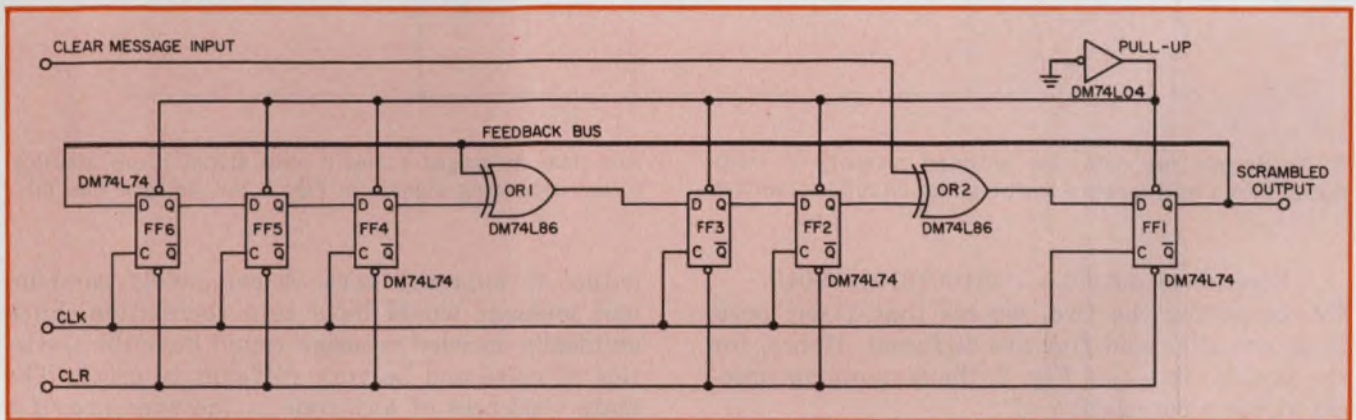

2. Data are scrambled by the modulo-2 addition of the message with a pseudorandom bit-stream that is gen-

erated in a feedback shift-register circuit. The clear message modifies and is modified by the bit-stream.

Fig. 1 is a simple implementation of many possible pseudorandom digital-sequence generators. For simplicity, the circuit shows only three D flip-flops ($n = 3$) and one EXCLUSIVE-OR. Such a small n is not a practical value for encrypting. The EXCLUSIVE-OR functions as a modulo-2 adder. The circuit provides a ONE output only when a single logic ONE is present at the inputs— $1 + 0 = 1$, $0 + 1 = 1$, $1 + 1 = 0$ and $0 + 0 = 0$. The rules are the same as for binary addition without a carry. As shown, the EXCLUSIVE-OR is connected between FF₁ and FF₂. The remaining stages are connected as a recirculating shift register, with the output of stage FF₁ fed back to FF₃ and ORed with the output of FF₂ to form the input of FF₁.

Table 1 shows the sequence of flip-flop states as the initial register contents are recirculated through the EXCLUSIVE-OR gate connections. In this example the flip-flops are arbitrarily preset with a 101-bit sequence. The pattern repeats after every group of seven clock pulses, in accordance with the sequence-length formula

$$2^n - 1 = 2^3 - 1 = 7$$

A different initial pattern merely starts the sequence at the corresponding point in the truth table (Table 1). The only disallowed combination of states for the registers FF₁, FF₂ and FF₃ is the all-ZERO pattern. It is easy to see that if the generator should, for some reason, fall into this

pattern, the successive states remain all ZERO. This disallowed all-ZERO pattern explains the (-1) in the sequence-length formula.

Next, the data are scrambled

The data scrambler of Fig. 2 uses six D-type flip-flops, with the output of the FF₁ stage fed back directly into the input of the FF₆ stage. The FF₁ output is EXCLUSIVE-ORed, by OR₁, with the output of the FF₄ stage to form the input to FF₃. The placing of EXCLUSIVE-OR, between FF₄ and FF₃ is arbitrary in this example. In the absence of data input, the circuit will function as a pseudorandom word generator. Since the system has six stages, it can make a maximum of $2^6 - 1$, or 63, state changes before the patterns repeat.

The uncoded message is fed to OR₂ and combined with the output of FF₂. FF₁ then receives and provides the scrambled output. The original message modifies the pseudorandom sequence, at the same time that the message is itself modified by this sequence.

Table 2 shows the sequence of flip-flop states for Fig. 2 with a specific 16-bit message fed into the circuit. The circuit starts with all flip-flops reset to ZERO. The input word and the scrambled output are as follows:

Message input — 1011001100110010

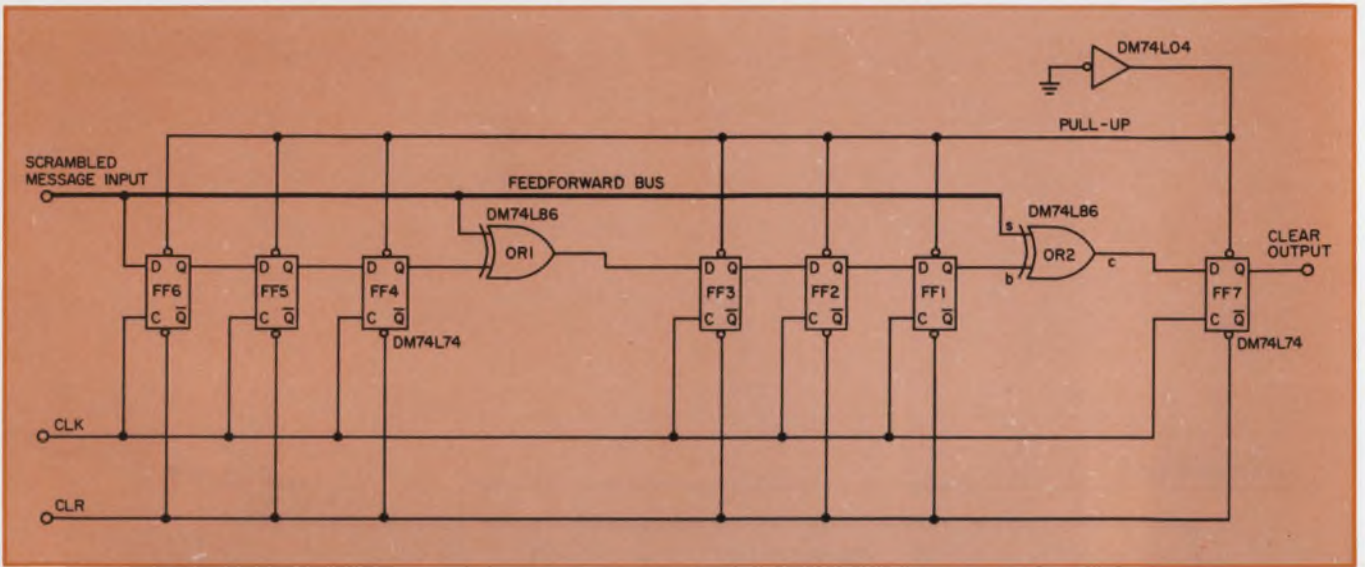

3. To decode the data, the encoded message is introduced into a feed forward shift-register circuit. Scrambled

and clear messages *s* and *c*, and signal *b* are identical to corresponding signals in Fig. 2 but delayed one bit.

Scrambled output — 1010010100000010

By comparing the two, we see that 11-bit positions are alike and five are different. Hence, for the simple circuit of Fig. 2, the scrambling process yields a correlation of

$$\frac{\text{Alike} - \overline{\text{Alike}}}{\text{total Bits}} = \frac{11 - 5}{16} = 0.375.$$

A longer input sequence and more flip-flop stages would cause the correlation of input and

output to approach zero. A completely randomized message would have zero correlation. Such an ideally encoded message would have the statistics of noise and be very difficult to crack. The main weakness of any code is the presence of a measurable degree of order or correlation. The more random a message appears, the more difficult it is to decipher.

The position of the EXCLUSIVE-OR used for

Table 2. Six-stage encoder

CLOCK	DATA INPUT	FLIP-FLOP STATES					
		FF6	FF5	FF4	FF3	FF2	FF1
1	1	0	0	0	0	0	1
2	0	1	0	0	1	0	0
3	1	0	1	0	0	1	1
4	1	1	0	1	1	0	0
5	0	0	1	0	1	1	0
6	0	0	0	1	0	1	1
7	1	1	0	0	0	0	0
8	1	0	1	0	0	0	1
9	0	1	0	1	1	0	0
10	0	0	1	0	1	1	0
11	1	0	0	1	0	1	0
12	1	1	0	0	0	0	0
13	0	0	1	0	0	0	0
14	0	0	0	1	0	0	0
15	1	0	0	0	1	0	1
16	0	1	0	0	1	1	0

Table 3. Six-stage decoder

CLOCK	DATA INPUT	FLIP-FLOP STATES						
		FF6	FF5	FF4	FF3	FF2	FF1	FF7
1	1	1	0	0	1	0	0	1
2	0	0	1	0	0	1	0	0
3	1	1	0	1	1	0	1	1
4	0	0	1	0	1	1	0	1
5	0	0	0	1	0	1	1	0
6	1	1	0	0	0	0	1	0
7	0	0	1	0	0	0	0	1
8	1	1	0	1	1	0	0	1
9	0	0	1	0	1	1	0	0
10	0	0	0	1	0	1	1	0
11	0	0	0	0	0	0	1	1
12	0	0	0	0	0	0	0	1
13	0	0	0	0	0	0	0	0
14	0	0	0	0	0	0	0	0
15	1	1	0	0	1	0	0	1
16	0	0	1	0	0	1	0	0

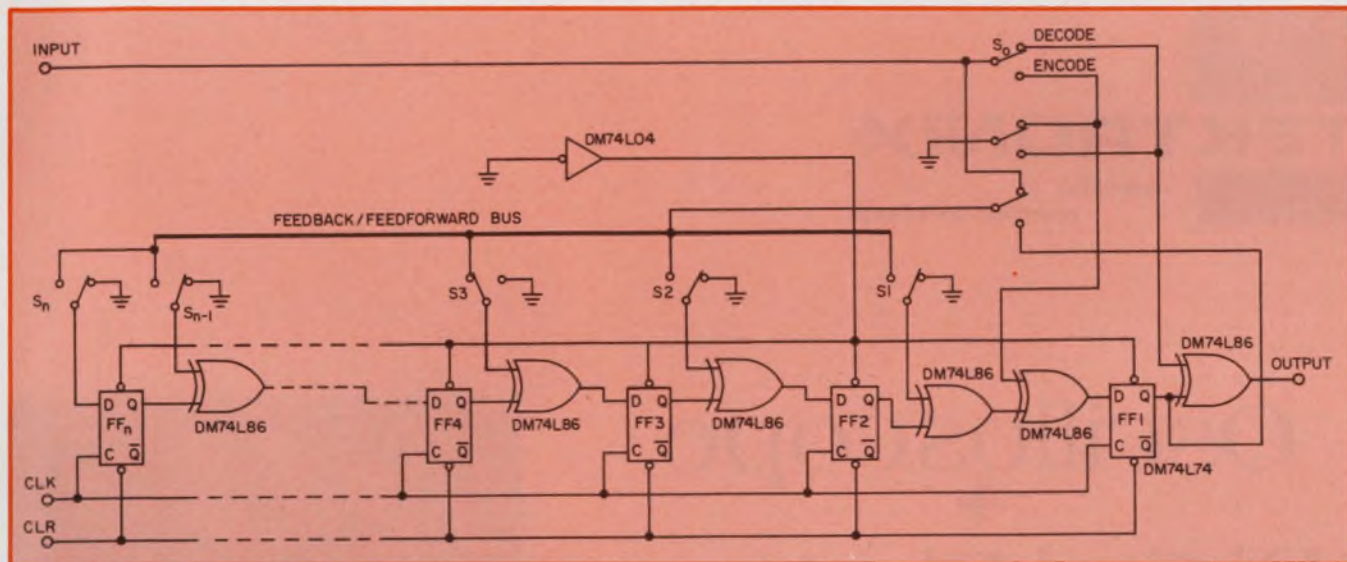

4. A flip of the switch changes the shift-register circuit into either an encoder or decoder. Setting switches S_1

through S_n changes the scrambling code. A 16-stage system provides up to 65,535 different codes.

feedback in the encoder of Fig. 2, so far arbitrarily chosen, dictates the manner in which the decoder must be configured to restore the message to its original format.

Fig. 3 is a circuit that will decode data scrambled by the circuit of Fig. 2. In the encoder circuit data was fed back to EXCLUSIVE-OR₁, and also directly to the input of the FF₆ stage. The decoding circuit of Fig. 3 uses a similar configuration with an EXCLUSIVE-OR, also between stages FF₃ and FF₄. However, no feedback is used. The shift-register stage, FF₇, serves only to synchronize the output data with the clock.

Table 3 shows the flip-flop states for Fig. 3 during the unscrambling process. The data input is the scrambled output from the encoding circuit (Fig. 2). The feedback and feedforward bus lines of Figs. 2 and 3 have the same signals on them. Also, both Figs. 2 and 3 have the same number of shift stages, FF₂ through FF_n, and these flip-flops have the same input points from the feedback/feedforward buses. Therefore the signals b (inputs to both OR_s) in both circuits are identical. In Fig. 2, the output of FF₂ mixes with and scrambles the clear message, c . In Fig. 3, b and s (scrambled message) are both delayed one clock pulse versus Fig. 2. By modulo-2 addition, if

$$X \oplus Y = Z, \text{ then } X \oplus Z = Y$$

In Figs. 2 and 3 therefore, if

$$b \oplus c = s, \text{ then } b \oplus s = c.$$

A combination scrambler and decoder

Conversely the circuit of Fig. 3 (the decoder) can also act as an encoder and be decoded by the circuit of Fig. 2. The circuit pair has a reciprocal transfer characteristic. The scrambled message, however, is different when the roles of the two circuits are reversed.

In the combination circuit of Fig. 4 a flick of a switch (S_0) converts the circuit into either an encoder or decoder of digital data. The encoding/decoding transfer characteristics of the circuits are determined by the settings of switches S_1 to S_n in the feedback/feedforward path.

A 16-stage register can generate a maximum of $(2^{16} - 1)$, or 65,535, bits before repetition occurs. Also, since the switches S_1 to S_n can be set in any pattern (except all to ground), there are 65,535 different coding sequences. However, not all are of the maximum length. And though not implemented in Fig. 4, another coding variation can be provided by starting the generator in any one of the 65,536 possible initial states.

Since the nature of scrambling requires hiding the message and showing no patterns—that is, a complete lack of redundancy—errors in transmission go undetected. In fact, an error picked up in transmission is multiplied by the decoding process. Each input bit affects several output bits. Therefore error detecting and correcting performed after decoding is made more difficult. In applications where large blocks of data are moved or stored, it may be wise to use a test word (not coded) for each data block to insure that the transmission process has not gone out of synchronism. Loss of synchronism would result in complete loss of data. However, here lie the seeds for code cracking. Any unencoded information, or error detection and correction schemes added after the message is encoded, provide clues for deciphering the message.

Fig. 4 is probably the simplest configuration that can be used for pseudorandom encoding and decoding, but the security it can provide is limited. The art of data encoding is highly developed, and for obvious reasons, the most advanced concepts are kept secret. ■■



TEKTRONIX®

committed to
technical excellence

Oscilloscope + Digital Plug-ins

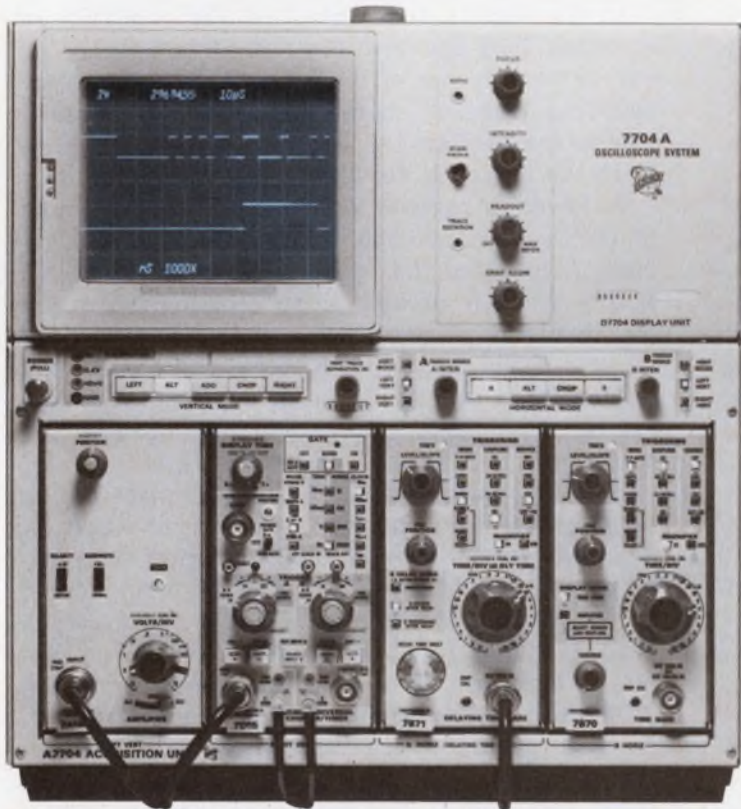

=

Unique
Solutions
to
Difficult
Problems

FEATURING
7DI5 Universal
Counter/Timer

PROBLEM:

Accurately measure the time between two nonadjacent pulses in a word train (displayed in upper trace).

SOLUTION:

Use the scope's delayed sweep gate to selectively control the counter's measurement interval (displayed in lower trace). A time interval of 29694.55 ns is measured and displayed on the scope's CRT READOUT.

7000-Series DIGITAL FAMILY

TEK's Digital Family consists of two counters, a DMM and a delay unit that improve measurement accuracy through digital technology. Now, both digital and analog data can be viewed together when teaming these measurement capabilities with a 7000-Series Scope.

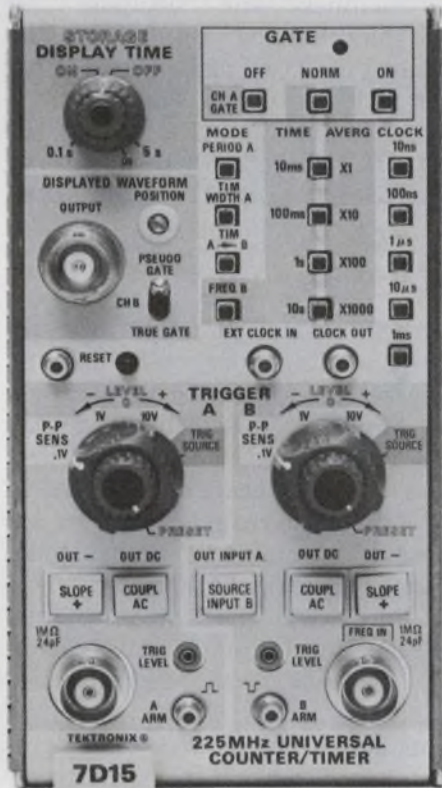

Applications unique with the new 7D15 Universal Counter/Timer include measuring: time intervals of selected portions of complex waveforms (such as telemetry and computers); time between nonadjacent pulses; time between desired events (such as radar)—while ignoring effects of noise; fre-

quency of burst—the arming feature permits measurement inside a burst so that burst turn on can't introduce possible error; and frequency of events—while ignoring signal ringing.

Teaming the 7D15 with a scope gives you more solving power for today's complex measurements. This unique combination allows you to: (1) *Display* on the CRT the measured signal together with the measurement interval, or the counter Schmitt trigger signal; (2) *Precondition* the signal via the scope's vertical amplifier to provide input possibilities such as, 10 μ V sensitivity, Differential input, and Current probe input; and (3) *Accurately Control* the start and stop points of measurement by selective arming.

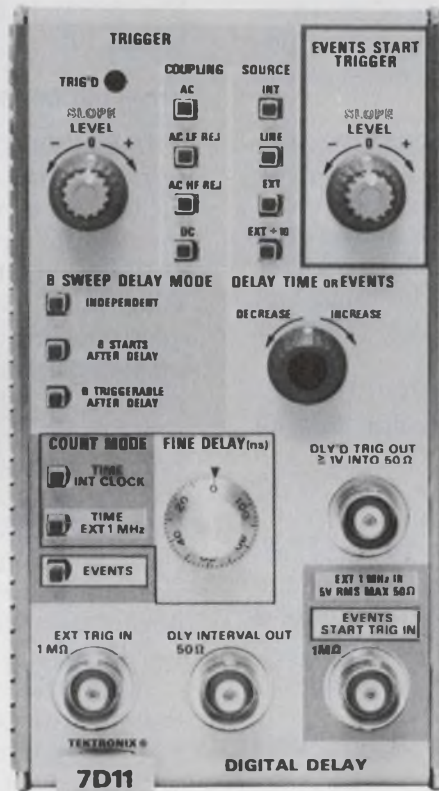

The new 7D11 Digital Delay Unit with its 100 ns-to-1 s delay range in Time-Delay mode and its 10,000,000 count range in the Events-Delay mode, fulfills many measurement requirements for accurate delays.

Applications in the Time-Delay mode include measuring: accurate low jitter sweep delays; propagation delays of delay lines or delay devices; delay path equalization in networks, logic systems, cable systems, or distribution amplifiers; oscillator stability; pulse width jitter, pulse-to-pulse jitter; and more.

Applications in the Events-Delay mode include: disc memory skewing adjustments; computer main storage or local storage timing adjustments; lost bit identification and location on disc memory or magnetic tapes; modulation analysis on time division multiplexing (TDM) or pulse modulation (PWM) in communication and data systems; and more.

The 7D13 Digital Multimeter with its unique temperature probe and 7D14 525-MHz Digital Frequency Counter are two more problem solvers in TEK's digital family.

TEK's concept of integrating these digital measurement capabilities with the scope brings you many advantages over separate test units:

- measuring convenience and confidence
- easier and faster solutions to complex problems
- fewer dollars invested
- more bench working space
- signal conditioning

Add to these, the new dimension of scope-controlled measurements and you realize the potential of the 7000-Series Integrated Test System concept. . . Watch for more to come.

For more information contact your local TEKTRONIX Field Engineer or write: Tektronix, Inc., P. O. Box 500, Beaverton, Oregon 97005.

Tektronix, Inc.

Offering sales, after-sales support and service . . . worldwide.

Pseudorandom codes can be cracked with just a short sequence of the text in both clear and scrambled form. Knowing the limitations is a first step to better designs.

On the surface, a pseudorandom code appears to be a good way to keep digital data secure. Thousands of long, nonrepetative sequences are available from a simple circuit (Fig. 1) to scramble data transmissions.^{1,2} A 20-stage circuit can supply a sequence of 1,048,575 bits. But the method does have a weakness. Although the encoded data may have the statistical appearance of randomness, a linear relationship exists between the message and the enciphered text. Only a limited amount of information—on the order of $2n$ (n = number of shift-register stages) bits of enciphered text and the corresponding message—is enough to break the code.

Let's examine the linear relationships. The basic shift-register circuits in Figs. 2 and 3, can be represented analytically by the delay operator D^j . If t_0 represents the delay of one shift register, then the transfer function of n shift register stages can be represented by D^{nt_0} . The input and output sequences are represented by $I(t-nt_0)$ and $O(t-nt_0)$.

All "additions" are done with EXCLUSIVE-ORs and therefore obey modulo-2 rules, and all operations are linear.

For Fig. 2, $O_a(t) = I_a(t) [(D^{2t_0} + 1)D^{3t_0} + 1]$ and

$O_b(t) = I_b(t) [D^5 + D^3 + 1]$, after dropping the t_0 notations and combining terms. Similarly analysis of the circuit in Fig. 3 shows that

$$\begin{aligned} O_b(t) &= [O_b(t) [(D^2 + 1)D^2] + I_b(t)]D \\ &= O_b(t) (D^5 + D^3) + I_b(t) D. \end{aligned}$$

Since in modulo-2 arithmetic if $A + B = C$ then $A + C = B$, it follows that

$$I_b(t) D = O_b(t) [D^5 + D^3 + 1].$$

An encipher/decipher operation is obtained by cascading the two circuits—with the output of Fig. 2 into the input of Fig. 3.

$$\text{Making } O_a(t) = I_b(t)$$

$$I_a(t) D = O_b(t)$$

Thus the final output of the pair of cascaded circuits equals the input delayed by one bit. The

original input text $I_a(t)$ is correctly recovered as $O_b(t)$ delayed by one bit.

A generalized combined encipher/decipher circuit is shown in Fig. 1. A similar analysis shows that the labels "encipher" and "decipher" on switch S_0 can be interchanged. By feeding the output of Fig. 3 into Fig. 2, we make the original encoder a decoder and vice versa. Thus

$$O(t_b) = I(t_a)$$

and $O_a(t) = I_b(t) D$. Therefore the input to Fig. 3, $I(t_b)$, is recovered as $O_a(t)$, also delayed by one bit.

Breaking the code

In many data blocks a small fragment of plain text and the corresponding encrypted text can be deduced or may become known by prearrangement with an accomplice. Very often a highly formatted text is transmitted. Formatting provides strong clues for code-cracking by intelligent guessing or covert prearrangement. For example, the heading of a column of names could contain the sequence, "space NAME space." This could be at a certain place in the text quite innocently or placed there by design. If an eight-bit code is assumed, this provides an unauthorized person with 48 bits (6 chars \times 8 b/char) of clear and corresponding enciphered text. This is more than enough information to break an ordinary pseudorandom linear code produced by a circuit of 20 stages.

In general, the code of any n -stage code generator, with arbitrary feedback—with switches S_1 to S_n arbitrarily set (Fig. 1)—can be broken with any $2n$ bits of clear and corresponding enciphered text. Breaking the code consists of determining the switch settings and the initial states of the flip-flop stages. Once these conditions are known, the complete text can be deciphered.

Consider the five-stage circuit in Fig. 2. In the most general formulation of the problem, assume that the plain-text data consisting of bits X_1, X_2, \dots, X_{2n} and the corresponding enciphered data Y_1, Y_2, \dots, Y_{2n} are known. The most important

C. H. Meyer and W. L. Tuchman, IBM System Development Div., Kingston, N.Y. 12401.

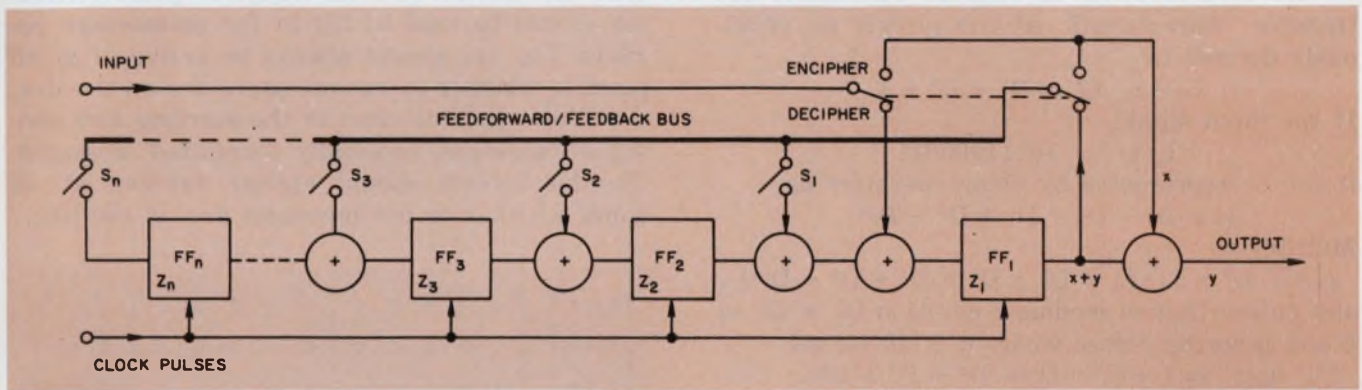

1. A generalized encipher/decipher system can generate pseudorandom, nonrepetitive sequences as long as

$(2^n - 1)$ bits. With $n = 20$ -stages of registers, many thousands of sequences are as long as 1,048,575 bits.

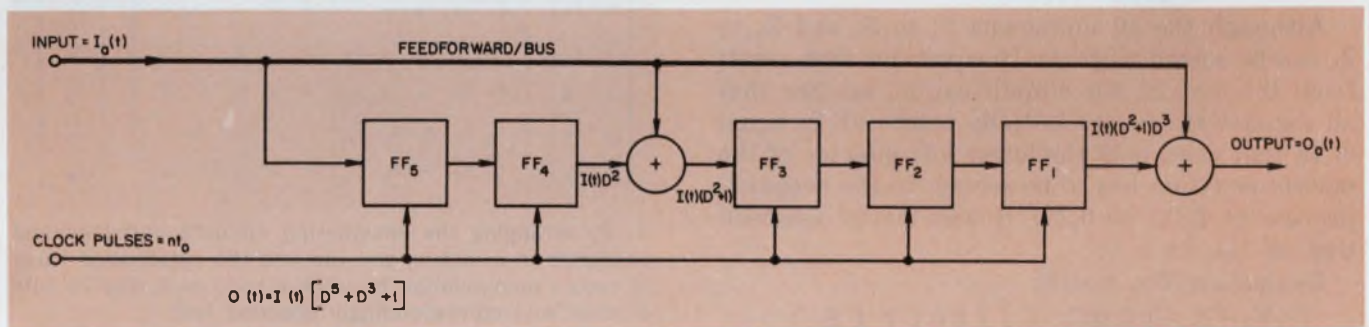

2. The transfer function of this five-stage encoder provides a linear relationship between input and output.

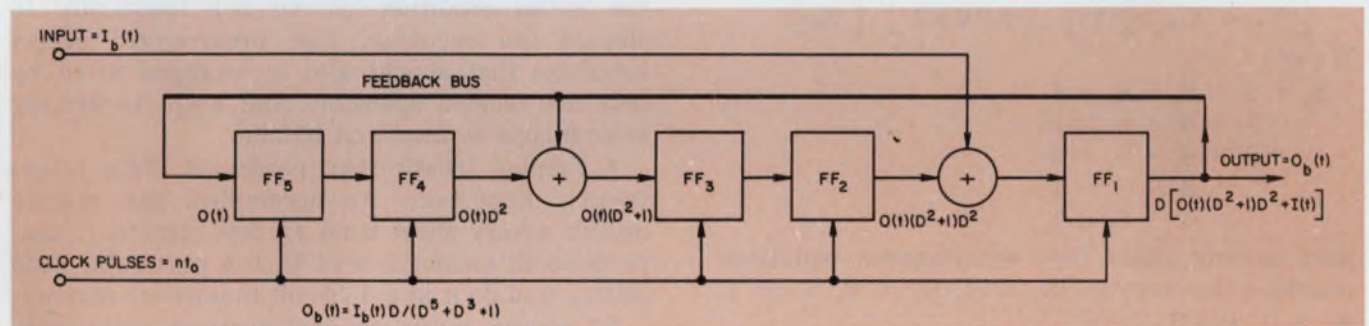

3. The decoder's transfer function is the reciprocal of the encoder and delayed by one clock pulse.

information, the code key, is represented by the states (open or closed) of the various switches $S_1, S_2, \dots, S_i, \dots, S_n$.

An open switch at point i is specified by $S_i = 0$ and a closed switch by $S_i = 1$. The initial state of the shift register stages are designated by Z_1, Z_2, \dots, Z_n , where Z_i can assume the values of either ONE or ZERO.

A careful analysis of a five-stage encoder will indicate that the shift register encoding scheme can be represented by the matrix in Fig. 4.

Using the well-known rules of matrix multi-

plication we can solve the matrix for the circuit of a five-stage encoder, where $n = 5$ in the generalized circuit of Fig. 1. With the encipher/decipher switch in the encipher position, we get

$$Y_1 + X_1 = Z_1$$

$$Y_2 + X_2 = S_1 X_1 + Z_2$$

⋮

$$Y_8 + X_6 = S_1 X_5 + S_2 X_4 + S_3 X_3 + \dots + S_5 X_1$$

⋮

$$Y_{10} + X_{10} = S_1 X_9 + S_2 X_8 + S_3 X_7 + \dots + S_5 X_5.$$

All additions and multiplications are by modulo-2 rules.

Let the switch settings of $S_1 \dots S_n$ correspond to the configuration of Fig. 2. Therefore, the transfer characteristic of the circuit as previously derived is

$$S_5 + S_3 + 1 = D^6 + D^3 + 1.$$

If the input signal,

$$I_a(t) = 10111000011$$

it can be represented by delay operators as

$$(1 + D^2 + D^3 + D^4 + D^9 + D^{10}).$$

Multiplying

$$(D^6 + D^3 + 1) \cdot (1 + D^2 + D^3 + D^4 + D^9 + D^{10})$$

and noting that in modulo-2 addition $D^n + D^n = 0$ and ignoring values where $n > 10$ we get

$$\begin{aligned} 0_a(t) &= 1 + D^2 + D^3 + D^6 + D^8 + D^{10} \\ &= 10101010101, \end{aligned}$$

and

$$\begin{aligned} X + Y &= I_a(t) + 0_a(t) \\ &= 00010010110. \end{aligned}$$

Although the 10 unknowns S_1 to S_5 and Z_1 to Z_5 can be solved with the 10 equations that result from the matrix, for simplification, assume that all register stages are initially reset—all Z s equal 0. In that case, only the lower left quarter of the matrix equation has to be solved. In the encoding process of $I_a(t)$ to $0_a(t)$ it was tacitly assumed that all the Z s = 0.

Evaluating the matrix

$$\begin{bmatrix} Y_6 + X_6 \\ Y_7 + X_7 \\ Y_8 + X_8 \\ Y_9 + X_9 \\ Y_{10} + X_{10} \end{bmatrix} \begin{bmatrix} 0 \\ 1 \\ 0 \\ 1 \\ 1 \end{bmatrix} = \begin{bmatrix} 1 & 1 & 1 & 0 & 1 \\ 0 & 1 & 1 & 1 & 0 \\ 0 & 0 & 1 & 1 & 1 \\ 0 & 0 & 0 & 1 & 1 \\ 0 & 0 & 0 & 0 & 1 \end{bmatrix} \cdot \begin{bmatrix} S_1 \\ S_2 \\ S_3 \\ S_4 \\ S_5 \end{bmatrix}$$

We get

$$\begin{aligned} S_1 + S_2 + S_3 + S_5 &= 0 \\ S_2 + S_3 + S_4 &= 1 \\ S_3 + S_4 + S_5 &= 0 \\ S_1 + S_5 &= 1 \\ S_5 &= 1. \end{aligned}$$

And solving these five simultaneous equations provides the answers $S_5 = 1$, $S_1 = 0$, $S_3 = 1$, $S_2 = 0$, and $S_4 = 0$.

Instead of this procedure a more elegant approach is to calculate the inverse of the 5×5 matrix:

$$\begin{bmatrix} S_1 \\ S_2 \\ S_3 \\ S_4 \\ S_5 \end{bmatrix} = \begin{bmatrix} 1 & 1 & 1 & 0 & 1 \\ 0 & 1 & 1 & 1 & 0 \\ 0 & 0 & 1 & 1 & 1 \\ 0 & 0 & 0 & 1 & 1 \\ 0 & 0 & 0 & 0 & 1 \end{bmatrix} \cdot \begin{bmatrix} 0 \\ 1 \\ 0 \\ 1 \\ 1 \end{bmatrix} = \begin{bmatrix} 0 \\ 0 \\ 1 \\ 0 \\ 1 \end{bmatrix}$$

Rules for protecting security

Knowing then the weakness of a linear pseudorandom scrambler, what can we do to help keep information secure? Several operational rules are apparent:

- Never send an encoded bit stream, where the clear text consists of all ONES or ZEROS. This exposes the pseudorandom sequence to possible recognition. A noise-triggered pulse generator should be used to fill in for no-message periods. The line should always be active, if at all possible whether or not messages are on the line.

- Don't provide clues to the starting and ending of messages, especially formatted messages. The bit stream should appear random at all times whether or not messages are on the line.

$Y_1 + X_1$	0	0	0	0	0	1	0	0	0	0	S_1
$Y_2 + X_2$	X_1	0	0	0	0	0	1	0	0	0	S_2
$Y_3 + X_3$	X_2	X_1	0	0	0	0	0	1	0	0	S_3
$Y_4 + X_4$	X_3	X_2	X_1	0	0	0	0	0	1	0	S_4
$Y_5 + X_5$	X_4	X_3	X_2	X_1	0	0	0	0	0	1	S_5
$Y_6 + X_6$	X_5	X_4	X_3	X_2	X_1	0	0	0	0	0	Z_1
$Y_7 + X_7$	X_6	X_5	X_4	X_3	X_2	0	0	0	0	0	Z_2
$Y_8 + X_8$	X_7	X_6	X_5	X_4	X_3	0	0	0	0	0	Z_3
$Y_9 + X_9$	X_8	X_7	X_6	X_5	X_4	0	0	0	0	0	Z_4
$Y_{10} + X_{10}$	X_9	X_8	X_7	X_6	X_5	0	0	0	0	0	Z_5

4. By arranging the enciphering circuit's variables and constants in a matrix, you can use the established rules of matrix manipulation to crack a code with only $2n$ bits of clear and correspondingly encoded text.

- Change the switch settings (S_1 to S_n) and the initial condition (Z_1 to Z_n) frequently to change the encoding. Use prearranged secret schedules that should also be changed often by only one trusted operator. And keep the setting mechanisms secured and hidden.

- Employ trustworthy personnel. This is extremely important. An accomplice can readily and in a very short time (a few minutes) compromise all messages sent with a particular code setting and do it in a difficult to uncover manner.

Of course, more complex systems using non-linear relationships and mathematical operation other than the simple modulo-2 make code-cracking a far more difficult task.³ Still, the system can never be more reliable than the people who operate it. And the problems faced by a potential intruder in compromising even the most advanced system are mostly a matter of time and expense to solve. ■■

References

1. Golomb, S., "Shift Register Sequences," Modern Algebra Series, Holden-Day, p. 40.
2. Donn, E. S., "Secure Your Digital Data," *The Electronic Engineer*, May 1972, pp. DC-5 to DC-7.
3. "Data Privacy, Cryptology and the Computer at IBM Research," IBM Research Reports, Vol. 7, No. 4, 1971.
4. Sinkov, A., "Elementary Cryptanalysis, A Mathematical Approach," Random House, New York, 1968.

RCA delivers on Linear ICs

(in quantity
from stock)



For price-delivery-quality

Check these 30 linear IC devices against your product needs! RCA Solid State and RCA Distributors have them in stock, and we have the production capability to keep them coming. Because RCA has long been one of the biggest volume producers.

That's why we can deliver in production quantities from current inventory. Our system is set up so that—within the hour your order is received, it's being processed for shipment from one of our warehouses. And with our distributor network, that means fast reaction anywhere in the United States.

RCA delivers PDQ on linear ICs—price, delivery, quality. See your RCA Distributor or local RCA Representative. RCA Solid State Division, Box 3200, Somerville, N.J. 08876.

RCA Solid State
products that make products pay off

Function	Type No.	Unit Price (100-999)
General purpose op amp (741)	CA3741T	\$1.95
	CA3741CT	.89
Dual general purpose op amp (747)	CA3747E	1.95
	CA3747CE	1.50
	CA3747T	3.95
	CA3747CT	1.50
Dual general purpose op amp (458)	CA3458T	1.20
(558)	CA3558T	3.00
Non-compensated general purpose op amp	CA3748CT	.95
	CA3748T	1.50
4 transistor array	CA3018	1.06
	CA3018A	1.50
5 transistor array	CA3045	1.80
	CA3046	1.06
	CA3086	.59
7 transistor LED driver array	CA3081	1.70
	CA3082	1.70
Quad diode array	CA3019	1.18
Dual Darlington array	CA3036	1.07
6 Diode array	CA3039	1.17
Dual differential amplifier	CA3026	1.50
	CA3054	1.50
Differential amplifier	CA3028A	1.07
	CA3028B	1.50
	CA3053	.59
Sense amplifier (541)	CA3541D	7.20
High voltage arrays	CA3118T	1.18
	CA3118AT	1.68
	CA3148E	1.18
	CA3148AE	1.68

NOW, 400V & 600V DARLINGTONS FROM



Delco Electronics

DIVISION OF GENERAL MOTORS CORPORATION, KOKOMO, INDIANA

Delco's new DTS-4000 series Darlington transistors with V_{CE0} 's of 400V and 600V are triple diffused mesa units built for rugged duty. They come to you with a practical 15 Ampere rating that you can depend on all the way up to the high voltage requirements of ac motor speed controls, for instance—or the 1.5 kW switching regulator in the illustration.

And they offer new possibilities

SAFE OPERATING CURVES

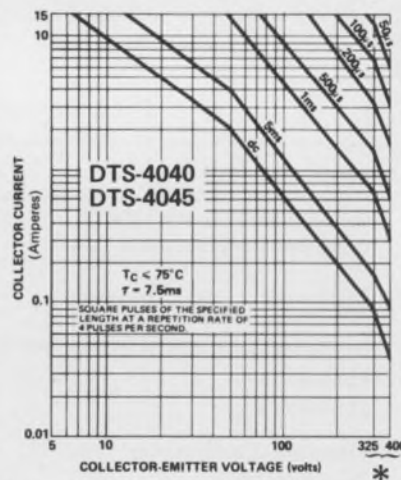
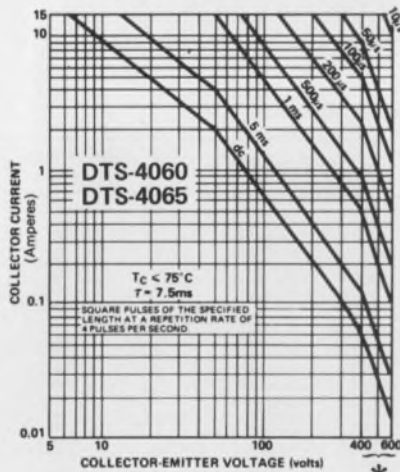

*Reverse Bias Required

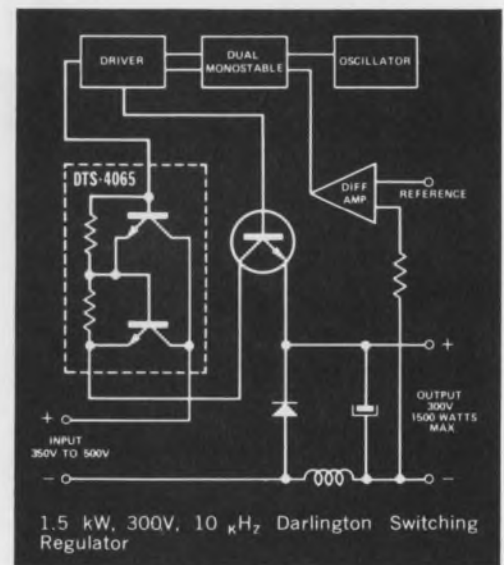

in circuit design where dc drive conditions may have created awkward problems when using SCR's.

Our new Darlington transistors can save you space and give you more design flexibility. The high energy capability of the DTS-4000 series is

TYPE	V_{CE0}	I_C (Cont.)	V_{EBO} (Max.)	$V_{CE0(sus)}$	h_{FE} @ I_C	t_f (com. base)	$P_D(max.)$
DTS-4040	400V	15A	20V	325V	250/3A	0.25 μ s	100W
DTS-4045	400V	15A	20V	325V	500/3A	0.25 μ s	100W
DTS-4060	600V	15A	20V	400V	250/3A	0.25 μ s	100W
DTS-4065	600V	15A	20V	400V	500/3A	0.25 μ s	100W

NPN—Triple diffused Darlington transistors packaged in solid copper TO-204MA (TO-3) cases.

HIGH ENERGY THE KOKOMOANS.

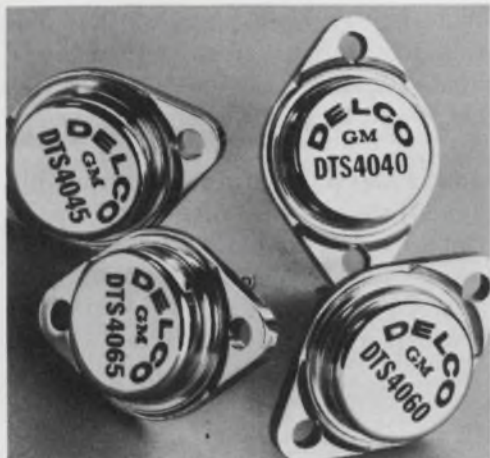

backed by safe operating curves up to 600 volts, as shown at left. And to further aid your circuit design h_{FE} is plotted continuously from 15mA to the maximum collector current rating of 15A.

As you expected, the new DTS-4000's are in stock and ready for delivery. Contact us or your nearest Delco distributor for complete details. Ask for Application Note 52 on the switching regulator.

Now available from these distributors in production quantities:

ALA., BIRMINGHAM • Forbes Distributing Co., Inc. (205)-251-4104
 ARIZ., PHOENIX • Sterling Electronics (602)-258-4531
 CAL., LOS ANGELES • Kierulff Electronics, Inc. (213)-685-5511 • Radio Products Sales, Inc. (213)-748-1271
 CAL., PALO ALTO • Kierulff Electronics, Inc. (415)-968-6292
 CAL., REDWOOD CITY • Cramer/San Francisco, (415)-365-4000
 CAL., SAN DIEGO • Radio Products Sales, Inc. (714)-292-5611
 CAL., SAN DIEGO • Kierulff Electronics, Inc. (714)-278-2112
 COLO., DENVER • Cramer/Denver (303)-758-2100 • Denver Walker Electronics (303)-935-2401
 CONN., NORWALK • Harvey/Connecticut (203)-853-1515
 FLA., MIAMI SPRINGS • Powell/Gulf Electronics (305)-885-8761
 FLA., ORLANDO • Powell/Gulf Electronics (305)-859-1450
 ILL., ROSEMONT (Chicago) • Kierulff Electronics (312)-678-8560

ILL., SKOKIE (Chicago) • Merquip Electronics (312)-282-5400
 IND., INDIANAPOLIS • Graham Electronics Supply, Inc. (317)-634-8202
 MD., BALTIMORE • Radio Electric Service Co. (301)-823-0070
 MASS., NEEDHAM HEIGHTS • Kierulff Electronics, Inc. (617)-449-3600
 MASS., NEWTON • The Greene-Shaw Co., Inc. (617)-969-8900
 MICH., ROMULUS • Harvey-Michigan (313)-729-5500
 MINN., MINNEAPOLIS • Stark Electronics Supply Co. (612)-332-1325
 MO., KANSAS CITY • Walters Radio Supply, Inc. (816)-531-7015
 MO., NO. KANSAS CITY • LCOMP-Kansas City, Inc. (816)-221-2400
 MO., ST. LOUIS • LCOMP-St. Louis, Inc. (314)-647-5505
 N.J., CLIFTON • Eastern Radio Corporation (201)-365-2600, (212)-244-8930
 N.Y., BINGHAMTON • Harvey/Federal (607)-748-8211
 N.Y., EAST SYRACUSE • Cramer/Eastern (315)-437-6671
 N.Y., ROCHESTER • Cramer/Rochester (716)-275-0300
 N.Y., WOODBURY • Harvey/New York (516)-921-8700, (212)-582-2590
 OHIO, CINCINNATI • United Radio, Inc. (513)-761-4030
 OHIO, CLEVELAND • Pattison Supply (216)-441-3000
 OHIO, DAYTON • Kierulff Electronics (513)-278-9411
 OKLA., TULSA • Radio, Inc. (918)-587-9123
 PENN., PHILADELPHIA • Almo Electronics (215)-676-6000
 PENN., PITTSBURGH • RPC Electronics (412)-782-3770
 S.C., COLUMBIA • Dixie Radio Supply Co., Inc. (803)-253-5333
 TEXAS, DALLAS • Adleta Electronics Co. (214)-741-3151
 TEXAS, FORT WORTH • Adleta Electronics Co. (817)-336-7446
 TEXAS, GARLAND • Kierulff Electronics, Inc. (214)-271-2471
 TEXAS, HOUSTON • Harrison Equipment Co., Inc. (713)-224-9131
 UTAH, SALT LAKE CITY • Cramer/Utah (801)-487-3681
 VA., RICHMOND • Meridian Electronics, Inc., a Sterling Electronics Company (703)-353-6648
 WASH., SEATTLE • Kierulff Electronics, Inc. (206)-763-1550
 WASH., TACOMA • C & G Electronics Co. (206)-272-3181
 CANADA, ONT., SCARBOROUGH • Lake Engineering Co., Ltd. (416)-751-5980
 ALL OVERSEAS INQUIRIES:
 General Motors Overseas Operations
 Power and Industrial Products Dept.,
 767 Fifth Avenue, New York, N.Y.
 10022. Phone: (212)-486-3723.
Kokomoans' Regional Headquarters.
 Union, New Jersey 07083, Box 1018, Chestnut Station, (201) 687-3770.
 El Segundo, Calif. 90245, 354 Coral Circle, (213) 640-0443.
 Kokomo, Ind. 46901, 700 E. Firmin, (317) 459-2175 (Home Office)



And now...the Tri-Flop: a logic block with three stable output states. It's easily implemented and offers considerable hardware savings.

Got an application that requires three stable output states? Here's a network—called a Tri-Flop—that will give you what you need, with considerably less hardware than the bistate devices you're probably using now.

The Tri-Flop (Fig. 1) has three inputs and three outputs. Only one input may be applied at a time to set the network in one of its three states. Also, at any given time, one of the outputs is in the ONE state, and the two others are at ZERO.

As shown in the figure, the circuit consists of three four-input NOR gates, with the output of each gate feeding the input of the two other gates. Each of the three inputs also feeds two of the three gates. Note that negative logic is used—that is, ONE = LOW and ZERO = HIGH.

When a LOW is applied at input 1, and a HIGH at the remaining inputs, the outputs of gates 2 and 3 are forced to be HIGH. This results in all inputs to gate 1 being HIGH, causing its output to be LOW. This LOW, in turn, feeds gates 2 and 3. Thus, when input 1 is removed, the LOW output of gate 1 will maintain a LOW input at

gates 2 and 3, insuring permanency of the state that was initiated by input 1. Similarly, when a LOW is applied—at different times—to inputs 2 or 3, outputs 2 and 3, respectively, are forced to be LOW.

The table shows the output/input relationship of the Tri-Flop. Note that LOW inputs can be momentary (pulsed) and that outputs remain in their last forced state until retriggered. The Boolean equations of the Tri-Flop for quiescent operation, in which all three inputs are HIGH, are:

$$\begin{aligned} \text{Output 1} &= \overline{(\text{Output 2})} \cdot \overline{(\text{Output 3})} \\ \text{Output 2} &= \overline{(\text{Output 1})} \cdot \overline{(\text{Output 3})} \\ \text{Output 3} &= \overline{(\text{Output 1})} \cdot \overline{(\text{Output 2})} \end{aligned}$$

For transient operation, where one of the three inputs is LOW, the equations are:

$$\begin{aligned} \text{Output 1} &= \text{Input 1} \\ \text{Output 2} &= \text{Input 2} \\ \text{Output 3} &= \text{Input 3} \end{aligned}$$

If one of the outputs is removed, the equations reduce to those of the familiar R-S flip-flop.

Many applications exist

As an example of a Tri-Flop application, let's compare the magnitudes of two numbers, A and

Demetrios Kostopoulos, Reliability Engineer, Systems Consultants, Inc., Ridgecrest, Calif. 93555.

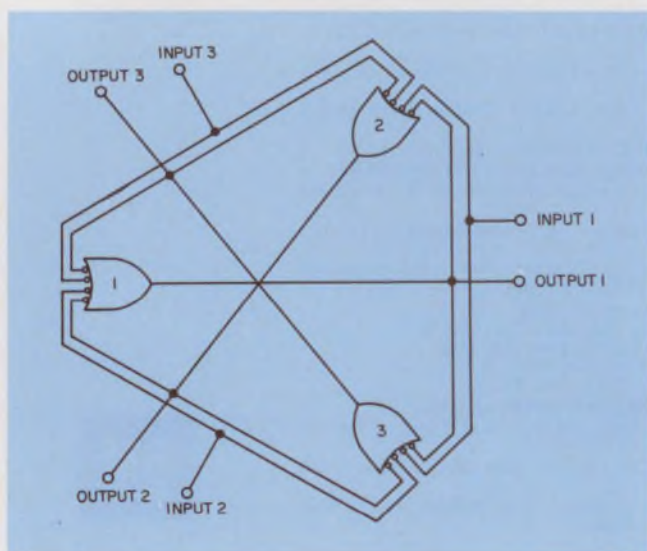

1. The Tri-Flop consists of three four-input NOR gates interconnected as shown.

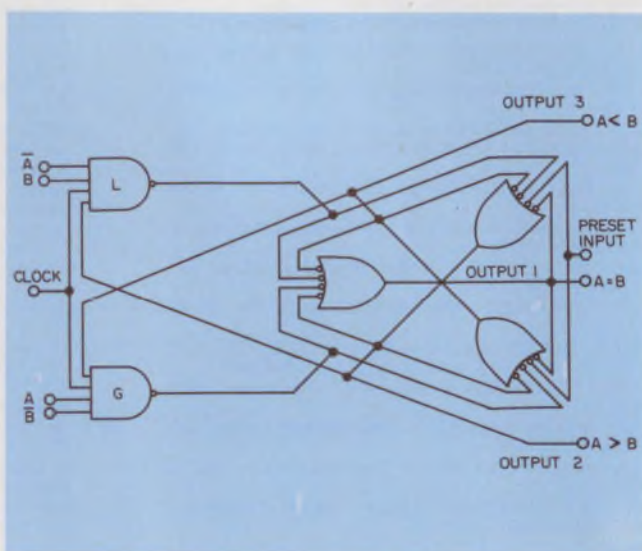

2. Magnitude comparator illustrates use of the Tri-Flop to compare two serial binary numbers.

B, where the three mutually exclusive states are $A = B$, $A < B$ or $A > B$. Figure 2 shows the Tri-Flop magnitude comparator, in which A and B are sequential binary numbers. A and B enter the comparator serially, with their most significant bits first. The comparator is initially set by a PRESET pulse, so that, at the beginning of the comparison, output $A = B$ is LOW, outputs $A < B$ and $A > B$ are HIGH, and the clock input is LOW.

With the most significant bits of A and B entered for comparison, the clock goes HIGH, enabling gates L and G. If the examined bit of A is less than that of B ($A = \text{ZERO}$ and $B = \text{ONE}$), gate L's output goes LOW, setting the Tri-Flop in the state in which output 3 is LOW and outputs 1 and 2 are HIGH. Output 3 indicates that $A < B$ and disables gate G, thus inhibiting the comparator from being altered by the following less significant bits.

If the examined bit of number A is greater than that of B ($A = \text{ONE}$ and $B = \text{ZERO}$), gate G's output goes LOW, setting the Tri-Flop in the state where output 2 is LOW and outputs 1 and 3 are HIGH. Output 2 indicates that $A > B$, and at the same time it disables gate L, inhibiting the comparator from being altered by the following less significant bits.

The first nonequal A and B bits decide the magnitude relationship and lock the comparator in the corresponding state. For example, if $A = 01101101$ and $B = 01110011$, the comparator will indicate that $A = B$ until the fourth bit (see timing diagram, Fig. 4). The $A < B$ output will

then go low, concluding the comparison.

For comparison, a conventional comparator design is shown in Fig. 3. Of the two designs, we see that considerable hardware savings exist with the Tri-Flop approach; the savings are greater when the network is used repeatedly.

Other Tri-Flop applications include polarity determination (positive, zero, negative), ternary arithmetic (0, 1, 2) and coordinate identification (X, Y, Z). ■■

Table: Tri-Flop truth table

INPUTS*			OUTPUTS**			COMMENTS
1	2	3	1	2	3	
H	H	H	NO CHANGE			STATES ALLOWED FOR TRI-FLOP OPERATION
L	H	H	L	H	H	
H	L	H	H	L	H	
H	H	L	H	H	L	
L	L	H	H	H	H	STATES NOT ALLOWED FOR TRI-FLOP OPERATION
H	L	L	H	H	H	
L	H	L	H	H	H	
L	L	L	H	H	H	

NOTE: *LOW INPUTS MAY BE MOMENTARY
**OUTPUT REMAIN AT LAST STATE UNTIL ARRIVAL OF LOW INPUT

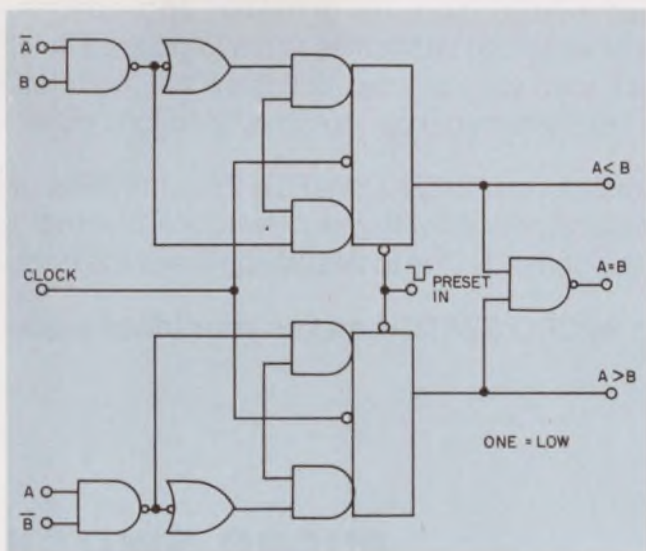

3. Conventional comparator circuit demonstrates the hardware savings when the Tri-Flop is used.

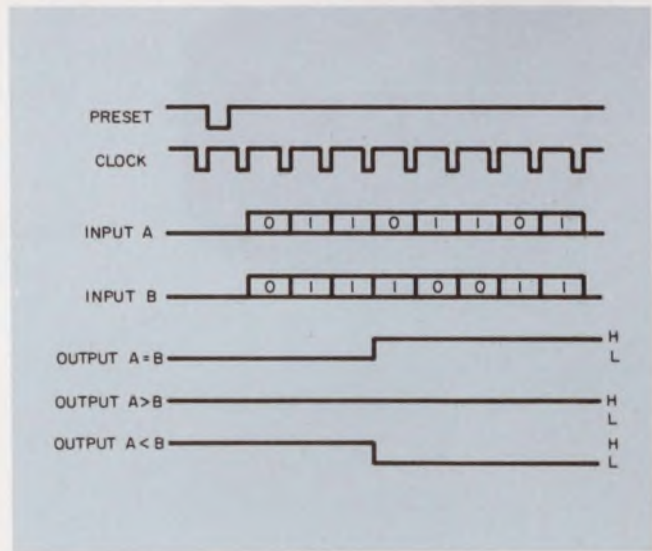

4. Timing diagram for Tri-Flop comparator with $A = 01101101$ and $B = 01110011$.

Push all you want. Our new switches won't give up.

Panel seal version
shown
actual size.

Our new Series 1, one-lamp pushbutton has a stationary lamp socket. This helps eliminate filament damage usually caused by a moving lamp and results in an extremely reliable lighted switch.

Since the Series 1 is bushing mounted, installation is easy. And should a lamp burn out, relamping is from the front of the panel—and without tools. In just seconds.

When contaminants might cause a problem, our panel seal option is the answer.

In addition to reliability, the Series 1 offers versatility that makes it ideal for commercial, industrial or military applications. There's a choice of switching capacities (from logic load level to 20 amps), solid state or snap-action switch modules, many terminal options and up to four poles.

Contact your MICRO SWITCH Branch Office or Authorized Distributor (Yellow Pages, "Switches, Electric") about the Series 1. One look and you'll see the light.

MICRO SWITCH makes your ideas work.

MICRO SWITCH

FREEPORT, ILLINOIS 61032

A DIVISION OF HONEYWELL

MICRO SWITCH products are available worldwide through Honeywell International.

INFORMATION RETRIEVAL NUMBER 37

If you're trying to create logic functions with your own hardwired circuitry, there's an easier way to go. Don't look now, but minicomputer state-of-the-art (and state-of-the-price) just caught up with your application.

The Naked Mini 8 is a computer that's a component. A powerful, fully-operational, byte-oriented, 8-bit computer. Completely tested and easy to interface. Ready to drop into your system like a simple component.

All you add is the power supply and control panel. Everything else is already there. A 1600 nanosecond cycle time, 4K core memory (expandable to 32K), fully-parallel broad-

side I/O, three vectored priority interrupts, two direct memory channels, and an unconditional one-year warranty — the longest in the business.

In 200 unit OEM quantities, you get all of this and more for \$1450. For full specs and price lists, write today: Computer Automation, Inc., 18651 Von Karman, Irvine, California 92664. (714) 833-8830. TWX 910-595-1767.



COMPUTER AUTOMATION, INC.
the NAKED MINI company

The computer that's a component.

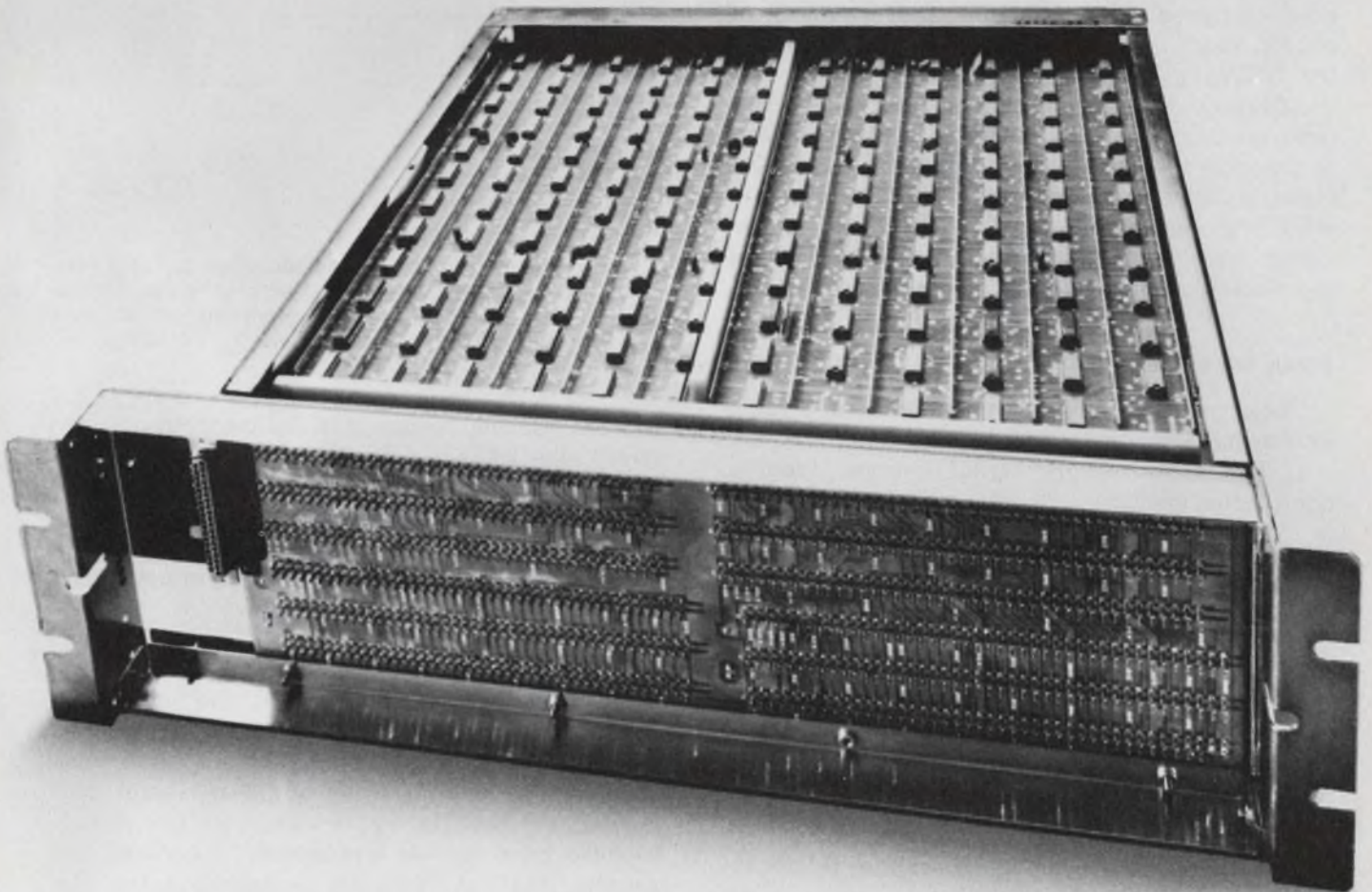

The NAKED MINI,TM \$1450.

INFORMATION RETRIEVAL NUMBER 38

Optimize photodiode detector design

by using a graphical approach to maximize avalanche diode gain and minimize preamplifier noise.

In very narrow optical filters, such as those used to detect laser radiation, internal amplifier noise often limits system performance. Since the typical front end consists of a photodiode coupled to a preamplifier, performance is improved if the diode can be made to furnish gain.

The use of avalanche gain within the photodiode to enhance the output signal reduces the effect of noise in the following amplifier. An accurate prediction of noise performance, of course, must include the effects of the diode and the following amplifier.

Although optimum avalanche gain in the system can be determined mathematically, the computation is tedious, and it obscures the gain and signal-to-noise-ratio trade-offs. A graphical approach is simple and fast, and it gives the designer greater insight into the optimization of the photodiode preamplifier combination.

Break down the problem

Three currents must be considered in analyzing avalanche photodiode action (Fig. 1):

1. *The mean square signal current from a photodiode operating in the avalanche mode.* It is expressed as

$$i_s^2 = (q m n_a \phi M)^2 / 2, \quad (1)$$

where q is the charge of an electron, m is the modulation index, n_a is the ac quantum efficiency, ϕ is the average photon flux and M is the avalanche gain.

2. *Internal photodiode noise current,* which increases at a greater rate than the signal because of the current gain associated with the avalanche process. It is given by

$$i_n^2 = 2q\Delta f (q n_0 \phi + I_{co}) M^d, \quad (2)$$

where Δf is the noise bandwidth, n_0 is the dc quantum efficiency, I_{co} is avalanche region leakage and d is a constant dependent mainly on the electron ionization ratio, which lies between 2.3 and 4.

3. *The total second stage noise current,* includ-

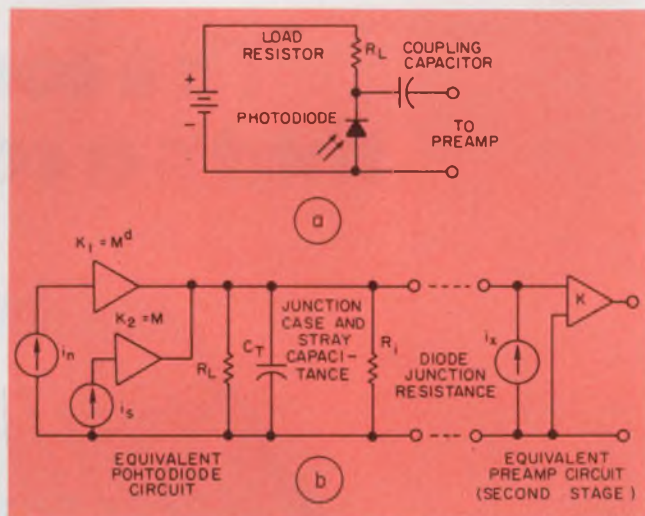

1. **Avalanche gain in the photodiode stage (a)** of a two-stage front end reduces the effects of noise in the second-stage preamp. The equivalent circuit of both stages (b) contains the signal current, i_s , and noise currents, i_n and i_x .

ing the thermal noise of the input circuit, the guard ring leakage noise of the detector and the equivalent input noise of the following transistor amplifier. It is expressed as

$$\bar{i}_x = (2qI_x\Delta f)^{1/2} \quad (3)$$

where I_x is the equivalent dc noise current.

Plot diode characteristics

By referring the diode signal and noise currents to the amplifier input terminals, we can compare the diode currents to the amplifier noise current. The determination of the optimum avalanche gain and the improvement of the signal-to-noise ratio is done graphically. This analysis assumes that, at moderate avalanche gains, the photodiode equivalent parallel resistance remains large compared with the normal circuit impedances.

A step-by-step procedure produces a graph (Fig. 2) of log current vs log M . This permits quick determination of optimum signal-to-noise ratio:

1. Using log-log paper, draw the second stage amplifier noise level i_x , which is independent of

Ralph Kordes, President, General Analog, 1552 Clearview Lane, Santa Ana, Calif. 92705

Avalanche in photodiodes

When photons of light interact with the atoms in a reverse-biased diode junction, free electrons are created. This is the basis of operation of a conventional photodiode. In an avalanche photodiode the doping level is such that, with the proper bias voltage, the free electrons can interact with other atoms and generate additional free electrons. This is the avalanche condition. The avalanche photocurrent can be made proportional to light intensity.

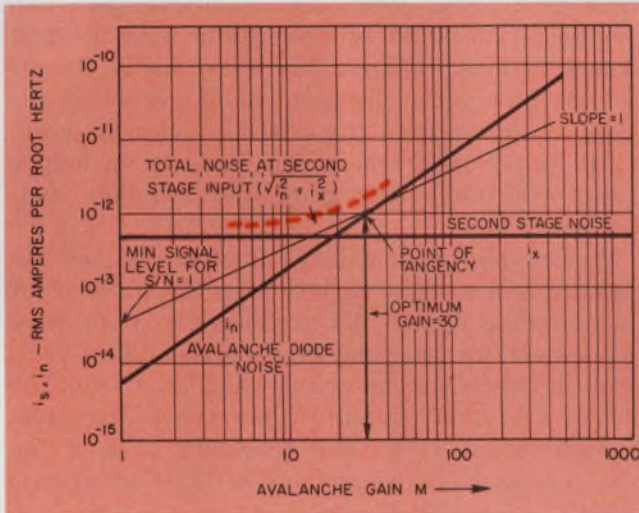

2. Optimum gain and minimum diode signal are found graphically with a root sum square of the noise currents, i_n and i_x . The optimum gain occurs at an avalanche gain of 30 in the design example. This value results in a signal-to-noise improvement of 14.3.

the gain parameter M , as a line parallel to the abscissa.

2. Calculate i_n for M equal to 1 (Eq. 2). This calculation gives a point on the ordinate where $M = 1$.

3. Draw a line from the $M = 1$ ordinate with a slope equal to $d/2$. This line represents the avalanche diode noise i_n at the second-stage input terminals as a function of avalanche gain (M). It is derived by taking the log of both sides of Eq. 2 and solving for the log of i_n over the log of $2q \Delta f (2 n_0 \phi + I_{co})M$.

4. Combine the noise sources on a root sum square basis to give a curve of total noise current at the second-stage input as a function of avalanche gain M (total noise = $\sqrt{i_n^2 + i_x^2}$). This curve is asymptotic to the avalanche and second-stage noise curves. The noise currents are combined by multiplying the intersection point by $\sqrt{2}$.

This gives a point on the total noise curve at the crossover point (the point at which the two currents are equal). The total noise curve can then be drawn by fairing it asymptotically to the second-stage noise curve and the avalanche diode

noise curve. If greater accuracy is needed, two additional points can be calculated on either side of the crossover point.

5. Draw a line with a slope of one so that it is just tangent to the total noise curve. This is the signal current curve and comes from taking the log of Eq. 1, which is the expression for the signal current at the second-stage input as a function of avalanche gain M . The point of tangency is therefore the point where $S/N = 1$.

6. Read off the optimum avalanche gain at the point of tangency between the total noise curve and the signal curve.

7. Read off the intersection of the signal current curve and the ordinate that is the minimum input signal level.

The signal current curve is any line with a slope of 1 (any signal level). If this line is always above the total noise curve, we have S/N values greater than 1; if it is always below, we have S/N values of less than 1. If it is tangent to the noise curve, we have a unique situation in which $S/N = 1$. If the signal current curve intersects the noise curve, we have a band of M values where S/N is greater than 1 (between the points of intersection).

Designing a front end

Consider an amplifier with the following specifications:

A. $i_x = 5 \times 10^{-13} \text{ A}/\sqrt{\text{Hz}}$ at 1 MHz. This is an average value across the bandwidth of interest.

B. The bandwidth is relatively narrow (of less than one decade).

C. $I_{co} = 2 \times 10^{-10} \text{ A}$, and this is large compared with the dc component of incoming radiation. This is especially true in the case of the detection of laser radiation, where pulse widths on the order of 10 to 100 ns at repetition rates of a few thousand Hertz are being considered.

D. The value of the electron ionization constant, d , is 3.

Using these data, we follow the seven-step procedure just outlined:

1. Draw a horizontal line at $5 \times 10^{-13} \text{ A}/\sqrt{\text{Hz}}$

2. If we assume that $q n_0 \phi$ in Eq. 2 is small compared with I_{co} , i_n is $5.65 \times 10^{-15} \text{ A}/\sqrt{\text{Hz}}$. This value of i_n is a point on the ordinate.

3. Since $d = 3$ for this example, draw a line with a slope of $3/2$ from this point.

4. The total noise at the second stage is the root sum square of i_x and i_n and is asymptotic to the avalanche diode noise curve and the second-stage noise curve.

5. The signal current curve is shown as a line with a slope of 1, and is drawn just tangent to the total noise curve.

6. The point of tangency occurs at $M \approx 30$.

7. Since the intercept of i_x with the ordinate

MORE SWITCH FOR LESS MONEY

NEW

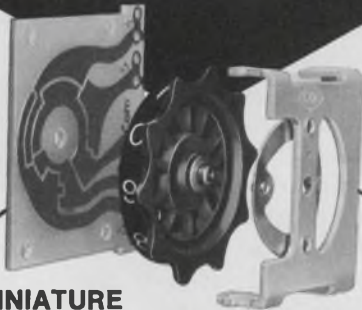

MINIATURE PRECISION THUMBWHEEL SWITCH

1,000,000 Detents (for quality)
Low Cost (for savings)

9 TOP QUALITY FEATURES

1. .05 ohms max. contact resistance.
2. 200 megohms min. insulation.
3. 1,000 volts min. dielectric strength.
4. 2 amps @ 115VAC current carrying capability.
5. 125 ma @ 115VAC current breaking capability.
6. Mounts on 1/2" centers only 1 1/2" behind panel.
7. Glass laminate with precious metal contacts & plating.
8. Multi-applications—you name it.
9. Over 1,000,000 detents.

IMMEDIATE DELIVERY . . . ASK THE PRICE—
BE PLEASANTLY SURPRISED.

CDI Covers The Spectrum of Switches Saves You Space • Effort • Time • Money

THUMBWHEEL SWITCHES



Completely sealed against hostile environments.

ROTARY SWITCHES

Snap-in, snap-out modules in seconds, eliminating downtime.

Tablet Pat.
2841660,
2971066,
3015000,
2956131,
2988607.



PUSHBUTTON SWITCHES



Mounts on 1/2" centers, retrofits most panel openings for miniature thumbwheel switches.



Miniature add/subtract units retrofit most minithumbwheel switch panel openings.

CDI earns its reputation every day for Consistently High Quality, Consistently Good Delivery.



CHICAGO DYNAMIC INDUSTRIES, INC.

PRECISION PRODUCTS DIVISION
1725 Diversey Blvd., Chicago, Illinois 60614
Phone: 312, 935-4600

occurs at $i = 3.5 \times 10^{-14} \text{ A}/\sqrt{\text{Hz}}$ this is the minimum detectable signal based on $S/N = 1$.

The plot of Fig. 2 is based on these calculations.

Don't forget practical problems

As shown in Fig. 2, the point of tangency is not sharply defined. Consequently M is not a critical parameter from a system performance standpoint. However, the bias voltage on the diode is critical, since the avalanche gain can change by an order of magnitude with a small change in bias voltage. This is especially true if the optimum M or the point of operation of the diode is approaching the critical avalanche gain, which is the gain where the diode is no longer linear (the diode has gone into complete avalanche).

In a system with a large photodiode load resistance and a wide variation in the dc level of the incoming signal, it's possible for M to vary by as much as a decade. The corresponding variation in the S/N ratio can be calculated from the plot of Fig. 2. When the ratio reaches excessively high values, it is then necessary to hold the bias potential on the avalanche diode at precise levels.

The ratio of the second-stage noise to the shot noise of the diode is the primary factor in the amount of signal-to-noise improvement that can be achieved through the use of an avalanche diode. It is apparent from Fig. 2 that the improvement in the signal-to-noise ratio is greatest for high noise ratios. This condition requires high optimum M values. Low M values are required for low noise ratios. Because the partial derivative of M with respect to the diode bias voltage (E_b) approaches infinity as E_b approaches E_{crit} (the bias potential where the diode is no longer linear), it follows that high M values require an increasingly more stable and precisely held bias potential.

Another factor in regard to high optimum M values is that the critical potential for the diode is a function of temperature and time and possibly other factors, which make the operation at high optimum M values undesirable.

As a result of these considerations a regulated, temperature-independent bias source for the photodiode is a prime requisite for proper operation. ■■

References:

1. McIntyre, R. J., "Multiplication Noise in Uniform Avalanche Diodes," *IEEE Trans. on Electron Devices*, Vol. 13, pp. 164-168, January, 1966.
2. Baird, J. R. and Shaunfield Jr., W. N., "A Model of the Avalanche Photodiode," *IEEE Trans. on Electron Devices*, Vol. 14, No. 5, May, 1967.

Complete RF Network Analysis — GROUP DELAY

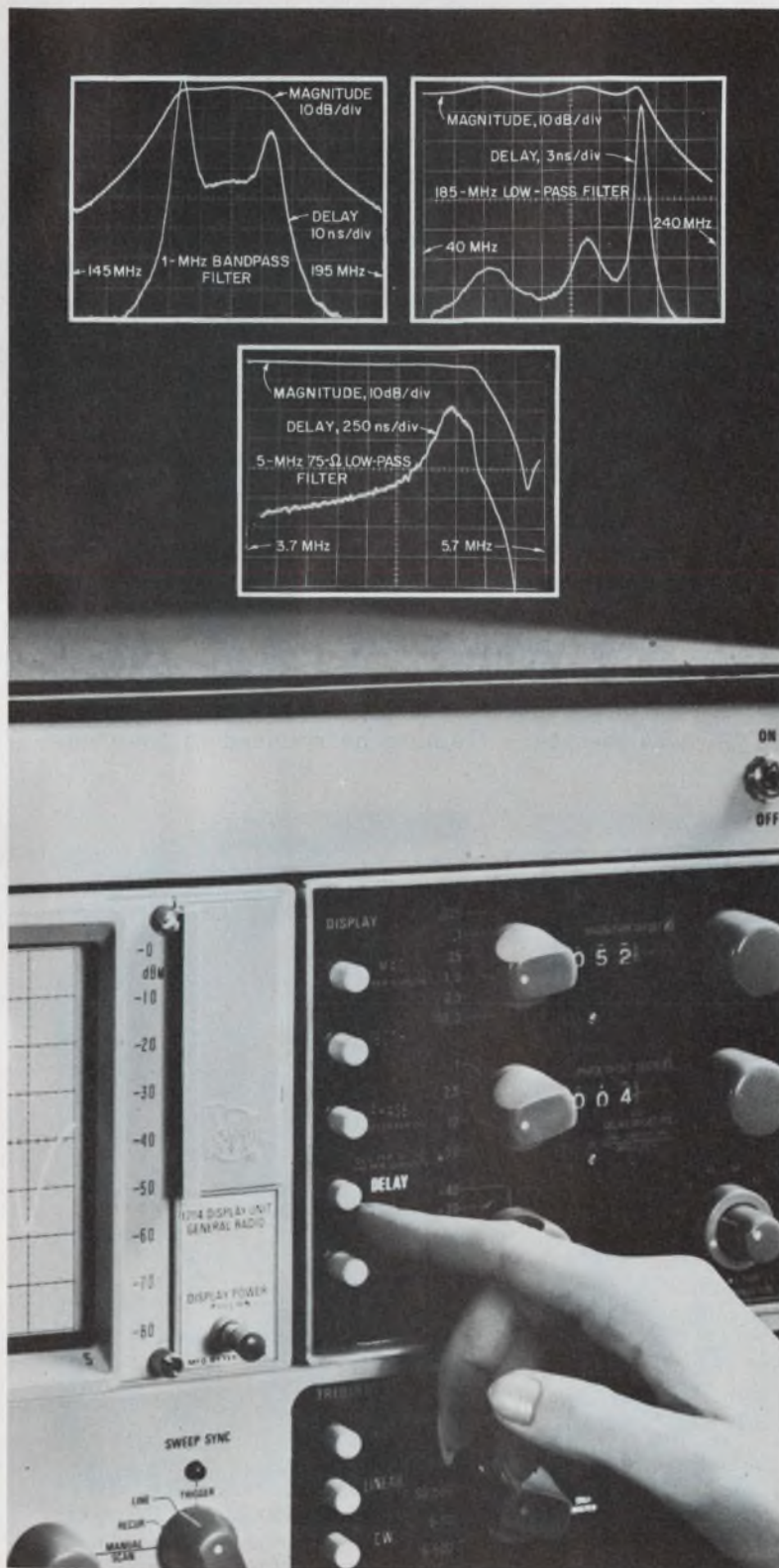

YOU may recognize group delay ($-\Delta\phi/\Delta\omega$) as a prime consideration, especially in the communications field (a non-uniform delay, for example, causes data-transfer errors in PCM systems and color distortion in TV systems).

YOU may also recognize group delay as something difficult and expensive to measure. Specialized equipment can measure it (but can do little else), some sweep-frequency analyzers can measure it (with a computer or over special frequency bands), or a manually tuned system can measure it (if you have a slide rule and plenty of time). Today, that's all changed.

YOU can now determine group delay simply, quickly, and inexpensively — a 295-dollar option to the GR 1710 RF Network Analyzer provides direct-reading group-delay measurements from nanoseconds to milliseconds over a frequency range of 400 kHz to 500 MHz.

YOU have to invest in a basic 1710 also, of course, but how could \$6850 be better spent? You'd have a compact system that provides measurements of nearly any transmission and reflection property and provides them from 400 kHz to 500 MHz with a 115-dB dynamic range and 0.005-dB resolution!

YOU should look into it.

 **General Radio**

NEW YORK (N.Y.) 212-964-2722, (N.J.) 201-791-8990 • BOSTON 617-446-0550
CHICAGO 312-992-0800 • WASHINGTON, D.C. 301-881-5333 • LOS ANGELES 714-540-9830
TORONTO 416-252-3395 • ZURICH (01) 55 24 20

GR COMPANIES • GRASON-STADLER • TIME/DATA • TECHWARE COMPUTING CORP.
GR ASSOCIATE • MICRONETIC SYSTEMS INC.

The ABC's of engineering management

in review, as told to us this year by eight men who made the successful transition from design bench to manager's desk.

Richard L. Turmail, Management Editor

- How do you get a promotion?
- How do you manage people?
- How do you make management decisions?
- How do you handle a project?

ELECTRONIC DESIGN asked engineering managers questions like these in a management series, "Challenges to the Engineer Who Manages." Since, according to reader response, the opinions of many of these managers were perceptive and helpful, we have compiled a review of their observations. Following are the opinions of eight of the managers on promotions, decision-making and the handling of people and projects.

Experience wins promotions

Unless you're heir to the family business or you marry the company president's daughter, you're not going to become a manager unless you have experience, knowledge and an ability to

manage people. Two kinds of experience are essential to promotions: the work experience and the training experience.

Rick Spofford, engineering manager of converter products at Analog Devices, Inc., Norwood, Mass., has worked as a designer, an applications engineer, a marketing engineer and a project engineer. He believes that this broad work experience has helped him get his present management spot, because it opened his mind to problems he might never have seen as an engineer.

"My years in marketing as an applications engineer," Spofford says, "have helped to broaden my background. If my career course had not included a couple of passes at marketing, my development as an engineering manager might have been slower."

On the other hand, Dick Moore, R&D manager at Hewlett-Packard, Loveland, Colo., says that one of the most important steps in his experience was the year's training he received in the com-



Dick Moore, R&D Manager, Hewlett-Packard, Loveland, Colo.



Herb Sobel, Lab Manager, Raytheon, Bedford, Mass.



Robert C. Wilson, President, Collins Radio Co., Dallas, Tex.



Rick Spofford, Manager of Converter Product Engineering, Analog Devices, Inc., Norwood, Mass.

pany's production department. He learned how all the gears of the departments meshed. He says that this training helped him make the transition from one management spot to another.

"Going from a design engineer to a group leader of from three to 10 people," Moore says, "isn't really too hard a transition. The next step when you're working through group leaders is tough; I think that a guy needs some kind of discontinuity in his work to grasp it."

Roger Cady, manager of PDP-11 computer engineering at Digital Equipment Corp., Maynard, Mass., explains: "A broad experience will give the engineer a breadth of knowledge of a product's function that no engineering spec could ever equal."

But Cady also believes that a good technical background helps an engineer advance. He says that some people want to become managers when they think they don't have it technically. "That's ironic," he says, "because a good engineering manager must be a good technical man."

Technical knowledge and an ability to get things done are cited by Ray Gerr, group leader at Ballantine Laboratories, as the main factors that led to his promotion. "I was a clean-up man," he says. "If a product didn't work, I cleaned it up by refining the design or by repositioning a resistor—or, as a last resort, by revising the specs."

Handling people the biggest challenge

As for managing people, four of the managers touched on the ways they do the job: by organizing, by inspiring, by inducing cooperation and by example.

"People-awareness are the two most important buzz words for an engineering manager to remember," Cady says, "because he works with people instead of things. My ability to work with people was the most important factor contributing to my promotion."

One of the ways Cady handles people is by



Robert W. Gress, Manager, Resistor Product Development, Corning Glass Works, Bradford, Pa.



Ray Gerr, Group Leader, Ballantine Laboratories, Boonton, N.J.

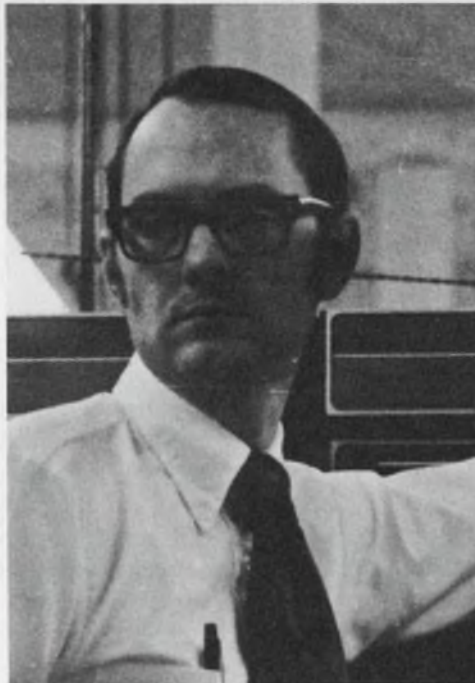

Roger Cady, Manager of PDP-11 Computer Engineering, Digital Equipment Corp., Maynard, Mass.



Howard Bogert, Engineering Vice President, Unicom, Cupertino, Calif.

asking them for 110% of their capacity and 120% of their knowledge on a project. He says that they realize then that they're going to have to learn something new before they can complete the job.

Gerr says that the best way he has found to manage engineers is to try to get them to work together as a team, to cooperate without being in competition with one another. "It's important to the success of my projects," he says, "for me to establish an atmosphere of trust and confidence. I want my people to know that they can ask questions without being called down for not knowing the answer.

Herb Sobel, laboratory manager at Raytheon, Bedford, Mass., says he tries to manage his people by example, by getting personally involved in a project. "I figure that an engineer is going to feel that if it's important enough for me to work on it, it's important enough for him to work on it," he says, adding that management methods should have enough flexibility to foster creativity. He believes that the electronics industry loses tremendous creativity by having too many controls on its people.

Spofford believes that a manager shouldn't feel that to motivate his people he must be more technically competent than any member of his staff. He says: "My strength as a manager is that I'm a catalyst; I can bring the experiences of engineers I've known together with the experiences of my staff and point out the differences and the similarities of the problems." Spofford also believes that an engineer's work should be varied, that he shouldn't be kept on any one product line for extended periods of time, even though he may be the most qualified for the product.

Decisions, decisions, always decisions

As the ad says, "No one can take the ultimate weight of decision off your shoulders," especially when you're a manager. But insight into decision-making can ease the burden. A successful decision-maker should be flexible, imaginative, informed and organized.

On flexibility, Spofford says: "One adjustment a new manager finds he must make is to take immediate action on whatever comes up, instead of deferring it for a couple of days as he could have done as an engineer."

On being imaginative, Gerr observes: "A manager is often forced to do what he was told never to do as an engineer—make a decision without having all the information to support it."

How important is being informed? Robert C. Wilson, president of the Collins Radio Co., Dallas, Tex., says: "Most engineers and managers are being called on every day to make decisions that require knowledge outside the realm

of engineering. The sooner they can apply a knowledge of business to their engineering decisions, the sooner they're going to get the unqualified support of corporate management."

And Moore says this about the need for a manager to be organized: "If I define properly what I'm going to engineer in the first place, then not only can I use design and production shortcuts that save me time, money and problems, but, I'll design a product that sells."

Pointers on projects

If you're a good decision-maker, your chances of running a successful project are pretty good. However, every project has its own peculiar set of problems. More than one project manager has lost his temper, and sometimes his confidence, worrying the product from design to production.

Here are four crucial phases of a project and what the managers have to say about them.

1. Design and prototyping phase.

Moore says: "Engineers tend to wring out their circuits and think the system will always come together easily. A model of the product is surer and will quickly reveal important system parameters. Keep the initial design group small in number. A large group is like a turning flywheel, which is hard to move into a new direction."

Howard Bogert, engineering vice president of Unicom, Cupertino, Calif., says: "If your entire manufacturing operation is out of house, you must anticipate the builder's problems and questions before you send him the design. It means that your engineers have to learn to be inter-disciplinarians; they're responsible for a number of functions that are usually handled by a variety of departments in an in-house operation."

2. Sudden problems.

Sobel says: "If I didn't have some kind of staff group that I could motivate quickly to handle sudden problems, I'd probably lose a year or more in getting some projects started."

3. The moment of truth.

Gerr says: "To be or not to be—that is the project question." He shares the answer with the marketing department. "When a project runs too long," Gerr observes, "my decision to keep it running depends on whether or not I think the product can still be produced inexpensively enough to make a profit for the company."

4. Product acceptance.

Robert W. Gress, manager of resistor product development at the Corning Glass Works, Bradford, Pa., says: "Before manufacturing can accept our new products for processing, we have to provide both the design and a manufacturing method. We must also sell our new programs to our marketing force, which in turn guides us as to what will sell in the marketplace." ■■

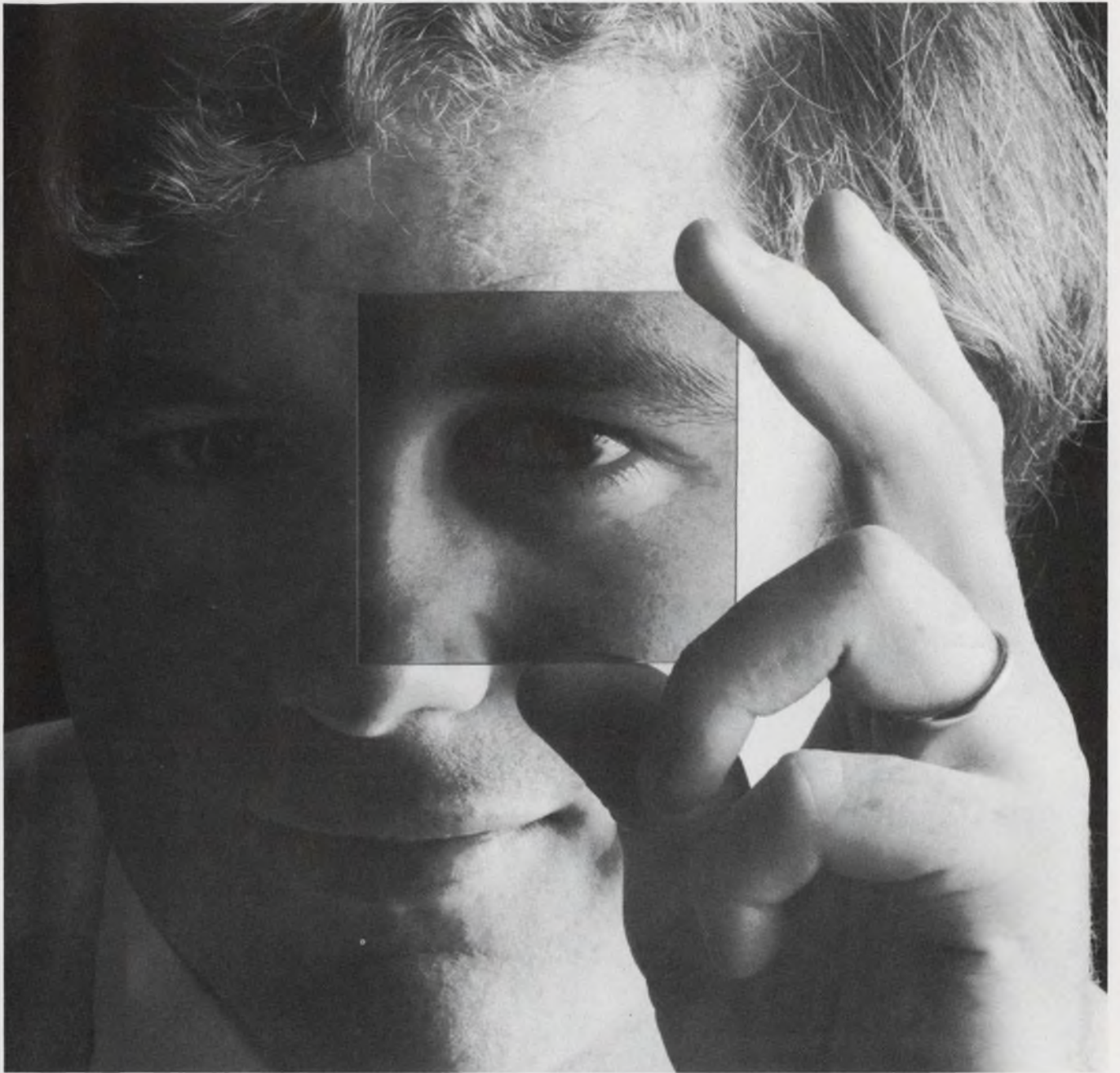

The iron mask may be just what you've been looking for ...Corning makes it

DUR-COR™ mask blanks are durable. They have a hard, iron oxide surface with low UV reflectance. You get reliable quality in a transparent photoplate, with resolution that can solve your most complex circuit design problems.

Call Jerry Child, project engineer, for details about DUR-COR photoplates.

Corning makes plenty of other materials for processing IC's. Such as quartz crucibles for silicon production; polished or as-drawn substrates for thin film deposition; and glass micro-sheet in a range of sizes.

Call Bryan Lanahan, engineering specialist, for information about these or other specialized glass products for producing IC's.

To call Jerry or Bryan, use our direct BUZZ LINE. Phone (607) 962-6836.

Electronic Materials Dept. A
CORNING
CORNING GLASS WORKS
Corning, N. Y. 14830



INFORMATION RETRIEVAL NUMBER 41



GROWBAR
FUSE

LINE ~ 104-127V
48.63 ~
200V MAX
FUSE
30A
250V

+S
+
-
ACG
AC



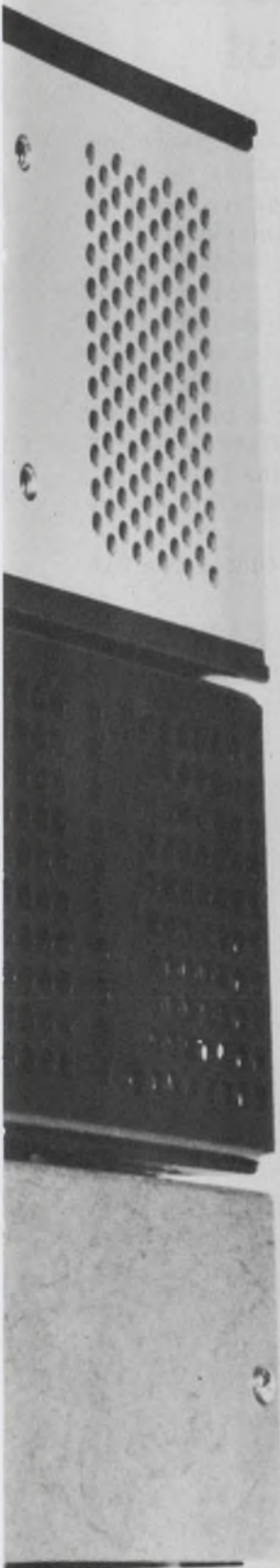

$\frac{1}{2}$ the volume $\frac{1}{4}$ the weight $\frac{1}{4}$ the heat

Third generation modular power supplies — at competitive prices.

The little one on the bottom delivers 33% more power than the middle one and 50% more power than the top one — all at 40°C ambient.

Here are all the particulars:

Series 650A — High Density Switching Regulator Power Supplies

Output: 5VDC/12Amp (Model 650A05)

Input: 100-130VAC, 47-500Hz; or 148-180VDC. For 198-264VAC input, substitute suffix E for suffix A.

Voltage Regulation: For any combination of line and load change: 0.2%.

Temperature Regulation: 0.005% / °C over the operating temperature range.

Operating Temperature Range, Free Air Convection: -20°C to +40°C (12A), +50°C (10A), +71°C (8A).

Output Noise: \leq 50MV P-P (Total)

Protection:

Overcurrent: Current limit type.

Overvoltage: SCR crowbar type automatic recovery.

Crowbar capacity: 50A peak. Factory set at 6.5V nominal.

Efficiency: 55% typical.

Remote On-Off Control: +5V \pm 2V (T²L) applied to "On-Off" terminal will reduce output to: \leq 1.5V in 10 μ sec, 0V in 500 μ sec.

Size: Overall, 2.5" x 4.88" x 7.8".

Weight: 3.25 lbs.

Price: \$200 each, FOB, Plainview, Long Island, N.Y.

For more information write to Trio Laboratories, Inc., 80 DuPont Street, Plainview, L.I., New York 11803. Phone: (516) 681-0400, TWX: 510-221-1861. Europe: Trio Laboratories Ltd., Woking, Surrey, U.K. Phone: 65834. Telex: 85225.

Logarithmic-feedback zero-crossing detector features wide input range and TTL output

The high frequency response and good dc characteristics of monolithic transistor arrays act to increase the range of a fast logarithmic-feedback zero-crossing detector. The circuit, with the component values shown in the diagram, works over a 50-dB range of input variation.

The CA3018 array, used as a "mini op amp," has a TTL-compatible output drive. Transistors Q_1 and Q_2 are a differential input pair, with Q_2 loaded by resistor R_6 . Transistor Q_3 acts as an output emitter follower. Resistor R_5 is bootstrapped to zener-connected Q_1 , enabling the single stage of amplification to provide more than 50 dB of voltage gain.

Negative feedback through diodes CR_1 - CR_4 ,

constrains the peak output limits to \pm twice the forward voltage drop per diode about the TTL transition region of 1.4 V. The negative feedback and the logarithmic variation of the output voltage with increasing signal input voltage allow the wide range of input variation. Positive feedback through resistor R_5 causes the circuit to have a defined lower threshold and a snap-action transition, allowing noise-free zero-axis detection. Phase control of the axis crossing is provided by resistor R_2 , which offsets the voltage center of the input transition by varying the bias on Q_2 .

Walter G. Jung, 1946 Pleasantville Rd., Forest Hill, Md. 21050.

CIRCLE NO. 311

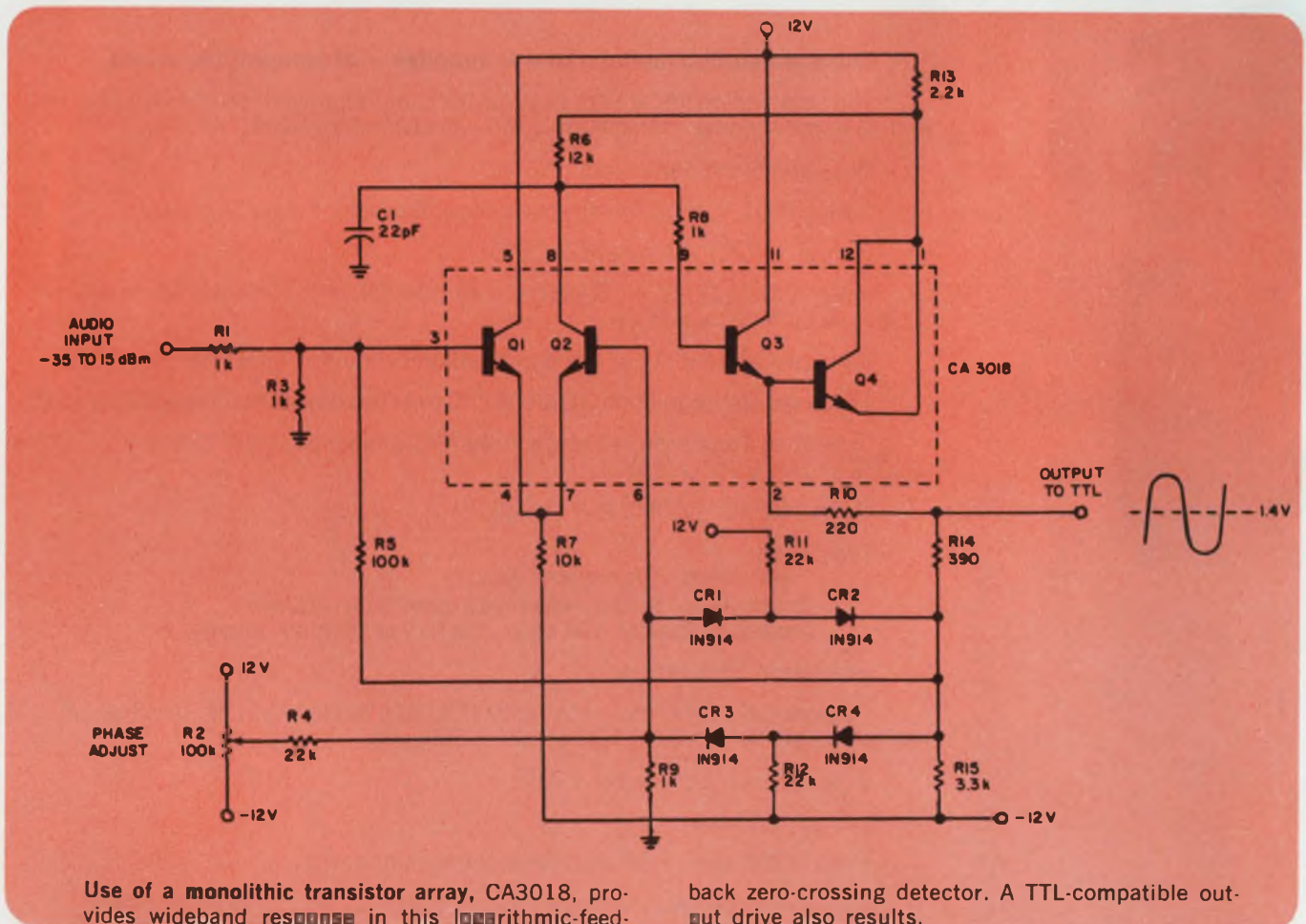

Use of a monolithic transistor array, CA3018, provides wideband response in this logarithmic-feed-

back zero-crossing detector. A TTL-compatible output drive also results.

Chip

off the old breadboard.



RCA put 1,238 devices on a 150 mil COS/MOS chip. What are your LSI requirements ?

The move is toward LSI. And RCA is ready now to develop custom COS/MOS circuits to your most demanding requirements.

For example, the 149 x 150 mil timing circuit above was integrated from a breadboard containing 1,238 discrete devices. Just one of many custom chips designed with RCA's unique silicon interconnect process to provide high packaging density.

RCA maintains a staff of systems engineers who are experienced in the

development of complex micropower arrays. They are backed by extensive facilities to speed the process of IC design and development.

These facilities consist of computers for logic simulation, artwork digitizer-plotter systems that can cut turn-around time by 33% in typical circuits, Mann Pattern Generator facilities to speed mask preparation, and Teradyne Model J-283 digital IC systems which functionally evaluate complex arrays.

Put RCA's COS/MOS team to

work to help reduce package count, cut assembly costs, and achieve excellent cost effectiveness in your systems.

When it comes to COS/MOS LSI, come to RCA.

Contact your local RCA Representative or RCA Distributor, or write RCA Solid State Division, Section 57K-9, Box 3200, Somerville, New Jersey 08876.

RCA Solid State
products that make products pay off

International: RCA, Sunbury-on-Thames, U. K., or Fuji Building, 7-4 Kasumigaseki, 3-Chome, Chiyoda-Ku, Tokyo, Japan. In Canada: RCA Limited, Ste. Anne de Bellevue 810, Canada.

INFORMATION RETRIEVAL NUMBER 44

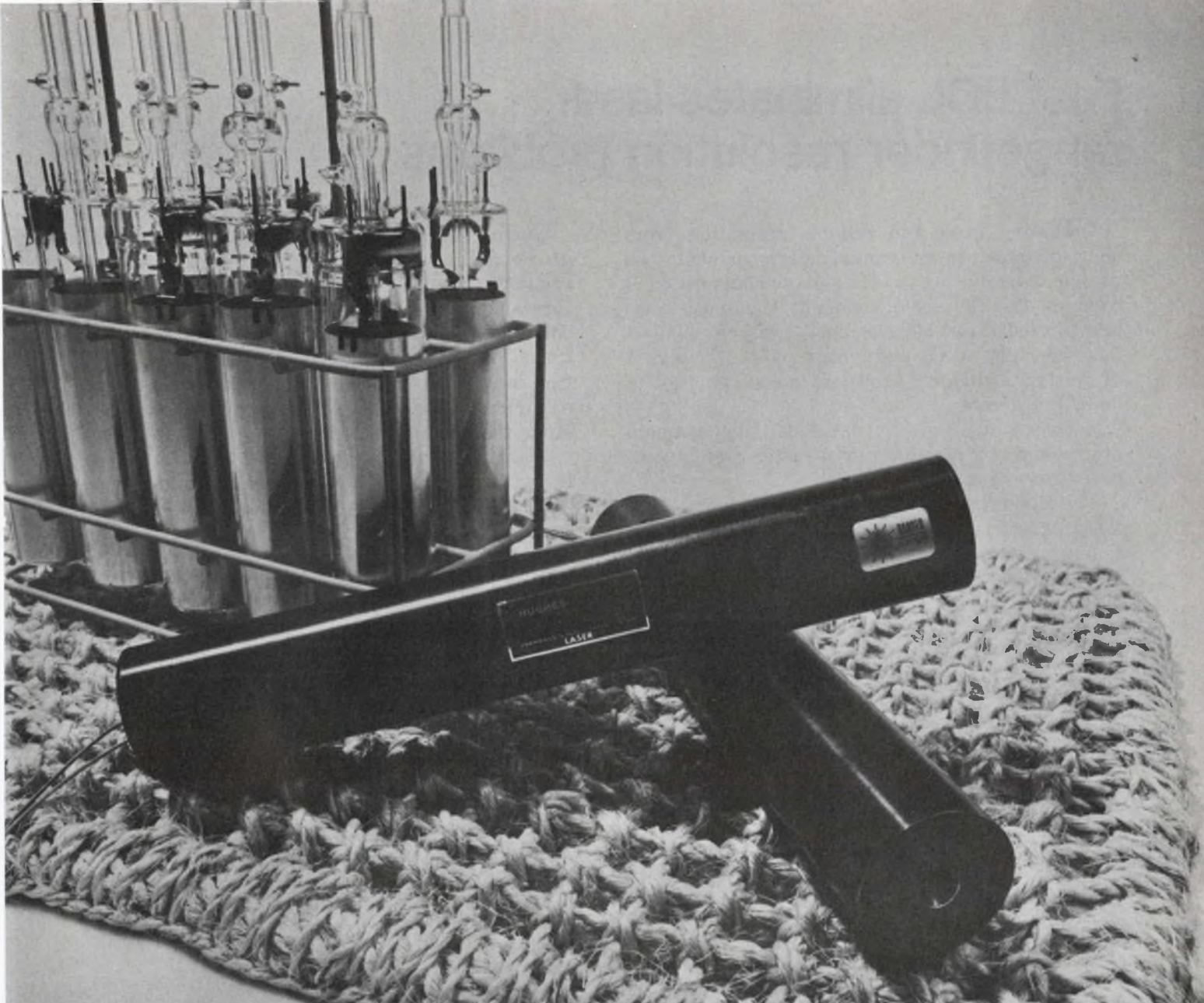

The low-fat lasers. Now they come in rugged new packages, too.

We already streamlined the product, giving you all the minimum daily OEM requirements at a low, fat-free price.

Now we've gone to work on the packaging.

We've encased our bare-bottle helium-neon lasers in cylindrical metal packages and added them to our line of low-fat lasers.

The new models offer one or two milliwatts of polarized or unpolarized output power. They come with flying leads

and an internal ballast resistor and have the output beam precision aligned with the 10½" package.

We've built unusual tube ruggedness into these new models. With package construction that allows the lasers to be used in systems without worrying about high-voltage exposure or mounting directly to a glass surface.

These units come at low-calorie prices, too. Available in minimum quantity of 10, from \$139.95* each and from \$99.95* a

unit in lots of one thousand. With them, you get an 18-month, no-hour limit OEM warranty.

Bottle-only lasers or packaged lasers. Hughes gives you the best of both, along with delightfully slim pricing.

For complete information, write:
3100 W. Lomita Blvd., Torrance, CA 90509.

*U.S.A. and Canada

HUGHES

HUGHES AIRCRAFT COMPANY
ELECTRON DYNAMICS DIVISION

FREE SAMPLES: IF YOU'RE AN OEM MAKING EQUIPMENT THAT COULD USE LOW-FAT LASERS IN QUANTITY, WE'LL GIVE YOU ONE. CALL DICK ROEMER: (213) 534-2121.

Fast ECL eliminates laser rangefinder resolution problems

Obtaining good and reliable resolution from short-distance laser rangefinders presents no problem when a MECL III voltage comparator is used as the threshold element. The most commonly used threshold element—a tunnel diode—has the right speed and sensitivity, but because of its low switching levels, rf noise can lead to detection errors.

A laser rangefinder with an MC 1650 comparator achieves a resolution of 1 meter over a nominal range of 1 km.

The rangefinder uses a 1 MW peak power Nd:YAG pulsed laser, an avalanche photodiode with a temperature-regulated biasing power supply, and a wideband amplifier between the photodiode and the comparator. Since the laser beam travels a meter in 6.673160 ns at standard temperature and pressure, a pulse repetition frequency of 149.89625 MHz should be used to get resolution of 1 meter.

The "main bang detector" samples a part of the outgoing laser beam and starts the range counter. The reflected beam, focused by the collection optics onto the silicon avalanche photodiode, provides a stop pulse. The counter uses MECL III logic for the first decade and MECL II and DTL logic for the later stages. The counter output is in BCD, ready for the LED readout, which displays the range in meters.

One of the most critical parts is the front end of the receiver—the circuit that stops the range counter. For 1-m resolution, the rise time of the threshold element should be around 1 or 2 ns. The MC 1650 comparator exhibits a 1.5-ns rise time. The comparator has a differential-amplifier input that makes it less sensitive to common-mode disturbances than tunnel diodes and other threshold detectors.

When the laser is pulsed, energy is transferred from the storage capacitor to the laser flash lamp. The firing of the flash lamp involves very high peak currents, resulting in electromagnetic noise strong enough to switch any low-voltage logic circuits close to the lamp.

To overcome this problem, the range counter should be reset after the flash lamp fires—but before transmission of the laser beam. Then whatever happens to the range counter when the flash lamp fires has no influence on ranging performance. The delay between the firings of the flash lamp and the Q-switch in the laser is about 150 μ s. The range counter should thus be reset about 100 μ s after the flash lamp fires.

This work was performed while the author was with Holobeam Inc., Paramus, N.J.

Mordehai Shmaia, State of Israel, Ministry of Defense, Armament Development Authority, P.O. Box 7063, Tel Aviv, Israel. CIRCLE NO. 313

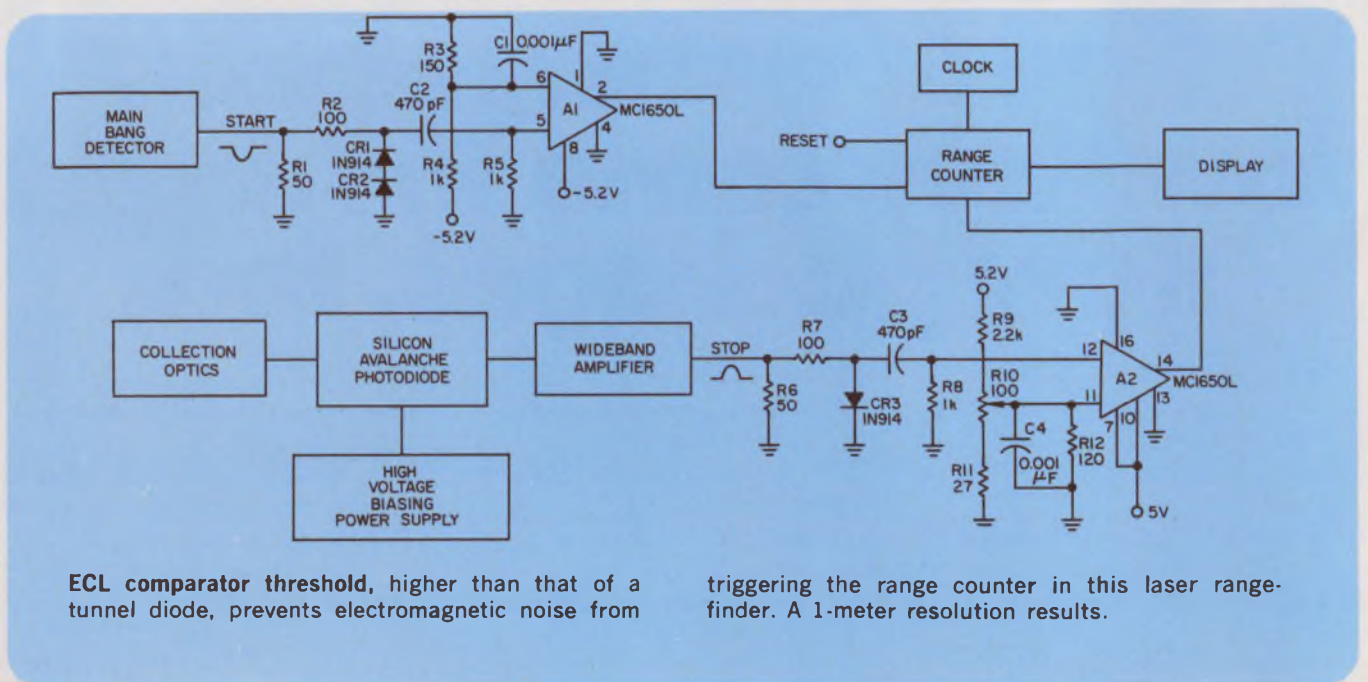

ECL comparator threshold, higher than that of a tunnel diode, prevents electromagnetic noise from

triggering the range counter in this laser rangefinder. A 1-meter resolution results.

New Stackpole keyboard: Typewriter feel and speed/ n-key roll accuracy without electronic network

New Stackpole/Magsat™ electronic keyboard with remarkable Magsat mechanical keyswitch offers *new economy* and features not available before in high thru-put keyboards.

- ⊕ Tactile/audible feedback and platform feel let typist switch to data entry with no special training, no decrease in speed or accuracy.
- ⊕ n-key rollover is achieved directly in the switch, not in an electronic network. Once operator initiates action, a one millisecond, one shot contact closure isolates the electronic output from the operator, achieving true by-pass. Key release time has no effect on order of data entry.
- ⊕ Static encoding provides greater economy, eliminates costly RFI problems and time dependency of scanners. Unprecedented coding flexibility is achieved with a unique and simplified p.c. board interconnection technique.
- ⊕ Less space and no stand-by power are needed. Sensitivity to frequency, temperature, and humidity is eliminated.

Any number of keys and formats are available to meet your quality, high thru-put keyboard needs. Bulletin 77-101 tells all.
Stackpole Components Company, P.O. Box 14466,
Raleigh, N.C. 27610. Phone 919-828-6201.



Designed with the operator in mind

Charge pump circuit eliminates bias supply for NMOS devices

A charge-pump technique replaces the required -2-V back-bias supply for NMOS devices, reducing circuit cost and enhancing those applications that are hindered by additional power supplies.

The circuit of Fig. 1 oscillates at 330 kHz (with capacitor $C_1 = 0.001 \mu\text{F}$) supplying bias voltages up to 3 mA at -2 V . This technique encourages the use of NMOS devices, emphasizing their ease of interfacing as a result of TTL/DTL compatibility.

To determine a suitable output current and load resistance, add up the maximum back-bias leakage currents of the NMOS devices. Then use a dc current (Fig. 2) of 10 times the calculated value. This current flows through the resistive divider $R_1\text{-}R_2$ to produce the required bias voltage.

age.

For example, a system using N-channel shift registers and a character generator has leakage currents totaling $100 \mu\text{A}$ with a bias supply specified as $-2\text{ V} \pm 20\%$. The resistive divider is chosen to draw 1 mA while dividing the supply from 2.5 V down to 2.0 V. Thus resistor $R_1 = 500 \Omega$ and $R_2 = 2\text{ k}\Omega$.

The bias supply of Fig. 1 has about 50-mV ripple. Although this does not affect the operation of NMOS devices, filter capacitor C_1 can be increased if less ripple is desired.

Bud Broeker, Motorola Semiconductor Products Inc., 5005 E. McDowell Rd., Phoenix, Ariz. 85008.

CIRCLE NO. 314

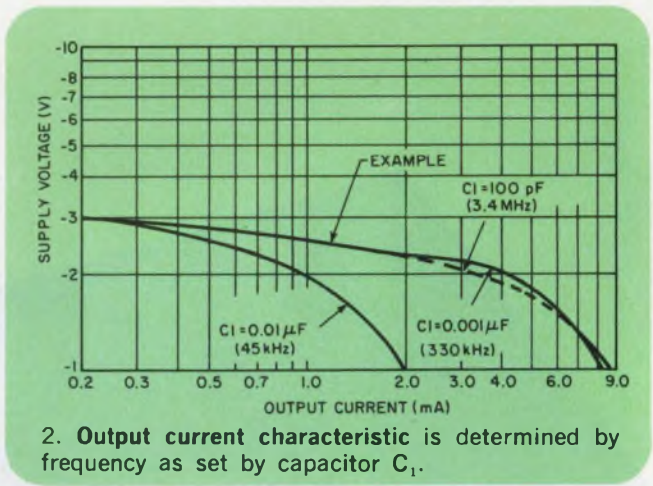
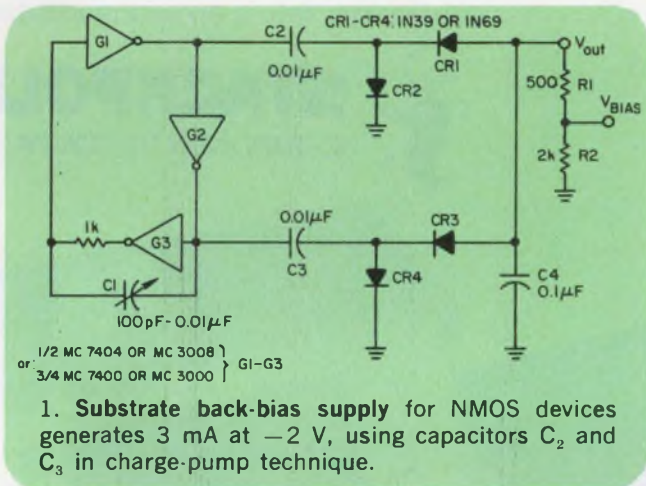

IFD Winner for July 6, 1972

Don Gazzano, Ampex Corp., 401 Broadway, Redwood City, Calif. 94063. His idea "Modified reed switch acts as overload current sensor" has been voted the Most Valuable of Issue award.

Vote for the Best Idea in this issue.

SEND US YOUR IDEAS FOR DESIGN. You may win a grand total of \$1050 (cash)! Here's how. Submit your IFD describing a new or important circuit or design technique, the clever use of new component or test equipment, packaging tips, cost-saving ideas to our Ideas for Design editor. Ideas can only be considered for publication if they are submitted exclusively to ELECTRONIC DESIGN. You will receive \$20 for each published idea, \$30 more if it is voted best of issue by our readers. The best-of-issue winners become eligible for the Idea of the Year award of \$1000.

ELECTRONIC DESIGN cannot assume responsibility for circuits shown nor represent freedom from patent infringement.

THE GOOD, THE DENSE & THE SPEEDY.

Whether you need a good, dense static shift register, a good, speedy dynamic shift register or a good title for a low-budget "spaghetti" western, we've got you covered.

Good & Dense.

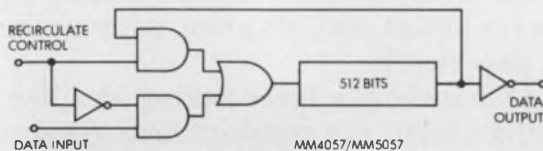

Our new MM4055/MM5055 family is a series of 512-bit silicon gate static shift registers featuring on-chip clock and recirculate logic, 2.2MHz maximum guaranteed operating frequency and TTL compatibility.

The MM4055/MM5055 has a 128 x 4 configuration. The MM4056/MM5056 has 256 x 2. While the MM4057/MM5057 is configured 512 x 1 in an 8-pin mini-dip for extremely high board density.

Good & Speedy.

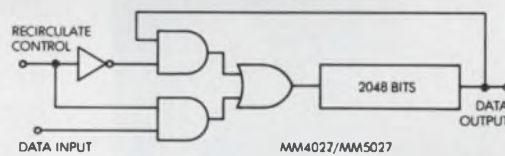

Our new silicon gate dynamic shift register, the MM4027/MM5027, is something else. 6 MHz maximum guaranteed data rate. 2048 x 1 configuration. On-chip recirculate logic. 8-pin mini-dip.

If you prefer, we've also got a 16-pin version (MM4025/MM5025) and a 10-pin version (MM4026/MM5026), both configured 1024 x 2.

We could go on and on. But suffice it to say, if you need some great shift registers, some great shift registers are what we've got.

National Semiconductor Corporation,
2900 Semiconductor Drive,
Santa Clara, California 95051.

Write us today. Better yet, call us at (408) 732-5000.

NATIONAL

Scottsdale, Ariz. (602) 945-8473	Mountain View, Calif. (415) 961-4740	Sherman Oaks, Calif. (213) 783-8272	Miami, Florida (305) 446-8309	Chicago, Illinois (312) 693-2660	Indianapolis, Ind. (317) 255-5822	Lenexa, Kansas (816) 358-8102
Burlington, Mass. (617) 273-1350	Glen Burnie, Md. (301) 760-5220	Farmington, Mich. (313) 477-0400	Englewood Cliffs, N.J. (201) 871-4410	Syracuse, N.Y. (315) 455-5858	Cleveland, Ohio (216) 961-5300	Beaverton, Oregon (503) 643-5445
						Dallas, Texas (214) 233-6801

Get the designer's edge.



At Sylvania, we make it our business to stay a step or two ahead of competition. Our customers like it that way because it helps them be more competitive in the marketplace too. Here's how:

The combined buying edge—Our expansion into the miniature lamp business actually helps you hold down purchasing headaches and costs. For one thing, there's no selection compromise, ever, because we now offer a complete array of miniature, sub-miniature and micro-miniature lamps *in addition to* our comprehensive line of T-2 lamps, pilot housings and associated hardware. With over 1000 styles, you can choose from the broadest line around... combine your P.O.'s for lowest possible price, without the extra paperwork.

The creative edge—We've never seen one, but what about a space-saving idea like a lamp that incorporates an IC in its base, or using a lamp as a constant heat generator. Go on and innovate; we'll help your good ideas get off the drawing board with more product versatility than any other single source can offer. And with Sylvania quality, you get a performance plus that gets your designs off to the best possible start... and the most reliably profitable future.

The delivery edge—You not only get more from Sylvania, you can bank on getting it fast. That's another way our broad-based production/distribution operation works to your advantage. And when you're working against time to get the edge on your competition, every advantage counts. So get all the advantages. Get with Sylvania now.

**ONE SOURCE,
ONE CATALOG.**



GET THE EDGE. Send for our

28-page illustrated color catalog packed with complete engineering/ordering information.

Sylvania Miniature Lighting Products Inc.
526 Elm St., Kearny, N.J. 07032 (201) 997-1850.

SYLVANIA

INFORMATION RETRIEVAL NUMBER 47

new products

Programmable transmitter is asynchronous or synchronous

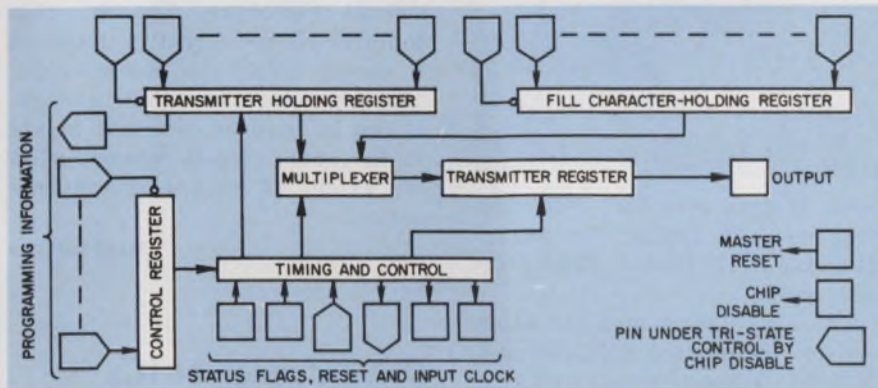

Western Digital Corp., 19242 Red Hill Ave., Newport Beach, Calif. 92663. (714) 557-3550. See text; 4 wks.

With the sudden popularity of universal asynchronous receiver/transmitter integrated circuits for data communications, the mixing of asynchronous and synchronous transmission in the same modem circuit has become a new frontier. Motorola was the first to address this problem with its MC2257 asynchronous/synchronous transmitter and MC2259 asynchronous/synchronous receiver.

Western Digital is now introducing a pair of circuits that surpass the Motorola circuits in capability, but substantially exceed them in price. Among the added or improved capabilities are internal programmability, full TTL compatibility, speed, word length and tri-state outputs.

Called the PT1482A transmitter (see diagram) and PR1482A receiver, the circuits are produced with silicon-gate MOS technology. An internal control register in each makes programming possible. An eight-bit word presented to the control register selects the following:

- Mode: Synchronous at up to 640 kHz down to dc. Asynchronous at up to 640 kbauds down to dc. Isochronous, with the same range of data rates as asynchronous operation but allowing transmission of asynchronous data over synchro-

nous equipment and lines.

- Clock: Choice of 1, 16, 32 or 64 times the 640-kHz transmitter clock.

- Word length: 5, 6, 7, or 8 bits plus odd, even or no parity.

- Stop bit length: 1 or 2 bits in the asynchronous mode.

Three registers in addition to the control register are included in the transmitter. They include a data register for holding the data word to be transmitted, a fill holding register for holding a sync word that is inserted into the data stream when no input data are in the data register, and a transmitter register for outputting the data as a serial bit stream.

The receiver also has three additional registers. They include a receiver register for accepting the serial input data, a holding register for outputting the data on up to nine parallel lines and a match register for identifying sync words transmitted by the transmitter.

Both circuits require power-supply voltages of +5 V, -12 V and ground.

The ICs can stand 0 to 70 C temperatures, and they come in a hermetic ceramic dual-in-line package.

Pricing on the PT1482A in 100 quantities is \$21.70. The PR1482A in the same quantities costs \$26.05. By comparison, the Motorola transmitter sells for \$9 and the receiver for \$10.75 in 100 quantities.

For Western Digital **CIRCLE NO. 251**
For Motorola **CIRCLE NO. 252**

Dual channel audio amp supplies 2 W

National Semiconductor Corp., 2900 Semiconductor Dr., Santa Clara, Calif. 95051. (408) 723-5000. \$3.95 (100 up); stock.

A dual audio amp IC, called the LM377, provides up to 2 W of continuous rms power into an 8-Ω load on each of its channels. Complete short circuit and thermal limiting is provided on the chip. Other features include an input impedance of >10 MΩ, gain of 100 dB, distortion only 0.5% at 1 kHz and power bandwidth of 65 kHz. The supply voltage is 18 V dc.

CIRCLE NO. 253

Calculator chip handles over 20 digits

General Instrument Corp., 600 W. John St., Hicksville, N.Y. 11802. (516) 733-3000.

A one-chip MOS calculator, called the C-500, handles numbers in excess of 20 digits while maintaining eight-digit accuracy. The unit features four function operation, constant in all four modes, chain operations and power calculations. A minus sign is used to indicate negative numbers. The new calculator stores exponents in the range 10^{-20} to 10^{+79} and will compute accurately any answer within that range without overflow.

CIRCLE NO. 254

741-type op amp is four times faster

Intersil, Inc., 10900 N. Tantau Ave., Cupertino, Calif. 95014. (408) 257-5450.

A high-speed version of the 741 op amp, named the 741HS, has a slew rate that's four times faster than the standard 741, plus improved input offset (I_{OS}) and input bias (I_b) currents. The military version of the 741HS has a slew rate of 0.7 V/μs, I_{OS} of 20 nA and I_b of 0.1 μA; the standard 741 has corresponding values of 0.2 V/μs, 300 nA and 1.5 μA, respectively.

CIRCLE NO. 255

Look at the shape our filters are in!



GROUP DELAY RESPONSE

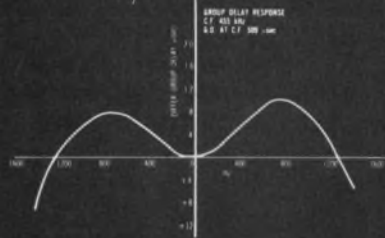

Designed for data transmission, Bulova has a line of group delay crystal filters that offer perfect phase linearity for optimum transmission conditions. Overshoot capable of being kept to 40 db (1%) below the steady state value — designs are so configured as to provide distortion-free selectivity at maximum speed, with a reduced error rate.

Bits or Bytes, Bulova has a complete capability to meet your data transmission specifications from 4KHz to 150MHz. For the latest information on our line of Crystal Filters, call (212) 335-6000, see EEM Section 2300, or write



BULOVA
FREQUENCY
CONTROL PRODUCTS

Electronics Div. of Bulova Watch Co., Inc.
61-20 Woodside Ave., Woodside, N.Y. 11377

ICs & SEMICONDUCTORS

Sense amp/line receiver good for 1103 RAM

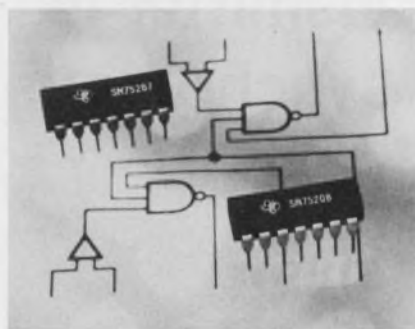

Texas Instruments Inc., P.O. Box 5012, M/S 308, Dallas, Tex. 75222. (214) 238-3741. Plastic, \$4.26 (100 up); stock.

A dual MOS sense amp and a line receiver—designated SN75207 and SN75208, respectively—replace the SN75107 and SN75108 and are ideal for 1103 MOS RAM applications. These devices' tight input sensitivity (± 10 mV) permit faster memory cycles and also make the ICs well-suited for line receiver applications by allowing use of longer transmission line lengths. The SN75207 features a TTL-compatible pull-up output while the SN75208 has an open collector output that permits wire-OR logic connections with similar output configurations.

CIRCLE NO. 256

Radio receiver ICs cover AM/FM bands

N. V. Philips, P.O. Box 523, Eindhoven, The Netherlands.

Three ICs for radio receivers, designated the TBA690, TBA700 and TBA570, cover both the AM and FM bands to 30 MHz. The TBA690, with an output power rating of 0.6 W, and the TBA700, with 1 W, have a supply voltage range from 2.7 V to 12 V; these are intended for operation with batteries. In addition to the class-B output stage, each IC incorporates a driver, preamp, two-stage i-f amp, agc and a stabilized bias circuit. The TBA570 is a general-purpose IC for both battery and main line operation. All active functions are integrated except the FM detector and the output stage.

CIRCLE NO. 257

4-channel decoder available on a chip

Electro-Voice, Inc., 600 Cecil St., Buchanan, Mich. 49107. (616) 695-6831.

A four-channel decoder IC chip accurately decodes all existing matrix systems, including E-V STERO-4 and CBS SQ, without manual switching. The IC chip contains all the circuitry required to decode except the power supply and a simple phase-shift network. It can be used at different points in the audio circuit depending on the extent of control vs economy desired.

CIRCLE NO. 258

Driver/receiver ICs replace standard types

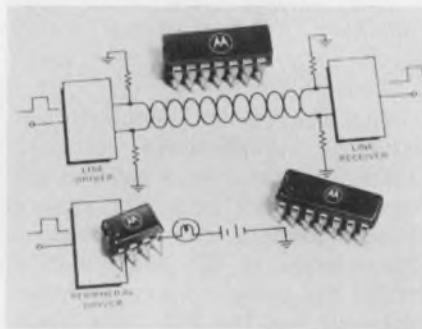

Motorola Semiconductor Products, P.O. Box 20912, Phoenix, Ariz. 85036. (602) 273-3466. MC55107L and MC55108L: \$4.80; MC55109L and MC55110L: \$5.15; MC75109P and MC75110P: \$2.80; MC75450P: \$1.40; MC75451P: \$1.05 (100 up).

Six driver/receiver ICs are pin-for-pin replacements for the industry standard 55107-110 and 75450-51 types. Two are dual line receivers—the MC55107, which features an active pull up and the MC55108, which uses open collector outputs. Two others are dual line drivers—the MC55109-110. The MC55109 switches a 6-mA current sink to either of two output terminals in response to the input logic conditions. The MC55110 sinks 12 mA. Both ICs provide a pair of inhibit inputs to disable the output currents and allow multiple drivers to share a pair of lines in party-line systems. The MC75450 and MC75451 are dual line peripheral drivers that may be used to interface TTL and DTL logic inputs.

CIRCLE NO. 259

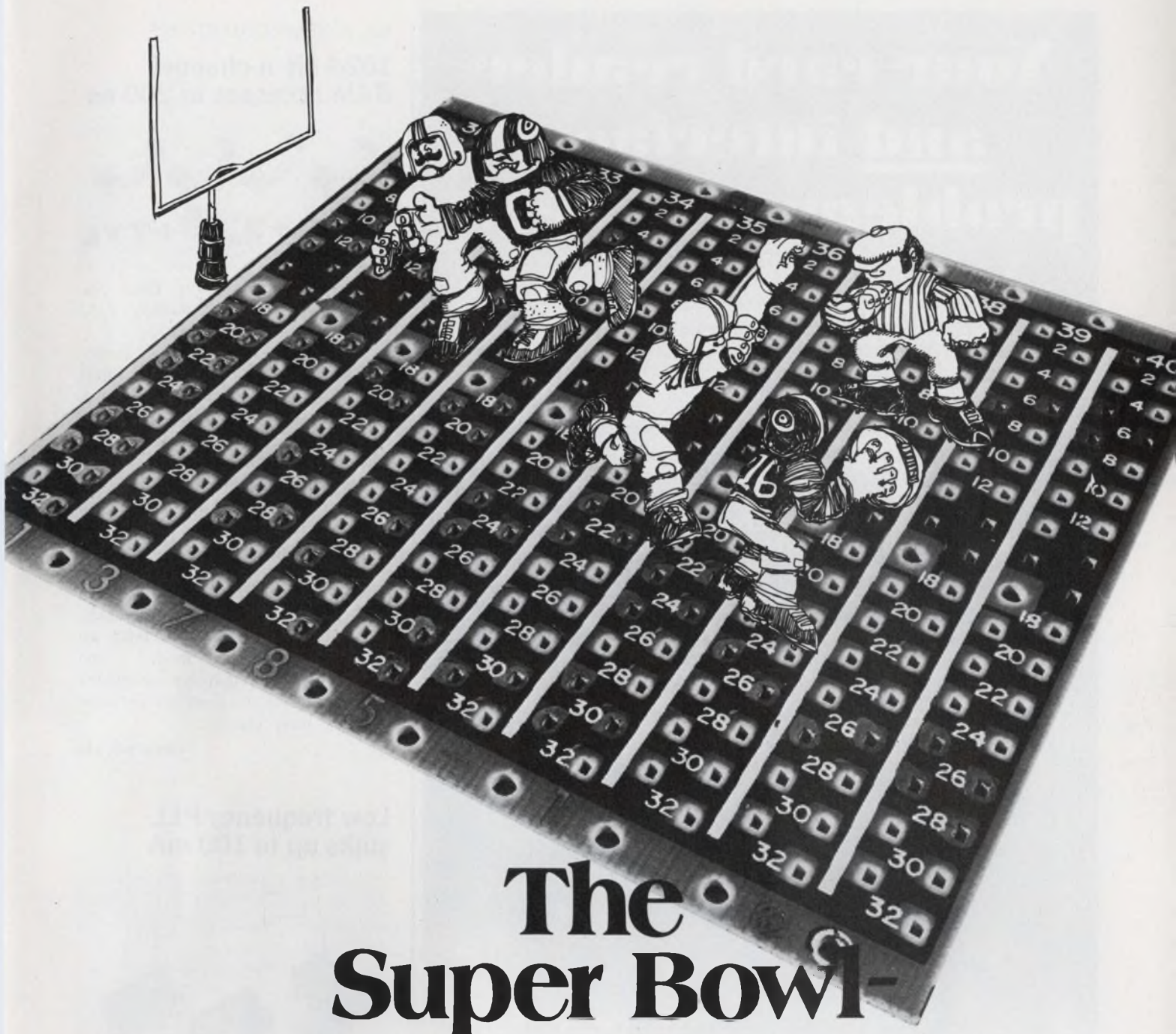

The Super Bowl at ACD

Pause for a moment. Then focus your imagination on the split end. The second effort man. He'll get downfield and snag the pass for those important fourth quarter yards.

Imagination—yes. But at ACD we've got imagination plus a whole houseful of second effort people. True, they've never been asked to build a board that looks like a football game;

but when they do, you can be sure it'll be worthy of the Super Bowl. Because at ACD no matter what the assignment—from art to delivery, from single-sided to multi-layer—we build the best.

Need professional help? Test us. Give us a fourth quarter situation with no time-outs and watch our second effort score for you.



ADVANCED CIRCUITRY

4811 West Kearney Street, Springfield, Missouri 65803, (417) 862-0751

INFORMATION RETRIEVAL NUMBER 49

Your card reader and interface problems end here.

Hickok designs static card readers with the user in mind. Starting with two rugged, reliable, economical models, we tailor the reader you need for use in programming system control and data collection.

You also receive the help you need. You select among a variety of electronic packages to interface the reader to your system. Packages like TTL-compatible scanners with two operating modes, sequential scanning and addressable by column number.

Reliability is built into Hickok readers with the multistrand continuous brush design. This technique eliminates errors caused by contaminants on the card and allows reading even of cards punched out of tolerance.

This design also saves you money, because it's easier to make. Even in single lots, the 264A Badge Reader is only \$175, and the 960A Card Reader, \$495.

When you're considering static card readers, call Hickok. We have the right unit at the right price for you.

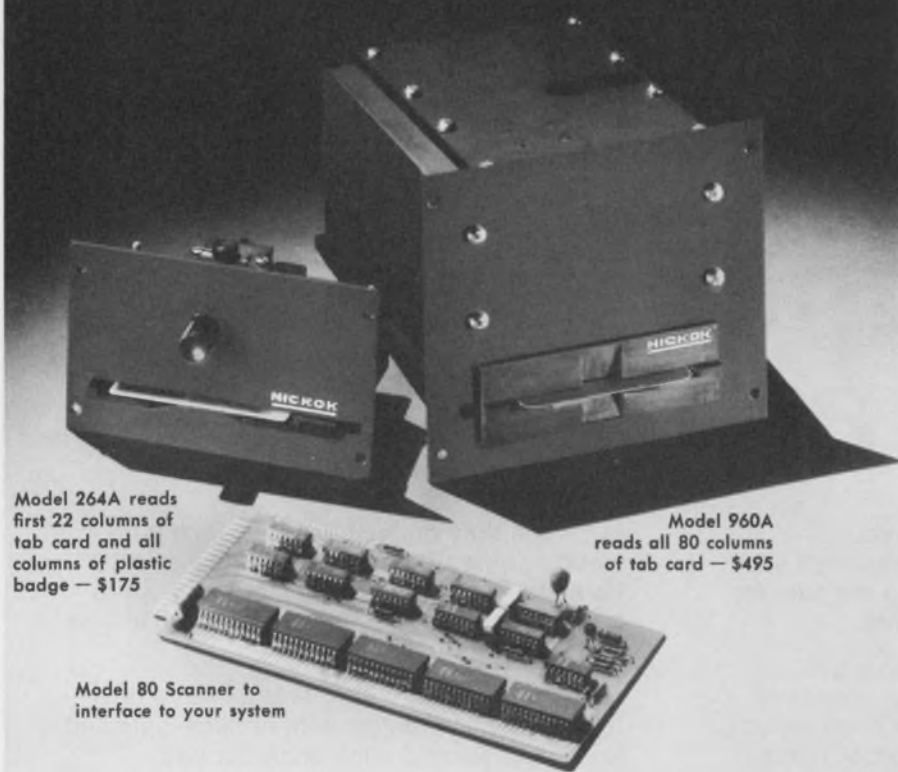

Model 264A reads first 22 columns of tab card and all columns of plastic badge — \$175

Model 960A reads all 80 columns of tab card — \$495

Model 80 Scanner to interface to your system

HICKOK
the value innovator

Instrumentation & Controls Division
The Hickok Electrical Instrument Co.
10514 Dupont Ave. • Cleveland, Ohio 44108
(216) 541-8060

INFORMATION RETRIEVAL NUMBER 50

ICs & SEMICONDUCTORS

1024-bit n-channel RAM accesses in 200 ns

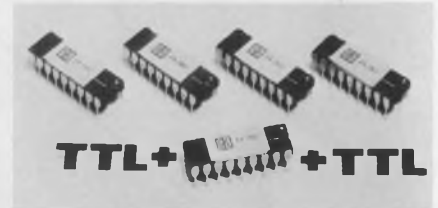

Electronic Arrays, 501 Ellis St., Mountain View, Calif. 94040. (415) 964-4321. \$27.50 (100 up).

The EA 1502—a 1024 × 1 random access memory with input level shifters and an output sense amp on the chip—eliminates the need for off-chip interface circuits while maintaining a 200-ns maximum access time from the TTL drive circuit to the TTL receiving circuit. The memory is an n-channel silicon-gate RAM. It operates on ±12 V power supplies with power dissipation typically 115 mW. It also has EA's proprietary bit cell design which permits an "automatic refresh mode" (one write pulse for each system cycle) and eliminates the need for periodic memory busy signals.

CIRCLE NO. 260

Low frequency PLL sinks up to 100 mA

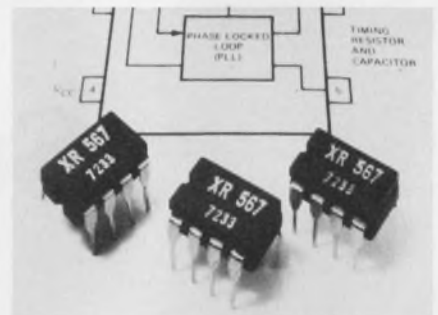

Exar Integrated Systems, Inc., 750 Palomar, Sunnyvale, Calif. 94086. (408) 732-7970. XR567CN: \$4.95 (100 up).

The XR-567, a monolithic phase-locked loop, operates over a 0.01 to 500 kHz frequency range and has a logic-compatible output that sinks up to 100 mA of load current. Center frequency stability, at 25°C case temperature, is 35 ppm/°C. Bandwidth is 0 to 14%, adjustable. The frequency range can also be adjusted over a 20:1 range by a single external resistor.

CIRCLE NO. 261

YOUR SHORTCUT TO FAME AND FORTUNE

Your IC designs might be great, but they're not worth a nickel until they're in saleable products.

And getting your designs to market profitably is where we can really help.

Fast, flexible, inexpensive. EECO plug-in IC packaging can cut your production costs by 40%, triple your packing density over PC boards, and cut your production cycle to just 5 weeks from the time your logic diagrams are ready.

With our wire-wrap hardware, prototypes are simpler (ask about our low-cost kits). Production changes are made instantly. And maintenance is faster and less expensive.

Be picky. Whether you're designing with standard IC's or LSI (with or without discretes), you can choose from the world's finest and largest selection of plug-in hardware.

For fewer connections, higher reliability and less costly production, use our 2D planes.

For easier maintenance and

lower spares costs, use our EECOLOGIC 2 plug-in cards.

For maximum density, try our newest 3D cards. They pack up to 70 IC's on a card and over a thousand IC's in a 7"H x 9½"D card cage.

Start selling now. Standard hardware delivery is 1-2 weeks, but we can save you even more with our automatic wiring service. Send us your logic diagrams and in just 5 weeks we'll send you finished products.

Wrapped, debugged, documented and ready to ship to your customers. Far faster and for a great deal less than you could do it yourself.

How to be an expert. We've put everything you need to know about IC packaging into a free kit. Besides details on our hardware and software, our IC Packaging Package includes several article reprints and design aids. To get it, just use the coupon or call (714) 547-5651 today.

Opportunity is knocking.



FREE: THE EECO KIT AND KABOODLE.

EECO, 1441 E. Chestnut Ave., Santa Ana, Calif. 92705

You're right — I've got some great IC designs. Show me how I can turn them into reliable finished products in just 5 weeks while cutting my production costs by as much as 40%.

Name _____

Company _____ Telephone _____

Address _____

City _____ State _____ Zip _____

INFORMATION RETRIEVAL NUMBER 51

Triple outputs in a modular DIP offered in new power-supply line

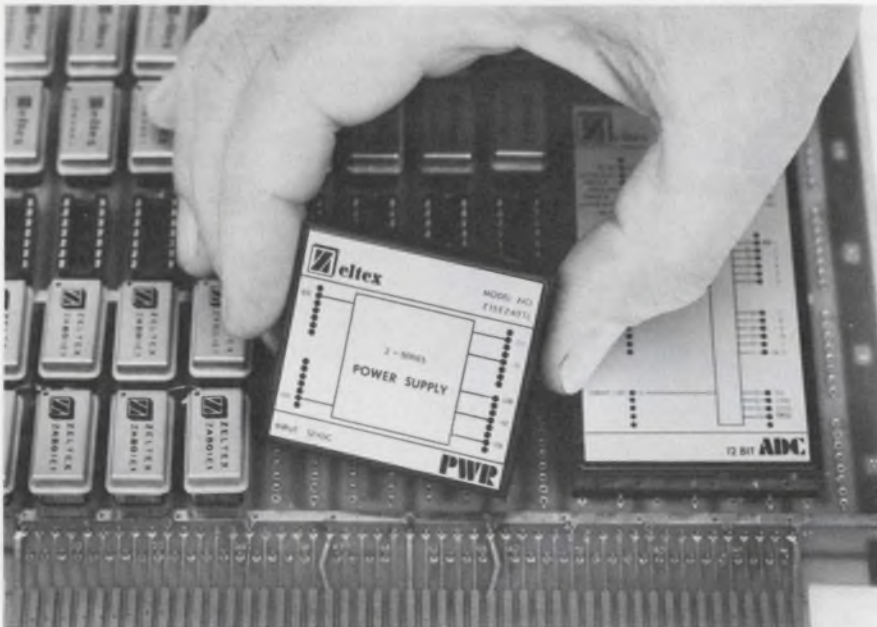

Zeltex, Inc., 1000 Chalomar Rd., Concord, Calif. 94520. (415) 686-6660. See text.

The already overcrowded modular power supply market has another entrant. But unlike the timid swimmer who gingerly sticks one toe into the water before entering, Zeltex, Inc., has plunged right in with a splash: It is offering triple, dual and single outputs in its new 48-model line, with choices of ac or dc inputs, two package sizes and unregulated or regulated out-

puts (with three degrees of regulation). To top it off, prices appear to be lower than those of competitive units.

Sure to create a big stir is the Z series triple-output supply. It's the first to be packaged in a 1.44-cubic-inch modular DIP. The supply provides both ± 15 V and +5 V at 40 and 200 mA, respectively. And input voltage can be either 12 or 28 V dc. Load and line regulation for the triple output version is, typically, 0.5%, and combined

ripple and noise is 5.0 mV. The triple-output Z Series costs \$99.

The dual-output models of the Z Series yield ± 15 V, with output currents ranging from 30 to 250 mA. Inputs can be either 115 V ac or 5 V dc. Three choices of regulation are available: precision ($\pm 0.02\%$), limited ($\pm 0.5\%$) and unregulated ($\pm 10\%$). Single output models are also available, with 5, 15 or 200-V outputs at 250, 100 and 20 mA, respectively. Input voltage can be either 115 V ac or 5 V dc.

The T-series is cased in a standard $2.5 \times 3.5 \times 0.88$ -inch package and is interchangeable with many competitive supplies. This series also offers triple, dual and single outputs in three input-voltage classes: 115 V ac, 230 V ac and 100 to 125 V ac. Output currents range from 25 to 1000 mA, and regulation from 0.02 to 1.0%.

Other important specs, applicable to both series, are short-circuit protection, an output impedance of 0.2Ω at 10 kHz, input isolation of $50 M\Omega$, input-output isolation of 500 V dc and no current derating from -25 to $+71$ C.

Prices for the Z Series range from \$19 to \$99 and for the T Series from \$16 to \$69.

CIRCLE NO. 250

ANA & LOG

ANALOGY

THE A-740 IS THE FASTEST, MOST ACCURATE PIN CUSHION CORRECTION MODULE AVAILABLE. CORRECTION ACCURACIES ARE BETTER THAN 0.2% BANDWIDTH IS 10 MHz; SLEW RATE: 40 V/ μ s MIN. IT ALSO MATHEMATICALLY CORRECTS DYNAMIC FOCUS DISTORTION.

THIS COMPLETE MINI ANA LOG COMPUTER IS PACKAGED IN A SINGLE 3.5" X 2.5" X 0.87" EPOXY MODULE, READY TO USE. DON'T WAIT ON PINS AND NEEDLES—WRITE FOR SPECS NOW.

intech INCORPORATED
 (408) 244-0500
 1220 COLEMAN, SANTA CLARA, CALIF. 95050

How much did it cost you last month



Four thousand dollars? That would be less than a 1% slipthrough of defective IC's for a relatively small application working with smaller PC Boards. Ten or twenty thousand dollars? The numbers increase drastically with greater volumes and higher complexity Boards. And we use a conservative \$25.00 estimate for replacement of a defective IC in a PC Board.

Packed into most IC shipments, from the most meticulous manufacturer, you'll find a nominal percentage of defective devices, due to transit damage, handling, or human error.

And did your supplier's tests fully cover your own tight functional parameters? Marginal-operating circuits can mean extensive trouble-shooting, rework and expensive replacement parts, just as often as catastrophic failures. And it costs real money either way.

OK, so inspection pays off, as a general rule. But how do you get down to specifics—what can testing do for you? We can help. Fairchild Systems, the leader in semiconductor test systems, offers a mathematical tool for determining the economic feasibility—and the financial justification—of pre-use testing your semiconductor parts. The name of the game is SAVE. Short for System Analysis of Value Economics: a computer-based procedure that knows how to simulate your particular operations over a broad spectrum of test inspections—incoming, QA, PCB, wafer and final production testing.

SAVE enables you to detail, step-by-step, all your applications, configurations, number of stations and daily work shifts. Types and quantities of devices used are accounted for, with your average rate of untested defectives balanced in.

After completed forms are run through Fairchild Systems' SAVE-programmed computer, you get the readout. Hard-nosed data on total

to find out nobody's perfect?

comparative costs for testing; including a breakdown of operating expenses, system costs, test equipment replacement, payback period, plus actual net savings realized.

You'll also use SAVE's figures for evaluating alternative system configurations to provide cost-effective solutions. And many plant designers take advantage of the in-depth operational simulation for "fine tuning" systems for optimum performance and maximum software/hardware utilization.

And SAVE's computerized analysis helps you determine the most productive, most economical level of test equipment from our advanced Sentry series—the large-scale Fairchild System with unbeatable speed, sophistication and flexibility. From MOS to bipolar, from IC's to discretes, or LSI—with software compatible to all, and the lowest throughput costs in the field—the Sentry family offers you total semiconductor testing capability with enormous expansion and adaptability options. And SAVE shows you how to make the most of it...and make your world just a little more perfect.

	Fairchild Systems 3500 Deer Creek Road Palo Alto, California 94302
<input type="checkbox"/>	Please send us your SAVE Economic Analysis Kit for semiconductor test systems.
<input type="checkbox"/>	with details on your modular testers.
<input type="checkbox"/>	with details on your Sentry Systems.
<input type="checkbox"/>	Call us immediately for individual application assistance.
Name _____	
Title _____	
Company _____	
Street _____	
City _____ State _____	
Zip _____ Telephone _____	

Fairchild Systems

Fairchild Systems Technology, a division of Fairchild Camera & Instrument Corporation.

INFORMATION RETRIEVAL NUMBER 53

Power supplies offer 4 V to 1 kV, to 23 A



Acopian Corp., 131 Loomis St., Easton, Pa. 18042. (215) 258-5441. \$35 to \$190; 3 days ARO.

The U Series of unregulated power supplies has been expanded to include models with outputs ranging from 4 to 1000 V at currents up to 23 A. (Previously, 10 A was the highest available output current rating.) They provide an economical means for powering loads such as relays, lamps, display devices and small motors. Outputs are capacitively filtered and may be used in either polarity. No derating is required through an ambient operating temperature range of -10 to +65 C. All models are housed in extruded aluminum cases.

CIRCLE NO. 262

12-bit d/a converter meets MIL-STD-883

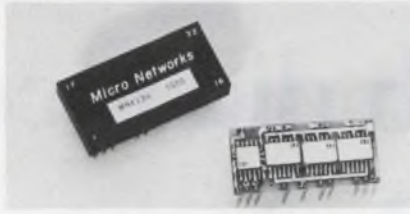

Micro Networks Corp., 5 Barbara Lane, Worcester, Mass. 01604. (617) 756-4635. \$265; 2 wks.

The MN413H d/a converter may be used either as a straight 12-bit d/a or as an 11-bit plus sign multiplying d/a. The unit is designed to meet or exceed the Class B requirements of MIL-STD-883. The linearity of $\pm 1/2$ LSB and absolute accuracy of ± 1 LSB are maintained over the full -55 to +125 C temperature range. The input logic is both TTL and CMOS compatible, with unit power dissipation of 500 mW typical. The unit is an assemblage of hybrid circuitry packaged in hermetically-sealed flat packs housed in a $1.7 \times 0.825 \times 0.260$ -in. shell.

CIRCLE NO. 263

Display tube supply gives 200 V at 25 mA



Instrument Displays, Inc., 225 Crescent St., Waltham, Mass. 02154. (617) 894-1577. \$18.00; stock.

Instrument Displays has introduced an encapsulated power supply producing 200 V at 25 mA from 115 V, 50 to 400 Hz or 220 V 50/60 Hz. It provides power for any readout requiring 170 to 200 V, and it has enough power for up to eight NIXIE display tubes. It can be soldered directly to the PC board or used with mating socket. Ripple and noise is 2 V pk to pk and operating temperature is -25 to +70 C. Size is $3.5 \times 2.5 \times 1.25$ inches.

CIRCLE NO. 264

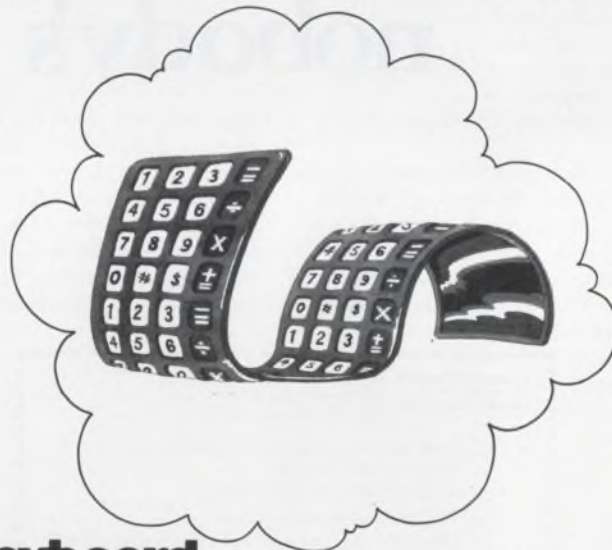

Tomorrow's keyboard.

(We left most of the key parts out.)

All the moving parts, for example.

And most of the expensive ones.

Instead we used unique, highly conductive elastomer materials, and thereby ushered in a new era.

We call this the Chomerics EF Keyboard. It's fail-proof, less than 3/16" thick, and it comes in any configuration you want to dream up.

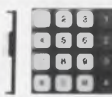

For calculators, communications equipment, special function terminals. For a price you won't believe.

The EF is the most revolutionary design/function keyboard in the world. Pretty soon everybody will be trying to make keyboards like it.

Meanwhile you'll have to come to us.
CHOMERICS 77 Dragon Court,
 Woburn, MA 01801 / (617) 935-4850

Chomerics knows keyboards like a book. You can have copies of our literature for the asking.



We have a
"complement"
for you!

SOLITRON'S NEW 5 AMP COMPLEMENTARY NPN/PNP PLASTIC POWER TRANSISTORS

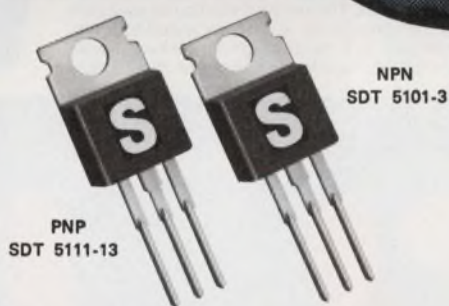

Our new series of 5 Amp Silicon NPN/PNP Plastic Power Transistors are manufactured by the triple diffused planar process, giving you these advantages: low leakage and fast switching times, with f_T typically 8 MHz. Other characteristics include typical gain of 100 @ 1.0 Amp and typical $V_{CE(sat)}$ @ 2.0 Amps of less than 0.5 Volts. They are constructed with tin plated leads to provide optimum solderability and permanent contact with a one piece collector. Intended for complementary use, these low cost devices are recommended for motor speed controls, inverters, series regulators and audio amplifiers. Available in a TO-220 package, the transistors are 80¢ per pair in 100 quantities.

TYPICAL GAIN SPECIFICATIONS

NPN Type Numbers	H_{FE} @ 1.0A, 4V	PNP Type Numbers
SDT 5101	35-70	SDT 5111
SDT 5102	60-120	SDT 5112
SDT 5103	100-300	SDT 5113

Write today for our spec sheets and application information.

Solitron

DEVICES, INC.

1177 BLUE HERON BLVD. / RIVIERA BEACH, FLORIDA / (305) 848-4311
TWX: (510) 952-7610

SAN DIEGO, CALIF.
8808 Balboa Ave.
CMOS, PMOS Circuits
Diodes, Rectifiers, &
Zeners
FET & Dual FET
Transistors
High Voltage Assemblies
Linear & Monolithic IC's

RIVIERA BEACH, FLA.
1177 Blue Heron Blvd
Hi-Rel Power Transistors
Si & Ge Power
Transistors
Hi-Rel Power Hybrids
PNP-NPN Industrial
Transistors

PORT SALERNO, FLA.
Cove Road
Microwave Connectors
Plaxial (R) Cable
Precision RF Coaxial
Connectors

JUPITER, FLA.
1440 W. Indiantown Rd
Microwave Stripline
Components
Microwave Diodes
RF and Microwave
Transistors
Hi-Rel Power
Transistors

TAPPAN, N.Y.
256 Oak Tree Road
Diodes & Rectifiers
Ferrite & Ferrite Devices
High Voltage Assemblies
Power Rectifiers
Thick Film
Hybrid Circuits

KENT, ENGLAND
Tubbs Hill House
London Road,
Sevenoaks
Solidev, Ltd.
Full line of
Solitron devices

BEN BARAO, ISRAEL
51 Hayarkon Street
AEL Israel, Ltd.
Full line of
Solitron devices

TOKYO 105, JAPAN
Rm. No. 21,
Kyodo Bldg
No. 4-10, 2 Chome
Higashi Shinbashi
Minato-ku
Full line of
Solitron devices

INFORMATION RETRIEVAL NUMBER 56

Dialight sees a need:

(**Need:** A large $\frac{5}{8}$ " high LED readout at a low \$5.80* price.)

See Dialight.

Each digit in this bezel assembly contains a Dialight light-emitting diode, decoder/driver, and resistor network that produces a bright, highly visible readout that can be easily installed in a panel. The readout display is supplied with discrete gallium phosphide or gallium arsenide phosphide diodes arranged in a seven-segment format. These generate a bright, highly legible red character (0.625 inch



high—the largest size character in the industry) with the lowest power consumption for a character of this size. Ideal for mounting on a control panel, or in a digital clock, meter, credit-card verifier, TV channel indicator, or hospital room status-board indicator. The contrast ratio between the illuminated and non-illuminated segments is further enhanced by a one-piece red nonglare window.



Dialight is a company that looks for needs...and develops solutions. That's how we developed the industry's broadest line of LED light sources, indicator lights and readouts. No other company offers you one-stop shopping in LED visual displays. And no one has more experience in the visual display field. Dialight can help you do more with LEDs than anyone else because we have done more with them. Talk to the specialists at Dialight first. You won't have to talk to anyone else.

Here are a few products in this family: **1.** Multidigit readout assembly in 0.205" character height **2.** Status display module with 6 LEDs with adjustable light cells **3.** LED readout in character height 0.625" **4.** Alphanumeric display complete with code generator/driver character height 0.300" **5.** 5 x 7 dot matrix alphanumeric display in character height 0.300" **6.** Hexadecimal display with logic character height 0.270" **7.** Single digit LED readout module in 0.125" character height. **8.** Numeric display with integral TTL MSI circuit chip with counter character height 0.270" **9.** Single digit LED readout module in 0.270" character height (MAN 1 equiv.). *1000 lot quantity for 730-0003

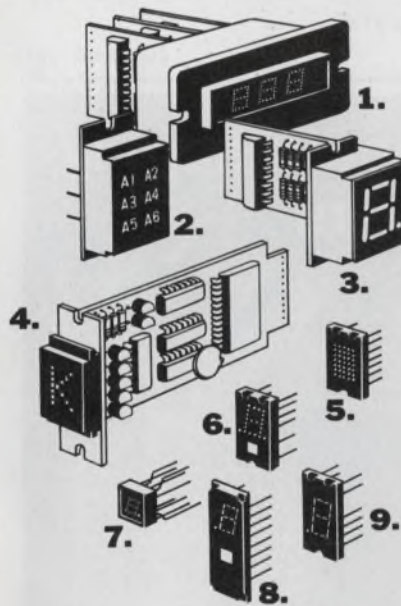

Please send data on your LED readouts.

NAME _____
 TITLE _____
 COMPANY _____
 ADDRESS _____
 CITY _____ STATE _____

DIALIGHT

Dialight Corporation, A North American Philips Company
 60 Stewart Avenue, Brooklyn, N.Y. 11237 (212) 497-7600

INFORMATION RETRIEVAL NUMBER 57

MODULES & SUBASSEMBLIES

Unit converts X-Y to polar coordinates



Computer Conversion Corp., 6 Dunton Ct., E. Northport, N.Y. 11731. (516) 261-3300. \$995 (large quantities); 6 weeks ARO.

These new solid-state devices convert inputs in rectangular form (X, Y) to equivalent polar coordinates (R, Angle), with an angular accuracy of ± 15 minutes of arc at $R = 10$. The converters accept X and Y inputs from 0 to ± 10 V dc and provide an output of R accurate to $\pm 0.1\%$ of full scale over a range of 0.05 to ± 10 V. Conversion time is 2 s max. and output impedance is less than 1Ω . Input power required for Part No. RP600 is ± 15 V at 100 mA and +5 V at 75 mA. The units are available in a single module package $3.2 \times 3.4 \times 1.8$ -in. high, with pin type header suitable for chassis or PC mounting.

CIRCLE NO. 265

Active bandpass filters are externally tuned

Frequency Devices, Inc., 25 Locust St., Haverhill, Mass. 01830. (617) 372-6930. From \$58 (100); stock to 2 wks.

Series 760 active filters are two-pole-pair Butterworth bandpass devices externally tunable over a 1000:1 range with four equal resistors. Three models, 760, 762 and 764, cover the range 0.05 Hz to 20 kHz with maximum center frequencies (f_0) at 50 Hz, 500 Hz and 20 kHz, respectively. Specifications include: factory set unity gain, adjustable to ± 20 dB; f_0 is $\pm 3\%$ with matched 1%, 100-ppm/ $^{\circ}$ C resistors; f_0 stability is $\pm 0.03\%/^{\circ}$ C; passband gain at f_0 is ± 0.03 dB; Z_0 is 1Ω ; Q_s of 5 or 10 are standard; case size is $2 \times 3 \times 1$ in. for 760 and $2 \times 3 \times 0.6$ in. for 762 and 764.

CIRCLE NO. 266

Digital translator converts binary to BCD

Interface Engineering Inc., 386 Lindelof Ave., Stoughton, Mass. 02072. (617) 344-7383.

Digital translators bridge the interface between binary angle data and BCD-encoded displays, printers and shaft positioning devices. Two models are available, packaged in $3 \times 4 \times 0.4$ -in. cubes. The DD107-5 is a parallel ripple-through translator that accepts up to 15 bits of binary angle input and provides an 18-line BCD output with resolution of 0.01° , an over-all accuracy of 0.015° and a full scale of 359.99° . The DD107-4 accepts up to 12 bits of binary angle input data and outputs 14-line BCD with a resolution of 0.1° , an over-all accuracy of 0.055° and a full scale of 359.9° . Conversion time of both models is 500 ns.

CIRCLE NO. 267

High-power supplies use regulating transformers

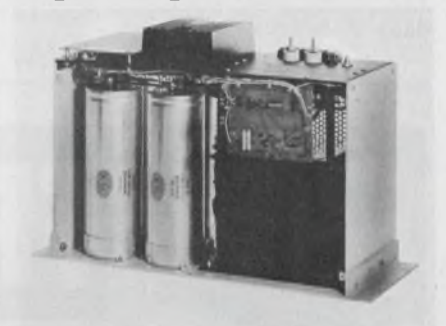

Technipower, Inc., Ridgefield, Conn. 06877. (203) 438-0333. \$150 and up (OEM).

Using a regulating transformer concept, the field-repairable RT series offers an economical approach to high-power ac-dc requirements without the usual disadvantages associated with ferro-resonant and SCR-type regulators. The units are available in 250, 500 and 1000 W power ranges with output voltages of 5 to 48 V dc and currents up to 120 A. Specifications of $\pm 0.5\%$ regulation for combined line, load and frequency, and ripple at 1% or 150 mV rms are featured. Overvoltage protection is optional for all models and a low-ripple option of 200 mV pk-pk is available on the 5-V model. Short-circuit protection, output-voltage adjustment and remote sensing are standard.

CIRCLE NO. 268

TV character generator stores 4 pages, shows 2



GCB Closed Circuit TV Corp., 74 Fifth Ave., New York, N.Y. 10011. (212) 989-4433.

Model CG-240 character generator has a four-page, two-channel capability that makes it possible to display one page of a channel while composing, editing or previewing any one of the remaining three pages of the preview channel. An audio-record/playback interface allows inexpensive off-line storage of additional display information. The character generator meets EIA RS-170 video standards and RS-232 data standards.

CIRCLE NO. 269

Electronic calculator prints output



Unicom Systems, Inc., 10670 N. Tantau Ave., Cupertino, Calif. 95014. (408) 255-3650. See text.

The 1000P—priced at \$295—is said to be the first electronic printing calculator under \$300. This is less expensive than mechanical printing calculators, which are usually in the \$500 to \$800 range. Major features include add, subtract, multiply, divide, grand-total memory register, automatic decimals, constants, chain calculations, credit balance, two-color printing, repeat add/subtract, automatic retention of last item and a buffered keyboard.

CIRCLE NO. 270

Translator converts codes to time display



Moxon Inc., SCR Div., 222 Michelson Dr., Irvine, Calif. 92664. (714) 833-2000. From \$1000; 1 to 4 months.

A new time-code translator, the Model 520, featuring plug-in-module construction, provides day/hour/minute/second panel displays. Low-power, seven-segment, wide-angle, gas-discharge displays are used. Some of the common codes handled by the translator include IRIG A, IRIG B, IRIG C, IRIG E, IRIG H, IRIG G, NASA 28, NASA 36, AMR-B2, AMR-C2, AMR-D5 and XR-3. Various parallel BCD formats, Slow-Code Type-B outputs and others are optionally available.

CIRCLE NO. 271



FREE

The World's Largest
Consumer
Electronics Catalog



• Stereo/Hi-Fi Components • Musical Instruments and Amplifiers • CB & Ham Equipment • Tools and Test Equipment • Police and Fire Monitor Receivers • Public Address Systems • Photography Equipment • Semiconductors, Books, Parts • Plus Much More!

Send For Your Free Lafayette Catalog Today!

Lafayette Radio Electronics, Dept. 45112
P.O. Box 10, Syosset, L.I., N.Y. 11791

Send Me the Free Lafayette Catalog 45112

Name

Address

City

State Zip

(Please include your zip code)

INFORMATION RETRIEVAL NUMBER 58

The PC power supply that delivers years of service and costs

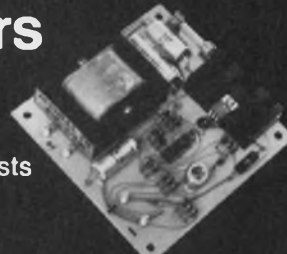

\$27 in single units

SPECIFICATIONS:

Size: 4.5 x 4.5 x 1.5

Input: 105-125V, 47-420 Hz

Output: Any DC voltage 3 to 30

Regulation: Line 0.005%
Load 0.05%

Ripple: Less than 250 microvolts

Recovery Time: 25 microseconds

Temperature:
Operating -20 to +71°C
Storage -65 to +85°C
Coefficient 0.01%/°C Max

Current Limiting:
Fixed-foldback type
Overvoltage: Optional

MODEL	VOLTAGE	AMPS	MODEL	VOLTAGE	AMPS
10-5	4.5 to 5.5	1.2	10-28	26 to 30	0.35
10-12	11 to 13	0.8	10-1212	±11 to 13	0.35
10-15	14 to 16	0.6	10-1515	±14 to 16	0.35
10-24	23 to 25	0.4	10-1818	±17 to 19	0.35

For Overvoltage Models, add -0 to Model number

QUANTITY	PRICE	WITH OVERVOLTAGE	DUAL SUPPLIES
1-9	\$27	\$32	\$35
10-24	\$24	\$28	\$32

DIRECT FROM STOCK
FREE - POWER SUPPLY CATALOG

Electrostatics, Inc.

7718 CLAIREMONT MESA BLVD. • SAN DIEGO, CA 92111 • (714) 279-1414

INFORMATION RETRIEVAL NUMBER 59

It's either
HALF THE PRICE
or
TWICE AS MUCH
for your money...

OmniScribe™

10" Strip Chart

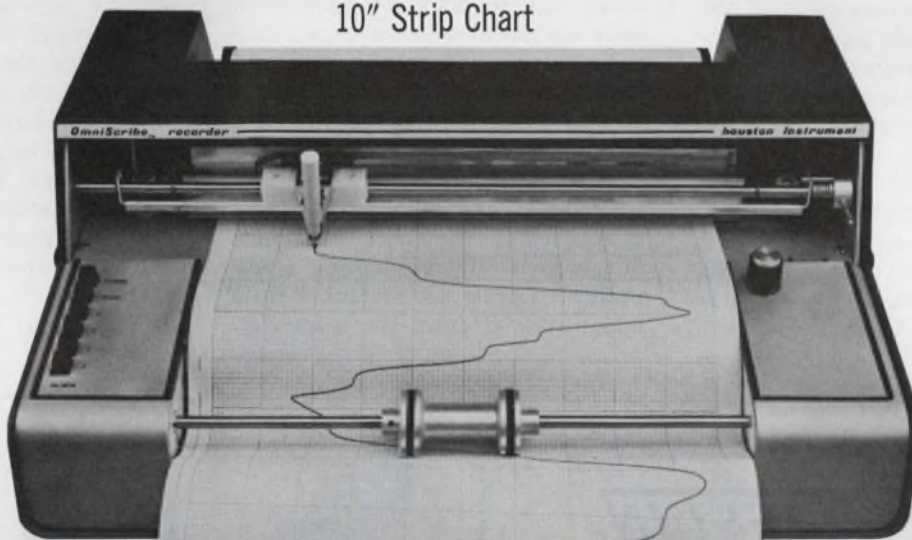

LOOK CLOSELY & DECIDE

1.

The multi-speed chart drive is the equal of any competitor on the market today. Further, the **OmniScribe™** is field adjustable, precisely for English/Metric scaling. Quick, fast, convenient.

2.

Houston Instrument has perfected sprocketless paper drive. It's accurate. It's self-aligning. It works!

3.

A unique operating feature is the non-contact re-balance potentiometer. It eliminates cleaning and trace "glitches" forever. It's beautiful!

4.

Did we mention the price? Just \$395 for single pen; \$595 for dual pen. With options to \$1400. What's more, all models are available off-the-shelf for immediate shipment.

THE FULL PRICE IS \$39500

*For single pen model

Write today for your complete brochure and price list. The **OmniScribe™** is either half the cost or twice as much for your money. You decide.

**houston
instrument**

4950 TERMINAL AVENUE, BELLAIRE, TEXAS 77401
(713) 667-7403 CABLE HOINCO.

INFORMATION RETRIEVAL NUMBER 43

Infrared scanner shows image on a CRT

Dynarad Inc., 1420 Province Hwy., Norwood, Mass. 02062. (617) 762-9450.

Dynarad's Model 210 infrared scanning systems use an optical system to scan and focus the infrared radiant energy from an object onto a sensitive detector. This detector is cooled in liquid nitrogen to increase its sensitivity. Its output is amplified, processed, and the thermally detected image is displayed on a cathode ray tube. By means of a calibrated dial, the temperature of any part of an object can be determined. The scanning system is passive. It simply receives the natural thermal radiation emitted by an object. Applications include breast cancer detection, pollution monitoring, nondestructive testing, electronic circuit evaluation, remote sensing, intrusion detection and power line monitoring.

CIRCLE NO. 272

Unit reads embossed data on cards



AMP Inc., 449 Eisenhower Blvd., Harrisburg, Pa. 17105. (717) 564-0101.

The new AMP embossed-card reader eliminates the need for cards with an extra coding medium such as punched holes or a magnetic stripe. It reads standard credit cards embossed with Farington 7B font in accordance with the ANSI X 4.13-1971 standard. The card actuates a transport mechanism, and a photoelectric device reads at 24 char/sec. The output is DTL (negative logic) compatible. Cards are inserted into and retrieved from the same slot.

CIRCLE NO. 273

Mini-calculator breaks a price barrier



Casio, Inc., Consumer Products Div., One World Trade Center, Suite 4011, New York, N.Y. 10048. (212) 432-9230. See text; stock.

The Casio mini-calculator, at the suggested retail price of \$59.95, is said to represent a major price breakthrough in electronic calculators. When the batteries begin to run down, the display will gradually darken. Batteries can therefore be replaced long before a miscalculation occurs. The life of the four penlight batteries, in continuous duty, is approximately 11 hours, and in intermittent duty about 14 hours. This is equivalent to about six months of average use.

CIRCLE NO. 274

RAPIDDESIGN®

Triangle-Lizer

COMBINATION TRIANGLE 30°, 45°, 60°, AND 90°

TRIANGLE-LIZER

This new template by RapiDesign combines into a single unit, 30°, 45°, 60°, 90° triangles and a protractor. Eliminates wasted motion and drawing board clutter by combining into a single template these often used instruments. The Triangle-Lizer, like all RapiDesign products, is a sturdy drafting instrument. One side is beveled for inking. The Triangle-Lizer comes in 3 sizes: 4", 6" and 8". Ask for Triangle-Lizer, one of nearly 200 RapiDesign templates at your drafting supply store, or contact us direct for a free 1972 catalog.

RAPIDESIGN, INC., P.O. BOX 6039, BURBANK, CA. 91505
A SUBSIDIARY OF BEROL CORPORATION
BEROL

INFORMATION RETRIEVAL NUMBER 61

NEW

smallest precision snap action switch yet!

Case dimensions of our new 4900 Series switches are less than .250" by .300" by .100". Ratings are 2 amp. 125-250V AC; 2 amp. (Res.) and 1 amp. (Ind.), 30V DC. Meet MIL-S-8805 specs. Available with 4 types of terminals, pin plunger and various lever type actuators.

new sub-miniature switches

Our new 4800 Series sub-miniature switches are rated 5 amp. 125-250V AC with 5 amp. resistive and 2½ amp. inductive ratings at 30V DC. Case dimensions are approximately .400" by .800" by .250". Available with 6 terminal types, a variety of lever actuators and optional bifurcated or dual gold contacts. Meet MIL-S-8805 specs. McGill Manufacturing Co., Inc., Electrical Division, Valparaiso, Indiana 46383

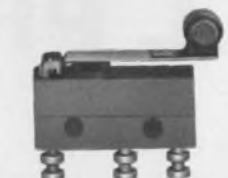

Available from Authorized McGill Electrical and Electronic Distributors

McGILL®
ENGINEERED SWITCHES

INFORMATION RETRIEVAL NUMBER 62

ELECTRONIC DESIGN 23, November 9, 1972

Programmed controller replaces fixed logic



Gulf-Western Industries, Inc., Eagle Signal Div., 736 Federal, Davenport, Iowa 52803. (319) 326-8111. \$2070 (unit qty.).

Controlpac 600 is a programmable logic controller that provides 16 inputs, 16 outputs, a 256-word pROM and a 256-bit RAM. Word size is 12 bits. This system can replace dedicated hard-wired, relay or solid-state logic systems. Although its internal wiring is also fixed, the program can be changed to accommodate many types of machines or processes. Inputs and outputs are expandable to 512 ports each, the pROM to 4096 words and the RAM to 512 bits.

CIRCLE NO. 389

Differential amplifier has remote gain control

Ectron Corp., 8133 Engineer Rd., San Diego, Calif. 92111. (714) 278-0600. From \$695.

The 760 series of programmable dc amplifiers, for data-acquisition and process-control systems, accepts TTL, binary or 10-line logic commands to control up to 10 gain steps. Available options include digital-data storage, local gain readout, manual gain override and a wide choice of performance characteristics such as 0.01% gain accuracy, 1 μ V/C stability, a 300-V common-mode rating, 126-dB common-mode rejection, active input filters and dual outputs.

CIRCLE NO. 390

WHILE SPENDING LONG SUNLESS DAYS IN ALASKA, PROFESSOR FLAKE CAME UP WITH THIS INGENUOUS INVENTION WHICH HE CALLS "THE COMBINATION CHICKEN-FOOLER AND THREE MINUTE EGG ALARM. CANDLE (A) BURNS DOWN TO THE POINT WHERE STRING BREAKS. THIS ALLOWS HAMMER (B) TO FALL KNOCKING SLEEPING BIRD (C) OFF SWING. REMOVAL OF BIRD'S WEIGHT ALLOWS PHONOGRAPH ARM TO FALL ON RECORD (D) AS RECORD PLAYER (E) BLASTS OUT "JADA," SQUIRREL THAT HAS BEEN TRAINED TO RESPOND, TURNS TREADMILL ATTACHED TO GENERATOR (F). GENERATOR LIGHTS BULB (G) AND CHICKEN, THINKING IT IS SUNRISE, LAYS EGG WHICH ROLLS INTO TEAKETTLE ON ELECTRIC HOT PLATE. (H) STEAM FROM TEAKETTLE TRAVELS THROUGH HOSE ATTACHED TO BED (I) AS STEAM INFLATES RUBBER BALLOON, IT PRESSES AGAINST POINT OF KNIFE (J) AND IS PUNCTURED. THE RESULTING NOISE AWAKENS SLEEPING MAN JUST IN TIME TO RETRIEVE THREE-MINUTE EGG FROM TEAKETTLE.

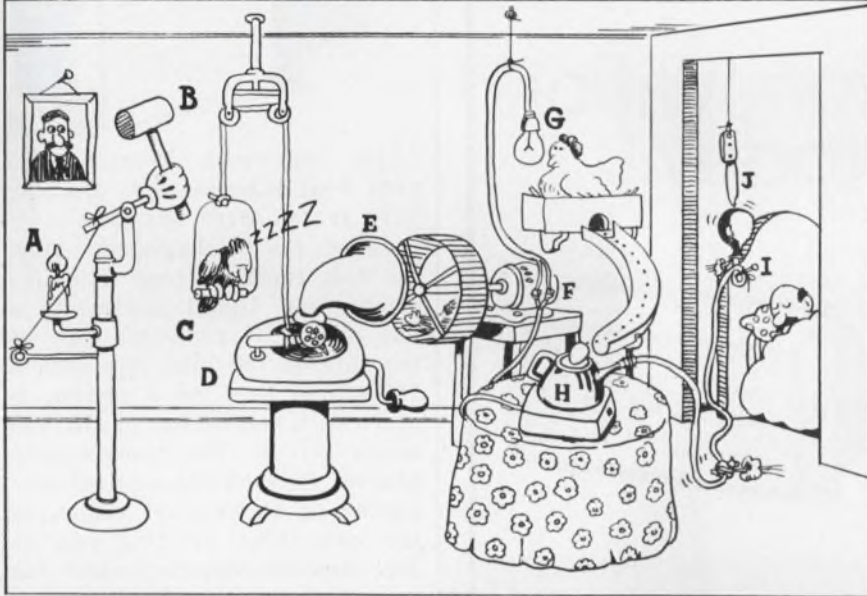

There's a better way to time yourself. Send for our E-Cell™ Kit.

A \$30 value to introduce you to the wide range of timing, counting, integrating, delaying, monitoring, sequencing and measuring capabilities of this remarkably useful electronic device. Ten functioning E-Cell components, ready to use, with schematics for circuit assembly. Full specifications. Applications Notes and Plug-in sockets. The whole works for only \$9.95.



Plessey Electro-Products
3860 Centinela Avenue, Los Angeles, California 90066

Enclosed is my check or money order for \$9.95.
Please send my E-Cell Applications Kit to:

Name _____	
Title _____	Company _____
Street _____	City _____
State _____	Zip _____



Plessey Electro-Products

INFORMATION RETRIEVAL NUMBER 64

innovation yesterday



Bell's first telephone—1876

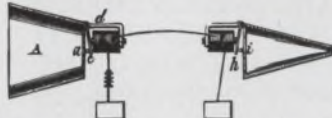

Bell's first telephone, 1876—a schematic diagram

innovation today



ECONOMY THUMBWHEEL Series 29000 Beautiful Switch. Beautiful Price.

The first telephone started a new era in communications. It was clever. Innovative.

Our new Series 29000 will be talked about on many a phone call. It's new. Innovative. Now, you can order a modular Thumbwheel switch that is competitive to the price of a common rotary switch. Available in 10 dial positions, there are numerous standard codes available. And it's sealed against normal exposure to dust, oil and other contaminants. So, write us or phone us for a catalog sheet and prices. Those are good ideas too.

THE **DIGITRAN** COMPANY
A Division of Becton, Dickinson and Co. [B-D]
855 So. Arroyo Parkway, Pasadena, Ca. 91105
Tel. (213) 449-3110 • TWX 910-588-3794

INFORMATION RETRIEVAL NUMBER 65

DATA PROCESSING

Printer/plotter uses electrolytic process



Litton Industries, Datalog Div.,
1770 Walt Whitman Rd., Melville,
N.Y. 11746. (516) 694-8300.

Called the Alphagraphic 1100, the unit functions both as a line printer and digital plotter. As a line printer it generates copy at the rate of 180 lines/min with a 128-column line. As a plotter, it provides a resolution of 75 elements per in. The manufacturer believes it to be the only printer/plotter on the market employing the electrolytic printing process. The machine requires neither ink nor toners and it readily interfaces with most minicomputers.

CIRCLE NO. 275

Digitizer traces lengths and measures areas

Numonics Corp., Hancock St. & Rt.
202, N. Wales, Pa. 19454. (215)
643-7410.

You can measure an area, locate coordinates, or trace a path length with Numonics' graphics calculator. It also connects to a variety of external computing devices to allow you to measure peak heights, compute averages, do computer-aided design and numerical controlling. Solutions appear on the display either continuously or upon command, and in the English or metric system. Reading area can be expanded from the standard 24 × 24 in. The resolution is from 1.0 to 0.25 mm. Slides can be projected onto a screen for measurement.

CIRCLE NO. 276

The Elegant Molded Parts

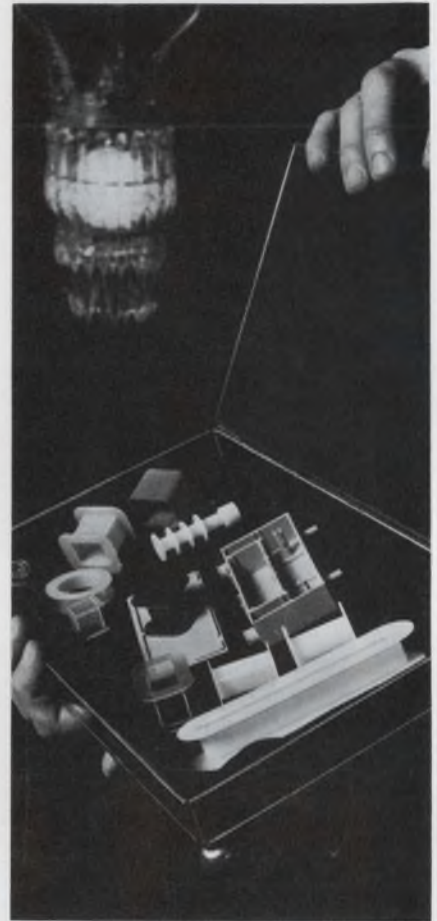

For elegant applications. Custom-made or standard, EPC parts come with thin walls down to 5 mils, tolerances to $\pm .05\%$ — even threaded bushings. In six different materials: fluorocarbon, nylon, glass-reinforced nylon, DAP, polyester and epoxy. For temperature ranges that go up to 200°C.

It's just the sort of selection and craftsmanship that you expect from EPC as an EAI component company. Look to EPC also for transformer kits. Or to EAI for thick-film audio amps. Capacitors. Custom coils. Solenoids. Active filters. Analog/digital converters and other special function modules. Plus a growing list of other elegantly crafted etceteras.



EPC

Electrical Plastics Corporation
500 Long Branch Avenue
Long Branch, New Jersey 07740
Tel. (201) 870-9500

A Subsidiary of Electronic Associates, Inc.

there's no such thing as "custom standard." but we come close.



FREE-STANDING

NEMA 12 single door; single door, dual-access; two-door, dual-access. Versatile mounting panel and relay rack angle arrangements. EMI/RFI shielding optional.

CONSOLES, CONSOLETS

Nearly 2 dozen models with a large variety of accessories. Sturdy 14 gauge steel construction. All-welded seams, gasketed doors, oil tight. NEMA 12. EMI/RFI shielding optional.

INSTRUMENT ENCLOSURES

Oil-tight. 12 standard sizes, 6 x 6 x 4 to 14 x 12 x 6. 14 gauge steel, continuously welded seams. No holes or knockouts. Gasketed covers. Optional interior mounting panels.

Your needs for instrument enclosures vary widely and delivery is important. That's why there are Hoffman distributors strategically located throughout the U.S.A. Offering precision-built enclosures of all different sizes and shapes. With factory backup on all catalog items. NEMA 12 and JIC type electrical/electronic enclosures, including pushbutton boxes and wireway. We also do custom fabrication. Write for catalog and name of nearest distributor.

Hoffman®

ELECTRICAL ENCLOSURES

HOFFMAN ENGINEERING COMPANY
Division of Federal Cartridge Corporation
ANOKA, MINNESOTA DEPT. ED-212

INFORMATION RETRIEVAL NUMBER 67
ELECTRONIC DESIGN 23, November 9, 1972

Modem interface tester checks terminal hook-up

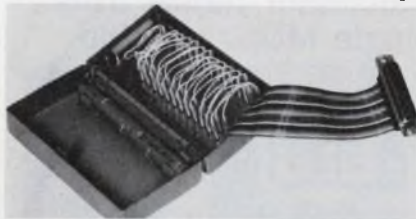

Nu Data Corp., 32 Fairview Ave., Little Silver, N.J. 07739. (201) 842-5757. \$95 (unit qty).

Series 921 modem-interface test-set checks interconnections between modems and terminals conforming to Standard EIA 232. The pocket-size test unit (4.5 x 2.5 x 1.6 in.) provides access to 25 interconnecting leads. It can disconnect any of these leads and cross-connect any terminal by cord patching. Seven leads are permanently monitored by LED displays. Interface signal voltages greater than +3 V will turn on the LED displays. Also two independent LEDs can be patched to any interface terminal on either the modem side or the terminal side. One independent monitor turns on for a positive voltage (+3 V to +24 V) and the other for a negative voltage (-3 V to -24 V). The input impedance of each display is 33,000 Ω. All the terminals can be probed with an external meter or oscilloscope. The unit is battery powered by two AA cells and weighs 3/4 lb with batteries.

CIRCLE NO. 277

PC data modems are Bell-202C compatible

Intertel, Inc., 6 Vine Brook Park, Burlington, Mass. 01803. (617) 273-0950. Mod. 2020: \$330; Mod. 2021: \$440 (unit qty); stock.

A pair of modems provide Bell-202C compatible operation at speeds to 1200 baud over dial-up telephone lines. The Model 2020 is Bell-202C5 compatible, while the Model 2021, which includes a five-baud reverse channel, is Bell-202C6 compatible. Standard features in both models include answer-back tone generation, automatic answering, receiver squelch, and soft-carrier turn off. They are constructed on a 4.5 x 9.0 in. (Model 2020) and 6.25 x 9.0 in. (Model 2021) PC card.

CIRCLE NO. 278

innovation yesterday

ELECTRIC FLAT IRON.
No. 259,054. Patented June 6, 1882.

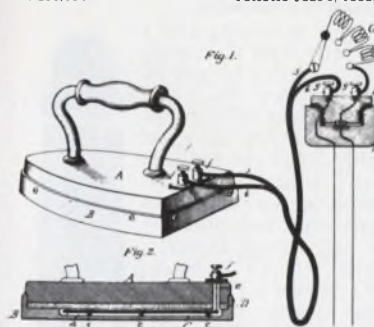

innovation today



**DIGISWITCH®
MINISWITCH®
The Original Thumbwheel Switches**

The electric iron was a wonderful invention. It made one of life's little chores easier. So did the Digiswitch and the Miniswitch when Digitran developed them in 1959. They're easier and more efficient to use. Nice large digits. And your equipment will look better too.

So, ask us about Digiswitch and Miniswitch. Ask us for a catalog. Or our wall chart showing the numerous codes available. Those are all good ideas too.

THE **DIGITRAN** COMPANY
A Division of Becton, Dickinson and Co. [B-D]
855 So. Arroyo Parkway, Pasadena, Ca. 91105
Tel. (213) 449-3110 • TWX 910-588-3794

INFORMATION RETRIEVAL NUMBER 68

TEC LED LITE

TRANSISTOR CONTROLLED LED INDICATOR SAVES PC BOARD SPACE

If you're driving LED's directly from IC outputs you're wasting valuable PC board space! TEC's new L-1017 Series LED Indicator requires 1/10th the current (only 1.6ma) of ordinary LED's (using 15ma)—lets you drive one L-1017, plus nine other loads from one IC logic circuit. Transistor driver and LED are housed in a .284 dia. x 1" long body that mounts in a $\frac{1}{8}$ " panel hole on $\frac{1}{2}$ " centers. Wire-wrap terminals standard. L-1017 Series turns on with "high" input, logic "1" (IC driven LED's indicate logic "0"). L-1017 signals: ON, +2.5 to +5VDC; OFF, 0 to +0.8VDC. Supply: +5VDC @ 15ma, maximum. Special lens design increases LED brilliance and side viewing—available in red or clear, spherical or flat top lens style.



2 X SIZE

Immediate Del. \$2.30 ea., 100-499 qty.

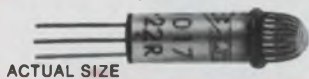

ACTUAL SIZE

DIRECT DRIVE LED INDICATOR

L-1015 Series LED Indicator is identical to L-1017 Series above in all mechanical details. Internal resistors allow operation directly from 5.0, 6.3, 10 and 24 VDC supplies—permit LED indicator substitution for incandescents.



ACTUAL SIZE

Immediate Del. Price, \$1.30 ea., 100-499.

TEC LED LITE INDICATOR PACKAGES



Select a rugged, long life LED indicator or switch/indicator from more than 20 TEC designs. More brilliance, easier mounting, attractive appearance are added to the various LED's packaged by TEC.

See TEC-LITE for the complete line of readouts, indicators, switches, display panels, keyboards, CRT terminals.

TEC, Incorporated; 9800 North Oracle Road, Tucson, Arizona 85704; or phone (602) 297-1111



INFORMATION RETRIEVAL NUMBER 69

DATA PROCESSING

Calculator family uses single MOS/LSI chip



Texas Instruments Inc., P.O. Box 5012, M/S 84, Dallas, Tex. 75222. (214) 238-3741. See text.

TI's line of electronic calculators uses a MOS/LSI calculator-on-a-chip integrated circuit to provide complete four-function capability: add, subtract, multiply and divide. The TI-3000 desk calculator (under \$85) uses an eight-digit gas-discharge readout; the TI-3500 (under \$100) desk model uses a 10-digit gas-discharge readout and provides chain or constant operation as well as two, four or floating decimal point. The TI-2500 portable calculator (under \$120) has an eight-digit LED display.

CIRCLE NO. 300

Precision electronic clock is TTL compatible



Thiem Industries, Inc., 1918 W. Artesia Blvd., Torrance, Calif. 90504. (213) 321-1911. From \$299; 45 days.

Using a precision time source, the Digitime Series M clock provides time-of-day, elapsed time, or count-down/up time, with a display and TTL-compatible logic outputs. The clock has a 24-hour time range with outputs in hours, minutes, tenths of minutes, seconds and tenths of seconds. A digital calendar companion unit can extend this range to days and months or elapsed days of the year.

CIRCLE NO. 301

Line printer adjusts speed to line width



Data Printer Corp., 201 Vassar St., Cambridge, Mass. 02139. (617) 492-7484.

Computer output printers, Models 236 and 306, accept almost any size paper and print at 200 to 600 lines/min. The printing rate is varied automatically according to the length of the printed line. Model 236 prints a 132-column line at 200 lines/min, a 96-column line at 300 lines/min and a 48-column line at 600 lines/min. The 306 prints 132-column line at 130 lines/min and 72 column line at 600 lines/min. Both models handle paper widths from 3-1/2 to 19-1/2 in. and a six-part form.

CIRCLE NO. 302

Minicomputer claims many firsts

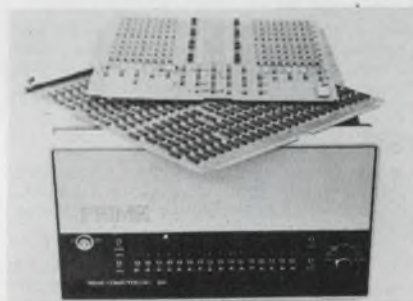

Prime Computer, Inc., 17 Strathmore Rd., Natick, Mass. 01760. (617) 655-6999. \$7100 (basic); Nov., 1972.

The PRIME 200 claims lots of firsts. It is the first small computer to employ only a MOS memory, eliminate all wires within the mainframe, employ 100% micro-programmed logic and offer both microdiagnostics and parity on every byte of information as standard features. The unit is a parallel 16-bit computer with a 750-ns cycle-time memory that is expandable in 8k increments to 32k words. It has a complement of 124 instructions.

CIRCLE NO. 303

Triple your data rate. With any data.

You can upgrade your data com systems to handle virtually any data transmission scheme at any rate up to 640 kilobits per second. With the new Western Digital Programmable Synchronous-Asynchronous Transmitter (P/SAT) and Receiver (P/SAR).

Because both chips are LSI subsystems, they're ideal for any equipment from computers and concentrators to modems and peripherals. They'll save you time and money on hardware, space, power, system design and manufacturing.

And because the P/SAT and P/SAR are both programmable, they'll give you all the flexibility your systems need. A single command defines all the transmission parameters, so you're not locked into synchronous, asynchronous or even isochronous operation. (In the isochronous mode, your equipment can transmit asynchronous data through synchronous equipment at up to 640 kilbaud rates.) A new command is all it takes to change the transmission scheme.

For easy system interface, our P/SAT (part PT1482A) and P/SAR (part PR1472A) are fully TTL-compatible; provide three-state inputs, outputs and status flags for bus compatibility; and are double-buffered.

They're the most powerful, most versatile data com chips available.

Contact us now for all the details. Western Digital has more data communications subsystem chips, standard and custom, working in more applications than anyone. We'd like to show you why. Western Digital Corp., 19242 Red Hill Avenue, Newport Beach, Calif. 92663. Tel: 714/557-3550.

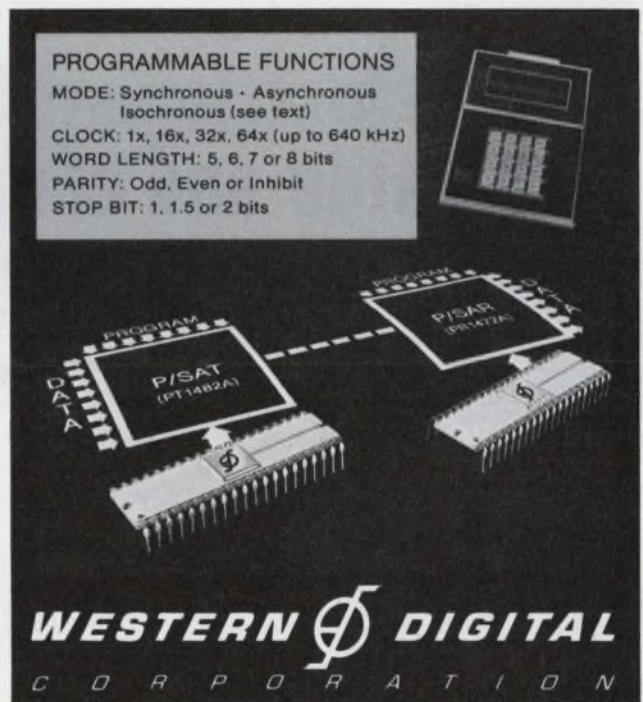

PROGRAMMABLE FUNCTIONS

- MODE: Synchronous - Asynchronous
Isochronous (see text)
- CLOCK: 1x, 16x, 32x, 64x (up to 640 kHz)
- WORD LENGTH: 5, 6, 7 or 8 bits
- PARITY: Odd, Even or Inhibit
- STOP BIT: 1, 1.5 or 2 bits

WESTERN DIGITAL
CORPORATION

MOS/LSI that works. Harder.

Staggered fingers let case-mounted semi's work harder in less space

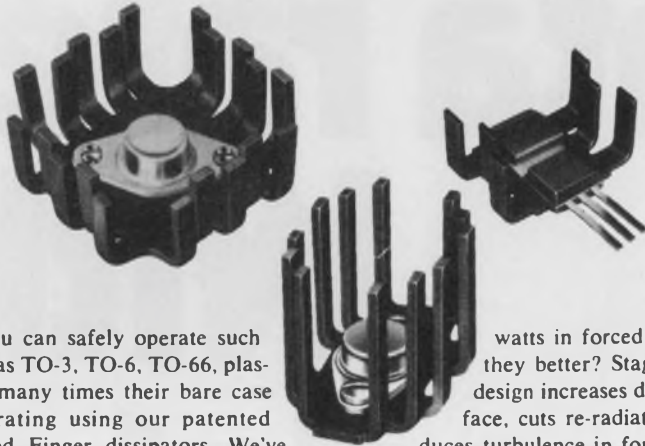

Now you can safely operate such devices as TO-3, TO-6, TO-66, plastics, at many times their bare case power rating using our patented Staggered Finger dissipators. We've got over 70 different models with dissipation capabilities ranging from 3 to 35 watts in natural convection, up to 125

watts in forced air. Why are they better? Staggered Finger design increases dissipating surface, cuts re-radiation, and produces turbulence in forced air. Send for catalog. IERC, 135 W. Magnolia Blvd., Burbank, Calif. 91502, a subsidiary of Dynamics Corporation of America.

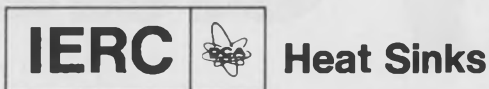

INFORMATION RETRIEVAL NUMBER 71

Optima Instrument Cases: versatile and colorful.

Designed for optimum usability, these hardy cases are available in 72 sizes for both 19 and 24 inch, panel-mounted instruments. Select from hundreds of two-color combinations of a tough, good looking, vinyl finish. Get information on the complete Optima line of cases, racks

and consoles. Write Optima Enclosures, Division of Scientific-Atlanta, Inc., 2166 Mountain Industrial Boulevard, Tucker, Georgia 30084. Or call (404) 939-6340.

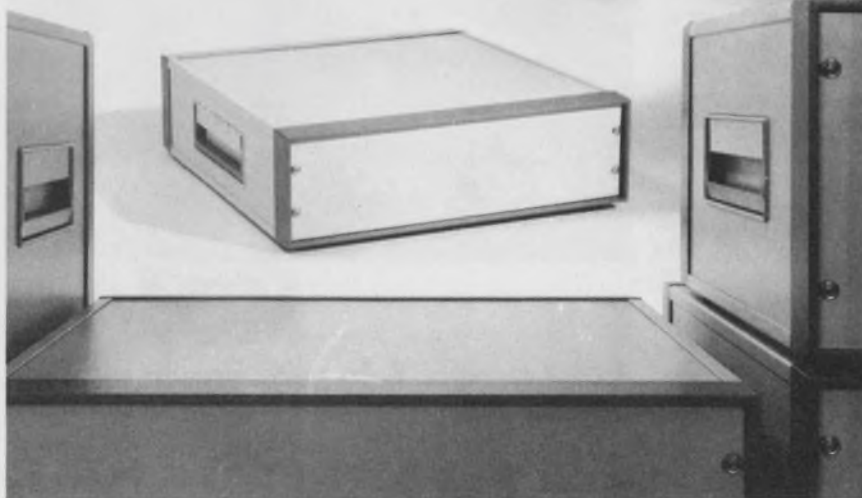

INFORMATION RETRIEVAL NUMBER 72

INSTRUMENTATION

CMOS shrinks DPM power input to 100 mW



Datascan, Inc., 1111 Paulison Ave., Clifton, N.J. 07013. (201) 478-2800. See text; 30 days ARO.

Datascan has developed the first DPM using CMOS technology. The 100 mW power input of the Model 820 (4.8 to 8 V at 20 mA, nom.) is said to be at least eight times lower than any other DPM now on the market. Typically, four D-cells can power the unit for at least 600 hours, making it ideal for portable applications. As for specs, the meter features 0.3-in. LED readouts, 100% overrange, auto-polar operation, an accuracy of $\pm 0.1\% \pm 1$ digit, a drift of $0.008\%/^{\circ}\text{C}$ max. and a reading rate of five per second. A specially designed input stage eliminates zero drift and keeps the bias current to less than 1 nA. The basic unit has a 100 mV FS range, with 5000 M Ω input impedance. Full scale ranges up to 100 V are also available, as are current shunts. In addition to low-power consumption—less than 10 μW for all the digital circuitry—the CMOS circuits result in a wide range of input supply voltage—from 3 to 15 V—high noise immunity of one-half the input voltage and a temperature range of -15 to $+70$ C. The unit is housed in a $3.5 \times 2.5 \times 1.3$ -in. aluminum case. The front bezel, which contains a red tinted filter, measures 1.5×3.2 in. Mounting and insertion into the panel is from the front. Prices should start at about \$200 for one unit and reduce to approximately \$150 each for 100 meter quantities. It is anticipated that future prices will be reduced by 50%.

CIRCLE NO. 304

The second edition of our microprogramming handbook is more revealing than the first

The original edition made many microprogramming concepts public for the first time. Now we have an expanded 450-page version with information on the Micro 1600, the mini that makes microprogramming irresistible. Our new paperback covers microprogramming from the most elementary stages all the way up to descriptions of complex computer architecture and special purpose applications.

Everything you need to know is there. Tutorial primer. Glossary of computer technology. Application information. Computer users' reference material. Complete details on hardware, software, and firmware for the Micro 800 and Micro 1600. Even if you already have the first edition, you'll value the second. Send for a copy today. It's free. Write to Microdata Corporation, 17481 Red Hill Ave., Irvine, Calif. 92705, (714) 540-6730.

Microdata



New solid-state lifetime switches are Magic Dot's contribution to state of the art. They operate on a capacitance principle, have no moving parts—and last a lifetime.

Unique design advantages include:

- Will not jam, wear or change characteristics
- Logic compatible with zero bounce
- Completely sealed for continuous performance in hostile environments
- Flexibility in size, shape and output characteristics
- No 'behind panel' space and ¼" to ½" height

New Magic Dot switches can give you the competitive edge by significantly enhancing the performance, reliability and packaging of your product, while they permit the mere touch of a finger to become man-to-electronics interface. Write or call today for detailed technical and applications information.

**these
switches
don't know
switches
fail!**

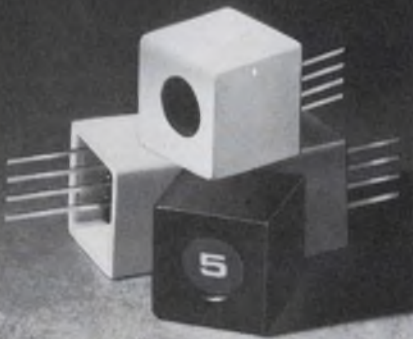

**Magic
dot**

MAGIC DOT, INC.
40 Washington Avenue South
Minneapolis, Minnesota 55401
612/333-8161

Counter-timer plugs into 7000-series scope



Tektronix, Inc., P.O. Box 500, Beaverton, Ore. 97005. (503) 644-0161. \$1475.

The 7D15 universal counter/timer is a scope plug-in. Signals from the scope can be used to arm and control the unit. The measured signal can be seen on the CRT, along with the measurement interval and the counter Schmitt trigger signal. Through various scope plug-ins, signals can be preconditioned. There are eight modes for this dc-to-225-MHz unit: time interval, time interval averaging, period, multiperiod, frequency, frequency ratio, totalize and manual stop watch. Resolution is 10 ns in single-shot time measurements, and is 100 ps in time-interval averaging. The CRT READOUT displays a full eight digits.

CIRCLE NO. 305

Monitor plug-ins allow in-shop measurements

Motorola Communications and Electronics, Inc., 1301 E. Algonquid Rd., Schaumburg, Ill. 60172. (312) 358-7900.

A full line of newly developed "off-the-air" plug-ins are now available for the Motorola S1327A Series service monitor. With better than 20 μ V sensitivity, these preselectors allow the technician to make frequency and deviation measurements of distant FM communication transmitters right from the shop or service van. Low-band 25 to 50-MHz vhf and high-band 145 to 175-MHz vhf units are presently available with 406 to 420-MHz uhf and 450 to 512-MHz uhf units to be available in the near future.

CIRCLE NO. 306

A MESSAGE FOR DADDIES

Get yourself a good, thorough examination once a year. Once a year, let your doctor really look you over. It'll take a little time, and a little patience. And maybe he'll poke around a little more than you'd really like. And so he should.

The whole idea is to keep you healthy. If nothing's wrong (and more than likely, there isn't) hooray! Come back next year. But if anything's suspicious, then you've gained the most important thing of all: time.

We can save 1 out of 2 persons when cancer is caught in time, caught early. That's a good thing to know. All Daddies should know how to take care of themselves so that they can have the fun of taking care of their kids. Don't be afraid. It's what you don't know that can hurt you.

 AMERICAN CANCER SOCIETY

the only printed circuit Relay

that plugs into your PC board without SOCKETS or SOLDERING

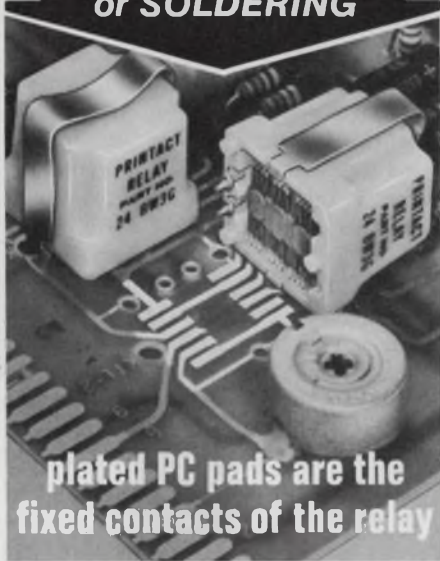

plated PC pads are the fixed contacts of the relay

Printact[®] MAGNETIC LATCHING AND NON-LATCHING RELAYS

The only relay designed to make full use of printed circuit technology. Unlike others adapted with terminal pins or sockets for solder mounting, Printact plugs directly into your module. Precious metal plated PC pads mate with shorting bar contacts on the pivoting armature, which is the single moving part. Held by a permanent magnet, it eliminates return springs, pigtailed, electrical and mechanical connections—assuring reliability for millions of cycles.

Inherent Custom Features include: Low Thermal EMF, Low Contact Bounce, Impedance Matching, 45-60 db Isolation, Bifurcated Contacts, and Encapsulated Coil—all at low cost!

Send for Test Sample and PC Board Preparation Aids to simplify design and production of your module.

For action write or call 212—EX 2-4800.

Executone

PRINTACT RELAY DIVISION
P.O. Box 1430ED
LONG ISLAND CITY, N.Y. 11101

INFORMATION RETRIEVAL NUMBER 76

Portable DMM offers 2-1/2 digits for \$170

Dynascan Corp., 1801 W. Belle Plaine Ave., Chicago, Ill. 60613. (312) 327-7270. \$169.95.

The Model 281 DMM features include a 2-1/2-digit display with automatic decimal point, 100% overrange, full overload protection, positive overrange and wrong polarity indication, high sensitivity, 1% accuracy and 10 M Ω input impedance. The 281's 32 ranges include dc and ac volts (0-1 kV), dc and ac current (0-10.0 A) and resistance (0-10.0 M Ω). All ohms ranges are constant-current. Dc accuracy is $\pm 1\%$ of reading, ± 1 digit. On the lowest ac V and dc V ranges, the 281 reads 100 mV FS. And test voltage on the lowest ohms ranges is only 100 mV.

CIRCLE NO. 307

Rf power amplifier delivers 10 W into 50 Ω



RF Communications, Inc., (part of PRD Electronics), 1680 University Ave., Rochester, N.Y. 14610. (716) 244-5830.

A new rf power amplifier is introduced by PRD Electronics, Inc. The Model RF-825 is a broadband power amplifier designed for high-power applications in the 10-Hz to 10-MHz frequency range. It requires no tuning and no adjustments. The amplifier provides a conservatively rated 10 W output into 50 Ω , but can deliver over 15 W when higher levels of drive are applied. The output impedance is less than 3 Ω . The RF-825 can also be operated to 20 MHz, and beyond, with reduced output. Significant features are the selectable 40/60 dB gain and selectable input impedances of 50 Ω or 1 M Ω . Harmonic levels at rated output are typically 50 dB down, and 30 dB down at 15 W.

CIRCLE NO. 308

Now the famous 829 has a "G" for good measure!

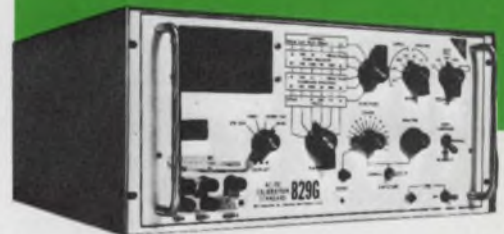

Calibrate or Measure with the

RFL Model 829G

RFL's famous 829, for 15 years the industry calibration standard, now gives way to the new 829G — still the industry calibration standard, but now it's twice as useful. The 829G provides a precision source of AC and DC volts, amps and ohms — plus precision measurements of these parameters from external sources. It offers four-terminal sensing in both source and measurement modes, and high accuracy, resolution and regulation, with 5-digit readout. 5 ranges of AC or DC, 0.1 to 1000V. 6 ranges of current, 100 μ A to 10A. 50, 60, 400, 1000 Hz AC plus EXT. And many other features — all for just \$3,600. Write for complete data today. RFL Industries, Inc., Instrumentation Div., Boonton, New Jersey 07005. Tel: (201) 334-3100 / TWX: 710-987-8352 / CABLE RADAIRCO, N. J.



RFL Industries, Inc.

INFORMATION RETRIEVAL NUMBER 77 ►

Portable DMM offers 3-1/2 digits for \$345



United Systems Corp., 918 Woodley Rd., Dayton, Ohio 45403. (513) 254-6251. \$345; stock.

A portable DMM, the Model 262C, has a 3-1/2-digit LED display and a basic accuracy of 0.05%. The unit operates from the 60-cycle line or with an integral eight-hour battery. A self-check battery status indicator is also integral. The complete unit is housed in a rugged all-metal case.

CIRCLE NO. 320

Two-channel recorder gives choice of plug-ins

Hewlett-Packard Co., 1501 Page Mill Rd., Palo Alto, Calif. 94304. (415) 493-1501. Starts at \$1740; stock.

A choice of input plug-ins, a new ink system, and carbide-tipped, stainless-steel pens are the hallmarks of a new two-channel oscillographic recorder. Three preamplifier plug-ins are available with sensitivities of: 1 μ V/div. with a differential, floated and guarded input; 1 mV/div. with a differential, balanced to ground input; and 20 mV/div. with a single-ended input. Chart width is 50 mm, 25% wider than available on other comparably priced recorders. Overshoot is less than 2%. Chart speeds are from 1 to 125 mm/sec. Frequency response over 50 divisions (55 mm) is $\pm 2\%$ of FS from dc to 40 Hz. Rise time measured at the pen, from 10% to 90% of 50 mm, is 7.5 ms for the Model 17400A plug-in, and 7.0 ms for the Models 17401A and 17402A.

CIRCLE NO. 321

512-MHz freq counter accepts 10 mV input



Ballantine Laboratories, P.O. Box 97, Boonton, N.J. 07005. (201) 335-0900. \$895.

This frequency counter, a 512-MHz, nine-digit instrument, is said to measure in one-fourth to one-tenth the time of similar instruments. The Model 5700A counts directly to 200 MHz and pre-scales by two only for its 512-MHz operation. The counter measures from 5 Hz to 512 MHz and offers a sensitivity at 500 MHz of 10 mV rms. The instrument also offers an optional frequency offset capability which enables the user to offset the counter's displayed frequency by a fixed number of cycles from the frequency being measured.

CIRCLE NO. 322

POWER SUPPLY HANDBOOK
YOUR'S **FREE**



A complete reference of definitions, principles of operation, load connections and performance measurements. A working tool for the Engineer. Yours for the asking . . . and its FREE from Power/Mate.

SEND FOR YOUR FREE COPY



POWER/MATE CORP.

514 S RIVER STREET HACKENSACK N.J. 07601
Phone (201) 343-6294 TWX (710) 990-5023

INFORMATION RETRIEVAL NUMBER 78

JANCO OFFERS A "TOTAL APPROACH" TO YOUR SWITCHING PROBLEM!

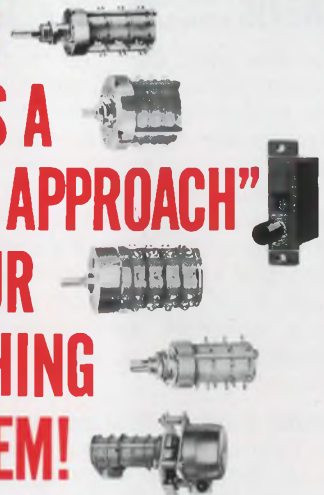

Standard rotary selector switches, miniature, micro-miniature, power, push-button, solenoid operated, keylock, momentary, etc. . . . Janco has the total line for your every need! You'll find this same "total approach" in Janco's quality of design and materials. And if Janco's basic switches do not completely fill your needs . . . Janco engineers will design one!

Janco
CORPORATION

3111 Winona Ave., Burbank, California 91504
Phone 213-845-7473 • TWX 910-498-2701

INFORMATION RETRIEVAL NUMBER 79

Our 256-track star is ready to run.

Librascope's new L107B Disc Memory racks up a new record in the low-cost compact field. Just 9" by 14", this head-per-track memory comes with either 128 or 256 data tracks. Packs up to 18 million bits of random-access storage. And weighs just 25 pounds.

Like its smaller running mate, the L107A (up to 7 million bits), the L107B has championship stamina. Long life, no routine maintenance, high reliability. And rugged. It can take 10G shock, without isolators, while operating in any position.

What's more, the big-capacity L107B is completely compatible with the smaller L107A's electronics. If you need more memory, simply upgrade from the A to the new B model by making a small space adjustment.

For full data on this front-runner, call (213) 245-8711. Or write to Librascope Division of The Singer Company, 833 Sonora Avenue, Glendale, California 91201.

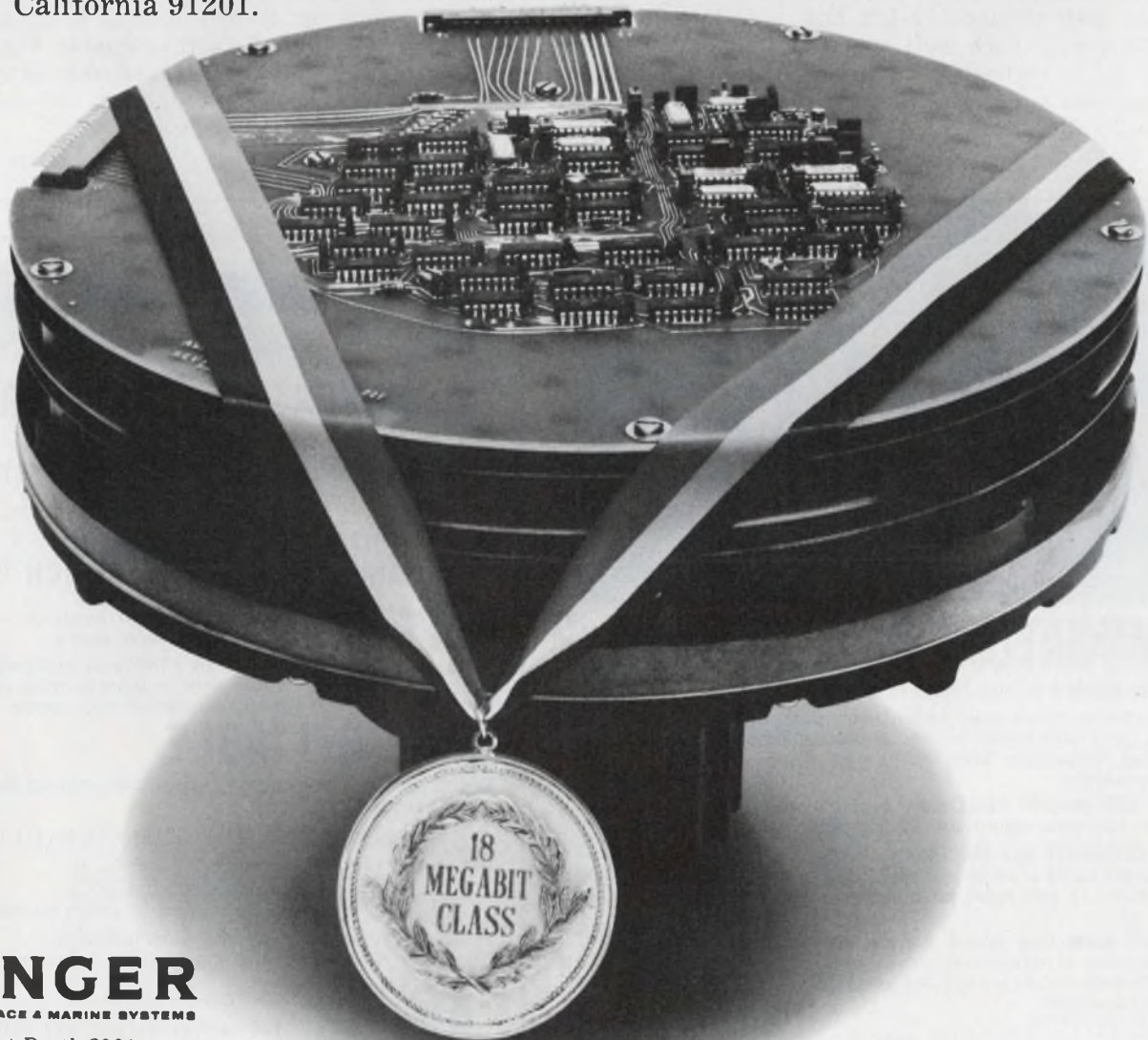

SINGER
AEROSPACE & MARINE SYSTEMS

See us at Booth 2064
Fall Joint Computer Conference.

INFORMATION RETRIEVAL NUMBER 80

Liquid-crystal display operates on low power



Radionics Laboratory Inc., P.O. Box 211, Kingston, N.J. 08528. \$50 (unit qty).

Liquid crystal readouts are effective in applications that need to conserve power. A three-digit unit draws only 10 μ A at 30-40 V and 20 Hz to 10 kHz. Suitable IC CMOS drivers are available from several manufacturers. Standard display units include 3, 3-1/2, and 8-digit models. Each digit is separated by a decimal point. Since tooling costs are moderate, specials are easily fabricated.

CIRCLE NO. 323

Tiny potentiometer has large size performance



New England Instrument Co., 14 Kendall Lane, Natick, Mass. 01760. (617) 873-9711.

High accuracy (0.35% absolute linearity) found in larger units is featured in NEI's new Filmpot. Some specs include: special linearities to 0.15%, a resistance of 250 Ω to 130 k Ω , low inertia, low torque (less than 0.1 oz-in.), a power rating of 1/2 W, and a temperature range of -65 to +125 C. Key features of this subminiature pot are its small case size, less than 1/2 x 1/2 in., and a life of over 10-million revolutions, per MIL-R-39023.

CIRCLE NO. 324

Slide switch provides 60 dB rf isolation

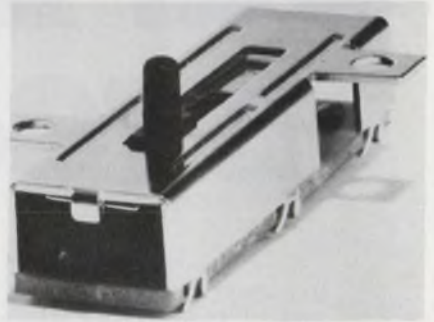

Stackpole Components Co., P.O. Box 14466, Raleigh, N.C. 27610. (919) 828-6201.

Stackpole's SS-156 DPDT high-separation slide switch provides signal isolation in excess of 60 dB (vs 40 dB for conventional switches) between the switch sections. The isolation is measured at approximately 70 MHz. In one application, a video source or antenna is selected as input to a receiver. Switch isolation is sufficient to insure that acceptable FCC levels of radiation from the antenna are not exceeded, when the video signal is selected.

CIRCLE NO. 325

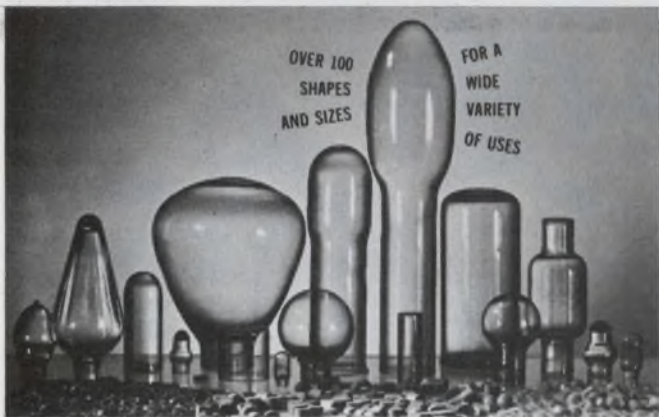

MINIATURE BULB BLANKS

Plus Beads & Brazing Pellets • Electronic Glass • Pressed Glass

General Electric tubing blown miniature bulb blanks come in many standard shapes for a wide variety of uses. Or we can help with special shapes and glass compositions. GE offers 50 years of proven ability in the bulb blowing industry.

BEADS AND BRAZING PELLETS For sealing to Dumet wire. Seven colors. Lead or hard glass composition. Brazing pellets available from stock.

HIGH RESISTIVITY O12 ELECTRONIC GLASS Long length tubing or cut to your specs. Electronic bulbs, TV neck repair parts, electronic flares, etc.

PRESSED GLASS High volume, low cost machine pressing of borosilicate glass components. Eliminates costly grinding and polishing.

LAMP GLASS DEPARTMENT,
GENERAL ELECTRIC COMPANY
24400 Highland Rd., Richmond Hts., O 44143

SEND FOR FREE
SPEC SHEET PACKAGE



INFORMATION RETRIEVAL NUMBER 81

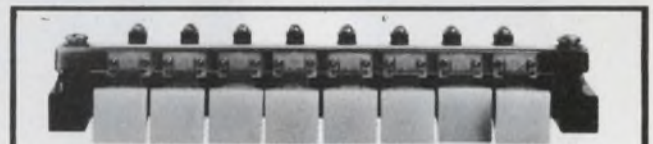

DESIGNERS and ENGINEERS

BEFORE YOU START,

CONSIDER MANUAL PUSH BUTTON SWITCHES
CAPABLE OF REMOTE CONTROL

CHANCES ARE A CAPITOL
MECHANICALLY OPERATED SWITCH IS

BETTER *provides many more contacts and
circuits in less total space

CHEAPER * frequently eliminates auxiliary
equipment — transformers, relays,
their installation and space

MORE RELIABLE*

Simple, quality construction. Fewer components insures
greater reliability

ILLUMINATED SWITCHES CAN ELIMINATE PILOT LIGHTS

Mechanical actions: interlocking, no-two operate, ac-
cumulative lock-up, push to lock push to release,
momentary. Combinations of all these are available on
the same strip. Plus, many combinations of contact assemblies.

* Proven by Vending machine, communication,
Computer, Recording and many other industries



WRITE FOR CATALOG

THE CAPITOL MACHINE AND SWITCH CO.
87 Newtown Road, Danbury, Conn. 06810

Representatives in principal cities Tel: 203-744-3300 TWX: 710-456-0385

INFORMATION RETRIEVAL NUMBER 82

Latching relay has separate release coil

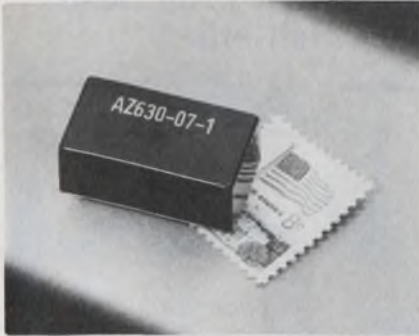

American Zettler, Inc., 697 Randolph Ave., Costa Mesa, Calif. 92626. (714) 540-4190. From \$2.41 (2500); stock.

The Thinpak series latching relay requires no continuous power to remain energized. Designated the AZ 630, the relays use two separate coils to eliminate polarity reversing problems when unlatching. The units are available with coil voltages from 6 to 60-V dc and their operate and release times are less than 3 ms. They have PC-style terminals with 0.1-in. grid spacing. Height is less than 0.5 in.

CIRCLE NO. 326

Posistor replaces start device in ac motors



Murata Corp. of America, 2 Westchester Plaza, Elmsford, N.Y. 10523. (914) 592-9180.

Posistor semiconductors eliminate the need for mechanical centrifugal switches and start relays in single-phase ac motors. The Posistor unit is connected in series with the starter winding. Initially it has very low resistance allowing maximum current to flow. After the motor comes up to speed, the resistance increases to isolate the starting winding from the power source. Available units cover the 120/220 V and 7 to 12 A ranges.

CIRCLE NO. 327

Mercury switch can take tough environments

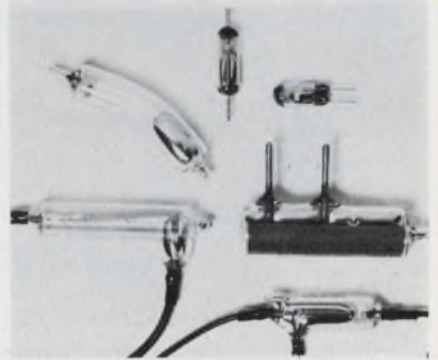

Compac Engineering, Inc., 398 Commercial St., San Jose, Calif. 95112. (408) 286-4844.

Mercury tilt switches in Compac's new line are actuated by a change in position or velocity. Electrodes are sealed in a glass envelope which has been evacuated, purged and back-filled with an inert gas to prevent oxidation and to provide a stable contact resistance. The mercury is purified. These sealed switches are particularly suited to industrial, dirt-prone environments.

CIRCLE NO. 388

For 29¢* - How Good Can This New Reed Relay Be?

Quantity of 1 million



DAMN GOOD!

Our new 1A Series offers Mil Q 9858A specs at the lowest commercial prices: Hermetically sealed coils — Magnetically shielded for high density packing — Switches 1 amp or 250V @ 20 watts — Coil voltages of 1, 3, 5, 6, 10, 12, & 24 volts — Contact resistance less than 100 milliohms — Micro size .275" OD x .950" long.

How do we do it at that price? Our secret is patent pending.

FREE SAMPLES

to letterhead or phone requests.

Electronic Applications Co.
2213 Edwards Ave.
So. El Monte, Calif. 91733
(213) 442-3212
Known for quality

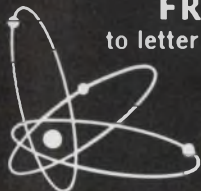

INFORMATION RETRIEVAL NUMBER 83

ELECTRONIC DESIGN 23, November 9, 1972

FIXED CAPACITORS... Hermetically Sealed ...in Glass!

FOR MAXIMUM RELIABILITY AND LONGER LIFE!

Now you can design circuit capabilities never before possible! "Glass-To-Metal" hermetic seal guarantees long-term reliability and greater strength! All potential problems are ruled out because they are sealed out... with glass! High to low temperature excursions (-100°C to +500°C or vice versa) will not affect the thermally matched components! Contact surfaces are non-oxidizing even under the most extreme conditions! Available in 4 sizes from .160 x .065 to .400 x .155 with capacitance ranges of 1 pf to .22 mfd. Write for catalog sheet.

Monolithic Dielectrics Inc.

P.O. Box 647 • Burbank, Ca. 91503
Phone (213) 848-4465

Subsidiary of

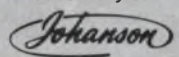

INFORMATION RETRIEVAL NUMBER 84

129

VIDEO STORAGE



Simple, low cost way to give your displays stop-action and four other competitive advantages—all in one small package.

Introducing the Hughes Model 639 video storage unit. A complete electronic image memory system. With all the circuitry, power and controls built-in to make your displays versatile exhibitions.

It stores alphanumeric, graphic, and pictorial data. With high resolution, high-speed writing capability, selective updating and fast erasure. It converts slow-scan and x-y information to TV format.

It integrates signals (automatically enhancing weak or low light images). It speedily processes and

stores input signals for conversion into TV displays for the medical, management, law enforcement, and many other applications.

If you need close-up images, there's a zoom control, with a positioning joystick. And because it's flexible, it can be customized to star in any graphic display system.

Write for new brochure:
2020 Oceanside Blvd., Oceanside, CA 92054.
Or call: (714) 757-1200.



INFORMATION RETRIEVAL NUMBER 86

NEW HUTSON CERMA-CEL* TRIAC's & SCR's

- 8 Amp ($I_{T(RMS)}$)
- 200V, 300V, 400V ($V_{D(ROM)}$)
- Miniature size — requires only slightly more space than direct chip mounting
- Thyristor die bonded to ceramic cell and secured within nickel-plated steel housing
- Can be reflow soldered. Correct amount of solder on housing head.
- Void-free-glass passivated, hermetically sealed chip
- Di-Mesa* construction for maximum operational reliability
- Extremely low-cost



Hutson's complete thyristor line includes 3A sensitive gates to 40A ($I_{T(RMS)}$) • 50V to 600V ($V_{D(ROM)}$). All popular packages & chip form

WRITE FOR FREE CATALOG

*T.M. HUTSON INDUSTRIES

HUTSON INDUSTRIES

BOX 34235 • 2019 W. VALLEY VIEW, DALLAS, TEX. 75234 (214) 241-3511 TWX 910-860-5537

Distributed by:

ALTA-LAND ELECTRONICS, INC. Salt Lake City, Utah. 801/486-7227 ■ BODELLE CO., INC., Chicago, Ill. 312/468-1016, Detroit, Mi. 313/273-6920 ■ THOR ELECTRONICS, Elizabeth, N. J., 201/354-2420 ■ In Canada: WEBER-SEMAD ELECTRONICS, Downsview, Ont. 416/635-9880.

European Marketing Director:

30 Rue Pierre Semard, Yerres, 91 France Tel: Paris 925-8258 • TELEX 21-311

Distributed in Europe by:

Belgium: C. N. ROOD S.A. Brussels 02-352135 ■ Denmark: E. V. JOHANSEN A/S, Copenhagen (01)* 295622 ■ Holland: RODELCO, Dan Haag 647808 ■ Spain: BELPORT, Madrid 234.62.62 ■ Sweden: ELEKTROFLEX, Sundryberg 08-29 50 40 ■ Switzerland: D. LEITGEB, Dubendorf 051 85 2201 ■ UK: CLAUDE LYONS, LTD, Hoddeston, Hertfordshire (09924) 67161

INFORMATION RETRIEVAL NUMBER 87

COMPONENTS

Read-after-write head uses Hall effect

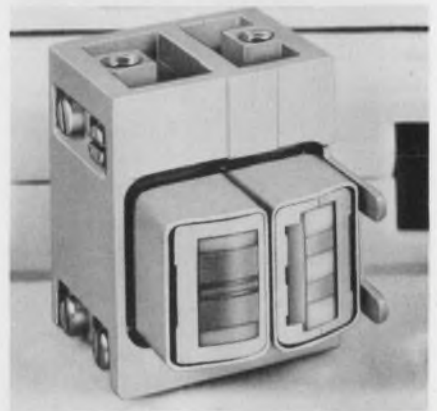

Pioneer Electronics Corp., Components & Data Products Div., 525 W. Remington Dr., Sunnyvale, Calif. 94087. (408) 245-3511. \$66.60 (100-299); stock.

The Model RAW-7201 magnetic reading head is a dual-gap, Hall-effect type that generates an output signal proportional only to the recorded magnetic flux. Output is totally independent of tape speed. This feature eliminates the need for additional circuitry to compensate for output-level variations at different tape speeds. The unit has read-after-write capability and is designed for 0.15 in. cassette applications.

CIRCLE NO. 328

Variable-speed motors provide 3% regulation

Sequential Information Systems, Inc., 249 N. Saw Mill River Rd., Elmsford, N.Y. 10523. (914) 592-5930. From \$150; 30 days.

A variable-speed motor line features permanent-magnet dc motors with built-in, solid-state controllers. Known as Pak-Drives, the systems' feedback circuits maintain set speed to better than 3% from no-load to full rated torque, 10% line voltage variations, and a 30:1 speed range. Even at low speeds the motors deliver smooth and full torque. Systems with better regulation and wider speed ranges are also available. The units are transformer isolated for short circuit and shock prevention. Four sizes with ratings of 1/24, 1/12, 1/8 and 1/4 hp provide a torque range of 14 to 110 oz-in.

CIRCLE NO. 329

Thermoplastic terminal block resists breaking

Curtis Development and Manufacturing Co., Inc., 3266 N. 33rd St., Milwaukee, Wis. 53216. (414) 445-1817. See text.

Thermoplastic terminal blocks offer freedom from breaking, unlike the more common phenolic models. The thermoplastic material is more pliable than thermosetting plastics. And thermoplastic materials can be molded faster, thereby providing lower costs—7¢ per pole in volume purchases. The new block is available with one to 25 poles on 7/16 in. centers. A 6-32 screw draws on an internal nut assembly to clamp wires, eliminating the need to put lugs on wires. A variety of back terminations are available, including PC, wire-wrap and quick-disconnect types. The block is rated at 300 V and 10 A.

CIRCLE NO. 330

Solid-state rectifiers replace high-volt tubes

Electronic Devices, Inc., 21 Gray Oaks Ave., Yonkers, N.Y. 10510. (914) 965-4400.

The R-2AV2 Solid-Tube is a solid-state rectifier for direct, plug-in replacement of vacuum tubes 2AV2, 2BA2 and 1V2 in color television receivers. Four additional solid-state units replace a total of 25 vacuum tubes. The units eliminate a potential source of X-ray radiation, run cool and are longer lived than the vacuum tubes. Peak-inverse voltage is 9 kV, peak-repetitive forward current is 100 mA, average forward current is 5 mA. Voltage drop at 5 mA is 20 V.

CIRCLE NO. 331

Thermal cut-off switch protects transformers

Micro Devices Corp., 1881 Southtown Blvd., Dayton, Ohio 45419. (513) 294-0581.

A Microtemp installed on a transformer winding can directly sense excessive temperature to interrupt the power and prevent damage. A second version provides a quicker-acting way to sense overload. It uses a small heating element fitted to the sensor. The heating element is connected in series with the secondary-coil winding.

CIRCLE NO. 332

Active Magnetic Pickup provides Digital Output

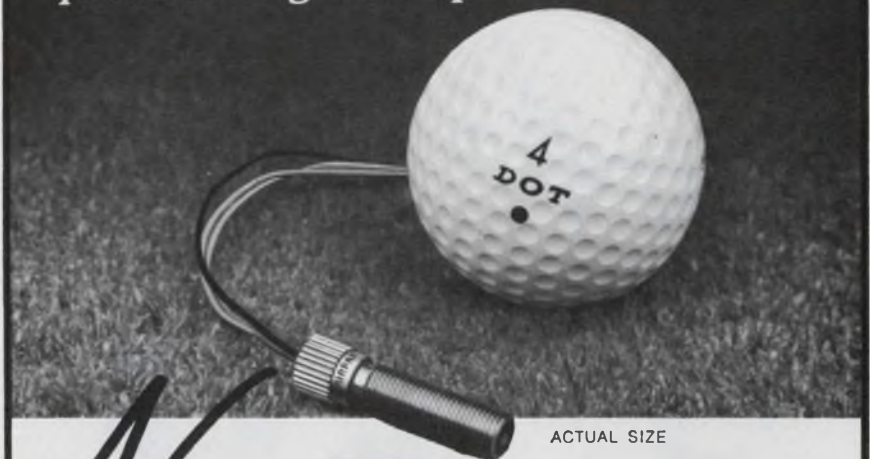

ACTUAL SIZE

New Digital Output Transducer *from Airpax*

Sensor, Amplifier and A/D Conversion in a single miniaturized unit.

Airpax scores with the "all-in-one" Digital Output Transducer that gives you the drive you need for digital circuitry.

When used in proximity to gears or other ferrous discontinuities, the D.O.T. features:

- TTL output independent of power-supply voltage (5 to 15V dc) and load impedance.
- Output for up to 5TTL inputs.
- Self-contained signal conditioning.
- Excellent noise immunity.
- Interface circuitry not required.
- Low-speed operation.
- Operation up to 50,000 Hz.
- Oil and moisture resistant.
- Reverse polarity protection on power supply.
- Wide temperature range.
- No mechanical linkage required.

Applications:

- Speed sensing and control
- Synchronizing
- Counting
- Positioning
- Flowmetering
- Timing

Write for full specifications.

AIRPAX™ ELECTRONICS

CONTROLS DIVISION
6801 W. Sunrise Blvd.
Ft. Lauderdale, Fla. 33313
Phone: (305) 587-1100

Another in the Airpax full line of "active" and "passive" magnetic pickups.

All American Line

Lowest Cost Quality Source Made in U.S.A.

Available 1 to 15 stations—multiple actuations. Basic switch U.L. listed at 3 and 6 amps 125v. Miniature or regular knobs available in variety of colors.

PUSHBUTTONS
as low as **16¢** per station

ULTRA-GLOW® ILLUMINATED
as low as **54¢** per station including bulb

UID
UID Electronics Corp.
4105 Pembroke Rd.
Hollywood, Fla. 33021
Phone (305) 981-1211

NEW
Industrial steel shaft
up to 4PDT

INFORMATION RETRIEVAL NUMBER 86

MIIDA MODEL 6354 3½ DMM with 0.1% DC ACCURACY.

- AUTOMATIC RANGING
- 0.1% (DC) and 0.5% (AC) voltage accuracy
- Measures to 200 megohms resistance
- 45Hz to 20 kHz frequency response
- Range and display hold mode
- Automatic polarity display
- Automatic over-range indicator
- Weight under 5 lbs.

\$319.95

Other Miida multimeters in full 4 and 4½ digits

Distributorships available



Miida Electronics,
a division of Marubeni America Corp.,
2 Hammarokjold Plaza, N.Y., N.Y. 10017
(212) 973-7152

INFORMATION RETRIEVAL NUMBER 87

PACKAGING & MATERIALS

Panel-mount socket accepts LEDs, lamps

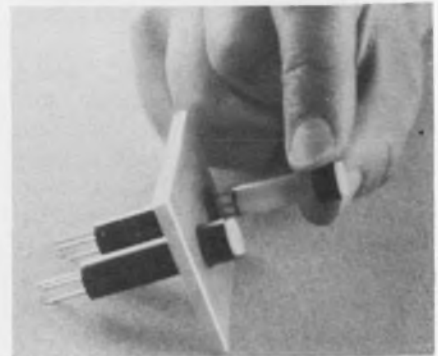

Data Display Products, 8036 Westlawn Ave., Los Angeles, Calif. 90045. (213) 641-1232. \$0.65; stock.

A panel-mount socket provides front-panel replaceability for Fan-In Series panel lights, which have a built-in lamp driver with an optional built-in lamp test. The sockets may also be used with the company's standard line of LEDs, incandescent, and neon 1/4 in. dia. panel indicators. The sockets are designed for no-mistake contact between light cartridge and socket; they are keyed so that the light will only start into the socket in the correct position, and no rotation in the socket is possible.

CIRCLE NO. 333

Capacitor packages reduce board space

Engineered Components Co., 2134 W. Rosecrans Ave., Gardena, Calif. 90249. (213) 321-6565.

Multi-Cap Packages contain various combinations of values of either metallized-polyester or metallized-polycarbonate capacitors in sizes ranging from 385-mils wide by 225-mils high in lengths of from 300 mils (with two capacitance values) to 1.40 in. (in 100-mil increments) which will accommodate up to 13 capacitance values. They are also available in a double width case 800-mils wide × 225-mils high with a length of 1.40 in. which could accommodate a maximum of 26 capacitance values. This packaging concept greatly reduces the board space required for a given set of components while reducing the number of parts that must be handled.

CIRCLE NO. 334

Edge-card connector has 60-contact positions

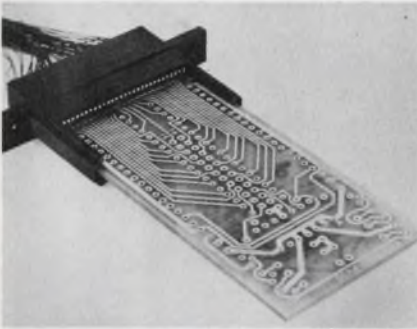

Berg Electronics, Inc., York Expwy., New Cumberland, Pa. 17070. (717) 938-6711.

A crimp-to-wire edge-card connector provides mechanical termination of wire in the No. 30 to No. 34 AWG range. The connector has 60 contact positions in a double-row housing with 50-mil centerline spacing. The connector has a 1-A rating; it features polarization and card guides.

CIRCLE NO. 335

Metal core PC board also dissipates heat

International Electronic Research Corp., 135 W. Magnolia Blvd., Burbank, Calif. 91502. (213) 849-2481.

A single-sided metal core circuit board serves as a heat-dissipator and structural-member, often acting as the complete power supply chassis. The metal circuit board is coated with Insultek, which displays the seemingly contradictory characteristics of high dielectric strength and high electrical surface resistance while exhibiting quite high thermal conductivity.

CIRCLE NO. 336

Laminated ribbon cable features 3-mil accuracy

Berk-Tek, Inc., P.O. Box 60, Reading, Pa. 19607. (215) 376-8071.

A laminated ribbon cable has the conductor spacing controlled to ± 3 mils to assure consistent and reproducible electrical characteristics. The cable is claimed to be available to any length and number of conductors in a wide range of insulations, sizes and color coding.

CIRCLE NO. 337

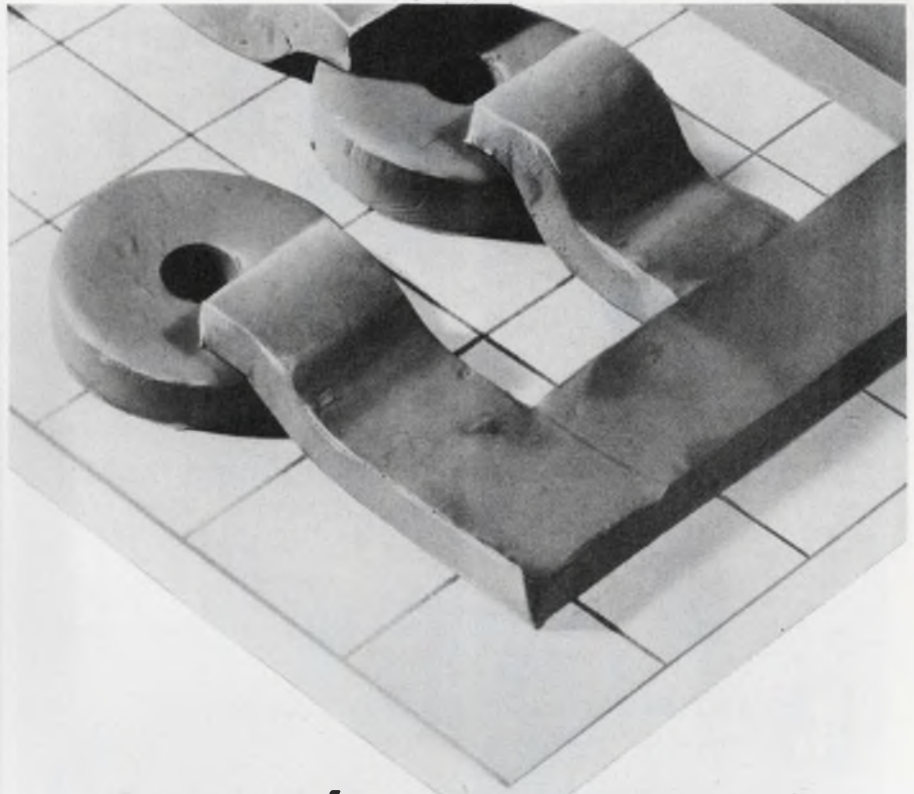

Having P/C repro problems? Maybe your artwork is too fat.

What you see here is a clay model representing art made with die-cut symbols. To your eye your artwork doesn't look like that. But the lens of the repro camera picks up the buildup of those die-cut symbols and tape.

Mecanorma symbols, on the other hand, are printed on an ultra-thin transparent carrier film just 20 microns thick! The tape lies flat. There is no buildup, hence there is no distortion, no parallax.

You can apply Mecanorma symbols with pinpoint accuracy, too. Unlike die-cut symbols, Mecanorma comes in handy transparent strips which give you rapid and precise positioning. No sticky situations, either. The symbols and the carrier sheet can actually come in contact with your work surface without the symbol sticking before you want it to.

And if you change your mind, you can quickly correct it with tape or rubber cement pick-up (it's 40% or 50% quicker than other methods). Mecanorma symbols come in a flat box so they're easy to store (they have a 7-year shelf life). And if you think variety is the spice of life, we have over 800 different symbols to keep you happy.

To prove Mecanorma symbols are all we say, we'll send you some samples and one of our catalogues. Free. Just write Keuffel & Esser Co., 20 Whippany Road, Morristown, N.J. 07960.



KEUFFEL & ESSER CO.





Synchron.® Your own personal timing motor.

Every Hansen synchronous timing motor is built for a designer like you. To specific requirements, with our confidential help.

We have several thousand models designed, tooled, and ready-to-build in any quantity. In five major styles.

Many speeds. Torque from 8 to 98 oz.-in. at 1 rpm. All competitively priced.

Add Hansen to your design staff. Call or write for complete specs, or contact one of our representatives below.



HANSEN MANUFACTURING COMPANY, INC.
PRINCETON, INDIANA 47670

Hansen Representatives: Carey & Associates, Houston and Dallas, Texas; R. S. Hopkins Co., Sherman Oaks, Calif.; Melchior Associates, Inc., San Carlos, Calif.; The Fromm Co., River Forest, Ill.; John Orr Associates, Grand Rapids, Mich.; H. C. Johnson Agency, Inc.; Rochester, N.Y.; Winslow Electric Co., Essex, Conn.; Kiley Electric Co., Villanova, Pa.; and Herbert Rude Associates, Inc., Teaneck, N.J.



INFORMATION RETRIEVAL NUMBER 89

If our boxes are bigger, it's because reliability takes room.

Stuffing DPM circuitry into a plastic pillbox may save some real estate, but cramped meters buy you a bundle of unnecessary problems.

Newport DPM's have room for large, sturdy connectors and hefty, cool-running power transformers. Amply-spaced PC traces are unaffected by humidity or handling. And solid aluminum shield-cases improve noise immunity, cooling characteristics and mechanical strength.

When small size overrules reliability, also expect Feature Fall-

Out, Option Omission and Spec Scrimping. But not with our new Series 2000A. It's the only ± 39999 count DPM available with 3-pole active filter, display-blanking and unique BIGS-BCD output.

Ask for details on the new Series 2000A DPM... or any of Newport's 150 matching meters with built-in reliability. The panel instruments you install and forget.

Newport Laboratories Inc., 630 East Young Street, Santa Ana, California 92705 (714) 540-4914.



SERIES 2000A DPM: $\pm 39,999$ counts • DC volts, current or ratio • .01% accuracy
BIGS-BCD outputs... buffered, isolated, gated and stored • $2\frac{1}{2}$ "H x 5"W x $7\frac{1}{2}$ "D.

Newport Digital Panel Instruments

INFORMATION RETRIEVAL NUMBER 90

MICROWAVES & LASERS

Rf fuses protect from dc to 2000 MHz



Alan Industries, Inc., Bldg. 22, Bakalar Municipal Airport, Columbus, Ind. 47201. (812) 372-8860. \$12.50; 1 wk.

A series of rf fuses to protect devices sensitive to excessive rf power from accidental burnout is available with 50 or 75 Ω impedances. Models cover the dc to 2000 MHz frequency range. Each fuse is calibrated with insertion loss recorded on the device at convenient frequencies. Standard breakdown points are between +23 dBm and +29 dBm.

CIRCLE NO. 338

Doubly balanced mixer improves front ends



Vari-L Co., 3883 Monaco Pkwy., Denver, Colo. 80207. (303) 321-1511. Stock.

The Z-Match Model DBM-100E, for applications in the 0.5 to 500 MHz range, claims improved receiver front-end performance due to high rejection of spurious signals and intermodulation products. Interport isolation is typically 55 dB and conversion loss is lower than in conventional designs. The 1-dB compression point is approximately 0.7 dBm with a LO signal of 17 dBm.

CIRCLE NO. 339

Space age reliability
VOLTAGE REFERENCE STANDARDS



- Less than 1 PPM/°C T.C. over 140° span (–55° to +85°C)
- Less than 1 PPM V_{out} change for $\pm 1\%$ V_{in} change.
- Long term stability less than 50 PPM/Year.
- AC or DC inputs available—less than 0.01 pf equivalent input capacitance on AC types.
- Custom made for precise output voltage or standard designs available.
- Calibration traceable to NBS.

TYPICAL APPLICATIONS

Guidance Systems
GSE Checkout Devices
Fire Control Computers

Missiles
Precision Instrumentation
A-D Converters

INSTRULAB, INC.

1205 Lamar Street, Dayton, Ohio 45404 (513) 223-2241

INFORMATION RETRIEVAL NUMBER 91

HAND CRAFTED MACHINED ALUMINUM KNOBS



ALCO's fine anodized finish enhances your front panel appearance — where it counts. Write or call for latest Designer's Catalog!

ALCO ELECTRONIC PRODUCTS, INC.
1551 OSGOOD STREET, NORTH ANDOVER, MASS. 01845

INFORMATION RETRIEVAL NUMBER 92

SLIDE SWITCH MINIATURES

This series offers multiple circuit switching in P.C. boards with limited space. Choice of upright or right-angle mounting. Compact size for P.C. mounting. Available with gold or silver terminals and contacts.

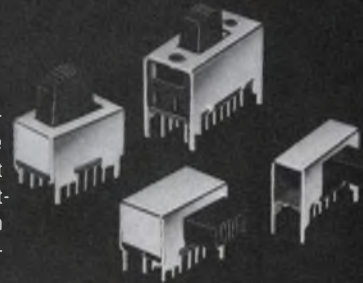

ALCOSWITCH®

IDEAL SIZE FOR PRINTED CIRCUITS

ALCO ELECTRONIC PRODUCTS, INC. NORTH ANDOVER, MASS. 01845

INFORMATION RETRIEVAL NUMBER 93

A 1/9 ad page size for only \$300 including production charges

Quick Ads will be placed in their own special section, attractively laid out to insure maximum attention. Each will have its own Information Retrieval Number, assuring many inquiries, many sales leads. You simply provide an 8 x 10" glossy photograph, plus approximately 40 words of copy. We do the rest at no cost to you.

For full information, including even lower frequency rates, mail the form at right to
Bryce Gray
Sales Manager
Electronic Design,
50 Essex Street,
Rochelle Park, N.J. 07662

Quick Ads

PLEASE RUSH ME FULL DETAILS ON QUICK ADS IN ELECTRONIC DESIGN

NAME _____ FIRM _____

STREET _____ CITY _____ STATE _____ TITLE _____

ZIP _____

MONOLITHIC CRYSTAL FILTERS

THE STATE OF THE ART

The Truth About Monolithics . . .



Truth is stronger than fiction. It's also said to be the greatest gimmick in advertising. That's what this series of ads is about — the truth about monolithic crystal filters. If you want the truth about the best filter for your application, talk to us. We've been making monolithic crystal filters longer than anyone else — and we've made more of them. We know what can't be done as well as what can.

Standard Substitute . . .



When is a conventional crystal filter unconventional? When it's a monolithic designed to be completely interchangeable with its conventional counterpart — and to be 10 to 50% less expensive. If you're still using conventional crystal filters and aren't ready to redesign your equipment, check with us. The next best thing to designing your new radio around a monolithic crystal filter is plugging a monolithic into your old one. It may be just what the doctor ordered to keep the patient alive and well a little longer.

Short Course . . .



Whether you're now using integrated crystal filters or just thinking about it, you'd probably like to know more about them. We're offering a limited number of reprints of an up-to-date survey article including specification guidelines. A copy is yours for the asking. Just drop us a note on your letterhead.

Like more information on monolithics? Drop us a line or call us.

Pti

Piezo Technology Inc.
2400 Diversified Way
Orlando, Florida 32804
305-425-1574

The Standard in monolithic
crystal filters.

evaluation samples

Scope tracer blanks

Oscilloscope signals can be recorded in color, faster and less expensive than with photographic techniques. Trace records can be in black, red and green using a normal single color oscilloscope. Direct positive record on a clear plastic film base with high contrast results in excellent electrostatic copies. Because of the clear base, the oscilloscope signals can be projected using overhead projectors or large slide projectors. The recording blanks are reusable or can be permanent. The cost per record is up to 80% less compared with photographic records. JTEM Scope Tracer.

CIRCLE NO. 340

Heat transfer washers

The A26-2020 aluminum oxide ceramic washer exhibits a very low thermal impedance and a breakdown voltage of 1000 V minimum. A low thermal resistance (0.15 C/W) insures that the full power capability of the semiconductor can be used. The thermal performance is approximately five times better than mica and is comparable with an equivalent hard anodized aluminum washer. Jermyn.

CIRCLE NO. 341

Rotary shaft seal

A spring loaded Teflon cartridge seal is designed for miniature applications where very low friction, compact size, long trouble free life, chemical inertness, and indefinite shelf life are necessary. The seal consists of a Teflon sealing ring, a stainless steel holding ring (or mild steel) and an elliptical garter spring with canted coils that can deflect over 50% of its original size upon loading. Pressures can be withstood from vacuum to 250 psi, temperatures from -65 to 400 F, and speeds to 5000 rpm depending on pressure, temperature and size. Bal Seal Engineering Co.

CIRCLE NO. 342

Dc power supplies

Regulated voltage, constant current dc power supplies come in voltages from 2 to ± 15 V and currents from 60 mA to 1 A. Volt sensor voltage comparators are also available. Requests will be followed by a questionnaire to determine qualifications before the sample is sent. California Electronic Manufacturing Co., Inc.

CIRCLE NO. 343

Epoxy resin

A solventless low-viscosity epoxy resin casting system is particularly effective for large mass castings because of its low shrinkage and low exotherm on cure. Tra-Cast 3010 can be used to impregnate finely wound coils and motor starters, or to coat printed circuits, or to embed transformers, modules, connectors and other types of circuitry where a low residual strain is needed in order to maintain the integrity of the embedded unit. Tra-Con, Inc., Resin Systems Div.

CIRCLE NO. 344

Terminal-insulating pod

Ultrapod, an ultrasonically applied insulating pod, offers a new method of insulating preterminated receptacles that is reported to be faster or less expensive than any conventional method in use today. The preformed pod is fed from continuous reels, folded over the terminal, ultrasonically sealed, and cut off in a single cycle of the automatic tooling which can apply insulating pods at rates up to 2000 per hour. AMP Inc.

CIRCLE NO. 345

Molding material

Designed for use in automotive, appliance and computer/communication applications, a thermosetting molding material costs 45¢/lb. A two-stage glass-and-mineral filled phenolic, the material is formulated to provide high heat, strength and electrical properties, plus good dimensional stability. Hooker Chemical Corp., a subsidiary of Occidental Petroleum Corp.

CIRCLE NO. 346

EXAR'S IC WAVEFORM GENERATOR SPEAKS FOR ITSELF

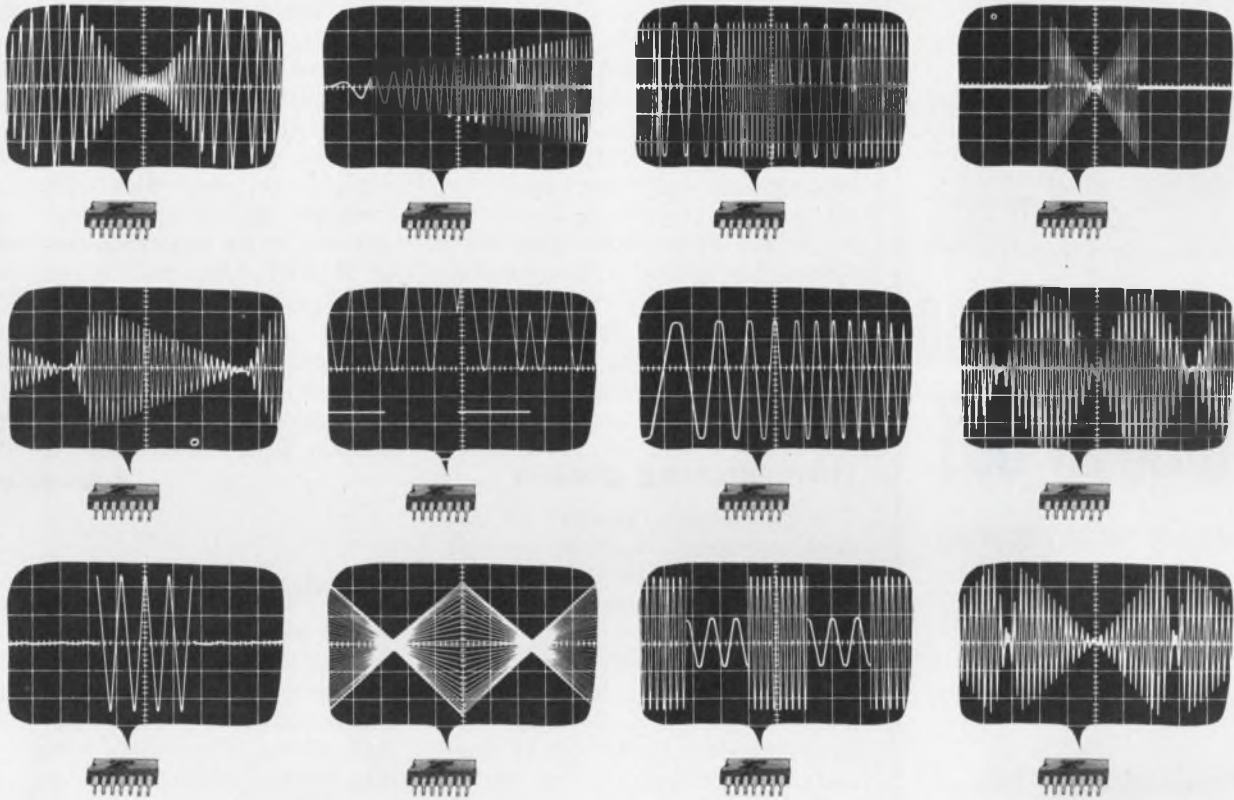

Yes, the XR-205 monolithic waveform generator speaks for itself in a cost-saving way that systems designers can understand.

Just one Exar XR-205 device provides sine, square, triangle, ramp and sawtooth waveforms without additional active components. By adding a second XR-205, you can create amplitude, frequency or phase modulated varieties of these basic waveforms. So two XR-205 for \$16.00 each, in 1-24 quantities, are able to replace comparable large discrete waveform generators selling from \$200 to \$1300. At the same time they greatly reduce system weight, complexity and power consumption.

Waveshaping is accomplished by a unique monolithic diode-resistor combination with only about 2 percent total harmonic distortion. The harmonic content of the sinusoidal output is relatively independent of the modulation input and frequency of operation.

Here's how the XR-205 works: each chip contains three separate logic sections. A Voltage-Controlled Oscillator section with a frequency range of 0.1 Hz to more than 10 MHz generates the basic waveforms by means of an emitter-coupled multivibrator. A Balanced Modulator provides the wave-shaping and amplitude modulation. A highly linear four quadrant analog multiplier is used for suppressed carrier modulation as well as for conventional double sideband AM generation. A Buffer Amplifier provides a low impedance output with high current drive capability.

To get you started at a modest cost, ask us for the XR-205K Waveform Generator Kit. The kit sells for \$28.00 in small quantities and is comprised of two XR-205 devices, a drilled and etched circuit card, and detailed assembly and hookup instructions.

For more information or an order call Jim Shales, Director of Marketing at Exar. He and his people speak your language.

EXAR SPEAKS YOUR LANGUAGE



EXAR INTEGRATED SYSTEMS

750 Palomar Sunnyvale, California 94087 (408) 732-7970 TWX 910-339-9233

EXAR SALES REPRESENTATIVES Alabama: Georgia, Mississippi, North Carolina, South Carolina and Tennessee: K&E Associates, Kennesaw, Georgia (404) 974-4264
Arkansas, Louisiana, Oklahoma and Texas: Evans-McDowell, Dallas, Texas (214) 238-7157 California: De Angelo, Rothman and Co., Whittier (213) 398-6239 Logan Sales
Co., Redwood City (415) 369-6726 Connecticut, Maine, Massachusetts, New Hampshire, Rhode Island and Vermont: Com-Sale, Waltham, Massachusetts (617) 890-0011
Indiana, Kentucky and Ohio: McFadden Sales, Columbus, Ohio (614) 221-3363 Iowa, Kansas and Missouri: Nevco, Inc., Kansas City, Missouri (816) 421-1751 New Jersey
and New York: MOS Associates, Floral Park, New York (516) 694-5923 Canada: Harvard Electronic Sales, Laval, Quebec (514) 681-1400 **EXAR DISTRIBUTORS** Califor-
nia: Intermark Electronics, San Carlos (415) 592-1641 San Diego (714) 279-5200 Van Nuys (213) 782-0362 Colorado: Intermark Electronics, Denver (303) 936-8284
Massachusetts: Gerber Electronics, Dedham (617) 329-2400 Washington: Intermark Electronics, Seattle (206) 767-3160

INFORMATION RETRIEVAL NUMBER 96

PSC Low Cost Tape Transports

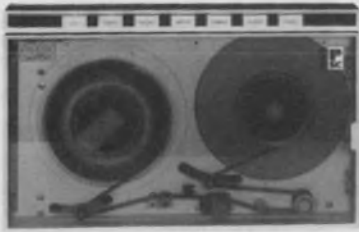

User Engineered THROUGH OUT

- Interface Industry Standard
- 7", 8½" or 10½" Reel Size
- 6.25, 12.5, 25, 37.5 or 45 IPS
- Phase Encoding or NRZI
- 200, 556, 800 or 1600 CPI
- Single or Dual Gap Heads
- Write, Read, Read Write or Read after Write
- Power Fail Safe
- Solid State IC Logic

Give us your requirements we'll custom assemble to your specification with off the shelf components.

Call: Chuck Quillen, Director of Marketing for more information.

(213) 245-8424



Producers Service Corp.
Computer Peripheral Div.
1200 Grand Central Ave.
Glendale, Calif. 91201

INFORMATION RETRIEVAL NUMBER 97

application notes

Logic probes

A series of application notes describes the application of two inexpensive digital test instruments to the diagnosis of specific logic functions. One measures logic levels and the presence or absence of pulses and pulse trains. The other determines period, pulse width, and delay of pulses and pulse trains in digital logic circuitry. Advanced Digital Research Corp., Mountain View, Calif.

CIRCLE NO. 347

Thermoforming glossary

A twelve-page glossary of the most commonly used terms and techniques in plastic sheet thermoforming contains over 85 thermoforming definitions as well as illustrations of the eleven most common thermoforming techniques. In addition there is a section on the advantages and limitations of thermoforming. Harva Co., Inc., Schenectady, N.Y.

CIRCLE NO. 348

Dual channel encoder

Application report TRN-104 "The Dual Channel Encoder" describes the required logic to be used with a dual channel incremental encoder to perform the functions of direction sensing, pulse multiplying, and mechanical noise cancellation. Various logic schemes are presented with associated diagrams to perform the required actions. Trump-Ross Industrial Controls Inc., Billerica, Mass.

CIRCLE NO. 349

Data communications

"Sherry's guide to data communication buzz words" is as delightful as it is enlightening. Sprinkled among the more serious definitions of common and not-so-common terms used in data communications, are salted away some puns, comments and photographs of Sherry. They add zest. International Communications Corp., Miami, Fla.

CIRCLE NO. 350

Self-extinguishing resin

Cycology ABS alloy, Grade KHP, a recently developed self-extinguishing thermoplastic resin with good molding and extrusion characteristics, is the subject of a 16-page technical report. The bulletin (P-177) points out that Cycology KHP not only meets the UL SE-0 rating for self-extinguishing characteristics of 60-mil thickness, but also provides the balance of engineering properties—impact strength; high temperature, chemical, and abuse resistance; and ease of molding—required in automotive, appliance, toy, electrical, electronics, communications, business machines and other applications demanding high-performance plastic resins. Borg-Warner Corp., Marbon Div., Washington, W. Va.

CIRCLE NO. 351

Disc drive formatting

A 32-page application note shows how to design a sector format for the company's disc drives. The application note provides an analysis of the parameters within a disc drive which contribute to sector format considerations. Each parameter is discussed and algebraic expressions are provided. Included in the application note are formulas for calculating a sector to provide information needed to determine sector timing requirements for specific applications. A table is supplied which gives calculated results for various sector, disc speed and data rate values. Pertec Corp., Chatsworth, Calif.

CIRCLE NO. 352

Valve sizing guide

A 12-page bulletin on valve sizing simplifies the usually difficult task of sizing a valve. The information is contained in easy to use tables. Given the specific gravity of the product and the pressure drop through the valve, the appropriate valve capacity can simply be read from the table. In addition, a brief introduction describes the pressure drop (and how to calculate it) in clear and elementary terms. Foxboro Co., Foxboro, Mass.

CIRCLE NO. 353

VERSATILITY RELIABILITY ECONOMY

YOU GET IT ALL IN THE NEW
CTS CERMIDE® THICK FILM MINI-POTENTIOMETER PACKAGE

(As low as 75¢ each in production quantities)

CTS Series 205 high power, mini pots offer immediate design versatility for instrumentation miniaturization (other applications too!) In any style you say . . . singles-duals-triples — straight or concentric tandems.

With proven CTS design features:
1 watt power rating • compact 5/8" diameter
• design versatility • TCR ±250 PPM/°C standard (lower on request)
50 ohms — 5 megohms • U/L approved SPST switch — 3 amp 125 vac • choice of mountings and terminals.



CTS CORPORATION
 Elkhart, Indiana



Write or phone
 CTS Keene, Inc., Paso Robles, Ca. 93446. Phone: (805) 238-0350.

INFORMATION RETRIEVAL NUMBER 98

who cares
 what a
 control knob
 looks like?

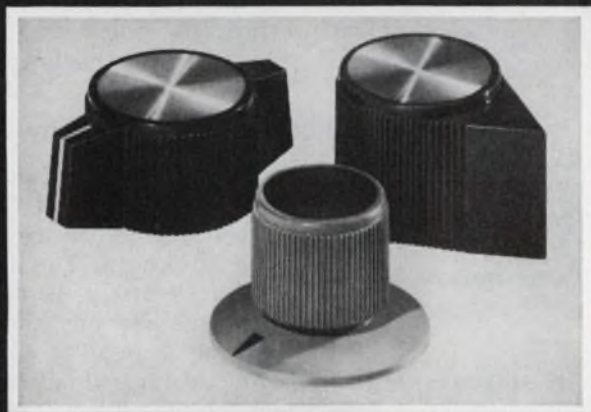

we do.

ROGAN

Outline your requirements for quotation and free knob sample. Also write for free, full-color catalog

3455 WOODHEAD DR., NORTHBROOK, ILL. 60062, (312) 498-2300

Beat This Deal

DIMENSIONS:
 3.5" x 3.5"
 x 3.5"



DIMENSIONS:
 6.0" x 6.2" x 3.0"

Purchase must be accompanied by this ad or reasonable facsimile. One free sample per customer.

FREE SAMPLE
 of the New World's
 Smallest Power Supply
 Module*

. . . with a minimum \$58 purchase of open frame power supplies . . . a "best value" in its own right.

***EE SERIES**

DIMENSIONS: 2" x 2" x .875"
 REGULATION: Line & Load 0.25%.

MODEL	OUTPUT	PRICE
EE 15 D 25	±15 Vdc @ 25mA	\$12
EE 12 D 25	±12 Vdc @ 25mA	12
EE 5 S 200	5 Vdc @ 200mA	14

RF OPEN FRAME SERIES

REGULATION: Line 0.01%; Load 0.05%
 NO DERATING -25°C to +71°C

MODEL	OUTPUT	PRICE
RF 5 S 2000	5 Vdc @ 2A	\$39.95
RF 5 S 3000	5 Vdc @ 3A	48.50
RF 5 S 5000	5 Vdc @ 5A	58.50
RF 5 S 7000	5 Vdc @ 7A	68.50
RF 12 D 500	±12Vdc@500mA	65.00
RF 12 D 1000	±12 Vdc @ 1A	88.50
RF 15 D 500	±15Vdc@500mA	65.00
RF 15 D 1000	±15 Vdc @ 1A	88.50

see EEM p. 954



SERVOTRON CORPORATION
 P. O. BOX 292 HAVERHILL, MASS. 01830
 TELEPHONE (617) 374-0777

INFORMATION RETRIEVAL NUMBER 99

ELECTRONIC DESIGN 23, November 9, 1972

INFORMATION RETRIEVAL NUMBER 100

139



Regulated Series

AC-DC POWER SUPPLY KITS

Save design time.

Tecnetics offers AC-DC Power Supply Kits with the convenience of matched components and proven performance.

Save yourself costly design time by choosing from a broad line of unregulated, regulated and highly regulated predesigned kits.

Simple and complete instructions supplied with each kit.

Prices start at \$13 in 1-9 quantities.

For instant information call our Hot Line (303) 442-3837.

See EEM catalog vol. 1 pp. 996-1005 for other Tecnetics products.

tecnetics inc.

Box 910 Boulder, Colorado 80302
(303) 442-3837 TWX910-940-3246

new literature

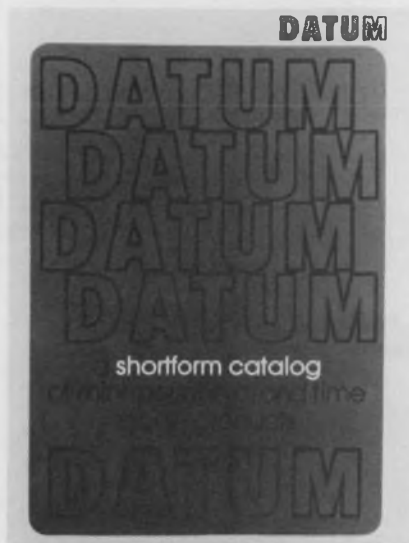

Minicomputer peripherals

A 12-page catalog covers the general product areas of each of the company's four divisions. A brief description of the company, specifications on typical magnetic tape input/output systems, a modular data acquisition system, digital cassette drives and mass memory devices, all with software and interfaces to a wide range of minicomputers are included. Datum Inc., Anaheim, Calif.

CIRCLE NO. 354

Tape transports

The 2900/2800/2500 disc-drive systems and the 8420 tape transport, 8803 controller and 2007 drive are described in three pieces of literature. Speed and cost savings for each of the units, all of which are designed as IBM-compatible peripherals, are featured. Mohawk Data Sciences Corp., Herkimer, N.Y.

CIRCLE NO. 355

I/O interface

A six-page brochure explains how interfacing a minicomputer to your process is no longer a custom engineering problem. Included is a compilation of condensed technical data and prices for the various products comprising the a/d line of products. Computer Products, Fort Lauderdale, Fla.

CIRCLE NO. 356

Switches and keyboards

"Design Engineer's Switch and Keyboard Selector Guide" describes more than 200 standard types of snap-action switches, matrix selector switches, thumbwheel and leverwheel switches and electronic data entry keyboards. The pocket-size, two-color brochure has 14 pages of illustrations, brief descriptions, sizes and electrical ratings for quick, easy reference. Included with this short-form catalog is a listing of offices in Europe, Australia, Japan, as well as Canada and the U.S. Cherry Electrical Products Corp., Waukegan, Ill.

CIRCLE NO. 357

Switching, control devices

An expanded line of switching and control devices is fully illustrated in a 50-page catalog. Descriptive photos, diagrams, drawings, comparative specs, dimensions, applications and prices of over 300 items in 12 product categories are included. Some of the products featured include liquid level switches, miniature relays, mercury plunger relays, mercury tilt switches, pressure switches, reed relays, security switches, magnets, keyboard switches and legends. All items listed are in stock for immediate delivery. Compac Engineering, Inc., San Jose, Calif.

CIRCLE NO. 358

Minicomputer biography

The biography of a minicomputer developed for use as an OEM system component is documented in a 16-page brochure. The four-color document describes the development, features and applications of the company's 16-bit NAKED MINI 16 and ALPHA 16 minicomputers and the philosophy that led to their creation. In addition to minicomputer performance and specifications, the brochure details the exhaustive quality assurance procedures that contribute to the products' reliability. Computer Automation, Inc., Irvine, Calif.

CIRCLE NO. 359

THE HANDS-OFF 500 MHz METER.



NO PRESCALING.

Our Model 6421B Frequency Meter direct-counts up to 500 MHz. That's right ... 500 MHz direct count.

Now there's no lost time waiting for prescaling, or the need to manually tune and interpret the heterodyne unit. The 6421B lets you read frequencies to one Hertz in one second.

There's more. The 6421B has a wide dynamic range (no need for external attenuators or dividers) and the right input impedance to do the job. For systems users, BCD outputs are standard, and most functions are programmable at no extra cost.

The 6421B is the perfect instrument for commercial communications frequency measurements.

Ask your local Beckman representative for details or call us direct at (312) 671-3300.

Beckman

INSTRUMENTS, INC.
ELECTRONIC INSTRUMENTS DIVISION

INFORMATION RETRIEVAL NUMBER 102

STRIP BUS by Rogers

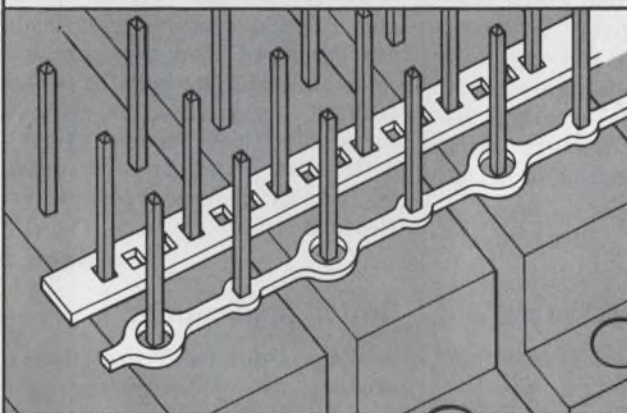

Low Cost Bussing Systems
Easy Installation
Reliable Solder Joints
Greater Pin Exposure



Write or call for details

Rogers Corporation / Rogers, Conn. 06263 (203) 774-9605

INFORMATION RETRIEVAL NUMBER 103

ELECTRONIC DESIGN 23, November 9, 1972

SHARP

Photo-Electric Components MUCH MORE THAN MEETS THE EYE!



SHARP offers an entire new spectrum for applications in Computers and Peripheral Equipment, Industrial or Medical Instrumentation, Communications, and Controls.

- Silicon Photo-Detecting Diodes
- Silicon Blue Cells
- Silicon Readout Cells
- NPN-Type Silicon Photo Transistors
- Photo-Coupling Diodes—GaAs Electro-Luminescent
- Full Range of LED's including GaAs Infrared, GaAsP Visible & GaAs Negative Resistance Types

Write or call. Technical Literature available.
MARKETED EXCLUSIVELY IN THE U.S.A. BY SHIGOTO...
one of the world's largest Manufacturing Importers.

Shigoto Industries Ltd.

350 Fifth Avenue, Empire State Bldg., N.Y., N.Y. 10001
(212) 695-0200 / TEL EX 22419

INFORMATION RETRIEVAL NUMBER 104



Half price sale on sapphire substrates.

(Tyco's cost that much less.)

Here it is, almost off-the-shelf. Polished, single-crystal sapphire substrates from Tyco, at about half the price of other suppliers'. If you've been settling for substitute materials because of cost, forget it. Now you can afford the positive isolation, perfect surfaces, and orientations you need for SOS, hybrid IC, and other microcircuit designs.

For full details about sapphire substrates, or the many other applications of Tyco's synthetic sapphire, call today. Collect. Frank Reed will tell you all about it.

tyco

SAPHIKON DIVISION

16 Hickory Dr., Waltham, Mass. 02154

(617) 890-2400

INFORMATION RETRIEVAL NUMBER 105

NEW LITERATURE



TI multiple semis

A multiple semiconductor catalog highlights all the product capabilities of the company's small-signal transistor department. The 96-page catalog covers devices with more than one chip in a package. The booklet also details the packaging of diodes and transistors in IC compatible packages. The products discussed include duals, quad transistors, Darlington pairs, double-emitter choppers, diode arrays and diode matrices. Interchangeability guides are provided. Other silicon small-signal low-power transistor numerical listings are shown along with a 1N listing of silicon diodes. Texas Instruments Inc., Dallas, Tex.

CIRCLE NO. 360

Panel mount switches

Five basic double-pole snap action switches and one single-pole switch with "push-push" alternate action, are illustrated and described in a four-page, two-color brochure. Included is complete ordering information (part numbers and prices). Cherry Electrical Products Corp., Waukegan, Ill.

CIRCLE NO. 361

Magnetic tape recorders

A short form catalog describes representative examples of the company's line of magnetic tape recorders/reproducers, transducers, recording oscillographs, computer peripherals and associated equipment. The 12-page color document contains photographs and brief, informative descriptions of the various products. Bell & Howell's Electronics & Instruments Group, Pasadena, Calif.

CIRCLE NO. 362

Pushbutton switches

A lighted pushbutton switch line—offering low power, 1 A or less, multifunction switching—is described in a four-color bulletin. The eight-page publication contains complete specifications, performance data, line drawings, photographs and a lamp selection guide. Oak Industries, Inc., Switch Div., Crystal Lake, Ill.

CIRCLE NO. 363

Test instrumentation

Detailed descriptions and specifications for the company's complete line of design and lab instrumentation are provided in a 36-page catalog. Included are standard electronic test and measurement equipment—frequency counters, scopes, generators, digital voltmeters, power supplies, strip chart recorder systems and modules and digital instrumentation. Also included is the Model EU-801E mini-computer interface, complete digital systems, individual modules and plug-in logic circuit cards. Also in the catalog is the Heath/Malmstadt-Enke Laboratory Station—a complete teaching/learning environment for all phases of electronics. Heath/Schlumberger Scientific Instruments, Benton Harbor, Mich.

CIRCLE NO. 364

Thermal digital printer

TP-10 thermal digital printer and TP-10M plug-in print module are described in a two-page, two-color bulletin. The bulletin includes features, capabilities, paper, options, specifications and prices of both units. PPM, Inc., Subsidiary of Torq Engineered Products, Inc., Bedford, Ohio.

CIRCLE NO. 365

Switch applications

"Uses Unlimited" describes the growing use of precision snap-action switches. Three unusual switching ideas submitted by readers are also featured in the eight-page publication. Two pages describing trends in limit and enclosed switches and reviewing the packaging varieties available in rotary switches complete the issue. Micro Switch, a div. of Honeywell, Inc., Freeport, Ill.

CIRCLE NO. 366

curtis relay socket assemblies



**Type RS assemblies:
Widest choice available from any source**

Almost any relay or timer can be mounted in these compact assemblies that feature printed circuit boards of glass epoxy G-10. Barrier-type screw, or clamp-type terminal blocks are highly break-resistant. Terminals are permanently numbered for quick identification. Highest quality sockets provide great conductivity, relay retention, and protection. Up to 24 sockets snap in/out of 48" pre-punched vinyl track using only 2 or 3 mounting screws.

Contact factory for your nearest local Curtis representative, distributor, or for additional information.

CURTIS DEVELOPMENT & MFG. CO., INC.



3236 N. 33rd St. • Milwaukee, Wis. 53216

INFORMATION RETRIEVAL NUMBER 106



versatile
instrument
package

CABINET SERIES

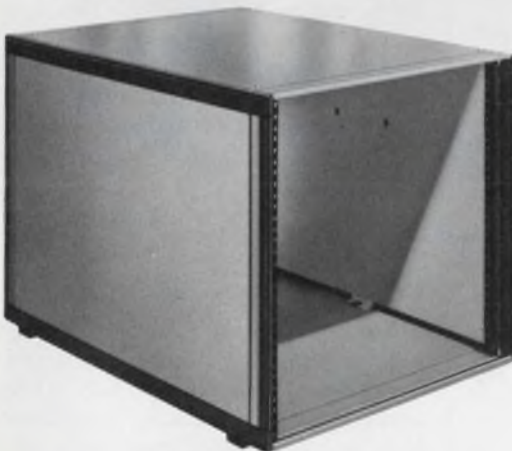

10 heights
from 5 1/4"
to 28"
with 17.9"
or 25.9"
depths.

Two week
delivery
from stock.

Accepts EIA 19"-wide panels. Positive nesting foot for vertical stacking. Single units can be fitted with tilt stands, chassis slides, fold-away cast handles, (self-retract strap available for 5 1/4" unit only). Pre-built with or without front and/or rear panels. **Ask for free VIP Design Guide, prices.**

Zero Manufacturing Co.

Zero-West (213) 846-4191 • 1121 Chestnut St. • Burbank, Ca. 91503
Zero-East (413) 267-5561 • 288 Main St. • Monson, Mass. 01057
Zero-South (813) 531-8991 • Int'l Airport • St. Petersburg, Fla. 33732

INFORMATION RETRIEVAL NUMBER 108

LOW-COST, MODULAR CONTROL SYSTEMS

numerical & computer



Quickly built with field-proven modules customized to your exact need, but giving you the benefit of production-type economies. Open and closed loop control types, pluggable integrated circuits. Operator training, field service furnished. Software and optional equipment available. Prompt quotations, fast delivery. Free literature and technical bulletins on request.

ELECTRONICS HOUDAILLE

ELECTRONICS DIVISION, HOUDAILLE INDUSTRIES, INC.
9035 Wehrle Dr., Clarence, N.Y. 14031 716-632-8412

INFORMATION RETRIEVAL NUMBER 107

NEW Heathkit 2 1/2 Digit DMM



only 79⁹⁵*

A compact, solid-state multimeter with digital readout — at a fantastic kit-form price. The new Heathkit IM-1202 has four overlapping ranges to measure voltages from 10 mV to 1000 V on DC (either polarity), 10 mV to 700 V rms on AC, 10 uA to 2.5A on AC or DC current. Five resistance ranges measure from 1 ohm to 2.5 megohms. Front panel polarity switch reverses inputs without changing leads. 6 lbs.

NEW Heathkit 30 MHz Counter



only
169⁹⁵*

The Heathkit IB-1100 gives 1 Hz to over 30 MHz counting on a full 5-digit readout with 8-digit capability. The lighted overrange indicator makes misreading virtually impossible. Stable time-base circuitry assures accuracy better than ±3 ppm from 22° to 37° C. Diode protected J-FET gives improved triggering over 100 mV to 150 V input range. Solid-state circuitry mounts on one large board for easy assembly. 6 lbs.

Send for FREE '73 Catalog

HEATH COMPANY, Dept. 60-11
Benton Harbor, Michigan 49022

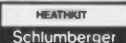

- Please send FREE Heathkit Catalog.
 Enclosed is \$ _____, plus shipping.
Please send model(s) _____

Name _____
Address _____
City _____ State _____ Zip _____

Prices & specifications subject to change without notice.
*Mail order prices; F.O.B. factory. TE-275

INFORMATION RETRIEVAL NUMBER 109

MORE!

new

V-PAC* POWER SOURCES

for

- Op amps
- Line receivers
- Comparators



Now, use standard +5v source to power your linear IC's. Simplify design, reduce system volume, eliminate extra power supplies, reduce manufacturing costs, with V-PAC power sources.

Operate from 7 to as many as 35 of these types from a single V-PAC source: 709, 741, 710, 711, 720.

Less than a third cubic inch, standard DIP pin configuration, V-PAC sources can be mounted on half-inch center cards with other components.

TYPE:	VA 12-12	VA 15-15	VA 12-6
VOLTAGES:	+12 -12	+15 -15	+12 -6

Write or call for full specifications.

WEST:

213-843-5200
214-233-4489
505-298-1875
312-654-8645
415-593-2189
206-747-9424

EAST:

513-761-5432
201-992-2505
803-288-4450
416-743-9130
617-272-7655
305-941-5514



Reliability, Inc.

5325 Glenmont, Houston, Texas
77036 • 713-666-3261

Europe and the Far East: TISCO (TI Supply Co.)
TWX: 910-881-1739 *TM, Reliability, Inc.

INFORMATION RETRIEVAL NUMBER 110

NEW LITERATURE

Thumbwheel switches

Circuit diagrams, specifications and other important features of the company's 545 series of thumbwheel switches are described in bulletin SW 6120. Typical applications include computers, business machines, automatic machine tools, test equipment, process controls, telemetering and utility controls. Dialight Corp., Brooklyn, N.Y.

CIRCLE NO. 367

Counters and controls

Precision counters and counter systems are covered in a 36-page catalog which includes a comprehensive section of technical information and application tips. Hecon Corp., Eatontown, N.J.

CIRCLE NO. 368

Modems

Models 1038 and 1039, a pair of Bell 103F compatible integral modems capable of asynchronous full duplex operation up to 300 baud on two-wire private lines, are described in a four-page brochure. Included are descriptions, detailed theory of operation and specifications. An outline drawing of the PC card is included as well as a block diagram and a data mode timing diagram. Intel, Santa Clara, Calif.

CIRCLE NO. 369

Digital clocks

A bulletin covers the Series 30,000 IC digital clocks, which feature a positive logic in addition to the negative logic. Also included are a description of the standby power feature and a price list. Chrono-Log Corp., Broomall, Pa.

CIRCLE NO. 370

Magnetic test system

The Delta 400 stored program magnetic test system is described in a 36-page brochure. The brochure includes sections on cost advantages, operating data, data acquisition and software details—as well as comprehensive application notes. Computest Corp., Cherry Hill, N.J.

CIRCLE NO. 371

Power supplies

A "Design As You Order" catalog allows the user to specify and order custom single or multiple output power supplies at standard prices. A simple-to-use order form is provided with each catalog. The complete power supply ordered is provided in an encapsulated miniature package that is pre-tested and ready for use. Arnold Magnetics Corp., Culver City, Calif.

CIRCLE NO. 372

Modular data comm system

A modular approach to adding low-cost IBM-compatible data communications capabilities to either an existing or future system is described in an eight-page brochure. The brochure contains a functional description and suggested design configurations for the data communications modules. They include a data communications formatter, a peripheral controller and associated control panel, a MOS buffer board and related peripheral formatters and equipment. Pertec Corp., Chatsworth, Calif.

CIRCLE NO. 373

Disc memories

A complete series of head per track disc memories is presented in a six-page brochure. These memories range in capacity from 0.5 megabits to 65 megabits. The literature describes track configuration, access time, data rate, electronic circuits and features a logic diagram. Alpha Data, Inc., Canoga Park, Calif.

CIRCLE NO. 374

High-level logic family

To keep pace with the progressive enlargement of the company's high-level logic family, the H100 series, an applications handbook has been published that sets out numerous suggestions for the use of these noise-free elements. An introduction to the logic, a presentation of the range and operation of the elements and some 50 applications are included. Copies of this handbook are available at \$3 each. SGS-ATES Semiconductor Corp., 435 Newtonville Ave., Newtonville, Mass. 02160.

THE MINNESOTA TWINS

46 of these . . . 0.125 ctrs.



46 of these . . . 0.100 ctrs.

Here's a hot new idea in direct card connectors . . . our new Series 9 has 92 standard models: 0.100 or 0.125-inch centers, any number of dual positions from 5 to 50! Bifurcated dual contacts, 5 mounting options, .025 sq. wrap tails. Between-contact polarization even on the 0.100-inch size. And we won't freeze you out on delivery . . . or cost, they're all standard!

Write for free information today:

NATIONAL CONNECTOR

5901 So. County Road 18 / Minneapolis, Minnesota 55436 / (612) 935-0133

DIVISION OF  **FABRI-TEK INC.**

INFORMATION RETRIEVAL NUMBER 111

Easier To Hook Up!

DORMEYER PULL TYPE TUBULAR SOLENOIDS

Now
with
Solder Type
Terminals!



They're still
available with
leads, too!

Write for
complete specs!

DORMEYER INDUSTRIES, Inc.

3414 No. Milwaukee Ave., Chicago, Illinois 6064

WORLD'S LARGEST MANUFACTURER OF SOLENOIDS—COILS—TRANSFORMERS



DORMEYER
Dependability

INFORMATION RETRIEVAL NUMBER 112

ELECTRONIC DESIGN 23, November 9, 1972

KEYBOARD SWITCHES

Series 3100
Mechanical Contacts



Series 2700
Reed Contacts

Announcing two new switches from Maxi-Switch. Use them individually to build calculator blocks or alpha-numeric keyboards, or order completed units from Maxi, with or without encoding. Both switches accept standard Maxi double-shot molded buttons.

Series 3100 mechanical keyboard switches combine simplicity, quality and long life in a low-cost package. Dual bi-furcated gold contacts wipe across gold plated mating surfaces each time the switch is operated. Action is clean, bounce minimal, and resistance finite. This rugged switch, with a life of over 10^6 cycles under load, is priced as low as .21 each in quantity.

For applications requiring reed contacts, specify the **Series 2700** switch. Pre-tested reeds are machine adjusted for consistent operation from switch to switch. Careful design isolates the reeds from mounting and operational stress. Switch rating is 10 watts, resistive load. Slanted plungers and bases are optionally available. You'll find no better reed switch at any price, and the price is right!

Maxi-Switch can meet all your switch needs for individual switches, interlatching keystrips, binary keystrips, numeric blocks, encoded keyboards with standard momentary action, or special interlatching designs. We can design and deliver custom switch assemblies to do your job most economically. Call Maxi-Switch, or contact your local Maxi representative for a quotation.

Give Maxi-Switch a try.
Write for free literature.

THE *Maxi-Switch* CO.

3121 WASHINGTON AVE. NO. • MINNEAPOLIS, MINNESOTA 55411

612-629-7601



See Maxi in EEM

INFORMATION RETRIEVAL NUMBER 125

DIP SIZE

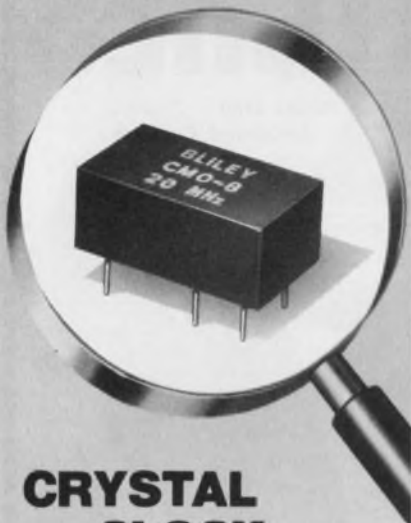

CRYSTAL CLOCK OSCILLATORS

■ Our new DIP size crystal clock oscillators are your best choice when space is a major consideration. Top quality Bliley crystals, with optimized circuitry, assure reliable performance in your high speed digital applications.

Type CMO-8 oscillators are supplied for any frequency in the 1-25 MHz range and will maintain tolerance without external adjustment. Specify ± 50 ppm over 0° - 50° C or ± 100 ppm over 0° - 70° C.

Compact unit operates on +5 Vdc supply with DTL/TTL output. Dimensions are .350" high x .460" wide x .800" long, with 6 pins spaced to mount in 14 pin DIP socket.

Our new bulletin 529K presents a wide selection of crystal clock oscillators as well as TCXO and VCXO units that may be specified for your state of the art applications. Request a copy on your letterhead.

Bliley *if you buy quality*

BLILEY ELECTRIC COMPANY

2545 West Grandview Boulevard
Erie, Pennsylvania 16512

INFORMATION RETRIEVAL NUMBER 115

bulletin board

Interdata has a limited two-for-one offer to universities and colleges using minicomputers for classroom training purposes. Under the terms of the offer, which expires Dec. 31, 1972, purchase of an Interdata Model 70 would carry with it at no extra cost an additional control store board that converts the general-purpose Model 70 into an Interdata Model 50 data communications processor. When sold separately, both the Model 70 and the Model 50 carry a single unit list price of \$6800 with 8-k bytes of core.

CIRCLE NO. 375

National Beryllia Corp. has issued an "odd lot" parts and price list of obsolete Berlox and alumina plates, discs, rods and tubes. All parts are first-quality material which can often be adapted to experimental and pilot plant requirements. Available in limited quantities only, the parts are priced below the normal cost of precision ceramics.

CIRCLE NO. 376

Price reductions

Optical Electronics, Inc., has reduced prices on its entire line of analog function modules and operational amplifiers. The price reduction averages 20% across the line and in some specific cases is as much as 68%. Some examples are: the Model 3329 has been reduced from \$79 to \$29, the Model 3337 has been reduced from \$65 to \$32 and the Model 5734B has been reduced from \$215 to \$73.

CIRCLE NO. 377

Raytheon Co.'s Special Microwave Devices Operation has reduced prices an average 50% on its line of Micro State GaAs microwave diodes. A typical component in the line, a 1-W diode operating in the 8 to 12.4 GHz frequency range, had been priced at \$195 in quantities of one to nine. The new price is \$95 in similar quantities. In orders of more than 100, the price is now \$65.

CIRCLE NO. 378

vendors report

Annual and interim reports can provide much more than financial-position information. They often include the first public disclosure of new products, new techniques and new directions of our vendors and customers. Further, they often contain superb analyses of segments of industry that a company serves.

Selected companies with recent reports are listed here with their main electronic products or services. For a copy, circle the indicated number.

Statham Instruments, Inc. Medical electronics.

CIRCLE NO. 379

Sola Basic. Air traffic control systems, transformers, meters, switches, communication systems and electronic controls systems.

CIRCLE NO. 380

Sparton Corp. Military electronics, transducers, switches and wave analyzers.

CIRCLE NO. 381

Harris-Intertype Corp. Electronic communications equipment, semiconductors, radio and broadcast equipment, control systems, aerospace, computers and memory systems.

CIRCLE NO. 382

Sanders Associates, Inc. Military electronics, electro-optics, radar, computer terminals and distributed processing systems, microwaves and switches.

CIRCLE NO. 383

Bell Industries. Ceramic capacitors, precision components, electronic systems and graphic arts.

CIRCLE NO. 384

New Hampshire Ball Bearings, Inc. Ball bearings and subassemblies.

CIRCLE NO. 385

National Semiconductor Corp. Discrete semiconductors, ICs, LEDs.

CIRCLE NO. 386

Scientific-Atlanta, Inc. Telecommunications, CATV, antennas and microwave test instrumentation.

CIRCLE NO. 387

Multiple-Output Power Supply Assemblies

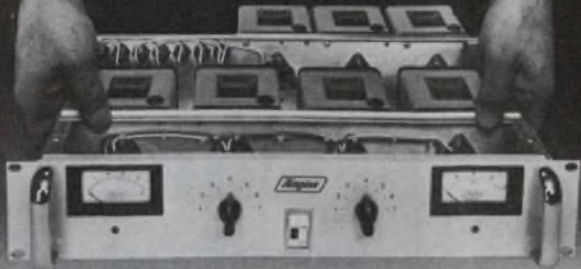

... shipped in only 9 days

Why get tied down with the details of designing and building power supply assemblies. Instead, let Acopian do it for you. Call us at (215) 258-5441 and tell us your requirements. We'll answer your questions, recommend the optimum complement of power modules, quote a firm price and assign a reference number for ease of requisitioning.

Your completely wired assembly will be shipped nine days after receipt of your order.



Acopian Corp., Easton, Pa. 18042
Telephone: (215) 258-5441

INFORMATION RETRIEVAL NUMBER 116

NOTHING ISOLATES LIKE OUR ISOLITES

Replace those old relays, reed relays and pulse transformers with up-to-date opto-isolators.

Litronix IsoLites give you faster switching speeds, no contact bounce, better reliability and 2500 volts electrical isolation. IsoLites can transmit from low frequency ac down to dc and eliminate ground loop problems. In long lines where common mode noise can build up, they may protect your equipment against a thousand volt jolt. Write for **free** application note and data sheets.

The 
bright guys
litronix

19000 Homestead Road, Cupertino, California 95014
(408) 257-7910 TWX: 910-338-0022

INFORMATION RETRIEVAL NUMBER 117

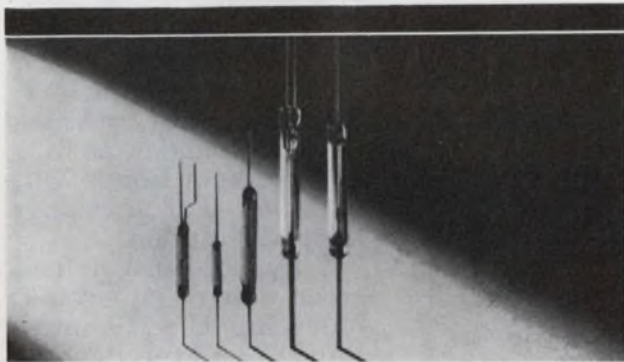

Star Performers

Hathaway Drireed Switches

The most advanced production techniques, rugged testing and quality control helps assure you that the Hathaway Drireed Switch you specify meets the standards you need. Hathaway has the broadest line of dry reed switches, one to fit most any application. Form A and Form C, in Micro Subminiature, Miniature, Intermediate, Compact and Standard sizes, have off-the-shelf availability. **Write to Hathaway for our new Drireed Switch Handbook and free samples.**



HATHAWAY

c o m p o n e n t s

A HATHAWAY INSTRUMENTS INC. COMPANY

P. O. BOX 45381 • SOUTHEAST STATION • TULSA, OKLAHOMA 74145

PHONE: (918) 663-0110

TWX 910 845-2129

INFORMATION RETRIEVAL NUMBER 118

now...you
can test
digital
IC's...



**economically...
to manufacturer's specs**

New Kurz-Kasch Model IC-590 is the first economically priced digital IC analyzer for accurate testing in the lab, shop, inspection, production, field or any other location.

The Model IC-590 is a completely portable, battery powered digital IC tester for use in conjunction with published IC specification sheets for static and dynamic testing of all 14 and 16 pin dual in-line IC modules of the DTL and TTL, 5 and 15 volt families. Flat pack and TO-5 modules may also be tested by using appropriate adapters. Price \$169.95.

A unique sister Model IC-591 is also available. It comes complete, as IC-590 above, internal power supply for highly regulated 5 volt, 1 amp operation and adapter cable for firing-up complete card units containing as many as 15 or more mounted IC's. Price \$295.00.

For complete technical data, write or call now: Tom Barth, Marketing Manager

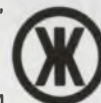

ELECTRONICS DIVISION

Kurz-Kasch, Inc.

1421 S. Broadway,
Dayton, Ohio 45401

(513) 223-8161

INFORMATION RETRIEVAL NUMBER 119

FREE

sample patches



Send for a free trial supply of Data-Links — the world's best splicing tapes and patches for perforated tape.

Available in polyester opaque, polyester clear and paper. Data-links are perfect for splicing, editing and repairing all types of perforated tape.

Data-link Corporation also carries splicers, winders, reels, and work stations — products for every application.

For free samples and the name of your nearest dealer, write or call Data-link direct. O.E.M. prices furnished upon request.

Some of our best ideas are full of holes.



PO BOX 2792
SAN DIEGO CALIF 92112
(714) 279 5430

INFORMATION RETRIEVAL NUMBER 120



A Scope-Mate® Hood and any Polaroid Camera* can produce B/W or color photos of CRT data.

- Versatile, low-cost, lightweight, easy to use.
- Standard hood fits 90% of all scopes.
- Models available for latest Tektronix and H-P scopes.
- Special hoods for large CRT displays.
- Shutter speeds from 1/100 to 3 sec. and bulb.
- Graticule illuminators, incandescent and U.V.
- Hoods from \$90.

Contact:

INTEGRATED CONTROLS, INC.
3045 Moore Street
San Diego, Calif. 92110
Phone: 714/295-5807

*Except Swinger and Square Shooter. Polaroid is a registered trademark of Polaroid Corp.

INFORMATION RETRIEVAL NUMBER 121

Electronic Design

ELECTRONIC DESIGN's function is:

- To aid progress in the electronics manufacturing industry by promoting good design.
- To give the electronic design engineer concepts and ideas that make his job easier and more productive.
- To provide a central source of timely electronics information.
- To promote communication among members of the electronics engineering community.

Want a subscription? ELECTRONIC DESIGN is sent free to qualified engineers and engineering managers doing design work, supervising design or setting standards in the United States and Western Europe. For a free subscription, use the application form bound in the magazine. If none is included, write to us direct for an application form.

If you do not qualify, you may take out a paid subscription for \$30 a year in the U.S.A., \$40 a year elsewhere. Single copies are \$1.50 each.

If you change your address, send us an old mailing label and your new address; there is generally a postcard for this bound in the magazine. You will have to requalify to continue receiving ELECTRONIC DESIGN free.

The accuracy policy of ELECTRONIC DESIGN is:

- To make diligent efforts to ensure the accuracy of editorial matter.
- To publish prompt corrections whenever inaccuracies are brought to our attention. Corrections appear in "Across the Desk."
- To encourage our readers as responsible members of our business community to report to us misleading or fraudulent advertising.
- To refuse any advertisement deemed to be misleading or fraudulent.

Microfilm copies are available of complete volumes of ELECTRONIC DESIGN at \$19.00 per volume, beginning with Volume 9, 1961. Work is now in process to complete the microfilm edition of Volumes 1-8. Reprints of individual articles may be obtained for \$2.00 each, prepaid (\$.50 for each additional copy of the same article) no matter how long the article. For further details and to place orders, contact the Customer Services Department, University Microfilms, 300 North Zeeb Road, Ann Arbor, Michigan 48106 telephone (313) 761-4700.

Want to contact us? If you have any comments or wish to submit a manuscript or article outline, address your correspondence to:

Editor
ELECTRONIC DESIGN
50 Essex Street
Rochelle Park, N.J. 07662



The U. S. Government does not pay for this advertisement. It is presented as a public service in cooperation with The Department of the Treasury and The Advertising Council.

Invest in the United States of America.

Almost 200 years at the same location.

The U.S.A.'s been in business a long time. So it's pretty solid.

And that's what makes U.S. Savings Bonds such a reliable and sure way to build a nest egg.

Bonds are completely safe, too. Lost, stolen, burned. It makes no difference. Your Bonds will be replaced if anything happens to them.

Why not turn a few green dollars into some blue chip U.S. Savings Bonds? Join the Payroll Savings Plan where you work or buy Bonds at your bank.

U.S. Savings Bonds. They're a solid way to save.



Now E Bonds pay 5 1/4% interest when held to maturity of 5 years, 10 months (4% the first year). Bonds are replaced if lost, stolen, or destroyed. When needed they can be cashed at your bank. Interest is not subject to state or local income taxes, and federal tax may be deferred until redemption.

Take stock in America.
Bonds are a safe way to save.

Advertising Sales Staff

Bryce Gray
Sales Manager

Rochelle Park, N.J. 07662

Robert W. Gascoigne
Daniel J. Rowland
50 Essex Street
(201) 843-0550
TWX: 710-990-5071

Philadelphia

Thomas P. Barth
50 Essex Street
Rochelle Park, N. J. 07662
(201) 843-0550

Boston 02116

Richard L. Green
20 Columbus Avenue
Boston, Mass.
(617) 482-7989

Chicago 60611

Thomas P. Kavooras
Berry Conner, Jr.
200 East Ontario
(312) 337-0588

Cleveland

Thomas P. Kavooras
(Chicago)
(312) 337-0588
(call collect)

Los Angeles 90303

Stanley I. Ehrenclou
Burt Underwood
2930 Imperial Highway
Inglewood, Calif
(213) 757-0183

San Francisco 94022

Jerry D. Latta
P.O. Box 1248
Los Altos, Calif.
(415) 965-2636

London W. 1

For United Kingdom and Holland
Brayton C. Nichols

For Eastern Europe

Peter Kehr

The American Magazine Group
9 Warwick Street

London, W. 1, England

Phone: 437 5462

Cable: Ammagnic, London

4800 Verviers, Belgium

For Continental Europe

Andre Jamar

Rue Mallar, 1

(087) 253.85 Telex 41563

Tokyo

Haruki Hirayama

Electronic Media Service

5th Floor, Lila Bldg.,

4-9-8 Roppongi

Minato-ku

Phone: 402-4556

Cable: Electronicmedia, Tokyo



AMERICAN BUSINESS PRESS, INC.

Design Data from Manufacturers

Advertisements of booklets, brochures, catalogs and data sheets. To order use Reader-Service Card.
(Advertisement)

Instant Diagnosis Of Ailing Bearings

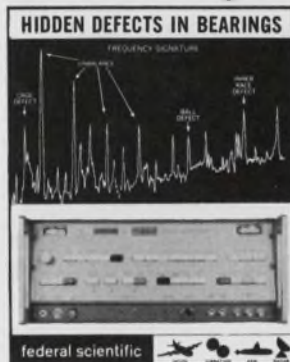

Mechanical occurrences in a bearing create concomitant frequency signatures. Free new 4-page "Application Note 3" shows how real-time frequency analysis can isolate the tell-tale frequencies of such specific defects as: cage and ball defects, unbalance, and inner/outer race defects. The readouts shown of typical defective jet engine bearings were obtained by an on-line Ubiquitous® Real-Time Frequency Analyzer and an oscilloscope. The Analyzer has no critical adjustments, is easily operated by non-technical personnel. For production, a Minicomputer/Analyzer System can automatically classify a bearing by comparison of its frequency signature to a known reference.

CIRCLE NO. 171

Federal Scientific Corporation

615 West 131 Street, New York, N.Y. 10027

1973 Electronic Components Drafting Aids Catalog



Free Catalog! Free Samples! Exciting innovations in pressure-sensitive electronic component drafting aids and methods are detailed in the new 1973 edition of the combined Bishop Technical Manual and Catalog 105.

84 illustrated pages of over 15,000 multi-pad configurations, symbols, tapes, sequential reference designations plus hundreds of time-and-money saving hints in making artwork for PC boards. Includes instructions for using the industry's only red and blue tape system for making two-sided boards in perfect registration.

Send now for free Catalog 105 and free samples.

Bishop Graphics, Inc.

CIRCLE NO. 172

7300 Radford Avenue, North Hollywood, California 91605

(213) 982-2000 Telex: 674672

Telephone Channel Simulation For Data Transmission Now Includes Frequency Translation



Telephone Channel Simulation has proven its worth repeatedly in evaluating data transmission equipment, methods and training of personnel. At the request of the industry, options for frequency translation and echo simulation have been added to existing phase jitter, phase hits, impulse hits, harmonic distortion, broad band noise and attenuation impairments. New catalog information updates the Seg line of this equipment which is the standard of the data communication industry.

CIRCLE NO. 173

SEG ELECTRONICS CORPORATION

Subsidiary of Comstron Corp.

120-30 Jamaica Avenue

Richmond Hill, N.Y. 11418

212-441-3200

DESIGN ENGINEERS

GTE AUTOMATIC ELECTRIC is successfully cutting over several new common controlled switching systems in the field. Due to these systems now being operational, the development of other small new intermediate and large computer controlled systems is resulting in the expansion of our laboratories.

Additional openings exist for logic design engineers with light experience (2 to 5 years) to join our systems development staff. Because our design groups are small you will receive independent as well as group design responsibilities. In addition you are expected to comprehend the system as a whole, coordinate and interact with engineers in all technical disciplines, and be able to make trade-off decisions. Depending on your previous design experience and interests, you will be responsible for originating, planning and designing circuits for new digital electronic systems or electronic logic modifications of existing electro-mechanical systems.

Basic education and work experience for these positions require a BSEE or equivalent with design experience in either electronic telephone equipment or computer type logic circuitry, preferably at the system design level. Two of these positions call for additional experience in assembler language programming or system software organization.

SALARY OPEN! Salary will be commensurate with experience and qualifications. Applicants should submit a detailed resume outlining applicable experience, education, salary history and goals. Resumes will be held in strict confidence: Send to:

Russell R. DeRose
Professional Employment

GTE AUTOMATIC ELECTRIC LABORATORIES

400 North Wolf Road, Northlake, Illinois 60164

An Equal Opportunity Employer

advertiser's index

Advertiser	Page	Advertiser	Page
ADC Products Inc., A Division of Magnetic Controls Co.	17	GTE Automatic Electric Laboratories	150
AMP, Incorporated	27	General Electric Company, Lamp Glass Dept.	128
Abbott Transistor Laboratories Incorporated	6	General Instrument Corporation.....	11
Acopian Corporation	147	General Radio Company	87
Airpax Electronics Controls Division	131		
Alco Electronic Products, Inc.....	135	Hansen Mfg. Co., Inc.....	134
Allen-Bradley Co.	38, 39	Hathaway Instruments, Inc.	147
Ampex Computer Products Division	22	Heath Company	143
Analog Devices, Inc.	65	Hewlett-Packard	1
		Hickok Instrumentation and Controls Division	106
Beckman Instruments, Inc.	141	Hoffman Engineering Company.....	119
Belden Corporation	12, 13	Houdaille Industries Inc., Electronics Division	143
Bishop Graphics, Inc.	149	Houston Instrument	115
Bliley Electric Company.....	146	Hughes Aircraft Company, Electron Dynamics Division	97
Bourns Products Inc., Trimpot Division	4, 5	Hughes Aircraft Company, Industrial Products Division	130
Bulova Frequency Control Products	104	Hutson Industries	122
Burroughs Corporation	Cover IV	Hy Comp, Inc.	152
CTS Corporation	139	InstruLab, Inc.	135
Capitol Machine & Switch Co.....	128	Intech Incorporated	108
Centralab, the Electronics Division of Globe-Union, Inc.	47	Integrated Controls	148
Chicago Dynamic Industries, Inc.....	86	International Electronic Research Corporation	122
Chomerics	110		
Computer Automation, Inc.....	83	Janco Corporation	126
Continental Connector Corporation..	48	Johanson Manufacturing Corp.....	151
Corning Glass Works	91		
Curtis Development & Mfg. Co., Inc.	143	Keuffel & Esser Co.	133
		Kurz-Kasch, Inc.	147
Dale Electronics, Inc.	Cover II		
Data Link Corporation	148	Lafayette Radio Electronics	114
Delco Electronics Division of General Motors Corporation.....	78, 79	Lambda Electronics Corp.....	Cover III
Dialight Corporation	112, 113	Ledex, Inc.	37
Digitran Company, The	118, 119	Litronix, Inc.	147
Dormeyer Industries, Inc.	145	Litton Advanced Circuitry	65
ECC Corporation	7	3M Company	31
ECCO	107	McGill Manufacturing Co.	116
Electrical Plastics Corporation.....	118	Magic Dot Inc.	124
Electro Materials, A Division of Illinois Tool Works, Inc.....	40	Magneto, Inc.	151
Electronic Arrays, Inc.	49	Maxi-Switch Co., The	145
Electronic Applications Co.....	129	Mechanical Enterprises	151
Electrostatics, Inc.	114	Microdata Corporation	123
Engineered Components Co.	151	MicroSwitch, A Division of Honeywell	82
Exar Integrated Systems	137	Miida Electronics	132
		Monolithic Dielectrics, Inc.	129
Fairchild Semiconductor, A Division Fairchild Camera and Instrument Corporation	66, 67	Motorola Semiconductor Products, Inc.	8, 9, 20, 21
Fairchild Systems Technology	109		
Federal Scientific Corporation	149	National Connector Corporation.....	145
Fitchburg CPI, A Division of Litton Industries	46	National Semiconductor Corporation	101
		Newport Laboratories Inc.....	134

Advertiser	Page
Oak Industries, Inc.	33
Optima, A Division of Scientific Atlanta, Inc.	122

Philips Industries	128A
Piezo Technology, Inc.	136
Plessey Electro-Products	117
Potter & Brumfield Division of AMF Incorporated	44, 45
Power/Mate Corp.	126
Printact Relay Division, Executone, Inc.	125
Producers Service Corporation.....	138

RCA Solid State Division.....	77, 95
RFL Industries, Inc.....	125
Rapidesign, Inc.	116
Reliability Inc.	144
Reticon	10
Rogan Corporation	139
Rogers Corporation	141

SEG Electronics Corporation.....	149
Servotron Corp.	139
Shigoto Industries Inc.	141
Signetics	14, 15
Siliconix Incorporated	50
Singer Company, The, Librascope Division	127
Solitron Devices, Inc.....	111
Sprague Electric Company.....	16
Stackpole Components Company.....	99
Sylvania Miniature Lighting Products, Inc.	102

Tau-Tron, Inc.	151
TEC, Incorporated	120
Tecnetics, Inc.	140
Tektronix, Inc.	43, 72, 73
Teledyne Relays, A Teledyne Company	2
Teletype Corporation	18, 19
Teradyne	25
Texas Instruments Incorporated, Components Group	52, 53
Trio Laboratories, Inc.	92, 93
Tyco Saphikon	142

UID Electronics Corp.	132
Unitrode Corporation	29

Vactec Inc.	35
------------------	----

Western Digital Corporation.....	121
----------------------------------	-----

Zero Manufacturing Co.....	143
----------------------------	-----

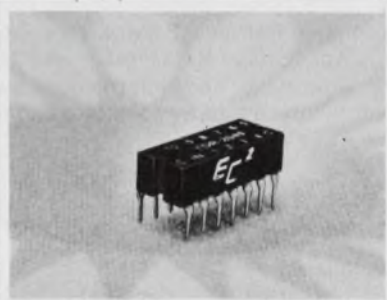

EC²'s "DIP Series" Lumped-Constant Delay Lines are packaged in a low silhouette epoxy encapsulated, 14-pin dual in-line configuration. EC² offers over 200 variations of DIPs, featuring either fixed or tapped delays, from 4 to 150 nanoseconds. Engineered Components Co., 2134 W. Rosecrans Ave., Gardena, Calif. 90249. (213) 321-6565.

INFORMATION RETRIEVAL NUMBER 181



Thin-Trim® variable capacitors are designed to replace fixed tuning techniques. Applications include crystal oscillators, CATV amplifiers, communication and test equipment. Series 9410 has high Q's with five capacitance ranges from 1.0 - 4.5 pf to 10.0 - 50.0 pf. Johanson Manufacturing Corporation, Boonton, N. J. (201) 223-2676

INFORMATION RETRIEVAL NUMBER 182

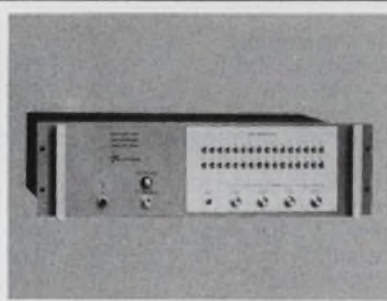

High speed pattern generator. Operates w/external sinewave input from DC to 300 MB/S. A 32 bit front panel switch selectable pattern, or data word, is available. Output levels are 1 volt or ECL compatible. Applications are in wide bit pattern sensitive testing. Price \$5,450 w/o options. Tau-Tron, Lowell, Ma.

INFORMATION RETRIEVAL NUMBER 183

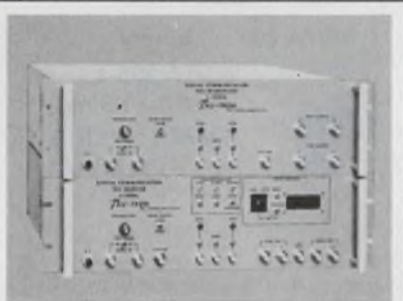

Wide band bit error rate detector — to 300 MB/S. Error counter/display included. 127 or 32,767 bit PRS is used. Sync is automatic & independent of transmission time. Error counts are identical to actual errors. Price \$14,600 w/o options. Tau-Tron, Inc., Lowell, Ma. 01852. (617) 458-6871.

INFORMATION RETRIEVAL NUMBER 184

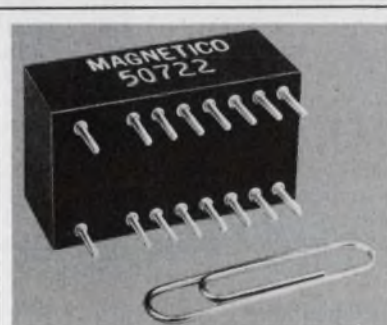

Scott-T-Transformers — Miniature size 13/16 x 1-1/2 x 5/8, input 90 or 11.8 volts, line to line, 400 Hz, output sine and cosine, 60 secs. accuracy, cost \$19. in quantity. Write for standard literature. Synchro to resolver & resolver to synchro. Magneto, Inc., East Northport, N.Y. 11731. (516)-261-4502.

INFORMATION RETRIEVAL NUMBER 185

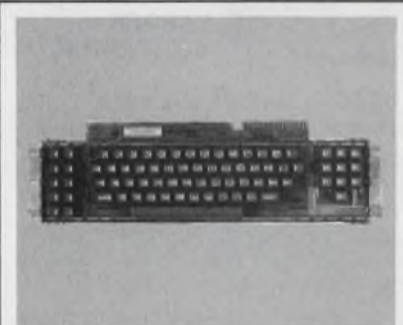

Custom keyboards in almost every possible configuration available on quick delivery. Model SS-11 key-switches use a bounce-free, long-life, mercury switch sealed in a flexible tube. With several methods of encoding, two-key & N-key rollover, tri- or quad-mode shifting & + or - logic. Mechanical Enterprises, Alexandria, Va. (703) 751-3030.

INFORMATION RETRIEVAL NUMBER 186

NEW MULTIPLYING

(VARIABLE REFERENCE)

DAC'S



MD/A 2000 . . . Binary

MD/A 2000-1 . . . Offset Binary

VERY SMALL, VERY ACCURATE

12 BIT $\pm 1/2$ LSB in 0.567" x 1.17" x 0.130" Package. TTL, DTL Compatible.

Analog input: 0 to $\pm 10V$. Linearity, $-55^{\circ}C$ to $+125^{\circ}C$: $\pm 1/2$ LSB. Full scale accuracy: @ $25^{\circ}C$ is $\pm 1/2$ LSB; @ $-55^{\circ}C$ to $+125^{\circ}C$ is ± 1 LSB. Settling time, F.S. $5\mu sec$. Reference input impedance is $10K\Omega$ to ground (constant). Rugged Tekform platform case can meet requirements of latest MIL specs including MIL STD 883.

10 BIT models also available.

MD/A 200 . . . Binary

MD/A 200-1

. . . Offset Binary

**SMALL HYBRID
WITH INTERNAL
AMPLIFIERS**



10 BIT $\pm 1/2$ LSB with Extremely Small Phase Shift.

Phase shift: 0.5° standard; to 0.05° on request. Analog input: 0 to $\pm 10V$. Output: $\pm 10V$ min. Settling time, $0^{\circ}C$ to $+70^{\circ}C$: $30\mu sec$, F.S., with $R_L = 10K$. TTL, DTL compatible. Dimensions: $0.82" \times 1.70" \times 0.310"$.

Military temperature range models also available.

MD/A 105 . . . Binary

MD/A 105-1

. . . Offset Binary

**LARGER
BUT FASTER.**



10 BIT $\pm 1/2$ LSB with Small Switching Transient.

Switching transient @ zero crossover point is $0.5V$ amplitude, $< 1\mu sec$ width. Reference input range: $\pm 5V$ @ $10mA$. Analog throughput distortion: 0.05% of input. TTL, DTL compatible. Package size: $2" \times 3" \times 0.6"$.

8 BIT models also available.

Write or phone for complete particulars. We would also be pleased to review any of your special requirements in thin film hybrid circuits.

HyComp



HyComp, Inc.

146 Main Street, Box 250

Maynard, Massachusetts 01754

(617) 897-4578

product index

Information Retrieval Service. New Products, Evaluation Samples (ES), Design Aids (DA), Application Notes (AN), and New Literature (NL) in this issue are listed here with page and Information Retrieval numbers. Reader requests will be promptly processed by computer and mailed to the manufacturer within three days.

Category	Page	IRN	Category	Page	IRN
Components			Modules & Subassemblies		
cut-off, thermal	131	332	converter	113	267
display, liquid-crystal	128	323	converter d/a	110	263
magnetic head, Hall	130	328	converter, polar	113	265
motor, speed-control	130	329	filters, active	113	266
potentiometer	128	324	power supplies	108	250
rectifiers, high-volt	131	331	power supplies	110	262
relay, latching	129	326	power supplies	110	264
slide switch, vhf	128	325	power supplies	113	268
start-relay, Posistor	129	327			
switches (NL)	142	366	Packaging & Materials		
switches, mercury	129	388	cable, ribbon	133	337
switching devices (NL)	140	358	connector, edge-card	133	335
terminal block	131	330	PC board	133	336
			packages, capacitor	132	334
Data Processing			socket, light	132	333
amplifier, dc, diff.	117	390			
calculators	120	300	new literature		
calculators	116	274	comm system	144	373
calculators, printing	114	270	counters and controls	144	368
character generator	114	269	digital clocks	144	370
clock, electronic, IC	120	301	disc memories	144	374
comm system (NL)	144	373	I/O interface	140	356
controller, program	117	389	magnetic test system	144	371
data modems	119	278	minicomputer	140	359
digitizer, tracer	118	276	modems	144	369
disc memories (NL)	144	374	peripherals	140	354
display, time	114	271	power supplies	144	372
infrared scanner	116	272	printer, thermal	142	365
minicomputer	120	303	semiconductors	142	360
printer, line	120	302	switches	142	366
printer/plotter	118	275	switches, keyboards	140	357
reader, card, embossed	116	273	switches, panel mount	142	361
tape recorders (NL)	142	362	switches, pushbutton	142	363
tape transports (NL)	140	355	switches, thumbwheel	144	367
tester, modem	119	277	switching devices	140	358
			tape recorders	142	362
ICs & Semiconductors			tape transports	140	355
audio amp	103	253	test instrumentation	142	364
calculator chip	103	254			
decoder, 4-channel	104	258			
digital clocks (NL)	144	370			
driver/receiver ICs	104	259	application notes		
op amp	103	255	data communications	138	350
PLL	106	261	disc drive formatting	138	352
RAM	106	260	encoder, dual channel	138	349
radio receiver ICs	104	257	logic probes	138	347
semiconductors (NL)	142	360	thermoforming	138	348
sense amp/line receiver	104	256	thermoplastic resin	138	351
transmitter	103	251	valve sizing	138	353
Instrumentation			evaluation samples		
amplifier, power	125	308	epoxy resin	136	344
counter, frequency	126	322	heat transfer washers	136	341
DMM	125	307	molding material	136	346
DMM	126	320	power supplies	136	343
monitor,			rotary shaft seal	136	342
communications	124	306	scope tracer blanks	136	340
panel meter, digital	122	304	terminal pod	136	345
plug-in, scope	124	305			
recorder	126	321			
Microwaves & Lasers					
fuses, rf	134	338			
mixer, doubly balanced	134	339			

Do you face
a make or buy decision
on power supplies?

How to use power hybrid voltage regulators to build your own power supplies.

There's another choice now in power-supply design. You're no longer restricted to a supply designed by others, nor to one you have to design from scratch. You can buy the heart of the supply—the voltage regulator—in a hybrid form that offers much more power output than monolithic regulators. Then you can design the rest of the supply and the heat sink, if necessary, using a straightforward procedure.

Hybrid regulators are now available in many models with outputs to 28 V dc and to 5 A. Dissipation at 25°C can reach 85 W—a far cry from the watt or so available in monolithic regulators.

Though there are differences in circuitry, specifications and packaging among regulators available from companies like Lambda, Melville, N. Y.; Micropac, Garland, Texas; and Tecon, New York; and Tecnetics, Boulder, Colo., designing with them are

A typical unit

This article in Lambda's new hybrid regulator brochure tells you how to use these devices to build your own power supplies. . . . Send for your free copy.

**Announcing:
NEW POWER HYBRID
VOLTAGE REGULATORS**
62W 5V 3A

\$25 ea.
(in quantity
of 1)

\$14 ea.
(in quantity
of 100)

\$11 ea.
(in quantity
of 1000)

**NEW
LOW PRICES ON**
85W 5V 5A

\$30 ea.
(in quantity
of 1)

\$18 ea.
(in quantity
of 100)

\$15 ea.
(in quantity
of 1000)

**100,000 hours MTBF
demonstrated**

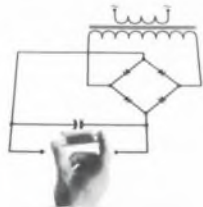

**WHETHER
YOU MAKE
OR BUY...**

LAMBDA
ELECTRONICS CORP.
A  Company

MELVILLE, NEW YORK 11746 515 Broad Hollow Road Tel. 516-694-4200 ARLINGTON HEIGHTS, (CHICAGO) ILL. 60005 2420 East Oakton St., Unit Q Tel. 312-593-2550
NORTH HOLLYWOOD, CALIF. 91605 7316 Varna Ave. Tel. 213-875-2744 MONTREAL, QUEBEC 100C Hymus Blvd., Pointe-Claire, Quebec-730 Tel. 514-697-6520

INFORMATION RETRIEVAL NUMBER 247

whatever your computer says...

SELF-SCAN® SAYS IT BEST

PANEL DISPLAYS



16 18 Character Position Panel, 5 x 7 Dot Matrix, Characters 0.4" High. Available as numeric only or alphanumeric panel with 64-character format.



32 37. 80 Character Position Panel, 5 x 7 Dot Matrix, Characters 0.2" High. Alphanumeric panel with 64-character format.



SELF-SCAN Panel Display Subsystem, 256 Character Capacity, 5 x 7 Dot Matrix, Characters 0.25" High. 64-character format, available with all drive electronics including memory, character generator, and timing.



Whether it's a police officer in a patrol car requesting information on a suspect, an architect specifying coordinates for plumbing fixtures in a new building, or a type setter verifying type for a mail-order catalog, SELF-SCAN panel displays guarantee the most accurate transfer of data between the operator and the computer. If you need a computer display and demand error-free communications, follow the lead of Kustom Electronics (1) in Chanute, Kansas; Science Accessories Corporation (2) in Southport, Connecticut; Automix Keyboards (3) in Bellevue, Washington, and the many other SELF-SCAN panel display users. Have a Burroughs salesman demonstrate his "terminal in a briefcase." You'll see why the SELF-SCAN panel display is the most effective man/machine interface device available today.

Burroughs Corporation, Electronic Components Division, Plainfield, New Jersey 07061. (201) 757-3400.

Burroughs

