

Electronic Design 21

FOR ENGINEERS AND ENGINEERING MANAGERS

VOL. 20 NO.

OCT. 12, 1972

OCT 11 1972

Old time-delay relays never die. They continue to compete with newer types. The result: a mass of custom and off-the-shelf units with overlapping characteristics and often incomplete specs. Yet all complete timers have the same five functional elements. Confused? For help in making a rational choice, see Page 62.





Wirewound or cermet – Dale's new low profile trimmers have important design advantages for your circuit.

A full watt in less space – You can increase both part density and power handling ability with either the 2700 (wirewound) or 8700 (cermet) series. Both dissipate one watt at 70° C.

More models – greater interchangeability Choose from three different terminal configurations with pin spacing identical to many larger models. Reduce space as much as 64.6% without sacrificing performance.

20-turn adjustability – Wiper arm adjusts smoothly, quickly. Sits tight under vibration and shock inside an immersion-proof case sealed for production soldering and board washing. Flame retardant SE-0 grade material available upon request.

Priced less than 60c in 50,000 quantities. Available fast. Many standard decade values stocked for off-the-shelf delivery. Get the details. Write today or phone 402-564-3131.

DALE ELECTRONICS, INC.

1300 28th Ave., Columbus, Neb. 68601

A subsidiary of The Lionel Corporation • In Canada: Dale Electronics Canada, Ltd.

SPECIFICATIONS	2700 WIREWOUND	8700 CERMET
Resistance	10-50K ohms	10-2 Meg.
Tolerance	±10%	±10% 100-500K ±20% all other values
T.C.	50 PPM/° C	±100 PPM/° C
Wattage	1 watt/70° C	1 watt/70° C
Operating Temp. Range	-65° C to +150° C	-55° C to +125° C
Adjustability	20 turns (with clutch to prevent overtravel damage)	
Dimensions	.25" high by .165" wide by .75" long	

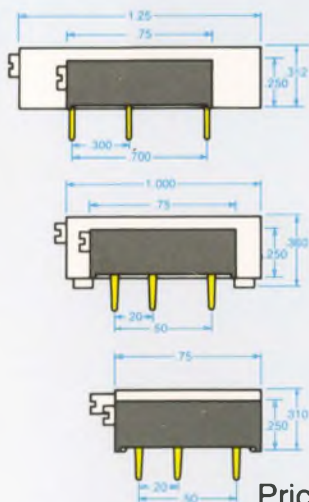

Heat-dissipation problems. Why tolerate them? Design in stability and reliability with the Dow Corning heat-sink system.

Forget heat, once and for all. Design in the Dow Corning heat-sink system for maximum component density, minimum heat.

Start with Dow Corning® 18 semiconductor potting compound in your solid-state, discrete components. This high-purity, greaselike material has excellent stability, low moisture content, high thermal conductivity, stable electrical properties. Protects junctions from heat failures, contaminants, mechanical and thermal shock.

Then, for maximum protection, design Dow Corning® 340 heat-sink compound between the device and the chassis or PC board. This compound combines a silicone material with metal oxides to ensure high thermal conductivity, low bleed, high temperature stability. Will not dry out, harden, or melt, even after long-term exposure to temperatures up to 392 F. It maintains a positive seal that improves heat transfer between device and chassis or PC board. Increases overall efficiency of your discrete, hybrid, or integrated components.

For complete technical data, write for our Thermal Conductors brochure. Dow Corning Corporation, Dept. A-2307, Midland, Michigan 48640.

Dielectric compounds from
DOW CORNING

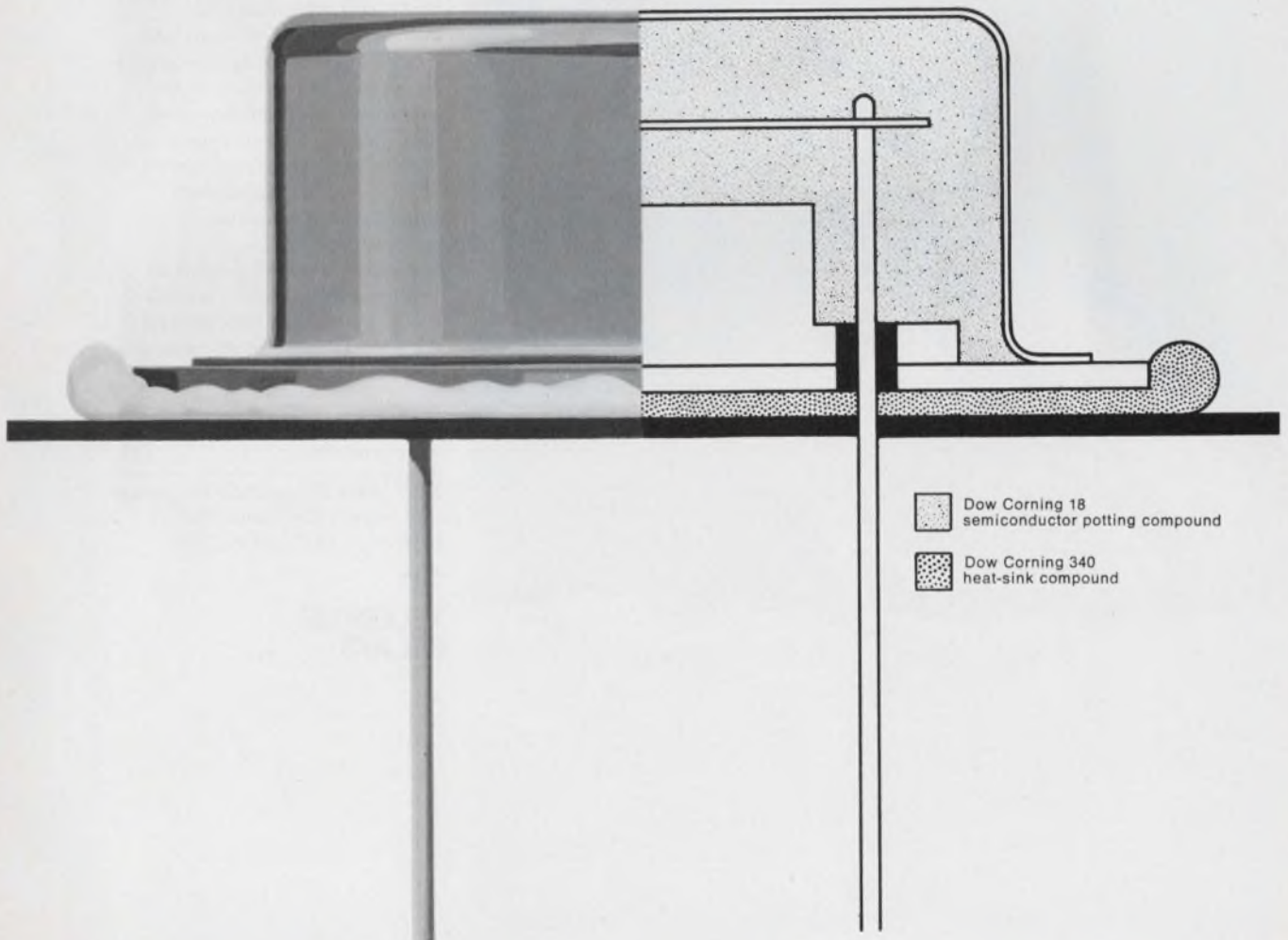

INFORMATION RETRIEVAL NUMBER 2

THINGS THAT STAND THE TEST OF TIME



TO-5 Relay

Time and desert sands have eroded the ancient pyramids of Egypt, but like massive stone

mountains they still stand in mute testimony to man's ingenuity. The TO-5 Transistor Case Relay is a modern-day counterpart. As tiny as the pyramids are mammoth, the TO-5 is no less ingenious or durable. Originally developed to conform to the extraordinary reliability and environmental requirements of defense and aerospace needs, the TO-5 is now available for sophisticated industrial applications.

The same pioneering spirit at Teledyne that created the TO-5 Relay is breaking new ground in the field of Solid State switching devices. This advanced family of Solid State relays will also stand the test of time. Send us your requirements.

3155 West El Segundo Boulevard
Hawthorne, California 90250
Telephone (213) 679-2205



**TELEDYNE
RELAYS**

NEWS

- 27 **News Scope**
- 30 **At the International Machine Tool Show:** Programmable controller, 'mini' for the poor man, upstages DNC.
- 36 **IC device integrates inductors;** Coil-less radio and TV coming.
- 38 **TI discloses** how it achieves nonvolatility in MOS memory.
- 40 **Exit the meter man;** enter electronics.
- 53 **Technology Abroad**
- 55 **Washington Report**

TECHNOLOGY

- 62 **Focus on Time-delay relays:** A special report on the many different types—some old, some new—with helpful guidelines for selecting the right one.
- 74 **Programmable calculator languages,** either algebraic or keyboard, are easy to learn. And with the algebraic, equations are entered almost as written—Part 2.
- 80 **Speed uhf microstrip amplifier design** by using an approach based on Smith-chart techniques and by avoiding common fabrication pitfalls.
- 88 **Detect errors in complex logic** with this two-rail checking technique. The method provides a less expensive solution than conventional parity or duplication schemes.
- 94 **Ideas for Design:** Television test-pattern modulator uses multiplier to improve linearity . . . Motor load-current sensor prevents false counter totals . . . Transconductance amplifier increases accuracy of sample-and-hold circuit . . . Variable threshold circuit separates sync pulses from composite video signal.

PRODUCTS

- 103 **ICs & Semiconductors:** Latch-decoder-driver chip simplifies display circuitry and lowers cost.
- 116 **Components:** Solid-electrolyte device is capacitor, battery or timer.
- | | |
|---------------------------|-----------------------------|
| 110 Packaging & Materials | 127 Modules & Subassemblies |
| 112 Instrumentation | 130 Microwaves & Lasers |
| 122 Data Processing | |

Departments

- 59 **Editorial:** Everything you always wanted to know about everything.
- | | |
|------------------------|--------------------------------|
| 7 Across the desk | 136 New Literature |
| 133 Design Aids | 140 Bulletin Board |
| 134 Evaluation Samples | 144 Advertisers' Index |
| 135 Application Notes | 146 Product Index |
| | 146 Information Retrieval Card |

Cover: Photo by Art Director, Bill Kelly—Time-delay relays courtesy of A. W. Haydon Products, Frederick Controls Products, Jettron Products, Inc., Magnecraft Electric Co., Potter & Brumfield Div. of AMF, Raymond Control Corp., Sigma Instruments, Inc., Struthers-Dunn, Inc., and Vanguard Relay Corp.

ELIMINATE RESISTOR STOCKPILES

WITH... **BOURNS**

SFRR™

SELECTABLE FIXED RESISTOR*

90 SELECTABLE RESISTANCE VALUES IN **1** TINY UNIT.

Model
4002

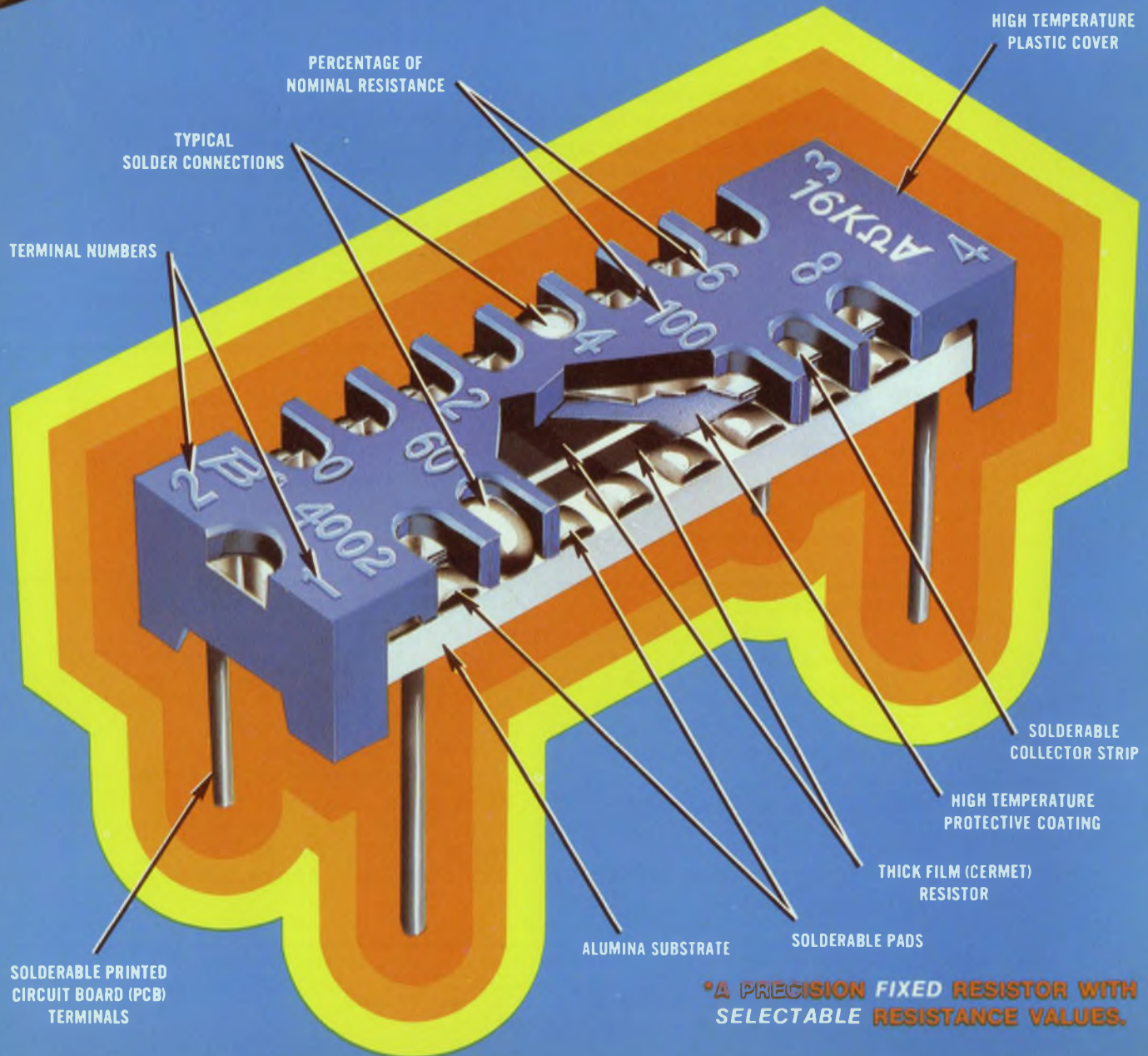

*A PRECISION FIXED RESISTOR WITH SELECTABLE RESISTANCE VALUES.

BOURNS NEW... UNIQUE CONCEPT IN RESISTIVE COMPONENTS ALSO OFFERS

- * 33 ohm to 1.25 megohm combined resistance range over 15 units
- * Selectability within $\pm 1\%$ of required resistance value over the entire range

BOURNS
SFR™
 SELECTABLE FIXED RESISTOR

- ... IS A STABLE, THICK-FILM, FIXED RESISTOR WITH ADJUSTABILITY OF $\pm 1\%$ OR BETTER
- ... REPLACES STANDARD FIXED RESISTORS IN APPLICATIONS WHERE FINAL RESISTANCE VALUE REQUIRED CAN'T BE PRECISELY DETERMINED AT THE DESIGN STAGE
- ... REPLACES "ONE-TIME ADJUST" VARIABLE RESISTORS IN APPLICATIONS REQUIRING LONG-TERM STABILITY
- ... RESISTANCE VALUE IS SELECTED, THEN PERMANENTLY, RELIABLY SET BY SOLDERING

LOOK AT THE \$\$ YOU SAVE ON INVENTORY!!

FOR EXAMPLE: Your application requires selection of individual resistance values from 550 ohms to 1000 ohms, or 40 different resistors at 10¢ each. One Model 4002 provides the same resistance selection within $\pm 1\%$ at 76¢*.

Result: 40 different resistor values: $40 \times 10¢ = \$4.00$
 One Model 4002: $1 \times 76¢ = .76$

YOU SAVE... \$3.24!!

*1,000 piece quantity price U.S. dollars, F.O.B., U.S.A.

it's easy to use

After mounting on PCB; probe the COARSE and FINE adjustment taps (Figures 1 and 2) to determine the precise resistance required. Solder the selected taps (Figure 3) and the SFR RESISTOR is permanently set.

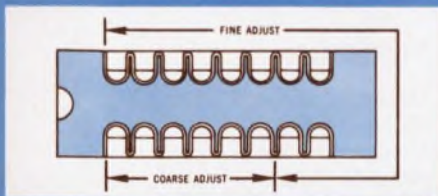

Figure 1



Figure 2



Figure 3

FOR COMPLETE DETAILS AND A BROCHURE:

- CALL SFR RESISTOR SALES COLLECT (714) 781-0270
- CONTACT YOUR LOCAL BOURNS REPRESENTATIVE.

FOR A FREE SAMPLE... write to the factory answering the following on your company letterhead.

- My application for the Bourns SFR Resistor is . . .
- It will replace (number) of fixed resistors in my inventory
- Approximate anticipated annual quantity usage: (number)



"SFR" is a trademark of Bourns, Inc. Patents Pending

BOURNS, INC., TRIMPOT PRODUCTS DIVISION • 1200 COLUMBIA AVE., RIVERSIDE, CALIF. 92507

INFORMATION RETRIEVAL NUMBER 4



How to Buy a Good Power Supply Without Spending a Bundle...

Take a long look at the Abbott line of over three thousand standard models **with their prices listed**. The unit shown above, for instance, is the Abbott Model R5S, a 60 Hz to DC converter which puts out 5 volts of regulated DC at 0.15 amps and sells for only \$83. Other power outputs from 2 to 240 watts are available with **any output voltage from 5 volts to 3,650 volts**, all listed as standard models in our catalog. These power supplies feature close regulation, short circuit protection, and the latest state of the art specifications for solid state modules.

If you really want to save money in buying your power supply, why spend many hours writing a complicated specification? And why order a special custom-built unit which will cost a bundle—and may

bring a bundle of headaches. As soon as your power requirements are firmed up, check the Abbott Catalog or EEM (see below) and you may be pleasantly surprised to find that Abbott already has standard power supplies to meet your requirements — **and the prices are listed**. Merely phone, wire, or write to Abbott for an immediate delivery quotation. Many units are carried in stock.

Abbott manufactures a wide variety of different types of power supply modules including:

- 60A to DC, Regulated
- 400A to DC, Regulated
- 28 VDC to DC, Regulated
- 28 VDC to 400A, 1 ϕ or 3 ϕ
- 24 VDC to 60A, 1 ϕ

Please see pages 618 to 632 of your 1971-72 EEM (ELECTRONIC ENGINEERS MASTER Catalog) for complete information on Abbott modules.

Send for our new 56 page **FREE** catalog.

abbott transistor

LABORATORIES, INCORPORATED
 5200 W. Jefferson Blvd./Los Angeles 90016 1224 Anderson Ave./Fort Lee, N.J. 07024
 (213) 936-8185 Cable ABTLABS (201) 224-6900

INFORMATION RETRIEVAL NUMBER 5

Vice President, Publisher

Peter Coley

Editors

Editorial Offices
 50 Essex St.
 Rochelle Park, N.J. 07662
 (201) 843-0550
 TWX: 710-990 5071
 Cable: Hadyenpubs Rochellepark

Editor-in-Chief: George Rostky

Managing Editors:

Ralph Dobriner
 Michael Elphick

Associate Editors:

Jules H. Gilder
 Richard Lee Goldberg
 Morris Grossman
 John F. Mason
 Stanley Runyon
 Edward A. Torrero
 Richard L. Turmail

Contributing Editor:

Peter N. Budzilovich

Editorial Field Offices

East

Jim McDermott, Eastern Editor
 P.O. Box 272
 Easthampton, Mass. 01027
 (413) 527-3632

West

David N. Kaye, Senior Western Editor
 2930 West Imperial Highway
 Inglewood, Calif. 90303
 (213) 757-0183

Editorial Production

Marjorie A. Duffy

Art

Art Director, William Kelly
 Richard Luce
 Anthony J. Fischetto

Production

Manager, Dollie S. Viebig
 Helen De Polo
 Maxine Correal
 Anne Molfetas

Circulation

Manager, Nancy L. Merritt
 Ron Deramo

Information Retrieval

Peggy Long

Promotion

Manager, Jeffrey A. Weiner
 Karen Costa

across the desk

Two added starters for Summer Olympics

In the Aug. 17 issue Jim McDermott authored an article entitled "Electronic Systems to Pace the 1972 Summer Olympics" (ED 17, p. 36). I was quite impressed with the amount of information Mr. McDermott was able to get into a two-page article covering what certainly was the biggest event in history. It was indeed amazing to read of the number of companies involved in providing the various electronic systems connected with the on-sight reporting of the events, as well as the television coverage.

However, I must say that I was very disappointed that one of our clients, the Robert Bosch Corp., (Robert Bosch, GmbH) was not even mentioned. It so happens that Bosch did supply over 90% of all the television broadcast equipment (cameras, 12 color TV studios, standards converters). Equipment by Fernseh, which televised the 1936 Olympics in Berlin, is also being used in Munich.

Jack Welsh
Vice President

Brand Advertising, Inc.
400 N. Michigan Ave.
Chicago, Ill. 60611

And yet another way to convert temperature

Concerning the letter by James M. Wrenn in the Aug. 17 issue ("A Foolproof Method to Convert Temperature," ED 17, p. 7), I should like to add the following:

While in high school I faced the problem of remembering the temperature conversion formulas, so I applied my newly acquired algebra and came up with a very easy formula: $5 F - 9 C = 160$. Thus, given any Fahrenheit or centi-

grade temperature, the conversion is relatively easy.

Here is an example: We know that at $-40 F$ the corresponding centigrade temperature is -40 . Thus:

$$\begin{aligned} 5(-40) - 9C &= 160 \\ -200 - 9C &= 160 \\ -9C &= 360 \\ C &= -40. \end{aligned}$$

Frank Sentyrz Jr.
Systems Analyst

Military Products Div.
3101 E. 80th St.
Minneapolis, Minn. 55440

Write? Right!

If you think you might find greater satisfaction in *writing* about engineering, read on. ELECTRONIC DESIGN is looking for engineers with a flair for clear, well-organized writing. The job entails soliciting, reviewing and editing technical manuscripts; interviewing industry authorities; researching and writing about electronic products and technology. This editorial position is a full-time job at ED's home office in Jersey.

If you think editorial work might suit you, shoot a note and a resume to Mike Elphick, Managing Editor, ELECTRONIC DESIGN, 50 Essex St., Rochelle Park, N.J. 07662.

A vote against technology per se

I have just read the editorial "Why 'Waste' Money on Space?" in the Sept. 2 issue (ED 18, p. 39), and I feel I must take exception to its views. First, on the statement that "problems here on earth are solved by more technology, not less," I strongly disagree. Technology has certainly solved many

(continued on p. 13)

Electronic Design welcomes the opinions of its readers on the issues raised in the magazine's editorial columns. Address letters to Managing Editor, Electronic Design, 50 Essex St. Rochelle Park, N. J. 07662. Try to keep letters under 200 words. Letters must be signed. Names will be withheld on request.



THE LONG LINE OF ECC

Sensitive and Standard Gate

SCR's

Fast delivery and competitive prices make ECC's extensive line of SCR's your best buy.

SENSITIVE GATE SCR's

TO-5 Metal; $\frac{5}{8}$ " Hex Stud; THERMOPAK* and THERMOTAB® Packages

$I_{T(RMS)}$ 0.8 - 10 amps

I_{GT} 50, 200, 1500 μ amps max

I_{TSM} 50, 100 amps min

V_{DOM} 30 - 600 volts min

STANDARD GATE SCR's

TO-5 Metal; $\frac{5}{8}$ " Hex Stud; THERMOPAK and THERMOTAB; $\frac{1}{2}$ " Press-Fit and Stud; $\frac{3}{4}$ " Press-Fit, Stud and TO-3 Packages

$I_{T(RMS)}$ 0.8 - 35 amps

I_{GT} 10, 25 ma max

I_{TSM} 50 - 325 amps min

V_{DOM} 30 - 800 volts min

$\frac{5}{8}$ " Hex Stud; THERMOPAK and THERMOTAB; $\frac{3}{4}$ " Press-Fit, Stud and TO-3 Packages are electrically isolated.

All ECC SCR's feature heavily glass passivated junctions for high reliability. They are available from your nearest ECC Sales Representative or Authorized Distributor.

*trademark of ECC



New Condensed Catalog contains technical data on these and other ECC semiconductors. To receive your copy, circle No. 240.

ECC

CORPORATION

P.O. Box 669 • Euless, Texas 76039
817/267-2601

**For years,
people thought
Teletype
machines only
talked to
themselves.**



Ever since the information explosion and solid-state technology, our machines have been running in a very fast crowd.

With computers.

In fact, Teletype equipment is compatible with practically every computer-based communications system. For proof, you don't have to look any further than our product line.

We built the model 33 to offer economy and reliability. For an economical wide-platen terminal, look at our new model 38. If you need heavy-duty operation, we make the model 35. And for the utmost in flexibility and vocabulary, check out our model 37.

Teletype's keyboard terminals operate at standard speeds. But if your speed requirements are greater, all our terminals are compatible with the 2400 wpm Teletype 4210 mag tape unit. We

also manufacture a series of paper tape senders and receivers with speeds up to 2400 wpm.

When you look into our product line-up, you'll find we're very big on flexibility. In assembled ASR, KSR and RO terminals. Or in individual components—printers, keyboards, readers and punches.

Take interface options. We offer three. Built-in modems, current interfaces and EIA Standard R-232-C interfaces.

We offer platen widths that range all the way up to 15 inches.

And optional character sets. Like Greek letters, algebraic and chemical symbols, as well as other graphics for charts and molecular structures.

We also cover error detection and station control with a complete group of solid-state accessories.

We're big on economy, too. Because on a price/performance basis, you won't find a better buy than Teletype equipment.

And we didn't forget service. Our applications engineers will work with you to make sure what you get is exactly what you need. And after the sale, we'll set up a maintenance program for you. Or, if you prefer, we'll train your people in the proper maintenance procedures.

It takes more than manufacturing facilities to build the machines Teletype Corporation offers. It also takes commitment. From people who think service is as important as sales. In terminals for computers and point-to-point communications.

That's why we invented a new name for who we are and what we make. The computercommunications people.



For more information about any Teletype product, write or call **TERMINAL CENTRAL:** Teletype Corporation, Dept. 89F, 5555 Touhy Avenue, Skokie, Illinois 60076. Phone 312/982-2500

Teletype is a trademark registered in the United States Patent Office.

Four solid reasons for solid state switching.

Right now, you feel pretty safe with conventional switching techniques. You know what they can do. As well as what they can't. Great. Except solid state can do so much more.

Solid evidence for solid state.

There's speed. Easily up to 100,000 operations per second.

There's reliability. Nothing moves, so nothing wears out. Billions of test operations have proved this.

There's no contact bounce. No contacts, so no bounce or contamination. There's size. Or lack of it. Most are no bigger than the eraser on your pencil.

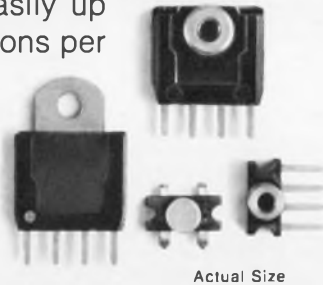

How it works.

The secret of our solid state switches is the Hall-effect principle. It's locked in a single silicon-integrated circuit chip package. Pass a magnetic field by the package and the switching action takes place, without the magnet ever touching.

It's versatile.

Just consider the ways a magnet can be moved past a switch. The list is almost endless. The specifications of our switches are also broad. Operating Temp. Range: -55° to $+125^{\circ}\text{C}$ are available. □ Voltage

Range: From 4.5 to 7.5 VDC. □ Output: 20 Ma digital signal. □ Magnet Size: Determined by the operating distance. (For instance, a 0.06" operating distance requires a magnet 0.187" in diameter by 0.187" long.)

An example.

Problem: To make certain the hole has been punched in a tab card.

Solution: Put a magnet on the punch and locate our solid state switch so it's actuated by the magnet when the punch moves.

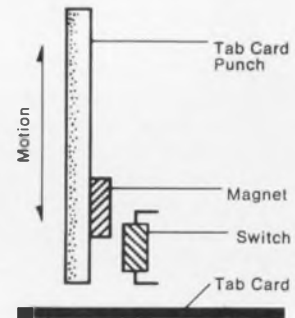

Benefits: Long life. No effect from paper dust. Direct control of digital circuits.

We're versatile too.

MICRO SWITCH has been in precision snap-action switching since 1932. And into solid state switching for more than 15 years.

Bring us your problem. We have experienced engineers who'll work with you to solve it. And if one of our existing products won't do the job, we can design one that will. It's all in a day's work. The quickest way to get started is a phone call to your MICRO SWITCH Branch Office. Or write to us direct.

MICRO SWITCH makes your ideas work.

MICRO SWITCH

FREEPORT ILLINOIS 61032
A DIVISION OF HONEYWELL

MICRO SWITCH products are available worldwide through Honeywell International.

INFORMATION RETRIEVAL NUMBER 7

INFORMATION RETRIEVAL NUMBER 8 ►

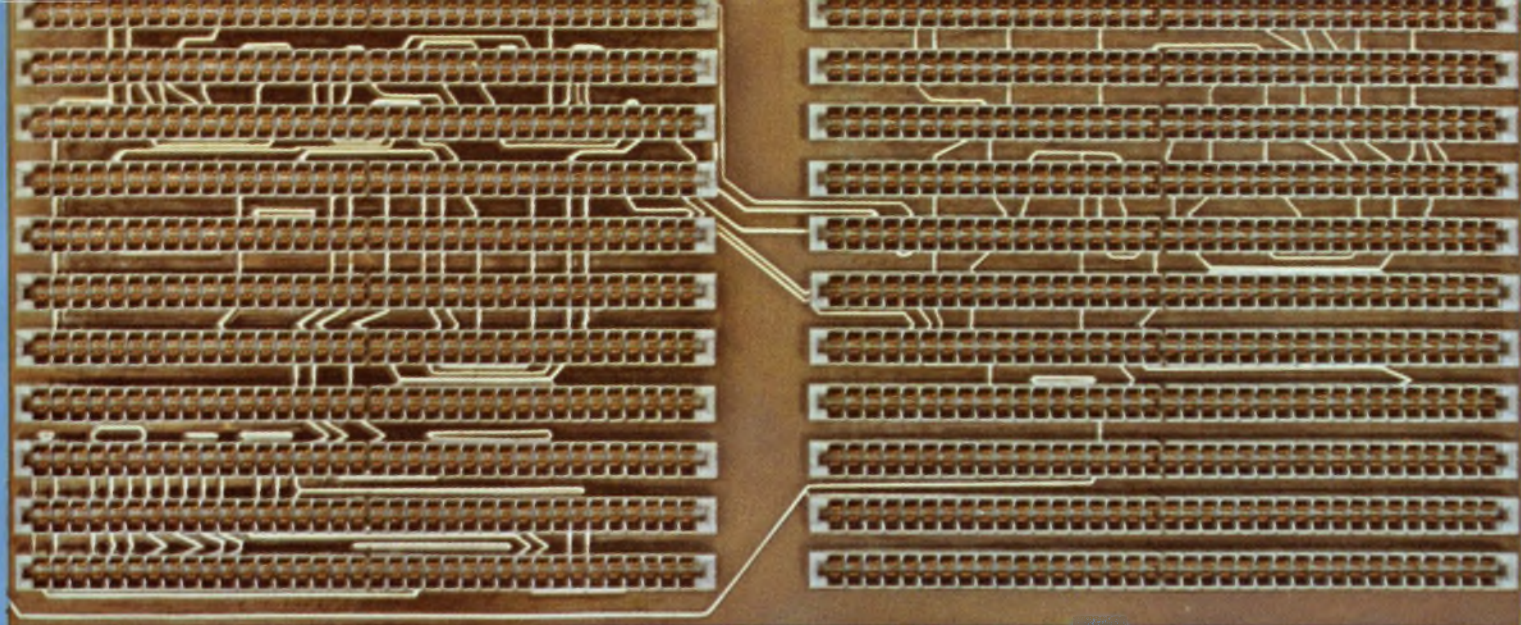

REDUCE INTERCONNECTING COSTS 50-75%

... using Elco's Series 6317*, 6320* and 6321* card edge connector systems. These new problem-solvers from Elco help you beat the "wrap-or-not-to-wrap" syndrome that crops up when you're designing a new circuit. Formerly you had one of two choices. Go the wire-wrapping route for design flexibility. Or choose p.c. wiring for manufacturing economy. Either way, you've had to accept trade-offs.

Wire wrapping lets you make circuit changes throughout the life of your equipment. But, at roughly 10¢ for each pair of terminations, a densely wrapped board can be expensive. On the other hand, committing all signal interconnections to p.c. wiring is the less costly alternative, but you're married to the circuit on your multi-layer board. So when a design change is called for, you have to discard the board and design anew.

That is, up until now.

Because Elco's press-fit card edge connector systems give you the best of both approaches.

In a typical application, you can specify 50 to 75% of your interconnections as p.c. wiring, including all grounds and voltage distributions. And thus cut as much as 75% from your overall interconnecting costs. Your interconnections will be made by press-fitting the contacts of our connectors into the plated-through holes of the board. The remaining interconnections will be made by wire wrapping the appropriate contacts.

Since your p.c. wiring is exposed, you now have the ability to make circuit changes and repairs using the wire wrap tail available on each contact. You're also able to replace damaged contacts without disturbing or removing the insulator or adjacent contacts. And you needn't worry about the integrity of the press-fit connection because it's mechanically stronger and electrically more reliable than the best soldered connection. Furthermore, circuit reliability in general is improved because the p.c. board is not subjected to the heat shock that accompanies most soldering processes.

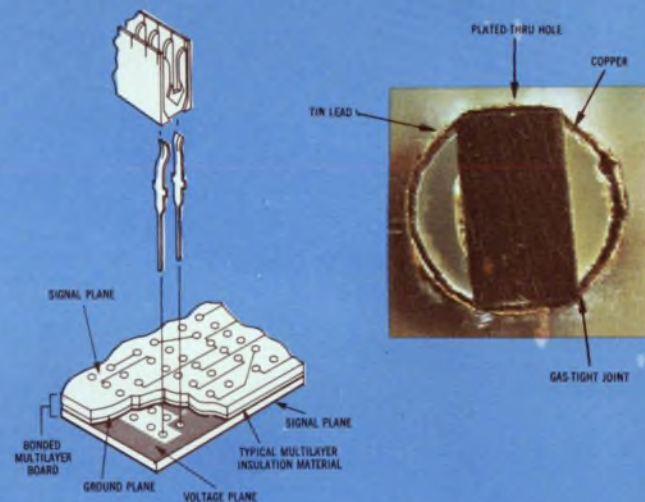

And Elco will go you even two better.

Give us your p.c. back panel laid out to our hole specs (.125" x .125" — Series 6317; .100" x .200" — Series 6320; .125" x .250" — Series 6321), and we'll fill the board with our "Economist" Series connectors. Or send us your specifications, and we'll even supply the board. In either case, we'll also complete the wire wrapping.

Just two more services in keeping with CONNECTRONICS, Elco's Total Connector Capability.

For full details and specifications on the "Economist," contact your local Elco representative, or:

Elco, Willow Grove Division,
Willow Grove, Pa. 19090
(215) 659-7000

Elco, Pacific Division,
2200 Park Place,
El Segundo, Calif. 90245
(213) 675-3311



We pack more performance into less space



and save you up to 50¢ on your dollar.

Amphenol's new 303 Series MINIform coaxial switch line is the answer to today's biggest component problem: Getting higher performance, using less space at the lowest possible cost.

High performance we have. From 0 to 1.0 GHz, the MINIform switches handle up to 150 watts CW, maintain maximum VSWR of only 1.1:1, 80 dB minimum crosstalk attenuation and 0.1 dB insertion loss. Maximum VSWR over the 1.1 through 3.0 GHz range is only 1.2:1 with power handling capabilities up to 70 watts CW.

True to their name, MINIform switches weigh only 1.2 ounces and occupy less than $\frac{1}{2}$ cubic inch of precious space.

Three popular termination styles are available: SMA connectors, Amphenol SUB-Minax 27 Series connectors and pc contacts for solder or solderless wrap terminations.

To find out more about MINIform and how it can cut your switch costs in half, write to Amphenol RF Division, Bunker Ramo Corporation, 33 East Franklin Street, Danbury, Connecticut 06810.

**BUNKER
RAMO** **AMPHENOL**

(continued from p. 7)

problems, but it often seems to create more than it solves. For example: automation and assembly-line techniques have led to employee boredom and menial tasks; transportation has created the decay of the inner city; industries have polluted our air and water; superior weapons have provided insecurity and slaughter.

Second, the editorial lists the various products and gadgets that NASA projects have created. But do we need them? And do we need the tremendous price we paid? Some we do need, and they could have been designed at far less cost if they had not been a "spinoff" of a wasteful race to the moon. But do we really need more gadgets like digital clocks, freeze-dried coffee, better caulking compounds? Our society is already too much a consumer of *things*, which are needed only because of a demand created by Madison Avenue (and NASA perhaps?). We should concentrate instead on improving the humanity of our society and not its material playthings.

Mart Peep

John Hopkins University
Baltimore, Md. 21218.

Tribute to a professional

An instrument salesman we know was taken aback, but just for a moment when, during a demonstration, an engineer handed him a business card with the following inscription: "I'm a bit of a bull-thrasher myself, but I always admire a professional. Please carry on."

Acknowledgment

The article "Use Statistics in Your Logic Design," by Irving Dlugatch (ED 26, Dec. 23, 1971, pp. 60-62) was based on "PERT as an Aid to Logic Design," by T.I. Kirkpatrick and N.R. Clark. The latter article, which appeared in the March, 1966, issue of *IBM Journal of Research and Development* (Vol. 10, No. 2, pp. 135-141) contains the design technique and numerical example used by Dlugatch.

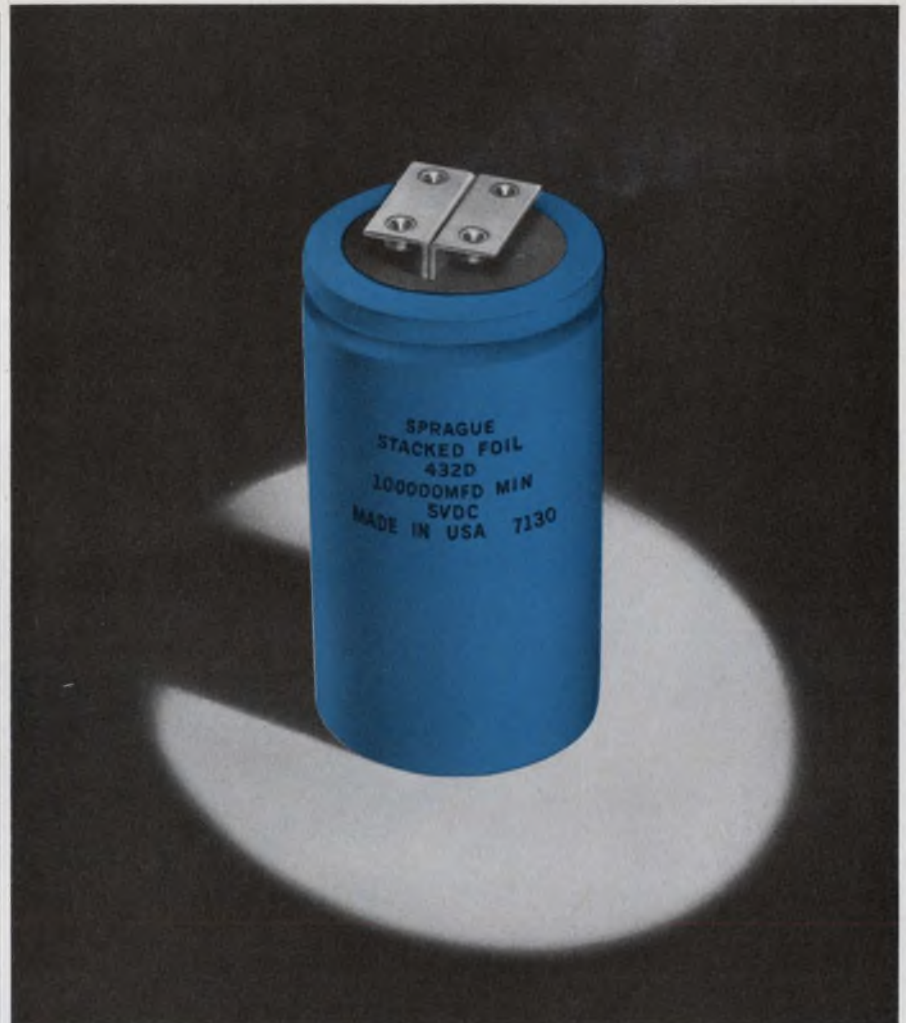

Stacked...with beautiful curves!

(stacked-foil construction with ultra-low impedance, ultra-low ESR, ultra-low inductance)

Revolutionary new Type 432D COMPULYTIC® Aluminum Electrolytic Capacitors offer capacitance values to 100,000 μ F with equivalent series resistance of typically less than 0.001 ohm and inductance of only 1 nH in a 3" x 5 $\frac{5}{8}$ " case. This same capacitor will handle 93 amperes of ripple current at 65 C and 1 kHz.

Impedance limits at 10 kHz are as low as 0.001 ohm with typical values of only half of the specified limits.

Terminals are ideal for use with laminated-bus power distribution systems found in modern EDP equipment, where the low ESR and impedance of Compulytic capacitors help insure continued operation of logic circuits even during momentary power outages.

Sprague Type 432D Capacitors are available in nine voltage ratings from 5 to 50 volts d-c, and are designed for operation over the temperature range from -40 to +85 C.

For complete technical data, write for Engineering Bulletin 3443 to: Technical Literature Service, Sprague Electric Co., 347 Marshall St., North Adams, Mass. 01247.

SPRAGUE®

THE MARK OF RELIABILITY

THE BROAD-LINE PRODUCER OF ELECTRONIC PARTS
INFORMATION RETRIEVAL NUMBER 10

**Two new P&B series
dry reed relays
give designers
9,627 options.**

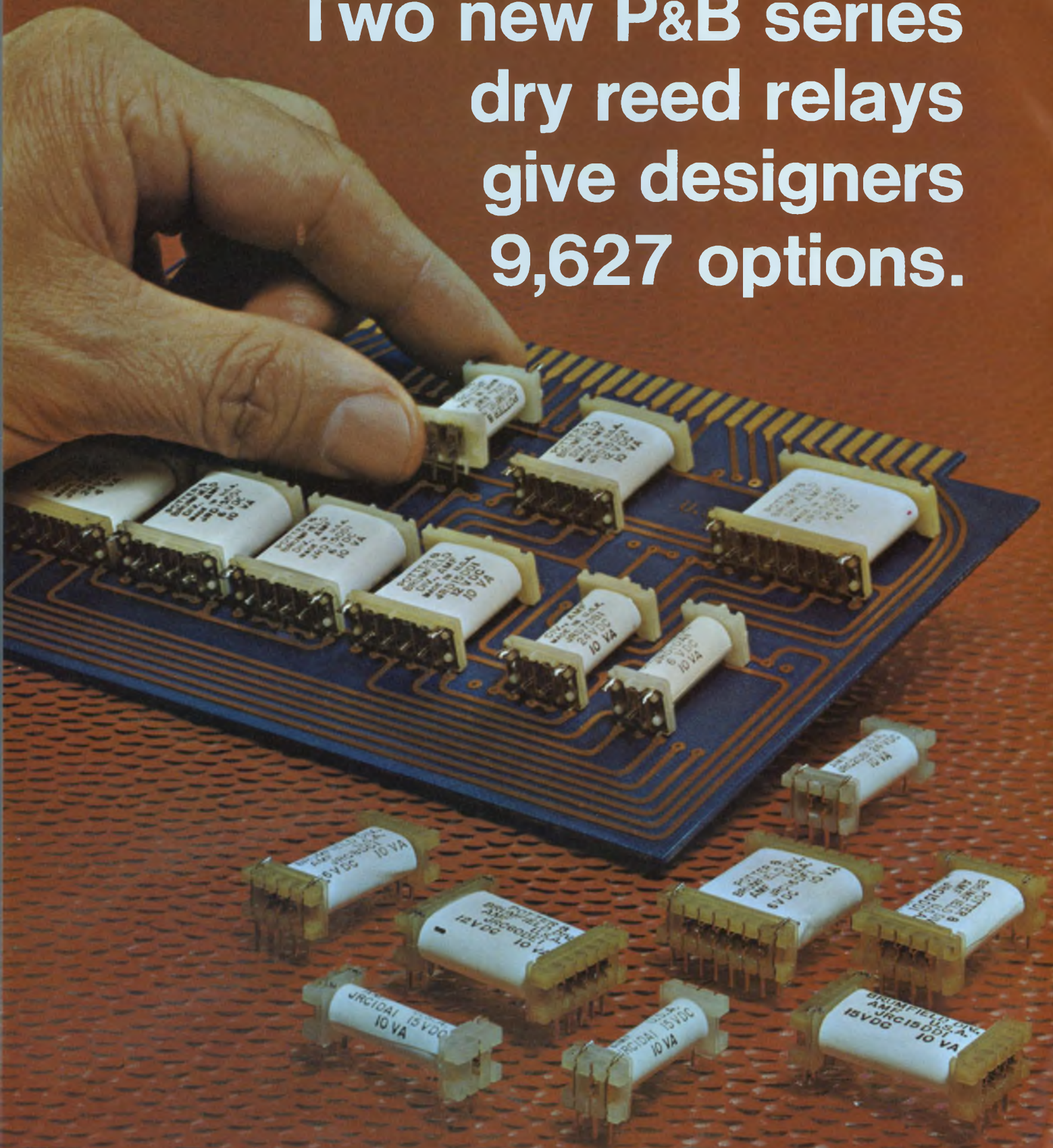

Now, your design work is simplified, your choice of dry reeds is broadened, with our new JRC and JRD series. And P&B Quality comes as a bonus.

With 9,627 options, these two new series of dry reed relays present printed circuit board designers new opportunities for creative engineering.

Each is miniature in size with terminals spaced on 1.0" centers.

Each offers a choice of contact arrangements and coil terminals.

Each is available now from authorized P&B electronic parts distributors.

Importantly, you get P&B quality at competitive prices in all quantities.

JRC reeds have terminals arranged for .100" x 1.00" grid spacing and feature a low profile (.36") to permit close stacking of pc boards. In-line termination is in keeping with the industry trend, and the JRC coil leads terminate at any of four corners. The terminals are supported by the bobbin, and any forces encountered are transmitted to the stand-off flange to prevent stressing the glass seal of the capsule.



P&B precision assembly machines make it possible to control gap variance in reeds to within 2/10,000ths of an inch. (1/10th the thickness of a human hair.)

Contact configurations are available in Form A (SPST-NO), Form B (SPST-NC) and combinations of Forms A and B. For DC restive loads, the contacts have a maximum rating of 10 watts, .5 ampere, and 200 volts. Typical operate speeds at 25°C are 1 millisecond including bounce for pick-up and .05 millisecond drop-

out. Available coil voltages range from 3 to 48VDC.

The JRC series may be ordered with 1, 2, 3, 4, 5 or 6 cavity bobbins.

New JRD dry reed relays offer design engineers the option of .150" x 1.00" grid spacing. Slightly larger than the JRC package, the JRD's are similar except they offer, in addition to Forms A and B, a true Form C (SPDT) contact configuration. JRD's may be ordered in 1, 2, 4 or 6 cavity bobbins.

JRC and JRD open style, dry reed relays are produced to exacting tolerances and provide design engineers with a wide selection of contact configurations for logic circuitry, instrumentation and low voltage applications. Both series are available with or without magnetic shielding.

For complete information, or advice, and for your copy of the 226 page relay catalog, write Potter & Brumfield Division, AMF Incorporated, Princeton, Indiana 47670. Or, simply call 812 385-5251.

Replacements for IBM Reed Relays. While not identical in all aspects, JRD Reed Relays have the same terminal spacings and electrical characteristics as those manufactured by IBM.

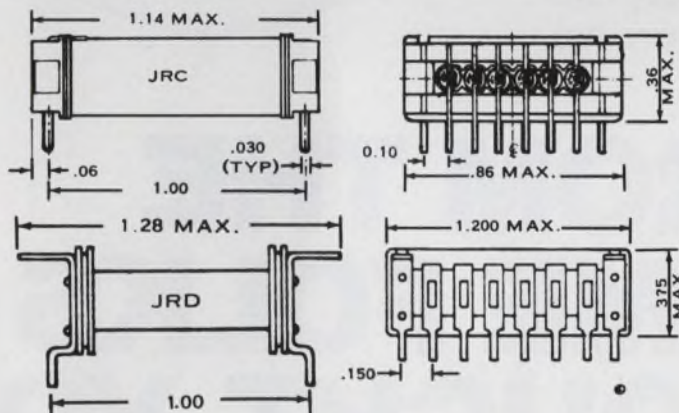

**P&B makes more of more kinds of relays
than anybody in the business.
Anybody.**

INTRODUCING THE EA 1502 BIPOLAR COMPATIBLE 1024-BIT RAM

The EA 1502 is another new addition to the growing line of N-Channel silicon gate products from EA. The EA 1502 accepts TTL inputs without external level shifting and sinks 1.6 mA on the output. It has an access time of typically 130 nanoseconds and dissipates only 115 mW (typical). In fact, in a systems configuration the EA 1502 outperforms the so-called high performance versions of the 1103, with lower power, bipolar compatibility, automatic refresh and low cost to boot! Oh yes, there's no address cycling requirements either. A single write pulse refreshes all data independent of the state of the address and chip enable inputs. Place your order early, everyone else is. \$27.50 in 100 quantities.

To make it easier for you to evaluate our EA 1500 series RAM's, we have an evaluation P.C. board available which contains all of the necessary interconnections for building a 2K by 4 memory. Ask about it!



**electronic
arrays,
inc.**

501 ELLIS STREET
MOUNTAIN VIEW, CALIFORNIA 94040
(415) 964-4321 TWX: 910-379-6985

*Stocking distributors: Burstein-Applebee Company,
Computer Components,
Cramer.*



MORE FROM THE VERY SAME FOLKS WHO BROUGHT YOU N-CHANNEL SILICON GATE.

**Other computers
have the capability
of our new 8-bit
NAKED MINI.™**

But they use 16 bits.

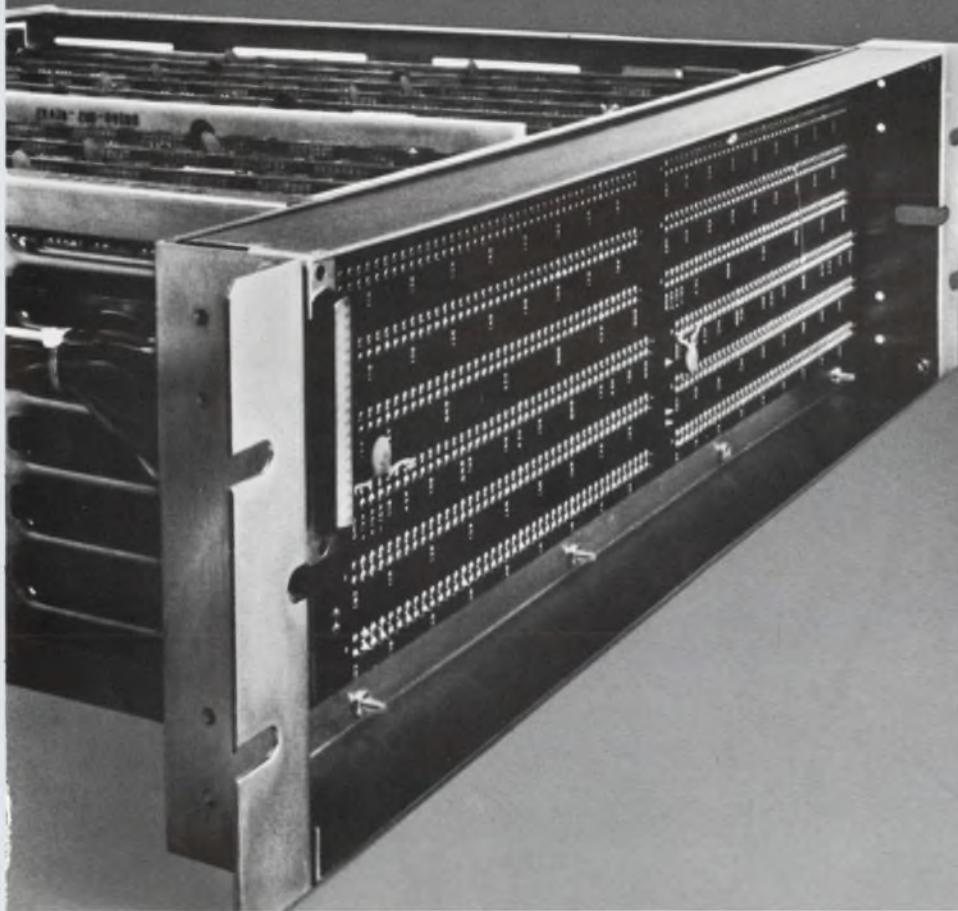

Every systems designer who's looking for a powerful, versatile computer for the lowest possible price should take a closer look at our byte-sized NAKED MINI 8.

Start by comparing its capability. It does everything a 16-bit machine can do except fast arithmetic (or inflate the price of your product). In byte-oriented applications like intelligent batch terminals, source data entry and data communications, the NAKED MINI 8 provides a potent capability that is unmatched by other 8,12, and most 16-bit machines.

Priced at \$1,450, in 200 OEM quantities, the NAKED MINI 8 represents the industry's lowest cost high-performance minicomputer.

So think about it. Capability and price. They're two good reasons you should ask about the computer that's also a component. Write 18651 Von Karman, Irvine, Calif. 92664 TWX 910-595-1767 (714) 833-8830



COMPUTER AUTOMATION, INC.
the NAKED MINI company

Introducing an ECMA-compatible cassette recorder for \$525.*

It's from Sycor. And it's compatible with not only the ECMA standard, but also the new ISO and ANSI standards.

Which is good news for marketing. Because by meeting these worldwide standards, Sycor's new recorder is capable of worldwide interchangeability. And this vastly increases its application potential. Especially when you consider how easily Sycor's Model 135 can fit within your price requirements. Because it sells for the lowest prices in the industry.

But there's also good news for engineering. Because the Model 135's price includes control and phase encoded electronics, a read-after-write head, and a 12.5 ips. read/write speed

with a transfer rate of 10,000 bits per second. And there are no interchangeability problems.

There's also good news for purchasing. Because with Sycor you get fast delivery and complete documentation from a proven supplier. (There are over 7,000 Sycor cassette recorders currently operating in 33 countries throughout the world.)

Sycor's remarkable new Model 135 digital cassette recorder. Good news for the entire OEM industry.

To find out more about it, contact Mr. R. M. Connor at Sycor Inc., 100 Phoenix Drive, Ann Arbor, Michigan 48104. Phone (313) 971-0900. TWX: (810) 223-6011.

*OEM price for 100 units

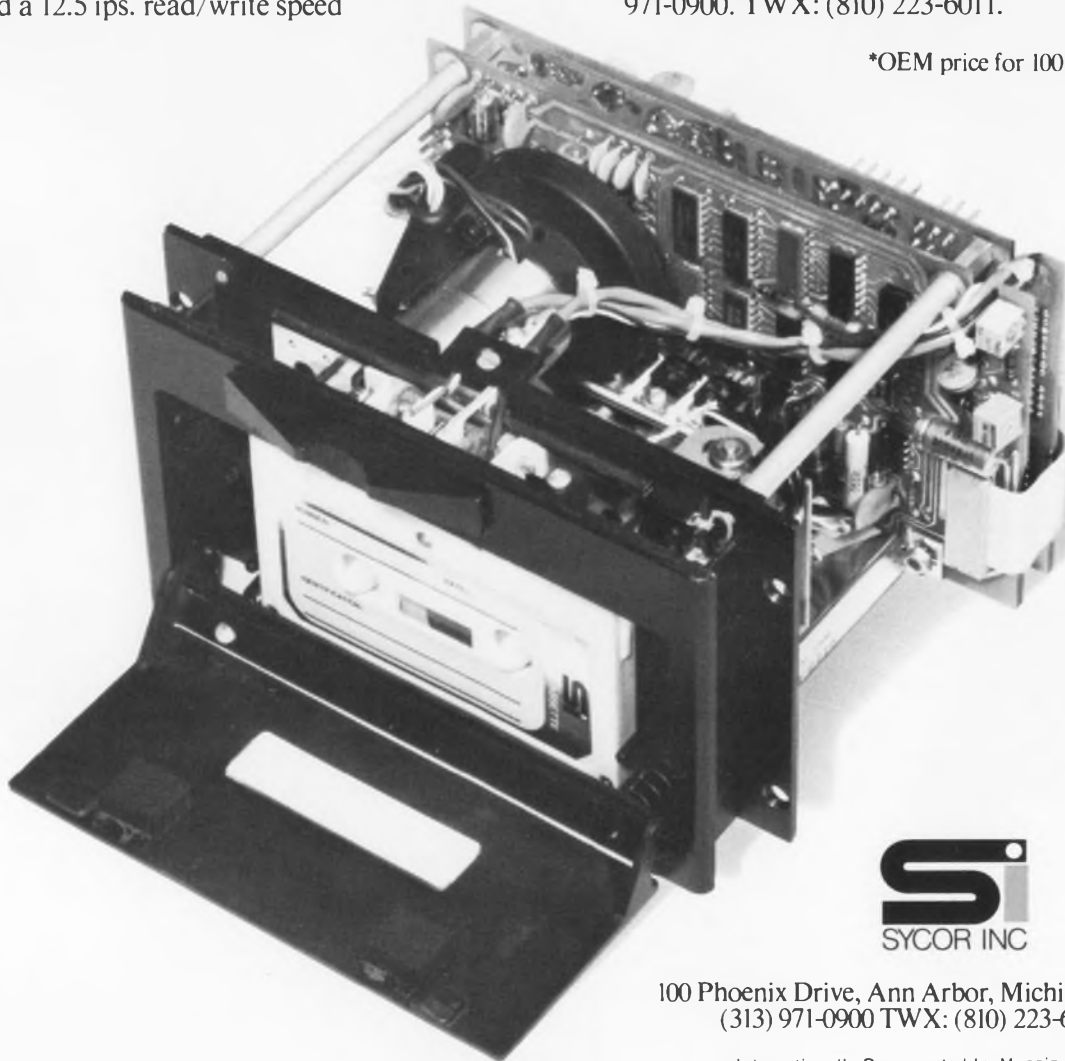

Si
SYCOR INC

100 Phoenix Drive, Ann Arbor, Michigan 48104.
(313) 971-0900 TWX: (810) 223-6011

Internationally Represented by Munzig International
Offices in Stockholm, London, Paris, Munich, Geneva

Press here to save on lighted pushbutton switches.



**buys all
the switch
you need.**

Oak's Series 300 gives you good looks and a small price-tag in lighted pushbutton switches. Plenty of switching performance for most jobs, without paying a premium. Even the Series 300 Split-Legend/4 Lamp Switch is less than \$1.60 (normal latch, 2P2T, glass alkylid insulation, no engraving, less lamps.)

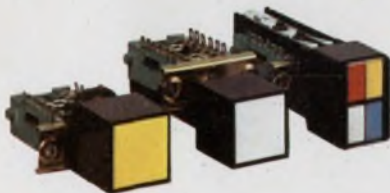

Three versions with switching up to 4P2T.

Choose from single, dual, or four lamp display as well as non-lighted type. One to twelve station, momentary, interlock, alternate action, or any combination available on the same switch bank. Lockout feature available for all types. Power Module 3A125VAC. Lighted indicators are identical in size and appearance, but without switching.



Built to take it.

Series 300 is built for reliable performance and long life. Applications galore — bank terminals, calculators, and copy equipment.

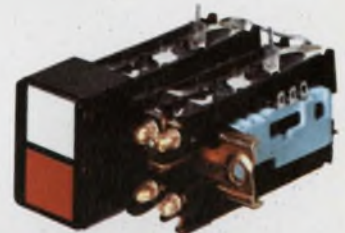

Modular design.

Single-legend/single-lamp, split-legend/4-lamp, and single-legend/redundant lamp switches have snap-on lamp holders. Plus replaceable legend plates, lens caps, and button assemblies. Front-panel relamping, too, without special tools on all types.

Gang them up by the dozen.

Order up to 12 switching stations on a single channel, any switching mix, with convenient panel-mounting studs. Color selection: white, lunar white, yellow, amber, orange, red, green, blue. Choose silk-screened, hot-stamped, or engraved-and-filled legends. Split-legend switches can be specified with any two, three, or four colors on insertable legend plates.



Write for our Series 300 Brochure

OAK Industries Inc.

SWITCH DIVISION / CRYSTAL LAKE, ILLINOIS 60014
TELEPHONE: 815 • 459 • 5000 ■ TWX: 910 • 634-3353 ■ TELEX: 72 • 2447

INFORMATION RETRIEVAL NUMBER 13

NEW 650-PAGE TTL BIBLE



The most usable TTL Data Book for the most usable TTL Family. 250 circuit functions in plastic or ceramic packages.

Our new TTL data book is like our TTL Family: most comprehensive, practical, easiest to use by far.

The TTL bible is structured to provide the designer with precise data on our TTL family in the most accessible form. He can find what he's looking for quickly and easily, whether he starts with a device number in any well-known series (9300, 5400/7400, etc.) or simply the device functional nomenclature. The indices and selection guides will direct him instantly to those devices suitable for his application, and complete specifications from which he can determine his best choice. A comprehensive industry cross-reference provides an overview of all major sources of TTL devices and their Fairchild equivalents.

The Fairchild TTL Family is a mix of more than 1,000 proprietary and second source device and package combinations selected to give the designer the broadest choice of performance/

cost trade-offs to optimize his system design. Over 100 new devices have been added to the family in the last year alone. There are logic, memory and interface functions in plastic, ceramic or flatpak, commercial or military temperature grade. Together, they provide a comprehensive line of standard off-the-shelf building blocks that can be interfaced directly with each other in the same system for maximum speed/power efficiency.

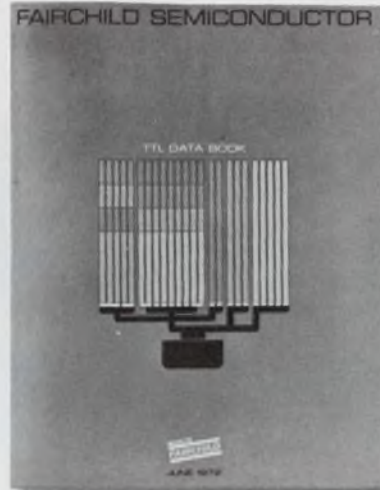

We offer more than 100 MSI devices, both proprietary and second source, that are widely accepted as the keys to optimum TTL system design.

For example: Our proprietary devices include the most complete range of TTL memories available anywhere – from 8-bit scratchpad registers to our new 93415 1024 x 1 bit RAM (made by Isoplanar) that has 60ns access time at 0.5mW/bit.

Our 9344 parallel multiplier eliminates a lot of hardware and software.

For simple solutions for A/D converters, minicomputers and high-speed systems, our 9334 8-bit addressable latch for general purpose storage, our 9338 8-bit multiple port register for high-speed storage in ALUs, and our 93H00 and 93H72 high-speed 4-bit shift registers. Our list of design-time and cost-saving proprietary devices is long and impressive.

250 proprietary and second source circuit functions:

- 54/74 & 9000 Standard SSI
- 74H00 High Speed SSI
- 74S00 Schottky SSI
- 9300 and 54/74 Standard MSI
- 9600 Monostable & Interface devices
- 93400 Memory devices

Book and family are designed for practical use. To get a copy of the former, about the latter, please write us on your company letterhead, giving us your name and title.

**MADE IN
FAIRCHILD**

Navy Standard Hardware Program packaging made easy and profitable

If you're supplying equipment to Navy Standard Hardware Program guidelines, our ingenious new SHP Packaging System will make coming up with the packaging absolutely simplistic and halve your packaging costs at the same time.

No sweat SHP

First off, we make designing the packaging so effortless we estimate you'll cut your total design load for the procurement by a third because that's what our first customers are experiencing.

Production consists of putting parts together — just a handful of different kinds — like an erector set. Only easier. That saves you thousands of dollars in design time, in dies and other tooling and a lot of trouble to boot.

Conductive, convective and strong

And when you get finished you'll have packaging for your circuitry with the high order of thermal efficiency you'd expect from industry's leading manufacturer of circuit heat dissipating devices. Plus mechanical integrity that's ready for the most demanding environments.

Packaging that cannot be individually produced for twice the price.

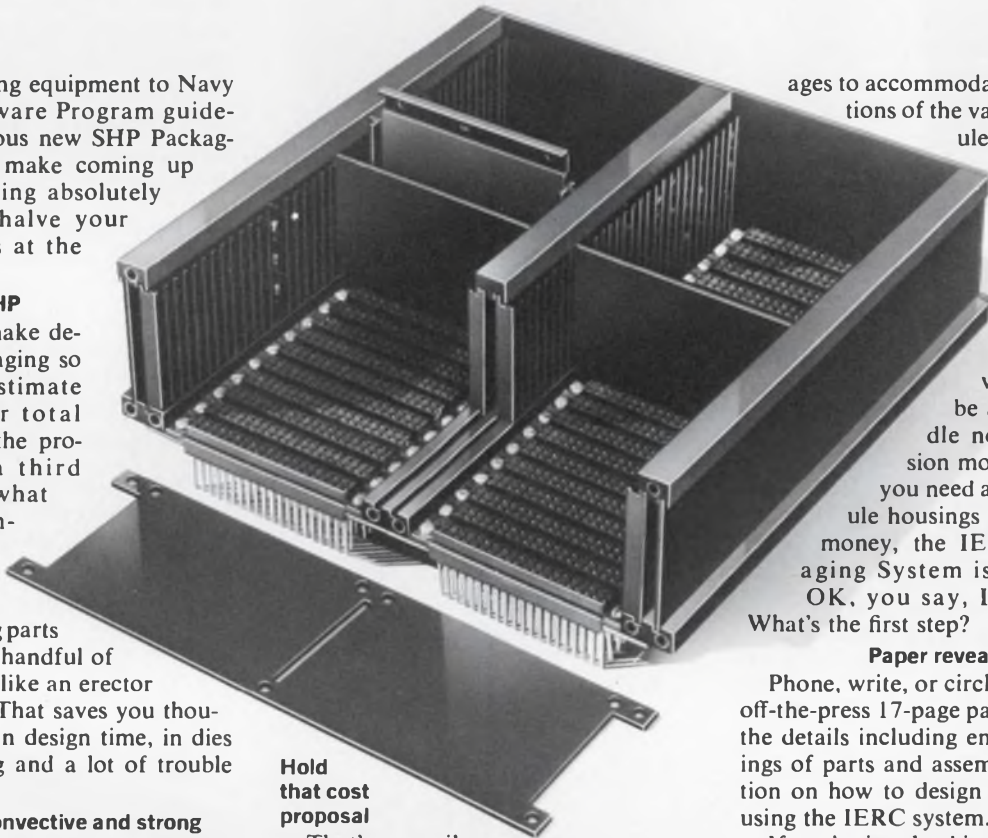

Hold that cost proposal

That's a pencil-sharpening fact you can ill afford to ignore if you're in the middle of preparing a proposal in response to an RFP that calls out SHP — or if you ever expect to bid an SHP program.

Here's how our new SHP Packaging System works:

We've designed six basic parts — plus a few specials for unusual configurations — with which you can build circuit module housings conforming to Navy Avionics Facility, Indianapolis, guidelines and dimensions for any of the common SHP-defined circuit modules using nothing but a screwdriver.

Ad infinitum

You can build these pack-

ages to accommodate any combinations of the various SHP modules, and the potential dimensions of the packaging in span and depth are for practical purposes limitless.

In fact, our system is so versatile it can be adjusted to handle non-SHP-dimension modules as well. If you need any kind of module housings and like to save money, the IERC SHP Packaging System is for you, too. OK, you say, I'm interested. What's the first step?

Paper reveals all

Phone, write, or circle to get our hot-off-the-press 17-page paper that gives all the details including engineering drawings of parts and assemblies and a section on how to design SHP packaging using the IERC system.

If you're involved in SHP or ever expect to be, get involved with the IERC SHP Packaging System today.

Ask about our SHP module plates including our revolutionary Metal Core Circuit Board plates for extremely high power densities, too. International Electronic Research Corporation, a corporate division of Dynamics Corporation of America, 135 West Magnolia Blvd., Burbank, Calif. 91502. (213) 849-2481.



Heat Sinks/Dissipators

VACTEC PHOTOCELLS *in the rocks*

The finest imported gin, ice and vermouth mixture can't penetrate Vactec's positive hermetic seals. Even the plastic passivated types are exceptionally stable. Other environmental extremes are just as routinely endured by Vactec Photocells. Capable of storage from -55°C to 85°C . Continuing to operate at liquid nitrogen cold (-196°C), and up to boiling water (100°C).

You simply can't buy a better photocell *anywhere*, and Vactec is competitive with import prices because of automated processing, assembling, and testing. Take advantage of Vactec engineering, research, and manufacturing in the heart of America. Because Vactec has 249 different types of cells in stock, we can ship before your order reaches an overseas supplier. Included is a complete line of visible detectors: photoconductors (CdS and CdSe); photo-voltaic cells (Se and Si); couplers of LED's or lamps and photoconductors called Vactrols. Vactec also has a photometer which measures from .0002 to 10,000 fc, for as little as \$300.00.

You needn't compromise. Vactec has it all. Quality, economy, and service.



VACTEC, INC.

2423 Northline Industrial Blvd.
Maryland Heights, Mo 63043
Phone (314) 872-8300

CTS *has the answer in*

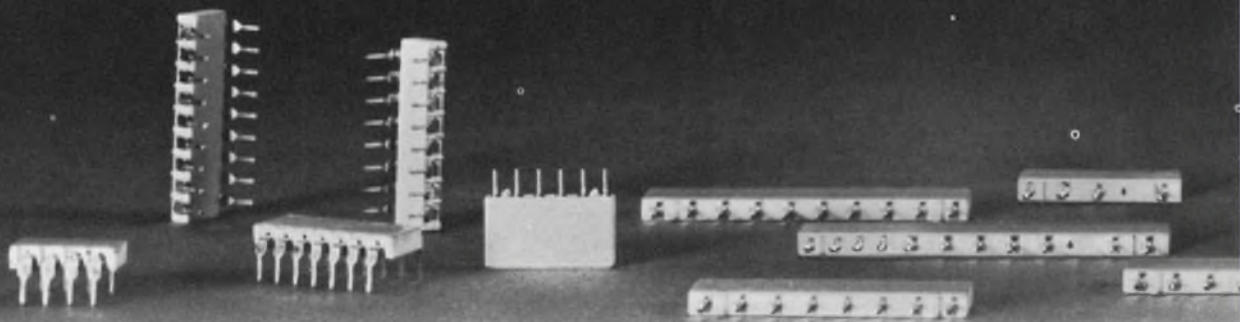

You name it—we have the exact cermet resistor network size and characteristics you need. Here's the choice you get right now: our *750 line* includes: .100" centers with 4, 6 & 8 pins; .125" centers with 2, 4, 6 & 8 pins; and .150" centers with 4 through 13 pins. And we're working on new designs right now!

All compact, extremely stable and highly reliable. Recently we packed even more circuitry into our *760 series*, giving you a choice of four popular space-saver packages: 8, 14, 16 and 18 flat lead styles. Packed with up to 17 resistors per module with flat leads standard (round leads on request).

cermet resistor networks. So ask us!

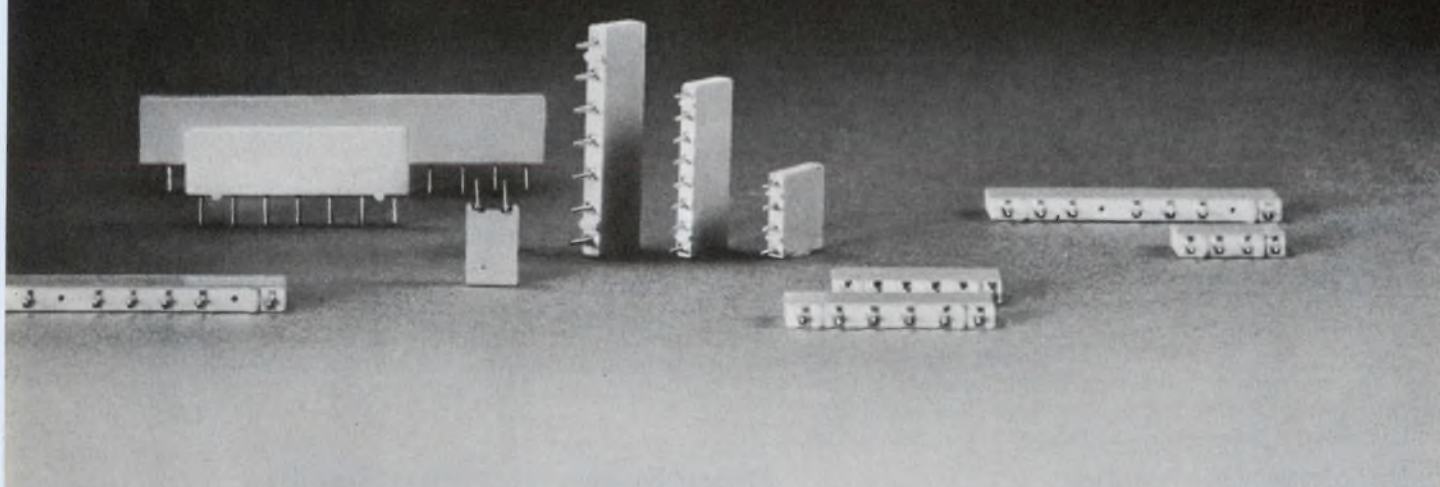

Our broad line provides an infinite number of circuit combinations, all with excellent TC, load and temperature characteristics supported by millions of hours of reliability testing. Ask your CTS sales engineer for data. Or write CTS of Berne, Inc., Berne, Indiana 46711. Phone (219) 589-3111.

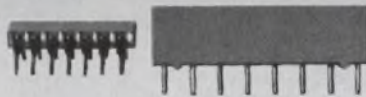

ACTUAL SIZE



CTS CORPORATION *Elkhart, Indiana*

A world leader in cermet and variable resistor technology.

KEEP PACE

practical guides for
designers, managers
from  HAYDEN

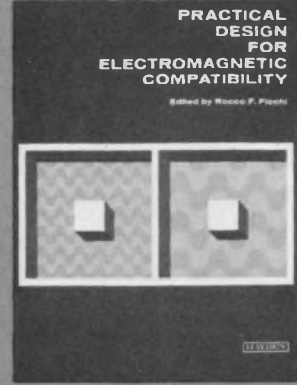

Practical Design for Electromagnetic Compatibility

Edited By ROCCO F. FICCHI

In one convenient source, all the basic information you need to analyze, predict, control, and reduce unwanted signals. It details measurement techniques and equipment, recent advances in filtering and shielding, and fully covers the special problems encountered in computers, semi-conductors, and solid-state devices. 272 pp., 7 1/8 x 9 3/4, illus., #5685-0, cloth, \$13.95

Durability and Reliability in Engineering Design

GILBERT KIVENSON

This thought-provoking work places at your disposal highly relevant findings from a variety of technical areas. It examines materials properties, breakdown mechanisms and phenomena, and failure modes along with steps to counter them; provides a capsule course in reliability theory; relates design considerations to the user's needs. 200 pp., 6 x 9, illus., #5851-9, cloth, \$9.95

The Successful Engineer-Manager

A Practical Guide to Management Skills for Engineers and Scientists

Edited by ROBERT C. HAAVIND and RICHARD L. TURMAIL

A well-organized, realistic guide to the critical areas of technical management — career, decisions, people, projects, finances, and communications. Articles carefully chosen from *Electronic Design* offer you valuable pointers on financial analysis, person-to-person dealings, project scheduling, promoting new ideas, and much more. 176 pp., 7 1/8 x 9 3/4, illus., #5879-9, cloth, \$8.95

Practical Instrumentation Transducers

FRANK J. OLIVER

You'll find virtually every known device for industrial or aerospace application covered in this complete, well-planned volume. Heavily illustrated, it reviews the state-of-the-art, clears up areas of confusion, presents pertinent data for specific applications. 352 pp., 7 1/8 x 9 3/4, illus., #5833-0, cloth, \$20.00

400 Ideas for Design, Volume Two

Edited by FRANK EGAN

Ranging from the ingenious to the amazingly simple, these top recent contributions to *Electronic Design's* "Ideas for Design" column are yours to use or adapt. They are gathered together by subject category for your convenience: amplifiers, design and laboratory aids, pulse, digital and control circuits, etc. 288 pp., 7 1/8 x 9 3/4, illus., #5067-4, cloth, \$11.95

Practical Relay Circuits

also by FRANK J. OLIVER

Grouping relays by function, this time-saver will give you a rapid overview of the circuits that can solve the problem at hand. You can then check operating principles, standards, and other specifications in manufacturers' data or sources such as Hayden's *Engineers' Relay Handbook*. 384 pp., 6 x 9, illus., #5802-0, cloth, \$14.95

Materials Science and Technology for Design Engineers

Edited by ALEX E. JAVITZ

The fundamentals of materials integrated with the hard facts of day-to-day engineering practice. The coverage offered you ranges from basic structure and behavior through new materials and applications, to environmental effects, reliability concepts, and cost effectiveness. 560 pp., 6 x 9, illus., #5640-0, cloth, \$23.95

Advanced Electronic Instruments and Their Use

SOL D. PRENSKY

Here, fully described and illustrated, are the highly sophisticated new instruments used for sensing, measurement, and control monitoring. You'll find detailed coverage of femtometers, solid-state multimeters, digital display devices, and much more. 208 pp., 6 x 9, illus., #0796-5, paper, \$6.95; #0797-3, cloth, \$9.50

15-DAY FREE EXAMINATION

Please send the book(s) circled on 15-day free examination. At the end of that time, I will remit payment, plus postage, or return the book(s) with no further obligation.

5685-0 5851-9 5879-9 5833-0 5067-4
5802-0 5640-0 0796-5 0797-3

Save Money!

Payment Enclosed. Publisher will pay all shipping and handling charges — same 15-day guarantee.

Name _____

Firm _____

Address _____

City/State _____ Zip _____

\$10.00 minimum for free exam orders. Because of higher billing and collection costs, we must ask for payment in full with any order for less than \$10.00. Same 15-day guarantee.



HAYDEN BOOK COMPANY, INC., 116 W. 14th Street, New York, N.Y. 10011

ISBN Prefix 0-8104

72-88

NEW advanced design RT SERIES

Line and Load Regulated Constant DC Power Supplies

Designed for tomorrow's increased power requirements . . .
Economically priced for today's standard applications!

Utilizing a new transformer concept, Technipower has been able to reduce costs while providing all the increased power requirements for tomorrow's more sophisticated systems. This enables the systems engineer the flexibility of using the RT SERIES for optimum performance at economical cost for a wide range of standard and complex applications: process control equipment, relay banks, computers, assembly line testing, communications equipment, op-amp and signal functions.



**BACKED BY TECHNIPOWER
5-YEAR WARRANTY**

500 WATT MODEL RT5-60.0

Length 19"
Width 7"
Height 12"

BEATS EVERY COMPARATIVELY PRICED UNIT IN VITAL PERFORMANCE SPECIFICATIONS. COMPARE!

Source Voltage Range	105 VAC to 125 VAC	Adjustable Output Voltage	Output Current Amperes	Size H D W	Standard Model Number	Price Per Unit
Source Frequency Range	57 Hz to 63 Hz	4.75-5.25	30.0	5 1/4 x 7 1/2 x 19	RT5-30.0	\$175
Line, Load, Frequency Effects	± 0.5% (Combined)	4.75-5.25*	60.0	7 x 12 x 19	RT5-60.0	.295
PARD (R.M.S.)	1% or 150 mv, whichever is greater	11.4-12.6	18.0	5 1/4 x 7 1/2 x 19	RT12-18.0	177
Ambient Temp. Operating	0°C to 50°C	11.4-12.6	36.0	7 x 11 1/16 x 19	RT12-36.0	228
Ambient Temp. Storage	-62°C to +85°C	22.8-25.2	10.0	5 1/4 x 7 1/2 x 19	RT24-10.0	150
Output Voltage Adjustment	± 5%	22.8-25.2	20.0	7 x 9 x 19	RT24-20.0	251
Short Circuit Protection	Current Limiting & Built-in Line Fuse	26.6-29.4	8.0	5 1/4 x 7 1/2 x 19	RT28-8.0	150
Remote Sense	Up to 2.0% of the Output Voltage	26.6-29.4	16.0	7 x 9 x 19	RT28-16.0	210
Polarity	May be used positive or negative	45.6-50.4	5.0	5 1/4 x 7 1/2 x 19	RT48-5.0	152
		45.6-50.4	10.0	7 x 9 x 19	RT48-10.0	197

Optional Features:

115/208/230 ± 10% Input, Overvoltage, Fixed Output Voltage,
Remote Adjustment, Metered Rack, Series Start

250 Watt Series and 500 Watt Series specified above, 1Kw Series also available. Contact Factory. OEM Quantity Prices Quoted Upon Request.
External overvoltage protection available for all asterisked models.
Internal overvoltage protection and metering options available for all unasterisked models.

TECHNIPOWER, INC.  [®]
A **BENRUS** SUBSIDIARY

Benrus Center, Ridgefield, Ct. 06877 • 203-438-0333 • TWX: 710-467-0666



MAN6 — .6" high, the MAN6 looks an inch high from across the room. The complete, gapless font makes all ten digits and nine letters unmistakably clear. It should find application in many instruments, consumer electronics, and cockpit displays.



MAN1 — The standard of the industry, the .27" MAN1 is mounted on a 14-pin DIP and encapsulated in clear epoxy. Directly compatible with IC's, it is being used in a wide variety of alphanumeric display sockets. (Shown in a demonstration clock face.)

The Monsanto GaAsLITE Display display.

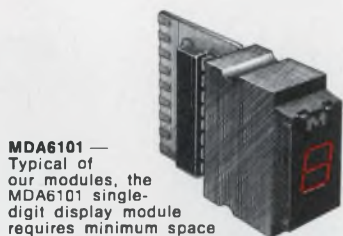

MDA6101 — Typical of our modules, the MDA6101 single-digit display module requires minimum space in computer, avionics and military systems. Contains a decoder-driver circuit designed to accept four-input BCD (8, 4, 2, 1) code and to provide .27" visual readout of decimal numbers and nine distinct letters. Provides decimal point input and has ripple-blanking input and blanking input/ripple-blanking output terminals for zero suppression and intensity control.

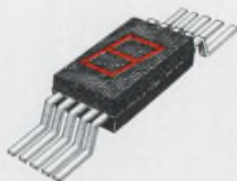

MAN3A — Encapsulated in transparent red epoxy, this small (.115") readout is very useful in desk calculator displays, portable instruments, and film annotation sockets. Displays ten digits and nine letters.



MAN2 — A 5 x 7 light-emitting-diode matrix, the .35" MAN2 alphanumeric displays the full 64-character ASCII code. Finds application as keyboard verifier, avionics display, in computer peripherals and has 2^{1/2} bits available for film annotation work.



MAN1002 — A .27" 7-segment hexinumeric display, the MAN1002 provides all numbers and the letters A, B, C, D, E, F, H, I, J, L, O, P, S, and U for digital and cockpit readouts that require this capability. Like all our GaAsLITE displays, it is shock resistant and impervious to vibration.

We're displaying our array of light-emitting diode displays to point out the obvious: We've got them all.

Big GaAsLITEs—the new .6" MAN6.

Low-cost little MAN3's, in single-digit or multi-digit packages.

5 x 7 dot matrix MAN2's.

9-segment hexadecimal MAN1002's.

Red, green, and yellow.

And a line of display modules that will answer the industry's felt need: pre-designed display sub-assemblies for nixie retrofit, edge-card plug-ins, etc.

So what more can you look for in solid-state, TTL-compatible,

long-lived light-emitting-diode displays? They're all in stock at our distributors. And the time is right. Get into GaAsLITEs. Display your wisdom.

If you'd like more information on our expanding line of module display products, clip the coupon and shoot it in.

If you need more information on displays, circle the bingo card number below. And if you're smart enough already, just tuck this name into your head when you order displays: **Monsanto Commercial Products Co.**, Electronic Special Products, 10131 Bubb Road, Cupertino, California 95014.

FREE DISPLAY MODULE BROCHURE

Dear Monsanto:

I'm curious about your new line of display modules. Do some contain complete IC driving circuits? Send me the Module Brochure, please.

Name _____

Title _____

Company _____

Address _____

City/State/Zip _____

Monsanto

INFORMATION RETRIEVAL NUMBER 20

Next computer generation: 'Polysystem' predicted

Networks of computer modules called "polysystems" are envisioned by a Univac staff scientist as "the next generation of computer architecture."

The scientist, Earl C. Joseph of the Univac Div. of Sperry Rand in St. Paul, Minn., points out that higher levels of circuit integration are providing computer-like functions on a single chip of silicon. These functions, he says, can be organized into a wide range of configurations for "increasing throughput performance and for greatly reducing programming and hardware costs."

Joseph believes that polysystems will come into wide usage during the 1976-78 period.

He calls the class of integrated circuits to be used LSI/GSI (for Large and Grand Scale Integration.) In this category he includes such macro computer functions as processors, memories and input/output terminals.

Joseph, who made his predictions in a paper at the recent IEEE computer conference in San Francisco, looks for a drop in semiconductor prices that will total 90% every five years in the 1970's. As a result, he says, "Before 1980 very capable data-processing functions may cost less than \$100 each in high-volume production. "Thus," Joseph continues, "the hardware of computers is approaching 'zero cost,' and we will lose interest in keeping such resources busy. With hardware logic and local memory projected to be so low cost, considerable design attention is being given to building major segments of the software into the hardware. Such considerations point to a trend toward dedicating processors and memory to functions and applications, the major result being a two-thirds reduction in the executive portion of the operating

system software, bringing considerably more efficient and cost-effective use of computers."

Joseph also believes that software costs will tumble by more than an order of magnitude in this decade but that hardware will become so cheap the program costs will still be the dominant ones in the use of computers.

New line said to double CMOS device speed

A 2:1 speed improvement over existing CMOS devices is claimed for a new line introduced by Harris Semiconductor of Melbourne, Fla.

With the aim of becoming a major factor in the CMOS integrated circuit market, Harris has introduced dielectrically isolated circuits known as DI/CMOS. Eight types are available now, 11 more will be offered by December and 16 more by next June, the company says.

Besides a doubling of the speed factor, the new CMOS devices decrease power dissipation by an order of magnitude, according to Donald R. Sorchych, vice president and general manager of Harris. These improvements, he continues, are made possible by the dielectric isolation, which results in smaller geometries and lower capacitance values.

Of the eight devices introduced, seven are pin-compatible with the RCA CD 4000 series. The other is a proprietary Harris device known as a triple true/complement buffer. In addition Harris will also be producing pin replacements for some devices in the Motorola MCM 14500 series.

Sorchych says that within the next year CMOS will become competitive in speed with Schottky-TTL as CMOS devices operate in

the 3-to-6-nsec range. Further, he predicts, within three years Harris will have CMOS devices on the market that will compete with ECL in speed and have lower power dissipation.

As for how the increases in speed will be accomplished, Sorchych explains that for the Schottky-competitive CMOS, dielectric isolation, silicon-gate technology and ion implantation will be used. For the ECL-competitive CMOS, a high-density polysilicon isolation process known as Polyplanar—similar to the Motorola VIP technique—and low-level switching will increase speed, Sorchych says.

Harris is not limiting its work in CMOS to logic devices. It has, the general manager reports, been applying CMOS to the memory area and plans to introduce a 256-bit CMOS random-access memory in the first quarter of 1973. The new RAM will have TTL-compatible inputs and outputs and will have the same pin configuration as 256-bit bipolar RAMs. It will be a static device and therefore require no clocks for memory refresh. It will consume only 10 mW of power and have an access time of 70 nsec and a cycle time of 100 nsec, according to Sorchych. It will also be the first CMOS device to use the polysilicon isolation technique.

64-bit bubble memory delivered to Air Force

A 64-bit shift register with a data density of 250,000 bits per square inch is reported to be the industry's first completely operational magnetic-domain bubble memory. North American Rockwell's Electronics Group in Anaheim, Calif., has delivered the memory to the Air Force Avionics Laboratory at Wright-Patterson Air Force Base.

The monvolatile memory heralds a mass-storage technology that has undergone decades of research at Bell Telephone Laboratories and elsewhere.

The North American Rockwell memory, as described by William C. Mavity, program development manager, uses a single crystalline material, as opposed to the polycrystalline films of domain-tip

memories. A nonmagnetic garnet film is magnetized by iron substituted for gallium or aluminum. The bubbles are formed as right circular cylinders 6 to 12 μ in diameter and 5 to 10 μ thick. A permalloy pattern includes control circuits, detector and gold leads deposited directly on the epitaxially grown magnetic film by the field-access technique.

Demonstrations of the device indicate that future bubble memories could provide a nondestructive readout with a capacity over 10^9 of data and the ability to synchronize data flow between sensors and data processor or transmitters.

1000 V delivered by thermal battery

A thermal battery designed for "one shot" operation and capable of delivering 1000 V for up to 50 seconds has been announced by Sandia Laboratories, Albuquerque, N.M.

Developed by Robert P. Clark, a staff member of Sandia's Power-Supply Development Dept., the battery is designed for use in nuclear weapons and other systems where high voltage would be needed only once, after a period of storage.

The battery contains two stacks of 84 cells each, connected in series. It is activated by an electrical signal that ignites a small heat-producing (pyrotechnic) charge. The heat melts the electrolyte, which then becomes conductive, and the battery produces electricity by an electrochemical reaction.

The output of the cell can be made to last as long as six minutes, Clark reports, by increasing the insulation.

Laser setup offers machine-tool control

A laser transducer system, small and rugged enough to be used for machine-tool control, has been developed. One-inch optical cube reflectors mounted on the machine work with a single laser to control up to eight axes that measure pitch and yaw as well as position.

The new system, announced by Hewlett-Packard and based on the company's laser interferometer,

has accuracies of better than 1 microinch per inch, says Fred London, product manager. The laser interferometer was previously designed as a calibration instrument to check other test transducers, he points out.

The helium-neon laser used in the new system, unlike other, similar types, radiates two frequencies close together, London explains. When one of the optical target cubes is moved along the direction to be measured, the frequency-modulated carrier is produced. The laser beam bounces off the reflectors and is combined in the interferometer system with a reference beam. This gives a Doppler signal when the target moves. This signal is taken from a detector and amplified.

Because position and velocity information is in the laser beam, the device is stable and the optics have no drift problems. Also, London points out, it requires no warmup, nor recalibration at any time.

Liquid crystals pushed for calculator display

With most displays for electronic calculators using light-emitting diodes, the North American Rockwell Microelectronics Co. has decided to stake its future in the calculator market on a chemical display phenomenon first noted in 1888—liquid-crystals.

Liquid crystals, which have been much talked about and much experimented with in the last decade, offer improvements in display quality and lower cost in microelectronic calculators designed to sell for around \$100, according to North American. The Anaheim, Calif., company says it is mass-producing such displays for more than 200,000 calculators ordered

by Lloyd's Electronics of Compton, Calif., and Sears, Roebuck and Co. of Chicago.

Dr. R. S. Carlson, president of North American Rockwell Microelectronics, believes his concern is the first to produce liquid-crystal displays in such large quantities.

"Combined with our ability to put a complete calculating system on a single microelectronic circuit at about one-fifth of the cost of a similar system produced last year," Carlson says, "the mass production of liquid-crystal displays makes possible 1972's lower calculator prices."

Computer show looks for a sellout in fall

The trade show may be in for a rebirth of sorts, if the Fall Joint Computer Conference is any indication. Organizers of the show report that over 80% of available space has already been reserved in the main exhibit hall and that, at the current pace of exhibitor interest, all 410 booths should be sold.

This year's conference, to be held Dec. 5 to 7 in the Anaheim (Calif.) Convention Center, is expected to draw 20,000 visitors according to the organizers, the American Federation of Information Processing Societies, Inc. (AFIPS). By comparison, the Spring Joint Computer Conference, last May in Atlantic City, N.J., drew less than 14,000 visitors. And the number of booths already sold for fall show exceeds the total for the spring conference.

More than 150 organizations are expected to participate in the fall conference—the first AFIPS-sponsored conference on the West Coast since 1968. The companies include a number of major organizations not present at the spring show.

News Briefs

Texas Instruments has decided to enter the calculator market in a big way after successfully test-marketing its first calculator—the Datamath. The company's initial announcement covered three calculators: the Datamath, renamed the TI-2500, and two desk models, the TI-3000 and TI-3500. TI plans to introduce a new calculator every 60 to 90 days for

the next 14 months.

Demand for technical manpower continues upward, according to the latest tally of the Engineer/Scientist Demand Index, maintained by Deutsch, Shea & Evans, New York City. The July index registered 80.7, up 13.5 from the preceding month and the first 80 plus tally since February, 1970.

Teradyne's L100 Automatic Circuit Board Test System speaks for itself.

<pre> PASSED GOOD: 43 BAD: 8 </pre>	<pre> FAILED FAILURE COUNTERS (BAD/TOTAL): FTEST 0/36 MTEST 5/83 BTEST 0/1 TTEST 0/2 </pre>
<pre> MT44 D8 THIS TEST PASSED MTEST ON PINS: M LIMIT :+ 500. MV ACTUAL:+ 248. MV </pre>	<pre> TT39 THIS TEST FAILED TIME FROM PIN 18 TO 21 ACTUAL: 00.195 US TMIN: 00.050 US TMAX: 00.190 US </pre>
<pre> FT35 THIS TEST FAILED <ALARMS>S1 FAILING PINS: 20 Z K </pre>	<pre> FT15 THIS TEST FAILED FAILING PINS: S R P N M L J </pre>

If you test circuit boards, you get the message. The L100 doesn't just tell you a bad board is bad. It helps you find out why. And in a fraction of the time you'd usually spend troubleshooting. We'd like to send you a brochureful of reasons why the L100 is the most money-saving system you can buy.

Write: Teradyne
183 Essex Street
Boston, Mass. 02111

In Europe:
Teradyne Europe
S.A., 11 bis, rue
Roquepine,
75 Paris 8°, France.
Tel. 265 72 62.



TERADYNE

AT THE INTERNATIONAL MACHINE TOOL SHOW

Programmable controller, 'mini' for the poor man, upstages DNC

Two years ago, on the brink of a recession, the International Machine Tool Show in Chicago featured 70 expensive DNC (direct numerical control) systems—setups that called for a hierarchy of computers, from large, general-purpose machines to minis, to control assembly-line operations.

"People didn't know how to use them, didn't know whether they even needed them or not, and certainly couldn't pay for them," one manufacturer's representative recalled last month at the 1972 machine-tool show.

Not surprisingly, DNC had nearly disappeared from the scene when this year's show opened in both the International Amphitheater and newly rebuilt McCormick Place in Chicago. In its place was a more practical star: the pro-

grammable controller, sometimes called the poor man's mini.

At the same time punched-tape NC (numerical control) machines, which were played down two years ago, were being promoted as simple, cheap workhorses of industry.

The programmable controllers, because they can do more than NC and are still relatively inexpensive, appeared to attract the greatest interest among the estimated 75,000 international visitors, who included a 116-man team of engineers from the Soviet Union.

"We want to sell what people need now, can work with easily, and can pay for," one manufacturer explained. "And the programmable controller is it."

The difference between a programmable controller and a minicomputer is that the programmable controller uses a read-only memory while the minicomputer may use a variety of memories, in-

cluding a read-write memory.

"With a programmable controller," said a representative of Digital Equipment Corp., Maynard, Mass., "you program the particular control functions you need and connect them with hard wire. To change the functions, you have to rewire the read-only memory."

One reason for using a read-only memory is that a minicomputer's read-write memory would be inoperable—drowned out by interference—in certain high electrical noise environments.

Why does the programmable controller represent such a big potential market? DEC says it's because there's an increasing need for "a simplified, cheap, reliable control device for use on machine tools and on transfer lines—moving an item in a production line from one station to the next—and for many more applications that are now emerging."

Trends in this area, DEC says, include improving the memories. The company has already announced a read-write memory for programmable controllers, but it would still not be able to operate in a high electrical noise environment. "And when you get to memories like this," he noted, "you're getting so close to a minicomputer that the difference becomes a matter of semantics."

DEC says industry sales for programmable controllers will hit \$100-million by 1975. William Ware, market manager for industrial systems in the Allen-Bradley Systems Div., Cleveland, foresees a more modest market: \$25-million to \$30-million by 1976. But even the lower estimate is worth fighting for, and many companies are.

General Electric's General Purpose Control Products Dept., Oak Brook, Ill., announced at the show its new Logitrol programmable

John F. Mason
Associate Editor



New World C-Line computerized numerical control system, introduced by Westinghouse, is said to provide "first all-stored logic numerical control."

Q-LINE SCRs



**WE PUT 14 YEARS OF
THYRISTOR EXPERIENCE
INTO EVERY
UNITRODE SCR.**

<input type="checkbox"/>	<input type="checkbox"/>	<input type="checkbox"/>	<input type="checkbox"/>	<input type="checkbox"/>	<input type="checkbox"/>	<input type="checkbox"/>	<input type="checkbox"/>	<input type="checkbox"/>	<input type="checkbox"/>
<input type="checkbox"/>	Unitrode Corporation Dept. 10X, 580 Pleasant St., Watertown, Mass. 02172								<input type="checkbox"/>
<input type="checkbox"/>	<input type="checkbox"/> Please send SCR information kit containing detailed specs and application notes.								<input type="checkbox"/>
<input type="checkbox"/>	NAME _____								<input type="checkbox"/>
<input type="checkbox"/>	TITLE _____								<input type="checkbox"/>
<input type="checkbox"/>	CO. _____								<input type="checkbox"/>
<input type="checkbox"/>	ADDRESS _____								<input type="checkbox"/>
<input type="checkbox"/>	CITY _____		STATE _____		ZIP _____		<input type="checkbox"/>		
<input type="checkbox"/>	<input type="checkbox"/>	<input type="checkbox"/>	<input type="checkbox"/>	<input type="checkbox"/>	<input type="checkbox"/>	<input type="checkbox"/>	<input type="checkbox"/>	<input type="checkbox"/>	<input type="checkbox"/>

See EEM Section 4800 And EBG Semiconductors Section for more complete product listing

And that means a better industrial product. Our performance record proves it. In industrial/commercial applications, the use of Unitrode SCRs doubled last year and has doubled again this year. For the military, Unitrode supplies more lead-mounted SCRs than everyone else combined. Unitrode is the only SCR supplier with Military Qualification Approval on all TO-5 and TO-18 mil. specs. Why this kind of acceptance? Our experience. It means a lot to people who've had experience with less.

Our broad line of SCRs including plastic and hermetically sealed metal types offers a wide range of choices for literally hundreds of applications. The Unitrode SCR product line ranges from our very popular, rugged 0.8 amp TO-92 plastic package and TO-18 hermetically sealed series to our 1.6 amp TO-5 and TO-39 series and 5 amp TO-59 stud series. Some series are available to 600 volts.

It's what you would expect from a company that makes thyristors a major part of its effort - not just a sideline.

For fast action, call Sales Engineering collect at (617) 926-0404 Unitrode Corporation, 580 Pleasant St., Watertown, Mass. 02172.



UNITRODE quality takes the worry out of paying less.

controller—an expandable, plug-in memory with a maximum capacity of 4 k, more than 2000 inputs and outputs, a portable programming panel that can visually display an entire circuit for rapid troubleshooting and a sample relay-for-mat programming design.

The central processing unit incorporates a plated-wire electrically alterable read-only memory, combining the advantages of a read-write memory during programming with the reliability of a read-only memory during operation. The central processing unit uses printed-circuit controller cards.

Allen-Bradley introduced a programmable machine logic and digital cutter compensation for its 4500 system of—a NC three-to-four-axis unit for machining centers. Described by the company as an "industry first," the 4500 system's optional feature replaces solid-state or relay magnetics that have to be hard-wired at the factory. The programmable machine logic allows the machine-tool builder to program his interface requirements in the NC unit at his own convenience after the machine has been built and delivered.

A new plug-in read-write core memory was also shown by Allen-Bradley for programmable controllers. The system, designed with a read-write processor rack, may have its program entered, changed, re-entered or changed again directly from the program panel. The purpose of the core memory is to allow new programs to be generated and tested and then transferred into the read-only memory for production use.

Eagle Signal, a division of Gulf-Western Industries in Davenport, Iowa, displayed a programmable logic controller that offers a read-only memory as well as a random-access memory. The unit is cheaper, per function, the company claims, than any other such device. The complete system is priced at \$2700, and it includes 16 inputs and 16 outputs, a 256-word PROM and a 256-bit RAM.

The reason for using the RAM is cost. Instead of storing the condition of a control relay in an unused output register, which can cost \$20 to \$30 per location, the RAM stores it at a cost of less than 20¢ per location.

Designated the Controlpac 600, Eagle's new controller needs only 1/10th the memory capacity of programmable controllers currently available when used in a typical transfer machine or material handling functions, according to the company's industrial design supervisor, Robert R. White.

CNC instead of DNC

What of DNC? About a half dozen systems were on display at the show. And one of these was a "tutorial" exhibit by IBM.



An optical projection profile grinding machine, built by Wasino Machine Co., Ltd., Nagoya, Japan, projects the grinding operation 25 to 50 times normal size. Wheels for grinding are directly below the projection screen.

"DNC won't come into its own for 10 years," one manufacturer predicted.

Replacing the hopes for DNC in the near future is CNC (computerized numerical control), which uses one minicomputer to control one or more machines.

Westinghouse displayed its New World C-Line, which uses the company's Prodac central-processing unit as its base and provides what Westinghouse calls the industry's "first all-stored-logic numerical control." The machine performs production monitoring, on-line editing of new tape programs to cor-

rect errors, and tapeless parts production.

Allen-Bradley introduced its Bulletin 1795 computer-control system, which does not require the operator to learn how to program.

"The engineer simply enters a ladder diagram, showing the desired magnetic requirements, by means of a typewriter-like keyboard," says L. O. Rexrode, manager of product planning for the Allen-Bradley Numerical Control Div. at Highland Heights, Ohio. "The translator programmer converts the information to the machine language required by the read-only memory for him."

The system is based on a general-purpose digital computer that may be connected to the manufacturing process through programmable controllers, numerical-control systems, solid-state controls and relay controls. Or the computer may be linked directly to the manufacturing machine.

Data General of Southbow, Mass., also introduced its Contour I CNC system, based on the company's Nova line of general-purpose minicomputers. The company says that Contour I can increase by 15 to 25% the productivity of the machines it controls by letting a parts programmer edit programs on-line at the machine. A single Contour I can control up to four three-axis machines simultaneously, with each machine running a different part of the program.

And General Electric introduced its Softwired 8500 NC system (a CNC) using its Mark Century computer. It is capable of operating machines with up to four axes in single machine configuration, and eight axes in a machine cluster.

A back seat for adaptive control

There was very little talk at the show of adaptive control—the technique for sensing a machine tool's progress on a part it's working on and adjusting the tool for any changes, errors or dangers that are indicated. In 1970 adaptive controllers received high billing. What happened?

"Industry is not ready for adaptive control," said John P. Reading Jr., assistant manager of marketing communications for Cincinnati Milacron, Cincinnati, Ohio.

More ways to light a one light.

*Licon has added LED's to one LPB switch line ...
another line offers neon or incandescent lamps ...
both feature patented Butterfly® switching.*

You always get a great choice with Licon® LPB switches. For example, take just two of our many lines – Types 01-700 and 01-600 single light switches. Our 01-700 line is now available with integral Light Emitting Diodes. That means virtually infinite light life and negligible operating current. And the 01-700's low profile design assures maximum light intensity. Or choose neon or incandescent lamps instead. In either line. Mounting styles? Type 01-600 line features bezel or bezel-barrier, in

a single switch or multiple in matrix. Time-saving, snap-in mounting. Switching action? Choose from momentary or alternate – plus a selection of non-lighted switches or non-switching indicator lights in matching styles. But whatever you choose, you also get patented double-break Butterfly switching which offers greater reliability and other advantages not possible with single-break switches. Licon LPB's are easily installed and serviced. Test light them yourself.

Call your local Licon rep or distributor for a lighted demo in your office. Or call or write for a Licon Switch Catalog.
**Licon, Division
Illinois Tool Works
Inc., 6615 W. Irving Park
Road, Chicago,
Illinois 60634.
Phone
(312) 282-4040.
TWX 910-221-0275.**



it LICON



Antoliy I. Kostousov, Minister of Machine Tool Industry of the Soviet Union, says if the "technology and price" are right, the Soviet group is prepared to buy a large amount of advanced machine tools.

"We do have a system for profile milling with adaptive control. It's technically ready for marketing as original equipment or for retrofitting. And we've also developed adaptive control for drilling. But we're not actively marketing any of it. There's just been no demand. Frankly we don't know who wants it."

General Automation, Anaheim, Calif., believes it does know and displayed adaptive control in a new line of production machine control systems called Adapt-A-Path. A representative explained its operation this way:

"Integrating highly complex control software with a very powerful minicomputer—the SPC-16—eight elements are controlled: control signals are matched exactly to the performance characteristics of a machine's drive system; tool errors are sensed faster than with conventional controllers; errors in tool movement are corrected; tools are driven directly from computer memory; standard or nonstandard program formats are followed easily; on-site parts programming and editing are performed without the need for a large central computer; the system can grow modularly; and programming is made simple."

Several manufacturers indicated that there were no computational problems in designing adaptive control but that good sensors were not available.

The economic picture improves

Aside from the electronic developments, another sharp contrast



A "united" American-Soviet emblem was a show-stopper at the Soviet diamond-tool booth at the show.

at this year's show was the enthusiasm of exhibitors. There was excitement over the fact that the industry had begun to emerge from its economic decline.

"A healthy upturn in the machine-tool business is an established fact this year," a Digital Equipment Corp. spokesman told *ELECTRONIC DESIGN*. "Two years ago the future was not certain, and, sure enough, the show was followed by a business slump.

"One potential source of new and very big business today hangs on the success of the Wankel engine. If it goes over, there will be a major retooling in Detroit."

First in line for providing production equipment for the Wankel engine is Tri-Ordinate Corp. of Berkeley Heights, N.J. The com-

pany has built and patented two machines—one to grind the cavity of the Wankel engine and one to cut the side-sealed groove of the rotor. Sample cavity grinders have been sold to both General Motors and Ford.

The grinder is run by a DEC PDP-14 programmable controller, but, explains Carl Hoglund, vice president of Tri-Ordinate, the unit is used more like a computer than a controller.

"We've programmed it," he said, "as if it were a computer, using various subroutine techniques and real-time processing techniques instead of just the normal control-ladder diagram setups."

In a way, the PDP-14 is used as if it were a single axis NC control unit, Hoglund explained. "We're doing all the logic stepping and logic pulsing through software," he noted, "and just using some of the outputs to put a step into the stepping-motor-drive circuitry."

The cutter is operated by simple semiconductor logic.

The Russians look and buy

Another source of new business that stirred interest and comment at the show was the Russian representation. Dressed in unmistakable Soviet business suits and comfortable open sandals, the 116-man delegation moved in solemn, organized fashion past the exhibits. They studied the products carefully, collecting brochures, taking notes and returning to ask questions and take photographs. They bought \$20-million worth of machinery and visited some 25 plants before going back to the Soviet Union.

At the show primarily to learn and to buy, the Russians had only one exhibit; it displayed diamond-tipped cutting tools.

The big international turnout—more than 36% of the nearly half million square feet of floor space was taken by foreign companies—was another significant aspect of the show. Richard Barton, manager of numerical control operations for General Electric in Waynesboro, Va., summed up the reaction of American exhibitors in these words:

"We know now that toolmakers in Europe and the Far East are not only good but they are aggressive salesmen." ■■

5 new capacitor ideas.



Last year, nobody
could offer you any of these

From Paktron, the one U.S. company that keeps making news in film capacitor development and manufacturing automation advances. *Metalized Film Capacitors* for use in voltage multiplier circuits to replace and outperform more expensive ceramic disc capacitors. New *Paktron® Metalized Polypropylene Capacitors* for high voltage/high current application — up to 1200 volts. *Molded Polyester Capacitors*

designed for PC board use in the widest possible capacitance range and popular voltage ratings. *Micromatic® Type PP Polypropylene Capacitors* for specialized applications in the instrumentation and telecommunications industries. *Wrap and Fill Capacitors* that combine polycarbonate type performance with metalized type stability and miniaturization. For details on any of these — plus a long

line of standardized film capacitors — write to the domestic leader in film capacitors: **Paktron, Division Illinois Tool Works Inc., 1321 Leslie Ave., Alexandria, Va. 22301. Phone (703) 548-4400. TWX 710-832-9811.**



 **PAKTRON**

The Innovating Electronic Group of ITW... PAKTRON ■ LICON ■ ELECTRO MATERIALS

IC device integrates inductors; Coil-less radio and TV coming

Even though integrated-circuit design has progressed enormously in the last few years, one problem has eluded solution: the integration of inductors. The problem may now be on its way to being solved by a Japanese device known as Semicon L.

Developed by Mitsumi Electric Co., Ltd., Tokyo, the new semiconductor inductance element is reported to have a Q that ranges from 50 to 100 and can operate at frequencies as high as 10 MHz. According to Dr. Takeo Miyata, head of the group that developed the device, it has opened up the possibility of fully integrating most circuits that have inductors, except possibly high-voltage ones.

The implications of this are significant: It could lead to the production of fully integrated radio and television sets.

Semicon L uses standard semiconductor processing techniques and is similar in construction to planar bipolar silicon ICs. It combines negative impedance conversion with a gyrator process to

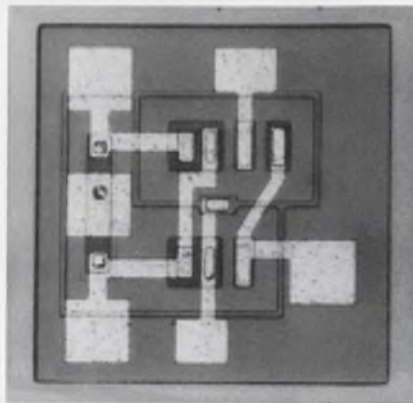

Semicon L chip measures 0.06 mm on each side and 0.15 mm thick. Standard processing techniques are used in fabrication.

produce a temperature-stabilized inductance with a high Q, according to Miyata.

Gyrators are certainly not new. However, in the past they were only able to produce stable inductors or high Q inductors, but not both together. Other problems associated with gyrator design in the past have been the need for high gains in the system and a limited frequency range of about 100 kHz.

Mitsumi says it overcomes these

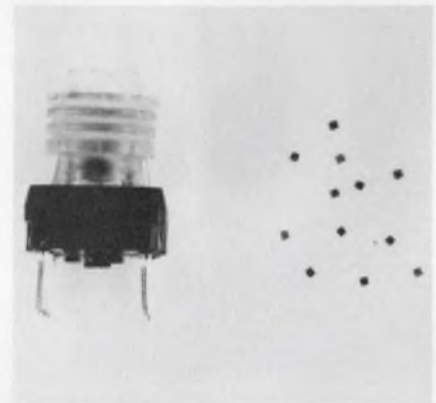

Small coil commonly used in transistor radio and TV sets (left) can now be replaced by a single Semicon L chip (right).

problems by incorporating a negative-impedance converter to produce a negative resistance and thus increase the Q. In addition, the company says, it obtains good temperature stability by making the temperature characteristics dependent on a resistance ratio. Elimination of the need for high gains is achieved by incorporating positive feedback in the device. The upper-limit frequency depends on the value of inductance. The smaller the inductance, the higher the frequency.

The new device is constructed on a 0.15-mm-thick chip whose sides are 0.06 mm in length. The chip is manufactured with standard diffusion and epitaxial-growth techniques. Arsenic, boron and antimony are used as the diffusing agents.

Dr. Miyata has proposed a new symbol for the device (see diagram of equivalent circuit). To use the chip, it is necessary to connect a capacitor between two terminals (B and GY in the diagram) and a resistor between one terminal (B) and ground. Emitter-bias current and collector-bias voltage are then

Jules H. Gilder
Associate Editor

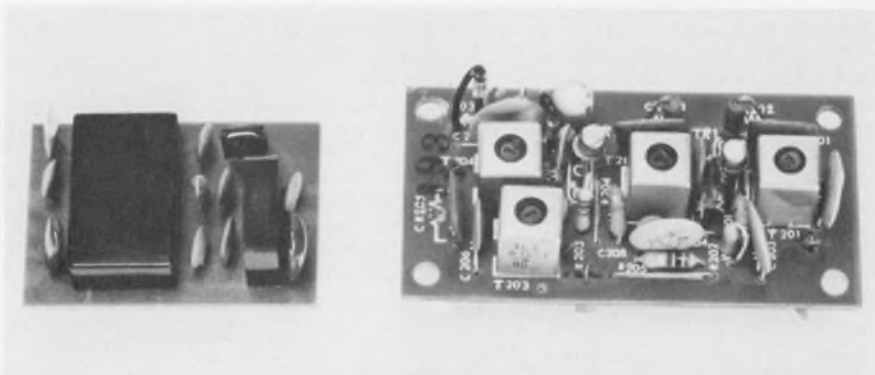

An integrated sound i-f detector using Semicon L (left) will be used to replace the more conventional discrete version (right) now used in television sets. The advantages include smaller size and fewer external components.

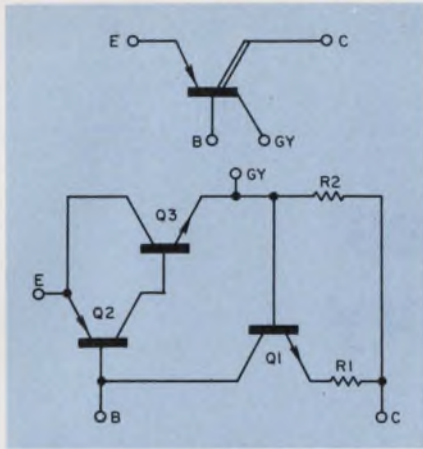

A new symbol (top) has been proposed by Mitsumi for the Semicon L device. Equivalent circuit is shown beneath it.

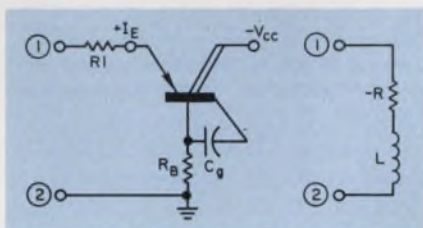

Bias circuit for Semicon L shows where the gyrating capacitance is connected and where the inductance is produced.

applied, and the inductance is produced across two other terminals (1 and 2 in the diagram).

Since Semicon L is a solid-state equivalent of an inductor, it should, Mitsumi believes, find wide application in tuners, filters, oscillators and amplifiers. Specific areas of application, Dr. Miyata says, include radios, television sets, tape recorders and various other devices. Mitsumi is now preparing a coil-less radio and television set for marketing in Japan sometime this month.

The advantages of such coil-less sets, Dr. Miyata says, include a reduction in the number of externally mounted components needed, an improvement in reliability, the ability to produce adjustment-free i-f stages and an increase in packing density because interference caused by magnetic fields is eliminated.

While Semicon L will cost just as much as a 600-square-micron bipolar IC does, Mitsumi says, the company does not intend to sell it as a discrete unit. Instead it plans to market it as part of a hybrid IC assembly. ■■

Voltage transient and overcurrent protection in one compact package, reasonably priced.

The Heinemann JA/Q[®] crowbar/circuit breaker.

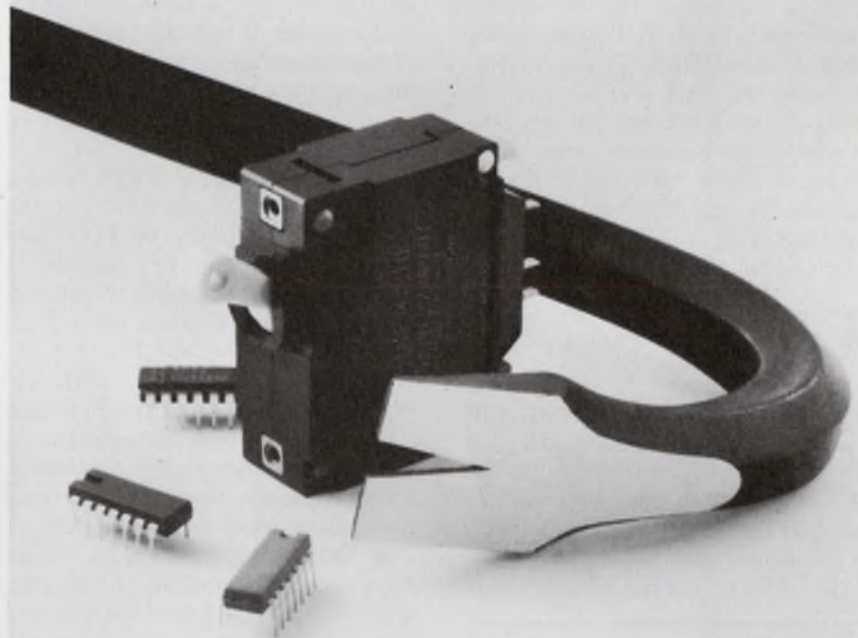

There are many ways to protect semiconductor devices, of course. Ours has one indisputable advantage over the others.

It's available now. As a single, tested component you can buy from a single, reliable source.

You save thereby a sizable chunk of time in getting your product ready for market. And reduce your costs as well—design costs, procurement costs, assembly costs, testing costs, and the overhead costs associated with all of the foregoing.

The JA/Q is broadly applicable to semiconductor circuits, whether discrete, IC, or hybrid. Its internal crow-

bar will clamp a voltage transient to ground within 500 nanosec, at $\pm 10\%$ of the firing voltage you specify. Within about 10 millisecc, the circuit breaker section will remove the protected load from the line.

The JA/Q package will also serve you as a conventional overcurrent protector, with time-delay or non-time-delay response and the performance accuracy unique to the hydraulic-magnetic circuit breaker.

Our Bulletin 3371 will give you detailed specifications on the JA/Q. Have us send you a copy. Heinemann Electric Company, 2616 Brunswick Pike, Trenton, N.J. 08602.



HEINEMANN

5330

INFORMATION RETRIEVAL NUMBER 24

TI discloses how it achieves nonvolatility in MOS memory

A design technique for building a dynamic MOS data-storage system that won't fail if there is loss of electrical power has been disclosed by Texas Instruments.

The method was outlined by Daren R. Appelt, technical support engineer at TI in Houston, to the Sixth Annual IEEE Computer Society International Conference. It employs a low-cost battery to maintain data-refresh capability for up to one month, and it makes possible the use of inherently volatile semiconductor memories to store industrial data.

Low power recommended

Appelt cautioned the conference, which was held last month in San Francisco, that the power requirements of most systems must be made as low as possible before they can be converted to a nonvolatile configuration. He then described TI's configuration (see

David N. Kaye
Senior Western Editor

block diagram) and gave the following design tips:

- Nickel-cadmium batteries are attractive for memory storage of less than one month. Gelled electrolyte, sealed, lead-acid batteries are useful for nonvolatile operation of several months. Both types of batteries can be recharged when the main power is restored to the system, and both have lifetimes of five to 10 years.

- Series voltage regulation should be used. However, since the battery would likely be 24 V, the amount of 5-V power required in the system should be minimized. Regulating 24 V down to 5 V is very lossy.

- Low power control logic requires that delay line or precision RC timing be used instead of digitally generated memory timing. Even discrete components may have to be used instead of ICs.

- MOS driver circuits must have a zero quiescent current mode so they will not draw power between refresh events. Drivers must be insensitive to powered-

down control logic. If this insensitivity is created by switching one or more of the driver supply voltages off during the refresh interval, the drivers must not generate transients on their outputs or else memory might be destroyed.

- MOS clock capacitance should be minimized so fewer drivers are required.

- Address line capacitance should also be minimized. If a Grey code instead of a binary code is used to cycle through the addresses, the address line switches only half as many times with an accompanying reduction in power.

- Power switching of the power to the control logic and the driver circuits is necessary. Appelt noted: "The use of a number of power switches, each supplying power to a portion of the load is preferred to a central power switch. Bulk power storage in the form of electrolytic bypass capacitors is required immediately upstream of each local power switch. The value of bypass capacitance at the load must be kept as small as possible to reduce the peak current requirements of the power switch and to reduce the power used in charging the bypass capacitance for each refresh event. Multilayer printed-circuit boards, with power and ground planes, are invaluable in providing a workable, efficient power-switching system."

- MOS leakage current must be minimized.

- Refresh timer circuits should be discrete instead of IC because of their lower power requirements. The refresh circuit is the only circuit that operates continually during the power-off condition.

All of these techniques, Appelt pointed out, have been incorporated in the TI 960A and TI 980A minicomputers. ■■

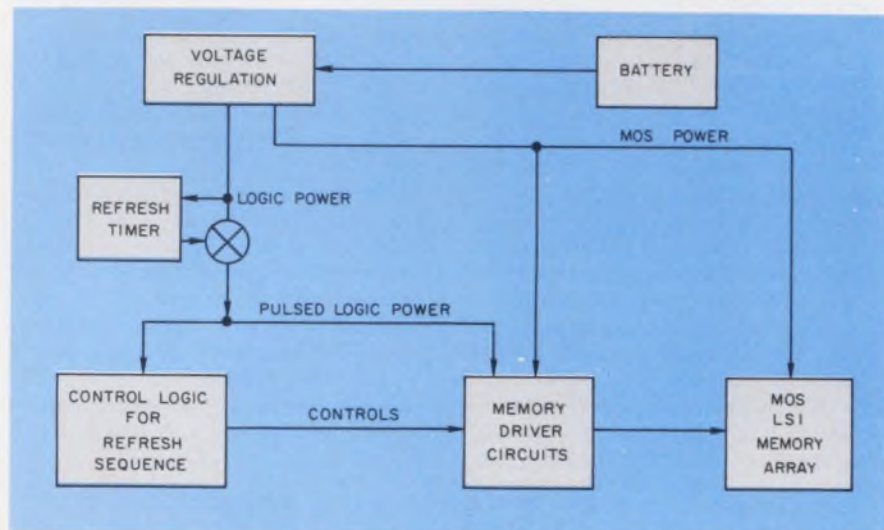

Nonvolatility in a dynamic MOS memory system can be achieved with this battery-switched configuration.

The Sperry eye test for display equipment buyers

E
S P



The above is a printed interpretation of the appearance of the more popular displays. You are encouraged to make the same comparison with actual devices.

The old saying "what you see is what you get" certainly applies to the purchase of equipment incorporating displays — panel meters, DVM's, multimeters, counters, instruments, calculators and other equipment. If you can't clearly and easily read the information being displayed then you're not getting full product value. And, you're obviously not getting equipment supplied with advanced Sperry planar displays†.

How do you tell if they're Sperry displays? Simply take the Sperry eye test.

1. Do the displays appear as uniformly bright, continuous characters with no irritating gaps or filaments and screens to reduce readability?
 YES NO
2. Do the displays remain bright and clearly legible with no glare or appreciable fading even under direct sunlight conditions?
 YES NO
3. Can you quickly, easily and accurately read the displays from 20 to 40 feet away?
 YES NO
4. When the unit is positioned within a 130° viewing angle, can you still clearly read the displayed characters?
 YES NO

If you answered YES to all four questions, you already have your eyes on equipment featuring preferred Sperry displays.

If you answered NO to any of the questions, you owe it to yourself to take a comparison look at products equipped with superior Sperry displays.

FREE BUYER'S GUIDE —

To help you make the right equipment selection, Sperry offers the handy "Buyer's Guide for Equipment featuring Electronic Displays". It's yours for the asking. Order your copy today by checking the reader service card or phone or write: Sperry Information Displays Division, P.O. Box 3579, Scottsdale, Arizona 85257, telephone (602) 947-8371.

SPERRY
INFORMATION DISPLAYS



It's a whole new ball game in displays!

 **SPERRY RAND**

† Patents Pending
* NIXIE is the registered trademark of The Burroughs Corporation.

Exit the meter man; enter electronics

The day of the meter man—that electric, gas or water utility representative who treks through the family home and down the cellar stairs to read the meter—appears to be numbered. Electronic meter-reading methods are moving in to take his place.

Among the setups that utilities are installing around the country are these:

- Systems that use the power lines to transmit meter data.
- Systems that convert meter data for transmission to the utility's billing computer via telephone lines.
- Airborne radio systems that poll remote units at customer sites.
- Meter transponders that transmit data via highly directional antennas to a command unit in a cruising van.

Until recently, the use of power lines as a transmission medium for automatic remote meter readers was largely unsuccessful because of the considerable noise present. But Automated Technology of Hackensack, N.J., has come up with a way to overcome this problem. It employs wide-dynamic-range receivers with high sensitivity to reject the low-level noise and statistical coding to eliminate high-level noise.

Although full details of the new method are not available, it is known that the system uses an optical encoder that is attached to the dial face of existing meters, with the shafts protruding through it.

The data, says Peter Mick, chief engineer for Automated Technology, are transmitted by a frequency-shift-keying modulator.

In addition to sending the meter data, says Mick, the new system permits men in the field to communicate with the central station over the power lines. And since the power line is the transmission medium, he continues, it is possible to use the system to locate, monitor and control power-network disturbances. During power shortages, for example, the utility can, without serious effect, selectively shut off power for short periods to such equipment as electric water heaters. Mick estimates that between 20 and 30% of the power used by consumers does "menial tasks," such as heating water.

Telephone networks used

Another approach to automatic meter reading is taken by the Cubic Corp. of San Diego. In its system interfacing hardware transforms the meter data into a form suitable for transmission over the telephone network.

According to Cubic's president, Walter Zable, the system, called Instaread, is being used by San Diego Gas and Electric to read meters in a 150-unit condominium in Coronado, Calif. In operation meter data is transformed into pulses which are then transmitted by telephone to the billing computer. In addition, a coded signal is added to the data to identify the

customer.

Contrary to the Automated Technology system, the Cubic approach is intended for large apartment blocks only.

Readex Electronics of Honeoye Falls, N.Y., has taken to the sky with its approach. Instead of connecting the meter directly to the utility computer by power or phone lines, it transmits the data to an airplane for recording on tape. As the plane flies overhead, it interrogates meter units at a rate of about 30,000 an hour. The data are stored on tape and then converted to a format compatible with existing computer equipment—eliminating the need for key punching.

A similar approach has been taken by Sangamo Electric. But instead of an airplane, it employs a cruising van. Transponders are mounted on neighborhood utility poles with a clear line of sight to the passing van. About a dozen meters are connected to each transponder, and the transponders are activated by an interrogation signal from the passing van. The data are recorded on computer-compatible magnetic tape and delivered to the utility billing center.

As for the future, Zable of Cubic thinks that it will be at least 10 years before automatic remote meter reading is in wide use in individual homes. Automated Technology's Mick is more sanguine of progress. It will become widespread in about five years, he says. ■■

A simple way to sense magnetic bubbles

An easily fabricated device has been developed for sensing magnetic bubbles, or tiny magnetized areas, in thin films of magnetic materials that have great potential for storing and processing large amounts of information.

According to its developers at the IBM Thomas J. Watson Research Center in Yorktown Heights, N.Y., the device holds great promise for computer-stor-

age and communication switching applications.

The new sensors are tiny stripes of magnetic material whose magnetization—and thus electrical resistance—changes when a magnetic bubble is nearby.

When the presence of a bubble is sensed, the magnetization of the material is converted to an electrical signal that is compatible with computer circuitry.

In a typical configuration a thin strip of magneto-resistive material—permalloy, for example—is deposited directly on the chip in which the bubbles are contained. The permalloy is initially magnetized along its "easy" axis. When the bubble is near the sensor, its fringing field rotates the magnetization of the sensor into the "hard" direction, changing its resistance. ■■

hp MEASUREMENT NEWS

innovations from Hewlett-Packard

OCTOBER edition



in this issue

A counter for mobile communications
(page 5)

New security for your pocket calculator
(page 2)

HP's first two-pen recorder
(page 3)

Automatic RF testing without programming

Microwave automatic network analyzers provide speed, accuracy and economy—and you don't need a programmer!

For cost-effective, comprehensive microwave testing, HP offers automatic network analyzers that amplify the design efforts of engineering labs, produce greater efficiency and better yields in production testing, and improve the service and accuracy of calibration facilities. A very comprehensive series of microwave application programs removes the need for a programmer.

The 8542B automatic network analyzer is a highly accurate stand-alone system. Model 8545A is an economy version that can be operated in the same stand-alone mode or linked to a time-sharing facility. The latter mode lets the

(continued on page 3)

New low-cost disc for OEMs

The 7901A packs 24 million bits into only 10½ inches of rack space; and it takes less than a minute to change a disc.



If you are an original equipment manufacturer in search of a low-cost high-quality memory for compact disc operating systems, HP has the answer. The new 7901A is a small, random-access moving-head disc drive with front loading, interchangeable cartridge and high-speed performance. The data capacity is 24 million bits with unlimited off-line storage.

OEMs will appreciate the flexibility of a complete DOS on a single removable cartridge. You get full capability at low cost, yet you can

change the system easily by removing a single disc or by adding up to three more disc drives to the same controller.

If you already use an HP disc operating system, you can add up to three more 7901A disc drives. The result: lots of memory and a system that keeps operating under adverse environmental conditions, such as temperature and humidity extremes.

To learn more, check M on the HP Reply Card.

New accessories enhance HP-35 pocket calculator

Three new accessories are now available to enhance the versatility of the HP-35, the pocket calculator that challenges a computer in handling complex problems. The HP-35 solves log, trig and exponential functions with a single keystroke.

To protect this 9 ounce wonder, lock it into the security cradles that attaches to your desk, lab table or work surface. Or, chain the cradle to the leg of your desk with a 6-foot flexible stainless steel cable. Only you can open the cradle with a special coded key. It's a practical way to stop pilferage and costs \$24.50.

The new battery holder lets you keep one pack of batteries always on charge while you are using the other pack. Price: \$18.00.

Since you can take the HP-35 anywhere, protect it against dust, dirt and moisture with a sturdy, hard leather field case. Only \$19.50.

For accessory information, check B on the HP Reply Card. To learn more about the HP-35 pocket calculator, check A.

Protect your calculator with a locked security cradle and cable; power it continually with a battery holder and spare pack.



Now, a two-pen x-y recorder for fast signals

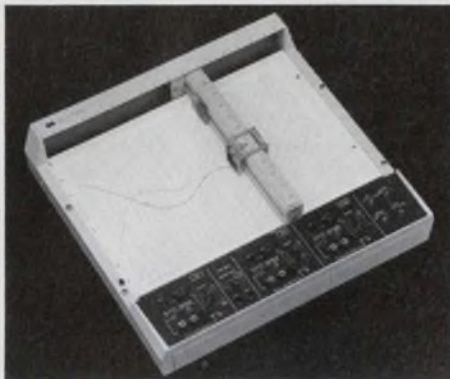

The new 7046A recorder uses standard 11 by 17 in. or European DIN A3 size paper. Metric calibration is available.

Now you can plot gain and phase vs. frequency, horsepower and torque vs. RPM, or temperature gradients and heat flow vs. distance—with HP's first two-pen recorder. The new 7046A is a high-performance x-y recorder that graphs fast changing signals that previously

couldn't be handled by two-pen recorders.

Acceleration on the x axis is 1500 in/sec² and on the y axis, 2500 in/sec². This high acceleration means quick response to small input changes. The high slewing speed (30 in/sec²) enables the unit to respond to large, fast input signal changes.

A unique "see-through" capillary disposable pen provides high quality tracing, and the thin-line design lets the pen tips cross over with minimum separation. You don't have to contend with messy refills. When the ink supply is low, you merely detach the whole pen and snap in a new one. For easy identification, use different ink colors for the two traces. Price: \$2650. For more on this fast two-pen recorder, check L on the HP Reply Card.

Multi-function meter has 12 operating modes



Polarity, function and digital information are shown on the easy-to-read 3450B front panel display.

A high-performance DVM, the 3450B five-digit multi-function meter measures ac, dc, ohms and ratio. All functions include auto-ranging and up to 20% over-ranging. It has 5 ranges of dc voltage (100 mV to 1000 V) with 4 ranges of 4-terminal ratio. Plug-in options let you add measurement capability for true rms ac, ohms, limit test, digital output and remote control. The 3450B uses a dual-slope integration technique which provides excellent noise immunity at up to 15 readings/second.

The ac option adds 4 ranges of true rms ac (1 V to 1000 V) and 4 ranges of ac ratio. Frequency response extends from 45 Hz to 1 MHz. The optional ohms converter measures 6 resistance ranges (100 Ω to 10,000 kΩ) as well as 4 ratio ranges. Another option—limit test—permits digital comparisons against two preselected limits.

The 3450B DVM costs \$3300; optional ac converter, \$1250; ohms converter, \$425; and limit test, \$375.

Other options are available. For details, check F on the HP Reply Card.

Continued from page 1

design engineer transfer measurement data easily to computer-aided design programs for the design of a given circuit.

Both systems measure amplitude and phase parameters under automatic control in single or multiple frequency bands from 100 MHz to 12.4 GHz. (Model 8542B can be extended to 18 GHz.) Test fixtures and adapters let you characterize active and passive components: transistors, amplifiers, antennas, cables, waveguide and strip-line components.

System calibration and error correction techniques provide measurement accuracy and speed impossible to achieve with manual methods. Depending on the device and the actual test performed, a system user realizes 5 to 20 times throughput improvement over the equivalent manual measurement.

A new series of application programs means that microwave engineers and technicians do not have to learn programming. It takes less than 5 minutes for them to fill out a simple form that completely defines how a complex

device is to be tested. ANA BASIC is provided for special measurement cases and further data manipulation capability. You get hardcopy alpha-numeric output at the system console. Or, an optional graphics display shows graphs, charts and data in visual form.

Automatic network analyzers start under \$50K.

For more information, check N or O on the HP Reply Card.

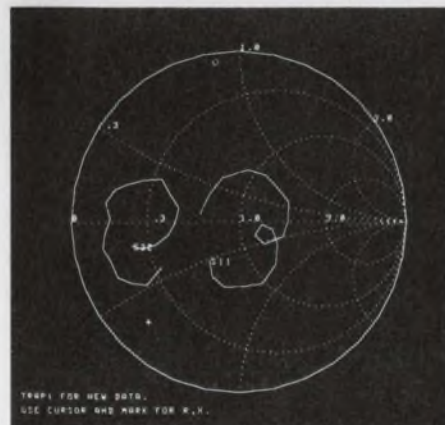

View Smith charts and other visual representations on the analyzer's interactive graphics console.

Fast storage and portable scopes for digital use

A superfast storage scope and a wideband portable display fast infrequent traces common to high-speed computers peripherals, and digital communications.



Two new oscilloscopes for digital applications are HP exclusives: the first storage scope capable of super-fast writing, 400 cm/ μ s; and the first wideband portable with switchable input impedance.

Superspeed writing is achieved by new surface processing that produces a bright display of hard-to-capture signals. Basic writing speed for the 184 scope is 100 cm/ μ s. With the high-speed option 005, writing speed is greater than 400 cm/ μ s. Full resolution is maintained in the reduced scan fast mode by increasing the cathode potential which reduces the spot size proportional to the scan area change. Thus, you view fast-rise signals, such as a 16-bit computer word, directly without having to photograph them.

And with storage, you can retain the display for 5 minutes from FAST mode or over 30 minutes from the standard mode. This powerful storage performance is provided in the 184 A/B mainframe which is fully compatible with all 180 series plug-ins to 100 MHz real-time, 18 GHz sampling, and time domain reflectometry.

To view fast digital traces in a portable environment, try the 1710A, a moderately-priced 150-MHz dual-channel portable with fast sweep (2 ns/div). For low duty cycle pulses that are normally encountered in peripherals and I/O equipment, a bright scan mode is available to increase the display brightness by a factor of two. Bright scan restricts the display to a 3 by 5 cm. area and the trace becomes correspondingly sharper, which maintains resolution while increasing brightness.

The 1710A is the first portable to offer switchable input impedance—either 50 ohms or 1 megohm, 12 pF. Signals with < 10 ns rise-time require 50-ohm matching circuitry to avoid waveform degeneration, but high impedance is more suitable for slower waveforms.

The 184 scope costs \$2200 (cabinet style) or \$2275 (rack style). Add \$500 for FAST writing, option 005. The 1710A portable scope costs \$2300.

There's more. Check C or D on the HP Reply Card.

New low-cost lab quality crystal oscillators

Two new inexpensive quartz oscillators—5 MHz and 10 MHz—match the low aging, high stability and fast warm-up formerly available only in expensive laboratory type designs.

Aging is better than 5×10^{-10} /day or 1.5×10^{-7} /year. With such low aging, a manufacturer of communication and test equipment can offer his customers a real cost saving by reducing the frequency of calibration necessary to stay within FCC accuracy requirements.

Rapid warm-up assures an output within $< 5 \times 10^{-9}$ of the final stabilized frequency within 15 minutes of turn-on. Excellent short-term stability and low noise make these component quartz oscillators suitable for communication systems where frequency multiplication is required.

The 10543A (5 MHz) costs \$850; 10544A (10 MHz), \$450. Quantity discounts are available. For more information, check E on the HP Reply Card.

You can use compact HP oscillators in communication and navigation systems, synthesizers, time-code generators, counters and spectrum analyzers.



DC current source has varied applications

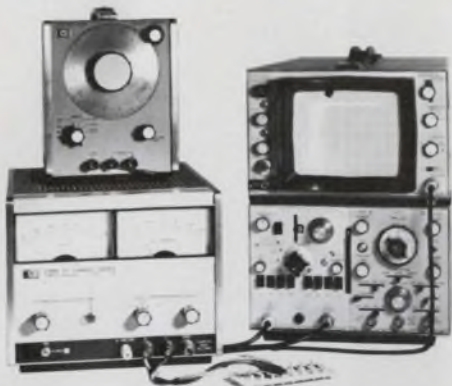

With a constant current source in the lab, you can:

- Evaluate reverse breakdown and forward V-I characteristics of p-n junctions.
- Measure silicon wafer resistivity and contact resistance.
- Test relays, meters, potentiometers, and electrolytic capacitors.
- Aid in coulometric titration and precision electroplating.
- Determine dynamic and incremental impedance of devices.

Here a dc current source is used to produce the reverse characteristics of a 6.2 V zener diode.

HP constant current sources supply precisely-regulated (30 ppm) dc current from 1 μ A to 0.5A. Current output is selected with high resolution (0.02%) by front panel switches. An external voltage or resistance can program the current source output.

An adjustable voltage limit circuit lets you set the maximum voltage compliance anywhere within the source's output voltage range. Monitoring load voltage with an external meter or the source's own meter won't degrade constant current performance.

Prices: \$475 to \$600.
To learn more, check R on the HP Reply Card.

Your signal generator now can cover UHF

The all-around capabilities of the HP 8660 series synthesized signal generators catapult into the UHF region with the 86602A RF plug-in unit. Notable features are:

- 1 MHz to 1300 MHz frequency range that you can set in 1 Hz steps. It covers all HF/VHF/UHF communications bands.
- Low phase noise, low spurious, and high stability. The 1300 MHz signal generator is an ideal source for multiplication to microwave communication band frequencies, or for frequency-agile LO uses.
- Wide range (+10 dBm to -146 dBm) calibrated output level.
- Excellent modulation characteristics: AM, FM and pulse.
- All functions are fully programmable for automatic testing, such as receiver tests.

A complete 1300 MHz synthesized signal generator system costs \$8700 to \$12K.

Interested? Check P on the HP Reply Card.

New low-cost counter for mobile communications

At last there is a long-needed solution to measuring mobile communications—on the ground, in the air, aboard ship. HP's 5300 series of compact, snap-together counters now features a 525-MHz module. It's battery-powered yet meets FCC measuring requirements when you add an optional temperature-compensated crystal oscillator. The new low-cost 5303B combines accuracy with portability, ruggedness with "operate-anywhere" power.

Sensitivity is 25 mV up to 80 MHz and 100 mV to 500 MHz. Input is protected against overload so you don't have expensive repairs for blown input circuits.

The counter has a six-digit display and is powered from ac or

Take a 5303B counter anywhere. It weighs only 5 $\frac{1}{3}$ lbs. (2.4 kg) and has a rugged cast aluminum case.

any dc source, 11 to 24 V. For field use, snap a rechargeable battery pack in the middle of the instrument; it will run over four hours continuously before recharge is needed.

Like all the other 5300 counters, the new portable has large-scale MOS integrated circuits and LED readout. The 5300A mainframe and 5303B module cost \$1195. Optional oscillator is \$175 and the battery pack, \$195.

Interested? Check K on the HP Reply Card.



New booklet on analyzer/ generator applications

Carrier frequency, 60 dB below modulation sidebands, is accurately measured using the tracking generator/spectrum analyzer. Our new application note tells you how.

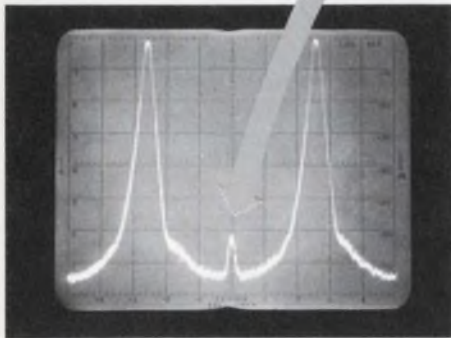

The modern spectrum analyzer—already eminently useful in lab, production and field applications—becomes significantly more powerful when coupled with a tracking generator. The combination can be used for precise frequency measurements of very low level signals and extremely wide dynamic range swept measurements of networks and devices. A new application note on tracking generator/spectrum analyzer applications gives many examples, including specific setups. Check Q on the HP Reply Card for your copy.

Get microwave switches at low OEM prices

Select the frequency range and performance you need for any switching application—at low OEM prices and without trade-offs. For SPST switches, HP offers the 33200 series optimized for octave bandwidths, and the wideband 33100 series diode switches, from 100 MHz to 18 GHz. Price: \$125 to \$175.

Also in the SPST line are high-performance stripline and coax switching elements that meet MIL-spec environmental conditions. These start at \$60.

If you need SPDT switches, try the 33016A solid-state unit, 0.1 to 18 GHz with >50 dB isolation and 80 ns switching. Price: \$370.

The precision 8761 electromechanical SPDT series covers dc to 18 GHz with exceptionally low insertion loss (<0.8 dB) and SWR (<1.3 at 18 GHz). Price: \$150.

For switching, level control or complex modulation, our absorptive modulators maintain constant match against attenuation to >80 dB. Three overlapping bands cover 1 to 18 GHz. Prices: \$365 to \$575. Quantity discounts are available. For details, check S on the HP Reply Card.

HP high-performance microwave switches fit both your system and your budget.



High-speed isolator breakthrough

Both isolators have isolation voltage greater than 2500 V, and are available in standard eight-pin dual-in-line plastic packages.

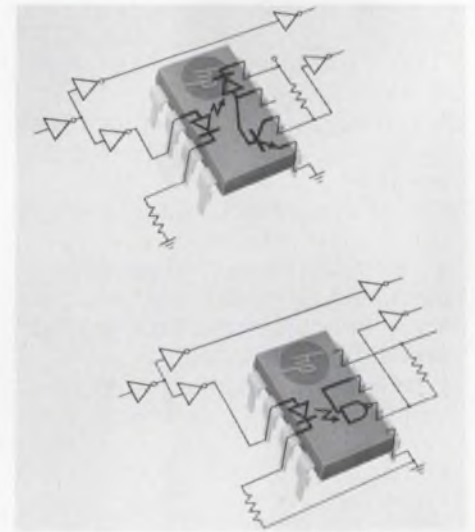

HP offers two new optically coupled isolators that take advantage of our advanced photo IC capability.

The 5082-4350 series isolators operate up to 5 MHz bandwidth. This device consists of a monolithic photo detector with a photo diode and high frequency transistor on the same substrate.

The 5082-4360 series operate up to 20 M bits. This device has a photo detector IC circuit consisting of a photo diode and high-frequency linear amplifier. It is completely TTL compatible at the input and output, capable of feeding eight TTL gate loads.

The 5082-4350 series prices start at \$2.00 in 1K quantity. The 5082-4360 is priced at \$4.50 in 1K quantity.

For ratings and other specifications, check G on the HP Reply Card.

New distributors appointed for HP optoelectronics

Hewlett-Packard announces a network of industrial distributors for its LED displays, LED lamps, detectors and optically-coupled isolators.

Explains Milt Liebhaber, HPA marketing manager, "The number of customer applications for optoelectronic devices is so broad that we wanted to expand our customer interface. New markets include portable calculators, displays for automatic typesetters, or anywhere the display of information is required. Designers for these products are used to ordering from familiar industrial distributors who can provide fast delivery from nearby stocks."

In the U.S., **Schweber Electronics** will stock the HP optoelectronics line in Waltham, Mass.; Westbury and Rochester, N.Y.; Rockville, Maryland; and Hollywood, Florida.

Hall-Mark Electronics will cover 11 southern states from offices in Dallas, Houston, Tulsa and Huntsville. The **Wyle Distribution Group** will serve western users from Liberty El Segundo, California; Elmar Electronics, Mt. View, California and Denver, Colorado; Liberty Arizona, Phoenix; Liberty Northwest, Seattle; and Western Radio, San Diego, California.

In Europe, four distributors have been appointed: Celdis Ltd. in the United Kingdom, I.S.C. France, and two in Germany—EBV Elektronik and Ingenieurbüro Dreyer.

"Of course, HP's own offices will continue to give direct technical aid, but our new distributors will make it possible for us to serve many users we might never reach ourselves," says Milt Liebhaber. "We are pleased to be associated with these distribution professionals."

New low-cost mini-LED

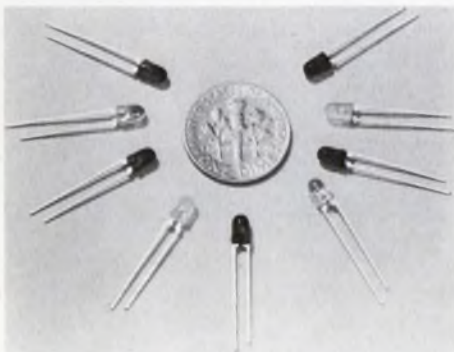

HP packs long life and high visibility into these 5082-4480 series mini-LEDs.

Our new T-1 mini-LED is only $\frac{1}{8}$ inch in diameter and is especially suitable for large scale x-y addressable arrays. These devices offer high brightness over a wide viewing angle. And three lens configurations are available—red diffused, clear diffused, and clear.

The price is mini, too—only 45 cents on 1K quantities. Delivery is from stock.

For details, check H on the HP Reply Card.

New large-size LED numeric display

Discrete solid-state lamps in a 5 by 7 dot matrix produce 1.5 inch digits for the new 5082-7500 display.

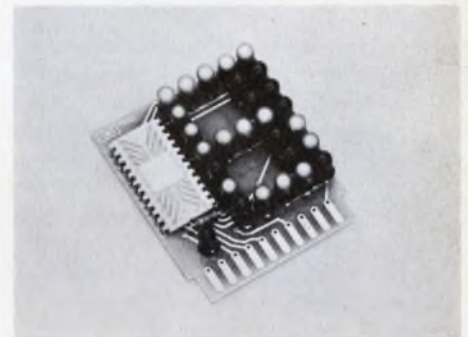

HP's new LED display is easily readable at distances up to 45 feet. The character is $1\frac{1}{2}$ inches high, and average brightness is typically 1.25 millicandelas. Built-in decoder/driver circuitry allows direct addressing using standard BCD code.

The new large-digit LEDs are ideal for process and supervisory control panels, medical equipment, or any application where you have to read numbers at a distance. These displays are available from stock.

Price: \$35 (1-99), \$26 (100-499), or \$23.50 (500-999).

To learn more, check I on the HP Reply Card.

New logic troubleshooting kit: the easy way to find bad ICs



The 5011T troubleshooting kit contains everything you need to test in-circuit ICs: a logic comparator, probe, pulser and clip.

With HP's new logic troubleshooting kit, you can repair TTL and DTL logic boards faster than ever before and realize substantial savings in test time and dollars. Each kit component is a handy troubleshooter; but working in various combinations, their value is even greater. The logic com-

The logic comparator is a self-contained functional in-circuit IC tester that borrows power and input signals from the test IC and applies them to a reference IC of the same type inside the comparator. Outputs from the test and reference circuits are compared. Differences in logic state are displayed by one of the 16 LEDs that pinpoints the failing node exactly. Even brief or intermittent failures are captured and stretched for a visible indication. Price: \$375.

Once a failure has been located, the logic probe and pulser provide exacting analysis. For example, the probe indicates if any pulse activity is present or if the suspect node is stuck high or low. The probe detects single pulses as narrow as 10 ns. Using both the probe and pulser on the same node, you can detect shorts to ground or the power supply. (The powerful burst of energy from the pulser won't pulse supply busses.) Price: \$95 each.

parator, probe, pulser, and clip are designed to work together for more effective fault isolation. Increased troubleshooting efficiency at low cost means that the 5011T logic kit pays for itself with just a few weeks of use.

You may purchase the instruments separately; however, you save 10% by buying them in the 5011T kit, only \$625. Quantity discounts are available.

For details, check J on the HP Reply Card.

Pulser/probe and pulser/clip combinations provide stimulus-response testing for in-circuit ICs. The pulser injects reset, shift and clock signals directly into flip-flops, counters and decoders while the logic probe and clip monitor the effect. The probe's pulse-stretching is handy for testing gates. The clip is ideal when testing sequential circuits such as counters and shift registers where responses at several outputs are of interest. The clip costs \$125.

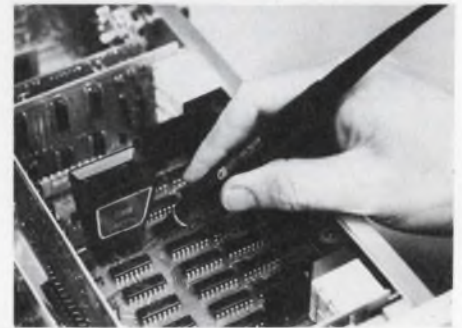
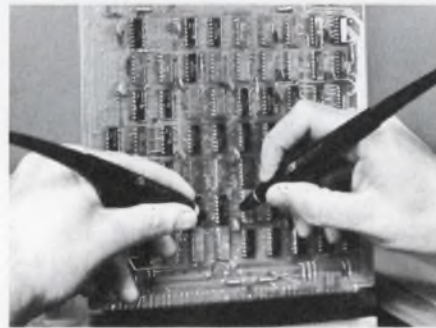

HEWLETT  PACKARD

Measurement, Analysis, Computation

East—W 120 Century Road, Paramus, N.J. 07652, Ph. (201) 265-5000.
South—P.O. Box 2834, Atlanta, Ga. 30328, Ph. (404) 436-6181.
Midwest—5500 Howard Street, Skokie, Ill. 60076, Ph. (312) 677-0400.
West—3939 Lankershim Boulevard, North Hollywood, Calif. 91604, Ph. (213) 877-1282.
Europe—Post Office Box 85, CH-1217 Meyrin 2, Geneva, Switzerland, Ph. (022) 41 54 00.
Canada—275 Hymus Boulevard, Pointe Claire, Quebec, Canada, Ph. (518) 561-6520.
Japan—Ohashi Building, 59-1, Yoyogi 1-chrome, Shibuya-ku, Tokyo 151, Japan, Ph. 03-370-2281/92.

Everything you always wanted to know about Drive Motors.



Into these five booklets we've crammed 156 pages of the latest information on Kearfott's line of Drive Motors.

Kearfott, as you probably already know, is a primary supplier of drive motors. And has a reputation for quality, service and on-time delivery.

We can furnish you with drive motors in individual units or in packages to fit any of your aerospace or industrial applications. From counters to computers. From business machines to printers and tape readers.

Let's take a look at the type and range of motors we're talking about.

DC TACHOMETERS

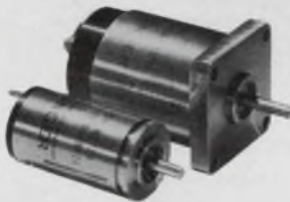

Kearfott Tachometers are designed specifically for precision speed sensing and as rate generators to help velocity servos achieve fast response.

Features include: outputs to 100V dc/1000rpm;

minimum ripple at high commutation frequency; high linearity; low friction torque.

These are ideal for computer tape transports where efficient data retrieval is a must. And for business machine and numerical control machine tools.

DC TORQUERS

You can get sizes 12 through 42, uncased for gimbal mount applications and cased for direct drive torque motor positioning.

Kearfott can also supply them with a variety of integral feedback elements such as potentiometers, synchros and tachometers—in a single housing.

You've a choice of standard design, inverted construction (inner member is magnetic and transfers power to an outer armature) and brushless Limited Rotation design.



DC MOTORS



These are Moving Coil Motors used for high-response DC servos such as High-Speed Printer and Capatan drives.

One of their unique features is that they need less cooling than equivalent competitive units. The reason: low internal impedance which allows a high cooling flow rate at low developed pressures.

Permanent magnet and wound-field types are available for standard aerospace and industrial applications, including high acceleration motors with integral tachometers for terminal printers.

AC MOTORS



Kearfott induction or synchronous motors of the hysteresis or reluctance type come in a broad range of frame sizes. And from sub-fractional power to 15 HP.

We can furnish motors that run on up to 440 volts ac, single, 2 or 3 phase. Induction motors that operate on 2, 4, 6, 8 or 12 pole design. And dual speed motors such

as needed for driving memory discs in large computers.

You can also get: high-slip motors for aircraft requirements at 400 cps; synchronous motors for constant rotating speeds with varying loads; gear motors for extremely low speeds or speeds incompatible with the power supply frequency.

STEPPER MOTORS

If you want precision control—for example for small peripheral devices, small line printers and tape readers—Kearfott Steppers provide it via discreet steps and high slew rates. And in a wide choice of stepping rates and torque levels.

Typical Kearfott units have 15° stepping angles, compatible with all 24-tooth sprockets. They give high holding torque, high stepping speed and fast response.

Units with other step angles, such as 1.8°, 7.5°, 10°, 30°, 45° and 90° are readily available in frame sizes through 50.

But why not get all the details? Mail the coupon for our new booklets now. The Singer Company, Kearfott Division, 1150 McBride Avenue, Little Falls, N.J. 07424.



SINGER

AEROSPACE & MARINE SYSTEMS

The Singer Company, Kearfott Division
1150 McBride Avenue
Little Falls, New Jersey 07424
Gentlemen:

ED-10

Rush me your new booklets on Kearfott Drive Motors.

Name _____

Title _____

Company _____

Address _____

City _____ State _____ Zip _____

SCIENCE/SCOPE

The use of radar to detect oil pollution on the high seas was demonstrated recently with a real-time, digitally-processed, synthetic-aperture radar system, developed by Hughes for the U.S. Navy, during a Coast Guard experiment off Pt. Conception, Calif. The system's advantages over ultraviolet scanner imagery and conventional and infrared photography: it has all-weather, day-and-night capability; its image can be viewed immediately; and it can scan a wide swath with high resolution. It is also a valuable means for locating vessels responsible for oil spillage.

U.S. Air Force Maverick missiles "destroyed" all targets during the Air Force-Army Combat Hunter joint test and evaluation of the Hughes-produced air-to-ground missile at Ft. Riley, Kans. recently. In the war games, a small friendly force with Maverick-equipped F-4 aircraft fought a delaying action against a tank-heavy enemy force. The F-4s carried captive training missiles with units that record data on the attack approach, target acquisition, and launch.

The first firm order for U.S. domestic communications satellites has been awarded to Hughes by Western Union Telegraph Company. Hughes will build three satellites, the first to be delivered in 18 months and the others to follow at three-month intervals. This would permit Western Union to have a satellite in operation before mid-1974. Western Union's satellites will be identical, except for antenna coverage, to the Anik 1 spacecraft Hughes is building for the Canadian Telesat system.

Pilots of the U.S. Air Force's F-15 air superiority fighter will have digitally-controlled electronic eyes to help them track their prey through the radar-blind zones that hamper present systems. The F-15 fire-control radar -- being built by Hughes under contract to McDonnell Douglas -- employs Kalman filtering, a sophisticated approach to extracting accurate information from noisy radar measurements.

A watchful eye on America's natural resources is being kept by a scanning device aboard NASA's Earth Resources Technology Satellite, which is now circling Earth every 103 minutes in a 565-statute-mile-high polar orbit. The scanner, called MSS (for Multispectral Scanner System), detects and records solar energy emitted or reflected from Earth in four bands of the electromagnetic spectrum, including near infrared, to produce photographs that indicate the health of fields, forests, rivers, and lakes. It was developed for NASA's Goddard Space Flight Center by Hughes and its subsidiary, Santa Barbara Research Center.

Hughes has openings for radar engineers in the following specialties: radar systems, microwave components and techniques, receiver/exciter circuits and subsystems, radar signal processing, mechanical design and stress analysis. Requirements: appropriate degree, two to 10 years of applicable experience, U.S. citizenship. Please send your resume to: Engineering Employment, Hughes Aircraft Co., Ground Systems Group, P.O. Box 3310, Fullerton, CA 92634. Equal opportunity M/F employer.

An ultra-lightweight, all-solid-state Manpack transceiver, developed by Hughes for the U.S. Marine Corps under contract to the Naval Electronics Laboratory, features automatic antenna tuning, 2- to 30-MHz coverage, and 280,000 channels. It weighs less than 10 pounds including its 82-watt-hour silver-zinc battery and can operate at least 16 hours before recharging is necessary. Operation is simple: set the frequency by rotating thumbwheel switches, select the mode, then push-to-talk.

Creating a new world with electronics

HUGHES

HUGHES AIRCRAFT COMPANY

technology abroad

A new heat-sink design, employing diamonds, has been developed for use in microelectronics by the De Beers Diamond Research Laboratory in Johannesburg, South Africa. The diamonds, measuring 1 to 2.5 mm across, are rounded, graded and surface-treated to improve their thermal conductivity. They are then metallized and hot-pressed into copper substrates. Alternatively, the copper may be drilled or burred to accommodate the sinks. De Beers says that mounting the heat sink in—instead of on—the copper substrate increases the effective diamond-metal interface by more than 100%. An improved heat-dissipating ability results.

CIRCLE NO. 315

Transistors for use in submarine cables, where high reliability and consistent performance are of paramount importance, are being studied by the British Post Office. The latest device under development is a 1.5-W transistor with a unity gain-bandwidth product of 3 to 4 GHz. It will be used in a 4000-circuit cable having an operational bandwidth of 30 to 40 MHz. Research into the potential reliability of the device has shown that less than one device in 4000 is predicted to fail in 20 years. The transistor gain is not expected to change by more than 3% in the same period.

CIRCLE NO. 316

A digital marine radar simulator, to train maritime students in radar operations, has been developed by Redifon Ltd. for the Bremen Nautical Academy, West Germany. The simulation includes four radar-equipped ships, six target craft and coastline generation. The system incorporates a Digital Equipment Co. PDP-8/M computer with 8-k words of core storage. Five solid-state radar

displays have anticollision, true-motion and relative-motion units. An exercise recorder will be provided in the final system to record continuously all movements of the simulated craft throughout an exercise.

CIRCLE NO. 317

An automatic braking system for automobiles, with a materials cost of less than \$250, has been developed by apprentices at the British Aircraft Corp., Surrey, England. The cost of fitting the system to production vehicles is estimated at \$160. The system operates by measuring three parameters—distance from an obstruction, closing velocity and the vehicle velocity as measured from the drive-shaft. This information is fed to a preprogrammed computer that decides on the action to be taken. The computer can decide that there is no danger or that closure of the throttle will supply sufficient deceleration, or it can activate gentle braking or slam on emergency braking.

CIRCLE NO. 318

A complex, computer-controlled system for determining the optimum length of hot steel billets prior to cutting has been installed by the British Steel Corp. The system, which employs a Digital Equipment Corp. PDP-8 computer with a 4-k word memory, provides optimized cutting of steel billets for subsequent feeding to a rod mill. The computer uses a logic-module system that sets the shears for cutting to the required length. The length of the hot bloom is measured prior to the final rolling stage by photoelectric cells. The measured value is then fed in four-decade decimal form to the computer and also to the operator's desk as a display.

CIRCLE NO. 319

Hughes is in industrial electronics, too: components, equipment and systems.



Microwave diodes (RS 282)



Electrical connectors (RS 287)



Microwave TWTs, TWTAs and solid state products (RS 289)



Direct view and scan converter storage tubes (RS 290)



Wire terminating and harness laying systems (RS 296)



Multiplex systems for remote communications/control (RS 292)

For complete information, write Bldg. 6,
Mail Station D-135, Culver City, CA 90230.
Or request by Reader Service (RS) numbers.

HUGHES

HUGHES AIRCRAFT COMPANY

Industrial Electronic Products

Bendix puts an end to the bends.



You know the bends. That's when connector pins are bent or damaged during mating by misaligned plug and receptacle.

The bends just can't happen with Bendix SJT connectors. Pins are recessed. Stronger, too. And that makes them 100% scoop proof. You get positive protection whether the pins are in receptacle or plug.

You get five-key polarization, too. And that makes mismatching a thing of the past.

Another key feature: Bendix 100% scoop-

proof SJT connectors conform to the mounting dimensions of low silhouette (JT) series II MIL-C-38999 connectors. They're available in lightweight shell sizes from 8 to 24 with from 3 to 128 crimp type contacts accommodating wire gauges from 12 to 28.

Now then. Like to put an end to the bends? Write for our new SJT catalog.

The Bendix Corporation, Electrical Components Division, Sidney, New York 13838.

Bendix

washington report

Sanguine ELF contractor race to begin

The Navy is about to start contractor competition for the validation phase of its Sanguine ELF submarine communications system. Three contractors will be picked to do 18-month studies leading to systems recommendations. The Navy is considering an underground antenna grid some 55 miles long, with a current level of about 150 A. Transmissions would be at 45 and 75Hz, which could reach submerged submarines, withstand a nuclear environment in case of war and be virtually un-jammable. Several sites appear to have the low-conductivity rock necessary for the system, including areas in Wisconsin, Texas and the Michigan peninsula. The cost of the total Sanguine system is estimated at between \$100-million and \$400-million.

U.S. fostering electronics exports

The Commerce Dept. is pushing the display of U. S. electronics know-how abroad in a series of trade missions. A group of communications-industry representatives, headed by John Sodolski of the Electronics Industries Association, recently participated in the first trade mission of its kind to the Soviet Union and Poland to explore the potential market for U. S.-manufactured communications equipment. Another group, specializing in electronic data-processing equipment, has just returned from Hong Kong, Seoul and Tokyo and has reported good results. Two more opportunities are on the Commerce Dept.'s calendar: The Jan 29-Feb. 2 show at the U. S. Trade Center in Bangkok, geared to industrial and scientific instruments, and the April 9-14 EDP commercial-equipment exhibition in Singapore for the Southeast Asian market.

Defense Dept. appealing budget trims

Final Congressional action on the new defense budget is expected rapidly. The Defense Dept. is appealing a number of reductions made by the House Appropriations Committee, hoping that the Senate will work things out in the military's favor. The House committee denied the Army's request for funds for a new helicopter program to replace the cancelled Lockheed Cheyenne. It said the fact that the Army spent \$450-million and took nine years to find out that Cheyenne helicopter would not work "does not instill confidence to recommend appropriations for a new program in this area."

The House Appropriations Committee also bore down heavily on Defense Dept. plans to put several missiles into production before they are completely tested. And it cut production funds for the Sparrow 7F, the Sidewinder 9L, Phoenix, NATO Sea Sparrow and the RGM-XX missiles. In other actions the committee did the following: Put in money to keep the F-111 aircraft production line open; told the Defense Dept. to restudy the Navy's S-3A antisubmarine warfare aircraft being developed by Lockheed and cut \$42.5-million from the Air Force's command-data buffer program.

TV-tuner deadline extended by FCC

The Federal Communications Commission has extended by one year its requirement that all TV receivers with 70-position tuners must be equipped with automatic-frequency-control (afc) circuitry and a channel selector capable of positioning the tuner within the afc pull-in range. The FCC has shifted the deadline date to July 1, 1975, but it has refused a request to exempt black-and-white sets from the afc requirement. The commission says that it is "concerned with achieving equal tuning accuracy for uhf and vhf channels on all receivers and that the only presently known method is to provide the afc circuitry, combined with a channel-selection device that can position the tuner within afc pull-in range.

A cut for U.S. sensor network in Vietnam

The military's elaborate network of sensors strewn along strategic infiltration routes in Vietnam to signal enemy movements has come in for sharp criticism from the House Appropriations Committee. In its report on fiscal 1973 defense spending, the committee said it had "never been favorably impressed with the success of the over-all sensor program in the past year." The committee has slashed the Army's \$12-million request for such sensors in half, and cut out entirely the Air Force's \$7.7-million fund, pointing out that South Vietnamese aircraft will not be able to read out the signals anyway once the U. S. is gone.

Capital Capsules: The House Science Research and Development Subcommittee managed to squeeze in two days of hearings on S-32, a bill already passed by the Senate. **The measure would focus technological talent on civilian-priority programs and aid scientists and engineers in several areas.** Passage is not expected at this session . . . NASA and the Small Business Administration have published a **brochure on potentially profitable Aerospace technology** entitled Tech Briefs. Available from SBA, 1441 L. St. N.W., Washington, D. C. 20416 . . . The FCC has selected Joseph Stern of the Goldmark Communications Corp. to **head a newly formed subcommittee on technical standards and quality for cable TV** . . . The MCI Communications Corp. is being backed by North American Rockwell so **MCI can buy some \$24-million in equipment from Collins Radio for MCI's nationwide tele-communication system** . . . The Navy navigation satellite launched Sept. 2 will be available in about five months for use by military and commercial ships. It is powered by a 30-W atomic generator developed by the AEC.

your best buy in a 100-MHz scope

-  5 mV/100-MHz Single Trace, Single Time Base **\$2075**
-  5 mV/100-MHz Dual Trace, Single Time Base **\$2550**
-  5 mV/100-MHz Dual Trace, Delaying Sweep **\$2850**
-  or a 50-MHz System as low as **\$1850**

... and an excellent introduction to the **TEKTRONIX 7000-Series Integrated-Test-System Concept.**

Instrument options, plus a modular design, allow you to purchase the basic system and then expand it as your measurement requirements increase. A real time saver, CRT READOUT, can be added to your scope for only \$400. Its use increases your measurement speed and accuracy in set up, test, and CRT photography. Other options give you:

- increased photographic writing speed
- a selection of CRT phosphors
- signal outputs
- EMI modification.

The 7603 and 5¼-inch rack R7603 are three-plug-in scopes. They allow you to mix or match plug-ins to suit your requirements, and provide amplifier combinations up to four traces. You can choose from 26 plug-ins including: Amplifiers, Time Bases, Curve Tracer, Optical Spectrometer, Sampling, TDR, Spectrum Analyzer, and the newly introduced Digital plug-ins.

The 7000-Series Digital plug-ins demonstrate the true value of the 7603. Together, they give you the advantages of both worlds—confidence in *seeing* what you're measuring and the *accuracy* of digital techniques. TEK's Digital Plug-ins offer

- Universal Counter/Timer with 3 basic modes
- Digital Delay Unit with Delay-by-Time and Delay-by-Events modes
- 525-MHz Direct Counter
- DMM with unique temperature mode . . . and more to come.

Take a look at this 100-MHz scope system today and make it your best buy. Contact your local TEKTRONIX Field Engineer or write: Tektronix, Inc., P.O. Box 500, Beaverton, Oregon 97005.

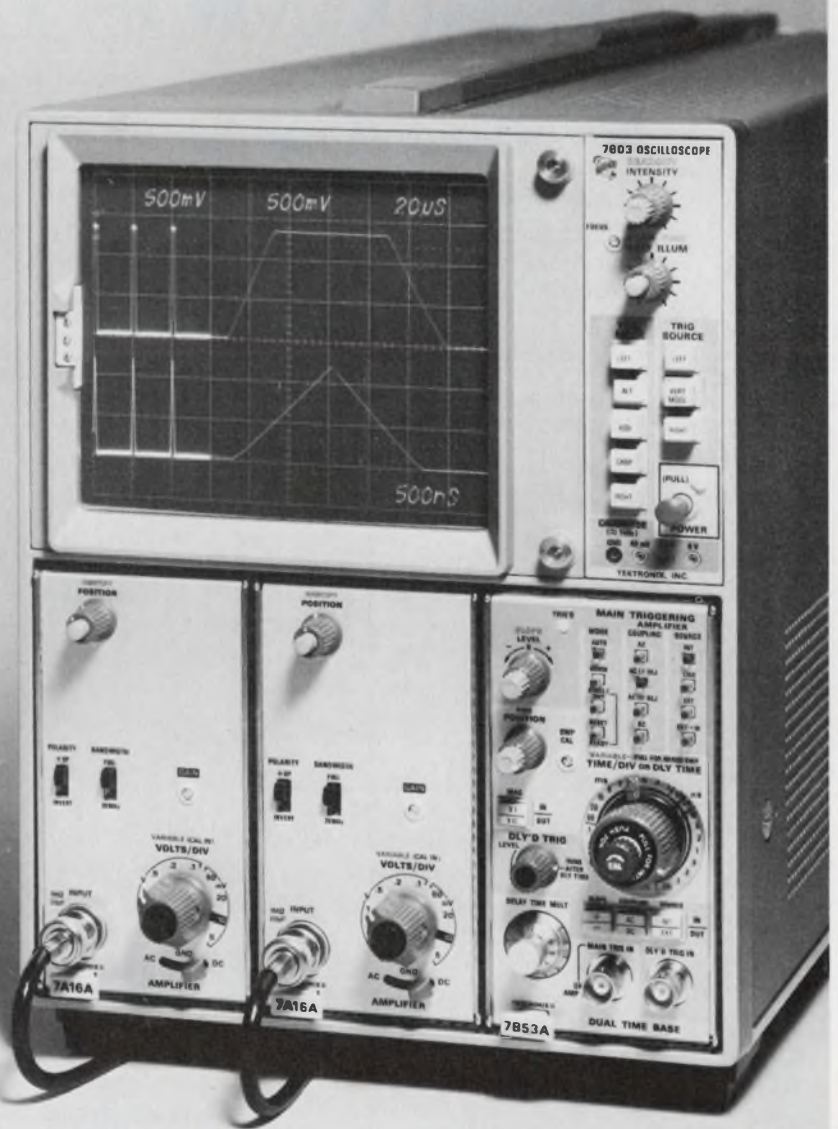

Tektronix, Inc.

Offering sales, after-sales support and service . . . worldwide



P-channel
J FET



N-channel
J FET

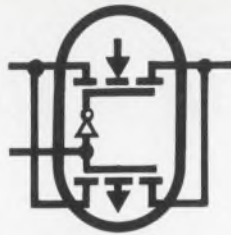

CMOS
FETs



P-channel
MOS FET



N-channel
MOS FET

Since 1962, Siliconix has evolved FET technology and applied it to a complete line of singles, duals, arrays, and IC's. So what's new?

Switch 16 channels with CMOS DG506.

Here is a single-pole 16-channel multiplexer using paired CMOS FETs, with drivers controlled by a 4-bit binary word input plus an Enable-Inhibit input — all on one chip! Check the functional diagram and then refer to the decode truth table to see what binary word input selects which switch.

The DG506 features:

- ± 15 V Analog signal range
- Break-before-make switches
- ON resistance < 500 ohms
- TTL, DTL, and CMOS direct control interface
- 36 mW standby power

DG506 Function Diagram

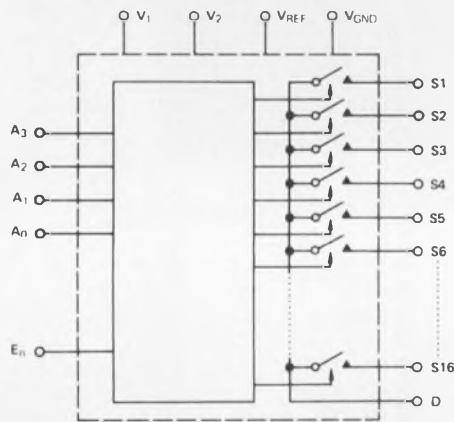

Decode Truth Table

A ₃	A ₂	A ₁	A ₀	E _n	ON SWITCH
X	X	X	X	0	NONE
0	0	0	0	1	1
0	0	0	1	1	2
0	0	1	0	1	3
0	0	1	1	1	4
0	1	0	0	1	5
0	1	0	1	1	6
0	1	1	0	1	7
0	1	1	1	1	8
1	0	0	0	1	9
1	0	0	1	1	10
1	0	1	0	1	11
1	0	1	1	1	12
1	1	0	0	1	13
1	1	0	1	1	14
1	1	1	0	1	15
1	1	1	1	1	16

Our catalog line of drivers and switches will cover most applications. If your switching problems are unique — and whose aren't — call our applications people. They're eager to help. For complete information,

write for data

Applications Engineering: (408) 246-8905



Siliconix incorporated

2201 Laurelwood Road, Santa Clara, California 95054

INFORMATION RETRIEVAL NUMBER 29

Everything you always wanted to know about everything

An intriguing title sucked me into a new book for engineers, "Stand Up! But Don't Get Off." I never discovered what the title meant, but I found the book admirable, charming and irritating. I admired the author's impassioned plea for unity among engineers, which I think is the reason for the book. And I found his free-style grammar and spelling rather charming.

But I found annoying his pretensions to being an authority on almost any problem known to man. Having presented an "Inventory of an Engineer," and having found that "He is a problem solver, par excellence," author Louis A. Warner, a professional engineer himself, proceeds to solve the world's problems.

In the midst of flailing against architects, who, I gather, are out to enslave or, at least, exploit, engineers, Warner disseminates advice on urban and suburban problems, poverty, drugs, unions, ecology, abortion, part-time amateur leadership of organizations, ghettos, commuting, child-rearing, legislative processes, politicians, crime, transportation, the guaranteed annual wage and engineering education.

Like a man who thinks so fast his pen can't keep up, Warner skips from subject to subject, making simplistic analyses of complex problems, and with the aid of cliches that gallop through his text with capital letters, dispenses platitudes and homespun "common sense" solutions to everything but halitosis.

In assuming the burden of so many problems, unfortunately, Warner waters down — no, *drowns* his main goals — engineering professionalism (which he calls ProETHIC) and unity of engineers. It's not clear whether he's advocating unity of all engineers or merely unity of professional (civil) engineers against the archenemy, architects. Promoting this unity, whichever it is, is the goal of the publisher (at \$2.75 plus 50¢ for shipping), NELF Press of Waterbury, Conn.

However worthy Warner's cause may be, and however valid his advice on everything, Warner's book has an important lesson for all of us: When you have an objective, go after it. Don't dissipate your efforts in side issues, however important they may be in themselves.



A handwritten signature in dark ink, appearing to read "George Rostky". The signature is fluid and cursive.

GEORGE ROSTKY
Editor

**You can teach our stepping switch
all the newest tricks.**

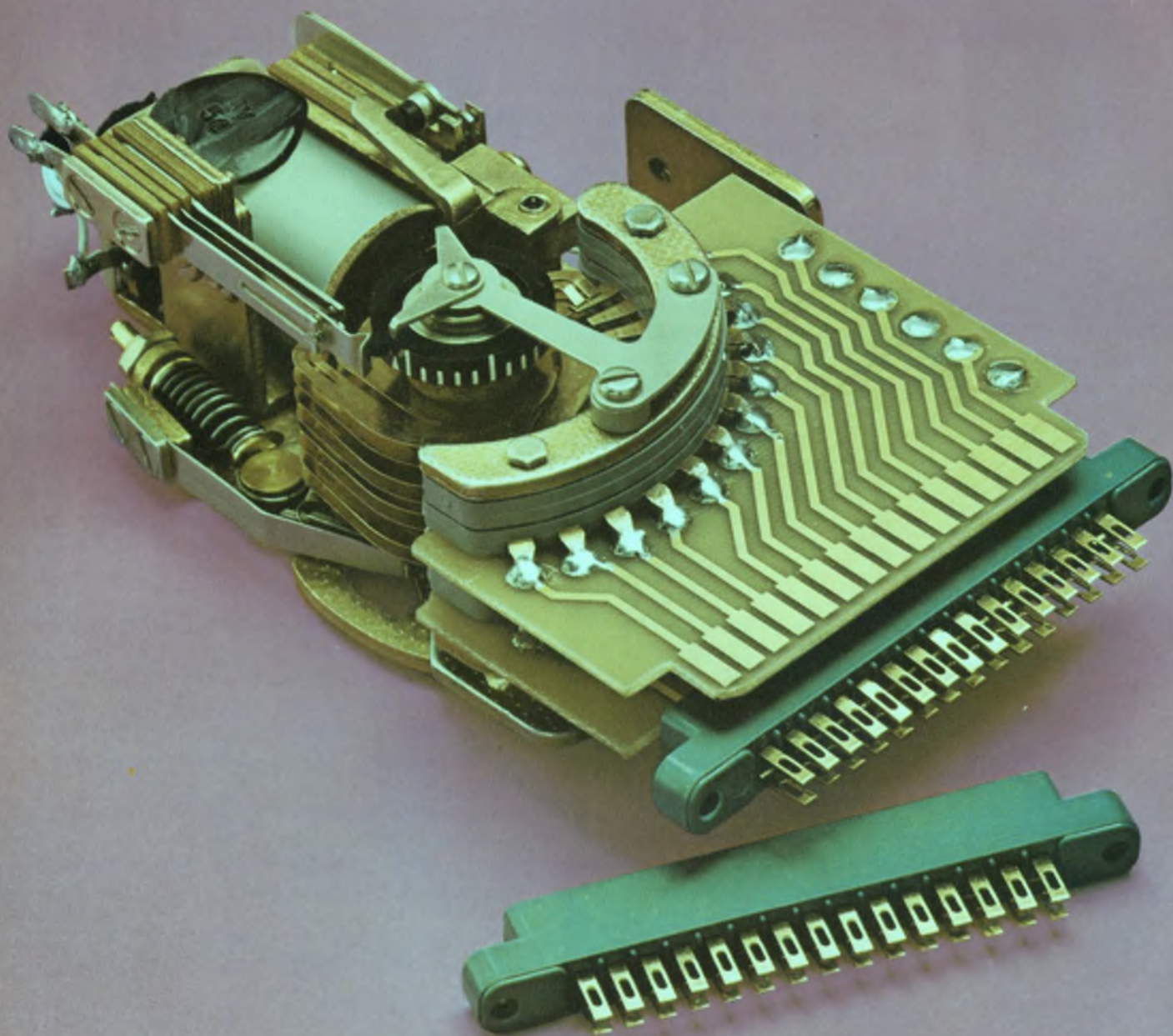

You can make a rotary stepping switch do just about anything solid state devices can do. Control. Time. Count. Program. Hunt. Test. Monitor. Indicate. Select. Yet with all that talent, a lot of people overlook it when they have a problem. That's too bad because it's often the most practical solution.



Think of the stepping switch as a time machine.

It conserves what you have the least of. Time. That's because most of the logic you need is built right in. It's part of the mechanical construction, not something you have to create. And by adding our Series 300 Time Delay module, you'll practically have a complete control system in the palm of your hand. Lots of people have created exotic solid state circuits only to discover they could have done the same thing faster and easier with a stepping switch.

Ten cents a contact.

That same exotic circuit probably costs three to five times more than a stepping switch, too. For example, a type 45 with 8 levels of 52 contacts will cost you about a dime a contact. We don't know of any switching method that costs so little.

**A better memory than an elephant.
And just as tough.**

A stepping switch never forgets after a power outage. When the juice comes back on, it starts up right where it left off. And it shrugs off doses

of 1250 volts because of inherently high insulation resistance and dielectric strength. This gives you a system reliability that can't be matched by solid state. Should the day ever come when maintenance is necessary, a plug-in style, like the type 44 in the picture, can be removed or installed in minutes.

10 million laps around the track.

And maybe 10 million more. We've yanked random units off our production line and worked them to death. Many have lasted twice as long as their rated 10 million wiper sweeps across the bank. One reason is our "free floating" pawl. It can't possibly bind or overthrow because we don't use pawl or armature stops.

Sometimes a stepping switch isn't the answer.

If you need to switch in microseconds, or squeeze your system into a TO-5 can, forget it. But if you're looking for a simple, economical, reliable, easy-to-design solution to a switching problem, consider the stepping switch. We'll be happy to help you do it. If you want a head start, write today for a copy of our 40-page manual. GTE Automatic Electric, Industrial Sales Division, Northlake, Illinois 60164.



GTE AUTOMATIC ELECTRIC

FOCUS

on Time-delay relays

Hunting for a good time-delay relay is like looking for an isolated branch in the Amazon. There's a jungle of relays to choose from. New types turn up continuously, but, contrary to expectations, the older types refuse to become obsolete. New uses are found for them. The result is a profusion that makes choosing a time-delay relay an awesome task.

Fortunately many of the selection pitfalls are common to all types or large groups of timers. Here are some of the more frequent traps to avoid:

- **Temperature effects**—Besides causing errors in timing, excessive temperature can permanently upset calibration or even destroy a timer. All too often the temperature information that manufacturers give is inadequate, unclear or ambiguous. It must be supplemented. Ask your vendor questions.

Oscillator-counter and ac motor-driven timers, which are controlled by frequency, are least affected by temperature. Uncompensated thermal timers are most influenced. But some thermal and electronic-RC types reduce temperature effects by incorporating temperature-compensation schemes.

Timers have an *operating* and a usually wider *storage-temperature* range. Don't mix them up. Performance specs don't apply over the wider storage-temperature range. And operating-temperature ranges are not standardized. A narrower temperature range, often hidden in a footnote, may explain a seemingly high accuracy rating.

- **Voltage effects**—In selecting electronic timers, buyers frequently ignore the effects of polarity reversals, power interruptions and high-voltage spikes, besides mere line-voltage varia-



tions. Or manufacturers bury the problems in the footnotes. Voltage spikes, generated by solenoids and other inductive loads across the same power source as the timer, can easily destroy an unprotected solid-state timer. Units unprotected against accidental polarity reversal are also potential victims. And a power interruption may cause a momentary transfer of the output contacts, with possible disastrous results to the controlled equipment. The better electronic timers guard against this.

- **Voltage-accuracy effects**—Some timers, particularly electronic units, incorporate regulator schemes to reduce line-voltage effects. Other timers, such as ac motor-driven units and those that use a stabilized oscillator and count pulses, are inherently immune to normal voltage varia-

tions. If the manufacturer's spec is muddy on voltage-variation effects, ask for clarification.

■ **Timing accuracy**—Question the specified figures. They are not always clearly defined. Look for footnotes; sometimes they provide a warning. Accuracies are always conditional, even if the specification doesn't clearly say so. Is the stated value the over-all accuracy? Does it take into account the full range of operating conditions, in any combination, or only the initial manufacturing tolerances? Or is the value the repeat accuracy—at a fixed temperature and voltage? Does repeat accuracy include the very first cycle? Or is it some average, excluding the first cycle and measured only after a stabilized condition is established? Does the percent accuracy refer to full scale? Or does it really mean percent of any setting? Some specifications, such as those in Potter & Brumfield's Catalog '72, spell out ex-

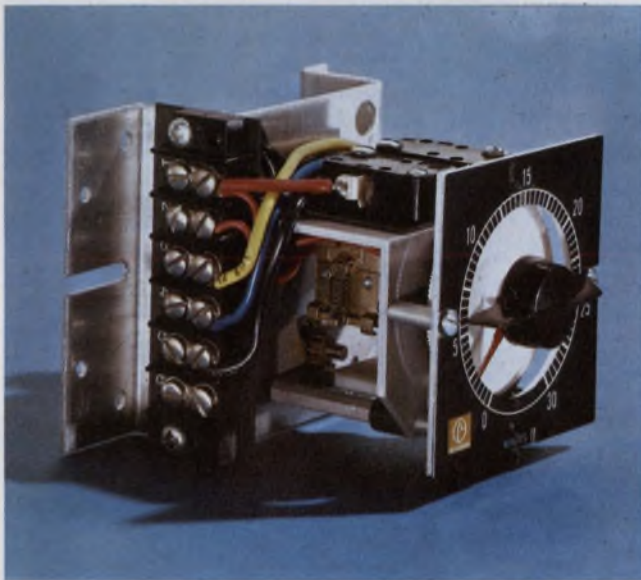

Easily read, colorful dials grace many timers. Such dials were previously the province of motor-driven units

actly what is meant, but in P&B's terminology.

■ **Time cycling**—Different vendors identify the same mode of operation differently. "Delay-on-energize," "delay-on-operate," "delay-on-pull-in" and "ON-delay" modes are the same thing. Also "reset" and "release" times are synonymous. But "recycle time," "recovery time" and "reset time" are not the same thing.

Not all timers have the same cycling capabilities. Your needs must be carefully spelled out—in a language your vendor understands. Be redundant. Include a timing chart that shows precisely the on and off periods required.

Some manufacturers, well aware of confusion in nomenclature, have attempted to codify definitions. Magnecraft's "Handbook of Time Delay Relays" does a creditable job. Leach—in its Bul-

letin-11, "How to Pick a Relay" series—defines the important basic cycling terms. But there is no common standard.

■ **Output coupling**—Matching the output relay to the load is a crucial topic in selecting any time-delay relay. However, this is a complex subject that deserves detailed treatment. Relays, contacts and loads are therefore left to the references,^{1,2,3}. Some timers use electromechanical relays, other units solid-state relays, and a few "timer modules" require an external relay device.

All timers are cousins under the skin

Many physical principles, employing such media as solids, liquids, gases, heat or electricity, are used to make time-delay units. But the operating principle for all is the same. As a result the old pneumatic timers and the most modern

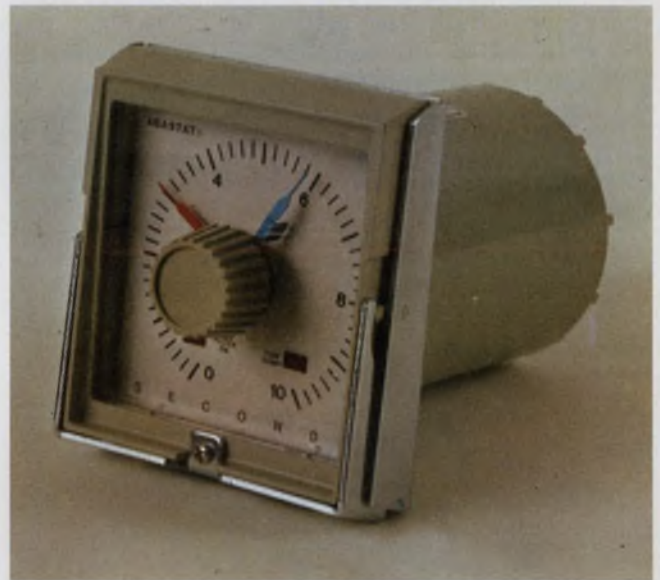

(above). Now the solid-state electronic unit (far left) is a look alike and competes in ranges to 300 seconds.

oscillator-counter timers must have the same five elements to be complete time-delay relays:

1. A **source of some medium** that can be turned on by a start signal. The dashpot chamber is the source for air, the medium in pneumatic timers. An oscillator is the source for electric pulses, the medium in oscillator-counter timers.

2. A **control element** that regulates the medium flow. An adjustable orifice controls the rate of airflow in a pneumatic timer, and an RC circuit controls the pulse frequency of an oscillator.

3. A **sink or accumulator** that disperses or receives the medium. In the pneumatic timer the atmosphere serves as the sink for the air in the dashpot, while the counter is the accumulator for the oscillator-counter timer.

4. A trigger device that signals the end of the delay. Often a snap-action switch is used in pneumatic timers, but a flip-flop would be used to flag the completion of a preset count in an oscillator-counter unit.

5. An output-coupling device that carries the output load. For pneumatics, the contacts of the snap switch can usually carry the output load directly, but the flip-flop would need an output relay. Thus many complete time-delay "relay" units don't even have an actual relay in them. Motor-driven timers also use snap-action switches, instead, to carry the output load, but electronic timers can have either an electromagnetic or a solid-state (SCR or triac) relay.

The physical device to implement each of these five elements is different for the different media. However, for all timers that are not factory preset, the user is provided with either a screwdriver adjustment, or a knob that is frequently calibrated. The adjustment may turn a potentiometer or vary the orifice of a dashpot, but the objective is the same—to set the timing to a desired value. The user is often not aware of the kind of component he is turning. Many solid-state timers with large colorful dial faces look so much like motor-driven timers that you can't tell them apart. But motor-driven timers and solid-state units have distinctly different characteristics.

Many factors are common to all or large groups of time-delay relays. But there are differences, too.

Electronic timers can pose problems

Of all the manufacturers in the timer field, the greatest number use electric charge as the timing medium in their timer units. Lower-cost (\$15 to \$30) RC-charge timers offer over-all accuracies of about $\pm 10\%$ and repeatability of $\pm 2\%$ to $\pm 5\%$, equal to the better pneumatic types (about \$50). While most of the lower-cost electronic timers are specified to operate over a temperature range of -10 to 55 C and can be stored safely from -55 to 85 C, pneumatics can operate in the -55 to 85 C range. However, electronic timers, especially the lower-cost units using solid-state components, often suffer from the following:

- **Failures** caused by line spikes and other transients, and polarity reversals on dc units.
- **Undesirable momentary contact transfer** upon power interruption during the timing cycle (aborted-cycle effect).
- **Varying time-cycle lengths**, depending on the length of time between reset and the start of a next cycle. This effect is observed if the timer is not permitted to rest for a full recycle period. In RC-charge timers, this phenomenon is

due in great part to the "soak-in" effect of the capacitor dielectric. After the initial discharge of a capacitor, some charge may reappear and shorten a subsequent cycle.

▪ **Serious deviation from calibration** when some timers, in particular those using an electrolytic capacitor, are not in use for a long time. This effect is often called the "first-cycle" effect, because when the timer is first operated, the period can be very far off (usually longer). But calibration is restored upon repeated cycling.

The better, and often higher-priced (\$30 to \$90) electronic units claim solutions to one or more of these problems.

Timeco, in its 007 repeat-cycle timer, has retained its patented cold-cathode tube as the trigger-point detector, because of the tube's resistance to failure from line transients. And many manufacturers of solid-state units, such as Hoagland, General Time, Potter & Brumfield, Magnecraft and Vanguard, provide built-in protection against transients. The most often encountered specification for transient safety is "twice rated voltage for 8 ms." However, inductive spikes, if not suppressed, can easily exceed this rating. Most better units also have protection against accidental polarity reversal.

Midtex offers its Type 614, which has a guard circuit to prevent undesired contact transfer in aborted timing cycles. However, Type 613 is an economical version that is not protected against this effect. Potter & Brumfield's lower-cost CU and CH Series also exhibit this potentially

What the words mean

Few time-delay relay manufacturers agree on terms in specifications. Worse still, the definitions of the terms that many do use in common are not always the same. Here is a short summary of the common terms in the timer field:

Release or reset time—the time required for the output switching device to return to the de-energized position upon removal of power.

Recycle time—the minimum time between operations to assure repeat accuracy within the specified tolerance.

Recovery time—the minimum time to assure repeat accuracy within the specified tolerance when the cycle is aborted during the timing interval. Recovery time is typically greater than the recycle time.

Aborted-cycle effect—a momentary transfer (pickup and dropout) of the output switching device, which may occur in some timers if the timing cycle is aborted. Depending on when the power is interrupted, the transfer duration may vary from a short pulse to the total time-



Some companies, like Raymond Precision Industries, concentrate on a specific category of timers. Motor-driven units in all shapes and sizes are available for special and general applications.

troublesome aborted-cycle effect, but its more expensive lines do not.

While most RC timers use the unijunction transistor or the newer, programmable unijunction as the trigger element, some manufacturers claim important advantages for other devices. Both Timeco, with its cold-cathode trigger element, and Regent Controls, with its linear-amplifier as the trigger element, permit the use of high-resistance RC circuits for their timing elements. This eliminates the need for high-valued capacitors and allows the use of smaller, more stable nonelectrolytic capacitors—even for long

delay value for the device.

Repeat accuracy—the percentage variation range of a delay time relative to previous delay times at nominal (and constant) voltage and temperature, and after specified recycle times for normal operation, or recovery times for aborted cycles.

Over-all accuracy—the percentage deviation range from absolute, in terms of percent of full scale or maximum setting, within which any time-delay setting will fall. The conditions of operation include any combination of temperature and voltage within the specified operating ranges, and with the unit in a normal cycling mode.

Operating-temperature range—a range of temperatures within which the unit's over-all accuracy is maintained.

Storage-temperature range—a range of temperatures within which the unit may be safely stored without damage or permanent alteration of calibration.

Time delays come in many forms

These five timing cycles do not exhaust all possibilities. Many more are possible. But not all vendors use the same names for the same cycles. When ordering a timer, make sure. Include a timing diagram.

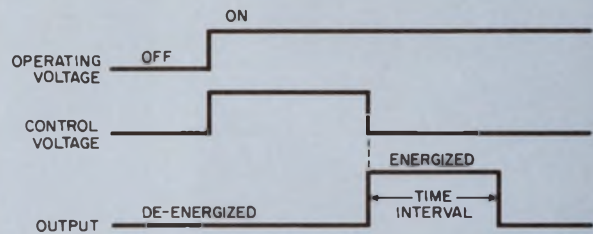

Time interval on release—The load circuits are energized after the input control circuit is de-energized and the load remains energized for a specified time interval.

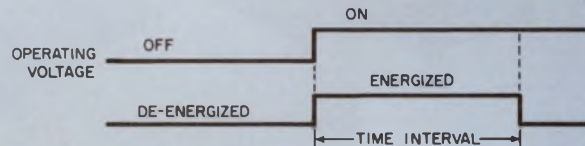

Time interval on operate—The load circuits are immediately energized, and remain energized, for only a specified time interval, after the input circuit is energized.

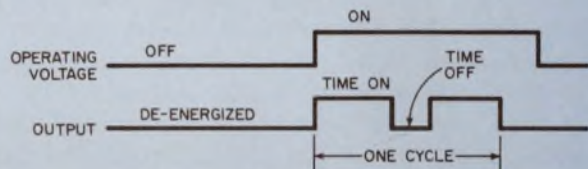

Repeat-cycle timer—An ON-OFF cycle repeats as long as the input circuit is energized.

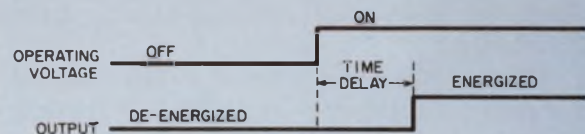

Time delay on operate—The load circuits are energized at a specific period of time after the input circuit is energized.

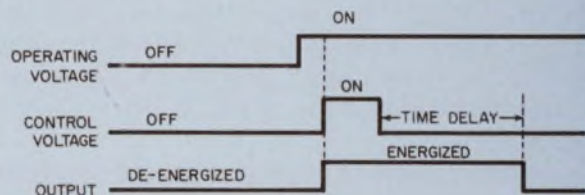

Time delay on release—The load circuits are energized when the input control circuit is energized, and they remain energized for a specific period of time after the control circuit is de-energized.



Agastat has kept and updated its venerable line of pneumatic timers (top left) and expanded its line to include RC-charge units (top middle), motor-driven timers (top right) and an oscillator-counter type (bottom right).

delays. This substantially reduces the soak-in effect, since the dielectrics of smaller capacitors (polycarbonate is a good choice) exhibit this phenomenon to a much smaller degree.

And by avoiding electrolytic capacitors, high-resistance RC timers can also alleviate the first cycle-effect. Although timers that suffer from first-cycle problems tend to restore their accuracy upon successive recycling, some time-controlled systems cannot use such a timer because serious damage can occur during this out-of-spec performance.

Further, while polycarbonates can tolerate a temperature range of -55 to 125 C, the better electrolytics are usually limited to roughly -55 to 85 C. But electrolytics tend to leak excessively (for timers) near their high temperature limit and lose too much capacitance at the lower limit. Many of the better electronic timers that use capacitors, like polycarbonates, therefore have a wider temperature range—with limits closer to the extremes of -55 to 125 C—at least for storage temperature, if not also for accurate performance.

In addition the use of polycarbonate capacitors together with a solid-state linear amplifier (as Regent's Model TM 101's timing circuit) can provide repeat accuracy of $\pm 1\%$ and over-all accuracy of $\pm 5\%$ for time ranges to five minutes. These figures appear to be better than

most, especially in the five-minute range, which is about the upper limit for RC-charge timers. However, Regent fails to include a temperature range on its TM 101 spec sheet. A private communication, though, gave the temperature range as 0 to 55 C—a bit higher at the lower limit than than most other RC-charge timers.

The resistor of the RC network also offers some options in selection. Wirewound or metal film resistors are more stable and less affected by temperature than composition types. And for fine resolution, multiturn pots are desirable.

Although many manufacturers indicate a greater than 100-to-1 time-delay span on a single dial scale, the lower end of the scale—below $1/10$ of full scale—is not likely to be accurate. Over-all percent accuracies are usually given as a percent of full scale. At the low end of the scale, the absolute value (or percent of set value) can therefore be off by a large amount. Most manufacturers supply timers in several ranges. Select a unit where most of your settings are in the top 75% of the scale.

One advantage claimed for electronic timers is their rapid reset (release) time. Do not confuse recycle time with reset time. Recycle time is often much longer. Published values for RC-timer reset times range from about 20 to over 100 ms. Reset time generally refers only to the time required for the output load-coupling device to re-

turn to its pre-timed-out condition. If the device is an electromechanical relay and the relay actuates upon time-out, then reset is the time to return the relay to its normal condition. But recycle time should include such phenomena as soak-in effect in addition to the reset time. And repeat accuracy is always conditional (whether stated or not) upon allowing the full recycle time before starting another timing cycle.

While practical considerations limit RC-charge timers to about five minutes at the upper end of their range, the lower end is limited to roughly 10 to 200 ms, where an electromechanical output relay is used. Solid-state relays are faster. The pull-in (the preferred term is "operate") and drop-out (the preferred term is "release") times of the output relay should be a small fraction of the cycle-time to avoid affecting over-all timing accuracy.

Electronic timer without relays

The term "relay" has been dropped by many vendors from the descriptions of their timer units. Instead names like "time delays" or "timing modules" are often used. In fact some manufacturers sell only the timing part of the complete timing device. The user must supply his own output relay. Too quick a reading of some literature may leave the erroneous impression that the units are complete and include an output relay.

Although manufacturers that advocate separation of timing function and relay are in the minority, there are certain advantages to the separation. Separation permits a timing unit to be matched with any number of different load-carrying relays. This permits not only greater freedom in mounting the now smaller timing function with other logic elements; the load-carrying unit, frequently larger and incompatibly packaged, can also be placed more suitably. Also, when a failure occurs, only the defective part need be replaced. One timing unit may outlive several relays.

Timing-only modules, such as Hi-G's Model 6100, Signetics' NE-555 and Calnex's Models 560 and 565, are normally suited to the millisecond-to-seconds range. When used with solid-state loads, some units can operate in the microsecond region; other units are offered on special order into the hours range. These modules should find favor with IC circuit designers because packaging, power requirements and interface voltages are IC-compatible. Properly mated to a relay, these units can control power loads, much as their larger electronic cousins do.

On the other hand, the user is left with the responsibility of choosing a proper mating relay or other output-coupling device. Many relay

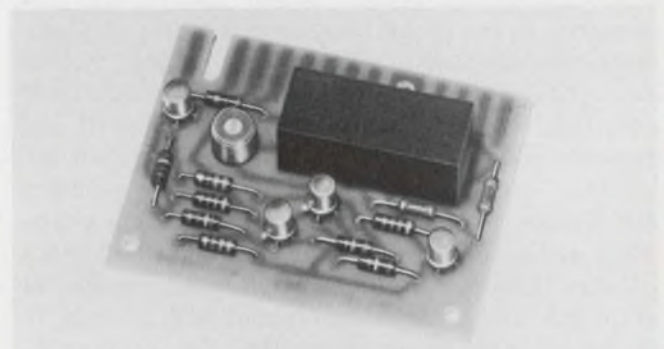

A diversity of principles and packages used in generating a time delay include (from top to bottom) hermetically sealed thermal timers by Jettron, an open low-cost thermal timer by Midtex, fluid-controlled timers from Heinemann and a mercury-column, electrolytic-action timing unit from Curtis.

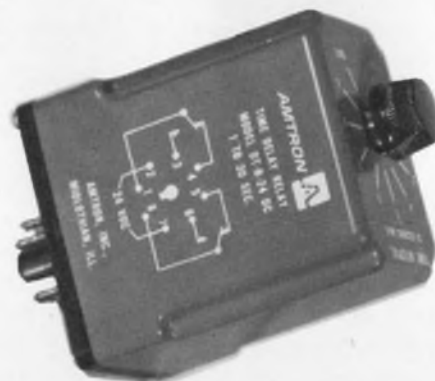
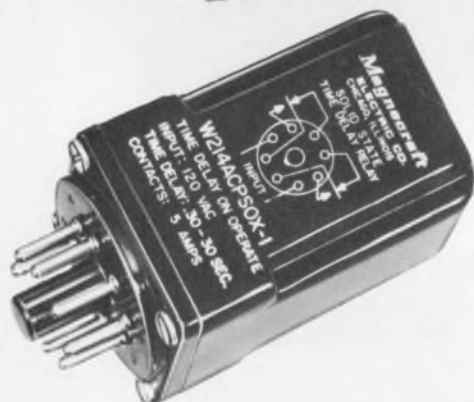

manufacturers—such as Leach, Struthers-Dunn and Potter & Brumfield, companies that also make a variety of time-delay relays—argue that they are best qualified to match the relay and timer parts since they make both. Further, they say that one package can be made to take less space than two and that wiring and assembly costs are less.

Motor-driven timers for long delays

The motor-driven timer finds wide application, in domestic appliances like washing machines, dishwashers and dryers. Motor timers are particularly suited to the sequence cycling of many independently switched devices, since motors have the power to drive multiple cams and switches. In ac units calibration is inherent and depends only on usually reliable line frequencies. Further, motor timers are particularly accurate for delays extending to hours or even years. They are not well-suited for very short intervals—below about one second. Full-scale ranges for standard units vary from about six seconds to 60 hours. The minimum setting for shorter intervals is about 0.1 second. Reset time (in reset types) is about 0.5 second. Some units have dials for setting the time delay; others are set by one or more cams or mechanical stops. A wide range of different contacts and sequences is offered.

Many sequencing units are custom designs.

A large variety of standard ac motor-driven timers, with repeat accuracies in the range of ± 0.5 to $\pm 1\%$, is available from many manufacturers—such as A. W. Haydon, General Time, Raymond Controls and even Agastat, formerly mainly identified with the pneumatic-timer field. Accuracy is rather independent of temperature, but the specified range varies. A. W. Haydon, for example, specifies -55 to 71 C, while Agastat gives -10 to 50 C.

Timer units with dc motors are made by far fewer vendors. A. W. Haydon includes dc motor-driven units in its line of timers with $\pm 2\%$ repeatability (of maximum range). Its 5600 Series units, governed by an escapement, has an “over-all” accuracy of $\pm 5\%$, and its ungoverned 5300 Series exhibits $\pm 10\%$ “over-all” accuracy. However, Haydon’s definition of over-all accuracy is at rated voltage and room temperature, but its repeatability is at “any combination of constant temperature and rated voltage.”

Fluidic timers still compete

Though they use one of the oldest techniques for implementing a time delay, pneumatic (air) units still compete very effectively, especially in industrial controls. Voltage spikes and other transients don’t bother pneumatics, and soak-in

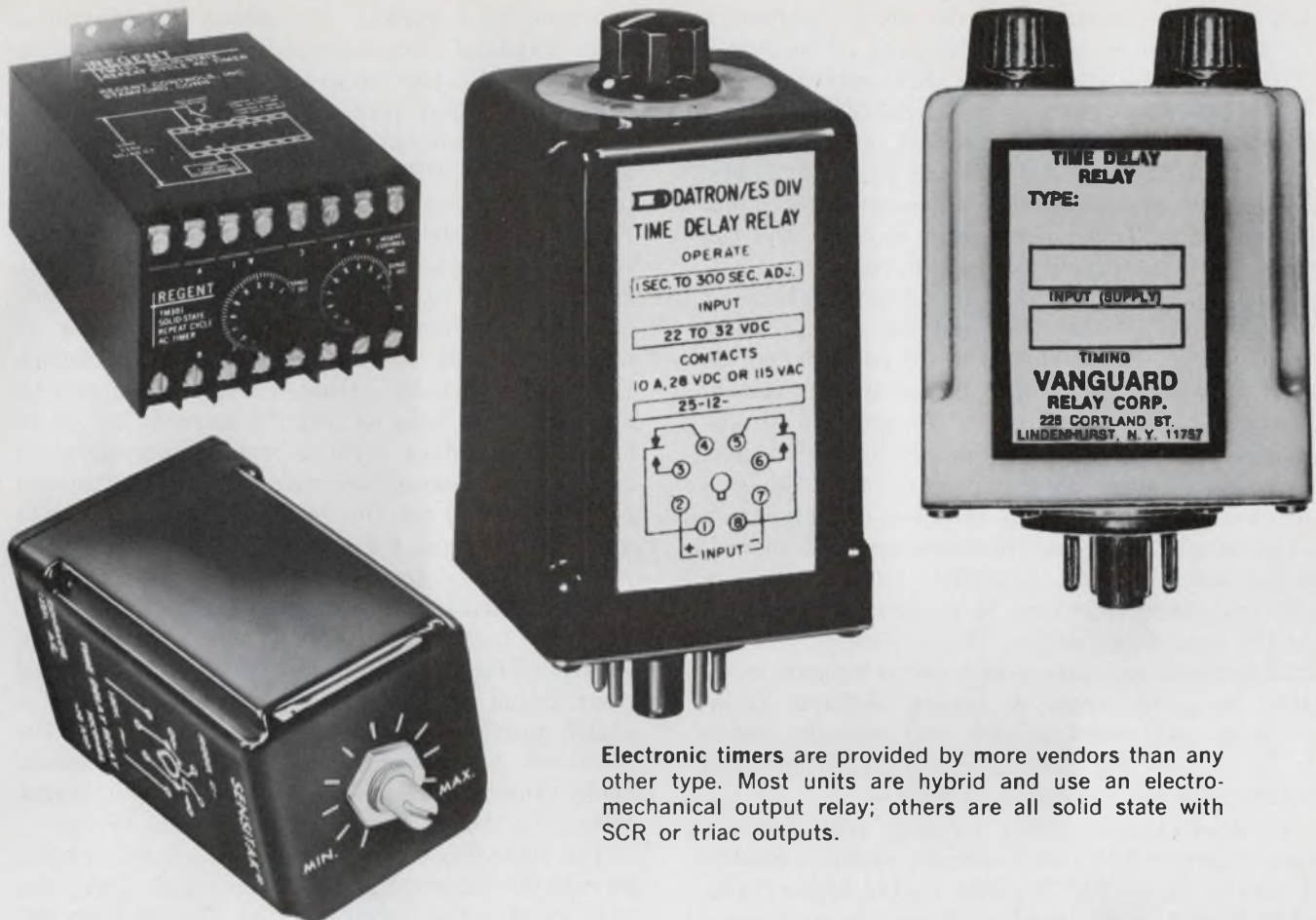

Electronic timers are provided by more vendors than any other type. Most units are hybrid and use an electro-mechanical output relay; others are all solid state with SCR or triac outputs.

and first-cycle effects don't have their equivalents in pneumatic timers. Though some or all of these problems can be solved in electronic units by special circuits and protectors, many users in the conservative machine-tool industry and in industries making industrial controls choose to stay with old reliables.

Low-cost dashpot units have screwdriver adjustments, and more elaborate lines feature calibrated dials. Magnecraft's Class 110 dashpot time-delay relays can be set by a screwdriver to delays of 0.2 to 45 seconds with $\pm 10\%$ repeatability. A temperature range (presumably operating temperature), from about -54 to 74 C, is given.

More advanced dial units, such as Agastat's 7000 Series, provides $\pm 5\%$ repeatability for dial settings of less than 200 seconds and $\pm 10\%$ for longer settings. One may assume that these accuracies are for constant room temperature, because a specification listed as Temperature Range states: "The effects of temperature on preset delays are less than $\pm 10\%$ between -18 C and 74 C, but rated performance can be obtained over -55 C to 74 C." The timers are offered in 10 ranges from 0.1 to 1 second through 1 to 300 seconds. Mounting position seems to be an important consideration in this timer's ratings.

In many air-delay timers, such as those made

by Naybor Laboratories, the delay time is independent of the applied voltage because the delay function is pneumatic after the dashpot is set initially by a solenoid stroke. The voltage need be only large enough to actuate the initial load. Other units, such as Magnecraft's Class 110, depend directly upon voltage for their timing, since the solenoid drives directly against the dashpot during the time delay.

Where precise timing is not essential, Heinemann's Silic-O-Netic time-delay relays offer fixed delays in 16 steps from $1/4$ to 120 seconds. Heinemann uses an iron core whose motion is constricted by a silicone liquid. Accuracy is only $\pm 50\%$ of the specified time delay at nominal voltage, with a time reproducibility of $\pm 25\%$. Reset times vary between 15 and 25% of the time delay. These units are sensitive to temperature variations.

Thermals are rugged and economical

Though not recommended for applications that call for high accuracy and repeatability, thermal timers find wide use because they are low-cost (\$4 to \$10 for the better ones), rugged and usually sealed and tamper-proof. Some really low-cost units (\$1 to \$4), such as those used for your car turn-blinker signal, find mass markets for millions of units. Many of the better units are

used in large quantities by the phone companies for time-out circuits to stop ringing or to switch off the dial tone after two or three minutes.

Jettron's data sheet, on its Model-501 line (formerly a McGraw-Edison product), supplies rather complete data, typical of many thermal timers. These units are sealed in a glass-envelope, radio-tube package. Tolerances are in seconds, and the variation is as much as ± 45 seconds (at 25 C and nominal voltage) for an operating time of 300 seconds. When the ambient temperature ranges from -60 to 85 C, the tolerance increases to ± 75 seconds. As would be expected, thermal timers are also sensitive to voltage variations. Heating rate varies as the square of the voltage.

After an initial operation, reset time depends on whether the unit had attained a "saturation temperature" or was "instantaneously" disconnected upon contact transfer. Saturation may take only three minutes, or as long as one hour, for the long-delay relays. The difference in reset time between saturation and instantaneous operation is quite large. A typical Jettron glass-envelope unit, rated at 300 ± 45 seconds, resets in 50 seconds for instantaneous operation, and 120 seconds for saturated operation.

Struthers-Dunn's 1972 catalog still includes some thermal units of venerable design. Midtex offers its Type 650 bimetal units, factory settable from 1 to 60 seconds. These timers have a self-compensating mechanical structure to help correct calibration changes caused by ambient temperature to a quarter of the changes in uncompensated units. And Hoagland has a variety of plastic-housed and aluminum-cased plug-in and screw-terminal thermal timers. Its general-purpose H-300 Series, in fixed delays from 5 to 180 seconds, has a $\pm 20\%$ timing tolerance. It is not clear from the catalog what conditions are necessary to attain this accuracy. No information is given on reset time, but ambient-temperature compensation is claimed for the -18 to 71 C range.

Because of the slow-moving mechanism in thermal-delay units, most of the better thermal relays incorporate a snap-action output switch to provide positive make-or-break action.

Other methods also find application

Although electronic, motor-driven, pneumatic and thermal time-delay relays make up the bulk of the timers available, other methods are also used. The old copper-slugged delay relay is still very much alive. Manufacturers of telephone-type relays, such as Clare, Automatic Electric and Magnecraft, still offer them. Magnecraft's Class 66SC telephone-type time-delay relay is a dc unit with a repeat accuracy of $\pm 10\%$ for constant ambient temperature and voltage. It is

available in a variety of contact combinations, with standard time delays ranging from 70 to 225 ms. The delays occur on either pull-in or release of the relay contacts.

Another old technique, a weighted armature, is used in the BPW series from Struthers-Dunn to provide about a 100-ms delay. A new type, Agastat's Model 3115 magnetic-timing relay, controls oscillator frequency (instead of charge time) with an RC circuit. A magnetic-core counter, upon receiving a predetermined number of pulses, triggers the output via a logic circuit. Fixed or externally adjusted time delays can be obtained to as long as 500,000 seconds (or more on special order) with a repeat accuracy of $\pm 0.25\%$ and over-all accuracy of $\pm 2\%$. Although reset time is 10 ms, the "off time" (recycle time) must be at least 0.4 second. The ambient-temperature range (operating?) is -55 to 100 C, and the operating voltage range is 18 to 32 V dc.

Curtis Instruments offers another new and rather different timing device. A tiny drop of clear liquid that moves back and forth in a sealed mercury-filled capillary tube, at a rate determined by current flow, provides standard cycle times between 15 minutes and 50 hours. Delays to 1000 hours are available on order.

The clear-liquid dot focuses light onto a photo-switch for controlling the output load. The company claims, but doesn't define, "instantaneous" manual reset.

And finally there is a new type of thermal timer, this one from Texas Instruments. This uses the well-known Klixon thermal snap-action switch in combination with a bulk-semiconductor ceramic, barium titanate, to produce a simple low-cost timer (\$1.25 to \$2.50 in OEM quantities) with very interesting properties. In addition to providing timing accuracies comparable to other thermal timers, the nonlinear action of the ceramic heater provides a wider range of operating voltage. Traditional wirewound-heater timers may fail to operate at all near their low-voltage extreme, and they burn out at the high end. But TI's thermal timers span a wider voltage range—for example, 208 to 277 V vs $\pm 10\%$ for traditional units. And saturated operation should provide greater repeatability, since the ceramic heater tends to generate a constant heat rate over a wide voltage range. Sensitivity to ambient temperature changes, however, is somewhat greater than the better thermal timers.

And so it goes. The oldies hang on and newer designs keep entering the competition. ■■

References

1. Oliver, Frank J., "Practical Relay Circuits," Hayden Book Co., Inc. New York, 1971, pp. 34-72.
2. National Association of Relay Manufacturers, "Engineers' Relay Handbook," Hayden Book Co., Inc., New York, 1969, pp. 91-97.
3. Grossman, M., "Focus on Reed Relays," ELECTRONIC DESIGN, July 6, 1972, pp. 50-59.

Need more information?

The companies and products cited in this report have, of necessity, received only cursory coverage. They've been selected for their illustrative, or in some cases, unique qualities. Companies not mentioned may offer similar products. Readers may wish to consult these manufacturers for further details:

Adams & Westlake Co., 1025 N. Michigan St., Elkhart, Ind. 46514. (219) 264-1141. **Circle No. 365**

Agastat Div., Amerace Esna Corp., 1027 Newark Ave., Elizabeth, N.J. 07208. (201) 352-2900. **Circle No. 366**

Airpax, P.O. Box 8488, Fort Lauderdale, Fla. 33310. (305) 587-1100. (William Witt) **Circle No. 367**

Aladdin Controls, 701 Murfreesboro Rd., Nashville, Tenn. 37210. (615) 242-3411. (F. Bassler) **Circle No. 368**

Allied Control Co., Inc., 100 Relay Rd., Plantsville, Conn. 06479. (203) 628-9654. **Circle No. 369**

American Relays Electronics Div., 39 Lispenard St., New York, N.Y. 10013. (212) 966-5650. **Circle No. 370**

American Zettler, Inc., 697 Randolph Ave., Costa Mesa, Calif. 92626. (714) 540-4190. (Gunther Rueb) **Circle No. 371**

Amperite Co. Inc., 600 Palisade Ave. Union City, N.J. 07087. (201) 864-9503. **Circle No. 372**

Amtron Inc., 14820 S. Kedzie, Midlothian, Ill. 60445. (312) 389-3955. (Larry Bell, Engr. Mgr.) **Circle No. 373**

Artisan Electronics Corp., 5 Eastmans Rd., Parsippany, N.J. 07054. (201) 887-7100. **Circle No. 374**

Automatic Switch Co., 50-56 Hanover Rd., Florham Park, N.J. 07932. (201) 966-2000. **Circle No. 375**

Automatic Timing & Controls Inc., 201 S. Gulph Rd., King of Prussia, Pa. 19406. (215) 265-0200. **Circle No. 376**

Bayside Timers Inc., 43-69 162nd St., Flushing, N.Y. 11358. (212) 463-8935. **Circle No. 377**

Betamate Electronic Devices, 6321 W. Slauson Ave., Culver City, Calif. 90230. (213) 390-3401. **Circle No. 378**

Bourns Inc., Instrument Div., 6135 Magnolia Ave., Riverside, Calif. 92507. (714) 684-1700. (S. Skilnyk) **Circle No. 379**

Branson Corp., Vanderhoof Ave., Denville, N.J. 07834. (201) 625-0600. (J. A. Witzler) **Circle No. 453**

Bulova Watch Electronics Div., 6120 Woodside Ave., Woodside, N.Y. 11377. (212) 335-6000. **Circle No. 380**

California Electronic Manufacturing Co., P.O. Box 555, Alamo, Calif. 94507. (415) 932-3911. (R. C. Dadd, Marketing Mgr.) **Circle No. 381**

Clare, C. P. & Co., 3101 W. Pratt Ave., Chicago, Ill. 60645. (312) 262-7700. (George Neeno) **Circle No. 382**

Cook Electric, 6201 W. Oakton, Morton Grove, Ill. 60053. (312) 967-6600. (W. Carlson) **Circle No. 383**

Cornell-Dubilier Electronics, 150 Ave. L, Newark, N.J. 07101. (201) 589-7500. **Circle No. 384**

Cramer Div., Conrac Corp., Mill Rock Rd., Old Saybrook, Conn. 06475. (203) 388-3574. **Circle No. 385**

Curtis Instruments, Inc., 200 Kisco Ave., Mount Kisco, N.Y. 10549. (914) 666-2971. (Ed Marwell) **Circle No. 452**

Cutler-Hammer Inc., 4201 N. 27th St., Milwaukee, Wis. 53216. (414) 442-7800. **Circle No. 386**

Digital Instruments Inc., 19025 Parthenia, Northridge, Calif. 91324. (213) 886-6467. **Circle No. 387**

Diversified Electronics Inc., 1913 W. Maryland St. Evansville, Ind. 47712. (812) 424-2288. **Circle No. 388**

Durakool Inc., 1010 N. Main St., Elkhart, Ind. 46514. (219) 264-1116. **Circle No. 389**

E-T-A Products Co. of America, 6284 N. Cicero Ave., Chicago, Ill. 60646. (312) 545-1553. **Circle No. 390**

Eagle Signal, Gulf & Western Systems Co., 736 Federal, Davenport, Iowa 52803. (319) 326-8111 **Circle No. 391**

Electronic Specialty Div., Datron Systems Inc., 18900 NE Sandy Blvd., Portland, Ore. 97220. (503) 665-0121. (Richard Lisdero, Prod. Sales Mgr.) **Circle No. 392**

Essex International, Inc., Controls Div., Logansport, Ind. 46947. (219) 753-7521. **Circle No. 393**

Frederick Controls Div., North American Philips Corp., E. Church & Seconds Sts., Frederick, Md. 21701. (301) 663-5141. (Paul Longo) **Circle No. 394**

Frost Controls Corp., 26 Pearl St., Bellingham, Mass 02019. (617) 966-1590. **Circle No. 395**

Furnas Electric Co., 1000 McKee St., Batavia, Ill. 60570. (312) 879-3410. **Circle No. 396**

GE General Purpose Control Dept., Rt. 66 and GE Rd., Bloomington, Ill. 61701. (309) 967-9011. **Circle No. 397**

GE Waynesboro, Waynesboro, Va. 22980. (703) 942-8161. (Jack Jeffers) **Circle No. 398**

GTE Automatic Electric, 400 N. Wolfe Rd., Northlake, Ill. 60614. (312) 562-7100. **Circle No. 399**

G-V Controls, Div. of Sola Basic, 101 Okner Parkway, Livingston, N.J. 07039. (201) 992-6200. (S. Speltz, Vice President) **Circle No. 400**

General Automatic Corp., 235 W. First St., Bayonne, N.J. 07002. (201) 437-7500. **Circle No. 401**

General Time Corp., a Talley Industries Co., Industrial Controls Div., 135 S. Main St., Thomaston, Conn. 06787. (203) 482-4481. **Circle No. 402**

General Time-Space & Systems Div., 1200 Hicks Rd., Rolling Meadows, Ill. 60008. (312) 259-0740. **Circle No. 403**

Guardian Electric Manufacturing Co., 1550 W. Carroll Ave., Chicago, Ill. 60607. (312) 243-1100. (Jack Rowell) **Circle No. 404**

Haydon, A. W. Div., North American Philips, 232 N. Elm St., Waterbury, Conn. 06720. (203) 756-4481. (Jim Phelan) **Circle No. 405**

Haydon Switch & Instruments, Inc., 1500 Meriden Rd., Waterbury, Conn. 06720. (203) 756-7441. **Circle No. 406**

Heinemann Electric Co., Route 1, Brunswick Pike, Trenton, N.J. 08638. (609) 882-4800. (B. Plesser) **Circle No. 407**

Hi-G Inc., Spring St., and Rt. 75, Windsor Locks, Conn. 06096. (203) 623-2481. (Paul F. King, Sales Mgr.) **Circle No. 408**

Hoagland Instrument Co., 65 Chestnut St., Red Bank, N.J. 07701. (201) 741-7319. (J. Robert Hoeffler, Vice President, Marketing) **Circle No. 409**

Industrial Solid State Controls, 435 W. Philadelphia St., York, Pa. 17405. (717) 848-2825. **Circle No. 410**

Industrial Timer Div., Esterline Corp., U.S. Highway 287, Parsippany, N.J. 07054. (201) 887-2200. (S. Karpel) **Circle No. 411**

Ingraham Industries Comar Div., 3349 W. Addison St., Chicago, Ill. 60618. (312) 588-2410. **Circle No. 412**

Jettron Products Inc., P.O. Box 7, 56 Route 10, Hanover, N.J. 07936. (201) 887-0571. (Edward Dietz, Chief Engr.) **Circle No. 413**

Leach Corp., Relay Div., 5915 Avalon Blvd., Los Angeles, Calif. 90003. (213) 334-8221. (Edward G. Combs, Prod. Mgr.) **Circle No. 414**

Logitek Inc., 42 Central Dr., Farmingdale, N.Y. 11735. (516) 694-3080. **Circle No. 415**

MKC Electronics Corp., 454 E. Donovan Rd., Kansas City, Kan. 66115. (913) 371-1351. **Circle No. 416**

Magnecraft Electric Co., 5575 N. Lynch, Chicago, Ill. 60630. (312) 282-5500. (H. Steinback, President) **Circle No. 418**

Micro Switch, a Div. of Honeywell, 11 W. Spring St., Freeport, Ill. 61032. (815) 232-1122. (F. Kafka, Public Relations) **Circle No. 419**

Midtex Inc., Aemco Div., 10 State St., Mankato, Minn. 56001. (507) 388-6286. (Robert K. Else, Gen. Mgr.) **Circle No. 420**

Naybor Electronics Inc., 26 Manorhaven Blvd., Port Washington, N.Y. 11050. (516) 767-4300. (Dominick Mangino, President) **Circle No. 421**

OPTO Mechanisms Inc., 40 Skyline Dr., Plainview, N.Y. 11803. (516) 433-8100. **Circle No. 423**

Ohmite Manufacturing Co., 3601 Howard St., Skokie, Ill. 60076. (312) 675-2600. **Circle No. 424**

Omnitec, Inc., P.O. Box 113, Syracuse, N.Y. 13211. (315) 455-5731. (R. W. Shutt, Marketing Mgr.) **Circle No. 425**

Paragon Electric Co., Inc., 1600 Twelfth St., Two Rivers, Wis. 54241. (414) 793-1611. **Circle No. 426**

Parko Electronics Co., Inc., 1540 S. Lyon, Santa Ana, Calif. 92702. (714) 547-0184. **Circle No. 427**

Philadelphia Scientific Controls, 1135 Cedar Ave., Croydon, Pa. 19020. (215) 785-3282. **Circle No. 428**

Potter & Brumfield, Div. of AMF Inc., 1200 E. Broadway, Princeton, Ind. 47670. (812) 385-5251. (Wm. Heuser) **Circle No. 429**

Raymond Precision Industries Inc., 217 Smith St., Middletown, Conn. 06457. (203) 347-5611. (S. Lapenson, Advertising Mgr.) **Circle No. 430**

Regent Controls Inc., Harvard Ave., Stamford, Conn. 06902. (203) 348-7734. **Circle No. 431**

Relay Specialties Inc., 3 Godwin Ave., Fair Lawn, N.J. 07410. (201) 797-3313. **Circle No. 432**

Sensor Corp., 97 Indian Field Rd., Greenwich, Conn. 06830. (203) 661-5600. **Circle No. 433**

Sigma Instruments, Inc., 170 Pearl St., Braintree, Mass. 02185. (617) 843-5000. (W. R. Cook, Marketing Mgr.) **Circle No. 434**

Signetics, 811 E. Arques Ave., Sunnyvale, Calif. 94086. (408) 739-7700. (P. Hansen) **Circle No. 451**

Solid State Electronics Corp., 15321 Rayen St., Sepulveda, Calif. 91343. (213) 894-2271. (E. Y. Politi, Technical Director) **Circle No. 435**

Square D Co., Executive Plaza, Park Ridge, Ill. 60068. (312) 774-9200. **Circle No. 436**

Standard Relay Corp., 40 Dale St., W. Babylon, L.I., N.Y. 11704. (516) 694-4436. **Circle No. 437**

Struthers-Dunn Inc., Lambs Rd., Pitman, N.J. 08071. (609) 589-7500. (Lawrence R. Davis) **Circle No. 438**

Symbolic Displays Inc., 1762 McGaw Ave., Irvine, Calif. 92708. (714) 546-0601. (W. Lang, President) **Circle No. 439**

Technology Products, Inc., 8944 Mason Ave., Canoga Park, Calif. 91306. (213) 882-9502. **Circle No. 440**

Tempo Instrument Inc., E. Bethpage Rd., Plainview, N.Y. 11803. (516) 694-4400. **Circle No. 441**

Tenor Co., P.O. Box 2766, Milwaukee, Wis. 53219. (414) 782-3800. **Circle No. 442**

Texas Instruments, Control Products Div., 34 Forest St., Attleboro, Mass. 02703. (617) 222-2800. **Circle No. 443**

Thermal Controls, 2711 Freemansburg Ave., Easton, Pa. 18042. (215) 253-2753. **Circle No. 444**

Timeco Inc., 1035 26th St., Box 8036, Huntington, W. Va. 25705. (304) 523-5149. (G. C. Wilson, President) **Circle No. 445**

Universal Relay Corp., 42 White St., New York, N.Y. 10013. (212) 925-9500. **Circle No. 447**

Vanguard Relay Corp., 225 Cortland St., Lindenhurst, N.Y. 11757. (516) 884-5000. (Bernard S. Gilman) **Circle No. 448**

Ward Leonard Electric Co. Inc., 31 South St., Mount Vernon, N.Y. 10552. (914) 664-1000. **Circle No. 449**

Zenith Controls Inc., 830 W. 40th St., Chicago, Ill. 60609. (312) 247-6400. **Circle No. 450**

The RAM built by hindsight.

Being the first 1024-bit MOS RAM, the 1103 was quickly designed into many systems. (A big reason we wasted little time second sourcing it.)

At the same time, we (along with many others) felt that there was plenty of room for improvement in terms of cost and performance on an overall system level.

Hence, we're now building our very own 1024-bit MOS RAM, the vastly superior MM5260.

Like the 1103, our MM5260 comes with chip-select.

Unlike the 1103, the thoughtfully designed MM5260 features a Tri-State™ logic common data I/O structure with TTL-compatible on-chip decoding and an internal sense amplifier. Plus precharge decoding to reduce system power dissipation significantly.

On a *system* level, the results speak for themselves: A power dissipation savings of almost 66% (two standard supplies versus three supplies); a 100%

reduction in the number of overhead circuits; and a 200% savings in overhead costs. All without sacrificing system speed or performance.

Finally, the new MM5260 comes in a 16-pin dual in-line package and is available for immediate delivery.

(Realizing the hard-core realities of phasing out an existing format, we will also continue to act as a volume supplier of the MM1103.)

We'd be remiss at this point if we didn't also mention that we offer a complete line of MOS clock drivers, including the MH0026, the industry's lowest cost high speed clock driver.

For complete information on any of the above, simply call (408)732-5000. Or write National Semiconductor Corporation, 2900 Semiconductor Drive, Santa Clara, California 95051.

National

WE'VE GOT THE

TIME



FOR YOUR APPLICATION . . . in all shapes, sizes, and timing ranges. Time Delay Relays with slow operate or slow release and time repeat accuracy to $\pm 1\%$. At Magnecraft we take great pride in the broad line of Time Delay Relays available from stock for immediate delivery and even more on special order.

Solid State Hybrid, Solid State-Static Output, Air Dash-pot, Copper Slug are some of the types to name just a few. Features such as plug-in, surface mount, printed circuit, screw terminals, solder terminals, quick connect terminals, panel mount, power switching, remote pot, knob adjust, screwdriver adjust, allen head adjust, open type, dust covered, hermetically sealed, economy, manually actuated, multiple contacts, auxiliary output, extended voltage, special purpose . . . the list is almost endless.

Maybe you don't need contacts rated to 100 amperes or timing repeatability to $\pm 1\%$ but we have them available just in case. That's where a broad line can save you money, you don't have to take more than you need. We have just the one to fit your needs . . . and if we don't, we'll make it.

Magnecraft ELECTRIC COMPANY

5575 NORTH LYNCH AVENUE • CHICAGO, ILLINOIS 60630 • 312 • 282-5500 • TWX 910 221 5221

FREE!



TIME DELAY RELAY HANDBOOK

Do you know how to properly specify a time delay relay? We have a dandy 92-page handbook that can help you. It describes applications you've never thought of. It offers suggestions on how to specify, testing procedures, comparisons of one type to another, principles of operation, and a glossary of terms. This is yours for the asking.

INFORMATION RETRIEVAL NUMBER 32

The Calculator and the Engineer—Part 2

Programmable calculator languages, either algebraic or keyboard, are easy to learn. And with the algebraic, equations are entered almost as written.

The programming of a desk-top calculator can be described in two ways:

First, a user without computer background may simply view the programming process as only an orderly listing, in tabular form, of all the mathematical terms and steps involved. The process thereafter involves only entering the variable numbers and symbols in the proper sequence. In most machines the numbers are entered on a 10-key pad, and the mathematical functions are chosen from a series of special-purpose switches and keys.

On the other hand, the user familiar with computers would look upon calculator programming in terms of a "language." According to this viewpoint the process of programming uses a combination of detailed machine-level instructions (such as +, -, ×, ÷) supplemented by a series of macro instructions (such as logs, trig function, square root) as the language. These instructions are implemented by firmware (readily replaced hardware) in the calculator.

Calculators come in two languages

Programmable calculators use either the keyboard language or algebraic language. The two differ more in entry format than programming philosophy or machine architecture. The best way to explain the difference is with a simple example. The steps necessary to enter the expression $2(3 + 4)/(5 + 6)$ into keyboard and algebraic language calculators are shown side by side in Fig. 1. A quick examination of the two lists shows that the algebraic sequence is closer to the way the expression reads when written. Algebraic calculators, however, require more internal logic to perform the computations.

Programming with the algebraic language

The algebraic language calculator is probably the most convenient of the two for the engineer

Kas Terhorst, Vice President, Product Planning, and Tom Budlong, Product Development Manager, Computer Design Corp., Santa Monica, Calif. 90404.

KEYBOARD		ALGEBRAIC
5	} = $\frac{2 \times (3+4)}{(5+6)}$ =	2
ENTER		X
6		(
+		3
STORE		+
3		4
ENTER)
4		÷
+		(
2		5
X		+
RECALL		6
÷)
		=

1. **Algebraic-language calculators** enter equations in almost the same order as they are traditionally written. Keyboard-language calculators need less internal logic, but data entry is not as "natural" for the engineer or scientist. Accounting and statistical analysis work is more suitably done on keyboard-language machines.

and scientist. To demonstrate a slightly more advanced and complete program using an algebraic programming process, consider the equation in Fig. 2a. This is a relatively simple equation, with only one variable. The logarithm function that it uses is an example of a macrofunction whose detailed programming is stored within the firmware of the calculator.

To demonstrate a program in detail, it is necessary to select a particular calculator. Let's use the Compucorp 425.

Each calculator has its own, individual programming characteristics. Some program modifications would therefore be required for calculators with a different architecture and internal logic. However, the basic philosophy holds generally for algebraic programmable calculators.

Programmable calculators have easily interpreted key-boards. This machine with 500 memory registers and the capacity to handle 4000 program steps can solve very sophisticated mathematical problems, and also provide control of systems.



(a)

EQUATION:

$$y = \frac{\ln(x)+2}{5.5}$$

(b)

HAND WRITTEN PROGRAM	PROGRAM PRINT-OUT	
HALT	0000	056
PRINT	0001	060
ln	0002	050 ln
+	0003	021 +
2	0004	002 2
÷	0005	024 ÷
.	0006	005 .
5	0007	012 5
*	0008	005 *
PRINT	0009	020 PRINT
ADV	0010	061 ADV
JUMP	0011	065 JUMP
0	0012	126 0
0	0013	000 0
0	0014	000 0

(c)

RESULT OF A PROGRAM RUN	
x	1.00000
y	0.36364 A
	2.00000
	0.48966 A
	3.00000
	0.56338 A

(d)

2. An equation containing transcendental functions like natural logarithms is easily programmed on an algebraic calculator. Enter variable x and answer y appears.

Fig. 2b lists the program steps to solve the equation. Fourteen steps are executed in the following order:

a) The HALT command is entered via a control switch. This halts processing and clears the keyboard for entry. At this point, the programmer would enter the value to be used for x , the variable in the numerator.

b) The PRINT command causes the entered value to be printed out for reference (see x , Fig. 2d).

c) The ln command activates the natural-logarithm function of the machine.

d) The + symbol calls up the ADD function.

e) This step enters the "2" quantity called for in the numerator.

f) The ÷ symbol sets the calculator up for

entry of the divisor.

g) Steps seven, eight and nine enter the number 5.5, and the = symbol triggers the calculation of the total.

h) The second PRINT command calls for printing of the answer (see y , Fig. 2d).

i) The ADV command instructs the calculator to advance the printout tape for the next calculation.

j) The JUMP command calls for the program to skip to the point in the program designated by the next two numbers. In this case, we have two zeros. These zeros at the end of the processing cycle instruct the calculator to go to Program Step 0000, which is the beginning of the program.

A printout of this program as it would appear on the calculator tape is shown in Fig. 2c. The column at the left on this tape is the program step number. Although step numbers can go to 9999, the 425 calculator holds a maximum of 4000 program steps. The second column on the tape lists command code numbers. These numbers are machine-language representations of the key entries. The third column shows the mnemonic symbol or numeric value corresponding to the key entries. The machine-language numbers on the tape are similar to program dumps of the assembly language of a full-scale computer.

Outputs for three runs on this program are shown in Fig. 2b. Once the program is entered into the calculator the user need only reference the storage area holding the program and then enter the value of x . Almost immediately, the calculator prints the answer y in the same decimal format as the x . This process can be repeated as often as desired.

For simplicity only a single variable was used

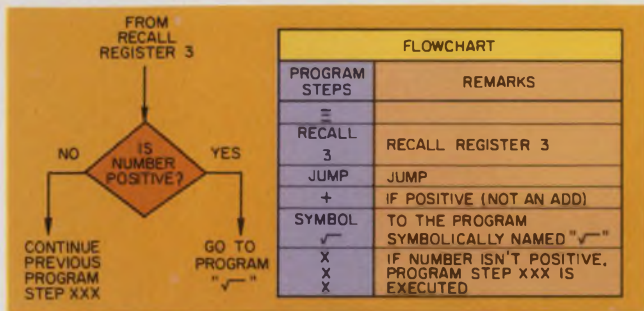

3. Single-decision branching is an important technique for producing complex program structures.

in this problem. Problems involving several variables can also be handled.

Programming with symbolic addresses

Since different calculators require different detailed treatment in programming, the fine points of calculator programming must be left to the comprehensive programming manuals that are supplied with individual calculators. But there are some general programming principles of broad application. Symbolic addressing is one of the techniques that can be employed on almost all algebraic calculators.

In the example of Fig. 1, the JUMP-0-0 command returned the program to its starting point. A different starting point requires a different command. Often a more convenient approach is to assign a symbolic name to the starting point. The end of the program would then command a JUMP to that symbolic name rather than zero.

To assign a symbolic name to a program point in the Compucorp 425, the user presses the key labeled SYMBOL in conjunction with any other function or number key. The "name" of that key then becomes the symbol of the program point.

This added level of sophistication permits the recall of programs independent of their locations in memory. A program may begin at step zero or any other step. And a program's location can be changed without the need to repeat all the steps, should that location be needed for something else. Symbolic addressing is a powerful tool for developing a number of concurrent programs.

Calculators can make decisions

Decision-making capabilities are an essential requirement of all but the simplest kind of program. A programmable calculator must therefore handle programs that are constructed with decision (or branch) points. Different sequences of commands are performed depending on the value, or almost any other aspect of a number, or a logic condition at a specific branch point in a program. Fig. 3 shows how a program, symbolically named "√" is performed if the number re-

called from register "3" is positive.

Many single-condition decisions—negative numbers, zero, switch settings, greater than, less than, etc.—can be combined to create highly complex multibranching programs, but over-all simplicity is still retained. The programmer spells out singly, each condition to be tested in a multiple-branch program no matter what the complexity is. A capacity of 4000 program steps can solve highly complex branching problems.

Indirect register addressing also helps

Many calculators provide certain keys dedicated to special registers whose contents are then used to address other registers. This feature is called indirect addressing. The data contents of these special registers can be automatically changed as directed by the program. Indirect addressing is particularly useful in loop portions of a program. An instruction in the loop may designate such a special register each time the loop makes its sequence. The contents of the special register can be changed before the start of a succeeding loop sequence. This provides considerable flexibility in programming complex sequences as other registers, indirectly addressed by each circuit of the loop, call up new data, or programming routines.

Program modification is made easy

It may be necessary to revise or modify a calculator program after it has been written. Initial debugging or changes in technical specifications may call for altering values. Or in using a calculator for a problem with many unknowns, an engineer can interact directly with the machine and continually change the program.

To modify a program for any purpose—debugging, revision or interaction—a user can take advantage of built-in features like:

- **Step-mode operation**—Any program can be stepped through—one instruction at a time—by the use of calculator switches, keys and combinations of both.
- **Back-up function**—Typical calculators have a back-up key to step the program back one step with each depression of the key. This may be the quickest way to the desired program point.
- **Program insert**—An insert key is available on a number of calculators. This puts the machine into a mode that permits the insertion of new program steps. The inserted material becomes a standard part of the original program.
- **Program delete**—Program steps can be deleted on many calculators by a key-operated delete.
- **Program listing**—A complete printout of the program can be called for at any time. Virtually all programmable calculators have this feature. ■■

For fast, accurate settings,

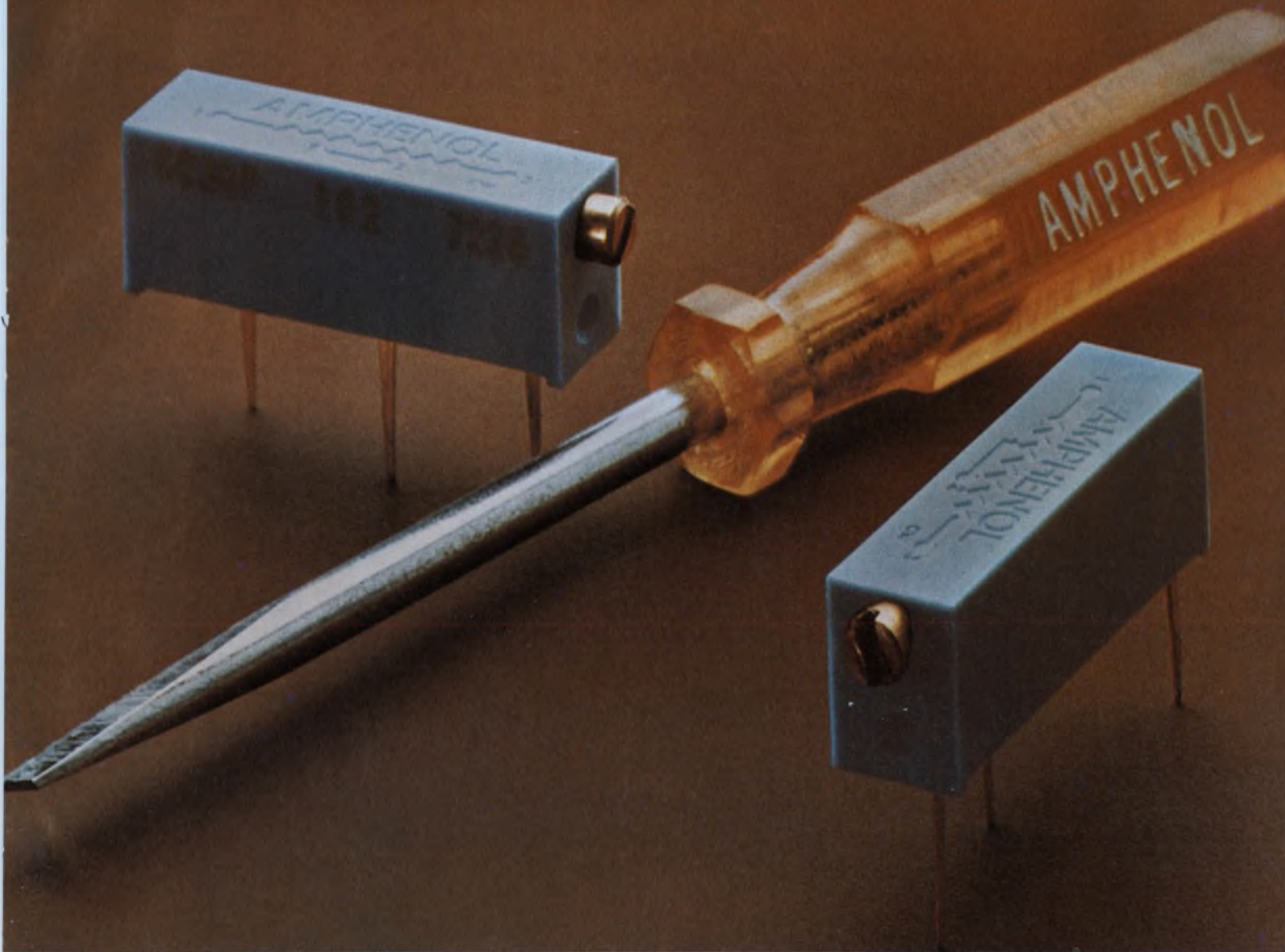

test drive our 6034 trimmer.

Amphenol's 6034 Series trimmers have multi-finger contacts to give you better setability, lower CRV, and longer rotational life.

This $\frac{3}{4}$ " cermet trimmer is designed with a low profile for maximum board stacking and has a solvent-resistant nylon case with epoxy seal for automated board cleaning processes. The Amphenol 6034 Series trimmer will operate at ambient temperatures up to 125°C and is completely humidity-proof. Three termination styles—P, K or Y terminals—are available.

The low-cost 6034 has a rotation life of 200 cy-

cles minimum with no discontinuity. All are 100% inspected for noise, total resistance, continuity and end resistance before shipping.

A barbed lead screw, with a 15-turn shaft adjustment, positively seals and eliminates end play. Without the typical O-ring there is no chance of pinching or breaking the seal.

Your local Amphenol distributor can arrange a "test drive" on your board. Let us set it up for you. Write Al Nemetz, Amphenol Connector Division, Controls Operations, Bunker Ramo Corporation, 2801 South 25th Avenue, Broadview, Illinois 60153.

**BUNKER
RAMO**

AMPHENOL

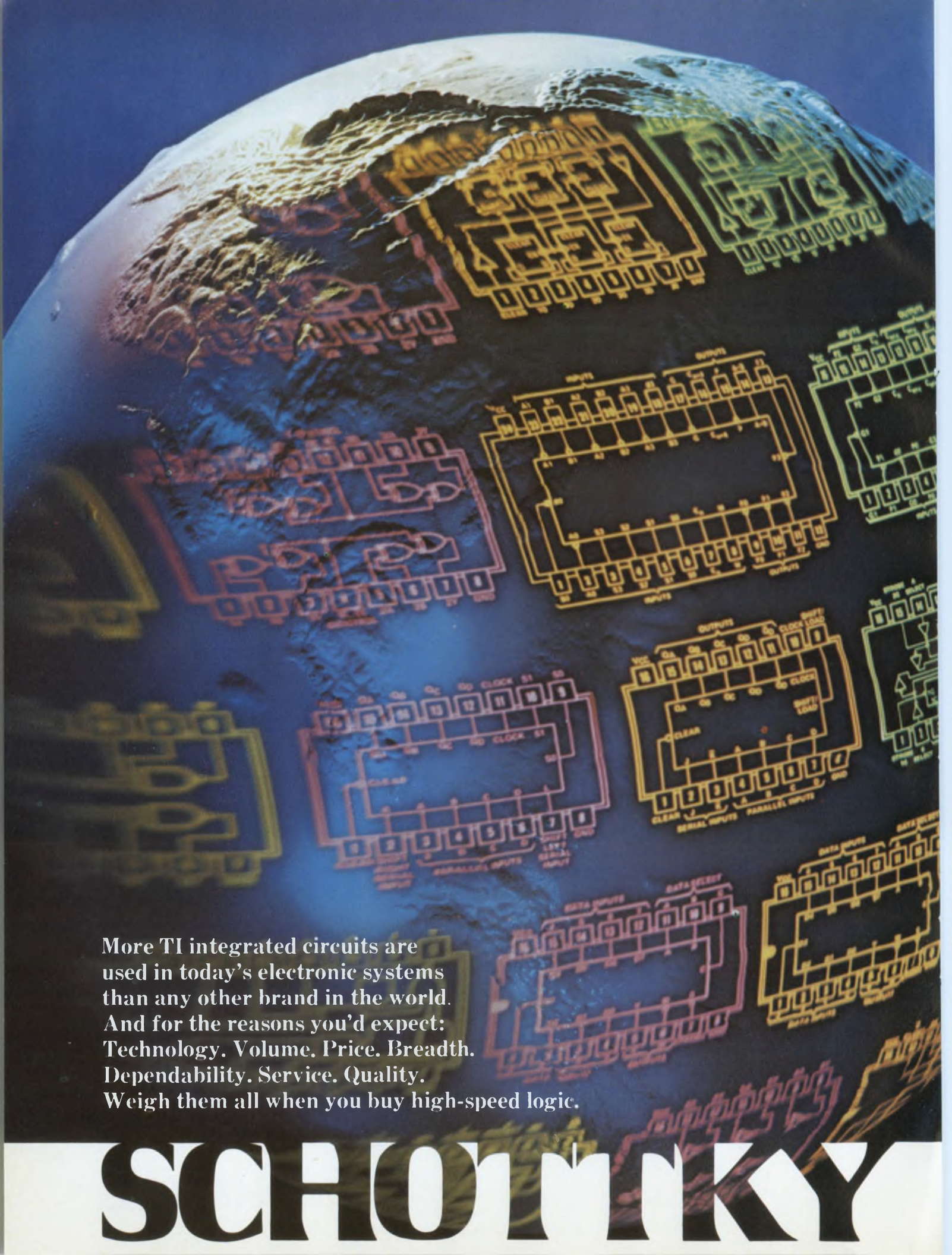

More TI integrated circuits are used in today's electronic systems than any other brand in the world. And for the reasons you'd expect: Technology. Volume. Price. Breadth. Dependability. Service. Quality. Weigh them all when you buy high-speed logic.

SCHOLLY

It's a 54/74 world.

And TI's 3-ns Schottky TTL expands your design horizons.

36 functions now...12 soon to come. And more tomorrow.

More and more designers are finding, as their competition gets keener, that TI's Schottky TTL gives them a competitive edge. Not only in system performance, but also in the price, delivery and reliability of their equipment.

The reason is simple. Since TI introduced it in 1965, 54/74 TTL has become the most popular, most second-sourced logic form. It offers an unmatched combination of reliability, design simplicity, volume availability, low cost, versatility and MSI complexity. It has set the standards for the industry.

Schottky 54S/74S TTL, introduced by TI in 1970, still offers all these advantages—but adds greatly improved performance. And again, TI's Schottky TTL is setting the standards.

Broadest choice of functions

TI has introduced and delivered more Schottky TTL circuits than any other manufacturer. We've announced 17 new ones this year—decoders, D-registers, shift registers, multiplexers, arithmetic elements—for a total of 36 MSI and SSI functions available now. Within six months, there will be 12 more (including some high-performance memories).

Some benefits of TI's Series 54S/74S are:

- **Volume availability**—TI has been building Schottky circuits for 2½ years. High-volume production experience keeps yields up, delivery lead-time short, and distributor stocks full.
- **Proven reliability**—the same built-in reliability found in all TI 54/74 circuits has been proven for TI Schottky TTL by extensive factory testing and field experience.
- **Full temperature operation, full package choice**—both industrial (0° to 70°C) and military (-55° to 125°C) ranges for all MSI and SSI functions, available in plastic and ceramic DIPs and ceramic flat packs.
- **Improved system performance**—average gate speeds are less than 3 ns at 19mW.
- **Full compatibility**—TI Series 54S/74S Schottky is

fully compatible with all 54/74 TTL—standard, high-speed, low-power and low-power Schottky.

Series 54S/74S Schottky MSI circuits

110-MHz Shift Registers/Storage Registers

SN54S/74S174	Hex D-type storage register
SN54S/74S175	Quad D-type flip-flop, complementary outputs/clear
SN54S/74S194	4-bit bi-directional shift register
SN54S/74S195	4-bit parallel-access shift register

Arithmetic Elements

SN54S/74S86	Quadruple Exclusive—OR
SN54S/74S135	Quadruple Exclusive—OR/NOR
SN54S/74S181	4-bit arithmetic logic unit and function generator
SN54S/74S182	Carry look-ahead generator for SN54S/74S181

Data Selectors/Multiplexers

SN54S/74S151	8 to 1-line
SN54S/74S251	8 to 1-line with tri-state outputs
SN54S/74S157	Quad 2 to 1-line, true output
SN54S/74S257	Quad 2 to 1-line with tri-state true outputs
SN54S/74S158	Quad 2 to 1-line, inverting output
SN54S/74S258	Quad 2 to 1-line with tri-state inverting outputs
SN54S/74S153	Dual 4 to 1-line

Decoders/Demultiplexers

SN54S/74S138	3 to 8-line
SN54S/74S139	Dual independent 2 to 4-line

Series 54S/74S Schottky SSI circuits

SN54S/74S00	Quadruple 2-input positive-NAND gate
SN54S/74S03	Quadruple 2-input positive-NAND gate, o.c. output
SN54S/74S04	Hex inverter
SN54S/74S05	Hex inverter, o.c. output
SN54S/74S10	Triple 3-input positive NAND gate
SN54S/74S11	Triple 3-input positive AND gate
SN54S/74S15	Triple 3-input positive AND gate, o.c. output
SN54S/74S20	Dual 4-input positive NAND gate
SN54S/74S22	Dual 4-input positive NAND gate, o.c. output
SN54S/74S40	Dual 4-input positive NAND buffer
SN54S/74S64	4-2-3-2-input AND-OR-INVERT gate
SN54S/74S65	4-2-3-2-input AND-OR-INVERT gate, o.c. output
SN54S/74S74	Dual D-type edge-triggered flip-flop
SN54S/74S112	Dual J-K negative-edge-triggered flip-flop (125 MHz) with preset and clear
SN54S/74S113	Dual J-K negative-edge-triggered flip-flop (125 MHz) with preset
SN54S/74S114	Dual J-K negative-edge-triggered flip-flop (125 MHz), common clock and clear
SN54S/74S133	13-input NAND gate
SN54S/74S134	12-input NAND gate with tri-state output
SN54S/74S140	Dual 4-input positive-NAND line driver

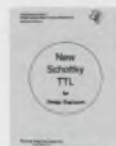

For Bulletin CC-408 on TI's 3-ns Schottky TTL, circle 216 on Service Card. Or write Texas Instruments Incorporated, P. O. Box 5012, M/S 308, Dallas, Texas 75222.



TEXAS INSTRUMENTS
INCORPORATED

Speed uhf microstrip amplifier design

by using an approach based on Smith-chart techniques and by avoiding common fabrication pitfalls.

Building uhf amplifiers with microstrip transmission lines offers the designer a number of advantages: high over-all efficiency, a variety of forms and ease of reproducibility. But getting the right design quickly and easily can be a problem: A direct mathematical calculation is tedious, while a computer calculation is not always possible.

Here is a step-by-step procedure that leads to a working amplifier on the "first cut." Smith-chart techniques give calculation shortcuts, while additional practical tips help overcome performance-degrading fabrication pitfalls.

Six basic steps to design

The design of a multistage amplifier calls for six basic steps:

Step 1: *Choose transistors* for required power output and gain.

Step 2: *Select microstrip-board* material and line width.

Step 3: *Compute characteristic impedance* and line wavelength.

Step 4: *Plot on a Smith chart* the normalized source and input impedance of the input-stage transistor.

Step 5: *Calculate matching network components.*

Step 6: *Repeat Smith-chart calculations* for interstage and output-stage matching networks.

To see how this procedure works, let's design a three-stage uhf amplifier (Fig. 1) with the following specifications: a frequency range of 450 to 512 MHz (tunable); minimum power output of 25 W; minimum gain of 15 dB; maximum input power of 800 mW and supply voltage (V_{CC}) of 12.5 V nominal.

Begin with the transistors

The first step—selecting the transistors—is based on power-supply voltage, output-power

capability and power gain at the highest operating frequency. The output-stage transistor should have sufficient power output at the required supply voltage. A search of the available types reveals that a 2N6136 can do the job with a minimum gain of 4 dB. A quick calculation shows that the power input to this device must be 10 W. Again, a survey of available parts shows that the 2N5946 is an obvious choice for the second, or driver, stage; it provides the required 10 W of drive with 6 dB of gain. A gain calculation reveals that 2.5 W of drive is required for the 2N5946.

Another look at available types shows that the 2N5944 is short by a half watt of the 2.5 W required. The next logical choice is a 2N5945, capable of 4 W output with a minimum gain of 8 dB. With the gain of the two stages already selected, the input totals approximately 390 mW—well below the 800 mW maximum specified.

Select a microstrip-board material

Next, choose the type of board and its thickness (Step 2). Teflon-bonded fiberglass is recommended because it is easy to work with. Although higher dielectric-constant materials are available for denser packaging, they are usually ceramics, which are much more difficult to work with.

The ratio of the line width to dielectric thickness for a given type of board determines the characteristic impedance (Z_0) of the microstrip line (Step 3). A line width equal to the width of the transistor leads (225 mil) is ideal, since it results in minimum discontinuities.

With a standard 1/16-inch fiberglass board and 225-mil line width, the characteristic impedance is calculated to be 41 Ω —a value that's easy to design with. In general, a characteristic impedance ranging from tens of ohms to a few hundred ohms is acceptable.

The characteristic impedance can be determined from published curves¹ or from²:

$$Z_0 = \frac{377 h}{(\epsilon_r)^{1/2} W_{eff} \left[1 + 1.735 \epsilon_r - 0.0724 \left(\frac{W_{eff}}{h} \right) - 0.836 \right]} \quad (1)$$

Glenn Young, Motorola Semiconductor Products, 5005 E. McDowell Rd., Phoenix, Ariz. 85008.

NOTE: All Microstrip Lines 5.72-mm Wide, 2.5-cm Long
 C12, C14—10 pF, Microwave Capacitor ATC Type 100-B-10-M-MS, Or Equiv.
 L1, L2, L3—5t #20AWB 3/16-Inch I.D.
 L4, L5, L6—0.15 μ H Molded Choke
 L7, L8—Ferroxcube VK200-20/4B, Or Equiv.
 Ferrite Bead—Ferroxcube 56 590 65/38, Or Equiv.

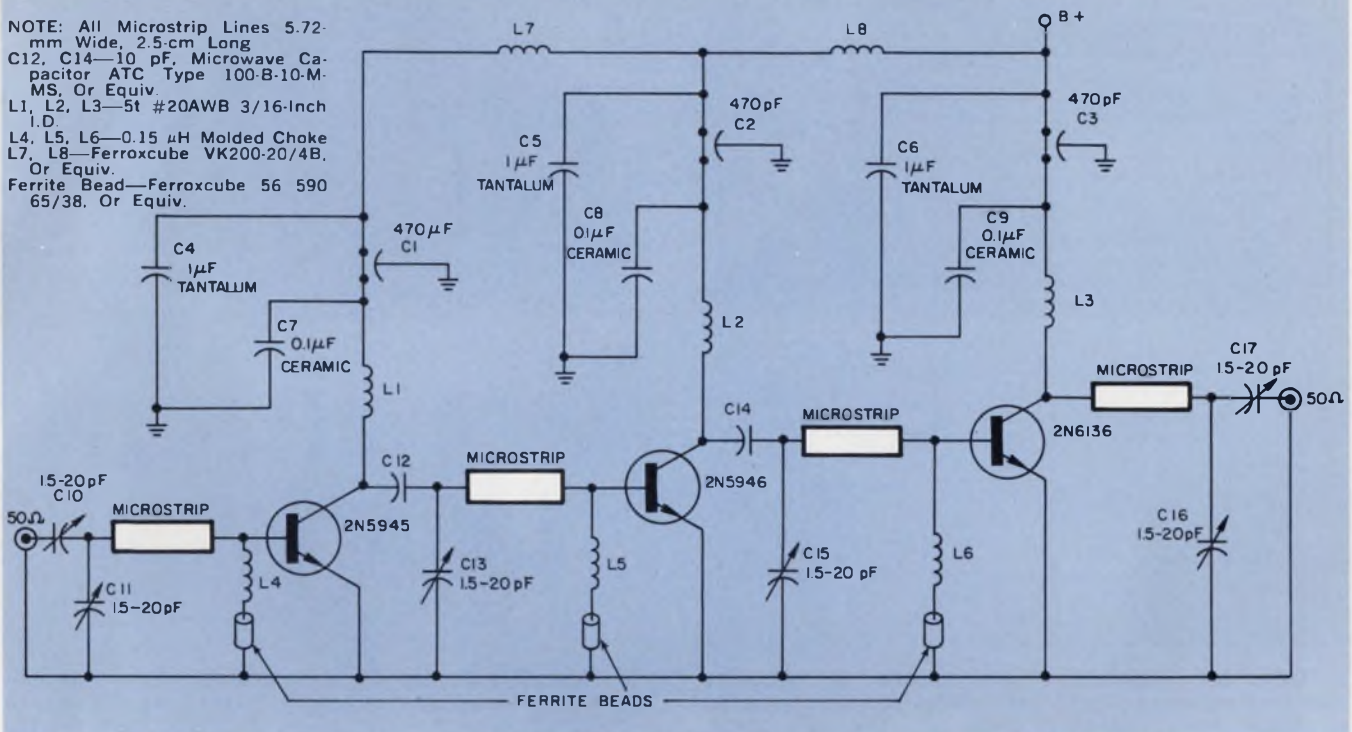

1. A three-stage, 450-to-512 MHz microstrip amplifier. This design features a minimum output power of 25

W, minimum gain of 15 dB and maximum input power of 800 mW. Nominal supply is 12.5 V.

where $W_{eff} = W + (t/\pi) [\ln(2h/t) + 1]$, W = width of microstrip line (225 mils), t = thickness of the conductor (1.4 mils for 1 oz copper), h = thickness of the dielectric (board thickness less $2t = 59.2$ mils) and ϵ_r = dielectric constant (2.5). (Inserting the values indicated results in a Z_0 of 40.89 Ω , or 41 Ω .)

The wavelength required as part of Step 3 is the effective wavelength at a convenient midband frequency in the microstrip line:

$$\lambda = \frac{\lambda_0}{\sqrt{\epsilon_r}} \left[\frac{\epsilon_r}{1 + 0.63(\epsilon_r - 1) \left(\frac{W_{eff}}{h} \right)^{0.1225}} \right]^{1/2} \quad (2)$$

where $\lambda_0 = c/f_0 =$ wavelength at frequency 470 MHz and $c =$ speed of light in a vacuum. The bracketed factor is a correction term to account for the mixed mode of propagation that exists in microstrip line. It can be used for microstrip line-width-to-height ratios of 0.6:1 or greater². For ratios less than 0.6:1, alter the (W_{eff}/h) factor in the denominator to $(W_{eff}/h)^{0.0279}$.

Inserting the appropriate values in Eq. 2 results in $\lambda = 43.9$ cm. This value includes the bracketed correction term, which is 1.088.

For Step 4—The Smith-chart plot—obtain the source and input impedances of the first-stage transistor. In our design, the source impedance is the commonly used 50 Ω . The transistor input impedance can be readily found from the data

sheet (Fig. 2a). Plot both impedances normalized to the microstrip characteristic impedance, 41 Ω .

This plot begins the synthesis of the first-stage matching network (Step 5). While a number of configurations can be used, the circuit of Fig. 2b allows a wide tuning margin to compensate for normal variations in such parameters as transistor impedances, either from part-to-part or over the band. A side benefit is that the series tuning element provides a dc blocking function, eliminating the need for coupling capacitors. For these reasons and because the circuit is so simple, it is selected for all stages.

Calculate matching network components

In general, the synthesis of the matching networks uses the large signal impedances of the transistors as specified on the data sheets. These parameters are not the same as those of small-signal, two-port parameters³.

Specifically, the conventional formula for the output resistance of a transistor— $R_L = V_{CC}^2/2P$, where $P =$ output power—is valid for the wide tuning range available with the lumped-constant networks used at lower frequencies. With uhf microstrip amplifiers a more accurate figure for output resistance is needed to reflect frequency dependence. For our design, the output resistance obtained by measurement in a microstrip test amplifier is used.

For the source impedance of $50 + j0 \Omega$, the

Transistor Series-Form Impedances At 470 MHz (From Data Sheets)

	$Z_{IN} (\Omega)$	$Z_{OUT} (\Omega)$
Input Transistor 2N5945	$1.7 + j1.7$	$7.8 - j7.5$
Interstage Transistor 2N5946	$1.2 + j3.1$	$5.0 - j0.5$
Output Transistor 2N6136	$1.3 + j4.11$	$3.2 + j1.96$

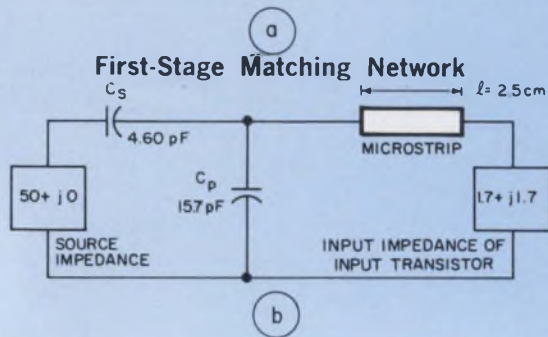

2. Transistor impedances are needed to calculate matching networks. These impedances can be measured or taken from published data (a). The input-stage matching network (b) sees a 50- Ω source and transistor input-impedance load.

normalized value is $1.22 + j0$. The load impedance of $1.7 + j1.7$ normalizes to $0.0416 + j0.0416$. These are plotted at points F and A, respectively, in Fig. 3.

An arbitrary choice is made here of 2.5 cm for the microstrip line length. The selection of any line length narrows the possible networks to one, while the choice of 2.5 cm leads to reasonably sized components. The electrical length = line length/ $\lambda = 2.5/43.9 = 0.057$ effective wavelengths.

Point A is rotated 0.057 wavelengths on a constant VSWR circle toward the generator to point B. Reactance, corresponding to C_p , must now be added in parallel with the impedance at this point. Since parallel additions are more easily handled in admittance form, point B is converted to an admittance by rotating it one-quarter wavelength on the same constant VSWR circle. This results in point C.

The constant-conductance circle that point C lies on is 0.26. The problem now is to move along this circle towards the generator until the reciprocal of the constant-resistance circle of the source impedance is intercepted. This circle does not exist on a standard Smith chart and must be constructed.

Determine the radius of the constant-resistance circle representing the real part of the source impedance. Then construct a circle of equal radius, with its center on the real axis and its circumference tangent to the outer radius of the chart at zero resistance. When this is

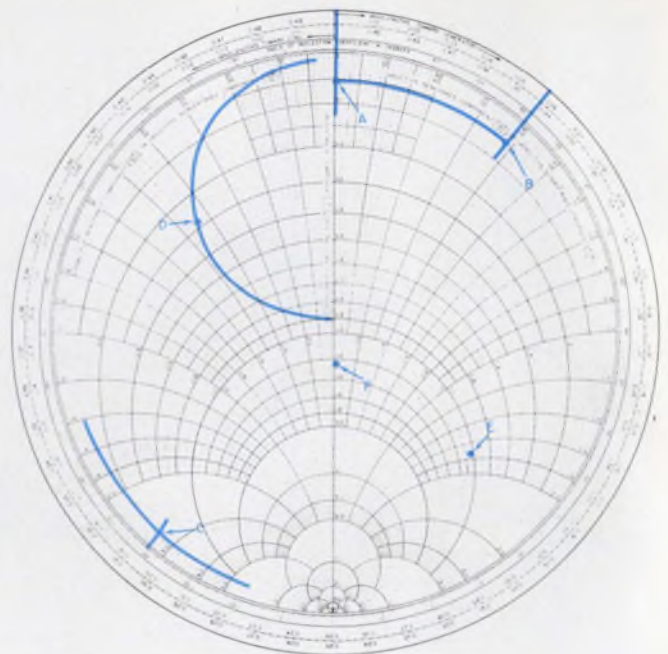

3. Capacitors C_s and C_p are calculated from this plot once the microstrip line length is fixed at 2.5 cm—a convenient value for our design. The capacitors for the remaining matching networks are determined in a similar manner.

done, the intercept with the 0.26 constant real circle is seen to lie at point D. The amount of parallel susceptance needed to move from point C to point D is $B_{CP} = (B_C - B_D)$. $Y_o = (2.36 - 0.38) 23.8 = 64.3$ mmhos. This is a parallel capacitance of $C_p = B_{CP}/2\pi f = 46.3/2\pi (470 \times 10^6) = 15.7$ pF.

All that remains is to determine the amount of reactance, corresponding to C_s , to reach the source at point F. First transpose point D, an admittance, to an impedance by rotating the point one-quarter wavelength on a constant VSWR circle. This moves point D to point E, which is on the 1.76 reactance line and represents a series reactance of $X_{CS} = X_E Z_o = 1.76 \times 42 = 74 \Omega$. A series capacitance with this reactance is $C_s = 1/2\pi f X_{CS} = 1/2\pi (470 \times 10^6) 74 = 4.6$ pF.

The interstage networks, as well as the output network, are solved in similar fashion with the following differences:

- In the case of the interstage networks, when the imaginary term of the source impedance is other than zero, plot point F at the complex conjugate of the source impedance.
- In the output network solution, the source is the output load of the amplifier ($50 + j0$), and the load is the collector impedance of the output device.

The completed amplifier, with performance data, is shown in Fig. 4. The use of porcelain dielectric chip capacitors (C12 and C14) for the series elements in the interstage networks pro-

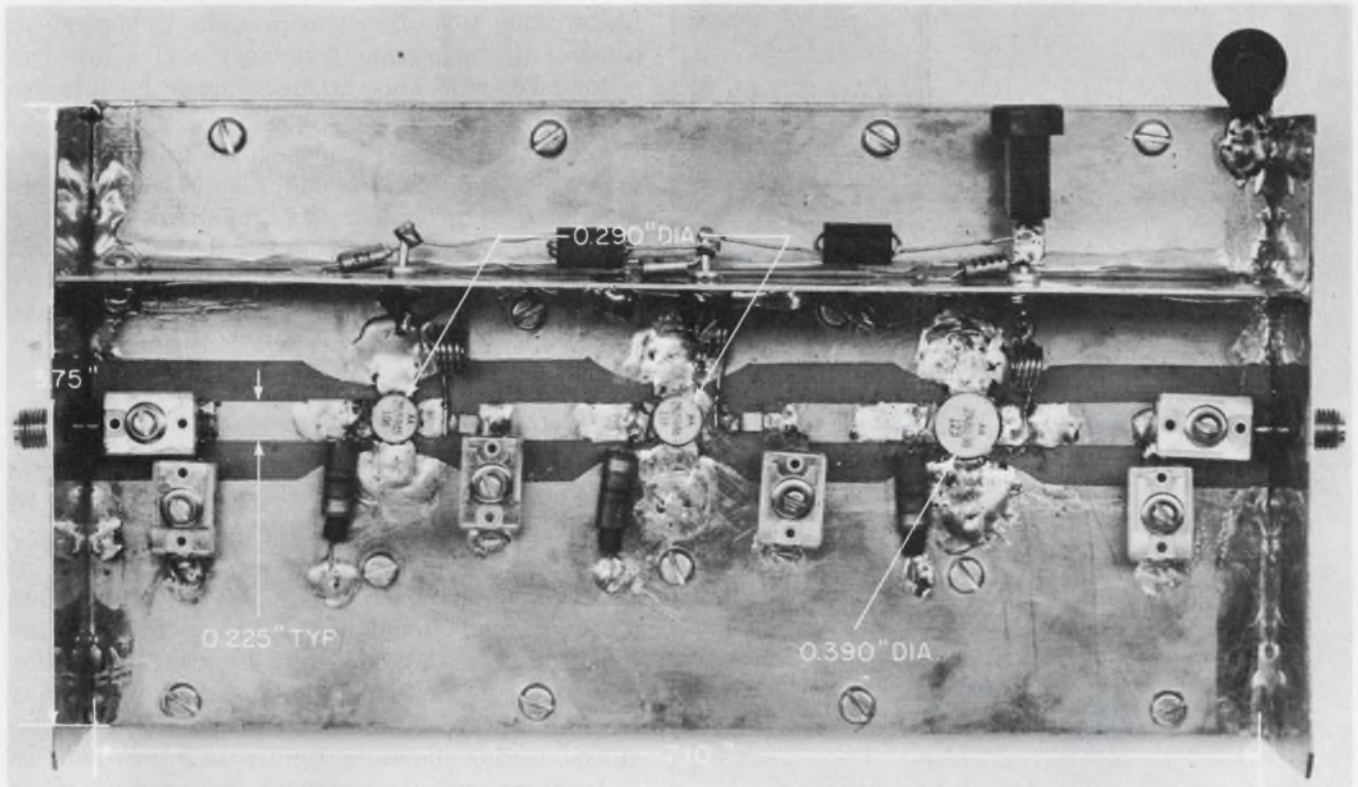

vides an additional 2.5 to 3.0 dB of gain over that obtained with compression trimmers. The chip dielectric capacitor use also reduces the number of tuning adjustments.

Don't forget practical problems

As in all rf power applications, solid-emitter grounds are imperative. In microstrip amplifiers, gain can be increased by grounding both emitter leads to the bottom fold of the microstrip board. Strips of copper foil can be wrapped through the transistor mounting hole.

While stability under normal operating conditions is essential, it should also be maintained over as wide a range of supply voltage and drive levels as possible. A good rule of thumb is this: If amplifier stability is maintained at all rf drive levels, with the supply voltage reduced to between 3 and 5 V, the amplifier will remain stable under all conditions of load.

Maintaining stability is a key factor in protecting the transistors from damage. In a stable amplifier that has adequate heat sinking, the transistors will withstand high VSWR loads, including open and shorted ones, without damage. The major controlling factors in obtaining wide range stability are these:

- Mechanical layout. A good one includes good emitter grounds, compact layout and short ground paths. Short and intelligent positioning of conducting paths reduces stray inductance and capacitance.

4. The completed amplifier is mounted on a 1/16-inch-thick Teflon-bonded fiberglass board with one oz copper on both sides (above). The over-all dimensions are about 4 × 7 inches. Performance data (below) reveal higher gains resulting from the use of dielectric chip capacitors for the series elements in the interstage networks.

Microstrip-Amplifier Performance Data

Frequency (MHz)	450	480	512
Power Gain (dB)	18	17.2	16
Bandwidth To -1 dB Points (MHz)	5	6	8
Over-all Efficiency (%)	44.5	46.5	48.5
Power Output (W)	25	25	25
Harmonics	All Harmonics Greater Than -20 dB.		
Stability	Amplifier Stable Under All Conditions Of Drive Down To $V_{cc} = 5.0$ V.		
Burnout	No Damage To Any Transistor With Load Open And Shorted and 0 to $\pm 180^\circ$ Phase Angle.		

- Biasing. The devices are all zero-biased for Class C operation. The use of relatively low Q-base chokes, with ferrite beads on the ground side, will maintain base-circuit stability. In some applications, the use of a resistor in series with the ground side of the base chokes on the output and driver stages may enhance stability. The approximate values of these resistors should be 10 Ω , 1/2 W for the driver and 1 Ω , 1/2 W for the output device. The addition of these stabilizing series resistors causes a slight loss in gain (about

World's smallest



power supply for op amps...\$14

This 2.3x1.8x1-inch module has tracking outputs of ± 15 V @ 25 ma with regulation of $\pm 0.1\%$ and ripple of 1 mv. It costs \$14.00 in 1,000 lots and only \$24.00 for one. Requisition Model D15-03. (For ± 12 V @ 25 ma, order Model D12-03.) Three-day shipment guaranteed.



Acopian Corp., Easton, Pa. 18042
Telephone: (215) 258-5441

INFORMATION RETRIEVAL NUMBER 34

WORLD'S #1 MINIATURE SWITCH

The original ALCOSWITCH has been expanded to include a number of "families" of toggles, pushbuttons, slides, rockers, paddles, and levers. All types available in various switching configurations. Make ALCO your one source of supply.



ALCO

ELECTRONIC PRODUCTS, INC.
NORTH ANDOVER, MASS. 01845

INFORMATION RETRIEVAL NUMBER 35

PLASTIC KNOBS

WITH SPUN ALUMINUM TOPS AND BRASS INSERTS

AS LOW AS
16¢
IN QUANTITY



ALCO KNOB
STANDS ALONE

DIV. OF ALCO ELECTRONIC PRODUCTS, INC., LAWRENCE, MASS.

INFORMATION RETRIEVAL NUMBER 36

0.1 to 0.2 dB over-all).

■ Collector-supply feed. The collector-supply feed system is designed to provide decoupling at or near the operating frequency and a low collector load impedance at much lower frequencies than the operating frequency.

■ Heat sinking. To protect against burn-out under all conditions of load, adequate heat sinking must be provided. It's important to use a good grade of thermal compound, such as Dow-Corning 340, on the interface between the device and its heat sink. Other companies also make compounds with good thermal qualities.

Take care in handling the device

Although the stripline package is a rugged assembly, some care in handling it should be observed. The most important mechanical parameter is stud-torque, specified on the data sheet at 6.5 inch-pounds maximum. This is an absolute maximum and should not be exceeded under any circumstances. A good limit to use in production assembly is 6 inch-pounds, and if for any reason repeated assembly/disassembly is required, torque should be limited to 5 inch-pounds.

Another major precaution to observe is to avoid upward pressure on the leads near the case body. Stresses of this type can crack or dislodge the cap. This type of stress sometimes occurs because of adverse tolerance build-up in dimensions when the device is mounted through a microstrip board onto a heat sink. Many times this stress develops because of solder build-up on the copper foil when a device is replaced. If device replacement should become necessary, take care to flow all solder away from the mounting area before the replacement device is attached. Finally, the stud nut should be carefully tightened with a calibrated torque wrench before the device leads are soldered to the board. ■■

References:

1. Caulton, M., Hughes, J. J., and Sobol, H., "Measurements on the Properties of Microstrip Transmission Lines for Microwave Integrated Circuits," *RCA Review*, September, 1966.
2. Sobol, H., "Extending IC Technology to Microwave Equipment," *Electronics*, March 20, 1967.
3. Hejhall, R., "Systemizing RF Power Amplifier Design," Motorola Application Note AN-282A.

Bibliography:

Smith, P. H., "Electronic Applications of the Smith Chart," McGraw-Hill, 1969.

Wheeler, H. A., "Transmission-Line Properties of Parallel Wide Strips by a Conformal-Mapping Approximation," *IEEE Trans. Microwave Theory and Techniques*, Vol. MTT-12, May, 1964.

Wheeler, H. A., "Transmission-Line Properties of Parallel Strips Separated by a Dielectric Sheet," *IEEE Trans. Microwave Theory and Techniques*, Vol. MTT-3, March, 1965.

Microwave Engineers Technical and Buyers Guide, Edition of the *Microwave Journal*, 1969.

New from TI: A line of low-cost relays.

You're an OEM manufacturer. One of your responsibilities is specifying relays. We've got something that could make you look good.

A new line of snap-acting time delay relays costing only \$1.10 to \$3.00 when ordered in quantity – up to 25% less than conventional creep-acting blade relays – 50% less than snap-acting blade relays – less than many conventional magnetic relays or contactors!

They're smaller than ordinary relays, too. They'll operate in any position, and they're resistant to shock and vibration. What's more, they have a proven life of over 100,000 switching cycles.

The secret is a snap-acting disc we call Klixon® and a new, low-cost electrically heated ceramic element mounted in a compact phenolic housing.

We have technical literature that spells it all out. You should send for it now.



Texas Instruments Incorporated
MS 10-5/OED
Attleboro, Mass. 02703

Gentlemen: Please send me your literature on time-delay relays.

Name _____

Company _____

Address _____

City _____

State _____ Zip _____

20 U/L recognized configurations to choose from.

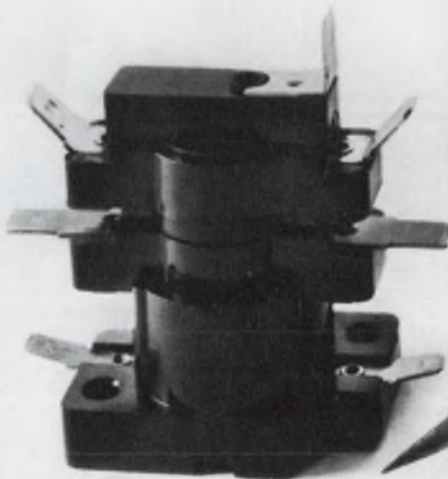

Contact ratings up to 10KW ... 100,000 cycles.

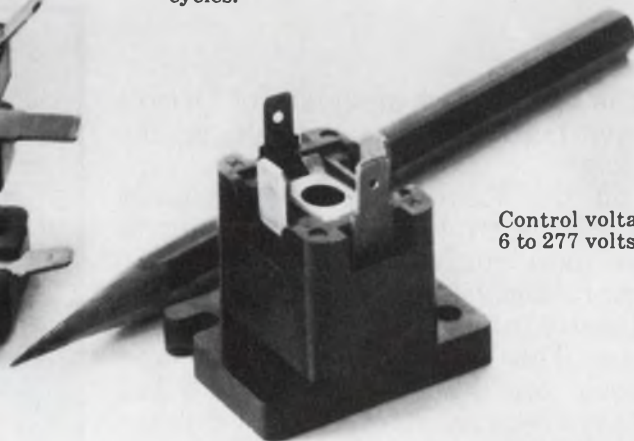

Control voltages from 6 to 277 volts.

Voltage compensated, operates under wide variations in voltage.

Relays can be re-set manually or automatically.

Shown actual size.

TEXAS INSTRUMENTS
INCORPORATED

INFORMATION RETRIEVAL NUMBER 37

Delco's
TO-66 silicon
transistors for

BIG POWER

Now the high-energy capability of Delco's silicon power transistors is available in the TO-66 package.

Like all the Kokomoans' silicon power transistors, they're triple diffused and built to survive the most rugged applications. Their high-voltage ratings make it practical to operate them directly from rectified 117-volt or 220-volt ac line. This allows lower weight and smaller circuit size because fewer, less bulky components are required than with low-voltage higher current systems. And, their energy capability is backed by the surest rating in the business—Pulse Energy Testing.

Use the new DTS-660 series when you need the high-voltage capability of our DTS-410, DTS-423 or DTS-425 but, in TO-213MA (TO-66) size.

They're in stock at Delco distributors now. For additional information, prices, and complete data, give yours a call or contact us at our nearest regional office.

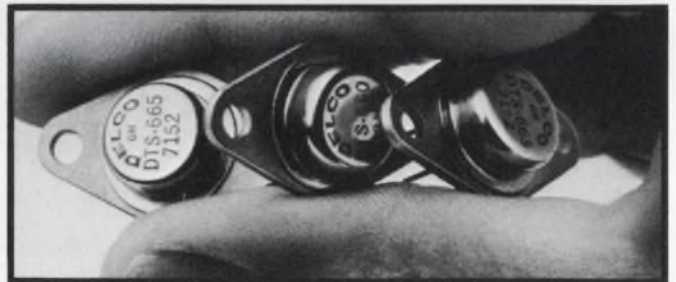

Type	I_c (Cont) (Peak)	V_{CE0}	h_{FE} @ $I_c = 1.0A$ min./max.	$V_{CE0}(sus)$ min.	P_D min.	Suggested resale price 1-99 quantity
DTS-660	3.5A 10.0A	200V	30 90	200V	60W	\$5.93 ea.
DTS-663	3.5A 10.0A	400V	30 90	325V	60W	\$9.57 ea.
DTS-665	3.5A 10.0A	500V	30 90	400V	60W	\$14.94 ea.

NPN triple-diffused silicon transistors in JEDEC TO-213MA (TO-66) packages.

IN SMALL SPACES



Delco Electronics

DIVISION OF GENERAL MOTORS CORPORATION, KOKOMO, INDIANA

Now available from these distributors in production quantities:

ALA., BIRMINGHAM • Forbes Distributing Co., Inc. (205)-251-4104
ARIZ., PHOENIX • Sterling Electronics (602)-258-4531
CAL., LOS ANGELES • Kierulff Electronics, Inc. (213)-685-5511 • Radio Products Sales, Inc. (213)-748-1271
CAL., PALO ALTO • Kierulff Electronics, Inc. (415)-968-6292
CAL., REDWOOD CITY • Cramer/San Francisco, (415)-365-4000
CAL., SAN DIEGO • Radio Products Sales, Inc. (714)-292-5611
CAL., SAN DIEGO • Kierulff Electronics, Inc. (714)-278-2112
COLO., DENVER • Cramer/Denver (303)-758-2100 • Denver Walker Electronics (303)-935-2401
CONN., NORWALK • Harvey/Connecticut (203)-853-1515
FLA., MIAMI SPRINGS • Powell/Gulf Electronics (305)-885-8761
ILL., ROSEMONT (Chicago) • Kierulff Electronics (312)-678-8560
ILL., SKOKIE (Chicago) • Merquip Electronics (312)-282-5400
IND., INDIANAPOLIS • Graham Electronics Supply, Inc. (317)-634-8202
MD., BALTIMORE • Radio Electric Service Co. (301)-823-0070
MASS., NEEDHAM HEIGHTS • Kierulff Electronics, Inc. (617)-449-3600
MASS., NEWTON • The Greene-Shaw Co., Inc. (617)-969-8900

MICH., ROMULUS • Harvey-Michigan (313)-729-5500
MINN., MINNEAPOLIS • Stark Electronics Supply Co. (612)-332-1325
MO., KANSAS CITY • Walters Radio Supply, Inc. (816)-531-7015
MO., NO. KANSAS CITY • LCOMP-Kansas City, Inc. (816)-221-2400
MO., ST. LOUIS • LCOMP-St. Louis, Inc. (314)-647-5505
N.J., CLIFTON • Eastern Radio Corporation (201)-365-2600. (212)-244-8930
N.Y., BINGHAMTON • Harvey/Federal (607)-748-8211
N.Y., EAST SYRACUSE • Cramer/Eastern (315)-437-6671
N.Y., ROCHESTER • Cramer/Rochester (716)-275-0300
N.Y., WOODBURY • Harvey/New York (516)-921-8700, (212)-582-2590
OHIO, CINCINNATI • United Radio, Inc. (513)-761-4030
OHIO, CLEVELAND • Pattison Supply (216)-441-3000
OHIO, DAYTON • Kierulff Electronics (513)-278-9411
OKLA., TULSA • Radio, Inc. (918)-587-9123
PENN., PHILADELPHIA • Almo Electronics (215)-676-6000
PENN., PITTSBURGH • RPC Electronics (412)-782-3770
S.C., COLUMBIA • Dixie Radio Supply Co., Inc. (803)-253-5333

TEXAS, DALLAS • Adleta Electronics Co. (214)-741-3151
TEXAS, FORT WORTH • Adleta Electronics Co. (817)-336-7446
TEXAS, GARLAND • Kierulff Electronics, Inc. (214)-271-2471
TEXAS, HOUSTON • Harrison Equipment Co., Inc. (713)-224-9131
UTAH, SALT LAKE CITY • Cramer/Utah (801)-487-3681
VA., RICHMOND • Meridian Electronics, Inc., a Sterling Electronics Company (703)-353-6648
WASH., SEATTLE • Kierulff Electronics, Inc. (206)-763-1550
WASH., TACOMA • C & G Electronics Co. (206)-272-3181
CANADA, ONT., SCARBOROUGH • Lake Engineering Co., Ltd. (416)-751-5980
ALL OVERSEAS INQUIRIES:
General Motors Overseas Operations
Power and Industrial Products Dept.,
767 Fifth Avenue, New York, N.Y.
10022. Phone: (212)-486-3723.

Kokomoans' Regional Headquarters.
Union, New Jersey 07083,
Box 1018, Chestnut Station,
(201) 687-3770.
El Segundo, Calif. 90245,
354 Coral Circle, (213)
640-0443.
Kokomo, Ind. 46901, 700 E.
Firmen, (317) 459-2175
(Home Office).



INFORMATION RETRIEVAL NUMBER 38

Detect errors in complex logic with this two-rail checking technique. The method provides a less expensive solution than conventional parity or duplication schemes.

Two-rail logic is an error-checking technique that is more versatile than any other. And even if that doesn't convince you, this may: It is also significantly less expensive.

In two-rail logic all data and control signals are generated in both true and complement form—that is, on two rails. The signals observed on the rails of any pair should always be complementary. If they aren't, an error condition exists.

Typically, the cost of a two-rail checking scheme is only 50 to 80% greater than that of an unchecked circuit, with the greatest savings occurring with the more complex circuits. This compares with the 100% increase that results when redundant methods are used.

Usually engineers employ such redundancy techniques as parity or duplication to detect errors in computing systems. Besides being more expensive, these also have a number of disadvantages.

Parity is useful and economical in storage systems where the data are moved but remain essentially unchanged. However, once the data are modified, as in addition or subtraction, the maintenance of correct parity becomes as complex as the modification of the data itself. It is very difficult to design a parity circuit that effectively checks an arithmetic or complex control unit, and such designs usually more than double the cost of an unchecked unit.

A second approach is to duplicate all of the circuitry and compare the two outputs. But, like parity, this method doubles the cost of the unit.

In contrast, two-rail logic allows reliable error checking to be maintained throughout complex logical transformations of data.

The technique can be understood by looking at the selection circuits in Figs. 1 and 2. In the discussion of these and other circuits, the following conventions are used: A pair of signal rails is designated by the upper-case character X; the individual rails are designated by the

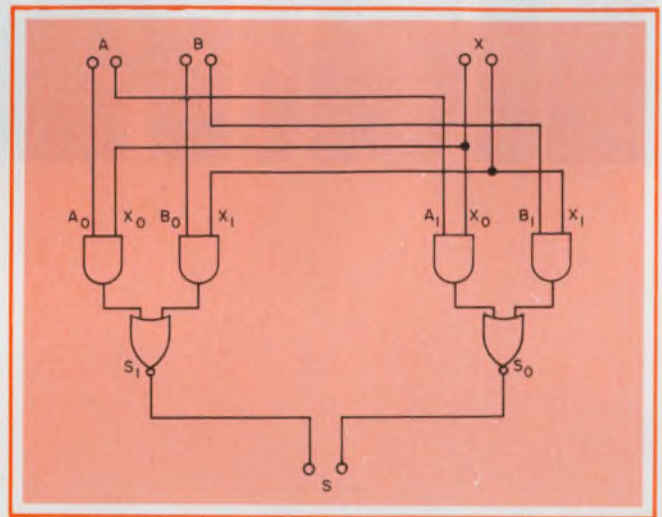

1. Application of two-rail logic is demonstrated by selection circuit in which all signals are generated in both true and complement form.

subscripted upper-case characters X_0 , X_1 ; and the value of the signal carried by the pair is designated by the corresponding lower-case character x . Under nonerror conditions, X_0 carries a logical ONE when $x = \text{ZERO}$ and X_1 carries a logical ONE when $x = \text{ONE}$.

Equal number of inversions are needed

Figures 1 and 2 represent two-rail implementations of the function

$$s = ax + bx.$$

Thus when $x = \text{ZERO}$, a is selected ($s = a$), and when $x = \text{ONE}$, b is selected ($s = b$).

In Fig. 1 the function is obtained with two independent generators, each of which inserts only one level of inversion between its inputs and outputs. In the circuit of Fig. 2, however, the circuit generating S_0 has two levels of inversion between the X inputs and the output, while S_1 has only one level.

For both of these circuits, consider the situation when $a = \text{ZERO}$, $b = \text{ONE}$, $x = \text{ONE}$. In a non-error situation this means that $A_0 = B_1 = X_1 = \text{ONE}$; $A_1 = B_0 = X_0 = \text{ZERO}$. The result of this is that $S_1 = \text{ONE}$, $S_0 = \text{ZERO}$,

Keith A. Duke, Advisory Engineer, Systems Development Div., International Business Machines Corp., Poughkeepsie, N. Y. 12602.

and, therefore, $s = \text{ONE}$.

Now consider a situation where an error occurs in the generation of X_0 , so that $X_0 = X_1 = \text{ONE}$. The circuit of Fig. 1 will then produce $S_0 = S_1 = \text{ZERO}$ and thus propagate an error indication. On the other hand, the circuit of Fig. 2 will produce $S_0 = \text{ONE}$, $S_1 = \text{ZERO}$. This is an erroneous result, which is not indicated as such.

In other words, a change in state of line X_0 from ZERO to ONE will cause S_0 to change from ZERO to ONE and S_1 to change from ONE to

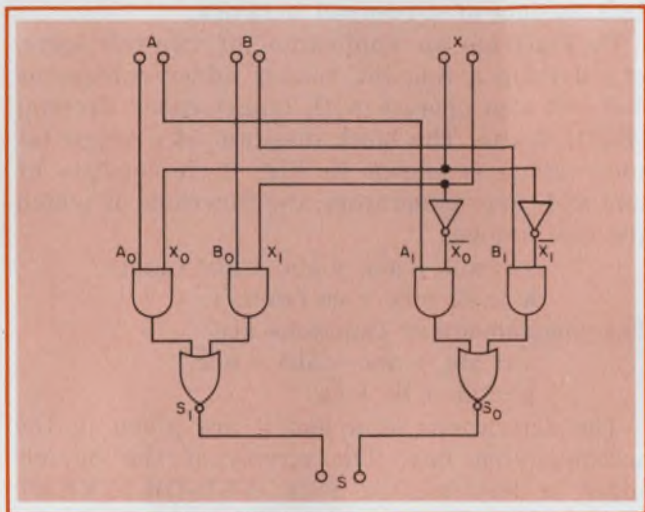

2. Additional stage of inversion in S_0 generator masks error, since S_0 and S_1 outputs are complementary. Equalizing the true and complement inversions avoids this.

ZERO. This situation can occur only when the number of inversions between the erroneous input and the two outputs differ by an odd number.

Signal inverters are frequently needed to provide sufficient power to drive subsequent stages. To insure that propagated errors are detectable when inverters are needed, apply this rule: The number of inversions an input signal must undergo in generating a function must equal the number that the input signal must undergo to generate its complement.

Thus a change in state of any input signal to any pair of function generators cannot affect both output signals simultaneously. It is best to generate every signal pair with only one inversion in each generator. Also, extra inverters should be added only if they are really needed for driving power.

Errors are propagated

This does not mean, however, that a complex logical network must be duplicated entirely to provide two-rail checking. If the network can be divided into subfunction stages, both the true

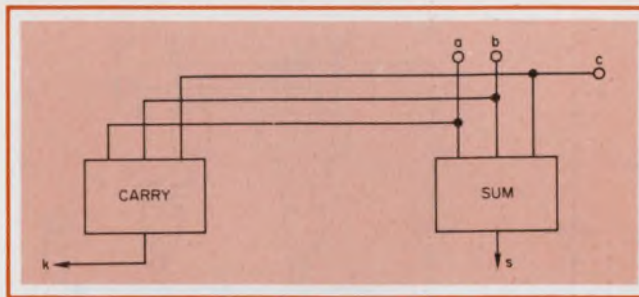

3. Block diagram of a conventional single-bit adder stage that uses single-rail logic. Sum and carry outputs are shown.

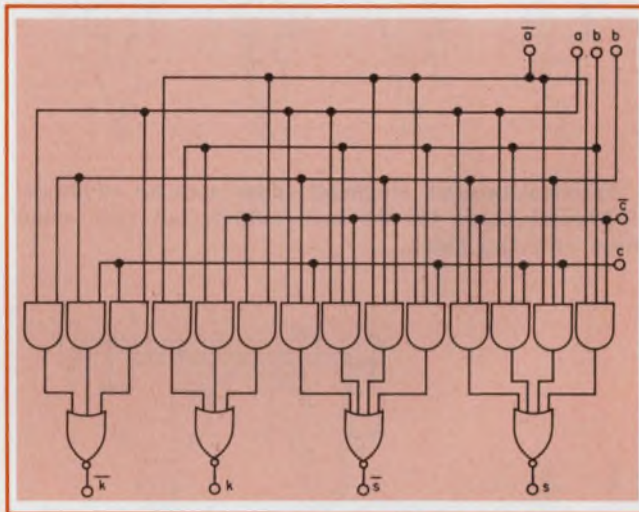

4. The single-bit adder implemented with two-rail AND-OR-INVERT logic. This configuration requires 14 AND gates, with each input driving six gates.

How to get complementary functions

Two basic rules are used to generate the complement of a Boolean expression in AND-OR form. The first rule is known as DeMorgan's Theorem:

$$\overline{(a + b)} = \bar{a} \cdot \bar{b}.$$

The second rule has no generally accepted name:

$$(x + a) \cdot (\bar{x} + b) = x \cdot b + \bar{x} \cdot a.$$

To derive the complement of s :

$$s = a \cdot b \cdot c + a \cdot \bar{b} \cdot \bar{c} + \bar{a} \cdot b \cdot \bar{c} + \bar{a} \cdot \bar{b} \cdot c.$$

Applying the first rule twice, we get

$$\bar{s} = (\bar{a} + \bar{b} + \bar{c}) \cdot (\bar{a} + b + c) \cdot (a + \bar{b} + c) \cdot (a + b + \bar{c}).$$

This expression is then factored, and the second rule is applied twice:

$$\begin{aligned} \bar{s} &= [\bar{a} + (\bar{b} + c) \cdot (b + c)] \cdot [a + (\bar{b} + c) \cdot (b + c)] \\ &= (\bar{a} + \bar{b} \cdot c + b \cdot \bar{c}) \cdot (a + \bar{b} \cdot c + b \cdot \bar{c}) \\ &= a \cdot \bar{b} \cdot c + a \cdot b \cdot \bar{c} + \bar{a} \cdot \bar{b} \cdot \bar{c} + \bar{a} \cdot b \cdot c. \end{aligned}$$

This technique allows most complements to be generated. As a further example, let's complement the expression k for a binary carry:

$$k = \bar{p} \cdot a + p \cdot c$$

Applying the first rule, we get

$$\bar{k} = (p + \bar{a}) \cdot (\bar{p} + \bar{c}).$$

Applying the second rule:

$$\bar{k} = \bar{p} \cdot \bar{a} + p \cdot \bar{c}.$$

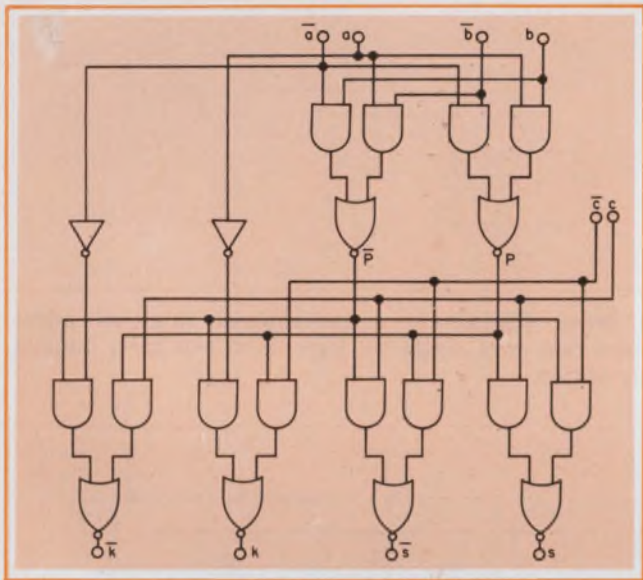

5. Practical two-rail, single-bit adder uses an additional OR-INVERT stage for the sum output, but each input drives only two gates.

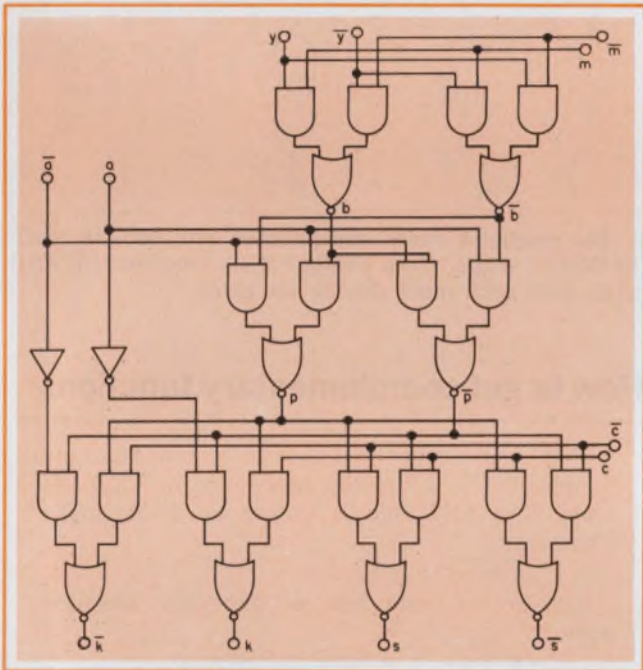

6. The single-bit adder is made into an adder/subtractor by adding the control signal, m, and an EXCLUSIVE-OR to the circuit of Fig. 5.

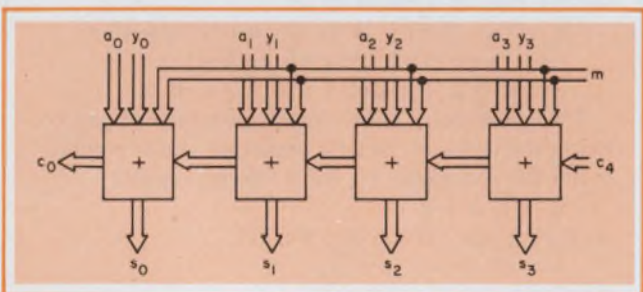

7. Four-bit adder/subtractor is formed by connecting four single-bit stages.

and complement signals from any stage can be used to generate the two required signals at a subsequent stage. Thus failures in early stages that propagate to later stages are detectable and the need for inverter stages is eliminated.

The circuit of Fig. 1 illustrates another feature of two-rail logic. If an error occurs when a and b have the same value, the output will be correct. Thus an error appearing at the input of any stage is either detectable at the output or it does not affect the output—the error is then effectively masked. Since propagated errors are detectable, error checkers are needed only at the final outputs of a two-rail network.

To illustrate an application of two-rail logic, let's develop a four-bit, binary adder/subtractor that can also operate with binary-coded decimal (BCD) digits. The block diagram of a single-bit adder stage is shown in Fig. 3. It consists of sum and carry generators, the functions of which are well known:

$$s = abc + \bar{a}\bar{b}c + a\bar{b}\bar{c} + \bar{a}b\bar{c} \text{ (sum)}$$

$$k = ab + bc + ca \text{ (carry)}.$$

The complementary functions are

$$\bar{s} = \bar{a}\bar{b}\bar{c} + \bar{a}bc + a\bar{b}c + a\bar{b}\bar{c}$$

$$\bar{k} = \bar{a}\bar{b} + \bar{b}\bar{c} + \bar{c}\bar{a}.$$

The derivations of s and k are given in the accompanying box. The circuit of the one-bit adder is implemented with AND-OR-INVERT (AOI) logic (Fig. 4). This circuit represents the minimum number of logic stages necessary to obtain the desired function. But in this configuration each input must drive six AND-gates; also more gates than are strictly necessary are used. A more practical circuit (Fig. 5) derives an intermediate half-sum or carry-propagate signal, p. The resulting set of equations are

$$\bar{p} = \bar{a}\bar{b} + \bar{a}b$$

$$p = \bar{a}b + \bar{a}\bar{b}$$

$$\bar{s} = \bar{p}\bar{c} + \bar{p}c$$

$$s = \bar{p}c + p\bar{c}$$

$$\bar{k} = \bar{p}a + p\bar{c}$$

$$k = \bar{p}a + p\bar{c}.$$

The two inverters in the path from the a to the k generator prevent the propagation of a false carry if an error causes both the a and \bar{a} lines to be set to ONE. (They are not strictly necessary, since such an error should appear at the sum output, s, without the inverters.) Note that although the sum output passes through two stages of AOI logic, the number of stages of logic in the carry-propagation path is not increased.

To convert the adder of Fig. 5 into a subtractor, only one input need be inverted. This can be done with a control signal, m, and an EXCLUSIVE-OR (Fig. 6):

$$b = \bar{y}\bar{m} + \bar{y}m$$

$$\bar{b} = \bar{y}m + ym.$$

Figure 7 depicts four such stages connected to

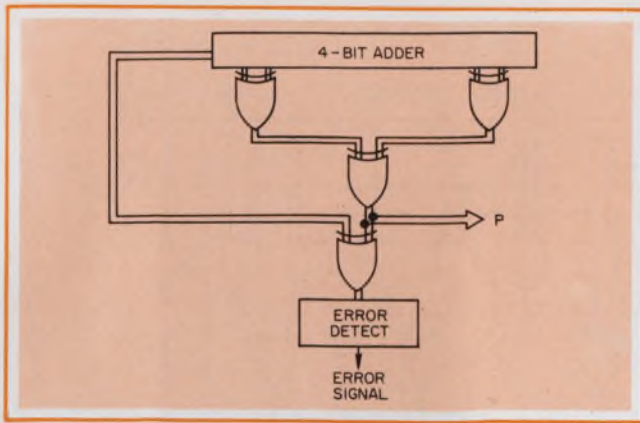

8. Sum and carry outputs of the four-bit adder are fed into an EXCLUSIVE-OR tree for a complete error check. The P, or parity, output is obtained as a by-product. The P, or parity, output is obtained as a by-product.

form a four-bit adder-subtractor.

All of the stages shown in these circuits propagate a single error at their inputs to a detectable error at their outputs. If a single input pair carries noncomplementary signals that affect an output, the output will also carry noncomplementary signals.

One detector checks entire network

In most circuits, however, error propagation cannot be guaranteed if more than one input pair is in error. One exception is the EXCLUSIVE-OR, which can be assembled into a tree (Fig. 8); any single or multiple error at the tree input will cause an error to appear at its output. Thus a single error detector placed at the output will check the entire network, whose outputs are fed into the tree. Fig. 8 shows such a checking tree connected to the four-bit adder. The output pair, P, represents the parity of the adder sum-output group.

If the adder is to be used with data transferred serially, it is necessary to delay the carry output for one cycle before using it as an input carry. This can be done by latching the signal at the end of each cycle. However, to maintain the integrity of the two-rail system, a latch-pair is required. Furthermore, if a two-phase clock system is being used, two latch-pairs will be necessary (Fig. 9).

The latch-pairs should be very carefully designed; their clock lines should also be two-rail encoded. This guards against a failure of a clock line that could result in a latch-pair not changing its value. No error would be detected in that event. Fig. 10 illustrates a suitable two-rail latch circuit.

The four-bit binary adder can be converted to a decimal adder (with each decimal digit coded by four binary bits) by adding two simple logic, or decimal-correction, networks: one at the input

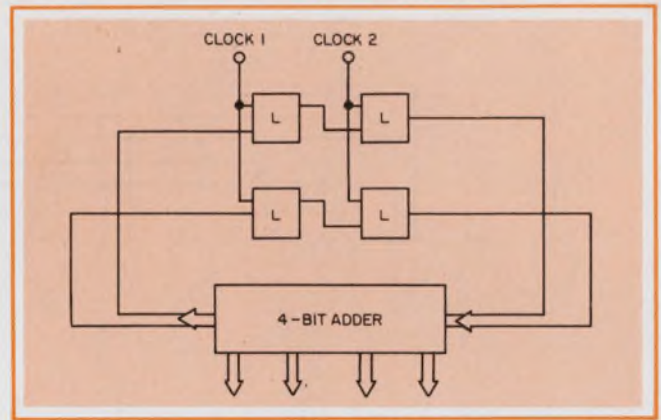

9. Two-rail latch pairs, connected as shown, are needed to delay the input carry with systems that use serial data transfer and two-phase clocks.

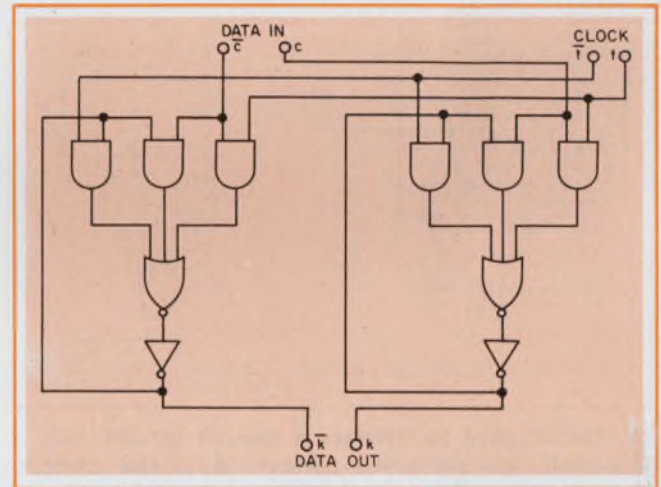

10. Latch-pair implemented with two-rail logic. Two of these are required in the circuit of Fig. 9.

to the adder and one at its output. The input network adds a count of six to each four-bit group, and the output network subtracts six when there is no carry-out from the group. (During subtraction the input network is bypassed, and the output network operates exactly as for addition.)

The decimal-correction networks operate differently for the various bits of each digit. Thus if the input digit is represented before correction by the bits x_0, x_1, x_2, x_3 , and after correction by a_0, a_1, a_2, a_3 , then the network is represented by the following equations:

$$\begin{aligned} a_0 &= x_0 + h \cdot x_1 + h \cdot x_2 \\ a_1 &= \bar{h} \cdot x_1 + x_1 \cdot x_2 + h \cdot \bar{x}_1 \cdot \bar{x}_2 \\ a_2 &= \bar{h} \cdot x_2 + h \cdot \bar{x}_2 \\ a_3 &= x_3 \\ \bar{a}_0 &= \bar{h} \cdot \bar{x}_0 + x_0 \cdot \bar{x}_1 \cdot \bar{x}_2 \\ \bar{a}_1 &= \bar{h} \cdot \bar{x}_1 + \bar{x}_1 \cdot x_2 + h \cdot x_1 \cdot \bar{x}_2 \\ \bar{a}_2 &= \bar{h} \cdot \bar{x}_2 + h \cdot x_2 \\ \bar{a}_3 &= x_3 \end{aligned}$$

(Note that the signal m controls subtraction; d controls decimal operation; and h represents the combination $d \cdot m$)

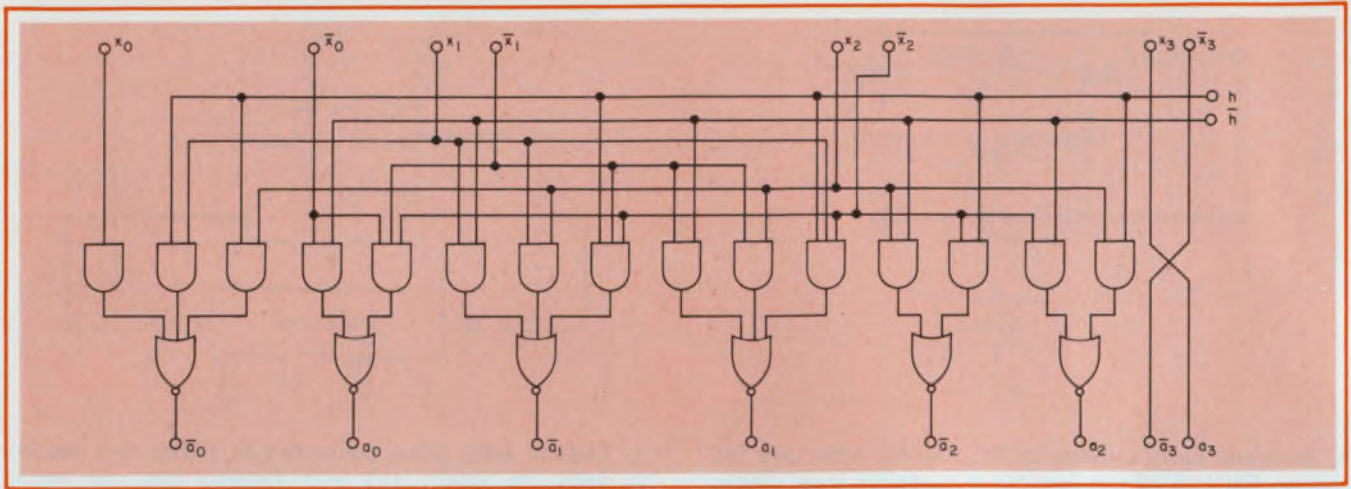

11. Input decimal-correction network adds a count of six to each four-bit group. If a similar network is con-

nected at the output of the adder it subtracts a count of six.

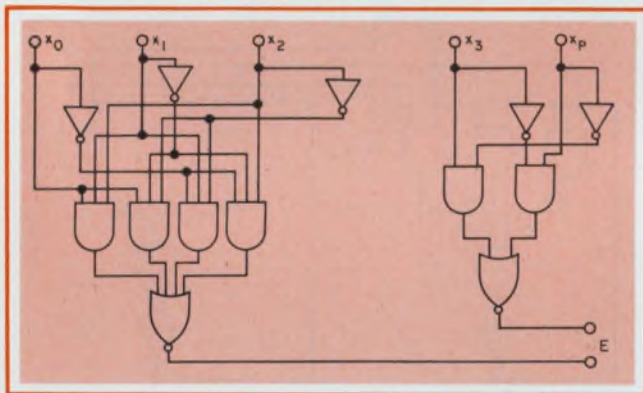

12. Circuit used to interface a two-rail network with a single-rail, parity-checked network. E carries complementary values if the input parity is correct.

The input decimal-correction network is illustrated in Fig. 11.

Similarly the output decimal-correction network corrects the adder input bits s_0, s_1, s_2, s_3 , to z_0, z_1, z_2, z_3 . The signal j represents the combination $d \cdot c_0$. The following equations then define the network:

$$\begin{aligned} z_0 &= \bar{j} \cdot s_0 + s_0 \cdot s_1 \cdot s_2 \\ z_1 &= \bar{j} \cdot s_1 + s_1 \cdot \bar{s}_2 + j \cdot \bar{s}_1 \cdot s_2 \\ z_2 &= \bar{j} \cdot s_2 + j \cdot s_2 \\ z_3 &= x_3 \\ \bar{z}_0 &= \bar{s}_0 + j \cdot \bar{s}_1 + j \cdot s_2 \\ \bar{z}_1 &= \bar{j} \cdot \bar{s}_1 + \bar{s}_1 \cdot \bar{s}_2 + j \cdot s_1 \cdot s_2 \\ \bar{z}_2 &= \bar{j} \cdot \bar{s}_2 + s_1 \cdot s_2 + j \cdot s_1 \cdot s_2 \\ \bar{z}_3 &= \bar{s}_3 \end{aligned}$$

This network is not illustrated, since it duplicates that shown in Fig. 11, with x, a, h , replaced by s, z, \bar{j} , respectively.

Other logic types can be used

Two-rail AND-OR-INVERT logic can be transformed into OR-AND-INVERT, AND-INVERT or OR-INVERT by an appropriate one-for-one replacement of the logic elements. This is best illustrated by considering an asymmetrical func-

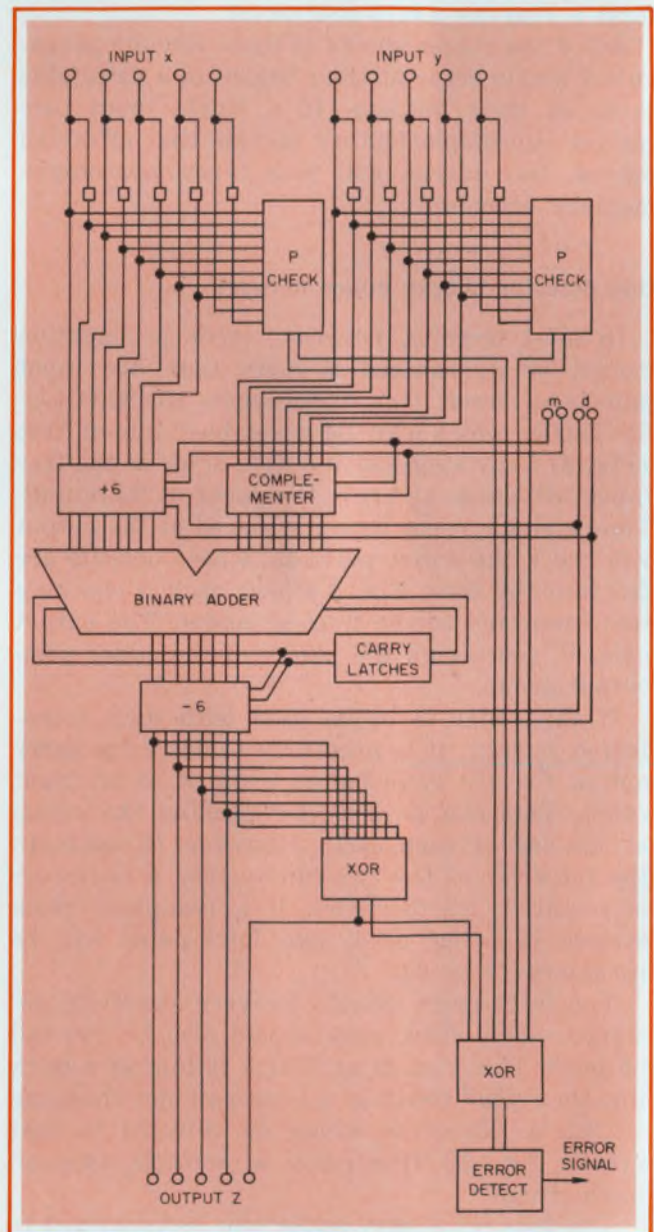

13. The complete binary/BCD adder/subtractor. Failures in either the inputs or the network are detected at the output of the single error detector.

tion, such as that for the a_0 generator in the decimal-correction circuit. Its equations are

$$\begin{aligned} a_0 &= x_0 + h \cdot x_1 + h \cdot x_2 \\ a_0 &= \bar{h} \cdot \bar{x}_0 + \bar{x}_0 \cdot \bar{x}_1 \cdot \bar{x}_2. \end{aligned}$$

Applying DeMorgan's Theorem, we get:

$$\begin{aligned} \bar{a}_0 &= \bar{x}_0 \cdot (\bar{h} + \bar{x}_1) \cdot (\bar{h} + \bar{x}_2) \\ a_0 &= (h + x_0) \cdot (x_0 + x_1 + x_2). \end{aligned}$$

The generator is now expressed in OR-AND form, with a simple one-for-one replacement of elements. However, both the inputs and the outputs are replaced by their complements—and this applies throughout a complex network, without the need to modify interconnections.

AND-INVERT circuits with a dot-AND capability at their outputs may be used directly as AND-OR-INVERT logic. If, however, the dotting capability is not available, a second level of AND-INVERT can provide the AND-OR function. In this case the outputs are doubly inverted and the one-for-one replacement requires modification of interconnections. Both OR-INVERT and OR-AND-INVERT logic can be similarly handled.

Finally let's consider the interfacing of a two-rail network with a single-rail, parity-checked network. We have shown (Fig. 8) how parity may be generated as a by-product of the two-rail checking procedure. It's necessary therefore to check the parity of the inputs only. This is most conveniently done immediately after the inputs are put into two-rail form.

A typical input-parity check circuit is shown in Fig. 12. This is essentially a single-rail EXCLUSIVE-OR tree, with the last stage missing. If the parity of the input data is correct, the signal pair, E, will carry complementary values. If the parity is incorrect, E will exhibit a two-rail error. This signal pair can thus be fed into the two-rail checker to provide a single-error pair for the entire network.

Figure 13 illustrates the complete binary/BCD adder-subtractor. Any single failure in the network, or any error of the input data, will be detected by an error signal at the output of the checkers.

At the output of the two-rail logic section, the signal pairs of each output group are fed to an EXCLUSIVE-OR (XOR) tree. This serves a dual purpose. It generates a parity bit for the group and condenses all error signals in the group to a single signal pair. The appropriate signals from each pair (including the output of the EXCLUSIVE-OR tree) constitute the group to be transmitted to the parity-check section.

A single-rail EXCLUSIVE-OR circuit may be used at the output of the two-rail EXCLUSIVE-OR tree to signal an error condition. If more than one output group is involved, the signal pairs from each tree may be further combined to generate a single error signal, depending on the degree of discrimination required. ■■

RELIABILITY	✓
QUALIFICATION	✓
EVALUATION	✓
ENVIRONMENTAL	✓
COMPONENT SCREENING	✓
DYNAMICS TESTING: SHOCK AND VIBRATION	✓

Whether it's a whole system or a single component... whether it's intended for commercial, military or industrial use... it's vital to your customers—and your company's image—that your product works and stays working.

Making sure of that is ATL's business. ATL has built a nationwide reputation as an independent source for a TOTAL ELECTRONICS & AVIONICS TESTING CAPABILITY few others can match.

How? Fifteen years experience as one of industry's leading test labs... a modern facility utilizing the most up-to-date test equipment... and references in almost every product area. Testing can be performed to your specs, military specs or to your industry standards. Where required, we can even establish a program for you.

Remember: the product you engineer is only as effective as the evaluation and reliability planning that go into it. Let ATL see that it gets the best of both.



**ASSOCIATED
TESTING
LABORATORIES, INC.**

NORTHWEST INDUSTRIAL PARK, BURLINGTON, MASS. 01803, (617) 272-9050
9 BRIGHTON ROAD, CLIFTON, N.J. 07012, (201) 473-6455

Television test-pattern modulator uses multiplier to improve linearity

An FM modulator that produces a TV carrier modulated by a test pattern can be improved by adding a balanced multiplier and a dc restorer to the basic crystal oscillator. The IC multiplier can be driven linearly to greater than 100% modulation. Also, peak modulation can be achieved because of the dc restorer. As an added feature, the circuit provides electronic amplitude control of the rf output.

The 61.250 MHz crystal (for the standard Channel 3 TV carrier frequency) controls the LM175 oscillator. The IC's internal temperature and supply-voltage compensation maintain precise frequency response.

The output of the buffer stage of the LM175 drives the LM1596 multiplier. Dc restorer diode CR₁ clamps the sync tips of the modulating signal to a dc voltage set by percent-modulation control R₃. This clamped modulating signal provides the other input to the multiplier. The multiplier output is coupled through a tuned circuit to a JFET attenuator. The available rf output voltage of 15 mV rms drives a 75-Ω load. The output voltage can be attenuated by up to 12 dB, as a function of the signal applied to the JFET gate. The attenuator drive may be any value

between -0.1 V and 5.5 V and may have a frequency from dc to 1 kHz.

When this circuit modulates an rf carrier with a test pattern (such as from a Tektronix 144 NTSC Test Signal Generator), the test pattern can be fed directly to the antenna of the television receiver. The agc of the receiver can be evaluated by driving the JFET attenuator with a square wave while monitoring the output of the first video stage of the receiver. Driving the attenuator from minimum to maximum attenuation in this manner engages the noise canceling circuitry in many conventional receivers. Sinusoidal drive to the JFET approximately simulates "airplane flutter" that can be troublesome in television design.

An additional attenuator pad inserted between the modulator and receiver provides an additional 120 dB of rf control. Care must be taken to shield the modulator, especially the output coil, to eliminate radiation around the attenuator stages and into the receiver.

T. Isbell and T. Mills, National Semiconductor Corp., 2900 Semiconductor Dr., Santa Clara, Calif. 95051.

CIRCLE NO. 311

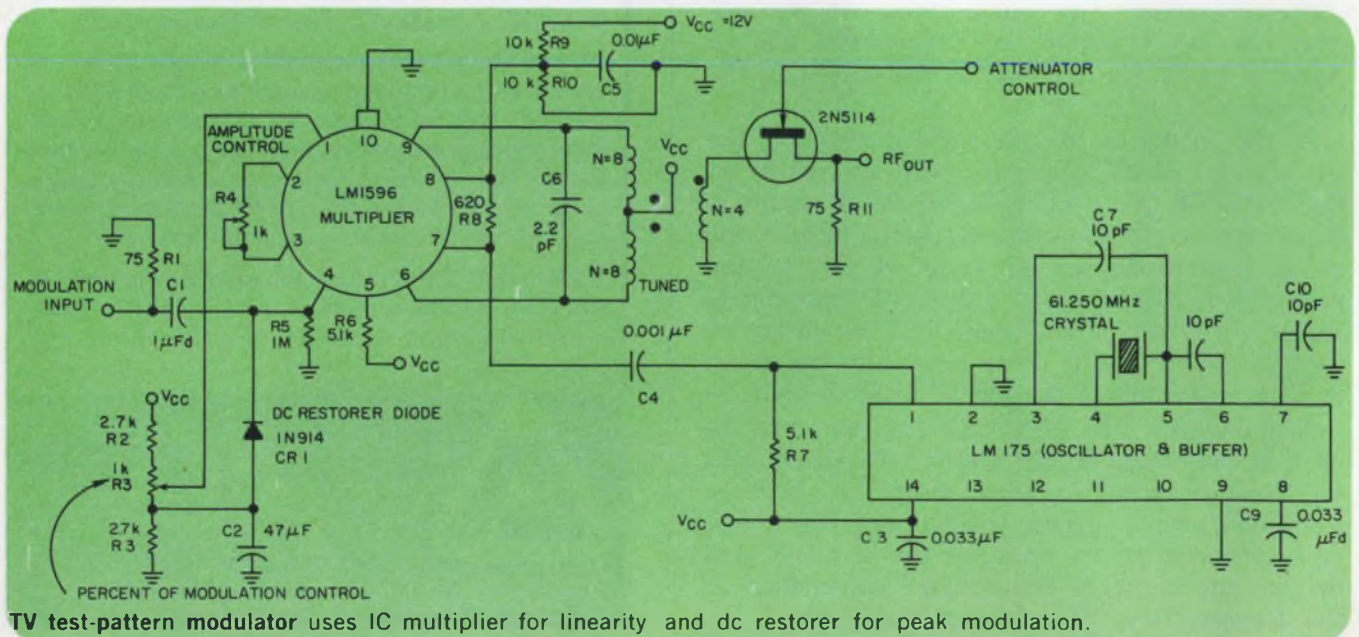

TV test-pattern modulator uses IC multiplier for linearity and dc restorer for peak modulation.

Motor load-current sensor prevents false counter totals

False totals of parts counted in a manufacturing operation can occur if the machine is cycled but the part to be worked on is not in place. One remedy is to narrow the time interval available for a part to be counted to that fraction of the machine cycle time during which the work actually occurs.

Parts counting is normally done by an electromechanical counter connected to a machine cycling relay or limit switch. If the counter is connected to a work-cycle auxiliary contact, so that a count occurs only when the part is worked on (Fig. 1), false counts are largely avoided. The work-cycle contact could be a normally-closed limit switch which is held open when a tool head, for example, is moved close to the part.

When the work-cycle contact is closed, transistor Q₃ is turned on. Pins 3 and 5 of the R-S flip-flop (gates G₃ and G₄) are both LOW, transistors Q₁ and Q₂ are both off, and the output relay is open.

As the work-cycle contact opens, transistor Q₃ turns off, placing a HIGH logic signal at pin 5 of the R-S flip-flop. This HIGH enables the flip-

flop to change state when a LOW arrives at its pin 1. When a part is worked on, the accompanying rise in motor current is sensed by current transformer T₁, thereby increasing the voltage at the noninverting input (pin 2) of the LM311 comparator. When the voltage at pin 2 of the comparator exceeds the threshold voltage set at its inverting input (pin 3), one input (pin 9) of NAND gate G₂ goes HIGH.

To prevent false counts caused by motor-starting inrush current, an auxiliary contact on the motor starter initiates an adjustable time delay. The delay allows the output (pin 11) of NAND gate G₁ to go HIGH only if a load current still exists after the inrush current has subsided. With both of its inputs (pins 9 and 10) HIGH, NAND gate G₂ produces a LOW at pin 1 of the flip-flop. Since the other input (pin 5) of the flip-flop is HIGH, the pin-3 output goes HIGH. Transistors Q₁ and Q₂ both switch on, and the output relay is actuated to register a count.

Fluctuating currents that occur while the part is being worked on cannot cause false counts because the flop-flop is latched. The flip-flop can-

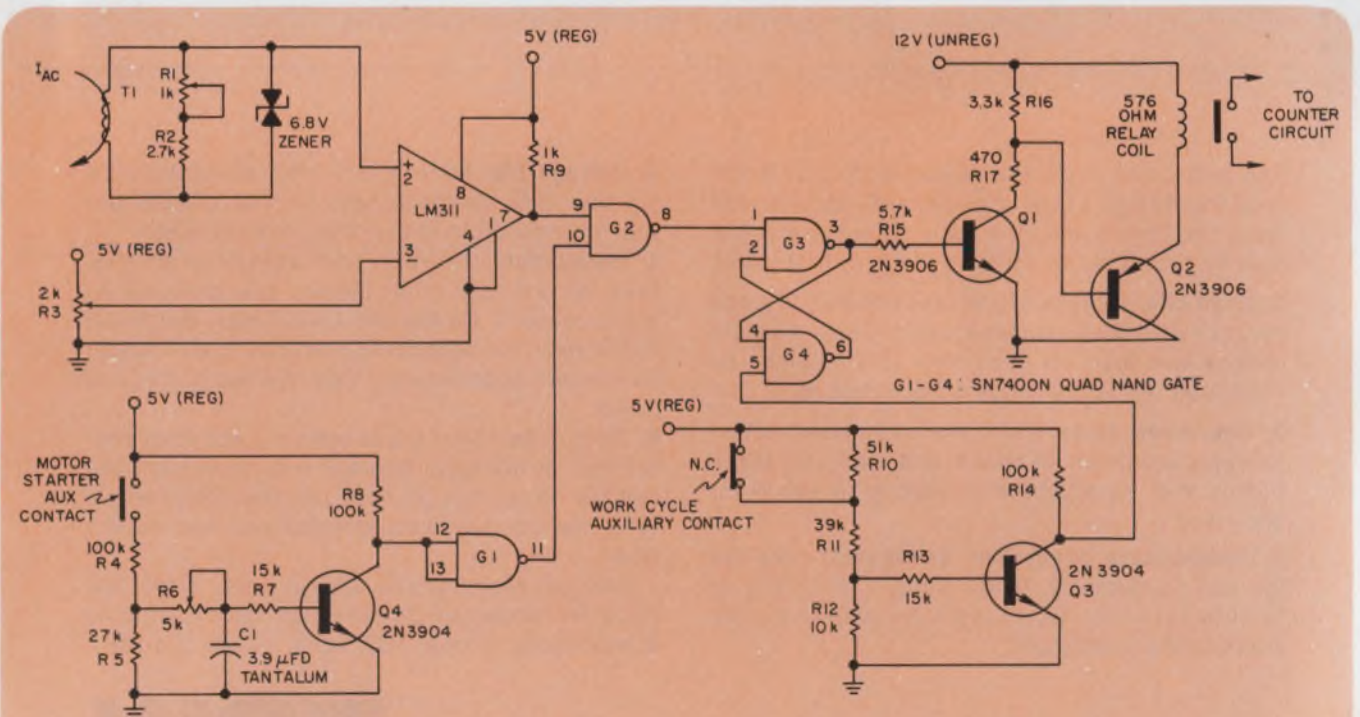

1. A rise in motor load current sensed by coil T₁ triggers an electromechanical counter when work is performed on a part in a manufacturing operation.

The work-cycle auxiliary contact prevents false counts when the machine is cycled without a part being produced.

MONSANTO LAUNCHES NEW 50MHz COUNTER ATTACK



New Model 100C

- 6 digit display
- Full-function to 50 MHz
- Priced at only \$565
- 7 digit option \$605



New Model 101C with BCD

- 6 digit display
- 1 part in 10^8 stability
- Priced at only \$695
- 7 digit option \$735

When Monsanto first introduced these full-function 50MHz Counter-Timers we established the standards for the industry and caught our competition with their guard down.

But our offensive couldn't be maintained by sitting on past successes. So, our NEW counter attack is again in your behalf, with new, realistic features and functional improvements. Contact your nearest Monsanto representative for a demonstration of our battle plan. Your reward will be a look at the best value on the market today.

For complete specifications request new brochure.

United Systems Corp.

918 Woodley Rd.
Dayton, Ohio 45403
(513) 254-6251
Subsidiary of

Monsanto

Monsanto: precision measurements to count on.

All Monsanto instruments are available for rental or lease through Rental Electronics, Inc.

not be reset until the work-cycle contact is closed again when the tool is withdrawn.

Either electronic or electromechanical counters may be used with this circuit (Fig. 2). If an electromechanical counter is used, the reed-relay contact should be connected in series with the coil of an intermediate relay. This auxiliary relay should have contacts sized to carry the current and voltage required to operate the counter solenoid. If an electronic counter is used, its sensitivity should be adjusted to trigger at about 4 V.

The maximum count rate is limited only by the maximum speed of the work-cycle auxiliary contact or by the maximum counting rate of the counter that is used. An inexpensive 50-mA power supply with 1% regulation is sufficient to fulfill power requirements.

Robert G. Warsinski, Ford Motor Co., Manufacturing Development Center, 24500 Glendale, Detroit, Mich. 48239.

CIRCLE NO. 312

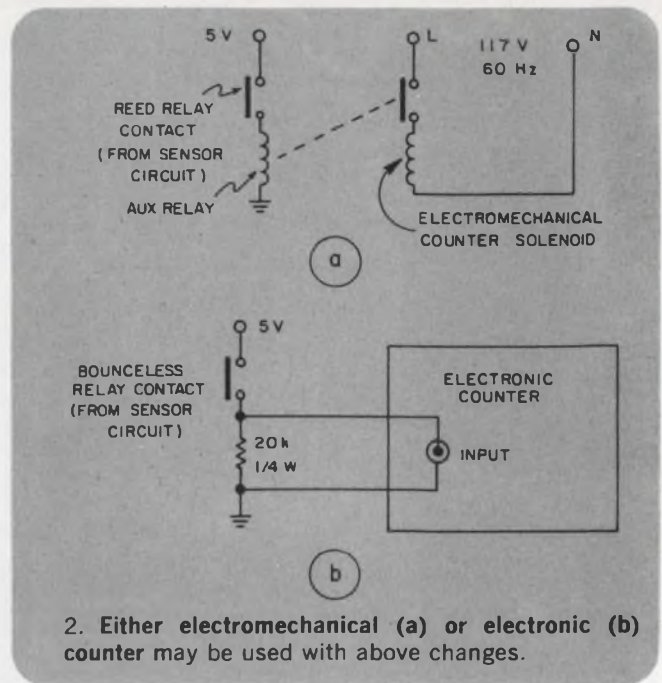

Transconductance amplifier increases accuracy of sample-and-hold circuit

A programmable operational transconductance amplifier (OTA) increases the accuracy of a sample-and-hold circuit. A MOSFET serves as a combined output and buffer device.

When the OTA is connected as a voltage-follower sampling circuit, as shown in the diagram, the circuit has unity gain for a HIGH logic input. Capacitor-resistor network R_1 - C_1 serves as a phase-compensation capacitor in the sample mode and as a storage element when the circuit is in the hold mode. The high open-loop voltage gain

of the OTA assures reproduction of the input with a maximum inaccuracy of only 2 mV, an input impedance of greater than 10 M Ω and a low output impedance.

Transistor Q_1 interfaces the circuit with DTL and TTL logic levels. The transistor can be omitted from circuits with CMOS logic. In this case, a simple resistor interface would suffice.

Since the OTA acts as a current amplifier, its 1.8-V/ μ s slew rate is uniform over the entire output range. Also, the slew rate is a function of the amplifier bias current I_{ABC} . The signal voltage present on storage capacitor C_1 at the time of I_{ABC} cutoff is read by the MOSFET. If 300-pA leakage current is assumed for the OTA, the circuit exhibits a pulse "tilt" of 1 mV/ μ s and a settling time of 1 μ s after slewing to within 1 mV of a 7-V step.

H.A. Wittlinger, RCA, Solid State Div., Route 202, Somerville, N.J. 08876.

CIRCLE NO. 313

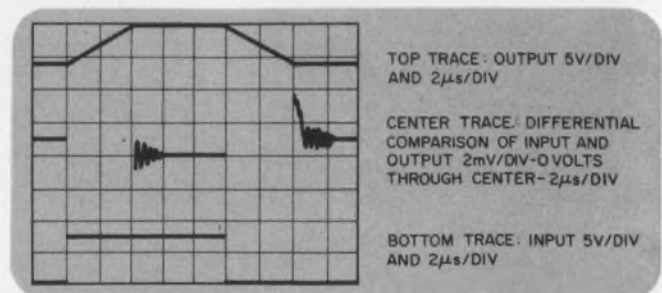
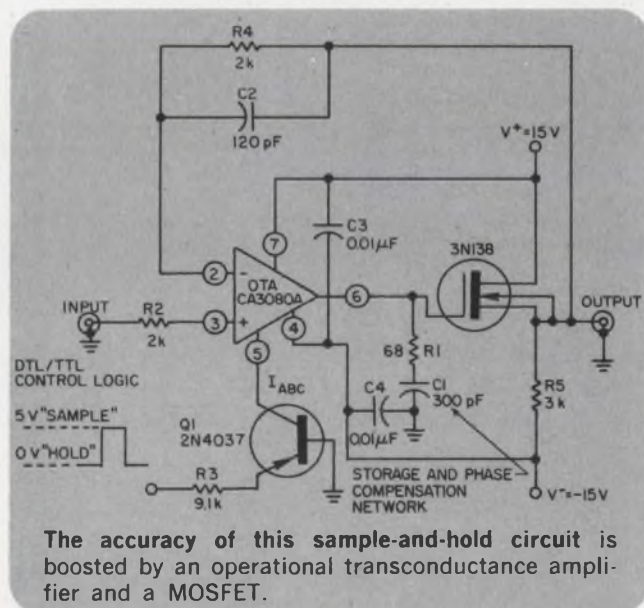



Culver Pictures

Reputation.

A good name that has been earned. A name that's associated with quality. A name that people trust.

Reputation is hard to gain and easy to lose. It's one of the things that doesn't show on a company's balance sheet. It's something beyond profit, or growth, or even product. It's part of a company's identity. Past, present, and future.

Matsushita Electric has a reputation as one of the world's finest electronics manufacturers. We've earned that reputation by doing things well. And we've kept it by doing things better. Year after year, for 53 years.

Sixteen years ago, we decided to name one of our hi-fi component speakers "Panasonic." Today the list of components we offer has grown from a few speakers to thousands of products . . . almost everything the OEM requires. And today the name Panasonic is famous on its own.

We still make speakers, some of the finest available.

But now there's more. Matsushita Electric makes both film and composition resistors. Fixed, non-linear, and variable resistors. We make varistors, thermistors, capacitors, ICs, electronic and cathode-ray tubes, power supplies, piezoelectric devices, and about any other electronic device you can think of.

One of our most extensive component lines is switches. We make button switches, toggle switches, limit switches, lever and roller switches, miniature and large switches. Each of our switches is designed to do a specific job. And each does it . . . reliably and economically.

The next time you specify components, any kind of components, think of Matsushita and Panasonic. We'll try to live up to our name.

Panasonic./Matsushita Electric

Industrial Division, 200 Park Avenue, New York, N. Y. 10017

Variable threshold circuit separates sync pulses from composite video signal

A sync separator circuit automatically maintains an optimum threshold with respect to an incoming composite video signal over a 100:1 signal amplitude range. The threshold is stable with respect to the level of the composite signal, enabling sync pulses to be separated by amplitude discrimination.

Op amp A₁ (see diagram) acts as a peak detector. When a sync pulse occurs at the input, the amplifier charges capacitor C₁ until the voltage across it (v_c) equals the pulse amplitude. The (R₁ + R₂)C₁ time constant is chosen to be several times the period between pulses. This allows v_c to track the peak amplitude of the sync pulses.

Op amp A₁'s stabilizing capacitor (C₂) should be large enough to prevent short, high-level noise spikes from affecting the threshold. Voltage

divider R₁ and R₂ applies v_t, a portion of voltage v_c, to comparator A₂ as a threshold voltage. Resistor R₃ provides hysteresis for clean switching, while zener diode CR₁ clamps the output to a logic-compatible level.

The circuit, with component values shown, separates a 1-ms sync pulse from an input with an amplitude ranging from 0.1 to 10 V. The circuit can be readily expanded to multilevel or dual-polarity thresholding, and is easily interfaced with logic circuitry for further processing of the separated pulses.

Maxwell G. Strange, Senior Engineer, NASA, Experiment Engineering Branch, Goddard Space Flight Center, Greenbelt, Md. 20771.

CIRCLE No. 314

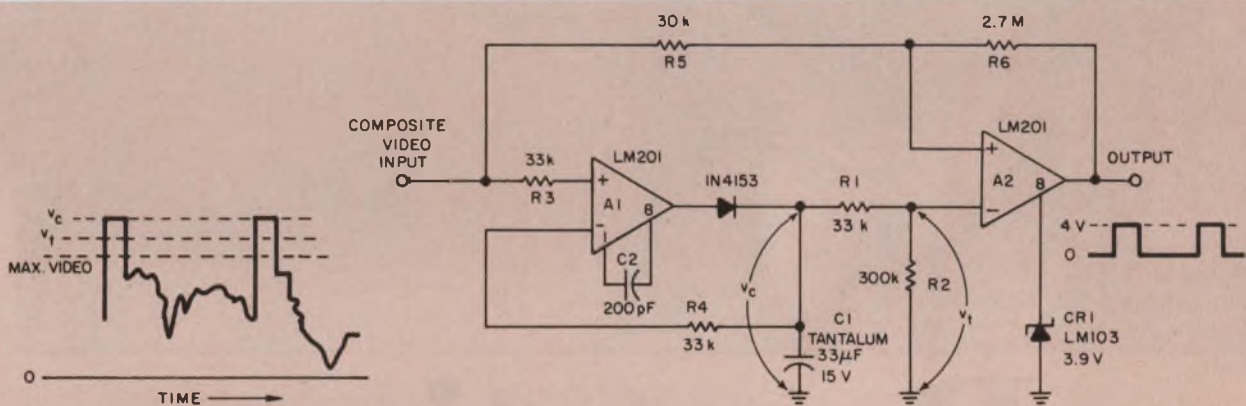

Peak detector A₁ holds capacitor voltage v_c at the peak value of input pulses. A fixed fraction of this

voltage (v_t) acts as a threshold to allow sync pulses to be stripped from the input signal.

IFD Winner of June 8, 1972

Srirama Durvasula, Honeywell Information Systems, Framingham, Mass. 01701. His idea "IC one-shot generates pulses with programmable widths" has been voted the Most Valuable of Issue award.

Vote for the Best Idea in this issue.

SEND US YOUR IDEAS FOR DESIGN. You may win a grand total of \$1050 (cash)! Here's how. Submit your IFD describing a new or important circuit or design technique, the clever use of new component or test equipment, packaging tips, cost-saving ideas to our Ideas for Design editor. Ideas can only be considered for publication if they are submitted exclusively to ELECTRONIC DESIGN. You will receive \$20 for each published idea, \$30 more if it is voted best of issue by our readers. The best-of-issue winners become eligible for the Idea of the Year award of \$1000.

ELECTRONIC DESIGN cannot assume responsibility for circuits shown nor represent freedom from patent infringement.



The upsetting problems, the roaring frustrations of defining, specifying and procuring the right printed circuit board connectors are over.

Over, because Winchester Electronics offers one of the world's largest, most varied lines of printed circuit connectors. To this purring thought, we'll add another. That Winchester Electronics has the unmatched capability to custom-design and produce special printed circuit connectors, as well. For you and you alone. Even if your order is relatively small and requires special tooling.

Our standard lines include connectors for single and double sided boards. With contact spacing of .100, .125, .150, .156 and .200. With as few as 6 contacts or as many as 100. And with an array of termination types that include wrap-post, solder-eyelet, dip-solder and crimp.

Add to these our ceramic substrate connectors. And our newest standard connector lines, the HSD and HMD*. With .156 contact spacing center-to-center plus .140 contact spacing between rows for double sided 1/16" cards. And add our DW



series edgeboard connectors. Featuring .025 square wrappable cantilever contacts on a .125 x .125 grid, 18 to 50 contacts per row.

Yes, add it all up. You'll see why Winchester Electronics has manufactured and delivered more than 15 million printed circuit connectors in the last 10 years. And why Winchester Electronics' record of successful innovations goes back for more than 3 solid decades.

So take the snarls out of your life, tiger.

With the all-inclusive line of printed circuit connectors from Winchester Electronics. You'll get what you need. When you need it. And at very competitive prices. Call the Authorized Distributor near you for details, now. Or, for applications, contact Winchester Electronics Division, Main St. & Hillside Ave., Oakville, Connecticut 06779. Phone(203)274-8891.



WINCHESTER ELECTRONICS

*The HMD meets performance requirements of MIL-C-21097.

When the shape of your 'things-to-come' need ultra-fine finishes...

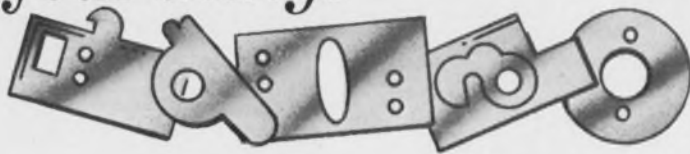

Specify "Fine Blanked"!

If you machine parts, Fine Blanking has technically brought to the press or metal working field, the same advantage that numerical control brought to machining methods. It accomplishes this by placing many manufacturing processes into one operation and in so doing, eliminates costly secondary operations. (Drilling, reaming, broaching, boring, milling, machining, etc.) When you consider the cost of labor today, floor space and machinery necessary to perform secondary operations, the benefits of Fine Blanking rapidly become apparent.



A unique process for producing parts with . . . dimensional accuracy measured in "tenths", flatness within .001 inches, accurate holes with diameters as low as 1/2 the metal thickness, sheared edge finishes of 16 to 40 micro inches, and perfectly square edges.

And The Firm to Specify Is—

PRINCIPAL

MANUFACTURING CORP.



5400 S. Janes Ave., Downers Grove, Ill. 60515, 312/852-3322-852-3323



While there is no guaranty that excellence and profitability always go hand in hand, there is a guaranty that excellence will always be the primary objective at Principal Mfg. Co.

INFORMATION RETRIEVAL NUMBER 44

We have documented proof you can **replace your oscilloscope for \$79.95**



The Kurz-Kasch logic probe is the most amazing new concept today in electronic testing. All digital logic circuitry can be tested for every condition you need to know. It actually replaces wide band pass type oscilloscopes costing \$2,000 and \$3,000. Write or call now for your free copy of that proof to: Tom Barth, Marketing Manager, Department ED

Free test data



Kurz-Kasch, Inc.
Electronics Division
1421 S. Broadway
Dayton, Ohio 45401
Telephone (513) 223-8161

INFORMATION RETRIEVAL NUMBER 45

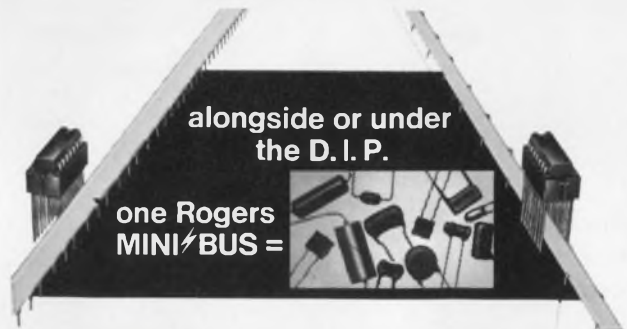

The evidence is accumulating. You may eliminate *all* discrete bypass capacitors — and get a lower-noise printed circuit board at frequencies where it counts — with a single Rogers Mini/Bus.

DELIVERY: Standard configurations are available on short notice. Telephone EAST: (203) 774-9605; WEST: (602) 963-4584 to know where we stand today on your requirements. Ask for our Mini/Bus brochure, showing standard parts.

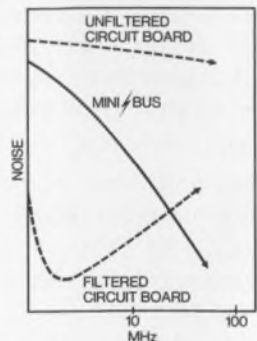

Rogers Corporation Rogers, Conn. 06263 (203) 774-9605

INFORMATION RETRIEVAL NUMBER 46

Latch-decoder-driver chip simplifies display circuitry and lowers cost

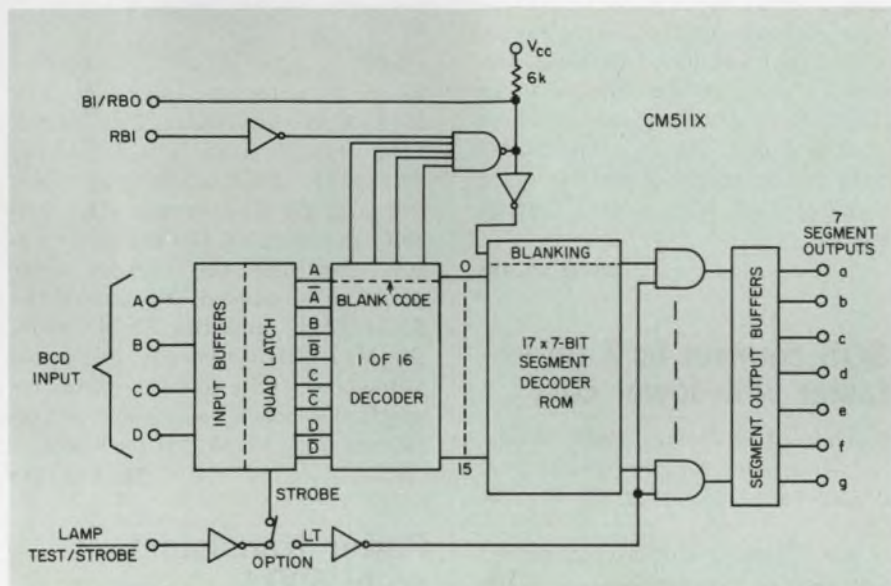

Computer Microtechnology Inc., 610 Pastoria, Sunnyvale, Calif. 94086. (408) 736-0300. See below; stock.

Low-voltage displays without built-in decoders can now be driven with monolithic bipolar latch-decoder-driver ICs. Two manufacturers—Computer Microtechnology (CMI) and Harris Semiconductor—have introduced seven-segment decoder-drivers that provide these functions, for the first time, on a single chip. Each device simplifies the decoding of a BCD input for a LED or incandescent display, when compared to the industry's standard decoder-driver, the 7447 (originally from Texas Instruments). But the CMI device offers significant advantages over the Harris unit in cost and operation for most low-voltage display applications.

Computer Microtechnology's latch-decoder-driver IC comes in three versions: the CM5111, a 20-mA constant-current driver for incandescent and common-anode LED

displays; the CM5113, a 50-mA current-limited device for multiplexing up to 10 displays in a common-cathode connection, and the CM5115, a 5-mA current-limited IC for a common-cathode display. Respective prices are \$3.15, \$3.55 and \$3.15 (100-999). All are commercial-temperature-range models and can fit into existing 7447 sockets—like the latter, the CM511X comes in a 16-pin DIP.

Harris' HD1-0140 differs from the CMI circuits in application, cost and size. Primarily intended for LED-display multiplexing, the HD1-0140 lists a current-limited 40 mA output capability (vs 50 mA for the corresponding CM-5113). It features a BCD data output (unlike the CM511X), in addition to the seven-segment output for the display. The BCD output could be used to drive printers, for example. The HD1-0140 is priced at \$7.55 (100-999) and comes in a 24-pin package.

Another difference is that the Harris unit has an edge-triggered

latch. Accordingly, the device must be clocked to display information. With the CMI circuit, data are displayed simply by enabling the strobe terminal.

A fundamental difference results from the type of decoder in each circuit. The HD1-0140 uses a standard bipolar type, while the CM511X has a 17×7 -bit ROM. As a result, the CMI device with a display can present more information. For example, corresponding to numerals 10 to 15, letters can be shown such as A, E, H and P.

And the user has the option with a CM511X of specifying any code to convert the four-bit input into a seven-segment output. However, for this flexibility there is a \$300 charge for the mask.

The advantages of the CM511X are even more impressive when compared to a driver circuit using a 7447. One CMI chip does the job of a 7447 decoder-driver, a 7475 quad latch and seven current-limiting resistors. And it consumes less than half the power of the 7447/7475 configuration.

At a cost of \$2.70 for the 7447 decoder, \$1.65 for the 7475 latch (average prices based on original and alternate-source listings) and 5¢ per resistor, the total price comparison becomes \$4.70 vs \$3.15 for a CM5111.

The constant-current outputs of the CM5111 outputs eliminate the need for the current-limiting resistors. They also compensate for variations in forward voltage drops when driving LEDs.

For further information on decoder-drivers, circle inquiry numbers as follows:

- Computer Microtechnology **CIRCLE NO. 250**
- Harris Semiconductor **CIRCLE NO. 251**
- Texas Instruments **CIRCLE NO. 252**

Triac line offered



Sarkes Tarzian, Inc., Semiconductor Div., 415 N. College Ave., Bloomington, Ind. 47401. (812) 332-1435. \$1.84 to \$5.45 (100 up).

Rated at 6, 8 and 10 A (at 85 C) three series of triacs are now available. Half cycle ON-state surge current is 66, 88 and 110 A, respectively. Each series is available with voltage ratings from 100 to 600 V. Gate trigger current is 50 mA at 25 C; gate trigger voltage is 3.0 V at 25 C; di/dt is 20 A/ μ s and commutating dv/dt is 5 V/ μ s.

CIRCLE NO. 253

Edge speeds under 50 ns with pulse oscillator

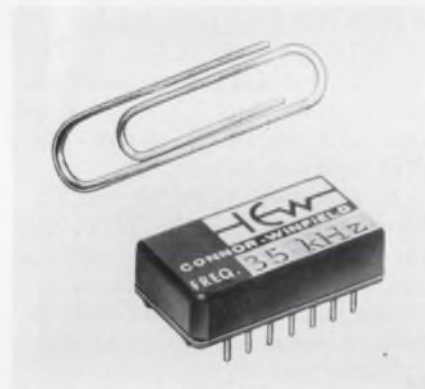

Connor-Winfield Corp., Winfield, Ill. 60190. (312) 231-5270.

A TTL pulse oscillator in a DIP features rise and fall times of less than 50 ns, fixed frequencies in the range 1 Hz to 50 kHz and tolerances of $\pm 0.1\%$ (20 to 40 C) or 0.25% (0 to 50 C). A fanout of four TTL loads is possible with a 5-mA supply; with a 20-mA supply, 10 TTL loads can be connected. The supply voltage is 5 V dc $\pm 5\%$.

CIRCLE NO. 254

Op amp achieves 500 V/ μ s slew rate

National Semiconductor Corp., 2900 Semiconductor Dr., Santa Clara, Calif. 95051. (408) 732-5000. LH0024CH: \$15; LH0032C: \$18 (100 up); stock.

Two very high speed op amps list a unity gain slew rate of 500 V/ μ s, small signal bandwidth of 70 MHz and full power bandwidth of 15 MHz. The LH0032/LH0032C uses a JFET input stage to achieve bias currents in the 10-pA range, while the LH0024/LH0024C employs a conventional bipolar input stage. Both devices have an offset of 2 to 4 mV, can be offset nulled with one external pot and can drive a 100- Ω load with a 10-V output swing.

CIRCLE NO. 255

SOS counter is 7 times faster with lower cost

Inselek, University Park Plaza, 743 Alexander Rd., Princeton, N.J. 08540. (609) 452-2222. P: See below.

An SOS (silicon-on-sapphire) seven-stage binary counter, designated the SO2, is said to be seven times faster than the fastest available circuit of this type—an ECL IC. And at \$9 (100 up), the SO2 is priced lower than the corresponding ECL device. The SO2 operates over the temperature range of -55 to 125 C, and requires only one-tenth the power of its bipolar competitor, according to the company.

CIRCLE NO. 256

Analog switches priced under \$1 per channel

Intersil, 10900 N. Tantau Ave., Cupertino, Calif. 95014. (408) 257-5450. P: See below.

A family of positive input-voltage analog switches, known as the IH5025 through IH5038 series, are available at less than \$1 per channel (in quantity). They switch up to 20 V into high impedance loads, and operate into the non-inverting terminal of op amps with no external driver required. Each package contains up to four SPST channels, with ON resistances of either 100 Ω or 150 Ω maximum.

CIRCLE NO. 257

Encoders feature priority decoding

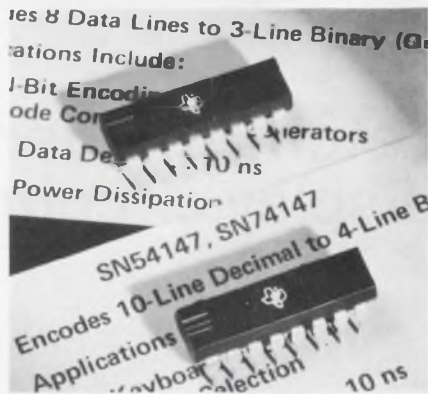

Texas Instruments Inc., P.O. Box 5012, M/S 308, Dallas, Tex. 75222. (214) 238-3741. SN74147N: \$3.19; SN74148N: \$2.27 (100 up); stock.

Two TTL IC encoders offer priority decoding of the inputs to ensure that only the highest order data line is encoded. Designated the SN54/74147 and the SN54/74148, the MSI circuits encode 10-line-to-4-line and 8-line-to-3-line data, respectively. Each is capable of replacing over seven SSI packages.

CIRCLE NO. 258

Power transistors go to 600 V



Solitron Devices, Inc., 1177 Blue Heron Blvd., Riviera Beach, Fla. 33404. (305) 848-4311.

Three npn silicon, planar power transistors—the SDT 5848, 5858, and 5868—are rated at 400, 500 and 600 V, respectively. Maximum current (I_c) ratings are 75, 60 and 30 A in the same order. All units are packaged in a 1-1/16 inch stud TO-114 case and feature a typical f_t of 15 MHz, power dissipation of 300 W (100 C) and thermal resistance of 0.33 $^{\circ}$ C/W.

CIRCLE NO. 259

Complete RF Network Analysis in COMMUNICATIONS

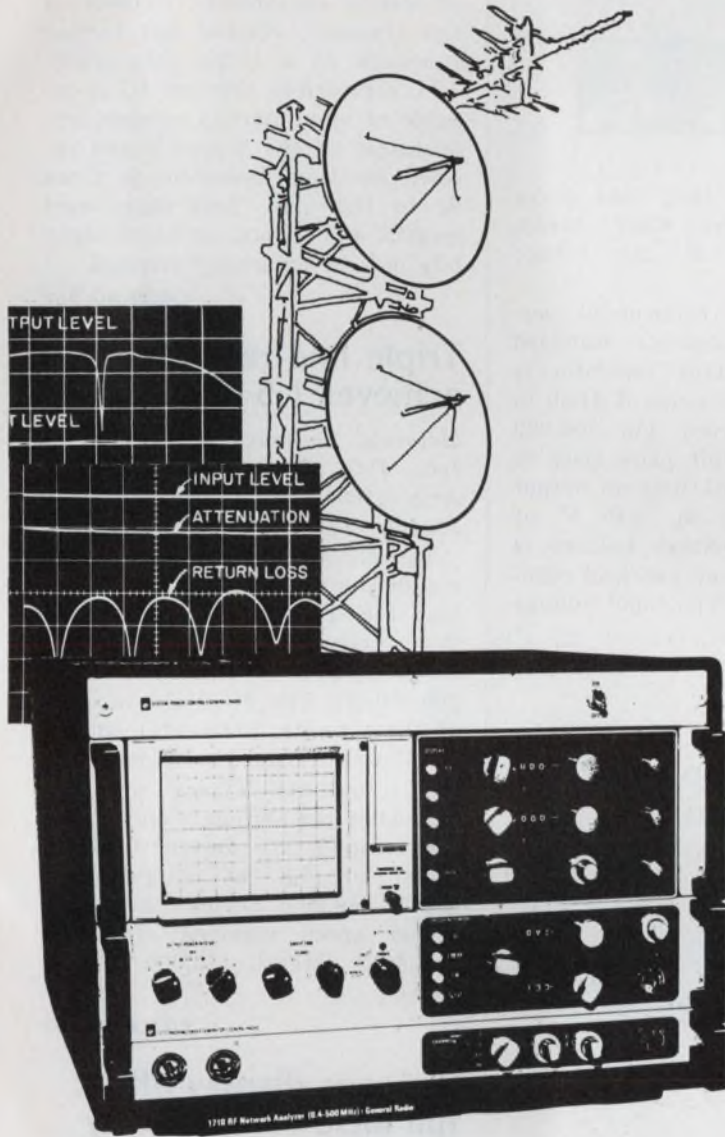

FOR cable measurements you need a wide 400 kHz-to-500 MHz sweep range and a simultaneous display of attenuation and return loss.

FOR antenna measurements you need a wide 115-dB dynamic range for pattern plotting and a polar display for impedance characterization.

FOR narrow-band response measurements you need high 0.005-dB resolution, excellent frequency stability, low residual fm, and low -110-dB crosstalk levels.

FOR bandpass characteristics you need a simultaneous display of phase and magnitude.

FOR comparison measurements you need a simultaneous display of two unknown channels — invaluable for measuring multiport devices such as diplexers.

FOR versatility you need a broad selection of 75-ohm or 50-ohm components, complete programmability for automatic systems, and an expanding line of accessories to adapt to changing requirements.

FOR all this you need a GR 1710 RF Network Analyzer completely equipped for communications measurements, including the basic analyzer, polar- and rectilinear-display capabilities, and all the necessary accessories . . .

FOR only \$7980.

 **General Radio**

NEW YORK (N.Y.) 212-964-2722, (N.J.) 201-791-8990 • BOSTON 617-644-0550
CHICAGO 312-992-0800 • WASHINGTON, D.C. 301-881-5333 • LOS ANGELES 714-540-9830
TORONTO 416-252-3395 • ZURICH (01) 55 24 20

GR COMPANIES • GRASON-STADLER • TIME/DATA • TECHWARE COMPUTING CORP.
GR ASSOCIATE • MICRONETIC SYSTEMS INC.

INFORMATION RETRIEVAL NUMBER 47

AMPERITE

Top Quality
STILL AT
LOW
PRICE



Thermostatic DELAY RELAYS

Offer true hermetic sealing...
Assure maximum stability and life.

Delays: 2 to 180 seconds*

Actuated by a heater, they operate on A.C., D.C., or Pulsating Current... Being hermetically sealed, they are not affected by altitude, moisture, or climate changes... SPST only — normally open or normally closed... Compensated for ambient temperature changes from -55° to $+80^{\circ}\text{C}$... Heaters consume approximately 2 W. and may be operated continuously. The units are rugged, explosion-proof, long-lived, and inexpensive!

TYPES: Standard Radio Octal and 9-Pin Miniature.
List Price, \$4.00

*Miniatures Delays: 2 to 120 seconds.

All Amperite Delay Relays are recognized under component program of Underwriters' Laboratories, Inc. for all voltages up to and including 115V.

PROBLEM? Send for Bulletin No. TR-81.

AMPERITE BALLAST REGULATORS

Hermetically sealed, they are not affected by changes in altitude, ambient temperature (-50° to $+70^{\circ}\text{C}$), or humidity... Rugged, light, compact, most inexpensive.

List Price, \$3.00

Write for 4-p. Bulletin No. AB-51.



AMPERITE

600 PALISADE AVE., UNION CITY, N.J. 07087

Telephone: 201 UNion 4-9503

In Canada: Atlas Radio Corp., Ltd.,
50 Wingald Ave., Toronto 10

ICs & SEMICONDUCTORS

Upgraded regulator priced at low \$1.50

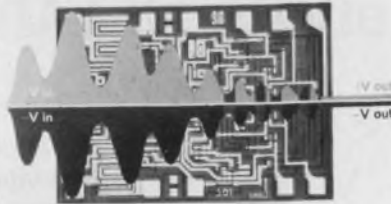

Silicon General, Inc., 7382 Bolsa Ave., Westminster, Calif. 92683. (714) 892-5531. P: See below; stock.

An improved, commercial version of the company's standard $\pm 15\text{-V}$ dual-tracking regulator is offered at the low price of \$1.50 in lots of 5000 pieces. For 100-999 quantities, the unit price rises to \$3.05. The SG4501 lists an output voltage tracking at $\pm 15\text{ V}$ of $\pm 5\%$. Output voltage balance is within 2% and line and load regulation are 0.1%. The input voltage range is $\pm 30\text{ V}$.

CIRCLE NO. 260

High speed op amp comes in mini-DIP

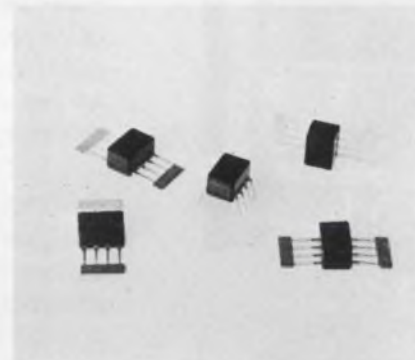

Optical Electronics Inc., P.O. Box 11140, Tucson, Ariz. 85706. (602) 624-8358. \$29 (10-29); stock.

The fast slew rate of the 9906 op amp—the minimum speed is listed as $250\text{ V}/\mu\text{s}$ —is available in an 8-pin mini-DIP. A companion mini-dip current booster is available for applications requiring up to 100 mA output current. Other features of the 9906 include 300-MHz GBW, 150 ns settling (to 0.1%) and 50-dB minimum CMRR at 1 MHz.

CIRCLE NO. 261

LSI chip provides data-interface circuit

Texas Instruments Inc., P.O. Box 5012, M/S 308, Dallas, Tex. 75222. (214) 238-3741. \$15 (250).

The TMS6010 MOS/LSI subsystem circuit converts data from serial communications links to data processing equipment. It combines full transmit, receive and format functions on a single chip. Fully TTL compatible, the new IC is capable of simultaneous independent operation of the transmit and receive function. Operation is from dc to 160 kHz. And data word lengths of five, six, seven or eight bits may be externally selected.

CIRCLE NO. 262

Triple line receiver achieves 1.5-ns delay

Motorola Semiconductor Products Inc., P.O. Box 20924, Phoenix, Ariz. 85036. (602) 273-3466. MC-10216L: \$2.50 (100 up); stock.

In addition to the company's standard speed (2.0 ns typ gate delay) MECL 10,000 parts, a triple line receiver termed the MC10216 has been added to the MECL 10,200 subset. The MC10216 consists of three linear differential amplifiers, with standard complementary MECL outputs. Typical propagation delay per section is only 1.5 ns when inputs are driven differentially, or 1.8 ns single-ended. MECL 10,200 Series parts are higher speed versions of corresponding MECL 10,000 Series parts.

CIRCLE NO. 263

Gaseous display offers full MOS compatibility

N. V. Philips, P.O. Box 523, Eindhoven, The Netherlands.

A planar gas-discharge display, termed Pandicon, is said to be the first such device featuring full MOS compatibility. The new display can be switched on both sides by MOS circuitry, in contrast to available displays that can only be switched on one side. A single MOS chip can drive the Pandicon for both decade and numeric selection. The device comes with displays from five to 17 digits. Character size is 8 mm with a typical power dissipation of 3 mW per segment.

CIRCLE NO. 264

Opto emitter-detectors
give 10^4 operations/sec

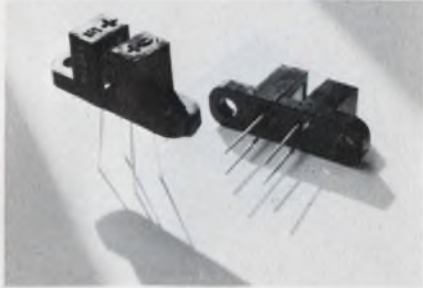

General Electric Co., Electronics Park, Bldg. #7, Mail Drop 49, Syracuse, N.Y. 13201. (315) 456-2021. H13A2: \$1.35; stock.

The company's Interrupter Modules—optoelectronic emitter-detector devices—feature 10,000 operations per second while offering solid-state reliability. Each plastic module contains an SSL source and sensor separated by a throat width of 0.125 inch. The H13A1 and H13A2 Modules have 20% operational stability between -20 and $+100$ C. The H13B1 and H13B2 offer a minimum output current of 12 mA.

CIRCLE NO. 265

Asynchronous rcvr/xmtr
operates on tones

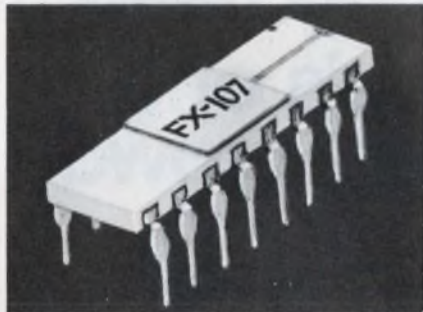

Consumer Microcircuits Limited, Rickstones Rd., Witham, Essex, England.

The FX-107 tone-operated asynchronous receiver/transmitter is believed to be the first on a chip. In the transmit mode, the new MOS IC generates a three-tone group. Virtually any number of "outstations" may be connected to the common line. In the receive mode, the FX-107 responds only to its programmed three-tone address code. The channel frequency/bandwidth selection consists simply of the connection of external resistors and the adjustment of one variable resistor.

CIRCLE NO. 266

Designed for today's IC, MOS and semiconductor circuits

NEW
Simpson
model 314
solid state
FET
VOM



- measures both low power and conventional ohms—no damage to IC's
- X1, X10 probe provides voltage ranges with 10 Megohm and 100 Megohm input impedances—no loading of semiconductor circuits
- AC and DC current ranges to 10 μ A, full scale
- 58 ranges available—high readability on extra large scale
- completely portable—battery power eliminates line cord nuisance

model 314 complete with X1, X10 (AC/DC Ohms) probe, batteries and instruction manual **\$195⁰⁰**

Carrying case \$17.00 RF probe \$11.75

**AVAILABLE NOW FROM ELECTRONIC
DISTRIBUTORS EVERYWHERE...
WRITE FOR BULLETIN T-814**



SIMPSON ELECTRIC COMPANY

5200 W. Kinzie Street, Chicago, Illinois 60644 • (312) 379-1121

IN CANADA: Bach-Simpson, Ltd., London, Ontario

IN INDIA: Ruttonsha-Simpson Private Ltd., International House, Bombay-Agra Road, Vikhroli, Bombay



DIVISION

INFORMATION RETRIEVAL NUMBER 49

350-V transistors boast 2- μ s speed



Silicon Transistor Corp., KSC Way (Katrina Rd.), Chelmsford, Mass. 01824. (617) 256-3321. P&A: See below.

The 2N6249, 50 and 51 switching transistors offer a V_{CE0} (sustained) of 350 V and typical switching speed of 2 μ s at 10 A. The combination of speed with high voltage and current makes these devices suitable replacements for SCRs in motor-speed controls and can eliminate the need for line transformers in inverters. Prices in 100 lots or greater range from \$4.74 to \$7.14.

CIRCLE NO. 267

Fast settling with high CM rejection in op amp

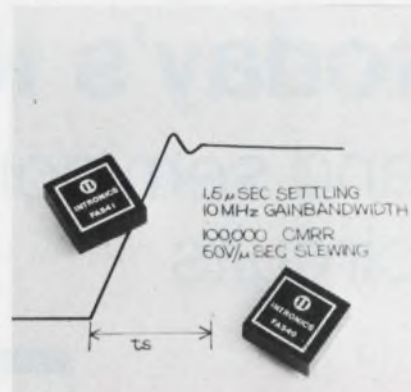

Intronics, Inc., 57 Chapel St., Newton, Mass. 02158. (617) 332-7350. FA540: \$55; FA541: \$68; stock.

The FA540 and FA541 are differential FET op amps that combine a settling time of 1.5 μ s with 100,000 common-mode rejection. In addition, the Model FA541 offers a low drift of 2 μ V/ $^{\circ}$ C minimum. Other specifications include a gain bandwidth of 5 MHz, 10-pA input current and 10^{11} - Ω input impedance. Both amplifiers are packaged in a miniature 1.25-inch square by 0.4-inch high epoxy case.

CIRCLE NO. 268

Optical couplers give 4-kV isolation

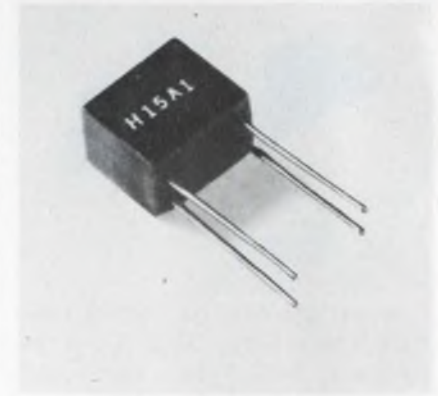

General Electric Co., Electronics Park, Bldg. No. 7, Mail Drop 49, Syracuse, N.Y. 13201. (315) 456-2021. P: See below.

Four models in the company's H15 series of optical couplers feature 4000 V isolation at a cost as low as \$1.35 (1000 quantities). The H15A1 and H15A2 modules have a typical rise/fall time of 3 μ s. The H15B1 and H15B2 modules feature high gain with up to 400% minimum transfer ratio. All four models fit into DIP sockets and are IC compatible.

CIRCLE NO. 269

PANEL LIGHTS

Best buy in the field!

TEC-LITE volume production pays off for you —with quality replaceable cartridge lites priced as low as 49¢ in 500 quantities.

Your choice of three lens styles, ten lens colors, three cartridge holders (one for PCB), a full range of voltages and either neon or incandescent lamps. The RCL Series can be clip-mounted on the panel or plugged into matching RCLH Series lite holders.

For more information on RCL Series Panel Lites — or any part of our complete line of display/control products and systems — write: **TEC, Incorporated, 9800 N. Oracle Road, Tucson, Arizona 85704. (602) 297-1111.**

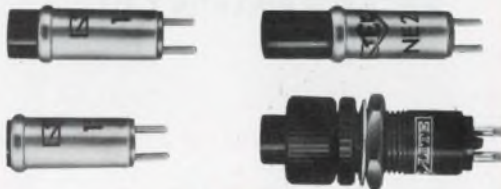

Actual Size

The Inner-Vator... there's one in every crowd.

You know the type . . . always into everything . . . making things happen. At Glowlite, we're proud of our Inner-Vators. That's what we call our circuit component neon lamps. They make things happen as arc suppressors, multivibrators, oscillators, photochoppers, voltage regulators, relays, SCR controllers, wave generators and lots of other things. The Inner-Vators are low-cost, have long-

life, precise size and shape, and other versatile characteristics. Pick the one that stands out from the crowd — Glowlite's Inner-Vator. Write for our catalog #ELD-272.



Pauls Valley, Okla. 73075 (405) 238-5541

Logic translators link TTL to MECL

Motorola Semiconductor Products Inc., P.O. Box 20924, Phoenix, Ariz. 85036. (602) 273-3466. MC1067P: \$4.33; MC1068P: \$4.33; MC10124L: \$4.50; MC10125L: \$4.50 (100 up); stock.

Converting back and forth between the different logic levels of TTL and MECL II and MECL 10,000 is now easier with the introduction of four TTL/MECL translators. For MECL 10,000 systems, the MC10124 translates TTL (input) to MECL (output), while the MC10125 provides the reverse conversion. Respective functions for MECL II systems are performed by the MC1067/1267 and MC1068/1268. All ICs are quad translators.

CIRCLE NO. 270

5184-bit character gen has 450-ns access

Signetics, 811 E. Arques Ave., Sunnyvale, Calif. 94086. (408) 739-7700. \$16 (100 up).

The Model 2526, a $64 \times 9 \times 9$ static character generator with TTL-compatible inputs, operates from +5 and -12 V supplies and features a typical access time of 450 ns. The 5184-bit character generator is a p-channel, silicon-gate MOS IC. Available in a 24-pin plastic DIP, the device is rated for operation over the 0 to 70 C temperature range.

CIRCLE NO. 271

1024-bit recirc SR halves clock C to 80 pF

Nortec Electronics Corp., 3697 Tahoe Way, Santa Clara, Calif. 95051. (408) 732-2204. \$5.50 (100-999); stock.

The 2512, a 1024-bit recirculating dynamic shift register, has a typical clock rate of 4 MHz with a clock capacitance of 80 pF. According to the company, that's about one half the value usually obtained with similar registers. An enhancement-mode p-channel MOS IC, the 2512 also features two-chip select controls for XY matrix selection, write-and-read controls and only 1 μ W/bit dissipation at 1 MHz. Power supplies are ± 5 V.

CIRCLE NO. 272

Now, get more insertion loss from a smaller-volume filter.



You can get it from these RFI/EMI low-pass feedthrough filters from AMP. Because of their unique ferrite-titanate composition, they provide suppression and environmental

characteristics never before available in miniature-sized filters at an economic cost.

It's all made possible by single-piece construction which distributes inductance, capacitance and resistance over the filter, making it act like a lossy transmission line. And provides superior mechanical strength, in the bargain.

These filters are free of the usual resonance effects of conventional lumped-element filters. And, through the use of special solders, can be joined safely to bulkheads at temperatures to 260°C, without damage or change in performance. Their operating range is -55°C to +125°C. No voltage derating is required at the higher temperature.

A variety of center-conductor, terminal-type and solder- or bolt-in mounting-type filters is available in two families of filters: "55" Series—the standard maximum suppression line—and the "25" Series—miniature and subminiature filters.

For more information on AMP low-pass feedthrough filters, write to **Capitron Division, AMP Incorporated, 1595 S. Mount Joy Street, Elizabethtown, Pa. 17022.**

Capitron is a trademark of AMP Incorporated.

AMP

INCORPORATED

Manufacturing and direct sales facilities worldwide: Barcelona, Brussels, Buenos Aires, Frankfurt, London, Mexico City, Paris, Puerto Rico, Sao Paulo, s'Herlogenbosch (Holland), Sydney, Stockholm, Tokyo, Toronto, Turin, Vienna.

INFORMATION RETRIEVAL NUMBER 52

A customer asked us to design a Teks® self-drilling fastener as corrosion resistant as the best stainless — but hard enough to drill, tap and fasten in carbon steel.

We did!



The M-Chrome™ Teks

Teks self-drilling fasteners of SAE 1022 case hardened — with our unique M-Chrome™ plating. Far exceeds the corrosion resistance of heat treated 410 stainless or commercial chrome plated carbon steel. Stronger than non-heat treated stainless and magnetic too, for improved assembly efficiency.

IT'S AVAILABLE RIGHT NOW!

M-Chrome™ Teks® self-drilling fasteners

Send for samples.

Product covered by at least one of the following U.S. Patents:
3,125,923; 3,463,045

SHAKEPROOF
DIVISION ILLINOIS TOOL WORKS INC.
ST. CHARLES ROAD • ELGIN, ILLINOIS 60120

Copyright Illinois Tool Works Inc., 1972

PACKAGING & MATERIALS

Subminiature connectors offer replaceable contact



International Telephone and Telegraph Corp., 320 Park Ave., New York, N.Y. 10022. (212) 752-6000.

A replaceable flexible-circuit/printed-circuit contact for the Bur-gun-D subminiature rectangular series of connectors permits manufacturers to buy contacts in bulk, then install them only as needed. Both right-angle and straight printed-circuit tails are available for mating on flexible circuits or printed-circuit boards. The Bur-gun-D subminiature rectangular connectors feature rear insert-and-release, crimp-snap-in contacts.

CIRCLE NO. 273

Breadboard interfaces DEC computers

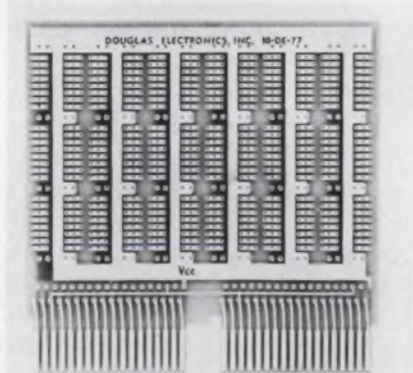

Douglas Electronics Inc., 718 Marina Blvd., San Leandro, Calif. 94577. (415) 483-8770. \$9; stock.

A breadboard is designed for use with DEC computers as well as other interface work. The 10-DE-77 board has double sided 36-contact connector fingers and accepts eighteen 14 or 16-pin dual-in-line packages. It is etched in two-ounce copper on flame retardant glass epoxy. Finish is 0.00002-inch gold. All holes are plated-thru No. 62 drill (38-mil).

CIRCLE NO. 274

Mounting frame accommodates 30 DIPs

Cambridge Thermionic Corp., 445 Concord Ave., Cambridge, Mass. 02138. (617) 491-5400.

A single bay mounting frame assembly accommodates up to six Cambion integrated socket strips, with 30 DIPs (14 or 16-pin). Each socket has solderless-wrap terminals and holds up to five dual-in-line packages with either 14 or 16 leads on 300-mil centers. A total of four strips can be used with this mounting.

CIRCLE NO. 275

Interconnect assemblies feature custom length

Woven Electronics, Div. of Southern Weaving Co., P. O. Box 189, Mauldin, S.C. 29662. (803) 288-4411. 1-3 wks.

IC interconnect assemblies are made to specifications for length, conductors, insulation and connectors. One type is loomed with twisted pairs and terminated with low profile 14 or 16-pin DIP IC connectors on one or both ends. Conductors may range from 30 to 24 AWG in any color arrangement.

CIRCLE NO. 276

Flexible PC material is fully solderable

Westinghouse Electric Corp., Box 657, Bedford, Pa. 15522. (814) 623-9014.

A resin-coated copper foil called Solder Flex does not lose its bond strength during continuous-flow solder processing because of a special polyamide-imide resin and processing technique. The process results in a natural high-temperature bond between the resin and the copper that eliminates the need for an adhesive interface. Solder Flex is available with a resin film thickness of 1, 1 1/2 or 2 mils on 1 or 2-ounce electro-deposited copper foil. Bond strength is a minimum of 4 lb., and shrinkage after exposure at 165 C for 30 minutes is only 0.8%.

CIRCLE NO. 277

Flexible test connectors permit live testing



Air-O-Tronics Products, Inc., P.O. Box K, Morrisville, N.Y. 13408. (315) 684-3705.

A single contact, flexible test connector permits continuity, signal and voltage testing; patching; probing and connecting. Flexcon can be used with "MS/AN," miniature, subminiature, commercial and solderless-wrapped terminals. Because the Flexcon test conductor is flexible, its shaft bends if an accidental sideload occurs during plug-in, thus preventing mating connector contact or insert damage.

CIRCLE NO. 278

Lead bending system aids reflow soldering



D-Vel Research Laboratories, Inc., Star Route, Williamsburg, N.M. 87942. (505) 894-6500. Stock.

A hand operated lead bending system can both bend and cut off 10-mil flat pack leads for reflow soldering. The equipment can handle up to 600 pieces per hour and produces an extremely uniform and accurate lead configuration. Packages as large as 1.3-in. square are easily accommodated.

CIRCLE NO. 279

Which of these General Electric lamps can help you most?

New Green Glow Lamp!



Finally, a broad spectrum bright green glow lamp from General Electric, that gives you greater design flexibility than ever before. It emits green and blue light with suitable color filters. It is called G2B.

What's more, the G2B is directly interchangeable electrically and physically with our high-brightness C2A red/orange/yellow glow lamp.

So you can use the G2B alone for 120 volt green indicator service. Or together with the C2A to emphasize multiple functions with color. For example: for safe/unsafe functions, dual state indications and to show multiple operations in up to 5 colors.

And remember. Both the G2B and C2A save you money because of their low cost, small size and rugged construction.

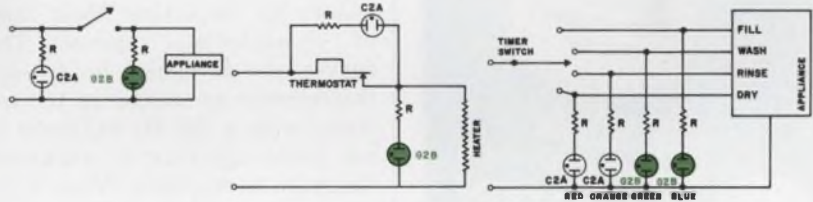

New Sub-Miniature Wedge Base Lamp.

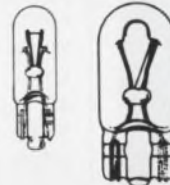

If space for indicator lights is your problem, this new GE T-1 1/4 size all-glass wedge-base lamp is your solution. It measures less than 1/4" in diameter.

The filament is always positioned

in the same relation to the base. It won't freeze in the socket, which virtually ends corrosion problems. And like its big brother — the T-3 1/4 wedge base lamp — it features a simplified socket design.

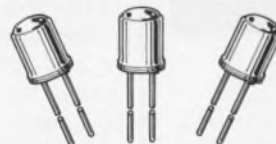

Get more than twice the useful output of other GE solid state lamps with GE SSL-54, SSL-55B and SSL-55C.

The increased energy concentrated in a narrow 20° cone allows you to use less sensitive detectors. Or to operate the lamps at lower current. Or to space lamps and detectors

farther apart.

All are excellent matches for GE photodetectors and can be used in many photoelectric applications. They're also particularly useful in applications demanding an infrared source capable of withstanding severe shock and vibration.

To get free technical information on any or all of these lamps, just write: General Electric Company, Miniature Lamp Products Department, Inquiry Bureau, Nela Park, Cleveland, Ohio 44112.

GENERAL ELECTRIC

INFORMATION RETRIEVAL NUMBER 54

**New
from
General
Electric**



Goldtop
Rechargeable
Nickel-cadmium
Batteries
for elevated
temperature
applications



Here's the rechargeable battery for your tough, high-temperature design applications. General Electric's new Goldtop nickel-cadmium batteries have a maximum sustained temperature capability of 65°C — permitting their use in spots previously too hot for nickel-cadmium batteries. And, at 65°C cell temperature, Goldtop batteries have a longer life expectancy than conventional units at 50°C cell temperature. Goldtop batteries are also available in a quick-charge version that can be recharged in 3½ to 4 hours using a standard charger. These cylindrical cell batteries are available in a wide variety of sizes and ratings.

For more information, write Section 452-02, General Electric Co., Schenectady, New York 12345, or circle reader service card.

452-02

GENERAL ELECTRIC

INFORMATION RETRIEVAL NUMBER 55

INSTRUMENTATION

Dynamic curve tracer costs just \$135



Judd Williams Co., P.O. Box 671, Winter Haven, Fla. 33880. (813) 293-5215. \$135.

The Model A Dynamic Transistor Curve Tracer, when teamed up with a general-purpose scope, becomes a complete semiconductor testing facility at a budget price. The curve tracer graphically analyzes the characteristics of transistors by displaying their family of characteristic curves. These curves are developed by sweeping the collector to emitter of the transistor with a 120-Hz parabolic signal while applying a synchronous staircase to the base. When testing bipolar transistors the instrument displays six curves which may be swept from zero to 80 V peak. The applied base current may be varied from 1 μ A to 5 mA. Five steps of gate voltages ranging from 0.2 V to 10 V are displayed for field effect transistors.

CIRCLE NO. 300

Phase angle standard has 0.015-degree accuracy

Dytronics Co., Inc., 4800 Evanswood Dr., Columbus, Ohio 43229. (614) 885-3303. \$7800; stock.

Dytronics announces the improved 311/RT-1/717S Primary Phase Angle Standard. This instrument is capable of generating a precise phase shift, or of measuring phase angle. The full phase range from 0 to 360 degrees is covered with an accuracy of 0.015 degrees over the mid-frequency range. The operating frequency is from 30 Hz to 10 kHz. This instrument uses a unique concept that is "primary." Operation is not affected by changes in component values. It's ideal for calibrating other phase angle meters or for making phase angle measurements where precision and dependability of measurements are required.

CIRCLE NO. 301

Solid-state power amp works into any load

Electronic Navigation Industries, Inc., 3000 Winton Rd. S., Rochester, N.Y. 14623. (716) 473-6900. \$295; stock.

The 500L rf amplifier will linearly boost a signal source by 27 dB and provide 300 mW from 2 to 500 MHz. Gain is flat to ± 1 dB over the 2 to 500 MHz range but full power output is available from 1.7 to 560 MHz, with larger gain variations. The 500L is unconditionally stable and can be connected to any load impedance, including a short, without failure or oscillation. Other specs include: a noise figure of 8 dB; an input/output VSWR of 2:1; and an input/output impedance of 50 Ω . Harmonics are at least 30-dB down at 200 mW output.

CIRCLE NO. 302

High-frequency scopes break price barrier



Tektronix, Inc., P.O. Box 500, Beaverton, Ore. 97005. (503) 644-0161. 465: \$1725; 475: \$2500; 60 days.

Tektronix, Inc. announces two small (25-lb.) portable oscilloscopes, the 465 and 475. Both scopes represent significant price-performance breakthroughs rather than simply another evolution in portable scope development. The 475's gain-bandwidth combination is 200 MHz at 2 mV/cm. The 465 has 100-MHz bandwidth at 5 mV/div. The 465 and 475 achieve full bandwidth at their highest sensitivity settings. They both contain a big, bright 8 \times 10 cm display with rise time graticule, the largest CRT display area available in general purpose portable oscilloscopes. The 475's sweep speed at 1 ns with X10 Mag is the fastest sweep available in any portable oscilloscope.

CIRCLE NO. 303

Wavesoldering system takes 15-inch PC board



Electrovert Inc., 86 Hartford Ave., Mt. Vernon, N.Y. 10553. (914) MO4-6090. \$ under 6000; 4 to 6 wks.

The ULTRAPAK-15 is a completely integrated and packaged wavesoldering system designed to meet virtually every production soldering requirement for boards up to 15 inches in width. The system includes foam fluxing, pre-heating, soldering and cleaning stations. The soldering station features an interchangeable nozzle arrangement capable of forming three different wave configurations with the option of soldering with or without oil. The pre-heating station includes dual controls to permit independent temperature regulation of the central and peripheral heating elements.

CIRCLE NO. 304

3-1/2-digit DPM mounts on front panel

California Instruments, 5150 Convoy St., San Diego, Calif. 92111. (714) 279-8620. \$115 (1-100).

The 8330 is said to be the first DPM that mounts on the front of a cabinet, not through it. Two small mounting holes and a third hole for conductors is all that is required for installation. There is no mating connector. All components are mounted on one side of a small PC board. This eliminates intricate and possibly unreliable interconnect schemes between PC boards. Plug-in seven-segmented LED are used for 3-1/2-digit readout. Response time for both turn-on and turn-off is less than one μ s. The 5-V powered 8330 is bipolar, with both positive (+) and negative (-) indication in the display. When the DPM is out-of-range, the main digits go to zero and flash on and off.

CIRCLE NO. 305

NEW AUTORANGING DIGITAL MULTIMETER... IN-PROBE DISPLAY, HIGH-SPEED READOUT, BATTERY OPERATION...

\$325.



For AC or DC voltage, resistance and even current, our Model 167 with unique in-probe readout lets you make time-saving measurements directly at the point of measurement. With up to 3-month battery life. The Model 167's combination probe/readout, with 3½ digit LED display, automatically indicates decimal point, polarity, range and function. Front panel terminals and probe receptacle allow alternative use as a bench instrument. The neat, sweet-to-hold 167 Auto-Probe DMM is only \$325 (less in quantity). Check it out and get our latest "How Sweet" button.

Measures easily ... 1 mV to 1000 VDC • 1 mV to 500 VAC RMS • 1 ohm to 20 megohms

with the convenience of ... 55 megohms input resistance • 2-sec. reading time to rated accuracy • 1200 volts overload protection • Complete choice of accessories.



KEITHLEY INSTRUMENTS

U.S.A.: 28775 AURORA ROAD, CLEVELAND, OHIO 44139
EUROPE: 14, AVENUE VILLARDIN, 1009 PULLY, SUISSE



The Model 167... another how-sweet-it-is Keithley Multimeter
Buy now using BankAmericard or Master Charge

INFORMATION RETRIEVAL NUMBER 56

Probe audibly signals logic ONES/ZEROS

Seatronics (UK) Ltd., 22-25, Finsbury Square, London, EC2A 1DT. £33.30; stock.

Seatronics (UK) Ltd.'s latest product, known as the "C-tone," enables a quick and easy check of digital circuits containing DTL and TTL components. It functions by registering logic levels ONE and ZERO as a corresponding high or low-pitched sound. Between the high and low logic levels, no sound is emitted. The "C-tone" measures single pulses from 25 ns and pulse trains with frequencies up to 20 MHz. Power required is 5 V \pm 5%, 4 mA. The unit will distinguish between single positive pulses and single negative pulses as well as pulse trains. Audible signals are given by a speaker or earphone which is included with the instrument.

CIRCLE NO. 306

Scanner moves beam \pm 30 degrees to 0.1%

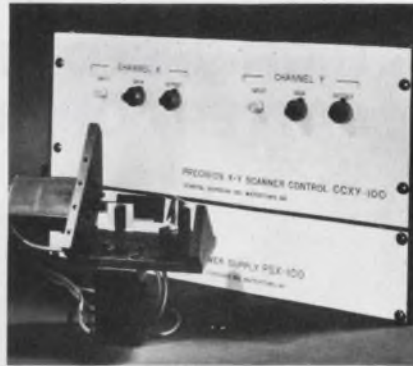

General Scanning Inc., 80 Coolidge Hill Rd., Watertown, Mass. 02172. (617) 924-6620.

Model CCXY-100 is a two-mirror servo-actuated system for deflection of light beams as large as 1-inch diameter. The mirror drives are limited rotation motors which combine high speed and accuracy. Step response is 5 to 20 ms and accuracy is 0.1%, or better. Available optical deflection is \pm 30 degrees about either axis.

CIRCLE NO. 307

10-MHz amplifier delivers 10 watts

Harris-Intertype Corp., PRD Electronics Div., 1200 Prospect Ave., Westbury, L. I., N.Y. 11590. (516) 334-7810.

The Model PRD Type 7825 is a broadband power amplifier designed for high power applications in the 10-Hz to 10-MHz frequency range. It requires no tuning. Once placed into an application or a system, the unit requires no adjustments. The amplifier provides 10 W output into 50 Ω and can deliver over 15 W with higher drive levels. Output impedance is less than 3 Ω , allowing the amplifier to drive R-L-C loads of any impedance. The PRD 7825 can also be operated to 20 MHz and beyond with reduced output. Significant features are the selectable 40/60-dB gain and selectable input impedances of 50 Ω or one M Ω . Harmonic levels at rated output are typically 50-dB down and 30-dB down at 15 W.

CIRCLE NO. 308

POWER SUPPLY HANDBOOK

YOUR'S

FREE



A complete reference of definitions, principles of operation, load connections and performance measurements. A working tool for the Engineer. Yours for the asking . . . and its FREE from Power/Mate.

SEND FOR YOUR FREE COPY



POWER/MATE CORP.

514 S. RIVER STREET HACKENSACK N. J. 07601
Phone (201) 343-6294 TWX (710) 990-5023

terminal blocks by curtis



GB Series surface connection or feed-through terminal blocks.

This U.L. recognized 20 amp., 300 volt series features inserts molded into a black, thermo-set phenolic base. Available with 1 to 26 terminals on 7/16" centers and 7/32" high barriers. For use with wire up to #12 AWG.

Model GBS (illustrated)—Surface connection with #6-32 binder head screws.

Model GBP—#6-32 surface connection plus feed-through .062 diameter pin for internal printed circuit connection.

Model GBFT—#6-32 surface connection plus feed-through, turret type pin for internal solder connection.

All models available with #8-32 surface connections. Also available with clamps to eliminate looping or lugging of wires. Terminals of Models GBP and GBFT are bright tin-plated for excellent solderability.

Contact factory for your nearest local Curtis representative, distributor, or for additional information.

CURTIS DEVELOPMENT & MFG. CO., INC.
3236 N. 33rd St. • Milwaukee, Wis. 53216

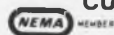

Digital HV tester is battery operated

ITT Jennings, 970 McLaughlin Ave., San Jose, Calif. 95116. (408) 292-4025.

A dc high-potential tester featuring digital readout of test voltage and leakage current is announced by ITT Jennings. The tester, designated the Model 16400, measures high-voltage leakage currents in insulation of electrical equipment. The Model 16400 operates either from an internal storage battery or from line voltage and contains an integral battery charger. The unit is compact and weighs less than 25 lbs. The high-voltage power supply is electronically regulated against line and load changes. Test voltage is adjustable from 500 to 25,000 V dc. Circuitry is all solid state and features an adjustable current limiter (30 to 300 μ A) for protection of the tester and for nondestructive testing of components. In addition, its functions are separately accessible, permitting its use as a portable laboratory high-voltage power supply or as a digital kilovoltmeter.

CIRCLE NO. 309

Precision amplifier selects gain remotely

Preston Scientific Inc., 805 E. Ceritos Ave., Anaheim, Calif. 92805. (714) 535-2704. \$1575; 30 days ARO.

The 8300XWB-RC instrumentation amplifier offers 0.01% gain accuracy, 0.005% gain linearity, 30 μ s settling time and bandwidth selection between 10 Hz and 100 kHz. Ten gain settings, from 1 to 1000 \times , are selectable by four optically-isolated binary-coded address lines. Or, up to seven gain levels may be selected by individually enabled lines, bypassing the address decoding logic. The 8300XWB-RC has a slewing rate greater than 3 V/ μ s and the output settles to \pm 0.01% of final value within 30 μ s. TC is less than 0.1 μ V/ $^{\circ}$ C (referred to input). Long-term (6 months) zero drift is \pm 5 μ V (referred to input), and \pm 1 mV (referred to output). CMR is a minimum of 150 dB at dc, 130 dB at 60 Hz, and 60 dB at 100 kHz.

CIRCLE NO. 310

dip clip

T.M.

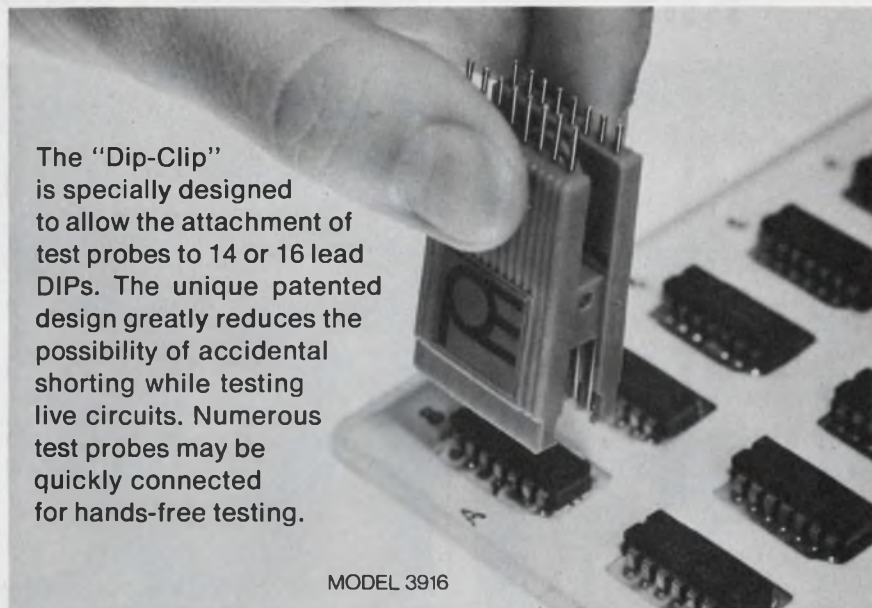

The "Dip-Clip" is specially designed to allow the attachment of test probes to 14 or 16 lead DIPs. The unique patented design greatly reduces the possibility of accidental shorting while testing live circuits. Numerous test probes may be quickly connected for hands-free testing.

MODEL 3916



POMONA ELECTRONICS

1500 E. Ninth St., Pomona, Calif. 91766 • Telephone: (714) 623-3463

INFORMATION RETRIEVAL NUMBER 59

the grabber

T.M.

Our plunger action Mini-Test Clip is designed specifically for reaching into densely packaged miniaturized circuitry to make rapid, reliable tests.

- Gold plated copper contact hook makes positive connection, and won't damage lead wires.
- Specially designed tip slides down over square Wire-Wrap pins for solid contact.
- Integrally molded wire assures greater reliability and eliminates time-consuming assembly.
- Molded nylon probe provides complete insulation to point of connection.
- Four models offer widest selection of connecting plugs. Write for complete information and prices.

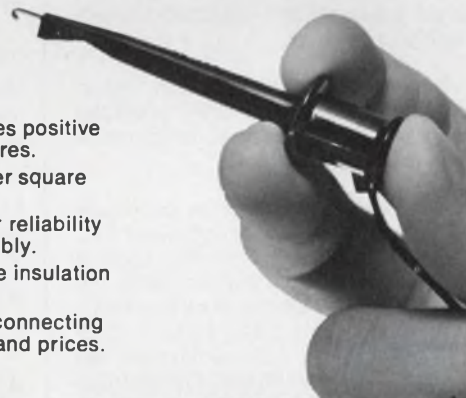

POMONA ELECTRONICS

1500 E. Ninth St., Pomona, Calif. 91766 • Telephone: (714) 623-3463

*Registered trademark of Gardner-Denver Co.

INFORMATION RETRIEVAL NUMBER 60

The Elegant Transformer Kits

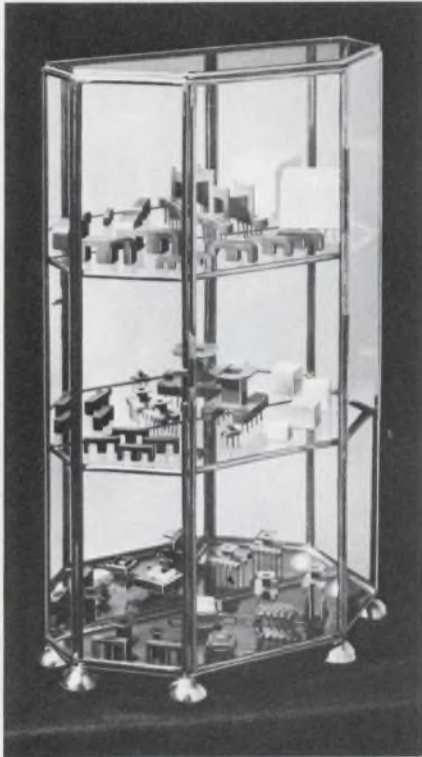

Select from 157 kits. To find the exact match for your needs. Plus ready-made economies. With ferrite cores. Steel frames. Cases. And bobbin/coil forms that pin precisely into standard printed-circuit patterns.

Six materials: fluorocarbon, nylon, glass-reinforced nylon, DAP, polyester and epoxy. For stability at temperature ranges from 105 to 200 C.

The complete collection expresses the craftsmanship you expect from EPC as an EAI component company. Look to EPC also for custom-molded parts. Or to EAI for thick-film audio amps. Capacitors. Custom coils. Solenoids. Active filters. Analog/digital converters and other special function modules. Plus a growing list of other elegantly crafted etceteras.



EPC

Electrical Plastics Corporation
500 Long Branch Avenue
Long Branch, New Jersey 07740
Tel. (201) 870-9500

A Subsidiary of Electronic Associates, Inc.

COMPONENTS

Solid-electrolyte device is capacitor, battery or timer

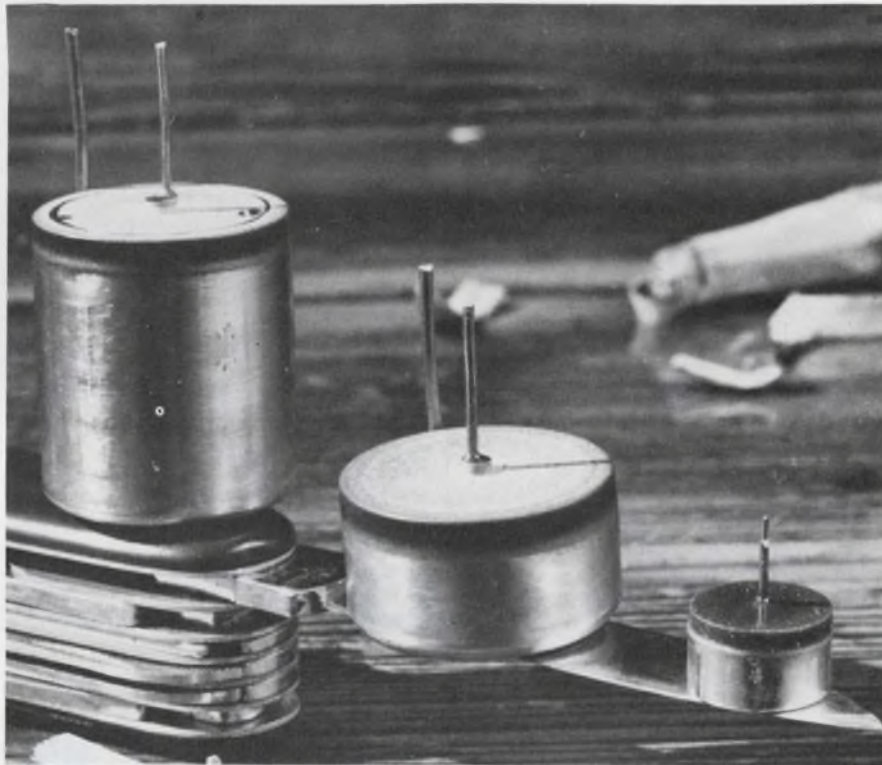

Gould, Inc., Dept. ETL, P.O. Box 3140, St. Paul, Minn. 55165. (612) 452-1500. See text.

The development of solid electrolytes with high conductivity has made possible several lines of solid-electrolyte devices, including batteries (primary and rechargeable), capacitors (in farad sizes) and Coulistor timers. Four primary-battery sizes are available. They range from 1.2 V (nominal) with a 40 mA-hr capacity (for \$5) to 3.6 V (nominal) and a 200 mA-hr capacity. Projected shelf-life is 15 years when stored at room temperature and one year at 160 F. End of life is considered reached when energy capacity has fallen to 90% of initial value.

Secondary (rechargeable) batteries provide environmental and shelf-life characteristics of a high-quality capacitor. The battery has a cycle life, measured in thousands of cycles, and charge retention, measured in years. It bridges the energy gap between electrolytic ca-

pacitors and ordinary secondary batteries. Four types of rechargeable solid-electrolyte batteries are available. They range from 3.75 (under \$20 in smallest capacity) to 5.63 V output.

The solid-electrolyte capacitor is a high-capacitance, low-volume, device with low-leakage. Seven capacitor sizes are available ranging from 0.01 (for \$5) to 5.0 farad capacitance.

Gould's Coulistor timer (\$10 for 100-up qty) operates as a current-time integrator. The charge rate can be set by applying an adjustable current from a constant-current source. A predetermined positive voltage signals the end of the timing cycle. The Coulistor can be cycled more than one million times with an accuracy of $\pm 5\%$ of set time over the temperature range -65 to $+160$ F.

Gould is accepting large quantity orders. Quantities under 1000 are filled immediately.

CIRCLE NO. 320

Solid-state relay fits two units in DIP socket

Grigsby-Barton, Inc., 3800 Industrial Dr., Rolling Meadows, Ill. 60008. (312) 329-5900. \$2.90 (1000 up); 5 wks.

Solid-state ac relays of the GB-870-series Reedacs can switch 480 W at 240 V or 240 W at 120 V. Two units will fit side-by-side in a single DIP socket. It uses a reed relay input and a triac in the output, combining the advantages of solid-state and relay techniques.

CIRCLE NO. 321

Rotary BCD switches for PC boards program logic

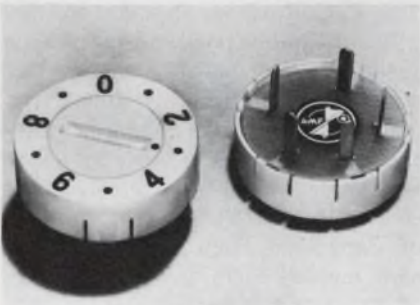

AMP Incorporated, Harrisburg, Pa. 17105. (717) 564-0101.

Specifically designed for PC board mounting, these compact (0.24 x 0.75 D in.) rotary BCD switches are fully enclosed. With a contact life expectancy in excess of 10,000 crosspoint operations, and a rating of 250 mA, these switches can program logic functions in machine tools, vending machines, test equipment and computers. The three available styles include screw-driver (or coin), barknob or thumbwheel versions.

CIRCLE NO. 322

Small alarm buzzer generates 70 dB

Cimatron Co., 1710 22nd St., Santa Monica, Calif. 90404. (213) 829-3541. \$1.30 (unit); stock to 30 days.

Producing 70 dB of sound from only 15 mW of power, the Micro-Buzzer measures 5/8 x 7/8 x 1/2 in. and operates on 1.5 V dc. It was first developed for portable electronic calculators to warn of errors and overflow conditions. It uses a type of stepping motor to develop the sound wave energy.

CIRCLE NO. 323

PDQ

from your Triad Distributor



TRIAD'S low cost, wide range adjustable, 40-watt power supplies.

Triad's WR Series of 4 models feature open top construction, extruded integral heat sink housing, all silicon semiconductors, 10-year life computer grade capacitors, FR glass epoxy pc boards, and electrostatically shielded transformers. All units are convection cooled, have automatic current limiting, and are designed to meet UL-CSA requirements. In stock and available now from Triad distributors.

B size slot supplies for OEM systems.



NCB Series in 5 voltage ranges delivers 25 to 45 watts of precisely regulated DC power at extremely low ripple. With built-in overvoltage protection, automatic fold back current limitation and reverse polarity protection. Lower in cost, they retrofit many models on the market today. In stock now at Triad distributors.



TRIAD-UTRAD DISTRIBUTOR

305 North Briant Street, Huntington, Indiana 46750

INFORMATION RETRIEVAL NUMBER 62

COMPONENTS

Wideband transformer covers 0.1 to 1000 MHz

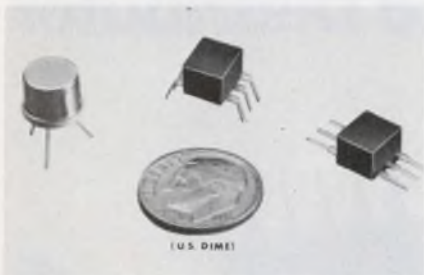

The Vari-L Co., 3883 Monaco Pkwy., Denver, Colo. 80207. (303) 321-1511.

Vari-L's Z-Match miniature wideband transformers are packaged either in a completely shielded TO-5 metal case, or in a 1/3-DIP with leads that can be easily bent into different positions. Z-Match transformers can be used for impedance step-up or step-down. Response is flat, within ± 1 dB, over the range 0.1-1000 MHz. VSWR is less than 1.3:1, and insertion loss is 0.5-dB max. Power handling ability is approximately 1 W.

CIRCLE NO. 324

Kit allows you to make your own resistors



Chronomite Laboratories, 21011 S. Figueroa St., Los Angeles, Calif. 90047. (213) 320-9452. \$12.95 (unit qty); stock.

The Instant-Ohm resistor kit is offered for making resistors, shunts, or multipliers, for repair, production and experimental use—on the spot—for about 2¢ each. Each kit contains seven resistance wires ranging from 0.5 to 300 ohms/ft., 11 epoxy bobbins, instructions, and simple schematics. Both Manganin and Karma wire alloys are used because of their low temperature coefficients. These fine-wire alloys were formerly available only in bulk.

CIRCLE NO. 325

Miniature transformers plug into PC cards

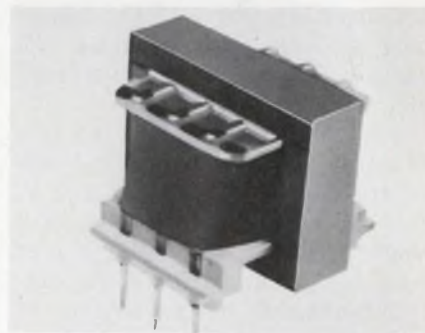

Bourns Pacific Magnetics Corp., 28151 Highway 74, Romoland, Calif. 92380. (714) 657-5195.

AU-9000 is a new series of miniature plug-in audio transformers for printed circuit applications. The transformers handle to 300 mW of audio power and have a frequency response that's flat within ± 3 dB from 300-10,000 Hz. The units match impedances ranging from 10 Ω to 200 k Ω by using reversible primary and secondary connections to extend the number of impedance combinations. Precision molded terminals permit rapid PC-board insertion.

CIRCLE NO. 326



versatile instrument package

CABINET SERIES



10 heights from 5 1/4" to 28" with 17.9" or 25.9" depths.

Two week delivery from stock.

Accepts EIA 19"-wide panels. Positive nesting foot for vertical stacking. Single units can be fitted with tilt stands, chassis slides, fold-away cast handles, (self-retract strap available for 5 1/4" unit only). Pre-built with or without front and/or rear panels. Ask for free VIP Design Guide, prices.

Zero Manufacturing Co.

Zero-West (213) 846-4191 • 1121 Chestnut St. • Burbank, Ca. 91503
Zero-East (413) 267-5561 • 288 Main St. • Monson, Mass. 01057
Zero-South (813) 531-8991 • Int'l Airport • St. Petersburg, Fla. 33732

INFORMATION RETRIEVAL NUMBER 63



Two week delivery from stock, pre-assembled or in kit form.

Multiple function + contemporary styling + affordable prices.

(1) Vertical Nestable; (2) Vertical Interlockable; (3) Horizontal Interlockable; (4) Rack Mountable; (5) Briefcase Portable; (6) Tiltable...in 14 standard sizes. Call or write for free VIP Design Guide and Prices.

Zero Manufacturing Co.

Zero-West (213) 846-4191 • 1121 Chestnut St. • Burbank, Ca. 91503
Zero-East (413) 267-5561 • 288 Main St. • Monson, Mass. 01057
Zero-South (813) 531-8991 • Int'l Airport • St. Petersburg, Fla. 33732

INFORMATION RETRIEVAL NUMBER 64

Five discrete resistors fit single substrate

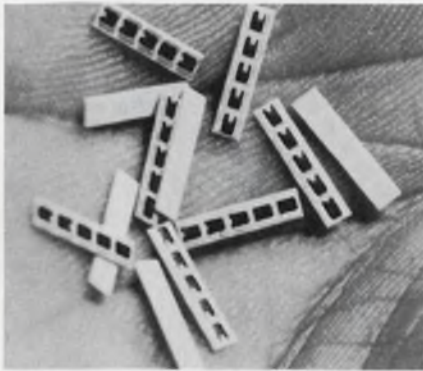

Hybrid Technology Corp., P.O. Box 718, Grand Prairie, Tex. 75050. (214) 262-2763. To \$.48 (OEM qty.); 2-4 wks.

With dimensions of $0.08 \times 0.35 \times 0.025$ in., multiple-resistor panels contain five electrically discrete resistors on a single substrate. The units are available with resistors in a range from 50Ω to $500 \text{ k}\Omega$, with a tolerance to $\pm 1\%$ and temperature coefficient of 300 PPM.

CIRCLE NO. 327

Illuminated pushbutton switch is RFI shielded



Airpax Electronics Inc., 1836 Floradale Ave., S. El Monte, Calif. 91733. (213) 579-2531.

Model LBM combines an RFI shielded SPST momentary-action switch with an indicator light. The switch button is available in six colors and clear plastic. Terminals are of the solder-lug type, and coin-silver contacts are rated 1 A at 120 V ac.

CIRCLE NO. 328

10 amps of switching in a 1" cube!

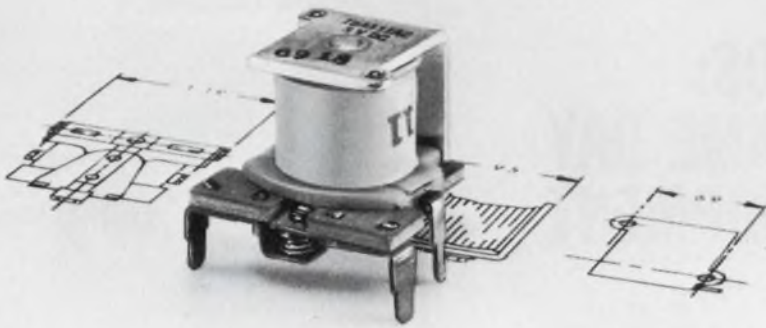

We call it our Series 19 Relay. You'll call it one of the most compact and reliable packages you've ever used.

Remarkable 10 amp Series 19 relay is low in cost, too — less than \$1.00 each in quantity. But price is only part of the story. The Series 19 also offers the advantages of miniaturization and the capacity to handle heavy switching loads. Result: more performance in a smaller overall package. Contact arrangement is SPDT. Rated 10 amps at 28 vdc or 115 v, 60 hz. Coil voltages available range from 3 to 24 vdc. The Series 19 is an ideal choice for a multitude of low level to 10 amp switching applications, including remote control, alarm systems and many other industrial and commercial uses. Equally important, the Series 19 is part of a whole family of interrelated low-cost relays which will lend themselves to multiple usage in the same system. Included are:



wide range of industrial and commer-

Series 10.

Sensitive, low cost, highly reliable SPDT relay rated at 3 amps, 28 vdc. Coil voltages 3-24 vdc. Can be used for a

cial control functions and alarm systems.

Series 28. Same as Series 10, but furnished with a dust cover for use in appliance controls, remote TV tuning, industrial process controls and similar functions.

Series 38. DPDT, 3 amp 28 vdc contacts. Coil ratings 3-24 vdc. Applications include business machine controls, antenna rotor controls, industrial process controls, etc.

GP. A miniature general purpose relay with 2, 4, or 6 PDT contacts, rated 1, 2 or 5 amps, 28 vdc or 115 v, 60 hz. Coil voltages: 6-115 vdc. Consider the GP for copiers, business machines, control or alarm systems, etc. Available with single or bifurcated contacts.



Send for information. Complete technical data on NAPCC relays available on request. Write today.

PRICE ELECTRIC RELAYS

NORTH AMERICAN PHILIPS CONTROLS CORP.

A NORTH AMERICAN PHILIPS COMPANY
E. Church & 2nd St. · Frederick, Md. 21701 · (301) 663-5141

INFORMATION RETRIEVAL NUMBER 65

DC-DC CONVERTERS

SDS: SAME DAY SHIPMENT



9500 SERIES DC-DC POWER SUPPLIES

Yes, we'll guarantee you shipment of most of our standard products the same day we receive your order.

That's because we're the DC-DC specialists. So, we can generally assure you of SDS. Take our 9500 Series of regulated 28V DC-DC power supplies. Whether you want 1,3,6 or 10 watts, they're ready to be shipped to you right off the shelf the same day your order reaches us.

And, to make sure you get the fastest service available, we've installed a new **HOT LINE**.

Just dial our regular phone number and ask our operator for the "HOT LINE." You'll get fast attention to your inquiry or order.

SDS and the **HOT LINE**.

Two more ways the specialists at tecnetics prove you're somebody special.

(See EEM catalog vol. 1 pp. 996-1005)

tecnetics inc.

P.O. Box 910, Boulder Industrial Park, Boulder, Colorado 80302
(303) 442-3837 TWX 910-940-3246

INFORMATION RETRIEVAL NUMBER 66

COMPONENTS

Counting indicator prints reading

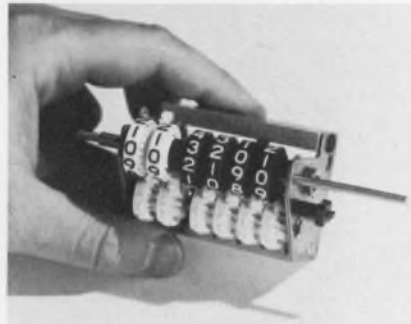

Veeder-Root, 70 Sargeant St., Hartford, Conn. 06102. (203) 527-7201.

The Series 7619 counter and printer, when mechanically driven by a servo-drive input, can convert analog voltages to a digital display and printout. With a step-per-motor drive, the counter can be used as an electrical printing totalizer. It requires a torque of only 0.5 oz-in. max. A built-in mechanism advances the unit wheel to the next full figure prior to print, and returns the wheel to the original position after print. Detent fingers lock all wheels during printing.

CIRCLE NO. 329

Thumbwheel switch clips into front panel



Syncon, Inc., P.O. Box 265, Freehold, N.J. 07728. (201) 462-1534. \$2 (unit qty) for 10-position unit.

Featuring a snap-lock mounting, the SM Series subminiature thumbwheel switches (0.312 in. wide) eliminate the need for close-tolerance panel cutouts and special mounting hardware. Standard versions include 10-position decimal, BCD, complementary BCD, and BCD plus complement in a variety of configurations.

CIRCLE NO. 330

Single resistor unit provides 90, 1% values

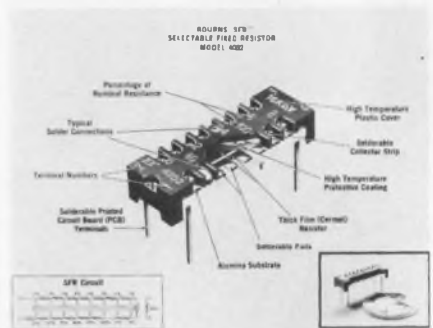

Bourns, Inc., 1200 Columbia Ave., Riverside, Calif. 92507. (714) 684-1700. \$0.76 (1000-1999); Sept. (from factory); Oct. (from dealers).

Bourns' SFR Selectable Fixed Resistors provide the equivalent of a box full of 1350 cermet resistors in only 15 units. Each unit's resistance can be set in steps of 1% from about 50% to 139% of the nominal value in two overlapping ranges. The 15 units cover values from 33 Ω to 1.25 M Ω in overlapping ranges. Although the absolute resistance as set by the numbers on a unit is only accurate to about $\pm 10\%$, a desired value can always be found to $\pm 1\%$ within a unit's range. The SFR resistors are rated at 1/2 W for maximum resistance and proportionately less for lower settings. The devices are especially suited to one-time-adjust, set-and-forget applications.

CIRCLE NO. 331

Crosspoint matrix handles dc to 60 MHz

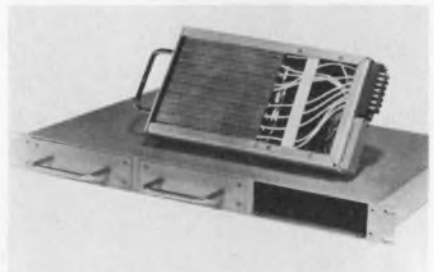

Trompeter Electronics, Inc., 8936 Comanche Ave., Chatsworth, Calif. 91311. (213) 889-1020.

A 300 crosspoint matrix consisting of three, 10 input by 10 output modules (100 coax crosspoints) is housed in a 1-3/4 \times 19 in. panel space. The coax matrix is usable from dc to 60 MHz. Interchannel isolation is -55 dB at 60 MHz.

CIRCLE NO. 332

Meter relay monitors and controls speed



Servo-Tek Products Co., 1086 Goffe Rd., Hawthorne, N.J. 07506. (201) 427-3100.

A control meter-relay speed-indicating system for use in process and control machinery has both single and double set-points. Speed ranges from 10,000 to 12,000 rpm full scale are available. The set points are adjustable to $\pm 2\%$ within 0 degrees of each other over the complete range. Repeatability is accurate to 0.5%. Relay contact outputs are rated at 10 A at 115 V ac.

CIRCLE NO. 333

Keyboard switch uses reed-switch contacts

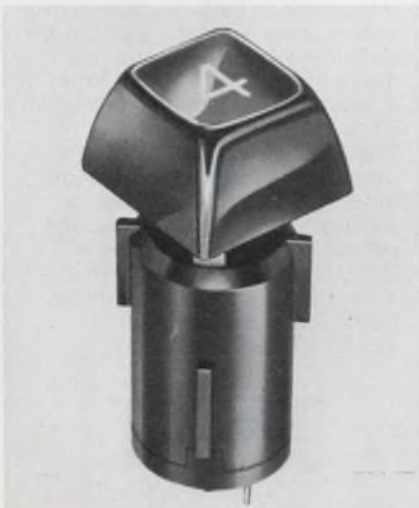

Maxi-Switch Co., 3121 Washington Ave., N., Minneapolis, Minn. 55411. (612) 926-2721.

Keyboard reed switches of the 2700 Series use an internal magnet to actuate the reed. Contact bounce is limited to 0.4 ms, resistance to 200 m Ω max and the contacts handle to 500 mA in dc resistive applications. The switches are also supplied in calculator blocks, fully encoded keyboards, and custom panel assemblies.

CIRCLE NO. 334

Hats Off

TO OUR NEWEST PERFORMERS: VARACTOR-TUNED GaAs OSCILLATORS

These unique VCOs complement an existing line of fundamental and doubling type oscillators covering 4 to 18 GHz. Units are available with isolators, linearizers and temperature-controlled environments to meet both commercial and military specifications.

Individual units feature smooth power output curves and monotonic tuning curves. Performance data for a typical 7 to 10 GHz unit is shown.

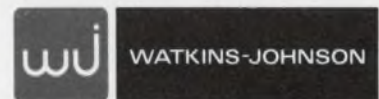
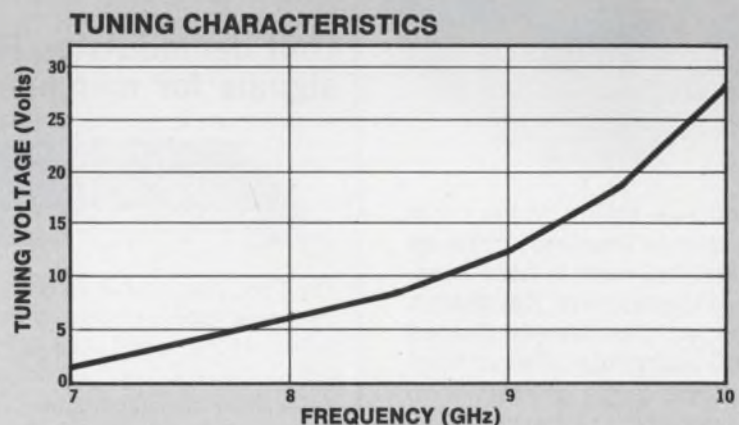
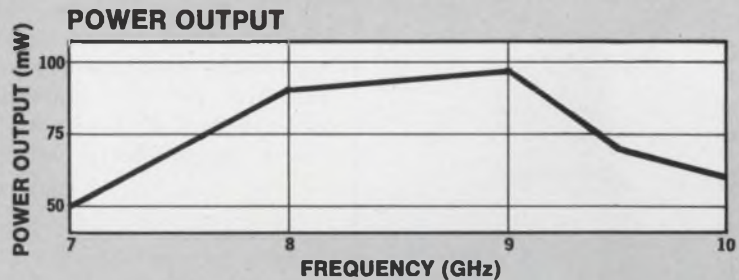

3333 HILLVIEW AVE., STANFORD INDUSTRIAL PARK
PALO ALTO, CALIF. 94304 • (415) 493-4141

INFORMATION RETRIEVAL NUMBER 67

Keystone Thermistors under glass

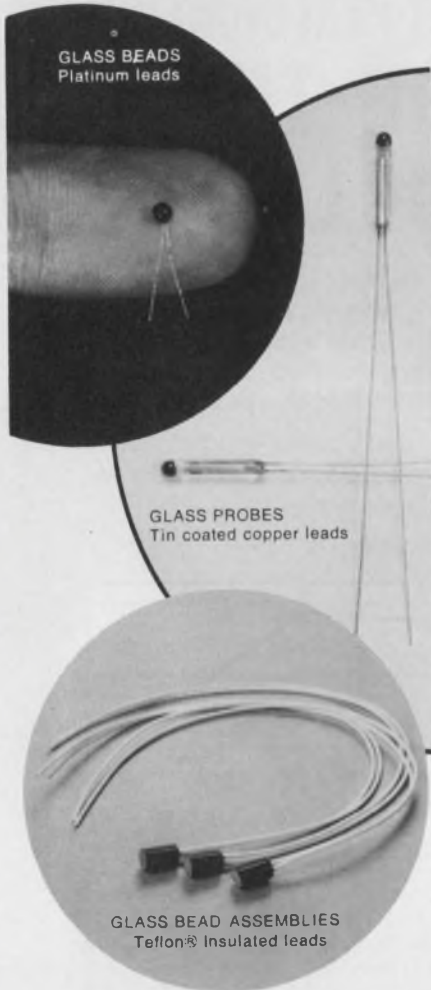

You can count on very fast response time and improved reliability even in hostile environments with Keystone's rugged glass beads, probes and assemblies. Select from a large range of resistance values (1 K to 1 meg at 25°C) and temperature levels from -50°C to 260°C. Easy to handle and assemble, these thermistors are ideal for temperature measurement and liquid level detection. *Send now for data bulletin.* Keystone Carbon Company, Thermistor Division, St. Marys, Pa. 15857.

INFORMATION RETRIEVAL NUMBER 69

DATA PROCESSING

Calculators employ MOS memories



Wang Laboratories, Inc., 836 North St., Tewksbury, Mass. 01876. (617) 851-7311. \$1200: Mod 452; \$800: Mod C-52.

Each of Wang's three new 400 Series calculators has as standard 32 functions, controlled by 16 dual-operation keys, 64-steps of learn-mode programming and eight extra storage registers. Optionally, a user can specify up to 320 program steps and 40 additional storage registers. MOS logic memories are used in all 400-Series calculators. The Economy 50 Series, designed for manual operation, leaves out learn-mode programming and an interface for the marked-sense-card programmer peripheral, available in the 400-Series units.

CIRCLE NO. 335

Unit demodulates FM signals for computers



Tri-Com, Inc., 12216 Parklawn Dr., Rockville, Md. 20850. (301) 881-9050. \$1000 per channel; 30-60 days.

A new FM demodulator recovers analog data from tape-recorded subcarriers for computer entry. The Model 602 allows computer selection of one-of-three channels and one-of-three filters. A quality monitor provides a signal to the computer when there is high-in-band noise. With subcarriers centered at 0.4 kHz to 1 MHz, data rates to 150 kHz can be recovered.

CIRCLE NO. 336

Give
your
sweep
and
signal
generators
a



Our boost is a 2-500 MHz RF Power Amplifier, known as the Model 500L. This completely solid-state laboratory instrument will boost the output of any signal source by 27 dB and provide more than 11 volts P-P into 50 ohms. A combination of hybrid integrated circuits and microstrip construction, our state-of-the-art amplifier will operate into any load impedance (from an open to a short circuit) without oscillation or damage.

The boost. Priced at \$295, it's one of the great bargains of our time. Give yourself a boost by writing to Electronic Navigation Industries, Inc., 3000 Winton Road South, Rochester, New York 14623. For an even faster boost, call 716-473-6900, TELEX 97-8283.



ENI . . . The world's leader
in solid-state power amplifiers.



INFORMATION RETRIEVAL NUMBER 70

Testing system handles wide range of assemblies



Adar Associates, Inc., 85 Bolton St., Cambridge, Mass. 02140. (617) 492-7110. \$110,000 to \$180,000.

Called Doctor 64, Adar's testing system does functional, parametric and dynamic testing of MSI, LSI, MOS, bipolar, hybrid, ROM, RAM, and discrete logic arrays and units. The 64 is composed of four major subsystems: computer, mainframe, test head and software. The software package is a user-oriented, declarative test language. The system is capable of measuring such things as rise time, fall time, propagation delay and access time.

CIRCLE NO. 337

Modem multiplexer serves six terminals

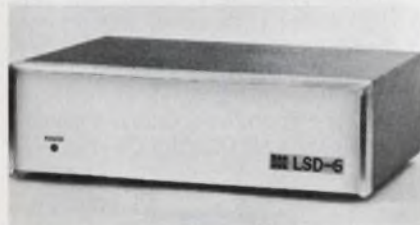

Rixon Electronics, Inc., 2120 Industrial Pkwy., Silver Springs, Md. 20904. (301) 622-2121.

An automatic, six-channel line multiplexer, the LSD-6, allows a single modem to service up to six data terminals on a first-come, first-served basis. By operating several LSD-6 units in tandem, the capacity of a single modem can be further extended to accommodate 11, 16 or 21 (or more) terminals.

CIRCLE NO. 338

Your card reader and interface problems end here.

Hickok designs static card readers with the user in mind. Starting with two rugged, reliable, economical models, we tailor the reader you need for use in programming system control and data collection.

You also receive the help you need. You select among a variety of electronic packages to interface the reader to your system. Packages like TTL-compatible scanners with two operating modes, sequential scanning and addressable by column number.

Reliability is built into Hickok readers with the multistrand continuous brush design. This technique eliminates errors caused by contaminants on the card and allows reading even of cards punched out of tolerance.

This design also saves you money, because it's easier to make. Even in single lots, the 264A Badge Reader is only \$175, and the 960A Card Reader, \$495.

When you're considering static card readers, call Hickok. We have the right unit at the right price for you.

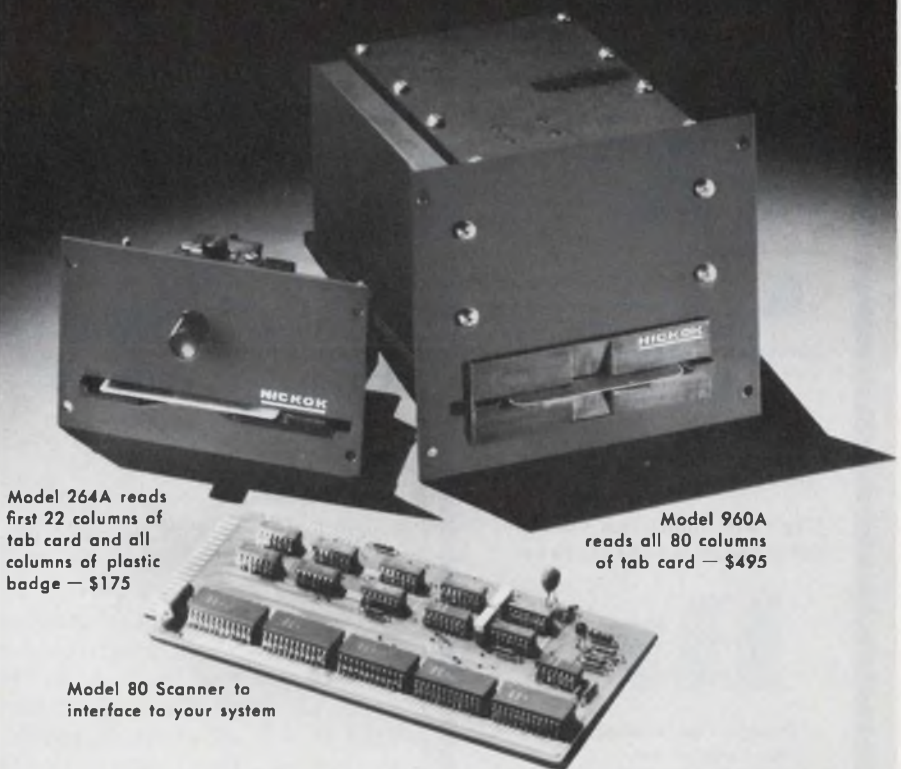

Model 264A reads first 22 columns of tab card and all columns of plastic badge — \$175

Model 960A reads all 80 columns of tab card — \$495

Model 80 Scanner to interface to your system

HICKOK
the value innovator

Instrumentation & Controls Division
The Hickok Electrical Instrument Co.
10514 Dupont Ave. • Cleveland, Ohio 44108
(216) 541-8060

INFORMATION RETRIEVAL NUMBER 71

MONOLITHIC
CRYSTAL FILTERS



The Truth About Monolithics . . .



Truth is stronger than fiction. It's also said to be the greatest gimmick in advertising. That's what this series of ads is about — the truth about monolithic crystal filters. If you want the truth about the best filter for your application, talk to us. We've been making monolithic crystal filters longer than anyone else — and we've made more of them. We know what can't be done as well as what can.

Standard Substitute . . .



When is a conventional crystal filter unconventional? When it's a monolithic designed to be completely interchangeable with its conventional counterpart — and to be 10 to 50% less expensive. If you're still using conventional crystal filters and aren't ready to redesign your equipment, check with us. The next best thing to designing your new radio around a monolithic crystal filter is plugging a monolithic into your old one. It may be just what the doctor ordered to keep the patient alive and well a little longer.

Short Course . . .



Whether you're now using integrated crystal filters or just thinking about it, you'd probably like to know more about them. We're offering a limited number of reprints of an up-to-date survey article including specification guidelines. A copy is yours for the asking. Just drop us a note on your letterhead.

Like more information on monolithics? Drop us a line or call us.



Piezo Technology Inc.
2400 Diversified Way
Orlando, Florida 32804
305 425-1574

The Standard in monolithic
crystal filters.

DATA PROCESSING

Video terminal circuit
drives TV displays

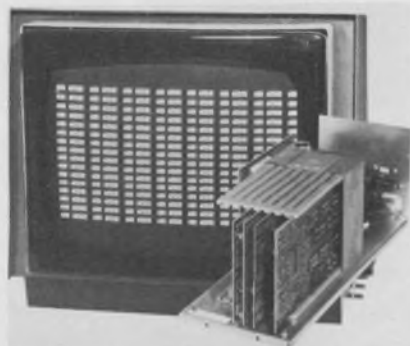

Ann Arbor Terminals, Inc., 6107 Jackson Rd., Ann Arbor, Mich. 48103. (313) 769-0926. \$670 to \$1200; 15 days.

Series 200 video terminal controllers in a "barebones" configuration (for OEMs) are functionally complete, including timing, memory, cursor and serial KSR boards plus power supply. The units are available for formats to 2000 characters, plus full graphics, and can drive single or multiple arrangements of either conventional TV sets or 525-line video monitors. Size is only 15 x 5-1/2 x 5-1/2 in.

CIRCLE NO. 339

Family of printers fits
many data devices



Traco Inc., 509 Rolling Hills Rd., Somerville, N.J. 08876. (201) 725-5333. From \$785 (unit qty).

Traco's family of digital printers includes strip and programmable carriage printers with 5 to 16 digits per line. Their maximum speed is 4 lines, or 64 characters, per second. They accept 1-in-10 or BCD code information. Many extras and special features can be fitted to the 15 different basic models.

CIRCLE NO. 340

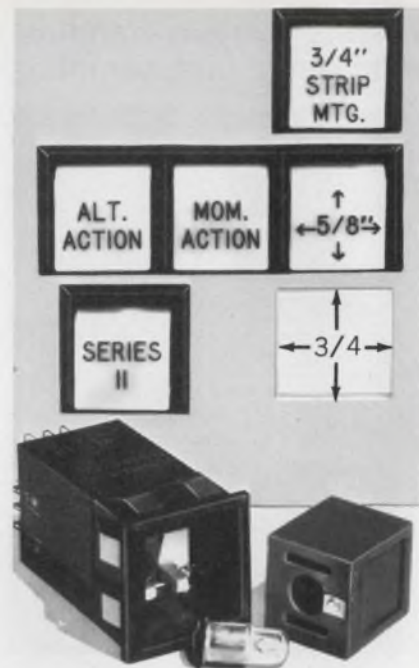

Mini
4-pole
lighted Sw.
costs less.

It's CLC's Series 11 Illuminated Pushbutton Switch . . . the only one fitting 3/4" panel cutout priced low as \$3.80 in qty.

Momentary or alternate actions • gold or silver contacts • 0.5 A/30 vdc to 10 A/115 vac • less than 3 msec bounce • 0.007 ohms resistance • 1,000,000 cycle life • 3/4" sq. lens cap • 1 15/32" body • 12 oz. operating force • snap-lock mtg. in to 1/8 to 1/4" panels • engraved legends • 5 lens/filter colors • front relampable • T-1 3/4 lamps • solder or Faston terminations • matching indicators • P. C. mtg. options.

SEND FOR COMPLETE DETAILS.



COMPU-LITE CORPORATION



17795C Sky Park Circle
Irvine, California 92707
Phone: (714) 546-9045

INFORMATION RETRIEVAL NUMBER 73
ELECTRONIC DESIGN 21, October 12, 1972

Use finger to locate points on a display



Intronics Inc., Bridge Plaza, Suite 204, Ogdensburg, N.Y. 13669. (315) 393-7550.

Called the TSD, for touch-sensitive digitizer, the system uses a piece of glass which is placed over a CRT display or hard copy. TSD can also be used with projection systems. The system's electronic circuitry automatically determines the location of a finger, felt-tipped pen, or other passive probe placed on the glass. The coordinates of the probe's location are converted into binary or BCD format.

CIRCLE NO. 344

Paper-tape reeling unit improves tape handling

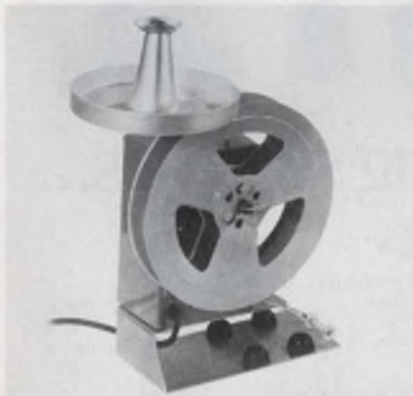

Data Specialties, Inc., 1548 Old Skokie Rd., Highland Park, Ill. 60035. (312) 831-3750. \$125; stock.

The TM35 is an automatic tape handling system used to simultaneously feed and collect tape for reading or merely to collect tape after perforation. The unit can be mounted rigidly to the Teletype-TM/35 unit without the use of tools.

CIRCLE NO. 345

NEW COOL-PAX MODULAR COOLING SYSTEMS FOR Power Semiconductors

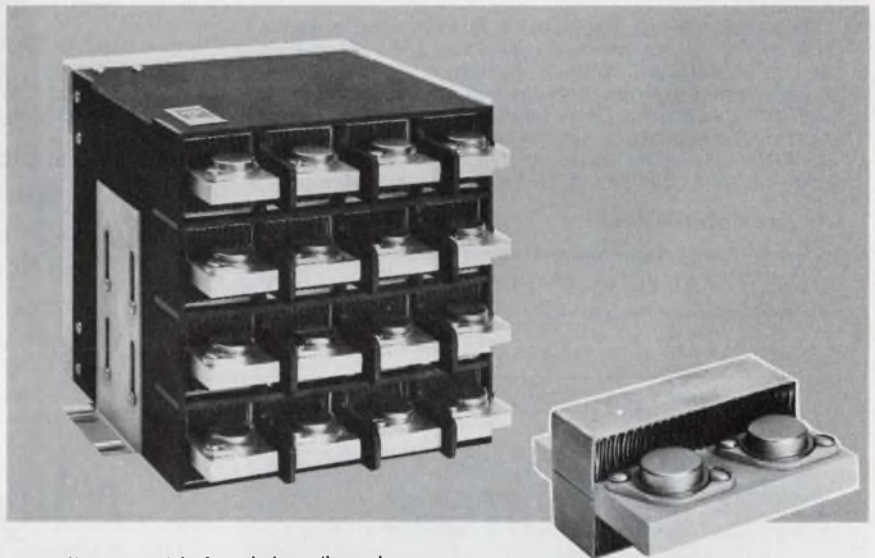

New concept in forced-air cooling using convoluted fin stock in modular assemblies accommodates any number of devices in case-common or single, isolated modules.

Modules are easily removed from system via a simple latching mechanism. Shown, a two-unit module.

Brazed aluminum compact cooling packages:

- Provide $.65^{\circ}\text{C}/\text{W}$ cooling for each transistor at 8 CFM
- Provide parallel air flow to all devices
- Greatly reduce volume and weight

The COOL-PAX Modular System is a new generation in electronic cooling. Its superior performance and greatly reduced volume and weight make the heavy extrusion obsolete. COOL-PAX systems improve packaging versatility and lower overall systems costs. Devices are easily accessible and wiring complexity is reduced.

COOL-PAX Systems are simple to specify, to analyze, and to predict performance. For technical applications data to analyze your own system, write for our new COOL-PAX Catalog 72-CP-7.

WRITE FOR FREE CATALOG



Thermalloy

P.O. BOX 34829
2021 W. VALLEY VIEW LANE
DALLAS, TEXAS 75234
(214) 243-4321 TWX 910-860-5542

INFORMATION RETRIEVAL NUMBER 74

Electronic time delay relays

- Transient voltage protected
- High density packaging
- Wide delay range



Protected against environmental extremes by an all-welded encapsulated construction, these solid state timers maintain timing accuracy over a wide range of voltage and temperature. Accuracy is further safeguarded by built-in transient voltage protection.

Three types are available, either factory preset or field adjustable. The 311 crystal-can module has SPST NO switching rated to 200 MA with delay times from 0.1 to 100 seconds. Series 312 and 313, rated 10 amps and 2 amps respectively, have DPDT switching. Delay times are from 0.1 to 400 seconds; reverse-action operation is also available.

Timers with longer delays, higher switching loads, closer tolerances, and other timing modes are also available.

Send for information now!

A. W. HAYDON CO. PRODUCTS

NORTH AMERICAN PHILIPS CONTROLS CORP.

A NORTH AMERICAN PHILIPS COMPANY
Cheshire, Conn. 06410 • (203) 272-0301

INFORMATION RETRIEVAL NUMBER 75

All-in-one-card RAM. Very fast access time: 125 ns. Very fast delivery: right off the shelf. Contains memory address register, decoding, storage sense amplifiers, write amplifiers, output buffers—everything needed for complete memory function. Up to 18K on a single card. For more words by more bits, just wire the cards together. Power consumption is less than one milliwatt per bit. Price is lower than any other card memory in this speed range. Give us a call. We'll quote price on the phone and ship one to you on a memorandum receipt that gives you a **Free Thirty Day Trial Period.**

All this from the people who know memories. **Electronic Memories & Magnetics Corp.** Phoenix Semiconductor Facility, 3883 North 28th Avenue, Phoenix, Arizona 85017. Phone: (602) 263-0202.



INFORMATION RETRIEVAL NUMBER 76

FIXED CAPACITORS... Hermetically Sealed ...in Glass!

FOR
MAXIMUM RELIABILITY
AND LONGER LIFE!

Now you can design circuit capabilities never before possible! "Glass-To-Metal" hermetic seal guarantees long-term reliability and greater strength! All potential problems are ruled out because they are sealed out... with glass! High to low temperature excursions (-100°C to +500°C or vice versa) will not affect the thermally matched components! Contact surfaces are non-oxidizing even under the most extreme conditions! Available in 4 sizes from .160 x .065 to .400 x .155 with capacitance ranges of 1 pf to .22 mfd. Write for catalog sheet.

Monolithic Dielectrics Inc.

P.O. Box 647 • Burbank, Ca. 91503
Phone (213) 848-4465

Subsidiary of

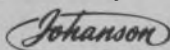

INFORMATION RETRIEVAL NUMBER 77

relays... general purpose, sensitive, miniature, mechanical and magnetic latching



stepping switches...



accessories...

plugs, sockets and dust covers



HIGH QUALITY • LOW COST • IMMEDIATE DELIVERY

SEND FOR FREE CATALOGS

SCHRACK ELECTRICAL SALES CORP.

1140 Broadway, New York, New York 10001 Tel: (212) 683-0790

INFORMATION RETRIEVAL NUMBER 78

ELECTRONIC DESIGN 21, October 12, 1972

Suppressor absorbs 32 kW, is stable

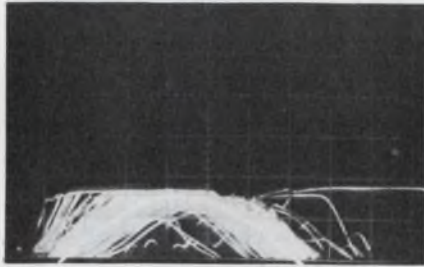

Aerospace Avionics, Inc., 1500 Ocean Ave., Bohemia, N.Y. 11716. (516) 589-9200.

Aerospace Avionics, Inc., announces a new line of surge suppressors which feature small size with exceptional energy-handling capability and high stability. Eight standard models cover the entire range required: four dc units rated for positive suppression of surges to 2.5, 5, 10 or 20 kW with clamping points of 35 V; four ac units rated to protect from 4, 8, 16 and 32 kW with clamping points to 180 V ac peak. All ratings are for one second duration. The units offer an adjustable operating point that is normally 20 times more stable than a Zener. Module sizes vary from 2 x 2 x 3 inches to 5 x 5 x 6 inches. Characteristics are: -55 to +125 C operating range (no derating); 55-1500 Hz at 15 g sinusoidal vibration; 6-9 ms 50 g shock on any axis; 95% humidity tolerance; ±1% clamp-point tolerance; 50 ppm/°C tempco of clamp point and ±20% adjustment of clamp point.

CIRCLE NO. 346

Coax attenuator can be remotely programmed

Matrix Systems Corp., 20426 Corisco St., Chatsworth, Calif. 91311. (213) 882-2008.

A programmable rf coaxial attenuator that can be remotely controlled by computer or other conventional means has been announced by the Matrix Systems Corporation. The module accepts a six-bit, parallel, binary input, which switches the attenuation over a range of 0 to 63 dB in one-dB steps. The frequency range is dc through 100 MHz, usable to 300 MHz. The unit is available in 50 or 75 ohms, with a maximum current rating of 90 mA.

CIRCLE NO. 347

CMOS oscillators draw only 5 μA

Statek Corp., 1200 Alvarez Ave., Orange, Calif. 92668. (714) 639-7810. \$150 ea. (1-4); \$36 ea. (500 units); stock to 4 wks. up to 50 units.

Statek announces its subminiature CMOS timing circuits with frequencies between 600 kHz and 1 cycle per six hours. These low-frequency crystal oscillators and timers draw as low as 5 μA at 3.5 V and are packaged in TO-5s or 1/4-by-3/8-by-0.07-inch flatpacks. Their rugged design enables these units to withstand shock greater than 1000 g and vibrations greater than 50 g from 10 to 2000 Hz.

CIRCLE NO. 348

Instrumentation amp has ±1 μV/°C drift

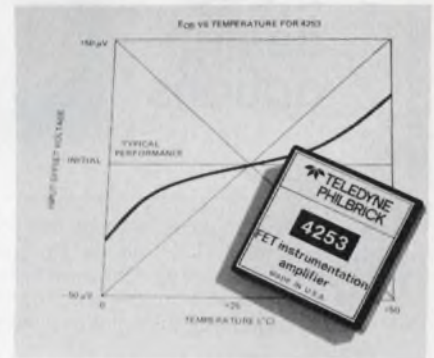

Teledyne-Philbrick, Allied Dr. at Route 128, Dedham, Mass. 02026. (617) 329-1600. 4253: \$75; 425301: \$125; stock to 3 wks.

Models 4253 and 425301 FET instrumentation amplifiers feature guaranteed maximum input offset drifts of ±2 μV/°C and ±1 μV/°C, respectively, over 0 to 50 C. Small differential signals can be amplified, with gains from 1 to 5000 selected by one external resistor, in the presence of ±10 V common-mode voltages: CMRR is 114 dB, min. for the 4253, and 120 dB, min. for the 425301. Input impedance is a high 10¹³ Ω, shunted by 3 pF. Bias current at 25 C is 10 pA, max. Other key specs are: ±10 V at 5 mA output; input offset drift with time of ±10 μV/month; ±10 V output offsetting; and 0.8 μV rms noise (1 Hz to 10 kHz). Size is 2 x 2 x 0.4 inches.

CIRCLE NO. 349



ANALOGY

TWO DOZEN OF INTECH'S BEST PRICE/ PERFORMANCE OF AMPS HAVE BEEN ASSEMBLED INTO ONE GREAT WINNING COLLECTION. EACH IS TESTED 100% ALL HAVE GUARANTEED MIN. AND MAX. SPECS INSTEAD OF THE USUAL TYPICALS. SEND THIS COUPON FOR OUR FREE OF CHARGE COLORFUL BROCHURE



DEAR ANA: PLEASE SEND ME YOUR FREE OF CHARGE, COLORFUL BROCHURE.

NAME _____ TITLE _____

COMPANY _____

ADDRESS _____

CITY _____ STATE _____ ZIP _____

intech INCORPORATED (408)244-0500
1220 COLEMAN, SANTA CLARA, CALIF. 95050

One progress indicating time delay relay

2,240 design options



Name your own specs. Chances are you can meet them — easily — with our 41300 Series Progress Indicating Time Delay Relay. It offers you these standards design options:

- 14 time ranges from 0-6 seconds to 0-60 hours
- 10 voltage/frequency options from 6-230 VAC, 50 or 60 Hz
- Choice of 4 control wiring modes
- 4 load switches
- Direct or reverse clutch operation
- Round or square bezels

In addition, overall accuracy is $\pm 0.5\%$ of dial scale and maximum reset time is 250 MS. Sound interesting?

Send for information now!

A. W. HAYDON CO. PRODUCTS

NORTH AMERICAN PHILIPS CONTROLS CORP.

A NORTH AMERICAN PHILIPS COMPANY
Cheshire, Conn. 06410 • (203) 272-0301

INFORMATION RETRIEVAL NUMBER 80

CHANCES ARE YOU'RE PAYING MORE FOR YOUR ALPHAMERIC STRIP PRINTER RIGHT NOW



... AND WITHOUT SOME OF THESE FEATURES.

- Input US ASCII standard, character by character
- 15 CPS
- 5 x 7 dot matrix presentation of characters

- High character flexibility
- Single print hammer—fewer moving parts
- Also available:
4552/01 Signal Input Serial dot-by-dot in the matrix
- 4552/02 Signal Input parallel column-by-column in the matrix
- Immediate delivery from stock

Facit Odhner Inc.
501 Winsor Drive
Secaucus, N.J.

Gentlemen:

I am interested in receiving detailed data on your Alphameric Strip Printer

Name _____

Title _____

Phone _____

Company _____

Address _____

City _____

State _____

Zip _____

ED-10



INFORMATION RETRIEVAL NUMBER 82

Meet the Extremists:

Measure from 1 Gamma to 50,000 Gauss!

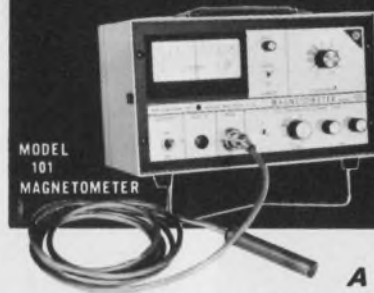

MODEL 101 MAGNETOMETER

A complete line of precision magnetic measuring equipment.



MODEL 505 GAUSSMETER

• Lowest cost
• Self-contained
A completely self-contained instrument for magnetic field measurement.



MODEL 750 GAUSSMETER

• Wide range
• Versatile
Features wide measurement range, high accuracy and ease of operation.



MODEL 3265 GAUSSMETER

• Unexcelled readability
• High precision
Features absolute, differential and incremental measurement operations.

Send for Free technical booklet on RFL Magnetics equipment.



RFL Industries, Inc.

Instrumentation Division • Boonton, N. J.

INFORMATION RETRIEVAL NUMBER 81

How long must you keep important papers?



Write for free booklet, ED-10. RECORD RETENTION TIMETABLE, describing Retention Periods as allowed by government authorities, and how to dispose of them safely without loss or worry!

ELECTRIC WASTEBASKET CORP.
145 West 45th St., New York, 10036
Selected dealers all over the United States.

INFORMATION RETRIEVAL NUMBER 83

A/d converter encodes 8 bits in 4.0 μ s, max.

Precision Monolithics Inc., 1500 Space Park Dr., Santa Clara, Calif. 95050. (408) 246-9225. 0800: \$160 (100-249); 0801: \$110 (100-249); stock to 3 wks.

The aim AD0800 a/d converter module provides eight-bit encoding in 4.0 μ s, max, while guaranteeing $\pm 1/2$ LSB max, linearity over the entire -25 to $+85$ C temperature range. The user can tailor the unit to his application by specifying the 10^{10} Ω input-impedance buffer option, bipolar input-voltage capability option, and by choosing from maximum FS tempcos ranging between 15 ppm and 120 ppm/ $^{\circ}$ C. An internal clock is provided. No adjustments are required, as the zero and FS errors are pretrimmed within $\pm 1/4$ LSB. Logic input and output levels are TTL/DTL compatible, with full noise immunity guaranteed. The unit operates with analog supplies ranging from ± 12 to ± 18 V; maximum power supply rejection is 0.01% per percent of supply change. Maximum power consumption is held to 1.85 W.

CIRCLE NO. 350

2x2x0.4-inch supply gives ± 15 V at 110 mA

Delta-Tronics Corp., 1316 Princess Dr., Tempe, Ariz. 85281. (602) 966-9380. \$59 (1-14); stock.

The Model 602 power supply provides ± 15 V at ± 110 mA from a 4.5 to 5.5 V dc source. Designated for on-the-board regulation, the unit requires no heat sink from 0 to 70 C ambient. Transient response is an outstanding feature. For full load steps, recovery is 5 μ s, maximum, with less than 0.4% over or undershoot. Combined line and load regulation is better than 0.2%. Output ripple is 35 mV pk-pk and 1 mV rms, maximum. Either output may be shorted to common with automatic recovery. Switching transients reflected into the 5 V line are internally filtered to less than 35 mV pk-pk.

CIRCLE NO. 351

Modules correct CRT pincushion distortion



Intronics, 57 Chapel St. Newton, Mass. 02158. (617) 332-7350. C102, \$395; C103, \$245.

Intronics' Models C102 and C103 Pincushion-Correction Modules accurately correct for distortion produced in flat and semi-flat precision CRT-display systems. These modules produce precise, corrected-voltage functions for horizontal and vertical deflections, and for dynamic focus. External controls provide for adjustment of correction magnitude, curvature symmetry, and keystone correction. Models are available for deflection angles in 5-degree increments up to 70 degrees, with an accuracy of 0.02% at 20 degrees and 0.2% at 60 degrees. Model C102 features 10-MHz BW, with a gain TC of 50 ppm/ $^{\circ}$ C max. Model C103 is an economy version of the C102 with 500-kHz BW. Modules are epoxy-encapsulated construction with a case size of 3.5 x 2.5 x 1 inches for the C102 and 3.5 x 2.5 x .625 inches for the C103.

CIRCLE NO. 352

Electronic filter offers selectable pass regions

Dynamics Electronic Products, Inc., 12117 E. Slauson Ave., Santa Fe Springs, Calif. 90670. (213) 945-2493. \$750 to \$1450; stock to 30 days.

The Model 6364 is an electronic filter with dc to 1-MHz response. The series are available with linear phase and /or Butterworth characteristics. Terminal slope on each skirt is 36 dB per octave. Cutoff frequencies can be selected over four decades in 0.1 decade steps. A front panel switch provides for low-pass, high-pass, bandpass and band-reject modes of operation. Low-pass or high-pass filtering can be independently switched out. Four different low-pass and high-pass frequency multipliers are available to cover the frequency band of dc to 1 MHz.

CIRCLE NO. 353

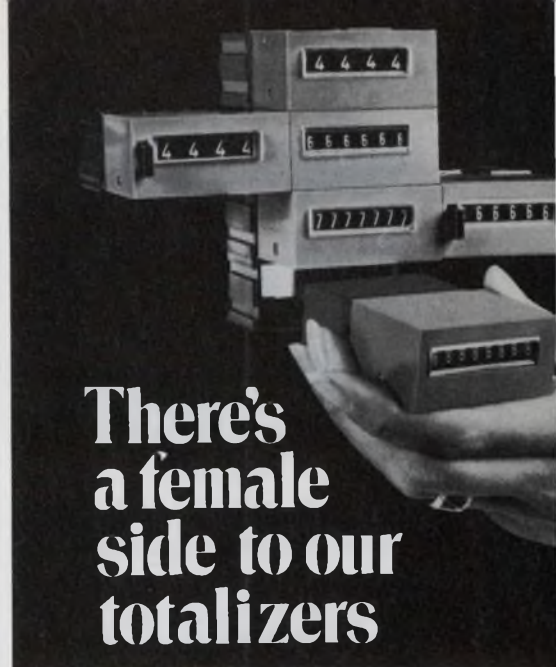

There's a female side to our totalizers

And a male top, a female bottom, and so on. That's because Hecon electromagnetic counters are, in fact, modular counter systems — starting with the unique interlocking socket boxes all the way to the counting modules themselves.

Right now we want to talk about the popular totalizer line of Hecon counters, useful for long-life counting — like coins, flow rates, tallies, production rates, as service meters, in test equipment . . . The line consists of six basic counters — four non-resettable units with 4, 6, 7 or 8 digits, and two resettable units with 4 or 6 digits.

All are configured in the Hecon 1" x 2" modular plug-in housing, which fits into the socket boxes. These units are also available with panel-mount covers.

Resettable totalizers have either manual or electrical reset capability. The modular electrical reset unit is an add-on and is mounted onto the socket box, when required.

The unique escapement mechanism by Hecon counts accurately, smoothly, quietly, and reliably. For extra-long life, all counting wheels have brass bushings.

You can select any voltage commonly used everywhere, from 6 V to 220 V, AC or DC. Counting speeds range from 10 to 60 counts per second.

Hecon totalizers are available from stocking distributors in every major trading area. For the name of your Hecon distributor, or to receive our new 36-page counter catalog, write or call Hecon Corporation, P.O. Box 247, Eatontown, New Jersey 07724. Phone (201) 542-9200.

In Canada:
Hecon of Canada, Ltd.,
80 Galaxy Blvd.,
Rexdale, Ontario.
Phone: (416) 678-2441.



16 Bit D/A Convertors with

UNPARALLELED STABILITY

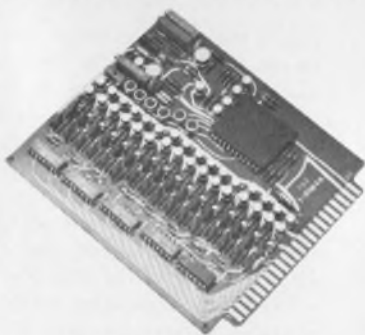

Note the features of
Model 1670R:

Total Temp Coeff.: 5PPM/°C
Resolution: .0015% FSR
Absolute Accuracy: .005% FSR
Linearity: .0015%
Input Register included
Settling Time: less than
20 μ sec.

Other versions available:

Glitch-free
12 thru 15 bits
Settling time to 1 μ sec.

If it's stability, accuracy,
speed, or all-around quality
performance you need in D/A
and A/D converters, get in
touch with Phoenix Data now!



PHOENIX DATA, INC.

3384 West Osborn Road
Phoenix, Arizona 85017
Ph. (602) 278-8528. TWX 910-951-1364

MICROWAVES & LASERS

A-band paramp offers
3-dB noise figure

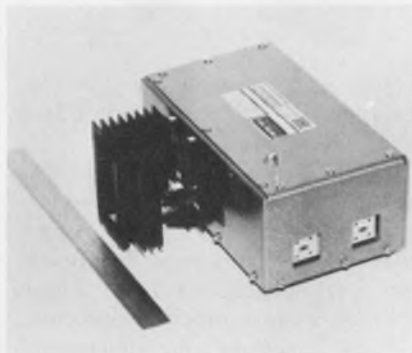

Control Data Corp., Boston Micro-
wave Products Div., 400 Border
St., E. Boston, Mass. 02128. (617)
569-2110.

A millimeter degenerate para-
metric amplifier, with a 26.5-to-
40 GHz range, features a maxi-
mum noise figure of 3 dB. This
choice figure is achieved over an
instantaneous bandwidth of 500
MHz with minimum gain of 15 dB.
At 33.5 GHz, the unit operates
with a pump frequency of 67.0
GHz at 50 mW maximum.

CIRCLE NO. 354

Functions programmed in vector voltmeter



PRD Electronics, Inc., 1200 Pros-
pect Ave., Westbury, Long Island,
N.Y. 11590. (516) 334-7810.

The PRD P2020, a program-
mable vector voltmeter, allows for
the programming (with TTL-com-
patible logic) of all voltage and
phase measuring functions through
a single rear-panel connector.
Phase lock is obtained automati-
cally over the entire 1.5 MHz to
2.4 GHz frequency range.

CIRCLE NO. 355

PSC Low Cost Tape Transports



User Engineered THROUGH OUT

- Interface Industry Standard
- 7", 8½" or 10½" Reel Size
- 6.25, 12.5, 25, 37.5 or 45 IPS
- Phase Encoding or NRZI
- 200, 556, 800 or 1600 CPI
- Single or Dual Gap Heads
- Write, Read, Read Write or
Read after Write
- Power Fail Safe
- Solid State IC Logic

Give us your requirements we'll
custom assemble to your specifi-
cation with off the shelf compo-
nents.

Call: Chuck Quillen, Director of
Marketing for more information.

(213) 245-8424



Producers Service Corp.
Computer Peripheral Div.
1200 Grand Central Ave.
Glendale, Calif. 91201

INFORMATION RETRIEVAL NUMBER 86
ELECTRONIC DESIGN 21, October 12, 1972

INFORMATION RETRIEVAL NUMBER 85

D-MOST FETs for 500 MHz to 1 GHz range

Signetics, 811 E. Arques Ave., Sunnyvale, Calif. 94086. (408) 739-7700. Tentative prices—SD200: \$5 (250-999); SD300: \$9 (250-999).

Two FETs, the SD200, a single-gate transistor, and the SD300, a dual-gate version, are manufactured with the company's D-MOST (Double-diffused Metal-Oxide Semiconductor Technology) process. They are designed for use in amplifiers operating at frequencies from 500 MHz to 1 GHz. The SD200 FET has a typical noise figure at 1 GHz of 5.0 dB, and typical feedback capacitance of 0.13 pF. The SD300 has corresponding values of 8 dB (at 1 GHz) and 0.02 pF.

CIRCLE NO. 356

Gunn diodes for direct dc to 4-30 GHz power

GHZ Devices, 16 Maple Rd., Chelmsford, Mass. 01824. (617) 256-8101.

The GC-5600 Series Gunn diodes generate direct dc-to-microwave power from 4 through 30 GHz. Six standard package styles are offered and power levels range from 10 mW to 300 mW. Broadband tuning of typically 2-GHz bandwidth is provided by the new diodes.

CIRCLE NO. 357

Absorbers good to 650 F

Emerson & Cuming, Inc., Microwave Products Div., 59 Walpole St., Canton, Mass. 02021. (617) 828-3300. \$26.00 to \$32.50 per sheet.

Two microwave absorbers, termed Eccosorb HT-98 and HT-99, operate in the temperature range of -70 F to +650 F. Both are made entirely of non-combustible inorganic foam materials. Eccosorb HT-98 comes in 12 x 18 x 2-inch blocks and gives a maximum power reflection of 2% from S-band through K-band. Eccosorb HT-99 comes in 12 x 18 x 3-inch blocks and gives 2% maximum power reflection from L-band to K-band.

CIRCLE NO. 358

A complete line of CUSTOMIZED ROTARY CERAMIC SWITCHES ...

For RF and POWER APPLICATIONS

RSC switches are available in a variety of switching models. RSC high precision, quality built units are designed for applications requiring long life maintenance-free service. Types include shorting and non-shorting, single and multi-deck, up to 18 pole positions. Features include, 10 to 100 amp current carrying capacity, 20° to 90° detents, 2000 to 24000 volts flashover and corrosion-proof construction.

Write for catalog no. 960 and complete information.

RADIO SWITCH CORPORATION

Rt. 79, Marlboro, N. J. 07746

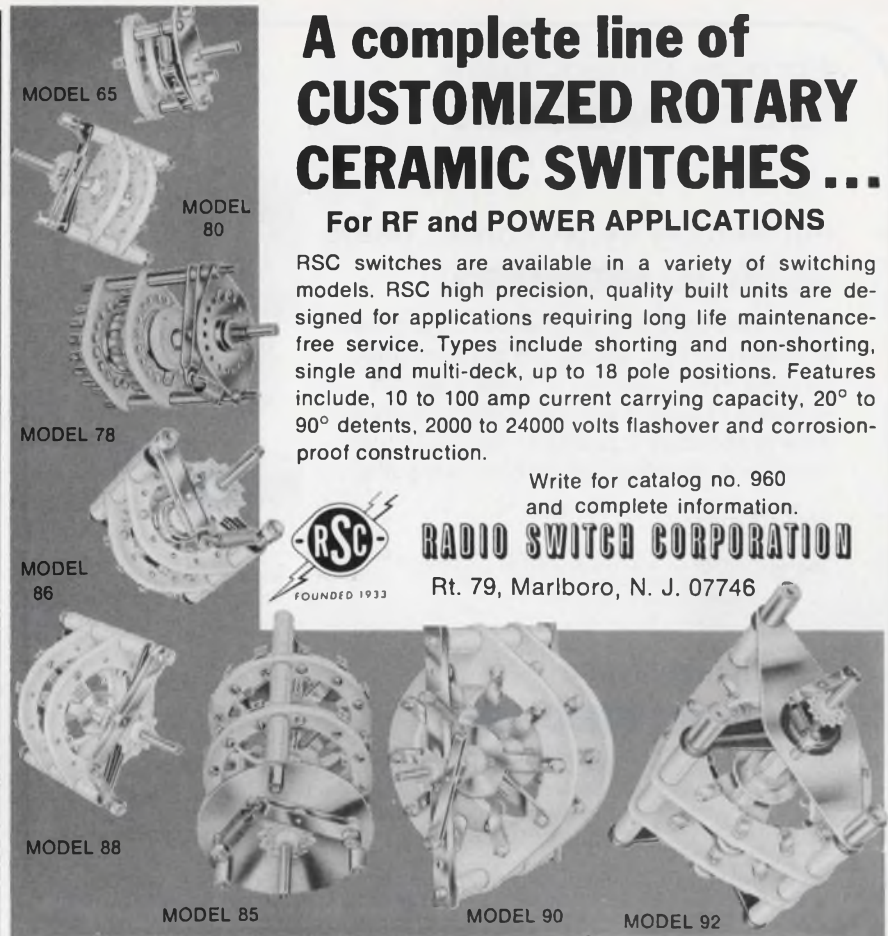

INFORMATION RETRIEVAL NUMBER 87

1/16" Wire Wrap® Panels Save Space!

New Funnel-Entry™ Wire-Wrap® Terminals

E.M.C.'s brand new Funnel-Entry™ design (pat. appl. for) simplifies manual or automatic insertion of I.C. leads. Terminals available in 2 or 3 levels of wrap, for 100-grid centers, separately or with E.M.C. panels (below).

Low-Profile for minimum space requirements

Nurl-Loc® Terminals* prevent twisting during wrapping

Four-finger contact assures positive electrical connection

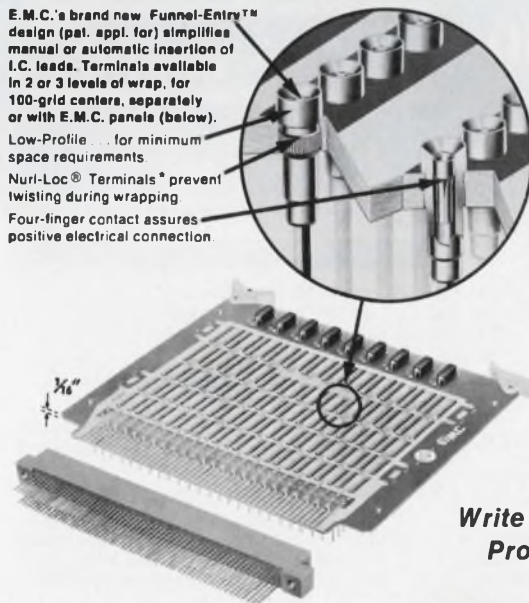

Save space, and plug into present PC connectors of any make! Brand new high-density packaging panels from EMC utilize 1/16" non-warping glass epoxy boards, and low profile Nurl-Loc terminals.

Typical board shown is 60-position mix pattern, for 40 14-Pin (voltage and ground committed) and 20 16-Pin (uncommitted) dual-in-line I.C.'s.

Standard test jacks are accessible from front. Eight decoupling networks are positioned for a cleaner voltage.

Write or Phone for Computer Products Catalog No. 71

ELECTRONIC MOLDING CORPORATION

96 Mill Street, Woonsocket, R. I. 02895
(401) 769-3800 • TWX 710-387-1350

Wire-Wrap® Gardner-Deser Co.

*Pat. No. D-223,109

WIRE-WRAP® I.C. PACKAGING PANELS • TRANSISTOR AND IC SOCKETS • TEST JACKS • TERMINALS • LAMP SOCKETS • BINDING POSTS

INFORMATION RETRIEVAL NUMBER 88

For price, delivery, quality
look to wabash

For mercury wetted contact relays
look to wabash

Expanded 5100 and 5500 series offer greater variety of P.C. mount and plug-in types, ranging from miniature to large 2-switch versions (3-switch version in plug-in). Available in sensitive C and D or neutral D contact forms, single-sided or bi-stable coils.



SPECIFICATIONS

Contact Rating 2 amps peak max.; 500v peak max.
100 VA peak w/proper contact protection
(up to 5A peak max. & 250 VA peak in
neutral Form D switches)

Contact Resistance 50 milliohms max.
Bounce None
Life Up to 1×10^9 Operations

For all relay types
look to wabash

NPE/New Product Engineering, Inc.
a subsidiary of Wabash Magnetics, Inc.
First and Webster Streets, Wabash, Indiana 46992
Phone 219/563-2191 TWX 810-290-2722

- RF SWITCHING & MERCURY WETTED RELAYS
- SUBMINIATURE REED SWITCHES
- DIP REED RELAYS
- SSR MODULES
- STANDARD & MINIATURE REED RELAYS

INFORMATION RETRIEVAL NUMBER 89

The "Automatic" DMM

\$345⁰⁰

STOCK DELIVERY



FULLY AUTOMATIC

- Autoranging** hands free operation eliminates error and assures over-voltage protection. Unique "up-down" logic increases reading speed.
- Automatic Zeroing** provides long term stability, minimizes recalibration.
- Automatic out-of-range indication** for all functions eliminates erroneous readings.
- Automatic Polarity**—Bipolar operation with "+" and "-" display.

FLOATING and GUARDED
80dB Common Mode rejection with 1 kilohm unbalance.

DUAL SLOPE INTEGRATION
40dB Normal mode noise rejection.

WIDE RANGE OHMMETER
100 milliohms to 200 megohms in 7 ranges.

FINEST CONSTRUCTION
Sturdy all-aluminum case with rotating handle used for adjustable stand.

QUALITY/PERFORMANCE/RELIABILITY

Guaranteed by California Instruments, originator of the digital multimeter/counter.

WRITE OR CALL COLLECT for a free brochure and a demonstration of this new Model 8310 3½ digit DMM . . . or our 4½ digit Model 8420, 8421 and 8300 digital multimeter/counters.

CALIFORNIA INSTRUMENTS
a division of
AIKEN INDUSTRIES, INC.

5150 Convoy Street • San Diego, California 92111 • (714) 279-8620

INFORMATION RETRIEVAL NUMBER 90

MICROWAVES & LASERS

Power divider/combiner now in DIP

R.F. Power Labs, Inc., 924-104th Ave., N.E., Suite 103, Bellevue, Wash. 98004. (206) 454-3886. P&A: See below.

The Model 2PD-5 rf power divider/combiner is said to be the first broadband device of this type packaged in a DIP. Compatible with all standard 14-pin dual-in-line IC components, the new unit features a frequency range of 2-to-300 MHz, insertion loss of 0.5 dB and minimum isolation of 30 dB. Pricing is \$9.65 and delivery is 3 weeks, both for 500-piece quantities.

CIRCLE NO. 359

Sapphire apertures transmit UV-to-IR

Swiss Jewel Co., 406 Lafayette Bldg., Philadelphia, Pa. 19106. (215) 925-2867.

Custom-built optical windows and lenses of synthetic sapphire (aluminum oxide) offer a wide band of transmission from 1450 Å to 7 μ. These apertures are inert to all acids and most alkalies, do not absorb water (zero porosity), withstand high temperatures (2040 C melting point) and high pressure (300,000 psi compression strength), and are scratch and wear resistant (9 Moh hardness).

CIRCLE NO. 360

P-i-n diodes come in hex-screw packages

Unitrode Corp., 580 Pleasant St., Watertown, Mass. 02172. (617) 926-0404.

The full line of microwave switching diodes manufactured by Unitrode can now be specified with a hex-screw package for fast, solderless field replacement. The basic fused-in-glass monolithic diode is brazed to an 0.25-inch long OFHC copper hex-socket screw. Designated as Style-H, these screw-in diode packages are specially designed for use in phased-array-radar equipment and other applications where fast, easy field replacement of components is essential.

CIRCLE NO. 361

STOCKED IN DEPTH FOR
IMMEDIATE DELIVERY

THE MOST
EXTENSIVE
LINE OF . . .

PLUG-IN
POWER
TRANSFORMERS

LOW COST

115 or 115/230V PRIMARIES

LARGEST SELECTION OF
VOLTAGE RATINGS

OPEN FRAME OR EPOXY MOLDED

SIZES FROM 1 TO 24VA

NO MINIMUM ORDER
REQUIREMENTS

Send for free catalog

SIGNAL
TRANSFORMER CO., INC.

1 Junius St. Brooklyn, New York 11212
(212) 498-5111

INFORMATION RETRIEVAL NUMBER 91

design aids

Pin connector chart

Specifications and order numbers for 27 nylon plug and receptacle connectors and their standard 93-mil or miniature 62-mil diameter terminals are shown in a four-section, two-color wall chart. Electrical and mechanical characteristics of connector housings and terminals are listed, along with information on tooling required for terminal crimping. All dimensions are listed for each housing, including panel cutout sizes for snap-lock mounting, and appropriate wire sizes with diameters of conductor and insulation crimp areas for applicable terminals. Molex Inc.

CIRCLE NO. 362

Air moving devices

A guide to the selection of air moving devices for cooling of electronics equipment, business machines, communications equipment and a host of other applications is designed as an illustrated 14 x 22-in. wall chart. The guide includes photos of ten different types of fans and blowers and discusses the various design parameters upon which proper selection depends. A glossary of symbols most commonly used in connection with air movers is given, together with formulas for calculating system resistance to air-flow, cooling air required, and the type of fan or blower best suited to the application based upon specific speed. Rotron Inc.

CIRCLE NO. 363

Thumbwheel switch codes

A wall chart lists standard codes for thumbwheel switches designed and produced by the company. "Our Codes Are No Secret" proclaims the chart, and to demonstrate, it includes 68 different codes for modular switches, as well as inviting inquiries on custom codes not provided in the chart. Digitran Co.

CIRCLE NO. 364

giga-trim capacitors for microcircuit designers

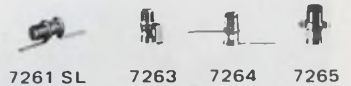

Giga-Trim[®] (gigahertz-trimmers) are tiny variable capacitors which provide a beautifully straight forward technique to fine tune RF hybrid circuits and MIC's into proper behavior. They replace time consuming cut-and-try adjustment techniques and trimming by interchange of fixed capacitors.

Applications include impedance matching of GHz transistor circuits, series or shunt "gap-trimming" of microstrips, external tweaking of cavities, and fine tuning of crystal oscillators.

Johanson

MANUFACTURING CORPORATION

BOONTON, NEW JERSEY 07005
201 / 334-2676

INFORMATION RETRIEVAL NUMBER 92 ►

Switch on **NOISE**,
Switch off **NOISE**,
Switch on **NOISE**,
Switch off **NOISE**.



Quiet!



Ceramag® ferrite beads provide a simple, inexpensive means of obtaining RF decoupling, shielding and parasitic suppression without sacrificing low frequency power or signal level. Install beads by slipping one (or more) over appropriate conductor(s) for desired effect. Sizes from .020" ID - .038" OD - .050" L. Beads available with leads for PC boards. Send for samples.



STACKPOLE
Electronic Components Division
St. Marys, Pa. 15857

evaluation samples

Pinheader/plug

The A23-2049 pin header/plug is compatible with most 16-lead D.I.L. sockets and provides a convenient plug-in housing for discrete components. The components are soldered between terminal extensions and protected by a clip-on cover. The device may also be used as a free plug—the cover being provided with slots in the top and one end for cable entry. Its dimensions are 0.89 in. long, 0.49 in. wide and 0.2 in. high. The gold plated brass contact pins extend 0.187 in. from the body. The cover and body are molded in glass filled Nylon A190. Jermyn.

CIRCLE NO. 454

PC test jack

The PCJ-100 Series test jacks conform to MIL-C-39024/11 and are for use with 80-mil diameter test probes. The entrance holes will not permit entry of a probe larger than 85-mil diameter. The 150-mil length of contact-tails eliminates the need for manually shortening the tails before assembly into the PC boards. Jolo Industries.

CIRCLE NO. 455

Metric conversion kit

The "Dial-A-Decimal" indicator permits direct readout of decimal and metric equivalents in fractions. The square foot converter two-way tables are for plastic sheets up to 96 by 120 inches, but they can be used as well on metals, glass, wood, etc. Designed to fit into a coat-pocket, the back cover includes a handy six-inch ruler for fast measurement in the field of sheet, rod and tube diameters and thicknesses. Decimal and millimeter equivalents of parts of an inch also are given on the same page. The "Dial-A-Decimal" guide is a circular scale that fits into a shirt pocket and shows decimal and metric dimensions, and their equivalents in fractions. Commercial Plastics & Supply Corp.

CIRCLE NO. 456

PC board support/spacer

Series TCBS screw fastened circuit board support/spacer is available in natural color nylon or black flame retardant material and is offered in five spacing heights—3/8-in., 1/2-in., 5/8-in., 3/4-in. and 7/8-in. The circuit board snaps over the top of the support's tapered head where it is held firmly in position by a tension flange which, compressed upon entry, springs back out to overlap and secure the board. A squeeze of the fingers permits removal of the board from the support. Richlok Corp.

CIRCLE NO. 457

LED pilot lamp

A pilot lamp uses a light emitting diode for high reliability and resistance to shock and vibration. The lamp comes as a complete package ready to interface with the user's circuit. Thus all electronic problems normally associated with this type of light are eliminated. For dc applications the package includes an appropriate current limiting resistor. For ac applications, a rectifier diode is also built in. Industrial Devices, Inc.

CIRCLE NO. 458

Wire connectors

A line of set-screw wire connectors is color-coded to aid in specifying or selecting the size desired. There are three sizes to accommodate most common wire combinations of Nos. 18-10 wire. Advantages include ease of inspecting wire splice at any time by simply unscrewing the protecting cap, and in the event of a change in wiring, the set-screw connector can be removed and used again to make the new connection. Holub Industries, Inc.

CIRCLE NO. 459

Wire harnesses

Wiring harnesses are available in lengths from one inch up. Wire from No. 22 to No. 6 AWG and with one to three conductors can be cut as well as stripped to any length up to 1-1/2 inches. Uninsulated or insulated strip terminals can be crimped to either end of the wire. Cadillac Wire Products.

CIRCLE NO. 460

application notes

Data communications

A four-page brochure offers two articles on minicomputers and data communications originally published in "Communication News." Both of the reprinted articles were authored by members of the technical staff of Interdata, Ltd., the company's wholly-owned U.K. subsidiary. "Decentralizing Communications and EDP Facilities," by John Woods, and "Using Minicomputers as Data System Front Ends," by Alan Lewis, are the two articles in the Interdata brochure. Interdata Inc., Oceanport, N.J.

CIRCLE NO. 461

Beryllia ceramics

A four-page data sheet, "Safe Handling of Beryllia Ceramics," describes various applications of beryllia ceramics and safeguards to be followed in handling them. Brush Wellman Inc., Elmore, Ohio.

CIRCLE NO. 462

Plastic design guides

Fourteen, two-page design and professional guides to plastic profile extrusions cover thermoplastic materials, extrusion techniques, and building industry applications. Crane Plastics, Columbus, Ohio.

CIRCLE NO. 463

CPVC pipe

A 16-page technical and engineering product bulletin on rigid high-temperature chlorinated polyvinyl chloride (CPVC) pipe includes a nomograph for calculating flow loss characteristics of water flow through a wide range of pipe sizes, detailed instructions for installing rigid CPVC pipe, abbreviated solvent cementing instructions, dimension/weight tables for Schedule 80 pressure fittings, and a tabulation of CPVC and PVC machining stock and other shapes. Harvel Plastics, Inc., Easton, Pa.

CIRCLE NO. 464

Noise spectra measurement

"Measuring Noise Spectra with Variable Electronic Filters" is the title of a 12-page Application Note (IAN-102). A simple, general method of measuring a noise spectrum with a variable electronic filter is described, and all the necessary information for measuring a noise spectrum with an Ithaco variable electronic filter is provided. Errors associated with making noise measurements are discussed in the appendices, such as clipping errors, sampling errors, errors associated with noise bandwidth, and measurement errors associated with instruments which measure the average absolute value but are calibrated to read the rms value of a sine wave. Ithaco Inc., Ithaca, N.Y.

CIRCLE NO. 465

Resolvers vs encoders

A four-page bulletin gives a detailed evaluation of rotary synchro resolvers vs rotary incremental optical encoders for use on numerical controls. The bulletin shows why encoders are favored over resolvers for certain applications as the positional feedback element in machine-tool control systems. Allen-Bradley Co., Highland Heights, Ohio.

CIRCLE NO. 466

Console flow chart

An engineering data sheet helps audio engineers create their own consoles by selecting one module from Column A and two from Column B, like a Chinese restaurant menu. The console menu is actually a columnar function flow chart of standard Fairchild/Robins units that can be assembled into four console configurations: channel modular, remote control, building block or combined systems. A seven-step specification procedure is suggested, including making an outline, or block diagram, of such required functions as equalization, limiting, monitoring, switching, reverberation, delegation, cue circuits and automatic ducking or cross suppression, and the number and kinds of inputs and outputs. Fairchild Sound Equipment Corp., Commack, L.I., N.Y.

CIRCLE NO. 467

Cut and formed leads reduce assembly costs.

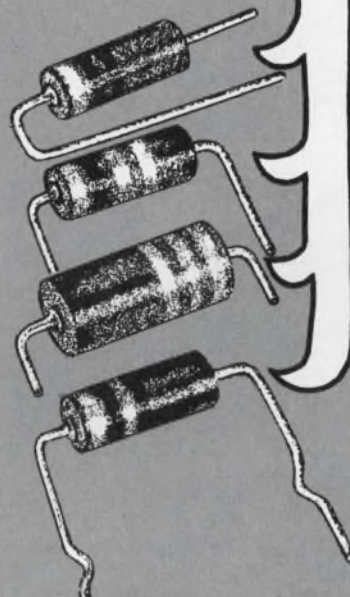

Now that's a nice twist.

Pre-shaped and trimmed resistor leads significantly reduce installation time. All Stackpole carbon composition resistors, 2, 1, 1/2, and 1/4 watts are available with cut and formed leads, to your specifications. Leads are coated for easy soldering. All resistors are 100% tested. Samples available. Send for Bulletin 80-100.



STACKPOLE

Electronic Components Division

Kane, Pa. 16735

For five cents, I'd start something.



me too.

Turn on with a Stackpole slide switch. Prices start at 5¢ for this field proven standard of the industry. Available in two sizes, Regular and the new 50% smaller Miniature Series. Fully UL and CSA approved. Rated from 1 to 10 amps @ 125 and 250 volts (Miniature Series rated at 3 amps @ 125 V). Over 23 basic types, 7960 variations of slide and rocker switch adaptations. For complete details, send for Bulletin 78/79-100.



INFORMATION RETRIEVAL NUMBER 95

new literature



Drafting aids

Technical Manual and Catalog 105 represents 84 pages of illustrated information and data on the company's product line, including multipad configurations, precision slit tapes, orientation symbols, sequential reference designations and hundreds of time-and-money saving hints. The catalog illustrates and describes new drafting film and tracing vellums, the deluxe 10X comparator and a reference to a precision technique for printing engineering and draftsman's formats to exacting specifications. Catalog 105 also shows how to order custom designs for special patterns. Bishop Graphics, Inc., N. Hollywood, Calif.

CIRCLE NO. 468

LED directory

A directory entitled "Mid-72 GaAsLITE Directory" contains 128 pages of detailed technical data on a wide variety of LED displays, discretes and opto-isolator products. Maximum ratings, typical characteristics, operating curves and applications information are included. Monsanto Commercial Products Co., Cupertino, Calif.

CIRCLE NO. 469

A/d, d/a converters

Detailed electrical and mechanical information on a sample/hold amplifier, wideband dc amplifiers, dc-dc converters, a/d, d/a converters and modular data acquisition systems is contained in a 14-page product guide catalog. Datel Systems, Inc., Canton, Mass.

CIRCLE NO. 470

Switchboard instruments

Switchboard Instruments Catalog (GEP-302A) includes a description of the complete line of the company's switchboard instruments to measure all electrical quantities. The 28-page publication includes prices, product specifications and standard connections, as well as the company's line of shunts and electrical transducers. Distributor and modification center locations are also listed. General Electric Co., Schenectady, N.Y.

CIRCLE NO. 471

Polypropylene capacitors

A data sheet describes polypropylene capacitors. Wesco Electrical Co., Inc., Greenfield, Mass.

CIRCLE NO. 472

D-subminiature connectors

Military (MIL-C-24308) and commercial D-subminiature connectors are described in a 20-page catalog. Detailed electrical and physical descriptions of the four major series of this connector type covering solder pot, PC board, wire-wrap and crimp snap-in terminations are included. In addition, a D-subminiature series that combines solder pot and high-voltage or coaxial contacts in the same insulator is described. Complete descriptions of hardware accessories that permit use of these connectors in cable-to-cable and cable-to-panel applications, in addition to the conventional rack and panel applications, are given. Cinch Connectors, an Operation of TRW Electronic Components, Elk Grove Village, Ill.

CIRCLE NO. 473

NC software glossary

A glossary of common words as they relate to NC software to help improve communication among companies both using and supplying numerical control is featured in an 18-page catalog. The publication is designed to reduce confusion in terminology which has resulted from the rapidly changing state-of-the-art in the application of NC machine tools. Copies of the glossary (\$2.50 ea.) may be obtained by sending payment and a self-addressed mailing label to: Publications Dept., National Machine Tool Builders' Association, 7901 Westpark Dr., McLean, Va. 22101.

Cassette tester

A data sheet describes the new M-400 cassette tester. Information Terminals, Mountain View, Calif.

CIRCLE NO. 474

Trimming potentiometers

Comprehensive lines of wirewound and infinite resolution trimming potentiometers are described in a 56-page catalog. The catalog features an array of easy-to-select trimming potentiometers with quick selection charts offering easy visual specification. In addition to standard wirewound configurations, the catalog includes both Cermet and Film-Met infinite resolution types. Included are electrical, mechanical and environmental characteristics, specifications, line drawings and product photos and features. Amphenol Connector Div., Controls Operations, Janesville, Wis.

CIRCLE NO. 140

Ceramic tape heads

A brochure details LTC lifetime ceramic heads and describes causes of conventional head wear. Many of the materials and processes investigated in the development of the company's LTC process are discussed and the application of the surface is fully described in text and diagrams. Test results are shown. The brochure details digital heads now available in terms of electrical and mechanical characteristics and specifications. Nortronics Co., Inc., Minneapolis, Minn.

CIRCLE NO. 141

Aluminum standards

"Aluminum Standards & Data," is a basic reference to mechanical, physical and other properties of aluminum. The 209-page volume is divided into three major sections: information of a general nature, nomenclature of industry terms and a standards section. Aluminum Association, New York, N.Y.

CIRCLE NO. 142

Megohmmeters

The L Series megohmmeters are described in an eight-page brochure. Bulletin 501 includes the Model L-8 high-precision, wide-range megohmmeter, the Model L-9, a fully programmable digital megohmmeter with a variety of control and recording outputs, and the Model L-10, a compact, low-cost megohmmeter. Beckman Instruments, Inc., Cedar Grove, N.J.

CIRCLE NO. 143

Video display terminal

A video display, called the CMC 103 Keystation, displays a complete 112-character data record plus 16 characters of mode and status information and is described in a four-page illustrated brochure. Computer Machinery Corp., Los Angeles, Calif.

CIRCLE NO. 144

CRT terminals

A two-color data sheet describes the application of the Series 200 video display controller to industrial process and production control systems. Ann Arbor Terminals, Inc., Ann Arbor, Mich.

CIRCLE NO. 145

Resistor networks

Short Form Catalog WR-145 shows nickel-chromium and tantalum nitride resistor networks available from stock for d/a applications. Engineering bulletins give detailed information on various devices such as binary-to-BCD adapter thin-film resistor networks, scaling network, thin-film resistor ladder networks and thin-film resistor chips. Sprague Electric Co., Worcester, Mass.

CIRCLE NO. 146

You're a penny-pinching, up-tight, li'l switch with no spark.

True.

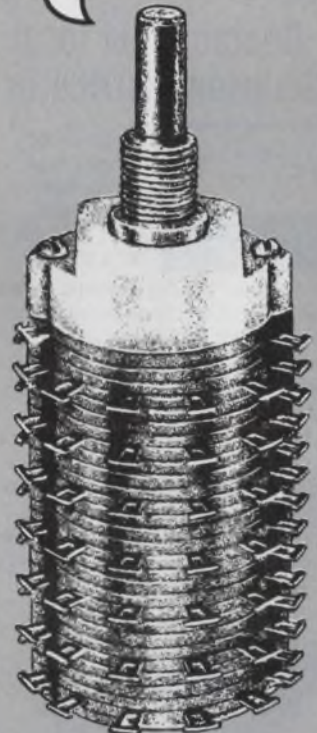

There's no better value than a Stackpole rotary switch. Fast delivery and quality features, but at a price you can afford. Unique design achieves a totally enclosed rotary, without sacrificing complex switching capability. Rigid construction and molded terminals produce a switch so tight it's explosion proof. Samples immediately. Production quantities in 1 to 2 weeks. Including switches with PC mounting. For details, send for Bulletin 73-103.



STACKPOLE
COMPONENTS COMPANY
Raleigh, N. C. 27610

INFORMATION RETRIEVAL NUMBER 96

IMMEDIATE DELIVERY!

Simpson

HAS OVER 101 METER RELAYS and CONTROLLERS IN STOCK!

Contact your local Simpson Distributor



Metal Cased Rugged Seal Contactless Controllers 3½", 4½" and 4" x 6" sizes

Many ranges including pyrometer models. Fail safe circuitry. Single or double set points. Sealed construction. Ask for Catalog 4100.



Phenolic Case Contactless and Contact Relays and Controllers 4½" size

Contactless in single and double set points. Contact in double set point models only. Wide variety of ranges. Ask for Catalog 4100.



Edgewise Controllers 3½" size.



Solid State Temperature Controllers 3.78" square

Has three-mode control, indication, adjustable time proportioning, cold end compensation, one or two set points, and many more features. Ask for Bulletin C-1207.

Consult Factory For Specials

Simpson
INSTRUMENTS THAT STAY ACCURATE



SIMPSON ELECTRIC COMPANY

5200 W. Kinzie Street, Chicago, Ill. 60644
(312) 379-1121

IN CANADA:
Bach-Simpson, Ltd., London, Ontario

IN INDIA:
Rulttonsha-Simpson Private Ltd.,
International House, Bombay-Agra
Road, Vikhroli, Bombay

NEW LITERATURE

Sputtering information

An illustrated six-page "Sputtering System Evaluator" brochure contains a check list of important points to consider when buying a vacuum sputtering system for semiconductor and metalworking applications. Also illustrated are representative models from the full line of sputter deposition and sputter etch system. A convenient table lists general specifications of the entire line. Designed as a handy reference, the brochure also contains a table of sputtering yields for various elements, plus a working example of the equation used to calculate desired sputtering rate and an informative question and answer section. Vacuum Industries, Inc., Somerville, Mass.

CIRCLE NO. 147

Microwave devices

A four-page brochure features specifications on 18 microwave devices: filters, hybrids, couplers, multiplexers and powder dividers. Transco Products, Inc., Venice, Calif.

CIRCLE NO. 148

Standoffs and spacers

Brass and aluminum standoffs, spacers and chassis fasteners for use in PC boards, metal fabrication, aerospace and general assembly applications are presented in a four-page brochure. Listed are combinations for 96 stand-offs and 156 spacers with appropriate model number sequencing, physical drawings and dimensions. Also given are specifications for materials and material finishes plus complete ordering information in a concise, easy-to-use manner. USECO, a div. of Litton Systems, Inc., Van Nuys, Calif.

CIRCLE NO. 149

Stepper motors

A wide variety of both stepper and synchronous motors are described in a 20-page brochure. The Singer Co., Kearfott Div., Little Falls, N.J.

CIRCLE NO. 150

Dynograph recorders

The Type R and Type RC Dynograph recorders are described in a four-page bulletin. The publication gives complete operating specifications and price information. The Type R Dynograph is a versatile, high-sensitivity unit; the Type RC Dynograph is a medium-sensitivity system which can be expanded readily to Type R capability. Beckman Instruments, Inc., Electronic Instruments Div., Schiller Park, Ill.

CIRCLE NO. 151

Keyboards

Type EF flatswitch arrays are illustrated and described in bulletin Comp No. 102. The data sheet details keyboard features, characteristics and specifications and includes illustrations of available 12 and 16-key formats and their dimensions. Chomerics, Inc., Woburn, Mass.

CIRCLE NO. 152

Dry-type transformers

How to select and apply the company's wide selection of UL listed QHT dry-type transformers is described in a 24-page booklet. Included is latest information on effects of NEC and OSHA regulations concerning dry-type transformers. Ordering guidelines for the general purpose, buck-boost and distribution transformers is covered as well as machine tool transformers, integral distribution centers, ac voltage stabilizers and portable oil testers. The publication contains complete specifications, dimensions, wiring and connection diagrams and other descriptive information. An accompanying supplement lists prices. General Electric Co., Schenectady, N.Y.

CIRCLE NO. 153

Switch application book

What is believed to be the first book on the application of precision switches includes a unique guide to the use of switches in hostile environments and a glossary of switch terms. The 145-page textbook is illustrated with numerous photographs, charts, graphs and line drawings. Manager of Editorial Services, Micro Switch, a Div. of Honeywell, Inc., 11 W. Spring St., Freeport, Ill. 61032.

IEE library

A list of the periodicals currently received by the Institution of Electrical Engineer's Library giving country of origin and frequency of publication has been compiled. In its present form, the list is an unchecked draft and has been produced as an interim version. It is expected that a final, checked version will be available shortly. IEE Library, London, England.

CIRCLE NO. 154

Lafayette catalog

Catalog No. 730 is a complete and authoritative buyer's guide to everything in electronics. It features four-channel stereo high-fidelity components and Citizen's Band two-way radio equipment. The catalog also describes four-channel stereo receivers, amplifiers, decoders, decoder/amplifiers, electronic test equipment, microscopes, telescopes and over 18,000 new and other major brands of electrical parts. Lafayette Radio Electronics, Syosset, L.I., N.Y.

CIRCLE NO. 155

Relays

Over 650 stock relays including general purpose, telephone type, dry reed, mercury-wetted, industrial power, plug-in, coaxial, hermetically sealed, time delay, solid state, PC, latching, high voltage and mercury displacement are covered in a 32-page, two-color stock catalog. Also included in the catalog are photos, dimensional line drawings, specifications, prices and ordering information. Magnecraft Electric Co., Chicago, Ill.

CIRCLE NO. 156

Rep directory

The 1972-73 Directory of Electronic Representatives provides a complete listing of more than 1800 electronic representative firms and branches in the U.S., indexed by geographical region and cross-indexed alphabetically. Each listing provides information indicating size of firm, types of products handled, territory covered and special facilities available. Electronic Representatives Association, Chicago, Ill.

CIRCLE NO. 157

Peripherals guide

A peripherals guide simplifies selection of the company's perforated tape and digital magnetic tape cassette systems. Basic technical data on perforated tape readers, spoolers, reader/spooler combinations as well as punch mechanisms, perforator systems and perforator/reader combinations is provided. Also included is information about digital magnetic tape cassette systems from tape decks only to full parallel systems. The brochure contains operating specifications, block diagrams, signal description and related data. Remex, Santa Ana, Calif.

CIRCLE NO. 158

Modular power supplies

The Mini/Mate Catalog illustrates encapsulated power supplies for today's applications. Over 90 percent of these power supplies can be shipped the same day the company receives an order. Power/Mate Corp., Hackensack, N.J.

CIRCLE NO. 159

Mainframe core memory

Operation and specifications of the Model ARM-22 mainframe core memory, which replaces and expands IBM 360/22 mainframe memory economically, is described in a brochure. Ampex Corp., Marina del Rey, Calif.

CIRCLE NO. 160

Pneumatic components

Catalog 472 shows how miniature pneumatic minimatic modular components work together in a step-by-step approach to design, installation and maintenance of pneumatic logic control circuits. The catalog consists of a full-color folder showing modular units ready for installation, color-coded cutaway of the basic unit, detailed drawings of plug-in valves and the manifold body and subplate. Included within the folder are 32 separate data sheets, each identifying and providing technical specifications on each of the valves and controls. Also included are data sheets for pressure regulators, connectors and auxiliary devices. Clippard Instrument Laboratory, Inc., Cincinnati, Ohio.

CIRCLE NO. 161

Photo Multiplier Power Supplies

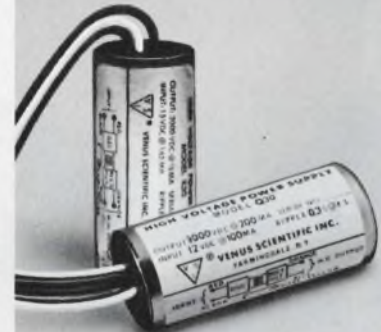

- Variable DC to DC Converters
- Output to 3000V. proportional to input
- Efficiency >50% at Full Load
- M.T.B.F. = 105,000 hours @ 71°C
- Shielded, Encapsulated
- Short Circuit Reverse Polarity Protection
- Immediate Delivery

MODEL	INPUT	OUTPUT	RIPPLE (P/P)	PRICE (1-9)
K15	3V. to 15V.	300V. to 1500V @ 1 ma	0.1%	\$149
K30	3V. to 15V.	600V. to 3000V. @ 0.5 ma	0.5%	\$158
Q30*	2V. to 12V.	500V. to 3000V. @ 0.2 ma	0.25%	\$168
Q15*	2V. to 12V.	250V. to 1500V. @ 0.4ma	0.5%	\$168

* Designed for battery applications — Idling current only 8 ma.

Both output and input floating. Separate case ground lead provided. Meets MIL STD810 where applicable. Operates at -55°C to +71°C. Dimension: 1" Dia. x 2 1/4" Long.

VSI manufactures a complete line of high voltage power supplies for Image Intensifiers, Photomultiplier & Cathode Ray Tubes. Send for our new catalog.

Venus Scientific Inc.

399 SMITH STREET
FARMINGDALE, N.Y. 11735
Telephone (516) 293-4100
TWX: 510-224-6492

MIIDA MODEL 6354 3½ DMM with 0.1% DC ACCURACY. ■ AUTOMATIC RANGING

- 0.1% (DC) and 0.5% (AC) voltage accuracy ■ Measures to 200 megohms resistance ■ 45Hz to 20 kHz frequency response
- Range and display hold mode ■ Automatic polarity display
- Automatic over-range indicator
- Weight under 5 lbs.

\$319.95

Other Miida multimeters in full 4 and 4½ digits
Distributorships available



Miida Electronics,
a division of Marubeni America Corp.,
2 Hammarckjold Plaza, N.Y., N.Y. 10017
(212) 973-7152

INFORMATION RETRIEVAL NUMBER 99

bulletin board

Hewlett-Packard has reduced prices on its 1700 series of scopes. Here are the model numbers and prices: Model 1700B is reduced to \$1475 from \$1680; Model 1701B is reduced to \$1550 from \$1825; Model 1706B is reduced to \$1500 from \$1775; Model 1707B is reduced to \$1575 from \$1975; Model 1707B (Option 020) is reduced to \$1625 from \$2050; and Model 1710A is reduced to \$2300 from \$3200.

CIRCLE NO. 162

RCA Solid State Div. has reduced prices on 16 types of linear integrated circuits used primarily in industrial applications. The reductions average 43 percent for 1000-unit quantities, but range from 16 percent on the CA3054 dual independent differential amplifier to 68 percent on the CA3741T high-gain operational amplifier. The latter's price, at 1000 units, is now \$0.90 compared with its former price of \$2.75.

CIRCLE NO. 163

Recognition Equipment Inc. has extended its Output Image computer output microfilmers (COM) innovative usage pricing programs that reduce the cost of using these products by approximately 50%. Usage pricing plans on the COM systems are offered on both per-frame and hours-used bases on contracts of 24 months or longer. Recognition Equipment's Output Image 600 produces computer output on 16 mm and 35-mm microfilm; Output Image 700 on 16 mm, 35 mm, 70 mm, and 105-mm microfilm. The two Output Image systems offer both alphanumeric and graphic capabilities for the cost of alphanumerics alone. Their standard character generator has the ability to produce 128 printed characters. Both products can draw graphs, charts, and other computer pictures illustrating the significance of hundreds of pages of text, the flight of a rocket, or a mechanical design.

CIRCLE NO. 164

Gudebrod has a New Fact Folder Program that will keep you



up-to-date
on
tying wire
bundles.

Send for it!

Gudebrod Bros. Silk Company, Inc.
Electronics Division
Dept A110 12 South 12th Street, Philadelphia, Pa.

INFORMATION RETRIEVAL NUMBER 100

Due to increases in sales and production rates, **Trio Laboratories, Inc.**, has reduced prices of both its **600 Series** and **620 Series high-density modular power supplies**. Single-unit price for the 600 Series, featuring both single and dual outputs to 125 W, is \$350 each, down from \$400 each; for the 620 Series (triple outputs/100 W) the unit price is \$400 each, down from \$450 each. The Export (E) (198-242 V ac input) versions of the above two series are now being offered at no additional charge, eliminating the previous \$50 surcharge.

CIRCLE NO. 165

Due to a rapid build-up in demand and increased production, **GE-MOV varistors** have been reduced in price up to 30% on 17 models currently available. **GE-MOV varistors** range in maximum energy-handling capability from 10 W-s, or joules, to 160 W-s. Maximum peak current rating is 1250 A. Ac voltage ratings range from 130 V to 1000 V rms.

CIRCLE NO. 166

Prices have been reduced from 17 to 40 percent per card on the **EECO 3D line of DIP socket plug-in cards**. The 3D line of cards offers the advantage of easy field replaceability while maintaining the advantage of unique circuit configurations made possible by the dual-in-line sockets with solderless wrap posts. The cards contain up to 70 DIP sockets of mixed 14 and 16-pin configurations.

CIRCLE NO. 167

Honeywell Inc. intends to increase prices for U.S. customers beginning Dec. 1 on certain **computer equipment and maintenance services**, consistent with guidelines approved by the Price Commission. Customers who will be affected are those whose contracts did not allow for the maximum allowable increase approved last year by the commission. Equipment price increases at that time averaged 4 to 5 percent on central processors and peripherals. Honeywell will immediately increase the hourly rates on maintenance contracts from \$30 to \$34, and on special "call-in" rates from \$36 to \$41.

CIRCLE NO. 168

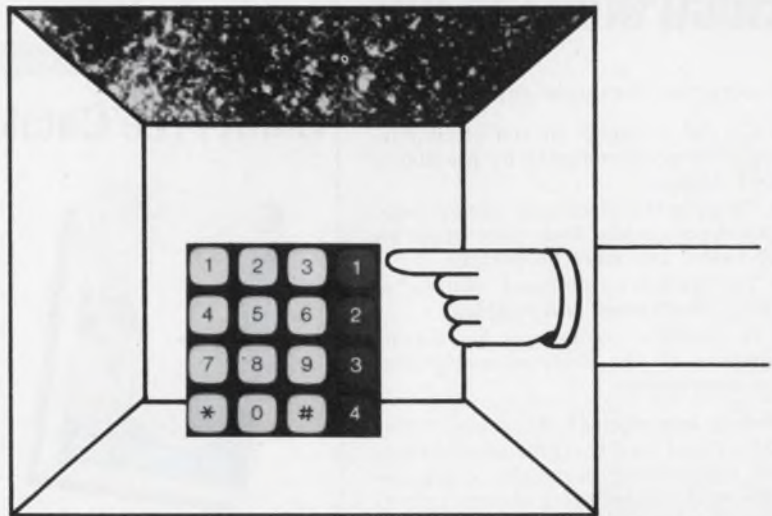

The Chomerics EF Keyboard

(It's the keyboard of tomorrow.)

And most of the key parts are missing. All the moving parts, and most of the expensive ones. Instead, the EF switches with a single piece of highly conductive rubber. It's fail-proof, less than 3/16" thick, and comes in any configuration you want to dream up. For a price you won't believe.

Pretty soon everybody will be trying to make keyboards like the EF. Meanwhile you'll have to come to us.

CHOMERICS 77 Dragon Court, Woburn, MA 01801 (617) 935-4850

INFORMATION RETRIEVAL NUMBER 101

electronic delay relayability

Reliability is built into 300 different configurations offered by Hoagland in its electronic time-delay relays.



These are solid solid-state-controlled time-delay relays

So we coined a word for the reliability in our relays... relayability.

Your choice of: time from .1 up to 300 seconds, AC or DC operating voltages in seven voltages, SPDT or DPDT, transient and polarity protection. Prices to fit all applications from economic to high reliability.

Write or call for our new descriptive catalog on electronic and thermal time delay relays. Hoagland Instruments, 65 Chestnut Street, Red Bank, New Jersey 07701. Phone: (201) 741-7319.

HOAGLAND

INFORMATION RETRIEVAL NUMBER 102

Electronic Design

ELECTRONIC DESIGN's function is:

- To aid progress in the electronics manufacturing industry by promoting good design.
- To give the electronic design engineer concepts and ideas that make his job easier and more productive.
- To provide a central source of timely electronics information.
- To promote communication among members of the electronics engineering community.

Want a subscription? ELECTRONIC DESIGN is sent free to qualified engineers and engineering managers doing design work, supervising design or setting standards in the United States and Western Europe. For a free subscription, use the application form bound in the magazine. If none is included, write to us direct for an application form.

If you do not qualify, you may take out a paid subscription for \$25 a year in the U.S.A., \$35 a year elsewhere. Single copies are \$1.50 each.

If you change your address, send us an old mailing label and your new address; there is generally a postcard for this bound in the magazine. You will have to requalify to continue receiving ELECTRONIC DESIGN free.

The accuracy policy of ELECTRONIC DESIGN is:

- To make diligent efforts to ensure the accuracy of editorial matter.
- To publish prompt corrections whenever inaccuracies are brought to our attention. Corrections appear in "Across the Desk."
- To encourage our readers as responsible members of our business community to report to us misleading or fraudulent advertising.
- To refuse any advertisement deemed to be misleading or fraudulent.

Microfilm copies are available of complete volumes of ELECTRONIC DESIGN at \$19.00 per volume, beginning with Volume 9, 1961. Work is now in process to complete the microfilm edition of Volumes 1-8. Reprints of individual articles may be obtained for \$2.00 each, prepaid (\$.50 for each additional copy of the same article) no matter how long the article. For further details and to place orders, contact the Customer Services Department, University Microfilms, 300 North Zeeb Road, Ann Arbor, Michigan 48106 telephone (313) 761-4700.

Want to contact us? If you have any comments or wish to submit a manuscript or article outline, address your correspondence to:

Editor
ELECTRONIC DESIGN
50 Essex Street
Rochelle Park, N.J. 07662

Design Data from

Giant Free Catalog! 4,000 Unusual Bargains



New 164-page catalog! Packed with 1,000's of hard-to-find buys in Optics, Science, Electronics. Loaded with optical, scientific, electronic equipment available from stock. Rare surplus buys. Many "one-of-a-kinds". Ingenious scientific tools. Components galore: lenses, prisms, wedges, mirrors, mounts, accessories. 100's of instruments: pollution test equipment, lasers, comparators, magnifiers, microscopes, projectors, telescopes, binoculars, photo attachments, unique lighting. Shop, save by mail! Request free Catalog "DA".

CIRCLE NO. 171

Edmund Scientific Co.

America's Largest Science-Optics-Electronics Mart

300 Edscorp Bldg., Barrington, New Jersey 08007 (609) 547-3488



The new PAR™ Model 129 Two Phase Lock-In/Vector Voltmeter, enables you to simultaneously measure the magnitude and phase angle with respect to a reference signal of virtually any low-level signal within its range of 0.5 Hz to 100 kHz—even if the signal is buried 60 dB beneath background noise. At the flip of a switch, you can also measure the in-phase and quadrature components of the vector. The Model 129 features fully automatic reference tracking, independent output expansion and filtering for each channel. Complete specifications are contained in bulletin T-314, available on request.

CIRCLE NO. 172

PRINCETON APPLIED RESEARCH CORPORATION

P.O. Box 2565
Princeton, New Jersey 08540

Practical Instrumentation Transducers



A thorough, authoritative information source on transducer selection and use. This well-planned guide by Frank J. Oliver covers virtually every known device for industrial or aerospace application. Stressing topics neglected elsewhere, it clarifies such areas as interference problems in hard-wire telemetry systems, and transducers as feedback devices in servo systems. Hundreds of diagrams, charts, and tables included. 352 pp., 7-1/8 x 9-3/4, illus., cloth, \$20.00. Circle the reader-service number for 15-day examination copies.

CIRCLE NO. 173

Hayden Book Company, Inc.

116 West 14th Street
New York, N.Y. 10011

Manufacturers

Advertisements of booklets, brochures, catalogs and data sheets. To order use Reader-Service Card (Advertisement)

Free Wallchart Of Waveform Comparisons

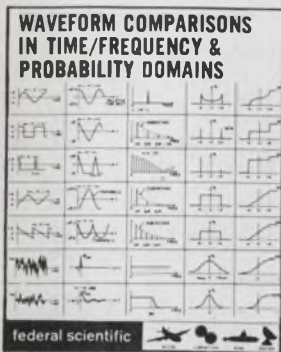

For analyzing random data such as noise, vibration, shock, underwater acoustic signals, and radar, this unique new engineering tool is a convenient picture-reminder of how 10 different basic waveforms look in terms of 5 different processing domains. The waveforms consist of 5 examples of repetitive waveshapes & 5 different random signals. The typical functions shown are: time, auto-correlation, averaged frequency spectrum (PSD), probability density, & cumulative distribution. Printed on heavy glossy stock, the 10" x 12" wallchart is free by writing directly to Federal Scientific, originators of the Ubiquitous® brand of real-time spectrum analysis equipment.

FEDERAL SCIENTIFIC CORP.

615 West 131st Street, New York, N.Y. 10027

CIRCLE NO. 174

Time Code Data Indexing Handbook

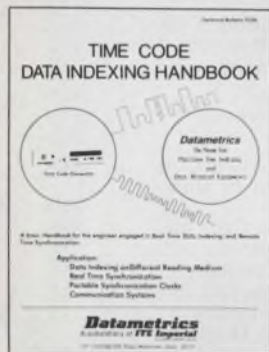

Datametrics is pleased to offer our new handbook entitled "Time Code Data Indexing Handbook" that presents a technical dissertation on the theory of data indexing and retrieval on different recording mediums such as magnetic tape, oscillographs, strip-chart recorders, and camera film. In addition presents a summary of available time code formats and their application. This handbook is an excellent guide for time data indexing, precision range timing, synchronized communication, and remote time synchronization.

Direct request for Technical Bulletin TCDI to Mr. Philip Micciche, Manager of Product Systems, c/o

Datametrics,

a subsidiary of ITE Imperial Corp.
127 Coolidge Hill Road,
Watertown, Mass. 02172 (617) 924-8505.

CIRCLE NO. 175

Real-Time Analyzer, Averager and Display Combined



SPECTRASCOPE (Model SD330) is a Real Time Analyzer, Spectrum Averager and Display 'Scope all in one. Compact and self-contained . . . as much at home in the field as in the laboratory.

- 0.15 to 20 kHz operation
 - 250-line Spectrum Analysis
 - Built-in flicker-free display — 20 analyses per second
 - Displays (1) raw data; (2) spectral content in 9 ranges from 25 Hz to 20 kHz; (3) averaged spectra to counteract noise or instability
 - Intensity marker for precise frequency location
 - Captures transient input signals
- Write for "SD330" brochure.

CIRCLE NO. 176

Spectral Dynamics Corporation
P. O. Box 671, San Diego, CA 92112

Electronic Design

Advertising Sales Staff

Bryce Gray
Sales Manager

Rochelle Park, N.J. 07662

Robert W. Gascoigne
Daniel J. Rowland
50 Essex Street
(201) 843-0550
TWX: 710-990-5071

Philadelphia

Thomas P. Barth
50 Essex Street
Rochelle Park, N. J. 07662
(201) 843-0550

Boston 02116

Richard L. Green
20 Columbus Avenue
Boston, Mass.
(617) 482-7989

Chicago 60611

Thomas P. Kavooras
Berry Conner, Jr.
200 East Ontario
(312) 337-0588

Cleveland

Thomas P. Kavooras
(Chicago)
(312) 337-0588
(call collect)

Los Angeles 90303

Stanley I. Ehrenclou
Burt Underwood
2930 Imperial Highway
Inglewood, Calif
(213) 757 0183

San Francisco 94022

Jerry D. Latta
P.O. Box 1248
Los Altos, Calif.
(415) 965-2636

London W. 1

For United Kingdom and Holland
Brayton C. Nichols

For Eastern Europe
Peter Kehr

The American Magazine Group

27 Maddox Street
London, W. 1, England
Phone: 499-0180
Cable: Ammagnic, London

Verviers, Belgium

For Continental Europe
Andre Jamar
1, Ru Mallar, 1
(087) 253.83 Telex 41563

Tokyo

Haruki Hirayama
Electronic Media Service
5th Floor, Lila Bldg.,
4-9-8 Roppongi
Minato-ku
Phone: 402-4556
Cable: Electronicmedia, Tokyo



AMERICAN BUSINESS PRESS, INC.

quick ads

advertiser's index



Thin-Trim® variable capacitors are designed to replace fixed tuning techniques. Applications include crystal oscillators, CATV amplifiers, communication and test equipment. Series 9410 has high Q's with five capacitance ranges from 1.0 - 4.5 pf to 10.0 - 50.0 pf. Johanson Manufacturing Corporation, Boonton, N. J. (201) 223-2676

INFORMATION RETRIEVAL NUMBER 181



A minicomputer interface, tape drive and formatter from \$4575.00. Ultra high speed incrementals at 3000 characters per second and up from \$3350.00. Continuous, incremental and low power tape transports from \$2000.00. Digi-Data Corporation, 4315 Baltimore Avenue, Bladensburg, Maryland 20710. (301) 277-9378.

INFORMATION RETRIEVAL NUMBER 182



Time delay relays. Delay on make, delay on turn off, and time interval models. Contact rating 10 amp DPDT. Priced from \$22.00. Delivery stock to 3 weeks. Hope Electronics, Box 773, Clifton, N.J. (201) 777-3522.

INFORMATION RETRIEVAL NUMBER 183

Advertiser	Page	Advertiser	Page
AMP, Incorporated, Capatron Division	109	Licon, Division Illinois Tool Works, Inc.	33
Abbott Transistor Laboratories Incorporated	6	Litton Industries, Triad Distributor Division	117
Acopian Corp.	84	Magnecraft Electric Company	73
Alco Electronic Products, Inc.	84	MicroSwitch, A Division of Honeywell	10
Amperite	106	Miida Electronics	140
Amphenol Connector Division, Bunker-Ramo Corp.	77	Monolithic Dielectrics, Inc.	126
Amphenol RF Division Bunker-Ramo Corp.	12	Monsanto Company	26
Associated Testing Laboratories, Inc.	93	National Semiconductor Corporation	72
Bendix Corporation, The, Electrical Components Division	54	New Product Engineering, Inc.	132
Bourns, Inc., Trimpot Products Division	4, 5	North American Philips Controls Corp.	119, 126, 128
Burrhoughs Corporation	Cover IV	Oak Industries, Inc.	17
CTS Corporation	22, 23	Paktron Division, Illinois Tool Works, Inc.	35
California Instruments Company	132	Panasonic/Matsushita Electric	99
Chomerics, Inc.	141	Phoenix Data, Inc.	130
Cincinnati Suz-Zero Products, Inc.	145	Piezo Technology, Inc.	124
Computer Automation, Inc.	16A	Philips Industries	61
Compu-lite Corp.	124	Pomona Electronics Co., Inc.	115
Curtis Development & Mfg. Co.	114	Potter & Brumfield Division of AMF Incorporated	14, 15
Dale Electronics, Inc.	Cover II	Power/Mate Corp.	114
Datametrix Division, CGS Scientific Corporation	143	Principal Manufacturing Corp.	102
Delco Electronics, Division of General Motors Corporation	86, 87	Princeton Applied Research Corp.	142
Digi-Data Corporation	144	Producers Service Corp.	130
Dow Corning Corporation	1	RFL Industries, Inc.	128
Dynascan Corporation	145	Radio Switch Corporation	131
ECC Corporation	7	Rogers Corporation	102
Edmund Scientific Co.	142	Schrack Electrical Sales Corp.	126
Elco Corporation	11	Shakeproof, Division of Illinois Tool Works, Inc.	110
Electrical Plastics Corp.	116	Signal Transformers Co., Inc.	133
Electric Wastebasket Corp.	128	Siliconix Incorporated	58
Electronic Arrays, Inc.	16	Simpson Electric Company	107, 138
Electronic Memories & Magnetics Corp.	126	Singer Inc., The, Kearfott Division	51
Electronic Molding Corporation	131	Sprague Electric Company	13
Electronic Navigation Industries	122	Sperry Information Displays Division	39
Facit-Odhner, Inc.	128	Spectral Dynamics Corporation	143
Fairchild Semiconductor, A Division Fairchild Camera and Instrument Corporation	18, 19	Stackpole Components Company	136, 137
Federal Scientific Corporation	143	Stackpole Electronic Components Division	134, 135
GTE Automatic Electric	60, 61	Sycor, Inc.	16B
General Electric Co.	112	TEC, Incorporated	108
General Electric Company, Miniature Lamp Dept.	111	TRW/IRC Fixed Resistors, An Operation of TRW Electronic Components	95
General Radio Company	105	TRW/UTC Transformers, An Operation of TRW Electronic Components	145
Glowlite Corp.	108	Tecnetics, Inc.	120
Gudebrod Bros. Silk Co., Inc.	140	Technipower, Inc., A Benrus Subsidiary	25
Hayden Book Company, Inc.	24, 142	Tektronix, Inc.	57
Hecon Corporation	129	Teledyne Relays, A Teledyne Company	2
Heinemann Electric Company	37	Teletype Corporation	8, 9
Hewlett-Packard	41, 42, 43, 44, 45, 46, 47, 48, 49, 50	Teradyne	29
Hickok Instrumentation and Controls Division	123	Texas Instruments Incorporated	85
Hoagland Instruments	141	Texas Instruments Incorporated, Components Group	78, 79
Hope Electronics	144	Thermalloy Company	125
Hughes Aircraft Company	52, 53	United Systems Corporation	97
Intech, Incorporated	127	Unitrode Corporation	31
International Electronics Research Corporation	20	Vactec Inc.	21
Johanson Manufacturing Corp.	133, 144	Venus Scientific, Inc.	139
Keithley Instruments	113	Watkins-Johnson	121
Keystone Carbon Company	122	Winchester Electronics, Division of Litton Industries	101
Kufz-Kasch, Inc.	102	Zero Manufacturing Co.	118
Lafayette Radio Electronics	145		
Lambda Electronics Corp.	Cover III		

387 ways to get it fast and get it right

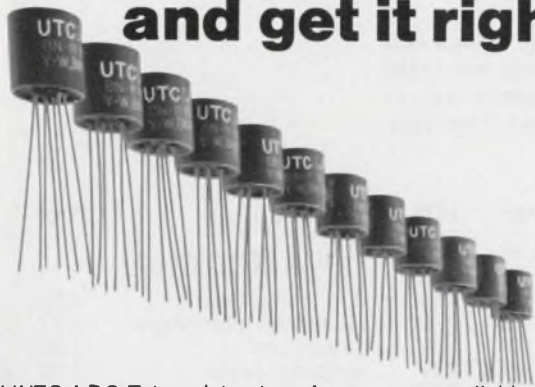

TRW/UTC I-DO-T transistor transformers are available rapidly from local distributors, in a choice of 387 specs and a choice of either insulated leads or cost and labor-saving plug-in terminals for PC boards.

These ruggedly constructed sealed units have the same electrical characteristics as UTC's DO-T MIL spec transformers and are ideal for push-pull driving, isolation and related applications.

Send for Bulletin 724, describing the entire line. TRW/UTC Transformers, an Operation of TRW Electronic Components, 150 Varick Street, New York, N. Y. 10013. Tel. (212) 255-3500.

TRW
UTC TRANSFORMERS

INFORMATION RETRIEVAL NUMBER 103

environmental test chambers

complete program testing facilities for: high and low temperature, altitude and humidity.
temperature ranges from: -150° to $+500^{\circ}$ F

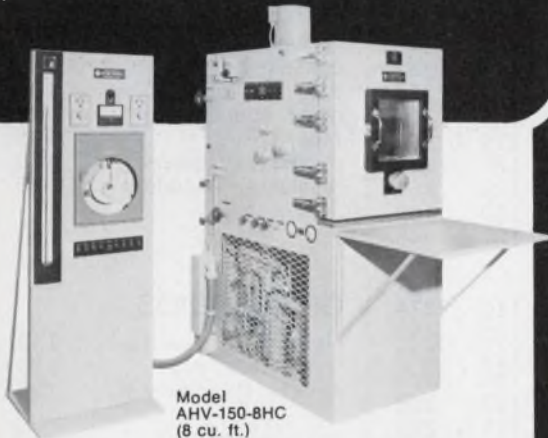

Model
AHV-150-8HC
(8 cu. ft.)
Temperatures -150° F to $+500^{\circ}$ F

Custom units, designed and built to your specifications. For FREE, NO OBLIGATION quote, send us your temp. range, size and chamber needs.

Get the facts today. Send for our new FREE test chamber brochure.

**CINCINNATI
SUBZERO
PRODUCTS INC.**

2612 Gilbert Ave., Cincinnati, Ohio 45206
Phone: (513) 751-8810

INFORMATION RETRIEVAL NUMBER 105

ELECTRONIC DESIGN 21, October 12, 1972

Introducing the expensive curve tracer that doesn't cost a lot.

The B&K Model 501A.

It hooks up to any scope, old or new. (Like our Model 1460 triggered-sweep scope.)

And it analyzes all semi-conductors including J-FET's, MOS-FET's, signal and power bipolar transistors, SCR's, UJT's and diodes. Fast and easy.

Constant current and voltage steps with 3% accuracy make the Model 501A an exceptional value. You can test transistors in circuit for GO/NO GO condition.

Badly distorted curves will indicate the stage where a fault exists.

Call your B&K distributor. Or write Dynascan Corporation.

\$129⁹⁵

Very good equipment
at a very good price.



Product of Dynascan Corporation
1801 West Belle Plaine Avenue, Chicago, Illinois 60613

INFORMATION RETRIEVAL NUMBER 104

FREE

The World's Largest
Consumer
Electronics Catalog



• Stereo/Hi-Fi Components • Musical Instruments and Amplifiers • CB & Ham Equipment • Tools and Test Equipment • Police and Fire Monitor Receivers • Public Address Systems • Photography Equipment • Semiconductors, Books, Parts • Plus Much More!

Send For Your Free Lafayette Catalog Today!
Lafayette Radio Electronics, Dept. 45102
P.O. Box 10, Syosset, L.I., N.Y. 11791

Send Me the Free Lafayette Catalog

45102

Name

Address

City

State

Zip

(Please include your zip code)

INFORMATION RETRIEVAL NUMBER 106

145

product index

Information Retrieval Service. New Products, Evaluation Samples (ES), Design Aids (DA), Application Notes (AN), and New Literature (NL) in this issue are listed here with page and Information Retrieval numbers. Reader requests will be promptly processed by computer and mailed to the manufacturer within three days.

Category	Page	IRN	Category	Page	IRN	Category	Page	IRN
Components			oscillator, pulse			104 254		
air moving devices (DA)	133	363	receiver, line	106	263	new literature		
buzzer, alarm	117	323	receiver/transmitter	107	266	a/d converters	136	470
capacitors (NL)	136	472	shift register	109	272	aluminum standards	137	142
capacitors, farad	116	320	transistors	108	267	capacitors	136	472
components, elec. (NL)	139	155	transistors, power	104	259	cassette tester	137	474
counter/printer	120	329	triacs	104	253	ceramic tape heads	137	141
crosspoint matrix	120	332	voltage regulator	106	260	components, elec.	139	155
keyboard switch	121	334	Instrumentation			connectors	136	473
LED directory (NL)	136	469	amplifier	115	310	core memory	139	160
LED pilot lamp (ES)	134	458	amplifier, power	112	302	CRT terminals	137	145
noise spectra (AN)	135	465	instruments (NL)	136	471	drafting aids	136	468
pneumatic components (NL)	139	161	logic probe	114	306	dynograph recorders	138	151
potentiometers (NL)	137	140	megohmmeters (NL)	137	143	IEE periodicals	139	154
relay, meter, speed	121	333	oscilloscopes	112	303	instruments	136	471
resistor, kit	118	325	panel meter, digital	113	305	keyboards	138	152
resistor networks (NL)	137	146	phase angle standard	112	301	LED directory	136	469
resistor, selectable	120	331	rf amplifier	114	308	megohmmeters	137	143
resistors, substrate	119	327	scanner, optical	114	307	microwave devices	138	148
solid-state relay	117	321	transistor tester	112	300	peripherals guide	139	158
stepper motors (NL)	138	150	voltmeter, HV	115	309	pneumatic components	139	161
switch, pushbutton	119	328	wavesolderer	113	304	potentiometers	137	140
switch, rotary, PC	117	322	Microwaves & Lasers			power supplies	139	159
switch, thumbwheel	120	330	absorber	131	358	relays	139	156
(DA)	133	364	apertures, sapphire	132	360	rep directory	139	157
transformer, PC	118	324	FETs	131	356	resistor networks	137	146
transformer, PC	118	326	Gunn diodes	131	357	sputtering systems	138	147
Data Processing			microwave devices (NL)	138	148	standoffs, spacer	138	149
calculators	122	335	paramp	130	354	stepper motors	138	150
console flow chart (AN)	135	467	p-i-n diodes	132	361	transformer, dry-type	138	153
CRT terminals (NL)	137	145	power divider/combiner	132	359	video display terminal	137	144
data communications (AN)	135	461	voltmeter, vector	130	355	application notes		
demodulator, FM	122	336	Modules & Subassemblies			ceramics, beryllia	135	462
dynograph recorders (NL)	138	151	a/d converters (NL)	136	470	console flow chart	135	467
multiplexer, modem	123	338	amp, instrumentation	127	349	data communications	135	461
paper tape handler	125	345	attenuator	127	347	noise spectra	135	465
peripherals guide (NL)	139	158	converter, a/d	129	350	pipe, CPVC	135	464
position digitizer	125	344	correction modules	129	352	plastic extrusions	135	463
printers	124	340	filter, electronic	129	353	resolvers, encoders	135	466
resolvers, encoders (AN)	135	466	oscillators	127	348	design aids		
system, testing	123	337	power supplies	129	351	air moving devices	133	363
video display terminal (NL)	137	144	power supplies (NL)	139	159	connectors, pin	133	362
video terminal	124	339	surge suppressor	127	346	switch, thumbwheel	133	364
ICs & Semiconductors			Packaging & Materials			evaluation samples		
analog switches	104	257	breadboard	110	274	header/plug	134	454
character generator	109	271	ceramics, beryllia (AN)	135	462	LED pilot lamp	134	458
counter, SOS	104	256	connectors	110	273	metric conversion	134	456
display, gaseous	106	264	connectors (NL)	136	473	spacer, PC board	134	457
encoders	104	258	connectors, pin (DA)	133	362	test jack	134	455
LED decoder/driver	103	250	connectors, test	111	278	wire connectors	134	459
logic translators	109	270	header/plug (ES)	134	454	wire harnesses	134	460
LSI chip	106	262	interconnect assemblies	110	276			
op amp	104	255	lead bending system	111	279			
op amp	106	261	material, PC	110	277			
op amp, FET	108	268	mounting frame	110	275			
optical coupler	108	269	pipe, CPVC (AN)	135	464			
opto emitter-detectors	107	265	spacer, PC board (ES)	134	457			
			standoffs, spacer (NL)	138	149			
			test jack (ES)	134	455			
			wire connectors (ES)	134	459			
			wire harnesses (ES)	134	460			

Do you face a make or buy decision on power supplies?

BUY LAMBDA LX SERIES

Choose from 8 packages, 47 models. All listed in Underwriters' Laboratories Recognized Components Index.* All designed to meet MIL environmental specifications.

"3" PACKAGE

DUAL OUTPUT ... \$85
 ± 15 TO ± 12 VOLTS 0.4 AMPS



"4" PACKAGE

SINGLE OUTPUT ... \$135
5 VOLTS 7.4 AMPS (with O.V.)

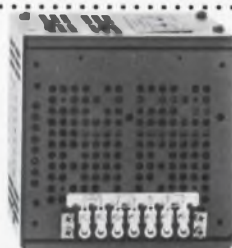

"A" PACKAGE

SINGLE OUTPUT ... \$85
5 VOLTS 4 AMPS (with O.V.)

DUAL OUTPUT ... \$125
 ± 15 TO ± 12 VOLTS 1 AMP



"CC" PACKAGE

SINGLE OUTPUT ... \$200
5 VOLTS 16 AMPS (with O.V.)

DUAL OUTPUT ... \$235
 ± 15 TO ± 12 VOLTS 4.0 AMPS



"B" PACKAGE

SINGLE OUTPUT ... \$125
5 VOLTS 5.8 AMPS (with O.V.)

DUAL OUTPUT ... \$150
 ± 15 TO ± 12 VOLTS 1.6 AMPS



"EE" PACKAGE

SINGLE OUTPUT ... \$425
5 VOLTS 45 AMPS (with O.V.)

DUAL OUTPUT ... \$435
 ± 15 TO ± 12 VOLTS 12.5 AMPS



"C" PACKAGE

SINGLE OUTPUT ... \$150
5 VOLTS 9 AMPS (with O.V.)

DUAL OUTPUT ... \$160
 ± 15 TO ± 12 VOLTS 2.5 AMPS



"D" PACKAGE

SINGLE OUTPUT ... \$235
5 VOLTS 27.5 AMPS (with O.V.)

DUAL OUTPUT ... \$280
 ± 15 TO ± 12 VOLTS 6.2 AMPS

TRIPLE OUTPUT ... \$375
 ± 15 TO ± 12 VOLTS 3.1 AMPS
5 \pm 5% VOLTS 12 AMPS
(with O.V.)

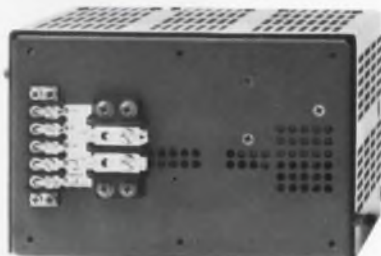

Line regulation 0.1% Load regulation 0.1%
Ripple and noise 1.5 mV RMS, 5 mV P-P.
AC input 105-132 VAC; 47-440 Hz.

All 5-volt models include built-in OV protection.

*LX-EE models presently undergoing qualifying tests.

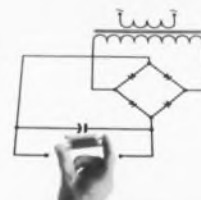

WHETHER
YOU MAKE
OR BUY...

LAMBDA
ELECTRONICS CORP.
A  Company

1-DAY DELIVERY

5-YEAR GUARANTEED

For information on other models up to 28 VDC, send for catalog.

MELVILLE, NEW YORK 11746 515 Broad Hollow Road Tel. 516-694-4200 ARLINGTON HEIGHTS, (CHICAGO) ILL. 60005 2420 East Oakton St., Unit Q Tel. 312-593-2550

NORTH HOLLYWOOD, CALIF. 91605 7316 Varna Ave. Tel. 213-875-2744 MONTREAL, QUEBEC 100C Hymus Blvd., Pointe-Claire, Quebec-730 Tel. 514-697-6520

INFORMATION RETRIEVAL NUMBER 233

SELLS ON SIGHT

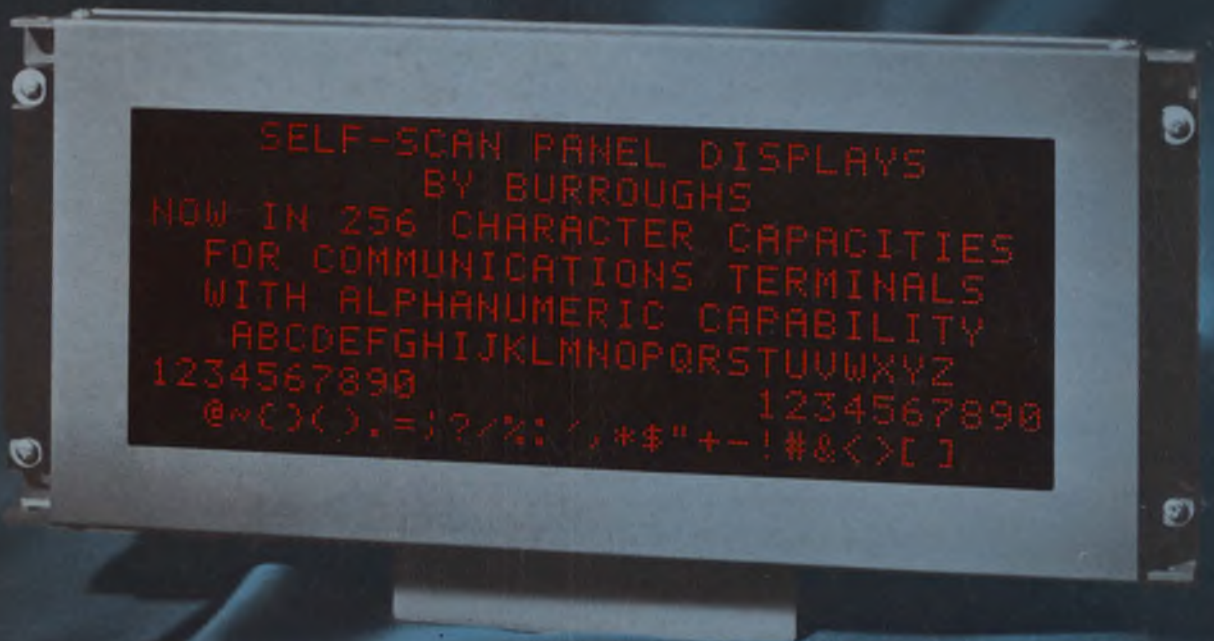

superior readability that competitors can't match

One look at an operating SELF-SCAN[®] panel display and you will know why you should be featuring one in your system. SELF-SCAN displays are a new solution to the operator machine interface that provides advantages to the system builder, to the system user, and to the system operator.

You can offer your customer the advantage of a custom-stylized unit that his operators can use efficiently. SELF-SCAN panels are measurably superior to CRT for operator accuracy while significantly reducing fatigue level in day in-day out high volume production applications.

The 0.2" high characters are in the popular 5x7 dot matrix format and are made up of dots on .040" centers. The unit is ASCII compatible and displays a modified 64-character ASCII character set.

256-character display subsystems are available from stock for immediate delivery. Call or write Burroughs Corporation, Electronic Components Division, Box 1226, Plainfield, New Jersey 07061, Phone: (201) 757-3400. Ask to have a Burroughs sales engineer stop by your office and show you his 256-character SELF-SCAN panel, keyboard, and power supplies packaged in a standard Samsonite[®] briefcase.

Burroughs

