

Electronic Design 19

VOL. 20 NO.

FOR ENGINEERS AND ENGINEERING MANAGERS

SEPT. 14, 1972

Choosing the right LED—visible or IR—isn't easy. Specs for like devices vary widely. Optical package design determines the output beam dispersion. And the

type of LED material governs radiation bandwidth and output, response speed and efficiency. For easier LED selection; use the simplified approach, Page 120.



We're quicker on the trigger in Coil Country.



New Dale Trigger-Type Pulse Transformers

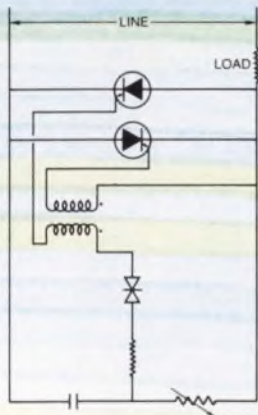

Available fast for SCR control circuits. New Dale Trigger-Type Pulse Transformers match your performance and budget requirements for industrial and commercial applications. Two styles with PC pins (PT20) or bobbin type leads (PT10) for use where trigger source isolation is employed in half or full wave SCR power control circuits. Available with turns ratio of: 1:1, 1:1:1, 2:1, 2:1:1 and 5:1. Primary inductance from 200 μ h to 5000 μ h. Interwinding capacitance as low as 400 pf. Leakage inductance as low as 3 μ h.





The price—very competitive in most any quantity. Phone today for a quote: 605-665-9301 or write:

DALE ELECTRONICS, INC.
East Highway 50, Yankton, S.D. 57078
A subsidiary of The Lionel Corporation

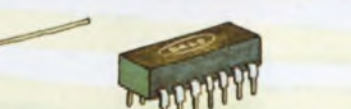

Check our expanded inductor capabilities...

Standard or special, Dale is moving up as a preferred source for inductive components. Readily available among our broadened standard lines are:

 <p>Conformal Coated Chokes Type IR-2, IR-4. Durable epoxy coating give equivalent performance, lower price than molded styles. Machine insertable. Tolerance $\pm 10\%$. Inductance: .10 μh to 1000 μh.</p>	 <p>Flame Retardant Molded Chokes Type IM-2, IM-4. Meet MIL-C-15305D. Grade 1, Class A, B. Tolerances: $\pm 5\%$, $\pm 10\%$, $\pm 20\%$. Inductance: 10 μh to 1000 μh.</p>	 <p>DIP Pulse Transformers Type PT-14, PT-16. Machine insertable, 14, 16 pin styles. Inductance: 1 μh to 2 mh. Tolerance $\pm 20\%$. Leakage inductance: As low as 0.2% of inductance. Interwinding capacitance: As low as 3 pf. ET product: Up to 10 volts/μsec.</p>	 <p>PC Mount Toroids Series TE. Meet MIL-T-27C. Type TF5SX20Z2. Epoxy encapsulated. High Q and wide selection of Q vs. frequency ranges. Inductance: .050 mh to 20 h. Tolerances: $\pm 1\%$, $\pm 2\%$, $\pm 5\%$.</p>	 <p>Custom Chokes, Toroids, Bobbins, RF Transformers, Variable Pitch Inductors Complete facilities to design and produce everything from prototype quantities to high volume production runs.</p>
--	--	--	--	---

For a fast quote or immediate design help, phone 605-665-9301 or write Dale Electronics, Inc., East Highway 50, Yankton, S.D. 57078. Circle 80 for Inductor Catalog.

First we made them easy to use. Now we've made them easy to get.

Yes, we now have distributors. The best there are around the world. These distributors have in stock our complete line of LED displays, LED lamps, isolators and photo-detectors.

Easy to use. All these products are solid-state and directly DTL-TTL compatible. And they are all designed for ease of application.

A complete LED lamp family. Our LED lamp family offers a complete selection of lens, lead and light output combinations. Our new T-1 Mini-LED is just 0.125" in diameter. This device offers high brightness over a wide viewing angle. And you have a choice of lenses: red diffused, clear, or clear diffused. This little gem, known as the 5082-4480, costs just 45¢ in 1,000 quantities. The T-1 3/4 long lead wire wrappable 5082-4880 lamps start at 55¢ each in 1,000 quantities; the short or bent lead 5082-4440 LEDs start at 49¢ in 1,000 quantities. Higher volume prices on all these devices are even more attractive.

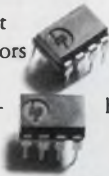

A new low-cost isolator. At 5 MHz bandwidth, it's 25 times faster than any other isolator on the market. It has a high DC isolation voltage of 2500 volts, and a high common mode rejection of 10 volts at 2 MHz, making the 5082-4350 ideal for eliminating ground loops in digital or analog line receivers, floating power supply and feedback networks. Prices start at \$2 each in 1,000 quantities.

A low-cost LED display. Our numeric and hexadecimal displays have simplified your designs with on-board electronics, standard package configuration, and categorized light outputs. Best of all, the 5082-7300 numeric has a new low price of \$8.25 in 1,000 quantities.

A new 1.5" LED numeric. This new LED display, visible from 60 feet, has on-board electronics, wide viewing angle, and is designed for edge mounting in a standard PC

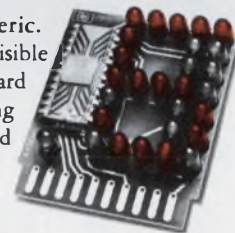

board socket. Solid-state reliability makes the 5082-7500 ideal where dependability is important. The price is \$23.50 each in 500 quantities.

Small character LED displays.

The 5082-7405 is a 5 digit end stackable display. It minimizes power consumption and offers ease of implementation with a standard 14 PIN DIP package. At only 7 mW per digit, this display is ideal for calculators, portable instruments and anywhere that low power and high brightness are important. The 5082-7405 is priced at \$3.20 per digit in 1,000 quantities. Easy to get. Call the distributor nearest you for immediate delivery. Or write us for more information. Hewlett-Packard, Palo Alto, California 94304.



HEWLETT  PACKARD
COMPONENTS

The Light Source

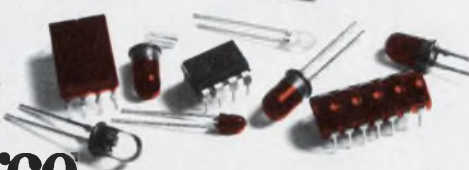

Distributor Stocking Locations:

SCHWEBER ELECTRONICS

Hollywood, Florida
(305) 927-0511
Rockville, Maryland
(301) 881-2970
Waltham, Massachusetts
(617) 891-8484
Rochester, New York
(716) 328-4180
Westbury, New York
(516) 334-7474

WYLE DISTRIBUTION GROUP

Liberty Electronics/Arizona
Phoenix, Arizona (602) 264-4438
Liberty Electronics
El Segundo, California (213) 322-8100
Elmar Electronics
Mt. View, California (415) 961-3611
Western Radio
San Diego, California (714) 235-6571
Elmar Electronics
Commerce City, Colorado (303) 287-9611
Liberty Electronics/Northwest
Seattle, Washington (206) 763-8200

HALL-MARK ELECTRONICS

Huntsville, Alabama
(205) 539-0691
Tulsa, Oklahoma
(918) 835-8458
Dallas, Texas
(214) 231-6111
Houston, Texas
(713) 781-6100

INFORMATION RETRIEVAL NUMBER 2

MAN-MADE DURABILITY

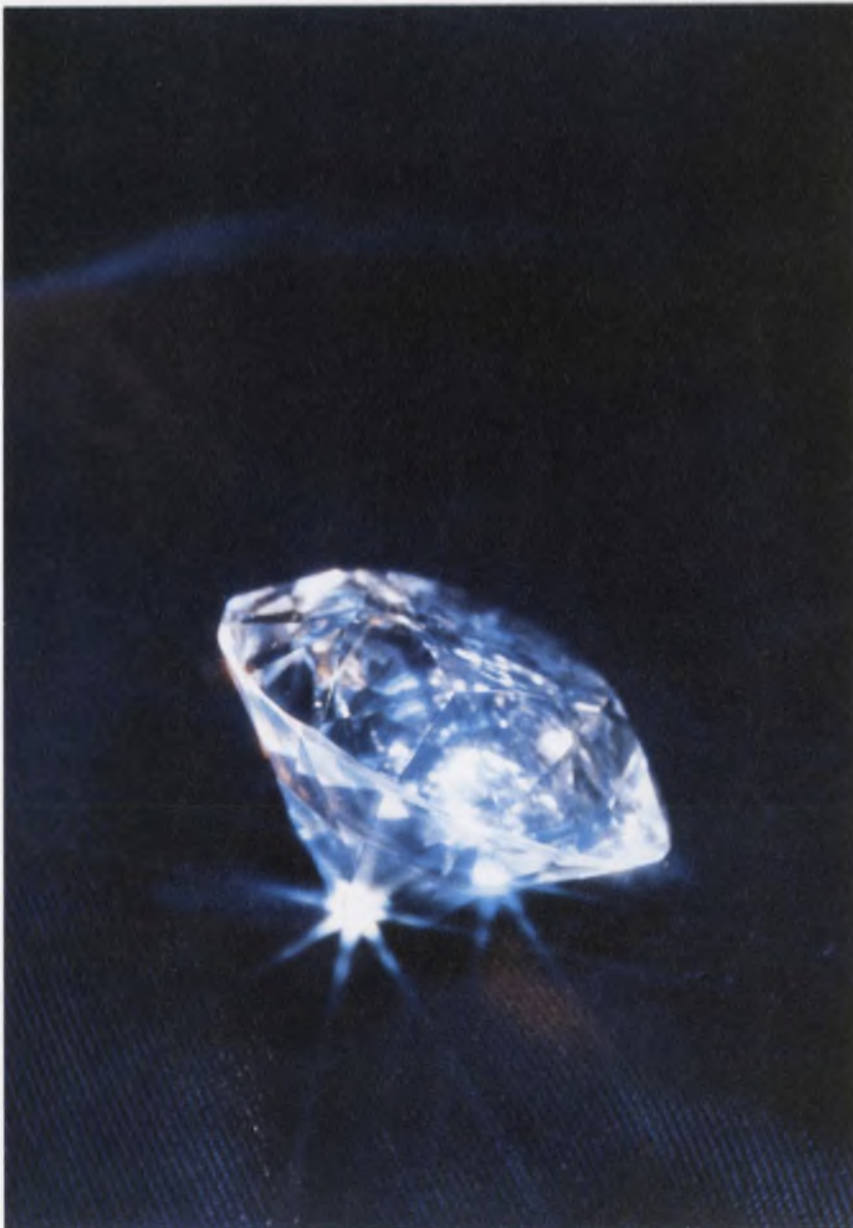

TO-5 Relay

The diamond is one of the most durable of earth's elements. Man can make it into a jewel or use it

as an industrial tool. It remains durable to the end. The "diamond" of the electro-mechanical relay world is the Teledyne TO-5. This accolade has been earned. The family of tiny Teledyne TO-5 general purpose Relays continues to withstand the critical requirements of long life, phenomenal reliability, and all-around hard use. These relays remain the standard for industrial, scientific, and aerospace applications throughout the world.

Durability and dependability are hallmarks of Teledyne Relays and its products. You can be assured of this same high quality from our newly developed family of advanced Solid State relays. Teledyne products are constructed to last.

Send us your requirements.

3155 West El Segundo Boulevard
Hawthorne, California 90250
Telephone (213) 679-2205



**TELEDYNE
RELAYS**

NEWS

- 21 **News Scope**
- 24 **LED makers** are getting the red out of indicator lamps. New material technologies are leading to bright, efficient displays in other colors.
- 30 **All-solid-state color TV camera**, the first, is built experimentally.
- 32 **Accelerometers in Atlas missiles** converted to earthquake sensors.
- 34 **Synthetic crystal** an alternative to quartz.
- 34 **Inexpensive satellite navigation set** developed.
- 48 **Technology Abroad**
- 69 **Washington Report**

WESCON '72—A special section Pages 74 to 118

TECHNOLOGY

- 120 **Which LED is best?** With a choice among visible and IR types, and with red, green and yellow colors, the buyer must know the tradeoffs and spec limitations.
- 128 **Increase optical-isolator speed** by modifying the phototransistor's operating mode. Frequencies over 10 MHz are possible, but there are tradeoffs.
- 134 **TV set is display for data terminal** in this all-digital character-generation system. It has a capacity of 1024 characters and uses dynamic MOS-RAM memories.
- 144 **Here are simple circuit models** for computer-aided analysis of complex systems. The models are derived with an isolated, equivalent-circuit technique.
- 150 **When a merger causes company friction**, a management truce committee can restore harmony in ranks by airing grievances without bruising egos.
- 156 **Ideas for Design:** Digital non-integration method boosts response time of vertical sync separator . . . diode gates cut costs and customize wideband coaxial switch design . . . Binary-to-gray translator needs no power supply . . . Packaged pulse-width modulator simplifies series-switching regulator design . . . Gated zero-start oscillator reaches steady-state amplitude on first cycle.
- 166 **Design Decisions:** Separate SCR bias gives low trip-level crowbar.

PRODUCTS

- 169 **ICs & Semiconductors:** Improved op amp regulator comes with lower price tag.
- 170 **ICs & Semiconductors:** Smallest IC-package line begins with popular linears.
- 174 **Modules & Subassemblies:** Indicator light plus TTL gives convenient package.
- 184 **Data Processing:** Data logger can operate 6 months on car battery.
- 180 Instrumentation
- 190 Components
- 192 Packaging & Materials
- 194 Microwaves & Lasers

Departments

- 73 **Editorial:** We communicate. Or do we?
- 7 Across the Desk
- 198 Evaluation Samples
- 200 Design Aids
- 200 Application Notes
- 202 New Literature
- 206 Bulletin Board
- 207 Vendors Report
- 212 Advertisers' Index
- 214 Product Index
- 216 Information Retrieval Card

Cover: Photo of bicolor LED by Messina Studios, Courtesy of Texas Instruments Inc.

5 LINEAR MONOLITHIC SUBSYSTEMS



Subsystems: highly complex functions on a single chip. That's where it's happening in linear today. Where Fairchild is. In op amps, voltage regulators and interface.

Look at the facts. In the last 6 months alone 5 new Fairchild monolithic linear subsystems were introduced and are now in volume production.

New 791 High power op amp

Our latest monolithic op amp subsystem has 1 amp output at ± 12 volts and automatic circuit protection. Everything is on one chip, so installation's easier. Fewer external connections, testing's easier, less external electronics. Naturally, system costs go down, system reliability goes up. Internally protected against short circuits, power and thermal overloads. 100-piece price: \$12.50.

750 Dual comparator

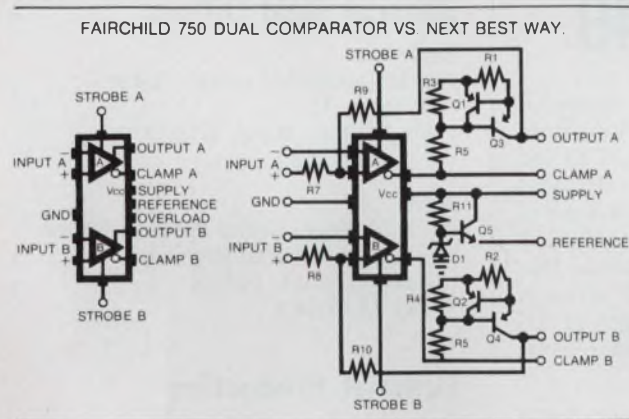

The world's first monolithic comparator subsystem. Eliminates up to 17 discrete components other comparators require for equivalent function and drive capability. A totally-self-contained subsystem consisting of two high-output current, independent comparators on a single chip. Eliminates the external components, board space, and virtually all the engineering calculations necessary to make other comparators function reliably and safely in complex control applications. 100-piece price: \$5.95.

776 Programmable op amp

This subsystem is the closest thing to a universal op amp yet devised. Already an industry standard, it's a high quality device that, with the addition of a simple external resistor, can be tailored for optimum performance over an enormous span of applications. The wide range of programmable characteristics make it one of the most versatile and useful op amps to appear in years. Applications range from a nanowatt amplifier to a high-accuracy sample and hold amplifier. 100-piece price: \$3.00.

7800 3-terminal voltage regulator

Seven members (5V, 6V, 8V, 12V, 15V, 18V, 24V) compose this family – the first with complete voltage regulation on one chip. The first high quality, sophisticated, versatile, yet simple way of solving VR design problems. At a price so low they can be inventoried in

quantity, for use as required. Complete and self-contained in one TO-220 or TO-3 package. And fully self-protected: internal current limiting, thermal shut-down, safe area compensation protect device from current, power, temperature fluctuations. Typical 100-piece price: \$1.75.

9616 EIA line driver (& 9617 receiver)

Our 9616 triple line driver subsystem has both internal inhibit and slew rate control. And it's all on one chip. Our 9617 EIA triple line receiver completes the set. They meet all EIA RS-232-C specs. And more.

Together, they provide the simplest low-cost solution to problems at the interface in data terminal equipment and data communications. 100-piece price is \$4.50 for the 9616; and \$3.50 for the 9617.

COMPARISON OF EIA DRIVERS

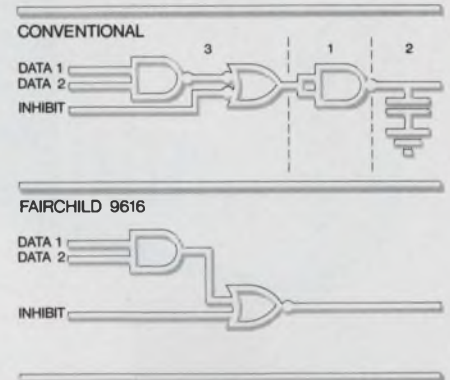

Conventional EIA Driver (1) requires external slew rate control capacitor (2) and external gating for inhibit function (3). 9616 EIA Driver requires neither.

93 Linear products in all

Can any other linear-maker make that claim? No way. Whatever your linear needs, the answers are MADE IN FAIRCHILD.

- Industrial controls: 1-Amp op amp; high current comparator, AC control.
- Op amps: general purpose; low input current; high speed; low drift.
- Voltage regulators: general purpose; high current; high and low voltage.
- Interface: drivers/receivers; comparators; D/A conversion; memory.
- Consumer: TV systems; entertainment systems; communications.
- Custom: automotive; consumer; military.

Check us or your friendly Fairchild distributor for products and literature.



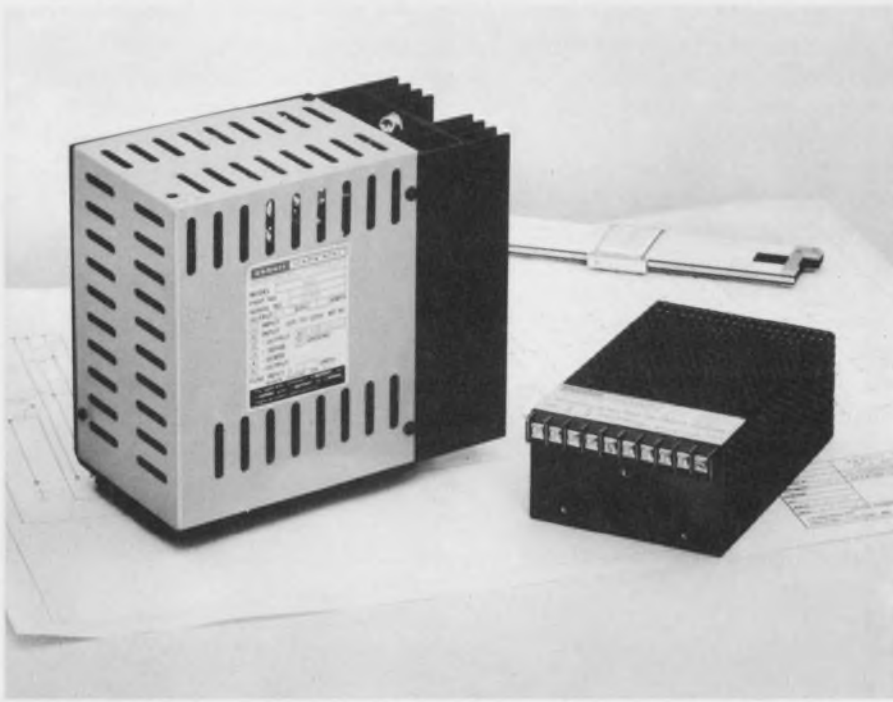

Reduce Your Power Supply Size and Weight By 70% for \$49

A new way has been found to substantially reduce power supply size and weight. Consider the large power supply shown at left in the above photo — it uses an input transformer, into a bridge rectifier, to convert 60 Hz to 5 volts DC at 5 amperes. This unit measures 6½" x 4" x 7½" and weighs 13 pounds. It sells for \$170 in small quantities. For just \$49.00 more, Abbott's new model Z5T10, shown at right, provides the same performance with 70% less weight and volume. It measures only 2½" x 4" x 6" and weighs just 3 pounds.

This size reduction in the Model Z5T10 is primarily accomplished by eliminating the large input transformer and instead using high voltage, high efficiency, DC to DC conversion circuits. Abbott engineers have been able to control the output ripple to less than 0.02% RMS or 50 millivolts peak-to-peak

maximum. This design approach also allows the unit to operate from 100 to 132 Volts RMS and 47 to 440 Hertz. Close regulation of 0.15% and a typical temperature coefficient of 0.01% per degree Centigrade are some of its many outstanding features. This new Model "Z" series is available in output voltages of 2.7 to 31 VDC in 9 days from receipt of order.

Abbott also manufactures 3,000 other models of power supplies with output voltages from 5 to 740 VDC and with output currents from 2 milliamps to 20 amps. They are all listed with prices in the new Abbott catalog with various inputs:

- 60 A to DC, Regulated
- 400 A to DC, Regulated
- 28 VDC to DC, Regulated
- 28 VDC to 400 A , 1 ϕ
- 24 VDC to 60 A , 1 ϕ

Please see pages 618 to 632 of your 1971-72 EEM (ELECTRONIC ENGINEERS MASTER Catalog) for complete information on Abbott modules.

Send for our new 56 page FREE catalog.



LABORATORIES, INCORPORATED
general offices eastern office

5200 W. Jefferson Blvd./Los Angeles 90016
 (213) 936-8185 Telex: 69-1398

1224 Anderson Ave./Fort Lee, N.J. 07024
 (201) 224-6900 Telex: 13-5332

INFORMATION RETRIEVAL NUMBER 5

Vice President, Publisher

Peter Coley

Editors

Editorial Offices
 50 Essex St.
 Rochelle Park, N.J. 07662
 (201) 843-0550
 TWX: 710-990 5071
 Cable: Hadyenpubs Rochellepark

Editor: George Rostky

Managing Editors:

Ralph Dobriner
 Michael Elphick

Associate Editors:

Jules H. Gilder
 Richard Lee Goldberg
 Morris Grossman
 John F. Mason
 Stanley Runyon
 Edward A. Torrero
 Richard L. Turmail

Contributing Editor:

Peter N. Budzilovich

Editorial Field Offices

East

Jim McDermott, Eastern Editor
 P.O. Box 272
 Easthampton, Mass. 01027
 (413) 527-3632

West

David N. Kaye, Senior Western Editor
 2930 West Imperial Highway
 Inglewood, Calif. 90303
 (213) 757-0183

Editorial Production

Marjorie A. Duffy

Art

Art Director, William Kelly
 Richard Luce
 Anthony J. Fischetto

Production

Manager, Dollie S. Vieblg
 Helen De Polo
 Maxine Correal
 Anne Molfetas

Circulation

Manager, Nancy L. Merritt
 Ron Deramo

Information Retrieval

Peggy Long

across the desk

Wowwed 'n bewildered by the wacky WOM

I'm writing to tell you how much I enjoyed the recent article on the WOM from Signetics ("A WOM From Signetics," ED 16, Aug. 3, 1972, p. 7).

I'm a bit confused as to the purpose of the Information Retrieval number. Will circling No. 365 get me a copy of the spec sheet? Or will it put me on the list of countless numbers of IEE's (Idiot Electronic Engineers) who were "taken" and seriously want more info on the product? In any case, I didn't have the nerve to circle the number, but I would appreciate receiving a copy of the spec sheet if one does exist.

An amateur radio organization I belong to (American Radio Relay League, publishers of *QST*) runs a similar type of article annually in its April issue. However, it doctors it up even more, so it's even harder to identify as a sham.

*Thomas P. Riley
Engineer*

Naval Underwater Systems Center
Headquarters
Newport, R.I. 02840

Which linearity is more linear?

Readers of the article in the Aug. 3 issue describing Analogic's new 16-bit d/a converter ("Almost 16-bit D/A Converter Is Industry's Fastest, Most Stable, Least Expensive," ED 16, p. 65) are left with two wrong impressions. First, they may think it is impossible to build a 16-bit DAC. Second, they are told the performance of the Analogic unit is superior to that of Analog Devices DAC-16QM.

We have been manufacturing the DAC-16QM for 18 months and have shipped several hundred units

all over the world. The linearity of every single unit, at every one of 65,536 codes, is individually recorded, and a copy of the results is shipped with the unit. While our preliminary data sheet claims a linearity error of $\pm 0.0015\%$ (± 1 LSB), fully 50% of the units shipped thus far have had a maximum linearity error of the supposedly elusive value of $\pm 1/2$ LSB. We have the records to prove it.

Furthermore we measure endpoint linearity, which is a more conservative and far more useful measurement than the more commonly used best-straight-line linearity. This is explained in our Analog-Digital Conversion Handbook.

Our preliminary data sheet was deliberately conservative because it was published at the same time the DAC-16QM, a state-of-the-art product, was introduced. Now, based on our extensive manufacturing history and the results of tests we have been running to establish long-term stability positively, we are preparing a revised data sheet. In addition to tightening several specifications, it will specify long-term stability. The DAC-16QM is a proven product. The new data sheet will show better just how good it really is.

Barry Hilton

Director of Engineering

Analog Devices, Inc.
Route 1 Industrial Park
P.O. Box 280
Norwood, Mass. 02062

Analogic Replies

Mr. Hilton states that "... fully 50% of the units shipped thus far have had a maximum linearity error of the supposedly elusive value of $\pm 1/2$ LSB," and he adds; "We

(continued on p. 13)

Electronic Design welcomes the opinions of its readers on the issues raised in the magazine's editorial columns. Address letters to Managing Editor, Electronic Design, 50 Essex St. Rochelle Park, N. J. 07662. Try to keep letters under 200 words. Letters must be signed. Names will be withheld on request.

giga-trim capacitors for microcircuit designers

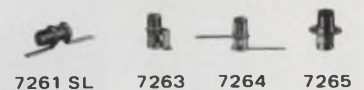
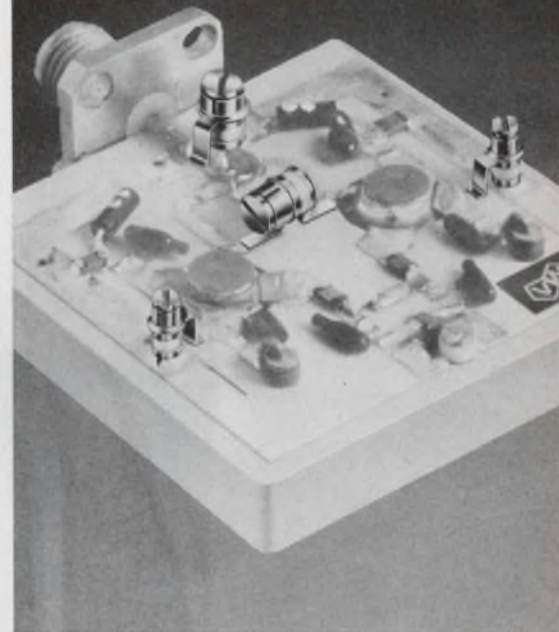

Giga-Trim[®] (gigahertz-trimmers) are tiny variable capacitors which provide a beautifully straight forward technique to fine tune RF hybrid circuits and MIC's into proper behavior. They replace time consuming cut-and-try adjustment techniques and trimming by interchange of fixed capacitors.

Applications include impedance matching of GHz transistor circuits, series or shunt "gap-trimming" of microstrips, external tweaking of cavities, and fine tuning of crystal oscillators.

Johanson

MANUFACTURING CORPORATION

BOONTON, NEW JERSEY 07005
201 / 334-2676

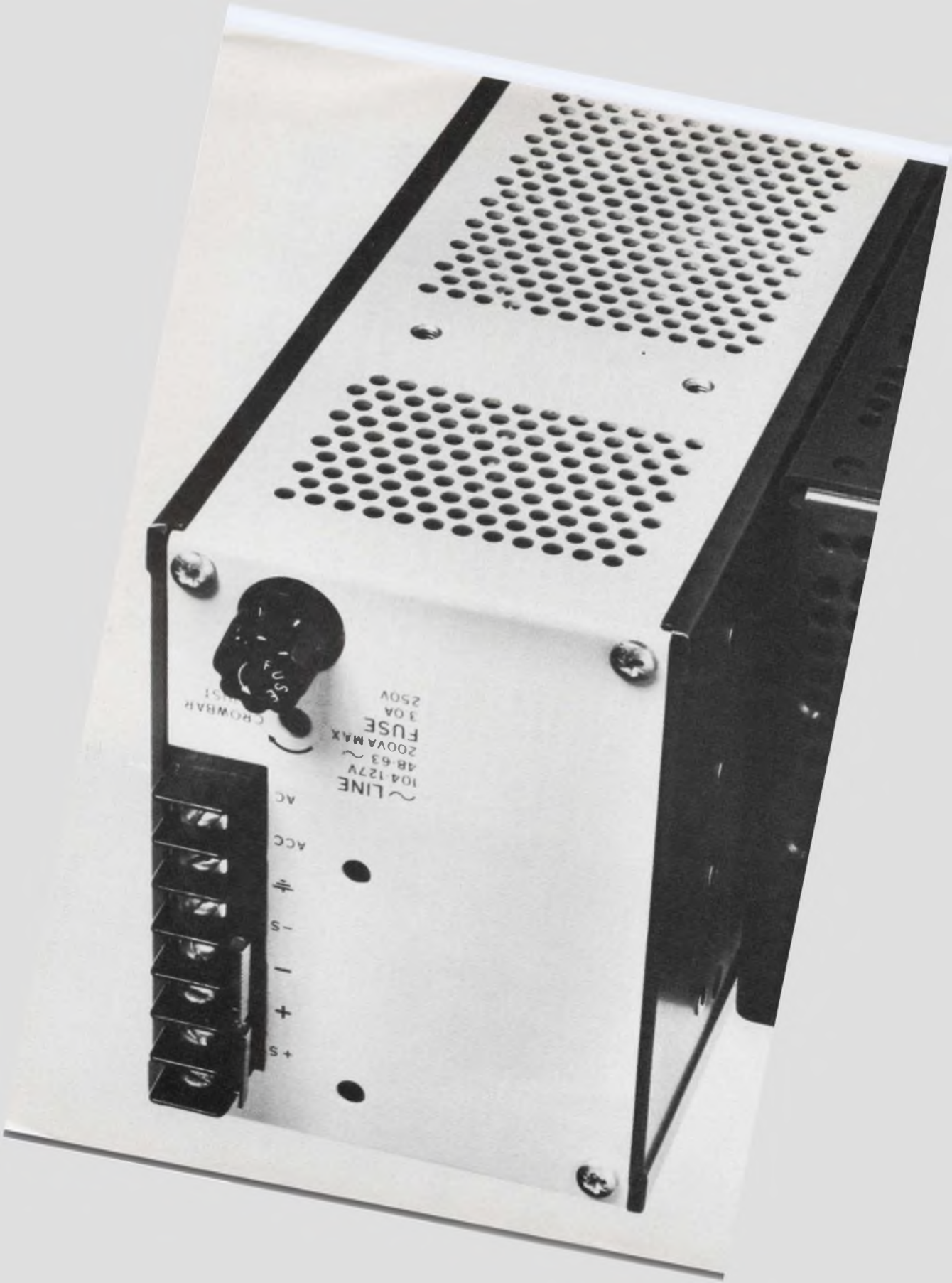

CROWBAR
10A



~ LINE
104-127V
48-63
200VA MAX
FUSE
3.0A
250V

AC

ACC

⊕

-S

-

+

+S

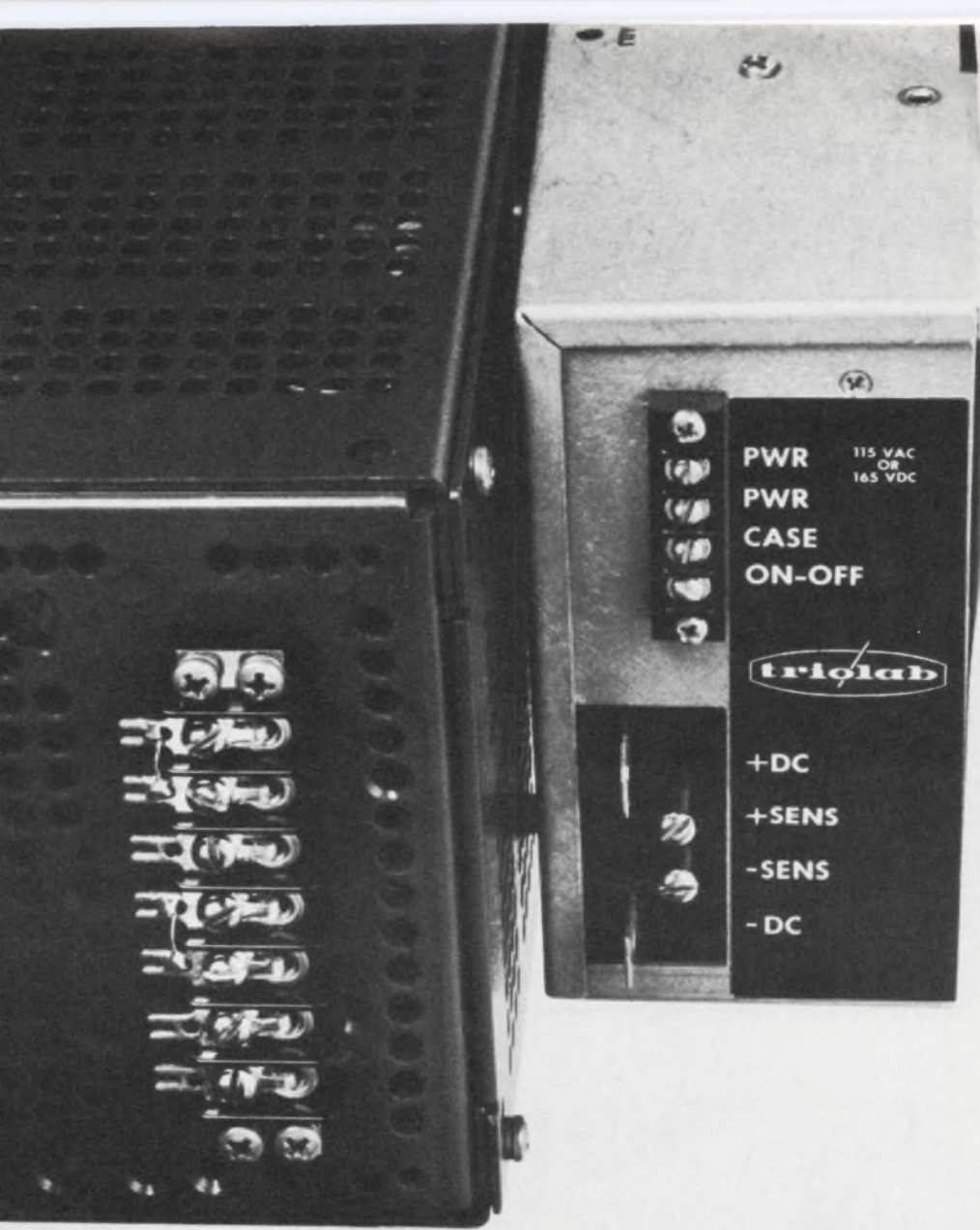

PWR 115 VAC
OR
165 VDC
PWR
CASE
ON-OFF



+DC
+SENS
-SENS
-DC



$\frac{1}{2}$ the volume $\frac{1}{4}$ the weight $\frac{1}{4}$ the heat

Third generation modular power supplies — at competitive prices.

The little one on the bottom delivers 33% more power than the middle one and 50% more power than the top one — all at 40°C ambient.

Here are all the particulars:

Series 650A — High Density Switching Regulator Power Supplies

Output: 5VDC/12Amp (Model 650A05)

Input: 100-130VAC, 47-500Hz; or 148-180VDC. For 198-264VAC input, substitute suffix E for suffix A.

Voltage Regulation: For any combination of line and load change: 0.2%.

Temperature Regulation: 0.005% / °C over the operating temperature range.

Operating Temperature Range, Free Air Convection: -20°C to +40°C (12A), +50°C (10A), +71°C (8A).

Output Noise: ≤ 50 MV P-P (Total)

Protection:

Overcurrent: Current limit type.

Overvoltage: SCR crowbar type automatic recovery.

Crowbar capacity: 50A peak. Factory set at 6.5V nominal.

Efficiency: 55% typical.

Remote On-Off Control: +5V ± 2 V (T²L) applied to "On-Off" terminal will reduce output to: ≤ 1.5 V in 10 μ sec, 0V in 500 μ sec.

Size: Overall, 2.5" x 4.88" x 7.8".

Weight: 3.25 lbs.

Price: \$200 each, FOB, Plainview, Long Island, N.Y.

For more information write to Trio Laboratories, Inc., 80 DuPont Street, Plainview, L.I., New York 11803. Phone: (516) 681-0400, TWX: 510-221-1861. Europe: Trio Laboratories Ltd., Woking, Surrey, U.K. Phone: 65834. Telex: 85225.

EA1500 N-CHANNEL Si GATE TAKES ON BIPOLAR.



501 ELLIS STREET
MOUNTAIN VIEW, CALIFORNIA 94040
(415) 964-4321 TWX: 910-379-6985

There's a lot of noise these days about RAMs and new super, bipolar processes. Well, we'd like to challenge all those bipolar claims. In fact, you can too. All one needs to do is pick up the data sheets and compare.

You may have heard or read that MOS is slower than bipolar. The fact is that the EA1500 N-channel silicon gate 1K RAM has an access time of 85nsec—worst case, including voltage variation, over the 0° to 70°C temperature range. Our "fair" competition also specs their 1K bipolar RAM at 85nsec—but at a nominal voltage and a junction temperature of 25°C!

OK, let's just assume it's a standoff in speed. In power dissipation, the EA1500 with a maximum, worst case, guaranteed .220mW/bit wins right out. The 93415 draws .684mW/bit at 75°C case temperature. That would take a whole bunch of air conditioning if you're going to use more than one.

Then, of course, there's price. The EA1500 sells for about one-third less than the 93415. That's 2.4¢/bit vs. 6.8¢ per bit in 100 up quantities. Just add up your bits and add up your savings. Finally, when you come to EA, you can get it. Because we don't tout it until we got it.



THE GREAT RAM CHALLENGE: N-CHANNEL VS. BIPOLAR.

EVERYBODY WANTS YOUR BACKPLANE CONNECTOR BUSINESS...

ELCO offers more to earn it.

THERE ARE **10** REASONS WHY:

1. Elco is the largest manufacturer of metal plate backplanes.
2. We became the largest by offering more variations than anyone.
3. Elco has another cost-saving design approach with a printed circuit press fit backplane system.
4. Elco can provide a full service by wire wrapping the backplane for you at our own facilities—no split responsibilities.

One of our representatives will be happy to explain reasons five through ten. Invite him over soon. Or call our General Sales Manager Fred Inacker at (215) 659-7000.

Elco, Willow Grove Division
Willow Grove, Pa. 19090
(215) 659-7000

Elco, Pacific Division
2200 Park Place
El Segundo, Calif. 90245
(213) 675-3311

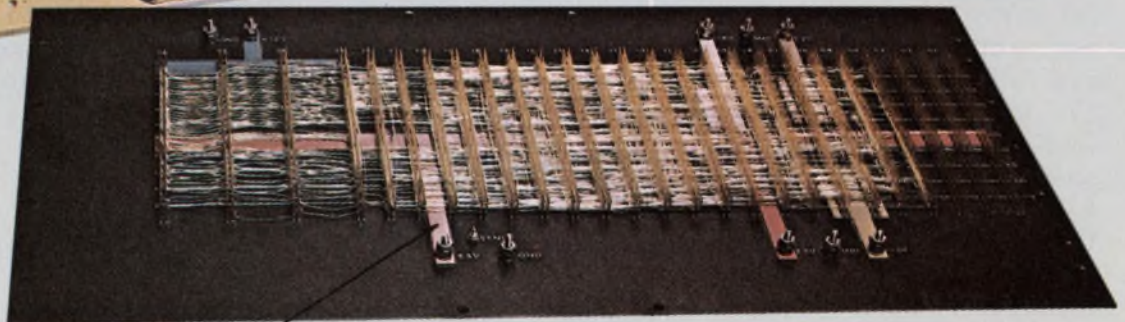
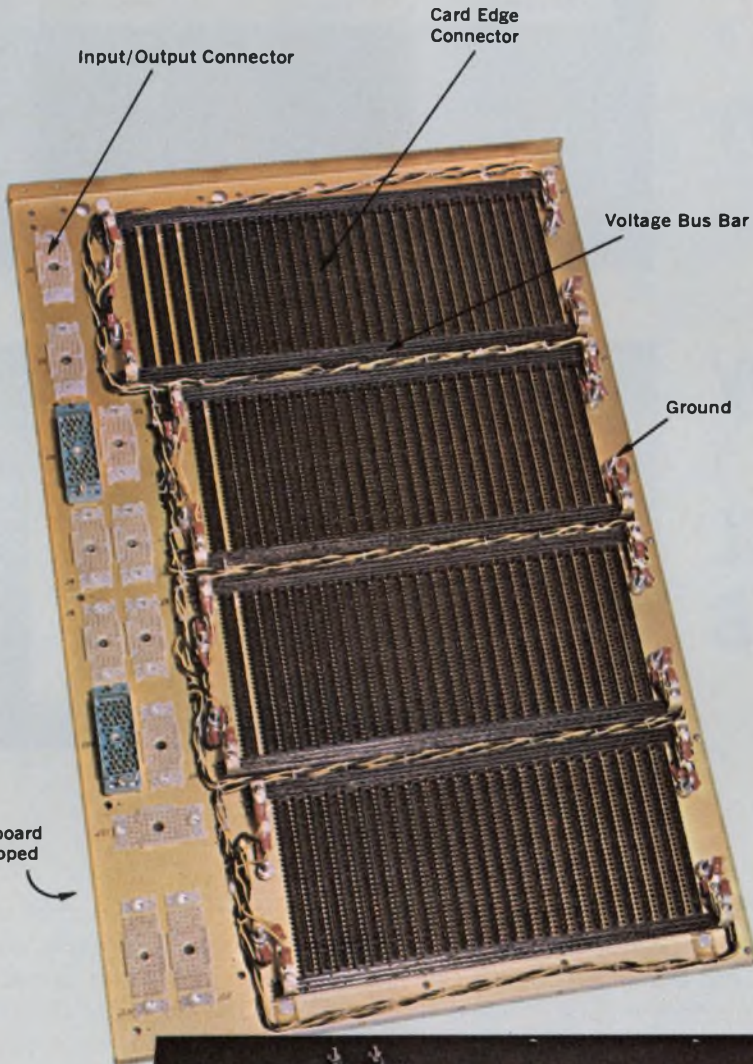

Variplate™ board with
color coded voltage bus bars

If you need
top-quality
panel
instruments
 with a clean,
 modern look...

Buy
Triplett's
 Series GL
 or GL/B

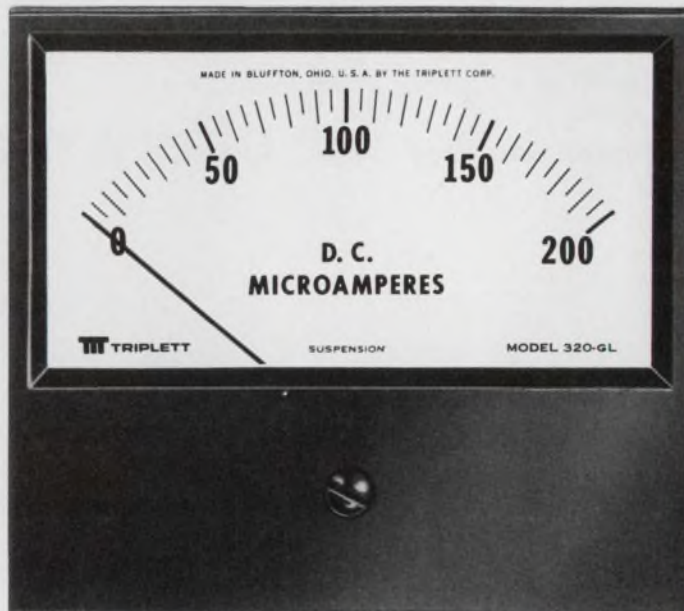

GL



GL/B (mounted appearance)

Triplett's newest panel instruments, the Series GL and GL/B, feature glass windows, matte-finish phenolic cases and a dial design that can readily accommodate multiple scales. They are available in 3½", 4½" and 5½" sizes.

The GL Series features a standard 2-stud mount with 3- and 4-stud mounts available.

The feature of the GL/B Series is behind-the-panel mounting with a bezel which is an integral part of the case.

There's a choice of more than 275 stock sizes and ranges — in DC microammeters, milliammeters, ammeters, millivoltmeters and voltmeters; AC milliammeters, ammeters, and voltmeters; RF thermoammeters; dB meters and VU meters. For those who need special instruments . . . custom dials, pointers, scales, accuracy, tracking, resistance, response time or practically any combination of unusual specs can be put into these new cases. For quick, dependable delivery

of small quantities of these adaptable new instruments, contact your Triplett Sales/Service/Modification Center or distributor. For prototypes or production quantities, contact your Triplett representative. Triplett Corporation, Bluffton, Ohio 45817.

TRIPLETT
 BLUFFTON, OHIO 45817
 Manufacturers of the World's
 most complete line of V-O-M's

wescon

at the convention center
 in Los Angeles, September 19-22, 1972

booth 1206/1207

INFORMATION RETRIEVAL NUMBER 10

ACROSS THE DESK

(continued from p. 7)

have records to prove it." At Analogic our policy is to record and ship 100% of the units in production with a linearity of 16 bits.

However, we believe that it is a disservice to any customer to make him believe that any group of digital-to-analog converters of a parallel-switching type—except as switched with the finest mechanical components and built from specially treated oil-filled resistors—has any reasonable chance of maintaining for several months either absolute or relative accuracy to 0.008%, which is one half the least significant bit at 16 bits!

Bernard M. Gordon
Chairman

Analogic Corp.
Audubon Rd.
Wakefield, Mass. 01880

A bouquet to RCA for 'plastic TO-5'

As an electronics circuit designer, I consider the TO-5, TO-18 and their plastic equivalents—TO-92, TO-105 and TO-106—devices designed for the producer, not the user. While they are not particularly difficult to handle, they are difficult to heat-sink. Now RCA has developed a simple variation of a competitor's package that seems close to the ideal. I refer to the so-called plastic TO-5, developed for low-frequency, small-signal and medium-power applications. Free standing, it is good for a watt (25 C), and screwed to a heat sink, it is good for up to 20 W. What can be more ideal?

RCA should be commended.

Howard H. Smith

Singer Instrumentation
3176 Porter Dr.
Palo Alto, Calif. 94304

Correction

In the New Product announcement for the Ferranti ZNP 100 monolithic photoswitch ("Photoswitch Believed to Be First CDI Product," ED 12, June 8, 1972, p. 96), the correct sensitivity of the device is 10 to 10,000 $\mu\text{W}/\text{cm}^2$. Because of a typographical error, the μ was omitted in the write-up.

Simplify board layout...

Cut package count...

Reduce equipment size...with



THICK-FILM RESISTOR NETWORKS

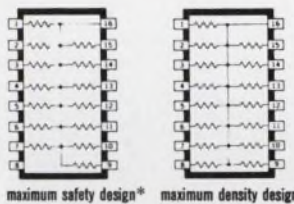

PULL-UP/PULL-DOWN
AND INTERFACE NETWORKS†

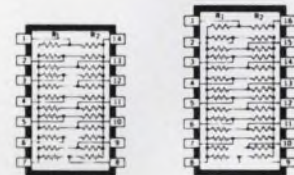

DUAL TERMINATING
NETWORKS

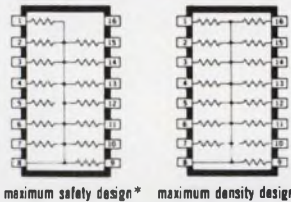

INDIVIDUAL TERMINATING
NETWORKS†

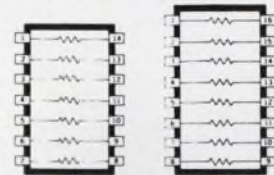

MULTIPLE ISOLATED
RESISTORS

POPULAR OHMIC VALUES IN THESE STANDARD RESISTOR NETWORKS ARE AVAILABLE FOR PROMPT DELIVERY FROM YOUR STOCKING SPRAGUE INDUSTRIAL DISTRIBUTOR

*This configuration prevents circuit damage if accidentally reversed during insertion
†Also available in 14-pin package

Sprague puts more passive component families into dual in-line packages than any other manufacturer:

- TANTALUM CAPACITORS
- CERAMIC CAPACITORS
- TANTALUM-CERAMIC NETWORKS
- RESISTOR-CAPACITOR NETWORKS
- PULSE TRANSFORMERS
- TOROIDAL INDUCTORS
- HYBRID CIRCUITS
- TAPPED DELAY LINES
- SPECIAL COMPONENT COMBINATIONS
- THIN-FILM RESISTOR NETWORKS
- THIN-FILM RESISTOR NETWORKS
- ION-IMPLANTED RESISTOR NETWORKS

For more information on Sprague DIP components, write or call Ed Geissler, Manager, Specialty Components Marketing, Sprague Electric Co., 347 Marshall St., North Adams, Mass. 01247. Tel. 413/664-4411.

THE BROAD-LINE PRODUCER OF ELECTRONIC PARTS



480-2117



The New Snap-On...

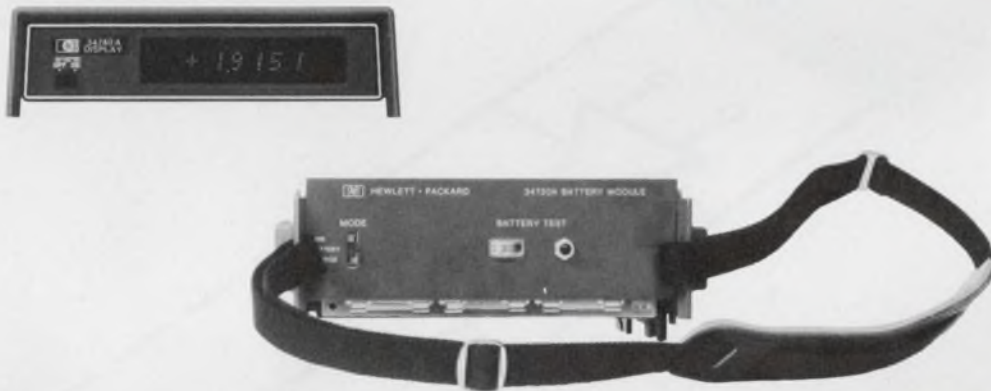

Low-Cost, 4-Digit Measurement System 3470.

- Bright LED Display section has 100% overranging.
- AC/DC/OHMS snap-on with display. (\$600 complete)
- DC snap-on with display. (\$475 complete)
- Snap-together expandibility with sandwich centers—battery pack (\$200); BCD (\$175).
- H-P's exclusive self-test accessory reduces down time (\$50).

If you need one of these low-cost DMM's, there's no time like the present. Pick up the phone and call your nearest H-P Representative, now. Or, write to Hewlett-Packard, Palo Alto, California 94304; Europe; P.O. Box 85, CH-1217 Meyrin 2, Geneva, Switzerland. In Japan: YHP, 1-59-1, Yoyogi, Shibuya-Ku, Tokyo, 151.



HEWLETT  PACKARD

DIGITAL VOLTMETERS
INFORMATION RETRIEVAL NUMBER 12

MC 1568 $\pm 15V$ Tracking Regulator Is

The Simple Supply

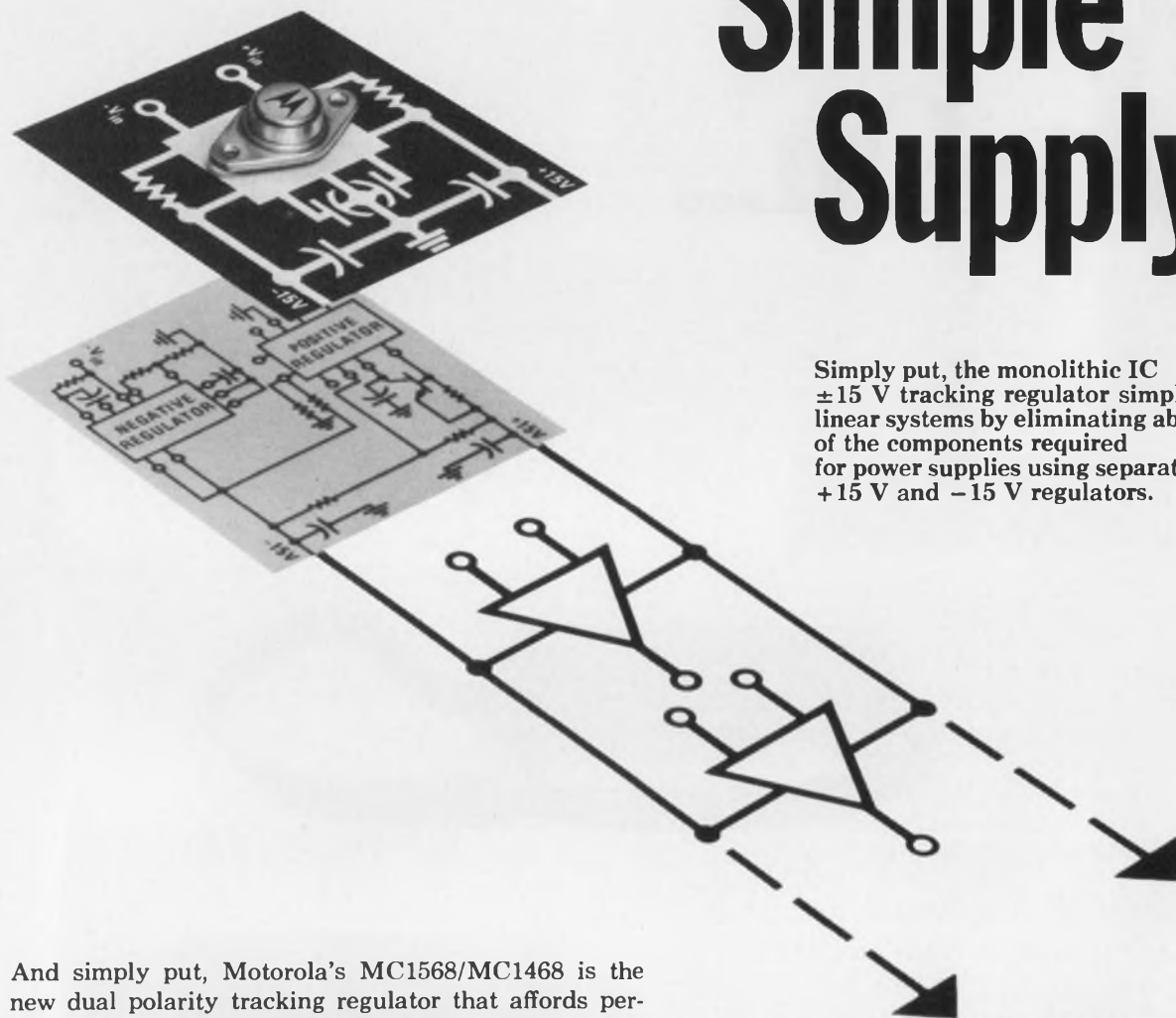

Simply put, the monolithic IC $\pm 15V$ tracking regulator simplifies most linear systems by eliminating about 2/3 of the components required for power supplies using separate $+15V$ and $-15V$ regulators.

And simply put, Motorola's MC1568/MC1468 is the new dual polarity tracking regulator that affords performance to exacting standards at prices every system can afford. Three package variations to accommodate differing power requirements bring the price/performance combinations to six. Simple to use and simple to choose. The "simple supply."

It's simple to buy, too; off-the-shelf from both the factory and the nationwide network of outstanding franchised Motorola distributors.

A rudimentary characterization of this exciting new regulator includes excellent tracking with output voltages balanced to $\pm 1\%$ output voltage variation due to temperature change held to 1% maximum, and line and load regulation of 0.06%. The balanced outputs are preset to $\pm 15V$ with initial tolerance of 0.2 V (max), but output voltages can be changed with a single, simple, external adjustment if desired.

Availability in the "R" (case 614) metal power package provides a unit with 9.0 W power dissipation at $T_c = 25^\circ C$. This permits full use of the 100 mA load current capability, as when running at the higher voltages (up to $\pm 30V$) the "simple supply" can handle.

Price? Simply put, low. In 100-999 quantities the top of the line MC1568R goes for just \$7.00, and the most economical MC1468G is a mere \$2.80.

There's more to be discovered about the "simple supply." Use the reader service number or by writing to Motorola Semiconductor Products Inc., P. O. Box 20912, Phoenix, AZ 85036. It's simple.



MOTOROLA LINEAR

— Serving a greater range of analog designs

Stable:

Our new phase-locked loops offer you greater V.C.O. stability, frequency range and functional capability.

HA-2800 for guaranteed frequencies up to 25 MHz.
 For use in frequency synthesizers.
 As an I.F. amplifier detector for F.M.
 Or phase modulation receivers.
 Operation guaranteed up to 25 MHz. V.C.O. output: compatible with both TTL and ECL and provides improved temperature coefficient and supply regulation. Supply voltage range: 12V to 30 V.

Supplied: 16-pin 100-999 units
 hermetic DIP
 HA-2800 - 55°C to + 125°C \$22.65
 HA-2805 0°C to + 75°C \$ 9.85

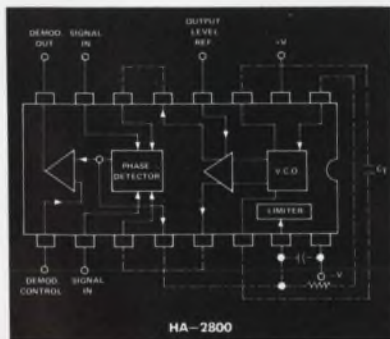

NO OTHER PHASE-LOCKED LOOPS COMBINE THESE FEATURES.

In addition to greater stability, frequency range and application versatility both devices feature:

Independent phase detector and voltage controlled oscillator in the same package.

Broken loop between the phase detector and the V.C.O., permitting inclusion within the loop of amplifiers, active filters, sweep circuits and other acquisition aids.

Isolated phase detector output, which allows adjustment of demodulated output gain and filtering without affecting the loop's characteristics.

For details see your Harris distributor, representative, or write direct.

HA-2825 for frequencies from 0.1 Hz to 3 MHz.

For use as amplifier/detectors, audio tone generators/detectors, and precision motor speed controls. V.C.O. output drives DTL/TTL and provides greatly improved stability. Supply voltage: $\pm 6V$ to $\pm 12V$.

Supplied: 14-pin 100-999 units
 hermetic DIP

HA-2825 0°C to + 75°C \$6.35

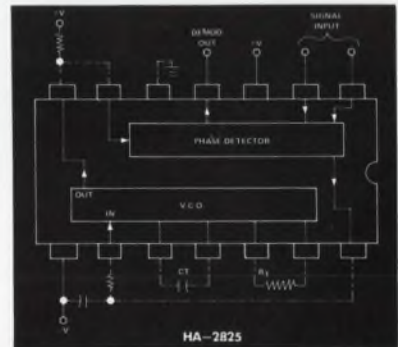

Harris



HARRIS SEMICONDUCTOR
 A DIVISION OF HARRIS-INTERTYPE CORPORATION

P.O. Box 883, Melbourne, Florida 32901
 (305) 727-5430

WHERE TO BUY THEM: ARIZONA: Phoenix—Liberty, Weatherford; Scottsdale—HAR (602) 946-3556 CALIFORNIA: Anaheim—Weatherford; El Segundo—Liberty; Glendale—Weatherford; Long Beach—HAR (213) 426-7687; Mountain View—Elmar; Palo Alto—Weatherford; HAR (415) 321-2280; Pomona—Weatherford; San Diego—Weatherford; Western COLORADO: Denver—Elmar; Weatherford WASHINGTON, D.C.: HAR (202) 837-4914 FLORIDA: Hollywood—Schweber; Melbourne—HAR (305) 727-5430 ILLINOIS: Chicago—Semi-Specs; Schweber; Palos Heights—HAR (312) 597-7510 INDIANA: Indianapolis—Semi-Specs MARYLAND: Rockville—Schweber MASSACHUSETTS: Lexington—R&D; Waltham—Schweber; Wellesley—HAR (617) 237-5430 MICHIGAN: Detroit—Semi-Specs MINNESOTA: Minneapolis—Semi-Specs MISSOURI: Kansas City—Semi-Specs; St. Louis—Semi-Specs NEW MEXICO: Albuquerque—Weatherford NEW YORK: Melville—HAR (516) 249-4500; Syracuse—HAR (315) 463-3373; Rochester—Schweber; Westbury—Schweber OHIO: Beachwood—Schweber; Dayton—Semi-Specs PENNSYLVANIA: Pittsburgh—Semi-Specs; Wayne—HAR (215) 687-6680 TEXAS: Dallas—Weatherford; Semi-Specs; HAR (214) 231-9031 WASHINGTON: Seattle—Liberty, Weatherford.

LEGEND FOR HARRIS SALES OFFICES & DISTRIBUTORS: Harris Semiconductor (HAR); Elmar Electronics (Elmar); Harvey/R&D Electronics (R&D); Liberty Electronics (Liberty); Schweber Electronics (Schweber); Semiconductor Specialists, Inc. (Semi-Specs); R. V. Weatherford Co. (Weatherford); Western Radio (Western).

INFORMATION RETRIEVAL NUMBER 159

OUR ANGLE: angle position indicators that do more and cost less

SHOULDN'T YOU TAKE A NEW READING ON THIS COST-PERFORMANCE ANGLE?

For better ways to measure synchro and resolver data, North Atlantic offers the best of both worlds: budget prices for the popular API-8025; superior performance and increased capability of the new 8525. • Both are interchangeable without any mechanical or wiring modifications. North Atlantic's solid-state 8525 offers an accuracy of 0.05° (3 minutes). Following a 180° step input, it synchronizes a five-digit NIXIE readout in 1/2 second flat. And it tracks at up to 1000° per second. Where cost can be traded against performance, the proven electromechanical API-8025 . . . a recognized indus-

MODEL 8525



MODEL 8025

try workhorse . . . is available with its 6 minute accuracy, 25°/second slew speed, and many options. • Input of the 8525 is any 60 or 400Hz resolver/synchro data from control instrumentation. The patented servo design eliminates all inertia and improves dynamic performance many times over. Its digital outputs are especially suited to the computer-oriented requirements of today's automatic test systems. The 8525 . . . priced at \$1885 . . . and the API-8025 priced at \$995 actually cost less because they perform more functions per dollar. And with greater reliability.

For complete information on the cost-performance angle, please write or phone now.

SEE US AT WESCON-BOOTHS 1500-01

NORTH ATLANTIC
industries, inc.

200 TERMINAL DRIVE, PLAINVIEW, NEW YORK 11803
cable: noatlantic / twx: 510-221-1879 / phone: (516) 681-8600

INFORMATION RETRIEVAL NUMBER 160

Press here to save on lighted pushbutton switches.



**buys all
the switch
you need.**

Oak's Series 300 gives you good looks and a small price-tag in lighted pushbutton switches. Plenty of switching performance for most jobs, without paying a premium. Even the Series 300 Split-Legend/4 Lamp Switch is less than \$1.60 (normal latch, 2P2T, glass alkyd insulation, no engraving, less lamps.)



Built to take it.

Series 300 is built for reliable performance and long life. Applications galore—bank terminals, calculators, and copy equipment.

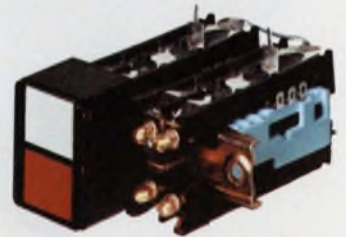

Modular design.

Single-legend/single-lamp, split-legend/4-lamp, and single-legend/redundant lamp switches have snap-on lamp holders. Plus replaceable legend plates, lens caps, and button assemblies. Front-panel relamping, too, without special tools on all types.

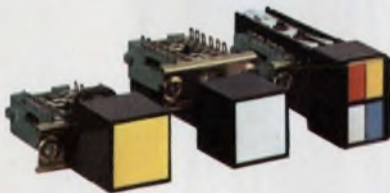

Three versions with switching up to 4P2T.

Choose from single, dual, or four lamp display as well as non-lighted type. One to twelve station, momentary, interlock, alternate action, or any combination available on the same switch bank. Lockout feature available for all types. Power Module 3A125VAC. Lighted indicators are identical in size and appearance, but without switching.

Gang them up by the dozen.

Order up to 12 switching stations on a single channel, any switching mix, with convenient panel-mounting studs. Color selection: white, lunar white, yellow, amber, orange, red, green, blue. Choose silk-screened, hot-stamped, or engraved-and-filled legends. Split-legend switches can be specified with any two, three, or four colors on insertable legend plates.



Write for our Series 300 Brochure

OAK Industries Inc.

SWITCH DIVISION/CRYSTAL LAKE, ILLINOIS 60014
TELEPHONE: 815 • 459 • 5000 ■ TWX: 910 • 634-3353 ■ TELEX: 72 • 2447

INFORMATION RETRIEVAL NUMBER 14

**The world didn't
need another
darned-good-and-expensive
rack and panel connector.**

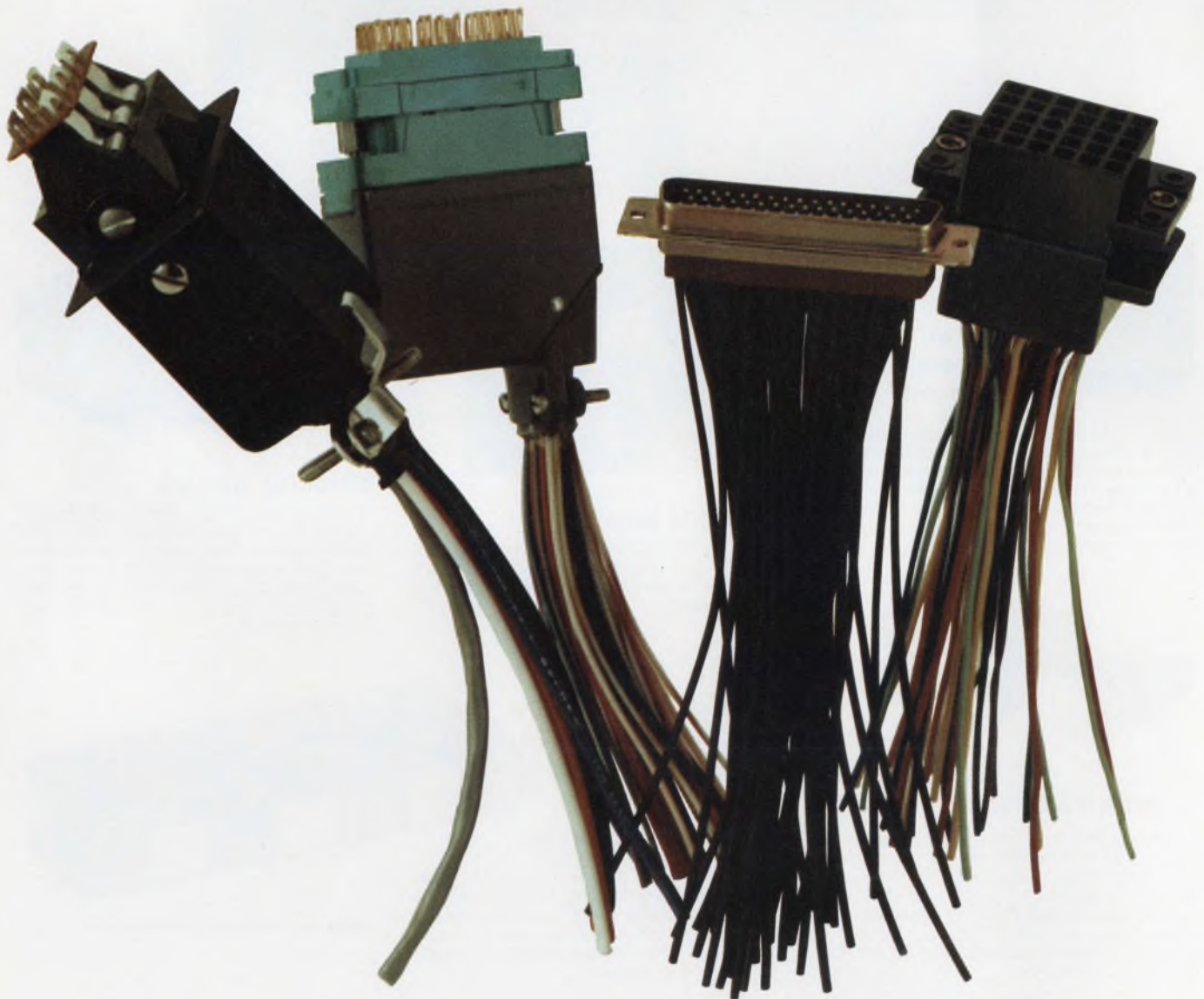

So we came up with a darned good one that costs you about 25% less.

If you still live in a "let's-go-first-class-and-hang-the-expense" kind of world, you may not need us. But if you live in today's world, read on, rejoice and return the coupon below. For several good reasons:

WE'VE GOT A DARNED GOOD NEW CONNECTOR

It's UL recognized. The glass-filled nylon insulator block is moisture resistant. Contacts are recessed, both in the male and female contact housings. It provides positive cable strain relief.

Our Tuning-Fork type contact has two important things going for it: low electrical resistance and little change in contact pressure over the specified contact life.



WE'VE GOT PROOF

Excellent contact alignment was maintained through 500 insertion-withdrawal cycles and no "scooping" action took place. The forces show a gradual increase over 500 cycles caused by plating abrasion.

Take a look at these results computed from more than 100 hours on our Instron testing machine:

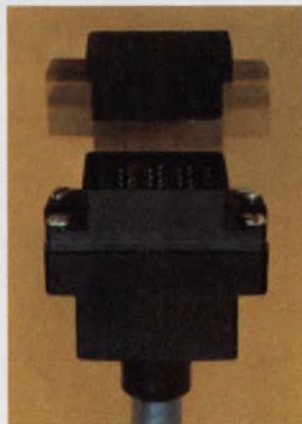

CONTACT INSERTION AND WITHDRAWAL
(Cadmium Plating)
First Cycle 100 Cycles 500 Cycles

Contact No.	Insertion (oz.)	Withdrawal (oz.)	Insertion (oz.)	Withdrawal (oz.)	Insertion (oz.)	Withdrawal (oz.)
1	6.9	5.3	8.1	6.4	9.2	6.5
2	7.2	4.5	7.8	6.0	8.9	6.6
3	7.1	5.1	8.0	5.4	9.2	6.0
4	6.5	4.7	7.8	5.4	8.6	5.3
5	7.4	5.4	7.9	5.9	8.9	6.5
Averages	7.0	5.0	7.9	5.8	9.0	6.2

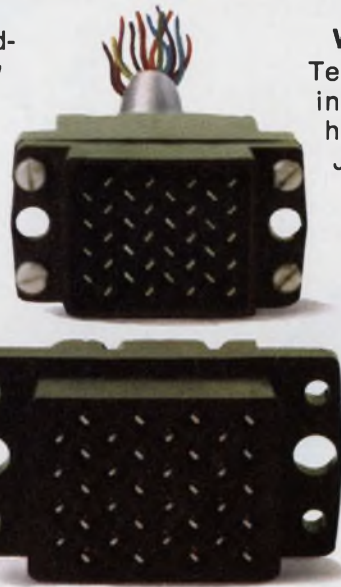

WE'VE GOT WHAT IT TAKES

Technical experience. True, we're new in multi-pin connectors. But we're old hat at making other types. We make JCM miniature coaxial connectors, for example — which are a lot more demanding and sophisticated from both an engineering and production point of view.

WE'RE AS GOOD BUT LESS EXPENSIVE

Of course, we want you to check it all out for yourself. So ask us about a free sample along with all its specifications.

Specs such as:

- Voltage Rating (adjacent contacts) 250 VRMS
- Flashover Voltage 1000 VDC
- Current Rating (con't max/ckt) 3 amp
- Contact Resistance (typical) 0.003 ohms
- Insulation Resistance 5000 megohms
- Insertion Force* 6 oz. min./12 oz. max.
- Withdrawal Force* 5 oz. min./10 oz. max.
- Cycle Life 500 min.

*Per contact



E. F. JOHNSON COMPANY
WASECA, MINNESOTA 56093

- Please send literature, price and test data.
- Yes, I'm interested in evaluating a test sample.
Call me at: _____

Name _____ Phone _____

Title _____

Firm _____

Address _____

City _____ State _____ Zip _____

The timer of 1001 uses.

(Priced so low it's measured in cents.)

At last. A true standard IC timer with almost universal applications. The new-low-cost 555. From Signetics-Linear, of course.

And the most extraordinary advantage of 555: it's so ordinary, and so simple to use. With designed-in flexibility that's never been matched, spec for spec.

555 functions interchangeably as a time delay, oscillator, pulse detector or power modulator. Timing from microseconds through one hour. With time delays completely resettable.

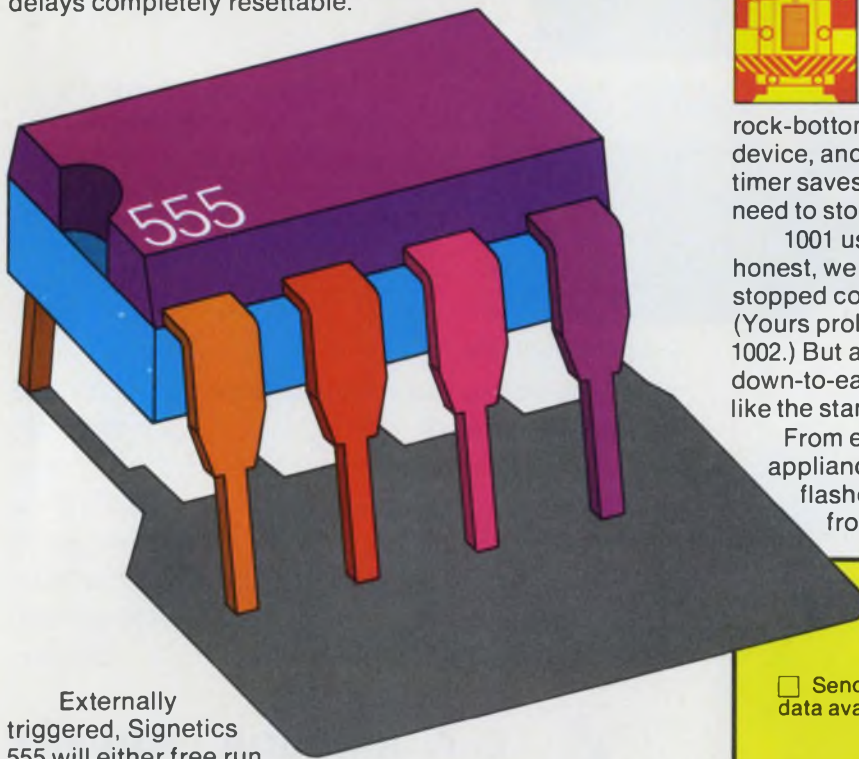

Externally triggered, Signetics 555 will either free run or latch, in adjustable duty cycles from 50% to 0.01%. Timing can be changed 10:1 with control. Operating from 5 to 15 volts with only a 1% change in timing. Output can source or sink 200mA. Temperature stability: 0.005% per °C.

And applying the adaptable 555 is practically child's play (if the kid knows basic math). Requires only a resistor and capacitor to do the job. With all kinds of options for starting the timing action. And you can operate 555 from just a single power supply.

All this, in one simple 8-pin dual in-line circuit. Available off-the-shelf now, from your distributor at



rock-bottom cost. The 100-up price is only 75¢ per device, and the multi-function capability of our 555 timer saves you still more on the parts you no longer need to stock.

1001 uses? To be honest, we haven't stopped counting yet. (Yours probably makes 1002.) But a versatile down-to-earth IC timer like the standard 555 suggests applications unlimited.

From exotic technology to household appliances... from copying machines to barricade flashers... Start thinking. And you can take it from there.

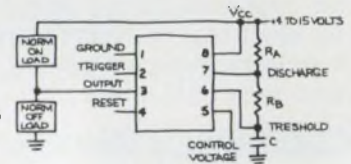

Signetics-Linear
811 E. Arques Avenue
Sunnyvale, California 94086

Send all the literature, specs and applications data available for the great 555 breakthrough.

Name

Title

Company

Address

City

State

Zip

Telephone

Signetics Corporation. A Subsidiary of Corning Glass Works.

signetics

Regulated power supplies 'stabilized' in new standard

If the terms in a new power-supply standard gain widespread acceptance, you'll no longer buy *regulated* power-supplies. They'll be *stabilized*.

The supplies will no longer have load regulation and line regulation, but rather load effects and source effects. And they won't have hum and ripple anymore. They'll have PARD, an acronym that derives from Periodic And Random Deviations, and one that was chosen over such variations as Continuous and Random Unwanted Deviations and Continuous and Random Amplitude Perturbations.

The new standard, from the National Electrical Manufacturers Association, has been more than 10 years in the making, and it is the most comprehensive and authoritative ever published on dc power supplies. The standard departs in several cases from terminology that may be more familiar to American engineers. That's because it was written to agree as much as possible with a forthcoming standard being prepared by the International Electrotechnical Commission. The problems in arriving at the standard were compounded by the fact that some terms with a clear meaning in one country had no meaning in another, or they had one meaning in one country and a different meaning in another.

For example, an IEEE committee had proposed "electronic power conditioner" and, in 1968, the American delegation at the Paris meeting of IEC's subcommittee SC22E has argued for the term. But "power supply" was too strongly entrenched internationally. "Regulated," however, lost out to "stabilized" because "regulate" suggests an ability to vary the output rather than to keep it constant. Similarly "source" was adapted to replace the American "line" and

the British "mains."

NEMA's power-supply section, the group responsible for the standard, comprises only seven member companies—Deltron, North Wales, Pa.; General Electric, Philadelphia; Hewlett-Packard's Harrison Div., Rockaway, N.J.; Kepco, Flushing, N.Y.; Schauer, Cincinnati, Ohio; Sola, Elk Grove Village, Ill., and Technipower, Ridgefield, Conn. But there were many others, including the editor of *ELECTRONIC DESIGN*, who participated in meetings and/or contributed ideas for the standard over the last dozen years.

Despite the impressive efforts that went into the standard, some authorities believe there are still specifications that could have been pinned down more firmly. Ambient temperature, for example, is defined as the medium in which the supply is immersed—usually the temperature of the air surrounding the supply. But the standard doesn't make clear whether the temperature is to be measured before or after the supply is turned on.

That difference can be profound. Power-supply vendors often tell the story of the engineer who shouts to the power-supply salesman: "Your spec said that this supply could deliver 10 A, and it puts out barely five." The salesman responds with: "But that's supposed to be at 23 C." And the engineer replies: "That's what the temperature was before we turned on that damned supply." The story may be apocryphal, but it sheds light on thermal problems that may be overlooked.

For a copy of the new standard, "Stabilized Power Supplies, Direct-Current Output," Pub. No. PY1-1972, is available for \$9 from Virginia Morgan, Publications Editor, NEMA, 155 East 44th St., New York, N.Y. 10017.

Epoxy IC package gives surer bonds

A new epoxy encapsulant called Doughmold is said to overcome a persistent problem in the plastic packaging of power ICs—the tendency for bonds to open.

Doughmold has been developed by Fairchild Semiconductor of Mountain View, Calif., and John Chu, microcircuit, design engineer at the plant, describes the packaging problem and solution this way:

"The prime failure mode in plastic packages is that of bonds opening up. Doughmold is matched in thermal expansion coefficient to the leadframe it encloses. Therefore, as the package heats up, the package does not stress the leadframe and cause bonds to open."

Chu notes that under current drive, the junction temperature of the Doughmold IC has been cycled from +25 to +125 C over 12,000 times without failure. The best previously reported total, he says, is about 6000 cycles.

Ambient-temperature cycling of power ICs tested with the new epoxy packages show over 200 cycles of -25 to +125 C variation without failure, Chu adds.

Norman Doyle, manager of systems and applications engineering at Fairchild reports: "Doughmold is already committed to a 5-W audio amplifier. Soon it will be also used on the $\mu A7800$ voltage regulator."

Doyle sees the package ultimately being used on all power ICs produced by Fairchild. The limiting factor at present is the availability of Doughmold.

New A-plant may use advanced electronics

The Atomic Energy Commission's first liquid-metal-cooled, fast-breeder reactor, planned for construction near Oak Ridge, Tenn., will incorporate much of the same electronic equipment used in today's water-cooled reactors. However, AEC officials say that there will be room for applying advances in technology—such as large-scale integrated circuitry—as the time nears for operation five to seven years from now.

The second-generation breeder

reactor is characterized by its ability to create, or "breed," more nuclear fuel than it consumes, permitting the nation's limited supply of uranium to be stretched a hundredfold. In addition it is considerably more efficient in operation than the water-cooled reactor and emits far less radioactive waste products.

The use of sodium as a coolant in the new breeder reactor will mean a shift in control-instrument design to make use of such sensors as a permanent magnetic flowmeter and an inductive liquid-level probe, rather than the side gauge and rotometer for flow now used in water-cooled systems.

The AEC says it hopes the Oak Ridge demonstration plant—which still must be approved by Congress—will signal a new era of power generation by nuclear energy in the more efficient reactor.

Red China expanding her satcom facilities

A \$5.7 million contract for the installation of a satellite communications earth station in Peking and the expansion of another such station at Shanghai has been signed by the China National Machinery Import and Export Corp. and RCA Global Communications, Inc.

The agreement follows a \$2.9 million award to RCA by Red China last January. That contract was for the installation of the Shanghai earth-station microwave terminals and 20 units of RCA's Videovoice system.

Under the new contract the Shanghai station is to be equipped with an antenna that is 98 feet in diameter in place of the existing 33-foot one. The new station at Peking will also get a 98-foot antenna and will have permanent buildings to house the other communications equipment.

Electronic envelope to guard SAC aircraft

Sentries guarding the big bombers of the Strategic Air Command will soon be augmented by a 40-pound electronic black box called the Parked Aircraft Security System (PASS). It generates an elec-

tronic field around an aircraft that, if interrupted by an intruder, sounds an alarm.

The cubic-foot alarm system can operate near an aircraft or on board from commercial power or its own battery. It is designed so that the effects of rain, snow, wind, lightning, vehicular traffic beyond the sensitive electronic envelope will not trigger an alarm.

The PASS systems are being produced by the Government and Aeronautical Products Div. of Honeywell, Inc., Minneapolis. The first of 100 of the systems were delivered to SAC last month.

New aircraft material resists radar detection

The attempt to make aircraft invisible to enemy radar by coating particularly reflective portions with radar-absorbing material has reached a new milestone, according to A. M. Lovelace, director of the Air Force Materials Laboratory at Wright-Patterson Air Force Base, Ohio.

Instead of coating the metallic parts of the aircraft, as is done now, aircraft makers can replace the metal with a new fiberglass honeycomb material that has radar-absorbing properties, Lovelace reports. The result is a much lighter plane. And the aircraft is also able to withstand greater heat without damage to the material's radar absorptivity.

Panels made with the new mate-

rial have been tested at Wright-Patterson for more than 1000 hours at temperatures as high as 600 F—a test that existing material would not be able to survive.

With greater resistance to heat, the aircraft can fly faster and use its speed as well, to avert ground-radar detection.

ERTS photos and data available to public

After seeing the first pictures taken from the new Earth Resources Technology Satellite, people with a vested interest across the U.S. and in other countries are beginning to flood the National Aeronautics and Space Administration with requests for copies. The photos and accompanying ground data are useful in agricultural planning and research related to geology, hydrology, oceanography and geography.

ERTS principal investigators receive the photos and data directly from the space agency, but anyone else can obtain them by writing to a number of Government agencies. One is the EROS (Earth Resources Observation Systems) Data Center, 10th & Dakota Aves., Sioux Falls, S.D. 57198. Another is the National Climatic Center, NOAA-Environmental Data Service, Federal Building, Asheville, N.C. 28801. Prices range from \$1.25 for a 70-mm black-and-white contact print to \$27 for a 40-by-40-inch color transparency.

News Briefs

"Paste" your panel meter to the front panel: California Instruments of San Diego, Calif., will soon introduce a 3-1/2 digit panel meter that is only 1/2-inch thick and will sell for about \$115. It uses LED displays and requires no more of a panel cutout than is required to get a cable through. The meter is about the size of a Philips audio cassette.

Signetics expects to save its customers an average of 5.5 cents for each IC purchased with a new program called SUPR DIP. It is a high-reliability-testing and inspection program that includes thermal shock and high-temperature functional tests prior to

shipping. It will eliminate incoming inspection testing that costs the customer an average of 8 cents an IC. Signetics will offer the program as an option on all TTL products, starting Sept. 15. The average charge will be 2.5 cents for each IC.

Congressional approval for dumping the English system of measurement and adopting the metric will, it appears, be delayed until next year. While the Senate has passed a bill to give the Secretary of Commerce 18 months to develop a plan for the conversion, the House has no plans for taking up the matter at this year's Congressional session.

100% ac testing of consumer ICs

Is it really necessary? Is it practical? Is it available?

Sample testing of TV and radio parts is no way to ensure a good night's sleep. Ideally, both makers and users of consumer ICs should test every device for ac characteristics.

But 100% ac testing sounds expensive, so what do people do? They compromise.

They tighten up on AQL specs.

They make dc correlations instead of true ac tests.

If the return rate climbs, or if bad parts show up in the finished product, they shout a little louder at the vendor or the inspector or the QC manager.

There's a better way.

Our J263 will automatically test for every ac spec from stereo channel separation to chroma demodulation angle to video i-f gain. And it will do it so fast that 100% testing is economically practical.

On an IC production line, the J263 will even wafer probe, and it will multiplex to as many as seven stations.

In incoming inspection, the J263 will datalog chapter

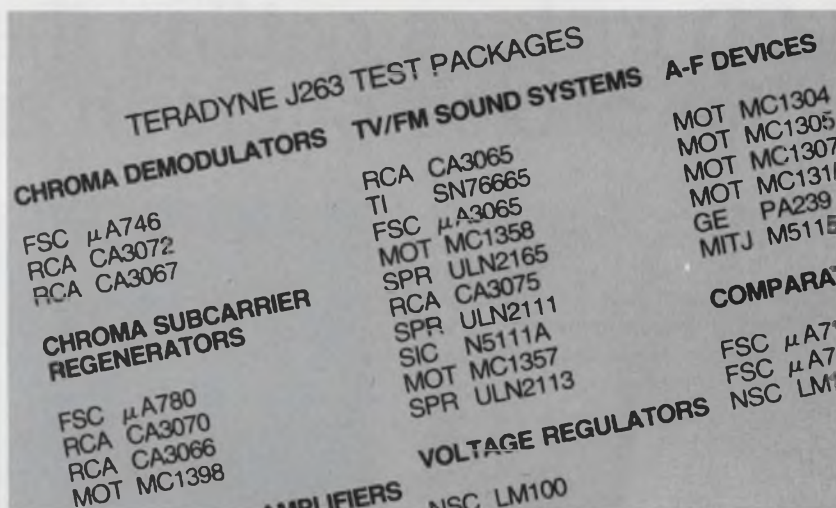

and verse on all your suppliers, so you'll know who's shipping you what.

Backing up the J263 is a long list of test packages. They include the applications hardware and software for just about any consumer IC on the market. All the tests have already been worked out with the key producers and users, so you start off with a thoroughly proven, debugged installation.

If the alternatives to 100% ac testing are getting you down, tell us to rush you a J263 brochure. It illustrates again that in testing, the best solution is always an honest one.

Write: Teradyne, 183 Essex St., Boston, Mass. 02111. In Europe: Teradyne Europe S.A., 11 bis, rue Roquépine, 75 Paris 8^e, France. Tel. 265 72 62.

TERADYNE

LED makers getting the red out, offer choice of green and yellow

Within six months to a year, green and yellow LED indicator lamps will be joining red in mass-produced quantities.

Recent announcements by producers like Monsanto, Ferranti Electric of Britain, Microsystems International of Ottawa, Canada, and Matsushita of Osaka, Japan, indicate the availability of the new colors in limited quantities.

The new colorful LEDs will open markets for two types of users, both of who are unhappy with red LEDs. One market consists of designers who refuse to substitute red when the application calls for another color. The second consists of users who—except for being forced to choose red for cost reasons—would prefer other colors that are more pleasing optically and also more functional—green LEDs for a “go” function, say and yellow for “caution.”

The announcements point to industry competition among three material technologies—gallium arsenide phosphide (GaAsP), gallium phosphide (GaP) and rare earth phosphors that glow under the stimulation of infrared radiation—to produce LEDs in colors other than red. Besides green and yellow, LEDs in blue are envisioned.

At present gallium phosphide (GaP) promises to produce the brightest, most efficient and most optically acceptable LED lamps and displays in a variety of colors. But GaP is more difficult and costly to make than competing material, such as GaAsP. And the industry is going through a learning period.

“The industry situation is like that 10 or 12 years ago,” says Rick Kniss, product marketing manag-



An animated display of the Olympic sports torch consists of electronically controlled arrays of red LEDs and green LEDs of the infrared phosphor-activated type. Matsushita Electric of Japan built the system.

er, HP Associates, Palo Alto, Calif. “At that time there were many problems in converting from the germanium transistor to the silicon technology. But liquid or vapor epitaxial grown-junction processes needed for GaP are a lot more tricky than silicon technology.”

The shortcomings of red LEDs alone as indicators and digital displays have been long recognized. Arpad A. Bergh, head of the Compound Semiconductor Materials Dept. at Bell Telephone Laboratories, Murray Hill, N.J., notes:

“Red is invariably associated with some kind of warning signal. Also, where visual comfort is a requirement, most people prefer green.”

“About eight percent of the population sees gray instead of red,” says Victore Pastore, North American marketing manager for Ferranti Electric’s operation in Plainview, N.Y.

“For males over 45,” he continues, “the eye begins to lose the ability to focus on red, and this effect increases with age. Also, the eyes tend to tire more rapidly when viewing red.”

Jim McDermott
Eastern Editor

Gallium arsenide phosphide (GaAsP) red LEDs are the most widespread devices available. They are also the lowest in cost, primarily because their processing technology is borrowed directly from the silicon industry. As a result, GaAsP materials are plentiful in wafer form.

With a change in the doping, a yellow light can be produced. Monsanto uses this approach for its

can be readily purchased in wafer form and implanted, the GaP manufacturer must prepare his own material essentially from scratch."

The basic process in making GaP devices is the vapor-phase or liquid-phase epitaxy. Monsanto, which uses vapor-phase processing for its red GaAsP devices is using vapor-phase epitaxy for its green GaP devices.

been prominent in developing the process.

There is wide agreement among scientists and manufacturers that today GaP has the greatest potential in the development of multi-color light-emitting devices.

For example, Dr. William Corderre, a member of the scientific staff at Bell-Northern Research Laboratory in Ottawa, Canada, the Canadian equivalent of Bell Tele-

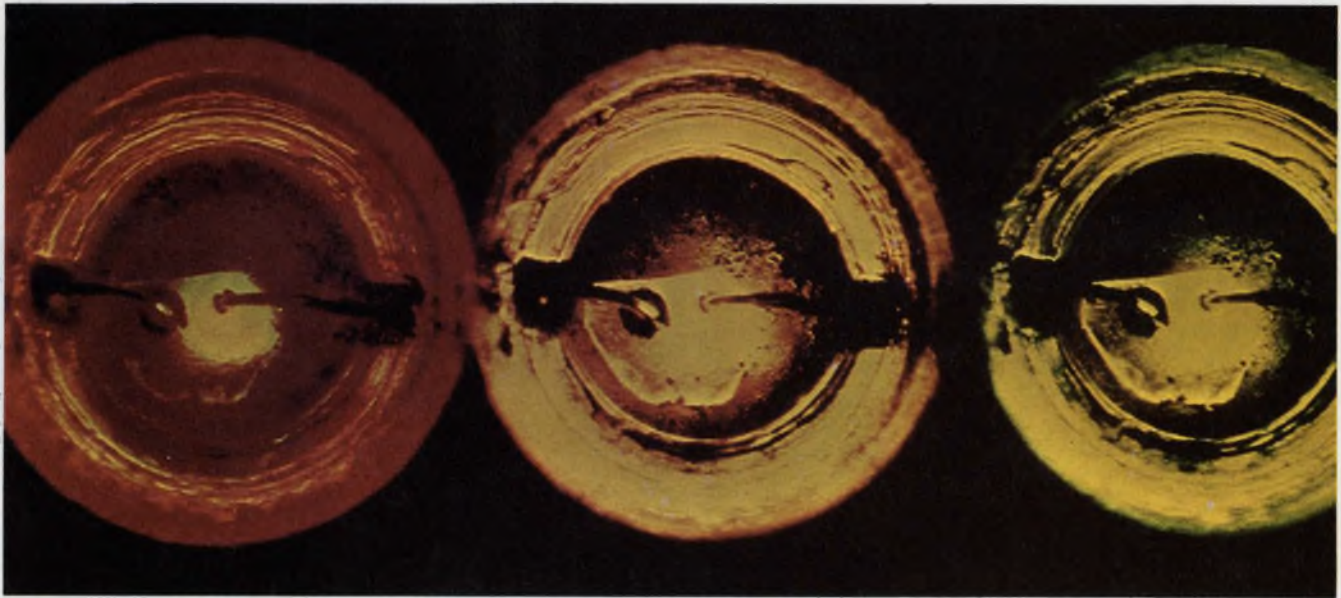

Gallium phosphide can change colors from red to green simply by adjusting the current flow through it. Here, an experimental Bell Laboratories diode is shown carrying an average current of 10 mA, but with a varying

duty cycle. Green light appears with a 2.6% duty cycle, yellow with 6%, and red is present with constant applied current. Texas Instruments has demonstrated the same effect with its GaP LEDs (see cover).

yellow LEDs, which produce light at 589 nm in the MAN 8 displays (photo p. 28) and discrete MV5322 lamp.

Gallium phosphide has been used for some time now by such companies as Opcoa and General Electric to make red LEDs. The material appears to be the only type useful for producing green LEDs on a competitive basis.

The costs of GaP devices, particularly the more-difficult-to-make green, are higher than those of GaAsP devices because of the more complicated grown-junction processing involved. Also, as Monsanto points out, it is much harder to make good ohmic contacts to the LED chip.

Jon Hall 2d, market development manager of solid-state lamps for General Electric at Nela Park, Cleveland, points out another cost-raising factor:

"In contrast to GaAsP, which

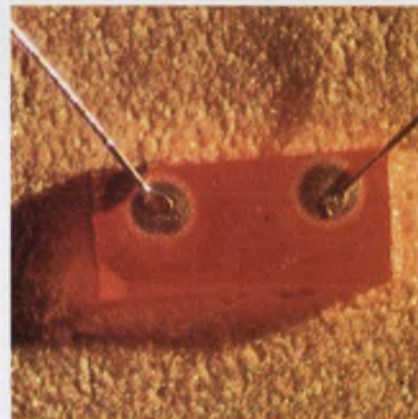

This experimental, high-brightness LED was prepared by RCA Laboratories with epitaxial vapor-phase deposition of InGaP onto a GaP substrate.

RCA disagrees with this approach, "Liquid-phase epitaxy produces the most efficient GaP diodes," says Ivan Ladany, a member of the technical staff of RCA Laboratories at Princeton, N.J. He notes that Bell Laboratories has

phone Laboratories, was given the task in 1969 of developing a long-term program for producing LEDs in various colors.

"We choose gallium phosphide," he says, "because the work at Bell Telephone Laboratories showed it to be the most efficient light emitter in the literature. In addition it had the potential of being able to radiate more than one color, by adjusting the doping.

"Since that time we have developed a high-efficiency process in which we can grow 20 one-inch slices at one time. With this, we have produced green GaP LEDs with an efficiency of 0.1% and red with an efficiency of about 4%."

This technology has been turned over to Microsystems International, a wholly owned subsidiary of Northern Electric, the Canadian equivalent of Western Electric. Microsystems is now selling red and green GaP discrete LEDs,

with operating current levels ranging between 5 and 10 mA.

Monsanto is producing green GaP LED, the MV5222, which operates at 50 mA (GaP is inefficient in the green), with a brightness of 300 ft-L. The device radiates at 565 nm. Encapsulated in green epoxy for greater contrast, this LED sells for \$1.95 each in quantities of 1000, compared with 71 cents for its red equivalent.

Monsanto's green MAN 5 display (photo p. 28) has an array made from seven discrete GaP segments. The price is \$11.25 each in quantities of 100, compared with \$8.70 for its MAN 1 equivalent. The MAN 5 requires 30 mA instead of the 20 mA for the MAN 1 unit.

The red GaP LED, unlike its GaAsP counterpart, reaches a saturation point beyond which an increase in current produces no additional light. As a result, it cannot be strobed effectively.

On the other hand, the green GaP LED does not show saturation; consequently it can be strobed. Its maximum output is limited only by diode temperature rise.

Getting colors from both sides

The red light in a GaP diode radiates from the n-side of the diode junction, while in a green diode it radiates from the p-side.

"It is possible experimentally," says RCA's Ladany, "to dope both sides of the junction so as to produce both colors simultaneously.

"At low currents," he explains, "the red radiation dominates and the emission appears reddish. As the current is increased, the red emission becomes limited by current saturation, and with higher currents, the color shifts towards the green."

When both sides of the junction emit simultaneously, the eye sees only the color combination produced by mixture of the red and green—namely, an orange or yellow.

The potential that this device has for becoming a multicolor LED is considerable.

A gallium-arsenide diode with a phosphor coating that emits green light when excited by the infrared radiation from the diode was re-

cently announced by the Matsushita Electric Industrial Co. in Kodoma, Osaka, Japan, as being available in sample quantities in that country.

This type of device is called an "up-converter" in that the IR radiation at 950 nm is converted to a higher optical frequency and shorter wavelength of 540 nm, which is bright green.

A brightness of 100 to 200 ft-L at 100 mW input is claimed. With a nominal forward input voltage of 1.3 V, the diode requires about 100 mA.

This type of device has been available in this country for some time from GE. However, its potential seems limited.

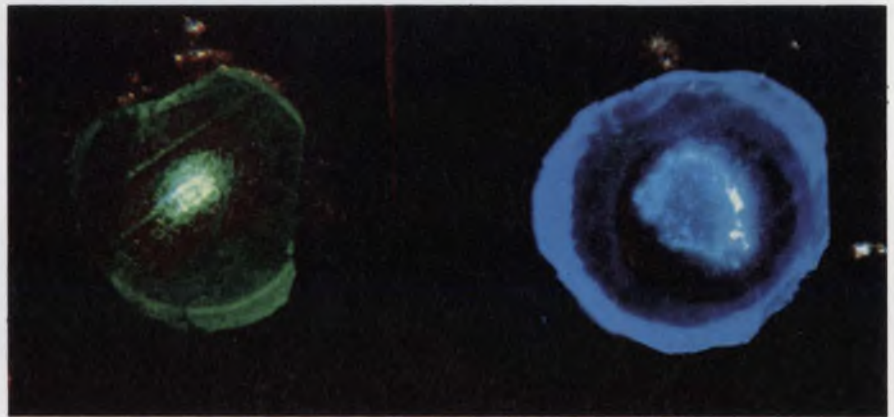

Gallium nitride is of interest as a LED because it can theoretically give electroluminescence and laser action over the entire visible spectrum. The green and blue GaN diodes, above, were demonstrated by RCA Labs.

"We're not pursuing its sale," reports GE's Hall, "because compared to GaP LEDs, it's too inefficient."

The GE unit, like Matsushita's, requires 100 mA. This relatively high current makes it incompatible with present T²L logic and ICs, Hall explains.

In contrast, he says, "gallium-phosphide green LEDs require but a few mA, and are inherently T²L and IC-compatible.

Another point Hall makes is that the GaAs device requires a metal TO can to dissipate the diode heating. This prohibits a sizeable reduction in price, because plastic encapsulation cannot be used.

Trying to compare the performance of LEDs of the GaAsP type to those of the GaP type is difficult, because essentially they are two different types of light emit-

ters. Some broad distinctions can be made, however, GaAsP diodes are fabricated from direct band-gap compounds. This means that the material itself absorbs about 98% of its own radiation, which issues from along the junction on the end of the device. Approximately 1.5% of the total light generated is visible from the GaAsP diode. However, the pattern of light that does emerge from the junction is fairly constant over a wide viewing angle.

On the other hand GaP diodes are fabricated from indirect-band-gap compounds. As a result, the GaP diode is transparent to its own generated light. Because of the markedly different patterns of

radiation of the GaAsP and the GaP diodes, the optical package for each varies widely.

While LEDs can be compared with each other in terms of several electrical and optical quantities, the optimum way to compare them is by visual merit. This represents the actual light delivered for the input power applied.

Market outlook: pros and cons

The market potential for green and yellow LEDs looks excellent to several manufacturers. Aaron Kestenbaum, president of Opcoa, Inc., manufacturer of red gallium phosphide diodes and displays in Edison, N.J., says:

"One of the brightest hopes of the LED business is the green diode. We now have a number of green GaP devices in the prototype stage, including a green,

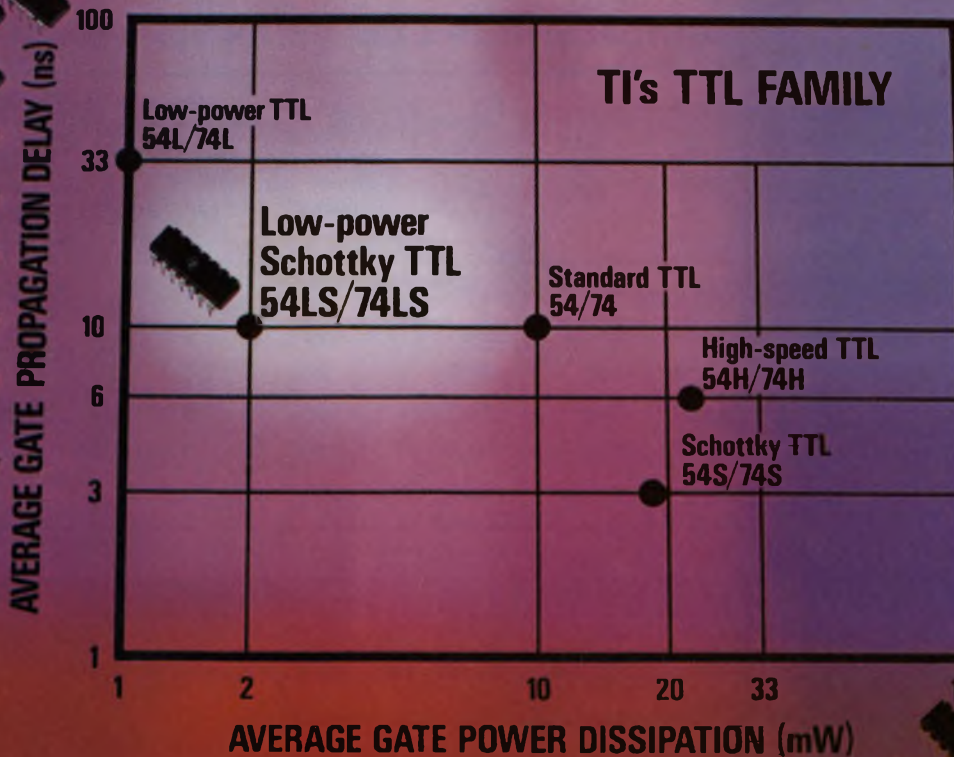

SCHOTTKY

Low-power Schottky: 10 ns at < 2 mW.

21 SSI and 13 MSI circuits now available in TI's new low-power Schottky TTL family. They provide all the performance of low-power TTL (Series 54L/74L) with increased speed of 10 ns/gate and power dissipation of less than 2 mW.

Low-power Schottky offers greatly improved speeds in portable or remote systems, or in any application where minimum power is a prime consideration. Compared to low-power TTL circuits, low-power Schottky TTL provides three times the speed with a power increase of less than 1 mW/gate.

Fully compatible, readily available

This new series is compatible with all TTL – standard, high-speed, low-power and Schottky. Evaluation quantities are available now from authorized TI distributors or direct from factory inventories; production quantities four weeks ARO.

Send for complete details

Circle 213 on Service Card for data sheets. Or write Texas Instruments Incorporated, P.O. Box 5012, M/S 308, Dallas, Texas 75222.



NEW LOW-POWER SCHOTTKY SSI CIRCUITS

	100-999
SN74LS00N Quad 2 NAND gate	\$0.96
SN74LS01N Quad 2 NAND gate, open collector	0.96
SN74LS02N Quad 2 NOR gate	0.96
SN74LS03N Quad 2 NAND gate, open collector	0.96
SN74LS04N Hex inverter	1.14
SN74LS05N Hex inverter, open collector	1.14
SN74LS10N Triple 3 NAND gate	0.96
SN74LS20N Dual 4 NAND gate	0.96
SN74LS22N Dual 4 NAND gate, open collector	0.96
SN74LS30N Single 8 NAND gate	0.96
SN74LS51N Dual 2 AOI gate	0.96
SN74LS54N 4-wide, 2-input AOI gate	0.96
SN74LS55N 2-wide, 4-input AOI gate	0.96
SN74LS73N Dual J-K edge-triggered flip-flop	1.91
SN74LS74N Dual D-type edge-triggered flip-flop	1.91
SN74LS76N Dual J-K flip-flop, preset and clear	1.91
SN74LS78N Dual J-K flip-flop, common clock	1.91
SN74LS112N Dual J-K edge-triggered flip-flop	1.91

SN74LS113N Dual J-K flip-flop, no clear	1.91
SN74LS114N Dual J-K flip-flop, common clock and clear	1.91
SN74LS228N Dual J-K edge-triggered flip-flop	1.91

NEW LOW-POWER SCHOTTKY MSI CIRCUITS

	100-999
SN74LS83N 4-bit full adder	\$3.51
SN74LS95AN 4-bit left-right shift register	4.78
SN74LS138N 3-to-8-line decoder/1-to-8-line demultiplexer	4.78
SN74LS139N Dual 2-to-4-line decoder/Dual 1-to-4-line demultiplexer	4.78
SN74LS153N Dual 4-to-1 data selector/multiplexer	4.78
SN74LS155N Dual 2-to-4-line decoder	4.78
SN74LS181N Arithmetic logic unit/function generator	25.85
SN74LS194N 4-bit bi-directional universal shift register	4.78
SN74LS195N 4-bit parallel-access shift register	4.78
SN74LS196N Presettable decade counter	4.89
SN74LS197N Presettable binary counter	4.89
SN74LS253N 3-state version of SN74LS153	5.74
SN74LS295N 3-state version of SN74LS95A	5.74

All prices are 100-piece quantities for plastic dual-in-line packages.

TEXAS INSTRUMENTS
INCORPORATED

seven-segment indicator."

Ferranti Electric is convinced there is a large market waiting for the semiconductor manufacturer who is willing to invest heavily in the materials and processing technology of the prime contender for green diodes, gallium phosphide. In fact, Ferranti has put its money where its overseas processing plants are located.

After a worldwide marketing survey, Ferranti has committed itself to producing volume quantities of standard 18-mil-square chips of green GaP emitters. These chips will produce 200 to 300 ft-L at 20 mA. Production of a million

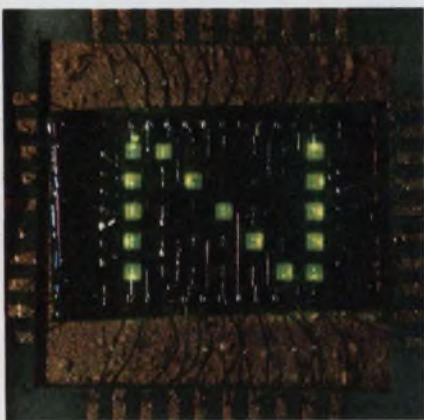

Green GaP dot matrix, by Ferranti, has a typical luminance of 600 ft.-L at 10 mA diode current.

chips a month is planned by December of this year, and 10-million a year by mid-1973. The ultimate capacity with present planned facilities will be 50-million chips a year, Pastore says.

The price projected for a five-million unit order, Pastore says, is 13 cents a chip—competitive with red chips.

But other industry sources are more cautious in their outlooks. "We found," says Jerry Lemberg, president of Quantum Science Corp., which recently completed a market survey in this field, "that the color of a LED is important until the customer has to pay extra for it. Then he chooses red."

James Wick, marketing manager of Motorola's Optoelectronics Div. in Phoenix, Ariz., reflects the general opinion of several LED manufacturers that have not yet offered LEDs with the new colors. The list includes Hewlett Packard,

Comparison of LED performance

LED type	Color of light	Wave-length of light, nm	Relative optical sensitivity, lumens per optical Watt	Commercial device performance	
				Efficiency, percent	Visual merit, lumens / elect. Watt
GaP	Red	690	15	1	0.15
GaP	Green	565	590	0.01	0.05
GaAsP	Red	670	20	0.1	0.02
GaAsP	Red	660	40	0.03	0.012
GaAsP	Orange	610	330	0.001	0.003
GaAsP	Yellow	585	500	—	—



New colored LED displays by Monsanto in a gallium arsenide phosphide yellow (MAN 8) at left, and in a gallium phosphide green (MAN 5) at right, are compared above with the red display industry standard (MAN 1), center.

Fairchild, Texas Instruments, Opcoa, GE and Dialight.

"We're currently restricting our output to red LEDs," says Wicks, "because the price of other colors we might produce would be so high that they would simply not be attractive to the normal user."

"However," he noted, "we do have a program of materials development and hope to have a green LED available in the first half of '73."

Competition for tungsten lamps?

RCA sees green GaP as having a greater potential than that of use in LED devices alone.

"The interest in green is easy to understand," says RCA's Ladany, "because the emission peaks at the wavelength corresponding to the maximum sensitivity of the eye. The radiation emitted by such a diode is 30 times brighter than

that produced by an equally efficient—on a power basis—red GaP diode.

"Since it has turned out to be possible to produce red diodes of 10% efficiency, it will only be necessary to obtain the same efficiency in the green to give every other light source in the world—including tungsten lamps—a run for the money."

As for other LED developments, RCA has produced experimentally a gallium-nitride (GaN) diode that gives off a blue and a blue-greenish light (see photo p. 26).

"The GaN diodes are a long-range effort of the laboratories," says Ladany. "While present materials problems are serious, it has been possible also to obtain yellow and ultraviolet emission from GaN deposited on a sapphire substrate. However, undesirably large voltages are presently required for this type of diode. ■■"

Someday other switches may have it.

But until then, only Licon can build and sell patented double-break Butterfly® switching. (Type 16 switch Butterfly mechanism shown twice its actual size.)

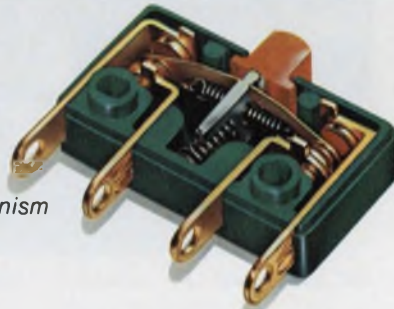

Why are Licon patented double-break Butterfly® switches better? Because they give a degree of reliability you simply can't get in single-break switches. It's inherent in the design. There are other advantages, too. A higher current rating than comparably-sized single-break switches. Two-circuit control with one switch. High shock and vibration resistance. And Licon's exclusive Butterfly wiping action which resists contact welding ... minimizes mechanical bounce to increase electrical life. And there's a

versatile variety of low-cost Butterfly switches available immediately. In subminiature switches, our Type 16 SPDT series offers a wide choice of terminal styles. With our Type 26 DPDT series you can control up to four isolated circuits. Type 36 3PDT series controls multipole circuits. Or try our subminiature Type 18 SPDT series which packs super reliability into super small volume. All these switches are snap action. All meet MIL specs. And all offer choice of contact arrangements, case and contact

materials. Check them out with your Licon distributor or representative. Or call or write for a Licon Switch Catalog. **Licon, Division Illinois Tool Works Inc., 6615 W. Irving Park Road, Chicago, Illinois 60634. Phone (312) 282-4040. TWX 910-221-0275.**



i t w LICON

The Innovating Electronic Group of ITW... LICON ■ ELECTRO MATERIALS ■ PAKTRON

All-solid-state color TV camera, the first, is built experimentally

Tiny charge-coupled devices, announced last spring by Bell Laboratories in Murray Hill, N. J., have made possible what Bell calls the first all-solid-state color television camera, which is also the smallest and lightest color TV camera and eventually may be the cheapest.

The charge-coupled devices, which are about the size of the head of a paper match (4 by 5 mm), have been used in the camera to sense the primary colors in a scene. Existing cameras use a relatively cumbersome system based on vacuum tubes, electron beam scanning and complex circuitry.

More concerned about how well the new camera would operate than its size and weight, Bell engineers nevertheless built an experimental model that weighs only three pounds and measures 8 by 9 by 5 inches. Future models, laboratory engineers say, will be "small and light enough to hold in one hand."

Prism used to split light

As with conventional tube cameras, light from the scene to be televised is split into red, blue and green images by a prism. Each primary color is focused on one charge-coupled device sensor. The image is converted into an electrical charge pattern by the sensor, and this pattern is then read out as a video signal.

A charge-coupled-device color TV camera has these advantages over conventional types, according to its inventor, Mike Tompsett:

- It completely overcomes difficulties of picture alignment and registration, and is insensitive to electromagnetic interference.
- It completely avoids color

fringing, caused by alignment problems and electronic "lag" in the tubes of existing cameras.

■ It is more rugged and reliable, requires less voltage and is instantly ready for use when turned on, since charge-coupled devices don't have to warm up.

How is this all accomplished?

Tompsett explains that with conventional cameras, the electron



All solid-state TV camera is tested by Bell Labs engineers, Mike Tompsett (left) and Ed Zimany. The unit uses three charge-coupled devices as image sensors instead of the more cumbersome vacuum-tube and electron-beam-scanning system of today's color cameras.

scan must be linearized and made accurate in x-y directions. The beam has to be shielded from electromagnetic fields. And temperatures must be regulated.

"With our device," he says, "the geometry is built into the solid-state device itself. This way you know exactly where each charge packet has come from. This eliminates the registration problem. Our

devices can be mechanically positioned. When they are produced, they can be preset in the factory."

Color fringing is eliminated by the very nature of charge-coupled devices. In conventional cameras the electron beam reads off only a certain percentage of the signal. A baseball flying across the screen leaves a slight trail. With charge-coupled devices, Tompsett says, the entire color charge is read off the first time, eliminating fringing.

The other advantages result from the camera's being all-solid-state.

3 CCD arrays in camera

There are three charge-coupled-arrays fabricated by deposition of tungsten metal electrodes on silicon dioxide over a silicon substrate. Each array contains 128 by 106 elements—about half the resolution required for one of Bell's Picture-phones.

"We could get enough resolution," Tompsett says, "by doubling the size of the arrays. This wouldn't affect the size of the camera at all. We're talking about doubling the size of something the size of a dime—making it the size of a nickel."

"Within a decade you will probably see studio TV color cameras built with charge-coupled devices," Tompsett says.

Present charge-coupled-device cameras have not yet reached the resolution required for commercial television applications because the fabrication processes for integrated circuits are not able routinely to make the devices large enough. However, Bell engineers expect the processing techniques to be sufficiently improved soon to make charge-coupled-device technology available for practical video systems. ■■

SAINT LOGIC

The best thing to come along since sliced bread



The state-of-the-art has not permitted any significant break-through in DVM logic until now. In the present DVMs on the market, certain trade-offs or sacrifices are necessary. For example, accuracy is given up for speed in many cases; speed is given up for accuracy; accuracy and speed have been given up for a lower price; accuracy and speed are given up for noise rejection.

The new Cimron DMM 50 is a five digit digital multimeter and is first in a family of multimeters to be introduced by Cimron this year. The Cimron DMM 50 offers high quality, high accuracy, high noise rejection and high speed at the same time.

In order to provide such a meter Cimron has employed a logic we call "SAINT." We've taken two logics and combined them resulting in one very powerful instrument. We use Successive Approximation (SA) logic for speed and integrating (INT) logic for its inherent noise rejection.

Each reading on the Cimron DMM 50 starts with an "Automatic Set Zero," then we examine the most significant of the five decades. Any part of a digit from zero through eleven is subtracted. This is called

our "subtractive digit" operation. The most significant decade can be zero through eleven. Next we integrate the four least significant decades.

The four operations of the "SAINT" technique are (1) automatic zero set; (2) subtractive digit; (3) integrate compare "one"; (4) integrate compare "two." This means the DMM 50 can operate at greater than 20 readings per second with a rejection of 60 dB at 60 Hz. An additional 60 dB of noise rejection may be switch selected.

Multimeter capabilities include: 5 ranges of DC and DC/DC ratio; 4 ranges of AC; 5 ranges of resistance; optical coupled data output and remote programming. Priced from \$1200.

Other Cimron products include AC Power Sources and Line Conditioners; Data Acquisition Systems; Pulse Generators; and a complete line of high performance DVMs.

For detailed specifications and demonstration contact your local Cimron Representative or Chuck Hasley at 714-774-1010, Lear Siegler, Inc., Electronic Instrumentation Div., Cimron Instruments, 714 North Brookhurst Street, Anaheim, California 92803.



LEAR SIEGLER, INC.

ELECTRONIC INSTRUMENTATION DIVISION
CIMRON INSTRUMENTS



SEE IT AT WESCON BOOTH 1313

Accelerometers in Atlas missiles converted to earthquake sensors

Accelerometers used on the old Atlas missiles are being adapted for use as earthquake detectors. The accelerometers are of the vibrating-string type and are capable of measuring single-axis accelerations over a range of 10^{-8} to 40 g's. This dynamic range is several orders of magnitude greater than that of any other earthquake sensor in use today.

Adaptation of the sensor and design of a data system around the device is being undertaken by Aerospace Corp. of El Segundo, Calif., under the direction of Dr. Robert O. Bock, director of the guidance and computer group.

About 1000 of the accelerometers left over from the Atlas program are owned by the Air Force.

David N. Kaye
Senior Western Editor

Aerospace acquired about 350 of the accelerometers. Bock's group is planning to package them in a strap-down configuration, three to an assembly. Each one will monitor a different axis. The accelerometer sensors operate over a temperature range of from -40 to $+200$ F and have a bandwidth of 700 Hz. This bandwidth is also many times greater than that of existing sensors. Accuracy is one part in 10^6 . Bock admits that 1% accuracy would be sufficient for earthquake detection.

Frequency difference yields g's

Each sensor consists of a pair of beryllium-copper wires (strings), each suspended between a proof-mass assembly and an insulated suspension point (see diagram).

The proof-mass assembly consists of two beryllium-copper blocks separated by a beryllium-copper spring. One spring extends out from each side of the proof mass assembly. Surrounding each string is a permanent magnet. When an ac current is passed through each string it is repelled first by one pole of the permanent magnet and then by the other in accordance with the magnetic field set up by the oscillating current in the string. Thus, the string vibrates at a fixed frequency.

The normal vibrating mode in these sensors is 4500 Hz. When an acceleration occurs along the axis of the strings, the inertia of the proof mass causes one string to tense and the other to relax. The string that tenses vibrates more rapidly and the other vibrates more slowly. The difference between the two vibration frequencies determines the acceleration. The measure of acceleration in the sensor is 64 Hz/g. Response time of the sensor is $1/700$ s.

Memory will be used

In the Aerospace concept, the currents passing through the two strings are first amplified and then the frequencies are counted. The difference between the two frequencies is then taken and the resulting digital signal will be entered in a memory along with a sample time. The type of memory to be used has not yet been determined.

Aerospace, a nonprofit corporation, plans to have working prototypes in the field by mid-1973. The technology will be made available to other companies at that time. The cost of the new earthquake sensors, Bock says, will be competitive with other techniques on the market. ■■

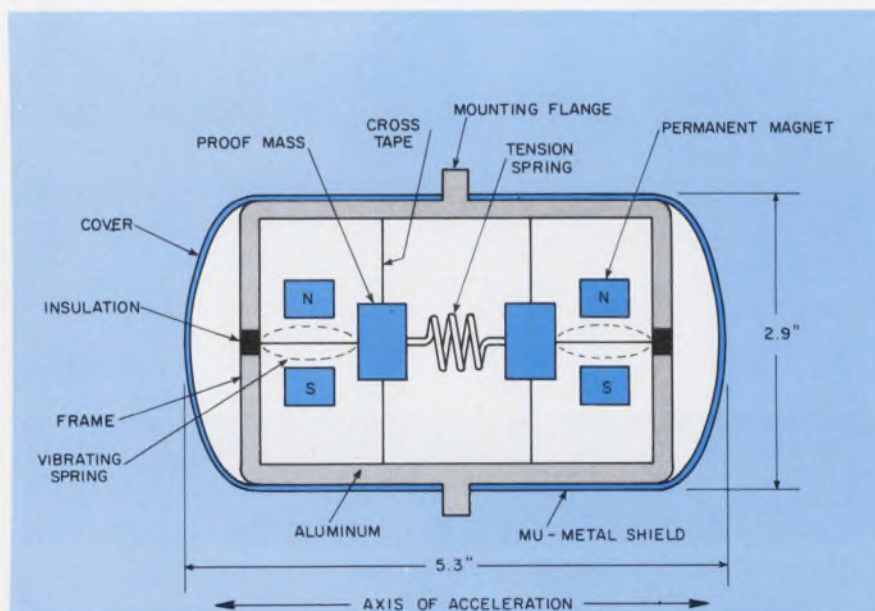

Earthquake monitoring over a 10^9 dynamic range is possible with this accelerometer, originally designed for use on the Atlas missile program. Acceleration is proportional to the difference of the frequencies of the currents carried in the two vibrating strings.

Put **2** crimps in your coaxial connector costs . . .

...plus these additional features

- Mechanically rugged
- Low total cost
- Fewer parts
- Quick connect/positive interlock
- Slide-on version does not require step 6
- Available for flexible and semi-rigid cables
- Available now thru Omni Spectra distributors
- Both miniature OMQ and subminiature OSQ series available
- Send for 32 page catalog



...with six fast assembly steps

1. Strip cable



2. Add outer ferrule



3. CRIMP center contact

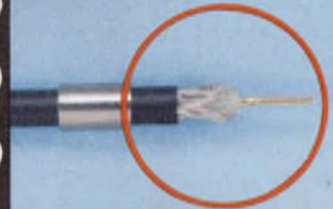

4. Add housing sub-assembly



5. CRIMP outer ferrule

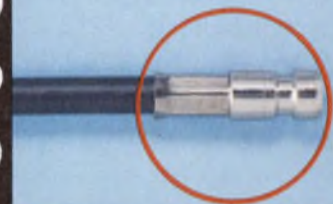

6. Add coupling sleeve



Synthetic crystal an alternative to quartz

Within the next few years, a synthetic piezoelectric crystal—lithium tantalate—is expected to join, and even replace, the traditional quartz crystal in many communications applications.

The crystal material, first grown on an exploratory basis in 1969 by engineers at Bell Telephone Laboratories, Murray Hill, N.J., is being produced in production quantities at the Western Electric Co.'s Merrimack Valley Works in North Andover, Mass.

A few thousand telephone communications devices with lithium tantalate crystals—such as oscillators, LC filters and monolithic filters—are expected to be produced by Western Electric in the next year. By 1975, according to a Bell Laboratories spokesman, the use of lithium tantalate in other devices should require in-house production that approaches the present level for quartz crystal units.

In some applications, the spokesman notes, the new crystals will do the same job as quartz crystals, but they will require fewer auxiliary components. For example, in the first planned application of the material, a filter with two lithium tantalate crystals and five other

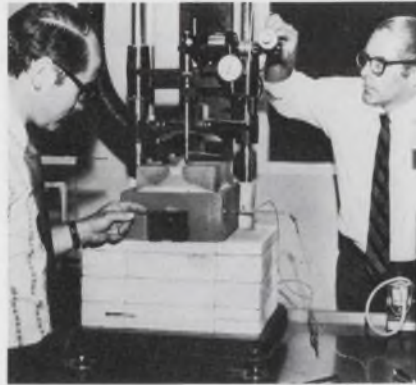

Crystal pulling machine in which lithium tantalate crystals are grown is adjusted by David Rudd of Western Electric Co. and Albert Ballman of Bell Telephone Laboratories. The synthetic crystals will be used for filters in telephone equipment.

components—capacitors, inductors, transformers—will be used instead of an equivalent quartz filter circuit with four quartz crystals and 14 other components.

Monolithic quartz filters have been found to do most jobs very well, but some applications require a higher frequency and wider bandwidth than are possible with a quartz device. The bandwidth of quartz is limited by its relatively

weak electromechanical coupling characteristics. Lithium tantalate has electromechanical coupling that is "five to six times better than quartz," according to Bell.

The new material, like quartz, has a low temperature coefficient of frequency. It also boasts characteristics of low acoustic loss and good handling. It exhibits good temperature stability, low impedance, high Q (efficiency rating), minimum coupling to unwanted modes, good machinability, low water solubility and hardness.

Unlike quartz, lithium tantalate does not occur in nature. It must be grown at high temperature from a melt of lithium oxide and tantalum pentoxide. The crystal boule, about three inches by three-quarters of an inch, is cut into small rod-shaped crystals, a few millimeters thick and a few centimeters in length, for use in filter devices.

Since synthetic lithium tantalate crystals are cut into smaller sizes than quartz, they are expected to be more compatible with integrated circuitry. They may also find use as a light modulator for optical transmission systems and as an infrared detector. ■■

Transit receiver developed for small craft

Small ocean vessels such as Navy patrol cutters, maritime and commercial fishing craft and even pleasure boats may one day be able to pinpoint their location by means of a low-cost, simplified version of the Navy's AN/SRN-9 Transit satellite navigation set.

The experimental receiver was developed for the Navy Space Projects office by the Johns Hopkins Applied Physics Laboratory, Silver Springs, Md.

About the size of a ham radio receiver, the set receives a 400-MHz signal transmitted by any of



Navigation system consists of low-cost receiver (left) and calculator.

the Navy's Transit navigation satellites orbiting the earth. Superimposed on these signals are timing data and information on the satellite's position in space. The receiver automatically processes and feeds the data into an electronic desk calculator programmed to calculate navigation fixes.

A spokesman for the Applied Physics Laboratory says that the model, including receiver and antenna, could cost less than \$5000 when produced in quantity. The calculator, which completes the navigation set, costs \$5000. ■■

NO MATTER WHERE YOU ARE . . .

BOURNS®
ENTIRE LINE
OF PRECISION POTENTIOMETERS
... IS STOCKED IN DEPTH

Bourns has 73 distributor locations; more than any other potentiometer manufacturer. One is near you... no matter where you are. Each has a complete stock of Bourns Precision Potentiometers; the industry's widest selection.

10-turns, 5-turns and 3-turns . . . in 1/2", 7/8", 1 1/16" and 1 3/16" diameters . . . with wirewound and INFINITRON® Conductive Plastic elements . . . in either bushing or servo-mount configurations.



For complete details, or to enter your order, contact your local Bourns distributor, a Bourns sales office, representative or the factory-direct.



BOURNS, INC., TRIMPOT PRODUCTS DIVISION • 1200 COLUMBIA AVE., RIVERSIDE, CALIF. 92507

BOURNS DISTRIBUTORS —

ALABAMA/Cramer/E. W. **ARIZONA**/Kierulff Elect. **CALIFORNIA**/Westates Elect. Corp. • Hamilton Electro Sales • Liberty Electronics • Elmar Elec. Inc. • Hamilton/Avnet • Electronic Supply Corp. • Western Radio **COLORADO**/Hamilton/Avnet • Kierulff **CONNECTICUT**/Conn. Electro Sales • Cramer Elect. Inc. **FLORIDA**/Cramer/E. W. • Hamilton/Avnet • Hammond Elect. Inc. **GEORGIA**/Jackson Elect. Co. **ILLINOIS**/Allied Elect. Corp. • Newark Elect. Corp. • Hamilton/Avnet **INDIANA**/Ft. Wayne Elect. Supply Inc. • Graham Elect. Supply Inc. **KANSAS**/Hall-Mark Elect. Inc. **LOUISIANA**/Southern Radio Supply Inc. **MARYLAND**/Cramer/E. W. • Pioneer/Washington Elect. Inc. **MASSACHUSETTS**/Electrical Supply Corp. • Cramer Elect. Inc. **MICHIGAN**/Harvey-Michigan **MINNESOTA**/Lew Bonn Co. • Hamilton/Avnet **MISSISSIPPI**/Ellington Electronic Supply, Inc. **MISSOURI**/Hamilton/Avnet • Hall-Mark Electronics Corp. **NEW JERSEY**/General Radio Supply Co. • Hamilton/Avnet • Eastern Radio Corp. **NEW MEXICO**/Electronic Parts Co. **NEW YORK**/Standard Electronics Inc. • Cramer/Binghamton • Cramer/Esco • Cramer/Eastern • Hamilton/Avnet • Federal Elect. Inc. • Schweber Electronics • Harvey Radio Co. **NORTH CAROLINA**/Cramer/E. W. **OHIO**/Hughes-Peters, Inc. • Pioneer **OKLAHOMA**/Hall-Mark Elect. **PENNSYLVANIA**/Pyttronics • Powell Elect. • Cameradio Co. **RHODE ISLAND**/Wm. Dandreta Co. **TEXAS**/Hall-Mark Elect. Co. • Hamilton/Avnet • Harrison Equip't Co. **UTAH**/Cramer **WASHINGTON**/Liberty Elect. **WISCONSIN**/Taylor Electric Co. **CANADA**/Varatronics • Cesco Elect. • Zentronics Ltd.

INFORMATION RETRIEVAL NUMBER 22

We started at the top.



On display
at WESCON
Booth 1205

And worked our way down.

And with our three new solid state models, our line of microwave power amplifiers goes all the way down to .5 GHz.

Which means we can offer you an extensive range of frequencies and power levels: from .5-18 GHz; in TWTAs or solid state.

Our TWTAs go from 1-18 GHz at 10 and 20 watts. Our new solid state units cover .5-2 GHz at 1 and 5 watts: models 1401H and 1402H cover .5-1 GHz at 1 and 5 watts, respectively; model 1403H covers 1-2 GHz at 1 watt power.

Result?—you can get the same Hughes reliability and proven quality at the bottom frequencies that you did at the top. Plus our full one-year no-hour limit warranty.

Each unit is compact, lightweight, and ruggedly built.

They each give a minimum of 30 db of gain over their octave bandwidth. They have transistorized RF hybrid microstrip circuitry. And an integral AC to DC power supply. And you can order 115 VAC or 230 VAC sources.

Hughes' growing line of microwave power amps: our frequencies get smaller, your choice gets bigger.

Write: Electron Dynamics Division,
3100 West Lomita Blvd.,
Torrance, CA 90509.
Or call. (213) 534-2121.

HUGHES

HUGHES AIRCRAFT COMPANY
ELECTRON DYNAMICS DIVISION

Biggest telescope in orbit

Orbiting Astronomical Observatory-C, the heaviest, most expensive and most complicated unmanned scientific satellite ever launched by the United States, went into a 460-mile orbit last month. It carries three small X-ray telescopes and a 32-in. reflecting telescope—the largest ever orbited—that provides spectral readings in the ultraviolet range.

The spacecraft is studying the interstellar absorption of hydrogen, oxygen, carbon, silicon and other common elements, and investigating ultraviolet radiation emitted from young hot stars in wavelength regions between 930 and 3000 Å.

The 4900-pound craft is 118 in. long and 40 in. in diameter. It is stabilized by an inertial reference unit, a rate and position sensor and star and solar trackers.

Grumman Aerospace in Bethpage, N.Y., is prime contractor for the craft.

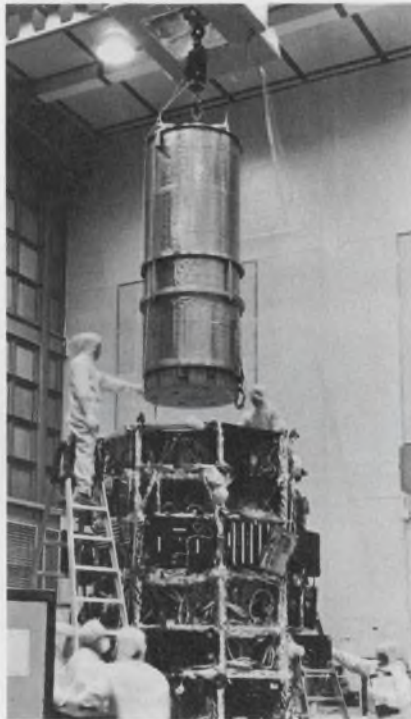

Technicians lower the 32-inch telescope into the OAO-C spacecraft.

Testing an airborne radar

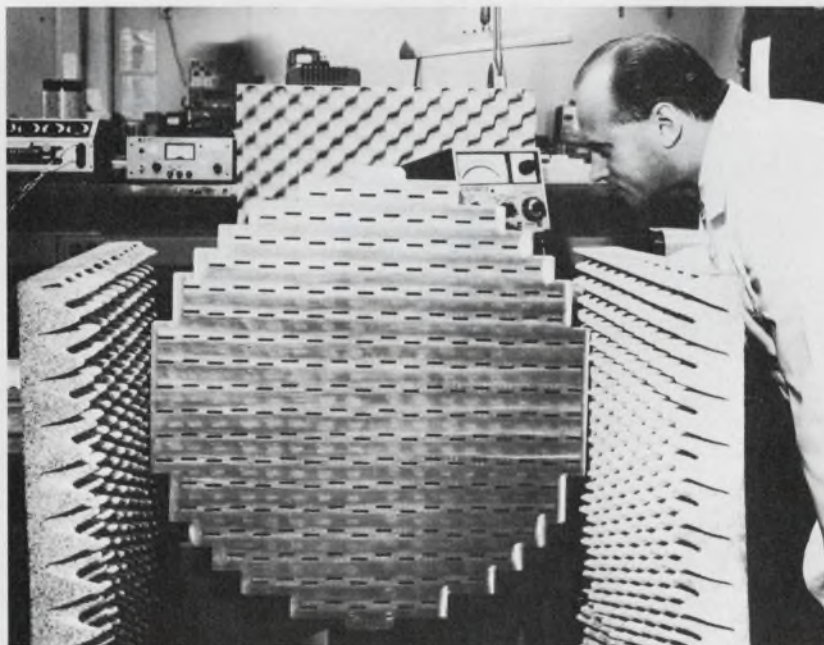

Flat-plated slotted array antenna used in weather radar systems onboard the Boeing 747 and McDonnell Douglas DC-10 is packed with radio-frequency absorbent material before being tested. The antenna in the new RCA radar produces a pencil beam of 5.2 degrees and operates at 5400 MHz with a power output of 70 kW.

Hughes is more than electronic components and equipment.

It's systems, too.



Numerical control systems (RS 295)



Wire terminating and harness laying systems (RS 296)



N/C positioning tables and systems (RS 297)



Multiplex systems for remote communications/control (RS 292)



FACT automatic circuit testers (RS 298)

For complete information, write Bldg. 6, Mail Station D-135, Culver City, CA 90230. Or request by Reader Service (RS) numbers.

HUGHES

HUGHES AIRCRAFT COMPANY

Industrial Electronic Products

**In November, TI announced
the 960A industrial
automation computer**

TI announces
the leader...



**Model 960A
\$2,850**

Quantities 1 to 100
 CPU with 4K memory \$2,850
 CPU with 8K memory \$4,350
 CPU with 16K memory \$7,350

in minicomputer
price/performance

TEXAS INSTRUMENTS
INCORPORATED



**Now, TI announces the 980A...
the price/performance leader
in general purpose computers**

Model 980A

\$3,475

Quantities 1 to 100
with hardware multiply and divide
and many other built-in standard features

TI continues its leadership in price and performance with the new Model 980A general purpose computer.

The 980A, as with the 960A, is a fast, powerful and flexible 16-bit computer at a low unit price with all the features, built-in and *standard*. Consider these many standard features, compare the price and you'll see why the 980A is the most cost-effective general purpose computer available today.

- Hardware, multiply/divide with 16 or 32-bit add and subtract
- 750-nsec add immediate
- 5.25- μ sec multiply
- 750-nsec, full-memory cycle time
- Bit/byte/word/byte string data addressing
- Memory parity
- Programmable memory protect and privileged instructions
- Power fail/auto restart
- Power supply to support 65K memory
- Memory biasing (dynamic relocatability)
- I/O bus with 4 ports basic (expandable to 14 in basic chassis, 256 overall)

CPU with 4K memory	\$ 3,475
CPU with 8K memory	\$ 4,975
CPU with 16K memory	\$ 7,975
CPU with 32K memory	\$13,975

(prices are FOB Houston and do not include illustrated tabletop cabinet)

- Main chassis semiconductor memory expandable to 32K. (Up to 65K with memory expansion unit: Two weeks memory protect with optional battery)
- Full, lockable front panel with break point and 4 sense switches
- Switch-initiated ROM bootstrap loader
- Auxiliary processor port
- Direct memory access channel (expandable to 8 ports)
- Four priority interrupts standard (expandable to 64)
- 98 basic instructions (16, 32 or 48 bit)
- 9 addressing modes
- 8 working registers plus status register

A pre-generated standard software system is supplied which allows the user to generate custom system software. Additional soft-

ware for the 980A includes:

- Symbolic assemblers and cross-assemblers for IBM 360/370
- FORTRAN IV
- Link and source editors (object and source)
- Modular executive control routine including disc management
- TI Language Translator (TILT) to extend FORTRAN, assembly, or create special application languages
- Service maintenance, debugging and utility programs.

For applications support, TI offers the resources of its experienced Applications Engineering group. Also, training courses on 980A software and hardware are scheduled regularly, and TI service facilities are located throughout the United States and abroad.

Would you like to know more about the new 980A price/performance leader? Write to Computer Products Marketing Manager, Texas Instruments Incorporated, P.O. Box 1444, Houston, Texas 77001. Or call (713) 494-2168 or any of the sales offices listed below.



Arlington, Va. (703) 525-1444 • Atlanta, Georgia (404) 237-8666 • Boston, Mass. (617) 890-7400 • Chicago, Ill. (312) 593-2340 • Cleveland, Ohio (216) 464-1192 • Dallas, Tex. (214) 238-3881 • Dayton, Ohio (513) 294-0774 • Denver, Colo. (303) 758-5536 • Detroit, Mich. (313) 352-5720 • Los Angeles, Calif. (714) 547-9221 • Minneapolis, Minnesota (612) 831-5094 • Newark, N. J. (201) 467-2670 • New York, N. Y. (212) 233-6890 • Orlando, Fla. (305) 644-3535 • Philadelphia, Pa. (215) 643-6450 • San Francisco, Calif. (408) 732-1840 • St. Louis, Mo. (314) 993-4546 • Bedford, England 58701 • Clamart, France 6450707 • Frankfurt, Germany 726441 • Bad Godesberg, Germany 65534

TEXAS INSTRUMENTS

INCORPORATED

INFORMATION RETRIEVAL NUMBER 25

STM. Not just



Sorensen's new modular DC power supplies give you twice the efficiency, half the size, for equivalent power ratings.

- **Efficiencies as high as 75%.**
- **Unequaled power outputs — standard package sizes.**
- **Low heat dissipation — eliminates external cooling.**
- **Excellent performance — check the specs.**
- **Built-in overvoltage protection — all units.**
- **Computer optimized filtering — superior RFI and noise performance.**
- **20 models now available — 20 more to come.**

Compared with competitive series-pass power supplies, Sorensen's STM switching-transistor power supplies provide unequalled space and money-saving benefits. And, unlike competitive units, STM power supplies offer overvoltage protection as a standard rather than an optional extra-cost feature.

Sorensen STM's are backed by our world-wide reputation for excellence. For more information write Sorensen Company, a unit of the Raytheon Company, 676 Island Pond Road, Manchester, New Hampshire 03103. Telephone (603) 668-1600. Or, TWX 710-220-1339.

another black box.

Package Size: Module III - 3-5/16" x 5-1/8" x 9-1/2" - Weight: 6.5 lbs.

Model	OUTPUT VOLTAGE Set Range		OUTPUT CURRENT (A dc)*				VOLTAGE REGULATION (comb. line and load)	RIPPLE rms p-p**		INPUT POWER					Price†
										AC			DC		
	min.	max.	40°C	50°C	60°C	71°C		Volts	Amps at 115 V	Freq. (Hz)	Volts	Amps at 150 Vdc			
STM3.5-24	3.0	4.5	24	19.4	14.9	9.6	.05%	5 mv	50 mv	105-132	1.8	50-440	150±15%	1.5	\$229
STM5-24	4.5	6.0	24	19.4	14.9	9.6	.05%	5 mv	50 mv	105-132	2.3	50-440	150±15%	1.5	229
STM9-12	6.0	10	12	9.7	7.5	4.8	.05%	3 mv	50 mv	105-132	2.1	50-440	150±15%	1.5	239
STM12-12	9.5	13.5	12	9.7	7.5	4.8	.05%	3 mv	50 mv	105-132	2.9	50-440	150±15%	1.5	249
STM15-10	13	17	10	8.1	6.2	4.0	.05%	3 mv	50 mv	105-132	2.7	50-440	150±15%	1.8	239
STM18-10	16	20	10	8.1	6.2	4.0	.05%	3 mv	50 mv	105-132	3.2	50-440	150±15%	1.8	249
STM24-8.5	19	25	8.5	6.8	5.3	3.4	.05%	3 mv	50 mv	105-132	3.3	50-440	150±15%	1.9	249
STM28-7	24	30	7.0	5.6	4.3	2.8	.05%	3 mv	50 mv	105-132	3.2	50-440	150±15%	1.9	249
STM36-4	29	43	4.0	3.2	2.5	1.6	.05%	3 mv	50 mv	105-132	4.0	50-440	150±15%	1.9	259
STM48-4	42	56	4.0	3.2	2.5	1.6	.05%	3 mv	50 mv	105-132	4.0	50-440	150±15%	1.9	269

Package Size: Module IV - 3-5/16" x 5-1/8" x 14" - Weight: 9.0 lbs.

STM3.5-36	3.0	4.5	36	29.1	22.3	14.4	.05%	5 mv	50 mv	105-132	3.8	50-440	150±15%	2.2	319
STM5-36	4.5	6.0	36	29.1	22.3	14.4	.05%	5 mv	50 mv	105-132	4.2	50-440	150±15%	2.5	324
STM9-20	6.0	10	20	16.2	12.4	8.0	.05%	3 mv	50 mv	105-132	3.8	50-440	150±15%	2.2	299
STM12-20	9.5	13.5	20	16.2	12.4	8.0	.05%	3 mv	50 mv	105-132	4.8	50-440	150±15%	2.8	289
STM15-15	13	17	15	12.1	9.3	6.0	.05%	3 mv	50 mv	105-132	4.3	50-440	150±15%	2.6	289
STM18-15	16	20	15	12.1	9.3	6.0	.05%	3 mv	50 mv	105-132	5.0	50-440	150±15%	3.0	299
STM24-13	19	25	13	10.5	8.0	5.2	.05%	3 mv	50 mv	105-132	5.5	50-440	150±15%	3.2	309
STM28-11	24	30	11	8.9	6.8	4.4	.05%	3 mv	50 mv	105-132	5.5	50-440	150±15%	3.2	309
STM36-6	29	43	6.0	4.8	3.7	2.4	.05%	3 mv	50 mv	105-132	4.5	50-440	150±15%	2.6	329
STM48-6	42	56	6.0	4.8	3.7	2.4	.05%	3 mv	50 mv	105-132	5.5	50-440	150±15%	3.2	329

*Free - air rating - no external heatsink **Worst case. Typically less than 30 mv †U.S.A. list prices

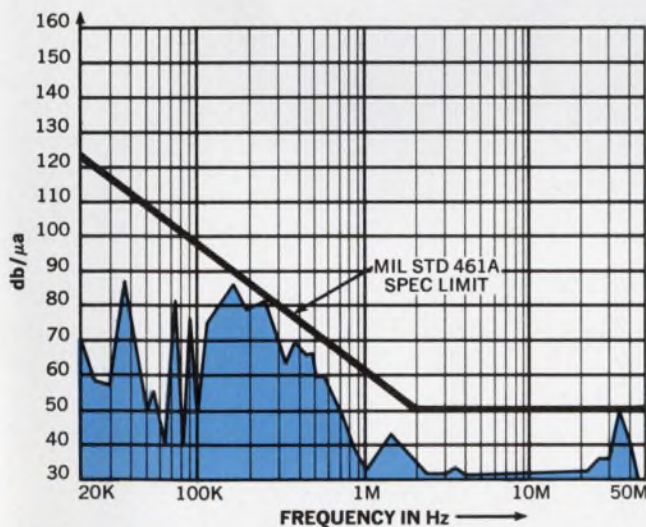

DC Load Leads. Conducted Current Level in db above a Microamp/ MHz

Specification	Sorensen STM5-24	Brand "X"
Size	3 ⁵ / ₁₆ x 5 ¹ / ₈ x 9 ¹ / ₂	4 ¹⁵ / ₁₆ x 7 ¹ / ₂ x 9 ³ / ₈
Volume	160 in ³	344 in ³
Price	\$229	\$235
Efficiency	58%	29%
Regulation (line & load combined)	0.05%	0.2%
Temperature Coefficient	0.01 % / °C	0.03 % / °C
Overload Protection	Current limiting-adjustable electronic	
Overvoltage Protection	Built-in adjustable, all models	Optional @ \$30 (except built-in, fixed, on 5-volt model only)

Compare this point-by-point spec-check between Sorensen's STM5-24 and Brand "X."

Sorensen POWER SUPPLIES

**Our terminal capabilities outnumber
your problems.**

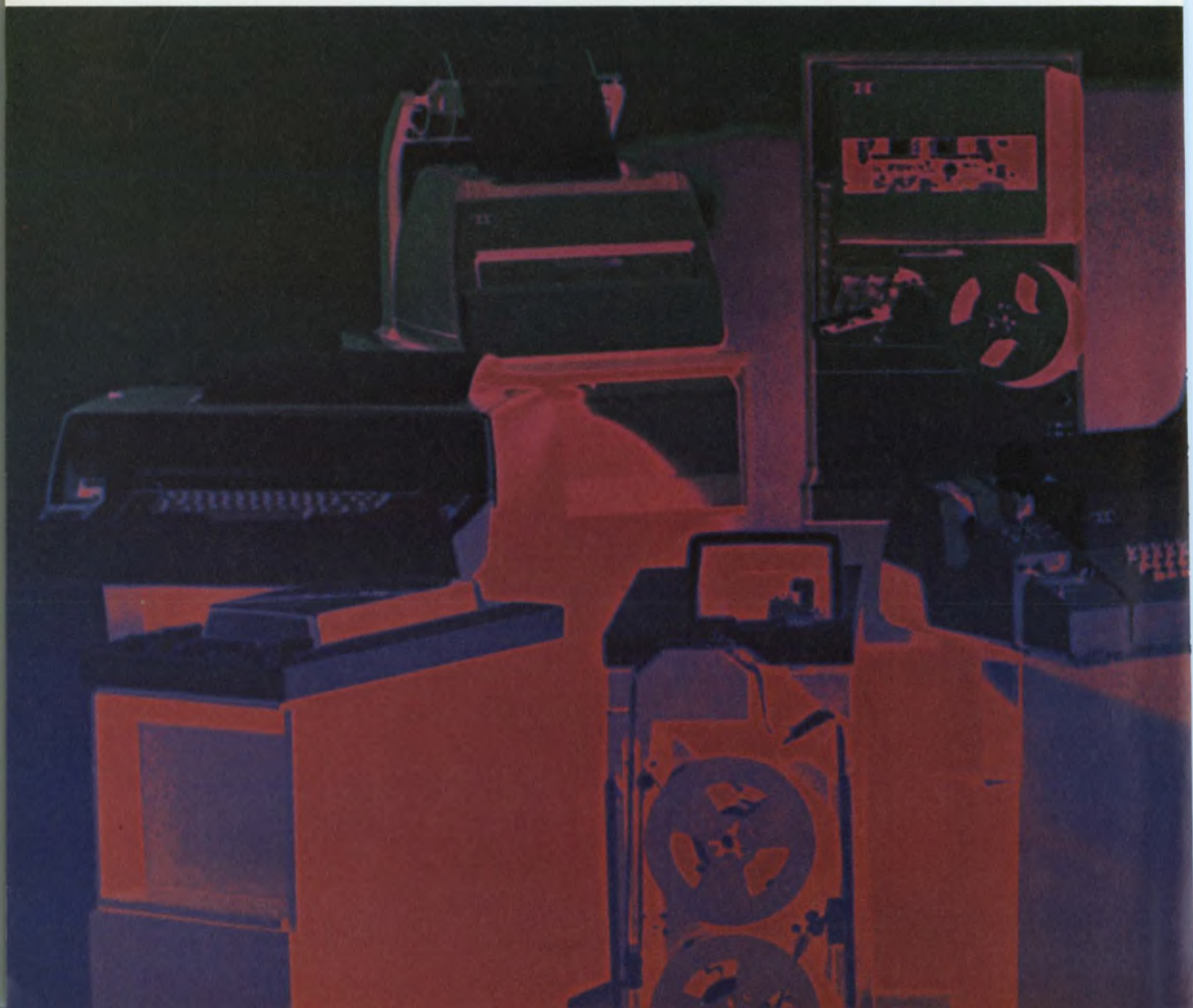

The answer to your remote-computing needs is probably right on this page.

Like our model 33. Economy and reliability have made it the most popular data terminal of its kind. Or like our new wide-platen model 38. We loaded it with big machine features but we left off the big machine price tag. For high-volume operations, our model 35 is built to run day and night, year in and year out. And if your system is highly complex, our model 37 delivers the utmost in flexibility and vocabulary.

To move information on-line at speeds up to 2400 wpm, all our keyboard terminals are compatible with the Teletype® 4210 mag tape data terminal. We also manufacture paper tape senders and receivers with speeds up to 2400 wpm.

To make sure you get what you need, we sell assembled ASR, KSR and RO terminals, as well as components—printers, keyboards, readers and punches.

You can also select from three different interface options: a built-in modem; a current interface; and an EIA Standard R-232-C interface.

Platen widths range all the way up to 15 inches.

Besides alphanumerics, we can give you Greek letters, algebraic and chemical symbols, as well as special graphics.

We also cover error detection and station control with a complete group of solid-state accessories.

And our machines never have to stand alone. Our applications engineers will work with you to make sure the terminal you buy from us is exactly what you need. And our maintenance

people are ready to make sure things keep running smoothly.

So whatever data terminal problems you're up against, come to us for help. Because when it comes to flexibility, reliability and economy, you can't beat the machines that carry our name.

It takes more than manufacturing facilities to build the machines Teletype Corporation offers. It also takes commitment. From people who think service is as important as sales. In terminals for computers and point-to-point communications.

That's why we invented a new name for who we are and what we make. The computer-cations people.



INFORMATION RETRIEVAL NUMBER 28

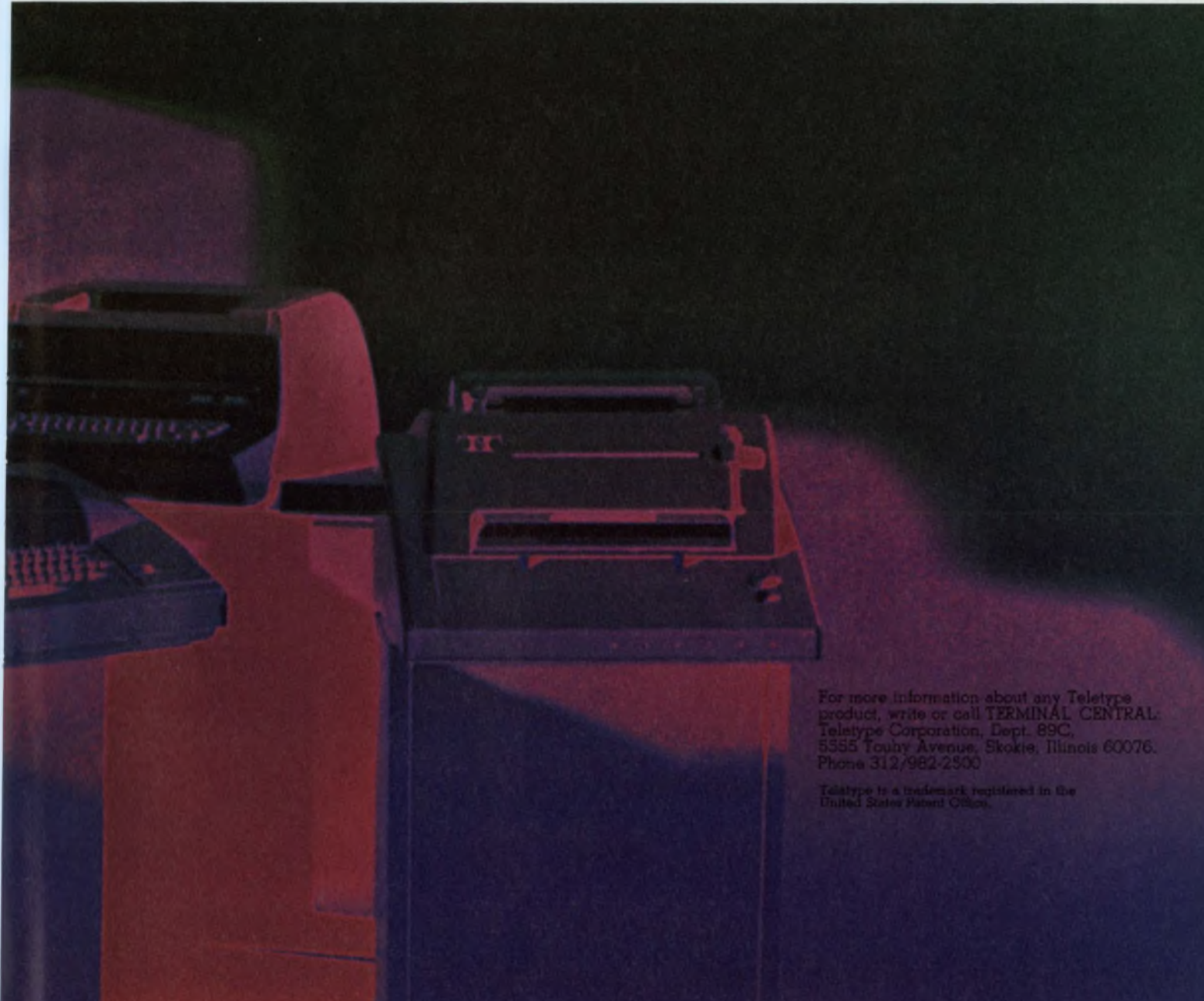

For more information about any Teletype product, write or call **TERMINAL CENTRAL**, Teletype Corporation, Dept. 89C, 5355 Touhy Avenue, Skokie, Illinois 60076. Phone 312/982-2500

Teletype is a trademark registered in the United States Patent Office.

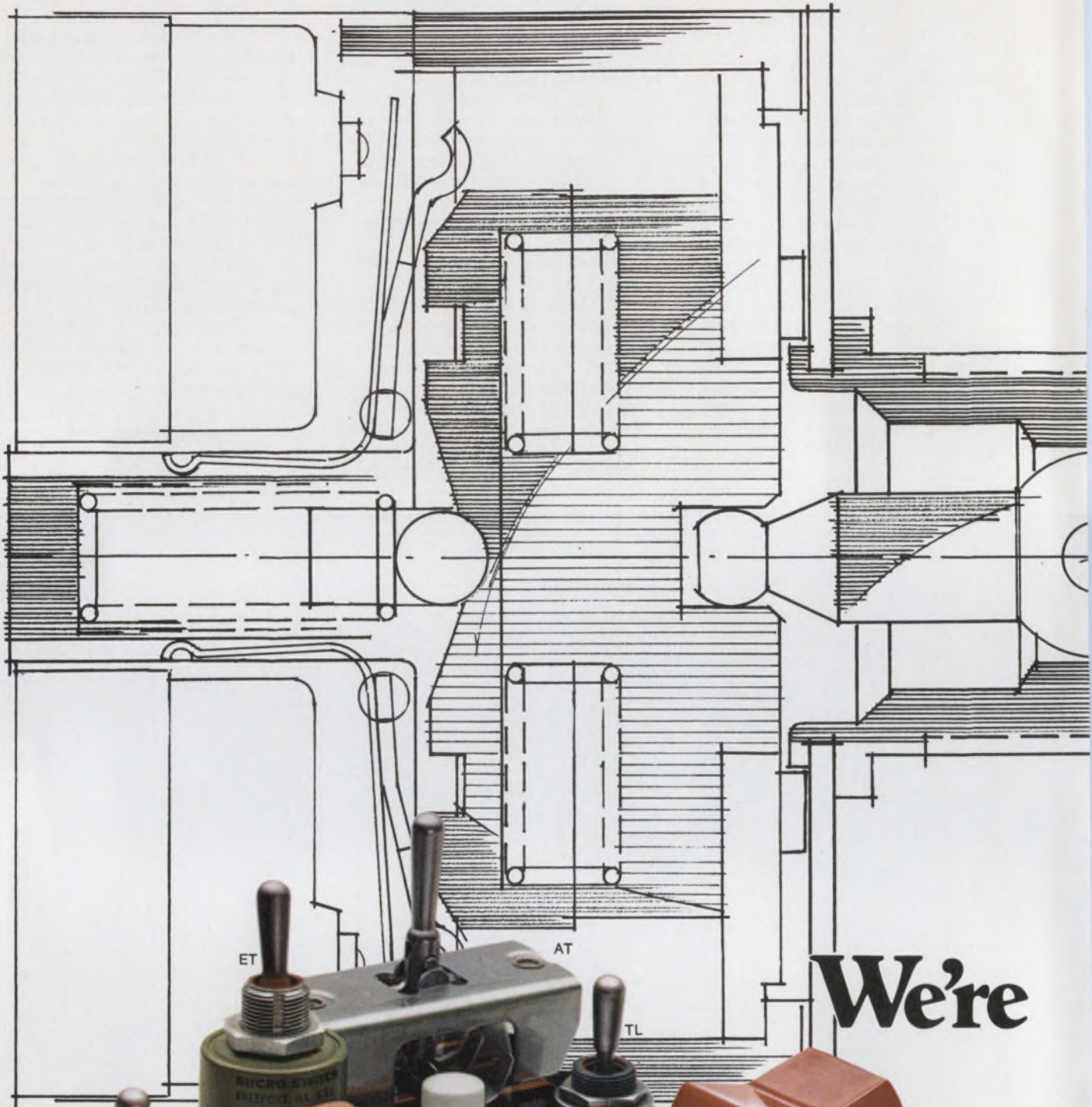

We're



MICRO SWITCH products are available worldwide through Honeywell International.

Think MICRO SWITCH when you're in the market for toggle switches. Because we offer one of the biggest selections in the world. With an almost limitless choice of size, circuitry, capacity and toggle action.

CHOICE NOT CHANCE.

If space is a problem, miniature TW's can provide versatility comparable to many larger switches. When cost is a problem, the new Series 8 features quality construction at a low cost. Standard-size TS toggles are excellent, moderately-priced switches available for both military and commercial use.

For environmental sealing, consider either the magnetically held ET (MIL-E-5272 and MIL-S-3950A) or the tough TL (MIL-S-3950A).

If you're looking for the versatility and styling of pushbuttons, but require toggle circuitry, take a long look at the TP or our new Series 8 rocker switches.

A CHOICE OF ASSEMBLIES, TOO.

AT toggle assemblies use snap-action switches to perform the switching operation. Up to twelve switches can be operated by one toggle. Choose from subminiature, high capacity, as well as sealed types.

There are plenty more. For information on any or all of them, see your MICRO SWITCH Branch Office or Authorized Distributor (Yellow Pages, "Switches, Electric"). Or write for our literature.

MICRO SWITCH makes your ideas work.

MICRO SWITCH

FREEPORT, ILLINOIS 61032
A DIVISION OF HONEYWELL

INFORMATION RETRIEVAL NUMBER 29

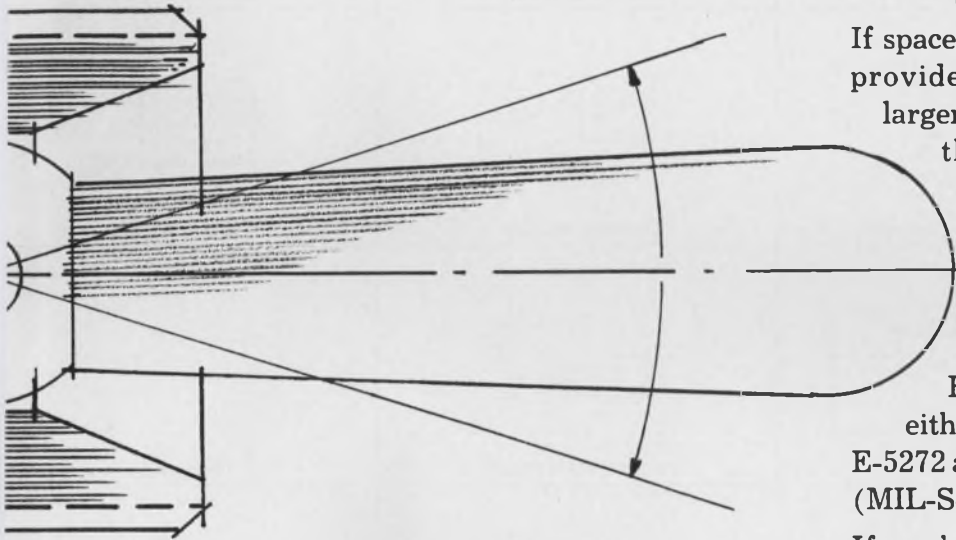

big in toggle switches.

THE SEEMINGLY ENDLESS POSSIBILITIES OF A TRANSISTOR- PRICED QUAD AMP.

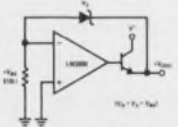
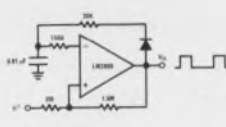
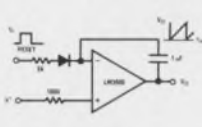
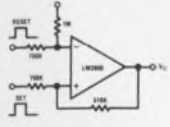
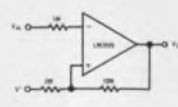
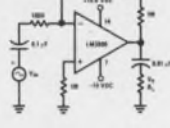
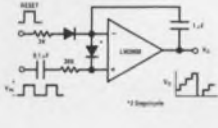
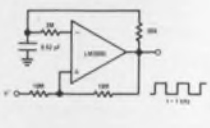
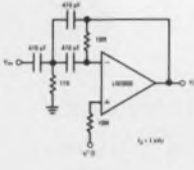
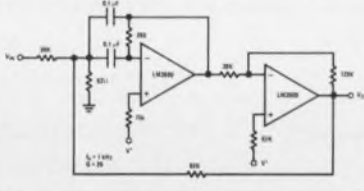
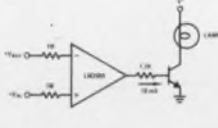
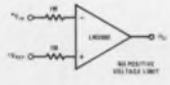
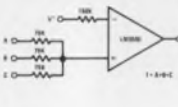
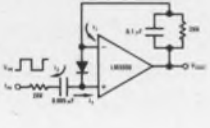
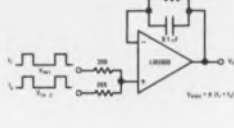
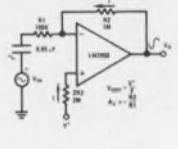
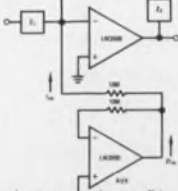
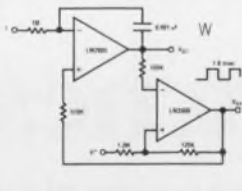
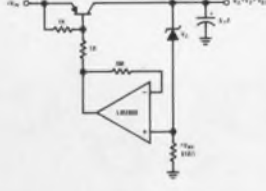
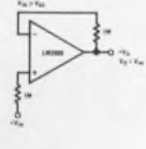
 <p>Voltage Regulator</p>	 <p>Pulse Generator</p>	 <p>Sawtooth Generator</p>	 <p>Bi-Stable Flipflop</p>
 <p>Schmitt Trigger</p>	 <p>Operating with $\pm V_{DC}$ Supply</p>	 <p>Staircase Generator</p>	 <p>Squarewave Oscillator</p>
 <p>Hi-Pass Filter</p>	 <p>Bandpass Filter</p>	 <p>Comparator with Lamp Driver</p>	 <p>Comparator</p>
 <p>"OR" Gate</p>	 <p>Frequency Doubling Tachometer</p>	 <p>Input Summing Tachometer</p>	 <p>Single Supply Biasing</p>
 <p>Reducing Input Bias Current</p>	 <p>Triangle/Square Wave Generator</p>	 <p>Low ($V_{in} - V_0$) Voltage Regulator</p>	 <p>Unity Gain Buffer</p>

When you've got a quad amp like our new LM3900 that works off a single power supply and costs just 75¢ per package in 100 up lots, the applications possibilities are nearly legion. Particularly when four independent, dual-input, internally-compensated amplifiers have been designed into each LM3900 package. (A very reassuring fact if you've been "getting by" with transistors or trying to find a "good, cheap" op amp.)

Naturally, we've got a booklet busting with single-supply applications (a mere sampling of which we've illustrated above).

For your copy of our LM3900 App

Note booklet, simply call (408) 732-5000.

Or write National Semiconductor Corporation, 2900 Semiconductor Drive, Santa Clara, California 95051.

JOIN THE NATIONAL LIBRARY.

At the same time, also ask for your official National Library Card and current-selection bibliography. Your passport to a veritable wealth of Digital, Linear, MOS and Transistor/FET product, application and design information from a single source.

NATIONAL

CUTLER-HAMMER'S BIG NEW LINE OF COMMERCIAL MINIATURES.

Toggles. Pushbuttons. Rockers. Rotaries. Available in a vast array of operator styles, colors, and shapes. Including illuminated pushbuttons and rockers. Many featuring snap-in mounting. And all in stock for fast delivery!

Now the same great quality, service and availability you've come to expect from Cutler-Hammer is available in miniature size—at a competitive price!

Make your selection. Standard or watertight. Single or multiple pole. A wide range of decorator caps, buttons, bezels that extend application flexibility. And for their size, hefty electrical/mechanical ratings.

Before you place that next order, check with your new source for commercial miniature switches—your nearest Cutler-Hammer Sales Office or Authorized Stocking Distributor.



CUTLER-HAMMER

SPECIALTY PRODUCTS DIVISION, Milwaukee, Wis. 53201



Switch
to No.1

More than just switches:
prompt availability,
field help, innovation,
quality assurance, too.

INFORMATION RETRIEVAL NUMBER 30

technology abroad

Cable television is getting under way in Europe with a 12-MHz transmission system supplied to the Belgium Regie des Telegraphes et des Telephones by the Telecommunication Div. of Philips of the Netherlands. The system will use a 1.2-to-4.4-mm coaxial cable. The 6.3-to-12.3-MHz band will be transmitted over distances up to 6000 km. The remaining portion of the frequency band (0.3 to 5.8 MHz) is available for the transmission of 1200 telephone channels. The equipment is composed of a demodulator and an equalizer network for group line delay correction. To this an echo equalizer may be added for eliminating the residual linear distortion after demodulation. The 12-MHz system, says Philips, complies with American standards for a 4000-mile circuit.

CIRCLE NO. 465

A magnetic solid-state component for tuning communication transceivers—the Magnetvariometer VL2—has been produced by AEG-Telefunken in West Germany. The new device is a current-dependent inductance type. Its principal advantage over tuning diodes, which are voltage-dependent capacitors, is that substantially higher power levels can be handled while retaining the small size of the component. The range from 2 to 150 MHz will be covered by 13 versions.

CIRCLE NO. 466

A system that provides rapid alignment of semiconductor slices for X-ray analysis uses a photon-counting technique. Evaluation by conventional X-ray methods is a slow process, particularly if the semiconductor slices are bent or damaged by strains from the processing techniques. Bending results in uneven exposure of X-ray topographs, because the beam strikes the slice under inspection

at the incorrect Bragg angle. Although the crystal can be rotated through a small angle to obtain an even exposure, this procedure increases the exposure time. The new technique—based on a concept originating at Bristol University, England, and developed by Precision Devices and Systems Ltd, Worcester, England—uses a digital photon-counter to detect the correct Bragg angle for the specimen. A control system automatically aligns the crystal slice. This alignment system reduces exposure time by 1/5 to 1/10th that of the conventional process.

CIRCLE NO. 467

A sensitive infrared detector system has evolved from thermistor bolometer research for the European Space Research Organization's satellite program. Developed in Britain by International Research and Development Co., Ltd., the new bolometer has been incorporated in a simple intruder alarm system that will detect—without any optical system—a 1-C temperature change of a foot-square area at a distance of 20 feet. The device uses a thin flake of thermistor material that is mounted on a cross-wire support and encapsulated in a transistor can. The bolometer is used with a simple transistor preamplifier that operates from a 9-V battery.

CIRCLE NO. 468

A remote supervisory control system—290 miles long—is to be built for a petroleum products pipeline. The system will link refineries and marketing terminals. The pipeline will be under the control of Serck 2D1 computers, working with color CRT visual-display units. A hard-wired master station, to be manufactured by Serck Controls, Warwicks, England, will control the refinery data-gathering system and also direct information into the pipeline telemetry system. At the master station, the principal operator interface will be two color display units that will provide information for manual control, while the computers run automatic typewriter logging and process computations.

CIRCLE NO. 469

NEW ZELTEX PRODUCT GUIDE Fall 1972

If your copy of the new Zeltex Product Guide is missing from this issue, just circle the reader service number below.

We'll send you a complete product guide plus any additional data you request on our latest products:

- New Modular Power Supplies—Triple Output ($\pm 15v$, $+5v$)
- New High Speed FET Amplifiers—(3000V/ μs)
- New Current Output DAC's—8,10 Bit (0-2mA)
- New Sample/Hold Amplifiers—(1 μs to 0.01%)

PRODUCT LISTING '72

- D-A Converters
- A-D Converters
- S/H Amplifiers
- Multi-Channel ADC
- FET Amplifiers
- Chopper-Stabilized Amplifiers
- Bipolar Amplifiers
- Instrumentation Amplifiers
- Analog Multipliers
- Power Supplies



DOOPS!

The Heavy-Duty DMM Bounces Back.

Don't worry about missing with the rugged Hickok 3300A Digital Multimeter. Its tough ABS case and shock-mounted components will take plenty of hard bounces.

Besides being tough, this 3½-digit Multimeter is versatile. It measures:

- DC/AC voltage from 100 μ V to 1.5 kV;
- DC/AC current from 100 nA to 2 A;
- Resistance from 100 m Ω to 200 M Ω .

And accuracy is good for 12 months.

The \$435 price includes real portability. The 3300A operates continuously 20 hours off its internal rechargeable battery. You can make measurements while recharging the battery. And the battery's good for 1000 recharges.

Notice the handy form factor — unique among digitals. It's made to carry around or to hang from a convenient spot by its handle.

You'll also like the automatic polarity and decimal point position, the out-of-range indication, 1500 volts off ground operation, and the continuous automatic zeroing. But you expect these from the company which was first with LSI circuits in digital multimeters.

Test it yourself. Call Hickok for a demonstration or for complete specifications.

HICKOK

the value innovator

Instrumentation & Controls Division

The Hickok Electrical Instrument Co.

10514 Dupont Ave. • Cleveland, Ohio 44108

(216) 541-8060

HICKOK

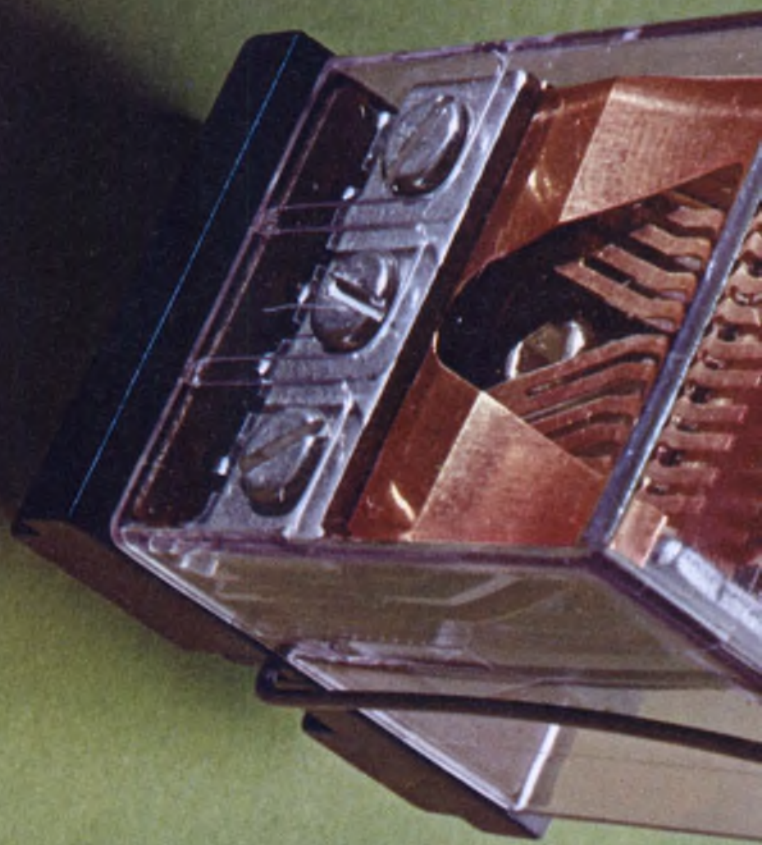

**Reliability is 756 little dents
and one big one.**





The big squeeze.

The heelpiece and frame are the backbone of our Class H relay. The slightest squiggle or shimmy out of either and the whole relay is out of whack.

756 tiny dents on the heelpiece, plus one big one on the frame, make sure this'll never happen.

They're the result of planishing, a big squeeze. Planishing is an extra step we go through in forming the pieces to add strength and stability by relieving surface strain. It also makes the parts extra flat.

This takes the biggest press in the industry and the biggest squeeze. Both exclusively ours.

A different kind of coil.

The heart of a relay is the coil. If ours looks different, it's because we build it around a glass-filled nylon bobbin. It costs us more, but you know how most plastic tends to chip and crack.

Also, moisture and humidity have no effect on glass-filled nylon. No effect means no malfunctions for you to worry about. No current leakage, either.

The coil is wound on the bobbin automatically. No chance of human error here.

We didn't forget the solder.

We use a solderless splice. That's because solderless splice connections are sure-fire protection against the coil going open under temperature changes, stress, or electrolysis.

A solderless splice is more expensive to produce, so it's usually found only on the most reliable relays. AE is the only manufacturer to use this method on all of its relays.

Finally, we wrap the whole assembly with extra-tough, mylar-laminated material. A cover is not really necessary here; but why take chances?



Springs and other things.

We don't take any chances with our contact assembly, either. Even things like the pileup insulators (those little black rectangles) get special attention. We precision mold them. Other manufacturers just punch them out.

It makes a lot of difference. They're stronger, for one thing; and because they're molded, there's no chance of the insulators absorbing even a droplet of harmful moisture. Finally, they'll withstand the high temperatures that knock out punched insulators.



Then there are the contact springs. Ours are phosphor-bronze. Others use nickel-silver. Our lab gave this stuff a thorough check, but found nickel-silver too prone to stress-corrosion. Atmospheric conditions which cause tarnish and ultimately stress corrosion have almost no effect on phosphor-bronze.



Two are better than one.

Our next step was to make sure our contacts give a completed circuit every time. So we bifurcate both the make and break springs.

Each contact works independently to give you a completed circuit every time.

Edge-tinned contact springs save you the job of solder tinning them later. Also, edge-tinning enables you to safely use the same relay with sockets or mounted directly to a printed circuit board. A simple thing, but it takes a big chunk out of the inventory you have to stock.

Etc. Etc. Etc.

There's a lot more to tell about what makes our Class H relay reliable. Now we're waiting to hear from you. GTE Automatic Electric, Industrial Sales Division, Northlake, Illinois 60164.

GTE AUTOMATIC ELECTRIC

VACTEC PHOTOCELLS

boiled to perfection

Heat, water, steam, or a combination of all three, can't penetrate Vactec's positive hermetic seals. Even the passivated plastic types are exceptionally stable. Vactec Photocells not only endure boiling water temperatures (100° C), but also other environmental extremes down to liquid nitrogen cold (-196° C).

Long term moisture like 500 to 5000 hours in a humidity chamber can be even more destructive than boiling. If you put Vactec to this test, be sure to include some competitive cells for comparison.

You simply can't buy a better photocell *anywhere*, and Vactec is competitive with import prices because of automated processing, assembling, and testing. Take advantage of Vactec engineering, research, and manufacturing in the heart of America. Because Vactec has 249 different types of cells in stock, we can ship before your order reaches an overseas supplier. Included is a complete line of visible detectors; photoconductors (CdS and CdSe); photovoltaic cells (Se and Si); couplers of LED's or lamps and photoconductors called Vactrols. Vactec also has a photometer which measures from .0002 to 10,000 fc, for as little as \$300.00.



VACTEC, INC.

2423 Northline Industrial Blvd.
Maryland Heights, Mo. 63043
Phone (314) 872-8300



washington report

Defense: Democratic style or Republican?

What is going to happen the day after the new Administration takes over? Both Democratic and Republican camps are busy making plans for what they will do for national defense if they find themselves at the nation's helm Jan. 20.

Robert Sherman, defense staff spokesman for Sen. George McGovern, says the reductions in the defense budget proposed by the Senator would be enacted as soon as possible, should he be elected. "The \$30-billion reduction by fiscal year 1975 would be phased in at about \$10-billion per year," Sherman told ELECTRONIC DESIGN. This would mean immediate cuts in the remainder of the 1973 budget, a DOD budget for 1974 of approximately \$65-billion, leading to the estimated \$54.8-billion for fiscal 1975.

"Our immediate job would be to prepare each program area for conversion to civilian programs," Sherman said. This means, he explained, that an effort would be made to transfer scientific and engineering forces employed on such programs as the B-1 bomber, the F-14 and F-15 fighters, and the Safeguard ABM, which would be the first targets for cancellation, to new technology programs, such as air traffic control, pollution control and the like. Some defense programs such as the light-weight fighter, might be accelerated if deemed the best solution to the fighter problem. In any case, McGovern would submit a new fiscal 1974 budget document to Congress ensuring that his program for that year would be considered.

The Nixon administration is also hard at work preparing budget estimates for its own fiscal 1974 plans, which will be sent to Congress regardless of the outcome of the election. That budget is shaping up at around \$85-billion, with large expenditures for the Trident submarine, B-1, F-14 and F-15 aircraft programs.

Congressional conferees recommend some defense cuts

House and Senate Armed Services Committee conferees have agreed to give the Army \$33.5-million of its \$40-million request to start work on development of a lighter, less complex replacement for the cancelled Cheyenne helicopter program.

In other actions the conferees told the Navy it must require Grumman Aerospace to build no less than 48 F-14 aircraft for the procurement money provided in the \$732.7-million funding. It approved the Air Force's AX aircraft prototype program and earmarked \$48-million for it. It approved the sea control ship, gave the Defense Dept. \$40-million instead of \$60-million for site defense of Minuteman, cut in half two

\$20-million requests—one for ICBM reentry research and the other for a sub-launched cruise missile, cut Trident R&D by \$20-million, provided \$127-million for procurement and \$28.7-million for R&D for four, instead of six, electronics-laden, advanced Airborne National Command Post aircraft.

Final House and Senate approval of the conferees' action is expected rapidly, followed by a report from the House Appropriations Committee on the actual spending bill.

NASA warns industry to cut costs

The nation's space program will be in "deep trouble" if something is not done about bringing costs down, and soon, says National Aeronautics and Space Administration Deputy Administrator George M. Low.

Low gives these tips to design engineers:

Avoid reinventing the wheel, use the best available from other programs; standardize; design for low cost by involving production engineers in the earliest stages of design; design to minimize testing and paperwork, taking advantage of the higher weight and volume that can now be carried; trade features for costs.

"This works in successful firms in the commercial world, and there is no reason why it shouldn't work on defense and NASA programs," Low says.

Senate committee to take harder look at spending

Sen. William Proxmire (D-Wis.), longtime gadfly to big spenders on defense and space programs, says he will open up hearings to outside witnesses to get "constructive" testimony before his subcommittee. Proxmire recently was given the chairmanship of a Senate subcommittee with the unwieldy name of Housing Urban Development-Space-Science-Veterans Appropriations. Here he will oversee the spending bills for NASA, the National Science Foundation and other agencies.

Capital Capsules: The Navy has awarded the final contract on the Omega navigation system to Northrop Corp.'s Electronic Div. All Navy ships, except ballistic missile submarines, will have the vlf navigation aid. . . . NSF is funding experimental TV courses in engineering through the University of Southern California. Participating are the Aerospace Corp., Hughes Aircraft and Air Force's Space and Missile Systems Organization. . . . Data from the defunct supersonic transport (SST) program has been catalogued and is available for dissemination by the National Technical Information Service of the Dept. of Commerce. . . . The National Science Foundation is looking for design studies for a national computer network that will enable scientists and engineers to have access to computerized research facilities and national data banks throughout the country. . . . An unprecedented \$1-billion bill aimed at creating a Civil Science Service Administration to put science and technology to work on social problems stands little chance of final Congressional approval this year despite a Senate passage of 70-8. The National Science Policy Act, sponsored by Edward Kennedy (D-Mass.), will not be taken up by the House this session, Science Committee sources say. This means it must be reintroduced and passed by the Senate in a new Congress next year.

Centralab hybrids... in line with your design requirements



Write
Centralab
for
Bulletin
No. 1429H3

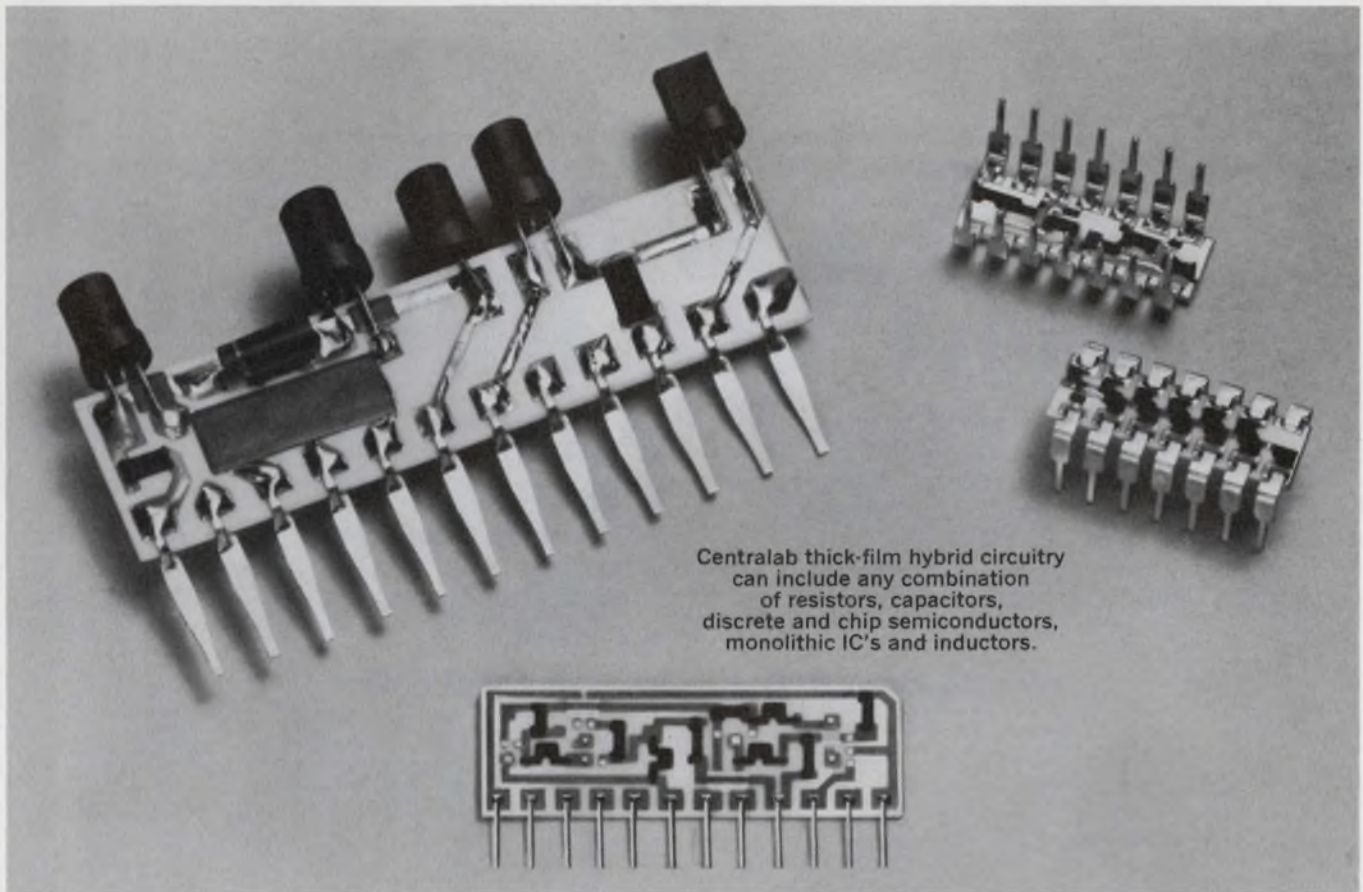

Centralab thick-film hybrid circuitry can include any combination of resistors, capacitors, discrete and chip semiconductors, monolithic IC's and inductors.

Come to us for thick-film capability

When you come to Centralab for custom thick-film hybrid circuits you have the assurance of over 27 years of experience in design and production. As the pioneer in hybrids we have developed over 50,000 custom designs. Today, no other manufacturer can offer you as much flexibility—in packaging, in circuit function and in reliability.

No other 300 mil. DIP, for example, can give you higher package power—up to 3 watts per package. Centralab offers you high density networks with as many as 28 resistors in a 16 lead DIP, 24 in 14 lead configurations. Compare resistor tolerance, as low as .5% and TC of 0 ± 100 ppm and you'll see that our kind of customized circuitry is unmatched anywhere.

Chip hybrids that combine fired-on resistors, capacitors and interconnections with diodes, transistors and IC's

are small in size but big in reliability.

Discrete networks were our first hybrids—in 1945. Our expertise is your assurance you'll get circuits that save space and reduce costs of assembly and provide improved reliability as well.

Custom designs meet the most demanding specifications such as complex functions or power drivers.

Our specialized designs include resistor values to 1 gigohm, voltages to 50 kV and resistor value ranges from 10 ohms per square to 10 megohms per square.

If you've a special application for hybrids, call Centralab. We have the capability to give you the performance and reliability that meet your specs—with delivery that meets your requirements. Write or call, A. R. Wartchow, Marketing Manager, Electroceramic Products, Centralab.

GET CENTRALAB THE "IN" LINE FOR YOUR DESIGN

Hybrid Microcircuits
Pushbutton & Rotary Switches
Capacitors
Potentiometers
Technical Ceramics
Ceramic Packages
Semiconductor Devices



CENTRALAB

Electronics Division
GLOBE-UNION INC.

5757 NORTH GREEN BAY AVENUE
MILWAUKEE, WISCONSIN 53201



P-channel
J FET



N-channel
J FET

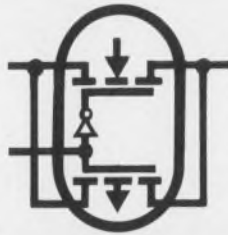

CMOS
FETs



P-channel
MOS FET



N-channel
MOS FET

Since 1962, Siliconix has evolved FET technology and applied it to a complete line of singles, duals, arrays, and IC's. So what's new?

Switch 16 channels with CMOS DG506.

Here is a single-pole 16-channel multiplexer using paired CMOS FETs, with drivers controlled by a 4-bit binary word input plus an Enable-Inhibit input — all on one chip! Check the functional diagram and then refer to the decode truth table to see what binary word input selects which switch.

The DG506 features:

- ± 15 V Analog signal range
- Break-before-make switches
- ON resistance < 500 ohms
- TTL, DTL, and CMOS direct control interface
- 36 mW standby power

DG506 Function Diagram

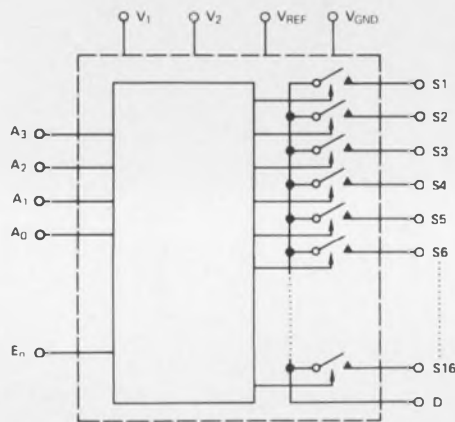

Decode Truth Table

A ₃	A ₂	A ₁	A ₀	E _n	ON SWITCH
X	X	X	X	0	NONE
0	0	0	0	1	1
0	0	0	1	1	2
0	0	1	0	1	3
0	0	1	1	1	4
0	1	0	0	1	5
0	1	0	1	1	6
0	1	1	0	1	7
0	1	1	1	1	8
1	0	0	0	1	9
1	0	0	1	1	10
1	0	1	0	1	11
1	0	1	1	1	12
1	1	0	0	1	13
1	1	0	1	1	14
1	1	1	0	1	15
1	1	1	1	1	16

Our catalog line of drivers and switches will cover most applications. If your switching problems are unique — and whose aren't — call our applications people. They're eager to help. For complete information,

write for data

Applications Engineering: (408) 246-8905



Siliconix incorporated

2201 Laurelwood Road, Santa Clara, California 95054

INFORMATION RETRIEVAL NUMBER 37

We communicate. Or do we?

I really blew one. In the May 11th issue I wrote an editorial, "It's a great idea for the other guy." And though I'm supposed to be good at communications, I misled lots of readers.

My intent was to show that too many of us readily embrace good ideas—for others. We favor better education, or better highways or better housing as long as we don't have to pay for them. If a good idea involves some sacrifice, we begin to back off.

The example I chose for my editorial was the metric system. I wrote that I heartily favored the metric system but (and here I tried to show how we balk when an idea may involve a sacrifice), adoption of metric units might make it necessary for me to abandon some familiar units of typography.

The response was quick, overwhelming and, in one way, unpleasant. All of it—every single letter and every single comment on the Information Retrieval Cards—favored the metric system. That pleased me. What I found unpleasant was the fact that almost everyone thought I was arguing *against* conversion to metric. And I thought I could communicate.

That response raised an important question in my mind—a question I'm sure has been posed by many a spouse: "Are we really communicating when we think we are? Are we getting through with the message we intend?"

How many bad design decisions have been made because two people thought they were communicating when they weren't? A fellow at the next bench asks about your experience with a particular component or with a particular vendor. You give an endorsement with some minor reservations. And he mistakes your reservation for a condemnation—and acts on it. That's a simple case.

What happens when a problem is more complex and the conversation more lengthy? Does the length of the conversation add clarity? Or reduce it?

People who specialize in semantics have long known about the weaknesses in our communications. But it's been said that only semanticists understand semanticists.

So, until we all become experts in the art, it may be necessary to develop shortcuts. Perhaps we need to test our listeners to see if we're making our points. Perhaps we'll have to punctuate our sentences with pauses filled with: "Hey Jack. What did I just say?"

That sounds clumsy. But is there a better way? Ideas anyone?



GEORGE ROSTKY
Editor

WESCON, 1972: A NEW BEGINNING



Two innovations feature this year's Western Electronic Show and Convention (Wescon) in Los Angeles. For the first time, the four-day program is being held in September instead of August (Sept. 19-22). Also, it's in the new Los Angeles Convention Center—a building covering eight city blocks in the downtown area. In fact, for the first time, virtually all Wescon conferences, sessions, exhibits, social events and activities are being held under one roof.

The new dates and site and the upturn in the economy are expected to boost attendance to over 25,000, compared with 24,755 in San Francisco last year. The number of booths is expected to

match the 536 of last year. Nevertheless these figures are a far cry from the 989 booths and 36,800 attendees at the last Wescon held in Los Angeles in 1970.

The technical program consists of 28 sessions, which, according to Wescon's management, "aims at offering solutions to real-world problems." Among the more important papers are ones in Session 2, which will take up "Problems and Potentials of ICs in Consumer Electronics." Here, the design and selection of ICs and the development of new circuits for new mass markets are being explored, with emphasis on ICs for home-entertainment systems and for such products as minicalculators and wristwatches.

Session 13 on "Programmable Calculators: Systems Components" provides a guideline to the design of calculator-based systems. Papers are showing how today's complex programmable calculator has narrowed the price and performance gap between calculators and minicomputers.

Another session—"Electronics for Automotive Safety and Control," Session 9—shows the almost explosive rate at which electronic systems for automobiles are expected to grow in the next five years. There are predictions that sales of electronic fuel and ignition-management systems, plus anti-skid braking, could alone reach \$1-billion within the decade.

Among the 1972 Wescon exhibits, the featured instruments include the "fastest" storage scope and a low-priced programmable ROM tester. Subassembly products include the "fastest" 12-bit modular d/a converter and a dc-to-ac converter with variable voltage outputs.

Once again, the major semiconductor manufacturers are not represented at the show.



Design trends in major engineering areas as reflected in the technical papers

Microelectronics	76
Automotive Electronics	78
Medical Electronics	80
Calculators and Computers	82
Management and Marketing	83

Outstanding new products

Instrumentation	90
Modules & Subassemblies	98
Data Processing	104
Packaging & Materials	108
ICs & Semiconductors	112
Microwaves & Lasers	112
Components	116

WESCON '72 The technical sessions

MICROELECTRONICS

Consumer ICs busting out all over, and semi memories advance, too

In two diverse areas—consumer electronics and semiconductor memories—the outlook is sunny for the microelectronics industry.

Microelectronics for consumer equipment is emerging as a powerful weapon in the American offensive to recapture electronics markets lost to foreign competition.

In semiconductor memories, microelectronics is on the verge of invading the last stronghold of magnetic memories—applications where it was necessary to store electrically alterable data without continuous application of power. Now electrically alterable nonvolatile semiconductor memories are in production in both systems and component houses.

The significance of the two trends is outlined in two sessions at Wescon: Session 2, "Present Problems and Future Potential of ICs in Consumer Electronics," and Session 4, "Electrically Alterable Nonvolatile Semiconductor Memories."

Joseph Obot of National Semiconductor, Inc., Santa Clara, Calif., says in a Session 2 paper on "Consumer ICs—Tomorrow's Promised Land": "While our dominant position in the electronics industry has been lost to the low-labor-cost areas of the Far East, consumer ICs hold the key to recapturing our position."

Growth areas, he points out, are the entertainment, automotive, calculator, camera and appliance segments of the consumer market, with growth limited only by the inventiveness of the industry.

The application of integrated circuits in these areas can minimize, or even eliminate, the need for hand assembly of discrete components on boards—an area in which the U.S. is not able to compete with foreigners because of labor costs. As an example, Obot cites the small-calculator market.

"Last year," he notes the Japanese controlled 70% of the U.S. market." But the advent of the American one-chip calculator has reduced the labor to 15 minutes a machine. Obot concludes that the lower labor costs of the Japanese have, in this case, been neutralized.

As a result, he says, whereas last year the Japanese controlled 70% of the market, this year



The IC on a chroma board for color television receivers is checked out by a National Semiconductor technician.

they will get only about 30%.

"One of the largest growth areas for the electronics industry will occur within the automotive segment of the consumer market," Obot comments in his paper. "Estimates ranging from \$1-billion to \$5-billion annually by 1980 for automotive electronic products have been made," he says. "But this depends on the speed with which Detroit puts electronic controls into the cars, as well as the pressure of Federal regulations imposed by the Dept. of Transportation."

Obot also notes that ICs in cameras—a growing market—are rapidly taking over the electromechanical operations still present in most of today's movie and still equipment.

Ion implantation cutting costs

Not only are labor costs cut with ICs, Obot points out, but reliability and performance can also be improved. And the use of ICs in modular designs minimizes maintenance costs in television

sets (see "Focus on Consumer ICs," ED 16, Aug. 3, 1972, p. 42).

A large variety of ICs are available for applications in television receivers, AM/FM radios and stereo players. However, essentially all are produced by the conventional methods of silicon wafer processing. To improve performance and to reduce costs, ion implantation is beginning to come into use, reports Ronald W. Lutz of the Sprague Semiconductor Div., Worcester, Mass. As one of the authors of a Session 2 paper entitled "New Developments in Consumer Integrated Circuits," he says:

"In conventional IC designs having resistors of fairly high value—from 2 to 5 k Ω per square—the use of ion implantation can significantly reduce the chip area, improve yields and consequently lower the device cost."

This is particularly true, he notes, where the chip size is greater than 5000 mil. While most chip-size reductions are 20 to 30%, in some cases the size can be further reduced by as much as 50%, he says.

A somewhat different but still developmental implantation—a tuned MOSFET rf amplifier with an ion-implanted varactor—is described in the same paper.

"Ion implantation," says J. D. MacDougall of Sprague, another co-author of the paper, "has been used extensively for manufacturing depletion and enhancement-mode devices on a single chip."

In a circuit that used p-channel-enhancement, dual-gate MOS devices, special techniques were employed at Sprague to obtain varactor diodes by ion implantation, MacDougall reports. The dual-gate MOS devices typically exhibit feedback capacitance of 0.01 pF. A single-stage, varactor-tuned rf amplifier, fabricated on a 40 \times 60-mil chip, gave a power gain of 30 dB at 70 MHz, with a noise figure of 3 dB, he notes.

Digital IC applications expand

While linear ICs dominate the consumer electronics field, the applications of digital ICs—in particular, CMOS—are growing. These low-power circuits are being incorporated in wristwatches and clocks, calculators and, most recently, FM and TV digital tuners and pocket pagers.

Don R. Carley of the RCA Solid State Div., Somerville, N. J., author of a Session 2 paper on "An Engineering Assessment of Digital Integrated Circuits for Consumer Applications," says that CMOS has these advantages in consumer applications: wide operating voltage range, low power drain, relatively high noise immunity and the need for only a simple power supply.

As an example, Carley points to the RCA

CD4000 family, featuring an operating range of 3 to 15 V. This range, he points out, makes it useful in automotive applications.

But more important than the supply-voltage operating range is the low quiescent power drain of CMOS devices. For LSI circuits of 1000 to 2000 active devices, Carley explains, typical leakage currents are in the nanoampere range, with a maximum of 1 μ A.

During switching, Carley adds, the power dissipated by the transistor is usually that required to charge the capacitance of the following stage. This power is equal to the product of the capacitance, the square of the voltage and the operating frequency. Typical dynamic power dissipation at 1 MHz is on the order of 1 mW.

Consumer applications, Carley says, generally have high electrical noise. The typical CMOS inverter stage has high dc noise immunity, because the output does not switch until the input voltage approaches half that of the supply voltage. This mid-voltage switching point is typical of CMOS.

The switching voltage point remains relatively insensitive to variations in ambient temperatures between -55 and 125 C.

RCA's CMOS devices, with normal production tolerances, have a noise immunity that is guaranteed to be at least 30% of the supply voltage. The dynamic (ac) noise immunity increases as the input pulse width of the noise becomes less than the propagation delay, Carley points out. Since typical CMOS circuits have switching speeds of about 50 ns at 5 V, they are not affected by high-speed noise pulses.

An important feature that Carley points to is the unusually low noise generated by CMOS switching circuits at narrow bandwidths. A comparison he gives is that of standard TTL circuits that generate noise transients of 40 to 60 mA, with a harmonic bandwidth of 20 to 200 MHz. Noise transients of but 1 to 3 mA, and with a bandwidth of only 3 to 30 MHz, are produced by CMOS circuits operating from a 10-V supply.

In a practical example, Carley points out that the 3-V circuits in a pocket-paging receiver, CMOS address-select logic produces transients of less than 100 μ A, with the harmonic spectrum lying between 50 to 500 kHz.

Semiconductor memories close 'gap'

To a large extent, the growth of the microelectronics industry has been paced by the demands of computer technology. Semiconductor memories—with advantages in speed, cost density and reliability—have been steadily replacing magnetic memories, except in that one area where it was necessary to store electrically alterable data without continuous application of pow-

er. Andrew C. Tickle of the Nitron Corp., Sunnyvale, Calif., notes in Session 4 that the new electrically alterable permanent-data semiconductor memories have two common features: They use MOS transistors that have been fabricated to allow a charge to be stored in the MOS dielectric as a "permanent" state. And the fabrication process provides a device with a nonlinear conduction medium, such as injection into or tunneling through a dielectric layer. Both characteristics allow the stored charge to be transferred through the layer, but only when a large voltage is applied.

The advantages of nonvolatile semiconductor memories, Tickle says, include these:

- They can retain data during power interruption.
- For battery-operated and portable systems, power drain is reduced, since the memory can be turned off when the system is not in use.
- For very large systems, nonvolatile storage reduces power requirements and minimizes heating problems, since power is consumed only in the section of the memory being addressed.

The most commonly used MOS storage transistor, Tickle says, is the metal nitride-oxide silicon (MNOS) type. It has a thin layer of oxide of some 20 to 60 Å between a silicon-nitride-gate dielectric and the substrate.

Because the dielectric constant of the silicon nitride is about twice that of the thin oxide layer, the applied field is doubled by the oxide. This field enhancement, Tickle explains, plus the thinness of the layer, permits tunneling of the charge to the oxide conduction band once the proper electric field magnitude has been reached.

The charge is then stored in traps at or near the nitride-oxide interface. While several years of real-time storage have already been demonstrated, Tickle says that data storage of 10 years may be reasonably expected.

Another type of semiconductor alterable nonvolatile memory is an array of floating gate, avalanche-injection MOS transistors. Produced by Intel Corp., Santa Clara, Calif., these have a floating silicon gate buried within their structure. As Harold V. Feeney Jr. of Intel explains it in a paper on "Minicomputer Applications of Electrically Alterable ROMs," when the drain diffusion is in the avalanche breakdown condition, electrons are trapped in the gate. For p-channel devices, this causes the transistor to be held in a permanently ON condition.

This device is not strictly electrically resettable, since there is no electrical method of removing the charge. To clear it, the memory is exposed to either X-rays or the radiation from an ultraviolet lamp. ■■

AUTOMOTIVE ELECTRONICS

If designers build well and slash costs, this market will go vroom!

One of the fastest-growing sectors of the electronics market in the 1970s is electronics for automotive safety and control—a subject that gets a thorough review in Session 9.

"Today's \$200-million-a-year sales for automotive electronics will increase 25% a year through 1980," says the session's organizer and chairman, R. R. Hoge, director of automotive electronics business for the Bendix Corp., Southfield, Mich. By 1980, he adds, "sales of electronic fuel and ignition-management systems, plus anti-skid braking, are expected to exceed \$1-billion alone."

For the engineer unfamiliar with this relatively new field, the session describes the harsh environment for which devices and systems must be designed. It outlines diagnostic equipment for auto maintenance. And two engineers tell how they designed their products—an electronic fuel-injection system and an anti-lock braking device.

The session concentrates on electronics that are, or are expected to be, an integral part of

the automobile: engine-emission controls, voltage and current regulators, headlamp controls, anti-skid braking, radar braking, automatic air-conditioner controls, solid-state displays, driver sobriety testers and on-board diagnostic sensors and circuits. It excludes electronics for entertainment, such as radios, tape recorders and communications.

"Electronic Fuel Injection—A Fuel Management Method Employing Optimal Electronic Contouring" is described by Todd L. Rachel, manager of engineering at the Bendix Corp.'s EFI Div. in Troy, Mich. (Bendix has an entire division devoted to electronic fuel injectors in Troy, Mich.) Multivariable input-output transfer functions were developed for the engine by Bendix with custom sensors and circuits. Stringent tolerances were required for the controls because of the wide range of environmental variables in battery voltage, ambient temperature, conducted transients and radiated fields.

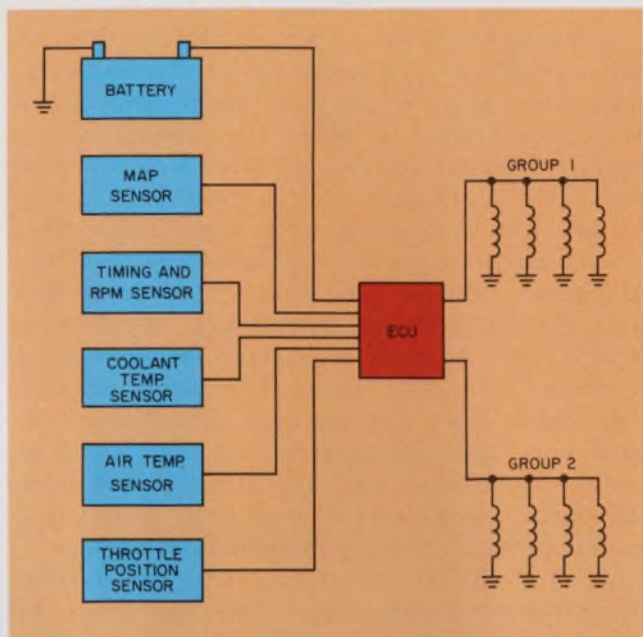

Sensors measure the engine parameters in this programmed control system and send the data on to a central electronic control unit which converts the multi-variable input information into a pulse which fires the injectors.

The subsystem works as follows: Sensors are attached to the most important engine parameters, and the readings are fed into an electronic control unit, which converts the information to a pulse. Through power amplifiers, the pulse fires the injectors for the proper duration and at the proper time with respect to the cylinder firing sequence.

Basically, Hoge explains, the electronic control unit calculates fuel requirements for the engine for all possible combinations of input variables. The electronic fuel injector controls accurately the air-fuel ratio that is pumped into the cylinders.

The "environmental problems" of vehicular electronics are "so formidable that the widespread use of electronics in automobiles is at least a decade behind what it might have been," says William J. Walsh, electronics group supervisor, Eaton Research Center, Southfield, Mich.

Besides severe temperature cycling, wide voltage variations and long operating life, Walsh includes two "environmental" factors usually not thought of in that light: "extreme cost sensitivity and servicing difficulties."

Pennies count when you talk of tens of millions of cars and trucks, Walsh points out. Also, the electronics industry is competing with non-electronic technologies. For 75 years Detroit has been figuring out nonelectronic ways of doing things, he says, and considerable ingenuity must be exercised to compete with "temperature-compensated gas gauges that cost less than 25 cents."

Coupled with the cost problem is one of servicing electronic equipment. Walsh strongly advises

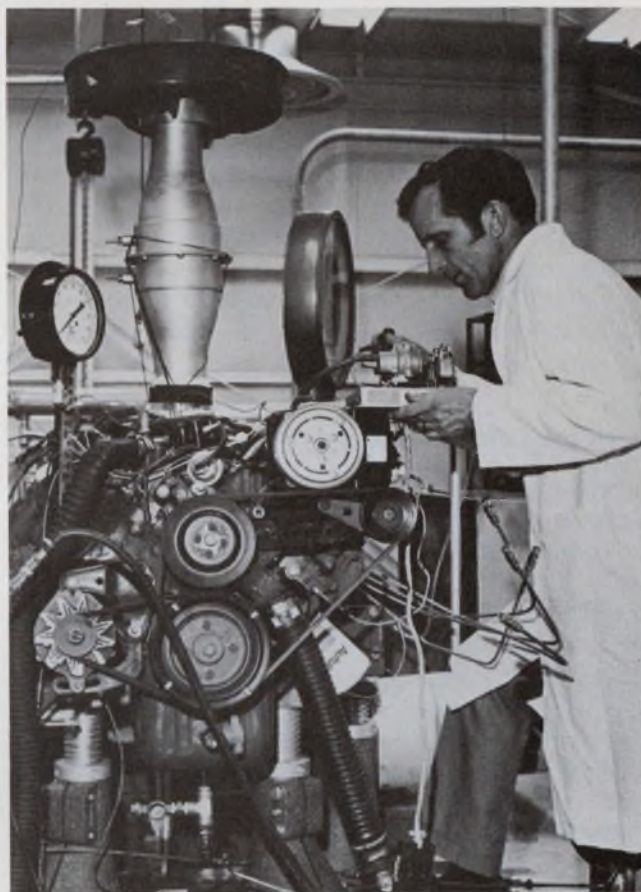

Electronic fuel injection system gets last minute test on car engine at Bendix Research Laboratories.

that present component capabilities be stretched and that new design philosophies be found.

The first technical hurdle, he says, is that of variable voltages: They run from the nominal 12-V battery supply (which may range from 9 to 16 V) to multi-sourced high-voltage transients— ± 600 V.

"As a design starting point," Walsh says, "it's a good rule of thumb that a viable circuit must be able to withstand repeatedly ± 100 V for up to 5 ms and 600 V for 50 μ s."

"At present achieving the required transient protection must be accomplished with some combination of two less-than-ideal alternatives: time smearing of the transient waveform or zener absorption."

Needed, Walsh says, is a device similar to a thyristor in energy-absorbing capabilities with a breakdown voltage of around 25 V.

To overcome damage caused by extremes of temperature, Walsh gives some ground rules:

- Where there are high temperatures, consider component power dissipation carefully. In particular, the use of plastic power transistors must generally be ruled out.
 - With thermal cycling stresses—the major cause of component failure—test each component carefully for quick, extreme temperature changes.
- In other areas, Walsh points out, the designer

must beware of solutions to problems that simply create more problems. For example, corrosion and moisture are best handled by encapsulating the module with an epoxy. And, as is known, potting protects components against the hazards of vibrations. But the use of an epoxy potting also results in poor reliability and high cost.

The long life of a car or truck—often seven years, operating as much as 20,000 hours—calls for extremely long MTBFs for electronic components.

Electronics for the highway

Session 20 moves out of the car and onto the highway. In a paper on "Synchronous Longitudinal Control and Automated Ground Transport—Some Practical Limitations," James G. Bender and Robert E. Fenton describe a hands-off approach to motoring. Both engineers are members of the Highway Research Group, Dept. of Electrical Engineering, at Ohio State University in Columbus. They favor the use of a position-error reference signal to keep cars in a "conveyor belt type" slot on the highway.

"A Microwave System for Distress Signaling by Disabled Motorists" is described by L. Schiff and H. Staras, engineers at RCA Laboratories in Princeton, N.J. Staras is the session organizer and chairman. Their system is designed so that when a motorist is in trouble, he puts his transceiver in the transmit mode by pressing one of a number of buttons. A canned digital message is emitted, over and over, by an rf signal of very low power—capable of being received at a maxi-

imum range of 100 feet. Passing vehicles that are not transmitting, and hence have their transceivers in the receive mode, pick up the transmitted message and store it. When the passing vehicle nears a roadside interrogator, it feeds the message to the interrogator station's receiver. This information is then passed on to a central station.

A major headache for car makers is described in a paper entitled "Anticipatory Crash Sensors for a Passive Restraint Deployment," by John B. Hopkins and F. Ross Holstrom, Transportation Systems Center, U.S. Dept. of Transportation in Cambridge, Mass. The solution offered is an X-band radar that has already been built and subjected to extensive analysis. Besides describing the radar, the authors discuss cost, microwave-radiation hazard and intervehicle interference.

When used in conjunction with an airbag, which can be deployed in 50 ms, the radar requires very little warning distance—about 0.5 to 1 meter when the car is traveling at 60 mph, the authors say. The radar is a 10-GHz bistatic cw homodyne Doppler in which position discrimination (ranging) is achieved through overlap of the antenna patterns. A Gunn diode oscillator is used, with 25-degree standard gain horns or planar antennas employed for both transmitting and receiving.

An approaching target (obstacle) in the region of the beam overlap is indicated by a Doppler output from the mixer. The Doppler frequency is 31.4 Hz/mph.

The retail cost of such a radar to the customer may eventually be as low as \$50 to \$75, the authors say. ■■

MEDICAL ELECTRONICS

A new title and job is emerging in a growing field: bioengineer

For years suggestions have been made that the electronics equipment of the aerospace industry be applied to the biomedical field. Albert M. Cook, coordinator of bioengineering for the California State University's Dept. of Electrical Engineering in Sacramento, proposes a transfer of aerospace engineers, rather than equipment. He outlines his views in Session 16, "Biomedical Engineering: Educating Engineers for Careers in Health Care Delivery."

In a related session—"Needs and Trends in Medical Electronics 1972," Session 12—Malcolm G. Ridgway, assistant director of the Biomedical Engineering Institute, Los Angeles, notes that medical electronics is undergoing rapid growth and that there will be many opportunities for

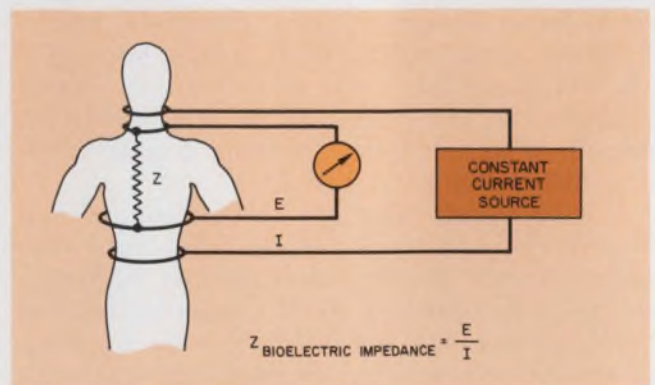

Bioelectric impedance monitoring in this illustration requires four electrodes. Two supply a known constant current, while the other two determine the voltage drop across the body's volume impedance.

medical engineers in hospitals.

Cook, in a paper on "Bioengineering Training for Aerospace Engineers," contends that the application of aerospace equipment to the biomedical field has failed, on the whole, to yield large returns. Only infrequently, he indicates, has it been possible to use the original equipment without adaptation. A better approach, he says, is to hire former aerospace engineers, present the concept for biomedical equipment to them and let them come up with the solution. They may use parts of existing aerospace equipment; they may end up designing new equipment. But, in any case, they are best qualified to deal with the problem, Cook argues.

Aerospace engineers generally require only basic training in bioengineering and current medical problems to apply some aerospace device or analysis technique that they used to biomedicine, Cook says. He points out areas where bioengineers will be needed: in hospitals, the medical-equipment industry, the Food and Drug Administration and consumer testing laboratories.

Duties of the bioengineer

For engineers who are interested in working in hospitals, a glimpse of the duties is given in Session 16 by Bruce H. Barkalow, a bioengineer at the Sutter Community Hospital, Sacramento, Calif. In a paper on "Bioengineering in a Community Hospital," he divides the bioengineer's tasks into several categories:

- Medical-equipment selection, which must take into account safety, reliability, quality and price.
- Design and fabrication of instrumentation as a way to save money.
- Maintenance of equipment.
- Training of personnel who will use the medical equipment.
- Technical support for research projects.

Barkalow says that the bioengineer is now a "misfit" in the hospital. Hospital personnel often think of an engineer as the man who replaces wall sockets or repairs the laundry. Few people are sure what the bioengineer really does.

Another misconception, Barkalow notes, is that administrators often view the bioengineer as a panacea for their problems. He often is expected to save his own salary and more by taking over maintenance contracts and buying the least expensive equipment and making it work.

For hospitals that can't afford to hire their own biomedical engineers, Ridgway, the assistant director of the Biomedical Engineering Institute, proposes in Session 12 the formation of regional biomedical engineering groups that would share their services.

The demand for this type of arrangement, he

says, has been brought about by increased stress on electronic safety in hospitals. Separate biomedical departments to control the equipment are expensive, and probably less than 1% of the hospitals in the country today have such a facility, Ridgway points out.

As for emerging medical equipment, two doctors and two engineers from the Dept. of Thoracic and Cardiovascular Surgery in the City of Hope National Medical Center, Duarte, Calif., discuss noninvasive monitoring—the monitoring of bodily functions without penetration of the skin. In their Session 12 paper, "Bioelectric Impedance Monitoring," Gordon B. Dove and associates note that such instrumentation is increasing in popularity because its application is less technical for the physician and less painful for the patient. In addition, they say, many doctors are opposed to invading the body with needles, tubes, catheters and X-rays, which are potential hazards.

Impedance is a sensitive indicator of subtle fluid-volume changes, the authors note, and impedance monitoring can be used to evaluate the peripheral vascular system; to determine cardiac output and the elasticity of the heart and its blood vessels; and to measure volume changes in the chest cavity and blood-flow characteristics in the lower extremities.

The basic operation of an impedance monitor, the paper explains, requires that an alternating current be applied to part of the body. The current is conducted by the electrolytic fluids of the body, and a voltage drop occurs. This voltage drop is proportional to the volume impedance of the body. In studies, the authors have found that body impedance decreases as body fluid increases.

Hospital safety a problem

Electronic safety in the hospital is discussed in Session 12 by Erich A. Pfeiffer, chief biomedical engineer for the Veterans Administration at Sepulveda, Calif. He points out that these circumstances make the hospital a place where electrical accidents are more likely to occur than in other environments:

- The operation of medical electronic equipment by personnel with little or no understanding of the possible hazards.
- The use of equipment that bypasses the body's natural protective insulation.
- A lack of official regulation until recently of medical electronic equipment.

Pfeiffer goes on to say that while many measures have been proposed to reduce the possibility of accidents, some are expensive to implement and others are of doubtful effectiveness. The challenge to the engineer is—as always—to build safe, easy-to-operate equipment at low cost. ■■

COMPUTERS AND CALCULATORS

It's getting so you can't separate the calculators from the computers

In the last few years calculators have advanced from simple adding machines to complex programmable devices that rival the minicomputer. Meanwhile minicomputers have been shrinking to sizes and prices that approach those of calculators.

The narrowing gap between calculator and minicomputer is emphasized in Session 13, "Programmable Calculators System Components," and in Session 26, "Design and Applications of Micro Computer Sets."

Session 13, organized by David N. Kaye, senior western editor of *ELECTRONIC DESIGN*, provides insights into the capabilities, programming and applications of programmable calculators. Session 26 concentrates on microprogrammed ICs and how they are helping to reduce minicomputer sizes and prices.

The panelists in Session 13 note that the increased use of peripheral equipment is a major factor in making the programmable calculator an aggressive competitor of the minicomputer. The peripherals being used with calculators include card readers, tape readers and punches, plotters, digitizers, printers, expandable memories and digital cassette tapes. Still, the calculator has its limitations.

In a paper on "Expanding Your System With Peripherals," Lowell W. Smith, a market specialist for Wang Laboratories, Inc., Tewksbury, Mass., notes that the calculator is basically designed to handle one task at a time. Another limitation, he admits, is the machine's lack of capacity. Most calculators have only 1-k to 2-k bytes worth of memory built in, he notes. Additional memory must be obtained by use of external core, tape or discs. But even with these, there is a limit beyond which a calculator becomes inefficient.

On the plus side, Smith says the programmable calculator can handle extremely complex tasks. In fact, he continues, they can often perform tasks that are not practical to run on computers because of the man-machine interaction required.

In another Session 13 paper, Paul Asmus of the Calculator Products Div. of Hewlett-Packard, Loveland, Colo., points out that while today's calculators are more powerful, they remain easy to use. Unlike minis, he notes, the program language is built in. A programmable calculator therefore is ready to use as soon as it comes out

of the shipping carton.

Two basic languages—keyboard and algebraic—are used in programmable calculators, Asmus continues. On a calculator with keyboard language each key defines a complete operation, and the operation takes place as soon as the key is pressed. With algebraic language, the entire expression is entered into the calculator in much

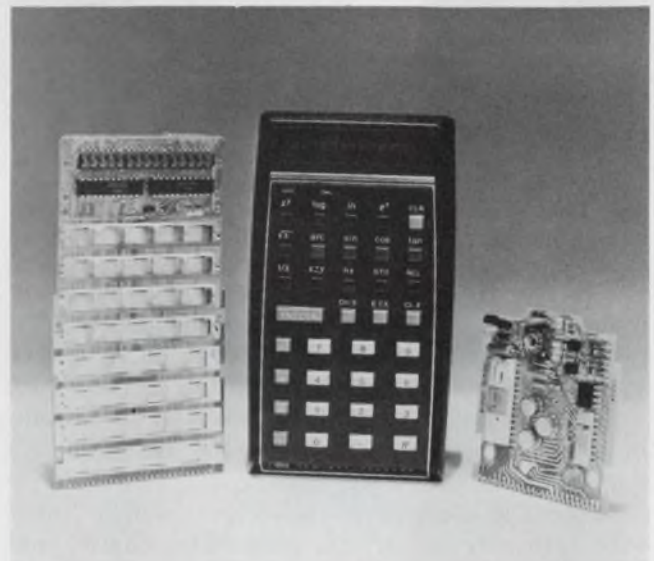

Electronic slide rule from Hewlett-Packard uses microprogrammed ICs to perform complex functions at the touch of a button.



Programmable calculators are now making use of a variety of peripheral equipment. Here a Wang calculator connects to an alphanumeric plotter and digital voltmeter to form an automated measuring system.

the same way it would be written on paper. After the expression is entered the user presses an execute key, and the operation is performed.

The algebraic calculator uses a language that is very similar to many well-known computer languages. Like the computer, it allows for program editing and diagnostic error messages. It also can provide a hardcopy printout of the program.

Microprogramming boosts computer efficiency

In Session 26, Thomas F. Prosser, president of PD Labs, Cupertino, Calif., notes that the increased use of microprogrammed chips is easing the burden of software programming and increasing the efficiency of computers. Special functions, such as sine and log, are preprogrammed into the chips.

These same chips, says Prosser, are also used in calculators—such as the HP-35, Hewlett-Packard's "electronic slide rule."

In a paper on "Large-Scale Building Blocks for Parallel Digital Processors," William H. Beall and George F. Reyling Jr. of the National Semiconductor Corp., Santa Clara, Calif., describe a set of MOS/LSI integrated circuits that are used to construct microprogrammable computer processors. The set, called a "General Purpose Controller/Processor," consists of a "control-and-read-only-memory" IC and a "registers-and-arithmetic-and-logic-unit" IC. The ICs, Reyling says, are intended for minicomputer applications where low-level control is required. They can also be used, he notes, in sophisticated calculators and "smart" terminals.

The processor, Reyling explains, contains a parallel four-bit arithmetic register. Processors

with longer word lengths can be configured by using multiple sets of ICs.

In another paper at the same session, George Keith and Edgar Leuthold of the Kearfott Div., Singer Co., Little Falls, N.J., describe the SKC-3000, a general-purpose microcomputer on a card. The card consists of 10 LSI circuits that implement arithmetic and control functions and a 7.5-k memory. The microcomputer can be programmed to perform specific tasks or to operate as a simple general-purpose machine with limited memory and input/output capability.

There has been much interest in parallel-processing systems, says Tse-yun Feng of the Syracuse University Dept. of Electrical and Computer Engineering, who organized Session 1, "Parallel Processing Systems." The interest, he says, results from a desire to improve computer throughput at relatively low cost.

Several parallel processors are discussed in this session, the most interesting of which is probably the ILLIAC IV, which has been under development by Burroughs for several years. In the paper on "ILLIAC IV and Its Use," George H. Barnes of the Burroughs Corp. describes the huge system and how it differs from conventional computers. It consists, he explains, of 64 processing elements, each with its own memory. Each memory has 2048 words of 64 bits, for a total of 131,072 words. The memory cycle time is 313 ns. Each processing element operates on different data, but the elements are all controlled by the same instruction.

Another interesting feature of the ILLIAC IV is its parallel-disc files, which transfer data at more than 500-million bits per second. The computer, says Barnes, is undergoing final checkout at Ames Laboratories in Sunnyvale, Calif. ■■

MANAGEMENT AND MARKETING

Foreign industries duel American for world electronics leadership

Watching the rest of the world go by may be an emerging pastime of the U.S. electronics industry, says Geoffrey C. Ziman, president of the Zi-Tech Co. of Palo Alto, Calif. He warns in Session 11, "The Dwindling Technology Gap," that "no longer can the U.S. take for granted its technical superiority in electronics."

Other nations have not only acquired the basic skills and components, he says, but are also advancing rapidly in applications. Helping this trend, he continues, are viable domestic markets, growing resources and "will-do attitudes."

Ziman, whose company imports technical products, adds that rising prosperity in Europe and other areas, an increasing availability of venture capital and the formation of such groups as the European Economic Community are other factors that are challenging U.S. leadership in electronics.

As an example of the challenge, Joseph Roizen of Telegen, Inc., Palo Alto, Calif., compares color TV at home and abroad and finds that the color image in Britain and on the Continent is superior to that of American television. The reason, he

says, is that abroad the color-encoding systems of either PAL or SECAM provide a more stable end result.

Although U.S. industry can't change its form of color encoding at this late date, Roizen says, technicians can provide better camera matching, better film color balance, more corrective control between different sources and improved VTR adjustment to meet the European challenge.

Governmental help suggested

"The decline of the United States' technological prominence," says Lewis F. Ellmore of the Singer Co., Kearfott Div., Paris, France, is attributed, in part, to diminished R&D, the rise of foreign technical capability and a general lack of demand for new technology whose apparent improvement over that existing is disproportionate to its cost."

In his paper, "Chauvanism and the Technology Gap," Ellmore observes that industry no longer competes against industry in the world but directly against cartels and indirectly against foreign governments. The policies of the U.S. Government, he says, could be modified to strengthen domestic industry and to provide assistance and support internationally.

Ellmore warns that the traditional techniques of market development and exploitation, and of international collaboration, require revision if the U.S. is to reverse its "technological decline."

Adaptation or extinction?

If the American electronics industry's struggle to remain pre-eminent is successful, the result for engineers will be "New Career Opportunities"—the subject of Session 3 at Wescon. Bruce S. Angwin, manager of a skills-conversion program at the National Society of Professional Engineers, organizer of the session, points to emerging job opportunities—and to present unemployment in the aerospace and defense sectors.

Robert A. Finch, who is with a skills-conversion project sponsored by the American Institute of Aeronautics and Astronautics, Los Angeles, gives this profile of the nation's unemployed technical professionals, based on data from multiple sources:

- There are approximately 93,000 unemployed, with 72% in the 35-to-54 age bracket and 58% over 45 years.
- Their average educational level is a bachelor's degree or equivalent.
- Their average earnings are \$13,200 a year (compared with an average of \$14,800 for engineers and scientists only).
- More than 45% have been unemployed for longer than six months.



U.S. superiority in electronics can no longer be taken for granted, manufacturers are warned.

Angwin notes that although many programs have been proposed and some implemented to salvage this reservoir of talent, the major obstacle to employment is a lack of communication. An effective career transfer requires some form of employee indoctrination and training and a mechanism for bringing employer and employee together, he explains.

If the unemployed technical professional would "review his assets in terms of the skills he has to offer, and not just the application of his skills to the most recent job he filled," Angwin says, "he would greatly improve his chances for employment."

Emerging job opportunities for the unemployed engineer are pinpointed by Fred G. Sufield, a management consultant from Los Angeles. They exist, he says, in ecology (mostly within the control agencies); transportation and traffic engineering; health and health service (the broad definition of management here, not necessarily project management); law enforcement; and consulting engineering.

But he reminds engineers that they have to conduct their own job search. He suggests that they forget the job titles and acronyms that they used in aerospace and defense jobs and sell their ability to meet schedules and to control and reduce costs. ■■

fail-proof

**UNITRODE IS SPECIFIED IN ALL MAJOR
MISSILE AND SPACE PROGRAMS
...WHERE THERE IS NO MARGIN FOR FAILURE.**

rectifiers

From HAWK to SAM-D, from MERCURY to VIKING, thousands of Unitrode rectifiers have been operating dependably for millions of hours under the most extreme environmental conditions. In Apollo alone, over three thousand Unitrode components have been used in everything from the Saturn booster and capsule telemetry system to the lunar module and cameras. Some reasons why? Unitrode's unique fused-in-glass construction for monolithic devices that are void-free and bonded, with very high forward and reverse

surge capability, mechanical strength and permanently stable electrical characteristics. And they provide more power in smaller packages. Unitrode also provides the broadest line of power rectifiers from 1A through 20A — over 100 types. Whatever your rectifier application, think of Unitrode for down-to-earth reliability. For fast action, and specific product information, call Sales Engineering collect at (617) 926-0404, Unitrode Corporation, Dept. 9 X 580 Pleasant Street, Watertown, Mass. 02172

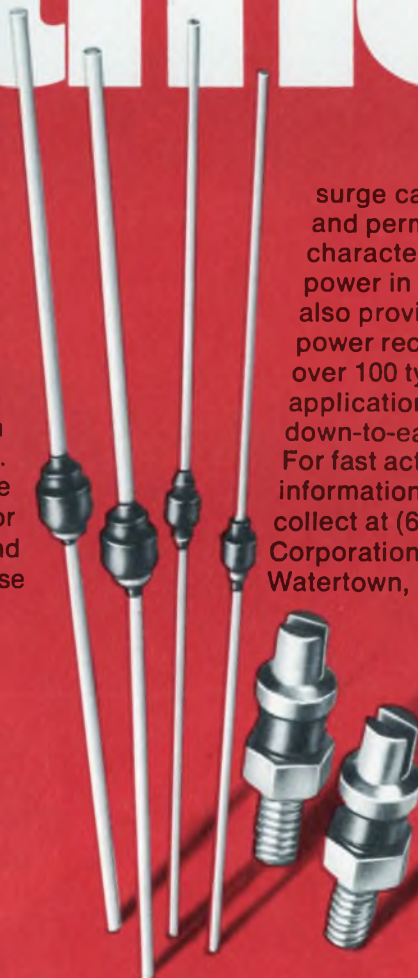

UNITRODE

**For free Reliability Calculator (while supply lasts)
write and let us know your particular
application needs.**

**Could you have found the costly fault
in this IC board in 5 minutes or less?**

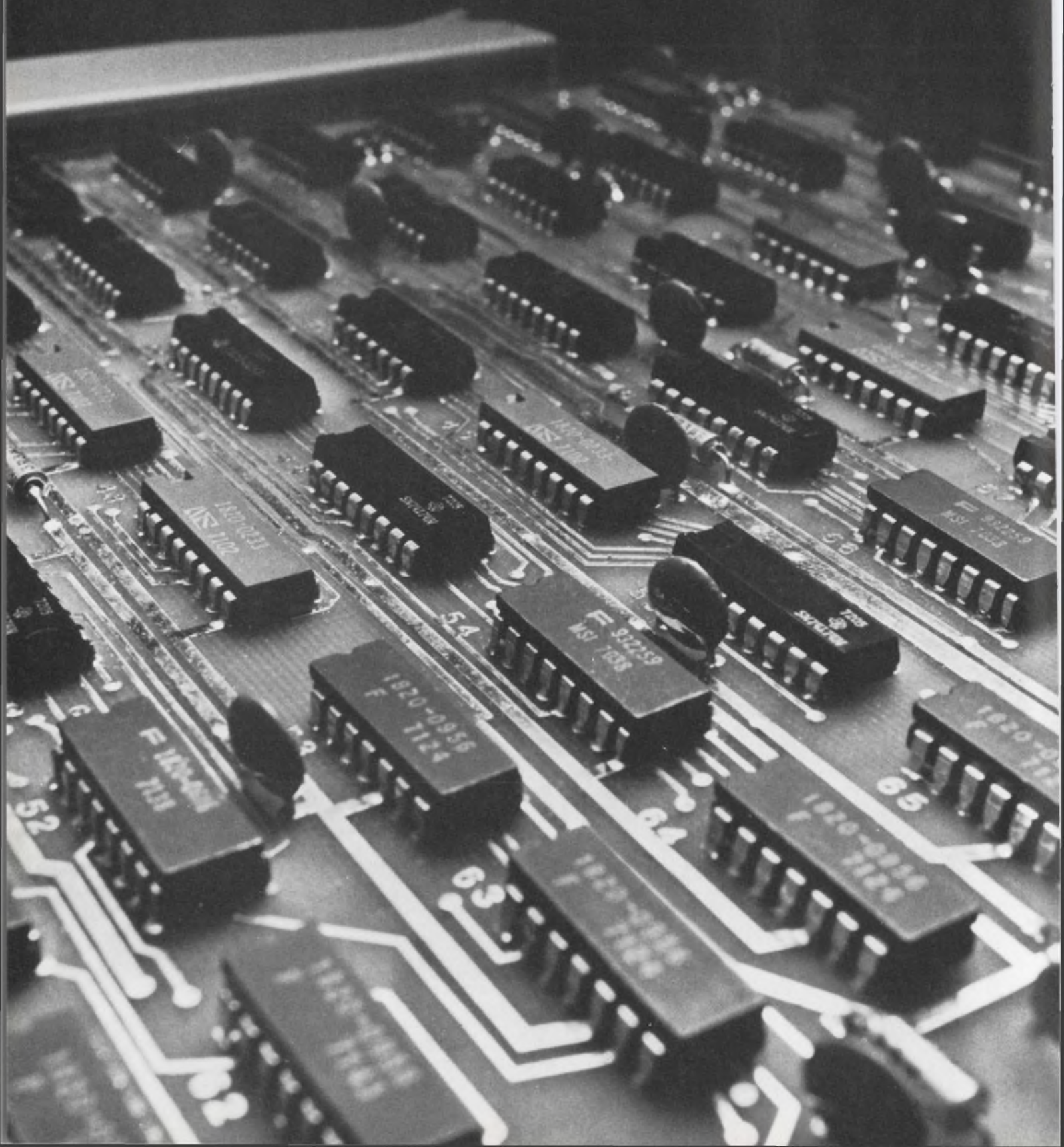

The IC Troubleshooters did.

From Hewlett-Packard, the IC Troubleshooters continue to bring super-sophistication to DTL and TTL troubleshooting. See logic states and pulse activity at a glance. Make a complete functional test on an in-circuit IC in less than 10 seconds. See instantaneously the state of all 14 or 16 pins via easy-to-read LED's. Monitor dynamic and static logic activity as easily as having an oscilloscope at your fingertips. Whether you're in service design or production, the HP IC Troubleshooters can save you time, money and headaches from the moment you start using them. Here's the lineup:



10525T Logic Probe — This brand new device handily picks off a pulse anywhere in the circuit and, via the light in the tip, tells you logic highs, lows, in-between bad levels and open circuits. It captures single pulses as narrow as 10 nsec, pulse trains to 50 MHz. \$95. **10525H** — High threshold model — also \$95.



10526T Logic Pulser — This brand new partner to the Logic Probe and Logic Clip completes a unique stimulus-response team. It injects a pulse into a circuit without trace cutting or unsoldering pins and

automatically drives low nodes high or high nodes low for 300 nsec. Over-rides "clamped" conditions with controlled TTL pulse. A single pulse at each triggering, and probe tip impedance is greater than 1 megohm when off. \$95.



10528A Logic Clip — Eliminating the cumbersome voltmeter route, this unique device clips directly onto an IC and 16 LED's tell you the state of all 14 or 16 pins instantaneously. No cables, no power connections. Auto-seeking of V_{cc} and ground. Only \$125.



10529A Logic Comparator — This device steals stimulus from the circuit under test to exercise a reference IC of the same type. Outputs are compared and differences displayed via LED's in the unit itself, one for each pin, localizing the malfunction to the node. Ten seconds or less completes an IC test, even for dynamic errors as brief as 200 nsec. \$375.



5011T Logic Troubleshooting Maxi-kit — Complete in a convenient case. You get all of the above instruments in order to optimize your stimulus-response monitoring and logic analysis for test purposes. Pulser injects signals to be monitored by Probe and Clip. Pulser can provide synchronizing pulses for test and reference IC's when checking tricky sequential circuits with the Comparator. Complete Maxi-kit, including 10% discount on all instrument prices, \$625.



Mini-kit 5015T also available (without Comparator) for \$285.

Call your local HP field engineering office to get your IC Troubleshooters as quickly as possible. Or write Hewlett-Packard, Palo Alto, California 94304; Europe: P.O. Box 85, CH-1217 Meyrin 2, Geneva, Switzerland; Japan: YHP, 1-59-1, Yoyogi, Shibuya-Ku, Tokyo, 151.

HEWLETT  PACKARD

02205

Some people still use old-fashioned ways to stop 1-time signals.

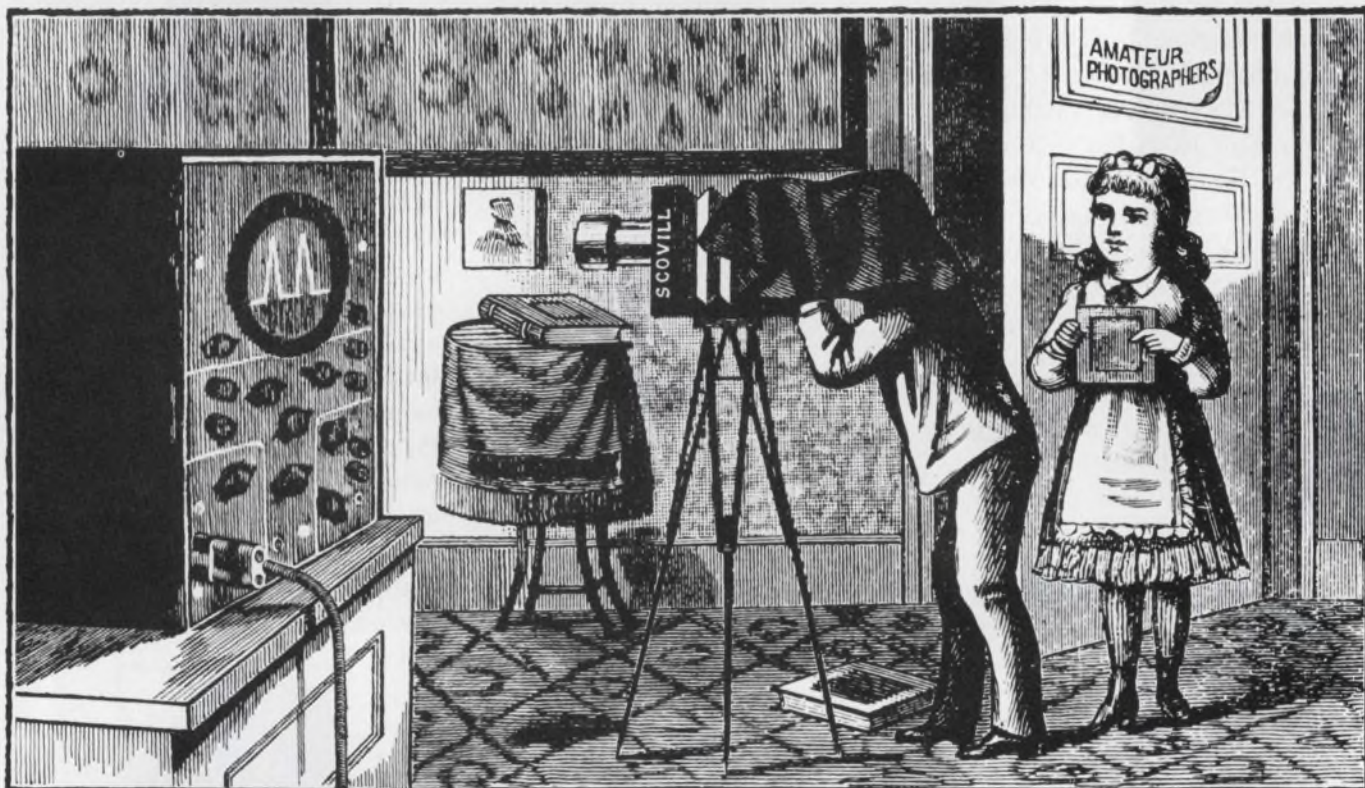

Tape deck, strip chart, conventional scope and camera — the old ways die hard.

And yet there *is* a better way — with one of our waveform recorders.

These are perhaps the world's only instruments ideally suited to measuring non-repetitive (or repetitive) signals. They are ideal for electronic trouble-shooting, shock and vibration studies, explosives testing, kinetic energy and plasma physics analysis, sonar applications, and many more.

They let you capture the signal, digitize it at rates up to 100 MHz, store it in memory, then transmit it in digital form, or reproduce it as a repetitive analog signal.

You can observe the stored waveform on a scope, make permanent records on a strip chart recorder, or feed the digital data directly to your computer for analysis. You can even record the data preceding your trigger signal for cause-effect or "leading edge" studies.

This kind of fast data acquisition is priceless — especially in such convenient, easy-to-use form.

We have the broadest line of waveform recorders in the world. Choose the speed, resolution, memory length, and price to fit your application. For full information, write or call Biotation, 1070 East Meadow Circle, Palo Alto, California 94303. (415) 321-9710.



"SEE US AT BOOTH #4913 WESCON
LOS ANGELES SEPTEMBER 19-20, 1972"

biotation
Always a trace ahead.

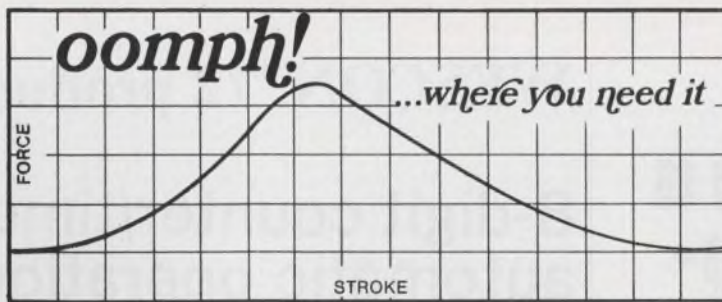

At Ledex we shape solenoids to give you the exact force and stroke you need.

All about oomph . . . and where to get it

The engineer needed a 2" stroke. Little force at the start, then a 40 lb. wallop in the middle. To reduce impact at the end, he wanted the force to tail off.

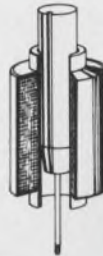

We call our answer the solenoid with the oomph in the middle. Just as the curve shows, it's designed so the maximum output comes out near the center of the stroke.

For other actuating applications, there are over 300 Ledex shelf model solutions to choose from. Here are just three examples:

- short fast stroke**



Move a short stroke load in 5 to 10 milliseconds with a Ledex flat-face pancake shape solenoid.
- long linear haul**



You can move big loads far with Ledex tapered plunger cylindrical solenoids.
- swift rotary action**



For action in an arc or uniform linear movement, or both, consider a Ledex rotary solenoid.

To get the exact force, stroke and speed you need, just describe your application to our actuating technology people. If your exact answer isn't already on our shelf, we'll design one for you.



the total technology people

LEDEX INC.
123 Webster Street
Dayton, Ohio 45401
(513) 224-9891

POSITIONING · SWITCHING · MICROELECTRONICS

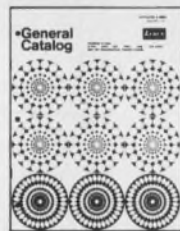

Over 400 ways to turn . . . push . . . pull . . . index . . . step . . . and switch, plus new microelectronic interface circuits. All from the shelf.

Ask for Catalog A-9500

*new things
keep
happening
at Ledex*

. . . the LMD-1,
a versatile
universal
control circuit
— now on the shelf

Shape, stretch, squeeze, and program pulses

Vary repetition from 1 ms to 10 minutes, or get independent ON-OFF pulses from 0.1% to 99.9%. You can also use the LMD-1 as a power driver and control 10A 50V loads at continuous duty.

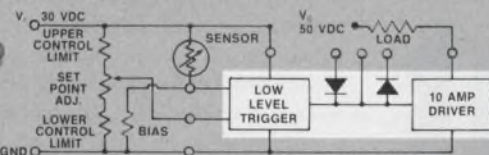

As an ON-OFF controller, LMD-1 can control any parameter convertible into resistance change. A 0.5 kW load can be controlled with only 80 nA typical bias input from the sensor. Schematics are available for applications at right.

ten LMD-1 applications

- Pulsar, programmable rate
- Pulsar, programmable on & off time
- Pulsar, programmable duty factor
- Schmitt Trigger
- Proportional pulse modulating controller
- Time delay on power application
- Time delay on switch opening
- Time delay/hold-in circuit
- One-shot, trigger on plus slope
- One-shot, trigger on minus slope

9309
9301
74107
7490
7475
7430
7420
7410
7404
7400
946
930

Push a button—solve a problem

If you're spending a lot of time finding bad ICs in your systems using bedsheet schematics and oscilloscopes, this in-circuit tester will solve your problem by testing any of 12 ICs at the push of a button. The KAR Model 113 is the fastest way to find a bad IC on a circuit card.

It tests packages up to 24 pins, fully buffers inputs, is portable, easy to use, and costs \$499.

Want to know more?

Write:

KAR

ELECTRONICS, INC.

4995 Telegraph Rd., S. Amherst, OH 44001 (216) 986-8817

INFORMATION RETRIEVAL NUMBER 41

WESCON '72 products

8-digit counter/timer gives automatic operation at \$575



Systron-Donner Corp., 1 Systron Dr., Concord, Calif. 94520. (415) 682-6161. \$575; October.

With the introduction of the Model 6250, Systron-Donner has kicked off its new 6200 line of low-cost counters. The 6250, a 50-MHz universal counter/timer, is the top of the line, and for \$575 it offers features heretofore found only on higher-priced units.

Included in the basic unit are an eight-digit, seven-segment display, with leading zero suppression; autoranging, a feature that automatically fills the register; an automatic gain control that eliminates manual input adjustments; manual or automatic selection of resolution on all functions, and an input sensitivity of 25 mV rms for sinusoidal inputs. Unlike competing units, whose sensitivity is halved for the higher-frequency ranges, the 6250's sensitivity remains constant to the top frequency of 50 MHz.

The new unit can measure frequency, period, time interval and total count. Frequencies can be measured from 20 Hz to 50 MHz with \pm time-base accuracy, ± 1 count, and a resolution of 0.1 to 100 Hz in the manual mode (1 Hz in automatic). Periods range from

1 μ s to 50 ms for sinusoids and 1 μ s to 99.999999 s for pulses or square waves. Resolution in the auto mode is 0.1 to 100 μ s.

Time interval, or A-B, measurements can be made from 1 μ s to 10^5 s, with a resolution of 0.1 μ s to 1 ms. A front-panel switch allows selection of positive or negative slopes. The time interval—as well as the period and frequency modes—has automatic decimal-point positioning and a units display.

The standard time base has a stability of ± 3 parts in 10^7 per month and ± 5 parts in 10^6 over 0 to 50 C. Line-voltage stability is ± 1 part in 10^7 for 10% line variations. However, for users who want greater stability, five other oscillators are offered as options, with up to ± 1 part in 10^8 stability.

Other key specs and standard features include 1-M Ω , 25-pF input impedance; BCD (1-2-4-8 serial) outputs; internal or external battery operation; readings held between samples; a 1, 10 and 100-step attenuator, operated by a front-panel switch; and overload protection. The 6250 measures 3-1/2 \times 8-3/8 \times 13-1/2 and weighs 10 pounds.

Booth No. 1704-11 Circle No. 250

MONSANTO LAUNCHES NEW 50 MHz COUNTER ATTACK



New Model 100C

- 6 digit display
- Full-function to 50 MHz
- Priced at only \$565
- 7 digit option \$605



New Model 101C with BCD

- 6 digit display
- 1 part in 10^8 stability
- Priced at only \$695
- 7 digit option \$735

When Monsanto first introduced these full-function 50MHz Counter-Timers we established the standards for the industry and caught our competition with their guard down.

But our offensive couldn't be maintained by sitting on past successes. So, our NEW counter attack is again in your behalf, with new, realistic features and functional improvements. Contact your nearest Monsanto representative for a demonstration of our battle plan. Your reward will be a look at the best value on the market today.

For complete specifications request new brochure.

United Systems Corp.

918 Woodley Rd.
Dayton, Ohio 45403
(513) 254-6251
Subsidiary of

Monsanto

Monsanto: precision measurements to count on.

The SPACE SAVERS from tecnetics .316 CUBIC INCH HYBRID CONVERTERS AND REGULATORS

As a team they're a miniature DC-DC regulated converter. Or, take them individually.



1.05" x .94" x .32"

HC hybrid converter:

- converts voltages at the point of load
- output isolated from input
- 3W output maximum
- less than 4W input typical
- outputs to 300 volts

HC hybrid converters:
\$59 hermetically sealed;
\$49 non-hermetic.
1-9 quantity.

VR regulator:

- maximum output current 250mA with 1W max. internal power dissipation
- output voltage +3 to +36 or -3 to -36 VDC
- continuous short circuit protection
- power dissipation limited

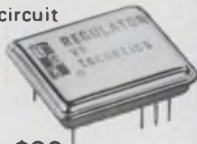

VR regulators: \$39
hermetically sealed only
1-9 quantity.

Hybrid converters and regulators—the space savers from Tecnetics. 2 x DIP mounting and off-shelf delivery. (See EEM catalog vol. 1 pp.880-885)

tecnetics inc.

P.O. Box 910, Boulder Industrial Park, Boulder, Colorado 80302
(303) 442-3837 TWX 910-940-3246

INFORMATION RETRIEVAL NUMBER 43

INSTRUMENTATION

Benchtop tester checks 4096 x 8-bit RAMs/ROMs



Spectrum Dynamics, Inc., 2300 E. Oakland Park Blvd., Fort Lauderdale, Fla. 33306. (305) 564-4369. \$7000; 60 days.

The Model 150 from Spectrum Dynamics is a dedicated bench-top tester that checks the functions of bipolar and MOS RAMs and ROMs at up to 8 MHz. The unit can handle static and dynamic DTL, TTL, MOS and ECL-compatible ICs in single-chip or system form. The chips can be organized with up to 4096 addresses, with or without decoding, and with up to eight data bits and select lines.

The 150 system contains all power supplies, clocks and drivers to permit direct connection to the memory. As an inspection device, it can test up to eight 4096-by-1-bit RAMs or ROMs. The user inserts the units in a socket, plugs in a PC-card memory system, selects the appropriate mode and depresses the RUN button. The units under test will be cycled automatically through address, select and data check. A GO light tells if the units pass the test, and an ERROR light if they fail. All information related to a failure is indicated by lamps and digital readouts. The test can

also be cycled continuously, or one part can be recycled.

As an engineering evaluation device, the tester can be cycled automatically or stepped and controlled manually by switches and push-buttons. All input and output signal lines are accessible, so the signals can be observed with a scope, and access and switching times can be measured.

Because of the built-in programmed addressing and data base, extensive programming is not required to prepare the device for test. The test form consists of a programmed sequence that checks correct address decoding, a deselect sequence that checks each select line, and a data sequence that consists of walking a ONE against a background of ZEROES and then walking a ZERO against a background of ONES. Any test pattern can be manually inserted.

Power available for the memory under test is 5 V at 2 A, ±15 V at 0.5 A, any two voltages from 0.75 to 15 V at 0.5 amp, or any single voltage to 30 V at 0.5 amp. These are set by the power-supply programmer card.

Booth No. 2405 Circle No. 251

NEW 3½ DIGIT PORTABLE DMM



GOT THE MESSAGE?

- 3½ Digit LED Display
- Rugged All Metal Case
- Battery & Line Operation Standard
- Basic Accuracy .05%
- Off Shelf Delivery
- Priced at only \$375.

Our DigiTec engineers got the message. We told them to take a good multimeter and make it better. We didn't put any restrictions on them, just gave them a free hand. Now instead of an improved meter, we have a new meter, from the inside out!

They started with a new A to D board which gave the meter improved basic accuracy (.05%), greater stability, and a 3½ digit LED display.

Next they tackled the metal case; building it

stronger, more rugged to house and protect. Controls were simplified and redesigned to provide the best possible human engineering factors.

They might have stopped there and been satisfied with an almost-totally new meter, but they had steam up and went on. A new 8 hour battery operation was made integral with a self check status, at no increase in price. That's right... all these improvements plus the battery operation and still only \$375.

Our model 262C Multimeter carries its own message and DigiTec Representatives carry a model 262C. **HAVE YOU GOT OUR MESSAGE?**

Representatives throughout the world. For complete specifications, request new catalog.

**DigiTec by
United Systems Corp.**

918 Woodley Rd.
Dayton, Ohio 45403
(513) 254-6251



DigiTec: precision measurements to count on.

MONOLITHIC
CRYSTAL FILTERS



The Truth About Monolithics . . .

Truth is stronger than fiction.
It's also said to be the greatest gimmick in advertising. That's what this series of ads is about — the truth about monolithic crystal filters. If you want the truth about the best filter for your application, talk to us. We've been making monolithic crystal filters longer than anyone else — and we've made more of them. We know what can't be done as well as what can.

Standard Substitute . . .

When is a conventional crystal filter unconventional? When it's a monolithic designed to be completely interchangeable with its conventional counterpart — and to be 10 to 50% less expensive. If you're still using conventional crystal filters and aren't ready to redesign your equipment, check with us. The next best thing to designing your new radio around a monolithic crystal filter is plugging a monolithic into your old one. It may be just what the doctor ordered to keep the patient alive and well a little longer.

Short Course . . .

Whether you're now using integrated crystal filters or just thinking about it, you'd probably like to know more about them. We're offering a limited number of reprints of an up-to-date survey article including specification guidelines. A copy is yours for the asking. Just drop us a note on your letterhead.

Like more information on monolithics? Drop us a line or call us.



Piezo Technology Inc.
2400 Diversified Way
Orlando, Florida 32804
305-425-1574

**The Standard in monolithic
crystal filters.**

INSTRUMENTATION

Storage-scope writing rate jumps to a lofty 400 cm/μs

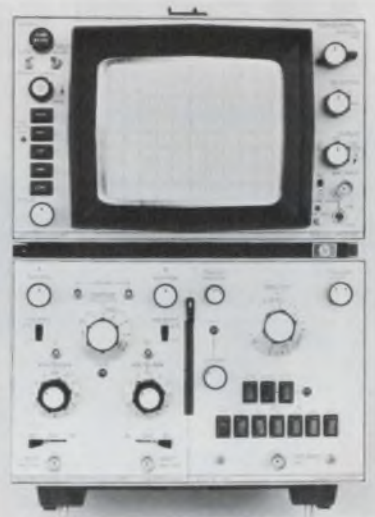

Hewlett-Packard, 1501 Page Mill Rd., Palo Alto, Calif. 94304. (415) 493-1501. P&A: See text.

With the introduction of a 400-cm/μs writing-speed option on its Model 184A, HP has retaken the lead in fast storage scopes—after having lost it to Tektronix shortly after winning it.

At the March IEEE Show, HP introduced the 184A, with a writing rate—in the central area of the graticule—of 100 cm/μs. Tektronix soon responded with the 7623 (see "Storage Scopes Leap Ahead in Writing Rate, Bandwidth, Tube Life," ED 14, July 6, 1972, p. 83). The 7623 offered 200 cm/μs over its central 4 × 5 matrix of 0.9-cm divisions.

Now HP comes back with a new option for the 184A, offering 400 cm/μs over the central 8 × 10 matrix of half-size (0.475-cm) divisions of the graticule. Automatic scan reduction in the high-speed mode assures that the event of interest will fall inside the fast-write region.

At the fast speed, you've got over 10 seconds to view your waveshape at a normal intensity of 50 ft-L and over five minutes at barely visible intensity. In contrast the 7623 can be viewed, if you're so inclined, for days at about 100 ft-L. Other modes offer various

tradeoffs between viewing time, intensity and writing speed.

Both mainframes offer a 100-MHz bandwidth. But while HP offers a 100-MHz, dual-trace plug-in (the 1805A), you need two single-channel plugs to obtain dual-trace 100 MHz on the 7623. Tek's fastest dual-trace is the 7A12, with a BW of 85 MHz.

The 184A is ostensibly the less costly of the two scopes: The basic bench-mount mainframe costs \$2200, with the 400-cm/μs option adding \$500 to the price for a total of \$2700. In contrast, the 7623 costs \$2850 for the mainframe and \$500 for the 200-cm/μs option. However, the Tek mainframe includes the deflection amplifier plus an alphanumeric readout of measurement parameters. If you don't want the readout, subtract \$400 from the base price. All of this means that prices should be compared on a full-system basis, including plug-ins.

For more information:
From HP

Circle No. 252
Booth No. 1208-11, 1304-11, 1404-7
From Tektronix

Circle No. 253
Booth No. 1101-4, 1113-16

Sweep, measure —50 dB reflection to ±1 dB

Wiltron Co., 930 E. Meadow Dr., Palo Alto, Calif. 94303. (415) 321-7428. About \$8000.

With a Wiltron precision swept-frequency reflectometer, it's possible to measure reflections in the —35 to —50 dB region on a swept basis with ±1-dB accuracy. The tester covers the 2 to 12.4 GHz range. A key feature permitting the unit's precision is its directivity of 36 dB—a value comparable or superior to that of more costly and narrower band systems.

Booth No. 1714, 15 Circle No. 254

Resistivity/type meter measures 0.05 Ω -cm



Matheson Gas Products, P.O. Box 85, E. Rutherford, N.J. 07073. (201) 933-2400. \$1450; stock.

The RTM-101 Resistivity/Type Meter is a precision instrument designed for quality control, production, and R and D. Compared with competitively-priced equipment, two separate test meters would be required to perform its two primary functions of measuring resistivity and determining conductivity type of silicon materials. The meter can accommodate a wide range of currents from 0.1 μ A to 10 mA, continuously adjustable, at a maximum compliance voltage of greater than 100 V. Model RTM-101 includes a Dumas four-point probe stand and standard Signatone probe head as the sensing element. Additional features include: tilt-up cabinet for ease of reading; voltage applied across probes only after wafer contact.

Booth No. 4308 Circle No. 255

Automatic probe is fast, has 4-inch X-Y travel

Pacific Western Systems, Inc., 855 Maude Ave., Mountain View, Calif. 94040. (415) 961-8855. \$10,500 base price; 30-45 days.

The Model SP-1 high-speed automatic-probe system is said to be three times faster than previous probers, has 4-inch X-Y stage travel and includes automatic chuck traverse to load/unload position upon completion of wafer test. Other features are: low profile and small prober base with remote controller for minimum bench space requirements. New tempered-steel blade-probe tips with nickel plating provide three to five times longer tip life. All operator controls are up front. Size is 25 \times 22 \times 12 inches. Weight is 145 lbs.

Booth No. 3608 Circle No. 256

This
Sweet
**MICROVOLT
MULTIMETER** is
SENSITIVE to 1 μ V,
STABLE within 2 μ V/day
and easy on the budget at
\$560

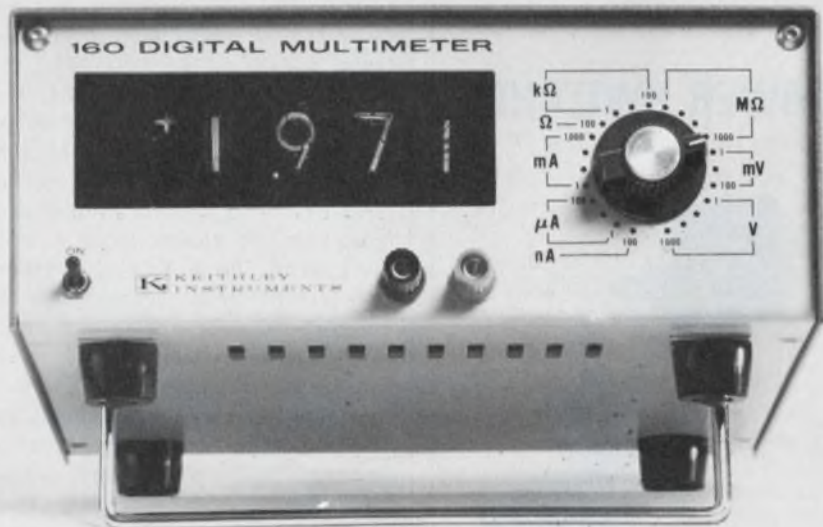

Users call it "the-how-sweet-it-is-meter". But it's really the Model 160 that...

- MEASURES WITH DIGITAL ACCURACY
 - Voltage** — 1 μ V to 1000V
 - Current** — 0.1 nA to 2A
 - Resistance** — 0.1 Ω to 2000 M Ω
- 100% OVERRANGING
- ANALOG and OPTIONAL BCD OUTPUT
- AC/DC PROBE ACCESSORY
- MANY MORE SWEET PERFORMANCE FEATURES



**KEITHLEY
INSTRUMENTS**

U. S. A.: 28775 Aurora Road, Cleveland, Ohio 44139
Europe: 14, Ave. Villardin, 1009 Pully, Suisse

SEND FOR FULL DETAILS AND YOUR FREE "HOW SWEET IT IS" BUTTON

IC'S DESERVE SMK SOCKETS!

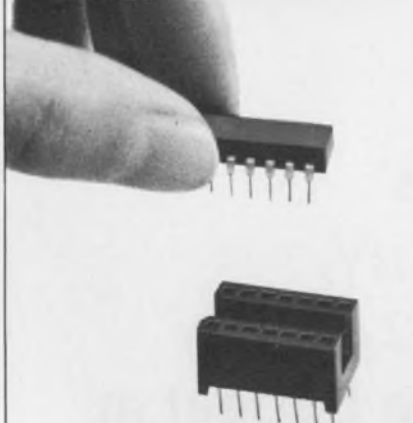

SMK IC sockets are designed and manufactured to satisfy a wide range of requirements, both in consumer products and industrial equipment. Sockets are available in dual in-line (14-, 16-, and 20-pin) and hybrid (7-, 9-, and 10-pin) types.

POWER SWITCHES

Satisfy UL Specifications (TV-3)



SJ-1973
(SPDT)



SJ-4957
(DPDT)

Positive action SMK Power Switches satisfy the stringent specifications of UL. Fifteen types have been approved under TV stipulations. Unique design makes the SMK switch well suited to a variety of applications.



SHOWA MUSEN KOGYO CO., LTD.

No. 5-5, 6-chome, Togo-shi, Shinagawa-ku,
Tokyo 141, Japan
Phone: 785-1111
Cable: "SHOWAMUSEN TOK"
Telex: 2466301 SMKTOK J

INSTRUMENTATION

8-channel recorder has 1 mV/div sensitivity

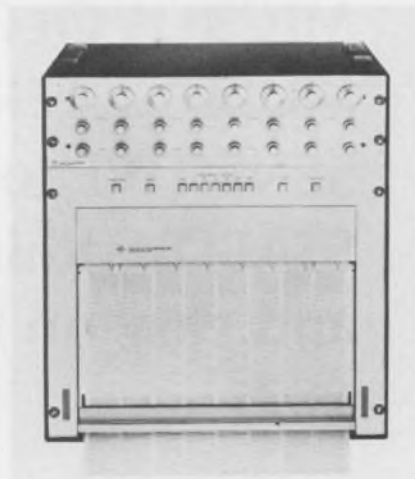

Gould, Inc., Instrument Systems Div., 3631 Perkins Ave., Cleveland, Ohio. 44114. (216) 361-3315.

Designated the Brush 481, this new 8-channel general purpose recorder, announced by Gould Inc., Instrument Systems Division, has built-in preamplifiers giving it a measurement range from 1 mV/division to 500 V full scale (there are 50 divisions across each 40 mm-wide channel). The unit, with carrying case, can be used in portable or bench applications; with a special kit it can be rack mounted. The preamplifiers have differential, floating, balanced-to-guard inputs that are isolated from each other, from chassis, and from the output. Thus they accept signal sources of any configuration—single-ended or balanced; grounded, floating, or driven off ground without affecting accuracy or creating system noise. Special features of the Brush 481 include pressurized ink writing for clear, crisp, dry and smudge-proof traces, rectilinear trace presentation; 99.5% linearity enforced by a servo pen positioning system; 40 Hz response at 50 divisions; and electronic signal limiters to protect pens from off-scale overloads. Twelve chart speeds from 0.05 to 200 mm/sec are pushbutton selected. Chart takeup for the 300-foot high contrast or the 400-foot reproducible roll paper may be external roll or Z-fold.

Booth No. 1300-02 Circle No. 257

Phase angle meter has 5% BW about spot freq

North Atlantic Industries, Inc., Terminal Dr., Plainview, N.Y. 11803. (516) 681-8600. \$990 and up; stock to 3 wks.

The Model 213 phase angle voltmeter performs complex measurements on ac signals in the 300 μ V to 300 V range (with 2% accuracy) and within the 30 Hz to 10 kHz band at any customer-selected single frequency. The unit measures in-phase and quadrature voltage, and phase angle (with 1-degree accuracy), relative to an arbitrary reference voltage; uses a built-in filter to measure the harmonic-free fundamental component of input voltages; and bypasses the filter to measure total input voltage, like an ordinary ac voltmeter. Finally, Model 213 operates as a phase-sensitive null detector with a 2 μ V resolution. The new instrument permits a 5% operating bandwidth around the spot frequency. By contrast, the earlier Model 212 had a phase-frequency gradient that required operation at precisely 400 Hz or other spot frequency in order to achieve rated accuracy.

Booth No. 1500, 01 Circle No. 258

4-digit DPM offers remote control

Electronic Research Co., 10000 W. 75th St., Overland Park, Kan. 66204. (913) 631-6700. \$400.

The ERC Model 4000 DPM is a full four-digit panel meter with 100% over-range and auto-polarity. The unit includes complete provisions for remote control of conversion cycle and reading rate. LEDs are used exclusively. All 4000 models are supplied with a true, floating differential input circuit. Transformer and optic isolators are used to achieve a minimum of 500 V isolation between the analog circuitry and the digital display logic. Completely guarded construction enables a third-wire guard drive to provide a solid 120-dB CMRR at 60 Hz. Five ranges are available with resolutions from 10 μ V to 100 mV. Input impedance is greater than 100 M Ω on basic ranges.

Booth No. 2812 Circle No. 259

Here's one for the road.

Our new Model 4440 mini-multimeter is the smallest battery operated digital multimeter on the market.

A true portable in every sense of the word, it's shock-proofed, fully overload-protected, and usable at up to 122°F. Fuses are externally replaceable. (We even throw in an extra set, on the house.)

You get eight to twelve hours of continuous field operation before you have to recharge. In an emergency, you can run it five hours or more on ordinary flashlight batteries!

For all its littleness, this rugged portable features a new 3½-digit LED display with automatic polarity, the latest LSI circuitry for more reliability than ever, and 17 full scale ranges that cover

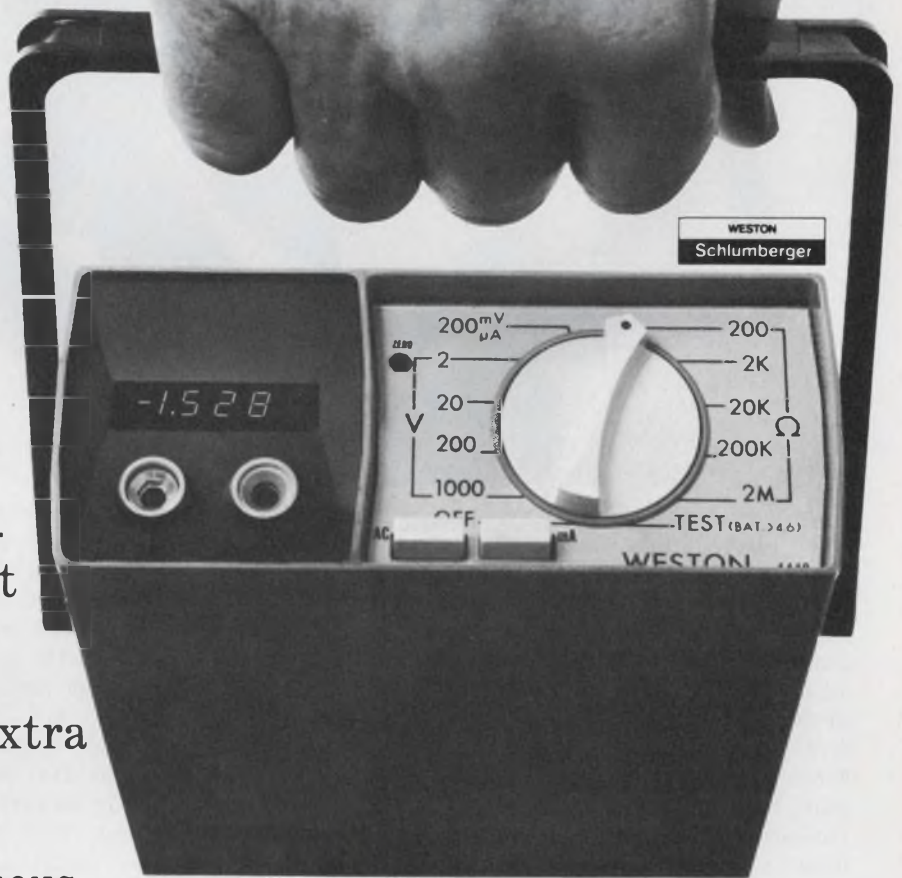

(A cordless DMM for only \$285.)

200 MV to 1000 volts AC/DC, 200 ohms to 2 megohms, plus AC and DC current.

Your local distributor will set you up with a Weston 4440 for \$285—complete with leads, batteries and recharger. Grab one. Weston Instruments Division, Weston Instruments, Inc., Newark, N.J. 07114. **WESTON®**

Compact 12-bit d/a converter settles in 50 ns to 0.05%

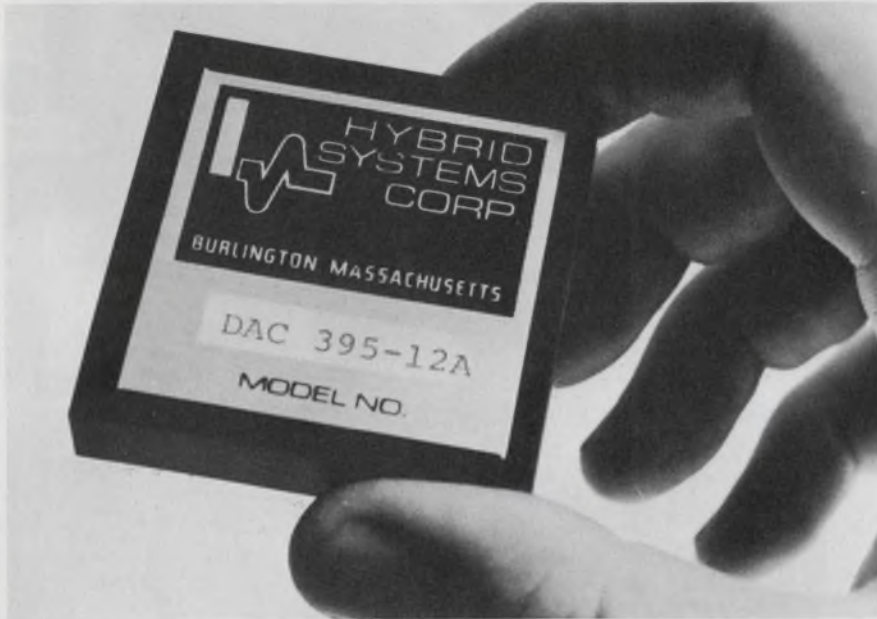

Hybrid Systems Corp., 87 Second Ave., Burlington, Mass. 01803. (617) 272-1522. \$125 (1-9); stock to 2 wks.

Digital-to-analog converters for computer-controlled CRT display systems must be fast, accurate and, preferably, compact and inexpensive. Until recently, no manufacturer offered a completely suitable unit. Now Hybrid Systems has introduced a DAC that is said to meet all the requirements. The company's DAC395-12A has a settling time of only 50 ns (to within 0.05%), 12-bit resolution and $\pm 0.0125\%$ linearity. Packaged in a 2-by-2-by-0.4-in module, it costs \$125 in unit quantity.

The DAC395-12A is believed to be the fastest modular 12-bit DAC available. Other companies sell faster settling DAC modules but only with 8 or 10-bit resolution. For example, Analog Devices' MDA-10F is a 10-bit converter with a settling time of 40 ns (to within 1/2 LSB). One example of a 12-bit competitor for the new Hybrid Systems unit is Teledyne Philbrick's 4014, which has a settling time of 100 ns (to within 0.01%). The Philbrick unit, how-

ever, costs \$195 in unit quantity.

Of course, high-speed, high-accuracy, converters have been available before now—but not as modules. The size and cost of high-performance converters has hitherto precluded their use in most display applications.

Engineers at Hybrid Systems based the design of the DAC395-12A on circuitry used in an earlier multiplying DAC—the DAC390. They eliminated the multiplying capability and optimized accuracy.

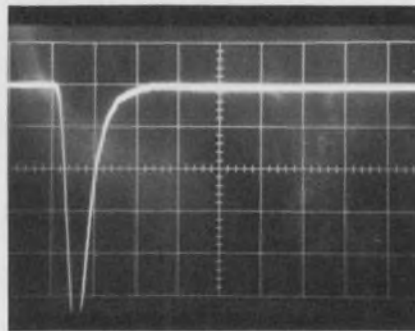

Scope trace shows the settling time of the new Hybrid Systems DAC for a 1-bit input change at the major carry point. Though there is a full-scale glitch, the output recovers and settles within 50 ns. The horizontal scale is 20 ns per div., and the vertical scale is 0.01% f.s. per div.

and speed, thus producing a new converter that offers better performance while having a smaller package and lower cost than the older multiplying version. But the DAC395-12A doesn't replace the DAC390. In typical CRT display systems both multiplying and non-multiplying DACs are needed. Characters and symbols can be generated from a series of straight lines with the nonmultiplying DAC controlling the initial position of a line and the multiplying DAC controlling the slope and length. The DACs must be fast so they can handle the large number of straight-line segments needed for complex figures. They must be accurate to insure that the line segments fit together.

Hybrid Systems achieved the desired linearity by using discrete thin-film resistors for the DAC's internal weighting network. Also, the company designed a reference source that has a power-supply sensitivity of only 0.002%/%. The over-all accuracy tempco is 30 ppm/°C. The complete unit operates from ± 15 V supplies.

The company's engineers achieved fast switching by using current-output switching circuitry. The DAC's relatively large output current of 5 mA (full scale) minimizes the effects of stray capacitance at the output and allows the unit to drive coaxial cable directly. To insure reliability, all active devices in the DAC395-12 are hermetically sealed in metal cans. No plastic or silicone packages are used for the transistors or ICs.

The DAC accepts either straight binary or offset binary input codes and is TTL-compatible. In addition to the A version, Hybrid Systems offers two reduced accuracy versions, B and C, with linearities of $\pm 0.025\%$ and $\pm 0.05\%$, respectively. The operating temperature range for all versions is 0 to + 70 C.

Booth No. 1414 Circle No. 260

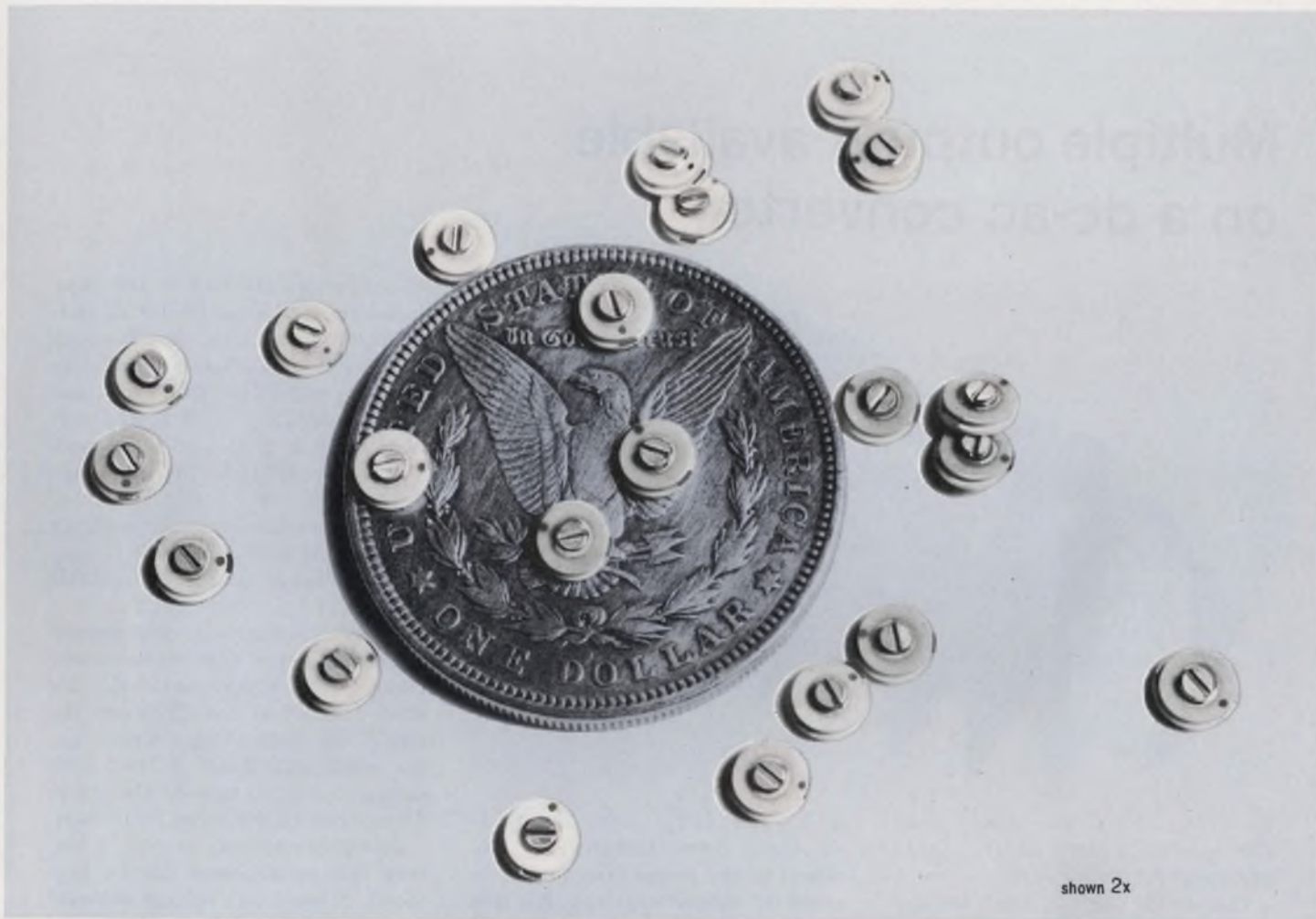

Introducing the littler trimmer.

Meet our new microminiature ceramic variable capacitor.

It provides maximum adjustable capacity for a given size—plus high reliability at low cost.

The DVJ5014 trimmer, with a height of .070 inches above the mounting surface, is only .245 inches in diameter yet matches the electrical performance of other capacitors many times its size. This trimmer features a slotted adjustment head.

Also available is the DVJ5009 series (with a height of only .045 inches above the mounting surface) featuring a flush adjustment head. In applications where cost rather than height is the prime consideration, use of the DVJ5014 is recommended.

Rotors for both models are constructed with a monolithic embedded electrode in a special pro-

prietary ceramic material and a stator body made from high alumina ceramic. These features provide a larger ΔC , and higher reliability than previously available, as well as complete environmental stability.

The new JFD microminiature ceramic variable capacitors are well suited for printed or hybrid circuit mounting as well as other applications involving ceramic substrates, microminiature crystal oscillators, stripline assemblies, multiplex transceivers, telemetry oscillators and transmitters, frequency multipliers, and other subminiature electronic circuits.

That's quite a lot for a little trimmer.

Why trade off performance to get lower prices? For full details write or call us or your local JFD field engineer.

Model	ACTUAL SIZE	Capacitance Picofarads Min.-Max.
DVJ5009		
DVJ5014		
DVJ5009/10		3-10
DVJ5014/10		
DVJ5009/15		3.5-15
DVJ5014/15		
DVJ5009/20		4-20
DVJ5014/20		
DVJ5009/30		5-30
DVJ5014/30		

JFD

A Riker-Maxson Subsidiary
JFD Electronics Corporation
 15th Ave. at 62nd Street
 Brooklyn, N.Y. 11219

Multiple outputs available on a dc-ac converter

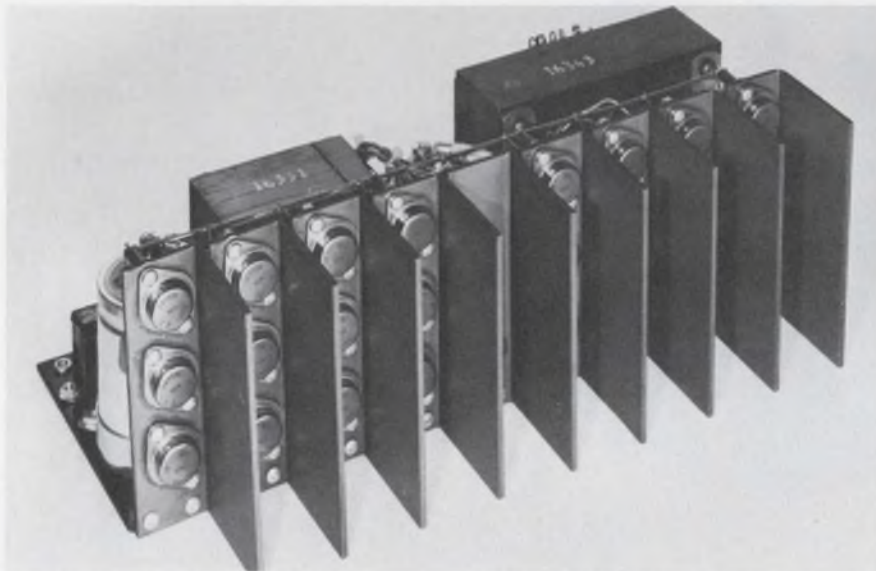

Powertec, 9168 De Soto Ave., Chatsworth, Calif. 92311. (213) 882-0004. P&A: see text.

Conversion of a dc voltage source into several ac sources can be done economically with Powertec's 23 Series modules. By adding the company's SM Series power supply modules, the user can convert from one dc voltage to another dc voltage.

Each module in the 23 Series consists of a switching regulator operating at about 20 kHz, a dc-to-

ac inverter and a single or multiple-output power transformer. The output at the power transformer is a 400-Hz square wave that has less than 5% combined line and load regulation and a frequency stability of better than 1%.

Modules come in three power ranges: 150 W, 300 W and 600 W. Each range can be provided in any of the following input voltage slots: 20-30, 40-60 and 100-150 V.

Transformers come with any desired number of taps. If small ac-

dc converters are tied to the taps, each can give a particular dc output voltage. Powertec provides such a line of regulated ac-dc converter modules, called the SM Series, and it gives voltages to 30 V and currents to 18 A. Prices on these modules run from \$14 to \$38 in quantities of 100.

Power ratings on the inverter series apply over a 0-to-60 C temperature range and are deratable to 71 C.

Price is relatively independent of the number of taps on the transformer. The 150-W unit sells for \$225, the 300-W for \$275 and the 600-W for \$325. These prices are for small quantities. A unit with specially ordered taps on the transformer can be delivered in 10 days.

In battery-driven systems, a battery failure indicator can be provided. A low-input voltage detector drives an isolated logic signal and an indicator lamp.

The 23 Series can be rack-mounted. The 600-W unit mounts in a 5-1/4-in-high rack, and the 150 and 300-W units require 3-1/2-in.

Open-frame construction is used. The 150, 300 and 600-W units weigh 8, 12 and 20 pounds.

Booth No. 1814-15 Circle No. 261



ANALOGY
THE A-245 IS A SUPER LOW DRIFT, LOW NOISE, LIKE 2µV P.P (MAX)-HI REL CHOPPER STABILIZED OP AMP. IT MEETS ALL REQUIREMENTS FOR MIL STD-883 TO MEET THE MOST STRINGENT AEROSPACE REQUIREMENTS. WRITE ANA ABOUT INTECH'S LINE OF HIGH QUALITY, HIGH PERFORMANCE OP AMPS, MULTIPLIERS AND INSTRUMENTATION AMPS. FLY ANA.

intech INCORPORATED
(408) 244-0500
1220 COLEMAN, SANTA CLARA CA 95050

The new Fluke Terminal/10 ATE, your test engineers will love you for it. So will your customers!



See all the new Fluke Instruments at WESCON

You invest in automatic test equipment to cut costs, increase production and improve quality of analog and digital boards, sub-assemblies and instruments. You want to get on stream fast, change programs to solve a variety of problems quickly and interface with your computer easily.

Fluke's new ATE Terminal/10 equipment can be on the air 90 minutes after you get it. We use bug free software throughout so you get high productivity from your programmers. We use a language you're already familiar with, such as BASIC, FORTRAN, FOCAL, OR ASSEMBLER.

Terminal/10 operates with any non-dedicated computer so you won't have to alter it in any way. Usually, the computer you already have will work just fine with Terminal/10. Up to sixteen Terminal/10 systems can be served by a single computer so you can handle a lot of jobs on a very efficient price performance basis.

Goodies Galore. Technically, the Fluke Terminal/10 ATE overcomes virtually



all of the drawbacks of earlier equipment for this purpose. We took enough time to design it, three years, learning from the other fellows' mistakes as we went along. For instance, we put in a neat switching matrix to give you the right mix of switching capabilities. You can have the Terminal/10 in either rack or table mount.

We used all the latest advances in systems architecture. An optional keyboard gives you direct communication with the module under test. You can have tone generators and a CRT to give you aural and visual communications.

The EIA compatible interface gives you a choice in CPU configuration and improves the reliability of system interface. So a Fluke Terminal/10 is available in exactly the configuration you need to meet your calibration, testing, and checkout requirements.

To arrange a demonstration or get complete information, call your local Fluke sales engineer or contact us directly.

Fluke, Box 7428, Seattle, Washington 98133. Phone: (206) 774-2211 TWX: 910-449-2850. In Europe, address Fluke Nederland (N. V.) P. O. Box 5053, Tilburg, Holland. Phone (04250)70130. Telex: 884-52337. In the U. K., address Fluke International Corp., Garnett Close, Watford, WD2,4TT. Phone: Watford, 33066. Telex: 934583.



INFORMATION RETRIEVAL NUMBER 51

Perfect mate for Integrations— Micro-Vectorbord® Tenth-Tenth Pattern "P"

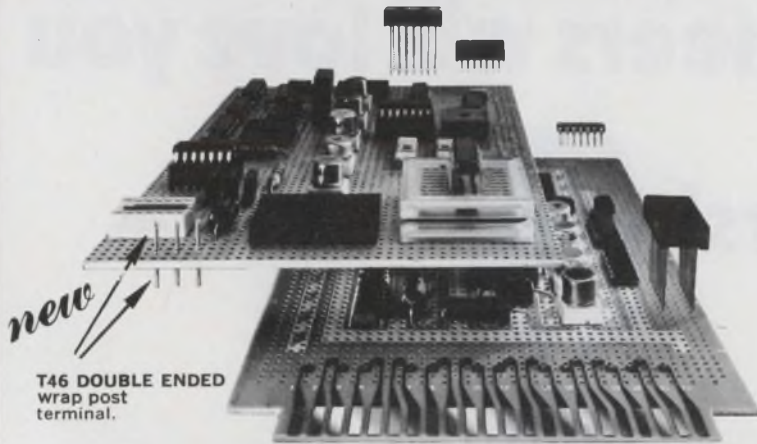

T46 DOUBLE ENDED
wrap post
terminal.

Precision punched .042" holes spaced .1" x .1" available in sheets of various sizes up to 8½" wide by 35" long, 1/16" thick Epoxy Glass, Epoxy Paper, Phenolic. Now all flame retardant. Copper Clad and Non-Clad. Also available in Plugboards with etched or Elco Varicon contacts, buses, ground planes.

MINIATURE PUSH IN TERMINALS FOR .042" HOLES.



T44 MINIWRAP .025"
Square, for wrapping.



K27 .042" Diameter



T42-1 Micro-Klip

Vector

Send for complete literature

ELECTRONIC CO., INC.

12460 Gladstone Ave., Sylmar, California 91342
Phone (213) 365-9661 • TWX (910) 496-1539



72-3

SEE US AT WESCON BOOTH NO. 3500
INFORMATION RETRIEVAL NUMBER 52



A NEW BABCOCK REED RELAY FOR YOUR EVALUATION

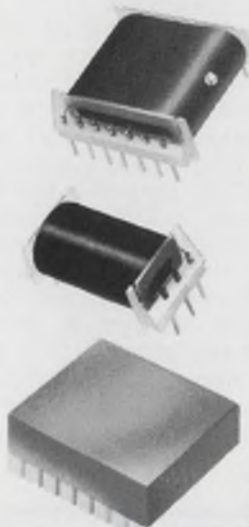

Check for yourself these relay features . . . gold-plated terminals—reed welded to terminals—glass reinforced bobbin—stand-off pads to facilitate board cleaning . . . THEN check its performance. The new 10-watt dry-reed and 50-watt mercury-wetted series is offered in 0.100" and 0.150" terminal spacings, in Forms A, B, and C and combinations, and in open frame and covered versions.

Send for your FREE sample and complete technical data; contact Babcock Electronics Corp., Subs. of Esterline Corp., 3501 No. Harbor Blvd., Costa Mesa, Calif. 92626.



BABCOCK

A UNIT OF ESTERLINE CORPORATION

INFORMATION RETRIEVAL NUMBER 53

MODULES & SUBASSEMBLIES

8-bit a/d converter costs just \$85

Datel Systems, Inc., 1020 Turnpike St., Canton, Mass. 02021. (617) 828-6395. \$85.00; 2 wks.

The ADC-EH 8-bit, a/d converter is packaged in a compact 2 x 2 x 0.375-inch module. It uses a single LSI monolithic IC to provide all the necessary successive-approximation logic. The analog input-voltage range is digitally programmable and can be either unipolar, 0 to +10 V FS or bipolar (± 5 V). The unit has $\pm 0.2\%$ accuracy and differential linearity. Parallel and serial outputs are a standard feature. ADC-EH can do an 8-bit conversion in 2 μ sec (throughput rate of 500 kHz). TC of differential linearity is ± 15 ppm/ $^{\circ}$ C of full scale and gain TC is $+25$ ppm/ $^{\circ}$ C of reading. Full 8-bit accuracy is maintained from 0 to 70 C, with -25 to $+85$ C operating range available at additional cost. ADC-EH is adjustment free and has a long-term stability of $\pm 0.1\%$ /year. All control inputs, outputs and data output lines are compatible with standard TTL/DTL logic levels. Input power requirements are +5 Vdc @ 125 mA, +15 V dc @ 35 mA and -15 V dc @ 25 mA.

Booth No. 4900, 01 Circle No. 262

Outlet-strip consoles give built-in controls

Waber Electronics, Inc., 300 Harvard Ave., Westville, N.J. 08093. (609) 456-7300. \$14.24 to \$23.64.

Three new desk-top outlet-strip consoles, designed to provide a greater degree of control for instruments and equipment, are being introduced by Waber Electronics, Inc. Models 95, 96 and 97 have four, six or eight "U" ground outlets, each controlled by its own switch and pilot light. These units have fuse or circuit breaker protection, and are available with either a six or fifteen-foot heavy-duty HSJ cord-set. Rating is 15 A, 130 V. The consoles are 2-3/4 x 2-3/4 inches and vary in length from 7-1/2 to 11 inches.

Booth No. 4301 Circle No. 263

New Stackpole keyboard: Typewriter feel and speed/ n-key roll accuracy without electronic network

New Stackpole/Magsat™ electronic keyboard with remarkable Magsat mechanical keyswitch offers *new economy* and features not available before in high thru-put keyboards.

- ⊕ Tactile/audible feedback and platform feel let typist switch to data entry with no special training, no decrease in speed or accuracy.
- ⊕ n-key rollover is achieved directly in the switch, not in an electronic network. Once operator initiates action, a one millisecond, one shot contact closure isolates the electronic output from the operator, achieving true by-pass. Key release time has no effect on order of data entry.
- ⊕ Static encoding provides greater economy, eliminates costly RFI problems and time dependency of scanners. Unprecedented coding flexibility is achieved with a unique and simplified p.c. board interconnection technique.
- ⊕ Less space and no stand-by power are needed. Sensitivity to frequency, temperature, and humidity is eliminated.

Any number of keys and formats are available to meet your quality, high thru-put keyboard needs. Bulletin 77-101 tells all.
Stackpole Components Company, P.O. Box 14466,
Raleigh, N.C. 27610. Phone 919-828-6201.



STACKPOLE
COMPONENTS COMPANY
INFORMATION RETRIEVAL NUMBER 54



Designed with the operator in mind

CMOS shrinks size and price of data-acquisition system

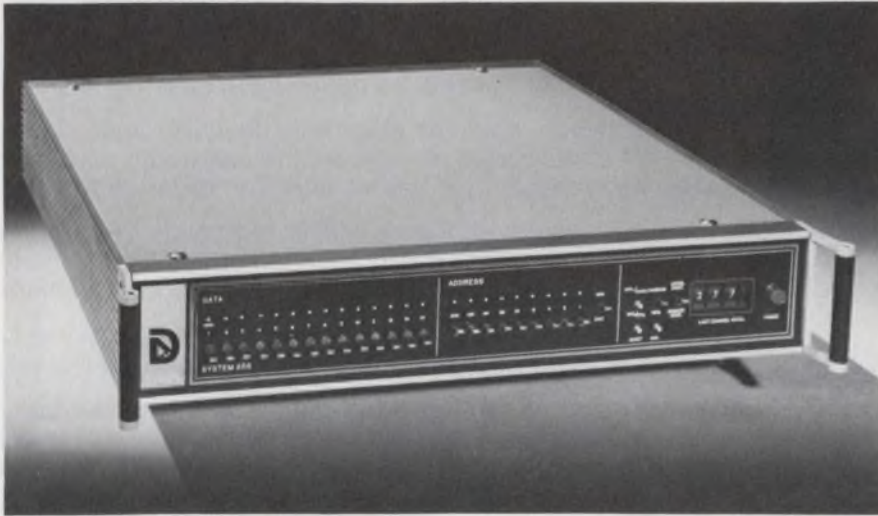

Datel Systems, Inc., 1020 Turnpike St., Canton, Mass. 02021. (617) 828-6395. P&A: See text.

Take a single 19 × 19 × 3.5-inch package, add 256 analog and 32 digital-to-analog channels, sprinkle with a pinch of the power consumption of previous systems and mix. Then charge a lower price, and you've got Datel's System 256, a computer-compatible data-acquisition and distribution system.

CMOS is the secret ingredient that allows Datel to offer four times the channel capacity (in one enclosure) of its closest competitor, Analogic's Series AN5800. CMOS consumes practically no power in the quiescent state (multiply the supply voltage by the pA-leakage current of the device) and it uses, dynamically, about a tenth the power per function of TTL logic.

As a result of its lower power dissipation, the 256 has less drift (caused by temperature rise), negligible cooling requirements and, of course, more hardware in a given area.

Analogic's AN5800 offers, in contrast, a maximum of 64 analog and eight d/a channels in its 19 × 19 × 3.5-inch package. Up to 256 additional channels are accommodated by stacking the basic units.

Both companies' systems offer flexible operation: Analog inputs can be single-ended, or differential (at half the number of channels), and they can be multiplexed either sequentially or in a random-address mode. Both units contain circuitry to insure that the LSB will always occupy the extreme right hand position in the output word, and both can be customized by choosing the required mixture of multiplexers, buffer amplifiers, a/d and d/a converters and sample-and-hold amplifiers. (The 256 can handle up to thirty-two 14-bit d/a converters, the AN5800 up to 8.)

Input resolution, drift, accuracy and throughput rates of the competing units depend mainly on the a/d converters selected. In general, accuracy and linearity decrease with a decreasing number of bits, but throughput rate increases; so tradeoffs must be made. With a 12-bit a/d, the 256 specifies an over-all system accuracy of ±0.025%; a tempo of ±40 ppm/°C over 0 to 70 C and throughput of 40 kHz. The AN-5800, with an equivalent 12-bit a/d, also specifies ±0.025% accuracy, but has a slightly lower—32 kHz—throughput and a lower tempo of ±13 ppm/°C.

However, price is where the competing units show large differences,

especially as the number of channels increases. For example, the single-ended 64-channel Datel system, with 12 bits, costs \$2129, including the sample and hold, MUX, a/d and front-panel controls and displays. An equivalent Analogic system costs \$2404. With 128 channels, the price difference is \$1910 in favor of Datel. And with 256 channels Datel soars away with a \$3665 advantage. The differences occur because of Datel's single-package design, plus the fact that the System 256 expands in 32-channel increments, while the AN-5800 expands in groups of eight.

For more information:

From Datel *Circle No. 264*

Booth No. 4900-4901

From Analogic *Circle No. 265*

Paper-tape reader has only one moving part

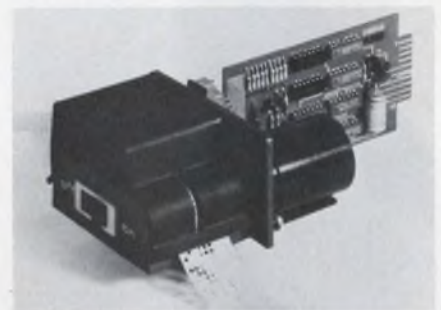

Addmaster Corp., 416 Junipero Serra Dr., San Gabriel, Calif. 91776. (213) 285-1121.

The Addmaster 601 paper-tape reader is a photoelectric, solid-state reader which operates with only one moving part. Data and control functions are at TTL levels. The 601 operates asynchronously from 10 to 120 chars/sec with 5, 6, 7 or 8-level tape in standard widths, which can be fanfolded or on reels. The reader stops on character and automatically detects end of tape or taut tape.

Booth No. 4800, 01 Circle No. 266

**Other computers
have the capability
of our new 8-bit
NAKED MINI.™**

But they use 16 bits.

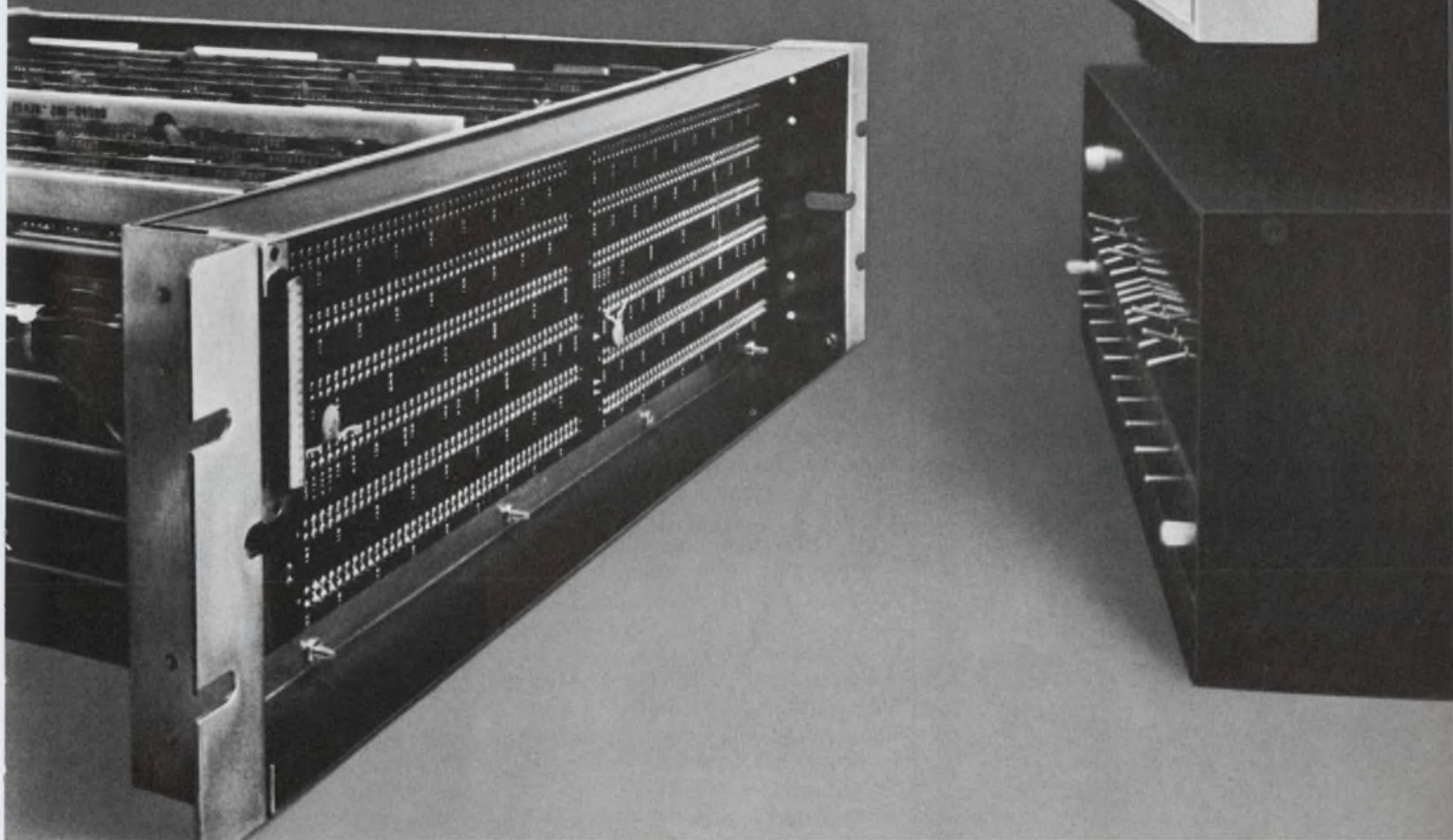

Every systems designer who's looking for a powerful, versatile computer for the lowest possible price should take a closer look at our byte-sized NAKED MINI 8.

Start by comparing its capability. It does everything a 16-bit machine can do except fast arithmetic (or inflate the price of your product). In byte-oriented applications like intelligent batch terminals, source data entry and data communications, the NAKED MINI 8 provides a potent capability that is unmatched by other 8, 12, and most 16-bit machines.

Priced at \$1,450, in 200 OEM quantities, the NAKED MINI 8 represents the industry's lowest cost high-performance minicomputer.

So think about it. Capability and price. They're two good reasons you should ask about the computer that's also a component. Write 18651 Von Karman, Irvine, Calif. 92664 TWX 910-595-1767 (714) 833-8830



COMPUTER AUTOMATION, INC.
the NAKED MINI company

TEC LED LITE

INDICATORS/SWITCHES



IC COMPATIBLE INFINITE LIFE

LED — latest state-of-the-art indicator made practical, readily useable, by TEC-LITE. Brightest LED's made brighter, side viewing by highly efficient lenses. Dozens of body and lens styles and sizes. Terminal options. Fast mounting. Priced from \$1.50.*



SWITCH/INDICATORS

TEC-LITE has combined rugged, long life LED with a full range of integral switches — momentary, alternate, and snap action in ratings to 15 amps. Price: \$4.50.*



T-1 1/4 BASED LED-LITE

Direct LED replacement for flanged base incandescent lamps in 5 to 28 volt models (with internal resistor). Converts all TEC-LITE replaceable lamp devices to LED! Lamps priced from \$1.30.*

*100-499 quantities.

SPECIAL LED DESIGNS

ILLUMINATED ROCKER SWITCHES



LED's mounted adjacent to each rocker switch provide status indication. Multiple switch assemblies available with a variety of handsome bezel designs.



LED DISPLAYS

One or more LED indicators incorporated in easy-to-mount bezels provide a new, attractive method of adding LED's to panels, instruments, etc.

See TEC-LITE for the complete line of readouts, indicators, switches, display panels, keyboards, CRT terminals.

TEC, Incorporated; 9800 North Oracle Road, Tucson, Arizona 85704; or phone (602) 297-1111



INFORMATION RETRIEVAL NUMBER 56

DATA PROCESSING

PDP-11/40 increases speed and lowers cost



Digital Equipment Corp., 146 Main St., Maynard, Mass. 01754. (617) 897-5111. See text; Nov.

The PDP-11/40 addition to the family of 16-bit minicomputers is designed to execute standard instructions at almost twice the speed and at a lower price than its predecessor, the PDP-11/20. Available as options are a hardware floating-point package that can further increase this speed by nearly 10 times, and a virtual-memory scheme able to address up to 124 k of 16-bit memory. Almost all the instructions of the PDP-11/45, the largest member of the PDP-11 family, are included. Price for a PDP-11/40 with 8 k of 900 ns memory, ASR-33 unit, cabinets and programmer's console, power supply and cables, installation, 90-day warranty and software is \$12,995.

Booth No. 3909-13 Circle No. 267

Video metrology system replaces microscope



Circon Corp., Santa Barbara Airport, Goleta, Calif. 93017. (805) 967-0404.

Circon's MV-9600 Micro-Video metrology system, which provides a TV screen, a digital display for measurements and a hard-copy printer, is suitable for a wide variety of inspection and production tasks. Large parts may be inspected and measured at magnifications of less than 10x. By rotating the turret lens assembly, 30x magnification is achieved. This magnification is suitable for miniature assembly work or printed circuit board inspection. At 100x, integrated circuits can be easily inspected.

Booth No. 4305 Circle No. 268

Card reader features nonforceable interlock



Sealectro Corp., 225 Hoyt St., Mamaroneck, N.Y. 10543. (914) 698-5600.

Sealectro's card and badge reader offers such features as remotely operated contacts, and a non-forceable interlock that senses improper card insertion. The reader is made from heavy-duty stamped assemblies. Because of improved mass production techniques, Sealectro can offer the unit at a low cost (price not stated).

Booth No. 2300 Circle No. 269

UP-FRONT SIMPLICITY: LEVER-LITE III

Rugged modular construction gives you a reliable lighted lever switch that provides front-of-panel convenience on the assembly line or in the field.

Our new "Lever-Lite" III switches were designed to simplify installation and servicing of lighted lever switches on computers, telecommunications systems, industrial control equipment, intercoms, broadcast consoles and scientific or test instruments of all kinds.

SIMPLE to mount and terminate. "Lever-Lite" III switches are installed from the front. In a single hole. The lever assembly (lever-actuator, lamp and socket, and color filters) simply

slips into its housing. An escutcheon that "snaps-in" place secures the lever assembly and "trims" the mounted switch. Switching and lamp terminals are solder lug type but also accept standard quick connect-disconnect receptacles.

SIMPLE to relamp. Front-of-panel relamping or changing of color filters can be done easily by removing the escutcheon and lever assembly with your fingertips.

SIMPLE to find what you need. "Lever-Lite" III switches are available in 2- and 3-position types. With locking, non-locking and talk-listen functions. You can order multi-color (different colors in each position), mono-color (one color in all positions) or non-illuminated "Lever-Lite" III switches. And they can be specified with SPST to 8PDT switching.

SIMPLE to get. Contact your local Switchcraft distributor, sales representative, or write us direct. Switchcraft, Inc., 5539 N. Elston Avenue, Chicago, Illinois 60630.

SWITCHCRAFT
INC.

INFORMATION RETRIEVAL NUMBER 57

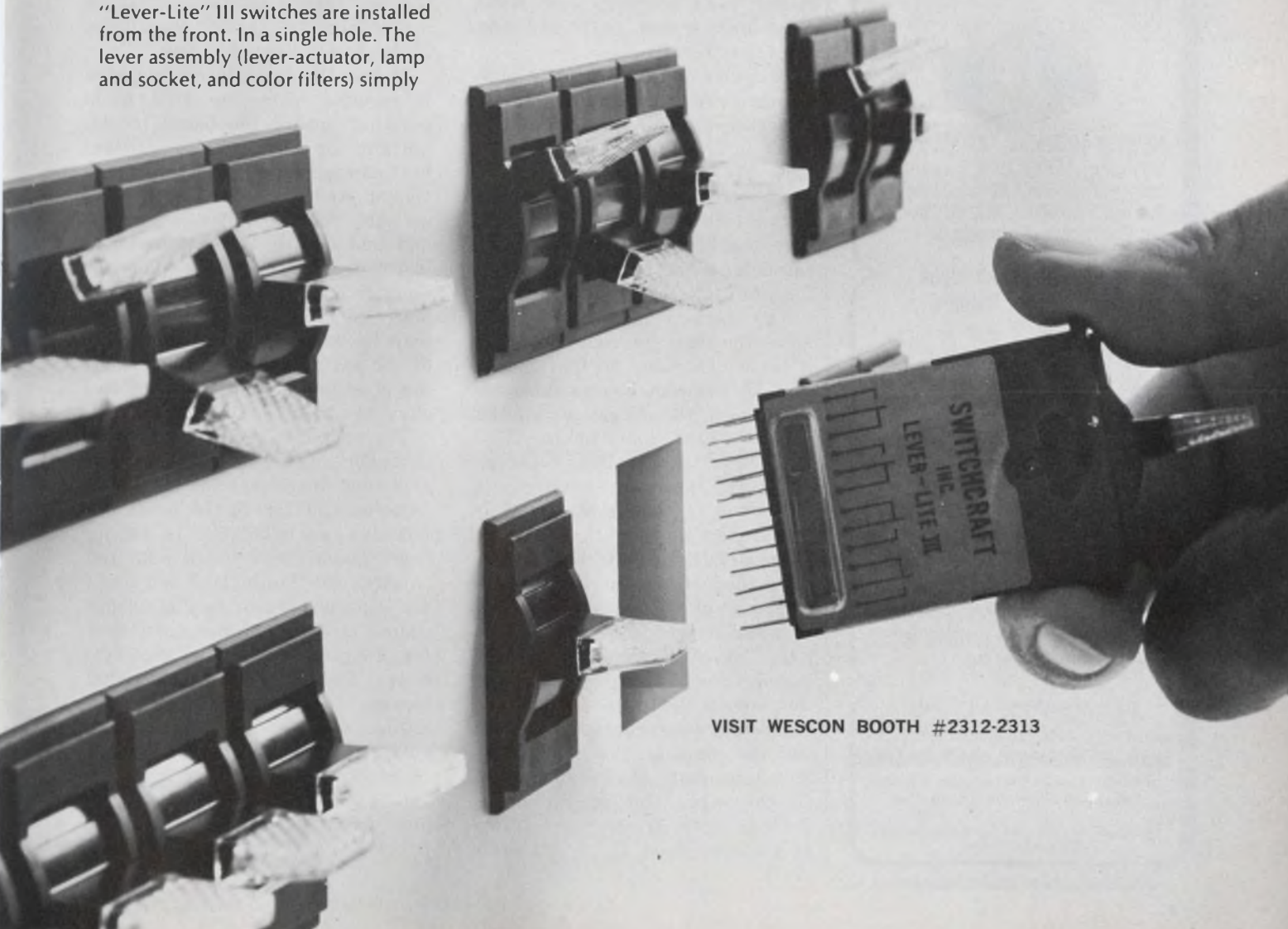

VISIT WESCON BOOTH #2312-2313

Tung-Sol[®] Bridge Rectifiers Provide High Thermal Efficiencies

Junction sizes and assembly techniques comparable to those used for discrete power rectifiers, are employed in the manufacture of Tung-Sol modular bridge rectifiers. As a result, Tung-Sol bridges offer superior overload capacities, greater thermal efficiencies and increased reliability.



NEW! B-50 Series—Single phase
DC rating—10A @ 75°C. Forward surge rating—300A @ rated load. Ratings from 50 to 600 PRV per leg. Epoxy case construction.



NEW! B-40 Series—Single phase
DC rating—15A @ 75°C. Forward surge rating—300A @ rated load. Ratings from 50 to 1,000 PRV per leg. Epoxy case construction.

Other Tung-Sol Bridges (With Higher Ratings)

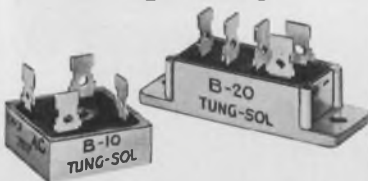

B-10 Series—Single phase
DC rating—30A @ 55°C. Forward surge rating—400A at rated load. 50 to 1,000 PRV per leg.

B-20 Series—Three phase
DC rating—35A @ 55°C. Forward surge rating—400A @ rated load. 50 to 1,000 PRV per leg.

Write for complete information.

SILICON PRODUCTS SECTION WAGNER ELECTRIC CORPORATION

630 West Mt. Pleasant Ave. Livingston, N.J. 07039
TWX: 710-994-4865 PHONE: (201) 992-1100
(212) 732-5426

Trademark TUNG-SOL Reg. U. S. Pat. Off. and
Marcas Registradas

INFORMATION RETRIEVAL NUMBER 58

PACKAGING & MATERIALS

Wrapped-wire board permits plug-in or wave-solder links

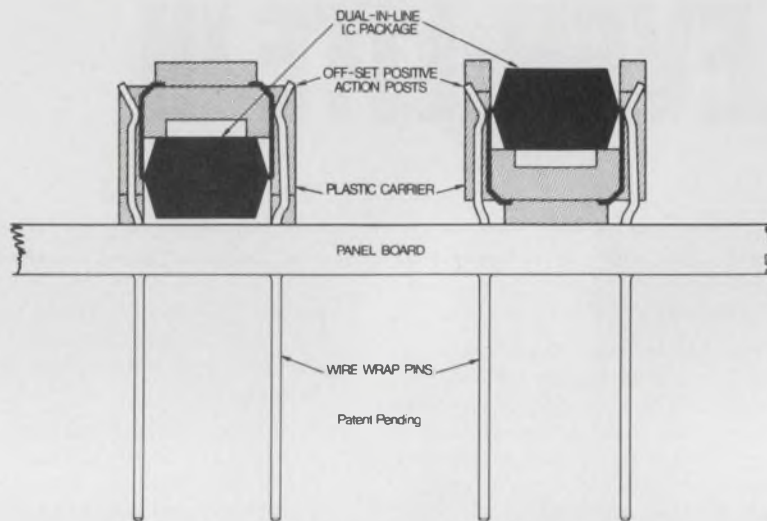

Augat, Inc., 33 Perry Ave., Attleboro, Mass. 02703. (617) 222-2202. P&A: see text; 4-6 wks.

In a new approach to DIP packaging, a circuit board with pins for solderless-wrapped terminations accepts unusual nylon carriers that allow the DIPs to be plugged in or wave-soldered to the circuit board. Because Augat's 8200-series boards give the designer this choice, he can defer a final decision on soldering until late in the design cycle.

The plug-in possibility eliminates the need for soldering when it is not essential to the application. If, however, wave-soldering is performed, the Augat IC carrier acts as a heat shield for the IC.

Whether the DIP IC is eventually plugged in or wave-soldered, its connection to the nylon carrier is always the same.

Each DIP is attached to the glass-filled nylon carrier through crimping of its leads around the channels on the sides of the carrier. The carrier is then inserted between rows of spring contacts on the board, resulting in a sound connection between the DIP leads and the contacts. The spring contacts terminate in wrapping pins on the other side of the panel. Each time an IC is inserted into or removed from the board, it is

the IC carrier assembly that is maneuvered, not the IC alone. Thus IC leads don't get damaged.

If the DIP carrier combination is inserted with the DIP leads pointing toward the board in the upright, or "live bug," position, heat damage from soldering is prevented. And, of course, the plug-in assembly facilitates design changes and field service. When the DIP is inserted with its leads pointing away from the board—in the "dead bug" position—its crimped leads may be wave-soldered to the tips of the spring contacts, thus yielding greater reliability under mechanical stress.

The contact pins, of gold-plated phosphor bronze, come on 100-mil grid centers. Boards for 30 to 180 patterns and for 14, 16 or 18-pin DIP ICs, are available. In 100-up board quantities, a board with 100 patterns for 14-pin DIP ICs costs 45¢ a pattern—a price that Augat claims is 40% cheaper than that for other socket wrapped-wire systems. There are no additional charges for custom designs, and set-up charges are waived for quantities over 50 boards. Enough IC carriers and tools for insertion and removal of the DIPs are supplied without charge.

Booth No. 3410, 11 Circle No. 270

it's all in the family



250 AMPS & 600 VOLTS

(SDT 5840) (SDT 5865)

*Solitron has expanded its high power, high current
NPN Silicon Planar Transistor Line!*

Six individual series of planar power transistors have been developed by Solitron to meet various application requirements for high current switching. These silicon power devices are constructed with the **largest single planar chip** in the industry. They are the most versatile high power, high current, fast switching transistors available today.

FEATURING:

- Hi-Rel Construction
- $f_t = 15$ MHz Typical
- Power Dissipation @
100°C = 300W
- Low Thermal Resistance,
 $\theta_{J-C} = 0.33^\circ \text{ C/W}$

*Also available in TO-68 Case

Series No.	Ic (max)	Vceo
SDT 5840	250A	100V
SDT 5850	200A	200V
SDT 5860	150A	300V
SDT 5845	75A	400V
SDT 5855	60A	500V
SDT 5865	30A	600V

From the House of Power

For complete information, prices and engineering application assistance, dial toll-free 1-800-327-3243. Or write:

Solitron

DEVICES, INC.

1177 BLUE HERON BLVD. / RIVIERA BEACH, FLORIDA / (305) 848-4311
TWX: (510) 952-7610

SAN DIEGO, CALIF
8808 Balboa Ave.
CMOS, PMOS Circuits
Diodes, Rectifiers, &
Zeners
FET & Dual FET
Transistors
High Voltage Assemblies
Linear & Monolithic IC's

RIVIERA BEACH, FLA
1177 Blue Heron Blvd.
Hi-Rel Power Transistors
Si & Ge Power
Transistors
Hi-Rel Power Hybrids
PNP-NPN Industrial
Transistors

PORT SALERNO, FLA
Cove Road
Microwave Connectors
Plaxial (R) Cable
Precision RF Coaxial

JUPITER, FLA
1440 W Indiantown Rd.
Microwave Stripline
Components
Microwave Diodes
RF and Microwave
Transistors
Hi-Rel Power
Transistors

TAPPAN, N.Y.
256 Oak Tree Road
Diodes & Rectifiers
Ferrite & Ferrite Devices
High Voltage Assemblies
Power Rectifiers
Thick Film
Hybrid Circuits

KENT, ENGLAND
Tubbs Hill House
London Road,
Sevenoaks
Solidev. Ltd.
Full line of
Solitron devices

BEN BARAQ, ISRAEL
51 Hayarkon Street
AEL Israel, Ltd.
Full line of
Solitron devices

TOKYO 105, JAPAN
Rm. No 21,
Kyodo Bldg
No. 4-10, 2 Chome
Higashi Shinbashi
Minato-ku
Full line of
Solitron devices

Sockets

Whatever your IC connection need, we can solve your problem—from our complete line of 800 standard socket products.



Besides being able to furnish everything from IC Sockets to a total IC interconnection system—with anytime availability through our local distributors, we've a couple more compelling reasons why you should contact us first: Robinson-Nugent quality and competitive pricing. For prompt attention to your requirements, contact the Socket People:



800 East Eighth Street
New Albany, Indiana 47150
(812) 945-0211 TWX 810-540-4082

INFORMATION RETRIEVAL NUMBER 60

NEW HUTSON CERMA-CEL* TRIAC's & SCR's

- 8 Amp ($I_{T(RMS)}$)
- 200V, 300V, 400V (V_{DRM})
- Miniature size — requires only slightly more space than direct chip mounting
- Thyristor die bonded to ceramic cell and secured within nickel-plated steel housing
- Can be reflow soldered. Correct amount of solder on housing head.
- Void-free-glass passivated, hermetically sealed chip
- Di-Mesa* construction for maximum operational reliability
- Extremely low-cost



Hutson's complete thyristor line includes 3A sensitive gates to 40A ($I_{T(RMS)}$) • 50V to 600V (V_{DRM}). All popular packages & chip form

WRITE FOR FREE CATALOG



• H. HUTSON INDUSTRIES

HUTSON INDUSTRIES

BOX 34235 • 2019 W. VALLEY VIEW, DALLAS, TEX. 75234 (214) 241-3511 TWX 910-860-5537

Distributed by:

ALTA-LAND ELECTRONICS, INC. Salt Lake City, Utah. 801/486-7227 ■ BODELLE CO., INC., Chicago, Ill. 312/468-1016, Detroit, Mi. 313/273-6920 ■ THOR ELECTRONICS, Elizabeth, N. J., 201/354-2420 ■ In Canada: WEBER-SEMAD ELECTRONICS, Downsview, Ont. 416/635-9880.

European Marketing Director:

30 Rue Pierre Semard, Yerres, 91 France Tel: Paris 925-8258 • TELEX 21-311

Distributed in Europe by:

Belgium: C. N. ROOD S.A. Brussels 02-352135 ■ Denmark: E. V. JOHANSEN A/S, Copenhagen (01)* 295622 ■ Holland: RODELCO, Den Haag 647808 ■ Spain: BELPORT, Madrid 234.62.62 ■ Sweden: ELEKTROFLEX, Sundyberg 08-29 50 40 ■ Switzerland: D. LEITGEB, Dubendorf 051 85 2201 ■ UK: CLAUDE LYONS, LTD, Hoddeston, Hertfordshire (09924) 67161

INFORMATION RETRIEVAL NUMBER 61

PACKAGING & MATERIALS

Module cage assembly boasts low cost



Vector Electric Co., Inc., 12460 Gladstone Ave., Sylmar, Calif. 91342. (213) 365-9661. \$79.50.

A module cage assembly for 19-in. rack mounting consists of a 5-1/4-in. high by 9.6-in. deep aluminum cage with ten installed "L" shaped aluminum card mounting panels. A circuit card up to 4-1/2-in. wide by 6-1/2-in. long may be mounted on each panel which has a 1.65-in. wide by 5-1/4-in. high front for mounting pots, switches, lights, or test points. Nearly any card edge connector can be mounted without drilling holes in the cage assembly on the rear set of extruded cross members. The CCM-13 module cages are shipped completely assembled with guides and ten installed card mounting plates ready for card attachment using the furnished screws and spacers. Booth No. 3500 Circle No. 271

Low profile DIP sockets come in 14, 16 or 24-pin

Circuit Assembly Corp., 3025 S. Kilson Dr., Santa Ana, Calif. 92707. (714) 540-5490.

With a height of only 125 mils above a panel board, a new line of low profile 14, 16 and 24-pin DIP sockets incorporates 145-mil long pins for solder tail connection. They include such features as: beveled entries to guide component leads into the socket without delay or damage to the pins; a chamfered corner to identify pin number one quickly; recessed socket ends to allow free flow of air thus preventing heat build-up; and a unique locking indent on the pins to hold the socket firmly in the board during the soldering phase. Booth No. 4214 Circle No. 272

Matrix board features mixed-level switching

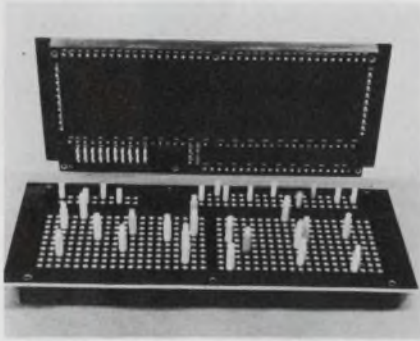

Co-Ord Switch Div., LVC Industries, 102-48 43rd Ave., Corona, N.Y. 11368. (212) 899-5588. P&A: see text; 4 wks.

A mixed-level matrix program board contains two patch areas with three-deck bussed contacts, one area with a two-deck bussed contact matrix, and a fourth area with a two level matrix having bussed contacts in deck one and isolated contacts in deck two. This mixed-level program board is 3/4-in. thick, and eliminates the necessity for three separate units. The design includes a 250-mil grid for compactness with phenolic block construction for toughness. Contacts may be provided with gold or silver plating, and panels may be supplied blank, silk-screened or engraved per customer's specification. Prices depend on the specifications required by the customers. Booth No. 2405, 06 Circle No. 273

Ribbon cable stripper boasts speed savings

Spectra-Strip Corp., P.O. Box 415, Garden Grove, Calif. 92642. (714) 892-3361.

The Series 300 Spectra-Stripper for round conductor ribbon cable, a fully programmable ribbon cable stripper, can cut harness terminating costs by 65% compared with manual methods in production situations. A 10-conductor ribbon cable can be repeatedly separated and stripped in as little as seven seconds. The Series 300 machine is presently designed for the popular 26 AWG in solid, stranded or over-coated tinned stranded conductors.

Booth No. 4315 Circle No. 274

Fundamentally!

100 mW from a 2 to 4 GHz VCO



Now you get a hefty 100 mW of fundamental power across the full 2 to 4 GHz range. W-J's voltage-controlled oscillators make it happen.

Currently available with any combination of isolators, heaters, filters and linearizers, these solid state VCOs are perfect for systems applications where small size, low input requirements and high reliability are essential. Units are designed to meet the environmental specifications of MIL-E-5400, class 2.

Tuning voltage requirements remain at +60 Vdc maximum. Tuning voltage vs. frequency curves are approximately exponential and monotonic, allowing ease of linearization. Varactor tuning ensures high tuning input impedance characteristics and a high-speed tuning capability.

**And see us during WESCON
September 19-22 at the
Hilton Hotel, Los Angeles**



WATKINS-JOHNSON

3333 HILLVIEW AVE., STANFORD INDUSTRIAL PARK, PALO ALTO, CALIF. 94304 • (415) 493-4141

INFORMATION RETRIEVAL NUMBER 62

Three chicks in all.



One will surely lay a gold egg.

Pictured above you see the third chick, an ultra compact 4-phase stepper motor PF1-20. This compact performer and five other steppers invite you to the realm of new product development wherever electrical digital information is required to be converted into mechanical movement. Strongly competitive prices are your extra benefit. For example, the PF1-20 is priced at \$13 per 1,000-unit order, CIF, USA., via air. For quantity discount and details, contact our International Department.

Mo del	PF1-20		PF2-20		PF4-36		PF5-48	
			A	B			A	B
(1)			18°		10°		7.5°	
(2)	40	40	80	190	200			
(3)	440	300	440	380	390	330		
(4)	1000	600	1000	440	430	1400		
(5)	0.4	3.2	5.5	140	120*	60*		

- (1) Step Angle
- (2) Current/coil
- (3) Max. pull-in rate PPS
- (4) Max. pull-out rate PPS
- (5) Max. pull-out torque at 100 PPS



NIPPON PULSE MOTOR CO., LTD.
No.13-16, 2-chome, Hongo, Bunkyo-ku, Tokyo, Japan
Cable: NIPULSEMOTOR TOKYO

INFORMATION RETRIEVAL NUMBER 63

ICs & SEMICONDUCTORS

3-A rectifier offers 1-ns forward recovery

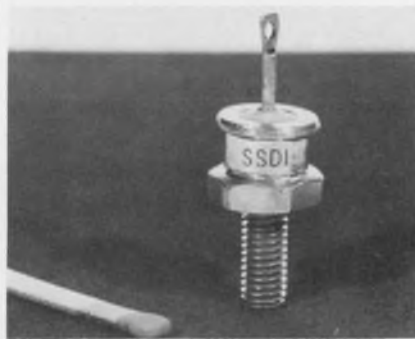

Solid State Devices, Inc., 12741 Los Nietos Rd., Sante Fe Springs, Calif. 90670. (213) 698-3711. 1RZ2A: \$3.50 (1000 up); 2-3 wks.

A series of 3-A stud-mounted rectifiers, termed the HSR-2A, feature a forward recovery of 1 ns max, a reverse recovery of 10 ns max and a forward voltage drop of 0.90 V max. The recovery times are believed the fastest for a rectifier having this rating. The new series is available in five versions with a PRV of 10, 25, 50, 75 and 100. Maximum I_r at 0.5 PRV for all types is 25 μ A.

Booth No. 2408 Circle No. 275

Solid-state switches for 5 to 30 V operation

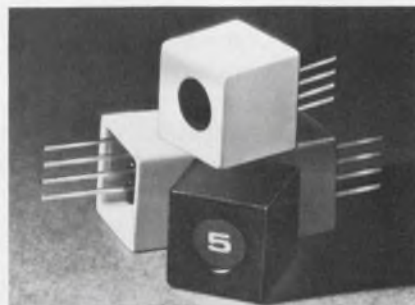

Magic Dot, Inc., 40 Washington Ave. S., Minneapolis, Minn. 55401. (612) 333-8161.

A line of solid-state switches, the F200 series, features operating voltages from 5 V dc to 30 V dc. And standby output current is comparable to the leakage current (I_{CEO}) of a silicon transistor. Output current sinking can reach 150 mA, while saturation voltage is +0.2 V at 50 mA and +0.8 V at 150 mA. The switches have zero bounce and will not jam, wear or change characteristics.

Booth No. 2921 Circle No. 276

MICROWAVES & LASERS

Emi/rfi filters reject to 90 dB, over 1 GHz

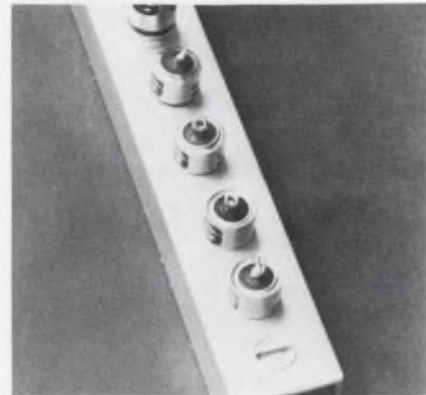

Genisco Technology Corp., 18435 Susana Rd., Compton, Calif. 90221. (213) 537-4750.

A line of subminiature emi/rfi interference control filters provide up to 90 dB of signal rejection, with full rejection characteristics to over 1 GHz. Voltage ratings of 200 V dc or 115 V ac are available at line frequencies up to 400 Hz with current ratings of 0.1, 0.5, 1.0, 5.0 and 10 A. The minifilters are rated to 125 C at full load and full line voltage.

Booth No. 2210 Circle No. 277

Program attenuators from dc to 1250 MHz



Alan Industries, Inc., Bldg. 22, Bakalar Municipal Airport, Columbus, Ind. 47201. (812) 372-8860. \$190 to \$360; 3 wks.

A series of programmable attenuators cover the frequency range from dc to 1250 MHz. Total attenuation available is 1.5, 15, 31, 63 and 127 dB, with 0.1 and 1.0-dB increments. These steps are inserted into the rf line by applying 17 to 26.5 V dc at 17 mA to each attenuation section. Switching speed is rated at 6 mA per bit. Each section has a life expectancy of 10^7 selections.

Booth No. 2203 Circle No. 278

The great 11th-hour wrap-up

We can turn your IC designs into products in just weeks instead of months.

And cut your packaging costs 40% or more doing it.

We've got the world's largest selection of plug-in IC hardware, everything from wire-wrap sockets to complete low-cost, high-density packaging systems.

They save you time and money during the initial design stages, because changes are readily made by simply re-routing your wiring and plugging in a new IC.

They save time and money in production, because the wire-wrapping can be automated and you're not locked into long lead-time PC boards, expensive connectors and back planes.

And they save you time and money on field main-

tenance and modification because of their plug-in flexibility and low-cost spares requirements.

To solve your IC packaging problems, just tell us which sockets, panels, drawers or special assemblies you need. We'll deliver in 1-2 weeks.

Or make it even easier on yourself. Just send us your logic diagram and we deliver a complete packaged system in just 5 weeks. Wrapped, tested, debugged and fully documented. For much less than you could do it yourself.

So why not write for our new catalog and get back on schedule today?

Electronic Engineering
Company of California,
1441 E. Chestnut Avenue,
Santa Ana, California,
Telephone (714) 547-5651.

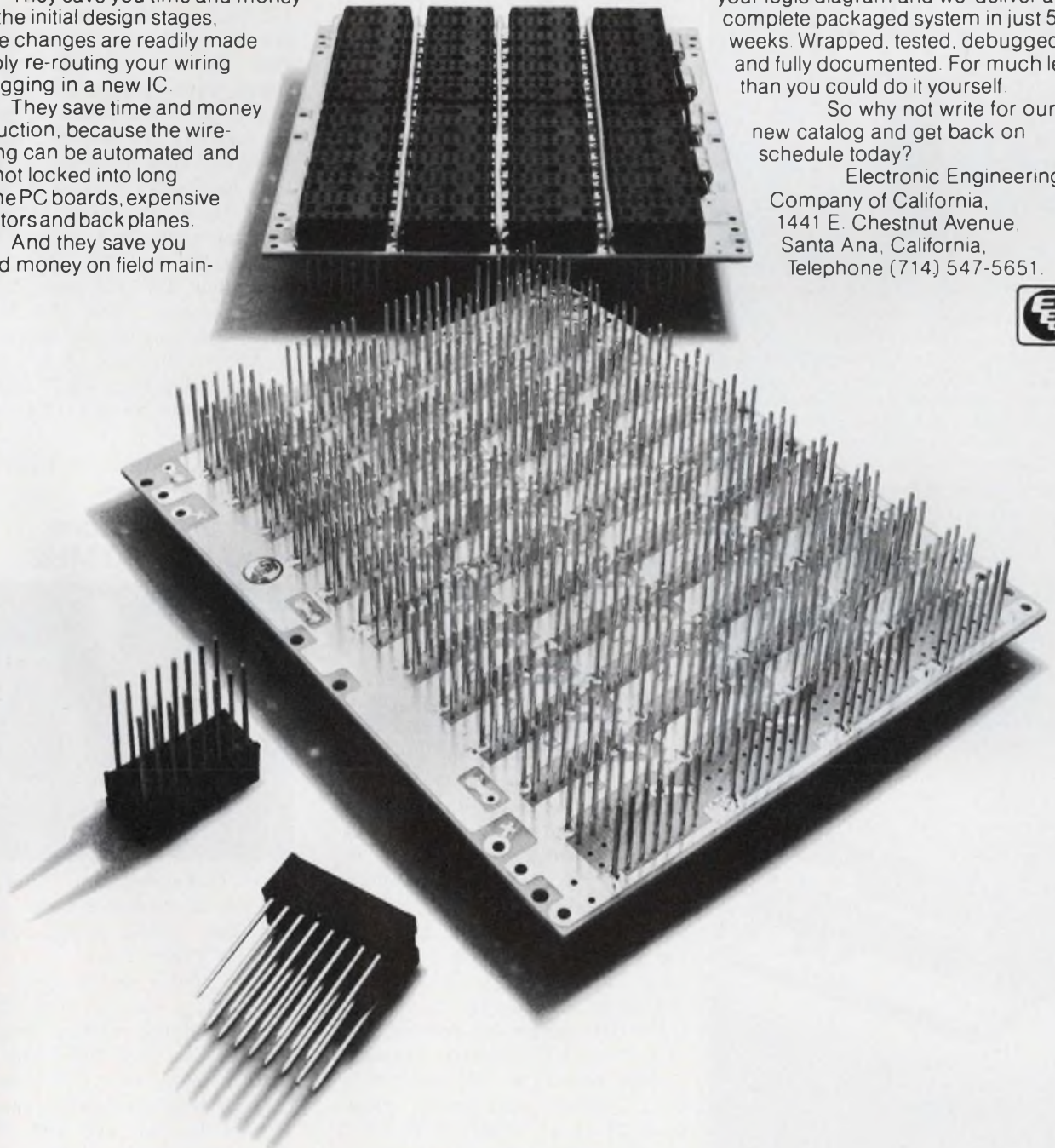

EECO logic panels: help when you need it most.

INFORMATION RETRIEVAL NUMBER 64

The AUTOMATIC RANGING DIGITAL MULTIMETER with the BEAUTIFUL FIGURE: \$319.95

Plus a few other figures which make that \$319.95 (stock delivery) look even more beautiful! The auto ranging Miida 6354 measures AC and DC voltage, AC and DC current, and resistance; on 27 ranges; with a voltage accuracy of .1% (DC) and .5% (AC); resistance measurements up to 200 megohms; 45 Hz to 20 kHz frequency response; weighing in at under 5 lbs.; and a host of technical refinements that engineers love. All solid-state, fully automatic... at a price that makes it a research-lab bargain and production-line affordable! Contact one of the most respected names in electronics: Miida Electronics, a division of Marubeni America Corp., 2 Hammerskjold Plaza, New York, N. Y. 10017/ Phone (212) 973-7152.

Miida



Distributorships available

"VISIT US AT WESCON BOOTHS
711-12-13 SEPT. 19-22"

INFORMATION RETRIEVAL NUMBER 65

MICROWAVES & LASERS

High frequency switches and matrices



Trompeter Electronics, Inc., 8936 Comanche Ave., Chatsworth, Calif. 91311. (213) 882-1020.

Trompeter Electronics offers a line of high frequency matrices and multipole-multithrow switches for the routing of i-f and rf signals under the condition of low VSWRs. These units are constructed using special crosspoint relays that incorporate a "stub" cutoff feature which isolates the signal from any additional discontinuities in the switching system. This feature precludes the operation of more than one crosspoint in any X-Y axis.

Booth No. 1105, 06 Circle No. 279

Miniature filters have reduced dc resistance



Republic Electronics Corp., 176 E. 7th St., Paterson, N.J. 07524. (201) 279-0300. Stock to 4 wks.

A line of low-pass broadband filters boast low dc resistances of 0.015 Ω for a 5-A unit and 13 Ω for a 60-mA unit. With a standard body diameter of 0.375 inch, the miniature filters cover the 30 kHz to 10 GHz range and are available in L, Pi and T networks (standard voltage ratings are 50 and 100 V dc). Typical attenuations range from 50 dB at 30 kHz to 70 dB at 10 GHz. The filters' specs are guaranteed under full load over the -55 to +125 C temperature range.

Booth No. 2600 Circle No. 280

Gunn-diode amp locks to 30 dB over 18 MHz

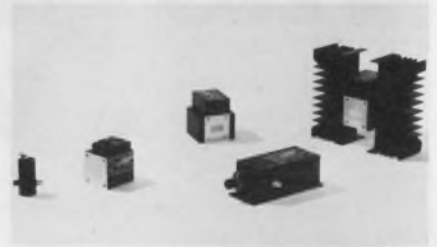

Litton Industries, Electron Tube Div., 960 Industrial Rd., San Carlos, Calif. 94070. (415) 591-8411.

Litton is exhibiting its X-band line of cw, transmitter sources. This includes a 1-W injection, locked Gunn-diode amplifier in the 10.7 to 11.7 GHz band. Designated the LS-1301, the amplifier provides a locking gain of 30 dB in an 18-MHz bandwidth, and 15-dB locking gain in a 100-MHz bandwidth. New mechanically tuned oscillators include the LS-1414 and the LS-1424. The LS-1414 provides 1-W output power from 10.7 to 11.7 GHz with single-knob tuning. FM or AFC is provided by a varactor. The LS-1424 offers 0.8 W minimum output power in the 12.4 to 13.0 GHz band.

Booth No. 2904 Circle No. 281

Step attenuators good to 1500 MHz



Alan Industries, Inc., Bldg. 22, Bakalar Municipal Airport, Columbus, Ind. 47201. (812) 372-8860. \$155 to \$220; 1 wk.

For panels with space at a premium, a line of step attenuators is offered with a frequency range up to 1500 MHz. The series features steps of 0.1, 1.0 and 10.0 dB with total attenuation ranges of 10.9, 49.0, 79.0 and 109 dB. All units incorporate direct reading dials to assure precise readings at a glance.

Booth No. 2203 Circle No. 300

A CAMBION® Double "QQ" Product Line

You decide which plug and patch components are best for your end use design. Whether your concept calls for modular construction to permit ease of assembly and service, or a tightly packaged sophisticated system, CAMBION mounting devices provide the ultimate in flexibility.

From basic breadboarding to production runs of finished equipment, you can use a variety of CAMBION mounting components. You can create your own discrete component mounting configuration with the famous CAMBION cage jacks, design a patchable panel, piggy-back with patch cords, develop special purpose circuit assemblies with a wide selection of CAMBI-CARDS®, and plug finished units into Wire-Wrap* card connectors mounted in multi-purpose card files with optional back planes.

Whichever way you go, the CAMBION plug and patch components you select have two things in common: quality that's built in from design through material selection and finished production, and availability of identical standard parts in quantity. The quality stands up as the quantity goes on. That's the CAMBION Double "QQ" approach.

When you want a sales engineer to show you samples of CAMBION's broad line of mounting devices, write or call us. For a designer's catalog to start now, send us your name and address. Cambridge Thermionic Corporation, 445 Concord Avenue, Cambridge, Massachusetts 02138. Phone: (617) 491-5400. In Los Angeles, 8703 La Tijera Boulevard, 90045. Phone: (213) 776-0472.

Plug and patch components cut design and maintenance costs.



Standardize on

CAMBION
The Guaranteed Electronic Components

Two solid-state relays fit single DIP socket

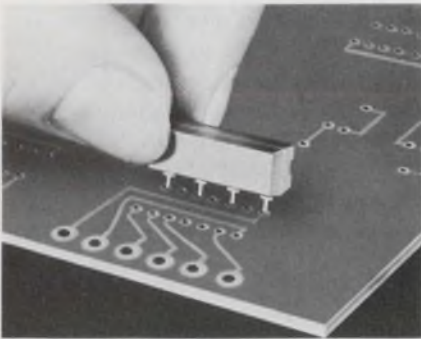

Grisby-Barton, Inc., 3800 Industrial Dr., Rolling Meadows, Ill. 60008. (312) 329-5900. \$2.90 (1000 up) for 120 V ac units; Stock to 5 wks.

The GB870 series of Reedac solid-state, ac relays can switch 480 W at 240 V ac or 240 W at 120 V ac. Two units will fit side by side in a single DIP socket. For isolation purposes, the input can be provided by an external reed relay or mechanical switch.

Booth No. 2813 Circle No. 301

Coaxial connector needs no twisting or threading

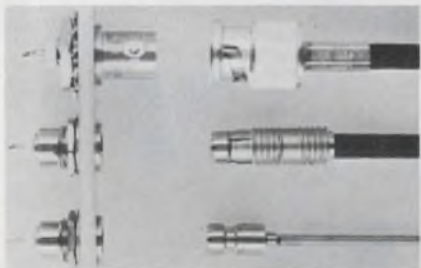

Omni Spectra, Inc., 24600 Hallwood Ct., Farmington, Mich. 48024. (313) 477-1234.

The OMQ series coaxial miniature connector is designed with a straight-in locking feature that permits the user to make connections without twisting or threading of coupling nuts. The new connector contains very few parts. Both the center contact and cable jacket are crimped onto the flexible cable. On semi-rigid cable, the center contact is crimped and the outer jacket soldered. Up to 49 connectors can be mounted in a 4 in. square space.

Booth No. 2309, 10 Circle No. 302

Pushbutton switch indicates its position

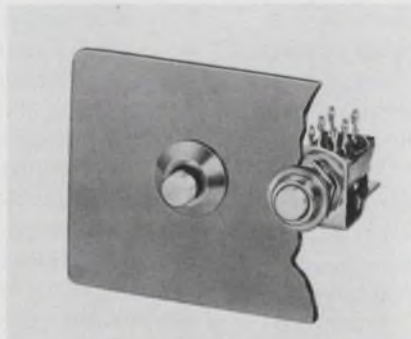

Switchcraft, Inc., 5555 N. Elston Ave., Chicago, Ill. 60630. (312) 792-2700. \$1.50: One form-C; \$2.50: Four form-C.

Nonilluminated, the DVR-2000 Series push switches present a black band at the base of a colored (available in seven colors) recognition cap to indicate the "out" position. When the pushbutton is depressed the black band disappears, leaving only the brightly colored recognition cap showing. The switches are available in push-lock/push-release and momentary-actuation types with one to four form-C contacts.

Booth No. 2312, 13 Circle No. 303

Thermostat provides isolated contacts



Elmwood Sensors, Inc., 1655 Elmwood Ave., Cranston, R.I. 02907. (401) 781-6500.

UL-approved snap-action thermostats, No. 3301, and No. 3100, which is hermetically sealed, are rated 6 A at 120 V and are available in narrow or wide differentials. The units are factory-preset and their silver contacts are thermally and electrically isolated.

Booth No. 2710 Circle No. 304

CRT displays 64 symbols or messages



Industrial Electronic Engineers, Inc., 7720-40 Lemona Ave., Van Nuys, Calif. 91405. (213) 787-0311. \$49.95 for complete kit.

The CRT nimo 64 can display the full typewriter keyboard (ASCII/EBDIC) symbols or even five-line messages using 1.5 in. square of panel space. No translation into special codes is required.

Booth No. 2613 Circle No. 305

Switch modules stack in phone-keyboard style

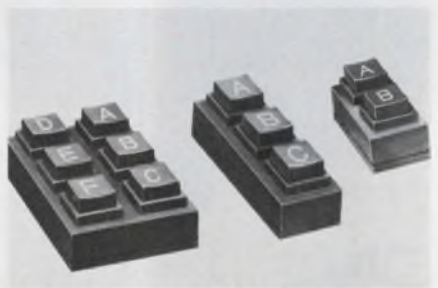

Grayhill, Inc., 561 Hillgrove Ave., La Grange, Ill. 60525. (312) 354-1040. From \$0.75 (100 up); 2-10 wks.

Series-82 push-button switch modules duplicate telephone-keyboard dimensions, styling and feel. They are available in one to six-button modules which, when stacked, will maintain 0.687 in. centers. Special legends and various colors are available. With SPST to 4PST contacts per button, internal connection of shorting bars permits special encoding. Contact rating is 100 mA at 5 V dc for a life of at least a million operations.

Booth No. 2605, 6 Circle No. 306

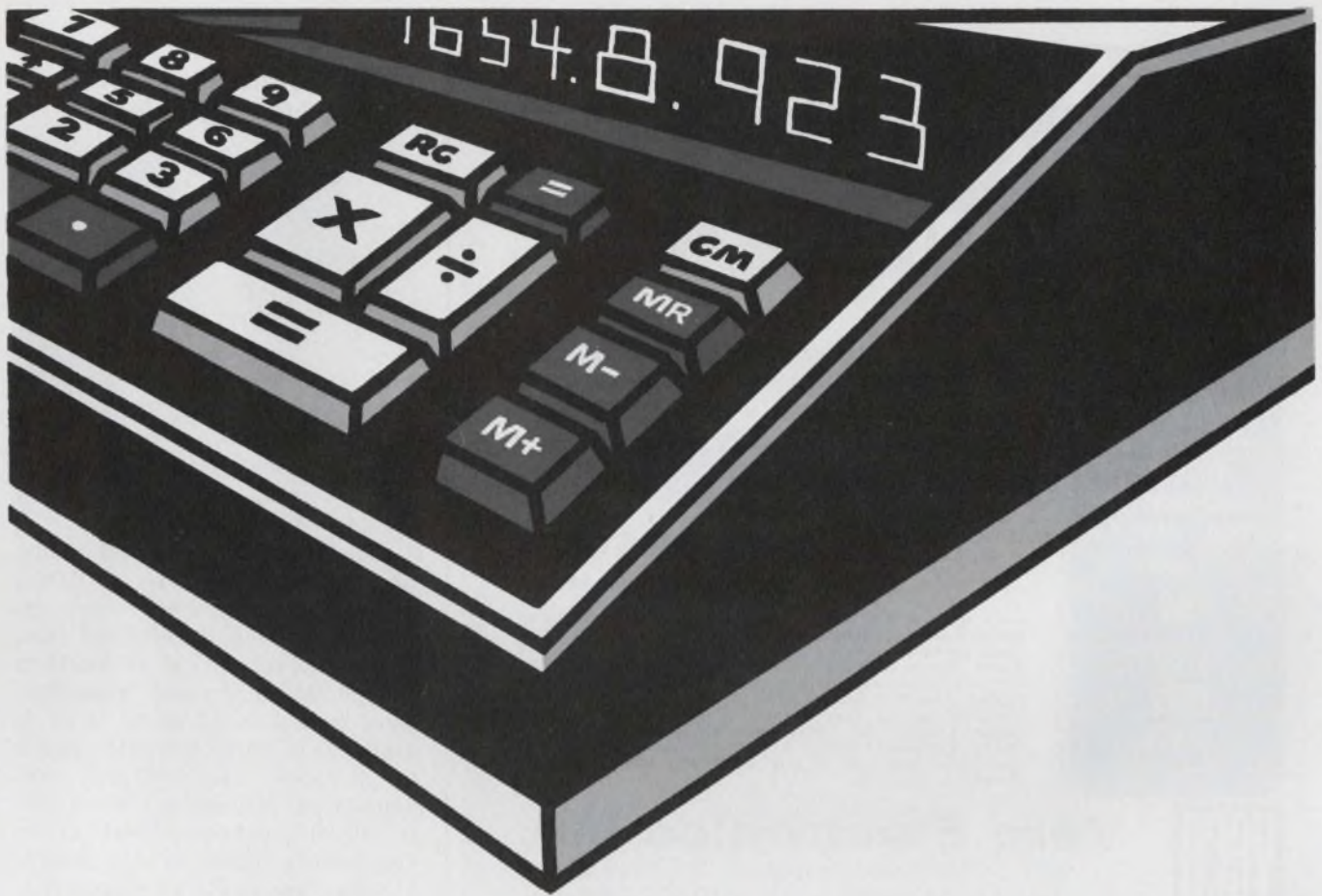

WE HELPED MAKE IT POSSIBLE!

Advances in electronics technology have brought about many changes in the things we use — like the business calculator.

Business calculators as a result of electronics technology now are smaller, lighter, more attractive and less expensive than was ever thought possible.

While Monsanto is not in the calculator business, we are in the business of making advancements like this possible through research and development of new electronic materials.

Take for example the silicon we produce for the semiconductor industry. For over 13 years we have been researching every avenue to improve our production capabilities and the final quality of our material. And even though we believe the material we produce is the best available, we will continue to look for other ways to make it better.

But it took more than Monsanto's silicon to make the business calculator the little gem it is now! Our gallium arsenide phosphide did its part too. Gallium arsenide phosphide emits light when a voltage is applied. This phenomenon enabled the calculator manufacturers to replace their tube displays with low-power consuming light-emitting diode displays.

Monsanto has the highest quality material available anywhere and our production is increasing every day.

Monsanto materials make it happen.

Monsanto

Advancements in Electronics through Materials Technology

P. O. BOX 8 ST. PETERS, MISSOURI 63376 (314) 272-6281

INFORMATION RETRIEVAL NUMBER 67

COMPLETE PACKAGING CAPABILITY

only
from
Vero

CASES
CONNECTORS
CARD FRAMES
MODULE RACKS
VEROBOARD
CARD HANDLES
FRONT PANELS
PANEL HANDLES

ALL
DELIVERED
FROM
STOCK



VERORACK 3

The ULTIMATE PC CARD FRAME

• Exceptional Strength • Precision Aluminum Extrusion Guide Rails • Concealed Guide Mounting • Identification Strip Standard in Front — Optional in Rear • Noryl Guide Temp. Range -60 +125 C • Selection of Guide Lengths • 4" & 4 1/2" Wide Guide Blocks With 5" Cards Spacing for Fastest Assembly Guides Slide Into Extrusions • Individual Variable Spaced Guides form 4" Available • Combine Guide Lengths for Extra Length Cards With Special Center Extrusion • Unique Extruded Connector Rails Allow Connector Mounting at any Point and Identification of Connector Position.

VERO

Vero Electronics Inc.

171 Bridge Road, Hauppauge, N.Y. 11787
Tel.: 516-234-0400 • TWX510-227-8890

INFORMATION RETRIEVAL NUMBER 68

NEW



Series MR1 (Rocker): 1-, 2-, 3-, and 4-pole
Nominal rating: 5 full amp./125 VAC



Series MP1 (Paddle): 1-, 2-, 3-, and 4-pole
Nominal rating: 5 full amp./125 VAC

NEW

WHAT MAKES OUR SWITCHES BETTER 'N THEIRS?

To begin with, let's get this straight — *we're biased.*

But we have reason to be, because we know about all the engineering that went into them. For instance, the unique, sturdy, rivet-pivot that pins the rockers or the paddles to the metal bushings so that they move freely but don't develop slop or work loose; the terminals that are anchored so firmly it practically takes an act of sabotage to yank them out; the "butt and shear" interior construction that gives smoother action and reduces arcing for longer life under load.

And materials: specially studied and selected from the mob of different ones available. Sifted out for their ability to do their thing better — such as the green-colored bodies (glass-filled DAP) in the 1- and 2-pole models. And let's not overlook the testing — here in our plant at our expense — not in your product at your expense.

You could say that these are all minor things, but the fact is, they all add up to an important total. All this goes for the whole line of J-B-T sub-miniature toggle switches that are definitely competitively priced in spite of definitely superior features. For the facts, get your copy of Catalog MT-40A.

J-B-T

J-B-T INSTRUMENTS INC.
NEW HAVEN, CONNECTICUT 06508
— (203) 772-2220

J-B-T

See you at the WESCON Show - Booth 2306

INFORMATION RETRIEVAL NUMBER 69

COMPONENTS

Paddle-handle switch snaps 100,000 times

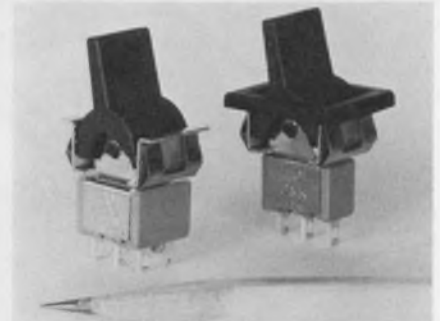

C & K Components, Inc., 103 Morse St., Watertown, Mass. 02172. (617) 926-0800. \$0.25 (1000 up).

In addition to a claimed reduction in installation time (to 30%), the subminiature J-60 switch offers snap action, an enclosed case, and UL approval. Over-all length is only 0.715 in., while above-the-panel height is 17/32 in. J-60 is available in 30 models with single to four-pole double-throw configurations. Minimum electric life is 100,000 make-and-break cycles (for models ending in -01). Paddle handles come in black unless otherwise specified.

Booth No. 2800 Circle No. 307

Relays feature 3-way terminal connector

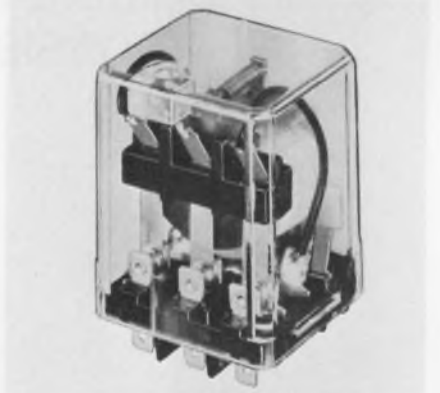

Magnecraft Electric Co., 5575 N. Lynch Ave., Chicago, Ill. 60630. (312) 282-5500.

Magnecraft's Class 388 general-purpose relay is a covered or open style unit with a wide choice of ac or dc coil voltages and SPDT to 3PDT, 10-A contacts. All relays have three-way pierced terminals (plug-in, solder or tab). For plug-in use, sockets with quick-connect, solder, or PC-terminals are available.

Booth No. 2400 Circle No. 308

If we didn't put a lot more quality into our capacitors, we couldn't get a little more for them



Sure: claiming quality is like coming out for the flag, motherhood and Girl Scout cookies; anyone can. But in the case of TRW's specialty, wound film and tantalum capacitors—and particularly with the tricky-to-make, metallized type—our quality is demonstrable.

Start with why we make certain of quality. It's because (are you ready?) we...care!

Before you get all choked with emotion, maybe we'd better explain our tough-minded reason. Obviously, one operation can't be run at two different levels of quality. And our business is based on long-term customers— who'd quickly become ex-customers if we didn't maintain superior quality.

So TRW has made caring a matter of policy. With SOP's for training, manufacturing and testing that eliminate even the possibility of cutting corners

or of fudging on quality— anywhere along the line.

Of course caring, alone, won't turn out a quality product. You also need considerable ability. That's where specialization comes in. It means we have more experience—a key factor with metallized capacitors, where every step from correct design to proper application is critical. It also means we make or process, in-house, more than the usual amount of basic materials— giving us better control over the quality of what goes into our product.

In short, we're willing—and able. Otherwise, would so many shrewd companies pay even the pittance extra that our capacitors have to cost? If that's not enough proof, put us to the final test: try us yourself.

Write or call TRW Capacitors, an Operation of TRW Electronic Components, Box 1000, Ogallala, Nebraska 69153. (308) 284-2611. TWX 910-620-0321.

TRW
CAPACITORS

Which LED is best?

With a choice among visible and IR types, and with red, green and yellow colors, the buyer must know the tradeoffs and spec limitations.

Problems are guaranteed when you're in the market for LEDs. Scratch the surface and you encounter facts like these:

- Visible light-emitting diodes include green, yellow and amber emitters. But only red LEDs are available in quantity and at low cost.

- The relative brightness of LEDs can be measured. But not all manufacturers employ the same rating specifications.

- There are infrared LEDs and diode lasers for IR applications. But manufacturers don't always specify what an infrared LED is made of, though this information is important in specifying the right LED for the job.

For new buyers, the best advice is: Move cautiously. And don't forget the old design principle of tradeoffs before making your selection.

Red, redder and reddest

Let's start with visible LEDs—the most widely used. It's been said that visible LEDs are available in three colors: red, redder and reddest. For many practical applications, this generalization is all too correct. The non-red LEDs aren't nearly as bright, power efficient or inexpensive as their red counterparts (see table).

Understandably, engineers don't want to be limited to three choices of the same color when specifying a LED indicator. Besides the frequent need of variety, red is often associated with danger or caution.

Moreover the human eye is more sensitive to green and yellow than to red. The result is that a red emitter with a peak spectral output of 650 nm must put out about 10 times the flux of a green emitter at 555 nm to appear equally bright. This can be achieved without resort to greatly increased power supplies, since typical red emitters are at least 10 times more efficient than the green and yellow units.

Besides having a much higher power-conversion efficiency, red emitters require a lower op-

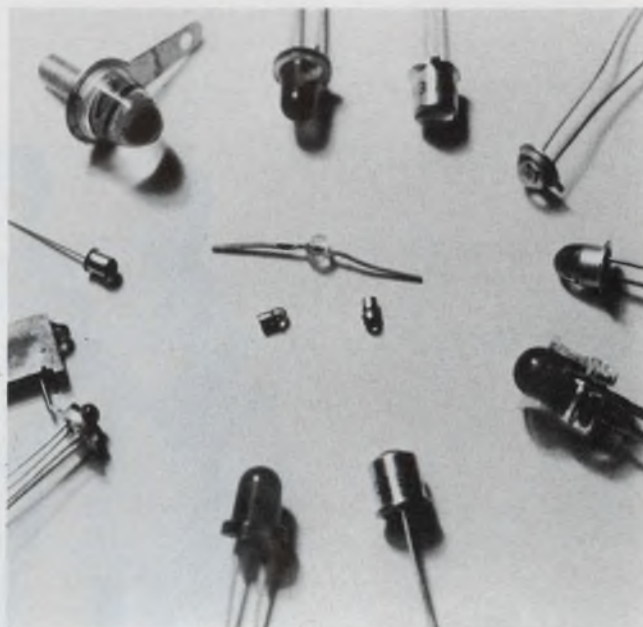

A variety of package and lead configurations are offered for both visible and IR LEDs. Most include an epoxy or glass lens. The latter lens, unlike epoxy types, is usually hermetically sealed with MIL-spec units available.

Comparison of available visible LEDs

	RED	AMBER	YELLOW	GREEN
VOLTS	1.6-2	2-2.8	3-4.5	3-4.5
LUMINOUS EFFICIENCY (%)	3.2-10	50-3	75-7	99-5
POWER EFFICIENCY (%)	0.06-0.1	0.01	(NO DATA)	0.0015
50 FT-L CURRENT (mA)	1	(NO DATA)	5	5
UNIT COST/1000 (\$)	< 0.50	0.99	3.95	1.95

Red LEDs—the most common visible type—are superior in brightness, efficiency, cost and lower operating voltage. But the human eye is more sensitive to green and yellow, and red, as a color, suffers from its long association with caution or danger.

Forrest M. Mims, 6901 Zuni SE A-12, Albuquerque, N.M. 87108.

erating voltage than either green or yellow units. As a result, red diodes can't be directly substituted for non-red units without going to power-robbing series resistors.

An important point about non-red emitters is as controversial as the photometric system used to rate their performance: How green are "green" LEDs? The answer is not very. Actually the green emitted by commercial LEDs now available is best described as a yellowish green. It's more the color of lime-flavored gelatine dessert than the green of grass or ivy.

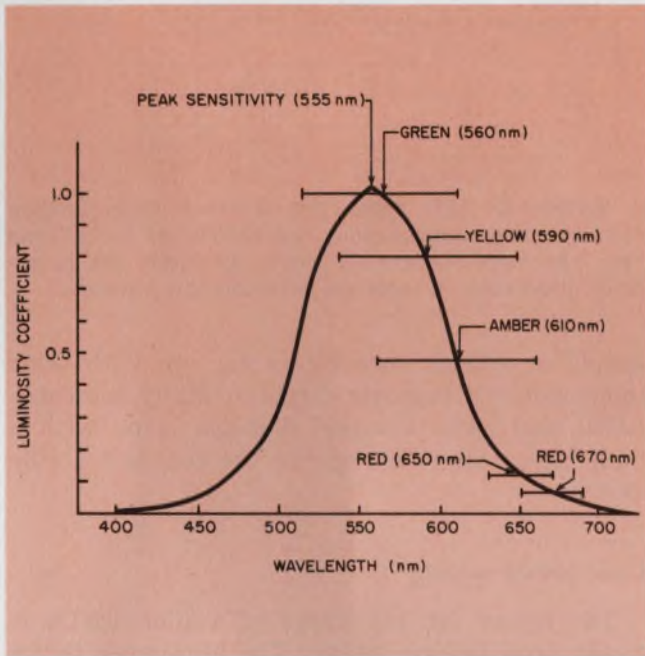

1. The photopic luminosity curve, the basis of the photometric system, gives relative eye sensitivity as the luminosity coefficient (luminous efficiency). Bars show range of available LEDs.

Manufacturers of LEDs almost always specify both peak wavelength and spectral half-width of their emitters. By plotting this information on a color-equivalent graph, the designer can get some idea of the actual color of a particular diode.

In fairness to the LED makers, it should be noted that the problem of obtaining "pure" green emission from a LED is not trivial. Conversion efficiency drops drastically at lower wavelengths, and the wavelength from LEDs is just not sufficiently monochromatic to obtain the pure green that engineers want. A look at a green or yellow LED through a diffraction grating reveals a spectrum ranging from the green to the reddish-orange. The eye integrates the various colors to get a LED's specified color output.

Any discussion of visible LEDs would be incomplete without some mention of the awkward science of photometry. The heart of the photometric system, as applied to LEDs, is the photopic luminosity curve (Fig. 1) standardized by the

Commission Internationale de l'Eclairage (CIE). This curve, applying to nondark adapted color (foveal) vision, shows the relative sensitivity of the human eye to the visible spectrum and is thus one of the more useful aspects of the sometimes confusing photometric system.

The fundamental unit of optical flux in photometry is the lumen. At the peak of the photopic luminosity curve (555 nm), 1 W equals 685 lumens. It would be convenient if one 555-nm lumen corresponded to one radiometric watt, but the photometric system has evolved from a meas-

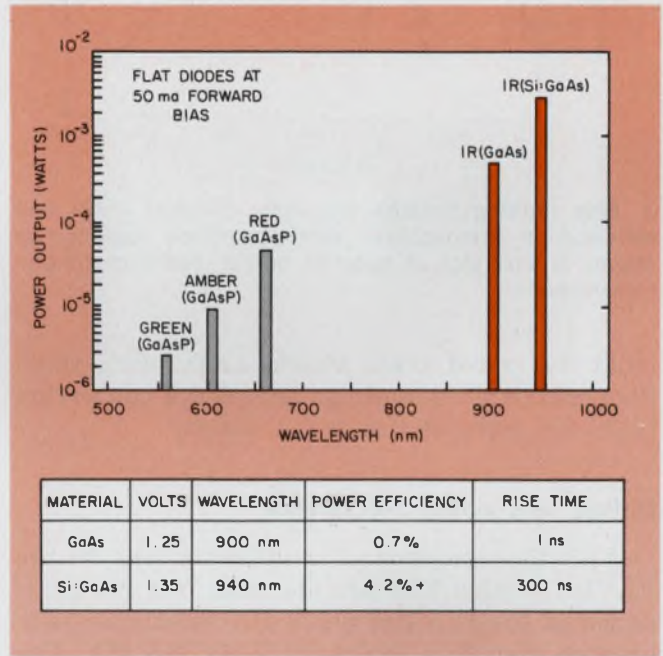

2. IR LEDs have increased output power, compared with emissions from visible LEDs. A table of the two basic types of IR LEDs reveals the key tradeoffs: For power, choose Si:GaAs; for bandwidth, use straight GaAs.

urement technique in which a specially made sperm candle is the basic standard (and in which one such candle emits a flux of 4π lumens).

The confusing aspects of photometry have resulted in what is no doubt the most controversial area of specifying LEDs. Perhaps a half dozen different photometric units are employed in rating the visible output of devices so similar that a more standardized specification system would seem in order. In addition to rating visible output in terms of lumens, manufacturers also employ units of luminance or brightness—foot-Lambert (fL)—and luminous intensity (candela). One foot-Lambert corresponds to $1/\pi$ candela/ft². Different manufacturers don't always use the same rating units.

There are several reasons behind the lack of standardization, and a typical example is provided by the data sheet for the Fairchild FLV100 and FLV101 GaAsP (gallium arsenide phosphide) LEDs. Unlike most manufacturers, Fair-

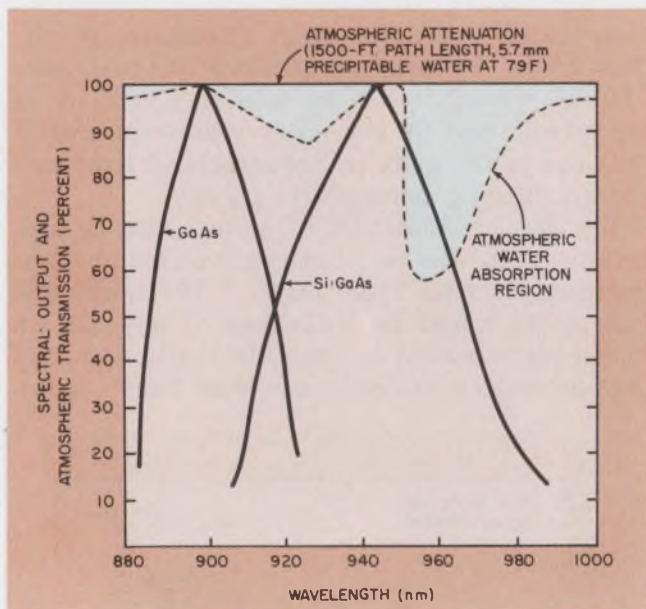

3. Also limiting Si:GaAs are wider spectral width and emission in atmospheric water-absorption regions, as shown in this plot of spectral output and atmospheric transmission.

child has rated these visible LEDs with three photometric units and has provided a conversion table for extrapolating a few others.

Diffuse lens makes a difference

With the exception of a diffusing lens on the FLV101, both LEDs are identical. Yet the luminance of the FLV100 (1500 fL) is substantially greater than that of the FLV101 (18 fL). The reason is that the source size of the diffused-lens diode is much larger than that of the diode with the clear lens. While both diodes emit approximately the same optical flux (the diffuse lens absorbs only about 10% of the FLV101's light), the uninitiated engineer would probably choose the FLV100 over the FLV101, based on the luminance data alone.

Actually the larger source size of the FLV101 makes it a more practical LED for many indicator applications. The light from a LED is so intense and originates from such a small point source that viewing can be uncomfortable in some situations. The addition of a diffuse lens spreads the light over a wider area and increases the viewing angle.

Another important benefit when a diffuse lens is placed in front of a visible LED is contrast enhancement. In the case of a LED mounted behind a clear glass or epoxy window, ambient light entering the window will be reflected from the header, wire leads and other structures surrounding the LED chip, so the diode's light output is partly, or even entirely, washed out. A red or circularly polarized filter will do much to alleviate this problem, and makers of LEDs usually

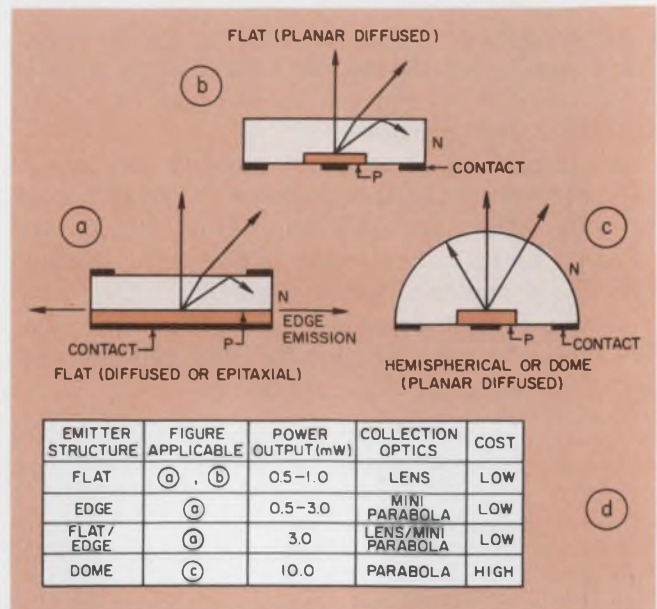

4. Various IR LED geometries enhance GaAs-junction radiation. The configurations can be flat, as in "a" and "b." The hemispherical, or dome, geometry (c) is another alternative. A table (d) provides the tradeoffs.

supply or specify such filters for use with their semiconductor numeric displays. Many indicator LEDs and some numeric displays come with a built-in red filter to improve the contrast of the device.

Look before buying

The lesson for the buyer of visible LEDs is clear: Look before buying. The luminance terms are useful only when similar types of LEDs are compared. The commonly used term for brightness—the foot-Lambert—is of little value in comparing two emitters when one has a diffuse lens.

Let the various photometric terms and ratings serve as only a general guide. Some manufacturers supply their sales representatives with elaborate display boards that contain a dozen or two brightly lighted LEDs. Since several companies second-source one another, such boards can be a big help in comparing a large number of emitters at one time. But before deciding on a final diode, particularly where large volume is involved, never buy without obtaining some samples and trying them out.

Another important thing to avoid in specifying visibility is optical overkill. A high degree of visibility is usually required for panel light applications, but a relatively low output can ordinarily be tolerated in, say, circuit-board troubleshooting and status indicators. Most visible-LED makers offer miniature plastic encapsulated units for less than 50¢ in volume. Requiring only a milliamp or so for proper operation, these LEDs put out plenty of light for use as status indicators.

The engineer is not hampered by the clumsy

photometric system when choosing an IR LED—radiant output power is always expressed in watts. Near-infrared-emitting LEDs are made with either gallium arsenide (GaAs) or silicon-compensated GaAs (Si:GaAs). GaAs is used in most IR LEDs, and its peak wavelength corresponds closely to the peak spectral sensitivity of several silicon detectors (Fig. 2). Also, GaAs has exceptionally fast frequency response and is therefore well suited for high bandwidth optical communications.

IR LEDs: The tradeoffs

Si:GaAs offers an important advantage over straight GaAs: While the unadulterated material has a typical power efficiency of less than 1%, commercial devices that use Si:GaAs are available with efficiencies exceeding 6%. Si:GaAs would seem a logical choice as an IR emitter were it not for several qualifying factors.

First, the frequency response of the material is much slower than that of GaAs, and rise times of half a microsecond are typical. Also, the spectral width of the material is more than twice as wide as that of the GaAs (Fig. 3). The result is that narrowband interference filters are not as efficient when used in a receiver in bright, ambient light. Finally the spectral emission region of Si:GaAs is partly in an atmospheric water-absorption region.¹

Choosing a material for an IR emitter is relatively simple. Always pick GaAs for high-bandwidth applications, or where power output is unimportant and the price is right. For general-purpose illumination or low-frequency modulation, use Si:GaAs. Where high conversion efficiency is a must, Si:GaAs is usually best.

Frequently manufacturers do not specify the semiconductor material used in their IR LEDs (though such information can be obtained by making a quick phone call). To find out what's being used, simply check the wavelength specifications. Anything near 900 nm means straight GaAs, while 940 nm indicates Si:GaAs.

Chips, domes and reflectors

Several novel techniques have been devised for extracting the maximum radiation from a GaAs junction (Fig. 4). A major problem has been how to affix the electrical contacts so they will have a high enough work function to provide low contact resistance, without at the same time blocking a significant amount of the IR.

The most common structure is flat. Both simple diffusion and planar techniques are used. Most flat IR LEDs are mounted so that only the light emitted from the top of the chip is usable. To collect more of the emitted flux, several com-

Who makes LEDs?

The products and manufacturers cited in this article don't represent a complete listing. Readers may consult the following for additional details by circling the appropriate information retrieval number:

Centralab Semiconductor [†] , 4501 N. Arden Dr., El Monte, Calif. 91734. (213) 579-0700.	CIRCLE NO. 400
Chicago Miniature Lamps [*] , 4433 N. Ravenswood, Chicago, Ill. 60607. (312) 784-1020.	CIRCLE NO. 401
Dialight [*] , 60 Stewart Ave., Brooklyn, N.Y. 11201. (212) 497-7600.	CIRCLE NO. 402
European Electronic Products ^{*,†} , 10180 W. Jefferson Blvd., Culver City, Calif. 90230. (213) 838-1912.	CIRCLE NO. 403
Fairchild Microwave & Optoelectronic Div. ^{*,†} , 2513 Charleston Rd., Mountain View, Calif. 94040. (415) 961-139	CIRCLE NO. 404
Ferranti Electric [*] , E. Bethpage Rd., Plainview, N.Y. 11803. (516) 293-8383.	CIRCLE NO. 405
General Electric ^{*,†} , Nela Park, Cleveland, Ohio 44101. (216) 266-2121.	CIRCLE NO. 406
Hewlett-Packard ^{*,†} , 620 Page Mill Rd., Palo Alto, Calif. 94304. (415) 493-1501.	CIRCLE NO. 407
Laser Diode Laboratories ^{**} , 205 Forrest St., Metuchen, N.J. 08840. (201) 549-7700.	CIRCLE NO. 408
Litronix ^{*,†} , 19000 Homestead Rd., Cupertino, Calif. 95014. (408) 257-7910.	CIRCLE NO. 409
Microsystems International [*] , 800 Dorchester Blvd., Montreal 101, Quebec, Canada. (514) 875-2814.	CIRCLE NO. 410
Monsanto ^{*,†} , 10131 Bubb Rd., Cupertino, Calif. 95014. (408) 257-2140.	CIRCLE NO. 411
Motorola Semiconductor Products ^{*,†} , 5005 E. McDowell Rd., Phoenix, Ariz. 85036. (602) 273-3466.	CIRCLE NO. 412
Opcoa [*] , 330 Talmadge Rd., Edison, N.J. 08817. (201) 287-0355.	CIRCLE NO. 413
RCA ^{*,**} , New Holland Ave., Lancaster, Pa. 17604. (717) 397-7661.	CIRCLE NO. 414
Raytheon ^{**,†} , 130 Second Ave., Waltham, Mass. 02154. (617) 899-8080.	CIRCLE NO. 415
Spectronics [†] , 541 Sterling Dr., Richardson, Tex. 75080. (214) 231-9381.	CIRCLE NO. 416
Texas Instruments ^{*,†,**} , Dallas, Tex. 75222. (214) 238-3741.	CIRCLE NO. 417

- * Visible LEDs
- † IR LEDs
- ** Laser diodes

panies mount the chip in a miniature parabola that collects the edge emission and projects it along an axis that is concentric with the top surface emission. Some edge emitters block the top surface emission with large area contacts, in an effort to improve electrical efficiency.

RCA and General Electric IR LEDs with a parabola reflector have efficiencies of about 4.2%. Texas Instruments' TIL31 is an outstanding example of a high-efficiency, low cost IR LED. With a typical output of 6 mW at 100 mA, the TIL31 sells for about 58¢ per milliwatt in single quantities—a bargain as semiconductor light emitters go.

Though a miniature parabolic reflector can significantly improve the performance of an edge emitter, more spectacular results can be had with a diode structure that permits more of the internally generated IR to escape. Since GaAs has a high index of refraction (3.6), internal radiation arriving at the surface interface of a flat diode at an angle exceeding about 16° is reflected back into the chip.

To eliminate the critical interface problem, LEDs can be made in the shape of a hemisphere, or dome. The light-emitting junction is diffused

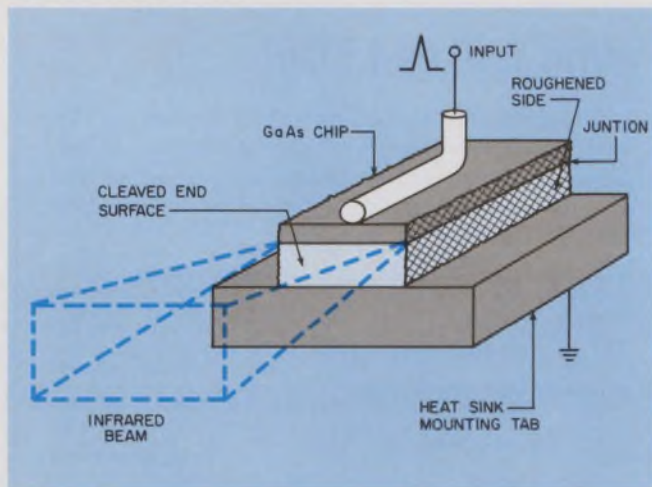

5. A laser diode. Take a standard GaAs IR LED with a very flat, uniform junction. Cleave two opposing sides of the chip to produce parallel reflecting surfaces, and drive it with brief high-current pulses.

into the base of the dome, which is made of low-absorbing, n-type material, and the resulting dome is mounted to a header. The hemispherical structure presents a continuously curved surface to internally generated radiation; therefore all IR arriving at the surface interface is emitted. If the n region were perfectly transparent to the IR, the dome structure would improve efficiency over a typical flat structure by a factor of 26. The fairly long path that the light must travel through the thick dome structure results in some losses of absorption but an actual efficiency improvement factor of about 10.

Texas Instruments is the biggest maker of domed diodes. It markets a variety of diodes with wavelengths ranging from the near-visible to 940 nm. Spectronics and Raytheon also make domed emitters.

While the domed diode is significantly more efficient than flat devices, it has disadvantages: high cost and the need for a parabolic reflector for efficient collection of the emitted radiation. The high cost is due to manufacturing complexity; the reflector requirement is a result of the diodes' nearly 2π steradian emission pattern.

The diode laser—a super LED

While LEDs are adequate for many engineering applications, for very high power output and ease of optical collimation, the diode lasers² can't be beat (Fig. 5). You might say it's a super LED.

Injection lasers, available commercially for as little as \$15 to \$20 in single quantities, produce 5 or 10 W of optical power from a tiny source measuring only a few mils across. The tiny emission point means that the laser beam, which itself is typically a broad 20° to 40° , can be easily

reduced to a small fraction of a degree with a single lens.

As with LEDs, injection lasers have some tradeoffs of their own. For example, conventional single heterostructure devices cannot operate continuously at room temperature but must be pulsed with current bursts that are no more than 200 ns wide. Also, high power outputs require high current inputs. The combination of high current and fast pulses means careful consideration must be given the design of pulse-generating electronics.

Help is on the way. The double heterostructure injection laser can be operated continuously at room temperature. Its power output is limited and its lifetime is shorter than that of the single heterostructure laser, though. The latter has lifetime problems of its own: Tests have shown that performance degrades much faster than that of LEDs.

Injection lasers which emit at visible wavelengths have been fabricated, and the infrared from a GaAs device cooled with liquid nitrogen appears a bright cherry red to the unaided eye (though its emission may be near 850 nm). But for practical purposes, consider injection lasers to be available mainly in the near-infrared. Experimental lead-salt lasers that emit in the middle IR are also being developed.

High currents increase emission

Most LEDs can be driven with fast-duration, high-current pulses. Data sheets generally specify maximum allowable current levels and duty cycles.

High-current operation can mean a big improvement in the operation of a pulse-modulated optical communications link. When driven with 3-A, 1- μ s pulses, GE's SSL-55C increases its emission to an impressive tenth of a watt.

Visible LEDs can also benefit from high-current operation. The technique can be particularly helpful in multiplexing LED numeric displays. If the brightness of each strobed display is increased, the average brightness can be made to appear the same as if the display were being operated at rated dc current levels. ■■

References:

1. *Infrared Detection* (wall chart), Santa Barbara Research Center, Santa Barbara, Calif. 1971.
2. Campbell, R. and Mims, F., *Semiconductor Diode Lasers*, Howard W. Sams & Co., Indianapolis, Ind., 1972.

Bibliography:

1. Smith, G., *LEDs and Photometry*, Litronix Appnote 1, March, 1971.
2. Glicksman, R., "Technology and Design of GaAs Laser and Noncoherent IR-emitting Diodes," *Solid-State Technology*, Sept./Oct., 1970.
3. Mims, F., *Light Emitting Diodes*, Howard W. Sams & Co., Indianapolis, Ind. (to be published).

1600 Volts/70 Amps even at 85°C

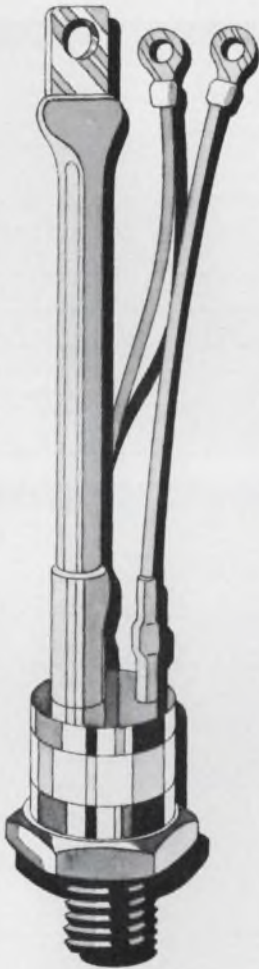

How do you like that for Thyristor Power!

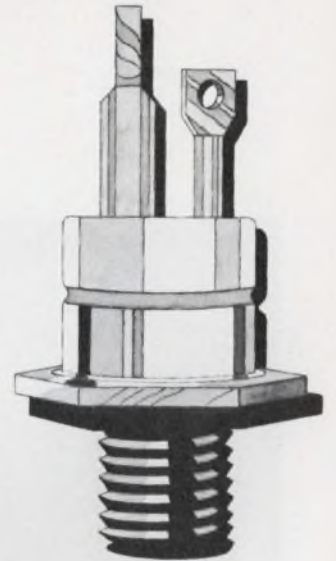

The BTW23-1600, 'described above' is one of a series of Amperex high-performance silicon thyristors that operate at repetitive peak potentials from 600 to 1600 volts and handles up to 70 amperes of current. We rate the entire series at 85°C because that's the kind of operating temperature you can expect in a tough industrial environment. Special avalanche properties allow our high performance thyristors to absorb large reserve transients without damage; and if you need guaranteed avalanche properties we can provide them too.

This series features di/dt of at least 100A/ μ sec and dV/dt up to 300V/ μ sec, both measured when junction temperature is 125°C... a practical value for industrial applications.

Our BTW series offers the performance you need for really demanding applications like controlling large motors in refrigeration systems or in automatic machinery, or controlling heating elements in industrial furnaces.

We offer a full line of advanced power handling devices, from low-cost metal and plastic

thyristors that sell for only pennies, up to the sophisticated high performance devices such as the BTW series.

The line includes general purpose stud-mounted types, fast turn-off types for inverter applications up to 25 KHz and special purpose types like our radar pulse modulator. It even includes a unique thyristor-like device with four accessible electrodes - an inexpensive TO-18 package that can be used as a silicon-controlled switch, a tetrode thyristor, or a programmable unijunction transistor.

We also offer a line of triacs, including both 400 volt plastic types (rated at 6 and 10 amps) and 25 and 50 amp stud-mounted types rated as high as 1600 volts.

Whatever your thyristor or triac requirements, ask Amperex; chances are we've got just the device you need. For complete technical data, for pricing information and for applications assistance, write: Amperex Electronic Corporation, Solid State and Active Devices Division, Slatersville, R.I. 02876. Tele: 401-762-9000.



Amperex®

TOMORROW'S THINKING IN TODAY'S PRODUCTS

Sold through
North American Philips Electronic Component Corporation

INFORMATION RETRIEVAL NUMBER 71

AMPEREX THYRISTORS

LOW-COST METAL & PLASTIC	GENERAL PURPOSE	HIGH PERFORMANCE	FAST TURN-OFF	TRIACS	SPECIAL PURPOSE
BTX18 1.6A, 100-500V	BTY79 10A, 400-1000V	BTW47 25A, 600-1600V	BTW30 24A, 300-1200V	BT110 6A, 400V	BR101/BRY39 SCS, UJT, THYRISTOR
BT100A 4.5A, 200-400V	BTY87 25A, 400-800V	BTW92 31A, 600-1600V	BTW31 31A, 300-1200V	BTW26 10A, 400V	BTX95 15A, 300A, 500-800V PULSE MODULATOR
BT101/BT102 15A, 200-400V	BTX48 25A, 1000-1400V	BTW24 50A, 600-1600V	BTW32 55A, 600-1200V	BTX94 25A, 400-1200V	
BT109 15A, 400V	BTY91 25A, 400-800V	BTW23 110A, 600-1600V	BTW33 110A, 600-1200V	BTW34 50A, 600-1600V	BR100 2A, 28-36V DIAC

Line drivers and

MOTOROLA LINE DRIVERS

TYPE	MC75109	MC75110	MC75113
BLOCK DIAGRAM			
OPERATING FREQ.	< 10 MHz	< 10 MHz	< 10 MHz
LENGTH OF LINE	< 5000'	< 10,000'	< 20,000'
INPUT	TTL	TTL	TTL
TYPICAL LOAD CURRENT	6 mA	12 mA	± 20 mA
PARTY LINE OPERATION	YES	YES	YES
STROBE	YES	YES	NO
POWER SUPPLIES	± 5 V	± 5 V	± 5 V
FEATURES	INSENSITIVE TO SUPPLY VARIATIONS OVER ENTIRE OPERATING RANGE INHIBITOR AVAILABLE FOR DRIVER SELECTION		CAPABLE OF SOURCING CURRENT WITH ONE OUTPUT AND SINKING CURRENT WITH THE OTHER

TYPE	MC1488	MC1580	MC1582	MC75450	MC75451
BLOCK DIAGRAM					
OPERATING FREQ.	< 2.5 MHz	< 10 MHz	< 10 MHz	1 MHz	1 MHz
LENGTH OF LINE	< 50'	< 5000'	< 5000'	< 500'	< 500'
INPUT	TTL	MECL	TTL	TTL	TTL
TYPICAL LOAD CURRENT	10 mA	8 mA	8 mA	—	—
PARTY LINE OPERATION	NO	YES	YES	YES	YES
STROBE	NO	NO	NO	NO	NO
POWER SUPPLIES	± 9 V	± 5 V	± 5 V	± 5 V	± 5 V
FEATURES	SATISFIES EIA STANDARD RS-232 SIMPLE SLEW-RATE CONTROL	COMMON-MODE INPUT RANGE ± 3.5 V COMMON-MODE OUTPUT RANGE -3 V / +9 V		TWO STANDARD TTL GATES TWO UNCOMMITTED HIGH VOLTAGE NPN TRANSISTORS	POSITIVE "AND" DRIVER OUTPUT TRANSISTORS INTERNALLY CONNECTED

MOTOROLA LINE RECEIVERS

TYPE	MC75107	MC75108	MC1581	MC1583	MC1584	MC1489/89A
BLOCK DIAGRAM						
INPUT SENSITIVITY	25MV MAX	25MV MAX	50MV MAX	50 MV MAX	60MV MAX	ADJUSTABLE FROM -3 V TO +3 V
PROPAGATION DELAY NSEC	25 MAX	25 MAX	20 MAX	30 MAX	37 NSEC	50 MAX
STROBE CAPABILITY	YES	YES	NO	NO	NO	THRESHOLD ADJUST AND RESPONSE CONTROL
OUTPUT	TTL ACTIVE PULL-UP	TTL OPEN COLLECTOR	MECL	TTL OPEN - COLLECTOR	TTL - ACTIVE PULL-UP	RESISTIVE PULL-UP
POWER SUPPLIES	± 5 V	± 5 V	+5 V, -5.2 V	± 5 V	± 5 V	+5 V
FEATURES	DIODE PROTECTED INPUT STAGE HIGH COMMON-MODE REJECTION RATIO HIGH DC NOISE MARGINS		± 3.5 V COMMON-MODE INPUT RANGE HIGH INPUT IMPEDANCE			SATISFIES EIA STANDARD, RS-232 BUILT-IN HYSTERESIS



- Supply variation immunity
- Diode protected inputs
- New design

receivers step ahead.

Line driver and receiver design advances don't come along every day. Now, in three simultaneous strides, two Motorola twisted-pair line drivers offer more than the types they replace, so do two receivers, and a brand new driver is introduced to serve a previously unmet need.

Output sink current is independent of positive and negative supply fluctuations, allowing immunity to supply variations over their entire operating range. Thus the MC55/75109 and 110 are superior to the line drivers they replace. Step one.

MC55/75107 and 108 are superior to the receiver types they replace because diode protection on all input stages preserves data transmitted during power down periods of a particular receiver in

party line applications. Step two.

Step three. The MC75113. A brand new push pull driver designed for high speed data transmission systems using balanced terminated lines. The first one specifically created for party line operation. Output sink current (typ) is 20 mA. Output common-mode voltage range is ± 3 V.

FOR PRICE WATCHERS

Circuit	100-999 \$ Price	Circuit	100-999 \$ Price
MC55107L	4.80	MC55109L	5.15
MC75107L	3.20	MC75109L	3.35
MC75107P	2.65	MC75109P	2.80
MC55108L	4.80	MC55110L	5.15
MC75108L	3.20	MC75110L	3.35
MC75108P	2.65	MC75110P	2.80
MC75113L	3.10		

In late 1969 we introduced the industry's first twisted pair line driver and receiver family, the MC1580 series. Hundreds of thousands of Motorola line drivers and receivers have been delivered since we introduced the industry's first

EIA RS232C drivers and receivers, the MC1488 and MC1489. And our new developments are only the latest steps in Motorola's continuing effort to meet the expanding needs of a dynamic industry.

These new devices are among the many in Motorola's broad line of linear interface circuits available now from Motorola distributors and sales offices. Since you probably want more information before you buy than the selection guide on the opposite page provides, circle the reader service number or write to Motorola Semiconductor Products Inc., Box 20912, Phoenix, AZ. 85036. We'll also send a copy of our handy new Linear IC Pocket Cross Reference as long as the supply lasts.

MOTOROLA LINEAR
— Serving a greater range of analog designs

Increase optical-isolator speed by modifying the phototransistor's operating mode. Frequencies over 10 MHz are possible, but there are tradeoffs.

Optical-isolator applications that call for speeds above a few kilohertz, or for handling serial data, require data-transfer rates that exceed the capability of LED-phototransistor couplers. Speed-enhancement circuitry must be added. But what kind?

For operation up to around 500 kHz, a base-emitter resistor and a high-current driver improve response time without unduly increasing circuit cost. Above 500 kHz, operation of the phototransistor in the photodiode mode and the addition of a low-power TTL inverter on the output side can increase the response to around 1.5 MHz.

Use of an integrated comparator amplifier instead of the inverter allows further speed improvement to above 10 MHz, but this increases the cost and power drain of the circuit.

Why use optical isolators?

LED-phototransistor optical isolators eliminate ground-loop problems by providing a complete electrical break between sections of the system. The need for such isolation is greatest when sections of the system are widely separated. Multi-station semiconductor-test systems provide a good example, as do direct-digital process-control and machine-numeric-control systems.

Numeric-control systems, in which data are transferred in parallel form, usually do not require data speeds in excess of a few kilohertz. In such cases the isolator circuitry can consist of simply the optical isolator, a LED driver at the input and an output TTL interface.

The basic optical isolator circuit

A typical circuit using a LED-phototransistor isolator to transmit logic signals is shown in Fig. 1. The ILT-1 optical coupler must sink the current from one TTL load plus a pull-up resistor. This load is roughly equivalent to a 4-k Ω

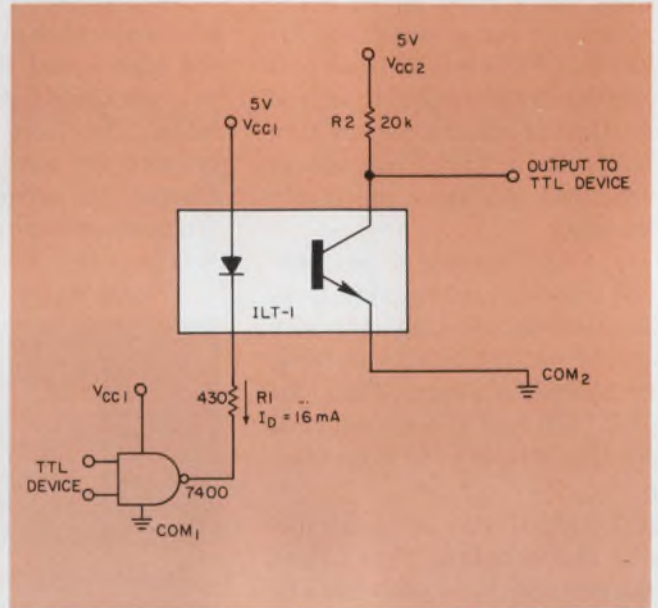

1. Electrical isolation between input and output circuits is provided by LED-phototransistor coupler ILT-1. Gate G_1 acts as an interface to adjoining TTL devices. The maximum repetition rate is about 3 kHz.

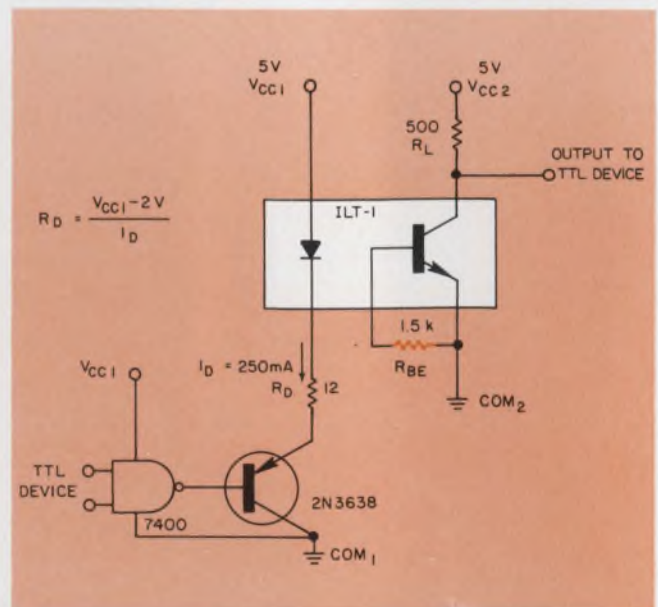

2. Addition of base-emitter resistor R_{BE} reduces the time constant caused by stored charge in the base region of the phototransistor.

David Barton, Litronix, Inc., 19000 Homestead Rd., Cupertino, Calif. 95014

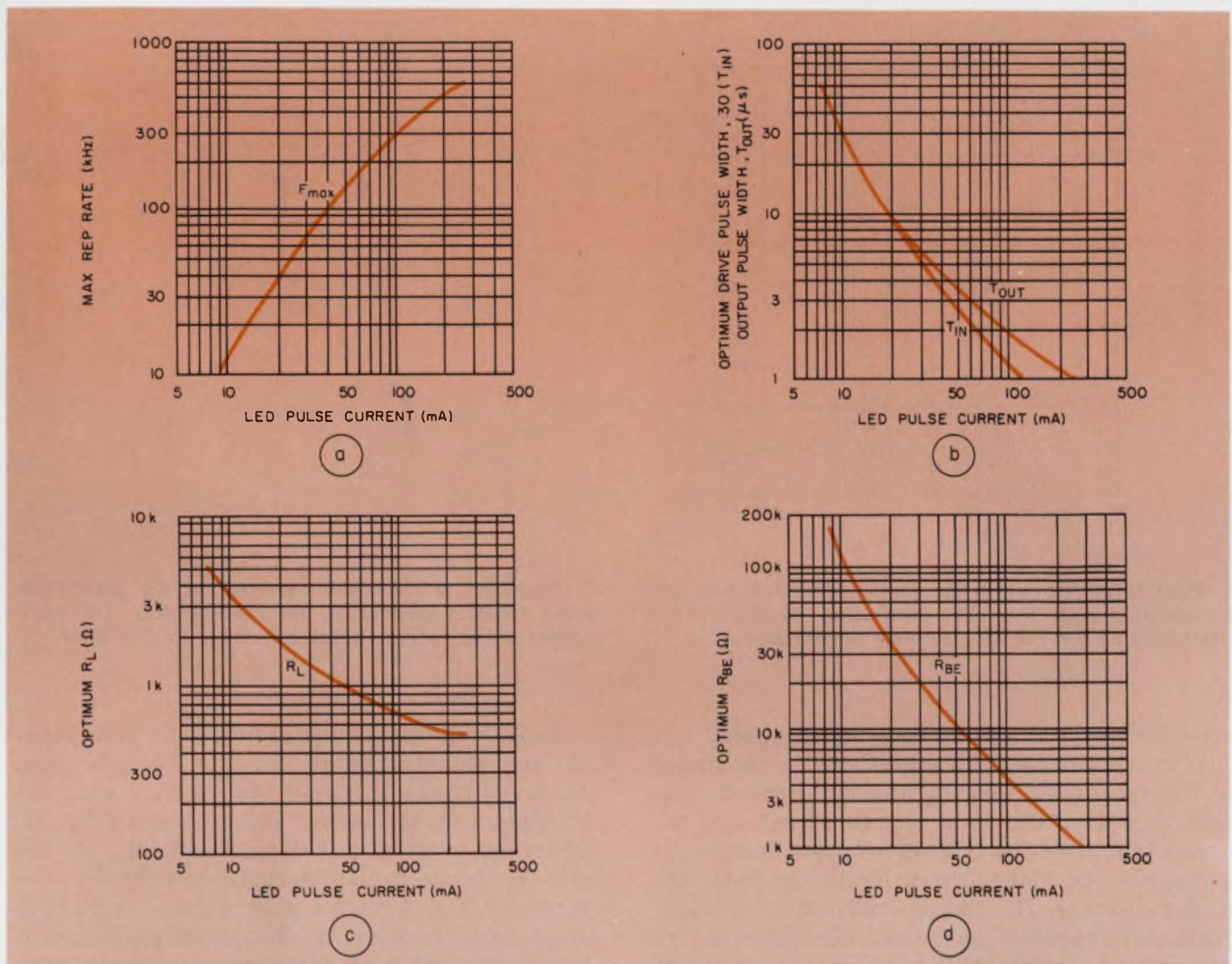

3. **Interdependence** of repetition rate (a), input and output pulse widths (b), optimum load resistance (c) and the optimum base-emitter resistance is demonstrated

by the behavior of these parameters with variations in LED pulse current for phototransistor-mode operation. The value of R_{BE} is thus determined.

resistor connected to the supply voltage V_{CC} .

The resistor in series with the LED half of the optical coupler must supply the worst-case load current divided by the current transfer ratio (CTR) of the isolator. If, for example, a Litronix Iso-Lit 1 is used, with a minimum CTR of 0.2, and if 30 per cent load variation is allowed, then 8.1 mA will be required. This is supplied by the 430- Ω resistor R_1 in series with V_{CC1} .

This basic optical isolator circuit has only enough power to drive one TTL device. The 7400 gate acts as an interface between the input stage and the photodiode. An inverter (not shown) is normally connected between the collector of the phototransistor and the TTL load to provide interfacing at the output.

The maximum repetition rate at which this circuit will operate is about 3 kHz. The severe speed limitation results entirely from the characteristics of the phototransistor half of the isolator. This device has a large base-collector junction area and a very thick base region to

maximize its light sensitivity. The collector-to-base capacitance, C_{ob} , is typically 25 pF. In the circuit of Fig. 1 this capacitance is multiplied by a large factor because of the Miller effect. In addition the large base region causes a correspondingly large base storage time.

To increase operation to 500 kHz

A simple method of reducing both the Miller effect and the base storage time is to add a resistor between the base and emitter of the phototransistor (Fig. 2). This resistor, R_{BE} , reduces the time constant caused by C_{ob} and removes stored charge from the base region faster than by recombination.

When such a base-emitter resistor is used, however, the required LED drive is increased, since much of the photocurrent generated in the base-collector junction is now deliberately dumped. Yet this method does not usually result in excessive current drain, because the average

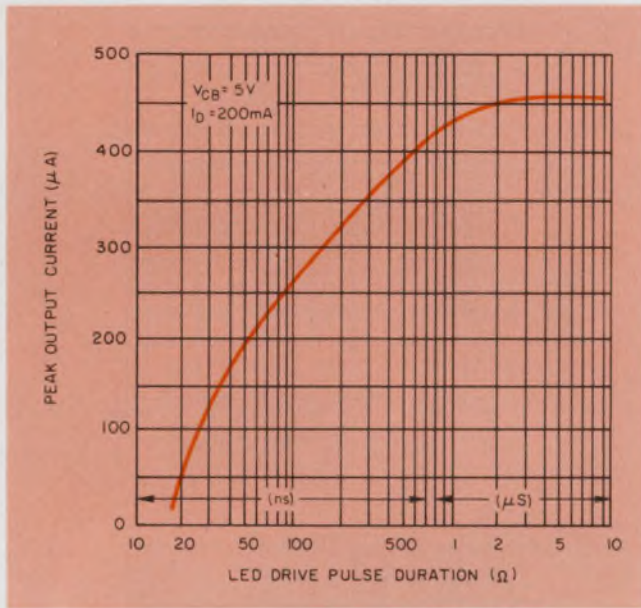

4. Peak output current in the photodiode mode is shown for variations in the LED drive-pulse duration. This demonstrates the need for external amplification.

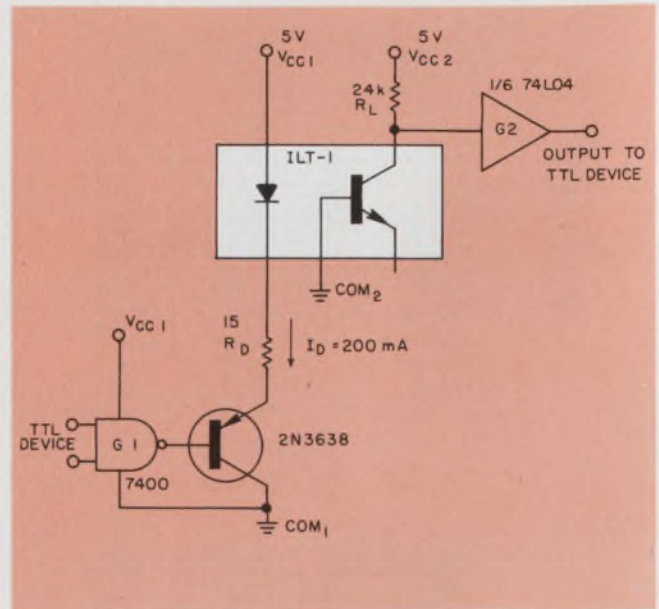

5. Operation of the phototransistor in the photodiode mode requires inverter G_2 for current gain. The component values shown boost operation to 1.5 MHz.

repetition rate is low in most applications.

If current drive is increased or the resistance of R_{BE} is reduced, turn-on time and turn-off time both decrease. The total charge stored also becomes smaller if the LED drive-pulse duration is decreased. As higher drive levels are used, the load resistance, R_L , can be reduced to enhance further the speed of the circuit. These parameters are related to one another in such a way that all should be changed together for best results.

One important generalization can be made concerning parameter interdependence: The LED drive pulse duration, T_{in} , the output fall time, t_f , output rise time, t_r , and propagation delay, t_p , should occur in a ratio that approaches 1.5:1:1:1. Without this relationship, the circuit will not operate at the highest possible repetition rate for a given drive level.

As a rule of thumb, the rise, fall and propagation times of the output pulse will all be approximately two-thirds of T_{in} . The output pulse duration, T_{out} , equals T_{in} at low currents but stretches out at high currents (Fig. 3b).

The important parameters for an Iso-Lit 1 with a CTR of 0.25 are plotted against LED pulse current (Fig. 3). This applies to phototransistor-mode operation only.

If the LED drive current is increased to 200 mA and optimum values of R_{BE} and R_L are used, the maximum repetition rate increases from 3 kHz to 500 kHz (Fig. 3a)—a 167:1 improvement. Other isolators will yield similar performance improvements if the LED drive level is scaled to allow for a different CTR. The required level is inversely proportional to the CTR.

Another method of increasing speed is to operate the phototransistor as a photodiode. Bias voltage is applied between the collector and base terminal, with the emitter being unused (Fig. 5). Operation to at least 10 MHz is possible, but the price is the need for external amplification. The graph of Fig. 4 shows peak output current vs drive pulse duration in photodiode-mode operation for 200-mA peak drive current. Since output current is small, some type of wide-bandwidth amplifier must be used to drive TTL loads.

Increasing speed to 1.5 MHz

A simple solution for intermediate-speed operation is the use of a low-power TTL inverter (one-sixth of a 74L04) as in Fig. 5. The collector of the phototransistor is connected to its input along with a 100-k Ω pull-up resistor R_2 . The base is connected to the common of the system's output side. The inverter will, in turn, drive one 7400-series device.

Such a circuit will operate to about 1.5 MHz. Its speed is limited primarily by stray capacitance, since effective load resistance is about 28 k Ω . The current drive required for 1.5-MHz operation is about 120 mA, with somewhat less needed at lower speeds.

Operating to 10 MHz

A device that provides a good TTL interface, with higher gain than that of an inverter, is the integrated comparator amplifier. Although discrete-component amplifiers can offer still better

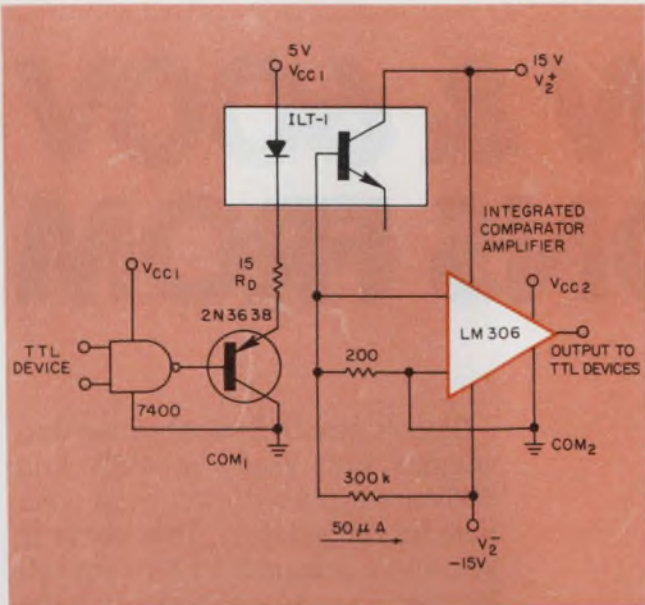

6. Operation is boosted to above 10 MHz by amplification from an integrated comparator, and by using the component values shown.

performance, the LM306 used in the circuit of Fig. 6 allows operation to above 10 MHz. Of course, either output logic sense can be chosen, since either comparator input can be driven.

In the circuit of Fig. 6, the phototransistor collector is connected directly to V_{cc} . Its base has a 200- Ω load resistor to ground, and is tied to one input of the comparator. A resistor connects the phototransistor base and the minus supply. Its resistance value is chosen to supply 50 μ A. The other comparator input is grounded. The voltage at the comparator input switches from -10 to +10 mV, or more when the photodiode turns on. The comparator output drives several TTL loads.

As one might expect, circuit complexity varies with increased speed. As we've seen, major breakpoints in circuit complexity occur at a few kilohertz, at a few hundred kilohertz and at slightly above 1 MHz. With each increase in complexity, the parts cost becomes greater but the power drain decreases. The deciding factor should be whichever is more important—parts cost or power drain.

To minimize parts cost, use the simplest circuit that will fulfill the desired speed requirement. Unused speed capability wastes parts and does not improve performance. Power consumption at a given duty cycle is roughly proportional to the maximum speed for both the phototransistor and photodiode modes. Since the required power level is lower for the more complex circuits, the designer may decide to switch to photodiode operation to minimize dissipation, even if the circuit doesn't have to handle high frequencies. ■■

OSCILLATORS

1 Hz to 250 MHz

LOW
CURRENT
DRAIN

< 5
MILLI-AMPS
AT 1 Hz

YES, THAT'S RIGHT . . . less than 5 ma current drain at the frequency of 1 Hz! If your new KLOOGE can't stand a high current drain oscillator, our new Series 162 is probably the answer. Not only is the Series 162 easy on the current drain and budget, it only requires an area of 1.5 x 1.5 x .62 inches . . . much smaller than a clock plus countdown.

INTERESTING? Call Wayne Benson, (area) 312 - 232-2600, and he will be glad to fill you in on all the details and send you our new catalog.



Series 162

- FREQUENCY: 1 Hz to 1 MHz
- FREQUENCY TOLERANCE: $\pm 0.001\%$
- TEMPERATURE RANGE: 0°C. to 60°C. typical
- SUPPLY VOLTAGE: -20V DC, or +5V DC, or +12V DC
- OUTPUT VOLTAGE: Compatible with MOS, TTL logic, Sinewave also available.
- SIZE: 1.5" x 1.5" x 0.62" PC board mount, Chassis mount also available.

SEE 1972-73 EEM Pg. 1573



Please write or call for

NEW 1973 CATALOG

Our new catalog covers various types of oscillators: VCXO, LCVCO, RCVCO, high stability, computer clocks, high output power, Navy standard hardware modules and low current drain oscillators from 1 Hz to 250 MHz. We'll even send you three neat conversion charts (3) to hang on your wall and impress your friends.

accutronics

A HAMMOND CORPORATION COMPANY

628 NORTH STREET • GENEVA, ILLINOIS 60134

NOW, 400V & 600V DARLINGTONS FROM



Delco Electronics

DIVISION OF GENERAL MOTORS CORPORATION, KOKOMO, INDIANA

Delco's new DTS-4000 series Darlington transistors with V_{CE0} 's of 400V and 600V are triple diffused mesa units built for rugged duty. They come to you with a practical 15 Ampere rating that you can depend on all the way up to the high voltage requirements of ac motor speed controls, for instance—or the 1.5 kW switching regulator in the illustration.

And they offer new possibilities

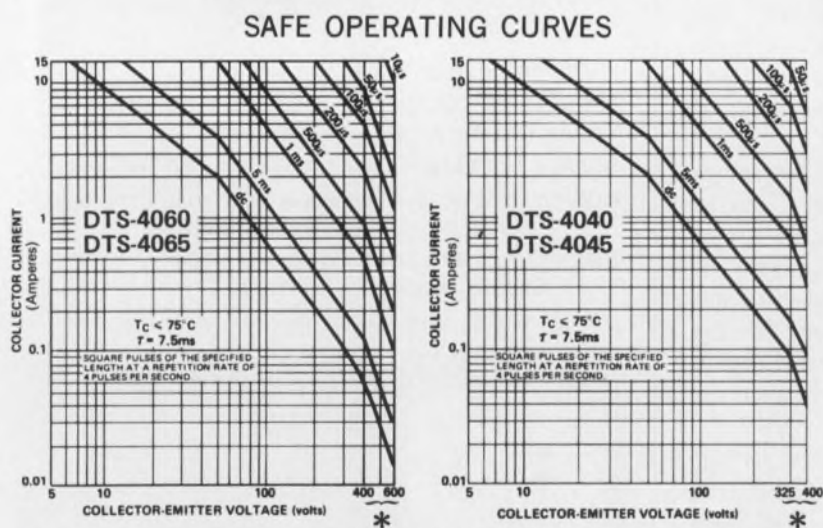

*Reverse Bias Required

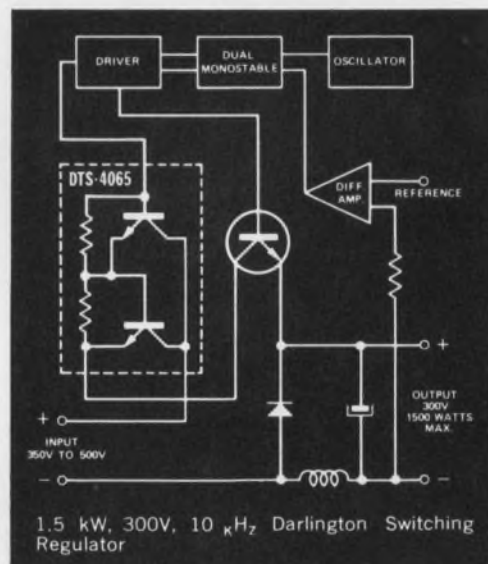

in circuit design where dc drive conditions may have created awkward problems when using SCR's.

Our new Darlington transistors can save you space and give you more design flexibility. The high energy capability of the DTS-4000 series is

TYPE	V_{CE0}	I_C (Cont.)	V_{EBO} (Max.)	$V_{CE0}(sus)$	h_{FE} @ I_C	t_f (com. base)	$P_D(max.)$
DTS-4040	400V	15A	20V	325V	250/3A	0.25 μs	100W
DTS-4045	400V	15A	20V	325V	500/3A	0.25 μs	100W
DTS-4060	600V	15A	20V	400V	250/3A	0.25 μs	100W
DTS-4065	600V	15A	20V	400V	500/3A	0.25 μs	100W

NPN—Triple diffused Darlington transistors packaged in solid copper TO-204MA (TO-3) cases.

HIGH ENERGY THE KOKOMOANS.

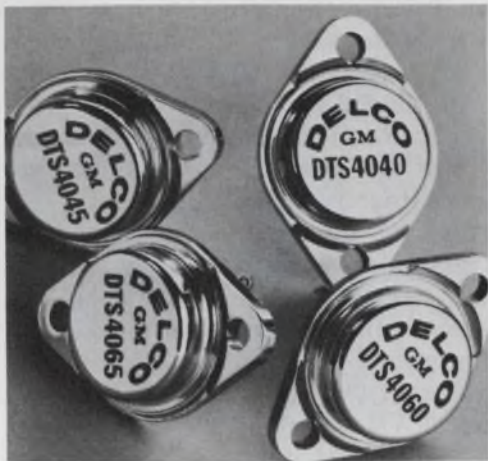

backed by safe operating curves up to 600 volts, as shown at left. And to further aid your circuit design h_{FE} is plotted continuously from 15mA to the maximum collector current rating of 15A.

As you expected, the new DTS-4000's are in stock and ready for delivery. Contact us or your nearest Delco distributor for complete details. Ask for Application Note 52 on the switching regulator.

Now available from these distributors in production quantities:

ALA., BIRMINGHAM • Forbes Distributing Co., Inc. (205)-251-4104
 ARIZ., PHOENIX • Sterling Electronics (602)-258-4531
 CAL., LOS ANGELES • Kierulff Electronics, Inc. (213)-685-5511 • Radio Products Sales, Inc. (213)-748-1271
 CAL., PALO ALTO • Kierulff Electronics, Inc. (415)-968-6292
 CAL., REDWOOD CITY • Cramer/San Francisco, (415)-365-4000
 CAL., SAN DIEGO • Radio Products Sales, Inc. (714)-292-5611
 CAL., SAN DIEGO • Kierulff Electronics, Inc. (714)-278-2112
 COLO., DENVER • Cramer/Denver (303)-758-2100 • Denver Walker Electronics (303)-935-2401
 CONN., NORWALK • Harvey/Connecticut (203)-853-1515
 FLA., MIAMI SPRINGS • Powell/Gulf Electronics (305)-885-8761
 ILL., ROSEMONT (Chicago) • Kierulff Electronics (312)-678-8560

ILL., SKOKIE (Chicago) • Merquip Electronics (312)-282-5400
 IND., INDIANAPOLIS • Graham Electronics Supply, Inc. (317)-634-8202
 MD., BALTIMORE • Radio Electric Service Co. (301)-823-0070
 MASS., NEEDHAM HEIGHTS • Kierulff Electronics, Inc. (617)-449-3600
 MASS., NEWTON • The Greene-Shaw Co., Inc. (617)-969-8900
 MICH., ROMULUS • Harvey-Michigan (313)-729-5500
 MINN., MINNEAPOLIS • Stark Electronics Supply Co. (612)-332-1325
 MO., KANSAS CITY • Walters Radio Supply, Inc. (816)-531-7015
 MO., NO. KANSAS CITY • LCOMP-Kansas City, Inc. (816)-221-2400
 MO., ST. LOUIS • LCOMP-St. Louis, Inc. (314)-647-5505
 N.J., CLIFTON • Eastern Radio Corporation (201)-365-2600, (212)-244-8930
 N.Y., BINGHAMTON • Harvey/Federal (607)-748-8211
 N.Y., EAST SYRACUSE • Cramer/Eastern (315)-437-6671
 N.Y., ROCHESTER • Cramer/Rochester (716)-275-0300
 N.Y., WOODBURY • Harvey/New York (516)-921-8700, (212)-582-2590
 OHIO, CINCINNATI • United Radio, Inc. (513)-761-4030
 OHIO, CLEVELAND • Pattison Supply (216)-441-3000
 OHIO, DAYTON • Kierulff Electronics (513)-278-9411
 OKLA., TULSA • Radio, Inc. (918)-587-9123
 PENN., PHILADELPHIA • Almo Electronics (215)-676-6000
 PENN., PITTSBURGH • RPC Electronics (412)-782-3770
 S.C., COLUMBIA • Dixie Radio Supply Co., Inc. (803)-253-5333
 TEXAS, DALLAS • Adleta Electronics Co. (214)-741-3151
 TEXAS, FORT WORTH • Adleta Electronics Co. (817)-336-7446
 TEXAS, GARLAND • Kierulff Electronics, Inc. (214)-271-2471
 TEXAS, HOUSTON • Harrison Equipment Co., Inc. (713)-224-9131
 UTAH, SALT LAKE CITY • Cramer/Utah (801)-487-3681
 VA., RICHMOND • Meridian Electronics, Inc., a Sterling Electronics Company (703)-353-6648
 WASH., SEATTLE • Kierulff Electronics, Inc. (206)-763-1550
 WASH., TACOMA • C & G Electronics Co. (206)-272-3181
 CANADA, ONT., SCARBOROUGH • Lake Engineering Co., Ltd. (416)-751-5980
ALL OVERSEAS INQUIRIES:
 General Motors Overseas Operations
 Power and Industrial Products Dept.,
 767 Fifth Avenue, New York, N.Y.
 10022. Phone: (212)-486-3723.
Kokomoans' Regional Headquarters.
 Union, New Jersey 07083, Box 1018, Chestnut Station, (201) 687-3770.
 El Segundo, Calif. 90245, 354 Coral Circle, (213) 640-0443.
 Kokomo, Ind. 46901, 700 E. Firmin, (317) 459-2175 (Home Office)



TV set is display for data terminal

in this all-digital character-generation system. It has a capacity of 1024 characters and uses dynamic MOS-RAM memories.

Want an excellent, low-cost display for a data terminal? Use an ordinary TV set. You can do it if you build this dot-matrix character-generation system that employs the same scanning raster as a television set.

You'll get these added benefits:

- The character-generation circuitry will be all-digital.
- 1024 characters, each generated by a 5×7 dot matrix, will be displayed in 16 rows by 64 columns—and that's a lot of characters.
- A full set of 64 ASCII alphanumeric characters will be available.

The Z-axis CRT-grid voltage in the alphanumeric display determines the dot pattern for forming the characters—the same way a TV picture is formed.

Since the characters must be written repetitively on the screen because of the short persistence of the display phosphor, a memory device must retain the display information. The memory must, of course, be capable of sequential readout at a rate fast enough to avoid limiting the re-

quired display definition and frequency.

A dynamic RAM has several advantages over a shift register often used as a CRT display memory. Not only can the RAM be used sequentially—like a shift register—for normal display-refresh operation; it also can provide rapid random access to change characters at its full speed.

The shift register, on the other hand, allows sequential access only. Changing randomly located characters in a shift-register CRT display can take up to many milliseconds, depending upon where the appropriate memory location is in the register with respect to cycle time.

The dynamic RAM offers a substantial speed increase in CRT/computer interface, with less than $1\text{-}\mu\text{s}$ access time. Also, whereas most of today's MOS shift registers come in a hard-to-handle, eight-lead, TO-5 metal can, dynamic RAMs come in a convenient dual-in-line package.

Currently, shift registers and the more versatile dynamic RAMs cost about the same in large quantities. But because of the potentially large demand for semiconductor RAMs in main-frame memories (to replace cores) their prices should eventually drop significantly below those of shift registers.

It's true that the dynamic RAM must be re-

Bob Bratt, Computer Applications Engineer, Motorola, Inc., Semiconductor Products Div. Phoenix, Ariz. 85008.

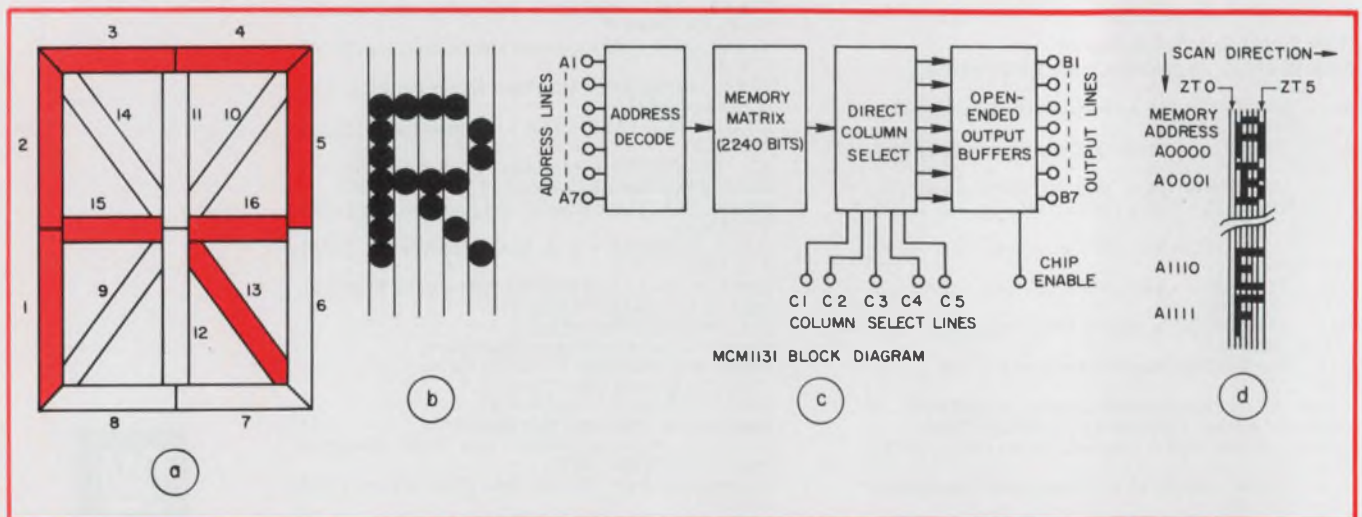

1. Either segments or dots can be used to form characters. The dot-matrix method uses all-digital circuitry.

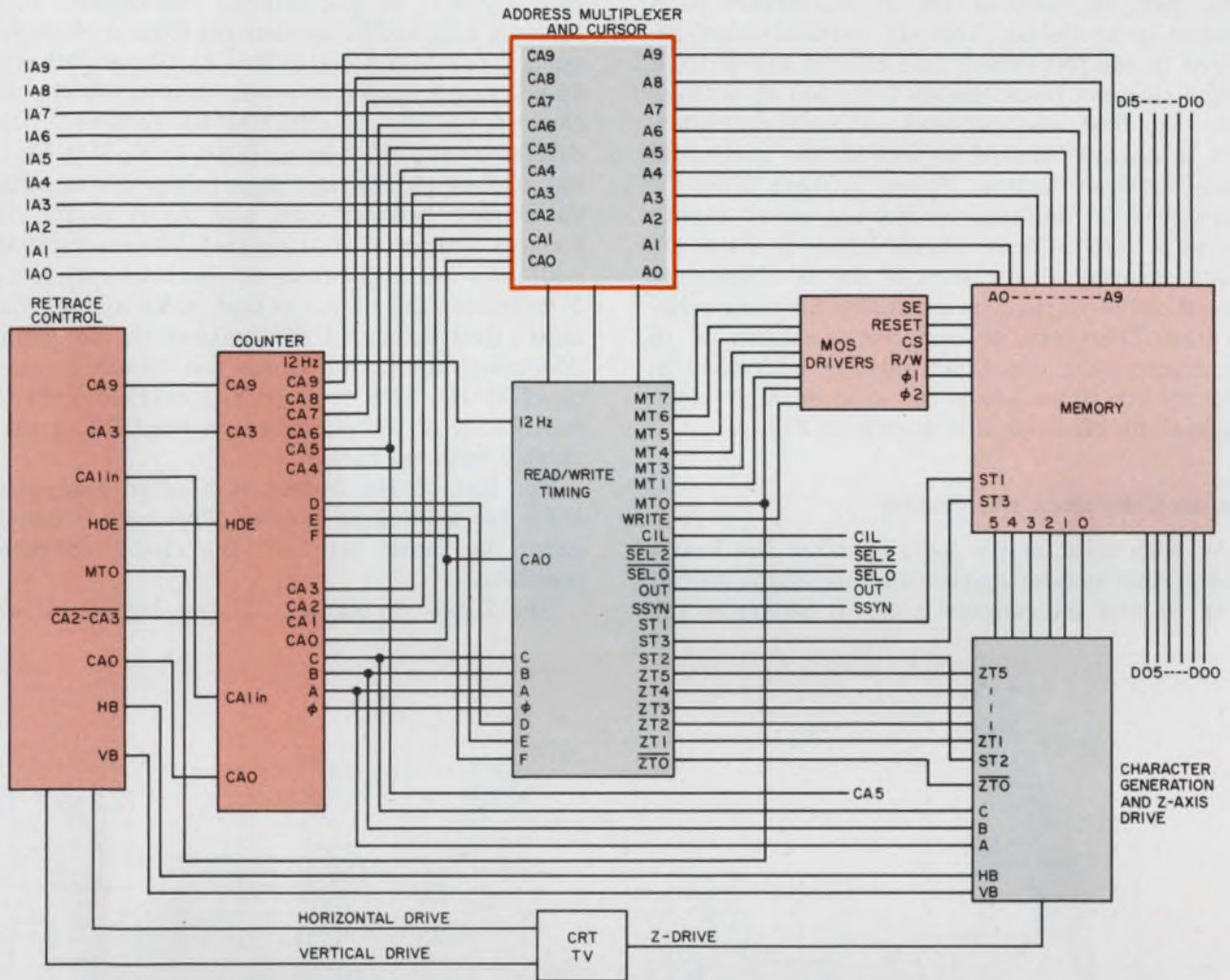

2. The CRT alphanumeric display system, shown in block form, requires only four logic cards to implement.

A TV receiver together with these logic cards comprises all the circuitry for a data terminal.

refreshed (all addresses accessed) at least every 2 ms. However, since the CRT system is constantly performing a sequential readout, the RAM is refreshed automatically.

CRT character generation

There are two popular methods for forming alphanumeric characters. One uses line segments and the other a dot matrix. A third, much less popular, method uses a template inside the CRT.

In the line-segment method, the character is formed from a pattern of straight lines as shown in Fig. 1(a) by turning off the electron beam during the time it is traversing the unused line segments. This technique has been described elsewhere.^{1,2}

The Dot-matrix method described here has the advantage that, unlike the line-segment technique, the character-generation circuitry is

digital throughout. Fig. 1(b) shows how a letter is formed from a 5×7 dot matrix. Characters are formed by turning off the electron beam during the time the unused dots are being scanned. This is done by using a specialized ROM to generate the matrix [see Fig. 1(c)]. The desired character dot-matrix appears when its address code is applied to the ROM. A complete character requires 35 bits. But all 35 bits at once would need a prohibitively large number of output pins. Therefore, the data is instead brought out a row (MCM1120) or a column (MCM1130) (as in this article) at a time.

Characters are generated with a vertical scan and present a set of parallel columns of characters on the tube face. Since normal TV operation calls for a horizontal scan, the TV picture tube is converted by merely rotating the CRT yoke 90 degrees.

Characters are written on the screen in the

sequence shown in Fig. 1(d). On each vertical scan, part of each of the 16 characters in a column is produced. The six vertical lines required to complete the whole column are written as the electron beam moves from top to bottom. Also, the first vertical scan of each character, ZT0, is always blanked to provide the horizontal space between letters. Space between lines of characters is obtained by leaving every eighth dot in a vertical scan blank. Intensity data (Z-axis information) for each of the 16 characters is read out of memory sequentially for each vertical line. Therefore, to complete a column of 16 characters, each character must be addressed in memory six times—once for each scan. A block diagram of the system is shown in Fig. 2.

The oscillator-clock and counter

As with most active logic circuits, the heartbeat of this system starts in an oscillator circuit (Fig. 3) and the counter it drives generates the

required total of 18, interval, position and scan-rate signals. A hex-inverter MC3009P, IC15, forms a ring oscillator that provides a clock frequency (ϕ) of 5.4 MHz. This oscillator drives an 18-bit synchronous counter, which divides the clock frequency by 196,608 as follows: IC14, divides by 16; IC13, by 8; IC10, by 6; IC9, by 16, and IC8, by 16. Signal ϕ determines the dot interval during vertical scan and A, B and C the memory timing; CA0 through CA3 determine the addresses for the 16 rows of characters. D, E and F determine the six scans that make up one character; CA4 through CA9 establish the 64 column addresses; and CA9 becomes the display frequency of 51 Hz. This frequency, combined with the persistence of the phosphor on the CRT, gives a display with no flicker.

The last, 12-Hz, output is used in generating 6 Hz for a blinking cursor. This cursor can be gated to mark any of the 1024 character positions.

The Z-axis is blanked during horizontal and

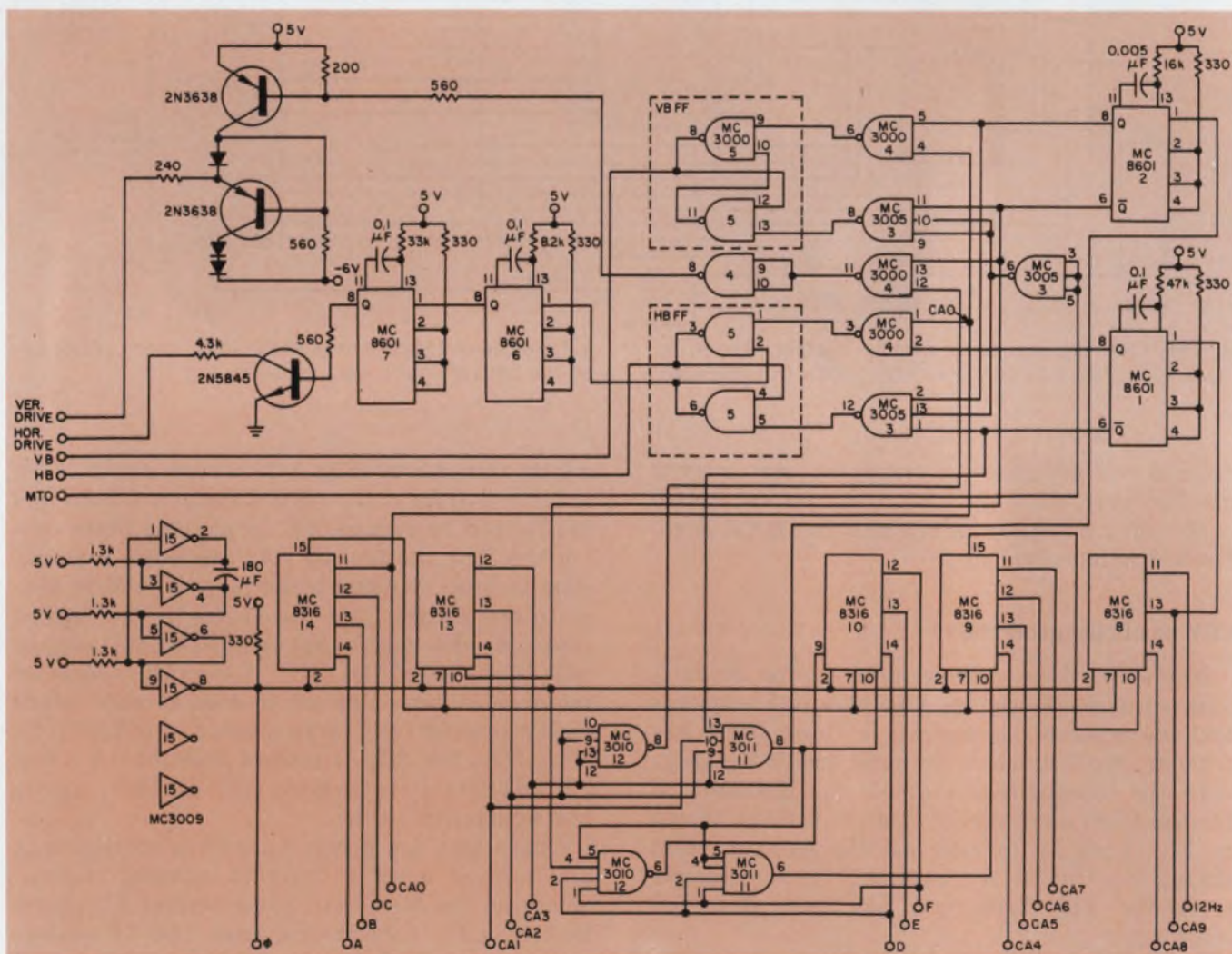

3. The basic timing and blanking signals are derived from an oscillator circuit (hex-inverter, IC15) and a

chain of counters (IC8 through IC14). Discrete component drivers couple logic signals to the TV set.

vertical retrace. The retrace timing is derived from the countdown chain.

Vertical and horizontal retrace control

The vertical retrace timing begins when CA3 goes from a ONE to a ZERO (Fig. 4) when the last character for any column has been read out of memory. This negative-going edge triggers a one-shot (IC2 of Fig. 3) whose Q output goes to a ONE. Because the Q output is NANDed with CA0, this delays blanking by one address period, so that the system has time to write the final character on the screen. Thus, when CA0 goes to ONE, the vertical blanking flip-flop (VB-FF) is set.

The horizontal retrace begins when CA9 goes from ONE to a ZERO (Fig. 5). At this time the last character of the last row has been read out of the RAM. The negative-going edge triggers a one-shot (IC1 of Fig. 3). Its Q output goes to a ONE, and it is NANDed with CA0, delaying blanking by one address, so that again the system

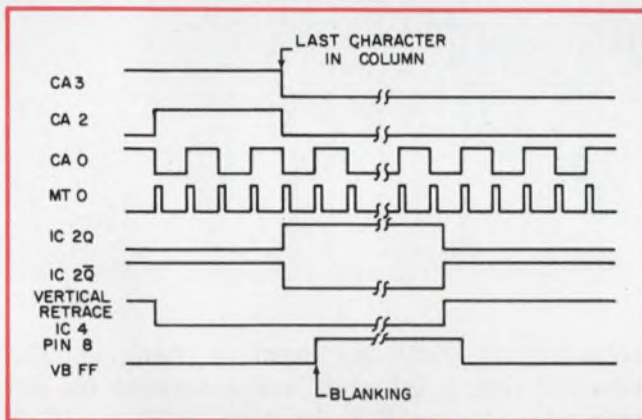

4. Vertical retrace starts when CA3 drops to zero. The interval is mainly determined by a one-shot (IC2 in Fig. 3). Retrace is blanked when VBFF is high.

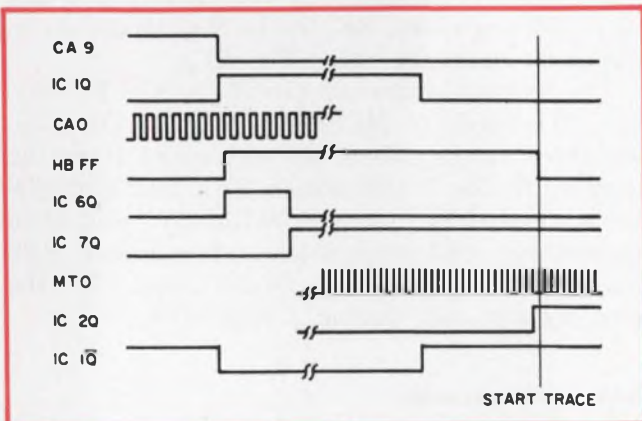

5. Horizontal retrace starts when CA9 drops to zero. This interval is mainly determined by a one-shot (IC1 in Fig. 3). Retrace is blanked when HBFF is high.

has time to write the final character on the screen. When CA0 goes to a ONE, the horizontal blanking flip-flop (HB-FF) is set.

The horizontal retrace must begin after the blanking pulse begins, and end before the blanking pulse ends, so that nonlinearities on the ends of the trace can be avoided. This timing is accomplished by two one-shots (IC6 and IC7).

The discrete-component horizontal-drive output stage forms part of an RC network (a second resistor and the capacitor are in the TV circuit) that generates the ramp signal for the horizontal traces.

Tracing begins when the one-shots (IC1 and IC2) return to their original state. In addition IC3 NANDs their outputs with MT0 to synchronize the trace, so it starts at the beginning of the first character. Similarly, the output of the horizontal one-shot, IC1, is NANDed with the output of the vertical one-shot, IC2, to synchronize the start of the horizontal trace with a vertical trace. Each time a retrace begins, part of the counter is stopped. When vertical retrace begins, the \bar{Q} output of IC2 stops all the counter outputs from CA1 through to the 12-Hz output. When horizontal retrace begins, the \bar{Q} output of IC1 stops all the counter outputs from D to the 12 Hz output.

Character generation and timing

The circuitry for timing and character generation is shown in Fig. 6. Counter-timing signals D, E and F are decoded in IC10 to select one of six outputs, and are translated to MOS voltage levels, ZT1 to ZT5. They determine which one of the five vertical sections of the character matrix is strobed in parallel into the Z-axis data register. These seven bits are converted by an eight channel data selector into serial information which controls the Z-axis during dot generation. Enable lines ZT1 to ZT5, together with a six-bit character identifying code from the memory (translated to MOS levels), address the character generator, IC19.

The output from the character generator is converted to TTL levels by a resistor divider. The dot pattern for a vertical character line is strobed into the Z-axis register, IC20 and IC21, by ST2 (MT0 inverted). These parallel data are converted to serial data by IC22 (an eight-bit data selector) as directed by the memory-timing counter bits A, B and C.

In addition ZT0 is inverted and delayed by one address period to form $\bar{ZT0}$, which disables IC22 for the first scan of a character column to provide the space between characters. The blank row for a space between lines of characters is provided by the normal logic ZERO on the cursor input of IC22 via the Z-axis driver, IC23. A

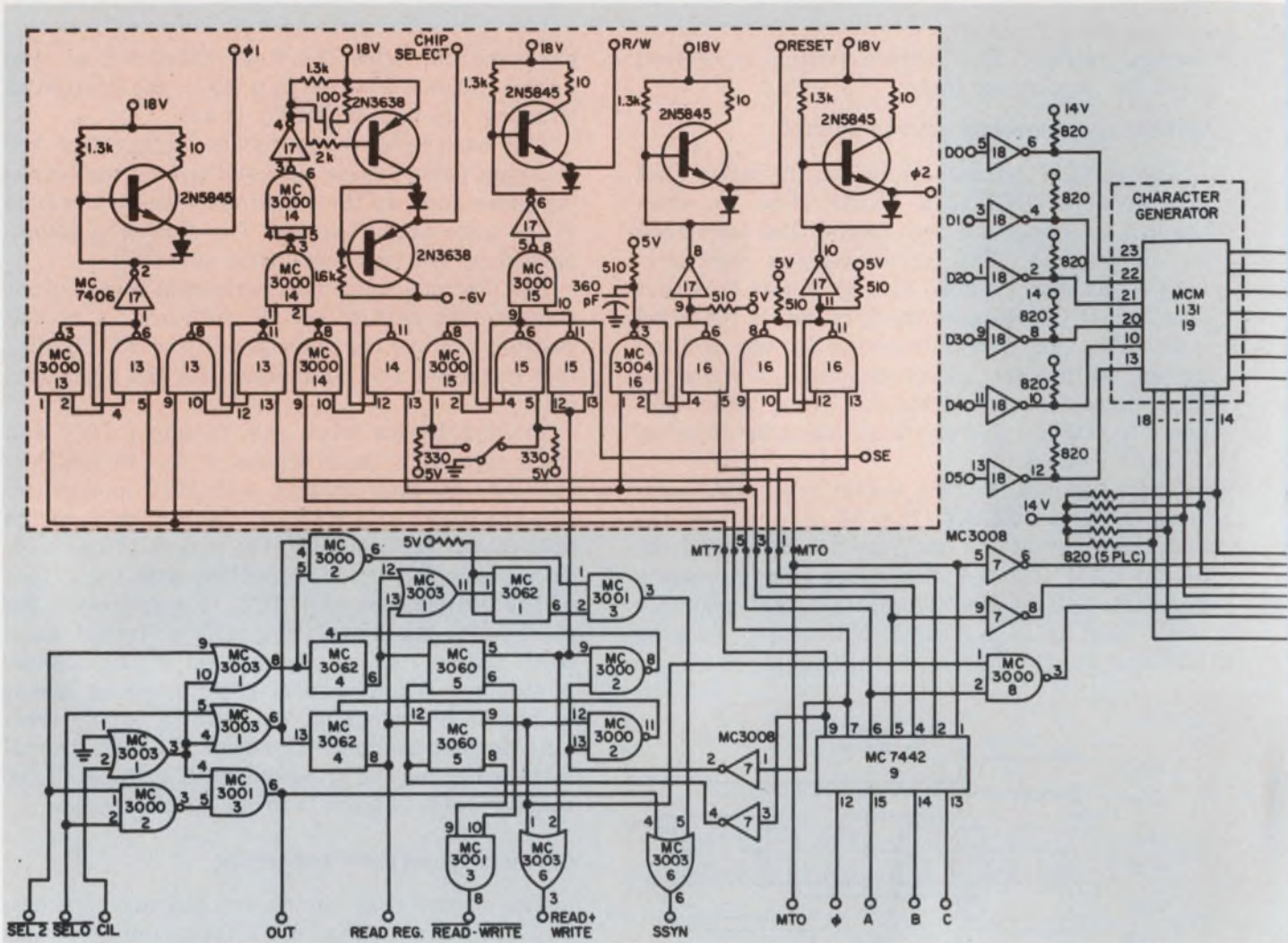

switch, SW1, selects either the inverted or non-inverted output from IC22 thus allowing a choice of black characters on a white background, or white characters on a black background.

In addition the vertical blanking (VB) and horizontal blanking (HB) signals are connected into the Z-axis driver, IC23. The Z-axis driver then feeds the composite signal to drive circuitry in the TV set.

IC11 divides the 12-Hz frequency by two. The resulting 6-Hz signal flashes the cursor character on the CRT face.

Dynamic-memory timing

The MCM1172L RAM chosen for the CRT system has relatively simple timing and output requirements. As shown in Fig. 7, timing is accomplished in integral multiples of 105 ns, and there are eight such intervals. These memory-timing intervals, MT0 to MT7 (note that MT2 is not used), are generated by decoding counter-output bits A, B and C in the 1-of-8 chip, IC9 (Fig. 6). The clock is combined with these three signals to eliminate unwanted spikes that can

be generated while the count is changing. The required timing intervals are generated by setting and clearing R-S flip-flops, IC13 to IC16, with appropriate timing pulses. An RC network on one side of the chip-select flip-flop, IC16, causes a delay of 20 ns between the trailing edges of $\phi 1$ and the chip-select signal.

The switch and the R-S flip-flop used in the write logic, IC15, are used for erasing the display. The erase line, SE, forces the input data to the blank character code (Fig. 8).

The discrete-component circuits in Fig. 6 translate TTL levels to MOS levels, D0 to D5. Also the three strobe pulses are generated from the memory timing. These pulses, ST1, ST2 and ST3 are generated by inverting MT4, MT0 and MT5 respectively. ST1 strobes the data register, ST2 the Z-axis register (ICs 20-21), and ST3 the read register only during a read cycle.

RAM read operation

Each of the six 1024-bit MOS memories is organized in 32 rows by 32 columns of dynamic storage cells. Input data and the address are

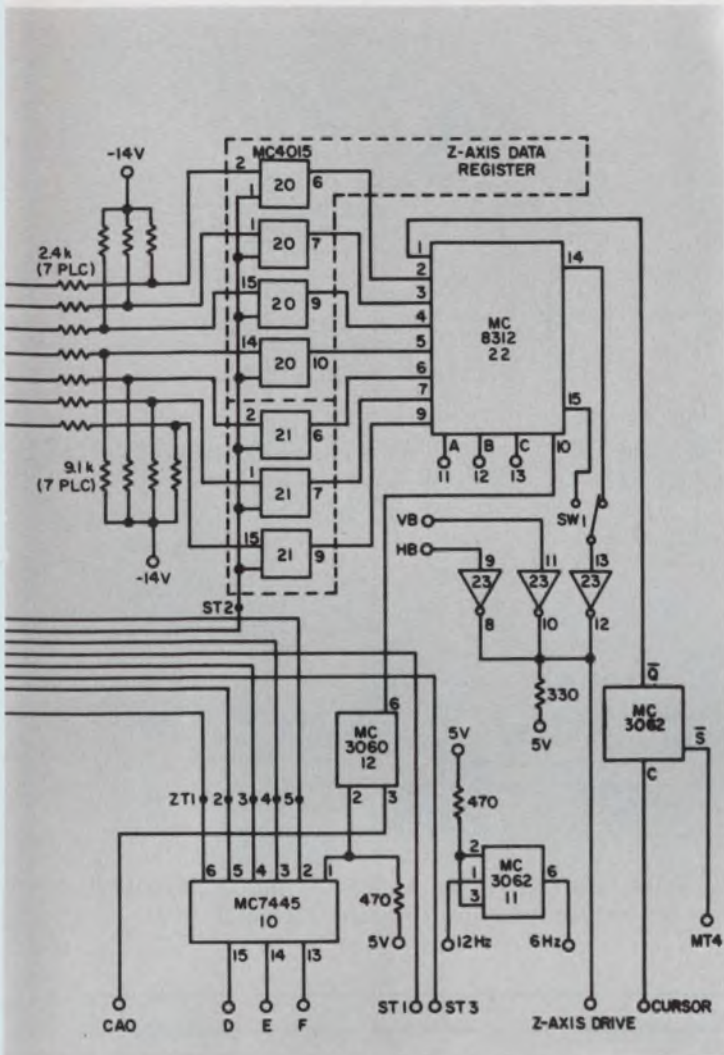

translated to MOS levels by IC3, IC4 and IC5 (Fig. 8). IC1 and IC2 force the character-code generator to blank when the CRT is erased.

Information is read out of the memories sequentially and strobed into the memory data register. An additional data register holds information that is to go to the computer after a read operation. The information in the memory data register is converted to a matrix by the character generator, IC19 (Fig. 6).

Because a ONE output of the memory is at least a 3-mA drain and the ZERO an open circuit, the memory can drive a transistor directly. The output of the memories is picked up by transistor inverters, and ST1 strobes the output into the memory data register, IC12 and IC13. When a read cycle is called for, ST3 (a start trace) gates the data into the output data register, IC14 and IC15.

RAM refresh cycle

Since the RAM data are stored as a gate-capacitance charge that will leak away with time, data must be refreshed at least once every 2 ms.

6. A ROM, IC19, generates data for a character, seven bits (one dot column in Fig. 1) at a time. The bits are strobed into the Z-axis register and then converted to serial data which modulates the CRT Z-axis.

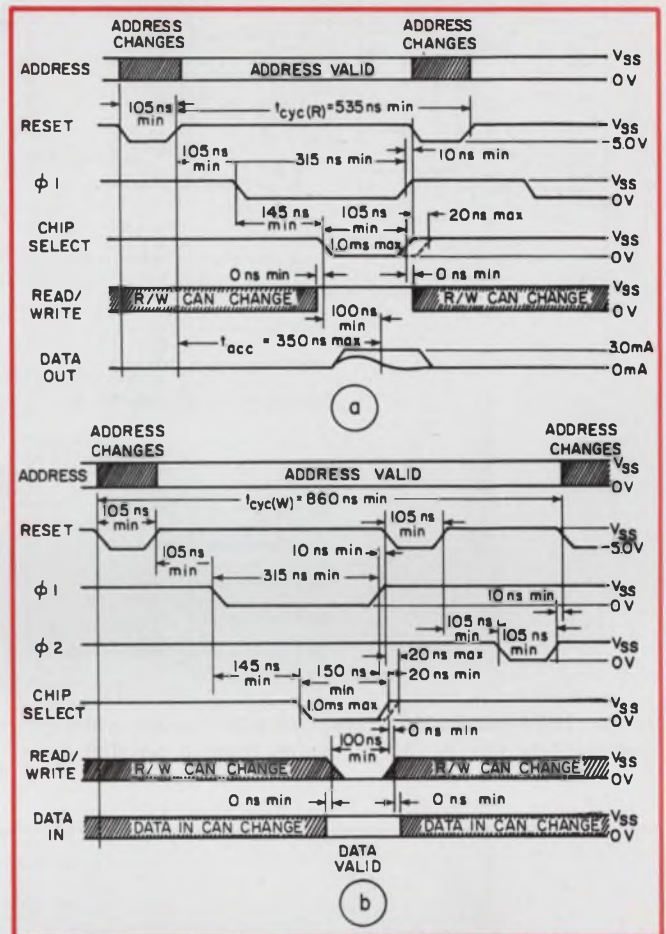

7. Memory timing is accomplished in integral multiples of 105 ns. There are eight such intervals. Timing is shown in (a) for reading the RAM-character code, and in (b) for the load (write) or refresh cycle.

Timing of the refresh cycle is shown in Fig. 7(b). The reset pulse from the timing generator precharges both the addressing circuitry and the read/write circuitry of the RAM. For proper operation, the addresses must be changed only while the reset is low. If an address is changed with the reset high, all address lines will be discharged and no cells addressed.

The $\phi 1$ pulse can be lowered after a 105-ns address-reset settling time. This pulse transfers the stored data from the column selected by the address code on lines A0 through A4 to an internal data buffer. This transfer takes 200 ns, after which the chip-select pulse will gate the information bit from the selected row of its buffers to the output. Meanwhile the memory retains the 32 bits of the selected column in its internal buffer.

The data can now be rewritten into the proper column to refresh the stored data. This is accom-

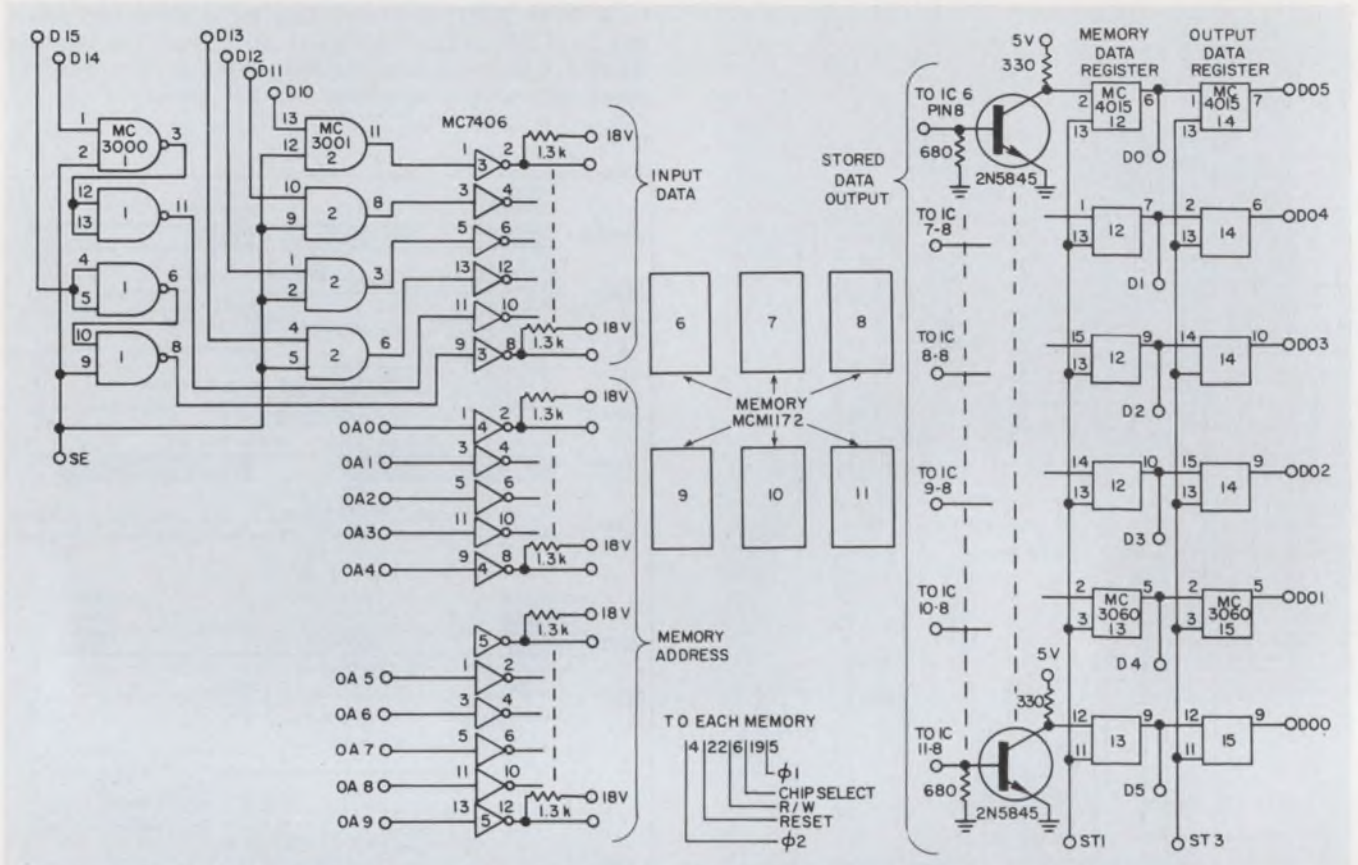

8. Six 1024-bit RAMs store character codes while refreshing the display. Six-bit words read in parallel from

the RAMs are entered sequentially to the memory-data register and address the character-generator ROM.

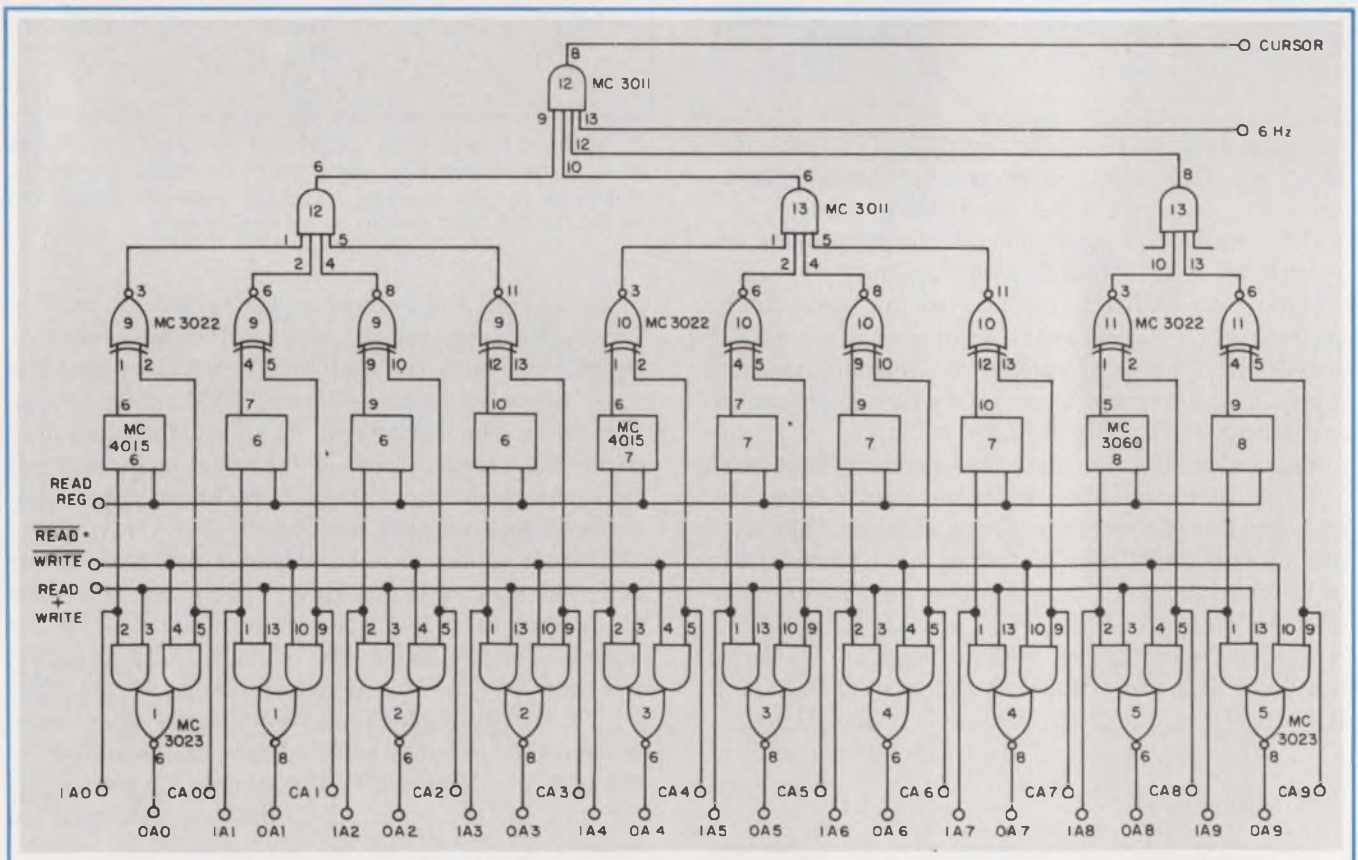

9. The address-multiplexer and cursor circuit time-shares the RAM-addressing inputs between the computer

and display system. The character addressed by the cursor register blinks at a 6-Hz rate.

plished by using a second reset pulse to again precharge the address and read/write lines and—after the 105-ns settling time—by applying the $\phi 2$ pulse to transfer the data from the buffer back into storage.

Selecting the read/write mode

Timing of the write cycle is also shown in Fig. 7(b). When the write cycle is required for loading the memory from the computer, the write command overrides the selected row of the buffer store and its refresh data. This is done at the time the data are brought from the selected column to the buffer with the $\phi 1$ pulse.

The read/write logic (IC1 through IC6 and IC11, in Fig. 6) selects the read or write. This circuit was designed for use with a bus-oriented minicomputer. When input line CIL is low and SEL 0 goes from high to low, a J-K flip-flop, IC4, is cleared, indicating that a write request has been received.

At the end of memory time interval MT6, a D flip-flop, IC5, is set, activating the write logic. During this cycle, input data are written into memory. Similarly SEL 2 activates the read logic.

The J-K flip-flops, which hold a request for a read or write operation, are reset at the end of the MT5 interval. Thereafter the system is ready to respond to another read or write request.

Address multiplexer and cursor circuit

The address multiplier is shown in Fig. 9 and consists of IC1 through IC5. It time-shares the RAM-addressing input from the computer or display system. When a read or write operation is to be performed, the input addresses from the computer are enabled (IA0-IA9). When a read + write operation is required (the sequential readout operation needed to refresh the picture on the CRT), the internally generated counter addresses are passed through (CA0-CA9). The selected address is inverted and directed to the memory.

The cursor address register, ICs 6, 7 and 8, holds the memory address to which the computer last read. Each time the counter address matches the one in the cursor address register, the exclusive-OR gates, ICs 9, 10 and 11, enable the 6-Hz input on the final AND gate, IC12, causing blinking of the addressed character.

Each of the logic subsections as delineated by Figs. 3, 6, 8, and 9 were constructed on a separate logic board. A TV set together with these four logic boards is the basic required circuitry for the data terminal. ■■

References

1. Armstrong, J. R. and Hern, C. L., "Convert your Scope to a Display Terminal," *Electronic Design*, Nov. 11, 1971.
2. Martin, L., "Use your Oscilloscope for Numeric Display," *Electronic Design*, Dec. 23, 1971.

This transceiver case had to be:

Deep drawn, Shaped,
Pierced, Lanced,
Louvered, Debossed,
Spot welded,
Texture painted.

Transceiver cases are used for the installation of transmitter-receiver units in police vehicles.

AMALCO designed and engineered it, made the necessary tools and dies and produced it from blank to the finished product all in our own plant. . . . and, we delivered it on schedule.

Besides the techniques required by the transceiver case we also do:

- Testing • Hydroforming • Spinning • Stamping
- Brake Fabrication • Heliarc, Spot and Stud Welding • Riveting • Heat Treating • Anodizing

. . . and we have our own prototype shop, too. If you have a fabrication problem, no matter how complex or how tight the specs, call Bill Lowry collect at (201) 233-3500.

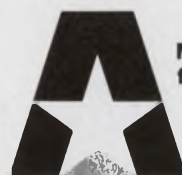

Manufacturers of Aluminum Products
for Industry Since 1910.

AMALCO

AMERICAN ALUMINUM COMPANY

230 SHEFFIELD ST., MOUNTAINSIDE, N. J. 07092

83



Norden Encoders perform for you!

Look at these new additions to Norden's line. More are on the way.

	Total Count	Revolutions for Full Count	Diameter"	Model Number
NEW! Optical Absolute	10,000	50	2.25	OADC-23/4/BCDQ-200L
NEW! Optical Absolute	1,000	1	2.25	OADC-23/3/BCD-1000L
NEW! Optical Incremental: Series now available with shaft seal—permits drenched operation.				
NEW! Contact Size 11	8,192	32 or 64	1.06	ADC-11/13/BNRY-256L
NEW! Contact Size 11 Altitude Reporting Encoder	1,280	16	1.06	ADC-11-ALT-1280
NEW! Contact Size 11	10,000	100	1.06	ADC-11/4/BCDX-100
NEW! Contact Size 11	3,600	36	1.06	ADC-11/4-36/BCDX-100
NEW! Rugged Industrial Grade Optical Incremental Encoders				
All available with quadrature and internal squaring circuit options	2,000 Pulses	1	3.500	OADC-35/2000/INC
	1,500 Pulses	1	3.500	OADC-35/1500/INC
	1,250 Pulses	1	3.500	OADC-35/1250/INC
	1,000 Pulses	1	3.500	OADC-35/1000/INC
	600 Pulses	1	3.500	OADC-35/600/INC
	500 Pulses	1	3.500	OADC-35/500/INC
	300 Pulses	1	3.500	OADC-35/300/INC
	200 Pulses	1	3.500	OADC-35/200/INC
	100 Pulses	1	3.500	OADC-35/100/INC
Optical Incremental Encoders				
All available with index marker, quadrature outputs and internal squaring circuit options. Other counts on special order	100 Pulses	1	2.250	OADC-23/100/INC
	250 Pulses	1	2.250	OADC-23/250/INC
	256 Pulses	1	2.250	OADC-23/256/INC
	336 Pulses	1	2.250	OADC-23/336/INC
	500 Pulses	1	2.250	OADC-23/500/INC
	512 Pulses	1	2.250	OADC-23/512/INC
	1,000 Pulses	1	2.250	OADC-23/1,000/INC
	1,024 Pulses	1	2.250	OADC-23/1,024/INC
IC-Compatible Encoders. For direct interface with TTL & DTL circuits				
Binary	128	1	1.750	ADC-ST7-BNRY-E/L
	8,192	64	1.750	ADC-13-BNRY-E/L
	524,288	4,096	1.750	ADC-19-BNRY-E/L
Binary-Decimal Code				
	100	1	2.250	ADC-ST2-BCD/L
	1,000	10	2.250	ADC-3-BCD/L
	10,000	100	2.250	ADC-4-BCD/L
	100,000	1,000	2.250	ADC-5-BCD/L
	1,000,000	10,000	2.250	ADC-6-BCD/L
	360	1	2.250	ADC-3-36BCD-E-360L
	3,600	10	2.250	ADC-4-36BCD-E-360L
	36,000	100	2.250	ADC-5-36BCD-E-360L
	360	1	3.250	ADC-ST3-36-BCD/L
	3,600	36	2.250	ADC-4-36-BCD/L
	36,000	360	2.250	ADC-5-36-BCD/L
	360,000	3,600	2.250	ADC-6-36-BCD/L
External Logic V-Scan Binary Encoders				
	128 or 256	1	1.750	ADC-7/8-BNRY-XB
	8,192 or 16,384	64	1.750	ADC-13/14-BNRY-XB
	524,288 or 1,048,576	4,096	1.750	ADC-19/20-BNRY-XB
Single Turn Gray Code Encoders				
Available with various levels of RFI suppression	256	1	1.066	ADC/11/8/GRAY
	256	1	1.750	ADC-ST8-GRAY
	512	1	2.250	ADC-ST9-GRAY
	1,024	1	3.062	ADC-ST10-GRAY
Multiturn Gray Code Encoders				
Available with various levels of RFI suppression	1,024	4	1.062	ADC-11/10GRAY256
	1,024	16	1.062	ADC-11/10GRAY 64
Low Cost Magnetic Noncontacting Encoders				
Incremental	128	1	1.750	MADC-18/128/INC
Binary	128(V scan)	1	1.750	MADC-18/7/BV
Binary	8,192(V scan)	64	1.750	MADC-18/13/BV
Binary	524,288(V scan)	4,096	1.750	MADC-18/19/BV

For more information and detailed specs, write Norden, Att: Components Dept., 200 Helen Street, Norwalk, Conn. 06856. Phone (203) 838-4471. TWX: 710-468-0788.

Norden DIVISION OF UNITED AIRCRAFT CORPORATION

We took everything they could throw at us

and came back for more.



We've written enough of the "book" on shielding to know there's no substitute for experience when solving tough EMI problems. That's why it took us practically twenty years to build our comprehensive line of shielding products... one solution at a time.

Perfection Mica offers bulk shielding materials for high or low density fields that are stress annealed for ease in punching, forming, spinning or drawing. These same quality materials are used in our line of portable or cabinet style mag-

netic tape preservers that prevent the degradation of vital taped information.

On the specialty side, there's our multi-cellular magnetic shield that permits sensitive instruments to operate in extreme magnetic field environments, or unique inter-8 weave cable for applications where either radiation or magnetic interference is a problem. We can furnish rooms that have lower spectrum magnetic shielding capability.

The tougher the shielding problem, the better we like it. Throw it at Perfection Mica.



PERFECTION MICA COMPANY / Magnetic Shield Division

740 Thomas Drive □ Bensenville, Illinois 60106 □ (312) 766-7800 □ TWX (910) 341-7277

INFORMATION RETRIEVAL NUMBER 78

Here are simpler circuit models

for computer-aided analysis of complex systems. The models are derived with an isolated, equivalent-circuit technique.

The usual circuit models for computer-aided design (CAD) are fine for detailed analysis of a simple linear circuit—an amplifier, say. But they are unnecessarily elaborate for analyzing large, complex systems that contain many amplifiers. What's needed are simplified models that can help speed system analysis while yielding adequate data.

Because it is the over-all transfer characteristics of a circuit that are important in systems work, circuit simulation by use of an isolated circuit-modeling technique provides the simple CAD models. The models can be derived directly from manufacturer's data.

Models for both steady-state and transient excitations can be derived. For the steady state, both zero and pole, first-order circuits are used. A second-order RLC circuit provides the equivalent circuit for transient modeling.

Modeling for steady-state response

Let's examine the isolated circuit technique as it applies to steady-state inputs. For analyzing circuits in the frequency domain, we use Bode gain-phase vs log-frequency plots to find the poles and zeros of the circuit. The insertion of "isolating amplifiers" between frequency-sensitive sections offers the designer greater computational freedom. The flexibility becomes quite apparent with multipole/zero models. The designer does not have to worry about the loading effects² of the ladder network; he can simply add or delete poles and zeros as needed.

The poles and zeros are determined from the break points of the amplitude frequency and phase-shift frequency (Bode) curves supplied by the manufacturer of the individual circuits (usually ICs). This data-sheet information, together with the input impedance, output impedance and open-loop gain, allows derivation of a complete equivalent circuit, as shown in Fig. 1a.

Note that the equivalent circuit has been separated into frequency-sensitive networks and

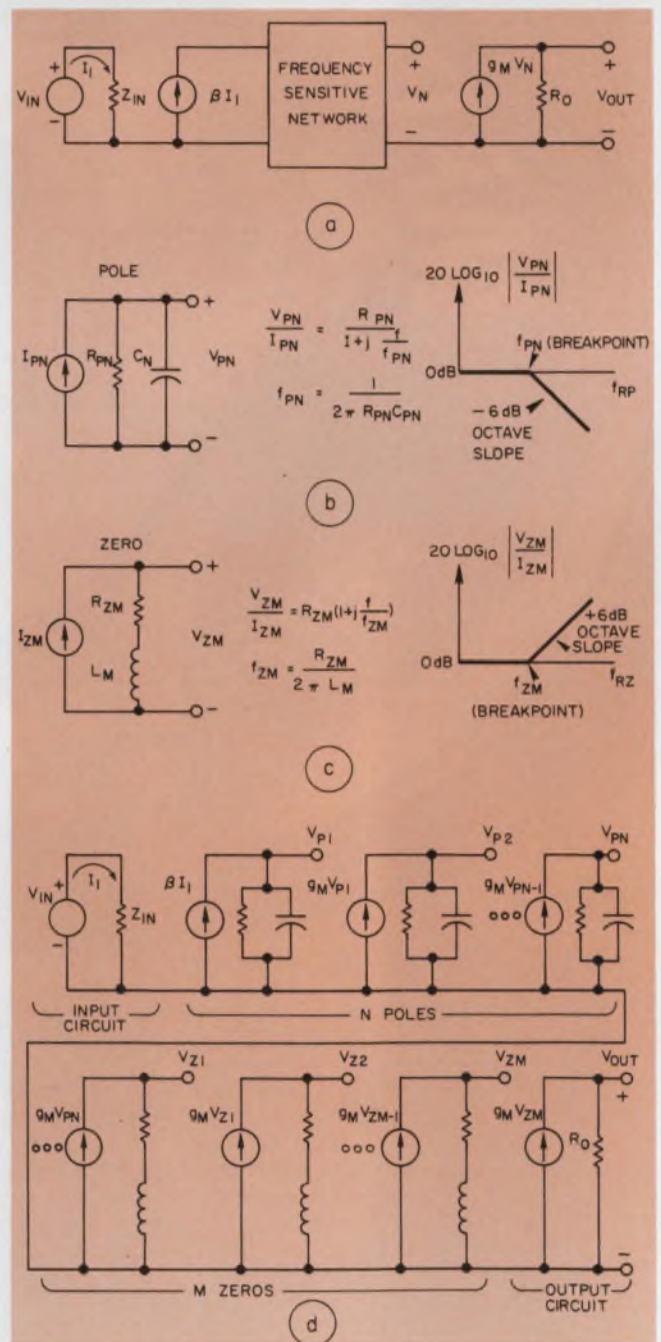

1. Simple, first-order isolated RC poles and RL zeros can be cascaded to simulate the transfer function of complex electronic circuits, such as operational amplifiers. Use of isolation technique avoids loading limitations.

Tom Terlizzi, Grumman Aerospace, RF and Video Product Support, Section 272, Plant 34, Bethpage, N.Y. 11714

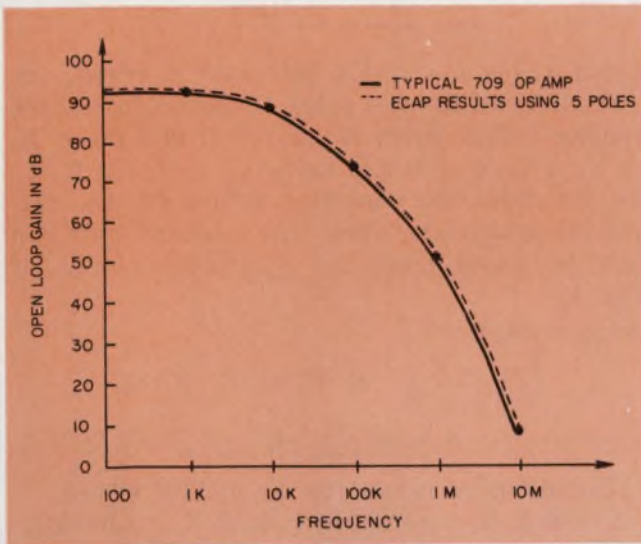

2. The typical $\mu A709$ op-amp, open-loop gain curve is matched to ± 1 dB with the isolated five-pole model.

isolated current-source amplifiers, $g_m V_n$. The frequency-sensitive networks are simulated by parallel RC networks for poles, or series RL networks for zeros (Figs. 1b, 1c and 1d).

Since each current source depends on the output voltage of the previous stage, the over-all open-loop transfer function is found by multiplying the over-all gain by the products of the individual stage impedances. Thus the over-all open-loop transfer function for an operational amplifier with n poles and m zeros is:

$$T = \frac{V_{out}}{V_{in}} = A \frac{\left(1 + j \frac{f}{f_{z1}}\right) \left(1 + j \frac{f}{f_{z2}}\right) \cdots \left(1 + j \frac{f}{f_{zm}}\right)}{\left(1 + j \frac{f}{f_{p1}}\right) \left(1 + j \frac{f}{f_{p2}}\right) \cdots \left(1 + j \frac{f}{f_{pn}}\right)}$$

where

$$A = \frac{\beta}{Z_{in}} (G^{m+n}) (R_{p1} R_{p2} \cdots R_{pn}) (R_{z1} R_{z2} \cdots R_{zm})$$

The break points are defined in Figs. 1b and 1c as f_{pn} and f_{zm} , and they refer to the frequencies at which the slopes of the gain curves start to change. To illustrate the technique, consider the popular $\mu A709$ op amp. From the op

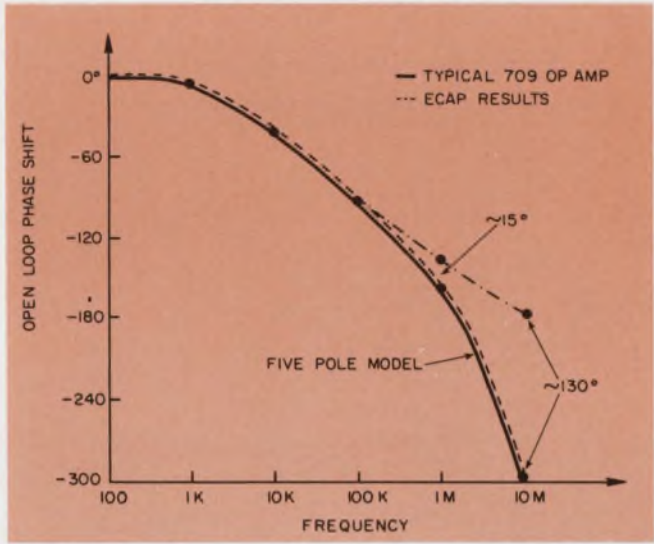

3. The $\mu A709$ phase curve is matched to $\pm 0.5^\circ$ over five decades of frequency with the five-pole model.

amp's open-loop gain curve (Fig. 2), we see that there are only poles, since the curve slopes downward with increasingly negative slopes.

The first two poles are found from the open-loop gain curve (Fig. 2) by finding the points of slope change: 0 dB to -6 dB/octave and -6 dB/octave to -12 dB/octave. In the example, these break points occur at 13.3 kHz and 1 MHz.

The open-loop phase curve of Fig. 3 suggests that there is a higher-order pole above 1 MHz, since the slopes are about 15 degrees apart at 1 MHz and roughly 130° at 10 MHz. Of course, a single pole can at most contribute a 90 degrees shift per decade.

Assuming the multiple pole is approximately one decade above 1 MHz and using the phase equation for a multiple pole, we obtain:

$$\Delta\theta \approx N \tan^{-1} \frac{f}{f_p}, \text{ with } \Delta\theta = 15^\circ$$

and $\frac{f}{f_p} = 0.1$ where N = number of poles,

we obtain $N \approx 3$.

Therefore there is a third-order pole at approximately 10 MHz. The break-point frequency can more accurately be found now, by using

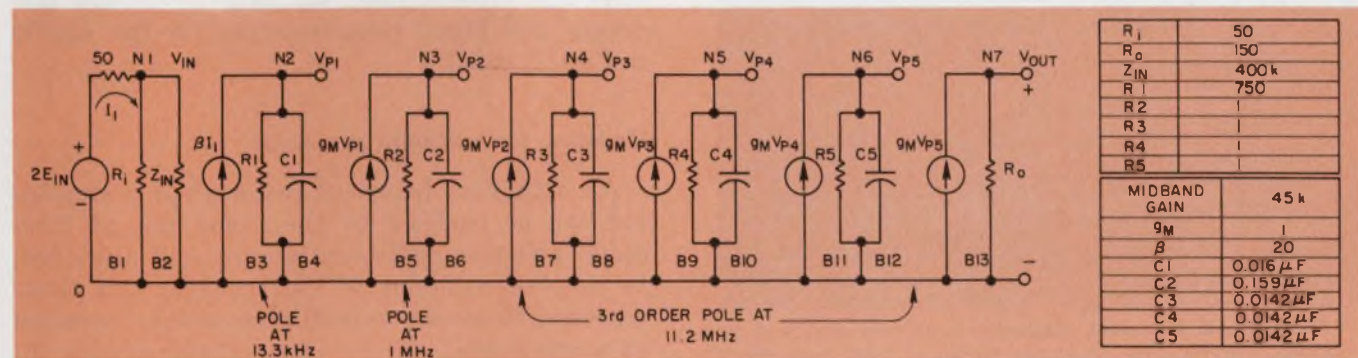

4. A five-pole model is derived from the break points of the gain curve and slope of the phase curve.

ECAP02 T34-2229 0513856393 TERLIZZI

```

C ISOLATED 5 POLE MODEL FOR THE UA709
  OPERATIONAL AMPLIFIER AC ANALYSIS
B1 N(0,1),E=2,R=50
B2 N(1,0),R=50
B3 N(0,2),R=750
B4 N(2,0),C=.016E-6
B5 N(0,3),R=1.0
B6 N(3,0),C=.159E-6
B7 N(0,4),R=1.0
B8 N(4,0),C=.0142E-6
B9 N(0,5),R=1.0
B10 N(5,0),C=.0142E-6
B11 N(0,6),R=1.0
B12 N(6,0),C=.0142E-6
B13 N(7,0),R=150
T1 B(2,3),BETA=20
T2 B(3,5),GM=1.0
T3 B(5,7),GM=1.0
T4 B(7,9),GM=1.0
T5 B(9,11),GM=1.0
T6 B(11,13),GM=1.0
FREQUENCY=100
PRINT,VOLTAGES
EXECUTE
  
```

5. A data input schedule is prepared for ECAP after the branches and nodes of the five-pole model are identified. Setting $G_m = 1$ simplifies the problem.

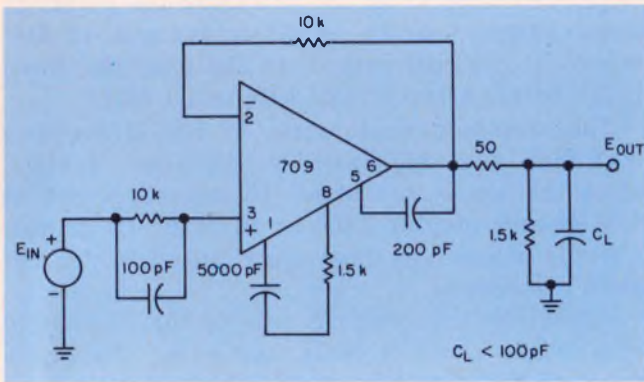

6. The $\mu A709$ in a feedback circuit is modeled for transient response by use of a second-order circuit. For transient analysis a step input is used.

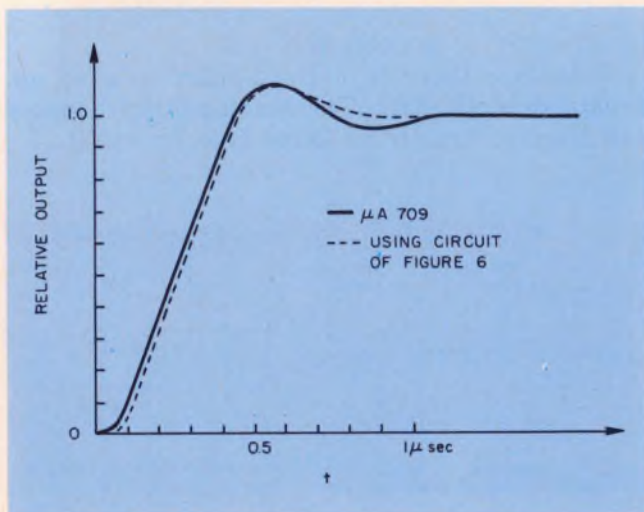

7. The typical transient response is closely matched by the RLC model. The response shows a 10% overshoot to a step input.

$$\tan \frac{15^\circ}{3} = \frac{1 \text{ MHz}}{f_p},$$

which yields $f_p = 11.2 \text{ MHz}$. As a result, the over-all model has five poles. Choosing reasonable resistor values yields $R_1 = 750 \Omega$ and $R_2 = R_3 = R_4 = R_5 = 1 \Omega$ and using $C_n = 1/2 \pi f_n R_n$, we determine the capacitor values for the frequency-sensitive network. The midband gain can now be found from the equivalent circuit of Fig. 4:

$$A(\text{open loop}) = \frac{E_{\text{out}}}{E_{\text{in}}} = \frac{\beta g_m^5}{R_i} R_o \cdot R_1 \cdot R_2 \cdot R_3 \cdot R_4 \cdot R_5$$

$$A = \beta g_m^5 \frac{R_o}{R_i} \cdot R_{(\text{combined})}$$

Using typical values for the $\mu A709$, where $A = 45 \text{ k}$, $R_o = 150 \Omega$, $R_i = 50 \Omega$, $Z_{\text{in}} = 400 \text{ k}\Omega$, and noting the condition that $Z_{\text{in}} \gg R_i$, we solve for A :

$$A = 45,000 = \beta g_m^5 \frac{(150)(750)}{(50)} \text{ and } 20 = \beta g_m^5.$$

For simplicity, the use of unity-gain amplifiers ($g_m = 1$), yields $\beta = 20$.

Numbering the nodes (N) for each branch (B_1 - B_{13}) and inserting the isolating gain ele-

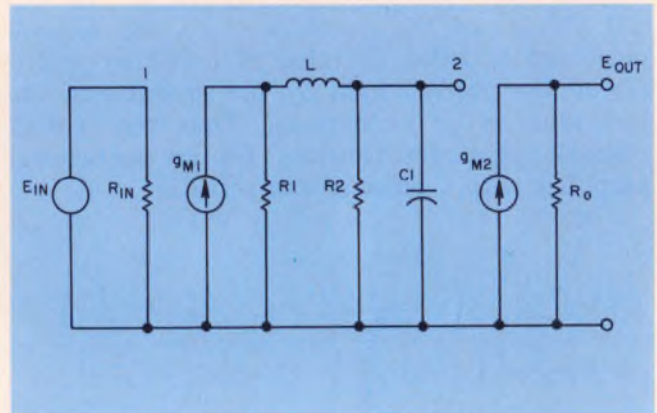

8. A second-order RLC circuit serves as a simple model for the feedback circuit's transient response.

ments (T) between branches in Fig. 4, we make the model ready for input to ECAP (Electronic Circuit Analysis Program) with the format in Fig. 5. Computation by ECAP results in a gain accuracy to $\pm 1 \text{ dB}$ and phase accuracy of $\pm 0.5^\circ$ over almost five decades of frequency. The results are superimposed on plots of typical frequency and phase measurements for the $\mu A709$ in Figs. 2 and 3.

Modeling for transient response

An amplifier's transient response to a step input can be modeled by the same type of first-order, pole-zero equivalent circuit just described, by close reproduction of its frequency and phase response. However, in most cases a simpler model (a single stage) can be obtained by working directly from the manufacturer's specification for

overshoot and rise time.

This can be done with the use of a second-order circuit³ for the model.

Again, using the $\mu A709$, but this time in a feedback circuit, as in Fig. 6, we can match the op-amp transient response (Fig. 7) closely with the equivalent circuit of Fig. 8. The manufacturer's specification and the response curve shows about a 10% overshoot. Reference to a standard set of curves^{3,4}, plotted for such an equivalent circuit (Fig. 9), shows that selection of a damping ratio (ζ) equal to 0.6 should provide a match.

Solution of the differential equation⁴ of the equivalent circuit shows that

$$T \text{ (period of overshoot)} = 2\pi\sqrt{LC}$$

$$\text{and } \zeta \text{ (damping ratio)} = R_1 T / 4\pi L.$$

Defining the rise time as between 10% and 90% of the final settling amplitude during the initial rise, Fig. 7 provides a value of $t_r = 0.3 \mu s$. From Fig. 7, for $\zeta = 0.6$, the normalized rise time

$$\frac{t_r}{T} = 0.27. \text{ Therefore } T = \frac{0.27}{0.3} = 1.11 \mu s.$$

Solving for L, we get

$$L = 0.148 \times 10^{-6} R_1.$$

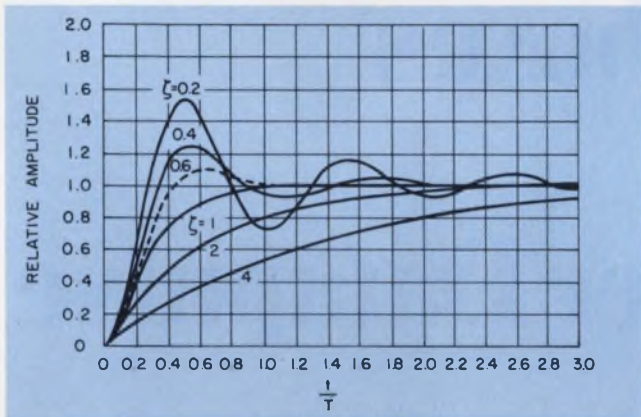

9. Normalized transient response curves are used to determine the parameters of the RLC model.

R_1 can be arbitrarily made equal to 1 Ω , for convenience. Then

$$L = 0.148 \mu H$$

$$\text{and } C = \frac{T^2}{4\pi^2 L} = 0.21 \mu F.$$

Finally R_2 is chosen so that $R_2 \gg R_1$. Selecting $R_2 = 1000 \Omega$ satisfies this approximation.

After preparing a very simple ECAP input schedule, similar to that of Fig. 5, we plot the resulting computations and compare them to the desired curve in Fig. 7. ■■

References

1. B. James Ley, "Computer Aided Analysis and Design for Electrical Engineers," Holt, Rinehart & Winston, Inc., 1970, Chapt. 3.
2. J. R. Greenbaum, "Make Linear Models of Op-Amps," *Electronic Design*, Vol. 19, Sept. 13, 1969, pp. 92-96.
3. Burr-Brown, "Operational Amplifiers," McGraw-Hill, pp. 186-197, Sec. 5.3.
4. Millman and Taub, "Pulse, Digital and Switching Waveforms," McGraw-Hill, New York, N.Y., pp. 73-75.

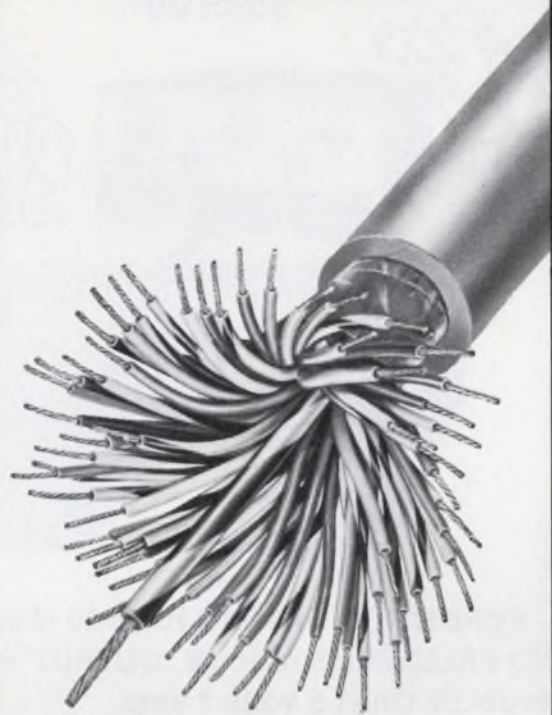

What do you
need in
Multi-Conductor
Cable?

Victor

will make it.

Get exactly what you need in multi-conductor cable. We'll design and produce multi-conductor cable to meet just about any individual requirement.

We have the plant, the equipment, the personnel and the know-how to solve your particular problem.

Victor
Electric Wire & Cable Corp.
WEST WARWICK, RHODE ISLAND

MODEL 99 20 MHz PULSER

\$285.00!



**MODEL 88 20 MHz PULSER
PLUS 5 volt 1 amp POWER SUPPLY**

\$395.00!



■ REPETITION RATES 2 Hz to 20 MHz ■ PULSE WIDTHS 20 nsec to 200 msec ■ RISE AND FALL TIME 5 nsec ■ OUTPUT +1 volt to +5 volts (40 ma sink) ■ POWER SUPPLY (Model 88 Only) 5 volts 1 amp.

2 new bargain boxes from Systron-Donner/Datapulse

The Models 88 and 99 both feature the same excellent pulse generating capabilities and, as an added convenience, the Model 88 provides an independent power supply output. TTL designers will really appreciate the exceptional versatility of the Model 88 . . . an extremely compact, light and portable source of high quality TTL driving pulses with a useful +5 volts TTL breadboard power supply built right in. The Model 99 duplicates the 88's pulse generator characteristics precisely, making it an outstanding bench instrument for use

in applications where a power supply is separately available or is not required. Both instruments employ advanced designs and incorporate standard, top quality components, with the emphasis on high grade performance and low end-product prices to meet and beat today's economies and purchase restrictions. Result: Two superbly engineered instruments at prices you can't afford not to afford. For complete specifications, demonstrations etc., call your nearby Scientific Devices man or contact us directly. **Datapulse Div., Systron-Donner Corporation, 10150 West Jefferson Boulevard, Culver City, California 90230. Phone: (213) 836-6100. TLX: 67-3219 TWX: 910-340-6766.**



The Systron-Donner Instruments Group:

Alpha Scientific □ Computer Systems □ Concord Instruments □ Datapulse □ Kruse Electronics □ Microwave □ Trygon Electronics

"When our competitors can just come up with rumors about us, then we know we are here to stay"

800-325-2595

your Toll-Free Number — to place your IC order, ask a question, or verify a rumor!

CATALOG NUMBER	ANY QUANTITY PER ITEM			MULTIPLES OF 10 PER ITEM			CATALOG NUMBER	ANY QUANTITY PER ITEM			MULTIPLES OF 10 PER ITEM		
	1-99 MIX	100-999 MIX	1000-UP MIX	100-990 MIX	1000-9990 MIX	10,000-UP MIX		1-99 MIX	100-999 MIX	1000-UP MIX	100-990 MIX	1000-9990 MIX	10,000-UP MIX
7400	.26	.25	.23	.22	.21	.20	74107	.52	.49	.47	.44	.42	.39
7401	.26	.25	.23	.22	.21	.20	74121	.56	.53	.50	.48	.45	.42
7402	.26	.25	.23	.22	.21	.20	74122	.70	.67	.63	.60	.56	.53
7403	.26	.25	.23	.22	.21	.20	74123	1.21	1.06	1.00	.94	.89	.83
7404	.28	.27	.25	.24	.22	.21	74141	1.63	1.55	1.46	1.38	1.29	1.20
7405	.28	.27	.25	.24	.22	.21	74145	1.41	1.33	1.26	1.18	1.11	1.04
7406	.52	.50	.47	.44	.42	.39	74150	1.63	1.55	1.46	1.38	1.29	1.20
7407	.52	.50	.47	.44	.42	.39	74151	1.20	1.13	1.07	1.01	.95	.88
7408	.32	.30	.29	.27	.26	.24	74153	1.63	1.55	1.46	1.38	1.29	1.20
7409	.32	.30	.29	.27	.26	.24	74154	2.43	2.30	2.16	2.03	1.89	1.76
7410	.26	.25	.23	.22	.21	.20	74155	1.46	1.39	1.31	1.23	1.16	1.08
7411	.28	.27	.25	.24	.22	.21	74156	1.46	1.39	1.31	1.23	1.16	1.08
7413	.58	.55	.52	.49	.46	.44	74157	1.56	1.48	1.39	1.31	1.23	1.15
7416	.52	.50	.47	.44	.42	.39	74158	1.56	1.48	1.39	1.31	1.23	1.15
7417	.52	.50	.47	.44	.42	.39	74160	1.89	1.79	1.68	1.58	1.47	1.37
7420	.26	.25	.23	.22	.21	.20	74164	1.89	1.79	1.68	1.58	1.47	1.37
7421	.26	.25	.23	.22	.21	.20	74166	1.98	1.87	1.76	1.65	1.54	1.43
7423	.80	.76	.72	.68	.64	.60	74176	1.62	1.53	1.45	1.36	1.28	1.19
7425	.50	.48	.45	.43	.40	.38	74177	1.62	1.53	1.45	1.36	1.28	1.19
7426	.34	.32	.31	.29	.27	.26	74180	1.20	1.13	1.07	1.01	.95	.88
7430	.26	.25	.23	.22	.21	.20	74181	5.20	4.90	4.59	4.28	3.98	3.67
7437	.56	.53	.50	.48	.45	.42	74182	1.20	1.13	1.07	1.01	.95	.88
7438	.56	.53	.50	.48	.45	.42	74192	1.98	1.87	1.76	1.65	1.54	1.43
7440	.26	.25	.23	.22	.21	.20	74193	1.98	1.87	1.76	1.65	1.54	1.43
7441	1.73	1.64	1.55	1.46	1.37	1.27	74196	1.98	1.87	1.76	1.65	1.54	1.43
7442	1.27	1.21	1.14	1.07	1.01	.94	74197	1.98	1.87	1.76	1.65	1.54	1.43
7443	1.27	1.21	1.14	1.07	1.01	.94	74198	2.81	2.65	2.50	2.34	2.18	2.03
7444	1.27	1.21	1.14	1.07	1.01	.94	74199	2.81	2.65	2.50	2.34	2.18	2.03
7445	1.71	1.62	1.53	1.44	1.35	1.26	NE501	2.99	2.82	2.66	2.49	2.32	2.16
7446	1.24	1.17	1.11	1.04	.98	.91	NE526	3.59	3.38	3.17	2.95	2.74	2.53
7447	1.16	1.10	1.04	.98	.92	.85	NE531	3.81	3.58	3.36	3.14	2.91	2.69
7448	1.44	1.37	1.29	1.22	1.14	1.06	NE533	3.81	3.58	3.36	3.14	2.91	2.69
7450	.26	.25	.23	.22	.21	.20	NE536	7.31	6.88	6.45	6.02	5.59	5.16
7451	.26	.25	.23	.22	.21	.20	NE537	7.53	7.09	6.65	6.20	5.76	5.32
7453	.26	.25	.23	.22	.21	.20	NE540	2.16	2.04	1.92	1.80	1.68	1.56
7454	.26	.25	.23	.22	.21	.20	NE555	.98	.93	.88	.83	.78	.73
7460	.26	.25	.23	.22	.21	.20	NE560	3.57	3.36	3.15	2.94	2.73	2.52
7470	.42	.40	.38	.36	.34	.32	NE561	3.57	3.36	3.15	2.94	2.73	2.52
7472	.38	.36	.34	.32	.30	.29	NE562	3.57	3.36	3.15	2.94	2.73	2.52
7473	.50	.48	.45	.43	.40	.38	NE565	3.57	3.36	3.15	2.94	2.73	2.52
7474	.50	.48	.45	.43	.40	.38	NE566	3.57	3.36	3.15	2.94	2.73	2.52
7475	.80	.76	.72	.68	.64	.60	NE567	3.57	3.36	3.15	2.94	2.73	2.52
7476	.56	.53	.50	.48	.45	.42	N5111	.90	.86	.81	.77	.72	.68
7480	.76	.72	.68	.65	.61	.57	N5556	1.87	1.77	1.66	1.56	1.46	1.35
7482	.99	.94	.88	.83	.78	.73	N5558	.80	.76	.72	.68	.64	.60
7483	1.63	1.55	1.46	1.38	1.29	1.20	N5595	3.40	3.20	3.00	2.80	2.60	2.40
7485	1.43	1.35	1.28	1.20	1.13	1.05	N5596	1.87	1.77	1.66	1.56	1.46	1.35
7486	.58	.55	.52	.49	.46	.44	709	.42	.40	.38	.36	.34	.32
7490	.80	.76	.72	.68	.64	.60	710	.42	.40	.38	.36	.34	.32
7491	1.43	1.35	1.28	1.20	1.13	1.05	711	.44	.42	.40	.37	.35	.33
7492	.80	.76	.72	.68	.64	.60	723	1.00	.95	.90	.85	.80	.75
7493	.80	.76	.72	.68	.64	.60	733	1.90	1.80	1.70	1.60	1.50	1.40
7494	1.18	1.12	1.05	.99	.93	.87	741	.44	.42	.40	.37	.35	.33
7495	1.18	1.12	1.05	.99	.93	.87	747	1.05	.99	.94	.88	.83	.77
7496	1.18	1.12	1.05	.99	.93	.87	748	.48	.46	.43	.41	.38	.36
74100	1.52	1.44	1.36	1.28	1.20	1.12							

We also stock a complete line of SCHOTTKY TTL devices, and 7-segment LED Displays.

Solid State Systems, Inc. is an independent NON FRANCHISED distributor of electronic components. All components are guaranteed to be brand new, manufacturers first run, fully tested and marked. We will ship within 24 hours or we will allow you a 10% discount.

SOLID STATE SYSTEMS, INC.

P.O. BOX 773, COLUMBIA, MO. 65201

PHONE (314) 443-3673 TWX 910-760-1453

When a merger causes company friction, a management truce committee can restore harmony in the ranks by airing grievances without bruising egos.

Ralph Ponce de Leon, general manager, Sloan Micro Products Dept., Burr-Brown Research Corp., Tucson, Ariz. 85706.

Mergers, like some marriages, aren't always made in heaven. Take, for example, the acquisition of Sloan Microelectronics Corp., a company that sold a custom product, by Burr-Brown Research Corp., a company that sells both catalog and custom products. Both discovered that selling a capability and selling a product require totally different approaches to marketing, project management and engineering.

After the acquisition, in which Sloan became a department of Burr-Brown, cooperation between the two groups was outstanding at the top management level. But getting the lower-level boys to mesh and generate products harmoniously was really difficult. We of Sloan were like a splinter entering the body—there was resistance on both sides. So we had to learn to integrate our engineering group into a new situation.

Service product causes internal friction

Tom Brown of Burr-Brown bought Sloan for what it could contribute in technology to his product line. He wanted our thin-film, monolithic and hybrid production capability. He didn't buy Sloan because it was an ongoing business, but then he saw the values of Sloan's capabilities in the market and allowed us to continue as a business. Besides contributing a new technological capability, we had a backlog of orders of what is essentially a service—the design of custom hybrids and monolithics and of some standard products. We also took along six engineering managers who had been trained to turn out a product for a specific customer rather than for a broad market. The half-million-dollar backlog would help pay, in part, for training our men in a new way of life.

Burr-Brown had sales engineers, applications engineers and a rep organization, but most of them did not understand the Sloan "product" or how to sell it. The product is strictly engineering, and you must prove that you can provide better service than the customer can get from another

hybrid house. The customer doesn't want to talk to the sales guy; he wants to talk to the engineer who's designing his product. This was a traumatic experience for many of the Burr-Brown salesmen.

At Burr-Brown, the generation of a product idea is the function of inputs from sales, engineering and the market places—and also the amount of money allocated. A product is born, and, at a given point, the project goes to manufacturing and stays there throughout its life.

For a standard product the development schedule, development costs and engineering are controlled by Burr-Brown. At Sloan all of these critical elements of product development are controlled by the customer. Product life is short. But there's more intimate touch between the Sloan engineer and the customer, who's deeply involved in the design. He doesn't want the design changed; he wants it implemented. So there's much travel back and forth on the part of the Sloan engineer.

But Burr-Brown engineers were not accustomed to designing a service product, and the sales engineers couldn't answer fabrication questions Sloan's customers were asking. They were used to an existing product, with specifications generated at Burr-Brown.

Burr-Brown and Sloan had separate national rep organizations, and we decided to retain both. But the Sloan reps wanted to talk to the hybrid engineer, not to the sales engineers. Burr-Brown's sales department had made the decisions in the past on whether or not to respond to a custom need. Now, sales might tell the rep "no," while engineering might want to take on the work for valuable experience on a future job. Sales didn't yet have the technical expertise to respond.

All this caused considerable internal friction. Delivery slippages became more and more frequent.

Even the engineers were at odds

A further source of friction was the feeling of Burr-Brown engineers that they were being kicked aside by Sloan engineers. The Burr-Brown guys had thought we were there to help them

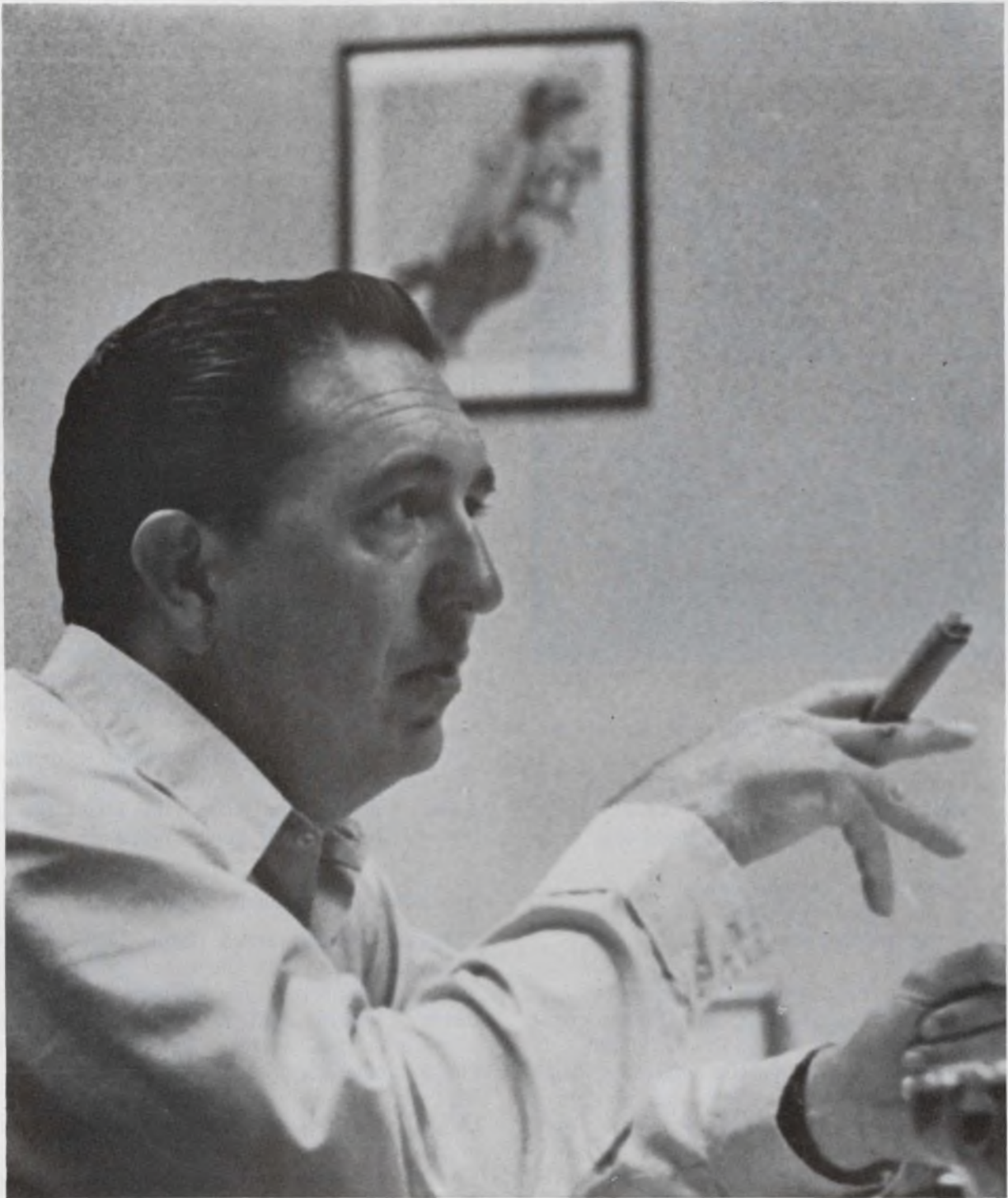

Ralph Ponce de Leon

Education: BSCE, University of Texas; MBA, Arizona State University.

Experience: Ten years at Motorola, Phoenix, Ariz.; hybrids—Micro Electronics section manager; one of the founders and president of Sloan Microelectronics, El Segundo, Calif.; currently manager, Sloan Micro-Products Dept., Burr-Brown Research Corp.

Publications: Presentation of papers—IEEE Conference on multi-level interconnects, 1966; Hybrid technologies at ISHM, Phoenix, Ariz.; Advances in Thin Film Technology at WESCON 1971; Active Filters, at Southwestern IEEE Conference, April, 1972.

Personal: Married; three children. Hobbies include, hunting, fishing, flying airplanes.



design their product and to help them understand our hybrid technology.

Sloan engineers acknowledged that role, but they also felt a need to meet the demands of their customers. They asked how they could take care of both inside and outside needs.

There were three possible solutions:

1. Drop the outside business.
2. Drop the inside business.
3. Grow up.

Burr-Brown management—including Jim Burns, director of marketing; Bob Eckes, engineering manager of op amps; Brian Conant, engineering manager of conversion products; Tom Fern, v.p. of sales, and the Sloan manager, myself—knew that there were problems and that we were probably contributing to them. We knew that neither the customers nor the internal needs of the company were being served. There was a lack of enthusiasm and a lack of willingness to work together. I'd return from a trip, and my guys would be lined up to tell me about the stupid things the other guys had done. When Tom Fern returned from a trip, his people would tell him about the stupid things we had done.

Committee used as integration tool

Tom Brown, president and chairman of the board of Burr-Brown, searching for a way to solve his management problems, decided to use a

peer management concept and in doing so, formed an action management committee to address the problem. A committee of this kind normally exists to chart goals, objectives and profits.

The committee that was formed made recommendations to Brown; he never exercised his right of veto. We managers got together to plan objectives, review progress in the light of previous objectives, and rate ourselves and one another. The ground rules were that we must agree unanimously on decisions and evaluations.

We began using the committee as an instrument to help integrate Sloan into Burr-Brown. Marketing presented its objectives for the corporation—which included continuation of Sloan's inside business (helping in the design of Burr-Brown products), outside business (its traditional custom design work) and projections for its growth. Sales presented the same thought. So did engineering. They all saw a significant portion of sales being generated by Sloan.

Burr-Brown engineering had recommended that Sloan engineering continue on its own, as in the past.

A series of meetings was called between Sloan engineers and the managers of the Burr-Brown departments with which there was friction. Each department was allowed free expression of problems, presented objectively, without implicating people.

There were about three one-hour informal sessions. The object was to stop quickly at the management level rumor-mongering about the problems of the different departments.

New interest in resolving problems

These sessions jarred people back to reality. Everyone recognized the other guy's problems, and more important, his feelings. People lost interest in hearing malicious rumors. They became more interested in resolving problems than in gloating over the other guy's problems. The feeling was: Let's educate and help the other guy instead of criticizing him. Let's take advantage of what he has to offer.

Once managers began turning down the scuttlebutt, there was a dramatic effect down through the ranks. People started inviting guys from other departments to their parties. There was evidence of harmony everywhere. Though it was a departure from tradition, Tom Fern, the sales v.p., encouraged the rep to go directly to Sloan engineers, as long as he was informed in documentation, since he's responsible for sales activities.

The fundamental barriers—tradition and technical insularity—were broken down. Cooperation and acceptance across the board became a personal policy. ■■

SPECS DON'T DO IT

You might order
this lamp for its
specs...

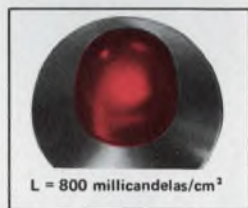

when you really
want this one!



... Specs can mislead you into choosing the lamp at top when you really want the bottom one, a lamp whose diffused beam fills the entire lens with a bright glow, providing an easy-on-the-eyes indicator, viewable from a wide angle.

There is no need to make such a compromise because the company whose LEDs you are presently using does not have such a lamp. Fairchild MOD, the technical leader in optoelectronics, offers a broad range of 15 different lamps to meet the exact requirements of your particular application. And you can make the right choice simply by looking at the lamps.

THE APPLICATIONS-ORIENTED LINE

15 Conventional Solid State Lamps—Red indicator lamps available with a red diffused, clear diffused or water-clear lens. Featuring black background when lamp is off. For front panel indicators and fiber optics interface.

3 Backlighting Lamps—To illuminate message indicators such as ON, FWD and REVERSE. Also available for use in standard incandescent lamp cartridges.

Narrow Beam Lamps—Project light beam (visible or infrared) up to 9 feet. Eliminate need for concave or convex lenses for distance. Used for 25 KV coupler; fiber optic source; counters; readers; traffic monitors; data link; pollution monitor; and shaft angle encoder.

Call your Fairchild semiconductor sales engineer for samples and prices. Compare and prove it to yourself. Ask for the new Fairchild Line Card and Cross-Reference Guide.

**MADE IN
FAIRCHILD**

FAIRCHILD SEMICONDUCTOR/MICROWAVE AND OPTOELECTRONICS

A Division of Fairchild Camera & Instrument Corp., 4001 Miranda Avenue, Palo Alto, Ca 94304. (415) 493-3100. TWX: 910-373-1278

INFORMATION RETRIEVAL NUMBER 83

"BAREFOOT" VACATIONS

to exotic islands



WINDJAMMER CRUISES



**explore Bahamas,
West Indies,
Virgin Isles, Mexico.**

**Comfortable
cabins... good
"Grub 'n Grog".**

**10 adventurous
days from \$200**

- Great for employee incentive programs
- Ideal for executive meetings and parties
- Wonderful for customer prizes



**WRITE CAP'N MIKE
FOR FULL INFORMATION
AND ADVENTURE BROCHURE
P.O. BOX 120, DEPT. 787A
MIAMI BEACH, FLORIDA 33139**

Twice as much for your money...

LOOK CLOSELY AND DECIDE

1. The multi-speed chart drive is the equal of any competitor on the market today. Further, the **OmniScribe™** is field adjustable precisely for English/Metric scaling. Quick, fast, convenient.
2. Houston Instrument has perfected sprocketless paper drive. It's accurate. It's self-aligning. It works!
3. A unique operating feature is the non-contact re-balance potentiometer. It eliminates cleaning and trace "glitches" forever. It's beautiful!
4. Did we mention the price? Just \$395 for single pen; \$595 for dual pen. With options to \$1400. What's more, all models are available off-the-shelf for immediate shipment.

OmniScribe™

10" Strip Chart

\$395

For single pen model



Write today for your complete brochure and price list. The **OmniScribe™** is either half the cost or twice as much for your money. You decide.

**houston
instrument**

4950 TERMINAL AVENUE, BELLAIRE, TEXAS 77401
(713) 667-7403 CABLE HOINCO.

INFORMATION RETRIEVAL NUMBER 85

Digital nonintegration method boosts response time of vertical sync separator

A digital approach to vertical sync separation results in a response time an order of magnitude faster than that for conventional integration methods.

The composite video information must be separated into its various components before it can be properly used. The first separation is that of the video and sound information from the sync information. The composite sync waveform is separated from the composite video waveform by a video stripper circuit (not shown). The composite sync waveform is separated into vertical and horizontal components by a gate circuit that detects pulse durations that are greater than those of horizontal sync pulses.

The composite sync waveform at the input of the vertical sync-separator circuit of Fig. 1 exhibits a logic ZERO during the horizontal sync intervals, the equalizing pulse intervals and the serration intervals. The waveform is applied simultaneously to the input of an inverter (G_1 in Fig. 1) and a cancel multivibrator (MM_1). The cancel multivibrator is designed to have a period of $5.5 \mu s$, which is longer than the horizontal sync and equalizing pulse intervals, but shorter than the serration intervals. A pulse is generated at input 2 (pin 5), of G_2 each time the composite sync switches from logic ONE to logic ZERO.

This generated pulse acts as a cancel pulse that is 180 degrees out of phase with the inverted composite sync pulse present at input 1 of G_2 . In this way all horizontal sync pulses and all equalizing pulses are canceled. The truth table of Fig. 2 indicates that the logic levels at the inputs of gate G_2 disable the gate.

When the first serration is encountered, however, the cancel pulse cannot cancel it, since the serrations are approximately $27 \mu s$ in duration. At the end of the cancel pulse interval, both inputs of G_2 are at logic ONE and the gate is enabled. This brings G_2 's output from logic ONE to logic ZERO. Since this level shift occurs at a time interval that is greater than one horizontal-sync pulse duration after the beginning of the first serration, G_2 is called the first serration detector.

To compensate for the time jitter typically encountered in monostable multivibrators, the

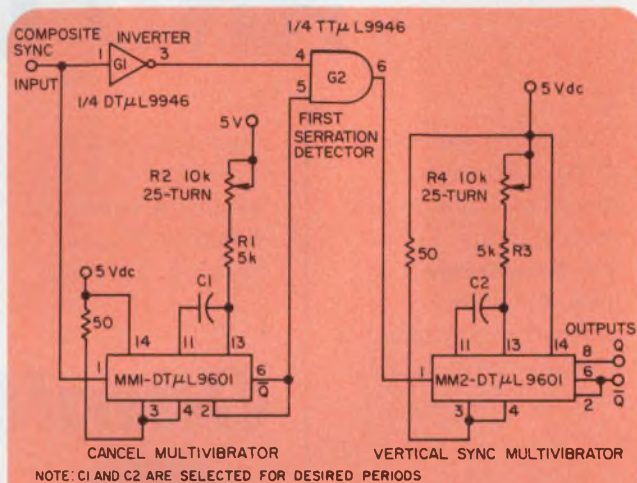

1. The first serration detector (G_2) of this vertical sync separator detects pulse durations that are greater than the horizontal-sync-pulse durations.

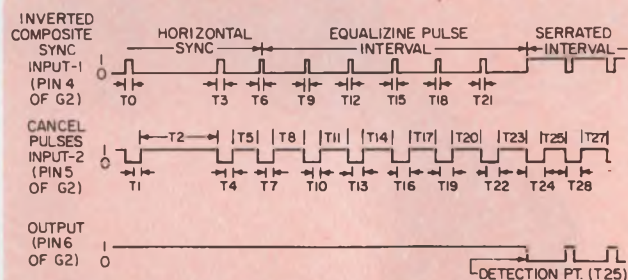

TRUTH TABLE UP TO TIME OF DETECTION

TIME	INPUT ONE	INPUT TWO	OUTPUT
T0	1	0	1
T1	0	0	1
T2	0	0	1
T3	1	0	1
T4	0	0	1
T5	0	0	1
T6	1	0	1
T7	0	0	1
T8	0	0	1
T9	1	0	1
T10	0	0	1
T11	0	0	1
T12	1	0	1
T13	0	0	1
T14	0	0	1
T15	1	0	1
T16	0	0	1
T17	0	0	1
T18	1	0	1
T19	0	0	1
T20	0	0	1
T21	1	0	1
T22	0	0	1
T23	0	0	1
T24	1	0	1
T25	1	1	0
T26	0	0	1
T27	1	1	0

2. Output waveform and truth table for the first serration detector (G_2) show how the gate is disabled until the first serration is encountered.

New from Helipot: the lowest trimmer profile in the business.

SHOWN ACTUAL SIZE

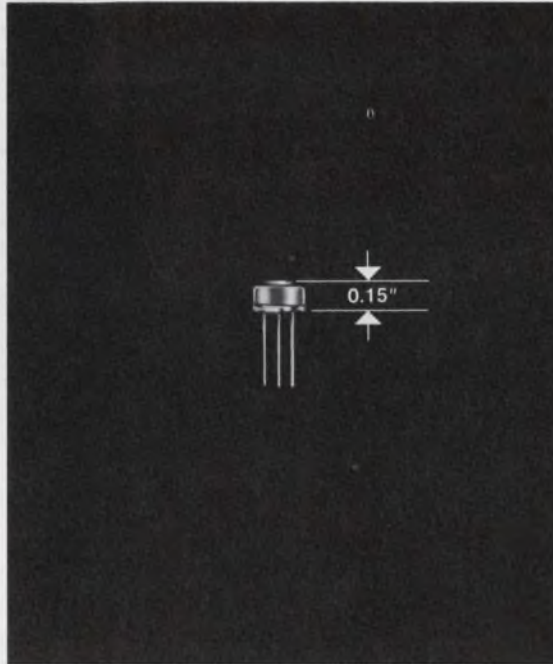

You can't do better than our Series 82 Trimmers for small size and low cost . . . and, of course, Helipot dependability. These ¼" single-turn, general-purpose cermet models have the lowest profile in the industry with a proven cermet resistance element that can be set to any voltage ratio within 0.05% of full scale. Sealed metal housings, solid stops, and essentially infinite resolution. They'll save you space—they'll save you money. (Our prices start at \$1.40 list.) Two good reasons to write for specs and prices today.

Beckman INSTRUMENTS, INC.

HELIPOT DIVISION

2500 Harbor Blvd., Fullerton, Calif. 92634

HELPING SCIENCE AND INDUSTRY IMPROVE THE QUALITY OF LIFE

INFORMATION RETRIEVAL NUMBER 86

cancel-pulse duration is adjusted to be approximately 20% longer than the horizontal-sync interval of $4.7 \mu\text{s} \pm 0.3 \mu\text{s}$. The resulting cancel pulse duration therefore yields a response time of approximately $5.5 \mu\text{s}$. This compares with approximately $55 \mu\text{s}$ for conventional integration methods of vertical-sync separation.

When the output of the first serration detector is applied to a vertical sync multivibrator (MM_2), the desired vertical sync interval is obtained. The period of MM_2 is set to be greater than, or equal to, the serrated interval of the

composite sync waveform (approximately $190 \mu\text{s}$). If the period were shorter than the serrated interval, retriggering would occur, since the first serration detector also detects each successive serration interval. This poses no problem, however, since typical integrated vertical sync duration is actually slightly longer than the serrated interval.

George J. Yates, Los Alamos Scientific Laboratory, University of California, P.O. Box 1663, Los Alamos, N.M. 87544 CIRCLE NO. 311

Diode gates cut costs and customize wideband coaxial switch design

When diode gates are used to build a wideband coaxial switch, the parts cost can be lowered to less than \$8 a channel (exclusive of power supply). This compares with \$200 to \$300 for commercial units. Also, the diode switch (see diagram) can be customized to a greater extent than commercial models, which do not come in all desired forms and often have delivery times of several months.

If switches S_1 and S_2 are in the position shown (N.C.), hot-carrier diodes CR_1 through CR_4 are biased off and input signals do not reach the buffer and driver. In the other position (N.O.), switches S_1 and S_2 bias on diodes CR_1 - CR_4 , and

the input is fed to the buffer-and-driver stage. The bias diodes (CR_x) provide isolation—which improves when the number of such diodes is increased.

The switch shown allows bipolar operation and has a bandwidth of approximately 700 MHz (0.5 ns rise time) for inputs below 0.5 V. Bandwidth deteriorates for input levels above $\pm 0.5 \text{ V}$, but if current I is increased, the narrowing in bandwidth will be compensated.

Andrew Chang, Electronic Engineer, Stanford Linear Accelerator Center, Stanford University, P.O. Box 4349, Stanford, Calif. 94305

CIRCLE NO. 312

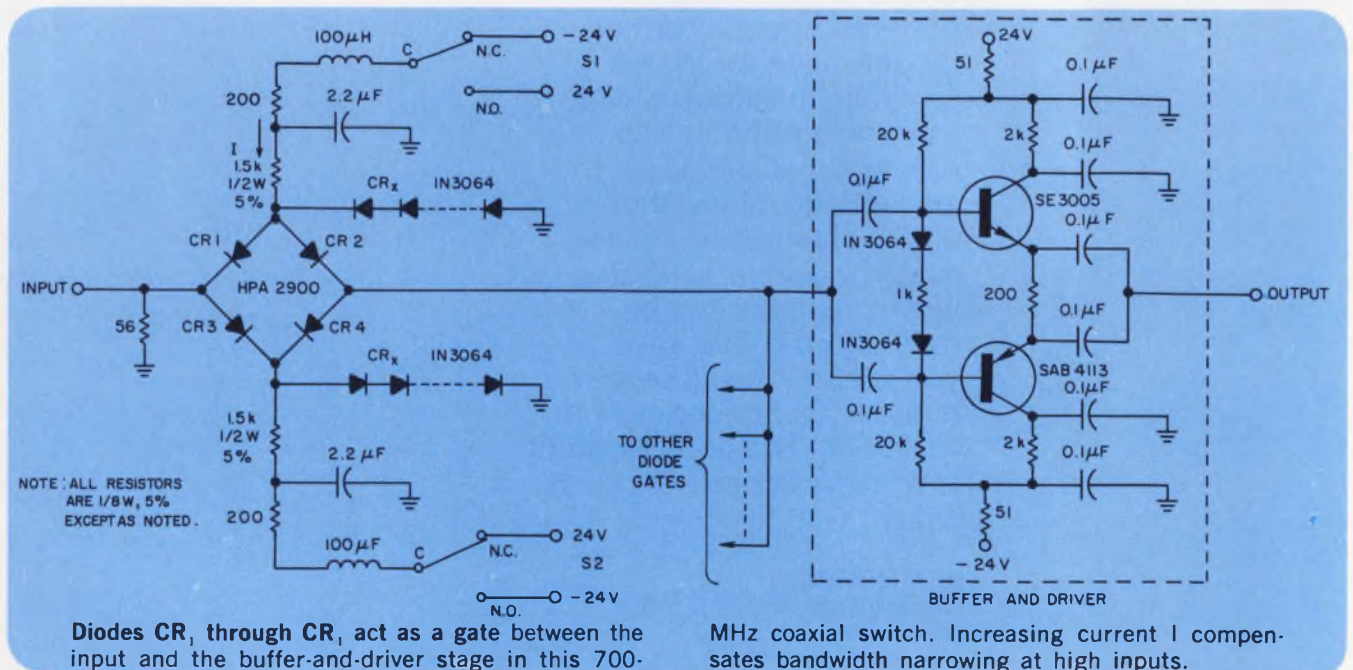

outperforms any signal source from 0.0001 Hz to 11 MHz

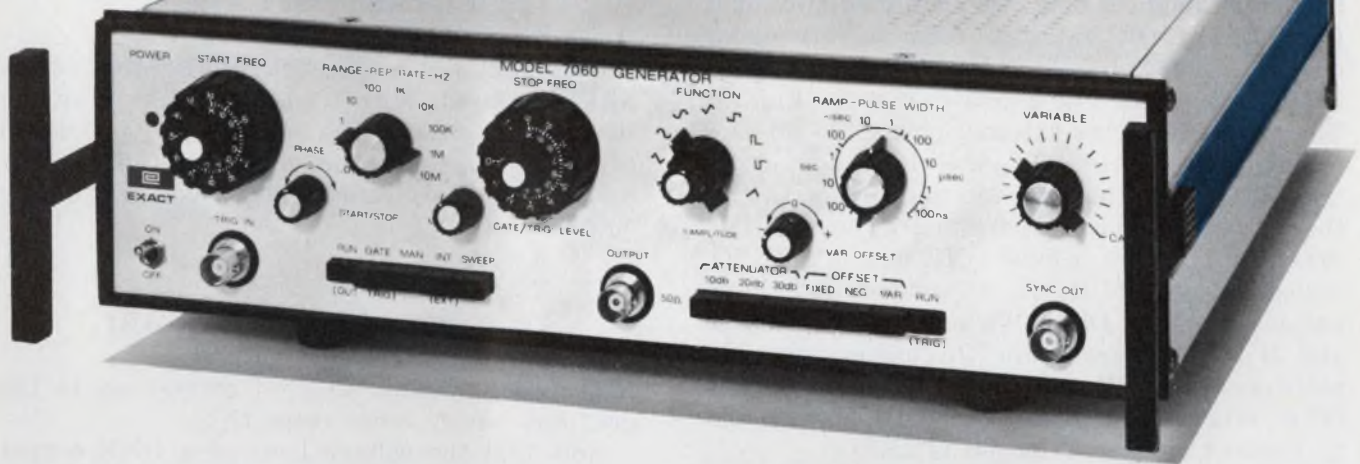

vcf/sweep function generator
works harder,
operates easier

The Exact Model 7060 VCF/Sweep Generator is one in a series of higher performance instruments designed to be more useful in more test applications.

Its frequency range, from 0.0001 Hz to 11 MHz, expands the versatility of function generators into new areas. For instance, the Model 7060's ability to produce sine² waveforms at 8 MHz now provides a signal source for transmission line testing. Frequency response is flat all the way out to 11 MHz, with high quality waveforms even at the highest frequencies.

For sweep applications, the Model 7060 offers "start" and "stop" frequency controls that let you precisely set starting and stopping frequencies. Accurate Kelvin-Varley dividers tell you exact frequencies without using a counter.

As a pulse generator, the Model 7060 produces pulses with widths variable from 100 ns to 1000 seconds, and repetition rates from 0.0001 Hz to a full 11 MHz. Ramp waveforms with ramp times from 100 ns to 1000 seconds are another first in this instrument.

The Model 7060 sets the pace in D.C. offset, too, with the ability to select either fixed positive or negative or variable ± 15 V offset. Offset also can be externally programmed with an analog voltage.

Two complete generators in one, the Model 7060 generates sine, square, triangle, ramp, pulse and sync waveforms, sweeps over a 1000:1 range and has pushbutton control of the operating modes of both generators. The main generator can operate in internal and external trigger modes. In the internal trigger mode, the ramp/pulse generator triggers the main generator. Other features include 80 db attenuation, V:f (voltage proportional to frequency) output, search mode, floating output, sync input for locking to an external frequency or clock and 30V P-P open circuit (15V P-P into 50 ohms) output.

Model 7060 VCF/Sweep Generator\$845.00
Model 7071 adds lin or logarithmic sweep plus gated sweep\$1095.00

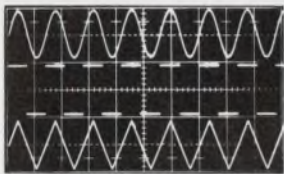

Sine, square and triangle waveforms.

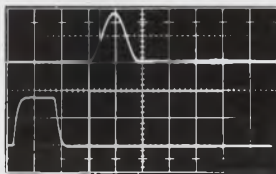

Sine² pulse (top waveform) and 100 ns pulse (bottom waveform).

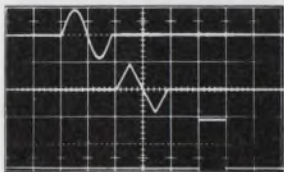

Single shot waveforms.

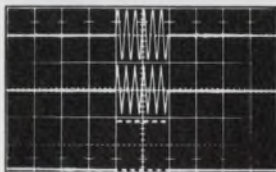

Burst mode

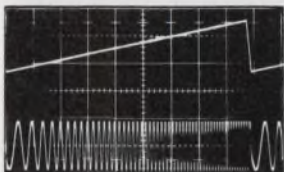

Sweeping with internal ramp.

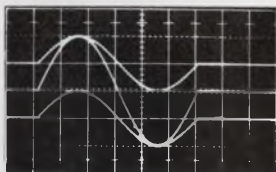

Fixed D.C. offset halves amplitude and offsets waveform positive or negative in relation to ground.

high frequency, low cost

Model 7030 VCF Generator with 0.0001 Hz to 11 MHz frequency range, 1000:1 VCF/Sweep capability, 80 db attenuation, Kelvin-Varley divider frequency control, variable time symmetry control, search mode, and fixed positive or negative or variable ± 15 V D.C. offset. Price \$595.00



EXACT
electronics, inc.

Box 160
Hillsboro, Oregon 97123
Telephone (503) 648-6661
TWX 910-460-8811

Amplitude Modulation



Model 7056
AM/FM Phaselock Generator
0.0001Hz-11MHz
Price: \$995

Binary-to-gray or gray-to-binary translator needs no power supply

A three-bit binary-to-gray or gray-to-binary translator requires only two connected two-input EXCLUSIVE-OR gates to form a three-input circuit. A double-pole switch converts the binary-to-gray translator into a gray-to-binary (Fig. 1). The circuit needs no external power.

The same exclusive-OR gate* is used in either translator. With the switch in the position shown, the circuit provides binary-to-gray conversion. When input A has a logic ONE and B a ZERO, transistors Q₁ and Q₂ do not conduct and the Y output is a logic ONE. When input A is ZERO and B is ONE, transistor Q₁ conducts through resistors R₁ and R₂ and the Y output is a logic ONE. When A and B are both ONE, both Q₁ and Q₂ conduct and the Y output is ZERO.

The truth table (Fig. 2 a) and Karnaugh maps (Fig. 2 b, c, d) for binary-to-gray conversion summarize the various circuit outputs. Truth outputs X, Y, and Z are the solutions to the Karnaugh maps, resulting in the equations

$$X = \Sigma 4, 5, 6, 7$$

$$Y = \Sigma 2, 3, 4, 5$$

$$Z = \Sigma 1, 2, 5, 6,$$

where 2, 3, etc. are the decimal equivalents to the input binary numbers. Thus Figs. 2 b, c, and d yield these respective solutions:

$$X = A$$

$$Y = A\bar{B} + \bar{A}B$$

$$Z = B\bar{C} + \bar{B}C.$$

Gray-to-binary conversion results when switch S₁ is depressed. With transistor Q₁ now having its base attached to the collector of Q₁, instead of to input B, a truth-table solution (not shown) for gray-to-binary conversion yields these binary outputs:

$$X = A$$

$$Y = A\bar{B} + \bar{A}B$$

$$Z = C(\bar{A}\bar{B} + AB) + \bar{C}(A\bar{B} + \bar{A}B)$$

$$Z = C\bar{Y} + \bar{C}Y,$$

where A, B, C and X, Y, Z correspond to the gray and binary codes respectively.

Note that the voltage level of a ONE output will vary slightly depending on the input combination. At no time, however, will the output be less than 4 V.

*Dighe, K.D., "Low-Cost Exclusive-OR Needs No Power Supply," *Electronics*, April 26, 1971, p. 56.

S. Y. Ramakrishnan, *Electronics Engineer, Space Science and Technology Center, Satellite Systems Div., Trivandrum 22, India.*

CIRCLE NO. 313

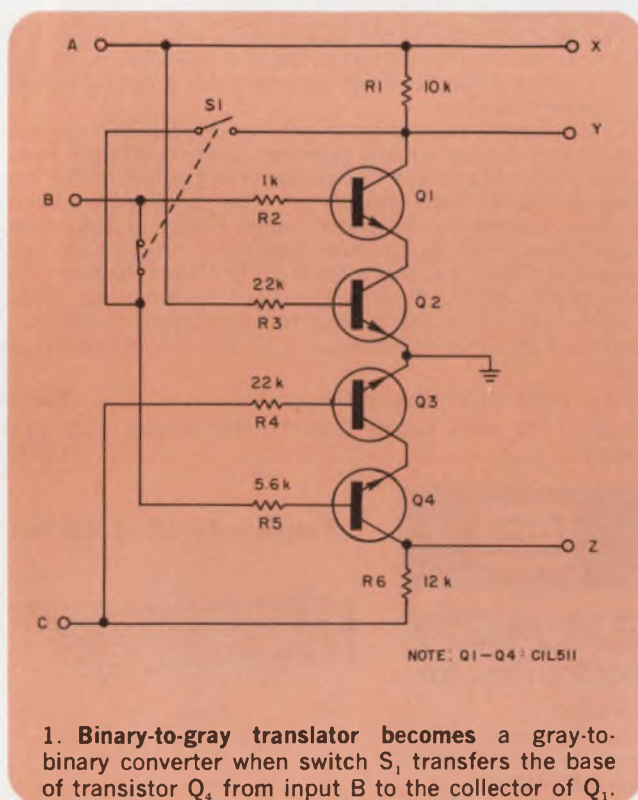

1. Binary-to-gray translator becomes a gray-to-binary converter when switch S₁ transfers the base of transistor Q₁ from input B to the collector of Q₁.

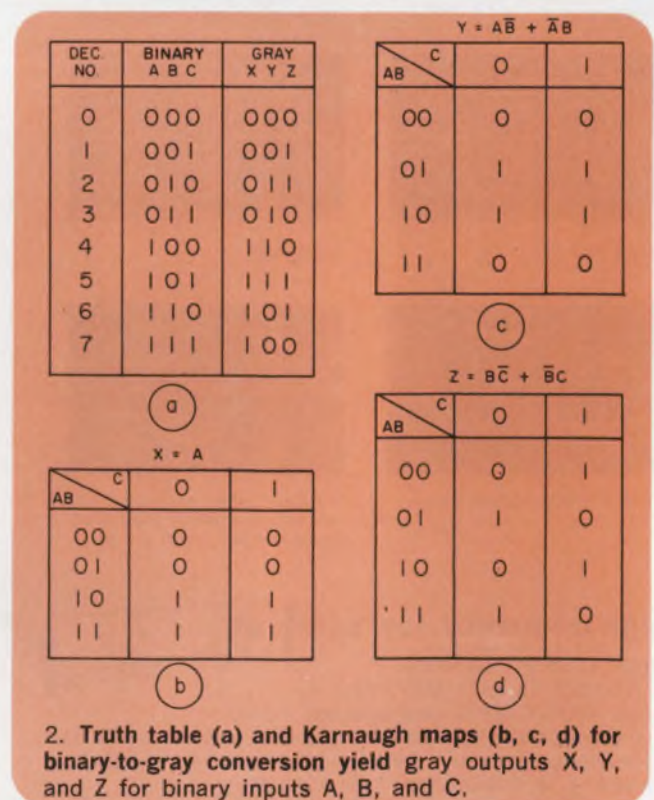

Complete RF Network Analysis ... **NOW!**



400 kHz to 500 MHz with 115-dB dynamic range and 0.005-dB resolution — these are not design goals of an idealized analyzer; they are performance facts of a remarkable new analyzer.

NOW used by a growing list of owners to measure group delay of CATV amplifiers and filters, to determine s-parameters of vhf transistors, to measure crosstalk of multiconductor coaxial cable, to test flatness of telephone filters and equalizers, to check the response of ECM and radar i-f modules . . .

NOW for **your** use to provide fast, accurate measurements of nearly any transmission and reflection property, including magnitude, phase, group delay, and s-parameters — all at the push of a button or the twist of a knob.

NOW with built-in rectilinear and polar display, 50- and 75-ohm capability, and three channels for simultaneous displays of two unknowns or of two characteristics of one unknown, plus a reference trace.

NOW the GR 1710 RF Network Analyzer — only a moment of your time for a demonstration, only \$6850 for a basic system.

LATER, even more.

For High-Frequency Measurements

 **General Radio**

NEW YORK (N.Y.) 212-944-2722, (N.J.) 201-791-8990 • BOSTON 617-446-0550
CHICAGO 312-992-0800 • WASHINGTON, D.C. 301-881-5333 • LOS ANGELES 714-540-9830
TORONTO 416-252-3395 • ZURICH (01) 55 24 20

GR COMPANIES • GRASON-STADLER • TIME/DATA • TECHWARE COMPUTING CORP.
GR ASSOCIATE • MICRONETIC SYSTEMS INC.

INFORMATION RETRIEVAL NUMBER 88

Packaged pulse-width modulator simplifies series-switching regulator design

A non-IC approach to series-switching regulator design eliminates the need for a sawtooth generator and a differential comparator. The 1F0001 packaged pulse-width modulator (see diagram) replaces the sense amplifier, function generator and function controller commonly found in series-switching regulators. The resulting efficiency is 75%, with 0.1% regulation for a 12-Ω load. Maximum load current is 1.25 A.

Voltage regulation is achieved when the error voltage of a few millivolts is sensed by the error-detecting bridge containing resistors R_1 , R_2 , and reference diode CR_1 . When a voltage higher than the desired level occurs on the regulator's output terminals, an error voltage that is positive with respect to point A is sensed at point B. This positive error signal, appearing at the negatively polarized terminal 6 of the pulse-width modulator, decreases the output pulse width at the base of Q_1 in proportion to the magnitude of the error signal. Consequently the output voltage is reduced to the desired level. Conversely, if the error voltage at point B is negative, the supply output voltage increases to the required level.

The regulated output voltage is stepped down by a train of isolated 3-V pulses appearing across resistor R_2 at the base of Q_1 , causing Q_1 to turn on and off as a function of the desired output voltage and unregulated supply voltage. The emitter of Q_1 is returned to R_2 through resistor R_3 and power supply (via terminal 4). The transistor switch thus chops the unregulated input so that only a desired portion of unregulated

supply voltage appears at the load.

The transistor switch oscillates at a repetition rate of 100 kHz. For an output voltage of 15 V—half the unregulated input of approximately 30 V—the pulse width at the base of the switching transistor is half of a full 10-μs pulse width, or approximately 4.5 μs.

The pair of isolated inputs to the pulse-width modulator (terminals 5 and 6) have opposite polarities (5 is positive, 6 negative). The other available inputs (positive at pin 7 and negative at pin 8), though not used in this design, can be used for overcurrent protection or other error compensation. Diode CR_1 provides the stable reference point for the error-detecting resistance bridge. Filter L_1 , C_2 converts the pulses at Q_1 's emitter to dc. Diode CR_3 , with the capacitor C_1 in parallel, protects the switching transistor from negative spikes.

Grounding problems—which occur in conventional switching regulators because the sense amplifier and error detector share a common ground—do not exist in this regulator design. Since the pulse-width modulator has a separate return to terminal 4 of the square wave power supply, it has floating output pulses that can be applied to the transistor base regardless of the emitter voltage. This avoids problems with fluctuating emitter voltages.

John Svalbe, President, Magnetic Electronics, Inc., P.O. Box 25517, W. Los Angeles, Calif. 90025.

CIRCLE NO. 314

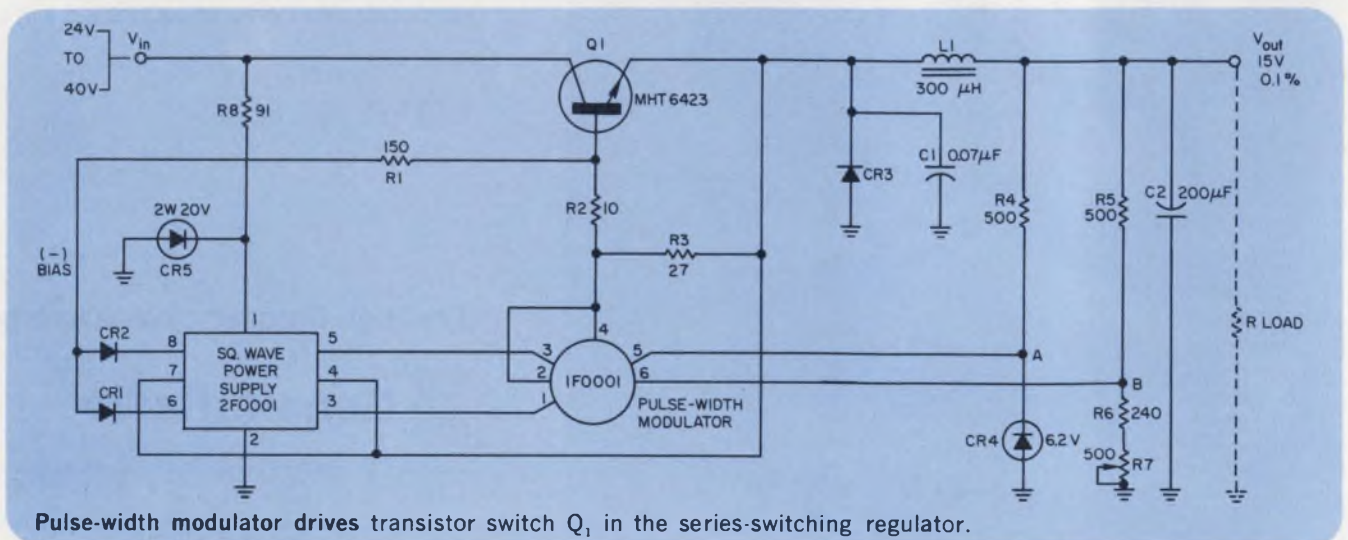

Pulse-width modulator drives transistor switch Q_1 in the series-switching regulator.

Subminiature tubular capacitors now offered in expanded ratings.

The latest revisions to our TT and TTX line of miniature aluminum electrolytic capacitors make expanded ratings available in $\frac{5}{8}$ " and $\frac{1}{2}$ " diameters, up to 5,000 mfd. All offer extra long life—on the job or off the shelf.

Both capacitors have the reliability of all-welded construction. They are cased in aluminum, with proven rubber end seals. PVC insulating sleeves are standard, but Mylar* insulating sleeves are available for high-temperature applications.

For more information on the expanded line write for TT Bulletin 4-104 or TTX Bulletin 4-105. Or see your authorized Mallory distributor. We'll show you how to get what you need, without paying more than you need to.

*Du Pont registered trademark.



MALLORY

MALLORY CAPACITOR COMPANY

a division of P. R. MALLORY & CO. INC.
Indianapolis, Indiana 46208

Electrical and Electronic Components • Sequence Timers • Metallurgical Products • Batteries

INFORMATION RETRIEVAL NUMBER 89

Gated zero-start oscillator reaches steady-state amplitude on first cycle

If you want sine-wave oscillation that always starts from zero when gated on, reaches its steady-state amplitude on the first cycle and remains on for a preset number of cycles, you can get it without the usual phase-locking circuitry.

The need for phase synchronization arises because the consecutive start times do not necessarily coincide with the zero of the sine wave. A simpler method is to maintain the energy in the tuned circuit even when no oscillations exist.

In the gated oscillator circuit shown, transistor Q_1 gates the oscillator portion by shunting the oscillator transistor Q_2 . The oscillator is a Colpitts type, tuned by inductor L_1 and capacitors C_1 , C_2 and C_3 .

When Q_1 is turned off by the input trigger, it presents a high impedance across Q_2 . The circuit begins oscillating, with the steady-state energy already established in the tuned circuit. Oscillation continues as long as the positive gate voltage is present at the base of Q_1 . Linearity control R_4 must be adjusted so that the current flow through Q_1 and L_1 maintains a constant oscilla-

tion amplitude throughout the full signal burst.

To insure minimum drift, inductor L_1 was wound on a Magnetics, Inc., type D temperature-stabilized Molypermalloy core, and Dur-mica capacitors were used. This resulted in an over-all zero temperature coefficient for the circuit and a total drift of 20 Hz over a 0 to 75 C range.

Oscillator frequency can be varied according to the formula:

$$f = \frac{1}{2\pi\sqrt{L_1 C_T}}$$

$$\text{where } C_T = \frac{C_1 C_2}{C_1 + C_2} + C_3$$

$$\text{and } C_1 \approx 9C_2$$

Frequencies from 5 kHz to 112 kHz can be obtained without serious depreciation of drift.

Ted Arken, Development Engineer and Vyta Pazemenas, Engineering Specialist, GTE-Sylvania, P.O. Box 205, Mountain View, Calif. 94040

CIRCLE No. 315

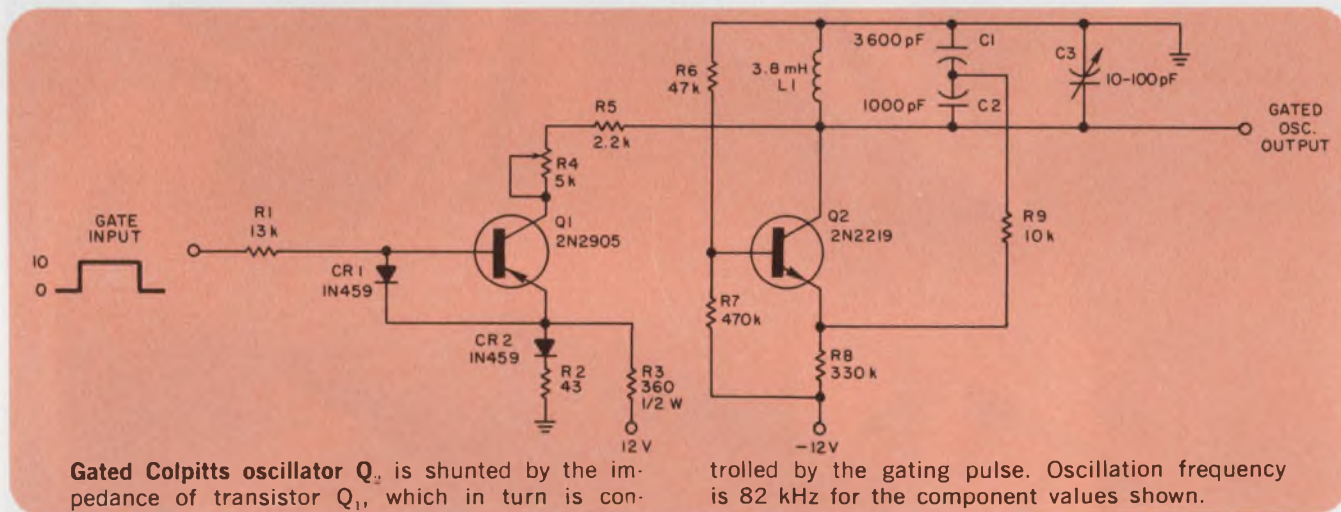

IFD Winner of May 11, 1972

Maxwell G. Strange, Senior Engineer, Experiment Engineering Branch, NASA, Goddard Space Flight Center, Greenbelt, Md. 20771. His idea "Optical coupling isolates ac current limiter to insulate load circuit from line power" has been voted the Most Valuable of Issue award.

Vote for the Best Idea in this Issue

SEND US YOUR IDEAS FOR DESIGN. You may win a grand total of \$1050 (cash)! Here's how. Submit your IFD describing a new or important circuit or design technique, the clever use of new component or test equipment, packaging tips, cost-saving ideas to our Ideas for Design editor. Ideas can only be considered for publication if they are submitted exclusively to ELECTRONIC DESIGN. You will receive \$20 for each published idea, \$30 more if it is voted best of issue by our readers. The best-of-issue winners become eligible for the Idea of the Year award of \$1000.

ELECTRONIC DESIGN cannot assume responsibility for circuits shown nor represent freedom from patent infringement.

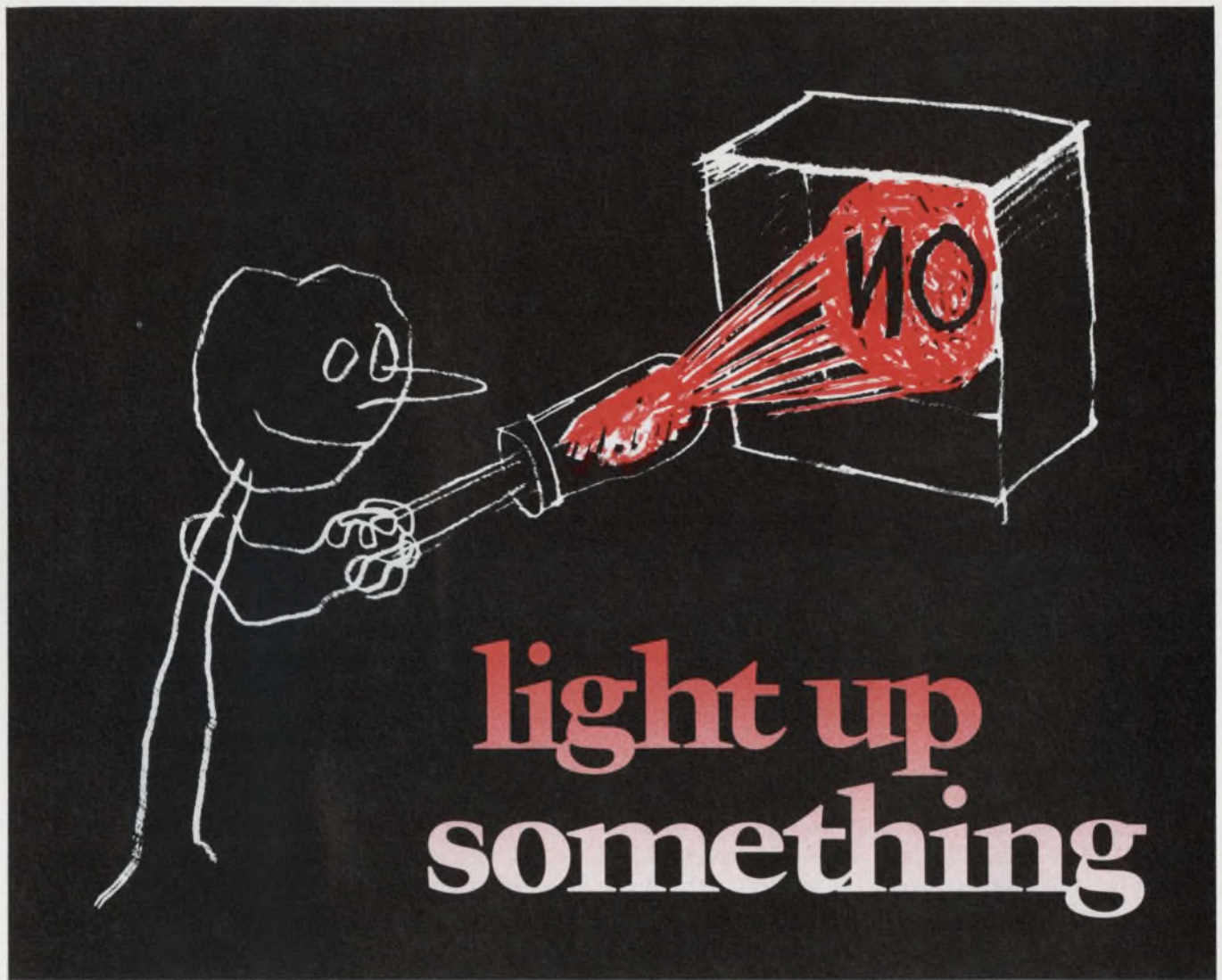

the illuminating GaAsLITE

The new MV5054 is so bright you can actually use it to illuminate things. Like on-off pushbuttons and switches and cash registers that tell clerks what to do next. Good for telephone PABX's. They're being used for computer panel backlighting, too.

Wherever you used to think incandescent you can now think GaAsLITE. These illuminators form their own beam, so there's no light wasted lighting up the inside of

the two bright spots

MV5054-1
2 mcd at 10 mA
MV5054-2
3 mcd at 10 mA



Any "GaAsLITE GUARANTEED" product that burns out during the lifetime† of the equipment in which it is installed will be replaced free of charge by an equivalent device provided that it has been run at or below data sheet ratings.

†Lifetime defined as system life of original equipment or ten (10) years, whichever comes first.

the switch. And since you'll never replace a GaAsLITE, you can mold it as part of a button. That gets rid of all the pieces and a big assembly cost.

The TTL-compatible MV5054 is made to illuminate a ¼" circle and the *lifetime cost* is 65¢ or less. You can mount it in a number of ways on your PC board and we also have a transparent mounting clip.

For more information and applications ideas call us at (408) 257-2140 or write us a letter. We have distributors all over the world who'll sell them to you.

Monsanto Commercial Products Co.
Electronic Special Products
10131 Bubb Road
Cupertino, California 95014

Monsanto

INFORMATION RETRIEVAL NUMBER 90

Separate SCR bias gives low-trip-level crowbar

A separate bias source for the crowbar SCR in a new power supply allows the trip level to be reduced to just a few millivolts above zero. In that way Hewlett-Packard's 6104A gets around the usual need for 2 to 3 V minimum to fire the SCR reliably in most power-supply crowbars.

As shown in the figure, the zener diode maintains the anode of CR₂ at approximately 7 V higher than the positive output terminal of the supply. Thus there is always sufficient potential to fire the SCR. Diode CR₁, normally back-biased, is necessary to fulfill this condition; without it, CR₂ would always be on.

CR₁ conducts when the SCR fires, discharging the output capacitor. When the capacitor has fully discharged and the load voltage has decreased to less than the drop across the conducting SCR, CR₁ again becomes back-biased. A front-panel LED indicator turns on when CR₁ and

CR₂ conduct.

When the crowbar fires, most of the base-drive current of the series regulator is diverted through CR₂ and the SCR. The regulator is thus turned off, reducing the load current to zero and greatly reducing the power dissipated during the crowbar condition. The diverted base-drive current supplies the SCR holding current, keeping the SCR conducting until the supply is turned off.

The crowbar trigger circuit is straightforward: Op amp A₁ compares a portion of the supply's output voltage (via divider R₁-R₂) with a variable reference (R₃ and the -6.2-V bias voltage), and the op amp conducts when the output exceeds the reference. The extra winding on trigger transformer T₁ allows the SCR to be triggered by an external pulse—or the winding can be used to trigger another crowbar.

CIRCLE No. 316

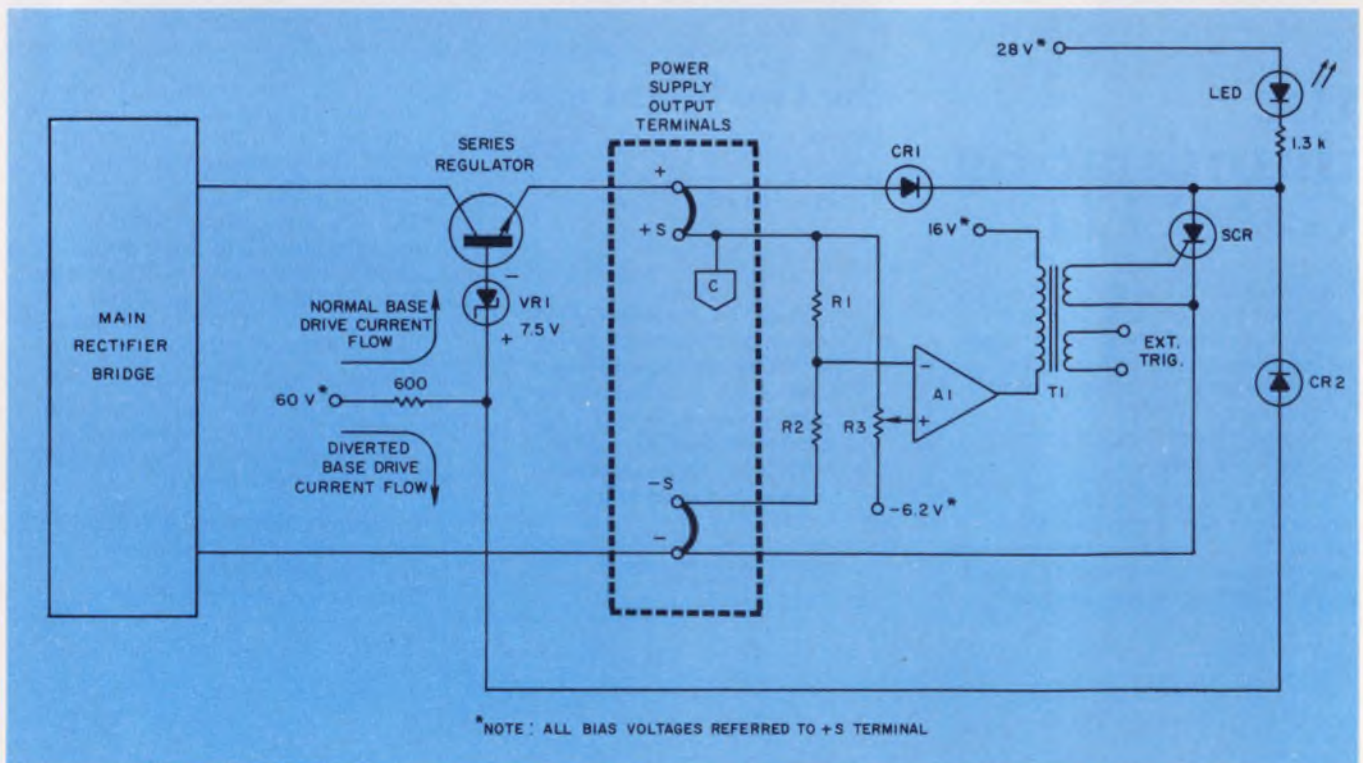

Overvoltage protection circuit goes into operation when the output voltage exceeds the set value by

just a few millivolts. This is accomplished by using a separate bias for the SCR.

Sometimes magnet specs are pushed to the limit. Here's a new limit.

Sintered Alnico

When your magnet requirements include high coercive force, intricate shapes, and close tolerances, sintered Alnico 8HE and 8H now provide a wider range of parameters to choose from. Coercive force 1800 Oersted and higher. Tolerances within 0.005 in.

The powdered metal process has been expanded through new manufacturing technology at Indiana General to give you the advantages of all six sintered Alnico materials in a wider range of sizes and configurations. You can now get high resistance to demagnetization and the lowest temperature coefficient of any magnet material in magnets to one-fourth pound.

Intricate shapes

Higher consistency and homogeneity of the sintered process result in finished magnets with extremely close tolerances, smooth surfaces and high physical strength.

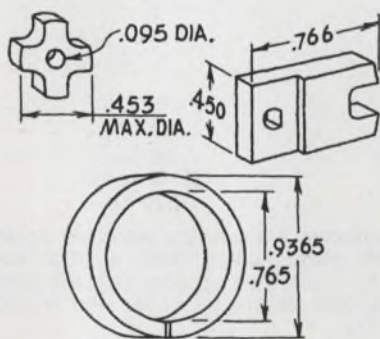

Intricate configurations such as these are typical of the many shapes produced through Indiana General's sintering facility. Precise tolerance and superior finish can eliminate grinding operations to lower your magnet cost in many applications.

Now—larger sizes

Our expanded sintering capability now offers you production magnets in the size ranges shown below.

MAXIMUM SIZES FOR PRODUCTION MAGNETS (1 IN. THICK)

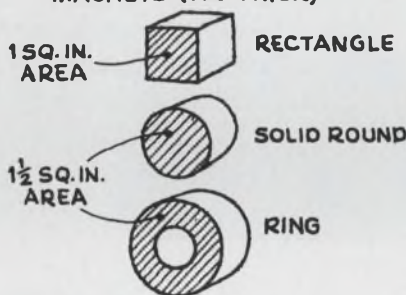

A wide variety of configurations within these parameters of area and length are available to meet your production requirements.

For applications involving larger sizes, special manufacturing processes are employed. Sintered magnets up to *four inches* in surface area are being produced at Indiana General. Please contact us for specific recommendation.

High residual induction— high coercive force

Alnico 8HE gives you highest residual induction (8,600 Gauss) and should be selected when the magnet material operates at the knee of the B/H curve (maximum energy) or above.

Alnico 8H has the highest coercive force (typically 1800 Oersted) and should be selected when the magnet material operates below the knee or near the coercive force of the material.

Get complete specs

Our new *Magnet Materials Manual* number 34 covers the complete family of sintered Alnico materials — 2, 4, 5, 6, 8HE and 8H. Magnetic and material characteristics, demagnetization curves and tolerances are shown for each Alnico grade.

For your copy of this comprehensive guide to the latest in metal magnet technology, just contact: Indiana General, Magnet Products, Valparaiso, Indiana 46383. Phone (219) 462-3131.

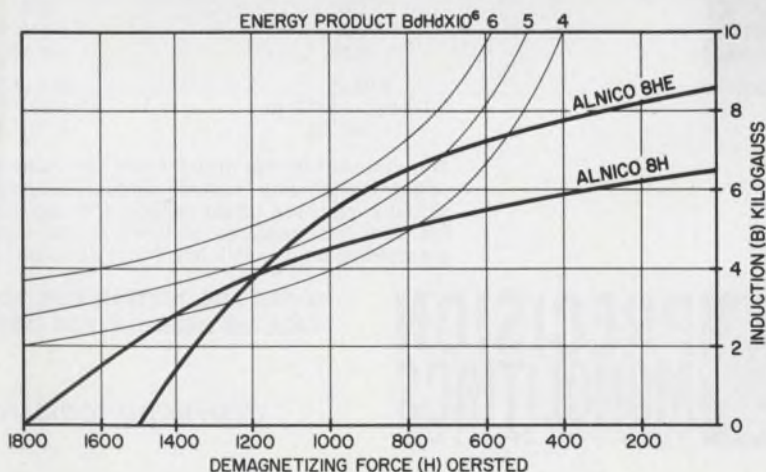

indiana general 

a division of Electronic Memories & Magnetics Corporation

INFORMATION RETRIEVAL NUMBER 91

3014

WORLD'S GREATEST OP-AMP?

If you had designed an op amp that guaranteed extremely low noise and drift (like the SSS725) and extremely low input current (like the SSS108A) and was easy to use with internal compensation and complete protection (like the SSS741), would you call it the world's greatest op amp?

WE CALL IT THE **MONO** OP-05!

Here are the facts on the new **MONO** OP-05 Instrumentation Operational Amplifier:

	monoOP-05	monoOP-05EJ	monoOP-05CJ
V_{os} Max (mv)	0.5	0.5	1.3
I_b Max (nA)	3.0	4.0	7.0
R_{in} Min (M Ω)	20.0	15.0	8.0
Noise Voltage Max (μ Vp-p)	0.6	0.6	0.65
TCV_{os} Max (μ V/ $^{\circ}$ C)	1.0	0.6	1.5
CMRR Min (db)	114	110	100
Slew Rate (V/ μ sec)	0.25	0.25	0.25
Price at 100 pcs.	\$19.95 (TO-99, -55 $^{\circ}$ C to +125 $^{\circ}$ C)	\$14.95 (TO-99, 0 $^{\circ}$ to +70 $^{\circ}$ C)	\$6.95 (TO-99, 0 $^{\circ}$ to +70 $^{\circ}$ C)

The monoOP-05 fits directly into 725, 108A and unnull'd 741 sockets, allowing instant upgrading of your system without redesign. And offset nulling (with a 20K Ω pot) actually improves offset voltage drift. So there it is — could an op amp that combined the very best features of three of the industry's best sellers be called the world's greatest op amp? We'll leave that decision up to you.



UNITS ARE WAITING FOR YOU AT YOUR LOCAL DISTRIBUTOR — OR
CALL US DIRECTLY FOR IMMEDIATE ACTION.

... delivering tomorrow's linear technology today!

A **BOURNS** Affiliate

WEST

Lee Egberman
Precision
Monolithics, Inc.
1500 Space Park Drive
Santa Clara, Calif. 95050
Tel. # (408) 246-9225

CENTRAL

Ed Raether
Precision
Monolithics, Inc.
605 E. Algonquin Rd.
Arlington Heights, Ill. 60005
Tel. # (312) 437-6697

EAST

Joe Stern
Precision
Monolithics, Inc.
100 Ricefield Lane
Smithtown, N.Y. 11787
Tel. # (516) 864-2666

new products

Improved op amp regulator comes with lower price tag

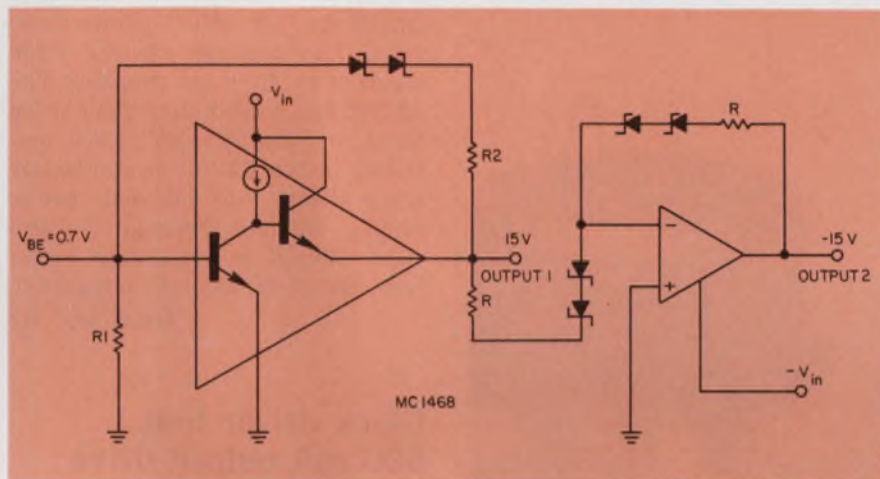

Motorola Semiconductor Products, Inc., P.O. Box 20912, Phoenix, Ariz. 85036. (602) 273-3465. P: See below; stock.

Along with Raytheon's RC 4194 and Silicon General's SG 4501, there is now a third dual-tracking voltage regulator on a chip—Motorola's MC1468. Motorola's and Silicon General's regulators are designed primarily to supply op amps; each is preset for a ± 15 -V output. The generally higher priced Raytheon device requires external resistors to do the job. And Motorola's new circuit edges past the Silicon General IC with lower cost and tighter tracking and regulation.

The Raytheon, Silicon General and Motorola ICs are all low-cost version regulators covering the 0 to 70 C temperature ranges. The Raytheon RC4194 is intended for general-purpose dual-voltage regulation. In any application, two external resistors are required for the setting of output voltages. For this versatility, the cost is \$3.90 (100-999)—that's about \$1 more than either the lowest priced Motorola or Silicon General regulator.

Motorola's MC1468 sells for as low as \$2.80 (100-999) in a 10-pin metal-can package (suffix G), and

reaches \$3.75 (100-999) for TO-66 packaging. Military versions, termed MC1568, range from \$6.25 to \$7.00 in the same quantities. By comparison, the SG4501 is priced at \$3.05 (100-999) in both 14-pin DIP and TO-100 packages.

In addition, Motorola's regulator maintains its ± 15 V output within ± 200 mV. The Silicon General device has a ± 700 mV deviation. And line and load regulation reach a maximum of 0.06% at room temperature for the MC1468 vs 0.08% at room temperature for the SG 4501.

The Motorola regulator is fabricated using the company's Isothermal layout techniques. This eliminates the effects of thermal gradients across the IC chip, ensuring that the output voltage varies a maximum of 1% over the operating temperature range.

A proprietary chip design makes it possible for the Motorola circuit to consume less chip area than the company's 723-type regulator. This permits unit prices under \$3.

For Motorola MC 1486/1586

CIRCLE NO. 320

For Raytheon RC 4194

CIRCLE NO. 321

For Silicon General SG 4501

CIRCLE NO. 322

Quad 80-bit static SR draws only 40 μ W/bit

Signetics, 811 E. Arques Ave., Sunnyvale, Calif. 94086. (408) 739-7700. \$9.20 (100).

The 2532 quad 80-bit MOS shift register features low power consumption (typically 40 μ W/bit), a frequency range of dc to 2.5 MHz, a single clock line and a recirculation path on the chip. The 2532, totally TTL compatible, is an original pin-for-pin replacement for the MK1007P and TMS3409 dynamic shift registers. Power supplies providing +5 V and -12 V are required.

CIRCLE NO. 323

Hf PLL simplifies phase demodulation

Harris Semiconductor, P.O. Box 883, Melbourne, Fla. 32901. (305) 727-5400. \$9.85 (100-999).

The HA-2800 high-frequency phase-locked loop has independent phase detector and oscillator. Loops broken between VCO and phase comparator allow loop and demodulation gains to be varied independently. Thus the monolithic IC is directly usable for phase demodulation. Moreover, the dc level of demodulated output voltage and/or gain can be selected. The HA-2800 has a minimum high frequency of 25 MHz and a low frequency rating of 1 kHz. Oscillator stability is listed as 250 ppm/ $^{\circ}$ C and 0.1%/V.

CIRCLE NO. 324

Phototransistor has low light, high gain

Spectronics, Inc., 541 Sterling Dr., Richardson, Tex. 75080. (214) 231-9381. \$4 (1000 up); stock.

The SD3442 and 5442 phototransistors can function at the low-light level of 1 mW/cm². And in one of three sensitivity ranges offered, the 5442-2 provides a light current of typically 6 mA at an irradiance level of 1 mW/cm². The SD3442 series is a flat lens version with a wide viewing angle—typically 90 degrees. The 5442 has the more directional viewing angle of typically 20 degrees.

CIRCLE NO. 325

Smallest IC-package line begins with popular linears

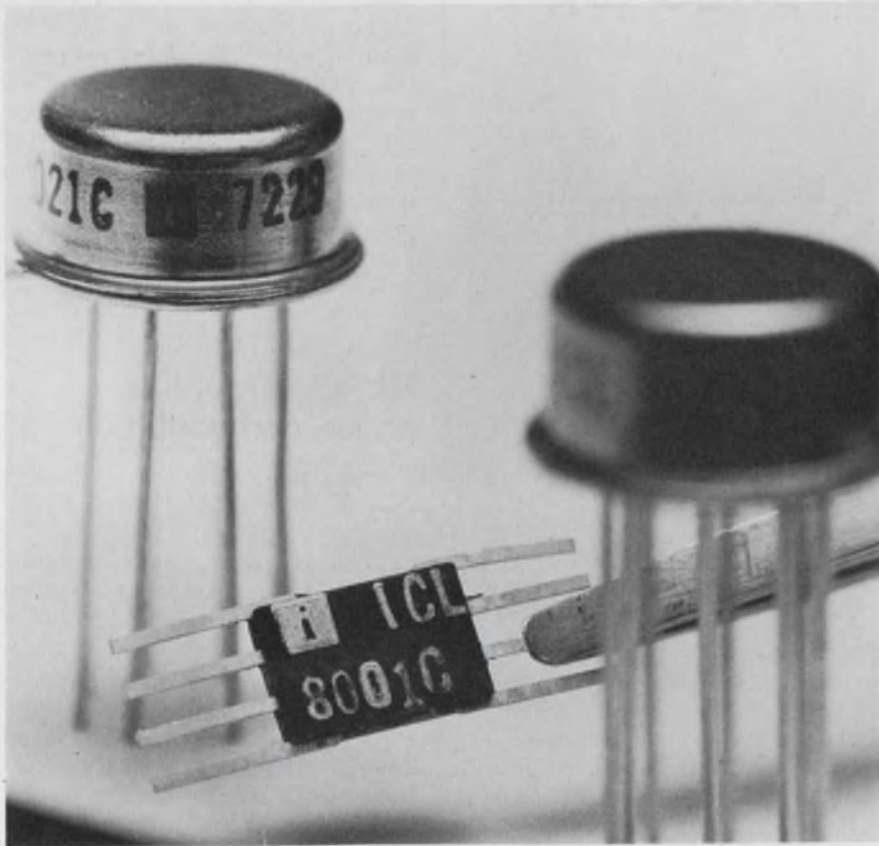

Intersil Inc., 10900 N. Tantau Ave., Cupertino, Calif. 95014. (408) 257-5450. P&A: See below.

Miniature IC-packaging shrinks to a new level with Intersil's introduction of its Pico Pak family—the smallest standard-package line yet. The circuits packaged in Pico Pak are a FET-input op amp (Model 8007), micro-power op amp (Model 8021) and low-power comparator (Model 8001). All are priced at the low level of the same linear ICs in TO-5 cans.

A Pico Pak measures 0.14×0.21 inches and consists of a silicone-plastic body with gold-plated kovar leads. It's significantly smaller than standard DIP, which measures 0.25×0.75 inches, and reduced in size from conventional flat pack, which measures 0.25×0.25 inches.

The miniMod series, another miniature package line, does not directly compete with the Pico Pak. Originally from General Electric

and now exclusively a Texas Instruments product, the miniMod consists of chips mounted on reels of plastic film. MiniMod ICs are primarily intended for automated hybrid fabrication, and thus, are not directly comparable to Pico Pak.

The 8007 op amp offers a 1-pA input current, with a 6-V/ μ s slew rate; input impedance reaches 10^{12} Ω . The 8021 op amp features a low-power consumption at 20 μ W (at $V_{SS} \pm 1$ V); offset voltage is 3 mV max, while power supply voltages can range from ± 1 V to ± 18 V. The 8001 comparator has a 250-nA input current, 30-mW power consumption and $\geq \pm 10$ V input voltage range. Prices in 100-up quantities are \$5.00, \$2.75 and \$3.00 for commercial versions, respectively.

For Intersil 8007, 8021 and 8001

CIRCLE NO. 319

For Texas Instruments miniMod

CIRCLE NO. 326

Monolithic audio preamp introduced

National Semiconductor Corp., 2900 Semiconductor Dr., Santa Clara, Calif. 95051. (408) 732-5000. LM381A: \$4.95 (100 up); LM382: \$2.25 (100 up); stock.

The LM381, believed the industry's first monolithic IC preamp, and the LM382, a similar IC with a resistor network, are dual preamplifiers for Hi-Fi stereo systems. The preamps operate from single 9 to 40 V dc supplies. The LM381 has a total equivalent noise input of only 0.45 μ V. Each amplifier in the LM381 is completely independent; an internal power supply decoupler/regulator provides 120-dB power-supply rejection and 60-dB channel separation.

CIRCLE NO. 327

Clock driver lists 500 mA output drive

Halex, Inc., 3500 W. Torrance Blvd., Torrance, Calif. 90509. (213) 772-4461. \$18 (100 up); stock.

The HX 0009 two-phase MOS clock driver features output drives to 500 mA, output swings to 30 V and repetition rates to 2 MHz. Standard TTL line drivers with external capacitors can be used to set pulse width. Packaging is $1/4 \times 3/8$ -inch flatpack (HX 0009 FP) and dual-in-line (HX 0009 DIP).

CIRCLE NO. 328

12-digit calculator chip runs on 5.5-7.5 V

Cal-Tex Semiconductor, Inc., 3090 Alfred St., Santa Clara, Calif. 95050. (408) 247-7660. < \$100 (high volume).

The CT5002 12-digit calculator MOS IC is said to be the first calculator chip specifically designed for 5.5-to-7.5 V operation. With the inexpensive 9-V battery used in pocket calculators, current drain is typically 5 mA. External part requirements have been reduced to approximately half of the 130 required by this circuit's predecessor. Simple external circuitry allows operation with 8 or 10-digit calculators.

CIRCLE NO. 329

COUNTER REVOLUTION!



EK-343

If you're on the verge of open insurrection over frequency counters that deliver too much price and not enough performance...

JOIN THE HEATH/SCHLUMBERGER COUNTER REVOLUTION!

We've got counters that will get you to over 80 MHz for only \$350... or to 600 MHz for just \$795. And check out some of our other revolutionary ideas: long-lived, highly visible LED readout... very high input sensitivity... BCD output... complete programmability for all functions... computer compatibility... handy gimbal mounts... combination carrying handle/tilt stand... lab-grade time base stability. Circle the reader service number below to get complete information... and join the Heath/Schlumberger Counter Revolution.

(A) SM-110A: 1 Hz to 200 MHz range... input sensitivity: 10 mV @ 35 MHz, 15 mV @ 200 MHz... 1 megohm/15 pf and 50 ohm inputs... 7-digit LED readout plus overrange... four switch-selected time bases... 1 MHz crystal time base... 7.5 ppm/yr stability **\$495.00**

(B) SM-110B: features same range, input sensitivity and readout as SM-110A above, plus 1 MHz TCXO time base stable to 1 ppm/yr... complete programmability for Range, Reset, Input Select, Count Inhibit, all standard TTL-level. Outputs: 7 digits of BCD, Overrange flag, Decimal Points, Print Command, 5V reference and ground **\$625.00**

(C) SM-110C: includes all the features of the A and B models as detailed above. Also provides a 600 MHz prescaler for the high frequency input for measurements into the UHF region. Prescaler can be switched in and out from the front panel..... **\$795.00**

(D) SM-114A 600 MHz Prescaler. Extends the useful range of any counter with more than 100 kHz capability. Three pushbutton selected ranges allow division of input frequency by 1, 10 or 100. 50 ohm input... less than 2:1 VSWR to 600 MHz... 50 mV rms input sensitivity. 50 ohm output, 1 V P-P..... **\$365.00**

(E) SM-105A... the world's most remarkable value. 10 Hz to well over 80 MHz range... 5-digit LED readout plus overrange... 8-digit measurement capability with kHz/MHz front panel switch... 100 mV input sensitivity... 1 MHz crystal time base with 1 ppm/mo stability... gimbal mount **\$350.00**

(F) SM-104A... same as SM-105A described above but with high stability TCXO time base (1 ppm/yr)... 5-digits of BCD output plus overrange and print command **\$450.00**

For additional information, use reader service number below or write:

Heath/Schlumberger Scientific Instruments
Dept. 531-263
Benton Harbor, Michigan 49022

HEATH

Schlumberger

High resolution,
low cost

SCAN CONVERTERS display any electronic information

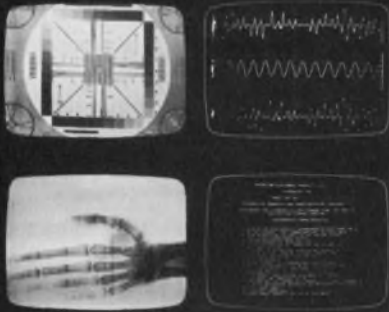

Any electronic information—from computers, lasers, TV cameras, scanners, X-ray, electron microscopes or whatever—can be displayed sharper, brighter, faster and at lower cost with PEP scan converters. Regardless of its format or speed. Even if it's only transient information. The reason: only PEP scan converters offer this combination of advantages:

- RESOLUTION to 3000 lines
- GRAY SCALE: 10 Logarithmic levels
- NON-DESTRUCTIVE readout
- WIDE RANGE of reading and writing speeds: video to DC
- WIDE system bandwidth: 30 MHz
- READ, write, selective erase, zoom, other functions
- LONG, trouble-free life

We're the people who developed high resolution, low cost scan conversion and image storage technology. Our Lithocon® silicon storage tube is the heart of all PEP scan converters, and makes them feasible for a whole new world of applications. Like microfilm/microfiche. Industrial process control. Facsimile. CATV systems. And X-ray, ECG and low light level detection systems. And hundreds more. We'll be happy to tell you about them. Write or call today for details. Princeton Electronic Products, Inc., P.O. Box 101, North Brunswick, New Jersey 08902; (201) 297-4448.



**PRINCETON
ELECTRONIC
PRODUCTS, INC.**

INFORMATION RETRIEVAL NUMBER 94

ICs & SEMICONDUCTORS

S-TTL 1024-bit ROM boasts 35-ns access

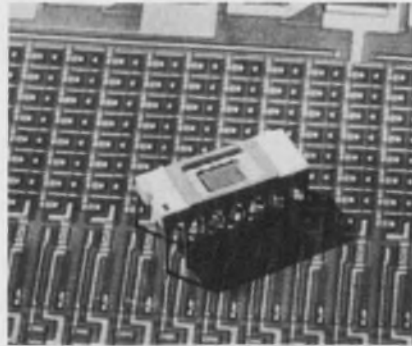

Signetics, 811 E. Arques Ave., Sunnyvale, Calif. 94086. (408) 739-7700. \$49 (1-24); stock.

The 1024-bit read-only memory, termed the 82S26, uses Schottky-TTL to achieve a 35-ns access time. Address-to-output propagation delay is under 60 ns, and enable-to-output delay is below 50 ns. Organized into 256 four-bit words, the 82S26 has a power consumption of typically 525 mW.

CIRCLE NO. 330

Protector limits transients to 18 V

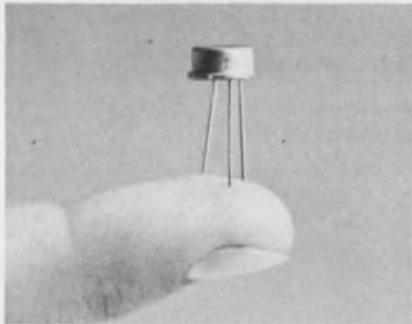

Data Device Corp., 100 Tec St., Hicksville, N.Y. 11801. (516) 433-5330. \$25 (1-9).

When placed in series with the power supply line, the overload protector automatically cuts off transients above 18 V or below 11 to 12 V. The device passes current from 0 to 1/2 A and requires 25 mA for its own operation. Operating resistance is approximately 1 Ω . The unit can take up to 30 V forward or 5 V reverse-polarity voltage without being damaged. Turn-off time is 2 μ s if the unit is passing up to 300 mA, and 1 μ s if it is passing 600 mA or more.

CIRCLE NO. 331

Optical isolators fastest with gain

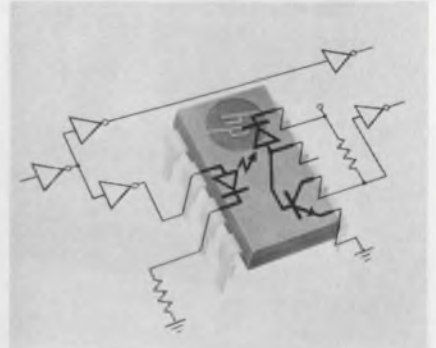

Hewlett-Packard Co., 1601 California Ave., Palo Alto, Calif. 94304. (415) 493-1311. \$2 (1000 up); stock.

Three optically-coupled isolators are the fastest with gain, according to the company. These Model 5082-4350 Series isolators have a propagation time of only 225 ns. Bandwidth is 5 MHz, compared to previously available units with bandwidths to about 200 kHz. Each of the three isolators is designed for different isolation applications.

CIRCLE NO. 332

MOSFETs offer low gate leakage current



Texas Instruments Inc., P.O. Box 5012, M/S 308, Dallas, Tex. 75222. (214) 238-3741. 3N207: \$4.40; 3N208: \$4.60 (100 up); 6 wks.

Two monolithic dual p-channel MOS field-effect transistors (MOSFETs) provide high input impedance and low gate leakage currents. Designated the 3N207 and 3N208, the devices feature input impedances of 10^{15} and 10^{12} Ω and gate leakage currents of 4 pA and 1 nA, respectively.

CIRCLE NO. 333

**It's downright humiliating!
Any field return is one too many!**

**Horace, you're never satisfied.
We may have just set the industry's
lowest return record!**

**I hate these impassioned
technical discussions.**



Even a 3.1% Function Generator return rate agitates Horace. IEC has trained him well.

It's an unwritten business rule that you don't discuss your problems with the outside world, but we're breaking tradition because we feel our F34 returns are worth talking about. This extremely low warranty repair record was established during the first year of production, even though industry statistics demonstrate that failure percentages are highest during the initial stage of product life. According to electronics manufacturers' trade association data, standard warranty returns can range from 10% for DVM's and oscilloscopes, to as much as 300% for some temperamental instruments. This is why we feel that our F34's current return rate of 3.1% is a real achievement.

Much of the credit for this reliable new function generator must go to IEC's Corporate Cal Lab, one of the few testing facilities with analysis standards one generation away from the National Bureau of Standards. The F-34 underwent the same kind of computerized error-analysis and evaluation testing that our Metrology staff developed for Polaris/Poseidon and other government programs.

With our stringent Quality Control system, we make sure that our test instruments measure up to performance standards, because we're vitally aware that downtime is a significant factor in test instrument selection. Over 300 generators were

shipped before one was ever returned, and to date, 96.9% have never required warranty maintenance. But because our QC people, like Horace, worry about that 3.1%, we'll try to do even better.

If you would like a perfectionist like Horace on your team, specify the F-34. It generates reliable 0.03Hz - 3MHz waveforms, with Variable Width Pulse for pulse generator applications, and an outstanding combination of operating features for \$495... In a hurry to match your requirements? Call John Norburg (collect) 714/772-2811.

OVERSEAS SALES OFFICES: AUSTRALIA, Parameters Pty., Ltd.; BELGIUM, LUXEMBURG, Etablissements L. de Greef S.P.R.L.; FINLAND, Havulinno Oy; FRANCE, Tekelec Airtronic, S.A.; ITALY, Romagnoli Elettronica; ISRAEL, Radat International Company, Ltd.; NETHERLANDS, Tekelec Airtronic, N.V.; NEW ZEALAND, David J. Reid, Ltd.; REPUBLIC OF CHINA, Bons International Co., Ltd.; SPAIN, Telco, S.L.; SWEDEN, M. Stenhardt AB; SWITZERLAND, Traco Trading Co., Ltd.; UNITED KINGDOM, Euro Electronic Instruments, Ltd.; WEST GERMANY, Tekelec Airtronic GMBH.

SEE IEC AT WESCON, BOOTH 2907 - TELL 'EM HORACE SENT YOU

INFORMATION RETRIEVAL NUMBER 95



**IEC INTERSTATE
ELECTRONICS
CORPORATION**

Subsidiary of A-T-O Inc.

Dept. 7000, Box 3117, Anaheim, Calif. 92803.

TWX 714-776-0280

TELEX 655443 & 655419

STOP EQUIPMENT DOWNTIME

— With new sensors
for voltage, frequency
and phase



Type VAA

VOLTAGE

When voltage on either three phase or single phase lines is too high or too low, the module de-energizes a built-in relay. This shuts down the system, or operates an alarm. A pick-up time delay and a drop-out time delay allows for permissible, temporary variations.



Type FAA

FREQUENCY

When input frequency changes from the specified limits, a built-in relay de-energizes to shut down the system or operate an alarm. A pick-up time delay and a drop-out time delay allow for permissible, temporary frequency variations.



Type PAA

PHASE

Three-phase loads, particularly rotating components, can be protected from damage in case of phase reversal or failure. A built-in relay operates an alarm or shuts down the system when phase rotation misses a sequence or is something other than ABC.

OR ANY COMBINATION

Logitek puts the capability of sensing changes in frequency, voltage and phase together in one package in the type PMA Power Monitor. The device de-energizes its built-in relay when any characteristics exceeds pre-set limits.

STANDARD SPECIFICATIONS

Input Operating	
Voltage (nominal)	120/208, 115/200 VRMS $\pm 20\%$
Frequency	60/400 Hz $\pm 20\%$
Phase	Single or 3-phase
Input Sensing	
Voltage Band	
Frequency Band	as required
Phase Sequence	ABC
Accuracy	$\pm 1\%$ (Voltage and Frequency Band)
Output Contacts	
Form	DPDT, 3PDT
Rating	2A, 10A
Operating Temp.	-55°C to +125°C



LOGITEK INC.

42 Central Drive
Farmingdale, New York 11735
(516) 694-3080

INFORMATION RETRIEVAL NUMBER 96

MODULES & SUBASSEMBLIES

Indicator light plus TTL gives convenient package

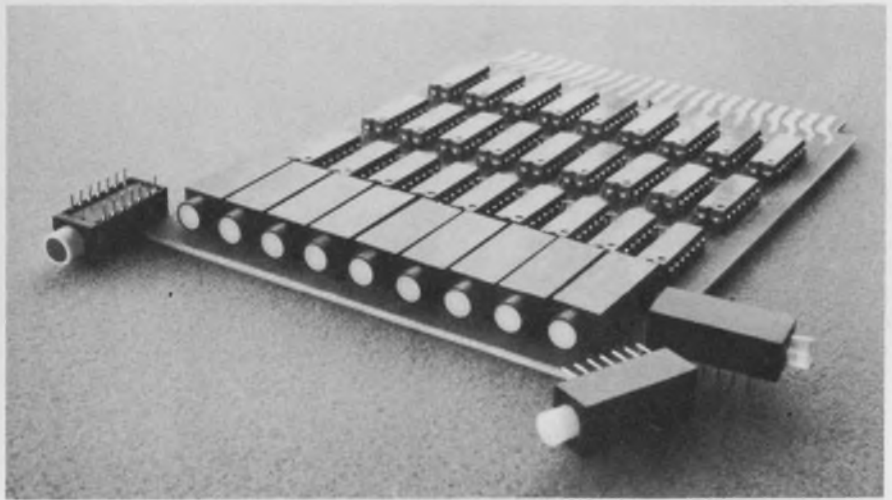

Data Display Products, 5428 W. 104 St., Los Angeles, Calif. 90045. (213) 641-1236. \$1.40 (1000 units with standard gates and either LED or incandescent lamp); stock to 2 wks.

Instead of mounting TTL logic in one part of your box and running cables to a panel of indicator lights, you can purchase DIPs that have an indicator light mounted in the same package as the TTL logic.

Called T²Lite by its manufacturer, Data Display Products, the combined unit sells for less than the total parts cost for an individual TTL integrated circuit, a lamp driver and an indicator lamp. When you add the saving of parts and labor in running a cable, the total savings can be substantial.

Typical applications include data registers, address registers, error registers, command registers, logic-ZERO indicators and logic-ONE indicators.

T²Lites are available with most types of 74-series and 74H-series integrated circuits.

Both LED and incandescent lamps are available, with a wide choice of different lenses and colors. Legends can be imprinted on the lenses if desired. MOS interfacing is offered as an option.

Life ratings on the indicator lights are 50 years for the LEDs and five to 18 years for the incandescents (depending upon the lamp

selected). LED units come with a built-in limiting resistor, and incandescent units come with a keep-alive bias resistor. The keep-alive resistor keeps the filament warm, even when the light is off, to minimize filament shock. This permits the unusually long life that is quoted.

In a typical mounting arrangement you can put a row of T²Lites along one end of a printed-circuit board. The board would then be edge-mounted to the front panel of the box. Dimensional tolerances on the units are sufficiently good to eliminate the need for special jiggling to obtain a straight row of lights.

CIRCLE NO. 334

Synchro to Binary unit updates in 5 ms

Astrosystems, Inc., 6 Nevada Dr., Lake Success, N.Y. 11040. (516) 328-1600. From \$295 (100s); stock.

This eight-bit (1.4°) Synchro to Binary Conversion Module occupies only 5.7 cubic inches. The module is mounted on a single PC card and an output register is included in the module. The high-speed unit offers an update rate of 5 ms and data-transfer time of less than 100 ns from the register.

CIRCLE NO. 335



Timefax[®] and Timemark[®] are the best recording papers for transmitting a picture of your plant baseball team. (Or almost anything else you can record.)

Sonar Recorders Timefax and Timemark electro-sensitive recording papers give instant access to the recorded information. You get an immediate dry copy. The fish won't get away or you won't run aground because you lost time processing the image.



Photo Facsimiles and Voice Characteristic Sonagrams Only the full range of neutral grey tones provided by Timefax and Timemark electro-sensitive recording papers will give you this recording ability.

Facsimile Receivers Timefax and Timemark papers give a dense black image on a white background. With Timefax and Timemark you get the highest quality copy in the industry.

Computer Print Out Using Timefax or Timemark papers you can record up to 60,000 characters per

second on an impactless computer printer or 30 characters per second on the simplest strip printer.

Industrial Event Recorders You can record a few inches per hour or hundreds of inches per second with maximum reliability because it's electro-sensitive recording.

Non-destructive Testing Very high resolution images will give you all the detail you need for flaw detection, surface profiling and spectrum analysis.

Electrical Writing Essentially that's what you do with Timefax and Timemark recording papers. You simply amplify the electrical output of your measuring transducer and this signal writes directly on our electro-sensitive recording paper. Couple this with the fact that the electro-sensitive recording process is completely dry and permanent. And it's hard to justify recording any other way.

We have a technical manual entitled "The Dry Electro-sensitive Recording Process". It was written to give design engineers a better understanding of the technical aspects of the electro-sensitive recording process. We would be happy to send you a free copy upon request.



FITCHBURG CPI
Litton

Box 1106, Scranton, Pa. 18501 Phone: 717-347-2035

INFORMATION RETRIEVAL NUMBER 97

Volts to kHz converter permits data sending

Teledyne Philbrick, Allied Drive at Route 128, Dedham, Mass. 02026. (617) 329-1600. \$59.00; stock to 3 wks.

The Model 4701 Voltage-to-Frequency Converter permits high-quality 2-wire transmission of digital data at low cost. The unit features 0.01% linearity and 27 ppm stability from 0 to +70 C, in converting 0 V to +10 V input to a corresponding 0-Hz to 10-kHz output ($f_{out} = 10 \text{ kHz} \times E_{in}/10 \text{ V}$). Output waveform is a train of DTL/T²L-compatible 30 μ s pulses. Input impedance is 23 k Ω and over-voltage protection is included. Fan-out is 10 standard T²L loads, and output is short-circuit protected. Offset voltage and full scale factor are adjustable by user. Requiring only $\pm 15 \text{ V}$, the Model 4701 is complete in a 1.5 x 1.5 x 0.4-inch module weighing only 25 grams. MTBF is 400,000 hrs (calculated per MIL Handbook 217A).

CIRCLE NO. 336

Thermocouple indicator resolves one degree

Newport Laboratories, Inc., 630 E. Young St., Santa Ana, Calif. 92705. (714) 540-4914. \$485; 2 wks.

The Series 260 gives digital temperature measurement from thermocouples, with 1° resolution. Conforming to NBS standards, Series 260 features digital linearization. Various models display directly in degrees F or, from thermocouple types J, K, T, S, R, or E. Each model covers the entire useful range of its thermocouple. The integral temperature-compensated reference junction corrects errors caused by ambient temperature changes to within 0.05°/degree. Series 260 has standard BCD outputs and automatic polarity. Options include a multipoint manual selector for 10 or 20 channels; and BIGS (buffered, isolated, gated and stored) BCD output isolation of up to 300 V common-mode on the analog input with respect to BCD output.

CIRCLE NO. 337

14-bit s/d converter tracks at 2400°/s

Transmagnetics, Inc., 210 Adams Blvd., Farmingdale, N.Y. 11735. (516) 293-3100. \$595 ea. (1-9); Stock to 2 weeks.

Transmagnetics announces its Model 1623E, a miniature, 14-bit, synchro or resolver-to-digital converter. The Solid-state device converts 60 or 400 Hz (at 26 or 115 V), three-wire synchro or four-wire resolver inputs to binary or BCD outputs. The unit operates over the temperature range of -55 to +85 C. Insulation resistance from any ac input to output is greater than 100 M Ω at 200 V dc. Outputs are TTL and DTL compatible. The Model 1623E will track inputs up to 2400 degrees per second. Conversion rates of 400 or 800 per second are available and can be factory set to as low as one per three seconds and one per second respectively. Power requirements are +5 V dc, $\pm 15 \text{ V}$ dc. Size is 2.625 x 3.125 x 1.0 inches.

CIRCLE NO. 338

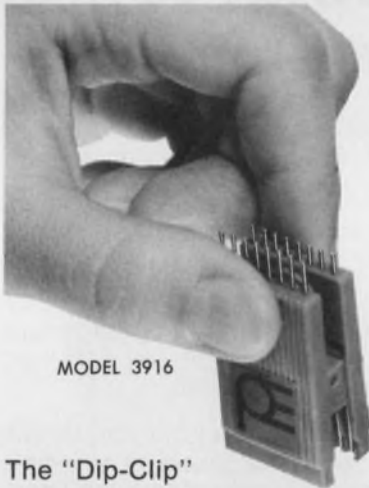

MODEL 3916

The "Dip-Clip" is specially designed to allow the attachment of test probes to 14 or 16 lead DIPs. The unique patented design greatly reduces the possibility of accidental shorting while testing live circuits. Numerous test probes may be quickly connected for hands-free testing.

dip clip

T.M.

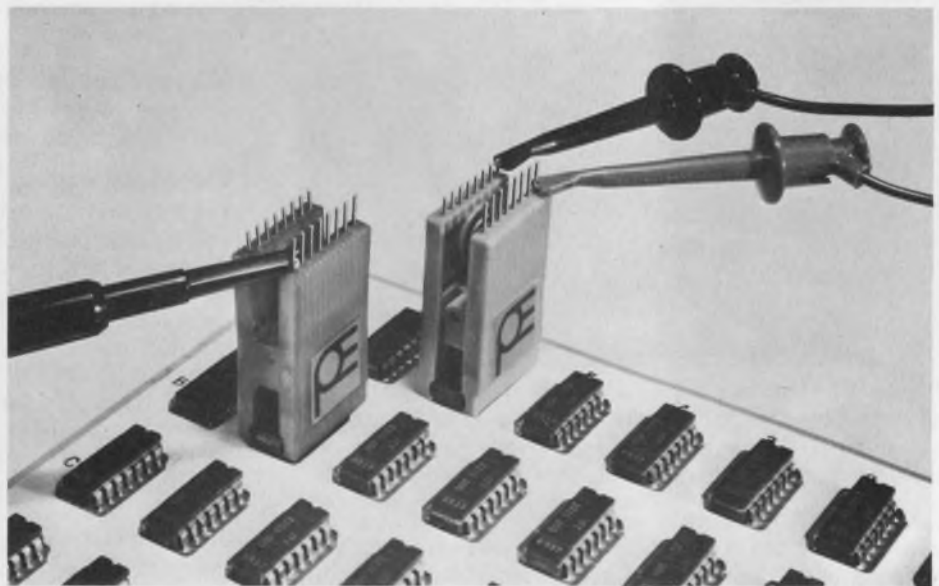

POMONA ELECTRONICS 1500 E. Ninth St., Pomona, Calif. 91766 • Telephone: (714) 623-3463

only from now - logic panels with decoupling capacitor provisions

for standard applications...

Decoupling efficiency of better than 98% is achieved from 1.34 kHz through 50 MHz by using Scanbe's suggested capacitor array.

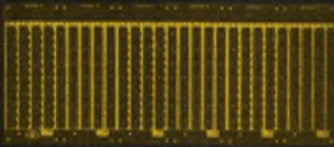

UNIVERSAL MODEL LPU

\$35.50 avg./zone (25 pc. quant.)

- 18, 36 or 54 pin rows
- For 14, 16, 24, 36, 40 LEAD DIPS

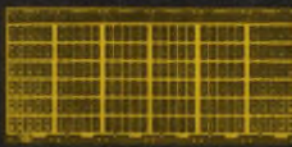

STANDARD MODEL LPS

\$35.00 avg./zone (25 pc. quant.)

- 14 or 16 LEAD DIPS
- 30 to 180 sockets in 30 socket zones



All of our universal, standard and custom series logic panels now incorporate this outstanding advance. All of our models are supported by the best, most complete line of quality accessories (including our ME-2 sockets) to optimize and assure top performance and reliability.

So if your logic panel needs call for quality performance, exclusive features and low price, get the best logic panels... only from Scanbe. Call or write for our latest logic panel brochure.

SCANBE MANUFACTURING CORP.

"The Packaging People"

3445 Fletcher Ave. • El Monte, Calif. 91731
(213) 579-2300 / 686-1202

CUSTOM LOGIC PANELS

Available in any shape, size or configuration. Any number of pins for descretes or decoupling capacitors.

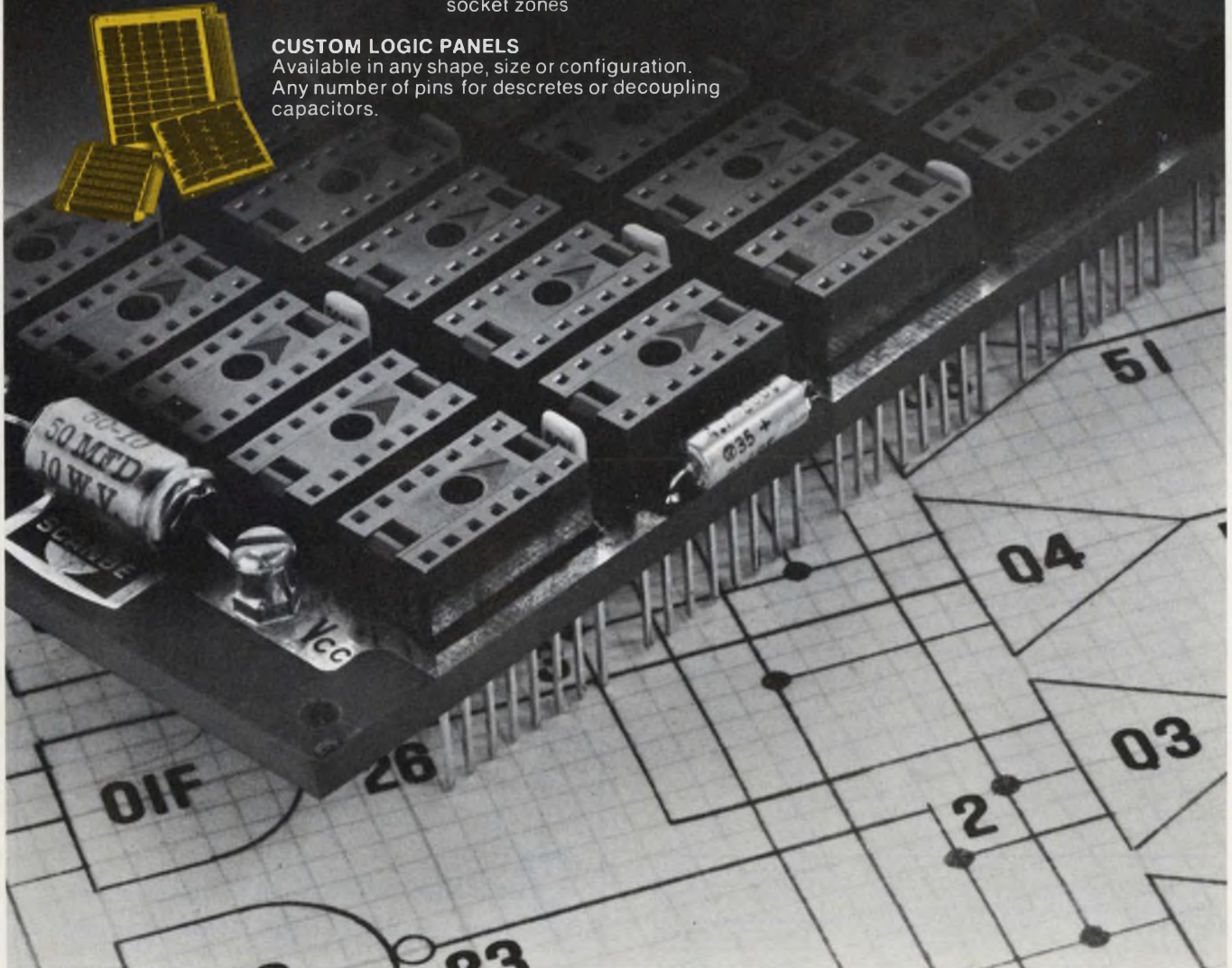

INFORMATION RETRIEVAL NUMBER 99

54 in.³ power supply yields 50 W dc

Abbott Transistor Laboratories, Inc., 5200 W. Jefferson Blvd., Los Angeles, Calif. 90016. (213) 936-8185. \$219 (1-4); 7 days ARO.

Abbott has developed a new technique that allows conversion of low-frequency ac lines (47 to 440 Hz) to 50 W of regulated power in a package that measures 4 x 6 x 2-1/4 inches and weighs three pounds. The Model Z9 delivers 9 A of output current. Dc outputs between 6 and 6.6 V dc are series-regulated to within 0.15% total for input voltage changes of no load to full load. Ripple is less than 0.02% rms or 50 mv pk-pk. Tempco is typically less than 0.01%/°C over the range of -20 to +80 C. Model Z9 is protected against short circuits of any duration and input transients of 180 V ac for 0.1 s. Standard features include remote error sensing and parallel operation.

CIRCLE NO. 339

Retroreflective scanner is self-contained

Micro Switch-Farmer Electric, Natick, Mass. 01760.

The Model Retro 4B scanner provides on/off control. A standard, cast-aluminum, watertight-housing contains an amplifier, light source, photocell, a SPDT relay rated at 10 A noninductive, and a transformer with an input of 115 V, 50/60 Hz. The standard unit scans up to 15 feet (4.6 m), with light energizing the relay. The No. 15 lamp has a life of 10,000 hours, while the Type J offers a 60,000-hour lamp life. The photocell is a silicon phototransistor. The unit is available in NEMA 4, 5 and 12 construction and operates from -22 to 150F. Options include on delays, off delays, dark operation, lamp-failure indicator, LED or neon output indicator, slim-line construction, 230-V operation, adjustable sensitivity, diasable terminal, and lamp safety circuit.

CIRCLE NO. 340

Thermocouple amplifier boosts signals by 100X

Omega Engineering, Inc., Box 4047, Stamford, Conn. 06907. (203) 322-1666. \$85.00.

The new OMNI-AMP I miniature thermocouple amplifier is a self-powered, completely portable microvolt amplifier that will boost thermocouple signals up to 100 times. This unique device can be placed directly at a thermocouple output jack or inserted between any standard thermocouple quick disconnect. OMNI-AMP I is ideally suited for use with fast response, fine gauge thermocouples. It is driven by two mercury cells, which will last over 100 hours in continuous service. A choice of seven fixed gains plus a variable gain are provided. These are settable by means of a recessed rotary selector switch. The frequency response is from dc to 10 kHz. The complete amplifier, including batteries, weighs less than eight ounces.

CIRCLE NO. 341

Compare Maxi-Mox to whatever resistor you're using now.

Our Metal Oxide Resistors Offer You Small Size and Reliability at High Voltage.

Compare Maxi-Mox vs wire wound. Our Maxi-Mox gives you equal stability and power capability in half the size and even greater stability and service life at high voltages.

Maxi-Mox resistors have resistance and voltage capabilities that far exceed metal film types. And size . . . Maxi-Mox resistors are three to ten times smaller than comparable value metal film units.

Maxi-Mox is available for fast delivery from stock in five standard sizes. With 100 ppm TCR available.



Model	Resistance Range	Power Rating @ 70°C	*Max. Oper. Volts	Length Inches	Diameter Inches
MOX-1	10K-500 megs	2.50W	7,500V	1.062	.284
MOX-2	20K-1000 megs	5.00W	15,000V	2.062	.284
MOX-3	30K-1500 megs	7.50W	22,500V	3.062	.284
MOX-4	40K-2000 megs	10.00W	30,000V	4.062	.284
MOX-5	50K-2500 megs	12.50W	37,500V	5.062	.284

For detailed specifications on Maxi-Mox, send for this technical bulletin. Victoreen Instrument Div. of VLN Corp. 10101 Woodland Avenue, Cleveland, Ohio 44104. Telephone: 216/795-8200.

DMA 688



Expertise in high voltage



CONDUCTIVE ELASTOMERS

- Highly to moderately, electrically conductive compounds to provide tailor-made electrical and mechanical properties
- Volume resistivity from .001 to 100,000 ohm-cm
- Molded parts
- Extruded shapes
- Standard sheets
- Heating
- Motion-sensing
- Static discharge
- Grounding
- Inter-Connecting
- Contacting
- Write for data #850.



TECKNIT® Technical Wire Products, Inc.

Eastern Division • 129 Dermody St., Cranford, NJ 07016 (201) 272-5500
Western Division • 427 Olive St., Santa Barbara, CA 93101 (805) 963-1867

10-bit d/a converter comes in 16-pin DIP

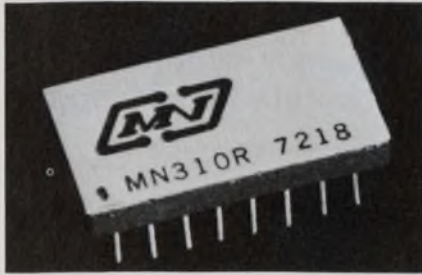

Micro Networks Corp., 5 Barbara Lane, Worcester, Mass. 01604. (617) 753-4756. \$39 ea. (1-24); \$23 ea. (250); stock.

Model MN310R is a complete multichip 10-bit d/a converter in a 0.490 × 0.900 × 0.140-inch 16-pin DIP. The unit includes monolithic switching networks, precision thin film resistor network, an op amp and internal reference. Slew rate is 0.5 V per μ s and settling time is 3 μ s max. Power consumption is a low 600 mW max. Output voltage is 0 to -10 V. The unit is TTL logic compatible and utilizes standard \pm 15 V supplies. Linearity is guaranteed \pm 1 LSB over the range of 0 to 55 C.

CIRCLE NO. 342

FET-input op amp offers \pm 5 μ V/ $^{\circ}$ C drift

Function Modules, Inc., 2441 Campus Dr., Irvine, Calif. 92664. (714) 833-8314. 350K: \$49 (1-9); 350J: \$35 (1-9); stock.

All FET-input op amps have high input impedance and low bias currents when compared with monolithic IC op amps. But low-cost FET op amps typically have high voltage drifts, high noise levels, and poor long-term stability. Function Modules has overcome the usual limitations of FET op amps in their Models 350J and 350K. A monolithic FET-input pair selected for low drift and low noise is used in the input stage. Key specs of the 350K are: input voltage drift of \pm 5 μ V/ $^{\circ}$ C, max.; input bias current of \pm 5 pA, max.; input voltage noise of 3 μ V pk-pk max (0.01 to 10 Hz) and 3 μ V rms max (10 Hz to 10 kHz); input current noise of 0.1 pA pk-pk (0.01 to 10 Hz); and a CMRR of 10^4 . The package is a 7-pin epoxy module that is 1.12 × 1.12 × 0.5 inches. The 350J has a maximum drift of \pm 15 μ V/ $^{\circ}$ C.

CIRCLE NO. 343

Great little tester...

the Simpson Handi-VOM[®]



Goes anywhere:

Small and light enough to carry in your shirt pocket, tool box or brief case. 3 $\frac{5}{16}$ " wide by 4 $\frac{9}{16}$ " high by 1 $\frac{3}{4}$ " deep. Only 12 ounces.

Does big-VOM jobs:

Ranges: DC Volts: 0-0.25, 1.0, 2.5, 10, 50, 250, 500, 1000 at 20,000 Ω /v. AC Volts: 0-2.5, 10, 50, 250, 500, 1000 at 5,000 Ω /v. DC Microamperes: 0-50. DC Milliampers: 0-1, 10, 100, 250, 500. Resistance: Rx1 (30 Ω center), Rx10, Rx100, Rx1k, Rx10k.

Has big-VOM features:

Accuracy: \pm 2% F.S. DC, \pm 3% F.S. AC. Self-shielding: Taut Band Movement. Varistor Protected: Resists 200,000% overloads. Tough, Rugged Case: Withstands even a bench fall.

Priced Right:

Model 160 with batteries, test leads and operator's manual	\$57.50
Vac-formed or leather carrying case	\$11.00
Amp Clamp Adapter lets you measure up to 250 amps in six ranges, Model 150	\$30.00
Adapter plugs	\$ 1.55

In stock at electronic distributors everywhere or write for Bulletin 2080

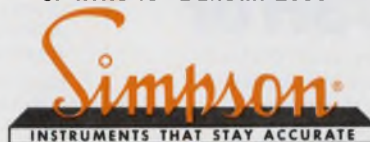

SIMPSON ELECTRIC COMPANY

5200 W. Kinzie St., Chicago, Ill. 60644, Phone: (312) 379-1121
Export Dept: 400 W. Madison St., Chicago, Ill. 60606, Cable SIMELCO
IN CANADA: Bach-Simpson, Ltd., London, Ontario
IN INDIA: Ruttonsha-Simpson Private, Ltd., International House, Bombay-Agra Road, Vikhroli, Bombay

Precise power supplies yield 0.25% accuracy

Hewlett Packard, 1601 California Ave., Palo Alto, Calif. 94304. (415) 493-1311. 6104A: \$440; 6105A: \$455; 6114A: \$525; 6115A: \$540.

Four high-accuracy, dc-power supplies have been introduced by HP. Two of the supplies, Models 6114A and 6115A, use four-digit pushbutton switches plus a 5th-digit vernier for rapid and accurate voltage setting. Output voltage accuracy is 0.025% plus 1 mV, with 200 μ V resolution. The other two supplies, Models 6104A and 6105A, are designed primarily for remote programming applications. Warm-up time to rated accuracy is five minutes. Models 6104A and 6114A provide 0 to 20 V at up to 2 A, and 20 to 40 V at up to 1 A, without manual switching. Models 6105A and 6115A give 0 to 50 V at up to 0.8 A, and 50 to 100 V at up to 0.4 A.

CIRCLE NO. 344

Log picoammeter handles 8 decades

Keithley Instruments, 28775 Aurora Rd., Cleveland, Ohio 44139. (216) 248-0400. \$875 to \$950; 90 days, ARO.

The 26000 series of all solid-state, logarithmic picoammeters display up to eight decades on a single meter scale without the need for range changing. The instruments are available with a number of range options in the span of 10^{-13} to 10^{-3} A (10^{-11} to 10^{-3} A, for example). Options include: positive-only, negative-only, or dual polarity input. Other specs are: A tempco of less than 2%/°C, referred to input current, from +10 to +30 C; a rise time (seconds to 90% of final current value), for the Model 26100, of three to six seconds, depending on input capacitance; departure from an ideal linear log relationship of less than 10 mV.

CIRCLE NO. 345

Frequency synthesizer is accurate to ± 10 ppm

Syntronics, Inc., 169 Millham St., Marlboro, Mass. 01752 (617) 481-7827. \$495.

A new, precision frequency synthesizer with an output range of 0.1000 Hz to 9.999 MHz has been introduced by Syntronics, Inc. The solid-state instrument puts out a TTL-compatible square-wave signal having a frequency accuracy and stability of ± 10 ppm from 0 to 50 C (with 1 ppm from 0-50 C available as an option). Frequency, to four significant figures, is selected manually by means of front-panel thumb wheels and a rotary switch which selects one of eight available ranges. Decimal point position is automatically indicated by LEDs on the front panel. The new unit measures only 8-3/4 \times 3-1/8 \times 6-3/4 inches and weighs approx. 5-1/4 lbs. Power requirements are 115 V, 50-60 Hz at 17 W.

CIRCLE NO. 346



FLICK or PUSH or TURN.

Flick the toggles, push the push-buttons, and turn the rotaries. They're miniature, subminiature or microminiature — they're very dependable yet competitively-priced — they're made-in-America so they're available off-the-shelf. And the prices are right. See for yourself. You'll find them all in the widest possible selection available anywhere in C&K's 16-page switch catalog shown above. It's yours for the asking.

C&K COMPONENTS, INC.

103 Morse St., Watertown, Mass. 02172, (617) 926-0800
Visit C&K at WESCON, Booth #2800.

INFORMATION RETRIEVAL NUMBER 103

best buy



\$ 1195.

5 1/2 DMM

Here's a precision DMM that delivers outstanding performance at a savings of 50%. Our 5 1/2 digit Model 2540 gives you DC Volts, AC Volts, Resistance, Voltage Ratio, Auto-Ranging, Auto-Polarity, Isolated BCD Outputs, Remote Triggering and Remote Ranging.

Basic accuracy is $\pm 0.001\%$ f.s. $\pm 0.007\%$ rdg. ± 1 digit guaranteed for 6 months, documented by full test data and Certificate of Conformance. All for \$1195.

Choose from eight 5 1/2 digit and 4 1/2 digit models. Call or write Bob Scheinfein (617) 246-1600, Data Precision Corp., Audubon Road, Wakefield, Mass. 01880.

DATA PRECISION
...years ahead

Visit us at WESCON.

INFORMATION RETRIEVAL NUMBER 104

ELECTRONIC DESIGN 19, September 14, 1972

high power linear amplifiers from MCL

Reliability in linear amplifiers begins with cavity amplifier design. MCL combines today's most advanced cavity designs with regulated power supplies, metering and cabinetry for total system dependability.

For example, MCL Model 10581 linear amplifier system covers a frequency range of 200 to 400 MHz for dependable command communications. Bandwidth at 3 db is 4 MHz and gain is 13 db. Servo controlled automatic tuning is available as an option. And MCL can provide this amplifier in the exact power and frequency configuration you require.

A wide range of high-reliability amplifier systems in addition to Model 10581 are available from MCL. For complete specifications on the amplifier that meets your high power microwave requirements, call (312) 354-4350, or write: MCL, Inc., 10 North Beach Avenue, La Grange, Illinois 60525.

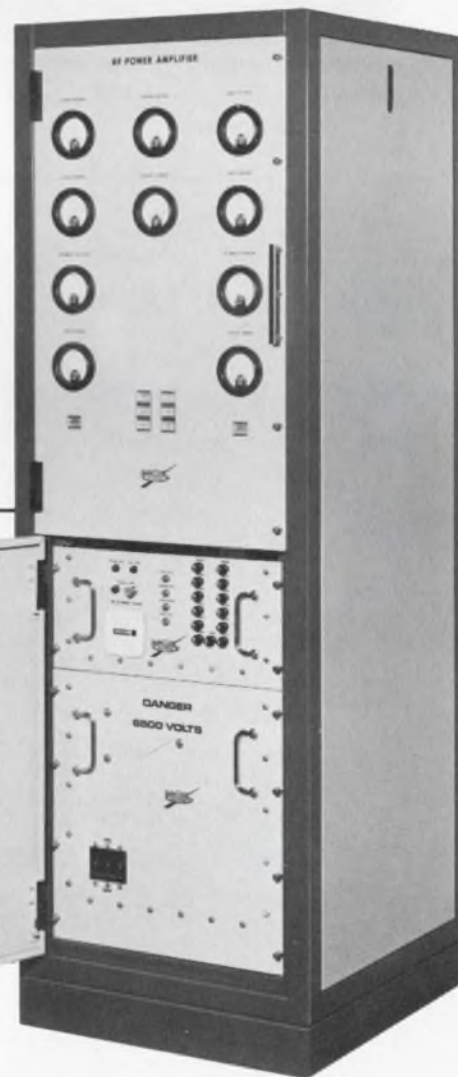

Opportunities developing now for RF engineers at MCL, Inc.—an equal opportunity employer.

INFORMATION RETRIEVAL NUMBER 105

0.02% DMM gives four digits for \$595

John Fluke Manufacturing Co., P.O. Box 7428, Seattle, Wash. 98133. (206) 774-2211. \$595.

The Model 8100B, a 0.02% digital multimeter, is now available from the John Fluke Manufacturing Co., Inc., at a saving of \$100 over the 8100A. The new Fluke 8100B measures ac and dc volts in four ranges to 1200 V and ohms in five ranges to 12 MΩ. Readout is for full digits plus "1" for 20% overranging. Features include an active two-pole switchable filter and automatic polarity indicator. All functions are pushbutton selectable. For \$100 extra, a rechargeable battery pack can be added to give the user complete portability with up to eight hours continuous operation from one charge. Other options include rf and high voltage probes, switched ac-dc current shunts and data output.

CIRCLE NO. 347

50 μV/cm oscilloscope has automatic timebase

Heath/Schlumberger Scientific Instruments, Hilltop Avenue, St. Joseph, Mich. 49085. (616) 983-3961. \$495.

The SO-29A high-gain oscilloscope provides seven calibrated sensitivity ranges from 50 μV/cm to 150 mV/cm. A completely automatic timebase with seven calibrated ranges from less than 3 sec/cm to 1 ms/cm allows hands-off triggering. When the waveform is less than the trigger threshold the timebase circuits automatically generate a baseline. Additional features include automatic intensity ranging to prevent phosphor burning on lower sweep speeds; regulated 9 V @ 20 mA and unregulated 20 V @ 30 mA voltages available for driving transducers; extremely low (10⁻¹¹ A) input bias current; 500-V transient, 150-V continuous input protection.

CIRCLE NO. 348

3-1/2-digit DMM is also a 10-MHz counter

Valhalla Scientific Inc., 7917 Balboa Ave., San Diego, Calif. 92111. (714) 277-2732. \$395; stock.

The Model 3003 DMM-counter offers a new solution for calibration and testing requirements. With both a frequency counter and ac-voltage measurement capability, the unit is ideal for response tests. It can measure center frequency and deviation limits associated with FM tape recorder calibration requirements. Model 3003 has 31 range-function combinations. These include: 5 ranges of both dc and ac volts, with 100 mV resolution; 6 ranges of ohms with 100 mV resolution; 6 ranges of ohms with 100 milliohms resolution; 5 ranges of both dc and ac current with 100 nA resolution; and 5 ranges of frequency counting to 10 MHz full scale. The basic accuracy of the instrument is 0.1%.

CIRCLE NO. 349

Need second-source for 0034 high-speed Dual Level Shifter?

A high quality, thin film hybrid. The Halex Model HX 0034 is intended for interfacing with MOS and junction F. E. T. circuits. Available in TO-100 and 14-lead dual in-line (HX 0034 DIP) packages. HX 0034 pin-for-pin replacement, \$15 each; HX 0034 DIP, \$18 each (100-piece lots). Off-the-shelf delivery.

For more information on the HX 0034, and HX 0034 DIP, high-speed Dual Level Shifter, and Halex custom microcircuits, precision resistor networks, and facilities, please write or call **Halex, Inc.** Box 2940 Torrance, California 90509 (213) 772-4461, (213) 542-3555, Telex 65-3442

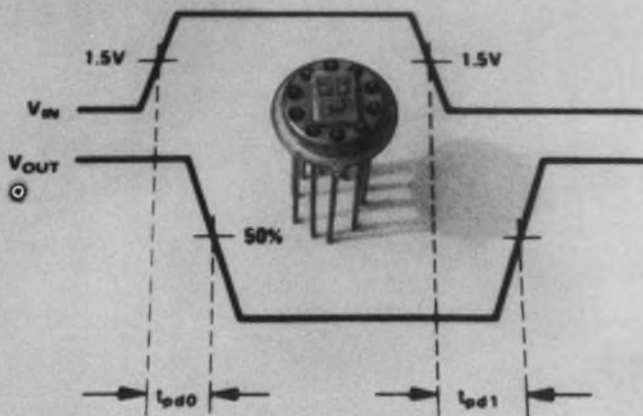

INFORMATION RETRIEVAL NUMBER 106

WHY PAY MORE AND GET LESS?

ALLEN AVIONICS
SPIRADEL®



(Now including Dual-in-Line "MINI" & "MIDI.") World's most advanced Delay Line, featuring low cost, high quality & small size.

FAST PROTOTYPES!

L-C
FILTERS



An economical source for custom-built prototype units. Filters can often be shipped in as little as 2 or 3 days.

WRITE FOR
NEW FILTERS
& DELAY
LINES
CATALOGS



SEE OUR PAGES IN EEM



INTRODUCING OUR NEW LINE
OF STANDARD-STOCKED
VARIABLE & FIXED
ATTENUATORS

Also available:
Custom-built Attenuators.

SEE US AT THE
WESCON SHOW — BOOTH 2209

ALLEN AVIONICS, INC. MFR. OF FILTERS & DELAY LINES
224 E. 2nd STREET, MINEOLA, N. Y. 11501 • Phone: 516-248-8080

INFORMATION RETRIEVAL NUMBER 107

Rf sweeper provides 10 mW to 18 GHz



Weinschel Engineering, Box 577, Gaithersburg, Md. 20760. (301) 948-3434. \$1450 (w/o plug-in); stock to 30 days.

The Model 430A Solid-State Sweeper is offered with a series of seven oscillator plug-in units to achieve a sweepable frequency range of 0.01 to 18 GHz. Internally leveled rf output power of these plug-in units is at least 20 mW from 0.01 to 2 GHz (40 mW from 1 to 2 GHz), 15 mW from 2 to 4 GHz, and, with the high power option, at least 10 mW across the 4 to 18 GHz range. Output power variation with internal leveling is ± 0.5 dB to 8 GHz. The unit's features include automatic sweeping, 0 to 100% symmetrical sweeping, stable CW, AM, and FM.

CIRCLE NO. 350

3-digit sig gen covers 50 kHz to 80 MHz



Logimetrics, Inc., 100 Forest Dr., Greenvale, N.Y. 11548. (516) 481-2222. \$1730.

A new AM signal generator, covering the 50 kHz to 80 MHz range, has been introduced by Logimetrics, Inc. The new instrument, Model 921A, provides three-digit frequency readout on a Nixie-tube display. In addition to the three-digit accuracy (0.01 to 1%), this solid-state unit provides a built-in overrange capability. Harmonic output of the unit is greater than 30-dB down and spurious AM, hum and noise sidebands are at least 70-dB down. The rf output level is maintained constant at better than 0.5 dB throughout the frequency range and a full 3 V is available from a 50 ohm source.

CIRCLE NO. 351

Which of these General Electric lamps can help you most?

New Green Glow Lamp!

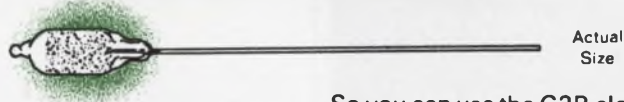

Finally, a broad spectrum bright green glow lamp from General Electric, that gives you greater design flexibility than ever before. It emits green and blue light with suitable color filters. It is called G2B.

What's more, the G2B is directly interchangeable electrically and physically with our high-brightness C2A red/orange/yellow glow lamp.

So you can use the G2B alone for 120 volt green indicator service. Or together with the C2A to emphasize multiple functions with color. For example: for safe/unsafe functions, dual state indications and to show multiple operations in up to 5 colors.

And remember. Both the G2B and C2A save you money because of their low cost, small size and rugged construction.

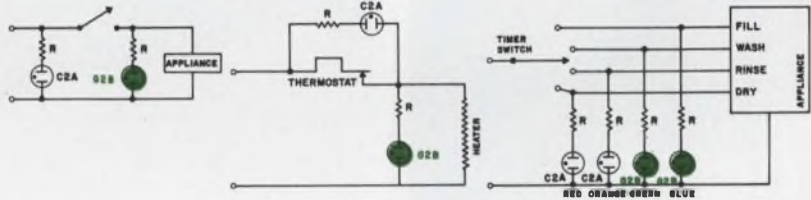

New Sub-Miniature Wedge Base Lamp.

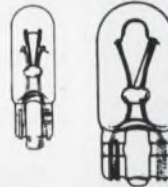

If space for indicator lights is your problem, this new GE T-1 $\frac{1}{4}$ size all-glass wedge-base lamp is your solution. It measures less than $\frac{1}{4}$ " in diameter.

The filament is always positioned

in the same relation to the base. It won't freeze in the socket, which virtually ends corrosion problems. And like its big brother — the T-3 $\frac{1}{4}$ wedge base lamp — it features a simplified socket design.

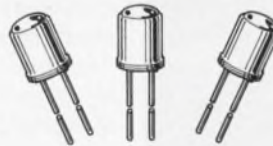

Get more than twice the useful output of other GE solid state lamps with GE SSL-54, SSL-55B and SSL-55C.

The increased energy concentrated in a narrow 20° cone allows you to use less sensitive detectors. Or to operate the lamps at lower current. Or to space lamps and detectors

farther apart.

All are excellent matches for GE photodetectors and can be used in many photoelectric applications. They're also particularly useful in applications demanding an infrared source capable of withstanding severe shock and vibration.

To get free technical information on any or all of these lamps, just write: General Electric Company, Miniature Lamp Products Department, Inquiry Bureau, Nela Park, Cleveland, Ohio 44112.

GENERAL ELECTRIC

New solid-state lifetime switches are Magic Dot's contribution to state of the art. They operate on a capacitance principle, have no moving parts—and last a lifetime.

Unique design advantages include:

- Will not jam, wear or change characteristics
- Logic compatible with zero bounce
- Completely sealed for continuous performance in hostile environments
- Flexibility in size, shape and output characteristics
- No 'behind panel' space and ¼" to ½" height

New Magic Dot switches can give you the competitive edge by significantly enhancing the performance, reliability and packaging of your product, while they permit the mere touch of a finger to become man-to-electronics interface. Write or call today for detailed technical and applications information.

**these
switches
don't know
switches
fail!**

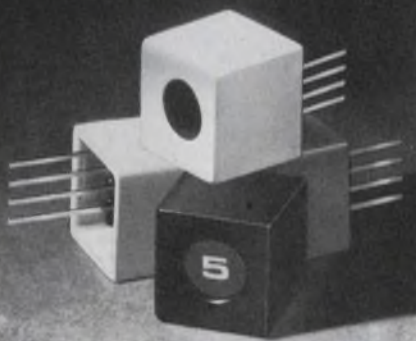

**magic
dot**

MAGIC DOT, INC.

40 Washington Avenue South
Minneapolis, Minnesota 55401
612/333-8161

WESCON Booth #2921

DATA PROCESSING

Data logger can operate 6 months on car battery



Monitor Labs, Inc., 10451 Roselle St., San Diego, Calif. 92121. (714) 453-6360. \$3200; 60 days.

Portable, battery-operated data-logging systems are finding a growing demand in the industrial and pollution-control fields.

A system that monitors 64 analog inputs, weighs only 20 lbs, costs \$3200 (for the basic mainframe) and can operate on a 12-V auto battery for six months has been introduced by Monitor Labs. The basic mainframe, called the 9100, includes an analog-to-digital converter, a preamp, logic and a clock.

The addition of 64 channels of CMOS or FET multiplexing costs an additional \$1200. Alternatively, 64 channels of reed-relay multiplexing costs \$1600. CMOS and FET multiplexing can be added incrementally in 16-channel modules. Reed-relay multiplexing is available in eight-channel modules.

With CMOS multiplexing, up to 10,000 channels/s can be scanned. Available full-scale voltage ranges are ± 0.1 V, ± 1.0 V and ± 10 V. A typical scan includes logging of the year, day, hour, minute, second,

channel identification, channel data reading and optional external data.

Interfaces can be provided to record the scanned data on any of several different magnetic-tape decks or paper-tape punches. Also, channel information is provided on the data logger in the form of a LED digital display.

Sensitivity of the input preamplifier is 100 μ V on the 0.1-V scale. This can be increased with an optional op-amp input stage that provides variable gain of between 40 and 300, with a separate gain control for each channel.

External sensors can automatically be warmed up prior to a scan. Scan intervals can be set from 0.01 s to nine days in several steps.

Power consumption of the data logger with a CMOS multiplexer is 240 mW (standby) and 4 W (operating).

The basic 9100 operates from 0 to 50 C. An extended temperature version is available, called the 9100 ET, and it works from -40 to $+65$ C. This version costs an additional \$500. Humidity of up to 95% at 40 C, noncondensing, is considered tolerable.

CIRCLE NO. 352

Safety is no big thing.

Microtemp Safety Thermal Cutoffs*

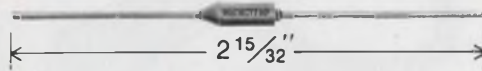

Actual Size

Experts in electronic safety have come to recognize the importance of positive circuit cutoff. The MICRO-TEMP safety thermal cutoff is the most reliable, accurate and inexpensive thermal cutoff available to the electronic industry. It assures positive protection against overheating for circuits and electrical components.

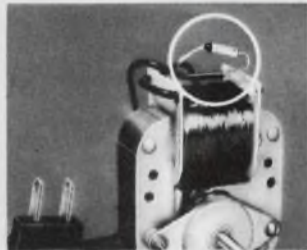

Typical application . . .
Upper limit motor protector

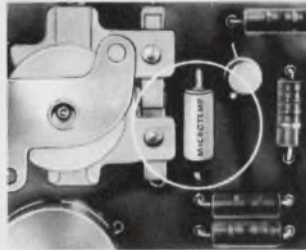

Typical application . . .
Circuit over-temperature protector.

During the past 10 years, millions of Microtemps have protected reliably in applications ranging from control thermostat backup protection to upper limit thermal cut-offs with accuracy to $\pm 3^{\circ}\text{F}$. For further information or assistance in your specific application, call or write . . .

*UL/CSA Listed



MICRO DEVICES CORP.

P.O. Box 501 Far Hills Station Dayton, Ohio 45419 (513) 294-0581

INFORMATION RETRIEVAL NUMBER 110

a better way . . .

JOT DRAFT™

RUB . . . IT'S TRANSFERRED

PERFECT REGISTRATION because you position patterns first, then rub them down.

CORRECTIONS ARE EASY because you can lift patterns with a knife and reuse them.

TOUGHER THAN STICK-ONS because the ink is underneath a hard plastic over-coat.

Try the JotDraft Sampler and convince yourself. It's an assortment of 746 patterns and pads (2X scale) for \$4.50. Or write for a free sample and catalog. You'll be glad you did!

The **DATAK Corporation**

85 Highland Avenue • Passaic, New Jersey 07055

INFORMATION RETRIEVAL NUMBER 111

ELECTRONIC DESIGN 19, September 14, 1972

New low-cost thumbwheel switch kit . . . mounts directly to your PC board!



EECO's 8000-series rotary switches let you incorporate the stator (switching pattern) as part of your board circuitry. You save on assembly time, save on interconnect wiring, save on switch mounting hardware. And you save on part cost: price of each kit is around \$2.00, in production quantities. Options include six colors, extra-wide and thin widths, lighted face, and single or double mounting. Paliney brushes provide a service life of over 1,000,000 detent operations.

Free Kit

If you use PC boards and rotary switches — or plan to — you need our Series-8000. Just circle reader number. We'll rush you specifications and a sample switch kit.

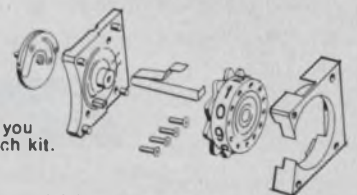

Electronic Products Division
Electronic Engineering Company of California
1441 East Chestnut Avenue, Santa Ana, California 92701
Telephone: (714) 547-5651

INFORMATION RETRIEVAL NUMBER 112

185

Card and code control access to secure areas



Remvac Systems Corp., 115 Fourth Ave., Needham Heights, Mass. 02194. (617) 449-0800.

Entry into secure areas requires possession of a properly-coded Remvac card and knowledge of a four-letter code. The Model 820 card reader scans the nonmagnetic, invisibly-coded card while the user enters a code word. When an incorrect or out-of-sequence button is pressed, the unit locks, preventing entry for a controllable time period. An optional alarm unit is available.

CIRCLE NO. 353

Secure-data cable uses infrared light



Quadri Corp., 2950 W. Fairmont, Phoenix, Ariz. 85017. (602) 263-9555.

Opticable I is an optical cable that uses infrared light as the transmitting medium. This makes the signals impervious to electromagnetic and electrostatic fields. Also, common techniques for detection and recognition of transmitted data outside the cable are prevented. The Models 2402-01 (5 MHz and 50 ft long) and 2402-02 (1 MHz and 70 ft long) are TTL compatible.

CIRCLE NO. 354

Card reader optically scans hand-marked card



Raymond Engineering Inc., 217 Smith St., Middletown, Conn. 06457. (203) 347-5611.

Card reader, Model 7901, is a ruggedized general-purpose, digital-data entry device. It optically senses and transmits data to computers in a serial format at an average of 320 b/s (32 bursts of 10 kb/s). Data is contained on pre-printed or manually marked cards with a capacity of 6400 bits. The card, illuminated by LED sources, is sensed by electronic-scanning photo units. Contrast adjustment is automatic.

CIRCLE NO. 355

Best buy power module for op amps

± 15 V (tracking) @ 400 ma...\$85

Line/load regulation of ±0.1% and ripple of 1.5 mv. 3.4" H x 5.1" W x 5.1" D. Order Model TD 15-40. For 1.0 amp outputs, specify TD 15-100. Price \$125. Other great buys are available to power balanced loads drawing from 25 ma to 8.5 amps. Three day shipment guaranteed. Five year warranty.

Acopian Corp., Easton, Pa. 18042
Telephone: (215) 258-5441

THE LOVE SWITCH

MINIATURE PRECISION THUMBWHEEL SWITCH

Our Customers Love Its
1,000,000 Detents (for high quality)
And Low Cost (for savings)!

9 Top Quality Features

1. .05 ohms max. contact resistance.
2. 200 megohms min. insulation.
3. 1,000 volts min. dielectric strength.
4. 2 amps @ 115VAC current carrying capability.
5. 125 ma @ 115VAC current breaking capability.
6. Mounts on 1/2" centers only 1 1/2" behind panel.
7. Glass laminate with precious metals contacts & plating.
8. Multi-applications—you name it.
9. Over 1,000,000 detents.

IMMEDIATE DELIVERY. ASK THE PRICE—BE PLEASANTLY SURPRISED.

CHICAGO DYNAMIC INDUSTRIES, INC.
PRECISION PRODUCTS DIVISION
1725 Diversey Blvd., Chicago, Ill. 60614 Phone 312, WE 5-4600

Keyboard code unit provides many code sets



Pickering Radio Co., Inc., Portsmouth, R.I. 02871. (401) 683-3100.

The kb/2000 is a keyboard code generator with many selectable output code sets such as International Morse, Baudot and ASCII in either serial or parallel form. It is designed to simulate the feel of a typewriter. The unit features, as an option, the ability to call up stored messages in the sequence selected by the operator while at the same time permitting the injection of characters or words.

CIRCLE NO. 356

Low-cost reader handles 1000 tab cards per min.



True Data Corp., 550 Newport Center Dr., Newport Beach, Calif. (714) 644-0240. \$1995 (unit qty); 60 days.

Easily interfaced with most existing controllers, the Model 1000, 80-column card reader is aimed at users who have programmable terminals or high-speed (9600 baud) line printers, operating at 600 line/min. or more. The reader uses a single rotating mechanism for picking, transport and stacking, and has a reflective, fiber-optic read head. It can handle up to 1000 cards/min.

CIRCLE NO. 357

NEW AT wescon BOOTH 1700

MODEL 102A SIGNAL GENERATOR



A frequency range of 5 to 520 MHz and low-distortion FM/AM feature the 102A. The FM bandwidth is dc to 200 kHz, with calibrated deviation to 300 kHz (uncalibrated to over 1 MHz). The AM bandwidth is dc to 200 kHz, with residual FM <0.25 ppm. Includes internal/external modulation, and six-digit LED frequency display. Price \$2700.

CIRCLE NO. 161

MODEL 93AD TRUE RMS DIGITAL VOLTMETER



Sensibly-priced true rms measurements from 300 μ V to 300 V, 10 Hz to 20 MHz, at a basic 1% accuracy are features of this programmable meter. The LED digital display, plus small edge-meter scaled in dBm, insures error-free readings. Selectable bandwidth and response time, BCD and analog outputs, are standard; dBm display and autoranging are optional. Price \$1135.

CIRCLE NO. 162

MODEL 72AD DIGITAL CAPACITANCE METER



A wide-range, basic accuracy of 0.25% and a resolution of 0.001 pF distinguish this new programmable capacitance meter. Values from 0.01 to 2000 pF are quickly measured at a 1 MHz test level of 15 mV rms. BCD and analog outputs are standard; available as options are autoranging and logic-level programming. Price: \$1135. (An analog version is available at \$875)

CIRCLE NO. 163

MODEL 172A CAPACITANCE RATIO TESTER



High-speed, simultaneous, semi-automatic measurements of semiconductor capacitance ratio at selected upper/lower bias limits, and of capacitance at a chosen bias, are now possible with the new 1 MHz digital 172A. BCD outputs, remote control, and autoranging are standard features. Ranges are 2 to 2000 pF fs, 0-20 ratio and 0-200 V bias. Price: \$2700.

CIRCLE NO. 164

**BOONTON
ELECTRONICS**
CORPORATION

ROUTE 287 AT SMITH ROAD
PARSIPPANY, NEW JERSEY 07054
TEL: (201) 887-5110
TWX: 710-986-8241

Manual punch weighs less than one pound

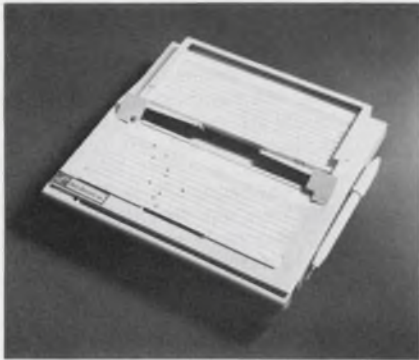

Data Products Corp., 6219 DeSoto Ave., Woodland Hills, Calif. 91364. (213) 887-8000. \$50 (unit qty).

Weighing less than one pound, the Model 200 Dynapunch, portable card punch, accommodates standard 40 and 80-column cards. This manual punch uses a stylus to enter data onto the card. Typical applications include meter reading, market research, inventory control, statistical data gathering, and EDP program corrections.

CIRCLE NO. 358

Data terminal handles mechanical design data



Spectral Dynamics Corp., P.O. Box 671, San Diego, Calif. 92112. (714) 278-2501.

Mechanical design analysis of structural configurations by a computer is made possible with the SD133 terminal. The terminal samples and digitizes up to eight analog voltages from a mechanical impedance system, which mathematically models the structure. The data is then stored in a recirculating memory, until all channels have been sampled, and transmitted in both serial and parallel form, using an ASCII code, at rates of 10, 15, 30 or 72 char/sec.

CIRCLE NO. 359

Circuit on PC card dials phone numbers

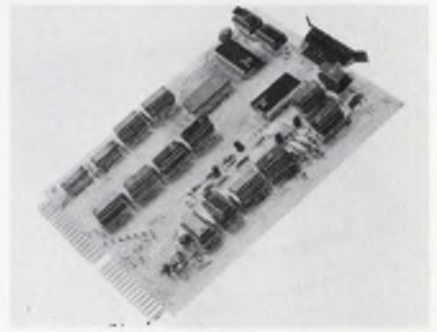

G-V Controls, Div. of Sola Basic Industries, 101 Okner Pkwy., Livingston, N.J. 07039. (201) 992-6200. Under \$100 (unit qty); stock.

The 906014 is a circuit on a 5-1/2 x 8 in. PC board designed to automatically poll telephone numbers either in sequence or individually upon discrete commands. One option retries the number if the first attempt finds it busy or not answering. Used in conjunction with G-V address modules, this sequencer can handle up to fifteen telephone numbers.

CIRCLE NO. 360

New PM

The people at Bodine have a new permanent magnet field D-C motor line: The 42A. Powerful and compact: Only 4.3" in diameter with continuous duty ratings of 1/8, 1/6 and 1/4 hp at 2500 rpm, 115V D-C. Plus parallel-shaft gearmotors in ratios up to 300:1. Output torques to 350 lb-in.

Delivers: exceptionally consistent output; high starting torque; low-speed operation; self-braking; surprising control capabilities; cool and quiet operation; outstanding brush life. Write for bulletin.

BODINE
ELECTRIC
COMPANY

BODINE MOTORS
GEARMOTORS
SPEED CONTROLS



Bodine Electric Co., 2528 W. Bradley Place, Chicago, Illinois 60618

INFORMATION RETRIEVAL NUMBER 115

CEM SPACERS



FREE samples... to prove stock spacers better, cost less than specials.

Why buy specials when we have 2.152 sizes and types of standard spacers in stock that are far better and less expensive than anything you can make, or buy. Anywhere.

You'll save drafting time by adapting C.E.M. standards. You'll get samples for prototypes when you need them. You'll eliminate tooling costs. You'll cut inventory costs. You'll get consistent quality - square ends, better roundness, no sharp burrs. You'll get immediate delivery. And you'll save a pot of money.

How can you beat all that? You can't. So send for our free samples of standard C.E.M. spacers. Complete engineering specs, prices, too. (203) 774-8571

CEM COMPANY, INC.
314 School St., Danielson, Ct. 06239

INFORMATION RETRIEVAL NUMBER 116

ELECTRONIC DESIGN 19, September 14, 1972

"THERE HAS TO BE AN EASIER WAY TO MAKE THESE REVISIONS."

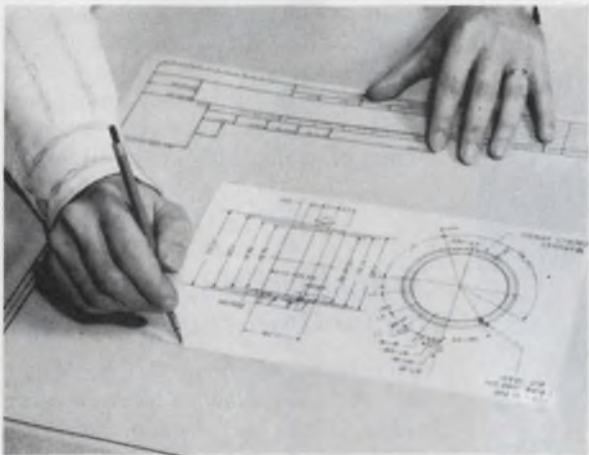

Shorten your drafting time with KODAGRAPH materials.

You've got a drawing that has to be revised, with new details to be added. You *could* redraw the whole thing, making the necessary changes in the process. But why not do it the easy way, with the help of a sharp, clear reproduction on Kodagraph film or paper?

From that reproduction, cut out the portions that are still useful, and tape them to a new drawing form. Then, make your revisions, redrafting only the portions that need changing. Finally, use Kodagraph film for a perfect print of the completed drawing.

For more ideas on saving design time with Kodagraph materials, fill out and mail the coupon.

Please send me complete details on the design shortcuts possible with Kodagraph materials.

Name _____

Position _____

Company _____

Address _____

City _____ State _____ Zip _____

Eastman Kodak Company
Business Systems Markets Division
Dept. DP871, Rochester, New York 14650

**PRODUCTS FOR
ENGINEERING DATA SYSTEMS**



**HIGH STABILITY
NPO
ATC 700 MINICUBE[®]
CHIP
CAPACITORS**



**UP TO
1000 pF IN A
.055" CUBE!**

☐ (ACTUAL SIZE)

- ☐ HIGHEST PACKAGING DENSITY NPO! !
- ☐ NO CAPACITANCE CHANGE WITH AC OR DC VOLTAGE
- ☐ 5100 pF IN A .110" CUBE
- ☐ READILY SOLDERABLE
- ☐ RUGGED

**UHF/MICROWAVE
CAPACITORS**

MINICUBE[®] is a registered trademark of ATC



**american
technical
ceramics**

1 NORDEN LANE
HUNTINGTON STATION, N. Y. 11746
516/271-9600 • TWX-510-226-6993

INFORMATION RETRIEVAL NUMBER 118

COMPONENTS

**High-contrast CRTs
read in bright sunlight**



Fairchild Camera and Instrument Corp., Dumont Electron Tubes, 750 Bloomfield Ave., Clifton N.J. 07015. (201) 773-2000. \$200 (unit qty) for 4 x 5 in. tube; 45 days.

Designated the HC-5000 series, a new line of ultra-high-contrast CRTs can be easily read in bright sunlight without the need for high power and hoods or shields. The tubes can legibly display five shades of gray, and they resist burn and fatigue.

CIRCLE NO. 361

**Resistor networks in
DIP aid logic designers**

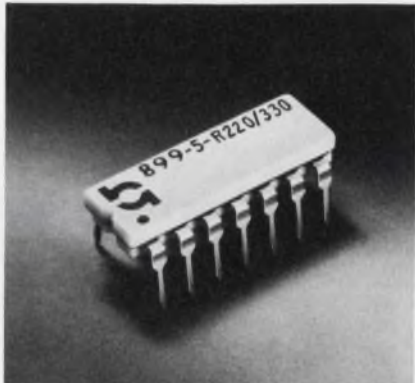

Beckman Instruments, Inc., 2500 Harbor Blvd., Fullerton, Calif. 92634. (714) 871-4848.

The series 898/899-5 DIP resistor packages are designed primarily for pulse-squaring networks or logic terminators. The resistors are series connected in groups of two with a common line for power and a common line for ground. The center point of each pair is brought out to a separate terminal for a total of 12 or 14 center points and two common lines.

CIRCLE NO. 362

**Neon lamp gives more
light than C2A brights**

Glowlite Corp., P.O. Box 698, Pauls Valley, Okla. 73075. (405) 238-5541.

Glowlite's H2A neon lamp puts out 50% more light and 35% more corona coverage than conventional C2A high-brightness neons at the same rated life. This T-2 lamp has 25,000-h average life with an 18-k resistor at 120 V ac. Formed-tip construction gives greater end-on illumination. The lamps are particularly suited for display panels under high-ambient light conditions.

CIRCLE NO. 363

**Fuse clips specially
designed for PC boards**

Bussman Manufacturing Div., McGraw-Edison Co., University & Jefferson St., St. Louis, Mo. 63107. (314) 421-1740.

A line of Tron fuse clips specially designed for PC boards is now available. One type has two mounting tabs bowed to hold the clip firmly while being wave soldered. Other clips are available with single mounting tabs. They can be furnished in beryllium-copper or spring-bronze metal with a wide range of solderable plating finishes.

CIRCLE NO. 364

**Transformers match
phone line requirements**

Microtran Co., Inc., 145 E. Mineola Ave., Valley Stream, N.Y. 11582. (516) LO 1-6050. \$3.10 to \$7.85 (100 up); stock.

Telephone coupling transformers, to interconnect voice and data-modem equipment, meet telephone company requirements for use on voice-grade telephone lines. The 11 items in the new series are designed for isolation, coupling, hybrid bridging, and holding-coil applications. The transformers have a frequency response of 300-3500 Hz ± 0.5 dB and a distortion of 0.5% max. over a signal level range of -45 dBm to +7 dBm. Balanced to 45 dB min., the transformers do not disturb line balance.

Booth No. 2206 Circle No. 365

BEAUTY AND CRAFTSMANSHIP... The Trimline Series

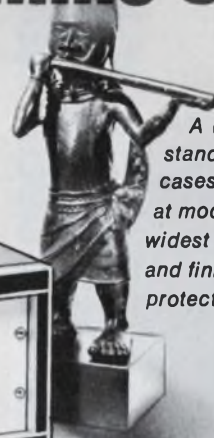

A distinctive line of standard enclosures and cases, available at moderate cost, in the widest range of sizes, colors and finishes to enhance and protect your product.



Complete catalog and prices on request.

PREMIER METAL PRODUCTS COMPANY

A Division of Sunshine Mining Company

337 Manida Street, Bronx, New York 10474 (212) 991-6600

OVER 1,200 ITEMS IN OUR GENERAL CATALOG

INFORMATION RETRIEVAL NUMBER 119

NOTHING ISOLATES LIKE OUR ISOLITES

Replace those old relays, reed relays and pulse transformers with up-to-date opto-isolators.

Litronix IsoLites give you faster switching speeds, no contact bounce, better reliability and 2500 volts electrical isolation. IsoLites can transmit from low frequency ac down to dc and eliminate ground loop problems. In long lines where common mode noise can build up, they may protect your equipment against a thousand volt jolt. Write for **free** application note and data sheets.

The 
bright guys
litronix

19000 Homestead Road, Cupertino, California 95014
(408) 257-7910 TWX: 910-338-0022

INFORMATION RETRIEVAL NUMBER 120
ELECTRONIC DESIGN 19, September 14, 1972

Reliable Precise Measuring device



Servo-Tek's SPEED INDICATING SYSTEM, a complete package for measuring speed in all applications. Nothing else to buy, no other black boxes, it's self-contained, it's self-powered.

- Accurate, Less Than 1% Full Scale
- Direct Reading — RPM
- Bidirectional and Suppressed Indicators Available

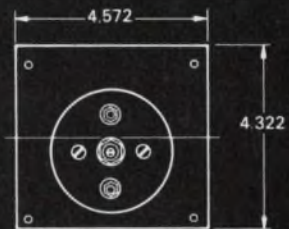
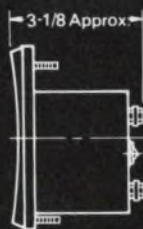

Ask for a copy of our NEW catalog.

SERVO-TEK[®]

PRODUCTS COMPANY

1086 Goffle Road, Hawthorne, N. J. 07506 • 201 - 427-3100
Servo-Tek of California, Inc.
8155 Van Nuys Blvd., Van Nuys, California 91402 • 213 - 786-0690

INFORMATION RETRIEVAL NUMBER 121

ONE MILLION ELECTRICAL LEADS

PER
SQUARE
INCH

Electrically conducting fibers through vacuum tight glass plate.

- Electrostatic Printing
- Projection Display
- Storage Targets
- Access through Vacuum Interface
- Mirror Caps on Conductor Ends

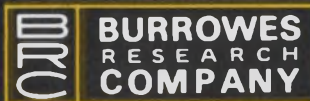

43 Bradford St., Concord, Ma. 01742
Tel.: 617/369-4442

INFORMATION RETRIEVAL NUMBER 122

Revolutionary New!!

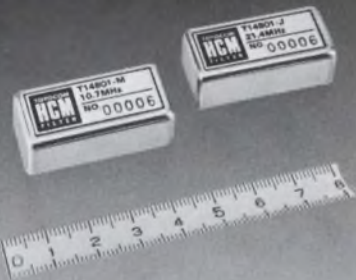

TOYO HCM FILTER T-1 SERIES

- **FEATURES:**
- These filters provide guaranteed rejection of 90dB. Their volume is 46.3% that of widely used 8-element conventional filters. Their height is only 12mm.
- Terminating conditions are uniform, allowing these filters to be used in a wide range of applications. These filters are fully compatible with other filters in terms of electrical characteristics. Ample consideration has been given to mechanical compatibility.
- Stringent environmental tests (shock and vibration tests) assure adequate quality control levels.

TOYOCOM
TOYO COMMUNICATION
EQUIPMENT CO., LTD.

EXPORT DEPARTMENT
TOYO BUILDING NO. 612, JINGU MAE
SHIBUYA-KU, TOKYO, JAPAN
CABLE: EXPORTOYOCOM, TOKYO
TEL: (03) 408-3355
TELEX: 02423001

INFORMATION RETRIEVAL NUMBER 123

PACKAGING & MATERIALS

PC connectors offer back panel mounting

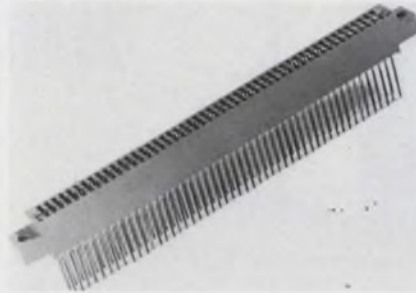

Elco Corp., Maryland Rd. & Computer Ave., Willow Grove, Pa. 19090. (215) 659-7000.

A family of discrete PC connectors, called Series 6307, are designed for back panel mounting and for point-to-point solderless wrapping. The connectors are available in five sizes: 25/50, 30/60, 36/72, 43/86, 50/100 contacts. The connectors feature bifurcated bellows contacts with 25-mil square solderless wrappable tails. The contacts are on 100-mil \times 200-mil centers and rated at 3 A and 6 m Ω resistance. The connector body is made of diallyl phthalate and accepts a 1/16-inch PC board.

CIRCLE NO. 366

Liquid-cooled heat sink features high efficiency

International Electronic Research Corp., Div. of Dynamic Corp. of America, 135 W. Magnolia Blvd., Burbank, Calif. 91502. (213) 849-2481.

A line of highly-efficient, liquid-cooled heat sinks is designed for use with pressure-mount semiconductors when space limitations and/or extremely high flux density prevent the use of natural or forced air cooling. The heat sinks feature a compact, extended surface design which can be used for single or double-side cooling of high current SCRs and diodes housed in the popular "hockey puck" package configuration. Efficiency of the new device is such that 1000 W can be dissipated with only a 20 C case rise. Fluids which may be used with the new device include H₂O, silicones, fluorocarbons and ethylene glycol.

CIRCLE NO. 367

Ag-filled epoxy boasts high bond strength

Transene Co., Inc., Route One, Rowley, Mass. 01969. (617) 948-2501. \$5.65/oz.; stock.

A low temperature thermo-setting silver product called Silver-Bond is used for conductive bonding in microelectronic assembly applications such as chip bonding of transistors and integrated circuits. It provides curing at 100 F and lap shear strength of 1500 psi.

CIRCLE NO. 368

Low voltage wire comes with adhesive backing

Hobby Hill, Inc., 415 N. State St., Chicago, Ill. 60610. (312) 944-2144. \$5/kit; stock.

Two thin strips of copper bonded to a pressure-sensitive plastic strip makes an invisible wiring for low-voltage applications. Conduct-O-Tape can be covered by paint, wallpaper or carpet. The wire is equivalent to 24 gauge and is rated at 5 A. The plastic coating is 1-mil nylon with a noncorrosive rubber backing. A complete kit consists of 10 feet of flat conductor, four corners, four splices, two adapter pieces, plus two wires to attach to leads from speakers, etc. Wire rolls are available with lengths from 5 to 500 feet.

CIRCLE NO. 369

Rectangular connector features self-mounting

Burndy Corp., Richards Ave., Norwalk, Conn. 06852. (203) 838-4444.

Qikmate, a nylon rectangular connector block, is designed for use with the Burndy Trim Trio system of power or subminiature coax contacts. The receptacle half of the connector snaps into a pre-punched rectangular chassis hole and holds in place with molded-in wings and stops. The plug then mates with quick disconnect type latches which grasp and retain the receptacle. Depressing the latches allows the two halves to be unmated easily. The connector block also features integral polarization to prevent mismatching and a molded protection skirt to protect the pins in the plug from possible damage.

CIRCLE NO. 370

Mini ⚡ Bus by Rogers

For noise and
cost reduction

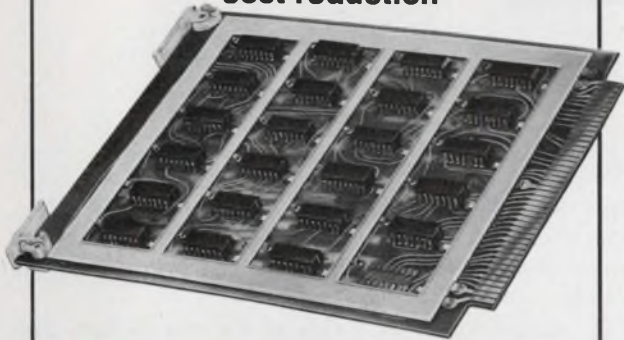

A small, voltage-distributing busbar for PC card application, each Mini/Bus gives you built-in capacitance . . . noise-cutting capacitance that means more reliable, compact circuit packaging at a fraction of multilayer prices. Write for data.



Rogers Corporation / Rogers, Conn. 06263

INFORMATION RETRIEVAL NUMBER 124

NO ONE

Customizes Switches Like CDI
Nor Has a More Complete Line

THUMBWHEEL SWITCHES



Completely sealed against
hostile environments.

ROTARY SWITCHES

Snap-in, snap-out
modules in seconds,
eliminating
downtime.

Tabet Pat.
2841660,
2971066,
3015000,
2956131,
2988607.

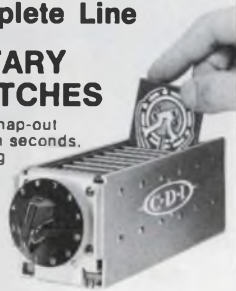

PUSHBUTTON SWITCHES



Miniature
add/subtract units
retrofit most minithumb-
wheel switch panel openings.



Mounts on
1/2" centers,
retrofits
most panel
openings
for miniature
thumbwheel
switches.

CDI earns its reputation every day for Consistently
High Quality, Consistently Good Delivery.



CHICAGO DYNAMIC INDUSTRIES, INC.

PRECISION PRODUCTS DIVISION
1725 Diversey Blvd., Chicago, Illinois 60614
Phone: 312. 935-4600

INFORMATION RETRIEVAL NUMBER 125

ELECTRONIC DESIGN 19, September 14, 1972

counting / timing application?

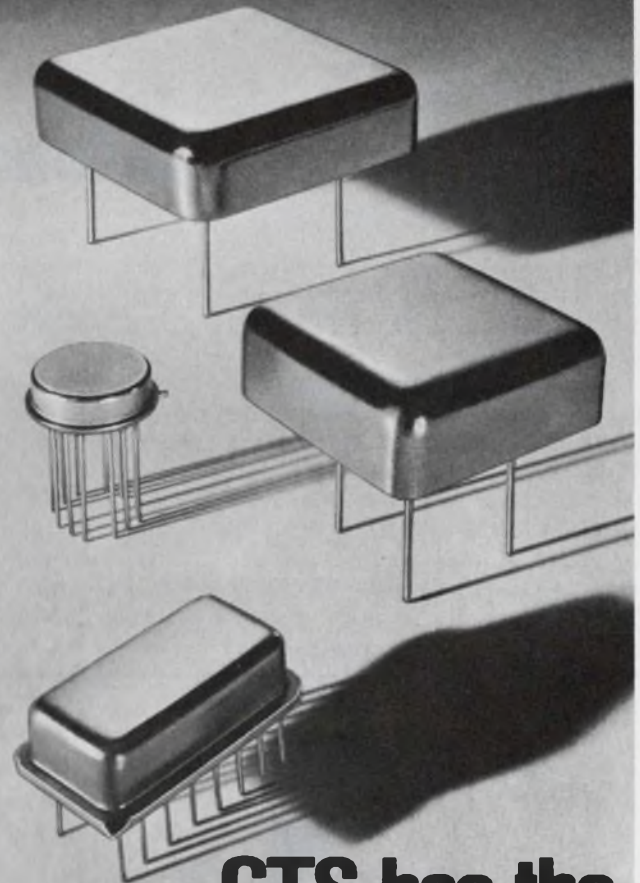

CTS has the oscillator you need.

Maybe it will be packaged in a standard can like our JKTO-77 and JKTO-78. Or our new JKTO-79, T0-8 package with a crystal-controlled hybrid microcircuit. Perhaps you'll need our low profile JKTO-73 for dual-in-line applications. In short, we have the right crystal oscillator for you.

And because these economical miniature oscillators are CTS designed and manufactured you can count on great operating characteristics. For example: Frequency Range: 20 KHz to 20 MHz; Stability: $\pm 50 \times 10^{-6}$; Operating Temperature: -55°C to $+125^{\circ}\text{C}$; Input: $+5\text{V DC} \pm 10\%$; Output: Square to drive TTL logic. (Other stabilities and temperature ranges are available.)

You get fast delivery on any CTS oscillator—at a price as likeable as the quality. For complete information write: CTS Knights, Inc., Sandwich, Illinois 60548. Phone: (815) 786-8411.

CTS CORPORATION
Elkhart, Indiana



INFORMATION RETRIEVAL NUMBER 126

37-GHz rcvr front end has 10-dB noise figure

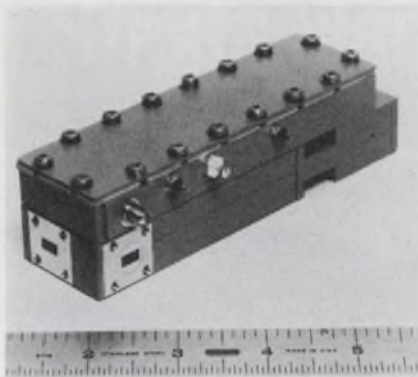

Control Data Corp., Boston Microwave Products Div., 400 Border St., E. Boston, Mass. 02128. (617) 569-2110.

An A-band receiver front end has a single sideband noise figure of 10 dB at 37 GHz. Termed the TRG Series A9100, the new unit also features a signal frequency range of 36.25-to-38.25 GHz, 3-dB i-f range of 670-to-1170 MHz and rf/i-f gain of 25 dB. VSWR is 1.5:1.

CIRCLE NO. 371

Scribing lasers permit accuracies in mils

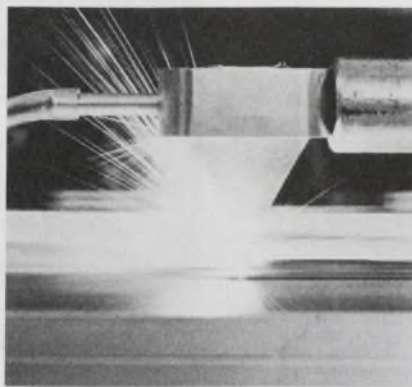

Apollo Lasers, Inc., 6365 Arizona Circle, Los Angeles, Calif. 90045. (213) 776-3343. 310: under \$5000; 320: under \$10,000; 4-6wks.

Moderately-priced CO₂ ceramic scribing laser systems feature precise scribe lines for accuracies to a few mils. The Model 320 laser can scribe 25-mil thick alumina at rates up to 4 ips. The Model 310 laser is capable of scribing 10-mil alumina at rates up to 1 ips. Both systems come complete with optics for use with a manual or motor-driven table.

CIRCLE NO. 372

Laser diodes emit 4-to-15 W peak power



Laser Diode Laboratories, Inc., 205 Forrest St., Metuchen, N.J. 08840. (201) 549-7700. \$8-27.60 (1000); stock.

A series of heterostructure gallium arsenide laser diodes, termed the LD60 series, boast minimum peak power of 4 W to 15 W. These diodes operate at 27 C up to duty cycles of 0.1% when biased in the forward direction with up to 200 ns current pulses. The diodes' small, TO-18 coaxial stud package locates the optical source on the studs' center rotational axis.

CIRCLE NO. 373

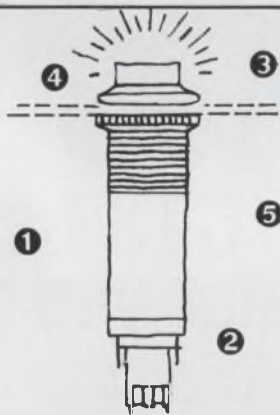

Push button—and lighted too!

Of course. The push button Series 80 lighted decorator line of switches from Grayhill. Your choice of:

- 1 **Actuation**—Momentary or alternate action.
- 2 **Circuitry**—Single pole, single throw; single pole, double throw; double pole, double throw.
- 3 **Styling**—Square, round, bezel, colors, lighted.
- 4 **Mounting**—Front panel, sub-panel or bushing. Lamps replaceable from front.
- 5 **Five designer colors** . . . and lighted too!

And if what you want isn't covered in the variations above, we can design one that is. We also have a companion line of indicator lights—Series 81.

For our latest Engineering Catalog write or phone: Grayhill, Inc., 565 Hillgrove Ave., La Grange, Illinois 60525. (312) 354-1040.

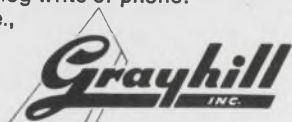

INFORMATION RETRIEVAL NUMBER 127

Now a *MINIATURE, RELIABLE*

Proportional Temperature Controller



RFL Model 70

For Only **\$3780** List Price

Controls Heat Precisely

FEATURES

- Wide temperature range
- Small size—3"x3½"x1"
- Adjustable gain & set points
- Up to 1.5 KW max. load
- Mounts easily for OEM use
- Controls to ±0.05°C of set point

APPLICATIONS

- Environmental chambers
- Induction heating equipment
- Constant temperature baths
- Injection molding equipment
- Vacuum forming machines
- Copy machine temperature control

Also custom temperature control and monitoring system



FREE Technical Data Booklet/write:

RFL Industries, Inc.
Thermocontrol Division • Boonton, N. J.

"SEE US AT WESCON. BOOTH 1213"

INFORMATION RETRIEVAL NUMBER 128

ELECTRONIC DESIGN 19, September 14, 1972

Miniature circulator lists 1-kW peak power

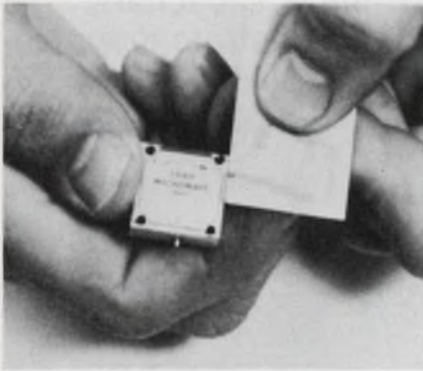

Trak Microwave Corp., 4726 Eisenhower Blvd., Tampa, Fla. 33614. (813) 884-1411. \$277 (6-10 pieces); 4-6 wks.

The Model 1419-1107, a 1.0 × 1.0 × 0.3 inch drop-in circulator, has a 1 kW peak, 50 W average power rating. Operating from 1.225 to 1.425 GHz, the circulator features 20-dB minimum isolation, 0.5-dB maximum insertion loss and 1.25:1 maximum VSWR. The new device can operate over the -40 to 71 C temperature range and in any 50-Ω stripline or microstrip circuit.

CIRCLE NO. 374

Duplexer offers 100-dB isolation across 3 MHz



Phelps Dodge Communications Co., Route 79, Marlboro, N.J. 07746. (201) 462-1880.

A base-station duplexer, designated catalog no. 526-509, has 100-dB isolation for 3-MHz minimum separation. It consists of six cavity resonators. When used in the normal fashion with three cavities in each channel, more than 120-dB of isolation is provided at 5 MHz spacing in the 450-470 MHz band and more than 100 dB isolation at 3 MHz when used in the 470-512 MHz range.

CIRCLE NO. 375

Automatic Industrial Controls

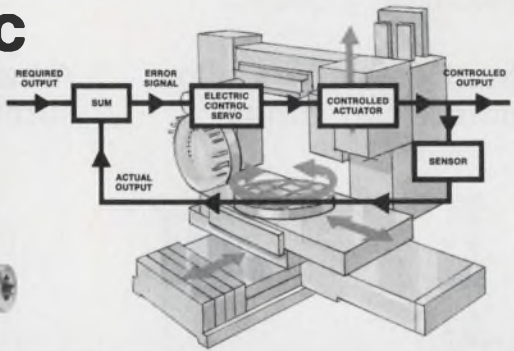

MPC COMPONENTS AND ELECTRIC SERVOS ARE ENGINEERED TO MEET THE INCREASING DEMANDS FOR INSTANTANEOUS AND PRECISE CONTROL OF TORQUE, SPEED AND POSITION FOR A WIDE RANGE OF INDUSTRIAL SERVO APPLICATIONS.

FEATURES:

- integrated component assemblies
- total capability
 - control & stepper motors
 - high capacity precision gearing
 - brushless position transducers
 - permanent magnet alternators
 - control electronics
 - brakes
 - rate tachometers
 - clutches
- rotary or linear motion
- operating temperatures to +450°F
- rugged construction for long life
- compact design
- proven application experience
- prompt delivery—standard inventoried sub-assemblies

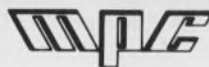

Contact MPC for Free Design and Application Catalog

MPC PRODUCTS CORPORATION

4200 WEST VICTORIA AVE. • CHICAGO, ILLINOIS 60646 • 312/583-5100



INFORMATION RETRIEVAL NUMBER 129

ELECTRONIC ENGINEERS:

CAREER OPPORTUNITIES WITH A FLORIDA COMPANY SPECIALIZING IN ADVANCED COMMUNICATIONS SYSTEMS AND HIGH TECHNOLOGY UHF RADIO EQUIPMENT

Electronic Communications, Inc., a subsidiary of NCR, has openings at all levels for electronic engineers experienced in the design and development of communication systems, RF, digital and audio equipment. You will be working with major UHF command and control systems, satellite relay and telemetry systems, and a variety of other challenging long-term programs. At ECI, you (like all of our pros) will function with a minimum of supervision and a maximum of opportunity for advancement. ECI is small enough to give your accomplishments high visibility, yet big enough to provide the facilities and benefits of the largest companies. ECI is on Florida's West Coast — the BEST COAST — in comfortable, sunny cosmopolitan St. Petersburg.

If you are tops in your field, and if you are interested in a career opportunity on long-term programs in an intriguing location, write in confidence today to Paul D. Jordan, Supervisor of Professional Placement, Electronic Communications, Inc., Box 12248, St. Petersburg, Fla. 33733.

A Subsidiary of NCR
An Equal Opportunity Employer — Male and Female



INFORMATION RETRIEVAL NUMBER 901

Shunt capacitors allow microcircuit tuning

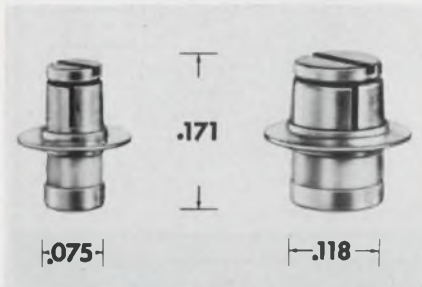

Johanson Manufacturing Corp., 400 Rockway Valley Rd., Boonton, N.J. 07005. (201) 334-2676. \$7.55 to \$3.85; stock.

The Models 7265 and 7285 multi-turn shunt capacitors permit precision tuning of microstrip, microstripline and coaxial circuits, as well as T and π matching elements in transistor MICs. The capacitors feature Qs as high as 4000 at 250 MHz. Both models incorporate a press fit design which assures protection from shorting and allows units to be resoldered without damage.

CIRCLE NO. 376

A-band modulator is subnanosecond switch

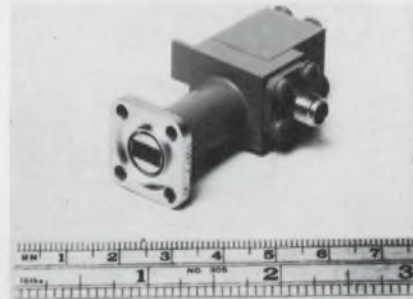

Control Data Corp., Boston Microwave Products Div., 400 Border St., E. Boston, Mass. 02128. (617) 569-2110.

A millimeter bi-phase modulator, the TRG Series A964, exhibits switching speeds of less than a nanosecond and maximum insertion loss of 4 dB (including circulation loss). It can be used in applications requiring phase shifting between 0 and 180 degrees in the 26.5-to-40 GHz range. The unit operates at 36.6 GHz with modulated output power of +8.5 dBm minimum.

CIRCLE NO. 377

Trimmer capacitors come substrate-mounted

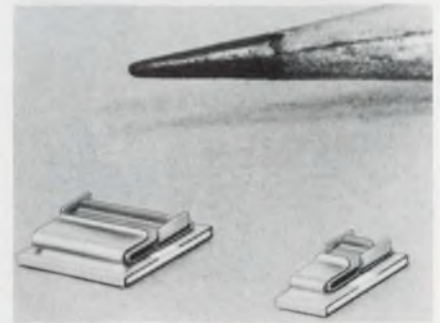

Voltronics Corp., West St., Hanover, N.J. 07936. (201) 887-1517. \$1.15 (10,000 up); stock.

Two ultraminiature trimmer capacitors for microelectronic tuning through the 5-GHz range are available in substrate-mounted versions that can be handled as conventional chips on metalized ceramic or standard PC boards. The CP2M tuning capacity is from 0.4 pF to 2.8 pF; the CP10M, from 0.8 pF to 9.3 pF. Voltage rating of both models is 150 V dc, and they can withstand 300 V dc voltage.

CIRCLE NO. 378

SMALLER THAN THE SMALLEST...

#12

SINGLE QUANTITY
and at HALF THE PRICE!

Power Supplies for OP AMPS, LINEAR & DIGITAL IC'S, LED'S, CONVERTERS & FUNCTION MODULES
"EE" modules measure 2" x 2" x .875, cost just \$12 per unit; Model EE15D25 provides $\pm 15V @ 25mA$; Model EE12D25 . . . $\pm 12V @ 25mA$. Model EE5S200 provides 5V @ 200mA for only \$14!

Spec'd to meet most applications. Regulation, line & load: 0.25% Ripple & Noise: 2mVrms. T.C. is 0.02% / °C. No derating: -25 to +71° C. From Stock.

* Acopian claims "World Smallest" for 2.3" x 1.8" x 1" module occupying 18% more volume.

PHONE (617) 374-0777

SERVOTRON

CORPORATION
P. O. BOX 292 HAVERHILL, MASS. 01830

DESIGNERS and ENGINEERS
BEFORE YOU START,
CONSIDER MANUAL PUSH BUTTON SWITCHES
CAPABLE OF REMOTE CONTROL

CHANCES ARE A **CAPITOL**
MECHANICALLY OPERATED SWITCH IS

BETTER *provides many more contacts and circuits in less total space

CHEAPER * frequently eliminates auxiliary equipment — transformers, relays, their installation and space

MORE RELIABLE*
Simple, quality construction. Fewer components insure greater reliability

ILLUMINATED SWITCHES CAN ELIMINATE PILOT LIGHTS
Mechanical actions: interlocking, no-two operate, accumulative lock-up, push to lock push to release, momentary. Combinations of all these are available on the same strip. Plus, many combinations of contact assemblies.

* Proven by Vending machine, communication, Computer, Recording and many other industries

CAPITOL

WRITE FOR CATALOG
THE CAPITOL MACHINE AND SWITCH CO.
87 Newtown Road, Danbury, Conn. 06810

Representatives in principal cities Tel: 203-744-3300 TWX:710-456-0365

WESCON SHOW BOOTH 2913

Chip

off the old breadboard.



RCA put 1,238 devices on a 150 mil COS/MOS chip. What are your LSI requirements ?

The move is toward LSI. And RCA is ready now to develop custom COS/MOS circuits to your most demanding requirements.

For example, the 149 x 150 mil timing circuit above was integrated from a breadboard containing 1,238 discrete devices. Just one of many custom chips designed with RCA's unique silicon interconnect process to provide high packaging density.

RCA maintains a staff of systems engineers who are experienced in the

development of complex micropower arrays. They are backed by extensive facilities to speed the process of IC design and development.

These facilities consist of computers for logic simulation, artwork digitizer-plotter systems that can cut turn-around time by 33% in typical circuits, Mann Pattern Generator facilities to speed mask preparation, and Teradyne Model J-283 digital IC systems which functionally evaluate complex arrays.

Put RCA's COS/MOS team to

work to help reduce package count, cut assembly costs, and achieve excellent cost effectiveness in your systems.

When it comes to COS/MOS LSI, come to RCA.

Contact your local RCA Representative or RCA Distributor, or write RCA Solid State Division, Section 571-14, Box 3200, Somerville, New Jersey 08876.

RCA Solid State
products that make products pay off

International: RCA, Sunbury-on-Thames, U. K., or Fuji Building, 7-4 Kasumigaseki, 3-Chome, Chiyoda-Ku, Tokyo, Japan. In Canada: RCA Limited, Ste. Anne de Bellevue 810, Canada.

INFORMATION RETRIEVAL NUMBER 40



specialized capacitors

to your specifications
at stock prices

Standard Condenser has designed and produced thousands of specialized capacitors for industry. In fact, what you think of as "special" may be among the many designs already available from stock at Standard. However, if you require capacitors of unusual shape, size, value and material, our engineering department will help you design and produce them to your exact specifications at stock prices. For immediate action, send us a sketch and complete details.

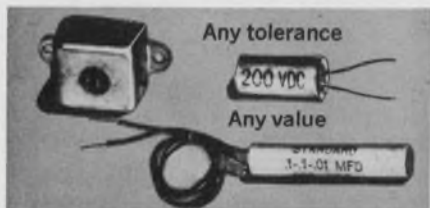

Send for Catalog and complete details.

Standard
CONDENSER CORPORATION
Dept. ED-1
1065 West Addison Street
Chicago, Illinois 60613 • (312) 327-5440

INFORMATION RETRIEVAL NUMBER 157

evaluation samples

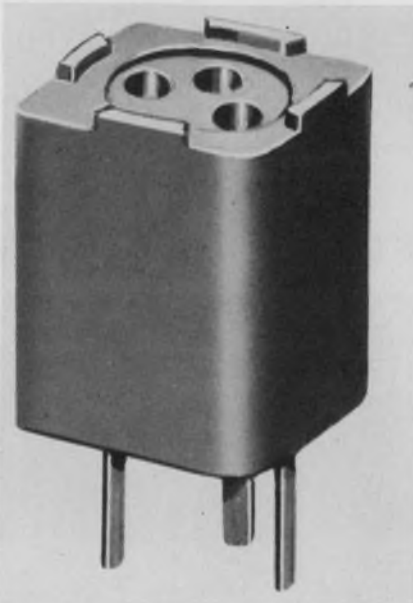

IC sockets

Less than 0.25-inch square, the A23-2044 TO18 socket allows close packing on 0.25-inch pitch without danger of adjacent devices shorting. The contact resistance is typically 11 m Ω and capacitance between contacts is 0.7 pF. Insulation resistance between contacts is over 10⁴ M Ω . The solder tails are suitable for boards up to 125-mils P.C.D. to simplify the layout of PC boards. Jermyn.

CIRCLE NO. 379

PC mount pins

PC mount pins for use with the Cambion cage jack line are available with or without through hole. These brass pins have 0.050-mil hard gold plate which is compatible with mating Cambion cage jacks. Pin lengths run from 100 mils to 1.00 inch and will swage into a 0.043-inch +0.002-inch hole. Cambridge Thermionic Corp.

CIRCLE NO. 380

Heat shrinkable tubing

Irradiated modified polyolefin (IMP) heat shrinkable tubing comes in sizes 46 mils to 1 inch I.D. and operates under a temperature range from -55 C to 135 C. Bi-Tronics Inc.

CIRCLE NO. 381

Plastic wiring duct

All varieties of Taylor plastic wiring duct are now being molded with interior scoring along the bottom of both sidewalls to facilitate removal of wall segments for junctioning, etc. Two simple cuts down the sidewall to intersect the scoring make it possible to remove the segment quickly and cleanly, eliminating the awkward lengthwise cut required on conventional duct. Since only the interior sides of the duct walls are scored, maximum bending strength is retained in the critical direction—toward the duct centerline. Taylor Industries Inc.

CIRCLE NO. 382

Wire markers

Clip-on type wire markers are specifically designed for applications either after or before the solder connection has been made or a solderless terminal has been attached. They may be removed at any time for recoding without breaking the terminal connection. Each is an individual marker with any numeral, letter or electrical symbol. Any number of markers can be used to form any code combination required. The same marker can be used for either a left or right hand entry. They are available in fourteen different sizes to fit a range of wire and cable diameters from 80 mils to 0.57 inches. Electrovert Inc.

CIRCLE NO. 383

Resin bonded PC board

A fully-pierced synthetic resin-bonded paper laminate is clad on one side with 1-oz. copper foil and has an over-all thickness of 0.062 in. The base materials are cut to width and punched with a 0.1 × 0.1 matrix holes. Some of the copper is then removed to leave parallel copper strips punched with holes. Boards are suitable for cutting and punching at room temperature and are normally protected with a flux preservative. They can also be manufactured from epoxy glass. The 0.01 × 0.01 universal board can be used for the mounting of dual-in-line packages, ICs, transistors and discrete components. Vero Electronics Inc.

CIRCLE NO. 384

MULTI POLE **BATON SWITCH**

This new **ALCOSWITCH** series satisfies many low current switching needs. Available in 2-8 poles & 2 or 3 positions. Panel wired or P/C mounting - all with identical baton actuators, including a mating power switch.



ALCO's
STB Series

ALCOSWITCH®

DIV. OF ALCO ELECTRONIC PRODUCTS, INC. NORTH ANDOVER, MASS. 01845

INFORMATION RETRIEVAL NUMBER 134

ECONOMY PRICED **KEYBOARD**

Gold clad contacts offer long operational life. N.O. momentary rated 100 ma @ 24 VDC. Basic models include 1x4 & 3x4 matrix. Also available with 2-shot molded 0-9 & 1-12 keytops. Low contact bounce. Write for further details.



"CR"
SERIES

ALCOSWITCH

DIV. OF ALCO ELECTRONIC PRODUCTS, INC. NORTH ANDOVER, MASS. 01845

INFORMATION RETRIEVAL NUMBER 135

We have documented proof you can **replace your oscilloscope for \$79.95**



Free
test
data



The Kurz-Kasch logic probe is the most amazing new concept today in electronic testing. All digital logic circuitry can be tested for every condition you need to know. It actually replaces wide band pass type oscilloscopes costing \$2,000 and \$3,000. Write or call now for your free copy of that proof to: Tom Barth, Marketing Manager, Department ED



Kurz-Kasch, Inc.

Electronics Division
1421 S. Broadway
Dayton, Ohio 45401
Telephone (513) 223-8161

INFORMATION RETRIEVAL NUMBER 136

ELECTRONIC DESIGN 19, September 14, 1972



**GO
FAIL
FREE**

LOWEST PRICE **\$395**
CO₂ CHAMBER...



RW-1100

Now you can Go Fail Free without going broke! \$395 buys Associated's Model RW-1100 full range low/high temperature chamber, a compact bench unit lab-engineered specifically for small parts and assembly testing and quality control. Associated hasn't scrimped on quality at your expense either. Look at the full performance features you'll get: -100°F to +350°F range (¾° stability)... half cubic foot work area... door-mounted temperature read-out... solid state temperature control... liquid CO₂ cooling.

LOWEST PRICE
MECHANICAL CHAMBER...



SW-5101

For a full range military testing capability, Associated's benchtop model SW-5101 extends from -100°F to +350°F at a phenomenally low cost. Add a host of other advantages such as single compressor design for simplified maintenance... all solid state control... high temperature failsafe. All for \$970!

Both units are fully presented in the all-new, complete Associated Environmental Equipment Catalog M-7-2. Why not get the whole story today?



ASSOCIATED/JADE HUNTINGDON VALLEY, PENNA. 19006 • (215) 947-3333

INFORMATION RETRIEVAL NUMBER 137



A major new program has created a number of positions for highly talented engineering and software specialists and engineers possessing a systems viewpoint.

Fields of endeavor include:

- Systems design in one or more areas such as analytical and/or hardware flight simulation; subsystem performance specifications; noise theory as related to control systems; digital filtering techniques; servo systems design and test.
- Design and/or analysis of guidance, flight control and navigation systems and/or instruments.
- Airborne computer software development with computer hardware and/or control systems experience desired.

All of the positions call for at least two years experience.

For an interview, please send your resume to our Professional Placement Manager, 1184 No. Mathilda Ave., Sunnyvale, Calif. 94088. An equal opportunity and M/F employer.

Lockheed Missiles & Space Company

A Subsidiary of Lockheed Aircraft Corporation
INFORMATION RETRIEVAL NUMBER 900

application notes

Reed switches

A 24-page manual, entitled Application Notes, contains an extensive compilation of technical information covering reed switching. Included in subjects covered are the operation of magnetic reed switches with permanent magnets and electromagnetic actuation. Physical dimension data, arc suppression and other considerations follow. Contact materials and reasons for each are covered. Last part of brochure includes nearly four pages of explanation of terms and definitions of industry words. Hamlin, Inc., Lake Mills, Wis.

CIRCLE NO. 389

Digital test instruments

A reprint of a magazine article describes the concept of using simple instrumentation to maintain digital systems in the field. The use of the logic probe and the need for timing information is covered. The reasons for adopting this maintenance approach include increased manpower efficiency, reduced capital investment, reduced training time, and a reduction in the number of troubleshooting errors. The use of the oscilloscope in this type of approach is discussed. Advanced Digital Research Corp., Mountain View, Calif.

CIRCLE NO. 390

Op amp

A four-page application bulletin, No. H001 for the Intersil ICH8500 and ICH8500A op amps, which have input bias currents of 0.1 and 0.01 pA respectively, contains a discussion of basic characteristics of the amplifiers, which are pin identical to the 741 op amp. Also included are applications and diagrams for pico ammeter circuits, sample-and-hold circuits, and a gated integrator. Intersil Inc., Cupertino, Calif.

CIRCLE NO. 391

design aids

Semiconductor memory chart

A two-sided, four-color wall chart measuring 14-1/2 by 22 inches give application and product data on semiconductor memories. One side of the chart shows a comparison between all types of ROMs and RAMs for capacity in bits, cost in bits per dollar, and performance in access rate. It provides detailed block diagrams showing the relationship of various types of memories in the computer system and in the computer's central processor. It explains the cost/performance relationships between memories and tells how to use the charts for design aids. The other side is a comprehensive product summary of Intersil's memory products, including bipolar pROMs, RAMs and drivers, and MOS RAMs and shift registers. Intersil, Inc.

CIRCLE NO. 395

Resistor MIL spec digest

The Fixed Resistor MIL Spec Digest is a handy and easy explanation of the MIL Spec numbering system for seven major fixed resistor specifications. It is complete with charts to interpret all digits of the MIL Spec numbering systems. TRW Inc., Fixed Resistor Distributor Marketing.

CIRCLE NO. 396

Modular terminals chart

A large application wall chart describes a wire termination system which allows complete flexibility to virtually custom design terminals to specifications from standard terminal modules. Each terminal unit can be snapped onto a mounting rail independently, and can be easily removed without disturbing adjacent terminals. The terminal system provides four methods of connection: screw, solder, clip and wrap. Hathaway Instruments, Inc.

CIRCLE NO. 397

Allochiral

The most rugged, reliable, solderless interconnect system available. Available now. (And you'll be pleased at its low cost!)

Lowest profile available
(.025" above board) permits more packaging density!

Allows for visual inspection
of point of connection to component lead!

Greater contacting surface - approximately 60% of lead perimeters!

One-piece construction for higher reliability, substantial savings - per contact, per board, per finished assembly!

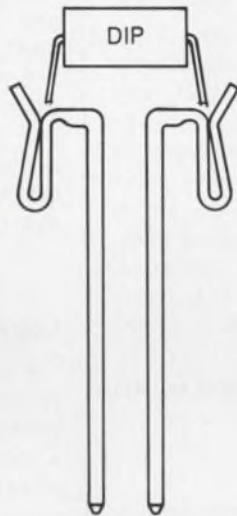

Permits extremely short lead-length - as short as .035" below device for full contact!

30° angle lead-in arms - for easier automatic or manual insertion!

And more, much more.

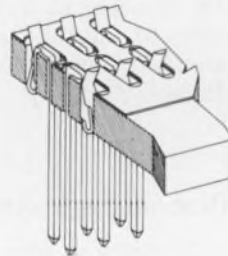

Robinson-Nugent invites your attention to its new, unique one-piece contact/terminal concept. When inserted in board, the unit becomes a properly aligned, self-supporting connector/socket for ICs or a complete back panel solderless interconnection system.

From the Socket People:



800 East Eighth Street
New Albany, Indiana 47150
(812) 945-0211 TWX 810-540-4082

INFORMATION RETRIEVAL NUMBER 138

PHOTO CONTROLS FOR EVERY PURPOSE

303 TYPES • 3003 VARIATIONS

- | | |
|-------------------|--------------------|
| ■ AUTOMATION | ■ FAULT DETECTION |
| ■ COUNTING | ■ LIMITING |
| ■ PACKAGING | ■ ORIENTATION |
| ■ CONVEYORS | ■ POSITIONING |
| ■ CUT-OFF | ■ INSPECTION |
| ■ DIE PROTECTION | ■ TENSION |
| ■ PROCESSING | ■ TRAFFIC CONTROL |
| ■ JAM-UP | ■ WEIGHING |
| ■ REGISTRATION | ■ WINDING |
| ■ MEASURING | an endless variety |
| ■ SMOKE DETECTION | of applications |
| ■ SORTING | |

Send for **FREE**
Complete Catalog



Contains latest released information on photo-electric controls developments, application survey, 61 complete application sketches and dimensional diagrams for innumerable practical uses.

AUTOTRON, INC.
3629 N. VERMILION ST.
DANVILLE, ILL. 61832
PHONE 217-446-0650

INFORMATION RETRIEVAL NUMBER 139

ELECTRONIC DESIGN 19, September 14, 1972

O.E.M. ENGINEERS!

PHOTO-ELECTRIC COMPONENTS by SHARP

For Production Application
In Computers, Instrumentation, EDP
and Communications Equipment

Select From A Wide Variety Of Devices

- Silicon Photo-Detecting Diodes
- Silicon Blue Cells
- Silicon Readout Cells
- NPN-Type Silicon Photo Transistors
- Photo-Coupling Diodes—GaAs Electro-Luminescent
- Thermo Module Elements & Water Cooled Tubes
- Full Range of LED's including GaAs Infrared, GaAsP Visible & GaAs Negative Resistance Types

Backed By Two-Way Guarantee of Quality
Manufactured by SHARP... a world leader in Electronics, marketed in the U.S.A. exclusively by SHIGOTO... one of the world's largest Manufacturing Importers.

Write or call with your requirements.
Technical Literature is available.

Shigoto Industries Ltd.

350 Fifth Avenue, Empire State Bldg., N.Y., N.Y. 10001
(212) 695-0200

INFORMATION RETRIEVAL NUMBER 140

Cost-Effective SemiConductor Testing



Semiconductor testing

An eight-page catalog/price list describes product lines in three areas serving semiconductor testing: (1) digital linear parametric and/or functional bench-top testers; (2) integrated circuit handlers; (3) real-time semiconductor memory test system. The catalog contains product description, photos and price information. Computest Corp., Cherry Hill, N.J.

CIRCLE NO. 418

Mixer preamps

Hybrid mixer preamplifiers for microwave and i-f applications is presented in a four-page bulletin. The bulletin describes and illustrates over 80 models including miniature coaxial, waveguide and coaxial series; gain and phase matched models and wideband and special preamp types. Charts show equivalent input noise power vs bandwidth and typical spurious signal performance. RHG Electronics Laboratory, Inc., Farmingdale, N.Y.

CIRCLE NO. 419

Component spacers

Applications and specifications for wash-away, component spacers are provided in a four-page brochure. Bivar, Inc., Santa Ana, Calif.

CIRCLE NO. 420

Triac and SCR guide

The 16-page Interchangeability and Cross Reference Guide for triacs and SCRs provides a comprehensive cross reference that simplifies the selection of the equivalent ECC device from hundreds of competitive types. It includes a simple, fast cross-checking chart listing the JEDEC and in-house device numbers of the major industry manufacturers. It also provides a full listing of package types of the original device and its replacement. Detailed package dimensions and lead configurations of the full line of ECC triacs and SCRs are included. ECC Corp., Euless, Tex.

CIRCLE NO. 421

Disc storage system

A low-cost disc storage system for the Micro 800 and Micro 1600 minicomputers is described in a four-page bulletin. Subjects covered include specifications and features of the controller and the 5.0-million byte disc drive. Photographs and diagrams illustrate functional characteristics, data flow and physical packaging of the system. Microdata Corp., Santa Ana, Calif.

CIRCLE NO. 422

Voltage reference diodes

An eight-page catalog covers approximately 1000 JEDEC registered types that are considered voltage reference diodes, namely zeners, temperature compensated zeners and codistors (controlled forward voltage diodes). Important design information normally excluded from standard specification sheets such as typical temperature coefficients of various zener diodes is included. The presentation of data enables the reader to quickly scan a line and immediately see the difference between standard types and suffixed versions. Computer Diode Corp., Codi Semiconductor Div., Fair Lawn, N.J.

CIRCLE NO. 423

Diodes and transistors

Diodes and high-frequency transistors are described in an eight-page short-form catalog. Listings include the line of Schottky, PIN, IMPATT and step recovery diodes. Chip, beam lead and other configurations for use in hybrid IC applications are shown. High-frequency transistors are listed along with their gain, noise figure and power output curves. Off-the-shelf PIN and Schottky diodes for military and aerospace applications that meet more rigid reliability specs are also included. The catalog is illustrated with dimensioned outline drawings of all these components, including pertinent electrical characteristics. Hewlett-Packard Co., Palo Alto, Calif.

CIRCLE NO. 424

Log/antilog amp

Features, specifications and applications of a dc logarithmic amplifier, Model 755, are discussed in a six-page data sheet. Principle of operation, a description of error terms, a complete error analysis for typical applications of logging current and voltage are presented. Also discussed are the options available to externally adjust all critical parameters. Analog Devices, Inc., Norwood, Mass.

CIRCLE NO. 425

Panel meters

A 28-page Panel Meter Catalog (GEP-307) provides technical information on the company's Big Look and Horizon Line panel meters. Described in the publication are voltmeters, ammeters, frequency meters, motor load indicators, current transformers, edge-wise panel meters, meter relays, controlling pyrometers, shunts and leads, resistors, elapsed-time meters, as well as parts and accessories. Prices and distributor locations are also included. General Electric Co., Schenectady, N.Y.

CIRCLE NO. 426

Snap-in switchlights

Photos and drawings show snap-in pushbutton switchlights available in three lens cap sizes. Clare-Pendar Co., Post Falls, Idaho.

CIRCLE NO. 427

Solid-state components

A comprehensive, easy-to-use, 100-page stock and price list catalog features semiconductor products such as digital and linear ICs, LEDs, liquid crystals, COS/MOS ICs, zener diodes, silicon transistors, ROMs, pROMs, thyristors and rectifiers, power hybrid circuits, silicon gate MOS LSI, op amps, three terminal IC voltage regulators, one package UAR/T and heat sink assemblies, plus many other solid-state products. The catalog lists those solid-state devices available from the firm's stocks manufactured by other companies. Semiconductor Specialists, Inc., Chicago, Ill.

CIRCLE NO. 428

2400 bps modem

Modem 24, a 2400 bps modem, is described in an illustrated eight-page data sheet. Included are features and technical data, as well as typical application diagrams. International Communications Corp., Miami, Fla.

CIRCLE NO. 429

Data sets

Bell-compatible 300, 1200 and 2400 bps data sets, plus other specialized data communications products are described in a two-color, four-page short-form catalog. Full specifications of the modems, as well as Bell equivalency and compatibility are given in chart form across the center spread of the catalog. The new catalog also describes a multichannel FSK/FDM data transmission system, a speech-plus adapter and a multiline switch for systems-oriented data communications applications. Ambac Industries, Tele-Dynamics Div., Fort Washington, Pa.

CIRCLE NO. 430

Relay sockets

A four-page brochure provides engineering data including illustrations, dimensions, drawings, ratings, specifications, optional connections and design features of the custom line of relay sockets. Custom Connector Corp., Cleveland, Ohio.

CIRCLE NO. 431



This solid-state
Digital Panel-Meter has everything
you've ever seen in other meters...
plus...

- Solid State LED Readout
- Up to 200 Readings Per Second
- Will Operate From 5VDC or 115VAC
- 11 Cubic Inches
- Floating, Bipolar Differential Inputs
- Optically Isolated Outputs
- Self Check Display Test
- 100 μ volt Resolution

Priced
from
\$119.00

World's smallest
Line-operated Digital
Panel Meter...

DATTEL
SYSTEMS, INC.

1020 TURNPIKE STREET, CANTON, MASS. 02021 • TEL. (617) 828-6395 • TWX 710-348-0135

INFORMATION RETRIEVAL NUMBER 141

For price, delivery, quality
look to wabash

For DIP reed relays
look to wabash

New 814 series 14-pin dual-in-line relay for high density packaging is epoxy-molded, automatically insertable, fits IC sockets. Comes as standard product in Form 1A with nominal coil voltage of 5, 6, 12 or 24 V. Options available in 2A, 1B and 1C (true form) packages. For fast delivery, competitive prices, call today.

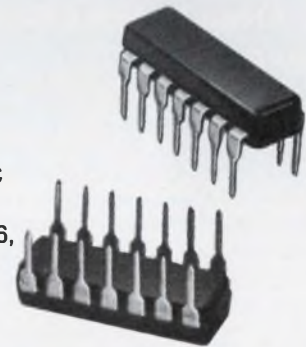

SPECIFICATIONS

Current (switch) 0.110 amps
Voltage 28v D.C.

Power (D.C.) 3 watts
Life up to 50×10^4 Operations
Configuration .100 \times .300 pin centers

For all relay types
look to wabash

NPE/New Product Engineering, Inc.
a subsidiary of Wabash Magnetics, Inc.
First and Webster Streets, Wabash, Indiana 46992
Phone 219/563-2191 TWX 810-290-2722

■ RF SWITCHING & MERCURY WETTED RELAYS ■ SUBMINIATURE REED SWITCHES
■ DIP REED RELAYS ■ SSR MODULES ■ STANDARD & MINIATURE REED RELAYS

INFORMATION RETRIEVAL NUMBER 142



not
for
everybody

UL Recognized RFI/EMI Filters for Data Processing Equipment

RtroN has developed 14 stock filter types (U.L. specification 478), for the RFI/EMI suppression requirements of data processing equipment. Terminal and bracket variations cover virtually every mounting need.

Custom designed multi-circuit RFI/EMI Filters in square, rectangular, bathtub and other enclosures are available.

Whatever your filtering needs may be, RtroN can design, produce, and deliver high reliability filters on time.

Phone or write for complete details.

RtroN

P.O. Box 743, Skokie, Ill. 60076

312 • 327-4020

NEW LITERATURE



Laser trimming

New publications describe in detail the company's laser systems for automated resistor trimming and for scribing ceramic substrates. Both systems are computer controlled, and are designed and warranted for high-volume, low-maintenance operation in the production environment. Electro Scientific Industries, Portland, Ore.

CIRCLE NO. 432

Tape drive

A brochure describes operations and specifications of the Model TMY digital tape drive. Ampex Corp., Marina del Rey, Calif.

CIRCLE NO. 433

Motorola semiconductors

The Motorola Semiconductor Data Library is a complete and easy-to-use reference for semiconductor components. In the three-volume set, books 1 and 2 provide complete data sheet specifications of all Motorola manufactured discrete semiconductors. The third book, the Reference Volume, contains a technical description of all EIA-registered semiconductors made by the industry (regardless of manufacturer), as well as a set of selector guides covering all discrete families made by Motorola. The latter will give a fairly accurate picture of the spread of specifications available for almost all discrete semiconductor product categories. The price is \$6.50 for the basic set; \$10 for the set and updates. Motorola Semiconductor Products Inc., 5005 E. McDowell Rd., Phoenix, Ariz. 85008.

IC data book

A 100-page CMOS Integrated Circuit Data Book includes a technical introduction to CMOS; a discussion on design and operating considerations; package descriptions; a discussion on chip preparation and handling and a review of devices available in the SCL 4000A, SCL 4400A and SCL 5000A series. Included with each device is a complete technical description, features, logic and other diagrams, chip photographs and electrical characteristics. Solid State Scientific Inc., Montgomeryville, Pa.

CIRCLE NO. 434

Author's guide

From manuscript to bound book, the stages your work will pass through on its journey to publication are many. Hayden's new 32-page Author's Guide tells what to do to help your publisher bring out the best book possible. Available free for a limited time. Hayden Book Co., Inc., 116 W. 14th St., New York, N.Y. 10011

Switches

A 24-page book contains an exhaustive breakout of the switch line, including subminiature toggle, rocker and paddle handle switches—subminiature and microminiature momentary push-button switches, and a 360 degree revolutionary rotary printswitch. Each switch family is detailed in photograph, schematic, chart and text. C&K Components, Inc., Watertown, Mass.

CIRCLE NO. 435

Byte I/O controller

The new multipurpose byte I/O controller which interfaces several input and output devices with the Micro 800 and Micro 1600 minicomputers is described in a four-page bulletin. The bulletin contains general information, standard features, a functional description, an instruction list, physical characteristics and specifications. Block and connection diagrams are also included. Microdata Corp., Santa Ana, Calif.

CIRCLE NO. 436

Balanced mixers

The Balanced Mixers Catalog includes a complete description of balanced mixers' characteristics and applications. The catalog contains information on 27 different mixers with specifications. Also shown is the unit price for each mixer. Summit Engineering Corp., Bozeman, Mont.

CIRCLE NO. 441

A/d converter

Detailed electrical and mechanical specifications and performance data on a low-cost a/d converter are contained in a two-page data sheet. Applications include medical, geophysical and oceanographic data logging. Datel Systems, Inc., Canton, Mass.

CIRCLE NO. 442

Time delay relays

Solid-state time delay relays are a feature of Publication No. 50-026. Items can be selected and purchased directly from the mini-mailer for a large array of part numbers covering the total product line. Each panel describes a product, gives salient features and dimensions, illustrates electrical connection of the timer, states OEM quantity prices and shows how to build the company's part number. Omnetics Inc., Syracuse, N.Y.

CIRCLE NO. 443

Transducers

A four-page bulletin presents the application and principle of operation of advanced solid-state transducer technology to the measurement of physical parameters such as pressure, stress, force, acceleration and temperature. Kulite Semiconductor Products, Inc., Ridgefield, N.J.

CIRCLE NO. 444

Microwave oscillators

Specifications for a range of varactors, oscillators, multipliers, comparators and coaxial components are covered in a 12-page short-form catalog. G. & E. Bradley Ltd., Microwave Div., London, England.

CIRCLE NO. 445

If our boxes are bigger, it's because reliability takes room.

Stuffing DPM circuitry into a plastic pillbox may save some real estate, but cramped meters buy you a bundle of unnecessary problems.

Newport DPM's have room for large, sturdy connectors and hefty, cool-running power transformers. Amply-spaced PC traces are unaffected by humidity or handling. And solid aluminum shield-cases improve noise immunity, cooling characteristics and mechanical strength.

When small size overrules reliability, also expect Feature Fall-

Out, Option Omission and Spec Scrimping. But not with our new Series 2000A. It's the only ± 39999 count DPM available with 3-pole active filter, display-blanking and unique BIGS-BCD output.

Ask for details on the new Series 2000A DPM... or any of Newport's 150 matching meters with built-in reliability. The panel instruments you install and forget.

Newport Laboratories Inc., 630 East Young Street, Santa Ana, California 92705 (714) 540-4914.



SERIES 2000A DPM: $\pm 39,999$ counts • DC volts, current or ratio • 01% accuracy
BIGS-BCD outputs... buffered, isolated, gated and stored • 2½"H x 5"W x 7½"D.

Newport Digital Panel Instruments

INFORMATION RETRIEVAL NUMBER 143

Model 55 printer in a case with interface and power supply

Add Addmaster's Model 55 to any instrumentation device for hard-copy printing.

12-column capacity
12 characters to each column

Numerals or limited alpha characters

TTL compatible

115V 60-cycle AC driven motor

Uses standard adding machine paper

Prints 3 lines (36 characters) per second

Accepts serial by character or full parallel B. C. D. data inputs

Under \$500.

 **ADDMASTER**
Addmaster Corporation

416 Junipero Serra Drive, San Gabriel, California 91776

INFORMATION RETRIEVAL NUMBER 144

FREE SAMPLE COPY



Some people claim that almost half of today's research and development is a duplication of prior effort. For many of your technical problems there are answers, most in some published form. But how can you keep up with the endless proliferation of new data in electrical and electronics engineering?

A timely, low-cost solution is a subscription to *Electrical & Electronics Abstracts*, the monthly INSPEC® journal that brings you up to date on the world's technical literature—quickly, concisely. This is the journal that many of the world's leading corporations—such as G.E., IBM, GT&E—use regularly to help keep abreast, and on top, of developments in their competitive fields.

Put INSPEC to work for you

At INSPEC over 500 information scientists and abstractors process and enter into their data base hundreds of items daily. Over 2,000 periodicals, 5,000 university theses, 600 reports, 9,000 patents, 1,200 books, 500 conference proceedings are abstracted yearly. At present more than 250,000 entries are available for computer recall.

Electrical & Electronics Abstracts is a marvel of quick, easy information retrieval with over 200 headings embracing all major areas of electrical and electronics engineering. The subject index contains almost 1200 fixed terms for assigning relevant entries. Each abstract is a bibliographic record including title, authors' names and affiliations, references, abstract (translated when necessary), classification code and subject indexing data. A yearly subscription includes semi-annual author and subject indexes without extra cost. (A microfiche edition is also available at the same subscription price.)

SEND FOR FREE SAMPLE ISSUE

If you think *Electrical & Electronics Abstracts* would be a valuable addition to your departmental, corporate or institutional library, why not make sure? Send for a free sample issue today. No obligation, of course. Our supply of surplus copies is limited, however, and requests will be filled on a first-come-first-served basis. Please type request on your organization's letterhead and mail to: The Institute of Electrical and Electronics Engineers, Dept. IN-S8, 345 East 47th Street, New York, N.Y. 10017.

*INSPEC is a joint publishing venture of the IEEE (U.S.A.) and the IEE (England). The above offer applies only in the Western Hemisphere. If your organization is situated outside the Americas, contact: The Institution of Electrical Engineers, Savoy Place, London WC2R 0BL, England.

bulletin board

IBM has agreed to service System 370/155 processing units that use ITEL/AMS monolithic main memory as replacements for IBM ferrite core memory. IBM had previously agreed to maintain certain models of the System 360, including models 30, 40, 50 and 65, with ITEL/AMS memory attached.

CIRCLE NO. 450

A videotape instructional course from Texas Instruments on semiconductor memories and their latest technologies will be conducted at 18 locations across the U.S. beginning September 25 and running through February, 1973. The 10-hour course is the third in a series of videotape instructional programs on advanced semiconductors and electronics systems being made available to the industry. A companion videotape course on metal-oxide-semiconductor (MOS) integrated circuits will also be presented in many of the same locations. To be conducted as open seminar-type sessions, The Semiconductor Memories Course will first be held in the Washington/Baltimore area September 25-26 with The MOS Course being shown on the 27th and 28th. Successive presentations will be in Philadelphia, Dallas, northern New Jersey, Long Island, Connecticut, Boston, Rochester, Dayton, Indianapolis, Chicago, Denver, Palo Alto, Los Angeles, Orange County, San Diego, Phoenix, Houston, Orlando, and Fort Lauderdale. Tuition is \$295 per individual for each course.

CIRCLE NO. 451

Price reductions

Computer Devices, Inc., has reduced prices for its Model 1030 Teleterm portable time-sharing terminals to \$3200. The terminal can be leased from Data Dimensions, Inc. in a variety of lease arrangements, such as a three-year plan at \$99 per month.

CIRCLE NO. 452

Litronix, Inc. has cut prices on its LED four digit numeric display, Data Lit 34 and on its LED 5 x 7 dot matrix alpha numeric display, Data Lit 57. Data Lit 34 now sells for \$11.80 in quantities of 250 to 999 compared to the former price of \$15.20—a 29% reduction. Data Lit 57 now sells for \$11 vs. \$13 in quantities of 100 to 999, a 15% reduction. For quantities of 1000 and up, the new price is \$10 compared to \$11.

CIRCLE NO. 453

Motorola Semiconductor Products Inc. has reduced the price of its quad op amp MC 3401 P (see ED 11, May 25, 1972, p. 89 or ED 10, May 11, 1972, p. 23) from \$1.75 to \$0.75 in 100-up quantities. This brings its price down to that of National Semiconductor's LM 3900, which was introduced at approximately the same time.

CIRCLE NO. 454

Installation of a faster computer and increased hardware sales volume has resulted in selective price reductions by EECO (Electronic Engineering Company of California). Increased sales of DIP socket boards resulting in production quantities enables up to 27% price reduction on a number of boards.

CIRCLE NO. 455

RCA Solid State Div. has reduced prices on its entire line of commercial types of COS/MOS ICs. The new base prices apply to more than 180 standard types, including dual in-line plastic, dual in-line ceramic, flatpack and chip configurations. The announced base prices average approximately 25% lower than previous base prices for plastic packages, approximately 20% lower for dual in-line and flatpack ceramic types, and approximately 50% lower for chips. The CD4001AE, a simple quad 2-input NOR gate in dual in-line plastic package, is now priced at \$0.78 for 100-999 quantities. The price is \$0.40 below the old price, or 34% lower. The CD4013AE, a flip-flop with set/reset capability, is priced at \$1.62, down \$0.78, or 33%. The CD4017-AE, an MSI decade counter, is now priced at \$4.24, down \$1.51, or 26%.

CIRCLE NO. 456

vendors report

Annual and interim reports can provide much more than financial-position information. They often include the first public disclosure of new products, new techniques and new directions of our vendors and customers. Further, they often contain superb analyses of segments of industry that a company serves.

Selected companies with recent reports are listed here with their main electronic products or services. For a copy, circle the indicated number.

Graphic Arts Technical Foundation. Nonprofit, scientific, technical organization.

CIRCLE NO. 457

International Controls Corp. Transmission towers, aerospace radiation products and subsystems.

CIRCLE NO. 458

The Susquehanna Corp. Plastics and aerospace.

CIRCLE NO. 459

Western Union International, Inc. Computers, switching systems, communications, alarm systems and pocket pagers.

CIRCLE NO. 460

Data Systems Analysts, Inc. Computer/communications systems and data processing.

CIRCLE NO. 461

Vernitrol Corp. Medical electronics, piezoelectric devices, components and computer services.

CIRCLE NO. 462

Spar Aerospace Products Ltd. Aerospace.

CIRCLE NO. 463

Electronic Memories & Magnetics Corp. Computer products, memories, disc drives and packs, magnet and ferrite products and permanent-magnet motors.

CIRCLE NO. 464

If you buy our DPM's because of low price, expect some pleasant surprises.

Newport builds low-cost DPM's loaded with standard features not even possible on competitive models.

Take our new Series 2000B — 4½ digits for \$280. Reads a full 20,000-counts at 30 readings per second without sacrificing 0.01% accuracy. And only Newport gives you *BIG-BCD outputs (*Buffered, Isolated, Gated) to reliably drive long cables or to form a multiplexing data buss.

Plan to significantly reduce checkout time. With the Series 2000B you can ignore ground loops.

True differential inputs compensate for common-mode noise voltage and guarantees immunity up to 6 volts. All this plus so much more are protectively packaged in an extruded-aluminum shield-case.

See for yourself! Ask for some pleasant surprises with details on the Series 2000B DPM, or any of Newport's 150 matching meters. The panel instruments you install and forget.

Newport Laboratories Inc., 630 East Young Street, Santa Ana, California 92705 (714) 540-4914.



SERIES 2000B DPM: ±19,999 counts • DC voltage and current models
30 rdgs/sec • 2½"H x 4½"W x 5"D. • 0.01% accuracy • BIG-BCD output

Newport Digital Panel Instruments

INFORMATION RETRIEVAL NUMBER 146

HIGH RELIABILITY
MORIRICA
QUALITY OF THE FIRST ORDER

PHOTOCELL-LAMP

GaAs LED + CdS CELL (Type: MCD-521)

- Input Reverse Voltage: 3V
Forward Current-Continuous: 30mA
Total Device Dissipation: 90mW
- Output ON-resistance: Max 1KΩ
OFF-resistance: Min 3MΩ
Maximum power dissipation: 125mW
Maximum Voltage: 150V DC

* For catalog, please write to:
MORIRICA ELECTRONICS, LTD.
205 Tozuka-machi, Tozuka-ku, Yokohama, Japan
Tel. 045-881-2331 Cable Address: MORIRICA YOKOHAMA

INFORMATION RETRIEVAL NUMBER 147

We Produce Lots of 'em QUICK

Silicon power transistors and diodes we mean. And a brand new line of micro-miniature, radiation resistant, Ion Implanted Voltage Variable Capacitor Diodes in DO-7 or DO-20 hermetically sealed packages. Capacitances of 3.3, 12, 15, 18 and 22 Pf. Q's of 50 to 300.

See them at WESCON

Don't be scared like a rabbit. Ask for our shortform catalog ED-1. We'll send it to you.

Quick!

SSDI Solid State Devices Incorporated

12741 Los Nietos Road
Santa Fe Springs
California 90670
Phone (213) 698-3711
TWX-910-586-1881

INFORMATION RETRIEVAL NUMBER 148

Advertisements of booklets, brochures, catalogs and data sheets. To order use Reader-Service Card.
(Advertisement)

New Monograph on Real-Time Data Processing Techniques

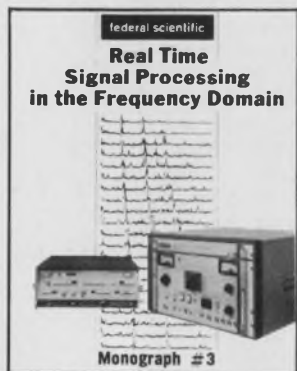

A new publication by Federal Scientific, originators of the Ubiquitous® Spectrum Analyzer, covers general and specific signal processing techniques and theoretical constraints.

- Random data processing and statistical certainty of Power Spectral Density Estimates
- Constraints in frequency analysis due to bandwidth, sampling and signal length
- Time domain weighting, with charts of theoretical performance using different weighting functions
- Theory of operation of time-compression analyzers
- Cross-property analysis and application in determining transmission and transfer functions by correlation and cross-power spectral density
- Processing of Transient data

CIRCLE NO. 171

Federal Scientific Corporation

615 West 131st Street, New York, N. Y. 10027

Signal Correlation And Fourier Analysis

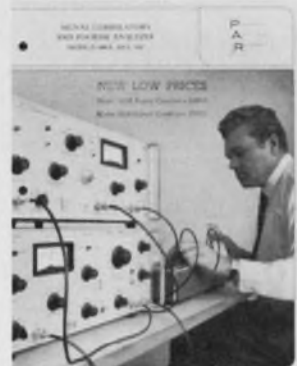

Two low-cost fast-operating correlation function computers offering half microsecond per point speed and superior dynamic range are described in an illustrated 20 page handbook, T-219. Included are a discussion of the correlation technique, typical applications and specifications for the PAR™ Signal Correlators, which are priced at \$4950 and \$5950. The brochure also discusses Fourier analysis and its application to computed correlation functions and provides specifications for the PAR Fourier Analyser. The information will be of interest to anyone involved in auto- or cross-correlation or power spectra measurements.

CIRCLE NO. 172

Princeton Applied Research Corporation

P. O. Box 2565, Princeton, New Jersey 08540
(609) 452-2111

1973 Electronic Components Drafting Aids Catalog



Free Catalog! Free Samples! Exciting innovations in pressure-sensitive electronic component drafting aids and methods are detailed in the new 1973 edition of the combined Bishop Technical Manual and Catalog 105.

84 illustrated pages of over 15,000 multi-pad configurations, symbols, tapes, sequential reference designations plus hundreds of time-and-money saving hints in making artwork for PC boards. Includes instructions for using the industry's only red and blue tape system for making two-sided boards in perfect registration.

Send now for free Catalog 105 and free samples.

CIRCLE NO. 173

Bishop Graphics, Inc.

7300 Radford Avenue, North Hollywood, California 91605
(213) 982-2000 Telex: 674672

ELECTRONIC DESIGN's function is:

- To aid progress in the electronics manufacturing industry by promoting good design.
- To give the electronic design engineer concepts and ideas that make his job easier and more productive.
- To provide a central source of timely electronics information.
- To promote communication among members of the electronics engineering community.

Want a subscription? ELECTRONIC DESIGN is sent free to qualified engineers and engineering managers doing design work, supervising design or setting standards in the United States and Western Europe. For a free subscription, use the application form bound in the magazine. If none is included, write to us direct for an application form.

If you do not qualify, you may take out a paid subscription for \$25 a year in the U.S.A., \$35 a year elsewhere. Single copies are \$1.50 each.

If you change your address, send us an old mailing label and your new address; there is generally a postcard for this bound in the magazine. You will have to requalify to continue receiving ELECTRONIC DESIGN free.

The accuracy policy of ELECTRONIC DESIGN is:

- To make diligent efforts to ensure the accuracy of editorial matter.
- To publish prompt corrections whenever inaccuracies are brought to our attention. Corrections appear in "Across the Desk."
- To encourage our readers as responsible members of our business community to report to us misleading or fraudulent advertising.
- To refuse any advertisement deemed to be misleading or fraudulent.

Microfilm copies are available of complete volumes of ELECTRONIC DESIGN at \$19.00 per volume, beginning with Volume 9, 1961. Work is now in process to complete the microfilm edition of Volumes 1-8. Reprints of individual articles may be obtained for \$2.00 each, prepaid (\$.50 for each additional copy of the same article) no matter how long the article. For further details and to place orders, contact the Customer Services Department, University Microfilms, 300 North Zeeb Road, Ann Arbor, Michigan 48106 telephone (313) 761-4700.

Want to contact us? If you have any comments or wish to submit a manuscript or article outline, address your correspondence to:

Editor
ELECTRONIC DESIGN
50 Essex Street
Rochelle Park, N.J. 07662

Electronic Design

Advertising Sales Staff

Bryce Gray
Sales Manager

Rochelle Park, N.J. 07662

Robert W. Gascoigne
Daniel J. Rowland
50 Essex Street
(201) 843-0550
TWX: 710-990-5071

Philadelphia

Thomas P. Barth
50 Essex Street
Rochelle Park, N. J. 07662
(201) 843-0550

Boston 02116

Richard L. Green
20 Columbus Avenue
Boston, Mass.
(617) 482-7989

Chicago 60611

Thomas P. Kavooras
Berry Conner, Jr.
200 East Ontario
(312) 337-0588

Cleveland

Thomas P. Kavooras
(Chicago)
(312) 337-0588
(call collect)

Los Angeles 90303

Stanley I. Ehrenclou
Burt Underwood
2930 Imperial Highway
Inglewood, Calif
(213) 757-0183

San Francisco 94022

Jerry D. Latta
P.O. Box 1248
Los Altos, Calif.
(415) 965-2636

London W. 1

For United Kingdom and Holland

Brayton C. Nichols

For Eastern Europe

Peter Kehr

The American Magazine Group

27 Maddox Street
London, W. 1, England
Phone: 499-0180

Cable: Ammagnic, London

Verviers, Belgium

For Continental Europe

Andre Jamar

1, Ru Mallar, 1

087) 253.83 Telex 41563

Tokyo

Haruki Hirayama
Electronic Media Service
5th Floor, Lila Bldg.,
4-9-8 Roppongi
Minato-ku

Phone: 402-4556

Cable: Electronicmedia, Tokyo



AMERICAN BUSINESS PRESS, INC.

If you depend on temperature measurements, rely on one of our 29 models.

Out-of-calibration DPM's make critical measurements all guesswork — and your engineering schedule wishful thinking.

But being right-on is tricky. That's why Newport's new Series 260 Digital Thermocouple Indicator guarantees accuracy from the start. Reference junction compensation counteracts ambient temperature changes with 0.05°/degree error.

Over the entire sensor range, a 31-segment digital linearizer guarantees drift-free measurements.

Fail-safe burn-out indication signals a thermocouple break or an off-scale reading. And Series 260 gives you extra protection with features like BIGS-BCD output, internal filtering and shielding.

Make sure your system works right from the start. Depend on our Series 260 or any of Newport's 150 matching meters. The panel instruments you install and forget.

Newport Laboratories Inc., 630 East Young Street, Santa Ana, California 92705 (714) 540-4914.



SERIES 260 DIGITAL THERMOCOUPLE INDICATOR: For TC types J,K,T,S,R,E and RTD's
1° resolution • °F or °C • -310° to +3100° F • BIGS-BCD outputs • 2½" H x 5" W x 6½" D.

Newport Digital Panel Instruments

INFORMATION RETRIEVAL NUMBER 149

Attention Advertisers:

Could you use copies of your ad exactly as it appeared in ELECTRONIC DESIGN? Then order your reprints directly from us; the minimum unit order is 500 copies.

Please specify if you would like the reprint line omitted on your copies and mail your written order to ELECTRONIC DESIGN, Production Dept., 50 Essex Street, Rochelle Park, New Jersey 07662.

500 1,000 Add'l M
8x10 or smaller

1 color, 1 side	\$74.70	82.95	18.15
2 color, 1 side	95.47	108.00	25.28
4 color, 1 side	311.03	342.00	44.33

Spreads

1 color	113.66	126.65	25.98
2 color	191.19	205.98	29.58
4 color	354.17	380.76	53.19

Prices FOB Waseca, Minn.

NEW FAMILY OF Newtron[®]

ONLY 5 VOLT POWER SUPPLY REQUIRED!
7 SEGMENT INCANDESCENT DIGITAL READOUT TUBE

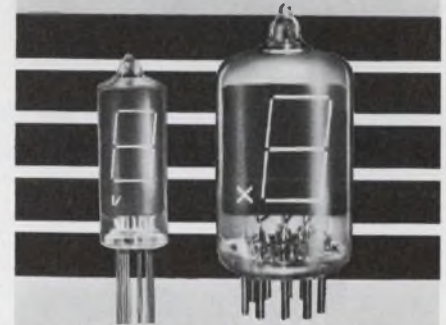

Types	Description	
	DA-1000 Series	DA-2900 Series
Dimensions	Diameter	Diameter
	Valve length	Valve length
	30mm	41mm
	Character height	Character height
	10 x 5mm	15.2 x 8.9mm
DC Filament Voltage	5.0V	5.0V
Filament Current (per segment)	10.0mA Max.	23.0mA Max.
Life Expectancy	100,000 Hrs. (Min.)	100,000 Hrs. (Min.)

• Other type: DA-1300, DA-1600 (12V), DA-2300 Series
• Special circuit design of counting display available upon request

Apollo 5-1, Tagoshi 6-chome, Shinagawa-ku, Tokyo 141, Japan
Phone: (03) 786-2005
CORPORATION Cables: "APOLLOHAGITA" TOKYO
• U.S. Distributor: DAIMETRICS CORPORATION
1311 Post Ave. Torrance, Calif. 90501 Phone: (213) 328-2080

INFORMATION RETRIEVAL NUMBER 150

NEW, UP-TO-DATE MARKET INTELLIGENCE ON COMPUTERS to Guide Your Selling Programs

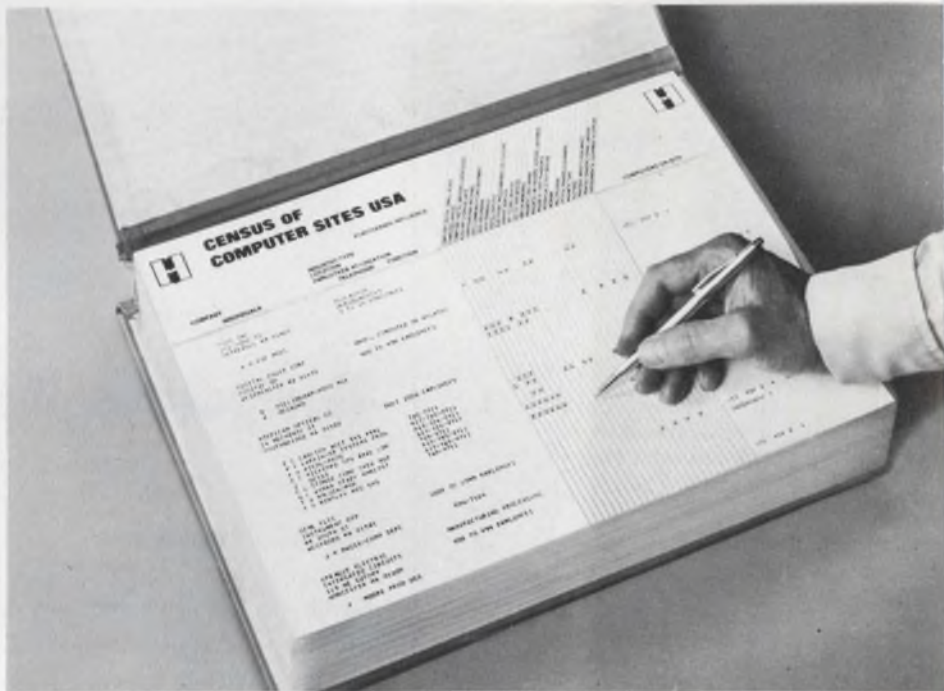

FIRST EDITION LISTS 57,200 COMPUTERS AT 25,000 U.S. COMPUTER SITES

INFORMATION COVERED IN THE CENSUS

The *Census of Computer Sites USA* provides the following information for each computer location:

- **COMPANY NAME**
Address, City, State, Zip
- **INDUSTRY CLASSIFICATION**
- **NAMES AND TITLES**
of general and data processing managing functions.
- **PURCHASING INFLUENCE**
for 26 categories of computers and computer-related products.
- **TELEPHONE NUMBERS**
- **HEADQUARTERS OR BRANCH**
- **NUMBER OF EMPLOYEES AT SITE**
- **COMPUTERS INSTALLED**
Number of systems or individual computers installed on site, by model and by manufacturer.
- **OTHER COMPUTERS MENTIONED**
Computers mentioned in some site reports, but not in sufficient number to achieve consensus.

PURCHASING INFLUENCE IS CHARTED

Purchasing influence based on each respondent's self-described purchasing activity is indicated for the following equipment:

- | | |
|--|--------------------------------------|
| Computer, Digital (small scale) | Magnetic Disc Drives |
| Computer, Analog | Magnetic Ink Readers, |
| Computer, Digital (Medium and large scale) | Sorters & Inscrivers |
| Auxiliary Storage Units | Magnetic Tape Transports |
| Card Punching Machines | Microfilm Output Devices |
| Data Communications Equipment | Modems |
| Data Recorders | Multiplexers |
| Data Terminals | Optical Readers & Scanners |
| Digital Displays | Magnetic Tape |
| Electronic Programmable Calculators | Plotters |
| Graphic Displays | Printers, Impact & Non-Impact |
| Key to Disc Devices | Printout Binders, Forms, Indexes |
| Key to Tape Devices | Environmental Equipment and Supplies |
| Add-on Memories | |

Computer Decisions CENSUS OF COMPUTER SITES USA

AVAILABLE IN PRINTOUT, MAGNETIC TAPE,
OR LABELS; COMPLETE, OR IN SUBFILE
from Hayden Publishing Company, Inc.

- WHERE COMPUTERS ARE LOCATED
- TYPES OF COMPUTERS ON SITE
- HOW MANY COMPUTERS ON SITE
- NAMES OF PURCHASING INFLUENCES

The *Census of Computer Sites USA* offers the largest, the most-highly qualified, the most current, and the most accurate computer site demographics available from any source. It can be used for:

- Sales Prospecting
 - Corporate Planning
 - Market Delineation
 - Market Profiling
 - Determining Sales Potential
 - Direct Mail
 - Trend Analysis
 - Sales Performance/Ratings
- Developed on a three-year timeframe in conjunction with

Computer Decisions magazine, the Census represents a \$3 million investment by Hayden Publishing Company, of which \$½ million has been devoted to gathering census data alone. It is based on more than 140,000 reports annually. Introductory rates range from \$750 (minimum order for subfiles) to \$8,000 for a complete charter subscription (includes next sequential update). For complete information, call Jim Gillespie, Census Manager, at 201-843-0550, or clip and mail this coupon today.

INFORMATION/ORDER FORM

We would like to know more about the *Census of Computer Sites USA*.

- Please send complete information and prices.
 Please have your representative call.
 We are ready to order. Please give us a quotation for:
Complete Census: Printout. Computer tape. Labels.
 We would like a subfile Geographical. By purchasing influence _____ By computer mfg./model.
 By industry. Custom.

Name & Title _____

Company _____ Telephone _____

Street _____

City _____ State _____ Zip _____

Clip and mail to: "CENSUS" c/o Computer Decisions
50 Essex Street, Rochelle Park, New Jersey 07662 • Tel.: 201-843-0550

advertiser's index

Advertiser	Page
Abbott Transistor Laboratories Incorporated	6
Accutronics, Inc.	131
Acopian Corporation	186
Addmaster Corporation	205
Alco Electronic Products, Inc.	199
Allen-Bradley Co.	Cover III
Allen Avionics, Inc.	182
American Aluminum Company	141
American Technical Ceramics	190
Amperex Electronic Corporation	125
Apollo Corp.	209
Associated/Jade	199
Autotron, Inc.	201
Babcock Relays, Division of Babcock Electronics Corporation	102
Beckman Instruments, Inc., Helipot Division	157
Biomation, Inc.	88
Bishop Graphics, Inc.	208
Bodine Electric Company	188
Boonton Electronics Corporation	187
Bourns, Inc., Trimpot Products Division	35
Burroughs Corporation	Cover IV
Burrowes Research Company	192
C & K Components, Inc.	180
CTS Corporation	193
Cambridge Thermionic Corporation	115
Capitol Machine & Switch Co.	196
CEM Company, Inc.	188
Centralab, the Electronics Division of Globe-Union, Inc.	71
Chicago Dynamic Industries, Inc.	186, 193
Cimron	31
Computer Automation, Inc.	105
Cutler-Hammer Specialty Products Division	47
Dale Electronics, Inc.	Cover II
Data Precision Company	180
Datak Corporation, The	185
Datapulse, Division, Systron-Donner Corporation	148
Datel Systems, Inc.	203
Delco Electronics, Division of General Motors Corporation	132, 133
Eastman Kodak Company	189
Elco Corporation	11
Electronic Arrays, Inc.	10
Electronic Communications, Inc.	195
Electronic Engineering Company	185
Electronic Engineering Co. of California	113
Exact Electronics, Inc.	159
Fairchild Semiconductor, A Division of Fairchild Camera and Instrument Corporation	4, 5
Fairchild Semiconductor/Microwave and Optoelectronics	153
Federal Scientific Corporation	208
Fitchburg CPI, Division of Litton Industries	175
Fluke Mfg. Co., Inc., John	101

Advertiser	Page
GTE Automatic Electric	66, 67
General Electric Company	183
General Radio Company	161
Grayhill, Inc.	194
Halex, Inc.	182
Harris Semiconductor	16A
Hayden Book Company, Inc.	213
Heath/Schlumberger Scientific Instruments	171
Hewlett Packard	1, 14, 15, 86, 87
Hickok Electrical Instrument Co., Inc., The Instrumentation & Controls Div.	65
Houston Instrument	155
Hughes Aircraft Company, Electron Dynamics Division	36, 37
Hutson Industries	110
IEEE	206
Indiana General, A Division of Electronic Memories & Magnetics Corporation	167
Intech, Incorporated	100
Interstate Electronics Corporation	173
J.B.T. Instruments, Inc.	118
JFD Electronics Corp./Components Division	99
Johanson Manufacturing Corp.	7
Johnson Company, E. F.	18, 19
Kar Electronics, Inc.	90
Keithley Instruments, Inc.	95
Kurz-Kasch, Inc.	199
Ledex, Inc.	197
Licon, Division Illinois Tool Works, Inc.	29
Litronix, Inc.	191
Lockheed Missiles & Space Company	200
Logitek, Inc.	174
MCL, Inc.	181
MPC Products Corp.	195
Magic Dot, Inc.	184
Magnecraft Electric Company	216
Mallory Capacitor Company	163
Meguro Denpa Sokki, K. K.	215
Micro Devices Corp.	185
MicroSwitch, A Division of Honeywell	44, 45
Miida Electronics	114
Monsanto Company	117, 165
Moririca Electronics Ltd.	207
Motorola Semiconductor Products, Inc.	16, 126, 127
National Semiconductor Corporation	46
Newport Laboratories, Inc.	205, 207, 209
New Product Engineering, Inc.	203
Nippon Pulse Motor Co., Ltd.	112
Norden Division of United Aircraft Corporation	142
North Atlantic Industries, Inc.	16B
Oak Industries, Inc.	17
Omni Spectra, Inc.	33
Perfection Mica Company	143

Advertiser	Page
Philips Industries, Power Supplies Dept.	67
Philips Industries, Test and Measuring Instruments Dept.	157
Piezo Technology, Inc.	94
Pomona Electronics Co., Inc.	176
Precision Monolithics, Incorporated	168
Premier Metal Products Co., Inc.	191
Princeton Applied Research Corp.	208
Princeton Electronic Products, Inc.	172
RCA Solid State Division	89
RFL Industries, Inc.	194
Raytek Inc.	215
Robinson Nugent, Incorporated	110, 201
Rogers Corporation	193
Rtron Corporation	204
Scanbe Manufacturing Corp.	177
Servo Tek Products Company	191
Servotron Corp.	196
Shigoto Industries Ltd.	201
Showa Musen Kogyo Co., Ltd.	96
Signetics Corporation	20
Siliconix Incorporated	72
Simpson Electric Company	179
Solid State Devices, Inc.	207
Solid State Systems, Inc.	149
Solotron Devices, Inc.	109
Sorenson Company, a Unit of the Raytheon Company	40, 41
Sprague Electric Company	13
Stackpole Components Company	103
Standard Condenser Corp.	198
Switchcraft, Inc.	107
TEC, Incorporated	106
TRW Capacitors, an operation of TRW Electronic Components	119
Tecnetics, Inc.	92
Technical Wire Products, Inc.	178
Teledyne Relays, A Teledyne Company	2
Teletype Corporation	42, 43
Teradyne	23
Texas Instruments Incorporated, Digital Systems Division	38, 39
Texas Instruments Incorporated, Components Group	27
Toyo Communication Equipment Co. Ltd.	192
Trio Laboratories, Inc.	8, 9
Triplett Corporation	12
Tung Sol Division, Wagner Electric Corporation	108
United Systems Corp.	91, 93
Unitrode Corporation	85
Vactec Inc.	68
Vector Electronic Company Inc.	102
Vero Electronics, Inc.	118
Victor Wire & Cable Corp.	147
Victoreen Instrument Div.	178
Watkins-Johnson Company	111
Weston Instruments, Inc.	97
Windjammer Cruises	154
Yewtec Corporation	215
Zeltex, Inc.	48, 49-64

KEEP PACE

practical guides for
designers, managers
from  HAYDEN



Practical Design for Electromagnetic Compatibility

Edited By ROCCO F. FICCHI

In one convenient source, all the basic information you need to analyze, predict, control, and reduce unwanted signals. It details measurement techniques and equipment, recent advances in filtering and shielding, and fully covers the special problems encountered in computers, semi-conductors, and solid-state devices. 272 pp., 7 1/8 x 9 3/4, illus., #5685-0, cloth, \$13.95

Durability and Reliability in Engineering Design

GILBERT KIVENSON

This thought-provoking work places at your disposal highly relevant findings from a variety of technical areas. It examines materials properties, breakdown mechanisms and phenomena, and failure modes along with steps to counter them; provides a capsule course in reliability theory; relates design considerations to the user's needs. 200 pp., 6 x 9, illus., #5851-9, cloth, \$9.95

The Successful Engineer-Manager

A Practical Guide to Management Skills for Engineers and Scientists

Edited by ROBERT C. HAAVIND and RICHARD L. TURMAIL

A well-organized, realistic guide to the critical areas of technical management — career, decisions, people, projects, finances, and communications. Articles carefully chosen from *Electronic Design* offer you valuable pointers on financial analysis, person-to-person dealings, project scheduling, promoting new ideas, and much more. 176 pp., 7 1/8 x 9 3/4, illus., #5879-9, cloth, \$8.95

Practical Instrumentation Transducers

FRANK J. OLIVER

You'll find virtually every known device for industrial or aerospace application covered in this complete, well-planned volume. Heavily illustrated, it reviews the state-of-the-art, clears up areas of confusion, presents pertinent data for specific applications. 352 pp., 7 1/8 x 9 3/4, illus., #5833-0, cloth, \$20.00

400 Ideas for Design, Volume Two

Edited by FRANK EGAN

Ranging from the ingenious to the amazingly simple, these top recent contributions to *Electronic Design's* "Ideas for Design" column are yours to use or adapt. They are gathered together by subject category for your convenience: amplifiers, design and laboratory aids, pulse, digital and control circuits, etc. 288 pp., 7 1/8 x 9 3/4, illus., #5067-4, cloth, \$11.95

Practical Relay Circuits

also by FRANK J. OLIVER

Grouping relays by function, this time-saver will give you a rapid overview of the circuits that can solve the problem at hand. You can then check operating principles, standards, and other specifications in manufacturers' data or sources such as Hayden's *Engineers' Relay Handbook*. 384 pp., 6 x 9, illus., #5802-0, cloth, \$14.95

Materials Science and Technology for Design Engineers

Edited by ALEX E. JAVITZ

The fundamentals of materials integrated with the hard facts of day-to-day engineering practice. The coverage offered you ranges from basic structure and behavior through new materials and applications, to environmental effects, reliability concepts, and cost effectiveness. 560 pp., 6 x 9, illus., #5640-0, cloth, \$23.95

Advanced Electronic Instruments and Their Use

SOL D. PRENSKY

Here, fully described and illustrated, are the highly sophisticated new instruments used for sensing, measurement, and control monitoring. You'll find detailed coverage of femtometers, solid-state multimeters, digital display devices, and much more. 208 pp., 6 x 9, illus., #0796-5, paper, \$6.95; #0797-3, cloth, \$9.50

15-DAY FREE EXAMINATION

Please send the book(s) circled on 15-day free examination. At the end of that time, I will remit payment, plus postage, or return the book(s) with no further obligation.

5685-0 5851-9 5879-9 5833-0 5067-4
5802-0 5640-0 0796-5 0797-3

Save Money!

Payment Enclosed. Publisher will pay all shipping and handling charges — same 15-day guarantee.

Name _____

Firm _____

Address _____

City/State _____ Zip _____

\$10.00 minimum for free exam orders. Because of higher billing and collection costs, we must ask for payment in full with any order for less than \$10.00. Same 15-day guarantee.



HAYDEN BOOK COMPANY, INC., 116 W. 14th Street. New York, N.Y. 10011

ISBN Prefix 0-8104

72-58

product index

Information Retrieval Service. New Products, Evaluation Samples (ES), Design Aids (DA), Application Notes (AN), and New Literature (NL) in this issue are listed here with page and Information Retrieval numbers. Reader requests will be promptly processed by computer and mailed to the manufacturer within three days.

Category	Page	IRN	Category	Page	IRN	Category	Page	IRN
Components			resistivity meter	95	255	CMOS data book	204	434
connectors, coaxial	116	302	rf sweeper	183	350	component spacers	202	420
converter, binary	190	361	signal generator	183	351	cradle relays	204	439
CRT display	116	305	storage oscilloscope	94	252	data sets	203	430
fuse clips	190	364	synthesizer, frequency	180	346	diodes	202	423
neon lamp	190	363	test instruments (AN)	200	390	diodes and transistors	202	424
noise spectra (AN)	200	392	voltmeter	96	258	disc storage system	202	422
reed switches (AN)	200	389				interface	204	436
relay, general purpose	118	308	Microwaves & Lasers			lamps, miniature	204	438
relay, solid state	116	301	amplifier, Gunn diode	114	281	laser trimming	204	432
resistor networks, DIP	190	362	attenuators	112	278	microwave devices	206	447
resistors (DA)	200	396	attenuators, step	114	300	microwave oscillators	205	445
switch, miniature	118	307	capacitors	196	376	mixer preamps	202	419
switch, pushbutton	116	303	capacitors	196	378	mixers, balanced	205	441
switches, keyboard	116	306	circulator	195	374	modem	203	429
thermostat	116	304	duplexer	195	375	panel meters	202	426
transformers, phone	190	365	filters, emi/rfi	112	277	relay sockets	203	431
			filters, miniature	114	280	relays, time delay	205	443
Data Processing			laser diodes	194	373	resistor packages	204	440
a/d converter	184	352	laser, scribing	194	372	semiconductor testing	202	418
cable	186	354	laser trimming (NL)	204	432	semiconductors	203	428
card punch, manual	188	358	modulator, bi-phase	196	377	sputtering systems	206	446
card reader	187	357	receiver, front end	194	371	standoffs and spacers	206	448
card reader, badge	106	269	switches and matrices	114	279	stepper motors	206	449
card reader, optical	186	355	tester, small reflection	94	254	switches	204	435
card reader, security	186	353				switches, rotary	204	437
code generator, key	187	356	Modules & Subassemblies			switchlights, snap-in	202	427
console flow chart (AN)	200	394	amplifier, thermocouple	178	341	tape drive	204	433
data-acquisition	104	264	converter	176	336	transducers	205	444
data terminal	188	359	converter, a/d	102	262	triacs and SCRs	202	421
metrology system	106	268	converter, d/a	98	260			
minicomputer			converter, d/a	179	342			
PDP-11/40	106	267	converter, dc-ac	100	261			
paper-tape reader	104	266	converter, s/d	176	338			
phone dialer circuit	188	360	converter, s/d	174	335			
			indicator, temperature	176	337			
ICs & Semiconductors			light, indicator	174	334			
audio preamp	170	327	op amp	179	343			
calculator chip	170	329	outlet strips	102	263			
clock driver	170	328	power supply	178	339			
isolators, optical	172	332	scanner, retroreflective	178	340			
MOSFETs	172	333						
op amp (AN)	200	391	Packaging & Materials					
overload protector	172	331	cage assembly	110	271			
package, miniature IC	170	326	card guides (ES)	198	385			
phase-locked loop	169	324	circuit board	108	270			
phototransistor	169	325	connector	192	370			
rectifier	112	275	connectors, PC	192	366			
ROM, 1024-bit	172	330	epoxy	192	368			
shift register	169	323	heat sink	192	367			
switches, solid-state	112	276	PC board (ES)	198	384			
voltage regulator	169	320	program board	111	273			
			sockets (ES)	198	379			
			sockets, DIP	110	272			
			stripper, ribbon cable	111	274			
			toggles (ES)	198	388			
			wire, low-voltage	192	369			
Instrumentation			new literature					
counter-timer	90	250	a/d, da converters	205	442			
digital multimeter	182	347	amp, log/antilog	202	425			
memory tester	92	251						
multimeter	182	349						
oscilloscope	182	348						
panel meter	96	259						
picoammeter	180	345						
power supply	180	344						
probe, automatic	95	256						
recorder	96	257						

application notes

console flow chart	200	394
noise spectra	200	392
op amp	200	391
reed switches	200	389
resolvers, encoders	200	393
test instruments	200	390

design aids

resistors	200	396
semiconductor memories	200	395
wire terminals	200	397

evaluation samples

card guides	198	385
epoxy, syntactic-foam	198	387
PC board	198	384
pins, PC mount	198	380
toggles	198	388
sockets	198	379
sockets, DIP	198	386
tubing, shrink	198	381
wire markers	198	383
wiring duct	198	382

TAUTBAND, 0.5% AND... Low Cost*



There are many other words that describe our complete line of portable standard instruments, too — like rugged, versatile and available. Yokogawa Electric has over 55 years of experience in the manufacture of precision instruments and is now introducing this complete line of taut-band portable standards

to the U.S. These instruments are reknown, world-wide, for their quality and precision. Write for our complete technical data and prices today. We're confident that we have a portable AC or DC standard voltmeter, ammeter or wattmeter that will more than meet your requirements at prices that will surprise you.

* low cost like . . .
AC Ammeter 2/5/10/20 Amps \$65.00
DC 17 Range Volt/Ammeter, 3 to
1,000 V, 1 mA to 30 A \$145.00
AC/DC Wattmeter 5/25 A, 120/240 V \$155.00

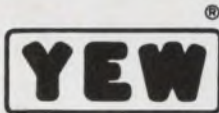

Yokogawa Electric
In the USA, contact:
Yewtec Corporation • 1995 Palmer Ave.
Larchmont, N.Y. 10538 • 914-834-3550

INFORMATION RETRIEVAL NUMBER 153

Now automated measurement of distortion to 0.05%

Programmable Oscillator
MST-840



Programmable Automatic
Distortion Meter MST-851

This hard-to-beat combination features programmable control or all functions and a fundamental reject band width not found in other distortion measuring sets, along with ample system reliability.

Distortion Measurement: ● Measured frequency range: 10Hz-100kHz (3 ranges) ● Distortion range: 0.1-30% (six ranges) ● Automatic control range (input): 62mV-77 5V ● Automatic control rate (input): Control within 800mm sec.

Level Measurement: ● Measured frequency range: 10Hz-300kHz ● Input impedance: 100 kilohms (unbalanced) ● Level range: +40 to -70dB (twelve ranges)

Signal-to-Noise Ratio Measurement: ● Measured frequency range: 10Hz-60kHz ● Measurement range: (0-70dB) to 0-120dB

Output: ● Distortion: Ac following elimination of fundamental ● Level: Ac following range selection.

Remote Signal: ● Code level: High state logical "1" (0: 0-1 1V 1: 2-5V) ● Frequency control: BCD, three places plus two bits ● Function: Eight instructions 8 bits

Frequency Display: ● Displayed frequency: Three decimal places

Our broad product line includes a Sequence Programmer and Programmable Intermodulation Distortion Meter.



MEGURO DENPA SOKKI K.K.

No. 5, 1, 2-chome, Chuo-cho, Meguro-ku, Tokyo, Japan
TEL: 715-1211 Cables: MEGURODENPA TOKYO

INFORMATION RETRIEVAL NUMBER 154

ELECTRONIC DESIGN 19, September 14, 1972



It's easy to diagnose sick circuits.

Do it with *ThermoProbe* or *Circuit Ryder*.® They're easy-to-use non-contact Infrared Thermometers that tell you at a glance when a specific circuit component is too hot—without touching it. Accurate heat readings, time after time, from room temperature to 500° C. on spots as small as 0.050 inch. Highly accurate readings in an instant for small motors, wires, armatures and brushes, too.

□ *ThermoProbe* is a highly versatile bench instrument for measuring minute components with a high degree of accuracy. It allows continuous temperature monitoring and recording. A built-in spotlight pinpoints the target you're measuring. And our famous *Circuit Ryder*, a portable, battery operated pistol, is extremely valuable for spot checking.

□ An entire line of non-contact Raytek Infrared Thermometers, giving accurate heat readings from 60 to 3,000° F., is available for almost any product or application. For more information or a no-obligation demonstration, write today to Peter Bliven, C.D. (Circuit Doctor), Raytek, Inc., 1277 Terra Bella Ave., Mountain View, Calif. 94040.



RAYTEK

A Division of Optical Coating Laboratory, Inc.

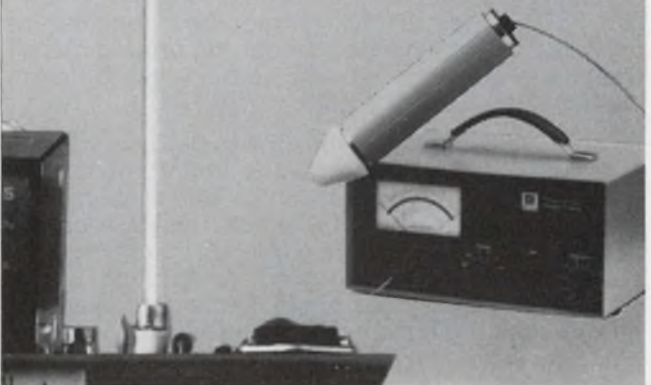

INFORMATION RETRIEVAL NUMBER 155

215

G P

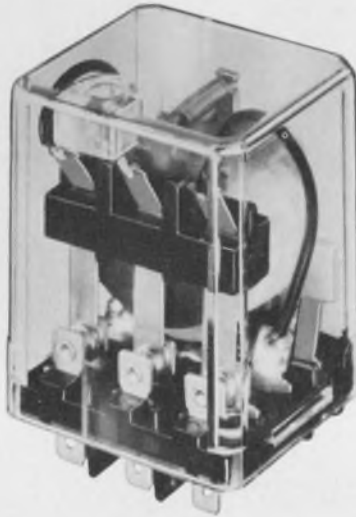

MAGNECRAFT'S NEW CLASS 388 GENERAL PURPOSE RELAY

Magnecraft is pleased to introduce the new Class 388 General Purpose Relay. This inexpensive, high performance line of stock relays offers many quality features found only in custom built versions. Available in either a covered plug-in or open style with a wide choice of AC or DC coil voltages and SPDT, DPDT, or 3PDT 10 amp contacts.

All Class 388 relays have 3-way pierced terminals. While spaced for standard plug-in mounting, the flat terminals (0.187" x 0.020") also accept quick-connect receptacles or direct soldering. For plug-in use, three types of chassis mounted sockets are available; quick-connect, solder, or printed circuit terminals. Covered plug-in version has a tough clear polycarbonate plastic cover.

In a highly competitive business, delivery can be a deciding factor. If delivery is important to you, be aware that Magnecraft ships better than 90% of all incoming orders for stock relays, received before noon, THE SAME DAY (substantiated by an independent auditing firm). In addition to our shipping record, most stock items are available off-the-shelf from our local distributor.

FREE!



DESIGNER'S CATALOG

The purpose of this 36-page catalog is to assist the design engineer in specifying the proper relay for a given application. The book completely describes General Purpose, Sensitive General Purpose, and Mechanical Power Relays. New products include the complete line of Class 388 General Purpose Relays.

Magnecraft ELECTRIC COMPANY

5575 NORTH LYNCH AVENUE • CHICAGO, ILLINOIS 60630 • 312 • 282-5500 • TWX 910 221 5221

"SEE US AT WESCON, BOOTH 2400"

INFORMATION RETRIEVAL NUMBER 156

Quality RFI/EMI
broadband filters...
broad line
availability.



If you're really
serious about cost,
be serious about quality.

Allen-Bradley gives you a choice of forty-two broadband filters in Pi, T and L configurations. These "hermetically" sealed low pass filters are designed to suppress conducted interference on DC and low frequency AC (0 to 400 Hz) power lines. Meet or exceed MIL-F-

15733. Available with gold or tin plating. Request Publication 5418. Call your A-B electronics distributor, or write: Allen-Bradley Electronics Division, 1201 S. Second St., Milwaukee, WI 53204. Export: Bloomfield, N. J. 07003. Canada: Galt, Ontario. U. K.: Bletchley, Bucks.

Voltage Rating		Minimum Insertion Loss (dB)			
-55°C to +85°C	-55°C to +125°C	0.30 MHz	1.0 MHz	10 MHz	1000 MHz
200 VDC 125 VAC	100 VDC	12 to 34	23 to 65	58 to 80	70 to 80
		16 to 52	35 to 80	65 to 80	70 to 80
100 VDC	50 VDC	26 to 63	37 to 80	66 to 80	70 to 80



Actual Size

ALLEN-BRADLEY
QUALITY ELECTRONIC COMPONENTS



INFORMATION RETRIEVAL NUMBER 247

meet the new members of...



the family of

PANAPLEX II™

PANEL DISPLAYS

Now there's more reason than ever for you to specify Burroughs' PANAPLEX II panel displays. We've taken our years of experience and come up with the best numeric display to fit your application. They're low priced, as low as \$1.00 per digit*. They're small in size, with a variety of character heights including .25", .4", and the new .2" and .70". Our PANAPLEX II panel displays offer you maximum application versatility in 8 to 16 digits of numeric readout. The 7-segment characters are bright and readable.

Each compact, thin, in-plane panel is packed with features that keep your cost down: MOS compatibility, low cost associated circuitry (in some cases direct interface to MOS), design flexibility, long life and low display power (under 5 mw per segment). All PANAPLEX II panel displays offer you Burroughs' assured reliability. If your products use numeric displays, specify the PANAPLEX II panel display.



You'll get the best readout at the best price, tailored for your application from Burroughs, the leader.

For additional information, write Burroughs Corporation, Electronic Components Division, P.O. Box 1226, Plainfield, New Jersey 07061; or call our special applications assistance number, (201) 757-3400.

*50,000 tube quantity, 12-digit panel; even less per digit, 16-digit panel.



Burroughs



INFORMATION RETRIEVAL NUMBER 248