

Electronic Design 15

VOL. 20 NO.

FOR ENGINEERS AND ENGINEERING MANAGERS

JULY 20, 1972

The fully automated factory, long a gleam in the eye of many a manufacturer, is nearing reality. The reason? New developments in machine and process control,

a trend to lower-cost, specialized industrial test instruments and fast, high-power semiconductors. For a special report on the latest industrial electronics, see P. 26.



RECEIVED
JUL 17 1972
[Redacted]

Odd Jobs Wanted



Highly respected company with reputation for fast handling of special resistance projects seeks challenging assignments in thick film. Completely equipped to design and/or produce special circuitry inside DIP and SIP packages. Laser trimming facilities for high volume needs. Also special capabilities for non-standard configurations, hybrids and high power requirements. Custom substrate preparation, including LED metalization, a specialty. References furnished. Contact your Dale Representative or call 402-564-3131.

Dale Electronics, Inc., Box 609,
Columbus, Nebraska 68601.
In Canada: Dale Electronics
Canada, Ltd. A subsidiary of
The Lionel Corporation.

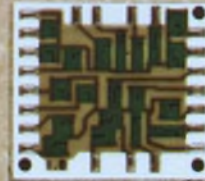

DEPENDABLE
DALE

141T Variable persistence and storage. Gives bright, high-resolution traces at slow scans. \$1800. Also available: economical normal persistence and large screen displays.

8556A Tuning Section, 20 Hz—300 KHz, with built-in tracking generator. \$1690.

8553B Tuning Section, 1 kHz—110 MHz. \$2275.

Tracking generators for wide dynamic range, swept frequency response measurements.

8443A 110 MHz Tracking Generator/Counter. \$3600 (\$2075 w/o Counter).

8444 A/B 1300 MHz Tracking Generator. \$2950.

8554L Tuning Section, 0.5—1250 MHz, \$3500.

8552B High Resolution IF Section has 10 Hz bandwidth, manual scan, two log plus linear scales, \$2950. Lower cost unit (8552A, \$2275) also available.

8555A Tuning Section, 10 MHz—40 GHz, \$6175.

8445A, 18 GHz Automatic Preselector, for wide scans, free from unwanted responses, \$2000.

HP's Family Plan: or how to add extra value to spectrum analysis.

With HP's neatly-interrelated spectrum analyzers, you can take your choice of tuning sections, displays and companion instruments to tailor a system for your measurement needs — all the way from 20 Hz to 40 GHz. Then, as your requirements expand, re-configure your system simply by adding the related piece of equipment. That's the value of our family plan.

By themselves, any of the 4 spectrum analyzers give you unparalleled signal analysis capability made possible by absolute amplitude calibration, low distortion, high resolution, and wide frequency scans coupled with the ability to zoom down to a narrow scan.

And the family value really multiplies when you add the companion instruments.

For example, the tracking generators combined with the analyzers make swept measurements over a 120 dB range thus forming precision swept frequency test systems.

And our automatic preselector for the microwave tuning unit does away with image, multiple and spurious responses.

All in all, HP's family of spectrum analyzers gives you the greatest depth and breadth of performance and the best value in signal analysis equipment available anywhere. For more information, call your local HP field engineer or write to Hewlett-Packard, Palo Alto, California 94304; Europe: 1217 Meyrin-Geneva, Switzerland.

HEWLETT  PACKARD

SIGNAL ANALYZERS

04111A

LONGEVITY CANNOT BE MEASURED BY SIZE

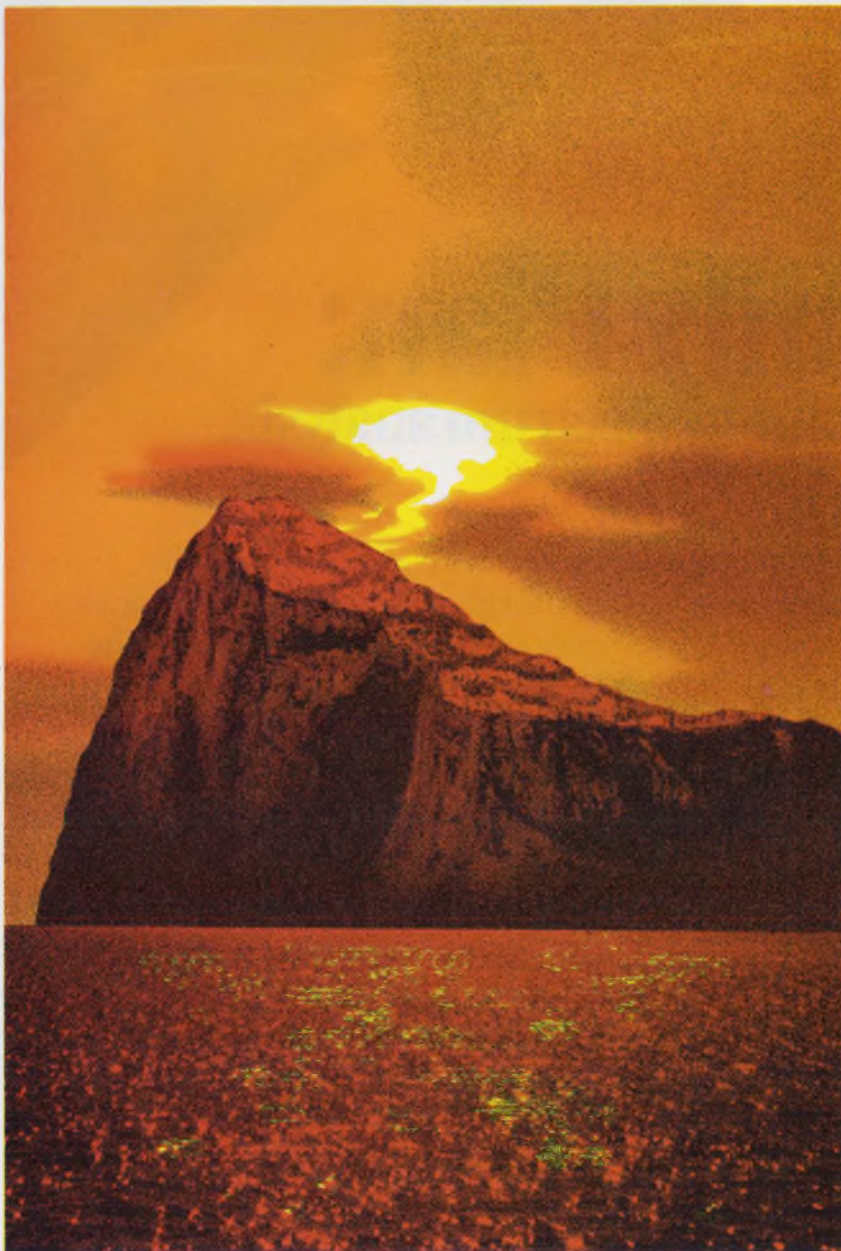

The Rock of Gibraltar has stood sentinel to the Mediterranean since time began. So have the small stones at its base. In the electronics world, both long life and stability of components play an important part. The Teledyne TO-5 is ideally suited for this role. Housed in a miniature TO-5 Transistor Case, the tiny Teledyne TO-5 Relay has consistently met the tests of time and continues to be the most advanced and reliable general purpose relay available today for both industrial and aerospace applications.

The same tenacity that made the TO-5 Relay the present day industry standard is also dedicated to the development of Solid State relays. Teledyne provides a broad family of devices to fit most aerospace and industrial applications. Send us your requirements.

3155 West El Segundo Boulevard
Hawthorne, California 90250
Telephone (213) 679-2205



**TELEDYNE
RELAYS**

NEWS

- 23 **News Scope**
- 26 **Industrial electronics: Where the action is.** A special report on the demand for new machine and control systems and components.
- 28 **Minicomputers are taking over** in factories in blue collar and white collar rolls.
- 34 **Power semiconductor devices** are pushing into brand new fields as costs fall and performance of systems soar.
- 40 **Technology Abroad**
- 43 **Washington Report**

TECHNOLOGY

- 54 **Improve efficiency in power control** by returning the load energy to the source. Circuit complexity goes up but size and dissipation go down.
- 60 **DPMs—Part 2 of a series. Will your DPM work with your system?**
- 64 **Boost op-amp bandwidths and slew rates** with input lag compensation instead of the usually recommended lag-compensation techniques.
- 68 **You have to earn management's support**, says this company president. You can, if you learn to sell ideas as business propositions as well as engineering feats.
- 74 **Ideas for Design**

PRODUCTS

- 83 **Modules & Subassemblies:** Small, low-cost modular power supplies woo light-minded users.
- 86 **Modules & Subassemblies:** Assemble pulse generators by the module.
- 88 **ICs & Semiconductors:** FET-input preamp combines speed and versatility.
- 92 **ICs & Semiconductors:** Internally compensated, fully protected, op amp beats key specs of 725 family.
- 94 **Data Processing:** Low-cost minicomputer race gets a new entry.
- 96 **Data Processing:** Tape-cassette unit replaces paper-tape punch and reader.
- 99 Components 108 Instrumentation
- 104 Packaging & Materials 104 Microwaves & Lasers

Departments

- 53 **Editorial:** Innovate in new designs or let the world slip by.
- 7 Across the Desk 122 Advertisers' Index
- 112 Application Notes 124 Product Index
- 114 New Literature 124 Information Retrieval Card
- 118 Bulletin Board

Cover: Photo by Robert Perron; courtesy of General Electric



Think Twice:

Extra contribution is one way to the top. Specifying HP scopes will help you, too.

Here's why.

You're an engineer on the way up. Your ideas, your designs, your work all reflect the extra contribution you're making. (You might even slip back to "the shop" after dinner and on weekends.) Rewards won't be long in coming.

There's one more thing you can do for yourself and your management. Show them a way to cut operating expenses and boost profits. How? By being critical and downright hardnosed in making your cost/performance comparisons on instrument purchases.

Scopes Have Changed.

Take laboratory oscilloscopes for instance. In the past several years, scope design and performance have changed—for the better. Many companies, maybe yours, are in the process of replacing older scopes, to take advantage of the extra capability these new models offer. To get the best buy now, you're going to have to do more than look at the name tag and spec sheet. Plug-ins are not compatible. Calibration is completely different. Controls and operations have changed radically. It's a whole new ball game. *Little* that you learned or used on older scopes—*whether theirs or ours*—can be transferred to the new models. You need new techniques, new training materials, new parts. Here are three specific reasons why you should investigate the HP 180 Series... why you should think twice.

HP Scopes Cost Less To Buy

Analyze your total measurement needs, then ask both manufacturers to submit prices. On latest model plug-in lab scopes, you'll find that HP can consistently save you money—lots of it. For example on a 75 MHz non-delayed sweep, plug-in system, ours is 24% less (with delayed sweep, 18% less); at 100 MHz, ours is 16% less; for 1 GHz sampling, you'll pay 54% less if you buy ours.

HP Scopes Cost Significantly Less To Operate

Because scopes have changed, training, operation, calibration, and repair are expenses that you'll have to contend with—no matter which make you buy. HP's new scopes are supported by simplified operation and live or videotaped training and repair sessions that can substantially cut your start-up and overall operating costs.

Calibration? We've cut the number of adjustments by 50%—and eliminated interactive adjustments. Therefore, when you're comparing oscilloscopes be sure to include in that comparison the cost of calibrating each manufacturer's unit.

Our users are reporting shorter training periods, faster, surer measurements, and savings up to 50% on calibration time and costs. Some companies buying Hewlett-Packard, cite this as the main reason.

HP Technological Leadership. More Performance. Fewer Problems.

HP innovations in general purpose lab scopes include: the first scope with a real time bandwidth of > 250 MHz; the first 18 GHz sampling scope; the first 100 MHz variable persistence and storage scope; and the first and only 100 MHz scope with a "big-picture" CRT (8x10 div, 1.3 cm/div). These are meaningful, functional innovations that boost your performance, not your costs.

Think twice! Once you make the comparison, we're certain you'll choose HP. Many engineers like yourself—engineers on the way up—have already made the switch. For more information on how you can help your company boost profits and how you can help yourself make faster, more positive measurements, write for our free "No Nonsense Guide To Oscilloscope Selection."

Hewlett-Packard, Palo Alto, California 94304. In Europe: 1217 Meyrin-Geneva, Switzerland.

**Scopes Are Changing;
Think Twice!**

HEWLETT  PACKARD
OSCILLOSCOPES

A Smart Way to Beat Your Power Supply Size Problem



1½" thin, 2¾" narrow, 2¾" short

yet this converter produces 1000 volts DC, regulated, from a battery input of 28 VDC! It weighs less than 15 ounces. This is only one of our wide variety of many small light weight converters, inverters and power supplies — there are over 3000 models listed in our newest catalog, including size, weight and prices. If you have a size problem, why not send for an Abbott catalog?

MIL SPEC ENVIRONMENT — All of the power modules listed in our new catalog have been designed to meet the severe environmental conditions required by modern aerospace systems, including MIL-E-5272C and MIL-E-5400K. They are hermetically sealed and encapsulated in heavy steel containers. New all silicon units will operate at 100°C.

Please see pages 618 to 632 of your 1971-72 EEM (ELECTRONIC ENGINEERS MASTER Catalog) for complete information on Abbott modules.

Send for our new 56 page FREE catalog.

RELIABLE — Highest quality components are used in Abbott power modules to yield the high MTBF (mean time between failure) as calculated in the MIL-HDBK-217 handbook. Typical power modules have over 100,000 hours MTBF — proving that the quality was built in from the beginning.

WIDE RANGE OF OUTPUTS — Any voltage from 5 volts DC to 3,650 VDC is available by selecting the correct model you need from our catalog with any of a variety of inputs including:

- 60 ∞ to DC, Regulated
- 400 ∞ to DC, Regulated
- 28 VDC to DC, Regulated
- 28 VDC to 400 ∞ , 1 ϕ or 3 ϕ
- 24 VDC to 60 ∞ , 1 ϕ

abbott transistor

LABORATORIES, INCORPORATED

5200 W. Jefferson Blvd./Los Angeles 90016
(213) 936-8185

1224 Anderson Ave./Fort Lee, N.J. 07024
(201) 224-6900

INFORMATION RETRIEVAL NUMBER 5

Publisher

Peter Coley

Editors

Editorial Offices
50 Essex St.
Rochelle Park, N.J. 07662
(201) 843-0550
TWX: 710-990 5071
Cable: Haydenpubs Rochellepark

Editor: George Rostky

Managing Editors:

Ralph Dobriner
Michael Elphick

Associate Editors:

Jules H. Gilder
Richard Lee Goldberg
Morris Grossman
John F. Mason
Stanley Runyon
Edward A. Torrero
Richard L. Turmail

Contributing Editor:

Peter N. Budzilovich

Editorial Field Offices

East

Jim McDermott, Eastern Editor
P.O. Box 272
Easthampton, Mass. 01027
(413) 527-3632

West

David N. Kaye, Senior Western Editor
2930 West Imperial Highway
Inglewood, Calif. 90303
(213) 757-0183

Les Brock, Western Editor
12378 S. Saratoga-Sunnyvale Rd.
Saratoga, Calif. 95070
(408) 255-9966

Washington

Michael Blake
922 24th St., N.W., #718
Washington, D.C. 20037
(202) 338-0700

Editorial Production

Marjorie A. Duffy

Art

Art Director, William Kelly
Richard Luce
Anthony J. Fischetto

Production

Manager, Dollie S. Viebig
Helen De Polo
Maxine Correal
Anne Molfetas

Circulation

Manager, Nancy L. Merritt
Ron Deramo

Information Retrieval

Peggy Long

across the desk

With tongue in cheek, press not too deep

I find that I can't tell from your editorial of May 11, 1972, (It's a Great Idea—for the Other Guy," p. 45) how far your tongue may be pressing in your cheek. I hope that it does so for at least a centimeter or two.

Would you truly be "uncomfortable" with a type specification of 3.5 mm, first 13 lines 80 mm wide, remainder 125 mm? And could you tell the difference visually between those values and the micrometric dimensions you give in your editorial?

The metric system needs sincere help to get established in the U.S., not more fun-poking of the "I'd walk 1609, meters for a Camel" variety.

*P. L. Lewis,
Director of Research
and Product Development*

Lockheed Aircraft Service Co.
Ontario International Airport
Ontario, Calif. 91764

In your editorial on the metric system you pose the question of what to do about such printing measures as the pica, point and em, and observe that you probably would not have to change them. I believe you are right; you probably won't. But even if you did have to, it would not be as awkward as you imply or imagine.

First, the em wouldn't change anyway, since it is a variable measure. Second, why must you ask for an 80.1146-mm column, when an 80-mm column would do as well and not be noticeably smaller to the naked eye? Third, why specify 3.5138-mm type, when you could say (and be understood) 3.5-mm

type. We do this now when specifying lumber (2 x 4s are not 2 inches by 4 inches finished), and hardware (1/4-inch bolts are not 0.2500 inch in diameter).

As you may have guessed, I am irritated by this kind of objection to a metric changeover. There are valid objections to going metric in some fields, but I don't feel your objections can be called such.

Yes, you would have to become familiar with a new system, but I know from personal experience in a metric country that one can pick up the new units and think in terms of them very rapidly.

Collier N. Smith

765 20th
Boulder, Colo.

In your editorial in the May 11, 1972 issue, you suggest that the metric system is a great idea, but only for the other guy. The letter from Robert H. Armstrong seems to have done you in. Why do you feel the need to specify the point, the pica and the em in millimeters when you don't specify them in inches now?

There appear to be many who think that physical dimensions will change with the adoption of the metric system. Not so. The pica won't change, the size of paper this letter is written on won't, a four-inch pipe won't become larger or smaller, and neither will a 2 x 4-inch piece of lumber.

So why don't you continue to specify printing jobs in point, pica and em, and let Mr. Anderson manufacture his printing equipment with the same dimensions as before, except he may have to buy new metric rulers for his workers—that's all!

(continued on p. 10)

Electronic Design welcomes the opinions of its readers on the issues raised in the magazine's editorial columns. Address letters to Managing Editor, Electronic Design, 50 Essex St. Rochelle Park, N. J. 07662. Try to keep letters under 200 words. Letters must be signed. Names will be withheld on request.



THE
LONG
LINE OF

ECC

LOW AND HIGH CURRENT

TRIACS

World's leading
Triac producer offers
fast delivery,
electrical isolation and
a variety of packages.

LOW CURRENT TRIACS

THERMOTAB® and THERMOPAK*; Swedge and TO-3; 3/8" Hex Stud, and TO-5 Metal and Plastic Packages

*trademark of ECC

$I_{T(RMS)}$ 0.8 - 16 amps

I_{gt} 1, 111 3, 10, 25, 50 ma max;
with or w/o internal trigger

I_{TSM} 20 - 150 amps

V_{DROM} 200 - 800 volts

For more information, circle No. 238

HIGH CURRENT TRIACS

3/4" Press-Fit, Stud and TO-3 Packages

$I_{T(RMS)}$ 25 - 40 amps

I_{gt} 1, 111 50 - 100 ma max

I_{TSM} 230 - 300 amps

V_{DROM} 200 - 800 volts min

For more information, circle No. 239

All packages are electrically isolated except TO-5 Metal Can. ECC triacs feature heavily glass passivated junctions for high reliability.

Contact your nearest ECC Sales Representative or Authorized Distributor for pricing and technical information.

ECC
CORPORATION

P.O. Box 669 • Euless, Texas 76039
817/267-2601

As components become more sophisticated, the versatility of silicones is more evident.

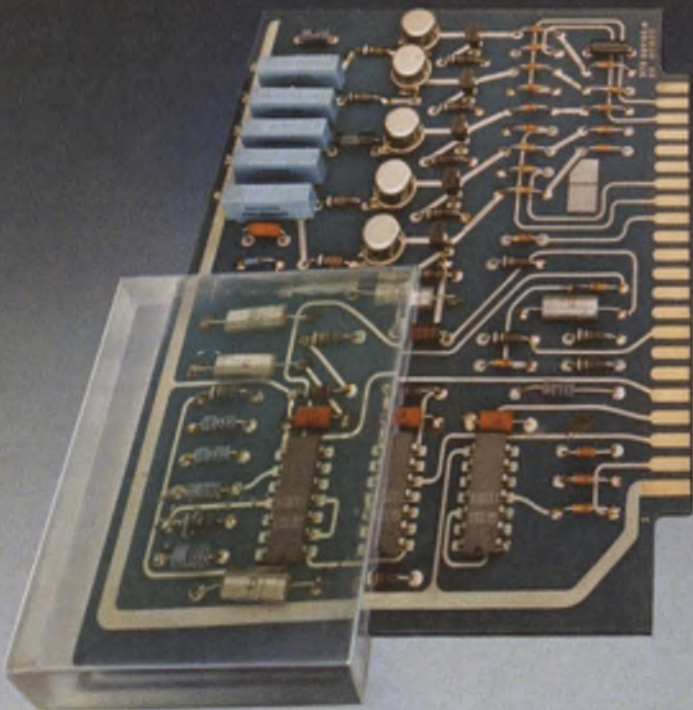

For see-through protection, encapsulate with this clear, resilient silicone resin. Self-extinguishing, it guards against humidity, heat, cold, radiation, thermal shock and vibration. Information retrieval number 221.

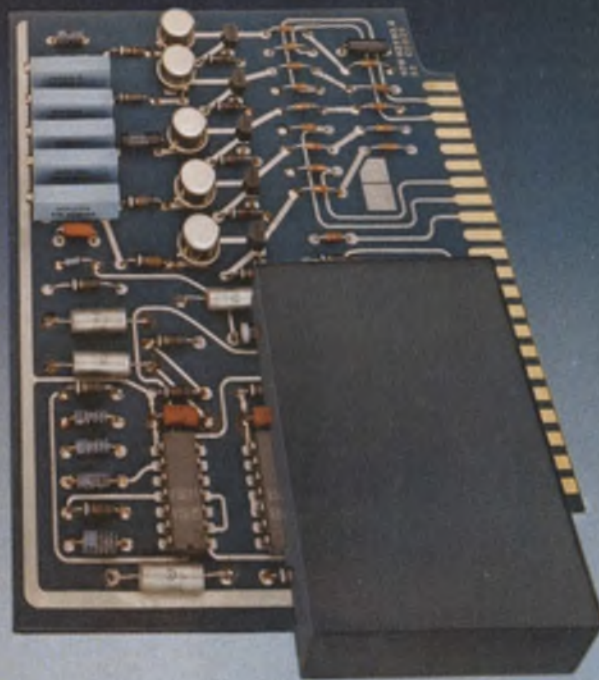

For added safety, specify this flame-retardant, pourable silicone elastomer. Uses for this low-cost packaging material include coating, potting and encapsulating. Information retrieval number 222.

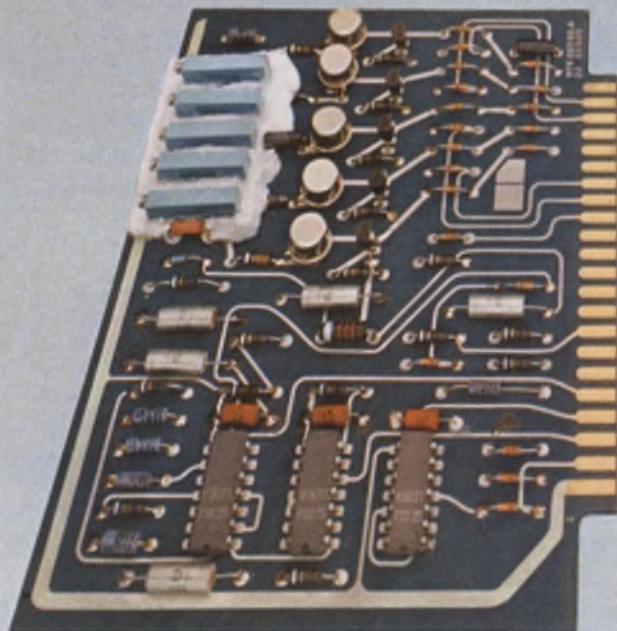

For excellent adhesion to corrosion-prone metals such as copper, use this new noncorrosive, one-part Dow Corning sealant. Cure mechanism produces no exothermic heat or acetic acid. Information retrieval number 223.

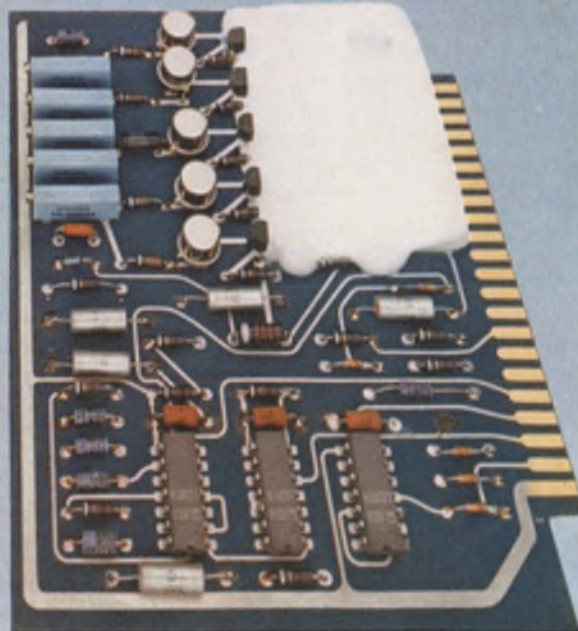

For protection against moisture, dirt, ozone, radiation and many solvents and chemicals, select this conformal coating. It flows on easily and cures at room temperature to a tough silicone rubber with excellent dielectric properties. Information retrieval number 224.

Silicones are unusual in the number of ways they protect. They resist change in hostile environments where other materials are unstable. They have excellent dielectric properties. With the electronic industry's concentration on higher performance and smaller components, the application areas where only silicone materials

can ensure design integrity have increased dramatically. Here are some of the newest examples. Many others are described in our Silicone Electronic Materials brochure available from your Dow Corning distributor. His name appears on the following page. Or write Dept. A-2202, Midland, Michigan 48640.

Electrical/electronic materials from

DOW CORNING

DOW CORNING

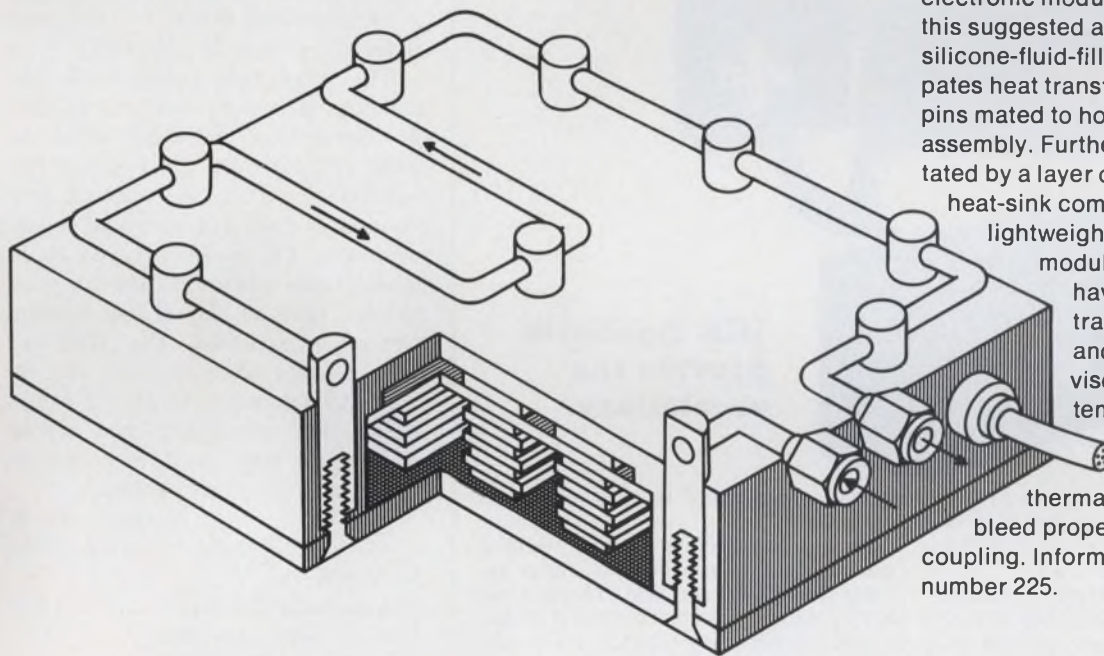

Silicones for cooling high-density modules. More efficient cooling of electronic modules is possible with this suggested assembly design. A silicone-fluid-filled coolant tube dissipates heat transferred to it from dowel pins mated to holes in the module assembly. Further conduction is facilitated by a layer of Dow Corning® heat-sink compound between a lightweight cold plate and module base. Silicone fluids have excellent heat-transfer properties and maintain constant viscosity over a wide temperature range. The heat-sink compound has high thermal conductivity and low bleed properties for long-term coupling. Information retrieval number 225.

Silicones add durability to Ominimite* transducer. This magnetostrictive device converts electrical energy into sound for ultrasonic cleaning systems. It is insulated with Dow Corning silicones. Bendix Instruments and Life Support Division uses coil forms fabricated from a Dow Corning silicone resin bonded glass laminate. Finished coils are dipped in Dow Corning® 997 varnish and baked. Silicones help add the physical and electrical stability required for long-term performance. Information retrieval number 226.

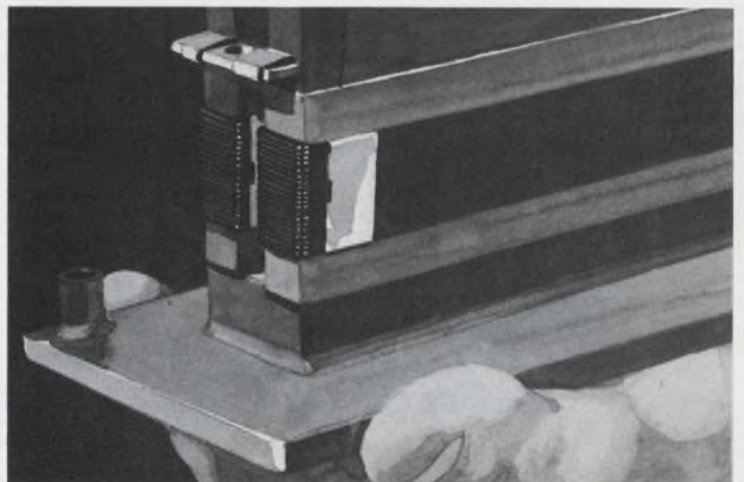

*TM, Bendix Corporation

When your machine has more to say...



IEE Readouts provide the vocabulary.

When your machine has more to say, IEE rear projection readouts let it speak out with an eloquence that make other display systems seem taciturn.

For instance, just one IEE rear projection readout will improve the vocabulary of your machine with up to 64 new phrases expressed in any combination of alphanumeric, in any language, accompanied by the symbols of any discipline, all displayed in a variety of colors and in the type styles that go best with your panel decor.

No gas discharge tube, or LED or what have you, can make that statement.

IEE units communicate — loud and clear!

Our big Series 80 rear projection readout lets your machine shout in huge 3 3/8-inch characters. Or we can say things discretely

with our fit-anywhere 1/2 x 3/4-inch Series 345 model.

All with single-plane viewing, variable brilliance, and the capability to change vocabularies right in the field. To assist, we have a powerful new low-cost hybrid driver/decoder for any of the readouts. Plus a host of other driver/decoders... all, competitively priced... purchased separately or customer mounted.

Rear projection readouts give you an order of display versatility a world apart from other techniques, and IEE builds more of them than anybody. Send today for our Short-Form Catalog on units that are long on talk. Industrial Electronic Engineers, Inc., 7740 Lemona Ave., Van Nuys, California 91405. Telephone: (213) 787-0311 • TWX 910-495-1707

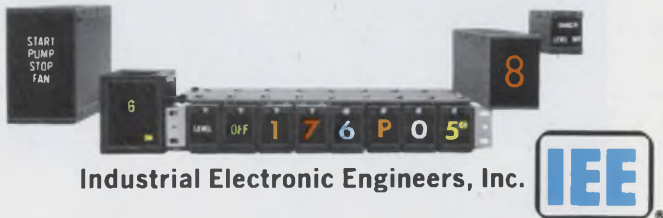

Industrial Electronic Engineers, Inc.



ACROSS THE DESK

(continued from p. 7)

I bet you will find the cost of switching to the metric system to be far less than staggering.

Erik Wiik,
Control Technology and Simulation
Union Carbide Corp.
Chemicals and Plastics
P.O. Box 8361
South Charleston, W. Va. 25303

Your editorial "It's a Great Idea —for the Other Guy" has inspired me to release all my pent-up feelings about metric-conversion articles and editorials. Distilled, they all seem to say "This is the way to go, but —" and then proceed to tell why it can't possibly be done or how great the difficulties are going to be. I would much prefer to see a concerted effort to show how little effort will be involved.

The straw that really broke the camel's back was your conversion of convenient working sizes to what you consider unwieldy metric equivalents—that is, precise conversion of rounded, nominal measurements. I'm quite sure you could comfortably communicate to your printer that he should use 3.5-mm Century Expanded, the first 13 lines 80 mm wide and the last 30 lines 127 mm wide. In fact, I would guess that eventually you would prefer 125 mm, as it is easier to think in 5-mm increments.

Harry D. Bush
Hybrid Research Dept.
Motorola, Inc.
Communications Div.
1301 E. Algonquin Rd.
Schamburg, Ill. 60172

I'm ashamed of you. It appears that you missed the point of metric conversion, and statements like yours are what have held up the changeover for the past 100 years.

Your fourth paragraph made a statement that you misinterpreted ("... metric systems would do away with furlongs, acres..."). This does *not* mean you have to abandon terms like pica, point and em. It means *redefine* them in terms of the meter (point equals 0.3523 mm, pica equals 4.227 mm). Now you can still use these terms

(cont. on p. 16)

Silicone Protectors

A full line of silicone encapsulating, insulating, sealing, coating and dielectric materials is available from Dow Corning Distributors at the following warehouse locations:

ALABAMA

Birmingham
Electrical Insulation Suppliers
205 252-9046
Mobile
Brownell Electro, Inc.
205 479-5405

ARIZONA

Phoenix
Essex International Inc.—IWI Div.
602 278-8568

CALIFORNIA

Berkeley
C. D. LaMoree
415 841-0601
Culver City
E. V. Roberts & Associates, Inc.
213 870-9561
Gardena
Specialized Products Co.
213 532-1230—213 770-8186
Los Angeles
Essex International Inc.—IWI Div.
213 264-7000
C. D. LaMoree
213 225-5666
Brownell Electro, Inc.
213 532-1150
Mountain View
K. R. Anderson Company, Inc.
415 961-6007
San Diego
A. E. Yale Enterprises
714 296-6148
San Francisco
Essex International Inc.—IWI Div.
415 626-5351

COLORADO

Denver
Waco Enterprises, Inc.
303 322-7708

FLORIDA

Orlando
Cramer/Florida, Inc.
305 841-1550
Brownell Electro, Inc.
305 424-5634
Electrical Insulation Suppliers, Inc.
305 855-7100
Tampa
Essex International, Inc.—IWI Div.
813 245-1651

GEORGIA

Allanta
Electrical Insulation Suppliers, Inc.
404 355-1651
Essex International Inc.—IWI Div.
404 691-8520
Chamblee
Prehler Electrical Insulation
404 451-4266
Hapeville
Brownell Electro, Inc.
404 762-5181

ILLINOIS

Chicago
Prehler Electrical Insulation
312-384-6100
Mt. Prospect
Magnuson Electronics, Inc.
312 956-0700
Niles
Essex International Inc.—IMC/IWI Div.
312 647-0044

INDIANA

Fort Wayne
Essex International Inc.—IWI Div.
219 742-7441
Hammond
Electric Supply Corp.
219 932-8840

IOWA

Marion
Ensco Distributing Corporation
319 377-6313

KENTUCKY

Louisville
E & H Electric Supply
502 587-0991

LOUISIANA

New Orleans
Williamson Distributing Corp.
504 486-5584
Shreveport
Williamson Distributing Corp.
318 424-6638

MARYLAND

Baltimore
Essex International Inc.—IWI Div.
301 644-0140
Pytronic Industries, Inc.
301 539-6525

MASSACHUSETTS

Cambridge
Brownell Electro, Inc.
617 864-7500
Newton
Cramer Electronics, Inc.
617 969-7700
Peabody
Essex International Inc.—IWI Div.
617 531-7100

MICHIGAN

Detroit
Essex International Inc.—IMC/IWI Div.
313 921-6000
Madison Heights
McNaughton-McKay Electric
313 399-7500
Southfield
Sheridan Sales Co.
313 358-3333

MINNESOTA

St. Paul
Magnuson Electronics, Inc.
612 227-8495
Prehler Electrical Insulation
612 622-1541—612 622-1542

MISSOURI

Kansas City
Essex International Inc.—IWI Div.
816 842-1613
St. Louis
Ensco Distributing Corp.
314-542-3935
Essex International Inc.—IWI Div.
314 371-2616

NEW JERSEY

Livingston
Robert McKeown Co., Inc.
210 922-0700 or 212 267-9264 (NYC)
Moonachie
Essex International Inc.—IWI Div.
201 641-4400 or 212 695-7495 (NYC)
North Bergen
Electrical Insulation Sales
201 864-2376 or 212 564-6273 (NYC)

NEW MEXICO

Albuquerque
Waco Electronics, Inc.
505 268-2409
Williamson Distributing Corp.
505 344-3564

NEW YORK

Buffalo
Summit Distributors, Inc.
716 884-3450
New York City
Brownell Electro, Inc.
212 619-7900 or 212 924-6000

NORTH CAROLINA

Charlotte
Brownell Electro, Inc.
704 394-4341
Electrical Insulation Suppliers, Inc.
704 392-2306
Essex International Inc.—IWI Div.
704 394-1315
Winston-Salem
Cramer/E. W. Winston-Salem
919 725-8711

Electrical / electronic materials
from

DOW CORNING

DOW CORNING

OHIO

Cincinnati
Cramer/Tri States, Inc.
513 771-6441
Electrical Insulation Suppliers, Inc.
513 771-4073
Sheridan Sales Co.
513 761-5432
Essex International Inc.—IMC/IWI Div.
513 771-6500
Cleveland
Essex International Inc.—IMC/IWI Div.
216 781-2310
Prehler Electrical Insulation
216 267-2650
Sheridan Sales Co.
216 524-8210
Columbus
McGraw-Edison Co.
National Electric Coil Division
614 488-1151

OKLAHOMA

Oklahoma City
Essex International Inc.—IWI Div.
405 236-5411

OREGON

Portland
Essex International Inc.—IWI Div.
503 655-0138
C. E. Riggs, Inc.
503 226-3286

PENNSYLVANIA

Harriburg
Pytronic Industries, Inc.
717 233-6591
Montgomeryville
Pytronic Industries, Inc.
215 643-2850
Philadelphia
Brownell Electro, Inc.
215 632-3030
Essex International Inc.—IWI Div.
215 236-7100
Prehler Electrical Insulation
215 725-5014
Pittsburgh
Essex International Inc.—IMC/IWI Div.
412 244-1145

TENNESSEE

Memphis
Brownell Electro, Inc.
901 323-8554
Electrical Insulation Suppliers, Inc.
901 947-4176

TEXAS

Dallas
Essex International Inc.—IWI Div.
214 339-8346
Specialized Products Company
214 358-4663
Williamson Distributing Corp.
214 741-5831
Houston
Essex International Inc.—IWI Div.
713 227-6358
Williamson Distributing Corp.
713 672-1715

UTAH

Salt Lake City
Hyer/Cramer Electronics
801 487-3681

WASHINGTON

Seattle
Atlas Packing & Rubber Co.
206 623-4697
Essex International Inc.—IWI Div.
206 763-8650
C. E. Riggs, Inc.
206 623-5707

WISCONSIN

Milwaukee
Essex International Inc.—IMC/IWI Div.
414 342-3927

8-2209

Single-Diffused

...better than EpiBase?

We've got both now. Single-diffused, UniBase* power Darlington. EpiBase* power Darlington. Plus capability to supply discrete power transistors in both technologies. The first to do this.

Great, you say. "Let me have the latest thing so I can edge my competitor's design."

Wait, though . . . not that easy. Unless you understand the basics of both technologies you won't get what you really want — an optimum device matched to true design needs, with the best trade-offs in device characteristics.

More and more engineers are educating themselves before designing in either process. Questioning and comparing to find out which is really better for their application. Probing. Analyzing. Asking.

"Are they structurally different?"

"Which is better for high-speed switching?"

"Is there an edge in safe operating area?"

"What are tradeoffs in inductive loads?"

"Which is more applicable to complementary designs?"

If you're satisfied with your supplier's answers, your education, your design, fine. If not, listen.

TAKING THE RIGHT SHAPE . . .

They're different, alright.

Single-diffused, UniBase, is achieved by diffusing collector and emitter into lightly doped P material with the base formed by the undiffused portion of the start material. Emitter and collector are equidistant from opposite chip sides. The deep emitter junction biases off high-current density area and leads to more uniform current distribution throughout the emitter. Result: very good safe operating area . . . with low frequency response due to distributed resistance and longer RC time constants.

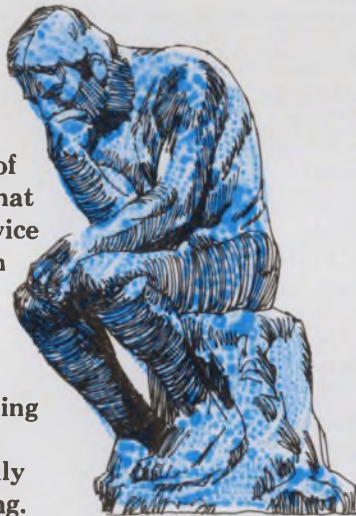
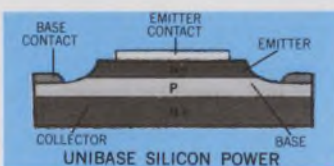

EpiBase offers devices with emitter diffused into an epitaxial base deposited on the collector substrate. The collector voltage depletes into the base region with resulting devices characterized by higher-frequency response and low switching losses with SOA equal to, or better than, UniBase except at or near device BV_{CEO} .

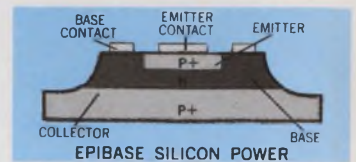

THE TRADEOFFS . . .

A couple. If switching efficiency, f_T or phase shift are your thing, EpiBase wins hands down. Although power-handling and safe area of the two are about equal, UniBase offers an edge in SOA if your design pushes ultimate device break-

Where the action is . . .

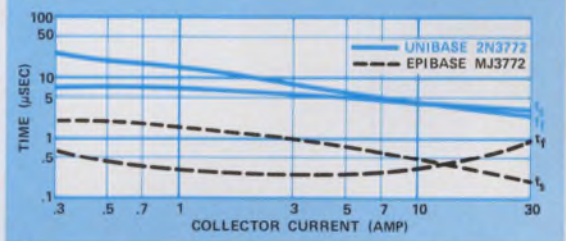

down capability. And, while beta-vs.-current curves are similar for EpiBase and UniBase transistors of given chip size, UniBase will exhibit higher sat voltages and slightly lower high-current beta. Again, a result of higher distributed resistance.

Typically, more gain and gain linearity can be had with EpiBase by sacrificing some ruggedness. With EpiBase, it's near-impossible to achieve high f_T and high SOA simultaneously . . . something's got to give.

Conversely, single-diffused offers a bit more SOA but slower action; and gain and gain roll-off figures of merit are only about half or less than EpiBase counterparts.

If your motto's "safety first" . . .

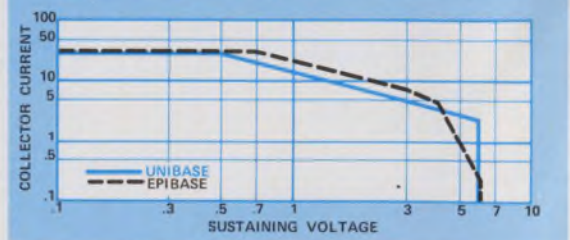

Power Darlingtons

THE APPLICATIONS . . .

Practically everywhere! Commonly, regulators, hammer drivers, inverters, converters, stereo and servo amps and power switching. Which for which? Easy. Follow our suggestions: we've factored in tradeoffs: gain, f_T , ruggedness and break-down voltage. In many applications such as regulated power supplies for high-speed logic, EpiBase is more desirable for its better response to fast-changing load conditions. And in all circuits demanding higher frequency response, EpiBase is your best bet. Because of that edge in SOA near device BV_{CEO} , UniBase is better where you're working into unclamped inductors — not recommended but sometimes unavoidable — where it must absorb stored energy.

| Your Design | EpiBase | UniBase |
|--------------------------|---------|---------|
| audio | ● | |
| series pass regulator | | ● |
| inverter | ● | |
| unclamped inductive load | | ● |
| power switch: slow | | ● |
| fast | ● | |

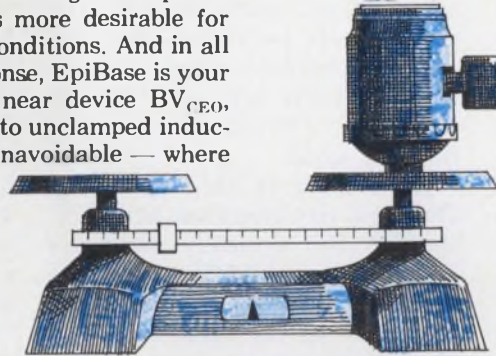

THE SPECS . . .

THE DARLINGTONS . . .

Sounds simple: power integrated circuits consisting of driver, output devices and emitter-base resistors on one monolithic chip. But advantages are revolutionary: super-high gain . . . new levels of efficiency, simplicity, cost-savings . . . direct, logic-to-Darlington interfacing . . . with EpiBase available in both NPN and PNP for complementary symmetry designs. Depending on your conclusions and your needs, your choice will be EpiBase or UniBase Darlingtons.

Draw those conclusions now. Match your design need with an unmatched solid-state power capability. Write us at Box 20912, Phoenix, AZ 85036 — contact your Motorola distributor on prototype or production.

EpiBase or UniBase . . . the choice is yours. But know this. We've got both.

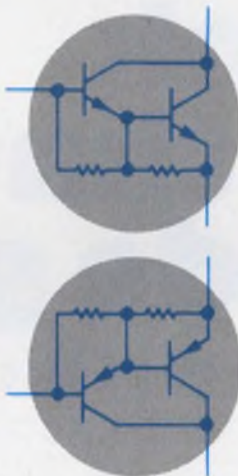

... EDORSO
... A • SPEEDORSO
... EDORSOA • SPEEDOR
... A • SPEEDORSOA • SP
... DORSOA • SPEEDORSOA
... EDORSOA • SPEEDORSO
... OA • SPEEDORSOA • SP
... EDORSOA • SPEEDOR
... RSOA • SPEEDORSO
... EDORSOA • SP
... A • SPEEDOR
... EDORSO
... RSOA • S

EPIBASE VS. UNIBASE

PRIME SPECS ON SOME PRIME

... NEW DISCRETES

| DEVICE | GAIN | FREQUENCY | SAFE OPERATING AREA |
|--|---|---|---|
| EpiBase 2N3055 | 20 @ 4A | 4 MHz | 60V/200 mA |
| vs. | | | |
| UniBase 2N3055 | 20 @ 4A | 200 kHz | 60V/1.5A |
| EpiBase MJ3771 | 15 @ 15A | 4 MHz | 40V/200 mA |
| vs. | | | |
| UniBase 2N3771 | 15 @ 15A | 200 kHz | 40V/3.75A |
| ... plus a choice between these discrettes | | | |
| MJ3772 EpiBase and 2N3772 UniBase | MJ6257 EpiBase and 2N6257 UniBase 2N6253 UniBase | MJ3773 EpiBase and 2N3773 UniBase | MJ6302 EpiBase and 2N6302 UniBase 2N6254 UniBase |

... NEW DARLINGTONS

| DEVICE | GAIN | FREQUENCY | SAFE OPERATING AREA |
|---|---|---|---------------------|
| EpiBase 2N6056 | 750 @ 4A | 4 MHz | 80V/100 mA |
| vs. | | | |
| UniBase MJ3521 | 500 @ 4A | 200 kHz | 80V/1.4A |
| EpiBase 2N6283 | 750 @ 10A | 4 MHz | 40V/1A |
| vs. | | | |
| UniBase 2N6356 | 400 @ 10A | 200 kHz | 40V/3.75A |
| ... plus a choice between these Darlingtons | | | |
| 2N6282 EpiBase and 2N6355 UniBase | 2N6283 EpiBase and 2N6357 UniBase MJ3520 UniBase | 2N6284 EpiBase and 2N6358 UniBase | |

°Trademark of Motorola Inc.



MOTOROLA POWER
—Technology By Design, For Design

INFORMATION RETRIEVAL NUMBER 8

N-Channel Si Gate RAM Boosts Memory Speed, Reduces Power and Cost.

Electronic Arrays, Inc., is producing a 1024-bit n-channel silicon gate RAM that is four times as fast as typical p-channel MOS RAMs, just as fast as bipolar. Yet the random-access memory circuit dissipates much less power than conventional RAMs and is easier to control in memory systems.

Precharge and refresh addressing are eliminated by a new internal design. The EA1500 goes from standby to active operation without precharge. In addition, every cell in the memory is refreshed by a single pulse, permitting the EA1500 to operate in an automatic refresh mode that simulates the operation of core memory systems.

Bipolar logic interfaces and power supply design are also simplified by the EA1500. The n-channel silicon gate process provides positive-logic operation on standard $\pm 15V$ supplies or $\pm 12V$ supplies.

The storage configuration is the standard 1024 x 1 expandable organization. Pinouts are compatible with those of conventional p-channel RAMs.

High-Speed Operation. Maximum access time of the EA1500 is 85 nanoseconds on $\pm 15V$ supplies, a speed previously achievable only with expensive bipolar RAMs. In contrast, access times of p-channel MOS RAMs range from about 180 to 500 nsec.

The EA1500 also has the fastest cycle times—150 nanoseconds for read, 270 nsec for write and only about 105 nsec for refresh. Ordinarily, it takes from 8 to nearly 30 microseconds to completely refresh a conventional MOS RAM because 32 pulses are required.

The n-channel process allowed Electronic Arrays to build buffering into all 1024 cells. Every pulse on the write line simultaneously refreshes all cells, although only an addressed cell can be written into.

Automatic Refresh. Since any write pulse refreshes the EA1500, the system designer can

simply pulse the write bus every system cycle. During write cycles, the normal write pulse is bused to all packages. The memory segments not accessed by an address will only be refreshed.

During read cycles, a refresh pulse is used between accesses, after the chip-enable (CE) pulse.

Called automatic refresh, the read-refresh technique lets the EA1500 simulate a core memory because there are no "memory busy" interruptions of the regular memory cycle.

Low Power Dissipation. During active operation at $\pm 15V$, the EA1500 typically dissipates 160 mW—only 35% to 40% as much as typical p-channel RAMs. Operation at the optional $\pm 12V$ differential cuts dissipation to less

than 90 mW while adding only about 100 nsec to the average cycle time.

Dissipation drops to about 35 mW during standby, Logic "0" standby, as noted above, avoids the high power consumption generally associated with precharging.

Evaluation P.C. Card. EA has made a memory board available for the potential user to evaluate the EA1500. The PC board contains all the necessary interconnections for a 2K x 4 memory board including address and data buffers, output sense amplifiers and timing signal generator. The timing signal generator is capable of demonstrating both "automatic refresh" and asynchronous operating modes.

Look at that dude go!

85 nsec 1024 Bit RAM

The all new EA1500 sets the pace for RAMs—high speed, low cost—using N-Channel Silicon Gate Technology. 85nsec access time! Yes sir, and that's worst case guaranteed. Price is a low \$25 bucks in 100 quantities. And then there's *Automatic Refresh*. Memory timing and control are simplified by the elimination of precharge and refresh addressing. A single write pulse does the job. The EA1500 RAM allows the memory system to be refreshed "invisibly," and that means no more memory busy signals.

In active operation, the EA 1500 dissipates only 160mW while standby is typically 11mW. It can be logically turned off between accesses, reducing standby dissipation to a few milliwatts.

The EA1500 interfaces easily with bipolar logic, operates on +15V and -15V supplies. For other good things about the Dude, write for our data pack and your free Dude pin.



electronic arrays, inc.

501 ELLIS STREET, MOUNTAIN VIEW, CALIFORNIA 94040, (415) 964-4321 TWX: 910-379-6985

Stocking distributors: Intermark, Cramer, Computer Components, Burstein-Applebee Company.

INFORMATION RETRIEVAL NUMBER 9

ELECTRONIC DESIGN 15, July 20, 1972

**Other computers
have the capability
of our new 8-bit
NAKED MINI.™**

But they use 16 bits.

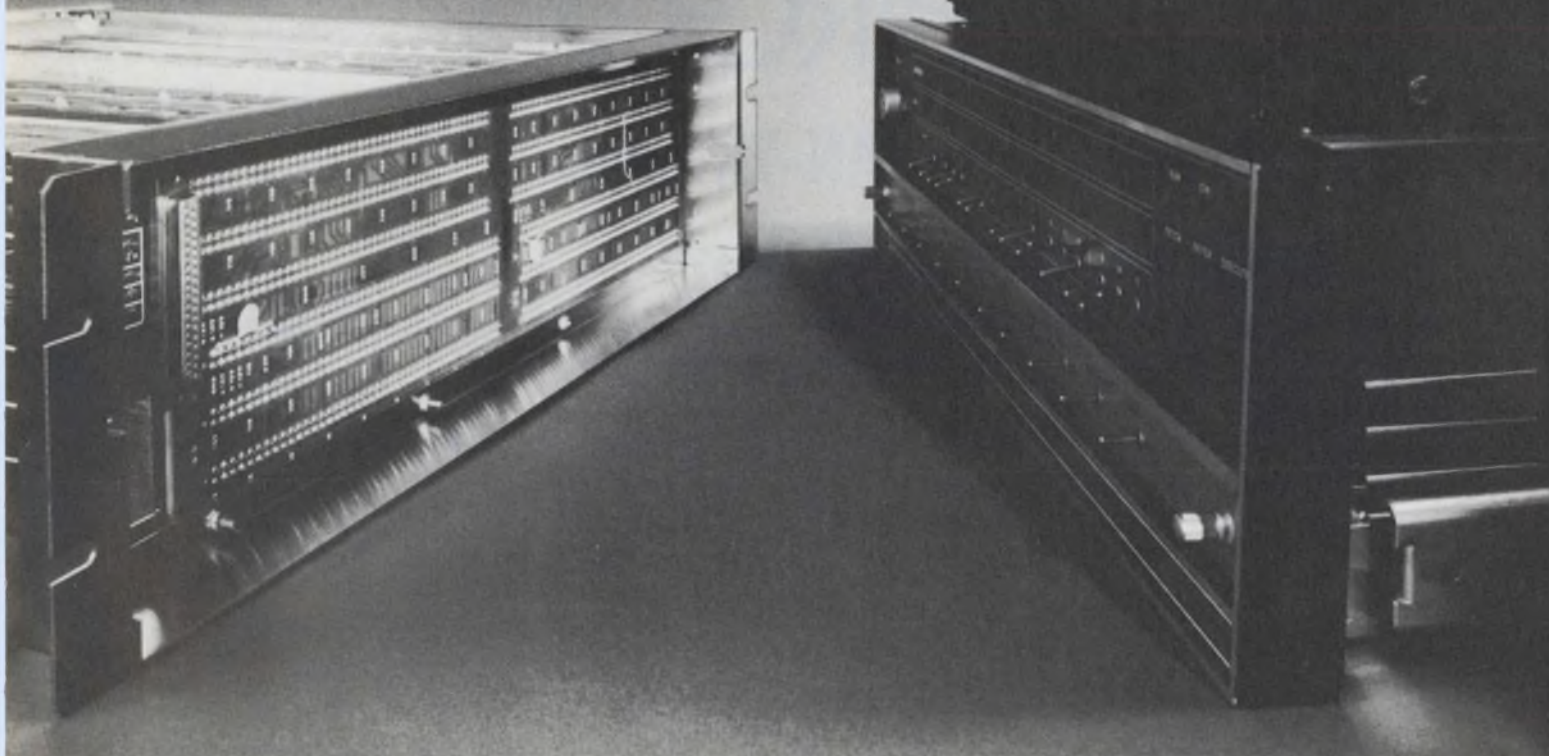

Every systems designer who's looking for a powerful, versatile computer for the lowest possible price should take a closer look at our byte-sized NAKED MINI 8.

Start by comparing its capability. It does everything a 16-bit machine can do except fast arithmetic (or inflate the price of your product). In byte-oriented applications like intelligent batch terminals, source data entry and data communications, the NAKED MINI 8 provides a potent capability that is unmatched by other 8, 12, and most 16-bit machines.

Priced at \$1,450, in 200 OEM quantities, the NAKED MINI 8 represents the industry's lowest cost high-performance minicomputer.

So think about it. Capability and price. They're two good reasons you should ask about the computer that's also a component. Write 18651 Von Karman, Irvine, Calif. 92664



COMPUTER AUTOMATION, INC.
the NAKED MINI company

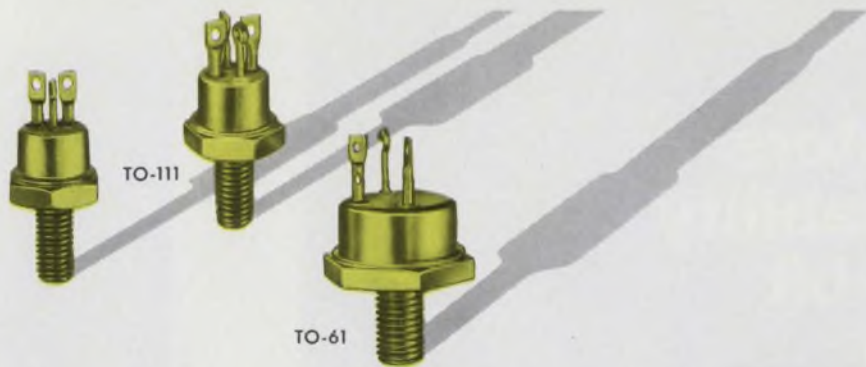

JAN-TX POWER TRANSISTORS FROM PIRGO

**eight JAN and eight JAN-TX types
available from stock now!**

| Type | Case | BV _{CEO} (sus) | h _{FE} @ 1A | V _{CE} (sat) |
|-----------------------------|--------|-------------------------|----------------------|-----------------------|
| JAN-TX 2N2812 / JAN 2N2812 | TO-61 | 60 | 40-120 | 1.5 @ 10A |
| JAN-TX 2N2814 / JAN 2N2814 | TO-61 | 80 | 40-120 | 1.5 @ 10A |
| JAN-TX 2N2880 / JAN 2N2880 | TO-111 | 70 | 40-120 | 2 @ 5A |
| JAN-TX 2N3749 / JAN 2N3749* | TO-111 | 70 | 40-120 | 2 @ 5A |
| JAN-TX 2N3996 / JAN 2N3996* | TO-111 | 80 | 40-120 | 2 @ 5A |
| JAN-TX 2N3997 / JAN 2N3997* | TO-111 | 80 | 80-240 | 2 @ 5A |
| JAN-TX 2N3998 / JAN 2N3998 | TO-111 | 80 | 40-120 | 2 @ 5A |
| JAN-TX 2N3999 / JAN 2N3999 | TO-111 | 80 | 80-240 | 2 @ 5A |

*isolated collector

Get them off-the-shelf
by calling your Sprague semiconductor distributor.
Or call Bill McCarthy at Pirgo.
603/224-1961

PIRGO ELECTRONICS, INC.,
PEMBROKE ROAD, CONCORD, N.H. 03301
A SPRAGUE ELECTRIC CO. SUBSIDIARY



INFORMATION RETRIEVAL NUMBER 11

ACROSS THE DESK

(cont. from p. 10)

in setting the print. You didn't ask for 0.1387-inch type with the first 13 lines 3.16236 inches wide and the rest 4.993 inches wide before conversion, so why do it now?

I can buy either a 6-mm bolt or a 1/4-inch bolt and I don't ask for a 6.35-mm bolt. Gradually, as 1/4-inch bolts are phased out, I'll use only 6-mm bolts. It should be your position to tout the simplicity of the metric system and not parrot useless "conversions" that have been thrown up for 100 years now.

Roger L. Smith
Senior Development Engineer
Goodyear Aerospace Corp.
Litchfield Park, Ariz. 85340

As an advertising type in electronics, I got a kick out of your May 11 editorial. However, I beg to differ with a statement in your last paragraph: "The point, pica and em are accepted and understood internationally." Did you ever specify some of the European-designed type faces, like Univers, Optima or Melior? That's when you run into 12 small, 12 large, 24 small, 24 large and some of these other goodies.

Jim Prosek
Promotions Manager
The Hickok Electrical Instrument
Co.

Cleveland, Ohio 44108

Ed Note: Our editor apparently failed to convey the message he had in mind. Early in the editorial, he stated explicitly: "Like most engineers, I strongly favor adoption of the metric system." But then he seemed to back away from this position. The intent of the editorial—conveyed perhaps too subtly—appeared in the last three lines: Too many of us accept good ideas only if they don't affect us. It's like the fellow who favors equal opportunity for all—as long as the poorer guys don't move into his neighborhood or into his kid's school. We ought to accept good ideas for their inherent worth to us all. We ought not reject them because the apparent short-term effect on us—as individuals—may be unpleasant.

Here's enough
to put you onto
flat flexible
cable....

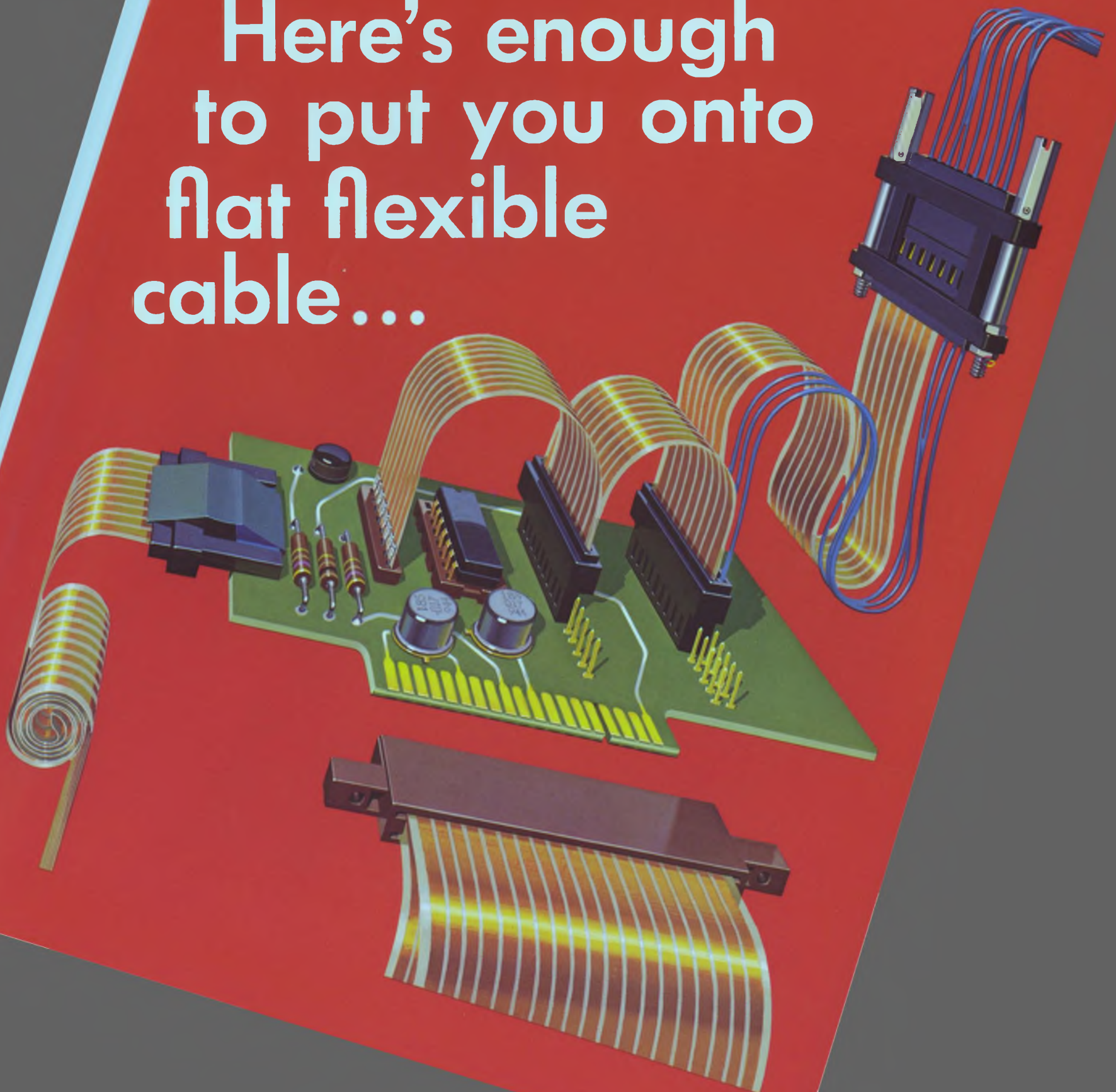

...Your widest choice of the most connectable connectors

Soup to nuts. Or more specifically: cable-to-cable, cable-to-round wire, cable-to-post, cable-to-strip receptacle, cable-to-board. You can go anywhere you want with flat flexible cable, with the AMP family of connectors. They're just what you need to take advantage of the savings in weight and space, and the opportunities for eliminating wiring errors and reducing costs which flat flexible cable can bring you.

These connectors are designed specifically for flat cable, with exceptionally low profile. After all, it makes sense to put a slim connector on slim cable. And they all use an exclusive insulation displacement crimp termination method, which makes connections quickly, reliably and economically.

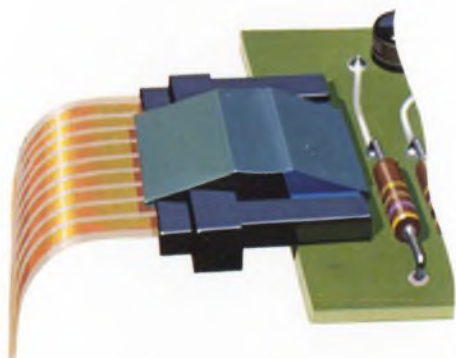

Two-piece cable to board

Another way to go from cable to board. A spring retention catch holds the mating sections firmly together.

Circle 102

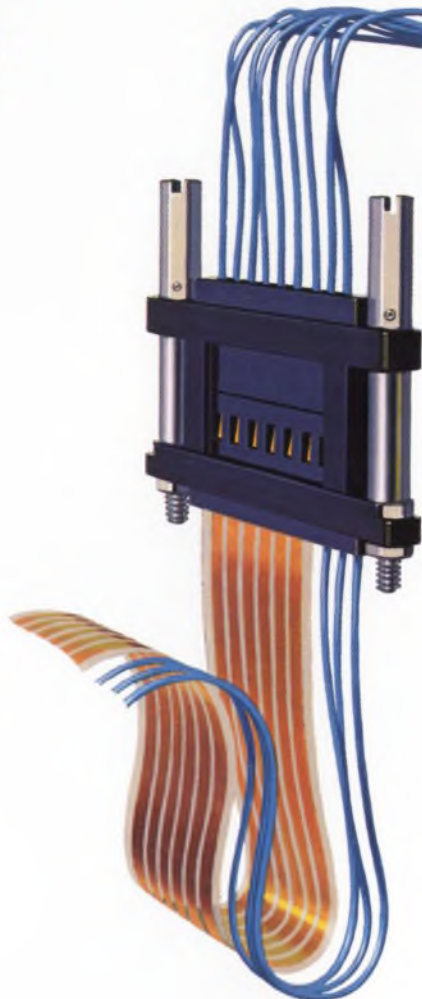

Round wire to cable

The transition from round wire to flat cable is easy, because intermateable A-MP contacts are available to handle both kinds of conductor, and fit into the same connector housing. You can mix wire and flat cable on the same half of the connector. And naturally, you can link cable to cable whenever you need.

Circle 101

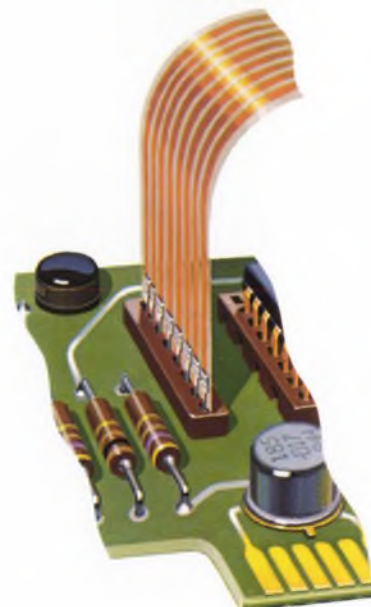

Cable to strip receptacle

This is easy. You don't even need a connector housing. A-MP contacts, after attachment to the cable, go directly into an A-MP strip receptacle of the same type used for DIP packages.

Circle 103



One-piece cable to board

This is the newest in our flat flex line . . . a one piece double row edge connector, which mates directly with bifurcated contact pads on single or double sided printed circuit boards. It can be supplied with or without mounting ears for fastening to the p/c board or rack.

Circle 104

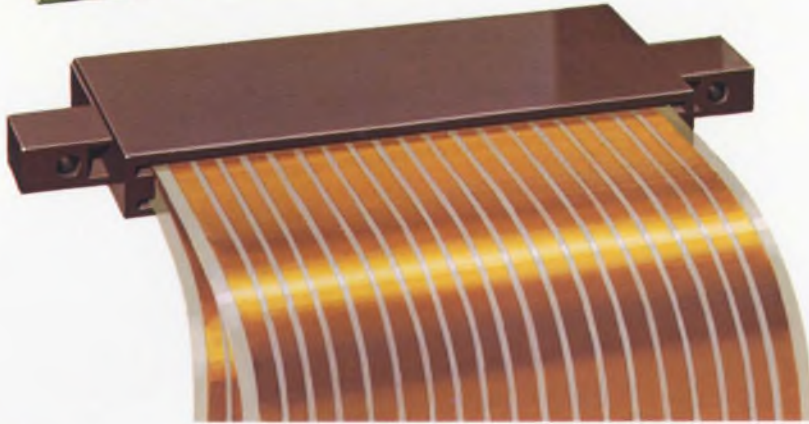

Cable to post

Single or double row connectors let you plug flat cable to posts on printed circuit boards. Up to 70 positions in standard housings.

Circle 105

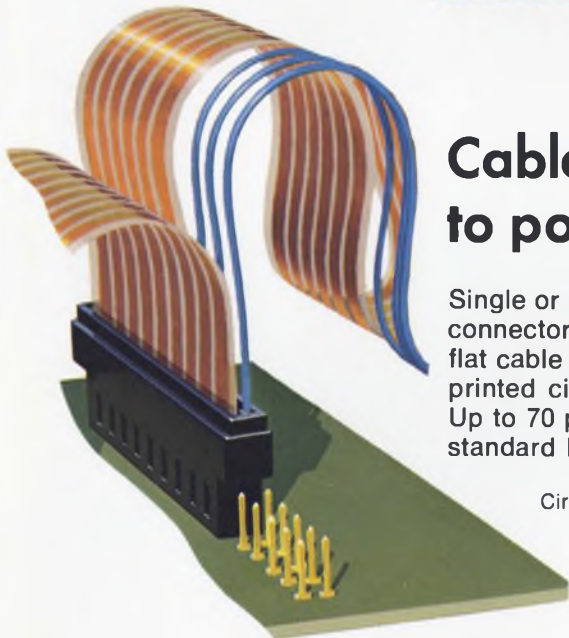

The fast, reliable way to terminate flat cable.

No stripping, no costly cable preparation is needed. Just cut cable to length and use an AMP-O-MATIC machine especially designed to handle flat cable. Our insulation displacement crimp method is shown in the drawing. The ears on the contact penetrate insulation on both sides of the conductor, then fold over to grip and force the insulated conductor up into the wire barrel, where insulation displacing lances make positive four-point contact with the conductor. The machine has the capability of terminating at the rate of 2 per second.

Circle 107



"Daisy Chain" connections

The AMP termination technique allows daisy chain or branch connections without any need for cutting the cable. Just machine-attach contacts across the width of the cable, fold cable back on itself and insert in the connector housing.

Circle 106

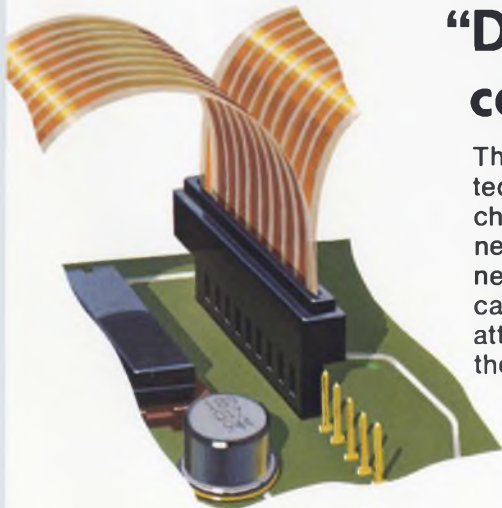

Thinking flexible etched cable? Think AMP. Our capabilities are unique. And complete.

Imaginative design is our specialty. We like to tackle . . . and solve . . . knotty problems like the cable illustrated here. We can control impedance from 50 to 125 ohms. Build a shield plane on one side of the circuit. Create performance values you've been reaching for but never before attained.

Long lengths. We can manufacture continuous lengths of cable, with repeat patterns up to 50 feet long. Widths to 22 inches.

Reliable termination. Our insulation displacement crimp technique assures interface with proved environmental stability, with the cost savings of automated application.

New economy. AMP solderless interconnection method lets us use lower temperature insulating film, eliminates costly complications.

Complete capability. We can supply you etched cable with all connectors assembled, ready to plug into your equipment. Let's start thinking together. For a consultation, write or call **AMP Incorporated, Industrial Division, Harrisburg, Pa. 17105.**

AMP
INCORPORATED

Manufacturing and direct sales facilities worldwide: Barcelona, Brussels, Buenos Aires, Frankfurt, London, Mexico City, Paris, Puerto Rico, Sao Paulo, s'Hertogenbosch (Holland), Sydney, Stockholm, Tokyo, Toronto, Turin, Vienna.

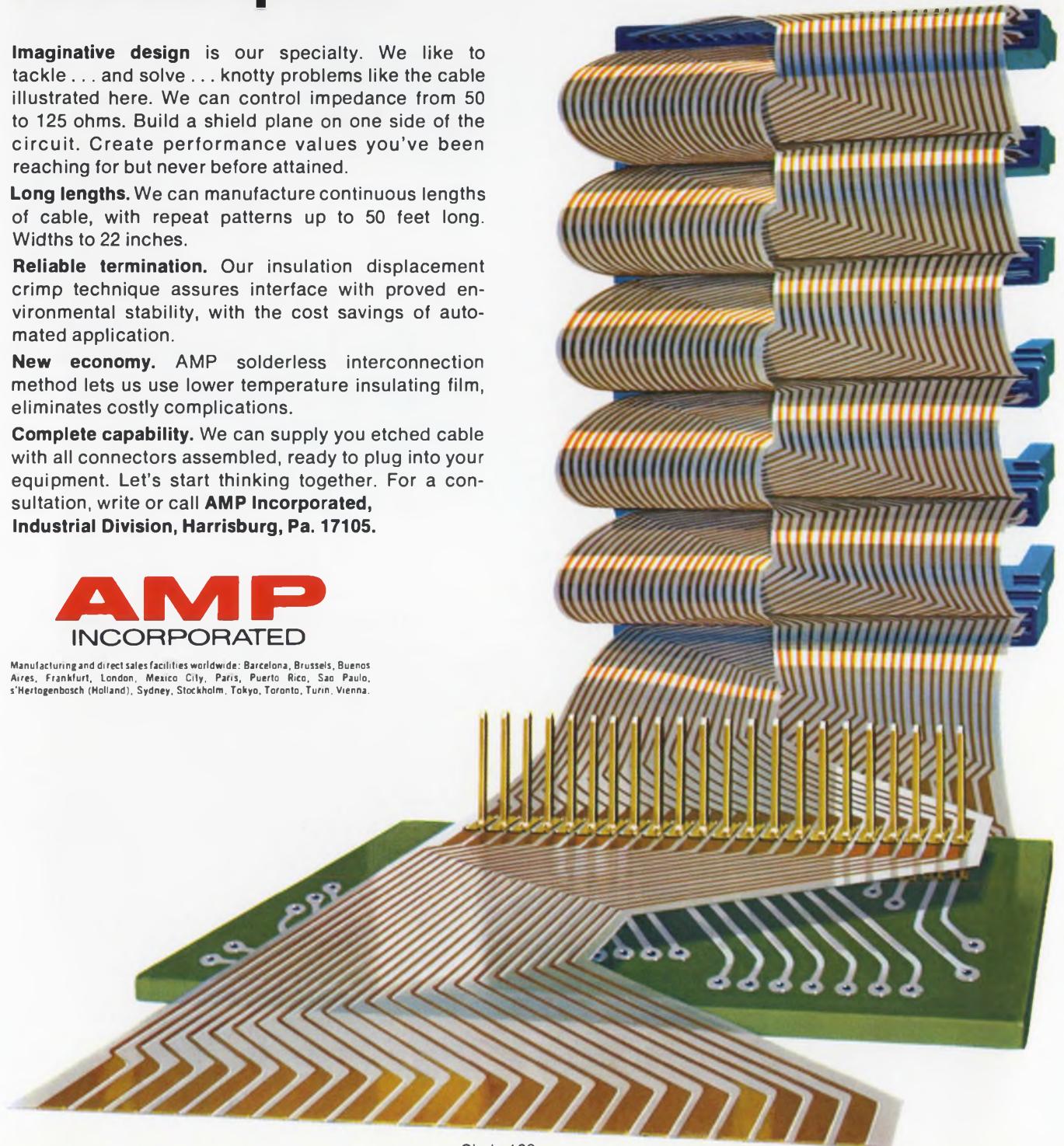

Centralab Technical Ceramics... in line with your design requirements

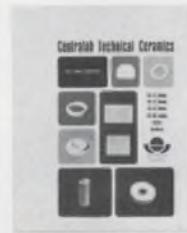

Write
Centralab
for
Bulletin
No. 1117TC3

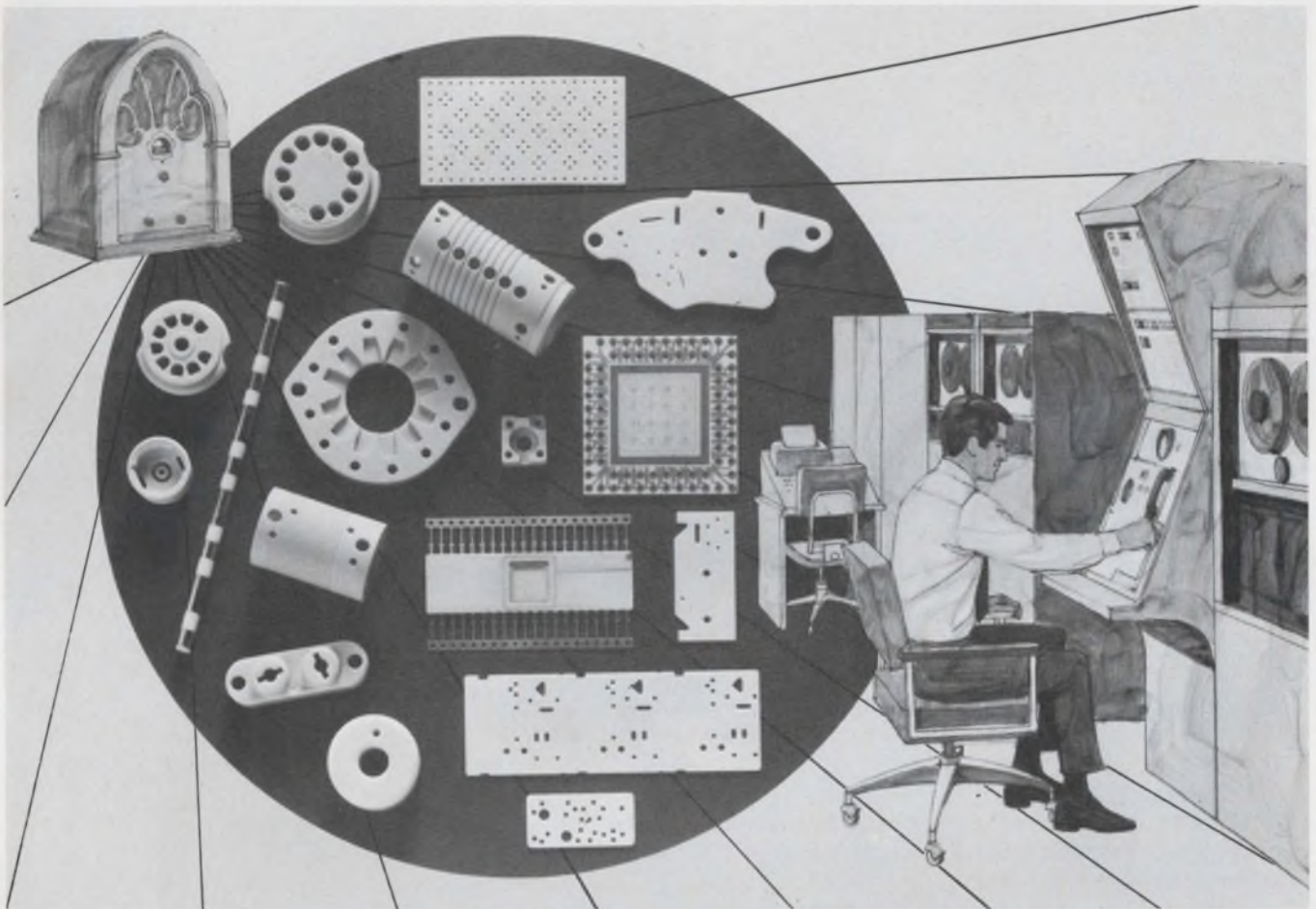

What's next for our ceramics?

We've been involved since 1928 when we built vacuum tube bases for six-tube radios.

Since then new-idea ceramics for electronics have put us in such varied applications as medical and scientific equipment, instrumentation, home and portable appliances, communications, office machines, computers and peripheral equipment. Our ceramics have found use as hybrid circuit and thin-film substrates, VHF tuner parts, LED substrates, MOS packages, LSI multilayer interconnections, SCR housings and vacuum tube parts.

So, what's next for our ceramics? Only your new design requirements will tell. You can specify aluminas, steatites, cordierites, or metallized ceramics in the configurations you need. A variety of metallizing systems is

available to insure satisfaction in your particular application. We also offer full capabilities in ceramic-to-metal assemblies and engineering service to aid you in design.

It's this kind of involvement that allows Centralab to be one of the largest manufacturers of technical ceramics. And, because we're also our own largest customer, it's important that we produce only the finest ceramics available. To us, developing better and more reliable ceramic materials for electronics means higher quality electronic components. It will mean the same to your products.

What's next for our ceramics? Whatever you need. For the complete capability story, call Centralab Technical Ceramic Sales at (414) 228-2942.

GET CENTRALAB THE "IN LINE" FOR YOUR DESIGN

Hybrid Microcircuits
Pushbutton & Rotary Switches
Capacitors
Potentiometers

Technical Ceramics
Ceramic Packages
Semiconductor Devices



CENTRALAB

Electronics Division
GLOBE-UNION INC.

5757 NORTH GREEN BAY AVENUE
MILWAUKEE, WISCONSIN 53201

INFORMATION RETRIEVAL NUMBER 12

The Great Escape

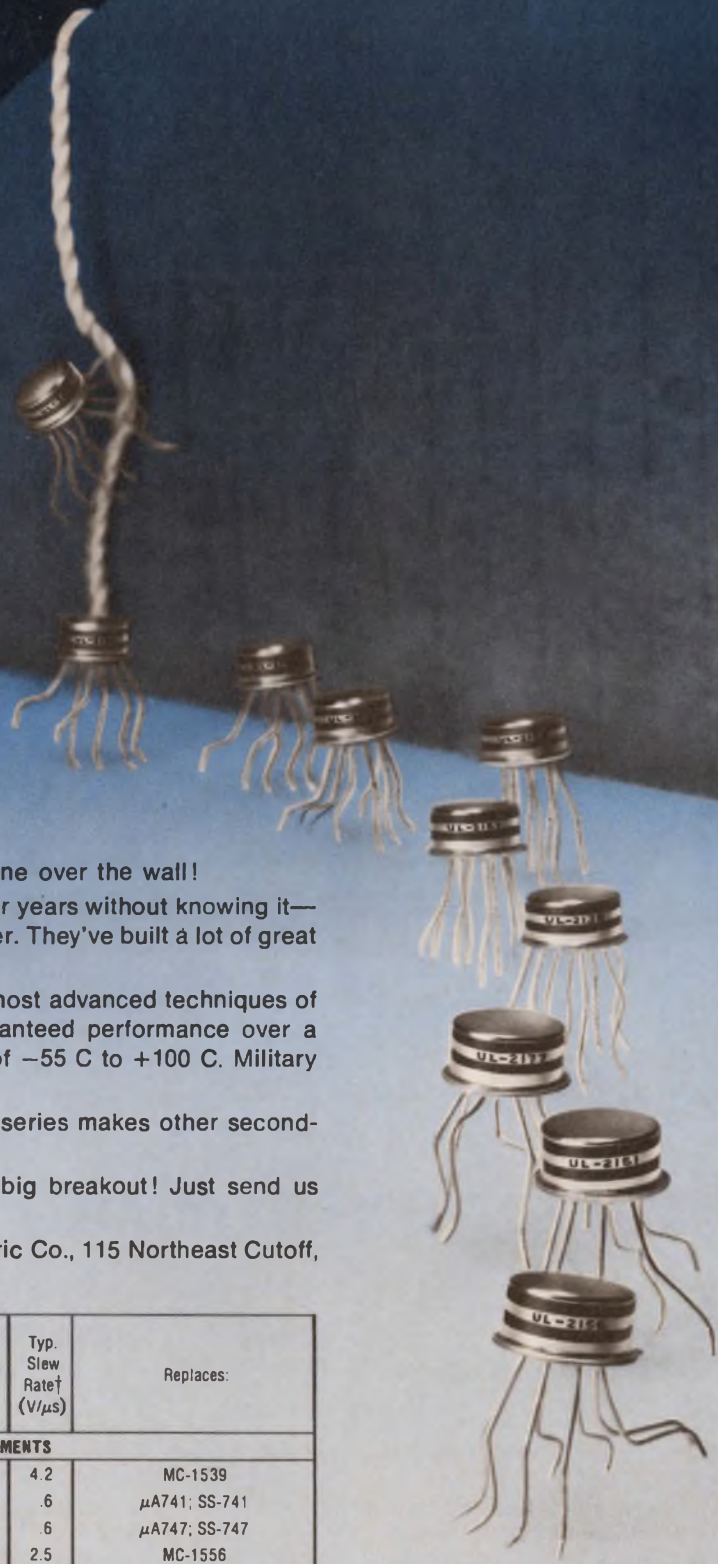

Sprague's monolithic op amps have gone over the wall!

You probably have been buying them for years without knowing it—under some other manufacturer's part number. They've built a lot of great reputations.

Sprague has done it by combining the most advanced techniques of processing and control. The result is guaranteed performance over a broadened commercial temperature range of -55 C to $+100\text{ C}$. Military versions operate to $+125\text{ C}$.

The same technology that made these series makes other second-source and proprietary designs as well.

Ask how you can share in Sprague's big breakout! Just send us your requirements!

Semiconductor Division, Sprague Electric Co., 115 Northeast Cutoff, Worcester, Mass. 01606. Tel. 617-853-5000.

| Sprague Series ULS | | Max. Input Offset Voltage† (mV) | Max. Input Bias Current† (nA) | Max. Input Offset Current† (nA) | Min. Gain† (dB) | Typ. Slew Rate† (V/ μ s) | Replaces: |
|--|-------------------------------|---------------------------------|-------------------------------|---------------------------------|-----------------|------------------------------|---------------------------------------|
| Internally Compensated | Require External Compensation | | | | | | |
| IMPROVED PIN-FOR-PIN REPLACEMENTS | | | | | | | |
| — | 2139 | 3 | 500 | 60 | 94 | 4.2 | MC-1539 |
| 2151 | — | 2 | 50 | 5 | 94 | .6 | μ A741; SS-741 |
| 2157* | — | 2 | 50 | 5 | 94 | .6 | μ A747; SS-747 |
| 2156 | — | 4 | 15 | 2 | 100 | 2.5 | MC-1556 |
| — | 2158 | 2 | 50 | 5 | 94 | .6 | μ A748; SS-748 |
| UNIQUE SPRAGUE DESIGNS | | | | | | | |
| 2171 | 2172 | 2 | 15 | 7 | 94 | 1.5 | Similar to MC-1556, SN-52771/SN-52770 |
| 2173 | 2174 | 2 | 3 | 1.5 | 100 | .3 | Similar to SG-118/LM-108, SG-108 |
| 2175 | 2176 | 2 | 3 | 1.5 | 100 | 1.5 | Similar to MC-1556, SN-52771/SN-52770 |
| 2177 | 2178 | 2 | .6 | .3 | 100 | .3 | Similar to SG-118A/LM-108A, SG-108A |

*Dual † $T_a = 25^\circ\text{C}$



Analog Products for Signal Processing

Flat CRT for military may go commercial

A two-inch-thick, flat cathode-ray tube with alphanumeric capability may make the difficult transition from a military product to a commercial product.

Initially developed for cockpit display applications by the Northrop Electronics Div. in Palos Verdes Peninsula, Calif., it is now being jointly investigated for commercial marketing by Northrop and GTE Sylvania's Electronics Components Group in Seneca Falls, N.Y.

Whereas the complex military version of the display costs several thousand dollars, a Sylvania official concedes that the display will have to be sold for less than \$100 to be a practical commercial product.

The display consists of a sandwich of six aperture plates, a wide-area cathode and an aluminized phosphor screen, packaged in a rectangular vacuum tube. The tube faceplate is 5.4 by 3.8 inches. However, this model is just a prototype. Future models may have larger screens.

Each aperture plate has 512, 5-by-7 matrices of holes through which electrons can pass. Each matrix represents one character. The aperture plates are all aligned so that an electron passing through a particular hole in one

plate will pass through the same hole in every plate. Each hole can be set at a positive or negative potential by a digital addressing scheme. If the hole is positive, the electron beam can pass through. If it is negative, the beam is blocked. Only if all aperture plates have that particular hole at a positive potential can the electron beam reach the phosphor screen to write a dot.

A wide-area cathode provides the source of electrons, which first pass through a beam-forming plate. The next four aperture plates select the row, column, row bit and column bit. And the final plate is a beam-focusing one to get a sharp dot on the screen.

The writing speed of the prototype is 512 characters in 1/60th second. The beam current at the screen is about 1 microamp.

Edward Elowe, manager of new product development at Sylvania says: "If Sylvania decides to go ahead with the project, the display—called Digisplay—should become a product in late 1973." He adds:

Since the public is used to looking at a CRT-type display for TV, we feel that flat-screen CRTs may be more acceptable to the public than other flat screen display technologies in a television application at a much later date."

Surface-wave device may shrink TV tuner

An acoustic surface-wave channel selector that may ultimately find application as a solid-state television tuner has been developed.

If it proves feasible, it would shrink a TV tuner to the size of a 25-cent piece. In addition, an acoustic surface-wave tuner is

LSI-compatible. By making the device on a silicon substrate, a designer could include amplifiers on the same chip.

The surface-wave device, a circular chip, has been developed by Westinghouse Research in Pittsburgh. According to Michael R. Daniel, senior scientist for Westinghouse, the commercial use of such a device is still a few years

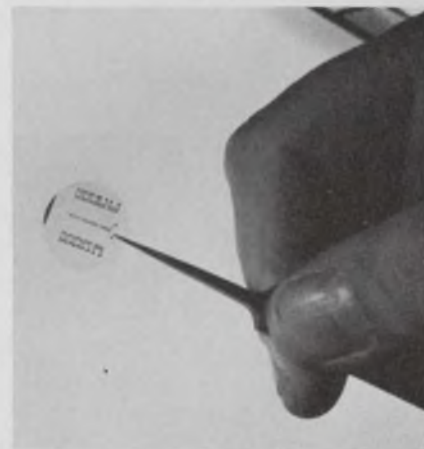

Acoustic surface-wave channel selector converts electrical signals to ultrasonic ones and back again.

off. The basic problem, he says, is not one of technology but rather of reducing the cost of the materials.

In operation, the device channels incoming signals into a middle strip (as shown in photo), where they are converted into ultrasonic waves on the surface of the disc. Five pairs of "combs" at the periphery of the chip can be used to tune in a single channel by converting a particular frequency into electrical signals for amplification. Channel selection would take place by using a switch to select the appropriate set of combs.

Video disc may provide home color-TV movies

Color movies that can be reproduced on a standard television set the way music is on a phonograph may not be too far away. MCA Technology, Inc., has developed a prototype of a video color disc system at its research laboratory in Torrance, Calif.

Kent Broadbent, executive in charge of research and development at MCA, says that video information from a regular color movie is recorded in microgrooves on the disc. When the disc is played back on an adapter that connects to the antenna terminals of a standard television set, the microgrooves are scanned by a laser beam, which reads out the stored video information. For a full-length movie, Broadbent notes, several discs may be needed.

Although MCA refuses at this time to disclose more technical de-

tails, Broadbent admits that some problems must still be solved in the disc duplication process. However, he anticipates that the disc will be ready for public demonstration later this year.

Dielectric materials made superconductive

Russian researchers report that they have made dielectric materials, such as arsenic and phosphorus, superconductive—until now a characteristic peculiar to metals only.

Acting upon the theory developed by Aleksei Abrikosov, member of the Soviet Academy of Sciences, scientists at the Dept. of Low Temperatures in the Moscow State University have found that when nonmetals are subjected to magnetic fields of 900,000 oersteds and temperatures close to absolute zero, they become superconductive.

The experiments show that at these super-low temperatures, super-high pressures and very strong magnetic fields, new state transitions occur in the material because of changes in the energy spectrum. Under these conditions, the scientists note, such concepts as "metal," dielectric" and "semiconductors become less meaningful.

The scientists see eventual application for the phenomenon in cryogenics, computers and communications equipment.

Danish tester screens assembly-line resistors

High-reliability test equipment, which heretofore has been used only on components going into special, critical systems, such as spacecraft, is now being used routinely to test resistors coming off a mass-production line.

Described as third-harmonic test equipment, the system is called the Component Linearity Tester. It was built by Radiometer A/S of Copenhagen, Denmark, and has been bought and installed on the production line of Vishay Inter-technology, Inc., in Malvern, Pa.

Modified to Vishay specifications, the unit is capable of detecting in resistors any nonlinearity or change in resistance value caused

by faulty welds, film aberrations, resistive-path inconsistencies, contact instability and other imperfections. The tester can also identify resistors with imperfections that might lead to failure.

A pure sinusoidal current at a frequency of 10 kHz is applied by the tester to the resistor. Non-linearity is determined by selectively measuring the third-harmonic voltage generated in the resistor.

Vishay says the tester eliminates the need for pull tests, visual inspections and checking for deviations from specified tolerances. The test is particularly valuable for hermetically sealed units, the company says.

Experiments sought for celestial satellite

Suggestions for experiments to be put aboard a small astronomical satellite called International Ultraviolet Explorer are due by Aug. 15.

With an expected launch in 1976, the 669-pound spacecraft is intended to make both high and low-resolution ultraviolet observations of stars, planets and other celestial objects.

Proposals for experiments should be submitted to either the National Aeronautics and Space Administration in Washington, D.C., the Science Research Council of the United Kingdom in London or the European Space Research Organization in Neuilly sur Seine, France.

Those whose experiments are chosen will form a user group of "guest observers" to help the three

sponsoring organizations plan the mission and to conduct the initial observation program.

The satellite is to carry a 213-pound instrument package that includes an 18-inch ultraviolet telescope and spectrograph. Three television cameras are to be used to record the spectra for transmission to earth. Solar-cell arrays and rechargeable batteries are to provide electrical power.

The project is being managed for NASA's office of Space Science by the Goddard Space Flight Center, Greenbelt, Md.

FCC to study crowding in land/mobile bands

In an effort to eliminate crowding on land/mobile communication frequencies, the Federal Communications Commission has ordered a specially equipped van to study the channels.

The van, to be provided by Fairchild Electrometrics of Amsterdam, N.Y., will contain several antennas, receivers, a minicomputer and a nine-track magnetic tape recorder. Under computer control, a receiver in the van will scan the land/mobile frequencies from 25 to 512 MHz. The signals for each monitored frequency will be recorded for 1 msec., with the scanning cycle repeating every 0.5 s, according to John McMann, chief systems engineer for the FCC's Office of Spectrum Management. The recorded signals will then be analyzed and processed by computer and the occupancy of each band determined. The study may lead to new channel assignments.

News Briefs

Scientists at the Naval Research Laboratory in Washington, D.C., report they may be close to developing an **operational technique for measuring storms** up to 1000 nautical miles away by using high-frequency radar.

Calculators get smaller and smaller. The Computer Design Corp. of Los Angeles has introduced a pair of 5 × 9 × 2-inch programmable calculators, called the Scientist 322 and the Statistician

342. An 80-step program memory can be entered via keyboard. The units will sell for \$795 and \$995, respectively, and use a 12-digit Burroughs Panaplex II display.

A new Microwave Technology Center has been established by RCA Laboratories in Princeton, N.J. The center, which will be at the David Sarnoff Research Center, combines all of RCA's applied microwave research activities under one management.

GE DESIGNED THESE TRIACS FOR YOU

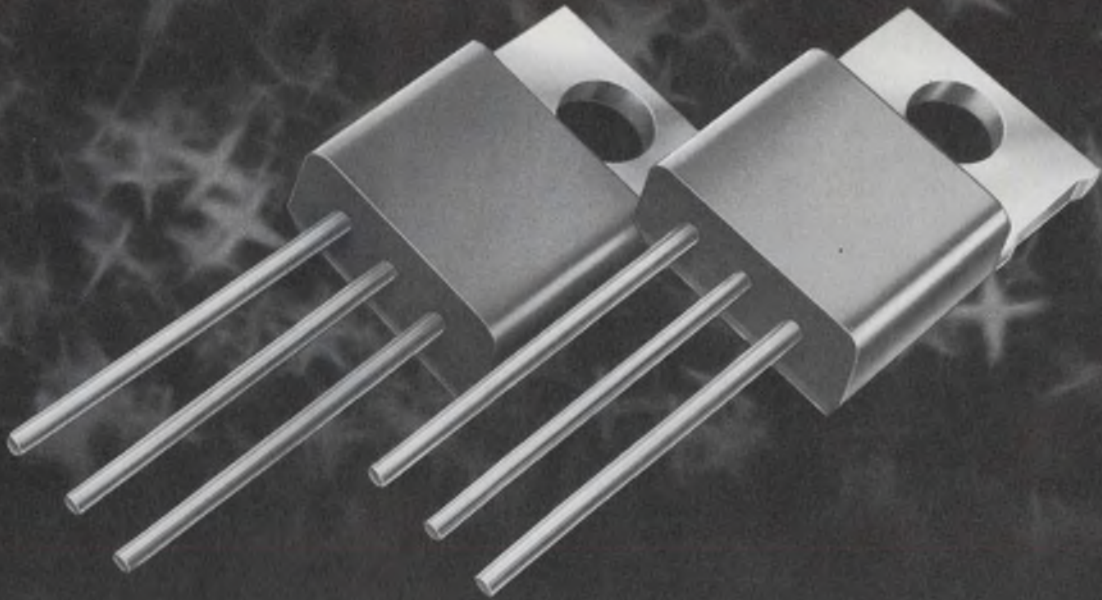

GE originated the triac in 1963 and now offers new standards of performance and reliability. Silicone encapsulated SC141 and SC146 triacs, up to 500 volts, and 6 and 10 amps respectively, feature the new proprietary **POWER-GLAS™** passivation process which creates a void free bond between the silicon chip and the matched glass. This results in low "off-state" currents of typically $10\ \mu\text{A}$. The SC141 and SC146, like all GE triacs, have inherent immunity from transient voltage damage and improved commutating dv/dt . Additionally these rugged packages incorporate a stress-free assembly system, which offers you torque limit-free tab mounting and easily formed round leads. For your convenience, GE offers 6 standard lead configurations. These features make the SC141 and SC146 your best value in 6 and 10 amp triacs.

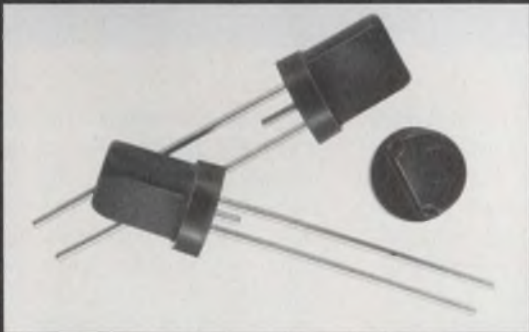

Another GE creative design, the ST4 asymmetrical trigger, is an ideal trigger for light dimmer applications. It features performance comparable to triggering circuits using at least 3 additional passive components and greatly reduces hysteresis effects by means of a single RC time constant. At 46¢ each in 1,000 unit level, it is truly an economical companion to GE **POWER-GLAS™** passivated triacs.

GENERAL  **ELECTRIC**

Interested in seeing how GE triacs and triggers can help you design? For free SC141B and ST4 samples write on company letterhead to GE Semiconductor Products Department, Electronics Park, Bldg. #7, Mail Drop 49, Syracuse, New York 13201.

Industrial electronics:

WHAT is the fastest growth area in today's electronics market? It's industrial electronics. The demand for specialized industrial equipment and components is expected to surpass Government electronics as a market in the next few years. The reasons are twofold: Much industrial equipment is believed overdue for replacement, particularly after the recent recession and because of the need for improving domestic productivity to compete with foreign imports. And the Federal Government is giving manufacturers a break on depreciation of equipment and on reinvestment of capital.

The growth is reflected in a demand for new process and machine control systems, specialized test instrumentation and new power devices.

Automating the factory

A major trend is the automation of machine and process-control functions in factories. Punched-tape numerically controlled systems are giving way to computerized numerically controlled systems. The new systems, tied to the development of cheaper, more versatile minicomputers, will in time lead to the ultimate in factory automation—the integrated manufacturing system.

A number of design problems need to be resolved before this development becomes a reality. For example, control panel boards that display information must be made smaller. One answer: A CRT display that operates on a "control-by-exception" basis; it displays only exceptions to normal operation.

Another problem is reliability. A

Ralph Dobriner
Managing Editor



single system failure could knock out total industrial production in a plant. The answer may lie in functional partitioning of subsystems and the use of high-reliability, hermetically sealed components.

Also, there is a need for more multiplexed communication systems to join the computers and various subsystems in the plant. These networks should incorporate a self-diagnostic capability.

Minicomputers are finding ever wider use in process-control systems, data-collection equipment, bulk memories, inventory control

and various monitoring functions. They are being used in areas previously untouched by computer technology. For example, in inventory control geographically separated warehouses have previously depended on a central computer to keep track of shipments. But this has been at the expense of complexity in the central computer and time-consuming data communications. Warehouses are now installing minicomputers to keep track of their inventories, and communication with the central computer is only for transactions involving

Where today's action is



Typical of today's automated testing system is General Electric's product quality analyzer which makes up to 35 electrical performance and safety checks on each GE refrigerator in just 10 seconds.

mains one of the more dynamic growth areas in a field where other discrete semiconductor components are rapidly succumbing to the inroads of integrated circuits.

In recent years power semiconductors have invaded every field of electronic amplification, switching and power control. Available discrete power transistor types already number in the thousands. They can dissipate 350 W, operate at currents up to 100 A and voltages as high as 1400 V. A new process recently developed by RCA may someday lead to devices with ratings as high as 4000 V. In the thyristor area, 4000-V prototype units are now being tested with research proceeding on 10-kV and 15-kV types.

Despite the progress being made in discrete power devices the wave of the future, according to designers in the field, is toward integrated circuits, as customers demand lower cost, higher reliability and more functions per device.

Test systems look to computers

Test-equipment manufacturers are increasingly adopting computer techniques to process instrument data as well as to control the measuring process. Many of today's instruments, such as counters and digital voltmeters, deliver information in machine language as well as visual readout.

One trend is toward the design of specific industrial test instruments rather than to use general-purpose laboratory-type test instruments. For example, industrial counters that have been developed

are not required to measure high frequencies if they are used in the communication or computer industries. But they must have much higher noise immunity and they must be able to withstand rugged environments, such as high vibration, shock, and corrosive atmospheres.

Pollution curbs have impact

Tightening government curbs on industrial pollution, along with increasing concern by the public and manufacturers on potential hazards in consumer products are also having a major impact in the use and design of industrial test systems.

A few years ago testing was done with relatively simple equipment. Now the pressure of government regulation has created a demand for sophisticated and complex data acquisition, display and evaluation systems. For example, automobile manufacturers are now using computer-controlled test systems for analyzing exhaust emission. These tests were once performed and recorded by hand and painstakingly analyzed later. The computer provides programmed instructions for the test. The system automatically, calibrates, averages and linearizes the digitized analog outputs of the gas analyzer sensors used to detect the pollutants. A test report is provided by the computer when the test cycle is completed.

The transportation industry is particularly interested in developing specialized test systems for analyzing fatigue, not only for private vehicles but also for tractors and earth-moving equipment.

The high cost of vehicle recall makes it attractive for manufacturers to conduct complex multi-channel fatigue studies on such components as rear axle and engine mounts. ■■

other warehouses or for management information.

The main spur to this dramatic expansion of minis in industry is their continued drop in cost and the desire for more efficient process and machine-control operations.

Minicomputers, in fact, have become inexpensive enough to control individual machines in a plant. A multitude of such computers can even be used to feed management data to a central computer, thereby bringing closer the day of the fully automated factory.

Power-transistor technology re-

Minicomputers taking over in factories in blue-collar and white-collar roles

The shift to automation in industrial plants is reaching a new stage. With the cost of minicomputers continuing to drop, factories around the country are preparing to change over to more efficient systems. The goal: fully automated factories, with software replacing hardwired logic.

Already the results are profound:

- It is now economically sound to design systems with a minicomputer controlling as few as two or even one machine. Called computerized numerical control (CNC) this technique is moving in on numerical (NC) systems, which follow taped instructions.

- Minicomputers can be used in remote areas of a plant to collect data from a number of nearby sensors and send the information to a main computer in a control room by a single wire. At present copper wire and its shielding is run from every sensor in a plant to the control room, and this costs more than a minicomputer with a single communications link.

- A hierarchy of computers can be created, all feeding data to a big central computer to manage an entire plant. This is helping to prepare the way for the ultimate in automated factories—the integrated manufacturing system (IMS), or computer-aided management system (CAM), as it is also called. This system not only operates the machines, controls the processes, moves materials and keeps inventories, but it also supplies management with reports on the manufacturing process. Philip Geier, chairman of Cincinnati Milicron, Inc., foresees such factories by 1985.

Moving toward the new stage in industrialization, the Foxboro Co.

John F. Mason
Associate Editor



A numerical control system runs a Burgmaster for the precision drilling needed for the casing for the AN/ARA-63 all-weather landing system receiver that Cutler-Hammer's AIL Div. is building for the Navy.

in Foxboro, Mass., has already added some management functions to its well-established process-control line. And General Automation in Anaheim, Calif., makes management control optional in its new computer-controlled machine tool systems, Adapt-A-Path.

"The computer for such systems," says Bruce Baldrige, Foxboro's manager of corporate market and product planning, "allows you to carry on first-level control functions of a plant plus obtain data for creating reports and for looking at trends over a long period of time. This information is gathered automatically and continuously. The industry is definitely reaching in this direction."

The trend toward full computer control of the factory follows one that saw pneumatic devices give

way to electronic analog equipment which in turn was replaced by digital systems.

The new thrust in automation is not without its design problems. Imperative to its success are solutions of these needs:

- Further centralization of controls.

- System reliability that will let equipment fail—if it must fail—piece by piece instead of catastrophically.

- Communications links that make use of such techniques as time-sharing and multiplexing.

- Computer equipment that can withstand harsher environments than it ever has before.

- Simplified software.

On centralization of controls, Foxboro's Baldrige notes: "Customers don't want a dozen control



Control panels for process control systems (top) sometimes extend 200 feet. Replacing these panels now are CRT displays such as Foxboro's Fox 1 that present only the portions of the system that need attention.

rooms. They want one computer to be in charge of the whole plant."

CRTs are cheaper now and are moving into industrial control, Baldrige says. The panel boards that display sensor information are becoming too large. Some panels in refineries are 200 feet long. "Just walking up and down a panel like this is a big job, and adjusting all the dials is worse," Baldrige says.

Foxboro's answer is a CRT display that operates on a "control-by-exception" basis. It displays only exceptions to the established norm. When something goes wrong, the CRT signals the operator with a red light. For details, the operator pushes a button and they appear on the CRT. Even without a problem the operator can look at any part of the system

on the CRT display.

Reliability is a very real design requirement for an integrated system, Baldrige indicates, because system failure could halt production, could turn out costly unusable products, or could permit an explosion if gases or certain chemicals were involved. "And our systems must operate constantly," Baldrige says, "24 hours a day, seven days a week, sampling many signals every second. And there is no scheduled down time."

Foxboro's manager of corporate development and engineering, Charles McKay, explains the company's solution. Since no system is completely failsafe the company's engineers design each subsystem so that if it fails it won't drag another subsystem down with it. They do this by functionally partition-

ing, or isolating, each subsystem so that failure in one function can't go through the interface to disrupt another function.

"You can't let a failure affect the power source that supplies the other functions," McKay explains. "Partitioning by function has been used in the aerospace industry but only now in process control."

Further, only high-reliability components are used. Foxboro no longer uses plastic encapsulated semiconductors—only the hermetically sealed, ceramic type or hermetically sealed TO-5 linear ICs. Carbon composition resistors have also been replaced by metal film resistors because of their increased stability and long life.

"We build our systems for 10 years of constant operation. For components that can't possibly last that long we design in redundancy," McKay says.

Foxboro, Kearney & Trecker of Milwaukee, and others express strong interest in CMOS for use in memories. "We're excited about CMOS," McKay says, "because of its low power requirements, which result in low temperatures, which in turn permit density packaging. We hope, however, that by the time they become available, there will be improvements in speed."

More control, more wires

Communication is becoming increasingly important to process control systems, McKay points out. Wire data links—radio would require too much bandwidth—are needed to connect the computers in the system, to join subsystems and plants. "The increasing number of wires required calls for much more time sharing," McKay says.

Two kinds of communications reliability are needed, he indicates: The communications equipment "must be incapable of causing an explosion," and the message received must be correct. All communications networks require self-diagnostic capability, which includes error checking codes and periodic automatic tests of the communications link.

McKay also foresees more multiplexing from the field—no one has built a commercial, remote field multiplexer yet—and following this, he adds, "there will be small, rugged, dedicated field computers

to work with the multiplexer."

Digital Equipment Corp., Maynard, Mass., has just built a rugged computer for severe environments, the PDP-11R20. This machine is built to withstand more shock, vibration and temperature extremes than standard computers can.

Also, to survive harsh environments, the company has built an industrial computer enclosure called the "ice box," which will house DEC's 19-inch rack-mounted standard equipment. Equipped with either an air-conditioner or an air-to-air heat exchanger, depending upon the ambient temperature and the pollution to be encountered, the container protects the enclosed minicomputer from hazards outside.

Computers tried on sea floor

An example of the extreme environmental requirements that the industry may expect is a recent request to DEC. A major oil company wanted a PDP-14 programmable controller, which they planned to put into a barrel of oil and sink to a pressure depth of 3000 psi in the Gulf of Mexico.

DEC sold them the machine without a guarantee, then waited as anxiously as the oil company to see what would happen. So far the barrel, with its programmable controller inside, are down to 1500 psi and doing well.

The oil company wants eventually to put such equipment on the ocean floor alongside producing wells to process information from each well and send it back, multiplexed, via a single cable. This would eliminate the costly manned platforms now needed in the sea.

Ruggedizing computers and their enclosures are only part of a big effort by computer manufacturers to find new applications and new markets. Another is cost reduction.

"We're more interested in cutting costs than in trying to make drastic improvements in performance, since performance is already extremely good," says Allan Devault, DEC's group manager of industrial products.

For new applications, DEC and other computer makers are looking toward more computerization of materials handling, automated warehousing and on-line testing in

both machines and process control systems. "Unless you test while you build you might completely finish a turbine blade that costs \$3000 and then find out it's defective," Devault says, "If something is ruined, it's a waste to keep on 'producing' it."

To help achieve the new goals of factory automation, semiconductor makers are striving to improve the components for computer memories. DEC uses MOS memories and bipolar solid-state memories, based on conventional IC technology, at present. But company engineers are watching the progress of magnetic-domain-tipped memories as

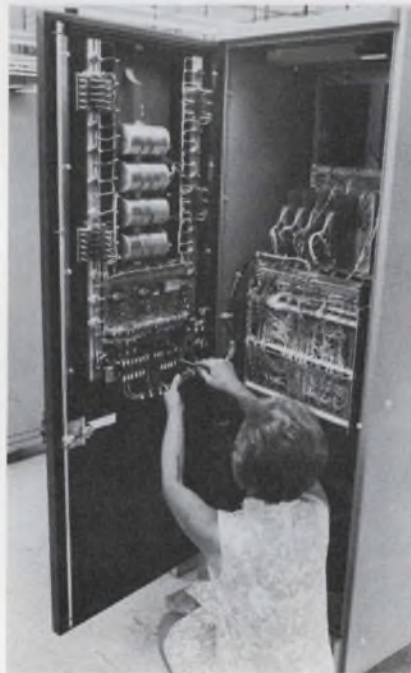

The dc power supply for Allen-Bradley's 7300 series computer-controlled system is built as part of the rear door to allow components to dissipate their heat.

well as bubble and photographic memories.

Unfortunately the MOS memory, Devault says, is knocked out when power is turned off. "We have to supply a standby battery or to provide some way to recopy the memories," he explains. "This can be done by using a system that detects a power failure 50 milliseconds before it happens, instructs the MOS memory to transfer its information for storage to a standby memory that is not affected by a power blackout. When power is restored, the standby disc memory is instructed to reload the MOS memory.

One need DEC foresees is simplification of software to enable the untrained user to communicate easily with his minicomputer. "CRTs as an interface will enter into this phase more and more," Devault predicts. "Operators, as a rule, don't like typewriter inputs."

Simplified software is a major concern of Kearney & Trecker, and, the company believes, it has made a major accomplishment in this area. The Milwaukee-based company, which will present its new computer-controlled machining center at the Machine Tool Show in Chicago in September, approaches the problem of software in two ways that are different.

According to Norman Buck, senior mechanical engineer in charge of software, the programmers have created a special computer language that helps them write the software for computer-controlled machining centers.

Also, electronics engineers who work on the system have mechanical design experience. And many of the software programmers are mechanical engineers. "During development there is a constant interplay between hardware and software design," Buck says. "This permits us to cut down on both. For example, in our new Milwaukee-Matic 200 machining center, we are able to get by with a 4K core memory whereas our competitors used three times as much memory. We have relied more on software in this machine than has been accomplished anywhere before," Buck says.

"As for eliminating hardware, we use logic to calculate measurements normally collected by sensors. Knowing the continual position of a tool along with the precise times, the computer tells us the rate the tool is moving. We don't need a tachometer which is often not reliable anyway."

Software eliminating hardware

General Automation also designs software in place of hardware whenever possible. Because of efficient programming, the company says, it has built a 3-axis machine that performs profiling, sculpturing and complex contouring tasks which heretofore were possible only with expensive 4 or 5-axis

Rust. Corrosion. Galvanic coupling. Why tolerate them? Eliminate corrosion indefinitely with Dow Corning silicone dielectrics.

The fish, shown here in a tank of water, has since spent over 312 hours in a salt-fog chamber under accelerated aging test ASTM B117-64. Parts coated with Dow Corning® 6 Compound show no signs of corrosion.

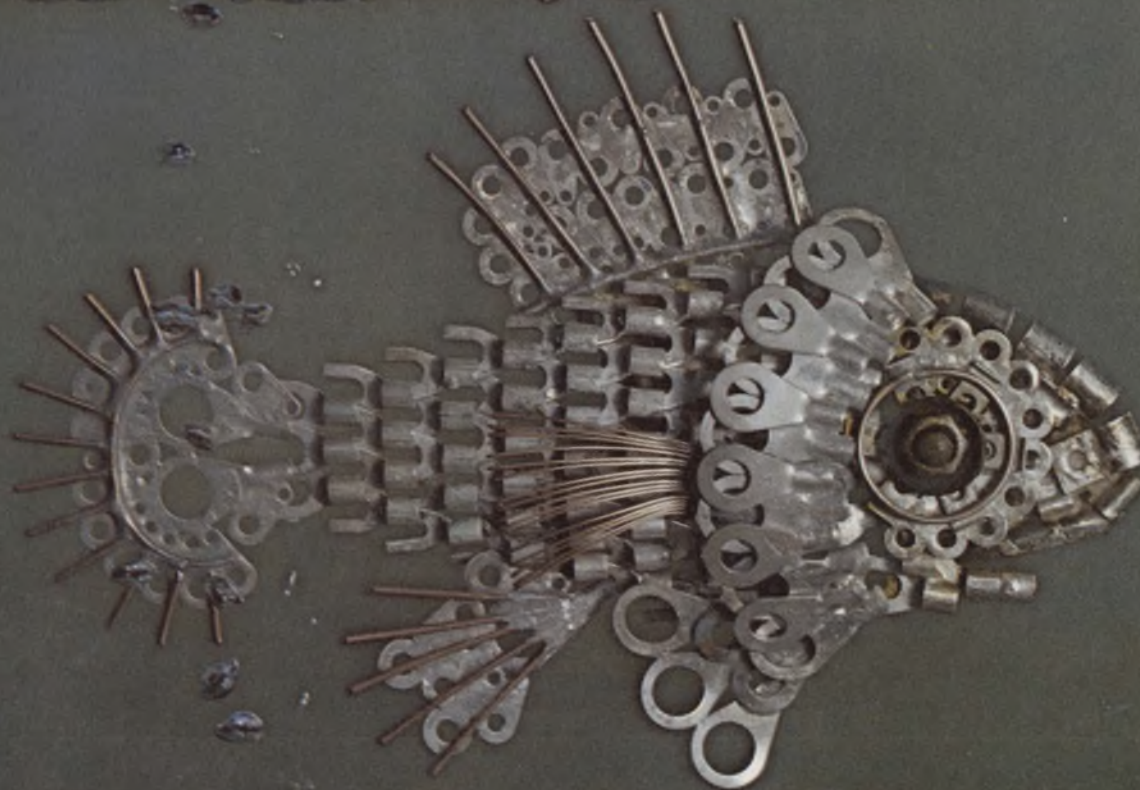

Now you can inhibit corrosion for up to 20 or 30 years or more with Dow Corning® dielectric compounds. We offer a wide range to solve virtually all corrosion and moisture problems found in electrical and electronic equipment.

For example, Dow Corning 2 compound is especially formulated to protect copper conductors and device leads. Our 6 compound inhibits rusting of iron and steel. Number

19 compound prevents galvanic corrosion of electrical connectors, particularly aluminum-to-copper and steel-to-aluminum. All three greaselike compounds have excellent dielectric properties, are water repellent, resist drying out in service, retain protective properties from -40 to 400 F.

For tougher moisture and water problems, our dielectric sealing compounds protect better, longer, than any other sealing materials. Our 4 compound is particularly effective

on ignition systems, disconnects, electronic assemblies, electrical terminals. Number 11 compound seals vacuum and pressure systems, transformers, sonar systems.

Take your first step now, to the prevention of corrosion. Write for full product information. Dow Corning Corporation, Dept. A-2308, Midland, Michigan 48640.

Dielectric compounds from

DOW CORNING

DOW CORNING

systems.

Warner & Swasey Co. in Cleveland, producers of heavy construction and production equipment and electronic controls, is increasing its line of NC turret lathes and other controls and it has just finished designing a crane load monitor.

The monitor will warn the crane operator when the combination of load weight and the angle and length of the telescopic beam is about to endanger the crane's stability. The monitor consists of an LSI power supply, a transducer or precise load cell bolt, an LSI load signal amplifier, a reference volt-

control, Redrode points out, is the lack of standard instructions available for programming such a system. "You might instruct a metal cutting machine to cut at a certain rate, maintaining a certain thickness. But how do you know that in following these commands the machine won't have to use excessive power or burn out the engine or wear out the cutter itself? There is much to be learned before adaptive control can be effective."

A number of companies now have big plans for direct numerical control (DNC), another winner at the Machine Tool Show two years ago, which has done badly, most

mer's manager of electronics development, H. P. Schutten, in Milwaukee, Wis. "We're looking very closely at liquid crystals to replace LEDs. They will require far less power and generate less heat."

"We're also looking at new ways to solve design problems. Instead of buying a semiconductor with given voltage characteristics and having to work with those characteristics, we need special semiconductors to work with the voltage current characteristics most convenient to us. Ion implantation techniques should be helpful here."

Safety must be designed in

One problem that designers will have to face more and more, says Cutler-Hammer's manager of digital products and systems development, Paul M. Kintner, is safety. Electronic equipment must be impervious to electrical noise. If an electronically controlled punch press has to operate next to an arc welder, whose electrical signals could close the press on a worker's arms, the electronics must be designed to counter this danger. "An electro-mechanical relay might be used to protect the operator." Provisions of the Occupational Safety and Health Act will be more and more rigidly enforced, Kintner says.

While working toward its goal of expanding its factory and management control capability, Cutler-Hammer has developed a static dc adjustable voltage drive, called the Responder, with design changes that the company feels will make maintenance easier.

All the electronics are grouped together in a single module. "This enables us to pretest larger sub-assemblies, thus achieving greater quality control," says designer John F. Linsley. "And it separates the dangerous high energy electrical portion from the electronics."

Also, the electronics portion is close to the front of the housing where it is easy to get to, and can be repaired without disassembling. Cutler-Hammer has also changed the colors of the printed circuit boards from green and black to blue and white. "It's easier to see the silk screening when you are working with blue and white and it's nicer to look at." ■■



PDP-11/45 computers are being tested before shipment by two PDP-11/20 minicomputers at Digital Equipment Corp.'s plant in Maynard, Mass.

age and switching system, a comparator and an alarm system.

Adaptive control, which received so much attention at the Machine Tool Show in Chicago two years ago, is still waiting in the wings because accurate sensors are not available, according to both Warner & Swasey, and Allen-Bradley's Systems Div. in Highland Heights, Ohio.

Some good sensors do exist, says Allen-Bradley's manager of product planning, L. O. Rexrode, but they are prototypes. "The immediate problem is to design sensors that are not only functional but also manufacturable." Allen-Bradley is developing its own spindle deflection sensor which it believes will be both accurate and easy to produce.

Another problem with adaptive

manufacturers agree, because of the economy. "If half your machines aren't running, there's no need to buy a computerized system to help them stay idle," one manufacturer says. But now things look brighter.

Allen-Bradley plans to get into DNC but only after it moves ahead sufficiently in its main priority to extend its computerized numerical control applications to areas such as lathes, including 2-turret, 4-axis machines with simultaneous control of each tool; inspection machines and multimachine systems whereby one computer will serve several different machines. The hardware for these new ventures will change very little, Rexrode says. The design work will be in the software.

Display devices for industrial control is an area where improvement is needed, says Cutler-Ham-

Get a clock driver free...with each Static Shift Register you order.



It's built right into the chip. Every 2500 Series MOS static shift register comes off Signetics' production line with its own on-board clock generator. Plus a real windfall of other major improvements. To help lower total systems cost, and make the parts easier to use.

Usability at a reasonable price.

That is what you've been after. And usability runs in the family of Signetics new MOS static shift registers, the most complete collection in the field.

Operating from DC up to 3 MHz, these optimized devices eliminate minimum frequency headaches. Go right down to DC without adding extra logic.

And because the Signetics line can be treated like TTL itself, no level shifters are necessary at either input or output—again lowering your overall component count and cost. Just as the built-in clock generator demands no expensive high-level clock drivers.

Power requirements are standard $\pm 5V$, $-12V$. And you recirculate data without external logic.

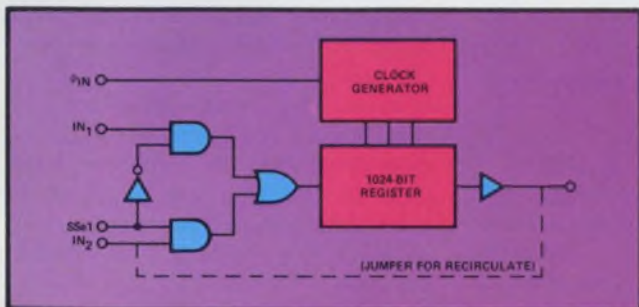

Signetics 1024-Bit Static Shift Register

For the first time, with the 1024-bit static shift register you can have the benefit of easy-to-use static shift registers for long bit length applications. And, a dual-128 for 128 column printers, or a quad-80 for 80 column CRTs.

Combine the on-board clock generator, with TTL compatibility and the wide range of bit density (from 50 up through 1024), and you've got more flexibility to work with, in both design and application, than you ever hoped to find in static shift registers.

| PARTS LIST | | | | |
|------------------|-------------|-----------------|-----------------|-----------------------|
| ORGANIZATION | DIP PACKAGE | CLOCK FREQUENCY | 100 PIECE PRICE | SIGNETICS PART NUMBER |
| 1024 x 1 | 8 pin | 2.0 | \$9.90 | 2533V |
| Quad 80 | 16 pin | 2.0 | 4.00 | 2532B |
| Dual 256/250/240 | 8 pin | 3.0 | 4.80 | 2527/28/29V |
| Dual 128/132 | 8 pin | 3.0 | 4.50/4.00 | 2521/22V |
| Hex 32/40 | 16 pin | 3.0 | 4.00 | 2518/19B |
| Dual 200/100/50 | 14 pin | 3.0 | 5.00/4.00/3.00 | 2511/10/09A |

You save on parts, on engineering no longer required. Yet end up with maximum memory on the board, at minimum cost in time, space and dollars.

Write Signetics for our helpful MOS Wall Chart and new Handbook, which organize the specs, technical data, and applications of all our MOS memory products—the broadest, most versatile line of static shift registers ever put on distributors' shelves, as well as optimized RAMs and ROMs.

Signetics/MOS
811 E. Arques Avenue
Sunnyvale, California 94086
(408) 739-7700

Please send us your MOS Wall Chart and new Handbook, with complete technical and applications data on Signetics user-oriented static shift registers.

Name

Title

Company

Address

City

State

Zip

Telephone

Signetics Corporation—a subsidiary of Corning Glass Works.

signetics

INFORMATION RETRIEVAL NUMBER 16

Power devices pushing into new fields as costs fall and performance soars

With costs dropping and voltage and current ratings rising dramatically, power semiconductors are invading every field of switching and power control.

The developments include these:

- Manufacturers such as Delco, Solitron and Texas Instruments have 1400-V transistors available, and work is being done to obtain 2200-V devices.

- Westinghouse has announced the availability of 2500-V thyristors and is testing prototypes of a 4000-V unit.

- Semiconductor manufacturers are responding to customer demands for more functions per device. As a result, power Darlington and power hybrids are becoming available, paving the way for the introduction of power integrated circuits.

More expensive and less-reliable devices are falling by the wayside as power transistors and thyristors find application in these areas previously considered unfeasible:

- They are being used in high-voltage dc systems and uninterruptible power supplies.

- They are replacing less reliable relays and thus allowing the construction of more complex equipment.

- They are being used to eliminate bulky transformers in power supplies.

- They are helping to conserve energy by dissipating less energy as heat.

With progress like this, power semis are turning up in mass transit systems, ac and dc motor-speed controls, emergency power supplies and induction heating equipment, among other applications.

The higher current and voltage-handling capabilities of power

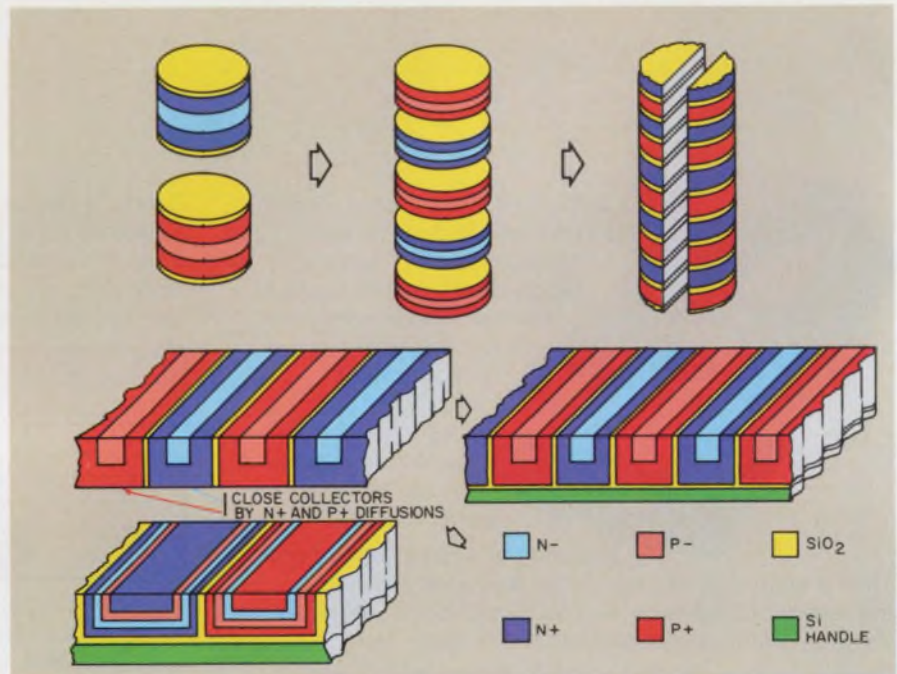

A new approach to power-integrated circuits is being studied by RCA. Stacked wafers of doped semiconductor material, separated by oxide, are sliced longitudinally and the device is completed with standard processing.

transistors are a result of improvements in semiconductor processing and materials in the last few years. Processes such as epitaxial base, double diffusion and triple diffusion are responsible for providing higher current, faster switching and higher voltages.

New process cuts cost

A fourth process, recently developed by the RCA Solid-State Div., Somerville, N.J., promises even more advances. This process is known as π - ν epitaxy and, according to Richard Denning, RCA's manager of power transistor engineering, it will allow the fabrication of devices that can handle twice the volt-amperes of present units of equivalent size at the same cost. Or the cost and size of the chip can be cut in half while maintaining present volt-ampere levels, Denning says.

The new npn structure uses alternately grown n⁻ and p⁻ epitaxial layers on an n⁺ substrate. Both n-base diffusion and n⁺ emitter diffusions are used in the conventional manner. There is no limit on the wafer thickness when the new RCA process is used, Denning reports. Other processes use wafers that are limited to a thickness of 7 mils, he continues, and that is too thin for automated, high-temperature processing.

"With π - ν epitaxy," Denning explains, "we can now use 14-mil wafers and therefore automate, reducing costs even further."

Looking to the future, Denning sees 2200-V transistors in two to three years. If care is taken with material and processing techniques, he continues, it will be possible to produce devices with ratings as high as 4000 V. But this, he says, is still three or four years away.



CUTLER-HAMMER SNAPS INTO ACTION WHEN YOU NEED PROTOTYPES.

Just watch our action when you call for service! The old-fashioned, dependable kind that just could be brand new to you. With fast application help, fast action on prototypes, and delivery dates you can count on.

Fact is, we have snapped into action in a big way. Coming up with new lines of precision snap-action switches, designed and manufactured

in the Cutler-Hammer quality tradition. We have samples in stock for immediate inspection.

But remember. If we don't have exactly what you want already, tell us and we'll snap into action to get you a prototype promptly.

Call your Cutler-Hammer Sales Engineer or Switch Distributor and ask him how our snap-action switches (and service) can help you meet your product development schedules on time.

Miniature—Five different types with U.L. rating up to 15 amps. Four terminal styles. Choice of actuators—straight lever, roller lever, simulated roller lever.
Sub-miniature—Four basic types with U.L. rating up to 10 amps. Four terminal styles. Same actuator choice as above.
Sub-subminiature—Four basic types with U.L. rating up to 7 amps. Four terminal types. Actuators—a variety of lever, leaf and roller lever types.

Switch
to No.1

More than just switches;
prompt availability,
field help, innovation,
quality assurance, too.

Action you want.
Action you'll get!



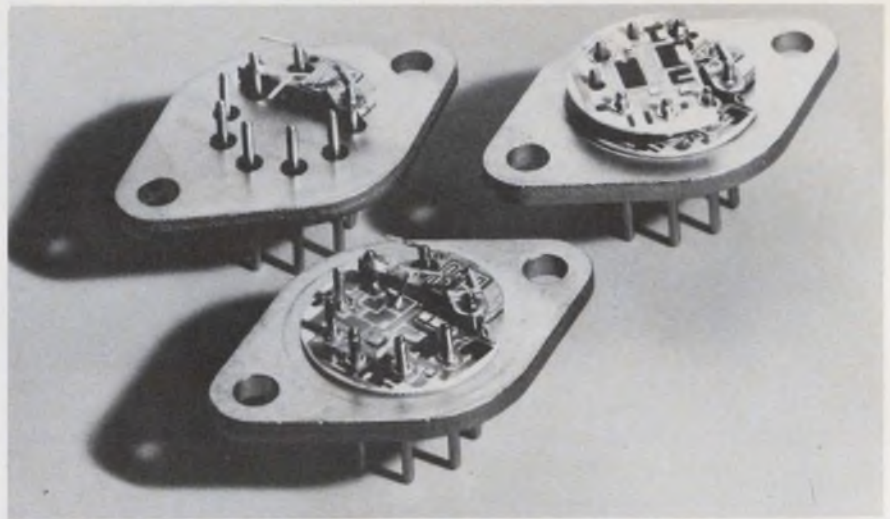

Motorola's monolithic dual Darlington (upper left) is the first of a new line of power devices that will be introduced soon. The dual hybrid power driver (lower left) is an example of the trend toward integration in power devices, as is RCA's high-current voltage regulator (right).

Like power transistors, the availability of the larger thyristors is linked to new processing techniques. In addition, package designs like the "hocky puck"—also known as the flat pack or the power disc—are surrounded by a heat sink and can dissipate heat from both the top and bottom of the package.

Improvements in the design of SCRs included the addition of p^+ and n^+ regions under the contact areas, the use of a shunt between the gate and the cathode and the use of gold doping. These design changes have resulted in improved forward drop and lower turn-on voltages; stabilized gate current, better blocking voltage and dv/dt capability; and reduced storage time and improved frequency performance.

Work is still being done to reduce the turn-off and turn-on times of SCRs, says Larry Carver, manager of advanced engineering for International Rectifier, El Segundo, Calif. By reducing the turn-off time, he continues, the designer can use smaller-value and less-expensive commutating capacitors in his design.

Hal Steinbruegge, applications engineer for Westinghouse Electric's Semiconductor Div. in Youngwood, Pa., agrees. Currently available high-voltage devices have turn-off times of about $10 \mu\text{sec}$, he points out—"we'd like to see them at about $1 \mu\text{sec}$."

The turn-on times for our big

two-inch wafers are now about $15 \mu\text{sec}$," Steinbruegge goes on. "We're trying to bring that down to about 1 or $2 \mu\text{sec}$."

Staney Hunt, manager of power product sales for Westinghouse, says that research is going on in the development of 10-kV and 15-kV devices.

SCRs pave way for power ICs

The SCR, which consists of two transistors on the same chip, was actually the first step toward power integrated circuits, says Frank

Taylor, marketing manager of power products at Texas Instruments, Dallas. The second step was the power Darlington.

Today, Taylor continues, the customer is demanding more complex functions from the components manufacturer. Power-device technology, he explains, is going the way of the small signal devices—integrated. Customers want the same low cost, high reliability and space and labor savings in power devices that they can get in small signal units.

Such semiconductor manufacturers as Motorola, RCA and Texas Instruments are, in general, starting out with integrated hybrids. Examples of this are RCA's HC-4000 series of high-current voltage regulators, TI's TIXH805 switch and Motorola's MCH2890R dual-power driver.

But the hybrid approach is not the only one being investigated. RCA is developing a new fabrication technique. In it (see illustration) individual wafers of p^+ , p^- , n^+ and n^- material are stacked, with a layer of oxide separating them. These stacked wafers are then sliced longitudinally. The collectors are then closed by n^+ and p^+ diffusions, and a layer of oxide is grown on the resulting slice. From here on, the slice can be handled like any power transistor or IC. With this technique, it is possible to produce an integrated array of high-voltage—300 to 1000-V—transistors. ■■



International Rectifier's diodes have replaced ignitrons in this caustic chlorine cell at Dow Chemical.

11 MHz function generators with...

Model 7056

lin/log sweep

am/fm modulation
plus phase lock

Model 7071

...from **EXACT**, of course!

With these two instruments and five others in our 7000 series, EXACT offers you the widest, most versatile line of broad frequency function generators (up to 20 MHz) available. Choose to meet your EXACT needs.

Model 7056 — 0.0001 Hz to 11 MHz.

Amplitude modulation and phase lock along with voltage controlled frequency provides am/fm and phase lock capability over the full frequency range of the Model 7056. AM is adjustable through 100% to suppressed carrier. Voltage control features include:

VCA: Voltage Controlled Amplitude for analog control of amplitude or wide band amplitude modulation (even suppressed carrier).

VCSS: Voltage Controlled Start-Stop for programming the start stop point of triggered or gated waveforms.

VCP: Voltage Controlled Phase for analog control of phase or phase modulation. (Phase lock)

In addition you get Voltage Controlled Frequency and Voltage Controlled Offset as in other models. You can digitally program any input with a D-A converter.

Model 7071 — 0.0001 Hz to 11 MHz.

A single burst of swept waveform is readily generated with this model in the gated sweep mode. Both linear and logarithmic sweep are available with precision start and stop frequency controls. A sweep-hold mode allows both ends of the sweep to be held and measured with a counter.

BOTH HAVE ALL THESE STANDARD FEATURES OF THE 7000 SERIES:

- VCF input
- Sine, square, triangle ramp and pulse
- 1000:1 sweep
- 80 dB attenuation (10dB steps)
- 20 MHz in the 7200 series
- 30 V P-P outputs
- ± 15 V dc offset
- Kelvin-Varley divider frequency controls
- Sync input for locking to external frequency
- Trigger/gate (except model 7030)

Prices in the 7000 series start at \$595. Send for complete specifications.

Suppressed carrier—
Top: Square wave
carrier. Bottom: Sine
wave carrier.

AM—Top: Triangle
modulating signal.
Bottom: Sine wave
modulating signal.

Top: 100% modulation
toward suppressed
carrier. Bottom: Ramp
modulation.

Top: Square wave
modulation. Bottom:
Ramp modulation.

Gated sweep, one burst
of swept waveform.

Top: Log sweep. Bottom:
V:F output.

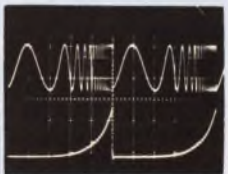
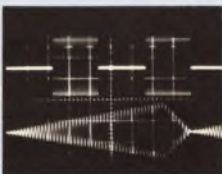
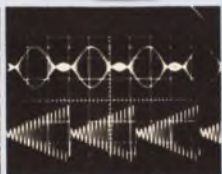

EXACT
electronics, inc.

P.O. Box 160, Hillsboro, Oregon 97123 • 503/648-6661

The C/MOS pioneer makes more news.

RCA COS/MOS base prices

Here's what the trade press is saying about COS/MOS technology:

☛ **COS/MOS expected to replace TTL as leading logic family** ☛

ELECTRONIC PRODUCTS MAGAZINE—MARCH, 1972

☛ **C/MOS cuts data system's size, power drain** ☛

ELECTRONICS—MARCH 13, 1972

☛ **Solid-state logic that mechanical engineers can use** ☛

PRODUCT ENGINEERING—JUNE, 1972

☛ **C/MOS outlook buoys Pitney Monarch** ☛

ELECTRONIC NEWS—JANUARY 10, 1972

☛ **C/MOS MSI is snowballing** ☛

EDN—JUNE 15, 1972

☛ **Very low power dissipation, exceptional noise immunity, wide power supply operating range (3 to 15 volts) and high dc fanout make COS/MOS a very attractive logic family** ☛

SOLID STATE TECHNOLOGY—MAY, 1972

☛ **plenty of competition for TTL... from an ever broadening line of CMOS circuits** ☛

THE ELECTRONIC ENGINEER—JUNE, 1972

☛ **CMOS is being considered more and more for applications once dominated by TTL or PMOS** ☛

ELECTRONIC DESIGN—APRIL 13, 1972

reduced an average of 25%

Here's what RCA is doing about COS/MOS cost effectiveness:

The swing to RCA COS/MOS keeps growing... for consumer products, for commercial and industrial equipment. Unit volume shipped thus far in 1972 is running at about three times the rate for the comparable period a year ago.

And now — RCA, the pioneer in COS/MOS, is able to offer a general base price reduction averaging approximately 25% over the entire commercial line of more than 180 types of COS/MOS IC's.

These reductions are possible through lower production costs based on improved yields. Through increased volume production leading to a broader base for fixed costs. And through improved engineering and production performance based on experience gained during more than eight years of COS/MOS development and production programs.

Base prices for COS/MOS circuits

in plastic packaging are now reduced by an average of approximately 25%. In ceramic by 20%. In flatpack by 20%. And in chip form by 50%.

New base prices apply to dual-in-line plastic, dual-in-line ceramic, flatpack and chip configurations. Check the table at right for base price reductions on popular circuits (100-999 unit levels).

These lower base prices extend COS/MOS cost effectiveness...open up even broader applications...make COS/MOS more advantageous for engineers designing new systems or redesigning present systems.

To find out how COS/MOS can have a major impact on your products — and their cost effectiveness — contact your RCA Representative or Distributor. Or write RCA Solid State Division, Section 57G-20, Box 3200, Somerville, New Jersey 08876.

| Circuit | Description | Previous Price (100-999) | New Price (100-999) | Percent Reduction |
|----------------|-------------|--------------------------|---------------------|-------------------|
| Plastic | | | | |
| CD4001AE | Gate | \$1.18 | \$0.78 | 34% |
| CD4013AE | Flip-Flop | 2.40 | 1.62 | 33% |
| CD4029AE | Counter | 6.90 | 6.35 | 8% |
| Chips | | | | |
| CD4001AH | Gate | 2.06 | 0.68 | 67% |
| CD4013AH | Flip-Flop | 2.96 | 1.39 | 53% |
| CD4029AH | Counter | 8.65 | 3.79 | 56% |

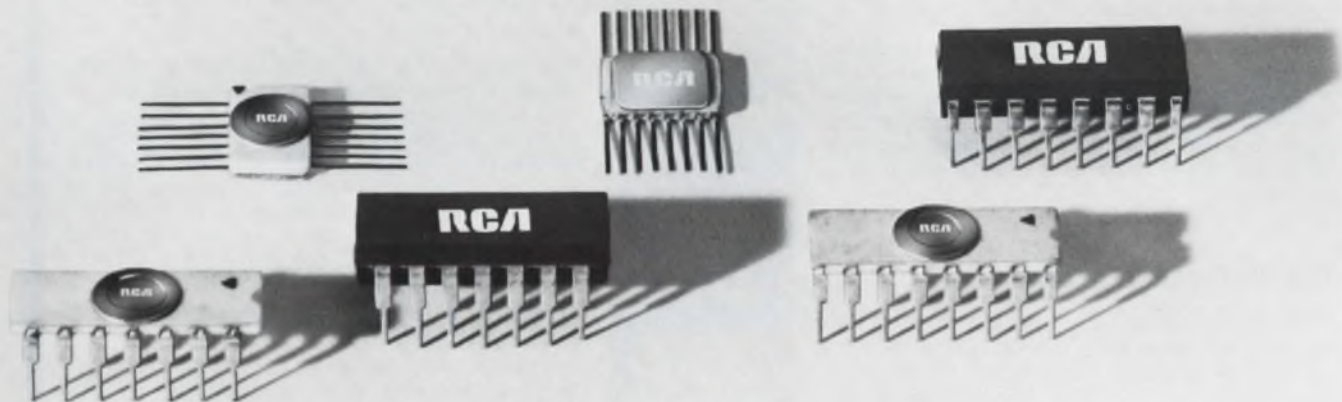

International: RCA, Sunbury-on-Thames, U.K., or Fuji Building, 7-4 Kasumigaseki, 3-Chome, Chiyoda-Ku- Tokyo, Japan. In Canada: RCA Limited, Ste. Anne de Bellevue 810, Canada.

RCA Solid State
products that make products pay off

Do you want to have the whole picture on Japan's great leap forward?

The Japanese Miracle and Peril Willard Price

Leading the world's nations in electronics, shipbuilding, cameras, watches, literacy rate . . . gaining rapidly in other areas, Japan has risen meteorically from the ashes of World War II. Such is the Japanese miracle. Within it looms the peril, expansionism, a Japanese passion that has recurred throughout her history. Willard Price, who has been interpreting Japan to the West for more than half a century, provides a fascinating, informative account of these inter-related themes as he probes Japan's history and the Japanese character for the root explanations of her dynamism.

256 pages, #6103-x, paperback

\$3.85

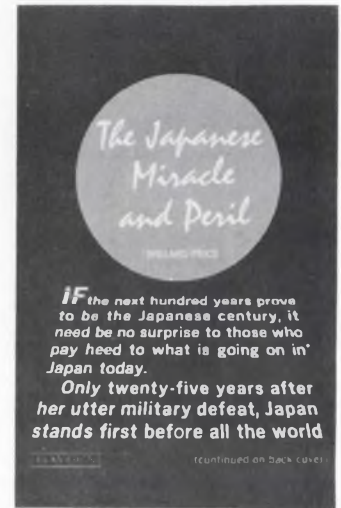

Other New and Informative Books from Hayden

Eight Lives in Jazz: Combo U.S.A.

RUDI BLESCH

Here are the stories behind the music, intimate portraits of the people who put their genius and dreams into a distinctly American sound. They all come alive in these pages: the late, legendary Louis "Satchmo" Armstrong; Sidney Bechet, Jack Teagarden; Lester Young; the bitter-sweet "Lady Day", Billie Holiday; Gene Krupa; Charlie Christian; and Eubie Blake.

240 pages, illustrated, #6104-8, paperback

\$3.65



America the Vanishing: Rural Life and the Price of Progress

Edited by SAMUEL OGDEN

From paradise to pollution-riddled land, the sorry fate of the American countryside is recounted by some of our best-known writers. Audubon, Muir, Twain and others evoke the small-town and rural life that has virtually disappeared. In stark contrast, E. B. White, Rachel Carson, and other contemporaries portray the impact of progress on our environment and way of life.

256 pages, illustrated, #6105-6, paperback

\$3.95

The Due Process Revolution: The Warren Court's Impact on Criminal Law

FRED P. GRAHAM

Demolishing the myth that the Supreme Court handcuffed the police, New York Times Supreme Court reporter Fred P. Graham reveals the background of such landmark decisions as Mapp, Escobedo, Miranda, and Wade. He places in perspective the Warren Court's courageous affirmation of the Constitution's promise of equality to all Americans.

377 pages, #6101-3, paperback

\$3.75



The Politics of Fear: Joseph R. McCarthy and the Senate

ROBERT GRIFFITH

This compelling, award-winning study of a shameful episode in recent American history views McCarthyism as a political phenomenon created and sustained by politicians hungry for power or fearful of the passions aroused in a divided nation. In its eventual censure, the Senate side-stepped the real issues and assumptions upon which McCarthy built his career.

376 pages, #6100-5, paperback

\$3.75

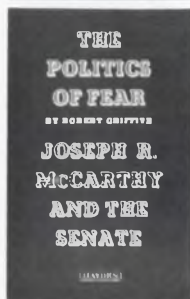

The Electronic Invasion

ROBERT M. BROWN

Anyone concerned with Big Brother's methods will find this best-selling exposé fascinating and instructive. It details all types of snooping gadgetry, names major manufacturers and buyers. The extent of governmental and corporate bugging is surveyed, and legal strictures are fully covered.

188 pages, illustrated, #0779-5, paperback

\$4.95

Humanizing Schools: New Directions, New Decisions

DOUGLAS H. HEATH

A disturbing analysis of today's youngsters and of where their schools are failing them. Reporting as one intimately involved as both educator and psychologist, Douglas H. Heath presents a realistic framework for deciding what must be done, and a compelling argument, why?

240 pages, #6003-3, cloth

\$6.95

At your bookstore or by mail with this convenient coupon.



HAYDEN BOOK COMPANY, INC., 116 W. 14th St., New York, N.Y. 10011

Please send the book(s) whose code numbers I have circled below. Enclosed is my check for the total amount, plus 25¢ to cover postage and handling on my order.

6103-X 6101-3 6105-6 6003-3 6104-8 0779-5 6100-5

If not satisfied, I may return the book(s) for full refund.

Amount enclosed: \$ _____

Send free 96-page catalog of all Hayden Books.

Name _____

Address _____

City _____

State _____ Zip _____

72-35 ED

More ways to light a one light.

*Licon has added LED's to one LPB switch line...
another line offers neon or incandescent lamps...
both feature patented Butterfly® switching.*

You always get a great choice with Licon® LPB switches. For example, take just two of our many lines – Types 01-700 and 01-600 single light switches. Our 01-700 line is now available with integral Light Emitting Diodes. That means virtually infinite light life and negligible operating current. And the 01-700's low profile design assures maximum light intensity. Or choose neon or incandescent lamps instead. In either line. Mounting styles? Type 01-600 line features bezel or bezel-barrier, in

a single switch or multiple in matrix. Time-saving, snap-in mounting. Switching action? Choose from momentary or alternate – plus a selection of non-lighted switches or non-switching indicator lights in matching styles. But whatever you choose, you also get patented double-break Butterfly switching which offers greater reliability and other advantages not possible with single-break switches. Licon LPB's are easily installed and serviced. Test light them yourself.

Call your local Licon rep or distributor for a lighted demo in your office. Or call or write for a Licon Switch Catalog. **Licon, Division Illinois Tool Works Inc., 6615 W. Irving Park Road, Chicago, Illinois 60634. Phone (312) 282-4040. TWX 910-221-0275.**



i t **LICON**
w



SN74LS83N



SN74LS194N



SN74LS138N

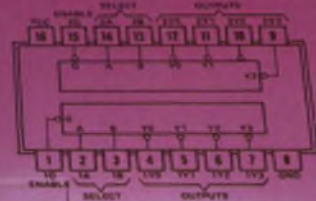

SN74LS196N

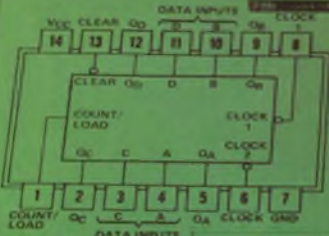

SN74LS138N

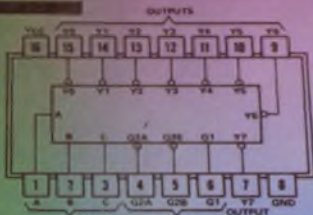

SN74LS295N

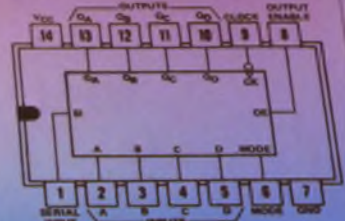

SN74LS181N

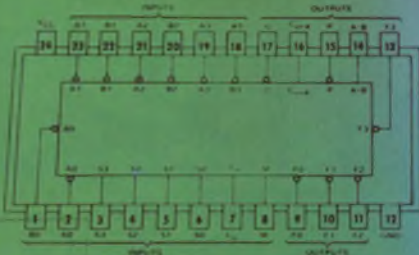

SN74LS153N

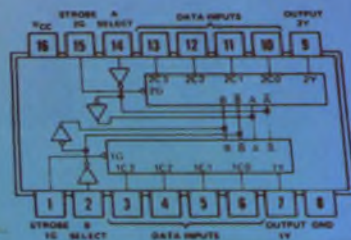

SN74LS197N

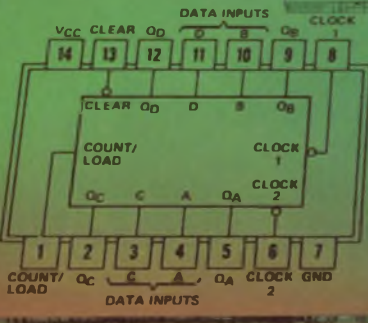

SN74LS155N

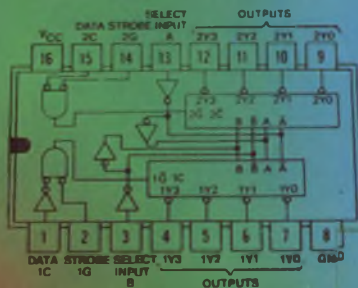

SN74LS95AN

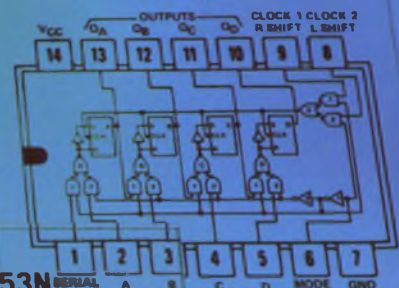

SN74LS253N

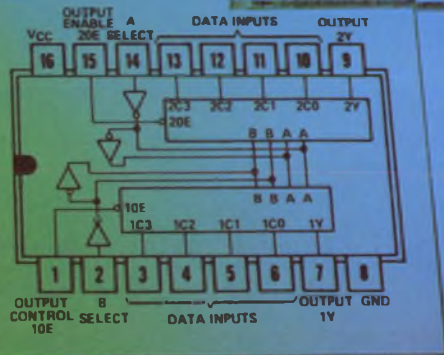

More TI integrated circuits are used in today's electronic systems than any other brand in the world. And for the reasons you'd expect: Technology. Volume. Price. Breadth. Dependability. Service. Quality. Weigh them all when you buy low-power logic.

SCHOTTKY

TI announces low-power Schottky MSI: 10 ns at less than 2 mW.

TI's new low-power Schottky TTL line provides all the performance of low-power TTL (Series 54L/74L) with increased speed of 10-ns/gate and power dissipation of less than 2 mW.

Improved performance in power-critical applications

Low-power Schottky offers greatly improved speeds in portable or remote systems, or in any application where minimum power is a prime consideration. Compared to their low-power TTL counterparts, low-power Schottky circuits require less than 1 mW/gate more power—but offer a three-fold increase in gate speeds.

Typical Speed/Power Performance Comparison

| Family | 54H/74H | 54/74 | 54S/74S | 54L/74L | 54LS/74LS |
|--------------------------------|---------|-------|---------|---------|-----------|
| Average Propagation Delay (ns) | 6 | 10 | 3 | 33 | 10 |
| Average Power Dissipation (mW) | 22 | 10 | 19 | 1 | 2 |
| Speed/Power Product (pJ) | 132 | 100 | 57 | 33 | 20 |

Full compatibility

TI's new low-power Schottky series is compatible with all TTL—standard, high-speed, low-power and Schottky. Together, these TI families offer more than 250 integrated circuit functions with compatible logic levels, voltage swings and noise margins. No interface circuits or level shifters are required.

Broad MSI line available now

TI's low-power Schottky TTL line now includes 13 high-complexity functions. These circuits offer you the full benefits of MSI design—fewer packages, smaller PC boards, fewer system interconnections—all contributing to lower component and system costs per gate, plus added reliability.

And within weeks, TI will introduce a full line of

low-power Schottky SSI, including 13 gates and eight flip-flops.

Here are the MSI functions available now:

| | DESCRIPTION | TYPICAL SPEED | TYPICAL POWER (mW) | 100-PIECE PRICE |
|------------|--|---------------|--------------------|-----------------|
| SN74LS83N | 4-bit full adder | 35 ns | 80 | \$ 3.51 |
| SN74LS95AN | 4-bit left-right shift register | 30 MHz | 52 | 4.78 |
| SN74LS138N | 3 to 8 line decoder. 1 to 8 line demultiplexer | 20 ns | 30 | 4.78 |
| SN74LS139N | Dual 2 to 4 line decoder. Dual 1 to 4 line demultiplexer | 20 ns | 35 | 4.78 |
| SN74LS153N | Dual 4 to 1 data selector/multiplexer | 15 ns | 35 | 4.78 |
| SN74LS155N | Dual 2 to 4 line decoder | 20 ns | 30 | 4.78 |
| SN74LS181N | Arithmetic logic unit/function generator | 30 ns | 105 | 25.85 |
| SN74LS194N | 4-bit bidirectional universal shift register | 30 MHz | 60 | 4.78 |
| SN74LS195N | 4-bit parallel-access shift register | 30 MHz | 52 | 4.78 |
| SN74LS196N | Presetable decade counter | 30 MHz | 55 | 4.78 |
| SN74LS197N | Presetable binary counter | 30 MHz | 55 | 4.78 |
| SN74LS253N | 3-state version of SN74LS153 | 20 ns | 45 | 5.74 |
| SN74LS295N | 3-state version of SN74LS95A | 30 MHz | 60 | 5.74 |

Immediate availability

Low-power Schottky circuits are available in the plastic dual-in-line package. Evaluation quantities are available immediately from your authorized TI distributor or direct from factory inventories. Production quantities are available four weeks ARO.

Send for data sheets

For complete information on TI's new, low-power Schottky family, circle 210 on the Reader Service Card. Or write Texas Instruments Incorporated, P. O. Box 5012, M/S 308, Dallas, Texas 75222.



RECENT SOLID STATE CONTROL DEVELOPMENTS

New Solid State Contactor Reduces Downtime, Has Trouble-Free Life



Vectrol's new series of solid state contactors feature no moving parts and are designed to operate under a variety of conditions found in most industrial applications without failure.

Designated the VSSC 1000 and VSSC 500 Series, one for normal loads, the other for extreme in-rush loads, these contactors eliminate replacement of contacts, coils, and other moving parts due to wear and welding associated with conventional electro-mechanical contactors.

The two series consist of 18 models for 30 and 42 amp loads, single phase. Additional models available soon for loads up to 80 amp and 3-phase operation. Other features: complete transient protection, zero voltage crossover-firing, input-output isolation. Request Bulletin 4615.

CIRCLE NO. 19

What do you need to know about solid state power and temperature controls?

NOW you can update yourself and your designs in solid state industrial control. Choose either a complete solid state power control system or select the electronic building blocks necessary to meet your system requirements. Our highly-experienced control specialists can reduce your valuable design time and help you realize substantial cost reductions. Get our new Short Form Catalog 64 that details our capabilities and gives you up-to-the-minute data on:

- ✓ SCR Triggers and Control Modules
- ✓ Solid State Temperature Controls
- ✓ SCR Power Controllers
- ✓ Solid State Relays



For your copy, circle the bingo number below

CIRCLE NO. 20

Write: Vectrol Inc., 1010 Westmore Ave., Rockville, Md. 20850 (301) 424-6900



SOLID STATE SCR CONTROL

technology abroad

Permanent magnets strong enough to use in high-speed, magnetically levitated interurban transportation systems will be developed in the not-too-distant future, according to Krupp of West Germany. Similar systems—in which the vehicle is suspended by the magnetic flux between the magnet and a repelling magnetic field induced in a metallic guide channel—have been suggested by the Stanford Research Institute and others. The SRI proposal, however, calls for the more complex superconducting magnet technology. Krupp says that high-efficiency permanent magnets, such as the rare earth/cobalt type, could speed 100-passenger vehicles at a cruising velocity of 450 kilometers an hour. The company predicts that the high present costs of this magnetic material will be reduced 90% through new mass-production techniques.

CIRCLE NO. 441

New solar cells developed for the Azur and Intelsat satellites by AEG-Telefunken of West Germany have improved photoelectric efficiency and reliability, says the manufacturer. The cell surface area is 2×6 cm. Titanium dioxide layers inserted between the cell surface and a cover glass reduce light losses due to reflection. The welding of titanium-palladium-silver contacts to the cells avoids the corrosion that occurs in soft-soldered contacts. The welded contacts also have better resistance to extreme temperature cycling.

CIRCLE NO. 442

Rapid diagnosis of kidney diseases by laser is being done by a West German physicist, J.H. Kraushaar. He passes a laser beam through urine samples, and impurities in the liquid break the laser beam up into speckle patterns. The patterns are caused by

coherent scattering of suspended particles. Different kidney malfunctions produce individual particles, and therefore unique speckle patterns. The clinical work is being done at the Urological Dept. of Justus-Liebig-University, Gies-sen.

CIRCLE NO. 443

A range of magnetostrictive electromechanical filters for multi-channel telephone use has been developed by Tesla, a Czechoslovakian company. It claims a 100% increase in channel density compared with conventional LC filter systems. The frequency range is between 50 and 120 kHz, available in 4-kHz spacings. Tesla is working to extend the range by 0.5 MHz.

CIRCLE NO. 444

A new range of silicon diodes with reverse voltage ratings of up to 18 kV and current ratings of 5 and 10 mA are being marketed by Switzerland's Brown Boveri. These diodes offer a favorable alternative to selenium high-voltage devices, since silicon has a lower forward voltage drop—and hence reduced power dissipation—and higher stability at elevated temperatures. The new devices are plastic encapsulated and are primarily designed for use in cascade multipliers for generating CRT beam voltages.

CIRCLE NO. 445

Fog buildup at airports can be detected in its early stages with a neutron probe developed by Bertin of France. A balloon sonde is equipped with a fast neutron emitter and neutron detector and tethered above the airport. Thermal neutrons backscattered from the hydrogen in water are registered by the detector, and the resulting pulses transmitted to a monitor via the tether cable.

CIRCLE NO. 446

BOURNS new DIP wirewound

and
cermet



Model
3095

Model
3099

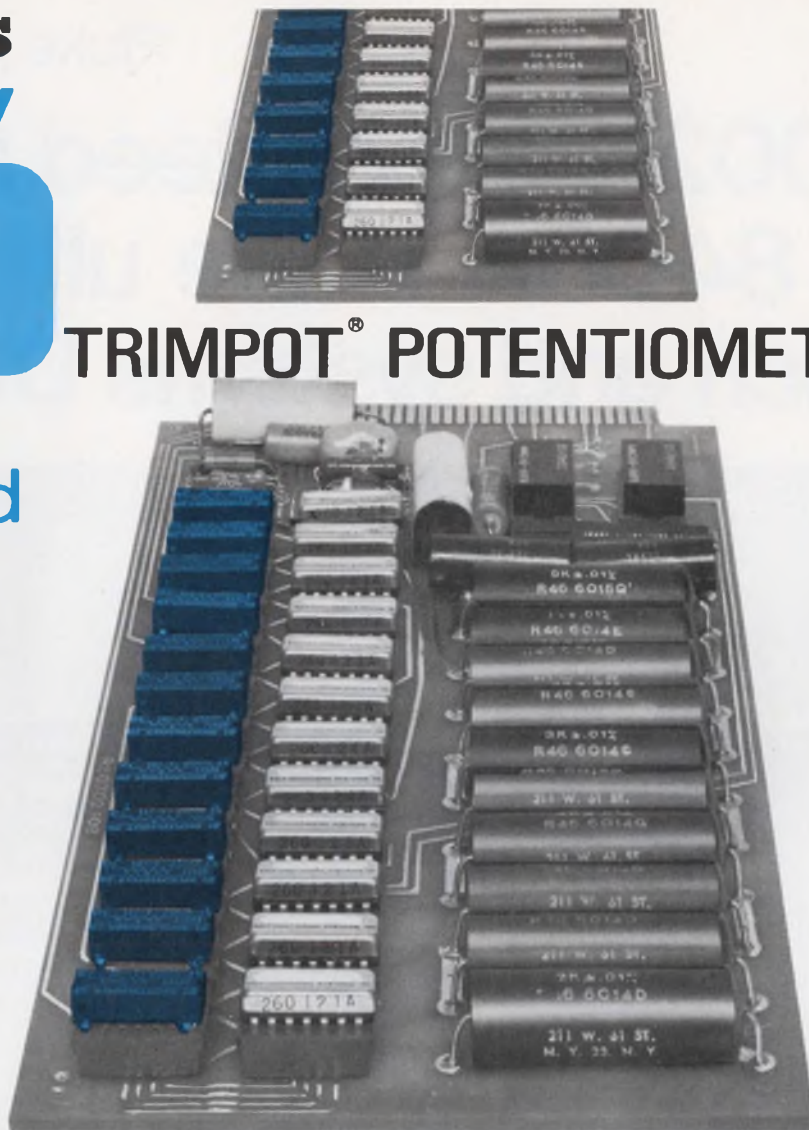

TRIMPOT® POTENTIOMETERS

BETTER IN THE LONG RUN...

...FOR AUTOMATED COMPONENT INSTALLATION

WIREWOUND OR CERMET

Bourns new TRIMPOT® Adjustment Potentiometers now offer the equipment manufacturer the best of both potentiometer element technologies, in the popular TO-116 DIP package.

AUTOMATIC OR MANUAL ASSEMBLY

Both models are designed specifically for compatibility with IC circuit-board layouts, and can be installed manually or with high-speed, high-volume automatic testing and insertion equipment for those LONG PRODUCTION RUNS.

RUGGED AND READY

Available in ready-to-use magazines, both models are sealed against humidity, and circuit-board cleaning solvents and processes.

DELIVERY

Both models are available for immediate delivery from stock.

LOOK AT THE SIGNIFICANT SPECIFICATIONS!

| | MODEL 3095 WIREWOUND | MODEL 3099 CERMET |
|--------------------|-------------------------|----------------------|
| Power Rating: | 1 watt at 70°C | 1 watt at 70°C |
| T.C. | ±50 ppm/°C | ±100 ppm/°C |
| Temperature Range: | -65°C to +150°C | -65°C to +150°C |
| Resistance Range: | 10 to 50,000 ohms | 10 to 2 megohms |
| Resolution: | 0.16 to 1.54% | Infinite |

To place your order, contact the local Bourns Field Office, Representative, Distributor, or the factory-direct: Bourns Trimpot Products Division, 1200 Columbia Avenue, Riverside, California 92507.



BOURNS, INC., TRIMPOT PRODUCTS DIVISION • 1200 COLUMBIA AVE., RIVERSIDE, CALIF. 92507

INFORMATION RETRIEVAL NUMBER 21

Fluke problem solvers

At .002% guaranteed accuracy, our 8400A is the ultimate bench and systems DVM



Built with an accuracy for all seasons, every season.

With a guaranteed accuracy of 0.002%, true RMS AC, 1 microvolt resolution, resistance measurements down to 100 micro ohms, auto polarity and ranging, you will find it's the top DVM in the field. And, in the Fluke tradition, you'll find this member of your measurement team won't be technically obsolete or out of style next year or the year after, because of its wide choice of systems and measurement options.

It's built to last. It's built to use.

It's the DVM to use for low-level, high speed measurement of distorted AC waveforms, physiological measurements, transducer calibration and virtually every other laboratory or field application demanding "state-of-the-art" digital measurement.

Here's what you get for \$2450: Five ranges of DC

from 0.1v full scale to 1,000v with up to 0.002% accuracy. 5½ digits with 20% overrange. Recirculating remainder A-to-D conversion for low power consumption and high reliability. 1500v peak overload resistance and the ability to meet tough environmental specs. Switched filter for DC, AC, resistance and ratio with better than 65 dB noise rejection.

Wide choice of options: Fluke uses single main frame construction with all options field installable. Get them when you buy or anytime later.

Choose from seven ranges of 4-terminal resistance. Four ranges of true RMS AC from 1 to 1,000 volts. Well isolated and buffered serial or parallel data outputs. Multiplexing of analog input, data output or remote control. Automatically adaptive time-outs with status flags.

For more information, call your nearby Fluke sales engineer or contact us directly.

Fluke, Box 7428, Seattle, Washington 98133. Phone: (206) 774-2211. TWX: 910-449-2850/In Europe, address Fluke Nederland (N.V.), P.O. Box 5053, Tilburg, Holland. Phone: (04250) 70130. Telex: 884-52337/In the U.K., address Fluke International Corp., Garnett Close, Watford, WD2, 4TT. Phone: Watford, 33066. Telex: 934583.



washington report



Michael H. Blake, Jr.
Washington Bureau

FCC adopts open domestic satellite policy

In the latest chapter of the long-playing saga on who should or shouldn't offer domestic communications satellite services, the Federal Communications Commission has ruled that all qualified applicants can provide such services so long as they can demonstrate that they are financially and technically qualified and the service is in the public interest. The agency has warned, however, that common carriers now offering "essential" services, such as telephone and telegraph, will have to demonstrate that they can pay for their satellite operations without passing on the costs to telephone and telegraph customers.

Under a new FCC policy, AT&T and the Communications Satellite Corp. (Comsat) are saddled with specific conditions: Within the continental 48 states, AT&T's initial use of satellites is limited to its regular and wide-area telephone services (MTT and WATS), and to the Defense Dept.'s Autovon (automatic voice) network system. AT&T also will be allowed to use the satellites as an emergency backup system for its standard land-line or microwave systems.

FAA orders ground monitor for new ILS

Under contracts totaling some \$685,000, Westinghouse Electric of Baltimore, and the AIL Div. of Cutler-Hammer, Deer Park, N.Y., will develop ground-monitoring equipment for an all-weather instrument landing system (ILS) for the Federal Aviation Administration. The monitor will maintain a near-continuous check on the performance of the ILS by measuring the path of aircraft making approaches to an airport.

During the first phase the two contractors will develop separate feasibility models of the ILS ground monitor. Both models will then be tested for 14 months at the experimental center in Atlantic City, N.J. Following evaluation of the two systems, one contractor will be selected to build two development (engineering) models of the ground-monitoring system for operational evaluation at two major airports.

Rohr sews up District of Columbia subway contract

After weighing in with a competitive bid so low that Rep. Earle Cabell (D.-Tex), chairman of a subcommittee of the House District of Columbia Committee, asked the General Accounting Office to check it out, Rohr Industries of Chula Vista, Calif., received a \$91.6-million contract to

supply 300 computer-controlled subway cars for the Capital. The award was made by the District of Columbia's Metro Board. Sixty of the cars are to be delivered in the summer of 1974, when the subway system, now under construction, is scheduled to begin operations. The remainder of the cars are to be shipped by 1976. All will be manufactured at Rohr's plant in Winder, Ga.

On top of this, Rohr has made two "handshake agreements" with foreign governments—one in South America—to develop high-speed ground transportation systems for them. These agreements were made at Transpo 72, the transportation exhibition held last month at Dulles International Airport, near Washington, D. C. Details and identities of the foreign buyers will be revealed after negotiations are completed.

One point seems clear: While Europe and Japan may be ahead of the U.S. in building sophisticated public-transportation systems, U.S. technology is not lagging and can still get foreign business if it keeps the costs competitive, which Rohr apparently did.

Ceramic-package 'dumping' complaint studied

The Treasury Dept. has opened an investigation into the import of electronic ceramic packages and related parts from Japan to determine if U.S. laws forbidding "dumping" are being violated. Japan has been the target of a number of anti-dumping investigations in the past over such items as TV sets and deflection yokes. The new inquiry follows a complaint to Bureau of Customs that ceramic packages are being dumped. The total value of electronic ceramic packages and parts imported from Japan in 1971 amounted to about \$2-million.

Meanwhile, Sen. Richard S. Schweiker (R.-Pa.) has introduced an anti-dumping bill, called officially The Fair International Trade Act of 1972, to "combat the flood of low-priced imports into the U.S." He says the bill would impose stricter sanctions on foreign sellers who sell their products in this country at unrealistically low costs while charging higher prices in their own countries to make up for low profits here. Among other things, the measure would authorize treble-damage legal actions against foreign companies that dump products.

Capital Capsules: Exporters and potential exporters of electronic equipment will be pleased to know that **procedures for clearing exports have been simplified.** Under the new procedure, announced by the Commerce Dept., the shipper's export declaration can be presented directly to the carrier by the exporter or the foreign freight forwarder prior to departure of the shipment. Previously the declarations had to be authenticated by a Customs' officer before they could be accepted by a carrier. For details, get Export Control Bulletin 63, dated June 13, 1972, from the U.S. Commerce Dept., Washington, D.C. 20230. . . . The Air Force Systems Command's Electronic Systems Div. will issue a **request for quotations (RFQ) this fall for development of a prototype Seek Storm system.** Seek Storm will provide Air Force weather-service aircraft with an improved weather radar. . . . The Soviet Union will exhibit a wide range of electronic equipment at the Washington State International Trade Fair next month in Seattle. Dubbed "Unimart 72," **the fair will feature a 16,000-square-foot Soviet exhibit, the largest single display at the show.** Russian-made equipment to be displayed will include signal generators, potentiometers, frequency meters, oscillographs, "mini TVs" featuring IC circuitry and instrumentation and measuring devices.

Five watt power in a cermet pot!



Allen-Bradley Type CJ. That's right, 5 watts at 70°C. Now you can have the stepless control of cermet without sacrificing power-handling capability. Replace wirewounds with performance that's hard to match. Low noise. No inductance. Smooth mechanical operation.

Operating temperature range -65°C to +150°C. Rotational life 50,000 cycles with less than 10% resistance change. Resistances from 100 ohms to 5 megs. Single, dual or triple section units with plain or locking bushings. Dust-tight and "splash-proof." Large variety of shaft

and bushing options available. Allen-Bradley CJ. Available through your A-B electronics distributor, or write today for further information to Allen-Bradley, Electronics Division, Milwaukee, Wisconsin 53204. Export: Bloomfield, N. J. 07003. In Canada: Galt, Ontario.

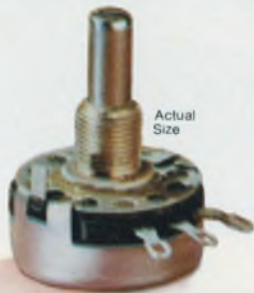

NEW DIMENSION ELECTRONICS
ALLEN-BRADLEY



A digital multimeter that measures true RMS and dBm directly.

Look what you can measure with the Hickok 3310 Universal Multimeter: true RMS voltage and current like these —

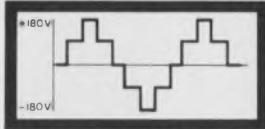

Sine wave synthesis by voltage switching
ERMS = 110.2 Volts; 43.1 dBm

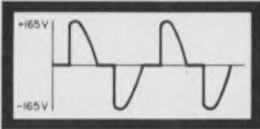

Load voltage using full-wave SCR phase control
ERMS = 98.6 Volts; 42.1 dBm



Sawtooth waveform
ERMS = 5.77 Volts; 17.4 dBm

For just **\$845⁰⁰**

You save money and receive performance with the Hickok 3310. Here are some of its RMS specs — 100- μ V resolution, 4:1 crest factor, bandwidth from 20 Hz to 50 kHz, RMS current capability from 100 nA to 2 A plus all-solid-state circuits for reliability and ruggedness.

But keep going. The 3310 reads from -40 dB to +60 dB with 0.1-dB resolution directly; no conversion or mental additions are necessary. You can choose between a 600 and 900-ohm internal reference with a front panel switch.

And don't forget the "multi." The 3310 measures DC voltage from 100 μ V to 1.5 kV, DC current from 100 nA to 2 A, and resistance from 100 milliohms to 200 megohms.

Then, there are the extras. You can add an internal rechargeable battery option with 20 hours consecutive operation or you can add a BCD-output option. Accessories extend ranges to 30 kV or 100 A, and one converts the 3310 to a 20-MHz counter. All accessories will fit into a convenient carrying case along with the 3310.

Try the 3310 for yourself. Call Hickok or your nearest Hickok field engineer for a demonstration and see RMS for yourself.

HICKOK
the value innovator

Instrumentation & Controls Division
10514 Dupont Ave. Cleveland, OH 44108
(216) 541-8060







shown
 $\frac{2}{3}$ actual size

16 NEW MULTIPLES FROM THE POWER HOUSE

Dual and Triple Output OEM Power Supplies

The most economical power/cost ratios in the power supply industry are now available in 16 new *multiple* output power supplies. These new units are specifically designed for computer, peripheral and instrument applications.

The same high quality components, low manufacturing costs, proven engineering design, reliability and economy incorporated in our highly successful single output OEM Series are here now in our new multiple output series and that means *multiple* satisfaction! We do it better for less, that's why Powertec is the leader in the OEM business. **EXCLUSIVE FEATURES:** Reliability • Economy • Proven Engineering Design • Low Manufacturing Costs • High Quality Components.

| | MODEL NUMBER | OUTPUT POWER | | | 100 PIECE** PRICE | |
|---|---------------|--------------------------|--------------------------|-------------------------------------|-------------------|----------------------|
| | | OUTPUT #1 | OUTPUT #2 | OUTPUT #3 | | |
| 2K - DUAL OUTPUT | | | | | | |
|  | 2K15D-1.3 | +12V, 1.5A or +15V, 1.3A | -12V, 1.5A or -15V, 1.3A | NA | \$37.00 | |
| | *2K5D-3.0 | 5V, 3.0A or 6V, 2.5A | 5V, 3.0A or 6V, 2.5A | NA | | |
| | Depth — 2.50 | *2K5, 15D | 5V, 3.0A or 6V, 2.5A | 12V, 1.5A or 15V, 1.3A | | NA |
| | Width — 7.87 | *2K5, 24D | 5V, 3.0A or 6V, 2.5A | 18V, 1.0A or 20V, 1.0A or 24V, 1.0A | | NA |
| Height — 4.00 | | | | | | |
| 2L - DUAL OUTPUT | | | | | | |
|  | 2L15D-2.8 | +12V, 3.0A or +15V, 2.8A | -12V, 3.0A or -15V, 2.8A | NA | \$65.00 | |
| | *2L5D-6.0 | 5V, 6.0A or 6V, 5.0A | 5V, 6.0A or 6V, 5.0A | NA | | |
| | Depth — 2.75 | *2L5, 15D | 5V, 6.0A or 6V, 5.0A | 12V, 3.0A or 15V, 2.8A | | NA |
| | Width — 9.38 | *2L5, 24D | 5V, 6.0A or 6V, 5.0A | 18V, 2.0A or 20V, 2.3A or 24V, 2.3A | | NA |
| Height — 4.88 | | | | | | |
| 2R - TRIPLE OUTPUT | | | | | | |
|  | 2R-70T | +12V, 1.5A or +15V, 1.3A | -12V, 1.5A or -15V, 1.3A | 5V, 6.0A or 6V, 5.0A | \$69.00 | |
| | *2R-72T | 5V, 3.0A or 6V, 2.5A | 12V, 1.5A or 15V, 1.3A | 5V, 6.0A or 6V, 5.0A | | |
| | Depth — 2.87 | *2R-74T | 5V, 3.0A or 6V, 2.5A | 18V, 1.0A or 20V, 1.0A or 24V, 1.0A | | 5V, 6.0A or 6V, 5.0A |
| | Width — 11.00 | *2R-76T | 12V, 1.5A or 15V, 1.3A | 18V, 1.0A or 20V, 1.0A or 24V, 1.0A | | 5V, 6.0A or 6V, 5.0A |
| Height — 4.88 | | | | | | |
| 2S - TRIPLE OUTPUT | | | | | | |
|  | 2S-140T | +12V, 3.0A or +15V, 2.8A | -12V, 3.0A or -15V, 2.8A | 5V, 12A or 6V, 8.0A | \$119.00 | |
| | *2S-142T | 5V, 6.0A or 6V, 5.0A | 12V, 3.0A or 15V, 2.8A | 5V, 12A or 6V, 8.0A | | |
| | Depth 4.00 | *2S-144T | 5V, 6.0A or 6V, 5.0A | 18V, 2.0A or 20V, 2.3A or 24V, 2.3A | | 5V, 12A or 6V, 8.0A |
| | Width 15.00 | *2S-146T | 12V, 3.0A or 15V, 2.8A | 18V, 2.0A or 20V, 2.3A or 24V, 2.3A | | 5V, 12A or 6V, 8.0A |
| Height 4.88 | | | | | | |

All outputs are floating, can be connected in any common configuration unless otherwise noted. Other voltages and currents available, consult factory for price and delivery.

*NON-STOCKED ** For quantities other than 100, contact factory.

SPECIFICATIONS: INPUT: 115VAC \pm 10V, 47-63 Hz • REGULATION: Line \pm .25%, Load \pm .25% • RIPPLE: 1mv RMS 5 & 15V • RESPONSE: 50 μ sec typical • TEMPERATURE: 0°C to 40°C derated to 71°C • O.L. PROTECTION: Current limit/foldback • Optional OVP available. **DELIVERY:** stocked models within 24 hours, 30 days for others.

Incidentally, if you don't see your exact model on the chart, we'll build an OEM *multiple* from stocked subassemblies in any voltage/current combination. Give us a call and we'll be glad to quote within 24 hours. Stay within the same size and power rating, and the price won't change.

POWERTEC INC. an Airtronics Subsidiary
9168 DeSoto Ave., Chatsworth, California 91311 • (213) 882-0004 • TWX (910) 494-2092

POWERTEC

INFORMATION RETRIEVAL NUMBER 25

Microdata gives you a new kind of minicomputer

The Twin Mini doubles throughput for just a few dollars more

Put two microprogrammable CPU's with separate control memories and I/O facilities into a Micro 1600 cabinet where they share a common core memory. That's the idea behind the Twin Mini. And it works wonders. For the first time, core memory is used so efficiently that your throughput rate is more than double that of other CPU's. Applications which normally call for much larger or more expensive computers can now be handled simply and economically by this effective combination of Micro 1600 parts.

You show us your requirements. We'll show you how to build a system with unmatched processing power per dollar. Your system may fit into a single Micro 1600 cabinet or overflow into two. Either way, the performance will match our claims or your money back. Find out how easy it is to do business with Microdata. Write for details.

MicrodataTM
Microdata Corporation
644 East Young Street
Santa Ana, Calif. 92705
(714) 540-6730

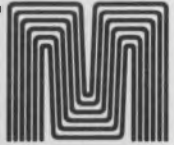

TM trademark Microdata Corporation



Do-it-yourself molded cables you don't have to do yourself— that's yankee ingenuity.

Doing it the hard way puts you in the cable assembly business. The accountants are happy, but chances are, you're not. You're still not getting your money's worth.

Do it the easy way. Switchcraft gives you the same thing as do-it-yourself assemblies, but takes all the grief off your hands and it ends up costing you less.

What you call custom, we call production.

We've got virtually every kind of plug, jack, junction, clamp, connector or wire you can specify. We just put them together the way you want. We even provide colors that match, complement or color-code your equipment. Ribs, dots, legends and various indices can be molded in for easy identification.

Reliability?

Our reputation is tested a million times every day. Each time somebody makes a Switchcraft connection. So we know about things that must work. Things like communications equipment. Or medical electronics. Instrumentation

and data processing. That's why we engineered and improved method for strain relief. That's why we maintain a precise match between cable diameter and plug/connector handle. Less wear, less exposure to moisture and contamination means more reliability.

And even though we've managed smaller, lighter weight assemblies, we don't sacrifice shielding. Of course, both our reputations are protected by 100% testing for continuity, shorts and voltage breakdown.

Want to save money?

Fair enough. Our expertise in the area of cables, connections and assemblies helps you specify right down to a gnat's arm. We'll literally lower unit costs with precise cable design and specifications.

Next, we'll pass along some of our manufacturing efficiency and you won't have to invest in the molded cable assembly business. Finally, Switchcraft reliability will save you plenty. Service and replacement costs for home-made cables will dwindle. And, if there is any

kind of problem, you'll find a Switchcraft representative right in your back yard. Not across the pond, so to speak.

It takes a little "yankee ingenuity" to provide all this, and still keep costs in line. But we manage.

Test us. Send for your free copy of our Switchcraft Engineering Specification File for Molded Cable Assemblies. Or contact Switchcraft or our local representative directly. See what Yankee ingenuity can do for you.

SWITCHCRAFT

SWITCHCRAFT

5555 N. Elston Ave.
Chicago, Ill. 60630

Please send me your Engineering Specification File for Molded Cable Assemblies, M-701a.

Name _____

Title _____

Company _____

Address _____

City _____ State _____ Zip _____

Comments: _____

INFORMATION RETRIEVAL NUMBER 27



Here's a great line to hand the government.

Our switches will help your aerospace/defense equipment meet military specifications. Here are a few examples.

PROXIMITY SWITCHES. Our solid state FW integral proximity (MIL-STD-810) can be used for landing gear, ordnance and cargo handling equipment.

FR two-piece reed proximities (MIL-STD-810) feature 10 million operations at rated load. Use the FR (not shown) to monitor things like aircraft entry, cargo and landing gear doors.

ENVIRONMENTALLY SEALED SWITCHES. EN limit switches are the most versatile environment-proof switches available. They're explosion and immersion proof (MIL-S-8805) and ideal for military/aerospace and commercial aircraft applications.

XE subminiatures are corrosion resistant as well as waterproof (MIL-S-8805). With a temperature range of -65° to $+221^{\circ}$ F, they're excellent for gun mount and door interlock applications.

HERMETICALLY SEALED SWITCHES. HR limits are explosion-proof (MIL-E-5272) as well as resistant to corrosion and shock (MIL-S-8805). High temp. capability makes them suited for aircraft engines and missile systems.

HM miniatures (MIL-S-8805) are for all-weather, multi-environment military/aerospace jobs.

See your MICRO SWITCH Branch Office or Authorized Distributor (Yellow Pages, "Switches, Electric"). Or write for our brochures.

MICRO SWITCH makes your ideas work.



MICRO SWITCH
FREEPORT, ILLINOIS 61032
A DIVISION OF HONEYWELL

MICRO SWITCH products are available worldwide through Honeywell International.

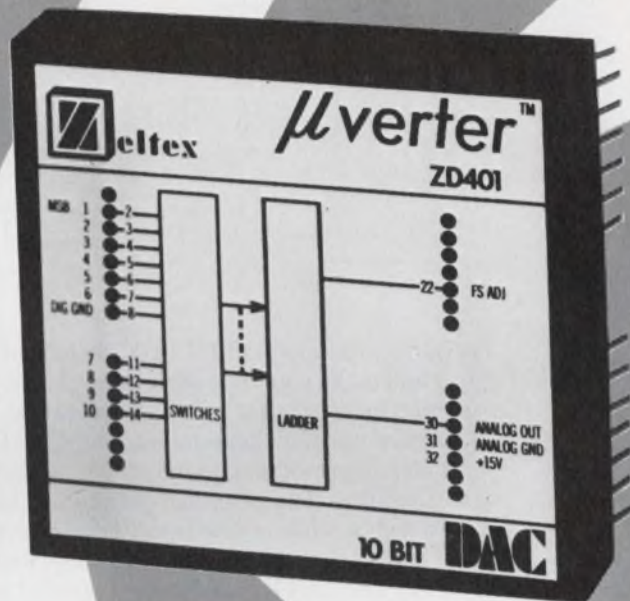
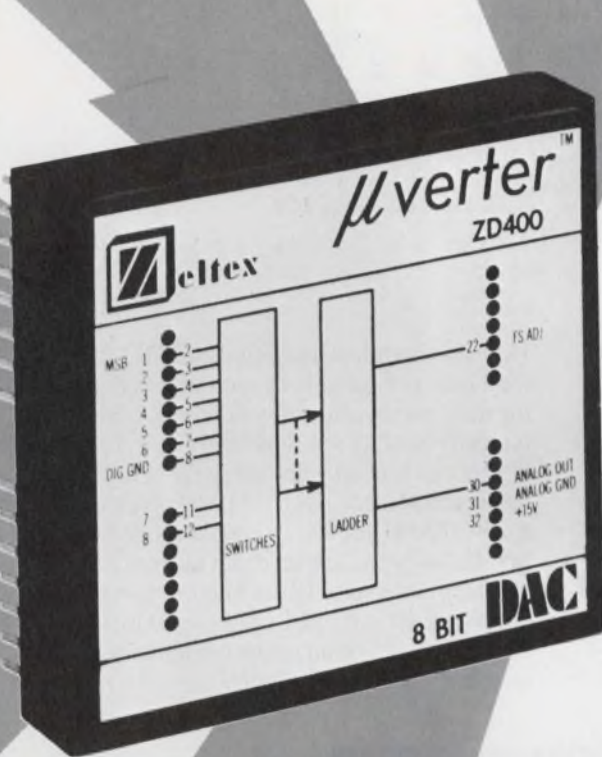

ZELTEX DACability!

Meet the two newest current DAC's to join our μ verter™ line: The ZD400 and ZD401... 8- and 10-Bit Models that sell for only \$8.00 and \$12.65 (in OEM quantities).

The ZD400 settles to $\frac{1}{2}$ LSB in less than 1 μ sec; the ZD401 is accurate to $\pm 0.05\% \pm \frac{1}{2}$ LSB. Output current for both converters is rated at 0 to +2.6 mA with a compliance voltage of +1.2V.

Plus higher reliability: Our thick-film DAC's are subject to 16 hours "stabilization bake" at 85°C reducing infant mortality to virtually zero; active resistor trimming guarantees accuracy; DIP leads provide compatibility with most DIP printed circuit boards, and high quality packaging meets most

shock, stress, and environmental conditions.

Use them for CRT ramp generators, special function generators, and for building custom ADC's.

Ask about our other 17 versions of DAC's—from 2-Digit BCD to 12-Bit Binary, from modules to systems— μ verters™ mean DACability!

Call or write today for a complete Zeltex Data Pak.

(415) 686-6660
 TWX (910) 481-9477
 1000 Chalomar Road
 Concord, Ca. 94520

Conversion Products Specialists

Zeltex INC.

to build a better VHF/UHF FET mixer:

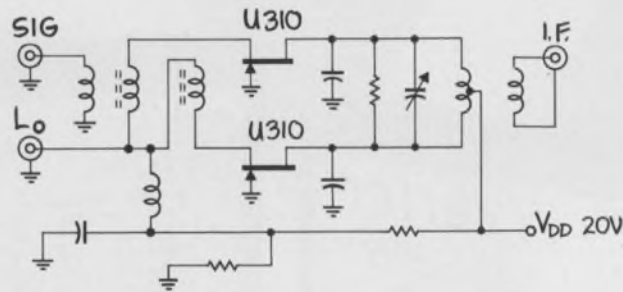

Try our U310 junction FET in this balanced mixer and make your own performance comparison. Our results are below. The inherent square-law transfer characteristic of the FET ensures high intermodulation intercept and signal desensitization. The grounded-gate connection is most stable, while source injection of both the signal and local oscillator make easy impedance matching into the FETs. Also, the balanced configuration reduces l.o. radiation from the signal port and suppresses the generation of even harmonics (which helps reduce intermodulation).

How do you select an optimum JFET for a mixer? Low gate capacitance is needed for wide bandwidth — the Siliconix U310 typically has $C_{gs} = 4.5$ pF and $C_{gd} = 1.9$ pF. Useful conversion gain comes from high transconductance. Our U310 has typical $g_{fs} = 14,000$ μ mhos. Dynamic range is bracketed by the lowest drain current for an acceptable noise figure and the maximum drain current — typically $I_{DSS} = 40$ mA for the U310. For an optimum balance, matched pairs are available.

50-250 MHz Mixer Performance Comparison

| Characteristic | JFET | Schottky | Bipolar |
|--|-----------|----------|-----------------------|
| Intermodulation Intercept Point | + 32 dBm | + 28 dBm | + 12 dBm [†] |
| Dynamic Range | 100 dB | 100 dB | 80 dB [†] |
| Desensitization Level (the level for an unwanted signal when the desired signal first experiences compression) | + 8.5 dBm | + 3 dBm | + 1 dBm [†] |
| Conversion Gain | + 3 dB* | - 6 dB* | + 18 dB |
| Single-sideband Noise Figure | 6.5 dB | 6.5 dB | 6.0 dB |

[†] Estimated * Conservative minimum

There's a lot more to this, so
write for data

and get the complete story on VHF/UHF mixing and the Siliconix U310.

Applications Engineering: (408) 246-8905



Siliconix incorporated

2201 Laurelwood Road, Santa Clara, California 95054

Innovate in new designs or let the world slip by

The major discussion at the recent long-range planning symposium called "Electronics 1985" (see "EIA crystal ball shows trends in electronics to the year 2012," ED 13, June 22, 1972, p. 34) involved the declining United States share of the world electronics industry. The economic figures supporting this view were impressive. Despite the expected growth of the world electronics market to \$205-billion by 1985 from \$56.7-billion in 1970, the U.S. share will have dropped from 49.8% to only 39.5% during that period. The message is clear: Should the U.S. fail to develop new products for domestic consumption or fail to expand into international markets, the domestic electronics industry will be in big trouble.



Granted that U.S. companies are today and will in the future become more world-oriented in their marketing efforts—meeting Japanese and European competitors head-on—it still boils down to a question of new technology and improved product design. As John Myers, vice president of Allen-Bradley Co.'s Electronics Div., noted: "It is ever-harder to compete with lower technology products in world markets—or even the U.S. markets—as manufacturing of them becomes more widespread. Putting it another way, a nation that cannot successfully make ICs can make and sell resistors and capacitors and relays and knobs and wire even though they may be far below ours in quality and design." Myers argues for the need to keep our technology high if we are to continue to be an effective world competitor.

As Carl Cottrell, Deputy Director, International Group of Hewlett-Packard put it: "Our industry is faced with maintaining our technological leadership against a fast-growing capacity for creative research and development from abroad. We have been exporting our know-how since World War II, and we are now seeing it returned in the form of well-engineered competitive products."

In short, if our industry is to compete in world markets, we must use innovative design to maintain and extend our technological advantage.

Ralph Dobriner

RALPH DOBRINER
Managing Editor

Improve efficiency in power control

by returning the load energy to the source. Circuit complexity goes up but size and dissipation go down.

In systems using solid-state power control, the load often stores a significant amount of energy. Preferably the control circuit should be designed to recover this energy rather than leaving it to be dissipated unproductively. Energy recovery, of course, improves circuit efficiency and reduces the dissipation requirements of the equipment.

A regenerative technique, to return power from the load to the source, can recover the stored energy. This technique may or may not prove worthwhile, depending on the specific application. The design decision will depend on the following factors:

- The efficiency of the load when acting as a generator.
- The over-all system efficiency improvement that can be obtained, compared with the increased cost and complexity of the system.
- The ability of the source to accept energy.

Once you decide to use regeneration, choose the simplest energy-recovery scheme, and be sure it is compatible with the type of control circuit used. To show where regenerative systems can be used, let's consider three general control circuits: ac-to-dc conversion systems, dc-to-ac conversion systems and dc-to-dc chopper regulators.

Four possible operating quadrants

Any electrical control system can operate in four possible quadrants. The number of quadrants in a design depends on the circuit configuration and the control elements. There is a forward power flow from source to load, if the equipment is operating in quadrants I or III (voltage and current are of the same polarity). If in quadrants II or IV (voltage and current are of opposite polarity), there is a reverse power flow from load to source. In many systems the equipment operates partly in quadrants I or III and partly in quadrants II or IV; the net power flow in this case depends on the relative magnitudes of the "positive" and "negative" flow.

One of the simplest power-conversion systems

is the three-phase, full-wave-bridge rectifier in Fig. 1. This circuit operates in quadrant I—power can flow only from the source to the load. Thus a simple diode-rectifier system cannot be used to recover energy.

As an example of operation in more than one quadrant, consider the controlled-rectifier circuit of Fig. 2. This circuit differs from the simple diode rectifier in one important aspect: the control elements (SCRs) can support voltage in both directions. Now, if the load and source characteristics are suitable, the circuit can operate in quadrant II and return energy to the source.

Typical waveforms for the SCR circuit are in Fig. 3. The load in this case could be a dc electromagnet, which needs a large amount of charging energy. After charging is complete, the converter output is readjusted to supply just enough ener-

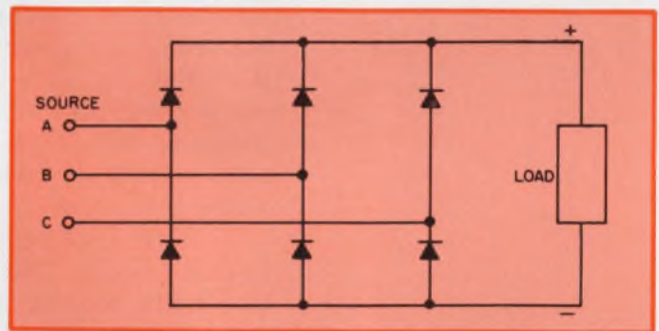

1. The common, three-phase full-wave bridge rectifier operates in quadrant I only. Regeneration cannot be used with this circuit.

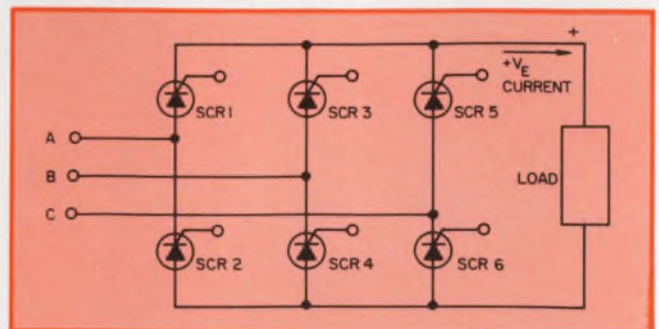

2. By substituting SCRs for the diodes in the full-wave bridge, the circuit can be made to return energy to the source by proper phasing of the firing sequence.

gy to overcome the circuit losses. Then, to discharge the magnet, the control circuit selects a firing sequence that will cause energy to return to the supply. This involves delaying the firing until near the end of the forward-biased period.

At the start of regeneration, at time t_0 , SCR 4 fires (Fig. 3e), and the firing pulses for all other SCRs (SCR 5 is already conducting) are inhibited until later, at time t_2 . But as seen in Fig. 3a, the output voltage of the converter changes sign at t_1 . After t_2 , the converter operates in quad-

rant II, and energy is returned to the supply.

Examination of the remainder of the waveforms of Fig. 3 shows that, after t_2 , the normal firing sequence is re-established. But because of the delay introduced by inhibiting the firing pulses until time t_2 , the converter returns energy to the supply. Note that in the regenerating mode the phase angle between the line-to-line voltage, V_{ac} and line current is almost 180° .

Note the absence, in the regenerative mode, of the free-wheeling diode, often used in SCR

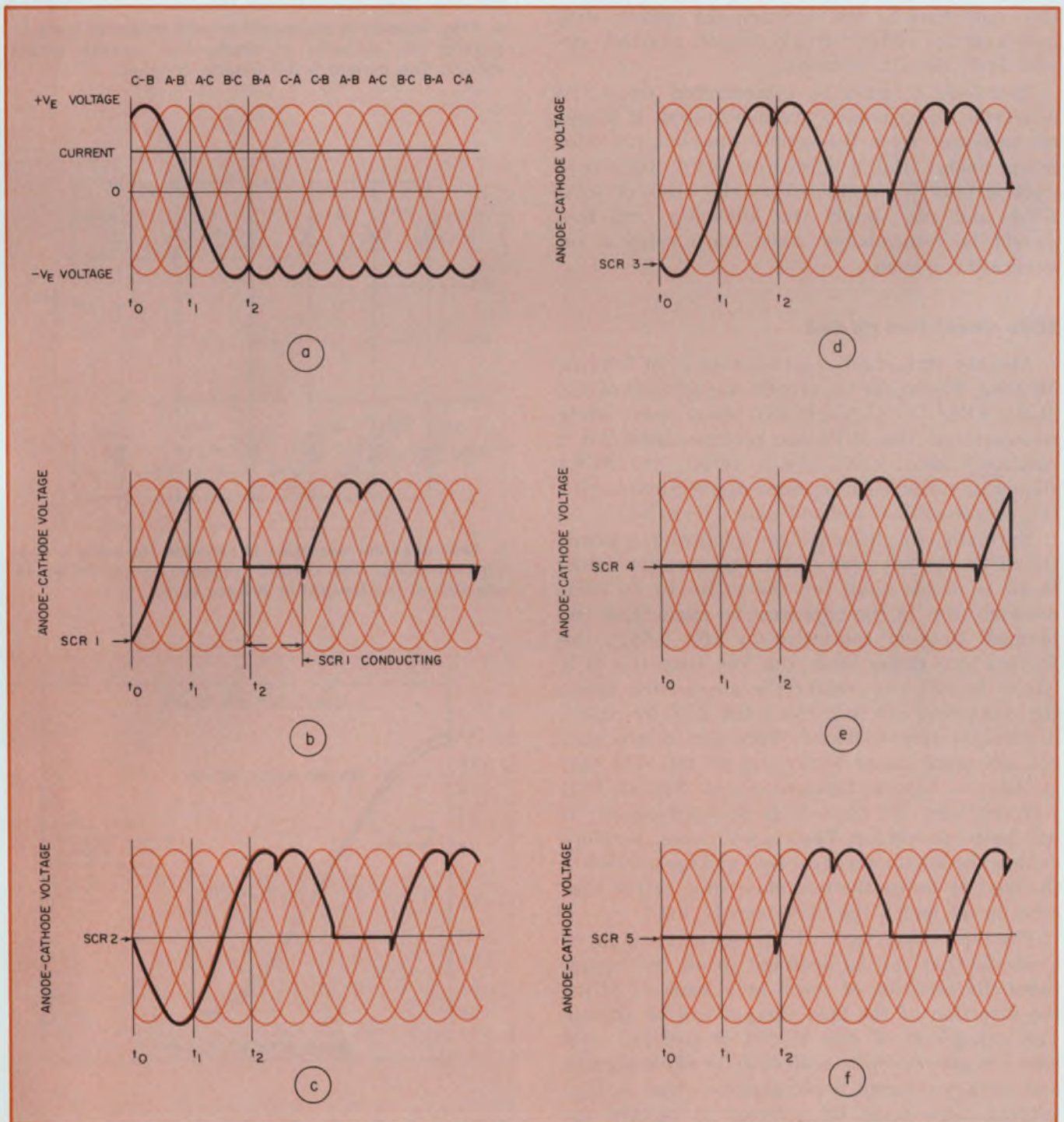

3. Waveforms for the SCR bridge show the output voltage/current, line voltage/current and the individual SCR

anode-cathode voltages and switching relationships for recovering the load energy.

circuits to carry the inductive current of the load when the SCRs are off.

In the regenerative technique freewheeling is accomplished by phasing the converter to produce an average output of zero. This is illustrated in the waveforms of Fig. 4, which show a phase lag of about 150° , that is, the SCRs are fired about 30° before the zero-voltage level. The output voltage then rises to half the positive peak line-voltage. Then, because there is an inductive current holding on the SCRs, the output follows the ac line down to half the negative peak. At this point the next SCR is turned on. Current thus continues to flow through the bridge, with zero average voltage at the output, and the current level remains constant.

However, it must be remembered when the converter delivers zero average output, it draws no ac power from the supply lines—it has zero power factor. But it does draw KVA. Industrial electric bills are computed on the basis of total KVA and not simply the kilowatts, and this should be remembered when considering a regenerative system.

SCRs should turn off fast

Another important consideration is SCR turn-off time. The anode-to-cathode waveshapes of the SCRs (Fig. 3b through 3f) show that, while regenerating, the SCRs are reverse-biased for a relatively short time. As a result, the SCRs should be suitable for inverter applications—with the necessary fast turn-off characteristics.

Normally, in phase-control applications where the SCRs are not used in the regenerative mode, there is ample time for the SCRs to be commutated. But in the regenerative application the turn-off time is controlled by the firing; the further you phase back, the less time the SCR has to be off; the greater the phase back angle, the closer you are to turning the SCR on before it becomes reverse-biased. This also means that you are much closer to turning off the SCR that is about to become forward-biased. But an SCR will not turn off when it is forward-biased; it will keep conducting. The turn-off time therefore defines the maximum "reverse" voltage applied to the load by fixing the minimum time before zero crossing at which the SCRs can be fired.

The dual converter in Fig. 5 is an example of a circuit that can be operated in all four quadrants. By selection of the R or F bank of SCRs, the direction of the load current can be chosen. The extra cost of this circuit is justified only where regeneration is economically advantageous and voltage reversal is not feasible—that is, load current alone must be reversed to recover the stored energy.

An example of this is a shunt motor that, for

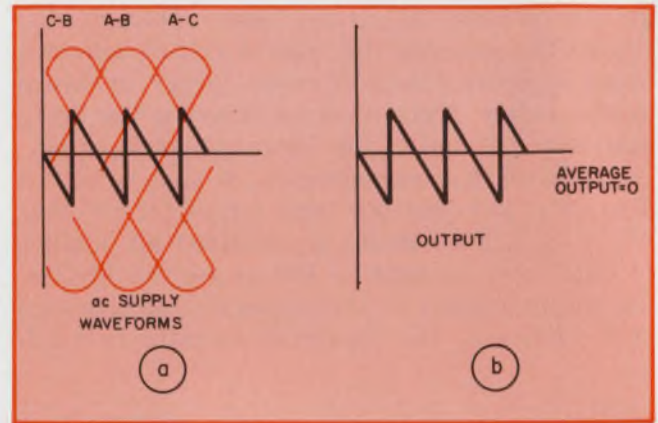

4. Free wheeling is accomplished with inductive loads by phasing the converter to obtain zero average output voltage. The current level remains constant.

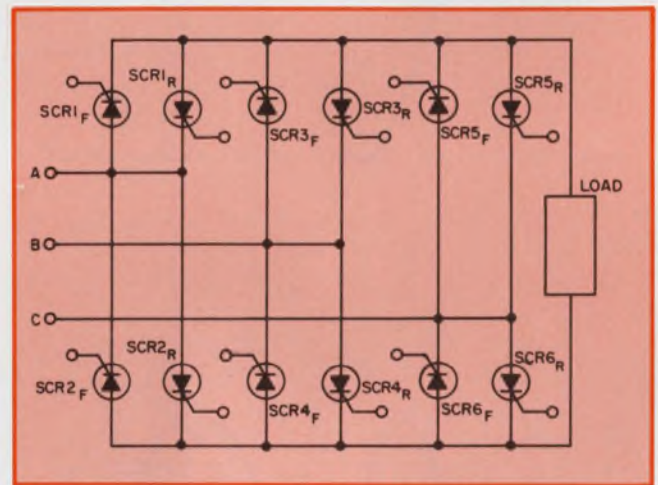

5. Four quadrant operation is possible by using a dual bank of SCRs. The current direction is controlled by selection of the forward or reverse bank.

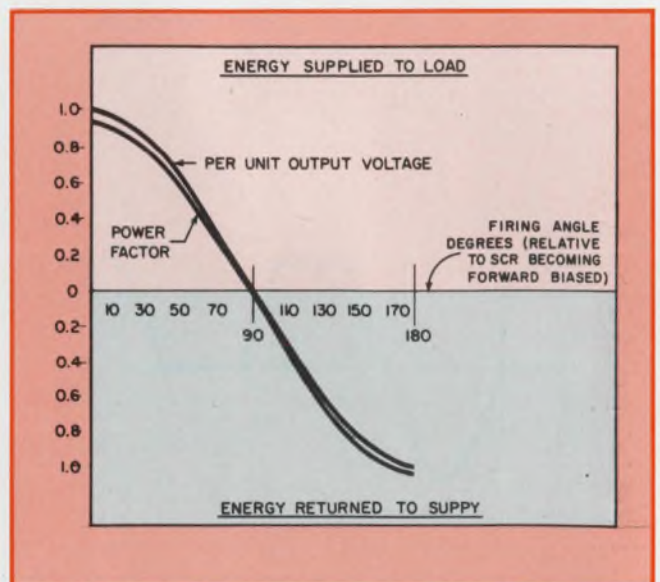

6. The power factor at the supply input terminal varies with the SCR firing angle. This must be taken into account when computing system efficiency.

some reason, cannot have its field winding voltage reversed. Thus the machine-generated emf does not change polarity, but current flows out of the machine during regeneration. The amplitude of the generated current is controlled by field strength up to the maximum and then by armature voltage control as the speed is reduced.

Once again, it must be recognized that the power factor of the system varies as a function of firing angle. Fig. 6 shows how both output voltage and input power factor vary as a function of firing angle.

What about ac loads?

By its very nature, an ac load often cannot store energy. But there are some exceptions. For example, an ac motor stores energy in the rotating mass of the rotor. A parallel-resonant circuit can also store energy, which can be recovered when the dissipative load is removed.

With these systems an important consideration is the ability of the dc supply (which is converted to ac) to accept energy from the ac load: A battery can accept energy, but a simple rectifier cannot. However, if other systems are connected to the same dc supply as the load undergoing regeneration, the stored energy can be applied to one or more of these, thereby reducing the total energy drawn from the supply. If the dc is derived from an ac source to which energy must be returned, then either a controlled converter or a dual converter is required. Which one depends on the ability of the dc-to-ac inverter to reverse either the voltage or the current of the dc link.

A regenerative system can be advantageous in an induction motor speed control circuit, where

controlled braking is a requirement or the system efficiency can be significantly improved. To achieve a controlled, regenerative brake, the inverter output frequency is set to be less than the equivalent rotor frequency. The rotating machine then acts like an induction generator. By contrast, during acceleration the inverter frequency is set to be greater than equivalent rotor frequency.

Chopper regulators can be regenerative

Chopper regulators are widely used where a dc supply voltage has to be modified (generally reduced) for voltage regulation. In motor-drive applications the braking function is accomplished by using the chopper regulator as a parallel switch when the machine is generating and as a series switch when the machine is motoring. A regenerative system is useful in dc motor drives to improve braking or efficiency—or both. It has a major advantage in that high braking torque can be maintained down to low speeds.

A chopper regulator operating in its normal mode is shown in Fig. 7a. The average voltage to the motor is controlled by alternately connecting and disconnecting the motor to the supply via SCR 1. During the OFF time of SCR 1, the motor current flows through D1 and decays at a rate that is a function of the winding inductance and the back emf of the motor. Generally the regulator is operated at that frequency that assures continuous current in the load.

When the motor must decelerate, the regulator connections are changed (Fig. 7b). At the same time the field winding has to be reversed to maintain the same polarity of motor-generated emf (the machine is rotating in the same direction, but with a reversed current flow). With the circuit connections in Fig 7b—and the SCR 1 conducting—the current in the machine will increase at a rate determined by the circuit inductance and the machine-generated emf. When the current reaches some preset maximum, SCR 1 is commutated OFF. Because of the inductive nature of the load, however, current continues to flow, and the inductively generated voltage, combined with the machine-generated emf, reach a value sufficient to force current back into the supply. The current during this period then decays at a rate that is a function of the load inductance and the difference between the machine-generated emf and the dc supply voltage. The motor can thus be decelerated in a controlled manner while returning energy to the supply, since the braking torque for this type of rotating machine is proportional to the square of the armature current. The current can be controlled, except at very low speeds where the armature current level is limited by a loop resistance. ■■

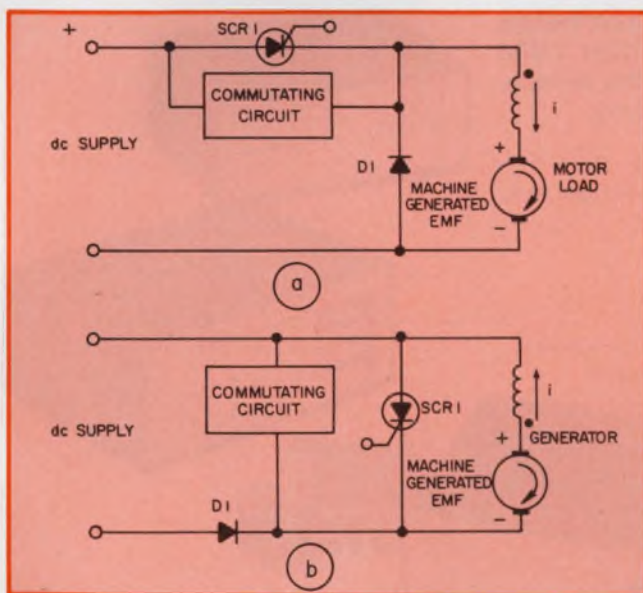

7. Regeneration can be used to control the braking of a chopper—regulator driven dc motor. High braking torque can be maintained at low speeds in this way.

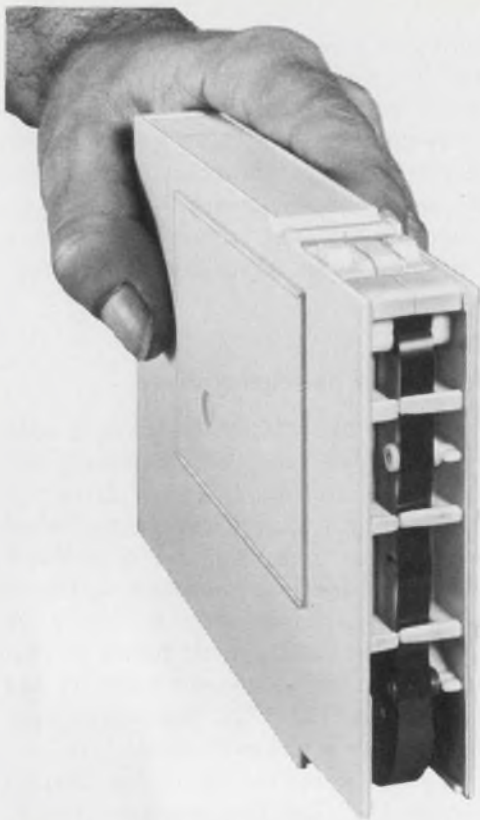

CARTRIFILE[®] and the COMMON CARTRIDGE

(Or how to expand mini-system memory power the easy way)

Now you can expand mini-system memory power the easy way. Simply incorporate one or more Tri-Data CartriFile tape units. There's a model to fit just about every need. And they all use a COMMON cartridge.

Our CartriFile family includes complete memories that are plug-to-plug compatible with all popular minicomputers. It also includes "bare essential" models for OEM system builders. You can choose two or four independently controllable tape drives. Prices range from \$975 to \$4950.

With a CartriFile in your system, you'll get a true feeling of security. It's no experiment. We've sold over 1,000 CartriFiles since 1968. They're providing ultra reliable service in hundreds of different applications.

If you have mini-system memory problems, give Tri-Data a call. CartriFile and the Common Cartridge may be just what you're looking for.



TRI-DATA

800 Maude Avenue / Mountain View / CA 94040
Phone (415) 969-3700 / TWX 910-379-6978



If you need
a tester
with **special**
scales, ranges,
accessories
or any
combination...

Buy a
Triplett tester
custom-designed
for you

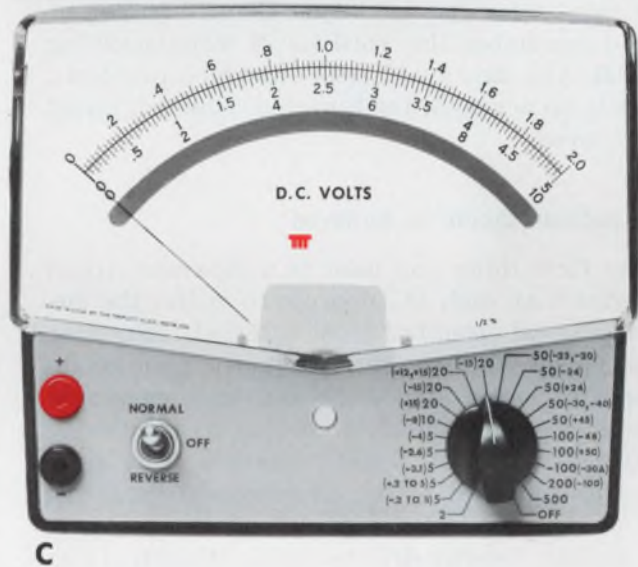
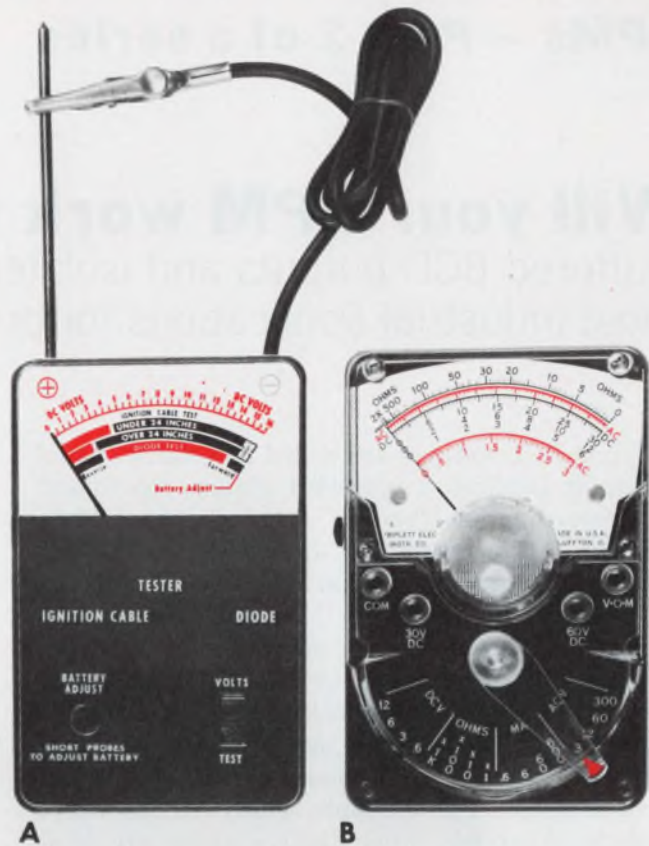

Triplett, manufacturer of the World's most complete line of V-O-M's, is ready, willing and able to design and manufacture special testers of virtually any size, style or type to meet your specifications.

Tester A (above) was designed to give auto mechanics a simple, rugged tester for "go/no go" tests that would otherwise be measured in electrical units unfamiliar to them.

Tester B is a modification of a

standard Triplett tester incorporating only the specific ranges needed by the field service engineers for whom it was designed.

Tester C has special ranges and special input connectors and cables to permit a single-point connection for trouble-shooting and servicing all the circuits of a complex business machine.

Several other buyers of standard Triplett test equipment request their company name on the dial to personalize their testers.

If you think a custom tester may solve some problems for you, contact your Triplett representative. He'll put you in touch with the Tester Designers and Engineers at Triplett who'll help you analyze the problem and suggest the optimum cost/result solution. Triplett Corporation, Bluffton, Ohio 45817

TRIPLETT
BLUFFTON, OHIO 45817

Manufacturers of the World's
most complete line of V-O-M's

INFORMATION RETRIEVAL NUMBER 31

DPMs – Part 2 of a series

Will your DPM work with your system?

Buffered BCD outputs and isolated inputs are needed in most industrial applications for proper interface.

When BCD outputs are added to a digital panel meter, it becomes a powerful system component for recording, controlling or computing, while simultaneously displaying numerical values. But you had better be sure that the BCD output circuits are compatible with the rest of the system.

Since the circuit configuration of the BCD outputs is seldom specified by the DPM manufacturer, the user often overlooks its significance. As a result, the DPM doesn't interface properly, and this can be especially serious in noisy industrial environments. For example, many DPMs won't operate accurately when their outputs are bundled into cables that are longer than 10 feet or so. If you remember the word BIGS when selecting a DPM, you can avoid most interface problems. BIGS is an acronym for Buffered, Isolated, Gated and Stored.

BCD outputs should be buffered

The first thing you need is a separate circuit in series with each BCD output to *buffer* the meter's internal circuitry from external influences. In a typical DPM the input signal is first conditioned by linear amplifiers and then compared with a reference signal, according to the timing control provided by decade counters. The BCD value is contained in the decade counters at the end of the conversion process and is applied to the display decoder-drivers either directly (Fig. 1a) or through storage elements (Fig. 1b).

The BCD outputs are generally connected directly to the counter output lines, so that noise picked up externally is applied to these circuits at full amplitude. As a result, DPM decade counters that use either TTL or RTL flip-flops are susceptible to false triggering.

If TTL storage elements are used, they also are susceptible to false triggering. By contrast, an RTL storage element has a buffered output and is therefore relatively immune to false triggering.

Another possible problem is that capacitive coupling between bundled BCD output lines may cause one flip-flop to change state when another changes state. This can be attacked by shielding each individual output line. However, this significantly adds capacitance between each output line and its shield ground. And this may prevent the flip-flops from toggling properly.

Further, counter and latch flip-flops make unsatisfactory line drivers, because the reflected signal caused by an improper line termination can change a flip-flop state.

Specifying a DPM with buffered BCD outputs can solve all these problems. Separate inverters or gates are generally used for buffering the internal BCD lines (Fig. 2). These can drive lines up to 100 feet or longer, with no errors in the data. DTL, RTL or open-collector TTL gates have an advantage over conventional TTL gates in that the output lines can sustain ground shorts without stressing the ICs.

Input isolation avoids ground loops

Common grounds between the analog input and the digital outputs exist in many of the less expensive DPMs available today. This restricts performance in applications where the BCD outputs

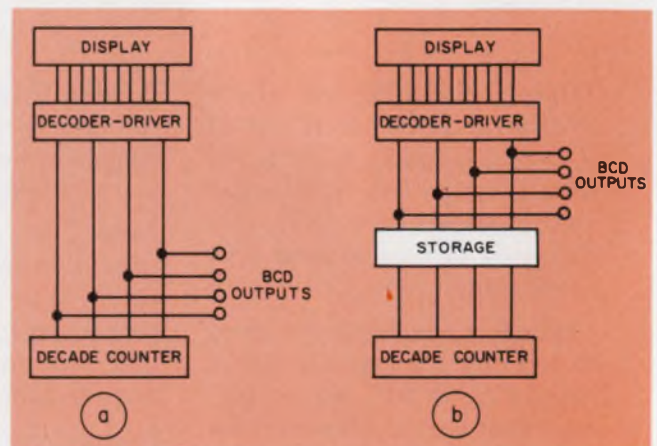

1. BCD outputs in a nonbuffered DPM are taken directly from the decade counter (a) or from the storage stage (b) if there is one.

are connected to another instrument or system component. Appropriate circuits added to the DPM can provide *isolation* by separating the input and output grounds.

Ground loops normally appear in a single-ended instrument when it is connected as in Fig. 3a. A ground current (I_g) as small as 1 mA, flowing through a resistance (R_i) of 1Ω in the input common line causes an error of 1 mV in the DPM reading. Since ground currents of greater than 1 mA can be expected in a realistic instrumentation system, a DPM with isolation should be specified whenever each digit of resolution represents 10 mV or less. Isolation of the grounds drastically reduces the flow of ground current and hence the resulting errors.

Several volts of isolation between analog and digital grounds can be built into the DPM by using a differential amplifier at the input (Fig. 3b). This is adequate for most applications. When greater isolation is required, a pulse transformer between the analog and digital circuits can provide isolation on the order of 300 V (Fig. 3c).

Gating can handle multiple DPMs

Gating can simplify the design and reduce the cost of a system that has multiple DPMs. A quad, two-input gate (per decade) provides BCD buffering and at the same time allows the DPM outputs to be enabled or disabled with a single-line control signal (Fig. 4). If the system has several DPMs feeding data to a remote location, all the BCD outputs can be connected to a common data bus. To transmit data, you activate an enable line to the selected instrument. The receiving equipment (printer, controller or remote display) sees only the outputs of the gate-enabled instrument. This technique reduces system complexity and results in substantial wiring savings. Gated outputs also provide for future expansion, even

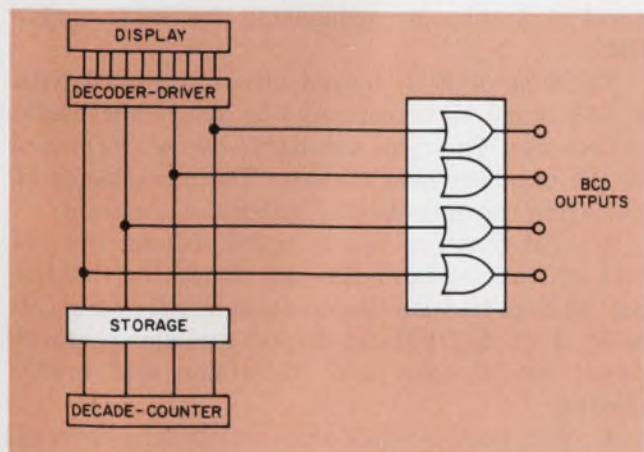

2. Inverters or gates buffer the BCD outputs and allow the DPM to drive lines of 100 feet or more. Buffers also prevent noise feedback to the BCD stage.

though the system may need only a single DPM at present.

Storage simplifies synchronization

Synchronization of the BCD output data to the instrumentation system's timing requirements can be simplified by adding data *storage* to the DPM.

A quad-latch inserted between the decade counter and the decoder driver provides the storage. With this feature, the DPM provides a flicker-free display, and the BCD outputs do not change during the conversion period.

If the DPM with storage also contains gated BCD outputs, the transfer of information into storage may be inhibited by the same signal that enables the BCD outputs. This further simplifies system operation.

Several DPMs with their outputs gated off and connected to a common bus can be commanded to read simultaneously. The data will be held and displayed on each DPM but will not be available to the data bus until an individual enable command is received. Data can then be transferred to the recording device or controller, one instru-

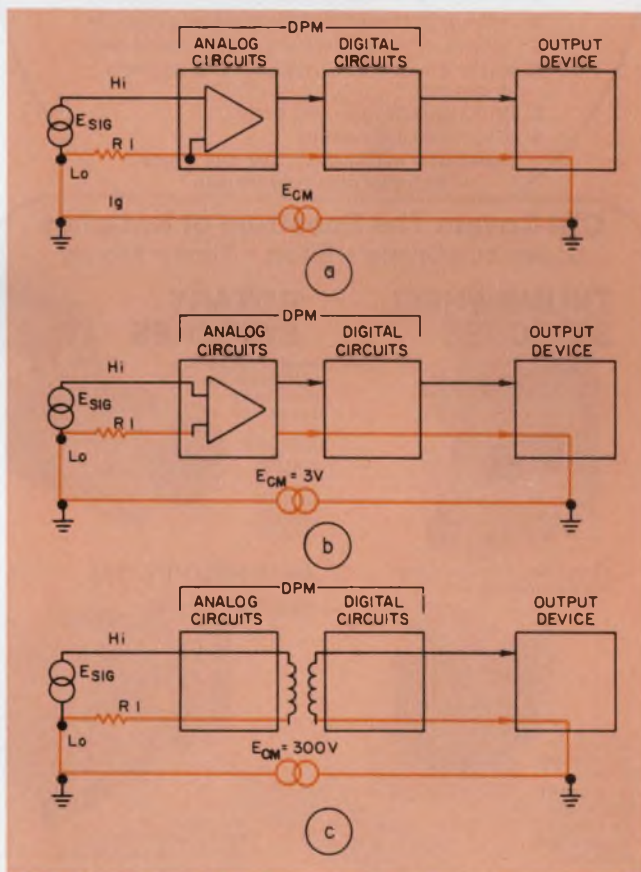

3. When the input circuit, DPM and output device have a common ground (as in "a"), currents flowing through the line impedance generate an error voltage. The error can be minimized by using a differential input (as in "b") or by isolating the input from the output with a transformer (as in "c").

MORE SWITCH FOR LESS MONEY

NEW

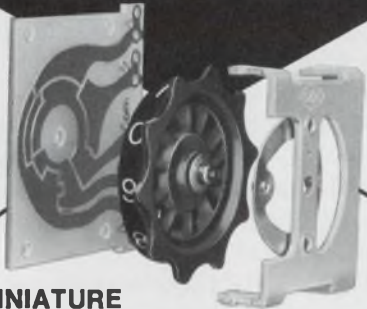

MINIATURE PRECISION THUMBWHEEL SWITCH

1,000,000 Detents (for quality)
Low Cost (for savings)

9 TOP QUALITY FEATURES

1. .05 ohms max. contact resistance.
2. 200 megohms min. insulation.
3. 1,000 volts min. dielectric strength.
4. 2 amps @ 115VAC current carrying capability.
5. 125 ma @ 115VAC current breaking capability.
6. Mounts on 1/2" centers only 1 1/2" behind panel.
7. Glass laminate with precious metal contacts & plating.
8. Multi-applications—you name it.
9. Over 1,000,000 detents.

IMMEDIATE DELIVERY . . . ASK THE PRICE—
BE PLEASANTLY SURPRISED.

CDI Covers The Spectrum of Switches Saves You Space • Effort • Time • Money

THUMBWHEEL SWITCHES



Completely sealed against hostile environments.

ROTARY SWITCHES

Snap-in, snap-out modules in seconds, eliminating downtime.

Patent Pat.
2841660,
2971066,
3015000,
2956131,
2988607.



PUSHBUTTON SWITCHES



Mounts on 1/2" centers, retrofits most panel openings for miniature thumbwheel switches.



Miniature add/subtract units retrofit most miniature thumbwheel switch panel openings.

CDI earns its reputation every day for Consistently High Quality, Consistently Good Delivery.



CHICAGO DYNAMIC INDUSTRIES, INC.

PRECISION PRODUCTS DIVISION
1725 Diversey Blvd., Chicago, Illinois 60614
Phone: 312, 935-4600

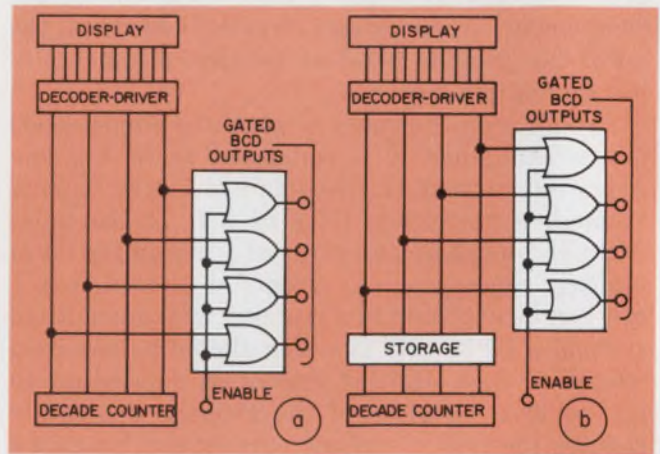

4. Busing of several DPMs to common BCD lines is achieved by gated outputs that use either DTL or open-collector TTL. The data from each DPM can be sequentially applied to the lines by the individual enable inputs.

Table. DPM IC-logic comparison.

| BCD output logic type | Fan out | Relative immunity to capacitive loading | Maximum bundles line length | Relative immunity to noise |
|------------------------------|---------|---|-----------------------------|----------------------------|
| RTL decade counter | 2.5 | Poor | 5' | Poor |
| TTL decade counter | 8 | Fair | 5' | Fair |
| TTL low power decade counter | 1 | Poor | 1' | Poor |
| RTL latch | 5 | Good | 100' | Good |
| TTL latch | 9 | Fair | 5' | Fair |
| TTL low power latch | 1 | Poor | 1' | Poor |
| RTL gate | 5 | Good | 100' | Fair |
| DTL gate | 8 | Good | 100' | Good |
| TTL gate | 10 | Good | 100' | Good |

ment at a time, by sequencing the BCD enable lines.

The type of BCD output circuit supplied with a DPM must be investigated to insure successful system use. The table compares the performance of the most common circuits. The advantages of buffering the outputs with gates are apparent.

A DPM that can satisfy most present and future systems needs might look something like the unit of Fig. 4b, with the isolation of either Fig. 3b or 3c. A single DPM can display and also perform signal conditioning, a/d conversion and multiplexing.

A final point: While this article has covered DPMs, a similar analysis can be applied to specialized panel instruments, such as digital thermometers, counters, totalizers and clocks. ■■



The PDP-11 family grows on. The rugged one: PDP-11R20

Some computer problems are plain impossible to bring to the computer. PDP-11R20 goes to them.

Goes where there are bad things like 5G shocks, 500Hz vibration, 55°C temperatures, 95% relative humidity, severe EMI, 30% voltage swings, 10% frequency transients. Even if the power source fails completely, the PDP-11R20 processor will resume when the power does — from just where it left off. You won't lose data.

Then there are convenience features: Peripheral connections are MIL type — quick and reliable. The computer will operate in any attitude — at weird angles, even upside down if it comes to that.

Aside from these and other protective features, the 11R20 is the same high-performance 16-bit computer as the PDP-11/20 and possesses the most powerful mini-computer architecture in the world. Like core memory expandable to 124K words, built-in multi line and level priority interrupt, 8 general purpose registers, over 400 instructions, direct memory access, automatic power fail and restart.

It goes on and on. So if you happen to have an ocean going ship, or a tank, or just an ordinary van, take PDP-11R20 to where the control or processing problems are. It will not only survive the environment, it will keep processing in the environment for a long time.

But first, send for the complete story. Digital Equipment Corporation, Main St., Maynard, Mass. 01754. (617) 897-5111.

European Headquarters: 81, route de l'Aire, 1211 Geneva 26 Tel.: 427950

digital

Boost op-amp bandwidths and slew rates with input lag compensation instead of the usually recommended lag-compensation techniques.

To get improved full-signal power bandwidths and slew rates in op amps, replace the conventional second-stage (or later) lag compensation circuits with an *input* lag-compensation network. Since the input network is at the low signal-excursion points of the op amp (the summing junctions), less time is required to change the capacitor charge than in the higher-level stages.

Equally important is the elimination of first-stage saturation that occurs with the standard compensation. As shown in Fig. 1a, the large jump in error voltage, e_r , saturates the first stages, thus limiting frequency response back towards the open-loop, first 3-dB break point. The input lag compensating network (Fig. 1b) integrates such an input jump, and keeps the error voltage within the linear response range of the first stage.

The input lag-compensation network

In designing an input lag-compensation network, you need know only the open-loop dc gain of the op amp, A_{OL} , and the first 3-dB frequency, f_{OL} . These parameters are usually given in data sheets (f_{OL} is often called the 3-dB point, the natural rolloff or the open-loop bandwidth).

For example, suppose you want to design a unity-gain, inverting 10-MHz amplifier—that is, one with $A_{CL} = 1$ and $f_{CL} = 10$ MHz—using the RCA CA3015 op amp. From RCA application note ICAN-5213, it can be seen that this op amp has an open-loop gain, A_{OL} , of 70 dB, a first break, F_{OL} , of 320 kHz, and a second break of 10 MHz. By using the manufacturer-recommended phase-lead compensation network, you move the second-break frequency out to 35 MHz.

Figure 2 shows a simplified Bode plot of the open-loop lead-compensated CA3015, as well as the desired closed-loop response of our example. Also shown is the required lag compensation plot, together with the equivalent amplifier circuits corresponding to the three frequency bands of interest.

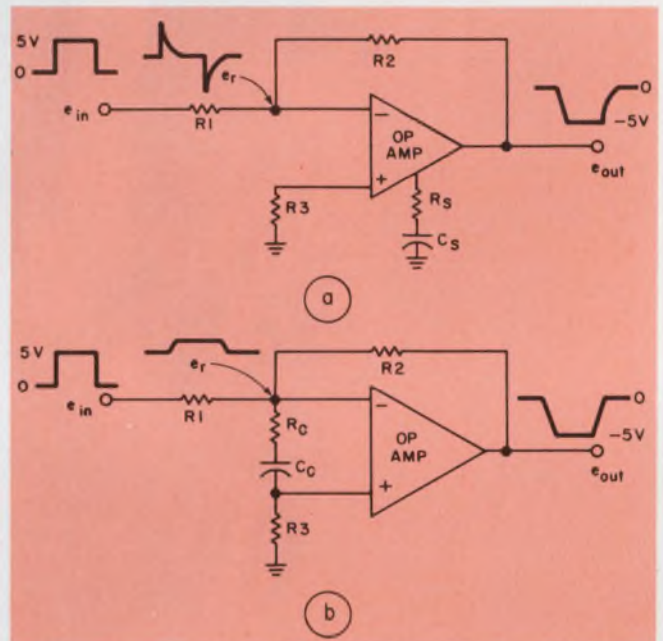

1. Increase in bandwidth and slew rates is obtained by placing the standard lag compensation network, $R_s C_s$, (a), across the op amp input or summing points, (b). The error voltage, e_r , is now averaged by the time constant $R_c C_c$, thus preventing first-stage saturation.

The first step in the design procedure is to select values for R_1 , R_2 , and R_3 , usually below 10 k Ω for high-speed response. R_3 can be any reasonable value, but to minimize dc offset, R_3 is usually made equal to the parallel value of R_1 and R_2 . You can thus let:

$$R_1 = 10 \text{ k}\Omega \text{ (input impedance).}$$

$$R_2 = (-A_{CL} R_1) = 10 \text{ k}\Omega \text{ (} A_{CL} \text{ is unity).}$$

$$R_3 = (R_1 \text{ in parallel with } R_2) = 5.1 \text{ k}\Omega, \text{ choosing the closest standard resistance value.}$$

The next step is to determine f_1 , the first 3-dB break frequency of the desired lag-compensation network. For stability, f_1 should be less than F_{OL} by a reasonable amount. The f_1 break frequency is determined graphically by extending the -1 closed-loop slope from f_{CL} back up to the intersection point on the open-loop response curve (Fig. 2). The equivalent calculation is:

$$f_1 = f_{CL}/10^x,$$

where $x = (A_{OL} - |A_{CL}|)/20$, and A_{CL} and A_{OL} are in dB. In the example under consideration, $f_1 = 3.16$ kHz.

The break at f_1 is caused by the compensation-network capacitor, C_c , which attenuates the open-loop gain at this frequency. An equivalent circuit explaining this effect appears in Fig. 3a, together with the lag-compensated, open-loop Bode plot of Fig. 3b. From this circuit, a simple calculation yields the value of C_c :

$$\tau_1 = 1/(2\pi f_1) = C_c [R_3 + (R_1 \text{ in parallel with } R_2)].$$

[For our example, where $R_3 = R_1$ in parallel with R_2 ,

$$C_c = (R_1 + R_2)/(4\pi f_1 R_1 R_2) = 0.005 \mu\text{F}.$$

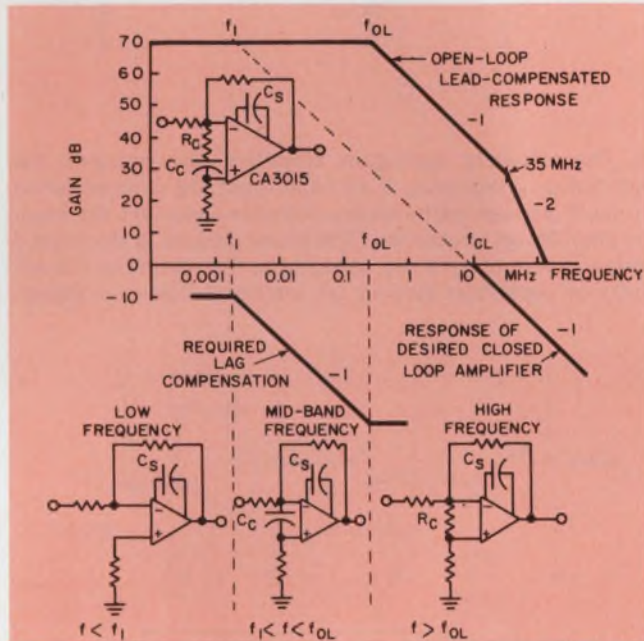

2. A unity-gain amplifier with the break at 10 MHz is obtained by supplementing the standard lead compensation network, C_s , with the input lag compensating network, $R_c C_c$. The equivalent amplifier circuits are sketched below the corresponding frequency bands.

The breakout frequency of our lag-compensation network is caused by the $R_c C_c$ time constant. As shown in Fig. 2, this lead break is set equal to the natural rolloff frequency, f_{OL} , for maximum feedback bandwidth. Thus R_c is calculated to be:

$$R_c C_c = \frac{1}{(2\pi f_{OL})}$$

and, for our example,

$$R_c = 100 \Omega.$$

The resulting unity-gain amplifier appears in Fig. 4, together with power-supply bypass capacitors and an emitter-follower power stage.

For best results, follow these tips

There are some practical hints for building op-amp circuits like the one just described. Here are seven hints:

1. Use high-frequency layout methods—that is, short lead lengths, single-point grounding, close spacing and (if possible) a ground plane. Stray

capacitance can cause oscillations up to the open-loop unity-gain crossover frequency of the op amp, usually above 100 MHz.

2. Dc power supplies should be decoupled right at the IC, using 0.1-to-0.01- μF ceramic capacitors. The decoupling should be good to 100 MHz.

3. For high-frequency operation, keep impedances low in the forward and feedback resistors. This reduces stray-capacitance effects on the roll-off.

4. Check the amplifier pulse response at design

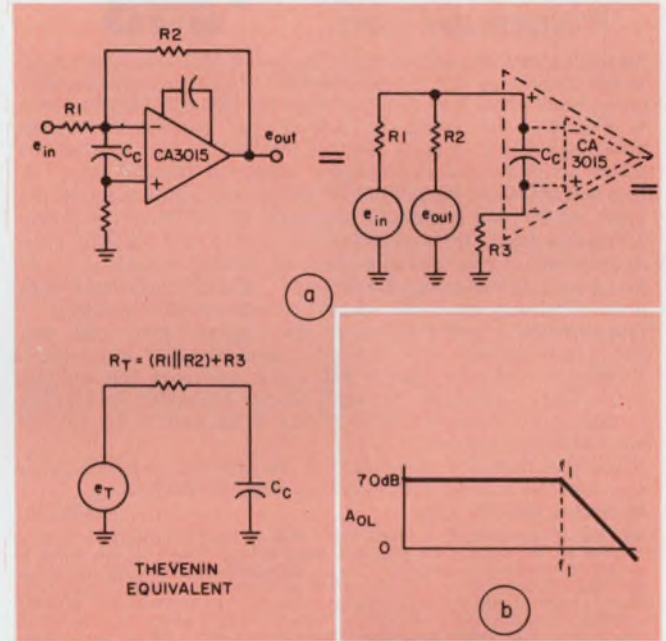

3. The amplifier equivalent circuit (a) shows the effect of the input lag-compensation capacitor, C_c , on the open-loop gain characteristics, (b). That is, C_c attenuates the effective open-loop gain of the amplifier at the frequency f_1 .

limits, using a scope with bandwidths as high as those of the open-loop unity crossover. Remember that a 100-MHz oscillation looks like a dc bias or a fuzzy line on a 5-MHz scope.

5. Watch output capacitive loading (such as long cables) and use one of the standard schemes—like a resistor, resistor-capacitor and emitter-follower buffering (Fig. 5).

6. Watch out for parasitic emitter-follower oscillations that occur when a modern, high f_t transistor is driven from a low-impedance source, such as an op amp. A 2N2219 transistor can produce oscillations with amplitudes of up to 100 mV at 150 MHz. Emitter or collector decoupling and placement of the follower outside the feedback loop will not help. Addition of a 27- Ω resistor (R_B in Fig. 5) eliminates these parasitic oscillations.

7. Be careful when using ferrite beads for limiting ringing or parasitics, often they will only mask a design problem. Printed-circuit boards often become larger when subsystems are

The Time Machine...



New Heath/Schlumberger Programmable Timer... **\$395***

Precise, low cost time measurements. The new SM-102A is a compact, light-weight time-measuring instrument capable of 100 nanosecond resolution (direct count). Both Start and Stop inputs are internally switch-selected to allow for a zero-crossing or TTL-level signal. Although time-interval measurement is its primary function, the SM-102A will also measure period, period average, events, scaled events and frequency ratio.

Excellent sensitivity. The SM-102A will trigger with as little as 100 mV rms input. And the input is protected to ± 50 V at DC and 25 V rms at 20 MHz.

Differential input. The true differential input of the SM-102A allows measurement of time interval between signals that do not have a common ground, as well as signals referenced to ground. Front panel binding posts and binding post-to-BNC adapters provide connection flexibility.

Programmable. Standard BCD output and programmability make automatic measurements easy. External control of range and reset is provided, as well as 5 digits of BCD output, over-range flag, and completion flag... a computer can easily program and control the SM-102A. Connect a TTL-compatible digital printer to the back of the SM-102A and recording is automatic.

If you have measurement problems in the anywhen, we have an accurate, low cost solution: the SM-102A... the Time Machine.

Assembled SM-102A, 8 lbs. **\$395.00***

SM-102A SPECIFICATIONS — START/STOP INPUT — Input Impedance: 1 megohm shunted by less than 50 pF. Maximum Input Voltage: ± 50 V DC referenced to ground for either, or both sides of Input. Sensitivity: Zero crossing mode: 100 mV RMS. TTL/relay mode: TTL compatible. Minimum Pulse Width: Zero crossing mode: 100 ns at 300 mV pk-pk. TTL/relay mode: 50 ns at TTL levels. **GENERAL —** Range: Time A-B: 0.1 μ s to 10^4 sec. Period Average: 5×10^{-4} sec to 9999.9 sec. Events: 1 to 99999. Resolution: Time A-B: 100 ms to 100 ns. Period Average: 100 ns/number of periods averaged. Accuracy: ± 1 count, \pm time base accuracy, \pm trigger error (start/stop). External Oscillator Input Range: DC to 12.5 MHz. Time Base: Frequency: 10 MHz. Aging Rate: less than 5 ppm/year. Line Voltage Stability: less than ± 1 part in 10^7 for 10% line variation. Temperature Stability: ± 5 ppm 10°C to 40°C ambient. Referenced at 25°C . Readout: Five 7-segment LED's plus 3 incandescent lamps and 2 decimal points for range indication and overrange. BCD Output: Rear panel connector for 5 digits of BCD, Overrange flag, Completion flag, 5-volt reference (1 K Ω impedance), Ground, and Range programming inputs (binary). Maximum cable length, 18'. **Power Requirements:** 105-125 volts, 50/60 Hz, 23 watts. (210-250 volts by changing internal switch and fuse). Fuse: 125 volt operation: $\frac{1}{4}$ ampere, 125 volt slow blow. 250 volt operation: $\frac{1}{8}$ ampere, 250 volt slow blow. Dimensions: $9\frac{1}{4}$ " deep, $6\frac{3}{4}$ " wide, $2\frac{1}{4}$ " high. Net Weight: $4\frac{1}{2}$ lbs.

The Heath/Schlumberger frequency machines

If frequency measurement is your problem, we have a solution to that as well. Our SM-105A provides 10 Hz to over 80 MHz range, 5-digit LED readout, 100 mV rms input sensitivity and time base stability of ± 10 ppm... for only \$350*. Our SM-104A frequency counter provides the same range as the SM-105A, but has a research-grade TCXO time base guaranteed stable to 1 part in 10^6 per year and 5-digits of TTL-compatible BCD output... for just \$500*.

For high frequency measurement, choose our new SM-114A Scaler for only \$365*. It extends the range of any 6 MHz, 50 ohm counter to 600 MHz. Prescale factors of 1, 10 & 100 are pushbutton-selected, with the $\div 1$ range providing 17 dB of amplification. Input sensitivity is 50 mV rms.



| | |
|--|---|
| HEATH Schlumberger | |
| Heath/Schlumberger Scientific Instruments Dept. 531-263 Benton Harbor, Michigan 49022 | |
| <input type="checkbox"/> | Please send additional information on the SM-102A Timer. |
| <input type="checkbox"/> | Please send additional information on the SM-105A, SM-104A and SM-114A. |
| <input type="checkbox"/> | Please send latest Scientific Instruments catalog. |
| Name _____ | |
| Title _____ | |
| Company/Institution _____ | |
| City _____ | State _____ Zip _____ |
| *Mail order prices; FOB Benton Harbor, Michigan Prices and specifications subject to change without notice. | |
| EK-336 | |

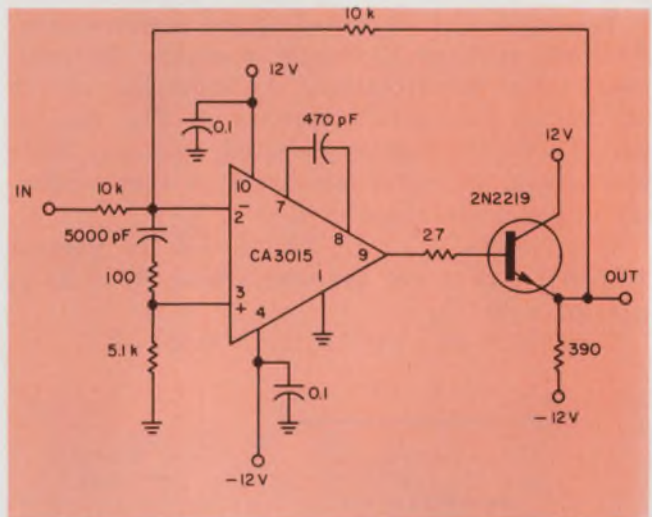

4. The complete unity-gain amplifier demonstrates the simplicity of designing a suitable input lag compensation to meet a given performance criterion, see text for step-by-step design procedure. The power supply is decoupled using a pair of ceramic capacitors. To minimize the effects of capacitive loading, an emitter follower is added.

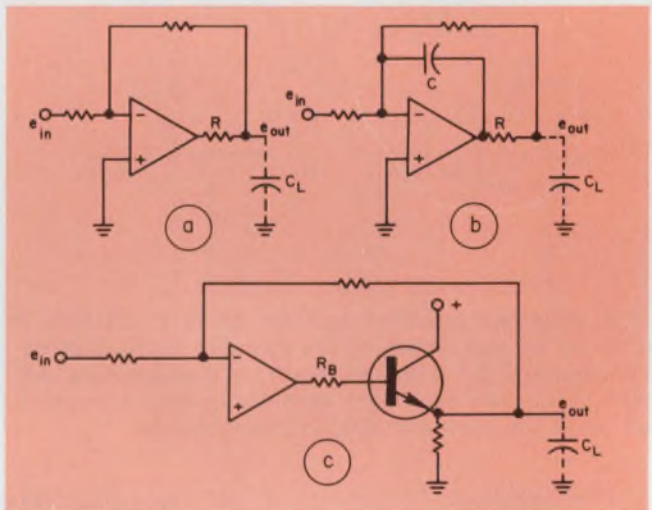

5. To minimize the effects of capacitive loading, a resistor (a), or a resistor-capacitor (b), or an emitter follower (c) can be added to an amplifier as shown. Also see text for several practical tips on layout, grounding, decoupling.

incorporated into complete systems, with more circuits sharing common power supplies, ground planes and coupling areas. Putting a problem circuit into the middle of a large PC board can create havoc because of unexpected circuit interactions. ■■

Bibliography

1. "Frequency Compensation Techniques for an Integrated Operational Amplifier," Fairchild Application Bulletin APP117/2, 1966.
2. "Feedforward Compensation Speeds Op Amp," National Semiconductor Linear Brief 2.
3. "Monolithic Operational Amplifiers—The Universal Linear Components," National Semiconductor AN 4.
4. "Applications of the RCA CA3015 and CA3016 Op Amp," RCA ICAN 5213.
5. "A Simple Technique for Extending Op Amp Power Bandwidth," Motorola AN 459.

high power linear amplifiers from MCL

Reliability in linear amplifiers begins with cavity amplifier design. MCL combines today's most advanced cavity designs with regulated power supplies, metering and cabinetry for total system dependability.

For example, MCL Model 10581 linear amplifier system covers a frequency range of 200 to 400 MHz for dependable command communications. Bandwidth at 3 db is 4 MHz and gain is 13 db. Servo controlled automatic tuning is available as an option. And MCL can provide this amplifier in the exact power and frequency configuration you require.

A wide range of high-reliability amplifier systems in addition to Model 10581 are available from MCL. For complete specifications on the amplifier that meets your high power microwave requirements, call (312) 354-4350, or write: MCL, Inc., 10 North Beach Avenue, La Grange, Illinois 60525.



MCL
INC

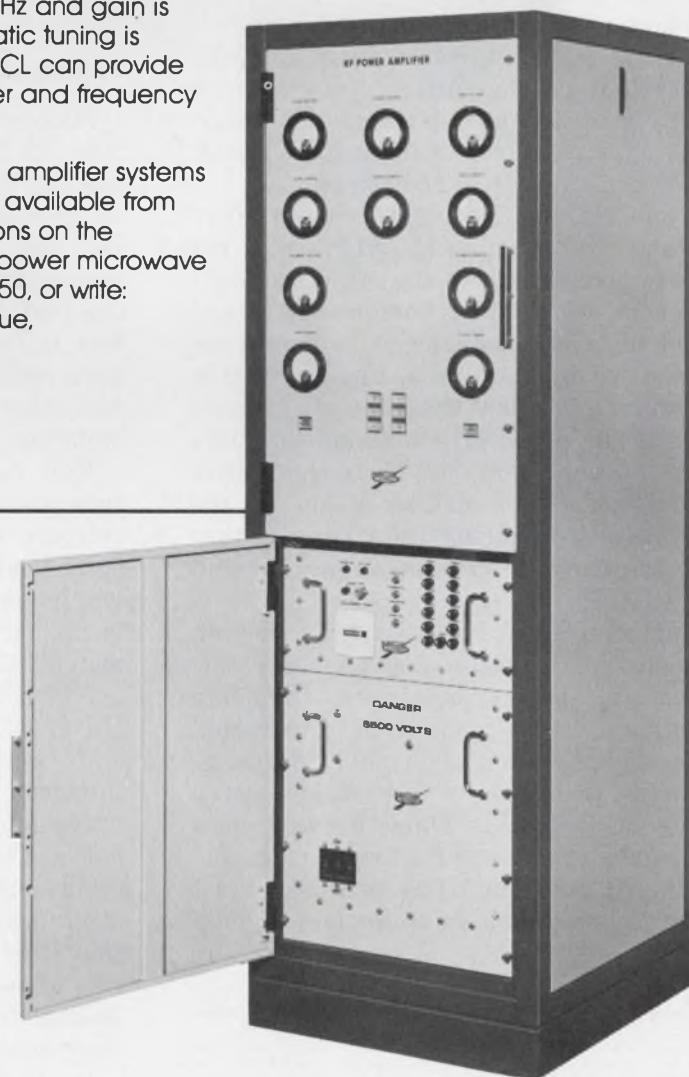

Opportunities developing now for RF engineers at MCL, Inc.—an equal opportunity employer.

INFORMATION RETRIEVAL NUMBER 35

You have to earn management's support, says this company president. You can, if you learn to sell ideas as business propositions as well as engineering feats.

Are you getting enough support from the management of your company? If the answer is "no," ask yourself why not. Half of you will probably say it's because management is shortsighted. But perhaps the reason management has failed to support engineering is because engineering has failed to do the right job for management.

Many engineers believe that management should always cooperate with them. But they have to recognize that there's competition for the time and support of management, and they must compete for it. Engineers can improve their competitive position in four ways:

1. Learn how to sell ideas to management.
2. Identify the technologies of their competitors and develop discriminating plans to give their company more technical leverage per dollar.
3. Translate the technologies in business terms.
4. Reassess their duties in the company.

I wonder how many engineers have determined which people around them decide whether or not their ideas are acceptable. All too often the engineer fails to consider what his customer likes and dislikes. And his first customer is probably his manager, followed by the purchasing agent, the production man and then the user. It doesn't do any good if the engineer complains that he's a genius but no one knows it. He must realize that the requirements for making a sale are the same everywhere—convincing the customer that the product has features that are important and meaningful to him.

And selling an idea at the next level is even more difficult. To corporate management, new and improved technology is money. Company management has just so many dollars to spend, and it can spend them on advertising, on salesmen, on a new plant, or in a thousand other ways. During the process of budgeting and planning, management gets reports from every department in the company. The engineer must realize that the investment in technology is only

one of many alternatives open to management, and it isn't necessarily a question of whether an engineering idea is good or bad.

I think that sometimes engineers get carried away and say things like: "Obviously we can improve product X, but management is too shortsighted to see it; they just don't understand."

The engineer who says that doesn't really put the whole business into perspective. If he did, he'd know that management has 10 ways to spend every dollar, and unless he makes his way more attractive than the nine other alternatives, management won't spend its money on engineering.

Cashing in on your knowledge

Success has always been success vs competition. It's fundamental. So if you want to sell your engineering, you have to know your company's competition; that's one thing that both engineering and management understand. If you're in semiconductors, you should know the technologies of Motorola, Fairchild and TI, and know how to improve on them—but not just from an engineering standpoint. You have to relate your technical knowledge to your company's business situation.

How do you do that? Well, suppose there are four products before us from four leading competitors. What conclusion are you going to draw from your analysis of these products? How are you going to apply your knowledge to your own particular business? Are you going to try to match the performance of your company's product with that of the competition by, say, raising the gain? Is one of the other engineers on the staff going to improve the reliability of the product? Is still another engineer going to improve the manufacturing process?

It's possible that four competent engineers could arrive at completely different conclusions about what should be done to beat the competition after looking at the same products. So unless you know what your company management is looking for, you won't know how to cash in on your analysis.

In an ideal situation, management would give the engineering department a strategy statement.

Robert C. Wilson, president, Collins Radio Co., Dallas, Tex. 75207



Robert C. Wilson

Education: B.S. degree in mechanical engineering, University of California.

Experience: Manager of manufacturing and plant operations; general manager, consecutively, of the radio receiver dept.; the consumer electronics div.; the industrial drives div.; and corporate vice president, all at GE. Executive vice president of North American Rockwell Corp., responsible for NR's industrial products and electronics groups. Currently president and chief executive officer of Collins Radio Co.

Societies: ASME; Tau Beta Pi; and associate member of AIEE.

Publication: Co-authored, "Capacitors for Industry."

Personal: Married, three children.

Employer: Collins Radio Company is an international electronics firm manufacturing a broad range of products for communication, computation and control functions. An important segment of the company's current activities include the design, development, and manufacture of data communication systems. The company, incorporated in 1933, started operations with eight people in a rented basement. Today, it employs more than 11,000 persons in locations throughout the world, including Dallas, Tex.; Cedar Rapids, Iowa; Newport Beach, Calif.; and Toronto, Ontario, Canada.

From that, the manager of engineering would determine a strategy to support the company goals. The designer himself would also determine his strategy, and after analyzing the competitor's products, he might say: "What our company really needs to compete is high serviceability in the field; it's the greatest leverage we can have."

That's the kind of technical identification an engineer can help his company with most.

Don't lose it in the translation

What about engineering breakthroughs? How does management translate an engineering breakthrough in business terms?

Suppose an engineer announces to the engineering manager that he has found a new device that will increase amplification in the company's widget 110? The manager asks:

Does this improvement allow me to take some cost out of another part of the system, making it less expensive to manufacture?

Is this improvement important to the customer? Will he pay more for it?

Can we standardize with this improvement?

Does it give us an opportunity to make units of a system play together better?

One thing an engineer should do to help his management, it seems to me, is try to translate his finding into end results that are meaningful to the business equation. Engineering is part of management, and there's an implicit obligation on the part of both engineer and manager. The general manager has an obligation to make sure he doesn't omit or shortchange the engineering input. The engineering function has an obligation to make sure management is aware of the contributions engineering can make to help him shape the business strategy.

Reassess through peer analysis

Since many businesses are fighting for their lives today, engineers can't afford to work in splendid isolation. If they're going to help their employer, they need to know more about the business part of their industry. What contributions then, should you, as an engineer, be making?

Why not reassess your responsibilities? Assemble your peers from the other functions of the business—finance, plans, relations, manufacturing, marketing and so on—and ask each to list the contributions that engineering should make to the business. Don't say anything; just listen.

I'll guarantee you that there wouldn't be one engineer in a thousand who would know what many of his contributions to the business should be. Do you, for example, consider yourself responsible for manufacturing and processing inventory? Probably not. But how many times have



you or other engineers at your company issued a design that doesn't have the right kind of standardization or parts? How many change notices have you put through at the wrong time to foul up manufacturing? You'd be amazed at the control you have over inventory processing.

To complete the analysis, ask each of your peers to grade you on the present contributions you're making to the business. They'll be expecting contributions from you that you haven't even thought of making. It's a handy-dandy way to broaden your perspective.

If the engineer who goes through this analysis is the right kind of individual, he'll accept the findings. If he's living in an engineering world and not in a business world, he'll reject the findings. Because, he'll rationalize, why should a marketing man grade an engineer? Does a marketer know anything about engineering? No, but he does know what contributions marketing would like to have from the engineering function.

On the other hand, the marketing man may not know what's expected of him either. He may say that he'd like to have a special widget for each of a thousand different customer groups. The manufacturing man may say that he has to have complete standardization or he won't be able to build a thing at cost. And the financial man may decide somewhere in between. As you can see, an engineer must understand a lot more than engineering, because an engineering viewpoint alone will seldom be the right one for business.

Most of you are being called on every day to make decisions that require knowledge outside the realm of engineering. The sooner you can apply a knowledge of business to your engineering decisions, the sooner you're going to get the unqualified support of management. ■■

**THE
1024-BIT
TTL RAM
IS HERE**



Our new 93415 RAM: 1024x1 bit.TTL.60ns access time at 0.5 mW/bit. And Isoplanar did it.

The 93415 RAM is the most complex monolithic bipolar read/write memory ever made.

This self-contained subsystem also features 30ns chip select access time, open collector (expandable) output, static TTL operation and decreasing power dissipation with rising temperature. Available now in prototype

quantities in 16-pin hermetic DIP.

What this means to designers of high-speed digital systems is that for the first time they have available a major TTL memory building block that can operate at speeds compatible with those of their systems' logic. Because it's static, the 93415 is simple to use, requires no complicated

peripheral electronics. And because of its functional density and capability, the 93415 gives the designer a fine opportunity to realize significant cost savings by 1) reducing package count, 2) reducing circuit board number and size, 3) reducing number of connections, 4) increasing system reliability.

Functional diagram of the 93415 TTL RAM

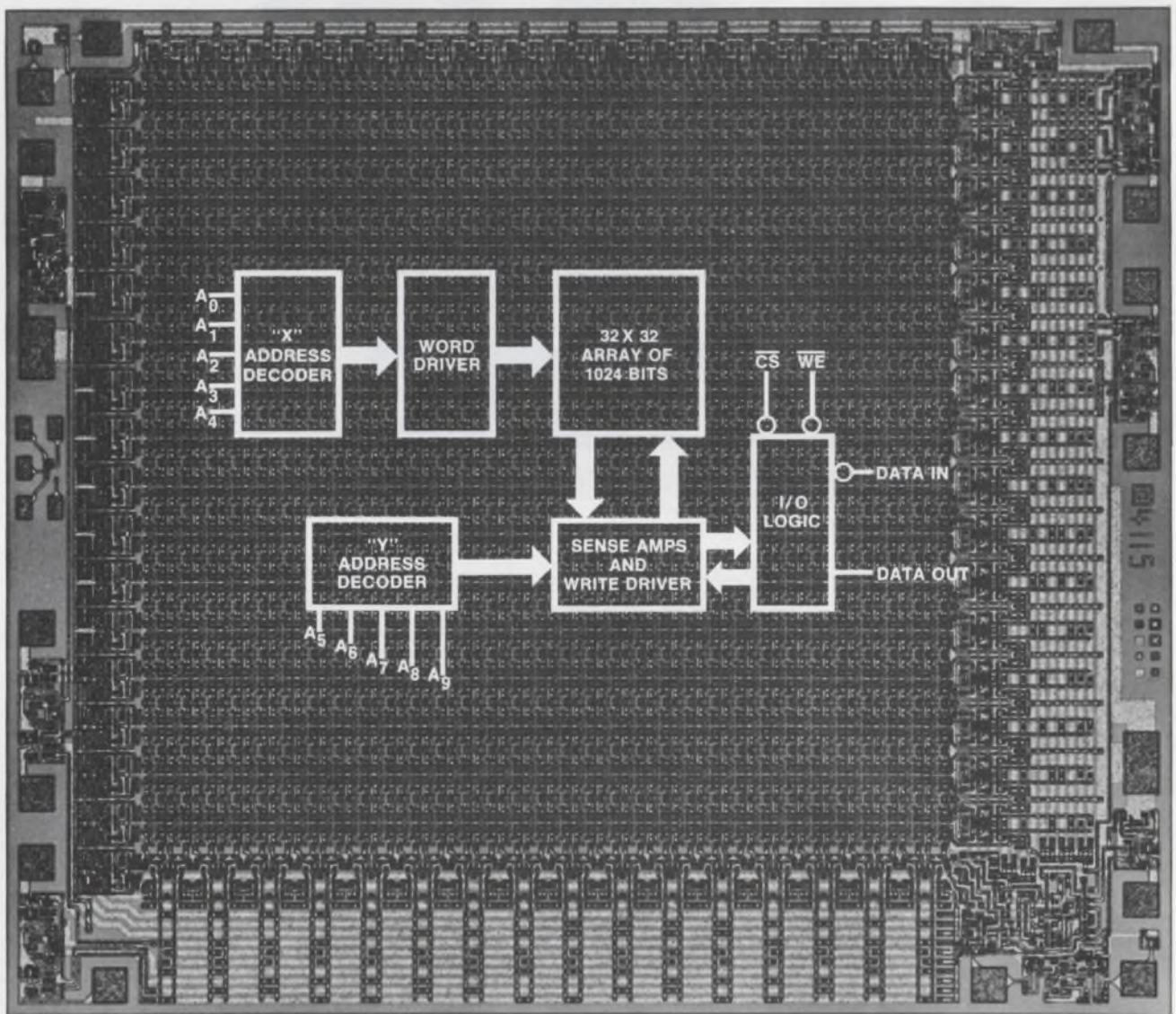

Significant Memory Applications

Some of the more exciting applications of 93415 are: as a fast writable control store for micro-programming, eliminating many present needs for fixed ROMs; as a large high-speed scratchpad to make multiprocessing more feasible; for simulation of long high-speed shift registers; for improvement of buffer or cache memory performance by increasing capacity without any power or size trade-off; and obviously for building cost-effective high-speed main-frame memories.

Isoplanar did it. Again

Our 93415 is the most recent, and most important, product of our isoplanar technology. Isoplanar proved itself last year with the successful introduction, and volume production, of our 93410 256-bit TTL RAM and our 95410, world's first 256-bit ECL RAM.

The introduction of the 93415, another industry first, is just one more demonstration of what isoplanar can do. Soon, isoplanar will do it again, with even more complex TTL and ECL memories.

What is Isoplanar? It's a bipolar fabrication process that replaces conventional planar P+ isolation diffusion with an insulating oxide. Result: High density. High yield. Low cost. Improved speed/power performance (from lower parasitic capacitance). Improved reliability (from planar surface). Isoplanar is the designer's assurance of proven reproducibility and deliverability.

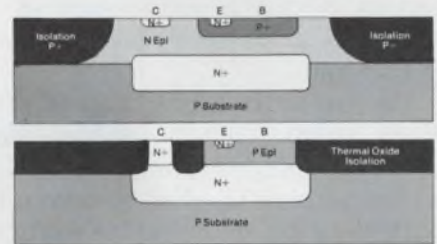

No space is required between base and collector regions and isolation in isoplanar bi-polar (bottom) compared to conventional planar bi-polar (top).

Fairchild Bipolar Memories

| BIPOLAR READ/WRITE MEMORY APPLICATIONS SUMMARY | | | | | |
|--|-----------------------------------|-----------------------------------|------------------------------|-------------------------------|--------------------------|
| ORGANIZATION | REGISTERS SYSTEM SPEED 5-30ns | SCRATCHPAD SYSTEM SPEED 15-60ns | CONTROL SYSTEM SPEED 20-70ns | BUFFER SYSTEM SPEED 50-80ns | MAIN SYSTEM SPEED > 75ns |
| 8 x 1 | (TTL) 9338, 93S39* (ECL) 9539* | | | | |
| 16 x 1 | | (TTL) 93407, 93433 (ECL) 95401 | | | |
| 16 x 4 | | | (TTL) 93403 (ECL) 95400 | | |
| 256 x 1 | | | | (TTL) 93410‡ (ECL) 95410‡ | |
| 1024 x 1 | | | | (TTL) 93415‡ (ECL) 95415‡* | |

*IN DEVELOPMENT ‡ISOPANAR DEVICES.

Availability

Some 93415 RAMS are already out in the field in evaluation quantities. Prototype quantities are available now from your friendly Fairchild distributor at the following prices:

| | | |
|---------|---------|---------|
| 1-24 | 25-99 | 100-999 |
| \$87.50 | \$80.50 | \$70.00 |

Volume shipments available during 4th quarter.

**MADE IN
FAIRCHILD**

Add thermal cutoff to current limiting for complete protection of passtransistors

Current-limiting techniques won't protect pass transistor junctions during partial short-circuits unless the heat sink is efficient enough to keep the junction temperature at a safe value during worst-case conditions. If a thermal cut-off protection circuit is used—such as in some integrated-circuit designs—no additional heat-sinking is required.

The circuit in Fig. 1 cuts off pass-transistor Q_3 when its base-emitter junction temperature rises above a predetermined level. Transistor Q_1 , which controls Q_3 , may be driven by an ON/OFF control signal, or it may be part of a linear regulation loop. When Q_1 turns on Q_3 , transistor Q_1 also turns on, with resistor R_3 limiting its base current. Transistor Q_2 turns on when the voltage drop across resistor R_5 exceeds the transistor's base-emitter voltage [$V_{BE(Q_2)}$] by at least a factor of R_1/R_2 . Transistor Q_1 , however, bleeds off the current that resistor R_4 feeds into Q_2 's base.

If a short-circuit occurs at the output, transistor Q_2 turns on, thus limiting the output current. Also, transistor Q_1 remains on—at least initially. As the base-emitter junction of Q_3 heats up, the junction voltage V_{BE} decreases by approximately 2.2 MV/C. When $V_{BE(Q_2)}$ drops sufficiently to turn off Q_1 , transistor Q_2 turns on—cutting off the pass transistor until either power or the control signal is removed and then reapplied.

The base-emitter voltage of Q_1 acts as a reference voltage. Therefore Q_1 should be maintained at the ambient temperature and should be thermally separated from Q_3 and its heat sink. The cut-off temperature is determined by the equation

$$T_{LIM} = T_A - \frac{V_{BE(Q_3)} - V_{BE(Q_1)}}{2.2 \times 10^{-3}}$$

where

T_{LIM} is the cut-off temperature of circuit in °C.

T_A is the ambient temperature in °C.

$V_{BE(Q_3)}$ is the base-emitter voltage of pass-transistor at $T_j = 25$ C and at the limiting current of the circuit.

$V_{BE(Q_1)}$ is the base-emitter voltage of the reference transistor at $T_j = 25$ C and at the operating current of Q_1 , supplied by R_1 .

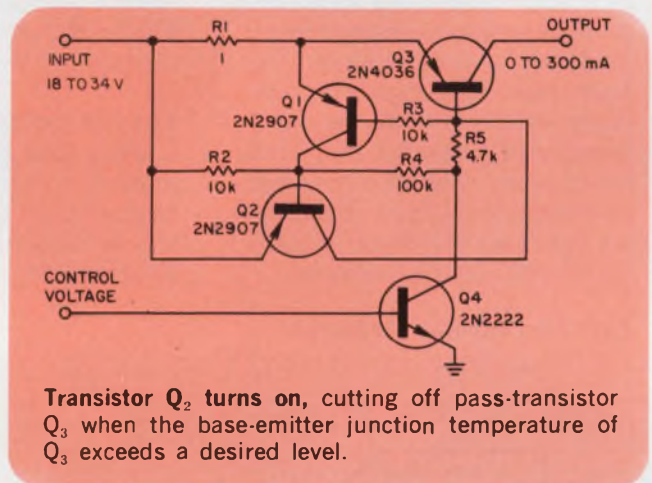

Transistor Q_2 turns on, cutting off pass-transistor Q_3 when the base-emitter junction temperature of Q_3 exceeds a desired level.

If it's assumed that Q_2 and Q_3 have equal base-emitter voltages at the same current and temperature, the current supplied by R_4 should be adjusted as follows to obtain the desired cut-off temperature differential:

$$I_{R_4} = \frac{I_{LIM(Q_3)}}{2^{(T_{LIM} - T_A) / 12}}$$

In addition to thermal cut-off protection, current limiting is provided to maintain operation below the rated maximum collector current of the pass transistor. The voltage $V_{BE(Q_2)}$ is the reference for current limiting, and a negative temperature coefficient of the limit results. For worst-case conditions, the limit must be below the transistor's maximum rating at the lowest possible operating temperature—and above the normal operating current at the highest possible operating temperature. The current limiting resistor R_1 is determined by the equation

$$R_1 = \frac{V_{BE(Q_2)} - (V_{CE})_{SAT(Q_1)}}{I_{LIM}}$$

For normal operating temperature ranges, the pass transistor should be rated for at least twice the normal operating current.

Bill Olschewski, Engineering Manager, Instrument Systems Corp., 789 Park Ave., Huntington, L. I., N.Y. 11743

CIRCLE No. 311

New from Helipot: the lowest trimmer profile in the business.

SHOWN ACTUAL SIZE

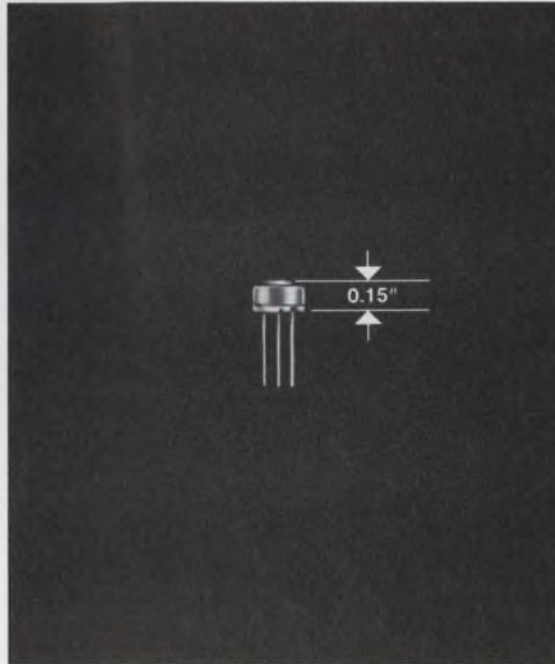

You can't do better than our Series 82 Trimmers for small size and low cost . . . and, of course, Helipot dependability. These $\frac{1}{4}$ " single-turn, general-purpose cermet models have the lowest profile in the industry with a proven cermet resistance element that can be set to any voltage ratio within 0.05% of full scale. Sealed metal housings, solid stops, and essentially infinite resolution. They'll save you space—they'll save you money. (Our prices start at \$1.40 list.) Two good reasons to write for specs and prices today.

Beckman INSTRUMENTS, INC.

HELIPOT DIVISION

2500 Harbor Blvd., Fullerton, Calif. 92634

HELPING SCIENCE AND INDUSTRY IMPROVE THE QUALITY OF LIFE

INFORMATION RETRIEVAL NUMBER 38

Scheme uses fewer gates in bidirectional shift register

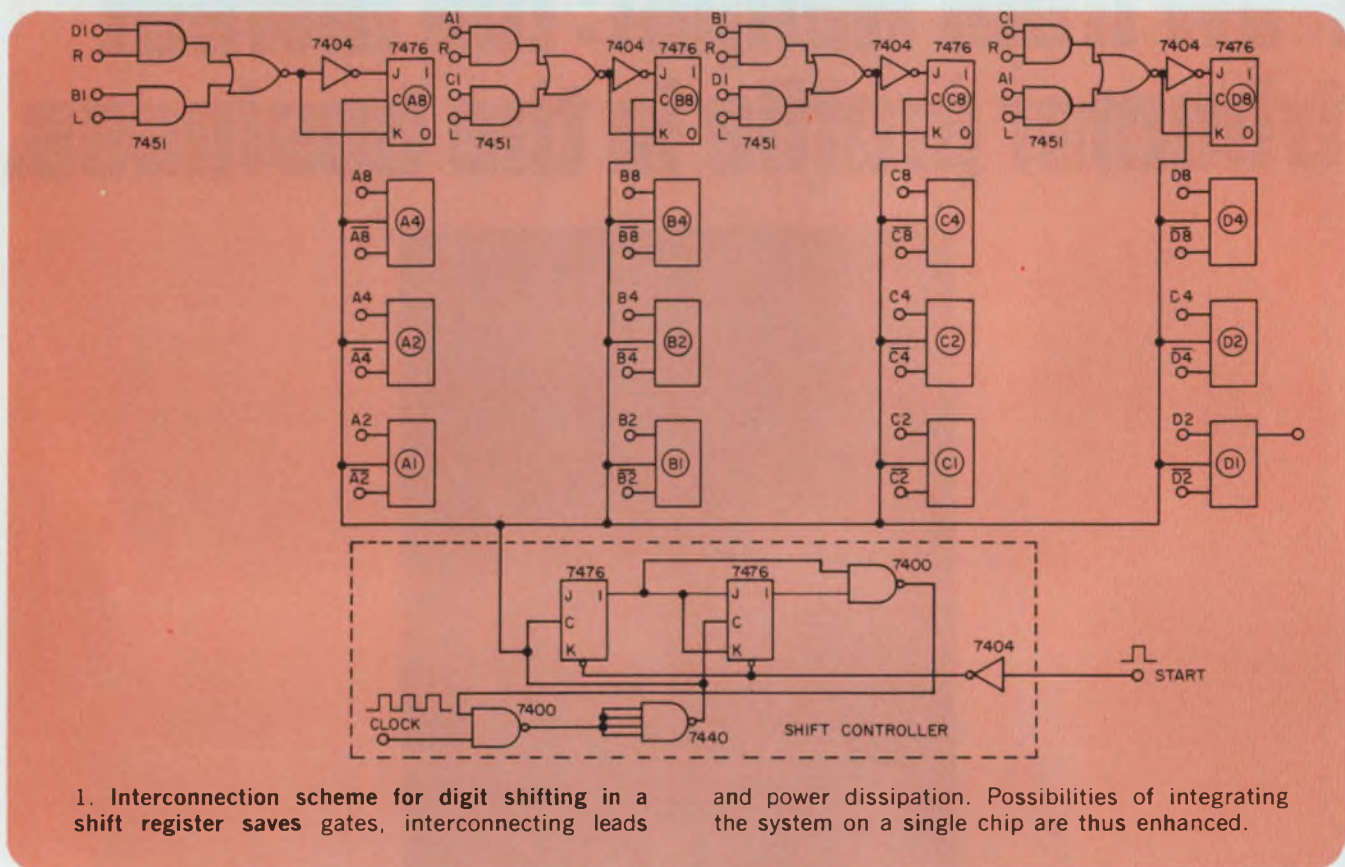

A BCD bidirectional shift register normally needs a number of gates at the inputs of the flip-flops to handle data entry from either side. If the connection scheme of Fig. 1 is used to shift the data, the number of hex ICs needed can be reduced from 10-5/6 to 3-5/6 for a four-digit register, or from 38-1/3 to 11 for 14 digits.

Left/right shifting is done through only one bit position among the four AND-OR-INVERT structures at the inputs of the most significant bit (MSB) of the flip-flops. Since each digit position is connected as a miniature ring-shift register, all the bits in one position are automatically shifted to the next higher or lower-order position after four clock pulses have been applied. The number of shift pulses required is thus independent of the number of digits involved.

A connection diagram for right-shifting a four-digit number is shown in Fig. 2. Cycling is performed by a simple modulo-four counter, which stops automatically after allowing four clock pulses.

Pradip K. Das, Dipak K. Basu and R. Dattagupta, Computer Center, Jadavpur University, Calcutta 32, India

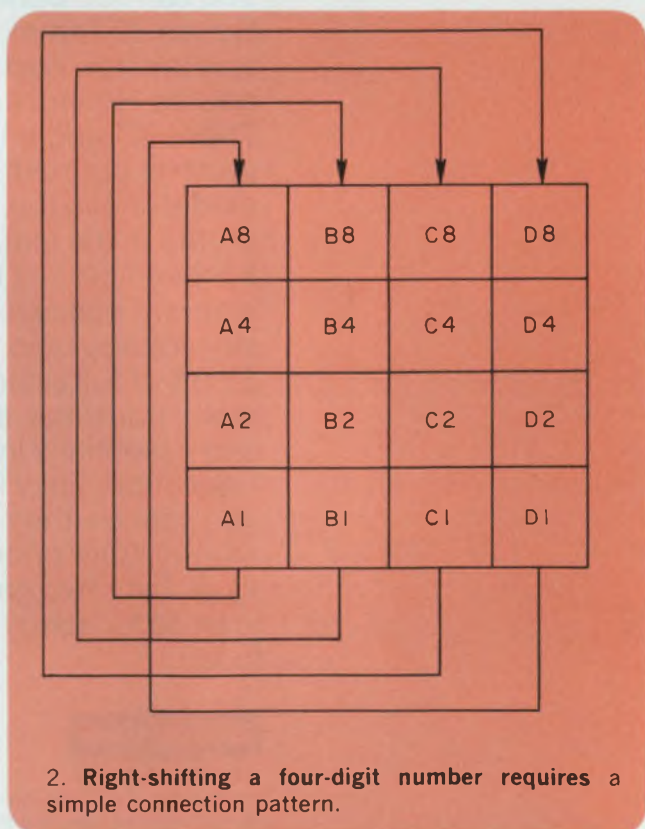

2. Right-shifting a four-digit number requires a simple connection pattern.

CIRCLE NO. 312



WE'LL SELL YOU A KEYBOARD SWITCH FOR 30¢



...and give you A PENNY CHANGE



How to save silver when buying gold: Spec Cherry Gold "Crosspoint" Contact keyboard switches. With a momentary Form A (SPST/NO) price tag of just 29¢ in 250,000 quantity . . . lower prices in higher quantities.

What do you get besides low price? Unique, proven Cherry Gold "Crosspoint" contact configuration that enhances reliability. Tested beyond 50,000,000 operations. (Test Report No. TK 10071 available on request.) You get Cherry's low profile Keyboard switch featuring rugged construction, 2½ ounce operating force and stable contact resistance (typically 25 milliohms over life). Made by the people who pioneered the Gold "Crosspoint" Contact in snap-action switches.

The result? Cherry keyboard switches are your ideal choice for computer terminals, electronic calculators and credit card validators.

TEST A FREE SAMPLE. Choose the 29¢ Form A switch . . . or any of Cherry's complete line of keyboard switch modules. Just TWX 910-235-1572 . . . or PHONE 312/689-7703 and ask Walt to give you facts on Keyboard Switches . . . or circle appropriate reader service number.



ACTUAL SIZE

**FORM A, MOMENTARY
(SPST/NO)**

Circle No. 211 for Free Sample

ALTERNATE ACTION (SPST)

Circle No. 212 for Free Sample

**DUAL FORM A, MOMENTARY
(DPST/NO)**

Circle No. 213 for Free Sample

CHERRY



CHERRY ELECTRICAL PRODUCTS CORP.
3609 Sunset Avenue, Waukegan, Illinois 60085

Makers of patented Leverwheel/Thumbwheel Switches, Matrix Selector Switches, Snap-Action Switches and Keyboards.

Use an IC voltage regulator in simple lab power supply

The $\mu A723$ IC voltage regulator, though originally intended for fixed-output power supplies, can also be used for adjustable-output regulators like those needed for lab supplies.

The circuit shown functions as a continuously variable 0-to-25-V, 0-to-1-A power supply, with line and load regulation of 0.05% in the voltage mode and 0.2% in the current mode.

An auxiliary floating dc voltage, V_a , feeds the IC regulator. If the V_{REF} output is connected to ground, the negative side of V_a is held at the $-V_{REF}$ level. Voltage V_a thus provides a negative reference voltage for the control potentiometers R_8 (current control) and R_{10} (voltage control).

Internal error amplifier A_1 's noninverting input is tied to ground, while its inverting input receives the error signal at the junction of sampling resistor R_{12} and reference resistor R_{13} . The output voltage is thus $(R_{12}/R_{13})V_R$, where V_R is the voltage at the slider of potentiometer R_{10} .

Internal output transistor Q_{i2} , connected as a common-emitter driver, controls the power control transistors Q_2 and Q_3 .

Current control results from a differential amplifier composed of internal current-limit transistor Q_{i1} and Q_1 . In the voltage mode, transistor Q_1 conducts while Q_{i1} is cut off. As the output current increases, so that the voltage on resistor R_1 equals the voltage at the slider of potentiometer R_8 , transistor Q_{i1} begins to sink the base current of Q_{i2} to maintain a constant output current. Resistor R_3 should have a value that permits Q_{i1} to sink the maximum output current—approximately 1 mA—of the voltage error amplifier A_1 . Closed-loop stability is provided by the two compensation capacitors, C_1 and C_2 .

L. Boiucaner, Electrical Engineering Dept., University of the Negev, P.O. Box 2053, Beer Sheva, Israel.

CIRCLE No. 313

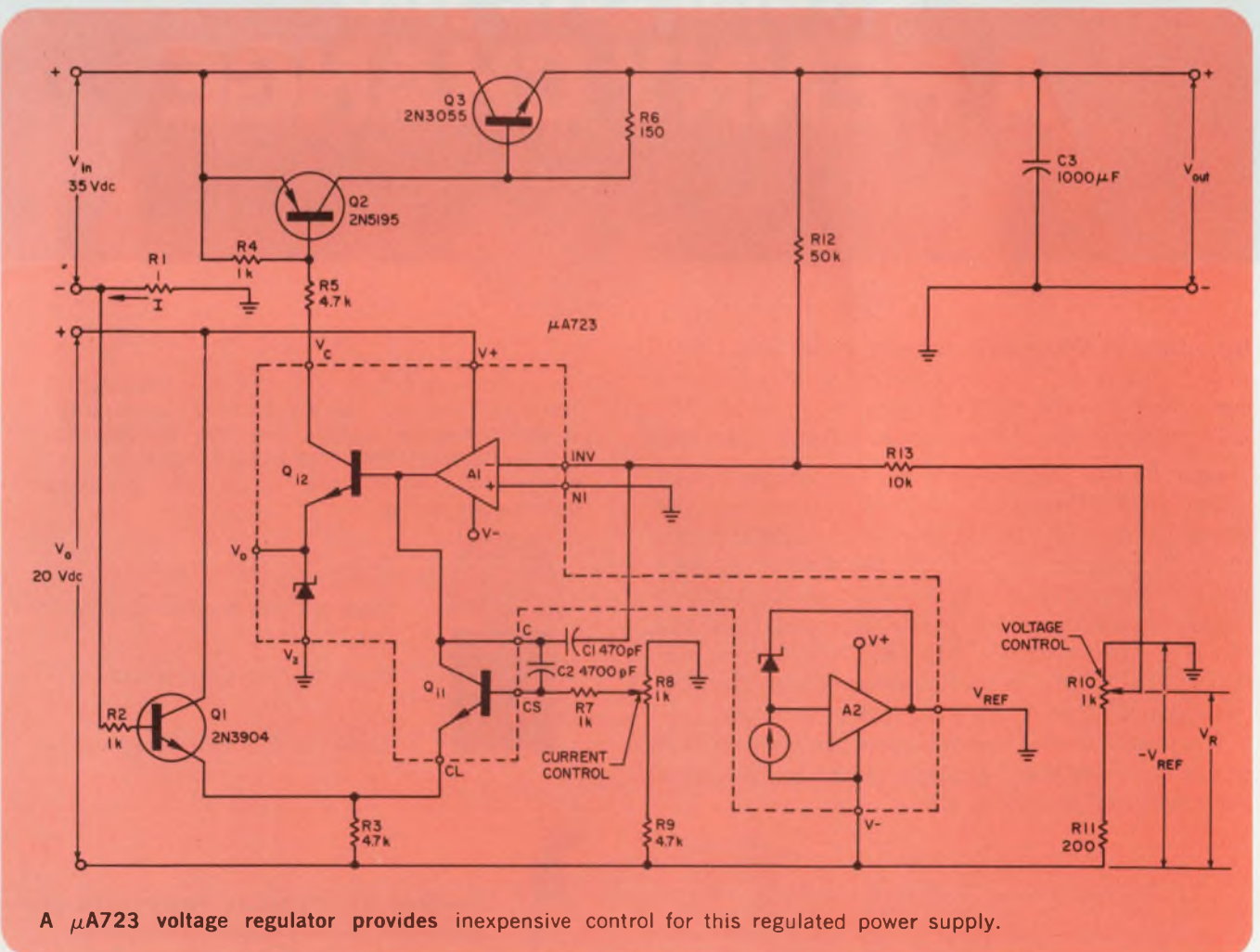

TRY TO SAY DIGITEC[®] AND NOT THINK DIGITAL THERMOMETRY

Difficult? Nearly impossible, especially if you're accustomed to highly accurate, wide ranged digital thermometers. You will automatically think DigiTec when you look for a thermocouple thermometer that is compatible with all five of the most common TC types in either °F or °C.

Your mind supplies DigiTec when you wonder who makes thermistor or platinum resistance instruments and can supply the related probes from stock without delay.



List all the features you require for your specific applications, including: Built-in battery pack, LED displays, guarded inputs, isolated BCD outputs, and data acquisition capabilities. DigiTec has them plus sophisticated circuitry, convenient, well-defined controls and prices ranging from \$395 to \$825. It's no

surprise that DigiTec and Digital Thermometry have become synonymous.

Write or call now for assistance in selecting the most suitable instrument for your application.

DigiTec by United Systems Corporation
918 Woodley Rd.,

Dayton, Ohio 45403 (513) 254-6251 Representatives throughout the world. For complete specifications, request new catalog.



DigiTec: precision measurements to count on.

Don Femling of National Semiconductor Wins Annual "Ideas for Design" Award

"I can't believe it. I can't believe it." Those words came from Don Femling as he received the annual "Ideas for Design" award for 1971. Femling had no idea of what was in the offing when he was called to the office of Pierre Lamond, General Manager of National's Santa Clara Div. Lamond simply asked, "Don, could you pop into my office for a moment?"

When he arrived, Don was puzzled to find a small, but silent, crowd. In addition to Lamond, there was National's Marketing Services & Communications Manager, Charles Signor, photographer, Don Shapero, ELECTRONIC DESIGN's Publisher, Peter Coley, and Editor, George Rostky.

Rostky broke the silence with, "Don, the readers of ELECTRONIC DESIGN think you're a pretty good designer; you've won the annual Ideas for Design award for 1971." He then presented a walnut-mounted, gold-toned-brass plaque, handsomely engraved with the inscription, ELECTRONIC DESIGN's Top Award to Don Femling of National Semiconductor Corporation in Recognition of his Innovative Contribution to Electronics Engineering for the Outstanding Idea for Design, 1971."

After several minutes of gaping at his plaque and muttering, "I can't believe it," Femling was

interrupted by Rostky's, "Oh, I almost forgot," whereupon Rostky handed Femling a check for \$1000. At this point, Femling modified his soliloquy to "Wow! I can't believe it."

Femling is a senior applications engineer with National, which he joined two years ago after spending eight years with Fairchild Semiconductor. The award-winning idea, "Digital IC tone detector responds immediately to inputs," ED 8, April 15, 1971, came to him when a boy-scout friend needed a tone detector for model-airplane control. He wanted to transmit 10 to 15 tones instead of four or five. The limited bandwidth available called for a more selective detector.

After he designed the detector, Femling realized that it could be used for process-control instrumentation and other applications where data could be transmitted over a single wire. The design uses inexpensive TTL ICs, so it's "cheap and dirty," says Femling, "but effective."

An active member of the Church of Latter Day Saints, Don and his wife Barbara Joyce have four children, Barbara, 23, Dawn, 15, Rhonda, 12, and Stean, 6. Don enjoys motorcycling, camping and fishing. Electronics has been his hobby since he was a boy.



Pierre Lamond is happy, too, but Don Femling is overjoyed with ELECTRONIC DESIGN's award.



IFD Winner for March 16, 1972

Mike Black, Design Engineer, Texas Instruments, Inc., M.S. 257, 13500 North Central Expressway, Dallas, Tex. His idea, "Voltage-to-frequency converter produces TTL logic output," has been voted the Most Valuable of Issue Award.

Vote for the Best Idea in this Issue.

SEND US YOUR IDEAS FOR DESIGN. You may win a grand total of \$1050 (cash)! Here's how. Submit your IFD describing a new or important circuit or design technique, the clever use of a new component or test equipment, packaging tips, cost-saving ideas to our Ideas for Design editor. Ideas can only be considered for publication if they are submitted exclusively to ELECTRONIC DESIGN. You will receive \$20 for each published idea, \$30 more if it is voted best of issue by our readers. The best-of-issue winners become eligible for the Idea of the Year award of \$1000.

ELECTRONIC DESIGN cannot assume responsibility for circuits shown nor represent freedom from patent infringement.

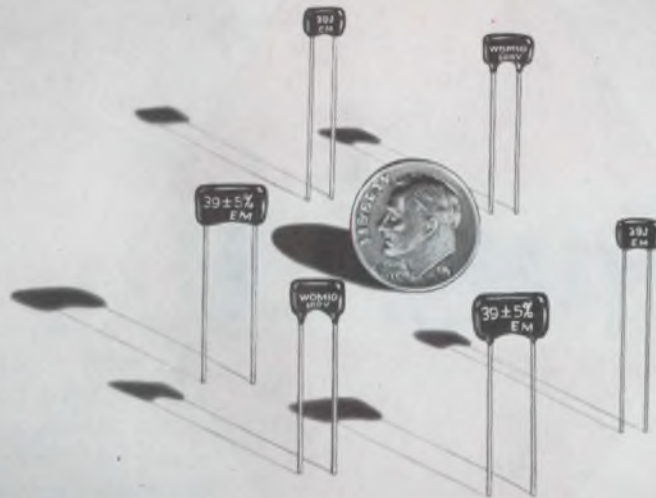

They're Small and Reliable*

EL-MENCO DM5 — DM10 — DM15 — ONE COAT DIPPED MICA CAPACITORS

| STYLE | WORKING VOLTAGE | CHARACTERISTIC | CAPACITANCE RANGE |
|-------|-----------------|----------------|-------------------|
| DM5 | 50VDC | C | 1pF thru 400pF |
| | | D, E | 27pF thru 400pF |
| | | F | 85pF thru 400pF |
| DM5 | 100VDC | C | 1pF thru 200pF |
| | | D, E | 27pF thru 200pF |
| | | F | 85pF thru 200pF |
| DM10 | 100VDC | C | 1pF thru 400pF |
| | | D, E | 27pF thru 400pF |
| | | F | 85pF thru 400pF |
| DM15 | 100VDC | C | 1pF thru 1500pF |
| | | D, E | 27pF thru 1500pF |
| | | F | 85pF thru 1500pF |
| DM5 | 300VDC | C | 1pF thru 120pF |
| | | D, E | 27pF thru 120pF |
| | | F | 85pF thru 120pF |
| DM10 | 300VDC | C | 1pF thru 300pF |
| | | D, E | 27pF thru 300pF |
| | | F | 85pF thru 300pF |
| DM15 | 300VDC | C | 1pF thru 1200pF |
| | | D, E | 27pF thru 1200pF |
| | | F | 85pF thru 1200pF |
| DM10 | 500VDC | C | 1pF thru 250pF |
| | | D, E | 27pF thru 250pF |
| | | F | 85pF thru 250pF |
| DM15 | 500VDC | C | 1pF thru 750pF |
| | | D, E | 27pF thru 750pF |
| | | F | 85pF thru 750pF |

Where space and performance are critical, more and more manufacturers are finding that El-Menco miniaturized dipped mica capacitors are the reliable solution. The single coat is available in three sizes: 1-CRH, 1-CRT and 1-CE.

The 1-CRH DM "space savers" easily meet all the requirements of MIL and EIA specifications, including moisture resistance. The 1-CE and 1-CRT units also meet the requirements of MIL and EIA specifications, except that they have less moisture protection because of their thinner coating; these capacitors, therefore, are ideally suited where potting will be used. Note: DM10 and DM15 units are still available in the standard 4-CR size.

Specify "El-Menco" and be sure . . . the capacitors with proven reliability. Send for complete data and information.

*Normally, El-Menco 39 pF capacitors will yield a failure rate of less than 0.001% per thousand hours at a 90% confidence level when operated with rated voltage and at a temperature of 85°C. Rating for specific applications depends on style, capacitance value, and operating conditions.

THE ELECTRO MOTIVE MFG. CO., INC.
WILLIMANTIC, CONNECTICUT 06226

Dipped Mica • Molded Mica • Silvered Mica Films • Mica Trimmers & Padders
Mylar-Paper Dipped • Paper Dipped • Mylar Dipped • Tubular Paper

West Coast Manufacturers contact: COLLINS & HYDE CO., 900 N. San Antonio Rd., Los Altos, California 94022
5380 Whittier Blvd., Los Angeles, California 90022

ALSO SOLD NATIONALLY THROUGH ARCO ELECTRONIC DISTRIBUTORS
INFORMATION RETRIEVAL NUMBER 41

OUR ANGLE: High Speed Accurate and Automatic Angle Position Indicators

WHAT'S YOUR ANGLE?

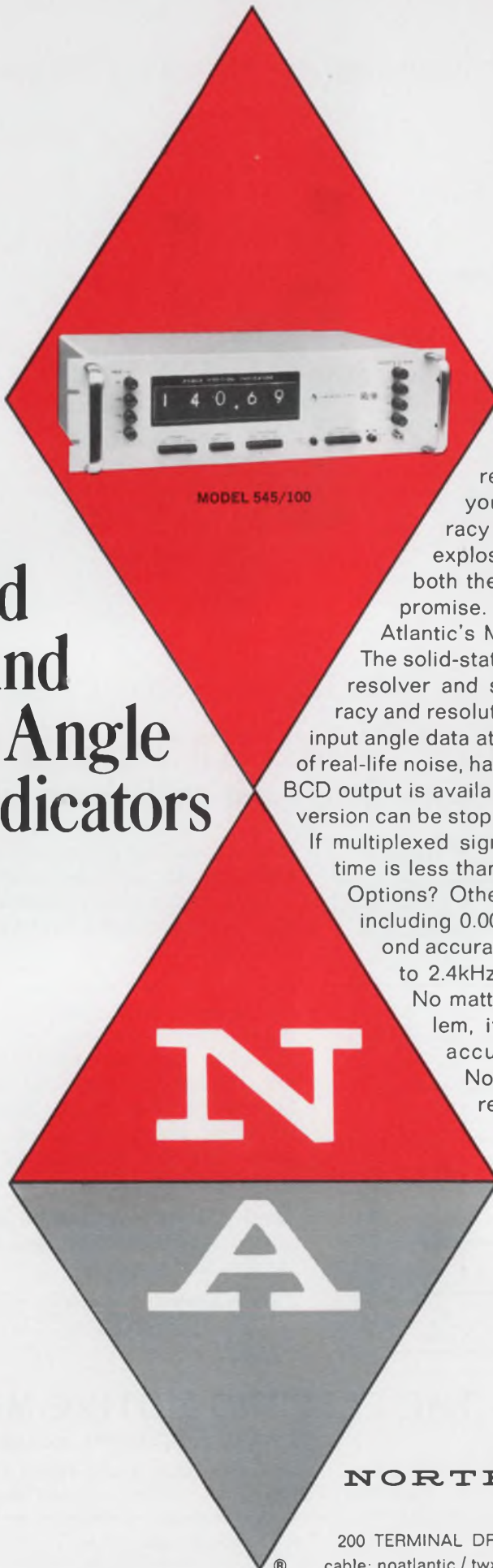

If you're converting synchro/resolver data to digital format, you need both speed *and* accuracy to keep pace with today's data explosion. Only one converter meets both these requirements without compromise. And for under \$4K. . . . North Atlantic's Model 545/100.

The solid-state Model 545/100 converts both resolver and synchro data with 0.01° accuracy and resolution. And continuously digitizes input angle data at 20,000° per second in the face of real-life noise, harmonics and quadrature levels. BCD output is available at the rear connector. Conversion can be stopped by a data freeze command. If multiplexed signals are your bag, acquisition time is less than 30 ms.

Options? Other models offer many options, including 0.001° resolution with 10 arc-second accuracy; data frequencies from 60Hz to 2.4kHz, binary output, small size.

No matter what your conversion problem, if you require ultra-fast, ultra-accurate tracking, contact your North Atlantic sales engineering representative today. He'll show you a better angle.

NORTH ATLANTIC
industries, inc.

200 TERMINAL DRIVE, PLAINVIEW, NEW YORK 11803
cable: noatlantic / twx: 510-221-1879 / phone: (516) 681-8600

Small, low-cost, modular power supplies woo light-minded users

Trio Laboratories, Inc., 80 Dupont St., Plainview, L.I., N.Y., 11803 (516) 681-0400. P&A: See text.

While it doesn't claim best regulation, smallest size and weight, largest power output, lowest noise, widest line-frequency range, best temperature coefficient or lowest cost, a 5-V power supply offers what Trio Laboratories feels is the best combination of size, weight and price.

At 40 C, Trio's 650A-05 delivers 12 A, offers combined line and load regulation (zero to full load) of 0.2%, operates from line frequencies of 47 to 500 Hz, changes no more than 0.05%/°C over -20 to +40 C (for 12-A output), spits out no more than 50 mV pk-pk of ripple and noise, fits in a 94-cubic inch package that weighs 3.25 lb and costs \$200.

While none of these specs is dazzling by itself, Trio can select one combination or another to show the superiority of its supply over competitive units. And because there are so many power-supply specs, so many different user requirements and hundreds of vendors, it's almost always possible to select a suitable spec combination to prove superiority.

Some combinations—like dollars per watt—may prove extremely important to most power-supply users, while others—like watts per pound—may be important to few. Further, competitive comparisons can sometimes be bent to suit the wishes of the man making the comparisons.

For example, Lambda does not have a 5-V, 12-A supply, but it has 5-V, 9-A and 5-V, 16-A supplies. The former matches Trio's \$3.33 per watt and the latter (the LXS-CC) beats Trio with \$2.50/W. In a size-and-weight competition, Trio's 0.64 W/in.³ and 18.5 W/lb easily top Lambda's 0.35 W/in.³

and 5.33 W/lb. But Lambda, with ripple and noise at 5 mV pk-pk, kills Trio, with 50 mV pk-pk.

Similarly Trio beats HP's new, \$175 62005E, an 8-A supply, on HP's 0.15 W/in.³, 3.05 W/lb and \$4.37/W. But HP has five times better line and load regulation, at 0.04%, and 25 times better ripple and noise, at 2 mV pk-pk.

In most cases, Trio's switching-regulator supply wins the size-and-weight competition. But not always. The Ro Associates 210, an 8.7-A supply, beats Trio's density with 0.95 W/in.³ (vs 0.64) and

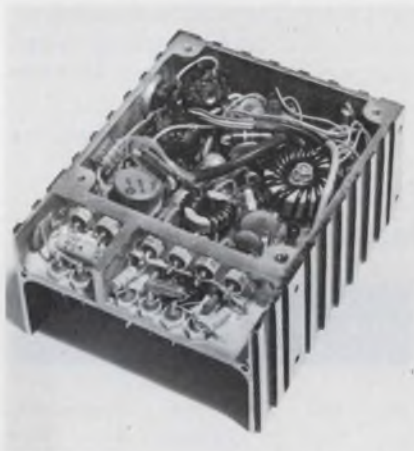

Part of a new line, Trio's 5-V, 12-A supply boasts advantages in size, weight and price.

almost matches Trio's 18.5 W/lb with 17.4 W/lb. Its noise output, 25 mV pk-pk, is half of Trio's. But at \$225, it costs \$5.17/W.

In the same way, Trio beats Technipower's soon-to-be-announced LPC (with 10 A at 55 C), which has 0.24 W/in.³ and 4.16 W/lb. Technipower's combined line and load regulation, at 0.5%, is worse than Trio's 0.2%. But the price—about \$80—makes for a nifty \$1.60/W.

With electrical specs similar to Trio's, Power/Mate's SWR 5-12

(which gives 12 A at 60 C), costs only \$150 (\$2.50/W). But Power/Mate's unit—using a switching regulator, as does Trio's—has volume and weight of only 45.6 in.³ and 2.2 lb, making for 1.32 W/in.³ and 27.3 W/lb. Further, Power/Mate's ripple and noise are only 20 mV pk-pk.

With substantially better regulation and noise, 0.02% combined line and load and 3 mV pk-pk, Faratron's FRD5 (delivering 13 A) beats Trio's electrical specs. But it loses on size (0.188 W/in.³) and weight (3.42 W/lb), and it just noses out Trio on cost (\$3.30).

At \$169 (\$2.82/W), Dynage's L5.25-12 beats Trio's price. It matches the ripple and noise, with 50 mV, loses on combined line and load regulation, at 0.5%, and loses with 0.41 W/in.³ and 5 W/lb.

If one were to pursue such comparisons with scores of competitive supplies, one would likely find more cases of "win some, lose some." Even here, where all the supplies mentioned include over-voltage protection, the comparisons are only partial. All vendors give quantity discounts—some greater than others. Current ratings for most are at 40 C, but some (like Power/Mate and Technipower) don't specify current ratings below about 60 C. And many supplies include features not listed here that may prove most decisive to you.

For more information from:

| | |
|-------------------|----------------|
| Dynage | CIRCLE NO. 250 |
| Faratron | CIRCLE NO. 251 |
| Hewlett-Packard | CIRCLE NO. 252 |
| Lambda | CIRCLE NO. 253 |
| Power/Mate | CIRCLE NO. 254 |
| Ro Associates | CIRCLE NO. 255 |
| Technipower | CIRCLE NO. 256 |
| Trio-Laboratories | CIRCLE NO. 257 |

grand idea

at an
under-grand
price

INTER-COMPUTER ELECTRONICS' IAD-5104N

Analog-Digital Converter

20 MHz
4 Bits

\$950



Designed as a video signal digitizer, the Inter-Computer Electronics' IAD-5104N offers a dramatic cost and size breakthrough in signal processing, testing and enhancement. An offer made good by its \$950 price tag and its NIM packaging.

The 5104N—one of a family of A/D Converters and Encoder Modules ranging from 500 kHz, 12 Bits to 100 MHz, 4 Bits.

From Inter-Computer . . .
the data handling company.

INTER-COMPUTER ELECTRONICS, INC.
A SUBSIDIARY OF AMERICAN ELECTRONIC LABORATORIES, INC.
P.O. BOX 507 • LANSDALE, PENNSYLVANIA 19446
(215) 855-0922 • TWX 510-661-4976 • CABLE: AMERLAB

INFORMATION RETRIEVAL NUMBER 43

MODULES & SUBASSEMBLIES

Sample-and-hold amp.
settles in 500 ns

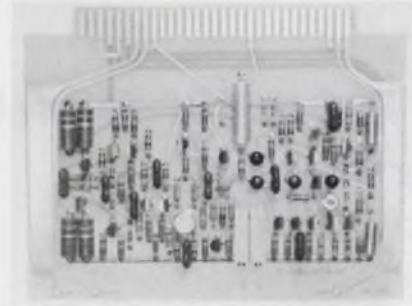

Tustin Electronics Co., 1656 S. Minnie St., Santa Ana, Calif. 92707. (714) 835-0677. \$240; stock to 2 wks.

The Model 2000 sample-and-hold amplifier features an accuracy of $\pm 0.01\%$ of full scale. Its settling time for a full-scale, step-function change of ± 10.0 V is 500 ns. Its aperture uncertainty time is 10 ns. Input impedance is 100 megohms shunted by 70 pF. Output voltage is ± 10.0 V and output current is 10 mA. Full power bandwidth is 1.0 MHz. Hold drift is 1.0 mV for 1.0 ms. The unit is mounted on a PC board featuring open board construction and its dimensions are $5.4 \times 4.2 \times 0.4$ inches.

CIRCLE NO. 258

CRT ten-gun display
features new font

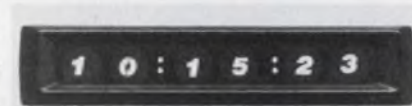

Industrial Electronic Engineers, Inc., 7720-40 Semona Ave., Van Nuys, Calif. 91405. (213) 787-0311. \$17.50 (1000); 4 wks.

A new type font which enhances readability and aesthetics is now being offered in the Series 6000, ten-position, nimo CRT. Letters, numbers and symbols are projected on the same plane in a $5/8 \times 1/2$ inch message area. The display is easily read from a distance of 15 feet, even in bright sunlight, and at a viewing angle of 160 degrees vertically and horizontally. Standard projected color is green, but blue and red are also available. Phosphor life under normal operating conditions is 10,000 hours at a brightness level of 100 ft-L, with no fear of catastrophic failures.

CIRCLE NO. 259

8-bit a/d converter
sells for \$59



Hybrid Systems Corp., 95 Terrace Hall Ave., Burlington, Mass. 01803. (617) 272-1522. \$59; stock to 2 wks.

The ADC590-8 8-bit a/d converter includes references, clock, switches and ladder and is packaged in a $2 \times 2 \times 0.4$ inch module. Its performance characteristics include: An input of ± 5 V or 0 to +10 V; a preset scale factor and offset so no external trimming is needed to meet rated accuracy of $0.1\% \pm 1/2$ LSB; and a conversion time of less than 200 μ s. The unit can operate over a temperature range of 0 to 70 C with an accuracy tempco of 50 ppm/ $^{\circ}$ C. The module requires ± 15 V and 5 V power.

CIRCLE NO. 260

Divider gives 0.5%
over 100:1 range

Burr Brown Research Corp., International Airport Industrial Park, Tucson, Ariz. 85706. (602) 294-1431. \$75.

The Model 4290 Analog Divider operates over a 100:1 denominator range and gives 0.5% of FS accuracy at 25 C, with no external trimming or external resistors. However, 0.1% accuracy at 25 C can be obtained by trimming. The unit operates over the temperature range of -25 to $+85$ C at a reduced accuracy of 1.5%. Accuracy drift is $0.02\%/^{\circ}$ C. Other key specs include: An input range of 0.1 to 10 V for the denominator; 5 mV to 10 V for the numerator, which must be less than the denominator at all times; a small signal BW of 100 kHz for denominator equal to 10 V, and 50 kHz for denominator equal to 0.1 V; and input and output impedances of 25 k Ω and 1 Ω , respectively.

CIRCLE NO. 261

How does Tantalum look without its military jacket? A lot better in the budget.

Take a solid tantalum capacitor out of the military specs and you notice one thing immediately.

Hardly any loss in reliability. And a big drop in price.

When you figure you can get KEMET® E Series dipped solid tantalums for about what you'd pay for aluminum electrolytics, you can start to see all sorts of problems disappear.

Rejects dwindle. Shelf life lengthens. Operational life soars.

KEMET E Series tantalums come in four case sizes from 0.175" diameter to 0.400" with plug in leads on either .125" or .250" precision centers. 0.1 to 330µF up to 50 volts. Off the shelf delivery on standard values.

Talk to your Union Carbide Sales Representative about them. Or write us at Union Carbide, Components Department, Box 5928, Greenville, South Carolina 29606. Telephone: (803) 963-7421.



COMPONENTS DEPARTMENT



Available through your KEMET distributor.

Assemble pulse generators by the module

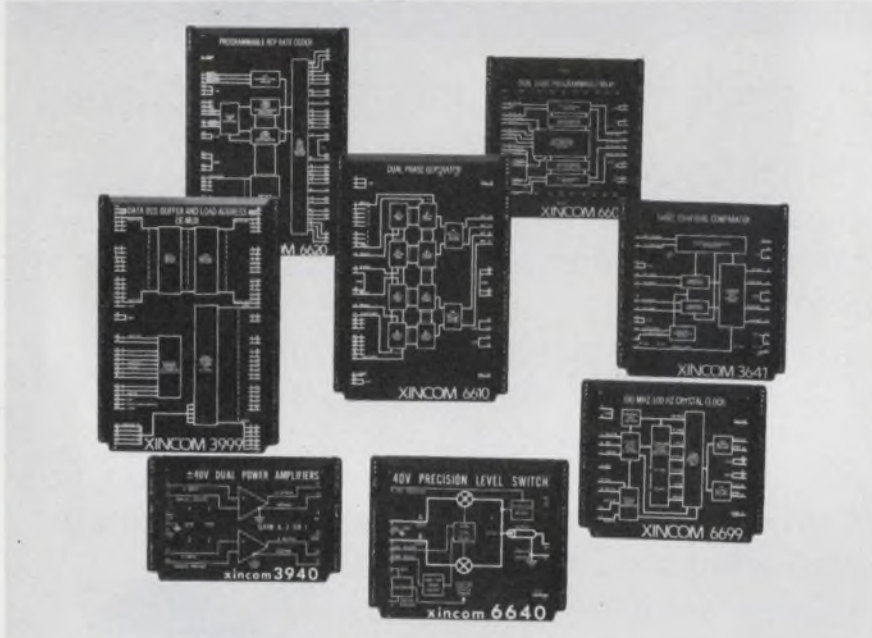

Xincor Corp., 20931 Nordhoff St., Chatsworth, Calif. 91311. (213) 341-5040. P&A: see text; stock to 90 days.

You can probably get the programmable pulse generator you really need—and no more—by assembling modules from a new Xincor series. Since the line has six timing modules (for frequency and multiple-phase generation), seven driving modules (for programmable amplitude and transition time) and interface modules, it's likely you can save the expense of performance your system doesn't need.

The key module in Xincor's new line, the 6699, is a 100-MHz crystal oscillator with decade count-down for six ranges down to 100 Hz.

The rep-rate coder, the 6620, controls frequency generation while the 6610 dual-phase generator programs start/stop timing for independent phases. With these modules, one can digitally program frequency as well as period from 30 ns to 10.2 s with up to 10-ns resolution.

Another module, the 6601, programs dual 1-ns delay with inac-

curacies less than 500 ps. And the 6602 programs 1-ns starts and stops. Still another module, the 3999 data-bus buffer and address demux, simplifies interfacing between Xincor modules and a digital controller or minicomputer.

Three driver modules generate 5 to 40 V at rates to 25 MHz. They are reverse-terminated to absorb reflections in both dynamic and steady states.

Other modules provide ± 40 -V level switching with slewing at 1 V/ns; ± 15 -V pulsing at programmable slew rates from 2 V/ms to 2 V/ns; and ± 5 -V pulsing with 2-V/ns transitions.

Rounding out the family are four drivers that strobe eight channels of input data to a single output with less than 1/2-ns skew for ECL, 1 ns for TTL.

All the modules come in Xincor's proprietary Pinto package with through-the-edge pins that are accessible from the top and bottom. In single quantities, module prices range from \$84, for the ± 5 -V ECL/TTL programmable pulser, to \$600, for the rep-rate coder or dual-phase generator.

CIRCLE NO. 262

1000 V/ μ s op amp settles in 200 ns

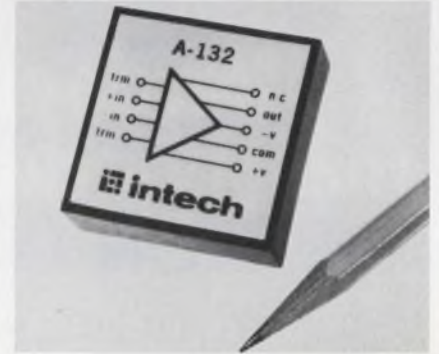

Intech Inc., 1220 Coleman Ave., Santa Clara, Calif. 95050. (408) 244-0500. \$57.

1000 V/ μ s slew rate and settling time to 0.01% in 200 ns are guaranteed features of Intech's new FET-input op amp, the Model A-132. Typical slew rate is 1500 V/ μ s and the settling time is typically better than 100 ns. The low output impedance and exceptional stability permit the A-132 to drive high speed logic, cables or other capacitive loads to 1000 pF. Open loop gain is 94 dB min. and bandwidth is 20 MHz min. Input bias current is less than 50 pA and input drift is 50 μ V/ $^{\circ}$ C. The A-132 comes in a 1.5 \times 1.5 \times 0.4 inch package.

CIRCLE NO. 263

400 Hz to dc converter gives 10 A at 14 to 30 V

Abbott Transistor Laboratories, Inc., 5200 W. Jefferson Blvd., Los Angeles, Calif. 90016. (213) 936-8185. \$434 ea.; 4-5 wks. ARO.

The W10 series power modules convert 115 V ac, 400-Hz power to any output between 14 and 30 V dc at a full load current of 10 A. The units regulate line voltage to $\pm 0.05\%$ or 10 mV (whichever is greater) for input changes of 105 to 125 V rms, at constant load. The load regulation is $\pm 0.05\%$ or 20 mV (whichever is greater) from no load to full load, at constant line. Ripple is 0.02% or 5 mV (whichever is greater), 25 mV peak-to-peak, max. Other features include a load transient recovery time of less than 100 ms for 50% step changes in load current, and a maximum TC of 0.03%/ $^{\circ}$ C. All specs are guaranteed under full load operation from -55 C to $+100$ C base-plate temp.

CIRCLE NO. 264



Norden Encoders perform for you!

Look at these new additions to Norden's line. More are on the way.

| | Total Count | Revolutions for Full Count | Diameter" | Model Number |
|--|----------------------|----------------------------|-----------|----------------------|
| NEW! Optical Absolute | 10,000 | 50 | 2.25 | OADC-23/4/BCDQ-200L |
| NEW! Optical Absolute | 1,000 | 1 | 2.25 | OADC-23/3/BCD-1000L |
| NEW! Optical Incremental: Series now available with shaft seal—permits drenched operation. | | | | |
| NEW! Contact Size 11 | 8,192 | 32 or 64 | 1.06 | ADC-11/13/BNRY-256L |
| NEW! Contact Size 11 Altitude Reporting Encoder | 1,280 | 16 | 1.06 | ADC-11-ALT-1280 |
| NEW! Contact Size 11 | 10,000 | 100 | 1.06 | ADC-11/4/BCDX-100 |
| NEW! Contact Size 11 | 3,600 | 36 | 1.06 | ADC-11/4-36/BCDX-100 |
| NEW! Rugged Industrial Grade Optical Incremental Encoders | | | | |
| All available with quadrature and internal squaring circuit options | 2,000 Pulses | 1 | 3.500 | OADC-35/2000/INC |
| | 1,500 Pulses | 1 | 3.500 | OADC-35/1500/INC |
| | 1,250 Pulses | 1 | 3.500 | OADC-35/1250/INC |
| | 1,000 Pulses | 1 | 3.500 | OADC-35/1000/INC |
| | 600 Pulses | 1 | 3.500 | OADC-35/600/INC |
| | 500 Pulses | 1 | 3.500 | OADC-35/500/INC |
| | 300 Pulses | 1 | 3.500 | OADC-35/300/INC |
| | 200 Pulses | 1 | 3.500 | OADC-35/200/INC |
| | 100 Pulses | 1 | 3.500 | OADC-35/100/INC |
| Optical Incremental Encoders | | | | |
| All available with index marker, quadrature outputs and internal squaring circuit options. Other counts on special order | 100 Pulses | 1 | 2.250 | OADC-23/100/INC |
| | 250 Pulses | 1 | 2.250 | OADC-23/250/INC |
| | 256 Pulses | 1 | 2.250 | OADC-23/256/INC |
| | 336 Pulses | 1 | 2.250 | OADC-23/336/INC |
| | 500 Pulses | 1 | 2.250 | OADC-23/500/INC |
| | 512 Pulses | 1 | 2.250 | OADC-23/512/INC |
| | 1,000 Pulses | 1 | 2.250 | OADC-23/1,000/INC |
| | 1,024 Pulses | 1 | 2.250 | OADC-23/1,024/INC |
| IC-Compatible Encoders. For direct interface with TTL & DTL circuits | | | | |
| Binary | 128 | 1 | 1.750 | ADC-ST7-BNRY-E/L |
| | 8,192 | 64 | 1.750 | ADC-13-BNRY-E/L |
| | 524,288 | 4,096 | 1.750 | ADC-19-BNRY-E/L |
| Binary-Decimal Code | 100 | 1 | 2.250 | ADC-ST2-BCD/L |
| | 1,000 | 10 | 2.250 | ADC-3-BCD/L |
| | 10,000 | 100 | 2.250 | ADC-4-BCD/L |
| | 100,000 | 1,000 | 2.250 | ADC-5-BCD/L |
| | 1,000,000 | 10,000 | 2.250 | ADC-6-BCD/L |
| | 360 | 1 | 2.250 | ADC-3-36BCD-E-360L |
| | 3,600 | 10 | 2.250 | ADC-4-36BCD-E-360L |
| | 36,000 | 100 | 2.250 | ADC-5-36BCD-E-360L |
| | 360 | 1 | 3.250 | ADC-ST3-36-BCD/L |
| | 3,600 | 36 | 2.250 | ADC-4-36-BCD/L |
| | 36,000 | 360 | 2.250 | ADC-5-36-BCD/L |
| | 360,000 | 3,600 | 2.250 | ADC-6-36-BCD/L |
| External Logic V-Scan Binary Encoders | | | | |
| | 128 or 256 | 1 | 1.750 | ADC-7/8-BNRY-XB |
| | 8,192 or 16,384 | 64 | 1.750 | ADC-13/14-BNRY-XB |
| | 524,288 or 1,048,576 | 4,096 | 1.750 | ADC-19/20-BNRY-XB |
| Single Turn Gray Code Encoders | | | | |
| Available with various levels of RFI suppression | 256 | 1 | 1.066 | ADC/11/8/GRAY |
| | 256 | 1 | 1.750 | ADC-ST8-GRAY |
| | 512 | 1 | 2.250 | ADC-ST9-GRAY |
| | 1,024 | 1 | 3.062 | ADC-ST10-GRAY |
| Multiturn Gray Code Encoders | | | | |
| Available with various levels of RFI suppression | 1,024 | 4 | 1.062 | ADC-11/10GRAY256 |
| | 1,024 | 16 | 1.062 | ADC-11/10GRAY 64 |
| Low Cost Magnetic Noncontacting Encoders | | | | |
| Incremental | 128 | 1 | 1.750 | MADC-18/128/INC |
| Binary | 128(V scan) | 1 | 1.750 | MADC-18/7/BV |
| Binary | 8,192(V scan) | 64 | 1.750 | MADC-18/13/BV |
| Binary | 524,288(V scan) | 4,096 | 1.750 | MADC-18/19/BV |

For more information and detailed specs, write Norden, Att: Components Dept., 200 Helen Street, Norwalk, Conn. 06856. Phone (203) 838-4471. TWX: 710-468-0788.



Subminiature PANEL LIGHTS THAT LAST (up to 50 years)



The FAN-IN Series — self-driven incandescents with built-in drivers and keep alive bias ■ Field proven reliability ■ Life ratings to 30 years ■ Interface directly with TTL and MOS ■ Mounting diameters to 1/4" ■ Prices start at an unbelievably low \$1.87 ea. (1000 qty.).

LED's — with built-in resistors for 3 to 28 volt applications ■ These high brightness little lights (3/16" and 1/4" mounting diameters) are rugged, reliable performers ■ Over 50 year life ratings ■ Priced at just \$1.19 ea. (1000 qty.).

Long life, low cost standard incandescent and neon lights are also available . . . single unit prices start below \$1.00

Data Display Products panel indicator lights are available in low profile and standard mounting models. They feature shock proof and fully insulated housings with gold plated, Wire-Wrap terminals. And, come in a wide variety of lens colors, with decorative lens collars to match any panel design.

Call or write for more information today!

the little light people

DATA DISPLAY PRODUCTS

8036 Westlawn Ave., Los Angeles, Ca. 90045
(213) 641-1232

INFORMATION RETRIEVAL NUMBER 46

FET-input preamp combines speed and versatility

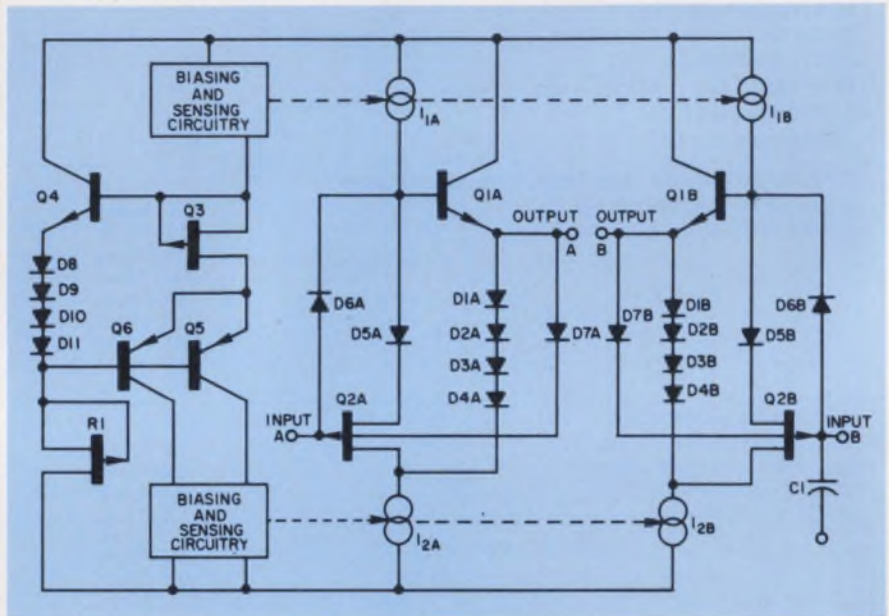

Harris Semiconductor, P.O. Box 883, Melbourne, Fla. 32901. (305) 727-5407. P&A: See text.

The HA-2000/2005 monolithic FET-input preamplifier offers high input impedance and low bias currents with high speed—an ideal combination for many linear circuit applications.

The Harris device lists an input impedance of $10^{12} \Omega$, bias current of 1 pA and slew rate of 100 V/ μ s. Its frequency response is flat to 10 MHz and down only 10 dB at 100 MHz.

The versatility of the basic preamp is indicated by its use in two other ICs offered by Harris in the company's new op-amp line. They are the HA-2050/2055 high slew rate (120 V/ μ s) op amp and the HA-2060/2065 wideband (100 MHz gain-bandwidth product) op amp. Both monolithic ICs use the basic circuit of the FET-input preamp (see circuit diagram).

The circuit is a unity gain differential amplifier stage with JFET inputs and bipolar transistor outputs in a configuration that does not lend itself to direct com-

parison with other monolithic FET circuits.

It has much wider common mode ranges than simpler JFET pairs, allowing op amps to be connected as voltage followers with full output swing. Both transistors can be used as high-impedance unity-gain buffers for differential or two single-ended signals for frequencies from dc to rf.

The new preamp is available in a military version (–55 to 125 C temperature range) as the HA-2000 for \$6.50 (100 up) and a commercial version (0 to 75 C) as the HA-2005 for \$4.35 (100 up). For each version, the minimum uncompensated offset voltage is 5 mV (suffix A) at \$10.95 and \$5.95 (100 up), respectively.

Maximum offsets reach 12 mV for the HA-2000 and 25 mV for the HA-2005. These voltages are about the same as those obtained with other monolithic FET circuits. And while a spec on drift is not listed, Harris says it is about 20 μ V/ $^{\circ}$ C, which can also be obtained with other FET circuits.

CIRCLE NO. 265

Look-ahead carry gen for fast add/subtract

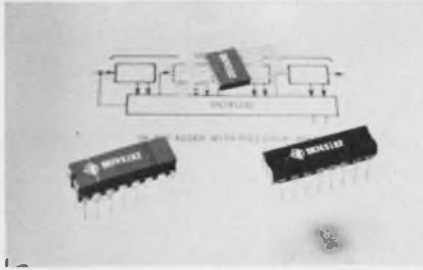

Texas Instruments Inc., P.O. Box 5012, M/S 308, Dallas, Tex. 75222. (214) 238-3741. SN74S182N: \$7.56, stock; SN54S182N: \$9.45, 2 wks.; 100 up.

The SN54S/74S182, A Schottky TTL look-ahead carry generator, can be combined with four SN54S/74S181 Schottky arithmetic logic units to provide the fastest TTL IC adder/subtractor available. Average propagation delay time through the longest delay path for the new IC is 6.75 ns while the speed of the standard TTL 182 is 13 ns. The increase in power consumption is only 16%.

CIRCLE NO. 266

Clock driver interfaces TTL clock, MOS system

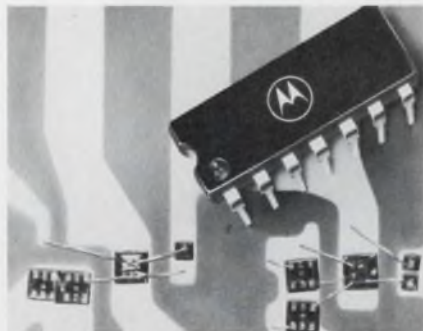

Motorola Semiconductor Products Inc., P.O. Box 20912, Phoenix, Ariz. 85036. (602) 273-3466. \$3.90 (100 up); stock.

The MHP401 hybrid IC clock driver can interface saturated logic circuits to the highly capacitive loads of MOS systems, and maintain high clock rates. While driving a 500-pF load and operating from +5 V and -12 V power supplies, the driver supplies clock pulses at rates up to 5 MHz. Maximum switching times when driving a 1000-pF load with +5 V and -12 V supplies and a 1-MHz input pulse (with a 20% duty cycle) are $t_{on} = t_{off} < 75$ ns.

CIRCLE NO. 267

MONO™ PRECISION MONOLITHICS INCORPORATED

IS NO.1

IN LINEAR IC TECHNOLOGY

... and here are the products that prove it —

D/A CONVERTERS

Complete 10 bit plus sign D/A Converter on a single chip!

monoDAC-02

Complete low cost 6 bit D/A Converter on a single chip!

monoDAC-01

Fast, low cost 10 bit current output DAC in a DIP!

A/MDAC-100

PRECISION COMPARATORS

Fastest precision voltage Comparator!

monoCMP-01

Lowest input current, most accurate voltage Comparator!

monoCMP-02

PRECISION OPERATIONAL AMPLIFIERS

Lowest noise, lowest drift precision OP Amp!

SSS725

New PMI-improved version of the 108A OP Amp!

SSS108A

Highest performance bipolar picoamp Op Amp!

monoOP-08

Lowest cost fast slewing, fast settling compensated Op Amp!

monoOP-01

Highest performance 741/747 Op Amps available!

SSS741/SSS747

All PRECISION MONOLITHICS products are processed per MIL-STD-883, of course — and tough spec specials are our specialty! Highest performance linear circuits at rock bottom prices — that's PRECISION MONOLITHICS!

Contact your local rep or stocking distributor for off-the-shelf delivery of these outstanding performers!

PRECISION MONOLITHICS...

delivering tomorrow's linear technology today!

START SAVING TODAY —
GET THE FACTS FROM OUR
NEW 1972 PRODUCT GUIDE

AVAILABLE NOW!
408-246-9225



1500 SPACE PARK DRIVE, SANTA CLARA, CALIFORNIA 95050

INFORMATION RETRIEVAL NUMBER 47

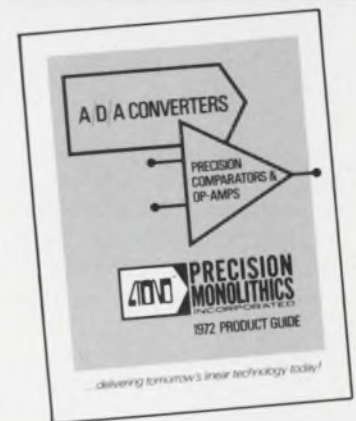

MOSFETs offer lower noise and higher gain

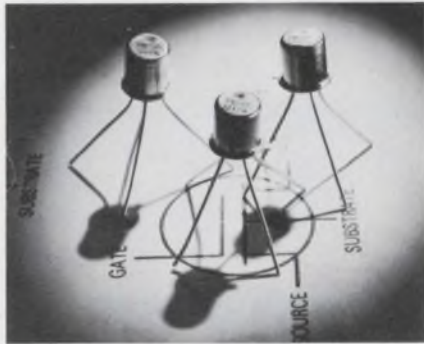

Texas Instruments Inc., P.O. Box 5012, M/S 308, Dallas, Tex. 75222. (214) 238-3741. 3N204 and 3N205: \$0.80; 3N206: \$0.70 (100 up); 2 wks.

Three n-channel dual-gate MOSFETs are said to feature lower noise and higher power gain than similar devices currently on the market. Designated the 3N204, 3N205 and 3N206, these MOSFETs feature typical noise figures ranging from 2 dB at 200 MHz to 7 dB at 900 MHz. Typical power gains vary from 24 dB at 200 MHz to 12 dB at 900 MHz.

CIRCLE NO. 271

Schottky-barrier diode rated at 50 A, 20 V



International Rectifier Corp., Semiconductor Div., 233 Kansas St., El Segundo, Calif. 90245. (213) 678-6281.

A hot carrier Schottky-barrier diode with low forward voltage drop, the type 50HQ020, has a listed rating of 50 A and 20 V. The diode's maximum peak forward voltage drop is 0.87 V at 157 A and 25 C; it's 0.65 V at 100 A. The 50HQ020 can be used for rectifier circuits operating at frequencies over 20 kHz.

CIRCLE NO. 272

Hybrid VCO good to 1 MHz

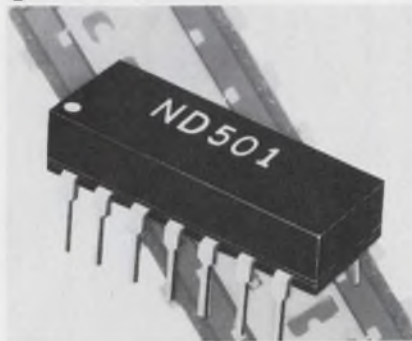

Novadyne Inc., 3500 "B" Westminster Ave., Santa Ana, Calif. 92703. (714) 839-5350.

The ND-501 hybrid voltage-controlled oscillator (VCO) offers center-frequency operation up to 1 MHz, as determined by external timing components. It can also be used with frequency deviations up to $\pm 50\%$ of center frequency. Linearity is typically $\pm 0.1\%$ at $\pm 40\%$ deviation. Temperature stability is typically 70 ppm/ $^{\circ}\text{C}$ over the range of -55 to $+125$ C.

CIRCLE NO. 273

Op amp lists guaranteed max long-term stability



Analog Devices, Inc., Route 1 Industrial Park, Norwood, Mass. 02062. (617) 329-4700. J: \$14; K: \$20; L: \$30 (100 up). Stock.

The first precision op amps to guarantee maximum temperature and long-term stability, according to the company, are the AD 508 IC series. It includes units with guaranteed maximum drift of ± 0.5 $\mu\text{V}/^{\circ}\text{C}$ and maximum long-term stability of ± 10 $\mu\text{V}/\text{month}$. The AD508 series is available in three drift versions: "J" with ± 5 $\mu\text{V}/^{\circ}\text{C}$ max, ± 15 $\mu\text{V}/\text{month}$ typical; "K" with 0.5 $\mu\text{V}/^{\circ}\text{C}$ max, ± 10 $\mu\text{V}/\text{month}$ typical; and "L" with ± 1.0 $\mu\text{V}/^{\circ}\text{C}$ max, and ± 10 $\mu\text{V}/\text{month}$ max.

CIRCLE NO. 274

One resistor programs micropower op amp

National Semiconductor Corp., 2900 Semiconductor Dr., Santa Clara, Calif. 95051. (408) 732-5000. \$8.75 (100 up).

With a single resistor connected between the supply and an internal bias network of the LM4250 op amp, operating characteristics can be fixed over a ± 1 V to ± 18 V supply range. These include the input characteristics, noise performance and standby power. At a nominal value of the programming resistor, maximum input bias current is 7.5 nA; input offset current, 3 nA; input offset voltage, 3 mV; noise current, 0.1 pA/ $\sqrt{\text{Hz}}$ and standby power dissipation, 255 μW .

CIRCLE NO. 275

Power transistors for high frequency use

RCA, Solid State Div., Route 202, Somerville, N.J. 08876. (201) 722-3200. 40934: \$6; 40936: \$9; 40940: \$7; 40941: \$6.90 (1000); stock.

A power transistor for hf SSB operation, the 40936, and three transistors for vhf/uhf power amplification are now available. The 40936 is a 28-V transistor for 2-to-30 MHz single-sideband amplifiers or other linear applications. The 40934, a 12.5-V vhf/uhf class C amplifier, provides 2 W with 7-dB gain at 470 MHz. And the 40940 and 40941 are 28-V vhf/uhf amplifiers that provide 5 W with 5.2-dB gain and 1 W with 10-dB gain, respectively, at 400 MHz.

CIRCLE NO. 276

Op amp guarantees 1000 V/ μs slew rate

Intech, Inc., 1220 Coleman Ave., Santa Clara, Calif. 95050. (408) 244-0500. \$57.

The A-132 FET-input op amp guarantees a slew rate of 1000 V/ μs and settling time of 0.01% in 200 ns. Typical slew rate is 1500 V/ μs and the settling time is typically better than 100 ns. Open loop gain is 94 dB min and bandwidth is 20 MHz min. Input bias current is less than 50 pA and input drift is 50 $\mu\text{V}/^{\circ}\text{C}$ for the A-132 and 25 $\mu\text{V}/^{\circ}\text{C}$ for a similar model A-133.

CIRCLE NO. 277

Which air movers for your system?



Rotron® has the answer.

There are at least three major reasons why you can rely on Rotron to provide the best possible answer to your air moving need.

1. Rotron makes the widest selection of fans and blowers in the industry.
2. Rotron has a reputation for producing only the finest air movers. It's a reputation well earned, and one Rotron intends to keep.
3. Rotron offers you this superior selection and quality at hard-nosed competitive prices.

What's more, Rotron field application engineers will be glad to work directly with you where custom solutions may be required. You get the benefit of more than 20 years experience in developing specific answers to specific air moving problems.

Finally, Rotron products are available through a large, nationwide network of stocking distributors, to meet your needs in fast off-the-shelf delivery time.

Next time an air moving question arises, check Rotron. You'll like the answer. Get more information now by writing for Rotron's Quick Reference Catalog.

Why settle for less when the best costs no more?



ROTRON INC., Woodstock, N. Y. 12498 ☐ 914 • 679-2401 ☐ TWX 510-247-9033
Pacific Div., Burbank, Cal. 91506, 213•849-7871 • Rotron N.V., Breda, Netherlands, Tel.: 49550, Telex: 844-54074

15728

INFORMATION RETRIEVAL NUMBER 48

Internally compensated, fully protected op amp beats key specs of 725 family

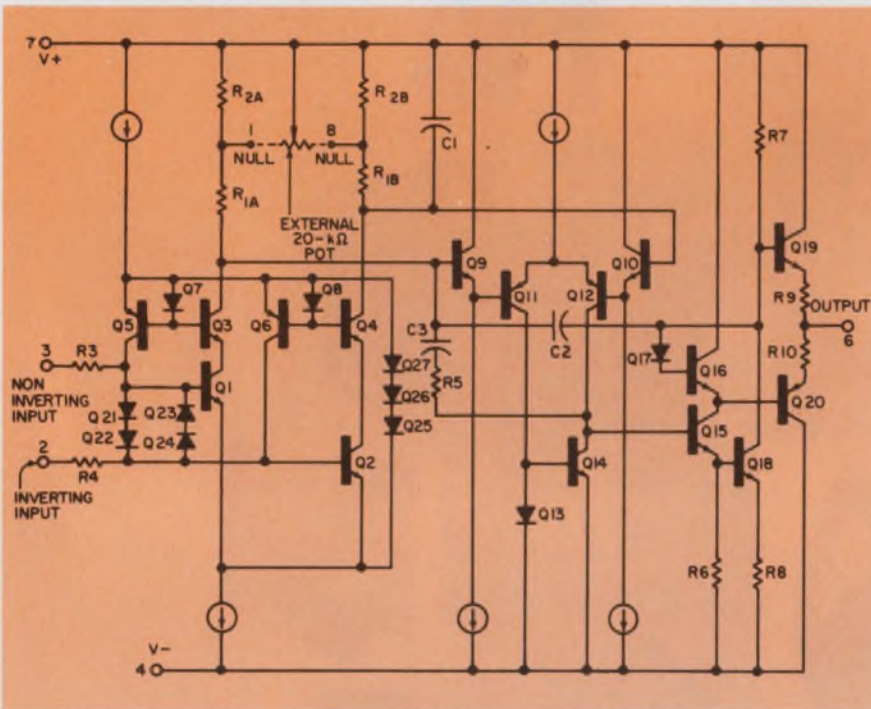

Precision Monolithics, Inc., 1500 Space Park Dr., Santa Clara, Calif. 95050. (408) 246-9225. P&A: See text.

The monoOP-05 op amp, internally compensated and with full input/output (I/O) protection, offers improved specs over Fairchild's μ A 725 op amp. In some cases, it also beats Precision Monolithics own premium version, the SSS725.

Compared to Fairchild's popular μ A 725 op amp, which has a cir-

cuit configuration similar to that of the new IC (see diagram), the monoOP-05 has lower maximum bias current (3 nA vs 100 nA), lower maximum offset current (2.8 nA vs 20 nA) and a greatly increased slew rate (0.25 V/ μ s vs 0.008 V/ μ s). Moreover, the μ A 725 requires four external components for frequency compensation and additional circuitry for I/O protection.

The monoOP-05 lists a maximum

pk-pk noise voltage of 0.7 μ V (10-Hz bandwidth), with 0.38 μ V typical, and a maximum drift of 0.6 μ V/ $^{\circ}$ C (E versions). By comparison, the μ A 725 has a higher typical pk-pk noise voltage of 1.0 μ V; no maximum noise voltage or drift spec is listed.

The SSS725 op amp has neither input protection nor internal compensation, but it does have output protection and essentially the same noise voltage and drift ratings as the monoOP-05.

But the monoOP-05 has a minimum common-mode rejection ratio of 114 dB, as compared to 120 dB for the SSS725. The new op amp also lags in power supply rejection ratio; the minimum value is 100 dB, compared to 114 dB with the SSS725.

The monoOP-05 is available in TO-99 packages that fit directly into existing 725 sockets with or without frequency compensation components. Prices for 100-249 quantities and the three versions offered are the following: monoOP-05J (-55 to 125 C range), \$19.95; mono OP-05EJ (premium, 0 to 70 C range), \$14.95; and mono OP-05CJ, \$6.95. Flatpack and 14-lead DIP packages are also available.

For Fairchild μ A 725 **CIRCLE NO. 278**

For Precision Monolithics monoOP-05 and SSS725

CIRCLE NO. 279

ANA&LOG

WE'RE REALLY GONNA FLY WITH THIS NEW HIGH SPEED CHOPPER, BABY.

IT SURE LOOKS LIKE A KLUGE.

OLD SPIKE NEVER GIVES UP.

I WISH YOU WOULD QUIT HANGING AROUND THAT DRIFTER ANA.

ANALOGY

THERE'S JUST NO COMPETITION IN A DRAG WITH THE A-226 CHOPPER. YOU'RE REALLY FLYING AT 100V/ μ S AND YOU NEVER EVEN KNOW IT--- NOT A CHOPPER SPIKE IN SIGHT. IT'S QUIET AS A BIRD AT 1.5 μ V/PD AND STAYS ON COURSE WITH LESS THAN 0.5 μ V/ $^{\circ}$ C DRIFT. WRITE FOR A DATA SHEET AND... FLY ANA.

intech INCORPORATED
(408) 244-0500
1720 COLEMAN, SANTA CLARA CA 95050

COS/MOS phase-locked loop handles 500 kHz

RCA, Solid State Div., Route 202, Somerville, N.J. 08876. (201) 722-3200, \$15 (1-24).

A COS/MOS micropower phase-locked loop, the CD4046A (preliminary), consists of a linear voltage-controlled oscillator and two different phase comparators having a common signal-input amplifier and a common reference input. This phase locked-loop features high operating frequency (up to 500 kHz), good linearity, an inhibit control for ultra-low standby power consumption, a zener diode to assist supply regulation and low frequency drift with temperature.

CIRCLE NO. 301

PMOS shift register guarantees 5 MHz

SGS-ATES, PR Dept., Via C. Olivetti 1, 20041 - Agrate Br., Milan, Italy.

A high-speed dynamic shift register, the M130, boasts a guaranteed speed of operation of 5 MHz. The two-phase M130 has a capacity of 1024-bits. Its fabrication uses the low threshold, silicon gate p-channel MOS process. In addition, quad 256-bit and dual 512-bit versions are available. Supply voltages for all devices are 5 V and -5 V, and operating temperatures are 0 to 70 C.

CIRCLE NO. 302

Comparators handle longer binary numbers

National Semiconductor Corp., 2900 Semiconductor Dr., Santa Clara, Calif. 95051. (408) 732-5000. DM-8130N: \$4.50; DM8160N: \$3.25 (100 up).

The DM7130/DM8130 ten-bit comparator determines equality or nonequality between two 10-bit binary words, while the DM7160/DM8160 compares two 6-bit words. Both monolithic ICs perform this function in about 20 ns. The devices are arrays of exclusive-OR gates with A and B inputs and NAND'ed outputs. If word A equals B, the output is ZERO. If not, the output is ONE. A strobe input forces the output to ONE. For longer words, the comparators may be paralleled.

CIRCLE NO. 303

Another Sprague Breakthrough!

PRODUCTION-ORIENTED SOLID TANTALUM CAPACITORS

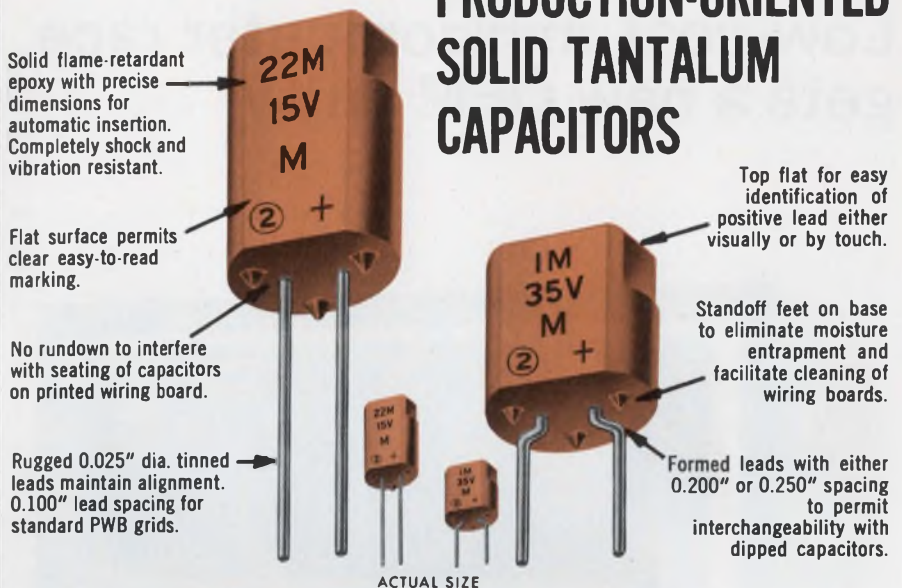

Type 198D Low-cost Econoline* Tantalum Capacitors Lead in Performance!

When it comes to low-cost solid tantalum capacitors, the new Sprague Type 198D Econoline Capacitors outperform all other designs. Here are some additional advantages:

- Low d-c leakage
- Low dissipation factor
- Wide voltage range, 4 to 50 VDC
- Capacitance range from 0.1 to 100 μ F
- Withstand severe temperature cycling and temperature shock over -55 C to +85 C
- Speedier handling for insertion
- Easier-to-read markings

The new Sprague Type 198D epoxy-encased Econoline Capacitor is tooled for mass production and priced competitively with imported dipped units. Investigate this new Sprague breakthrough without delay.

Call your nearest Sprague district office or sales representative, or write for Engineering Bulletin 3546 to: Technical Literature Service, Sprague Electric Co., 347 Marshall Street, North Adams, Mass. 01247.

*Trademark

THE BROAD-LINE PRODUCER OF ELECTRONIC PARTS



Low-cost minicomputer race gets a new OEM entry

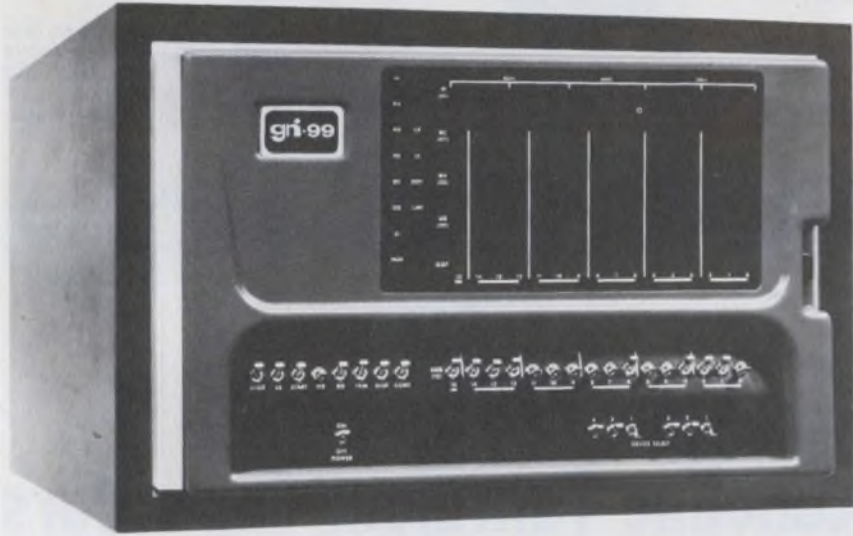

GRI Computer Corp., 320 Needham St., Newton, Mass. 02164. (617) 696-0800. Price: See text.

Improved and lower priced, the new GRI-99 mini line uses the universal-bus architecture that GRI Computer introduced in its GRI-909 about three years ago. An 8-k unit sells for as low as \$2975, while the largest 32-k unit sells for \$7798 in quantities of 25 and up.

With additional hardware registers, including an index register, up to 32,768 16-bit words of directly addressable memory can be plugged in 8-k increments into the mini's 10-1/2-in.-high mainframe. A 4-k unit is also available for \$2500 (25 and up).

As many as nine additional ports can be added for more input-output options. The central processor is modularized, too. Hard-wired firmware modules can be added to provide hundreds of computer instructions. The computer uses the latest LSI and MSI circuits, and the console display has LED indicators for

increased reliability and life.

Three models are being offered. The Model 10 is sold with a blank console for dedicated applications that require no operator interaction. The Model 30 is equipped with an operator's console, permitting manual access to any register or peripheral device. Both the Models 10 and 30 have 12 registers. The Model 40 has extended math capability, including multiply/divide and floating point hardware and 18 registers. Also, an expanded display console permits simultaneous display of the internal computer registers.

Core cycle time is 1.76 μ s, and the instruction executive takes 440 ns. The maximum I/O data rate is 568-k of 16-bit words/s, with +4-V logic ONE, TTL compatibility.

Other features include: unlimited priority interrupt levels, seven address modes, 233 instruction types with many variations and a well documented library of software, using the GRI-909 set.

CIRCLE NO. 304

Hard-copy printer uses electrostatic technique



Infomax, 757 N. Pastoria Ave., Sunnyvale, Calif. 94086. (408) 736-6881. \$3750 (unit).

The Model 76 is a nonoptical, desktop copier. Using electrostatic techniques, the unit generates a printed 8-1/2 \times 11 in. page from the same type of video signals as the input to a CRT display. Using a roll of electrostatic copying paper, a multistylus assembly selectively charges areas of the paper. The charged areas pick up a "toner," which is fused to the surface of the paper to produce a black and white image.

CIRCLE NO. 305

Two types of two-channel analog recorders offered



Esterline Angus, Box 24000, Indianapolis, Ind. 46224. (317) 244-7611.

Minigraph portable analog recorders are offered in two models, each weighing 3-1/2 lb. Two-channel Minigraphs have two-independent galvanometer-measuring systems which record side-by-side on identically calibrated chart areas. Time-shared Minigraphs synchronously switch two inputs to produce two-independent traces on the full chart width. For identification, one trace is broken, the other solid. An inkless recording system records on pressure sensitive paper.

CIRCLE NO. 306

**It's downright humiliating!
Any field return is one too many!**

**Horace, you're never satisfied.
We may have just set the industry's
lowest return record!**

**I hate these impassioned
technical discussions.**



Even a 3.1% Function Generator return rate agitates Horace. IEC has trained him well.

It's an unwritten business rule that you don't discuss your problems with the outside world, but we're breaking tradition because we feel our F34 returns are worth talking about. This extremely low warranty repair record was established during the first year of production, even though industry statistics demonstrate that failure percentages are highest during the initial stage of product life. According to electronics manufacturers' trade association data, standard warranty returns can range from 10% for DVM's and oscilloscopes, to as much as 300% for some temperamental instruments. This is why we feel that our F34's current return rate of 3.1% is a real achievement.

Much of the credit for this reliable new function generator must go to IEC's Corporate Cal Lab, one of the few testing facilities with analysis standards one generation away from the National Bureau of Standards. The F-34 underwent the same kind of computerized error-analysis and evaluation testing that our Metrology staff developed for Polaris/Poseidon and other government programs.

With our stringent Quality Control system, we make sure that our test instruments measure up to performance standards, because we're vitally aware that downtime is a significant factor in test instrument selection. Over 300 generators were

shipped before one was ever returned, and to date, 96.9% have never required warranty maintenance. But because our QC people, like Horace, worry about that 3.1%, we'll try to do even better.

If you would like a perfectionist like Horace on your team, specify the F-34. It generates reliable 0.03Hz - 3MHz waveforms, with Variable Width Pulse for pulse generator applications, and an outstanding combination of operating features for \$495... In a hurry to match your requirements? Call John Norburg (collect) 714/772-2811.



IEC INTERSTATE
ELECTRONICS
CORPORATION

Subsidiary of A-T-O Inc.

Dept. 7000, Box 3117, Anaheim, Calif. 92803.

TWX 714-776-0280

TELEX 655443 & 655419

The Elegant Transformer Kits

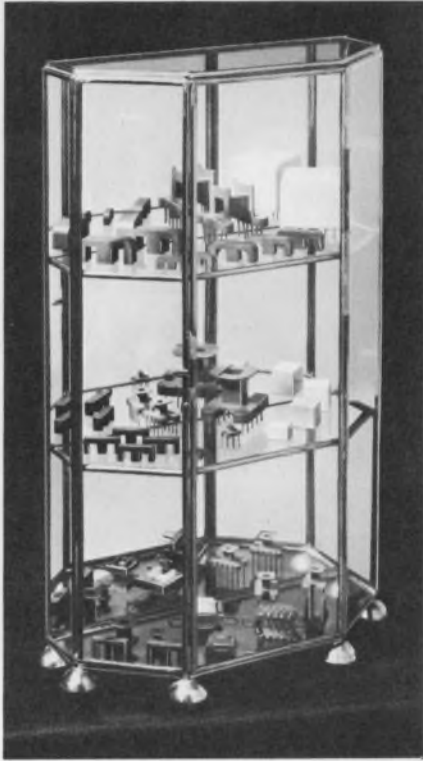

Select from 157 kits. To find the exact match for your needs. Plus ready-made economies. With ferrite cores. Steel frames. Cases. And bobbin/coil forms that pin precisely into standard printed-circuit grid patterns.

Six materials: fluorocarbon, nylon, glass-reinforced nylon, DAP, polyester and epoxy. For stability at temperature ranges from 105 to 200 C.

The complete collection expresses the craftsmanship you expect from EPC as an EAI component company. Look to EPC also for custom-molded parts. Or to EAI for thick-film audio amps. Capacitors. Custom coils. Solenoids. Active filters. Analog/digital converters and other special function modules. Plus a growing list of other elegantly crafted etceteras.



EPC

Electrical Plastics Corporation
500 Long Branch Avenue
Long Branch, New Jersey 07740
Tel. (201) 870-9500

A Subsidiary of Electronic Associates, Inc.

INFORMATION RETRIEVAL NUMBER 52

Tape-cassette unit replaces paper-tape punch and reader

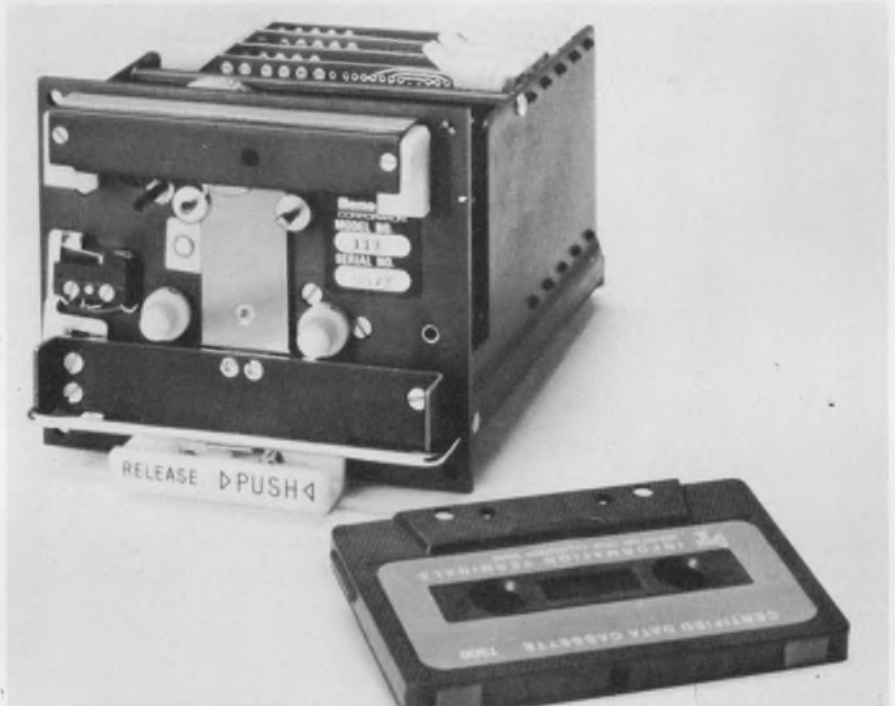

Memodyne Corp., 369 Elliot St., Newton Upper Falls, Mass. 02164. (617) 527-6600. \$700 (with electronics); 4 wks.

Acting much like a punch-paper tape system, the Model 113 tape-cassette unit records individual characters or plays them back, one at a time, asynchronously. This type of operation is particularly suited to key-to-tape-to-printer systems, displays and numerical controls applications. While accepting a seven-bit, parallel-input word, the Model 113—also called the Incre-Deck—records the data on the tape serially. Upon command, it plays back an eight-bit, parallel-ASCII code. The eighth bit is an internally added, odd-parity bit.

The Incre-Deck uses a Philips-type cassette, can store 36,000 ASCII characters at 120 b/in. and handles data to a speed of 30 char/sec. It uses a NRZI tape format that requires two tracks, one each for logic ONE and ZERO.

A stepping motor drives the unit in the record and read modes, while

a separate-brushless dc motor is used for the high-speed rewind. The capstan and pinch roller, used in record/read, must be manually released for high-speed rewind. This can prove inconvenient, though.

The use of a stepping motor results in a start time of only 3 ms and a stop time of 7 ms. Thus large tape gaps between characters do not occur.

A "load forward" mode runs the tape continuously until a lead hole is sensed by the EOT/BOT sensor. Backspace and automatic high-speed rewind modes complete the functions supplied. Missing, however, is a fast-search mode that could be very useful, since not all processes flow smoothly from start to finish. Many times it is necessary to start in the middle of a sequence. Or it may be necessary to go back for troubleshooting.

All input and output signals are TTL-compatible. File-protection and cassette-in-place sensing are provided.

CIRCLE NO. 307

Digitizer creates wire-wrap program from list

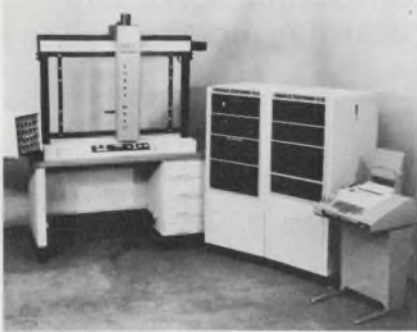

Houdaille Industries, Inc., Electronics Div., 9020 Wehrle Dr., Clarence, N.Y. 14031. (716) 632-8412.

This digitizer system generates a program tape for numerically-controlled, wire-wrapping machines directly from a "to-from" list. Flexible operation is virtually independent of part geometry. Consisting of a 4-k digital computer, teletypewriter and crosshair gun sight, the system connects directly to existing numerical controls. Originally developed for the Houdaille Econo-Wrap wire-wrapping machine, it can be retrofitted to other manufacturer's equipment.

CIRCLE NO. 308

Bridge amplifier eases pressure measurements



Fogg Systems Co., Inc., Box 2226, Denver, Colo. 80222. (303) 758-2979, \$396; 30 days.

Bridge amplifier, Model 50, with a battery power supply, measures pressure from resistive-bridge transducers, in remote locations. Digital dials permit a two-step calibration to obtain output scale factors such as 100 mm Hg/V or 1000 psi/V so that data can be conveniently displayed in digital form. Its ± 3 V output into 3 k Ω (or greater) is compatible with most recording and display devices.

CIRCLE NO. 309

Some people still use old-fashioned ways to stop 1-time signals.



Tape deck, strip chart, conventional scope and camera — the old ways die hard.

And yet there *is* a better way — with one of our waveform recorders.

These are perhaps the world's only instruments ideally suited to measuring non-repetitive (or repetitive) signals. They are ideal for electronic trouble-shooting, shock and vibration studies, explosives testing, kinetic energy and plasma physics analysis, sonar applications, and many more.

They let you capture the signal, digitize it at rates up to 100 MHz, store it in memory, then transmit it in digital form, or reproduce it as a repetitive analog signal.

You can observe the stored waveform on a scope, make permanent records on a strip chart recorder, or feed the digital data directly to your computer for analysis. You can even record the data preceding your trigger signal for cause-effect or "leading edge" studies.

This kind of fast data acquisition is priceless — especially in such convenient, easy-to-use form.

We have the broadest line of waveform recorders in the world. Choose the speed, resolution, memory length, and price to fit your application. For full information, write or call Biomation, 1070 East Meadow Circle, Palo Alto, California 94303. (415) 321-9710.



biomation
Always a trace ahead.

INFORMATION RETRIEVAL NUMBER 53

Modular controller programs temperature



Electronic Design Labs, Inc., 1618 Olney Ave., Philadelphia, Pa. 19141. (215) 224-3565.

The Auto-Digital Programmer provides temperature control over periods from 8 hrs to 42 hrs based on a maximum temperature level of 1950 F. It furnishes a precise ramp voltage (increasing or decreasing) from 0 to +10 V. Zero F corresponds to zero volts and 1950 F corresponds to +10 V. The operator can decide what the starting temperature should be. The programmer can drive up to five-independent, modular three-mode controllers.

CIRCLE NO. 320

Meter analyzes vibration in 10-Hz to 10-kHz band



Vibro-Meter Corp., 875 N. Virgil Ave., Los Angeles, Calif. 90029. (213) 666-2313.

Designed for on-the-spot analysis of industrial vibration problems, Model VM-3/C accepts input signals from piezoelectric or velocity pickups and offers readouts in acceleration, velocity or displacement. A tunable-narrow, bandpass filter allows scanning over a range of 10 Hz to 10 kHz with readout of frequency and amplitude.

CIRCLE NO. 321

Kit teaches servo and control principles



Electro-Craft Corp., 1600 Second Street S., Hopkins, Minn. 55343. (612) 935-8226.

This educational and experimental kit provides introduction to the theory and practice of dc motors, speed controls and servo systems. It includes a dc motor-generator, a transistor-control unit and other parts for the 20 experiments outlined in the accompanying 144-page text.

CIRCLE NO. 322

Pertec introduces the new T8000 Transport.

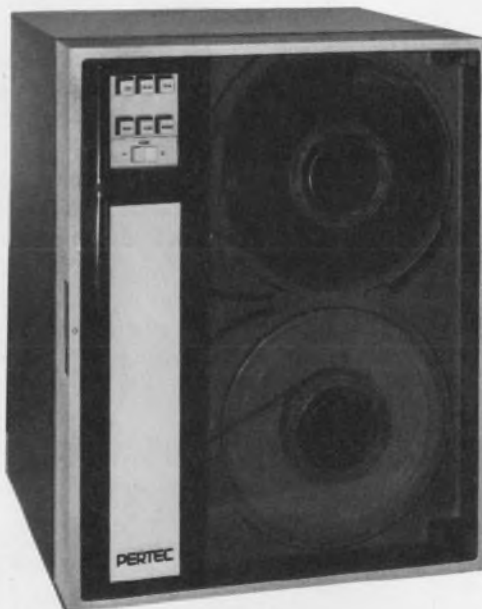

Position transmitter resists high temperature



Industrial
Linear Position Transmitter
Model 5175

Bourns, Inc., 6135 Magnolia Ave., Riverside, Calif. 92507. (714) 684-1700. 6 wks.

The Model 5175, a linear-potentiometric position transducer, is suited for industrial applications where high temperatures (30 to 500 F) and harsh environment are encountered. Constructed of stainless steel and Teflon-insulated lead-wires, it has a linearity of $\pm 0.5\%$ and is available with resistance-range options of 1, 2, 4 and 6 in., and 2000, 5000 and 10,000 Ω .

CIRCLE NO. 323

Magnetic pickup heads feature 5% cross feed



Magnusonic Devices, Inc., 124 Duffy Ave., Hicksville, N.Y. 11801. (516) 938-4700. 4 wks.

Dual-gap (read-after-write) and single-gap (read-write) digital-cassette and card-reader magnetic heads feature full-width to four-track formats in ECMA and ANSI configurations. They are designated models 226-1/2 and 129-1/2. The dual-gap heads demonstrate a cross feed of only 5% (write-to-read). Heads may be used for NRZI and phase-encoded recording with packing densities of 800 BPI (NRZI) and 3200 FRPI (phase encoded).

CIRCLE NO. 324

Differential pressure unit has one moving part



Unitran Corp., 2555 Honolulu Ave., Montrose, Calif. 91020. (213) 249-1955.

A potentiometric-pressure transducer for differential-pressure measurements, the Model P9, employs only one moving part, eliminating pivots, linkages, gears, etc. It has an isolation diaphragm for dirty, corrosive or conductive pressure media. Standard units have ranges from ± 1 to ± 2500 lb/in.² differential pressure, at 3000 lb/in.² max line pressure with 500 to 10,000 $\Omega \pm 10\%$ resistance.

CIRCLE NO. 325

Packed with customer inspired features. At the same low price.

Now you can have the easiest tape loading and the most rugged transport for your data entry, remote terminal, or minicomputer system. And it won't cost you any more.

Pertec introduces new 10½-inch reel tape transports with increased data reliability and convenient new features that you have been looking for. Like an all new quick-lock hub which automatically seats the tape reel. Retractable tension arms and contoured head cover for easier tape loading. A new tape cleaner. A fast 200 ips rewind speed. Rotatable card cage for ease of maintenance. And a rugged, attractive new design to enhance your own system.

And these IBM compatible transports also have all the standard Pertec reliable features such as single-adjustment electronic write deskewing, remote edit capability, dynamic braking, photo-sensing arm positioner, low power consumption and temperature stable head guide assembly.

Pertec T8000-Series transports are available in 7 or 9 track, NRZI or 1600 cpi phase encoded or the new NRZI/PE electronically switchable tape formats. They're completely compatible with the popular Pertec 6000-Series transports and our own exclusive data formatter. Tape speed is up to 45 ips and you can choose from a variety of models including read only.

Pertec's new T8000 transports are backed by a complete factory-trained customer service and support organization in 30 U.S. cities and 20 foreign countries. We also offer complete application assistance to help you in your special requirements.

For more information on the new Pertec T8000 transport and the company behind it, write or call today. Pertec Corporation, Peripheral Equipment division, 9600 Irondale Avenue, Chatsworth, California 91311. (213) 882-0030.

PERTEC
PERIPHERAL EQUIPMENT

LEAD SPREADERS

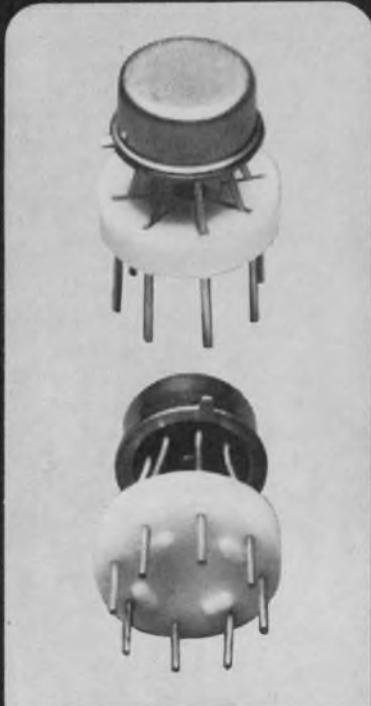

for INTEGRATED CIRCUITS

Thermalloy lead spreaders reduce your production cost and improve reliability. Wide lead-in grooves accurately align leads with circuit board holes for fast assembly. Spreading leads to a larger diameter prevents solder bridges and allows visual inspection of topside solder joints for improved reliability.

Thermalloy stocks 13 lead spreaders for 6, 8, 10 and 12 lead I.C.'s. The newly expanded line now includes 57 mounting pads and converters for TO-5, TO-18, I.C. and Epoxy cases.



FREE
Samples and
Catalog
on request

Thermalloy
Company
8717 DIPLOMACY ROW
DALLAS, TEXAS 75247
PHONE: 214-ME 7-3333

INFORMATION RETRIEVAL NUMBER 55

COMPONENTS

Pressure transducer includes amplifier



Standard Controls, Inc., 2401 S. Bayview, St., Seattle, Wash. 98144. (206) 723-1705. \$199 and up.

Series-212 strain-gauge pressure transducers, constructed of all stainless steel, offer pressure ranges from 0-5 to 0-10,000 lb./in.² with static-error accuracies of less than $\pm 0.35\%$. A thick-film integral amplifier provides a low impedance, 0-5 V dc output. The built-in power-supply regulator operates on raw 28 V dc.

CIRCLE NO. 326

Adjustable clutch/brake controls start/stop



Omni-Action Controls, Div. of Dynamic Instrument Corp., 115 E. Bethpage Rd., Plainview, N.Y. 11803. (516) 694-6000.

Dynamic's clutch-drag/brake allows the drag torque to be adjusted and set to the required value. The clutch can be run in either direction at speeds to 2000 rpm. In cassette drives it permits a soft start, to eliminate tape breaking or stretching, and a constant-drag torque for a soft-rapid stop.

CIRCLE NO. 327

Hexadecimal display has built-in logic



Texas Instruments Inc., P.O. Box 5012, M/S 308, Dallas, Tex. 75222. (214) 238-3741. \$12.50 (100 and up); 4 wks.

A hexadecimal display, the TIL-311, comes complete with logic in a single 14-pin DIP. With 0.270-in. high characters, it can form the numerals 0 through 9, the letters A through F and two decimal points. It contains a TTL-MSI integrated circuit with a four-bit latch, decoder, and driver. Average luminous intensity is 50 μ cd with a 5-V supply.

CIRCLE NO. 328

Heat switch operates 100 ft from source

Infrared Industries, Inc., P.O. Box 989, Santa Barbara, Calif. 93102. (805) 684-4181. \$295.

The Thermodot Model TD-100 heat switch is believed the only industrial long-range (to 100 ft) noncontact sensor offered in the U.S.A. Target temperatures are 400 to 3000 F. The unit is all solid-state, and self-contained in one box. It senses radiated heat from all materials with a response rate of 300 operations/min. Life is 100 million contact closures, minimum.

CIRCLE NO. 329

Stepping motors provide many stepping angles

Electric Indicator Co., Inc., 195 Danbury Rd., Wilton, Conn. 06897. (203) 762-8655.

Stepping motors, both permanent-magnet or variable-reluctance types, designated Series WK, are used in applications which require an accurate pattern of fixed, repeatable rotor positions. The permanent-magnet units will magnetically lock at the last command position when de-energized. The variable-reluctance stepping motor provides discrete angular steps when the stator windings are excited, but rotates freely when excitation is removed.

CIRCLE NO. 330

Repeat-cycle timer has two circuits per package

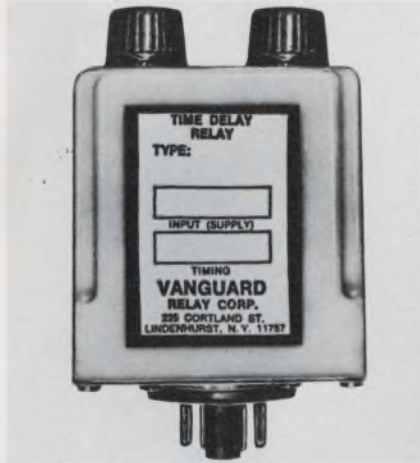

Vanguard Relay Corp., 225 Cortland St., Lindenhurst, N.Y. 11757. (516) TU4-5000. \$25.50 (unit qty.).

Combining the timing functions of two separate fixed or adjustable timers into one compact plug-in unit, this repeat cycle timer uses solid state circuitry to control 10 A (switching) SPDT output relays. Transistorized circuitry consists of two RC timing networks triggering unijunction transistors. Other features include: diode polarity protection on dc, input-output isolation, operation on all ac and dc voltages from 24 V.

CIRCLE NO. 331

Toggle switch mounts on PC board



C&K Components, Inc., 103 Morse St., Watertown, Mass. 02172. (617) 926-0800.

This right-angle mounting, SPDT subminiature toggle switch measures $0.5 \times 0.28 \times 1.04$ in. Designed for PC mounting, it features a terminal support of half-hard brass, Electro-tin plated. The contacts and terminals are normally gold-plated brass. Available in two models, one has a minimum life of 100,000 make-and-break cycles, the other only 40,000 cycles.

CIRCLE NO. 332



Best Hand in the Game!

We play to win the game of $4\frac{1}{2}$ digit DPM's with the Model 4000. A full four digit panel meter with 100% over-range and a complement of other features and capabilities.

Our deck is stacked with provisions for remote control of conversion cycle and reading rate, plus complete isolation of analog and digital grounds.

The spots on our LED's are big, bright and reliable.

Circuit design, component selection and mechanical packaging have all been carefully dealt to provide the highest level of quality.

You can buy in our game for the moderate price of \$400 complete . . . no ad-on options required.

We're holding a full house in the field of Digital Measure, Compare, Control Components.

For full details write direct or contact your ERC representative. Offices are located in or near most major cities.

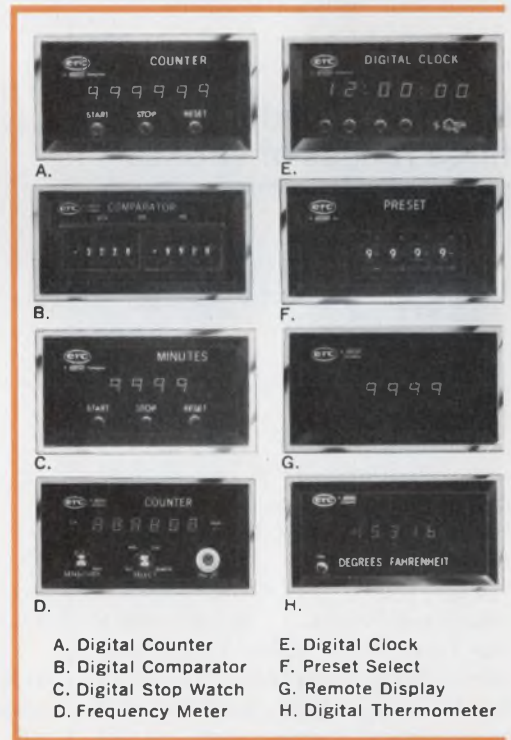

- A. Digital Counter
- B. Digital Comparator
- C. Digital Stop Watch
- D. Frequency Meter
- E. Digital Clock
- F. Preset Select
- G. Remote Display
- H. Digital Thermometer

a textron company



electronic research co.
Box 913 • Shawnee Mission, Kansas 66202 • Phone 913, 631-6700

Slide potentiometer saves PC board space

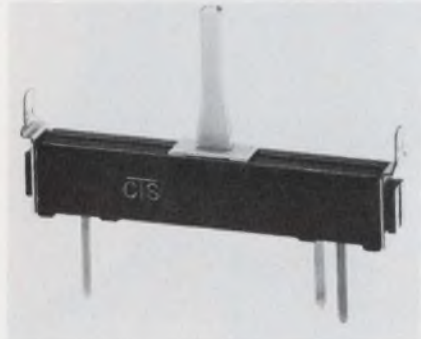

CTS of Brownsville, Inc., 1100 Roosevelt St., Brownsville, Tex. 78520. (512) 546-5184.

The Series 470 linear-motion, composition-slide control is said to give the performance of a full-size rotary control in a compact molded housing (profile of 5/16 × 5/8 in.). Thus it permits close mounting on PC boards. With a power capability of 1/2 W and a travel of 1-3/4 in., it includes other features such as: resistance values from 200 Ω to 5 MΩ; wirewrap, PC, or solder lug terminals; top or bottom twist tab mounting, and a choice of resistance tapers.

CIRCLE NO. 333

Position transducer has three ranges of strokes



Columbia Research Laboratories, Inc., MacDade Blvd. & Bullens Lane, Woodlyn, Pa. 19094. (215) 532-9464. Industrial types: \$45 up (1000 up); 4 wks.

The family of LVDT linear, variable-differential transformers has three basic sizes. The miniature sensors are 0.375 in. OD, with lengths starting at 0.500 in. and measurement ranges from ±0.005 to ±0.150 in. The standard units are 0.875 in. OD, with lengths starting at 1.125 in. and ranges from ±0.040 to ±1.000 in. The high stroke LVDTs are 0.625 in. OD with lengths starting at 4.5 in.

CIRCLE NO. 334

Minifilters provide 90-dB noise rejection

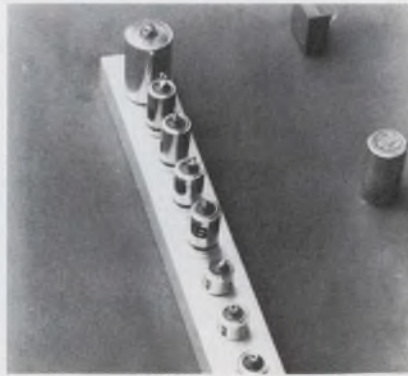

Genisco Technology Corp., 18435 Susana Rd., Compton, Calif. 90221. (213) 451-8491.

Providing up to 90 dB of noise rejection to over 1 GHz for both conducted and radiated EMI/RFI, a series of small filters are available in four basic circuits. The "L" type are the least expensive. The "Pi" capacitive-input filters and the "T" inductive-input filters provide a higher level of rejection, and the "2L" filters have the sharpest cutoff and rejection. With ratings of 200 V dc or 115 V ac, they operate at line frequencies to 400 Hz with current from 0.1 to 10 A.

CIRCLE NO. 335

Trimmer capacitor cuts size and boosts capacity



Voltronics Corp., West St., Hanover, N.J. 07936. (201) 887-1517. \$3.50 (1000 up); 3-4 weeks.

These capacitors are offered either side or top tuned in eight standard maximum values from 5.5 pF to 40 pF with considerable size saving. For instance, a 20 pF trimmer 0.44 in. long is 40% shorter than a sealed 16 pF (MIL-C-14409C) unit 0.734 in. long. Yet it has 25% more capacitance. The dielectric is glass.

CIRCLE NO. 336

Rotary switch on single wafer has many options

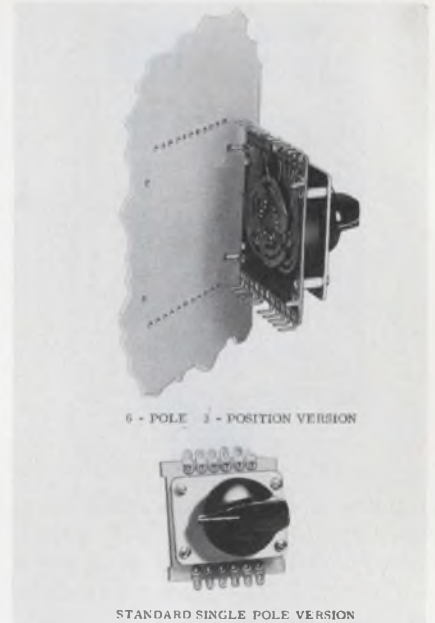

Chicago Dynamic Industries, Inc., 1725 Diversey Blvd., Chicago, Ill. 60614. (312) 935-4600. Single pole, \$3.00 (100 and up); 3 wks.

The Series-SP rotary switch, it is claimed, has a design that offers more options on a single wafer than previously available. It has a capability of up to six poles, three positions, on one wafer. Back-of-panel space is less than 1 in., with other dimensions from 1-3/4 × 2 to 2-1/4 × 3 in. The basic switch is single pole, with 8, 10, 12 or 16 positions, silver contacts, standard bushing for panel mounting, and solder lug terminals.

CIRCLE NO. 337

Powerful permanent magnets uses samarium

Varian Assoc., 611 Hansen Way, Palo Alto, Calif. 94303. (415) 493-4000.

Powerful magnets, up to 50 times stronger than common iron magnets, are being produced from an alloy of samarium (a rare-earth element) and cobalt. They resist demagnetization and withstand extremely high temperatures. Applications include: microwave tubes for satellite communications, electronic wristwatches, tiny but powerful electric motors and for scientific research into high-speed transport systems in which passenger vehicles are suspended in air by magnetic "levitation."

CIRCLE NO. 338

"LISTEN, WE JUST CAN'T AFFORD TWO NEW PROCESSORS!"

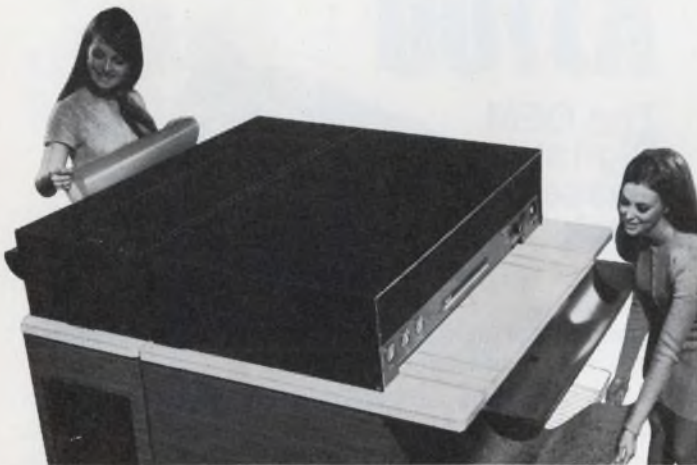

**You only need one.
The KODAK
SUPERMATIC-STAR
Processor.**

It's almost a complete processing department in only 25 square feet of floor space. Lets you process Kodagraph wash-off films . . . plus conventional Kodagraph films and Super-K papers, all in two minutes or less.

For the full story on this two-in-one processor, send in the coupon. We'll process your inquiry fast.

Please send me full details on the Kodak Supermatic-Star processor.

Name _____

Position _____

Company _____

Address _____

City _____ State _____ Zip _____

Eastman Kodak Company
Business Systems Markets Division
Dept. DP853, Rochester, N. Y. 14650



ENGINEERING DATA SYSTEMS

Copper clad laminates yield high uniformity

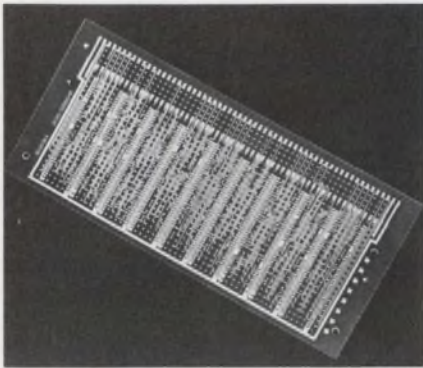

Fortin Laminating Corp., 1323 Truman St., San Fernando, Calif. 91340. (213) 365-9651.

A line of thin foil 1/2-ounce copper clad laminates designed to give more uniform PC boards eliminate the normal waste in the etching of 1, 2 or 3 ounce copper foil laminates. The laminates are processed similar to regular boards, but with a minimum of waste because of their extreme foil thinness.

CIRCLE NO. 339

Track-type, 3-pole block cuts assembly time 1/3

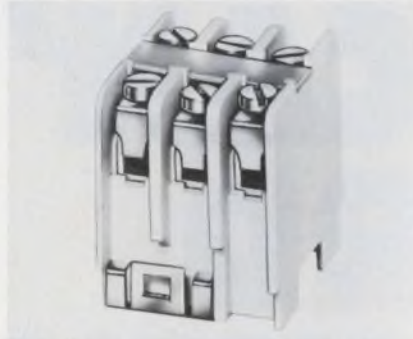

Curtis Development and Manufacturing Co., Inc., 3266 N. 33rd St., Milwaukee, Wis. 53216. (414) 445-1817. \$0.51 (1000 quantities); 2 wks.

A 3-pole, 3PSW series unit has expanded the Curtis line of track-type terminal blocks, which formerly included only double pole units. Ratings of the new unit are 25 A at 600 V in a unit handling up to #10 AWG wire, and 50 A at 600 V in units handling up to #8 AWG wire.

CIRCLE NO. 340

IC sockets increase packaging density

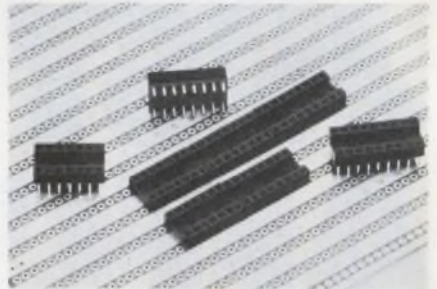

Stanford Applied Engineering Inc., 2165 S. Grand Ave., Santa Ana, Calif. 92705. (714) 540-9256. 14-pin: \$0.41; stock.

A line of 14, 16, and 18-pin dual-in-line sockets reduce the over-all height of socket mounted components by nearly 50%. Only 150 mils, the 3100 series sockets may be end-to-end mounted on 100-mil centers and side-by-side mounted on 400-mil centers to give high packaging density. The sockets have a special SAE designed spring that accepts round, square or rectangular leads as large as 25 mils.

CIRCLE NO. 341

ROCKER SWITCH

New brilliance in a miniature rocker featuring front panel lamp replacement. Entire switch simply snaps into .655" x .728" hole. Choice of 3 doublepole switching actions; 4 lens colors & 4 voltages. Replaceable lamp. Rated 6A @ 125 VAC.

ILLUMINATED



MSLN-206 DPDT

SNAP IN AND OUT!

ALCOSWITCH® MINIATURE SIZE
DIV. OF ALCO ELECTRONIC PRODUCTS, INC., LAWRENCE, MASS.

INFORMATION RETRIEVAL NUMBER 58

ROCKER & PADDLE MINIATURES

New series of economy "snap-in" switches have high 6 amps rating. Features ease of installation in .49 x .59" hole. Choice of SPDT & DPDT in 4 colors, adds distinction to front panel. Molded "silver" terminals & contacts.



SPDT ROCKER

SPDT PADDLE

ALCOSWITCH®
DIV. OF ALCO ELECTRONIC PRODUCTS, INC., LAWRENCE, MASS.

INFORMATION RETRIEVAL NUMBER 59

AJ700

The OEM Digital Cassette Deck



...because it makes *no* compromise in performance or quality at low cost.

The secret is an exceedingly straight-forward design for the ultimate in reliability and long life, with minimum maintenance. The result is a cassette deck that is small, lightweight, and quiet. Two reel motors with two capstans give bi-directional recording, and electronic clutching and braking reduces wear. Our unique tape guiding system helps eliminate problems of cassette variables. All serviceable elements are accessible for quick, easy maintenance... in the field. And the AJ700 operates in ANY position.

There's more to the AJ700. Write or call us:

We promise what we say, and we service what we sell!

Anderson Jacobson

1065 Morse Ave. ■ Sunnyvale, California 94086 ■ (408) 734-4030
Sales offices in principal cities throughout the U.S.A.

INFORMATION RETRIEVAL NUMBER 60

Apply heat-shrinkable tubing automatically

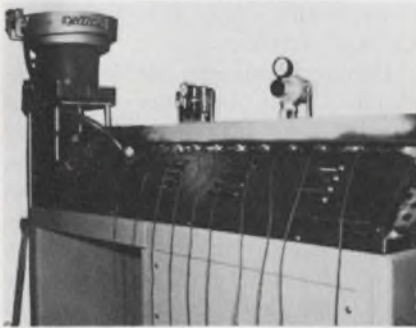

Varied Industrial Products, 445 Fifth Ave., Paterson, N.J. 07514. (201) 279-2334. \$4200; 8 wks.

By automatically applying heat shrinkable tubing onto solderless terminals, the RTS-Mark I increases production rates to 1500 assemblies per hour. This compares to 300 to 400 per hour by manual operation. The machine accommodates all wire sizes from 22 to 8 AWG and a wide variety of solderless terminal sizes. Only 115-V single-phase power and 80 psi air pressure are required.

CIRCLE NO. 342

Overcoat protects magnetic discs

Integrated Memories, Inc., 260 Fordham Rd., Wilmington, Mass. 01887. (617) 658-5073.

Lubriccoat, a protective overcoat for magnetic recording media, can be applied to either plated or oxide-coated discs. The excellent abrasion resistance of Lubriccoat significantly improves the head-to-disc interface without any permutation of the performance characteristics of either the disc or the head. Lubriccoat will prove to be very effective in applications where the recording heads are loaded so that the heads come in direct contact with the recording media. Experiments have shown that a stop/start operation can be carried out even at constant head-loading weights of 1800 grams without causing any deleterious effect to the heads or recording media. Another factor causing some head crashes is the head-load angle due to mechanical failures, or human elements involved. With Lubriccoat, a head-load angle of up to 20° is permissible.

CIRCLE NO. 343

What is a buffered tape transport?



We'll answer that question.

Kennedy Model 1708 series tape transports offer a solution to many recording problems where data rates are too high for incremental recorders but where the interface simplicity of the incremental is desirable.

Model 1708 accepts data asynchronously at high rates until an input buffer is full — then records the data at 15 ips.

Meanwhile data is being stored in a second buffer. At data rates below 5500 characters/second gap time is zero; data flow is uninterrupted. Alternatively data bursts at rates up to 250 Khz can be accepted.

Tapes produced are fully formatted 9-track, 800 cpi. Read-After-Write check and asynchronous read options may be incorporated. Both 8½ and 10½ inch reel versions are available.

We haven't made incrementals obsolete — we have extended their speed and flexibility to new levels.

For complete information on Model 1708 and buffered tape transports, contact Kennedy Co. today.

KENNEDY CO.

540 W. WOODBURY RD., ALTADENA, CALIF. 91001 • (213) 798-0953

KENNEDY
QUALITY
COUNT ON IT

INFORMATION RETRIEVAL NUMBER 61

COMPLETE
PRESS-FIT SERIES

TRIACs & SCR's

- SCR's 8A to 35A [$I_{T(RMS)}$]
50V to 600V (V_{DROM})
- TRIAC's 6A to 40A [$I_{T(RMS)}$]
50V to 600V (V_{DROM})
- Electrically isolated & non-isolated types.
- 1/2" and 3/4" sizes
- Press-fit, Stud Mount & TO-3 Out-line Mounting Flange
- Shorted-emitter, center-gate design for lower switching losses and improved critical & commutating dv/dt ratings & di/dt characteristics.
- Patented Di-Mesa construction with void-free glass-passivated chips for maximum operational reliability.
- Other triacs and SCR's in all popular package configurations and in chip form.



Write for new
Hutson catalog



*T.M. HUTSON INDUSTRIES

HUTSON INDUSTRIES

BOX 34235 • 2019 W. VALLEY VIEW
DALLAS, TEXAS 75234 (214) 241-3511
TWX 910-860-5537

Distributed by:

BODELLE CO., INC., Chicago, Ill. 312/468-1016
Detroit, Mi. 313/273-6920 ■ NEWARK ELECTRONICS
CORP., Inglewood, Cal. 213/678-0441
THOR ELECTRONICS, Elizabeth, N.J. 201/354-2420
Canada: WEBER-SEMAD ELECTRONICS, Downsview, Ont.

European Marketing Director:

30 Rue Pierre Semard, Yerres, 91 France
Tel Paris 925 8258 TELEX 21-311

Distributed in Europe by:

Switzerland: D. LEITGEB, Dubendorf
Sweden: ELEKTROFLEX, Sundbyberg
Spain: BELPORT, Madrid
Holland: RODELCO, Den Haag

INFORMATION RETRIEVAL NUMBER 62

PACKAGING & MATERIALS

Relay socket saves mounting space

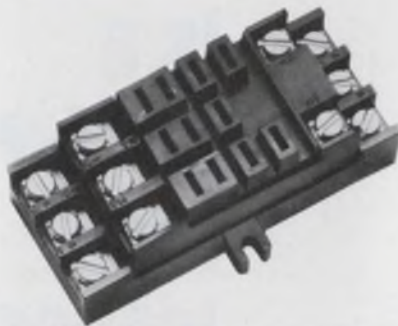

Custom Connector Corp., 1738 E.
30th St., Cleveland, Ohio 44114.
(216) 241-1679.

The QC series square base relay socket is for use with 187-mil quick-connect terminals. Dimensions over-all are: 3.156 in. long by 1.640 in. wide by 1.202 in. deep. It has an insulated base for mounting directly on the panel or channel to save installation time and materials.

CIRCLE NO. 344

Pressure-sensitive tape drains static electricity



Zippertubing Co., 13000 S. Broad-
way, Los Angeles, Calif. 90061.
(213) 321-3901.

Conducto-Tape, a new pressure-sensitive tape, prevents the build-up of static electricity. All types of electrical cables, components, and assemblies may benefit from its application as a wrapping or sealing material. It can provide protection in volatile environments as in aircraft, mines, ships, submarines, around explosives and in high-oxygen areas.

CIRCLE NO. 345

Optic coatings resist damage

Perkin-Elmer Corp., Industrial
Products Div., Main Ave., Norwalk,
Conn. 06856. (203) 762-6972. \$115/
surface; stock.

Damage resistant coatings with-stand power densities of up to 500 mW/cm² in a 55 ns pulse. The durability of the new coatings, which conform to all requirements of MIL-C675A, allows them to be cleaned easily with alcohol, acetone, or a mild detergent solution. The hard high field damage resistant coatings can be supplied at any specific reflection value up to 99%. The reflection is less than 0.25% at 6943 Å or 1.06 μ.

CIRCLE NO. 346

Epoxy is designed for screening circuitry

Ablestik Laboratories, 833 W.
182nd St., Gardena, Calif. 90248.
(213) 321-6252.

A silver-filled, electrically con-ductive epoxy is ideally suited for screening circuitry on LED pack-ages. Designated Ablebond 466-2, it is specifically designed to mini-mize outgassing and provides low volume resistivity (0.00050 to 0.00075 ohm-cm) up to tempera-tures as high as 600 F. The epoxy cures in 5 minutes at 300 F or 30 minutes at 250 F and has a work life of 8 hours at 77 F.

CIRCLE NO. 347

Thick film screens come in mesh sizes 80 to 400

Sel-Rex Co., 75 River Rd., Nutley,
N.J. 07110. (201) 667-5200.

A line of thick-film screens for the production of hybrid microcir-cuits are precision-matched to the frame for accurate and repeatable production of printed circuits. The screens are available in three types: uncoated, emulsion and electro-formed (Letro-Screen), and all are pretensioned to stabilize the wire and minimize loss of tension in the printer. Stainless steel mesh have openings from 7 mils to 1.5 mils. Patterns can be placed on the screen with accuracies of ±0.001 inch.

CIRCLE NO. 348

Thick film substrates are free-abrasive ground

Accumet Engineering Corp., 25 Broad St., Hudson, Mass. 01749. (617) 568-8311.

Accu-Ground thick film 96% Al_2O_3 substrates eliminate imperfections such as excess material, scratches, indentations and bumps. Free-abrasive grinding also gives reduced camber, narrow thickness variations and uniformity of surface finish.

CIRCLE NO. 349

Epoxy panel boards boast 125-mil thickness

Garry Manufacturing Co., Electronic Div., P.O. Box 94, North Brunswick, N.J. 08902. (201) 545-2424.

Dual in-line assemblies are available in 14 and 16-pin configurations on 100-grid centers with square contact termination for two or three levels of solderless wrap. The glass epoxy boards are able to plug into any standard 54-mil to 71-mil PC card-edge connector or plane-mounting. A variety of panel sizes is available to fill almost all IC packaging needs.

CIRCLE NO. 350

Thick film compositions offer production ease

E. I. Du Pont de Nemours & Co., Inc., 11444 Nemours Bldg., Wilmington, Del. 19898. (302) 774-2358.

Three thick film conductor compositions offer exceptional fired film properties and outstanding production rheology. Gold composition DP-8760 has superior die bonding capabilities for either chip, wire, or beam-lead bonding. The composition easily resolves 5-mil lines on 10-mil centers through a 325-mesh stainless steel screen. Pt/Au composition DP-8895 also exhibits excellent resistance to solder leaching and may be resoldered many times without excessive leaching. Pd/Ag DP-9061 offers outstanding initial adhesion and a superior degree of aged adhesion not found in previous Pd/Ag compositions.

CIRCLE NO. 351



How would you get a measurable signal from only 6,000 electrons per second?

Most people do it Victoreen's way

With just 6,000 electrons, our 10^{12} RX-1 will give you a good clean one millivolt signal . . .

We've been making hi-meg resistors for over 30 years, making it possible for engineers like you to make big things out of little things. And with Victoreen RX-1 resistors, hi resistance is just one of the nice things you get . . . how about accuracy to $\pm 1\%$, good stability, and ranges from 10^7 to 10^{14} ohms . . .

Victoreen . . . where else can you get so many accurate ohms for your money?

DMA 722



VICTOREEN
INSTRUMENT DIVISION
10101 Woodland Avenue
Cleveland, Ohio 44104

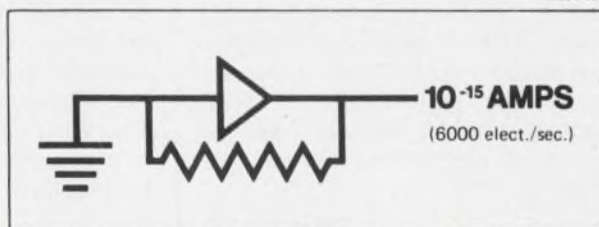

INFORMATION RETRIEVAL NUMBER 63

3-digit DVM can't break



Dana Laboratories, Inc., 2401 Campus Dr., Irvine, Calif. 92664. (714) 833-1234. \$350; 30 days.

The Model 3300 3-digit DVM has a ruggedized case made of Lexan and is virtually unbreakable. Because the 3300 operates at a low temperature, the case needs no ventilation louvers, permitting use where dust, dirt, and water often present problems. The 3300 operates on ac or on battery for eight continuous hours. Insignificant zeros are eliminated preventing erroneous readings. Special cam rotary switches prohibit selection of improper combinations of ranges and functions. Overload protection is 250 V for ohms measurements and 1000 V when measuring ac or dc. The 3300 has five dc, four ac, and five ohms ranges, 120-dB CMR, and 100% overranging. It weighs 5-1/2 lbs.

CIRCLE NO. 352

Epoxy die bonder uses no heat

Nordex Inc., 50 Newtown Rd., Danbury, Conn. 06810. (203) 743-7673.

The RES 4100 epoxy die bonder combines epoxy die-mounting technology with production speeds and reliability. Among the 4100's features is epoxy dispensing without hypodermic needles yet compatible with existing methods. Other features include solid-state, modularized circuitry, modular mechanics; ultra precise time and pressure control; positive cycle interlocking; unique LED display; dual, built-in microscope lights; and precision micrometer adjustments on both heads and table. Services required are 50 psi air, 20" Hg vac. and 115 V ac.

CIRCLE NO. 353

Solderability tester performs four tests



Electrovert, Inc., 86 Hartford Ave., Mt. Vernon, N.Y. 10553 (914) MO 4-6090.

The Electrovert universal solderability tester performs the four most widely used solderability test procedures for pw boards, leads and terminals. These include: the solder globule test which gives a numerical description for the solderability of wires and leads, the edge dip test, dip test and meniscus test. Each is performed in accordance with accepted standards and specifications. Operation of all test procedures is highly automated to eliminate operator error and assure continuous, repeatable, precision operation.

CIRCLE NO. 354

Cassette tester measures winding torque



Information Terminals Corp., 1160 Terra Bella Ave., Mountain View, Calif. 94040. (415) 964-3600.

The M-400 cassette tester allows tape cassette manufacturers, duplicators and users to follow ANSI specs in checking cassettes and in servicing cassette drives. The unit measures the winding torque and determines force exerted on heads by individual pressure pads. Winding torque is indicated by a meter. An eight gram-centimeter holdback torque may be switched in and out. The winding torque, when a head is penetrating a cassette, may also be measured.

CIRCLE NO. 355

Roughness tester offers digital display



Measurement Systems Div., Gould, Inc., 4601 Arden Drive, El Monte, Calif. 91731. (213) 442-7755.

The DR-20 digital readout system is available as an option on the new Surf-Indicator AD-22 and is designed for production line operation. An operator can detect average surface-roughness variations from 0-2000 microinches in a matter of seconds. Automatic scaling eliminates operator error. The display meter has large (0.5-inch) numbers that can be read directly as English or metric units for either AA or rms applications. The new DR-20 System meets or exceeds ANSI B46.1-1962 and Military Standard MIL-STD-10A for stylus type instruments.

CIRCLE NO. 356

Wire identifier displays in any format



Educational Computer Corp., P.O. Box 32, Radnor, Pa. 19087. (215) 687-2600. \$2560, numeric readout; \$3060, alphanumeric. 60 days.

The ID-256 displays any user-devised coding system to identify specific terminals or connector pins to which wires are to be mated. As many as 256 wires in a cable harness may be uniquely identified by a four-character, alphanumeric format completely devised and specified by the user. With field-programmable, plug-in memory boards, the user can interchange identification display codes for a particular wiring or cabling application. Size is 6 x 6 x 7 inches and weight is less than 7 lbs.

CIRCLE NO. 357

And it doesn't look like a circuit breaker.

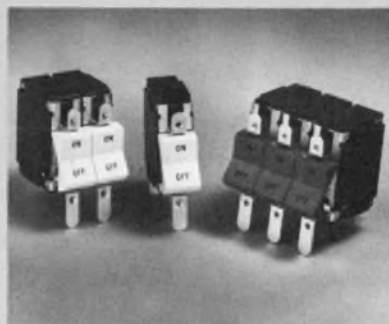

Therein lies its beauty.

When you use the JC rocker-handle circuit breaker as a front-panel on-off switch you get overload protection, too. Without the expense of using a switch and a breaker.

Behind that handsome rocker handle is the engineering and construction you know Heinemann for. Hydraulic-magnetic protec-

tion. Which means precise ratings from 0.020 to 30 amp. 32, 50, and 65V DC; 125 and 250V at 60 Hz and 400 Hz. Job-matched time delays or non-time-delay response. Temperature-stable trip points. Optional special-function internal circuits. One, two, or three-pole

models. And a five-year warranty.

Oh, yes. The rocker handle comes in white or gray.

A pretty attractive package. All around.

Write us for Bulletin 3381. Heinemann Electric Company, 2616 Brunswick Pike, Trenton, N.J. 08602. Or Heinemann Electric (Europe) GmbH, 4 Düsseldorf, Jägerhofstrasse 29, Germany.



HEINEMANN

4933

**Low-level limiters
for 1/2 to 12 GHz**

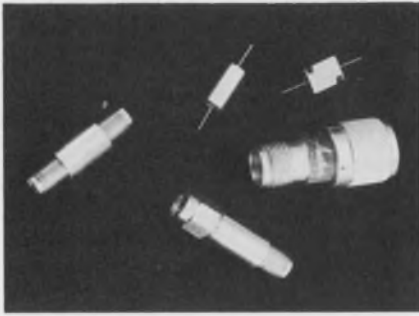

Aerotech Industries, 825 Stewart Dr., Sunnyvale, Calif. 94086. (408) 732-0880.

A line of low-level limiting diode junctions, integrated into a miniature 50-Ω coaxial transmission line structure, operate over the frequency range 400 MHz to 12.4 GHz. Termed the A9L200 series, the limiters also operate in octave bands to 18 GHz. These devices are available as leaded modules for coax or stripline use or with either SMA or TNC connectors.

CIRCLE NO. 358

**Waveguide switch has
2/3 height reduction**



Transco Products, Inc., 4241 Glencoe Ave., Venice, Calif. 90291. (213) 821-7911.

The P/N 33C90600 waveguide switch in WR-650 has a waveguide height of 1 inch instead of the standard 3-1/4 inches. The switch also features the Transactor actuator with direct drive and no mechanical linkage between actuator and rf rotor. According to the company, features like these make the switch inherently more reliable than conventional actuators.

CIRCLE NO. 359

**90° octave-band hybrids
in 20-to-80 MHz range**

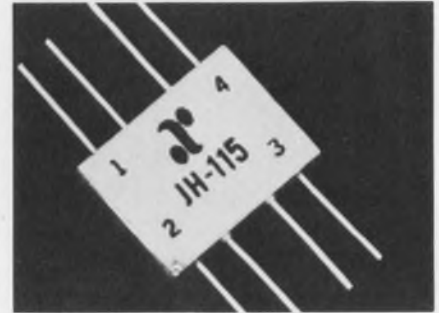

Anzac Electronics, Div. of Adams-Russell Co., Inc., 39 Green St., Waltham, Mass. 02154. (617) 899-1900.

Two quadrature hybrid devices—the JH-114 for the 20-to-40 MHz range, and the JH-115 for the 40-to-80 MHz range—are four-port 90° hybrid devices. They can supply isolated outputs of an input signal, with an isolation of 20 dB min and 25 dB typical. Third order intermodulation ratio is -85 dB (typical) with two 20 dBm signals. Both units provide 3° phase tracking.

CIRCLE NO. 360

tach
on to
this
one



Servo-Tek DC TACHOMETER GENERATORS are great for precision speed sensing and velocity feedback. Convert speed to an analog voltage signal with low driving torque; just right for rate damping in all types of servos.

- High Linear Speed/Voltage Relationship
- Highly Stable
- Minimum Ripple
- Low Driving Torque
- Outputs from 2.6 to 45v dc/1000 rpm

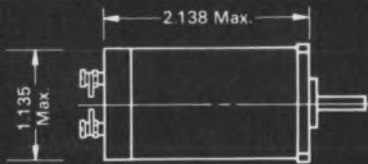

Ask for a copy of our NEW catalog.

SERVO-TEK
PRODUCTS COMPANY

1086 Goffle Road, Hawthorne, N. J. 07506 • 201 — 427-3100
Servo-Tek of California, Inc.
8155 Van Nuys Blvd., Van Nuys, California 91402 • 213 — 786-0690

INFORMATION RETRIEVAL NUMBER 66

"IT'S GOOD BUSINESS
TO HIRE THE HANDICAPPED."

ISN'T THAT A GREAT IDEA, SNOOPY?



THE PRESIDENT'S COMMITTEE ON EMPLOYMENT
OF THE HANDICAPPED, WASHINGTON, D. C.

'BAREFOOT' VACATIONS

to exotic islands

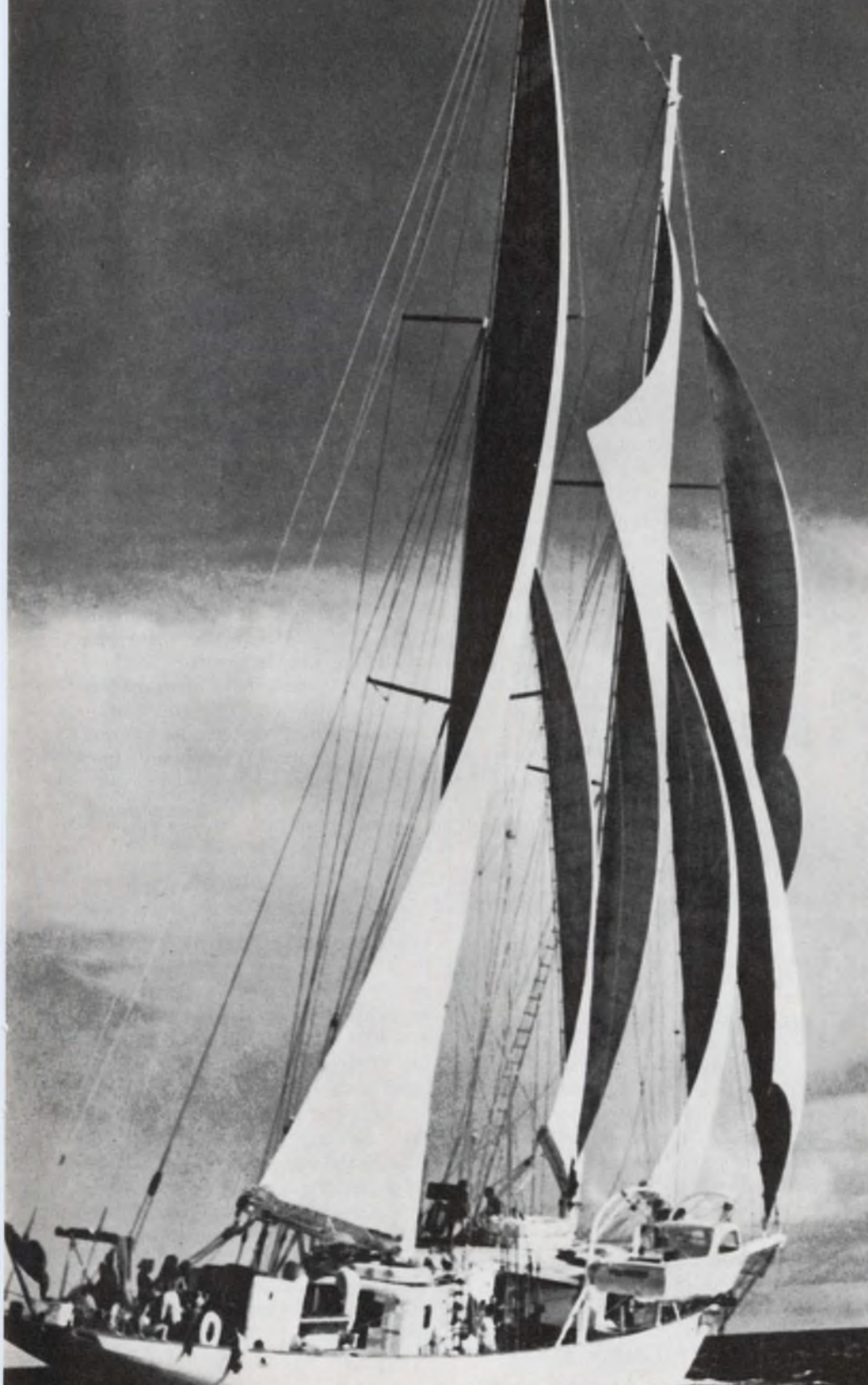

WINDJAMMER CRUISES



**explore Bahamas,
West Indies,
Virgin Isles, Mexico.**

**Comfortable
cabins... good
"Grub 'n Grog".**

**10 adventurous
days from \$200**

- Great for employee incentive programs
- Ideal for executive meetings and parties
- Wonderful for customer prizes



**WRITE CAP'N MIKE
FOR FULL INFORMATION
AND ADVENTURE BROCHURE**

**P.O. BOX 120, DEPT.
MIAMI BEACH, FLORIDA 33139**

application notes

Real time clock

An application note discusses the advantages in using a real time programmable clock calendar for reading time and date into a computer memory under program control. A brief discussion is included covering several possible jobs that could be performed by the clock/calendar, such as, job identification, accounting, control, machine language identification, time limiting, timing of iterative loops, automatic preparation of log, and others. A comparison is made with the use of a register in the computer memory as an interval timer, or core-clock. The several serious disadvantages of core-clocks for real time purposes are discussed. Chrono-Log Corp., Broomall, Pa.

CIRCLE NO. 361

Induction motor speed

How certain types of loads make practical some degree of speed variation in induction motors is detailed in the latest Motorgram (Vol. 52, No. 2). A "Chief Engineer's Handbook" article concentrates on induction motors having conventional squirrel cage nonsynchronous rotor, and the hysteresis synchronous rotor. Basic methods of varying induction motor speeds are described—by changing frequency of power source, the number of motor stator poles or the amount of rotor slip—and the advantages and disadvantages of each presented. Bodine Electric Co., Chicago, Ill.

CIRCLE NO. 362

Electromagnetic shielding

An eight-page catalog outlines repeatable and nondestructive electromagnetic shielding test procedures; shielding calculations; shield design considerations; a sheet and foil stocking guide; and photomultiplier tube shield availabilities. Eagle Magnetic Co., Inc., Indianapolis, Ind.

CIRCLE NO. 363

Op amp noise

A six-page application note simplifies the computation of total equivalent input noise for operational amplifiers. Several examples of the use of the formula are given by its application to the SSS725, the industry's lowest noise, lowest drift operational amplifier. Also presented is a discussion of the effects of power supply noise and type of frequency compensation used. Precision Monolithics Inc., Santa Clara, Calif.

CIRCLE NO. 364

Transformer control

Tech Tips 2-2 tells how to identify and avoid problems caused by poorly designed or damaged thyristor firing-circuit packages used for phase control of transformer primaries. Seven illustrated pages explain the basic circuitry and tell how to isolate causes of such common problems as: erratic blown fuses without load shorts, equipment shutdown by overcurrent logic, current surges in the power bus, strange sounds from the transformer laminations. Westinghouse Electric Corp., Semiconductor Div., Youngwood, Pa.

CIRCLE NO. 365

Magnetic shielding

Application notes covering a wide range of magnetic shielding problems offer design engineers a comprehensive file of case histories concerning magnetic shielding problems. Perfection Mica Co., Bensenville, Ill.

CIRCLE NO. 366

Transfer oscillators

A 20-page application note describes AM, FM measurements with the transfer oscillator. Transfer oscillators, in combination with electronic counters, are widely recognized as the least costly means of measuring great frequency ranges, 50 MHz to 18 GHz or more, for example. They are equally well accepted as the preferred or only way to measure pulsed rf or heavily modulated signals. Hewlett-Packard Co., Palo Alto, Calif.

CIRCLE NO. 367

A/d conversion

A 20-page article explains the cost/performance trade-offs of analog-to-digital conversion subsystems. The subjects covered are: typical per channel costs and specifications for low level differential, solid state, multiplexers, low level systems featuring an amplifier per channel; low level relay multiplexers; high level, differential and single ended, solid state multiplexers; and the related costs of slow speed conversion systems vs state of the art very high speed systems. Tustin Electronics Co., Santa Ana, Calif.

CIRCLE NO. 368

Serial impact printers

A nine-page technical article outlines the principles of serial impact printers. The article explains how the letters, numerals and symbols of a "print-on-the-fly" machine are "wrapped" around the surface of a print wheel that is motor-driven at high speed, and electronically synchronized with a print hammer that drives the paper against selected characters as the print wheel spins into position. The note also explains the principles of the dot matrix printing method, then compares the "print-on-the-fly" approach with this alternative, and somewhat faster, dot matrix method. Printer Technology Inc., Woburn, Mass.

CIRCLE NO. 369

Triac power controls

A basic approach to the design of triac power controls for use in the switching of three-phase power is described in a six-page application note. Application Note AN-6054, "Triac Power Controls for Three-Phase Systems," lists basic design rules, describes an integrated-circuit zero-voltage switch used for triac triggering and explains methods for isolation of the dc logic circuitry in power controls for three-phase systems. Specific design requirements for triac power controls intended for use with both resistive and inductive balanced three-phase loads are also discussed. RCA Solid State Div., Somerville, N.J.

CIRCLE NO. 370



pdp11/05

PANEL LOCK

POWER

OFF

The smallest PDP-11 just got bigger.

Bigger in performance. Not in price. Or size. It's a power package that's designed to shake up the competition.

We've given the 11/05 a real time clock.

We've replaced the standard 1.2 usec memory with one that's 0.9 usec fast.

And added our PDP-11 multi-level automatic priority interrupt.

So now you can spend less time writing programs and more time out selling

your systems.

Now the 11/05 will do your job, any job, better, more efficiently than ever before.

You can even use it for disc-based systems.

But the 11/05 still goes for the same, easy-to-take \$4,795 per. Including 4K core.

Or \$3,070 in quantities of 100.

For which you still get the same UNIBUS™ architecture, direct memory access, hardware stacking, vectored interrupts, automatic power fail protection and all the other

features that have made the PDP-11 the best-selling 16-bit computer on the market.

We've already sold a lot of 11/05's.

And we're going to sell a lot more.

Because now the 11/05 is an even bigger bargain.

Digital Equipment Corporation, Maynard, Mass. 01754. (617) 897-5111. European headquarters: 81, route de l'Aire, 1211 Geneva 26. Tel.: 42 79 50.

digital

new literature



Digital panel meters

The Digitizers, an eight-page short form catalog, describes a complete line of high performance DPMS and data conversion systems and modules. The catalog lists over 100 instruments and devices, providing typical system configurations, product descriptions, specifications and prices. Analogic, Wakefield, Mass.

CIRCLE NO. 371

Thick-film hybrids

Features and benefits offered by thick-film hybrid circuits in economically solving circuit design and packaging problems are described in an eight-page illustrated brochure. Costs, performance ranges and times for product development, prototype delivery and alteration turn-around are compared for thick-film and IC techniques. Specifications and capabilities of circuits are also listed. Color photos of a variety of products illustrate the company's capabilities. Corning/Spacetac, Burlington, Mass.

CIRCLE NO. 372

Oscilloscopes

Test instruments—oscilloscopes, probes and other accessories—are described in a two-color, 28-page catalog. Dynascan Corp., Chicago, Ill.

CIRCLE NO. 373

Pots and counting dials

A complete line of precision potentiometers and counting dials is described in an 84-page catalog. The catalog features quick selection charts offering easy visual specification. Included are electrical, mechanical and environmental characteristics, specifications, line drawings and product photos and features of the precision potentiometers. For the counting dial line, the company offers mechanical, operational, material and environmental specifications, line drawings, and product photos and features. Amphenol Connector Div., Janesville, Wis.

CIRCLE NO. 374

Piezoelectric couplers

A four-page bulletin provides an overview of the wide assortment of piezoelectric couplers. Photographs show seven different models of the couplers. The bulletin contains line drawings of the configuration and principal connections used with the seven models of couplers. Included is a table of specifications for each of the seven couplers, including input, transfer characteristics, filter, output impedance, bias, signal and power. Kistler Instrument Co., Redmond, Wash.

CIRCLE NO. 375

Stepping motors

A 16-page M Series Slo-Syn Stepping Motor catalog MSM1171 describes a line of advanced design, high-speed stepping motors, controls and drives. Useful formulas and sample selection calculations are given as well as complete engineering data and specifications. The Superior Electric Co., Bristol, Conn.

CIRCLE NO. 376

Telephone components

Hundreds of items of wire and cable, patch cords, plugs and telephone components are described in the 16-page catalog, 2A. Lynn Electronics Corp., Feasterville, Pa.

CIRCLE NO. 377

Industrial relay

Engineering bulletin, General Purpose Solid-State Hybrid Industrial Relay, provides end-user information on a family of solid-state relays, definitions of terms applicable to these relays and rating-derating curves. Midtex Inc., Mankato, Minn.

CIRCLE NO. 378

Industrial switches

Numerical display switches, numerical sequence stepping switches, electromechanical memory bank, mechanical numerical counter and general purpose relays for industrial applications are described in a two-page two-color condensed catalog. Detailed electrical and mechanical specifications are given on the nine components listed. Chicago Dynamic Industries, Inc., Chicago, Ill.

CIRCLE NO. 379

Ratio transformers

RatioTrans precision variable ac voltage dividers are described in an eight-page brochure. RatioTrans dividers are provided with certificate of accuracy showing traceability to NBS standards. Charts are provided for selection of 25 different types according to electrical characteristics, dimensions and features. Singer Instrumentation, Los Angeles, Calif.

CIRCLE NO. 380

Modular power supplies

A four-page data sheet describes a line of 23 dc regulated miniature modular power supplies. The center spread of the bulletin is a table listing model number, dc output voltage and current, regulation, ripple rating, temperature coefficient, cast size and prices. Ambac Industries, Inc., Tele-Dynamics/Wanlass Div., Fort Washington, Pa.

CIRCLE NO. 381

Connectors

Hermetic and titanium connectors for aerospace applications are described in a series of bulletins. All are designed to meet MIL spec standards. Gulton Industries, Inc., Connector Div., Newport Beach, Calif.

CIRCLE NO. 382

Greater RFI/EMI shielding in new, narrow-width contact strips from Instrument Specialties

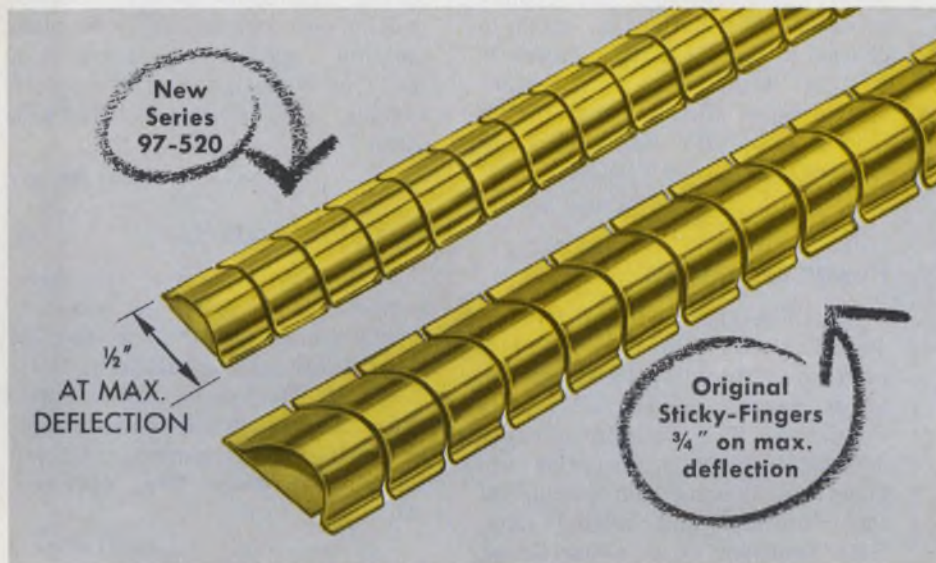

Latest addition to *sticky fingers*® line!

Instrument Specialties now offers Sticky-Fingers self-adhesive, beryllium copper contact strips in three variations to solve your most critical RFI/EMI problems.

Comparable to the shielding effectiveness of the original Sticky-Fingers, our newest series 97-520* offers shielding effectiveness of 92 dB at 10 GHz plane wave or greater than 92 dB at 1 MHz magnetic, and has a dynamic range of 0.10". Yet, it measures a scant $\frac{3}{8}$ " wide, and $\frac{1}{2}$ " at maximum deflection.

Supplied in standard 16" lengths, series 97-520 is ideal for metal cabinets and electronic enclosures where variations exist in the space to be shielded, and where high shielding effectiveness must be maintained in narrow spaces, even with frequent opening and closing of the cabinet.

Select the exact series that fits your application best. Write today for a complete catalog, list of finishes available, and our latest Independent Shielding Evaluation Report. Address: Dept. ED-68

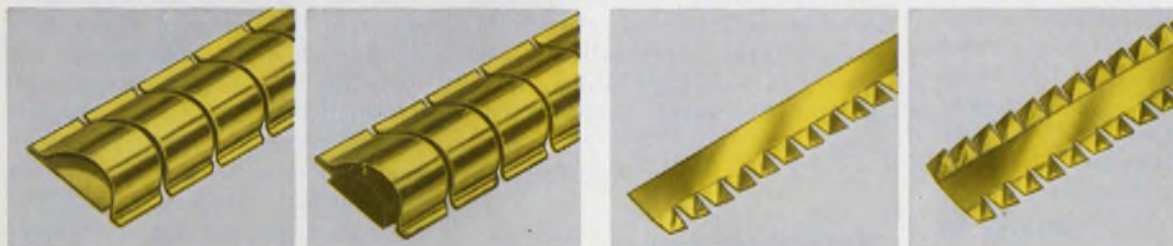

Series 97-500*—the original $\frac{3}{4}$ " wide Sticky-Fingers. Specify when you require greatest possible shielding and where space permits. Also, supplied as 97-510 with Magnifil® for optimum magnetic shielding.

For those all-purpose applications where economy and space are both factors, specify the $\frac{3}{8}$ " wide single-twist series 97-555, or $\frac{1}{2}$ " wide double-twist series 97-560 Sticky-Fingers.

Specialists in beryllium copper springs since 1938

*Patented



Electronic hardware

A new 3-ring, vinyl bound quick reference catalog and cross-reference guide is available to specifiers and purchasing agents of PC jacks, plugs, pins and terminals. The 20-page cross-reference section shows equivalents to most manufacturers, with same-day shipments on items in stock, including many odd and discontinued numbers. Concord Electronics Corp., New York, N.Y.

CIRCLE NO. 383

Solid-state switches

Product Sheet 16SS describes the division's latest addition to its Hall-effect solid-state switch line, a pulse output device. The four-page product sheet lists features and typical applications for the 16SS and describes the Hall-effect operating principle and construction of the 16SS1. The publication shows ratings and electrical characteristics, mounting dimensions and ordering information. Product Sheet 16SS also offers a concise description of magnetic field characteristics and reviews the use of calibrated Hall elements to measure flux densities. Honeywell Inc., Micro Switch Div., Freeport, Ill.

CIRCLE NO. 384

Thermocouples

A condensed two-color, six-page catalog describes and illustrates thermocouples, connectors, instrument service and special design services. Marlin Manufacturing Corp., Cleveland, Ohio.

CIRCLE NO. 385

Panel connectors

A catalog containing detailed electrical and physical specifications describes the 8, 16, 24 and 32-contact connectors and 14, 24, 36 and 50-contact connectors. In addition to the standard rack and panel configurations, the catalog contains information on cable to chassis and cable to cable styles, as well as "high barrier" and other special types. Cinch Connectors, an Operation of TRW Electronic Components, Elk Grove Village, Ill.

CIRCLE NO. 386

Power regulators

An eight-page technical bulletin describes the company's recently introduced "building block" system of dc power sources and remote regulators. The bulletin provides detailed technical information, applications, thermal and mechanical considerations and related data. ERA Transpac Corp., Cedar Grove, N.J.

CIRCLE NO. 387

Solderless terminals

Stator terminals, Bobbin tabs, Brush terminals, Welding tabs, Staking terminals, Ring tongue terminals and nearly 100 other types of Amplivar terminals and splices are fully described in catalog 332-1. AMP, Inc., Harrisburg, Pa.

CIRCLE NO. 388

Crimp removable contacts

An expanded line of miniature and microminiature rectangular plug and socket connectors and solderless crimp termination removable contacts that conform to MIL-C-28747 specifications are covered in a 34-page catalog. Continental Connector Corp., Woodside, N.Y.

CIRCLE NO. 389

Blowers and fans

Miniature cooling devices for electronic enclosures are described in a 16-page short-form catalog. The catalog describes features, design characteristics and performance tests. Pamotor, Burlingame, Calif.

CIRCLE NO. 390

Injection phenolics

A 36-page brochure details injection molding of Genal injection phenolics and Genal pellets. The brochure covers all aspects of thermoset injection molding in detail: materials available, selection guide, typical properties charts, processing equipment, complete molding procedures, rheological data, mold design and mold conversion. GE Plastics, Pittsfield, Mass.

CIRCLE NO. 391

Resistor products

Precision resistors, trimmers, networks and resistance measurements are described in a six-page short form catalog, Bulletin G-11. Performance tables, circuit diagrams and illustrations are included. Vishay Intertechnology, Vishay Resistor Products Div., Malvern, Pa.

CIRCLE NO. 392

Optoelectric components

Optical/electrical characteristics of all devices in the company's lines of light emitting diodes, phototransistors, photodarlington and photodiodes, as well as optical coupler isolators, emitting diodes and opto chips are detailed in a 12-page illustrated reference guide. Package configurations are illustrated with photographs and dimension drawings. An application report is included which details characteristics and typical use. Spectronics, Inc., Richardson, Tex.

CIRCLE NO. 393

Semiconductor guide

A supplement to the EGC Semiconductor Replacement Guide lists recent industrial additions to the EGC line. The 12-page supplement, designated ECG 212D-2, cross references more than 7100 industrial part numbers with the Sylvania types which replace them. The solid-state devices listed include: zener diodes, silicon controlled rectifiers, triacs, diacs, silicon rectifiers, unijunction transistors and several types of switches. Applications include numeric control systems, automatic process lines and motor controllers. GTE Sylvania, Inc., New York, N. Y.

CIRCLE NO. 394

We've pulled a switch. DC input to drive an AC airmover. We call it, "The DC Boxer."

An integrally mounted solid state converter does it. Eliminates brush wear, arcing and attendant noise problems and adds years to service life.

Fan mounts with all the ease of a standard Boxer (4-11/16" sq., 1 1/2" deep), no extra connections or fasteners required. Eight models deliver up to 120 cfm cooling output.

Available with patented Grand Prix sleeve, or rugged ball bearings, both rated at 10 or more years operating life.

Other airmovers? Of course!

Send for our full-line catalog No. ND4r. It's free, and contains performance data, electrical and mechanical specifications on more than 100 units.

And valuable application information too.



For immediate service, contact us at **IMC Magnetics Corp., New Hampshire Division**, Route 16B, Rochester, N.H. 03867, tel. 603-332-5300. Or the IMC stocking distributor in your area. There are more than 50 nationwide and overseas.



IMC New Hampshire Division Airmovers are available at the following locations:

- Ariz., Phoenix/Parts Electronics**, 1310 No. 7th Street 85002/(602) 258-6476
- Calif., Los Angeles/El-Com Sales**, 5134 Valley Blvd. 90032/(213) 223-1351/1353
- Conn., Fairfield/U-Tronics, Inc.**, 273 Linwood Ave., 15222/(203) 838-4106
- Fla., Orlando/Hammond Electronics, P.O. Box 3671 32802/(305) 241-6601**
- Ill., Chicago/Newark Electronics Corp.**, 500 U. Pulaski St. 60624/(312) 638-4411
- Iowa, Cedar Rapids/Deeco Inc.**, 2500 16th Ave. S.W. 42400/(319) 365-7551
- N.Y., Deer Park/Conco**, 151-13 W. Industry Court, 11729/(516) 586-1110
- N.Y., Farmingdale/Arrow Electronics**, 900 Broad Hollow Rd. 11735/(516) 694-6800
- N.C., Winston-Salem/Kirkman Electronics, Inc.**, 901 W. 2nd St. 27108/(704) 724-0541
- Ohio, Dayton/Esco Electronics**, 3130 Valleywood Dr. 45429/(513) 298-9816
- Penn., Philadelphia/Simco Electronics**, 3907 No. Broad St. 19140/(215) 229-1880
- Penn., Pittsburgh/Cameradio Company**, 2801 Liberty Ave. 15222/(412) 391-4106
- S.C., Greenville/Carolina Radio Supply**, 221 W. Washington St. 29602/(803) 239-5125.
- Tex., Dallas/Texas Inst. Supply**, 6000 Denton Drive 75235/(214) 238-2011
- Canada, Ottawa 3, Ont./Wackid Radio & TV**, 312 Parkdale Ave./(613) 728-1821

Send for the complete IMC Distributor Directory.

INFORMATION RETRIEVAL NUMBER 69

Meet the Extremists:

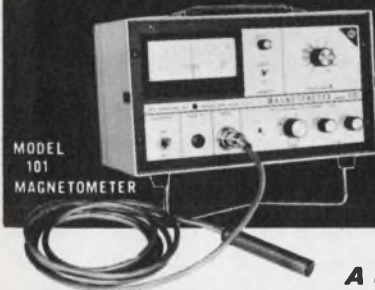

Measure from
1 Gamma
to
50,000
Gauss!

A complete line of precision magnetic measuring equipment.



MODEL 505 GAUSSMETER

- Lowest cost
- Self-contained

A completely self-contained instrument for magnetic field measurement.

MODEL 750 GAUSSMETER

- Wide range
- Versatile

Features wide measurement range, high accuracy and ease of operation.

MODEL 3265 GAUSSMETER

- Unexcelled readability
- High precision

Features absolute, differential and incremental measurement operations.

Send for Free technical booklet on RFL Magnetics equipment.



RFL Industries, Inc.

Instrumentation Division · Boonton, N. J.

Need 0009 MOS Clock Driver pin-for-pin replacement?

The Halex Model HX 0009 Two-Phase MOS Clock Driver provides fixed-width clock pulses for MOS registers. Pin-for-pin replacement, \$18. each, in 100-piece lots, off-the-shelf delivery. Also, 1/4" x 3/8" Flat-Pack (HX 0009 FP) and dual in-line (HX 0009 DIP) versions.

For more information on these products, custom hybrids and precision, thin-film, resistor networks, or Halex facilities and capabilities, circle No. 170.

Or write

■ **HALEX INC.**

Box 2940, Torrance, California 90509

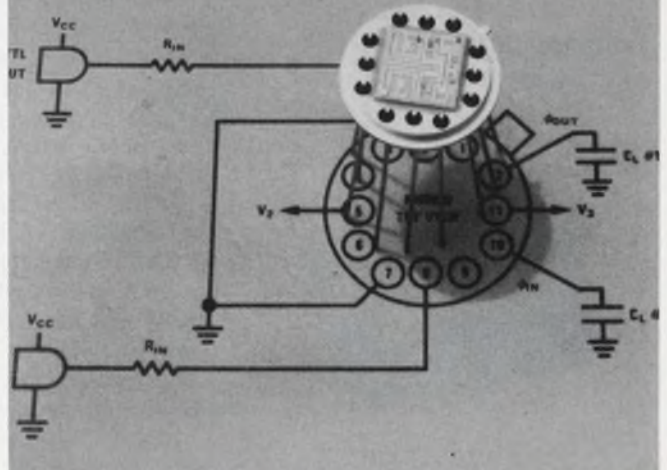

INFORMATION RETRIEVAL NUMBER 70

ELECTRONIC DESIGN 15, July 20, 1972

117

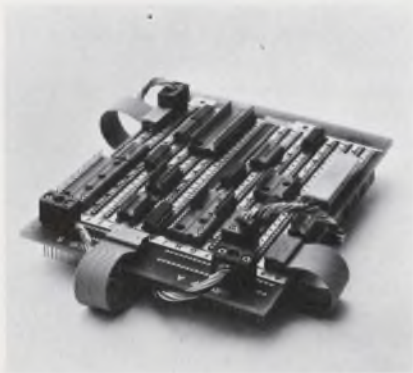

Augat accessories give you more to plug in.

Wouldn't you know that Augat, the leader in wire-wrap panels, would come up with the most complete line of plug accessories around?

Like Augat interfacing plug assemblies for I-O connections. Or Augat adapter plugs to interpose discrete components or to let you build working modules on-the-spot. Or flat cable plugs with a unique "U" contact design for easy assembly without crimping, stripping or soldering. Plus header and jumper assemblies, too.

We'll also give you single-source supply for all panel interconnecting needs, including panels, sockets and enclosures. For quick information on price and delivery, call us at (617) 222-2202. Or write for our catalog. Augat Inc., 33 Perry Ave., Attleboro, Mass. 02703. Our representation and distribution is nationwide and international.

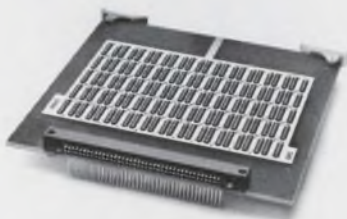

Plug into Augat®

INFORMATION RETRIEVAL NUMBER 72

bulletin board

National Semiconductor Corp. is introducing eight CMOS pin-for-pin replacements for RCA's 4000A series. The new second source types operate from a 3 to 15 V power supply, have a power dissipation of 10 nW typical, and have a typical noise immunity of 0.45 V_{dd} . They are available in molded and ceramic DIP packages. The flat pack is available on special order.

CIRCLE NO. 395

Texas Instruments has introduced twelve low-power Schottky TTL/MSI integrated circuits. Available in plastic dual-in-line packages, the ICs feature speeds up to 15 ns and power dissipations ranging from 30 to 105 mW.

CIRCLE NO. 396

Price reductions

Versatec has announced that because of increased volume and manufacturing efficiencies, they will be able to reduce the cost of the Matrix 200, 200A, 1100 and 1100A non-impact printers at customer savings up to 20%. The Matrix 200 is a raster scan plotter which provides graphic plots on 8-1/2-inch wide paper in the form of dotted lines, at a paper speed of 1.6 ips. Price of the Matrix 200 has been reduced from \$6500 to \$5600. The Matrix 200A is an extremely versatile unit which combines the features of a 600 line-per-minute printer and a raster scan plotter. Price of the Matrix 200A has been reduced from \$7900 to \$6700. The Matrix 1100 is a hard copy output device which produces graphic plots in the form of dotted lines using electrostatic writing. Cost of the Matrix 1100 has been reduced from \$7200 to \$6300. The Matrix 1100A is a versatile hard copy output device which combines the features of both a 500 line-per-minute printer and raster scan plotter. Cost of the Matrix 1100A has been reduced from \$8800 to \$7900.

CIRCLE NO. 397

A method of producing high-density hybrid substrates that can cut costs by 50% or more over ceramic substrates has been announced by Photronics, Inc. of Goleta, Calif. Components are mounted on conductive pads that are flush with the PC board surface to within 1 micron. Line widths of 2 mils on 10-mil centers are readily achieved in the surface conductors and pads. The multilayer portion of the substrates is produced with solid-post interlayer connections rather than with plated through-holes, conserving surface area and yielding maximum component density.

CIRCLE NO. 398

Burr-Brown Research Corp. has reduced prices on its Model 4550 quad current switches, monolithic integrated circuit units containing four logic-operated current switches designed for use in precision digital-to-analog converters. The eight-bit 4550s which formerly sold for \$22 in 100 quantity, are now priced at \$8. Twelve-bit units which sold for \$36 are now priced at \$19.50. New processing techniques and lowered manufacturing costs have made the price reductions possible. The 12-bit quad nonlinearity specification, which was previously $\pm 0.01\%$, has now been improved to $\pm 0.005\%$.

CIRCLE NO. 399

Price cuts of up to 37% have been announced by Solid State Scientific, Inc., on its SCL 5000 series of CMOS shift registers and read/write random access memories. The SCL5553D (hermetic DIP), a 256 \times 1 RAM read/write, is reduced from \$37.50 each to \$23.50 in quantities of 100-999. The same component in hermetic flat pack, SCL5553F, is being reduced from \$37.50 to \$27.30. Model SCL5136, 64-bit static shift register is being reduced from \$19.50 to \$15.50, in hermetic flat pack, and from \$19.50 to \$11.15 in TO-5 style. Additionally, this model is now available in hermetic DIP at \$12.90 and plastic DIP at \$8.10. Quantities on all prices are 100-999.

CIRCLE NO. 400



the Elite*3 BREADBOARDING SYSTEM

\$350.

**Use it FREE
for 5 days!**

**Design, test, layout and build
circuits with any combination
of components and modules . . . FREE!**

This advanced concept circuit design test system features built-in independent circuit monitor lights, built-in isolated pushbuttons, toggle arrays, universal acceptance with ELI's SK-10, common hook-up wire interconnection and unlimited fan in/fan out capability. Send P. O.; unit will be shipped at once. Try it absolutely FREE for 5 days. If not satisfied, return it and you won't be billed. Trying is believing! How can you go wrong?

Don't use the BINGO card . . . order now!



EL INSTRUMENTS, INCORPORATED
61 First Street, Derby, Conn. 06418
Telephone: 203/735-8774

INFORMATION RETRIEVAL NUMBER 64

Who ever heard of Plug-in delay/interval
Timers that are reliable, economical and
interchangeable for as low as \$27.90?

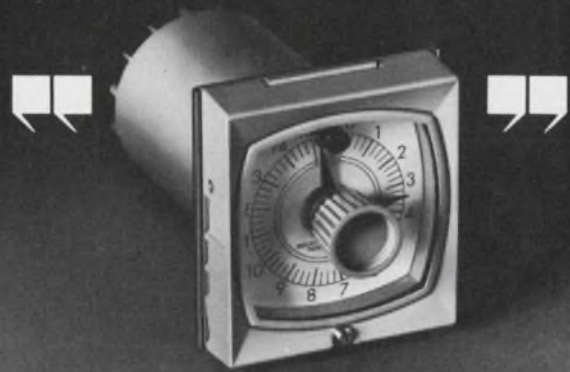

You just did.

It's our new Series GP
which is completely inter-
changeable with over
80% of today's most
widely used plug-in
delay/interval timers.
The GP is designed for
easy installation in stan-
dard 3-inch diameter

panel holes.

Delivery is stock to 6
weeks, depending upon
quantity. Consult us for
further information and
the GP Bulletin 310.
Call 201-887-2200.



INDUSTRIAL TIMER

A UNIT OF ESTERLINE CORPORATION

Industrial Timer Corporation, U.S. Highway 287, Parsippany, N.J. 07054

INFORMATION RETRIEVAL NUMBER 65

A 1/9 ad page size for only \$300 including production charges

Quick Ads will be placed in their own special section, attractively laid out to insure maximum attention. Each will have its own Information Retrieval Number, assuring many inquiries, many sales leads. You simply provide an 8 x 10" glossy photograph, plus approximately 40 words of copy. We do the rest at no cost to you.

For full information, including even lower frequency rates, mail the form at right to
Bryce Gray
Sales Manager
Electronic Design,
50 Essex Street,
Rochelle Park, N.J. 07662

Quick Ads

PLEASE RUSH ME FULL DETAILS ON QUICK ADS IN ELECTRONIC DESIGN

NAME _____ FIRM _____ STREET _____ CITY _____ STATE _____ ZIP _____

TITLE _____

3 NEW MINIATURE REAL-TIME SPECTRUM ANALYZERS

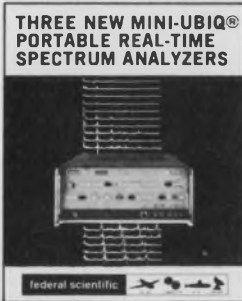

New features highlight Federal's 3 new Mini-Ubiq[™] portable analyzers:

- Widest choice of ranges - 12 ranges from 10Hz to 50kHz
- Improved selectivity with 24dB/bandwidth-octave analysis filter
- Highest frequency and amplitude accuracy
- Computer control of input amplitude range, analysis range, and presampling filter
- Operation with weighting function on or off
- Sweep termination adjustable for high sweep rates
- Earphone monitor of filtered input

Write for FSC-L-522/100.

Federal Scientific Corp.

a subsidiary of Elgin National Industries, Inc.
615 West 131st Street, New York, N. Y. 10027

CIRCLE NO. 171

1972 Electronic Components Drafting Aids Catalog



Free Catalog! Free Samples! Exciting innovations in pressure-sensitive electronic component drafting aids and methods are detailed in the new 1972 edition of the combined Bishop Technical Manual and Catalog 105.

84 illustrated pages of over 15,000 multi-pad configurations, symbols, tapes, sequential reference designations plus hundreds of time-and-money saving hints in making artwork for PC boards. Includes instructions for using the industry's only red and blue tape system for making two-sided boards in perfect registration.

Send now for free Catalog 105 and free samples.

Bishop Graphics, Inc.

7300 Radford Avenue, North Hollywood, California 91605
(213) 982-2000 Telex: 674672

CIRCLE NO. 172

Automatic Crossover Power Modules



With the PTR Design, Kepco, Inc., offers six OEM power modules in the ranges 0-7V/5.5A to 0-100V/0.6A with a monolithically controlled automatic crossover system for the control of either voltage or current. You get the full output over a temperature span from -20°C to +71°C with no derating for temperature!

PTR power modules are meant for systems compatibility. Both the voltage and the current stabilization levels are programmable (digitally if you use the Kepco low-cost SN programmers); a "flag signal" is fed back so your system can know which mode is operative.

The Kepco PTR power modules cost \$225.00 and are backed by a five (5) year warranty. Send for our 4-page PTR data sheet.

Kepco, Inc.

131-38 Sanford Ave.
Flushing, N.Y. 11352

CIRCLE NO. 173

ELECTRONIC DESIGN's function is:

- To aid progress in the electronics manufacturing industry by promoting good design.
- To give the electronic design engineer concepts and ideas that make his job easier and more productive.
- To provide a central source of timely electronics information.
- To promote communication among members of the electronics engineering community.

Want a subscription? ELECTRONIC DESIGN is sent free to qualified engineers and engineering managers doing design work, supervising design or setting standards in the United States and Western Europe. For a free subscription, use the application form bound in the magazine. If none is included, write to us direct for an application form.

If you do not qualify, you may take out a paid subscription for \$25 a year in the U.S.A., \$35 a year elsewhere. Single copies are \$1.50 each.

If you change your address, send us an old mailing label and your new address; there is generally a postcard for this bound in the magazine. You will have to requalify to continue receiving ELECTRONIC DESIGN free.

The accuracy policy of ELECTRONIC DESIGN is:

- To make diligent efforts to ensure the accuracy of editorial matter.
- To publish prompt corrections whenever inaccuracies are brought to our attention. Corrections appear in "Across the Desk."
- To encourage our readers as responsible members of our business community to report to us misleading or fraudulent advertising.
- To refuse any advertisement deemed to be misleading or fraudulent.

Microfilm copies are available of complete volumes of ELECTRONIC DESIGN at \$19.00 per volume, beginning with Volume 9, 1961. Work is now in process to complete the microfilm edition of Volumes 1-8. Reprints of individual articles may be obtained for \$2.00 each, prepaid (\$.50 for each additional copy of the same article) no matter how long the article. For further details and to place orders, contact the Customer Services Department, University Microfilms, 300 North Zeeb Road, Ann Arbor, Michigan 48106 telephone (313) 761-4700.

Want to contact us? If you have any comments or wish to submit a manuscript or article outline, address your correspondence to:

Editor
ELECTRONIC DESIGN
50 Essex Street
Rochelle Park, N.J. 07662

Electronic Design

Advertising Sales Staff

Bryce Gray
Sales Manager

Rochelle Park, N.J. 07662

Robert W. Gascoigne
Daniel J. Rowland
50 Essex Street
(201) 843-0550
TWX: 710-990-5071

Philadelphia

Thomas P. Barth
50 Essex Street
Rochelle Park, N. J. 07662
(201) 843-0550

Boston 02116

Richard L. Green
20 Columbus Avenue
Boston, Mass.
(617) 482-7989

Chicago 60611

Thomas P. Kavooras
Berry Conner, Jr.
200 East Ontario
(312) 337-0588

Cleveland

Thomas P. Kavooras
(Chicago)
(312) 337-0588
(call collect)

Los Angeles 90303

Stanley I. Ehrenclou
Burt Underwood
2930 Imperial Highway
Inglewood, Calif
(213) 757-0183

San Francisco 94022

Jerry D. Latta
P.O. Box 1248
Los Altos, Calif.
(415) 965-2636

London W. 1

For United Kingdom and Holland
Brayton C. Nichols

For Eastern Europe
Peter Kehr

The American Magazine Group

27 Maddox Street
London, W. 1, England
Phone: 499-0180
Cable: Ammagnic, London

Verviers, Belgium

For Continental Europe
Andre Jamar
1, Ru Mallar, 1
087) 253.83 Telex 41563

Tokyo

Haruki Hirayama
Electronic Media Service
5th Floor, Lila Bldg.,
4-9-8 Roppongi
Minato-ku
Phone: 402-4556
Cable: Electronicmedia, Tokyo



AMERICAN BUSINESS PRESS, INC.

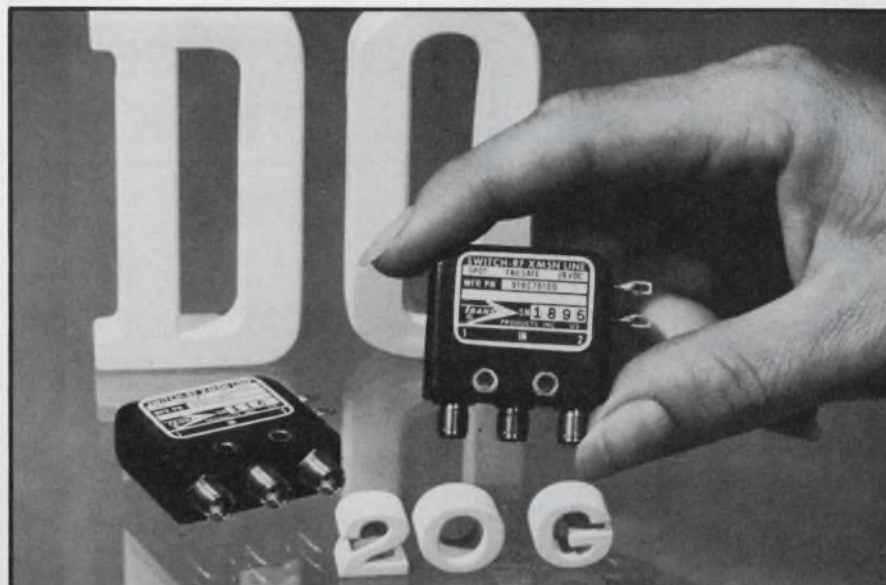

WHY SELECT THIS COAXIAL SWITCH?



an equal opportunity employer

In one word—reliability. Switches similar to Type-DO are on INTELSAT, SKYLAB, ERTS, HELIOS programs. Transco connector center conductors won't push-in or pull-out.

Transco Products, Inc., 4241 Glencoe Ave., Venice, Calif. 90291

INFORMATION RETRIEVAL NUMBER 73

Attention Advertisers:

Could you use copies of your ad exactly as it appeared in ELECTRONIC DESIGN? Then order your reprints directly from us; the minimum unit order is 500 copies.

Please specify if you would like the reprint line omitted on your copies and mail your written order to ELECTRONIC DESIGN, Production Dept., 50 Essex Street, Rochelle Park, New Jersey 07662.

| | 500 | 1,000 | Add'l M |
|------------------------|---------|--------|---------|
| 8x10 or smaller | | | |
| 1 color, 1 side | \$74.70 | 82.95 | 18.15 |
| 2 color, 1 side | 95.47 | 108.00 | 25.28 |
| 4 color, 1 side | 311.03 | 342.00 | 44.33 |
| Spreads | | | |
| 1 color | 113.66 | 126.65 | 25.98 |
| 2 color | 191.19 | 205.98 | 29.58 |
| 4 color | 354.17 | 380.76 | 53.19 |

Prices FOB Waseca, Minn.

Three chicks in all. One will surely lay a gold egg.



Nippon Pulse's ultra compact 4-phase stepper motor — that is! Ranging from the above pictured PF1-20, seven models in all, with MSI drive unit. Diameter ranges from 12 to 51mm; maximum torque, from 0.4 to 3,200 gr-cm; and stepping angle, from 7.5 to 18°. All, giving you a long dependable service, are offered at strongly competitive prices. For details, write us today.

PF1-20: Diameter, 12mm; Max. Pull-out Torque, 0.4 gr-cm; Max. Pull-in Rate, 440 pps; Max. Pull-out Rate, 1000 pps; Stepping Angle, 18°

International Department
NIPPON PULSE MOTOR CO., LTD.
No.13-16, 2-chome, Hongo, Bunkyo-ku, Tokyo
Japan Cable: NIPULSEMOTOR TOKYO

INFORMATION RETRIEVAL NUMBER 74

\$590
 (100 piece quantity)
14-bit
Accurate
Synchro
Conversion



- Solid State miniaturized module
- DTL/TTL compatible
- Digital output register
- 5ms conversion time

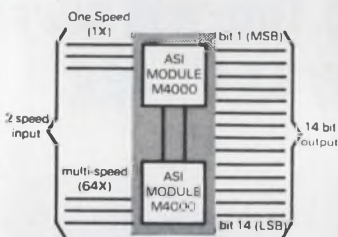

The block diagram shows two ASI modules which form a complete 14-bit 2-speed converter. No external mixing logic or programming is required. For further information contact astrosystems, inc.

astrosystems



astrosystems, inc.
 6 Nevada Drive
 Lake Success, New York 11040
 (516) 328-1600

INFORMATION RETRIEVAL NUMBER 75

advertiser's index

| Advertiser | Page | Advertiser | Page |
|---|----------------|--|-----------|
| AMP, Incorporated | 17, 18, 19, 20 | Inter-Computer Electronics, Inc. | 84 |
| Abbott Transistor Laboratories, Incorporated | 6 | Interstate Electronics Corporation .. | 95 |
| Alco Electronics Products, Inc. | 104 | Johanson Manufacturing Corp. | 123 |
| Allen-Bradley Co. | 45 | Kennedy Co. | 105 |
| Anderson Jacobson | 104 | Kepeco, Inc. | 120 |
| Astrosystems, Inc. | 122 | Lambda Electronics Corp. | Cover III |
| Augat, Inc. | 118 | Licon, Division Illinois Tool Works, Inc. | 37 |
| Beckman Instruments, Inc., Helipot Division | 75 | MCL, Inc. | 67 |
| Biomation | 97 | Microdata Corporation | 48 |
| Bishop Graphics, Inc. | 120 | MicroSwitch, A Division of Honeywell | 50 |
| Bourns, Inc., Trimpot Products Division | 41 | Motorola Semiconductor Products, Inc. | 12, 13 |
| Burroughs Corporation | Cover IV | Nippon Pulse Co., Ltd. | 121 |
| CTS of Brownsville, Inc. | 123 | Norden Division of United Aircraft Corporation | 87 |
| Centralab, the Electronics Division of Globe-Union, Inc. | 21 | North Atlantic Industries, Inc. | 82 |
| Cherry Electrical Products Corp. | 77 | Pertec Corporation | 98, 99 |
| Chicago Dynamics Industries, Inc. ... | 62 | Pirgo Electronics, Inc. | 16 |
| Computer Automation, Inc. | 15 | Powertec, Inc. | 47 |
| Cutler-Hammer Specialty Products Division | 35 | Precision Monolithics, Incorporated | 89 |
| Dale Electronics, Inc. | Cover II | Pulse Engineering, Inc. | 124 |
| Data Display Products | 88 | RCA Solid State Division | 36B-C |
| Digital Equipment Corporation .. | 63, 113 | RFL Industries, Inc. | 117 |
| Dow Corning Corporation .. | 8, 9, 11, 31 | Rotron, Incorporated | 91 |
| ECC Corporation | 7 | Servo-Tek Products Company | 110 |
| F. L. Instruments, Inc. | 119 | Signetics Corporation | 33 |
| Eastman Kodak Company | 103 | Siliconix Incorporated | 52 |
| Electrical Plastics Corporation | 96 | Sprague Electric Company | 22, 93 |
| Electro-Motive Mfg. Co., Inc., The | 81 | Stevens Arnold, Incorporated | 123 |
| Electronic Arrays, Inc. | 14 | Switchcraft, Inc. | 49 |
| Electronic Research Co. | 101 | Tangent Template Co. | 123 |
| Elmwood Sensors, Inc. | 123 | Teledyne Relays, A Teledyne Company | 2 |
| Exact Electronics Inc. | 36A | Texas Instruments Incorporated, Components Group | 38, 39 |
| Fairchild Semiconductor, A Division Fairchild Camera and Instrument Corporation | 71, 72, 73 | Thermalloy Company | 100 |
| Federal Scientific Corporation | 120 | Transco Products, Inc. | 121 |
| Fluke Mfg. Co., Inc., John | 42 | Tri Data | 58 |
| General Electric Company | 25 | Triplett Corporation | 59 |
| Halex Inc. | 117 | Tucker Electronics Company | 123 |
| Hayden Book Company Inc. | 36D, 75, 123 | Union Carbide, Components Dept. ... | 85 |
| Heath Company | 123 | United Systems Corporation | 79 |
| Heath Schlumberger Scientific Instruments | 66 | Vectrol, Inc. | 40 |
| Heinemann Electric Company | 109 | Victoreen Instrument, Div. of VLN Corp. | 107 |
| Hewlett-Packard | 1, 4, 5 | Windjammer Cruises | 111 |
| Hickok Instrumentation & Controls Division | 46 | Zeltex, Inc. | 51 |
| Hutson Industries | 106 | | |
| IMC Magnetics Corporation | 117 | | |
| Industrial Electronic Engineers, Inc. | 10 | | |
| Industrial Timer, A Unit of Esterline Corporation | 119 | | |
| Instrument Specialties Company, Inc. | 115 | | |
| Intech, Incorporated | 92 | | |



Thin-Trim® variable capacitors are designed to replace fixed tuning techniques. Applications include crystal oscillators, CATV amplifiers, communication and test equipment. Series 9410 has high Q's with five capacitance ranges from 1.0 - 4.5 pf to 10.0 - 50.0 pf. Johanson Manufacturing Corporation, Boonton, N. J. (201) 223-2676

INFORMATION RETRIEVAL NUMBER 181

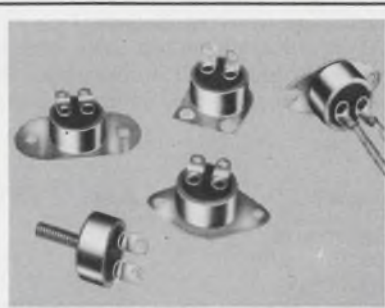

Prototypes of precision snap-action thermostats from Elmwood, widely specified for quick, reliable response; proven industrial and military performance record. Environ. expos. -85° to 550°F; narrow or wide diff.; rated to 15 amps. Wide choice of brackets, terminals. Elmwood Sensors, Inc. (401) 781-6500. TWX 710-381-6413.

INFORMATION RETRIEVAL NUMBER 182

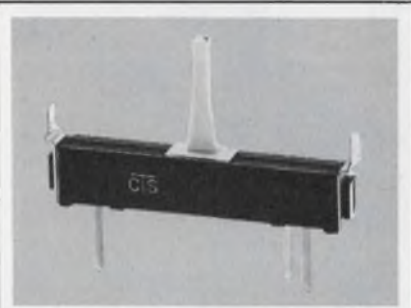

Big Savings in New CTS Series 470 1 3/4" Linear Motion Composition Slide Control — Full size performance in space saving 5/16" x 5/8" molded housing. Only 21¢ in quantity. Excellent settability, stability . . . low noise. Varied mountings. 1/2 watt power; 200 Ω - 5 meg Ω CTS of Brownsville Inc., Brownsville, Texas 78520. (512) 546-5184.

INFORMATION RETRIEVAL NUMBER 183



Treating materials according to their function, these design aids combine essential background with immediately workable data and techniques. Series in Materials for Electrical and Electronics Design, Edited by Alex. E. Javitz. Hayden Book Co., Inc., New York, N. Y. 10011.

INFORMATION RETRIEVAL NUMBER 184

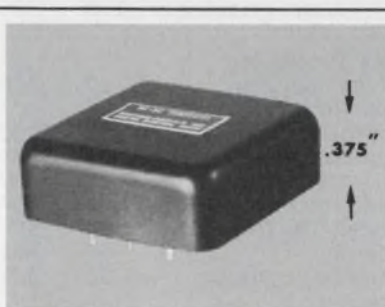

Isolated dc/dc converters. Isolation 10 pF and 8 kV dc max. Inputs from 5 to 36 V dc available. Outputs single or dual 8 to 15 V dc 4.5 watts. Noise 5 mv peak (BW 10 M Hz). Regulation 0.05% (Line or Load). Custom Designs no charge. Stevens-Arnold, Boston, Mass. (617) 268-1170.

INFORMATION RETRIEVAL NUMBER 185

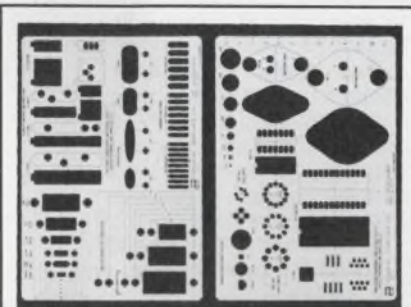

P. C. DRAFTING TEMPLATES, The P. C. Designer is a comprehensive template set for p. c. layouts and assembly drawings. Component body outlines, layout patterns and pad diameters conform to MIL-STD 275 and IPC CM-770. Set #PC-2 (2:1), \$12.00 TANGENT TEMPLATE CO., P. O. Box 20704, San Diego, Ca. 92120. (714) 282-0494.

INFORMATION RETRIEVAL NUMBER 186



TUCKER 600 Universal Counter-Timer. A 7-digit (with 2 over flow digits) 512MHz instrument that offers small size, all major counter functions and delivery from stock. Price \$1095.00. Send for free catalog listing thousands of new and reconditioned instruments. Tucker Electronics Co., P. O. Box 1050, Garland, Texas. (214) 348-8800.

INFORMATION RETRIEVAL NUMBER 187



The Successful Engineer-Manager, Edited By R. C. Haavind and R. L. Turmail. Depth discussion and insights of the experts isolate the fine points of management: career, decisions, people, projects, finances, communications. Hayden Book Co., Inc., New York, N. Y. 10011.

INFORMATION RETRIEVAL NUMBER 188



New Heathkit desktop calculator adds, subtracts, multiplies, divides, in chain or mixed functions, includes use of a constant. Floating or selectable decimal. Overflow & plus or minus indicators. Bright 8-digit readout. 120/240 VAC operation. Sells for only 129.95 F.O.B. Heath Co., Dept. 60-7, Benton Harbor, Mich. 49022

INFORMATION RETRIEVAL NUMBER 189

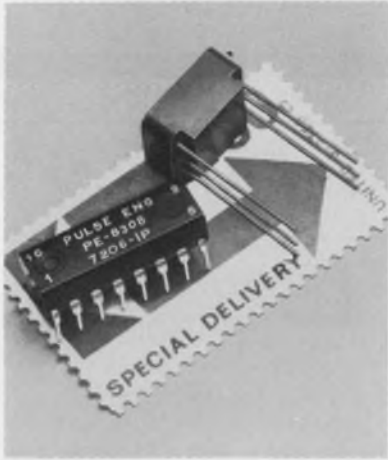

Immediately available Pulse Transformers Delay Lines

Now you can save time and money by specifying standard Pulse transformers or delay lines from our wide range of in-stock components. We have the most commonly used designs—complete and reliable. And Pulse engineers are ready to assist you with unique designs.

Typical Applications

1. SCR and TRIAC control
2. Small signal coupling and isolation
3. Baluns
4. Floating switches
5. Line drivers and receivers
6. DC isolation
7. Timing delays

For the broadest selection of in-stock components, available for immediate delivery in any quantity, call our catalog sales department.

SCR & TRIAC CONTROL TRANSFORMERS

(not shown)

| Catalog Number | Turns Ratio ±10% | OCL mh MIN | ET V _μ S MIN | Cw/w pf MAX | LL (μh MAX) |
|----------------|------------------|------------|-------------------------|-------------|-------------|
| 61000 | 1:1 | 0.2 | 180 | 24 | 3.2 |
| 61001 | 1:1 | 1.0 | 360 | 30 | 15.0 |
| 61002 | 1:1 | 5.0 | 866 | 36 | 64.0 |
| 61003 | 2:1 | 0.2 | 180 | 24 | 5.0 |
| 61004 | 2:1 | 1.0 | 360 | 30 | 13.0 |
| 61005 | 2:1 | 5.0 | 866 | 36 | 65.0 |
| 61013 | 1:1 | 0.2 | 290 | 30 | 6.2 |
| 61014 | 1:1 | 1.0 | 700 | 36 | 26.0 |
| 61015 | 1:1 | 5.0 | 1500 | 42 | 130.0 |
| 61016 | 2:1 | 0.2 | 290 | 30 | 8.9 |
| 61017 | 2:1 | 1.0 | 700 | 36 | 24.0 |
| 61018 | 2:1 | 5.0 | 1500 | 42 | 125.0 |

Pulse Engineering Inc.

A Varian Subsidiary
P. O. Box 12235
San Diego, Calif.
92112
(714) 279-5900
TWX:910-335-1527

product index

Information Retrieval Service. New Products, Evaluation Samples (ES), Design Aids (DA), Application Notes (AN), and New Literature (NL) in this issue are listed here with page and Information Retrieval numbers. Reader requests will be promptly processed by computer and mailed to the manufacturer within three days.

| Category | Page | IRN | Category | Page | IRN |
|------------------------------------|------|-----|----------------------------------|------|-----|
| Components | | | power supply | 83 | 257 |
| capacitor, trim | 102 | 336 | power supply | 86 | 264 |
| clutch-brake | 100 | 327 | pulse generators | 86 | 262 |
| display, LED | 100 | 328 | | | |
| filters, EMI/RFI | 102 | 335 | Packaging & Materials | | |
| heat switch | 100 | 329 | coatings, optic | 106 | 346 |
| magnetic heads | 99 | 324 | conductors, thick film | 107 | 351 |
| magnets, permanent | 102 | 338 | epoxy | 106 | 347 |
| motors, stepping | 100 | 330 | lubricants, disc | 105 | 343 |
| potentiometer, slide | 102 | 333 | machine | 105 | 342 |
| switch, rotary | 102 | 337 | panel boards | 107 | 350 |
| switch, toggle | 101 | 332 | PC boards | 104 | 339 |
| timer, repeat cycle | 101 | 331 | screens, thick film | 106 | 348 |
| transducer, position | 99 | 323 | socket, relay | 106 | 344 |
| transducer, position | 102 | 334 | sockets, DIP | 104 | 341 |
| transducer, pressure | 99 | 325 | substrates | 107 | 349 |
| transducer, pressure | 100 | 326 | tape, anti-static | 106 | 345 |
| | | | terminal block | 104 | 340 |
| Data Processing | | | | | |
| bridge amplifier | 97 | 309 | new literature | | |
| cassette drive, data | 96 | 307 | blowers and fans | 116 | 390 |
| controller, temp. | 98 | 320 | components | 116 | 393 |
| digitizer, wire-wrap | 97 | 308 | components, telephone | 114 | 377 |
| kit, servo | 98 | 322 | connectors, hermetic | 114 | 382 |
| minicomputer | 94 | 304 | components, industrial | 114 | 379 |
| printer, electrostatic | 94 | 305 | connectors, rack, panel | 116 | 386 |
| recorder, analog | 94 | 306 | contacts | 116 | 389 |
| vibration analyzer | 98 | 321 | couplers | 114 | 375 |
| | | | DPMs | 114 | 371 |
| ICs & Semiconductors | | | hardware | 116 | 383 |
| comparators | 91 | 303 | hybrid circuits | 114 | 372 |
| diode, Schottky | 90 | 272 | modular power supplies | 114 | 381 |
| driver, clock | 89 | 267 | oscilloscopes | 114 | 373 |
| look-ahead generator | 89 | 266 | phenolics | 116 | 391 |
| MOSFETs | 90 | 271 | potentiometers | 114 | 374 |
| op amp | 90 | 274 | regulators | 116 | 387 |
| op amp | 90 | 275 | relays, industrial | 114 | 378 |
| op amp | 90 | 277 | resistors | 116 | 392 |
| op amp | 92 | 279 | semiconductors | 116 | 394 |
| phase-locked loop | 91 | 301 | stepping motors | 114 | 376 |
| preamplifier | 88 | 265 | switches | 116 | 384 |
| shift register | 91 | 302 | terminals, solderless | 116 | 388 |
| transistors, power | 90 | 276 | thermocouples | 116 | 385 |
| VCO | 90 | 273 | transformers, ratio | 114 | 380 |
| | | | | | |
| Instrumentation | | | application notes | | |
| die bonder | 108 | 353 | a/d converters | 112 | 368 |
| tester, cassette | 108 | 355 | clock, real time | 112 | 361 |
| tester, roughness | 108 | 356 | op amps | 112 | 364 |
| tester, solderability | 108 | 354 | oscillators, transfer | 112 | 367 |
| voltmeter, digital | 108 | 352 | printers, impact | 112 | 369 |
| wire identifier | 108 | 357 | shielding, magnetic | 112 | 363 |
| | | | shielding, magnetic | 112 | 356 |
| | | | speed control, motor | 112 | 362 |
| | | | transformer control | 112 | 365 |
| | | | triacs | 112 | 370 |
| | | | | | |
| Microwaves & Lasers | | | | | |
| hybrids | 110 | 360 | | | |
| limiters, low-level | 110 | 358 | | | |
| switch, waveguide | 110 | 359 | | | |
| | | | | | |
| Modules & Subassemblies | | | | | |
| amplifier, sample/hold | 84 | 258 | | | |
| converter, a/d | 84 | 260 | | | |
| display, CRT | 84 | 259 | | | |
| divider | 84 | 261 | | | |
| operational amplifier | 86 | 263 | | | |

Do you face a make or buy decision on power supplies?

BUY LAMBDA LX SERIES

Now 39 models in 7 package sizes...
single, dual & triple outputs

new
dual output model
in "CC" package



DUAL OUTPUT
LXD-CC-152: $\pm 15V$ to $\pm 12V$, 4.0A, \$235

new
dual and triple output
models in "D" package

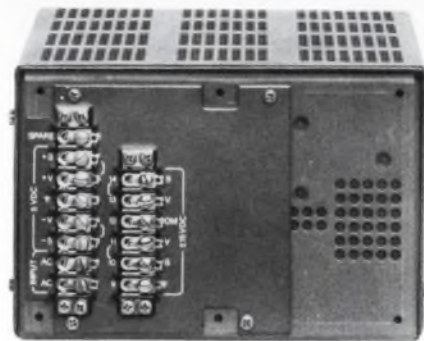

DUAL OUTPUT
LXD-D-152: $\pm 15V$ to $\pm 12V$, 6.2A, \$280
TRIPLE OUTPUT
LXT-D-5152: $\pm 15V$ to $\pm 12V$, 3.1A, \$375
5 \pm 5% VOLTS 12.0 AMPS (WITH O.V.)

**all listed in Underwriters'
Recognized Components Index***

**all designed to meet MIL
environmental specifications**

all in stock for 1-day delivery

all guaranteed 5 years

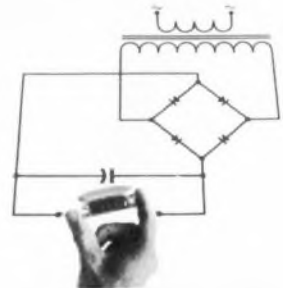

**WHETHER
YOU MAKE
OR BUY...**

LAMBDA
ELECTRONICS CORP.
A  Company

*Dual and triple models presently undergoing qualifying tests.

MELVILLE, NEW YORK 11746 515 Broad Hollow Road Tel. 516-694-4200 ARLINGTON HEIGHTS, (CHICAGO) ILL. 60005 2420 East Oaktan St., Unit Q Tel. 312-593-2550
NORTH HOLLYWOOD, CALIF. 91605 7316 Varna Ave. Tel. 213-875-2744 MONTREAL, QUEBEC 100C Hymus Blvd., Pointe-Claire, Quebec-730 Tel. 514-697-6520

SELLS ON SIGHT

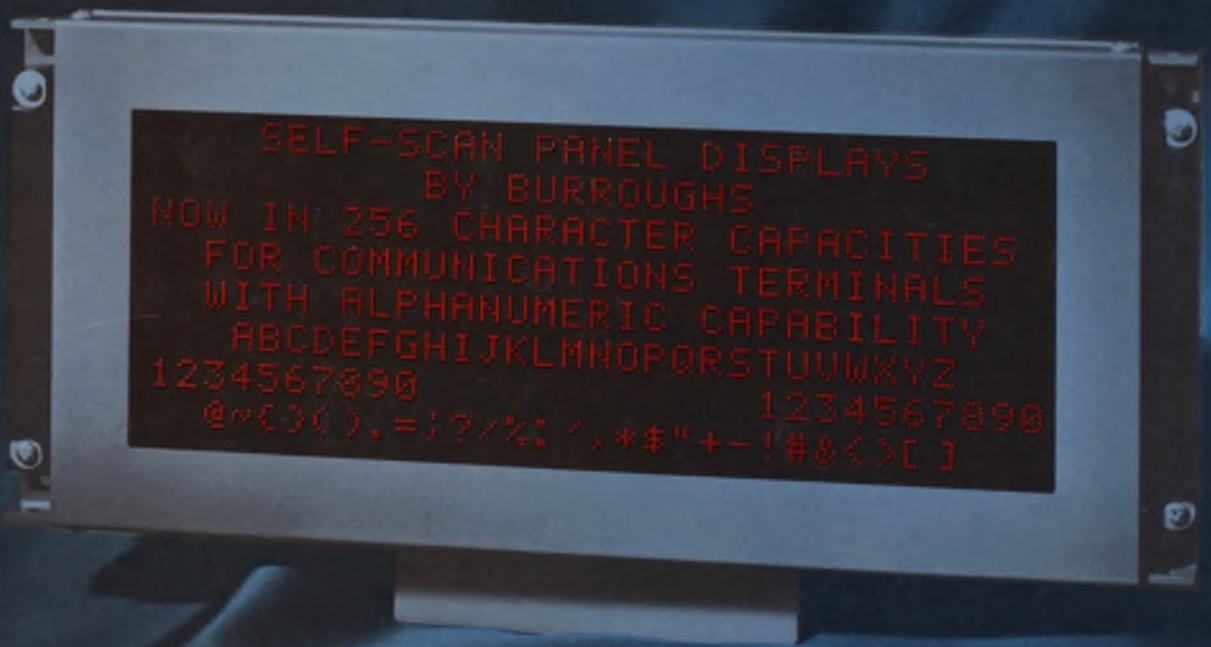

superior readability that competitors can't match

One look at an operating SELF-SCAN[®] panel display and you will know why you should be featuring one in your system. SELF-SCAN displays are a new solution to the operator machine interface that provides advantages to the system builder, to the system user, and to the system operator.

You can offer your customer the advantage of a custom-stylized unit that his operators can use efficiently. SELF-SCAN panels are measurably superior to CRT for operator accuracy while significantly reducing fatigue level in day in-day out high volume production applications.

The 0.2" high characters are in the popular 5x7 dot matrix format and are made up of dots on .040" centers. The unit is ASCII compatible and displays a modified 64-character ASCII character set.

256-character display subsystems are available from stock for immediate delivery. Call or write Burroughs Corporation, Electronic Components Division, Box 1226, Plainfield, New Jersey 07061, Phone: (201) 757-3400. Ask to have a Burroughs sales engineer stop by your office and show you his 256-character SELF-SCAN panel, keyboard, and power supplies packaged in a standard Samsonite[®] briefcase.

Burroughs 