

Electronic Design

VOL. 19 NO.

5

FOR ENGINEERS AND ENGINEERING MANAGERS

MARCH 4, 1971

New high-speed, low-power ECL combines 2-ns delays with 25-mW dissipation regardless of frequency. The new logic family has a 150-MHz toggle rate and

is compatible with other ECL families. Available circuits will include logic gates, flip-flops and complex functions for high design flexibility. Full details on P. 61



1971
MARCH 4, 1971
ELECTRONIC DESIGN
MAGAZINE

AST



DALE NEXT RIGHT



.75"



1.00"



1.25"

Take the Dale Interchange for a better deal in low-cost trimmers

Dale commercial and industrial trimmers interchange with scores of competitive models—including the ones you aren't totally satisfied with right now. Dale pricing is intensely competitive... and delivery is hard to beat. Quality is so high that we average less than 1% customer rejection for *all* causes. In three basic rectilinear sizes: 1.25", 1.00" and .75" Dale trimmers offer the versatility of wirewound or film elements—standard to handle normal production environments—sealed to approximate MIL-R-27208A standards. Consider all your circuit adjustment trade-offs—then call Dale for a better deal. Phone 402-564-3131.

Choice of element in 3 body styles

FILM ELEMENT

8400 SERIES Sealed/Unsealed; 10Ω to 2 Meg., ±10% 100Ω thru 500K, ±20% all other values; .75 watt at 25°C, derated to 0 at 125°C; T.C. 150 ppm/°C, 100 ppm available; .31 H x .16 W x .75 L.

8300 SERIES Sealed/Unsealed; 10Ω to 2 Meg., ±10% 100Ω thru 500K, ±20% all other values; .75 watt at 25°C, derated to 0 at 105°C; T.C. 150 ppm/°C, 100 ppm available; .36 H x .28 W x 1.00 L.

8100 SERIES Industrial counterpart RJ-11; 10Ω to 2 Meg., ±10% 100Ω to 500K, ±20% other values; .75 watt at 70°C, derated to 0 at 125°C; T.C. 150 ppm/°C, 100 ppm available; .28 H x .31 W x 1.25 L.

WIREWOUND ELEMENT

2400 SERIES Sealed/Unsealed; 10Ω to 50K, ±10%; 1 watt at 40°C, derated to 0 at 125°C; .31 H x .16 W x .75 L.

2300 SERIES Sealed/Unsealed; 10Ω to 50K, ±10%; 0.5 watt at 25°C, derated to 0 at 105°C; .36 H x .28 W x 1.00 L.

2100 SERIES Industrial counterpart RT-11; 10Ω to 100K, ±10%; 1 watt at 70°C, derated to 0 at 125°C; .28 H x .31 W x 1.25 L.

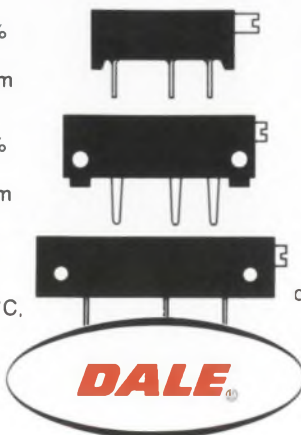

Write for Catalog B

INFORMATION RETRIEVAL NUMBER 123

DALE ELECTRONICS, INC.

1300 28th Ave., Columbus, Nebr. 68601
In Canada: Dale Electronics Canada Ltd.
A Subsidiary of The Lionel Corporation



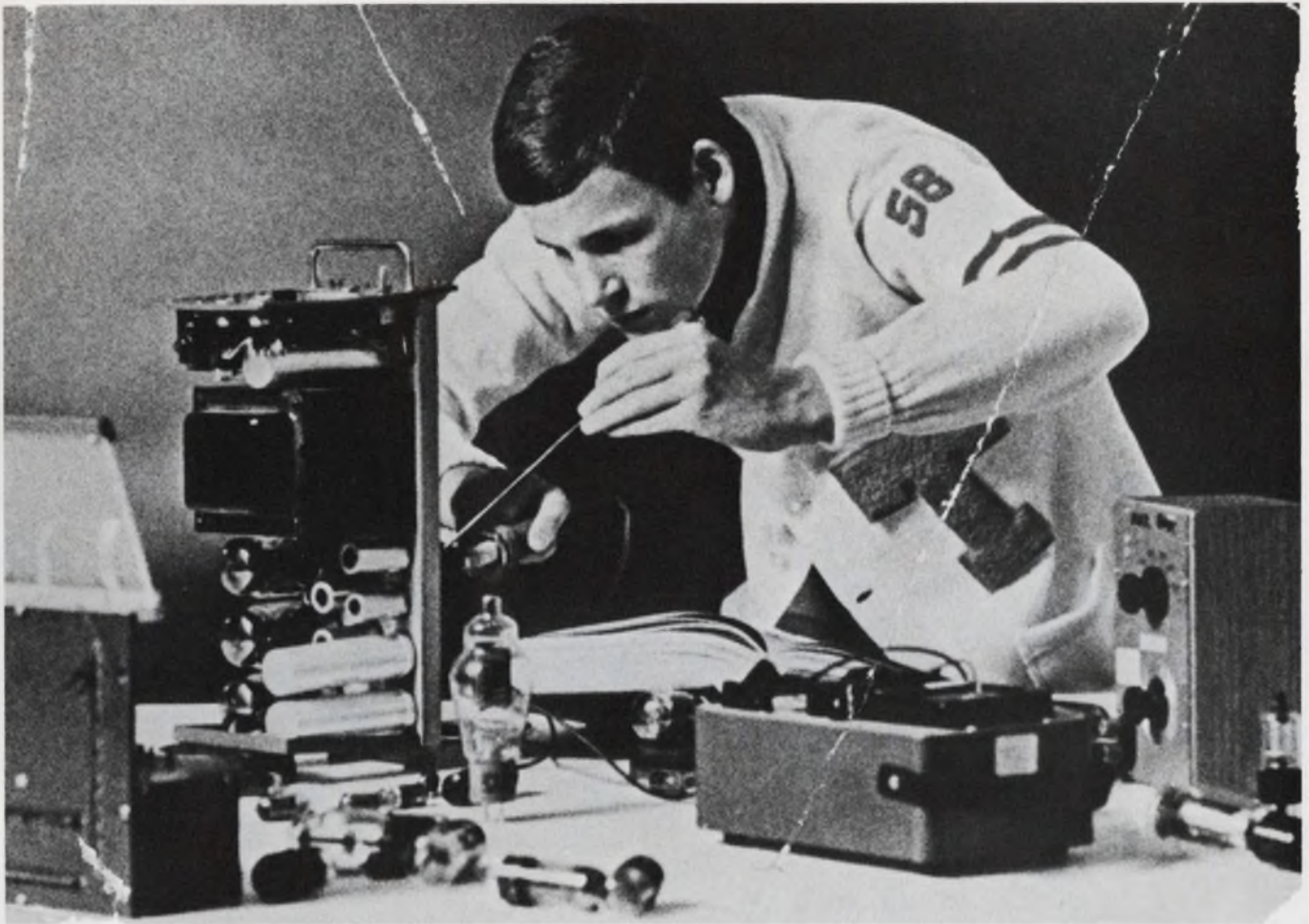

Are you still using the same scope you used in college?

If so, you've been missing out on the greatest achievements in scope technology. During the last five years, Hewlett-Packard has quietly but firmly assumed technological leadership in the oscilloscope industry with the revolutionary HP 180 Scope System.

HP's innovations in general-purpose lab scopes include: the first scope with a real-time bandwidth of 250 MHz; the first 18 GHz sampling scope; the first 100 MHz variable-persistence storage scope; the first calibrated TDR scope with 35 ps rise time; and the first and only high-frequency (100 MHz) scope with a "big picture" CRT (8 x 10 div, 1.3 cm/div). And all these have a broad range of compatible plug-ins.

And, as these "for instances" illustrate, HP's innovations are *functional* improvements that increase your scope's usefulness. No "bells and

whistles" that add little to performance and a lot to the price.

This functional approach has been applied to our lower-priced field-service scopes, too. No frills. Just function. With HP, you get the most favorable price/performance ratio of any scopes on the market. And all HP scopes are backed by comprehensive training and service organizations to optimize your scope investment.

It's amazing how many engineers have clung to the "old school traditions" while scope technology has progressed in quantum leaps. Call an HP Field Engineer and find out what the state-of-the-art is today. He'll be glad to give you a side-by-side demonstration with your "old school scope." Or write Hewlett-Packard, Palo Alto, California 94304. In Europe: 1217 Meyrin-Geneva, Switzerland.

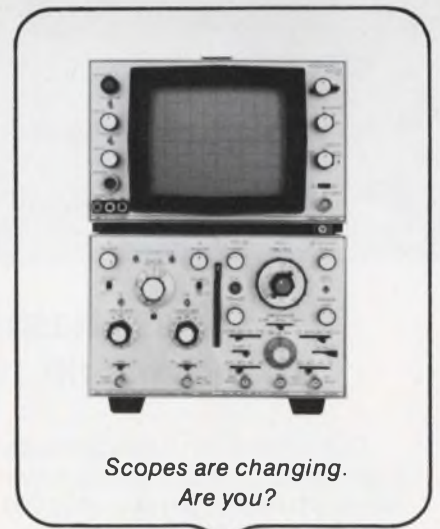

Scopes are changing.
Are you?

081/3

HEWLETT  PACKARD

INFORMATION RETRIEVAL NUMBER 2

Siemens

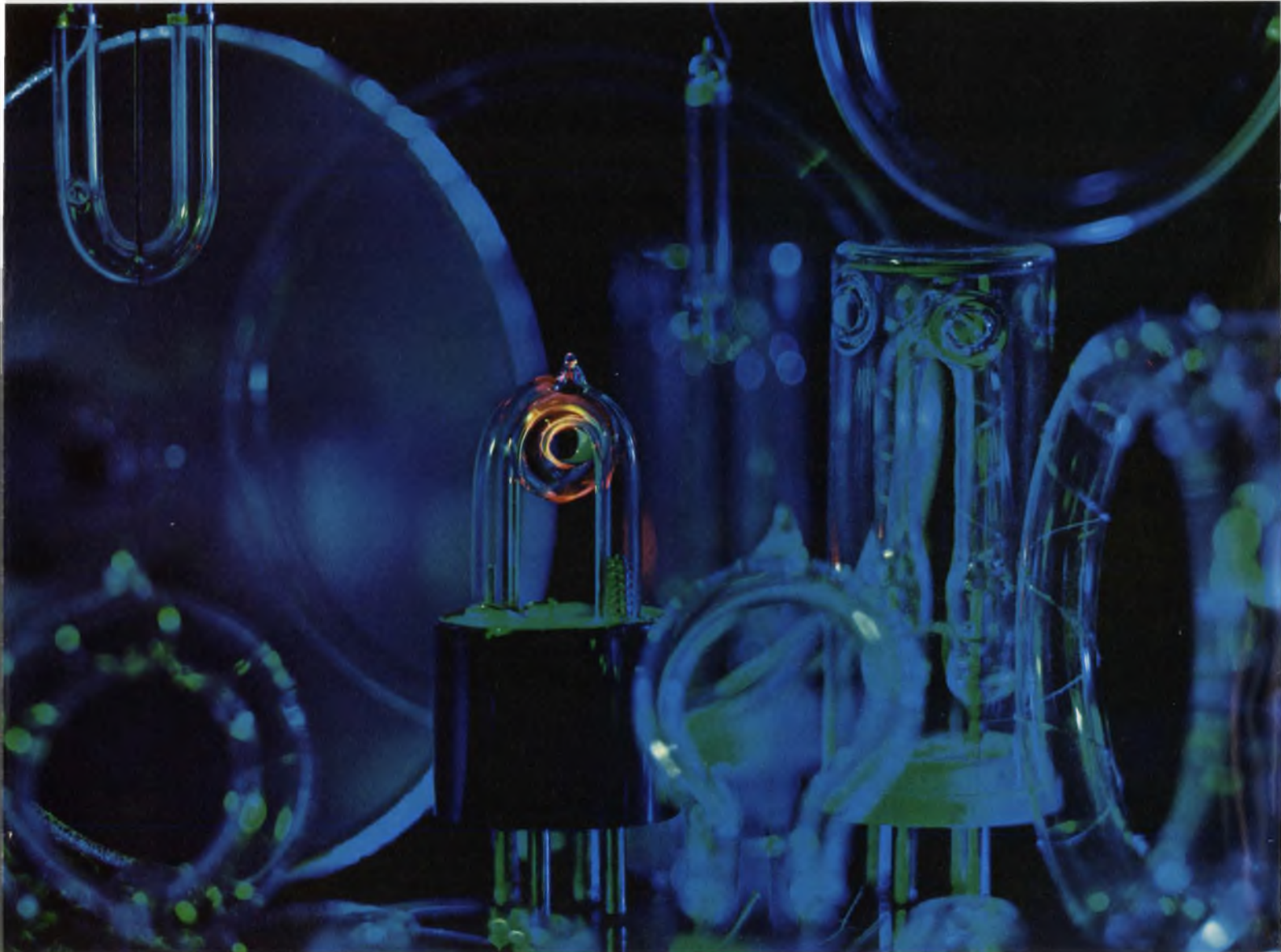

These flash tubes produce bursts of sunlight from small amounts of power. We can put them to work for you.

Our xenon flash tubes produce high intensity light covering wavelengths from the ultraviolet to the near infrared. And they can be pulsed thousands of times as fast as incandescent lamps.

These characteristics plus a very high efficiency make them ideal for laser stimulation, aircraft anti-

collision lights, beacons, timing devices, high-speed inspection systems and photographic lights.

We turn out these tubes by the millions in sizes and shapes to meet many different requirements. Some are low-cost units produced in high volume. Others, sophisticated, one-of-a-kind designs.

There's an answer to your problem in our files or experience. Tell Larry Boone about your needs.

Siemens Corporation, 186 Wood Avenue South, Iselin, N.J., 08830. (201) 494-1000. Siemens. A three billion dollar name in quality products.  **SIEMENS**

NEWS

- 21 **News Scope**
- 24 **New LSI packaging opens the way for the micro-mini era.** A roundup of trends that offer greater flexibility to the designer.
- 28 **Designers of vhf-FM radios vie for new pleasure-boat market—** estimated at 25,000 units in 1971 and 30,000 in '72.
- 30 **No task too difficult for hand-held radar.**
- 31 **Computer control gives better silicon wafers.**
- 33 **Technology Abroad**
- 35 **Washington Report**

TECHNOLOGY

- 40 **Cut the maintenance costs** of motor control systems while improving performance. Use ICs for analog and digital speed controllers.
- 46 **Solid-state loads provide versatility** in power-supply testing. Here's a use for power transistors that you may have overlooked.
- 50 **Here's a microwave choke** that's easy to build and also easy to design. As a bonus, this coaxial configuration is compact.
- 53 **Do your IC op amps act like fuses?** Learn the reasons why they blow and some steps you can take to protect them.
- 54 **U. S. management: better than you think,** according to two European engineers, who say our firms are more creative.
- 56 **Ideas for Design**

PRODUCTS

- 61 **ICs and Semiconductors:** New ECL has 2-ns speeds and 25-mW dissipation.
- 65 **Microwaves & Lasers:** 500-MHz double balanced mixer costs only \$7.95.
- 67 Instrumentation
- 68 Components
- 70 Data Processing
- 71 Modules & Subassemblies
- 73 Packaging & Materials

Departments

- 39 **Editorial:** Don't waste our EEs—put them in classrooms.
- 7 Letters
- 13 Designer's Calendar
- 74 Design Aids
- 74 Evaluation Samples
- 75 Application Notes
- 76 New Literature
- 77 Bulletin Board
- 80 Advertisers' Index
- 80 Information Retrieval Card

Cover: Motorola unveils a new line of ECL. Photo by Phil Koenig, New York City.

When is True RMS Really True RMS?



$$\sqrt{(DC)^2 + (AC_{rms})^2}$$

TRUE RMS = $\sqrt{(dc)^2 + (ac_{rms})^2}$ — and HP's new 3480 DVM is the only four-digit multi-function meter that can give you this true RMS value — ac, dc, or ac plus dc. And, the 3480 eliminates the errors caused by average responding converters. With the 3480 you get measurements within 0.1%, not just to within 1%! (A 1% third harmonic distortion = $\pm 0.33\%$ error or ± 33 counts of error in a four-digit average responding DVM.)

Whatever type of signal you're measuring — from the purest sine wave to the most irregular pulse train — the HP 3480 DVM gives you the results you need in one second. And, when you're working with an ac-plus-

dc signal, you don't have to make two separate readings and then calculate the combined RMS value. It's all there, in one set of figures.

THE SECRET: A PAIR OF MATCHED THERMOPILES. At the heart of the 3480, there is a tiny chip, less than $\frac{1}{4}$ " square, which contains matched sets of thermopiles. One measures the heat produced by the signal you're testing; the other does the same for a reference voltage.

The full scale ranges of the HP 3480 DVM are from 100 mV to 1000 Vac and the frequency range is from 1 Hz to 1 MHz. And with the correct plug-in, the 3480 can give you up to 1,000 **straight-dc** or **ohms** readings per second — with 5 dc ranges and 6

ohms ranges.

Prices range from \$1150 for one range of dc to \$3375 for multi-function ac, dc and ohms capabilities with isolated BCD and isolated remote control.

Find out how the HP 3480 DVM can help solve *your* measurement problems. Contact your local HP field engineer, or write to Hewlett-Packard, Palo Alto, California 94304. In Europe: 1217 Meyrin-Geneva, Switzerland.

090/12

HEWLETT  PACKARD
DIGITAL VOLTMETERS

Doing it with AC and DC Motors, Drive Amplifiers, Instrument and Power Servomotors, Tachometers, Blowers and Fans, Stepper Motors, High Accel-Low Inertia Motors, Spindle Drives, Clean Air Supplies and Commercial Instrument Motors.

In fact there is very little we haven't done in the development, design and manufacture of precision rotating electrical equipment and other types of packages and sub-system assemblies. Just look over this partial list, then call in one of our Engineering Representatives to help you in the selection and design of products for your specific application.

Yes, whatever your needs, DIEHL'S more than 80 years' experience plus our modern research and production facilities assure you of the solution. Call your nearest DIEHL Engineering representative or write: Diehl Division, Funderne Avenue, Somerville, New Jersey 08876 (201)725-2200.

Send for your free copy of "Do It With Diehl" catalog.

SINGER
DIEHL DIVISION

Diehl's done it!



How To Solve Your Power Supply Problem In 24 Hours



400 Δ to DC
Model W15D
Size 2½" x 3½" x 3½"
Output 15 VDC at 2.5 amps

28 VDC to DC
Model C28D
Size 2¾" x 3¼" x 3⅝"
Output 28 VDC at 1.8 amps

DC to 400 Δ
Model S3D
Size 2¾" x 3" x 4"
Output 115 VAC at 30 VA

60 Δ to DC
Model R5S
Size 6½" x 4" x 7½"
Output 5 VDC at 5 amps

Abbott has four new lines of hi-performance power supply modules. *Most of the popular voltages are carried in stock for shipment within 24 hours from receipt of order.* All types of converters are available with any output voltage you need from 5 to 3,500 VDC—and DC to 400 Hz inverters, with either 1 ϕ or 3 ϕ outputs.

400 Hz to DC

Designed especially for 400 Hz input, these hi-performance converters feature close regulation ($\pm 0.05\%$), low ripple (0.02%), automatic short circuit protection, complementary overvoltage protection and will meet the electromagnetic interference requirements of MIL-STD-461. *Popular sizes are in stock for immediate delivery.*

DC to 400 Hz

These small lightweight inverters change 28 VDC to 115 Volts 400 Hertz at operating temperatures of 100°C at base plate. Six power ratings between 5 and 120

watts are available as well as frequencies of 400, 800, 1200 or 1600 Hertz and 115 or 27 volts output. *Popular sizes are in stock for immediate delivery.*

28 VDC to DC

These hi-performance converters change 28 VDC to any voltage between 5 and 100 VDC. They feature close regulation ($\pm 0.05\%$), low peak to peak ripple of less than 50 millivolts and electromagnetic interference protection to meet the requirements of MIL-STD-461. *Popular voltages are in stock for immediate delivery.*

60 Hz to DC

Highly dependable, these convection cooled power supplies have output voltages from 5 to 100 VDC. They feature close regulation ($\pm 0.05\%$), low ripple (0.02%), operation at 160°F ambient and minimum size and weight. *Popular voltages are in stock for immediate delivery.*

Please see pages 930 to 949 of your 1970-71 EEM (ELECTRONIC ENGINEERS MASTER Catalog) for complete information on Abbott modules.

Send for our new 68 page FREE catalog.



LABORATORIES, INCORPORATED
5200 W. Jefferson Blvd./Los Angeles 90016
(213) 936-8185
1224 Anderson Ave./Fort Lee, N.J. 07024
(201) 224-6900

INFORMATION RETRIEVAL NUMBER 6

Publisher

James S. Mulholland, Jr.

Editors

New York Office
850 Third Ave.
New York, N.Y. 10022
(212) 751-5530
TWX: 710-581-2874
Cable: Haydenpub

Editor: Frank Egan
Managing Editor: Ralph Dobriner
Managing Editor: Raymond D. Speer
Microelectronics, Steven A. Erenburg
Computers, Raymond D. Speer
Microwaves, Michael J. Riezenman
Circuits, Lucinda Mattered
Management, Richard L. Turmail
News, John N. Kessler
Military-Aerospace, John F. Mason
New Products, Roger Allan
Copy, Marion Allen

Field Offices

Massachusetts
Jim McDermott
P.O. Box 272
Easthampton, Mass. 01027
(413) 527-3632

West Coast
David Kaye
2930 Imperial Highway
Inglewood, Calif. 90303
(213) 757-0183

Washington
Don Byrne
1425 N St. NW
Washington, D.C. 20005
(202) 667-6568

Editorial Production

Dollie S. Viebig

Art

Art Director, Clifford M. Gardiner
Assistant, William Kelly
Rita Jendrzewski

Production

Manager, Thomas V. Sedita
Helen De Polo
Kathleen McConkey
Leslie Stein

Circulation

Manager, Nancy L. Merritt

Information Retrieval

Peggy Long

letters

'Heading downhill'— or just misunderstood?

Sir:

The quality of your Ideas for Design section seems to be heading downhill if the item on page 92 of the Dec 6, 1970 (ED 25) issue is any indication.

"Eliminate Warm-up Resistors in Lamp-driver Circuits," No. 312, details a method of switching lamps with a constant-current switch. What is not mentioned is that this method increases the short-term switch dissipation by a large amount and can result in switch transistor failures. Higher-dissipation transistors must be used when constant-current switches are used.

Robert M. Walker

MOS Design Engineering
Fairchild Semiconductor
Mountain View, Calif.

Author's reply

From the comments of Mr. Walker on Ideas for Design circuit No. 312, it is my opinion that he does not understand the problem solved by the circuit and may not understand how the circuit works.

It should be obvious that the constant current mentioned in the article is a very small base current to transistor Q_2 . This current is provided temporarily via resistor R_2 , and transistor Q_2 does not saturate during this time. Q_2 is of course rated to allow the minimal power dissipation required.

The collector current is limited by the base current supplied by R_2 , thus allowing the lamp to quickly (a few thousandths of a second) warm up with a current that is equal to or below the lamp's rated current. This technique minimizes

the current surge that would normally occur in a conventional lamp-driver circuit.

Further, I cannot understand how Mr. Walker can effectively analyze the design shown when no component identification is given.

The principal feature of the circuit is that lamp-current transients (greater than ten times rated value), which play havoc with power supplies and surrounding circuits, can be substantially reduced. In addition, no standby power is required.

Alphonso H. Marsh, Jr.

Air safety should be a 'first' project

Sir:

If the SST aircraft goes, with it go 150,000 jobs is the lament of many engineers throughout the aircraft industry. At first it would seem to be a serious blow to our economy and progress in aircraft technology; on the other hand it could be a blessing.

Now is a good time to work on improving our existing aircraft.

Work could and must be done to minimize the danger to life and property in air travel. Today's jumbo jets are half empty on many airline routes. To entice more passengers, some airlines are offering more leg room, better food, exotic wines, and more movies to regain lost revenues. But until the public is convinced of improved airline safety this space will go begging.

Now is the time for industry and government to get together and fill this void.

John J. Pirch, EE

Air Systems
NADC
Johnsville, Pa. 18974

Electronic Design welcomes the opinions of its readers on the issues raised in the magazine's editorial columns. Address letters to Managing Editor, Electronic Design, 850 Third Ave., New York, N.Y. 10022. Try to keep letters under 200 words. Letters must be signed. Names will be withheld on request.

AMPERITE

Top Quality
**STILL AT
LOW
PRICE**



**Thermostatic
DELAY RELAYS**

Offer true hermetic sealing ...
Assure maximum stability and life.

Delays: 2 to 180 seconds*

Actuated by a heater, they operate on A.C., D.C., or Pulsating Current... Being hermetically sealed, they are not affected by altitude, moisture, or climate changes... SPST only — normally open or normally closed... Compensated for ambient temperature changes from -55° to +80°C... Heaters consume approximately 2 W. and may be operated continuously. The units are rugged, explosion-proof, long-lived, and inexpensive!

TYPES: Standard Radio Octal and 9-Pin Miniature.
List Price, \$4.00

*Miniatures Delays: 2 to 120 seconds.

All Amperite Delay Relays are recognized under component program of Underwriters' Laboratories, Inc. for all voltages up to and including 115V.

PROBLEM? Send for Bulletin No. TR-81.

AMPERITE
BALLAST REGULATORS

Hermetically sealed, they are not affected by changes in altitude, ambient temperature (-50° to +70°C), or humidity... Rugged, light, compact, most inexpensive.

List Price, \$3.00
Write for 4-p. Bulletin No. AB-51.



AMPERITE

600 PALISADE AVE., UNION CITY, N.J. 07087
Telephone: 201 UNION 4-9503
In Canada: Atlas Radio Corp., Ltd.,
50 Wingold Ave., Toronto 10

RF.

Your Shortest Distance Between 2 Points Is A Broad Line.

However you're getting your message across. . . . if you're transmitting, a broad line of RF devices gives you drivers and pre-drivers specifically designed, packaged and priced to play in the same communications band you're working in — amateur, land-mobile, marine, aircraft, whatever.

. . . if you're receiving, a broad line offers low-noise, high gain amplifiers that also function in test equipment, frequency-sampling, WB-amplifier, CATV and general oscillator applications from 60 to 450 MHz and at NFs low as 2.5 dB.

. . . if you're doing both, a broad line offers both. The point is, a broad line of RF types gives you choice instead of compromise. Accuracy instead of trial-and-error. Performance, not failure.

One company truly gives you broad line.

Motorola gives you over 120 different RF devices and 19 individual cases, the majority interchangeable to fit custom needs.

And in the widest number of packages for optimized use of the industry's varied case designs from tiny Micro-T's* to large-wattage, flanged chassis-mounts. From one easy source.

Gigahertz? Of course.

Four new gigahertz RF power types, in fact, that range from 1 to 10 W power out @ 1 GHz, stripline packaged for lower lead inductance and rugged to resist load mismatch damage.

Circle the reader number for data on the

new 2N5922-25 gigahertz units. You'll also get a Selector Guide outlining the broadest RF transistor line in the industry.

Or, write Box 20912, Phoenix 85036 on your letterhead telling us what your specialized category of RF interest is: CATV, low-noise amplifier, marine, portable/land-mobile, aircraft or military radio. We'll send you pertinent device data.

Contact your Motorola distributor with the coupon to realize 10% off the up-to-999 published price on any Motorola RF small signal or RF power device. They'll go the distance for you.

10% OFF RF

(Distributor) _____

I get the point about Motorola RF!

I want up to 999 of these RF types off-the-shelf from you at 10% off their regular published price:

Name _____

Title _____

Company _____

Address _____

City _____

State _____ Zip _____



MOTOROLA RF

Not just more megahertz. More communication.

four interface problems:

1. Eliminate interface maintenance between a telegraph line and TTL logic for \$3.55.

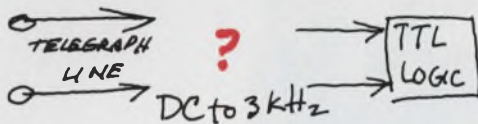

3. Eliminate ground loop spikes between computer and remote terminal for \$3.95.

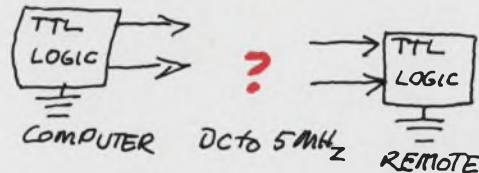

2. Trigger a remote SCR from TTL logic for \$4.50.

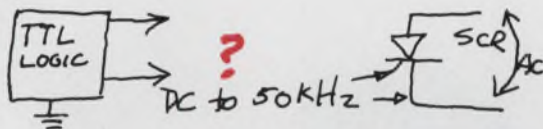

4. Couple TTL logic to 1.5 kV CRT blanking grid for \$3.95.

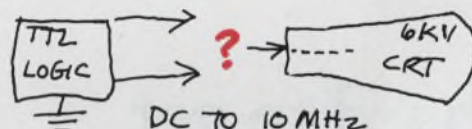

four opto-isolator solutions:

1. GaAs infrared LED
 $t_r = 40 \text{ ns @ } R_s = 50 \Omega$
 $I_F < 100 \text{ mA cont.}$
 $V_F = 1.3 \text{ V}$
 $V_{BR} = 3 \text{ V}_o$
 $\lambda = 9000 \text{ \AA}$
 This emitter makes solutions 2, 3, and 4 possible.

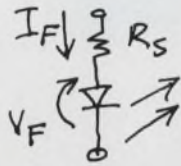

3. Silicon phototransistor MCT 2
 $t_r = 2 \mu\text{s @ } R_L = 100 \Omega$
 $f_{\frac{1}{2}} = 200 \text{ kHz @ } R_L = 100 \Omega$
 $V_{BRCEO} > 30 \text{ V}$
 $I_C/I_F = 35\% \text{ typ.}$
 $I_{C \text{ sat}}/I_F = 5\% \text{ typ.}$
 Solves 1 above.

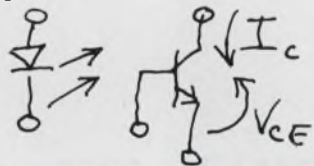

2. Silicon photodiode MCD 2
 $t_r = 110 \text{ ns @ } R_L = 100 \Omega$
 $V_R = 20 \text{ V}$
 $f_{\frac{1}{2}} = 5.5 \text{ MHz @ } R_L = 100 \Omega$
 $V_{BR} > 75 \text{ V}$
 $I_L/I_F = 0.2\% \text{ typ.}$
 Solves 3 and 4 above.

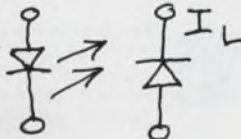

4. Silicon photoSCR MCS 2
 $t_{on} = 5 \mu\text{s @ } I_F = 20 \text{ mA}$
 $I_A < .15 \text{ A cont.}$
 $V_A = 200 \text{ V max.}$
 $I_{F \text{ turnon}} < 10 \text{ mA}$
 Solves 2 above.

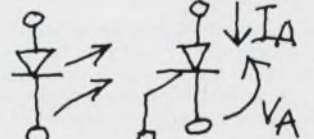

...and an answer kit: \$9.95.

The opto-isolator solves tough design problems. To let you work with these new devices, we've put together an *Opto-isolator Answer Kit*. Contains an MCT 2, MCD 2, MCS 2 in our six-lead Iso-DIP package at about half the price of the discrete parts — plus a new volume of GaAsLITE Tips that shows how to design opto-isolators into your problem circuits. Order from your Monsanto distributor or write Monsanto Electronic Special Products, 10131 Bubb Road, Cupertino, CA 95014. (408) 257-2140. All part prices are suggested resale price in 1,000 quantities

Monsanto

Distributors: In US—Schweber, Semiconductor Specialists, K-Tronics, and Kierulff. UK, Semiconductor Specialists; Semi Comps. France, RTF. West Germany, A.Neyen-Enatechnik. Denmark, Scansupply. Belgium, Techmation. Norway, Arthur F. Ulrichsen A/S. Switzerland, Omni Ray A.G. Italy, Silverstar Ltd. Sweden, GP-Ingenjorsfirman. Japan, New Metals and Chemicals Ltd. Corp. Australia, Hawker Siddeley. Israel, Monsel. Canada, Schweber; Canadian Dynamics. The Netherlands, Techmation n.v.

INFORMATION RETRIEVAL NUMBER 9

When you're known for Rolls-Royces,



Series 72 Pulse and Telegraph Polar Relay
... pulse repetition to 400/sec., life in hundreds of millions of operations

it's hard to get Volkswagen buyers to think of you.

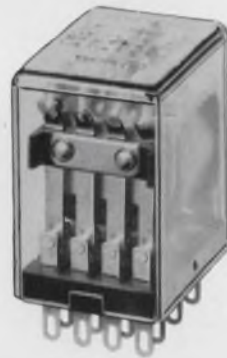

Series 67
General purpose
AC & DC, 4PDT, 5A

SIGMA has 2000 good, different general-purpose relays— many for 50¢/pole.

If you think of Sigma as a sensitive, close-differential relay house, you're partly correct. We're also a low-priced, general purpose relay house — as a substantial number of vending machine, alarm system, industrial control, copier and communications equipment manufacturers will attest.

For demanding applications such as computer peripherals, you can have one-cubic-inch 4PDT switching, on AC or DC coil signals, of low-level to 5-amp. loads at least 100,000 times with the Series 67. Fast wiring, mounting and interchangeability results from PC or solder terminals, or in sockets with PC or solder terminals.



Single-, two- or three-pole switching of loads up to 10 amps, for one million operations at 28 VDC or one-half million at 115VAC, is provided by the versatile and quickly-installed Series 68.

For up to 6PDT switching of low-level to 5 amp. loads by voltage adjustment, or 1-amp. loads on sensitive current adjustment, the Series 62 combines long life (up to 50 million operations with bifurcated contacts) with moderate cost.



For positive response to coil signals as low as 50 mw, at a cost of under 75¢/relay in quantity, the Series 65 is well-suited to TV channel selectors, slide projectors, vending machines and similar uses involving SPDT switching of 1-amp. loads.

Up to 3PDT switching of 5- or 10-amp. loads, on AC or DC voltages, is available in the compact and low-cost Series 50; wide application in automated equipment, switching small motors, solenoids and other relays.



We'll be glad to supply detailed technical data on any of the general-purpose relays mentioned, with complete price and delivery information on standards. Better yet, tell us your requirements (load, life, cost, driving signal, operating speed and environment) and let us recommend the relay best suited to the job. We can save you time, disappointment and perhaps some money as well. Sigma Instruments, Inc., 170 Pearl St., Braintree, Massachusetts 02185.

SIGMA INSTRUMENTS INC

New AMP I.C. receptacle fits any package.

Ampeconomation
COST SAVINGS BY DESIGN WORLDWIDE

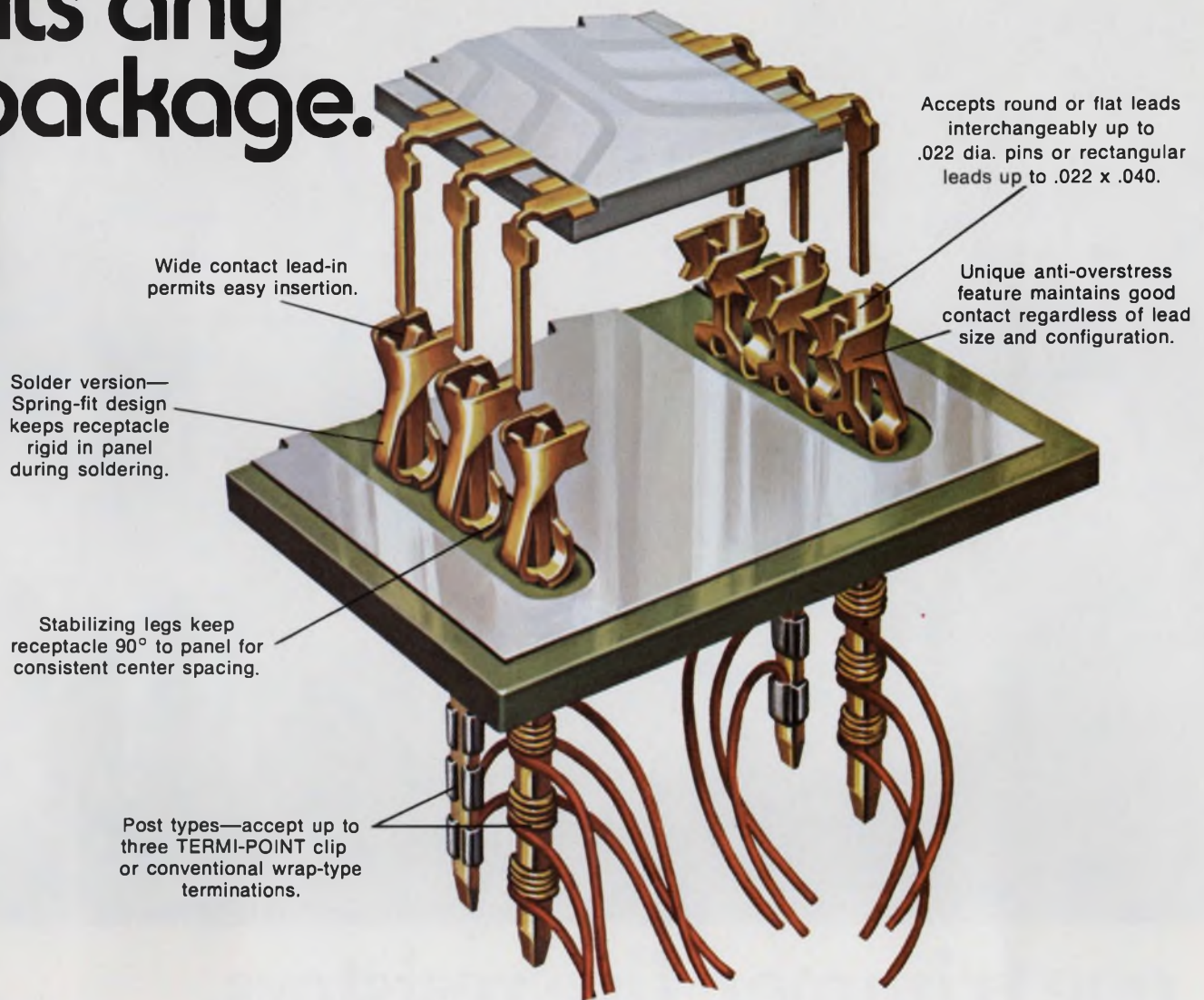

Choose your way of using it.

1. You build the panel.

We'll supply IC receptacles with a carrier strip and special insertion tooling for high-speed assembly to the board or panel. And work with you on setting up production.

2. We build the panel.

We'll put our time-tested panel production know-how to work for you in standard or custom panels. Placing IC receptacles as randomly or uniformly as you want.

3. Either of us wires the panel.

We have two basic types of panel for point-to-point wiring: one uses TERMI-POINT★; the other uses conventional wrap techniques. Either can be wired in your plant or in ours.

And the price is right.

Forget the usual claim that something better always costs you more. AMP's many advantages are yours at low per-unit prices. And you'll save even more using our assembly technique.

For more information on IC receptacles or on our general panel capability, write: **AMP Incorporated, Industrial Division, Harrisburg, Pa. 17105.**

★Trademark of AMP Incorporated

AMP
INCORPORATED

INFORMATION RETRIEVAL NUMBER 11

Think of it as a six pack...



one trimmer, five resistors, in one package. That's TRN.

Our new Trimming Resistive Network will cut resistor insertion and preparation cost by at least a 6:1 ratio. In addition it satisfies engineering requirements better than anything on the market. For instance, the TRN provides cermet TCR performance values of 50 or 100 ppm/°C. The one-paste, one-step deposition method that we use allows for uniform, predictable TCR drift within the range of ± 2 ppm/°C of each other for each resistor in the circuit. In addition, the unit features a ratio accuracy with respect to the variable re-

sistor available as low as $\pm 1\%$.

All componentry is housed in a single shell, which means that ambient temperature for each resistor in the circuit is the same for all others. Plus, you get versatility of applications, reliable long life and dimensions that are perfect for automatic insertion machines.

Like to know more? Write Bill Dunn. He's at Amphenol Controls Division, 120 S. Main Street, Janesville, Wisconsin 53545.



AMPHENOL
THE BUNKER-RAMO CORPORATION

designer's calendar

MARCH 1971

S	M	T	W	T	F	S
	1	2	3	4	5	6
7	8	9	10	11	12	13
14	15	16	17	18	19	20
21	22	23	24	25	26	27
28	29	30	31			

March 22-25

IEEE International Convention and Exhibition (New York City).
Sponsor: IEEE. J. M. Kinn, IEEE, 345 E. 47th St., New York, N. Y. 10017.

CIRCLE NO. 405

March 31-Apr. 2

Reliability Physics Symposium (Las Vegas). Sponsor: IEEE. O. D. Trapp, Fairchild Semiconductor, 464 Ellis St., Mountain View, Calif. 94040.

CIRCLE NO. 406

APRIL 1971

S	M	T	W	T	F	S
				1	2	3
4	5	6	7	8	9	10
11	12	13	14	15	16	17
18	19	20	21	22	23	24
25	26	27	28	29	30	

April 12-15

National Telemetry Conference, (Washington, D. C.) Sponsor: IEEE. H. B. Riblet, Johns Hopkins Univ., 8621 Georgia Ave., Silver Spring, Md. 20910.

CIRCLE NO. 407

April 13-16

INTERMAG, International Magnetism Conference (Denver, Colo.) Sponsor: IEEE. Bernard F. DeSavage, U. S. Naval Ordnance Laboratory, Silver Spring, Md. 20910.

CIRCLE NO. 408

a switch in time:

1 nsec

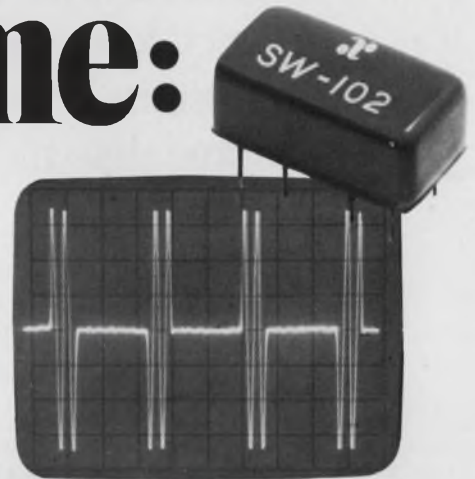

10-200 MHz

HIGHER SWITCHING SIGNAL REJECTION*

Better than 30 dB (100-200 MHz) • Better than 45 dB (10-50 MHz)

LOWER DRIVE POWER

15 ma, 0.5 V (Model SW-102)

HIGHER ISOLATION BETWEEN OUTPUTS

Better than 50 dB typical (10-200 MHz)

LOWER INSERTION LOSS

2.0 dB nominal (10-200 MHz)

THREE SPDT SWITCHES PROVIDE FOR THESE INPUT POWER LEVELS:

SW-102
0 dBm

SW-103
+10 dBm

SW-104
+20 dBm

Faster switching with extremely good video suppression and lower drive power all in one of the smallest packages available...

*Call us if
you're thinking of switching...or
to switch if you already are.*

*Switching signal rejection measured with a +5 dBm sinusoidal signal applied to drive port and the fundamental component measured at either output.



DS-109
POWER DIVIDER
10-500 MHz
30 dB isolation



TV-50
POWER DIVIDER
20-200 MHz
30 dB isolation



MD-113 DOUBLE-
BALANCED MIXER
10-1000 MHz



HFK-472 DOUBLE-
BALANCED
MIXER
5-2200 MHz



MTV-50 2-WAY
POWER DIVIDER
40-400 MHz
30 dB isolation



39 Green Street • Waltham, Mass. 02154
(617) 899-1900 TWX (710) 324-6484

INFORMATION RETRIEVAL NUMBER 13

Electronic Memories discreetly suggests a very low cost system for expansion modules or smaller main frame memories and that may even replace some disc memories: Micromemory 4000.

We recommend you read carefully. Because there's been a lot of wishful talk about a product like this one. The big difference is that we actually have it. We're talking about a 32K x 18 bits card type memory with control logic that allows it to be operated as 65K by up to 9 bits. Cycle time is 1.5 usec and access time is 800 nsec. And, starting April, we can deliver this memory off-the-shelf. By that we mean within days from receipt of order. Not weeks or months. And we don't want to talk price in this message; but we will say that the cost will cause many computer manufacturers to review their "make-or-buy" decisions. If you've been searching for a truly low-cost main frame memory or reliable expansion modules, we can assure you that this new family of "Micromemories" will open up

a whole new area of system thinking. With regard to disc memories. With regard to claims you have seen or heard about semiconductor memories. With regard to other claims about low-cost core memory systems. If you have system responsibility, you really owe it to yourself to get the full details on our "Micromemory" family.

Here and Now. This ad is just a few weeks premature. The design is fully proved and tested. The prototypes are in existence. But our claim to production quantities will have to wait until April.

EM Electronic Memories is a division of Electronic Memories & Magnetics Corporation, 12621 Chadron Avenue, Hawthorne, California 90250. Telephone (213) 644-9881.



("Just one little 'new-and-sensational' wouldn't hurt.")

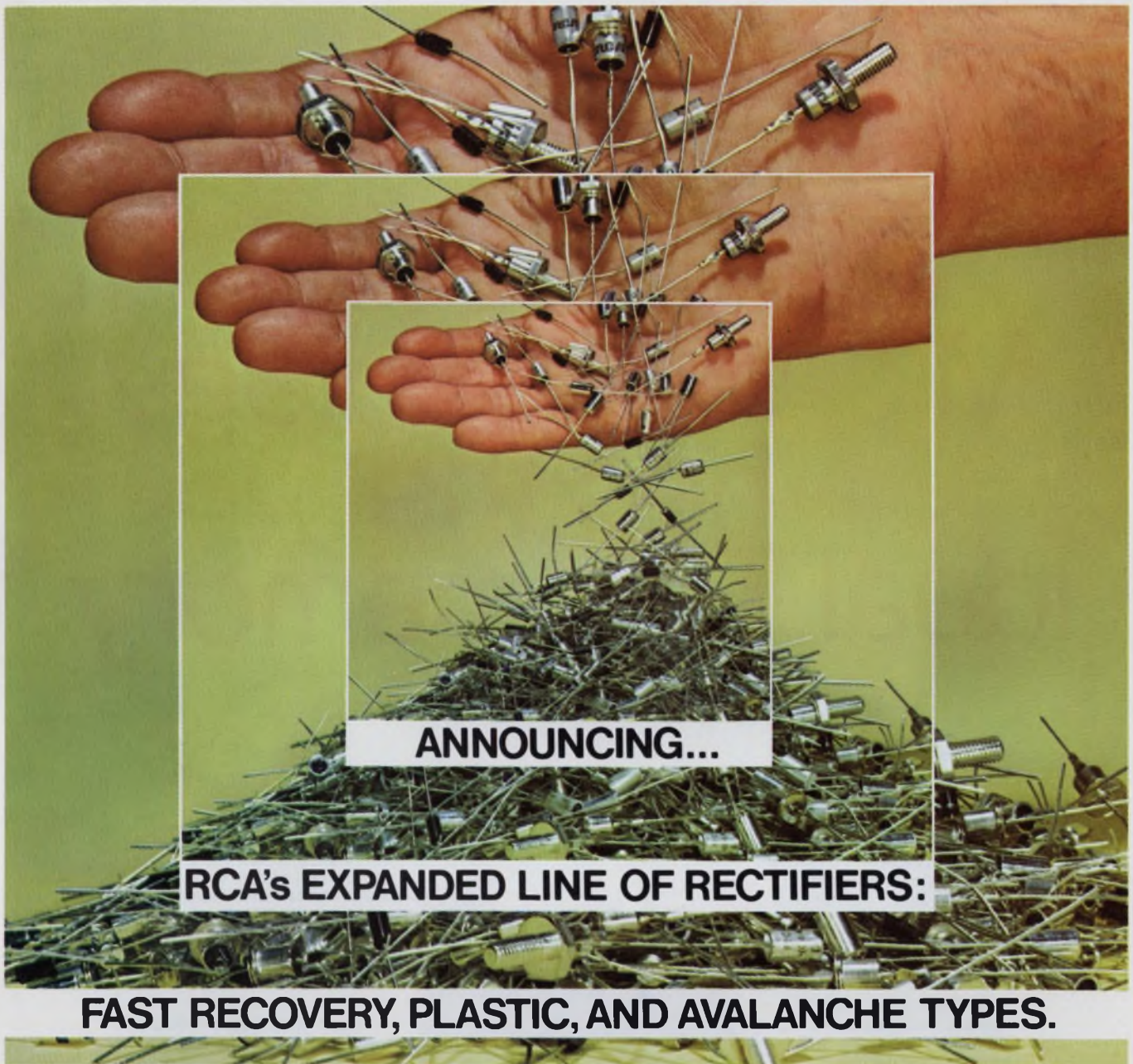

Here they are: production quantities of RCA's new fast-recovery silicon rectifiers, rugged plastic rectifiers, and hermetically-sealed controlled avalanche rectifiers. Constructed to the highest standards of quality and reliability, these and the many others in RCA's established rectifier line are immediately available to fill your application needs.

Make use of RCA's 1- and 3-ampere diffused junction silicon rectifiers (DO-26 and modified DO-4 packages) in high-speed inverters, choppers, and other high-frequency applications. Use RCA's 1- and 1.5-ampere plastic rectifiers (DO-15 package) in home entertainment equipment, industrial controls, appliance controls, and light industrial equipment. In instruments where reliable transistor protection is required, use RCA's hermetically-sealed (DO-26) controlled avalanche rectifiers.

For more details, call your local RCA Representative or your RCA Distributor, or write: RCA, Commercial Engineering, Section 57C-4/UR10, Harrison, N.J. 07029. International: RCA, 2-4 rue du Lièvre, 1227 Geneva, Switzerland, or P.O. Box 112, Hong Kong.

Rectifier	Max. Repetitive Peak Reverse Voltage (VRRM) (V)	Maximum Forward Current Avg. (I _F) (RMS) (A)	Peak Surge** Non-Repetitive I _{FSM} (A)	Reverse Recovery Time (trr) (μs)	Package	Capability
TA7892-TA7895*	200-800	1.0	1.5	35	0.5	DO-26 fast recovery
TA7898-TA7901	200-800	3.0	4.5	75	0.5	modified DO-4 fast recovery
TA7996, TA7802-TA7806*	100-1,000	1.0		35		plastic DO-15 general-purpose
1N5391-1N5399	50-1,000	1.5		50		plastic DO-15 general-purpose
40808	600	.5		35		DO-26 controlled avalanche (700-1100 V)
40809	800	.5		35		DO-26 controlled avalanche (900-1300 V)

*RCA Developmental types

**For one-half cycle of applied voltage (f = 60 Hz)

RCA Thyristors

INFORMATION RETRIEVAL NUMBER 75

Computer Microtechnology has the ideal TTL memory

1024 words x 4 bits.
Also available 2k x 2 (2401)
and 4k x 1 (2402).
The 2400 series expands easily
to match your word and bit
requirement. Access: 400 nsec.
Cycle: 600 nsec.

Our coding tells us the
complete history of each of the
16 MOS/LSI storage chips
and 6 bipolar decoding and
sensing chips that make
the 2400 work.

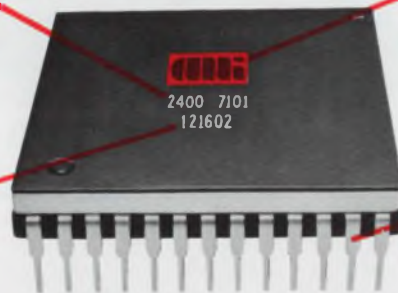

You're going to see this logo
on a lot of parts.
Computer Microtechnology
has ROMS, RAMS, and
REGISTERS.

These 26 pins plug 4096 bits
of fully decoded read/write
memory into your circuit board.
A real savings in pc board
and system assembly costs!

The CM 2400 is a simple static read/write memory. No timing signals to refresh.
Power required is very low — .4 mW/bit. It needs only two power supplies,
+5V and +10V, for compatibility with all DTL and TTL systems. It features complete
TTL interface, in and out, and has standard TTL noise immunity on all pins.

It's easy to use: Plug it in and get on the air. No hairy design problems.
No big assembly and subsystem test problems. No waste of circuit board real estate.

And no delivery problems. We've built your TTL memory for you.
Get details from us at (408) 736-0300, (617) 891-0002, or (714) 835-8323.

Get parts from stock at Kierulff, K-Tronics, F-J-R Electronics or Schley Electronics.



Computer Microtechnology Inc., P. O. Box 7050, Sunnyvale, Calif. 94086

INFORMATION RETRIEVAL NUMBER 15

The SCR Power Supplies are high efficiency, high power units designed for a wide range of applications where both precise constant current and constant voltage operation are required. Competitive comparison shows E/M power supplies have lowest voltage ripple, more watts per cubic inch and per pound.



The EMX Power Supplies are specifically designed as constant current sources for Xenon and other high pressure lamps. The EMX series provides stable light output and features automatic starting, igniter pulse timing control, output current adjustment and provisions for certain remote functions. Low lamp current ripple insures maximum life.



The EM Power Supplies have the same advantages and the same applications where the precise regulation of the SCR Power Supply is not required. The EM Power Supplies are a low-cost 1% regulated voltage and current DC source in the medium power ranges up to 10 kw.



GUARANTEED FOR FIVE YEARS

Applications:

Precision Welding	CW and Pulse Lasers
Semiconductor Aging	Focusing Coils for Accelerators
Diode Testing	Electroplating
Relay Testing	Battery Charging
IC and Transistor Testing	Electronic Memory Systems
Capacitor Forming	Cryogenic Magnet Applications
High Pressure Lamps	

CALL TOLL FREE (800) 631-4298

Write today for your copy of our 1971 Power Supply Catalogs. Complete specifications, accessories and prices for your ready reference.



ELECTRONIC MEASUREMENTS INC.

405 Essex Road, Neptune, New Jersey 07753

WHEN THINKING PRECISE kw POWER SUPPLIES . . . it's E/M

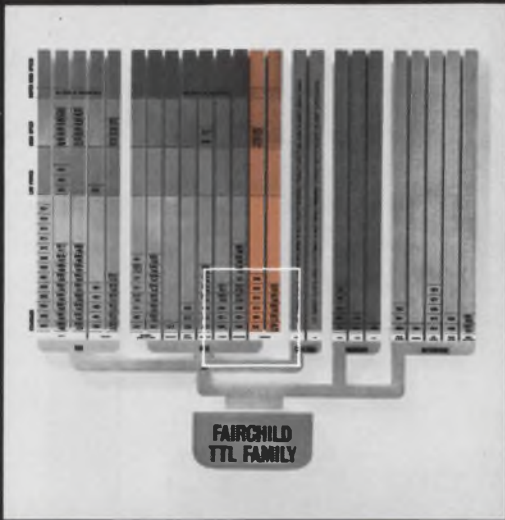

The Fairchild TTL family offers the freedom-loving designer the broadest range of speed/power trade-offs and an extraordinary variety of memory, interface and logic functions, including TTL/MSI Counters for every possible application in both old and new digital systems.

Shift Register		Full Adder		
7495 Left/Right Shift Register		9348 12 Bit Parity Generator/Checker	9356 Binary Counter	
7494 Shift Register	9377/7477 Quad Latch	9342/74182* Carry Lookahead	9350 Decade Counter	9393/7493 Binary Counter
7491 Shift Register	9375/7475 Quad Latch	9341/74181* 4 Bit Arithmetic Logic Unit	9316 Binary Counter	9392/7492 Divide by 12 Counter
8 Bit Shift Register	9334* 8 Bit Addressable Latch	9340 4 Bit Arithmetic Logic Unit	9310 Decade Counter	9390/7490 Decade Counter
8 Bit Shift Register	9314 4 Bit Latch	9324 5 Bit Comparator	9306 Up/Down Decade Counter	9366/74193 Up/Down Binary Counter
10 Bit Shift Register	9308 Dual 4 Bit Latch	9304 Dual Full Adder	9305 Variable Modulo Counter	9360/74192 Up/Down Decade Counter

REGISTERS

LATCHES

OPERATORS

COUNTERS

MSI

More TTL freedom you can count on: our new MSI

SUPER COUNTER

The new Fairchild 9305 Variable Modulo Counter actually covers more counting applications than the combined capability of the 7490, 7492 and 7493. With no additional logic, it can count or divide in ten binary modes: 2, 4, 5, 6, 7, 8, 10, 12, 14 and 16. And with the simple addition of two gates, it can divide in three additional modes: 11, 13 and 15. What's more, this most versatile counter provides 50% duty cycle outputs for division by 8, 10, 12, 14 and 16.

To further the flexibility of the 9305, all of the counting modes are programmable by logic, rather than hard wiring. And, of course, an asynchronous Master Set and Reset are provided.

Best of all, you can get this high speed counter for

lower cost than any *one* of the competitive counters it replaces. So now you can design in and inventory just one device instead of several, saving the kind of time and money that adds up to real design freedom. It's Fairchild's counter revolution.

A TTL/MSI Counter for every application.

The 9305 is just one of a complete line of proprietary and second source counters. Want to count up? Down? In serial? Parallel? Synchronously or asynchronously? Fixed modulo or variable? You name it, our TTL family has an MSI counter you can count on.

Call your local Fairchild distributor. He has the complete line. Right over the counter.

FUNDAMENTAL MODULOS

THE FAIRCHILD COUNTER FAMILY		2	3	4	5	6	7	8	9	10	11	12	13	14	15	16
FIXED MODULO RIPPLE COUNTERS	9350†	●			●					●						
	9356†	●		●				●								●
	9390/7490	●			●					●						
	9392/7492	●	●			●						●				
	9393/7493	●		●				●								●
SEMI-SYNCHRONOUS VARIABLE MODULO COUNTER	9305	●		●	●	●	●	●		●	○	●	○	●	○	●
SYNCHRONOUS UP COUNTERS WITH PARALLEL LOAD*	9310									●						
	9316															●
SYNCHRONOUS UP/DOWN COUNTERS WITH PARALLEL LOAD*	9306									●						
	9360/74192									●						
	9366/74193															●

†Available with center or corner power supply pins.

*All Parallel Load Counters can be pre-set so the counter can be made to count in any modulo.

○ With 2 external gates.

FAIRCHILD
SEMICONDUCTOR

Up-to-date and thorough PE Examination Guides

These two volumes offer the most convenient and economical coverage of the subject matter that must be mastered to successfully pass the preliminary examination (Engineer-in-Training) and the final examination for the professional license in electrical engineering.

Each concise, carefully organized volume presents problems from recent state examinations together with complete step-by-step solutions. Providing rapid access

to important topics, vital for "open book" examinations, each also includes numerous pertinent illustrations and lists of references for further study.

Prepared by practicing engineers, the books have been written on the premise that the reader is versed in engineering, and that he is approaching the time when his State Board of Examiners will consider him qualified for taking the examinations.

BASIC ENGINEERING SCIENCES AND STRUCTURAL ENGINEERING FOR ENGINEER- IN-TRAINING EXAMINATIONS

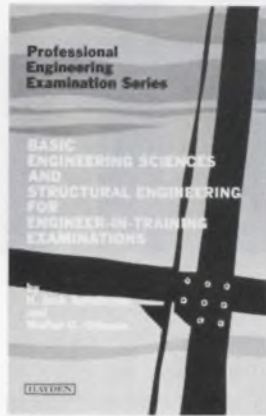

H. JACK APFELBAUM, P.E., Department of Mechanical Engineering, Lowell Technological Institute; and WALTER O. OTTESEN, P.E., Patent Counsel

Comprehensive and well balanced in its coverage of the concepts and techniques fundamental to all areas of engineering practice, this volume presents nearly two-hundred problems carefully chosen from recent examinations given by the individual states. Typical of the material the reader is likely to encounter in Engineer-in-Training Examinations, these are conveniently arranged by subject, and cover three broad areas: background material in mathematics, physics, and chemistry; the basic engineering sciences: statics, dynamics, fluid mechanics, thermodynamics, electricity, and engineering economy; and seven chapters detailing topics in structural engineering. Introductory sections precede each subject area and its fully worked-out problems, providing background in the specific concepts, principles, and terminology. More than three-hundred detailed illustrations insure a complete grasp of problem-solving techniques. #5712, 408 pages, illustrated, \$13.95

ELECTRICAL ENGINEERING AND ECONOMICS AND ETHICS FOR PROFESSIONAL ENGINEERING EXAMINATIONS



JOHN S. LYONS, P.E.; and STANLEY W. DUBLIN, Institute of Environmental Medicine, New York University Medical Center

Presenting a wide range of problems in electrical engineering, this book concentrates on the subjects and topics that form the basis for an ever-changing technology. The portion of the book devoted to economics and legal and ethical considerations is equally complete, providing in-depth understanding that will prove valuable in future engineering assignments.

Almost one-hundred problems in electrical engineering range from basic circuitry to the uncategorizable "bonus" problems frequently encountered in examinations. More than one-hundred-seventy illustrations illustrate the text. The section on economics features an unusual approach to such topics as interest, costs, valuation, and the like — the summarized use of formulas in solving nearly fifty typical problems. #5715, 320 pages, illustrated, \$12.95.

Hayden Professional Engineering Examination Series, LAWRENCE J. HOLLANDER, P.E., Editor-in-Chief. Subsequent volumes will focus on mechanical and civil engineering.

Send no money — clip or duplicate this coupon today!

15-DAY FREE EXAMINATION

Please send the book(s) checked below on a 15-day free examination basis. At the end of that time, I will remit payment, plus postage, or return the book(s) without further obligation.

- #5712, Basic Engineering Sciences and Structural Engineering for Engineer-in-Training Examinations, \$13.95
- 5715, Electrical Engineering and Economics and Ethics for Professional Engineering Examinations, \$12.95
- Further information on the Hayden Professional Engineering Examinations Series



HAYDEN BOOK COMPANY, INC.
116 W. 14 St., New York, N.Y. 10011

Name _____

Firm/Institution _____

Address _____

City/State _____

Payment enclosed (Hayden pays postage). Same return guarantee. On all overseas orders payment in U.S. dollars must be enclosed.

71-34 1

Spec for spec, every one of the 28 designs in our new family of high-performance A/D and D/A converter modules is the best in its class. Each provides an optimum combination of stability, linearity, accuracy, and speed. Several are unique. Yet every one is priced to compete with *ordinary* converters. *How do we do it?*

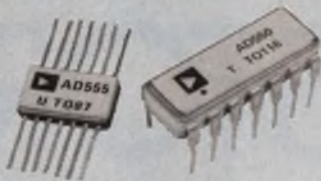

secret ingredients

It's simple, really. We start out way ahead, with *fourth-generation* IC quad switches—our exclusive μ DAC™ quads, which incorporate circuit and processing innovations that make high-performance 16-bit conversion a practical reality at practical prices . . . and superb 8-to-12-bit conversion a snap.

The current quads have a unique type of internal reference compensation (another headache gone!) and proportional junction geometry, for minimum intrinsic V^{BE} errors.

The voltage quads are optimized by dielectric isolation of all critical junctions for minimum resistance and resistance mismatch. These quads give us conversion linearity to within 0.01% without tweaking or trimming!

Then we complement the near ideal performance of μ DAC switches with μ DAC ultra-stable thin-film resistance networks . . . laser-trimmed for virtually perfect linearity. (And how does a T.C. of 1PPM/°C sound?) And since we designed μ DAC networks for optimum compatibility with μ DAC quads, the rest is all downhill.

These years-ahead "secret ingredients" were designed and built in our new "outer-limits" fourth generation IC engineering and

production facility. They gave us an unfair advantage over all other manufacturers of converters. Now that the secrets are out, of course, they'll be playing catch-up ball. (Don't wait for them.)

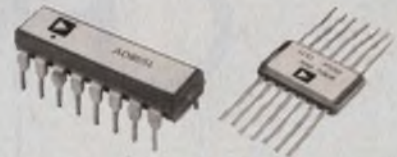

more secret ingredients

FIVE REPRESENTATIVE DESIGNS

DAC-16QM
16-bit D/A Converter (also 14-bit DAC-16QM)
Linear within 0.0008%! From ordinary $\pm 15V$ op amp supplies — no need for 100 volt current-source supplies. Gain T.C. is 1ppm/°C. Completely universal — up to 14 possible codes.

DAC-12M
Multiplying 12-bit D/A (also 8-bit DAC-8M)
Four-quadrant multiplier; accepts one digital and one or two analog (bipolar or unipolar) inputs; output is their product. Accuracy, $\pm 0.024\%$.

ADC-12QM
12-bit A/D Converter (also 8-bit & 10-bit designs)
Relative Accuracy, 0.0125%; differential linearity, $\pm \frac{1}{2}$ LSB; T.C. of linearity, ± 3 ppm/°C; T.C. of reading ± 5 ppm/°C. Output: serial/parallel; binary, BCD; TTL;

DAC-12QM
12-bit D/A Converter (also 8-bit & 10-bit designs)
Output: 0 to 5 or 10VDC (or $\pm 5, \pm 10V$) @ 10mA; 50V/ μ sec slew rate; Linearity & F.S. Accuracy, $\pm \frac{1}{2}$ LSB each; T.C., ± 7 ppm/°C.

DAC-12OS
12-bit D/A Converter (also 8-bit & 10-bit designs)
Same performance as DAC-12QM, but without input storage register.

SIZES: 2" x 2" x 0.4" or 2" x 2" x 0.36" or 2" x 4" x 0.4" as shown below.



Write today for this complete "data package" on all the converter products of: ANALOG DEVICES, INC., Route 1 Industrial Park, Box 280, Norwood, Mass. 02062.

For immediate delivery from stock, or other prompt, personal assistance, call: Dick Ferrero at (617) 329-4700; TWX: (710) 394-6577.



We use Secret Ingredients
...in 28 new D/A & A/D Converters

Attention Data Systems OEM's:
Secret Ingredients for Sale. In Stock. Call for Evaluation Units & Quotes.

CHOOSE YOUR RESISTOR STYLE.

WE MAKE BOTH.

WITH WIREWOUND RESISTORS,
SOME SOURCES OFFER
VITREOUS-ENAMEL...OTHERS HAVE
SILICONE-COATED UNITS.

IN SPECIFIC APPLICATIONS,
ONE MAY BE BETTER SUITED
THAN THE OTHER.

SPRAGUE GIVES YOU
A CHOICE.

Unique all-welded end cap construction eliminates moisture paths along leads. End caps securely anchor leads to resistor body. Expansion coefficient of coatings closely matched to that of ceramic base and end caps.

Blue Jacket[®] vitreous-enamel types are made in wattage ratings from 1 through 11 watts, with resistance values up to 60,000 ohms. Standard resistance tolerance, $\pm 5\%$. Tolerances to $\pm 1\%$ available upon special order.

Acrasil[®] silicone-coated types are available in resistance values to 250,000 ohms. Wattage ratings range from 1 through 10 watts. Standard resistance tolerance, $\pm 1\%$. Tolerances to $.05\%$ may be specified.

For complete technical data on Blue Jacket and/or Acrasil Resistors, write for Engineering Bulletins 7410E and 7450B, respectively, to Technical Literature Service, Sprague Electric Company, 347 Marshall Street, North Adams, Massachusetts 01247.

THE BROAD-LINE PRODUCER OF ELECTRONIC PARTS



highlighting

THE ISSUE

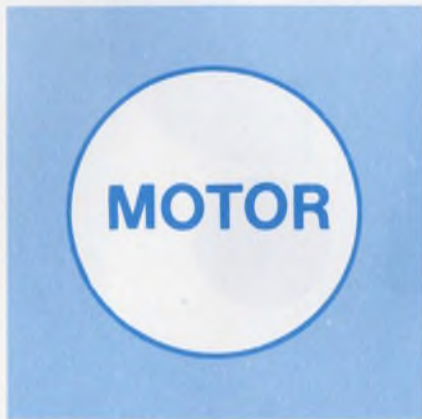

The main reason for updating the design of control systems with integrated circuits is to reduce their size and cost. And it isn't necessary to change the basic control technique to accomplish these objectives.

Two new versions of a motor speed and acceleration control offer this opportunity to reduce maintenance costs. One is an analog system, while the other is a digital servo-system.

Both are practical circuits, adaptable to any commercial power pack requiring dc control inputs. Each fits on a printed-circuit card, making assembly cost low and facilitating replacement and off-line repair if necessary.

Page 40

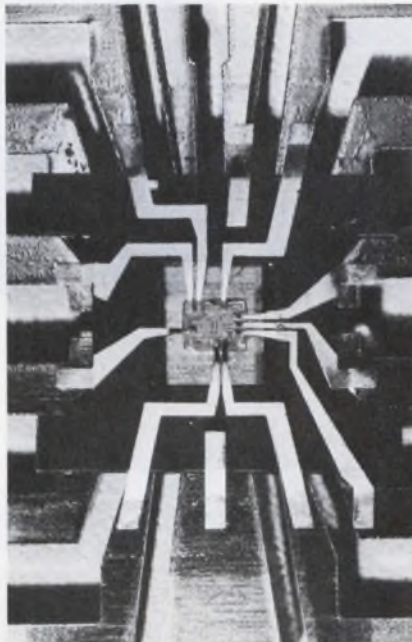

New trends in packaging, such as General Electric's multibond process of gang-bonding 72 IC leads at one time (above), are increasing reliability and cutting costs. Other trends include: more multichip, multilevel packages, and more use of plastics for encapsulation.

The net results of advances like these is that designers will be able to build smaller equipment that uses less power and is actually more reliable.

The one-chip calculator and one-chip central processor units are already here; the road ahead is limited only by the designer's ingenuity.

Page 24

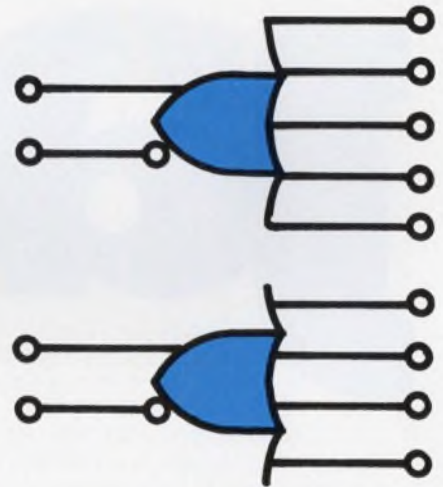

MECL 10,000, a new family of emitter-coupled logic with an unbeatable 50-pico-Joule speed-power product (2-ns delay and 25-mW dissipation per gate) has arrived on the logic scene.

Until now the emphasis in emitter-coupled logic has been on speed, with power dissipation often sacrificed. With MECL 10,000, power dissipation is constant—it is not a function of the operating frequency.

Compatible with other MECL families, MECL 10,000 offers the logic designer the flexibility of wired-OR and wired-AND options.

Page 61

Log Jamm?

Compress wide dynamic range signals to a usable output for recording or signal transmission — without range switching — with Teledyne Philbrick nonlinear modules.

These self-contained modules also simplify the whole area of logarithmic computation and algebraic equation solving. Applications vary from readout of wide dynamic range signals generated in air, water, and noise pollution measuring systems to color recognition in textile mills. Additional applications are in the medical field where instruments measure biological impurities. Teledyne Philbrick's application staff is ready to help you apply a log module to your problem, be it simple or exotic. Contact your local field engineer or call Skip Osgood, Product Manager, Nonlinear Division at (617) 329-1600, collect. Teledyne Philbrick, Allied Drive at Route 128, Dedham, Mass. 02026. TWX (710) 348-6726. Telex: 92-4438.

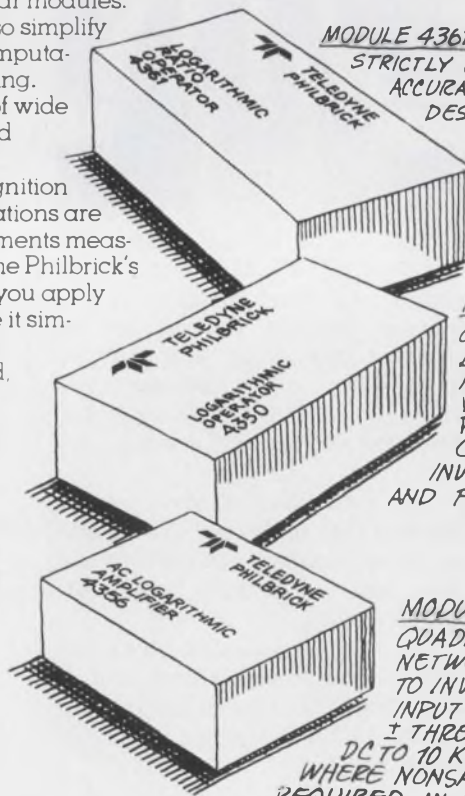

MODULE 4361 SINGLE QUADRANT MODULE.
STRICTLY CURRENT INPUT LOG RATIO.
ACCURATE LOG RATIO CIRCUIT SPECIFICALLY
DESIGNED FOR PHOTO TUBE
APPLICATIONS, POLLUTION
DETECTION AND CALORIMETER
CIRCUITRY.
IN LOTS OF 100 - \$73.

MODULES 4350/4351
OUTPUT PROPORTIONAL TO
LOG OR ANTILOG OF INPUT SIGNAL.
MEASURES LOG CURRENT, LOG
VOLTAGE, OR ANTILOGS. 4350'S
POSITIVE, 4351'S NEGATIVE. A PAIR
COMPUTES SQUARES, CUBES, ROOTS,
INVERSE SQUARES AND CUBES, INTEGRAL
AND FRACTIONAL POWERS AND ROOTS.
IN LOTS OF 100 - \$73.

**MODULE 4356 BIPOLAR LOG, FOUR
QUADRANT CONTINUOUS FUNCTION
NETWORK WITH OUTPUT PROPORTIONAL
TO INVERSE HYPERBOLIC SINE (\sinh^{-1}) OF
INPUT SIGNAL. LINEAR THROUGH 0 WITH
 \pm THREE DECADES OF AC/DC LOGGING.
DC TO 10 KHZ BANDWIDTH RANGE. IDEAL
WHERE NONSATURATING AMPLIFIER IS
REQUIRED IN SPEECH COMMUNICATIONS.
IN LOTS OF 100 - \$68.**

 **TELEDYNE PHILBRICK**
NONLINEAR

New ABM net planned, a backup for Safeguard

WASHINGTON—The Defense Dept. is pushing development of a new, short-range antiballistic missile system that would supplement the present Safeguard defense in the event it were overcome with more enemy missiles than it could handle.

The Army will manage the program and will ask "very soon," according to a Defense Dept. spokesman, for requests for proposals to bid "on a new missile, smaller than Sprint: a new phased-array radar, much smaller than Safeguard; a new computer and brand new software."

The new, hard-point system would be built close to present ICBM sites, presumably to pick up what the Spartan and Sprint missiles missed or to intercept submarine-launched missiles, which travel at a lower trajectory.

A total of \$25-million in R&D funds was allocated in the last fiscal year, and three times as much is being sought for fiscal year 1972.

How big the Safeguard net would grow depends on debates now under way in the National Security Council. A decision is ex-

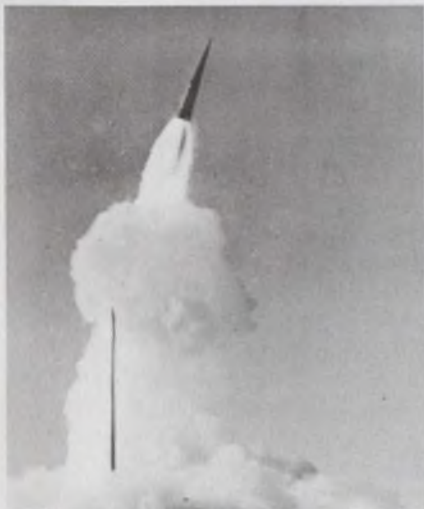

Back-up missile for Sprint is proposed by Dept. of Defense.

pected to be ready for Defense Secretary Melvin Laird when he testifies on the nation's military posture before the House Armed Services Committee starting March 9.

... meanwhile foes of the ABM unite

An organization called Computer Professionals Against ABM, claiming membership of more than 500 computer specialists who oppose the ABM on "purely technical grounds," hopes to prove to Congress that there is sufficient opposition to the system to preclude its moving ahead.

Safeguard won't work, says the group. It is too difficult to guess what the enemy's tactics will be, the members argue. It takes up to five years to program a computer, and then the enemy might use a different tactic. And the best-planned program can malfunction.

Since there is no opportunity for testing under extended operating conditions, the system can not be brought to reliable operating status, the group argues. Moreover, according to the chairman of the group's executive committee, Daniel D. McCracken, the Soviet Union's ABM does not work: "They have an ABM system of their own that their scientists privately tell our scientists is useless."

A Defense Dept. spokesman, responding to the group's objections, told ELECTRONIC DESIGN that integrated systems tests now under way are working well. As for overwhelming the computer program, the spokesman said: "There are not so many strategic options as the group seems to believe. There are only so many things a re-entry vehicle can do. Our computers have been, and are being, programmed to handle a number of incoming

missiles that are using more than one offensive technique."

Safeguard could be overwhelmed, the defense spokesman admitted, but not because of any problem in computer programming. The danger is that the system could be inundated with incoming missiles if they were in excess of a certain classified number.

The spokesman added: "We are aware of the Soviet capabilities and our own, and we are very far ahead of the Soviets in the art of electronic countermeasures."

McCracken is currently making a wide swing across the country, presenting objections to the program and collecting signatures on a petition to dismantle Safeguard.

Coronary monitor learns heart-beat information

In about 15 seconds, a new electrocardiogram monitor can "learn" the characteristics and timing of a patient's QRS waveforms—signals that are used by doctors to describe the heart's function. The monitor will issue an alarm at a nursing station if it senses abnormal conditions.

The equipment, developed by American Optical Corp., Framingham, Mass., uses a simple RC averaging circuit to compare each instantaneous signal with the average interval. If the time deviates by more than 10 or 20% from that average, an audible and visible alarm is triggered.

The monitor also classifies the QRS waveforms into one of eight categories. If the waveform information stored in the monitor's memory differs from the patient's heart action, alarms are set off.

Honeywell announces new family of computers

Honeywell Information Systems, the offspring of a merger between GE's business computer operation and Honeywell's computer interests, has announced that its new family of computers is about to compete in the market.

With sales and rental revenue at \$861-million—up 13% over the 1969 GE and Honeywell combined computer revenue—Honeywell Information Systems in Wellesley

Hills, Mass., is offering the 6000 series in July (some models won't be available until the second quarter of 1972).

The new series includes six single-processor models—the 6030, 6040, 6050, 6060, 6070 and 6080. Memory cycle time for the first four models in the series is 1.2 μ s for two 36-bit words (12 characters); cycle time for the larger units is 500 ns for the same amount of information.

Three disk packs are being offered: the largest, the 190, has a capacity of from 266 million to 2.12 billion 6-bit characters. Memory can be added to the disk drive units in increments of 133 million characters.

All six members of the Honeywell family are fully compatible with the company's 600 systems.

For peripherals, Honeywell is adding three CRT terminals: the 765 and 775, which have 22-line, 46-character-per-line displays, and the 785, which has a 22-line, 92-character-per-line display.

Tuning in on IR —a laser first

A technique for tuning a laser over a broad infrared range—from 3 to 4.5 microns—has been developed by Prof. C. Forbes Dewey Jr. and Dr. Lon Hocker of the Massachusetts Institute of Technology. It is the first method for tuning a laser over the infrared region of the spectrum, according to Dewey.

Since many gases in the atmosphere resonate at infrared frequencies, the technique could find application in monitoring air pollutants or in laboratory work involving infrared absorption spectroscopy.

The tunable infrared system uses two lasers: a ruby and a tunable organic dye. The beams from both lasers are combined in a lithium niobate crystal, which, in turn, emits a difference frequency in the infrared. (The output beam from the crystal is the difference between the two inputs.) By tuning the dye laser in the visible range, they can vary the infrared output from the crystal between 3 and 4.5 microns.

Dewey says that it should be

possible to tune between 2 and 13 microns with current technology and that the longer wavelength limit should be extendable to 25 microns when better nonlinear crystals become available.

The prototype system was able to emit over 6 kW of power in 20-ns pulses. Dewey expects to increase power output many times with minor adjustments to the system.

'Portable' recon system being used by RAF

How do you convert a combat fighter-bomber into a reconnaissance aircraft—in less than an hour?

Attach a 24-foot-long pod containing side-looking radar, infrared linescan equipment and a battery of five optical cameras.

The detachable recon system, developed by EMI, Ltd., in England, has gone into service with the British Royal Air Force. It will be carried beneath RAF Phantom fighter-bombers. The sidelooking radar points downwards and sideways on each side of the plane. A fixed beam scans the ground through the forward movement of the plane. The results are recorded on film, which is then processed to provide high-definition radar maps of the terrain at both high and low altitudes.

In the linescan system, an infrared detector scans the ground beneath the aircraft at a rapid rate, recording on film minute temperature differences of objects on the ground.

'Early warning system' for machinery available

An "early warning system" for machine breakdowns that can be designed from off-the-shelf components has been developed by the Electronics & Instruments Group of Bell & Howell Co., Pasadena, Calif.

Called the 1-175 all-purpose, vibration-monitoring system, the unit has 250,000 possible design combinations for industrial applications in almost any industry, according to the company's prod-

uct manager, H. I. Henderson.

"It can be used on any rotating or reciprocating machinery, such as turbines, electric motors, compressors and internal combustion engines," he says.

Various types of transducer pickups can be connected to the 1-175 to detect faint, abnormal vibrations in terms of velocity displacement and acceleration of parts of a machine. Using this information, the monitoring system pinpoints any minor bearing knock, misalignment, imbalance or failing part before it causes major damage. It sounds an alarm or shuts down the machine.

To diagnose dangerous vibrations, an optical filtering system is used. The unit also features a time-delay adjustment of from one to 10 seconds that allows for normal and transient vibrations.

Pacemaker battery check is only a phone call away

Engineers at ESB, Inc., Philadelphia, have developed a heart pacemaker monitor that allows patients with implanted pacers to check the batteries of these devices over the telephone.

Heart surgeons usually replace implanted batteries every two years as a precaution, because they can never be sure when the battery is rundown. The new monitor, by offering precise information, can extend the interval between implant operations to 36 months.

William Raddi, section leader at ESB's research center in Yardley, Pa., says the pacer pulse rate is proportional to battery voltage. To measure pulse rate, a patient simply telephones his doctor or clinic and places the phone handset in a cradle in a home unit. With one hand, he holds down an electrode in the unit, and with the other, he places a second electrode over his heart.

The magnitude of the pacemaker stimulating pulse is typically .5 to 50 mV and between 1 and 2-ms duration. This signal is converted to a 50-ms tone burst, which is audibly coupled to the telephone line and then transmitted to a receiver in the cardiologist's office. The receiver displays information in digital format.

Take A Bow, Showoffs!

Meet The New REDHEAD* On Your Block For Less'n A Buck

MLED630 69¢

It offers 1,100 fL typical brightness at 50 mA input current and a wide, 120° field of view. It's cased in the popular, TO-18-type package with a unique, molded plastic lens for durability and long life, and . . . it's very low cost — only 69¢, 1,000-up!

Use it compatibly with RTL, DTL and T²L for low-drive-current (200 fL @ 10 mA) applications requiring high visibility, low drive power, fast response . . . and economy!

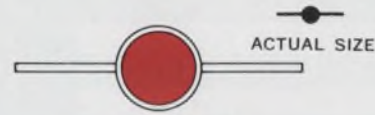
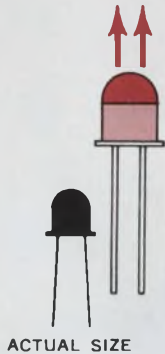

Tiny Micro-T* Red LED Shows Big Performance

MLED50 49¢

For space-limited, panel and circuit condition indicators, light modulators, shaft or position encoders, punched card readers, optical switching and logic circuits you can't get a mightier light than this: 750 fL showoff at 20 mils, 330 fL at 10. *Plus* nano-amp leakage. *Plus* molded plastic lens for wider viewing angle. *Plus* easy insertion into PC boards and custom designs.

A 6,600 angstrom Atlas in a pinhead package!

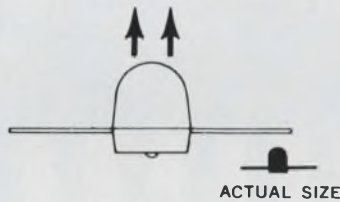

Do Invisible Things With 9,000 Å, Infra-Red LEDs

MLED60/90 99/85¢

Narrow-beam light emission is the keynote of these two new plastic infra-red LEDs, lensed for high, on axis power output (either 550 or 350 μ W at 50 mA input) providing a greater signal to coupled silicon detectors.

Low prices make them ideal for card/tape reading as well as industrial processing and control and other designs requiring infrared power output and stable characteristics.

Our Micro-T size = your high density application need.



Turn Red Reliably With Tiny LED Pill

MLED610 \$2.30

Only 50 mils turns it up to 1,100 fL brightness — enough for most designs requiring metal-package reliability for high density mounting — PC boards, for example, that demand the ultimate in rugged shock, thermal and moisture resistance.

It's the only red LED in the tiny "pill" — use it in space-limited designs that need exacting, IC-compatibility. And in custom arrays where your thing is close-tolerance-spacing.

The Gallium-arsenide-phosphide die is passivated for more reliability.

Turn red today.

7-Unit Detector Team Upstages Plastic Prices

MRD3050-56 55¢ to \$1.35

Fast and rugged with a wide range of radiation sensitivities available from 0.02 to 0.4 mA/mW/cm² minimum, this hermetic TO-18's performance and reliability contrasts with its low, low price — thousand-ups start small as 55¢! MRD3050-56 is their name and industrial is their game in processing, inspection, counting, sorting, etc. The 3-leaded package also provides external base for added control and Annular† construction ensures proven stability and reliability.

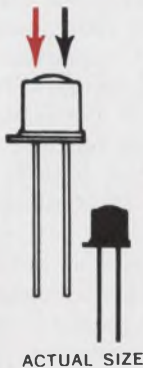

Circle the reader service number for data sheets on these new 5 or write Box 20924, Phoenix 85036 on your company letterhead for complete answers to most opto design aspects in our updated *Let There Be Light* brochure.



Hermetic devices for plastic prices!

*Trademark Motorola Inc.
†Patented Process Motorola Inc.
All Prices Are 1,000-up.



MOTOROLA OPTO
Let There Be Light ↓↓↓↓

New LSI packaging opens the way for the micro-mini era

John N. Kessler
News Editor

Miniaturization has been the by-word in electronic circuitry since the introduction of the IC. But as circuit densities have increased dramatically—from MSI to LSI, the circuit package has more and more become the limiting factor on circuit or system size. Now, new packaging concepts are being developed by most semiconductor manufacturers to remove this limitation.

The upcoming developments in LSI packaging include these:

- Multilevel, multichip packaging is emerging, and it may make dual-in-line packaging obsolete. The designer will be working with larger chips that will require more leads. The one-chip calculator and one-chip central processor units are already here; the road ahead is limited only by the designer's ingenuity.

- Plastic, once considered unacceptable for operation in high-temperature, high-humidity environments because of its lack of hermeticity, is being developed for LSI use, and it promises to slash costs drastically.

- Better automated techniques have been announced for LSI packaging, with increased reliability and decreased costs.

The net result of advances like these is that designers will be able

to build much smaller equipment that uses less power and is actually more reliable.

Business looks good, too. The semiconductor packaging industry is climbing the dollar ladder—from \$244-million last year to \$330-million in 1974, according to a survey by Quantum Science Corp., market researchers with headquarters in New York City. Quantum's forecast for all phases of the semiconductor industry, including the cost of chips, is for a rise from \$1.66-billion in 1970 to \$2.78-billion in 1974.

The increasing level of integration is the most obvious change: more devices will be packed on each chip with more conductors and more leads. "We're putting two and a half to three times as many devices on a chip as we were two years ago," says Warren Wheeler, vice president, American Micro-systems, Inc., Santa Clara, Calif.

"In five years," says Ray Rinnie,

manager of components development, at IBM, "there will be a significant number of multiple-chip packages on the commercial market."

Rinnie also sees a slight change taking place in the approach to systems design. "In the past," he says, "systems designers optimized for a minimum number of circuits. As we go to higher levels of integration, we'll have to try to reduce the number of pins, as well as the number of circuits." Unless this is done, the cost of interconnections as a part of a finished system becomes greater as circuit density gets greater.

Multilevel, multichip packages

Texas Instruments in Dallas is exploring the use of multilevel, multichip packages (stacks of interconnected substrates). E. L. (Pete) Johnson, manager of hermetic seals development, sees

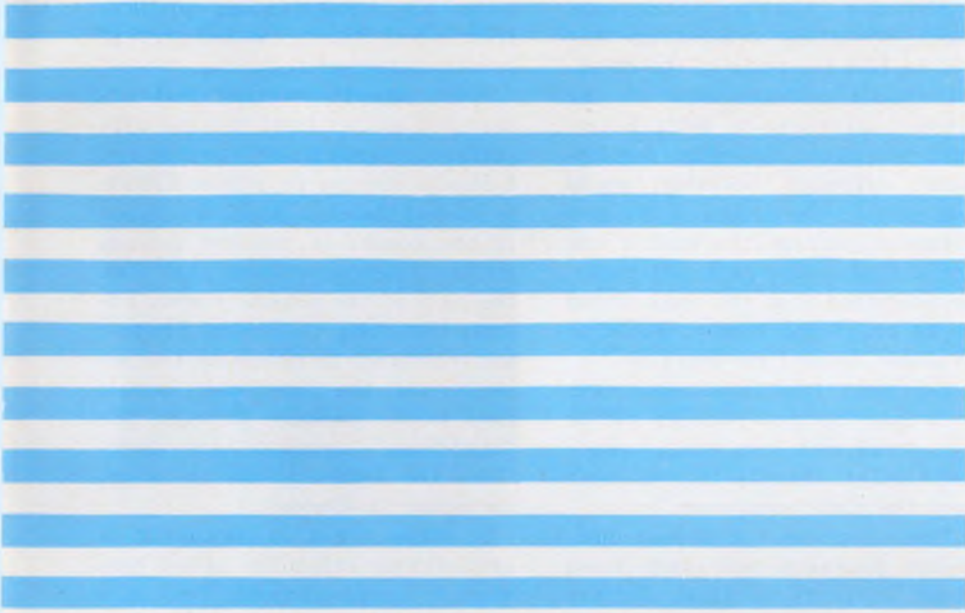

multilevel packages replacing dual-in-line packages "at the design stage in new computer systems" for mainframe memories. (The IBM 370/145 is doing this already and deliveries are slated for later this year.)

This is also the view of David Nixen, manager of components development at North American Rockwell Microelectronics, Anaheim, Calif.

This technique will be particularly applicable for computers, he says, where there is a need for massive memory systems.

Johnson also points out that MOS memories and bipolar decode or sense amp driver chips can be placed in one large multilevel package.

Computer Microtechnology, Inc., Sunnyvale, Calif., introduced just such a package last year. It is a 4096-bit RAM containing both MOS and bipolar IC chips. The RAM consists of 16 MOS memory chips (256 bits per chip), four bipolar (2 of 8) decoder chips and two bipolar read-write sense amplifiers.

Bell Laboratories, Murray Hill, N. J., has developed even more complex beam-lead interconnected packages for telephone electronic switching systems.

At TI several types of multilevel memory packages are in the prototype and design stages. "There will be substantial activity in this area now and in the years to come," says Johnson. One TI multilevel package has 60 leads and contains eight 256-bit beam-lead memory chips. Most of the exploratory designs are 22-to-64-lead packages, which contain eight 256-bit memory and peripheral chips.

But Motorola, after spending millions of dollars trying to develop an 8192-bit multilayer, multi-chip hybrid memory module, abandoned the project last November.

As at TI, the new packages at Motorola's huge Phoenix plant are those with more than 40 leads. While most of Motorola's volume for the next several years will be 14, 16, and 24-lead packages, the company expects there will be an increasing demand for packages with 40 or more leads that are both highly reliable and inexpensive.

Today, a typical dual-in-line package with 20 leads on each side is approximately 2 inches long. "As it stands, this package has many advantages, such as easy insertion," says Michael J. Callahan, Motorola's director of integrated circuit engineering, "but with 40 and more leads, there are significant

problems with the design of the dual-in-line package."

Bonding the leads to the chips.

One of the major problems is getting that number of leads bonded to the chip. Present techniques include:

- Wire bonds.
- Ball bonds.
- Beam leads.
- Flip chips.

One of the things that Motorola is looking at is a matrix of pins, similar to IBM's interconnection technique. This approach increases the density of interconnections. So for high-speed circuitry, says Callahan, the distance from the pin to the chip is minimized. He estimates that 40 leads can be extended from a 1-inch-square package.

A new leadless ceramic package that mounts on its edge became available four months ago. The package was jointly developed by American Micro-systems, Inc., Santa Clara, Calif., Coors Porcelain, Golden, Colo., and Texas Instruments in Attleboro, Mass. AMI is delivering MOS circuits using edge-mounted packages that they claim "cut packaging costs in half."

Edge-connector packages are also being examined at Motorola for lower performance applications. This configuration would be more adaptable to MOS than bipolar circuitry, according to Callahan, because the power requirements are less, and consequently heat dissipation is less of a problem.

As circuitry is packed together more tightly, the heat dissipation problem increases. Right now there is no standard way to measure or even define the thermal characteristics of a package. In this area, the design engineer must balance the reliability of hermetically sealed ceramic package with the low-cost advantage of plastic packages.

At Interdata Corp., in Oceanport, N. J., Arthur R. Furman, vice president of development for manufacture, says in typical commercial environments (0 to 50°C), plastic-encapsulated packages perform equally as well as ceramic

packages. "But at higher than 50° C," says Furman, "there will probably be some outgassing of impurities within the plastic that eventually find their way into the wafer." This kind of contamination, he says, may cause long-term drift characteristics and can be critical in military applications.

But National Semiconductor, Santa Clara, Calif., manufactures a product line that includes molded and silicone-encapsulated packages that meet stringent military power requirements—all the way up to 125° C.

The cost of the semiconductor package is regarded as high because the cost of the integrated circuit chip has gone down so rapidly.

"In the past," says Wheeler of AMI, "the cost of the package was inconsequential because there was so much invested in the chip itself." But now the chip is no longer the controlling factor in the cost of the finished device, says Wheeler.

Package cost varies depending on the size, shape, type of encapsulation and quantity ordered, but

for many dual-in-line and flat packs, the cost is estimated to be less than one-third to more than one-half the cost of the finished device.

Signetics Corp., Sunnyvale, Calif., is working on a package that will be half the price of the cheapest plastic package now on the market, according to Fritz Beyerlein, manager, flip-chip development. Although Beyerlein would not indicate the design of the new Signetics package (he said it was not a dual-in-line or a flat pack), he estimated that the price would be 2¢ or 3¢ and that it would be available "some time this year."

Beyerlein told ELECTRONIC DESIGN that "the new package will be very small with very small leads—awkward to handle if you don't have the right equipment."

Present prices for 40-lead dual-in-line packages now vary from about 75 cents to \$1.00. Murray Klavens, manufacturing engineer at General Instrument Corp., Hicksville, N. Y., says his company hopes to be marketing 14-, 16-, 24- and

40-lead dual-in-line packages below the 40 cents mark by the end of the year. Klavens says materials are being looked at that are neither ceramic nor plastic that will help solve the encapsulation problem from a cost standpoint and prevent contamination of the chip.

Most experts mention that encapsulation goes hand-in-hand with surface passivation techniques, typically the use of silicon nitride to protect the chip itself. But much of the reliability problem focuses on the interconnections that link the chip to the outside world. Efforts like those at General Electric and Fairchild to automate the assembly of the integrated circuit chip to its package through the "multibond" technique are directions the industry has to move, according to Klavens.

A major trend in packaging is toward more reliability in low hermeticity encapsulations. This is a result of both advances in passivation techniques, such as the use of silicon nitride on the IC chips, and materials advances in the use of single- and double layer plastic seals.

A higher density of leads is a direct result of increasing the functional density of the IC chips. This, in turn, will affect the designer because the complexity of wiring arrangements also increases. Ray Rinnie of IBM expects that this will lead more companies to develop new automated programs to determine optimum wiring arrangements.

For high performance circuits, leads will become shorter and reliability a more stringent factor. Most packaging experts are inclined to believe that in this area ceramics will continue to be dominant even though much better plastic seals are being developed.

A firm believer in ceramics is Warren Wheeler of American Micro-systems. In the past two years, he says, the price of ceramics packages has gone down by more than a factor of two. "I wouldn't expect the ceramic suppliers to say 'Well, we've gone as far as we can go; we're going out of business.'"

But this is exactly what Fritz Beyerlein of Signetics believes. "In five years," he says, "there isn't going to be any other package around but plastic." ■■

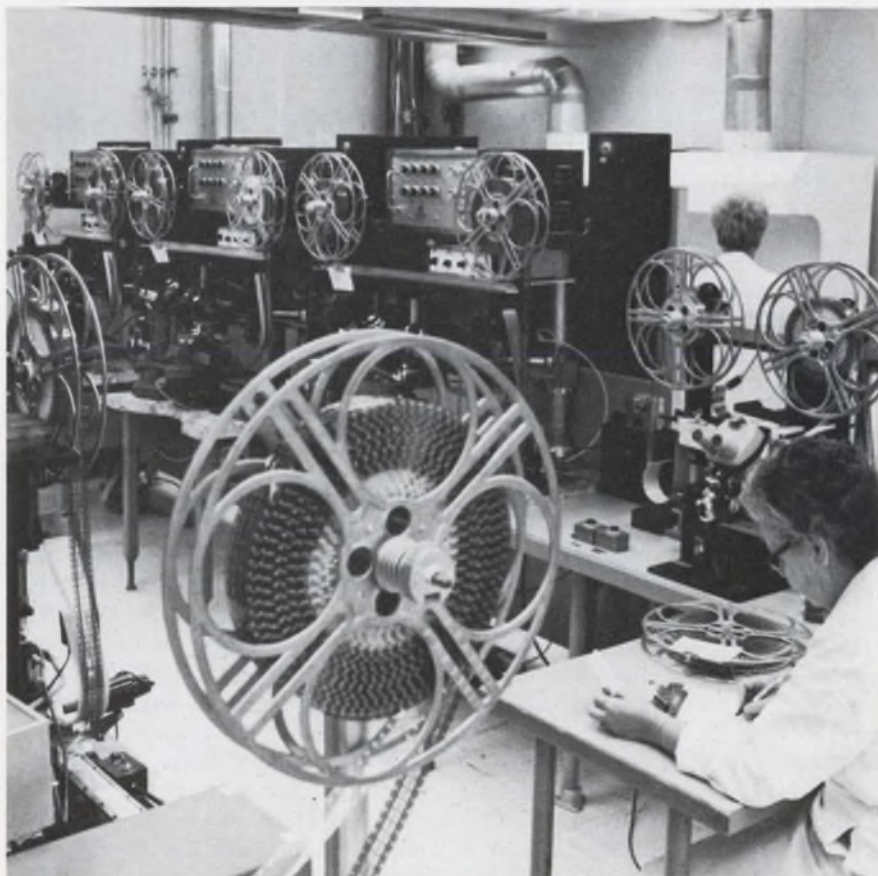

General Electric's miniMod method of automatically producing IC's on a tape eliminates many hand operations, and permits mechanized testing.

Xtal Filters.

Damon shapes up fast!



Whether your signal shaping need is a sharp rejection notch, a band-pass or a single side-band filter – call Damon. Choose from dozens of computer-assisted standard designs including Butterworth, Chebyshev, Gaussian or Bessel. Or let Damon create a custom filter to your specs. Either way, you're sure of the exact crystal filter you need. A production run or a prototype, Damon meets your schedule. Try us. Damon/ Electronics Division, 115 Fourth Ave., Needham, Mass. 02194. Phone: (617) 449-0800.

Band-Pass Filters

PARAMETER	RANGE
Center Frequency	10 Khz-75 Mhz
Bandwidth01%-3% of C.F.
Phase Linearity	<±5%
Transient Overshoot	>40 db
Shape Factor	<1.25:1
Differential Phase Shift	<±2°
Group Delay Uniformity	<±5%

Band-Reject Filters

PARAMETER	RANGE
Center Frequency	10 Khz-35 Mhz
Reject Bandwidth01% to .5% of C.F.
Pass Bandwidth	Up to 100% of C.F.
Shape Factor	<1.8:1
Notch Rejection	>80 db
Insertion Loss	<0.5 db
Ripple	<0.25 db

Single Side-Band Filters

PARAMETER	RANGE
Center Frequency	10 Khz-35 Mhz
Pass Bandwidth01% to 2% of C.F.
Carrier Rejection	>40 db
Shape Factor Carrier Side	<1.15:1
Shape Factor Side-Band Side	<1.25:1
Insertion Loss	<3 db
Ripple	<1 db



Designers of vhf-FM radios vie for new pleasure-boat market

A variety of new vhf-FM marine radiotelephones are moving to the market place in response to a recent decision by the Federal Communications Commission.

By Jan. 1, 1972, pleasure boats must be equipped with a vhf-FM radio transceiver before the FCC will license installation of a marine-band radio (2 to 4 MHz) — and then it will license them only if the radio is single side-band. The reason that marine-band radios will be permitted at all is to provide facilities for the relatively few ocean-going pleasure boats that require over-the-horizon communications. The reason for SSB is that it provides a more economical use of the over-loaded band than double sideband does.

Three-watt, 6-channel vhf-FM radiotelephones shown at the National Boat Show in New York City's Coliseum last month range in price from \$200 to \$795. If more power is desired for the \$795 unit, a 25-W booster amplifier, with a mounting bracket, is available for \$295 more. Additional accessories can run the final cost up to \$1475.

John F. Mason
News Editor

ITT Decca Marine, Inc., in New York City is marketing the more expensive unit, which is built in Sweden by ITT's Standard Radio and Telephone Co. The less expensive unit is being sold by Standard Communications Corp. of Wilmington, Calif., a subsidiary of Standard Radio of Japan.

Rising market predicted

"The market for vhf-FM radios for boats this year is about 25,000 units," according to ITT Decca's product line manager, David King. "This figure should move up to 30,000 in 1972 and 35,000 in 1973."

Most of the radios are fully transistorized, although there are still a few that use tubes. And the use of ICs is growing. ITT Decca's STR-15 unit uses two ICs, King says, and the company plans to design more into future systems.

RF Communications, Inc., a subsidiary of Harris-Intertype Corp., in Rochester, N. Y., has designed a new line of fully transistorized pleasure-boat radios to supplement its more expensive RF-401 commercial radio.

"The heavy-duty capability has been retained in the pleasure-boat

line," says Robert LaRose of the company's Marketing Dept., "but features such as remote control and search ringing were not." (Search ringing means that the system alerts the operator when another radio is searching for the radio's frequency over as many as four channels.)

ITT Decca's new radio, which King admits was kept expensive to retain the sophistication of the company's sturdy and reliable commercial line, "contains circuitry never before used in the vhf field."

Two separate filters are used: a crystal followed by a ceramic, which accounts for its selectivity and protection against adjacent channel interference.

Two i-f frequencies are used instead of one (10.7 MHz and 455 kHz). According to King, this provides more selectivity and avoids noise interference.

A scanner automatically monitors the safety channel while tuned into the selected channel. The unit does this by listening to the selected channel for approximately 0.9 second and then changing over to channel 16 (the distress, safety and calling channel) for about 0.1 second. If a signal is present on chan-

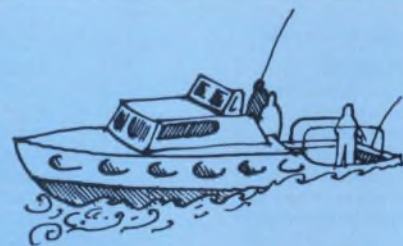

Ensign II, vhf-FM radio-telephone built by RF Communications, Inc., can operate with a coat hanger if the antenna is lost.

MULTI-GENERATOR!

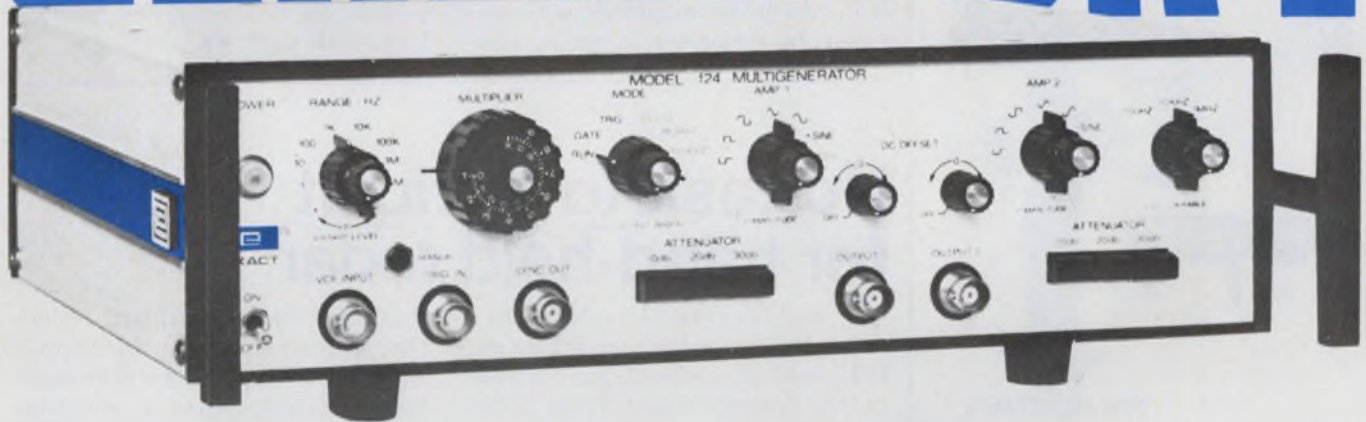

More signal sorcery from Exact

You've come to expect multiple functions from many kinds of instruments. Now Exact is introducing a low-cost waveform generator that will do so many jobs we've decided to call it a "Multigenerator."

The new Model 124 Multigenerator, priced at only \$595, produces a variety of *usable* signals previously attainable only by employing several instruments, either separately or in tandem. Start with normal sine, square and triangle waveforms. Then add plus-and-minus sine, plus-and-minus square, plus and minus pulse—with both the repetition rate and the pulse width controlled internally. You also can generate haversines, gate for burst outputs, trigger for single shot, or sweep symmetrically up and down. The Model 124 will produce offset waveforms and \sin^2 pulses without fiddling with DC offset. And you can vary pulse amplitude without affecting DC offset.

The Model 124 has dual output amplifiers—each with individual function selection, 80 db attenuation in 10 db steps, two separate generators, 1000:1 VCF, frequency range from 0.1 Hz to 5 MHz and output voltage of 20 V open circuit (10V into 50 Ω).

In PULSE, BURST AND SWEEP MODES, the second generator is used to trigger, gate or sweep the frequency, respectively. The second generator can be used to modify the main generator in a number of other ways, opening up almost unlimited waveform possibilities.

The Model 124 is only 3½" high, 12½" wide and 10½" deep. (Small for a waveform generator that will do so much.)

Price \$595 (\$50 extra for expanded frequency range of .01 Hz to 5MHz on main generator.)

Waveform generators from \$295



EXACT
electronics. inc.

Box 160
Hillsboro, Oregon 97123
Telephone (503) 648-6661
TWX 910-460-8811

A subsidiary of
Vector Management Corp.

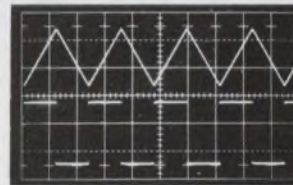

Triangle and square waveforms.

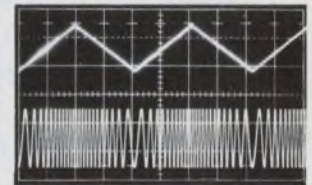

Sweeping up and down with internal triangle.



Pulsed haversine and \sin^2 burst.

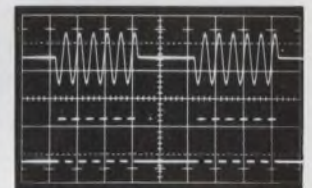

Tone burst and pulse burst.

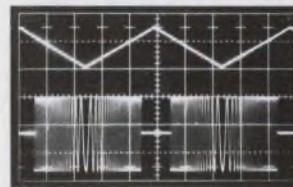

Gated with sweep, internal triangle gates and sweeps main generator.

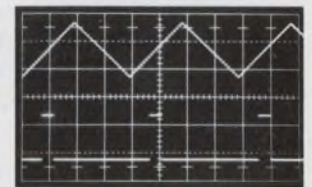

Pulse mode—pulse delay controlled by internal triangle generator.



Single shot—sine wave output using pulse mode, start-stop control at 0°. For phase relationship studies.

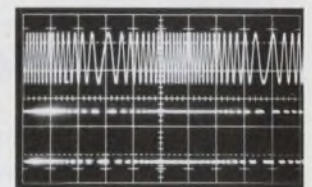

Sine output from amplifier #1, square output from amplifier #2; both amplifiers swept simultaneously in sweep mode.

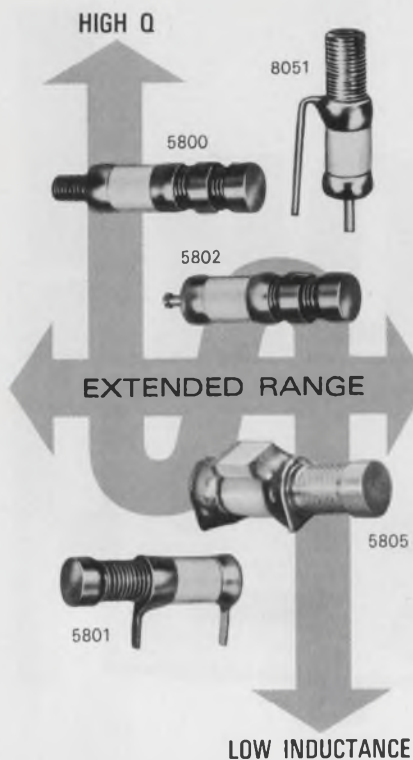

SUB-MINIATURE LOW INDUCTANCE CAPACITORS

Q > 10,000 @ 100 MHz

Now available with all these plus features: + 10:1 capacitance ratio in a micro-miniature size + Extra fine tuning < .35 pf per turn + Improved contact mechanism for noise-free tuning + Rugged construction.

SPECIFICATIONS

SIZE: 1/4" diameter, 1/2" long

CAPACITANCE RANGE:
0.35 pf — 3.5 pf; .5 pf — 5.0 pf

WORKING VOLTAGE: 250 VDC (500 VDC Test)

INSULATION RESISTANCE: 10⁶ Megohms

TEMPERATURE RANGE: -65°C to -125°C

TEMPERATURE COEFFICIENT: 0±50 PPM/°C

For immediate delivery and complete technical information call 201-334-2676.

Johanson

MANUFACTURING CORPORATION
ROCKAWAY VALLEY ROAD
BOONTON, NEW JERSEY 07005

ELECTRONIC ACCURACY THROUGH
MECHANICAL PRECISION

INFORMATION RETRIEVAL NUMBER 23

nel 16, the receiver stays locked on this channel. If no signal is present, the receiver reverts to the selected channel.

There are no volume or squelch controls; these functions are automatic.

Unusual in a vhf set, the voltage-control oscillator is used to derive the transmit frequency from the same crystal that provides the receive frequency. The advantage is that the transmitting frequency is known to be compatible with the receiving frequency. Cost is also

reduced, because only one crystal per channel is required, rather than two.

Intech, Inc., in Santa Clara, Calif., is offering an entire line of vhf-FM radios, featuring interchangeable modules for easy maintenance while at sea. The company's Mariner model provides 55 channels.

Raytheon's Marine Products Operation in Manchester, N. H., has a wide range of vhf-FM radio telephones, as well as a new marine-band SSB unit. ■■

No task too difficult for hand-held radar

A highly versatile continuous-wave doppler radar, small enough to be held in one hand, has arrived in the United States from Scotland. It promises to handle a variety of jobs—industrial, research, marine, police, and military.

Manufactured by James Scott Ltd., Glasgow, Scotland, the radar will be marketed in the U. S. by Rank Precision Industries, Inc., in West Nyack, N. Y.

According to the company's sales manager, Michael FitzPatrick, research laboratories will use the device to measure precisely the vibration of components under test. It will be used on production lines to measure rotational speeds up to 1-million rpm. It can be useful on trains to provide exact measurement of velocity over the ground and to warn of obstacles on the track. Police cars, parked out of sight, will find the device handy for measuring the speed of receding cars. It can be used for docking boats. And prisons, factories, and the military will find the radar helpful in detecting movement.

The radar measures 4.75 by 3.75 by 2.25 inches, weighs 30 ounces and can be mounted on a tripod. It uses a Gunn-effect diode as the microwave frequency generating element.

The radar transmits at 13.418 GHz with a power output of 5 mW unmodulated cw.

The radar's frequency response has a low-speed capability of six inches per minute or a high speed

that can register ballistic velocities. This wide-velocity spectrum is accomplished by using a very wide-band receiver with a wideband amplifier.

To satisfy the unit's wide range of applications, four readouts are available, FitzPatrick says. An audio readout—a clucking noise—can be heard over a built-in loudspeaker to indicate the movement of personnel who have entered an area.

A linear scale on a miniature moving coil meter shows the rate of closure or departure of an automobile or other fast-moving target. This comes in ranges of 10 mph and 100 mph. A pulse output is another means of providing linear velocity measurements. The pulses are obtained by combining the transmitted frequency with the return frequency and feeding the result into a frequency-to-digital pulse converter. The pulses then correspond to a given speed, FitzPatrick explains.

A waveform readout is provided for measuring fast rotational velocities. While a doppler shift will not reveal rotational velocity—since the shift doesn't identify a given spot on the target as it reappears—waveforms do. The same spot on a revolving target will produce an identical waveform that can be matched up.

The radar, called Mini-radar Mk II, will sell for \$1750 in small quantities and \$1220 for more than 100 units. ■■

Computer control gives better silicon wafers

A new computer process control system that grows large diameter silicon crystal ingots of exceptionally high quality is now in use at IBM's Component's div. in East Fishkill, N. Y.

Ingots, 2-1/4 inches and larger, are sliced and polished to form silicon wafers. These are then processed in a series of complex operations to produce monolithic logic and memory chips (see photo).

A company spokesman noted that crystal growth as currently performed manually is highly operator dependent. Crystals grown under such conditions often have low yields because of unwanted diameter variations and uneven doping.

IBM's new method, which employs their 1800 Data Acquisition and Control System, precisely controls ingot diameter, crystal resistivity and structure by monitoring the melt temperature and by varying ingot and crucible lift and rotation speeds. Monitoring signals, all analog, are digitized, multiplexed and fed into the computer control system. With the computer, system response to process variations is much faster than can be accomplished manually. ■■



Better yields of higher purity silicon wafers for IBM logic and memory circuits are provided by computer control of ingot growth.

A NATIONAL® EXCLUSIVE . . .

FULL-POWER OPERATION TESTED*

850A-1700V

SCRs

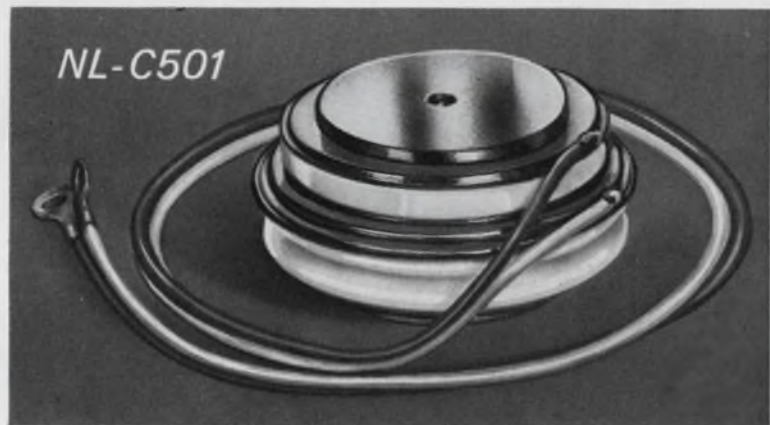

***Every NL-C501 SCR is tested at full current and voltage ratings under a reactive load to validate the critical device parameters. No "cheater" circuits are used in testing. Only National provides this positive assurance of device performance.**

NL-C501 PLUS FACTORS

- ⊕ Voltage range up to 1700 V.
- ⊕ Double diffused construction to assure repeatable performance
- ⊕ Shorted emitter for minimum dv/dt of 100 V/ μ sec.
- ⊕ Disc construction for either reverse polarity or parallel assembly
- ⊕ Also available in factory assembled back-to-back heat sink

We welcome requests for detailed data and application assistance. Contact . . .

NATIONAL ELECTRONICS, INC.
a varian subsidiary

Geneva, Ill. 60134, phone 312-232-4300

Centralab push button switches brighten your design...

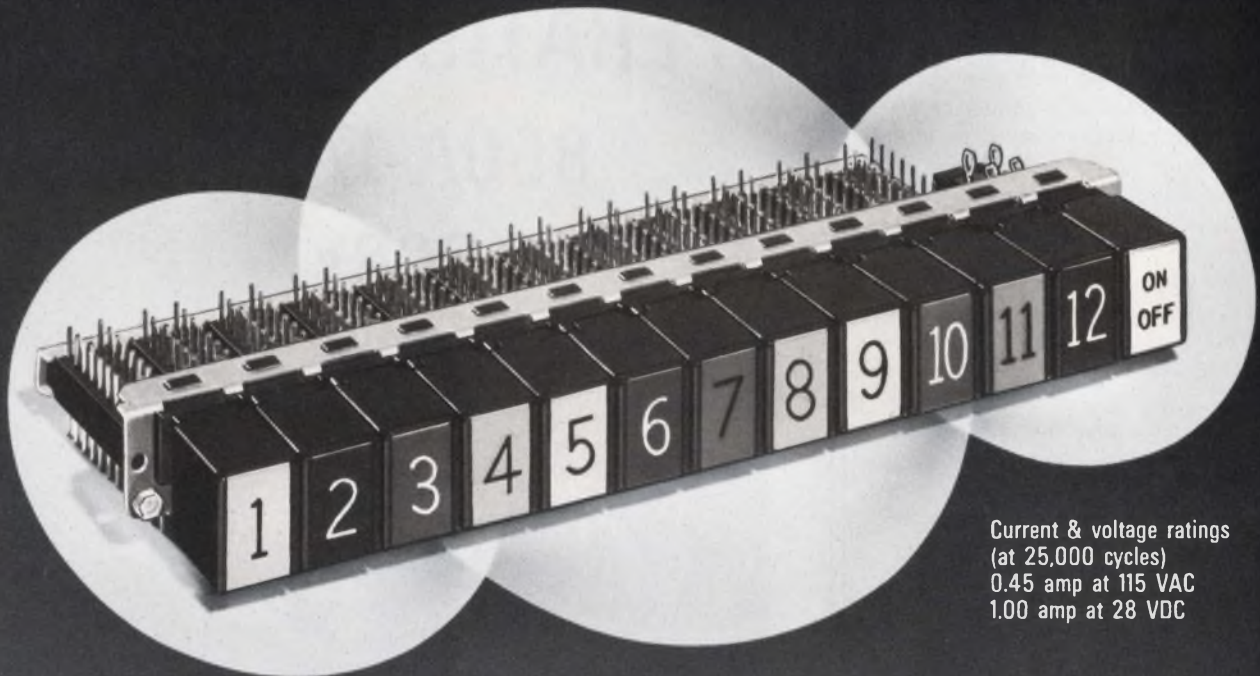

Current & voltage ratings
(at 25,000 cycles)
0.45 amp at 115 VAC
1.00 amp at 28 VDC

...for as low as \$1.25 per module

When it comes to economy and performance the spotlight is on Centralab. Our push button switches* (lighted or plain), which provide convenience and efficiency through modular design, are a bright example. In the first place, it's worth repeating that you can buy Centralab domestically manufactured lighted push button switches for as low as \$1.25 per module in production quantities. Plain modules are as low as 21 cents each. What's more, with our new RSD (Rapid Switch Delivery) program, we can deliver in four weeks, sooner in emergencies. On prototype orders, we'll deliver in two weeks.

Then there's the plain module itself, which contains only four parts to give longer, more reliable life. Two, four, six or eight pole, double-throw designs are available for printed circuit or panel mounting. As many as 29 modules can be ganged on a common mounting bracket in the PB-10 Series, 15 modules

in PB-15 and PB-20 Series. And standard functions include momentary, interlocking, push-push and push pull.

In lighted modules, interchangeable lenses and filters provide maximum color utility and aesthetic appeal. Front bulb replacement is another convenience feature.

For consumer and industrial applications, Centralab push button switches are lighting the way to new economy, performance and efficiency. For complete specifications, write Switch Sales Manager, Centralab Electronics Division, Globe-Union Inc.

*Isostat Licensed



CENTRALAB

Electronics Division
GLOBE-UNION INC.

5757 NORTH GREEN BAY AVENUE
MILWAUKEE, WISCONSIN 53201

M-7102

Immediate delivery on prototype quantities

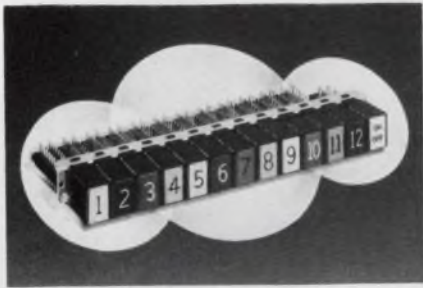

These Centralab Field Assembly Distributors can provide prototype quantities of push button switches on the day of your order:

Almac/Stroum Electronics
Seattle, Washington 98108
Phone: (206) 763-2300

Cameradio Company
Pittsburgh, Pennsylvania 15222
Phone: (412) 391-7400

Kierulff Electronics, Inc.
Los Angeles, California 90022
Phone: (213) 685-5511

Pioneer-Standard Electronics, Inc.
Cleveland, Ohio 44103
Phone: (216) 432-0010

Radio Distributing Company, Inc.
South Bend, Indiana 46624
Phone: (219) 287-2911

Electronic Expeditors, Inc.
Milwaukee, Wisconsin 53209
Phone: (414) 374-6666

Gopher Electronics Company
St. Paul, Minnesota 55113
Phone: (612) 645-0241

Fisher/Brownell
Santa Clara, California 95050
Phone (408) 244-6182

Hammond Electronics
Orlando, Florida 32802
Phone: (305) 241-6601

Herbach & Rademan, Inc.
Philadelphia, Pennsylvania 19134
Phone: (215) 426-1700

Summit Distributors, Inc.
Buffalo, New York 14202
Phone (716) 884-3450

Esco Electronics, Inc.
Dayton, Ohio 45403
Phone: (513) 224-9192

Kirkman Electronics
Winston-Salem, N.C. 27108
Phone (919) 724-0541

DISTRIBUTOR PRODUCTS



CENTRALAB
Electronics Division
GLOBE-UNION INC.

technology abroad

A one-fifth reduction in size compared to conventional memory core stacks has been achieved by Siemens of Munich, Germany. This space-saving has been obtained by mounting two core arrays, one on the front and one on the back of a single board. Most of the soldering and welding points are eliminated by this method of fabrication, and under favorable circumstances this type of stack has just 4% of the welds of a conventional array.

A rugged, overload-resistant TV camera for the videophone and industrial closed-circuit TV markets is under development by the English Electric Valve Co. of Chelmsford. The British firm developed a tube with a solid-state silicon target incorporating some 300,000 isolated silicon diodes. This array is scanned in the conventional manner by an electron beam, which sequentially releases the light-induced charge built up on each silicon diode. The picture area uses 187,750 of these diodes. The company expects development samples to be available this year.

A new and effective system for tracking aircraft at low altitudes has been developed for the Swedish Air Force by AGA at Stockholm-Lidingo. Called the AGA Avista (Audio-Visual Tracking of Aircraft), the new system is essentially a backup in case of radar interference or of low-level attack where radar would be ineffectual. The system uses a chain of manned observation posts, each of which is equipped with a signal box having six buttons arranged in a circle around a seventh. When an aircraft is detected, the observer presses the button most nearly aligned with the approaching plane. Signals are computer-processed and stored in a memory. The aircraft's route is tracked with a trail of lamps, and only relevant data is forwarded to the various arms of the de-

fense system. (Peripheral reports are eliminated by the filter stations.) AGA says the total time for complete presentation averages only 10 seconds.

Shortening the length of its experimental TV camera "mini-tubes" by 0.6 inch, while reducing the danger of short-circuiting, leakage current and flashover, has been accomplished by Philips Laboratories of Eindhoven, in The Netherlands. The tube now has an over-all length of 4.4 inches. Rather than taking electrical leads out through pins in the tube base, the Philips engineers used contacts mounted radially on the wall of the tube. Strips of foil were melted into the tube wall and spot-welded to electron-gun connectors. As a result, the waste space that conventionally contains both the getter and the conductive strips between the gun and the base can be eliminated. Also the "getter mirror," (a common source of electrical problems) can be placed remote from gun components and leads.

A silent high-speed printer with no moving parts has been developed by the Paillard Co. of Yverdon, Switzerland. Paillard, which sees a big market for the product in the computer industries, has signed a licensing agreement with the Japanese Casio company and is negotiating similar agreements with several U. S. firms. In operation, ink droplets are fired from a specially designed nozzle at a rate of about 5000 per second. Two sets of electrostatic plates are arranged around the nozzle. One pair pulls out individual droplets by electrostatic attraction, accelerates them and simultaneously charges them. Meanwhile, an electrostatic field applied to the other electrode pair deflects the droplets. Paillard says a printing speed of 120 characters/second is possible for characters measuring 0.09 inch by 0.06 inch.

If you need rugged accuracy
over a wide range
of measurements...

Buy
Triplett's 630-NA



Model 630-NA

\$103

1. 70-range V-O-M with single range switch and DC polarity-reversing switch.
2. Accuracy 1½% DC and 3% AC; mirrored scale.
3. Diode overload-protected suspension movement; temperature compensation.

Its diode overload-protected suspension meter movement; simplified, long-scale, mirrored dial; and 70-range measurement capability to 6,000 V AC and DC, 12 A DC and 100 megohms demonstrate that Triplett's Model 630-NA V-O-M can handle practically any electrical measurement you may need.

All these features add up to 1½% DC accuracy (3% AC) and the ruggedness necessary

to make this a take-anywhere tester that's ideal for design, maintenance, quality control and production applications.

It's a real value at \$103 so see it right now at your local Triplett distributor. If you'd like 200,000 Ohms per Volt DC and 20,000 Ohms per Volt AC sensitivity rather than the 630-NA's 20,000 and 10,000 Ohms per Volt DC and AC, respectively, and you're willing to use a spe-

cial high-voltage probe for the 3 and 6 KV ranges in order to get that extra sensitivity, ask your distributor for Triplett's Model 630-NS at \$122. For more information, or for a free demonstration, see him or your Triplett sales representative. Triplett Corporation, Bluffton, Ohio 45817.

TRIPLETT

The World's most complete line of V-O-Ms
... choose the one that's just right for you.

ELECTRONIC DESIGN 5, March 4, 1971

washington report

DON BYRNE, WASHINGTON BUREAU

NASA asks \$30-million for grand tours of planets

NASA has earmarked \$30-million of its budget for outer planetary exploration and says it is committed to a program that includes grand-tour missions to Jupiter, Saturn and Pluto in 1976-77 and to Jupiter, Uranus and Neptune in 1979. Included in the planning is the development of a Jupiter orbiter as a possible alternate to the first of the grand tours.

Defense Dept. facing new battles for funds

The succession of Sen. Allen J. Ellender (D-La.) to the chairmanship of the Senate Defense Appropriations Subcommittee may mean some rough going for both the Defense Dept. and the Administration. Senator Ellender is known as a tough man when it comes to money, and in fact last year, when he was the ranking Democrat behind the then ailing chairman, Richard Russell, he led the battle in the Senate to cut \$2.3-billion from the Administration's defense budget request.

In recent weeks Senator Ellender has stated publicly that while he believes in a strong America, he also believes it can be done with much less spending. He noted in making that statement to the press that there "was no doubt about it" that he expected a confrontation between himself and the Administration on defense spending. Last year the Senator voted to limit the ABM, and in hearings before his subcommittee, he challenged the need for the B-1 bomber.

FAA to call for ideas on microwave landing system

The Federal Aviation Administration expects in the next month or so to issue requests for proposals on the development of a microwave instrument landing system. If all goes well, the agency says, it should be able to begin letting contracts for the system sometime in July. A five-year plan for the development and deployment of the new landing systems is being put together by the Dept. of Transportation, the FAA and NASA. FAA officials have declined to speculate on the costs of the system until the requests have been answered.

GAO crackdown on contractors asked in bill

A bill introduced by Rep. Bertram L. Podell (D-N. Y.) and co-sponsored by 59 more Congressmen would greatly expand inspection of Government contracts by the General Accounting Office. At present the GAO, the Congressional watchdog agency, need not issue investigative reports with any specific frequency or on any particular subject unless requested to do so by a Congressional committee. The new bill would require the office to investigate all Government contracts "characterized by cost overruns of 10% or more and/or late delivery."

An annual report on the contracts would be required to go to Congress before the authorization and appropriation procedures began for a new fiscal year. "My proposal," Podell says, "would make such scrutiny a yearly project so that Congress . . . would have the information required to appropriate wisely, not into bottomless pits but into viable systems and programs." The Congressman referred specifically to the C-5A and F-111 aircraft and the Cheyenne helicopter in introducing the bill.

Blueprint of national R&D objectives due

Dr. E. E. David Jr., the President's science adviser, will present a report to the White House in May on the status of science and technology in the U. S. If the report is approved by the White House, it will then go to Congress as a sort of annual report. Hopefully, says Dr. David, the report will be a "first attempt . . . to blueprint our national R&D objectives." He also says there will be a section of the report spelling out areas of scientific and technical cooperation with other nations.

Volpe sees SST noise picture brightening

Transportation Secretary John A. Volpe says that three significant breakthroughs in noise research have led to a "dramatically improved outlook" for the supersonic transport. Speaking to a Dept. of Transportation and Society of Automotive Engineers conference on aircraft and environment, Volpe described the three advances as follows: ground-runup tests that showed that the SST prototype engine produced significantly "less effective perceived noise" than originally estimated; wing flap tests by NASA that indicated it is possible to improve lift and reduce takeoff distance, thus raising the aircraft's altitude over communities near airports, and tests on advanced suppressors that showed better acoustic performance than anticipated.

Capital Capsules: Pollution control is getting to be big business. In this year's budget more than a dozen **federal agencies will split up to \$1.29-billion to contain pollution.** Air and water-pollution control will account for \$991-million; noise, \$34-million, and radiation, \$155-million . . . **The Commerce Dept. has exhibit space available for three overseas shows of interest to electronic firms:** Test and production equipment for the electronics industry in a show in Osaka, Japan, Oct. 1-7; the 25th International Congress and Exhibition for Automation and Instrumentation in Dusseldorf, Germany, Oct. 14-20, and a U. S. computer and software show in Munich, Germany, Nov. 29-Dec. 3. Information is available from the Bureau of International Commerce in Washington or at any Commerce Dept. field office . . . **The Administration will spell out its telecommunications policies by mid-year** through the Office of Telecommunications Policy. Dr. Clay T. Whitehead, director of the office, made the commitment in a letter to Sen. John O. Pastore (D-R. I.), chairman of the Senate Commerce Communications Subcommittee, who had requested a broad policy statement from the White House . . . **Sperry Rand's Systems Management Div. in Great Neck, N. Y., has been selected by the Dept. of Transportation to develop a system for planning and managing the Dept. of Transportation's R&D program.** The one-year contract is for \$186,000 . . . **The Post Office's R&D request has jumped \$34-million to \$95-million for the coming fiscal year.** Most of the increase will come in work on letter-coded mail sorters and bulk-mail processing devices.

Kurz-Kasch Digital Logic Instruments*



... complete logic systems analysis through the Logic-Probe concept

Rugged, all solid-state, Kurz-Kasch logic probes are designed for fast, accurate testing of logic levels in all types of integrated circuit systems. A simple readout system indicates "true", "zero", or "pulse" readings precisely through color-coded visual electronic readouts in the probe tip. Absence of logic levels is indicated by all readouts remaining OFF.

Applications Logic levels can be accurately tested in virtually any (DTL, TTL, RTL) IC system including desk calculators, business machines, N/C devices, computers or telephone systems. Power is derived from the unit under test allowing use in the field or in the lab.

Specifications

Readout Light Red = Logic "1"
Readout Light White = Logic "0"
No Readout Light = "infinity"

High input impedance prevents loading of circuit under test.
Size $\frac{5}{16}$ " dia., 6" long, 26 $\frac{3}{4}$ " leads with pin terminals

A pulse detection feature is available on most models of logic probe. A third readout is provided to display high speed pulse trains or a single cycle pulse of less than 50 nanoseconds on the standard Model LP-520. Overload protection to +50, -20 volts DC is also available.

Standard Probes Logic probes are presently available in five standard models. MODEL LP-500 for use in testing 4.75-5.0 V DC logic systems. MODEL LP-510 for testing 4.75-5.0 V DC systems . . . includes overload protection to +50, -20 V DC. MODEL LP-520 . . . for 4.75-5.0 V DC logic systems . . . includes overload protection and pulse detection features. MODEL LP-530 for testing of 12-15 V DC logic systems . . . includes overload protection to +50, -20 V DC. MODEL LP-540 . . . for 12-15 V DC systems . . . includes overload protection and pulse detection features.

Kurz-Kasch shrinks square wave generator to logic probe size Model LG-580 is a new shirt pocket size, all solid-state logic (square wave) generator for trouble-shooting, testing, or inspection of digital circuitry. Use it to . . . set flip-flops . . . run counters . . . perform clock functions. A unique one-shot mode plus 100 Hz, 1 K Hz, 100 K Hz, and 1 M Hz signals are injected through the probe tip. The Model LG-580 is power lead reversal protected and is priced at \$79.95. The Model LG-580 is for all 4.75-5 V DC systems. Also available is Model LG-581, same as Model LG-580 above, except for use with 12-15 V DC systems —\$89.95.

Special Probes As a routine service, Kurz-Kasch will custom design logic probes to user specifications. Custom designs can include: both positive and negative logic levels from 50 to 30 volts . . . special pulse detection characteristics . . . floating or grounded cases . . . custom power supply requirements . . . power lead reversal protection . . . and your choice of logic crossover parameters.

Kurz-Kasch logic probes provide all the information you need to quickly and accurately evaluate all logic systems . . . and they are the most economical logic testing instruments available. Standard Models range in price from \$39.95 to \$69.95. Write today for complete details on all standard and special logic probes.



Kurz-Kasch, Inc.

Electronics Division,
1421 S. Broadway, Dayton, Ohio 45401.

*Patent #3,525,939 applies, others pending.

INFORMATION RETRIEVAL NUMBER 27

TWF has created a great line...

A proprietary manufacturing process, plus a unique memory and interface expertise, has enabled Qualidyne to produce unusually high quality components with down-to-earth prices.

Read Only Memories

1024 Bit, Bipolar ROM	QRO 1024
256 Bit, Bipolar ROM	QRO 256

Line Drivers and Receivers

Dual Differential Line Drivers	QC9614, QC7830/8830
Dual Differential Line Receivers	QC9615, QC7820/8820
EIA RS232 Line Drivers	QC496, 1150, 1152, 1488
EIA RS232 Line Receivers	QC497, 1160, 1162, 1489

Sense Amplifiers

A.C. Coupled DTL Sense Amplifiers	QC1440/1540, QC1441/1541
D.C. Coupled TTL Sense Amplifiers	QC7520/21, QC7522/23, QC7524/25 QC5520/21, QC5522/23, QC5524/25

Operational Amplifiers

General Purpose Operational Amplifier (non-compensated)	QC101, 201, 301, QC748, QC748C
General Purpose Operational Amplifier (compensated)	QC107, 207, 307, QC741, QC741C
Super Operational Amplifiers (non-compensated)	QC108, 208, 308
Super Operational Amplifiers (compensated)	QC1556/1465
Micro Power Operational Amplifier	QC1100, QC1735

Audio Amplifiers

Hearing Aid Amplifier	QC100AL, QC100AH
Hearing Aid Amplifier	QC183L, QC183H

Diode Arrays

16 Diode Core Driver Array	QDA 2501
16 Diode Core Driver Array	QDA 9999

Dual Transistors

NPN Junction Isolated Monolithic Dual	QD100 Series
NPN Super Beta Dual	QD200 Series
PNP Junction Isolated Monolithic Dual	QD400 Series
NPN Dielectrically Isolated Dual	2N4044 Series
NPN High Frequency Dual	2N3423/3424

Custom Wafer Fabrication ... either from your design or ours. Contact us for complete details.

That's our line. We'd like to hear from you.

Contact us directly.



Qualidyne Corporation
3699 Tahoe Way / Santa Clara
California 95051 / (408) 738-0120



We put more quality into less space.

Don't waste our EEs— put them in classrooms

A surprising revelation shook last year's Nerem show in Boston: Someone came up with the "startling" fact that, while there is an over-supply of social-science teachers in Massachusetts, there is a shortage of mathematics teachers.

What has this got to do with engineers or the electronics industry? A great deal. One would think the unemployed Route 128 engineers, who are refugees from the space race, would be just the right type to teach the needed subject. The IEEE, which, incidentally, had for the first time set up a special center for job seekers at the show, thinks so. After all, they reason, institute members are heavy on math—particularly its practical application.

Unfortunately, the pundits of education say no. It seems that, no matter how much math you have, or how many degrees, you cannot teach unless you have a specified number of how-to-teach credit hours. Thus engineers interested in teaching are finding their way barred by red tape.

This unfortunate situation may be true in Massachusetts and in some other areas across the country, but there are exceptions. A call to the American Institute of Physics Teachers in Washington revealed that many school systems are willing to waive certain certification requirements—some for a temporary period—if there is a particular need for a teacher.

Robert Clark, assistant professor at the University of Texas, heads a unique program for putting PhD physicists from industry into the classroom to teach math, physics and science. They could also be used for supplemental training of science teachers—a must in today's rapidly changing technological world. He has recently placed four physicists directly into teaching jobs.

What we propose is that, in this year of the engineering job crunch, a lot more thought should be given to putting the engineer in the classrooms of the secondary schools or community colleges—not as students but as teachers. We further recommend that a study be made pinpointing the precise regions of the country where there is a shortage of science, math or physics teachers. The federal Government should consider giving grants to bright engineers to cover the expense of relocating them to these areas where they are needed.

Today's unemployed engineer can bring a lot of valuable knowledge, skills and practical experience to the classroom. He's simply too valuable a resource to waste.

RALPH DOBRINER

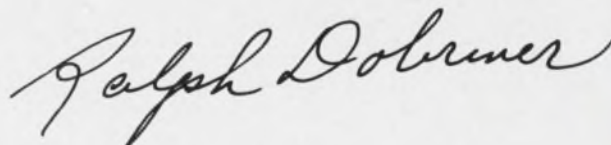

Cut the maintenance costs

of motor control systems while improving performance by using ICs for both analog and digital speed controllers.

The main reason for updating the design of control systems with integrated circuits is to reduce its size and cost. But ICs also offer reduced maintenance costs. And it isn't necessary to change the basic control technique to accomplish these objectives.

Two new versions of a motor speed and acceleration control offer this opportunity to reduce maintenance costs. One is an analog system, while the other is a digital servo-system.

The analog control has only one maintenance adjustment, and the other has none. Long-term accuracy of the analog control is kept high by avoiding pitfalls such as offset-balancing potentiometers, tight-tolerance components and ampli-

fier compensation networks. Inherently high accuracy is assured in the digital system by a new type of decimal rate multiplier and a digital error detector.

Both are practical circuits, adaptable to any commercial power pack requiring dc control inputs. They will control ac or dc motors, eddy-current clutches, hydrostatic transmissions, and other electromechanical power systems normally controlled by analog circuits. Each fits on a printed-circuit card, making assembly cost low and facilitating replacement and off-line repair if necessary.

Jack Christian, Hybrid Product Marketing Manager, National Semiconductor Corp., 2900 Semiconductor Drive, Santa Clara, Calif. 95051

"Black Box" Design

The design basis for each system is the classical "back box" control circuit of Fig. 1. The first two stages generate a dc reference voltage pro-

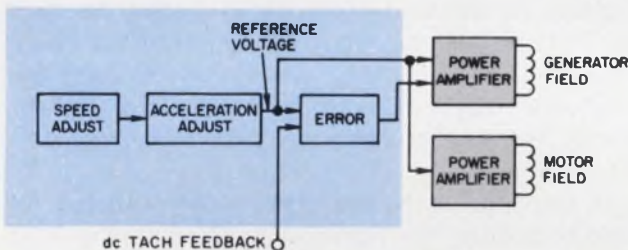

1. A classical speed control system generates a dc reference voltage that is proportional to the desired speed and acceleration. The power amplifier outputs are continuously adjusted by tachometer feedback to get steady-state motor operation. An updated controller (either analog or digital) can be designed with ICs to reduce size and cost.

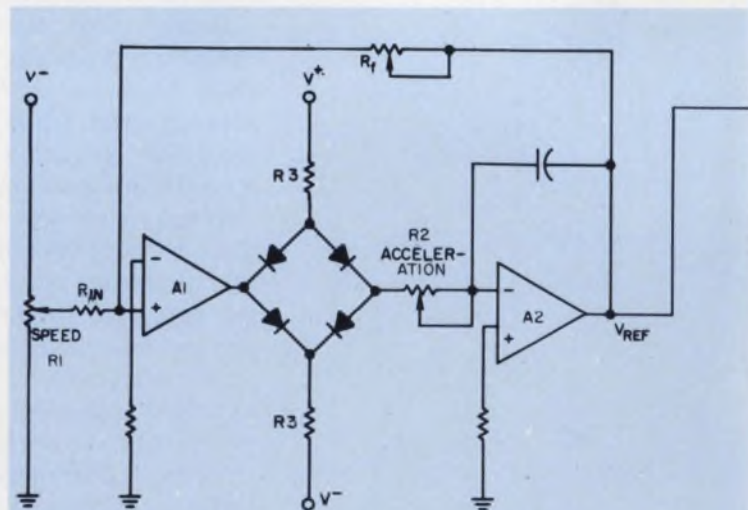

2. The speed and acceleration settings are integrated, by the first two amplifiers in the analog system, to generate a reference voltage, V_{ref} . This voltage is shaped by A_3 and D_1 , compared with tachometer feedback in A_1 , and amplified by A_5 and A_6 to control the motor-generator combination.

portional to the desired motor speed and acceleration. This is summed with an error voltage derived from tachometer feedback and amplified. The resulting control voltage is used to drive the motor at a steady speed.

One of the attractive features of this technique is that the range of the reference voltage can be chosen to suit any power supply and power amplifier ranges. So, a new power system can be easily interfaced with an existing control system. More often than not, the purchaser of electromechanical power equipment must build these interfaces himself.

Also, the black-box approach shortens design time. A different control scheme might reduce the number of ICs needed, but unless a large number of controls are to be built, the extra design effort is not warranted. The classical system can be implemented with standard, industrial-grade ICs that are inexpensive compared with engineering time.

Let's consider the special requirements of a typical Ward Leonard motor speed-control system. The system consists of an ac motor driving a dc generator that powers a dc motor. The dc voltage, controlling current in the generator field windings, must be linear from zero rpm to base speed while that for the motor field must be non-linear from base speed to rated speed. The non-linear output controls motor field strength and prevents the motor from exceeding the rated maximum rpm. Two op amps shape the reference

voltage accordingly.

Amplifiers A_1 and A_2 of the analog control (Fig. 2) generate a rate-controlled dc reference voltage proportional to speed and acceleration settings. Speed is selected by the operator with R_1 and acceleration with R_2 . The variable resistance R_1 in the major feedback loop establishes the level of V_{ref} in volts per rpm. Normally, R_1 is the only maintenance adjustment. To make the system easy to check and adjust, V_{ref} can be made a nice, round number such as 1 mV/rpm.

Amplifiers A_3 through A_6 add the tachometer feedback, shape V_{ref} , compensate for system dynamics and provide the gain needed to drive the power amplifiers. The component values of the RC network and shaping circuit are not shown because they are chosen according to power-supply voltages and the characteristics of the power amplifiers and electromechanical system. Conventional op amp design equations are used to determine component values.

The input stage is designed to ensure that V_{ref} will stabilize after any change in control settings, regardless of operating conditions. When R_1 is changed, A_1 switches a positive or negative current out of the current-steering gate. The current flows into the inverting input of A_2 at a rate determined by R_2C_1 , making the voltage across the integrating capacitor change to the new value of V_{ref} .

The gain amplifier A_2 is unity, so the A_1 - A_2 combination operates as an inverting amplifier

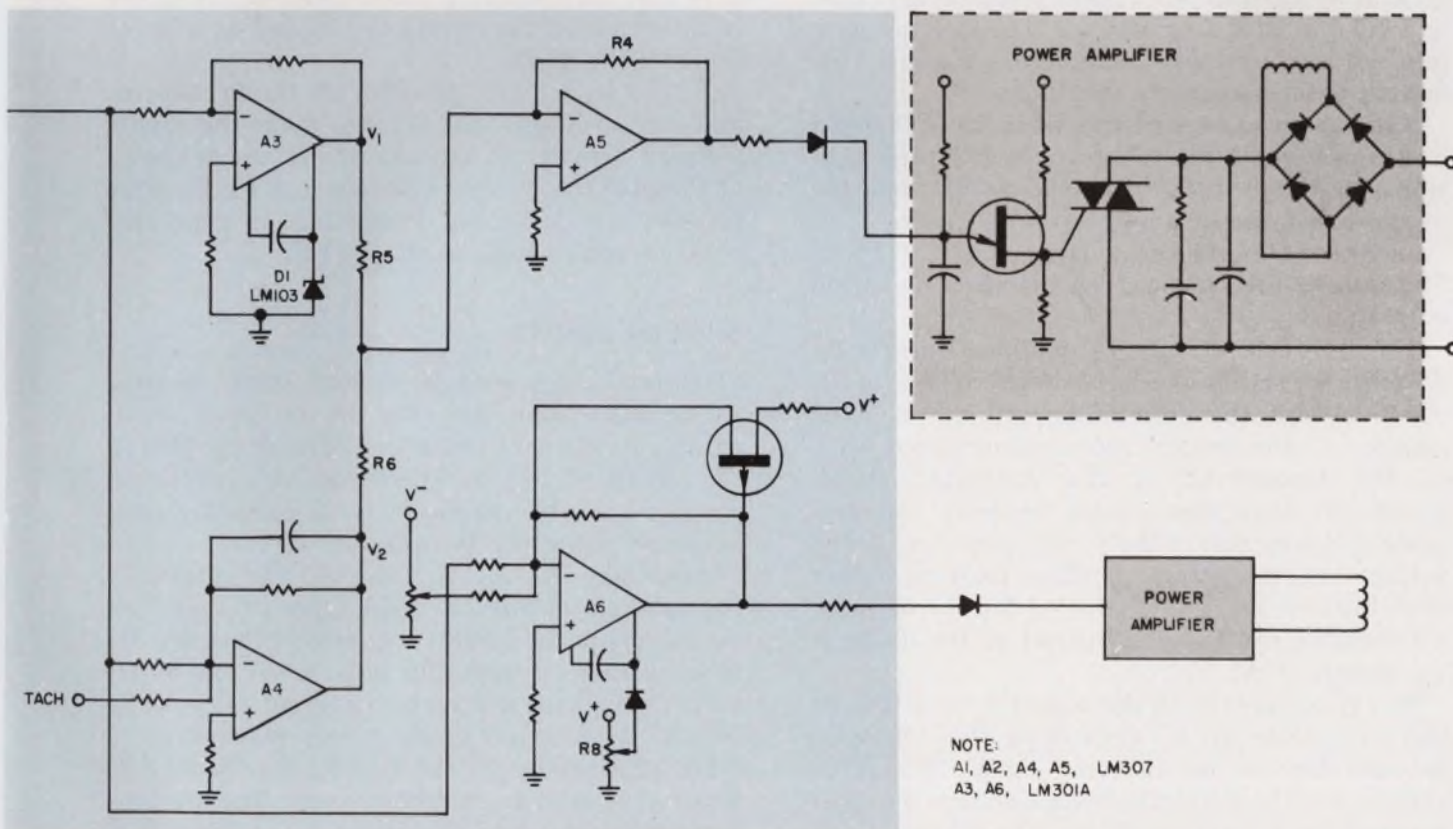

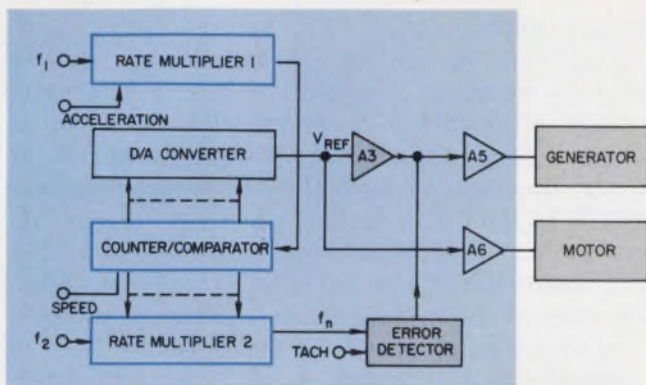

3. The digital servosystem generates the reference and error voltages with decimal rate multipliers (DRMs). Frequencies f_1 and f_2 are for multiplier scaling. The output amplifiers of the analog system are retained.

with $V_{out} = -V_{in}(R_f/R_{in})$. Since V_{out} in this case is V_{ref} , the speed range can be calibrated with R_1 , which divides the negative supply voltage. R_1 is chosen to make the range of $-V_{in}$ equal to the desired range of V_{ref} . The actual value of V^- is immaterial.

After the value of R_f needed to get the desired range of V_{ref} is calculated. R_{in} and the resistance to ground on the inverting input of A_1 are made equal to R_f . This minimizes offset drift.

The major-loop feedback through R_f causes A_1 to operate as a switch with a frequency well above the dynamic range of any electromechanical system. Typically, A_1 will oscillate at a frequency of a few kilohertz. With the switch duty cycle at 50%, equal amounts of positive and negative current flow from the current-steering gate into A_2 , keeping the voltage across the integrating capacitor essentially constant.

The rate of change in V_{ref} when R_1 is changed is a function of the integrator's RC time constant, as determined by capacitor C_1 and the source resistance of amplifier A_2 . That is,

$$\Delta V_{ref}/\Delta t = V^+ / (R_2 + R_3) C_1.$$

The rate, or acceleration, can therefore be varied with R_2 .

The reference voltage is amplified linearly by A_3 until it reaches the breakdown voltage of D_1 which clamps the output. A_3 will normally be clamped at the voltage representing about 10% of the breakpoint in the generator curve. A_5 should have ample gain to drive the unijunction transistor in the power amplifier. If the voltage into the power amplifier must be higher than the 30V maximum allowed for the op amp, a transistor can be used instead of the diode at the output of A_5 .

V_{ref} is summed with the negative dc output of the tachometer by A_4 , generating the difference between the two as an error signal. The error voltage and the shaped reference voltage are then summed by A_5 and amplified. The summing and

amplifying characteristics of A_5 are

$$V_{out} = -R_4(V_1/R_5 + V_2/R_6),$$

where V_1 is the shaped V_{ref} and V_2 is the error signal.

The same equation applies to the inputs to A_1 from the tachometer and V_{ref} . However, A_1 's feedback resistor should be chosen for unity gain. A capacitor is put across the feedback resistor to make A_1 act as a low-pass filter compensating for the system dynamics. In effect, it slows down the response time of the electronic circuitry to that of the motor providing the tachometer input. This type of filter is normally designed to have a 6 dB per octave roll-off.

The motor control voltage is shaped by A_6 , a nonlinear, inverting summing amplifier. When V_{ref} is zero, the output is determined by V^- and is therefore high. The output remains high until V_{ref} rises to the rpm value representing the breakpoint on the motor curve. Then the J-FET takes over, acting as a voltage-variable resistor.

At the breakpoint, the current into the inverting input due to V^- , V_{ref} and feedback is equal to the positive current through the junction field-effect transistor from V^+ . The output of A_6 makes the gate of the J-FET more negative with respect to V^+ and the resistance of the J-FET channel drops. This drop drives the input still higher and the output still more negative. Consequently, the output drops nonlinearly as V_{ref} continues to rise.

The curve begins to level off as the J-FET channel resistance reaches minimum. To make sure that the maximum rated speed of the motor is not exceeded, the output is clamped at a lower limit by the diode.

R_f and R_s are used to establish the breakpoint and clamp voltage. Like R_1 , they make the supply voltages immaterial, but are preset and trimmed at the time the system is installed. A FET source resistance or nonlinear diode function generator could be used instead of the J-FET.

Select the right ICs

Obviously, any good IC op amp might be used for analog control. But note the absence of compensation networks and offset-adjustment pots in the circuit of Fig. 2. These can be a continual source of trouble, particularly if operating temperatures are going to vary.

Amplifiers A_1 , A_2 , A_4 , and A_5 are internally compensated devices. Several types of these are available, but the LM307 was selected because its offset voltage is typically only 2 mV at 50-k Ω source resistance and its bias current is typically 70 nA. By restricting the source resistances to 5 k Ω , offset and drift can be kept low enough to make offset adjustment unnecessary. The low bias current helps maintain accuracy by making leak-

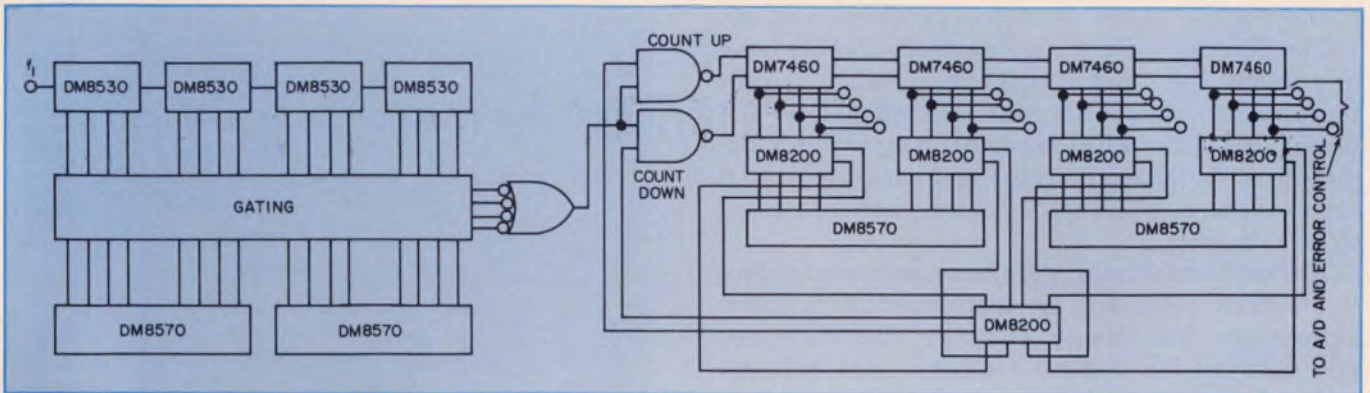

4. The rate multiplier and counter-comparator produce the digital reference voltage. Desired speed is set into the comparator (DM8200). The counter cycles at the rate set into the decimal rate multiplier until the counter

and comparator contents match. After going through a d/a converter, the counter outputs provide the reference voltage. Each stage of the DRM multiplies the reference by a decimal fraction to govern the counter rate.

age of the integrator and filter capacitors negligible. Also, the tolerances of the network components is non-critical.

An internally compensated amplifier cannot be used for the shaping amplifiers because the clamp diodes have to be hung on compensation inputs. However, the LM301A op amp requires only a 30 pf capacitor, rather than an RC network, for compensation. The LM301A has offset and bias as low as the LM307.

For best accuracy, D_1 should be an IC voltage regulator diode such as the LM103. It contains three bipolar transistors and a FET connected to give a very sharp breakdown and low temperature drift. An LM103 connected to ground could also be used in place of the diode and R_8 on A_6 .

Do it digitally

The speed and acceleration reference voltages can be developed digitally. This method can also be interfaced directly with existing equipment.

The digital servosystem of Fig. 3 generates the reference and error voltages with decimal rate multipliers and a digital phase detector. Amplifiers A_3 , A_5 and A_6 of the analog system are retained, however, because the power system still requires two shaped-dc control inputs. The amplifiers cost less than the d/a converters that an all-digital control would require.

Rate multiplier 1 multiplies a scaling frequency by a decimal fraction to get an output rate proportional to the desired acceleration. The speed is selected with a digital comparator. A bidirectional counter is driven with the rate multiplier output until the selected speed is reached. The

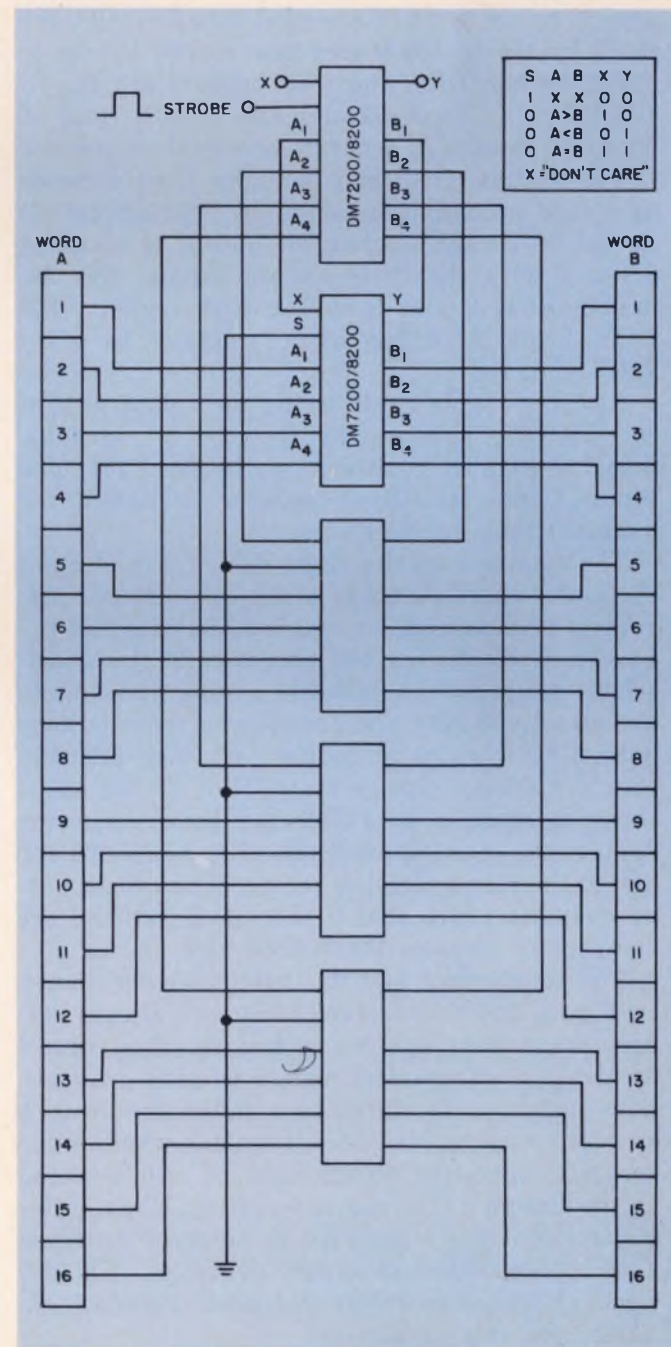

5. A digital magnitude comparator detects a match between the speed setting (word A) and the counter contents (word B). The comparator output states, shown by the truth table, determine whether the counter counts up or down while hunting for the correct output.

counter output is converted to a reference voltage.

The counter output also controls another rate multiplier, the input frequency of which is proportional to the pulse rate that should be fed back from a digital tachometer. Any error is detected by the phase detector and converted to an error voltage. V_{ref} and V_{error} are then processed by the op amp.

Although rate multipliers have been used before in machine tools and as mathematical function generators, this design (Fig. 4) and the speed and acceleration control technique are believed to be unique.

Here, the input control switches are DM8570 TTL shift registers storing BCD numbers (8-4-2-1 notation). The counters are connected in a nonstandard BCD mode (5-4-3-1) to simplify the gating and decoding. The first decade multiplies f_1 by up to 0.9, the second by up to 0.09, the third by up to 0.009 and the fourth by up to 0.0009. When OR'd the four outputs are $f_{out} = (ABCD) f_{in}$. Four decades and a high ratio of f_{in} to f_{out} results in accurate acceleration control.

The scaling frequency actually used depends upon the acceleration range in rpm/second. It should be chosen so that the output is obtained directly with the BCD control inputs (for example, BCD 2 and 9 in the first register and BCD 1 and 5 in the second register to select 2,915 rpm/sec).

Register inputs avoid tying up a data processor between changes in the control settings. Serial-to-parallel registers can be used for tape inputs, and logic-level selector switches for manual inputs or overrides.

The counters on the right side of Fig. 4 store the motor speed that was previously selected. Assume a present motor speed is 1,450 rpm and f_{out} has been selected as 400 rpm/sec. If the speed-select inputs on the DM8200 comparator inputs are also 1,450 rpm, the comparator outputs keep both NAND gates at logical "0". The DM7460 counters cannot change state. Now, if the speed input is changed to 1,000 rpm the comparator enables the count-down input of the DM7460 for 450 of the rate multiplier pulses. When the counter contents again match the speed setting, the comparator disables the NAND gate again.

The comparator and its truth table are shown in Fig. 5. Speed and acceleration are always referenced to zero by this technique. The control system, or an operator using selector switches, does not have to calculate a difference from a previous setting. Nor does it matter whether the motor is operating steady-state or still servoing in the direction of a previous setting. The counter control provides a basis for servo error detection that is independent of system dynamics. A ladder network makes an excellent digital-to-analog converter for this application.

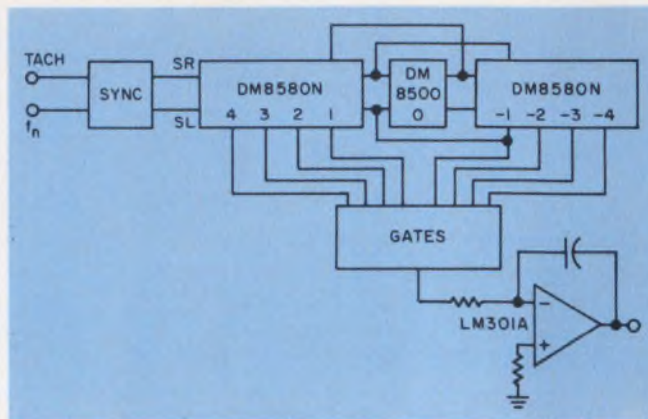

6. An error voltage is generated by a digital phase detector. The shift register shifts right if the tachometer frequency is too high and shifts left if it is too low. The changes in digital output polarity cause the op amp to generate the correct analog error voltage.

Output speed errors are detected by a simple form of digital phase detector (Fig. 6). The circuit rapidly compensates for motor slowing or speedup due to changes in mechanical loading.

The two 4-bit registers and the J-K flip-flop form a 9-bit shift register. The J-K is in a null position for a "1" bit. If the tachometer count frequency is higher than the expected frequency, f_n , the bit will shift right. For example, a tach count 2 Hz higher than f_n will put the bit in the -2 position (the minus sign represents the error voltage polarity that will slow the motor). Conversely, a too-low tach frequency will allow f_n to shift the bit left to a speed-up position. The sync circuit prevents coincidence of f_n and tach pulses by delaying one of them.

When decoded, the bit positions are pulse-width-modulated square-wave inputs to the op amp. They are integrated by the op amp, producing the dc error voltage.

Since the rate multiplier which generates f_n is controlled by the speed counter, f_2 should provide the same scaling as f_1 . For simplicity, though, assume that f_{out} of the first rate multiplier equals acceleration in rpm/sec. For example, if the tachometer count is 360 pulses per revolution and maximum speed is 1,000 rpm, the tachometer frequency will be 6 kHz. However, the counter is storing BCD 1,000. The second rate multiplier will multiply f_2 by 0.1 in its first decade and by zero in all other decades. So f_2 must be 60 kHz.

The minimum error that can be detected depends on the tachometer output in hertz. The 360 cpr tach generates a 6 Hz signal for a 1 rpm error. In the error detector, this would shift the bit location in 1/6th second, allowing the register to detect 1/6 rpm error per bit of register. Long delays in the electromechanical system response to error correction can be accommodated by lengthening the register. ■■

were
Photocells ~~are~~ too expensive
for my application

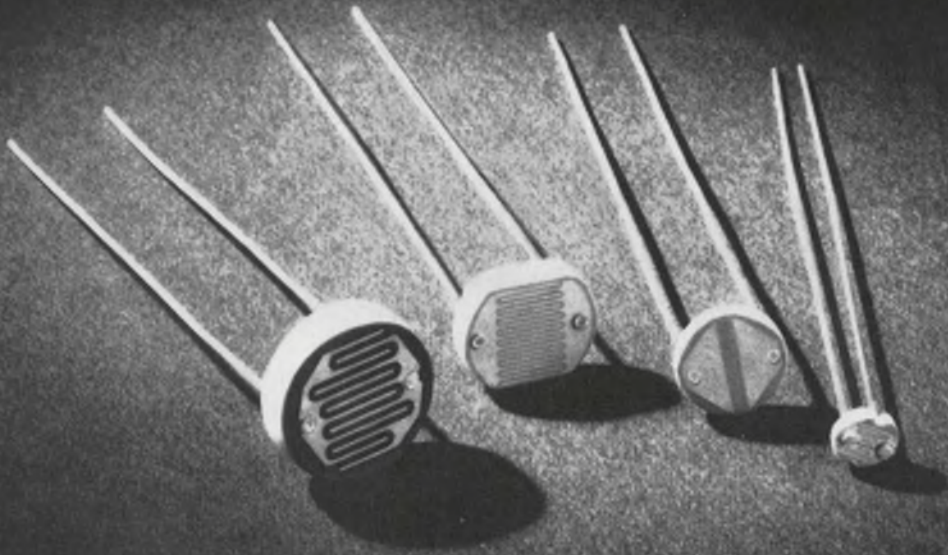

New low-cost design offers many new application possibilities

Plastic encapsulated cells are now readily available in 4 sizes from .170 inches to .435 inches in diameter... and they're as rugged and nearly as reliable as hermetically sealed cells for many applications.

Look again at the applications where you thought photocells were too expensive. We'll send you free samples if you'll tell us why you need them: Call (914) 664-6602 or write Clairex®, 560 South Third Avenue, Mount Vernon, New York 10550.

CLAIREX ELECTRONICS

A DIVISION OF CLAIREX CORPORATION

Solid-state loads provide versatility

in power-supply testing. Here's a use for power transistors that you may have overlooked.

Solid-state circuitry is today's answer to a good many engineering problems and applications. The transistor has replaced the vacuum tube in countless applications. But with all these advances, one area may have been overlooked: the transistor makes an ideal high-power resistor for dc signals or for signals that can be converted to dc. One interesting application of this transistor-resistor substitution involves the ordinary, everyday chore of power-supply testing.

Proper testing of power supplies involves considerably more than simply plugging them in and measuring the output voltages. One of the most important parameters specified and tested is the load regulation of a power supply. Many of the other parameters, such as output, ripple and noise, are specified at both no load and full load. Since varying the input voltage to a supply is ordinarily a simple matter, the measurement of voltage, ripple and noise requires only the connection of suitable instrumentation. But the one tough problem remains: what do you use to provide a load for the supply?

For a one-time-only test of a specific supply, the most economical method is probably to connect a resistor (or combination of resistors) of the proper value that is capable of dissipating the maximum output power of the supply under test. For production testing, however, or for incoming inspection testing of varying quantities of different types of power supplies, this method has too limited a versatility to be desirable.

Several techniques for loading power supplies to be tested include: rheostats, fixed resistors (switched for different values of load current), and solid-state loads. The tester has to be versatile, simple to operate, and should require only a new test procedure if the need to test a new power supply arises.

The factors affecting the selection of a loading method to dissipate approximately 1350 watts in a tester are listed in the table. An arbitrary scale, 1, 2 and 3—for poor, fair and good, respectively

—was assigned, and each factor was evaluated and rated according to this scale. The use of this kind of chart reduces the design decision to simple arithmetic. In this case the choice was solid-state.

Define the load requirements

The first step in designing solid-state load circuits is the definition of the voltage, current and power requirements for each load. From this information the type and quantity of semiconductor devices required for each load can be determined.

The voltage, current and power are interactive in solid-state loads. At voltages above about 10 V, power becomes the important factor in determining the number of devices necessary to safely sink the load current. Below this voltage the collector current becomes the limiting factor. The dc safe-operating curves for the device selected provide a quick reference for determining the maximum allowable current at any given voltage (or maximum voltage at a specified current).

There is one apparent disadvantage to using transistors as active load elements: they are polarity-sensitive. This disadvantage is "apparent" only, since a bridge rectifier (Fig. 1) protects the transistors and also protects much of

Load Comparison

Factor	Rheostat	Fixed Resistor	Solid State
Cost	3	2	3
Size/watt	1	2	3
Ease of control	2	1	3
Heat on front panel	1	3	3
Space on front panel	1	3	3
Versatility	3	1	3
Operator ease	2	3	2
Sustaining requirements	3	1	3
Reliability	3	2	2
Maintainability	3	3	3
Total	22	21	28

Jon L. Turino, Test Equipment Design and Analysis, Xerox Data Systems, 701 S. Aviation Blvd., El Segundo, Calif. 90245.

the intervening circuitry as well.

The diodes in the bridge must be capable of handling the full load current of the power-supply output. They must have a PIV rating in excess of the maximum output voltage expected across the load, and the reverse leakage must be less than 0.01% of the full load current in order to avoid introducing significant error in the ammeter reading for load current.

The actual load configuration (Fig. 2) is a "super emitter follower." This configuration allows a standard 2-W potentiometer to control currents up to about 100 A, since the base current to the driver transistor, Q_1 , is a small fraction of the load current. The base current is approximately I_L/B_1B_2 where I_L is the load current and B_1 and B_2 are the dc current gains of the driver and load transistors respectively.

Choose the right number of transistors

An insight into the current/power limiting relationship can be gained by examining two load requirements. The 2N3773 transistor was chosen as the active load element. Conservative ratings

were used—based on the premise that it is less expensive to use more devices than to replace devices destroyed by exceeding their maximum ratings. The values were 50 W maximum per transistor and 10 A maximum collector current.

For example:

- If it is necessary to load a 4-V supply at 60 A, the power dissipation is 240 W. While 240 W requires only five devices at 50 W each, the 60-A current requirement dictates six devices.
- If it is desired to load a 25-V supply at 10 A, the current requirement dictates only one device while the power dissipation requires five devices.

Note: in both cases, the larger number of devices should be used.

Once the number and type of devices is determined from the voltage and current requirements, the circuit design becomes relatively simple. The governing condition for determining the values of the emitter resistors and the base current-limiting resistor is the minimum voltage at which maximum load current must be drawn. After the voltage drops across the bridge diodes and the IR drop across the emitter resistor are subtracted from the power supply output voltage, there must be at least $V_{BE1} + V_{BE2}$ remaining in order that the maximum current will not be limited by circuit resistance. This condition is also used to determine the value of the base current limiting resistor. The voltage drop across it must be less than $V_L = (V_{BE1} + V_{BE2} + V_{RE})$ at the base current required by the driver transistor with the full load current sunk by the load transistors.

Consider the specification of a load capable of sinking 10 A at voltages between 10 (minimum) and 25 (maximum). The number of devices is determined at the maximum voltage/maximum current condition. In this case it is 10 A times

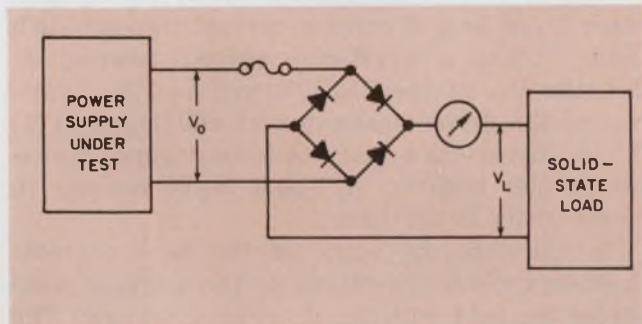

1. The diode bridge eliminates the polarity-sensitivity problem associated with solid-state loads. An ammeter before the bridge converts the tester for ac use.

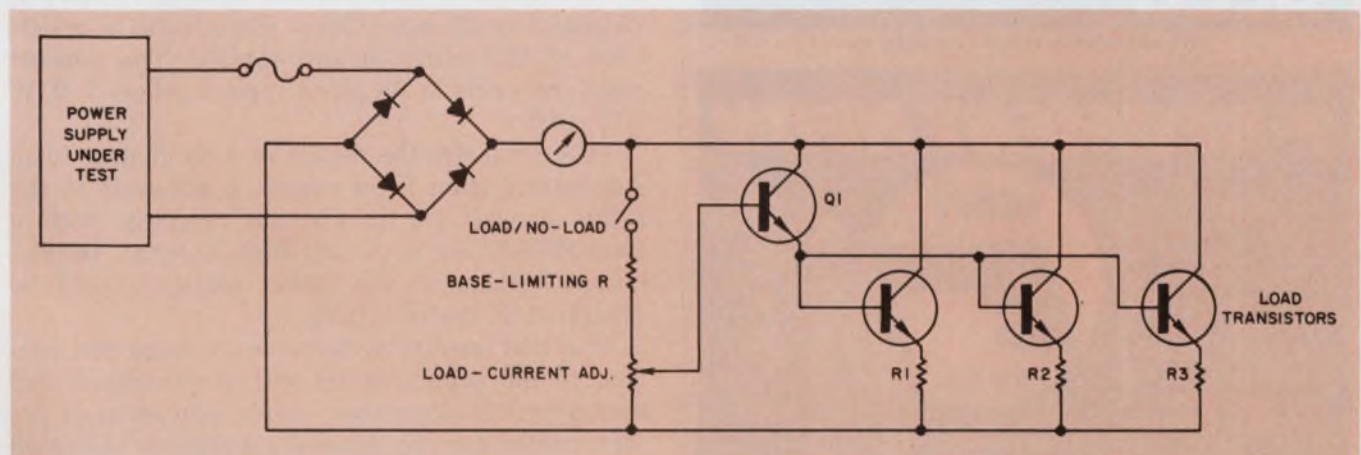

2. A 2-W potentiometer can control currents up to about 100 A. The number of transistors needed for a given

load depends on both current and power requirements. The circuit acts as an adjustable current sink.

UNUSUAL BARGAINS

... MANY U. S. GOV'T SURPLUS

FREE!
GIANT
CATALOG



NEW LOW-COST ULTRASONIC CLEANER
Now a top quality unit for only 49.95. Cleans dirt, grime completely, quickly, safely. Small, delicate parts, precision electronic items, lab instruments, jewelry, coins, even dentures sparkle like new. 1/3rd pint capacity. Operates on regular house current. 1 year guar. Solid state generator with automatic turn-off to prevent overheating. Power control regulating knob. Grounded. No radio interference. 8" x 4" x 1" stainless steel and metal cabinet.
Stock No. 71.003DA \$49.95 Ppd.
LARGE INDUSTRIAL 1 1/2 GAL. SIZE
No. 85.128DA (Wt. 37 lbs.) \$259.95 FOB



ERECT IMAGE LOW POWER SCOPE
\$80 Value—only \$39.95. Direct measuring. 6X, 10X & 20X. Extremely sturdy with dual-knob rack and pinion focusing, color corrected optics, turnable body for inclined viewing. Basic 6X scope includes achromatic objective, wide field eyepiece w/light shield. Mounted accessories lenses for 10X & 20X slip over objective. Has 1/2" scale with .005" graduations for 10X use; 1/4" scale w/.0025" for 20X. 8" high vertical pillar—goes up 8" & locks. Wt. 4 lbs.
Stock No. 70.266DA \$39.95 Ppd.

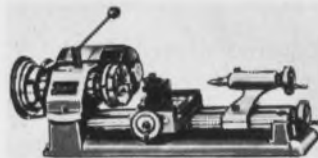

UNIMAT "MINI MACHINE SHOP"
Compact, power tool for metal, plastics, wood with full capabilities of precision machine shop. Works as lathe or vertical drill press. Complete with motor, 1 of a kind for industrial miniaturization, home workshop, model shops, labs, etc. Use basic tool to turn, face, bore, ream, polish. Converts in 1 minute to vertical machine to mill drill, jig-bore, surface grind. 40-p. Instr. booklet.
No. 85.175DA (33 lbs.) \$149.50 F.O.B.



GIANT FREE CATALOG
Completely new 1971 edition—148 pages. Bargains galore! New categories, items, illustrations, 1,000's of buys for industry — Optics, Science, Math. On-the-job helps, quality control aids. Optics for research labs, design engineers, experimenters. Instruments for checking, measuring... to speed work. Improve quality, cut costs. Huge selection of telescopes, microscopes, and other hard-to-get war surplus bargains. Write for Catalog DA.

EDMUND SCIENTIFIC CO. 300 EDS CORP BLDG. BARRINGTON, NEW JERSEY 08007
ORDER BY STOCK NUMBER • OPEN ACCOUNT TO RATED FIRMS • MONEY-BACK GUARANTEE

INFORMATION RETRIEVAL NUMBER 30

THINK DIGITAL

Brite, new 7-segment fiber-optic readout features compact size & low-current drain. Digits are 0.350" high. A 5-Digit display dissipates about 1-watt; stays cool. 2.5V, 20 mA/segment. Accessories available.

MS-2520

ALCO ELECTRONIC PRODUCTS, LAWRENCE, MASS.

895
1000 LOTS.

INFORMATION RETRIEVAL NUMBER 36

7-SEGMENT NEON

New series of single plane 7-segment neon readouts for brighter & wider angle viewing. Only .41" dia. Displays 0-9, some alpha & decimal. Long-life operation. 4.95 each or 2.69 in 1000 lots.

NOW! 2.69
1000 Lots

ELFIN COLD CATHODE DISPLAY TUBES

ALCO ELECTRONIC PRODUCTS, LAWRENCE, MASS.

INFORMATION RETRIEVAL NUMBER 37

25 V or 250 W. At 50 W per transistor, five 2N3773 transistors are required (power-dissipation criteria being the governing factor). Using a typical dc current gain of 50, the emitter current of the driver transistor will be 200 mA and its base current will be 200/50 or 4 mA.

Using one-half of the potentiometer power rating, the allowable current through it is $I = P/E$ or 1/25, which equals 40 mA. At 25 V the 40-mA current allows us to use a 625-ohm potentiometer. Since this value is not critical, a 1000-ohm pot will suffice. The lower the value of the potentiometer, of course, the greater the stability of the load, but the change from 625 to 1000 ohms makes little difference.

Having specified the number of devices and the potentiometer value, we now switch to the minimum voltage-maximum current condition to calculate the values of the base current limiting resistor and the emitter resistors.

At a load current of 10 A, let us assume a diode drop of 1.0 V each. Since there are, in effect, two diodes in series with the load voltage (regardless of polarity) and the drop across the ammeter (50 mV typical) is negligible, there is a potential of 6 V available across the actual load.

If all five load resistors shared current equally, there would be 2 A emitter current through each device. Using a worst-case current sharing of 2:1, the V_{BE} of the 2N3773 will be 1.5 V. The V_{BE} of the driver transistor at 200 mA will be 0.5 V. This leaves 4 V at 4 A to be dropped across the emitter resistor. A 1-ohm 20-W resistor in each emitter is sufficient.

To calculate the value of the base current-limiting resistor we return to the nominal drop across the load with equal current sharing. The voltage drop across this resistor must be slightly less than $V_L = (V_{BE1} + V_{BE2} + V_{RE})$ at 2 V at 4-mA base current. The 4-V drop across the 1000-ohm potentiometer causes 25 mA to flow so that the total current through the limiting resistor is 25 plus 4 or 29 mA. Using Ohms Law, a resistance of 68.9 ohms is appropriate. The nearest standard value is 68 ohms, and a single 1/2 W will suffice.

This completes the design of a solid-state load. Adequate cooling is, of course, a necessity if the active devices are to operate properly with a long MTBF. As with any high current system, output voltage of the power supply should be measured at the terminals.

In actual operation, the input voltage and current to the supply under test is controlled and monitored. The operator simply adjusts each potentiometer for the desired current as indicated on the ammeter for each output and measures voltage, ripple, noise and other characteristics. ■■

ELEXON BLUE RIBBON POWER SUPPLIES

- INPUT: 120 or 240 VAC ± 10% 47-420 Hz
- REGULATION: .1%, RIPPLE & NOISE .1%



VOLTAGES IN BOLD AVAILABLE OFF THE SHELF FROM...

NEWARK
ELECTRONICS CORPORATION

MODEL NO. & SIZE	VOLTAGE															LIST PRICE
	3	4	5	6	8	9	10	12	14	15	16	18	20	22	24	
	AMPS															
ELV-25 4Hx5-1/2Wx6-1/2L	5	5	5	4.2	3.2	2.8	2.6	3	2.6	2.4	2.2	2	1.8	1.6	1.5	66.00
ELV-75 5-1/8Hx5-3/4Wx8L	15	15	15	12.6	9.6	8.4	7.8	7	6.1	5.8	5.5	5	4.6	4.3	4	90.00
ELV-125 6Hx6-1/2Wx11L	25	25	25	21	16	14	13	12	10.3	9.6	9	8	7.2	6.5	6	148.00
ELV-250 6Hx10-1/2Wx11L	50	50	50	42	32	28	25	20	18	17	16	14	12.5	11.4	10.4	190.00

OVERVOLTAGE CROWBAR - \$10.00

ELEXON INC.

1422 E. ST. GERTRUDE • SANTA ANA, CALIFORNIA • 92605
CALL (714) 540-9510

INFORMATION RETRIEVAL NUMBER 31

Mini ⚡ Bus by Rogers

For noise and cost reduction

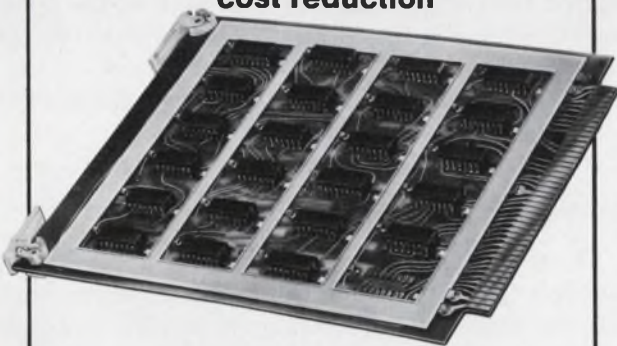

A small, voltage-distributing busbar for PC card application, each Mini/Bus gives you built-in capacitance . . . noise-cutting capacitance that means more reliable, compact circuit packaging at a fraction of multilayer prices. Write for data.



Rogers Corporation / Rogers, Conn. 06263

INFORMATION RETRIEVAL NUMBER 32

ELECTRONIC DESIGN 5, March 4, 1971

In electronics... "The more you know, the more money I can pay you."

For men already working in electronics, here's a new college-level, home-study course in Electronics Engineering from CIE.

Are you missing out on good, high-paying job opportunities because your electronics knowledge is limited or out of date?

Send coupon below for complete information, or write: Cleveland Institute of Electronics, 1776 E. 17th St., Cleveland, Ohio 44114

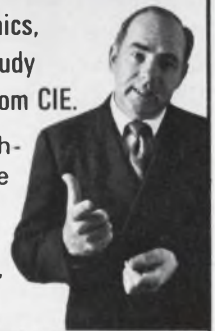

CIE Cleveland Institute of Electronics

1776 East 17th Street, Cleveland, Ohio 44114

I'm interested. Please send me your 44-page catalog with details about CIE's new advanced course in Electronics Engineering.

Name _____ (please print)

Address _____

City _____ State _____ Zip _____

Veterans & Servicemen: check here for G.I. Bill information.
Accredited Member National Home Study Council

ES-2

INFORMATION RETRIEVAL NUMBER 33

Here's a microwave choke that's easy to build and also easy to design. As a bonus, this coaxial configuration is compact.

Are you looking for a good way to block unwanted signals in microwave systems? You can, of course, design microwave radial chokes to meet specific bandwidth requirements, but this can be an aggravating business. The job is often mathematically complicated, and the final design can pose difficult fabrication problems.

A good alternative to the radial choke is a choke made from a quarter-wavelength shorted stub in series with the inner conductor of a coaxial line (Fig. 1). Such a choke is easy to fabricate. It is also compact since it occupies no more volume than the piece of coaxial cable from which it is made. And the curves of Fig. 2 make it easy to design the choke for a specified amount of attenuation over a specified bandwidth.

Using the design curves

Since the length of the shorted stub must be a quarter wavelength at the center frequency, f_0 , the only line parameter that can be varied to change the bandwidth of the choke is the impedance of the stub, Z_1 . Each of the curves of Fig. 2 is a plot of the normalized bandwidth, $\Delta f/f_0$, obtained with a given ratio of stub impedance to main-line impedance, Z_1/Z_0 , for a specified attenuation level. For example, the curve labeled "3 dB" gives the normalized 3-dB bandwidth as a function of Z_1/Z_0 .

As an example of how the curves are used, let's say that a choke is needed for the signal arm of a tunable parametric amplifier. We will require that the choke provide at least 10 dB of rejection at the pump frequency, which ranges between 5.5 and 6.5 GHz. The choke is to be used in a 50-ohm system.

What is the required stub impedance? And what is the transmission loss at 1 GHz?

The normalized 10-dB bandwidth is $(6.5 - 5.5)/6 = 1/6 = 0.167$, which gives a value of

$Z_1/Z_0 = 0.84$, as shown in color in Fig. 2. Since $Z_0 = 50$ ohms, $Z_1 = 42$ ohms.

The signal at 1 GHz is 5 GHz away from f_0 , so that $\Delta f = 10$ GHz. This gives a normalized bandwidth of $10/6 = 1.67$. The intersection of the curves for $Z_1/Z_0 = 0.84$ and $\Delta f/f_0 = 1.67$ occurs above the 0.25-dB transmission-loss curve, indicating that there is less than 0.25 dB of attenuation at 1 GHz.

To fabricate the choke, it is wise to start with a fairly large-diameter piece of 50-ohm cable, so that machining the inner conductor doesn't present any problems. An upper limit on the size of the outer conductor is set by the possibility of a mode other than the normal TEM mode being supported by the line. Type-N cable, with an outer diameter of about an inch, is a good choice at the frequency under consideration. The dimensions A and B are chosen so that their ratio satisfies the equation

$$Z_1 = (60/\sqrt{\epsilon_r}) \log_e (B/A)$$

where ϵ_r is the relative dielectric constant of the cable dielectric material.¹ (For air, $\epsilon_r = 1$).

As indicated in Fig. 1, the gap between the end of the quarter-wavelength section and the main line is approximately the same as the spacing between the inner and outer portions of the stub itself.

The coupling between the two inner conductors can be made by using a simple press fit.

Deriving the curves

The curves of Fig. 2 are derived by recognizing that the shorted length of line, reflected back into the main line, appears as a parallel resonant circuit, or trap, in series with the line. The effective load on the main line (Z_r in Fig. 1) is the line impedance in series with the load impedance,

$$Z_r = Z_0 + Z_1 = Z_0 + jZ_1 \tan(2\pi L/\lambda), \quad (1)$$

where L is the line length and λ is the wavelength.

Starting with Eq. 1, the voltage reflection coefficient, $\Gamma = (Z_r - Z_0)/(Z_r + Z_0)$, can be calculated as a function of Z_1 , Z_0 , λ and L. If the line

Stewart M. Perlow, Manager, Transistor Engineering, KMC Semiconductor Corp., Parker Rd., Long Valley, N. J. 07853 and Peter Torriano, Senior Member Technical Staff, ITT Defense Communications Div., 492 River Rd., Nutley, N. J. 07110.

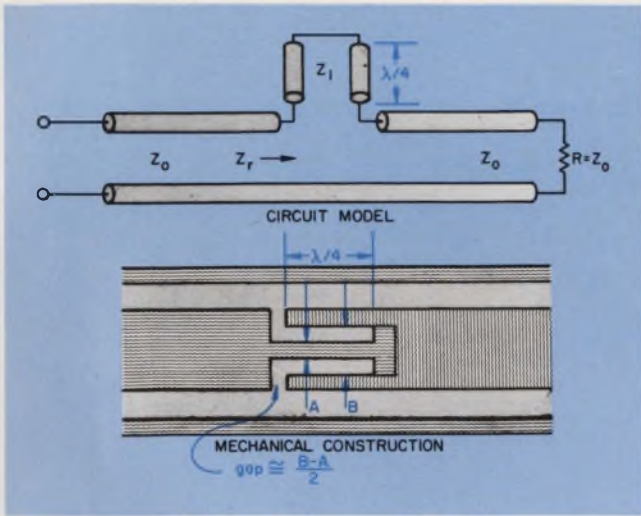

1. The choke is a quarter-wavelength shorted stub in series with the inner conductor of a coaxial line. Fabrication is easy since the two inner-conductor pieces can be joined together with a simple press fit.

length, L , is chosen equal to $\lambda_0/4$ at frequency f_0 , then the square of the magnitude of the reflection coefficient can be written as

$$|\Gamma|^2 = \frac{[(Z_1/Z_0) \tan(\pi f/2f_0)]^2}{4 + [(Z_1/Z_0) \tan(\pi f/2f_0)]^2} \quad (2)$$

where f_0 is the center frequency of the choke and f is the frequency at which Γ is measured.

Defining the bandwidth, $\Delta f = 2|f_0 - f|$, yields the equation

$$\Delta f/f_0 = 2 - (4/\pi) \arctan \frac{2|\Gamma|}{(Z_1/Z_0)\sqrt{1-|\Gamma|^2}}, \quad (3)$$

which is plotted in Fig. 2. Actually, Eq. 3 gives the bandwidth vs Z_1/Z_0 with Γ as a parameter, but it is a simple matter to convert Γ to transmission loss and come up with Fig. 2. ■■

Reference

1. Westman, H. P., editor, *Reference Data for Radio Engineers*, fourth edition, International Telephone and Telegraph Corp., New York, 1956, p. 589.

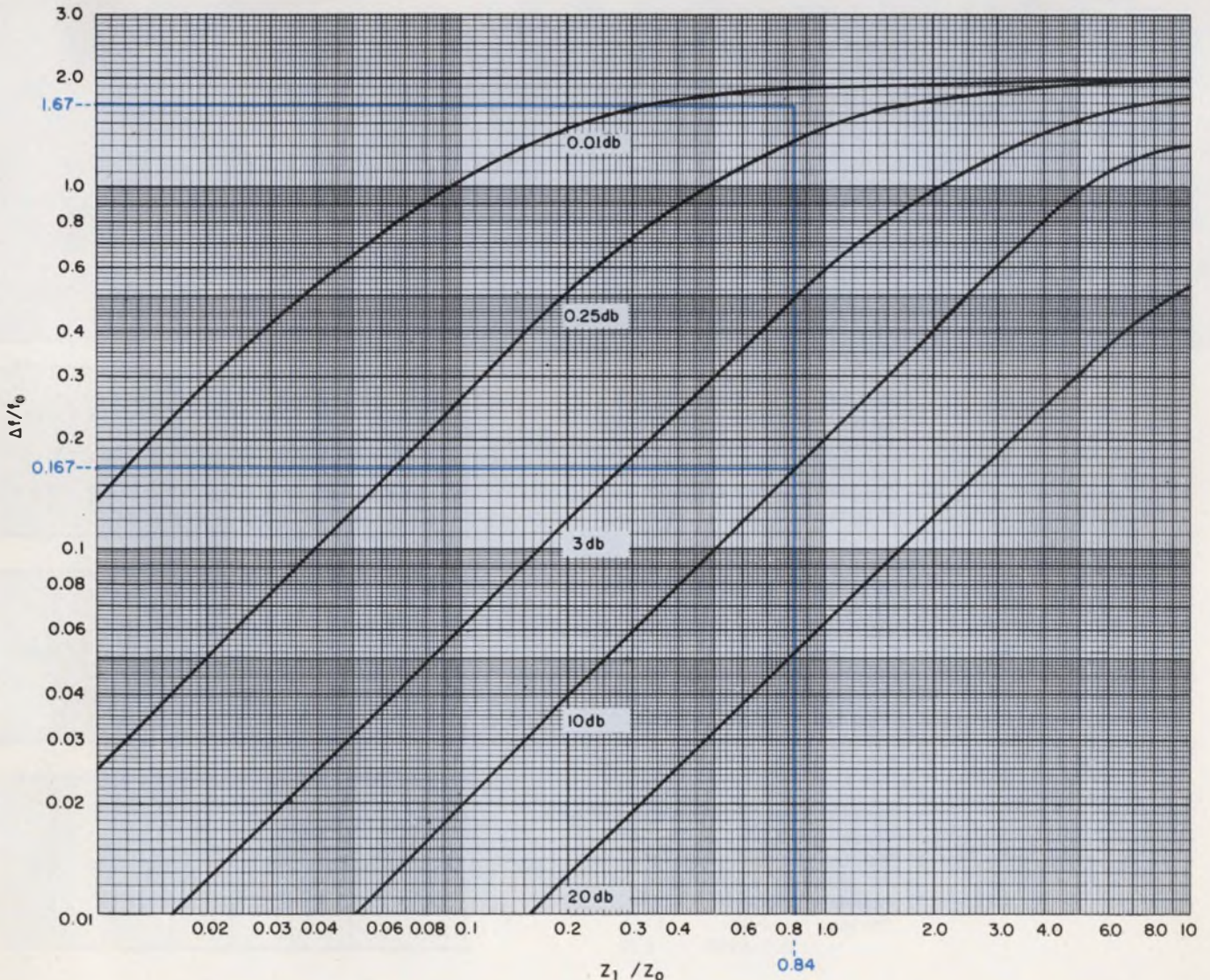

2. You can find the correct impedance ratio for a normalized bandwidth with this set of curves. In the example shown in color, a 10-dB normalized bandwidth of 0.167

requires an impedance ratio of 0.84. This same ratio causes less than 0.25 dB of attenuation at the extremes of a normalized stopband of 1.67.

New from Helipot... Standard Resistor Networks in dual in-line packages

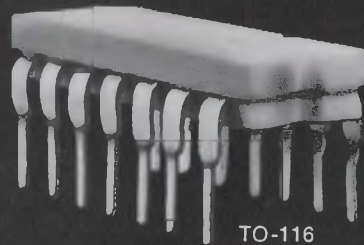

TO-116

DIGITAL PULL-UP NETWORKS

Model: 899-1-R2K and 899-1-R6K

For: unused gate pull-up, wired "OR" pull-up, parallel high speed pull-up

Standard Tolerance: $\pm 2.0\%$
Pricing: 1-99 \$1.45
1,000-4,999 0.81

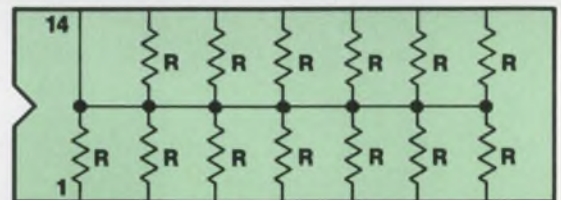

ANALOG SCALING NETWORKS

Model: 899-2-R10K

For: gain ranging, series attenuation, voltage division

Standard Tolerance: $\pm 0.1\%$ voltage ratio
Tracking: ± 15 ppm/ $^{\circ}\text{C}$
Pricing: 1-99 \$2.75
1,000-4,999 1.55

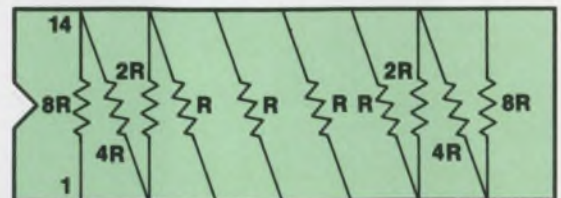

DIGITAL LINE TERMINATOR ARRAYS

Model: 899-3-R110

For: twisted pair termination, coaxial line termination

Standard Tolerance: $\pm 2.0\%$
Pricing: 1-99 \$1.25
1,000-4,999 0.72

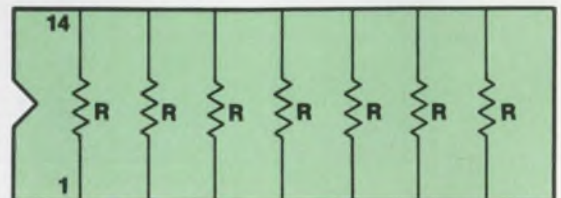

Beckman INSTRUMENTS, INC.

HELIPOT DIVISION
FULLERTON, CALIFORNIA

HELPING SCIENCE AND INDUSTRY IMPROVE THE QUALITY OF LIFE

Call your local Helipot Sales Engineering Representative for additional information and application assistance.

Do your IC op amps act like fuses?

Here are some of the reasons why they blow and some steps you can take to protect them.

All too often monolithic op amps fail catastrophically during incoming inspection tests. The symptoms are usually open outputs and zero power drain from the power supply. The same failure mode occurs in installed equipment.

Examination of the IC chip (Fig. 1) will probably show that the V^+ or V^- metallization has been fused. All IC op amps will blow this thin-film wiring when the substrate is forward-biased—the main cause of op-amp failure.

How do op amps become forward-biased?

- Transients occurring when the power supply is turned on and off are the most frequent cause.
- Discharging an input capacitor (Fig. 2) through the op amp is another frequent cause.
- Sudden increases in the common-mode input

Eugene R. Hnatek, Senior Product Marketing Engineer, National Semiconductor Corp., 2900 Semiconductor Drive, Santa Clara, Calif. 95051.

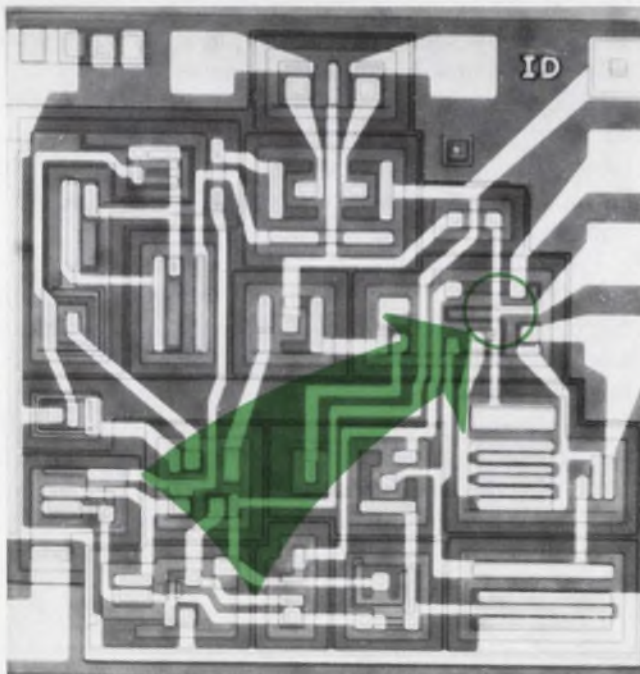

1. The V^+ metal will fuse due to high common-mode or power-supply transients. It usually occurs where the metallization width is extremely small (see circle).

voltage can cause the voltage at the input terminals to exceed V^+ or V^- .

What are the solutions?

- A high-voltage diode inserted in each power-supply lead (Fig. 3) will prevent failures caused by transients and power-supply reversals.
- A zener diode placed across the op-amp supply terminals will provide protection against over-voltage.
- A resistor inserted in each input signal line will limit the transient inputs caused by high common-mode voltages.

It is particularly important that the transient current should be limited in applications such as integrators and voltage followers, where the common-mode input voltage may suddenly rise above the power-supply voltage. Current transients should be limited to about 25 mA for older op amps, such as the $\mu A709$ or LM101, and to 10 mA for new types such as the LM108. ■■

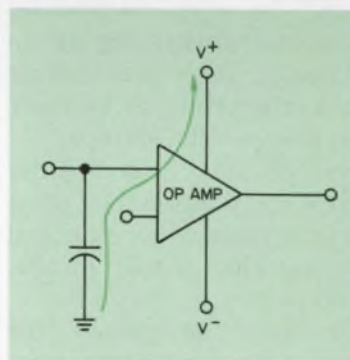

2. The capacitor can discharge through the op amp when the power-supply output goes to zero volts. This and other power-supply transients will cause the thin-film wiring connected to the supply pads to blow.

3. High-voltage diodes inserted in the power-supply leads will prevent failures due to power-supply reversal. The zener diode protects against overvoltage. Resistors inserted in the op-amp input leads limit the current due to common-mode input transients.

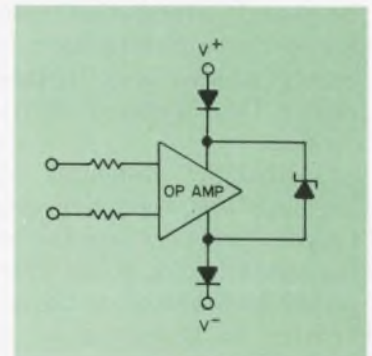

U.S. management: better than you think, according to these foreign engineers. They report that firms here are more paternal, daring and creative than those in Europe.

Richard L. Turmail, Management Editor

When you refer to company management, many of you do so with your thumbs down. You've long complained about low salaries, lack of respect and authority, and of being the victims of ill-conceived management policies.

It's possible that your firm, while not exactly "Paradise Productions," is also not as mis-managed as you may think. Perhaps it'll even be helpful to you on the job to know that your employer probably would have a better than even chance of out-managing his European counterpart.

At least that's the opinion of two likely candidates to make the comparison, Frenchman Jacques Holtzinger, and Czechoslovakian Henry Kohoutek. Both are presently employed at Hewlett-Packard's Loveland Division in Colorado.

Comparing business and life styles

Holtzinger observed that in the U. S. management knows how to use profit to grow. "Utilizing investment research," he says, "companies are always trying to create, always trying to anticipate customers' needs. It means taking risks, and it requires manufacturers to be more aggressive in sales than they are in Europe."

Both foreigners agreed that U. S. companies are accustomed to the hard sell because they work within a consumer society where the standard of living is more important than a way of life, which comes first in Europe.

Holtzinger explained that the reason for Europe's lag in the state of the art is its underdeveloped information resources. It seems that European engineers have traditionally and stubbornly trusted only themselves for information rather than getting additional input from the outside.

"Although," Kohoutek remarked, "there is little hope for economic change in nations like Czechoslovakia where the economy is managed by the government, many European companies are trying to organize to compete. The risk is much greater in Europe than in the United States,

however, because the punishment for failure is greater—you can even hurt your social standing if you fail there."

The Czech engineer also noted that Europe has not been as export-oriented as the U. S., but that the trend is changing.

"Firms are beginning to take advantage of U. S. political drawbacks in business," he said, "such as refusal to trade with certain Communist countries. Then, too," he added, "there's a feeling that America is intoxicated by its successes, and is resting on its laurels."

Part-time degrees frowned upon

But what about the individual engineer? Where does he receive better training?

Both engineers noted that there's much more opportunity to expand intellectually and professionally in the United States.

"Here," Holtzinger said, "company employees can earn a college degree by going to school part time in the evenings and on weekends. Company management sometimes even pays for this education or sponsors in-house courses.

"Earning a degree by bits and pieces is frowned upon by management in Europe where full-time enrollment is customary. Companies in Europe do not normally encourage employees to improve themselves," he added.

Kohoutek commented, "U. S. business schools are well developed, while their counterparts in Europe are often five years behind in training methods. Most European managers go to U. S. business schools."

It is ironic, according to Kohoutek, that while young engineering managers in Czechoslovakia have theoretical knowledge of all management methods, they cannot practice what they've learned because they work in a noneconomic market—where the profits go to Russia.

What price motivation?

Both foreigners agreed that employees in the U. S. are highly motivated because management



Jacques Holtzinger, marketing product manager for H-P's transmission measuring set, is a native of Versailles, France. He was a field engineer in H-P's Paris office. He was brought over here to learn a little English, get to know the marketing engineers he'll be contacting daily when he returns to France, and take a close look at American management methods during his visit in Loveland, Colo.



Henry Kohoutek left Czechoslovakia in 1968 where he headed production at Tesla Co. in northern Bohemia. From 1962 to 1966 he headed development of transistorized calculators and small EDP devices. This required business trips into both East and West Europe to compare their design and production. He joined H-P in February, 1969 as a logic designer, and plans to remain in the U. S.

encourages them to take the initiative and share the profits.

"In France," Holtzinger offered, "company management is more security-minded and has a more conservative view of profit sharing—mainly because it knows that the company is not going to grow that much."

Holtzinger also said that strong class distinctions are still prevalent in Europe. An engineer in France finds it almost impossible to raise himself to the management level. Apparently the hierarchy there extends to business circles as well as social ones.

"In the United States," Holtzinger added, "the manager is more understanding because he was an engineer once himself."

Kohoutek said that in Czechoslovakia employees are motivated only by the promise of wage increases. Managers, for example, earn up to 60% over their base salary if they reach their production goal. If they do not reach their goal, however, they not only forfeit the bonus but they could lose half of their year's salary as well. An American engineer would have trouble paying his mortgage at that rate.

"You have to remember," Kohoutek said, "that personal career improvement is strongly affected by the Communist Party. Promotions are strictly a matter of party policy."

Freedom and the well-defined goal

In summing up their observations, both Europeans agreed that U. S. engineers are fortunate because their companies usually have a clear-cut goal—profit.

"Management," Holtzinger said, "must have a clear idea of what the company goal is. When a firm's goal can be dispersed over a wide field of interest, as it sometimes is in Europe, management efforts are diluted and everybody suffers. It's easier to find an optimum management method when the goal is well-defined. It also means that the engineer is going to know exactly what's expected of him."

Kohoutek said, "Freedom is the keynote. American management has emphasized freedom in decision-making, risk-taking, finance and change, and its success here and in Europe cannot be denied." ■■

ideas for design

Use sample-and-hold method to simplify serial d/a converters

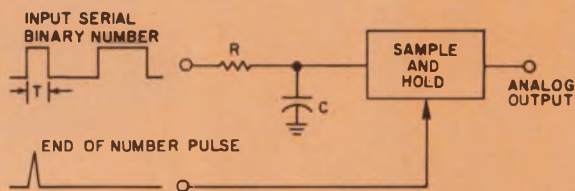

A serial d/a converter stresses simplicity. Acquisition of capacitor charge is used to effect the conversion. The least significant bit of the binary signal is supplied to the input first.

Using a minimal number of parts, a digital-to-analog converter operates with a serial binary number, the least significant bit being fed first. The circuit's RC time constant is chosen so that half of the capacitor charge is gained (or lost) in one pulse period. At the end of the transmission, the voltage on the capacitor will be half of the first bit, one fourth of the second bit, one eighth of the third bit, etc., thereby forming the analog of the binary number. For this circuit, $RC = T/0.693$.

Peter K. Bice, Design Engineer, Microwave Div., Hewlett-Packard Co., 1501 Page Mill Rd., Palo Alto, Calif. 94304.

VOTE FOR 311

Active FET drain load minimizes circuit noise

For low-noise circuit operation, you can build an active FET drain load that automatically biases the FET at its I_{DSS} (zero bias) current.

Under dc conditions, Q_2 acts as a bipolar current source with Q_3 providing dc feedback to set the collector current of Q_2 equal to the I_{DSS} current of Q_1 . When power is applied, Q_1 draws current from Q_2 's collector. As Q_2 's collector voltage de-

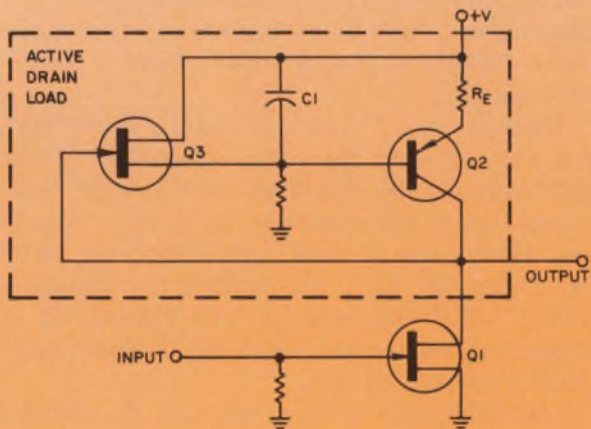

An active drain load for FET preamplifiers automatically sets the optimum bias conditions for low-noise circuit operation.

creases, source-follower Q_3 allows the voltage on the base of Q_2 to go toward zero, thus further increasing Q_2 's collector current.

This process continues because of the feedback provided by Q_3 until the base voltage of Q_2 reaches the value that sets Q_2 's collector current at the I_{DSS} current of Q_1 . The base-collector voltage of Q_2 is always equal to the gate-source voltage of Q_3 , thus assuring that Q_2 always operates in a linear region. R_E is chosen so that the drain voltage of Q_1 is always greater than the pinch-off voltage for any I_{DSS} within Q_1 's tolerances.

For small ac signals the drain-load impedance (typically $> 3 \text{ M}\Omega$) seen by Q_1 is:

$$R_L \approx (1 + h_{fe}) h_{oe}$$

This provides a voltage gain (typically > 600) from Q_1 of:

$$A_v \approx g_m R_L / (1 + g_{os} R_L)$$

The noise contribution of Q_2 and Q_3 can be considered as a voltage source in series with the base of Q_2 and a current source in parallel with Q_3 . The impedance of C_1 is chosen to be sufficiently low to make the current noise of Q_2 and Q_3 negligible. The noise voltage of Q_2 is typically half that of a low-noise FET while its voltage gain (typically < 100) is $A_v \approx 1/g_{os} R_E$.

Larry G. Smeins, Development Engineer, Space Science Electronic Design, Ball Bros. Research Corp., Boulder Industrial Park, P. O. Box 1062, Boulder, Colo. 80302.

VOTE FOR 312

Why search any further?



Since we have the industry's most complete line of monolithic and matched dual FETs, it's almost certain you'll only have to "one-stop" shop... at Siliconix.

Reliability? Every unit is manufactured to meet MIL-S-19500. In fact, our entire line exhibits performance that actually goes beyond the standard industry ratings.

Our data sheets spell out the details, but here are some excerpts. Our U280 series monolithic duals and 2N5196 series matched pairs for general purpose use. For high frequency applications our matched pair 2N5911 series has a



Monolithic Dual FETs

typ. g_m of 6,000 μmho . The 2N5906 series has a 1 pA max. input current.

Low noise? The 2N5515 series exhibits input noise less than 10 nV/ $\sqrt{\text{Hz}}$ and CMRR >100 dB.

Look at it this way. When you order from Siliconix, you no longer have to pour through hundreds of data sheets.

Or circle bingo card after bingo card. Or even pray that a delivered unit's performance matches its printed specs.

All you have to do is call your Siliconix representative.

When you do you'll be ordering from the source with you in mind.

New York: Sy Levine (516) 796-4680 New England: Al La Croix (617) 769-3780 St. Louis: Jim Spicer (314) 291-3616 Minneapolis: Ed Koelgen (612) 920-4483 Southern California: Dave Ferran (213) 420-1307 Northern California: Chuck Brush (408) 246-8000 In Europe: Siliconix Limited, Saunders Way, Sketty, Swansea, Great Britain. Siliconix GmbH, 7024 Bernhausen, Postfach 1340, W. Germany. Siliconix 9, Ave d'Arromanches, 94-Saint-Maur, France.



Siliconix incorporated

2201 Laurelwood Road • Santa Clara • Calif. 95054
Phone (408) 246-8000 Ext. 201 • TWX: 910-338-0227

Low-cost audio-range oscillator uses an SCR and an RC network

With only one SCR and three other components, you can build a medium-frequency-range oscillator. The circuit can even drive a low-impedance speaker directly, if the speaker is inserted between the supply and the SCR and if a voltage source of low impedance is provided.

Resistor R_1 provides gate drive, while resistor R_2 and capacitor C comprise an RC network driven by the SCR. At initial turn-on, the capacitor acts as a low impedance and a surge current flows through the SCR. As the capacitor charges towards its peak voltage level, the anode-to-cathode potential of the SCR decreases, causing current through it to fall below the level needed to sustain conduction, and the cycle repeats.

Since resistor values will vary with the different supply voltages, SCRs, and frequencies, it is suggested that two 10-k Ω potentiometers (with limiting resistors) be used to determine optimum resistance values. Low-power SCRs will os-

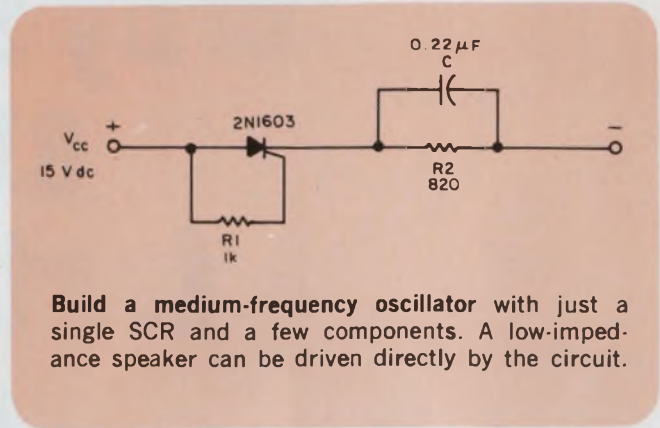

Build a medium-frequency oscillator with just a single SCR and a few components. A low-impedance speaker can be driven directly by the circuit.

cillate with a capacitance of as little as 0.02 μF , while high-current devices require a capacitance of at least 0.22 μF .

Leon Fink, Jr., Engineering Technician, 1605 Grace Street, Arlington, Tex. 76010.

VOTE FOR 313

Precision ramp generator responds to clock in 25 ns

A precision ramp generator, which offers triggered or free-run operation modes, features fast response to input signals: the ramp will start approximately 25 ns after the input clock falls. The circuit's high-end repetition rate is around 200 ns, and ramp linearity is within 1%.

Assume that FF_1 (one half Signetics' 8824) is reset, FF_2 (one-half Snignetics' 8824) is set, and the switch is in the trigger (S_2) position. When the input clock falls, FF_2 will set, causing D_2 to disconnect. Timing capacitor C is then charged by the constant-current source formed by Signetics' 5709 and the 2N3638 transistor.

The charging rate is set by resistor R . When the voltage across C reaches V_{R1} , comparator CA (Signetics' 5710) switches. This resets the flip-flops and begins discharging C . When the capacitor discharges to the level of V_{R2} , comparator CB (Signetics' 5710) sets FF_2 , which in turn disables the reset of FF_1 . This latter flip-flop is now ready for another clock pulse.

When the switch is in the free-run (S_1) position, FF_2 is continually set and reset, giving a repeating ramp output. Diodes D_1 through D_3 should be high-speed computer types like the 1N914. For good linearity, the charging current should range from 0.1 to 10 mA.

Ronald R. Siebert, Senior Electronics Technician, Signetics Corp., 811 E. Arques Ave., Sunnyvale, Calif.

VOTE FOR 314

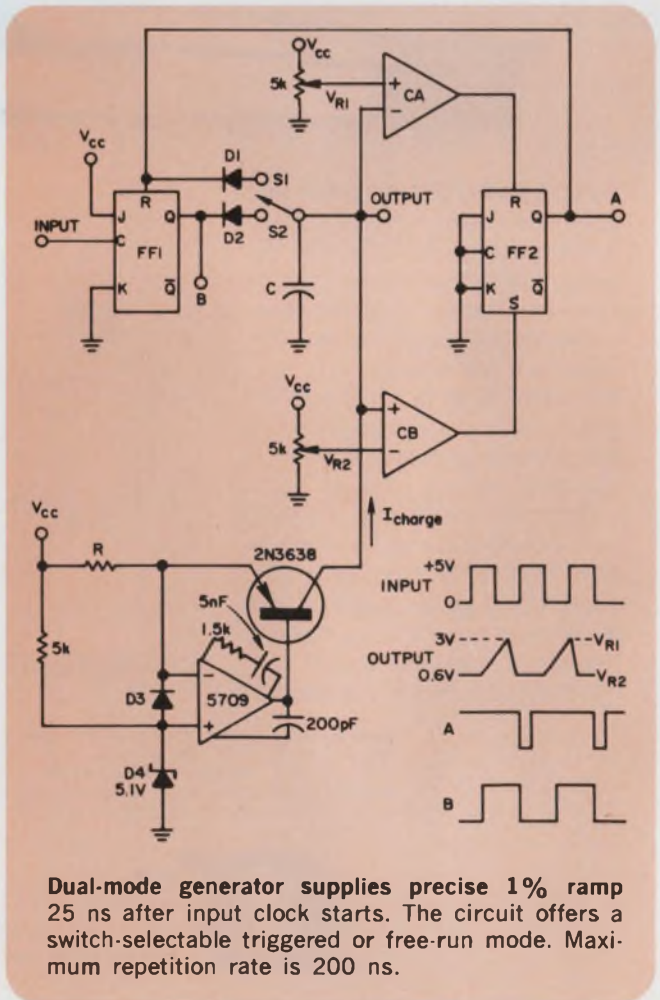

Dual-mode generator supplies precise 1% ramp 25 ns after input clock starts. The circuit offers a switch-selectable triggered or free-run mode. Maximum repetition rate is 200 ns.

spark & noise eaters



Electro Cube RC networks can chew and swallow at least 200,000,000 tough, jagged edge arcs, sparks and noise transients (when operated according to specifications). Standard molded units have 125 to 500 VAC, 200 to 2,000 VDC ratings. Custom metal or molded units, single or multicircuit, designed to your electrical, packaging and mounting requirements. Brochure on request. Call or write for engineering assistance. (213) 283-0511. 1710 South Del Mar Ave., San Gabriel, Calif. 91776.



electro cube, inc.

Capacitors, RFI Filters, RC Networks
INFORMATION RETRIEVAL NUMBER 38



Precision Metal mini-pins for every mini-purpose.

Precision-machined ultra-miniature pins to fit every need. Diameters from .005" to .093"; lengths to 1". For use in connectors, micro modules, headers, as solder terminals — for commercial and military applications. Made of free cutting brass (QQB-626, Comp. 22). Supplied with a variety of plating options. Choose from over 500 stock items including miniature and standard size terminals.



Send for free, complete, illustrated catalog.
PRECISION METAL PRODUCTS CO.
41 ELM ST. STONEHAM, MASS. 02180
Telephone: (Area Code 617) 438-3650

INFORMATION RETRIEVAL NUMBER 39

ELECTRONIC DESIGN 5, March 4, 1971



ENVIRONMENTAL TEST CHAMBERS



SERIES HH-5100



MODEL RW-1100

The same concern with fail free product performance that has made ATL's own test facilities synonymous with "assurance" goes into every ATL-manufactured chamber. Now... these precision-packaged, lab-quality chambers are available to you at "classroom costs."

MODEL RW-1100 offers full-size chamber performance in a compact bench unit. With a low/high temperature range of -100°F to $+350^{\circ}\text{F}$ ($\frac{3}{4}^{\circ}$ stability), it is ideally suited for small parts and assembly testing and quality control. Additional design advantages are: one-half cubic foot work space... door-mounted temperature readout... solid state temperature controller... liquid CO_2 cooling.

For tight tolerance T-H testing, SERIES HH-5100 chambers combine new instrumentation packaging, refrigeration and recirculating humidity systems for weeks of peak operation on one gallon of water. Temperature range is -100° (or -65°) to $+350^{\circ}\text{F}$ ($\pm 1^{\circ}$). Available with single- or dual-cascade refrigeration in 4, 8, or 24 cubic ft. capacity. You'll be amazed at the complete specs... and even more amazed at the pricing! Request catalog M-7-2.



ASSOCIATED TESTING LABORATORIES, INC.

200 ROUTE 46, WAYNE, N.J. 07470 • (201) 256-2800

INFORMATION RETRIEVAL NUMBER 40

Measure pulse periods of 500 ns with hot-carrier-diode circuit

A simple circuit employing hot-carrier diodes makes it possible to measure pulses with periods as short as 500 ns, to a resolution of 1%. The circuit is sensitive only to pulse duration, and not to pulse amplitude.

The NAND gates (one-quarter Texas Instruments SN7400) are used as charging and discharging current switches. The hot-carrier diodes (Hewlett-Packard 5082-2800) on the gate outputs speed up gate risetime because the diodes can turn on in picoseconds once their threshold is reached. TTL gate risetime, which is typically 8 to 10 ns, is therefore multiplied by approximately two orders of magnitude.

Assume that capacitor C is charged. A pulse applied to the reset gate, G_2 , discharges C as shown by the voltage waveform V_z . Once the capacitor voltage reaches zero, the hot-carrier diode bridge prevents leakage current from entering C . The capacitor is now ready to acquire or remember the pulse duration to be measured.

The input pulse from the charge gate, G_1 , passes the constant-current diode, which acts as a regulated current source of 2 mA to linearly

charge C . The duration of the input pulse is then represented by a linearly increasing voltage across C . Even when G_1 's output goes to 0 V, the capacitor remembers the input signal.

Because of the linear nature of capacitor charge, the voltage across C is:

$$v = (i t)/C$$

If i is 2 mA, C is 1 nF, and t is 500 ns, then v equals 1 V.

A major advantage of the circuit is its ability to provide an added safeguard against unwanted leakage current to the capacitor, which would introduce an error into the period measurement. The setting of the charge gate and the disabling of the reset gate can be made coincident in time, so that leakage effects are minimized.

Since the over-all circuit has a good characteristic, a slow op amp can be used to raise the voltage across C to an appropriate level for subsequent a/d conversion. The maximum allowable capacitor voltage is approximately 500 mV to retain linearity.

Don Evans, Systems Engineer, University of California, Lawrence Radiation Laboratory, Berkeley, Calif. 94720.

VOTE FOR 315

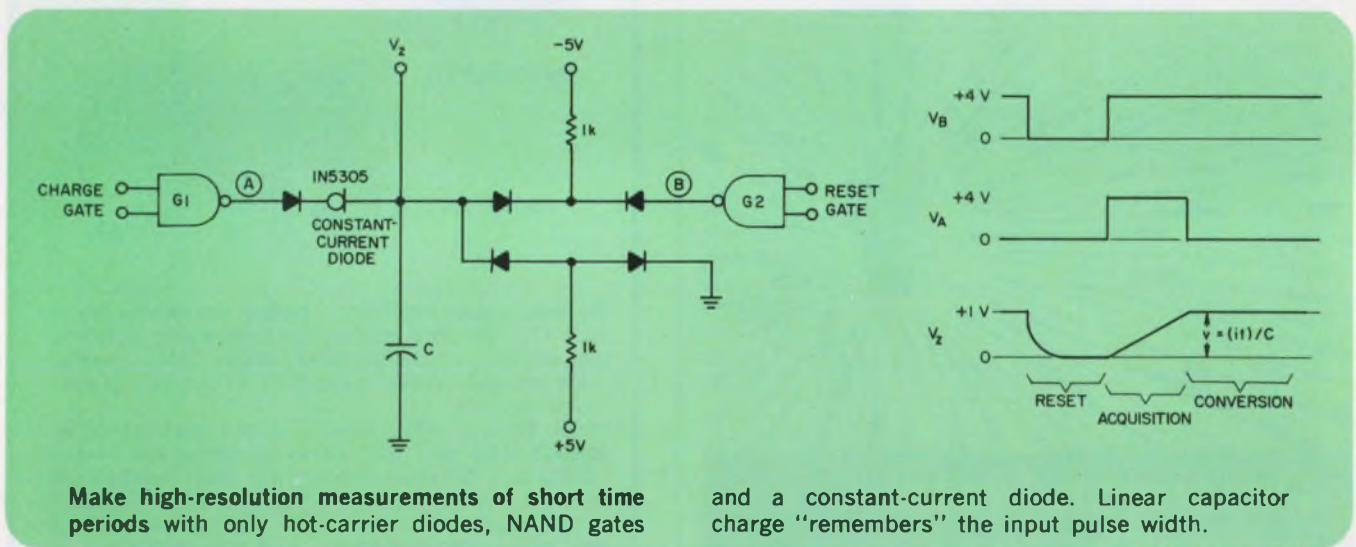

IFD Winner for November 8, 1970

James E. Blecksmith, Senior Engineer, Electronic Engineering Co. of California, 1441 E. Chestnut Ave., Santa Ana, Calif. His idea "A Simple Astable Multivibrator Uses Only Two Inverters" has been voted the Most Valuable of Issue award.

Vote for the Best Idea in this Issue.

VOTE! Go through all Idea-for-Design entries, select the best, and circle the appropriate number on the Reader-Service-Card.

SEND US YOUR IDEAS FOR DESIGN. You may win a grand total of \$1050 (cash)! Here's how. Submit your IFD describing a new or important circuit or design technique, the clever use of a new component or test equipment, packaging tips, cost-saving ideas to our Ideas-for-Design editor. You will receive \$20 for each accepted idea, \$30 more if it is voted best-of-issue by our readers. The best-of-issue winners become eligible for the Idea Of the Year award of \$1000.

new products

New generation of emitter-coupled logic unfolds 2-ns speed and 25-mW dissipation

Motorola Semiconductor Products, Inc., 5005 E. McDowell Rd., Phoenix, Ariz. Phone: (602) 273-6900. P&A: see text.

MECL 10,000, a new family of emitter-coupled logic with an unbeatable 50-pico-Joule speed-power product (2 ns delay and 25 mW dissipation per gate), has arrived on the logic scene.

Until now the emphasis in emitter-coupled logic has been on speed, with power dissipation often sacrificed (see curve, below left). With MECL 10,000, power dissipation is low and is not a function of the operating frequency (see curve, below right).

Compatible with other MECL families, MECL 10,000 offers the logic designer the flexibility of wired-OR and wired-AND options. With these design innovations and use of series gating techniques, a system can be considerably simplified. The number of IC packages used in a system can be reduced by as much as 25%.

Switching rise and fall times are deliberately kept long enough (3 ns) to keep internally generated system noise low and to eliminate the need for multi-layer

boards. Conventional system layouts, including two-sided printed circuit boards and backplane wiring, can be used.

Full compatibility with other MECL families allows the use of MECL 10,000 with MECL III—in critical timing chains, for example—to obtain the highest speed and lowest power dissipation in an overall design.

The new logic family offers good stability, too. Operating characteristics are constant within ± 15 mV (logic 0) and ± 100 mV (logic 1) for a $\pm 10\%$ change in power supply voltage or over a temperature range of 0 to $+75^\circ\text{C}$. This means that precise and expensive power supply regulation is not required.

MECL 10,000 also offers approximately twice the noise immunity of saturated logic, measured as a percentage of logic swing. Logic swings are kept small (800 mV) to minimize system noise and the logic ONE and ZERO states are symmetric about the internal bias point for greater noise immunity.

Still another advantage is easy driving of transmission lines, especially twisted-pair and 50- Ω

cables. MECL 10,000 functions have open-emitter output circuits which can drive 50- Ω lines directly, and provide complementary outputs, which will direct drive up to 100 feet of twisted-pair cable.

Presently available are the MC10109L 4-5 input OR/NOR gate, the MC10119L 3-3-3-4 input OR/AND gate, the MC10131L dual D flip-flop and the MC10181P 4-bit arithmetic logic unit.

These available devices cost \$2 or \$1.60; \$2.50 or \$2; \$7 or \$5.60 and \$20 or \$16 for quantities of 100 to 999 and 1000 to 4999, respectively. The family will be available in 16-lead dual-in-line black alumina ceramic packages (suffix L) with the exception of the MC10181, which will be available initially in 24-lead dual-in-line plastic packages (suffix P).

Planned for 1971 are 26 functions. Five of these are complex: the MC10160 12-bit parity checker/generator, the MC10164 8-line multiplexer with enable, the MC10179 look-ahead carry block and the MC10161 and MC10162 3-bit decoders with two enables, with true and inverted outputs.

CIRCLE NO. 250

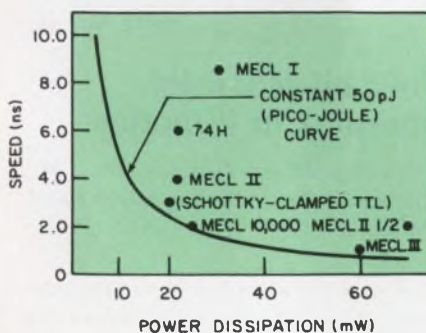

The best speed-power product of any available logic family is offered by the new MECL 10,000 series with a speed-power product of 50 p-J (top). Its low power dissipation of 25 mW per gate is constant as a function of frequency up to 150 MHz (right).

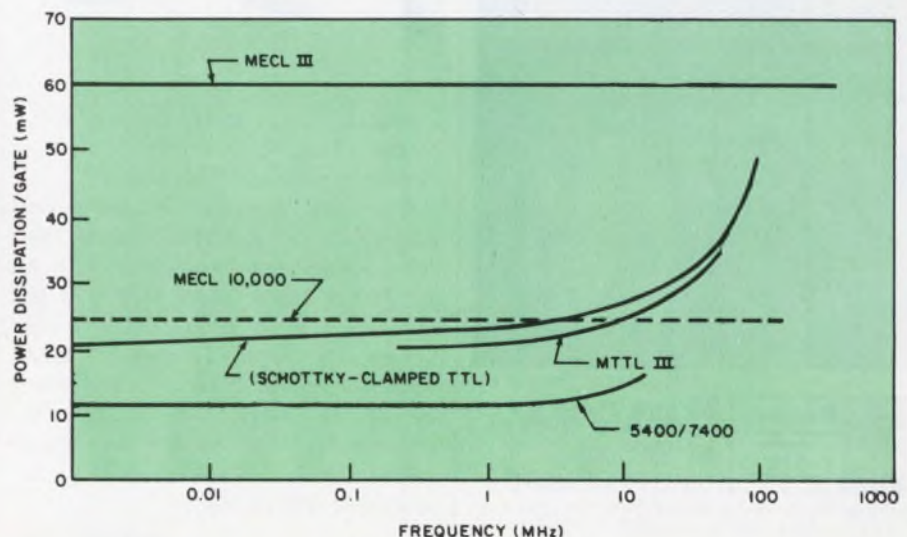

Select BULOVA/ATP oscillators to meet your frequency/ timing needs

- Computer Clocks
- Terminals
- Facsimile
- Timing Systems
- Data Transmission
- Peripherals I/O
- Security/Alarm Systems
- Process Control

ATP capability can provide oscillators to meet all your frequency needs — with many frequencies available from stock.

FEATURES

- Accuracies up to $\pm .0005\%$
- Low Cost, light weight & small size
- Low power drain down to $6\mu\text{a}$
- Reliability — Typically 90% for 200,000 hours
- Logic Circuit Compatibility

If you have a frequency/timing requirement, ATP has the oscillator you need — or can design what you need. Reliability, accuracy and size criteria can be quickly met, with appreciable savings in engineering time and production costs. Call American Time Products at 212-335-6000.



BULOVA
ATP
BULOVA
AMERICAN
TIME PRODUCTS

Electronics Division of Bulova Watch Co., Inc.
61-20 Woodside Ave., Woodside, N. Y. 11377
(212) 335-6000

INFORMATION RETRIEVAL NUMBER 41

ICs & SEMICONDUCTORS

Schottky TTL gates expand 54S/74S ICs

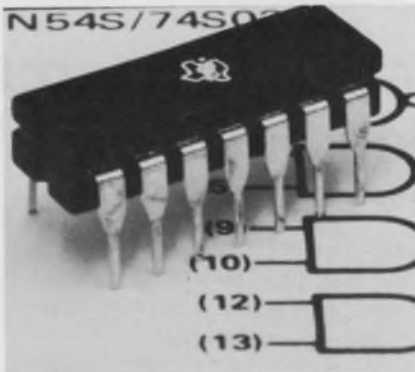

Texas Instruments, Inc., 13500 N. Central Expressway, Dallas, Tex. Phone: (214) 238-2011. P&A: \$3.89, \$4.67, \$3.89; stock.

Three new Schottky-barrier TTL ICs are the SN74503N quadruple 2-input NAND gate with open-collector outputs, the SN74504N hex inverter and the SN74522N dual 4-input positive open-collector NAND gate. These devices offer typical speeds of 3 ns/gate and typical power dissipations of 20 mW/gate.

CIRCLE NO. 251

Vhf/i-f transistor has 1 dB of noise

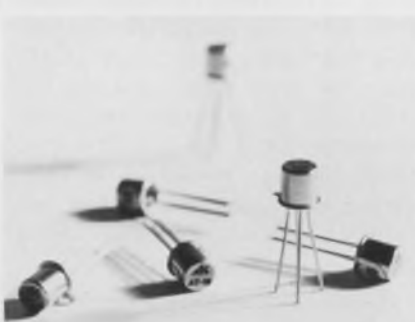

Avantek, Inc., 2981 Copper Rd., Santa Clara, Calif. Phone: (408) 739-6170. P&A: \$25; stock.

Designed for use in low-noise operations in the vhf/i-f bands, the AT-16 amplifier transistor with a frequency range of 20 to 200 MHz exhibits a noise figure below 1 dB across its rated frequency band (guaranteed to 1 dB at a frequency of 60 MHz). Its unity-gain crossover (f_T) is 3 GHz, occurring above 25 mA. Packaging is in a standard TO-72 case.

CIRCLE NO. 252

16-segment LSI ROM has decoder/driver

Kenics Electronics Corp., 125 Harvard St., Cambridge, Mass. Phone: (617) 868-5100. Availability: stock.

Sixteen-segment alphanumeric displays can be made with the B-101 1024-bit bipolar LSI ROM decoder/driver. Each B-101 has decoders, register, memory and buffers on one chip to generate 64 characters from a six-bit input.

CIRCLE NO. 253

Op amp trio improve specs

Signetics Corp., 811 E. Arques Ave., Sunnyvale, Calif. Phone: (408) 739-7700.

Three improved op amps are the 533 which is similar to the popular 709 but plugs into standard op amp sockets; the 536 which is similar to the 740 with a lower offset voltage and the 537 which is the same as the 108 but has a larger differential input voltage.

CIRCLE NO. 254

Bipolar 30-ns ROM packs in 2048 bits

Monolithic Memories, Inc., 1165 E. Arques Ave., Sunnyvale, Calif. Phone: (408) 739-3535. Price: 3¢/bit.

A 2048-bit bipolar read-only memory is now available. The MM6205 has a power dissipation of 0.2 mW/bit and typical access time of just 30 ns. The MM6205 is DTL compatible.

CIRCLE NO. 255

Four-bit MSI latch operates in 2 modes

Advanced Micro Devices, Inc., 901 Thompson Pl., Sunnyvale, Calif. Phone: (408) 732-2400. Price: \$1.95.

A new second-source general-purpose four-bit latch operates in either D-type or reset/set modes. The Am9314 offers an active level, a low-input enable gate and an asynchronous master reset terminal that overrides all inputs and produces low outputs.

CIRCLE NO. 256

2048-bit MOS ROM is programmed electrically

Intel Corp., 365 Middlefield Rd., Mountain View, Calif. Phone: (415) 969-1670. Price: \$48.

A new 2048-bit MOS ROM can be electrically programmed and shipped 24 hours after receipt of the buyer's program instructions. Type 1601 is claimed to be the only MOS ROM that is programmed electrically instead of with a mask.

CIRCLE NO. 257

Retriggerable multi has infinite pulse width

Sprague Electric Co., N. Adams, Mass. Phone: (413) 664-4411.

A new retriggerable monostable multivibrator, type USN9601A, features a 50-ns to infinity pulse-width range with the proper selection of an external RC network. It is TTL/DTL compatible and employs leading-edge or trailing-edge triggering. Packaging is in a 14-pin DIP.

CIRCLE NO. 258

24 hot-carrier diodes come in an \$8.40 kit

Hewlett-Packard, 1501 Page Mill Rd., Palo Alto, Calif. Phone: (415) 326-7000. P&A: \$8.40; stock.

To give emphasis to a 40% reduction in hot-carrier diode prices, Hewlett-Packard offers circuit designers a kit of 24 diodes—8 sets of 3 different diode types for only \$8.40. The 5082-0050 kit has \$32 worth of diodes when sold separately.

CIRCLE NO. 259

COS/MOS digital IC operates from 1.5 V

RCA, Solid State Div., Route 202, Somerville, N. J. Phone: (201) 485-3900. Price: \$35 (samples).

A new COS/MOS digital IC, the TA5987, operates from a 1.5 V supply and dissipates nanowatts of standby power. It is functionally identical to the CD4007 12-V version and is used in NAND, NOR, triple-inverter and dual-transmission gates.

CIRCLE NO. 260

What You Should Know About...

Miniature High Voltage Resistors

new Mini-Mox resistors offer 100 ppm TCR plus low noise characteristics

If you are responsible for design of high-voltage, highly-stable miniaturized electronic networks and equipment, the new Mini-MOX resistor can be a life saver. Mini-MOX resistors have all the ingredients you need to cook-up new designs for ultra-critical applications. For instance, Mini-MOX resistors are a fraction the size of conventional types; they meet or exceed MIL-R-10509-F for environmental parameters . . . 100 ppm or less; stability better than $\pm 2\%$ for 2,000 hours at full load; low-voltage coefficient less than 5 ppm/volt, measured between 100 volts and full-rated voltage; in addition, typical quantech noise at 20 megohms is less than 0.5 microvolt/volt.

All these characteristics combine to provide extremely-rugged and highly-stable resistor configurations that are virtually immune to environmental extremes. Available off-the-shelf in a wide range of resistance values, Mini-MOX resistors are ideally-suited for high-voltage applications where long-term stability and power-to-size ratios are critical.

Available off-the-shelf in a wide range of resistance values, Mini-MOX resistors are ideally-suited for high-voltage applications where long-term stability and power-to-size ratios are critical.

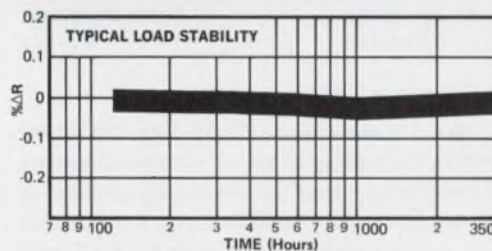
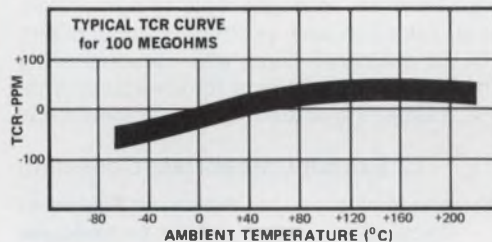

Model	Resistance	Rating @ 70°C	*Max. Oper. Volts	Length Inches	Diameter Inches
MOX-400	1-2500 megs	25W	1000V	.420	.130
MOX-750	1-5000 megs	50W	2000V	.790	.130
MOX-1125	1-10,000 megs	1.00W	5000V	1.175	.130

Write for complete Technical Data Sheet on Mini-MOX Resistors: Victoreen Instrument Div. of VLN Corp., 10101 Woodland Avenue, Cleveland, Ohio 44104. Telephone: 216/795-8200



Expertise in high voltage

DMA 557

INFORMATION RETRIEVAL NUMBER 42

256-bit 330-mW array accesses in 40 ns

Collins Radio Co., Newport Beach, Calif. Phone: (714) 833-0600. Price: \$25.

A new MOS/LSI 256-bit read/write storage array with a power dissipation of 330 mW accesses in 40 to 100 ns depending upon the driver circuitry. The device is organized into 64 words by 4 bits and operates from -55 to +85°C.

CIRCLE NO. 261

MOS shift registers have tri-state outputs

Signetics Corp., 811 E. Arques Ave., Sunnyvale, Calif. Phone: (408) 739-7700. P&A: \$3.45, \$4.60, \$5.75; stock.

Three new static shift registers are available with three-state outputs: 1, 0 and OFF. They are the 2509 dual 50-bit, the 2510 dual 100-bit and the 2511 dual 200-bit registers.

CIRCLE NO. 262

Bipolar 1024-bit ROM accesses in 30 ns

Qualidyne Corp., 3699 Tahoe Way, Santa Clara, Calif. Phone: (408) 738-0120.

The QR01024 and QR0256 are 1024 and 256-bit bipolar ROMs with access times of 30 and 35 ns, respectively. The former is organized as 256 4-bit words and the latter as 32 8-bit words. Both are DTL/TTL compatible and have on-chip decoding.

CIRCLE NO. 263

MOS binary-code ICs convert three codes

Texas Instruments, Inc., 13500 N. Central Expressway, Dallas, Tex. Phone: (214) 238-2011. P&A: \$18.80; stock.

Three new MOS LSI binary-code converters convert USACH, Selectric and EBCDIC codes. They are TMS2602JC (USACH to Selectric or Selectric to USACH), TMS2603JC (EBCDIC to USACH) and TMS2604JC (USACH to EBCDIC or Selectric to EBCDIC).

CIRCLE NO. 264

Single-chip IC + display makes 35-MHz counter

Motorola Semiconductor Products, Inc., Box 20924, Phoenix, Ariz. Phone: (602) 273-6900. Price: \$9.

With the new MC4050 counter-latch-decoder IC, a pulse counter/display that measures frequencies up to 35 MHz can be made with the simple addition of a numeric readout. The single-chip IC has a counter, a latch, a decoder and display drivers for 40-mA loads.

CIRCLE NO. 265

6.8 to 200-V zeners are pulse-rated at 5 W

Semicon, Inc., 10 North Ave., Burlington, Mass. Phone: (617) 272-9015. P&A: from 77¢; stock.

A new series of 5 W pulse-rated zener diodes is available with voltage ratings from 6.8 through 200 V. The TZC series zeners feature 200-A forward surge-current ratings and voltage drops of 1 V at 5 A. All are rated for zener-mode current capacities to 147 A.

CIRCLE NO. 266

IEEE 71

**One Time
One Place
Entire Industry**

FOCUS

March 22-25, 1971
New York Coliseum & New York Hilton

Great Contacts . . . Great Feedback . . . Great Convention

Pursue your interests in depth. Talk to authorities. Get the answers at this all-in-one, problem-solving event, focused on every segment of the industry! Over 400 demonstrating exhibitors and 80 technical sessions combine for an educational happening to benefit you immediately.

12 Exhibit Categories (Coliseum)

<p>Manufacturing Processing Packaging Components</p>	<p>Microelectronics Enclosures Instrumentation Computers</p>	<p>Peripheral Equipment New Technologies Communications Science</p>
---	---	--

50 Technical Program Sessions (Hilton) including:
 Computer-Aided Manufacture • Computers, Utilization, Programming • Electro Optics, Hard Copy Graphics • Communications Microwave Devices • Microelectronics • New Manufacturing Techniques Semiconductors & Magnetic Devices • Transportation & Aerospace Engineering Challenges for the Future

30 Technical Application Sessions (Coliseum) including:
 Automated Test & Assembly • Components & Microelectronics • Computer Applications • Instrumentation • Application of New Technologies • Marketing (sponsored by EIA) Manufacturing, Processing, Packaging

IEEE 71 INTERNATIONAL CONVENTION AND EXPOSITION

Write IEEE Convention Department for Advance Program and registration discount details.
 The Institute of Electrical and Electronics Engineers, Inc.
 345 E. 47th St., New York, N.Y. 10017



THIS IS A RELAY

**A MERCURY-WETTED
RELAY THAT OPERATES
IN ANY POSITION**

Don't be fooled by the dual-in-line package. It's a Logcell® mercury-film relay that is completely compatible with DTL/TTL power driver IC's. It operates in any mounting position without contact bounce. And you can mount it into DIP-drilled printed circuit boards or DIP sockets without special handling. Other features include:

- Long life – tested to billions of cycles
- 2.5 millisecond speed
- Thermal noise less than 1 microvolt
- AC noise below instrumentation levels
- 10^{-6} to 1 ampere load switching range
- Open circuit resistance in excess of 10,000 megohms
- 0.05 ohms maximum contact resistance
- Available in bi-stable or mono-stable configurations

Logcell DIP relays open new vistas of switching system operation and packaging. For more information, write Fifth Dimension Inc., Box 483, Princeton, New Jersey 08540 or call (609) 924-5990.



FIFTH DIMENSION INC.

MICROWAVES & LASERS

IR sensor detects reflective objects

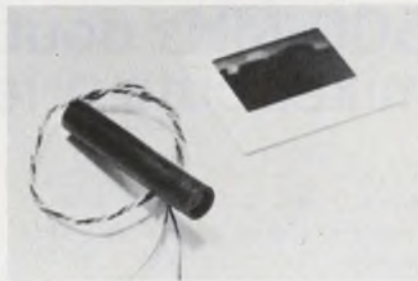

Kolt Engineering, 16550 Shady View Lane, Los Gatos, Calif. Phone: (415) CA 9-5030. Price: \$75.

A new infrared sensing device emits IR light and detects reflective objects in the light path. Designated the model IR-10, it senses IR rays reflected into its lens and produces a common +5 to +15-V signal output which can be used directly in DTL or TTL circuits. It is cylindrical in shape measuring 2-in. long by 3/8-in. in dia.

CIRCLE NO. 267

5-W FM transmitter is a 2-oz 4-in.³ unit



Ground/Data Corp., 4014 N. E. 5th Terr., Fort Lauderdale, Fla. Phone: (305) 563-2527. Price: \$600.

A new voice-operated 5-W FM transmitter for the 136 to 175-MHz portion of the vhf spectrum occupies only 4.4 in.³ and weighs 4 oz. The crystal-controlled unit, model 1014D-5, has an operating efficiency from battery to antenna of 60%. A voice-operated switch reduces operating power by 95% when no audio input is present. The transmitter operates from a 12-V source.

CIRCLE NO. 268

NEW! AUTOMATIC RESET TIMING



SERIES
400

...with independent AC or DC clutch control

Deltrol Controls' NEW Series 400 Fixed Time Cycle Automatic Reset Timer incorporates features which give the designer advanced engineering excellence and higher value per dollar spent. Check these features yourself:

- ✓ Clutch control is independent of timer motor and may be operated on either AC or DC voltage while timer motor is operated on AC.
- ✓ Remains in timed-out position without the use of an external relay or without stalling the timer motor. At end of time-cycle, motor is turned off while clutch holds switch position.
- ✓ Reset time is not a function of total time cycle. Reset time is 25 milliseconds maximum.
- ✓ Standard fixed time cycles of 5, 10, 15, 20, 30, 60 seconds; 5, 10, 15, 20, 30, 60 minutes. Other time cycles on request.
- ✓ Recognized under the Components Program of Underwriters Laboratories, Inc. (File No. E19033).
- ✓ Lower cost...more value per dollar. Interchangeable with higher priced units.

Write for complete specifications & prices

DELTROL CONTROLS

1461

2745 So. 19th St. Milwaukee, Wis. 53215
Phone (414) 671-6800 Telex 2-6871

Here are 4
out of 4000

DIALCO SUBMINIATURE INDICATOR LIGHTS



SHOWN ACTUAL SIZE

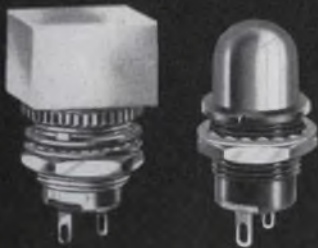

Designed to meet requirements of MIL-L-3661B and MIL-L-6723.

Sizes for mounting in $1\frac{1}{32}$ ", $\frac{1}{2}$ " or $1\frac{1}{32}$ " clearance hole.

Incandescent for 1.35 to 28V and neon for 105-125V AC-DC or 110-125V AC.

Patented built-in current limiting resistor (U.S. Patent No. 2,421,321).

Wide selection of lens shapes and colors, hot-stamped or engraved legends.

Available off-the-shelf for prompt delivery.

Send for free catalog



Dialight Corporation

60 Stewart Ave., Brooklyn, N. Y. 11237.
(212) 497-7600



A NORTH AMERICAN PHILIPS COMPANY
INFORMATION RETRIEVAL NUMBER 46

MICROWAVES & LASERS

500-MHz double balanced mixer cuts price to \$7.95

Mini-Circuits Laboratory, Div. of Scientific Components Corp., 2913 Quentin Rd., Brooklyn, N. Y. Phone (212) 252-5252. P&A: see text; stock.

Representing a price/performance breakthrough in double balanced mixers, a new dc to 500-MHz mixer with 6 dB of conversion loss and isolation of 40 dB can now be purchased for as low as \$7.95 (500 quantities). Even for quantities as low as 6 units, the new mixer costs just \$9.45.

Packaged within an emi-shielded metal enclosure and a hermetically sealed header (enclosure is 0.8 by 0.4 by 0.4 in.), the model SRA-1 exhibits a typical noise figure of just 1/2 to 1 dB greater than its conversion loss. Its pins are oriented on a 0.2-in. grid for printed circuit board mounting.

The SRA-1 has 50- Ω impedance

for all of its ports and 6 dB conversion loss at a local-oscillator power level of +7 dBm. Its operating and storage temperature range is rated from -55 to +100°C.

Absolute ratings include total input power of 50 mW, total peak input current of 40 mA and a pin temperature rated for 10 seconds at 5100°F.

High reliability is characteristic of the SRA-1. Each unit carries with it a one-year warranty by the manufacturer. Only well-matched hot-carrier diodes and rugged transmission-line transformers are used.

Internally silicone rubber is incorporated as an insulator against any wire shorts and to provide protection against shock and vibration.

CIRCLE NO. 269

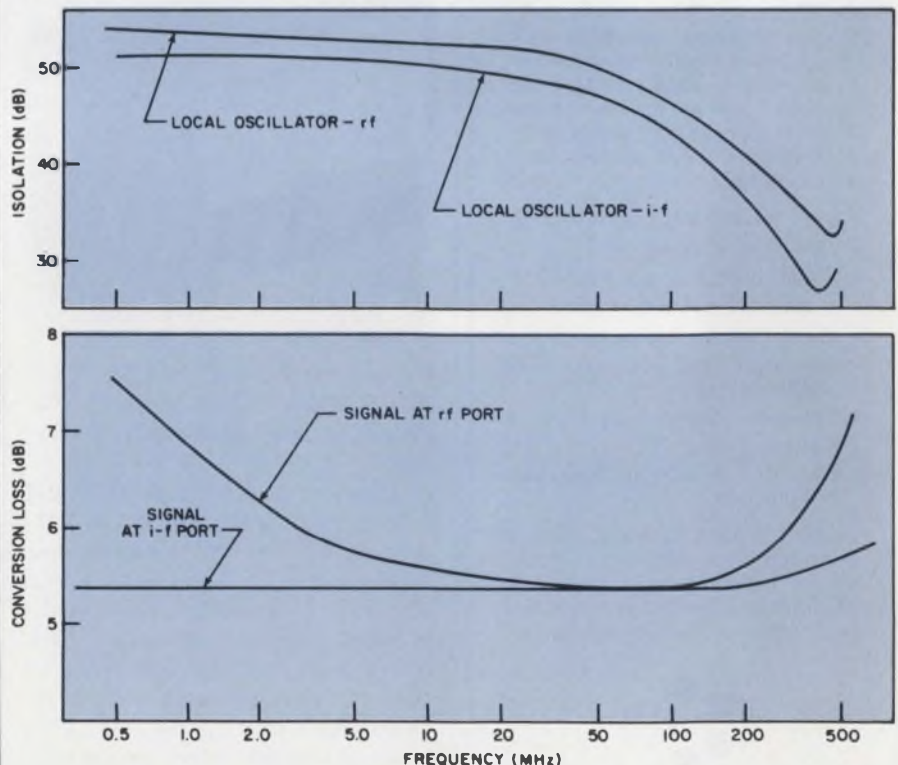

New low-cost high-performance double balanced mixer shows a typical 6-dB conversion loss from 0.5 to 500 MHz (bottom curve). Top curve shows typical isolation.

FET VOM with 55 ranges costs \$75



Dynascan Corp., 1801 W. Belle Plaine Ave., Chicago, Ill. Phone: (312) 327-7270. Price: \$74.95.

The B&K 179 FET VOM with 55 ranges of measurement, a 3-MHz ac response and 10-MΩ input impedance is priced at only \$74.95. Included are eight dc and ac voltage ranges for ±0.3 to ±1000 V, eight ranges for dc and ac currents from 0.03 to 300 mA and seven resistance ranges for 0 to 500 MΩ. Accuracy is ±2% and ±3% for dc and ac measurements, respectively.

CIRCLE NO. 270

\$985 systems DMM has many features



Dana Laboratories, Inc., 2401 Campus Dr., Irvine, Calif. Phone: (714) 833-1234. P&A: \$985; 30 to 60 days.

The 4700 digital multimeter offers ac and dc voltage and resistance measurements, isolated BCD output, and remote programming without adding accessories or options at a \$985 price. Standard features include auto-ranging, auto-polarity, 100% overranging, five dc (0.1 V to 1 kV), four ac (1 V to 1 kV) and six resistance (0.1 Ω to 10 MΩ) ranges.

CIRCLE NO. 271

the Giant Killer strikes again...

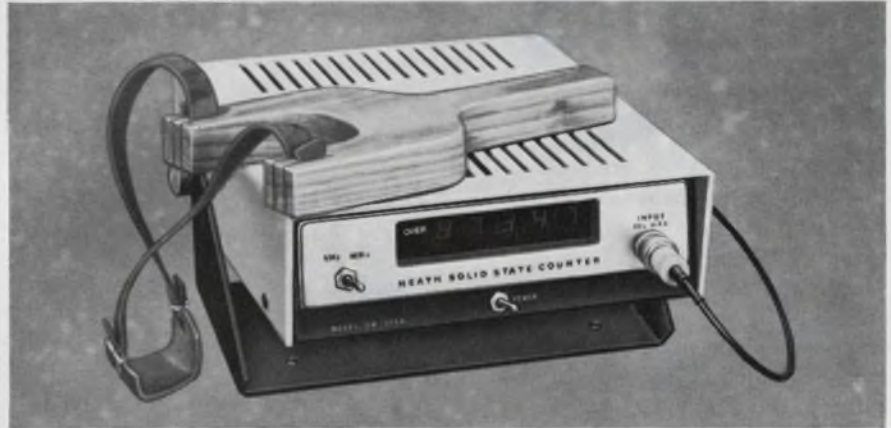

New Heath SM-105A

\$350.00*

ASSEMBLED & TESTED

- 10 Hz to over 80 MHz range
- Advanced design — new Texas Instruments 74S Series superspeed Schottky TTL
- 5-digit LED readout
- Wide range input without adjustment
- 1 megohm input
- Crystal clock
- Send for free SM-105A spec sheet... and watch the giants fall!

SM-105A SPECIFICATIONS — Sensitivity: 100 mV RMS to 50 MHz; 250 mV RMS, 50 MHz to 80 MHz. Frequency Range: 10 Hz to 80 MHz. Input Impedance: 1 Megohm shunted by less than 15 pF. Overload: 50 V RMS from 10 Hz to 15 MHz; from 15 MHz to 80 MHz derate linearly at 0.8 V RMS/MHz from 50 V RMS. Maximum DC input is ±50 V. Time Base: 1 MHz ±2 Hz. 0° C to 40° C ambient, ±10 ppm. Readout: Five 7-segment light-emitting-diode displays. One single light-emitting-diode for overrange. Overrange: Flashing, 40 ms on, 60 ms off. Power Requirements: 120/240 VAC, 12 watts. Dimensions: 9¼" D x 6¾" W x 2¼" H. Net Weight: 3½ lbs. Shipping Weight: 6 lbs.

<p>FREE HEATH SCIENTIFIC INSTRUMENTATION CATALOG</p> <p>Investigate these and other new ideas in Spectroscopy, Digital Instrumentation, Lab Equipment and Test Equipment. Send for your FREE catalog now.</p>	<p>HEATH COMPANY, Dept. 520-28 Benton Harbor, Michigan 49022</p> <p><input type="checkbox"/> Please send free Heath Scientific Instrumentation Catalog</p> <p>Name _____</p> <p>Address _____</p> <p>City _____ State _____ Zip _____</p> <p>*Mail order prices; FOB factory. Prices & specifications subject to change without notice. EK-296</p>
	<p align="right">  a Schlumberger company </p>

LED indicator lights come in cartridges

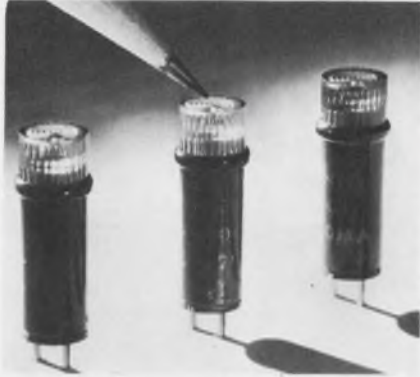

Monsanto Co., Electrical Special Products, 10131 Bubb Rd., Cupertino, Calif. Phone: (408) 257-2140. P&A: \$3.35; stock.

A new line of LED cartridge indicator lights are available to directly replace incandescent and neon versions. The plug-in cartridges, the MV9000 series, are available in red, green and amber colors in versions from 4 to 30 V and 10 to 50 mA. A voltage-setting resistor is built into each cartridge which has polarized pins.

CIRCLE NO. 272

12-position switch costs just \$1.96

RCL Electronics, Inc., 700 S. 21 St., Irvington, N. J. Phone: (201) 374-3311. P&A: \$1.96; stock.

A new 12-position miniature rotary switch is priced at only \$1.96 in OEM quantities. The CC switch has up to 12 active shorting or non-shorting positions per deck with 30-degree spacing. Terminal contact holes accept two AWG #22 wires.

CIRCLE NO. 273

7-segment 5-V readout uses but 5 mA/segment

Readouts, Inc., Box 149, Del Mar, Calif. Phone: (714) 755-2641. P&A: \$3.02 (1000-piece quantities); stock.

Series 5 low-power 7-segment incandescent readout requires current of only 5 mA/segment at 5 V. The new readout mounts in 14-pin DIP sockets and can be soldered to printed-circuit boards.

CIRCLE NO. 274

Proximity reed switch is magnet actuated

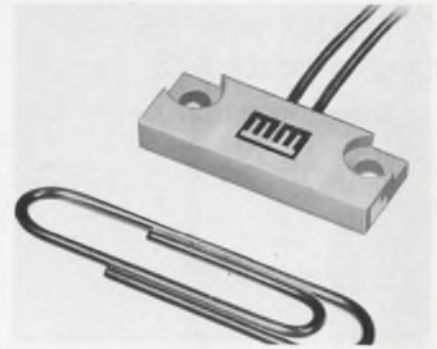

McClintock Matrixes, Inc., Washington, Rd., Woodbury, Conn. Phone: (203) 263-4624. Availability: stock.

The 35-2-3 is a tiny spst form A magnet-operated proximity reed switch that is calibrated and individually tested. It has a 3-W contact rating (28 V at 0.1 A maximum) and actuates in 200 μ s. When used with the 40-1-3 alnico magnet assembly, it can be actuated within 3 mm (0.12 in.). The 35-2-3 operates over the temperature range of -75 to +105°C.

CIRCLE NO. 275

a good rule to follow...

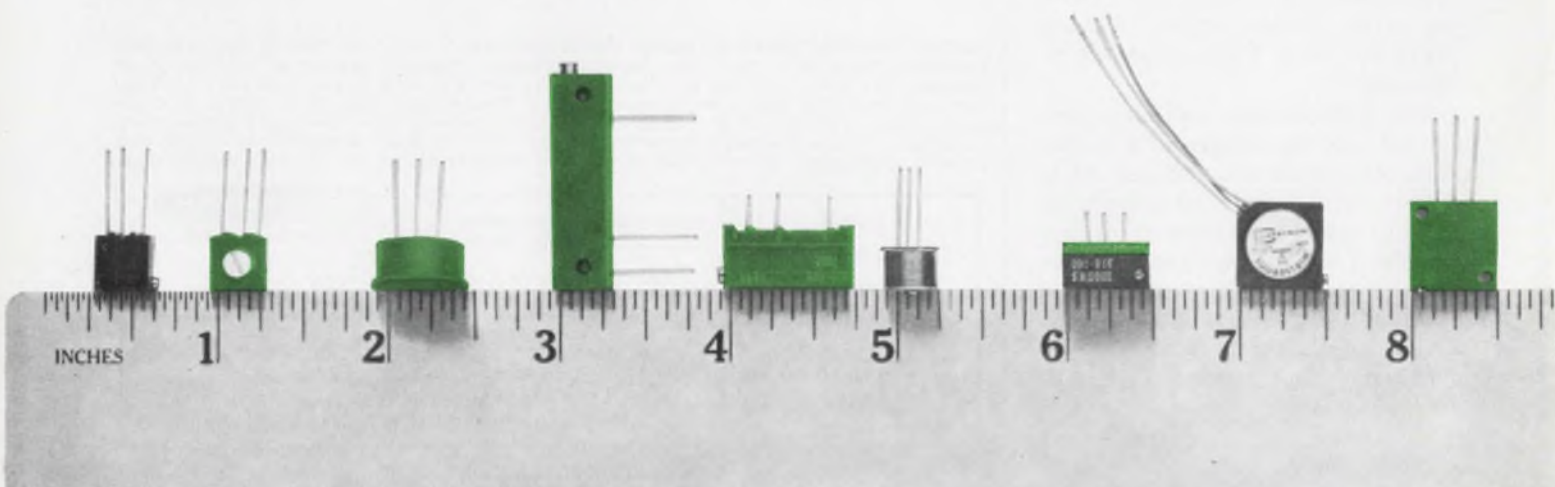

2-phosphor CRT display shows color separation

GTE Sylvania, Inc., Electronic Tube Div., Seneca Falls, N. Y. Phone: (315) 568-5881.

A 12-in. multicolor display tube with a two-phosphor screen, type SC5224P22G/P22R, provides color separation from reddish orange to green by switching the value of anode voltage.

CIRCLE NO. 276

Tiny thermistor flakes span 30 kΩ to 2 MΩ

Thermometrics, Inc., 15 Jean Pl., Edison, N. J. Phone: (201) 548-2299. P&A: \$9.70 to \$14.70; stock to 3 wks.

The series F40, F80 and F120 thick-film thermistors are 0.001-in.-thick flakes not supported by substrate backings. They are designed for lead or customer mounting to substrates. Resistances span 30 kΩ to 2 MΩ at 25°C.

CIRCLE NO. 277

Digital 10-turn dial is just 1-in. wide



Spectrol Electronics, 17070 E. Gale Ave., City of Industry, Calif. Phone: (213) 964-6565.

The model 15 is a new digital turns-counting dial that measures only 1-in. wide and stands less than 1-in. off the panel. It features a smooth operating mechanism, a positive braking action, and a removable knob that conceals set-screws and permits access to the potentiometer shaft after mounting. The 10-turn dial displays a count from 000 up to 999.

CIRCLE NO. 278

Circuit breakers detect under-voltages

Airpax Electronics, Cambridge Div., Woods Rd., Cambridge, Md. Phone: (301) 228-4600. Price: \$7.25, \$7.95.

New magnetic circuit breakers protect against ground line opens by detecting under-voltage reverse-polarity and polyphase open conditions, and providing an open circuit. Size APL is rated for 250 V ac at 50-A contacts.

CIRCLE NO. 279

DIP reed relays are TTL compatible

Self-Organizing Systems, Inc., Zestron Div., Box 9918, Dallas, Tex. Phone: (214) 276-9487. P&A: under \$2 (260); stock.

Four new series of 14-lead DIP reed relays can be plugged into IC sockets or wire-wrap boards for TTL compatibility. They include Series 260, 262, 265 and 267.

CIRCLE NO. 280

when ordering pots.

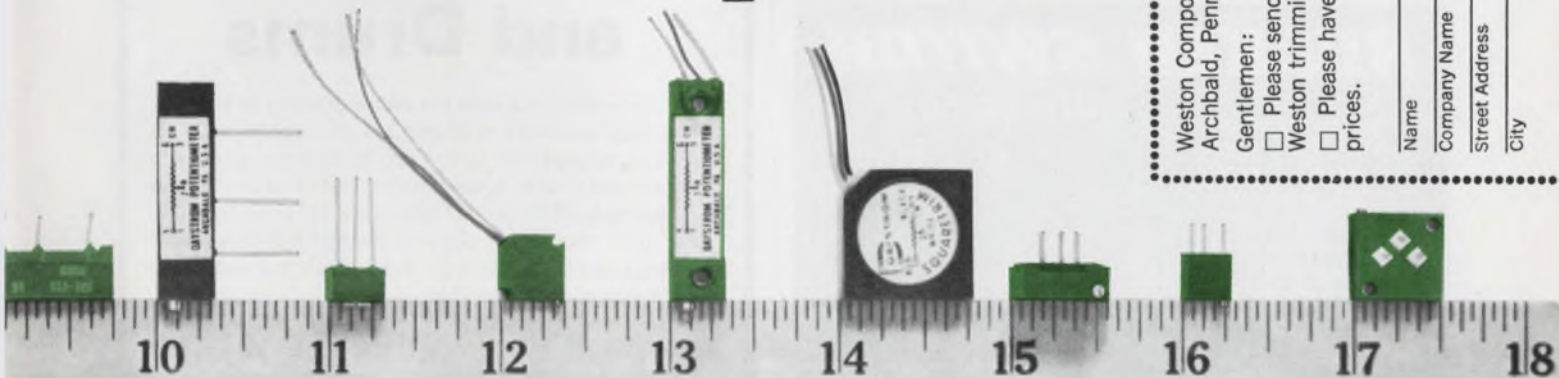

WESTON®

Weston Components, a Schlumberger company
Archbald, Pennsylvania 18403

Gentlemen:

- Please send me a copy of your new catalog of Weston trimming potentiometers.
- Please have a salesman call to discuss samples and prices.

Name	Title
Company Name	Mail Station
Street Address	
City	State
	Zip

Desk-top data processor contains a memory



Cogar Corp., Box 110, Herkimer, N. Y. Phone: (315) 866-3040.

The new System 4 desk-top data entry and processor unit contains a keyboard, a visual display, dual cartridge-loaded tape decks and a memory. On its magnetic-tape cartridges the system has stored routines for data-entry, verification, editing, blocking, searching and communications. Its 5-in. CRT can display 4 or 8 lines of 32 characters. It can be purchased with 2k memory bytes expandable to 16k bytes. The monolithic memory executes instructions in 4 to 9µs.

CIRCLE NO. 281

Core memory system drops under 1.5¢/bit

Electronic Memories, 12621 Chadron Ave., Hawthorne, Calif. Phone: under 1.5¢/bit.

The Micromemory 4000 core memory with a basic module of 32,768 words at 18 bits/word, access of 800 ns and cycle time of 1.5µs costs under 1.5¢/bit. Logic is provided for zoning 18-bit words into two 9-bit bytes or for 65,536 words of 9-bits/word.

CIRCLE NO. 282

Printing calculator records without ink

Canon USA, Inc., 415 Lexington Ave., New York, N. Y. Phone: (212) 697-9720.

The Canola EP-150 desktop 15-digit calculator prints all calculation procedures and results electronically on electro-sensitive paper. The new printing method which uses no ink results in read-outs of 4 lines per second.

CIRCLE NO. 283

14-digit calculator sells for \$785



Facit-Odhner, Inc., 501 Winsor Dr., Secaucus, N. J. Phone: (201) 866-5111. Price: \$785.

The economical model 1129 14-digit calculator with optional decimal round-off can be programmed for 0, 1, 2, 3, 4 or 6 decimal places with or without round-off, with the turn of a knob. It has an accumulating memory register and constant factor retention for multiplication. The register permits the accumulation of positive or negative results, for further processing.

CIRCLE NO. 284

WORLD'S NO. 1 MINIATURES

The original miniature switch is available with standard, flat, long and plastic toggles. Normally supplied with silver contacts. Gold-plating or P.C. terminals are available on request. Common 1/2" case size. Rate 5A @ 115VAC.



MST SERIES

ALCOSWITCH® 124 STYLES ON THE SHELF FOR IMMEDIATE DELIVERIES.
DIV. OF ALCO ELECTRONIC PRODUCTS, INC., LAWRENCE, MASS.

INFORMATION RETRIEVAL NUMBER 48

ROCKER SWITCH

U/L RATED

Low-cost rocker switch has high current in 1/2" case. 100,000 on-off operations. Low-silhouette rocker. U/L approved. Choice of SPST on-off @ 85¢ ea., SPDT on-on @ 95¢ ea.



ALCOSWITCH® 10A @ 125 VAC.
DIV. OF ALCO ELECTRONIC PRODUCTS, INC., LAWRENCE, MASS.

INFORMATION RETRIEVAL NUMBER 49

For the Computer Industry



Print Bars and Drums

At Buckbee-Mears we etch the entire drum in one operation. Costly assembly problems are eliminated because there are no segments to line up. We are also geared to etch print bars faster at lower costs. Our print drums and bars are made of hardened tooled steel for extra long life.

For more information, see your nearest Buckbee-Mears representative. Or contact Bill Amundson, our industrial sales manager. You'll be glad you did.



BUCKBEE - MEARS COMPANY

245 E. 6th St., St. Paul, Minn. 55101 / (612) 227-6371

INFORMATION RETRIEVAL NUMBER 50

ELECTRONIC DESIGN 5, March 4, 1971

MODULES & SUBASSEMBLIES

6-bit d/a converter costs down to \$25

Teledyne Crystalonics, 147 Sherman St., Cambridge, Mass. Phone: (617) 491-1670. P&A: \$25 (100 to 249); stock.

The CDAS2/A is a thin-film hybrid d/a converter, complete with a ladder network and a 6-bit switching system, costing only \$25. It is contained in a 12-lead modified TO-8 package and features a 1- μ s settling time.

CIRCLE NO. 285

10 mV to 10-V log amp has constant bandwidth

Optical Electronics, Inc., Box 11140, Tucson, Ariz. Phone: (602) 624-8358. P&A: \$250; stock.

A new bipolar logarithmic amplifier maintains a constant dc to 3-MHz bandwidth over all input levels from 10 mV through 10 V. The 2533 has a 60-dB dynamic range and a 1% typical logarithmic error.

CIRCLE NO. 286

Fast 10^{10} - Ω follower has a \$69 price tag

Analogic Corp., Audubon Rd., Wakefield, Mass. Phone: (617) 246-0300. P&A: \$69; 2 to 3 wks.

The new Ampac MP210 ± 10 -V unity-gain FET follower amplifier slews at 25 V/ μ s, settles to 0.01% in 1.5 μ s, has 10^{10} Ω input impedance and costs only \$69. Short-proof circuitry provides a ± 30 -mA output.

CIRCLE NO. 287

6-bit a/d converter operates to 30 MHz

Computer Labs, 1109 S. Chapman St., Greensboro, N. C. Phone: (919) 292-6427. P&A: \$13,200; 4 to 6 wks.

The model VHS-630 6-bit a/d converter provides a random or periodic word rate to 30 MHz. Aperture time is 75 ps, transient response is 15 ns and overvoltage recovery is 30 ns. It operates from 115, 208 and 220 V ac.

CIRCLE NO. 288

thin metal parts problems?

**Recording Head Laminations - Springs - Washers
Grids - Clips - Timing Discs - Shields - Fluidic Gates**

without question, ask Hamilton!

Leader in Precision Photoforming®

computer head laminations

Photoformed by Hamilton offer a level of dimensional repeatability not available through any other process. Volume production of magnetic alloys, beryllium copper, brass and other alloys in gages as thin as 0.00025" with thickness tolerances of ± 0.00005 " is standard. Only Hamilton can offer melt selection, controlled processing of the thin strip and annealing to desired permeability levels. With Photoforming®, guaranteed permeability levels are available. Fret spraying and stacking, under the tightest controls, is also available.

instrument springs are a natural application for Photoforming®. Part after Photoformed part, springs like the Archimedes spiral shown here exhibit physical consistencies that other manufacturing methods cannot duplicate. Through Hamilton's stringent control of thickness and flatness tolerances, and materials testing procedures, instrument sensitivity and accuracy is enhanced.

fluidic laminations and other precision parts being developed at the leading edge of technology are well within the capabilities of Hamilton's Photoforming® engineers. In prototype discussions, they provide the parts manufacturing technology required for sound decisions.

Hamilton gives the design engineer long experience in materials selection, processing controls and manufacturing feasibility needed in new applications.

More than just a photoetching house, Hamilton Photoforming® combines the newest, most advanced chemical machining facilities and equipment with years of thin metals technical experience. Fully equipped metallurgical and magnetic laboratories provide the backup that assures highest quality . . . Hamilton Photoformed quality. Call or write for immediate assistance or complete literature.



**PRECISION METALS DIVISION
HAMILTON**
WATCH COMPANY • LANCASTER, PA. 17604
PHONE 717/569-0451

INFORMATION RETRIEVAL NUMBER 51



GET
BEAUTY
AND
THE BEST
IN NEW

STYLELINE MODU-MOUNT CABINETRY

- NEW ALUMINUM TRIM
- NEW VINYL INSERTS
- NEW EXTENDED PANELS
- SIX NEW COLORS
- AND MANY MORE

FEATURES BY . . .

Honeywell

"Styleline" Series 4000 Cabinets offer you 84 different frames with hundreds of modular panels and styling combinations to enable customizing your systems, yet retaining standard parts economy with rapid delivery!

DESIGNERS FACTBOOK

... all the design data and specs you want at your elbow are yours... FREE... if you let us rush your copy of this new 52-page factbook.



Honeywell

Wabash, Indiana 46992

MODULES & SUBASSEMBLIES

Power op amp kit handles 50 W rms

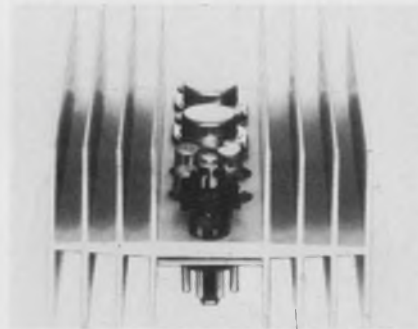

Opamp Labs, 172 S. Alta Vista Blvd., Los Angeles, Calif. Phone: (213) 934-3566. Price: \$35.

Model 440KR differential dc operation power amplifier kit consists of a 4009 op amp driving a dual class-AB power amplifier producing a 50-W rms output. It has no crossover distortion and open-loop voltage gain up to 800. The entire amplifier is constructed on an octal plug-in heat sink. It can be bought fully wired and tested for a price of just \$60.

CIRCLE NO. 289

723 voltage regulator comes in a flatpack

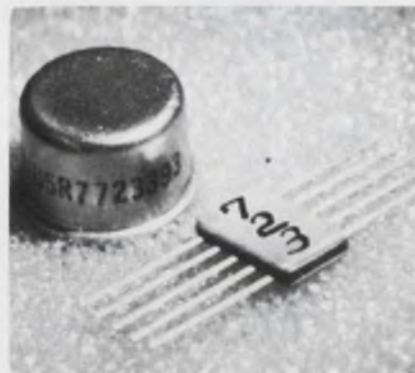

Mini-Systems, Inc., Washington Park, N. Attleboro, Mass. Phone: (617) 695-0206. P&A: \$11.45; stock.

The popular 723 IC voltage regulator, which until now was available only in TO-5 or 14-lead DIP cases, is now available in a 10-lead flatpack 1/8 by 1/4 by 0.055 in. The new MS723 has the same ratings of the TO-5 and DIP 723 versions but is only 1/20 of the size of a TO-5 model. 100% testing of all parts insures compliance with all specifications.

CIRCLE NO. 290

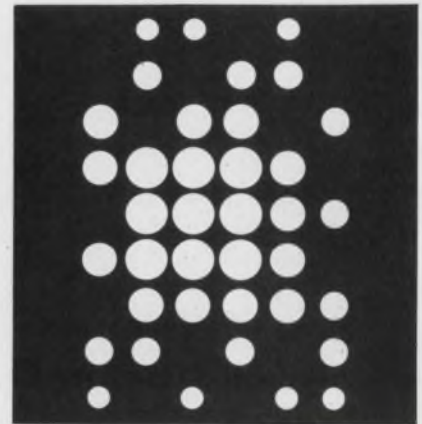

No matter how you work and read and learn...

you still need the Hanover Fair!

Here you will profit from the know-how of experts in research, production and distribution.

Materials, products, processes. New techniques and solutions. A dozen trade fairs in one — that's the Hanover system.

Information, contacts. More knowledge. Better knowledge.

For a sound investment visit Hanover — the trip that saves travelling!

New: Opening day is a Thursday.

HANOVER FAIR '71



Thursday, April 22
— Friday, April 30
World Market of Industry

For information, room reservation forms and admission tickets:

German American Chamber of Commerce
666 Fifth Avenue
New York, N. Y. 10019
(212) 582-7788
77 E. Monroe Street
Chicago, Ill. 60603
(312) 782-8557

Card edge connector mates 1/16-in. boards



Fabri-Tek, Inc., National Connector Div., 9210 Science Center Dr., Minneapolis, Minn. Phone: (612) 533-5361. Price: \$1.27 (#250025).

A new low-cost card edge connector accommodates 1/16-in. PC boards. It features a nylon connector block which retains removable gold-plated crimp connectors for AWG #18 wire. 10-terminal (#250025) or 15-terminal (#250052) connector models are available, each spaced on 0.156-in. centers in a single readout.

CIRCLE NO. 291

Flexible flat cable is completely shielded



Malco Mfg. Co., Inc., 5150 W. Roosevelt Rd., Chicago, Ill. Phone: (312) 287-6700.

A new flexible flat cable features a complete layer of shielding throughout its length. It is designed for 0.025-in. wrapost terminals and has low-resistance contacts which are automatically crimpable. At its ends, a wafer-thin molded connector separates and locks the crimped cable into place forming a solid strain relief.

CIRCLE NO. 292

IC packaging panel has regulated voltages

Augat, Inc., 33 Perry Ave., Attleboro, Mass. Phone: (617) 222-2202. P&A: \$123 to \$197; stock to 3 wks.

A new IC packaging panel contains regulated-voltage and ground planes separated into four groups, each tied to a voltage-regulator socket pattern. The panel has 72 patterns for 14 and 16-lead DIPs.

CIRCLE NO. 293

Clear silicone liquid cures to a gel at 25°C

General Electric, Silicone Products Dept., Waterford, N. Y. Phone: (518) 237-3330.

A new clear silicone liquid cures at room temperature to an energy-absorbing silicone rubber gel when catalyzed. RTV-619 is based on the same chemistry as RTV silicone rubber products and has a viscosity of 750 centipoises.

CIRCLE NO. 294



Need *fast delivery* on rotary switches for power, control or instrument applications? You can order literally *hundreds* of types *from stock!* Or specify special switches and have them assembled pronto from *millions* of components off-the-shelf! Our standard lines range all the way from ½ up to 200 amperes...from simple pushbutton to complex gear-train units...from one to 75 poles per switch. Whether you need standard, special or custom switches, the only way you'd get them any quicker is to have them on hand right now!

Send for Bulletin C-1 describing our lines and catalogs or tell us your specific needs for detailed specifications.



ELECTRO SWITCH
CORP.

Weymouth, Massachusetts 02188

Telephone: 617/335/5200 TWX: 710/388/0377

INFORMATION RETRIEVAL NUMBER 54

SOLID-LITE

SOLID STATE NUMERIC INDICATORS AND LAMPS

New Solid-Lite display devices use gallium phosphide, the most efficient visible light emitting semiconductor. You get bright light at low current.



SOLID-LITE Solid State Numeric Indicators

- Large (.33" x .21") bright numerals are pleasing to the eye
- Standard 14-pin dual-in-line package
- Low voltage operation at less than ¼ watt total power
- Compatible with TTL and DTL IC's
- Single-plane wide-angle viewing
- High reliability — long life
- Excellent shock and vibration resistance
- Low cost



SOLID-LITE Solid State Lamps

- 2 millicandelas luminous intensity at 15 mA and 2.1 V
- Area light source — not a pinpoint
- Easy wide-angle viewing
- IC compatible
- Excellent shock and vibration resistance
- High reliability — long life
- Low cost

For technical literature or applications assistance, write or call OPCOA, Inc., 330 Talmadge Road, Edison, New Jersey 08817; phone (201) 287-0355.

OPCOA

INFORMATION RETRIEVAL NUMBER 55

evaluation samples



Temperature recorders

New 1/8 by 1/4-in. model 430 self-adhesive temperature recorders provide an accuracy of $\pm 1\%$ in detecting temperatures from 100 to 500°F. These heat-sensitive pastel indicators turn permanently black upon exposure to calibrated temperatures. Rated temperature is printed below each indicator window for accurate readings at a glance. Each indicator has a maximum thickness of 0.01 in. Models are available up to 3/4 by 1-3/4 in. A free evaluation sample and a six-page catalog are available. William Wahl Corp.

CIRCLE NO. 295

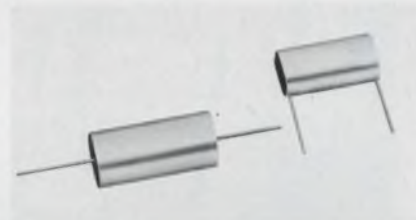

Mylar capacitors

A new series of rectangular metalized-mylar capacitors with axial and radial-lead styles feature small size, high efficiency and precise stability. Series 17W (axial) and 17U (radial) capacitors are available from stock in 100, 200, 400 and 600-V units in a capacitance range from 0.001 to 20 μF with tolerances from 20 to 1%. Sizes range from 0.12 by 0.22 by 0.4 in. to 0.75 by 1 by 1.68 in. Operating temperature is from -55 to $+125^\circ\text{C}$ and dissipation factor is less than 1% at 1000 Hz and 25°C . Samples and literature are available free of charge. S&EI Manufacturing.

CIRCLE NO. 296

design aids



Hardware calculator

The Universal Reference Calculator #5010, is a single-source reference that provides instant up-to-date information on standard screwheads and set screw points, shoulder screws, miniature screwheads, washer dimensions, rivets, roll pin-and-hole diameters and pipe threads. Also given are standard sheet-metal bend radii, drilled-hole tolerances, steel, aluminum, brass and wire gauges and material density. Tables for drill sizes, minimum surface finishes for various feature tolerances, decimal equivalents as well as standard slide-rule C and D scales are also included. TAD Products Corp.

CIRCLE NO. 297



Keyboard design kit

A new MOS keyboard design kit has been developed to aid designers and engineers in specifying the proper MOS keyboard needed for a broad range of applications. The kit is comprised of 17 data sheets covering four keyboards, with USASCII code ROM charts, a lighted keyswitch, eleven keytop shapes and a changeable legend style keytop. Three available profiles are illustrated. Included is a two-page keyboard specifications worksheet with complete instructions for use. C. P. Clare & Co.

CIRCLE NO. 298

application notes

Emi/rfi handbook

A comprehensive 16-page engineering handbook describes and illustrates methods of measuring emi/rfi and explains techniques of protecting equipment both from line and equipment-generated interference. It explains how to specify emi/rfi filters and test methods used for measurement of interference. A complete set of schematics on all phases of test procedures and extensive graphical data on acceptable limits of broadband and narrowband emissions are included. Components Corporation.

CIRCLE NO. 340

Op amps/converters

A copy is available of the December, 1970, issue of Analog Dialogue which is devoted to the application and theory of op amps, data conversion devices and related circuit and system components. This newest 16-page issue features a three-page article on the design of a new 5-pA FET-input IC op amp that employs laser trimming for sub-millivolt offsets. A following six-page article entitled: "Choosing and using dual FETs" goes into the design and application of low-drift and low-noise semiconductor pairs. Analog Devices.

CIRCLE NO. 341

Monolithic i-f amplifier

An application booklet describes a monolithic i-f amplifier that includes an FM demodulator for use as a 5.5-MHz TV sound channel amplifier. Schematic diagrams and response curves are included. AEG-Telefunken Corp.

CIRCLE NO. 342

Rotating memory devices

"How to Select a Rotating Memory Device" is the title of a technical note on storage devices for data processing. It comparatively discusses drum and disc memories with tape systems. Iomec Inc.

CIRCLE NO. 343

ADLAKE DRY REED RELAYS

Quality and reliability are key design parameters built into Adlake's complete line of DRY REED RELAYS. Advanced electrical, mechanical and packaging features qualify these *standard*, *intermediate*, and *miniature* size devices for an extremely wide range of commercial, industrial, and military switching applications, such as control panels, machine process control instrumentation, and telephone and communications apparatus, to mention just a few.

ELECTRICAL DETAILS:

- Contact Arrangements:
Up to 4-A or 2-B
- Contact Current Ratings:
Switch 0.5 A; carry 3 A
(Miniature & Intermediate)
Switch 1.5 A; carry 6 A (Standard)
- Contact Resistance:
Initial—50 milliohms, max.;
end-of-life—2 ohms max.
(Standard)
Initial—200 milliohms max.;
end-of-life—2 ohms max.
(Intermediate & Miniature)
- Contact Life:
Rated Loads—20 x 10⁶ operations
Dry Circuit—500 x 10⁶ operations
- Contact Voltage Ratings:
100 VDC or 150 VAC
(Miniature or Intermediate)
150 VDC or 250 VAC (Standard)
- Insulation Resistance:
10¹² ohms (min.)
- Operating Speed:
1 to 2.5 ms
(Miniature & Intermediate)
2.5 to 4.5 ms (Standard)
(Varies with sensitivity and number of poles; including contact bounce and coil time)

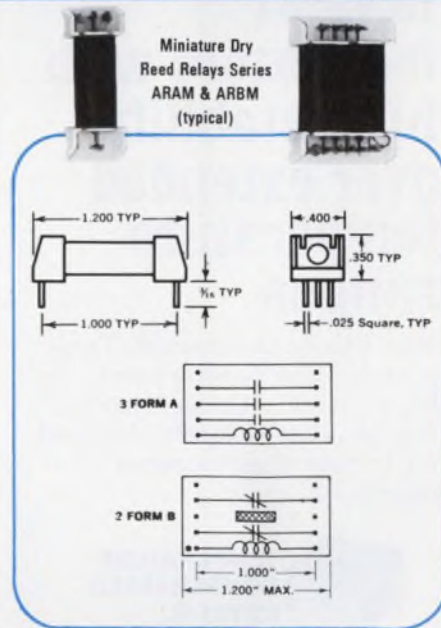

PACKAGING DETAILS:

- Environmental Protection:
Hermetically sealed contacts. Rhodium plating on contacts for higher loads and longer life characteristics.
- Shielding:
Magnetic shielding layer
- Shock:
200G max. 11 ± 1 ms
(Miniature & Intermediate)
100G max. 11 ± 1 ms (Standard)
- Vibration:
30 G max. 0-1700 cps
(Miniature & Intermediate)
0-600 cps (Standard)
- Temperature Range:
—55 to 105°C

Choose from 123 cataloged items. Dry Reed Relays with special features are available on special order with surprisingly short delivery times.

MERCURY WETTED CONTACT RELAYS

Low, stable contact resistance and "1-billion-operation" life qualify Sensitive Mercury Wetted Contact Relays for a wide array of switching applications, such as digital and analog computers, telecommunications system, multiplex, industrial control equipment, power control devices. New Series MWK and AWK Sensitive Relays offer contact form K (SPDT, center off)—ideal for multiple channel switching.

MERCURY DISPLACEMENT RELAYS

Time delay and load relays meet the toughest, most demanding switching applications. Non-adjustable time delay relays offer contact forms A and B with delays up to 1 hour, current ratings to 15 amps. Load relays switch from 30 to 100 amps with contact forms A and B.

USE READER SERVICE NUMBER FOR COMPLETE INFORMATION



THE ADAMS & WESTLAKE COMPANY

A SUBSIDIARY OF ALLIED PRODUCTS CORPORATION

ELKHART, INDIANA 46514 • 219 - 264-1141 • TWX 219-522-3102 • TELEX 25-845B • CABLE ADLAKE

INFORMATION RETRIEVAL NUMBER 56

BULOVA Crystal Oscillators with high stability over extended temperature ranges

Now Bulova has available Temperature Compensated and High Stability Crystal Oscillators that are uniquely designed for increased performance capability.



TCXO-30

TEMPERATURE COMPENSATED CRYSTAL OSCILLATOR

Frequency Stability:
 $\pm 5\text{pp} 10^7$ over temperature
range of -55°C to $+85^\circ\text{C}$.

Employs a computer-selected-and-optimized compensation network designed to maintain frequency stability over wide temperature ranges without the need for an oven ($\pm 0.5\text{PPM}$ from -55°C to $+85^\circ\text{C}$). Operating over a frequency range of 3MHz to 5MHz, it consumes only 50MW and is just four-cubic-inches. Aging rate is $1.0\text{pp} 10^8$ per week.



PCOXO-101

HIGH STABILITY CRYSTAL OSCILLATOR

Frequency Stability:
 $\pm 1.0\text{PP} 10^8$ over
temperature range of
 -55°C to $+70^\circ\text{C}$

Within a plug-in package is a high precision crystal and an oscillator circuit with AGC to maintain low constant crystal drive in a stable DC proportional control oven. The result is a crystal oscillator of unusual high frequency stability ($\pm 1.0\text{PP} 10^8$ from -55°C to $+70^\circ\text{C}$), a short term stability of $1\text{PP} 10^{10}$ per second, an aging rate of $1\text{PP} 10^9$ per day and with a frequency output of 1.0 or 5.0 MHz.

If you have a crystal oscillator problem that needs solving, call (212) 335-6000, see EEM section 2300, or write —



BULOVA
FREQUENCY
CONTROL PRODUCTS

Electronics Division of Bulova Watch Co., Inc.
61-20 Woodside Ave., Woodside, N. Y. 11377

INFORMATION RETRIEVAL NUMBER 57

new literature

Ceramic capacitors

A new catalog contains 16 pages of miniature ceramic capacitors. It covers a multitude of sizes and capacitance values in both NPO and W dielectrics. Included are radial and axial-leaded models with molded, epoxy and resin-coated cases, chip, coaxial feed-through and filter capacitors. USCC/Centralab.

CIRCLE NO. 344

Broadcast generator

A new color synchronization generator for broadcast television stations that provides jitter-free synchronization from a digitally generated time base is described in a data sheet. Cohu Electronics, Inc.

CIRCLE NO. 345

Wirewrap packaging

Wirewrap packaging systems are the subject of a new eight-page catalog. It details hardware and assembly of two basic packaging systems using standard matching components available from one source. Robinson-Nugent, Inc.

CIRCLE NO. 346

Silicone fluids

A complete description of a full line of silicone fluids is available in a new data book. General Electric Co.

CIRCLE NO. 347

Components

Catalog 747 is a 232-page book containing over 1300 IC accessories, logic cards and thermoelectric devices. Cambridge Thermionic Corp.

CIRCLE NO. 348

Toroids

A 20-page brochure provides complete design and specification data on a new line of toroid components specifically designed and tested for pulse-transformer and pulse-inductor applications. Indiana General.

CIRCLE NO. 349

Rf instruments

A new 48-page rf instruments catalog contains coaxial load resistors and attenuators, absorption, directional peak and average wattmeters, rf filters and power sensors. Bird Electronic Corp.

CIRCLE NO. 350

Power op amps

A six-page foldout data sheet gives comprehensive specifications on 11 different power op amp modules with outputs ranging from 22 to 1000 W. Analog Devices.

CIRCLE NO. 351

Tape-handling accessories

Several ways to help organize and simplify handling of paper and paper tape on data communications terminals are described in a 16-page catalog. Teletype Corp.

CIRCLE NO. 352

PC connectors

A new 16-page catalog covers an expanded group of right-angle plug and socket connectors for printed circuit applications. Continental Connector Corp.

CIRCLE NO. 353

Microwave devices

A 48-page catalog contains microwave sources and ferrite devices. Included are solid-state sources, triode oscillators and amplifiers, circulators, isolators, sub-assemblies, microminiature i-f amplifiers and crystal-controlled oscillators. Trak Microwave Corp.

CIRCLE NO. 354

Correlation analyzer

A new four-page bulletin describes a real-time digital correlation and probability analyzer. Computational flexibility, increased dynamic range, time resolution and dial-in capability are described with illustrations. Signal Analysis Industries Corp.

CIRCLE NO. 355

Pushbuttons

A new 24-page two-color catalog covers a wide variety of oil-tight pushbuttons for heavy duty service in industrial controls. Ward Leonard Electric Co.

CIRCLE NO. 356

Logic modules

Two bulletins describe a line of static logic modules with their specific advantage and typical application descriptions. Jordan Controls, Inc.

CIRCLE NO. 357

Potentiometers

A design guide and engineering handbook on precision potentiometers provides circuit design criteria and performance guides on a complete line of precision infinite-resolution potentiometers. Computer Instruments Corp.

CIRCLE NO. 358

10-DAY FREE EXAM

Interactive Graphics for Computer-Aided Design

by M. DAVID PRINCE,
Lockheed-Georgia Company

This book deals with one of today's major emerging technologies: man-computer graphics for computer-aided design (CAD). Intended as a guide for engineers who want to use CAD in their work, it covers the principles of CAD, showing how CAD lets the engineer test a hypothesis quickly, see its effects, and modify the result in a multiple-pass optimization process—thus permitting a superior design within budget and time constraints. The application of CAD principles to design engineering, analysis, and manufacturing are also discussed.

301 pp, 237 illus (1971) \$13.95

For a free brochure giving a complete description and table of contents, and 10-day free examination offer, circle the reader service number below.

Addison-Wesley
PUBLISHING COMPANY, INC.
Reading, Massachusetts 01867



THE SIGN OF
EXCELLENCE

INFORMATION RETRIEVAL NUMBER 58

ELECTRONIC DESIGN 5, March 4, 1971

bulletin board

of product news and developments

A new diagnostic logic-module test station designed especially for medium and low-quality lot sizes has been announced by Automation Dynamics of Northvale, N. J. Model QC-560, priced at \$14,000, can be used to test and debug most types of PC logic cards. It is capable of reducing test and set-up time by as much as 50% over most bench assemblies and provides complete facilities for static and dynamic testing and waveform analysis.

CIRCLE NO. 359

Honeywell, Information Systems has introduced three new mini-computers—the 115/2, 1015 and 2015—for a monthly rental range of \$4000 to \$25,000. It has also announced a nationwide marketing plan for the model 58 which rents from \$815 to \$2900 per month.

CIRCLE NO. 360

Fairchild Semiconductor has expanded its standard TTL IC line with the introduction of 25 new low-cost TTL ICs in its 5400 series. The new 9N00/5400 second-source products are available in ceramic DIP and flatpack cases.

CIRCLE NO. 361

Teledyne Semiconductor has announced sweeping across-the-board price cuts for their entire line of dual FETs. Representative of these price cuts is the popular 2N3958 dual FET, which sells for \$1.47 when ordered in quantities of 100 to 999.

CIRCLE NO. 362

Grayhill, Inc., LaGrange, Ill., is reducing prices by 25% on their series 39-201 and 39-204 pushbutton switches. Previous list prices of \$2.65 and \$2.75, respectively, have been reduced to \$1.95.

CIRCLE NO. 363

AUTO-RANGING DVM

... the DART IV, the new digital auto-ranging tester from Non-Linear Systems ... the first low cost systems compatible ... (also portable) ... multifunction 4-digit DVM to bridge the gap between low cost, manual range and the high cost automatic range units ... now only



\$795

Be on target with faster, automatically selected readings ... better accuracy ... greater stability ... and more measurement capability. All at the lowest available cost per measurement!



... the DART IV,
Digital Auto-Ranging
Tester ... available now!



NON-LINEAR SYSTEMS, INC.
DEL MAR, CALIFORNIA
(714) 755-1134 /
TWX 910-332-1132

INFORMATION RETRIEVAL NUMBER 59

ELECTRONIC DESIGN's function is:

- To aid progress in the electronics manufacturing industry by promoting good design.
- To give the electronic design engineer concepts and ideas that make his job easier and more productive.
- To provide a central source of timely electronics information.
- To promote two-way communication between manufacturer and engineer.

Want a subscription? ELECTRONIC DESIGN is sent free to qualified engineers and engineering managers doing design work, supervising design or setting standards in the United States and Western Europe. For a free subscription, use the postfree application form inside the back cover. If none is included, write to us direct for an application form.

If you do not qualify, you may take out a paid subscription for \$25 a year in the U.S.A., \$35 a year elsewhere. Single copies are \$1.50 each.

If you change your address, send us an old mailing label and your new address; there is generally a prepaid postcard for this inside the back cover. You will have to requalify to continue receiving ELECTRONIC DESIGN free.

The accuracy policy of ELECTRONIC DESIGN is:

- To make reasonable efforts to ensure the accuracy of editorial matter.
- To publish prompt corrections whenever inaccuracies are brought to our attention. Corrections appear at the end of the Letters column.
- To refuse any advertisement deemed to be misleading or fraudulent.

Microfilm copies are available of complete volumes of ELECTRONIC DESIGN at \$19.00 per volume, beginning with Volume 9, 1961. Work is now in process to complete the microfilm edition of Volumes 1-8. Reprints of individual articles may be obtained for \$2.00 each, prepaid (\$.50 for each additional copy of the same article) no matter how long the article. For further details and to place orders, contact the Customer Services Department, University Microfilms, 300 North Zeeb Road, Ann Arbor, Michigan 48106; telephone (313) 761-4700.

Want to contact us? If you have any comments or wish to submit a manuscript or article outline, address your correspondence to:

Editor
ELECTRONIC DESIGN,
850 Third Avenue,
New York, N.Y. 10022.

NEW PLUG-IN PRINTED CIRCUIT POWER SUPPLIES



Power/Mate Corp. has introduced a new complete line of 129 models of Printed Circuit DC regulated power supplies—now described in this 4 page catalog. These 129 CARD-PAC models collectively cover from 3.6 to 48 vdc and currents up to 2 amps. The CARD-PACS feature adjustable DC outputs, low cost, high performance and Power/Mate's full five year warranty. The catalog covers complete specifications, model numbers, sizes and prices. Write, call or twx for your free copy.

CIRCLE NO. 171

Power/Mate Corporation

514 South River Street
Hackensack, New Jersey 07601
(201) 343-6294

FREE – Miniature Switch Guide



Up-to-date, comprehensive engineering information on miniature rotary and push button switches from Grayhill. This 100 page data book contains dimensional drawings, photos, charts, tables and prices on Grayhill's standard and custom models. Electrical rating, material specifications, operating features, options, part numbers and how to order information is given on each switch. This is an indispensable guide when your design requirements call for miniature switches. It is available, Free, by writing to

CIRCLE NO. 172

Grayhill, Inc.

565 Hillgrove Avenue
La Grange, Illinois 60525
(312) 354-1040 TWX-910-683-1850

Economical High Performance Electrometers



Superior performance and lower costs than previously available are offered in a new line of electrometers from P.A.R. Included in the line is the Model 134, with wide range and high stability, priced at just \$615; the Model 135, with self-contained battery power supply, \$675; and the Model 136 with digital display and BCD output at only \$995.

All instruments feature drift, offset and noise specifications lower than any competitively-priced electrometer. In addition, guarded input circuits and fast recovery from large overloads are provided. A full line of accessories is also available. Write or call for new brochure, demonstration or applications assistance.

CIRCLE NO. 173

Princeton Applied Research Corporation
Box 565, Princeton, New Jersey 08540 — (609) 452-2111

Manufacturers

Advertisements of booklets, brochures, catalogs and data sheets. To order use Reader-ServiceCard (Advertisement)

Highest Resolution in New Spectrum Analyzers

**1,000-line
and 2,000-line
Real-Time
Spectrum Analyzers**

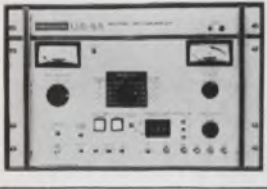

For the on-line processing of underwater acoustic signals, radar, sonar and other data where the maximum frequency resolution is always sought, new UA-9A series 1,000-line and 2,000-line Low Frequency Real-Time Spectrum Analyzers have been designed by Federal Scientific, originators of the Ubiquitous® analyzers.

High-speed versions produce complete 1,000-line spectra in 40 msec, and 2,000-line spectra in 160 msec.

And now any UA-6A series 500-line Ubiquitous analyzers in the field can be expanded at the factory to 1,000-line or 2,000-line performance.

CIRCLE NO. 174

Federal Scientific Corporation

a subsidiary of Elgin National Industries, Inc.
615 West 131st Street, New York, N. Y. 10027

PC Drafting Aids Catalog

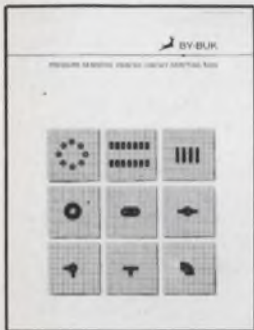

Thousands of time saving, cost saving artwork ideas are found in the By-Buk P-50 catalog of pressure sensitive printed circuit drafting aids. With the most practical artwork patterns for: TO cans, multi-pads, dual-inlines and flat packs featured. Donuts, connector strips, teardrops, ovals, tapes, tees, elbows, etc., by the hundreds are included in the most comprehensive list of sizes. Opaque black, transparent red and transparent blue materials for one and two-sided board designs. For a free copy and samples, write today.

CIRCLE NO. 175

Webtek Corporation

(formerly By-Buk Company)
4326 W. Pico Blvd.
Los Angeles, California 90019
(213) 937-3511

Experi/Board: From Schematics to Electronics in Minutes

EXPERI/BOARD
schematics to electronics
in minutes



Circuit Accessories Co. has introduced a new method of breadboarding, "Experi/Board." CAC's "Experi/Board" is introduced and suddenly all other methods of breadboarding are obsolete. For integrated circuits or discrete components, the engineer can't find a faster way to bring his ideas from schematics to electronic realities than with "Experi/Boards." The new "Experi/Boards" are offered in 24 different sizes and models. The four page catalog covers complete specs, model numbers, mechanical dimensions and prices. "Experi/Boards" are shipped from stock. Write, call or TWX for your free catalog.

CIRCLE NO. 176

Circuit Accessories Co.

514 S. River Street
Hackensack, New Jersey 07601
(201) 343-6294 TWX: (710) 990-5023

Electronic Design

Advertising Sales Staff

Keith Aldrich
Sales Manager

New York 10022

Robert W. Gascoigne
Samuel M. Deitch
Daniel J. Rowland
850 Third Avenue
(212) Plaza 1-5530
TWX: 867-7866

Philadelphia 19025

Mort Sullivan
P.O. Box 126
Dresher, Pa.
(215) 884-6880

Boston 02154

Joseph F. Palmer
1268 Main Street
Waltham, Mass.
(617) 894-2700

Chicago 60611

Thomas P. Kavooras
Berry Conner, Jr.
200 East Ontario
(312) 337-0588

Cleveland

Thomas P. Kavooras
(Chicago)
(312) 337-0588
(call collect)

Los Angeles 90303

Stanley I. Ehrenclou
2930 Imperial Highway
Inglewood, Calif.
(213) 757-0183

San Francisco 94022

Jerry D. Latta
95 Main Street
Los Altos, Calif.
(415) 941-3084

London W. 1

For United Kingdom and Holland
Brayton C. Nichols
For Eastern Europe
Peter Kehr
44 Conduit Street
Tel: REGent 4714

Verviers, Belgium

For Continental Europe
Andre Jamar
1, Ru Mallar, 1
087) 253.83 Telex 41563

Tokyo

Haruki Hirayama
Electronic Media Service
5th Floor, Lila Bldg.,
4-9-8 Roppongi
Minato-ku
Phone: 402-4556
Cable: Electronicmedia, Tokyo



AMERICAN BUSINESS PRESS, INC.



CONDUCTIVE SILVER/SILICONE ELASTOMER

TECKNIT CONDUCTIVE ELASTOMER ● Highly conductive pure silver/silicone ● Copper free ● Volume resistivity: 0.01 ohm-cm. ● Excellent Total Shielding Effectiveness ● Maintains electrical and physical properties over wide environmental conditions: -100°F. to +400°F. ● Wide range of compressibility: 30 to 80 durometer ● Uses include electrical contacts, grounding, static discharge and EMI/RFI shielding ● Available in sheets, strips, die cut, molded and extruded parts ● Patent pending ● Write for data #850.



TECKNIT® TECHNICAL WIRE PRODUCTS, INC.

East Division • 129 Dermody St., Cranford, N.J. 07016 (201) 272-5500
West Division • 427 Olive St., Santa Barbara, Calif. 93101 (805) 963-1867

INFORMATION RETRIEVAL NUMBER 60

Pulse Transformers Delay Lines

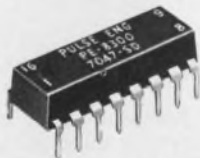

Actual Size

send for our new catalog
OR CALL:

ABINGTON, PA. 215-887-4343
BOCA RATON, FLA. 305-391-3803
CHICAGO, ILL. 312-992-3720
SANTA CLARA, CA. 408-248-6040
WALTHAM, MASS. 617-894-0950



P.O. Box 12235
San Diego, Ca. 92112
714-453-6010
TWX 910-322-1134

INFORMATION RETRIEVAL NUMBER 61

ZIPPERTUBING® R.F.I. SHIELDING JACKETING

for quick application
and protection of
multi conductor cables!

TYPE
SHN 3



SHN 3
for R.F.I.
shielding and
protection.
Tinned copper
braid, attached
to inside overlap
provides gasket
type seal and
solderable
termination point.

SHX 4
—of special knitted
compounded wire for
highly flexible R.F.I.
shielding.

CPE
conductive polyethylene
for electrostatic protection.

MS
provides low frequency
magnetic shielding

for full information
on specialized,
high-performance
jacketing, contact

THE ZIPPERTUBING®

13000 S. BROADWAY, LOS ANGELES, CALIF. 90061
Los Angeles Phone: (213) 321-3901

BALTIMORE • BOSTON • CHICAGO • CLEVELAND
DALLAS • NEW YORK • ORLANDO • PHOENIX
SAN FRANCISCO • WEST GERMANY



INFORMATION RETRIEVAL NUMBER 62

advertiser's index

Advertiser	Page
AMP, Incorporated	11
Abbott Transistor Laboratories Inc.	6
Adams & Westlake Company, The	75
Addison-Wesley	77
Alco Electronic Products, Inc.	48, 70
Amperite	7
Amphenol Controls Division, The Bunker-Ramo Corporation	12
Analog Devices, Inc.	17
Anzac Electronics, Division of Adams-Russell	13
Associated Testing Laboratories, Inc.	59
Beckman Instruments, Inc., Helipot Division	52
Buckbee Mears Company	70
Bulova, American Time Products	62
Bulova Frequency Control Products	76
Centralab, The Electronics Division of Globe-Union, Inc.	32, 33
Circuit Accessories Co.	79
Clairex Corporation	45
Cleveland Institute of Electronics	49
Computer Microtechnology, Inc.	16
Dale Electronics, Inc.	Cover II
Damon Electronics Division	27
Deltrol Controls	65
Dialight Corporation	66
Edmund Scientific Company	48
Electro Cube, Inc.	59
Electro Switch Corp.	73
Electronic Measurements, Inc.	16A
Electronic Memories, A Division of Memories & Magnetics Corp.	14
Elxon, Inc.	49
Exact Electronics, Inc.	29
Fairchild Semiconductor	16B, 16C
Federal Scientific Corporation	79
Fifth Dimension, Inc.	65
German American Chamber of Commerce	72
Grayhill, Inc.	78
Hamilton Watch Company Precious Metals Division	71
Hayden Book Company, Inc.	2, 16D
Heath Company	67
Hewlett-Packard	I, 4, Cover III
Honeywell, Inc.	72
IEEE	64
Johanson Manufacturing Corp.	30
Kurz-Kasch, Inc.	37
Monsanto Company	9
Motorola Semiconductor Products, Inc.	8, 23
National Electronics, Inc.	31
Non-Linear Systems, Inc.	77
OPCOA, Inc.	74
Power/Mate Corp.	78
Precision Metal Products Co.	59
Princeton Applied Research Corp.	78
Pulse Engineering, Inc.	80
Qualidyne Corporation	38
RCA Electronic Components and Devices	15, Cover IV
Rogers Corporation	49
Siemens Corporation	2
Sigma Instruments, Inc.	10
Siliconix Incorporated	57
Singer Company, The, Diehl Div.	5
Sprague Products Company	18
Technical Wire Products, Inc.	80
Teledyne Philbrick	20
Triplett Corporation	34
Victoreen Instrument Division	63
Webtek Corporation	79
Weston Components	68, 69
Zippertubing Co., The	80

Cut this out and tape it on the front of your present scope.

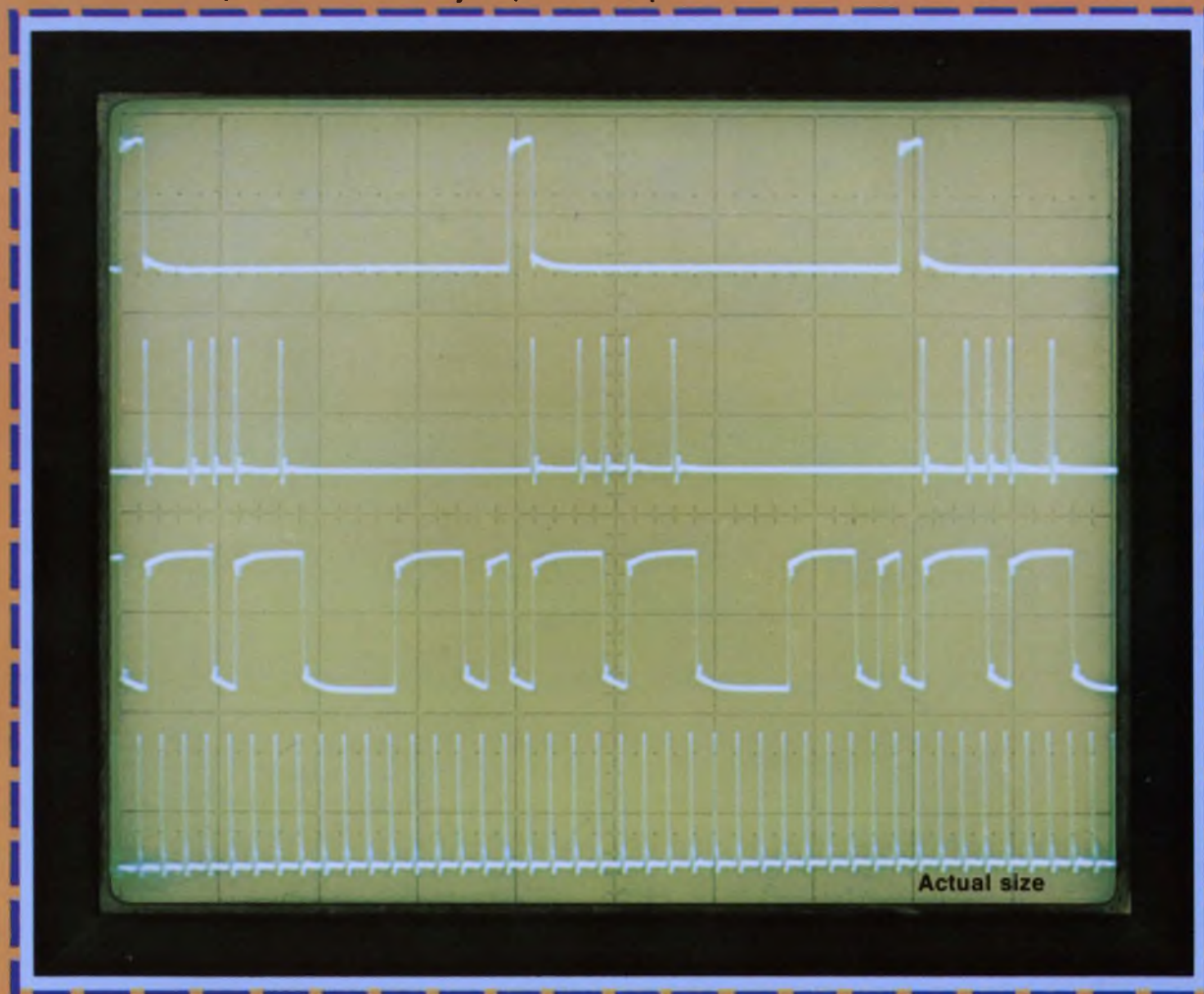

See how much easier you could measure high-frequency waveforms on HP's new scope?

Get the big picture! The 180-Series oscilloscope family now has a "big brother"—the 182A—a scope with a viewing area 66% larger than any other high-frequency scope, and three times larger than some. Yet, despite its larger viewing area, the 182A takes up no more bench space than the 180A, and maintains full bandwidth of 180 System plug-ins to 100 MHz.

The result is easy viewing for you—even at a distance. The 182A's 8-div x 10-div CRT is marked off in big 1.3-cm x 1.3-cm squares. And internal graticules allow accurate readings from any angle—a real plus in systems-testing work.

This new big-screen CRT is possible because of HP's pioneering advances in CRT technology. Improved HP expansion-mesh magnification techniques used in the 182A CRT make it possible to have a big-screen scope with 100 MHz capabilities, while still



HEWLETT **hp** PACKARD

OSCILLOSCOPE SYSTEMS

retaining the sensitivity required for compatibility with solid-state vertical amplifiers. Thus, you get easy-to-interpret displays, even in 4-channel or TDR work.

Because the 182A is part of the 180 "family," it will take ten different 180 System plug-ins—up to and including the 100 MHz 1802A dual-channel vertical amplifier—without degradation. This means you can upgrade your existing system without having to replace any of your present HP plug-ins. It also assures compatibility in the future.

Price of the 182A mainframe is only \$1100; plug-ins start at \$525. For further information on the new 182A, or any element of the HP 180-System "family," contact your local HP field engineer, or write to Hewlett-Packard, Palo Alto, California 94304. In Europe: 1217 Meyrin-Geneva, Switzerland.

Improve circuit reliability and cost-effectiveness by using RCA's high noise-immunity COS/MOS ICs in your new and existing logic designs for industrial controls, automotive equipments, instruments and appliances. Indeed, use COS/MOS ICs in any application where relays, solenoids or other devices create electromagnetic fields that may cause false switching; or where crosstalk, power-line and ground-line noises are of sufficient amplitude to trigger digital circuits and introduce errors.

Take advantage of the economies inherent in COS/MOS by using RCA's plastic-packaged CD4000E series, im-

mediately available in production quantities. RCA is now producing 21 types of plastic COS/MOS ICs which have a noise threshold of 45 per cent of the applied voltage over the entire operating-voltage range of 5 to 15 volts and over the wide operating-temperature range of -40°C to $+85^{\circ}\text{C}$. This broad line of ICs, offering many outstanding performance features in addition to high dc and dynamic noise immunity, makes it possible for you to build a complex logic system with one logic technology and effect substantial cost savings. And, if you find that a standard COS/MOS IC does not fulfill your special logic-circuit

requirements, ask your RCA Representative or RCA Distributor for price, delivery and technical information on COS/MOS ICs.

See your local RCA Representative or RCA Distributor for price, delivery and technical information on COS/MOS ICs. For detailed information on COS/MOS noise immunity, request bulletin ST-4322 "Complementary MOS Logic and Applications" from RCA, Commercial Engineering, Section 57C-4/CD51, Harrison, N.J. 07029. International: RCA, 2-4 rue du Lievre, 1227 Geneva, Switzerland, or P.O. Box 112, Hong Kong.

RCA COS/MOS ICs: broadest line of high noise-immunity ICs for industrial environments

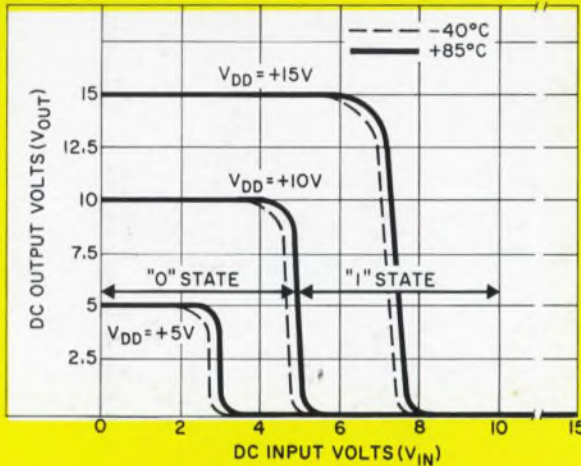

Switching Characteristics for RCA COS/MOS Devices

This switching curve shows that digital systems using COS/MOS devices can function reliably over a wide range of operating voltage and temperature. For example, the Noise Immunity for COS/MOS systems is 45% of the supply voltage for any voltage from 5 volts to 15 volts, regardless of ambient temperature. Also, logic systems designers can confidently use RCA COS/MOS devices in systems which utilize unregulated and poorly filtered power supplies. For example, a 10 volt supply with a ± 5 volt ripple is a reliable power source for a COS/MOS system!

RCA

Integrated Circuits