

Electronic Design

FOR ENGINEERS AND ENGINEERING MANAGERS

VOL. 19 NO.

3

FEB. 4, 1971

Solid-state displays are edging their way into new instrument designs. They have very definite advantages, such as increased reliability and extreme ruggedness. And their prices are becoming increasingly attractive. There are trade-offs involved, though, for both instrument designer and user. For details, see pgs. 24 and 51.



Stay thin with Dale



Honeywell Series 32 Computers Use Dale Thinline Connectors to Link Processing Options

Dale's EBTL 050 gives you the lowest profile available in a .050" edgeboard connector. This is one reason Honeywell uses it to interconnect processing options for its Series 32 Computers. Reliability is another reason. Connector failure in this application could shut down the entire system and risk data loss. According to Honeywell, the EBTL 050 "combines minimum insertion force with maximum withdrawal" and withstands low frequency vibration testing without discontinuity of more than 50 nanoseconds. And the cost is as low as the profile. Keep your package, and your budget, thin—call Dale for your next .050" requirement.

*Phone 402-564-3131 for details or
write for Connector Catalog.*

DALE ELECTRONICS, INC.
Box 180, Yankton, South Dakota 57078
In Canada: Dale Electronics Canada, Ltd.
A subsidiary of The Lionel Corporation



EBTL 050 THINLINE SERIES

Contacts: 8, 16, 20, 25, 32, 50
or 64 per side on .050" centers

Current Rating: 0.5 amp.

Board Thickness:
1/16" (.056"-.068")
1/32" (.027"-.035")

Profile:
.190" (1/16" boards)
.158" (1/32" boards)

Body: Glass-filled
phenolic.



R.M.S. VOLTS--the scale says-- but what about the circuits behind that scale?

All of us have been making rms readings of ac voltages for years. We know we have, it says so right on the front of the meter.

If someone were to ask what we mean by rms voltage, we could quickly explain the concept of "root mean square." In the interest of accuracy we might add that the rms voltage indication on most meters is true only for a sinusoidal wave. Unfortunately, most measurements are not made on true sinusoidal waves. However, for many applications, average responding meters are adequate.

But it would seem logical, where accuracy is important, to use a meter that measures true rms voltage no matter what the wave shape—a true rms voltmeter.

Why isn't this done more often? Well, until recently, most true rms voltmeters were expensive, limited

in capability and rather slow responding.

Now Hewlett-Packard has adapted the thermocouple concept used in standard laboratories; added protective amplifiers to insure overload protection (800 V p-p); and reduced final-value step function response to less than 5 seconds.

When you combine these features with a low price of \$600, it adds up to the HP 3400A—the first practical true rms voltmeter for general use in the 10 Hz to 10 MHz range. And, a high crest factor (ratio of peak to rms) allows you to measure noise and other non-sinusoidal wave forms at a ratio of 10:1 full scale or 100:1 at 10% of full scale. You get accurate noise and pulse measurements—without having to make non-standard corrections.

The 3400 isn't just a fine true rms

voltmeter—although that's plenty in itself. It can also be used as an ac/dc converter and a current meter. Typical dc output accuracy is 0.75% of full scale from 50 Hz to 1 MHz. Use the HP 456A AC Current Probe (\$250) and you get quick dependable current measurements. The 456A probe has a 1 mA to 1 mV conversion allowing direct readings up to 1 amp rms.

So, if all your measurements aren't made on true sinusoidal wave shapes and if you like direct accurate rms voltage indication no matter what you're measuring, it's time to check into the HP 3400A true rms voltmeter. For more information, contact your local HP field engineer. Or, write to Hewlett-Packard, Palo Alto, California 94304. Europe: 1217 Meyrin-Geneva, Switzerland.

099/198

INFORMATION RETRIEVAL NUMBER 2

HEWLETT  **PACKARD**
ANALOG VOLTMETERS



Siemens



No one knows ferrites like a ferrite user. We produce and use more quality ferrites than anyone.

Siemens, a world leader in the design and manufacture of sophisticated telecommunications and computer systems, has also become the world's leading producer of linear, memory and microwave ferrites. Ferrites that are performance and reliability engineered to meet our demanding

system requirements.

Siemens pioneered T38 with permeabilities of 10,000, T9 and T10 high-density ferrites for recording heads, SM6 and M6 filter inductors for high packing densities, 12 mil extended temperature cores, plated wire memories and CVB7 microwave material.

Siemens design engineers are ready to assist you in solving your ferrite problems.

Siemens Corporation, 186 Wood Avenue South, Iselin, N.J., 08830. (201) 494-1000. Siemens. A three billion dollar name in quality products. **SIEMENS**



NEWS

- 21 **News Scope**
- 24 **LEDs: The No. 1 challenger to Nixies** in digital readouts. They offer several advantages, but the price must drop.
- 26 **Hardware for the 'cashless society.'** Automated credit-verification systems have started to emerge in strength.
- 27 **A new job for the busy computer:** Designing artificial heart valves by means of a light pen and CRT screen.
- 28 **Technology Abroad**
- 31 **Washington Report**

TECHNOLOGY

- 36 **Good microstrip multipliers** don't just happen. A solid step-by-step design approach is needed, and early testing of the subcircuits is advised if future headaches are to be avoided.
- 42 **Divide frequencies by any integer.** Use a common-gate TTL or RTL ripple counter and save on components while preserving flexibility.
- 46 **Selecting preamps for lowest noise** can be difficult if the candidates aren't described the same way. Here's how to compare amplifiers by converting their specs to noise-figure contours.
- 49 **Ideas for Design**

PRODUCTS

- 51 **Instrumentation:** New, compact DPM uses LEDs.
- 52 **Microwaves & Lasers:** YIG-tuned filter is stripline compatible.
- 55 **Components:** High-isolation solid-state relay uses photon coupling.
- 53 Data Processing
- 54 ICs & Semiconductors
- 56 Modules & Subassemblies
- 58 Packaging & Materials

Departments

- 35 **Editorial:** Requalify now . . . don't be sorry later.
- 7 Letters
- 13 Designer's Calendar
- 58 Evaluation Samples
- 59 Design Aids
- 59 Application Notes
- 60 New Literature
- 61 Bulletin Board
- 64 Advertisers' Index
- 64 Information Retrieval Card

Cover: Photo of Hewlett-Packard light-emitting-diode DPM display by Henry Ries



Now there's a better way.

Our new DOS brings batch processing costs down to \$819 a month.

If you've been hanging on to old-fashioned ways because you thought a computer was too expensive, think again. Our new Disc Operating System brings the cost of computation and general purpose processing right down to where your budget lives.

With our new DOS, you'll easily create, check out and run your own programs. Use it for scientific calculations, business-accounting functions, information retrieval, inventory control, school administration — in fact, problem-solving of all kinds.

Anyone who can poke a typewriter key or pencil-mark a card can use our DOS. Because compilation, loading and execution are under the control of a teleprinter keyboard or batch input device.

On the other hand, if you're already batch processing with another system, give this a thought. Our DOS can probably do everything you're doing now — for about half the cost.

Because both the software and the hardware are fully modular, our DOS accommodates the needs of many different applications. Lets you vary the number of input/output devices. Add more core memory. Use a card reader as well as teleprinter. Add a line printer, paper tape punch, photo reader and magnetic tape. Other advantages include software protection and program segmentation. Plus automatic program retention so your programs can be easily reused.

Our basic DOS includes an 8K computer with direct memory access, 2.4 million-character disc, one teleprinter and one high-speed paper tape reader. Price is just \$35,600. Or \$819 per month on a five-year lease. And it's upward expandable for your future needs.

Get the full story by calling your local HP computer specialist. Or write to Hewlett-Packard, Palo Alto, California 94304; Europe: 1217 Meyrin-Geneva, Switzerland.

HEWLETT  PACKARD

DIGITAL COMPUTERS



How to Buy a Good Power Supply Without Spending a Bundle...

Take a long look at the Abbott line of over three thousand standard models **with their prices listed**. The unit shown above, for instance, is the Abbott Model R5S, a 60 Hz to DC converter which puts out 5 volts of regulated DC at 0.15 amps and sells for only \$83. Other power outputs from 2 to 240 watts are available with **any output voltage from 5 volts to 3,650 volts**, all listed as standard models in our catalog. These power supplies feature close regulation, short circuit protection, and the latest state of the art specifications for solid state modules.

If you really want to save money in buying your power supply, why spend many hours writing a complicated specification? And why order a special custom-built unit which will cost a bundle—and may

bring a bundle of headaches. As soon as your power requirements are firmed up, check the Abbott Catalog or EEM (see below) and you may be pleasantly surprised to find that Abbott already has standard power supplies to meet your requirements — **and the prices are listed**. Merely phone, wire, or write to Abbott for an immediate delivery quotation. Many units are carried in stock.

Abbott manufactures a wide variety of different types of power supply modules including:

- 60A to DC, Regulated
- 400A to DC, Regulated
- 28 VDC to DC, Regulated
- 28 VDC to 400A, 1 ϕ or 3 ϕ
- 24 VDC to 60A, 1 ϕ

Please see pages 930 to 949 of your 1970-71 EEM (ELECTRONIC ENGINEERS MASTER Catalog) for complete information on Abbott modules.

Send for our new 68 page FREE catalog.

abbott transistor

LABORATORIES, INCORPORATED
5200 W. Jefferson Blvd./Los Angeles 90016
(213) 936-8185 Cable ABTLABS

1224 Anderson Ave./Fort Lee, N.J. 07024
(201) 224-6900

INFORMATION RETRIEVAL NUMBER 5

Publisher

James S. Mulholland, Jr.

Editors

New York Office
850 Third Ave.
New York, N.Y. 10022
(212) 751-5530
TWX: 710-581-2874
Cable: Haydenpub

Editor: Frank Egan
Managing Editor: Ralph Dobriner
Managing Editor: Raymond D. Speer
Microelectronics, Steven A. Erenburg
Computers, Raymond D. Speer
Microwaves, Michael J. Riezenman
Management, Richard L. Turmail
News, John N. Kessler
Military-Aerospace, John F. Mason
New Products, Roger Allan
New Products, Lucinda Mattera
Copy, Marion Allen

Field Offices

Massachusetts
Jim McDermott
P.O. Box 272
Easthampton, Mass. 01027
(413) 527-3632

San Francisco
Elizabeth de Atley
Suite 6, 95 Main St.
Los Altos, Calif. 94022
(415) 941-3087

Los Angeles
David Kaye
2930 Imperial Highway
Inglewood, Calif. 90303
(213) 757-0183

Washington
Don Byrne
1425 N St. NW
Washington, D.C. 20005
(202) 667-6568

Editorial Production

Dollie S. Viebig
Richard D. Grissom

Art

Art Director, Clifford M. Gardiner
Assistant, William Kelly
Rita Jendrzejewski

Production

Manager, Thomas V. Sedita
Helen De Polo
Kathleen McConkey
Leslie Stein

Circulation

Manager, Nancy L. Merritt

Information Retrieval

Peggy Long

letters

Engineers don't starve—they only lose prestige

Sir:

In observing the present crisis in engineering employment, especially in the aerospace and defense industries, two alarming facts have become apparent. Going hungry is *not* one of these ugly facts. I maintain that an engineer has the ability to do damn near anything. He may sweat in times like these, but he won't starve! Far more important than our own financial security are the future of America's technical foundation and the prestige of the engineering profession.

The glaring facts are these:

1. The United States' defense establishment, founded on technology, is being destroyed from within. Technology must be continually moving forward, just to keep our nation's strength equal to the task of maintaining our freedom and preventing aggression against the free world. In these matters, to stand still is to die, and to willfully slide back, as we are doing today, is suicide. As engineers are forced out of work and find more secure, easier, and sometimes more enjoyable ways of making a living, they are forever lost to our future technical manpower needs.

2. The prestige of being a professional engineer is fast becoming a thing of the past. Engineers are individuals, not members of a tough-minded organization of responsible people concerned with the protection of the profession and its members. Therefore, companies are taking advantage of this to fire people, deny cost-of-living and merit raises, cut salaries, demand free overtime from engineers, and subject them to de-

grading systems of surveillance to detect anyone who isn't eagerly doing more than his share.

Many careers are being destroyed and engineers are being taken advantage of today by management. We of the profession, if we are to deserve the prestige of being called professional individuals, must exercise our responsibility to our nation, its people, and its future. We must make certain that the present irresponsible dismantling of the foundations of our national existence and the undermining of our technical expertise and professional prestige are stopped right now!

A Concerned Engineer

Editor's note: In asking us to withhold his name, the writer says, "I believe a letter signed by one unknown engineer will not be as effective as one signed as above, who could be anyone and who may well be speaking for everyone."

Bureau of Standards doesn't test products

Sir:

"Clearing" a dozen or more makes of microwave ovens, reportedly tested by the National Bureau of Standards (see "Capital Capsules," ED 25, Dec. 6, 1970, p. 46), should have been attributed to the Bureau of Radiological Health of the Department of Health, Education and Welfare. Although the NBS is developing monitoring instruments and measurement techniques for BRH, it does not pass judgment on the acceptability of specific products.

Jim Kluge

National Bureau of Standards
Boulder, Colo.

Electronic Design welcomes the opinions of its readers on the issues raised in the magazine's editorial columns. Address letters to Managing Editor, Electronic Design, 850 Third Ave., New York, N.Y. 10022. Try to keep letters under 200 words. Letters must be signed. Names will be withheld on request.

the diversified detective



Victory Engineering introduces the slimmest sleuth... a new thermistor infrared detector for a wide range of applications. Employing highly sensitive 25-micron thin film flakes, the new sensors are used for such varied applications as: monitoring rotating shaft temperatures, clear air turbulence, automobile emission control, horizon sensing, tracing systems, scanning and imaging, submarine detection.

At near room temperatures, the thin film flakes change $-4\%/^{\circ}\text{C}$. Response speed depends on mounting... either free-standing or substrate mounted (the latter for higher energy applications). Chopping rates on free-standing units are flat to 7.5 cps and fall off approximately 3 db at 10 cps. Detectivity runs approximately 5×10^6 .

For complete details, contact:

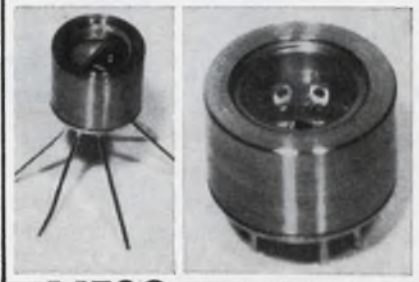

VECO
VICTORY ENGINEERING CORPORATION
VICTORY ROAD
SPRINGFIELD, N.J. 07081
(201) 379-5900 • TWX: 710-983-4430

INFORMATION RETRIEVAL NUMBER 6

four interface problems:

1. Eliminate interface maintenance between a telegraph line and TTL logic for \$3.55.

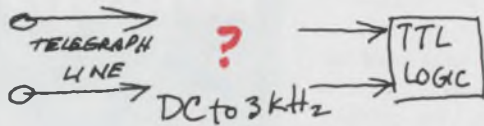

3. Eliminate ground loop spikes between computer and remote terminal for \$3.95.

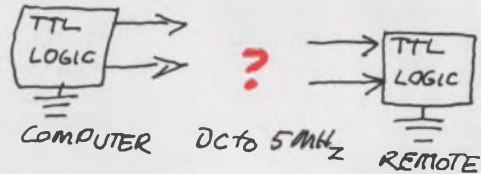

2. Trigger a remote SCR from TTL logic for \$4.50.

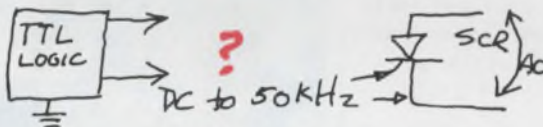

4. Couple TTL logic to 1.5 kV CRT blanking grid for \$3.95.

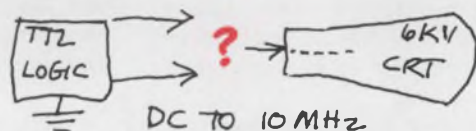

four opto-isolator solutions:

1. GaAs infrared LED
 $t_r = 40 \text{ ns @ } R_s = 50 \Omega$
 $I_F < 100 \text{ mA cont.}$
 $V_F = 1.3 \text{ V}$
 $V_{BR} = 3 \text{ V}$
 $\lambda = 9000 \text{ \AA}$
 This emitter makes solutions 2, 3, and 4 possible.

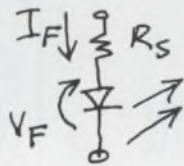

3. Silicon phototransistor MCT 2
 $t_r = 2 \mu\text{s @ } R_L = 100 \Omega$
 $f_{1/2} = 200 \text{ kHz @ } R_L = 100 \Omega$
 $V_{BRCEO} > 30 \text{ V}$
 $I_C/I_F = 35\% \text{ typ.}$
 $I_{C \text{ sat}}/I_F = 5\% \text{ typ.}$
 Solves 1 above.

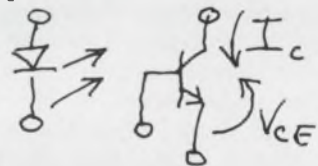

2. Silicon photodiode MCD 2
 $t_r = 110 \text{ ns @ } R_L = 100 \Omega$
 $V_R = 20 \text{ V}$
 $f_{1/2} = 5.5 \text{ MHz @ } R_L = 100 \Omega$
 $V_{BR} > 75 \text{ V}$
 $I_L/I_F = 0.2\% \text{ typ.}$
 Solves 3 and 4 above.

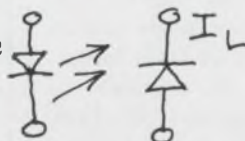

4. Silicon photoSCR MCS 2
 $t_{on} = 5 \mu\text{s @ } I_F = 20 \text{ mA}$
 $I_A < .15 \text{ A cont.}$
 $V_A = 200 \text{ V max.}$
 $I_F \text{ turnon} < 10 \text{ mA}$
 Solves 2 above.

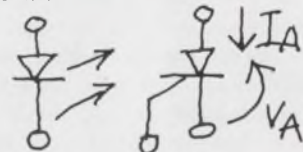

...and an answer kit: \$9.95.

The opto-isolator solves tough design problems. To let you work with these new devices, we've put together an *Opto-isolator Answer Kit*. Contains an MCT 2, MCD 2, MCS 2 in our six-lead Iso-DIP package at about half the price of the discrete parts — plus a new volume of GaAsLITE Tips that shows how to design opto-isolators into your problem circuits. Order from your Monsanto distributor or write Monsanto Electronic Special Products, 10131 Bubb Road, Cupertino, CA 95014. (408) 257-2140. All part prices are suggested resale price in 1,000 quantities

Monsanto

Distributors: In US—Schweber, Semiconductor Specialists, K-Tronics, and Kierulff. UK, Semiconductor Specialists; Semi Comps. France, RTF. West Germany, A.Neye-Enatechnik. Denmark, Scansupply. Belgium, Techmation. Norway, Arthur F. Ulrichsen A/S. Switzerland, Omni Ray A.G. Italy, Silverstar Ltd. Sweden, GP-Ingenjoersfirman. Japan, New Metals and Chemicals Ltd. Corp. Australia, Hawker Siddeley. Israel, Monsel. Canada, Schweber; Canadian Dynamics. The Netherlands, Techmation n.v.

Short circuits.

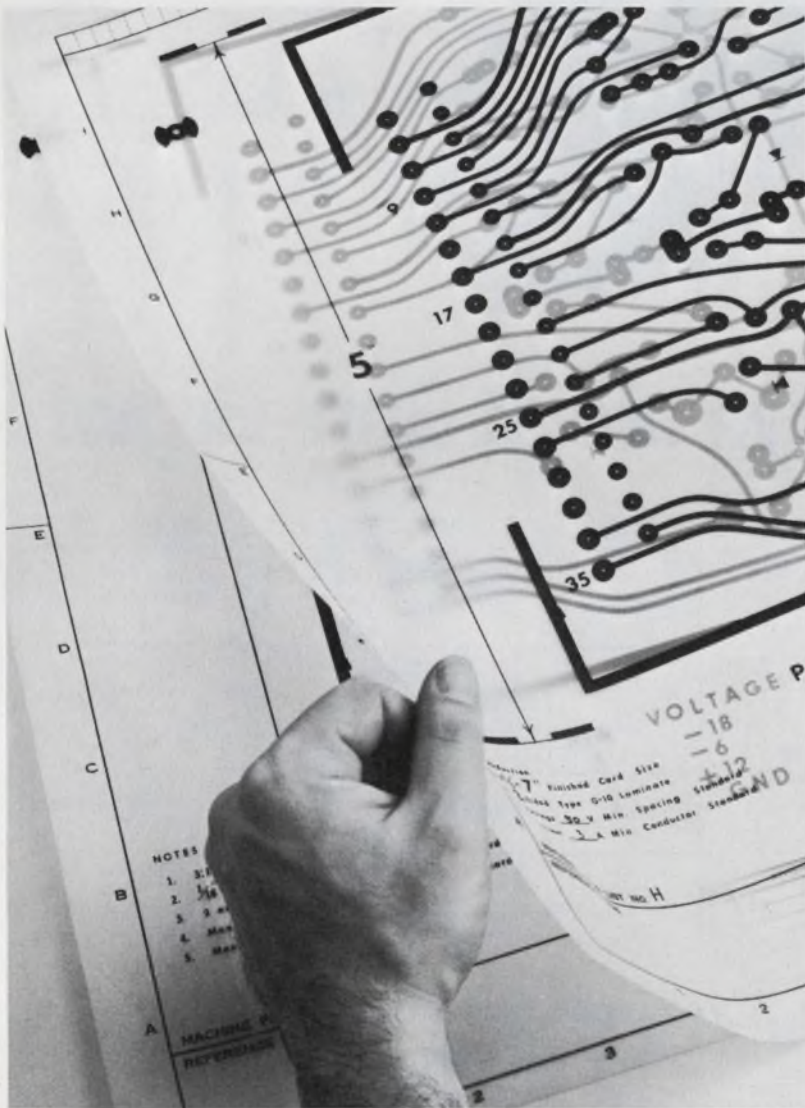

Now you can bypass slowdowns in printed circuit design.

Do your design problems include tape slippage and lack of dimensional stability on master layouts, numerous design changes, and other annoyances that hamper efficient printed circuit design?

If so, we believe that reproducing your taped master on KODAGRAPH ESTAR Base Film is the answer. For more information, contact your Kodak Technical Sales Representative, or write: Eastman Kodak Company, Business Systems Markets Division, Department DP514, Rochester, New York 14650.

DRAWING REPRODUCTION SYSTEMS BY KODAK

Kodak

Need a fast wideband op amp?

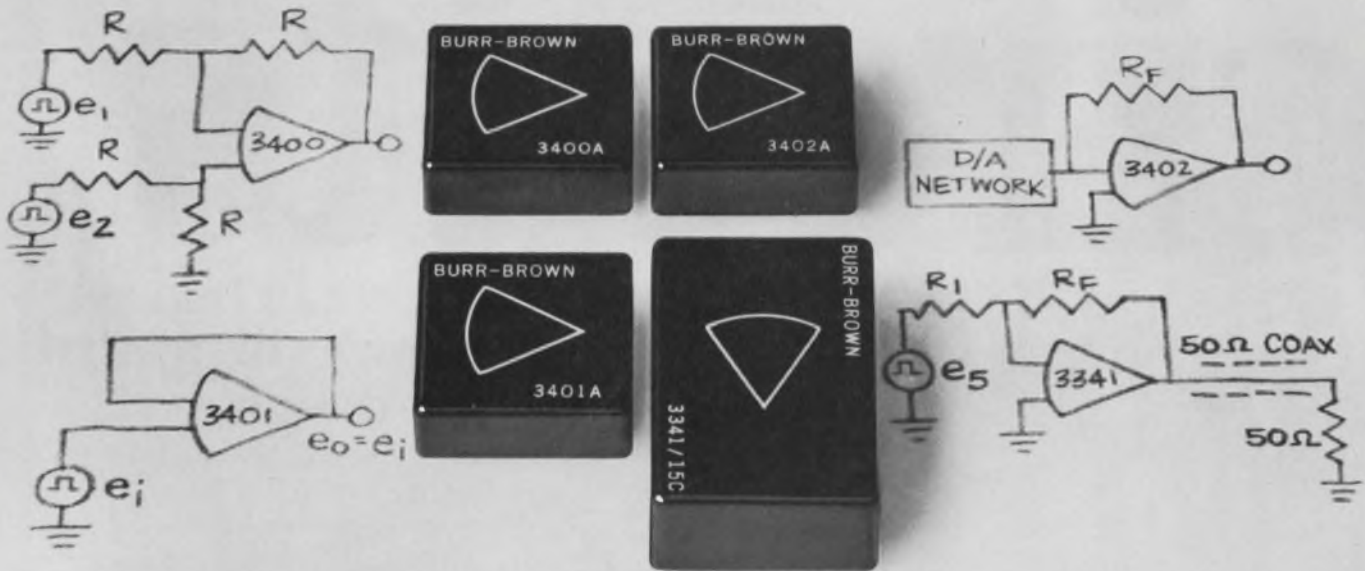

Your 10 best buys are at Burr-Brown

This wideband bunch from Burr-Brown is the industry's most comprehensive line of high speed operational amplifiers. From 10 fast settling models, you can select the one that best meets the exact requirements for your specific application. The four illustrated models are representative of the performance range of the high-speed line. All units are available from stock.

For complete technical information on all 10 of our fast response, wideband op amps, contact your Burr-Brown Engineering Representative or use this publication's reader service card.



MODEL	KEY FEATURES/PRICE	APPLICATIONS
3400A	Industry's fastest differential op amp. 100 MHz bandwidth. 1000 V/ μ sec slew rate. 1 μ sec settling to .01%. FET input. Price (1-9) \$55.00	Video and pulse amplification.
3401A	The industry's only fast settling op amp with guaranteed accuracy as a noninverting buffer. Gain accuracy better than .01%. 1 μ sec settling to .01%. FET input. Price (1-9) \$42.00	A/D, D/A converters . . . and multiplexers.
3402A	Fast settling, 1 μ sec to .01%. Differential FET input. Low Cost, (1-9) \$37.00	Ideal for high-speed precision D/A converters with monolithic quad switches.
3341/15C	Slew rate of 1000 V/ μ sec. Bandwidth, 50 MHz. Output current, ± 100 mA. Price (1-9) \$69.00	High speed line driving

BURR-BROWN
RESEARCH CORPORATION

International Airport Industrial Park • Tucson, Arizona 85706
TELEPHONE: 602-294-1431 • TWX: 910-952-1111 • CABLE: BBRCORP



Operational Amplifiers
Instrumentation Amplifiers
Active Filters
Multiplier / Dividers
A/D-D/A Converters

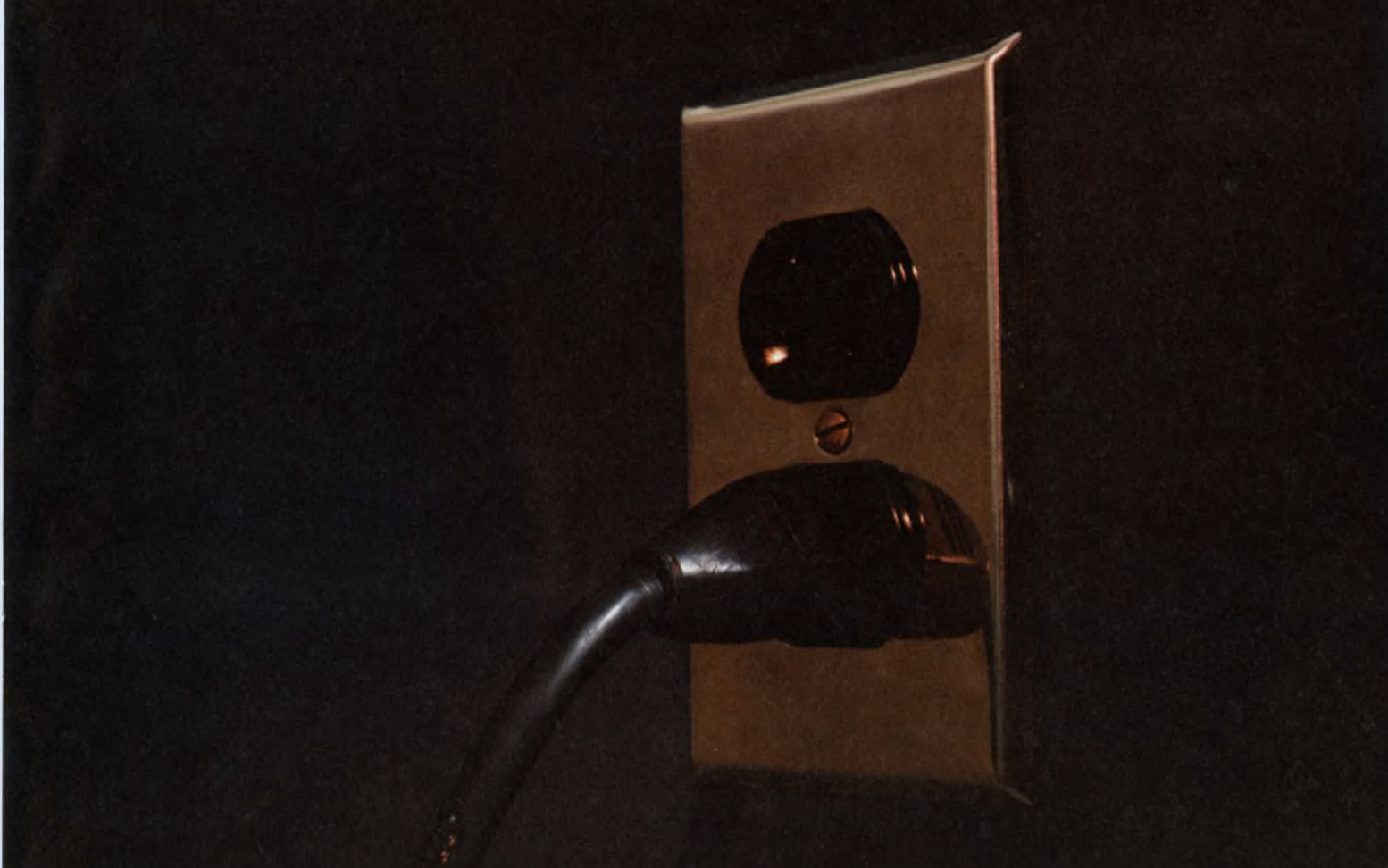

Stop line pollution before it stops you.

Clean it up with Cimron AC Power Sources.

You can't predict what's going to come out of the wall. Why risk the potential danger caused by even small line fluctuations or brownouts. Cimron's Series 7000/6000 AC Power Sources clean up line pollution that can cause problems in complex testing facilities and precision laboratory applications. An economical AC power source will insure against pollution that can create catastrophic errors in digital systems.

Each Cimron continuous-duty AC power source features a front panel output voltage meter; circuit breaker;

output amplitude control and voltage range indicator lamps. Available in 58 different modular configurations, they come in single, two and three phase models with all silicon solid state construction.

Single phase models can be ordered from 175VA to 2400VA; two phase from 350VA to 4800VA and three phase from 350VA to 7200VA.

The plug-in oscillator is designed to prevent accidental range changes with a load on the AC power source. A three-position card selector slides into the oscillator receptacle hole to

protect most models.

Series 600 plug-in oscillators cover the range from 45 to 10,000 Hz and are available in continuously variable, digital controlled, or fixed frequency models.

Our short form selection guide will show you how to keep it clean. Write Cimron, Dept. E-117, 1152 Morena Blvd., San Diego, California 92110.

CIMRON

LEAR SIEGLER, INC.



CIMRON DIVISION

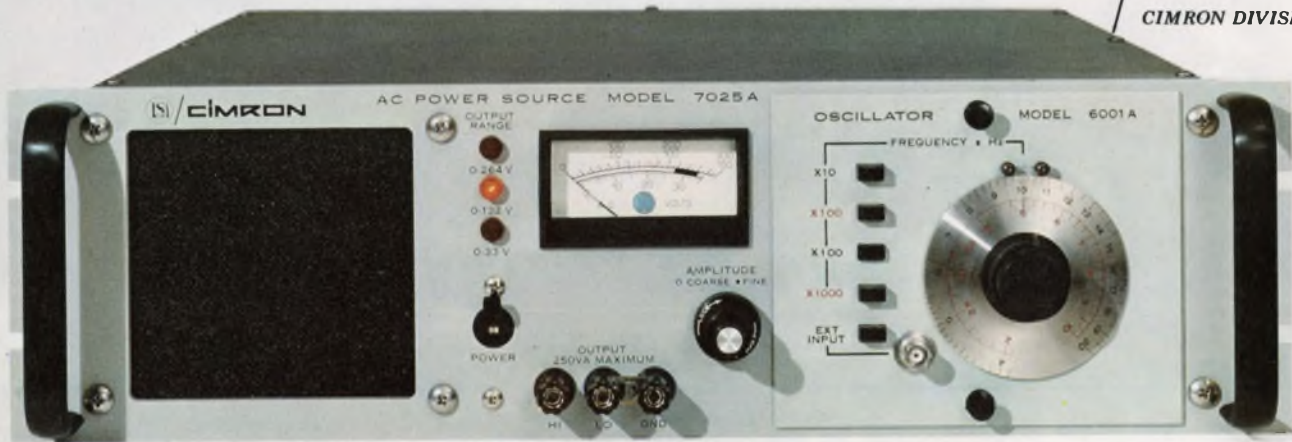



For Power...Now it's North!

When it comes to power North Electric puts it all together!
Four decades of experience . . . *plus* the best engineering
and economy available in standardized power modules.
They're packaged and ready . . . off-the-shelf.
For power to match your requirements — call North!
419/468-8244 or TWX 419/468-4860.

North Electric Company • Electronics Division / Galion,
Ohio • A subsidiary of United Utilities, Incorporated



NSP-9

designer's calendar

FEBRUARY 1971						
S	M	T	W	T	F	S
	1	2	3	4	5	6
7	8	9	10	11	12	13
14	15	16	17	18	19	20
21	22	23	24	25	26	27
28						

Feb. 17-19
International Solid State Circuits Conference (Philadelphia, Pa.)
 Sponsors: IEEE et al. Lewis Winner, 152 W. 42nd St., New York, N. Y. 10036.

CIRCLE NO. 404

MARCH 1971						
S	M	T	W	T	F	S
	1	2	3	4	5	6
7	8	9	10	11	12	13
14	15	16	17	18	19	20
21	22	23	24	25	26	27
28	29	30	31			

March 22-25
IEEE International Convention and Exhibition (New York City).
 Sponsor: IEEE. J. M. Kinn, IEEE, 345 E. 47th St., New York, N. Y. 10017.

CIRCLE NO. 405

March 31-Apr. 2
Reliability Physics Symposium (Las Vegas). Sponsor: IEEE. O. D. Trapp, Fairchild Semiconductor, 464 Ellis St., Mountain View, Calif. 94040.

CIRCLE NO. 406

April 12-15
National Telemetry Conference, (Washington, D. C.) Sponsor: IEEE. H. B. Riblet, Johns Hopkins Univ., 8621 Georgia Ave., Silver Spring, Md. 20910.

CIRCLE NO. 407

New! MOSFET design data for performance-minded engineers



The important things you need to know about MOS Field-Effect Transistors and RCA's comprehensive product line

In 20 pages, the new RCA MOSFET Product Guide gives you:

- features and design benefits of MOS Field-Effect Transistors
 - single-gate types
 - dual-gate types
 - dual-gate-protected types
- quick selection guides
- data charts categorized by application
- typical circuits for
 - communications equipment
 - television and FM tuners
 - choppers and oscillators

For information on RCA's high-performance, economy-priced MOSFET line, contact your local RCA Representative or your RCA Distributor. For your copy of the "RCA MOSFET Product Guide" (MOS-160C), write: RCA, Commercial Engineering, Section 57B-4/ZT4, Harrison, N.J. 07029. International: RCA, 2-4 rue du Lièvre, 1227 Geneva, Switzerland, or P.O. Box 112, Hong Kong.

RCA
Solid State Division

INFORMATION RETRIEVAL NUMBER 12

If our new alphanumeric digital printer didn't work, neither would thousands of Friden calculators.

But of course Friden* calculators do work. Including the thousands of electronic printing models we've sold for the past 4 years.

With this ad, we're introducing 30-character and 40-character alphanumeric printers, both of which work exactly the same as the standard Friden 20-character model. A little wheel zips across the tape, printing up to 28 columns at 46 characters per second, inking itself on a roller made of solid ink.

Popping in a new ink roller when required is the only service that's needed. And there are no adjustments to make.

It's a printer you can count on. Ask anybody who owns one of our calculators.

And if you'd like complete information on all three Friden digital printers, ask Mr. Gary Dotzler, Sales Manager, OEM Products, Friden Division, The Singer Company, San Leandro, California 94577.

SINGER
FRIDEN DIVISION

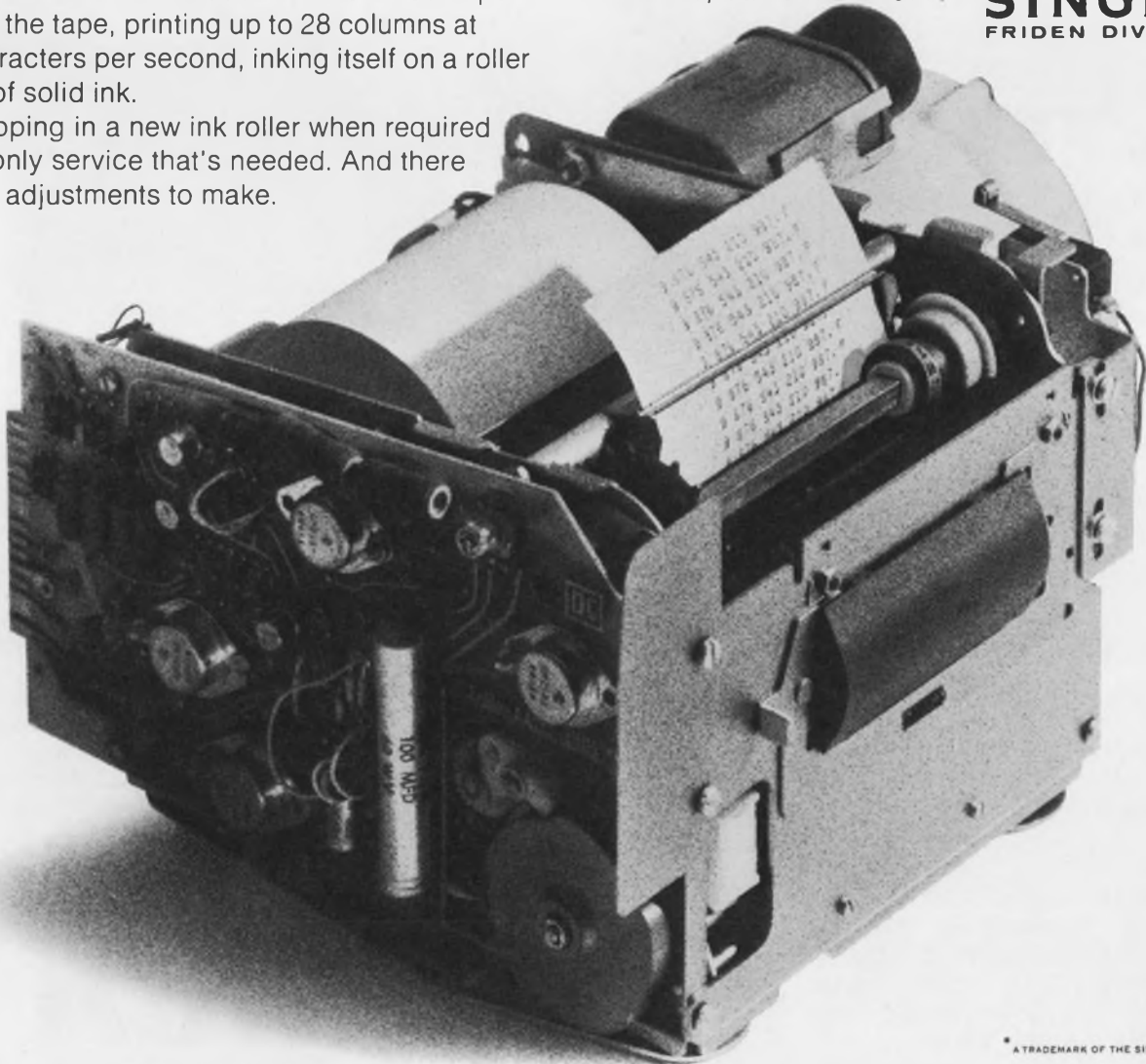

* A TRADEMARK OF THE SINGER COMPANY

Belden the Special "Specials" specialist

Here's what to do when cable catalog specs just won't do the job: Dial Area Code 317 ■
Then dial 966-6681 ■ You'll get action ■ From a man who devotes full time to solving
engineered cable problems ■ A Belden specialist that "lives"
with your design parameters from engineering through the
actual production run ■ Cables for underwater-under-
ground devices . . . extra-high voltage and pulse ap-
plications . . . medical instrumentation . . . low-level
signal interference problems . . . unusual environ-
mental conditions . . . he's tackled them all ■
Phone now.

850

DIAL (317) 966-6681

BELDEN



... new ideas for moving electrical energy

Computer Microtechnology has RAMS, ROMS,

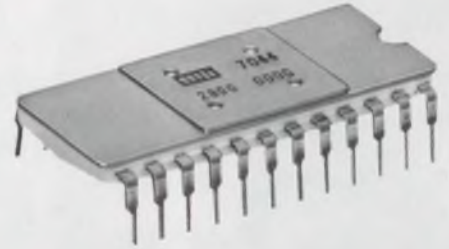

CM 2800 Here's a 1024-bit high speed TTL ROM using circuit design techniques that match delays through the chip. The 50 nsec access time is virtually independent of the direction the address lines are moving or the specific address bits involved. This will help you avoid race conditions in synthesizing logic functions and high speed microprograms. It's shallow, but wide: 128 x 8. Low power (400 mW) and high speed let it work at speeds comparable to TTL gate delays. Your code converter doesn't have to be the weak link in your system anymore. In 24-pin DIP.

CM 2850 Another TTL ROM, identical in specs with the CM 2800, but arranged 256 x 4. The outputs are OR-tieable. Dual chip selects make expansion simple. (Anyone for 256 x 16? Run four side by side.) Packaged in 16-pin DIP. Price: under 2¢/bit in volume. Same goes for CM 2800.



CM 2900 For people whose performance is hung up by an MOS character generator, we offer a bipolar 1120-bit device organized 224 x 5. Power is 450 mW typ. Access 50 nsec. Designed for your 5 x 7 dot matrix, with standard font for ASCII code. Customs available, and fast. 4 week turnaround from receipt of your truth table. Can easily be paired up to give you a high resolution 7 x 10 dot pattern. **BIG POINT:** With a TTL character generator, you need only one power supply. Think about that. Then send a p.o.

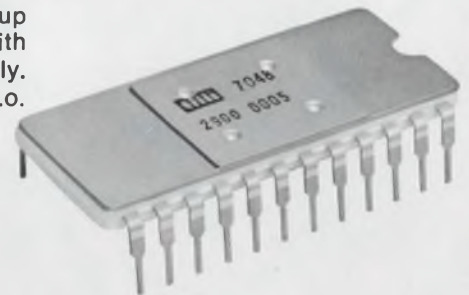

and REGISTERS

And for our next act, MOS. We know that bipolar does not serve all masters. If you're one of those masters who look to MOS for ROMS, ask us about our 1024-bit, 2048-bit, 2240-bit, 2560-bit and 4096-bit chips. For information about any of our ROMS, RAMS, or REGISTERS, circle the bingo card or call us collect at (408) 736-0300, (617) 891-0002, or (714) 835-8323. For delivery, call our distributors in your area: Kierulff, K-Tronics, F-J-R Electronics, or Schley Electronics.

Computer Microtechnology Inc.
P. O. Box 7050, Sunnyvale, Calif. 94086



RF.

If You Get The Message From The Data Sheet, It's A Signal You'll Get Through.

Ever wondered what "infinite VSWR" is? Or why many RF transistors don't conform to JEDEC-registered specs like they should? Or what a "typical" power-out spec is?

Lots of data sheets keep you wondering. Ours don't.

We spec everything from input/output resistance and capacitance (y & s parameters) for small signal stuff to impedance parameters for large signal devices. Like good blueprints, our data sheets tell you everything you need to know about the RF device you've selected so traditional trial-and-error is minimized. And so is your design's failure.

We call them True Blueprints around the factory.

You can take a realistic view of Motorola RF devices because we do. Load mismatch, depending on the unit, is usually performed at a 10:1 or 30:1 VSWR. One that's testable. Acceptable. And designable.

And output power degradation of 5% or more after mismatch testing is reason for rejection. Our "true blues" state that.

You're assured "worst case" design considerations through min/max ratings where they count: power out, efficiency, power gain, noise, f_T , etc.

You're assured each device meets a registered minimum performance standard and is therefore subject to production controls. The one you buy next month will perform like the one you bought last month.

You're even given fine points like leakage current, sat and emitter-base breakdown voltages just because JEDEC says that's what you should be given.

We want to give you something else, too: 10% off your next order for up to 999 of any Motorola RF small signal or RF power transistor to prove our devices are as good as our data sheets. Fill in and mail the coupon to your local Motorola distributor. He'll get through to you immediately to take your order.

Circle the reader number to get 8 of the most comprehensive RF device data sheets in the industry — from small signal to power.

10% OFF RF

(Distributor)

I get the message about Motorola RF!

I want up to 999 of these RF types off-the-shelf from you at 10% off their regular published price:

Name _____
Title _____
Company _____
Address _____
City _____
State _____ Zip _____



MOTOROLA RF

Not just more megahertz. More communication.

Your *custom* pulse transformer is a *standard* DST[®] transformer

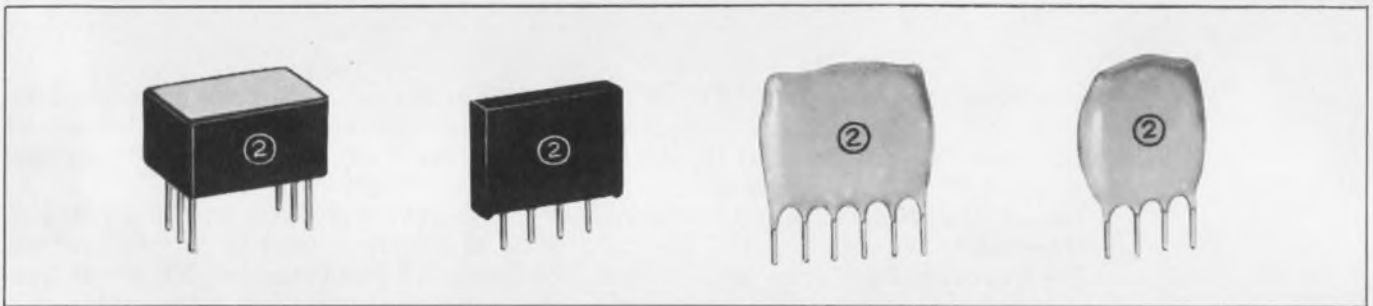

Some of the case styles in which Sprague DST Pulse Transformers are available. Note the in-line leads.

You can select the transformer design you need from the new Sprague DST Family, a fully-characterized series of Designer Specified Transformers which Sprague Electric has pioneered. It's easy. Start with the two basic parameters dictated by your circuit requirements: primary (magnetizing) inductance and volt-second capacity.

New Sprague engineering data gives basic information from which all nominal sine wave parameters are derived. This data allows you to specify the one transformer from thousands of possibilities which will optimize performance in your application.

Design Style A minimizes magnetizing inductance change as a function of temperature. Typically it's $< \pm 10\%$ change from 0 to 60C; $< \pm 30\%$ from -55 to $+85$ C.

Design Style B and C give you broad band-pass characteristics, and still keep magnetizing inductance change $< \pm 15\%$ from 0 to 60 C.

Design Style D is *fast*. Associated leakage inductance and coupling capacitance are kept at a minimum. This style is just what you need for interstage and coupling devices in computer drive circuits.

The Sprague DST Series packs a lot of transformer into minimum volume packages — epoxy dipped for minimum cost, or pre-molded. The 100 mil in-line lead spacing is compatible with integrated circuit mounting dimensions on printed wiring boards.

To solve your pulse transformer design, start now. Write for Engineering Bulletin 40,350 to the Technical Literature Service, Sprague Electric Company, 347 Marshall St., North Adams, Massachusetts 01247.

SPRAGUE COMPONENTS

PULSE TRANSFORMERS
THIN-FILM MICROCIRCUITS
TRANSISTORS
CAPACITORS
RESISTORS

INTEGRATED CIRCUITS
INTERFERENCE FILTERS
PULSE-FORMING NETWORKS
TOROIDAL INDUCTORS
ELECTRIC WAVE FILTERS

CERAMIC-BASE PRINTED NETWORKS
PACKAGED COMPONENT ASSEMBLIES
BOBBIN and TAPE WOUND MAGNETIC CORES
SILICON RECTIFIER GATE CONTROLS
FUNCTIONAL DIGITAL CIRCUITS

SPRAGUE[®]
THE MARK OF RELIABILITY

'Sprague' and '®' are registered trademarks of the Sprague Electric Co.

highlighting

THE ISSUE



A new dual-two-stage filter that is able to use YIG-tuning techniques and still be compatible with microwave integrated circuits is now on the market. The unit has two separate two-stage filters within the same magnetic structure, yet measures a mere 0.75 inch in diameter and 2.1 inches in length.

Designed for use in the S band from 2 to 4 GHz, the new YIG-tuned filter is adaptable to two, three, and four-stage filter configurations in addition to the two-stage designs mentioned. It can also be used as the magnetic structure for YIG-tuned oscillators.

Page 52

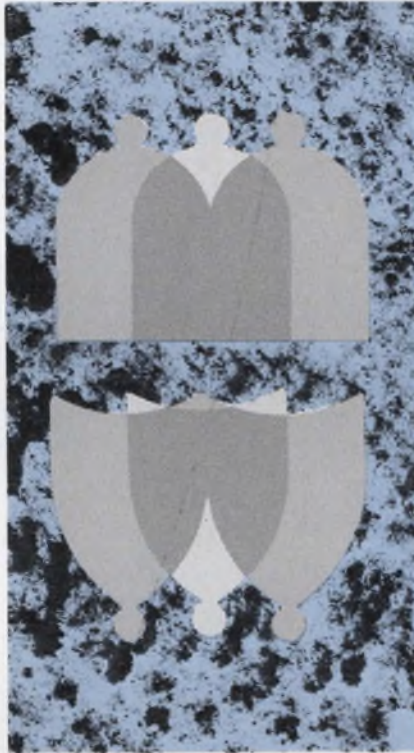

You can divide clock frequencies by any integral divisor by selectively controlling the input signals to a common pulse-gated ripple counter. And only one monostable-gate generator is needed—an advantage that is most apparent for large input/output frequency ratios that would otherwise require many external gates.

Either TTL or RTL logic can be used for the circuit, and the method is easily adaptable to MSI or conventional manufacturing. For example, 10 flip-flops and four dual gates, either deposited on one MSI chip or assembled from ICs onto a circuit card, can provide a low-cost, adjustable divider to cover the entire audio range from one clock frequency.

Page 42



Of the many challenges to the Nixie tube for the title of king of digital readout devices, the strongest is the light-emitting diode (LED).

Significant space savings for designers, a lifetime of 10 years or more and TTL compatibility are the main features being offered.

And prices, while generally higher than those for Nixies now, are reported to be headed downward.

At least 10 LED manufacturers have already entered the fray. Some offer dot-matrix displays and others seven-segment displays, in digit sizes from 1/8 inch to 0.85 inch. The package may be dual in-line, flatpack or edge-mounted.

Page 24

A UNIQUE LIGHT-A UNIQUE PRICE

the FAN-IN series

\$1.87 ea. Model I60, 1,000 quantity

INCANDESCENT INDICATORS with BUILT-IN DRIVERS^①

18 YEAR LIFE - NO REPLACEMENT COST

^① includes: KEEP-ALIVE BIAS
LAMP TEST (optional)

Input Loading - 1/2 of 1 TTL (0.8mA)

Supply Voltage 5 & 28V (others available)

Subminiature Size (1/4 or 3/8 mounting hole)

Shock-Proof
Wrap Terminals (gold-plated)
Fast, Simple Installation
Have performed to MIL-E-5400,
Class II equipment

We have lights without drivers, too-at equally attractive prices.

FREE SAMPLE - Request on company letterhead

PHONE: (213) 641-1232

DATA DISPLAY PRODUCTS

8036 WESTLAWN AVE., LOS ANGELES, CALIF. 90045

Over-the-counter market gets an electronic 'board'

The over-the-counter stock market now has its own "board"—an electronic one. A nationwide computer system for reporting quotations, averages and volumes on 2300 over-the-counter stocks went into operation this month.

Built and operated by the Bunker-Ramo Corp. for the National Association of Securities Dealers, the electronic "stock exchange" consists of 40,000 CRT terminals and keyboards at more than 700 over-the-counter market-maker and stock-retailer sites. In its computer center at Trumbull, Conn., Bunker Ramo has two Univac 1108 computers, either of which is capable of operating the entire system by itself. Three banks of core totaling 196-k words are used to store the stock quotations.

From each of the terminals, market makers enter and update their quotes and instantaneously interrogate the central computers to obtain the quotations of all other market makers on any given issue in the system. Previously all of this communication was done by telephone.

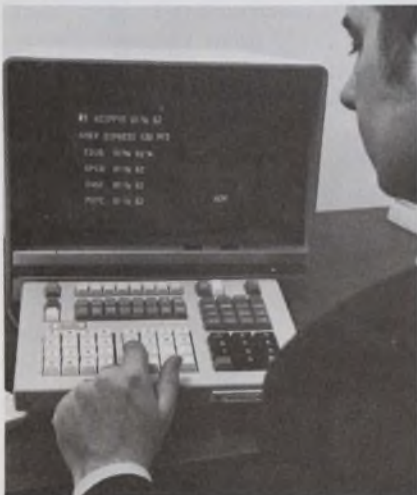

Over-the-counter "board" is part of nationwide system that went into operation this month. It was developed by Bunker Ramo.

The electronic system has a capacity of 20,000 stocks. Unlike the New York and American Exchanges, the new over-the-counter system provides more than one bid and ask quotation on each issue. If 10 market makers are quoting on an issue, the quotes of all 10 are shown on the subscribers terminal.

Bunker Ramo estimates that the system will handle 56 entries and interrogations per second—more than one million calls a day.

The computer center at Trumbull Conn., is linked by high-speed, dedicated data lines to subcenters in New York, Chicago, San Francisco, Dallas and Atlanta.

Microwave radio system links local police to FBI

A microwave radio communications system that uses a minicomputer to store and switch messages will be installed in San Mateo County, Calif., next week.

It will link all police departments in the county to each other and, by way of Sacramento, to state data bases with information on stolen cars and gun registrations. The Federal Bureau of Investigation records in Washington, D. C., will also be accessible, providing data on 2.5-million active records including wanted persons lists.

The key to the system is a new Motorola MDP 1000 minicomputer. This machine stores messages received over the microwave link from local police offices and forwards them to addressed agencies at 100 words per minute.

William D. Goheen, communications supervisor of San Mateo County, explains that in other police communication systems a clerk at the initiating agency must cut a tape, dial the address and then send the message at 100 wpm by

tape. This requires a trained teletypewriter operator.

Ultimately Goheen hopes to have a terminal with a standard typewriter keyboard and CRT display in every police car. Patrolmen will then be able to access the switching computer by radio link and thus have fingertip access to data bases throughout the state and in Washington, D. C. Such a terminal is already available, Goheen says, from Sylvania Electronic Systems, Mountain View, Calif.

Navy's new subs to get improved electronics

Electronic subsystems for the Navy's SSN 688 nuclear, high-speed, attack submarines will be a big step ahead of subsystems on the Sturgeon-class attack sub, now in use.

The new underwater fleet will be equipped with an improved sensor system (IBM has a \$50-million contract for five of these sonars); an improved acoustic countermeasure system; advanced fire control; a central computer complex (as opposed to the minicomputer-for-every-subsystem concept); improved navigation capability, and an advanced electronic countermeasures receiver.

The new submarines will carry dual-purpose versions of the wire-guided Mark 48 torpedo—dual in that it is capable of destroying both submarines and surface ships. Two dual-purpose Mark 48s are being built. Clevite is building one, the Mod 1, and Westinghouse the other, the Mod 2.

The first 12 ships will cost an estimated \$1.9-billion. The Newport News (Va.) Shipbuilding and Dry Dock Co. will build the lead ship and four other submarines, and General Dynamics Corp.'s Electric Boat Div. in Groton, Conn., will build seven.

Digital control center cuts software costs

A major factor in the high cost of digital process control equipment is the cost of developing and maintaining programs. A present rule of thumb is that a manufacturer designing a new system should ex-

pect to spend a dollar for software for each hardware dollar he spends.

Fisher Controls Co. of Marshalltown, Iowa, has come up with a digital control center—which it calls dc²—that reduces the software cost to the user to 1/10th that of the hardware. This has been accomplished, according to J. B. Duncan, dc² product manager, by the use of a read-only memory in conjunction with a new real-time process control language called pc²—which is derived from the BASIC language.

This means that the compiler is in the hardware and is always available for use by the programmer. The executive or monitor programs are written by the user as he develops his programs.

For a control project involving 25 direct digital control loops and a normal number of other functions, such as discrete outputs and alarming, the dc² price would be about \$50,000. The software costs for this project would be typically \$5000, Duncan says. Deliveries begin in March.

Electron-beam mining to be tested in field

Is there a future for electronics in mining operations? The U. S. Interior Dept.'s Bureau of Mines has decided to find out. It has awarded a contract to Westinghouse Electric Corp., Pittsburgh, to field-test an electron-beam rock excavation machine that the company has developed.

The 36 kW machine makes use of a high-energy electron beam to melt deep but narrow cuts in rocks. The beam is produced without the aid of the huge vacuum chamber heretofore used with most high-energy electron beams. Instead the beam is passed through a series of small chambers, each separated by an aperture of 1/10th of 1/20th of an inch in diameter. Each chamber is pumped to preserve a partial vacuum. In the process, the beam is focussed electromagnetically and delivered to the surface where it is needed.

The electron-beam method has the potential of cutting the cost and increasing the speed of drilling and tunneling through rock.

The tests will be supervised by

Westinghouse's Missile Launching and Handling Dept. in Sunnyvale, Calif., supported by the company's research laboratories near Pittsburgh. Test operations will be carried out by the Hi-Z Mining Corp. of Albuquerque, N. M. The \$240,000 contract is being funded by the Defense Dept.'s Advanced Research Projects Agency.

1500-W power plant to be unfurled in space

The first satellite with a roll-up solar-cell array—a 1500-W power plant—is slated to be launched by the Air Force in October. The array will be rolled up on a 10-inch drum during launching.

The satellite was developed for the Air Force Systems Command, Wright-Patterson AFB, Ohio, by Hughes Aircraft Co., El Segundo, Calif.

According to David Massie, project engineer for the Air Force Aero Propulsion Laboratory, the new design will be 50% lighter than traditional rigid, folded-wing solar arrays, and it will be smaller in volume by 50 to 75%.

When the satellite is in its 400-mile-high polar orbit, the solar cells will be extended as two 16-by-15-1/2 foot panels. Massie says the satellite is an experimental one that will be used to test the concept of developing power plants of 5000 to 10,000 W for future military satellites. Most satellites have solar cells that produce 100 to 1000 W.

The satellite has four electronic subsystems—one for extending the solar array, another for acquiring and tracking the sun, a third for controlling the power and energy storage, and the fourth for operating the instrumentation.

Underwater holograms tested in Navy sub

An acoustic holographic system has been installed on a Navy deep submersible vehicle and for the first time has displayed underwater objects in three dimensions in real time.

The system, which has a range of several hundred feet, was developed by Bendix Research Laboratories, Southfield, Mich., under a

contract with the Office of Naval Research.

There are six major components in the Bendix system:

- a sound transmitter
- a receiving array of hydrophones.
- signal processing equipment to convert acoustic signals to optical signals.
- a laser to reconstruct the optical signals to a true image in real time.
- a closed-circuit TV monitor on which the image is displayed.

The Navy says the system can be used for rescue operations and bottom topography mapping.

'Silicon Valley' gets new semiconductor firm

"Silicon Valley's" first new semiconductor company for 1971 is Antex Industries, Inc., in Palo Alto, Calif. It was founded by Ken T. Chow, former president of Electro-Nuclear Laboratories, Menlo Park, Calif., a manufacturer of silicon photocells and detectors.

The new company will design and manufacture custom MOS devices for watches and calculators. It will also make gallium arsenide single crystals for the light-emitting-diode industry.

Laser to spot fog banks and alert Coast Guard

A laser device is being developed by the U. S. Dept. of Transportation for detecting fog banks a half mile to three miles away.

The Coast Guard, which is to use the device, has Videograph equipment at present. This detects general fog conditions but not individual fog banks.

The new system would operate by beaming the laser light outward from a shore installation. As the light beam reached a fog bank, it would trigger alarms, such as fog-horns and buoy signals, in unmanned lighthouses.

Studies are continuing on ranging the fog-detection device so that it not only detects the fog bank but determines its distance from shore. The work is being carried out at the Dept. of Transportation Center in Cambridge, Mass.

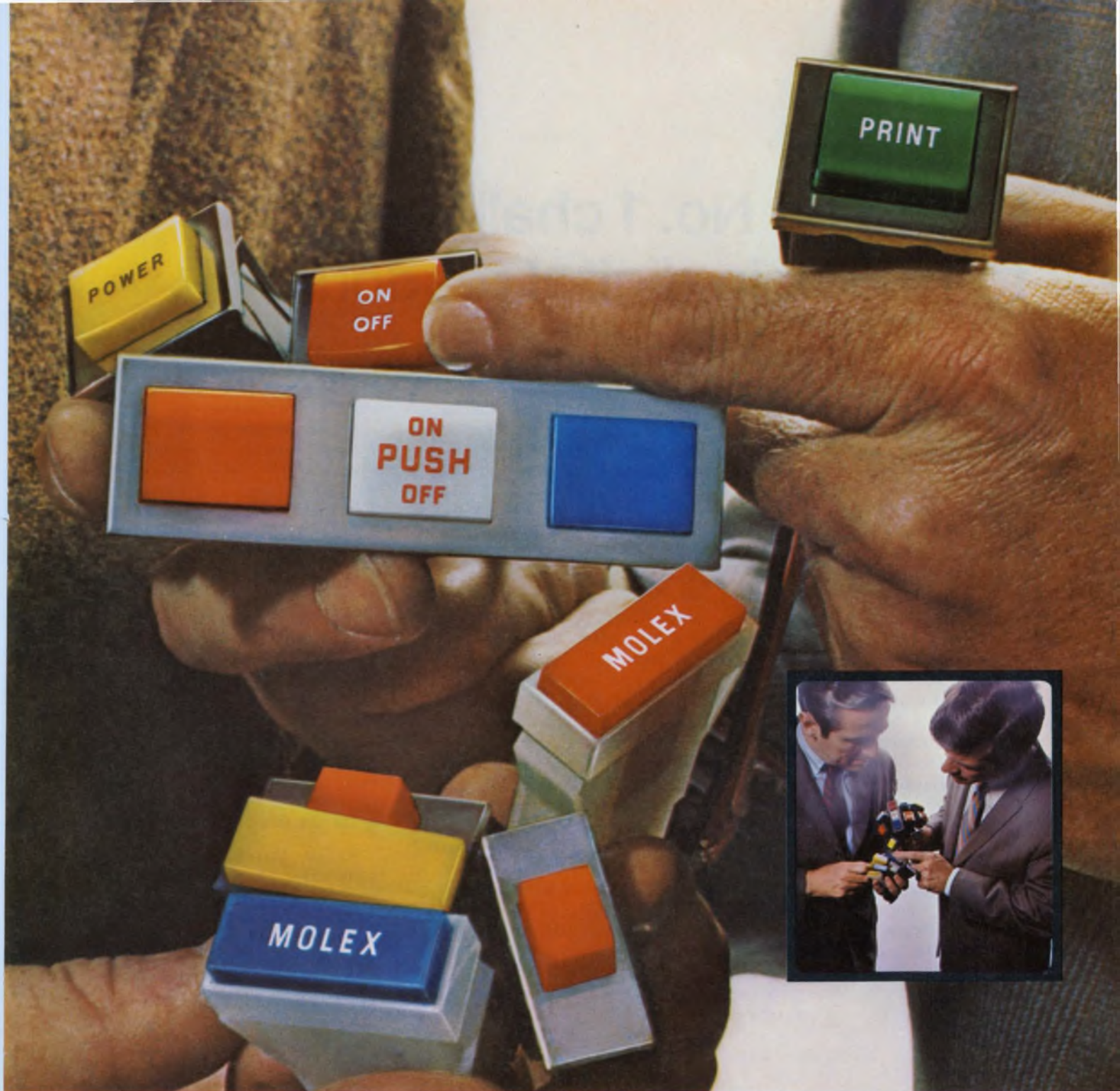

HERE ARE TWO EASY WAYS TO SOLVE LIGHTED PUSH BUTTON SWITCH PROBLEMS. Economically. Reliably. Fast. The Molex 1175 snap mounts. Offers spade or wire terminals for fast, easy assembly. A choice of nine colors, 500 variations. And look at the Molex 1820. You can use one, or a gang of them, for an infinite variety of applications. Lighted push button can be wired to light independently of the switch. And it's available in colors galore. Best of all . . . both switches are priced considerably under one

dollar in quantity. ■ These components are good examples of the Molex creative approach to design problems. And we have the ability to design reliability and ease of assembly into a product without letting costs run wild due to over-engineering. ■ If this makes sense, and you would like a *free sample* of either the 1175 or 1820 switch, write: Molex Incorporated, Downers Grove, Illinois 60515. Or phone (312) 969-4550.

...creating components that simplify circuitry



LED: The No. 1 challenger to Nixies in digital readouts

Of the many challenges to the Nixie tube for the title of king of digital readout devices, the strongest is being mounted by the light-emitting diode (LED).

Significant space savings for designers, a lifetime of 10 years or more and TTL compatibility are the main features being offered.

And prices, while generally higher than those for Nixies now, are reported headed downward. A figure of \$10 to \$11 per digit is fairly common at present. But in very large quantities—10,000 to 100,000 digits—prices on the order of \$3 for a 1/4-inch-high digit have been quoted. In 18 to 24 months, say several manufacturers, including Aaron Kestenbaun, president of Opcoa in Edison, N. J., the price of LED readouts in 1/4-inch digits should be down to \$1 to \$2 per digit for large-quantity orders.

At least 10 LED manufacturers have already entered the fray. Some offer dot-matrix displays, others seven-segment displays. Some offer 1/8-inch digits, others 1/4-inch and still others digits as large as 0.85 inch. The package may be dual-in-line, flatpack or edge-mounted.

Present Nixie prices, according to a spokesman for Burroughs of Plainfield, N. J.—the producer of the trademarked tubes—range from \$6.75 to \$45 per digit. In large quantities—50,000 to 100,000—the Nixie price is typically anywhere from less than \$3 to \$7, the spokesman reports.

Nixies range in digit height from 3/10ths inch to 2-1/2 inches. "Almost all" the Nixies sold today, Burroughs says, are the "long-life" type, good on the average for 100,000 hours or 12 years.

David N. Kaye
West Coast Editor

Other gas-discharge tubes that compete with Nixies offer comparable price, size and performance.

The basic material from which the LED is fabricated is still the subject of disagreement. Some manufacturers say that gallium arsenide phosphide (GaAsP) is best; others like gallium phosphide (GaP).

GaAsP proponents note that its wavelength is closer to the optimum sensitivity of the human eye—it has better "luminous efficiency" than GaP. Moreover more research has been done on the production of GaAsP than on GaP; manufacturers know more about the material.

In favor of GaP is this strong argument: Potentially it's cheaper to manufacture, because liquid-phase epitaxy can be used instead of vapor-phase epitaxy. The GaP epitaxial layer can be grown in about five minutes, as opposed to one day for the epitaxial layer of GaAsP. The GaP readout also holds promise of a green readout, which is more sensitive to the eye than the red that present LEDs admit.

Only one manufacturer is using GaP at present, however: Opcoa. The process was developed originally at Bell Telephone Laboratories, and Opcoa's present engineering team was formerly with Bell.

What does the designer have to know about LEDs to select or design instruments with digital displays? First, he must know the tradeoffs.

On the plus side:

- LED displays run off 5 V and are driven directly by integrated circuits. Nixies require 150 to 200 V and a special power supply. So the LED user picks up major cost and space savings.

- LEDs have rapid rise times (in nanoseconds), making it very easy to multiplex several digits off a single decoder driver. This permits the display of several digits with the use of only enough power to drive a single digit continuously.

- LED displays are single-plane devices. Whereas the Nixie is constructed with 10 cathodes, one behind the other, LED digits are all generated on a single flat plane. The result is a significantly greater viewing angle for the LED.

- LED displays are small, flat and thin. They can be designed into portable, compact instruments, or space can be left for additional circuitry in bench instruments. Nixies generally take up much more space than LED devices.

On the minus side:

- The character size of LEDs is generally quite small. If a readout must be clear from a distance of 25 feet or more, Nixies or some other form of large readout must be used. Tests with 1/4-inch LEDs have shown that the maximum reading distance is 10 to 12 feet.

- When LEDs fail, the display may black out suddenly and completely. Nixies usually fail gradually—the elements put out less and less light once they start to degrade.

- Nixies provide a curved digit that is very readable. The seven-segment digits in LEDs are somewhat boxlike in character, and when the digits are changing, they look like 8s. The digits in dot-matrix LEDs are better formed, but still not as complete as the Nixie digits. In addition either circularly polarized, narrowband red or smoked black filters are recommended over the displays of all LEDs to mask reflected light and to make them more readable.

(continued on next page)



Model RDS-16 Desk Pollution Monitoring System,
made by Time-Zero Corp., Hawthorne, Calif.

Type 707 Spectrum Analyzer, made by AIL Div. of
Cutler-Hammer, Deer Park, N. Y.



Type 3330 Digital Panel Meter, made by
Digilin, Glendale, Calif.

**Instruments
with LED
displays**



Model 3431A Digital Panel Meter, made by Hewlett-Packard Co., Loveland, Div., Loveland, Colo.

■ Because of their rapid rise times, LEDs have no persistence. When the current is turned off, the light output ceases in nanoseconds.

Multiplexing with LEDs

A major design consideration with LEDs is that of multiplexing several off a single decoder driver.

Strobe rates of 1 kHz and higher are recommended. Since the human eye tends to be a peak detector, low-duty-cycle, high-peak current pulses can be fed into LEDs

giving a high-intensity display.

If a single decoder driver is used with each digit, the current should be kept under 50 mA, or the junction will heat up and the LED will go into a saturated state. If this occurs, an increase in current will not yield an increase in light output.

At lower current levels, or in short pulses, light output is proportional to the input-drive current. In any case, current-limiting resistors are necessary on the cathode pins for burnout protection.

Several instruments with LED readouts—spectrum analyzers, calculators, various types of monitoring consoles, digital panel meters and digital counters—have already reached the market, and many more are expected. All of Hewlett-Packard's new digital voltmeters, for example, will have LED displays from now on. The first H-P instrument with a LED display, a digital panel meter, has just hit the market (see "DPM Uses LED Display and Custom Parts for Reliability," p. 51 this issue of ED.) ■■

Hardware for the 'cashless society'



New standard-size credit card designed by Bell Labs engineers for credit verification via telephone.

Perhaps it's the economic state of the nation or perhaps it's just an idea that has finally ripened, but the hardware for automated credit-verification systems has begun to emerge, and it looks as if such equipment will replace cash registers in the same way that checks have replaced cash.

Bell Telephone Laboratories, Murray Hill, N. J., announced last month that American Express would be using new Bell plastic credit cards that can be inserted in credit card telephones.

TRW, Inc., Redondo Beach, Calif., will introduce a national computerized credit-reporting system next month that features a new keyboard terminal for use at a point of sale.

And Video Systems Corp., Pennsauken, N. J., displayed its credit-card validation and inventory control systems last month at the National Retail Merchants Association Convention in New York City.

At the same convention, Concord Computing of Bedford, Mass., demonstrated its Validier, which operates through a Touch-Tone telephone. The system authorizes credit and processes sales slips.

Data banks containing credit information for millions of people are being formed, and the hardware and systems needed for accessing that information are being designed and marketed. This leaves the safeguarding of credit information largely to the discretion of sales clerks and cashiers.

The problems of making absolutely certain that the holder of a credit card is, in fact, the authorized owner is greatly facilitated by telephone-line transmission to a central data bank. But two Bell Laboratory engineers, Dan Miller, and Terry Prince, agree that secret user codes and even voiceprint comparisons by telephone may eventually find a place in the "cashless society."

The Bell System's plastic credit card meets size requirements set by the American Standards Institute, New York City. The card can be used not only for ordering merchandise but also "to verify bank balances or pay bills," Miller says.

The credit-verification systems use a Touch-Tone telephone or a specially designed keyboard to input information to a central computer. The computer replies either by synthesized speech or a special tone indicating that credit is approved or denied. The amount of each transaction, the date and personal identification are recorded and numbered.

The TRW credit authorization system will be used by a number of banks, supermarkets and national department store chains, including Arnold Constable, Montgomery Ward, the May Co., Broadway, Orbach's and Nordstrom Best.

The Video Systems Corp. equipment is a desk-top video terminal with alpha-numeric keyboard and seven control keys for entering, deleting and updating information. More in the nature of a mini-computer this system—called the Inventron—is for controlling inventory, showing work in progress, and displaying back-order lists to sales managers as well as providing customer credit and credit card validation.

The Validier uses a wide-area dedicated communications network and can be installed in increments, starting with a single department and expanding to an entire store or chain. A typical credit transaction takes less than 15 seconds to complete, according to Concord Computing Co. ■■

New job for the busy computer: Designing artificial heart valves

Designing an artificial valve for a heart patient can now be done by computer. The cardiovascular system varies from person to person, and the designer's conventional approach is a painstaking cut-and-try method.

But the new computer techniques developed at the University of Utah's Computer Sciences Div. hold promise of easing and speeding the work. The techniques are useful not only for designing artificial hearts and valves; they can be used to study the flow of blood through arteries. It's hoped that the latter use will prove beneficial in research on atherosclerosis.

The experimental approach

Without the computer, the designer of an artificial heart valve must build a Plexiglas model of the patient's aorta with the valve in it. Then a fluid that contains visible particles is run through the model, and the designer looks for areas of turbulence—that is, areas where the velocity of the fluid flow is changing constantly in both magnitude and direction. This is a danger sign, telling the designer to modify the shape of the valve. Excessive turbulence in a real aorta produces lesions in the artery wall, leading

eventually to strokes or internal hemorrhaging.

With the computer, the shapes of the aorta and the valve are outlined on a CRT screen, and turbulence is indicated by large dense spots. The motion of the valve back and forth in the aorta is observed on the screen. Furthermore the shape of the valve can be changed instantaneously by a light pen and the change in turbulence studied.

Dr. Harvey S. Greenfield, research professor at the University of Utah, Salt Lake City, explains that the technique consists basically of entering the general equations of fluid motion into the computer, having it solve them for particular valve and artery shapes and sizes, then displaying these solutions on the CRT.

The figures below for example, are drawings of views on the CRT screen. The diagram at left shows a longitudinal cross-section of the aorta, with a disk-shaped valve in the left end. The valve moves on the screen from the full open position shown leftward to a closed position in the narrow passageway. The lines along the walls of the aorta indicate the direction of motion of the blood, and the black spots indicate turbulence. The drawing at right shows a three-

dimensional plot of the turbulence. The height of the peaks gives an approximate indication of the amount of turbulence.

New research tool possible

Dr. Greenfield says that CRT displays of a valve moving back and forth in the aorta show excessive turbulence in the same areas as Plexiglas models that contain similar valves.

Furthermore, he notes, the computer displays of blood flow through the arteries indicate excessive turbulence in the same areas where surgeons consistently find lesions in atherosclerosis patients. He anticipates, therefore, that computer-aided design will be a useful technique for studying atherosclerosis as well as for designing artificial heart valves and hearts.

Researchers at the University of Utah plan eventually to use a head-mounted display system (see "Computer Constructs 3-D Castles in the Air," ED 19, September 13, 1970, p. 32) that will allow the viewer not just to observe a picture of a moving heart valve or diseased artery on the CRT, but actually to "step inside" the artery and view the theoretical "blood" as it flows toward him. ■■

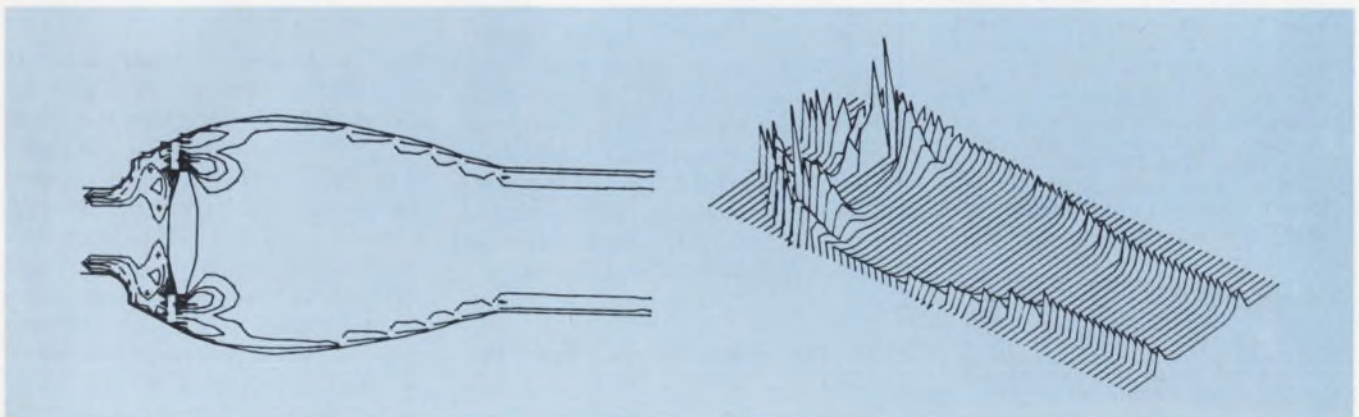

CRT drawing shows aorta cross-section (left) and 3-D plot of areas of blood-flow turbulence.

Introducing the high-low **POWER SUPPLY**



(high
performance—
low profile)

Acopian's new low profile power supply offers outstanding performance. Line and load regulation is .005% or 2 mv. Ripple is 250 microvolts. Prolonged short circuits or overloads won't damage it. And built-in over-voltage protection is available as an option.

Yet, it's the thinnest, flattest, most "placeable" 4.0 amp series regulated power supply ever offered . . . just 1.68" low. This low profile makes it perfect for mounting on a 1 3/4" high panel, or vertically in a narrow space.

Standard models include both wide and narrow voltage ranges. Outputs from 0 to 48 volts. Current ratings from 1 to 4 amp. Prices are low, too, starting at \$80.

For the full low-down on the new low-down power supply, write or call Acopian Corp., Easton, Pa. 18042. Telephone: 215-258-5441. And remember, Acopian offers 82,000 other power supplies, each shipped with this tag . . .



technology abroad

A 16-stage deflector capable of steering a laser beam into a raster of 65,536 half-overlapping positions has been introduced by Philips Research Laboratories of Hamburg, Germany. It permits random addressing at a rate of 250 kHz, and the beam may be switched from position to position in 0.2 ns. Philips spokesmen claim that a 5-by-5-foot display produced by the new system can be seen in daylight. Light losses in the system are only about 10%.

A laser system that can measure flow rates from 1 kilometer per second to 0.01 millimeter per second has been devised by scientists at Brown Boveri Research Center in Baden, Switzerland. The technique can be used with any transparent liquid, provided it contains diffracting particles. The system involves focusing a He-Ne laser to a fine point through a glass tube and into the liquid whose velocity is to be measured. Readings are taken of the beam frequency from three perpendicular directions to compute the total velocity vector.

A traveling-wave cathode-ray tube with an extremely high (0-to-6 GHz) bandwidth has been perfected by the Philips Research Laboratories at Val-de-Marne, France. The device can reproduce extremely brief nonrecurrent events. The transient signal is impressed onto a helical delay line that also serves to deflect the tube beam current. The signal travels at substantially the same speed as the electrons composing the beam current. This means that individual electrons experience a constant magnetic field, and the signal is faithfully reproduced.

All the arithmetic and logic for Sumlock Comptometer's newly announced desk calculator have been squeezed onto just five microcir-

cuit chips. Sumlock, a London-based calculator company, designed the metal-oxide microcircuits in collaboration with a team of engineers based at the Glenrothes (Scotland) facility of General Instruments Microelectronics. Although a few three-chip calculators have been produced by American MOS manufacturers—mostly for Japanese calculator companies—the Sumlock design approach remains a novel and low-cost solution to design problems. By multiplexing timing and control signals and keyed information onto a common bus, the pin count has been drastically reduced. Sumlock engineers were able to use 11-lead TO-5 cans costing only a few cents.

Low-cost ship-to-shore communications for merchant shipping via satellite has been proved feasible as a result of tests recently completed by the British Post Office in collaboration with the radio operating companies and suppliers of equipment. NASA and the U. S. Coast Guard also gave assistance. To cut costs, the normal dish antenna stabilized against ship roll was eliminated. In its place a crossed Yagi array was installed on the experimental container ship, Atlantic Causeway. The resulting 30-degree beam width kept the satellite in sight even during the most severe rolling.

The multi-role combat aircraft now being jointly developed by Great Britain, Germany and Italy is to be fitted with a low-light-level TV laser system. This will be jointly developed by Barr & Stroud, Ltd., and the British Aircraft Corp., two British firms, and Eltro GmbH of Heidelberg, Germany. The low-light-level system will be used in reconnaissance, and the laser system will probably be an essential feature of an automatic ranging facility.

Monolithic analog switching circuits so cheap you deserve an explanation

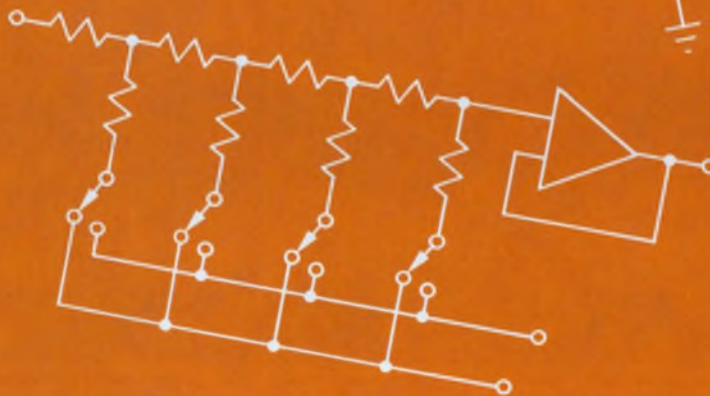
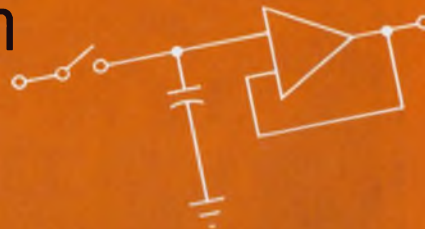

There are many reasons. Broad experience in monolithic FET and bipolar circuitry. High reliability (military) experience. Low cost packaging. High yield. Automatic assembly.

Together they explain why only Siliconix can bring you a full line of monolithic analog switching circuits at discrete component prices.

Our 100 piece prices for driver + switch are \$3/switch function while quantity prices drop below \$2.

The BK line includes 4 and 6 channel

MOS switches; 4 and 6 channel switch drivers (4 channel with decode); 2xSPST, 4xSPST, SPDT and DPDT MOS switches with drivers; and 2xSPST and SPDT JFET switches with drivers.

So: whatever your application—multi-channel analog switching, sample and hold, or D/A conversion—we have the low cost monolithic device for you. They're all dual in-line hermetic packages specified over -20 to $+85^{\circ}\text{C}$ range.

For more information on our BK series call any Siliconix sales office.

New York: Sy Levine (516) 796-4680 **New England:** Al La Croix (617) 769-3780 **St. Louis:** Jim Spicer (314) 291-3616 **Minneapolis:** Ed Koelfgen (612) 920-4483 **Southern California:** Dave Ferran (213) 420-1307 **Northern California:** Chuck Brush (408) 246-8000 **In Europe:** Siliconix Limited, Saunders Way, Sketty, Swansea, Great Britain. Siliconix GmbH, 7024 Bernhausen, Postfach 1340, W. Germany. Siliconix 9, Ave d'Arromanches, 94-Saint-Maur, France.



Siliconix incorporated

2201 Laurelwood Road • Santa Clara • Calif. 95054
Phone (408) 246-8000 Ext. 201 • TWX: 910-338-0227

Cut this out and tape it on the front of your present scope.

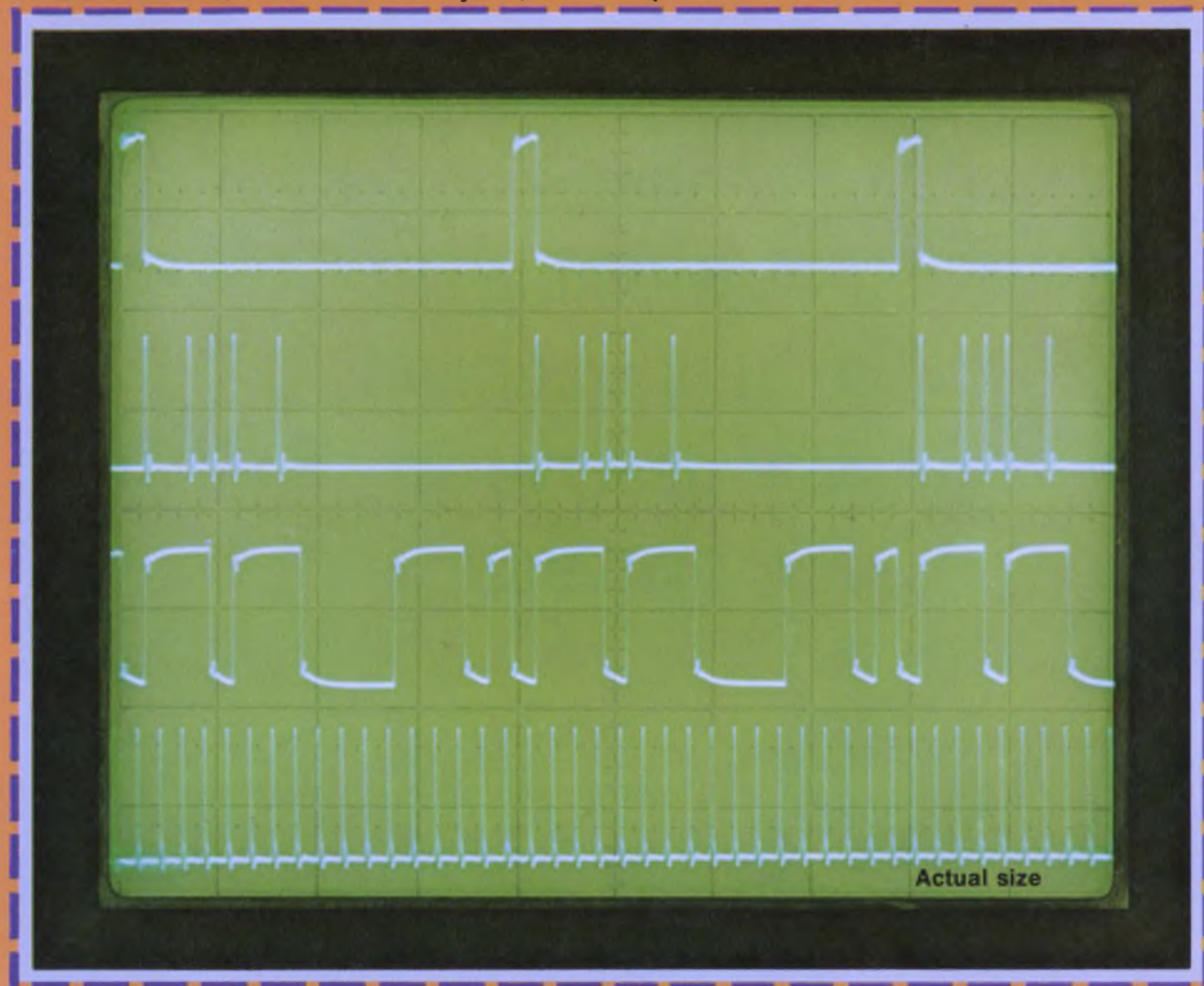

See how much easier you could measure high-frequency waveforms on HP's new scope?

Get the big picture! The 180-Series oscilloscope family now has a "big brother"—the 182A—a scope with a viewing area 66% larger than any other high-frequency scope, and three times larger than some. Yet, despite its larger viewing area, the 182A takes up no more bench space than the 180A, and maintains full bandwidth of 180 System plug-ins to 100 MHz.

The result is easy viewing for you—even at a distance. The 182A's 8-div x 10-div CRT is marked off in big 1.3-cm x 1.3-cm squares. And internal gratitudes allow accurate readings from any angle—a real plus in systems-testing work.

This new big-screen CRT is possible because of HP's pioneering advances in CRT technology. Improved HP expansion-mesh magnification techniques used in the 182A CRT make it possible to have a big-screen scope with 100 MHz capabilities, while still



080117 A

HEWLETT *hp* PACKARD

OSCILLOSCOPE SYSTEMS

retaining the sensitivity required for compatibility with solid-state vertical amplifiers. Thus, you get easy-to-interpret displays, even in 4-channel or TDR work.

Because the 182A is part of the 180 "family," it will take ten different 180 System plug-ins—up to and including the 100 MHz 1802A dual-channel vertical amplifier—without degradation. This means you can upgrade your existing system without having to replace any of your present HP plug-ins. It also assures compatibility in the future.

Price of the 182A mainframe is only \$1100; plug-ins start at \$525. For further information on the new 182A, or any element of the HP 180-System "family," contact your local HP field engineer, or write to Hewlett-Packard, Palo Alto, California 94304. In Europe: 1217 Meyrin-Geneva, Switzerland.

washington report

DON BYRNE, WASHINGTON BUREAU

Tax break for business stirs mixed reaction

It's still too early to tell what effect President Nixon's relaxation of tax-depreciation regulations will have on capital spending in the electronics industry. Some manufacturers are wary that it will have any effect this year. Although tax benefits will be felt in fiscal 1971, these observers note that most companies have already planned their major purchases for this year. On the other hand companies that have deferred capital improvements may be encouraged to start them soon, other observers feel.

The Electronics Industry Association says its members are still studying the new regulations and are unsure how they might influence major purchases or the job market.

The changes in the tax law will permit businesses to cut the average depreciation "life" of machinery by 20% and to take a full year's depreciation on anything bought in the first half of the year and a half year's depreciation on purchases in the last six months. The "reserve-ratio" test, under which businesses formerly were required to justify the actual period of time during which equipment was used and its depreciation "life," also has been eliminated.

\$15-million sought for new military network

The Defense Dept. is expected to ask Congress for about \$15-million this year to fund Tritac, an Army-Navy-Air Force tactical communications network proposed as a replacement for Project Mallard, which died in the Senate last year. Mallard included foreign governments in the net as well as the three American military services, and this led many legislators to believe the project was so complex that it would be unworkable. There are still problems remaining, such as what type of computer operation is to be used in message switching.

Airlines accept Administration's uhf satellite plans

The Administration's decision to put up two uhf satellites for aviation use won't be disputed by the nation's airlines, despite the fact that they and the Federal Aviation Administration have preferred a vhf system in the past. A spokesman for the Air Transport Association told ELECTRONIC DESIGN that the carriers could live with the plan, as outlined by the Office of Telecommunications Policy. The satellites are to be operational by 1980. "At least we now have a policy," the spokesman said—something that has been lacking for almost a decade.

The Office of Telecommunications Policy is looking for the first satellite to be launched over the Pacific in 1973, with tests following, and a similar satellite over the Atlantic in 1975. The system is to operate near 1600 MHz and will involve automatic data collection, data processing, surveillance and traffic control, with displays utilizing digital data links and digital processing techniques. The Dept. of Transportation will run the system, with NASA and the State Department participating.

The airlines favored a vhf system because it matched existing equipment that they have and because it could be put into operation faster. But now, beset by financial woes, the carriers seem content to accept the uhf system and wait until some future date, when their money problems hopefully will be a thing of the past. NASA and European governments were the leading exponents of the uhf system.

\$2-billion increase in defense budget expected

Sources in the House Armed Services Committee indicate that the Defense Dept. budget for fiscal 1971-72 will come in at about \$76-billion, compared with the \$74-billion estimated for 1970-71. A part of the increase, the sources say, will be for increased payroll costs. But R&D spending is expected to rise sharply—possibly as much as a billion—from the \$7-billion in 1970-71. Defense purchases are expected to remain about the same. A large part of the R&D increase will be for the B-1 bomber and new submarine programs.

NASA denies plans for robot moon exploration

Reports that robot moon-exploration plans are being worked on within NASA are denied by officials of the agency. The plans, according to reports circulating in Washington, will be formalized by this spring.

The robot programs supposedly resemble those that the Russians now have in operation, and the feeling is that if NASA did go to mechanical exploration of the moon it could, hopefully, lead to greater cooperation with the Russians. It might also, say the reports, take the budgetary heat off NASA from Congressional critics of the manned-flight program. But the furthest that manned-flight officials will go is to say that for a while they "toyed" with the idea of making the lunar exploration vehicle in dual mode—that is it could stay on the moon, move about, continue to scoop up samples and then later meet with another Apollo crew at a prearranged rendezvous. But this, they hasten to add, was dropped some time ago.

Capital Capsules: The Air Force now estimates that each of the 325 F-5-21 aircraft it plans to buy from Northrop will carry about \$100,000 in off-the-shelf electronics. Flyaway costs of the aircraft are estimated at \$1.6-million apiece. . . . The Housing and Urban Development Department is working on a project to put 1500 unemployed aerospace technicians to work in the Model Cities program. Initial cost of the program is estimated at \$4-million. . . . The Federal Aviation Administration has confirmed Gustav E. Lundquist as associate administrator for engineering and development. He had been acting administrator. David H. Israel, former No. 2 man of the Defense Communications Planning Group in the Defense Dept. has been named director of the FAA's Office of Systems Engineering Management. He is a pioneer in the use of computers in air traffic control, the FAA says. . . . NASA has decided that its proposed Orbiting Solar Observatory needs to be bigger, to handle larger experimental packages, and also should have more power and an improved command system. So the space agency has increased its contract with Ball Brothers Research Corp. of Boulder, Colo., some \$4-million. The contract now comes to about \$10-million. A launching is scheduled for mid-1971. . . . Turbetrain service between Boston and New York will continue for another two years under a \$3.8-million contract the Dept. of Transportation has signed with the United Aircraft Corp. Two new cars will be added to each train, and all cars will be modified to cut noise and vibration.

push in the two center plug-ins and...



have an oscilloscope that digitally measures: frequency, resistance, current, voltage, and temperature. You still retain all normal scope features such as delaying sweep and dual trace. The CRT display at right is just one of many measurements possible with a scope/DMM/counter combination.

The 7D13 Digital Multimeter has 3 1/2-digit readout. It measures DC voltages to 1000 V with an accuracy of $\pm 0.1\%$, ± 1 count; DC current to 2 A; resistance to 2 M Ω ; and temperature from -55°C to $+150^{\circ}\text{C}$.

The 7D13 input can be floated up to 1.5 kV above chassis potential. This allows considerable flexibility in measuring parameters that have a high common-mode voltage. A unique probe is supplied for measuring both voltage and temperature.

The 7D14 Digital Counter is *directly gated* to 500 MHz and has 8-digit readout. Both 50- Ω and 1-M Ω inputs are provided. Sensitivity is 100 mV P-P (35 mV RMS), about three times better than most counters. The signal connected to the vertical ampli-

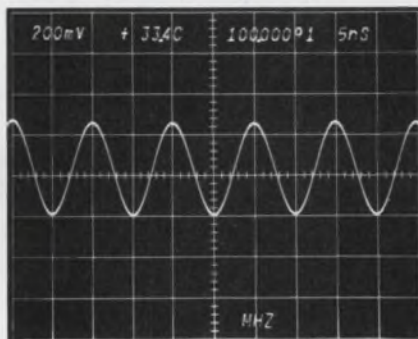

The output of an oscillator is displayed and its frequency is simultaneously correlated against changes in temperature.

fier can also be routed to the 7D14 through the oscilloscope's trigger source switches. All eight 7000-Series vertical amplifier plug-ins (differential comparator, 10- μV differential, current amplifier, etc.) are available as signal conditioners for the counter.

The counter's Schmitt trigger circuit output can be displayed directly on the CRT. This gives a picture of the actual triggering point, thus, many signals that are difficult to trigger on with other counters are now measured with greater reliability.

The 7D14 will determine ratios from 0 to 10^5 and totalize from 0 to 10^8 . The delayed sweep from the oscilloscope can drive the counter gate. By doing this, signals are displayed on the CRT with the ones being counted intensified.

For complete information on these exciting plug-ins, contact your nearby Tektronix field engineer or write: Tektronix, Inc., P.O. Box 500, Beaverton, Oregon 97005.

Prices of instruments shown: 7504 90-MHz Oscilloscope \$2000, 7A12 Dual-Trace Amplifier \$700, 7B52 Dual Time Base \$900, 7D13 Digital Multimeter \$560, 7D14 Digital Counter \$1400. The 7D13 and 7D14 are compatible with all five 7000-Series mainframes.

U.S. Sales Prices FOB Beaverton, Oregon

Tektronix lease and rental programs are available in the U.S.



TEKTRONIX®

committed to
technical excellence

INFORMATION RETRIEVAL NUMBER 22

Sorensen's new SRL power supply has a great thing going for it.



Built-in overvoltage protection that can be quickly set and instantly checked even under full load.

SRL is a new low voltage, regulated DC power supply for systems and laboratory applications. We designed it by asking power supply users what they liked and didn't like, the features they wanted or needed. Features like exclusive front panel monitoring and adjustment of overvoltage setpoint without removing the load.

SRL comes in 14 models: 4 voltage ranges to 60 VDC, 4 power levels to 2000 watts. It offers higher power density, low ripple and noise, fast response time over full load range, operation to 71°C, IC reliability.

Check out SRL. Or any of the hundreds of other Sorensen power supplies with output voltages from 3 to 150,000 VDC, output currents from 1.5mA to 1000 A. They are all listed, with prices, in the Sorensen catalog. Write for your free copy to Raytheon Company, Sorensen Power Supplies, 676 Island Pond Road, Manchester, New Hampshire 03103. Tel: 603-668-1600.

Model	Output Power			
	Voltage (VDC)	Current (ADC)		
		55°C	60°C	71°C
SRL 10-25 50 100	0-10	25	22	16.7
		50	44	33.5
		100	88	67
SRL 20-12 25 50	0-20	12	10.5	8
		25	22	16.7
		50	44	33.5
SRL 40- 6 12 25 50	0-40	6	5.3	4
		12	10.5	8
		25	22	16.7
		50	44	33.5
SRL 60- 4 8 17 35	0-60	4	3.5	2.68
		8	7	5.36
		17	14.9	11.4
		35	31	23.4

Sorensen
POWER SUPPLIES

editorial

Requalify now... don't be sorry later

One of the most important assets of a magazine like ELECTRONIC DESIGN is its readership. In keeping with this concern, the editors are turning the editorial page in this issue over to our Circulation Manager.

My primary concern, as Circulation Manager, is to maintain your continued subscription, mailed personally to you.

In the Nov. 8, 1970, issue we initiated a new technique for renewals. A renewal card was bound into each copy, and a special label was supplied that could easily be affixed to the renewal card.

For those of you who missed the card the first time, we have bound another in this issue, just inside the front cover. If you have already responded, of course, your issue will not have the insert,—unless you mailed it to us only recently. Flip back and check to see if there is a renewal card. By using the special label and checking eight answers you can easily renew ELECTRONIC DESIGN for 1971.

Don't become one of the letter writers after the fact, when it becomes more difficult to process your subscription without lost issues or involved correspondence. All subscriptions are being renewed at one time; only during this period will we be asking for your cooperation.

So now it's up to you. Don't let us use another name from our waiting list to replace yours. Take this opportunity to renew your subscription, and be confident that ELECTRONIC DESIGN will be sent to you 26 times a year.

Nancy Merritt

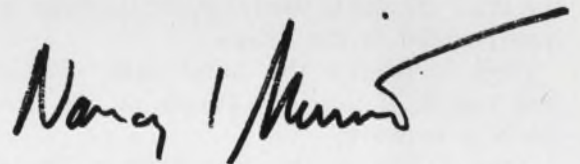
A handwritten signature in black ink that reads "Nancy Merritt". The signature is written in a cursive style with a long, sweeping horizontal line extending to the right from the end of the name.

Good microstrip multipliers don't just happen. A solid step-by-step design approach is needed, and early testing of the subcircuits is advised.

Second of two articles

Designing microstrip frequency multipliers isn't easy. All multipliers, of course, are grossly nonlinear, making their analysis difficult. And the varactor is a two-terminal device, which means that the input and output circuits of varactor multipliers will tend to interact.

These two problems are common to all varactor multipliers. And when the difficulties of designing in microstrip are added to them, the task can become overwhelming if it is not attacked in a methodical fashion. The following 10-step design procedure has been found to be an effective aid:

Step 1. Calculate the diode parameters demanded by the application.

Step 2. Select a varactor diode from Step 1. This selection involves a decision about the use of a packaged device or an unmounted chip.

Step 3. Calculate the circuit parameters for the specified diode, drive level and frequencies.

(Burckhardt¹ provides an excellent discussion of the calculation of circuit parameters.)

Step 4. Decide whether or not to include an idler in the multiplier.

Step 5. Recalculate the circuit parameters with the idler (if one is used) unless the idler is to be incorporated in the filters.

Step 6. Design the input filter. Breadboard and test it, if possible. Decide on the design of the bias network.

Step 7. Design the output filter. Breadboard and test it, if possible.

Step 8. Breadboard and test a scaled-up version of the complete multiplier by building it on a thin piece of material with a low dielectric constant. Teflon fiberglass 1/32 inch thick is a good choice.

Step 9. Transpose the design to microstrip.

Step 10. Build and test the microstrip multiplier.

To get a feel for some of the practical problems that come up in the design of multipliers, let's go over the design of an actual doubler to 4 GHz.

The chief goals are to minimize the size of the doubler, to be able to handle 2 W of input power at 2 GHz and to have a bandwidth of 1 to 2%.

Because of the power requirement, a shunt-mounted Motorola type 1N5154 is selected. To maximize the power-handling capability of the chip, a hole is made in the substrate material and the diode is mounted directly onto a copper base plate.

From the manufacturer's data sheet, the diode's circuit parameters are calculated to be:

$$R_{in} = 10 \Omega$$

$$C_{in} = 3.4 \text{ pF} (= -j23.4 \Omega \text{ at } 2 \text{ GHz})$$

$$R_{out} = 19 \Omega$$

$$C_{out} = 3.4 \text{ pF} (= -j11.7 \Omega \text{ at } 4 \text{ GHz})$$

$$\text{Diode efficiency} = 60\%$$

Alumina ($\epsilon_r = 9.5$) is used as the substrate material, because of its low cost and ready availability. A standard thickness of alumina blanks is 0.025 inch; it will be used in the design.

As the multiplier is only a doubler, there is no need for an idler circuit. These circuits are needed only in higher-order multipliers to deal with the undesired harmonics. (For example, a tripler with an input frequency of f_0 and an output frequency of $3f_0$, may exhibit enhanced efficiency if an idler at $2f_0$ is included in its design.)

Use resonant-line filters

Since the design goals require only a 1 to 2% bandwidth, resonant-line filters can be used on both the input and output. This type of filter consists of a quarter-wave open-circuited shunt stub located a quarter-wavelength away from the diode. The filter blocks the frequency at which the quarter-wave relationships hold. Since only the lengths of the quarter-wave sections are specified for frequency separation, the impedances can be adjusted to match the diode.

In choosing the impedances, care must be exercised to ensure that the resulting line widths are physically practical. That is, a thick-film process may give repeatable results only with line widths of 0.005 inch or greater. For a given substrate material and thickness, this sets an upper limit on

Bob Weirather, Microwave Engineer, Motorola, Government Electronics Div., 8201 E. McDowell Rd., Scottsdale, Ariz. 85252.

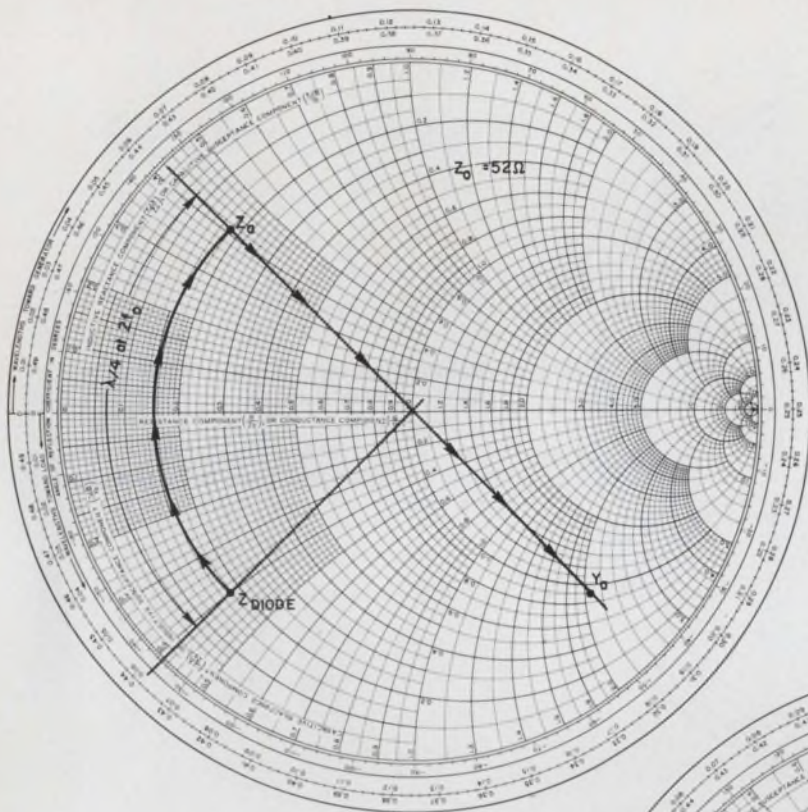

1. Z_{diode} is rotated an eighth of a wavelength at f_0 by the line connecting the input filter to the diode. This transforms it into Z_{in} , or, equivalently, to Y_{a} which turns out to be 50Ω in parallel with an inductance.

2. A $29\text{-}\Omega$ line is used at the output to match the diode to 50Ω . The line is extended beyond the quarter-wave point (at $2f_0$) to add some inductive reactance, which cancels the diode series capacitive reactance.

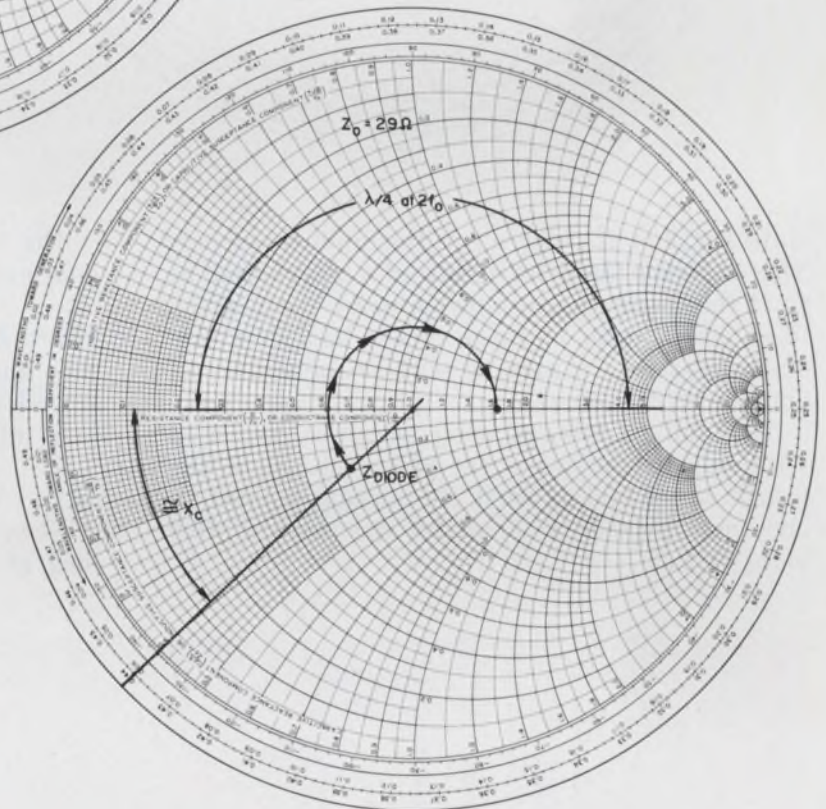

Z_0 . Similarly, the lower limit on Z_n is set by the difficulty in connecting low- Z_n (wide) and high- Z_0 (narrow) lines.

An important factor in these calculations is the lead inductance from the microstrip to the chip. The wire bond (0.1 inch) has been calculated to have an inductance of approximately 0.2 nH.

Since the diode impedances are now known, let's match it to the 50-ohm source and load. Assuming no interaction between input and output, the diode chip impedances with lead inductance are:

$$Z_{\text{in}} = 10 - j23.4 + j2.5 \Omega \\ = 10 - j20.9 \Omega$$

and

$$Z_{\text{out}} = 19 - j11.7 + j5.0 \Omega \\ = 19 - j6.7 \Omega.$$

Smith charts ease the job

If the diode input impedance is normalized to 52 ohms, it becomes $Z_{\text{in norm}} = 0.192 - j0.402$. To design the input filter, this impedance is plotted on a Smith chart (Fig. 1) and rotated a quarter-

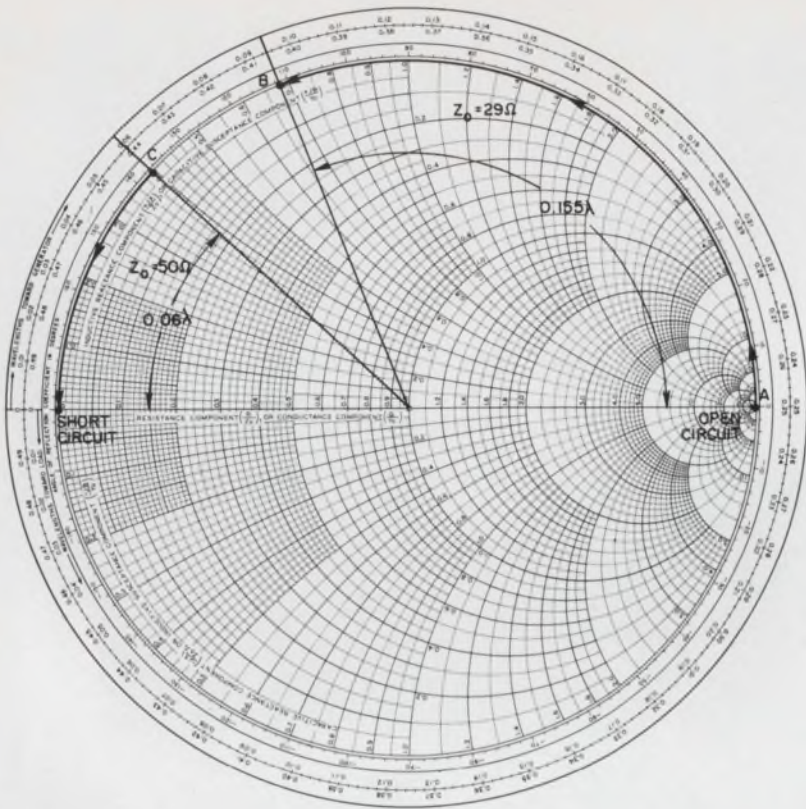

3. Rotating an open circuit, Point A, by 0.155λ converts it to $j20\ \Omega$, Point B, on a $29\text{-}\Omega$ line. On a $50\text{-}\Omega$ line, $j20\ \Omega$ is at Point C so that only 0.06λ of additional rotation is needed to transform the open into a short.

wavelength at $2f_0$, where f_0 is the input frequency. This corresponds to an eighth of a wavelength at f_0 . If the transformed impedance, Z_n , is converted to an admittance, Y_n , it appears to be a shunt 50-ohm resistance in parallel with an inductive reactance of 25.6 ohms.

To eliminate this reactance, it can be resonated with the quarter-wave (at $2f_0$) stub. Since the length of the stub is fixed, its impedance must be chosen to provide a capacitive reactance of 25.6 ohms at f_0 .

The impedance of an open stub less than a quarter-wave long is given by

$$Z = -jZ_0 \cot(2\pi\ell/\lambda) \quad (1)$$

where Z_0 is the characteristic impedance of the stub and ℓ is its length.² The stub is a quarter-wave long at $2f_0$; therefore, at f_0 , $\ell = \lambda/8$. Plugging into Eq. 1 yields

$$Z = -jZ_0 \cot(\pi/4)$$

or $Z_0 = Z \tan \pi/4 = Z = 25.6\ \Omega$.

Now, if desired, a stub that is a quarter-wave long at $3f_0$ may be added at the same point to

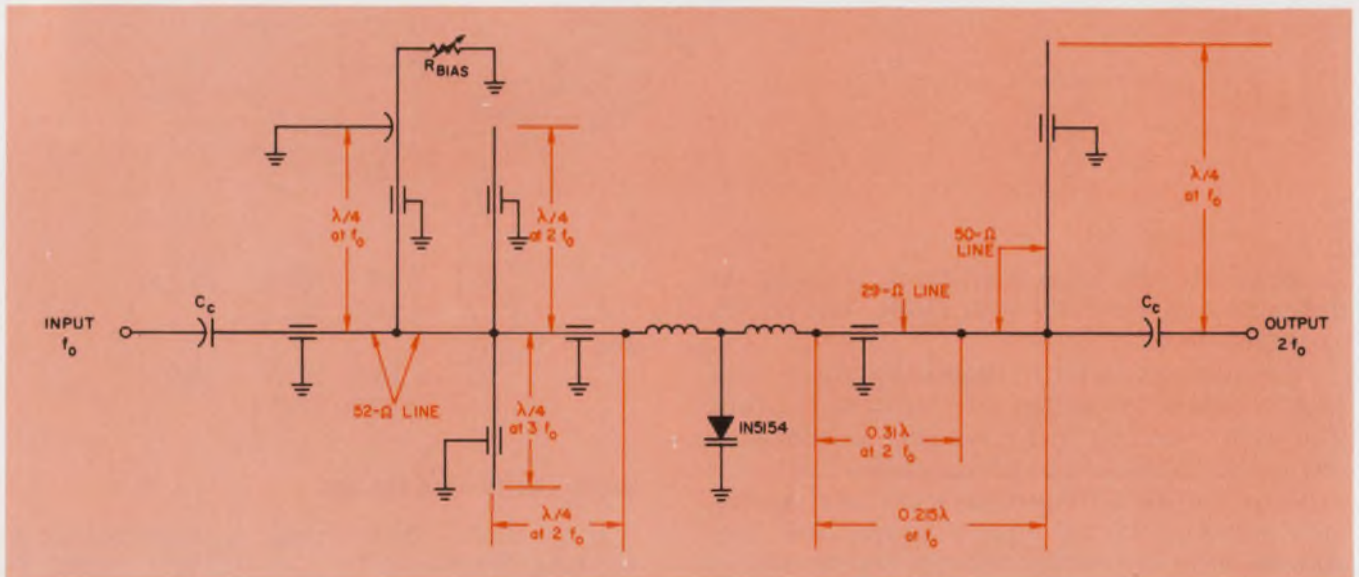

4. The bias is introduced before the input filter to avoid the formation of a low-frequency idler. Note that this com-

plete doubler design includes a stub to block the third harmonic at the input.

block the third harmonic. If this stub is added, a new calculation of impedances for both stubs will have to be performed.

For the output filter, a slightly different approach is used. The same idea of putting a quarter-wave stub a quarter-wave away from the diode is used to block the input frequency, f_0 . But instead of using a 50-ohm line between the diode and the stub, and adjusting the stub impedance to match the diode (at $2f_0$), a line will be selected with an impedance that is the geometric mean between the output resistance of the diode and the desired impedance (50 ohms). If the diode's output impedance (at $2f_0$) were a pure resistance, then the geometric-mean matching section would be a quarter-wave long at $2f_0$. However, the diode has a series capacitive reactance, making it necessary to increase the length of the matching section.

To find out how long to make the matching section, we again turn to the Smith chart (Fig. 2). The geometric mean between 19 and 50 ohms is 31 ohms. Using the chart and a normalizing impedance of 31 ohms, it becomes evident that the match cannot be made simply with one length of line. However, switching from 31 to 29 ohms makes the job quite simple.

The normalized diode output impedance is $0.66 - j0.23$ ohms, which when rotated by 0.31λ , matches the diode to 50 ohms at $2f_0$. The quarter-wave (at f_0) stub spaced approximately a quarter-wave (at f_0) from the diode does not affect the match at $2f_0$ because it looks like an open circuit at that frequency.

The quarter-wave (at f_0) stub is not placed exactly a quarter wavelength from the diode because the output line is not uniform. The line has a 29-ohm section that is 0.155λ long (0.31λ at $2f_0$ equals 0.155λ at f_0) and the remainder has a characteristic impedance of 50 ohms. To see where to place the stub, we recall that we want it to look like an open circuit at the diode.

Rotating an open circuit by 0.155λ transforms it to $29 \times j0.69 = j20$ ohms on a 29-ohm line (Point B in Fig. 3). Switching from a 29-ohm line to a 50-ohm line moves the impedance from B to C, which means that only 0.06λ of additional rotation is needed to transform the open circuit into a short circuit. Hence, the $\lambda/4$ stub should be located $0.155\lambda + 0.06\lambda = 0.215\lambda$ from the diode.

Note that no filter is needed to block the third harmonic, because the quarter-wave stub at f_0 blocks all of the old harmonics.

Self-bias is used

The varactor is biased by adding a resistor between the input and ground (Fig. 4). When the input drive signal goes negative, the resistor

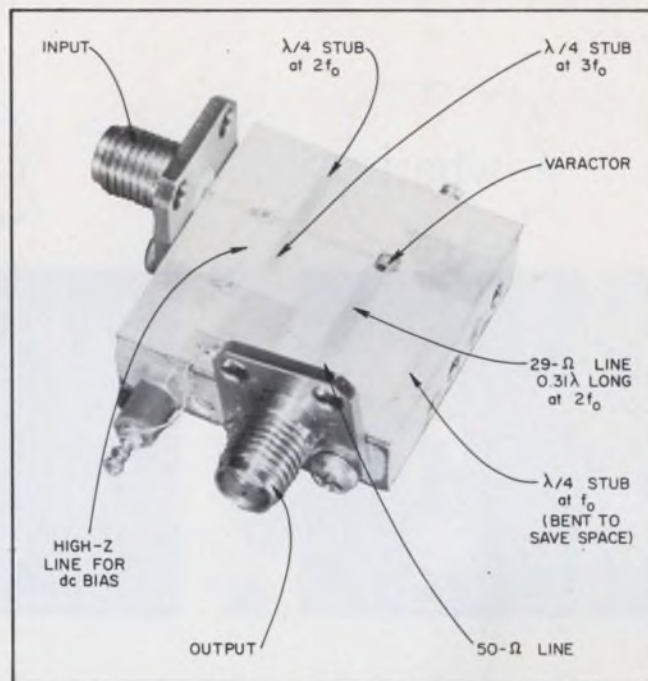

5. The complete doubler is only 1 inch square. It can provide an output of 1 W at 4 GHz with an efficiency of 45%. The unit has a maximum VSWR of 1.5 : 1 and a 1-dB bandwidth in excess of 5%.

provides a path through which the input coupling capacitor, C_c , charges up to a negative potential. The bias resistor is variable, to allow adjustment of the bias voltage with changes in input drive level.

As suggested in the first article in this series, the bias is applied through the input filter through a quarter-wavelength capacitively shorted line. This lowers the probability that the bias circuit will cause problems by creating a low-frequency idler. An even better technique is to use a resistor instead of a quarter-wavelength shorted line; this is more effective at suppressing idlers over a wide bandwidth.

The doubler of Fig. 4 was actually constructed on a 1-inch \times 1-inch alumina substrate (Fig. 5), and driven to a power output of 1 W. The doubler had an over-all efficiency of 45%, a maximum VSWR of 1.5, and a 1-dB bandwidth in excess of 5%.

The difference between the calculated diode efficiency (60%) and the measured over-all efficiency (45%) was caused by losses in the input and output circuits.

Note that the resonant line filter used at the output has been bent to save space—a good technique to use when small size is important. ■■

References

1. Burckhardt, C. B., "Analysis of Varactor Frequency Multipliers for Arbitrary Capacitance Variation and Drive Level," *Bell System Technical Journal*, April, 1965, pp. 675-692.
2. Klein, Carl F., "Designing with Microstrip is Easy," *Electronic Design*, Jan. 4, 1970, p. 101.

what!



really!



yes, mag
tape
terminals



TELETYPE?

It's true.

After helping a jillion feet of paper tape wind and unwind its way through communications systems everywhere, Teletype announces the addition of magnetic tape data terminals.

There are some basic advantages in both mediums. But as you are well aware, the medium that's right for a system depends a lot on the application criteria.

The new magnetic tape data terminals have many operational features that make life less complicated for the operator.



New, modular line of Teletype® 4210 magnetic tape data terminals.

For example, take a look at the tape cartridge, which was specifically designed for reliability required for data transmission.

Its vital statistics are: 3" x 3" x 1".

It contains 100 feet of 1/2" precision magnetic tape.

It will hold 150,000 characters of data, recorded at a density of 125 characters per inch. The equivalent of a 1000 foot roll of paper tape.

This means that your data is easier to store, easier to handle, easier to work with than ever before. And it's reusable.

DATA COMMUNICATIONS

equipment for on-line, real-time processing

The units have a "fast access" switch which will move tape forward or reverse at a speed of 33 inches per second. A digit counter provides a reference point to help locate various areas of the tape.

Four ASCII control code characters can be recorded in the data format to aid character search operations. When the terminal's "search" button is pressed, tape moves at the rate of 400 characters per second

Also magnetic tape adds high speed on-line capability to low speed data terminals.

You can zip data along the line at up to 2400 words per minute. For example: Take a standard speed Teletype keyboard send-receive set, and a typical typist. Add a new magnetic tape unit to this combination and the on-line time savings can pay for the magnetic tape terminal in short order.

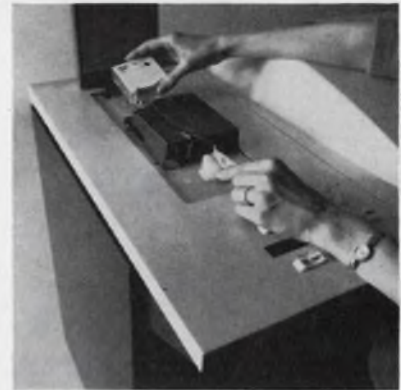

Straight-through threading makes tape loading and unloading exceptionally easy.

They can send or receive at high or low speed. Or can be used independently as stand-alone terminals on-line.

If you would like to know more about this new line of Teletype magnetic tape data terminals, please write Teletype Corporation, Dept. 89-15, 5555 Touhy Avenue, Skokie, Illinois 60076.



until the control code selected is detected. Then the terminal stops the tape automatically.

A "single step" switch is also provided which enables you to move the tape forward or backward one character at a time. In editing or correcting tape, you can send a single character using this feature.

You can take better advantage of voice grade line speed capabilities.

An operator can prepare data for magnetic tape transmission using the keyboard terminal in local mode. Then send it on-line via the magnetic tape terminal up to 2400 words per minute.

These new modular magnetic tape data terminals offered by Teletype are perfectly compatible with model 33, model 35, model 37 and Inktronic® keyboard send-receive equipment.



Teletype 4210 magnetic tape data terminal with 37 keyboard send-receive set.

machines that make data move



INFORMATION RETRIEVAL NUMBER 24

Divide frequencies by any integer.

Use a common-gate TTL or RTL ripple counter and save on components while preserving flexibility.

The division of clock frequencies by any integral divisor can be accomplished by selectively controlling the input signals to a common pulse-gated ripple counter. The number of components is reduced in comparison to other methods of frequency division because only one monostable-gate generator is needed. This advantage is most apparent for large input/output frequency ratios that would otherwise require many external gates.

Either TTL or RTL logic can be used for the circuit, and the method is easily adaptable to MSI or conventional manufacturing. For example, 10 flip-flops and four dual gates, either deposited on one MSI chip or assembled from ICs onto a circuit card, can provide a low-cost, adjustable divider to cover the entire audio range from one clock frequency.

Timing determines the divisor

The basic operating principle of the divider is the control of gating of flip-flops in a ripple counter.

Counts that are powers of two are obtained directly without any external gating. A two-stage counter divides by four; a three-stage by eight; an n -stage by 2^n . When a four-stage counter is used, for example, every 16th clock pulse causes one output pulse to appear.

Now, if the first flip-flop stage of the counter does not respond to one clock pulse in 16, it will take 17 clock pulses for the output flip-flop to flip. If two clock impulses in 16 are inhibited in the first flip-flop, 18 clock pulses will be required to make the fourth flip-flop respond. In the first case, the clock frequency, f_{cl} , is divided by 17; in the second case it is divided by 18.

Let f_o be the output frequency, n be the number of flip-flop stages in the counter and M be the number of clock pulses inhibited. Then

$$f_o = f_{cl} / (2^n + M) \text{ or } f_{cl} / f_o = 2^n + M$$

How are the clock pulses inhibited at the first

flip-flop? If each output pulse from the last flip-flop enables a monostable-gate-pulse generator, the monostable output can be applied to the inhibit input of the first flip-flop. By adjusting the length of the monostable pulse, the first flip-flop can be made to ignore one, two or more clock pulses each time the output stage goes high.

The circuit using TTL flip-flops that performs in this way is shown in Fig. 1. The duration of the inhibiting monostable-gate pulse is determined by the value of C in Fig. 1. The resistance of the RC network is the output of the NAND gate, typically 1 k Ω . If C is made variable, the duration of the inhibit period is also variable, and the value of M is adjustable.

The frequency ratio of a counter can be made to be less than 2^n by using a slightly different technique. In this case, the ratio is $2^n - M$, and M extra pulses must be inserted to make the first flip-flop "think" that more, rather than fewer, clock pulses have appeared. Using a four-stage counter as an example, an extra pulse at the first flip-flop, triggered by the output pulse, results in an output response for only 15 clock pulses—or division by 15.

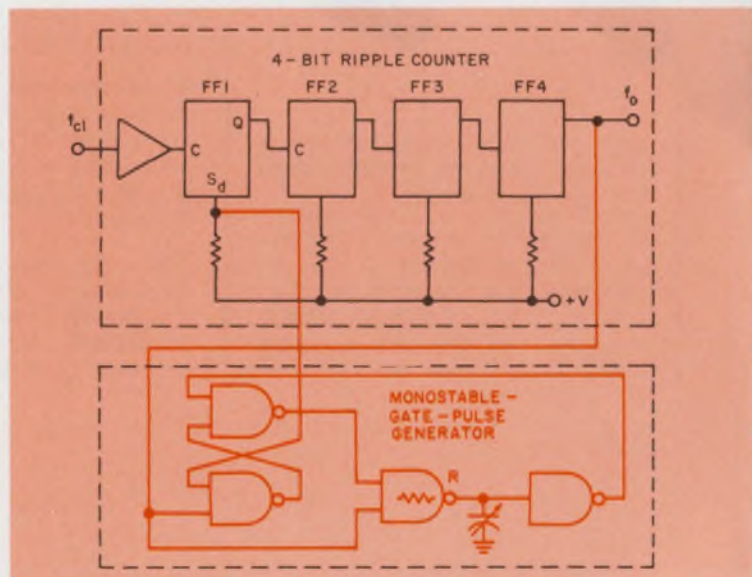

1. The division ratio of a four-bit ripple counter will increase to more than 1/16 if a variable width inhibit pulse (controlled by RC) is applied.

Ralph W. Burhans, Research Engineer, Dept. of Electrical Engineering, Ohio University, Athens, Ohio 45701 and Richard K. Blake, Engineer, North Electric Co., Galion, Ohio 44833.

However, a difficulty arises in this approach: making M greater than one is impractical because there is not enough time between clock pulses to insert more than one extra pulse at the first flip-flop stage.

The solution to the problem is to use only one short pulse, but to insert it at different stages. As previously described, one extra pulse at the first stage ($M=1$) reduces the frequency division ratio, f_{c1}/f_o by one. If the extra pulse is inserted only at the second stage, the ratio would be reduced by two ($M=2$). If inserted at both the first and second stages, the ratio is reduced by one plus two ($M=3$). Thus M can be made to have any negative value up to 2^n by inserting the extra pulse at the proper stage or stages. Note that the extra pulse must occur between clock pulses.

In order to generate the additional gating pulse, a monostable-gate-pulse generator is again used. However, the pulse generated need not be adjustable in duration, and it must be shorter than a clock pulse.

A convenient means of directing the monostable pulse to the proper flip-flop stage is to use an octal switch (see box). A nine-stage divider using octal switches is shown in Fig. 2. This circuit, with RTL flip-flops, can divide the clock frequency by any integer from one to 512 by proper setting of the octal switches.

The stability of the circuit is primarily dependent on the RC-time constant of the monostable-gate generator. This stability can be very good in circuits with negative values of M , because fixed values of R and C are used. The stability is not as good in circuits with positive M , particularly as M becomes larger, because adjustable values of C are used. ■■

What is an octal switch?

An octal-coded switch is a three-gang selector switch with two, four and eight segments on each gang as shown in the diagram. Its output, at the terminals labeled 1, 2 and 4, constitutes a single parallel octal word or byte.

If this switch is to be used in a frequency divider in a subtract mode, the input terminal is connected to the gate pulse generator output, and the terminals 1, 2 and 4 are connected to the corresponding C_d or S_d terminals of the ripple counter. This first word or 8^0 switch is used with the first three stages of the counter. A second word or 8^1 switch would be used with the 8, 16 and 32 stages, and so on.

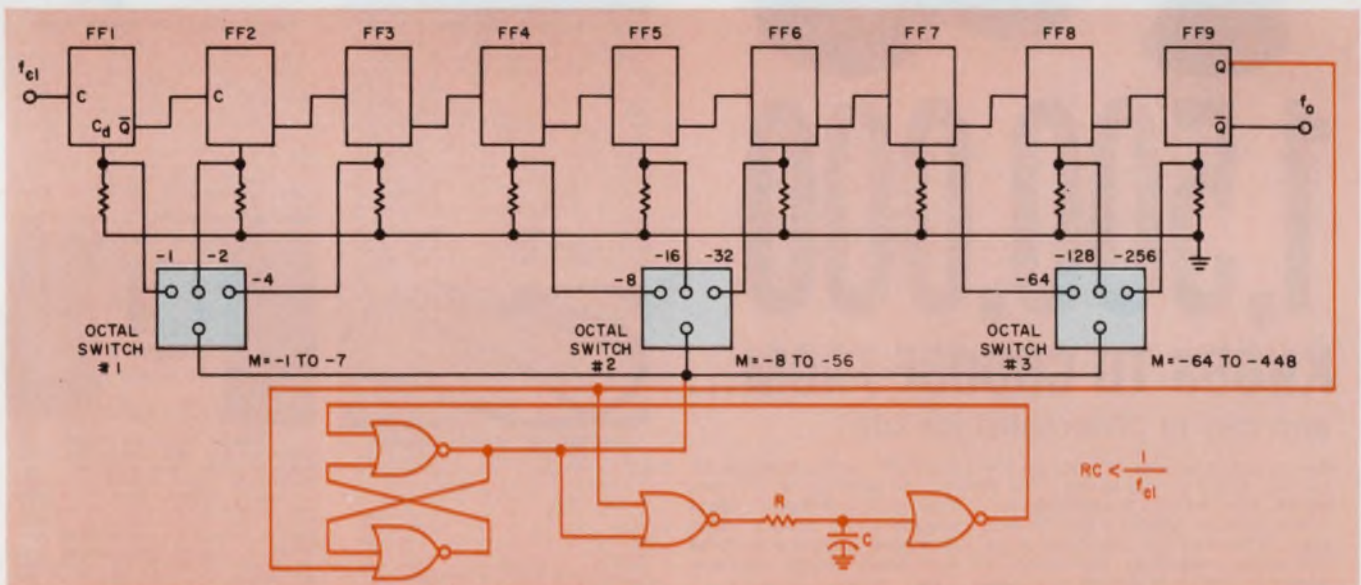
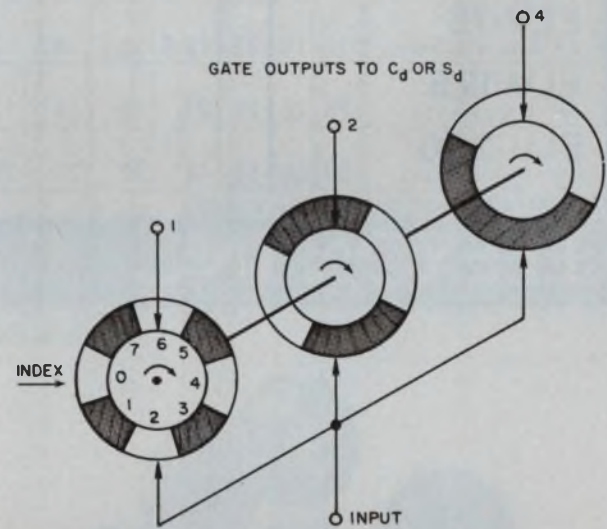

2. An RTL ripple counter with nine stages is similar in operation to the TTL circuit of Fig. 1. By selectively connecting the gate pulse to the C_d inputs through three

octal switches, division ratios from one to 512 can easily be chosen by setting the switches to the appropriate values. Adjustable pulse widths are not required.

ELEXON BLUE RIBBON POWER SUPPLIES

- INPUT: 120 or 240 VAC ± 10% 47-420 Hz
- REGULATION: .1%, RIPPLE & NOISE .1%



VOLTAGES IN BOLD AVAILABLE OFF THE SHELF FROM ...

NEWARK
ELECTRONICS CORPORATION

MODEL NO. & SIZE	VOLTAGE																LIST PRICE
	3	4	5	6	8	9	10	12	14	15	16	18	20	22	24		
	AMPS																
ELV-25 4Hx5-1/2Wx6-1/2L	5	5	5	4.2	3.2	2.8	2.6	3	2.6	2.4	2.2	2	1.8	1.6	1.5	66.00	
ELV-75 5-1/8Hx5-3/4Wx8L	15	15	15	12.6	9.6	8.4	7.8	7	6.1	5.8	5.5	5	4.6	4.3	4	90.00	
ELV-125 6Hx6-1/2Wx11L	25	25	25	21	16	14	13	12	10.3	9.6	9	8	7.2	6.5	6	148.00	
ELV-250 6Hx10-1/2Wx11L	50	50	50	42	32	28	25	20	18	17	16	14	12.5	11.4	10.4	190.00	

OVERVOLTAGE CROWBAR - \$10.00

ELEXON INC.

1422 E. ST. GERTRUDE • SANTA ANA, CALIFORNIA • 92605
CALL (714) 540-9510

INFORMATION RETRIEVAL NUMBER 25



1,500,000

KNOBS TO CHOOSE FROM...

and they're "Warranted for Life"

Kurz-Kasch has over 1 1/2 million low cost, high quality knobs in inventory, ready to ship to you. (You save . . . no tooling cost on stock knobs, specials 4 to 6 weeks delivery.) Your local distributor's stock is available at factory prices. Select instrument and control knobs from 24 families with 367 basic sizes and shapes in general purpose phenolics, melamines and ureas. All Kurz-Kasch knobs are warranted for the life of the product on which they're used. Send now for free 20 page catalog. (Also found in THOMAS REGISTER "THOMCAT."®)



Kurz-Kasch, Inc.

1421 S. Broadway
Dayton, Ohio 45401
513/223-8161

INFORMATION RETRIEVAL NUMBER 26

UNUSUAL BARGAINS

... MANY U. S. GOV'T SURPLUS

FREE!
GIANT
CATALOG



NEW LOW-COST ULTRASONIC CLEANER
Now a top quality unit for only 49.95. Cleans dirt, grime completely, quickly, safely. Small delicate parts, precision electronic items, lab instruments, jewelry, coins, even dentures sparkle like new. 1/3rd pint capacity. Operates on regular house current. Precision American-made. Full 1 year guarantee. Solid state generator with automatic turn-off to prevent overheating. Power control regulating knob. Grounded to prevent shock. No radio interference. 8" x 4" x 4" stainless steel and metal cabinet.
Stock No. 71,003DA \$49.95 Ppd.
LARGE INDUSTRIAL 1/2 GAL. SIZE
No. 85,128DA (Wt. 37 lbs.) \$259.95 FOB



ERECT IMAGE LOW POWER SCOPE
\$80 Value—only \$39.95. Direct measuring. 6X, 10X & 20X. Extremely sturdy with dual-knob rack and pinton focusing, color corrected optics, turnable body for inclined viewing. Base 6X scope includes achromatic objective, wide field eyepiece w/light shield. Mounted accessory lenses for 10X & 20X slip over objective. Has 4" scale with .005" graduations for 10X use; .2" scale w/.0025" for 20X. 8" high vertical pillar—goes up 8" & locks. Wt. 4 lbs.
Stock No. 70,266DA \$39.95 Ppd.



DIAGNOSE MECHANICAL TROUBLE
Professional Stethoscope. Designed for use by physicians. This super-sensitive Stethoscope is ideally suited for detecting faults in machines and engines, and in fluid, air and gas leakage. Tens of uses in auto repair shops, labs and for hobby and educational applications.
Stock No. 50,270DA \$7.90 Ppd.
BARGAIN PRICE STETHOSCOPE
Stock No. 50,223DA \$3.25 Ppd.



GIANT FREE CATALOG
Completely new 1971 edition—148 pages. Bargains galore! New categories, items, illustrations. 1,000's of buys for industry — Optics, Science, Math. On-the-job helps, quality control aids. Optics for research labs, design engineers experimenters. Instruments for checking, measuring . . . to speed work, improve quality, cut costs. Huge selection of telescopes, microscopes, and other hard-to-get war surplus bargains. Write for Catalog DA.

EDMUND SCIENTIFIC CO. 300 EDSCORP BLDG.
BARRINGTON, NEW JERSEY 08007
ORDER BY STOCK NUMBER · OPEN ACCOUNT TO RATED FIRMS · MONEY-BACK GUARANTEE

INFORMATION RETRIEVAL NUMBER 27

INFORMATION RETRIEVAL NUMBER 28 ▶



**The TAA300 was the world's
best 1 watt audio amplifier
IC when it was introduced
three years ago.**

**To this day there's still
nothing around that
beats it...and it's
under a dollar!**

Last year our TAA300 IC audio amplifier sold for upwards of a dollar; now, production and handling economies have given us a real price breakthrough. For the first time, the TAA300 now sells for \$1.00 each in lots of 10,000 and for as little as 80¢ apiece for 100,000. For mass-produced equipment, the TAA300 is your most economical investment in audio amplification.

High efficiency and low quiescent current make the TAA300 the best choice for battery-powered portable equipment such as phonographs, radios, TV audio systems, walkie-talkie audio and speech amplifiers, cassette tape systems and miniature hi-fi sets.

Here are the important characteristics—in addition to economy—of the TAA300:

- 1 watt audio output, Class B push-pull ■ 10 mV sensitivity, 10 K input impedance
- no output transformer needed ■ operates on any battery supply from 4.5 to 10.5 V
- quiescent current only 8 mA at 9 V ■ typical noise figure less than 6 db from 30 to 30,000 Hz ■ TO-5 10-lead package.

For detailed specifications and application data and for pricing information, write: Amperex Electronic Corporation, Integrated Circuits Division, Cranston, Rhode Island 02920 or phone 401-737-3200.

Amperex®

TOMORROW'S THINKING IN TODAY'S PRODUCTS

A NORTH AMERICAN PHILIPS COMPANY

Selecting preamps for lowest noise

can be difficult if the candidates aren't described the same way. Here's how to make the most commonly needed conversions.

A problem forever confronting the engineer in his quest for improved signal-to-noise (S/N) ratio is that of comparing preamplifiers offered for sale. One manufacturer describes the noise performance of his amplifier by providing a plot of equivalent noise-voltage density (e_n) and equivalent noise-current density (i_n) as functions of frequency. Another prefers to provide a plot of R_e and R_i as functions of frequency, where R_e is the Johnson noise equivalent of the amplifier's input short-circuit noise-voltage generator and R_i is the Johnson noise equivalent of the amplifier's input open-circuit noise-current generator. A third manufacturer provides full noise-figure contours for his amplifier. As a result, the researcher is all too frequently faced with the problem of comparing apples with oranges with pears.

Noise-figure contours are best

It is generally conceded that noise-figure contours are the best means of specifying the noise characteristics of an amplifier. Each contour is the locus of points of constant noise figure on a graph whose ordinate is the source resistance and whose abscissa is the frequency of operation. The complete set of contours (Fig. 1) allows the experimenter to quickly determine how much the amplifier will degrade the input S/N ratio for any specified frequency and source resistance.

And, fortunately, the formulas relating noise figure to R_e and R_i , and e_n and i_n , are simple. Noise-figure contours can easily be generated when the noise data is in terms of R_e and R_i or e_n and i_n . If only a few points are of interest, these same formulas can be used to compute the noise figure at these points, and the evaluation can be quickly completed without plotting the contours.

Assume that a prospective preamplifier buyer is holding two specification sheets—one showing a set of noise-figure contours for amplifier A (Fig. 1), and the other a plot for R_e and R_i as

functions of frequency for amplifier B (Fig. 2). To convert the R_e and R_i curves into NF contours, one can use the formula

$$NF \text{ (dB)} = 10 \log_{10} [1 + (R_e/R_s) + (R_e/R_i)] \quad (1)$$

where R_s is the source resistance from which one intends to operate.

A good way to begin comparing amplifiers is to compute the minimum noise figure, NF_{min} , for a few values of R_e and R_i to see if the two amplifiers are in the same ballpark. NF_{min} is given by

$$NF_{min} \text{ (dB)} = 10 \log_{10} [1 + 2\sqrt{R_e/R_i}] \quad (2)$$

For example, amplifier B will have a minimum noise figure at 10 kHz of approximately 0.03 dB, indicating immediately that the amplifier does indeed have excellent noise performance. By checking a few other points, it becomes clear that amplifier B is quieter than amplifier A. The whole story is told by plotting the noise figure contours for amplifier B and comparing them with those provided for amplifier A.

Plotting the contours

The first step in plotting the contours is to solve Eq. 1 for R_s . The result is

$$R_s = 1/2 [R_i (10^{NF/10} - 1) \pm \sqrt{(R_i - 10^{NF/10}R_i)^2 - 4R_eR_i}] \quad (3)$$

Next, decide on the contours to be plotted. The same contours as are shown for amplifier A are the logical choice. What remains is simply to insert a value of noise figure, along with R_e and R_i at one frequency, into Eq. 3, and solve for the two values of R_s that yield the desired noise figure.

By repeating the process enough times with different values of R_e and R_i , enough values of R_s will soon be accumulated to enable one contour to be plotted. The entire process is then repeated for as many contours as desired. A logical choice of values for R_e and R_i are those at 1-2-5 frequency multiples. These values will result in three sets of values for R_s per frequency decade, with approximately equal spacing between sets when plotted on log/log paper. In general, one should begin with the smallest contour of interest and work outward.

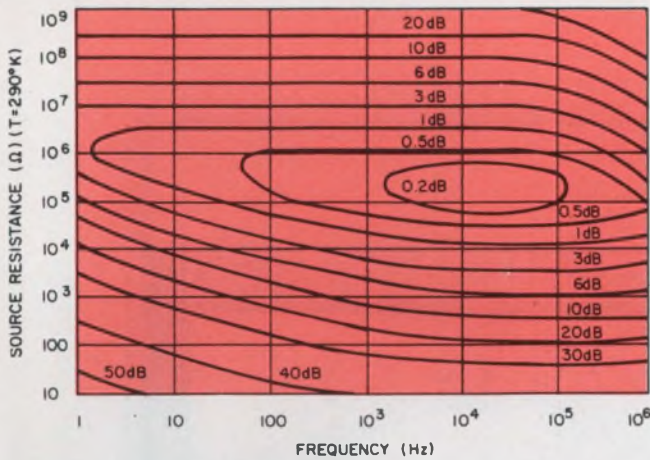

1. Noise figure is a constant for a given contour. Note that the NF is a single-valued function of source resistance and frequency, although there are two values of R_s for each combination of frequency and NF.

Admittedly this is a lot of work, and Eq. 3 gets messy with the values typically taken by R_e and R_i . Fortunately, small, reasonably powerful desktop computers abound that can handle Eq. 3 with ease, particularly if $10^{NF/10}$ is evaluated in advance.

An interesting characteristic of the noise-figure contours is that for a low-noise amplifier having $R_i \gg R_e$, the 3-dB contour contains R_e and R_i to a good approximation, with the upper curve of the contour representing R_i and the lower representing R_e . Over the region where the upper and lower curves are widely separated, the approximation is quite close. At the ends, where the curves converge and close, the approximation is inaccurate.

This closeness of the 3-dB contour to the R_e and R_i curves gives us another method for quickly comparing amplifiers. By estimating R_e and R_i from the 3-dB contour, one obtains noise-performance data for both amplifiers in the same terms. However, it is frequently not obvious from the R_e and R_i plots which of the two amplifiers will be quietest at a particular combination of frequency and source resistance, particularly when the regions bounded by the two sets of R_e and R_i are not centered on the same point. To estimate the relative noise performance at a given point of interest, Eq. 1 must be used.

Converting from e_n and i_n

Except for one additional step—that of converting e_n and i_n to R_e and R_i —the procedure is exactly the same as before. The conversion equations are

$$R_e = e_n^2 / 4kT \quad (4)$$

and

$$R_i = 4kT / i_n^2 \quad (5)$$

where k is Boltzmann's constant, T is the absolute temperature, e_n is the equivalent input noise-

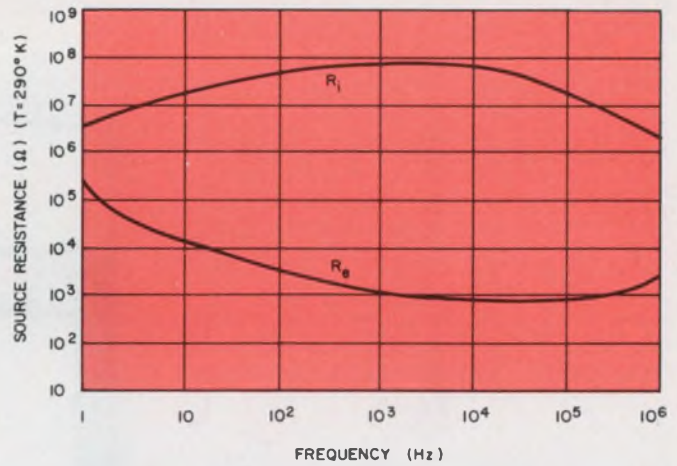

2. A plot of R_e and R_i is roughly equivalent to a 3-dB noise-figure contour in the region where the curves are widely separated. This particular amplifier has a minimum noise figure of 0.03 dB at 10 kHz.

voltage density in $V/\text{Hz}^{1/2}$ and i_n is the equivalent input noise-current density in $A/\text{Hz}^{1/2}$.

For convenience, one should again make the conversions at frequency multiples of 1-2-5 to obtain three approximately equal spaced points per decade on log/log paper. Once the conversions are completed, the values of R_e and R_i can be converted to noise-figure contours as directed earlier.

Another way of comparing amplifiers is to compute the total noise referred to the input (E_{tni}) given any of the three ways of specifying noise performance. This will often prove the quickest and easiest way of estimating the relative noise performance of different amplifiers at the intended operating frequency and source resistance. E_{tni} is expressed as a function of NF and as a function of e_n and i_n in the two formulas that follow:

$$E_{tni} = \sqrt{4kTR_s} \times 10^{NF/20} \quad \text{Vrms}/\text{Hz}^{1/2}, \quad (6)$$

$$E_{tni} = \sqrt{4kTR_s + e_n^2 + (i_n R_s)^2} \quad \text{Vrms}/\text{Hz}^{1/2} \quad (7)$$

Note that Eq. 7 can be used to convert R_e and R_i to E_{tni} by first using Eqs. 4 and 5 to convert R_e and R_i to e_n and i_n . ■■

Test Your Retention

Here are questions based on the main points of this article. Their purpose is to help you make sure you have not overlooked any important ideas. You'll find the answers in the article.

1. Why are noise-figure contours the preferred way of specifying an amplifier's noise figure?

2. Do NF contours contain any information not contained in plots of R_e and R_i or i_n and e_n ?

*If your problem
is in-circuit
testing of
transistorized
and integrated
circuits . . .
Solve it with
Triplett's 601*



Model 601

1. Low power ohms — 7 ranges with 75 mV power source.
2. High sensitivity — 10 mV AC full scale at 10 megohm input impedance; 100 mV DC at 11 megohm input resistance.
3. Simplified scale — only 4 arcs for all 53 ranges.

It has 7 low-power resistance ranges that apply only 75 mV to the device under test . . . does not activate or damage solid-state component . . . full-scale DC measurements down to 100 mV and 10 μ A and AC as low as 10 mV and 10 μ A, it's obvious the Model 601 was designed for in-circuit testing.

Add such features as 10 megohm input impedance on AC

and 11 megohm input resistance on DC, voltage readings to 2% DC and 3% AC (current: 3% DC and 4% AC), separate range-selection and function-selection switches, and a simplified dial on which all 53 ranges are read on only 4 scales, and it's equally obvious that here's a V-O-M that has what you need to do the job better, faster and more easily. See the capable Model 601 —

priced at \$166 — at your local Triplett distributor. For more information, or for a free demonstration, call him or your Triplett sales representative right away. Triplett Corporation, Bluffton, Ohio 45817.

TRIPLETT

The World's most complete line of V-O-M's... choose the one that's just right for you

ideas for design

Stabilize a constant-current supply with an op amp

Constant-current sources usually perform adequately, but they can be subject to errors from several sources. Some of the errors are variations in power-supply level; variations in transistor parameters due to changes in temperature or current; and variations in the reference voltage of a zener diode due to current changes. The constant-current circuit shown in the diagram uses an IC op amp that overcomes all of the errors listed, at the cost of only a few additional components.

If $R_1=R_5$ and $R_4=R_2R_3/(R_2+R_3)$ in the circuit, the output current, I_o , is given by:

$$I_o = R_3 E_r / R_2 R_3$$

This result indicates that the load current is independent of the supply voltage and the load resistance. It depends only on the resistances of three resistors and the reference voltage of a zener diode. In addition, the zener diode is isolated from the load so that its current does not change. Its reference level is thus constant, and

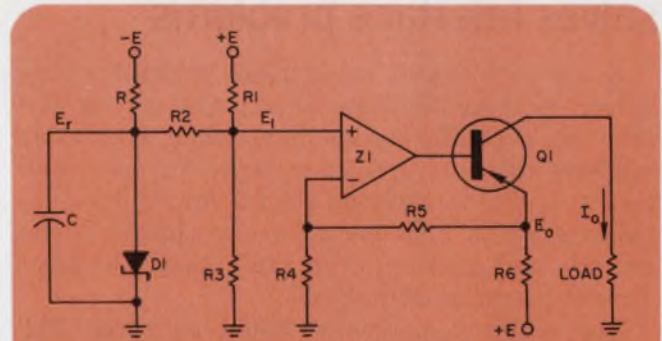

A very accurate, stable constant-current supply makes use of op amp Z_1 . Neither the zener diode, D_1 , nor the amplifier carries any load current. The output transistor, Q_1 , which supplies the load, has its V_{be} within the feedback loop to minimize the effect of this parameter on performance.

as a result I_o is stable.

R. C. Scheerer and J. Logis, Jr., Westinghouse Electric Corp., Aerospace and Electronic Systems Div., Baltimore, Md.

VOTE FOR 311

Voltage-to-frequency converter provides linearity of 0.4%

A simple low-cost circuit can be used as either a sawtooth generator or as a voltage-to-frequency converter with a system linearity of better than 0.4% over a two-decade frequency range. The temperature stability of the circuit is almost exactly that of the unijunction used.

Due to the negative input voltage V_i , the current through R_1 must be equal to the current in the feedback capacitor C . This assumes that the amplifier (Fairchild's $\mu A741$) has sufficient gain to make its input current negligible.

For a constant V_i , the voltage at point A increases linearly with a slope of V_i/R_1C volts per second. R_3 is chosen so that its current is always greater than the current through R_1 . Excess current, therefore, flows to the amplifier through D_2 . When point A reaches the triggering potential of the unijunction, point A is shorted to ground via R_4 , and C discharges through D_1 .

During this discharge period, the output of the amplifier will reach its positive saturation potential. After the rapid discharge of C , the cycle is

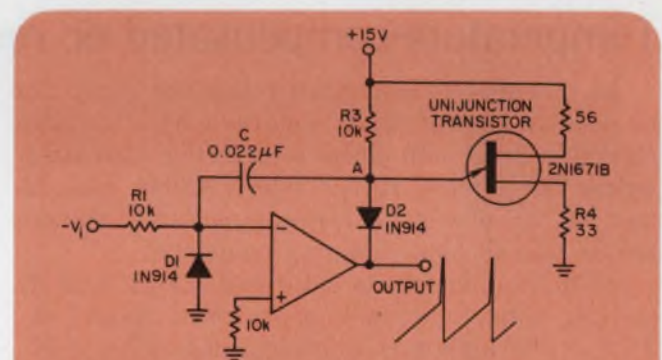

A voltage-to-frequency converter with 0.4% linearity can also operate as a sawtooth generator. This uncomplicated inexpensive circuit provides good temperature stability, too.

repeated. For frequencies greater than a few kilohertz, it is better to use an amplifier with a higher slew rate, like Fairchild's $\mu A709$.

G. Pranzo Zaccaria, Engineer of European Space Research and Technology Centre, 40 Estec, Noordwijk, Holland.

VOTE FOR 312

Inexpensive isolator circuit solves interface problems

A low-cost circuit can replace expensive line-driver/receiver elements at a parts cost of less than \$5 per information line, while alleviating cumbersome intersystem wiring. It can solve problems like interfacing digital information between systems that operate from isolated power sources, and interfacing in the presence of large ground potential differences.

The major components would be three DIP quad transformers (Pulse Engineering) and two hex inverters (Signetics' 8H90). To make full use of all device packages, 12 stages represent the least common denominator.

Data transitions differentiated by R_1 and C_1 commence transformer action, which is sustained by positive feedback through A_1 and A_2 , the active pull-up inverters. As the transformer approaches and finally reaches saturation, the positive feedback is maintained through the low dc resistance of its secondary. Resistor R_2 is necessary as a current path for the transformer, since A_1 is a TTL element and cannot sink current flowing out of the transformer secondary during

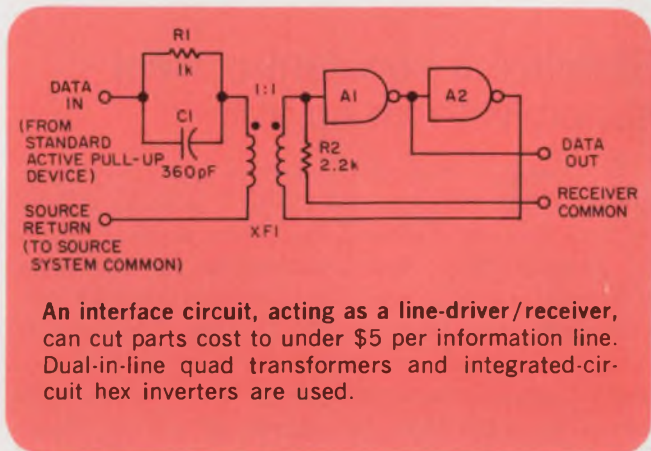

An interface circuit, acting as a line-driver/receiver, can cut parts cost to under \$5 per information line. Dual-in-line quad transformers and integrated-circuit hex inverters are used.

positive half cycles.

This circuit has been operated with $\pm 20\%$ supply voltage variations over a range of -55 to $+85^\circ\text{C}$. Performance speed can vary from 1 to 5×10^6 pulses per second. Propagation delay is less than 50 ns.

Bud Norris, Design Engineer, Leach Corp., Controls Div., P. O. Box 820, 1499 Huntington Dr., South Pasadena, Calif. 91030.

VOTE FOR 313

Temperature-compensated dc restorer offers variable clamping

An inexpensive monolithic transistor array can be used as a low-drift dc restorer with a variable clamping level and good interfacing characteristics. The circuit, RCA's type CA3018, uses Q_1 and Q_2 as a temperature-compensated voltage source and Q_3 as a clamping transistor.

With no input, Q_3 is saturated via R_1 and its emitter potential closely approaches that of Q_1 . This is the high-output state, whose level is determined by the emitter of diode-connected Q_2 .

When a signal is applied, Q_3 's base-collector junction rectifies positive signal peaks, while the base of Q_3 is clamped one diode drop more positive than Q_1 's emitter. Since Q_3 is saturated, its two junction drops cancel, and the positive signal peak is referenced to Q_1 's emitter.

During the negative portion of the input, Q_3 comes out of saturation and passes the signal as a normal emitter-follower. Q_1 can be used as an additional emitter-follower as shown.

Walter Jung, Senior Engineer, Control Concepts Corp., Rockville, Md.

VOTE FOR 314

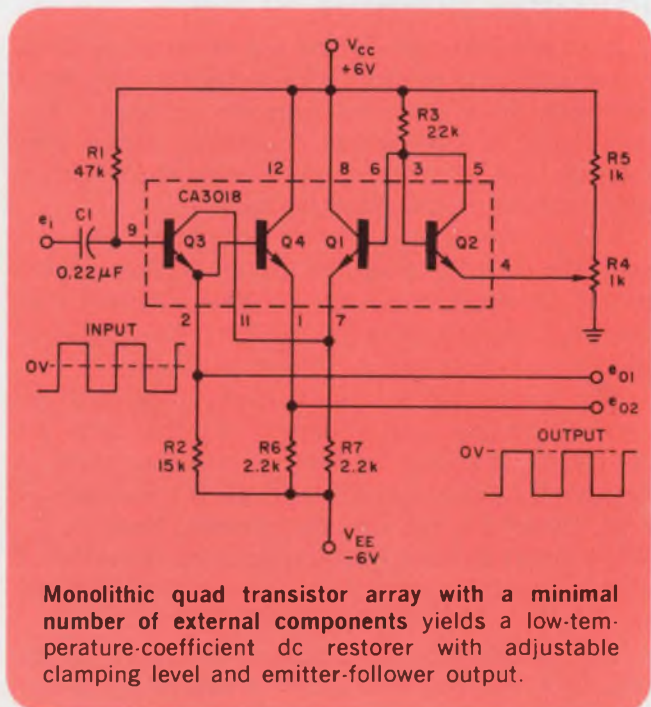

Monolithic quad transistor array with a minimal number of external components yields a low-temperature-coefficient dc restorer with adjustable clamping level and emitter-follower output.

new products

DPM uses LED display and custom parts for reliability

Hewlett-Packard Co., Loveland Instrument Div., P. O. Box 301, Loveland, Colo. Phone: (303) 667-5000. P&A: \$225 in quantity; stock by May.

Using light-emitting diodes in a 4 by 7-dot matrix to display 0 to 1,000 V, the model 3431A digital panel meter with custom components for increased reliability dissipates only 5 W of power and measures 1.7-in. high by 3.5-in. wide and just 2.9-in. deep.

This single-range 11-oz DPM features an accuracy of $\pm 0.1\%$ of reading ± 1 digit and includes 100% overranging capability with the last three displayed digits blanking for overload measurements.

The 3431A is characterized by many distinctive features such as full-scale and 10% of full-scale auto-ranging flags, a 55-ms response time from zero to full scale and programmable sampling rate of 0, 1, 2, 4, 8 and 15 readings/s.

Other features include automatic and manual polarity and remote polarity selection. Hold, read, trigger and decimal locating functions are all also remotely controlled.

An integral power supply can be operated from either 115 V ac over 50 to 400 Hz or optionally from a

5 to 15-V-dc source for portable applications.

Other characteristics include an input impedance of 10 M Ω , low bias current of 30 nA and BCD output (serial-digit parallel-bit). Common-mode rejection ratio is 80 dB and the operating temperature range is from 0 to 60°C

A host of options are available with the 3431A DPM. These include 1 to 3 remotely controlled LED annunciators and remote display for panel-space miniaturization applications.

Other options include full-scale voltage ranges of 10.00 and 100.0 V and the isolation of digital and analog grounds by 500 V.

Later models will have additional options, including parallel-character BCD output for printers and data loggers, a 230-V ac power supply, and other dc power supplies.

By designing the 3431A with custom IC components total parts count is significantly reduced, thereby enhancing reliability. The meter's metal front panel pops out to unveil the mounting hardware and service adjustments. The thin panel also allows the user to easily paint or silk-screen the panel to his own taste.

CIRCLE NO. 250

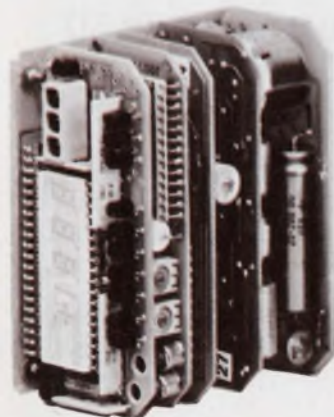

Plug-in display together with plug-in PC boards (left) simplify servicing in the new 3-1/2 digit LED DPM (right).



31-range multimeter retails at only \$89

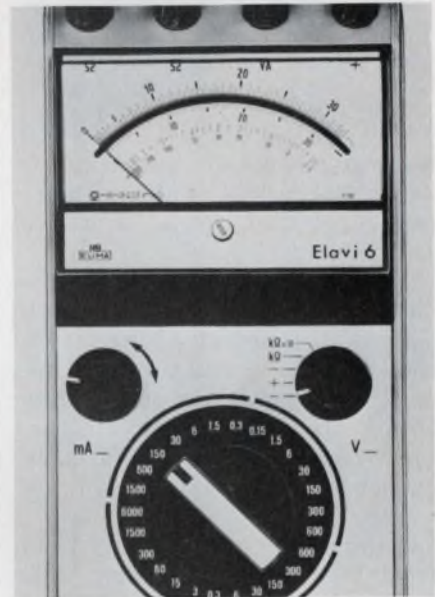

Epic, Inc., 150 Nassau St., New York, N.Y. Phone: (212) 349-2470. Price: \$89.

The Elavi 6 is a low-cost portable multimeter housing 31 measurement ranges for only \$89. It checks 150 mV to 600 V dc at 1.5% accuracy, 6 to 600 V ac at 2.5% accuracy and resistance in two ranges of 1 and 10 M Ω . It also measures dc current from 0.3 to 1500 mA and ac current from 0.3 to 6000 mA. Internal resistance is 33 k Ω /V and 10 k Ω /V for dc and ac, respectively.

CIRCLE NO. 251

Counter for \$625 reads out to 50 MHz

General Radio Co., 300 Baker Ave., West Concord, Mass. Phone: (617) 369-4400. Price: \$625.

Covering the frequency range from dc to 50 MHz, a new five-digit universal counter sells for only \$625. Model 1192-B offers an internal room-temperature crystal oscillator and an over-all stability of better than 2 ppm per month. Its sensitivity is 10 mV up to 20 MHz, 20 mV to 35 MHz, and 30 mV to 50 MHz. Measurement parameters include frequency, period and time interval.

CIRCLE NO. 252

MIC YIG filter is 2.1-in. long



Watkins-Johnson Co., 3333 Hillview Ave., Palo Alto, Calif. Phone: (415) 326-8830. Price: \$1000 to \$3000.

Able to use YIG-tuning techniques and still be compatible with microwave integrated circuits, a new YIG-tuned dual-two-stage filter (two separate two-stage filters within the same magnetic structure) measures a mere 0.75 in. in diameter and only 2.1 in. in length.

Designed for use in the S band from 2 to 4 GHz, the new YIG-tuned filter is adaptable to two, three and four-stage filter configurations in addition to the two-stage designs mentioned. It can also be used as the magnetic structure for YIG-tuned oscillators.

An important characteristic of the new YIG-tuned filter is its compatibility with stripline packaging. It uses stripline output tabs for direct interconnections to stripline or microstrip assemblies. If the user desires, small coaxial type connectors can also be fitted on the filter.

Despite the fact the YIG-tuning techniques require large magnetic fields and consequently large currents, the filter's small size and tabular or solenoidal shape results in an optimum configuration for low tuning power. It dissipates only 0.45 W at 4 GHz compared with conventional cubical filters which dissipate 0.6 W.

This reduction in power reduces the heat which must be dissipated within the microwave integrated circuit package, thus minimizing heat dissipation problems.

An additional advantage is the reduction in the filter's coil inductance to about one-half that of conventional filters thus reducing filter/driver interface problems for fast sweep-rate devices.

CIRCLE NO. 253

2-in.³ mixer-preamp covers 1 to 18 GHz

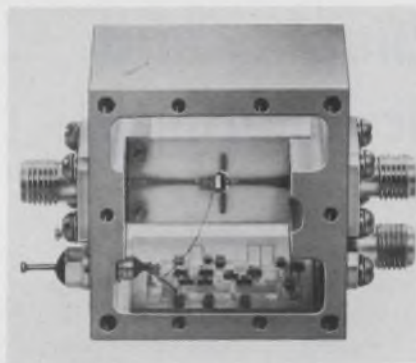

RHG Electronics Laboratory, Inc., 94 Milbar Blvd., Farmingdale, N. Y. Phone: (516) 694-3100. P&A: \$950; 45 days.

A new 2-in.³ hybrid IC mixer preamplifier includes a mixer with multi-octave rf coverage for the frequency range of 1 to 18 GHz. Model DM1-18/10HH has instantaneous i-f coverage from 10 to 200 MHz. Noise figure ranges over 7.5 to 11 dB and VSWR is 2:1. Isolation is greater than 20 dB and output capability is greater than 0 dBm.

CIRCLE NO. 254

2 to 18-GHz antenna has a VSWR of 2

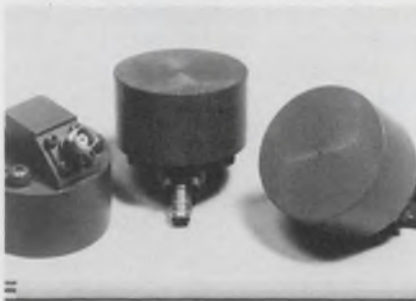

American Nucleonics Corp., 6036 Variel Ave., Woodland Hills, Calif. Phone: (213) 347-4500.

A new broadband cavity-backed spiral antenna, model AM-277, performs over a frequency range of 2 to 18 GHz with a VSWR of less than 2.0 and a VSWR of 1.0 over the frequency range of 2 to 16 GHz. Gain is 2 dB over the frequency range of 7 to 16 GHz. Units are available with right-hand circular polarization with several optional connector locations.

CIRCLE NO. 255

Stripline varactor diode rates at 90 GHz

Marconi Co., Ltd., Marconi House, Chelmsford, Essex, England.

A new GaAs varactor diode is available with three figure-of-merit ranges from 40 to 90 GHz. The device, designated XMD3A, is a diffused mesa diode mounted in an LID package in a square configuration for stripline applications. Package dimensions are 0.15 by 0.045 by 0.024 in.

CIRCLE NO. 256

1-GHz crystal source supplies 2 W cw

Trak Microwave Corp., 4726 Eisenhower Blvd., Tampa, Fla. Phone: (813) 884-1411.

A new crystal-controlled 1-GHz oscillator supplies 2 W for cw and pulsed operation. Stability of the 5038-1100 unit is $\pm 0.001\%$ and fundamental frequency is 125 MHz. The hybrid thin-film and lumped constant device operates from ± 12 V dc and measures 1 by 1.5 by 6 in.

CIRCLE NO. 257

4 to 18-GHz amplifiers have 4-GHz bandwidths

RCA Electronic Components, 415 S. 5th St., Harrison, N. J. Phone: (201) 485-3900.

New cw linear amplifiers for use in C, X and Ku-band frequencies (4 to 18 GHz) provide instantaneous bandwidths of 4 GHz or more. They make use of the negative-resistance characteristic of transferred-electron devices to obtain stable broadband amplification.

CIRCLE NO. 258

750-foot-lambert LED costs just \$1.50

Litronix, Inc., 10440 N. Tantau Ave., Cupertino, Calif. Phone: (408) 257-7910. P&A: \$1.50; stock.

The Red-Lit 50 is a visible-red LED with a brightness of 750 foot-lamberts and current drain of 20 mA selling for only \$1.50. The unit uses an epoxy package 80-mils wide that is elongated in the direction of the leads. Viewing angle is 45 degrees.

CIRCLE NO. 259

2000-word wire ROM accesses in 150 ns

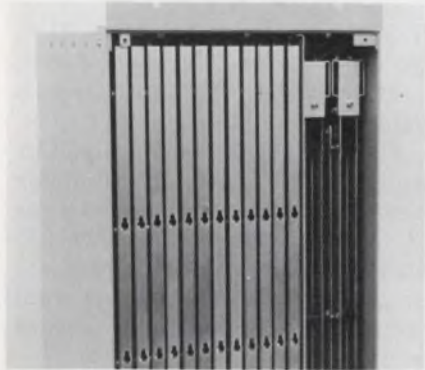

Toko, Inc., Memory Div., 1-17, 2-Chome, Higashi-Yukigaya, Ohta-Ku, Tokyo, Japan. P&A: 10¢/bit; 2 months.

Utilizing nondestructive readout wires, the FS-100A read-only wire memory allows repeated readouts with an access time of 150 ns and a cycle time of 200 ns. It has a memory capacity from 1-k words at 72 bits each up to 2-k words at 72 bits each. Despite its construction as a fixed memory for readouts only, it is designed to enable swift rewriting electronically.

CIRCLE NO. 260

Low-speed transports work down to 1.5 in./s



Peripheral Equipment Corp., 9600 Irondale Ave., Chatsworth, Calif. Phone: (213) 882-0030. P&A: From \$4675; 45 days.

The new PEC 1000/2000 series of incremental write/synchronous-read tape transports range in tape speeds from 1-1/2 to 25 in/s. They offer high performance and reliability in IBM-compatible 7 and 9-track NRZI formats. Models are available in 9-track, 800-characters/in. or 7-track, 800, 556, or 200-characters/in. versions.

CIRCLE NO. 261

LED

New low cost LED Vactrol photon isolator

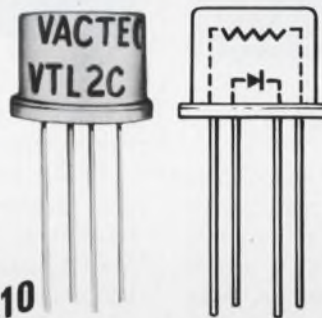

\$3.10

as low as ~~\$4.20~~ each in 1,000 quantities

- all solid state
- 4 types of photoconductors combined with LEDs
- hermetically sealed TO-5 enclosure
- unlimited life—no filaments
- ideal for environments where shock and vibration are a problem
- applications include photochoppers, linear isolators, noiseless switching, SCR and triac turn-on, audio level controls, etc.

Part Number	LED	PHOTOCELL		
	Current (ma) (1.65v typ.)	Max. Cell Resistance	Typical Rise Time (ms)*	Decay
VTL2C1	40	10 KΩ	.5	3.5 ms **
VTL2C2	40	500 Ω	3.5	500 ms †
VTL2C3	40	2 KΩ	2.5	35 ms †
VTL2C4	40	100 Ω	6.0	1.5 sec †

* To 63% conductance

** To 1 meg

† To 100 K Ω

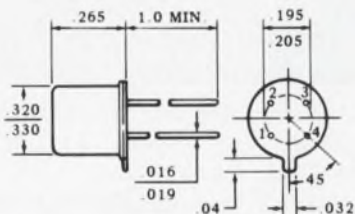

1-3 PHOTOCELL
2-4 LED

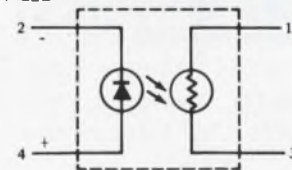

Write for Bulletin VTL2C. Also a complete line of neon and incandescent Vactrol photon isolators.



VACTEC, INC.

2423 Northline Ind. Blvd.
Maryland Heights, Mo. 63043
Phone: (314) 872-8300

Specializing in standard Cds, Cdse, and Se sells; custom engineering for every photocell need. Listed in EBG under "Semi-Conductors" and in EEM Sec. 3700.

IC sense amplifier reads 3-mV signals

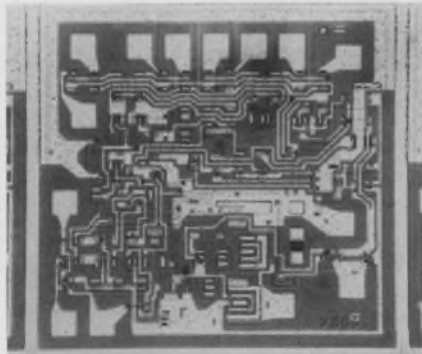

Signetics Corp., 811 E. Arques Ave., Sunnyvale, Calif. Phone: (408) 739-7700.

NE528B four-channel monolithic sense amplifier for plated-wire memories can read 3-mV signals and translate them to TTL levels. Propagation delay is 20 ns, bias current is 1.5 μ A and input resistance is 2 k Ω . Input channels are selected by means of three TTL inputs, one of which is capable of totally disabling the input circuits. The amplifier can be wire OR'd.

CIRCLE NO. 262

Arithmetic logic IC performs in 19 ns

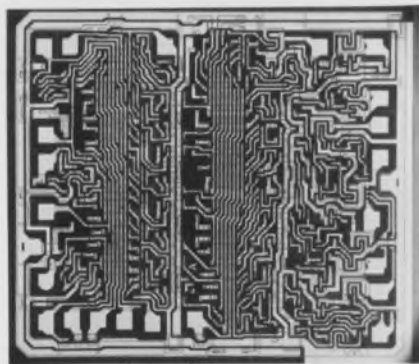

Advanced Micro Devices, Inc., 901 Thompson Pl., Sunnyvale, Calif. Phone: (408) 732-2400. Price: \$16.50.

Two four-bit arithmetic logic units, the Am74181 and Am9341, can perform 16 arithmetic operations including addition and subtraction in 19 and 23 ns, respectively. They can also double and compare on two four-bit binary words. Both units can be used with internal or external look-ahead carry logic and to receive external carry signals.

CIRCLE NO. 263

Quad peripheral drivers handle 1 A and 180 V

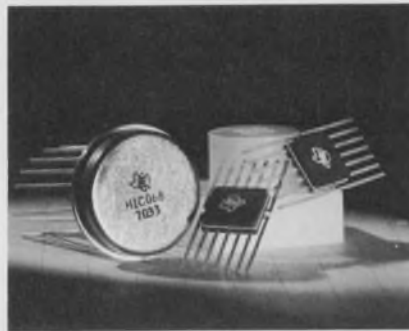

Texas Instruments, Inc., 13500 N. Central Expressway, Dallas, Tex. Phone: (214) 238-2011. P&A: \$12.70, \$12.90, \$11.65; stock.

Three new hybrid quad peripheral drivers interface transistors with up to 1 A of current and 180 V of breakdown voltage. The HIC-040 drives four 2N3725 transistors with collector current per transistor of 1 A at a 50-V breakdown. The HIC067 has a drive capability of 150 mA and a 40-V breakdown. The HIC068 handles 100 mA at a 180-V breakdown.

CIRCLE NO. 264

Voltage-variable diodes lower leakage to 5 μ A

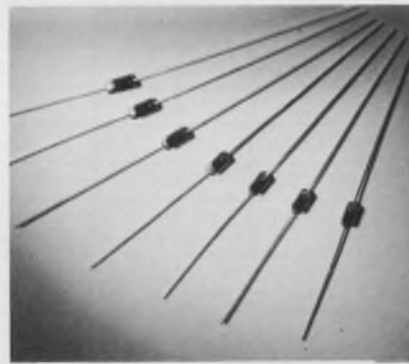

MSI Electronics, Inc., 34-32 57 St., Woodside, N. Y. Phone: (212) 672-6500. P&A: \$3.25; stock.

1N4809A through 1N4815A are voltage-variable capacitance diodes with low leakage of 5 μ A and precision tracking characteristics for use in circuits where Q is of secondary importance. In capacitance values ranging from 33 through 100 pF, these diodes exhibit capacitance ratios of more than 2:1 up to the maximum voltage of 60 V for 33-pF devices to 20 V for 100-pF devices.

CIRCLE NO. 265

2560-bit 500-ns ROM costs only \$29

Hughes Aircraft Co., MOS Div., 500 Superior Ave., Newport Beach, Calif. Phone: (714) 548-0671. P&A: \$29; 45 days.

The IROM8560 is a monolithic ion-implanted 2560-bit read-only memory featuring an access time of 500 ns and costing only \$29 (100-lot quantities). It is organized as 256 words at 10 bits per word and has address input lines decoded on the chip.

CIRCLE NO. 266

1024-bit MOS RAM accesses in 400 ns

Mostek Corp., 1400 Upfield Dr., Carrollton, Tex. Phone: (214) 242-1491. Price: \$75.

Using ion-implantation techniques, the MK4006P 1024-bit dynamic MOS random-access memory features an access time of 400 ns, and a write cycle time of 650 ns. It is DTL/TTL compatible and is available in a 16-pin package. Decoding is provided on the chip.

CIRCLE NO. 267

200-V bridges carry up to 3 A

Rectifier Components Corp., 124 Albany Ave., Freeport, N. Y. Phone: (516) 868-0470. Price from \$4.30.

The new BCS300 series of controlled rectifier bridges include 50, 100 and 200-V rms types with output currents to 3 A. Conduction for each rectifier element is through 180 degrees. Packaging is in 1 by 0.5-in. cases.

CIRCLE NO. 268

Dual-gate MOSFET lowers cross modulation

Fairchild Semiconductor, 464 Ellis St., Mountain View, Calif. Phone: (415) 926-3563. P&A: \$1.10; stock.

A new low-cost dual-gate MOSFET has cross modulation performance close to that of a vacuum tube for rf applications up to 400 MHz. The FT0601 is designed to reject third-order harmonics.

CIRCLE NO. 269

Solid-state 1-A relay maximizes I/O isolation



Teledyne Relays, 3155 W. El Segundo Blvd., Hawthorne, Calif. Phone: (213) 679-2205. P&A: \$50 (803); 12 wks.

Achieving total input-to-output isolation with photon coupling, a new 1-A spdt solid-state DIP flat-pack relay with automatic current limiting for short-circuit protection requires a control current of only 2 mA and operates over the temperature range of -55 to $+125^{\circ}\text{C}$ without the use of any heatsinks.

Series 801 relay eliminates two shortcomings found in previous solid-state relays: inefficiency due to large required control currents and sensitivity due to temperature changes.

Two voltage control ranges of 2.7 to 6 V (5-V digital-logic compatible) and 18 to 36 V are available. Each relay has two input pins for both voltage ranges so that the user need only select the desired input.

The 801 relay features a $5\text{-}\mu\text{s}$ risetime and a typical contact-voltage drop of 0.25 V at 1 A. It achieves its 1-A current rating throughout the entire 4 to 40-V range. Snap-action and 2:1 hysteresis features are built in.

Current is automatically limited to 3 A when the relay's output load is short-circuited for up to 3 s. This current-limiting capability forms the basis of the 801's use in a new power controller designated the series 803.

Under no-overload conditions, the 803 power controller (which contains an 801 relay) is identical in performance to the 801 except that it is a spst switch. When overload or short-circuit conditions in the 801 relay persist for more than 3 s, the 803 controller takes over and trips the 801 relay thereby de-energizing the load.

CIRCLE NO. 270

Ferrite toroids cut TC to 0.2%

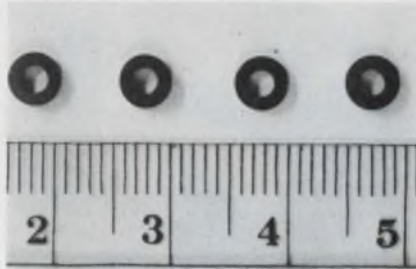

Litton Industries, Airtron Div., 200 E. Hanover Ave., Morris Plains, N. J. Phone: (201) 539-5500.

A new series of ferrite toroids features temperature coefficients as low as ± 0.2 to $\pm 0.5\%$ over the temperature interval of -40 to $+85^{\circ}\text{C}$. The toroids are in sizes of 0.18 in. in outside dia by 0.09 in. in inside dia by 0.05-in. high. Magnetic permeability measured at 5 MHz may be controlled in the range of 20 to 100. Q values at 2 to 12 MHz are from 50 to 75.

CIRCLE NO. 271

Small chip resistors pack in $10^{11}\text{-}\Omega$ values

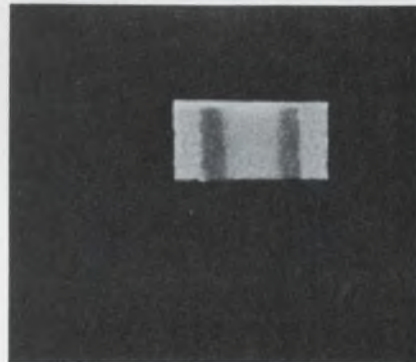

Eltec Instruments, Inc., Box 46, Lancaster, N. Y. Phone: (716) 683-8421. P&A: \$2 (1000-piece lots); 1 wk.

Available in 0.05 by 0.1 by 0.12-in. chips, model 110 glass resistors span a range of 10^3 to $10^{11}\ \Omega$. Their glass and gold terminals are fired onto the top surface of a ceramic chip. Standard values of 10^3 , 10^9 , 10^{10} and $10^{11}\ \Omega$ have a tolerance of $\pm 25\%$. Operating temperature is -270 to $+200^{\circ}\text{C}$ and temperature coefficient of resistance is $-0.3\%/^{\circ}\text{C}$.

CIRCLE NO. 272

SOLID-LITE

SOLID STATE NUMERIC INDICATORS AND LAMPS

New Solid-Lite display devices use gallium phosphide, the most efficient visible light emitting semiconductor. You get bright light at low current.



SOLID-LITE Solid State Numeric Indicators

- Large (.33" x .21") bright numerals are pleasing to the eye
- Standard 14-pin dual-in-line package
- Low voltage operation at less than $\frac{1}{4}$ watt total power
- Compatible with TTL and DTL IC's
- Single-plane wide-angle viewing
- High reliability - long life
- Excellent shock and vibration resistance
- Low cost



SOLID-LITE Solid State Lamps

- 2 millicandelas luminous intensity at 15 mA and 2.1 V
- Area light source - not a pinpoint
- Easy wide-angle viewing
- IC compatible
- Excellent shock and vibration resistance
- High reliability - long life
- Low cost

For technical literature or applications assistance, write or call OPCOA, Inc., 330 Talmadge Road, Edison, New Jersey 08817; phone (201) 287-0355.

OPCOA

COMPONENTS

Plastic dpdt relay accepts 1 ampere

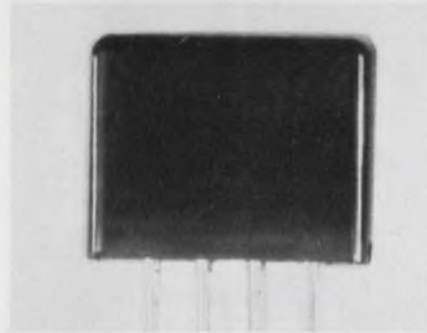

Deutsch Relay Div., 65 Daly Rd., E. Northport, N. Y. Phone: (516) 266-1600.

Series 3115 dpdt low-cost 1/6-crystal-size industrial relay in a plastic enclosure can handle 1 A of current. The series consists of three models which feature a balanced-armature design to withstand large shock and vibration forces. Operating temperature range is from -25 to $+85^{\circ}\text{C}$. Pick-up sensitivity is 200 mW at $+25^{\circ}\text{C}$. Coil resistance ranges from 65 to 1350 Ω .

CIRCLE NO. 273

Preset timing module spans 50 ms to 60 s

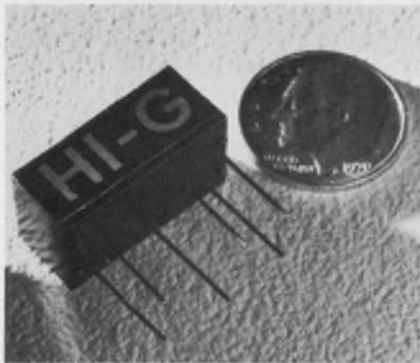

Hi-G, Inc., Electronic Products Div., Spring St. & Route 75, Windsor Locks, Conn. Phone: (203) 623-2481.

Series 6100 timing module provides factory preset time delays from 50 ms to 60 s in a DIP package measuring 3/8 by 1/2 by 7/8 in. Application of power to its input initiates the timing cycle. At the end of the preset time interval, the module's output switch closes until it is reset by removal of input power. Switch rating is 1/2 A resistive at 28 V dc.

CIRCLE NO. 274

MODULES & SUBASSEMBLES

LED-fiberoptic display shows large characters

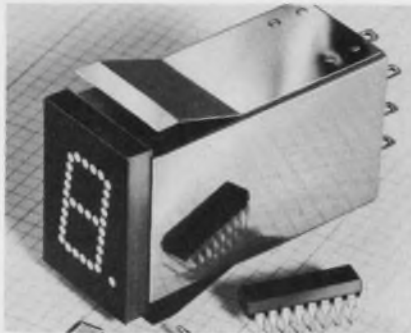

Master Specialties Co., 1640 Monrovia, Costa Mesa, Calif. Phone: (714) 642-2427. Price: \$25.

Combining 56-mil-dia optical fibers with LEDs, the 908 readout forms 0.85-in.-high by 0.43-in.-wide dot-pattern characters. The fiberoptics pipe over 99.5% of the illumination from the LED sources to a 7-segment character face providing 160-degree viewing. Contrast ratio is 50:1 (fiber-to-face) and each LED operates at 50 mA and 5 V dc. Current-limiting resistors are built in.

CIRCLE NO. 275

Seven-segment display plugs into 16-pin DIPs

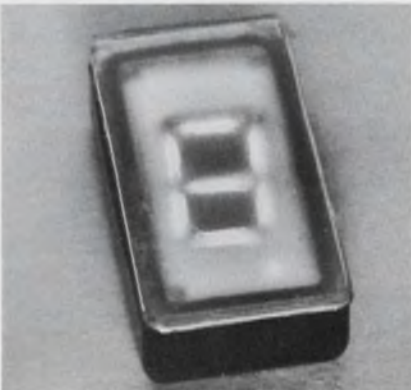

Luminetics Corp., Box 1943, Pompano Beach, Fla. Phone: (305) 933-4551. Price: \$2.90.

The series 90 MiNitron seven-segment incandescent display plugs into standard 16-pin DIP sockets. Dimensions of the display housing are 0.867-in.-high by 0.453-in.-wide by 0.024-in.-deep. Character height is 0.36 in. with a 5-degree slope. The display is rated at 5 V dc and 9 mA per segment. Filters are available in a variety of colors depending on application.

CIRCLE NO. 276

Differential amplifier slews at 30 V/ μs

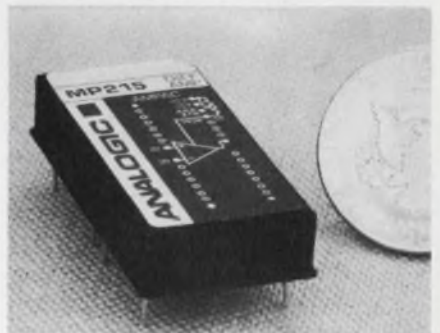

Analogic Corp., Audobon Rd., Wakefield, Mass. Phone: (617) 246-0300. P&A: \$80; 2 to 4 wks.

The Ampac MP215 differential inverting amplifier features open-loop gain of 2×10^5 and frequency response to 4 MHz, while slewing at 30 V/ μs and settling to 0.01% in 1.5 μs . Its temperature coefficient is 20 $\mu\text{V}/^{\circ}\text{C}$ and input impedance is $10^{11} \Omega$. Input bias current is only 50 pA and noise is only 15 μV rms. Output is ± 10 V at 20 mA and is short-circuit proof to ground.

CIRCLE NO. 277

Fast multiplexer is 0.01% accurate



Varadyne Systems, 1020 Turnpike St., Canton, Mass. Phone: (617) 828-6395. P&A: \$198; stock.

Model MM-8 eight-channel analog multiplexer with a 1- μs settling time features an accuracy of 0.01%. All its addressing logic inputs are compatible with DTL/TTL levels. Full-scale inputs can be either ± 5 or ± 10 V. Each channel can sequentially switch at a 500-kHz rate. The MM-8 is self contained in a plastic module measuring 0.8 cubic in.

CIRCLE NO. 278

Frequency converters mount on PC boards

Anadex Instruments, Inc., 7833 Haskell Ave., Van Nuys, Calif. Phone: (213) 873-6620. P&A: from \$175; 4 wks.

The new series 1700-5096-XX of frequency-to-voltage converters on PC boards offer twelve input-frequency ranges that provide a 0 to 5-V dc output directly proportional to the frequency input. Ranges are from 100 Hz to 50 kHz.

CIRCLE NO. 279

Fast-settling op amp reaches 0.01% in 0.15 μ s

Dynamic Measurements Corp., 6 Lowell Ave., Winchester, Mass. Phone: (617) 729-7870. P&A: \$40; stock.

A new FET fast-settling op amp, the FST-157, has an input impedance of $10^{12} \Omega$, a dc gain of 300,000, a gain-bandwidth-product of 12 MHz and settles to 0.01% within 0.15 μ s. Overload recovery time is 1 μ s and frequency response is at a 6-dB/octave rate.

CIRCLE NO. 280

10-bit d/a converters cut settling to 200 ns

Teledyne Philbrick Nexus, Allied Dr. at Rte. 128, Dedham, Mass. Phone: (617) 329-1600. P&A: \$70, \$75; stock.

Models 4006 current and 4007 voltage 10-bit d/a converters with settling times of 200 ns and 25 μ s, respectively, are contained in low-profile 2 by 2 by 0.4-in. packages. Both are DTL/TTL compatible and have DIP configurations.

CIRCLE NO. 281

Fast 75-MHz buffer gets to 0.1% in 40 ns

Intronics, Inc., 57 Chapel St., Newton, Mass. Phone: (617) 332-7350. P&A: \$175; stock to 2 wks.

The model FA501 FET follower buffer with a risetime of 5 ns, an output of ± 100 mA at ± 5 V and a dc-to-75-MHz bandwidth settles in 40 ns to 0.1% of final value. It occupies 3.7 cubic in. of space and mounts on PC boards with relative ease.

CIRCLE NO. 282

More new drivers... level adapter/level shifter

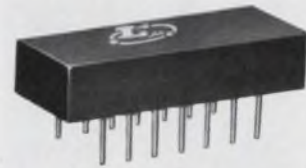

LMD-9 SHIFTER
LMD-10 ADAPTER

Now available from shelf

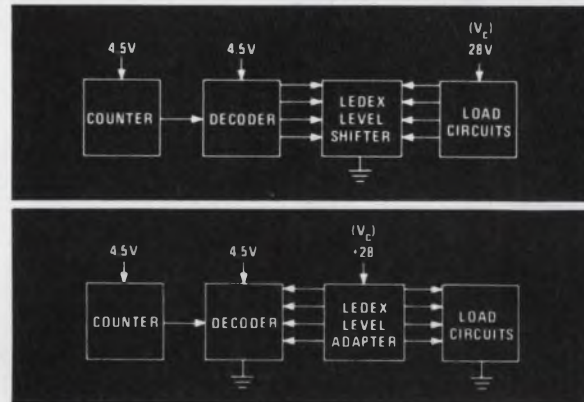

Typical Application and Connection Diagrams

Typical Specifications

Voltage	30V
Output	200ma
Total package power	450mw
Input	35V
Voltage drop	1.5V
Surge	0.75 Amp

Our LMD-9 is an interface quad driver and level shifter NPN circuit designed to solve your low-to-high voltage and current switching applications when the load is on the hot side.

When the load is on the ground side, use our LMD-10, a quadruple PNP adapter and driver, for your interface between low level integrated circuits and high voltage levels.

You can use the drivers with solid state stepping switches, to convert low level counter decoder outputs to levels compatible with your application. You can also use them as multiple position drivers, inverters to drive higher power transistors, or to form the electrical equivalent of NO or NC switch contacts.

Fast Custom Design

We're equipped to give you fast design and prototype service on any custom hybrid microelectronics package. Our engineers will come to you, if that's what you need.

You'll find our delivery dependable and our production standards among the highest in the industry.

The circuit described above is now stocked. Ask for catalog sheet. Or, for the whole story on our capability, write for brochure "Custom Hybrid Microcircuits."

Specialists in hybrid microelectronic circuits



LEDEX MICROELECTRONICS, LEDEX INC.
123 Webster Street, Dayton, Ohio 45401 phone (513) 222-6992

INFORMATION RETRIEVAL NUMBER 32

DIP packaging system accepts MSI LSI ICs



Malco Manufacturing Co., Inc., 5150 W. Roosevelt Rd., Chicago, Ill. Phone: (312) 287-6700.

Dip-Mates are new dual-in-line packaging systems for MSI and LSI packages. Dip-Mates keep thermal problems to a minimum by air cooling the top and bottom of the plugged-in package. They consist of a thin voltage plate which is sandwiched to a base plate which functions as the ground plate. An insulated aluminum voltage plate contains a hard anodized finish.

CIRCLE NO. 283

Alumina substrates break-off in pieces

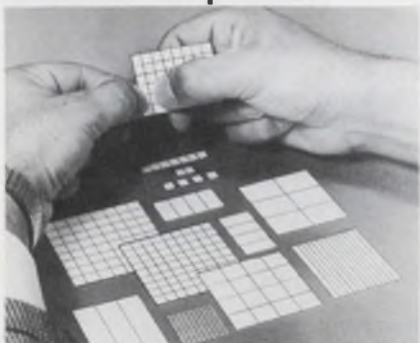

Ekon Electronics, 9760 Cozycroft Ave., Chatsworth, Calif. Phone: (213) 882-2063.

New scored alumina ceramic substrates with surface finishes of 15 μm . or less break cleanly into individual pieces after multiple circuit patterns have been deposited. The new substrates are available in sizes as small as 0.05 by 0.05 in. with 96% and 99.5% alumina compositions. Other compositions as well as colored ceramics for tracing and coding are also available.

CIRCLE NO. 284

Complete unsolder tool retails for \$200

The Marconi Co., Ltd., Marconi House, Chelmsford, Essex, England. Price: under \$200.

A portable unsoldering tool complete with a sprung component remover and a range of fittings for different component packages sells for under \$200. The unit consists of an electrically heated pot of molten solder with a metal piston floating in it.

CIRCLE NO. 285

Resistance-wire kit spans 0.5 to 300 Ω/ft

W.E.S.H. Scientific Corp., 19025 A Parthenia, Northridge, Calif. Phone: (213) 886-6488. P&A: \$2.95; stock.

Intended for making any value resistor, the Flextrim 101 low-cost kit contains both manganin and karma wire alloys in 7 resistance wires ranging from 0.5 to 300 Ω/ft (5000 Ω/ft optional). It also contains 11 epoxy glass bobbins.

CIRCLE NO. 286

High-temperature tape withstands 4000°F

Aremco Products, Inc., P. O. Box 145, Briarcliff Manor, N. Y. Phone: (914) 762-0685. P&A: \$19.50 (1/2-in. 18-yard roll); stock.

Pyro-tape 546 is a high-temperature glass-plastic tape which can withstand continuous temperatures of 500°F and flash temperatures up to 4000°F. It is available 0.006-in. thick with an adhesive backing in 1/2 and 1-in. widths.

CIRCLE NO. 287

50-ppm resistive pastes have 1-M Ω square value

Cermaloy Div. of Bala Electronics Corp., 14 Fayette St., Conshohocken, Pa. Phone: (215) 828-4650. P&A: \$150/troy oz; stock.

Resistivities up to 1 M Ω /square are available from the series 500 noble-metal resistive pastes with temperatures coefficients of 50 ppm/°C. These pastes are recommended for firing conditions of 875°C for eight minutes at peak temperature.

CIRCLE NO. 288

evaluation samples



Pushbutton switches

Free samples of lighted pushbutton switches are available in personalized colors to match any equipment. The color-dyed switches, designated the 1820 series, may be ordered in any color or color combination for the switch parts of the button, nylon bezel and housing. Metal bezels come in chrome, black oxide or brass-plated steel. The 1820 line is rated for 2 to 9-A service at 125 or 250 V ac. Options include spst or spdt models. All switches have built-in diffusing screens to produce a glow light without an objectionable hot spot. Molex, Inc.

CIRCLE NO. 289

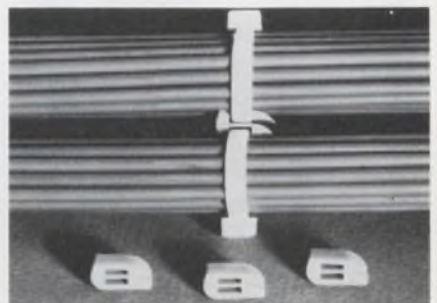

Harness ring

A new open-connector harness ring permits a harness to be added to existing wire bundles without installing additional cable ties to the initial bundles and without cutting off the original ties. The CROS ring is installed with a cable tie on the auxiliary harness. A slot in its top permits it to be fastened to any previously installed miniature, intermediate or standard cross-section cable tie. Free samples are available. Panduit Corp.

CIRCLE NO. 290

design aids

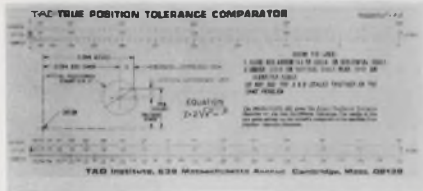

Tolerance comparator

The True Position Tolerance Comparator is a 4-1/2 by 11-in. plastic sliding-scale device that provides instant analysis of true position tolerancing and dimensioning. The Inspector's Aid side of the comparator shows coordinate measurements with respect to circular tolerance zones on the drawings. The Manufacturer's Aid side shows how far from true position the tool settings may deviate. The comparator comes with an instruction manual and costs \$7.50. TAD Products Corp.

CIRCLE NO. 291

application notes

Operational amplifiers

A brief guide to the salient features of contemporary monolithic operational amplifiers covers the subject with detail and clarity. It is intended to give some familiarity to those with little or no knowledge of operational amplifiers. Circuit diagrams and basic operational amplifier terms are given. Signetics Corp.

CIRCLE NO. 292

Silicon solar cells

A four-page application report thoroughly discusses the physical and electrical properties of silicon solar cells. Several curves illustrate the cells' different characteristics. AEG-Telefunken Corp.

CIRCLE NO. 293

Beam-lead sensors

How a designer can achieve maximum design freedom and product reliability by employing a beam-lead sensor array instead of a large number of individual discrete phototransistors is discussed in an application report. The report explains beam-lead sensor array technology and the advantages of such an array compared to one comprising individual phototransistors mounted and wired separately. Texas Instruments Inc.

CIRCLE NO. 294

Trapatt diodes

A three-piece set of application literature on an avalanche trapatt diode is available. General Electric.

CIRCLE NO. 295

Mini Bus by Rogers

For noise and cost reduction

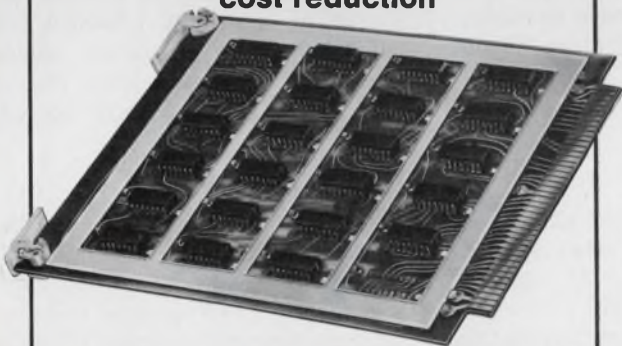

A small, voltage-distributing busbar for PC card application, each Mini/Bus gives you built-in capacitance . . . noise-cutting capacitance that means more reliable, compact circuit packaging at a fraction of multilayer prices. Write for data.

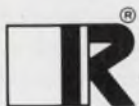

Rogers Corporation / Rogers, Conn. 06263

SAMPLES PROVE IT!

We do it for someone like you every day—Gries' special methods and Value Engineering combine to give you the highest small parts functional value. We take the most imaginative engineering ideas and turn them into precise, uniform, tiny, zinc alloy die castings. You get higher value and gain savings every step of the way . . . basic part through final assembly.

NO SIZE TOO SMALL!
MAXIMUM SIZE FOR ZINC ALLOY: 2", 1/2 oz.

See what "higher value"

GRC TINY ZINC ALLOY DIE CASTINGS
can do for you



Get this **SAMPLE KIT**

Write today on company letterhead

Gries Reproducer Co.

Division of Coats & Clark Inc.

40 Second St., New Rochelle, New York 10802 • (914) 633-8600

Plants in: New Rochelle, N. Y.; Warren, R. I.; Toccoa, Ga.

In Canada: Gries Div., Dynacast Ltd. Lachine, Que.

new literature



Computer handbook

A 300-page handbook describing the hardware and software features and uses of PDP-12 laboratory computer systems is available. The handbook is designed as a basic guide for users of PDP-12 systems and as an aid to individuals who are considering the acquisition of a laboratory computer. It contains sections on biomedical, chemical, educational, industrial and clinical laboratory computer systems. Digital Equipment Corp.

CIRCLE NO. 296

How long must you keep important papers?

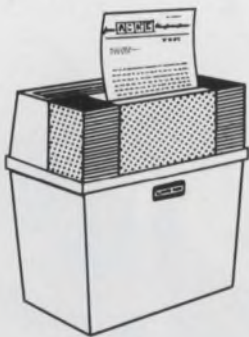

Write for free booklet, ED-2 RECORD RETENTION TIMETABLE, describing Retention Periods as allowed by government authorities, and how to dispose of them safely without loss or worry!

 **ELECTRIC WASTEBASKET CORP.**
145 West 45th St., New York, 10036
Selected dealers all over the United States.

INFORMATION RETRIEVAL NUMBER 35

Potentiometers

A four-page brochure describes conductive plastic potentiometer elements and gives information on their electrical parameters. Waters Manufacturing, Inc.

CIRCLE NO. 297

Video switchers

Distinctive features of new production video switchers are listed in detail in a six-page two-color technical data sheet. Cohu Electronics, Inc.

CIRCLE NO. 298

IC rework

Effective IC repair, rework and modification of advanced electronic assemblies is the subject of an eight-page brochure. Pace Inc.

CIRCLE NO. 299

Recorders

A four-page illustrated brochure describes portable and rack-mounted general-purpose recorders. Gould, Inc.

CIRCLE NO. 320

Digital recorders

A four-page brochure describes a cassette magnetic-tape operating system for mini-computers. Dicom Industries

CIRCLE NO. 321

Imaging devices

A new quick-selector guide provides rapid and comprehensive reference to a full line of imaging devices. Products are discussed from a performance vs application point of view. Westinghouse.

CIRCLE NO. 322

Sound system components

A six-page catalog gives detailed specifications and descriptions of a line of commercial sound components and special-purpose sound system products. Bell P/A Products Corp.

CIRCLE NO. 323

Tape readers

A four-page brochure describes photo-electronic punched-tape readers capable of reading speeds up to 600 characters/s. Decitek Div. of Jamesbury Corp.

CIRCLE NO. 324

Hobbyist catalog

An 80-page hobbyist catalog includes watches, geiger counters, logic cards, electronic kits, cameras, lenses and many more items of interest. B. & F. Enterprises

CIRCLE NO. 325

MOS/LSI ICs

MOS LSI shift registers, logic cards, memories and custom circuits are described in a brochure. Philco-Ford.

CIRCLE NO. 326

Temperature indicators

A new comprehensive four-page catalog describes a line of compact digital temperature indicators. Thermo Electric.

CIRCLE NO. 327

Analog multipliers

Two foldout data sheets describe a pair of internally trimmed and wideband transconductance analog multipliers. Analog Devices Inc.

CIRCLE NO. 328

Rocker switches

A four-page data brochure describes rocker and paddle-handle switches. It contains photographs, schematics, specifications, ordering information and prices. C & K Components, Inc.

CIRCLE NO. 329

Capacitors

Two catalogs cover a full line of capacitors. The line includes dipped silver mica, aluminum electrolytic, MIL-approved ceramic and polyester film capacitors in all sizes. Miconics Industries, Inc.

CIRCLE NO. 330



GC Electronics catalog

The 1971 edition of the GC Industrial Electronic components catalog containing nearly 1700 electronic items is available. The 84-page catalog lists connectors, adapters, alignment tools, clips, plugs and jacks, binding posts, cable clamps and cable ties. Chemicals, nylon and metal hardware, PC materials and connectors, spacers, switches, test prods, wire strippers, grommets and lacing cords are also included. GC Electronics Division of Hydrometals, Inc.

CIRCLE NO 331

Connectors

A new connector that meets MIL-E-5400K requirements is described in a four-page bulletin. Microdot, Inc.

CIRCLE NO. 332

Cable ties and clamps

A brochure describes a full line of one-piece cable ties, clamps and marker ties. Panduit Corp.

CIRCLE NO. 333

Wire and cables

Three wire and cable lines are described in a new catalog. The three lines feature flexibility and durability. Calmont Engineering and Electronics.

CIRCLE NO. 334

Magnetic alloy

A soft magnetic alloy for operation at high flux densities in motor, generator and transformer laminations, torque devices, pole pieces and solenoid cores is described in a new brochure. Westinghouse Electric Corp.

CIRCLE NO. 335

bulletin board

of product news and developments



A new approach to 35-mm slide and synchronized-cassette sound programs is the "Syncromedia" system developed by Setco Audio-Visual, Inc., St. Louis, Mo. The system is a combination Norelco "Synchroplayer", a speaker and a "Carousel" projector, put together in a portable plastic carrying case. The new system may be ordered with or without the projector and starts in prices from \$275. If the projector is desired as part of the "Syncromedia" unit, then the total price is \$375. According to Setco, the projector slips easily into the case and is ready for operation in a matter of seconds.

CIRCLE NO. 337

Price reductions averaging 10% on SSL series solid-state lamps have been announced by General Electric.

CIRCLE NO. 338

Potter Instrument Co., Inc., Plainview, N. Y. announced a price reduction on its SC-1035 single-capstan tape transport from a previous price of \$3800 each (100-unit quantities) to a new price of \$2850 each (100-unit quantities).

CIRCLE NO. 339

Price reductions on three LEDs ranging up to 45% were announced by Litronix, Inc. The three devices are the Red-Lit 2, 4 and 7 LEDs. Each of the three LEDs now costs as low as 99¢.

CIRCLE NO. 340

RCA Electronic Components has announced price increases ranging from 3 to 7% on five sizes of color TV CRTs.

CIRCLE NO. 341

Design Data from Manufacturers

Advertisements of booklets, brochures, catalogs and data sheets. To order use Reader-Service Card. (Advertisement)

Highest Resolution in New Spectrum Analyzers

1,000-line and 2,000-line Real-Time Spectrum Analyzers



For the on-line processing of underwater acoustic signals, radar, sonar and other data where the maximum frequency resolution is always sought, new UA-9A series 1,000-line and 2,000-line Low Frequency Real-Time Spectrum Analyzers have been designed by Federal Scientific, originators of the Ubiquitous® analyzers.

High-speed versions produce complete 1,000-line spectra in 40 msec, and 2,000-line spectra in 160 msec.

And now any UA-6A series 500-line Ubiquitous analyzers in the field can be expanded at the factory to 1,000-line or 2,000-line performance.

CIRCLE NO. 171

Federal Scientific Corporation
a subsidiary of Elgin National Industries, Inc.
615 West 131st Street, New York, N. Y. 10027

Put your frequency in shape for data transmission

Bulova computer-programs LC filter designs to select and shape frequencies that meet your data transmission specifications — commercial or military — for maximum performance, from DC to 80 MHz. Bulova can supply standard or custom designed low and high pass filters or bandpass filters to shape signals, eliminate noise and reduce error rate, or to make maximum use of the bandwidth available. Tone channel filters, IRIG filters or special filters and inductors are made to meet high use, long-life reliability.

Bits, Bytes, words — for your data transmission, or any other job that demands quality electric wave filtering, look to Bulova for performance that's reliable at costs that are realistic.

For data on Bulova LC filters, call (212) 335-6000, see EEM Section 2300, or write —



BULOVA
fcp

BULOVA

FREQUENCY CONTROL PRODUCTS

Electronics Division of the Bulova Watch Co., Inc.

61-20 Woodside Avenue, Woodside, New York 11377, 212-335-6000

INFORMATION RETRIEVAL NUMBER 36

We Have The Most Complete Line Of Airborne Antennas



**ECM
CNI
TELEMETRY
DATA LINK
AUGMENTATION**

Only a representative sample shown...antenna laboratory fully instrumented through Ka Band. New anechoic chamber...all new equipment 1,000 to 40,000 MHz. Ask Transco, the company with

the most experience, to supply an engineering proposal for your next requirement. TRANSCO PRODUCTS, INC., 4241 Glencoe Ave. • Venice, Calif. 90291 • (213) 821-7911 • Telex 67-4657 TWX (910) 343-6469



an equal opportunity employer

INFORMATION RETRIEVAL NUMBER 37

Electronic Design

ELECTRONIC DESIGN's function is:

- To aid progress in the electronics manufacturing industry by promoting good design.
- To give the electronic design engineer concepts and ideas that make his job easier and more productive.
- To provide a central source of timely electronics information.
- To promote two-way communication between manufacturer and engineer.

Want a subscription? ELECTRONIC DESIGN is sent free to qualified engineers and engineering managers doing design work, supervising design or setting standards in the United States and Western Europe. For a free subscription, use the postfree application form inside the back cover. If none is included, write to us direct for an application form.

If you do not qualify, you may take out a paid subscription for \$25 a year in the U.S.A., \$35 a year elsewhere. Single copies are \$1.50 each.

If you change your address, send us an old mailing label and your new address; there is generally a prepaid postcard for this inside the back cover. You will have to requalify to continue receiving ELECTRONIC DESIGN free.

The accuracy policy of ELECTRONIC DESIGN is:

- To make reasonable efforts to ensure the accuracy of editorial matter.
- To publish prompt corrections whenever inaccuracies are brought to our attention. Corrections appear at the end of the Letters column.
- To refuse any advertisement deemed to be misleading or fraudulent.

Microfilm copies are available of complete volumes of ELECTRONIC DESIGN at \$19.00 per volume, beginning with Volume 9, 1961. Work is now in process to complete the microfilm edition of Volumes 1-8. Reprints of individual articles may be obtained for \$2.00 each, prepaid (\$.50 for each additional copy of the same article) no matter how long the article. For further details and to place orders, contact the Customer Services Department, University Microfilms, 300 North Zeeb Road, Ann Arbor, Michigan 48106; telephone (313) 761-4700.

Want to contact us? If you have any comments or wish to submit a manuscript or article outline, address your correspondence to:

Editor
ELECTRONIC DESIGN,
850 Third Avenue,
New York, N.Y. 10022.

ELECTRONIC DESIGN 3, February 4, 1971

Electronic Design

Advertising Sales Staff
Keith Aldrich
Sales Manager

New York 10022
Robert W. Gascoigne
Samuel M. Deitch
Daniel J. Rowland
850 Third Avenue
(212) Plaza 1-5530
TWX: 710-581-2874

Philadelphia 19025
Mort Sullivan
P.O. Box 126
Dresher, Pa.
(215) 884-6880

Boston 02154
Joseph F. Palmer
1268 Main Street
Waltham, Mass.
(617) 894-2700

Chicago 60611
Thomas P. Kavooras
Berry Conner, Jr.
200 East Ontario
(312) 337-0588

Cleveland
Thomas P. Kavooras
(Chicago)
(312) 337-0588
(call collect)

Los Angeles 90303
Stanley I. Ehrenclou
Jerry D. Latta
2930 Imperial Highway
Inglewood, Calif.
(213) 757-0183

San Francisco 94022
Arthur R. Shields, Jr.
95 Main Street
Los Altos, Calif.
(415) 941-3084

London W. 1
For United Kingdom and Holland
Brayton C. Nichols
44 Conduit Street
Tel: REGent 4714

Verviers, Belgium
For Continental Europe
Andre Jamar
1, Rue Mallar, 1
(087) 253.83 Telex 41563

Tokyo
Haruki Hirayama
Electronic Media Service
5th Floor, Lila Bldg.,
4-9-8 Roppongi
Minato-ku
Phone: 402-4556
Cable: Electronicmedia, Tokyo



AMERICAN BUSINESS PRESS, INC.

Switching Matrices

DC AUDIO VIDEO
IF RF TO 3 GHZ

Available in

COAX—TWINAX—TRIAx
Programmable • Electrically
or Mechanically Actuated.
Low Cross Talk—High
Isolation.

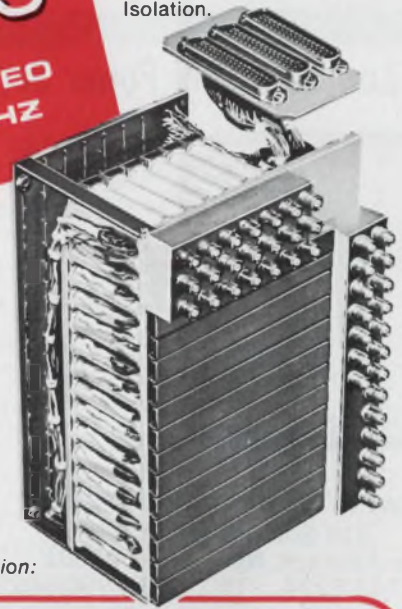

**Analog and Digital
Data Transmission
Distributing Systems
Information Retrieval
Telemetry • Television
Antenna Switching
Voice Communication
Surveillance • Computer Logic**

For Free Catalog / Complete Information:

TROMPETER Electronics, Inc.

8936 COMANCHE AVE. • CHATSWORTH, CAL. 91311
TEL. (213) 882-1020 TWX: 910-494-1210

INFORMATION RETRIEVAL NUMBER 38

DZUS ADJUSTABLE PAWL LATCHES

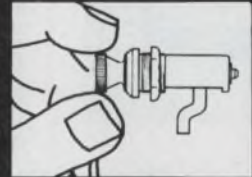

MINIATURE LATCH, SERIES DP-109

**in miniature and larger size units
Wide Grip Ranges. Easy to Install. Low Cost**

DZUS adjustable pawl latches are designed for use on compartment doors, sliding drawers and modular construction systems requiring ready access and easy after-locking. The units offer wide grip ranges and adjustability for positive latching. Where gaskets are used, the spindle can be tightened to the necessary take-up for a "custom fit". Projection into the cabinet is less than 1 inch. DZUS miniature and larger size latches are supplied fully assembled, ready for quick installation. Choice of finishes.

Write or call for data sheets.

LARGER LATCHES, SERIES DP-106
Available in various head styles

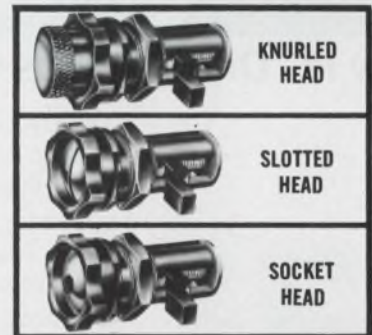

SALES, STOCK AND TECHNICAL SERVICES NATIONWIDE



DZUS FASTENER CO. INC.

425 UNION BLVD., WEST ISLIP, L. I., N. Y. 11795 • 516-669-0494
West Coast Office: 910 S. Brookhurst, Anaheim, Calif. 92804

INFORMATION RETRIEVAL NUMBER 39

Design Data from Manufacturers

Advertisements of booklets, brochures, catalogs and data sheets. To order use Reader-Service Card (Advertisement)

advertiser's index

New Low Cost Mini Power Supplies



Power/Mate Corp. has introduced a new complete line of 119 models of miniature DC regulated power supplies now described in this 6-page catalog. These 119 Mini Mate models collectively cover from 3.6 to 48 vdc and currents up to 2 amps. The Mini Mates feature adjustable DC outputs, low cost, high performance and Power/Mate's full five year warranty. The catalog covers complete specifications, model numbers, sizes and prices. Write, call or twx for your free copy.

CIRCLE NO. 172

Power/Mate Corporation

514 South River Street
Hackensack, New Jersey 07601
(201) 343-6294 TWX (710) 990-5023

Instant Circuit Boards!™



Engineers at CIRCUIT-STIK, INC., have developed a complete family of circuit sub-elements and circuit materials designed to work together producing "INSTANT PROTOTYPE CIRCUIT BOARDS." Individual circuit boards can be assembled and tested from engineering sketches the same day. CIRCUIT-STIK's sixteen page catalog describes circuit sub-elements and materials that are pre-drilled, pre-plated, fluxcoated, and have pressure sensitive adhesive substrates ready for mounting and soldering of electronic components. (U. S. Patent #3,538,389 and other patents pending)

SEND FOR YOUR FREE CATALOG AND SAMPLES

CIRCLE NO. 173

Circuit-Stik, Inc.

1518 West 132nd Street, Gardena, California 90249
Telephone (213) 532-1450

New PC Drafting Aids Catalog

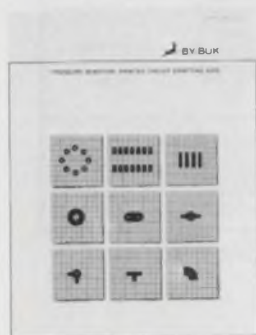

The By-Buk 1970-71 catalog of pressure sensitive printed circuit drafting aids is now available. With thousands of ideas to promote accuracy and efficiency in printed circuit master artwork layouts. Featured are new artwork patterns for: TO cans, multi-pads, dual in-lines and flat packs. Also the most comprehensive listings of conductor line tapes, pads, donuts, connector strips, elbows, corners, etc. Available in opaque black, transparent red and transparent blue materials. Send for your free catalog and samples.

CIRCLE NO. 174

By-Buk Company

4326 W. Pico Blvd.
Los Angeles, California 90019
(213) 937-3511

Advertiser	Page
Abbott Transistor Laboratories Incorporated	6
Acopian Corp.	28
Amperex Electronic Corporation.....	45
Belden Corporation	15
Bulova Frequency Control Products..	62
Burr-Brown Research Corporation....	10
By-Buk Company	64
Circuit Stik, Inc.	64
Computer Microtechnology, Inc.....	16
Dale Electronics, Inc.	Cover II
Data Display Products	20
Dzus Fastener Co., Inc.	63
Eastman Kodak Company	9
Edmund Scientific Company	44
Electric Wastebasket Corp.	60
Elexon, Inc.	44
Federal Scientific Corporation	61
Gries Reproducer Corp.	59
Hayden Book Company, Inc.	2
Hewlett-Packard	1, 4, 5, 30
Kurz-Kasch, Inc.	44
Lear Siegler, Inc., Cimron Division...	11
Ledex Microelectronics, Ledex, Inc.	57
Molex, Incorporated	23
Monsanto Company	8
Motorola Semiconductor Products, Inc.	17
North Electric Company	12
OPCOA, Inc.	55
Power/Mate Corporation	64
RCA Electronic Components and Devices	13, Cover IV
Raytheon Company, Sorenson Power Supplies	34
Rogers Corporation	59
Siemens Corporation	2
Siliconix Incorporated	29
Singer Company, The, Friden Division	14
Sprague Electric Company	18
Tektronix, Inc.	33
Teletype Corporation	40, 41
Transco Products, Inc.	62
Triplet Corporation	48
Trompeter Electronics, Inc.	63
United Systems Corporation ...	Cover III
Vactec Inc.	53
Victory Engineering Company	7



a "NEW" Generation of Multimeters at a "NOW" Price



Unique
self-check
calibration

- AC, DC, volts and current, Ohms
- .1% basic accuracy
- 100 μ V resolution, AC and DC
- Auto-Polarity on DC ranges
- Automatic zero correction
- Self-contained Battery Pack, Optional

\$375

DIGI/EC®

by UNITED SYSTEMS CORPORATION

918 Woodley Road • Dayton, Ohio 45403 • (513) 254-6251

For complete specifications request catalog

Representatives throughout the World

INFORMATION RETRIEVAL NUMBER 122

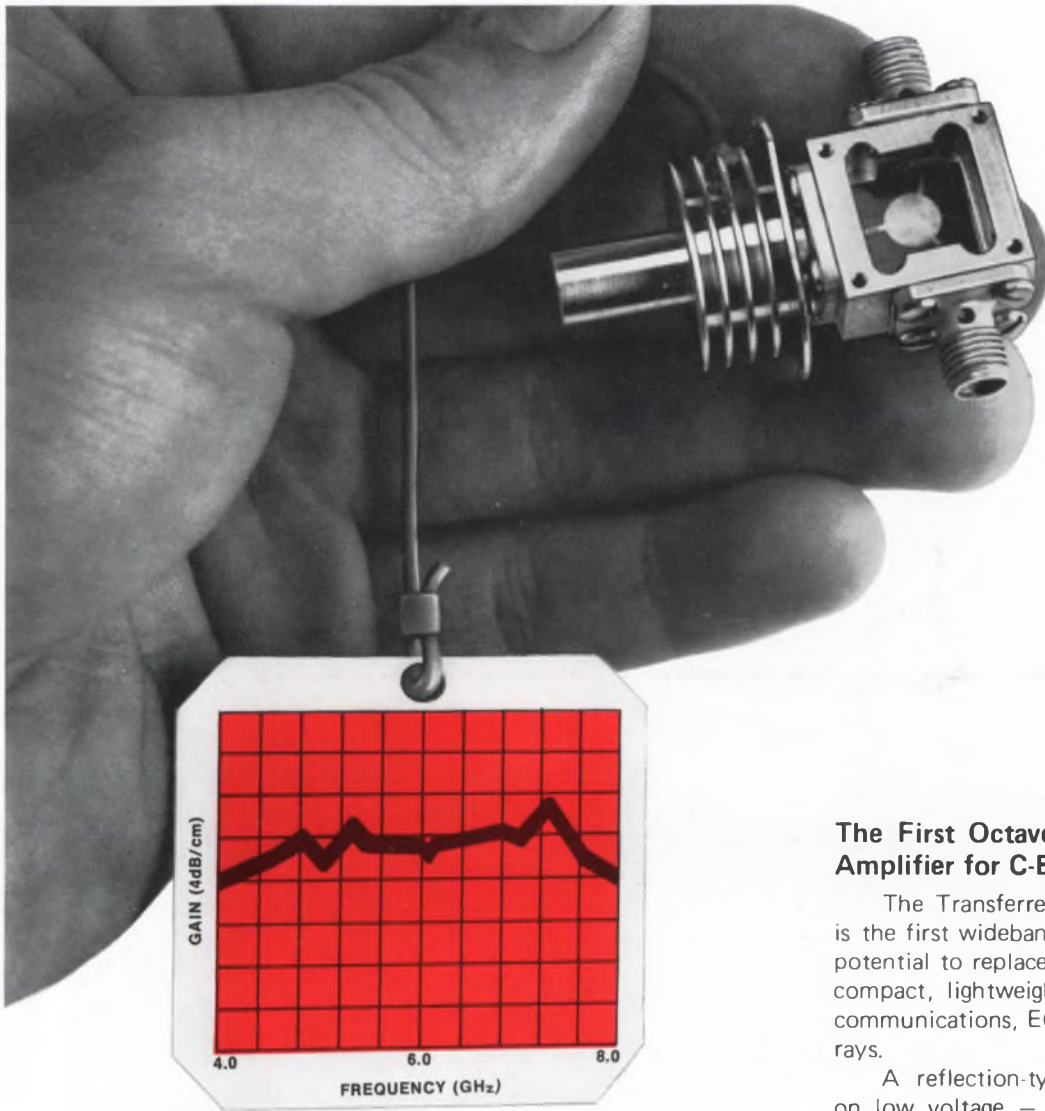

TEA... the RCA Transferred-Electron Amplifier

The First Octave-Bandwidth Solid-State Amplifier for C-Band and Above

The Transferred-Electron Amplifier (TEA) is the first wideband microwave amplifier with potential to replace bulky vacuum devices with compact, lightweight, highly-reliable units for communications, ECM, and airborne phased arrays.

A reflection-type amplifier that operates on low voltage — 15 V supply or even less, RCA's TEA employs GaAs bulk-effect diodes developed by the David Sarnoff Research Center. This unusually linear device offers the potential of outputs in excess of 1 W and a noise figure of 15 dB over octave and even multi-octave bandwidths.

A single-stage amplifier, for example, has demonstrated an output of more than 250 mW (1 dB gain compression) at 4 to 8 GHz with an 8 dB linear gain. A two-stage amplifier, with a 2 GHz bandwidth centered at 6 GHz and a small signal gain of 22 dB, has demonstrated a power output of 200 mW. Stable linear amplification has been achieved over a total dynamic range of 90 dB. Similar results have been measured also in X-band.

With more than two decades of microwave background, always look to RCA for innovations like the TEA, the beginning of the solid-state traveling-wave tube. For more information, see your local RCA Representative or call Microwave Marketing, (201) 485-3900, TWX 710-995-4474. For technical data, including a copy of MWD-305B on RCA TEOs and TEAs, write: RCA, Commercial Engineering, Section 57B-4 /ZM10, Harrison, N.J. 07029. International: RCA, 2-4 rue du Lièvre, 1227 Geneva, Switzerland.

RCA