

Electronic Design 23

VOL. 17 NO.

FOR ENGINEERS AND ENGINEERING MANAGERS

NOV. 8, 1969

Computer-aided-design programs can simplify your job, if you know what they are and where to find them. Time-sharing services offer hundreds. ECAP is excellent for

linear circuit analysis; CSMP is handy for servos; and NASAP does transfer functions. To pick the right program and its source, see the report starting on p. C8





**TRW/Globe
sells motion**

Application #2: cooling and blowing.

Globe won't make you "bend metal" around an off-the-shelf design. You won't be asked to repackage everything in your system—except the blower—to make our job easier. Globe will give the performance your system needs.

The difference at Globe is how blower and motor designers work together to match the elements of your system. Globe designs AC, DC or DC to AC at any voltage. If a new impeller

design is the answer we'll begin delivery within eight weeks.

Behind every Globe blower is a Globe motor already tooled and tested. Globe has been making motors longer than other blower people have been in business. Until you call in Globe, don't lock yourself into a solution.

TRW Globe solves problems in motion. Any kind of motion: intermittent or continuous, rotary or linear, air or liquid or mechanical linkage. If you

have a problem in motion, let Globe's *system engineers* make your job easier. Contact TRW Globe Industries Div. of TRW Inc., 2275 Stanley Avenue, Dayton, Ohio 45404 Phone: (513) 228-3171

TRW®



ZAP!

HP's new 1100 V, 110 kHz calibrator keeps it from happening.

Let's face it, anybody that works with over 1000 volts learns to keep one hand in his pocket.

But, while it will always be primarily your responsibility when working with high voltage to protect yourself — it isn't your responsibility alone.

When Hewlett-Packard engineers developed the HP 746A High Voltage Amplifier for the HP 745A calibrator they had three definite goals in mind:

1. Give you the capability to calibrate to 1100 volts at 110 kHz.
2. Do it for a reasonable price.
3. Make it the safest piece of high voltage equipment available.

How well did they succeed? Well, the 745/746 calibration system provides outputs from as low as 0.100000 mV in 1 nV steps to as high as 1099.999 V in 1 mV steps. You get 7 voltage ranges, all with 6-digit adjustability. Frequency is from 10 Hz to 110 kHz in four overlapping decade ranges. You get direct error measuring capability plus the accuracy and stability you expect from an HP working standard.

Price? \$6500 for the whole system. Or, if you already have an HP 745A add the 746A for just \$2000.

Safety? It starts by lighting the red lightning bolt (international symbol for high voltage) whenever the 1100 V output is present. An overload causes the output to be automatically removed. Two sequential steps are required to obtain the high voltage output. These and many more safety features make the HP 746 the safest piece of high voltage equipment available today!

But the best way to convince yourself is to get the complete information on this complete calibration system. For more information, call your local HP field

engineer. Or, write to Hewlett-Packard, Palo Alto, California 94304. Europe: 1217 Meyrin-Geneva, Switzerland.



099/24

HEWLETT  PACKARD

WORKING STANDARDS

INFORMATION RETRIEVAL NUMBER 2

Hardly a lab or production test line is without a Datapulse 101 or 110B pulse generator. If you select pulse generators you should know why:

Thousands of users have discovered that the compact 101 delivers unusually high performance for only \$395. And they recognize that years from now, the 101's specs will still be a match for most pulse test needs: rep rates to 10 MHz, 5 ns rise, simultaneous $\pm 10V$ outputs, width and delays to 10 ms, double pulses, and sync/async gating.

But when you want to tailor waveshapes to order, you need the unequalled control offered by the 110B: rep rates to 50 MHz, variable linear rise and fall from 4 ns to 500 μs , full baseline offset, 10 ns to 5 ms width, -10 ns to +50 ms delay, simultaneous $\pm 10v$ outputs, complement capability, paired pulses, and gated bursts. It all means that the 110B can simulate just about any pulse or waveform that can occur in circuits operating to 50 MHz. And it sells for a modest \$1250.

And talk about reliability! Just ask one of the thousands of 101 and 110B users. Then ask us for a demonstration. Write Datapulse Division, Systron-Donner Corporation, 10150 W. Jefferson Blvd., Culver City, California 90230. (213) 836-6100.

Meet the general-purpose pulsers you're most likely to see at work



Still first. Two of 144 Systron-Donner instruments

Electronic counters	Digital voltmeters
Pulse generators	Digital panel meters
Microwave frequency indicators	Microwave signal generators
Digital clocks	Laboratory magnets
Memory testers	Data acquisition systems
Analog computers	Microwave test sets
Time code generators	
Data generators	

DATAPULSE
DIVISION
SYSTRON  DONNER

NEWS

- 21 **News Scope**
- 25 **Can a computer design another computer?**
Major concerns are pressing automated methods, but they face problems in interfacing and updating.
- 32 **Holographic TV tape player on way for home**
RCA SelectaVision, demonstrated as feasible, aims to offer \$400 unit that will attach to any color set.
- 34 **In Japan, everything is coming up ICs**
Their heavy, growing use in consumer products is apparent at industry's annual electronics show.
- 43 **Washington Report**
- 48 **Sidelights**
- 51 **Editorial: Why not join the computer revolution?**
- C1 **Special Computer Section**
- C8 For design the program is the thing
- C20 Visualize a new design graphically
- C38 Fall Joint Computer Conference products

TECHNOLOGY

- 66 **Design stable current-feedback pairs** using dual transistors. They offer excellent V_{be} and h_{fe} matching.
- 72 **Build flip-flops with AOI gates.** LSI arrays of these gates are smaller and faster than NAND arrays and use 30% less power.
- 84 **Test op amps carefully.** To design test circuits for speed and accuracy, learn the problems and sources of error.
- 90 **Learn the ABCs of metal purity** and watch the reliability potential of your designs increase.
- 94 **Management is "sinful" say most respondents** to our "crybaby" article, but they find it's easier to see errors than to solve them.
- 101 **Ideas for Design**

PRODUCTS

- 112 **Modules & Subassemblies:** Ten-bit \$69 d/a converter settles in 750 ns.
- 116 **Instrumentation:** Double divider achieves accuracy of 0.01 ppm.
- 120 ICs & Semiconductors
- 122 Components
- 126 Packaging & Materials
- 130 Microwaves & Lasers
- 132 Data Processing
- 133 Production

Departments

- 16 Designer's Datebook
- 136 Evaluation Samples
- 138 Design Aids
- 139 Annual Reports
- 141 Application Notes
- 142 New Literature
- 158 Advertisers' Index
- 160 Information Retrieval Service

Information Retrieval Service Card inside back cover

Cover Photo: Courtesy of Service Bureau Corp., New York, N. Y.

We'll go to any length to get into your memory

National's capable of going a long way (or short) to get the right MOS shift registers into your memory. The applications are unlimited.

For starters, you get a variety of bit lengths from our standard line, available immediately. Your National distributor's got them on the shelf and waiting.

If you can't find the register length your application requires, give us a call. We'll program your register length into our standard process. We've been making MOS so long, our memory's capable of anything.

How's that register?

DYNAMIC		
Dual-25	MM400	-55°C to +125°C
	MM401	-55°C to +125°C (Internal 20K pull-up resistor)
	MM500	-25°C to +70°C
	MM501	-25°C to +70°C (Internal 20K pull-up resistor)
Dual-50	MM402	-55°C to +125°C
	MM403	-55°C to +125°C (Internal 20K pull-up resistor)
	MM502	-25°C to +70°C
	MM503	-25°C to +70°C (Internal 20K pull-up resistor)
Dual-100	MM406	-55°C to +125°C
	MM407	-55°C to +125°C (Internal 20K pull-up resistor)
	MM506	-25°C to +70°C
	MM507	-25°C to +70°C (Internal 20K pull-up resistor)
Dual-64	MM410	-55°C to +125°C
Accumulator	MM510	-25°C to +70°C
Triple-60+4	MM415	-55°C to +125°C
Accumulator	MM515	-25°C to +70°C
STATIC		
Dual-16	MM404	-55°C to +125°C
	MM504	-25°C to +70°C
Dual-32	MM405	-55°C to +125°C
	MM505	-25°C to +70°C
8-bit	MM408	-55°C to +125°C
Serial to Parallel	MM508	-25°C to +70°C
8-bit	MM409	-55°C to +125°C
Parallel to Serial	MM509	-25°C to +70°C
Dual-32	MM419	-55°C to +125°C
Split clock	MM519	-25°C to +70°C

Write or call National Semiconductor, 2975 San Ysidro Way, Santa Clara, California 95051.

(408) 245-4320. TWX: 910-339-9240 Cables: NATSEMICON

National/MOS





Meanwhile, back on earth.
Arrow-Hart scores a
breakthrough in lighted push-
button switches. Snap-on
contact blocks make up to
4-pole double throw
form Z switches. 31 stock
components = 25,344 different
variations. Six colored
lenses in three shapes. Is your
imagination beginning to run
away with you? Write or wire
for folder. We call all this
Adapt-a-Switch. You'll
call it ingenious.



**Arrow
Hart**

ARROW-HART, INC.
HARTFORD, CONN.

Your RF designs can get you

THERE*

from here

To get them "THERE," more than one hundred RF types are standards at Motorola and total capability is best suggested by the hundreds of additional special types supplied.

*"THERE" can mean the moon or beyond if such is your requirement. Motorola RF transistors have operated in equipment on the surface of the moon and they have journeyed to Mars. "THERE" can be nearly anywhere, terrestrial or extraterrestrial, you want your designs to go if your RF transistors are from here, from Motorola.

RF Power transistors from 100 mW to 100 W at frequencies from 2 MHz to 2 GHz also included the first commercially available VHF PNP high-power types. Many are BET† transistors with the reliability, lower lead inductance, and greater safe operating area from balanced emitters with deposited discrete Nichrome resistors.

Low noise and other small-signal amplifiers include JAN, JAN-TX and other Hi-Rel types. UHF and Microwave Oscillators are available, too.

For a brochure giving key specifications on preferred standard types write to Technical Information Center, Motorola Semiconductor Products Inc., P.O. Box 20912, Phoenix, Arizona 85036.

† Trademark of Motorola Inc.

- where the priceless ingredient is care!



MOTOROLA
Silicon RF Transistors

JFD COMPONENTS

RELIABILITY PROVEN IN DEEP SPACE



MINUTEMAN



APOLLO/LM



PIONEER

JFD continues to earn its reputation as a leading state-of-the-art discrete components manufacturer. OEM manufacturers — Military, Space and Commercial — display their confidence by specifying JFD for miniaturized fixed and variable capacitors, LC networks and tuners.

JFD components have helped make possible such sophisticated systems as — Minuteman, guidance and control (Autonetics Division North American Rockwell Corp.) — Apollo Command Module S-band transponder and Up Data Link and Lunar Module S-band transceiver (Motorola Inc.) — Pioneer, deep space data probe (TRW Inc.). These are only a few of JFD's more dramatic application credits.

JFD will continue to innovate and set higher industry standards of quality and reliability essential to 'Space Age' circuitry.

Use the coupon at the right to learn more about JFD components.

JFD

SUBSIDIARY OF RIKER-MAXSON CORPORATION

JFD ELECTRONICS CORP. / COMPONENTS DIVISION

15th Avenue at 62nd Street • Brooklyn, N. Y. 11219/ Phone 212-331-1000 • TWX 710-584-2462

PLEASE SEND ME THE LATEST DATA ON THE FOLLOWING COMPONENTS LINES:

- PISTON TRIMMER & TUNING CAPACITORS
- MVM/VAM AIR VARIABLE CAPACITORS
- CERAMIC VARIABLE DISC AND MICROMINIATURE CAPACITORS
- STANGARD 'LOW-COST' FIXED & VARIABLE CAPACITORS
- UNICERAM — SUBMINIATURE & MICROMINIATURE HI Q AND HI K FIXED CERAMIC CAPACITOR
- COMPACTUNER-MODULAR MULTIGANG TUNERS
- MINIATURE LC TUNERS
- MICROMINIATURE MTLT TUNERS
- MINIATURE TANK CIRCUITS
- METALIZED INDUCTORS
- METAL FILM & WIREWOUND RESISTORS
- LADDER NETWORKS

NAME _____ TITLE _____

COMPANY _____

ADDRESS _____



Let TI's special HI-REL Task Force take you through the turbulent sometimes uncharted universe of MIL-STD-883.

We'll keep you on course.

Scout's honor.

Others have called 883 a lot of confusion, a mixed bag, and even "unprintable words."

But we have tried to keep our mouth shut, our shoulder to the centrifuge, and our nose to the stress levels.

While our best minds solved the problems.

Quietly, TI has committed itself to 883. Money, manpower and facilities.

And we're ready to deliver "in accordance to MIL-STD-883."

In fact, we've been delivering 100% tested ICs for years. Millions of them for Minuteman, Sprint, Poseidon, F-111 and other programs.

And some of these had even tighter requirements than 883!

From this experience, TI has organized special HI-REL Task Forces to help you meet 883. A special Task Force has been created for DTL, another for linear, and the one pictured here for TTL ICs.

Its members are some of TI's top

managers in the areas of reliability engineering, process engineering, product sales, military marketing, product planning, product engineering, quality control engineering, manufacturing and HI-REL assembly.

They're specialists in Series 54 and 54H TTL ICs, now available from TI in both flat pack and ceramic dual-in-line packages... standardized for 883 Classes A, B and C.

The Task Force's assignment starts with your problem: determining the specific test procedures and levels you'll need to satisfy 883 requirements.

Once the most practicable test plan has been devised, the Task Force sees it through. Thousands of TI personnel in many departments may be involved in your program, but the Task Force is responsible for its success.

Task Force members can cross departmental boundaries, step on toes and crack bottle necks, if need be, to keep your program on target.

In addition, you have the industry's best test facilities going for you at TI...from more than 50,000 burn-in sockets to environmental shake, rattle and roll labs, to IR scanners, microprobes, Radiflo and variable data loggers.

One thing more.



TI has prepared a comprehensive 40-page procurement specification incorporating MIL-STD-883 - supplemented by 100 pages of detailed product specifications. From your first source for TTL ICs.

Use it to plot your course, and TI's HI-REL Task Force will keep you on it. Scout's honor.

Write for "MACH IV High Reliability Procurement Specification MIL-STD-883." Texas Instruments Incorporated, PO Box 5012, MS 308, Dallas, Texas 75222. Or just circle reader service number 107.



TEXAS INSTRUMENTS
INCORPORATED

**Reliability is staggered steps
and a hunk of DAP.**



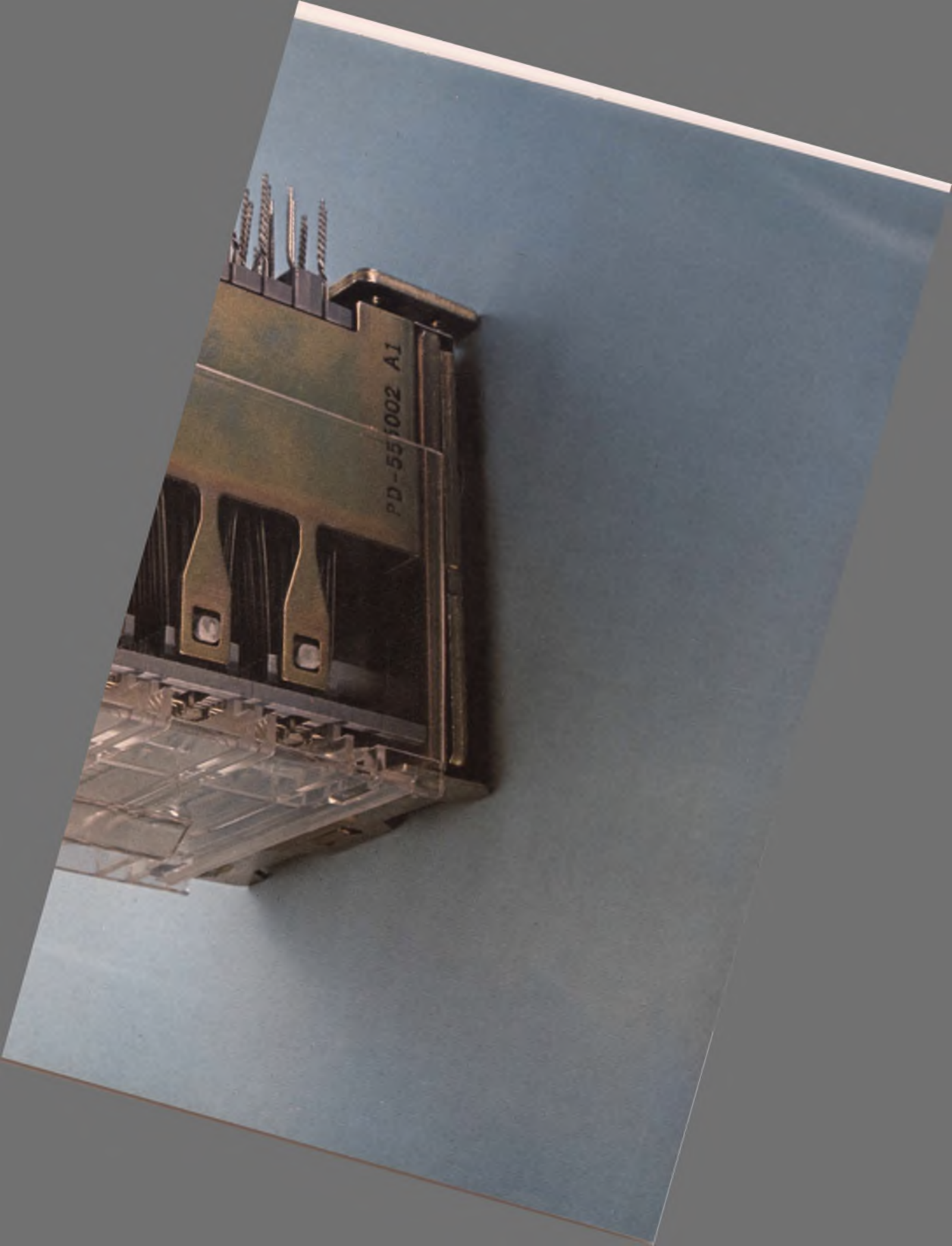

PD-551002 A1

Expect over a billion operations.

Our Class W wire-spring relay is different. In fact, there's nothing like it in the entire industry. Where else can you find a relay with lots of contacts and a mechanical life of more than a billion operations! That's about two and a half times the life of the best conventional relay around.

Another nice thing about our Class W is that it takes up a lot less space and costs less than using a bunch of other relays. That's because we build our Class W relay with one, two or three levels of contact assemblies, with 17 form C combinations per level. By the way, they're available with gold contacts for low-level switching.

Making it tough on creepage.

All those staggered steps you see on the side were put in to raise the breakdown voltage between terminals. These molded steps add extra creepage distance between the terminals. This really counts for high voltage testing, or when using our Class W in unfavorable ambient conditions.

These steps, and all the molding compound used for insulating the contact springs, are made from

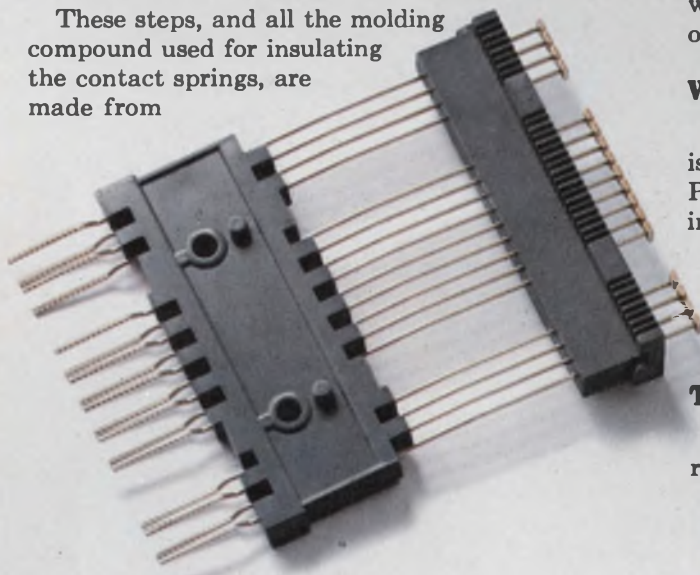

diallyl phthalate. (They call it DAP for short.) It has great insulating properties and it wears like iron. Even if the humidity is high, you have excellent protection.

Redundancy—two springs are better than one.

Each of our long wire-spring contacts has an independent twin with the same function. One tiny particle of dust could prevent contact on other relays. Not with our Class W. You can be sure one of the twins will function. That's back-up reliability.

The twin contacts are twisted together at the terminal end. Then we give them a spanking (you might call it swedging) to provide solderless wrap.

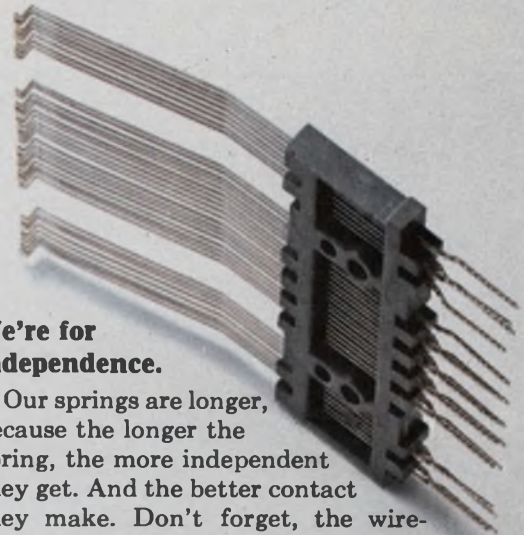

We're for independence.

Our springs are longer, because the longer the spring, the more independent they get. And the better contact they make. Don't forget, the wire-spring relay is the most reliable way to get a permissive make or break contact. You can rely on it.

The middle contact springs have to be stationary. To make sure they stay that way forever, we actually mold them between two thick pieces of DAP on both ends. Just try to move one.

When we say flat, it's flat.

Each frame, banged out by a gigantic machine is extra thick and extra flat. Then they're planished. Planishing is another step we go through in forming the frame to add strength and stability by relieving surface strain.

We've made our spring-loaded pile-up clamp extra thick, too. Once it's tightened down, the whole pile-up is nice and tight, and stays tight.

There's more.

We could tell you a lot more about our Class W relays. Like how the tough high-temp molded

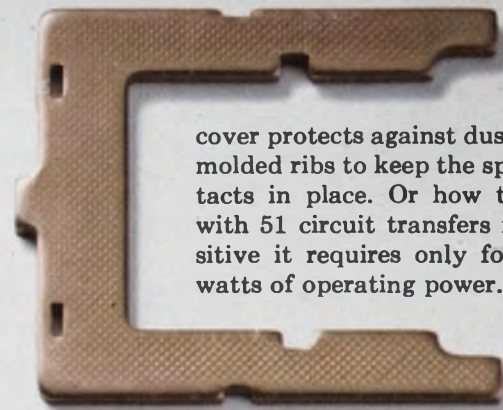

cover protects against dust and has molded ribs to keep the spring contacts in place. Or how this relay with 51 circuit transfers is so sensitive it requires only four to six watts of operating power.

But why don't you let us prove how much reliability we put into our Class W? We'll be waiting to hear from you. Industrial Sales Division, Automatic Electric Company, Northlake, Ill. 60164.

AUTOMATIC ELECTRIC
GENERAL TELEPHONE & ELECTRONICS

New S. S. White system trims microelectronic hybrid resistors at 1,000 per hour...or more



If you're into hybrid circuitry in a big way, or hope to be, our Model AT-701AR may be just what you need. It offers high capacity, accurate trims, high yield — or, just what you need to keep your customers and your comptroller happy.

Model AT-701AR is similar to our highly successful Model AT-701A, but with the addition of a rotary feeding system which lets operator load and unload substrates during the machine's trimming cycle. Capacity is limited only by the man-

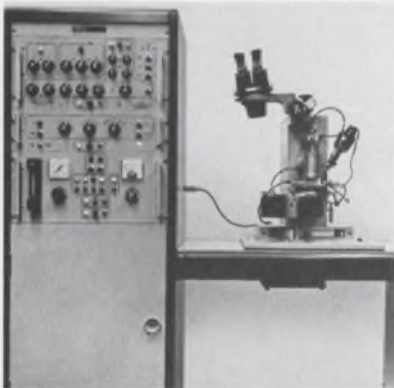

Model AT-701AR

ual dexterity of your operator.

Accuracy of the AT-701AR is guaranteed — within 0.5%. 0.1% is attainable with care and some sacrifice of speed. Trimming is monitored by a precision system of electronics featuring a four-wire Kelvin bridge, and tolerances may be programmed from $\pm 0.1\%$ through $\pm 11\%$. (No use making them better than the specs require!)

But suppose the Model AT-701AR is too big or too small for you?

Call us anyway. If you can get by with something like 600 accurate trims an hour, we can offer you our Model AT-701A, to which you can add the turntable feature later. If you're still experimenting, we have Model LAT-100 for breadboarding. It is accurate to 1% better, takes substrates up to 4 x 4 inches and sells for only \$5,950. If you're *really* big, there's the Model AT-704A, a rotary-feed

machine that trims four resistors simultaneously, monitors, and inspects them at the breathtaking rate of 4,000 per hour. And if *that's* not fast enough for you, buy two.

All the S. S. White resistor trimming systems are based on the proven Airbrasive® method of removing resistance material which produces neither heat nor shock, does not alter the substrate.

Call 212-661-3320 to arrange for a live demonstration. Speak to Hal Skurnick or Don Davis. These same gentlemen will be demonstrating the Model AT-701AR and the Model LAT-100 at major electronics trade shows around the country, and if that's not quick enough for you, we will arrange for you to visit our factory. We have also prepared an extensive technical bulletin on this equipment, called, rather cryptically, the "RT-14", a copy of which is yours for the asking.



RT-14

Write to S. S. White Division, Pennwalt Corporation, Dept. 28, 201 East 42nd Street, N.Y., N.Y. Tel.: 212-661-3320

PENWALT
S.S. WHITE
INDUSTRIAL PRODUCTS



NEW
 ...from CLARESEARCH
 ...Ultraminiature
 reed relays

■ Two new lines of Picoreed relays give you a wider choice in sensitivity, contact configurations and space-saving size. For example, note the new low profile of Types PRA and PRB—allows .375" pcb mounting centers. And note the new high sensitivity of Types PRAH and PRBH.

Both lines available in one to five Form A contacts with traditional Clare reliability. 100,000,000 operations at signal levels. 5 volt (must-operate 3.75v), compatible with standard 5 v DTL and TTL logic families. 6, 12 and 24 volt standard relays also available.

For information, circle Reader Service number, or write for Data Sheet 971A. C. P. Clare & Co., Chicago, Illinois 60645...and worldwide.

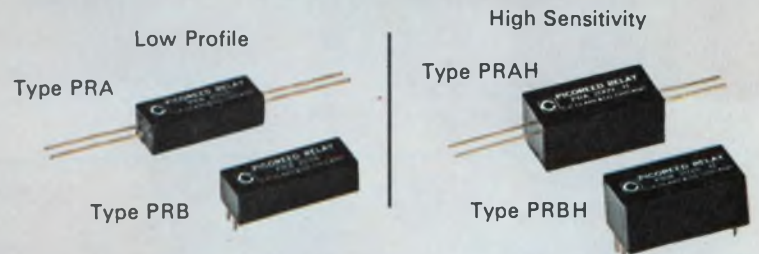

<i>Electrical and Dimensional Characteristics</i>	Types PRA/PRB— Low Profile		Types PRAH/PRBH— High Sensitivity	
	Form 1A	Form 5A	Form 1A	Form 5A
Operate time, including bounce	500 μ s	600 μ s	600 μ s	900 μ s
Average nominal power for 5 volt units	65 mw	250 mw	46 mw	140 mw
Pcb mounting centers	.375"	.375"	.500"	.500"
Length	.781	.800	.800	.800
Width*	.250	.675	.400	.800
Height	.187	.225	.350	.350

*Widths vary according to number of switches. One through 5 available.

LOOK FOR



CLARE ON THE RELAY

a GENERAL INSTRUMENT company

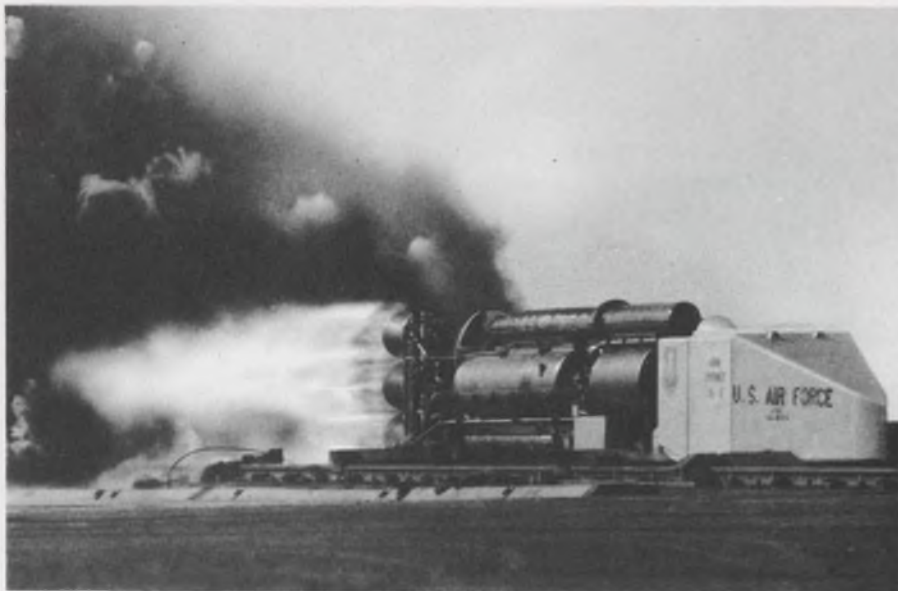

Abbott Power Supplies on this Test Sled Have Been Subjected to 30 G's Vibration

Air Force personnel tested three Abbott model* power supplies used to power electronic equipment on the Air Force Rocket Sled at Holloman Air Force Base. Test conditions consisted of 1½ minute sweeps of 30-G's peak sine vibration from 40 cps to 1500 cps, on each of three axis. Throughout these tests the Abbott power supplies operated within specifications.

All Abbott Power Supplies are hermetically sealed and encapsulated in heavy steel containers to meet the tough environments of the space age (MIL-E-5272C) with temperature extremes up to 100°C and conditions of altitude, vibration, shock, sand, dust, humidity, salt spray, fungus, sunshine, rain, and explosion. Under these conditions the power supply must operate normally. Abbott power modules use only the highest quality semiconductors and MIL-T-27B transformers in their construction to obtain the high degree of reliability under tough environments demanded by today's military requirements. To withstand heat sink temperatures of 100°C all silicon semiconductors are used exclusively.

The Abbott line of power modules includes output voltages from 5.0

volts DC to 10,000 volts DC with output currents from 2 milliamperes to 20 amperes. Over 3500 models are listed *with prices* in the new Abbott Catalog with various types of inputs:

- 60 ϕ to DC, Regulated
- 400 ϕ to DC, Regulated
- 28 VDC to DC, Regulated
- 28 VDC to 400 ϕ , 1 ϕ or 3 ϕ
- 60 ϕ to 400 ϕ , 1 ϕ or 3 ϕ

Included in the Abbott catalog is a listing of environmental parameters per MIL-E-5272C together with the cost and time required to qualify an Abbott Module. Many Abbott power supplies have already been completely tested and qualified to various environmental specifications. Copies of these test reports are available by phoning or writing to Abbott at the address below.

*Model CL24D-55A, Ser. Nos. 4327, 4328 and Model A1D-70A, Ser. No. 5358, were tested.

**TO: Abbott Transistor Labs., Inc., Dept. 97
5200 West Jefferson Blvd.
Los Angeles, California 90016**

Sir:
Please send me your latest catalog on power supply modules:

NAME _____ DEPT. _____

COMPANY _____

ADDRESS _____

CITY & STATE _____

Designer's Datebook

NOVEMBER 1969						
Sun	Mon	Tue	Wed	Thu	Fri	Sat
						1
2	3	4	5	6	7	8
9	10	11	12	13	14	15
16	17	18	19	20	21	22
23	24	25	26	27	28	29
30						

DECEMBER 1969						
Sun	Mon	Tue	Wed	Thu	Fri	Sat
7	8	9	10	11	12	13
14	15	16	17	18	19	20
21	22	23	24	25	26	27
28	29	30	31			

For further information on meetings, use Information Retrieval Card.

Nov. 18-20

Fall Joint Computer Conference (Las Vegas) Sponsor: IEEE, AFIPS, E. Grabbe, TRW Systems Inc., Bldg. R3, Room 2070, One Space Park, Redondo Beach, Calif. 90278

CIRCLE NO. 417

Nov. 18-21

Magnetism and Magnetic Materials Conference (Philadelphia) Sponsor: IEEE, Brooks Harris, Univ. of Penna., Philadelphia, Pa. 19104

CIRCLE NO. 418

Dec. 4-5

Vehicular Technology Conference (Columbus, Ohio) Sponsor: IEEE, R. E. Fenton, Ohio State Univ., 2015 Neil Ave., Columbus, Ohio. 43210

CIRCLE NO. 419

Dec. 8-10

National Electronics Conference (Chicago) Sponsor: ITT, IEEE, et al, National Electronics Conference, Inc., Oakbrook Executive Plaza No. 2—Suite 629, 1211 W. 22 St., Oak Brook, Ill. 60521

CIRCLE NO. 420

Dec. 8-10

International Symposium on Circuit Theory (San Francisco) Sponsor: IEEE, R. A. Rohrer, Fairchild Semiconductor Inc., 4001 Junipero Serra Blvd., Palo Alto, Calif. 94304

CIRCLE NO. 421

Dec. 10-12

Asilomar Conference on Circuits and Systems (Pacific Grove, Calif.) Sponsor: IEEE, Santa Clara Univ., et al, Shu-Park Chan, Univ. of Santa Clara, Santa Clara, Calif.

CIRCLE NO. 422

Please write for your FREE copy of this new catalog or see EEM (1969-1970 ELECTRONIC ENGINEERS MASTER Directory), Pages 1834-1851.

abbott transistor

LABORATORIES, INCORPORATED

5200 W. Jefferson Blvd./ Los Angeles 90016
(213) WEBster 6-8185 Cable ABTLABS

INFORMATION RETRIEVAL NUMBER 10

HAPPENINGS IN ELECTRONICS

Hottest Product of the Year #3.

November '69

Motorola has hit the market this year with several very exciting products in linear ICs. In chronological order we have seen: the one and only 4-quadrant Multiplier (MC1595); the one and only high voltage 'floating' Voltage Regulator (MC1566); and now the Super-Beta Op Amp (MC1556) with an open loop voltage gain of 100,000 minimum. In addition to being internally compensated, it also boasts of very low bias current (15 nA max.) and offset current (2 nA max.). Add to this choice list of features the fact that the new device offers a five times improvement in slew rate (2.5 v/ μ S) over the 741, and you have a new standard to shoot for in the Op Amp market. Application-wise, the low bias and offset currents make it possible to design better Log Amplifier circuits (1% error over 5 decades of log conversion); and Gyrator circuits which can achieve a theoretical maximum Q of 50. The Super-Beta Op Amp in the military version (MC1556) sells for 42.00 in 1 to 24 pc quantities; the commercial version (MC1456) for 22.50. For technical data, circle #241.

The more complicated MSI becomes, the simpler it becomes.

MSI (medium scale integrated) technology enables Fairchild to extend their 1-out-of-10 decoder (9301) into a 1-out-of-16 decoder (9311). The 60% increase in possible outputs is accomplished at a 25% increase in price, resulting in lower system costs. In addition to the savings in component cost, there is a far more significant savings in reduced wiring and assembly costs. Design time is shorter, design is simpler, and systems are easier to build and understand. Fewer soldered joints increases system reliability and make maintenance easier. Why not look into total capability with Fairchild CCSL building blocks done the MSI way? They are designed to be used as a family. For a 54-page brochure on Fairchild's MSI Family (2nd edition), circle #242.

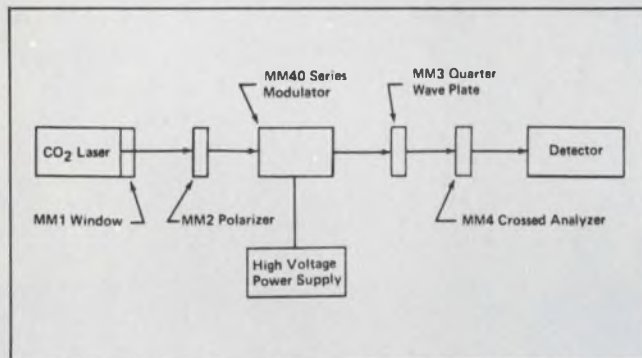

Modulating the Laser Carrier Beam.

Information, such as a telephone conversation or a TV picture, can be transmitted on a CO₂ laser beam. This can be done by modulating the amplitude (intensity) of the light. A schematic of a gas laser modulating system is at the left. The electro-optical modulator crystals and modulator accessories made by Monsanto are available from Schweber. A brochure prepared by Monsanto entitled "Fundamental Concepts of CO₂ Laser Modulators," as well as data sheets of the devices diagrammed in the schematic, can be obtained by circling #243.

New IC eliminates RFI in Power Control Systems.

Conventional methods of switching AC power on and off create undesirable radio frequency interference (RFI). The one method that holds RFI to a minimum requires that switching take place at the precise moment that the AC power crosses the zero voltage (or current) point on the sine wave. This minimizes the tremendously high instantaneous switched power spikes that must be suppressed by costly and bulky filter networks. Fairchild now offers a monolithic IC, the uA742 "Trigac", that will perform as a zero crossing trigger in response to a sensor signal. The Trigac will generate a high energy pulse for external thyristor firing at zero crossing of load currents. The 1 to 24 pc price is 7.45. You can obtain a 30-page brochure on the applications of the uA742 Trigac by circling #244. Schweber ships the Trigac immediately from stock.

Review of new catalogs:

1. RCA LINEAR DIGITAL IC PRODUCT GUIDE. This publication contains the latest information on RCA's entire integrated circuit line, both arrays and complete circuits. The print type and layout have been designed with one end in view—easy readability. Generous space is provided for listing of condensed electrical characteristics, features, and applications. (For detailed data, individual technical bulletins are available.) Also included with each device listing is an uncramped schematic indicating all values of resistors where used. Circle #245.

2. THE NEW AMPHENOL CONDENSED CATALOG OF INDUSTRIAL COMPONENTS offers some improvements over previous versions of this much needed compilation. What was sorely missed in the last edition is now provided, namely, a general index of all the Amphenol products arranged conveniently by product category and series #. Now it is easy to look up the connector you need under connector categories such as Microphone, Rack & Panel, Printed Circuit, RF Coaxial, etc. Circle #246.



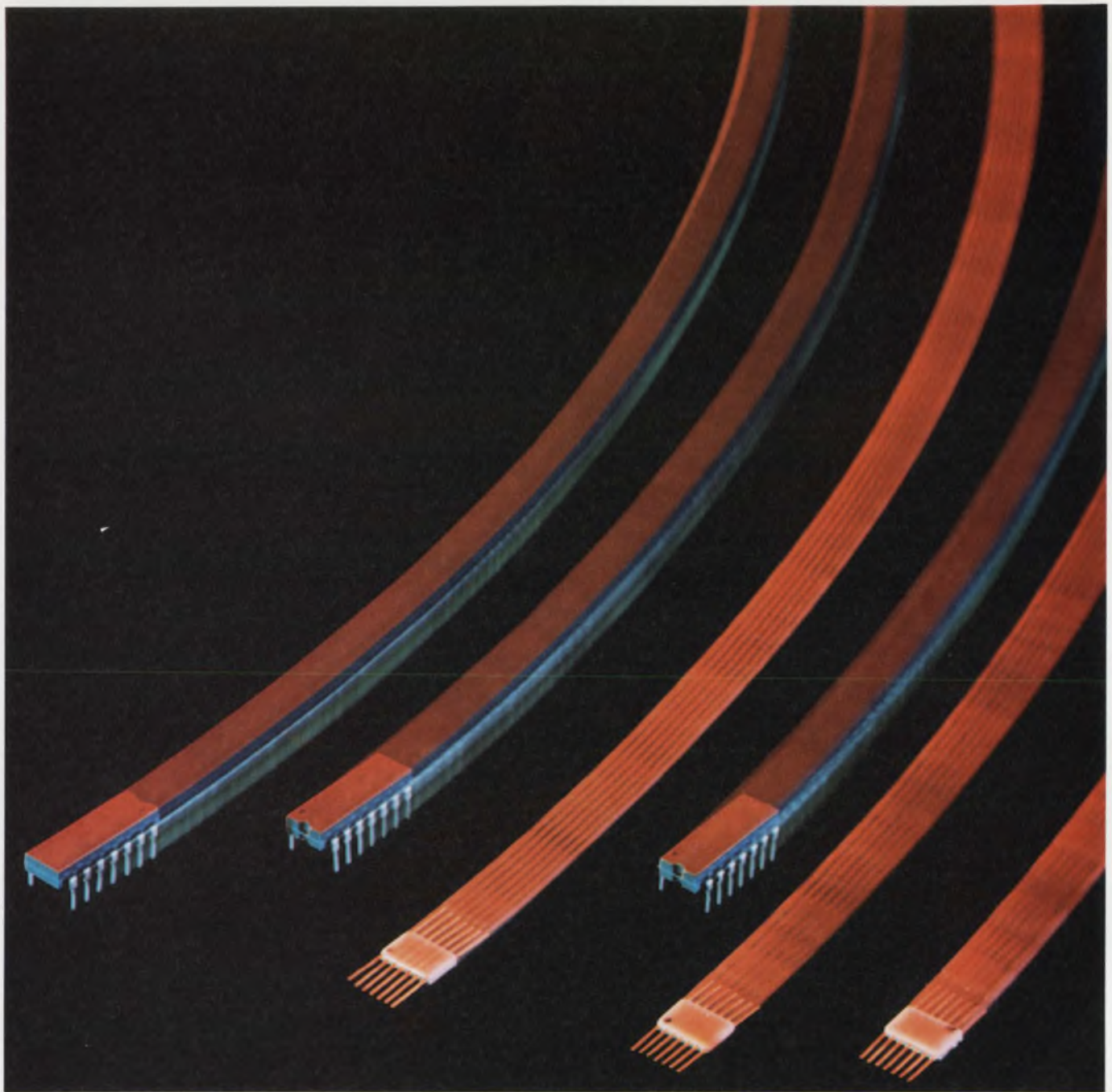

Sprague Digital ICs. Illustration: Series 54H/74H in flatpack and DIP

Just arrived. Series 54H/74H. The fast ones.

Just about the fastest saturated logic circuits around. Series 54H/74H from Sprague. The whole family. Flip-flops and all.

Use them in arithmetic and processing sections, where speed really counts. Mix and match them with Sprague's standard Series 54/74.

Get off to a fast start with Sprague Series 54H/74H.

TYPICAL CHARACTERISTICS	GATES	FLIP-FLOPS
Propagation Delay	6 nsec	17 nsec
Power Dissipation	22 mW	80 mW
Noise Immunity	1 V	1 V
Temperature Range	Series 54H Series 74H Packages	
	-55 to +125° C 0 to +70° C DIP or Flatpack	

Call Sprague Info-Central (617) 853-5000 extension 5474.



News

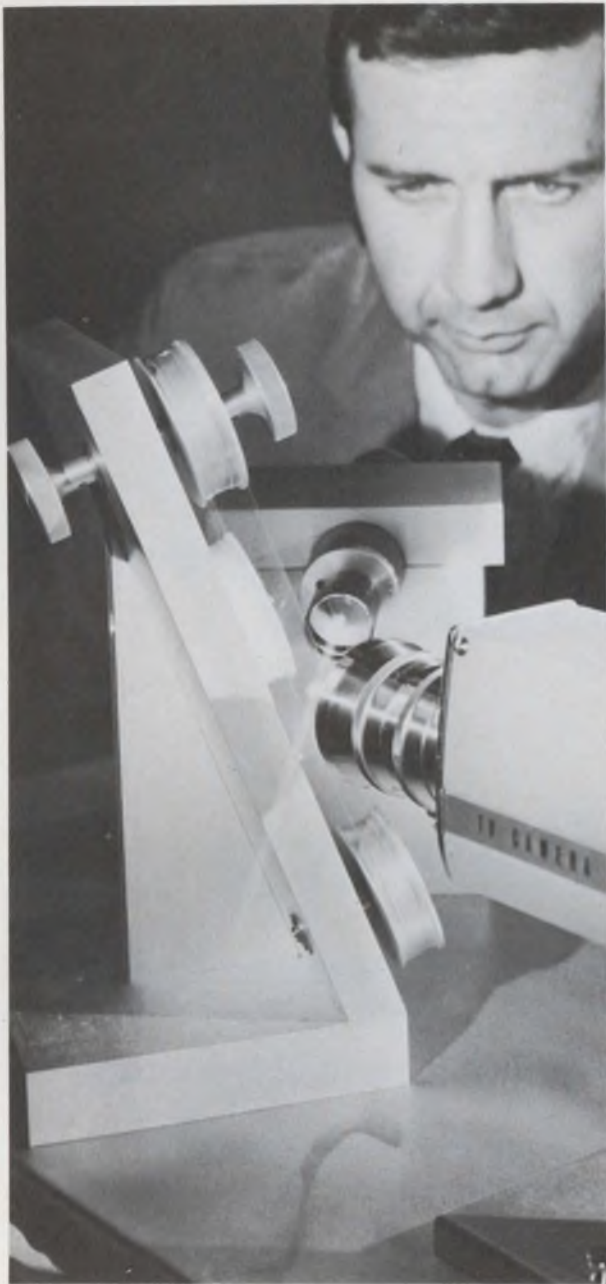

Color TV tape player system demonstrated by RCA makes use of laser and holographic techniques. p. 32.



Designing a computer with another computer may someday be feasible, provided interface problems are solved. p. 25.



The 1969 Japanese Electronics Show revealed the extent to which integrated circuits have invaded the consumer products area. p. 34.

Also in this section:

Lightning detector prevents explosions. p. 38.

News Scope, p. 21 . . . **Washington Report**, p. 43 . . . **Editorial**, p. 51.

...stymied by costs of stacked-mica capacitors?

Try SPRAGUE DIPPED SINGLE-FILM MICA CAPACITORS

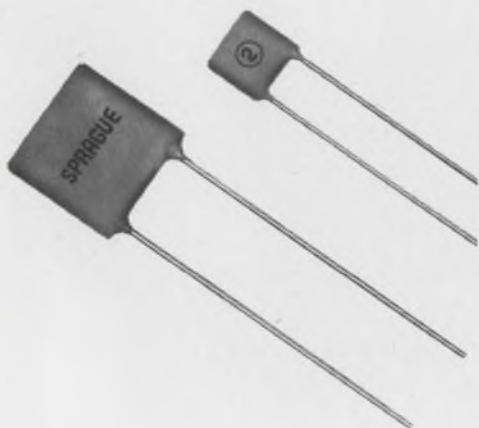

INFORMATION RETRIEVAL NUMBER 821

Mass produced silvered-mica capacitors for entertainment and commercial equipment. Combine excellent stability and retrace characteristics with economy. Ideal alternative to more expensive stacked-mica and ceramic disc capacitors. Exclusive manufacturing process prevents dielectric delamination as a result of temperature cycling. Designed for operation at 500 volts d-c. Capacitance values from 10 pF through 470 pF.

48C-9151

Tiny in size...Giants in volume efficiency!

Type 160D, 161D

Solid-Electrolyte Tantalex[®] Capacitors

for hearing aids and ultra-miniature circuits

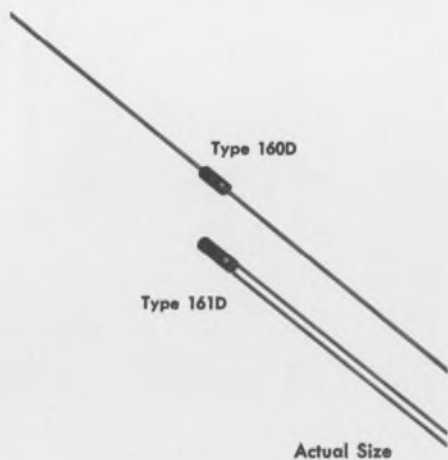

INFORMATION RETRIEVAL NUMBER 822

Tiny Type 160D/161D Tantalex Capacitors are sealed within a polyester film tube with tightly-bonded epoxy fill, so the assembly is both electrically insulated and highly resistant to moisture. They are available with axial leads as well as in single-ended construction.

Offering extremely high capacitance per unit volume (for example: 0.25 μ F @ 20 VDC in a case only .065" D. x .125" L.), Tantalex Hearing-aid Capacitors let you select from a broad range of ratings in five different case sizes.

48C-9125

For information on Dipped Mica Capacitors, request Engineering Bulletin 1010A. For the full story on Type 160D/161D Capacitors, write for Engineering Bulletin 3515D. Address Technical Literature Service, Sprague Electric Co., 347 Marshall St., North Adams, Mass. 01247.



Sprague and 'S' are registered trademarks of the Sprague Electric Co.

THE BROAD-LINE PRODUCER OF ELECTRONIC PARTS

News Scope

Air Force seeks larger role in space shuttle

With the cancellation by the Defense Dept. of the Manned Orbiting Laboratory project, the Air Force found itself, this year, with only an unmanned role in space. It now sees an opportunity to obtain a larger role in NASA's manned earth orbital project through development of the space shuttle, a re-usable logistical craft considered necessary to resupply such a space station.

NASA is expected to seek close to \$300 million for a space-shuttle program in its fiscal 1971 budget request. Detailed design contracts are expected to be awarded by the space agency early next spring. Four firms are currently performing conceptual study contracts: General Dynamics, Lockheed Aircraft, McDonnell Douglas, and North American Rockwell.

Boeing and Martin Marietta were expected to be the sole contenders for the design contract; however, Boeing and Lockheed have now agreed to present a team bid next year. Boeing will handle the launch vehicle, and Lockheed will work on the shuttle itself. It will be a hotly contested program if approved by Congress—in excess of \$5 billion during the next decade. The first planned flight would be in 1976.

The Air Force, reportedly, has prepared and is quietly circulating a program proposal titled "The Space Transportation System—A National Objective." Its purpose is to create a dual program in which re-usable (landable) spacecraft might be concurrently developed for both civil and military space projects. This would provide the Air Force with a means for manned investigations in space of orbital craft, as well as enhanced earth surveillance capability.

If any kind of shuttle is approved, a large development effort will

be required for on-board electronics. Many subsystems such as space-ground communications, environmental control, and rendezvous and landing radars can be adapted from the Apollo program. Major changes, however, will be needed for the on-board guidance and navigation system, the supporting digital computer, and the introduction of an adaptive electronic flight control system. Considerable preliminary work on the latter system has already been accomplished through the X-15 program and the X-20 Dyna Soar project.

Although not now under contract for study of the shuttle, Martin Marietta, through its Baltimore and Denver divisions, can be expected to be a strong contender for a design effort. Martin has a long history in experimental and design work on lifting bodies, manned and unmanned.

Military scopes to show plane's height, identity

The Defense Department has ordered its first production run of equipment that will automatically provide military air traffic controllers with identification and altitude of aircraft on its radar scopes. At present, scopes show unidentified blips that reveal position but not the aircraft's altitude or specific identity.

System-engineered at Wright-Patterson Air Force Base, Ohio, the systems, designated AN/TPX-42, are being produced by AIL, a division of Cutler-Hammer, Deer Park, N.Y. Over the next four years AIL will produce 304 units under a contract amounting to \$40.4 million.

The company plans to deliver the first units to the Air Force in

September, 1971. They will be installed in military air terminals and ground-controlled approach facilities in the U.S. and at overseas U.S. bases.

The Federal Aviation Administration is already installing such a system, but has equipped only a handful of terminals thus far. In spite of FAA's slight time gain, the military will probably have its system fully operable before FAA, because the civilian agency is holding out for a more complex system. Besides identifying an aircraft, FAA wants the whole flight plan displayed.

Semiconductor memory will set speed record

For the first time, memories can be accessed at the speed of logic. By the second quarter of 1970, Advanced Memory Systems, Inc., of Sunnyvale, Calif., will be offering semiconductor memory systems with a total access time of less than 15 ns for up to 32K bits, says Jerry Larkin, vice president of marketing. This compares with 60 to 80 ns for most semiconductor memory systems presently available, Larkin notes.

The new systems will be modular in construction, made up of individual PC cards that contain sixty-four 64-bit chips, plus decoding and buffering. The access time of the individual chips, Larkin says, is 5 ns. Logic gates add 1.8 ns per level, while wiring and connectors account for the remainder of the total system access time.

"Having control and buffer memories available that are roughly five times faster than any previous semiconductor memory system will greatly increase the throughput per dollar of the computer," Larkin points out, "and make it possible to build larger and faster systems."

The first product in the new line—a 32-word by 8-bit card containing sixteen 16-bit chips—will be available by the first of the year, says Larkin. This will be suitable for small special-purpose memories and register replacements. It will be followed in the second quarter of the year by high-speed buffer memory systems made up of PC

cards that contain sixty-four 64-bit chips in a variety of configurations— 4096×1 and 512×8 will be available off the shelf and other configurations on order. The company expects to offer not only the PC cards, but also to build self-contained custom systems in a variety of sizes and configurations, complete with power supply.

The new memories will be compatible with either GML or TTL, says Larkin, but the TTL-compatible systems will be somewhat slower—under 20 ns for 32K bits.

Astronaut and royalty form new corporation

Scott Carpenter, the astronaut-aquonaut, and Prince Bernhard of the Netherlands, have joined resources and gone into business. Backed by a staff of business, legal and technical experts, they are offering engineering services to anyone interested in the world beneath the seas.

Called Sea Sciences Corp., the new group will "conceive and design oceanographic systems and hardware for use by developing nations and private industry."

Carpenter is president of the corporation and Prince Bernhard is chairman.

Engineers' week to focus on environmental design

The largest National Engineers Week ever observed will be launched on February 22 and continued through the 28th, in an attempt to focus national attention on the profession's work in providing solutions to pollution, waste disposal and environmental problems that plague the country. The forecast was made recently by The National Society of Professional Engineers, sponsors of the program.

The 535 local chapters of NSPE are spearheading the theme of the week's observance—"Engineering . . . Environmental Design for the

1970's"—by featuring career conferences in high schools, exhibits on engineering achievements, university seminars, open-house tours through engineering schools, talks by engineers before civic and student groups, and numerous other projects for improving the nation's environment in the 1970s.

15-20% growth seen for computer industry

"The data-processing industry will grow at a compound rate of 15 to 20% a year over the next 10 years" is the prediction of William R. Lonergan, vice president of RCA Information Systems Div. As chairman of the Data Processing Group of the Business Equipment Manufacturers Association, Lonergan made this forecast at the organization's 11th annual exposition in New York.

A pacesetter in data-processing expansion will be the mini-computer industry, now "growing at an astounding rate," Lonergan said. But terminals for large data-processing machines will continue to provide the main thrust in this line, he added.

Other trends Lonergan is looking for include increases in on-line, time-sharing systems (they constitute 13% of the market now, with prospects of accounting for half of it by 1975); more large-scale multifunction systems; and more attention to "coupling man and machine."

The future of the office-machines market was described in an equally optimistic light by Lawrence Avanzino of the executive staff of Olivetti Underwood Corp., who presented a report in behalf of A. C. Buehler Jr., executive vice president of Victor Comptometer Corp.

"With the advent of microminaturization of electronic components, adding machines and calculators are now being built in very compact sizes and are being sold for home and non-office use," Avanzino noted.

He estimated that over-all sales of business machines, plus their supplies, would reach \$5.5 billion this year—growth of nearly 15% over last year.

Some of the new devices that

help account for this growth, Avanzino said, include smaller, faster electronic calculators—"one company is actually producing a pocket calculator no larger than a wrist-watch"; copiers; accounting machines with computer-like elements, such as memory stores; facsimile equipment for transmitting pictures over telephone wires; visual display for calculators; microfilm libraries, and dictation in home offices, resulting in "dictation by telephone anywhere, anytime."

Phonograph records store data at low cost

The standard 45-rpm phonograph record has joined the computer revolution. E.G. & G., Inc., of Bedford, Mass., has announced its new system of random access, read-only storage, using the familiar discs as the medium. Each 7-inch record can store up to 5 million bits of data and can be read out at rates up to 16 kbits/s. The pickup stylus is mounted on a lead screw, and it can access any point on the disc in 2-10 s. A series of sync pulses is recorded to aid location of the data.

The discs must be recorded by E.G. & G from data supplied by the user. A turn-around time of 48 hours is promised. This is quick enough, according to Norman Harvey, manager of E.G. & G's System Development Div., to allow use of the technique in inventory control where once a week updating is adequate. The low-cost discs can reduce data storage costs for users of small computers.

Other proposed applications of the idea include the storing of routines and subroutines on the records. A payroll program, for example, can be recorded and inexpensively reproduced for use on any computer equipped with the interfacing equipment. Heretofore, reproduction of programs in simple read-out form was a tedious and expensive exercise in punching paper tape or recording on magnetic tape.

The records are expected to cost about \$100, with \$1 of the total for the record itself and the remainder for handling the software. The system is expected to be available during the third quarter of 1970.

For 60¢ you can buy a diode with 100 picosecond switching time, low forward resistance, low reverse current, low stored charge and all the other parameters that add up to better-than-PN junction performance. Hewlett-Packard's 5082-2810/11 Hot Carrier Diodes are the best—coming and going— that you can buy for high-speed switching

at low cost. They're 4½ times faster than any PN junction. Try to beat that combination in a circuit design.

In thousand quantities, the 5082-2811 diodes are 60¢ each and the 5082-2810 diodes are 90¢. So before you order another PN junction diode, or any other high-speed semiconductor, try one of HP's new hot carrier diodes.

Call or write to Hewlett-Packard, Palo Alto, California 94304; Europe: 1217 Meyrin-Geneva, Switzerland.

HEWLETT *hp* PACKARD

SOLID STATE DEVICES

**Hot Carrier Diodes for
Switching
Logic
Clamping
Sampling
Log Conversion
A-D Conversion**

Fastest speed. Lowest price.

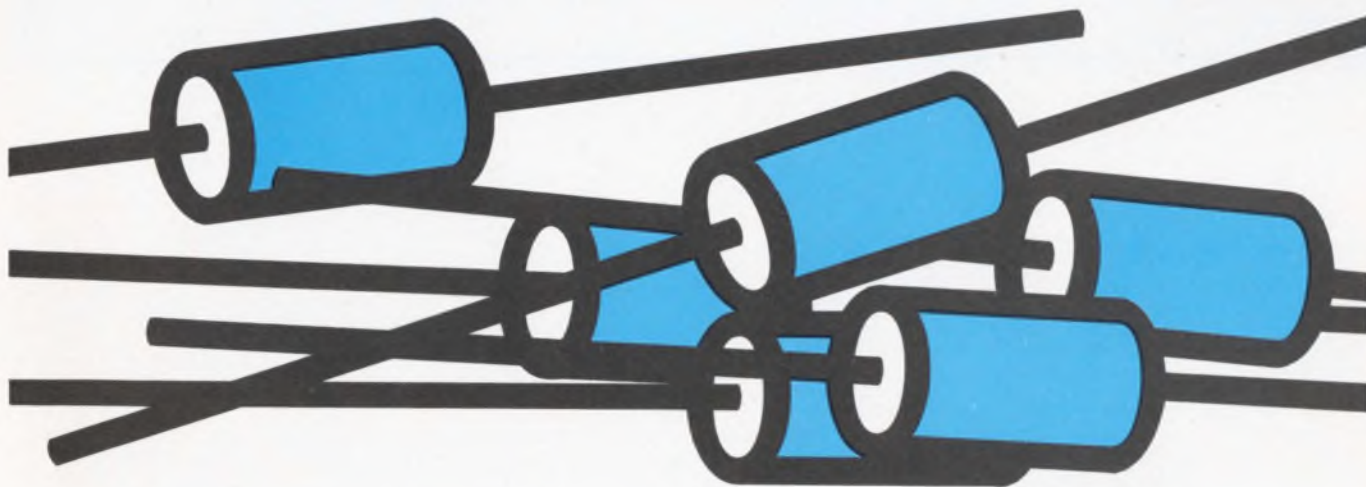

new

dimensions

WITH

QMF*



(4 TIMES ACTUAL SIZE)

4 POLE 65 MHz
TO-5 PACKAGE

(here's valuable bandwidth information you'll want to save)

Regardless of what they are called, M^CCoy Electronics Co. makes available the most complete offering of multi-electroded devices in the industry. From 5 to over 200 MHz, both crystal and filter technologies are combined to provide you assurance of competence, quality and reliability. We engineer and fabricate...

***Quartz Mechanical Filters
Uncoupled Filter Devices
Custom Innovations ...**



M^CCOY ELECTRONICS COMPANY
MT. HOLLY SPRINGS, PENNSYLVANIA 17065
Tel. 717-486-3411 TWX: 510-650-3548
a subsidiary of OAK ELECTRO/NETICS CORP

Put our experience to work for you!

INFORMATION RETRIEVAL NUMBER 15

ELECTRONIC DESIGN 23, November 8, 1969

Can a computer design another computer?

Major firms are pressing automated methods, but they face problems in interfacing and updating

David N. Kaye
West Coast Editor

Suppose a computer could be used to design another computer from start to finish. A vastly improved computer—smaller and more efficient—could be designed in a fraction of the time it now takes. Costs would probably drop dramatically, too. But is it feasible?

Major companies are already working on the problem, a survey by *ELECTRONIC DESIGN* shows. Their work is stressing only parts of the design of the total computer system, however. One company is pursuing the automated design of software, for example, another is delving into logic, a third is working on peripheral equipment, and so forth. The big questions are: How do you interface all these areas of concentration? And how do you update the computer-aided program at any point without having to start from the beginning again?

In the design of any computer system, engineers are faced with three major problem areas:

- Software and machine languages.
- Circuit analysis and simulation.
- Mechanization.

The first two areas speak for themselves, but mechanization is often defined in different ways by different people. Alan Hecht, manager of operations for Automation Systems, Inc., in Encino, Calif., expresses the majority opinion this way: "Mechanization is the step where you are going from logic equations into actual hardware."

Two approaches to software

Computer-aided design in the software area is being employed in two different ways: for the development of programs and pro-

gramming languages, and also for the generation of the instruction sets and operation codes that specify those functions that the computer will ultimately perform.

Hewlett-Packard Corp. in Palo Alto, Calif., has been looking into the automatic generation of programs for computers. Roy Caly, software manager of the Data Products Group, says:

"Work in software generation by software has been going on for several years primarily on an experimental basis looking at compiler generation. However, much more work will have to be done to get something that will meet a computer supplier's needs. We have a study program in this area working toward the development of several languages for a single machine."

Commenting on computer-aided software design techniques, Dr.



Engineers at Xerox Data Systems simultaneously use a time-shared computer in order to aid them in their designs.

(computer, continued)

Jack Shemer, principal member of the technical staff at Xerox Data Systems in El Segundo, Calif., says:

"As in the area of hardware design, computer-aided software developments have been greatly aided by time sharing. Xerox Data Systems text editors and assembly-language debugging aids, like EDIT and DELTA, are helping programmers implement operating systems by permitting them to examine and modify points in a program's execution flow, while sitting at a time-shared terminal.

"These are starting points, but they are indicative of future trends in this area. In time we hope to see automatic flow-charting and code optimization, verification and diagnostic techniques made available to programmers at the terminals. Along with these we need improved graphic devices that will permit the programmer to interact more effectively with the computer and, ideally, a comprehensive data storage and retrieval system. Through this system, the current status of any program under development would be readily available to its implementers for exami-

nation, use and modification. It would thereby mitigate the duplication of efforts and communications problems that arise in the development of software for any system."

One area that has had a great deal of early activity is automatic flow-charting. Programs have been written for different languages by many individuals. One example is a program written for the MAD language by Dr. Marshall D. Abrams, assistant professor of electrical engineering at the University of Maryland. According to Dr. Abrams, "The program will take any program written in MAD and automatically draw the corresponding flow chart."

Dr. Fred Haney, also a principal member of the Xerox Data Systems technical staff in El Segundo, has demonstrated that computer-aided design of instruction sets is feasible. He is presenting a paper describing his technique at the Fall Joint Computer Conference in Las Vegas this month. Dr. Haney's program accepts inputs that specify required features of the instruction set, cost and value coefficients for the features in the model, and the memory size and word size of the computer. The program contains a set of operators, each of which specifies one new part of the in-

struction set. These operators are applied alternately with an evaluation program to determine an optimal sequence for applying them. The output from the program specifies the instruction format for the computer, including operations and their codes, addressing methods and the locations of each field in the instruction.

"If we someday design and produce computers automatically," says Dr. Haney, "software development will become an obvious bottleneck. The design of software can be automated, but industry is not yet ready. The problems of describing, designing and implementing software are much more numerous and diverse than those related to hardware."

Trial and error used

One way of solving the problem of which are the best instruction sets is to set up a test computer that will operate in accordance with the proposed sets. Such a technique exists and has been under development at Standard Computer Corp. in Santa Ana, Calif., and also at International Business Machines. The technique is called emulation.

In order to achieve the emulation capability, Standard has used a new type of system architecture. They call it a computer-within-a-computer. It is composed of conventional functional stations such as main memory, register stacks, arithmetic units, I/O devices, etc., surrounding the nucleus of the machine—namely, the small, very high-speed inner-computer, which supplies the necessary system control. This novel concept eliminates the permanent bind between the various functional stations customary in most other computers. Programming of the system can be done on two levels. One is the usual type of system programming. The other is a separate programming of the inner-computer. This is called micro-programming.

Laszlo L. Rakoczi, vice president of Corporate Planning at Standard Computer, described the technique to ELECTRONIC DESIGN:

"We have a special assembly language called ICAP [Inner Computer Assembly Program], which can be used to define instruction sets. You can state your machine

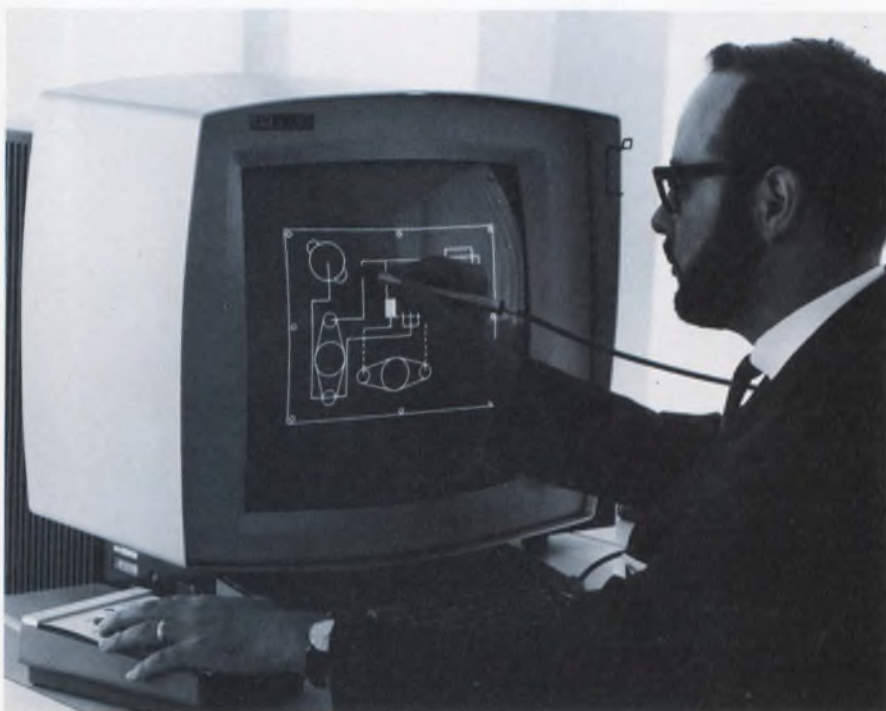

Circuit-board layout is checked out with a light-pen-actuated graphic console by Norman Schweitzer, a staff engineer at TRW Systems.

These guys have Utilogic II.

SIGNETICS STOCKING DISTRIBUTORS

ALABAMA

Huntsville 35801: *Compar Corp.*, 904 Bob Wallace Ave., Room 114
Phone: (205) 539-8476

ARIZONA

Scottsdale 85251: *Compar Corp.*, 84 West 1st Street
Phone: (602) 947-4336 TWX: (910) 950-1293

CALIFORNIA

Burlingame 94010: *Compar Corp.*, 828 Airport Blvd.

Phone: (415) 347-9501

Culver City 90230: *Hamilton Electro Sales*, 10912 W. Washington
Phone: (213) 870-7171

Burbank 91504: *Compar Corp.*, 2908 Naomi Avenue
Phone: (213) 843-1772

Los Angeles 90022: *Wesco Electronics, Inc.*, 5650 Jillson Street
Phone: (213) 685-9525 TWX: (910) 580-1980

Palo Alto 94303: *Wesco Electronics, Inc.*, 3973 E. Baysshore Road
Phone: (415) 968-3475

San Diego 92111: *G. S. Marshall*, 7990 Engineer Road, Suite 1
Phone: (714) 278-6350

El Monte 91731: *G. S. Marshall*, 9674 Telstar Avenue
Phone: (213) 579-1500 TWX: (910) 587-1565

CANADA

Downsview, Ontario: *Cesco Electronics, Ltd.*,

24 Martin Ross Avenue

Phone: (416) 638-5250

Montreal, Quebec: *Cesco Electronics, Ltd.*, 4050 Jean Talon West

Phone: (514) 735-5511

Ottawa, Ontario: *Cesco Electronics, Ltd.*, 1300 Carling Avenue

Phone: (613) 729-5118

Quebec: *Cesco Electronics, Ltd.*, 128 West Ballier Street

Phone: (418) 524-3518

COLORADO

Denver 80110: *Compar Corp.*, 300 East Hampden Avenue

Phone: (303) 781-0912 TWX: (910) 933-0183

Denver 80216: *Hamilton Electro Sales*, 1400 West 46th Street

Phone: (303) 931-0580

CONNECTICUT

Hamden 06500: *Compar Corp.*, 2357 Whitney Avenue

Phone: (203) 288-9276 TWX: (203) 772-0439

FLORIDA

Orlando 32805: *Hammond Electronics*, 911 W. Central Blvd.

Phone: (305) 241-6601

ILLINOIS

Elmhurst 60126: *Semiconductor Specialist, Inc.*,

195 Spangler Ave., Elmhurst Industrial Park

Phone: (312) 279-1000 TWX: (910) 254-0169

Addison 60101: *Compar Corp.*, 315 Laura Drive

Phone: (312) 543-8833

MARYLAND

Baltimore 21208: *Compar Corp.*, Pikesville Professional Bldg.,

7 Church Lane

Phone: (301) 484-5400 TWX: (710) 862-0860

Rockville 20850: *Pioneer Washington Electronics, Inc.*, 1037 Taft St.

Phone: (301) 427-3300

MASSACHUSETTS

Burlington 01803: *Avnet Electronics Corp. of Mass.*,

207 Cambridge Street

Phone: (617) 272-3060

Newton Highlands 02161: *Compar Corp.*, 88 Needham Street

Phone: (617) 969-7140 TWX: (710) 335-1686

Watertown 02172: *Schley Electronics Corp.*, 36 Arlington Street

Phone: (617) 926-0235

MICHIGAN

Southfield 48075: *Compar Corp.*, 21250 10½ Mile Road

Phone: (313) 357-5369

Detroit 48240: *Semiconductor Specialists Inc.*,

25127 West Six Mile Road

Phone: (313) 255-0300

MINNESOTA

Minneapolis 55416: *Compar Corp.*, 3925 Monterey Avenue,

P. O. Box 16095

Phone: (612) 922-7011

Minneapolis 55423: *Semiconductor Specialists Inc.*,

7742 Morgan Avenue South

Phone: (612) 866-3434

MISSOURI

St. Louis 63141: *Compar Corp.*, 11734 Lackland Industrial Drive

Phone: (314) 542-3399

NEW JERSEY

Cherry Hill 08034: *Hamilton Electro Sales*,

1608-10 West Marlton Pike

Phone: (609) 662-9337

Haddonfield 08033: *Compar Corp.*, 15 Potter Street

Phone: (609) 429-1526

NEW MEXICO

Albuquerque 87110: *Compar Corp.*, 2129 San Mateo, N.E.

Phone: (505) 265-1020 TWX: (910) 989-1659

NEW YORK

Albany 12205: *Compar Corp.*, 6 Highland Avenue

Phone: (518) 489-7408 TWX: (710) 441-8224

Buffalo 14202: *Summit Distributors Inc.*, 916 Main Street

Phone: (716) 884-3450

New York 10011: *Terminal-Hudson Electronics*, 236 W. 17th St.

Phone: (212) 243-5200 TWX: (710) 581-3962

Woodbury 11797: *Compar Corp.*, 335 Crossways Park Drive

Phone: (516) 921-9393 TWX: (510) 221-2170

NORTH CAROLINA

Winston-Salem 27101: *Compar Corp.*, 1106 Burke Street

Phone: (919) 723-1002 TWX: (510) 931-3101

OHIO

Cleveland 44103: *Pioneer Standard Electronics*,

5403 Prospect Avenue

Phone: (216) 432-0010

Fairborn 45324: *Compar Corp.*, 16 South Broad Street

Phone: (513) 878-2631

Fairview Park 44126: *Compar Corp.*, 19500 Center Ridge,

Rocky River, or P. O. Box 4791

Phone: (216) 333-4120

PENNSYLVANIA

Philadelphia 19132: *Milgray-Delaware Valley, Inc.*,

2532 North Broad Street

Phone: (215) 228-2000 TWX: (710) 670-3400

TEXAS

Dallas 75207: *Hamilton Electro Sales*, 2344 Irving Blvd.

Phone: (214) 638-0900

Dallas 75241: *Compar Corp.*, 8609 N.W. Plaza Blvd., Suite 222

Phone: (214) 947-4336

Houston 77019: *Hamilton Electro Sales*, 1216 West Clay Street

Phone: (713) 526-4661 TWX: (910) 881-3721

Houston 77036: *Universal Electronics*, 5723 Savoy

Phone: (713) 781-0421

WASHINGTON

Kirkland 98033: *Compar Corp.*, 12610 N.E. 104th Street

Phone: (206) 822-4191

Seattle 98108: *Kierulff Electronics*, 5940 6th Avenue, South

Phone: (206) 763-1550

Now you can get it II.

What's more, they've got a great big handbook, II—on Utilogic II! Descriptions, specs, usage rules, how-to's, design ideas on the only integrated circuit logic family that gives you I) lowest cost per gate function, II) choice of AND, OR, NAND and NOR logic, and III) silicone DIP's. XXXII pages in all! See any of the guys above—and you can get it II!

Signetics

Signetics Corporation/811 E. Arques Ave., Sunnyvale, California 94086/A subsidiary of Corning Glass Works

INFORMATION RETRIEVAL NUMBER 16

(computer, continued)

language and that assembler will accomplish the programming to 'build' the machine by loading the proper micro-program. We can emulate either other real or hypothetical machines. You can state your desired machine language in terms of coded instruction sets. The inner computer then will behave the way you have defined your machine."

At this point, if the computer that has been emulated does not satisfy the desired performance, it is a simple matter to try another group of instruction sets.

Analysis and synthesis

The design of the actual computer hardware must begin with a system block diagram. In the view of many, this diagram will one day be generated automatically from a statement of the performance specifications that the computer must meet.

Although the block diagram is still manually created, computer-aided design already is being used to simulate the system architecture and check its performance. At the Autonetics Div. of North American Rockwell in Anaheim, Calif., Dr. William T. Clary, manager of

software, points out:

"We are simulating the capability of the computer in total. In the simulation, faults can be injected. This gives the capability of forming a file of primary symptoms of failures that can occur."

According to Dr. Melvin Breuer, assistant professor of electrical engineering at the University of Southern California in Los Angeles, the next step is the automatic generation of a register transfer description from a system description. The register transfer description describes the flow of information within the computer from register to register. This step is currently being pursued by several firms, but does not yet exist.

Dr. Breuer notes that after this should come the automatic generation of the gating structure from the register transfer description. Programs to perform this step already exist and are being used by most major computer manufacturers.

At this point, Dr. Breuer continues, simulation of the gate-level logic must take place. During the simulation the gate-level logic is operated upon to check the design and also to look for faults, such as unrealizable states. In addition the gate-level logic should be checked against the system and register level simulations.

An additional check that is sometimes used is a logic simulation that works directly from the Boolean logic equations. Once the gate-level logic is defined, it is often checked by generating the Boolean logic equations automatically and then using logic minimization programs and Karnaugh map manipulation routines to see whether the gating structure arrived at is the most efficient physical logic structure that can be obtained.

One problem Dr. Breuer notes is that in a gate-level simulator "you have to simulate sequentially what is actually happening in parallel in the computer."

Roger D. Houck, manager of the design technology lab at the Hughes Aircraft Co. in Fullerton, Calif., says: "The major problem in simulation is giving the data back to the guy in a form in which he can handle it. We try to provide it in bite-size chunks."

Once the gating structure has been determined, several circuit-analysis programs come into play to design and check out the additional computer circuitry. Some examples of circuit analysis packages currently available are IBM's ECAP, Xerox Data Systems' CIRC, and Control Data Corp.'s SYSCAP.

An area that Dr. Breuer feels requires a good deal more work is automatic circuit synthesis directly from logic equations.

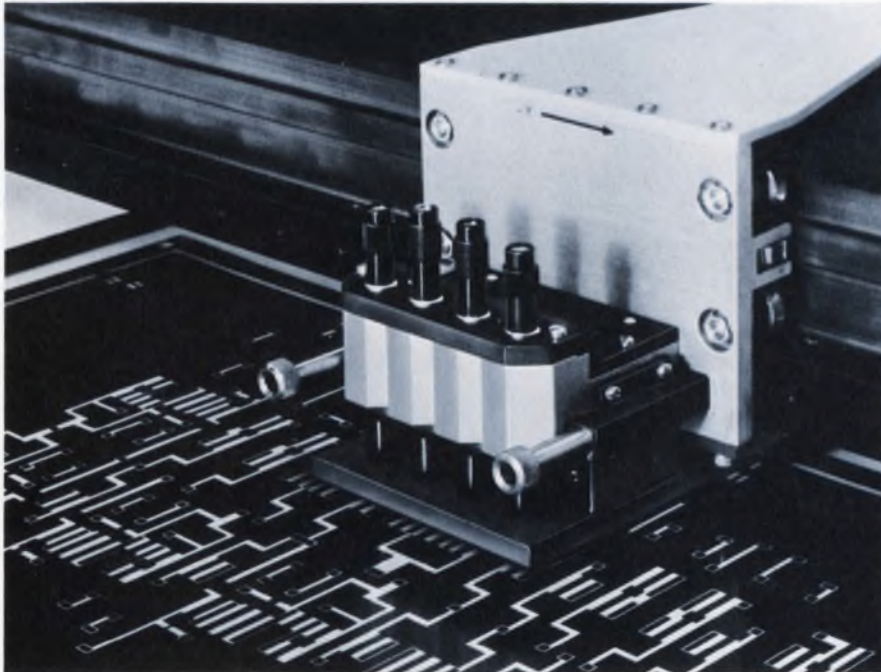

Integrated-circuit mask art work is automatically cut using a computer-driven plotter built by California Computer Products.

Creating hardware from logic

To automatically create hardware from logic, the gate-level circuitry must be assigned to integrated circuit chips. Alan H. Halpin, manager of the Design Automation Dept. at TRW Systems in Redondo Beach, Calif, told ELECTRONIC DESIGN:

"Logic will have to be automatically partitioned with functions assigned to particular integrated circuit chips. We now have to do this step manually, but automatic partitioning is coming in the near future."

Roger Houck of Hughes notes: "The way that you partition your logic depends upon the way that you can most easily self-test the hardware."

As LSI technology puts more and more of the computer on a single



now ... the fast-recovery
MAGNUM™

The first 20 amp,
500 nanosecond
rectifier assemblies
with full-power operation
up to 40kHz.



Here's what we mean when we say
"They're reliability designed from the inside out."

All four of the diodes in this aluminum heat-sink case are Unitrode's individually fused-in-glass controlled avalanche, fast-recovery high-surge diodes. So you start with monolithic parts that have typical failure rates of less than 0.0006%, and you have the added bonus of the convenience of the Magnum package.



This is what's in the heart of our diodes

With the silicon die metallurgically bonded between terminal pins of the same thermal coefficient, the hard glass sleeve is fused to the entire outer silicon surface. Result — a voidless, monolithic structure.



- #682 Series Three Phase 20 amp Bridges
- #683 Series Single Phase 20 amp Bridges
- #684 Series Single Phase 10 amp Bridges

PIV'S to 600V.
Standard Recovery 25 amp
Magnums also available

For fast action, call Fred Swymer COLLECT

UNITRODE



580 Pleasant Street, Watertown, Massachusetts 02172 • (617) 926-0404

INFORMATION RETRIEVAL NUMBER 17

(computer, continued)

chip, partitioning will become less and less of a problem.

Ultimately the single-chip LSI computer will become a reality. According to Dr. Robert Jackson, chief engineer at General Automation, Inc., in Orange, Calif.;

"Soon there will be semiconductor computers as off-the-shelf items. There will also be specials—basic configuration to which the purchaser will add options. These options will be incorporated, using computer-aided design, into the appropriate semiconductor masks."

At present, however, since the single-chip computer is not yet a reality, several chips must be used. These chips are then mounted on printed-circuit boards that must be created. The printed-circuit boards are connected to each other by means of either a printed mother board or a multi-pin back panel. When the back panel approach is used, the wiring must be done automatically. Finally, according to Allan G. Lindgren, project manager of component and circuit control for Control Data Corp. in Arden Hills, Minn., the whole thing must be packaged with careful consideration to design and heat transfer problems.

Masks are complex area

Mask making for integrated circuits is the most complex area of mechanization. Several techniques have been developed for automatically generating the art work necessary for fabricating integrated-circuit masks.

The usual procedure is to store as standard cells in the computer's memory the art work necessary to create several standard logic functions. For example, if a NAND gate is called for, the computer merely instructs an automatic drafting machine to draw the masks that result in a NAND gate. Since many gates and transistors will appear on a digital integrated circuit, the computer implements the logic in the form of a grouping of the standard modules that it has at its disposal. It then computes the art work necessary to get the logic on a single chip and has a plotter draw the appropriate

integrated circuit masks.

An implementation of this type of technique will be described by William K. Orr, director of design automation for the Singer Co., Palo Alto, Calif., in his paper "Computer-Aided Design for Custom Integrated Systems" at the Fall Joint Computer Conference later this month.

Orr used bipolar integrated-circuit technology to make his circuits. His largest circuit had 43 gates and 6 flip-flops on a single chip. Orr told ELECTRONIC DESIGN: "We work with a high-level register transfer language that we developed to describe the logic." The computer then utilizes an approach similar to that described, which Orr calls the polycell approach.

"One of the drawbacks," he says, "to the polycell approach is that you cannot take advantage of techniques that will minimize the amount of chip area used."

Automated design approaches are currently being worked on that will automatically generate masking information for complex MOS/LSI circuits. One such system has been developed by Collins Radio Co. and is geared to custom requirements. This system, however, also uses a cellular approach and therefore also does not result in "minimum real estate" chips.

A new company working in the field of MOS/LSI design is Macrodata, Inc., in Chatsworth, Calif. Macrodata is placing primary emphasis on minimum real estate design and on automated design techniques. Dr. William C. W. Mow, president of Macrodata, explains that, "For true LSI, the design technique should be based on the constraints of the device and the process parameter rules rather than the performance parameters. Implicit in the design technique is the minimization of area per logic function. Therefore, an understanding of the design rules imposed by the wafer fabrication process is absolutely necessary.

"Design rules evolving from the process development," he says, "are in the form of intrinsic design parameters such as threshold voltage, breakdown voltage, thin oxide capacitance and other parameters essential to designing a transistor to produce the performance as required by the logic gates. Further-

more, process rules also impose physical design restraints on the layout of the transistor and the other elements required to achieve the desired logic-gate performance."

Mow claims that his technique, implemented through a light-pen display-driven computer system, yields extremely high densities for random control logic with guaranteed single layer metal. Using his technique, Mow has designed over 3,000 MOS transistors into a cell size of 160 × 160 mils. The cell array is a processor that has the capabilities of divide, square root, partial add and subtract, two 32-bit general-purpose registers, three 8-bit address registers, one 8-bit op-code register, up-down counters, and associated control logic. In addition to the above, the cell can operate as a digital differential analyzer.

Looking ahead to interaction

Most designers are looking forward to on-line interactive graphic display design aids. The feeling is that, once all of the separate design aids discussed in this article can be interfaced and tied together, the whole package can be utilized by the designer to save a great deal of time and money.

Morris L. Bernstein, supervisor of the Computer Programming Unit at Northrop Electronics Div. in El Segundo, Calif., believes that the designer will be able to:

- Describe the logic to the computer.
- Get a block diagram automatically from the display.
- Get a loading analysis from the computer.
- Do a logic simulation automatically.
- Get hardware directly from a computer-controlled fabrication.

Tom L. Sides, senior staff engineer for Advanced Design Automation at Burroughs Corp. feels that what will make the interactive approach a winner is that the whole design will be "updatable with fast turn-around times."

Although some think that a totally automated design will ultimately come, Dr. Breuer disagrees. He feels that the interactive approach with the designer still in the loop will always be better. ■■

Diode Arrays

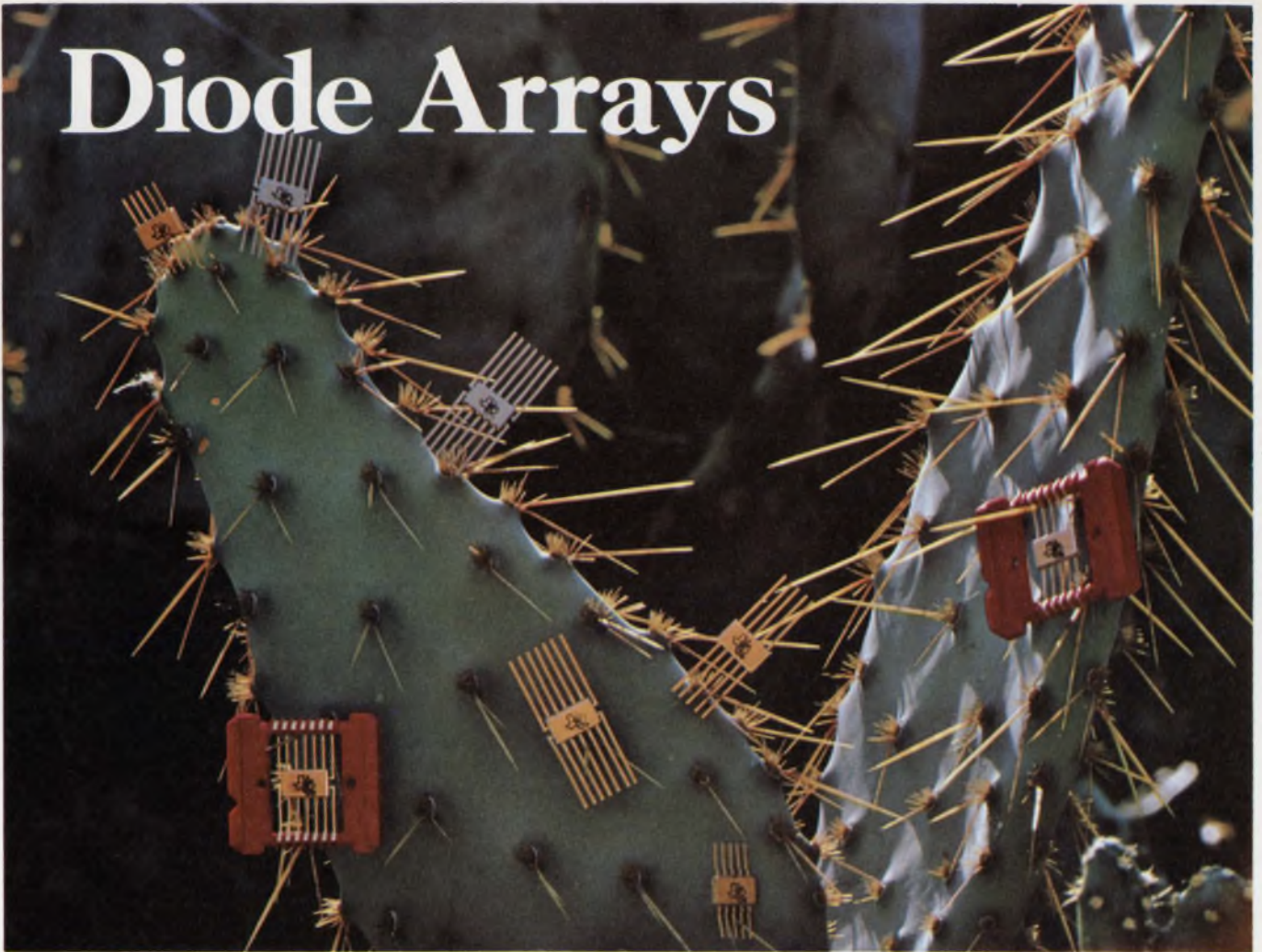

8 answers to prickly problems

Solve thorny computer memory problems with these 8 diode arrays from TI.

Unbeatable core-drivers, they assemble quickly and cut P-C board space requirements. Up to 65%! Saves you time, trouble and costs. And they're smaller, lighter, more reliable, too.

Performance? They're real sticklers for fast recovery, low capacitance, and high forward conductance. With closely matched electrical characteristics through a broad temperature range.

Try them. They're available fast: Through TI distributor and factory stocks. In arrays of 8, 16 and 20 diodes. Common cathode or anode connections. In flat packs

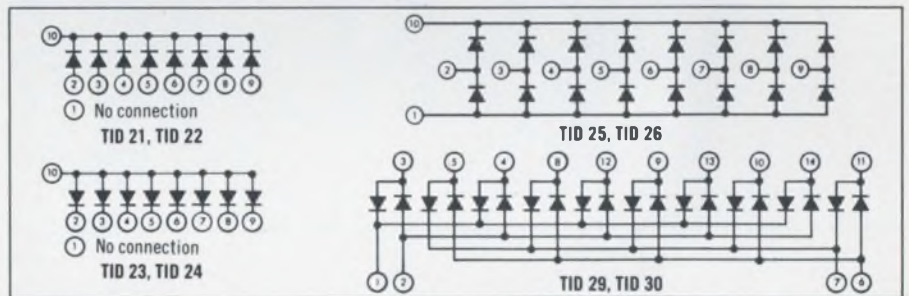

with 10 or 14 leads.

These 8 arrays are part of TI's preferred semiconductor line, selected to save you time and money in specifying discrete components.

If one of these doesn't fill your specific needs, TI makes custom arrays of 2 to 20 diodes in flat packs, 10-lead TO-5 metal-can and

dual in-line packages.

Write for TI's brand new *Preferred Semiconductors and Components* catalog: Texas Instruments Incorporated, P.O. Box 5012, MS 308, Dallas, Texas 75222. Or just circle reader service number 122.



TEXAS INSTRUMENTS
INCORPORATED

Holographic TV tape player on way for home

RCA SelectaVision, demonstrated as feasible, aims to offer \$400 unit that will attach to any color set

Jim McDermott
East Coast Editor

A laser in the home?

That's what RCA is proposing in a television tape player it is developing for the consumer market. The picture-and-sound player, which makes use of a laser and holography to play back images, is being designed for attachment to any standard color TV set.

A laboratory model has demonstrated the feasibility of the con-

cept, according to Dr. James Hillier, executive vice president of RCA Research and Engineering at Princeton, N.J. Present plans call for a start on production of the player, called SelectaVision, in 1972 at a price of about \$400.

Already there are signs that intense competition is shaping up between RCA and CBS, developer of the Electronic Video Recording (EVR) system, which uses regular film, a film transport mechanism

and straightforward TV circuitry, and is now selling for \$800.

A unique feature of the RCA design is that it will play full-color programs that have been recorded on tapes made of clear, inexpensive plastic material—the same kind used in supermarkets to wrap and display meats. This tape should cost about one-tenth that of film types.

RCA's SelectaVision will emboss the cheap, clear vinyl plastic tapes with a hologram containing the TV picture plus the color coding required to convert the various elements and areas of the transparent film to the proper colors.

Holograms are made with coherent laser light, and a visual image is obtained by passing the laser light back through the filmed hologram. The hologram used on the SelectaVision tape is the Fraunhofer type.

3 basic elements used

The principal elements of the SelectaVision player are a helium-neon laser, a vidicon color TV camera and a tape transport. In the laboratory model, which RCA showed to the press last month, the player had these characteristics:

Tape speed—7-1/2 ips.

Tape width—1/2 inch.

Tape thickness—2 mils.

Laser wavelength—6328 Å.

Laser power—2 mW.

Luminance bandwidth—3 MHz.

Chrominance bandwidth—0.5 MHz.

Playing time—1/2 hour.

Reel size—6 inches.

To play back the tape, the laser beam is aimed to pass through the hologram portions, producing a virtual and a real image. The latter is projected directly into the camera lens and contains two types of information, one superimposed on the other. The first type is a series of fine vertical lines corresponding to 3.5 and 5-MHz sub-carriers, which provide the color-coding signals that determine the

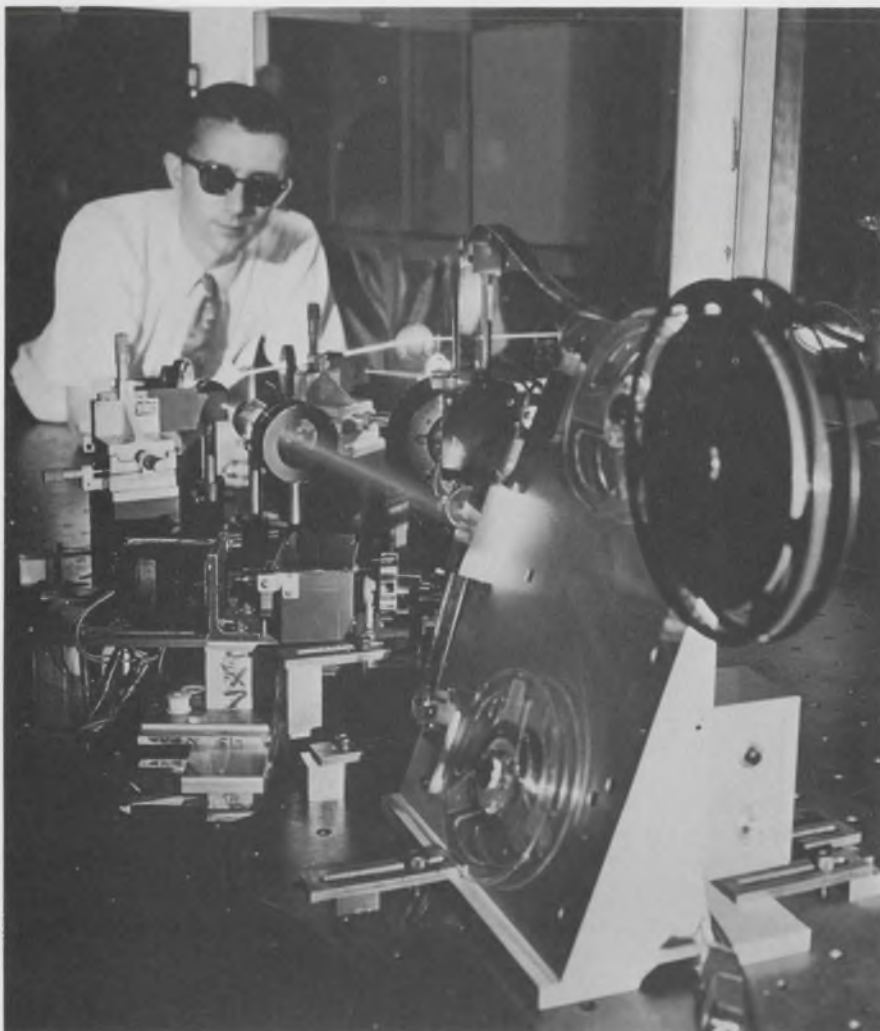

The laboratory setup for making a master holographic tape of a motion picture film for RCA SelectaVision. The movie film coming from the reel at the right is illuminated by a laser beam.

reproduced colors in the various areas of the picture. The second image is that of the black-and-red (white) picture of the scene, which provides the luminance signal.

It is a peculiar property of holograms that they contain, throughout the entire hologram, all the information needed to reconstruct complete images. Thus, a hologram can be cut in halves, quarters, eighths and so on, and each piece can reconstruct the original scene. Picture resolution and contrast decreases, but the scene remains, and it is this quality that makes holograms scratch and dust-proof.

Another property of interest is this: In the Fraunhofer holograms used in the SelectaVision system, as the tape moves through the laser beam, the passing image from one hologram fades out, while the approaching fades in, and the two images are almost perfectly superimposed. Because an image is always projected onto the vidicon, regardless of the tape position, there is no need for synchronism between tape motion and camera scanning rate.

This permits a simple, reliable playback mechanism requiring neither a shutter nor electronic synchronizing circuits. As a result, the tapes can move at any speed, with a proportional rate of scene movement.

A third property of Fraunhofer holograms of interest is the fact that the image is essentially collimated light, and consequently the viewer can move to or away from the image and it does not change. This phenomenon is observable when the human eye surveys a distant scene. The light from it is collimated—that is, it reaches the eye in straight lines. If a person moves toward or away from the scene, it does not change appearance.

Because of this fact, the SelectaVision camera is relatively insensitive to displacement with regard to the film. The camera can be moved toward the tape, even right against it, or away from it, up to one or two inches, without changing the viewing results. This loose tolerance allows for misalignment in the product without penalty.

The process by which a color program is converted to an em-

bossed hologram on the clear vinyl tape is accomplished by RCA in five steps.

A series of 'masters'

First, the composite color TV signal is fed to an electron-beam recorder, which exposes a film to give what is known as a "color-coded" master. In the second step, this master is used to make a hologram on a new plastic film coated with a photoresist. The photoresist hardens where laser light strikes it and in the third step is etched in a bath, to provide a strip of plastic containing micron-sized depressions that correspond to the hologram of the scene being reproduced. This is called the "hologram master."

This master is then electroplated with a coat of nickel, after which the plastic film is stripped away to leave a thin nickel tape with holograms impressed on it, like an engraving. This fourth step produces the "nickel master."

In the final step, the nickel master and clear vinyl tape are fed, one on top of the other, through a set of heated rollers. The heat and pressure emboss holographic depressions in the vinyl tape, which is then ready for playback.

According to Chase Morse Jr., executive vice president of RCA's operations staff, development of the home player and associated program albums will be undertaken by a new corporate group. It is planned to offer a library of 100 program albums in 1972 at a target price of \$10 for each half-hour program.

Mindful of the forthcoming competition, Robert Brockway, president of the CBS EVR Div. in New York City, says: "Comparison of a SelectaView consumer player at under \$400 and an EVR player at \$800 for the ruggedized, heavy duty, industrial machine is invalid."

In addition he notes:

"Cartridge costs for the consumer market have not been announced, nor have our plans in this area been disclosed. However, it should be pointed out that the EVR cartridge manufacturing process is extremely price-volume sensitive."

Brockway also has this to say about RCA's use of lasers in its systems: "While laser technology is exciting, because of its recent emergence, EVR utilizes photographic material and techniques of known value and performance levels." ■■



A designer's concept of RCA's SelectaVision TV tape player sits atop a standard color receiver. Cartridges of proposed low-cost color tapes are inserted in the unit at the top right.



In Japan, everything is coming up ICs

Their heavy, growing use in consumer products is apparent at industry's annual electronics show

Haruki Hirayama
Tokyo Correspondent

The extent to which the booming Japanese electronics industry has emphasized the use of integrated circuits in its consumer and industrial product areas was evident at last month's Japan Electronics Show held at the Minato Fair Grounds in Osaka.

In fact, there may be no country on the globe where so much serious effort has been concentrated on putting ICs into consumer products. The reason is obvious—60% of Japan's total industry sales consists of consumer electronic products against only 16% in the U.S.

All large entertainment equipment manufacturer, such as Toshiba, Hitachi, Sanyo Electric, Hayakawa Electric, etc. were showing IC-incorporated TVs, radio, stereos, transceivers and the like. For example, Sanyo Electric exhibited a 17-inch all-IC (except for the tuner) television receiver and a 3-inch cordless TV, incorporating nine ICs. Toshiba displayed its IC FET a-m/fm pocket radio and 19-inch color TV with IC automatic control.

Progress in IC devices

ICs themselves were on display by more than a dozen Japanese manufacturers and several U.S. makers, such as GE Motorola

Semiconductor, RCA, etc.

Indicative of Japan's progress in IC processing techniques was Nippon Electric's 2PD-116, manufactured by a combination of MOS and bipolar technologies. The company also showed its line of linear ICs for TV and its series of MOS-type ICs for low-speed computers.

Sony Corp. introduced a high-output monolithic linear IC with a 26-W maximum output containing four npn transistors, a diode, and six resistors on a silicon substrate measuring 1.5 by 1.75 millimeters.

Oki Electric Industry displayed a 40-bit semiconductor IC fixed-memory, while Sanken Electric Co. exhibited a hybrid power-IC with a 120-W minimum output.

Impact on OEM market

The impact of ICs on Japanese OEM markets was noted especially in the booths of components manufacturers. They exhibited ICs or miniaturized components used in conjunction with ICs. Electric Co., Ltd.; Toko, Inc.; Michicon Capacitor, Ltd.; Kyodo Electronic Laboratories, Inc.; and others displayed ICs of their own, along with the large semiconductor manufacturers.

Matsuo Electric Co., Ltd., displayed miniaturized tantalum chip capacitors (0.01 μ f to 22 μ f, 6.3 to 35 V) useful in hybrid circuits.

The noticeable design trend of TVs seems to be turning toward more use of new "non-contact" TV tuners, eliminating switching contacts by use of tuning diodes. A few models using these new tuners were shown by each set manufacturer in the show, and more and more sets of this type are expected to come out in the future.

In the meantime, ceramic filters are starting to be used in a number of high-quality radio receivers in place of conventional intermediate-frequency transformers for their sharp receiving selectivity.

Production machines shown

A boom is also on for the manufacturers of IC production machines as the result of brisk inroads of ICs into both industrial and consumer OEM markets. IC production machines, almost 100% dependent upon imports a year ago, are now being manufactured domestically, and some are going to be exported to U.S. markets. Products of high interest in this category were the bonder of Kokusai Electric, which combined ultrasonic bonding technology with the technology of heat welding; the scribe of Tokyo Seimitsu Co.; and the photo-mask reduction camera of Dai Nippon Screen Mfg.

Exhibited by Rikadenki Kogyo Co. was a new response recorder, model B-34, with a very high pen speed under stable performance. The recorder features a fixed chopper, a special 400-Hz modulation ac amplifier and an inverter



**Allen-Bradley Type G
variable resistors
help seal Sylvania's
rescue transceivers against**

**ocean
dunkings**

Built primarily for aiding in the location and recovery of downed airmen, Sylvania's emergency rescue transceiver must be reliable under extremely adverse conditions. It is lightweight and compact enough to be carried in the pocket of a flight jacket. It must withstand impact and immersion in salt water without damage.

Essential to meeting these requirements is Allen-Bradley's Type G variable resistor. It's rugged. It's compact. And it provides the necessary seal against water. This particular Type G has two "O" rings—one between the bushing and shaft, and one between the bushing and mounting panel. This dual seal prevents water entering the enclosure, as well as the control.

The Type G variable resistor features the Allen-Bradley solid, hot-molded resistance track. It gives long life—less than 10% resistance change after 50,000 complete cycles. The noise level is extremely low, and the smooth adjustment provides virtually infinite resolution. Low inductance permits operation across a broad frequency spectrum.

For complete details and immediate delivery on this 1/2-inch diameter Type G 1/2-watt variable resistor, call your authorized A-B industrial electronics distributor. Or write: Marketing Dept., Electronics Div., Allen-Bradley Co., 1201 South Second Street, Milwaukee, Wis. 53204. Export Office: 1293 Broad St., Bloomfield, N. J., U.S.A. 07003. In Canada: Allen-Bradley Canada Limited.



Type G
variable
resistor
shown
actual size

Sylvania AN/PRC-90 dual channel rescue transceiver permits two-way voice communication, the transmission of Morse code or the sending of a homing beacon.



ALLEN-BRADLEY
QUALITY ELECTRONIC COMPONENTS

(Japan, *continued*)

Photo-mask reduction camera was exhibited by Dai Nippon Screen Co. at recent Japan Electronics Show in Osaka.

for a 400-Hz power supply.

Shown in Yokogawa Electric's booths was a direct-recording type of electromagnetic oscillograph, model 2915. This 18-channel instrument is equipped with a trace identifier and uses 178-mm self-folded recording paper.

Omron Electronic displayed photoelectric switches for all-purpose automation, ranging from machine assembly, pharmaceutical production, to steel manufacturing. Tohoku Metal Industries exhibited a new thermal lead switch, a combination of a magnet and a temperature sensitive ferrite, which conducts switching functions in accordance with changes in temperature.

Facsimile TV a hit

Though current IC technology was the dominant theme at the show, a number of exhibits still in the developmental area drew wide interest. One of the real crowd pleasers was Mitsushita Electric's

(Panasonic) "Basic Technology Development Corner."

On display was a home facsimile TV system. Show visitors, including Crown Prince Akihito, watched fascinated as a facsimile page of a magazine came out of the slot of the console cabinet of a TV set a few inches below the screen. All viewers saw was a 1/4 inch perpendicular stripe on the edge of the screen.

The technology behind this kind of facsimile utilizing TV signals is not new, but it was said to be the first demonstration of such a system. Potential applications are seen in the newspaper field and as a means of sending explanatory notes along with telecasts.

Also on display by Mitsushita were:

A semiconductor film strain-transducer phono cartridge for ultra-high-fidelity reproduction, and weighing only 0.75 g.

A high-speed video-tape duplicator that can transfer information from a 60-minute tape onto

another tape in three minutes.

A phono-motor in which the turntable is directly coupled to a low-speed commutator motor incorporating a low-cost manganese-aluminum magnet.

Other exhibits at the show included:

- A 300-MHz oscilloscope for computer servicing, made by Iwatsu Electric Co., Ltd., model SS-311, with 5-mV/cm sensitivity for two-phenomenon measurement. A 200-MHz oscilloscope exhibited with the 300-MHz model features very compact size (10-1/4 inches wide by 6-1/4 inches high by 16 inches deep).

- An integrating digital voltmeter, made by Takeda Riken Industry Co., with a readout error of 0.006%. The company also showed a new microvolt dc range unit, model TR 6018, with 10-nV resolution capability.

- An ultra-high-speed 2-1/2 D core memory was exhibited by TDK Electronics Co., Ltd. The system contains 12-mil cores, has a 300-ns cycle time and a capacity of 32K words.

Foreign exhibitors flock in

One outstanding feature of this year's show was the increase in the number of exhibitors from overseas. The 87 foreign participants accounted for 28% of the total number of exhibitors. And this figure includes 46 U.S. exhibitors under the sponsorship of the U.S. Commerce Dept. and about a dozen independent U.S. exhibitors.

These U.S. manufacturers displayed ICs, semiconductor materials, measuring instruments and production machines. The results were amazing: a Commerce Dept. official announced that sales during the week-long exhibition had amounted to \$1,650,000, and that total sales of the exhibited items should reach \$100-million during the next year.

Future shows in Japan promise to be even more attractive to overseas design engineers, for the country's electronic industries have been growing at a fantastic speed—more than twice as fast as those of the U.S. and West Germany, according to statistics over a period of 10 years. This year's show attracted 170,000 visitors. ■■

Allen-Bradley's experience in resistor production reaches...

to the moon and back!



TYPE BB 1/8 WATT



TYPE EB 1/2 WATT



TYPE HB 2 WATTS

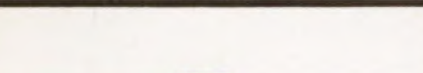

TYPE CB 1/4 WATT



TYPE GB 1 WATT

A-B industrial grade hot-molded fixed resistors are available in all standard resistance values and tolerances, plus values above and below standard limits. A-B hot-molded resistors meet or exceed all applicable military specifications including the new Established Reliability Specifications at the S level. Shown actual size.

After more than three decades and untold billions of hot-molded resistors, Allen-Bradley has accumulated manufacturing "know-how" which cannot be approached by anyone else. The fact that the resistors made by A-B over the years—if placed side by side—would more than reach to the moon and back, may be impressive. But "how" they are made is the key.

Allen-Bradley resistors are produced by an exclusive hot-molding technique—developed by A-B. They're made by completely automatic machines—also developed, built, and used only by Allen-Bradley. The human element of error is removed. Uniformity is so precise from one resistor to the next—year in and year out—that

long-term resistor performance can be closely predicted.

The reputation for quality and performance established by Allen-Bradley hot-molded resistors is reflected in the fact that they have been an integral part of virtually every U.S. space probe. And they are "on" the moon. No other resistor applications demand a higher measure of reliability.

For immediate delivery at factory prices, call your authorized A-B industrial electronics distributor. Or write: Marketing Department, Electronics Division, Allen-Bradley Co., 1201 South Second St., Milwaukee, Wis. 53204. In Canada: Allen-Bradley Canada Limited. Export Office: 1293 Broad Street, Bloomfield, N.J., U.S.A. 07003.

EC69-60A

QUALITY ELECTRONIC COMPONENTS

© Allen-Bradley Company, 1969



ALLEN-BRADLEY



Lightning detector prevents explosions

An electronic lightning detector designed to prevent premature detonation of explosives stored at demolition or construction sites has been developed by the Eric Bull Company of Oslo, Norway. Despite safety precautions, such detonations may be caused by high currents induced in blasting-cap wiring—even by atmospheric static.

The device automatically flashes green, white and red lamps to warn of impending danger level—either from increasing electric field intensity or from approaching lightning. A large yellow lamp flashes for each dangerously near strike. The unit is about the size of a traffic light, and is mounted near where the blasting wires are rigged. A warning bell or siren can be attached.

Earlier detectors, according to Bull, were either too complex or too sensitive to be used outside of the laboratory. Some were triggered by welding equipment or ignition systems. Others warned of lightning strikes only when they were already too close.

The Norwegian detector, called "Triple Lightning Sentry," consists of three parts: an electric field detector, a detector preamplifier and a control-indicator unit. A radioactive isotope ionizes the surrounding air. When an electric field is present, the ions flow in the direction of the field and cause a positive or negative current to be induced in the field detector. The current, usually 10^{-12} to 10^{-8} amp, is amplified and fed into threshold detectors set for various danger levels.

These preset levels are adjusted according to the country that uses the detector. There is no international agreement as to what constitutes a dangerous electric field condition. Norwegian meteorologists, for example, have measured fields of 4 kV to 5 kV per meter at the boundaries of cold-warm air weather fronts.

The detector sells for about \$1500, a high price admits designer Bull, "but meaningless compared to loss of an arm or life." ■■

Looking for a little jack?  How's this for size?
 (Actual Size)

We've been making miniature jacks for over 10 years. But this new one is half again as small as any horizontal mounting type we've offered before. It accepts a 0.080" diameter tip plug on either end and has a maximum current capacity of 5 amperes. Operating voltage is 1500 volts RMS at sea level, 350 at 50,000 feet. Contact resistance is less than 2 milliohms. Capacitance between adjacent jacks is less than 1 pF at 1 MHz. Comes in 10 colors meeting Federal Standard #595.

Johnson makes hundreds of different jacks and plugs . . . and carries most of them in stock for immediate delivery. Or perhaps you have a unique need. Our engineers will work it out for you. Just give us a call. Meanwhile, return the coupon.

E. F. JOHNSON COMPANY/3310 Tenth Ave. S.W./Waseca, Minnesota 56093

- Send me a sample of your new miniature jack and complete design details.
- Send me information on your complete connector line and other Johnson components.

NAME _____ TITLE _____

FIRM _____ ADDRESS _____

 CITY _____ STATE _____ ZIP _____

E. F. JOHNSON COMPANY

INFORMATION RETRIEVAL NUMBER 21

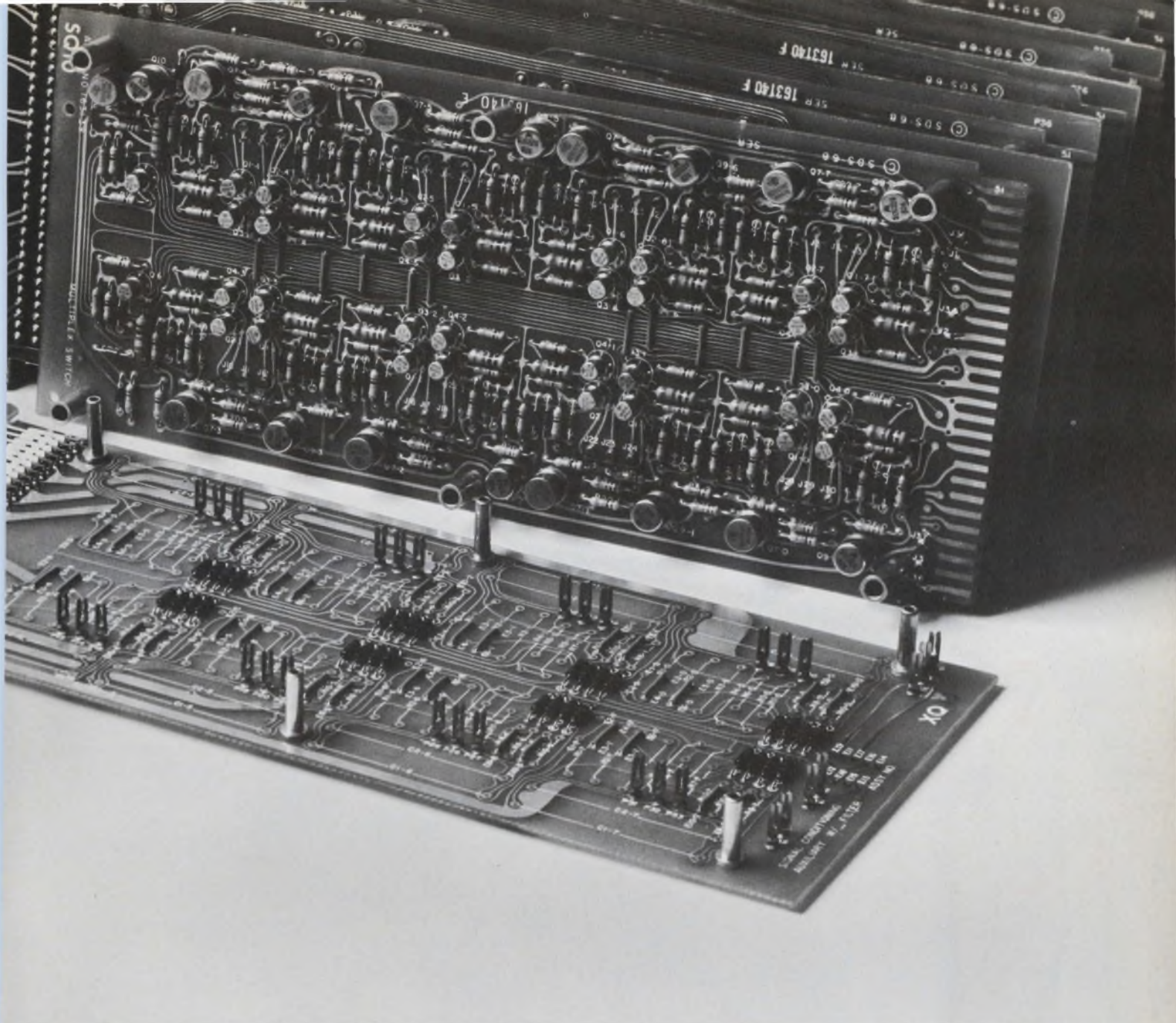

Look into our new low level multiplexer. It's good for your system.

Our DM40 solid-state differential multiplexer makes a great front-end, with amplifier per channel performance. It accepts analog signals from thermocouples, strain-gauges, resistance bridges, transducers, amplifiers and the like. It has very low noise and you don't have to worry about acquisition errors due to previous channel overload. The DM40 takes 128 input lines and you can hook eight units together for a total of 1024 inputs. It multiplexes and amplifies each signal and transmits it to your digitizer at a rate up to 10KHz. When you use it with one of our controller-digitizers you can get 13 different gain ranges.

In fact, the DM40 is even better when you get all your system components from us. This way you can be sure they'll work as a system. No interface problems to solve, no missing hardware to engineer. Our components are made to get along together.

After all, they come from a good family.

DM40 Minispecs:

Input signals:	From 2.5 millivolts full scale to 10 Volts full scale.
Gain Accuracy:	0.02% between steps.
Linearity:	0.005%
Zero Stability:	1 microvolt rti +20 microvolts rto/°C.
Crosstalk:	120db
Common Mode Rejection:	120db, DC; 100db, 60Hz.
Noise:	10 microvolts peak rti +100 microvolts peak rto.

Write for complete specifications.

XDS

Xerox Data Systems
El Segundo, California



We make components for guys who can't stand failures.

We make our capacitors and resistors to perform like 40 million people were watching in on the count down.

And we build an extra measure of performance into all of them, to let you make sure your equipment delivers all you designed into it. Because like you and the guys who use your equipment, we can't stand failures either.

Take our glass capacitors, for instance. There's only one reason why they've been designed into the Surveyor, Minuteman, Gemini, Apollo, Saturn, Titan, Syncom, Sparrow, Hawk, and a number of other major aerospace and missile projects. With our glass capacitors, circuit designers could get the proven stability and reliability that these important systems demanded. U.S. Air Force tests have established that our glass capacitors have much better stability and much higher insulation resistance than ceramic and mica capacitors can deliver.

And take our precision tin oxide resistors. They're the best of the metal film class. Because the resistive tin film is completely oxidized and

molecularly bonded to the glass substrate, our tin oxide resistors are impervious to moisture and environmental degradation. No other resistor can deliver the same stability and reliability over load life. They offer guaranteed moisture resistance across all ohmic values to set a standard of reliability that can't be matched by metal film, wire wounds, carbon comps or metal glaze resistors. After a 56-day-long heat test in an environment of extremely high humidity, our tin oxide resistors showed a resistance change of just 0.2 per cent. And in an ambient temperature test—now in its ninth year—not one of the 600 tin oxide resistors being tested has exceeded a resistance change of 1.5 per cent.

But don't only think of Corning for aerospace and other precision applications. We've got something to offer when economy and value are the prime considerations. At Corning we've been active in improving these important capacitor and resistor characteristics, too.

We've developed the Glass-K™ capacitor to give you the volumetric efficiency and economy of mono-

lithic ceramic capacitors, but with the much improved stability and reliability that only a glass dielectric can add.

In resistors, our tin oxide resistors already offer long term economy over metal film, precision wire wound and metal glaze resistors. And our new C3 resistors, in addition to giving you a small case size, compete costwise with carbon comps.

At Corning we make components for guys who can't stand failures. Guys like your most important customers. Guys like you. So, next time you're designing a system, reach for your CORNING® capacitor and resistor catalogs and call your local Corning authorized distributor for off-the-shelf delivery. They'll help you design-in that extra measure of performance.

If you don't have our catalogs, ask your Corning distributor for copies or drop us a line at: Corning Glass Works, Electronic Products Division, Corning, New York 14830.

CORNING
ELECTRONICS



Our arrays aren't proud. They'll talk to any TTL family.

To most DTL families, too.

Because Sylvania functional arrays are designed to be compatible.

They use the same 5-volt power supply common to TTL circuitry. Their input-output levels are the same as SUHL I, SUHL II, 5400 and 7400N.

In short, you can use Sylvania functional arrays without interface problems.

And you get other advantages by using our arrays.

You get input/output buffering and the high noise immunity common to TTL circuitry.

You get the highest functional density at the lowest possible cost.

And you also get your choice from one of the largest lines of arrays available in the industry.

Sylvania functional arrays are avail-

able in military and commercial temperature ranges.

If you want to talk to TTL systems, talk to Sylvania first.

Sylvania Electronic Components, Semiconductor Division, Woburn, Massachusetts 01801.

SYLVANIA
GENERAL TELEPHONE & ELECTRONICS

Improved electronics sought



Advanced electronics create problems

No one questioned the Army's need for more versatile electronic systems last month at the Association of the U. S. Army's annual meeting in Washington.

Stressing the future dependency of the military in field operations on electronic systems, Gen. W. C. Westmoreland, Army Chief of Staff, said, "I see battlefields or combat areas that are under 24-hour real or near real-time surveillance of all types" and "I see battlefields on which we can destroy anything we locate through instant communications and the almost instantaneous application of highly lethal firepower."

Indicating other areas where effort may be worthwhile, the former military commander in Vietnam pointed out that in land operations the ground forces have five recognized functions, but have emphasized only three: mobility, firepower, and command and control. "To me, the other two—intelligence and support—have not been sufficiently stressed," he declared.

In discussing the need for improvements Gen. F. J. Chesarek, commander of the Army Materiel Command, pointed out that one improvement also calls for another: "The proven high profitability of accurate heavy firepower in a short time span on point targets not only requires rapid-fire weapons of a variety of calibers and range, but also demands that priority be given to improving our target acquisition processes, which in turn requires a parallel effort in automating the results for better command and control."

A first priority now emphasized by the Army, said Chesarek, is "on improving and integrating its means of surveillance, target acquisition, and night observation—the STANO program." He stressed that "the trend toward ever growing sophistication and technical complexity

Washington Report

CHARLES D. LAFOND
WASHINGTON BUREAU

of the equipment must be constrained by emphasizing design simplicity, to include major emphasis on reliability and maintainability." To attain this, he said, the Army must begin with comprehensive planning during the very early stages of development, must be assured "that reliability and maintainability requirements expressed in requirements documents are achievable within the current or projected state-of-the-art."

Marine research plan proposed

Five years is better than none—and a five-year, \$200-million expanded program for marine research is what the Nixon Administration proposed last month, after studying guidelines for a 10-year national oceanographic effort. The guidelines were submitted by the Commission on Marine Science, Engineering and Resources, last January in a report called "Our Nation and the Sea."

The Administration policy statement—made despite difficulties in obtaining R&D money from Congress this year—is the first concrete proposal made since submission of the report. The funding increase will be sought for five research areas, with the initial start of \$30 million in fiscal year 1971, according to Dr. Edward Wenk, Jr., executive secretary of the Marine Council. The Administration will seek Congressional support of:

- The International Decade of Ocean Exploration, a co-operative program to be supported by many nations beginning in 1970.
- A broad arctic marine research effort concentrating on potential pollution problems resulting from commercial petroleum, gas and mining exploitations.

Washington Report

CONTINUED

- A pilot study of lake pollution, cleanup, and control.
- A large increase in oceanographic laboratories along the three U.S. coastlines.
- And a grant-in-aid program to help states manage their coastlines (ports, fisheries, waste disposal, etc.)

Army defense weapon is Europe-bound

The first of the new low-level air defense weapons, the Chaparral/Vulcan, reportedly will be deployed in Europe during the next few months. The weapons system, in battalion strength, will provide an immense concentration of fire power against low-level aircraft.

The Chaparral is a modified Sidewinder 1-C air-to-air missile originally developed by the Navy. Built by Philco, the Army version will use only the infrared homing head; according to informants, no plans now exist for use of the replacement radar head developed by Motorola.

The new weapon provides an effective range of over 10 miles and is installed in groups of four on a launcher atop an M548 cargo carrier. Its passive detector provides input to a miniaturized computer within the missile, which generates steering commands to movable fins that use proportional navigation techniques. The companion 20-mm Vulcan automatic gun operates like a Gatling gun at 3000 rounds per minute.

The Chaparral gunner uses an optical sight and fires when the passive IR detector locks onto the target. The Vulcan gunner employs a lead-computing sight and a range-only radar. A typical battalion will use 24 Chaparral fire units, 24 Vulcan fire units, and 12 forward area alerting radars. The latter provide target information by data link to each fire unit.

Informants say that Philco has been working

on an improved IR seeker and improved movable fins and control system to obtain faster directional response for the Chaparral. The greatest weakness of the weapon occurs when it's launched head on against an oncoming jet aircraft. The engine-thrust radiation is not clearly definable to the present IR head.

RCA fights to control Alaskan network

Some months ago, Radio Corp. of America won the right to purchase for \$28.4 million the nonmilitary portion of the Alaska Communications System, owned by the U.S. government. As a part of its bid, RCA noted its intention to spend an additional \$27.6 million for improvements and expansion of the network, and also to reduce customer telephone rates by over 30%. The company wants to supply new telephone service to 124 outlying towns; a wideband microwave system to connect major cities with an earth station the Communications Satellite Corp. plans to build near Talkeetna, Alaska; and the introduction of direct-distance dialing.

Since then, however, a fight has developed between RCA Alaska Communications Inc. and three other firms in seeking approval to build the three critical microwave stations between Anchorage and the planned satellite communications ground terminal.

RCA claims an exclusive right for the development of all communications associated with the Alaskan network. The firm argues that the building of this microwave link was an important consideration in its bid to purchase the network. The link will cover nearly a 90-mile span and cost about \$400,000, but it will handle 120 satellite circuits initially and thus will become a source of high revenue.

The Communications Satellite Corp., Matanuska Telephone Assoc., Inc., and Western Union International have petitioned the FCC to authorize building of the link through a consortium consisting of the four interested firms.

The FCC has indicated that formal hearings might be held to solve the conflict, but insiders here believe the White House agrees with RCA and might quietly intercede in that firm's favor.

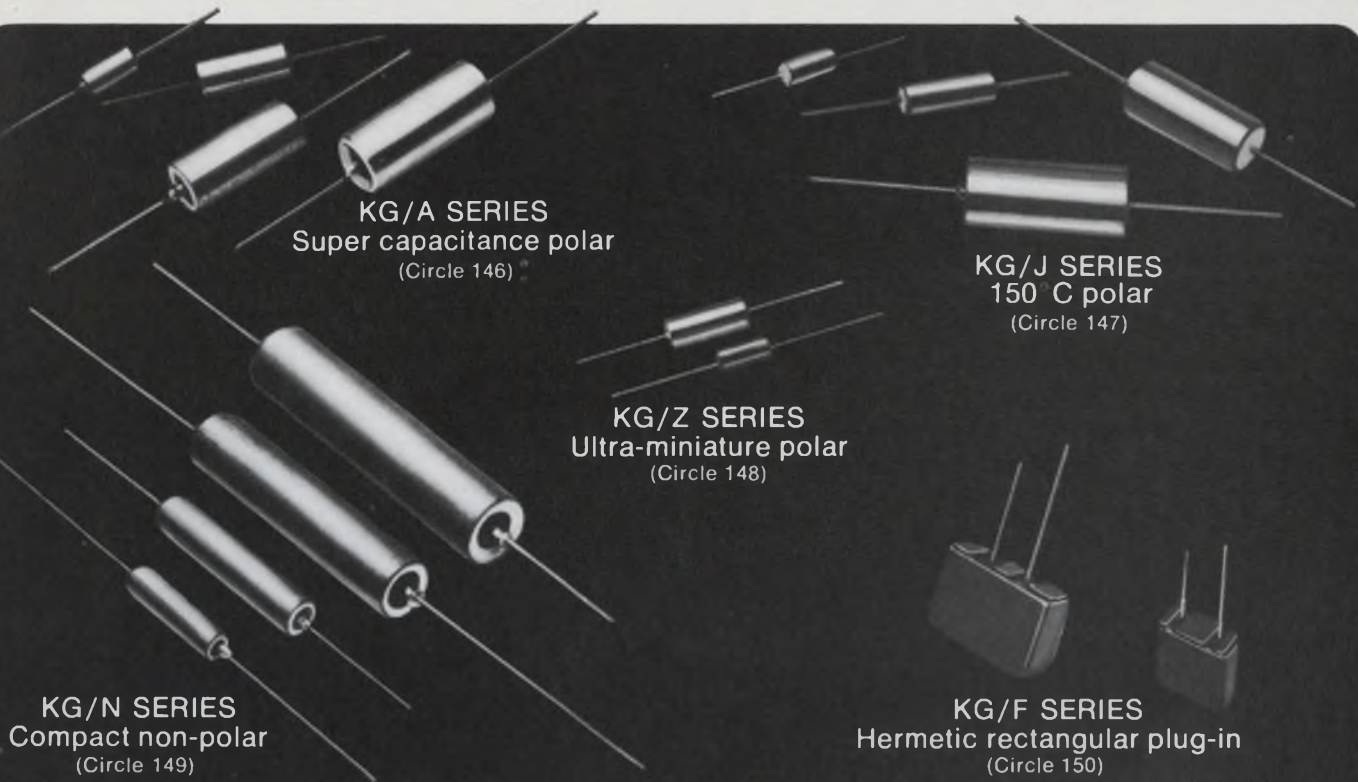

KG/A SERIES
Super capacitance polar
(Circle 146)

KG/J SERIES
150 °C polar
(Circle 147)

KG/Z SERIES
Ultra-miniature polar
(Circle 148)

KG/N SERIES
Compact non-polar
(Circle 149)

KG/F SERIES
Hermetic rectangular plug-in
(Circle 150)

**OVER SEVEN BILLION PARTS HOURS OF TEST DATA
PROVE KEMET® KG HIGH RELIABILITY REQUIREMENTS
FAR EXCEED ANY APPLICABLE MIL SPEC.....**

...and we've expanded the line!

Now your high reliability choice is even wider . . . from the only line with separate KG high reliability production and testing facilities.

Every KG capacitor is 100% tested for temperature cycling, grading (life test), leakage, capacitance, dissipation factor, x-ray, seal test, and visual and mechanical. Fourteen additional tests are performed periodically.

Life test data is fed into our computerized

Automatic Failure Detection system. When you receive a shipment of KG capacitors the *exact failure rate* has previously been established, and you receive copies of the test data to prove it.

And performance? Failure rates as low as .0001% per 1,000 hours. Shock capability of 10,000G at 0.2 milliseconds. Peak vibration to 100G at 2,000 Hz, if required. Leak rates as low as 1×10^{-8} Atm. cc/sec. J series capacitors available at 150°C or as low as -196°C for cryogenic applications.

Call your Regional Sales Office today for complete information.

NEW ENGLAND: 300 First Avenue, Needham Heights, Mass. 02194 Tel.: (617) 444-5400 TWX: 710-325-1329 ●
MID-ATLANTIC: Tarrytown Technical Center, Electronics Division, Tarrytown, New York 10591 Tel.: (914) 592-9300 ● **CENTRAL:** 120 So. Riverside Plaza, Chicago, Ill. 60606 Tel.: (312) 822-7022 TWX: 312-222-0491 ●
11901 Madison Avenue, Cleveland, Ohio 44101 Tel.: (216) 221-0600 TWX: 810-421-8494 ● **WESTERN:** 13601 E. Whittier Blvd., Whittier, Calif. 90605 Tel.: (213) 698-8077 TWX: 910-586-1342 ● 2680 Bayshore Frontage Road, Mountain View, Calif. 94040 Tel.: (415) 969-9390 TWX: 910-379-6444

**MATERIALS SYSTEMS DIVISION
COMPONENTS DEPARTMENT**

P.O. Box 5928, Greenville, South Carolina 29606 · Tel: (803) 963-7421/TWX: 810-287-2536



THE DISCOVERY COMPANY

KEMET — No. 1 in Reliability

YOUR LOGICAL KEYBOARD CHOICES HAVE JUST BEEN NARROWED TO ONE.

The one built around the most reliable and least expensive switching element ever developed:

“If you’re using magnetic cores in your computer memory, why should you settle for anything less on your keyboard?”
Now, with the Series 550 Keyboard from Licon, you needn’t settle for anything less.

Unlimited configurations at very limited cost: To put it simply, we can put a key station wherever you put a hole. You can design a completely custom keyboard.

Contact bounce is gone forever — you can adapt the Series 550 to your equipment with no special circuitry.

Virtually infinite life cycle: No mechanical linkages to wear out; no multi-connection chips to malfunction. Now you can have the near total reliability of magnetic core switching in a completely solid state keyboard.

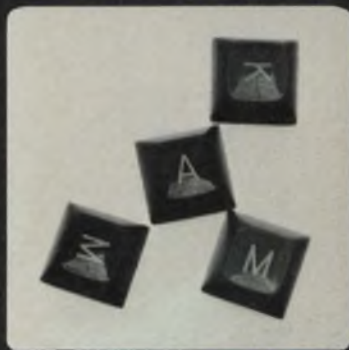

**NO
BOUNCE**



Fast easy way to go electronic: You can add our keyboard to your system (regardless of its type or coding or present keyboard configuration) with little more involved than changing connections.

Completely modular key elements adapt to any coding. If you ever want to change your original codes, you don't have to select new key elements.

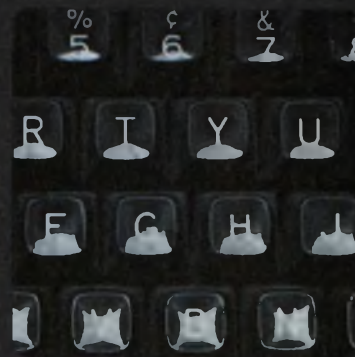

Smile when you discover the price. You can order the splendidly simple, completely solid state Licon Series 550 Keyboard, have it arranged and coded to your specific design. Tell us what you need—and how soon you want it. You'll keep the smile.



Now, the only logical choice:



Licon[®]
Division Illinois
Tool Works, Inc.

6615 W. Irving Park Rd.
Chicago, Illinois 60634
Phone (312) 282-4040
Or send for free
brochure.

★★★★★★★★★
LICON ★★
SERIES ★★
550 ★★
KEYBOARD

ITW Licon Precision Switches
ITW Paktron Film Capacitors
ITW Electromaterial Multi-Layer
Ceramic Capacitors

The new boy on the block



Charles G. Marrara

The impact of microelectronic advances (ICs, medium-scale integration, large-scale integration) and the rise of computer-aided design are constantly broadening the field of systems engineering.

And to keep pace,

we've added a new man to the staff—ELECTRONIC DESIGN's first systems editor, Charles G. Marrara. We think you'll find he talks your language. Charlie's career has included work on torque-stabilized camera platforms for aircraft, as principal engineer at Fairchild Camera and Instrument Co. and at Aeroflex Laboratories, and also a stint as project engineer on MK III SINS (Ship's Inertial Navigation System) at Sperry Gyroscope Co.—all on Long Island, N. Y.

Marrara earned his BSEE at the University of Buffalo, N. Y., and his MSEE at Polytechnic Institute of Brooklyn in New York City.

Keep an eye on him.

Three men and a CRT in a tent

There are times, Technical Editor Milt Lowenstein has decided, when magazine work can be suffocating. Such a time cropped up when he faced the prospect of helping to photograph the face of a large cathode-ray tube to illustrate his picture story on graphic ECAP (Electronic Circuit Analysis Program), p. C20. A graphic terminal had to be photographed, and to eliminate reflections from the tube face, it was necessary to envelop the operating end of the terminal in a tent of old tarpaulins, propped up with makeshift poles and held together with masking tape. The inhabitants of this tepee were a programmer, a photographer with a camera on a tripod—and Milt. As the minutes inside stretched into hours, the oxygen supply sagged while the temperature soared. Black spots began to appear—before the human lenses, not the camera's, thank goodness. Everybody made it out alive ultimately, and we hope you'll agree the story was worth the effort.

Milt's picture story is the second part of his special report on computer-aided design programs, which begins on p. C8.

Further computer news is contained in a story by David Kaye on the Fall Joint Computer Conference, to be held Nov. 18-20 in Las Vegas. ELECTRONIC DESIGN will have two editors at the conference—Managing Editor Frank Egan and Milt Lowenstein.



**“My neck
might save
your heart!”**

High blood pressure causes strokes and contributes to heart attack in man. But giraffes aren't hurt by the sky-high pressure pushing blood up their 10 feet of neck. Why? Medical scientists are searching for this and many other life-saving answers through research you make possible with your Heart Fund dollars.

GIVE...
so more will live 
HEART FUND

Photo courtesy World Health Organization

Pick the perfect tuning diode for your design from this selection of 118 standard types.



We'll help.

One of Motorola's 118 EPICAP* Tuning Diodes probably fits your requirements better than any other electronic or mechanical device you may be designing with now. Sure, there may be a few applications where bulky mechanical types are still needed, but you'll find the flexibility and simplicity of diode tuning will be more appealing for most designs.

We want to help, so we made up the EPICAP Tuning Diode Selector Guide to show Q, TR, and nominal capacitance for each device, and working voltage, package type, and line highlights by series. Send for it.

Motorola EPICAP Tuning Diodes range from high-production-volume, low-cost plastic AFC diodes like the MV2201 to the epitome of quality and performance for the most exacting

commercial and military communications applications like the premium 1N5461A or 1N5139. Most are abrupt junction diodes, but some, like MV1401, are the hyper-abrupt junction types needed for applications involving tuning over a wide frequency range. Nominal capacitance values from 1.0 pF to 550 pF are covered, and maximum working voltage ranges from 12 V to 60 V. Package variations include ceramic, plastic, and two different glass cases.

Motorola's tuning diode facilities are geared for volume production and quick turn-around to assure fast delivery on any quantity large or small. For information contact your Motorola Sales Office or Distributor. Or write: Motorola Semiconductor Products Inc. P. O. Box 20912, Phoenix, Arizona 85036.

*Trademark of Motorola

—where the priceless ingredient is care!



MOTOROLA

EPICAP Tuning Diodes

Why Picker X-Ray tests circuit boards with the Teradyne J259

Most people know Teradyne's J259 as an IC test system. Which is not surprising, since it won its campaign ribbons on IC production lines and in IC incoming-inspection departments.

Note, however, that the J259's official name is "Computer-Operated Circuit Test System." Nothing in that name says the circuits have to be integrated. An important point, which was not lost on engineers at Picker X-Ray.



Picker uses its J259 to test circuit boards going into x-ray generators. The J259 whips through the 70 or 80 tests required on a board in a split second, automatically typing out the results of any test that is failed. Test data on a rejected board then accompanies the board to trouble-shooting, where a technician refers to his copy of the test program and keys the failed test to the bad component or connection.

Picker tests more than 50 different boards with the J259. What does Picker like most about the system?

Its efficiency. Only with an automatic system is it economically and humanly practical to test all the boards all the time.

Its strong software. The "datalog rejects only" mode used so profitably by Picker is only one of dozens of fea-

tures included in Teradyne's library of software packages for classification, datalogging, and evaluation.

Its device-protective and self-protective circuits and software. Picker wanted absolute protection of both boards and test instrumentation.



Its reliability. Picker will not take chances with its boards. An undetected bad board can destroy an \$1800 x-ray tube. The J259, like all Teradyne test equipment, is designed and built to make accurate measurements in industrial environments for many, many years.

Its provisions for the addition of special-purpose accessories. Picker uses the J259's unique Network Selector, for example, to interconnect a constant-current source consisting of a simple network of current-limiting diodes.



Teradyne's J259 makes sense to Picker X-Ray. If you're in the business of testing circuits — integrated or otherwise — it makes sense to find out more about the J259. Just use reader service card or write to Teradyne, 183 Essex St. Boston, Mass. 02111.

Teradyne makes sense.

Publisher

Hugh R. Roome

Editor

Howard Bierman

Managing Editor

Frank Egan

Technical EditorsMilton J. Lowenstein
Charles G. Marrara
Michael J. Riezenman
Raymond D. Speer**Management Editor**

Richard L. Turmail

News EditorsRalph Dobriner, Chief
John N. Kessler**Washington News Bureau**

Charles D. LaFond, Chief

Military-Aerospace Editor

John F. Mason

East Coast Editor

Jim McDermott

West Coast EditorsElizabeth deAtley
David N. Kaye**New Products Editors**Lucinda Mattera
Roger Allan**Copy Editor**

Marion Allen

Editorial ProductionDollie S. Viebig
Richard D. Grissom**Art Director**

Clifford M. Gardiner

Art Assistant

William Kelly

Technical IllustratorsRita Jendrzewski
Lynn E. Thompson
JoJo Miskimmon**Production Manager**

Thomas V. Sedita

Asst. Production Manager

Helen De Polo

Production AssistantsBernard Wolinsky
Kathleen McConkey**Circulation Manager**

Nancy L. Merritt

Information Retrieval

Genate Piccinetti

EDITORIAL



Why not join the computer revolution?

The time has come for every electronic design engineer to link up with a design partner—the digital computer. The revolution in design techniques based on use of the computer is now well advanced.

Unfortunately many electronic engineers haven't yet accepted this. They haven't bothered to learn to program the machines, and, as a result, technology is beginning to pass them by. But it isn't too late. Those who have not yet learned programming have a second chance. There are computer design programs that anyone can use, because the programming has been done by someone else. These can introduce engineers to the computer terminal (see Special Report beginning on page C8).

The use of such design programs can simplify the solution of many common electronic problems and can save considerable time. More important, the familiarity that the engineer gains by interacting with a computer terminal can build the confidence necessary to stimulate his learning of formal programming.

Once a designer becomes fully adept at the computer terminal many benefits accrue to him and to his company. He finds that the time he can save in performing routine calculations allows him to give more thought to the conceptual aspects of his designs. (A computer can't develop new concepts. This is one area where the designer is still supreme.)

The computer can also remove many of the job irritants that occur all too frequently in engineering. Who hasn't had to check wire lists and cabling interconnections? With the repetitive abilities of the computer at hand, these tedious tasks need never again be performed by engineers.

Each generation has added to the dimensions of education. Once, all that was required was a knowledge of Latin and Greek. Soon, the ability to use a computer will be another mark of the educated man. In a very few years, time-shared terminals will be as familiar in engineering offices as slide rules are now. When that day arrives, you must be prepared to participate.

No revolution is painless, and learning a new skill can hurt. In this case, there is no alternative. You must be able to program to survive.

You can't lick 'em. Why not join 'em?

MILTON J. LOWENSTEIN

automate

Unique Gardner-Denver Grid-Drill™ drills electronic circuit boards at a rate of 130 cycles per minute—at total positioning accuracies of less than $\pm .0006$ "

No other production machine drills so many holes so accurately in so short a time as this new n/c Gardner-Denver Grid-Drill. Perfect for multi-layer and through-hole plating, for computers of this generation—and the next.

Handles as many as four stacks of panels as large as 15" x 20" each. Drills hole sizes from .010" to .125". Fingertip control adjusts spindle speed from 10,000 to 50,000 rpm. Each spindle is programmed for "use" or "not use," allowing the use of one, all, or any combination of spindles for each cycle. Individual spindles are located in "packages," the spacing and number of which are dependent on the type and volume of work. Packages are customized to your application.

How's this for accuracy? Table location, over a 20" travel, is accurate within $\pm .0006$ ". Repeatability of positioning—within .0003". Spindle runout—within .0005" TIR.

Production rate, including table movement, spindle programming and drilling, is as high as 130 cycles with each spindle per minute.

Gardner-Denver is also the maker of the famous automatic Wire-Wrap® machine. Both machines spectacularly increase production—and lower the cost—of electronic equipment. Call for further information, or write for Bulletins 14-121 and 15-1.



GARDNER-DENVER

Gardner-Denver Company, Quincy, Illinois 62301



How to save on relays

A quotation from Line Electric includes lots of values that add to the total savings possible.

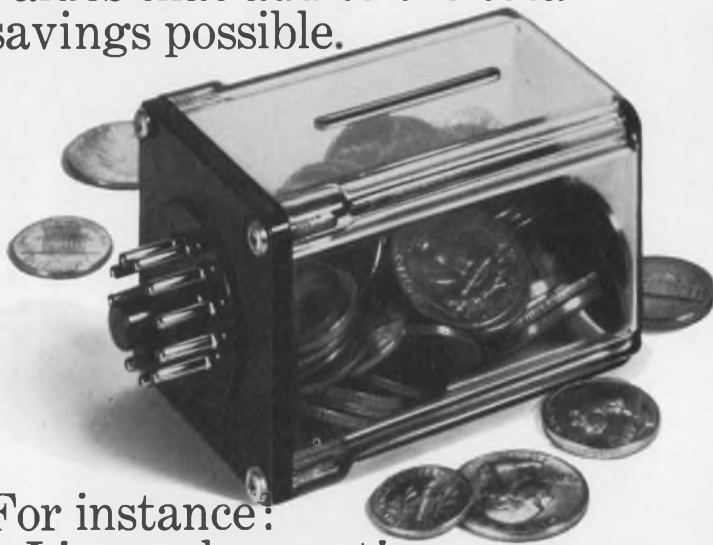

For instance:

- Line makes on-time deliveries to meet your production line schedules.
- Line offers excellent engineering help free.
- Line maintains the highest manufacturing standards in the industry.

Add these values together and you get all-round savings on your relay purchases. Not to mention the headaches you can avoid.

Won't you check us out and see how much better you can do at Line? Send for free copy of our new 1969 catalogue containing all the most frequently used industrial type relays. We guarantee you'll learn something to your advantage.



In a hurry, call (201) 887-8200 and ask for Relay Sales Manager. We like to do business by phone.

*LINE ELECTRIC COMPANY, U.S. Highway 287, Parsippany, N.J.
Manufacturers of relays and the best service in the business.
SUBSIDIARY OF THE SINGER COMPANY*

Space-saving trimmers

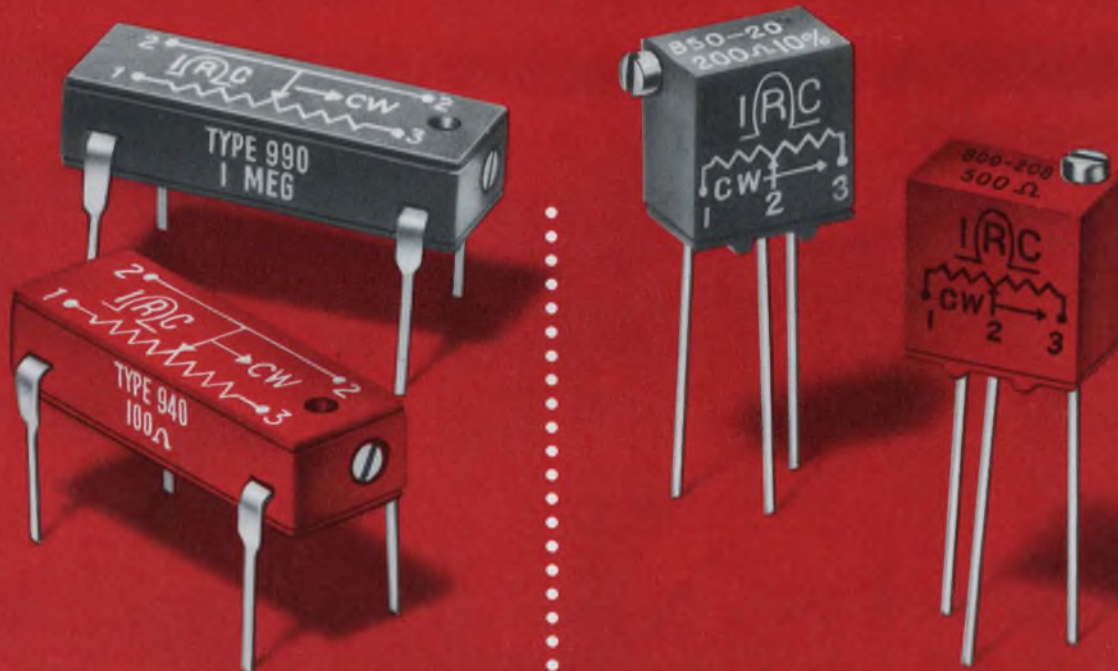

DIP construction matches IC size. Cuts assembly costs.

5/16-in. doubles performance of 1/4-in. trimmer—cuts cost almost in half.

These new IRC precision trimmers in dual-in-line packages simplify PC board layout. Only .200-in. high, their pin spacing is the same as the TO-116 size integrated circuit. It is fully compatible with high-speed automatic inserting equipment.

Pin spacing of these IRC 5/16-in. square trimmers matches the 1/4-in. square unit. Only .031-in. larger on each side, they can cut your cost almost in half and give you three times the power rating of the 1/4-in. and 40% better resolution.

Both DIP and 5/16-in. are available with precision wirewound and infinite resolution Metal Glaze elements. All units are fully sealed and impervious to common industrial solvents because of a silicone rubber shaft seal and epoxy bonding at all seams.

These units, like all IRC Metal Glaze trimmers, have a maximum guaranteed TC of $\pm 150\text{ppm}/^\circ\text{C}$ over the entire resistance range, with typical TC being $\pm 100\text{ppm}/^\circ\text{C}$, and at no added cost. For complete technical information and prices, contact your IRC Industrial Distributor or write IRC St. Petersburg Division of TRW INC., 2801 72nd St., North, St. Petersburg, Florida 33733.



DIVISION OF TRW INC.

INFORMATION RETRIEVAL NUMBER 31

- Four full digits plus "1" for 20% overranging
- Rechargeable battery operation optional
- Measures ac and dc volts in four ranges to 1200 volts
- Measures ohms in five ranges to twelve megohms
- Active 2 pole switchable filter
- Automatic polarity indicator
- All functions push-button selectable



The digital multimeter you can believe

Announcing the Fluke 8100A, a completely portable 0.02% digital multimeter for \$695.

The only way to build a multimeter with no last digit uncertainty is to add an "extra digit." That's exactly what we've done with the new Fluke 8100A. Here is an instrument with nine times the accuracy of three digit units selling at only half the price of comparable four digit multimeters.

How?

We've used an A to D conversion technique new to the DVM field. The result is an instrument with low power drain, simplicity of circuitry, troublefree oper-

ation and the ~~uncommon~~ accuracy you expect from Fluke.

Standard features include ac measurement accuracy of 0.2% and resistance, 0.1%. For real portability, batteries will operate the multimeter continuously up to eight hours without recharging. Battery operation, the only option, is priced at \$100. Accessories available include high frequency and voltage probes, switched ac-dc current shunts and a ruggedized case.

FLUKE

Fluke, Box 7428, Seattle, Washington 98133. Phone: (206) 774-2211. TWX: 910-449-2850. In Europe, address Fluke Nederland (N.V.), P.O. Box 5053, Tilburg, Holland. Phone: (04250) 70130. Telex: 884-50237. In the U. K., address Fluke International Corp., Garnett Close, Watford, WD2 4TT. Phone: Watford, 27769. Telex: 934583.

- Five full digits plus "1" for 20% overranging
- Basic unit measures 0 to 1100 volts dc in three ranges
- Auto ranging and polarity with active 3-pole switchable filter
- 25 millisecond sampling speed
- Full systems capability with timing signals and ready indicator
- Low cost options include ac voltage, millivolt-ohms, external reference (ratio) and fully isolated remote programming and data output.



The first really new DVM in a decade

Announcing the Fluke 8300A, a 0.005% digital voltmeter with full systems capability for \$1295

There are a lot of good DVM's around. All but one share a common set of faults—overwhelming complexity and high cost. And as you might guess, the DVM that beats the others cold is the new Fluke 8300A.

Why?

Because Fluke uses a new A to D technique which reduces componentry by up to 500 percent. Obviously, when components are eliminated, good things happen. Power requirements go down, reliability goes up, circuitry is simplified, troubleshooting is speeded and reduced. Most important to the system

designer, lowered costs mean we can invest some of the savings in features you need in a DVM.

With all its features and accuracy, the Fluke 5-digit DVM sells for less than many 4-digit units. We price the options low, too. A fully loaded Fluke 8300A sells for \$2995. Comparable but not equal competitive instruments cost as much as \$5000.

And when the Fluke name goes on the front you know you're getting quality instrumentation... in keeping with the Fluke philosophy of bringing you standards lab performance in portable instrumentation.

Fluke, Box 7428, Seattle, Washington 98133. Phone: (206) 774-2211. TWX: 910-449-2850. In Europe, address Fluke Nederland (N.V.), P.O. Box 5053, Tilburg, Holland. Phone: (04250) 70130. Telex: 894-50237. In the U.K., address Fluke International Corp., Garnett Close, Watford, WD2 4TT. Phone: Watford, 27769. Telex: 934583.



Big Jackpot in Connector Strain Relief

GLENAIRS NEW *Qwik-Ty*

THE BIGGEST PAYOFF YET FOR CONNECTOR USERS

INSTALLED COST — DOWN

A 'lode' of installed cost saving with Qwik-Ty. Reduces assembly time up to 12 to 1 over conventional cable-clamping methods.

WEIGHT SAVING — UP

SLIM-LINE Qwik-Ty's weigh as much as 50% less than standard MS clamps. Additional FAT TRIMMING is achieved by eliminating wrapping tape used in present cable clamp installations.

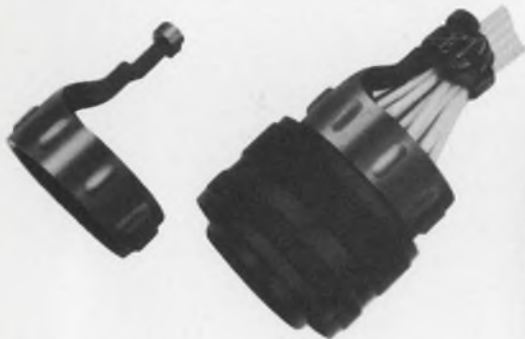

HOW IT WORKS

No more wrapping the wires to make the bundle fit the I.D. of the clamp. Simply wrap a tie strap or lacing cord around Qwik-Ty's arm and wires are snug and tight . . . IN SECONDS.

EASY MAINTENANCE TOO

For quick access to wires . . . cut the strap or cord, perform wire or connector maintenance, then tie off again. It's that easy.

Available for connectors	Qwik-Ty Series
MIL-C-26482	GTR00
MIL-C-26500	GTR01
MIL-C-27599	GTR04
MIL-C-38300	GTR01
MIL-C-38999	GTR04
MIL-C-81511	GTR03
NAS-1599	GTR02

and others

*Patents Pending

Call or write for demonstration and literature . . . today. It'll pay off.



GLENAIR, INC.

1211 Air Way, Glendale, California 91201
Phone (213) 247-6000, TWX 910-497-2066

INFORMATION RETRIEVAL NUMBER 45

INFORMATION RETRIEVAL NUMBER 83 ▶





TRIMPOT®
Single Turn
POTENTIOMETERS

... ARE SUPERB!!!

We think "superb" is just the right word when we talk about Trimpot single-turn potentiometers. They have outstanding specifications. For instance, our 8 single-turn models range in diameter from 1/4" to 1/2"; have wirewound, cermet or carbon elements; cover the temperature range from -55 to +175°C; are available in resistance ranges from 10 ohms to 1 megohm; and have a power rating from 0.25 watt to 1.0 watt.

Technically, that says a lot for our single-turns. But there's more. There's a Bourns unit to answer every single-turn application . . . competitively priced . . . ready for immediate delivery from factory or distributor stocks.

Find out the entire single-turn story from the factory, your local stocking Bourns distributor, or field representative.



Check 83

With these resistance meters...



you can go to extremes.

Use the HP 4329A High Resistance Meter for high-voltage components, leakage current, testing insulation qualities of PC boards and materials used in switches and relays—or use it as a picoammeter.

At the opposite extreme, use the 4328A Milliohmeter for contact resistance, trouble-shooting grounds, semiconductor junction or contact lead bond quality.

The compact, solid-state 4329A has a resistance range from 5×10^5 ohms to 2×10^{16} ohms, with selectable test voltages from 10 to 1000 volts. Lighted range and scale indicators afford fast, accurate readings. Analog output. Price: \$750; model 16008A Resistivity Cell for volume and surface resistivities, \$200.

The 4328A gives you 20 microhm sensitivity from 100 ohms down to the milliohm range. It has a built-in phase discriminator for making precise measurements

on samples with series reactance up to twice their resistance values. And each probe combines both current drive and voltage sensing. At only seven pounds, it's a convenient package for either field or production line. Price: \$450; with option 01, internal rechargeable battery, \$475.

Call your local HP field engineer for the details, or write Hewlett-Packard, Palo Alto, California 94304; Europe: 1217 Meyrin-Geneva, Switzerland.

HEWLETT  PACKARD

RESISTANCE METERS

18903



The older it gets the more you'll appreciate it.

Victoreen now makes resistors which can work . . . and work . . . and never tire under the load. Or, they can sit . . . and sit . . . and never tire waiting around. We call them Mastermox — metal oxide glaze resistors.

When called upon to work, the stability of a Mastermox allows as little as 1% drift under full load in 2000 hours — with more than 40 watts power dissipation per cubic inch. On the shelf, Mastermox resistors' metal oxide glaze structure permits less than 0.1% drift per year.

Try Mastermox resistors. No permanent effect from voltage and temperature cycling. High resistance range accuracy — 10K ohms to 10,000 Megohms. Precision as good as $\pm 0.5\%$.

Mastermox. Even the old ones are new ones.

Model	Resistance Range	Power Rating @ 70°C	*Max. Oper. Volts	Length Inches	Diameter Inches
MOX-400	1 - 2500 megs	.25W	1,000V	.420 ± .050	.130 ± .010
MOX-750	1 - 5000 megs	.50W	2,000V	.790 ± .050	.130 ± .010
MOX-1125	1 - 10000 megs	1.00W	5,000V	1.175 ± .060	.130 ± .010
MOX-1	10K - 500 megs	2.50W	7,500V	1.062 ± .060	.284 ± .010
MOX-2	20K - 1000 megs	5.00W	15,000V	2.062 ± .060	.284 ± .010
MOX-3	30K - 1500 megs	7.50W	22,500V	3.062 ± .060	.284 ± .010
MOX-4	40K - 2000 megs	10.00W	30,000V	4.062 ± .060	.284 ± .010
MOX-5	50K - 2500 megs	12.50W	37,500V	5.062 ± .060	.284 ± .010

*Applicable above critical resistance. Maximum operating temperature, 220°C. Encapsulation: Si Conformal. Additional technical data in folder form available upon request. Or telephone: (216) 795-8200.

mastermox

VICTOREEN INSTRUMENT DIVISION
10101 WOODLAND AVENUE • CLEVELAND, OHIO 44104
EUROPE: ARNDALE HOUSE, THE PRECINCT, EGHAM, SURREY, ENGLAND • TEL: EGHAM 4887



INFORMATION RETRIEVAL NUMBER 48

Signal Generators...

here's the one
that replaces
them all.....*

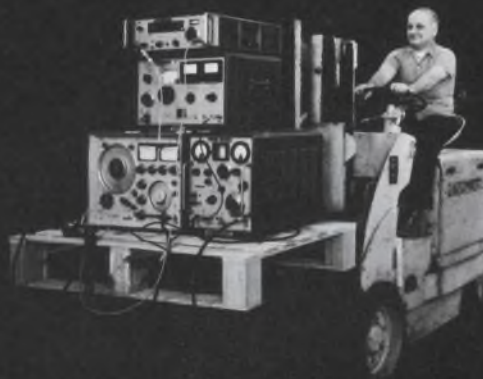

The New SG-1000 outperforms all other signal generators from LF to UHF (singly or in combination)

The new Model SG-1000 Signal Generator has obsoleted all others within its frequency range... singly or in combination. The specifications of this 5¹/₄" high instrument are unequalled... and are rarely approached.

- LF to UHF coverage... 61 kHz, to 512 MHz, extendable to 1024 MHz with simple passive doubler
- Output frequency is read directly on three digit display with two digit extension
- Unsurpassed frequency accuracy and resolution... typically 0.005%... without the commonplace problems of human error in readout.
- Unparalleled modulation capability, AM, FM, pulse, video (100 MHz bandwidth!)

simultaneous combinations such as AM/FM, FM/pulse, etc. with negligible interaction

- Automatic leveling... within ± 0.25 dB over entire frequency range from +20 dBm to -146 dBm
- Doubles as a frequency counter for measuring external signals between 100 Hz and 2 MHz

And if you are still not convinced that the Model SG-1000 has obsoleted most of your present signal generating equipment, consider the fact that its spectral purity approaches that of a crystal oscillator... that it has negligible warm-up drift... no "settling time" after band switching... and many other performance features not found in ordinary generators.

For additional technical information, or for Singer's new Application/Data Bulletin SG-10, contact your nearest Singer Field Representative or write directly to The Singer Company, Instrumentation Division, 915 Pembroke Street, Bridgeport, Conn. 06608. (203) 366-3201. In Europe contact: The Singer Company, Instrumentation Division, P.O. Box 301, 8034 Zurich, Switzerland, Telephone: (051) 47 25 10

SINGER
INSTRUMENTATION

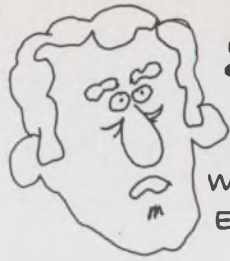

SO ON THE THIRD GO-AROUND WE HAD A CIRCUIT OUR SUPPLIER SAID HE COULD MAKE BECAUSE THEY WERE GETTING THIS NEW EQUIPMENT...

ONLY IT DIDN'T TEST TOO WELL BUT THEY COULD FIX THAT WITH SOME NEW STUFF THEY WERE GETTING...

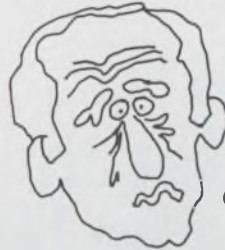

AND WITH THEIR EXPANSION PROGRAM THEY'D SOON HAVE CAPACITY TO MAKE ENOUGH CIRCUITS IN TIME FOR OUR REVISED REVISED REVISED SCHEDULE...

AT REVISED REVISED REVISED COST—

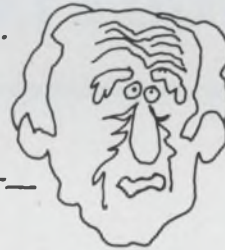

THAT'S WHAT THEY SAID...

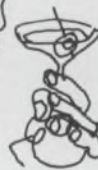

SO, I'M CELEBRATING THAT ALONG WITH MY THIRTY-THIRD BIRTHDAY.

Aerojet microcircuits solve problems. First time around.

We've already done our homework on our own in-house program. Seven years of it. And we've already invested our own money in the most advanced, automated equipment. Millions of dollars worth. So when we say we're ready to tackle your problems in thin-film microcircuits... we're *really* ready.

The benefits to you start immediately because you don't need to compromise your design. Aerojet thin-film circuits can be built to meet an incredible range of specifications. We know components and can offer you many that are unobtainable elsewhere because we developed them ourselves. You get exactly what you need. Fast.

It's in actual production that Aerojet's investment in ahead-of-the-field equipment pays off. We're automated to the highest possible degree. This gives us big advantages in precision, speed and constant traceability. Defects get caught early. And costs come down. And schedules are met! For example, the largest of our six vacuum

deposition chambers can produce 10,000 circuits in a single production cycle. Automated machines and computers can test 100 circuits in less than a minute... measuring and storing component values. A computer "knows" each individual circuit and can trace it through the entire process.

But there's much more. You almost need to see it to believe it (by all means come and take a look or ask to see our movie).

Aerojet's aerospace projects demand the utmost in reliable, sophisticated microcircuit technology. We can apply our experience to your problems... in depth, in quantity and at highly competitive prices.



So get us involved early and get results the first time around. Contact the Aerojet field office in your area, or: Aerojet Microelectronics, Electronics Division, 1100 West Hollyvale Street, Azusa, California 91702. Phone (213) 334-6211, Extension 6561.

The
Choice
is **TTL.**

Now, an MSI dual quad latch that won't break the bank...

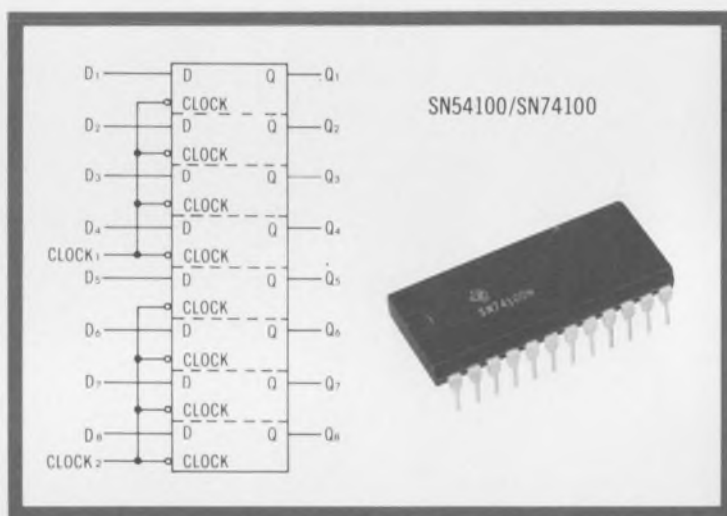

\$7.42 from TI—your first source for TTL.

If the cost of temporarily storing 8 bits is more than you really like to pay, then TI's new MSI dual quad latches (SN54100/SN74100) will please you.

For example, the SN74100N, in 100-999 quantities, is a cost-conscious \$7.42.

These new MSI functions combine two independent quadruple latches in a single, 24-pin dual-in-line plastic package. Typical power dissipation is 40 mW per latch. And the SN54100/SN74100 are fully compatible with TI's other TTL



and DTL integrated circuits.

As attractive as the price is, you'll want more details before you buy. Our new 424-page TTL catalog contains a data sheet on these dual quad latches as well as sheets on all TI Series 54/74 circuits. Circle 110 on the Reader Service Card, or write Texas Instruments Incorporated, P. O. Box 5012, M.S. 308, Dallas, Texas 75222. Or call your authorized TI Distributor.



TEXAS INSTRUMENTS
INCORPORATED



**An Electronic Design
Special Report**

**Fall Joint Computer
Conference 1969**

500 CHARACTERS PER SECOND

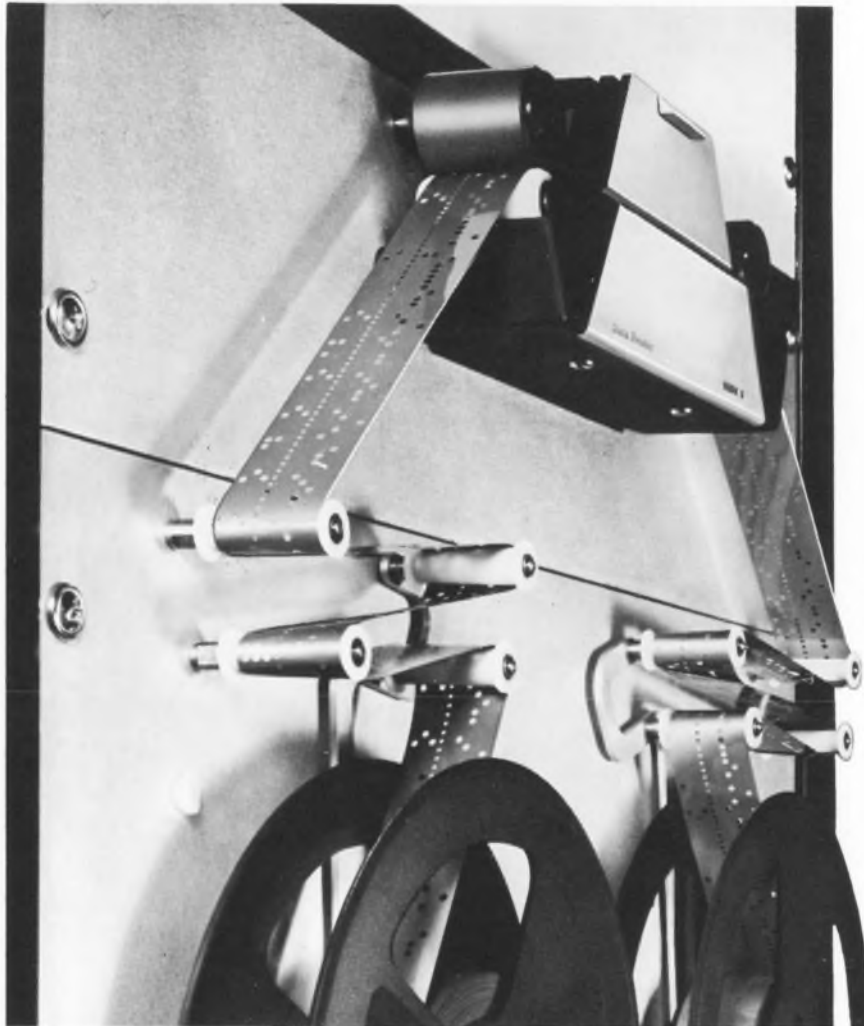

- Stop on a character
- High reliability

\$745*

MARK V data-reader TAPE READERS

Speed, reliability and economy are combined in Datascan's new paper tape reader to offer you more value than presently available. Photo-electric sensing and capstan drive assure long trouble-free life and a heavy-duty casting provides dimensional stability. And it's bi-directional, too.

Datascan's 7 years of experience has led to a most reliable series of tape readers for use in the most caustic environments such as found in the Graphic Arts and machine tool industries.

Interfaces available for all small computers.

*Consists of a readhead assembly, control electronics and power supply.

See our new Spooler too at Booth 7415 FJCC



Write for new
brochure.

Datascan

DATASCAN, INC.

906

1111 Paulison Avenue, Clifton, N. J. 07013 • Telephone 201-478-2800

*Call or Write for
Demonstration*

NORTHERN N.J., MET. N.Y.C.
 • MALOY-STAGNITTI & CO., INC.
 4 Horizon Road
 Fort Lee, N.J. 07024
 201-224-6911

**MAINE, VERMONT, NEW HAMPSHIRE,
MASS., CONN., R.I., N.Y. STATE**
 • DANER-BUCHLER, INC.
 684 Commonwealth Avenue
 Newton Centre, Mass. 02159
 617-969-4650 or
 • Rochester, N.Y.
 716-232-5100

**S. N.J., E. PA., MARYLAND,
DELAWARE, N. VIRGINIA**
 • Eastern Instrumentation
 613 Cheltenham Avenue
 Philadelphia, Pa. 19126
 215-927-6269 or
 • 1002 Ingleside Avenue
 Baltimore, Md. 21228
 301-744-3675 or
 • 2600 Virginia Avenue NW
 Washington, D.C. 20037
 202-333-8880

W. PA., W. VA., W. MD.
 • Russell F. Clark Company
 10517 Lindberg Avenue
 Pittsburgh, Pa. 15235
 412-242-9500

**N.C., S.C., TENN., GA.,
ALABAMA, MISS., FLA., S. VA.**
 • Lee Associates, Inc.
 200 E. Marks Street
 Orlando, Florida 32803
 305-241-4445

OHIO, KENTUCKY, INDIANA
 • A.C. Wahl & Assoc., Inc.
 135 Williams Avenue
 Lockland, Ohio 45215
 513-821-3270

MICHIGAN
 • Anderson Electronics, Inc.
 30785 Grand River Avenue
 Farmington, Michigan 48024
 313-476-9161

OKLAHOMA, LOUISIANA, ARK., TEXAS
 • Preceptron, Inc.
 11422 Harry Hines Blvd.
 Dallas, Texas 75229
 214-241-3143 or
 • P.O. Box 12064
 Houston, Texas 77017
 713-488-5435

CALIFORNIA, NEVADA
 • B. J. Wolfe Enterprises
 10760 Burbank Blvd.
 N. Hollywood, Calif. 91601
 213-877-5518 or
 • 10601 S. Saratoga-Sunnyvale Road
 Cupertino, Calif. 95014
 408-252-5010

**S. IDAHO, WYOMING, UTAH, ARIZONA,
COLORADO, NEW MEXICO**
 • Cropley, Inc.
 1523 E. Easter Circle
 Littleton, Colorado 80120
 303-794-4231

WASHINGTON, OREGON, N. IDAHO
 • McLaren-Topp Co., Inc.
 13547 S. E. 26th.
 Bellevue, Washington 98004
 206-746-5750

**ILL., WISC., MINN., IOWA,
N. DAKOTA, S. DAKOTA**
 • Data Electronics Co., Inc.
 5505 N. Menard Avenue
 Chicago, Ill. 60630
 312-774-1452 or
 • 8633 Harrison Circle
 P.O. Box 20081
 Minneapolis, Minn. 55431
 612-881-6386 or
 • P.O. Box 979
 Milwaukee, Wisconsin 53201
 414-645-1550

1969 Fall Joint Computer Conference

special report

by Milton J. Lowenstein, Technical Editor

For design, the program is the thing. Circuit analysis, analog simulation and logic simplification programs are examples of the design aids now availableC8

Visualize a new design graphically. Interactive ECAP designs a circuit on a graphic terminal. Photographs show the sequence of operationsC20

products

X-Y recording system uses novel two-axis linear motor to boost throughput 100 timesC38

Desktop impact line printer, a mini-computer peripheral, writes 120 lines per minuteC40

Modular self-encoding keyboard cuts single-unit costs down to \$2.50 per keyC42

Cover photo: Courtesy of IBM Corp., White Plains, N.Y.



With a little

The new Bit 483 mini computer is not lucky. It's a machine with about as much daring
as a hammer.

We designed quiet, dull reliability into the soul of our new 483.
And then we started stamping out that soul like cookies. If anything was a gamble, that was.
But then, a guy named Ford kind of took the initial risks on mass-production.
He showed that mass-producing something like the 483 would allow us to deliver the 483
yesterday. And that producing in volume would allow us to discount the price.
Putting your money on the 483 means putting your money on a general purpose



Bit of luck.

digital computer with proven design performance and unparalleled problem solving capability. BYTE orientation. Variable word length. Cycle stealing data channel. 350 nanosecond memory access time. Binary and decimal arithmetic. Priority interrupt. And a complete line of I/O options.

That makes the 483 the cost/performance leader in the mini computer field. And we're making it the best serviced computer in any field.

Frankly, the kind of people who take a chance on the 483 are the kind of devil-may-care people who take a chance on t.v. sets, the horseless carriage and peanut butter in the jar.



BIT, INCORPORATED
5 Strathmore Road
Natick, Mass. 01760

INFORMATION RETRIEVAL NUMBER 182

Visit us at FJCC booth 6304-6

16 1/2"

This is actual size.

5 1/4"

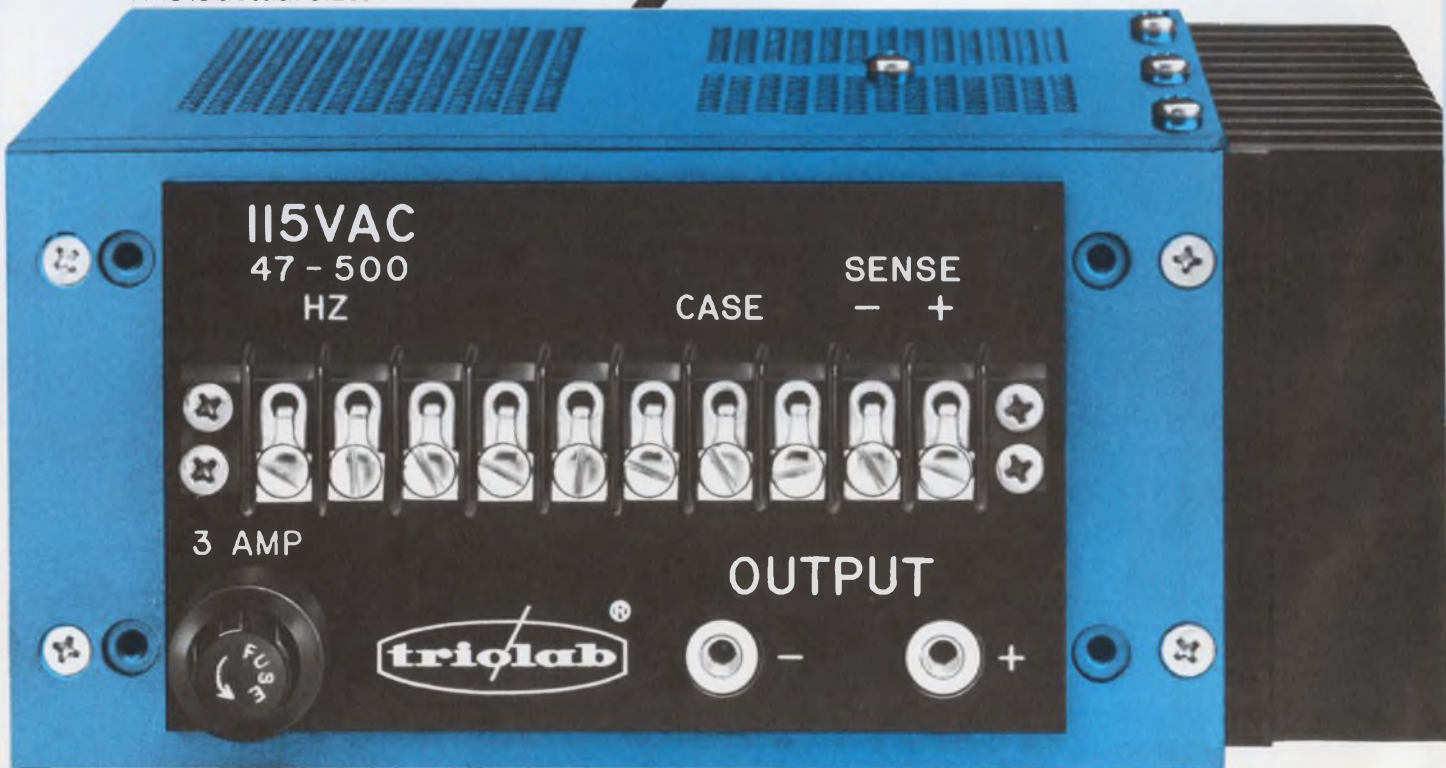

115VAC
47 - 500
HZ

CASE SENSE
- +

3 AMP

OUTPUT



- +

- Drastically smaller, lighter, cooler, more reliable — serving today's miniaturization needs.
- High efficiency — 60-90% depending on model.
- 100 watt output — maintains full regulated power from -20 to +71°C ambient — no derating or heat sink.
- Ripple & noise (including all spikes) 50 MV P-P — input and output meet MIL-I-6181.
- Maintains regulated output power at rated full load for 30 MSEC after AC power dropout.
- Over-voltage crowbar and self recovering over-current protection.
- Remote sensing.
- Can be mounted on 3 sides.
- Input power 105-125VAC, 47-500 Hz.
- Designed for both military and industrial applications.
- All models \$400 each.

SINGLE OUTPUT

Voltage Adj ±10%	Output Current	Operating Temperature	Model Number
3VDC	20A	-20°C to +71°C — No derating, no heat sink required	SP607
4VDC	20A		SP608
5VDC	20A		SP601
6VDC	17A		SP602
7VDC	15A		SP609
10VDC	10A		SP603
12VDC	9A		SP610
15VDC	7A		SP604
22VDC	5A		SP605
30VDC	4A		SP606

DUAL OUTPUT

±7VDC	7.5A	SP611
±10VDC	5A	SP612
±12VDC	4.5A	SP615
±15VDC	3.5A	SP613
±22VDC	2.5A	SP614

This 5V/20A power supply saves you more space than we can show on these two pages.

trio/labs' 100 Watt Switching Regulator Power Supplies
 setting new standards for high efficiency, low noise, computer/military applications

Trio Laboratories, Inc., 80 Dupont Street, Plainview, L. I., N. Y. 11803. Tel: (516) 681-0400. TWX: (510) 221-1861.



Many engineers are refusing to use a computer in their design work because they think they must learn a software language, like BASIC or FORTRAN, before they can operate the machine. That's too bad—for them. Because it's possible today to design with a computer without the slightest knowledge of how to write a program.

It's even possible to change the design—improve it—as the engineer and computer work together.

This is all being made possible by prepared programs on interactive terminals. These programs cover the design of circuits and analog and digital systems, and they are available commercially through a wide selection of time-sharing services. None requires more than the entering of data according to a set of very simple rules. The results are presented immediately for interpretation by the designer. The interactive feature makes it possible to refine the results by running the problem a second time with improved data inputs.

Once a terminal is available to the designer, all he has to do is choose the applicable program and begin to solve his problem. For circuit problems, he might want to use ECAP or one of its descendants, like ACNET\$ or RECAL. Or he might want to use the unique features of NASAP. If he is dealing with analog systems that require time-domain solutions, he can make use of one of the CSMP family of programs. Programs are also available to reduce the labor of simplifying digital system operation.

Few electronic design engineers have access to large, batch-process computers. Even if they did, it would do them little good, because of the tentative nature of engineering design in its early stages. But look what happens with interactive on-line programming:

The engineer still does the creative work; the machine does the routine work. Together they solve problems that up to just a few years ago were considered impossible because of their complexity. Complete solutions are possible for multi-loop networks, cascaded amplifiers of many

stages and nonlinear control systems in the time domain. Formerly computational labor involved in solving these problems was so great that approximations were made on paper and the designs proved out on breadboards. With interactive on-line computation, a great deal of breadboarding is eliminated.

The design programs available not only help solve many engineering design problems, there is a side benefit: They bring to the computer terminal many previously reluctant engineers who are thus introduced to machine computation painlessly. They become aware of the advantages of the technique, and this whets their appetite to learn conventional programming. In fact, many of the prepared design programs can be made more versatile by the use of subroutines written by the user.

Most of the prepared programs are written in one of the standard computer languages. For the most part, FORTRAN IV is favored, although other levels of FORTRAN as well as BASIC are sometimes used.

All computer-aided design programs can be classified as analysis or synthesis. Today most of the available prepared programs are of the analysis type. Synthesis programs are still in the future, but their coming—in five years, possibly—will usher in a new design revolution.

Analysis programs require the user to enter system or circuit configuration data according to formalized rules. The machine then analyzes the problem and prints out the solution. The engineer supplies the design knowledge.

Synthesis programs, on the other hand, will take system or circuit specifications as inputs and provide a complete design to optimize whatever parameters the engineer desires.

Currently available prepared programs include these circuit analysis programs: ECAP, NET-1, SCEPTRE, ACNET\$, DCNET\$, RECAL, CIRC and NASAP, among others. There are also analog simulation programs that can handle simulations of servos, dynamic systems and analog computers. These include CSMP, ANALG\$, SSP, COSS and others. Digital simulation programs are typified by LOGIC and LDSIN.

Filter design programs constitute another

For design, the program is the thing

class, which is quite large because of the many different filter design options and the relative ease of writing programs for them. Another category is that of the mathematical programs. These have been around the longest. Some are relatively simple subroutines, such as matrix inversion and determinant evaluation, while others are more sophisticated, such as root-locus, L-transform, and F-transform.

But the ease with which prepared programs can be used may lull the user into a false sense of security. He must have some understanding of what he is doing to avoid making unrecognized mistakes. The manuals supplied by the services selling the program do not always alert the user to potential difficulties. In fact, sometimes the original writer of the program is not aware of the limitations of his program.

There are several categories of program limitations. Restricted memories, difficulty in the handling of nonlinearities, lack of numerical accuracy, unsuitable integration intervals and awkward input or output formats are some of them.

Small memories restrict the size of the problem that can be solved, but this is usually made clear by the instruction books. There are ways around this limitation, such as by breaking the problem into smaller pieces and treating each piece separately.

Lack of modeling capabilities for nonlinearities is more serious. If a problem must deal with nonlinearities, a program must be chosen that can do the job; no other alternative is possible (see comparison charts on p. C11 and p. C16).

Numerical inaccuracy might, to the casual observer, be thought of as a thing of the past. However, even with 10 significant figures, the difference between two numbers of almost equal magnitude might introduce significant errors. For example, $1.111111111 - 1.111111000 = 0.000000111$; the accuracy of the result is only three significant figures. In the design of electronic circuits, a situation of this nature can arise in differential amplifier computations. The user of the program must be aware of this possi-

bility and must interpret the results correctly.

A problem can arise in the integration of a differential equation when it contains time constants with widely different values. This can cause the program to give erroneous results because of nonconvergence of the integration routine. There are methods for dealing with the problem, but the user must be aware that it exists.

Numerical integration is very commonly used in solving a wide variety of problems in prepared programs. The size of the interval is significant in determining the accuracy of the solution. In some programs the intervals can be chosen by the user, but he must make a proper choice. In other cases, the interval is hidden inside the program and the user has no knowledge of it, much less any control over it.

These are only some of the problems that can arise when using a prepared program. There are others, but, as a user becomes more sophisticated and adept, he begins to guard against the pitfalls.

Less serious is the use of awkward input-output formats, which can lead to user mistakes because of confusion in interpretation. In addition inability to use a graphic terminal or the lack of an output plotting routine can limit the usefulness of a program by requiring the user to perform the very kind of work that the computer is supposed to eliminate.

Other difficulties of a non-technical nature also can arise. Instruction books supplied by time-sharing services do not always answer the questions a user might want to ask. Manuals are commonly used for promotional purposes as well as instruction. As a result, they sometimes do not give adequate information about the limitations of a program. The only recourse then is to contact the service for further information or assistance, a procedure that, at the very least, is time consuming.

What you must remember is that sometimes the difficulties are inherent in the program, and sometimes they are characteristic of the terminal of the service.

Analyses of circuits become routine

Let's examine some prepared circuit-analysis programs and how they work. All solve the network problems of linear and, to a more limited extent, nonlinear circuits, both active and passive (see Table 1 for a representative listing).

Electronic Circuit Analysis Program (ECAP) is typical of the circuit-analysis programs. It was developed by IBM, and it is probably the most widely used analysis program. Its basic elements are resistance, inductance (self and mutual) and capacitance; current and voltage sources; dependent current sources defined by transconductance (g_m) or current gain (β); and a switch. All elements are linear. No modeling capability is built into the program, other than what can be synthesized from the available elements. Nonlinear models can be constructed on a piecewise linear basis by using switch-controlled broken slopes (Fig. 1).

The size of the circuit that can be analyzed is limited to a specific number of nodes and branches. A branch consists of a passive element that may be in series with a current or voltage source. A node is a junction of two or more branches. The actual number of nodes and branches permitted is determined by the storage capacity of the memory assigned in the central computer. Usually memory cannot be transferred from branches to nodes or vice versa. If, for example, a program is limited to 20 nodes and 50 branches, a circuit with 21 nodes and 25 branches cannot be analyzed.

ECAP solutions can be a dc, ac or transient analysis of the voltage across any or all node pairs, or the current through any or all branches. Generally the user will only want to know the node voltage (referred to as "nv" in the program) or branch current (ba) of just a few of the many alternatives. He can easily specify which he wants. Other possible outputs include element currents (ca), element voltages (cv), branch voltages (bv), or element power loss (bp). Worst-case analysis can be performed if tolerance data are supplied.

A typical ECAP statement looks like this: "150 B3 N(2,3), R=2E3, E=10." Which translates to: "line 150 describes branch 3, which connects nodes 2 and 3 with a 2-k Ω resistor in

series with a 10-volt source." (See Graphic Computer Terminal Performs Visual Analysis, p. C20, this issue of ELECTRONIC DESIGN.)

ECAP is available in many forms. It can be found in batch mode, which is not interactive, and in batch mode with graphic terminals, which is interactive. It is available on-line from many time-sharing services, with widely varying branch, node and element capacities. Some services have made minor adjustments to improve the modeling capabilities of the basic program. Some versions of ECAP allow the user to write his own subroutines in the program by means of a USER statement.

The ACNET\$ and DCNET\$ approach

Another form of circuit-analysis program is General Electric's AC or DC Linear Network Analysis—ACNET\$ or DCNET\$ (the dollar sign is GE's touch). The two programs are similar, except for the ac or dc choice, which must be made before accessing the program. There is no transient option, but it is possible to perform a frequency-sweep analysis of the ac circuit. In addition to worst-case tolerance analysis, there is an option to perform a Monte Carlo analysis at a specific frequency. The statistical analysis capability is highly developed in both ACNET\$ and DCNET\$. Modeling capabilities are as limited as ECAP, and output is in data printout form.

Data input to ACNET\$ and DCNET\$ is by coded values. The order of input is branch, node from which current flows, node into which current flows, type of element (resistor=0, capacitor=1, inductor=2, dependent current source=3, independent voltage source=4 and independent current source=5), value of element tolerance, and number of the branch that controls a dependent current source. The dependent source is controlled by the current in the resistive part of the control branch. A typical line of input data in ACNET\$ is: "1070 7,4,3,3,50,10,3," which, translated, means that line 1070 defines branch 7 between nodes 4 and 3 and contains a dependent current source with a current gain of 50 and a tolerance of 10%. The dependent current is controlled by the resistive current in branch 3.

It is apparent that this form of data input can be confusing, since it requires reference to the code for the meaning of each entry. ECAP avoids this difficulty by using defining letters as prefixes. Debugging a program written in this type of shorthand can be quite tedious.

Coded CAP interacts during data entry

Coded CAP is the circuit-analysis program of Com-Share, Inc. It is similar in concept to the ECAP and ACNET\$ and DCNET\$ programs. The

Table 1. Comparison of representative circuit analysis programs

Prog. name	Offered by	Size		Analyses					Output format		Non-linear modeling capabilities
		Branches	Nodes	AC	DC	Trans	Worst case	Statistical	Print	Plot	
ECAP	SBC (C/360)	75	30	✓	✓	✓	✓		✓		piecewise linear (broken slope)
ECAP	ITC	60	20	✓	✓	✓	✓		✓	✓	
ECAP	TYM	60	20	✓	✓	✓	✓		✓		
ECAP	ITT	50	20	✓	✓	✓	✓		✓		
ECAP	AL	200	50	✓	✓	✓	✓		✓		
ECAP	DN	60	20	✓	✓	✓	✓		✓		
ECAP	CN	75	30	✓	✓	✓	✓		✓		
ACNET	GE	15	11	✓			✓	✓	✓		
DCNET	GE	15	11		✓		✓	✓	✓		none
Coded CAP	CS	75	25	✓	✓		✓	✓	✓		(see ECAP)
CIRC	TYM	(1)	(1)		✓		✓		✓		diode/transistor
RECAL	RD	200	80 (2)	✓	✓	✓	✓	✓	✓	✓	diode
NASAP	CAC	40	20	(3)					✓	✓	(1)
NASAP	AL	40	20	(3)					✓		(1)
NASAP	ITT	45	25	(3)					✓	✓	(1)
NASAP	CN	44 (elements)		(3)					✓	✓	(1)

(1) Cannot be characterized
 (2) A trade-off between branches and nodes is possible
 (3) Pole-zero and transfer function analysis

AL Applied Logic Corp., 1 Palmer Sq., Princeton, N.J. 08540

CAC Call-a-Computer, 1500 S. Lilac Drive, Minneapolis, Minn. 55416

CN Comnet, Computer Network Corp., 5185 MacArthur Boulevard, Washington, D.C. 20016

CS Com-Share Inc., Ann Arbor, Mich. 48106

DN Data Network Corp., 460 12th Avenue, New York, N.Y. 10018

GE General Electric Co., Information Service Dept., 7735 Old Georgetown Road, Bethesda, Md. 20014

ITC International Time Sharing Corp. of Minnesota, Inc., 4620 W. 77th Street, Minneapolis, Minn. 55435

ITT ITT Data Services, P.O. Box 402, Route 17 and Garden State Park-

way, Paramus, N.J. 07652

RD Rapidata, 350 5th Avenue, New York, N.Y. 10001

SBC Service Bureau Corp., 1350 Avenue of the Americas, New York, N.Y. 10019

TYM Tymshare, Inc., 525 University Ave., Suite 220, Palo Alto, Calif. 94301

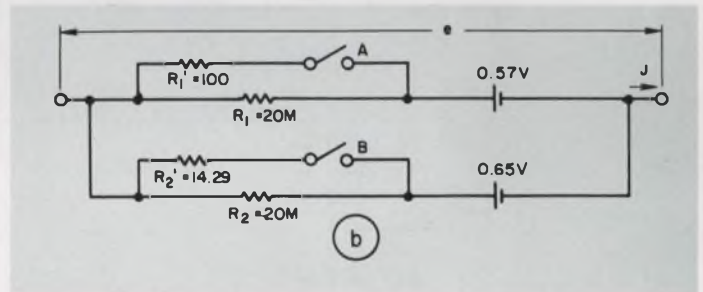
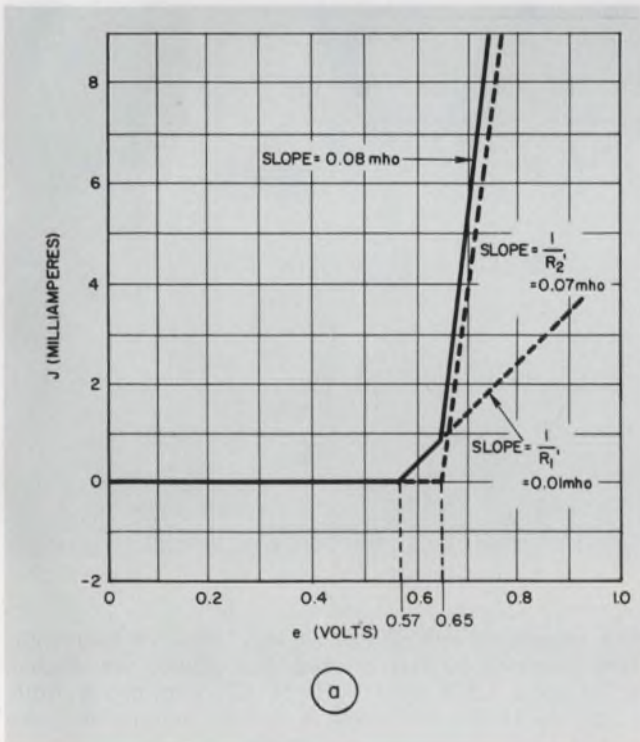

SWITCH	$e \leq 0.57V$	$0.57V < e \leq 0.65V$	$e > 0.65V$
A	OPEN	CLOSED	CLOSED
B	OPEN	OPEN	CLOSED

1. The modeling capabilities of ECAP are limited to the broken slope models that can be constructed with passive elements and switches. Here is an example from the C/360 manual. It is a model of an I-V characteristic (a) that is 0 mA from 0 to 0.57 volts, has a slope of 0.01 mho from 0.57 volts to 0.65 volts and has a slope of 0.08 mho above 0.65 volts. The equivalent circuit is shown in (b) and the table of switch closures in (c).

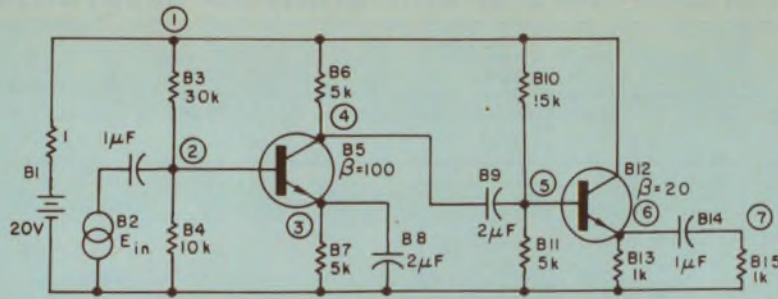

BASE CIRCUIT

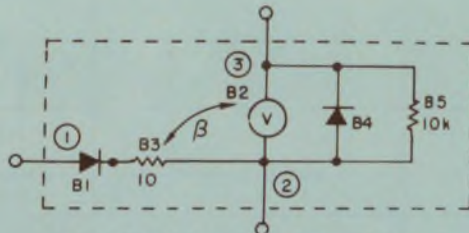

PRESPECIFIED TRANSISTOR MODEL

(a)

READY
 :L
 100 B1,N0-1,E=20,R=1
 110 B2,N0-2,ES=1,C=1U
 120 B3,N1-2,R=30K
 130 B4,N2-0,R=10K
 140 B5,#NPN,N2-3-4,100
 150 B6,N1-4,R=5K
 160 B7,N3-0,R=5K
 170 B8,N3-0,C=100U
 180 B9,N4-5,C=1U
 190 B10,N1-5,R=15K
 200 B11,N5-0,R=5K
 210 B12,#NPN,N5-6-1,20
 220 B13,N6-0,R=1K
 230 B14,N6-7,C=2U
 240 B15,N7-0,R=1K
 250 #NPN,P1
 260 B1,N1-4,D=ON,E=.5,R=600
 270 B2,N3-2,BETA=P1*B3
 280 B3,N4-2,R=10
 290 B4,N2-3,D=OFF,E=.5,R=100
 300 B5,N3-2,R=100K

(b)

COMMAND ?PRINT,NV,BC

NODE VOLTAGE

1, 2, 3, 4	19.9940	4.94090	4.43622	15.596
5, 6, 7	4.35732	3.75302	0.000000	

BRANCH CURRENT

1, 2, 3, 4	0.600582E-02	0.000000	0.501770E-03	0.494090E-0
6, 7, 8, 9	0.879564E-03	0.887243E-03	0.000000	0.000000
10,11,13,14	0.104244E-02	0.871464E-03	0.375302E-02	0.000000
15	0.000000			

(c)

COMMAND ?AXIS,-10,50,-180,180;SWEEP,LOG,F=10,10K,13;PLOT,NV,DB,?

+ = NV, ? -10.0000 = MIN 50.0000 = MAX 0.600000/DIV
 * = PHASE -180.000 180.000 3.60000

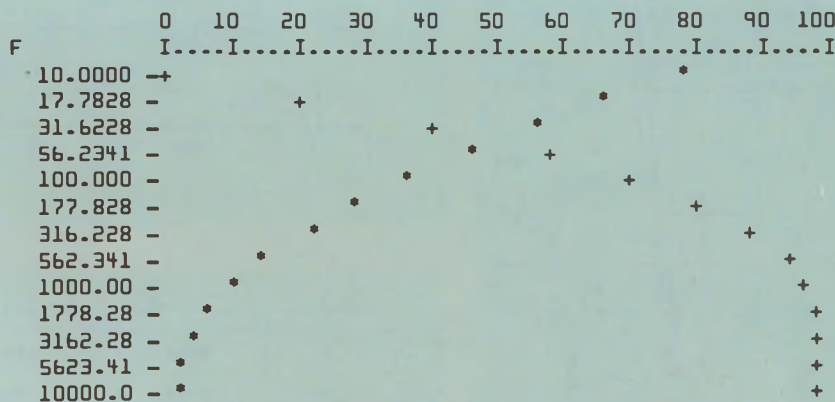

(d)

2. RECAL'S modeling capability includes the use of diodes. (a) shows a circuit with a transistor model that uses diodes. (b) is the input data for this circuit. (c) is a print output of the dc node voltages and branch currents. (d) is an output plot of the voltage at node 7,

both magnitude and phase. A log sweep of frequency from 10 Hz to 10 kHz is used. Magnitudes are plotted in dB on a scale from -10 to 50, and phase from -180° to 180°. The scale is actually numbered from 0-100 so interpolation is required.

Glossary:

Batch (mode, processing, environment) The processing of data in a single machine run. Program and data are fed in and results are obtained with no interruption of the computer possible. (See interactive)

CAD Computer-aided design

Commerical time-sharing A method of computer use with remote terminal, interactive and time-sharing characteristics. The user of the machine pays for the time used.

Conversational operation Similar to interactive mode, but the user must await for a question to be posed by the computer before interacting.

Graphic terminal A cathode-ray tube (CRT) display. Sometimes the term is used to include an X-Y plotter.

Interactive (mode, processing) The process by which the programmer or computer user can communicate with the machine and modify its operation as the results of the computation suggest ideas. (See Batch)

Print, plot, print-plot The possible output formats on a teletype or electric typewriter terminal. Print refers to tabulated lists of output data; plot refers to a plot of the output data performed by the typewriter and using symbols like "x" or "*" to indicate data points — the plot is discontinuous; print-plot refers to the availability of both formats at the same terminal.

Remote terminal A terminal located at a substantial distance from the central computer. It usually accesses the computer through a communication link such as a telephone line.

Terminal A device that permits gaining access to a central computer — can be a teletype, electric typewriter, a graphic terminal or other device.

Time-sharing The process by which one central computer can be used simultaneously by many different people. The time used at one terminal for input of data or output of results is used for computation at another terminal.

data lines resemble ECAP. One notable difference is that when a current or voltage source is entered, the program asks whether it is dependent. If the user's answer is affirmative, the program requests the element number on which it is dependent.

Analyses available include ac, dc worst-case and statistics on tolerance buildup. The modeling capabilities are as limited as in ECAP.

RECAL stores models

Rapidata's entry in the circuit-analysis field is called RECAL (Rapidata Electronic Circuit Analysis). Its input-output appearance is similar to ECAP, but with less punctuation. It is a linear program, but it allows the use of diodes in modeling other devices. A transistor model, for example, can be constructed with diodes, resistors and current gain (Fig. 2). The model is specified in a subroutine, which can then be invoked as often as desired if the same model is to be reused.

RECAL can perform ac, dc, transient and worst-case analysis, if tolerance data is provided. Output can be in printed or plotted form. RECAL has one other unique feature. By using a flexible storage allocation technique, it states the limit on the size of the program in terms of nodes plus branches. This is especially useful in circuits with large numbers of nodes, where standard ECAP might run out of storage locations.

Scientific Data Systems of Santa Monica, Calif., makes its analysis program, CIRC, available on-

line in Tymshare's time-sharing system. It is unique in that data input is completely interactive. The user draws his circuit-diagram numbering nodes, components and supplies. He then accesses the program via a typewriter and proceeds to answer these questions that the program fires at him:

Q. Number of nodes?

A. 2.

Q. Are special Eqs. used?

A. No.

Q. Specify the quantity of the following CIRC standard elements that are used, Res., Vrs., Dio., Tran.

A. 2,0,0,0,1. (The circuit has two resistors and one transistor.)

This procedure continues until all the questions are answered and the circuit is fully specified. Only dc analysis is available at present.

CIRC provides nonlinear models that simulate semiconductor components. Transistor parameters, for example, are entered directly into the program at the program's request. They include such parameters as collector and base saturation currents, V_{be} and others, as well as beta.

NASAP goes on-line

Until recently, NASAP (Network Analysis for Systems Application Program) developed by NASA, existed solely in batch mode. Now, however, it can be found on-line from Call-a-Computer, Comnet, ITT Data Services and Applied

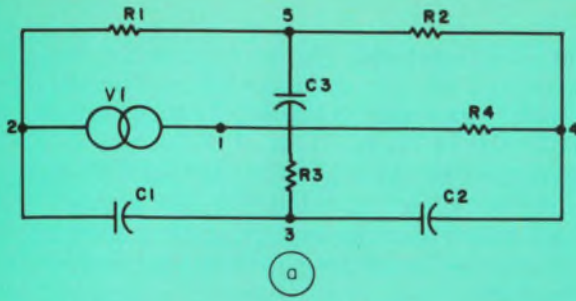

```

200 NASAP PROBLEM
201 *SAMPLE PROBLEM
202 *TWIN TEE
203 V1 1 2 1
204 R01 2 5 50
205 R2 5, 4 50
206 R3,3,1,25
212 R4 4 1 10K
213 C1 2 3 52 U
214 C2 3 4 52U
215 C 03 5, 1 104U
216 OUTPUT
217 VR4/VV1
218 EXECUTE

```

(b)

TRANSFER FUNCTION

K = .1000E+01

NUMERATOR POLYNOMIAL

```

.1000E+01 TIMES S** 3
.3846E+03 TIMES S** 2
.1479E+06 TIMES S** 1
.5690E+08 TIMES S** 0

```

DENOMINATOR POLYNOMIAL

```

.1000E+01 TIMES S** 3
.1927E+04 TIMES S** 2
.7426E+06 TIMES S** 1
.5747E+08 TIMES S** 0

```

(c)

ROOTS OF THE TRANSFER FUNCTION

K = .1000E+01

NUMERATOR ROOTS (ZEROS)

```

S = -.3847E+03
S = .2984E-01 - J .3846E+03
S = .2984E-01 + J .3846E+03

```

DENOMINATOR ROOTS (POLES)

```

S = -.1039E+03
S = -.3846E+03
S = -.1439E+04

```

(d)

3. This sample problem in NASAP demonstrates its unique capabilities. (a) is the circuit to be analyzed and (b) is the program equivalent. The results can be presented as the quotient of two polynomials as in (c), in pole-zero form as in (d) or in a plot of magnitude and phase (not shown). Gain, K, is shown separately in the transfer functions.

Logic. Other services are considering adding it to their libraries.

NASAP uses a flow-graph approach. The network to be analyzed is viewed as a signal flow diagram. However, this internal organization, which distinguishes one program approach from another, is not of too great interest to the user. He is primarily concerned with what the program can do for him. In terms of the input format, NASAP looks very much like ECAP.

The major advantage of NASAP is that it can provide the user with information about a network that is not available from other programs. It can give the transfer function of a network as the quotient of two polynomials together with its time response to an impulse function. It can also give the roots of the numerator polynomial (zeros) and of the denominator polynomial (poles). The output format is a print or plot of magnitude and phase (Fig. 3).

Batch programs provide greater capability

Programs for circuit analysis began in the batch mode, and some are still lodged there. Among the programs associated with batch processing only, the best known are SCEPTRE, CIRCUS and NET-1. Many of the batch-mode concepts may soon be turning up on time sharing terminals; so even if you don't have access to a batch-mode facility, it may be useful to examine these programs briefly.

SCEPTRE was originally developed to investigate the effects of radiation on semiconductors. Its development was sponsored by the Air Force Weapons Laboratory, and the name is an acronym for System for Circuit Evaluation and Prediction of Transient Radiation Effects. Its greatest advantage is its well-developed modeling capability. FORTRAN subroutines can be written to describe a wide variety of nonlinear models of semiconductor devices. The subroutines, once written, can be stored in memory for use at any point in a SCEPTRE program. The models can be based on diode types of nonlinearity, or they can be based on a tabulation of voltage-current characteristics.

The SCEPTRE program is very effective for transient analysis, less so for dc analysis. One problem with SCEPTRE is that non-monotonic functions such as those that describe SCRs, UJTs or tunnel diodes, sometimes confuse the program into nonconvergence.

NET-1 is based on the solution of simultaneous sets of nonlinear algebraic and differential equations. The latter are usually expressed in matrix form to simplify treatment and notation. In addition the system of equations must have a unique solution. It is best to determine this fact

in advance by use of topological methods. NET-1, by its nature, can handle nonlinear modeling of diodes and transistors without too much difficulty. It can also, of course, handle the general run of circuit problem. NET-1 was developed by the Atomic Energy Commission.

CIRCUS, an Army Signal Corps program, is similar to NET-1 in concept. It can provide diode and transistor models for nonlinear analysis. It can also handle four-layer diodes and FETs.

The programs that are still found only in the batch mode are not likely to find their way into time-sharing. One reason for this is that the easily adapted programs have already made the transition. Another is the fact that time-sharing services will, increasingly, be developing their own software; they may make use of ideas from the batch programs, but most of the new work is likely to be original.

Do-it-yourself subroutines

The earliest prewritten programs were those that were intended to perform as subroutines in FORTRAN or BASIC programs written by the

users. This so-called general-purpose computing is still very much alive and is used by those engineers who have become adept at programming and who prefer to have some insight into the nature of the computing process.

The mathematical programs are offered as subroutines by most time-sharing services in one form or another. Matrices can be inverted and determinants evaluated. These subroutines are valuable in solving the simultaneous equations of network mesh or node analysis. Nonlinearities can be treated by using iteration techniques.

Other specialized tasks can be performed by using the subroutine library. Power spectra or frequency-domain analysis can be accomplished using Fourier transform or Fourier integral methods. Some services provide direct and inverse Laplace transform routines to help solve analog computer or servo problems, although the analog simulation routines can do this job more easily.

The uses that can be made of a time-sharing system library of subroutines is limited only by the skill of the programmer and the complexity of his problem.

Solve servo problems by simulation

When a digital computer solves analog problems, the keyboard replaces the breadboard.

The user specifies the analog block, either operation or function generation, and the method of interconnection. He then has a simulated analog system. He can apply test inputs and watch system response. If his system is oscillatory or too lively, he can increase damping factors and check the response again. This interaction continues until he is satisfied with the system.

However, more than analog computers can be designed this way. Servo systems, nonfeedback dynamic systems and operational amplifiers can also be handled. The major programs include

IBM's Continuous System Modeling Program (CSMP) also offered by ITT Data Services, Tymshare and Applied Logic, GE's ANALG\$, Com-Share's Com-Share On-Line Simulation System (COSS) and International Time Sharing's SSP.

Start with a block diagram

An analog simulation is similar to a breadboard. An engineer who is designing a servo system first draws a block diagram and analyzes the performance of the system he envisions. The traditional second step is to build a breadboard of the system. Now, instead of assembling amplifiers, motors, tachometers and the like, the engineer sits down in front of a computer terminal and invokes one of the magic acronyms.

ANALG\$ is written in FORTRAN. Interconnections and blocks are specified by keyboard inputs. Besides handling linear systems, the response of nonlinear and time-varying systems can be obtained. Output results are obtained in hard copy—a distinct advantage over the traditional breadboard. On-line modification of configuration, initial conditions or timing can be accommodated. A system is limited to 250 blocks; there are 31

Table 2. Comparison of representative analog simulation programs

Prog. name	Offered by	Size			Output format			Time sharing	Batch
		No. of diff. blocks	No. of user def. blocks	No. of tot. blocks	Print	Plot	Graphic		
CSMP	SBC (C/360)	31	5	75	✓	✓	✓	✓	✓
CSMP	IMB (S/360)	34	(1)		✓	✓	✓		
CSMP	ITT	30	0	75	✓	✓	✓	✓	
CSMP	TYM	29	(3)	150	✓	✓	✓	✓	
CSMP	AL	26	(3)	75	✓	✓	✓	✓	
ANALG	GE	30	20 (2)	250	✓	✓		✓	
COSS	CS	29	9	150	✓	✓		✓	
SSP	ITC	26	10 (2)	200	✓	✓	✓	✓	

(1) Many additional from FORTRAN Library and MACRO Functions
 (2) Function generators only
 (3) FORTRAN subroutines

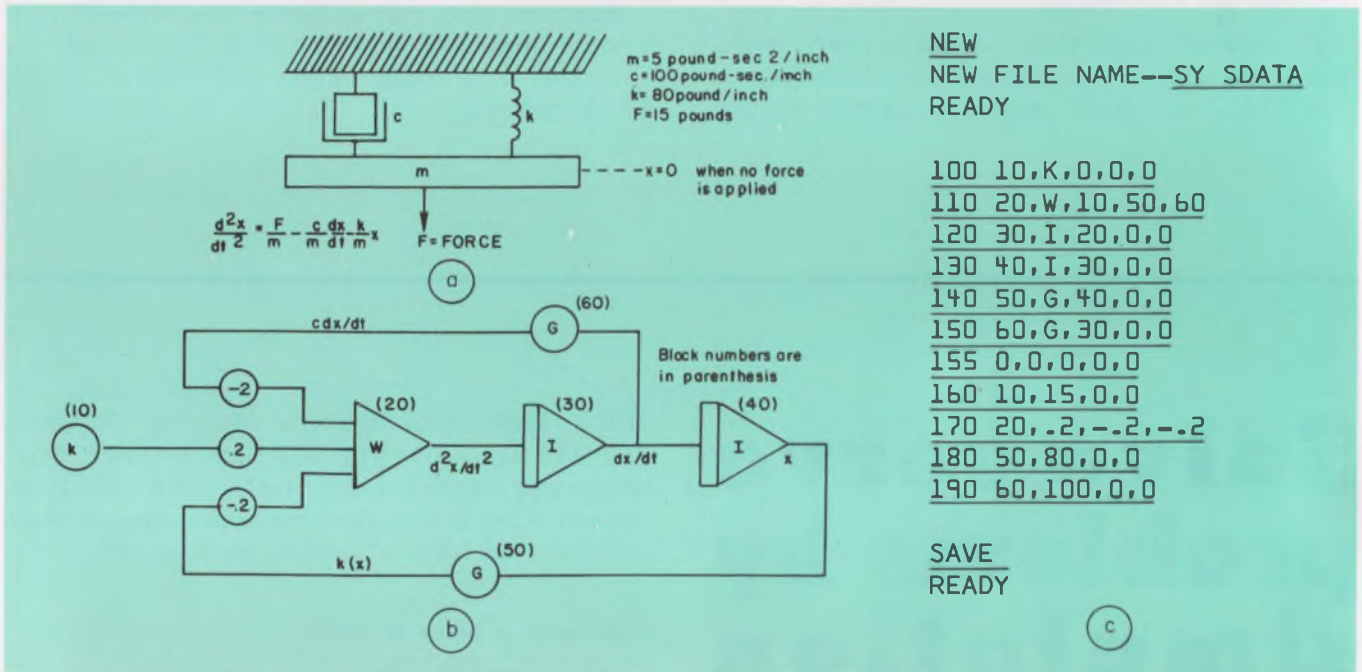

4. A simple resonant mechanical system is described in (a). A block diagram of the system is drawn in (b) as the first step in using an ANALG\$ simulation. Block K is a constant; I is an integrator; G is gain; W is a

weighted summer. The numbers alongside the blocks are the block numbers. The input lines for this system are listed in (c). The output which can be print or plot is not shown.

different blocks to choose from. Numerical integration can use either a second or fourth-order Runge-Kutta routine at the option of the user. A system, once defined, can be stored in files for future investigations.

System blocks include the commonly encountered summing, multiplication and division, inversion, integration and exponentiation; the non-linear limiting, clipping, relay, offset and bang-bang; trigonometric functions; jitter and several others. One very useful function is the function generator, which enables the user to

create his own function by fitting a curve to 11 data points.

Each system block is assigned a letter or symbol name. The user assigns a block number to each block in his diagram. A line of data will then look like this: "20 30, S, 20, 0, 0." The first entry is the line number. The second is the number of the block that is named by the third entry (S=sin function). The fourth, fifth and sixth entries are the numbers of the blocks whose outputs form the input to block 30. Block 20 is the only input to block 30. Initial condition en-

tries are similar, but the block name is omitted, and the last three entries are initial conditions or parameters. Figure 4 shows this process for a simple example.

The output from the ANALG\$ program can be either a tabular printout of the output of each of four blocks at stated time intervals, or a plot of the outputs of four blocks vs time.

CSMP is similar in concept to ANALG\$ (see "Build Digital Models of Analog Systems, ED 21, Oct. 11, 1969" pp. 90). The size of CSMP, in terms of the number of blocks available and the number that can be used in one program, varies greatly with the system. CSMP on the IBM 1130 is limited to 25 standard simulation blocks and five special user defined blocks.

FORTRAN expands CSMP library

Batch-oriented system 360 CSMP has 34 functional blocks in its library. Simple arithmetic operations are performed by conventional FORTRAN arithmetic statements, and the program is augmented by the availability of such FORTRAN library routines as absolute value, cosine, log and exponential.

The user of an IBM S/360 CSMP program can

expand the library of functions by writing his own MACRO subroutine. These are groups of CSMP functions that perform a complex operation more than once. An example of this might be a transfer function consisting of the quotient of two second-order polynomials that might recur several times during the study of a filter. The MACRO allows this complex transfer function to be combined into one operation, which can then be invoked whenever it is needed. S/360 CSMP also has provision for seven different kinds of numerical integration. These are Runge-Kutta, Simpson, trapezoidal, rectangular and second-order Adams, with uniform time intervals chosen by the user. In addition there are fifth order Milne predictor-corrector and fourth-order Runge-Kutta, with the integration interval variable and under program control.

CSMP outputs can be tabular printout or print-plot, similar to the ANALG\$ forms.

Other versions of analog simulation use similar formats. COSS, for example, names its blocks with three letter titles, and SSP is simply International Time Sharing's name for CSMP—a poor choice, since IBM also uses the letters "SSP" to designate its extensive Scientific Subroutine Package.

Shift logic problems to the computer

The most recent addition to computer-aided design programs are those relating to logical systems. It is curious that it has taken so long for these to appear, since logic design is so closely associated with computers and computer programming. The programs currently available range from simple Boolean analysis of parallel gate networks to analysis of sequential networks with counters and shift registers.

Perhaps the most sophisticated program in this group is Rapidata's—appropriately named LOGIC. The designer first sets up a block diagram of his system, which can include any type

of logic gate, flip-flops, adders, shift registers, one-shot multivibrators, clocks, word generators or the like. The blocks have two or three-letter program names. The designer assigns numbers to the blocks. A line of input data consists of a line number, block number, block name, propagation delay of the block in a set of self consistent units, list of inputs to the block or logical constants. The format is similar to those of the circuit or analog programs—only the names are changed.

LOGIC can handle up to 500 blocks of the types described, plus up to 36 switch registers, which are set to the desired state by the operator. They cannot be set or reset by the program. There is an output display module that is the equivalent of a 15-channel sampled chart recorder. It displays the output of an operating logic circuit.

The output of a run consists of a timing diagram of the system under study. The time is printed out whenever a change of state occurs in the system. Each block has two output positions, a LOW and HIGH. An entry is made for each block number (up to a total of 15 blocks) in one of the positions. In addition specified time

intervals may be studied without going through the entire time sequence. In fact, the program itself may be used to control the output by printing out time periods when a change is occurring and where the change has occurred. Figure 5 shows a study of a simple system.

The LOGIC program is extensive enough to study complex systems. One capability that is not likely to be used to any extent is to program a computer and then use it to solve problems.

A less elaborate logic-oriented program is ITT Data Services' LDSIN, which performs minimization of Boolean functions up to seven variables. The input and output forms are the standard sum of products or AND OR form. Functions may contain "don't care" items.

Other services are promising digital simulation

programs for the near future. One of these is Data Network, Inc., which hopes to have a parallel-sequential logic analysis program on line before the end of 1969. It is tentatively called LOGICS.

The digital simulations are probably in for the greatest development in the near future. The reasons include these: It is a relatively untouched field ripe for exploitation; there is a fair demand for this service, and logic programs can be written in a short time.

Digital programs will be particularly useful in designing digital control systems and displays. This is a field that has been expanding rapidly as users become aware of the advantages of static control systems over dynamic systems and their costs come down.

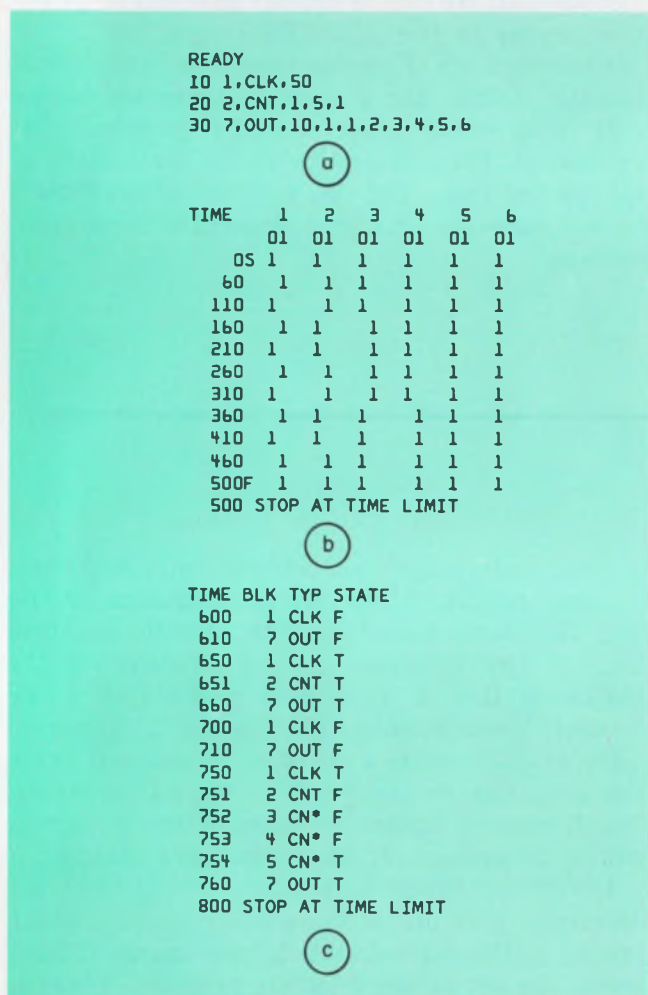

5. This is a LOGIC simulation of a clock (block 1) with a delay of 50 time units, a five stage counter (blocks 2-6) and an output block (7) with a delay of 10 time units. (a) is the data input. (b) is a print-out of the time and the states of blocks 1-6 at each time the output changes starting at 0 time and ending at 500 time units. Any other time period could have been specified. (c) is a printout of the times any changes of state occur starting at time 600 and ending at time 800. In this mode, the time of an event, the number of the block in which it occurs, the type of block involved and the new state of the block are given.

Where does the designer go from here?

What of the future of computer-aided design? Remote processing—the terminals in one place and the central computer in another—should grow. Robert Sarnoff, the president of RCA, said recently, "Remote processing is expected to advance from a 13% share of the market last year to some 50% by 1973."

Of course, the 1973 computer user market will also be much larger than the 1968 market. A large part of this increase will occur in the engineering and scientific fields, and it will be pushed along by the development of new and more powerful design programs.

This new tool is expected to challenge the role of the designer. The quality of his work will rise rapidly as the tedium of engineering design is taken over by the machine. Fewer competent men will turn out more and better results. More lower-echelon people, whether trained as engineers or technicians, will be needed to perform the routine work. A new sharp line of demarcation is expected to separate the two groups.

The men who enter the elite group will be those

who have become adept at the use of computers. There are implications here that go far beyond the world of business and industry. The effects will be felt in education, government and economics as well.

Are graphic terminals in the cards?

One clouded element in the coming explosion of remote processing is the role of the graphic terminal. Rapidata's Barry Schindler, the programmer of RECAL and LOGIC and a former practicing design engineer, says: "The CRT is the optimum medium as far as I am concerned, but its just that it's not economic yet."

Henry Mulkiwicz, manager of applications development at ITT Data Services, concurs: "Our feeling at the moment is that the expense of graphic terminals is prohibitive. Until we can see the cost curve coming down, we can make no plans for these terminals."

A somewhat dissenting position is taken by Aron Kronenberg, technical staff member of Applied Logic. He says: "Usually graphic terminals are given inadequate support. They sometimes hide the assumptions and limitations of the software. Their major utility now is to simplify topologic reduction. They are very expensive, but there are signs that they will become cheaper. At the moment they are not too useful, but if the software problems and the hardware expense can be overcome, things may change drastically."

There will be advances in other areas of computers and computer auxiliary equipment in the near future. Conventional terminals will become faster thus reducing the time lost during interactive operation. Computer inputs will be broadened to include the results of tests on equipment being performed in real time. The programs will be used in trouble shooting as well as design. A great deal of the original work in these areas is being done by the manufacturers of the computers. The great advances of the future, however, are more likely to come from those who are in closer contact with the actual user.

At this writing there are some 200 to 300 commercial time-sharing services selling time on a wide variety of machines and with a wide variety of software capabilities. About half of these services are active in the engineering-scientific field. Most are struggling for existence. The ones that are established can turn more of their attention to the improvement of their services.

When the expected shakeout occurs soon, the survivors will compete on the basis of what they offer to customers. Many of those active in the field speculate on what the future holds. They look for these developments:

- Circuit synthesis programs that will take

requirements as inputs and deliver complete designs optimized for whatever parameter the engineer specified.

- Use of the results of a circuit-synthesis program to lay out LSI devices with the desired performance.

- System synthesis programs that will choose from among many alternatives, consider the tradeoffs and justify the conclusions.

- Combination system and circuit synthesis programs that will virtually eliminate the engineer as an original contributor to technology. His role in design would be assumed by the programmer.

These predictions may not sound flattering in their assessment of the role of the design engineer. Some say the drastic changes that are coming will actually strengthen the position of the engineer. At present his position is the unknown in the equation, and there is no computer program now available that can supply the missing information. ■■

Bibliography:

- CADAR Bulletin*, published by the Computer Aided Design and Realizability Committee of the IEEE Technical Activities Board, Issues 5-9, January-November, 1968, and Issues 10-14, January-September, 1969.
- Coburn, Lynn, Magnell, James P., "Technology Profile of Commercial Time-Sharing Services," *Modern Data*, July, 1969, pp. 36-50.
- Jensen, R. W., Lieberman, M. M., *IBM Electronic Circuit Analysis Program*, Prentice-Hall, Inc., Englewood Cliffs, N.J. 1968.
- Silberberg, Martin Y., and Luke, Charles A., "Build Digital Models of Analog Systems," *Electronic Design* (ED 21), Oct. 11, 1969, pp. 90-95.
- Weik, Martin H., *Standard Dictionary of Computers and Information Processing*, Hayden Book Company, Inc., New York, 1969.
- Zobrist, George W., *Network Computer Analysis*, Boston Technical Publishers, Cambridge, Mass., 1969.

Service to readers

For further information, circle the applicable information retrieval number below.

Applied Logic Corp.	250
Call-a-Computer	251
Computer Network Corp.	252
Com-Share, Inc.	253
Data Network Corp.	254
General Electric Co., Information Service Dept.	255
International Timesharing Corp. of Minnesota, Inc.	256
ITT Data Services	257
Rapidata	258
Service Bureau Corp.	259
Tymshare, Inc.	260

Visualize a new design graphically

A photo-by-photo description of interactive ECAP in operation.

An analysis of an electronic circuit can be carried out by using a digital computer and ECAP (see Special Report on page C8). When a graphic CRT (cathode-ray tube) terminal with a light pen input is added to the facilities, a truly visual interactive process can be implemented.

The CRT is both the input and output element of the computer. Some instructions, however, must be fed into the machine by more conventional means. A keyboard in front of the CRT and a set of switches alongside it are provided for this purpose. Figure 1 shows the general arrangement. Values of components, for example, are typed in by means of the keyboard, and the switches are used to set up the desired sequence of operation on the tube face.

The light pen is the operator's method of communication with the graphic terminal. The pen resembles a penlight flashlight with a wire emerging from one end and a small light bulb at the other. The operation of a switch activates certain areas of the CRT face. The light pen can then be pressed against these active areas—the technical term is “detecting on” — to perform various tasks.



1. The designer who provided the circuit-design know-how, Alan Desroches, an engineer at IBM Kingston, is pointing at the circuit, while programmer Chapin Day

aims the light pen at the display. The selector switches are to the left of the display unit, and the keyboard is in front of the CRT.

A simple single-stage transistor amplifier is used here to demonstrate the technique. The amplifier intentionally has an unusual frequency response to illustrate the plotting capabilities of this approach. The circuit is shown in Fig. 2.

User chooses from "menu"

The user begins with a blank screen. He operates a switch to initiate the action, and a series of "menu" items appears on the screen below a horizontal line. Among the menu choices is "AC." Since he wishes to perform a frequency analysis, he detects on AC. The symbol AC then appears above the upper horizontal line on the screen. The designer is now ready to begin drawing his circuit.

He locates the initial and final nodes of the first branch by detecting on the desired spots with his light pen. He then operates a different switch to place a new series of menu items on the screen. The choice now is among WIRE / RESISTOR / CAPACITOR / INDUCTOR (see Fig. 8). He detects on RESISTOR with his light pen, and he sees Fig. 3 on the face of his CRT.

(photos continued on next page)

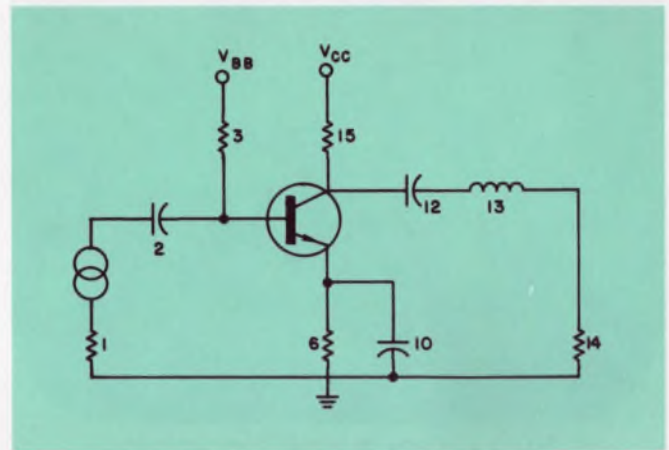

2. A single-stage transistor amplifier is the example selected for a graphic ECAP analysis. The numbers represent the branches of the final ECAP circuit. An R-L-C output network has been chosen to give a dramatic peaked frequency response.

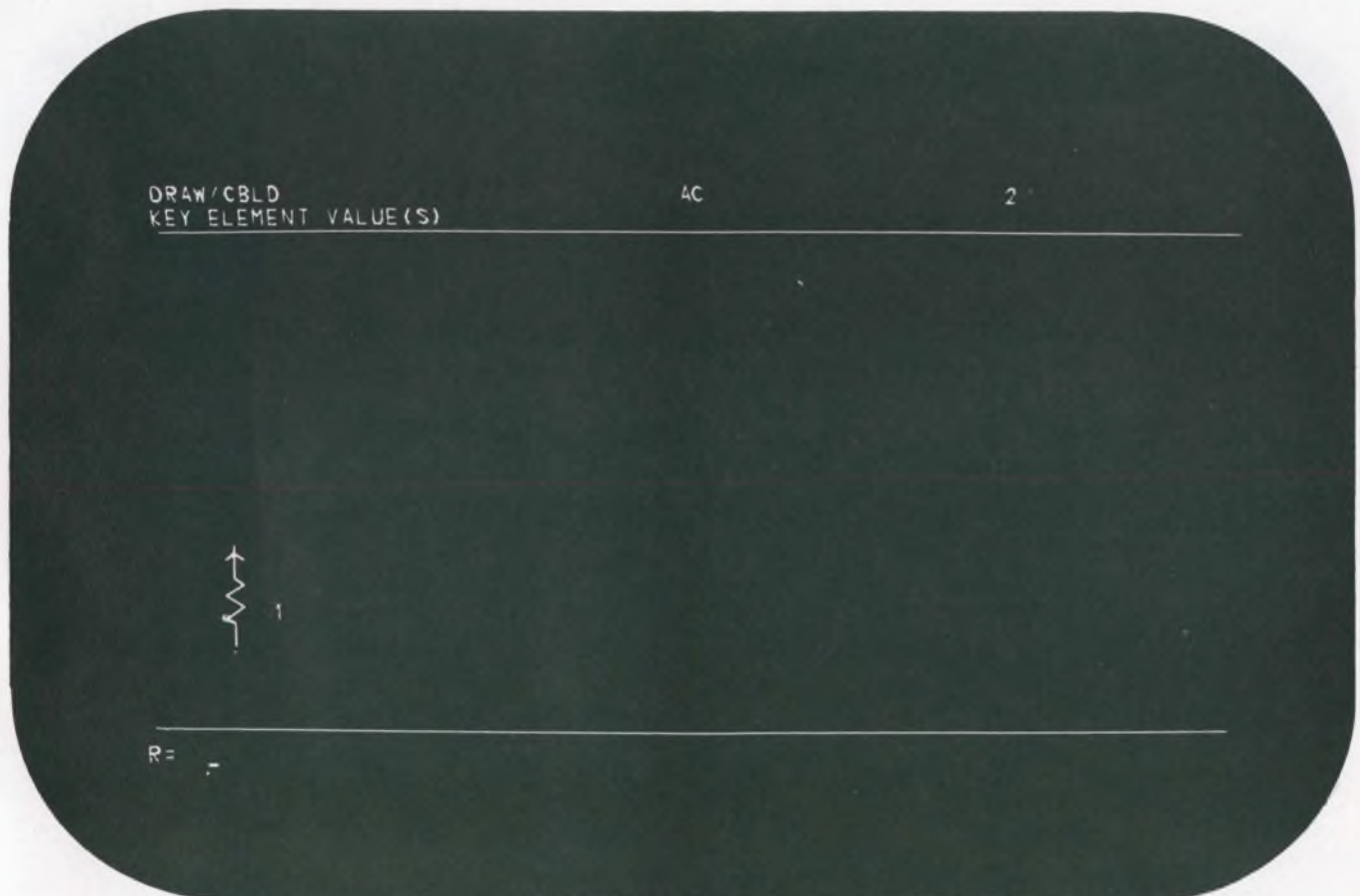

3. After a resistor is selected for branch 1, the display looks like this. The terminal requests a value for the resistor, and the user enters the value using the keyboard.

Since the basic branch is a single passive element in parallel with a current source or in series with a voltage source, the next choice appears in Fig. 4.



4. **FIXED E** is now detected from the menu items, and this is the new appearance of the screen. (A source may be omitted if the branch is to be passive by detecting **NEW BRANCH** or **FINISH ROUTINES**.)



6. By detecting the bottom node with the light pen, and then **GROUND** from a new series of menu items (not shown here) a ground symbol appears. **NEW BRANCH** is then detected from the menu items, and this display then appears where the instruction, **SEL INITIAL NODE** at the top, calls for the initiation of a new branch.



5. The computer requests the value of the voltage source, and the user keys in 1.0 V at zero phase.



7. The next branch begins at the upper node of the first branch, and after selection of a $5 \mu\text{F}$ capacitor the display looks like this.



8. The circuit is built up to this point, branch by branch. Here wire extensions that make the diagram more legible are shown at either node of branch 5. The menu items at the bottom of the display are the passive element choices available, and when detected by the light pen are next to appear on the CRT.

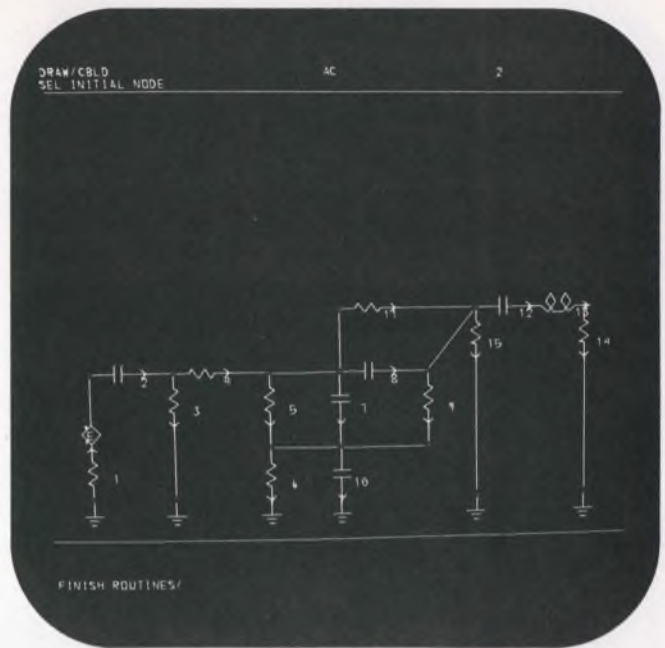

10. The passive part of the circuit is completed with the addition of the load components. The next step will be to put a current source in branch 9 dependent on current source in branch 5.

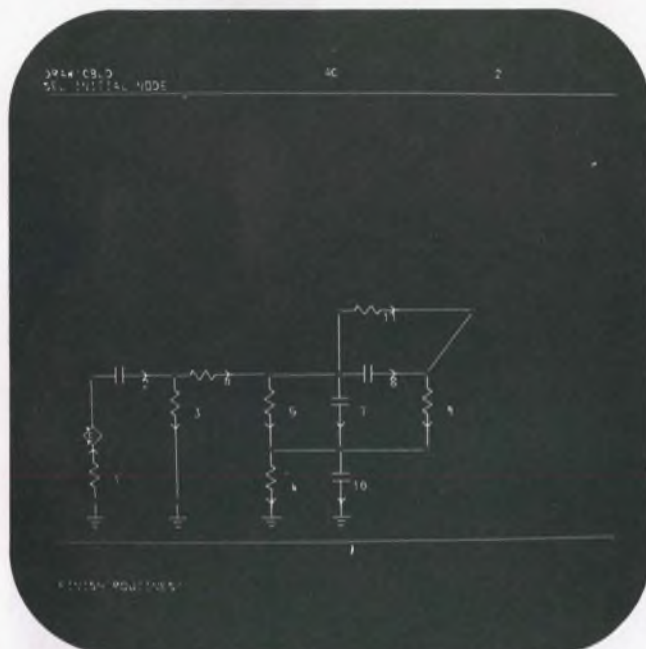

9. Branches 7 through 11 are added in a similar fashion. Branches 4, 5, 7, 8, 9, and 11 represent the equivalent circuit of the transistor without showing the gain as yet. The hybrid-pi transistor equivalent is used.

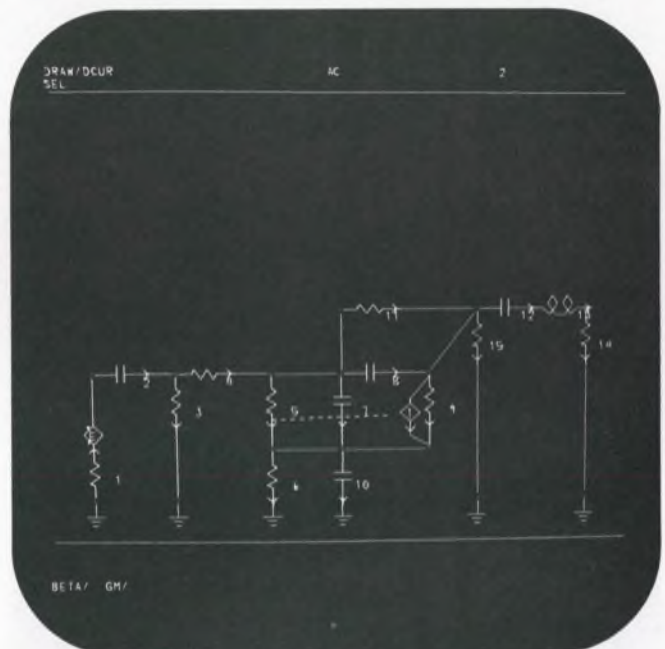

11. A dependent current link can now be inserted. By detecting FINISH ROUTINES on the previous display, we are asked to SEL FROM BRANCH (select the "FROM" branch), whereupon the user detects branch 5, and SEL TO BRANCH (select the "TO" branch), whereupon he detects branch 9. A dependent current now appears across branch 9 with a dotted line to branch 5. A menu choice is given between BETA and GM for expressing the dependence of branch 9.

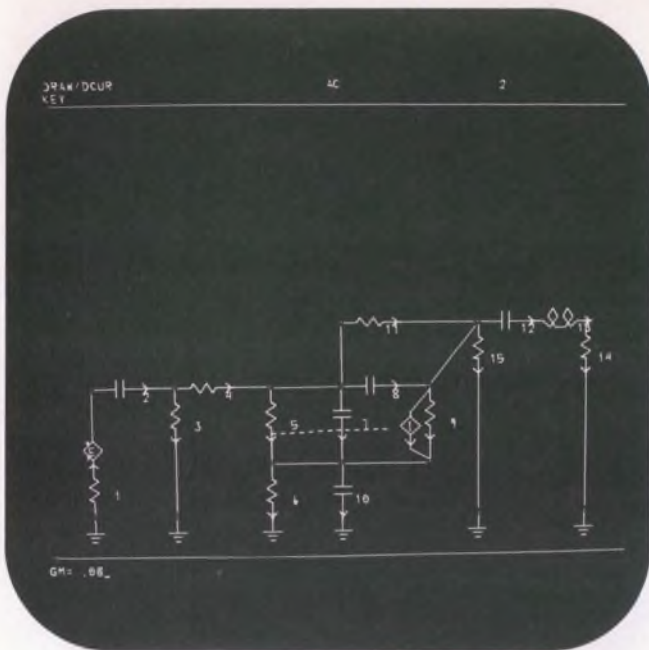

12. With the dependence decided upon in terms of transconductance, the circuit designer detects GM. The terminal responds with a request for a value of GM, and the user keys in 0.08.



14. A display of the input data is now asked for. The computer replies with conventional ECAP language listing as shown here. The results of the print (PR) statement will not be shown. The originally chosen frequency (FR-600E3) is changed by the MODIFY statement to cover the range 100E3 to 10E6.

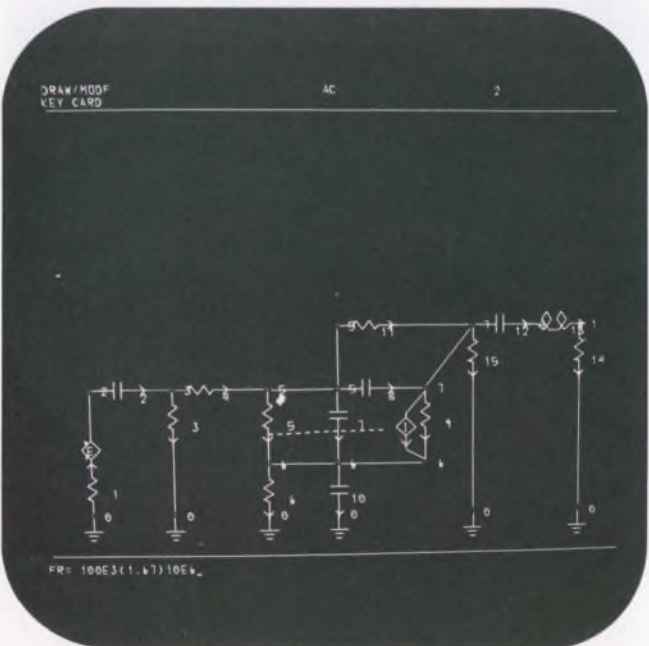

13. A frequency response plot is now requested by detecting FREQ from menu items. When values are asked for, the user keys in 100E3 (1.67) 10E6. Translated, this means a frequency response from 100 kHz to 10 MHz with each frequency in the plot 1.67 times the previous one.

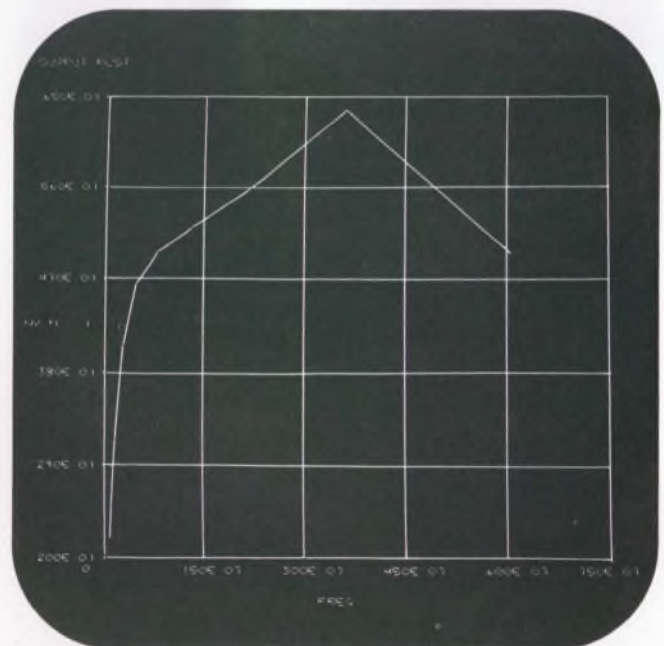

15. The computer plot of the voltage across branch 14 has approximately 14 frequency steps as a result of the choice of the frequency multiplier=1.67. The inductor of branch 13 is used as a parameter to vary the peaked frequency response. Here $L=20 \mu\text{H}$. The computer automatically selects the vertical and horizontal scales so the curve fills the screen.

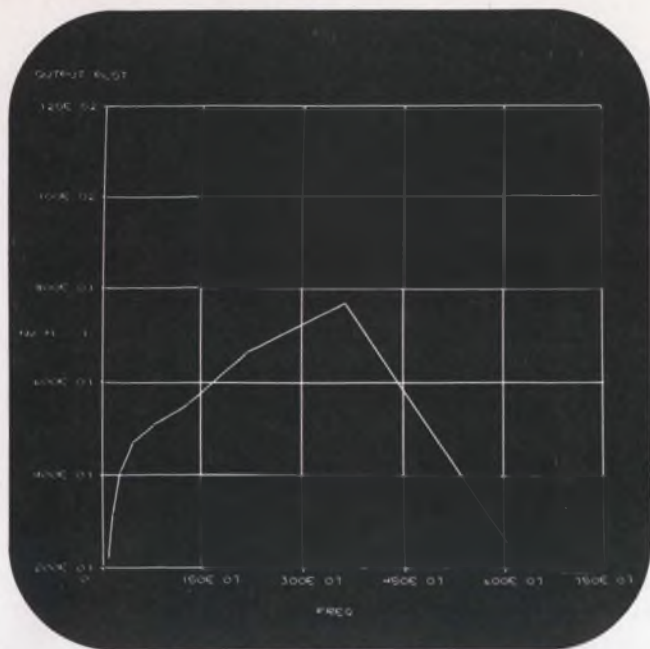

16. The inductance of branch 13 is now increased to $40 \mu\text{H}$, giving this response.

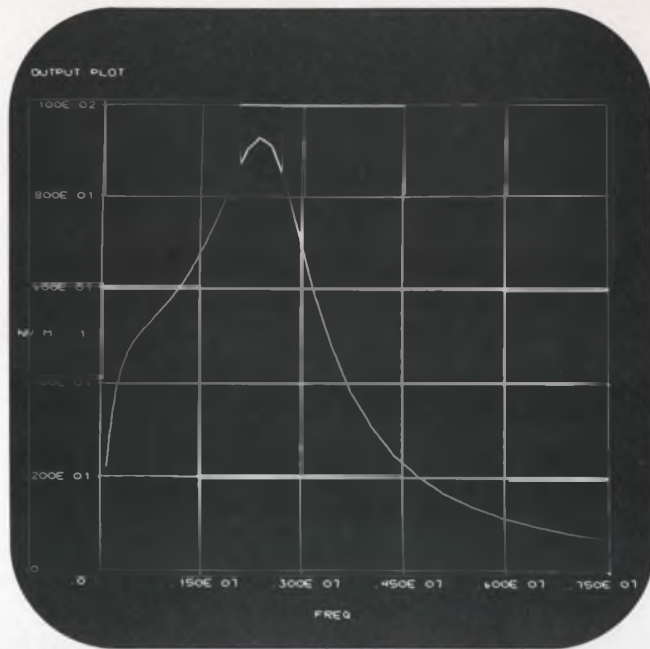

18. The frequency response is repeated here with a frequency multiplier of 1.08, which gives about 100 frequency steps. $L=80 \mu\text{H}$. Compare this with Fig. 17.

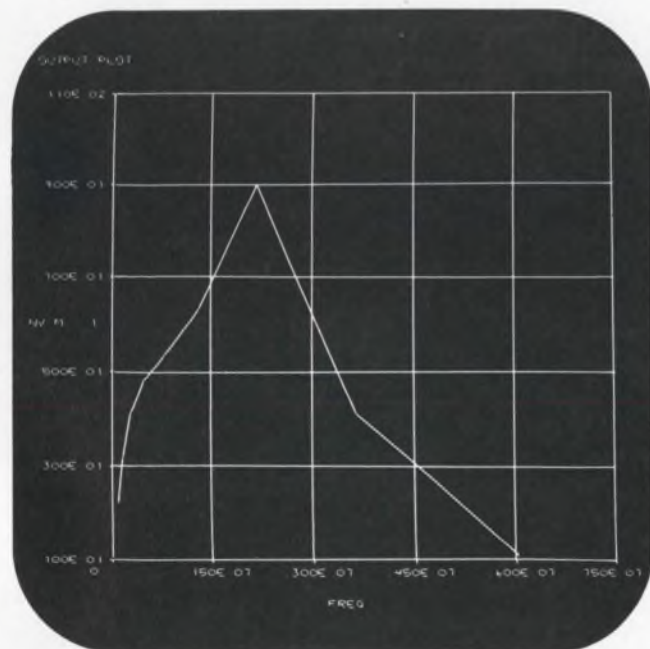

17. Here $L=80 \mu\text{H}$, and the resonance is more pronounced. Note that, although the frequencies to be plotted are logarithmically related, the frequency scale is linear. ECAP does not plot frequencies on a log scale.

This picture story on the use of ECAP was written with the cooperation and assistance of the IBM Systems Development Laboratory in Kingston, N.Y. Among those who aided with this presentation are: Almerin C. O'Hara, Manager, Scientific Computing Department; Chapin W. Day, Staff Planner and programmer; Alan Desroches, Associate Engineer and circuit designer; Bruce A. Brough, Laboratory Information Manager; and Robert J. Strini, Industrial Photographer.

Save Time

Are you still toying with do-it-yourself test set-ups?
And taking data one measurement at a time?
Let GR relieve the manpower and money strain in your lab, production,
or inspection facility with these automatic test systems:



1790 LOGIC-CIRCUIT ANALYZER • tests logic circuits with as many as 96 inputs and 144 outputs • up to 4000 tests per second • GO/NO-GO or complete diagnostic testing • easy test language • autoprogramming lets the device determine proper outputs



AUTOMATIC LEAKAGE-CURRENT
and CAPACITANCE-MEASURING SYSTEMS
• picoampere current resolution • 0.1%
basic capacitance-measuring accuracy

Give thought to any of these automatic instruments
as the nucleus of your custom-designed GR system:



1682 AUTOMATIC 1-MHz CAPACITANCE BRIDGE • 20,000 pF to 20.00 nF full scale • 0.1% accuracy • 20 measurements per second • five-wire connections

1683 AUTOMATIC RLC BRIDGE • Resistance: 20.000 m Ω to 2000.0 k Ω full scale • Inductance: 2000.0 nH to 200.0 H • Capacitance: 100.00 pF to 10.00 mF • 0.1% basic accuracy • up to 20 measurements per second • five-wire connections



1654 IMPEDANCE COMPARATOR • 0.003% impedance-difference resolution • 100 Hz to 100kHz – 4 fixed frequencies • wide impedance ranges: 2 Ω to 20 M Ω , 0.1 pF to 1000 μ F, 20 μ H to 1000 H • stable solid-state circuits • Fast sorting (greater than 4000/h) with accessory limit comparator

General Radio Company • West Concord, Mass. 01781 • (617) 369-4400

Save Money

Every purchase requires a thorough comparison of specifications – and for over half a century customers who wanted the *best* in performance and quality have looked to General Radio.

It was worth paying a few extra dollars to get a top-performing GR product!

TAKE ANOTHER LOOK! We still offer the finest instruments available, but now, with new design techniques and automated test methods, you can't beat the price, either!

Quantity discounts, too, for two or more!

Look at these examples of technical and fiscal ingenuity from GR:



1192 COUNTER • dc to 32 MHz (to 500 MHz with scaler) • 10-mV sensitivity • crystal time base • 5, 6, or 7 digits and data output – \$575 and up.

1808 AC MILLIVOLTMETER • 1.5 mV to 150 V full scale in six ranges • 20-dB dynamic meter range • up to 12.5-M Ω input impedance • accuracy $\pm 1\%$ at full scale – \$295.



1340 PULSE GENERATOR • 0.2 Hz to 20 MHz • 2.5 s to 25 ns duration • 5-ns rise time • 10-V output with ± 1 -V offset • amplitude, period, duration modulation – \$395.

1310-B OSCILLATOR • 2 Hz to 2 MHz • 20 V $\pm 2\%$ constant output • 0.25% maximum distortion • all solid state – \$275.



Now get a closer look!

Write or phone General Radio Company,
West Concord, Massachusetts 01781, telephone (617) 369-4400.
In Europe, write Postfach 124, CH 8034 Zurich 34, Switzerland.

GENERAL RADIO



We have a memory that will make design engineers look like heroes.



How about a small to medium size memory with an access time of 250 nanoseconds. Cycle time of 500 nanoseconds. With 4K to 16K words of from 10 to 60 bits. And the lowest price going.

The CE-50 state-of-the-art, $2\frac{1}{2}$ D, three wire memory is available now. That's immediate delivery for the latest and best small to medium size memory you can buy anywhere.

The CE-50's spec sheet is nothing less than heroic. But what else could you expect from the company that's delivered more than 100 million bits of $2\frac{1}{2}$ D memories. The numbers and facts are yours for the asking. Write: Memory Products, Lockheed Electronics Company, Data Products Division, 6201 East Randolph Street, Los Angeles, California 90022.

See the CE-50 in action at Island 3200, FJCC

LOCKHEED ELECTRONICS

A Division of Lockheed Aircraft Corporation

Design for Reliability/Performance from Diehl

Diehl helps you build more reliability by building more reliability into all its components. Example: Our motors from $\frac{3}{4}$ " diameter have housings and end bells of high-strength aluminum alloys. Stainless steel shafts. And dynamically balanced rotors with spring-loaded precision bearings for quieter operation and longer life. What's more, every Diehl component is backed by 78 years of motor-making experience. These are only a few reasons... there are many more!

For more information on how Diehl helps you build more reliability call Diehl... or contact our Engineering Representatives in principal cities.

Induction and Synchronous Motors

with high torque for recorders, business machines, capstan and reel drives.



Disc & Drum Memory Drives

in both synchronous and induction types. 80% to 95% efficiency for cool running and minimal thermal expansion.



Vortex Blowers

that provide greater capacity for vacuum control and for cooling.



DC Motors-Gears

$\frac{3}{4}$ " to 2 $\frac{1}{2}$ " diameter with a wide RPM range for a wide variety of aerospace and industrial applications.



Stepper Motors

for precise control via discrete steps and high slew rates.



Precision DC Tachometers

for precise linear velocity operation.



Moving Coil Motors

with extremely high efficiency. Ideal for use wherever high speed response is called for.



THE SINGER COMPANY · Diehl Division

Finderne Avenue, Somerville, N.J. 08876/(201) 725-2200 • TWX 710-480-9325

FOR A WIDE SPAN



OF SIGNAL LEVELS

Telonic's new Log Amp Detector operates over a dynamic range of 105 dB *without switching scales*. That's a 178,000 to 1 voltage swing which can be displayed on a scope or XY plotter in sweep operation, or read on the instrument's meter for fixed frequency measurements.

And if that doesn't make it the most versatile detector ever built, consider a few more

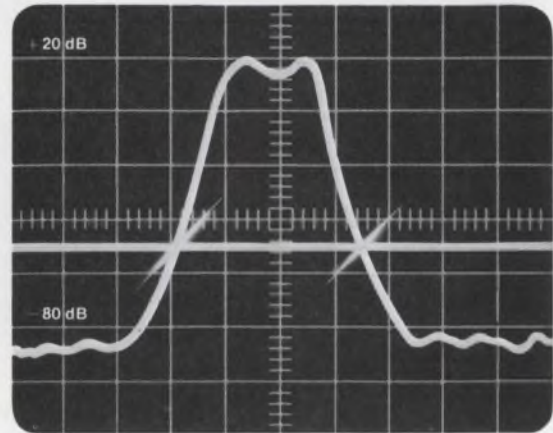

features: a tangential sensitivity of -85 dBm, frequency range of 400 kHz to 130 MHz, direct readout in dBm, and a calibrated reference line for swept operation.

Capable of accepting any RF input within its frequency range and as low as -85 dBm, the 6001 Log Amp Detector converts the signal to a log DC output for display or readout. Its *calibrated* dynamic range is -70 dBm to $+20$ dBm and convenient Expansion and Offset controls permit even closer looks at low level signals.

(Note: For users of Telonic's 2003 Sweep/Signal Generator, the Log Amp Detector is available as a plug-in unit, Model 3353).

Write our Marketing Dept. for complete specifications.



TELONIC INSTRUMENTS
A Division of Telonic Industries, Inc.
60 N. First Avenue
Beech Grove, Indiana 46107
Tel: 317 787-3231 • TWX: 810 341-3202

You say you want a

low-profile snap-in mounting push button switch or matching indicator that is interchangeable with most 4-lamp displays . . . available in a full range of cap colors . . . with a choice of bezels with or without barriers in black, gray, dark gray or white.

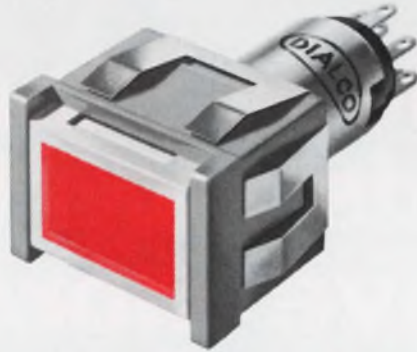

and a

legend presentation that's positive (like this one) or negative (like the one below) or just plain (like the one above) . . . one that's white when "off" and red, green, yellow (amber), blue or light yellow when "on" . . . or colored both "on" and "off."



and a

highly reliable switch proven in thousands of installations . . . available in momentary or alternate action . . . N.O., N.C. or two circuit (one N.O., one N.C.) . . . that accommodates a T-1 $\frac{3}{4}$ bulb with midjet flanged base, incandescent, in a range of voltages from 6-28V.



*etc.
etc.
etc.*

Now, Dialight gives you custom panel designing with a standard line of push-button switches and matching indicators

Dialight offers a broader range of switch and indicator possibilities than you'll find anywhere in a standard single-lamp line. Sizes: $\frac{3}{4}$ " x 1", $\frac{5}{8}$ " square and round. Send today for our new full-color catalog L-209.

DIALIGHT

Dialight Corporation, 60 Stewart Ave., Brooklyn, N. Y. 11237

INFORMATION RETRIEVAL NUMBER 188

If these standard hybrids won't do it... we have more where they came from

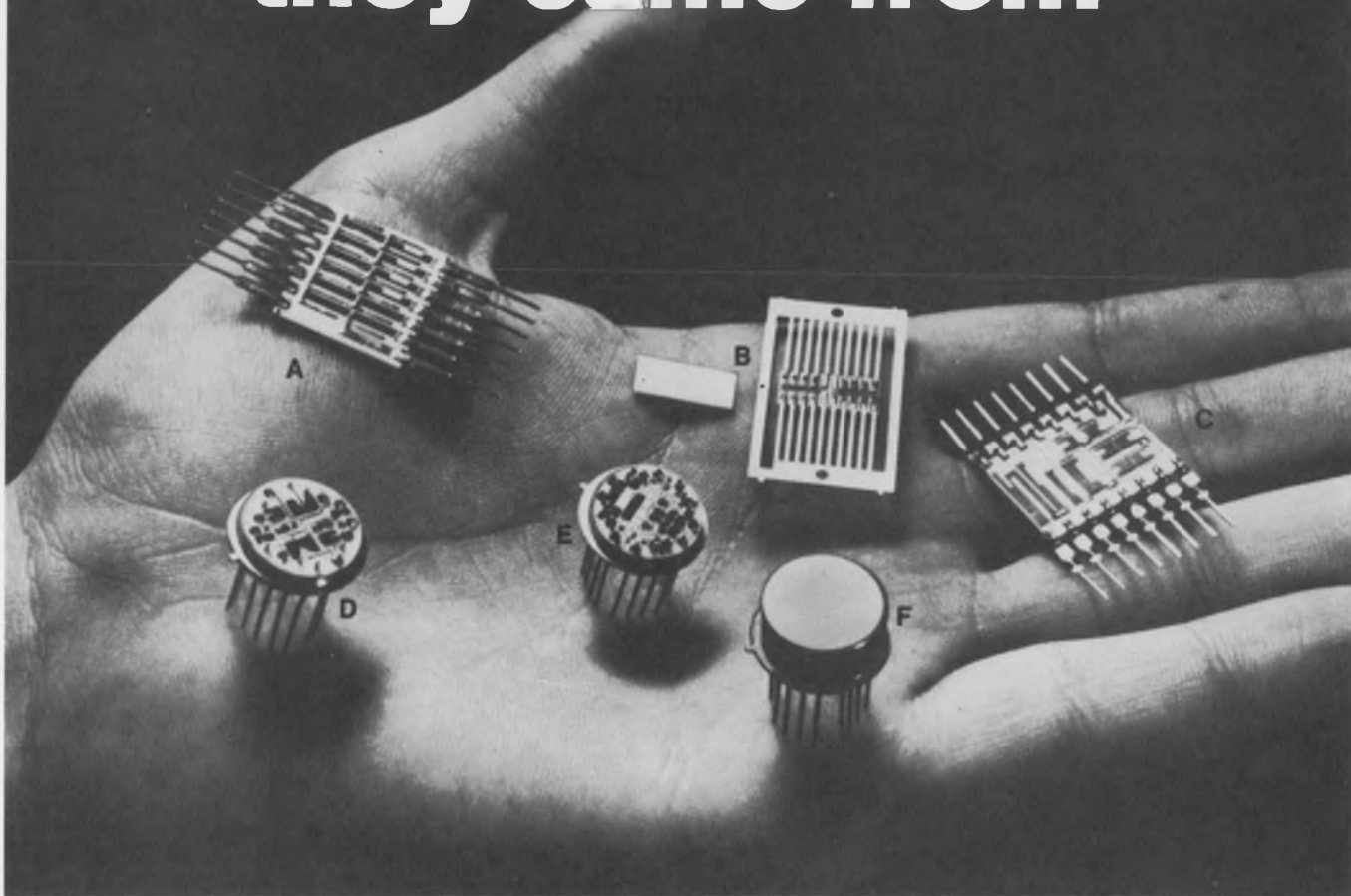

Standard hybrids featured in MEPCO "circuit of the month" program: A D/A binary voltage summing ladder; B ceramic sandwich resistor flatpack; C D/A binary current summing ladder; D DTL to MOS level shifter; E precision high speed ladder switch; F relay, lamp, core driver.

MEPCO microcircuit design engineers have perfected a good number of standard hybrid microcircuits lately. No doubt you've heard about our "standard circuit of the month" program. They're all designed to meet the most stringent high-reliability design requirements, while offering the time and cost advantages of mass production.

If we haven't yet perfected a standard circuit to meet your needs, it could very well

be that we're working on it now. Or perhaps we can find the fit among the hundreds of custom hybrids we've developed this year.

Before you look any further, ask us to show you a completely packaged hybrid integrated circuit that can outperform its counterpart. Write or call us collect for complete information, or talk to your MEPCO representative.



Meet the FIRST FAMILY

of Data Acquisition, Conversion, and Communication Peripherals at the

Sahara Hotel (Space 30004-30005) in
Las Vegas during FJCC Nov. 18-20

Designed to provide step-ahead performance in an almost unlimited variety of applications, Dynamic System Electronics Corporation will present its First Family of data acquisition, conversion, and communication components and subsystems in Space 30004-30005 at the Sahara Hotel in Las Vegas during the Fall Joint Computer Conference, November 18-20.

In its First Family line, DSE will show optical sensors and other equipment designed to meet the needs of the 70's as well as standard components and subsystems which permit system flexibility and expandability without excessive costs for engineering.

First to offer a complete data acquisition and conversion system in a package, DSE products have proved their on-the-job capability and dependability in:

- Monitoring and converting medical functions,
- Controlling plant operations,
- Analysis and control of chemical processes,
- Oil field exploration and monitoring,
- Testing and evaluation of aircraft structures,
- Missile range and data monitoring,
- Radar data reduction,
- Graphic data terminal

... to mention only a few of the areas where DSE has served industrial, commercial, and military customers.

If you are interested in step-ahead answers to your current or prospective needs, by all means check in at Space 30004-30005 during the FJCC or contact us at the address below.

DSE

DYNAMIC SYSTEM ELECTRONICS

1040 West Alameda Drive, Tempe, Arizona 85281
Phone (602) 967-8644 • TWX 910-950-1941

SUBSIDIARY OF SOUTHWESTERN RESEARCH CORPORATION

STEP-AHEAD EQUIPMENT DESIGNED FOR THE 70's



MICROVERTER 310

Multiplex and analog-to-digital system on a card 6" x 5" x 1".

$\pm 5V$, $\pm 1V$, 0 to 10V Full Scale input. Single ended or Differential. Up to 12 bits, binary, or 3 digits, BCD. Internally supplied reference.



AUTOVERTER 860

Low-level, auto-ranging, multiplex and analog-to-digital system.

$\pm 10mv$ to $\pm 10V$ Full Scale. 12 bits, binary. Differential input. Programmable gain or Automatic range determination.



MIDIVERTER 855

Multiplex and analog-to-digital system with solid-state numeric display.

$\pm 10V$ Full Scale. Single ended or Differential. Up to 15 bits binary, 17 bits BCD. Throughput rates to 100 KHz.



MIDICOUPLER 880

Provides a complete span of linkage equipment for: Computer satellite systems, Patient monitoring, Audio Visual, etc; Computer to computer, data preprocessing, "Man-less" interface; Computer to Communications links, Modems, bulk storage, etc.

If you're in the market for a mini computer, look at the Micro 800 first.



(You'll probably end up with one anyway.)

Here's one reason why: Microprogramming

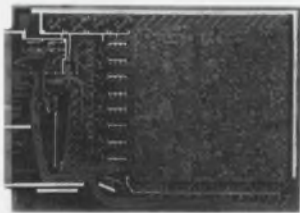

Microprogramming gives you a more efficient system, tailor-made to your requirements, for less money. Since firmware absorbs many functions normally handled by core memory and interface hardware, requirements for both are reduced substantially. On the other hand, standard hardware can be retained even while changing architecture to match your particular demands. With little time and practically no effort, you can optimize computer

characteristics for a particular operation without making a single hard wire change.

Here's another: Delivery

We began building 800's before we began selling them, and now we're in volume production. It's only natural then that delivery is off-the-shelf with custom variations taking a modest 30 days extra. Especially if your requirements are urgent.

Here's one more: Price

The Micro 800 costs \$3200 with quantity discounts ranging up to 40%. For \$3200 you get a basic processor with 16 multi-purpose registers, 256 words of read-only store, basic console, enclosure and power supply to function as a micro programmed controller. In addition, you get the fastest digital computer in its class with a 1.1 μ s memory cycle time and a 220ns micro

command execution time. Core memory capacity is 0-32K bytes.

We also sell a microprogrammed adaptation of the 800 with 512 words of read-only store, a 4096-word by 8-bit core memory and a teletype interface. We call it the Micro 811 and it goes for \$6300. Our third model, the \$6900 Micro 810, is like the 811 except that 768 words of read-only store are used to implement an expanded instruction repertoire, including multiply and divide.

Just about any question you'll have is answered in our new mini-seminar booklet. We'll send you a copy gladly. But we'd really rather have you ask for a call from our marketing representative. You'll save a lot of time if you do because we're sure you'll end up with an 800 anyway. It's irresistible.

See Micro Systems products at the FJCC, Booth 5915.



MICRO SYSTEMS INC. 644 EAST YOUNG STREET • SANTA ANA, CALIFORNIA 92705 • TELEPHONE (714) 540-6730

INFORMATION RETRIEVAL NUMBER 191

INFORMATION RETRIEVAL NUMBER 229 ►

COMES WITH EVERY GE
COMPUTER GRADE CAPACITOR

Extensive research and development



Research at General Electric is directed toward one basic philosophy: to give every customer the most reliable product at a reasonable price. Toward this end, our capacitor research staff in Irmo, S.C., working with their colleagues in the GE Research and Development Center and the Material Supply Operation in upstate New York, have contributed unique innovations in electronic capacitor development.

An outstanding example is the GE 86F computer grade capacitor. Advanced foil technology produces an exceptionally reliable product with useful service life in excess of 10 years when operated within rated conditions. GE 86F 500 computer grade capacitors offer the highest capacitance available per case size — up to 540,000 microfarads at 5 volts. This can mean up to a 30 percent reduction in the number of units required, or a significant reduction in assembly size, when you specify GE computer-grade capacitors. In addition, you gain a unit with high ripple current capability, low ESR, and a long shelf life.

High-capacitance units are available in nine case sizes — diameters $1\frac{3}{8}$ " to 3" with lengths up to $8\frac{5}{8}$ " — for operation up to 100VDC.

Choose from other standard ratings of computer grade capacitors for operation up to 450VDC (370,000uf maximum at 5VDC) . . . or let General Electric special-design a computer grade capacitor to fit your application.

Call your GE Electronics Distributor or GE ECSD District Sales Manager or write Section 43038, General Electric Company, 1 River Road, Schenectady, N. Y. 12305.

Electronic Capacitor & Battery Dept., Irmo, S. C.

GENERAL  ELECTRIC

THE PRACTICAL REFERENCE SHELF

FUNDAMENTALS OF INTEGRATED CIRCUITS Lothar Stern

A practical guide to integrated circuits — their theory, manufacture and applications. This book offers complete discussion of the various techniques of integrated circuit fabrication and their strong influence on circuit design and performance. From a marketing viewpoint, it compares the relative qualities of the numerous IC's devised to date in terms of economics and logistics.

The book covers basic semiconductor principles, monolithic integrated circuits, thin-film circuits and their characteristics, hybrid and other integrated structures. There is also discussion of packaging, design and layout principles, and LSI. A volume in the *Motorola Series in Solid-State Electronics*. 208 pages, 7 x 10, illustrated, cloth cover.
#5695\$8.95

LEVEL-HEADED LETTERS

Dr. Dugan Laird and Joseph R. Hayes.

Will help the executive to write better letters, faster. In practical, down-to-earth style, this book shows how to find the real reasons for writing; provides a simple plan for organizing ideas logically and psychologically, and points out ways to get affirmative responses from readers. Shows how to avoid cliches, verbiage and how to inject an air of informality into letters. Key feature is the programmed learning section on painless grammar. 134 pages, 6 x 9.

Paper cover, #5032\$3.50
Cloth cover, #5033\$4.95

PROJECT ESTIMATING BY ENGINEERING METHODS Paul F. Gallagher.

A practical approach to attaining consistently accurate estimates by summarizing many general practices and introducing specific methods proven valuable in various kinds of work. Five methods of estimating are discussed, the fifth of which combines the two most important developments in the field: standard hours and the learning curve. To insure complete understanding, full coverage is given to construction and use of learning curves. Nearly 100 pages of learning curve tables appear in the appendix. 344 pages, 8½ x 11, illustrated, cloth cover.
#5018\$15.00

PRACTICAL PA GUIDEBOOK: HOW TO INSTALL, OPERATE AND SERVICE PUBLIC ADDRESS SYSTEMS

Norman H. Crowhurst

A practical guide covering all aspects of the subject. The book shows how to select and install the appropriate equipment, covers routine operation and maintenance of the finished system. Special attention is given to solving the problems encountered in providing successful service. 136 pp., 6 x 9, illus., paper.
#0778\$3.95

THEORY AND APPLICATIONS OF TOPOLOGICAL AND MATRIX METHODS Keats A. Pullen.

The dependence of electrical circuit theory on topology (theory of line graphs) is of growing importance because line graphs for networks represent their flow patterns. Application of topological methods has lagged behind the use of matrix methods only because of minor application problems. This volume resolves these problems in a logical and understandable way. 100 pages, 5½ x 8½, paper cover.
#0300\$2.50

INDUSTRIAL STROBOSCOPY Gilbert Kivenson.

A comprehensive description of the history, development and use of stroboscopy in industry, commerce and research. Stroboscopy for analysis and measurement has spread to many specialized areas of science and engineering, such as high-speed cinematography, photometry, radiometry, torsional vibration and other areas. This book discusses the state of the art today and areas of further usage. 284 pages, 6 x 9, illustrated, cloth cover.
#5045\$9.95

DESIGN OF LOW-NOISE TRANSISTOR INPUT CIRCUITS William A. Rheinfelder.

Design engineers and others interested in low-noise circuit design will find this book a real time saver. Gives a multitude of labor saving graphs and design curves for the practical circuit designer. Simple derivations of all important formulas help the reader obtain a deeper insight into the fundamentals of practical low-noise design. 128 pages, 6 x 9, illustrated, cloth cover.
#5014\$5.50

WAVEFORM MEASUREMENTS Rufus P. Turner.

Complete how-to information on the various techniques of electrical waveform measurement—from troubleshooting to signal synthesis. Book details procedures for the isolation and measurement of a single harmonic from a multisignal mixture, measurement of total distortion, calculation of harmonic values from heights of the wave patterns, etc. 96 pages, 5¾ x 8¼, illustrated, paper cover.
#0775\$2.95

UNDERSTANDING SILICON CONTROLLED RECTIFIERS

Saul Heller

A compact, illustrated guide to the capabilities and operation of the versatile SCR and the triggering circuits associated with these devices. Throughout the book, schematic diagrams illustrate the application of the various SCR's as static switches, phase-control switches, inverters, choppers, etc. Emphasis is placed on choosing the right SCR to do a given job. 134 pages, 5¾ x 8¼, illustrated, paper cover.
#0782\$3.50

TRANSISTOR AND DIODE NETWORK PROBLEMS AND SOLUTIONS Harry E. Stockman.

This two-way reference demonstrates the practical application of theory and serves as sourcebook of step-by-step mathematical solutions to practical problems. With schematic situations covering the entire field of transistor and diode networks, the reader develops effective techniques by comparing his own solution methods with the author's. 352 pages, 6 x 9, illustrated.
#5694\$9.95

TRANSISTOR AND DIODE LABORATORY COURSE Harry E. Stockman

Structured on engineering concepts and facts, this new course first provides a groundwork in transistor technology. Two-part theory viewpoints are applied continuously to give the work an engineering slant. The balance of the experiments deal with more intricate transistor networks, such as the theory and operation of multivibrators, and the concept of parametric action. 128 pages, 7¼ x 10, illus.
#5671\$3.95

REVIEW ANY OF THESE BOOKS FOR 10 FULL DAYS — FREE!

HAYDEN BOOK COMPANY, INC. 116 W. 14 St., N. Y., N. Y. 10011

Please send me the books circled below, on a 10-day free examination. At the end of that time I will remit payment, plus postage, or return the books without obligation.

5695	0778	5014
5694	5032	0775
5671	5033	0782
5018	0300	5045

Payment enclosed (Hayden pays postage). Same return privilege.

Name _____
Firm _____
Address _____
City _____ State _____ Zip _____

On all overseas orders, payment in U.S. dollars must be enclosed. Publisher pays postage with same return privilege.

ED-869

The non-catalog connector.

If you can't buy it. We'll make it. Any kind of printed circuit connector.

Tell us how many positions, how many contacts. And what kind of shape it ought to be in.

We'll take it from there, and turn out a connector for you, at a price that's probably the lowest in the business.

The biggest reason is our contacts—because they're the biggest single factor in the price of connectors.

We put more gold at the contact area than any plater does. But we weld it there instead of plating it. So we use less gold overall.

As a result, our contacts are the best you can buy. (Maybe that's why many of our competi-

tors use them.)

We also do our own wire drawing, coining, forming, bending, and solder plating. We design our own tooling and mold our own plastic bodies. And we assemble and test the whole connector ourselves.

If you're looking for ordinary connectors look in ordinary catalogs.

But if you want something a little special, now you know where you can go.

Sylvania Metals & Chemicals, Parts Division, Warren, Pennsylvania 16365.

SYLVANIA
GENERAL TELEPHONE & ELECTRONICS
INFORMATION RETRIEVAL NUMBER 192

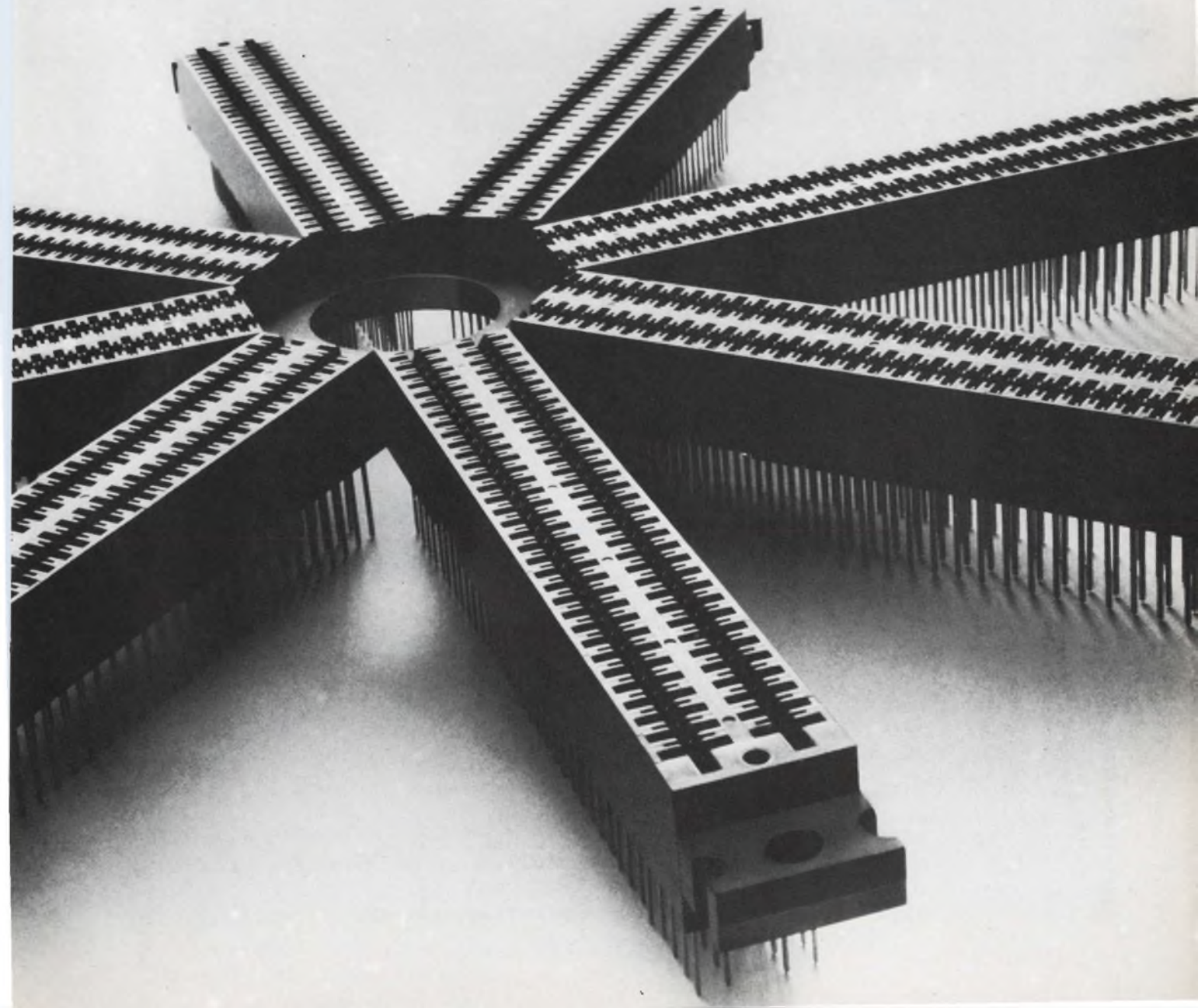



Philco has something new in Series 74 T²L... glassivated chips in cerdip packages.

Why consider another source for Series 74 T²L? Here are three good reasons from Philco-Ford.

- **RELIABILITY**—as a final production step, we put an added layer of glass over the completed chip. This glassivation process protects the circuit against damage, and gives an extra measure of reliability.
- **HERMETIC DUAL IN-LINE PACKAGES**—All Philco-Ford Series 74 circuits are manufactured in hermetically sealed ceramic dual in-line packages . . . AND at prices comparable to plastic. Your assurance of quality is the experience we have gained in manufacturing many millions of cerdip DTL and T²L circuits.
- **CLAMP DIODES** — All Philco-Ford Series 74 circuits have been designed with clamp diodes input to reduce ringing and improve system noise immunity.

All popular Series 74 circuits are now available from our Lansdale facility, one of the country's largest IC manufacturing plants.

For complete data and prices, contact your nearest sales office. Or write Philco-Ford Corporation, Microelectronics Division, Blue Bell, Pa. 19422.

Contact the nearest Philco-Ford Sales office:

Suite 714, 9841 Airport Blvd.
Los Angeles, Calif. 90045
(213) 641-8105

3939 Fabian Way
Palo Alto, Calif. 94303
(415) 321-8740

2225 West North Ave.
Melrose Park, Ill. 60160
(312) 345-1000

Northwest Industrial Park
Second Avenue
Burlington, Mass. 01803
(617) 272-1600

Blue Bell, Pa. 19422
(214) 646-9100

20000 Rotunda Drive
Eng. Bldg. 3, Room 2060
Dearborn, Mich. 48121
(313) 323-3797

609 Saw Mill River Road
Ardsley, N.Y. 10502
(914) 693-3700

900 Don Mills Road
Don Mills, Ontario, Canada
(416) 444-2541

Room 428, State Tower Bldg
Syracuse, N.Y. 13202
(315) 422-3154 or 3155

the better idea people in bipolar IC's

PHILCO



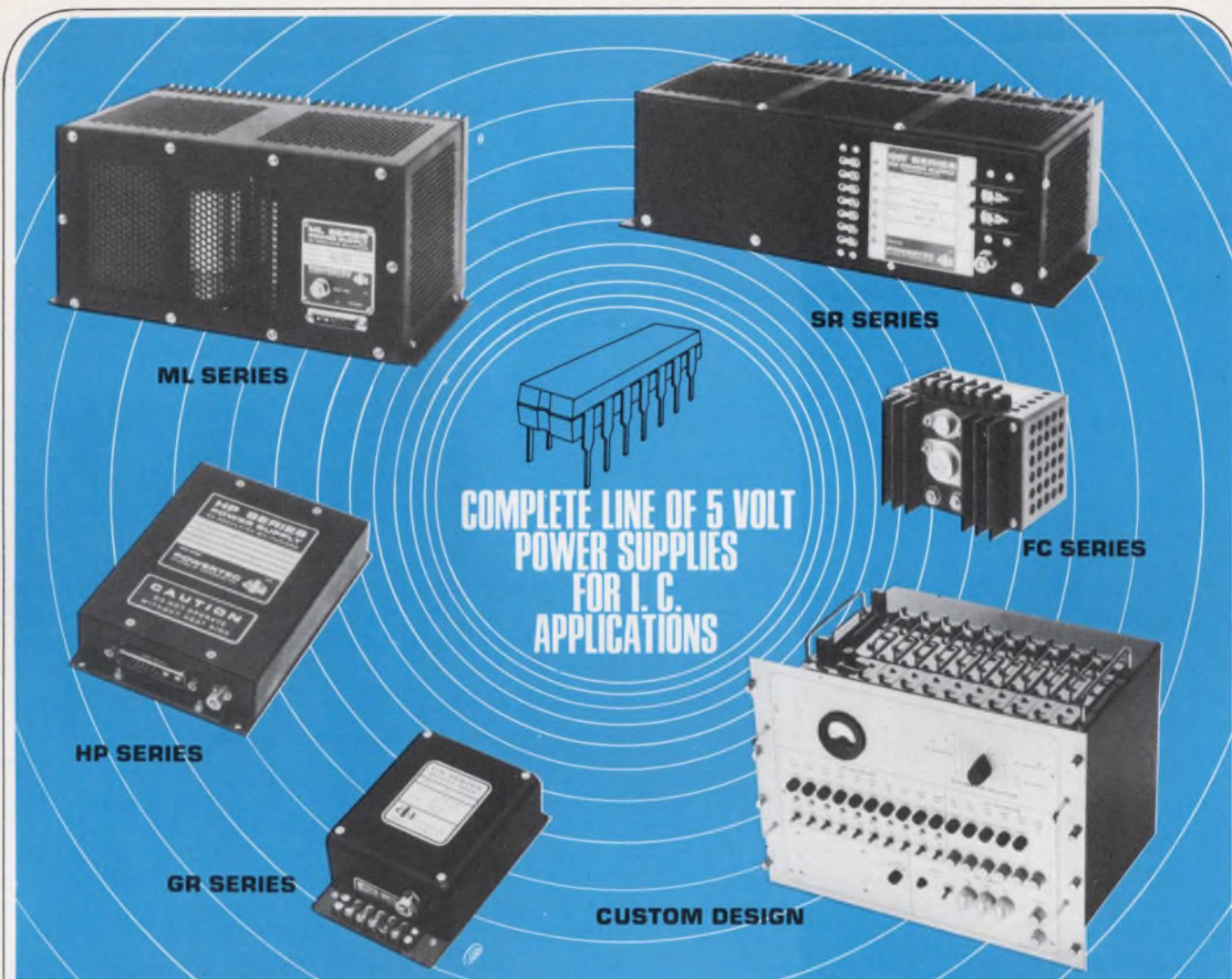

LOGIC POWER

A FEW EXAMPLES OF POWERTEC'S BROAD LINE OF POWER SUPPLIES

GR SERIES 5V-2.5A \$49

- 31 STANDARD MODELS • FULL RATING TO 71°C
- 47 TO 440 HZ INPUT • COMPUTER GRADE COMPONENTS

SR SERIES 5V-35A \$249

- 64 MODELS AVAILABLE • OPTIONAL OVP • REMOTE SENSE CAPABILITY • HIGH EFFICIENCY

ML SERIES 5V-20A \$379

- 100% MILITARY • MEETS MIL-E-16400, MIL-T-21200 • $\pm 0.00075\%$ REGULATION • DOCUMENTATION PACKAGE

HP SERIES 5V-30A \$789

- MILITARY AIRBORNE TO MIL-E-5400 • 400 HZ, 3 PHASE INPUT • 24 MODELS AVAILABLE
- 2 WATTS PER CUBIC INCH

FC SERIES 5V-5A \$179

- $\frac{1}{5}$ THE SIZE OF CONVENTIONAL SUPPLIES • HIGH FREQUENCY SWITCHING APPROACH • 20 STANDARD MODELS • OPTIONAL OVP

CUSTOM DESIGN

POWERTEC HAS A COMPLETE FAMILY OF BASIC BUILDING BLOCK CIRCUITS THAT ARE READILY ADAPTABLE TO YOUR CUSTOM SYSTEM SPECIFICATIONS



POWERTEC DIVISION

9168 DESOTO AVE., CHATSWORTH, CALIF. 91311 • Phone (213) 882-0004

Plotter with floating motor scans 40 in./s within 0.001 in.

Xynetics, Inc., 6710 Variel Ave., Canoga Park, Calif. Phone: (213) 887-1022. P&A: \$100,000; first quarter, 1970.

Just another X-Y plotting system, you say. Not so! This one is special—it is really unique.

The ADS-1 is an automatic drafting system that can operate at speeds of 40 inches per second while achieving a resolution of ± 0.001 inches. In reality, the operating speed of this amazing system is limited only by the control pulse rate and the pen ink flow.

How is it done? The answer is simple; it's all in the motor. The ADS-1 incorporates a revolutionary two-axis motor design that is the result of a newly patented concept called the Sawyer Principle. To simplify matters, let's first look at how single-axis operation is controlled.

The basic elements are: a magnet assembly, called a forcer, which consists of a permanent magnet connected to two electromagnets; and a completely passive platen or toothed base that is made of a fer-

romagnetic material. The forcer floats above the platen as shown in the figure below.

The permanent magnet produces an equal flux in all four pole tips of the electromagnets. Flux in pole tips 1 and 2 is opposite in polarity to that in 3 and 4.

Electromagnet A is now on and electromagnet B is now off. When an appropriate current is applied to B, it induces an additional magnetic force at pole tips 3 and 4. The forces at 3 add, while those at 4 cancel.

The forcer now has a new preferred position as shown by the flux lines, and will move to the left. Energizing electromagnet A so that pole tip 2 has an additive force will continue motion to the left. To complete a full cycle to the left, B is energized again (4 contributes) and then A (1 contributes).

Four flux changes result in a linear displacement that is equal to the pitch of the toothed base. Movement to the right can be initiated by first energizing 4.

The complete motor in the plotting system uses two forcers align-

ed at right angles to each other and combined into a single assembly. The platen is cross-scored to form equi-distant rectangular islands of equal size and height.

The scorings are filled with a non-magnetic material to provide a smooth surface. The forcer assembly is then supported on the platen by a stable airbearing.

However, because of the airbearing and waffle-iron characteristics of the platen, the motor is not restricted to only axis-parallel movements. It can move in any direction that is the vector resultant of two orthogonal commands.

To obtain its 0.001-inch resolution, the ADS-1 uses two d/a resolvers. These continuously control position by supplying a current to electromagnet A that is a cosine function and a current to electromagnet B that is a sine function.

By incrementally controlling the phase of the electromagnet current drive, the resolvers move the head 0.001 inch for each command. There are a total of 40 incremental steps to move through one full pitch of the platen as shown on the oscilloscope face below.

Each digital-to-analog resolver consists of a 10-state up-down counter, sign logic, analog switches and a ladder network.

Booth No. 21004 Circle No. 357

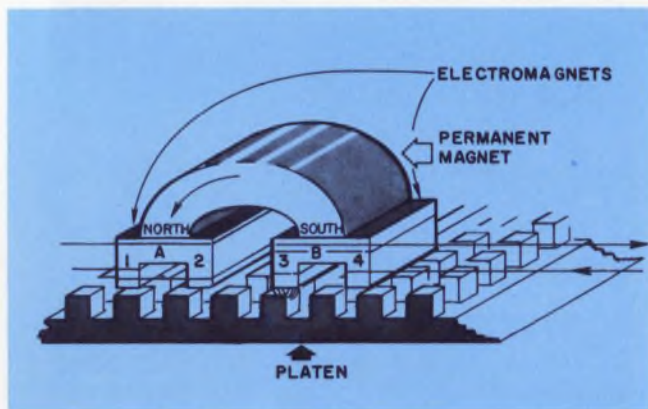

Sawyer Principle motor design allows new X-Y plotting system to draw at 40 in./s. A permanent-magnet/electromagnet assembly simply skims over a toothed base.

Scope trace of d/a resolver output shows Lissajous pattern of 40 incremental steps for one full motor cycle.

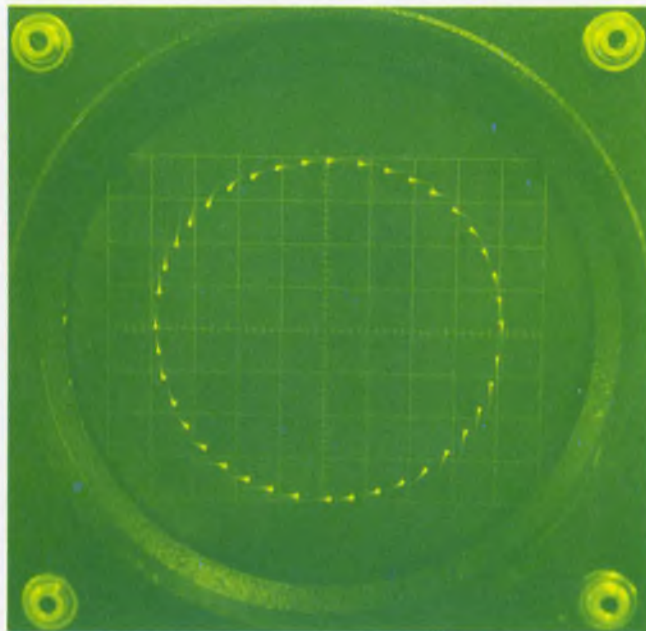

From ROTRON... the Innovators in cooling devices

A Complete Line of MODULAIR® Panel Blowers That Guarantee More Air/Per Kilowatt/Per Dollar!

Me too? Not really. We waited until now to come out with a new and complete line of panel blowers because it takes time to profit by the mistakes of others. We had to find out what you really wanted in a panel blower and then design it for you—**RIGHT!**

We're glad we waited and we think you will be, too. For this new line of Modulair Panel Blowers has all the good features you said you wanted. Plus some unique features. And **NONE** of the bad ones.

For instance, air deliveries from 240 to 650 CFM and we guarantee the performance. Complete line including 8¾", 7" and 5" panel heights in either full or recessed versions. All units supplied with washable dust filters which are accessible through the front panel. RFI/EMI filter models

available as optional and mount in the same panel space as standard models. MB8100 and MB7100 series feature unique "Centraxial" impeller for full width exhaust throughout the enclosure eliminating all hot spots. No housing modifications required for blast direction. All units easily adapt to any ducting system requirement. Units available with dual speed blowers and thermal controls as optional. Convince yourself that this new line of panel blowers is superior to anything you've ever seen or used.

Send for our complete Modulair catalog. Write Rotron Incorporated, Woodstock, New York 12498.



MODULAIR

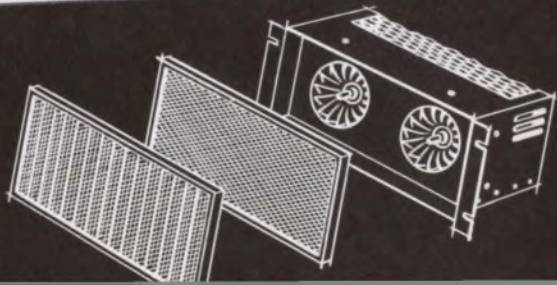

Typewriter-sized desktop impact line printer hammers out 200 lines/minute at 500 kHz

Nortec Computer Devices, 94 Nickerson Rd., Ashland, Mass. Phone: (617) 881-3160. P&A: \$6000; 3 months.

Only slightly larger than an electric typewriter, a new desktop impact line printer can operate at rates of 200 lines per minute over a 132-column page. The model 200 is primarily intended as a printout device for today's expanding market of mini-computers.

Its standard character set consists of 64 alphanumeric ASCII symbols. Up to six copies can be made at data input rates as fast as 500 kHz.

To achieve its small size and high speed, the new printer incorporates three major design innovations. These are a flexible metal font belt instead of a drum, stored-energy frictionless hammers, and IC matrix hammer drive circuitry.

The novel belt design allows the operator to read a line almost as soon as it is printed since it is not obscured by a drum. The belt is narrow, about 3/4 in. wide, with characters arranged serially along it.

Standard belts have six character sets, each containing 64 symbols. Belts with four sets of 96 characters or eight sets of 48 characters can also be supplied.

Each frictionless hammer consists of a striker mounted on two precision vertical springs. Before the printing cycle, all hammers are cocked and held by permanent magnets. When released, the hammers strike the paper against the font belt by using energy derived from the motor.

As a direct result of the hammer design, the model 200 printer can use a functional matrix of power integrated circuits for the hammer drive circuits. Only 37 drivers are needed for all 132 hammers. In addition, the size of the power supply needed can be reduced.

Booth No. 6405 Circle No. 354





High speed commercial memory system — **NANOMEMORY 2600**. Full cycle time of 600 nanoseconds, and word capacities of 16K by 18 or 8K by 36. It's all done with a second-generation 2-1/2D drive system with efficient circuit and logic design, for reduced component count and high MTBF, and wide operating margins — the real feature of the 2-1/2D configuration. It is easily expandable in the field, and comes in a standard 19" rack.



Perfect for high speed, large capacity mainframe memory systems... **NANOSTAK 3020**... technology breakthrough in 3W, 2-1/2D stacks. Stackable, compact size is an amazing 25% of competitive planar stacks and offers a significant advantage in form factor for system packaging. Extremely fast 650 nanosecond cycle time for 8K or 16K by 40, or 32K by 20 word memories



Compact, ATR compatible memory system **SEMS-6** for use in military and rugged commercial aircraft applications. Reliable performer is optimized around 8K or 16K with maximum capacities of 8K by 40 or 16K by 20. Full cycle time of 2 microseconds, with access time of 700 nanoseconds. Meets MIL-E-5400, low power consumption and lightweight.



Five new memory cores for your next stack or system. All are medium or high drive, all coincident current, and all are fast switching for your high speed applications. Four new cores available in 18 mil, 20 mil, and two types of 30 mil sizes for use from 0° to 70°C. Also, a new wide temperature range 18 mil core for severe environments of -55° to +100°C.

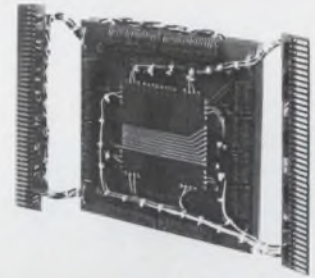

Rugged design for ground based mobile equipment, **NANOSTAK 020** commercial memory stack. High speed 850-nanosecond full cycle time for 4K memories. Features 3W, 3D organization with word capacities to 16K by 40. Built-in reliability and dependability. Available with wide temperature range cores for operation in severe environments.

Who else but Electronic Memories could introduce five brand spanking new memories—at once

Only Electronic Memories, the technology leader, could introduce five important new memories at once. Each one offers significant advances to provide you with faster, more reliable, and lower cost memories. Each one is loaded with outstanding new design features to give you faster access, larger capacity, and more economical operation. From cores and stacks to megabit memories, Electronic Memories has the memory products for your next, faster, more powerful computer system. For more facts and figures, just write.

EM **electronic memories**
a division of electronic memories & magnetics corporation
12621 chadron avenue, hawthorne, california 90250
telephone (213) 772-5201 TWX: 910-325-6213

visit us at **FJCC, Booths 301-304**

INFORMATION RETRIEVAL NUMBER 196

POWER FOR PEANUTS...

only **\$14***



NOT JUST A SINGLE OUTPUT... BUT A DUAL REGULATED PLUG-IN POWER SUPPLY... PROVIDING ALL THE BASIC ESSENTIALS FOR MOST IC & OP AMP APPLICATIONS

±6, ±12, ±15V @ 25mA
REGULATION: 0.20% max.
 RIPPLE & NOISE: 2 mV, P — P
NO DERATING
SHORT CIRCUIT PROTECTED
DIMENSIONS:
 3.5" x 2.5" x .875"

*in 1000 lot quantity. And only \$19.95, 1-9 quantity.



SEMICONDUCTOR CIRCUITS, INC.

163 MERRIMAC STREET
 WOBURN, MASSACHUSETTS 01801
 TEL: (617) 935-5200

INFORMATION RETRIEVAL NUMBER 197

Non-electronic \$68 keyboard encodes within key station



Synergistics, Inc., Ten Tech Circle, East Natick, Mass. Phone: (617) 655-1340. P&A: \$68 for 65 keys; 6 to 8 wks.

Providing 65-key layouts for as little as \$68 in quantity, a new modular self-encoding keyboard uses only gold-impregnated sliding self-wiping contacts as active components. Electronic circuits do not perform the encoding function; each key is its own decoder.

Completely modular in configuration, the new keyboard consists of three basic elements—terminal strips and key strips for the supporting structure, and individual key stations.

Each key station is composed of five parts. Three of these are: a molded plastic cap containing the symbol or character identification; a molded plastic housing that is the basic structural member and protective enclosure; and a guide stem for aligning the basic key to the key module assembly.

The fourth member of the key assembly is the code contact, a stamped spring material with ten contact arms. These spring-loaded

arms form the prime code-generating conductors for the key assembly and are connected directly to the guide stem.

The fifth element is the code mask. It is made of a plastic material and is used to establish the coded output of the key. The mask allows only the desired spring-loaded arms to make contact.

Each key station is connected to a key strip, which consists of ten wire conductors and contact pins contained in molded plastic. This plastic strip can accommodate any number of keys, depending on its length.

Contact pins in the key strip form the point of contact for the code contacts of the key assembly. Depressing a key causes a pulse output on a combination of key strip wires. The pulses are then conducted through another pin connection to the terminal strip.

Each key strip is pinned to a terminal strip, a piece of molded plastic containing ten conductors. The terminal strip completes the given keyboard or control panel configuration.

Booth No. 27006 Circle No. 356

You've seen the pictures...

The great digital systems kit!

step 1: TAKE RAYTHEON COMPUTERS
NEW SECURITY! SECURITY



RAYTHEON

The great digital systems kit!

step 2: PLUS IN RAYTHEON COMPUTERS
TO NEW TTL MODULES



RAYTHEON

The great digital systems kit!

step 3: COLLECT DATA FASTER WITH
A NEW 20 MHz 16 BIT CPU AND DATA
CONVERTER



RAYTHEON

The great digital systems kit!

step 4: USE THE MINIVERTER™ TO
EASILY TEST TO EACH FROM
YOUR ANALOG SIGNALS TO THE TIME



RAYTHEON

The great digital systems kit!

step 5: CONVERT SIGNALS TO A/D
OR D/A SIGNALS IN 100 NS AT 100 MHz



RAYTHEON

The great digital systems kit!

Steps 6 to 12:



PLUS 100+ OTHER MODULES, PLUS YOUR Raytheon Computer™ 1600-80,000*
*Price is approximate. Actual price varies by quantity.

RAYTHEON

Now read the book.

Bulletin SP-230D

The great digital & analog systems kit



RAYTHEON COMPUTER

RAYTHEON

The perfect finish to our Great Digital Systems Kit new product program—over 170 pages of meaty description, specs, logic diagrams and schematics on our TTL and DTL modules; dozens of packaged analog/digital instruments like our MINIVERTER™ and other data acquisition equipment; hardware and accessories; wire-wrapping service and applications help. Write or call for yours today. Raytheon Computer, 2700 S. Fairview St., Santa Ana, Calif. 92704. Phone (714) 546-7160.

RAYTHEON

Multi-purpose computer expander system adds on-line real-time service versatility

Scientific Resource Corp., sub. of Paragon Systems, Inc., 2803 Buffalo Speedway, Houston, Tex. Phone: (713) 621-7250. P&A: \$6650 to \$30,000; 90 days.

Comp·Ex is a new multi-purpose computer expander that extends the capabilities of IBM's 1130 computer to on-line real-time business and industrial applications. Through the use of various channel options, the new system allows the computer to be directly connected to a wide variety of instruments and peripheral devices. These include analog-to-digital converters, CRT displays, data sets, teletypes, magnetic tape systems and relay registers.

Via the expander, the 1130 computer can function in a broad range of applications, like intercomputer communications, event scheduling, process control, graphic data display, information retrieval, inventory control, and patient monitoring. The interfaces for each of these may be made by a direct connection to the expander or over telecommunications data links.

All input/output functions are program supported by systems software, accessible through the standard 1130 Fortran or Assembly

language. There are no additional details for hardware addressing; Comp·Ex functions are separate and independent and do not alter the standard 1130 system hardware.

The new expander has a modular structure that permits incremental expansion by the addition of channel interface boards as required. The maximum configuration handles 32 channels of digital data transfer.

Each channel has interrupt capability. Comp·Ex keeps track of the priority level assigned to each channel and the levels on which the channel will interrupt. To meet changing data handling requirements, priority and level assignment as well as reassignment may take place dynamically and under program control.

The basic expander system consists of a controller, a power system, and up to eight interface channel boards. The controller contains all the necessary data transfer logic and control logic for communications between the interface channel boards and the IBM 1130.

Interface channel circuit boards use both DTL and TTL integrated circuits. In order to minimize errors in circuit wiring and loading,

each channel board is automatically machine wired, point-to-point through computer-generated wiring lists. In addition, each channel board contains its own plug-in channel address code module so that individual boards can be installed into any available board slot.

Several interface channel options are available. These include: a digital input/output interface channel, a real-time clock, a data communications interface, a teletype interface, a data set interface, a universal a/d multiplexer interface, a universal d/a converter interface, a graphics terminal, and a magnetic tape transport.

A cycle-steal option can be supplied for many of the interface channels. This option allows a channel to perform cycle stealing and data chaining for high-speed data transfer independent of program control.

One interface channel can cycle-steal up to 135,000 words per second. Multiple cycle-stealing channels can be interlaced to achieve a maximum data rate of 270,000 words per second.

All basic driver routines are supplied with Comp·Ex and are operated under the 1130 monitor.

Booth No. 13000 Circle No. 358

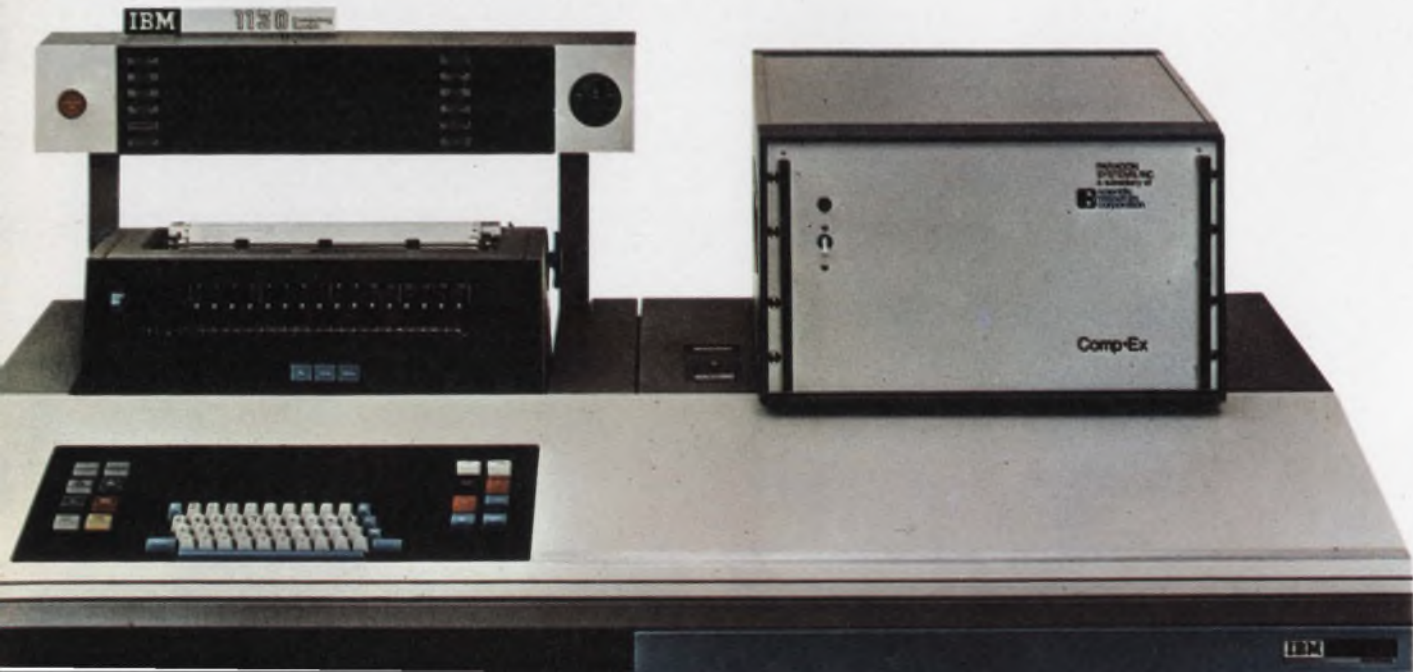

did you know?



General Electric **volt-pac**[®] variable transformers help you vary voltage dependably...year after year,* after year, after year, after year, after year, after year, after year, after year...

Send in this coupon for free bulletin giving complete details on Volt-Pac transformer features, ratings and application data; or see your GE sales representative today.

* Laboratory tested for over one million failure-free operations.

.....
Section 413-34
General Electric Company
Schenectady, New York 12305
Please send me free bulletin GEA-8110 on Volt-Pac Variable Transformers.

NAME _____

COMPANY _____

TITLE _____

ADDRESS _____

CITY _____ STATE _____ ZIP _____

GENERAL  ELECTRIC

INFORMATION RETRIEVAL NUMBER 199

Communications terminal is self-contained data center

Remcom Systems Inc., 2705 National Drive, Garland, Tex. Phone: (214) 328-9991. P&A: from \$18,500; January, 1970.

Packaged in a single cabinet, a new medium-speed data communications terminal is a self-contained free-standing unit that consists of a line printer, a card reader, a communications line interface and control electronics. Available communication interfaces allow the 2780 to operate at switched line rates up to 2000 bits per second, and private or leased line rates as fast as 9600 bits per second.

The 2780 can satisfy the requirements of a broad range of applications, including remote batch and remote job entry operations. It also can handle many special needs requiring transmission over common carrier or private communications lines.

Further broadening the terminal's versatility is a large selection of options like multi-point (polled) line control and double buffers.

Many options are available as field modifications. Peripheral subsystems include card punches, and paper-tape punches and readers.

The new terminal offers a range of transmission block sizes. These are determined by the capacity of the line buffer. Five line buffer capacities are available in two configurations for 200, 300, 400, 500 or 600 bytes.

The double-buffer option permits alternate use of two buffers for sequential transmission blocks. While one buffer is being loaded, the other is being unloaded.

Message formats, code structures and control sequences used by the 2780 are specified in accordance with Binary Synchronous Communication (BSC) conventions. This means that the new terminal can maintain compatibility with a large number of existing operating systems and terminals.

Three printer models are available with print rates of 150, 300, or 600 lines per minute.
Booth No. 5301 Circle No. 355



Record/retrieve system codes for man/machine



Interface Mechanisms, Inc., 5503 232nd St. S.W., Mountlake Terrace, Wash. Phone: (206) 774-4156. Price: from \$20/month.

Dual Image is a modular data recording and retrieval system that provides both a human-readable character and a machine-readable code on a single paper tape. This new concept in man/machine readable media is especially suited for remote data entry since information can be entered at typing speeds via the keyboard, or from digital devices at rates up to 75 Hz.

Booth No. 1042 Circle No. 279

Solid-state keyboard transduces contacts



TEC, Inc., 6700 S. Washington Ave., Eden Prairie, Minn. Phone: (612) 941-1100. P&A: \$100 typical; fourth quarter, 1969.

Using a unique transducer with a power requirement of only 8 mW, a new solid-state contactless keyboard converts key depressions into encoded DTL/TTL-compatible data outputs. The data output is an eight-bit binary number (including optional parity) per the ASCII code, or any other code. Speeds are as fast as 50 characters per second.
Booth No. 1503 Circle No. 266

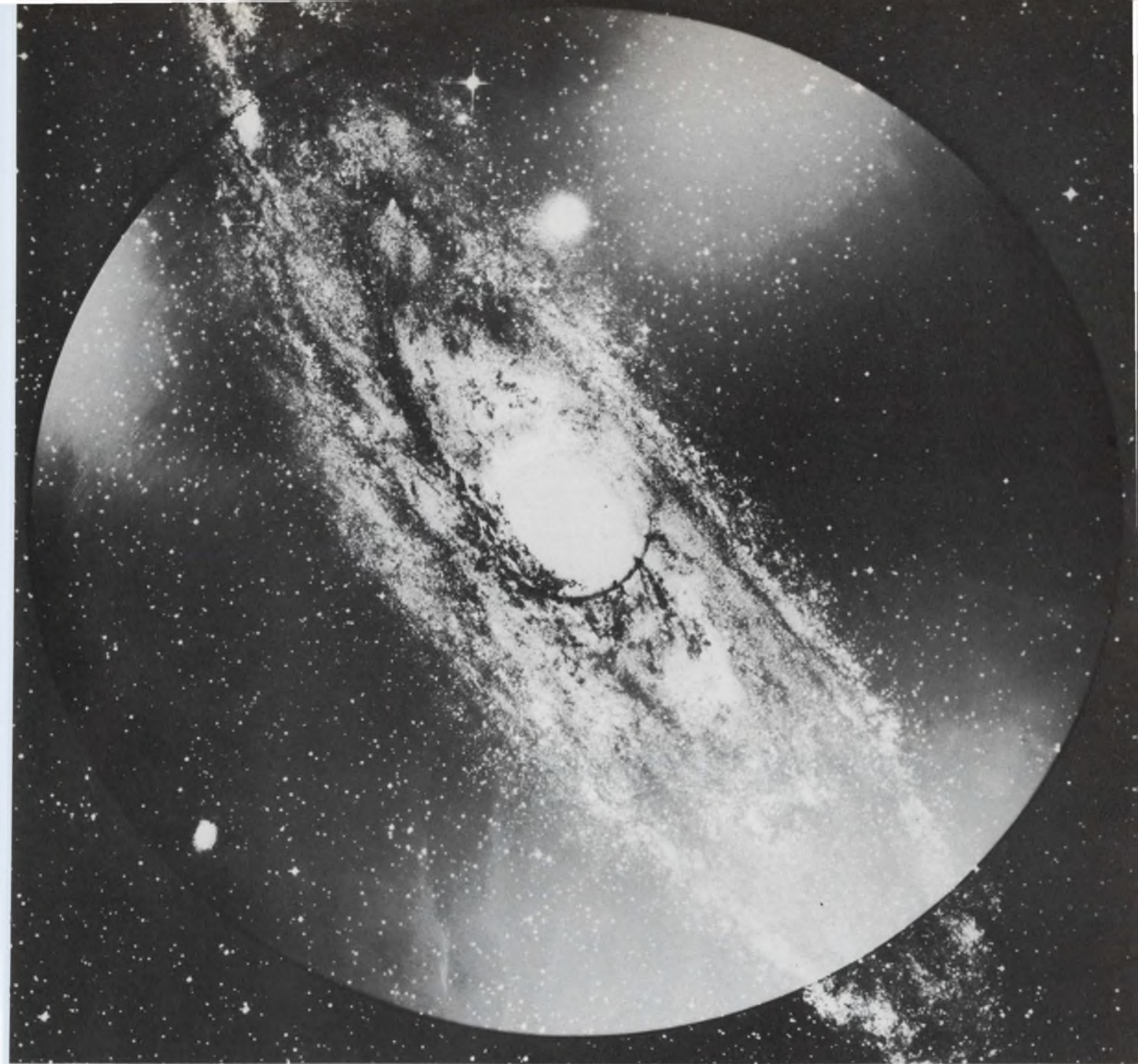

Data Instrumentation Recorders that know no bounds

In the field of instrumentation recording, no manufacturer offers the versatility, quality, or deliverability of DMI. As the pioneer in plated magnetic disc recording, this capability is unquestioned. Our recorders are methodically produced, meticulously tested, and universally accepted by some of the more sophisticated users of instrumentation recorder analysis equipment.

No wonder — considering our constant concern with progress and excellence. The new IDR-200, for example, already stands alone in the field of instrumentation recording. It is utterly versatile . . . available in single or dual channel models . . . both reproducing simultaneously if you wish. It stores 25 seconds of 2 MHz data on a 14" plated magnetic disc.

And it is operationally practical as well as functional. Meant to capture and store data for wideband transient analysis, signal analysis, spectrum analysis, data reduction,

correlation studies, telemetry, and one-shot phenomena. The possibilities know no bounds.

For those with less demanding situations, we offer the IDR-100 — a durable performer in wide-band instrumentation disc recording of the more compact variety. While it is a bench-top device, its specifications are comparable to the finest instrumentation tape recorders.

If the Data Instrumentation Disc Recorder is not a familiar device to you, or you wish to learn more about the usage of this medium and its many applications, write or call for a data package.

The Disc People



1400 Terra Bella Avenue, Mountain View,
California 94040, Telephone (415) 961-9440

Remote computer terminal prints 30 characters/s

Gulton Industries, Engineered Magnetic Div., 13041 Cerise Ave., Hawthorne, Calif. Phone: (213) 679-0111. P&A: from \$5500; January, 1970.

Designed for business and scientific applications requiring high input/output transmission rates, a new remote computer terminal can print 64 graphics of the USACII code at a speed of 30 characters per second. The LG 10/30 can also interface with equipment needing printer outputs of 10 or 15 characters per second.

The new terminal accommodates up to 132 print positions with its 132-column asynchronous page

printer. Printing is performed by a rotating helical wheel and a single solenoid-actuated print hammer. Completing the printing system is a Porlon ink-impregnated roller that is easy to change and provides very clear impressions.

Readability is good on all standard business forms, including six-part carbon-interleaved forms or three-part carbonless forms. Paper widths can be as large as 14-7/8 in.

In addition, the LG 10/30 features adjustable paper guides to print from 26 to 132 columns at 10 characters per inch and six lines per inch. Its paper skipping rate is 30 lines per second.

Booth No. 3400 Circle No. 353

Economy CRT display shows 800 characters



Beehive Electrotech, Inc., 1473 S. Sixth West, Salt Lake City, Utah, Phone: (801) 487-0741. P&A: \$3495; 60 to 90 days.

Alpha 101 is an 800-character Teletype-compatible CRT computer display terminal that sells for only \$3495. This stand-alone single-unit package measures just 12-in. wide by 14-in. high by 20-in. deep and weighs only 30 pounds. The unit has an adjustable internal clock for synchronous transmission up to 2400 baud.

Booth No. 22015 Circle No. 281

Modular CRT readout mixes character styles



Madatron Corp., 110 Route 10, Whippany, N.J. Phone: (201) 759-8600.

Coupling unlimited character display with high resolution, modularity, and single-plane viewing, a new CRT readout can present virtually any type of graphic symbol—letters, numerals, foreign alphabets or characters, dollar signs, and musical symbols. These characters can be displayed in any size or style, and the display is visible up to a viewing angle of 160°. The display modules are miniature (3/4-in) CRTs.

Dunes Hotel Suite Circle No. 296



Announcing a new panel savings plan.



Big dividends from small pushbuttons.

It doesn't take much to reduce the size of your control panels and cabinet fronts.

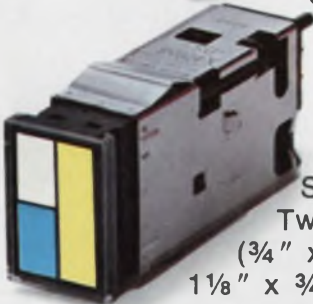

All it takes is compact miniature pushbuttons. Like the new MICRO SWITCH illuminated DS.

Two sizes are available ($\frac{3}{4}$ " x $\frac{3}{4}$ " for our 1-unit and $1\frac{1}{8}$ " x $\frac{3}{4}$ " for our $1\frac{1}{2}$ -unit). And

both can be matrix mounted on $\frac{3}{4}$ " or $1\frac{1}{8}$ " centers. So there's no need for spacers or barriers.

A long-term investment.

A rugged metal housing encloses each switch and protects against the bumps and bangs of military and commercial use.

The housing also helps provide our DS pushbuttons with exceptional RFI attenuation capability. Incorporated into the housing are welded skirts that assure positive metal-to-metal grounding between the switch and adjacent units. And also between the switch and our rigid, box-girder matrix frame.

Your choice of options.

Pick the mounting that best fits your application. Either individually mounted switches (meet the requirements of MIL-S-22885) or custom matrix configurations featuring plug-in switches that are best for remote stations or indicating functions.

You can have up to four lamps in every switch. And either one, two, three or four-way split section screens. (The $1\frac{1}{2}$ -unit provides more than one-third additional legend area.) Full guards are available for single-unit switches.

Then save even more space by combining both 1-unit and $1\frac{1}{2}$ -unit switches in the same matrix. A single frame will handle up to sixteen 1-unit switches or up to ten $1\frac{1}{2}$ -units.

Who can participate in the plan.

MICRO SWITCH DS pushbuttons meet both commercial and military requirements. So they can be used in almost any panel from power plant control to tactical ground support equipment.

For more information, call your MICRO SWITCH Branch Office or Distributor (in the Yellow Pages under "Switches, Electric"). He'll show you how little it takes to participate in our savings plan.

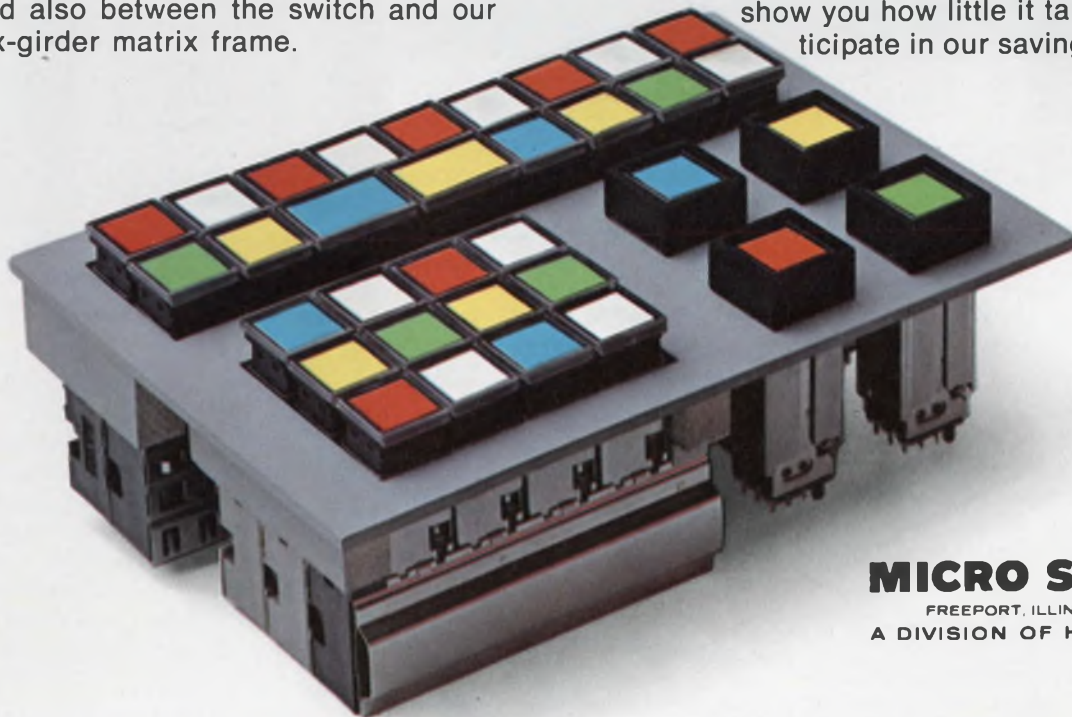

MICRO SWITCH

FREEPORT, ILLINOIS 61032

A DIVISION OF HONEYWELL

Vacuum-controlled transport threads tape automatically



Digital Information Devices, Inc., 210 Welsh Pool Rd., Lionville, Pa. Phone: (215) 647-3700. P&A: \$1700 to \$3000; 3 months.

V-Series digital magnetic tape transports feature automatically loaded computer-compatible tape cartridges and a vacuum-controlled tape movement. Designed for data acquisition systems, the new tape drives enable the user to build and buy according to need. Models are available from a basic rack-mounted deck to free-standing floor or table units.

Besides reducing operator handling, the tape cartridge feature allows the tape to be used in a non-computer environment without contamination problems from dust and dirt. After a tape reel is placed in the cartridge and started on the

take-up reel, the cartridge is then loaded and placed into the tape drive. The transport automatically threads the tape and advances it to the load point. On an unload signal, the tape is automatically re-wound and retracted into the cartridge, which then ejects for operator access.

The tape system of the new transports employs dual vacuum capstans to move the tape. The vacuum handles reel locking on the hubs, loading and unloading the tape, and tape positioning, guiding and buffering.

V-Series units operate from 18-3/4 to 37-1/2 inches per second at data transfer rates of 15 to 30 kHz. Tapes can have seven or nine channels for packing densities up to 800 bits per inch.

Booth No. 17006 Circle No. 335

Tape handler cleans and tests



Recortec, Inc., 162 S. Whisman Rd., Mountain View, Calif. Phone: (415) 961-8821. P&A: \$6250; 6 wks.

Called a tape evaluator cleaner, a new off-line desktop handler is designed to evaluate, clean, and wind computer magnetic tapes. This device enables data processing installations to select error-free tapes for critical applications, to identify error-prone tapes in a library, and to evaluate new tapes before they are utilized. It operates at 120 inches per second, and cleans and tests a 2400-ft reel in less than six minutes.

Booth No. 20002 Circle No. 264

CRT terminal controls itself



Imlac Corp., 296 Newton St., Waltham, Mass. Phone: (617) 891-1600. Price: \$6545 to \$9450.

Incorporating a 4k mini-processor and a dynamic CRT display for input/output ability, the PDS-1 communications terminal can replace on-line electromechanical devices without modifying the central system or present communications facilities. Since the controller is preprogrammed to simulate the terminal's exact characteristics, the PDS-1 can function from 1 to 9600 baud using any bit structure or code level.

Booth No. 6706 Circle No. 277



Small Wonder: \$6000

Our mini-printers were born with some big advantages. An exclusive one-piece print hammer, for example, whose ancestors made Data Products line printers famous for day-in day-out dependability and super-crisp printing. This in turn, permitted the price break-through. The 80-column printer in large OEM quantities is priced under \$6K. It has a drum speed of 1760 rpm and listings as fast as 1110 lpm for 20 columns. (It can also be engineered into a fully-interfaced communications terminal by our Systems Division which sells, leases, installs and maintains our products for the end-user market.) Then there's the new 132-column printer we're now making. It's a little bigger small wonder. Ask Bob Allen. (213) 887-8000.

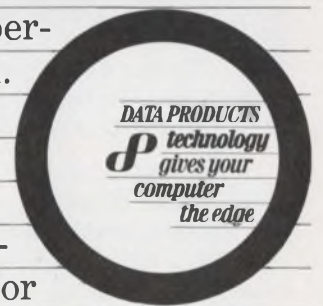

DATA PRODUCTS

6219 De Soto Avenue/Woodland Hills, California 91364

Los Angeles 213/887-8000 Minneapolis 612/927-8747 Dallas 214/239-9641 Acton, Mass. 617/263-3961 Bethesda, Md. 301/652-8120
Melbourne, Fla. 305/723-0720 Chicago 312/325-6630 Amsterdam, The Netherlands 020/156-297 London, England 01-579-3116

Magnetic tape terminal boosts Teletype speed



Universal Data Acquisition Co., Inc., P.O. Box 36166, Houston, Tex. Phone: (713) 782-5761. P&A: \$3230; 120 days.

The 5800 Twindek multi-purpose terminal expands the capabilities of a teletypewriter by providing batch input/output transmission at 110 characters per second. Transmission is over voice-grade telephone lines via a modem. Twin incremental magnetic tape decks, one read and one write, are used for data storage. Up to 200,000 characters may be stored on the reusable cartridges.

Booth No. 12001 Circle No. 274

Equalized data modem transmits 96 kbits/s



Codex Corp., 150 Coolidge Ave., Watertown, Mass. Phone: (617) 926-3000. P&A: \$13,975; 30 days.

By means of a specially developed digital adaptive equalizer, a new data modem can quadruple the capacity of 2400-bit-per-second voice-grade lines to 9600 bits per second. Model AE-96 automatically measures and compensates for intersymbol amplitude and delay distortion. Initial circuit equalization, via a pushbutton, requires only 3.5 seconds.

Booth No. 8510 Circle No. 283

Video display views in color

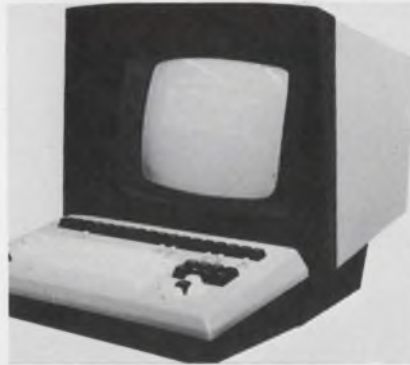

Delta Data Systems Corp., Woodhaven Industrial Park, Cornwells Heights, Pa. Phone: (215) 639-9400. P&A: \$7100; 60 to 90 days.

Featuring full compatibility with the mini-computers used in process control and other systems applications, a new video display terminal allows information to be entered on its screen in one of four colors. Any character can be any one of the colors. The Delta 1 video display includes such features as TV compatibility, and blink and formatting.

Booth No. 6409 Circle No. 284

Computer terminal types and plots



Typagraph Corp., 7525 Convoy Court, San Diego, Calif. Phone: (714) 279-5690. Price: \$200/month rental or \$6000.

A new computer terminal for time-sharing and general-purpose use incorporates all the functions of a precision X-Y plotter with those of a normal teleprinter. Model 3 performs both text typing and graphic plotting on the same continuous sheet of paper. It can plot or print in any direction (up, down, right or left) in variable-spacing increments with a resolution of 0.02 in.

Booth No. 6301 Circle No. 293

MOS-encoded keyboard gives four code levels



Honeywell Inc., Microswitch Div., Chicago and Spring St., Freeport, Ill. Phone: (815) 232-1122. Price: \$88 in quantity.

With its MOS encoding large-scale integrated circuit, a new universal solid-state keyboard can generate up to four levels of code from a single key. This makes the unit compatible with remote communications terminals or data preparation devices such as keypunch machines, and key-to-magnetic tape, key-to-disc and key-to-cassette machines.

Booth No. 7301 Circle No. 282

Versatile displays work at 1200 baud



Sycor, Inc., 117 N. First St., Ann Arbor, Mich. Phone: (313) 769-1500. Price: \$7000 to \$9400.

Two new programmable video terminals offer asynchronous transmission in ASCII code (11-bit character structure) at 110, 600, or 1200 baud, half- or full-duplex modes, with parity check. Both units are completely self-contained and do not require an external controller. They allow customized keyboard layouts, stored messages that can be displayed with a single key stroke.

Booth No. 1600 Circle No. 285

Clairex standard photocells meet 98% of all requirements...

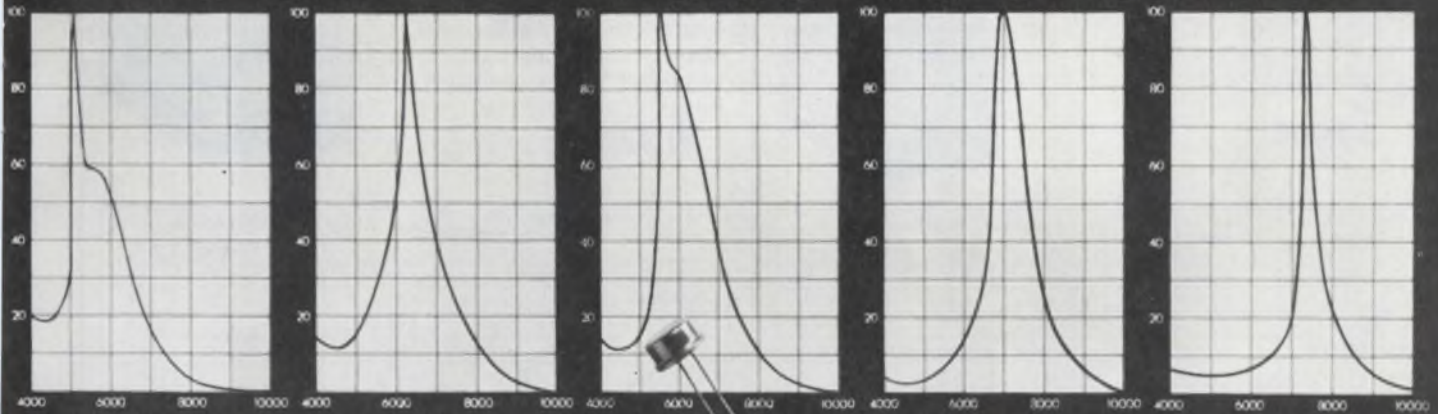

but if you really
need a special...
we'll design it for you.

Clairex has the widest line of standard cells available. Light control has been our business since 1953.

For complete information on our stock photocells or for special assistance with your problems call (212) 684-5512 or write Clairex, 1239 Broadway, New York, N. Y. 10001.

CLAIREX ELECTRONICS, INC.



OEM REGULATED POWER SUPPLIES

FREE: Send for complete catalog.

GENERAL SPECIFICATIONS

Voltage Input: 105-125VAC, 47-420cps

Current Output: 1.25 to 34 amps

Voltage Output: 0 to 48 volts

Regulation: $\pm 0.01\%$ line and load

Ripple: Less than 250 microvolts

Response Time: Less than 20 microseconds

Output Current vs. Temperature: Full rated output at 45°C ambient, and is derated for operation to 71°C. A modest amount of forced air cooling will permit full output at 71°C. Consult factory for details.

Overload & Short Circuit Protection: Solid state short circuit and overload protection. Instantaneous recovery, and automatic reset. Cannot be damaged by prolonged short circuits or overloads.

OEM SERIES A

3 $\frac{1}{16}$ " W x 3 $\frac{3}{8}$ " H x 5 $\frac{1}{8}$ " D

Net Wt.: 3 $\frac{3}{4}$ pounds

Shipping Wt.: 4 $\frac{3}{4}$ pounds

Price:

\$7900



MODEL	ADJUSTABLE VOLTAGE RANGE, ± 0.5 volts	AMBIENT TEMPERATURE			
		45°C	50°C	60°C	71°C
OEM-3-A	3.0 \pm .5 volts	1.25 amps	1.17	1.03	.88
OEM-3.6-A	3.6 \pm .5 volts	1.25 amps	1.17	1.03	.88
OEM-4-A	4.0 \pm .5 volts	1.25 amps	1.17	1.03	.88
OEM-4.5-A	4.5 \pm .5 volts	1.25 amps	1.17	1.03	.88
OEM-5-A	5.0 \pm .5 volts	1.25 amps	1.17	1.03	.88
OEM-6-A	6.0 \pm .5 volts	1.25 amps	1.17	1.03	.88
OEM-8-A	8.0 \pm .5 volts	1.25 amps	1.17	1.03	.88
OEM-10-A	10.0 \pm .5 volts	1.25 amps	1.17	1.03	.88
OEM-12-A	12.0 \pm .5 volts	1.25 amps	1.17	1.03	.88
OEM-15-A	15.0 \pm .5 volts	1.25 amps	1.17	1.03	.88
OEM-18-A	18.0 \pm .5 volts	1.00 amps	.94	.82	.70
OEM-20-A	20.0 \pm .5 volts	.90 amps	.84	.74	.63
OEM-24-A	24.0 \pm .5 volts	.80 amps	.75	.66	.56
OEM-28-A	28.0 \pm .5 volts	.70 amps	.66	.58	.49
OEM-36-A	36.0 \pm .5 volts	.60 amps	.56	.49	.42
OEM-48-A	48.0 \pm .5 volts	.30 amps	.28	.25	.21

OEM SERIES C

5 $\frac{3}{32}$ " W x 3 $\frac{5}{16}$ " H x 7 $\frac{5}{8}$ " D

Net Wt.: 8 $\frac{1}{4}$ pounds

Shipping Wt.: 10 $\frac{1}{4}$ pounds

Price:

\$13700



MODEL	ADJUSTABLE VOLTAGE RANGE, ± 0.5 volts	AMBIENT TEMPERATURE			
		45°C	50°C	60°C	71°C
OEM-3-C	3.0 \pm .5 volts	4.00 amps	3.7	3.3	2.8
OEM-3.6-C	3.6 \pm .5 volts	4.00 amps	3.7	3.3	2.8
OEM-4-C	4.0 \pm .5 volts	4.00 amps	3.7	3.3	2.8
OEM-4.5-C	4.5 \pm .5 volts	4.00 amps	3.7	3.3	2.8
OEM-5-C	5.0 \pm .5 volts	4.00 amps	3.7	3.3	2.8
OEM-6-C	6.0 \pm .5 volts	4.00 amps	3.7	3.3	2.8
OEM-8-C	8.0 \pm .5 volts	4.00 amps	3.7	3.3	2.8
OEM-10-C	10.0 \pm .5 volts	4.00 amps	3.7	3.3	2.8
OEM-12-C	12.0 \pm .5 volts	3.75 amps	3.5	3.1	2.6
OEM-15-C	15.0 \pm .5 volts	3.50 amps	3.3	2.9	2.4
OEM-18-C	18.0 \pm .5 volts	3.25 amps	3.0	2.6	2.2
OEM-20-C	20.0 \pm .5 volts	3.00 amps	2.8	2.4	2.1
OEM-24-C	24.0 \pm .5 volts	2.75 amps	2.6	2.2	1.9
OEM-28-C	28.0 \pm .5 volts	2.50 amps	2.3	2.0	1.7
OEM-36-C	36.0 \pm .5 volts	2.00 amps	1.9	1.6	1.4
OEM-48-C	48.0 \pm .5 volts	1.25 amps	1.17	1.03	.88

OEM SERIES B

3 $\frac{1}{16}$ " W x 3 $\frac{3}{8}$ " H x 6 $\frac{3}{8}$ " D

Net Wt.: 5 $\frac{1}{4}$ pounds

Shipping Wt.: 6 $\frac{3}{4}$ pounds

Price:

\$10200



MODEL	ADJUSTABLE VOLTAGE RANGE, ± 0.5 volts	AMBIENT TEMPERATURE			
		45°C	50°C	60°C	71°C
OEM-3-B	3.0 \pm .5 volts	2.50 amps	2.3	2.0	1.7
OEM-3.6-B	3.6 \pm .5 volts	2.50 amps	2.3	2.0	1.7
OEM-4-B	4.0 \pm .5 volts	2.50 amps	2.3	2.0	1.7
OEM-4.5-B	4.5 \pm .5 volts	2.50 amps	2.3	2.0	1.7
OEM-5-B	5.0 \pm .5 volts	2.50 amps	2.3	2.0	1.7
OEM-6-B	6.0 \pm .5 volts	2.50 amps	2.3	2.0	1.7
OEM-8-B	8.0 \pm .5 volts	2.50 amps	2.3	2.0	1.7
OEM-10-B	10.0 \pm .5 volts	2.50 amps	2.3	2.0	1.7
OEM-12-B	12.0 \pm .5 volts	2.50 amps	2.3	2.0	1.7
OEM-15-B	15.0 \pm .5 volts	2.50 amps	2.3	2.0	1.7
OEM-18-B	18.0 \pm .5 volts	2.25 amps	2.1	1.8	1.6
OEM-20-B	20.0 \pm .5 volts	2.00 amps	1.9	1.6	1.4
OEM-24-B	24.0 \pm .5 volts	1.90 amps	1.8	1.5	1.3
OEM-28-B	28.0 \pm .5 volts	1.80 amps	1.7	1.4	1.2
OEM-36-B	36.0 \pm .5 volts	1.20 amps	1.1	1.0	0.8
OEM-48-B	48.0 \pm .5 volts	0.60 amps	.56	0.5	.42

OEM SERIES D

5 $\frac{3}{32}$ " W x 3 $\frac{5}{16}$ " H x 9 $\frac{3}{8}$ " D

Net Wt., 11 $\frac{1}{2}$ pounds

Shipping Wt.: 14 pounds

Price:

\$15400



MODEL	ADJUSTABLE VOLTAGE RANGE, ± 0.5 volts	AMBIENT TEMPERATURE			
		45°C	50°C	60°C	71°C
OEM-3-D	3.0 \pm .5 volts	6.00 amps	5.6	4.9	4.2
OEM-3.6-D	3.6 \pm .5 volts	6.00 amps	5.6	4.9	4.2
OEM-4-D	4.0 \pm .5 volts	6.00 amps	5.6	4.9	4.2
OEM-4.5-D	4.5 \pm .5 volts	6.00 amps	5.6	4.9	4.2
OEM-5-D	5.0 \pm .5 volts	6.00 amps	5.6	4.9	4.2
OEM-6-D	6.0 \pm .5 volts	6.00 amps	5.6	4.9	4.2
OEM-8-D	8.0 \pm .5 volts	5.60 amps	5.3	4.6	3.9
OEM-10-D	10.0 \pm .5 volts	5.20 amps	4.9	4.3	3.6
OEM-12-D	12.0 \pm .5 volts	5.00 amps	4.7	4.1	3.5
OEM-15-D	15.0 \pm .5 volts	4.50 amps	4.2	3.7	3.1
OEM-18-D	18.0 \pm .5 volts	4.20 amps	3.9	3.4	2.9
OEM-20-D	20.0 \pm .5 volts	4.10 amps	3.8	3.3	2.8
OEM-24-D	24.0 \pm .5 volts	3.50 amps	3.3	2.9	2.4
OEM-28-D	28.0 \pm .5 volts	3.30 amps	3.1	2.7	2.3
OEM-36-D	36.0 \pm .5 volts	3.00 amps	2.8	2.4	2.1
OEM-48-D	48.0 \pm .5 volts	2.00 amps	1.9	1.6	1.4



POWER/MATE CORP. 514 South River Street / Hackensack, N. J. 07601
Phone (201) 343-6294 / TWX (710) 990-5023

INFORMATION RETRIEVAL NUMBER 204

- *QUANTITY DISCOUNTS UP TO 50%
- *HIGH PERFORMANCE AT NO EXTRA COST

QUICK SELECTOR TABLE OF CONTENTS

Model	Voltage	Current
OEM-A	0-48	0.5 amps
OEM-B	0-48	1.5 amps
OEM-C	0-48	Up to 4
OEM-D	0-48	Up to 8
OEM-E	0-48	Up to 12
OEM-F	0-48	Up to 18
OEM-G	0-48	Up to 24
OEM-H	0-48	Up to 34

AVAILABLE OPTIONS

1. Built-in over-voltage protection at \$30 per unit. Use suffix "OV".
2. Fungus proofing, with MIL-V-173 varnish, for all fungus nutrient components, at \$10 per unit. Use suffix "F".
3. AC input. All units are available with 208 VAC $\pm 10\%$ (use suffix "L") or 230 VAC $\pm 10\%$ (use suffix "LL") at no extra cost.

HOW TO ORDER

To specify voltage and current, including those not listed, place the required voltage after OEM-, and the current after the case size A, B, etc. For example — OEM-34C-2.25.

OEM SERIES E

5 $\frac{3}{32}$ "W x 5 $\frac{3}{32}$ "H x 9 $\frac{3}{8}$ "D
 Net Wt.: 15 $\frac{1}{2}$ pounds
 Shipping Wt.: 19 pounds
 Price:

\$17700



MODEL	ADJUSTABLE VOLTAGE RANGE, ± 0.5 volts	AMBIENT TEMPERATURE			
		45°C	50°C	60°C	71°C
OEM-3-E	3.0 \pm .5 volts	12.00 amps	11.3	9.9	8.4
OEM-3.6-E	3.6 \pm .5 volts	12.00 amps	11.3	9.9	8.4
OEM-4-E	4.0 \pm .5 volts	12.00 amps	11.3	9.9	8.4
OEM-4.5-E	4.5 \pm .5 volts	12.00 amps	11.3	9.9	8.4
OEM-5-E	5.0 \pm .5 volts	12.00 amps	11.3	9.9	8.4
OEM-6-E	6.0 \pm .5 volts	11.00 amps	10.3	9.1	7.7
OEM-8-E	8.0 \pm .5 volts	10.50 amps	9.9	8.6	7.3
OEM-10-E	10.0 \pm .5 volts	9.50 amps	8.9	7.8	6.6
OEM-12-E	12.0 \pm .5 volts	9.30 amps	8.7	7.7	6.5
OEM-15-E	15.0 \pm .5 volts	8.00 amps	7.5	6.6	5.6
OEM-18-E	18.0 \pm .5 volts	7.50 amps	7.0	6.2	5.2
OEM-20-E	20.0 \pm .5 volts	7.00 amps	6.6	5.8	4.9
OEM-24-E	24.0 \pm .5 volts	6.00 amps	5.6	4.9	4.2
OEM-28-E	28.0 \pm .5 volts	5.50 amps	5.2	4.5	3.8
OEM-36-E	36.0 \pm .5 volts	5.00 amps	4.7	4.1	3.5
OEM-48-E	48.0 \pm .5 volts	3.00 amps	2.8	2.5	2.1

OEM SERIES G

7 $\frac{1}{2}$ "W x 5 $\frac{3}{32}$ "H x 11 $\frac{1}{8}$ "D
 Net Wt.: 25 $\frac{3}{4}$ pounds
 Shipping Wt.: 30 $\frac{1}{4}$ pounds
 Price:

\$26800



MODEL	ADJUSTABLE VOLTAGE RANGE, ± 0.5 volts	AMBIENT TEMPERATURE			
		45°C	50°C	60°C	71°C
OEM-3-G	3.0 \pm .5 volts	24.00 amps	22.5	19.8	16.8
OEM-3.6-G	3.6 \pm .5 volts	23.00 amps	21.6	19.0	16.1
OEM-4-G	4.0 \pm .5 volts	23.00 amps	21.6	19.0	16.1
OEM-4.5-G	4.5 \pm .5 volts	22.00 amps	20.7	18.2	15.4
OEM-5-G	5.0 \pm .5 volts	22.00 amps	20.7	18.2	15.4
OEM-6-G	6.0 \pm .5 volts	21.00 amps	19.8	17.4	14.7
OEM-8-G	8.0 \pm .5 volts	20.00 amps	18.8	16.5	14.0
OEM-10-G	10.0 \pm .5 volts	18.00 amps	16.9	14.8	12.6
OEM-12-G	12.0 \pm .5 volts	17.00 amps	16.0	14.0	11.9
OEM-15-G	15.0 \pm .5 volts	16.00 amps	15.1	13.2	11.2
OEM-18-G	18.0 \pm .5 volts	15.00 amps	14.1	12.4	10.5
OEM-20-G	20.0 \pm .5 volts	14.00 amps	13.2	11.5	9.8
OEM-24-G	24.0 \pm .5 volts	13.00 amps	12.2	10.7	9.1
OEM-28-G	28.0 \pm .5 volts	12.00 amps	11.3	9.9	8.4
OEM-36-G	36.0 \pm .5 volts	10.00 amps	9.4	8.7	7.0
OEM-48-G	48.0 \pm .5 volts	7.00 amps	6.6	5.8	4.9

OEM SERIES F

7 $\frac{1}{2}$ "W x 5 $\frac{3}{32}$ "H x 9 $\frac{3}{8}$ "D
 Net Wt.: 20 $\frac{1}{4}$ pounds
 Shipping Wt.: 24 $\frac{1}{4}$ pounds
 Price:

\$20800



MODEL	ADJUSTABLE VOLTAGE RANGE, ± 0.5 volts	AMBIENT TEMPERATURE			
		45°C	50°C	60°C	71°C
OEM-3-F	3.0 \pm .5 volts	15.00 amps	14.1	12.4	10.5
OEM-3.6-F	3.6 \pm .5 volts	15.00 amps	14.1	12.4	10.5
OEM-4-F	4.0 \pm .5 volts	15.00 amps	14.1	12.4	10.5
OEM-4.5-F	4.5 \pm .5 volts	15.00 amps	14.1	12.4	10.5
OEM-5-F	5.0 \pm .5 volts	15.00 amps	14.1	12.4	10.5
OEM-6-F	6.0 \pm .5 volts	15.00 amps	14.1	12.4	10.5
OEM-8-F	8.0 \pm .5 volts	14.20 amps	13.4	11.7	9.9
OEM-10-F	10.0 \pm .5 volts	12.80 amps	12.0	10.6	8.9
OEM-12-F	12.0 \pm .5 volts	12.00 amps	11.3	9.9	8.4
OEM-15-F	15.0 \pm .5 volts	11.00 amps	10.3	9.1	7.7
OEM-18-F	18.0 \pm .5 volts	9.90 amps	9.3	8.2	6.9
OEM-20-F	20.0 \pm .5 volts	9.40 amps	8.8	7.7	6.5
OEM-24-F	24.0 \pm .5 volts	8.70 amps	8.2	7.2	6.1
OEM-28-F	28.0 \pm .5 volts	8.00 amps	7.4	6.6	5.6
OEM-36-F	36.0 \pm .5 volts	7.40 amps	6.9	6.1	5.2
OEM-48-F	48.0 \pm .5 volts	4.50 amps	4.2	3.7	3.15

OEM SERIES H

7 $\frac{1}{2}$ "W x 5 $\frac{3}{32}$ "H x 16 $\frac{1}{2}$ "D
 Net Wt.: 34 $\frac{1}{2}$ pounds
 Shipping Wt.: 39 $\frac{1}{2}$ pounds
 Price:

\$31800



MODEL	ADJUSTABLE VOLTAGE RANGE, ± 0.5 volts	AMBIENT TEMPERATURE			
		45°C	50°C	60°C	71°C
OEM-3-H	3.0 \pm .5 volts	34.00 amps	32.0	28.1	23.8
OEM-3.6-H	3.6 \pm .5 volts	33.00 amps	31.0	27.3	23.1
OEM-4-H	4.0 \pm .5 volts	33.00 amps	31.0	27.3	23.1
OEM-4.5-H	4.5 \pm .5 volts	32.00 amps	30.1	26.5	22.4
OEM-5-H	5.0 \pm .5 volts	32.00 amps	30.1	26.5	22.4
OEM-6-H	6.0 \pm .5 volts	31.00 amps	29.2	25.6	21.7
OEM-8-H	8.0 \pm .5 volts	29.00 amps	27.3	24.0	20.3
OEM-10-H	10.0 \pm .5 volts	25.00 amps	23.5	20.7	17.5
OEM-12-H	12.0 \pm .5 volts	23.00 amps	21.6	19.0	16.1
OEM-15-H	15.0 \pm .5 volts	21.00 amps	19.8	17.4	14.7
OEM-18-H	18.0 \pm .5 volts	19.00 amps	17.9	15.7	13.3
OEM-20-H	20.0 \pm .5 volts	17.00 amps	16.0	14.0	11.9
OEM-24-H	24.0 \pm .5 volts	16.00 amps	15.1	13.2	11.2
OEM-28-H	28.0 \pm .5 volts	15.00 amps	14.1	12.4	10.8
OEM-36-H	36.0 \pm .5 volts	12.00 amps	11.3	9.9	8.4
OEM-48-H	48.0 \pm .5 volts	8.50 amps	8.0	7.0	5.9

POWER/MATE CORP.

514 South River Street / Hackensack, N. J. 07601
 Phone (201) 343-6294 / TWX (710) 990-5023



INFORMATION RETRIEVAL NUMBER 205

CRT display terminal is fully self-contained



Hypertech Corp., 7343 W. Wilson Ave., Harwood Heights, Ill. Phone: (312) 867-4200.

Suitable for off-line data entry and/or retrieval, as well as on-line use with a computer, a new portable desktop terminal is a completely self-contained unit. Model GTU-1 has its own keyboard, micro-processor, video display system, and two magnetic-tape cassette recorder/reproducers. It is said to be compatible with virtually any electronic data processing system in use today.

Booth No. 35001 Circle No. 350

Compact mini-computer incorporates processor



Micro Systems Inc., 644 E. Young St., Santa Ana, Calif. Phone (714) 540-6730. P&A: from \$10,000; 30 days.

With a feature-packed basic configuration, a new mini-computer includes a micro-programmed processor with a systems control panel, a power supply, a 4096 by 9-bit core memory, memory parity, a real-time clock, and six communications rate clocks. The Micro 812 system also has provisions for accommodating up to five communications interface boards. It can accommodate up to six different baud rate combinations at one time.

Booth No. 5915 Circle No. 263

Microfilm readers see 95,000 lines

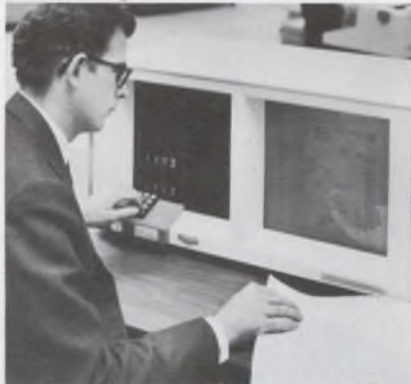

Microform Data Systems, Inc., Palo Alto Office Center, Palo Alto, Calif. Phone: (415) 327-6495.

Two new microfilm readers, the manual Mindex/330 and the automatic Mindex/350, use six-inch ultrastrips that can store more than 95,000 lines of computer printout. Within a few seconds, the proper image can be displayed. With the automatic reader, the proper page is electronically accessed from a keyboard. A hard-copy print attachment is also available.

Booth No. 5010 Circle No. 262

Digital computer cycles in 1 μs



Wilkinson Computer Sciences, Inc., P.O. Box 350, Bedford, Mass. Phone: (617) 275-8881. P&A: \$8810; 30 days.

Available in memory sizes from 4k to 65k words, a new high-speed general-purpose digital computer offers a cycle time of 1 μs. Model 881 has a minimum memory of 4k words with eight-bit lengths. There are 78 basic instructions and four true hardware priority interrupts. Add time is 3 μs; hardware multiply time is 7 μs for a 16-bit product.

Booth No. 122 Circle No. 340

Rugged mini-computer meets MIL environments



Rolm Corp., 10925 N. Wolfe Rd., Cupertino, Calif. Phone: (408) 257-6440. Price: \$20,000.

Designed to meet the environmental requirements of Mil-I-5400, Mil-E-16400, and Mil-I-6181, a new 16-bit-word general-purpose mini-computer conductively cools its electronics to provide an operating temperature range of -55 to +95°C. In addition, model 1601 extensively uses MSI TTL integrated circuits to achieve a mean-time-between-failure in excess of 11,000 hours.

Booth No. 7418 Circle No. 351

Parallel mini-computer contains 1.5-μs memory



Fujitsu Limited, 680 Fifth Ave., New York, N.Y. Phone (212) 265-5360. P&A: \$9210; 4 to 5 months.

The FACOM-R is a 16-bit, stored-program, general-purpose parallel mini-computer that has a memory with a 1.5-μs cycle time. The memory is expandable from 4k to 32k words. Various peripheral units can be attached to the new machine. These include an a/d converter, X-Y plotter, line printer, optical mark reader, CRT display, disc file, and a communications control adapter.

Booth No. 7318 Circle No. 265

ON ONE CHIP:

A PLATED-WIRE, HARDENED SENSE AMP

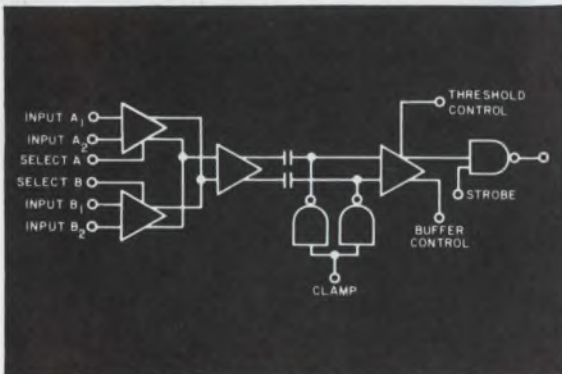

- The first application of linear and digital technology in one monolithic sub-system.
- The RA-2540R system in a single chip performs the functions of two hardened differential amplifiers and a hardened voltage comparator
- 1 mV signal sensitivity in high noise environment
- 10 ns access time
- Internal D.C. restoration
- Selectable dual channel
- Hardened
 - Photo current compensation
 - Dielectric isolation
 - Thin film resistors
 - Advanced device design

You always get: Off-the-shelf delivery, full plated-wire temperature range and compliance with MIL-STD-883 . . . when you pick the BEST IC for the job from Radiation's fast expanding linear-hardened line.



Lexington, Massachusetts (617) 862-1055
Norwalk, Connecticut (203) 853-3641
Washington, D.C. (202) 337-4914
Dallas, Texas (214) 231-9031
Long Beach, California (213) 426-7687
Palo Alto, California (415) 321-2280
Albuquerque, New Mexico (505) 268-3549

P.O. Box 37, Melbourne, Florida 32901 (305) 727-5430

RADIATION
INCORPORATED

SUBSIDIARY OF HARRIS INTERTYPE CORPORATION
MICROELECTRONICS DIVISION

INFORMATION RETRIEVAL NUMBER 206

Core memory system accesses in 350 ns



Fabri-Tek, Inc., 5901 S. County Rd, 18, Minneapolis, Minn. Phone: (612) 935-8811. Price: from \$2000.

Providing an access time of 350 ns, a new core memory system is a 3-D three-wire random-access storage unit with a capacity of 4096 words by 18 bits or 8192 words by nine bits. Model 480 can be expanded with plug-ins to a capacity of 16,384 words by 18 bits or 8192 words by 36 bits. Full-cycle time is 900 ns plus modify time.

Booth No. 5200 Circle No. 280

Document reader eases operation



Motorola Instrumentation and Control Inc., P.O. Box 5409, Phoenix, Ariz. Phone: (602) 959-1000.

Model MDR-1000 document reader is an optical-mark machine that translates data to USASC11 language or to other binary decimal codes from punched or pencil-marked forms for near-real-time entry in bit-serial or bit-parallel form. It drives telephone data sets, acoustic couplers, and common carrier circuits.

Booth No. 305 Circle No. 288

Acoustic data terminal runs on six batteries



Technitrend, Inc., Data Communications Systems, 7300 N. Crescent Blvd., Pennsauken, N.J. Phone: (609) 665-4910. P&A: \$230 to \$350; stock to 30 days.

Operating from six ordinary batteries, a new portable data terminal converts an ordinary dial telephone into a remote input/output terminal. It is designed for use with computer-controlled voice-response systems. To operate, the user places the telephone handset in the terminal's cradle, dials the computer, waits for an audible tone response, and depresses pushbutton keys to give messages to the computer.

Booth No. 18003 Circle No. 261



Miniature High Q Air Capacitors!

- SIZE: .220" dia. 15/32" length
- Q @ 100 mc: >5000
- CAPACITANCE RANGE: 0.4 — 6 pf
- NON-MAGNETIC

New miniature series features high quality materials and workmanship typical of all Johanson Variable Air Capacitors.

Write or Phone

Johanson MANUFACTURING CORPORATION
400 Rockaway Valley Road, Boonton, N. J. 07005 (201) 334-2676



Compact data terminal runs on-line/off-line



Dura Div., Intercontinental Systems Inc., 2600 El Camino Real, Palo Alto, Calif. Phone: (415) 328-5660.

In a package only slightly larger than a standard electric typewriter, a new data terminal provides complete paper-tape and edge-card input/output capabilities, a heavy-duty keyboard/printer, and a terminal control unit. Model 1051 can reduce computer usage costs because it enables the user to transmit error-free data on-line.

Booth No. 7308 Circle No. 295

Breakthrough For Automation!

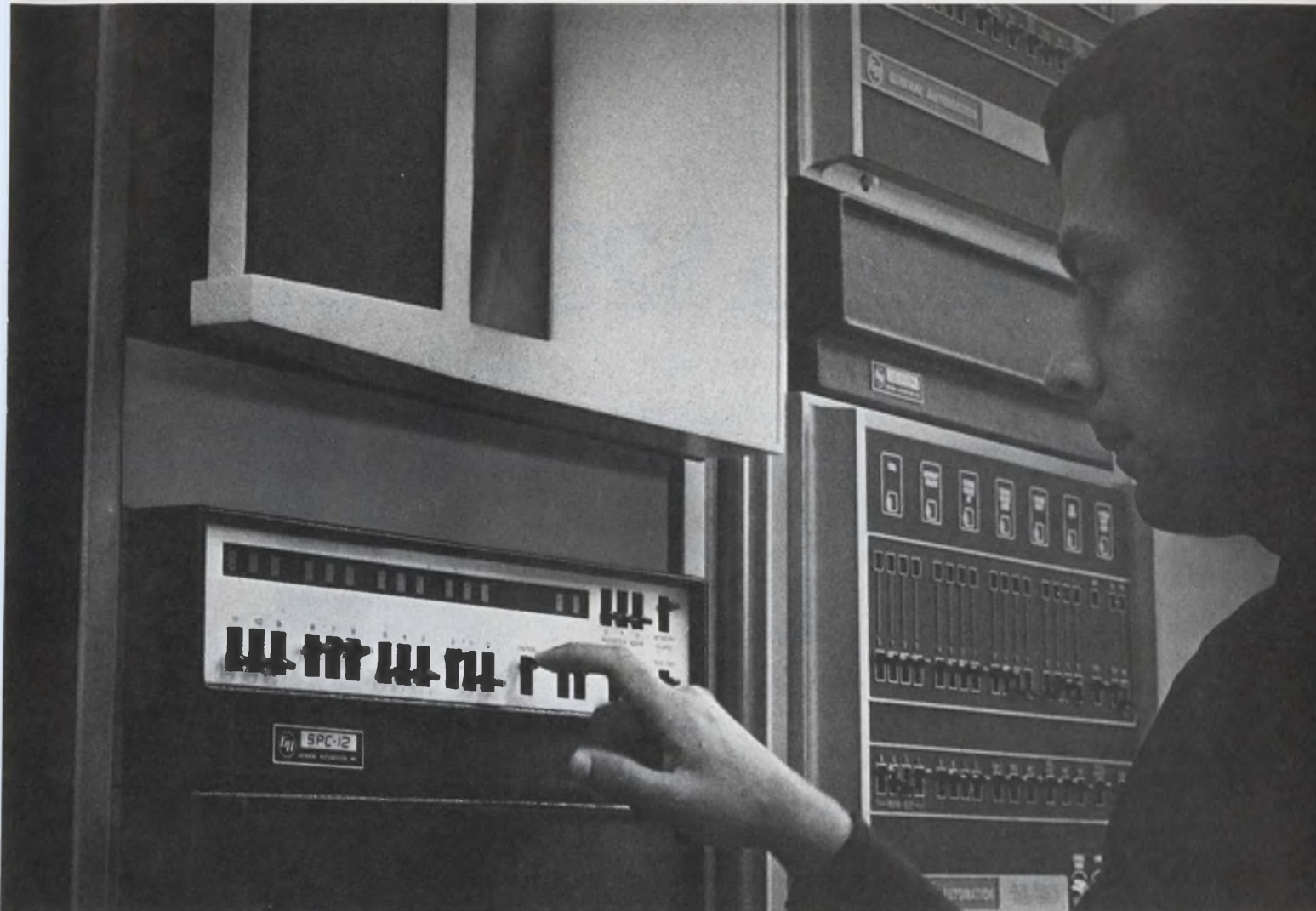

A COMPLETE, LOW-COST AUTOMATION SOLUTION

If you need an OEM computer for your next automation product, General Automation has the complete, low-cost solution . . . pre-engineered and ready to install . . . and that includes all the computers, interfaces, software and services.

Our SPC-12 automation computer offers you new levels of computer value and reliability . . . it's specifically designed to work in industrial environments. The SPC-12 plugs in and works, the first time, and keeps on working. Hundreds are on the job working.

And to add even more value to your product, our unique family of mini-controllers tie the SPC-12 directly to

machines, devices, communications networks, sensors and instruments, eliminating excessive and redundant electronics. Your products can serve more markets.

If you require software or services our Automation Sciences Division will provide you with complete software programs and technological services to get your product to the market faster.

Put this complete low-cost automation computer in your product today for only \$5000.00 . . . and much less in OEM quantities. You'll be surprised just how easy it is. Call or write today, there's a General Automation office near you.



GENERAL AUTOMATION, INC.
Automation Products Division

706 West Katella, Orange, Calif. (714) 633-1091, TWX 910-593-1601

Sales Offices: Waltham, Mass. (617) 899-6170 • New Rochelle, N.Y. (914) 235-9300 • Silver Spring, Md. (301) 593-6010 • King of Prussia, Pa. (215) 265-6525 • Atlanta, Ga. (404) 261-6203, 261-6204 • Cleveland, O. (216) 351-2275 • Des Plaines, Ill. (312) 298-4650 • Dallas, Tex. (214) 358-0271 • Los Altos, Calif. (415) 941-5966 • Orange, Calif. (714) 639-3791 International, Wren House Portsmouth Rd. Esher, Surrey, England; Esher, 65764

See SPC-12 at F.J.C.C., Booths 8101-8104, November 18-20, Las Vegas

Announcing Digitest 500,
the \$250 digital multimeter
from Honeywell.

No kidding. \$250

This world's smallest multimeter may be inexpensive to buy, but that's the only thing cheap about it.

Take capability. Our Digitest 500 gives you five functions (resistance, AC and DC voltages, AC and DC currents), plus 17 ranges to choose from. And it can be operated from 117V 50-60Hz line or an external 12V source. Or consider accuracy: Digitest 500 is five times as accurate as the conventional VOM.

As you can see, we've made it both compact and lightweight (2½ lbs.), by using a large-scale integrated circuit. So the Digitest 500 is just 2½" x 5" x 9", but has polarity indication, a moving decimal point, an overload indicator and built-in calibration check. Plus overrange up to 100% (on all ranges except 300VAC).

To get a free demonstration – or more details – write Don Anderson, M.S. 206, Honeywell Test Instruments Division, P.O. Box 5227, Denver, Colorado 80217.

Honeywell





It won't work.

There's a lot more to making modules than buying a few IC's and slapping them on a board. For one thing, the modules almost never work – the first time. Almost never the second time. Occasionally the third time. And that's only the prototype.

Chances are, Digital already has the optimum design, computer tested, fully debugged, manufactured, and sitting there on the shelf. Frustrating, isn't it?

Digital's M Series is the most complete, fully compatible, high speed, integrated circuit, inexpensive line of modules anywhere. We manufacture several million a year – many for our own computers – and know how.

Send for our new Logic Handbook. It tells you what, why, and how to build logic systems from modules. But, alas, not how to build the modules themselves.

DIGITAL EQUIPMENT CORPORATION, Maynard, Massachusetts 01754. Telephone: (617) 897-5111 / Cambridge, Mass. / New Haven / Washington, D.C. / Parsippany, Palisades Park, N.J. / Princeton, N.J. / Rochester, N.Y. / Long Island, N.Y. / Philadelphia / Pittsburgh / Cleveland / Dayton / Huntsville / Cocoa, Fla. / Chicago / Denver / Ann Arbor / Salt Lake City / Houston / Albuquerque / Los Angeles / Palo Alto / Seattle. INTERNATIONAL, Carleton Place and Toronto, Ont. / Montreal, Quebec / Edmonton, Alberta, Canada / Reading and Manchester, England / Paris, France / Munich and Cologne, Germany / Oslo, Norway / Stockholm, Sweden / Sydney and West Perth, Australia.

digital
MODULES • COMPUTERS

MOS memory card stores 1600 bits

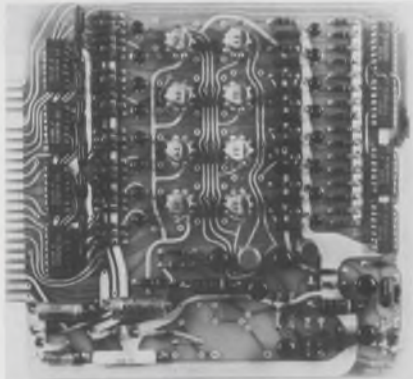

Cambridge Memories, Inc., 285 Newtonville Ave., Newtonville, Mass. P&A: \$300 typical; 30 days.

Said to be the first character-buffer memory unit that employs MOS technology for storage, the MOS-8S sequential-access system is completely TTL interfaced, and stores up to 1600 bits on a 5-3/4 by 5-3/4-in. plug-in card. It is available in several configurations, ranging from 50 one-bit words to 200 eight-bit words. The memory system can operate as a data formatting unit or line buffer.

Booth No. 8422 Circle No. 286

Fast data set works 2400 bits/s



RFL Industries, Inc., Communications Div., Boonton, N. J. Phone: (201) 334-3100. P&A: \$1900; 60 days.

Using four-phase differentially coherent modulation, a new high-speed data modem transmits and receives serial binary data over a voice bandwidth at a synchronous rate of 2400 bits per second. Model 3952 is designed for use with all present-day transmission equipment, including conventional and dedicated telephone lines, power lines, microwave and radio.

Booth No. 6718 Circle No. 342

Three-wire 3-D memory stores 16k at 40 bits

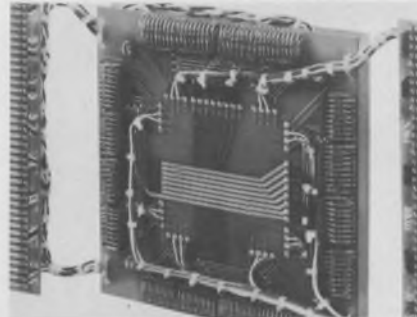

Electronic Memories & Magnetics Corp., Electronic Memories Div., 12621 Chadron Ave., Hawthorne, Calif. Phone: (213) 772-5201.

Rugged enough for ground-based military applications, a new three-wire three-dimensional memory stack features 22-mil cores, sub-microsecond speeds, and capacities from 4096 to 16,384 words of up to 40 bits. Nanostak NS-020 offers 800-ns operation for 4096 words, and a slightly slower operation for larger sizes. The unit also increases reliability by reducing solder joints by 50%.

Booth No. 301 Circle No. 275

Data entry terminal uses adding machine



Applied Peripheral Systems, Inc., sub. of R/G Computing & Processing, Inc., P.O. Box 56221, Houston, Tex. Phone: (713) 785-5040. P&A: \$1850; December, 1969.

Designed for entering, collecting and transmitting information for any application where numbers are the primary data, model DG 4 data entry terminal utilizes a 10-key adding machine to enter data and produce hard copy. When one of the adding machine function keys is pressed, numbers are stored in memory, then recorded on a 1/4-in. magnetic tape cassette.

Booth No. 6422 Circle No. 298

Three-wire memory cycles in 900 ns

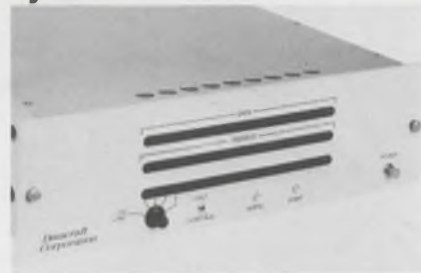

Datacraft Corp., P.O. Box 23550, Fort Lauderdale, Fla. Phone: (305) 933-2651.

Intended for use in modern computing and data handling systems, a new three-wire 3-D magnetic core memory system offers a full-cycle time of 900 ns. Basic memory capacity for model 22 is 8192 words with 20-bit lengths or 4096 words with 40-bit lengths. In addition, this new memory does not require any field adjustments; all parameters are permanently set at the factory.

Booth No. 5001 Circle No. 348

Core memories trim work times

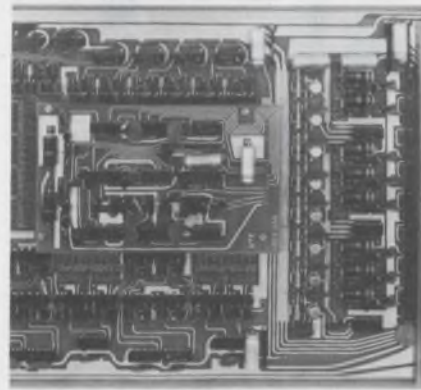

United Telecontrol Electronics, 3500 Sunset Ave., Asbury Park, N.J. Phone: (201) 988-0400. P&A: \$162 to \$1500; 60 days.

Mesa 200 core memories provide an economical approach to coincident-current data storage for OEM applications. There are four models available: the 5030, a 1k-by-1 high-speed buffer; the 5033, a 4k-by-1 high-speed buffer; the 5034, a 1k-by-8 full-cycle memory; and the 5035, a 4k-by-16 full-cycle memory. Buffer memories can perform in 1 μ s, while full-cycle units operate in 2 μ s.

Booth No. 8504 Circle No. 278



That's our Molex Mini-Connector. It's doing big things. Like saving assembly steps. And time. And money. Getting wiring in place with greater production efficiency and operational integrity than you might think possible. Our business is creating these mini-devices to meet your system requirements. We take it seriously. And have the facilities, design capabilities, know-how and everything it takes to produce economical connections . . . fast!

If you would like a free sample of our Mini-Connector, please write. If you would like a sample of performance, you can make connections by calling (312) 969-4550



ELIMINATE DOWN-TIME ON ROTARY & THUMBWHEEL SWITCHES

and also get accurate, precise control

UNLIMITED APPLICATIONS

CDI switches offer fast sure settings and quick read-out for computer, automated and control equipment, and for test and programming applications, etc.

QUICK SERVICEABILITY

Unique 5-second wafer replacement obsoletes other switches. Simply lift out old wafer, slip in new wafer. No unsoldering . . . no disassembling . . . no wire removing.

EXTREME VERSATILITY

Regardless of size or shape needed CDI is well prepared to meet your every switch requirement.

THUMBWHEEL SWITCHES



Digital and Binary. Meet MIL-S-22710. For critical reliability applications. Available with internal lighting MIL-L-25467A. Switch modules with panel and switching elements separately sealed for complete protection are available. Bezel types have no visible screws when rear mounted.

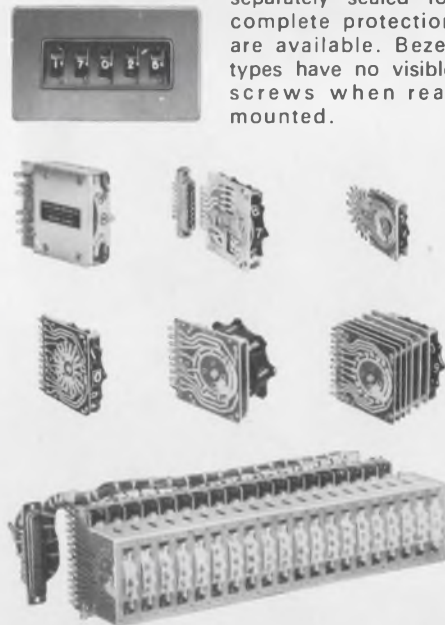

PUSHBUTTON SWITCHES



NEW MINI 10-POSITION ADD/SUBTRACT

Retrofits most miniature thumbwheel switch panel openings. 8 & 12 positions available. Simply push one button to add, the other to subtract. Each decade mounts on 1/2" centers. Over 1,000,000-operation service life.

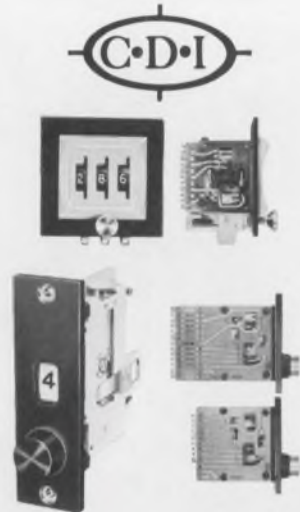

ROTARY SWITCHES

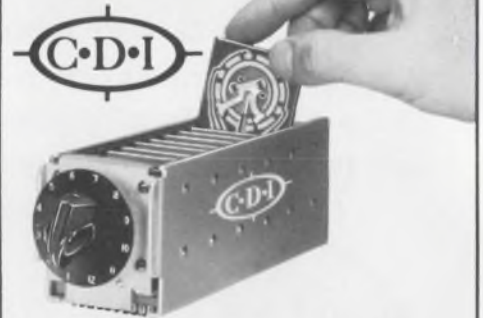

For critical reliability applications. Meet MIL-S-22710. Removable wafers permit quick changing of programs, configurations, circuits. CDI patented switches with dust covers available in sizes 2" x 2", 3" x 3" and 4" x 4" with lengths to accommodate up to 36 wafers. Operation may be manual, motor or solenoid.



Mfd. under Tabel U. S. Patents 2,841,660, 2,971,066, 3,015,000, 2,956,131, 2,988,607



CHICAGO DYNAMIC INDUSTRIES, INC.

PRECISION PRODUCTS DIVISION 1725 Diversey Blvd., Chicago, Illinois 60614. Phone 312, 935-4600

ALL POWER TRANSISTORS LOOK ALIKE... BUT THEY'RE NOT EQUAL

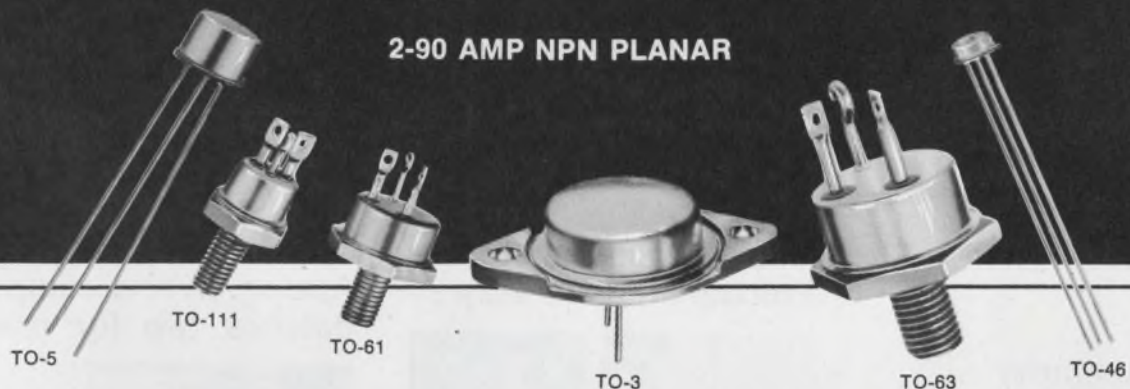

To the eye, the only difference between Pirgo power transistors and other makes is the name behind them. But that's quite a difference.

Pirgo is a new company—not committed to old ways of doing things. We have the most modern equipment and quality control facilities for the production of NPN and PNP planar silicon transistors rated from 2 thru 90 amps.

Pirgo's management group grew up with the semiconductor industry. We are staffed with skilled management and engineers of the highest technical capability.

Pirgo is an affiliate of the Sprague Electric Company, and draws upon the full resources and sales staff of Sprague.

All of this translates to high reliability, outstanding service, and on-time delivery. Even our low price policy is unusual.

Don't take our word for it. Ask for a copy of our new catalog, then send us your toughest spec. Or contact your local Sprague Electric sales engineer. We'll show you what a difference a name makes.

Pirgo products are available from authorized Sprague semiconductor distributors.

PIRGO  **ELECTRONICS INC.**
A Sprague Electric Company Affiliate

130 CENTRAL AVENUE
FARMINGDALE, NEW YORK 11735
Tel.: 516-694-9880

Real-time computer accepts 65k words



Scientific Data Systems, a Xerox Co., 701 S. Aviation Blvd., El Segundo, Calif. Phone: (213) 772-4511. Price: from \$2300/month.

The fourth multiple-use Sigma computer, Sigma 3, is now available. Primary hardware features include a multi-port core memory expandable from 8192 to 65,536 words, a 975-ns memory cycle time, a separate I/O processor for concurrent compute and I/O operations, 28 I/O channels, and 100 levels of priority interrupt. In addition, there are three operating systems, two Fortran compilers, and more than 100 numerical sub-routines.

Booth No. 2700 Circle No. 294

Digital computer reduces software



Clary Datacomp Systems, 404 Junipero Serra Dr., San Gabriel, Calif. Phone: (213) 283-9485.

A new stored-program digital computer uses its hardware to implement many important functions for which other computers use software. Model 404 includes load, trace and dump functions as hardware. Instructions for multiplying and dividing, automatic formatting, and performing decimal arithmetic eliminate the need for complicated routines.

Booth No. 8411 Circle No. 343

Fast-Fourier processor does 128 points in 3 ms



Time/Data Corp., 490 San Antonio Rd., Palo Alto, Calif. Phone: (415) 327-8322. P&A: \$40,000; fourth quarter, 1969.

Offering a real-time bandwidth of 20 kHz, the System 90 fast-Fourier-transform peripheral processor can perform 128-point transforms in 3 ms, and 2048-point transforms in only 56 ms. Data can be processed in a continuous stream or in individual data blocks. In the continuous mode, throughput rate is 40,000 words per second.

Booth No. 8423 Circle No. 345

Medium-sized computers execute steps in 1.2 μs



Systems Engineering Laboratories Inc., 6901 W. Sunrise Blvd., Fort Lauderdale, Fla. Phone: (305) 587-2900. P&A: from \$150,000; January, 1970.

Featuring an average execution time of 1.2 μs, two new families of medium-sized computers are said to operate 40 to 50% faster than previously available units costing 20 to 40% more. The 32-bit computers, Systems 86 and Systems 88, boast an input/output transfer rate of 1.66 million words per second.

Booth No. 2900 Circle No. 267

Data concentrator services 64 lines



Varian Data Machines, a Varian sub., 2722 Michelson Dr., Irvine, Calif. Phone: (714) 833-2400. Price: \$32,500 typical.

Up to 65 full-duplex data-communication lines can be simultaneously serviced by the 520/DC data concentrator system for interactive time-sharing networks. In such applications, the new system gathers data from a number of local low-speed terminals and concentrates it for economical transmission over one or more high-speed lines to a distant computer center.

Booth No. 101 Circle No. 299

Analog/hybrid computer patches two for one



Applied Dynamics, Inc., P.O. Box 1488, Ann Arbor, Mich. Phone: (313) 971-4444.

The AD/Five analog/hybrid computer features a unique reversible patchboard that can be rotated 180°, allowing one board to contain the patching for two distinct problems. The new computer can be linked to any commercially available digital computer to form a single hybrid system. In addition, it will function as a stand-alone analog or a multiple-console hybrid.

Booth No. 6900 Circle No. 292

From Analog to Digital

LOW COST A/D CONVERTER: \$495. The low cost ADC-U is completely self contained . . . includes reference, logic, weighted current sources, internal clock. Built around the famous MINIDAC, the ADC-U offers high-speed and high resolution. It is available in 8, 10, and 12 bit models with conversion times of 4, 6, and 10 microseconds respectively. The ADC-U is recommended for OEM applications . . . 8 bit model is priced at just \$495 (1-9). A best buy!

FAST A/D CONVERTER: 1 μ sec CONVERSION. The compact plug-in ADC-10-F is optimized for high speed operation. Total conversion time is just 1 μ sec for full 10 bit resolution. 8 bits also available at lower cost. Completely self contained, the module requires only power supply connections and your inputs! Output is parallel TTL logic. Where high speed conversion to 10 bit resolution is required, the ADC-F is recommended. Unit price is \$1990.00.

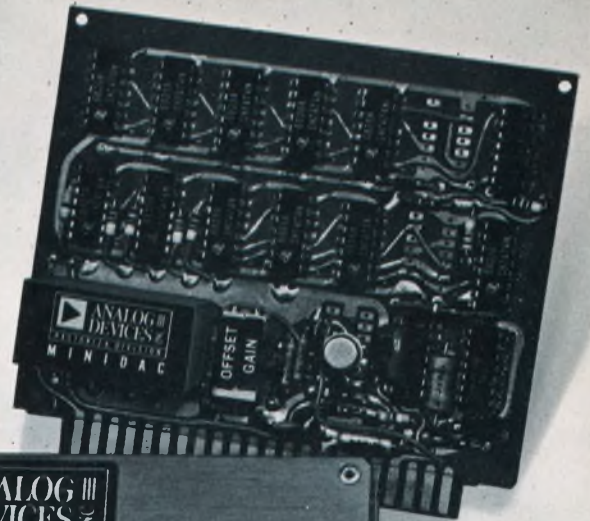

& Back Again

HIGH RESOLUTION D/A CONVERTER: 14 BITS. The DAC-R offers up to 14 bit (magnitude and sign) resolution in a self contained D/A converter module. Also featured is fast settling time (20 μ sec to ± 1 LSB) and "glitchless" operation. A wide variety of input codes are available, output is ± 10 V @ 5 mA. Cost is \$995.

MINIDAC — TINY YET COMPLETE D/A CONVERTER. This miniature D/A converter has become the basic building block in a wide variety of data handling systems. It is useful in high-speed display systems, A/D conversion, character-sensing devices, and test equipment. It includes precision reference sources, switches, weighted current sources. Either binary or BCD input requirements are compatible with DTL or TTL . . . Output is 0-5 mA current source. Settling time is just 300 nsec. The MINIDAC is available in two package styles: minimal volume MDA-U and minimal height MDA-L, and three choices of input resolution. MDA-L units with 8, 10, or 12 bit resolution prices (1-9) are \$140, \$165, \$195 respectively.



Conversion Modules from Pastoriza

FREE NEW CATALOG includes a complete line of Multiplexers, Sample/Hold Modules, Power Supplies, Op Amps, etc. Use the reader service card or call your local sales office.



221 FIFTH ST., CAMBRIDGE, MASSACHUSETTS 02142
TEL: (617) 492-6000 TWX: 710-320-0326

These new, low-priced Burr-Brown op amps

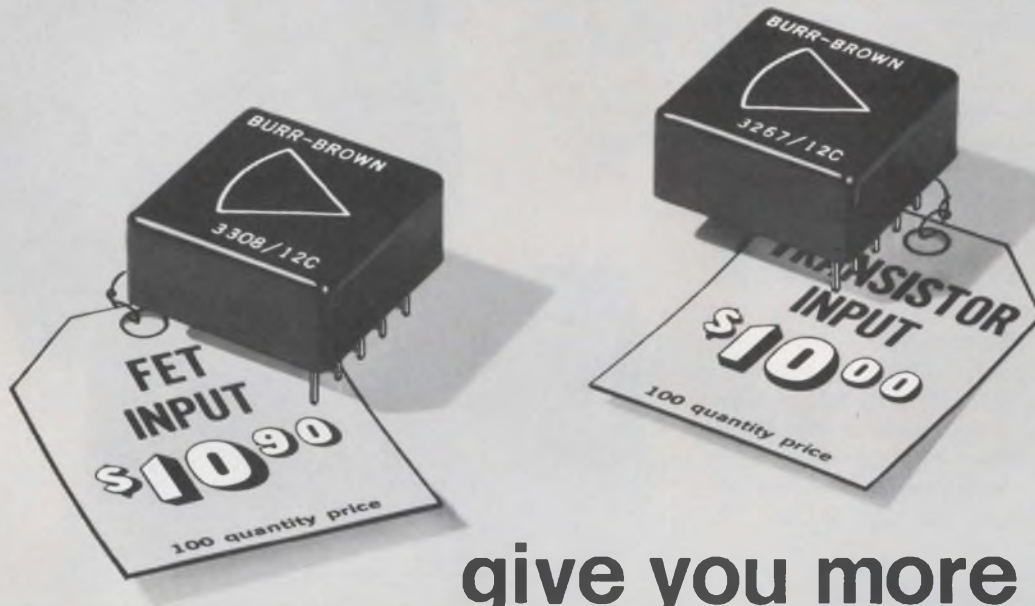

give you more than you bargained for!

Here are two new general purpose operational amplifiers that will meet the performance and price requirements of your most economy-minded applications. There's a FET input unit and a transistor input unit, both with the built-in quality you expect from Burr-Brown . . . at an unexpected low price.

HIGHLIGHT SPECIFICATIONS	FET INPUT	TRANSISTOR INPUT
Model Number	3308/12C	3267/12C
Voltage Drift, max., -25 to +85°C	50 $\mu\text{V}/^\circ\text{C}$	20 $\mu\text{V}/^\circ\text{C}$
Bandwidth, full power	100 kHz	100 kHz
Bias Current, max., @ 25°C	100 pA	50 nA
Bias Current Drift, max., -25 to +85°C *		0.6 nA/ $^\circ\text{C}$
Open Loop Gain, min.	106 dB	114 dB
Slew Rate, min.	6 V/ μsec	6 V/ μsec
Rated Output	$\pm 10\text{ V @ } 5\text{ mA}$	$\pm 10\text{ V @ } 5\text{ mA}$
100 quantity price, FOB Tucson, Arizona, USA.	\$10.90	\$10.00

*Bias current doubles for every +10°C.

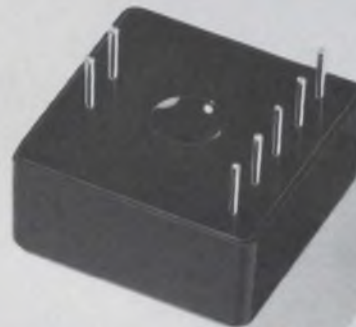

Standard 7 pin package

FOR COMPLETE TECHNICAL INFORMATION on the new economy FET input series or the new economy transistor input series, contact your Burr-Brown Engineering Representative or use this publication's reader service card.

BURR-BROWN

RESEARCH CORPORATION

International Airport Industrial Park • Tucson, Arizona 85706
TELEPHONE: 602-294-1431 • TWX: 910-952-1111 • CABLE: BBRCORP



Operational Amplifiers
Instrumentation Amplifiers
Function Modules
Active Filters
Power Supplies

ENGINEERING REPRESENTATIVES: ARGENTINA, BUENOS AIRES — Boris Garfunkel E Hijos S.A. / AUSTRIA, VIENNA — Dipl Ing Peter Marchetti — AUSTRALIA, BURWOOD (VIC.) — Kenelac Imports Pty Ltd. / BELGIUM, BRUXELLES — Delta Equipment S.A. / COLOMBIA, BOGOTA — Instrumentación Henrik A. Langabaek & CIA, Ltda. / DENMARK, GLOSTRUP — V. H. Prins / ECUADOR, GUAYAQUIL — Suministros Técnicos Ltda. / UNITED KINGDOM & IRE, WATFORD — Fluke International Corporation Garnett Close / FINLAND, HELSINKI — Nores & Co Oy / FRANCE, PARIS — Societe S.E.P.T.A. / GERMANY, MUNICH — Dipl Ing Ernst Fay / GREECE, ATHENS — Greek Electronic Company Ltd. / HOLLAND, RYSWIJK — Air-Paris International N.V. / INDIA, BOMBAY — Vibronics Private Limited / INDIA, SRIRAMNAGAR — Industrial &

Research Products / ISRAEL, TEL-AVIV — Racom Electronics Co. Ltd. / ITALY, MILANO — Strumentazione Industriale Regolazioni / JAPAN, TOKYO — Kyokuto Boeki Kaisha Ltd. / MEXICO, MEXICO D.F. — Electro Promociones Internacionales S.A. / NEW ZEALAND, AUCKLAND — W & K McLean Ltd. / NORWAY, OSLO — Hugo Risso A/S / PORTUGAL, LISBON — Telectra / PAKISTAN, KARACHI — I. and S. Corporation / SOUTH AFRICA, JOHANNESBURG — David Pollock (Pty) Ltd. / SPAIN, MADRID — Distesa / SWEDEN, STOCKHOLM-VALLINGBY — Teleinstrument AB / SWITZERLAND, ZURICH — Telemeter Electronic AG / TURKEY, KARAKOY — Telekom.

FOR MODEL 3308 CIRCLE 231 ON INQUIRY CARD

FOR MODEL 3267 CIRCLE 232 ON INQUIRY CARD

Can Your Make-or-Buy Decision be Influenced with a \$189.95 Digital Frequency Counter?

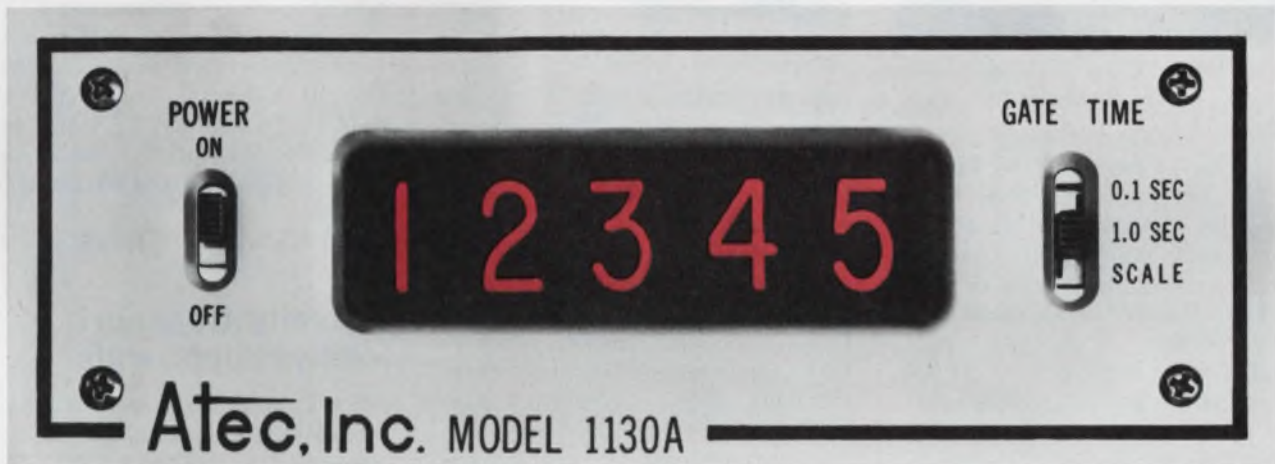

(ACTUAL SIZE)

This new Model 1130A panel-mount counter from Atec operates at rates up to 3MHz, uses the power line for a time base, has an input sensitivity of 500 Mv, and contains its own power supply. Yet the cost is just \$189.95.

Two front-panel controls turn power on and off, and select a measurement time of 0.1 seconds, 1.0 seconds or "totalize." Design is all-IC. Readout is four digits with a one digit overrange and 1-2-4-8 BCD output is available for printer drive. Panel space required is 6 $\frac{5}{8}$ " wide by 2 $\frac{3}{8}$ " high; the 1130A is 12 inches deep. No mounting hardware is required. And you get all of this for only \$189.95.

If you need crystal stability, ask for our 1131A. It contains the same features as the 1130A, plus BCD outputs and gate times of 0.001, 0.01, 0.1, 1 and 10 seconds. The crystal has 1 part in 10⁶ stability. The 1131A costs \$325. Quantity discounts are available.

Send us the conditional purchase order below. We'll send you an 1130A or an 1131A. Use it for 10 days and then decide whether you'll make or buy.

Atec, Inc.

1125 LUMPKIN STREET, HOUSTON, TEXAS • PHONE (713) 468-7971
MAILING ADDRESS: P.O. BOX 19426 • HOUSTON, TEXAS 77024

Please send me an

- Atec 1130A
 Atec 1131A

for evaluation.

If it won't do the
job, I'll return it
within 10 days with-
out obligation.

My purchase order number is _____

Name _____ Title _____

Company _____

Address _____

City _____

State _____ Zip _____

INFORMATION RETRIEVAL NUMBER 216

Magnetic tape readers accept 800 bits/in.



Datran Corp., 179 West Rocks Rd., Norwalk, Conn. Phone: (203) 847-9669.

Working at rates of 200, 556, or 800 bits per in., series 8500 IBM-compatible incremental/synchronous magnetic tape readers function over seven or nine tracks as well as bidirectionally in all three read modes. Their high-speed data transfer rates involve up to 24,000 characters per second; synchronous data transfer rates can be 1000 characters per second; incremental/asynchronous data transfer rates of 600 characters per second are possible.

Booth No. 22009 Circle No. 341

Key entry system links 8 stations



Inforex, Inc., 21 North Ave., Burlington, Mass. Phone: (617) 272-6470. P&A: \$610/month; first quarter, 1970.

Basically, a new intelligent key entry system is a central control unit linking as many as eight key entry stations to a large buffer. Programs and entry forms, stored in the memory, can be made available on demand to any of the key-stations. Standard system functions include all keypunch and key verifier functions.

Booth No. 8508 Circle No. 346

Cassette tape recorder has three transports



Dicom Industries, 684 W. Maude Ave., Sunnyvale, Calif. Phone: (408) 732-1060. Price: from \$330.

A new magnetic tape cassette recording system features three independent cassette transports and a universal controller providing simplification of computer interface. In addition, model 344 offers both computer on-line and asynchronous off-line capabilities. Also available are single- and two-transport systems for program control in a dedicated computer system, keyboard data entry and remote data recording.

Booth No. 5903 Circle No. 289

Economy tape handler reels out 24 in./s



Digitronics Corp., 1 Albertson Ave., Long Island, N.Y. Phone: (516) 484-1000. P&A: \$3000; first quarter, 1970.

Compatible with the IBM 360 system, a new low-cost magnetic tape handler operates at 24 inches per second, handles 8-1/2-in. reels and includes all read/write, servo and motion control electronics. Model 3600 handles 800, 566, or 200 bits per inch, 1/2-in. wide magnetic tape, and has a high-speed rewind of 120 inches per second.

Booth No. 1301 Circle No. 291

Read-only memory stores 2 x 10⁵ bits

Memory Technology, Inc., 83 Boston Post Rd., Sudbury, Mass. Phone: (617) 443-9911.

Called the Multiple Small Braid System, a new family of Braid transformer read-only memories is said to offer the largest capacity in the industry—up to 200,000 bits. Capacities range from 512 to 8192 words with 24 to 48 bits per word. The system is field expandable in 512-word increments, and field alterable since individual bits, words or the entire memory contents may be changed within a few minutes.

Booth No. 4405 Circle No. 270

Cassette transport follows commands

International Computer Products, Inc., P.O. Box 34484, Dallas, Tex. Phone: (214) 239-5381. P&A: from \$285; stock.

Using a spindle drive to reduce tape wear, digiDeck general-purpose two-track tape transport can record data on standard cassettes under program control, automatically move the tape, and upon command, playback the recorded data. The unit uses convenient plug-in modules, and can be supplied in four versions: tape control only, read only, write only, and a read/write model.

Booth No. 6426 Circle No. 271

Numeric data terminal displays keyboard entry

Applied Peripheral Systems, Inc. sub. of Computing & Processing Inc., P.O. Box 36221, Houston, Tex. Phone: (713) 785-5040. Price: \$1850.

Suitable for most computer time-sharing services, a new numeric data terminal, model DG-3, stores and transmits ASCII-coded characters in teletype format. Numbers on the keyboard, up to twelve successive characters, are stored in the memory and are immediately shown on a lighted Nixie display.

Booth No. 6422 Circle No. 273

Facts.

The Mark 260 delivers more of them...with less fuss, bother and cost...than any other oscillograph you can buy.

Facts start with accuracy.

And the Mark 260 is about as accurate as you can get. We *guarantee* 99½%. So when you're looking at the chart of a Mark 260, what you see, is fact. We owe it all to a fool-proof position feedback system that enforces pen position all the way across the chart. There are no springs, no strings. Or any of the other tricky mechanisms that you'll suffer with in other recorders.

Those traces you see are a lot more than just accurate. They're crisp and clear and reliable from one edge of the chart to the other. They won't smudge or smear. (And you can chalk that up to a patented pressurized ink-

writing system that puts the trace into the paper and not just on it.)

You can forget about recalibration problems, too. We took care of that little nuisance at the factory. So change those settings to your heart's delight. The Mark 260 will keep right up with you. And save you piles of time and piles of chart paper in the bargain.

That's what you get with a Mark 260. It's the go-anywhere, do-anything 6-channel recorder by Brush. At a price per channel that will surprise you.

More facts. Less fuss, bother and cost.

Ask your Brush representative for a demonstration. Or write for Mark 260

Bulletin 942-2: Clevite Corporation, Brush Instruments Division, 37th and Perkins, Cleveland, Ohio 44114. We'll include one of the most comprehensive handbooks on signal conditioning you'll ever find.



CLEVITE BRUSH

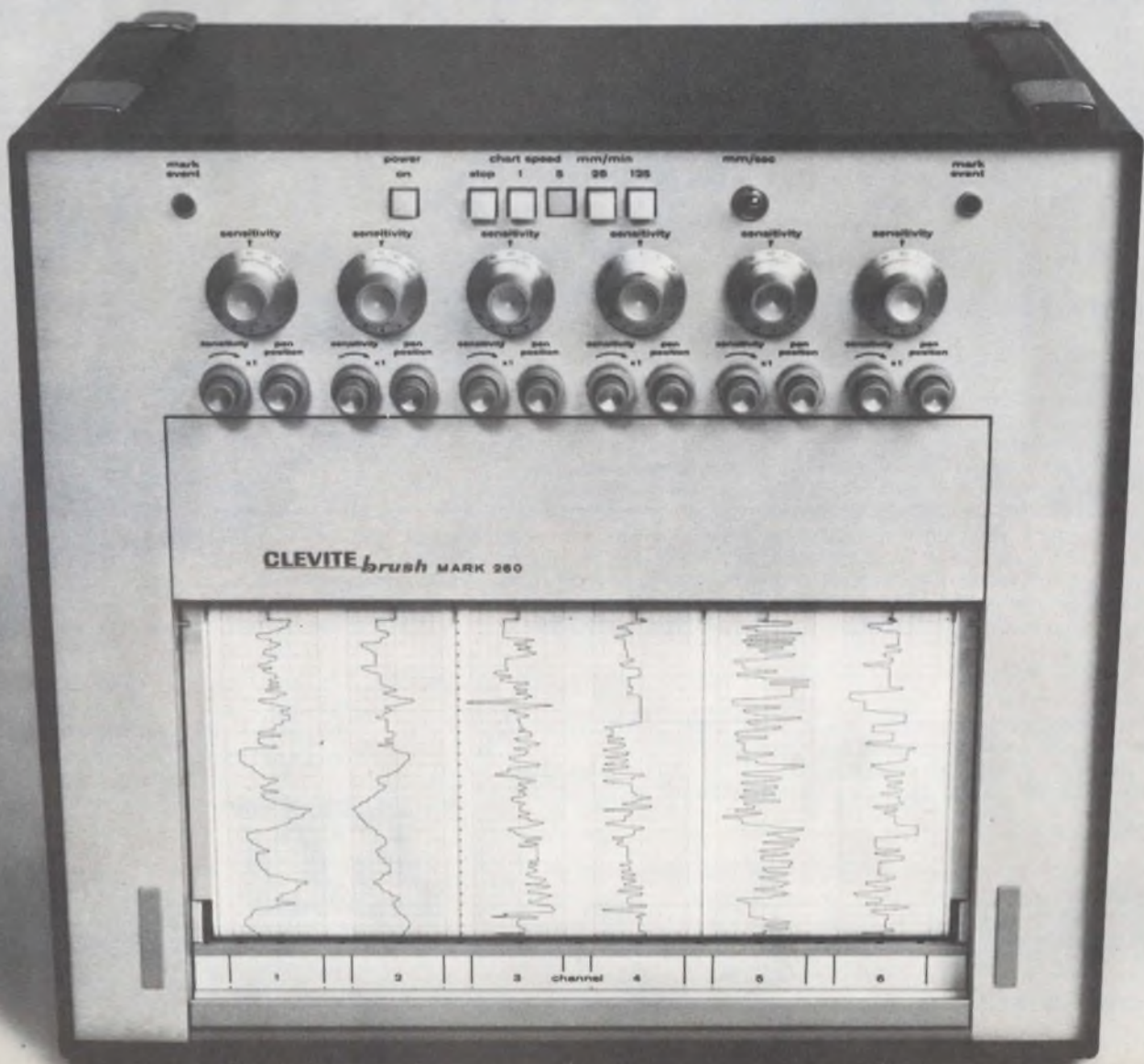

Lots of people have told us they could use an active filter with low power requirements and a low enough price.

How does 0.3 mW at \$10* sound?

Ask for carload prices or send \$12 for an evaluation sample.

You'll find there's a lot to evaluate. Like that power spec—ideal for all kinds of battery-powered gear. Plus a price/performance combination that we think will eliminate a lot of in-house filter making, even for commercial applications. Mail the coupon and a check or P.O. for \$12.00 today (please attach your company letterhead). We'll respond by air with a sample FS-60 and our brand new Filter Design Handbook. 'Till then, here are the basic specifications: Delivers band-pass, high-pass and low-pass outputs simultaneously Any desired form of the second order transfer function Complex zeros anywhere in the S-plane Multi-loop negative feedback for added stability F_c and Q of basic unit can be tuned by adding external resistors Frequency range from DC to 10 kHz Q range from 0.1 to 500 Voltage gain is adjustable to 40dB Supply voltages from $\pm 2V$ to $\pm 15V$ with 0.3 mW power consumption Dimensions: (14-pin DIP) 0.804" x 0.366" x 0.474" IC hybrid construction.

Gentlemen at KTI:

Please send me an FS-60 evaluation sample. Our check P.O. is attached, in the amount \$12.00. Send me more information on:

FS-60 All active filters Hybrid subsystems
 Please add my name to your permanent mailing list

Name _____

Company _____

Address _____

City _____

State _____ ZIP _____

My applications are: _____

PRICES:	1 - 49	\$28	5,000 - 9,999	\$14
	50 - 199	\$23	10,000 - 19,999	\$12
	200 - 999	\$19	*20,000 - 49,999	\$10
	1,000 - 4,999	\$16		

KTI

KINETIC TECHNOLOGY, INCORPORATED

3393 De La Cruz Boulevard

Santa Clara, California 95051

(408) 246-8100 TWX: 910-338-0279

The name to remember for Hybrid Integrated Systems and Active Filters . . .

We put so much in this hybrid thick-film sandwich, we call it our hero.

But it's a hero for more reasons than that. For while our exclusive custom package gives you 50% more circuit area than conventional TO-8 substrates, it doesn't use any more space.

A typical package has 16 leads on 0.100" centers. Conforming to a TO-8 pin configuration.

The outer dimension is .610" square, with height depending upon the number of substrates. A metal cover is sealed to the header to give an hermetic seal of 1×10^{-9} CC per second of helium, at a differential pressure of one atmosphere.

So now you can design a complete system into one module. For instance, a four substrate unit may consist of an operational amplifier, switching circuits, resistor networks and a D/A converter.

What's more, it's not expensive like other hybrid thick-film packages. First, because it contains more. Also, because it's more economical to produce. Since each substrate is analyzed individually, unacceptable ones are replaced without affecting the others.

That means we have higher yields and lower costs.

Also, it means extremely high reliability of the delivered product.

Economy of space and cost, system capability and high reliability make a great combination for a sandwich. To find out what you can put on it, call or write:

Columbia Components Corporation, 60 Madison Avenue, Hempstead, N. Y. 11550, (516) 483-8200. On the West Coast: (213) 272-9525.

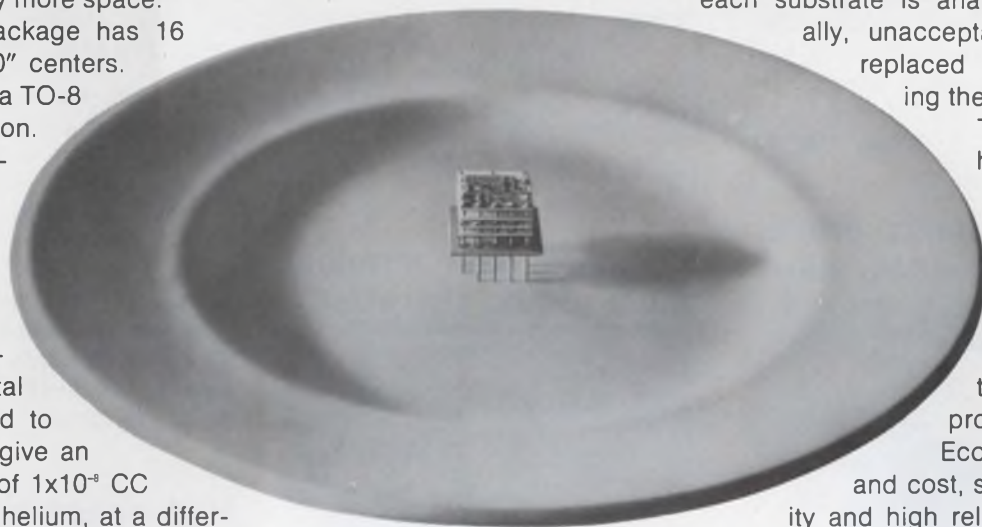

COLUMBIA COMPONENTS CORP.

A SUBSIDIARY OF COMPUTER INSTRUMENTS CORP.

Graphic display system forms character in 1 μ s



Information International, 12435 W. Olympic Blvd., Los Angeles, Calif. Phone: (213) 478-2571. Price: \$70,950.

Employing a character generator with an average writing time of less than 4 μ s per character, a new sophisticated time-shared graphic display system consists of a display controller interfaced to the appropriate computer, and up to six display consoles operating independently of one another. The TSD 1060 allows the user to test concepts, vary graphic information and insert text.

Booth No. 8117 Circle No. 290

Communications printer writes 300 lines/min



Datamark, Inc., Cantiague Rd., Westbury, N.Y. Phone: (516) 333-8910. P&A: \$14,500; 90 days.

Able to print data received over telephone lines, a new data communications line printer operates at a worst-case print speed of 300 lines per minute with a full 65-character type font. Other available type fonts involve 96 and 128 characters, including optical scanning characters, upper- and lower-case letters, and special symbols. The printer uses nylon or silk ribbons.

Booth No. 5912 Circle No. 347

Self-contained console protects input data

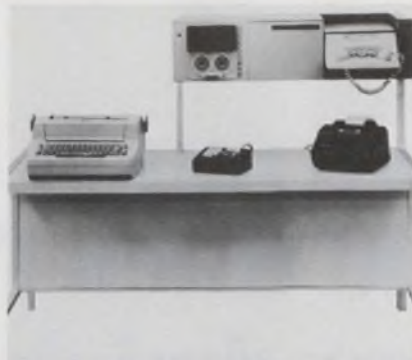

Computer Communications, Inc., 701 W. Manchester Blvd., Inglewood, Calif. Phone: (213) 674-5300.

Performing several functions in a single console, a new self-contained data terminal offers the multiple advantages of data protection, elimination of keypunch errors, and efficient use of phone lines and computers. The CAL 30/30 accepts operator input on standard typewriter and adder keyboards, records data on magnetic tape cartridge, and transmits to a computer via phone line.

Booth No. 10001 Circle No. 287

Keyboard data terminal packs 280k characters



Tally Corp., 830 S. 180th St., Kent, Wash. Phone: (206) 251-5500. Price: \$395/month.

Featuring keyboard-to-tape data entry, a new data terminal provides a storage capacity of 280,000 characters per reel, with 140,000 characters available on each of two data channels. Model 1021 operates with a Bell 202C-2 data phone or equivalent modem that transmits or receives at 1200 bits per second. During transmission, the new terminal exercises error detection and correction routines.

Booth No. 3109 Circle No. 349

Telephone terminals sense line conditions

Victor Comptometer Corp. Business Machines Group, 3900 N. Rockwell St., Chicago, Ill. Phone: (312) 539-8210.

Unlike non-intelligent terminal systems, series 800 telecommunications terminals respond to the changing conditions inherent in a telecommunications environment. The new terminals are on-line to a large central computer and off-line to magnetic tape units and a communications control. They feature control, logic, arithmetic and storage capabilities.

Booth No. 5 Circle No. 268

Plated-wire stack reads in 150 ns

Lockheed Electronics Co., Data Products Div., 6201 E. Randolph St., Los Angeles, Calif. Phone: (213) 722-6810.

Designed for use in nondestructive readout memory systems, a new plated-wire memory stack provides read cycle times of 150 ns or less and write cycle times of 300 ns. Measuring only 13 by 17 by 1/2 in., the stack contains 73,728 bits that may be organized into any standard configuration between 512 words of 144 bits and 4096 words of 18 bits.

Booth No. 3200 Circle No. 269

High-speed terminal prints and tapes

Novar Corp., 2370 Charleston Rd., Mountain View, Calif. Phone: (415) 964-3900. Price: \$6000.

A new hard-copy impact printer and electronic data transmission terminal can prepare hard copies of business papers while simultaneously making digital copies for high-speed transmission by tape cartridge over regular telephone lines. Model 5-50 is capable of transmitting 240 characters per second; in a basic three-minute transmission period, it can transmit 43,200 characters.

Booth No. 1801 Circle No. 272

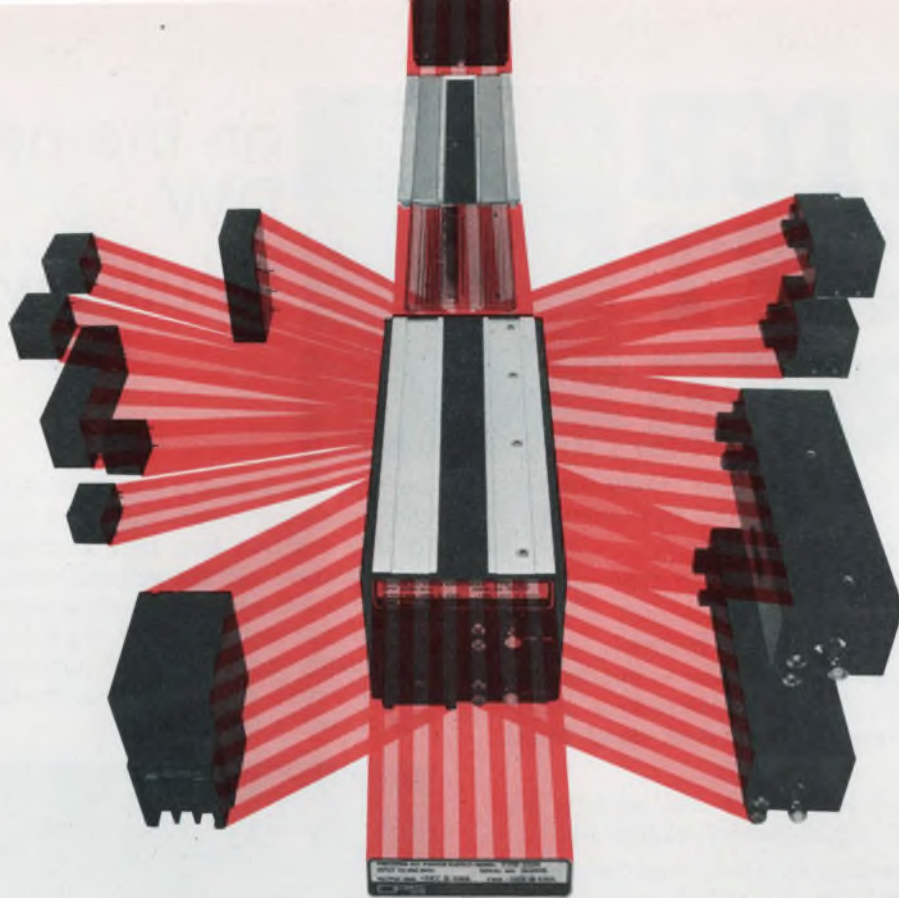

**Computer Power Systems
invents the wireless.**

**Our new 2000-series
power supplies not only give you
the best specs in the
business*, save space and
money (prices start at \$410),
they're also fun to pull apart.**

* 500 V to 5 KV, single or dual. Drift .005% /hr., .01% /24 hours. Precision regulation, less than .001%. Ripple 2 MV P-P max. (Typ. 1 MV). Fred Martin will tell you how this supply will help your CRT, COM, PM-TUBE, FSS or nuclear instrumentation. Ask him. **Computer Power Systems**, 722 East Evelyn Avenue, Sunnyvale, California 94086. (408) 738-0530.

SWITCH CRAFT FORUM



on the new
DW
"Multi-Switch"®*

I can tell you right now, if the new DW "Multi-Switch" doesn't save on space and cost, and offer plenty of versatility it's going to be a dud!

That's the point. Switchcraft designed this compact pushbutton switch to do both. It's not just a scaled down version of an existing "Multi-Switch".

I'll buy your design philosophy so long as you haven't sacrificed the versatility and quality we've been accustomed to on your larger switches. And, don't forget economy.

Let's tackle your points one by one, and see how the new Series 65000 DW "Multi-Switch" shapes up!

We've guaranteed versatility by using simplified modular construction. Essentially, the switch consists of a frame up to 18 stations long, latch bar for function control and switching modules that provide up to 2C (DPDT) circuitry.

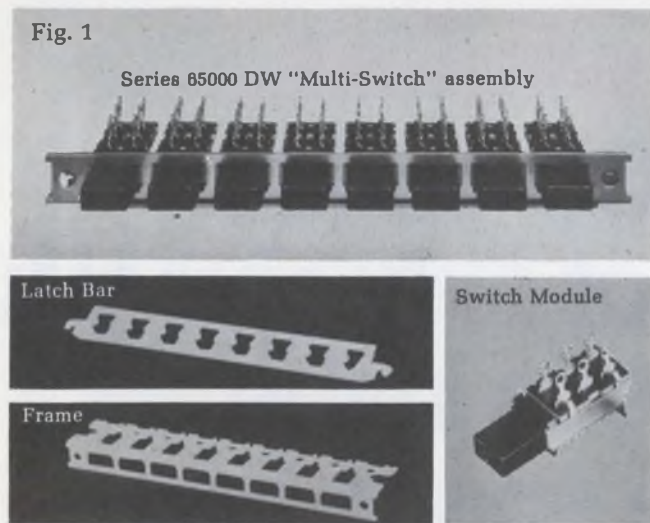
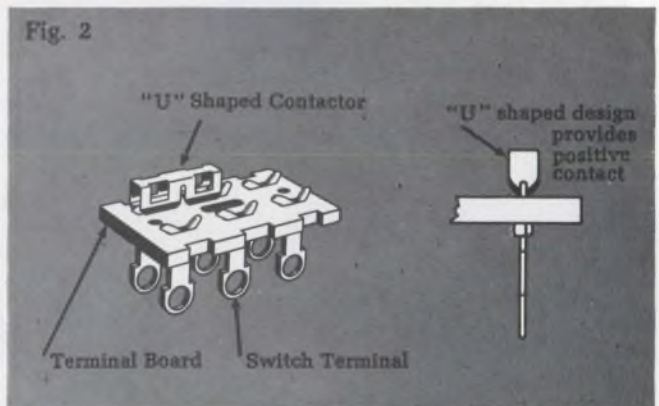

Fig. 1 shows how these elements are combined to complete the switch. The latch bar and mating actuator configuration determine the functional operation, such as: Interlock, All-lock, Non-lock, and even special functions. The push-to-lock, push-to-release function is also available and can be combined with Interlock, All-lock, Non-lock on the same switch frame without any interaction between the various functions.

We don't have space to cover all the versatility details, such as, printed circuit terminals, pushbutton engraving, accommodation for mounting with Tinnerman nuts, etc. JUST CIRCLE THE READER SERVICE NUMBER FOR NEW PRODUCT BULLETIN #174.

*Patent applied for

An example of quality construction is the rigid frame, and double-wipe contactors used for extreme reliability. Fig. 2 shows how the "U" shaped contactor provides positive contact and minimizes "bounce". Also, the molded nylon pushbutton actuators are an integral part of the module. They can't be lost or pilfered. Our quality story ties right into economy. You can't buy a better made, compact multiple-station pushbutton switch for the money.



We'll accept the commercial, only because you have the reputation to back it up. The design looks great, but what about ratings and special circuit applications?

Typical ratings for silver-plated contactors would be 3 amps. A.C., 0.5 amps. D.C. 125v. non-inductive. For dry circuit applications, gold flashed contactors and terminals could be furnished. As usual, we're glad to engineer specials to accommodate your volume requirements.

I'll probably have more questions after we get a few samples on test. In the meantime, I'd like certain members of my staff to get complete engineering details on the DW "Multi-Switch" switch.

Just have them drop us a request on your company letterhead for complete technical scoop. Also, we'll add their name to our TECH-TOPICS mailing list to receive this engineering-application magazine every-other month. Over 10,000 engineers find the application stories very interesting and useful in their work.

*Patent applied for

SWITCHCRAFT
INC.

5529 North Elston Avenue • Chicago, Illinois 60630

HISTORY

**After 60 years
Allen-Bradley appoints
Schweber Electronics —
their 1st distributor for
electronic components.**



Seated, Seymour Schweber, President of Schweber Electronics (left) and Arloe Paul, President of Allen-Bradley.

A kit containing brochures, specifications and price list of Allen-Bradley Electronic Components is now available. Circle reader service number 247.

Call any of these locations for immediate delivery of A-B components:

WESTBURY, NEW YORK: 516/334-7474 □ WALTHAM, MASS: 617/891-8484 □ ROCKVILLE, MD: 301/427-4977 □ CLEVELAND, OHIO: 216/333-7020
HOLLYWOOD, FLA: 305/927-0511 □ HUNTSVILLE, ALA: 205/539-2756 □ TORONTO, CANADA: 416/925-2471

INFORMATION RETRIEVAL NUMBER 247

Control processors work 20-bit words



Philco-Ford Corp., Electronics Group, 3825 Fabian Way, Palo Alto, Calif. Phone: (415) 326-4350. Price: \$9950 typical.

Designed for on-line, real-time, monitoring and control systems, six new control processors offer word sizes of 12, 16 or 20 bits, along with memory cycle times of 1.9 or 3.5 μ s. All units in the 1200 series can test or modify individual bits of information within a word by means of a set of bit manipulation instructions. Compatible peripheral equipment is available.

Booth No. 123 Circle No. 297

Digital plotting system inks 12 inches/second



Milgo Electronic Corp., Computer Graphics Div., 7620 N.W. 36th Ave., Miami, Fla. Phone: (305) 691-1220. P&A: from \$26,000; 60 days.

Drawing at speeds up to 12 inches per second, a new general-purpose X-Y plotting system uses hybrid design techniques to produce smooth fast plots from digital data. The DPS-7 operates on-line or off-line with a seven- or nine-track magnetic tape input. Two models are available having plot surfaces of 30 by 30 in. or 45 by 60 in. A vacuum system holds paper firmly to the plotting surface.

Booth No. 7700 Circle No. 276

Cassette recorder packs 5×10^6 bits



Computer Access Systems, Inc., 3050 W. Clarendon Ave., Phoenix, Ariz. Phone: (602) 279-5591. P&A: \$800; 30 to 60 days.

Depending on writing techniques and data blocking requirements, a new digital magnetic tape recorder permits a packing density in excess of 5,000,000 bits per cassette. Model 300 offers a maximum recording density of 1500 bits per inch and a tape capacity of 300 feet. The unit has read/write capability for tape speeds from 2 to 20 inches per second.

Booth No. 6716 Circle No. 359

Fast computer offers flexibility



Business Information Technology, Inc., 5 Strathmore Rd., Natick, Mass. Phone: (617) 237-2930.

A new high-speed digital computer, model 483, is a general-purpose variable-word-length unit that features an expandable memory, simultaneous input/output, and an extensive system of interrupts. The organization and built-in growth potential of the 483 make it particularly suitable for a number of business, scientific and engineering applications.

Booth No. 6304 Circle No. 360

Serial printer writes at 30 Hz



Automated Business Systems Div., Litton Industries, 600 Washington Ave., Carlstadt, N.J. Phone: (201) 935-2200.

A new asynchronous serial character printer features a print speed of 30 Hz numeric and 25 Hz alpha-numeric, with vertical spacing at 100 Hz, and forward and reverse tabulating at 144 Hz. Under program control, model 30 produces an output of 10 lines per second. Positive detent assures smudge-free printing of one original and up to six hard copies.

Booth No. 5500 Circle No. 344

Digital data test set goes to 9600 bits/s



Transmission Measurements Inc., 1051 Clinton St., Buffalo, N.Y. Phone: (716) 852-4500. P/A: \$4390; stock.

Controlled by either a built-in or an external clock, a new universal data test set generates and receives asynchronous or synchronous digital data at rates from 24 to 9600 bits per second. There are various 1 and 0 patterns for model 1-3, including a 511-bit pseudo-random pattern. The receiver and measuring circuits provide three readings: peak telegraph distortion, bias distortion and error count.

Booth No. 19010 Circle No. 352

THE WORLD'S MOST ACCURATE FREQUENCY SWITCH

FASTER DATA TRANSMISSION

New, GO-NO-GO Audio Switches which fire whenever the input frequency goes above, below, or is within certain definite frequency limits are now available. Accuracies as close as 1 cycle per thousand can be maintained. Maximum response time is the length of two input cycles. All units are completely solid state.

The input frequency can be in the form of a sine or square wave. Or even in pulses in which case it measures the length of time between pulses. Frequencies from 1 hz to 40,000 hz can be handled easily and directly. Higher frequencies can be handled if dividers and/or mixers are incorporated.

Highpass, lowpass, and band-pass functions are all available.

GOSH instruments inc

P.O. BOX 36 • WETHERSFIELD, CONNECTICUT 06109 • (203) 527-4794

INFORMATION RETRIEVAL NUMBER 223

NEW
TELEMETERING
FREQUENCY
SWITCHES
1 hz to 40,000 hz
RESPONSE LIKE
THIS

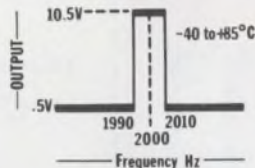

from
\$99.50
Single piece

- **400 cycle power**
- **1% distortion**
- **.5% frequency and voltage regulation**



The completely transistorized model CRS-100A frequency converter (100VA output) offers all this in only 3 1/2" panel height... and high reliability, too!

Others are available rated at 30 VA to 15 KVA with fixed or adjustable output frequencies. Call or write today for complete details.

CML, Inc.

A subsidiary of Tenney Engineering, Inc.
350 Leland Avenue, Plainfield, New Jersey 07062
(201) 754-5502 • TWX: 710-997-9529



INFORMATION RETRIEVAL NUMBER 224

ELECTRONIC DESIGN 23, November 8, 1969



KEPCO TALKS POWER SUPPLY TECHNOLOGY:

APPROACHING THE IDEAL IN CURRENT REGULATION

For partly technical, partly historical reasons, current regulators have long played second fiddle to their voltage regulator cousins. Some of the technical problems derive from the fact current regulators have largely been mere adaptations, retaining a number of fundamental characteristics more suited to voltage than to current control.

These include:

- Dynamics
- Near-zero operation
- Metering

Recent developments with voltage-agile power supplies for computer programming together with the advent of precision I-C amplifiers with controlled offsets have enabled Kepco to develop a current regulator approaching ideal more closely than any previous instrument.

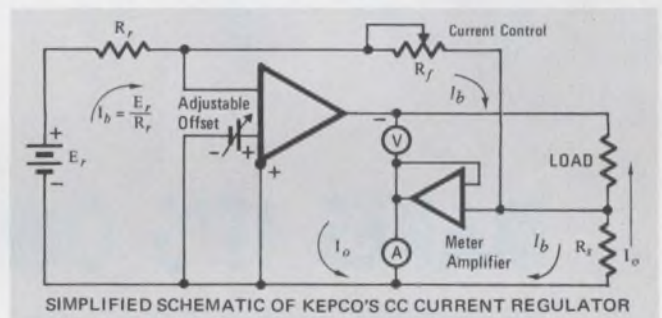

Dynamically, CC regulators are unrestrained by the usual large shunt output capacitor of conventional voltage sources. This means that a change in load resistance will produce an immediate response in the load voltage *without waiting* for a capacitor to charge! It also means that when you short the output (the proper way to idle a current source), you no longer need worry about a current surge from the output capacitor. No capacitor, no surge.

In range, most current regulators have been limited in their near-zero operation by the presence of feedback control current (I_b in the diagram) flowing through the sensing resistor. Because this current flows in the opposite direction to the load current through R_s , it's easy to see how the current in R_s can become zero while the current in your load is not. Hence, most current regulators specify a minimum value. The Kepco CC supply gets around this problem by introducing an adjustable offset across the amplifier's input. By setting this voltage to equal the $I_b R_s$ product, the power supply is fooled into going all the way to zero current.

Meters have always been a problem. How to read the load voltage accurately without shunting the output with an undesirable conductance? Another I-C amplifier to the rescue. It converts *both* meters to high impedance affairs so they don't degrade performance.

There's lots more, of course, multirange control and metering, 10-turn output control, 0.0005% line and 0.005% load regulation. Send for a copy of our new Catalog B-693 and check out the CC Plug-In Current Regulators—six models 0-2A to 0-0.2A and 0-7V to 0-100V.



Write Department CT-05

KEPCO, INC. • 131-38 SANFORD AVENUE • FLUSHING, N.Y. 11352
(212) 461-7000 • TWX # 710-582-2631

INFORMATION RETRIEVAL NUMBER 225

C79

THE NEW **Gulton** MINI BROAD BAND FILTER

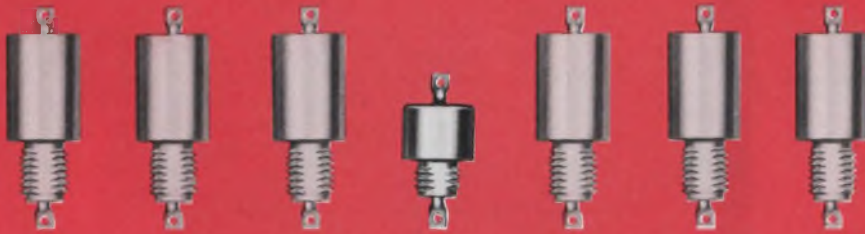

MAKES IT'S OWN GENERATION GAP

Introducing Gulton's "new generation" MINI BROAD BAND filter. The MINI BROAD BAND filter series is another Gulton TOTAL CAPABILITY development for EMI protection. 50% smaller than "old generation" broad bands, this new series offers guaranteed minimum attenuation characteristics over a wide temperature range as compared to the current broad band filters which offer attenuation characteristics at 25°C only. The MINI BROAD BAND filter consists of an "L" type network and has a working voltage of 50VDC, and current ratings from 60ma to 15amps.

Outstanding features include:

- 50% reduction in size over miniature broad band filters.
- Guaranteed minimum attenuation - 55°C to + 125°C with full load applied.
- No derating in working voltage.
- Available in numerous current ratings.

The MINI BROAD BAND filters meet or exceed the applicable parameters of MIL-F-15733. You can find the answers to your EMI problems at Gulton. For information write:

Gulton Industries, Inc.

Metuchen, New Jersey 08840 / Tel. (201) 548-2800 / TWX 710-998-0592

Advertisers' Index

Advertiser	Page
Analog Devices, Inc.	C67
Atec, Inc.	C69
BIT, Incorporated	C4, C5
Burr-Brown Research Corporation	C68
CML, Inc.	C79
Chicago Dynamics Industries, Inc.	C64
Cinch Manufacturing Company	C83
Clairex Electronics, Inc.	C53
Clevite Corporation, Brush Instruments Division	C71
Columbia Components, Inc.	C73
Computer Decisions	C81, C82
Computer Power Systems	C75
Data Memory, Inc.	C47
Data Products Corporation	C51
Datascan, Inc.	C2
Dialight Corporation	C31
Digital Equipment Corporation	C61
Dynamic System Electronics	C33
Electronic Memories, Inc.	C41
General Automation, Inc.	C59
General Electric Co.	C45
General Radio Company	C26, C27
Gosh Instruments, Inc.	C79
Gulton Industries, Inc.	C80
Honeywell Test Instrument Division.....	C60
IMC Magnetics Corp.	C84
Johanson Manufacturing Corp.	C58
Kepeco, Inc.	C79
Kinetic Technology, Incorporated	C72
Lockheed Electronics Company	C28
Mepco, Inc.	C32
Micro Systems Inc.	C34
MicroSwitch, A Division of Honeywell.....	C49
Molex Products Company	C63
Philco-Ford Corporation, Microelectronics Division	C36
Pirgo Electronics, Inc.	C65
Power/Mate Corp.	C54, C55
Power Tec Division, Airtronics, Inc.	C37
Radiation, Incorporated	C57
Raytheon Computer	C43
Rotron Incorporated	C-39
Schweber Electronics	C77
Semiconductor Circuits, Inc.	C42
Singer Company, The, Diehl Division	C29
Switchcraft, Inc.	C76
Sylvania Electric Products, Inc., Electronics Components Group	C35
Telonic Instruments, A Division of Telonic Industries, Inc.	C30
Trio Laboratories, Inc.	C6, C7

BUSINESS REPLY MAIL

No Postage Stamp Necessary if Mailed in the United States

POSTAGE WILL BE PAID BY

COMPUTER DECISIONS

HAYDEN PUBLISHING COMPANY, INC.

850 THIRD AVENUE

NEW YORK, NEW YORK 10022

FIRST CLASS
Permit No. 725
New York, N. Y.





FOR CONNECTOR CONFIDENCE

CINCH ROYAL D MARK III SUBMINIATURES

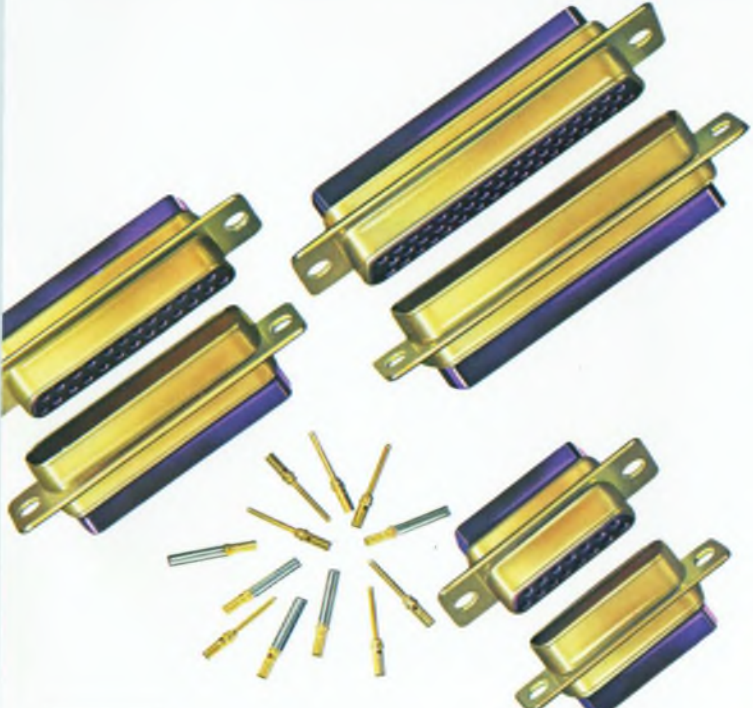

There is an added feeling of confidence that comes with knowing that your D-subminiature connectors will be delivered on time and meet all your specifications at competitive prices.

Cinch Royal D MARK III* rack and panel connectors are confidently used in a wide range of military and industrial applications. They are precision, high density connectors with 0.109" contact centers, meet MIL-C-24308 specifications, and are available in 9, 15, 25, 37 and 50 contact configurations.

The Royal D MARK III incorporates a rear release crimp-on, snap-in contact assembly. A diallyl phthalate insulator provides a hard, closed entry socket for positive contact alignment and high bend resistance. A simple plastic tool permits quick contact removal and replacement without damage to the contact or insulator.

Be confident! Let Cinch supply your Royal D MARK III on fast, dependable delivery schedules. Call your local Cinch Electronics Group Sales Office or write to Cinch Manufacturing Company, 1501 Morse Avenue, Elk Grove Village, Illinois 60007.

IMMEDIATE DELIVERY from stock—can be made through Cinch Electronic distributors.

C-6912

*Manufactured under license agreement with ITT Cannon Electric, Inc.



INFORMATION RETRIEVAL NUMBER 227



CINCH MANUFACTURING, CINCH-GRAFIK, CINCH-MONADNOCK, CINCH-NULINE AND PLAXIAL DIVISIONS OF UNITED-CARR INC., A SUBSIDIARY OF TRW INC.



INFORMATION RETRIEVAL NUMBER 228

IMC's master piece.

**It's entitled, "The Master Catalog."
We squeezed all our products into it.
This limited edition available only from
your IMC sales representative.**

Arizona Division  Rotary solenoids/Electrohydraulic subsystems/Solenoid valves/Hydraulic and pneumatic components

Eastern Division  Airmovers: centrifugals, fans, tubeaxials and vaneaxials/Motors: induction, synchronous hysteresis, reluctance, polarized, torque and servomotors/Solid-state AC-motor controller systems

New Hampshire Division  Boxer, MiniBoxer, SuperBoxer, IMCair and Condor fans/IMCair centrifugal blowers

Western Division  Tormax stepper motors and controllers/Synchros/Resolvers/Solenoids/Flag indicators

All members of the IMC corporate family  IMC Magnetics Corp., 570 Main Street, Westbury, N.Y. 11591, (516) 334-7195

Technology

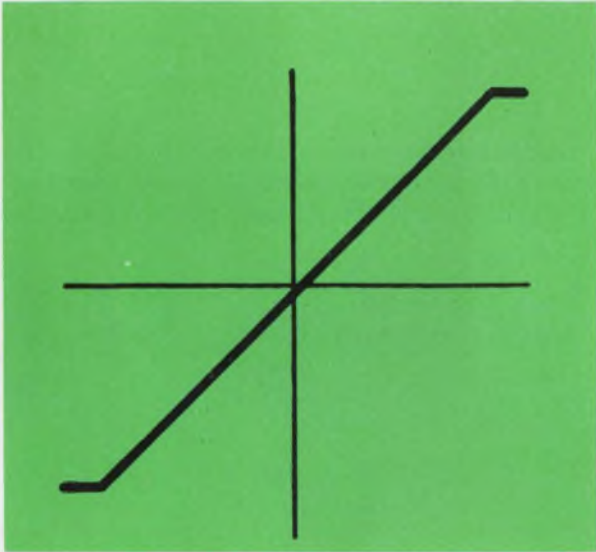

Caution: Check op amps carefully and design test circuits for accuracy. p. 84.

MISTREATED?
 YES
NO

Are you a victim of management "sins"? Find out what nearly 250 other EEs think on p. 94.

Also in this section:

Design stable current-feedback pairs using dual transistors. p. 66.

Build flip-flops with AOI gates. They use less power than NAND arrays. p. 72.

Learn the ABCs of metal purity and watch design reliability grow. p. 90.

Ideas for Design. p. 101.

Build stable current-feedback pairs

using dual transistors. They offer excellent V_{be} and h_{fe} matching for current stability over temperature.

Dual transistors make excellent two-stage feedback amplifiers. Formed as two adjacent chips on a wafer, the transistors are called "sister dice," and their characteristics—and any changes in them—are very closely matched.

These matched characteristics allow stabilizing of the output current up to an ambient temperature of about 150°. And by using the low-level biasing possible with these devices—collector currents of 100 μA to 300 μA —the designer can reduce the noise figure of the device for a chosen source impedance, and minimize the over-all noise of the amplifier. Dual transistors have also found wide application in differential and operational amplifiers and in chopper circuits.

The dual units have very good base-emitter voltage tracking. A tight V_{be} and h_{fe} match and good V_{be} tracking are easily obtainable in dual npns. The tracking parameter ΔV_{be} is usually specified at equal collector currents, generally around 100 μA in each device. With the 2N2060B data sheet, for example, the change in ΔV_{be} from 25°C to 125°C is specified as a maximum of 5 $\mu\text{V}/^\circ\text{C}$ at a current of 100 μA .

A current-feedback pair amplifier using the 2N2060B dual npn transistor is shown in Fig. 1. In this amplifier, part of the emitter current of Q_2 is fed into the base of Q_1 for proper bias. Transistor Q_1 provides bias for Q_2 through direct coupling. Bypass capacitors around the emitter resistors, R_{e1} and R_{e2} , eliminate a large portion of the ac feedback and help raise the gain. Emitter resistor R_{e1} provides enough ac feedback to lower the noise level and keep the amplifier from becoming unstable.

Stability factors define performance

To adequately determine how good ΔV_{be} tracking is used in this amplifier, the dependence of the output collector-current on the base-emitter voltage must first be explored. This can be done with the aid of stability factors.

In single transistors, the change in collector cur-

rent may be expressed as a linear function of the changes in the temperature-sensitive parameters— I_{cbo} , V_{be} and h_{fe} or β . This linear function may be written as

$$\frac{\delta I_c}{\delta T} = S_{I_c, I_{cbo}} \left(\frac{\delta I_{cbo}}{\delta T} \right) + S_{I_c, V_{be}} \left(\frac{\delta V_{be}}{\delta T} \right) + S_{I_c, \beta} \left(\frac{\delta \beta}{\delta T} \right) \quad (1)$$

where

$$S_{I_c, I_{cbo}} = \frac{\delta I_c}{\delta I_{cbo}},$$

$$S_{I_c, V_{be}} = \frac{\delta I_c}{\delta V_{be}},$$

and

$$S_{I_c, \beta} = \frac{\delta I_c}{\delta \beta}.$$

These S terms are called stability factors and are functions of I_{cbo} , V_{be} and β . If the stability factors due to I_{cbo} and β can be neglected, the change in I_c can be expressed solely in terms of $S_{I_c, V_{be}}$. This is a reasonable assumption if the device is made of silicon (I_{cbo} is small at room temperature), and β is less than 100 at room temperature (so that any temperature increase in β will not produce a large value of $(\beta + 1)I_{cbo}$). Thus a device with a relatively low β was chosen for this design.

The change of I_c with temperature, then, is expressed as

$$\frac{\delta I_c}{\delta T} = S_{I_c, V_{be}} \left(-\frac{\delta V_{be}}{\delta T} \right). \quad (2)$$

For the circuit shown in Fig. 1, the total change in output collector current, I_{c2} , may be expressed as the sum of the stability factor due to V_{be1} and V_{be2} ,

$$\frac{\delta I_{c2}}{\delta T} = S_{I_{c2}, V_{be1}} \left(\frac{\delta V_{be1}}{\delta T} \right) + S_{I_{c2}, V_{be2}} \left(-\frac{\delta V_{be2}}{\delta T} \right). \quad (3)$$

By using delta functions in place of the partial terms, Eq. 3 is approximated by

$$\frac{\Delta I_{c2}}{\Delta T} \approx S_{I_{c2}, V_{be1}} \left(\frac{\Delta V_{be1}}{\Delta T} \right) + S_{I_{c2}, V_{be2}} \left(\frac{\Delta V_{be2}}{\Delta T} \right). \quad (4)$$

Thus, in order to have a minimum change in I_{c2} , it

Howard T. Russell, Member of the Technical Staff, Fairchild Semiconductor, Mountain View, Calif.

is necessary to set Eq. 4 equal to zero, and the result is that

$$S_{I_{c2}, V_{be1}} \left(\frac{\Delta V_{be1}}{\Delta T} \right) = - S_{I_{c2}, V_{be2}} \left(\frac{\Delta V_{be2}}{\Delta T} \right). \quad (5)$$

As previously stated, the maximum base-emitter voltage differential change from 25°C to 125°C for the 2N2060B is 5 μV/°C, which means that

$$\frac{\Delta (V_{be1} - V_{be2})}{\Delta T} = 5 \mu\text{V}/^\circ\text{C}, \quad (6)$$

or

$$\frac{\Delta V_{be1}}{\Delta T} = \pm 5 \mu\text{V}/^\circ\text{C} + \frac{\Delta V_{be2}}{\Delta T}. \quad (7)$$

Equation 7 may be substituted into Eq. 5, and the result is

$$S_{I_{c2}, V_{be1}} + S_{I_{c2}, V_{be2}} = \pm (5 \mu\text{V}/^\circ\text{C}) \left(\frac{S_{I_{c2}, V_{be1}}}{\frac{\Delta V_{be2}}{\Delta T}} \right). \quad (8)$$

Since

$$\Delta V_{be2}/\Delta T = -2.5 \text{ mV}/^\circ\text{C}, \text{ then}$$

$$S_{I_{c2}, V_{be1}} + S_{I_{c2}, V_{be2}} = \pm (2 \times 10^{-3}) S_{I_{c2}, V_{be1}} \quad (9)$$

Now all that remains is to determine the stability factors of V_{be1} and V_{be2} for the circuit of Fig. 1. Once this is done, design criteria are derived that will minimize any change in I_{c2} over temperature. Also, as will be seen, the term on the right of Eq. 9 is negligible and is set equal to zero, which makes calculations much easier.

Derive the stability factors

The circuits of Fig. 2 are now used to develop the equivalent base circuit of Q_1 , so that the stability factors can be derived. The loop equation around the base-emitter circuit of Fig. 2a is

$$V_{b1} = Z_b I_{b1} + V_{be1} + (R_{e1} + R'_{e1}) I_{e1}. \quad (10)$$

From Fig. 2b, the Thevenin equivalent voltage V_{b1} and equivalent impedance Z_b are given as

$$V_{b1} = R_{e2} I_{e2} \quad (11)$$

and

$$Z_b = R_f + R_{e2}. \quad (11a)$$

The loop equation now becomes

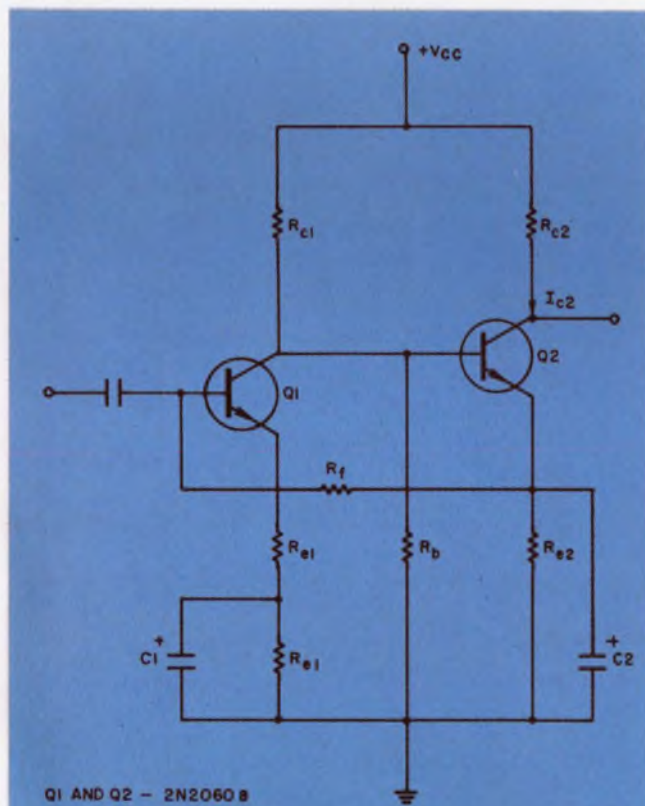

1. Dual npns form a current-feedback pair, in which part of the emitter current of Q2 is fed to Q1 for proper bias. Matched characteristics allow stabilization of the output current up to 150°C.

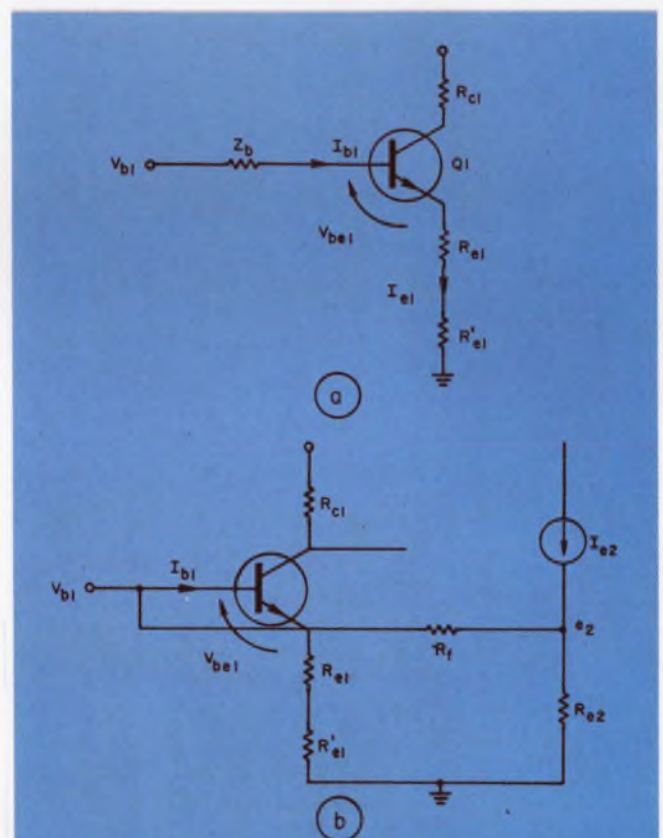

2. Loop equations are derived for the base-emitter circuit (a) and the feedback pair (b) and are solved for I_{c1} and I_{c2} . The stability factor is obtained by differentiation.

$$R_{e2} I_{e2} = (R_f + R_{e2}) I_{b1} + V_{be1} + (R_{e1} + R'_{e1}) I_{e1}. \quad (12)$$

If the collector-base leakage currents are neglected in both devices, then the emitter and base currents in Eq. 12 can be written as

$$I_{e1} \simeq \frac{I_{c1}}{\alpha}, \quad (13)$$

$$I_{e2} \simeq \frac{I_{c2}}{\alpha}, \quad (13a)$$

and

$$I_{b1} \simeq \frac{I_{c1}}{\beta}, \quad (13b)$$

where α and β are room-temperature values and are assumed equal for both devices (since the collector currents are equal). By substituting these equations into Eq. 12 and solving for I_{c2} , we obtain

$$I_{c2} = \frac{\frac{R_f + R_{e2}}{\beta} + \frac{R_{e1} + R'_{e1}}{\alpha}}{\frac{R_{e2}}{\alpha}} I_{c1} + \frac{1}{\alpha} \times V_{be1}. \quad (14)$$

To find I_{c1} in terms of I_{c2} , the circuit model in Fig. 3 is used (the base current I_{b2} can be neglected

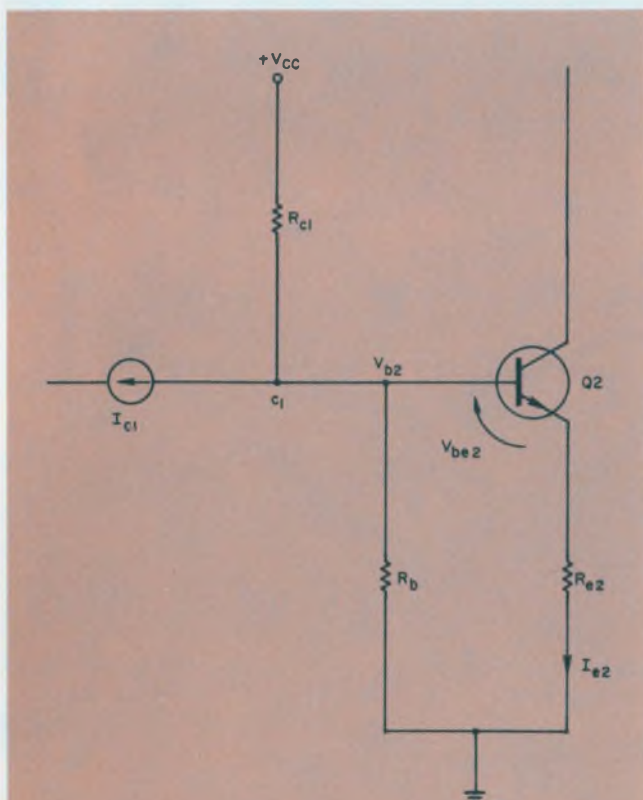

3. The dependence of I_{c1} on I_{c2} is explored by means of this circuit model. The expression for I_{c2} as a function of V_{be1} and V_{be2} is differentiated with respect to V_{be1} and V_{be2} to yield the stability factors δ_c / δ_{be1} and δ_c / δ_{be2} .

when compared to I_{c1}):

$$V_{b2} = \left(\frac{R_b}{R_b + R_{c1}} \right) (V_{cc} - I_{c1} R_{c1}) = V_{be2} + R_{e2} I_{e2}. \quad (15)$$

Solving for I_{c1} ,

$$I_{c1} = \frac{V_{cc} - \left(\frac{R_b + R_{c1}}{R_b R_{c1}} \right) V_{be2} - \left(\frac{R_b + R_{c1}}{R_b R_{c1}} \right) \left(\frac{R_{e2}}{\alpha} \right) I_{c2}}{\left(\frac{R_b + R_{c1}}{R_b R_{c1}} \right)}. \quad (16)$$

Now, substituting Eq. 16 into Eq. 14 and solving for I_{c2} , it is seen that I_{c2} is a function of V_{be1} and V_{be2} .

$$I_{c2} = \frac{\alpha}{A R_{e2}} \left[\left(\frac{R_f + R_{e2}}{\beta} + \frac{R_{e1} + R'_{e1}}{\alpha} \right) \frac{V_{cc}}{R_{c1}} + V_{be1} - \left(\frac{R_f + R_{e2}}{\beta} + \frac{R_{e1} + R'_{e1}}{\alpha} \right) \left(\frac{R_b + R_{c1}}{R_b R_{c1}} \right) V_{be2} \right],$$

where

$$A = 1 + \left(\frac{R_f + R_{e2}}{\beta} + \frac{R_{e1} + R'_{e1}}{\alpha} \right) \left(\frac{R_b + R_{c1}}{R_b R_{c1}} \right). \quad (17)$$

The stability factors due to these parameters are found by differentiating Eq. 17 with respect to

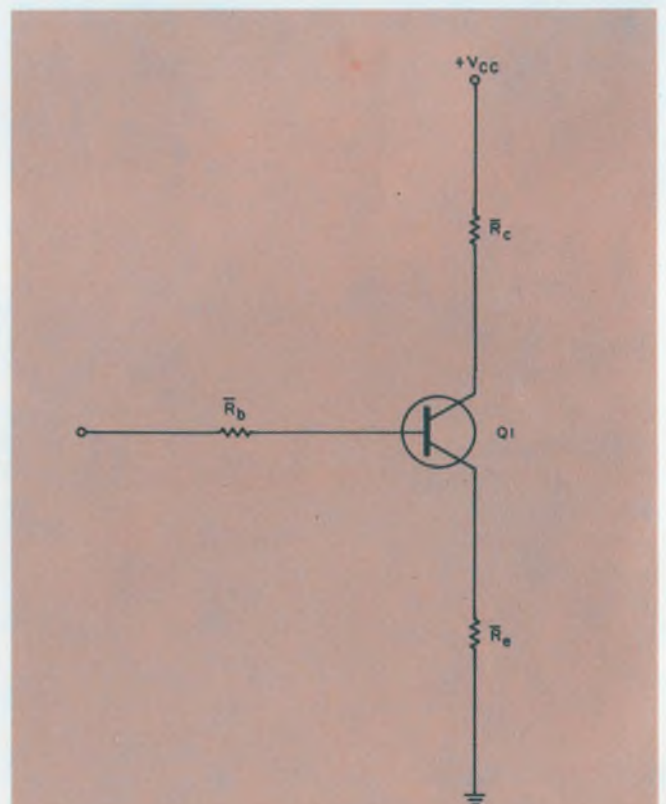

4. The stability of I_{c2} over temperature is indicated quantitatively by Eq. 21. It describes this simplified input stage in which all circuitry is reduced to Thevenin equivalents connected to the input transistor.

V_{be1} and V_{be2} . Thus,

$$S_{I_{c2}, V_{be1}} = \frac{\alpha}{A R_{e2}} \quad (18)$$

and

$$S_{I_{c2}, V_{be2}} = - \left(\frac{\alpha}{A R_{e2}} \right) \left(\frac{R_f + R_{e2}}{\beta} + \frac{R_{e1} + R'_{e1}}{\alpha} \right) \left(\frac{R_b + R_{c1}}{R_b R_{c1}} \right). \quad (19)$$

Substituting these two equations into Eq. 9,

$$\frac{\alpha}{A R_{e2}} - \left(\frac{\alpha}{A R_{e2}} \right) \left(\frac{R_f + R_{e2}}{\beta} + \frac{R_{e1} + R'_{e1}}{\alpha} \right) \left(\frac{R_b + R_{c1}}{R_b R_{c1}} \right) = \pm (2 \times 10^{-3}) \left(\frac{\alpha}{A R_{e2}} \right) \quad (20)$$

The term on the far right can be neglected, so that

$$\beta \left(\frac{R_{c1} R_b}{R_{c1} + R_b} \right) = R_f + R_{e2} + (\beta + 1) (R_{e1} + R'_{e1}). \quad (21)$$

To use the tracking parameter ΔV_{be} to analyze the temperature stability of the output current I_{c2} , it is necessary to do the following:

- Bias both stages for the same collector current,
- Assume the β 's of each device are equal at room

temperature, and

- Set the sum of the base-emitter voltage stability factors equal to zero.

The end result is a selection of the circuit components based on Eq. 21. This equation applies only to the circuit shown in Fig. 1, but for any feedback configuration around the two stages, a general equation that governs the design criteria may be derived.

In short, Eq. 21 is

$$\beta \bar{R}_e = \bar{R}_b + (\beta + 1) \bar{R}_e. \quad (22)$$

The bars indicate the Thevenin's equivalent resistance seen by the respective terminals of the first stage, Q_1 . This is shown in Fig. 4.

The results obtained by using Eq. 21 indicate that I_{c2} changes less than 100 nA/°C, which may produce a 5 per cent change at 150°C. This may be qualitatively explained by considering that there is some increase in β with temperature that contributes to the change in I_{c2} , and that the amount of change in resistor values over temperature also adds to the change in I_{c2} .

A possible solution to eliminate these two contributions would be to use a much lower β device (in which case the amplifier gain would be reduced), and to use 1 per cent metal film resistors, which are more expensive than the 5 per cent resistors used in this amplifier.

The circuit in Fig. 5 is a CFP amplifier using a 2N2060B for which the resistor values satisfy Eq. 21. This amplifier is biased at 248 μ A and 250 μ A for I_{c1} and I_{c2} respectively. The output current, I_{c2} , drifts approximately 88 nA/°C which is about a 4.5% change from 25°C to 150°C. At 1 kHz the voltage gain is about 76 dB and the average 5 kHz output noise is 5 mV. ■ ■

Reference:

• M. S. Ghauri, "Principles and Design of Linear Active Circuits," McGraw-Hill, 1965.

Test your retention

Here are questions based on the main points of this article. Their purpose is to help you make sure you have not overlooked any important ideas. You'll find the answers in the article.

1. Why are dual transistors most suitable for the current-feedback amplifier?

2. What collector current bias-level does the author suggest? Why?

3. What are the three steps that the author suggests for analyzing the temperature stability of I_{c2} ?

4. What percentage change in I_{c2} , from 25°C to 150°C does the author achieve in his circuit?

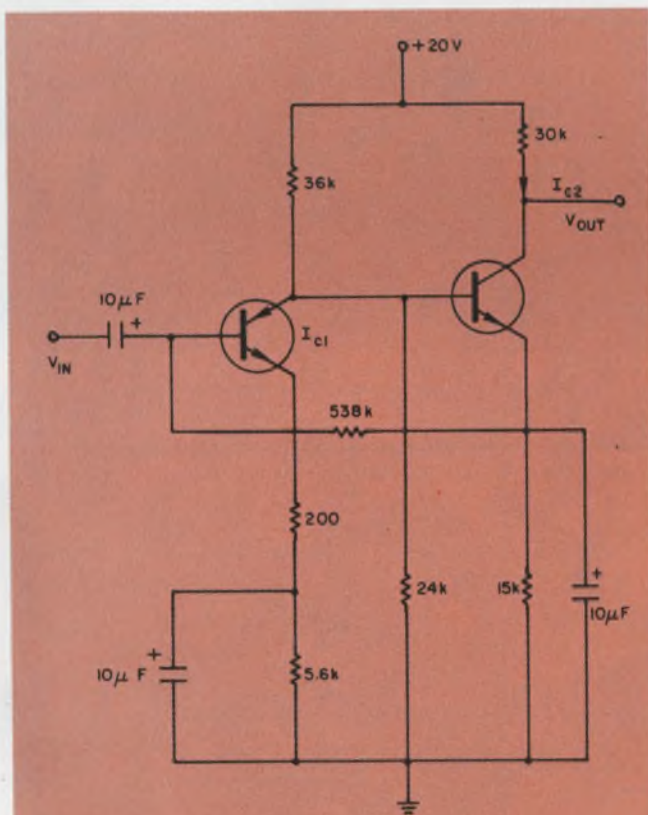

5. A current-feedback pair amplifier using a 2N2060B dual transistor has an I_{c2} drift of about 88 nA/°C, only a 4.5% change from the 250 μ A collector current from 25°C to 150°C. The kHz voltage gain is 76 dB.

BELDEN...new ideas for moving electrical energy

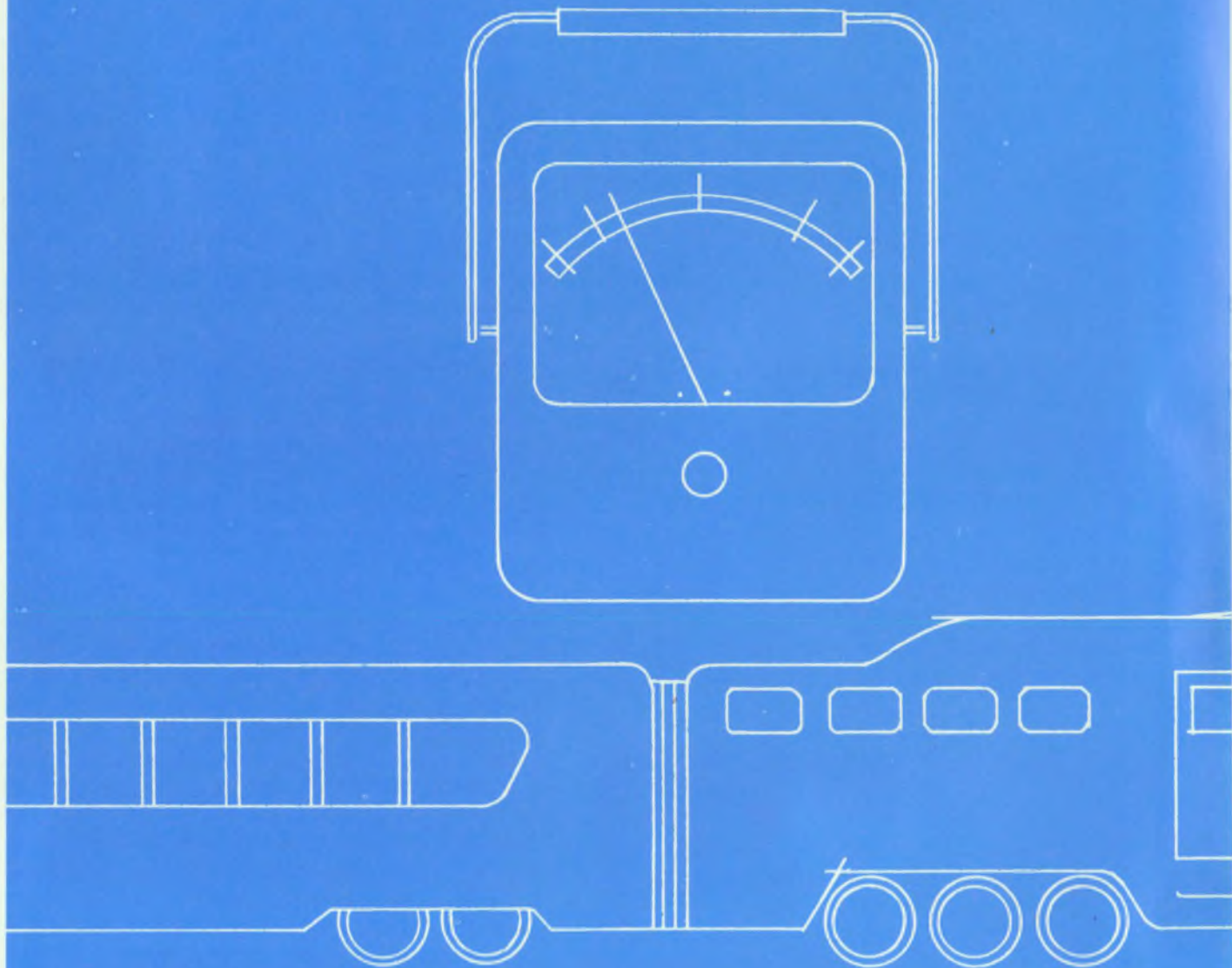

Belden's systems savvy is



BELDEN

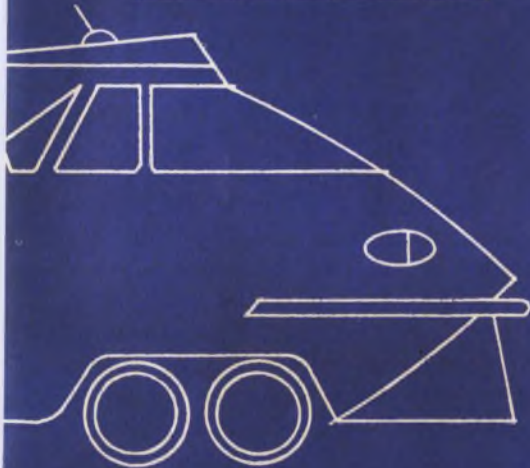
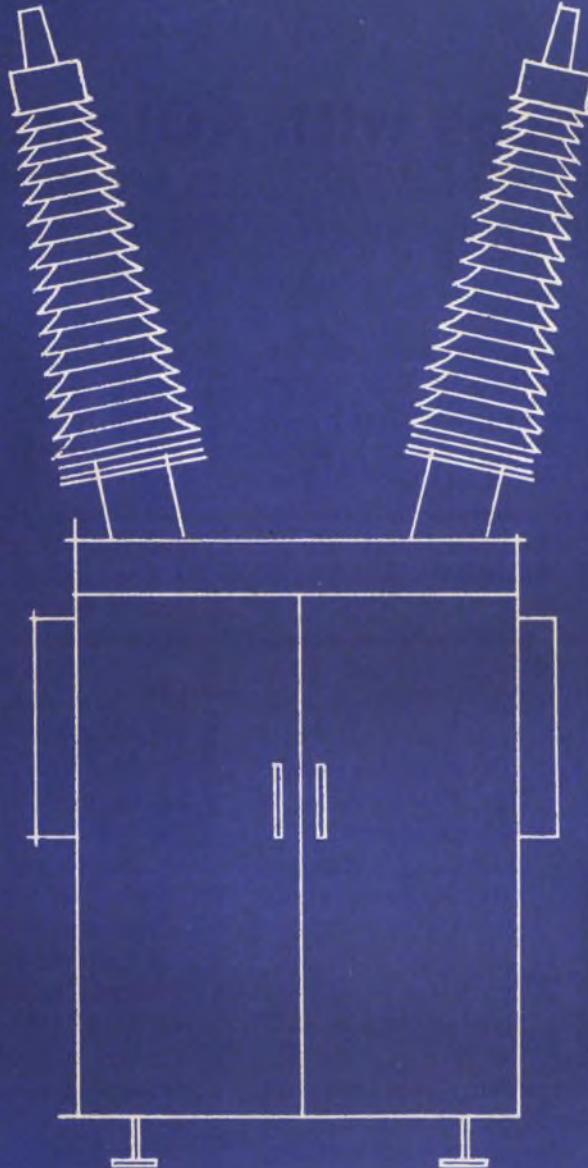
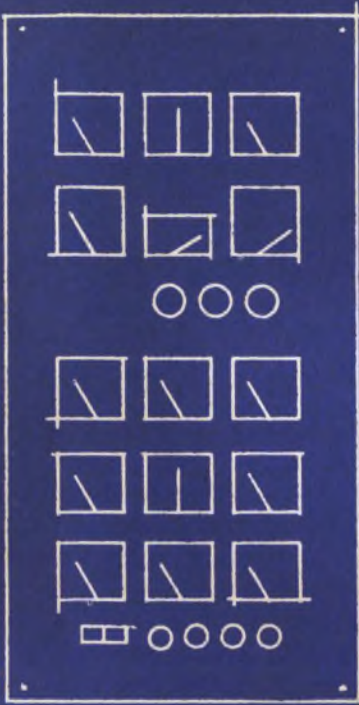

no big deal

It's a lot of little deals, that add up to something big. Like lower costs. Fewer production headaches. Enhanced product reliability. By poking and probing into your product's electrical system and the way it's manufactured and used, Belden Wire Systems Specialists may be able to suggest a wire or cable that costs less. Or that lasts longer, or that takes up less space*. Or maybe they'll suggest a different put-up that saves you assembly time. Or a solution to a stripping problem. They'll also offer you one responsible source for all your wire needs. Because we're the

people who make all kinds of wire for all kinds of systems. So if you're making plans or having problems, get yourself a good deal. Call or write: Belden Corporation, P.O. Box 5070-A, Chicago, Illinois 60680. And ask for our catalog, and the reprint article, "Key Questions and Answers on Specifying Electronic Cable."

*For example: Beldfoil® shielding in Belden cable. It isolates conductors better than anything yet. And it's thinner. You can pack more conductors into a conduit . . . hold down size and weight.

G-2-B

Build flip-flops with AOI gates.

LSI arrays of AND-OR-INVERT gates are smaller and faster than NAND arrays and use 30% less power.

Why use specially designed single or dual flip-flop cells for bistable elements in LSI arrays when it's more economical to interconnect gates as needed to form flip-flop building blocks? The blocks can be characterized and used without reference to their internal gates—if no flip-flops are required, then the uncommitted gates in the array can be used in other building-block configurations.

This approach has been used for over a year in NAND gate arrays (*ED 12, June 6, 1968, pages 82-86*) and is now finding application in AND-OR-INVERT (AOI) gate arrays, which offer speed, dissipation and size advantages over NAND gates. (See box). The LSI arrays, of course, make it possible to use gate assemblies as flip-flops because there are no lead-capacitance or interconnection problems in a well-designed array.

A general-purpose J-K flip-flop

The logic diagram of a general-purpose AOI gate J-K flip-flop is shown in Fig. 1. The circuit consists of a master latch (gates A1, A2, A3, A4, X, and Y) and a slave latch (gates A5, A6, A7, A8, Q, and Q). The master latch is controlled by the S and R inputs only while the CP (clock pulse) input is in the ONE state, and the slave latch is controlled by the master latch only while the CP input is in the ZERO state. The ONE-to-ZERO transition of CP, therefore, causes the contents of the master latch to become insensitive to the master latch, which is then controlled by the S and R inputs. The S_D (set direct) and C_D (clear direct) inputs influence both master and slave latches independently of CP, and therefore asynchronously set and clear the flip-flop, respectively.

Figure 1 tabulates, as a function of time and applied inputs, the output of all gates. For a first-order analysis it is assumed that each NOR has a normalized propagation gate delay of 1

unit of time and that AND gates have negligible delay. Inputs S2, S3, R2, R3, and SD are assumed to be held at logic ONE state throughout. Their operation will be examined later.

At time 0 (Fig. 1), we start with arbitrary initial and stable conditions, flip-flop reset, S1 and S2 zero, clock and C_D at logic ONE. At time 1 the clock is dropped to ZERO; no change in output occurs. At time 2 and S1 input is set to ONE, and at time 3 the clock is raised to ONE.

Two NOR delays are required for the circuit to reach stability at time 5; this is commonly referred to as the "set-up" time of a flip-flop. The outputs do not change. At time 6 the clock is dropped, and after 2 NOR gate delays, the flip-flop is set. At time 9 the C_D line is dropped to ZERO and after two delays, the flip-flop is reset. The operations of R1 and S_D are similar in operation to S1 and C_D , by symmetry.

The operation of S2, S3, and R2, R3, may be inferred by their control of gates A1 and A4. All S inputs must be HIGH for a clocked set operation and all R inputs must be HIGH for a clocked reset operation. The synchronous and asynchronous truth tables and the logic symbol (Fig. 1) may be determined from the sequence table. The most common logic symbol convention (MIL-STD-8068) was chosen for these examples. The uncircled outputs (gate outputs shown without a terminal circle) provide HIGH outputs in response to HIGH inputs (logic ONE), the circled inputs in response to LOW inputs (logic ZERO). The slave may change state on the ONE and ZERO transition of the clock.

After this analysis, the flip-flop is treated as a logic block, and the internal operation need not be analyzed again.

Gated latch

For applications requiring the storage of data, but not shifting or counting, a simple latch will suffice. Figure 2 illustrates an AOI latch of great logic utility. From the sequence table, Fig. 2b, we see that the latch may be set when C_D and the S inputs are at logic ONE, and reset when

Robert M. Walker, Section Head, and Richard B. Derickson, Supervising Engineer, Systems and Arrays Engineering, Fairchild Semiconductor, Mountain View, Calif.

Advantages of AOI gates

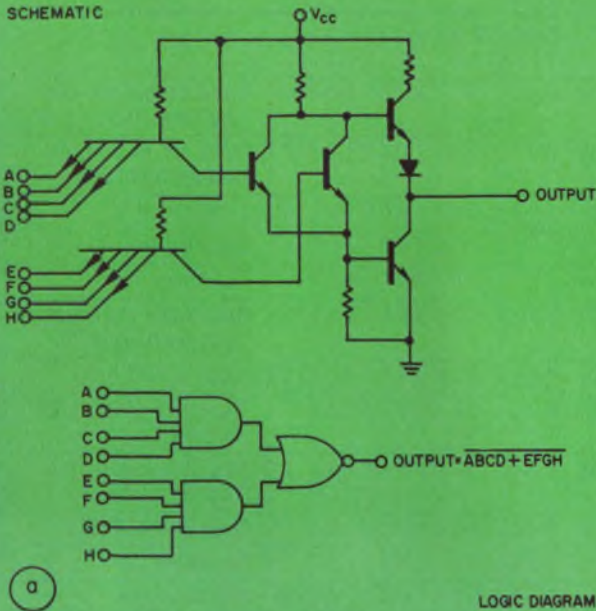

NAND GATE LOGIC
 $G = \overline{BC} + \overline{AB} + \overline{CD} + \overline{AD}$

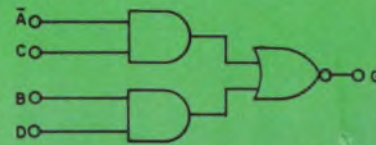
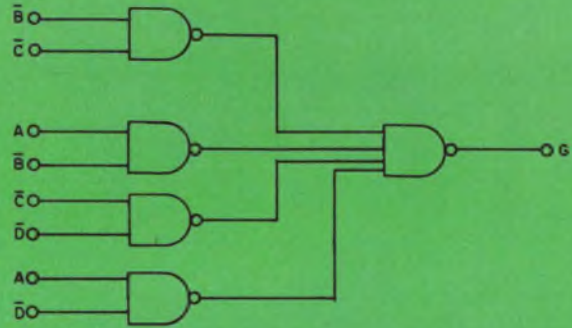

The AND-OR-INVERT (AOI) gate has three very important advantages over the NAND gate in TTL arrays. An LSI logic array of AOI gates typically uses 20 to 30% less silicon area, has 30% lower delay, and uses 20% less power than the equivalent function using NAND logic.

These advantages are derived mainly from the fact that fewer AOI gates than NAND gates are needed to perform a typical logic function. An AOI gate in an LSI array has a logic power approximately 60% greater than that of a NAND gate.

A TTL AOI gate is shown schematically and logically in the figure (a). The AND-OR func-

tion is produced with a single inversion. Usually the output is usable in logic circuit "as is," but extra inverters can be applied when needed.

A single AOI gate requires as much as 25% more silicon than a typical NAND gate because it includes three more components—two transistors and a resistor. Propagation delay is similar to that of a NAND gate—approximately 1 ns per gate—and the AOI gate dissipates more power. A NAND gate dissipates about 13 mW, while an AOI with two ANDs will dissipate about 30% more than this. It is only in combination that AOI circuits offer advantages (b), but here the advantages are significant.

C_p and the R inputs are at logic ONE. The direct inputs S_D and R_D operate logic ZERO levels time 6 through time 11. When both S_D and C_D are ZERO, Q and \overline{Q} are both ONE (at time 13). From this analysis, the truth table and logic symbol are generated.

Tristable flip-flop

An interesting variation of the general-purpose J-K flip-flop is the tristable flip-flop, shown in Fig. 3. It consists of master and slave tristable latches. The master latch may be controlled by the S inputs only while CP and ENABLE are in the ONE state. The slave latch may be controlled by the master latch only while CP or ENABLE are in the ZERO state. The CP transitions, therefore, cause information transfer, much the same as in the J-K flip-flop. Note

that the simultaneous application of ONES to more than one of the inputs of to a tristable flip-flop results in an ambiguous state.

A sequence table for the tristable flip-flop (Fig. 3) is similar to that for the general purpose J-K flip-flop. Again, normalized gate delays are used. Each NOR has a propagation delay of 1 unit of time, and AND gates have negligible delay. At time 0 we start with initial and stable conditions: the flip-flop in state "A"; CP, SB1, SC1 at logic ZERO; and all other inputs at logic ONE. Inputs SA2, SB2, and SC2 are assumed to be held at logic ONE.

The set inputs are changed, followed by a ONE to ZERO transition of CP at time 5. This transition causes the outputs A, B, and C to assume a new stable state, C, at time 7. The set inputs are again changed, followed by a ONE-to-ZERO

(text continued on page 77)

Sequence Table

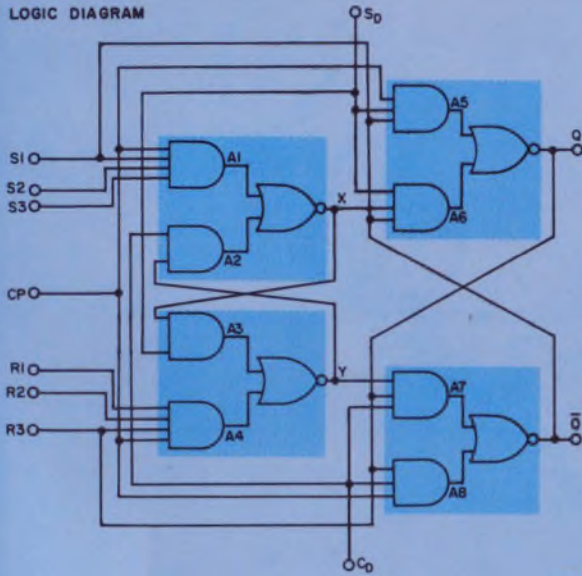

Type	Inputs	Gate Inputs	Remarks
	SRCC	AAXAAYAAAA	Q \bar{Q}
	11	PD 12 34 56 78	
00	0011	0011001100	01 Initial conditions, flip-flop reset; inputs = 0
01	0001	0011000100	01 Clock set to zero, no change of inputs
02	1001	0011000100	01 S1 input set to 1
03	1011	1011001100	01 Clock set to 1
04	1011	1000001000	01 Transitory state
05	1011	1100011000	01 New stable state, outputs unchanged
06	0001	0100010000	01 Clock, S1 set to 0
07	0001	0100010010	11 Transitory state, both outputs 1
08	0001	0100010010	10 New stable state, flip-flop set
09	0000	0000010000	10 Clear direct set to 0
10	0000	0011010100	11 Transitory state
11	0000	0011000100	01 Flip-flop reset

SYNCHRONOUS ENTRY TRUTH TABLE

INPUTS AT T_n		OUTPUT AT T_{n+1}	
S1-S2-S3	R1-R2-R3	Q	\bar{Q}
0	0	NO CHANGE	
1	0	1	0
0	1	0	1
1	1	UNDEFINED	

ASYNCHRONOUS ENTRY TRUTH TABLE
(INDEPENDENT OF CLOCK AND SYNCHRONOUS ENTRY)

INPUTS		OUTPUTS	
S_D	C_D	Q	\bar{Q}
0	0	1	1
1	0	0	1
0	1	1	0
1	1	NO CHANGE	

LOGIC SYMBOL

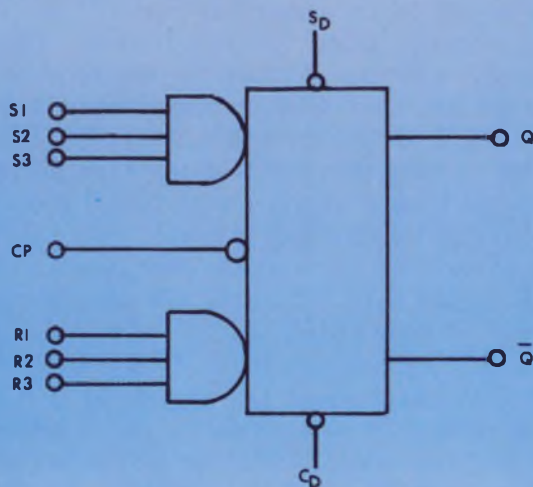

1. Four AOI gates form a J-K flip-flop. The logic diagram is drawn and then analyzed using the sequence table. For first-order analysis all NOR elements are assumed to have normalized delays of 1 and all AND gates to have negligible delay. The flip-flop is considered as a master latch (A1-A4, X, Y) driving a slave latch (A5-A8, Q, \bar{Q}). The master latch may be controlled by the S and R inputs only while the clock C_1 input is in the ONE state, and the slave may be controlled by the master only while the input is in the ZERO state. We see that the ONE to ZERO clock transition causes the outputs to assume their new value ("trailing-edge" triggering). Analysis of the sequence table yields synchronous and asynchronous entry truth tables. Note that for J-K operation, \bar{Q} must be connected to an S input, and Q to an R input. The logic symbol is derived from the truth tables, and then may be used without reference to the operation of the internal gates.

LOGIC DIAGRAM

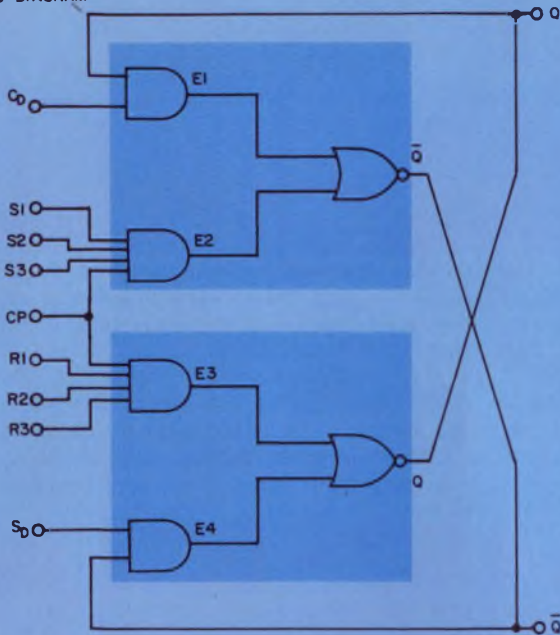

TRUTH TABLE						
UNCLOCKED INPUTS		CLOCKED INPUTS			OUTPUTS	
S _D	C _D	S ₁ ·S ₂ ·S ₃	R ₁ ·R ₂ ·R ₃	CP	Q	Q̄
1	1	X	X	0	NO CHANGE	
1	1	1	0	1	1	0
1	1	0	1	1	0	1
1	1	1	1	1	0	0
0	1	0	0	X	1	0
1	0	0	0	X	0	1
0	0	0	0	X	1	1

Sequence Table

Time	Inputs				Gate Outputs								Remarks				
	C	P	R	S	D	D	D	D	X	Y	D	D	D	D	Q	Q̄	
	1	D	1	1	1	2	3	4			5	6	7	8			
000000	1	1	1	0	0	1	0	0	0	1	0	0	1	1	0	1	Flip-flop reset
000001	0	1	1	0	0	0	0	0	0	1	0	0	0	1	0	1	Clock lowered
000002	0	1	1	0	0	0	0	1	1	1	0	0	0	1	0	1	Transitory state
000003	0	1	1	0	0	0	0	1	1	0	0	0	0	1	0	1	New stable state, output unchanged
000004	1	1	1	0	0	0	1	1	1	0	0	1	0	1	0	1	Clock raised
000005	1	1	1	0	0	0	1	1	1	0	0	1	0	0	0	0	Transitory state, both outputs = 0
000006	1	1	1	0	0	0	1	1	1	0	1	1	0	0	1	0	New stable state, output set
000007	1	1	0	1	0	0	1	0	1	0	1	1	0	0	1	0	R1, S1 set to 01
000008	0	1	0	1	0	0	0	0	1	0	1	0	0	0	1	0	Clock lowered
000009	0	1	0	1	1	0	0	0	1	1	1	0	0	0	1	0	Transitory state
000010	0	1	0	1	1	0	0	0	0	1	1	0	0	0	1	0	New stable state
000011	1	1	0	1	1	1	0	0	0	1	1	0	1	0	1	0	Clock raised
000012	1	1	0	1	1	1	0	0	0	1	0	0	1	0	0	0	Transitory state
000013	1	1	0	1	1	1	0	0	0	1	0	0	1	1	0	1	New stable state

LOGIC SYMBOL

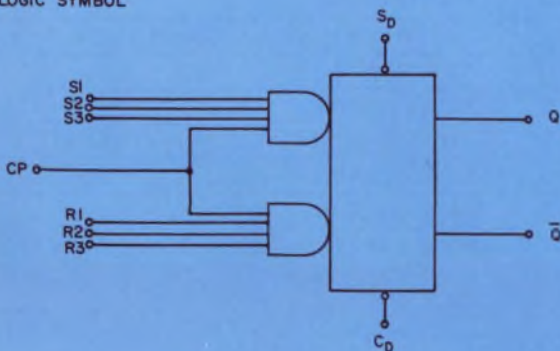

2. Two AOI gates form a gated latch. From the sequence table we note that the latch may be set when the S inputs are ONE (C_p may be considered an S input) or reset when the R inputs are ONE, and that direct inputs C_d and S_d operate with logic ZERO levels. The truth table and logic symbol are derived from the sequence table. The gated latch is useful for general storage applications, where a full master-slave flip-flop is not required.

LOGIC DIAGRAM

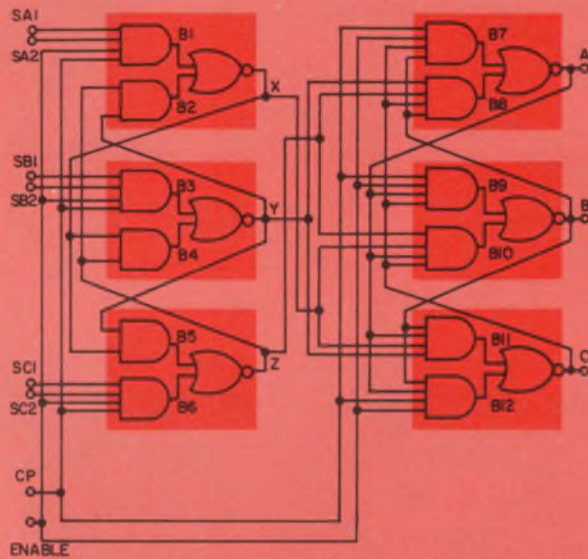

3. The tristable flip-flop is an interesting variation of the J-K flip-flop. Its three stable states result in an unconventional but potentially cost-saving design. When both inputs of an AND gate are at logic ONE, the selected state is obtained on the ONE to ZERO transition of the clock. The three stable states are 011, 101, 110; when the selected output is LOW, the other outputs are HIGH. A synchronous entry truth table and a logic symbol are derived from the sequence table.

Sequence Table

Time	Inputs	Gate Outputs	Remarks
	S S S C A B C	B B B B B X Y Z B B B 1 1 1 P 1 1 1 1 2 3 4 5 6 7 8 9 0 1 2	A B C
000000	0 1 0 0	0 1 0 0 0 0 0 1 1 0 1 0 0 0 0	0 1 1 Initial stable state
000001	0 0 0 1	0 1 0 0 0 0 0 0 1 1 0 1 0 0 0	0 1 1 SA1, SB1, SC1 set to 001
000002	1 0 0 1	0 1 0 0 0 1 0 1 1 1 1 0 0 0 0	0 1 1 Clock set to 1
000003	1 0 0 1	0 0 0 0 0 1 0 1 0 1 0 0 0 0 0	0 1 1 Transitory state
000004	1 0 0 1	0 0 0 0 1 1 1 1 0 1 0 0 0 0 0	0 1 1 New stable state, outputs unchanged
000005	0 0 0 1	0 0 0 0 1 0 1 1 0 0 0 0 0 0 0	0 1 1 Clock set to 0
000006	0 0 0 1	0 0 0 0 1 0 1 1 0 0 0 0 0 1 0	1 1 1 Transitory state, all outputs 1
000007	0 0 0 1	0 0 0 0 1 0 1 1 0 0 0 0 0 1 0	1 1 0 Outputs stable
000008	0 0 1 0	0 0 0 0 1 0 1 1 0 0 0 0 0 1 0	1 1 0 SA1, SB1, SC1 set to 010
000009	1 0 1 0	0 0 1 0 1 0 1 1 0 0 0 0 0 1 1	1 1 0 Clock set to 1
000010	1 0 1 0	0 0 1 0 0 0 1 0 0 0 0 0 0 0 1	1 1 0 Transitory state
000011	1 0 1 0	0 0 1 1 0 0 1 0 1 0 0 0 0 0 1	1 1 0 New stable state, outputs unchanged
000012	0 0 1 0	0 0 0 1 0 0 1 0 1 0 0 0 0 0 0	1 1 0 Clock set to 0
000013	0 0 1 0	0 0 0 1 0 0 1 0 1 0 0 0 0 1 0	1 1 1 Transitory state, all outputs 1
000014	0 0 1 0	0 0 0 1 0 0 1 0 1 0 0 0 0 1 0	1 0 1 Outputs stable
000015	0 1 0 0	0 0 0 1 0 0 1 0 1 0 0 0 0 1 0	1 0 1 SA1, SB1, SC1 set to 100
000016	1 1 0 0	1 0 0 1 0 0 1 0 1 0 0 1 1 0 0	1 0 1 Clock set to 1
000017	1 1 0 0	1 0 0 0 0 0 0 0 0 1 0 0 1 0 0	1 0 1 Transitory state
000018	1 1 0 0	1 1 0 0 0 0 0 0 1 1 0 0 1 0 0	1 0 1 New stable state, outputs unchanged
000019	0 1 0 0	0 1 0 0 0 0 0 0 1 1 0 0 0 0 0	1 0 1 Clock set to 0
000020	0 1 0 0	0 1 0 0 0 0 0 0 1 1 0 1 0 0 0	1 1 1 Transitory state
000021	0 1 0 0	0 1 0 0 0 0 0 0 1 1 0 1 0 0 0	0 1 1 Outputs stable (returned to initial state)

SYNCHRONOUS ENTRY TRUTH TABLE					
INPUTS AT T_n			OUTPUTS AT T_{n+1}		
SA1-SA2	SB1-SB2	SC1-SC2	A	B	C
0	0	0	NO CHANGE		
1	0	0	0	1	1
0	1	0	1	0	1
0	0	1	1	1	0
1	1	X	NOT ALLOWED		
X	1	1	NOT ALLOWED		
1	X	1			

X = "DON'T CARE", i.e. MAY BE 1 OR 0

COUNTING SEQUENCE TABLE

COUNT	Y			Z		
	A	B	C	A	B	C
0	0	1	1	0	1	1
1	1	0	1	1	0	1
2	1	1	0	1	1	0
3	0	1	1	1	1	0
4	1	0	1	0	1	1
5	1	1	0	1	0	1
6	0	1	1	1	0	1
7	1	0	1	1	1	0
8	1	1	0	0	1	1

LOGIC SYMBOL

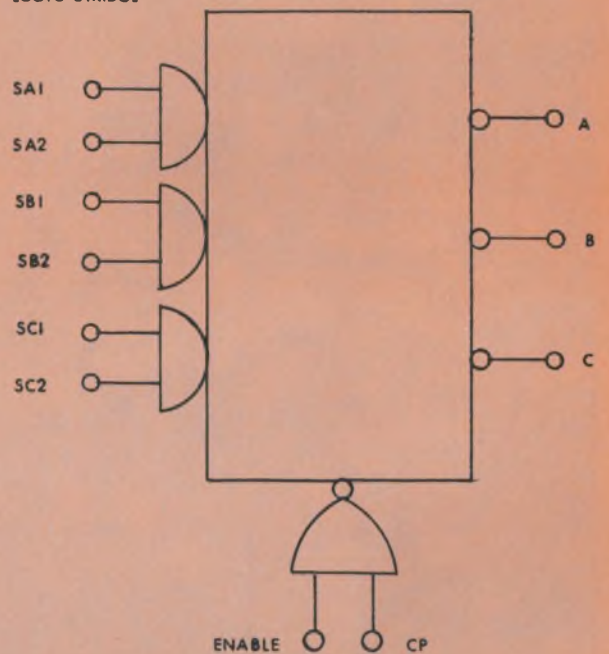

MODULE 9 COUNTER

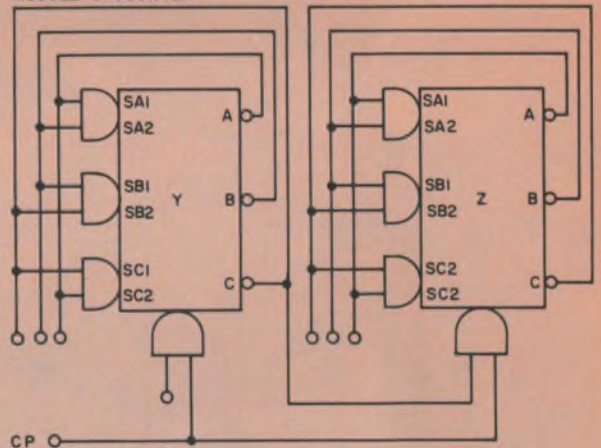

(Continued from p. 73)

transition of CP at time 12, causing the outputs to assume a new state \bar{B} , at time 14.

A synchronous input truth table for the tristable circuit and a logic symbol are shown in Fig. 3. As may be seen from the truth table, the outputs A, B, and C assume three combinations or states: 011, 101, and 110. If all three input pairs are ZERO, the next state will be the same as the present state.

This circuit is particularly useful for applications involving the use of modulo 3. For example, a single tristable may be connected as a modulo 3 counter; it requires only six AOI gates. A modulo 3 counter using the more conventional bistable flip-flop approach would require eight

AOI gates. A modulo 6 counter could use one tristable and one bistable to advantage. A modulo 9 counter using two tristable flip-flops is shown in the figure.

Multifunction flip-flop

The multifunction flip-flop (Fig. 4) differs from the J-K flip-flop only in the complexity of the master latch. Instead of being controlled by a "set gate" and a "reset gate," the master latch is controlled by a group of "set gates" and a group of "reset gates." This merely increases the number of sources that may control the master latch.

At time 0, the flip-flop is reset. With the J,

LOGIC DIAGRAM

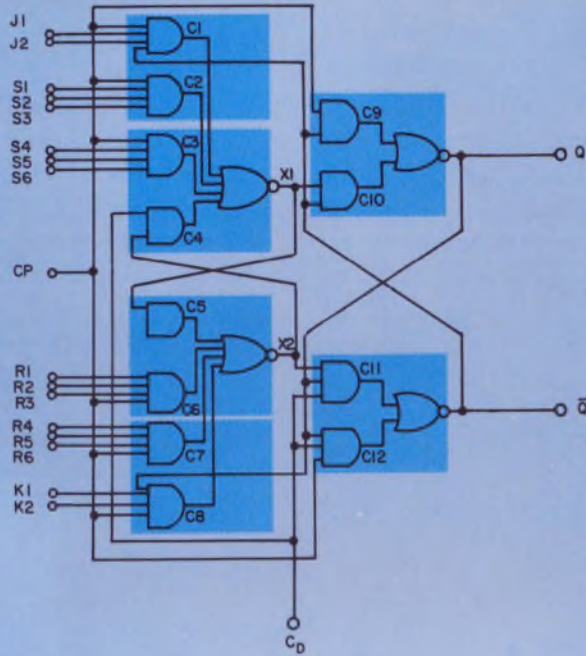

SYNCHRONOUS ENTRY TRUTH TABLE

INPUTS AT T_n						OUTPUTS AT T_{n+1}	
J1-J2	S1-S2-S3	S4-S5-S6	K1-K2	R1-R2-R3	R4-R5-R6	Q	\bar{Q}
0	0	0	0	0	0	NO CHANGE	
1	x	x	0	0	0	1	0
x	1	x	0	0	0	1	0
x	x	1	0	0	0	1	0
0	0	0	1	x	x	0	1
0	0	0	x	1	x	0	1
0	0	0	x	x	1	0	1
1	0	0	1	0	0	TOGGLE	
x	1	x	x	1	x	NOT DEFINED	
x	x	1	x	1	x		
x	1	x	x	x	1		
x	x	1	x	x	1	NOT DEFINED	

X INDICATES INPUT IS A "DON'T CARE",
i.e. MAY BE EITHER 1 OR 0.

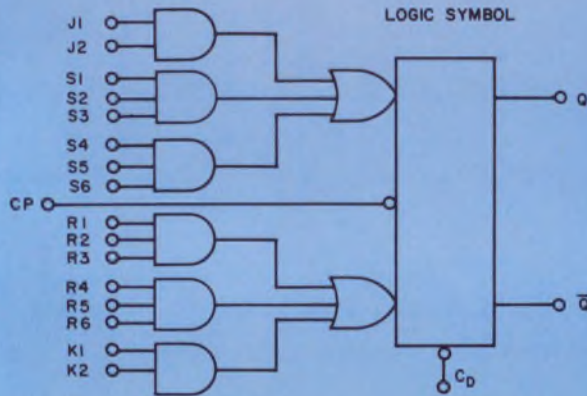

4. The multifunctional flip-flop has a more complex master latch circuit, controlled by a group of set gates and reset gates. The number of sources which control the master latch is thus greatly increased. The operation of the flip-flop is described by the truth table, which indicates that the set and reset condition may come from three sources, as controlled by the 2- and 3-input AND gates. This type of circuit is commonly used in shift-left, shift-right parallel load registers.

K, S, and R inputs ZERO, CP is raised and lowered, and no change takes place. At time 2, J is set to ONE. The clock is raised, then lowered, and the flip-flop is set at time 8. Note the transitory state at time 7 when both Q and QN are ONE. With both J and K set to ONE, the flip-flop toggles at time 14. S and R inputs are examined through time 35. The direct clear C_D is set to 0, and the flip-flop is reset at time 38.

From the analysis, the truth table of Fig. 4 can be generated. As shown, set and reset conditions may result from three input conditions to the 2- and 3-input AND gates. A logic symbol, Fig. 4, illustrates this graphically. This type of

circuit can be used to build a shift-left/shift-right parallel load register.

R-S flip-flop

In all the previous flip-flops described, the master latches are sensitive to their inputs when the clock input (C_P) is HIGH (or ONE) and the slave latches sensitive to their inputs when the clock input is low (or ZERO). The special-purpose flip-flop shown in Fig. 5, however, is such that the master latch (gates D1, D2, D3, D4, X, Y) is sensitive to the set and reset inputs only when the clock inputs are low, and the slave

Sequence Table

Time	Inputs	Gate Outputs	Remarks
	CCJSSRRK	CCCCCCCXC	CCC —
	PD114141	12345678129012	111QQ
000000	01000000	0000100010010001	Flip-flop reset
000001	11000000	0000100010110001	Clock raised
000002	01100000	0000100010010001	Clock lowered, S1, K1, R1, R4, set to 1000
000003	11100000	1000100010110001	Clock raised
000004	11100000	1000000000100001	Transitory state
000005	11100000	1001000001100001	New stable state
000006	01000001	0001000001000001	Clock lowered J1, K1, S1, S4 set to 0100
000007	01000001	0001000001001011	Transitory state, both outputs 1
000008	01000001	0001000001001010	New stable state, output set
000009	11000001	0001000101001110	Clock raised
000010	11000001	0000000100000110	Transitory state
000011	11000001	0000100110000110	New stable state
000012	01010000	0000100010000010	Clock lowered K1, R1, R4, S1 set to 0001
000013	01010000	0000100010010011	Transitory state, both outputs 1
000014	01010000	0000100010010001	New stable state, output reset
000015	11010000	0100100010110001	Clock raised
000016	11010000	0100000000100001	Transitory state, output unchanged
000017	11010000	0101000001100001	New stable state, output unchanged
000018	01000100	0001000001000001	Clock lowered, S1, S1, S4, R1, set to 0001
000019	01000100	0001000001001011	Transitory state, both outputs
000020	01000100	0001000001001010	New stable state, output set
000021	11000100	0001010001001110	Clock raised
000022	11000100	0000010000000110	Transitory state
000023	11000100	0000110010000110	New stable state
000024	01001000	0000100010000010	Clock lowered K1, R1, R4, S1 set to 0001
000025	01001000	0000100010010011	Transitory state
000026	01001000	0000100010010001	New stable state, output reset
000027	11001000	0010100010110001	Clock raised
000028	11001000	0010000000100001	Transitory state
000029	11001000	0011000001100001	New stable state
000030	01000010	0001000001000001	Clock lowered
000031	01000010	0001000001001011	Transitory state
000032	01000010	0001000001001010	New stable state, output set
000033	11000010	0001001001001110	Clock raised
000034	11000010	0000001000000110	Transitory state
000035	11000010	0000101010000110	New stable state
000036	01100001	0000100010000010	Clock lowered J1, R4, S1, S4, set to 0100
000037	01100001	0000100010010011	Transitory state
000038	01100001	0000100010010001	New stable state, output set

latch is sensitive to the master only when the clock inputs are HIGH. The set and reset inputs are "active low" (any low set input will set the flip-flop, and any low reset input will reset the flip-flop). Simultaneous low inputs on both set and reset sides of the flip-flop cause an ambiguous state.

The detailed operation of the flip-flop of Fig. 5 is described by the sequence table. At time 0, the flip-flop is reset. On the clock ZERO to ONE transition at time 4, the ZERO on the S1 input causes the flip-flop to set. A ZERO on the R1 input causes the flip-flop to reset at time 13.

Note that the presence of one or more zeros on the input causes an undefined output.

The synchronous entry truth table and logic symbol, Fig. 5, are derived from this sequence table. Basically, any low input (logic ZERO) will act to set (S inputs) or reset (R inputs) on the ZERO-to-ONE clock transition. Two C_P inputs are provided, and a ZERO on either will inhibit clock action.

This design is useful for special applications where a gated "leading edge" clock and active-level LOW (logic ZERO) inputs will control the flip-flop state.

LOGIC DIAGRAM

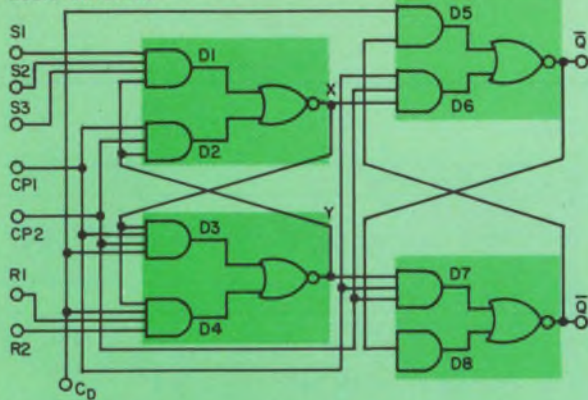

SYNCHRONOUS ENTRY TRUTH TABLE						
INPUTS, T_n					OUTPUTS, T_{n+1}	
S1	S2	S3	R1	R2	Q	\bar{Q}
1	1	1	1	1	NO CHANGE	
0	x	x	1	1	1	0
x	0	x	1	1	1	0
x	x	0	1	1	1	0
1	1	1	x	0	0	1
1	1	1	0	x	0	1
ONE OR MORE ZEROS					UNDEFINED	

NOTE: ASYNCHRONOUS ENTRY TRUTH TABLE SAME AS FIG.2

LOGIC SYMBOL

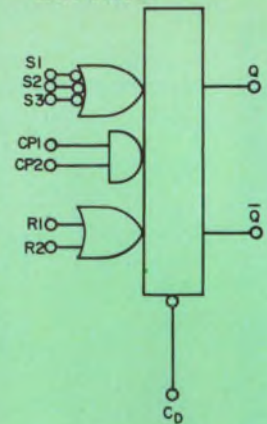

Sequence Table

Time	Inputs				Gate Outputs				Outputs		Remarks
	S	C	S	R	E	E	E	E	Q	\bar{Q}	
	D	D	1	1	1	2	3	4			
000000	1	1	1	0	1	1	0	0	1	0	Output set
000001	1	1	0	1	1	0	1	0	1	0	S1, R1 set 01
000002	1	1	0	1	0	0	1	0	0	0	Transitory state
000003	1	1	0	1	0	0	1	1	0	1	New stable state, output reset
000004	1	1	1	1	0	1	1	1	0	1	S1 set to 1, all inputs set to 1
000005	1	1	1	1	0	1	1	0	0	0	New stable state, both outputs 0
000006	0	1	0	0	0	0	0	0	0	0	SDN, S1, R1 set to 0
000007	0	1	0	0	1	0	0	0	1	1	Transitory state
000008	0	1	0	0	1	0	0	0	1	0	Output set
000009	1	0	0	0	0	0	0	0	1	0	SDN, CDN set to 10
000010	1	0	0	0	0	0	0	1	1	1	Transitory state
000011	1	0	0	0	0	0	0	1	0	1	Output reset
000012	0	0	0	0	0	0	0	0	0	1	All inputs 0
000013	0	0	0	0	0	0	0	0	1	1	New stable state, both outputs 1

5. The special-purpose R-S flip-flop is useful for applications requiring "leading edge" triggering or logic-ZERO set and reset inputs. The operation is analyzed with the aid of a sequence table. The flip-flop outputs change on the ZERO-to-

ONE clock transition and are controlled by a logic ZERO on any input. Two clock C_p inputs are provided, and a ZERO on either input will inhibit clock action. The synchronous entry truth table and logic symbol illustrate the operation. ■■

Test your retention

Here are questions based on the main points of this article. Their purpose is to help you make sure you have not overlooked any important ideas. You'll find the answers in the article.

1. For what 3 reasons are AOI gates better than NAND gates in LSI arrays?

2. What is the advantage offered by the multifunction flip-flop?

3. Why is it more economical in LSI arrays to build necessary flip-flops from gate elements than use specially designed flip-flop cells?

4. What is a common application for the gated latch circuit?

5. What particular advantage does the tristable flip-flop offer?

6. What special advantage is offered by the R-S flip-flop?

NEW TI ELECTRONIC CHEMICALS.

They've already made
our first customer
very happy.

For years, Texas Instruments has been manufacturing electronic chemicals for just one customer: ourselves. They've worked so well for us, we'd like you to try them. The same chemicals we use in silicon production, high-temperature gas reactions and epitaxial technology. All of which require, as you know, purity to parts-per-billion standards plus extremely high integrity in lot-to-lot uniformity.

Perhaps the wealth of experience behind TI chemicals can offer you some improvements... even if it's just the security of a new source. In either case, your files should contain the following data sheets:

- Epitaxy Grade Trichlorosilane (5 and 55 gallon stainless drums)
- Epitaxy Grade Silicon Tetrachloride (5 and 55 gallon stainless drums)
- Boron Tribromide Dopant (50 and 100 gram ampules)

Please write. You'll find us very eager to double our satisfied customer list.

TEXAS INSTRUMENTS INCORPORATED
Chemical Materials Division
P. O. Box 5621 • M/S 924
Dallas, Texas 75222



TEXAS INSTRUMENTS INCORPORATED

A small part of our new, high-capacity electronic chemicals facility.

**The deepest source
for answers to ceramic
magnet questions.**

INDIANA GENERAL *We make it easy for the design engineer.*



Try drawing on Indiana General. After all, we introduced ceramic magnets commercially in the U. S. And since our engineers work for the pioneer in the field, they've a knowledge of ceramic magnet materials and technology that your engineers just can't be expected to match.

Besides materials, where can we help you? In design assistance. Production capacity. New applications. Costs. Plus the broadest materials range anywhere. We can often ship the type, size and shape you want right off the shelf.

Or, maybe we can send you something a little more animated. Like our engineers, who conduct magnet seminars frequently all over the country. If you'd rather stay home and curl up with a good book, try "Ceramic Permanent Magnet Motors," by our James Ireland. It's the definitive work on design. Just what you'd expect from a vice president of the corporation that gave ceramic PM motor design its start.

For some lighter reading on what we can do for you with ceramic magnets, write for our Indox manual, or bulletins.

Mr. C. H. Repenn, Sales Manager
Indiana General Corporation
Magnet Division
Valparaiso, Indiana 46383

Let's see if your ceramic magnet knowhow can make it easier for me. Please send me the following magnet literature:

- Indox Ceramic Magnets manual
- Catalog (stock) Indox Magnets
- Designing DC Motors with Indox Permanent Magnets
- Ceramic Magnet Axial Gap Synchronous Drives.

NAME _____ TITLE _____

COMPANY _____

ADDRESS _____

CITY _____ STATE _____ ZIP _____

Caution: test op amps carefully.

To design test circuits for both speed and accuracy, learn the problems and the sources of error.

The IC op amp is a complex circuit, often containing 25 or more linear devices, and it is very difficult to test. The designer must worry about a wide array of temperature-sensitive parameters and the interactions between them, and he must use extreme care in making measurements to ensure that his test circuit in no way affects the results.

What are some of the pitfalls the designer must avoid to do the job properly? He must know what parameters are significant, what are the possible sources of error, and where the problems lie.

Many separate tests required

The number of significant parameters to be tested, for instance, is often underestimated. A complete check of a typical op amp's performance can include as many as 40 tests—such as those summarized in the Table for the 709. If the circuit is one of the more complex ones, such as the 711 dual sense amplifier, where digital tests (such as strobed output levels, strobed input thresholds, and strobe current) must be included, the number of required tests can easily go over 60. And this is for one temperature only. Check the op amp at two or more temperature levels and the number of tests can go over 100.

All of these tests must be done quickly and economically, of course, and this usually dictates automated handling and perhaps computer control of the test apparatus. Testing speed must be high, the system must be flexible to allow for changing definitions of specifications, and operation must generally be simple and straightforward for use by the production staff. And sources of error must also be anticipated.

Consider sources of error

Allowance must be made for the lead capacitance, lead resistance and leakage resistance in-

variably encountered in remote testing at wafer probers, in temperature chambers, and on automatic handlers. Typical remote test heads involve about an ohm of resistance in series with the contacts, and perhaps 100 megohms of shunt leakage resistance. The possibility of error introduced by these effects must be examined and allowed for in test equipment design.

And the sources of error are not always so obvious. Consider a common, and apparently simple, test of dc gain. Typical transfer characteristics exhibit asymmetrical positive and negative gain, gain droop near the limits of output swing, or decrease in gain near zero output voltage, commonly referred to as crossover distortion (Fig. 1). Gain is also highly dependent on the amplifier load.

Heating effects, too, can cause problems. Many amplifiers have an input stage that is not symmetrically located with respect to the output stage. Heat generated by the output stage causes an unequal temperature shift in the two transistors of the input stage, causing a change in the input offset voltage, which appears as a change in gain with time.

The time required to achieve thermal equilibrium ranges from 20ms to as much as several seconds. It is important that each measurement time be specified, so that the effects of heating are the same for each unit tested. And test sequences should be carefully planned, of course, to maximize the overall test rate (by ensuring, for example, that tests involving high power dissipation in the device do not immediately precede temperature sensitive gain tests, thus avoiding a waiting period for the device to cool).

For a meaningful measurement of dc gain, then, one must specify at least the two output voltage points between which gain is measured, the load, and the measurement time—a far more stringent specification than one would at first expect.

The problems discussed so far are merely a few of those that face the designer, but they serve to illustrate the job he faces in testing op amps. And the difficulties do not end with an

William A. Attridge, Member of the Technical Staff, Teradyne Inc., Boston, Mass.

Table. Basic DC tests for the 709 op amp.

Test No.	Parameter	Conditions
1	V_{D1}	$R_s = 10K\Omega, V_s = 15V$
2	V_{D1}	$R_s = 10K\Omega, V_s = 9V$
3	V_{D1}	$R_s = 100\Omega, V_s = 15V$
4	V_{D1}	$R_s = 100\Omega, V_s = 9V$
5	I_{D1}	$V_s = 15V$
6	I_{D1}	$V_s = 9V$
7	$I_{in} (-input)$	$V_s = 15V$
8	$I_{in} (-input)$	$V_s = 9V$
9	$I_{in} (+input)$	$V_s = 15V$
10	$I_{in} (+input)$	$V_s = 9V$
11	A_v min	0 to +10V, $R_i = 2K\Omega, V_s = 15V, R_s = 100\Omega$
12	A_v min	same as 11, except 0 to -10V
13	A_v max	same as 11, except, $R_i = 10 K\Omega$
14	A_v max	same as 13, except 0 to -10V
15-18	A_v min- A_v max	same as 11-14, except $V_s = 9V, 0$ to +5V, 0 to -5V
19	V_{out} max (positive)	where $A_v = 10,000$
20	V_{out} max (negative)	same as 19
21	V_{out} max (positive)	$V_s = 9V$
22	V_{out} max (negative)	$V_s = 9V$
23	CMRR	-8 to +8V, $V_s = 15V, R_s = 100\Omega$
24	CMRR	same as 23, except $R_s = 10 K\Omega$
25	CMRR	same as 23, except -5 to +5V, $V_s = 9V$
26	CMRR	same as 25, except $R_s = 10 K\Omega$
27	SVRR	$-V_s = +15$ to +19V, $R_s = 100\Omega$
28	SVRR	same as 27, except swinging $-V_s$
29	SVRR	same as 27, except swinging $+V_s$, and $-V_s$
30-32	SVRR	same as 27-29, except $R_s = 100 K\Omega$
33	$+I_{cc}$	$V_{cc} = 15V$
34	$-I_{cc}$	$V_{cc} = 15V$
35	$-I_{cc}$	$V_{cc} = 18V$
36	$+I_{cc}$	$V_{cc} = 18V$
37	Differential Input Voltage (+input)	5V min, $1\mu A$
38	Differential input Voltage (-input)	same as 37
39	Common Mode Breakdown Voltage (positive)	10V min, $10\mu A$
40	Common Mode Breakdown Voltage (negative)	same as 39

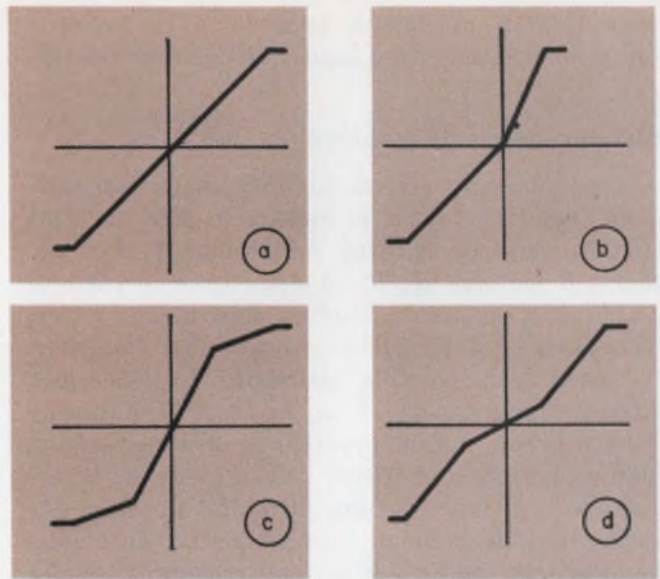

1. The dc transfer characteristics of op amps are seldom ideal, as in the linear transfer curve (a). Practical op amps have asymmetrical positive and negative gain (b), a decrease in gain near their output swing limits (c), a decrease in gain near zero output level (d), or a combination of these.

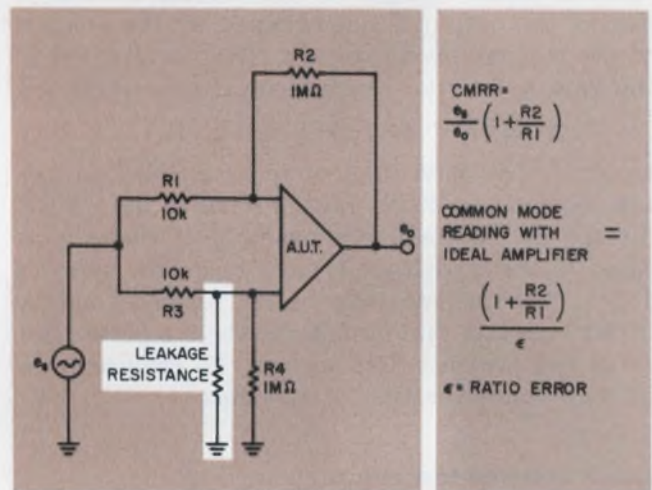

2. This CMRR test circuit requires careful matching of resistor ratios R_1/R_2 and R_3/R_1 , but leakage effects make close matching difficult. Matching error must be less than 0.01% for the circuit to be practical.

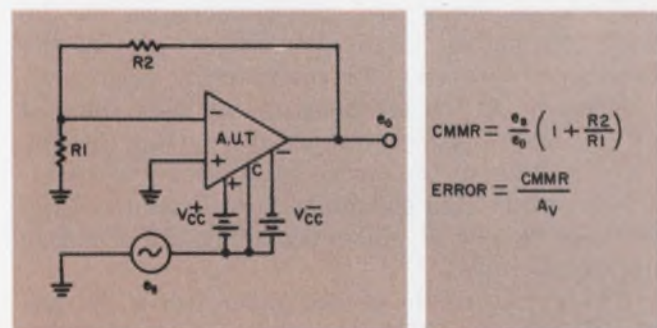

3. Error is inversely proportional to gain in this CMRR test circuit, which limits its usefulness to op amps with comparatively high gain (1×10^5) and low CMRR (1×10^5).

inspection of parameter behavior. The test circuits themselves often cause misleading results.

Test circuits create problems

A popular test circuit for measuring common-mode rejection ratio is shown in Fig. 2. This circuit requires careful matching of the two ratios R_1/R_2 and R_3/R_4 . A difference in ratio of 0.01% will produce a reading equivalent to a rejection ratio of 1 million with an ideal amplifier. It would seem possible, therefore, to measure a device with a CMRR of up to 100,000 with only a 10% error, but in practice it is impossible to hold an accuracy of 0.01% in one megohm. Shunt leakage resistance, often encountered when the socket is placed in an oven or on an automatic handler, can be as low as 100 megohms. Under these conditions the measurement of an amplifier with a CMRR of 100,000 would yield an equivalent reading of 10,000—an error of 1000%.

One approach to the above problem is to maintain the inputs at ground potential and swing the voltages at all other terminals by the desired common-mode voltage. In the circuit shown in Fig. 3, the output is not changed by the amount of the common-mode voltage. That is all right if the gain is infinite, which is what the expression

$$\text{CMRR} = (e_s/e_o) [1 + (R_2/R_1)]$$

assumes. The percentage error resulting from the assumption of infinite gain is equal to the CMRR divided by the gain. For example, if the gain is equal to the CMRR—a typical case—the error is 100%. The designer can be led seriously astray by test circuits that do not answer the needs. But there are systems that answer the requirements of high-volume testing of op amps.

Use a buffered test circuit

One of the critical areas in any test system is the performance circuit, which provides the appropriate electrical environment for the device. In this circuit (Fig. 4) the device under test is buffered to reduce the loading effects of the feedback networks and the capacitance of the cables to the test instrument, and to provide the loop gain necessary for maintaining accuracy.

The gain of the feedback circuit is established at any one of several values by varying R_F . The input voltage of the device can thereby be amplified to levels high enough to permit multiplexing without danger of noise degrading the accuracy of measurement.

The output of the device under test will track the V_o supply in this circuit, precisely establishing the output level of the device.

When all four supplies ($+V_s$, $-V_s$, V_{GND} , and V_o) are set to their nominal values, the output

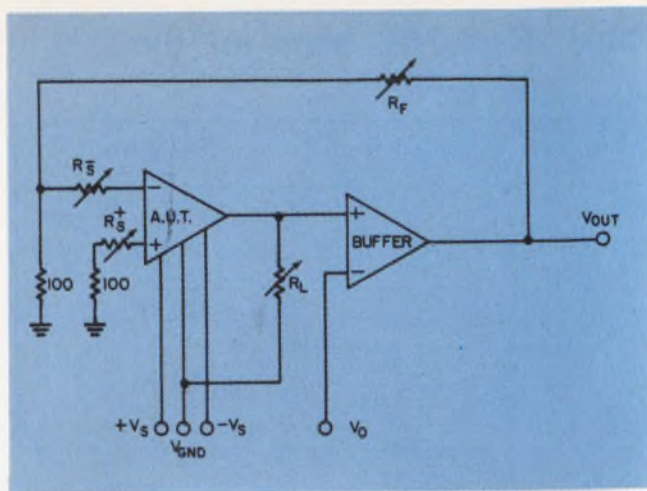

4. A buffered test circuit is best, because it reduces the loading effects of the feedback network, adds loop gain for accuracy and maintains the inputs at an effective ground. The output level of the buffer is a measure of the input offset voltage. By changing the values of the source resistances and the voltage supplies by known incremental amounts, and noting the effects on the output voltage, the user can measure input bias current, sensitivity to supply voltage, gain, and common mode rejection.

level of the buffer V_{OUT} represents the equivalent input offset voltage of the device at any chosen value of source resistance R_s . On those devices where differential input current is high, causing significant error in determining true input offset voltage, the current can be measured and its effect canceled.

Offset voltage is thus measured at an effective zero-ohm source impedance. Input currents are determined by measuring, at the output of the buffer, the change in equivalent input voltage when the appropriate source resistance is changed by a known increment.

Negative bias current is measured by changing the value of the inverting terminal source resistance by a known increment; positive bias current by incrementing the positive terminal source resistance; and differential input current by incrementing both resistances.

The effect of supply voltage change on the input can be measured by incrementing one or more of the four supplies. Thus, gain is measured by incrementing V_o , positive supply voltage rejection by incrementing $+V_s$, and common-mode rejection by incrementing all four.

By providing the ability to program the V_o supply between any two levels, it is possible to measure gain between any two points on the transfer characteristic. Thus, we can measure gain from zero to plus, independent of gain from zero to minus; we can measure the gain around zero to check for crossover distortion; and we can also measure gain near the limits of full output swing. ■■

Our new reed pushbuttons aren't for everyone. They're a superior breed that perform in a superior manner. But if you demand dependability and long life—even under severe environmental conditions—our reed pushbuttons fill the bill.

Heart of each pushbutton is a reed switch with its glass-enclosed, hermetically sealed contacts. Contaminants just can't get in.

Pressing the button moves a permanent magnet over the reed elements, operating the switch. No mechanical contact is made, eliminating a major cause of switch breakdown.

No wonder reed pushbuttons have been successfully tested at many millions of operations, even under the most severe conditions.

Gold-plated stationary contacts make our reed pushbuttons perfect for dry circuits, too. And our design hardware includes collars and buttons in a wide choice of shapes and colors to give you unmatched design flexibility.

Our line consists of 11 series including two mercury-wetted contact forms and two forms for mounting on keyboards. Ratings range from 0.25 to 3.0 amps, SPST to 4 PDT.



Our selection of Designer Line toggle switches (ac/dc and ac-only); rockette switches; and full-size, compact and ultra-miniature pushbuttons give you unlimited design flexibility.

Introducing the pushbuttons that redefine dependability.

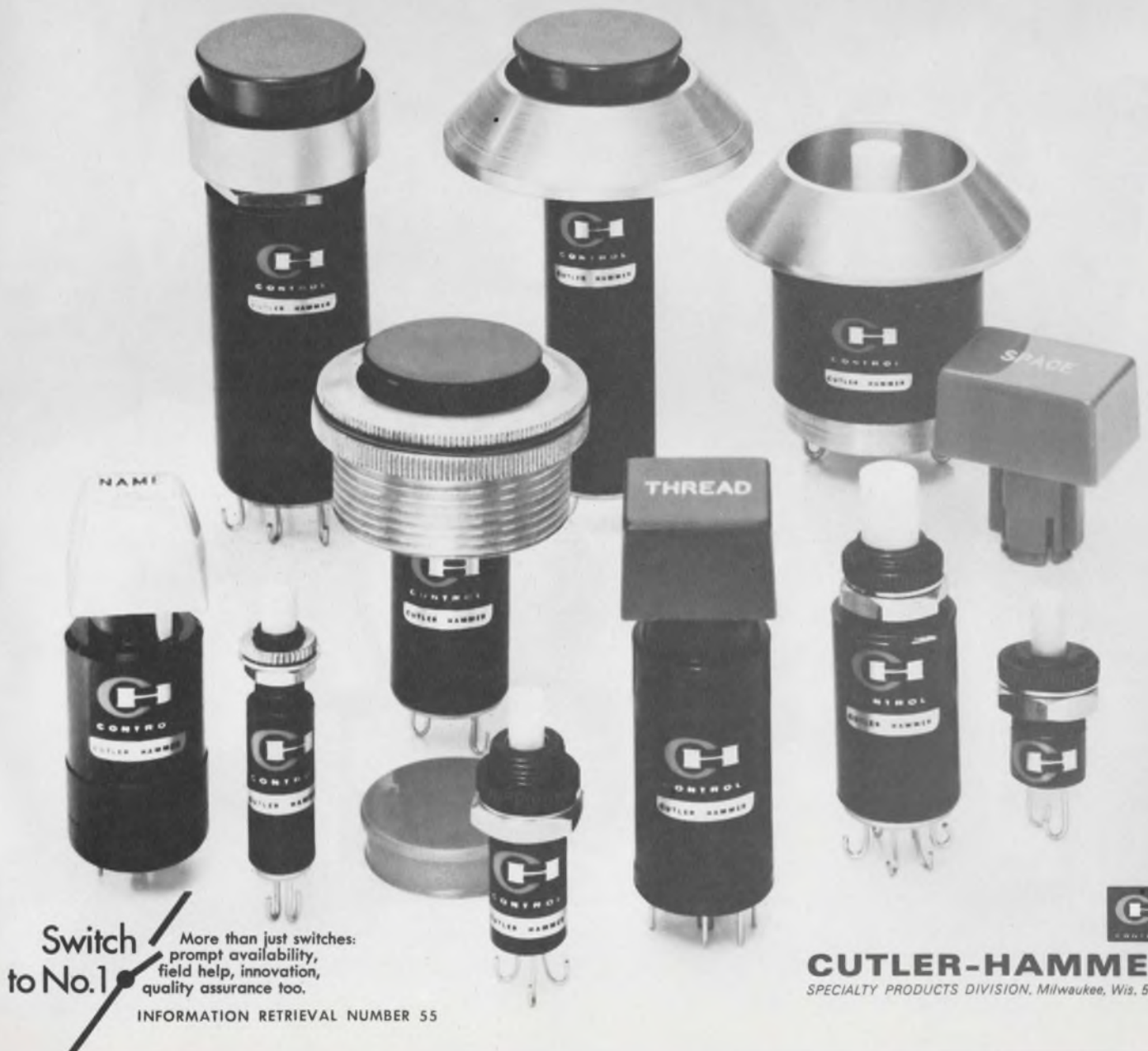

Switch
to No. 1

More than just switches:
prompt availability,
field help, innovation,
quality assurance too.

INFORMATION RETRIEVAL NUMBER 55



CUTLER-HAMMER
SPECIALTY PRODUCTS DIVISION, Milwaukee, Wis. 53201

**Now we're in the memory business.
And here's a bipolar scratch pad**

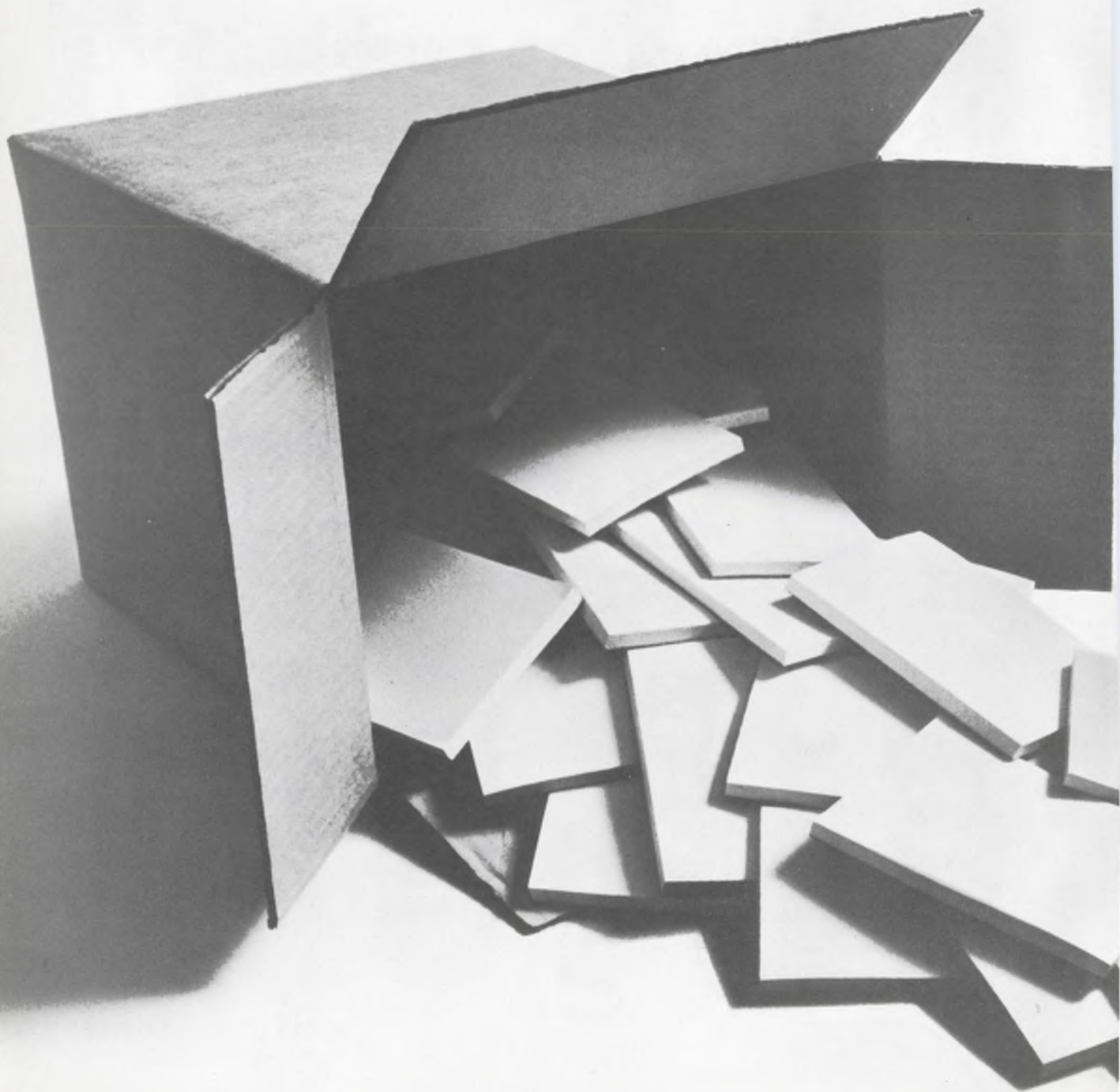

to help you remember.

Anyone with half an eye can see the bright future of the semiconductor memory business. And for months Raytheon's been deploying to nab a lion's slice of that action. We herded up all the processing niceties of our high-rel military components. All the 10th-mil-tolerance magic of our Ray III TTL. All our way-out beam-lead technologies. And now we're in the business.

Leading off with our spanking new 64 bit bipolar RAM. We guarantee a 45 nanosecond read time, but it usually coughs up a word in under 35 ns. And the entire chip, including on-chip address decoding, write and sense circuitry, perks along on only 350 mW. Cost per 100-999 is \$51.50 (-55° to $+125^{\circ}\text{C}$ version) and \$38.00 (0° to $+70^{\circ}\text{C}$). Available now, off distributors' shelves, in a 16-lead DIP. Flatpacks coming up.

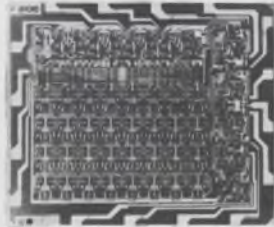

What else? Before the end of the year, look for beam-lead 256-bit and 512-bit multi-chip arrays in 24 pin DIP packages.

And by next June, a monolithic beam-lead 256-bit bipolar scratch pad in a 16-pin DIP. With super-quick access times, thanks to far tighter tolerances and new cell designs. Plus Schottky barrier diodes, washed emitters and like that.

Then in 1970 we'll be unveiling a line of IC read-only memories. And after that it's just a little time until we're mainly in the mainframe memory business.

All of which proves you better keep us in mind when you're in the memory market. The company that gets the ideas and delivers the goods. Raytheon Semiconductor, Mountain View, California. (415) 968-9211.



RAYTHEON

INFORMATION RETRIEVAL NUMBER 56

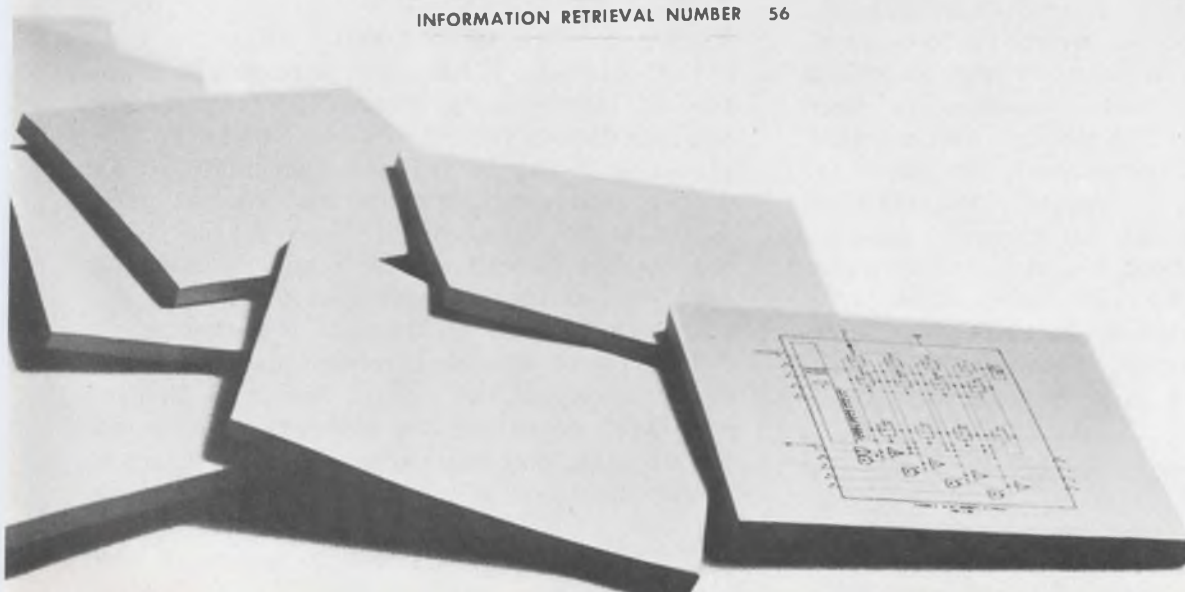

Learn the ABCs of metal purity and watch the reliability potential of your designs increase. You don't have to be a chemist, either, to get results.

What does an electronics designer have to know about metal purity? Nothing, you may say, if your applications don't require pure metals. But that is the short-sighted view; some day you might find yourself in a design situation where you would have to know the elements of metal purity and its effects on circuits, components and systems; what purity measurement techniques exist; and into what categories high-purity metals fit.

Where metal purity is essential

Some design areas that definitely require knowledge of metal purity include:

- *Semiconductors.* They provide a prime example of how trace (or impurity) elements can readily degrade performance. The case for pure germanium and silicon in bipolar transistors is well known. A more recent example would be MOS devices, in which the trace elements are sodium and potassium. One part per million of these elements can wreck the device by upsetting the number of electron carriers.

- *Thin-film technology and the growth of superconductivity applications.* These have also added impetus to the need for high-purity magnetic alloys. Impurity additions in superconducting metals depress the critical temperature of transition from the superconducting to the normal state. The magnetic field transition is extremely sensitive to the presence of certain residual gases. Tantalum, which is quite susceptible to contamination by nitrogen and oxygen, demonstrates a depression in the critical temperature from 4.48°K to less than 4.2°K when so contaminated.

- *Metals.* Which are now being considered for power transmission at cryogenic temperatures. Commercial-grade copper and aluminum have resistance ratios of about 100 at liquid hydrogen temperatures (20°K). By using high-purity metals, this ratio (and conductivity) can be increased several orders of magnitude, thus yielding greater efficiency in power transmission.

- *Magnetic materials in thin-film form.* These have also shown a sensitivity to gaseous pickup. Impurity atoms are known to create magnetic anisotropy through disturbance of the symmetry of a crystal lattice in a preferred direction.

- *High-purity aluminum,* which is currently utilized as a conductor in cryogenic magnets operating at and below liquid nitrogen temperature (77°K). This substance is a prime competitor for superconductors in many applications because of its inherent reliability.

How is purity defined?

It has long been common practice in the metals industry to describe metal purity in terms of a number of nines. For example, "three nines" pure means 99.9% of theoretical purity. The foreign-element content is obtained by subtracting this value from 100%. Ultrahigh purity, usually considered as five nines or more, is often stated in terms of the foreign-element content, in parts per million or parts per billion. The relationships between purity, number of nines and foreign-element content in parts per million are as follows:

	Metal of interest	Foreign-element content	
	% of theoretical purity	%	Parts per million
99.0	2 nines	1	10,000
99.9	3 nines	0.1	1,000
99.99	4 nines	0.01	100
99.999	5 nines	0.001	10
99.9999	6 nines	0.0001	1

Unfortunately, it has also been common practice to ignore many elements when making analyses, thus giving incomplete results. This is particularly true for gaseous elements such as oxygen, nitrogen, hydrogen and carbon. The "justification" for omitting these elements from the analysis is that special techniques must be used, such as vacuum fusion for O₂, N₂ and H₂, and conductometric techniques for carbon.

The cost of obtaining content data on these elements exceeds the cost of analyzing the remaining 9 or so metallic elements in emission spectroscopy, and approaches the cost of mass spectroscopy for all metallic elements. It is

G. T. Murray, Materials Research Corp., Orangeburg, N. Y.

tempting to forget them, but it is not justifiable to report a metal as being a certain number of nines pure when the gaseous elements have been omitted. An example of this is chromium, which has been marketed as five nines, or 99.999, but was found to contain 0.5% oxygen. In reality, this chromium was at best only 99.5%.

Unless all elements are reported on, "nines classifications" are meaningless.

Measurement techniques abound

The method of measuring purity depends on the level of foreign element present. Impurity elements, referred to as trace elements, can be detected by:

- Emission spectroscopy
- Mass spectroscopy
- Radioactivation analysis
- Atomic absorption spectroscopy
- R/R ratio measurement.

Emission spectroscopy is one of the most common methods. It is relatively inexpensive, and it is used to detect trace elements in the range of 10 to 1000 ppm.

Mass spectroscopy is more expensive, but it can detect trace elements down to 0.01 ppm. It is generally the best method for the five-nines level and the best method to obtain information on all purity elements.

Radioactivation analysis is extremely accurate and sensitive for many elements. Its chief limitation is that some elements cannot be detected by this means.

Atomic absorption spectroscopy is excellent when only a few trace elements are present. It is used in the 0.1-10 ppm range.

R/R ratio measurement is based on measuring electrical resistivity at two different temperatures. 298°K and 4.2°K are the typical temperatures used. This technique is used below the 100-ppm range.

High purity comes in three categories

A recent survey groups available "high-purity" metals into intermediate, high and ultrahigh-purity categories, as shown in the table. Gaseous elements are included in these figures.

The lowest category is *commercial*, which refers generally to purity normally achieved in the process of freeing the metal from its ore. Commercial metals are usually sold in carload lots to primary consumers. In most nonelectronic applications, metals are most often used in alloy forms, and ultrahigh purity is not usually of primary importance.

As the need for better purity became evident,

Grades of purity

Metal	Commercial	Intermediate	Highest
Aluminum	99.9	99.99	99.999+
Antimony	99.99	99.99+	99.995
Bismuth	99.95	99.99	99.999
Cobalt	99.6	99.8+	99.99+
Chromium	99.3	99.9+	99.995
Copper	99.5	99.99+	99.999
Gold	99.9	99.99+	99.999
Hafnium	96.+	96.8	97, (\approx 3wt% Zr)
Indium	99.99	—	99.999±
Iron	99.5	99.9+	99.996
Lead	99.9+	99.99+	99.999
Magnesium	99.9+	—	99.98±
Molybdenum	99.9	99.96	99.99+
Nickel	99.7	99.9+	99.997
Niobium	99.6	99.9+	99.98+
Palladium	99.8+	99.95	99.98
Platinum	99.9+	99.95	99.992
Rhenium	99.95+	—	99.996
Rhodium	99.8	—	99.99
Ruthenium	99.8+	99.95	99.995
Silver	99.9+	99.99+	99.999
Tantalum	99.7	99.9+	99.997
Tin	99.8	99.99	99.999
Titanium	99.	99.8	99.97
Tungsten	99.5	99.95	99.998+
Vanadium	99.5	99.8	99.978
Zinc	99.99	—	99.999
Zirconium	99.5	99.95	99.98

manufacturers began selecting the better lots of commercial purity metals to meet this need. In some cases, a second chemical or vacuum melting refining was introduced by the metal producer, yielding *intermediate* purities.

Metals of the highest purity have most often been produced by a zone refining process. Exceptions are gold, indium, silver and chromium, which use other refining methods.

In the zone refining process, a molten zone is made to move slowly along a bar of metal. In some cases, this may be achieved by resistance or induction heating of the metal bar as it rests in an open crucible or boat. A variation of some refining is float-zone refining (Fig. 1).

Other methods of purification include distillation, chemical techniques involving intermediate compound formation, electro-refining, and more advanced methods such as chromatographic and ion exchange are also used. ■■

Bibliography:

- Armington, A. F., Brooks, M. S., Cali, J. P., and Rubin, B. "Ultrapurification," New York Academy of Science, Vol. CXVIII, Art. 16, February 19, 1965, pp. 611-644.
- Wilhelm, H. A. "Purity Grade Metals Available from American Producers," Report No. IS-2029, Ames Laboratory, Iowa State University, November, 1967.

For over 20 years, wire insulations of Du Pont TEFLON fluorocarbon resins have provided maximum performance and reliability under extremes of temperature and adverse environments. But did you know there are composite constructions of TEFLON and polyimides

**TEFLON: all by itself
the most
thoroughly proven,
high-reliability
insulation**

**Now consider
the additional
advantages
of TEFLON plus
polyimides**

which offer you extra performance benefits for all wiring applications? TEFLON plus polyimide constructions guard against installation damage because of their toughness and abrasion resistance. They are made in two forms: a polyimide enamel over a primary insulation of TEFLON or a polyimide tape wrapped around the TEFLON.

Both these "TEFLON plus..." constructions are rated for use over a wide temperature range—up to 260°C. They are easily printed and potted, nonflammable, chemical-resistant, lightweight and have a small diameter. They provide the optimum dielectric quality which you expect from insulations made with TEFLON.

If you'd like additional information on composites of TEFLON plus polyimides (or composites using mineral fillers or polyvinylidene fluorides with TEFLON), write us and let us know about the specific application you have in mind.

Write: Du Pont Company, Room K 7297, Wilmington, Del. 19898.

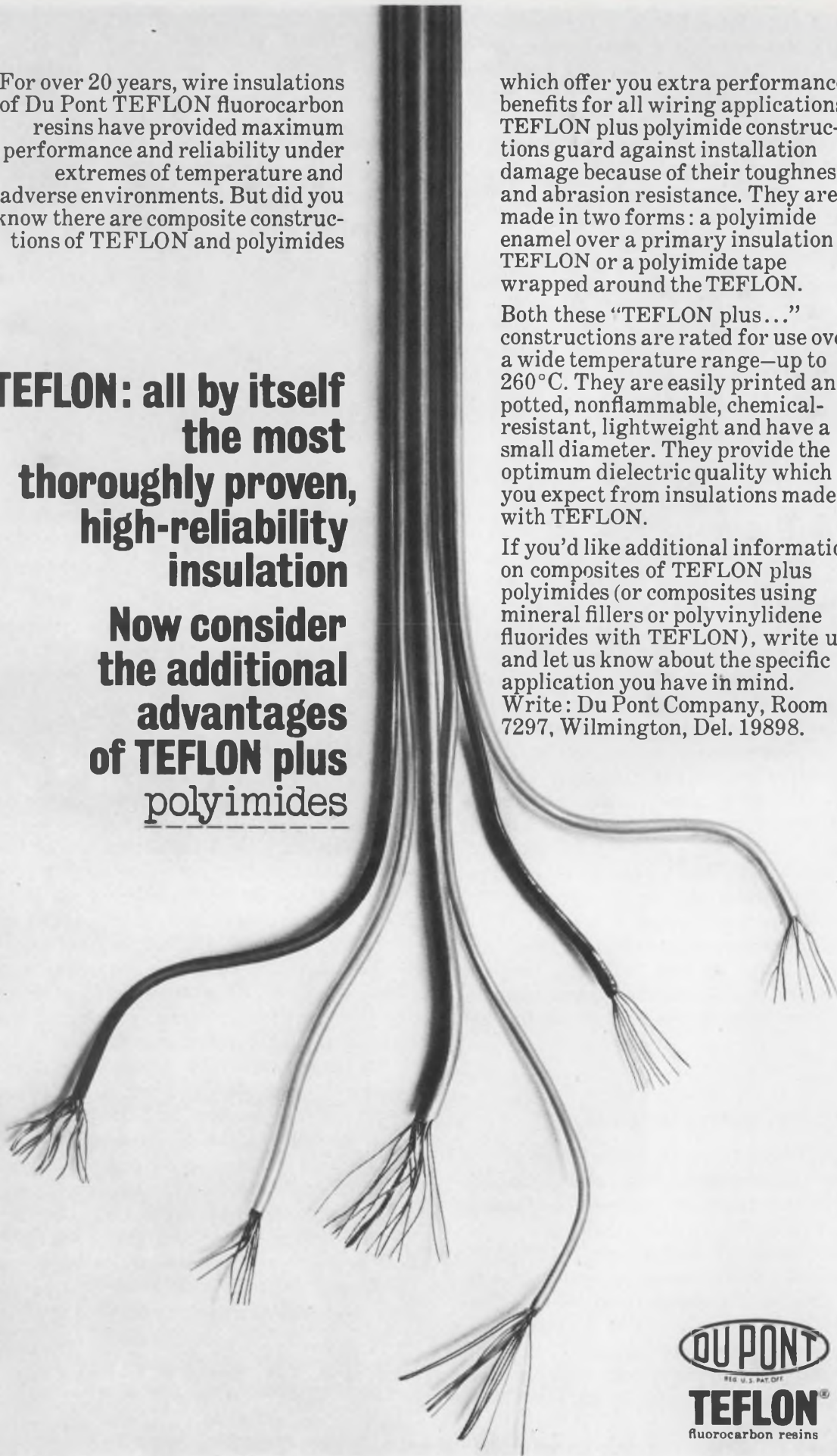

Techno has 3/8" RTR24 style (MIL-R-39015) wirewound trimmers qualified at the P confidence level for 0.1% FR.

Available for immediate delivery.

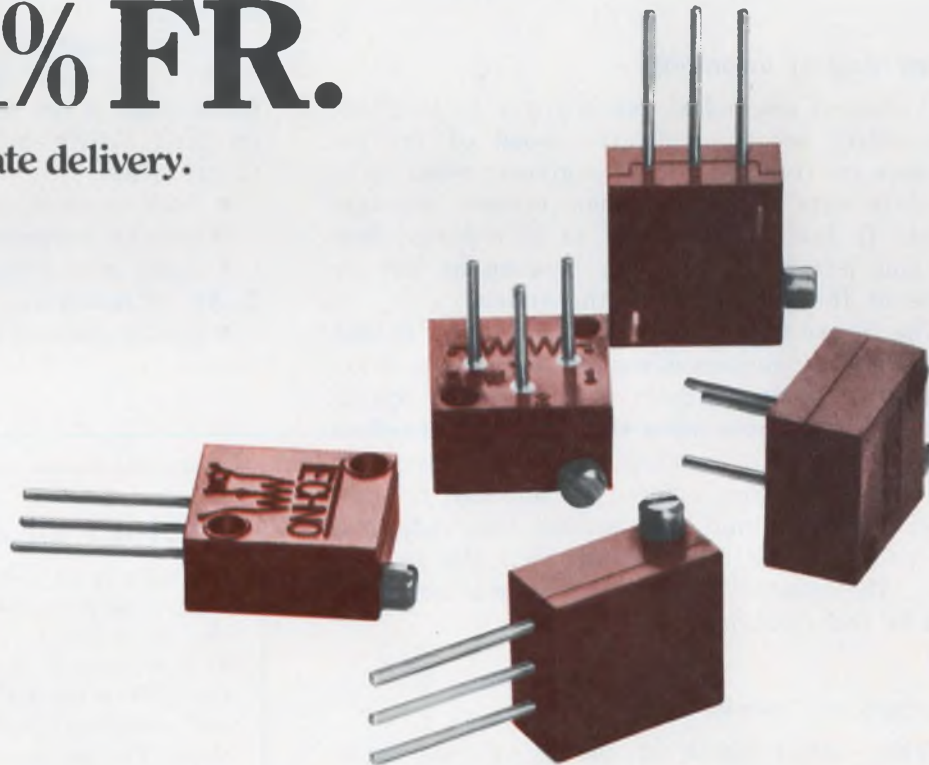

Write for Bulletin ER

TECHNO-COMPONENTS CORP.

A SUBSIDIARY OF OAK ELECTRO/NETICS CORP.
7803 LEMONA AVENUE / VAN NUYS, CALIFORNIA 91405
(213) 781-1642 / TWX: 810-495-2015

INFORMATION RETRIEVAL NUMBER 58

Yes! Engineering management is "sinful,"

say most respondents to our "don't be a crybaby" article. But they find it's easier to uncover errors than to solve them.

Richard L. Turmail, Management Editor

When engineers and engineering managers were asked to "get involved" in an article-survey covering management "sins" that we published recently, they responded, or perhaps we should say, they RESPONDED! (See opposite page for background data.)

From 32 states and the District of Columbia we heard over 250 "voices" sounding off loud and clear on whether or not engineers have legitimate gripes about their working conditions under engineering management. Eighty-seven per cent of them agreed that at least one of the "sins" depicted in the article was valid. Ten per cent of them said that they disagreed with the article (even though they, too, indicated that at least one of the "sins" was valid). The remaining three per cent made no choice.

A few suggest unionizing

Engineers are not so much angry as they are frustrated, according to the mood of the responses we received. Some engineers seem to be at their wits' end under their present management. In fact, one engineer in 20 reported that he had left the profession because of one or more of the sins listed in the article.

The figure that attracts most attention is that one out of 10 engineers suggest forming a union because it seems to them to be the only option left. A union would allow them to bargain collectively for better working conditions, they say. This solution was offered reluctantly because most engineers said they valued their personal independence but didn't know what else to suggest. The question of unionization was not solicited by the questionnaire.

Solutions no "picnic"

When asked which of the "sins" they considered to be valid, the "art of indecision" is the management fault considered to be the bane of 40% of the EEs who responded. Close on the heels of that "dog" follows "inconsiderate administration." Mentioned least by respondents was the "paper tiger." Twenty-five per cent of

the engineers said that all management sins depicted were valid; only 5% of the respondents reported that none of them were valid.

Sin solutions

When asked how they would correct the "sins" they deemed valid, many respondents said: "I wish I knew," or "I don't know," or "What you ask is impossible!" However, over half of the engineers who answered our survey offered about three solid solutions for each management error. We have selected the three solutions most often mentioned, and we have also presented one solution per "sinful" engineer suggested by responding managers.

The solutions follow:

1. Inconsiderate administration

- Establish genuine overtime payment for all extra time.

- Have managers rated by their subordinates as well as their superiors when performance measurements are made. In this case, rate them on their ability to anticipate the modification of priorities.

- Back unionization.

What the engineer can do:

- Come in and leave at the regular time.

2. Art of indecision

- Send copies of priorities to higher management.

What it's all about

What's it all about? Well, in our September 1 issue we published half a dozen management sins in an article titled "No engineer wants to be a crybaby!" But, it pointed out, *there are times when the EE has a legitimate gripe, and one concerned engineer commented on six of them.* The engineer-author is Bernard Daien of Arizona. The Editor and the Management Editor of ELECTRONIC DESIGN had a disagreement about publishing the article.

(See editorial [opposite page] and abbreviated version of management sins on p. 96.)



Are you a crybaby — or a mistreated engineer?

We had a staff disagreement at ELECTRONIC DESIGN recently. Since it hasn't yet been resolved, I'm going to let you in on it. It concerns the article "No Engineer Wants to Be a Crybaby," on page 94 of this issue.

Our Management & Careers Editor, Dick Turmail, received the article from a contributor, received it and passed it along to me for comment. Dick thought it offered a sound indictment of engineering management, with six case histories of sins perpetrated against the design engineer.

But as I read the article, I recalled my dozen engineering years with a major corporation research laboratory and with small engineering firms, and something in the article seemed to be missing. Sure, I worked a number of overtime hours and weekends without pay—but I remember the satisfaction of completing tough jobs on schedule. Nowhere did the article describe the challenge of the assignment, the exciting group sessions as solutions were analyzed, the sigh of relief at the success.

In the cover letter accompanying the article, I noted with interest, the author called attention to what he described as 17 "management biased" articles in recent publications. It's about time the engineer's view was aired, he said.

I read the article again and told Dick that engineers would be labeled "crybabies" if the article was published. "Show it to other members of our staff who have spent years in engineering, and they'll tell you the same thing," I predicted to Dick. Well, he did, and some newcomers to our staff—experienced former industry engineers—agreed with the author of the article, not with me. Publish the article, they insisted.

The basic disagreement is this: I maintain that the managerial sins described—inconsideration, indecision, excessive paperwork, etc.—do exist in engineering but are not unique to our profession. Employed lawyers, businessmen, salesmen, accountants—you name them—all encounter the same frustrations. That doesn't excuse the sins, of course, but it does exclude the engineer from exclusive claims to such abuse.

Here's where you come in. We've put together a brief questionnaire on page 98 that should take no more than two minutes to complete. Be frank. Let me know whether you agree with me that engineers are treated no better or worse than your acquaintances in other endeavors. Or tell me that I'm all wet and completely naive in my position on this issue.

But please be specific. If you're an engineer, indicate the managerial sins you deem most common and offer suggestions for improvements. If you're a manager tell how engineers can help you improve your relationship with them.

Your responses can lead to an interesting forum on engineering management, as viewed from both sides of the desk. Don't just sit there. Turn to page 94 and get involved!

HOWARD BIERMAN

Directory for management "sins"

1. Inconsiderate administration

Although Bill regularly works late on the job, the company frowns whenever he arrives a few minutes late in the morning. Bill feels the company has no consideration for his family, and he can't figure out why management failed to listen to his advice on rescheduling the work hours.

2. The art of indecision

Joe asks for a priority list of the "hot" projects he is working on. Management wants the Jones job out first but doesn't want to hold up the other jobs to do it. No matter which job Joe finishes first, he will be blamed for getting the other jobs out late.

3. The paper tigers

To ensure that a project schedule was met, management insisted upon extra paper work in order to maintain controls. Len's engineering time was cut in half because of the red tape, and management is furious over "the way those engineers have no idea of time and money."

4. Appearance of performance

Walter, a competent engineer, spends time thinking, planning and scheduling before he acts. As a result, he performs his work with deceptive ease. Management, however, has a tendency to beam benevolently upon those EEs who produce more noise than results. Walter is passed over at promotion time because he doesn't seem to be a "pusher."

5. Two speeds—fast and faster

Barney works at full throttle and is extremely productive. When the company comes up with a "crash program," and Barney is told that he'll have to work faster, he is confused and disillusioned. A wise administrator would understand that Barney cannot perform his work indefinitely at full speed.

6. Technician's work at EE's wages

Because management is often reluctant to pay the wage a good technician merits, many engineers find themselves doing so much technician's work that they must put aside their engineering chores.

- Make dollar impact of indecision and accompanying delays more apparent to higher management.

- Make a decision! A wrong decision is better than no decision.

What the engineer can do:

- Keep his mind open to the possibility that indecisiveness is not always the fault of the manager. Sometimes problems are brought about by the sales force, customers and other areas of management.

3. Paper tigers

- Schedule weekly meetings to cut down on written reports.

- Establish standard reporting techniques.

- The manager himself is probably in the best position to help with paper work on rush schedules; it will also enable him to observe the members of his group and select the most efficient member for promotion.

What the engineer can do:

- Make every effort to meet the estimates that are made. Account for all required paper work, typing, reporting, as well as time for engineering. If he has estimated it in detail and met the estimates, who can argue?

4. Appearance of performance

- Limit measurement of productivity by results.

- Use an outside consulting service to indicate where the level of competence is for various levels of management.

- Rotate project management so that successful projects can be identified with a specific manager.

What the engineer can do:

- Prepare a paper on his ability to plan. Write an article on project planning. Present a talk on what was required in thinking ahead, planning and managing a major project. Point out pitfalls encountered along the way and explain how they were handled. People are frequently recognized by the amount of noise they make.

5. Two speeds—fast and faster

- Recognize that poor scheduling is poor management, not poor engineering. Be more aware of the critical steps that must be taken promptly in order to avoid extra pressure at the lower level.

- Form a committee of managers, salesmen, and engineers to establish priorities.

- When work output is low, management should automatically prod the slowest worker, not the fastest.

What the engineer can do:

- Pace himself and not pull out all the stops from the starting gun. Remind himself that he is competing in a marathon race, not a 100-yard

dash will end at the stroke of 5 pm.

6. Technician's work at EE's wages

- Prompt EEs to recommend production assemblers who can be promoted to technician trainees for engineering assembly work. This is very good for morale, and it's much easier to replace production assemblers than technicians.

- Hire job shoppers if work is temporary.

- Assign the best senior engineer a force of technicians and especially junior engineers. Monitor the program closely so that, as the situation warrants, the young engineer is given increased responsibility and freedom.

The position of "monitor" should be given the same status as that of project engineer. The pay scale should be arranged accordingly since this individual can be the single most important source of increased group capability. This program should constitute an integral part of the engineering facility, which not only efficiently completes projects, but also serves as an in-house educational facility.

What the engineer can do:

- Remember that it doesn't hurt to get his hands dirty once in a while.

Don't stop—there's more

Responding engineers were asked to list other management errors they have noticed on the job. The following "sins" are those most frequently noted in order of response:

1. *Indefiniteness*: Management often fails to establish adequate specifications for the "black box" at the beginning of the project, a "sin" that necessitates a "crash program" to meet the deadline. Two reasons for this oversight are: (1) directives given by a manager who is far removed from the project; and (2) management attention to the solution of problems more proportional to their understanding than to the project's need.

2. *Secrecy*: No inside information is circulated regarding company direction, even when the data directly affects the engineer.

3. *Time pinching*: Not enough time is allotted the engineer for writing reports and for research. There never seems to be enough time to do the job right, but always enough time to do the job wrong two or three times.

4. *Overbid*: The short-term profit motive prompts the companies to try to get all the jobs on the market. They should be more selective, because often more bids are accepted than the engineering staff can accommodate by deadline.

5. *Supportless*: Often lower and middle management fail to support subordinates in dealings with upper management.

6. *Great expectations*: Management has a tendency to pack engineers into noisy, crowded

areas, with the expectation of getting maximum efficiency.

7. *No contact*: Many engineering managers do not have the ability to relate to their staff on a personal level. This trait is often manifested by an unwillingness to discuss an engineer's deficiencies until the job review.

8. *Off-handedness*: Some managers employ a casual, almost cavalier approach in the evaluation of personnel. In many cases, their opinion is based on emotion, rather than on facts.

Engineering comments . . .

"Obviously the author needs a strong manager."

"I don't have time to answer the questionnaire. Due to some of the sins depicted above, I am moving to another job."

"People are not consumables!"

Some of the highlights on the more serious side are:

"Only when EEs fail to produce as a result of abuse will management try a more human approach."

"Of particular importance is the competent older designer who is not a management type, and how he fits into the corporate picture. Most companies do not handle this problem adequately, from either the financial or the prestige point of view."

"On balance there is a tendency to reward defect correction, rather than good design. The squeaky wheels seems to get the grease."

"A general contempt [is noted] for the welfare and interests of engineers and an attitude which reflects management's opinion that an engineer is a hired hand and a tool of management, which like any other tool can be cast aside when no longer needed, or replaced with a lower cost model at intervals."

In a nutshell:

Perhaps more than any other statement offered on the questionnaire, the following one best summed up the problem of communication between engineers and their managers:

"Management must learn to build on people's strength rather than on their weaknesses. Recognition must be given to the psychological contents of a job as much as to the technical content. Some men work brilliantly at their pace and collapse under pressure. Others can antagonize everyone they meet and should be put where personal contacts are at a minimum.

"Man is the measure. However, it is not the place of a company to undertake a program of psychological rehabilitation. Learn how to use people, but don't try to change them . . ." ■■

HIGH-VOLTAGE CAPACITORS? POTTER HAS THEM...

WITH THE SIZE, PRICE AND DELIVERY YOU NEED.

For years we have been designing and supplying High Voltage capacitors for uses from simple ripple filters to Plasma generators.

This experience has gained us a reputation for optimum design, manufacturing techniques, and quality control. Whatever your requirement happens to be, either standard catalogue series (off the shelf) or special design, check with a Potter Sales or Engineering representative now!

Standard Catalogue characteristics:

Meets or exceed applicable portions of MIL C19978

Temp. -55°C to +125°C

Diss. Factor 0.5% Max @ 25°C 60 Hz

Voltages from 600 WVDC to 150 KVDCW

We are also specialists in Metalized Polyester film and Ceramic capacitors and EMI/RFI filters, Standard, Custom and Microminiature.



THE POTTER COMPANY

For: Hi Voltage Caps, EMI Filters: P. O. Box 337, Wesson, Miss. 39191
For: Ceramic Caps and Microbrute Filters: 508 W. Florence, Inglewood, Calif. 90301

INFORMATION RETRIEVAL NUMBER 59

TRUE SOLID-STATE RELAY



Opening New Relay Applications in Multiplexing, Isolated Sensing, High Speed Isolated Control, etc. Offered in A - B - C Contact Configurations for Direct Replacement of Mechanical Types.

- Switching Time less than 65μ sec
- Contact Open Resistance . . . 10⁹ ohms
- Contacts Capable of switching DC to 4 M HZ
- Non-Polarized Effective Coil
- Effective Coil Accuate/Release Voltage Hysteresis . . . less than 10 mV . . .
- Non-Polarized Contacts
- No Reference Required Between Effective Coil and Effective Contacts
- Life Expectancy—tested to 10¹⁰ operations with no failure.

SHAFFSTALL-BALL CORPORATION

5149 E. 65th Street, Indianapolis, Indiana 46220
Phone: 317-257-6296

INFORMATION RETRIEVAL NUMBER 60

GRC[®]

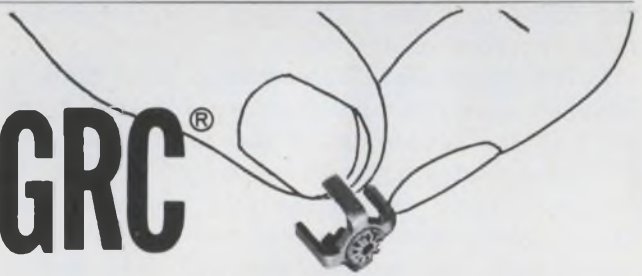

solves critical assembly problem for movie editor with tiny die cast part . . .

Atlas-Warner discovered a critical problem in the designing of their movie editing machine: assembly of a 0.162" dia. gear to a prism holder; must be precisely oriented and fixed. GRC unique automatic die casting techniques met the challenge with a precision part—and did it well within cost needs. Your products can probably benefit from this kind of specialization.

**WRITE TODAY FOR
SAMPLES AND BROCHURES**

NO MINIMUM SIZES!
Maximum Sizes: 2" long, 1/2 oz.

GRIES REPRODUCER CO.

Division of Coats & Clark Inc.



GRIES
world's foremost producer of small die castings & plastic moldings

40 Second St., New Rochelle, New York 10802 • (914) 633-8600
Plants in: New Rochelle, N. Y.; Warren, R. I.; Toccoa, Ga.
In Canada: Gries Div., Dynacast Ltd., Lachine, Que.

INFORMATION RETRIEVAL NUMBER 61

ELECTRONIC DESIGN 23, November 8, 1969

THE 5000 PERM TOROID

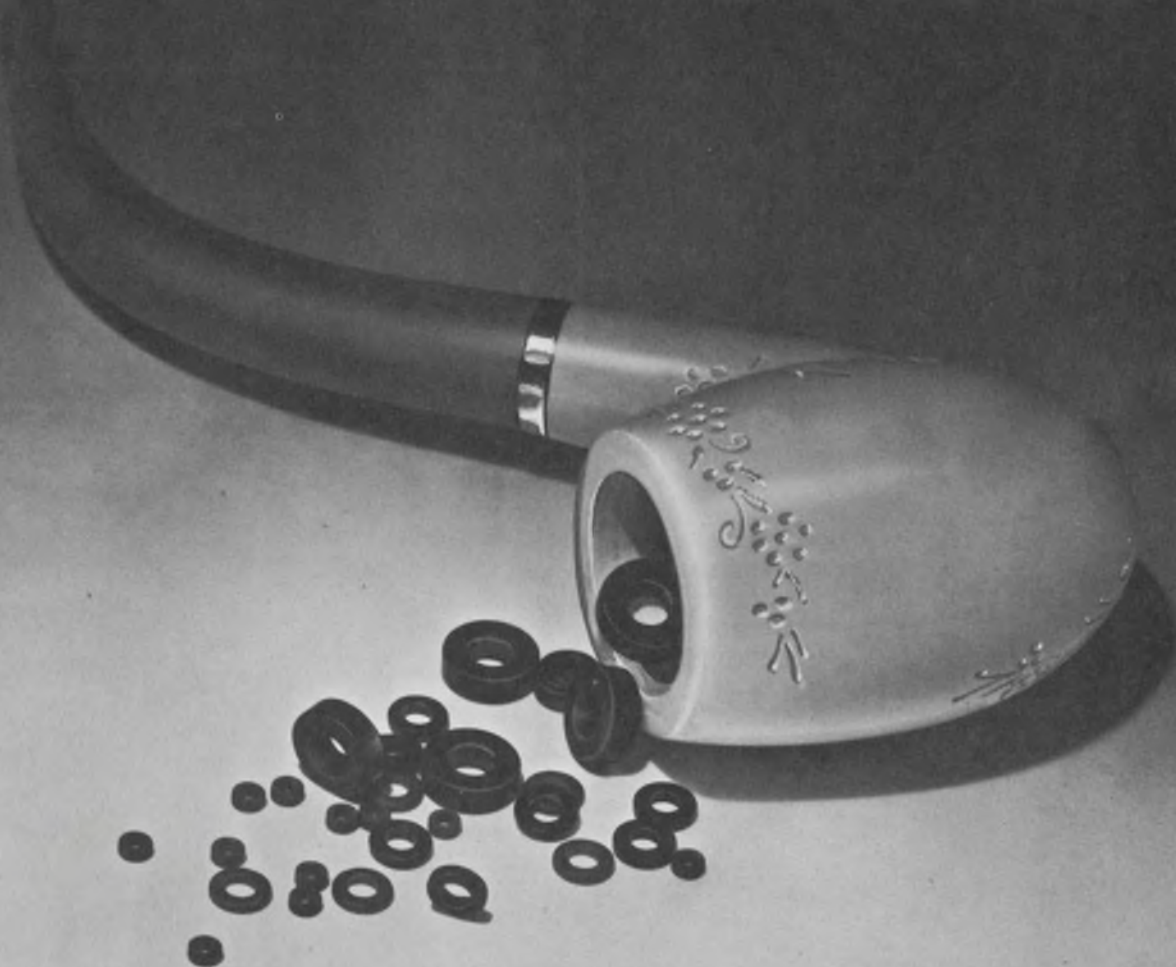

NO LONGER A PIPE DREAM

That's right. 5000 initial permeability. And we mean it!

Perhaps your designs for pulse transformers have gone up in smoke for want of a powerful enough material. Well, now you've got it. And then some. Stackpole Ceramag® 24H ferrite material.

Ceramag® 24H is a precision engineered product. Exact processing, density checks, rigid kiln controls and precise

sintering. You get more out of it simply because we put more into it.

Here are a few more conservative characteristics. Maximum permeability, 6900. Typical. Saturation flux density, 4100 gauss and residual magnetism of 850 gauss. If curie point is significant to your operation, how about one of 175° C. Then there's temperature coefficient. Ceramag® 24H goes + 0.700% / ° C at -25°

C to 25° C and -0.450% / ° C at 25° C to 75° C. And all of this with a disaccommodation factor of 1.4×10^{-6} .

Ceramag® 24H is ready. Are you? Drop us a line and we'll send you some even more interesting facts about this fantastic new material. And the charts to prove it. Stackpole Carbon Company, Electronic Components Division, St. Marys, Pa. 15857. Ph: 814-834-1521



STACKPOLE

Electronic Components Division

ALSO A LEADER IN THE MANUFACTURE OF QUALITY FIXED COMPOSITION RESISTORS

INFORMATION RETRIEVAL NUMBER 62

$\pm 50 \text{ ppm}/^\circ\text{C}$

in all Helipot Cermet Trimmers

This significant advance in Helipot's cermet technology is now available at only a dime/unit more . . . 100 ohms thru 2 megohms. In addition, you get essentially infinite resolution, environmental stability, reliability, no catastrophic failures — all superior to wirewound trimmers. We'll also deliver off-the-shelf, locally stocked trimmers with a standard tempco of $\pm 100 \text{ ppm}/^\circ\text{C}$ in the 100 ohm thru 2 megohm range.

Beckman

INSTRUMENTS, INC.

HELIPOT DIVISION

FULLERTON, CALIFORNIA • 92634

INTERNATIONAL SUBSIDIARIES: AMSTERDAM; CAPE TOWN; GENEVA; GLENROTHES, SCOTLAND; LONDON; MEXICO CITY; MUNICH; PARIS; STOCKHOLM; TOKYO; VIENNA

Inexpensive audio IC serves as regulator

It is possible to replace an IC voltage regulator with an IC audio amplifier and thus save costs.

For example, a PA234 audio amplifier IC can be used as a regulator for low positive voltages. The PA234 is normally used as a 1-watt audio amplifier. It is the least expensive of a family of such ICs as the PA222, PA234, PA237 and PA246. As a regulator, the PA234 is dissipation-limited to 800 mW and so is useful up to several hundred milliamperes.

Figure 1 shows the complete schematic for a 15-V regulator. Actually only about half of the PA234 internal circuitry is used. It can be seen from Fig. 2 that the power-supply impedance is about 2.5 Ω.

Since pin No. 10 is *not* grounded (as it is in normal audio service) the heat-sink-tab must not be grounded either; it should be thermally connected to the chassis (or other dissipator)

by means of a solder lug, mica washer, and silicone grease.

Henry D. Olson, Research Engineer, Radio Physics Lab., Stanford Research Institute, Menlo Park, Calif.

VOTE FOR 311

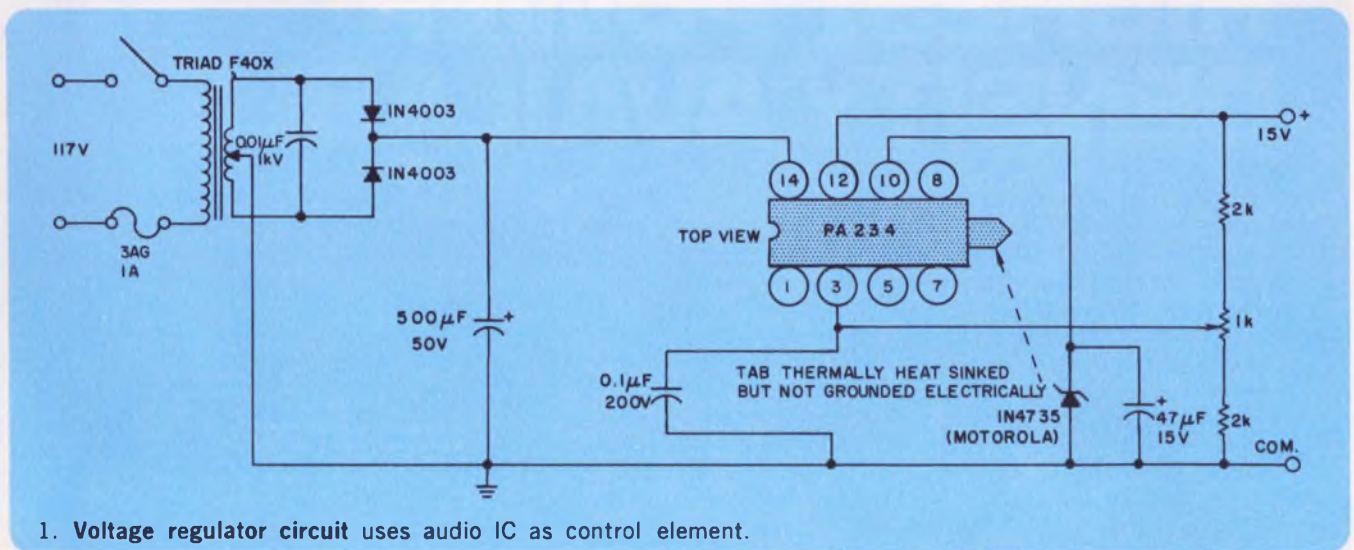
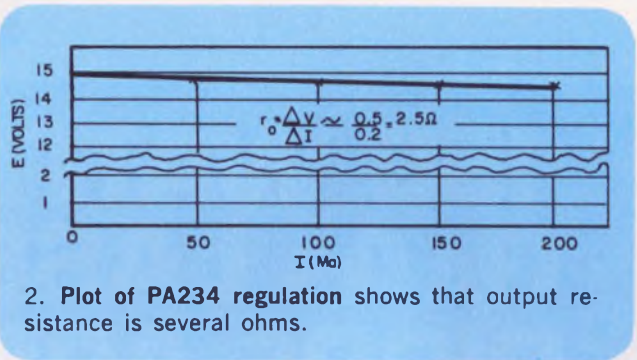



150 WATT GaAs LASER DIODE ARRAY. HIGHEST POWER DENSITY AVAILABLE.

Sperry now offers a 150 watt gallium arsenide laser diode array—offering the highest peak power density available today. This high peak power density ideally suits the array to such applications as fuzing, optical radar, intrusion detection, communication, tracking and guidance, and beacon devices.

The 150 watt, 0.050" diameter source—that needs no cooling

—provides the following characteristics:

- 150 watts peak power minimum
- package diameter 0.50 inch
- pulse width of 80 nanoseconds
- output beam 22° diameter (f/2.6)
- infrared output at 9100Å
- prf at nominal ambient over 1500 Hz.

This unit is matched to the

Sperry standard 150 amp. solid-state modulator which also powers our 10 to 25 watt line of gallium arsenide devices.

For additional information, write to *Electro-Optics*, Sperry Gyroscope Division, Great Neck, New York 11020 (Telephone: 516-574-2598).

SPERRY
GYROSCOPE DIVISION

Temperature stable supply uses IC as error amplifier

Precision voltage sources with temperature coefficients better than ± 10 ppm/ $^{\circ}\text{C}$ typically use reference diodes. Although reference diodes with stabilities better than 10 ppm/ $^{\circ}\text{C}$ are available, they are quite expensive and usually demand critical biasing.

The μA726C , dual npn monolithic IC, when connected as shown (a), is a good 7-volt reference. Its temperature coefficient is typically better than 1 ppm/ $^{\circ}\text{C}$ from 0 to 75°C . The excellent stability is due to the heated substrate, which normally operates near 135°C .

FET Q_1 is biased near its zero temperature coefficient drain current value to provide essentially constant current to the IC reference circuit. Q_2 and Q_3 are series pass transistors, while Q_4 and R can be added for current limiting.

A negative supply can be obtained by constructing a similar circuit and using another secondary winding and bridge rectifier to provide power.

This circuit has an over-all temperature coefficient of $+4$ ppm/ $^{\circ}\text{C}$ from 25 to 75° . Output impedance is 0.013 ohm, and line regulation is 0.025% V_{out} for input voltage changes from 21 to 35 volts.

Work sponsored by the U.S. Atomic Energy Commission under contract with Union Carbide Corp.

E. J. Kennedy, Development Engineer, Instrumentation & Controls Division, Oak Ridge National Laboratory, Oak Ridge, Tenn.

VOTE FOR 312

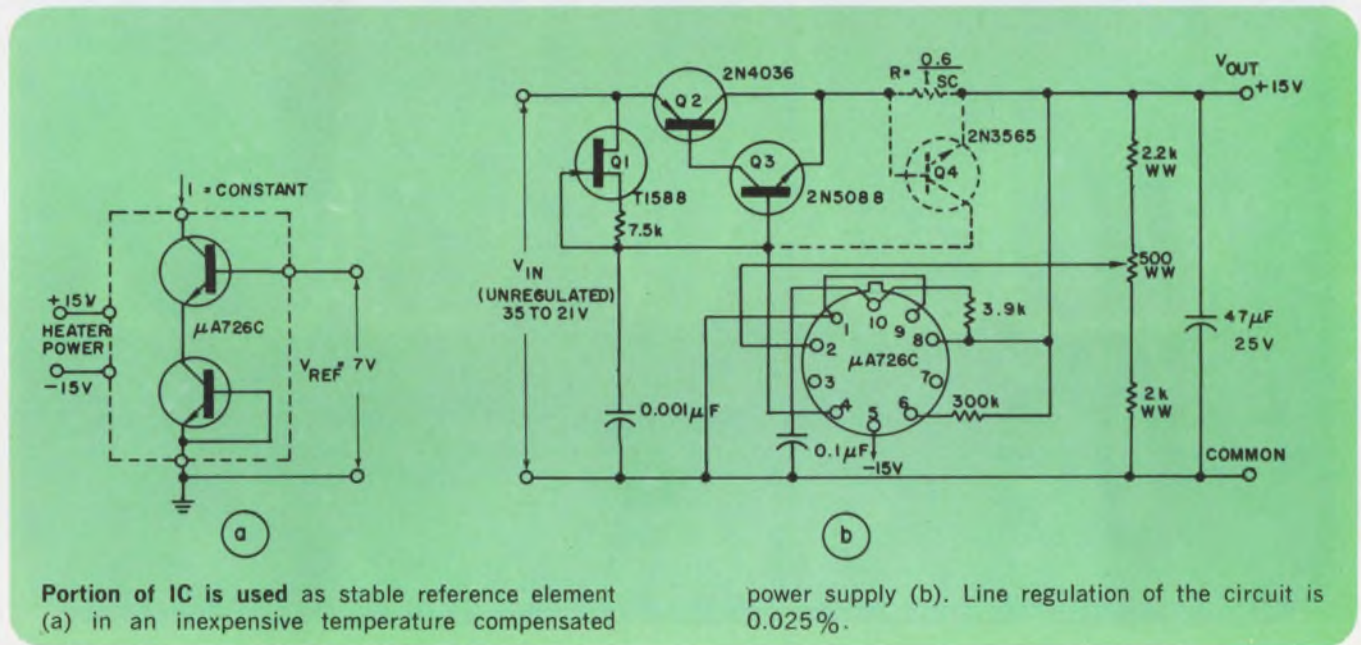

Linear pulse-width modulator uses monostable multivibrator

The usual operations of sample, hold and pulse-width modulation are accomplished separately in conventional pulse-width modulators. But in the circuit shown these operations are all combined.

Transistors Q_3 and Q_4 (Fig. 1) form the

monostable multivibrator, with C_2 as the charging capacitor. In the stable state, Q_3 conducts. Input triggering blocks Q_3 by making the voltage at point B positive. Capacitor C_2 then discharges through Q_2 , which acts as a constant-current source. Thus, the voltage at point B drops linear-

TRW Announces Ultra-Linear RF Power Transistors... 2 to 150 MHz

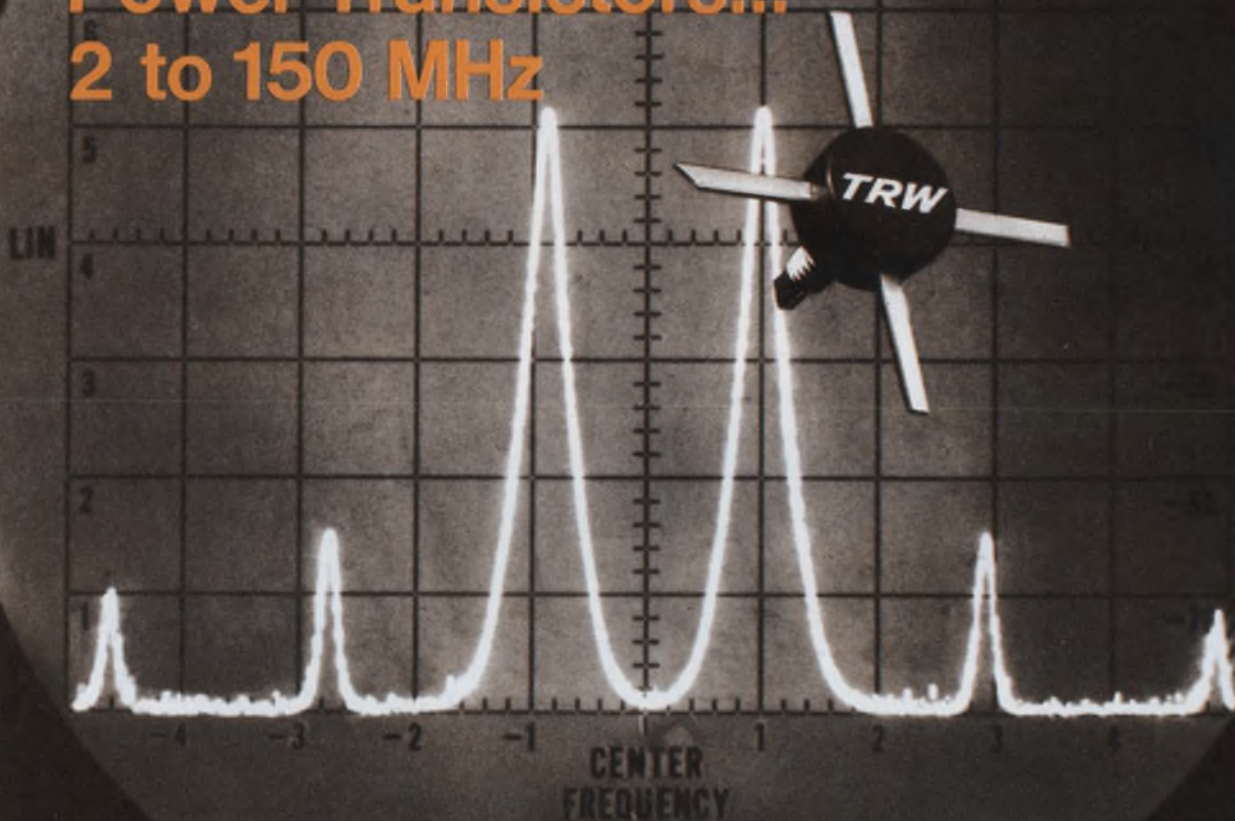

20 to 100 watts...- 32 dB intermodulation guaranteed

TRW offers three new 28-volt RF transistors to meet a range of output power needs in either SSB or CW. All are designed for Class A, Class AB, or Class C operation. All will withstand severe output mismatch. All are available in low profile, strip-line packages.

The 2N5707 provides 20 Watts

P.E.P. in SSB use from 2 to 30 MHz, and 30 Watts CW output to 150 MHz. The 2N5708 provides 40 to 50 Watts respectively over the same frequencies, and the 2N5709 furnishes 80 and 100 Watts in the same operating modes. All three have excellent broadband capabilities.

Contact any TRW Distributor or

INFORMATION RETRIEVAL NUMBER 65

TRW Semiconductors, 14520 Aviation Boulevard, Lawndale, California 90260. Phone: (213) 679-4561. TWX 910-325-6206. TRW Semiconductors Inc. is a subsidiary of TRW Inc.

TRW®

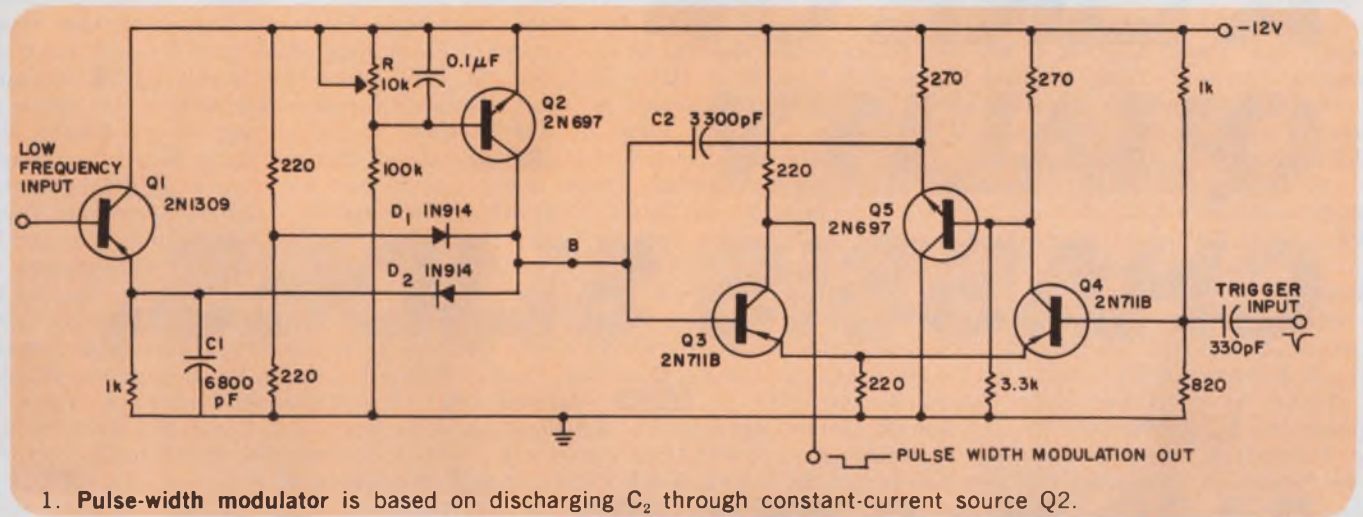

ly until it becomes negative enough to make Q_3 conduct again. This marks the end of the output pulse, and the multivibrator returns to its stable state.

Pulse-width modulation is introduced by limiting the positive peak of the voltage at point B to the momentary value of the low-frequency input. This is accomplished by diode D_2 and the emitter follower Q_1 .

Diode D_1 clips the negative peak of the voltage at point B, shortening the recovery time of the multivibrator. Q_5 is an emitter follower, which improves circuit linearity. The potentiometer, R , permits adjustment of the desired pulse width in spite of beta variations in Q_2 .

Recovery time of the multivibrator is less than $3 \mu\text{s}$. With $C_2=3300 \text{ pF}$, as shown, pulse widths can be modulated between $1 \mu\text{s}$ and $20 \mu\text{s}$. By increasing C_2 , larger pulse widths can readily be obtained. Maximum repetition rate with $C_2=3300 \text{ pF}$ is 45 kHz . Linearity of the circuit is excellent, as shown in Fig. 2.

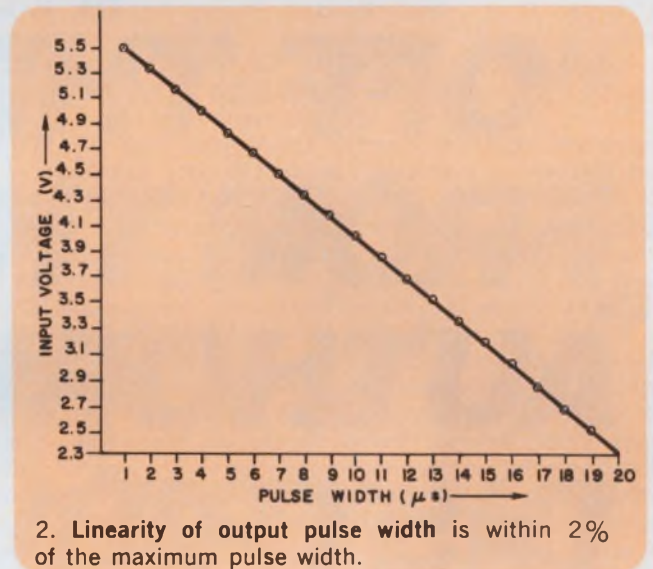

Aruind Shah, Chief Assistant, Institute for Technische Physik an der ETH, Zurich, Switzerland

VOTE FOR 313

Wide-range agc amplifier uses optoelectronic control circuit

Optoelectronic components have zero signal distortion and extremely wide dynamic range. Therefore an audio agc amplifier that uses an optoelectronic device as the control element will have excellent characteristics.

In the circuit (a), LD_1 consists of a lamp and photoresistor in a TO-5 package. If the output voltage exceeds the reference set by R_0 , an error voltage is generated by amplifier A_2 . This error voltage increases the power to the lamp of LD_1 ,

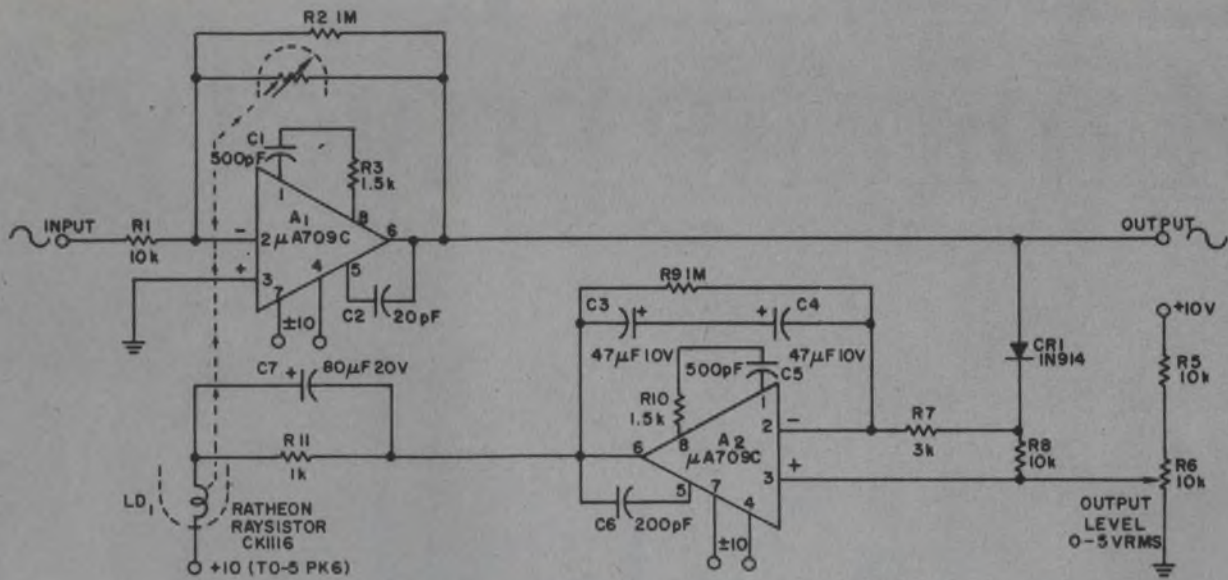

(a)

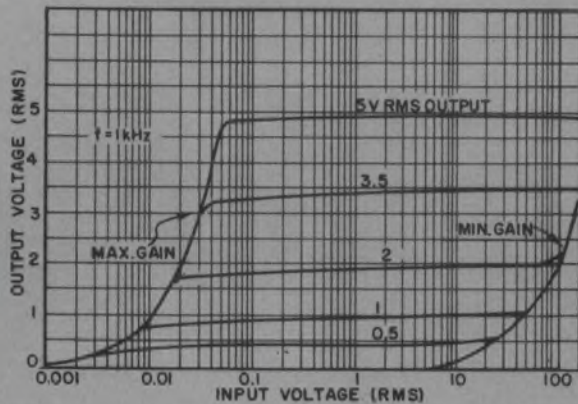

(b)

Optoelectronic control element LD₁ holds the output of the agc amplifier (a) at a constant level over a 74-dB input voltage range (b).

thus lowering the resistance of the photoresistor, which in turn decreases the gain of A1. A constant output level results.

R₁₁ and C₇ form a compensating network, which improves the transient characteristics of the control system by canceling a pole in the transfer function of LD₁.

Frequency of the circuit is flat from 5 Hz to 220 kHz at 1-V rms input and output.

Dennis R. Morgan, Graduate Student, Syracuse Univ., Syracuse, N.Y.

VOTE FOR 314

VOTE

VOTE! Go through all Idea-for-Design entries, select the best, and circle the appropriate number on the Reader-Service-Card.

SEND US YOUR IDEAS FOR DESIGN. You may win a grand total of \$1050 (cash)! Here's how. Submit your IFD describing a new or important circuit or design technique, the clever use of a new component or test equipment, packaging tips, cost-saving ideas to our Ideas-for-Design editor. You will receive \$20 for each accepted idea, \$30 more if it is voted best-of-issue by our readers. The best-of-issue winners become eligible for the Idea Of the Year award of \$1000.

Send us those programing short cuts

In line with the impact that time-sharing terminals are having on the work of the electronic designer, **ELECTRONIC DESIGN** will now accept computer programs and subroutines as Ideas for Design. The only requirements are that the program perform some useful design calculation or function, that it be in a recognized computer language, and that it not exceed 60 lines.

So come on—send us those programing short cuts and clever subroutines.

Introducing the 7½ minute prototype.

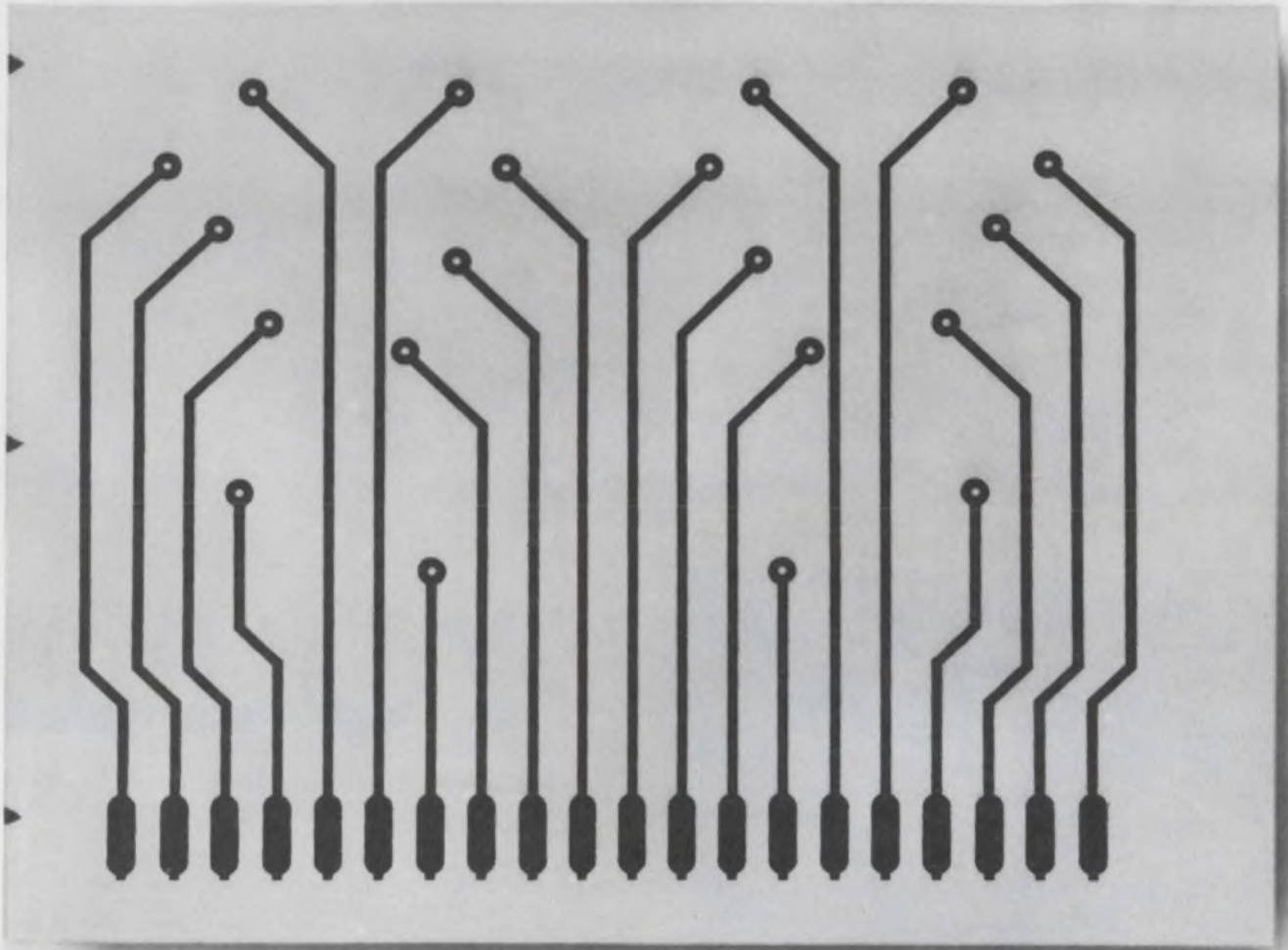

Getting prototype circuit boards used to be the biggest nuisance in design projects.

It took a lot of man-hours, expense, and a lot of space for bulky, awkward equipment.

No more. With Xerox Standard Equipment, chemical resist images can be transferred to copper-clad laminates and prepared for conventional etching—in 7½ minutes flat.

For just pennies per prototype.

And there are no wet, messy chemicals (the xerographic process is

completely dry).

No air-controlled darkroom (the Xerox equipment can be set up in a small corner almost anywhere).

No need for highly-trained technicians (most people can learn to handle it in just 60 minutes).

Of course, the 7½ minute prototype is only one of the ways you can use Xerox Standard Equipment.

If you have another 7½ minutes, we'll explain some of the others. Write Dept. BC14, Xerox Corporation, Rochester, New York 14603.

XEROX

Crystal-controlled oscillator operates from one mercury cell

Crystal controlled oscillators are used in many applications, including lab standards, clock generators, oscilloscope calibrators, etc. The circuit shown is powered by a single 1.35-volt mercury cell and provides a 1-volt square-wave output.

As shown, the crystal is a tuned circuit between transistors Q1 and Q2, which are connected in the common-emitter configuration. Positive feedback provided by means of R permits oscillation. The signal at the collector of Q2 is squared by Q3, which switches between cut-off and saturation. R₇ permits short-circuit-proof operation.

Robert L. Billion, Design Engineer, UNITEC, 6, Rue Irvoy, 38 - Grenoble, France.

VOTE FOR 315

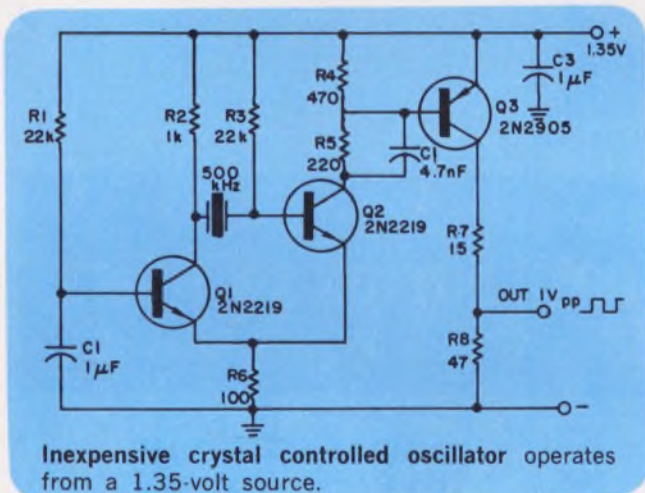

Voltage-controlled oscillator uses two integrated circuits

An inexpensive IC dual gate, three resistors and two capacitors can be combined to form a voltage controlled oscillator, with a total component cost under \$1.00.

As shown in the figure, the gates are connected in a free-running multivibrator configuration. The frequency is controlled by a dc voltage at the input. The circuit was designed for a center frequency of 50 kHz. As the control voltage is varied from +4 to +9 volts, the output frequency varies from 30 to 70 kHz.

The center frequency is determined by the timing components (R₂, R₃, C₁, C₂), and the con-

trol voltage range by the series isolating resistor (R₁).

Les Toth, Project Engineer, Cohu Electronics, Inc., San Diego, Calif.

VOTE FOR 316

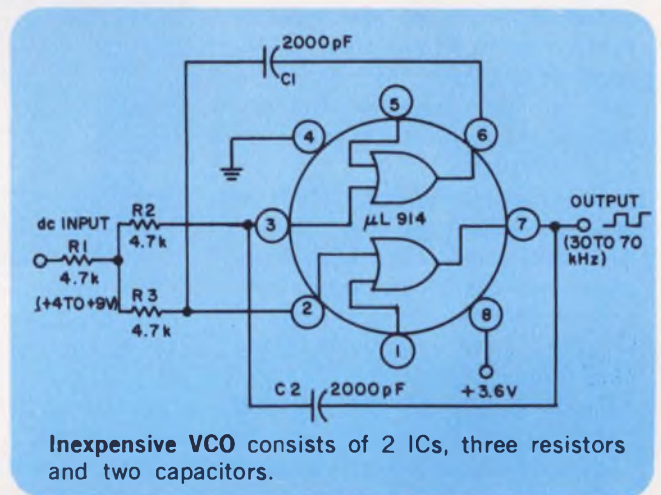

Inexpensive radio-controlled door opener uses only one SCR

A simple and effective receiver for actuating garage doors, alarms, warning systems, etc., can be constructed with very few parts.

The SCR, which has very low trigger current—30 µA is typical—forms the key. An input power of only 30 µW activates the relay, and a high Q tuned antenna circuit assures rejection of spurious signals.

Use of a whip or wire antenna is adequate up to 100 feet from a low-power transistor transmitter. A momentary-off switch resets the circuit.

Paolo Antoniazzi, Electronic Engineer, Soc. Gen. Semiconduttori, SGS, Agrate (Milano), Italy

VOTE FOR 317

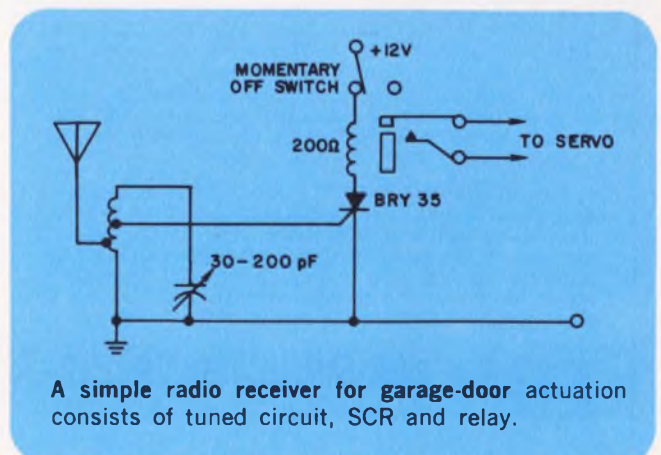

EASTMAN 910[®] Adhesive bonds aluminum to aluminum, lets test instruments withstand missile vibration

Any adhesive used in missile testing must have exceptionally high shear strength to withstand extreme vibration and shock. That's one reason Philco-Ford Corporation's Aeronutronic Division uses EASTMAN 910 Adhesive to bond aluminum accelerometers and strain gages, mirrors and lenses to aluminum test missiles.

At its Newport Beach, California plant, Philco-Ford uses two drops of this unique adhesive for each bond, giving the thinnest possible film compatible with full surface coverage. A completely cured, exceptionally strong bond is rapidly formed.

Philco-Ford has used EASTMAN 910 Adhesive in this application for over 10 years, and reports complete satisfaction. The company also uses it to bond Buna-N rubber rings between sections



of its Mach 3 supersonic wind tunnel, and to bond piezoelectric accelerometers to test specimens made of aluminum, magnesium, steel or glass.

EASTMAN 910 Adhesive is versatile, forms a bond with almost any material. It requires no heat, solvent evaporation, or catalyst. Offers fast setting, high strength and low shrinkage. Comes

ready to use, cures at room temperature with only contact pressure. And gives about 20 one-drop applications for only a nickel.

For technical data and further information, write to Chemicals Division, EASTMAN CHEMICAL PRODUCTS, INC., Kingsport, Tennessee. EASTMAN 910 Adhesive is distributed by Armstrong Cork Company, Industry Products Division, Lancaster, Pennsylvania.

Here are some of the bonds that can be made with versatile EASTMAN 910 Adhesive. Among the stronger: steel, aluminum, brass, copper, vinyls, phenolics, cellulose, polyesters, polyurethanes, nylon; butyl, nitrile, SBR, natural rubber, most types of neoprene; some woods. Among the weaker: polystyrene, polyethylene (shear strengths up to 150 lb./sq. in.).

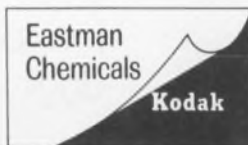

See Sweet's Product Design Catalog File

INFORMATION RETRIEVAL NUMBER 68

80 MHz WIDEBAND RF POWER AMPLIFIER



MODEL RF-805

- 10 Watts Output into 50Ω
- 0.1 Volts In — 22.5 Volts Out
- .05 MHz to 80 MHz Broadband
- Low Distortion
- Solid State
- Flat 47 db Gain

The RF-805 is a solid state amplifier, broadband from .05 to 80 megahertz, which produces ten watts with —30 db harmonic and intermodulation distortion. Lower distortion is available at lower output levels. Gain is 47 db minimum, constant within 1 db, so that full output is developed with less than 0.1 volt at the 50 ohm input. Accurate output metering and overload protection is provided.

The RF-805 will raise the power of most manual and swept tuned signal generators and thus extend the usefulness and versatility of available signal generators. Receiver testing, wattmeter calibration, antenna testing, RFI testing, attenuator measurements, and filter and component testing will be aided with the use of this equipment.



R F COMMUNICATIONS, INC.
1680 University Avenue • Rochester, N. Y. 14610

INFORMATION RETRIEVAL NUMBER 69

FOR EXCELLENCE IN PUSH BUTTON SWITCHES SPECIFY GRAYHILL

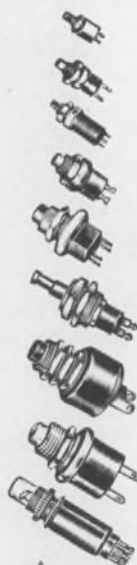

A WIDE SELECTION TO CHOOSE FROM...

- Ratings To 10 Amp.
- SPST, SPDT, DPST, DPDT
- Diameters From 1/4" To 7/8"
- Behind Panel Dimension As Small As .32"
- Momentary - Push-Pull - Lighted - Alternate Action (Push-On, Push-Off)
- Wiping, Snap Action And Butt Contacts
- Solder Lug, "Faston" Or Printed Circuit Terminals
- Life Expectancy Up To 1,000,000 Operations

For your Grayhill Engineering Catalog offering complete technical data—contact



565 Hillgrove Avenue
LaGrange, Illinois 60525
Area Code 312, Phone 354-1040

... the Difference Between Excellent and Adequate

INFORMATION RETRIEVAL NUMBER 70

Products

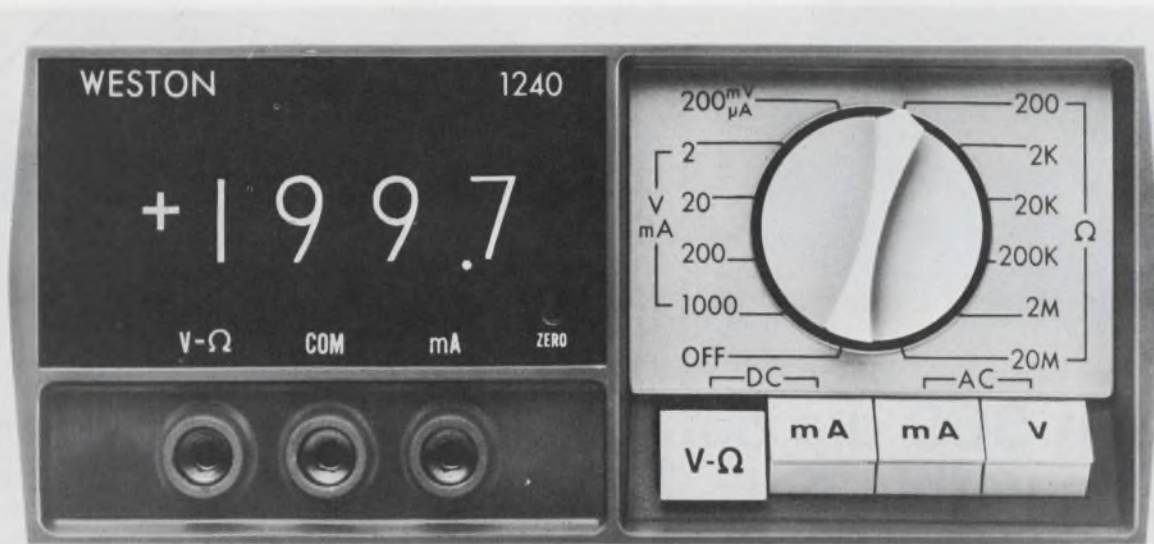

Low-cost portable four-digit multimeter with 26 ranges can accurately measure ac and dc

voltage, ac and dc current, and resistance too. Turn to p. 118.



Compact \$69 10-bit d/a convert-er settles in 750 ns, p. 112.



Audio frequency switches are now on-loan samples to readers of ELECTRONIC DESIGN, p. 136.

Also in this section:

Double potentiometric divider achieves accuracy of 0.01 ppm, p. 116.

High-voltage silicon thyristor handles 10,000 V at 400 A, p. 120.

Thin-film spiral inductors have Q of 30 and resonance at 1.8 GHz, p. 122.

Evaluation Samples, p. 136 . . . **Design Aids**, p. 138 . . . **Annual Reports**, p. 139.

Application Notes, p. 141 . . . **New Literature**, p. 142.

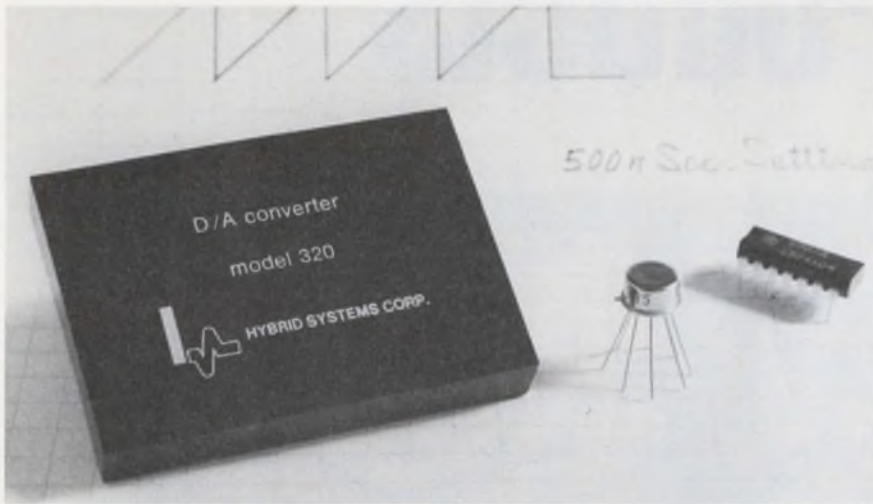

Ten-bit \$69 d/a converter settles within only 750 ns

Hybrid Systems Corp., 95 Terrace Hall Ave., Burlington, Mass. Phone: (617) 272-1522. P&A: \$69; stock to 2 wks.

Slashing its single-unit costs down to \$69, a new completely self-contained 10-bit digital-to-analog converter offers a fast settling time of 750 ns to one-half the least significant bit. In addition, model 320 provides an output linearity of three-quarters the least significant bit.

This fully encapsulated unit has a current source output with a

full-scale value of 15 mA. It can accept power supply voltages over the range of 10 to 15 V dc.

The 320 uses its power supply as an internal reference voltage. As a result, its output current is directly proportional to the reference voltage.

In addition, the new converter is packaged for high-density PC-board applications. Its dimensions are 2.5 by 1.75 by 0.4 in.

Suggested new applications include CRT computer display systems and industrial control.

CIRCLE NO. 361

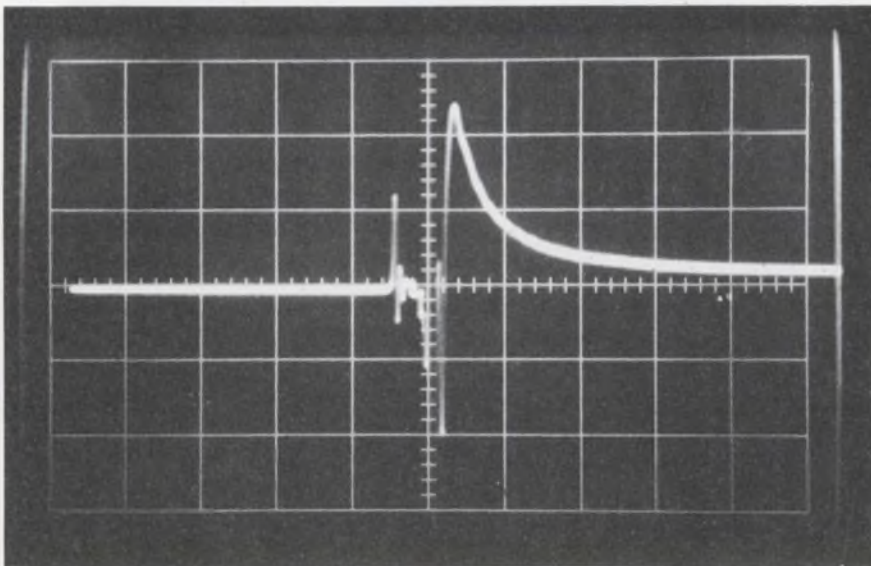

Self-contained \$69 10-bit d/a converter displays an output settling time of 750 ns. The spikes shown are produced by command instrumentation.

Op amp bias current help down to 2 pA

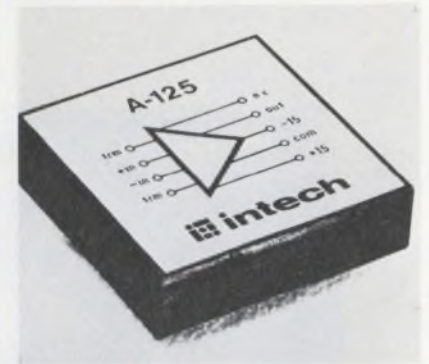

Intech Inc., 1220 Coleman Ave., Santa Clara, Calif. Phone: (408) 244-0500. P&A: \$95; stock.

Providing low noise of $3 \mu\text{V rms}$ and maximum drift of $25 \mu\text{V}/^\circ\text{C}$, a new FET operational amplifier displays a typical low input bias current of only 0.2 pA and maximum of 0.5 pA . The model A-125 differential input operational amplifier has a 10^5 minimum gain, a bandwidth of 2 MHz and an output of $\pm 10 \text{ V}$ at 5 mA. It measures 1.5 by 1.5 by 0.4 in.

CIRCLE NO. 362

FET-input op amp lowers cost to \$10

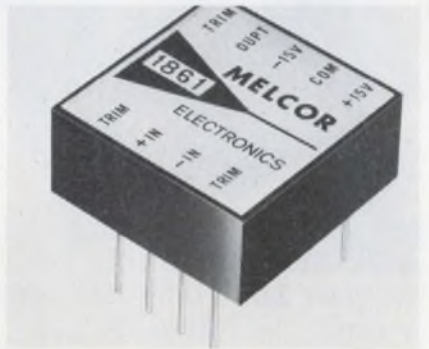

Melcor Electronics Corp., 1750 New Highway, Farmingdale, N.Y. Price: \$10.

Featuring an FET-input stage, low bias current, and IC construction, a new operational amplifier sells for only \$10 in unit quantities. The model 1861 has an output of $\pm 10 \text{ V}$ at $\pm 5 \text{ mA}$ minimum, dc gain of 15,000 and unity gain bandwidth of 1 MHz. All shaping networks are internal and only an external zeroing potentiometer may be required.

CIRCLE NO. 363

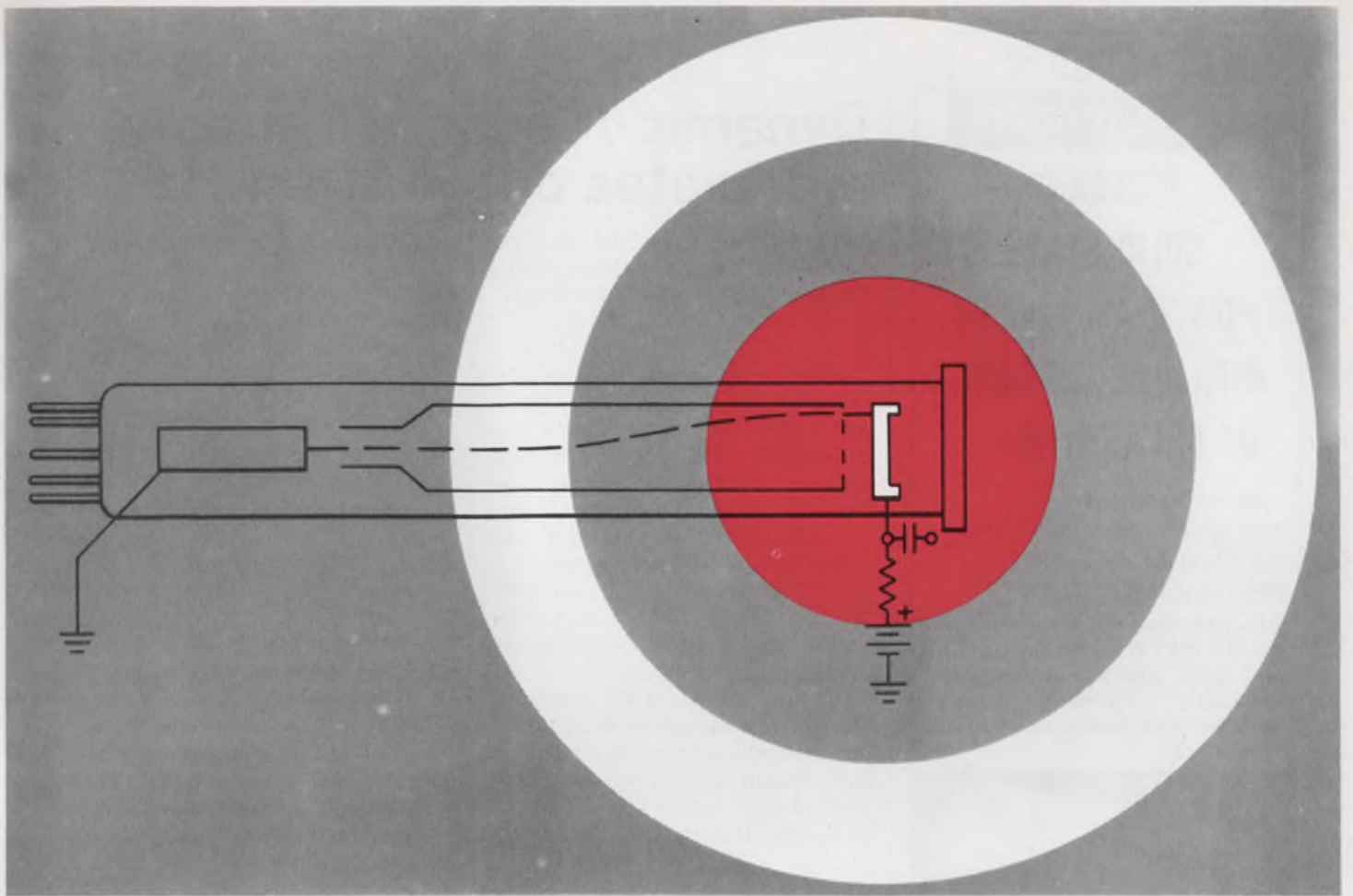

A solid state target in a camera tube

Bell System PICTUREPHONE® service will need small, reliable TV camera tubes for use in offices and homes, where lighting ranges from dim to very bright. Conventional vidicon tubes are unsuitable, so Bell Labs developed a new kind.

The heart of the new tube is a light-sensitive target containing nearly 700,000 silicon photodiodes in an area less than a half inch square. They are made by diffusing boron, a p-type impurity, through a silicon-dioxide mask into n-type silicon.

A scanning electron beam charges the p material negatively, reverse-biasing the diodes. Holes, created by incident light, are collected by the electric field at the p-n junctions, and individual diodes discharge by an amount proportional to the local light intensity. Recharging of the diodes by the scanning electron beam produces a varying current ... the output signal.

Among the tube's advantages: Its target tolerates high-temperature baking ... a processing step to improve reliability. Conventional vidicon targets cannot stand this.

Silicon's high thermal conductivity and chemical stability help make the new tube immune to "burn-in" (degradation of performance from continuous exposure to a fixed image, very bright light, or

a strong scanning electron beam).

The time between a change in target illumination and a like change in output is much shorter with the new target. This improves response to fast-changing scenes.

The light-sensitive face of the new target is optically flat. So, a multi-layer antireflection coating can be applied for better sensitivity and minimum received-picture "halo".

Silicon targets have relatively uniform response through the visible and near-infrared—from 4,000 to 9,000 Å. Quantum efficiency (electrons per photon) exceeds 0.5. So, these targets have at least 10 times the sensitivity of a standard vidicon camera tube in incandescent light.

This new camera tube is in the latest model PICTUREPHONE set, now undergoing field trials.

From the Research and Development Unit of the Bell System—

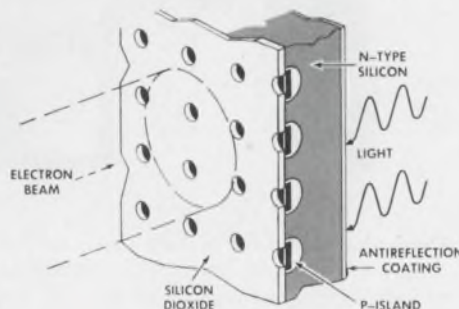

Bell Labs

C-COR AMPLIFIERS

WIDEBAND SOLID STATE POWER AMPLIFIERS WITH A BROAD RANGE OF CAPABILITIES...

Passband 0.1 to 470 MHz

Power Output +100 mW to +7 Watts

Gain 6 to 25 dB

Price \$130 to \$910

These off-the-shelf models represent examples of C-COR's design capability for wideband power amplifiers using distributed techniques . . . an effective means of paralleling active devices to obtain high power outputs.



The Model 3010-A illustrated is a solid-state distributed amplifier module which provides an output of 1/2 Watt of linear power from 1 to 425 MHz. The module is designed so that efficient heat transfer is obtained in mounting.

Examples of Wideband Power Amplifiers:

Model	Passband 3 dB. Nom.	Power Output	Gain Nom. dB
3007	0.1 to 230 MHz	+22 to +28	20
3008	1 to 40 MHz	+35 to +38.5	20
3010-A	1 to 425 MHz	+27	25
3010-C	4 to 470 MHz	+27	25
3016	0.1 to 240 MHz	+26 to +30	23
3502	1 to 300 MHz	+20	6

In addition, C-COR has wideband post amplifiers with outputs up to 60 Watts.

Write or telephone for catalog and technical data on your amplification requirements . . . or check C-Cor listings in EEM.

"C-COR Amplifiers . . . Rated First
Where Performance is Rated First."



C-COR

ELECTRONICS, INC.

60 Decibel Road
State College, Pennsylvania 16801
814 238-2461

INFORMATION RETRIEVAL NUMBER 71

Dynamic-focus CRT supply modulates out to 100 kHz

Computer Power Systems Inc., 722 E. Evelyn Ave., Sunnyvale, Calif. Phone: (408) 738-0530. P&A: \$1110; 60 days.

Able to be modulated at repetition rates from dc to 100 kHz, a new high-voltage power supply can dynamically focus CRT displays. Called a CRT dynamic-focus supply, the CPS-1000 delivers an output voltage of 1 to 5 kV at 2 mA.

Normally, the electron beam of a CRT is focused for the center of the tube. When it goes out of focus at the edges, the dc power supply voltage must be adjusted.

High-resolution CRTs require the supply's voltage to be adjusted automatically at very high frequencies. Usually, a high-voltage supply is floated on a waveform or signal generator. However, this is a costly

and power-consuming solution.

The CPS-1000, which sells for \$1110, provides the advantages of high reliability and low power consumption through its all-solid-state construction. Package size is only 4-1/2 by 4-5/8 by 9 in.

The performance key to the new supply is the design by which its high-voltage dc bias circuits share a common reference with the modulation input signal at ground potential. The dc bias is precision regulated at 0.0025% line or load.

Risetime or falltime is only 1.5 μ s for a full output swing. Settling time is less than 5 μ s to come within 1% of the final output value.

Both high- and low-voltage sections of the new supply consist of interlocking epoxy blocks. There are no soldered wire connections,

CIRCLE NO. 364

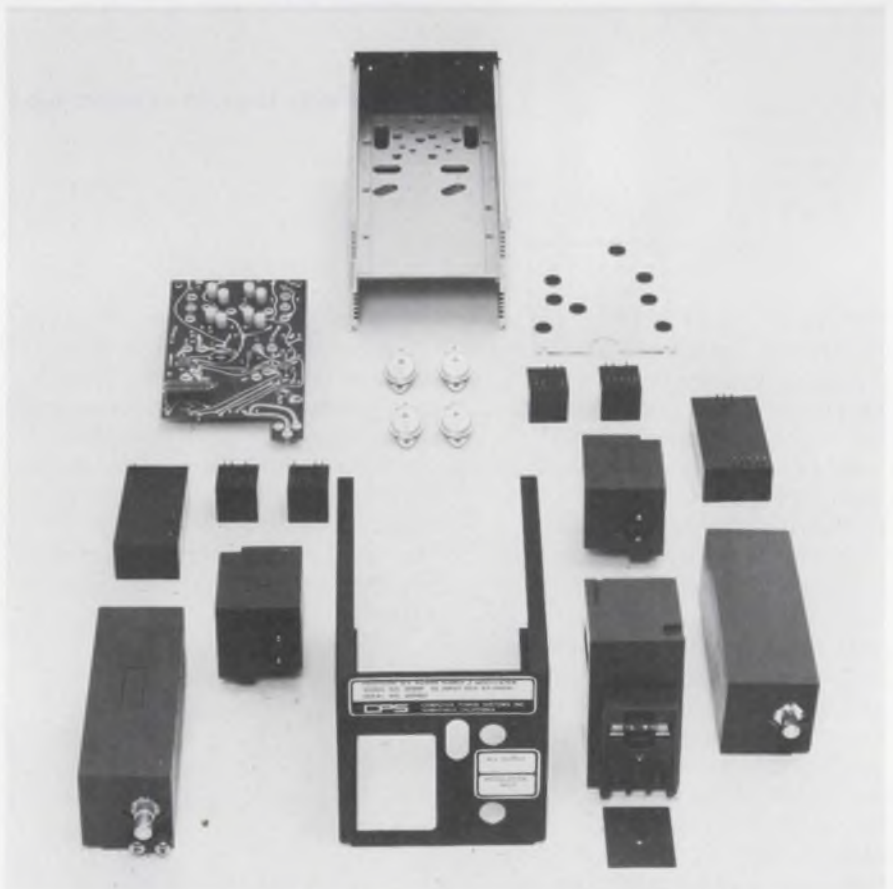

Dynamic-focus CRT supply can modulate high voltages from dc to 100 kHz. This compact unit delivers an output of 1 to 5 kV at 2 mA. It is constructed of interlocking epoxy blocks with no soldered connections.

Random-noise module spans 20 Hz to 20 kHz



Allison Laboratories, Inc., P.O. Box 9849, Austin, Tex. Phone: (512) 454-9591. P&A: \$85; stock.

Covering the audio frequency range from 20 Hz to 20 kHz, a new solid-state random-noise module adapts easily to circuits requiring a broadband test signal with uniform characteristics. Model 655C has good voltage and temperature stability over the temperature range of 0 to 50°C. The unit is non-microphonic and is powered by 22.5 V dc at 3 mA. It will supply 1 (± 2 dB) V rms into a 10-k Ω load.

CIRCLE NO. 365

Stable clock drives MECL

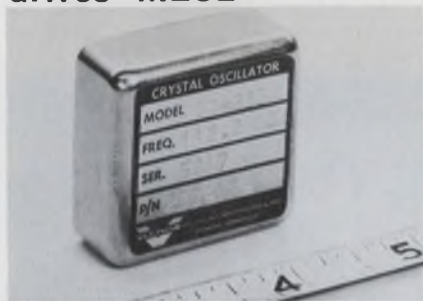

Vectron Laboratories, Inc., 146 Selleck St., Stamford, Conn. Phone: (203) 324-9225. Availability: stock.

Providing a stable fixed frequency to better than $\pm 0.0003\%$ over the temperature range of 20 to 30°C and $\pm 0.0025\%$ from 0 to 70°C, in the 25- to 125-MHz region, a new crystal oscillator produces output levels compatible with high-speed emitter-coupled logic (MECL). The CO-233M is factory set to $\pm 0.0005\%$ of the specified frequency while operating from a source of -12 to -30 Vdc at 20 mA.

CIRCLE NO. 366

locally... off the shelf

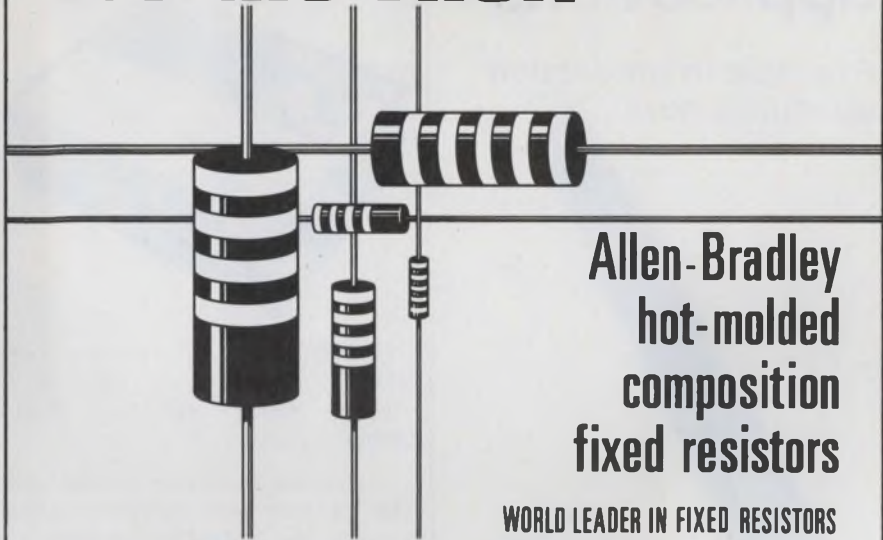

Allen-Bradley hot-molded composition fixed resistors

WORLD LEADER IN FIXED RESISTORS

Unequaled for reliability—Allen-Bradley hot-molded resistors are *unique* in meeting the requirements of MIL-R-390008 *Established Reliability Specifications* at the highest level—the "S" level. This is true for all four ratings—RCR32 (1 watt), RCR20 ($\frac{1}{2}$ watt), RCR07 ($\frac{1}{4}$ watt), and RCR05 ($\frac{1}{8}$ watt). And over the complete resistance range from 2.7 ohms (10 ohms for $\frac{1}{8}$ watt) to 22 megohms.

The distributors listed below are the only authorized Allen-Bradley distributors, and each has added a new dimension of service—fully stocked to give you fast delivery on hot-molded fixed resistors, hot-molded and cermet variable resistors and trimmers, discoidal capacitors, and high-frequency low pass feed-thru filters.



call now!

PHILADELPHIA

ALMO ELECTRONICS CORP.

A Subsidiary of Sterling
Electronics Corporation
Roosevelt Blvd. at Blue Grass Road
Philadelphia, Pennsylvania 19114
(215) OR 6-6000

BOSTON

CRAMER ELECTRONICS INC.

320 Needham Street
Newton, Massachusetts 02164
(617) 969-7700

SAN FRANCISCO

ELMAR ELECTRONICS INC.

A Subsidiary of Wyle Laboratories
2288 Charleston Road
Mountain View, California 94040
(414) 961-3611

LOS ANGELES

KIERULFF ELECTRONICS INC.

A Subsidiary of Ducommun Inc.
2585 Commerce Way
Los Angeles, California 90022
(213) 685-5511

CHICAGO

NEWARK ELECTRONICS CORPORATION

A Subsidiary of Premier
Industrial Corporation
500 North Pulaski Road
Chicago, Illinois 60624
(312) 638-4411

NEW YORK

SCHWEBER ELECTRONICS

Jericho Turnpike
Westbury, New York 11590
(516) 334-7474

©Allen-Bradley Company 1969

EC69-88A

INFORMATION RETRIEVAL NUMBER 72

Silicon Rectifier for B&W TV applications

Available in production quantities now!



In quantities greater than 50,000 Pcs.

- Diffused silicon.
- Fast recovery.
- Ferrule mounted.
- Available with wire leads.

When you think of Varo Semiconductor products, remember this — we're the company that not only made the first silicon high voltage rectifier ever used in consumer TV sets, but we received the first order for multipliers to be used in consumer TV production, too.



SEMICONDUCTOR DIVISION, 1000 N. SHILOH ROAD, GARLAND, TEXAS 75040 (214) 272-4551

INFORMATION RETRIEVAL NUMBER 73

Double-divider potentiometer is accurate to 1 part in 10^8



Julie Research Laboratories, Inc., 211 W. 61 St., New York, N.Y. Phone: (212) 245-2727. P&A: \$3500; 45 days.

By using a double divider system, a new potentiometer makes possible the instantaneous comparison of two voltage sources to an accuracy of 1 part in 10 million (0.1 ppm) to 1 part in 100 million (0.01 ppm).

Batches of hybrid linear or IC operational amplifiers can now be tested instantaneously and accurately for linearity and temperature coefficient checks since the potentiometer system is several

orders of magnitude more accurate than the specifications of the product being measured. Usually these checks must be made over weeks or months.

Essential to the model DVD108J divider's high order of accuracy is the design of a novel 16-dial Kelvin-Varley type voltage divider, which uses high-stability precision resistors combined with high-resolution Waidner-Wolff trimmers.

The Waidner-Wolff elements consist of low-value resistors that are shunted by adjustable high-value resistors to provide high-resolution adjustments for the divider decade resistors and to reduce the effects of thermal emfs in the measurement circuit to less than $0.001 \mu\text{V}$.

Manufacturers of high-accuracy instruments can also use this potentiometer to test components for stability and accuracy on a component or assembled-product level.

Operational amplifier users such as circuit designers can also perform tests on a system basis.

CIRCLE NO. 367

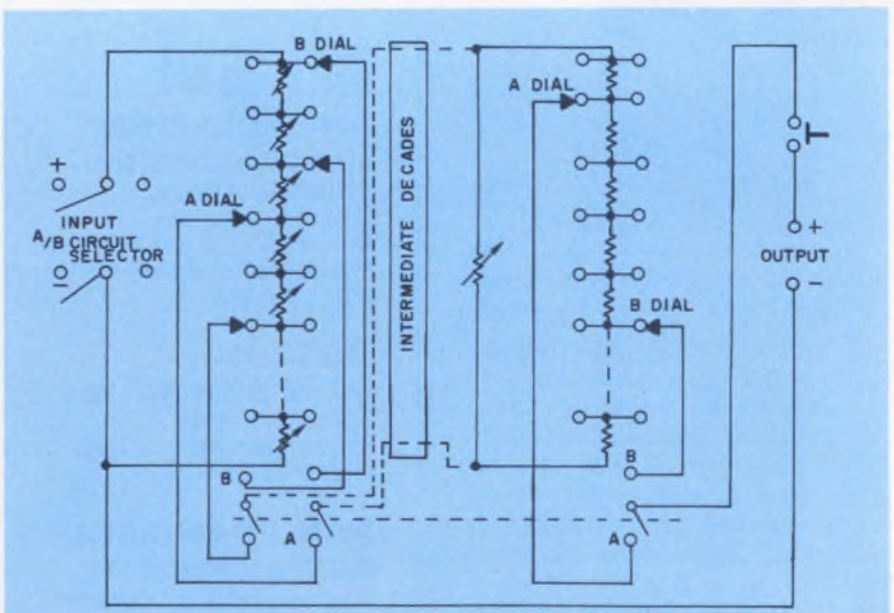

By using the same voltage divider resistor ladder for both A and B measurements, the potentiometer achieves an accuracy of 1 part in 100 million since deviations of the ladder's accuracy are kept common to both A and B.

Low-cost \$29.95 VOM
has 11 MΩ ds input

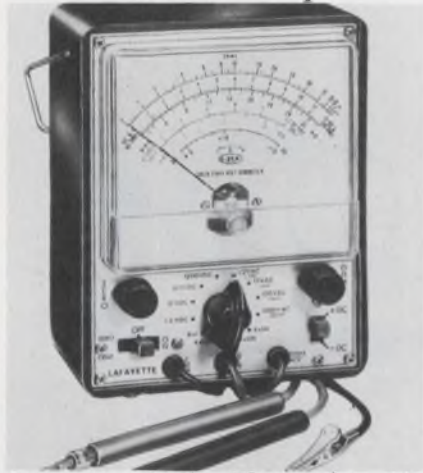

Lafayette Radio Electronics, 111
Jericho Turnpike, Syosset, N.Y.
Phone: (516) 921-7700. P&A:
\$29.95, 39.95, stock.

A new FET-input volt-ohm-meter features an 11-MΩ input impedance on dc and a 1-MΩ input impedance on ac ranges for a price tag of \$29.95 in kit form and \$39.95 in wired form. The meter measures dc and ac pk-pk voltages from 0 to 1200 V and resistance from 0 to 1000 MΩ in four ranges each.

CIRCLE NO. 368

DPM with 3-1/2 digits
is 0.1% accurate



Beede Electrical Instruments, Penacook, N.H. Phone. (603) 753-6362.

A new digital panel meter offers a 3-1/2-digit non-blinking display at an accuracy of 0.1% ±1 digit to full 100% overranging. The series DM-100 unit offers bipolar and unipolar models available in 6 current ranges from 0-19.99 μA to 0-1.999 A; 5 voltage ranges from 0-1999 mV to 0-1 kV dc; and 2 voltage ranges of 0 to 19.99 and 0 to 199.9 V ac.

CIRCLE NO. 369

immediate delivery

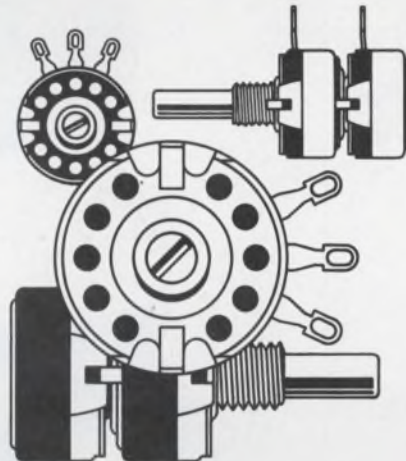

**Allen-Bradley
hot-molded
variable
resistors**

The famous Type J variable resistor has a solid hot-molded resistance element, which ensures smooth adjustment at all times—resolution is essentially infinite. Low inductance permits the Type J to be used in high-frequency circuits replacing wire-wound controls.

Type J controls are available in single and dual units. Rated 2.25 watts at 70°C in values from 50 ohms to 5.0 megohms, with a wide variety of tapers.

The distributors listed below are the only authorized Allen-Bradley distributors, and each has added a new dimension of service—fully stocked to give you fast delivery on hot-molded fixed resistors, hot-molded and cermet variable resistors and trimmers, discoidal capacitors, and high-frequency low pass feed-thru filters.

call now!



PHILADELPHIA

ALMO ELECTRONICS CORP.
A Subsidiary of Sterling
Electronics Corporation
Roosevelt Blvd. at Blue Grass Road
Philadelphia, Pennsylvania 19114
(215) OR 6-6000

BOSTON

CRAMER ELECTRONICS INC.
320 Needham Street
Newton, Massachusetts 02164
(617) 969-7700

SAN FRANCISCO

ELMAR ELECTRONICS INC.
A Subsidiary of Wyle Laboratories
2288 Charleston Road
Mountain View, California 94040
(414) 961-3611

©Allen-Bradley Company 1969

LOS ANGELES

KIERULFF ELECTRONICS INC.
A Subsidiary of Ducommun Inc.
2585 Commerce Way
Los Angeles, California 90022
(213) 685-5511

CHICAGO

NEWARK ELECTRONICS CORPORATION
A Subsidiary of Premier
Industrial Corporation
500 North Pulaski Road
Chicago, Illinois 60624
(312) 638-4411

NEW YORK

SCHWEBER ELECTRONICS
Jericho Turnpike
Westbury, New York 11590
(516) 334-7474

EC69-89A



Wide Band, Precision CURRENT MONITOR

With a Pearson current monitor and an oscilloscope, you can measure pulse or ac currents from milliamperes to kiloamperes, in any conductor or beam of charged particles, at any voltage level up to a million volts, at frequencies up to 35 MHz or down to 1 Hz.

The monitor is physically isolated from the circuit. It is a current transformer capable of highly precise measurement of pulse amplitude and waveshape. The one shown above, for example, offers pulse-amplitude accuracy of +1%, -0% (typical of all Pearson current monitors), 10 nanosecond rise time, and droop of only 0.5% per millisecond. Three db bandwidth is 1 Hz to 35 MHz.

Whether you wish to measure current in a conductor, a klystron, or a particle accelerator, it's likely that one of our off-the-shelf models (ranging from 1/2" to 10 3/4" ID) will do the job. Contact us and we will send you engineering data.

PEARSON ELECTRONICS INC

4007 Transport St., Palo Alto, California 94303
Telephone (415) 326-7285

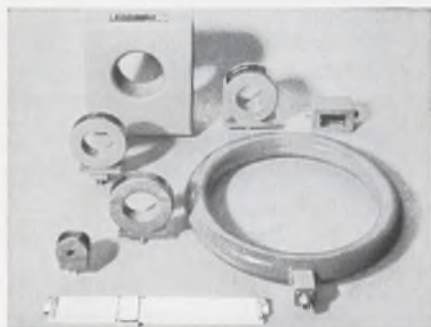

INFORMATION RETRIEVAL NUMBER 75



Four-digit DMM for \$379.50 measures five functions

Weston Instruments, Inc., 614 Frelinghuysen Ave., Newark, N.J. Phone: (201) 243-4700. P&A: \$379.50; stock.

Featuring 26 ranges of measurement in one instrument, a new four-digit multimeter can measure ac and dc voltage, ac and dc current and resistance in a single package for a price of only \$379.50 complete.

The new multimeter, the model 1240, measures dc voltages from 0 to 1000 volts in five ranges at a rated accuracy of 0.1% of reading $\pm 0.05\%$ of full-scale on all ranges; and ac voltages from 200 mV to 500 volts in five ranges at a rated accuracy of 0.5% of reading ± 1 digit on all ranges for the frequency range of 40 Hz to 10 kHz and 1% of reading ± 1 digit on all ranges for the frequency range of 10 to 20 kHz.

Dc and ac currents can be measured in five ranges each from 200 μ A to 2 A, and resistance checks

can be made from 200 Ω to 20 M Ω in six ranges at a rated accuracy of 0.5% of reading ± 1 digit for the first five ranges and 1 to 2% of reading for the last range.

The multimeter input uses a bipolar a/c converter circuit, operating on the dual-slope principle, for an input impedance of 100 M Ω dc and 1 M Ω at 50 pF ac.

Ac voltages are converted to dc by an active-sensing rms calibrated converter assembly while currents are measured by the voltage drops established across a precision ring-shunt network.

Operator convenience is stressed by the inclusion of a single range selector, four feather-touch function switches, an adjustable tilt stand and carrying handles, rack-mountable standard unit and a plug-in battery pack for complete portability.

Long life is assured by the use of overload-protection fuses that can be replaced externally.

CIRCLE NO. 370

Multi-channel scope displays 8 waveforms

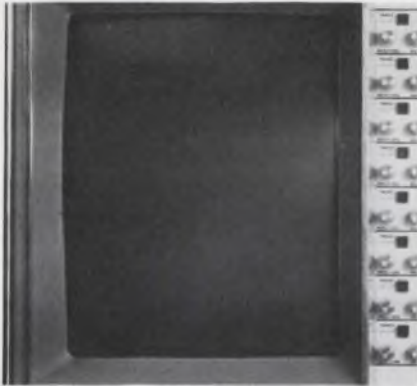

Marcom, Inc., 6325 Cambridge St., Minneapolis, Minn. Phone: (612) 929-3924.

Up to eight waveforms can be displayed and analyzed simultaneously on two new eight-channel oscilloscopes. The models are available with independently controlled channels having gating-amplifier inputs and a 21-in. glare-free display tube. Frequency response is flat from dc to 500 Hz and 3-dB down at 700 Hz. Sweep speeds are 25, 50 and 100 mm/s.

CIRCLE NO. 371

Low-cost probe eases logic testing



Acron Corp., 1209 River Ave., Lakewood, N.J. Phone: (201) 364-7200. P&A: \$99.50; 2 wks.

Called Acro-Probe, a new hand-held probe tests and evaluates any computer logic circuit status by touching the probe tip to a 0- or 1-stage terminal. Circuit status is indicated by a light on the top of the probe that shows red, green, some combination, or no color. The probe has a variable threshold setting and responds to pulses from dc to 5 ns. It can also detect open circuits while operating on a supply voltage of ± 3 to ± 30 V.

CIRCLE NO. 372

now... local stock

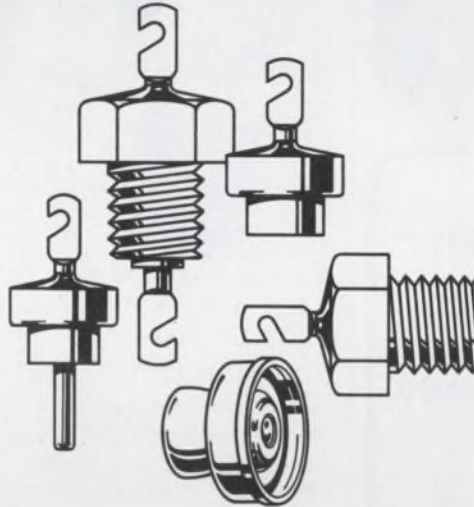

Allen-Bradley discoidal capacitors

Discoidal design provides efficient filtering into the ultra-high frequency range—there are no parallel resonance effects up through 1000 megahertz. Insulation resistance is in excess of 100,000 megohms—assures superior direct current blocking.

Compact in size, yet rugged in construction. These capacitors resist the thermal shock of soldering and require no special handling during assembly. Available in a wide range of capacitance values.

The distributors listed below are the only authorized Allen-Bradley distributors, and each has added a new dimension of service—fully stocked to give you fast delivery on hot-molded resistors, hot-molded and cermet variable resistors and trimmers, discoidal capacitors, and high-frequency low pass feed-thru filters.



call now!

PHILADELPHIA

ALMO ELECTRONICS CORP.
A Subsidiary of Sterling
Electronics Corporation
Roosevelt Blvd. at Blue Grass Road
Philadelphia, Pennsylvania 19114
(215) OR 6-6000

LOS ANGELES

KIERULFF ELECTRONICS INC.
A Subsidiary of Ducommun Inc.
2585 Commerce Way
Los Angeles, California 90022
(213) 685-5511

BOSTON

CRAMER ELECTRONICS INC.
320 Needham Street
Newton, Massachusetts 02164
(617) 969-7700

CHICAGO

NEWARK ELECTRONICS CORPORATION
A Subsidiary of Premier
Industrial Corporation
500 North Pulaski Road
Chicago, Illinois 60624
(312) 638-4411

SAN FRANCISCO

ELMAR ELECTRONICS INC.
A Subsidiary of Wyle Laboratories
2288 Charleston Road
Mountain View, California 94040
(414) 961-3611

NEW YORK

SCHWEBER ELECTRONICS
Jericho Turnpike
Westbury, New York 11590
(516) 334-7474

©Allen-Bradley Company 1969

EC69-90A

INFORMATION RETRIEVAL NUMBER 76

NEED HIGH VOLTAGE CAPACITORS FAST?

... Prompt Delivery -

NO!

... Immediate Delivery
YES!



GLASS
CONTAINERS



METAL CAN
CONTAINERS

Our list of satisfied "blue chip" customers is growing and growing which necessitated a large expansion of our manufacturing and engineering facilities. Now, we can supply a complete range of voltages from 2,000 to 50,000 volt capacitors from our expanded "stock on hand". Don't take excuses, we'll supply you faster than at any time in our many years in the field—**BETTER PRODUCTION FROM US—
BETTER DELIVERY FOR YOU!**

Write for complete list of Standard High Voltage Capacitors in stock—or, send specifications for custom quotations.



Plastic Capacitors, INC.

2620 N. Clybourn • Chicago 14, Ill.
DI 8-3735

INFORMATION RETRIEVAL NUMBER 77

High-voltage thyristor handles 10,000 volts



Hitachi New York Ltd., 501 Fifth Ave., New York, N.Y. Phone: (212) 867-1422.

Believed to have the world's largest power capacity, a new thyristor handles 10,000 V and 400 A. This new device, known as the CH99, is a silicon semiconductor component that can be used for solid-state circuit interrupters and high-tension static converters. Other applications include heavy electric machinery.

CIRCLE NO. 373

Dual IC amplifier isolates to 140 dB

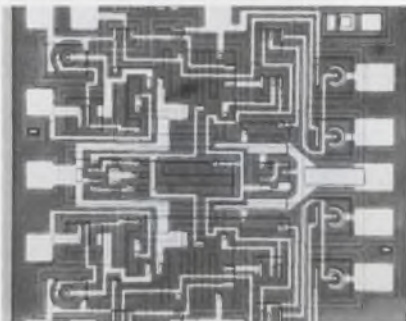

Fairchild Semiconductor, 313 Fairchild Drive, Mountain View, Calif. Phone: (415) 962-3563. Price: \$3.75.

Providing a channel separation of 140 dB to minimize interaction between its two amplifiers, a dual wideband operational amplifier achieves a gain of 20,000 and an input impedance of 150 kΩ. Model μ A749, which is latch-up proof and short-circuit protected, features a 20-MHz unity-gain bandwidth. Each of its two amplifiers has differential inputs and an uncommitted pnp output stage.

CIRCLE NO. 374

MOS shift registers slash prices 65%

National Semiconductor Corp., 2975 San Ysidro Way, Santa Clara, Calif. Phone: (408) 245-4320. P&A: \$10, \$21.60; stock.

OEM prices have been slashed down, up to 65%, on an entire line of military-temperature-range MOS shift registers. For example, the model MM406 dual 100-bit register has gone from \$60 to \$40 and the model NH0009 MOS hybrid two-phase clock driver has gone from \$27 to \$21.60 in lots of 100. All these circuits meet military specifications.

CIRCLE NO. 375

High-voltage transistor switches 3×10^6 pps

Westinghouse Electric Corp., Semiconductor Div., Youngwood, Pa.

Operating at voltages as high as 375 V, a new transistor has a switching speed of three million pulses per second (3×10^6 pps) at a peak current of 30 A. Known as the # 1823, it is a double-epitaxial type and is claimed to be the fastest high-voltage unit available for high-current applications. Applications include power supplies, voltage regulators, inverters and converters.

CIRCLE NO. 376

Four-layer diode switches in 20 ns

American Power Devices, Inc., 7 Andover St., Andover, Mass.

A new series of Shockley (0-layer) diodes features ultra-fast switching with a turn-on time of 20 ns and a turn-off time of 40 ns typical. Series APD4C50 diodes can switch voltages up to 50 V and hold currents from 1 to 100 mA. The switched voltage changes less than ± 2 V from -55 to $+71^\circ\text{C}$. Applications include sawtooth and pulse generation, antenna and cross-point switching and SCR triggering.

CIRCLE NO. 377

Low-cost multiplexer handles 10 channels

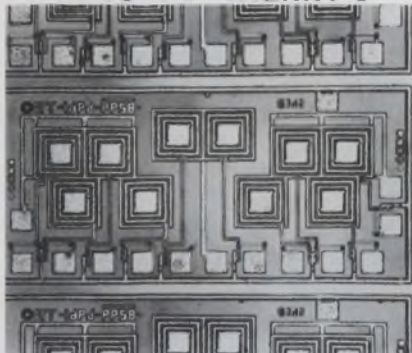

General Instrument Corp., 600 W. John St., Hicksville, N.Y. Phone: (516) 733-3333. P&A: \$21.20; October, 1969.

Having a low cost of \$21.20 in lots of 100, a new 10-channel MOS multiplexer features an input resistance of $10^{10} \Omega$. Low threshold capability, integrated zener clamp protection, square-law linear transfer characteristics and low cross talk leakage and on-resistance are other features. Model MU-6-2281 is available in a 24-lead dual-in-line package.

CIRCLE NO. 378

Operational amplifier drives ± 300 -mA loads

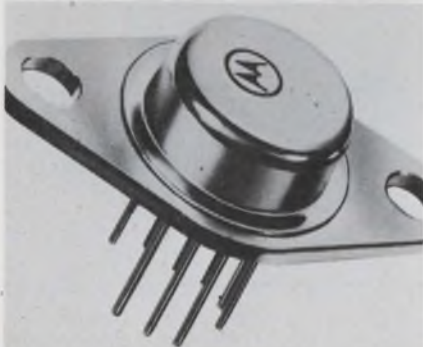

Motorola Semiconductor Products Inc., P.O. Box 20924, Phoenix, Ariz. P&A: \$14; stock.

Featuring unity voltage gain, a new IC operational amplifier has 70-dB current gain and can supply load currents of ± 300 mA. The MC1538R operates from -55 to $+125^\circ\text{C}$ and has a 0.4-M Ω and a 10- Ω input and output impedance, respectively. Power bandwidth is typically 1.5 MHz at 20 V pk-pk, and small-signal bandwidth is typically 8 MHz.

CIRCLE NO. 379

now... no delay

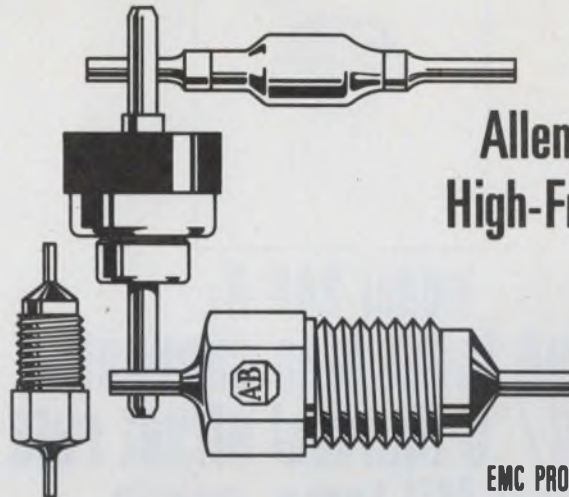

Allen-Bradley High-Frequency Filters

EMC PRODUCT FROM A-B!

These miniature low-pass filters have been specifically designed for use in demanding EMC applications, where the necessary attenuation of undesired high frequencies cannot be obtained with conventional feed-thru capacitors. Attenuations of 75 db or more can be obtained in the frequency range of 50 MHz to 10,000 MHz.

DC working voltages of 200 and 500 volts with feed-thru currents of 10 and 25 amperes, respectively, are featured in this product line.

The distributors listed below are the only authorized Allen-Bradley distributors, and each has added a new dimension of service—fully stocked to give you fast delivery on hot-molded fixed resistors, hot-molded and cermet variable resistors and trimmers, discoidal capacitors, and high-frequency low pass feed-thru filters.

call now!



PHILADELPHIA

ALMO ELECTRONICS CORP.
A Subsidiary of Sterling
Electronics Corporation
Roosevelt Blvd. at Blue Grass Road
Philadelphia, Pennsylvania 19114
(215) OR 6-6000

LOS ANGELES

KIERULFF ELECTRONICS INC.
A Subsidiary of Ducommun Inc.
2585 Commerce Way
Los Angeles, California 90022
(213) 685-5511

BOSTON

CRAMER ELECTRONICS INC.
320 Needham Street
Newton, Massachusetts 02164
(617) 969-7700

CHICAGO

NEWARK ELECTRONICS CORPORATION
A Subsidiary of Premier
Industrial Corporation
500 North Pulaski Road
Chicago, Illinois 60624
(312) 638-4411

SAN FRANCISCO

ELMAR ELECTRONICS INC.
A Subsidiary of Wyle Laboratories
2288 Charleston Road
Mountain View, California 94040
(414) 961-3611

NEW YORK

SCHWEBER ELECTRONICS
Jericho Turnpike
Westbury, New York 11590
(516) 334-7474

©Allen-Bradley Company 1969

EC69-91A

INFORMATION RETRIEVAL NUMBER 78

only from
BELL & HOWELL



model 248 A₂
5pA input bias current
10 μ V/ $^{\circ}$ C thermal offset rate
full Mil temp. range
hybrid fet op amp

\$63.⁰⁰*

*...and these other high performance
hybrid op amps*



model 247 A₁
Bipolar
1 μ V/ $^{\circ}$ C
Mil Temp. Range
\$34.00*



model 108 FET
5 pA Bias Current
5 μ V/ $^{\circ}$ C to 100 μ V/ $^{\circ}$ C
Thermal Rates
\$54.00 to \$18.00*



model 008 B₁ FET
5pA Bias Current
25 μ V/ $^{\circ}$ C Thermal Rate
\$31.00*



model 007 Bipolar
1 μ V/ $^{\circ}$ C to 20 μ V/ $^{\circ}$ C
Thermal Rates
\$26.00 to \$11.00*

*Price for 25-99 Quantities — Stock Delivery

CONTROL PRODUCTS DIVISION

706 Bostwick Ave., Bridgeport, Conn. 06605 (203) 368-6751



BELL & HOWELL

COMPONENTS

**Thin-film inductors
increase Q up to 30**



Motorola Semiconductor Products Inc., P.O. Box 20924, Phoenix, Ariz. Phone: (602) 273-6900. P&A: \$3.95 to \$4.30; stock.

Fabricated on a 0.01-in.-thick alumina substrate, a new series of thin-film spiral inductors features small size, low cost, inductance values of 28 to 230 nH, and a high Q of 20 to 30. Types MCH5800 through MCH-5805 exhibit a high self-resonant frequency of 0.7 to 1.8 GHz and are designed for use in uhf and microwave circuits.

CIRCLE NO. 380

**Tiny position switches
trim dia to 0.5 in.**



Daven Div. of Thomas Edison Industries, Municipal Airport, Manchester, N.H. Phone: (603) 669-0940.

Said to be the smallest switches of their type, two new series of 12-position switches measure only 0.5 in. in diameter. Series G and K switches include shorting and non-shorting types that carry and switch currents of 3 and 1 A, respectively. Versions are available with a choice of terminations; models vary from one-pole 12-position up to four-pole three-position.

CIRCLE NO. 381

Bi-pin plug-in lamps widen design selection

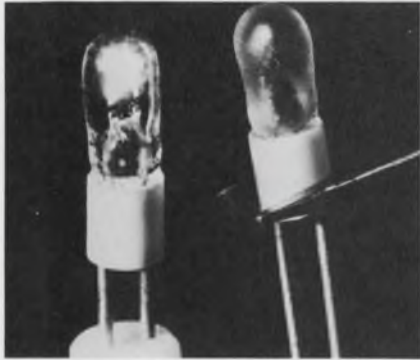

Lamps, Inc., 1700 S. Western Ave.,
Gardena, Calif.

A new series of bi-pin T-3/4 and T-1 lamps designed to fit readily available sockets, provides fast positive contact and plug-in versatility. These lamps are available in voltages from 1.5 to 28 V and currents from 8 mA \pm 1.5 mA to 0.32 A, and stock designs that include standard tips for undistorted end viewing, as well as integral-end condenser lenses for greater light intensity.

CIRCLE NO. 382

Thin-film capacitors are 2.4-mils thick



Sprague Electric Co., Marshall St.,
North Adams, Mass.

Measuring only 2.4-mils thick is a new line of micro-miniature tantalum beam-leaded thin-film capacitors for hybrid and ceramic substrate applications. Type 950D capacitors are available in a range of values from 100 to 3000 pF at tolerances of \pm 5 and \pm 10%. Their tantalum pentoxide dielectric provides a high dielectric strength and constant providing superior utilization of substrate area.

CIRCLE NO. 383

locally... off the shelf

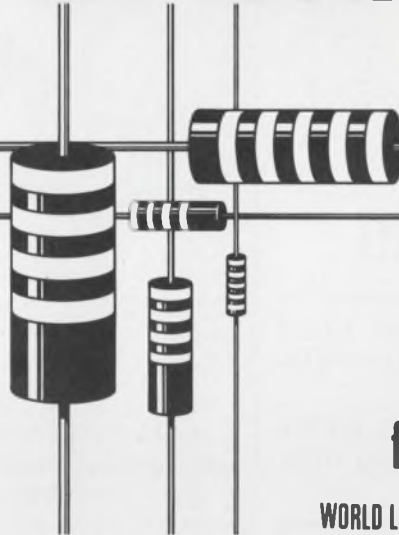

Allen-Bradley hot-molded composition fixed resistors

WORLD LEADER IN FIXED RESISTORS

Unequaled for reliability—Allen-Bradley hot-molded resistors are *unique* in meeting the requirements of MIL-R-390008 *Established Reliability Specifications* at the highest level—the "S" level. This is true for all four ratings—RCR32 (1 watt), RCR20 ($\frac{1}{2}$ watt), RCR07 ($\frac{1}{4}$ watt), and RCR05 ($\frac{1}{8}$ watt). And over the complete resistance range from 2.7 ohms (10 ohms for $\frac{1}{8}$ watt) to 22 megohms.

The distributors listed below are the only authorized Allen-Bradley distributors, and each has added a new dimension of service—fully stocked to give you fast delivery on hot-molded fixed resistors, hot-molded and cermet variable resistors and trimmers, discoidal capacitors, and high-frequency low pass feed-thru filters.



call now!

PHILADELPHIA

ALMO ELECTRONICS CORP.
A Subsidiary of Sterling
Electronics Corporation
Roosevelt Blvd. at Blue Grass Road
Philadelphia, Pennsylvania 19114
(215) OR 6-6000

BOSTON

CRAMER ELECTRONICS INC.
320 Needham Street
Newton, Massachusetts 02164
(617) 969-7700

SAN FRANCISCO

ELMAR ELECTRONICS INC.
A Subsidiary of Wyle Laboratories
2288 Charleston Road
Mountain View, California 94040
(414) 961-3611

©Allen-Bradley Company 1969

LOS ANGELES

KIERULFF ELECTRONICS INC.
A Subsidiary of Ducommun Inc.
2585 Commerce Way
Los Angeles, California 90022
(213) 685-5511

CHICAGO

NEWARK ELECTRONICS CORPORATION
A Subsidiary of Premier
Industrial Corporation
500 North Pulaski Road
Chicago, Illinois 60624
(312) 638-4411

NEW YORK

SCHWEBER ELECTRONICS
Jericho Turnpike
Westbury, New York 11590
(516) 334-7474

EC69-88A



FET QUADS AS VCRs

Problem: Find technique for solid state control of quad attenuator or phase shift networks.

Solution: Siliconix VCR13N Quad FET; 5% tracking from 200–2K ohms.

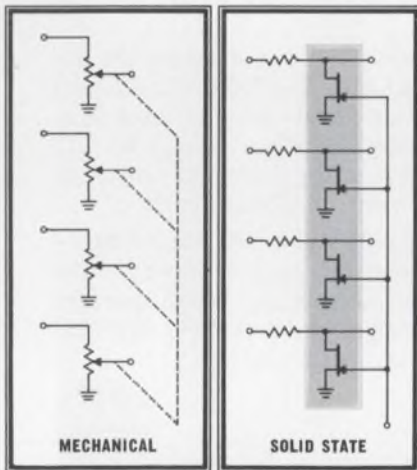

These quad VCRs are specially matched to give close tracking over the specified resistance range. Others: Single and dual voltage controlled resistors (VCR10N, VCR11N) for many applications such as multipliers, phase shift circuits, attenuators, feedback resistors in variable gain amplifiers or . . . what have you?

For immediate applications assistance call the number below.

Siliconix
incorporated

2201 Laurelwood Rd. • Santa Clara, Calif. 95054
(408) 246-8000 Ext. 201 • TWX: 910-338-0227

*Applications Power: A broad product line and a service-oriented applications team waiting to serve you!

COMPONENTS

Fast stepper motor moves in 7.5° steps

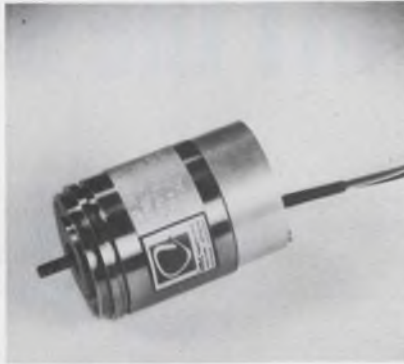

IMC Magnetics Corp., 570 Main St., Westbury, N.Y. Phone: (516) 334-7195. Availability: stock.

Having a size of 1.437-in. OD (size 15), stall torque of 4 oz.-in. and running torque of 1.8 oz.-in. a new three-phase stepper motor responds up to 600 pulses per second bidirectionally, in 7.5° steps. The motor, model 015-011, uses a variable reluctance design feature where a ferromagnetic multi-toothed rotor interacts with an electromagnetic stator.

CIRCLE NO. 384

Trigger transformers mount on PC boards

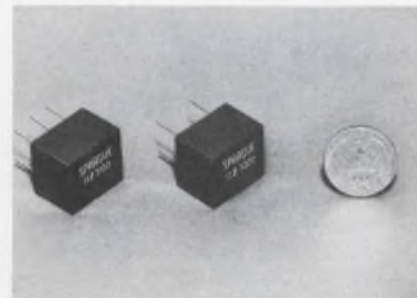

Sprague Electric Co., 347 Marshall St., North Adams, Mass. Phone: (413) 664-4411.

Specifically designed for use on printed wiring boards, a new series of pre-molded-case trigger transformers is now available for commercial and industrial SCR triggering applications. The Trigate 11Z3000 family of pulse transformers features ten designs in a 240-V rms series and four designs in a 550-V rms series.

CIRCLE NO. 385

Trimmer resistor is ±10-ppm stable

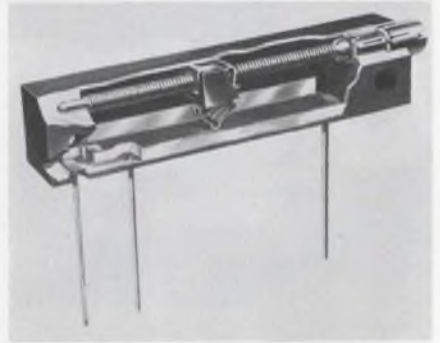

Vishay Resistor Products, div. of Vishay Intertechnology, Inc., 63 Lincoln Highway, Malvern, Pa. Phone: (215) 644-1300.

A new non-inductive precision trimmer resistor featuring zero dc offset and no thermal noise exhibits a temperature coefficient of ±10 ppm. This new trimmer, which uses multi-fingered wipers on redundant resistance paths, displays this coefficient over the temperature range of -55 to +125°C. It also has less than 2 Ω of end resistance for all values.

CIRCLE NO. 386

Disc capacitors trim to +125°C



Spectrum Control, Inc., 152 E. Main St., Fairview, Pa. Phone: (814) 474-5593.

Exhibiting typical Q factors of 500, a new line of rotary ceramic disc trimmer capacitors operate over the temperature range of -55 to +125°C. Available in five mounting bases and several terminal styles, the units range in value from 1.5 to 75 pF at 350 Vdcw. They are available in either zero or extended temperature coefficient materials. Their glass-reinforced polyester base material is said to have twice the flexural strength of XXXP phenolic.

CIRCLE NO. 387

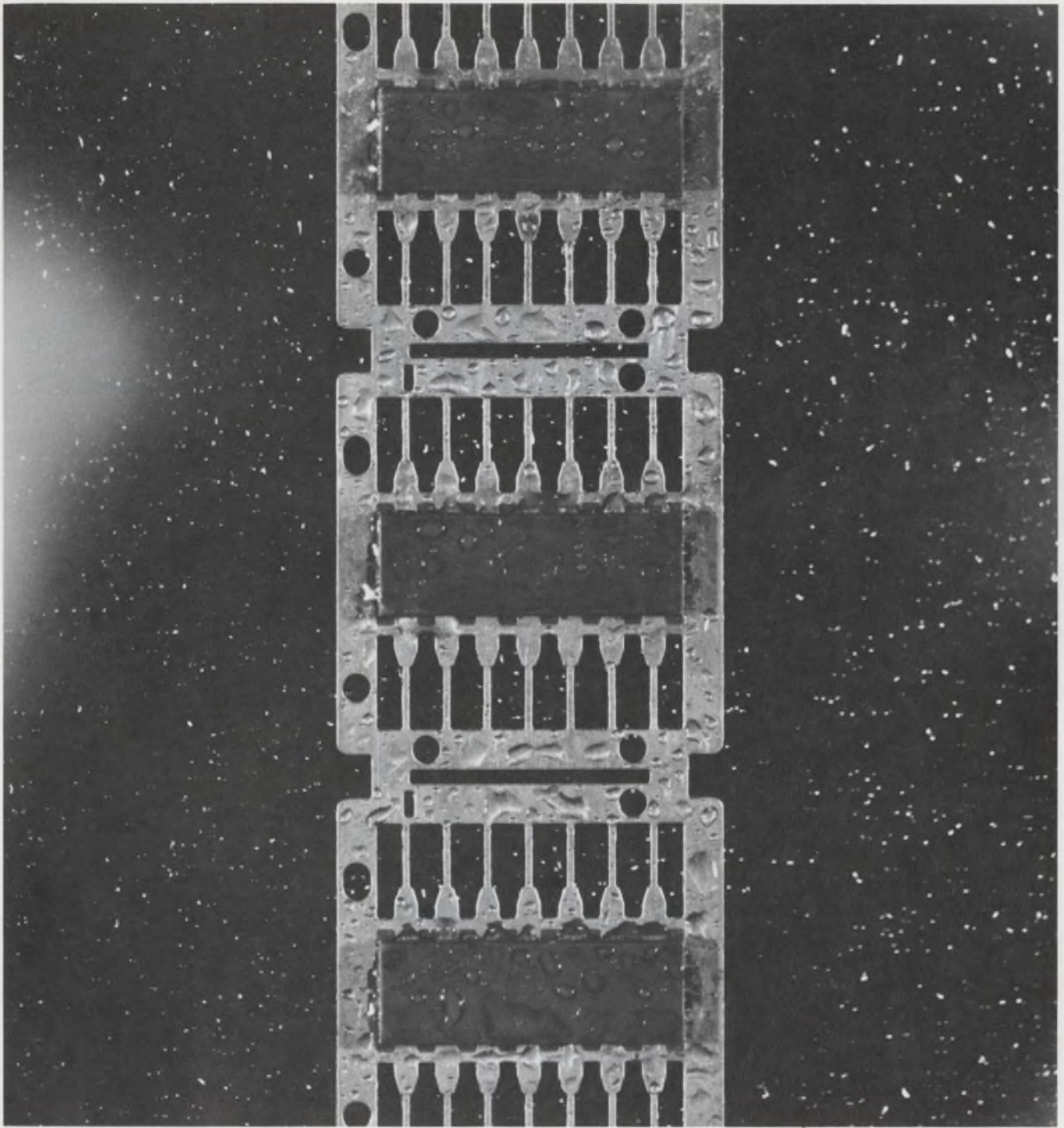

Keep your power dry

Dow Corning® silicone molding compounds and four organic plastics were tested under identical conditions—93% relative humidity at 70C for 5000 hours. The organic plastics absorbed nearly five times as much moisture as the silicones. Moral: silicones protect your power devices from galvanic corrosion. Other advantages of silicones include

superior resistance to thermal shock, cracking and burning. No derating is necessary, the initial cost is low, and you get faster production because of good mold release and minimum flash. Dow Corning silicone molding compounds are a genuine bargain that can improve your product and save you money. Our new booklet gives complete details on Dow Corning silicone

molding compounds. For your copy, write Dow Corning Corporation, Dept. A-9433, Midland, Michigan 48640.

Electrical / Electronic materials from

DOW CORNING

DOW CORNING

INFORMATION RETRIEVAL NUMBER 81

PRECISION WIRE



for electronic applications

CRM specializes in wire for precision electronic applications. All CRM wires are made with absolute uniformity of composition, smooth surface finish, and freedom from contamination. Packaging on unique platform-mounted spools in vapor-proof double plastic containers protects quality in storage and use.

.. Spectrographically controlled Gold and Aluminum bonding wire

.. Platinum alloys for potentiometers

.. 6-9's aluminum and other metals for vacuum deposition

.. Fine wire for thermistors

.. Custom enameled fine wire

Call or write CRM for a quotation or a copy of the latest, complete CRM catalog.

**CONSOLIDATED
CRM REACTIVE
METALS, INC.**

a Division of CONSOLIDATED REFINING CO., Inc.
117 Hoyt Avenue, Mamaroneck, N.Y. 10543
Tel: (914) 698-2300 □ TWX 710-566-1112

PACKAGING & MATERIALS

Dual-clad Teflon sheet shields and heat-sinks



Rogers Corp., Rogers, Conn. Phone: (203) 744-9605.

Primarily developed for packaging microwave equipment that requires shielding or heat dissipation, RT/duroid 5870, a glass microfiber-reinforced Teflon sheet, is now available clad on one side with 1/16-, 3/32- or 1/8-in. thick aluminum. The other side of the 0.01-to-0.25-in. dielectric is copper-clad in the desired etching thickness. This low-loss material can be used at frequencies up through Ku band.

CIRCLE NO. 388

Conical PC-board fillet centers leads to 0.1 in.



AMP Inc., Eisenhower Blvd., Harrisburg, Pa. Phone: (717) 564-0101.

Requiring only 0.055-in.-dia holes, a new conical-shaped fillet for securing component leads in PC boards permits center-to-center lead spacings as close as 0.1 in. The unit retains itself in standard 1/16-in.-thick boards, while firmly gripping component leads and keeping the components in place until soldering is completed. Bench-mounted machines can insert the fillets by a vibration and multiple-punch technique.

CIRCLE NO. 389

Flat-ribbon coax cable reduces OD to 48 mils



Spectra-Strip Corp., P.O. Box 415, Garden Grove, Calif. Phone: (714) 892-3361.

Carrying PVC over Teflon insulation, a new miniature flat-ribbon bonded coaxial cable using coaxial conductors has a nominal OD of only 48 mils. Up to 100 bonded conductors are available in 48-mil-thick ribbon cables, with no change in the cable's physical and electrical properties. The cable has a 45-Ω impedance and a 32 pF capacitance.

CIRCLE NO. 390

TO-66 heat sinks dissipate 9 W

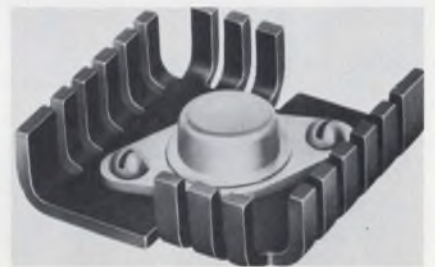

International Electronic Research Corp., 135 W. Magnolia Blvd., Burbank, Calif. Phone: (213) 849-2481. Price: from 20¢.

Mounted only to an epoxy board in free air, a new line of low-cost heat dissipators for TO-66 metal cans allows 9-W dissipation from the package while maintaining case temperature at 134°C. Only 7/16-in. high, the units are suited to low-profile printed-circuit-board applications. Series UP3-TO66-B dissipators are stamped from aluminum with a multiple-finger configuration for convection efficiency.

CIRCLE NO. 391

Heat-transfer tube loops helical wires

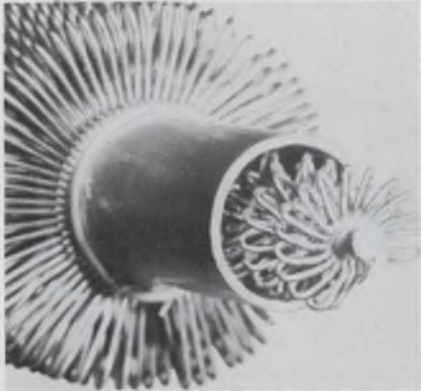

Thermonetics, div. of G & O Corp., 145 Winchester Ave., New Haven, Conn. Phone: (203) 526-5121.

Revolutionizing heat transfer performances is the new STILL tube that consists of the basic tube with fins of elongated loops of continuous wire in a helical formation to give a heat-transfer rate 20 times that of ordinary tubes. Each loop of wire is bonded metallurgically to the tube by a special process that insures thermal conductivity.

CIRCLE NO. 392

Small jack receptacle stops rf radiation

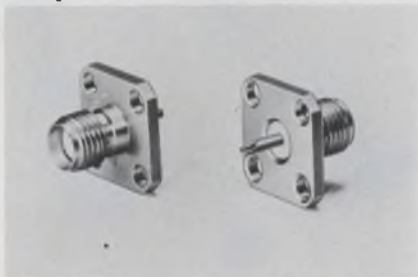

Sealelectro Corp., RF Components Div., 225 Hoyt St., Mamaroneck, N.Y. Phone: (914) 698-5600.

Designated part number 50-645-4504-31, a new 3-mm series SRM jack receptacle is claimed to prevent rf radiation. The receptacle is constructed of gold-plated stainless steel, Teflon, and gold-plated beryllium copper. It does not use epoxy to retain the contact and insulator, and meets requirements regarding contact and dielectric torque and captivation.

CIRCLE NO. 393

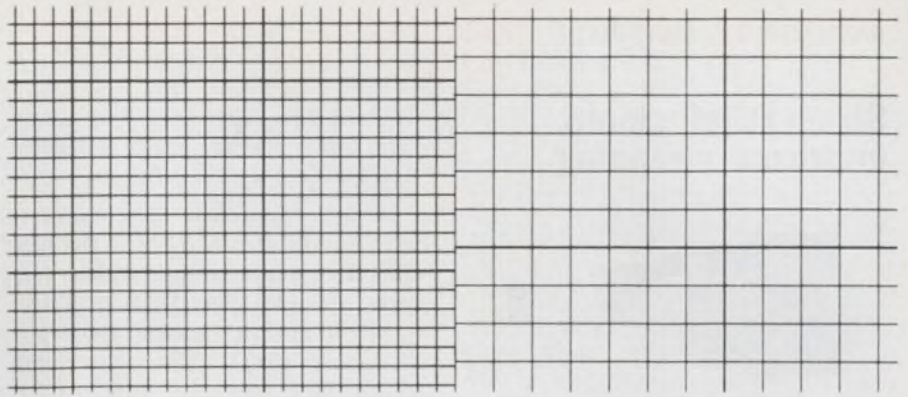

How accurate can you get?

(You'll never know till you try new K&E STABILENE® Precision Grids.)

Our new grids are individually made from precision original-negative masters under carefully controlled conditions of temperature and humidity. The masters have a line-to-line accuracy of .0005", and a total accumulated accuracy of .002" over 48".* When you're making (or checking) large precision layouts and artwork for printed circuits you just can't get any closer.

New K&E Precision Grids are produced on K&E STABILENE®, the Mylar-based film that is the most dimensionally stable design media other than glass.

K&E Precision Grids are available in opaque black line or non-reproducible blue line, in standard sizes up to 36" x 48" and a large variety of configurations.

They're the world's most accurate grids from a company with a century of experience in supplying the creative engineer and draftsman. These precision grids are only one product in a wide range of stable base materials, including the CUT 'N STRIP type most often used for electronic circuitry layouts.

For further information see your K&E representative, or write Keuffel & Esser Company, 20 Whippany Road, Morristown, N.J. 07960.

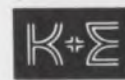

CREATIVE PRODUCTS
FOR THE CREATIVE ENGINEER
KEUFFEL & ESSER CO.

*For comparable accuracy, grids must be used at prescribed ambient conditions.

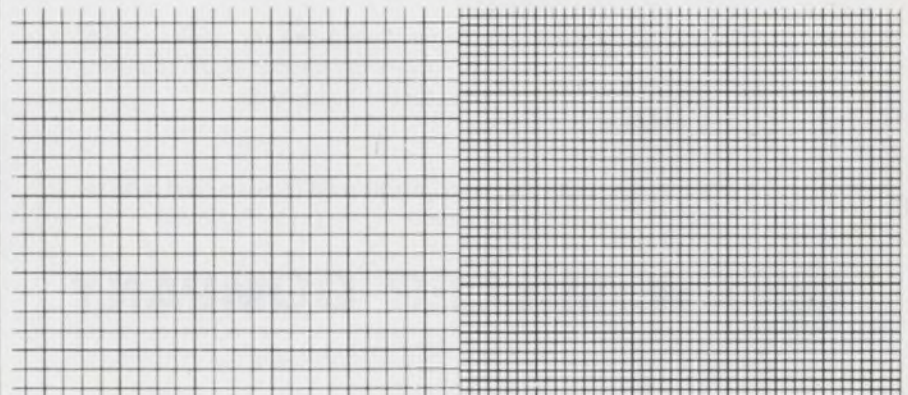

INFORMATION RETRIEVAL NUMBER 85

Strain-relief clamp improves strapping

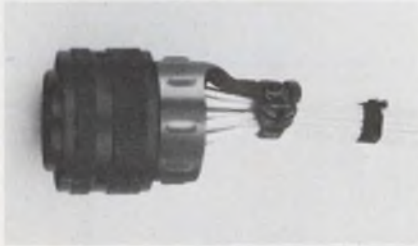

Glenair, Inc., 1211 Air Way, Glendale, Calif. Phone: (213) 247-6000. Availability: 4 to 6 wks.

A new approach to connector-wire bundle strain relief is the new Quik-Ty strain relief which features a single, specially-shaped arm to accommodate plastic tie-straps or lacing cords. The new clamp weighs 50% less than standard MS 27291 clamps.

CIRCLE NO. 394

Heat radiators mount power devices

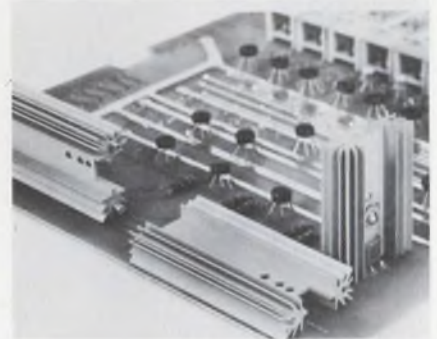

Birtcher Corp., Industrial Div., 745 Monterey Pass Rd., Monterey Park, Calif. Phone: (213) 264-6610. Availability: 30 days.

Series 30-9 heat radiators can be used as a semiconductor/component chassis mount or a high-power-transistor mount that accommodates both plastic-case and tab-mount devices. The units are available in a variety of hole patterns to suit most commonly used power transistors and diodes. Functional dimensions are 1/2 by 1-3/8 in. by any required height.

CIRCLE NO. 395



Ideal for network, filter, delay line and computer applications, 70F Series RF chokes give designers high reliability in a small package. Coils are impregnated with moisture resistant lacquer; can be fungus proofed or encapsulated on special order.

Expanded Series (.1 uh to 100 mh) Subminiature RF Chokes



70F Series RF chokes are stocked in 88 standard inductance values to cover the .1 uh to 100 mh range completely. To insure fast delivery, J. W. Miller Company stocks the industry's widest line of RF chokes and RF & IF coils in depth. Virtually all orders are shipped on the same day the purchase order is received.



Screened room with precision test equipment assures close tolerance measurements for special coil characteristics. Special coil samples are shipped within 2 weeks; production coils are shipped within 3 weeks after sample approval.



Guide to Better Coil Selection gives 10-point check list of factors to consider when specifying coils . . . write for your copy today.

For your special coil requirements, call a Miller coil design specialist — (213) 537-5200.



J.W. MILLER COMPANY

19070 REYES AVE. • P.O. BOX 5825 • COMPTON, CALIF. 90224
GET FACTORY PRICES FROM YOUR LOCAL DISTRIBUTOR IN QUANTITIES TO 750.

IC cable assemblies end in connectors

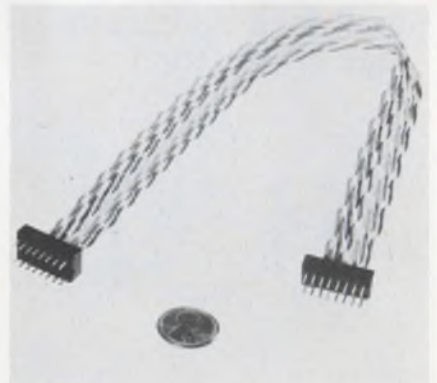

Circuit Assembly Corp., 3023 S. Kilson Dr., Santa Ana, Calif. Phone: (714) 545-0146.

Both 14- and 16-pin dual-in-line connectors terminate a new line of IC interconnecting cable assemblies and jumpers. The cable and jumper assemblies are available with flat-ribbon cable of the multicolor single or twisted pair (TW/2) types. The connectors have gold-plated pins measuring 0.015 by 0.025 by 0.19 in. arranged in a dual line.

CIRCLE NO. 396

Stacking connector contacts positively

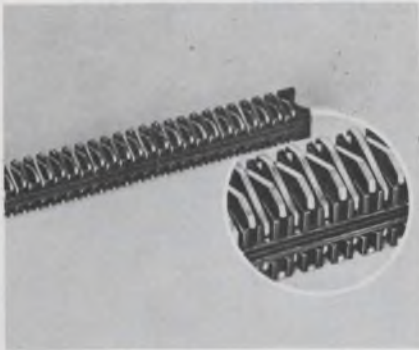

Hugh H. Eby Co., Div. of REDM Corp., 4701 Germantown Ave., Philadelphia, Pa. Phone: (215) 324-7000.

A new stacking connector for interconnecting PC boards creates symmetrical contact pressure thereby eliminating any torque of the installed connector body and intermittent contacts. The Bal-Con 9775-81 has contact centers of 0.05 in. Contacts are made of beryllium copper material and are gold-over-nickel finished.

CIRCLE NO. 397

Versatile heat sinks accept single-tab units

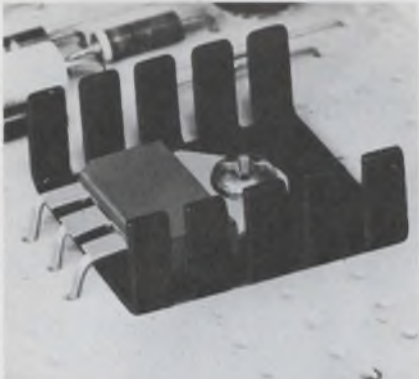

Themaloy Co., 8717 Diplomacy Row, Dallas, Texas. Phone: (214) ME 7-3333.

Accommodating flat plastic power semiconductors, a new line of heat sinks will fit most types of case configurations using a single-tab mounting hole such as SCRs, power transistors, triacs and quadracks. The Series 6106 units offer maximum mounting surface with minimum circuit-board space requirements and are available in two sizes with several hole patterns.

CIRCLE NO. 398

Want A Special Plate Connector For That New Design?



YOUR BEST SOURCE
IS MALCO

Tooled Parts Unlimited...

MALCO has expanded the capability of its WASP and MINI-WASP Plate-Type Connector Systems to meet the special needs of printed circuit edge connector users. The CARDEC Modular Plate Connector System is tailored to fulfill your individual requirements. It provides maximum packaging density with instantaneous reaction to ground and power distribution, (without wiring) for low noise, high speed circuits. In one complete package, compatible with LSI's, IC's or any circuit, CARDEC offers you *all the built-in extras you need*, plus the advantages of modular component design for inexpensive and flexible replacement capability.

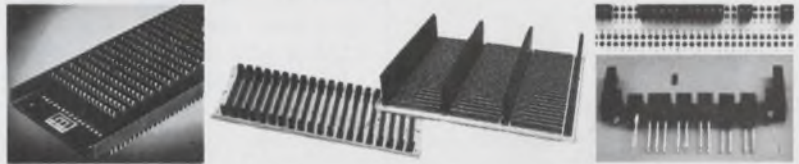

CARDEC 200—The Cardec 200 Card Edge Plate Connector System is designed for direct entry P. C. card applications. The Cardec 200 version accepts $\frac{1}{16}$ " printed circuit cards with contacts on .200" centers with .045" square wrap tails. This connector system features the ground plane concept and modular construction of the "Wasp" Connector line while affording the economy of edge connector systems. REQUEST BULLETIN NO. 681.



CARDEC 125—Cardec 125 is a modular card edge connector system with contacts on .125" centers for maximum packaging density (.047" cards on solid .250" centers). In addition to the features of Cardec 200, this system offers printed circuit card voltage bus hardware for low resistance voltage distribution. As with all the Malco Plate Connector lines, Cardec 125 is supplied in your configuration completely assembled and ready for automatic wire-wrapping right out of the package. REQUEST BULLETIN NO. 681.



Other Malco Tooled Products: Wasp and Mini-Wasp Fork and Blade Connector Systems, Plus A Complete Line Of Circuit Hardware and Precision Stampings.

Consult our engineering staff about your application and design problems.



PRECISION ELECTRONIC TERMINALS AND CONNECTORS
MALCO MANUFACTURING COMPANY INC
6150 W ROOSEVELT RD. · CHICAGO, ILLINOIS 60660 · PHONE (312) 287-8700

BUILDING BLOCKS for your system

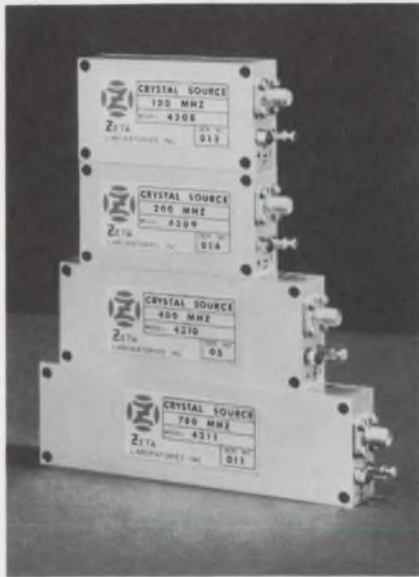

CRYSTAL SOURCES

Model No.	Frequency (MHz)	Small Quan. Price
4208	50-125	\$250.00
4209	125-250	325.00
4210	250-500	400.00
4211	500-1000	475.00

Delivery: 30 days or less

10 milliwatts power output
 • $\pm 0.003\%$ frequency stability over -20°C to $+65^{\circ}\text{C}$
 • 45-db spurious and harmonic rejection
 • no restriction on load VSWR
 • 15 VDC at 30 to 65 mA
 • reverse-polarity protected
 • 3-mm female RF connector
 • 2.8 to 4.9 cu. in.
 • 2.4 to 4.5 oz.

Crystal-controlled microwave sources up to 18 GHz



ZETA LABORATORIES, INC.

616 National Avenue, Mountain View, CA 94040
 Telephone (415) 961-9050

INFORMATION RETRIEVAL NUMBER 90

130

MICROWAVES & LASERS

Adjustable He-Ne laser angles beam within $\pm 2^{\circ}$

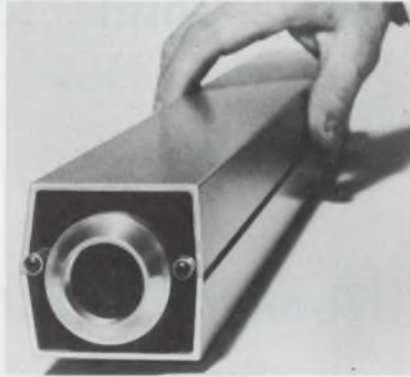

University Laboratories Inc., 733 Allston Way, Berkeley, Calif. Phone: (415) 848-0491. Price: \$465 or \$545.

By the use of two fingertip control levers, two new helium-neon gas lasers allow the laser beam to be adjusted vertically and horizontally over an angle of $\pm 2^{\circ}$. Model 351 and model 361 have 3- and 4-mW outputs respectively but are otherwise identical. They emit at 6328 \AA with a beam divergence of 1.6 milliradians and diameter of 0.7 mm.

CIRCLE NO. 399

Compact oscillators give 1500 W in S band

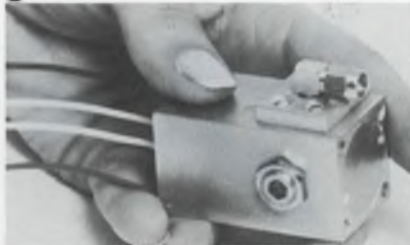

General Electric Co., Tube Dept., 316 E. Ninth St., Owensboro, Ky. Phone: (502) 683-2401.

Intended for grid-pulsed service at S band, a new 3-oz tube/cavity-combination oscillator provides a peak power output of 1500 W with a plate voltage of 1750 V dc. This microwave circuit module, model C-2014, occupies a volume of only 2.44 cubic inches. Use of a bonded heater planar triode results in fast warm-up, tolerance to vibration and shock, and wide operating temperature range.

CIRCLE NO. 400

YIG three-stage filter tunes over 12.4 GHz

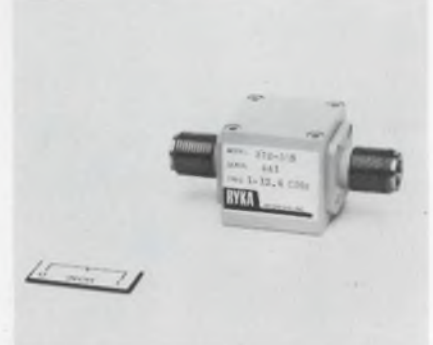

Ryka Scientific Inc., 641 N. Pastoria Ave., Sunnyvale, Calif. Phone: (408) 738-0930. Availability: 30 days.

A nominal bandwidth of 20 to 45 MHz and an insertion loss of 4 dB are features of a new three-stage YIG filter that tunes over a 1-to-12.4-GHz band. The model 312MS unit has typical linearity of $\pm 0.1\%$ and hysteresis of 15 MHz. Extended range versions can be tuned from below 1 GHz to 18 GHz. It measures 1.4 by 1.4 by 1.4 in. and weighs 12 oz.

CIRCLE NO. 401

K-band tunnel diodes exhibit I_p/I_v of 20



Gemini Semiconductors Inc., Sub. of Johanson Mfg. Corp., 400 Rockaway Valley Rd., Boonton, N.J.

Providing an operating frequency range through 26.5 GHz, a new line of tunnel and back-detector diodes feature a peak-current (I_p) to valley-current (I_v) ratio of greater than 20. These gallium-arsenide and germanium diodes have tangential sensitivities greater than -50 dBm and do not require dc bias.

CIRCLE NO. 402

Stabilized transistors give 20 W at 175 MHz

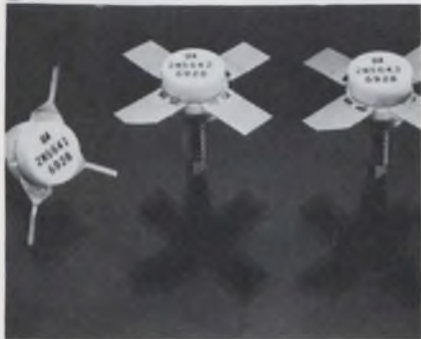

Electronic Components Div. of United Aircraft, Treviso, Pa. Phone: (215) 355-5000. P&A: \$6.40, \$21.30 and \$40.40; stock.

By using tantalum-nitride emitter resistors for improved ballasting, a new line of transistors can provide stable outputs of 5, 10 and 20 W at 175 MHz with an applied voltage of 13.6 V. Types 2N5641, 2N56642 and 2N5643 can also operate at a-m and fm frequencies with power outputs of 7, 20 and 40 W at an applied voltage of 28 V.

CIRCLE NO. 403

Rfi shielding forms are heat-shrinkable



Chomerics, Inc., 77 Dragon Court, Woburn, Mass. Phone: (617) 935-4850.

Rfi shielding, shield grounding and cable insulating are provided by a new line of molded straight and 90° sleeving transitions, break-outs, splice covers, and angular and custom boots. Cho-Shrink molded parts are cross-linked heat-shrinkable polyolefin materials that are treated on the inside surface with a silver-based conductive coating.

CIRCLE NO. 404

YOKE SPECIALISTS

FOR INFORMATION DISPLAYS



Syntronic's devotion to precision and attention to detail assure skillfully engineered deflection yokes in prototype or full production quantities. A complete line of value engineered yokes offer cost saving solutions to your CRT projects. Consult scientifically oriented Syntronic Yoke Specialists for the right yoke for your display.



Syntronic INSTRUMENTS, INC.
100 Industrial Road, Addison, Ill.
Phone: Area 312, 543-6444

INFORMATION RETRIEVAL NUMBER 91

ELECTRONIC MOTOR SPEED CONTROLS

The most complete source of every type: SCR, Variac, Transistorized, Ferrite, 172 models. 1/1000 to 150 H.P. From .01 RPM to 15,000 RPM. Low-cost and feature packed models: 1000:1 range, reversing, braking, speed readout, remote control, positioning, feedback, 0.25% reg. Custom controls and systems. Thousands of motors, controls; hundreds of accessories, clutches, brakes, timers, etc.



FREE CATALOG

28 pages of variable speed motor controls

IBB MOTOR & CONTROL
CORP. • 96 Spring Street, New York, N.Y. 10012
Phone (212) 966-5777

INFORMATION RETRIEVAL NUMBER 92

VITREOSIL®

PURE FUSED
QUARTZ
TAKES
MORE
SHOCK,
HEAT
AND
ACID

THAN GLASS
OR PORCELAIN —
RESISTS
TEMPERATURES TO
1050°C —

HANDLES
MOST HOT ACIDS
WITHOUT ETCHING —

WITHSTANDS
CONSTANT THERMAL
SHOCK —

EXCELLENT
ELECTRICAL AND
OPTICAL
PROPERTIES —

LABORATORY AND
INDUSTRIAL WARE —

SPECIAL
FABRICATION —

SPECTROSIL®
FOR PURITY

ASK FOR
FREE CATALOG —

THERMAL
AMERICAN
FUSED QUARTZ CO.

RT. 202 AND
CHANGE BRIDGE RD.
MONTVILLE, N. J.
07045

INFORMATION RETRIEVAL NUMBER 33

DATA PROCESSING

Keyboard/tape system simplifies operation



*General Computer Systems, Inc.,
12011 Coit Rd., Dallas, Tex. P&A:
\$4250/month rental, \$150,000; 90
days.*

Replacing conventional punch-card systems in central data processing installations, a new keyboard-to-magnetic-tape system is said to reduce data processing input costs by as much as 50%. Data/Tape 2100 has a keyboard-printer that includes a paper-tape roll record of the operator's work. In addition, highly sophisticated software routines provide easy operator editing.

CIRCLE NO. 405

Compact core memory takes 5k 32-bit words



*Litton Industries Guidance and
Control Systems Div., 5500 Canoga
Ave., Woodland Hills, Calif. Phone:
(213) 887-3702.*

Weighing only three pounds, a new 4096-word 32-bit core memory system occupies 0.072 cubic feet and operates over the temperature range of -55 to $+85^{\circ}\text{C}$. Model LCM-6000 has an access time of 650 ns and a cycle time of 2 μs . It satisfies the requirements of MIL-E-5400 and does not need field adjustments or alignments.

CIRCLE NO. 406

Document reader transmits in parallel



Motorola Instrumentation and Control Inc., P.O. Box 5409, Phoenix, Ariz. Phone: (602) 959-1000.

Especially adaptable to the needs of the OEM market, a new document reader can transmit either 8 or 12 parallel data bits to data recording equipment. Besides reading punched data, model MDR-8000 can read cards or page-size forms of varying sizes and shapes, which are marked with an ordinary lead pencil. Documents can be read directly to magnetic or paper tape for subsequent entry into a computer at high speed.

CIRCLE NO. 407

Facsimile transceivers act like data terminals



*Recognition Equipment Inc., 1500
W. Mockingbird Lane, Dallas, Tex.
Phone: (214) 637-2210.*

Making inroads in optical character recognition, new facsimile transceivers can be used as remote data input terminals to send information to a central processor for character recognition and translation into computer language. This means that data can be entered without keying the information into the terminal. The documents generated can be used for other recordkeeping operations, and the machine itself can still perform other office functions.

CIRCLE NO. 408

Frame that lights up mounts on glasses



Eye Lite Products, 1697 Elizabeth Ave., Rahway, N.J. Phone: (201) 382-7799. Price: \$7.50 less batteries.

Operating on only two standard "D" cells, a new device lets you see in darkness, where illumination is needed for repairs or emergencies, while leaving your hands free. This new device, known as Eye-Lite, is an eyeframe which contains a battery case that may be worn over glasses. Both the eye-frame and the battery case are made of lightweight plastic.

CIRCLE NO. 409

Natural-light lamps near sunlight purity



Edmund Scientific Co., 380 Edsco Bldg., Barrington, N. J.

With a rating of 91% on the chromatic index scale, a new series of lamps comes close to duplicating the sun in natural lighting. Natur-escient lamps create an outdoor atmosphere that produces the best environment for employee morale and production efficiency. They provide up to 20,000 user-hours and are available in three sizes: 15 W and 18-in. long, 20 W and 24-in. long and 40 W and 48-in. long.

CIRCLE NO. 410

We've already designed and produced YOUR A/D CONVERTER- at a much lower cost than you could!

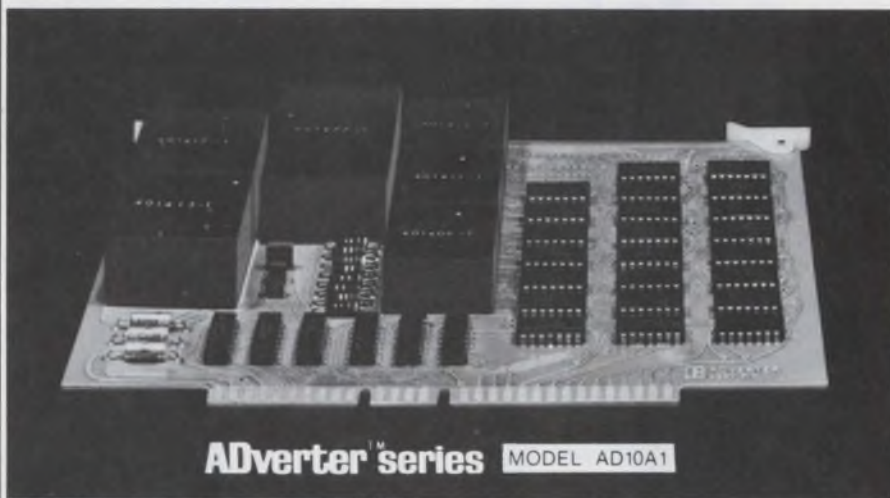

We'll send it to you for only \$475⁰⁰_{Div: 1-9}

The ADverter Series Model AD10A1 is a complete analog to digital converter contained on a single printed circuit board. It converts an analog input voltage to a 10 Bit binary code in both a serial and parallel output format. Binary coded decimal output is available as an option.

The AD10A1 is a continuous conversion system which contains its own clock and does not require a start pulse when operating in this mode. The parallel outputs are continuously available and are not destroyed during conversion. An analog input is all that is necessary to get an output which is updated every 55 μ sec at the nominal internal clock rate.

The AD10A1 can also be operated in a strobe or interrogate mode by applying a start pulse to initiate a

conversion and placing the mode input at a logic "1" (+5V Nom.). Grounding the mode input returns the converter to continuous operation.

The AD10A1 contains an end point adjust feature which allows the user to adjust the input voltage range at both the nominal 0 volt input and the +10 volt input.

Digital to analog conversion equipment and synchro conversion equipment is available from Ditrان also.

For further information call your Local Clifton Sales Office or Ditrان, 25 Adams Street, Burlington, Mass. 01803, (617) 272-6210, TWX 710-332-6668.

DITRAN 
DIVISION OF CLIFTON
LITTON INDUSTRIES

INFORMATION RETRIEVAL NUMBER 94

Find it fast! in the **FREE NEW 1970 Newark industrial electronic catalog**

A \$9,000,000 INDUSTRIAL ELECTRONIC INVENTORY
720 PAGES • OVER 70,000 ITEMS; 500 MAJOR LINES
INCLUDING THE COMPLETE LINE OF



PRECISION POTS



Wirewound, single and multi-turn, linear and non-linear, diameters from 1/2" to 3".



TRIMMER POTS

Wirewound and non-wirewound, to 1 Megohm. Single, 15, 25, 42 turn, square, round, rectangular and TO-9 case size.



TURNS—COUNTING DIALS

Digital or concentric readout.

Immediate delivery from stock—factory OEM prices
—fast efficient service from 11 Newark warehouses.
One source for the products
you need, in the quantities
you need.



For your free catalog write to:

Main Office & Warehouse

NEWARK ELECTRONICS CORPORATION

500 North Pulaski Chicago, Illinois 60624
(312) 638-4411

WAREHOUSES IN

- | | | |
|--|--|---|
| ★ Minneapolis, Minn.
(612) 331-6350 | ★ Los Angeles Area
(213) 678-0441 | ★ |
| ★ Cincinnati, Ohio
(513) 421-5282 | ★ Grand Rapids, Michigan
(616) 452-1411 | ★ |
| ★ Denver, Colorado
(303) 757-3351 | ★ New Orleans, Louisiana
(504) 834-9470 | ★ |
| ★ Detroit, Michigan
(313) 548-0250 | ★ Dallas, Texas
(214) 271-2511 | ★ |
| ★ New York City
(212) 255-4600 | ★ Houston, Texas
(713) 782-4800 | ★ |

INFORMATION RETRIEVAL NUMBER 95

PRODUCTION

Rapid foam dispenser injects down to 1/2 g



Kenics Corp., 1 Southside Rd.,
Danvers, Mass. Phone: (617) 774-
8600.

Manufacturers can now encapsulate sub-assemblies and components in reactive foam material, at a rate greater than 2000 pieces per shift per machine, with excellent quality control and without automatic loaders. This is possible with the new 700 Micro-Pot dispensing system which injects three shots of polyurethane foam in a preset measure range from 1/2 to 3 grams.

CIRCLE NO. 411

Desoldering machine handles multiple leads



Air-Vac Engineering, 100 Gulf St.,
Milford, Conn. Phone: (203) 874-
2541. Price: \$1500.

Automatically desoldering multi-lead components, a new compact machine, model DSM-2A, causes molten solder to flow beneath the printed circuit board, covering only the total area of the component leads. This allows all lead joints on the component to become molten simultaneously so that the component can then be removed by hand with an extractor tool. Solder that touches the circuit board is always clean and free of oxide.

CIRCLE NO. 412

Plastic clean station increases productivity



Techni-Tool, Inc., 1216 Arch St.,
Philadelphia, Pa. Phone: (215)
568-4457.

Designed with the clean room in mind, a new space-control center unit known as Opti-Man increases productivity and reduces fatigue by offering both a lefthanded and a righthanded tool and component station. The unit is formed of unbreakable polyethelene plastic, is impervious to most solvents, is easily cleaned and has no cracks or corners to collect dirt.

CIRCLE NO. 413

Transistor lead cutter trims without distorting

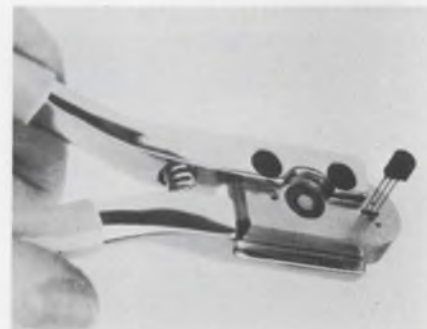

ETM Corp., 144 W. Chestnut Ave.,
Monrovia, Calif. Phone: (213)
359-8102.

A new shear cutter trims transistor leads with absolutely flat burr-free ends, and eliminates any longitudinal stress or distortion due to cutting. Model 2024 cuts all three leads on various three-lead TO packages to the same length in a single action. It has an integrated six-hole pattern for cutting leads up to 0.025-in. in dia on 0.1- or 0.2-in.-dia pin circles, and 0.05- or 0.1-in. center-to-center in-line patterns.

CIRCLE NO. 414

Versatile tool works 16 ways



Simonds Machine Co., Inc., Southbridge, Mass.

Up to sixteen different jaws, such as cut-and-crimp, cutter dyke, shear and filament jaws, can be used with a new sixteen-in-one tool called the SP-01 Squeeze-Eze. This versatile tool is ideal for application in electronic assembly, mechanical assembly and wire cutting, since it allows the user to machine his own jaws for a particular crimping, forming or cutting need.

CIRCLE NO. 415

RF power generator produces 2000 watts

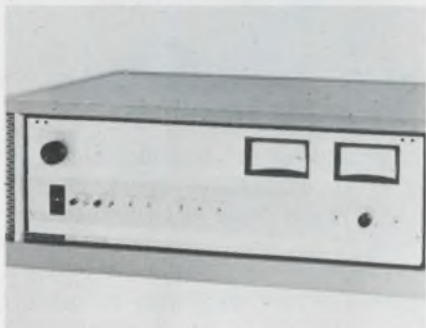

International Plasma Corp., 25222 Cypress Ave., Hayward, Calif.

A new crystal-controlled 2000 W rf generator, the PM 103, offers three ranges of continuously-variable rf ionization power: 0-500, 0-1000 and 0-2000 W. It operates at $13.56 \pm 0.005\%$ MHz and its resonance is automatically maintained over the entire range. The unit can be operated manually, by remote control or by computer program. Easy-to-read and use controls and meters are located on the front panel.

CIRCLE NO. 416

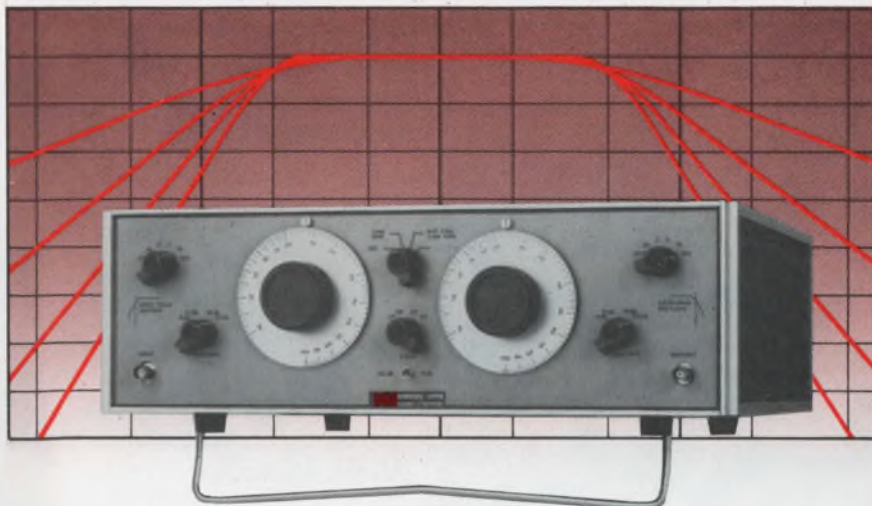

New multifunction filter with selectable attenuation slopes covers 0.02 Hz to 20 KHz

MODEL 3750 — All solid-state. Functions include low-pass, high-pass, band-pass, and band-reject. Attenuation slopes may be set at 6, 12, 18 or 24 db-per-octave, with maximum attenuation greater than 80 db. Gain switch may be set at 0 or 20 db. Designed for line or battery operation with batteries internal and rechargeable. Bench model: $5\frac{1}{4}$ " high x $16\frac{5}{8}$ " wide x $13\frac{1}{16}$ " deep. Rack model: $5\frac{1}{4}$ " high x 19" wide x $13\frac{1}{16}$ " deep.

Price, without batteries, \$850

MODEL 3700 — A new, all solid-state variable band-pass filter covering the 0.2 Hz to 20 KHz range. Attenuation slopes: 24 db-per-octave, extending to greater than 80 db. Selectable band-pass gain: 0 or 20 db. Line or battery operation with batteries internal and rechargeable. Bench model: $3\frac{1}{2}$ " high x $8\frac{5}{8}$ " wide x $13\frac{1}{16}$ " deep. Rack model: $3\frac{1}{2}$ " high x 19" wide x $13\frac{1}{16}$ " deep.

Price, without batteries, \$550

WRITE FOR THE NEW K-H CATALOG containing complete specs on the entire line.

OVERSEAS SALES OFFICES: BELGIUM, C. N. Rood s. a. DENMARK, SC Metric A/S; FRANCE, Antares; GERMANY, Nucletron Vertriebs-GMBH; HOLLAND, C. N. Rood n. v.; ITALY, Dott. Ing. Mario Vianello; SWEDEN, Teleinstrument; ISRAEL, R.D.T. Elect. Eng. Ltd.; JAPAN, Shoshin Shoji Kaisha, Ltd.; AUSTRALIA, Sample Electronics (Vic.) Pty., Ltd.; G. B., B & K Inst. Ltd.

KH KROHN-HITE CORPORATION

580 Massachusetts Ave., Cambridge, Mass. 02139, U.S.A.
Phone: (617) 491-3211 TWX: 710-320-6583

Oscillators / Filters / AC Power Sources / DC Power Supplies / Amplifiers

INFORMATION RETRIEVAL NUMBER 96

WORKHORSE!

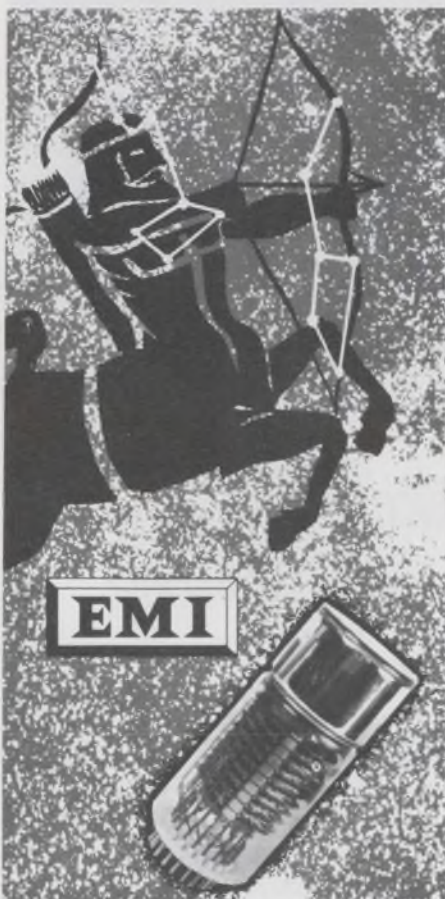

TYPE 9750

Nothing fancy, and not expensive. Just a good old 10 stage photo-multiplier but: It has a superb alkali cathode with excellent collection efficiency (which is fundamental for good S/N ratio), highly stable CsSb dynodes which provide a gain of 10^{10} at just over 1,000 volts, and a dark current of 10^{-10} A. at that voltage (50 A/L).

As usual EMI has provided a number of variations: 9750QB with a spectroil window for UV and low level counting applications, (liquid scintillation) 9750B with Pyrex window for visible applications, and finally 9750KB for those who prefer the B-14A overcapped base. In the "K" configuration, it is directly interchangeable with our 9656KB or a number of competitive types.

The 9750 with its high quantum efficiency and low dark current gives excellent resolution for low energy gamma rays. When used with a thin two inch sodium iodide crystal with a beryllium window, the resolution for Fe^{55} is of the order of 40%.

Flying spot scanners, photometers, thermoluminescent dosimeters, low level scintillation counting are all applications for which the 9750 is highly suitable. Detailed specifications on request from:

GENCOM DIVISION varian/EMI

80 EXPRESS STREET, PLAINVIEW, N. Y. 11803
TELEPHONE (516) 433-5900

Evaluation Samples



Audio switches

Said to be the industry's most accurate frequency switches, a new line of go/no-go audio switches maintain accuracies as close as one cycle per thousand. The units fire whenever the input frequency is above, below, or within certain definite frequency limits. Maximum response time is the length of two input cycles.

Input signals can be either sine or square waves. When pulses are the input signal, the switch measures the time between pulses. Input frequencies can be between 1 Hz and 40 kHz.

A free evaluation sample of these audio frequency switches is available, on loan, to the readers of ELECTRONIC DESIGN.

These units have a typical starting price of \$99.50. Choose from 15 standard industrial and commercial models. Operating temperatures range from -55 to $+125^{\circ}\text{C}$.

The manufacturer is Gosh Instruments, Inc., 1252 Berlin Turnpike, Wethersfield, Conn. Phone: (203) 527-4794.

CIRCLE NO. 423

Woodgrain laminates

Add that finished professional look to your latest project. You can dress up dull panels and give new sparkle to plain-Jane cabinets and consoles. Now, actual usable swatches of six vinyl-to-wood laminates are accompanied by covering literature. Woodgrains like walnut, fruitwood, and teak are faithfully reproduced in vinyl and permanently bonded to hardboard or flakeboard. Florals, linens, a w n i n g stripes, tapestries and other patterns are also available. Poloron Products Inc.

CIRCLE NO. 424

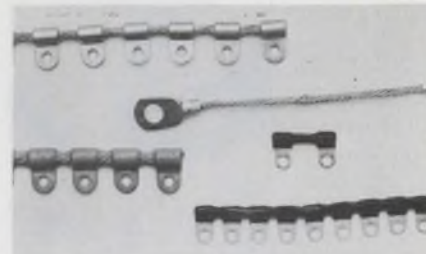

Jumpers and busses

Plated to withstand corrosion, a wide variety of bonding, disconnect, current-return and power jumpers make use of an integral cable-terminal construction. This means that the cable extends through the full length of the terminal pad. Standard units meet military specifications MS-25083, AN-749, AN-751, and AN-752. Both insulated and non-insulated bus assemblies are also available for power distribution applications. An evaluation sample will be supplied free. Janco Corp.

CIRCLE NO. 425



Grounding terminals

Providing a reliable electrical ground connection to a chassis, new Fas-N-Fast high-carbon-steel grounding terminals effectively cut through paints, oxides, porcelainized surfaces and dirt to achieve a positive contact. The terminals are permanently locked in place by the resilient deflection of their sawtooth edges; to remove them, they must be fully destroyed. This safety factor prevents the inexperienced person from tampering with the connection and accidentally removing the ground termination. The units will fit a 0.156-in.-dia hole, accommodate panel thicknesses from 0.02 to 0.075 in., and will accept AWG wire sizes from #18 to #14 and #12 to #10 (or two #14). Free samples are available. AMP Incorporated.

CIRCLE NO. 426



Nylon anchors

Designed to withstand temperatures from -66 to $+340^{\circ}\text{F}$, new virgin-nylon anchors are resistant to common solvents, are vibration-proof, and act as thermal as well as electrical insulators. These new anchors feature a slotted body with a series of serrated edges that lock them into place. Three sizes are available: 3/16-in. dia by 7/8-in. long, 1/4-in. dia by 1-in. long, and 5/16-in. dia by 1-1/2-in. long. All units have a collar that prevents them from falling into over-sized holes or hollow walls. Free evaluation samples are supplied. Fastway Fasteners, Inc.

CIRCLE NO. 427



International connector

A new three-circuit nylon connector is now available that is designed to meet European and Japanese as well as U. S. specifications. Model 1991-3 features integrally molded mounting ears that snap-lock into a panel; no hardware is needed. The plug and receptacle are keyed to prevent mis-mating. Crimp-type male and female terminals may be inserted in either plug or receptacle, and are made of tin-plated brass, modified copper, phosphorous bronze, and gold-plated or silver-plated brass. The connector is supplied loose or in chain form. A free sample is available. Molex Products Co.

CIRCLE NO. 428

A single capable source for both lamps and fiber optic light guide systems

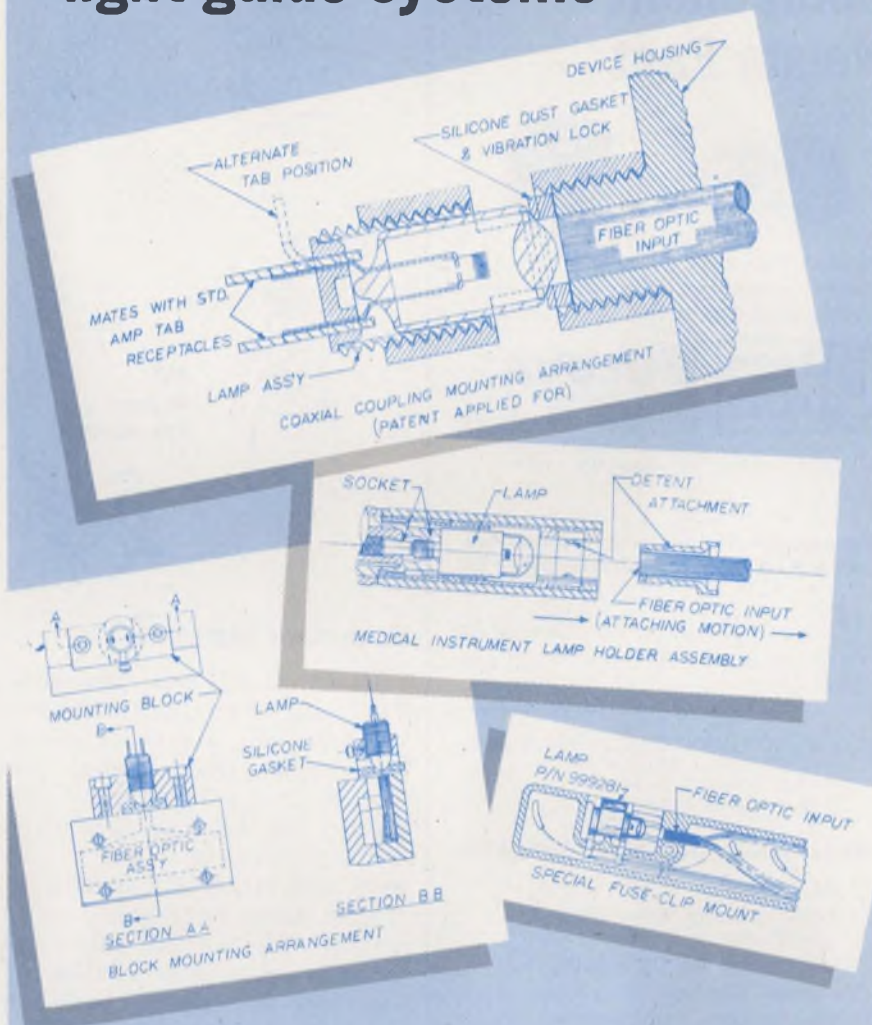

There are obvious advantages in speed, cost and often in efficiency of the ultimate system in having one source produce both miniature lamps and fiber optic assemblies. Welch Allyn has that capability.

We are major suppliers of fiber optics and incandescent illumination sources to principal computer manufacturers and other light guide users.

In addition to our standard lamp designs, we have recently developed a new family of customized miniature vacuum lamps for fiber optic and photo-sensitive device applications with selectable lens-filament combinations and basing for optimum utilization of energy.

Our lamp-fiber optic systems are designed for maximum efficiency and are often less costly than standard multiple-lamp systems.

Phone or write for more information

WELCH ALLYN, INC.
Skaneateles Falls, N.Y. 13153
(315) 685-5788



BULOVA Can Fill Your Magnetic Component Needs Fast



We have over 3,200 prints to choose from. Should you need something special, we can design and produce to your specs quickly.



BULOVA
FREQUENCY
CONTROL PRODUCTS

Electronics Division of Bulova Watch Co., Inc.
61-20 Woodside Ave., Woodside, N.Y. 11377

For prompt action on your immediate needs
call Mel Liberman at (212) 335-6000 — Or



check the MAGNETIC COMPONENT
type(s) you are interested in and direct your
request to —

BULOVA WATCH COMPANY, INC.
ELECTRONICS DIVISION
61-20 Woodside Avenue
Woodside, New York 11377

WE'LL SEND YOU OUR LATEST DATA

- RC Networks
- Amplitude and Phase (Delay) Equalizers
- Modulators and Demodulators
- Lumped Constant Delay Lines
- Discriminator Transformers
- Band Reject Filters (up to 200 kHz)
- High Pass Filters (cutoff down to 10 Hz)
- Low Pass Filters (cutoff up to 50 MHz)
- Band Pass Filters (up to 50 MHz)
- Hybrid Transformers
- High 'Q' Coils
- Radio Frequency Inductors and Transformers (50 kHz to 50 MHz)
- Ultrasonic Transformers (20 kHz to 50 kHz)
- Audio Transformers and Inductors (0.5-20 cubic inches)
- Broadband Transformers (10 kHz to 100 MHz)

NAME _____

FIRM _____

ADDRESS _____

CITY _____ STATE _____

ZIP _____ PHONE _____

INFORMATION RETRIEVAL NUMBER 99

Design Aids

DANDY FOR DOODLING

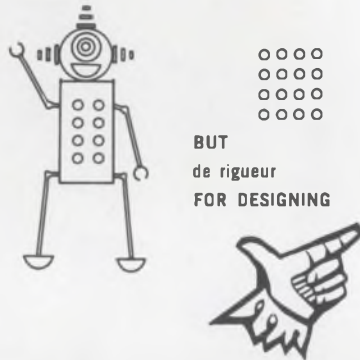

BUT
de rigueur
FOR DESIGNING

Schematic template

Handy as an escape mechanism during boring meetings or tiresome telephone calls, a drafting and design template lets you doodle your way to creative-artist status. Or, you can use this convenient design aid to simplify and speed up artwork generation for designs involving relays, switches and control systems. The template allows you to easily draw those symbols you use most—for example, basic contact forms, resistors, diodes, lamps, numerals, grids, and many others. Automatic Electric Co.

CIRCLE NO. 429

Calibrated scales

Pinpoint distances accurately with the right rule that goes where you go and stays where you put it. Samples of a new line of calibrated metric and scale tapes help you decide what is the best aid for your designs. All tapes have a pressure-sensitive adhesive backing for easy application to most surfaces. Both fractional and decimal scale tapes can be 6 or 12 in. in length. Complementary literature comes with the tape aids. Vernier Location Tape Co., Inc.

CIRCLE NO. 430

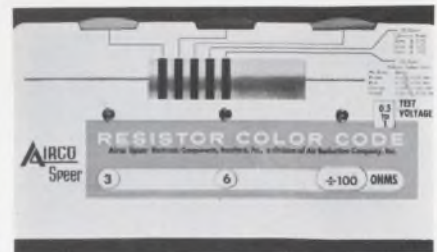

Color-code guide

A newly updated wheel-type indicator is a doubly useful tool for design engineers. On one side, it offers five-band color-code information on fixed composition resistors; this includes those resistors that meet or exceed the requirements of MIL-R-39008. On the other side, the indicator offers color-code information on molded inductors per MIL-C-15305. This new handy pocket-sized resistor-inductor coder is made of a sturdy material for durability under frequent use. Airco Speer Electronic Components.

CIRCLE NO. 431



Dielectrics chart

A new chart-like folder deals with a line of thermally conductive dielectric materials for bonding, encapsulating, coating or sealing electrical/electronic components. The chart presents illustrated applications data on each product, plus information on the form of the material, mix preparation and cure temperature. Listed properties of the cured products include: service temperature, bond strength for adhesives, flexural strength for the casting resins, thermal expansion, thermal conductivity, dielectric strength, volume resistivity, dielectric constant, and dissipation factor. Emerson & Cuming, Inc.

CIRCLE NO. 432

Annual Reports

Learn how to read annual reports in "How to investigate a company." For a copy, circle no. 474.

AAI Corp., P.O. Box 6767, Baltimore, Md.: test equipment, materials handling, weapons and flight-simulation systems; sales, \$26,089,000; income, \$279,000; assets, \$13,565,000; liabilities, \$9,418,000.

CIRCLE NO. 433

Alpha Industries, Inc., 381 Elliot St., Newton Upper Falls, Mass.: diode switches, solid-state sources, microwave components; sales, \$4,705,008; income, \$323,997; assets, \$3,552,072; liabilities, \$566,328.

CIRCLE NO. 434

Gerber Scientific Instrument Co., P.O. Box 305, Hartford, Conn.: graphic display and drafting systems, machine tools, garment cutters; sales, \$9,132,810; earnings, \$765,914; assets, \$5,197,193; liabilities, \$2,187,667.

CIRCLE NO. 435

K & M Electronics, Inc., 7360 Ohms Lane, Minneapolis, Minn.: educational and commercial electronic systems; sales, \$2,448,393; net income, \$45,132; current assets, \$909,964; liabilities, \$647,781.

CIRCLE NO. 436

Midtex Inc., 838 Baker Building, Minneapolis, Minn.: relays, magnetic tape head assemblies and electronic keyboards; revenues, \$4,519,772; earnings, \$18,129; assets, \$2,806,061; liabilities, \$923,111.

CIRCLE NO. 437

Saxon Industries, Inc., 450 Seventh Ave., New York, N.Y.: paper products for printing, publishing and education, photocopiers, packaging materials; sales, \$134,690,369; earnings, \$2,784,899; assets, \$44,794,258; liabilities, \$22,596,359.

CIRCLE NO. 438



**World Famous
Simpson 260[®]
Millions now
in use!**

Better than ever

**with New
Taut Band
Movement
cannot develop
error-causing
friction.**



- **SELF-SHIELDING, SHOCK PROOF . . .** for outstanding accuracy and repeatability.
- **VARISTOR PROTECTED** against even 200,000% overloads.
- **RUGGED DEPENDABILITY** that has no equal.

New Taut Band 260[®]-5 complete with test leads, batteries, and 40-page operator's manual . . . **\$65.00**

New Taut Band 260[®]-5M with anti-parallax mirror scale and knife-edge pointer . . . **\$67.00**

New Taut Band 260[®]-5P with circuit breaker overload protection of VOM circuitry . . . **\$97.00**

GET "OFF-THE-SHELF" DELIVERY FROM
YOUR LOCAL ELECTRONIC DISTRIBUTOR

Simpson

ELECTRIC COMPANY



5200 W. Kinzie Street, Chicago, Illinois 60644 • Phone (312) 379-1121
Export Dept: 400 W. Madison Street, Chicago, Illinois 60606. Cable Simelco
IN CANADA: Bach-Simpson Ltd., London, Ontario • **IN INDIA:** Ruttonsha-Simpson Private Ltd., International House, Bombay-Agra Road, Vikhroli, Bombay

INSTRUMENTS THAT STAY ACCURATE

INFORMATION RETRIEVAL NUMBER 100



THE QUIET ONE IS NOW THE QUIET THREE

We unveiled The Quiet One last fall. (Remember? The potentiometer that's four times as noise-free as the Allen Bradley series J. And twice as linear. And twenty times as durable. And competitively priced.)

What happened? You might say The Quiet One went over with a bang. OEMs and engineers kept ordering, reordering, suggesting new applications. And soon we had to expand The Quiet One to The Quiet Three.

How do they differ from each other? Only in shaft and bushing. They can meet MIL-R-94 specs. They're available in resistance categories from 100 to 1-meg ohms. And you can get them at any of the distributors listed in the column to the right. So speak up. Ask for The Quiet One (or Two or Three). Loud and clear.

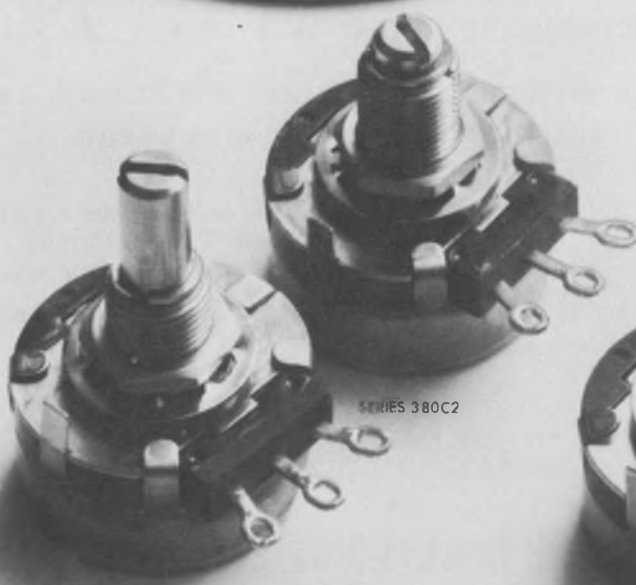

SERIES 380C3

SERIES 380C2

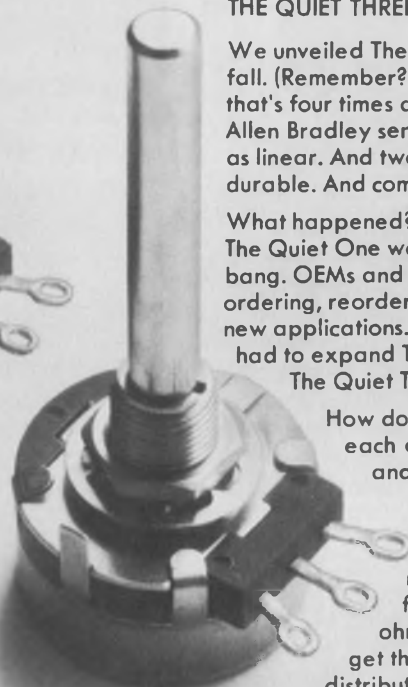

SERIES 380C1

CLAROSTAT

HERE'S WHERE TO SPEAK UP
FOR THE QUIET ONE
SERIES 380C1
SERIES 380C2
SERIES 380C3

STOCKING DISTRIBUTORS

ALABAMA ACK RADIO SUPPLY Birmingham JAMES W. CLARY CO. Birmingham **ARIZONA** INLAND ELECTRONICS Tucson STERLING ELECTRONICS Phoenix **CALIFORNIA** DUNLAP ELECTRONICS Sacramento Oakland and Mountain View ELECTRONIC SUPPLY Riverside ELMAR ELECTRONICS Mountain View TERMINAL HUDSON Mountain View HOLLYWOOD RADIO & ELECTRONICS, INC. Hollywood MILO OF CALIFORNIA San Diego RICHEY ELECTRONICS North Hollywood SANTA MONICA ELECTRONICS Gardena R.V. WEATHERFORD CO. Glendale WESCO ELECTRONICS Los Angeles WESCO ELECTRONICS Palo Alto **CANADA** TRITEL ASSOCIATES Downsview, Ontario **COLORADO** NEWARK-DENVER ELECTRONICS Denver ELECTRONIC PARTS CO. Denver **CONNECTICUT** BOND RADIO Waterbury CRAMER ELECTRONICS N. Haven J.V. ELECTRONICS East Haven WESTCONNELLECTRONICS Bridgeport **FLORIDA** CRAMER ELECTRONICS Ft. Lauderdale ELECTRONIC EQUIPMENT CO. Miami ELECTRONIC WHOLESALERS, INC. Miami ELECTRONIC WHOLESALERS, INC. Orlando GRICE ELECTRONICS Pensacola HAMMOND ELECTRONICS Orlando **GEORGIA** ACK RADIO SUPPLY Atlanta JACKSON ELECTRONICS Atlanta **ILLINOIS** ALLIED RADIO CORP. Chicago J&M ELECTRONICS Rockford NEWARK ELECTRONICS CORP. Chicago PACE/AVNET ELECTRONICS Schiller Park OHMTRONICS Palatine **IOWA** DEECO, INC. Cedar Rapids **INDIANA** GRAHAM ELECTRONICS Indianapolis FORT WAYNE ELECTRONICS Fort Wayne **KANSAS** RADIO SUPPLY CO. Wichita **KENTUCKY** P.I. BURKS Louisville **LOUISIANA** STERLING/CRESCENT RADIO & SUPPLY New Orleans EPCOR New Orleans RALPH'S RADIO & ELECTRONICS Lafayette **MAINE** HOLMES ELECTRONIC SUPPLY Portland MARYLAND EMPIRE ELECTRONICS Bethesda KANN-ELLERT ELECTRONICS Baltimore PYTRONICS Baltimore RADIO ELECTRONIC SERVICE Baltimore **MASSACHUSETTS** CRAMER ELECTRONICS Newton DEMAMBRO ELECTRONICS Boston GERBER RADIO Dedham GREENE-SHAW CO., INC. Newton INDUSTRIAL COMP. Wilbraham A.W. MAYER CO. Boston MILO OF NEW ENGLAND INC. Lawrence STERLING ELECTRONICS Watertown **MICHIGAN** ELECTRONIC SUPPLY Kalamazoo NEWARK-DETROIT ELECTRONICS Detroit NEWARK INDUSTRIAL ELECTRONICS Grand Rapids **MINNESOTA** HARRY STARK ELECTRONICS SUPPLY Minneapolis **MISSISSIPPI** MAY ELECTRONIC SUPPLY Pascagoula **MISSOURI** ECI SEMICONDUCTORS Kansas City OLIVE INDUSTRIAL ELECTRONICS St. Louis VAN SICKLE St. Louis **NEBRASKA** SCOTT ELECTRONIC SUPPLY Lincoln **NEW JERSEY** GENERAL RADIO Camden FEDERATED PURCHASER Springfield STATE ELECTRONICS Hanover **NEW HAMPSHIRE** EVANS RADIO Concord **NEW MEXICO** ELECTRONIC PARTS Albuquerque **NEW YORK** ARROW ELECTRONICS Farmingdale CRAMER Eastern Syracuse H.L. DALIS, INC. Long Island City HARRISON RADIO E. Farmingdale MILO ELECTRONICS New York NEWARK ELECTRONIC CENTER New York PEERLESS RADIO CORP. Lynbrook ROME ELECTRONICS Rome SIMCONA ELECTRONICS Rochester STANDARD ELECTRONICS Buffalo E.E. TAYLOR Albany TAYLOR ELECTRONICS Baldwin TERMINAL HUDSON New York **NORTH CAROLINA** KIRKMAN ELECTRONICS Winston-Salem CAROLINA RADIO SUPPLY CO., INC. Greensboro **OHIO** AKRON ELECTRONICS Akron JOHN BECKER Dayton THOMPSON RADIO SUPPLIES Columbus HUGHES-PETERS, INC. Cincinnati and Columbus NEWARK-HERRINGER Cincinnati W.M. PATTISON SUPPLY Cleveland RADIO ELECTRONIC PARTS Cleveland UNITED RADIO Cincinnati **OKLAHOMA** RADIO INC. Tulsa TRICE WHOLESALE ELECTRONICS Oklahoma City **OREGON** ALMAC/STROUM ELECTRONICS Portland LOU JOHNSON Portland **PENNSYLVANIA** ALMO INDUSTRIAL ELECTRONICS Philadelphia GEORGE D. BARBEY CO. Reading CAMERADIO Pittsburgh DIAL SALES Edgely HERBACH & RADEMAN Philadelphia A.A. PETERS, INC. Allentown PHILADELPHIA ELECTRONICS Philadelphia FRED PURSELL CO. Scranton PYTRONIC INDUSTRIES Harrisburg R.P.C. ELECTRONICS Pittsburgh ROSEN ELECTRONIC CO. York SIMCO ELECTRONICS Philadelphia **RHODE ISLAND** W.H. EDWARDS CO. Providence **SOUTH CAROLINA** CAROLINA RADIO SUPPLY Greenville DIXIE RADIO SUPPLY Columbia **TENNESSEE** ELECTRA DISTRIBUTING Nashville MC CLUNG APPLIANCES Knoxville **TEXAS** ALL STATE ELECTRONICS Dallas STERLING ELECTRONICS Austin LENERT CO. Houston MC NICOL, INC. El Paso STERLING ELECTRONICS San Antonio STERLING ELECTRONICS Houston SWIECO, INC. Fort Worth WICKS RADIO Corpus Christi **UTAH** KIMBALL ELECTRONICS Salt Lake City **VERMONT** RUTLAND ELECTRONIC SUPPLY Rutland **VIRGINIA** DISTRIBUTORS, INC. Portsmouth MERIDIAN ELECTRONICS Richmond VIRGINIA RADIO SUPPLY Charlottesville **WASHINGTON** ALMAC/STROUM ELECTRONICS Seattle WASHINGTON ELECTRONICS Seattle **WASHINGTON, D.C.** CAPITOL RADIO WHOLESALERS ELECTRONIC WHOLESALERS **WISCONSIN** See Illinois.

Application Notes



Data conversion guide

A new 24-page handbook provides applications information, fundamental descriptions, and comprehensive specifications for a wide range of a/d and d/a converters, sample-and-hold amplifiers, multiplexers, instrumentation amplifiers, buffer modules, encapsulated power supplies, and related digital building blocks. Hardware described in the handbook forms the basic building blocks for many forms of data collection, processing, reproducing, and display equipment. Analog Devices, Inc., Pastoriza Div.

CIRCLE NO. 439

Fuses and breakers

The second editions of the Airpax Technical Journal, "The Choice of Protection," includes information on methods of protecting electrical and electronic circuits and components from the damaging effects of short circuits. Design discussions along with characteristic charts cover lead and semiconductor fuses; mechanical, thermal and magnetic breakers; three-phase and high-voltage circuits; transient tripping; and magnetic and electronic time delays. Airpax Electronics, Cambridge Div.

CIRCLE NO. 440



Relay handbook

A comprehensive 84-page handbook on time-delay relays assists the design engineer in specifying the proper relay for his application. The handbook shows principles of operation, applications and design requirements. There is also a glossary of terms as well as specifying and testing data. Copies are available to qualified design engineers. Magnecraft Electric Co.

CIRCLE NO. 441

FETs vs bipolars

A 16-page application report compares the use of field-effect transistors versus bipolar transistors in the input stages of vhf tuners. Design information includes equations, tables, curves and circuit diagrams. Opening with a discussion on vhf tuner input stages, the report goes on to show several design methods and ends with a comparative summary. Telefunken Sales Corp.

CIRCLE NO. 442

Electrical control

Consisting of 371 pages, a new electrical control catalog includes a glossary of electrical control terms, general information on motor control and power supplies, and a graphic reference to the National Electrical Code requirements. There are also product descriptions of single- and three-phase motor controls, circuit breaker load centers and fusible service equipment, pushbuttons, limit switches, and relays and timers. Cutler-Hammer.

CIRCLE NO. 443

CLAROSTAT Dept. 102
Dover, N.H.. 03820

**Introducing
a little revolution
in fail-safe
reed switching.**



This new Cunningham Hystareed™ Magnetic Latching Relay operates *without permanent biasing magnets* or holding currents. Latches and stays latched. Won't change its programmed state because of vibration, shock, power interruptions or transients. Needs no adjustment or calibration. Available with up to six form A's, or four form C's in a single assembly. Operates as standard relay for scanning.

Ideal for: data acquisition, low-level switching, computer interfacing, logic control, industrial machinery control.

Samples available. For complete facts, request Brochure No. 606B. Write or phone Cunningham Corporation, Carriage St., Honeoye Falls, N. Y. 14472. Phone (716) 624-2000.

**Cunningham
Corporation**

SUBSIDIARY OF GLEASON WORKS

INFORMATION RETRIEVAL NUMBER 102

New Literature



IC read-only memory

Operational description and applications data, on a new MOS p-channel IC static 1024-bit read-only memory is in a new 26-page data sheet. The booklet includes word-by-bit options and memory system expansion information, logic, timing and bipolar system block diagrams. Also included are mechanical data, maximum ratings and electrical characteristics. Memory test programs for evaluation are also provided, for each of the following word-by-bit organizations: 128 by 8, 256 by 4, 512 by 2 and 1024 by 1. Each memory test program form has a complete program table. Union Carbide Corp., Semiconductor Dept.

CIRCLE NO. 444

Miniature connectors

Detailed information on MIL-C-81511 Astro/348 connectors is in a new 20-page full-color catalog. The connectors use a one-piece molded dielectric retention system instead of metal retention clips, thus increasing the number of contacts without affecting performance, for the same-size shell. Complete electrical and mechanical specifications, performance characteristics, hardware, accessories, and detailed illustrated instructions on the assembly of the connectors is provided. Cinch-Nuline Div. of United-Carr, Inc.

CIRCLE NO. 445



Emergency power

An extensive line of solid-state uninterruptible power systems and frequency-conversion equipment is the subject of a new eight-page color brochure. It explains the operating and construction features of these transient-free systems which are used for emergency power in many applications. Models covered range from a 250-VA system to a 1-million VA system. Military and commercial frequency changers, static inverters, power sources and line regulators are also shown. Avtel Corp.

CIRCLE NO. 446

Relays

A new 44-page catalog describes the characteristics and specifications of a complete line of mercury displacement, dry reed and mercury-wetted contact relays. The Adams & Westlake Co.

CIRCLE NO. 447

Lafayette catalog

The latest electronic and stereo high-fidelity equipment is shown in the new 112-page Lafayette catalog. It features stereo receivers, amplifiers, tuners and tape recorders with an expanded line of cassette-tape players. Also included are appliances, citizen's-band apparatus, televisions and radios and their accessories and photographic equipment. Lafayette Radio Electronics Corp.

CIRCLE NO. 448



New Connectors increase packaging density

CAMBION Miniature Connectors . . . the easy, reliable way to incorporate many components into your circuit designs . . . patch in other circuit boards . . . hook up ICs . . . provide convenient pluggable/patchable compatibility for hard-wired components . . . engineer greater current carrying capacity with low contact resistance . . . insure a new level of reliability in circuit interconnection systems. CAMBION produces more mini-connectors than anyone else in the world. Jacks, plugs, sockets, patch-strips for PC and conventional applications; cage jacks, "C" and "D" spring jacks, taper pins and receptacles; combination plug-jacks, patch cords and other miniature connectors. More than 1000 varieties, including color-coded and insulated types. For full details on the best connector for your needs, call Cambridge Thermionic Corporation, 469 Concord Avenue, Cambridge, Massachusetts 02138. Phone: (617) 491-5400. In Los Angeles, 8703 La Tijera Boulevard 90045. Phone: (213) 776-0472.

Standardize on

CAMBION

The Guaranteed Electronic Components

INFORMATION RETRIEVAL NUMBER 103

NEW WAKEFIELD Heat Sink / Clamp for Press-Pak SCRs

"Press-Pak" semiconductor sizes up to 2.25"D are handled. Uniform contact pressure is provided for needed parallelism and centering accuracy. U-clamp insulation rated 5000v a-c. Optional force indicator reads in "lbs/leaf". The clamp assembly may be ordered with 2, 3, 4, or 5 leaves for maximum clamping forces of 800, 1200, 1600, or 2000 lbs. respectively.

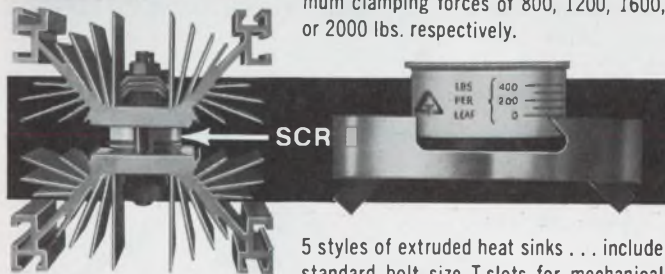

5 styles of extruded heat sinks . . . include standard bolt size T-slots for mechanical and electrical mounting of busswork or supports. Assembly put together fast and accurately without special tools.

REQUEST TECH BULLETIN . . . presents natural convection, forced convection in cfm and fpm, and thermal transient data . . . for black and chromate conversion finishes.

WAKEFIELD ENGINEERING, INC.

WAKEFIELD, MASS. 01880 • (617) 245-5900 • TWX 617-245-9213

INFORMATION RETRIEVAL NUMBER 104

ELECTRONIC DESIGN 23, November 8, 1969

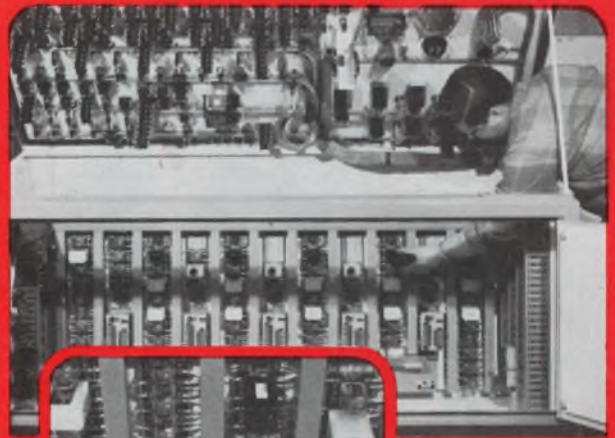

RS8 and RS14 sockets in concrete batching control by Wisconsin Electrical Mfg. Co. of Milwaukee.

CURTIS TRACK-MOUNT RELAY SOCKET ASSEMBLIES SLASH INSTALLATION COSTS

Compact, factory-assembled printed circuit relay socket assemblies snap in (or out) vertically into pre-punched vinyl track. Lengths to 48" securely hold up to 24 relay sockets with only 2 or 3 mounting screws.

Curtis quality barrier-type terminal blocks feature screw terminals. Sockets have recessed center post chambers for easy fracture-free relay replacement. All 3 relay types mount in the same 2 7/8" wide track.

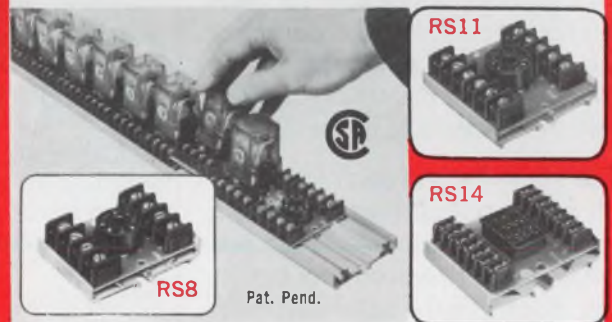

RS8 Octal socket assembly for 8 pin 2 P.D.T. relays. Assembly 2" long. Rated: 10 amps, 250 volts.

RS11 Socket assembly for 11 pin 3 P.D.T. relays. Assembly 2 7/8" long. Rated: 10 amps, 250 volts.

RS14 Socket assembly for 14 pin 4 P.D.T. relays. Assembly 2" long. Rated: 5 amps, 125 volts.

Send today for **FREE** information and name of your local Curtis representative or distributor.



CURTIS
DEVELOPMENT & MFG. CO.
3236 N. 33rd St., Milwaukee, Wi. 53216

INFORMATION RETRIEVAL NUMBER 105

He has
a new view
of life



He's had a heart attack, but he's back on the job. He saw for himself how modern drugs, coronary care units, and new methods of rehabilitation are helping doctors fight the Nation's Number 1 killer.

Heart scientists predict many exciting advances in the foreseeable future, provided more funds are available for research, education and community service. Help make these predictions come true. Give generously to fight the Number 1 threat to your life.

GIVE...
so more will live
**HEART
FUND**



Contributed by the Publisher

NEW LITERATURE



TTL IC logic

A comprehensive 88-page brochure includes three sections that are devoted to TTL IC logic circuits. One section provides general design characteristics information, another section on electrical characteristics gives specific test limit and test condition information while a third section on parameter measurement provides ac- and dc-measurement methods and procedures. Sprague Electric Co.

CIRCLE NO. 449

IC specifications

Based on MIL-STD 883, a new general procurement specification for a quality assurance program called "Unique 883" is contained in a 32-page document. It describes high-reliability specifications for integrated circuits along with procurement and product assurance policies of the manufacturer. Numerous drawings illustrating the criteria for accepting and rejecting features of high-reliability construction are included. Also contained is an appendix of processing information and attachments for visual specifications and quality assurance procedures. Fairchild Semiconductor.

CIRCLE NO. 450

Plastic fasteners

A new 24-page catalog lists and illustrates a comprehensive line of molded, machined and stamped plastic fasteners. New items are included such as molded nylon machine screw hex nuts, phenolic screw spacers and threaded stand-offs, PVC threaded rods, nylon wing screws and phenolic hand screws and nuts. Products Components Corp.

CIRCLE NO. 451

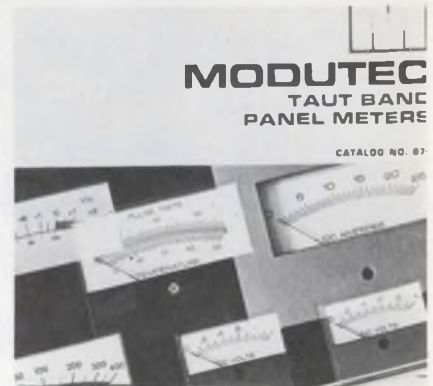

Panel meters

Listing over 3000 types of panel meters is a new 16-page catalog. It includes five different series of meters and many options and modifications that are available for all models and sizes. Modutec, Inc.

CIRCLE NO. 452

Precision instruments

Both general-purpose and special two-way radio test equipment and service aids are detailed in a new 36-page precision-instruments catalog. Test equipment shown includes VOMs, frequency meters, generators, oscilloscopes, voltmeters, multimeters, testers, power supplies, test jigs, wattmeters, counters, kits and all accessories. Motorola Communications & Electronics, Inc.

CIRCLE NO. 453



Electric counters

A new series of compact electric counters is described in a new catalog. It shows six models with refined electromagnetic drives and small sizes. They operate on only 3 W of power with speeds up to 1000 counts per minute. Durant Digital Instruments, a Cutler-Hammer Co.

CIRCLE NO. 454



Stepping motors

Twenty new models of stepping motors designed to position loads remotely in 20 or 30° increments with a break-away torque of 160 and 130 oz-in. respectively are discussed in a new eight-page catalog. Unidirectional and bidirectional versions are discussed with a section on engineering considerations complete with tables and graphs showing performance characteristics under varying operating conditions Ledex Inc.

CIRCLE NO. 455

Silicon semiconductors

Chip devices, zener regulators, reference diodes, solar cells, rectifiers, tunnel diodes, thyristors and photovoltaic devices are the subject of a new 24-page catalog. Included are photos of products, part numbers, dimensioned drawings and detailed performances and specifications, along with an interchangeability table. Centralab Electronics, div. of Globe-Union Inc.

CIRCLE NO. 456

Particle detectors

Entitled "Guide to the Selection and Use of Position-Sensitive Detectors," a 20-page manual shows how detectors can simultaneously analyze the energy and position of incident particles. Examples of applications are also given. Nuclear Diodes, Inc.

CIRCLE NO. 457

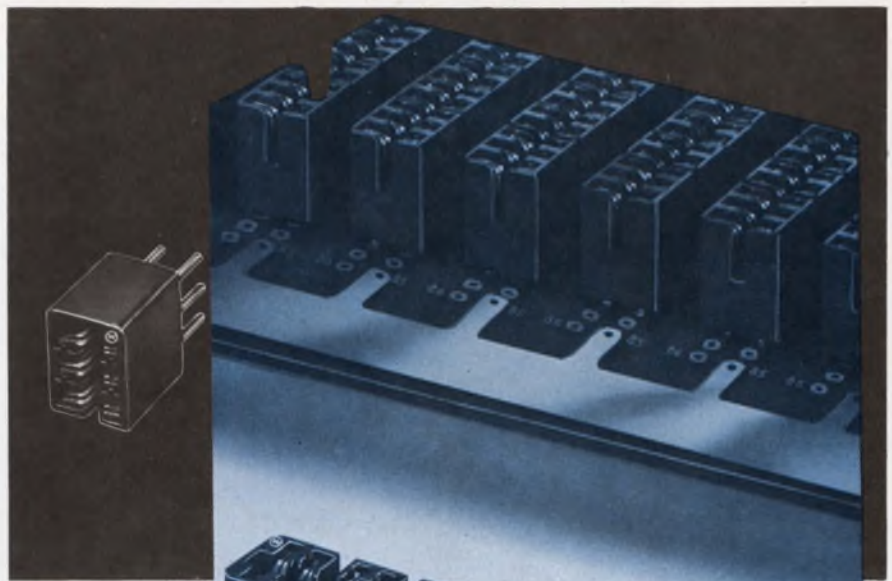

maximize
mother
board
circuitry
with
Methode's
new connecting
concept

FAST! FLEXIBLE!
ECONOMICAL!

"RELI-AMOD"

provides an innovative approach
to build-up
of edge-type connectors.

- 4- and 6-pin modular sections, dual readout, .031 square wire-wrap contact terminations
- on .150 x .200 grid centers for 1/16" PC Board
- built to Mil-C-21097 . . . molded of glass-filled DAP materials
- can be "customerized" to desired specifications
- available in plastic carriers for high-speed automated assembly
- combining individual connector modules to desired lengths permits simple breadboarding of prototypes

Methode Electronics, Inc.
CONNECTOR DIVISION

7447 WEST WILSON AVENUE, CHICAGO, ILLINOIS 60656
PHONE: 312/867-9600

INFORMATION RETRIEVAL NUMBER 109

Best Buys in Lab & Shop Instruments Come From Heath



IP-28 1-30 VDC Power Supply

A Versatile Low Voltage Source For All Solid-State Work. Variable output . . . 1-10 & 1-30 VDC ranges. Adjustable current limiting in 2 ranges . . . 10-100 mA & 10 mA-1A. Floating output . . . AC & DC Programming . . . external Voltage Sensing. Switch-selected metering of both voltage & current. Excellent load & line regulation. 9 lbs. Kit, \$47.50 *

Low Cost IP-18 1-15 VDC Power Supply



Your Best Buy In A Low Voltage Source. Continuously adjustable output 1-15 VDC. Adjustable current limiting 10-500 mA. AC & DC Programming . . . Darlington Pair voltage regulation for excellent stability . . . floating output for positive or negative ground. Simple, fast circuit board construction. 5 lbs. Kit, \$21.95 *



EU-80A Voltage Reference Source

Lab Standard Accuracy At Low Cost. An extremely accurate, stable reference for recorder calibration & linearity checks, meter calibration, op amp circuits, recorder offsetting and many other uses. 0-10 VDC output . . . 15 ppm/hr stability . . . push-button polarity reversal, chopped DC, sum-difference & calibrator modes. Voltage-to-current accessory included. 6 lbs. Factory Assembled, \$100.00 *



EU-30A Decade Resistance Box

Provides Excellent Resistance Arm For AC & DC Bridges. Selects values from 1-999,999 ohms in 1 ohm steps. 0.1% & 1% precision resistors. Connections between decades allow precise voltage divider applications. Mechanical digital readout. 3 lbs. Factory Assembled, \$50.00 *



HEATH COMPANY, Dept. 26
Benton Harbor, Michigan 49022
 Please send FREE Heathkit catalog.
 Enclosed is \$ _____, plus shipping.
Please send model (s) _____
Name _____
Address _____
City _____ State _____ Zip _____
Prices & Specifications subject to change without notice.
*Mail Order Prices; FOB Factory. TE-213

INFORMATION RETRIEVAL NUMBER 112

NEW LITERATURE



Instruments

Two instrument sections, one analog, the other digital, comprise a new catalog that lists devices such as galvanometers, microammeters, millivoltmeters, true rms voltmeters, wattmeters, ammeters and digital multimeters. Both sections show instrument photographs in a left hand vertical column on each page and specifications and data in a right hand column of the page. Greibach Instruments, div. of Solitron Devices, Inc.

CIRCLE NO. 458

Precision tools

A new 24-page catalog illustrates with detailed drawings, dimensions and specifications, over 500 various spring adjusters, gauges, burnishers and precision hand tools. The tools are grouped in 13 classifications and are listed in numerical sequence. These tools are precision-made of carbon steel, are nickel-chrome plated, and can be modified to suit a particular requirement. Also included in the catalog is a metric-to-inches conversion chart. Jonard Industries Corp.

CIRCLE NO. 459

Two-terminal lamps

A line of two-terminal subminiature indicator lights is shown in a new 12-page two-color catalog. Described are indicators accommodating T-1-3/4 incandescent bulbs with midget-flanged base in a voltage range of 1.35 to 28 V, and assemblies accommodating T-2 neon-glow lamps. The catalog includes ordering information. Dialight Corp.

CIRCLE NO. 460



Tantalum capacitors

Details of four sizes and a wide range of specifications and ratings are given in a new four-page brochure describing a line of solid-electrolyte tantalum capacitors. P. R. Mallory & Co., Inc.

CIRCLE NO. 461

Stepper motors

A line of four-phase and eight-phase stepper motors and associated logic circuits are the subject of a new 16-page booklet. Described are three motor classifications: one line for industrial use, another for instrumentation and computer applications and a third for military specifications and requirements. Charts and tables are included to show design and operating characteristics. The A. W. Haydon Co.

CIRCLE NO. 462

Tunnel diodes

Providing technical notes and definitions of terms, a four-page pamphlet describes a complete line of amplifier, detector, mixer and switching tunnel diodes. The devices are available in germanium, gallium-arsenide, and gallium-antimonide materials. Specifications and packaging information is included. Aertech Industries.

CIRCLE NO. 463

Power supply devices

Describing four new lines of power components, power instruments, and power systems, a 16-page catalog contains complete performance specifications, price information and ordering data. Lambda Electronics Corp.

CIRCLE NO. 464

Integrated Circuit Card Logic



IC logic

Over 60 TTL IC logic cards are described with specifications and construction details in a 122-page manual. Shown are standard and special-purpose designs along with a variety of mechanical packages and accessories. Dynatronics, Electronics Division of General Dynamics.

CIRCLE NO. 465

Electromechanical devices

Fully illustrated in a new selection guide are electromechanical components and equipment like pressure and position transducers, accelerometers and load cells. Designed to assist the engineer, scientist and teacher, the new catalog contains sections on counters, flow meters, precision potentiometers, servomechanisms, test equipment and timers. Other categories include gyros, military synchors, fractional-horsepower motors, blowers and stepping switches. American Relays, Electronics Div.

CIRCLE NO. 466

Nuclear detectors

An entire line of detectors and electronic instruments for nuclear physics and X-ray research is described in a new publication. There are sections on surface-barrier and lithium-drifted silicon and germanium detectors, preamplifiers, amplifiers, time derivation instruments, linear signal processors, data handling equipment, pulsers and power supplies. Comparison tables are furnished for amplifiers and data handling equipment. Ortec Inc.

CIRCLE NO. 467

SUPERSOCKETS!

**NEW BARNES
HIGH-RELIABILITY PRODUCTION
MOUNTING DIP SOCKETS
... NONE BETTER**

Maximum reliability, longest life, highest quality, low cost too—all in one socket! New Barnes 121-2002 Series Production Mounting DIP Sockets. 10,000-plus insertion capability also increases usefulness for aging and burn-in applications. Interchangeable phosphor/bronze double wiping action type contacts/terminals replace easily—even while sockets are wired on P.C. boards! Accepts standard 14-lead DIP devices, features chamfered lead entrances and removable lids in black & white for easy color coding. Get the SUPERSOCKETS from Barnes. Send for more data.

barnes
CORPORATION

Lansdowne, Pa. 19050 • 215/MA 2-1525

barnes / THE WORLD'S MOST COMPLETE LINE OF SOCKETS, CARRIERS AND CONTACTORS FOR I.C.'S

INFORMATION RETRIEVAL NUMBER 113

HIGH DENSITY IC PACKAGING PANEL Modular Type

**INCREASES FLEXIBILITY
IN PROTOTYPING,
PRODUCTION AND
FIELD SERVICE.**

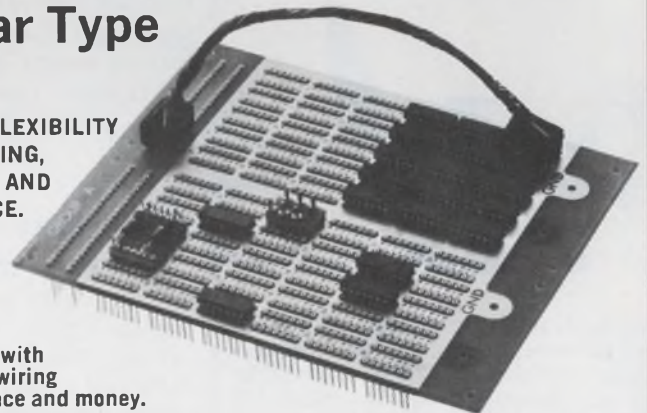

**P Series Panel with
Point to Point wiring
saves time, space and money.**

- Available in multiples of 30 IC pattern sections up to 180 patterns.
- Two pins of each pattern tied directly to power and ground planes. Different numbers available for different pin assignments.
- IC pattern also accepts I.O. plugs and adaptor plugs for discrete components.
- Excellent contact retention and low contact resistance.
- Wire Wrap terminations with Tri-level connection length.

Request Complete IC Folder

AUGAT INC.

Tel: 617-222-2202

31 Perry Ave., Attleboro, Mass. 02703

INFORMATION RETRIEVAL NUMBER 114

"Speaking of lamps..."



IEE builds subminiature lamps with stabilized filaments, longer life, uniform brilliance, unmatched reliability . . . at half the cost of competition. Seems like magic, but it isn't. It's extra long aging at rated voltages. (Forced aging shortens lamp life.) It's extra care in selection. It's such features as handmounted Swiss tungsten filaments and multi-point testing, all inherent in a stringent, quality assurance program for over 500 varieties. Let your IEE representative shed a little light on lamp savings for you today. (Get the rub?) Industrial Electronic Engineers, Inc., 7720 Lemona Avenue, Van Nuys, California 91405. (213) 787-0311, TWX-910-495-1707.

IEE
SUB-MINIATURE
LAMPS

INFORMATION RETRIEVAL NUMBER 115

NEW LITERATURE



Power converters

Over 3500 power conversion devices are listed with prices and application photos in a new 76-page catalog. It covers conversion equipment types such as ac to dc, dc to dc, dc to ac, single- and three-phase and high-temperature models. Abbott Transistor Laboratories, Inc.

CIRCLE NO. 468

Motor catalog

Describing five series of instrument and timing motors, a new six-page fold-out catalog tells of permanent-magnet synchronous motors, non-governed dc units, clutch mechanisms, dual motors and heavy-duty chart drives. General technical information includes explanations of motor and gear train ratings, torque definitions and data on friction and clutches. Conrac Corp., Cramer Div.

CIRCLE NO. 469

Power connectors

A complete line of rugged rectangular plug and socket connectors is covered in a new 36-page catalog. Six complete series are described with various numbers of contacts between 7 and 104. Aluminum hoods, polarizing screwlocks, protective shells and mounting shells are some of the optional accessories available. Terminations include turret type, solder cup and taper pin wiring. A variety of molding materials are available including glass reinforced diallyl phthalate type GDI-30 per MIL-P-19833 specifications. Continental Connector Corp.

CIRCLE NO. 470

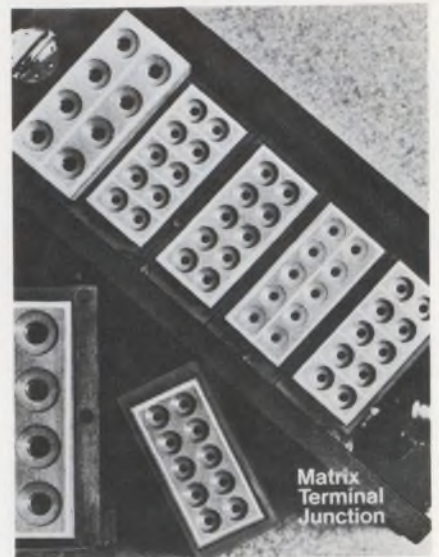

Wiring devices

Describing a complete family of wire connecting devices, a new 12-page multicolor brochure gives full details on terminal junction systems that use a contact-retention and contact-wiping design. Included are detailed descriptions of the modular function of the blocks and mounting rails, different sizes and configurations, and multiple applications. There is also users' information on installation and the necessary tools for crimping, inserting and extracting of contacts. Matrix Science Corp.

CIRCLE NO. 471



Variable transformers

Ratings, dimensions, performance curves and schematic connection diagrams are in a new 64-page catalog on variable transformers. Included are transformers up to 244 kVA in manual, motorized, oil-cooled, explosion-proof, metered and adjustable speed drive models. The Superior Electric Co.

CIRCLE NO. 472

Components

Capacitors, potentiometers and switches are included in a new 32-page catalog. It includes some new devices among its products and illustrates and specifies them along with dimensioned line drawings. Centralab Electronics Div. Globe-Union Inc.

CIRCLE NO. 473

Strip-chart recorders

A new six-page two-color catalog illustrates and describes a complete line of miniature strip-chart recorders. Recorder models are arranged by family and include such types as ac (ammeters, voltmeters and volt-ammeters), temperature (thermometers and pyrometers), dc (voltmeters, ammeters, microammeters and milliammeters), solenoid-actuated and event recorders. Amprobe Instrument, div. of SOS Consolidated Inc.

CIRCLE NO. 338



AMPHENOL
PRECISION POTENTIOMETERS - COUNTING DIALS PD-1

Potentiometers

Showing a variety of wirewound precision potentiometers and turn-counting dials, a new 72-page catalog is illustrated with cutaway views and actual-size photographs. Numerous diagrams depict overall dimensions and optional mounting styles. In addition, a discussion of linearity considerations tells how equivalent performance can be obtained by more than one method of specification. Bunker-Ramo Corp., Amphenol Controls Div.

CIRCLE NO. 339

BETA DISPLAYS

BETTER DISPLAYS

Remember. You can't do better than Beta. Here is a full range of high resolution CRT display system modules that have proven themselves in situations ranging from applesauce processing to creating the recently televised Apollo moon pictures. Send for Engineering Data Sheets today.

± 35 VOLT DEFLECTION AMPLIFIERS



The models DA223, DA224 and DA225 are dc-coupled, all-silicon, solid-state modular packages capable of supplying up to ± 2.0 , ± 4.0 and ± 6.0 amperes of deflection current respectively to each axis of a directly-coupled deflection yoke. A unique method of damping optimizes the amplifier for the particular yoke being used by means of an adjustable potentiometer. The amplifiers also feature extremely fast settling time and high bandwidth. The user has the choice of operating the amplifiers Class A for achieving nonlinearities of $\pm 0.02\%$ maximum or Class AB for minimum power consumption.

HIGH & LOW VOLTAGE CRT POWER SUPPLIES



SERIES HV provides regulated high voltage outputs for CRT electrodes - anode, focus grid, G2, and filament.

Model No.	Anode Output Range
HV8	1-8 kv
HV20	5-20 kv
HV30	15-30 kv

SERIES PAK provides regulated low voltage outputs for Beta modules - ± 35 volts, ± 20 volts, G1, and filament.

Model No.	± 35 volt (deflection) Output
PAK7	7 amperes
PAK16	16 amperes

MODULAR CRT BUILDING BLOCK COMPONENTS



Individual, compatible plug-in circuits such as: DF2050 Dynamic Focus Generator; DF347 Electromagnetic Dynamic Focus Amplifier; DF2496 Electrostatic Dynamic Focus Amplifier; LC2656/2676 Precision Linearity Correction Circuit; LC916/918 Linearity Correction Circuit; VA2076 Video Amplifier (10 MHz); VA2075 Gamma-Corrected Video Amplifier (10 MHz); VA2769 Video Amplifier (10 MHz, 60 volt output); VA2077 Video Amplifier (30 MHz); SG1190 X-Y Sawtooth Generator; PP529 Phosphor Protection Circuit; DA341 Deflection Amplifier (± 200 ma); DA1340 ($\pm .75$ amperes); EDA800 Electrostatic Deflection Amplifier (350 volts plate-to-plate positive or negative); EDA1504 Electrostatic Deflection Amplifier (500 volts plate-to-plate positive or negative); FR1882 Static Focus Regulator; BA1714 Blank/Unblank Amplifier. All Beta circuitry features silicon semiconductors and temperature stable metal-film resistors throughout.

PRECISION TUBE AND COIL MOUNTS



Flexible combinations of standard assemblies for the precision mounting and alignment of CRTs, yokes and coils: CRTM Basic CRT Mount includes removable bezel, rods and neck end clamps; DSTM Dual Gun Recording Storage Tube Mount, includes rods and neck clamps both ends; MCM Micro-positioner Coil Mount allows 6 independent motions and positive lock; FYM Fixed Yoke Mount for application where micropositioning is not required; FYMS Fixed Yoke Mount for servo-type mounted yokes; CCM Centering and/or Alignment Coil Mount; MS983 Magnetic Shield Enclosure.

Beta Instrument

377 Elliot St., Newton Upper Falls, Massachusetts 02164 / Tel. 617 969-6510 / TWX 710-335-6973

INFORMATION RETRIEVAL NUMBER 116

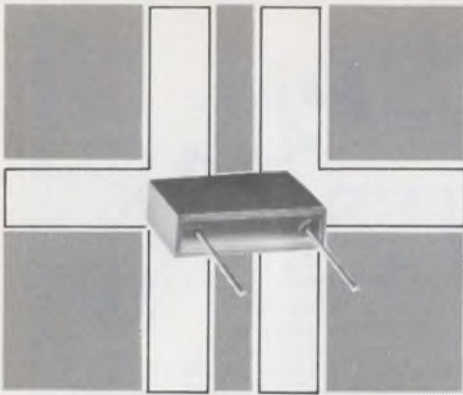

THINKING THIN?

The 17N metallized mylar thin rectangular capacitor is designed for solid state and applications that require high density packaging. Constructed of the best grade materials, encapsulated in epoxy cases with tin plated copper-weld radial leads for easy insertion.

FEATURES:

- IR 50K Meg x Mfd. Min +25°C
- DF less than 1K Hz +25°C
- Dielectric Strength 200% of rated VDC — 1 Min. Max.
- Temp. Range -55°C to +125°C
- MIL-C-18312C will meet or exceed the applicable portions
- Sizes: .001 Mfd. .095T x .295H x .395L
Up to: 5.0 Mfd. .4T x .75H x 1.24L
- Voltages from 100VDC to 600VDC

Write for detailed data or call for immediate quotations and delivery.

S&E Manufacturing/Capacitors

18800 Parthenia Street, Northridge, California 91324
P.O. Box 832 • (213) 349-4111 • TWX 910-493-1252
INFORMATION RETRIEVAL NUMBER 117

Specify KEYSTONE BATTERY HOLDERS

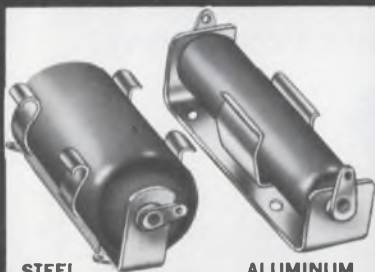

STEEL

ALUMINUM

A complete standard line of battery holders for use with all type batteries. Available for immediate shipment from stock, single or multiple holders.

- LOW COST
- STURDILY CONSTRUCTED
- LIGHTWEIGHT

Free engineering service for your special custom built holders.

A holder for every application. Also a complete line of Standardized Components or Modification of our Standard Line.

- TERMINAL BOARDS • TERMINALS
- PLUG-IN HOUSING • STAKING TOOLS
- PRE-PUNCHED BOARDS • BUSHINGS

NEW FREE CATALOG ON REQUEST

KEYSTONE ELECTRONICS CORP.

49 Bleecker St., New York, N.Y. 10012

INFORMATION RETRIEVAL NUMBER 118

NEW LITERATURE



IC shift register

A new MOS p-channel IC dual 25-bit dynamic shift register is discussed in a new six-page brochure. It shows how this bipolar compatible shift register solves DTL and TTL problems by eliminating the need for interfacing. A block diagram shows how inputs can be driven by DTL or TTL and the output can drive DTL or TTL. Negative logic definitions are included for MOS systems and positive logic definitions for bipolar systems. Maximum ratings, guaranteed electrical characteristics, and mechanical data are also provided in addition to applications information. Union Carbide Corp., Semiconductor Dept.

CIRCLE NO. 321

Leaf-switch design

To simplify the engineer's task in specifying leaf switches custom-designed to his requirements, a four-step approach is given in a new six-page two-color leaf-switch design guide. It helps to visualize how complex-logic and critical-sequencing circuitry can be designed into leaf switches for low cost and long life. Shown and discussed are the standard parts for which extensive tooling is already available and from which 90% of all leaf switches can be built. Drawings of blades, contacts, lifters, spacers, and other parts are included, and options relating to each are explained. Chicago Switch, Inc.

CIRCLE NO. 322

Circular connectors

Miniature circular connectors are described in a new 36-page catalog. A variety of configurations is available, including both potted and hermetically sealed versions. Also shown are types with coaxial, shielded or thermocouple contacts. Other connector types detailed are high-reliability, environment resistant, high-temperature, and sub-miniature and hermetic miniature units. The Bunker-Ramo Corp., Amphenol Connector Div.

CIRCLE NO. 323

Toroidal inductors

Miniature and subminiature rf toroidal inductors are the subject of a new six-page two-color brochure. Included are encapsulated, moisture and shock-resistant and immersion-proof bottom-lead and side-lead toroids for application in printed circuits and modules which are designed to meet MIL-C-15305, grade 1, class B. In addition, the brochure includes outline drawings and typical Q vs. frequency curves on each toroid group. Vanguard Electronics Div., of Wyle Laboratories.

CIRCLE NO. 324

Thermocouples

Industrial thermocouples with optional union disconnect fittings, insulated thermocouples, thermistor elements, quick-disconnect plugs and jacks and related supply items are all covered in a new eight-page Colman Co., Industrial Instruments sensing-elements catalog. Barber-Div.

CIRCLE NO. 325

Electromechanical products

A broad range of components and systems for aircraft, missile and industrial use are listed and illustrated with prices in a new 156-page catalog. Included are transducers, recorders, instrumentation and accessories, synchros, servo motors, generators, related components and systems. Ast/Servo Systems, Inc.

CIRCLE NO. 326

Low-power switches

Contained in a new 12-page catalog is complete data on four popular low-power switch families: rotary, pushbutton, lever and slide. Included are photographs, line drawings of electrical characteristics, mechanical specifications and prices on hundreds of popular switch types. A cross-referenced selection guide provides the information necessary for finding the right low-power switch for any equipment or circuit application. Oak Manufacturing Co., a division of Oak Electro/Netics Corp.

CIRCLE NO. 334

Storage tubes

A new 14-page booklet discusses display storage tubes. There is a description of each tube's construction, a discussion of the nature of the storage surface, principles of charging, magnetic shielding, bombardment-induced conductivity effects, the dual-effects storage surface, tube options and a glossary and nomenclature of tube terms. Hughes Aircraft Co., Vacuum Tube Products Div.

CIRCLE NO. 336

Precision lubricants

Listing a comprehensive range of special lubricants for delicate mechanisms, a new six-page publication gives data and prices on a variety of time-piece lubricants, instrument and delicate machinery oils and greases, extreme-environment lubricants, damping greases, and barrier films to retard oil creep. Lubricant kits and applicators are also described, along with a list of military specifications applying to instrument lubricants. In addition, there is a cross-reference that shows 48 types of instruments and devices with the recommended lubricant. William F. Nye, Inc.

CIRCLE NO. 337

Serviceability... at your finger tip



The 1M Matrix System's exclusive flip latch ejects the push button to put total front panel serviceability at your finger tips... for easy lamp, legend or indicator switch module change. Then check its exclusive mechanical action, RFI/EMI shielding, easy panel installation, production-oriented backplane wiring, small size (.750" centers), light weight, (1.6 oz./ switch), 384 standard display options, **mil spec quality** ... and you'll specify STACOSWITCH 1M Matrix everytime.

Send today for 1M Matrix Catalog.



STACOSWITCH

STACO, INC. CALIFORNIA

1139 Baker Street/Costa Mesa, California 92626 • Tel. (714) 549-3041

INFORMATION RETRIEVAL NUMBER 119

YOUR HEART FUND FIGHTS

HEART ATTACK
STROKE
HIGH BLOOD
PRESSURE
INBORN HEART
DEFECTS



Cut Circuit Costs

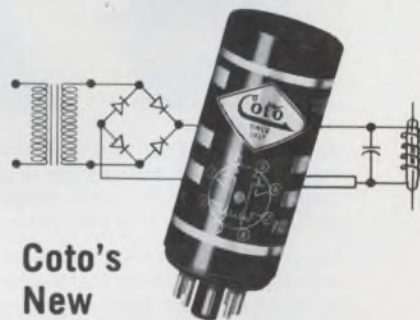

Coto's
New

A.C. Reed Relay

Replaces Costly AC/DC Circuits!

Contacts: Forms A or C with single or multiple poles.

Ratings: to 3 amperes or up to 5000 volts D.C.

Inputs: 60-800 Hz voltages available.

Physical: Available in 8 and 11 pin plug-in housings with electromagnetic shielding. Electrostatic shielding available on order.

Write for complete specifications. For special requirements, give complete details for quotation.

Coto-Coil COMPANY, INC.
59 Pavilion Ave.
Providence, R. I. 02905
Phone (401) 941-3355

INFORMATION RETRIEVAL NUMBER 120

Anodized knobs

Machined aluminum anodized knobs are listed in a new eight-page catalog. The various types include concentric, spinner, skirted, and knurled models in sizes of 1/2, 3/4, 1 and 1-1/4 in. Anodizing can be either natural, black or gold; two-tone models are also available with contrasting bodies and tops. Alco Electronic Products, Inc.

CIRCLE NO. 151

Connectors

The latest 24-page catalog on high-temperature connectors outlines and discusses six different series of connectors which operate up to 350 and 1300°F, along with their latest tooling status with detailed assembly instructions. ITT Cannon Electric, div. of International Telephone and Telegraph Corp.

CIRCLE NO. 152

Dc motors

A wide selection of twenty-five 6- and 12-V dc motors, and five gear-heads with ratios from 3:1 to 60:1 is fully described in a new 16-page illustrated catalog. These motors feature low cost, small size, high torque and low power consumption. Also described are lines of motor accessories, bearings and gears. Newman Co., Motor Div.

CIRCLE NO. 153

INNOVATION



Tomorrow's better mousetrap—a creative solution to the challenge of change—begins with a curious mind open to the ever expanding horizons of technical innovation. We need EE's with an insatiable desire to venture into the realm of these possibilities in an environment of encouragement and challenge.

Hallicrafters isn't satisfied with yesterday's electronic progress—past innovations that have fostered our reputation as the leader of the electronic communications and countermeasure industry. Instead, we are constantly striving to make the best even better.

In pursuit of electronic excellence, Hallicrafters needs graduate electronic engineers who thrive on challenging assignments offered in an atmosphere of intellectual and creative freedom—who prosper in an environment of curiosity, controversy and commitment.

Specifically we have openings for EE's in ECM Systems, Solid State, Microwave, Antennas, Communications and Electronics Packaging.

Consider the satisfaction of working for Hallicrafters, a company where pride in electronic expertise is the basis of progress. Consider becoming an integral part of a company that regards thinking highly and rewards it accordingly.

Please submit your resume, in complete confidence, to: Professional Placement Director, The Hallicrafters Co., 600 Hicks Road, Rolling Meadows, Illinois 60008.

An Equal Opportunity Employer.

the hallicrafters co.

A Subsidiary of Northrop Corporation



Microwave circulators

More than 100 high-power differential phase-shift circulators are shown in a 12-page catalog. Given are specifications for L-, S-, C-, X-, Ku-, and Kt-band devices. Other data includes frequency range, peak and average power, isolation, insertion loss and physical specifications. Raytheon Co., Special Microwave Devices Operation.

CIRCLE NO. 154



Dual extrusions

Featuring 12 problem/solution case histories, a new four-page brochure describes dual extrusions that consist of two different thermoplastic materials combined into a single extrusion. The illustrated case histories include examples from the fields of construction, transportation, recreation equipment, and interior partitions. Ten user advantages of dual extrusions are also summarized in the brochure. Crane Plastics, Inc.

CIRCLE NO. 155



Moly-permalloy cores

Twelve sizes of 550 Mu moly-permalloy flake cores, nine of them new, are described in a new, illustrated bulletin. The bulletin describes how these cores reduce size, copper resistance and distributed capacity, improve temperature stability and reduce costs. A table lists the nine new and three existing sizes. Design information is illustrated in graphs covering permeability versus flux density and loss characteristics and inductance versus temperature. Q curves are included for each of the twelve 550 Mu cores. Magnetics Inc., Components Div.

CIRCLE NO. 156

Capacitors

General characteristics and ordering data are highlighted in a 44-page brochure. It details paper-dielectric capacitors with an operating temperature range of -55 to $+125^{\circ}\text{C}$ and voltage ratings of 100 to 1000 V dc. San Fernando Electric Manufacturing Co.

CIRCLE NO. 157

Rf coils

A new 80-page catalog describes a standard line of industrial rf coils, chokes, filters, i-f transformers and related components. Catalog 70 itemizes 3500 components with detailed specifications. Also included are prices and dimensional drawings for coil forms like ceramic and resinite. J. W. Miller Co.

CIRCLE NO. 158

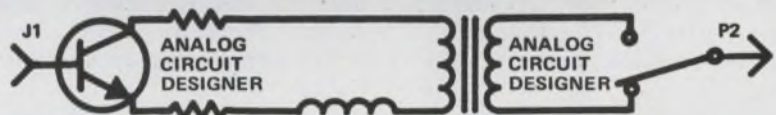
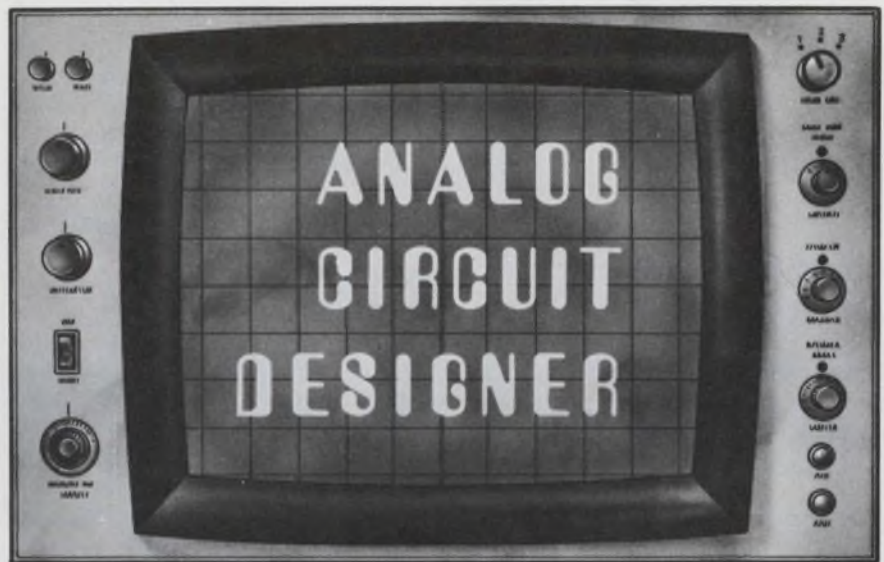

Radiation Systems Division has several openings for experienced analog circuit designers to perform detailed analysis and design of circuitry for display and simulation equipment. This equipment includes chart recorders, large screen, optical, alphanumeric displays, and hard copy CRT applications.

These circuit designers will use discrete components and integrated circuits to design analog display circuitry such as:

- power supplies ■ phase lock loops
- sweep circuits ■ function generators
- active filtering ■ feedback amplifiers
- special function generators
- signal conditioners
- wideband video amplifiers
- special purpose simulators

At Radiation, the individual we're looking for will find a challenging environment that provides diversity, stimulation, and the opportunity to advance the state-of-the-art. As Florida's largest electronics R&D company, Radiation offers a climate for careers as well as a climate for healthful outdoor living.

If you have a technical degree and heavy experience in analog circuit design, look into these opportunities by contacting Mr. C. A. King, Manager Professional Employment, Systems Division, Radiation Incorporated, P. O. Box 37 Melbourne, Florida 32901



SUBSIDIARY OF HARRIS-INTERTYPE CORPORATION

An Equal Opportunity Employer (M/F)

Fiber-glass rods

A new six-page folder describes a variety of fiberglass reinforced polyester square, rectangular and round rods. Complete data regarding mechanical and physical properties including the electrical insulating values for the various types of rods are given. Also included are list prices for each type rod as well as examples of capabilities employing the pultrusion process. The Glastic Corp.

CIRCLE NO. 159

Precision instruments

Instruments for laboratory and industry are featured in a new eight-page bulletin. Included are portable precision instruments such as bridges and potentiometers, potentiometer accessories, measuring, limit-testing and trimming instruments, with data on a new resistance trim-tester. Also included are laboratory resistance standards, bridges, ratio sets and potentiometric instruments. James G. Bidle Co.

CIRCLE NO. 160

Silicones

Silicone insulating varnishes and adhesive resins are the subject of a new 12-page technical booklet. It contains a description and property evaluation of each product in a complete line of varnishes and adhesive resins. The booklet also outlines the application procedures and recommendations for general shelf maintenance and handling. General Electric Silicone Products Dept.

CIRCLE NO. 161

Switches

A full line of subminiature slide switches, sharp rocker switches, panel lights, multi-pole slide switches and leaf switches is described in detail in a four-page catalog. Also discussed are a new Klipsocket and miscellaneous custom-engineered products. Included are five case histories of unusual switch problems solved by the firm's engineering group. Chicago Switch, Inc.

CIRCLE NO. 162

Ac power systems

Four types of static uninterruptible ac power systems and three types of emergency lighting systems are described in two new four-page folders. There are diagrams of continuous, forward transfer, reverse transfer, and forward electromechanical transfer systems. In addition, a chart compares the characteristics of various systems as they pertain to suggested applications, such as real-time computers, process control systems and data loggers. Exide Power Systems Div., ESB Inc.

CIRCLE NO. 163

Microwave devices

Consisting of 32 pages, a new catalog describes a complete line of ferrite microwave devices. Included are three- and four-port isolators and circulators, five-port circulators, co-isoguide devices, ferrite switches and drive electronics, and miniature isolators and circulators. Advanced Microwave Labs.

CIRCLE NO. 164



CIRCUIT DESIGN ENGINEERS

A leader in inertial navigation systems, such as the F14 and S3A programs, announces openings for circuit design specialists. BSEE's with 5-10 years experience in either platform electronic and control systems, power conversion or signal processing.

Please write J. D. Anderson
5500 Canoga Avenue,
Woodland Hills, California 91364



An equal opportunity employer M/F

INFORMATION RETRIEVAL NUMBER 903

"IT'S GOOD BUSINESS TO HIRE THE HANDICAPPED."

ISN'T THAT A GREAT IDEA, SNOOPY?



THE PRESIDENT'S COMMITTEE ON EMPLOYMENT OF THE HANDICAPPED, WASHINGTON, D. C.

Free Career Inquiry Service

Absolutely Confidential

23

Respond to the career opportunities advertised in this issue. Fill out and send us this handy resume. **Electronic Design** will do the rest – neatly typed copies of this form will be mailed to the companies of your choice, indicated by the circled Career Inquiry Numbers at the bottom of this page.

Name	Home Phone
-------------	-------------------

Home Address (Street)	City	State	ZIP Code
------------------------------	-------------	--------------	-----------------

Age	U.S. Citizen <input type="checkbox"/> Yes <input type="checkbox"/> No	Security Clearance
------------	---	---------------------------

Prime Experience	Secondary Experience

Desired Salary	Availability Date
-----------------------	--------------------------

Employment History – present and previous employers

Company	City, State	Dates	Title
		to	
		to	
		to	

Education – indicate major if degree is not self-explanatory

Degree	College	City, State	Dates
			to
			to
			to

Additional Training – non-degree, industry, military, etc.

Professional Societies

Published Articles

Career Inquiry Numbers:

- | | | | | | | | | | | |
|-----|-----|-----|-----|-----|-----|-----|-----|-----|-----|-----|
| 900 | 901 | 902 | 903 | 904 | 905 | 906 | 907 | 908 | 909 | |
| 910 | 911 | 912 | 913 | 914 | 915 | 916 | 917 | 918 | 919 | 925 |

ELECTRONIC DESIGN
 850 Third Avenue
 New York, New York 10022

ELECTRONIC DESIGN'S function is:

- To aid progress in the electronics manufacturing industry by promoting good design.
- To give the electronic design engineer concepts and ideas that make his job easier and more productive.
- To provide a central source of timely electronics information.
- To promote two-way communication between manufacturer and engineer.

Want a subscription? ELECTRONIC DESIGN is sent free to qualified engineers and engineering managers doing design work, supervising design or setting standards in the United States and Western Europe. For a free subscription, use the postfree application form inside the back cover. If none is included, write to us direct for an application form.

If you do not qualify, you may take out a paid subscription for \$25 a year in the U.S.A., \$35 a year elsewhere. Single copies are \$1.50 each.

If you change your address, send us an old mailing label and your new address; there is generally a prepaid postcard for this inside the back cover. You will have to requalify to continue receiving ELECTRONIC DESIGN free.

The accuracy policy of ELECTRONIC DESIGN is:

- To make reasonable efforts to ensure the accuracy of editorial matter.
- To publish prompt corrections whenever inaccuracies are brought to our attention. Corrections appear at the end of the Letters column.
- To refuse any advertisement deemed to be misleading or fraudulent.

Microfilm copies are available of complete volumes of ELECTRONIC DESIGN at \$19.00 per volume, beginning with Volume 9, 1961. Work is now in process to complete the microfilm edition of Volumes 1-8. Reprints of individual articles may be obtained for \$2.00 each, prepaid (\$.50 for each additional copy of the same article) no matter how long the article. For further details and to place orders, contact the Customer Services Department, University Microfilms, 300 North Zeeb Road, Ann Arbor, Michigan 48106; telephone (313) 761-4700.

Want to contact us? If you have any comments or wish to submit a manuscript or article outline, address your correspondence to:

Howard Bierman, Editor,
ELECTRONIC DESIGN,
850 Third Avenue,
New York, N.Y. 10022.

Design Data from

Selection Guide for Tubular Parts



A new Selection Guide for thin metal tubing and tubular parts covers over 90 alloys regularly drawn and fabricated including glass-to-metal sealing alloys. To facilitate mating with other parts during assembly, electronic parts are offered with ID-radiused ends. The same machinery that does the cutting and ID-radiusing also forms flares, flanges, bulges and constrictions at the same time thereby minimizing costs. Automated ID-radiusing is limited to O.D.'s of 0.040" to 0.187", walls of 0.003" to 0.025" and lengths of 1/8" to 5/8". Standard forming techniques extend these sizes to 0.625" max. O.D., 0.003" min. O.D., walls as thin as 0.0005" and unlimited lengths.

Uniform Tubes, Inc.
Collegeville, Pa. 19426

174

DRAFTING AIDS CATALOG



Send today for the By-Buk Printed Circuit Drafting Aids P-45 Catalog featuring the most comprehensive listings of basic pressure sensitive printed circuit drafting shapes, tapes and aids. Contains thousands of pads, tees, elbows, corners, donuts, connectors, fillets, colored tapes, multi-pads for dual in-lines, flat packs, TO cans and more. Here is your guide to better printed circuit drafting. Scores of ideas to speed master artwork preparation time and reduce drafting costs. Send for your free catalog and samples.

By-Buk Company
4326 West Pico Blvd., Los Angeles, Calif. 90019
Phone: (213) 937-3511

175

CRT AND SHIELD CATALOGS



Two information-packed catalogs are available from Inter-Tech to give you data on CRTs and the shields to go with them. One is a catalog of more than 100 proven-quality British CRTs now available in the U. S. It's a 32-page summary of valuable facts on tubes for: radar, oscilloscopes, data display, and TV. The second brochure gives you data on a complete line of shields. Send for your CRT catalog and you'll automatically receive both.

THE INTER-TECHNICAL GROUP, INC.
P. O. Box 23 / Irvington-On-Hudson, New York 10533
Phone: (914) 591-8822 / TWX 914-693-0164

176

Manufacturers

Advertisements of booklets, brochures, catalogs and data sheets. To order use Reader-ServiceCard (Advertisement)

Free Op-Amp Catalog/Handbook



Analog Devices' 1969 edition of "A Selection Handbook and Catalog Guide to Operational Amplifiers" contains design reference data, comprehensive specifications and applications information for over 100 op-amps. Also included is detailed information on Analog function modules, instrumentation amplifiers and modular power supplies.

An "instant action" registration card is included which may be used to request up-dating material on newly developed products and application techniques.

This 36 page catalog/handbook is a must for all engineers who design with operational amplifiers.

Analog Devices, Inc.

221 Fifth Street
Cambridge, Mass. 02142
(617) 492-6000

177

Quality Fasteners For All Designs



This 8-page catalog provides design data on the complete group of DZUS 1/4-turn self-locking fasteners for standard, high speed and panel applications, as well as universal high strength multiple thread fasteners for high tensile and shear stresses. Dzus stud assemblies, wire forms and receptacles offer an exceptional, wide variety of combinations from stock to fit specific fastening requirements. Diagrams and tables give full details for rapid, unlimited design selection. Condensed or complete Catalog available on request.

Dzus Fastener Co., Inc.

425 Union Boulevard
West Islip, L. I., N. Y. 11795

178

New IF, RF, Microwaves Components Catalog



New 100-page catalog covering Merrimac's broad line of RF, IF and microwave components — including standard, miniature and ultraminiature models. Products include quadrature (90°) hybrids; hybrid junctions, power dividers; directional couplers; attenuators; phase shifters; mixers; mixer preamps and comparators; bandpass filters; and special products. Each product section includes general technical information. Special sections are devoted to facilities and capabilities, ordering information, sales reps. **Send for your free copy now!**

Merrimac Research and Development, Inc.

41 Fairfield Place
West Caldwell, New Jersey 07006

179

Electronic Design

Advertising Sales Staff

Keith Aldrich
Sales Manager

New York 10022

Robert W. Gascoigne
Thomas P. Barth
Samuel M. Deitch
850 Third Avenue
(212) Plaza 1-5330
TWX: 867-7866

Philadelphia 19066

William C. Repetto
P. O. Box 206
Merion Station, Pa.
(215) MA-3-5888

Boston 01945

Richard Parker
P. O. Box 645
Clifton Station
Marblehead, Mass.
(617) 742-0252

Chicago 60611

Thomas P. Kavooras
Berry Conner, Jr.
200 East Ontario
(312) 337-0588

Cleveland

Thomas P. Kavooras
(Chicago)
(312) 337-0588
(call collect)

Los Angeles 90303

Stanley I. Ehrenclou
W. James Bischof
2930 Imperial Highway
Inglewood, Calif.
(213) 757-0183

San Francisco 94022

Arthur R. Shields, Jr.
175 San Antonio Rd., S 243
Los Altos, Calif.
(415) 941-3084

London W. 1

For United Kingdom and Holland
Brayton C. Nichols
44 Conduit Street
Tel: REGent 4714

Verviers, Belgium

For Continental Europe
Andre Jamar
1, Rue Mallar, 1
(087) 253.83 Telex 41563

Tokyo

Haruki Hirayama
Electronic Media Service
Rm. 601, Daini Miyauchi Bldg.
6-8-14, Roppongi,
Minato-ku
Phone: 402-4556
Cable: Electronicmedia, Tokyo



Advertisers' Index

Advertiser	Page	Advertiser	Page	Advertiser	Page
Abbott Transistor Laboratories Incorporated	16	Gardner-Denver Company	52, 53	RCA Electronic Components and Devices	Cover IV
Aeromet General Corporation	63	Gencom Division, Varian/EMI	136	R. F. Communications, Inc.	110
Allen-Bradley Co.	35, 37, 115, 117, 119, 121, 123	General Automation, Inc.	C59	Radiation, Incorporated	C57
Analog Devices, Inc.	C67, 157	General Electric Company	C45, C34-A	Raytheon Computer	C43
Arrow-Hart, Inc.	6, 7	General Radio Company	C26, C27	Raytheon Company, Semiconductor Operation	88, 89
Atec, Inc.	C69	Glenaire, Inc.	58	Rotron Incorporated	C39
Augat, Inc.	147	Golay, S. A. Bernard	C34-B		
Automatic Electric Company	12, 13	Gosh Instruments, Inc.	C79		
		Grayhill, Inc.	110		
		Gries Reproducer Corp.	98		
		Gulton Industries, Inc.	C80		
				S & E I Corp.	150
B & B Motor & Control Corp.	131	Hathaway Instruments, Inc.	159	Schweber Electronics	17, C77
BIT, Incorporated	C4, C5	Hayden Book Company, Inc.	C34-B	Semiconductor Circuits, Inc.	C42
Barnes Corporation	147	Heath Company	146	Shaffstall Ball Corporation	98
Beckman Instruments, Inc., Hellpot Division	100	Hewlett-Packard	1, 23, 60	Signetics Corporation	27
Belden Corporation	70, 71	Honeywell Test Instrument Division	C60	Siliconix Incorporated	124
Bell Labs	113			Simpson Electric Company	139
Beta Instrument Corp.	149			Singer Company, The, Diehl Division	C29
Bourns, Inc.	59			Singer Company, The, Instrumentation Division	62
Bud Radio, Inc.	106	IMC Magnetics Corp.	C84	Sperry Gyroscope Division	102
Bulova Watch Company	138	IRC, Division of TRW, Inc.	55	Sprague Electric Company	18, 20
Burr-Brown Research Corporation	C68	Indiana General Corporation	82, 83	Stackpole Carbon Company	99
ByBuk Company	156	Industrial Electronic Engineers, Inc.	148	Staco, Incorporated	151
		Inter-Technical Group, Inc., The	156	Switchcraft, Inc.	C76
				Sylvania Electric Products, Inc., Electronic Components Group	42, C35
				Syntronic Instruments, Inc.	131
				Systron-Donner Corporation	2
				TRW Globe Industries, Division of TRW, Inc.	Cover II
				TRW Semiconductors, A Subsidiary of TRW, Inc.	104
				Techno-Components Corp.	93
				Telonic Instruments, A Division of Telonic Industries, Inc.	C30
				Teradyne	50
				Texas Instruments Incorporated, Components Group	10, 11, 31, 64
				Texas Instruments Incorporated, Chemical Materials Division	81
				Thermal American Fused Quartz Co., Inc.	132
				Trio Laboratories, Inc.	C6, C7
				Uniform Tubes, Inc.	156
				Union Carbide Corporation	45
				Unitrode Corporation	29
				Varo Semiconductor Division	116
				Victoreen Instrument Division	61
				Wakefield Engineering, Inc.	143
				Welch-Allyn, Inc.	137
				White Industrial, S. S., A Division of Pennwalt Corporation	14
				Xerox Corporation	108
				Xerox Data Systems	39
				Zeta Laboratories, Inc.	130
				<i>Career Advertising:</i>	
				Hallcrafters Co., The	152
				Litton Guidance & Control Systems	154
				Radiation, Incorporated	153

1750 ways to keep in touch

At H. A. Wilson we have over 1750 precious and sintered metals and alloys available for electrical contact applications. Yes! Even more than any other company. This wide variety enables us to produce every conceivable form of contact in sizes ranging from the microminiature forms used on Apollo spacecraft to up to 1 1/4 in. square (NEMA #6 and #7) motor starters. Combine this wide selection of materials with our engineering and production capabilities, and it's obvious there are few, if any, contact problems we can't solve. Even yours.

Contact the H.A. Wilson Technical Service Department today.



ENGELHARD

ENGELHARD INDUSTRIES DIVISION
ENGELHARD MINERALS & CHEMICALS CORPORATION
2655 U. S. ROUTE 22 UNION, NEW JERSEY 07083

INFORMATION RETRIEVAL NUMBER 125

True to Form



**HATHAWAY
TRUE FORM "C" DRIREED SWITCH**

To keep circuits in good shape Hathaway developed the True Form "C" Drireed switch. Yes, *Drireed!* If you ever heard talk about Form "C" reed switch problems, you should know they weren't ours. We make our Model FCD reliable in a .8" long x .135" dia. piece of special glass. You can switch 200 volts or .125 amps. and up to 2 watts through it time and time again. And again. **Send for our full line mini-catalog.** Address: 5250 East Evans Avenue, Denver, Colorado 80222, (303) 756-8301 TWX 910-931-0569.

HATHAWAY
components

A DIVISION OF HATHAWAY INSTRUMENTS, INC.

*To buy less
would cost you more*

INFORMATION RETRIEVAL NUMBER 126

ELECTRONIC DESIGN 23, November 8, 1969

LAFAYETTE RADIO ELECTRONICS



FREE!

**1970 LAFAYETTE
CATALOG 700
496 Pages**

Lists Lafayette's Own Value Engineered Components plus Quality Designed Equipment From Many Leading Manufacturers for

- HOME • INDUSTRY
- LABORATORY

Semiconductors • Capacitors • Connectors • Controls • Fuses and Circuit Breakers • Relays • Resistors • Wire and Cable • Transformers • Test Equipment

All Components Are Immediately Available From Stock!

LAFAYETTE Radio ELECTRONICS Dept. 45099 P.O. Box 10
Syosset, L.I., N.Y. 11791

Please Send the FREE 1970 CATALOG 700 **45099**

Name _____
Address _____
City _____
State _____ Zip _____

INFORMATION RETRIEVAL NUMBER 127

Information Retrieval Service

All products, design aids (DA), application notes (AN), new literature (NL), and reprints (R) in this issue are listed here with Page and Information Retrieval numbers. Reader requests will be promptly processed by computer and mailed to the manufacturer within three days.

Category	Page	IRN	Category	Page	IRN	Category	Page	IRN
Components			transistor, switching	120	376	detectors, particle	145	457
capacitors, thin-film	123	383	Instrumentation			diodes, tunnel	146	463
capacitors, trimmer	124	387	digital panel meter	117	369	extrusions	152	155
inductors, thin-film	122	380	divider, double	116	367	fasteners, plastic	144	451
lamp, bi-pin	123	382	multimeter, digital	118	370	knobs, anodized	152	151
motor, stepper	124	384	probe, logic	119	372	IC logic	144	449
resistor, trimmer	124	386	scope, eight-channel	119	371	IC logic	147	465
switch, 12-position	122	381	VOM, FET-input	117	368	IC specifications	144	450
transformers, trigger	124	385				inductors, toroidal	150	324
			Microwaves & Lasers			instruments	144	453
Data Processing			diodes, tunnel	130	402	instruments	146	458
communications			filter, YIG	130	401	Lafayette catalog	142	448
terminal	C50	277	laser, He-Ne	130	399	lubricants	151	337
computer, analog	C66	292	oscillator, S-band	130	400	memory, IC	142	444
computer, digital	C66	343	shielding, rfi	131	404	motor catalog	148	469
computer, real-time	C66	294	transistors, power	131	403	motors, dc	152	153
computer, small	C56	340				lamps, two-terminal	146	460
computer expander	C44	358	Modules & Subassemblies			meters, panel	144	452
computer terminal	C48	353	converter, d/a	112	361	motors, stepping	146	462
computer terminal	C52	293	noise module	115	365	motors, stepping	145	455
computers,			op amp, FET	112	362	potentiometers	149	339
medium-sized	C66	267	op amp, modular	112	363	power, emergency	142	446
data concentrator	C66	299	oscillator, crystal	115	366	power devices	146	464
data entry terminal	C62	298	supply, CRT	114	364	recorders, strip-chart	149	338
data system	C46	279				relays	142	447
data terminal	C46	355	Packaging & Materials			semiconductors	145	456
data terminal	C56	350	cable assemblies	128	396	shift register, IC	150	321
data terminal	C58	261	clamp, cable	128	394	switches, leaf	150	322
data terminal	C58	295	coax, ribbon	126	390	switches, low-power	151	334
data terminals	132	408	connector, stacking	129	397	synchros and motors	150	326
display, color	C52	284	fillet, PC-board	126	389	thermocouples	150	325
display terminal, CRT	C48	281	heat dissipators	126	391	tools, precision	146	459
keyboard	C46	266	heat radiators	128	395	transducers	147	466
keyboard, modular	C42	356	heat sinks	129	398	transformers, variable	148	472
keyboard, solid-state	C52	282	heat-transfer tube	127	392	tubes, storage	151	336
keyboard/tape system	132	405	insulating sheet	126	388	wiring devices	148	471
memories, core	C62	278	jack receptacle	127	393			
memory, core	C58	280				Application Notes		
memory, core	132	406	Production			data conversion guide	141	439
memory, high-speed	C62	348	cutter, lead	134	414	electrical control	141	443
memory, MOS	C62	286	cutting tool	135	415	FET/bipolar talk	141	442
memory, stack	C62	275	desoldering machine	134	412	fuses and breakers	141	440
mini-computer	C56	263	dispenser, foam	134	411	relay handbook	141	441
mini-computer	C56	265	eyeframe, lighted	133	409			
mini-computer	C56	351	generator, rf	135	416			
modem, high-speed	C52	283	lamps, natural-light	133	410			
modem, high-speed	C62	342	plastic station	134	413			
plotting system	C38	357				Design Aids		
printer, line	C40	352				color-code guide	138	431
reader, document	C58	288				dielectrics chart	138	432
reader, document	132	407				scales, calibrated	138	430
readers, microfilm	C56	262				template, schematic	138	429
readout, CRT	C48	296	New Literature					
tape evaluator	C50	264	capacitors, tantalum	146	461			
tape terminal	C52	274	circulators, microwave	152	154			
tape transports	C50	335	components	149	473			
video terminals	C52	285	connectors	152	152			
			connectors, circular	150	323			
ICs & Semiconductors			connectors, miniature	142	445			
diode, four-layer	120	377	connectors, power	148	470			
multiplexer, 10-channel	121	378	converters, power	148	468			
op amp, dual	120	374	cores, moly-permalloy	153	156			
op amp, IC	121	379	counters, electric	144	156			
shift registers, MOS	120	375	detectors, nuclear	147	467			
thyristor, silicon	120	373				Evaluation Samples		
						anchors, nylon	137	427
						connector, universal	137	428
						jumpers	136	425
						laminates, woodgrain	136	424
						switches, audio	136	423
						terminals, grounding	136	426



Programmable.

Full-function programmability
DC to 50 MHz Counting Range
Universal counter / timer functions
BCD output

... all for only \$1285

The new Monsanto Model 110A offers you a broader range of operational advantages than any counter/timer in its price range. Front-panel functions are tailor-made for programming with the Monsanto Model 501A Digital Programmer, or with virtually any other contact-closure or logic-level source.

Now consider these other features of the Model 110A: the full complement of counter/timer functions; dc to 50 MHz counting range; marker and gate outputs; provision for external time base; and BCD output. Plus the inherent reliability of Monsanto "4th generation" integrated circuit construction. Plus the 2-year Monsanto warranty.

Price of the Model 110A is \$1285; of the Model 501A, \$375. For a demonstration or technical data call your local Monsanto Field Engineering Representative or contact us direct. Monsanto Company, Electronic Instruments, West Caldwell, New Jersey 07006; (201) 228-3800.



RCA-TA7205
(actual size)

Here—available—is the world's highest power, highest gain, highest efficiency transistor for operation at 2 GHz. In addition to the features above, this silicon n-p-n "overlay" transistor also offers 11-W output with 11.5-dB gain at 1.2 GHz at 60% efficiency.

The package is all new: hermetically-sealed, ceramic-metal, coaxial type that can be used in large signal applications in coaxial, stripline, and lumped-constant circuits.

RCA's multiple-emitter-site "overlay" construction is a feature recently patented.

The RCA-TA7205 is intended for reliable performance in such applications as microwave communications, S-band telemetry, microwave relay link, phased-array radar, distance measuring equipment, and collision avoidance systems.

Ask your local RCA Representative or your RCA Distributor for more detailed information. For technical data, write: RCA Electronic Components, Commercial Engineering, Section PG11-1, Harrison, N.J. 07029.

**5.8-W (typ.) output,
7.6-dB gain,
45% efficiency,
at 2 GHz,
in common-base circuit.
New and now—
RCA-TA7205**

RCA