

Electronic Design 22

VOL. 17 NO.

FOR ENGINEERS AND ENGINEERING MANAGERS

OCT. 25, 1969

Are midair collisions avoidable?
The recent Indianapolis tragedy has turned up disturbing facts about airport traffic radars. An investigation by this magazine

has found evidence of the use of outmoded equipment, inferior maintenance and strong need for better design. For a penetrating look at FAA radars, see page 25.





The Performance Champ—world's fastest general-purpose real-time scope!

The HP 183A Oscilloscope system adds one more way that you **see more—do more** with the field-proven 180 scope system.

Now you can measure from dc to 250 MHz—real time! Now you have a vhf scope that also gives you a bright dual-trace with a fast-writing speed of 4 cm/nsec on a big 6 x 10 cm screen. Plus, a sensitivity of 10 mV/div for low-level signal measurements—sweep speeds of up to 1 nsec/div for easier viewing of high frequency signals—and complete compatibility with the entire 180 series of plug-ins.

Sound expensive? Well, the 183A mainframe with a 250 MHz dual-channel vertical amplifier and a > 250 MHz time base costs only \$3150. That's less than some systems that don't even approach this kind of high frequency performance.

The basic 183A mainframe uses the all-new step-ahead technique of a CRT transmission line deflection system to provide real-time bandwidth beyond 500 MHz. And since it contains only the CRT and power supplies,

future, improved plug-ins will give you full performance in the mainframe you buy now. You won't have to worry about built-in mainframe limitations—now or in the future.

If you're interested in maximum scope performance per dollar invested, then the HP 180 system is the answer. From 50 MHz, to 100 MHz, to sampling, to variable persistence and storage scopes, the 180 system has the right combination to meet your requirements. You get more for your dollar today. You get more for your dollar in the future. You get the best performing, most versatile high-frequency scope system available today!

For more information, call your local HP field engineer. Or, write to Hewlett-Packard, Palo Alto, California 94304. Europe: 1217 Meyrin-Geneva, Switzerland.

089/14A

HEWLETT  PACKARD

OSCILLOSCOPE SYSTEMS

ACTUAL SIZE

g of the heart;
 . India; about
 ian. See CON-
 .A pl.] 1 An
 mature sori or
 g the stigma in
 so, any similar
 , tunic] — IN-

ed in industry.
 manufacture.
 lock or security
 .LY adv.
 participation in
 that industry.
 an industry, as

amounts, usu-
 being paid in

ustrial system,
 ufacturing in-
 A condition of
 in peaceful in-
 :T adj. & noun.
 render indus-

injustice; also, an unfair act.
IN·ER·TAN·CY (-ēr'·un-sī) *noun* The state of being free from error; as applied to Scripture, plenary inspiration.
IN·ER·RANT (-ēr'·unt) *adj.* Exempt from error; unerring.
IN·ERT (-ürt') *adj.* 1 Destitute of inherent power to move; possessing inertia; inactive. 2 Sluggish. 3 Devoid of active chemical properties; as, the *inert* gases; neutral. See synonyms under HEAVY, IDLE, LIFELESS, PASSIVE, SLOW. [*L. inerts* <in-, not, + *ars*, art] — **IN·ERT·LY** *adv.* — **IN·ERT·NESS** *noun* — **IN·ER·TION** *noun*.
INERT GASES Helium, neon, argon, krypton, xenon, and radon.

in-er-tia? — The word just doesn't exist at General Radio!

IN·ES·SEN·TIAL (-shū) *adj.* 1 Unessential; not essential. 2 Immaterial. — **IN·ES·SEN·TI·AL'·I·TY** *noun*.
IN·ES·TI·MA·BLE *adj.* Above price; very valuable. — **IN·ES·TI·MA·BLY** *adv.*
IN·EV·I·TA·BLE *adj.* 1 That cannot be prevented; unavoidable. 2 Hence, jocularly; customary; usual. See synonyms under NECESSARY. [*L. inevitabilis* <in-, not, + *e*, out, + *vito*, shun] — **IN·EV·I·TA·BLE·NESS**, **IN·EV·I·TA·BL'·I·TY** *noun* — **IN·EV·I·TA·BLY** *adv.*
INEVITABLE ACCIDENT See FORCE MAJEURE.

cal
 IN·F
 cor
 ph
 IN·F
 2
 cor
 gro
 IN·F
 IN·F
 em
 noi
 IN·F
 wal
 IN·E
 I
 of
 FAJ
 IN·E
 IN·E
 sati
 no
 teri
 bid
 tai
 mo
 in
 VOY
 <ir

GR is on the move, quoting and building custom automatic measuring systems. We're busy putting our established impedance bridges into automatic component and network testing systems — our real-time analyzers into acoustical-analysis systems.



"Automatic Capacitance-Comparison System".

Even with access to our own excellent instruments, we wanted the added efficiency and savings of automatic systems for our own programs. So we took those same instruments, applied our know-how to the problems of interface and automation, and came up with in-house test systems. The result: new and sophisticated GR instruments that could not have been produced and competitively priced without automatic measurements.

NAME YOUR SYSTEM!

If you want quantity measurements of capacitance, loss, dc bias effects on ac impedance, leakage current, or analyses of logic circuits or of sound and vibration, you, too, can profit from the time and dollar economies of a General Radio system — and we mean *system!* We'll supply the complete measurement capability, from power supply to peripheral devices to packaging (and if you need a special device made elsewhere, we'll get that, too!).

So triumph over inertia in your production and inspection areas — write or phone your system requirements to General Radio Company, West Concord, Mass. 01781; telephone (617) 369-4400. In Europe, write Postfach 124, CH 8034 Zurich 34, Switzerland.



Here's the fastest, most accurate source of programmable pulses available anywhere. The new Datapulse System 140 generates rep rates to 100 MHz, pulse widths from 5 ns, and independently variable rise and fall times from 2 ns.

Your program sets the upper and lower levels of the output waveform to any values between +10v and -10v. Each level can be independently positioned with an accuracy of $\pm 2\%$ of programmed value ± 20 mv. Pulse amplitude (the difference between levels) may be varied from 50mv to 5v into a 50 ohm load. Accuracy is typically $\pm 2\%$ of value for the other programmable pulse parameters: rep rate, pulse delay, pulse width and transition times.

System 140 can be programmed from computer, punched tape, magnetic tape, or other logic sources. All pulse parameters are controlled by BCD inputs compatible with DTL logic levels.

For complete information contact Datapulse Division, Systron-Donner Corporation, 10150 W. Jefferson Blvd., Culver City, California 90230. Phone (213) 836-6100.

Tests fast ICs automatically: the only 100 MHz programmable pulser!

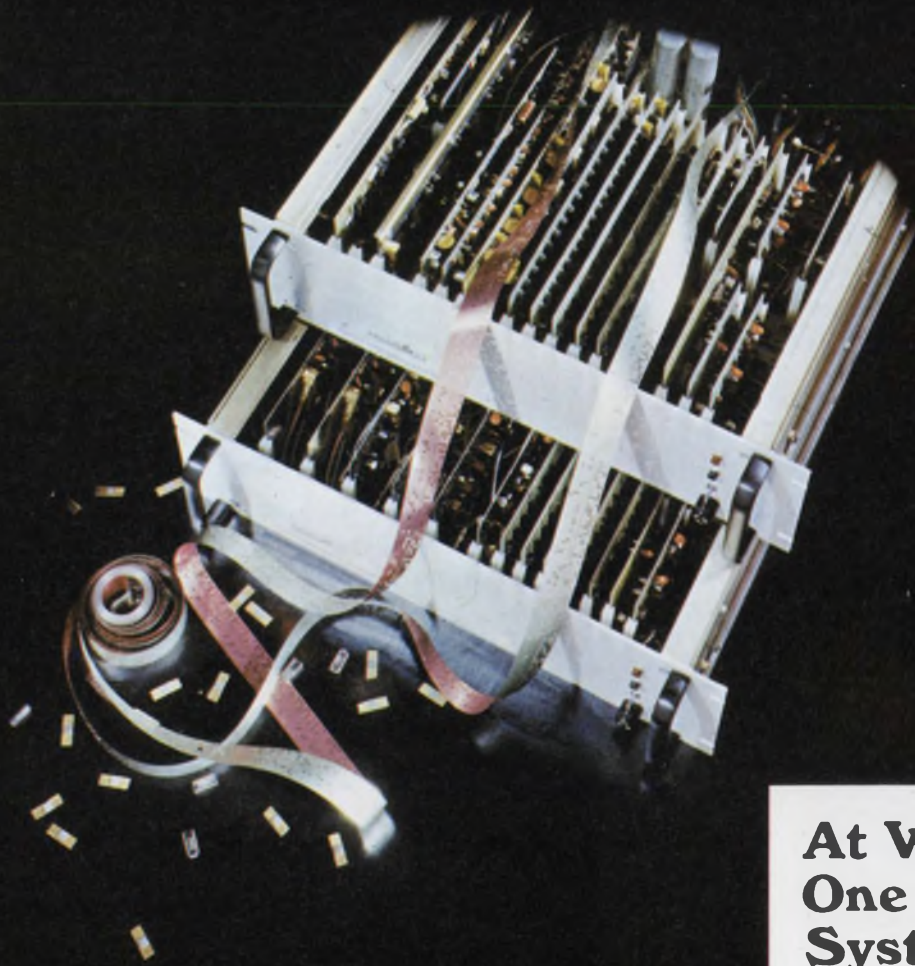

At WESCON. One of 157 Systron-Donner instruments.

Electronic counters	Digital voltmeters
Pulse generators	Spectrum analyzers
Microwave frequency indicators	Digital panel meters
Digital clocks	Microwave signal generators
Memory testers	Laboratory magnets
Analog computers	Data acquisition systems
Time code generators	Microwave test sets
Data generators	

DATAPULSE
DIVISION

SYSTRON  DONNER

Electronic Design 22

VOL. 17 NO.

FOR ENGINEERS AND ENGINEERING MANAGERS

OCT. 25, 1969

NEWS

- 21 **News Scope**
- 25 **Why doesn't radar prevent midair collisions?**
Indianapolis tragedy suggests that outmoded equipment and improper care are creating hazards.
- 32 **Plan national private-line microwave net**
Pending FCC go-ahead, firm will offer customized service with infrared and millimeter access loops.
- 36 **Infrared sensors star in new displays**
- 41 **Washington Report**
- 46 **Letters**
- 49 **Sidelights**
- 51 **Editorial: Are you doing as well as you probably should?**

TECHNOLOGY

- 61 **Chip Bonding: Promises and Perils**
- 62 Vendors promote their technology
- 68 New chips pose problems
- 74 Designers face the challenge
- 82 **Convert Boolean algebra to arithmetic;** then use ordinary algebra to simplify gate and counter logic expressions.
- 86 **A high-speed dual-polarity log amplifier** can be made by cascading differential amps. It provides rise times as low as 10 ns.
- 92 **SCR model simplifies computer programs.** An equivalent circuit and a subroutine can be used with SCEPTRE or other computer-aided techniques.
- 98 **How well are you engineering your career?** Check this survey article to see where you rank among other electronics engineers.
- 107 **Ideas for Design**

PRODUCTS

- 118 **Data Processing:** Magnetic tape system can operate at 15 MHz.
- 126 **Instrumentation:** Modular waveform generator offers flexibility.
- 132 ICs & Semiconductors
- 136 Microwaves & Lasers
- 140 Components
- 144 Modules & Subassemblies
- 146 Packaging & Materials
- 148 Production

DEPARTMENTS

- 14 Designer's Datebook
- 150 Evaluation Samples
- 152 Design Aids
- 154 Annual Reports
- 156 Application Notes
- 158 New Literature
- 170 Advertisers' Index
- 172 Information Retrieval Service

Information Retrieval Service Card inside back cover

Cover Photo: Wreckage of Allegheny Airlines jet near Indianapolis where it collided with a light plane last month (UPI photo).

ELECTRONIC DESIGN is published biweekly by Hayden Publishing Company, Inc., 850 Third Avenue, New York, N.Y. 10022. James S. Mulholland, Jr., President. Printed at Brown Printing Co., Inc., Waseca, Minn. Controlled circulation postage paid at Waseca, Minn., and New York, N.Y. Copyright © 1969, Hayden Publishing Company, Inc. 78,111 copies this issue.

If you've been discounting the Fairchild



8000A function tester, cheer up...we have, too.

We've just cut the price of our 8000A Function Test System by 30%. And it's yours for the asking (and \$70,000) because we're delivering from stock.

In a month or less, you can be running functional tests on your complex digital circuits for as little as a nickel apiece. On PC cards, modules or hybrids. On ICs, MSI, LSI or even system sub-assemblies. Test up to 288 pins total, 72 simultaneously. If your circuit does something logical, the 8000A tells you if it's doing it right.

You don't have to slow down your testing by comparing your circuits against a standard that might or might not be right. You don't have to throw together

another thousand dollar black box every time you change your circuit. And you don't need high-priced help to run the 8000A — an unskilled operator can test your most sophisticated circuits. So if the price doesn't get you, the performance should.

Call Norm Baumann now for our detailed specs and find out how the 8000A gets more parts out the door faster. And makes sure a lot fewer come back.

FAIRCHILD SYSTEMS TECHNOLOGY

A Division of Fairchild Camera and Instrument Corp.



974 East Arques Ave., Sunnyvale,
California 94086, (408) 735-5011

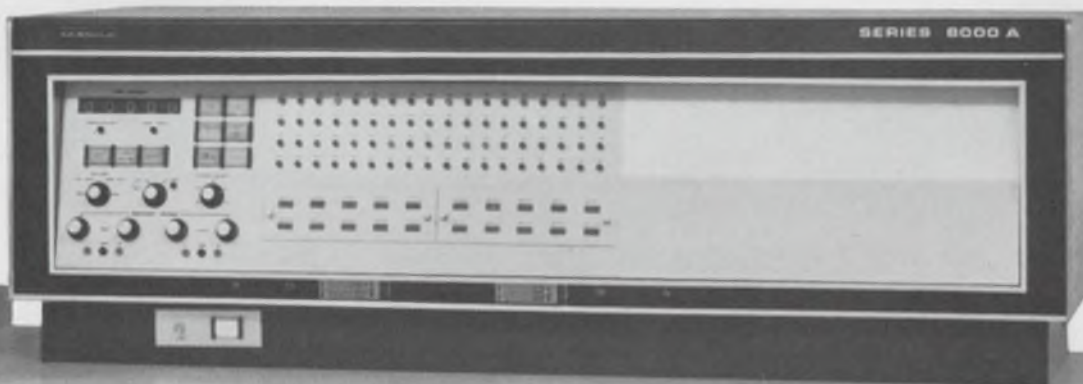







Several hundred thousand unfair advantages.

There you are, busting your back trying to beat another company to market with a new, improved electronic Thing.

Everything looks good — up to the point where sub-assembly X has to be connected to board B. And you've never seen a connection like that before.

What do you do now? Take an R&D break? Give a connector-maker a panic call, and half your budget, to develop a special?

Sweat not. We're sitting over here with several hundred thousand different connectors. Most of them were specials, once. Many of them are patented. And all of them are ready. Now.

Card edge connectors. Two-piece PC connectors. Board-to-board connectors. Miniatures. Sub-miniatures. Dual-in-Line receptacles. Back panel metal plates. Rack and panel connectors. Mil spec cylindrical connectors. Tube and transistor sockets. Even new Mojo™ modular card edge connectors which you sort of invent as you go along. All available with the respected Varicon™ metal-to-metal connection that fully meets Mil-E-5400.

Because they're ready, you get a jump on your competitor while he re-invents one. Because they're standard, you put your Thing together for less money than he can. It may be unfair. But it's fun. And profitable.

But what if we *don't* have a standard for you? Still no problem. Because, with hundreds of thousands of different connectors already behind us, your special will just be a not-quite-standard. So we'll be able to save a lot of time and R&D, too.

We have several pounds of catalog, containing more information about connectors than you probably care to have. So don't just send back a reader information card. Call, write, wire, or TWX us, and tell us either your specific problem or your general field of interest. We'll send you the pertinent few ounces.

Elco Corporation, Willow Grove, Pa. 19090. (215) 659-7000 TWX 510-665-5573.



ELCO Connectors

INFORMATION RETRIEVAL NUMBER 5

NOW...THE SECOND SOURCE THAT'S **FIRST** IN QUALITY

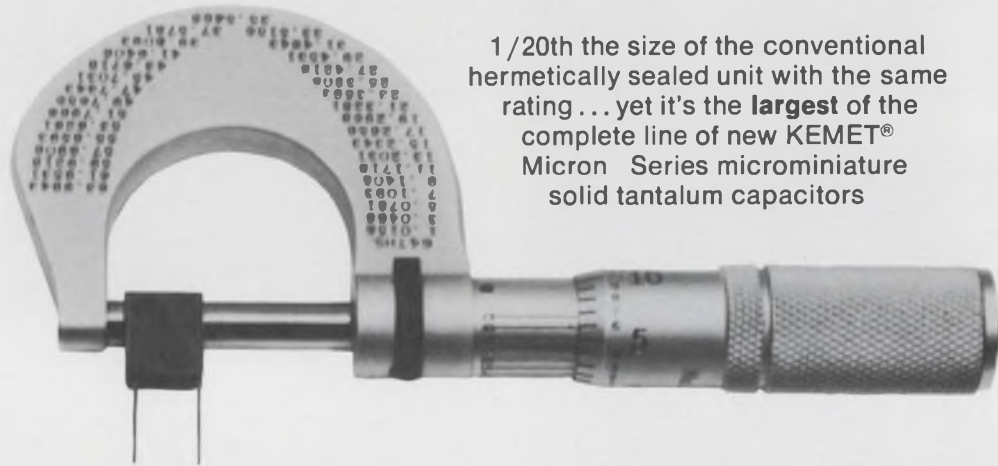

1/20th the size of the conventional hermetically sealed unit with the same rating... yet it's the **largest** of the complete line of new KEMET® Micron Series microminiature solid tantalum capacitors

JUST TAKE A LOOK AT OUR QUICK COMPARISON WITH BRAND "X"

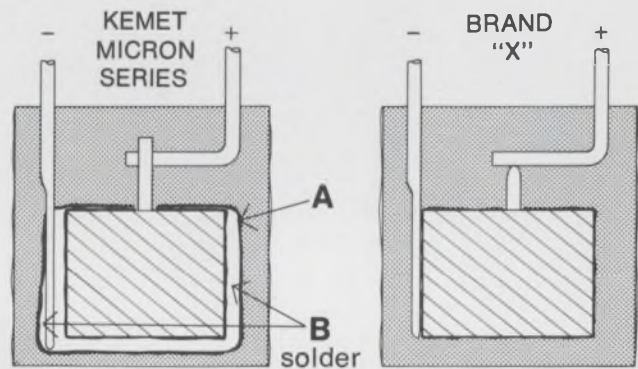

Construction Features	KEMET	BRAND "X"
A. Silicone barrier coat over anode prior to encapsulation to provide superior moisture resistance.	YES	NO
B. Negative lead solder bond to obtain superior mechanical bond for high shock and vibration, to assure better temperature cycling capability, to prevent open circuits, and to provide better electrical characteristics due to superior electrical contact.	YES	NO

Available with capacitance-voltage ranges from .001 to 220 μ F, 2 to 50 volts.

Call your Regional Sales Office today for complete information.

NEW ENGLAND: 300 First Avenue, Needham Heights, Mass. 02194 Tel.: (617) 444-5400 TWX: 710-325-1329 ●
MID-ATLANTIC: Tarrytown Technical Center, Electronics Division, Tarrytown, New York 10591 Tel.: (914) 592-9300 ●
CENTRAL: 120 So. Riverside Plaza, Chicago, Ill. 60606 Tel.: (312) 822-7022 TWX: 312-222-0491 ●
WESTERN: 13601 E. Whittier Blvd., Whittier, Calif. 90605 Tel.: (213) 698-8077 TWX: 910-586-1342 ●
 2680 Bayshore Frontage Road, Mountain View, Calif. 94040 Tel.: (415) 969-9390 TWX: 910-379-6444

T 370

T 372

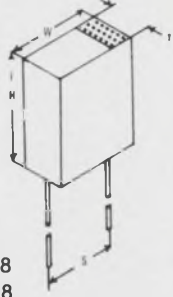
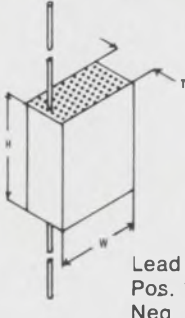

Polar Rectangular 3-35 VDC

Radial Leads		Axial Leads		Case Dimensions—Inches					
				Case Size	H Case Height Max.	W Case Width Max.	T Thickness Max.	S Lead Spacing	Capacitance μ F
Lead Length: Pos. $1-5/8 \pm 1/8$ Neg. $1-3/8 \pm 1/8$		Lead Length: Pos. $1-5/8 \pm 1/8$ Neg. $1-3/8 \pm 1/8$		A	.125	.070	.040	.050	.001-1.5
				B	.165	.120	.070	.100	.0047-10
				C	.225	.185	.075	.150	.68-22
				D	.290	.220	.110	.180	2.2-47
				E	.310	.230	.130	.200	6.8-68
				F	.475	.375	.150	.300	10-220

T 374

T 376

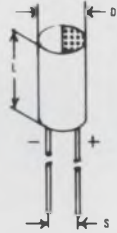
Polar Cylindrical 2-50 VDC

Radial Leads		Axial Leads		Case Dimensions—Inches				
				Case Size	L Case Length Max.	D Case Diameter Max.	S Lead Spacing	Capacitance μ F
Lead Length: Pos. $1-5/8 \pm 1/8$ Neg. $1-3/8 \pm 1/8$		Lead Length: Pos. $1-5/8 \pm 1/8$ Neg. $1-5/8 \pm 1/8$		A	.125	.070	.050	.001-2.2
				B	.160	.070	.050	.001-.68
				C	.200	.080	.050	.33-10
				D	.225	.100	.070	.68-22
				E	.250	.150	.120	1.5-47

T 371

Non-Polar, Radial Lead 2-50 VDC

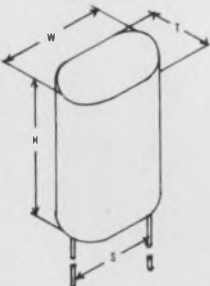
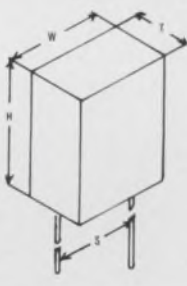
A, B, C, E & G Case		D, F, H & J Case		Case Dimensions—Inches						Case Dimensions—Inches					
				Case Size	H Case Height Max.	W Case Width Max.	T Thickness Max.	S Lead Spacing	Capacitance μ F	Case Size	H Case Height Max.	W Case Width Max.	T Thickness Max.	S Lead Spacing	Capacitance μ F
				A	.135	.120	.070	.100	.001-1.0	F	.240	.140	.180	.100	.47-10
				B	.160	.120	.070	.100	.001-2.2	G	.270	.290	.155	.200	1.5-22
				C	.200	.140	.080	.100	.15-4.7	H	.315	.180	.220	.150	3.3-22
				D	.180	.125	.125	.100	.1-4.7	J	.335	.230	.230	.200	6.8-33
				E	.235	.190	.105	.125	.33-10	Lead Length: All Cases $1-5/8 \pm 1/8$ "					

T 373

Non-Polar, Axial Lead 2-50 VDC

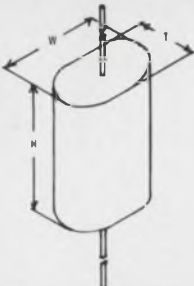
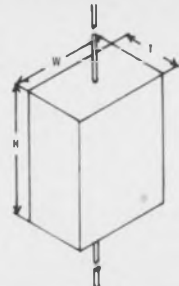
A, B, C, E & G Case		D, F, H & J Case		Case Dimensions—Inches					Case Dimensions—Inches				
				Case Size	H Case Height Max.	W Case Width Max.	T Thickness Max.	Capacitance μ F	Case Size	H Case Height Max.	W Case Width Max.	T Thickness Max.	Capacitance μ F
				A	.175	.120	.070	.001-1.0	F	.280	.140	.180	.47-10
				B	.210	.120	.070	.001-2.2	G	.310	.290	.155	1.5-22
				C	.240	.140	.080	.15-4.7	H	.370	.180	.220	3.3-22
				D	.220	.125	.125	.1-4.7	J	.390	.230	.230	6.8-33
				E	.275	.190	.105	.33-10	Lead Length: All Cases $1-5/8 \pm 1/8$ "				

**ELECTRONICS DIVISION
COMPONENTS DEPARTMENT**

P.O. Box 5928, Greenville, South Carolina 29606. Tel.: (803) 963-7421 TWX: 810-287-2536



THE DISCOVERY COMPANY

Union Carbide's Electronics Division is a total supplier to the Electronics Community through its Semiconductor Department, Components Department, Crystal Products Department, KORAD® Department, and Instrument Department.

**We've ironed out the
pressing problem of
gluing ferrite parts.**

INDIANA GENERAL *We make it easy for the design engineer.*



Know what happens to magnetic characteristics, costs and delivery schedules when small ferrites are epoxied together to make a large one? It's enough to make you come unglued. So Indiana General's *pressing* them. The results are single piece large parts with dimensions that will open your eyes — and a lot of new design opportunities.

We've already made tubes up to 7" o.d. x 12" long, and 15" tubes with a wall thickness of only 0.250". Solid plates, 6" x 6" x 2". Pot cores up to 7" o.d. And these aren't even our maximum capabilities. Nor our only configurations. For instance, we're working right now on 6½" o.d. flared yokes, and in the future, 10" o.d. x 20" tubes.

Whether your applications involve very low frequency or high frequency/high power, material selection is critical. And Indiana General not only makes single piece large parts; we make them with the "right" ferrites. Our 0-5 is the industry's best material for VLF, due to its high permeability and low power loss characteristics needed for "brute force" demands of denser-than-air media. And we introduced Q-1, Q-2 and Q-3 ferrite materials to the market for HF/HP; they're still the leader.

So instead of looking high and low for high power, low frequency ferrites, look to Indiana General. Where we stick with the solution of magnetics problems to keep them from becoming sticky ones for you. Our coupon brings you further technical information on our large ferrite parts.

Mr. K. S. Talbot, Manager of Sales
Indiana General Corporation
Electronics Division/Ferrites
Keasbey, New Jersey

Let's take a closer look at how single piece large ferrites can make it easier for me.

NAME _____ TITLE _____
COMPANY _____
ADDRESS _____
CITY _____ STATE _____ ZIP _____

The Trend is TTL... the Choice is TI.

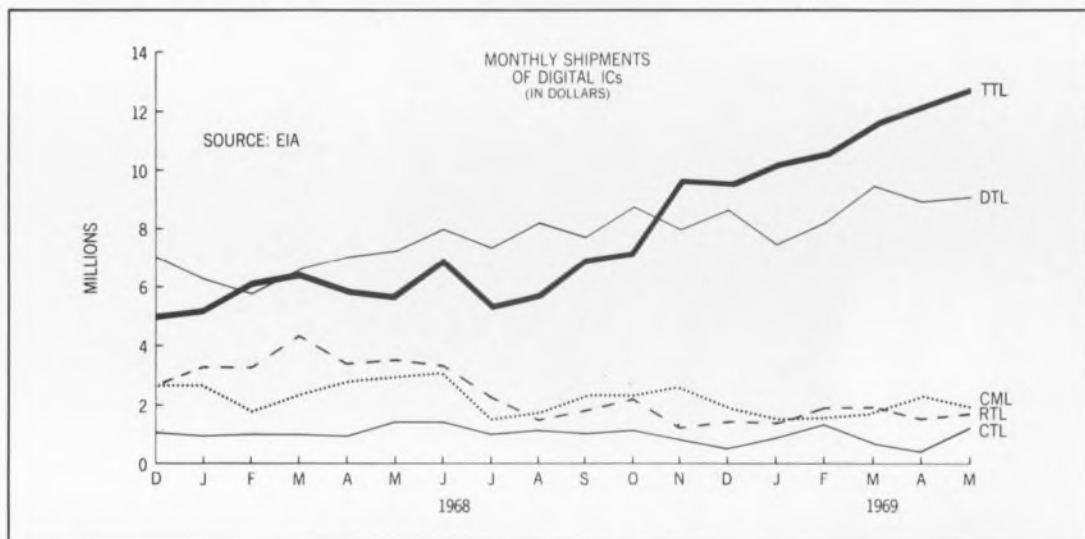

(And the broadest choice is getting broader.)

- Now, more than 90 distinct Series 54/74 circuits to choose from...including 35 MSI circuits.
- Three compatible performance ranges – standard, high speed, low power.
- Three packages – flat pack, ceramic or plastic dual-in-line.
- Two temperature ranges.
- All from the first TTL source – TI.



Could you ask for anything more? Yes. TI's new 424-page TTL catalog which contains data sheets on all Series 54/74 circuits. Circle 166 on the Reader Service Card or write Texas Instruments Incorporated, P.O. Box 5012, M.S. 308, Dallas, Texas 75222. Or see your nearest authorized TI Distributor.



TEXAS INSTRUMENTS
INCORPORATED

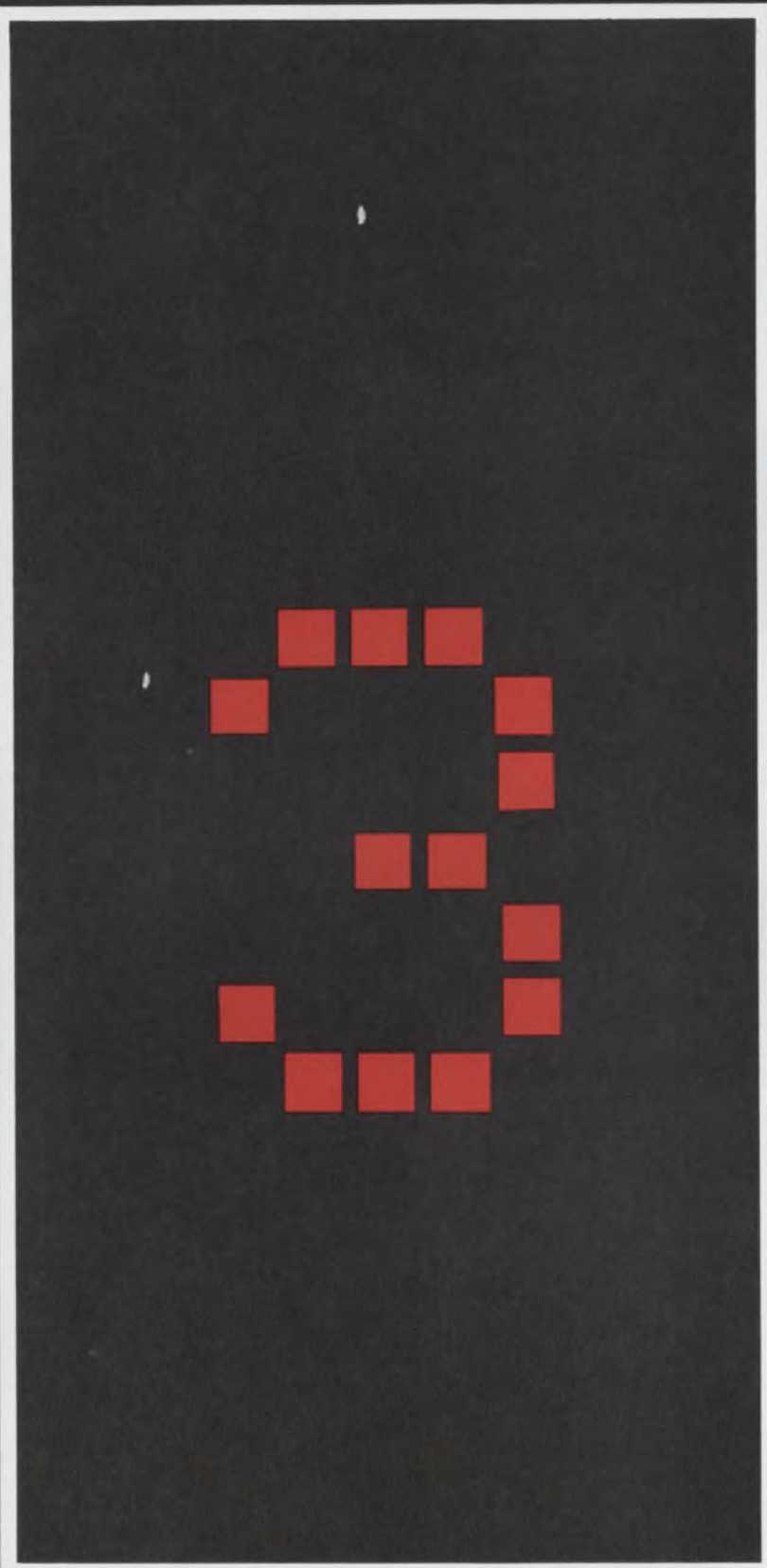

Display of strength

There are several sound reasons to use our solid state numeric displays. One of the most important is this: they're so strong, they won't die of shock. So they can be used in the most demanding applications.

Another decisive factor is size: each display package measures just 1"x 0.5"x 0.16". And that's all there is to it. In this tiny framework, you get everything necessary to display numerals 0-9. The chip includes an IC driver/decoder and gallium arsenide phosphide diodes that make the bright red numerals visible clear across a room, even at an acute angle.

The display needs less than 5 volts to drive it, and takes a straightforward four line 8-4-2-1 BCD input. You can vary the brightness.

And, as the modules are IC compatible, no special interfacing is required. You can buy our solid state numeric display in three-character packages, as well as the solo component. And our small displays of strength cost just \$42 each in 1000 quantities.

For all the bright details about this new technology for numeric indicators, call your local HP field engineer. Or write Hewlett-Packard, Palo Alto, California 94304; Europe: 1217 Meyrin-Geneva, Switzerland.

HEWLETT  PACKARD

SOLID STATE DEVICES

Designer's Datebook

NOVEMBER 1980						
Sun	Mon	Tue	Wed	Thu	Fri	Sat
						1
2	3	4	5	6	7	8
9	10	11	12	13	14	15
16	17	18	19	20	21	22
23	24	25	26	27	28	29
30						

DECEMBER 1980						
Sun	Mon	Tue	Wed	Thu	Fri	Sat
	1	2	3	4	5	6
7	8	9	10	11	12	13
14	15	16	17	18	19	20
21	22	23	24	25	26	27
28	29	30	31			

For further information on meetings, use Information Retrieval Card.

Nov. 17-18

Laser Technology Seminar (Rochester, N.Y.) Sponsor: Univ. of Rochester, Institute of Optics, H. F. Sander, SPIE, 216 Avenida del Norte, Redondo Beach, Calif. 90277.

CIRCLE NO. 410

Nov. 17-19

Symposium on Adaptive Processes (University Park, Pa.) Sponsor: IEEE et al, G. J. McMurty, Dept. of EE, Penn State Univ., University Park, Pa. 16802.

CIRCLE NO. 411

Nov. 18-20

Fall Joint Computer Conference (Las Vegas) Sponsor: E. Grabbe, TRW Systems Inc., Bldg. R3, Room 2070, One Space Park, Redondo Beach, Calif. 90278.

CIRCLE NO. 412

Nov. 18-21

Magnetism and Magnetic Materials Conference (Philadelphia) Sponsor: IEEE, B. Harris, University of Pa., Philadelphia, Pa. 19104

CIRCLE NO. 413

Nov. 20-21

Radio Technical Commission for Aeronautics Meeting (Washington, D.C.) Sponsor: RTCA, Radio Technical Commission for Aeronautics, 2000 K St. N.W., Washington, D.C. 20006

CIRCLE NO. 414

Dec. 4-5

Vehicular Technical Conference (Columbus, Ohio) Sponsor: IEEE, R. E. Fenton, Ohio State University, 2015 Neil Ave., Columbus, Ohio 43210

CIRCLE NO. 415



Slot supplies have you in a rut? GET OUT OF IT!

Replace obsolete, narrow-range slot supplies with POWER/MATE CORP.'s UniPower Series. These nine all-purpose, wide voltage range power supplies can replace thousands of narrow-range slot supplies and give you these big advantages: current output up to 34 amps • adjustable to any range from 0-34 volts • regulation to 0.005% • ripple a low 250 microvolts. The wide voltage range of the UniPower Series simplifies your power supply requirements because you can stock fewer units. In addition, these modules can be mounted in standard size racks or on any of three surfaces and in any position!



UNI-30F

The UniPower Series of Nine

- Uni-76 — 0-34 volts, 0.5 amps — \$76.00
- Uni-88 — 0-34 volts, 1.5 amps — \$99.00
- Uni-30C — 0-30 volts, up to 5 amps — \$134.00
- Uni-30D — 0-30 volts, up to 8 amps — \$151.00
- Uni-30E — 0-30 volts, up to 12 amps — \$174.00
- Uni-30F — 0-30 volts, up to 18 amps — \$205.00
- Uni-30G — 0-30 volts, up to 24 amps — \$265.00
- Uni-30H — 0-30 volts, up to 34 amps — \$315.00
- UniTwin-164 — dual output 0-25 volts, 0.75 amps — \$164.00

OUTPUT VOLTAGE vs. OUTPUT CURRENT FOR VARI-RATED UNI SERIES														
VOLTAGE MODEL	0-6V	8	10	12	14	15	16	18	20	22	24	26	28	30
	UNI-76	0.05 amp throughout range												
UNI-88	1.5 amps throughout range													
UNI-30C	5.0	4.6	4.4	4.2	4.1	4.0	3.8	3.6	3.4	3.2	3.0	2.8	2.6	2.5
UNI-30D	8.0	7.6	7.3	6.9	6.6	6.4	6.2	6.0	5.7	5.3	5.0	4.7	4.4	4.0
UNI-30E	12.0	11.2	10.8	10.3	9.8	9.5	9.2	8.8	8.3	7.9	7.4	6.9	6.4	6.0
UNI-30F	18.0	16.9	16.2	15.5	14.8	14.4	14.0	13.3	12.6	11.9	11.2	10.5	9.8	9.0
UNI-30G	24.0	22.5	21.6	20.6	19.6	19.1	18.6	17.7	16.7	15.8	14.8	13.8	12.9	12.0
UNI-30H	34.0	31.9	30.5	29.2	27.8	27.1	26.4	25.0	23.7	22.4	21.0	19.7	18.3	17.0

SPECIFICATIONS: Regulation — up to $\pm 0.005\%$ or 1 MV for line and load; Ripple — Less than 250 microvolts; Response Time — Less than 20 microseconds; Overload and Short Circuit Protection — Solid state. Instantaneous recovery, and automatic reset. Cannot be damaged by prolonged short circuit or overload. Internal or External Adjustable OVP Available.

FREE: Send for complete catalog. Write to:



POWER/MATE CORPORATION
514 S. RIVER ST., HACKENSACK, NEW JERSEY 07601
PHONE: (201) 343-6294 TWX: (710) 990-5023



NEW AMI/MOS FAMILY — Random Access Memory Circuits. Mass produced RAMS by AMI can be programmed in your system for various word lengths, providing complete system design versatility. The 128 bit matrix, for example, can be hooked up as a 4 x 32, 2 x 64, or 1 x 128. Available now, these low cost, solid state memories are only part of the AMI/MOS story, which includes RAMS, ROMS, Shift Registers and other standard MOS products. Send for details. Better yet, hop a jet and visit our production facility — America's largest.

NOW IN PRODUCTION
RAMS
IN HANDY MATRIX



AMERICAN MICRO-SYSTEMS, INC.

3800 Homestead Road, Santa Clara, California 95051
Telephone 408-246-0330, TWX 910-338-0018
CUSTOM & STANDARD MOS ARRAYS/MEMORIES/REGISTERS/LOGIC

INFORMATION RETRIEVAL NUMBER 10

Announcing Digitest 500, the \$250 digital multimeter from Honeywell.

No kidding. \$250

This world's smallest multimeter may be inexpensive to buy, but that's the only thing cheap about it.

Take capability. Our Digitest 500 gives you five functions (resistance, AC and DC voltages, AC and DC currents), plus 17 ranges to choose from. And it can be operated from 117V 50-60Hz line or an external 12V source. Or consider accuracy: Digitest 500 is five times as accurate as the conventional VOM.

As you can see, we've made it both compact and lightweight (2½ lbs.), by using a large-scale integrated circuit. So the Digitest 500 is just 2¾" x 5" x 9", but has polarity indication, a moving decimal point, an overload indicator and built-in calibration check. Plus overrange up to 100% (on all ranges except 300VAC).

To get a free demonstration – or more details – write Don Anderson, M.S. 206, Honeywell Test Instruments Division, P.O. Box 5227, Denver, Colorado 80217.

Honeywell



SEMICONDUCTOR NEWSBRIEFS

PUBLISHED BY MOTOROLA SEMICONDUCTOR PRODUCTS INC.

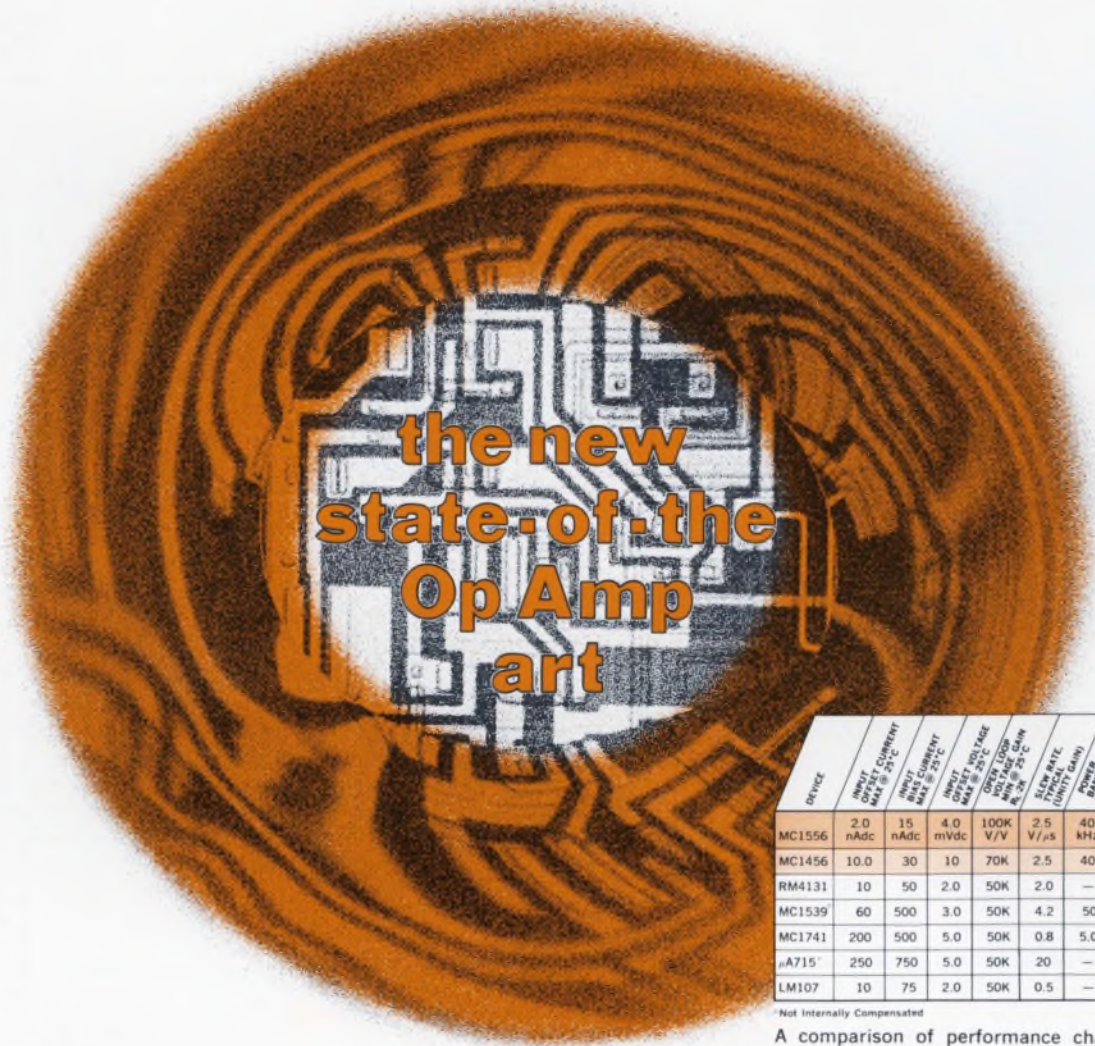

the new
state-of-the
Op Amp
art

DEVICE	INPUT OFFSET CURRENT MAX @ 25°C	INPUT BIAS CURRENT MAX @ 25°C	INPUT OFFSET VOLTAGE MAX @ 25°C	OPEN-CIRCUIT GAIN @ 25°C	COMMON-MODE REJECTION RATIO @ 25°C	SLEW RATE (TYPICAL)	POWER DISSIPATION (TYPICAL)	PRICE 100/UP
MC1556	2.0 nAdc	15 nAdc	4.0 mVdc	100K V/V	2.5 V/μs	40 kHz	45 mW	\$28.00
MC1456	10.0	30	10	70K	2.5	40	90	\$15.00
RM4131	10	50	2.0	50K	2.0	—	57	\$20.00
MC1539	60	500	3.0	50K	4.2	50	150	\$ 7.50
MC1741	200	500	5.0	50K	0.8	5.0	85	\$15.00
μA715	250	750	5.0	50K	20	—	210	\$48.00
LM107	10	75	2.0	50K	0.5	—	90	\$33.00

*Not Internally Compensated

A comparison of performance characteristics clearly indicates the superiority of the MC1556 over other popular monolithic Op Amps.

... makes others obsolete!

Most high-performance op amps today are of monolithic construction — to save space and to increase reliability. A few are internally-compensated — to reduce the need for external componentry and their associated higher cost.

Only one offers all three benefits . . .

(1) high performance; (2) monolithic construction; and, (3) internal compensation! That's the **MC1556**, an operational amplifier that promises to become the new linear IC standard of the industry!

The MC1556 and its reduced temperature-range counterpart, the MC1456, For details Circle Reader Service No. 121

are designed for use as summing amplifiers, integrators, or amplifiers with operating characteristics as a function of the external feedback components.

Both of these new linear circuits are available from distributor stock in the 8-pin TO-99 "G" suffix package.



Balanced Modulator/Demodulator IC Ups Carrier-Suppressed Performance

Closely-matched transistors, on a single monolithic chip, give Motorola's new **MC1596G** the ability to provide a high signal-to-carrier ratio and low-distortion, in a variety of modulator/demodulator designs. As its output is the

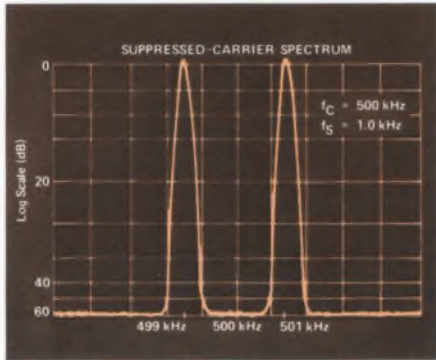

The MC1596G provides high, balanced, signal strength vs. carrier performance.

product of both an input voltage (signal) and a switching function (carrier), the MC1596G can serve to improve the performance, yet lower the cost of functions such as: synchronous AM-FM and phase or single side-band detection, frequency

For details circle Reader Service No. 122

IF Wideband Amplifier Has A Wide AGC Range, High Gain

Now Motorola offers the designer of precision RF/IF circuits a wideband amplifier that has both a broad AGC range (60 dB min. from dc to 60 MHz) and a minimum power gain of 40 dB at 60 MHz... the **MC1590G**! Packaged in the TO-99 hermetic 8-lead metal-can (-55 to +125°C), and inexpensive — only \$3.95 in 100-up quantities — it will be warmly welcomed by builders of high-performance military and commercial communications equipment, radar and video instruments. It also makes an excellent audio amplifier with AGC.

The power gain and AGC range of the MC1590G is equal to, or better than two well engineered discrete-component stages. And, the AGC has little effect on IF response as the input and output impedances remain practically constant. As the MC1590G can replace a complete discrete device assembly consisting of several capacitors, a slew of resistors and two or more IF transistors, a substantial savings in componentry and mounting costs can be realized. In addition, the wide-range gain control of the

For details circle Reader Service No. 123

doubling, mixing and, of course, suppressed-carrier and amplitude modulation.

When used as a balanced modulator, this linear IC provides a high suppressed-carrier figure of typically 60 dB at 0.5 MHz and 40 dB at 10 MHz; and, a high common-mode rejection ratio of 85 dB (typ.). In addition, it has adjustable gain and signal-handling capabilities and balanced inputs and outputs — and can operate over a wide bandwidth (transadmittance: carrier-300 MHz; input signal — 80 MHz). It operates over the full -55 to +125°C temperature range.

And even though the MC1596G gives you all these superior performance characteristics, in a single, hermetically sealed, long-leaded version of the TO-100 case, you can reduce your modulator-circuit costs by up to a factor of three. For example, designs of this nature using discrete devices require expensive, closely-matched balancing transformers and a diode bridge. Even in quantity, a single transformer may cost as much as the total 100-up price of the MC1596G — only \$4.80!

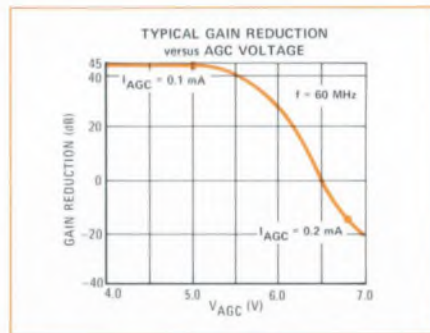

MC1590G appreciably lessens "detuning" effects.

Here are some other parameters that help make the MC1590G an outstanding value for high-performance HF and VHF designs:

- High Power Gain (typ):
 - 50 dB at 10 MHz
 - 45 dB at 60 MHz
 - 35 dB at 100 MHz
- Single-power-supply operation:
 - 6.0 to 15 Volts
- Low Reverse Transfer Admittance:
 - > 10 μmhos (typ) @ 60 MHz

Five More IC Complex-Functions Join Motorola's Burgeoning MTTL Line!

The **MC4012** 4-Bit Shift Register leads-off five new MTTL complex-function introductions. Consisting of four D-type flip-flops (operated in the synchronous mode), the MC4012 can be operated in either the serial or parallel-mode by application of a proper signal on the mode control. It will simplify the design of parallel-to-serial and serial-to-parallel converters, divide-by-N counters, number converters and adder/subtractor systems.

And, when your problem is the logical addition of two binary numbers, Motorola's new **MC15482/17482** provide an optimum answer! These units perform the addition of two 2-bit binary numbers and the look-ahead "carry" is provided internally between the two-bits. They can be interconnected to form longer words. Although functionally the same, the **MC25482/27482** have the exclusive OR of the two sets of input bits brought out. This reduces package-count when using these adders in look-ahead "carry" applications. Both types can be plugged directly into designs presently served by older TTL adders.

The new **MC5493/7493** 4-bit binary counters provide true high-speed counting versatility. For example, by using only one external gate it is possible to count to 7, 9, 10, 11, 12, 14, or 15. Hook-up two of them, add two gates and you can divide by any number up to 256.

And, for reliable Nixie Driver designs consider Motorola's new **MC7441AP**. It delivers up to 55 Volts with a maximum 200 μA leakage current. Output clamp-diodes are included to prevent oscillation. The MC7441A combines with the MC7475 quad-latch and MC7490 decade counter to form a complete read-out system.

These new Motorola complex-function MTTL integrated circuits are all available for your immediate evaluation from your local distributor's warehouse stock.

Type	Function	Price (100-up)
MC4012L	4-Bit Shift Register	\$11.50
MC15482/17482L	2-Bit Full Adder	16.00/9.00
MC25482/27482L	2-Bit Full Adder	16.00/9.00
MC5493/7493L	4-Bit Binary Counter	21.25/13.15
MC7441 AP	BCD-TO-Decimal Decoder And High-Level Driver	7.00

L suffix denotes TO-116 ceramic dual in-line case
P suffix denotes TO-116 Plastic dual in-line case

For details circle Reader Service No. 124



New Homogeneous-Bond Annular Silicon Power Transistors Shrug-Off High Temperature Excursions

Combining Annular, epitaxial, passivated die structures . . . with a unique homogeneous high-temperature “hard-

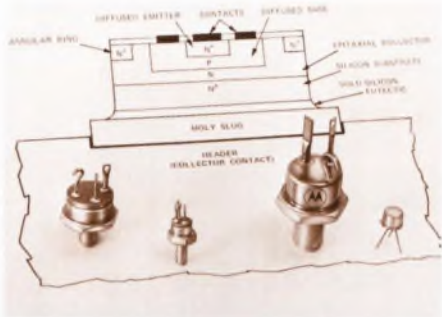

solder” die-to-header bonding method, Motorola advanced silicon power technology now adds a whole new dimension of reliability for power switching/amplifier circuits! Designers of industrial and military equipment which must operate

at top efficiency and be fail-proof — even when subjected to stringent overload and temperature-excursion conditions — can now specify silicon power transistors with assurance of long-term reliability.

For instance, the units’ closely matched expansion coefficients preclude the development of “hot-spots” and/or junction rupturing due to high internal heating and thermal fatigue. (Extensive stress-testing has proven their ability to withstand 5,000 temperature cyclings, as performed on intermittent life tests, without any apparent damage or degradation!) And, Annular die structures virtually eliminate high-leakage problems so common to ordinary diffused-junction devices.

The first of these ultra-rugged power transistors are available in an assortment of hermetic “stud” and lead-mount metal cases, with I_C 's from 5 to 60A.

Type No.	Package	Polarity	I_C (cont.)	V_{CE0} (sus)	$V_{CE(sat)}^* @ I_C$	$h_{FE} @ I_C/V_{CE}$	$I_{CBO}^* @ V_{CB}$
MJ7200 MJ7201	TO-114	NPN	60 A	80 V 100 V	1.0 V @ 20 A	20-100 @ 20 A/5 V	100 μ A @ 100 V 100 μ A @ 120 V
MJ7000	TO-63	NPN	30 A	100 V	1.0 V @ 10 A	20-100 @ 10 A/4 V	5.0 μ A @ 100 V
MJ500 MJ501	TO-59 (col. to case)	PNP compl. to 2N5477/80	7.0 A	60 V 80 V	1.2 V @ 7.0 A	25-180 @ 2 A/2 V	10 μ A @ rated V_{CB}
MJ6700 MJ6701	TO-59 (isolated -col.)	PNP compl. to 2N5346/49		60 V 80 V			
MJ8100 MJ8101	TO-39	PNP compl. to 2N5336/39	5.0 A	60 V 80 V	0.7 V @ 2.0 A		

*Maximum

For details circle Reader Service No. 125

Premium NPN 20A And 30A Amplifiers And Switches For Peanut Prices

Specify the 2N3771/72 and you'll get power amplifiers that can handle V_{CE0} 's of 40V and $I_C = 30A$ (2N3771) and 60V and $I_C = 20A$ (2N3772); dissipate up to 150W at $T_C = 25^\circ C$; and, deliver minimum betas (h_{FE}) of 15 at 15A and 10A, respectively. Or, when you require the same power handling capability plus nanosecond switching speeds and saturation voltages below one-volt, plug-in the MJ3771/72. Whichever you need, you'll get peak-performance from all, all at the same low prices (\$2.50 each in 100-up quantities)!

In addition, you'll be getting high f_T values (especially with the MJ series) and exceptionally good safe operating areas. Check over the highlights in the

accompanying table and order units for evaluation from your distributor right now. He has ample local stock, backed by extensive factory inventory and production capacity.

Both series are packaged in low-silhouette TO-3 cases and operate over a -65 to $+200^\circ C$ temperature range.

Highlights	MJ3771/12	2N3771/72
Major Usage $\dagger I_C$ (cont) *typ	Pwr. Switching ($t_r = 350ns^*$ @ 10A)	Pwr. Amplifier (up to 20/30A \dagger)
Low $V_{CE(sat)} @ I_C$ (max)	1V @ 15A(71) 1V @ 10A(72)	2V @ 15A(71) 1.4V @ 10A(72)
High $f_T @ I_C/V_{CE}/f$ (min)	2 MHz @ 1A/ 10V/1.0 MHz	0.2 MHz @ 1A/ 4V/50 kHz
V_{CE0} & I_C (cont)	40V & 30A(71); 60V & 20A(72)	
Low Prices (100-up)	\$2.50	

For details circle Reader Service No. 126

Rugged 60K Beta, 10-Amp, 40-Watt Darlington's Debut

Now there are rugged power Darlington amplifiers/switches around with nearly “out of sight” beta values . . . the MJ3801-02 series . . . and they run cool, calm and collected even under extremely high temperature conditions! At 6 Amps and 4 Volts, for example, the MJ3801 furnishes an ultra-high 10,000-60,000 gain range, while at 10 Amps it has an h_{FE} of over 1,000.

And, their Annular, passivated, two-

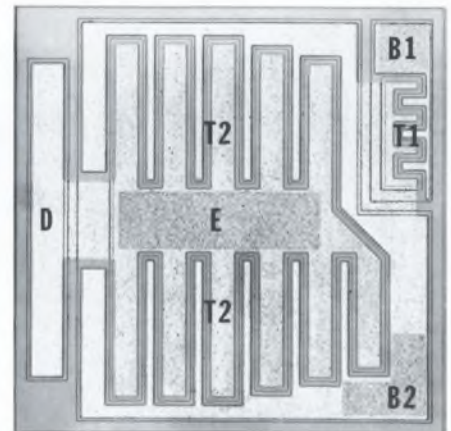

The 110-mil square die for the MJ3801-02 contains two power transistors in a Darlington configuration and a large diode.

transistor-plus-diode power chips (see illustration) are high-temperature “hard-solder” bonded into high-dissipation, TO-66, three-leaded cases. The result: micro-amp leakages, nanosecond switching and highly efficient, reliable performance, even when subjected to fatiguing high junction temperatures to $200^\circ C$!

Check the highlight specs in the accompanying table. They will show you how these new power Darlington's can up the performance of even your most stringent series-pass regulator, ultra-high-gain amplifier, motor-control and inverter application requirements. And, get the whole story by perusing the data sheet for these reliable power Darlington amplifier transistors.

Highlights	MJ3801	MJ3802
High $h_{FE} @ I_C = 6 A$	10 K to 60 K	1.0 K to 20 K
Low Leakage Current (I_{CBO})	10 μ A (max) @ 80 V	
High I_C	10 A (cont); 15 A (peak)	
Low $V_{CE2(sat)} @ I_C/I_B$	1.5 V (max) @ 6 A/15 mA	
High BV_{CE0}	80 V (min)	
Fast Rise-Time	200 ns (max) @ 6 A	
Prices (100-up):	\$11.95	\$7.95

For a copy circle Reader Service No. 127



250-350V Thermopad Transistors Make H-V Design Costs Tumble

Imagine being able to get 250/300/350-Volt silicon power transistors for your line-operated audio and servo amplifier, low-current, high-voltage converter and AC line-relay designs . . . at quantity prices well below the one-dollar mark! Well, now with Motorola's new NPN 2N5655-57 Thermopad plastic packaged silicon power series you can do this and more!

Not only are they able to handle sustaining voltages up to 350 V (at inductive I_C 's of 100 mA), but they also provide high gain figures. For example, they have an h_{FE} of 30-250 at 50 mA. In addition, they display a maximum $V_{CE(sat)}$ of just 1.0 V at 100 mA; a minimum $f_T = 10$ MHz at 100 mA/10 V/10 MHz; and, an output capacitance of 25 pF at 10 V/100 kHz.

Their exclusive Annular triple-diffused die structures also provide exceptionally low-leakage currents (e.g. — maximum I_{CEX} values are only 100 μ A at rated V_{CE}) and excellent safe operating areas. Continuous I_C is a high 500 mA with a peak of 1.0 Amp. They operate up to junction temperatures of +150°C and dissipate 20 Watts at $T_C = 25^\circ$ C.

All three types are immediately available. 100-up prices: 2N5655 (250 V) — 75¢; 2N5656 (300 V) — 90¢; and, 2N5657 (350 V) — \$1.10. Call your Motorola distributor for evaluation units TODAY!

For details circle Reader Service No. 129

COMPLEMENTARY (POSITIVE AND NEGATIVE) PULSE GENERATOR (60 V-PEAK-TO-PEAK) OUTPUT TO 10 AMPS

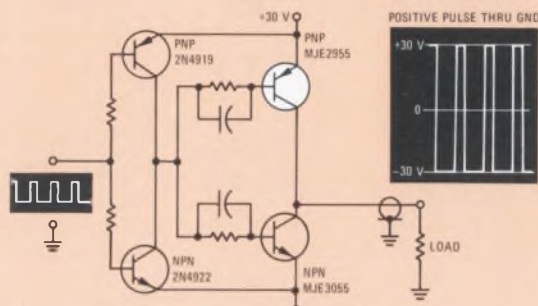

The PNP MJE-2955 complements its NPN counterpart to form low-cost, transformerless power-outputs as shown in the diagram.

Popular Plastic 90-Watt NPN Now Has A PNP Power-Mate!

The MJE3055, a Thermopad plastic-packaged, low-cost version of the popular NPN 2N3055 silicon power transistor (introduced in NEWSBRIEFS Vol. 2 No. 4), now has a PNP "alter ego" . . . the MJE2955! All its electrical and mechanical specifications are the same as its NPN counterpart, making the pair a perfect match for complementary power-output designs.

And, their low prices qualify them for a broad range of consumer/industrial applications, where economical transformerless design simplicity is keynoted. Or, they can be used separately to optimize either PNP or NPN polarity circuits.

The 60-Volt PNP MJE2955 dissipates a full 90 Watts at $T_C = 25^\circ$ C, due to

its unique 0.030" direct chip-to-heat-sink Thermopad case design (operating temp. range: -55 to $+150^\circ$ C). Its beta is spec'd at two points, affording a complete picture of its high-gain-holdup capability over a wide current range.

And, as with its NPN mate, the MJE-2955 offers both high frequency response and fast switching times. It should prove a boon to designers of servo and low-frequency amplifiers as well as series and shunt regulators and power supplies, requiring both economy and top performance.

PNP Type	h_{FE} @ I_C	$V_{CE(sat)}$ @ I_C (max)	f_T (min)	Price (100-up)
MJE2955	20-70 @ 4 A 5 min @ 10 A	1.1 V @ 4.0 A	2 MHz @ 500 mA	\$1.95

For details circle Reader Service No. 128

Five Fresh FETs Fit Frugal Fast-Switching Functions!

One of Motorola's five new Unibloc plastic, N-Channel JFETs should prove to be both an economical and high-performance solution for whatever low-power chopper or high-speed switching design requirement you may have. Labeled the 2N5638-40 series and the 2N5653/54, they all have exceptionally low resistance and capacitance values, thus assuring fast switching characteristics. For example, the rise time of the 2N5638 is just 5.0 ns max. @ I_D (on) = 12 mA. They all have breakdown voltages of 30 Volts at $I_G = 10 \mu$ A and gate-currents (I_{G1}) of 10 mAdc. In addition, the units exhibit low leakage currents, as demonstrated by a maximum specified I_{GSS} value of 1.0 nA at 15 Volts.

And, as they are packaged in economical, yet rugged, TO-92 Unibloc transfer-molded cases, their prices are as much as one-half lower than their previously available metal-can counterparts.

Immediate prototyping needs are readily available from your local distributor and Motorola's extensive production capability can match even your most stringent large-quantity scheduling requirements.

Characteristics	2N5638	2N5639	2N5640	2N5653	2N5654
Low $r_{ds(on)}$ (max) @ $f = 1.0$ kHz	30 Ω	60 Ω	100 Ω	50 Ω	100 Ω
Low C_{iss} @ 12 V $f = 1.0$ MHz	10 pF (max)				
Low C_{rss} @ 12 V $f = 1.0$ MHz	4.0 pF (max)			3.5 pF (max)	
Fast Rise Time (max) (t_r) @ 10 V/50 Ω @ 12 mA	5.0 ns	8.0 ns @ 6 mA	10 ns @ 3 mA	5.0 ns @ 5 mA	8.0 ns @ 5 mA
Prices (1,000-up)	95¢	80¢	70¢	72¢	64¢

For details circle Reader Service No. 130



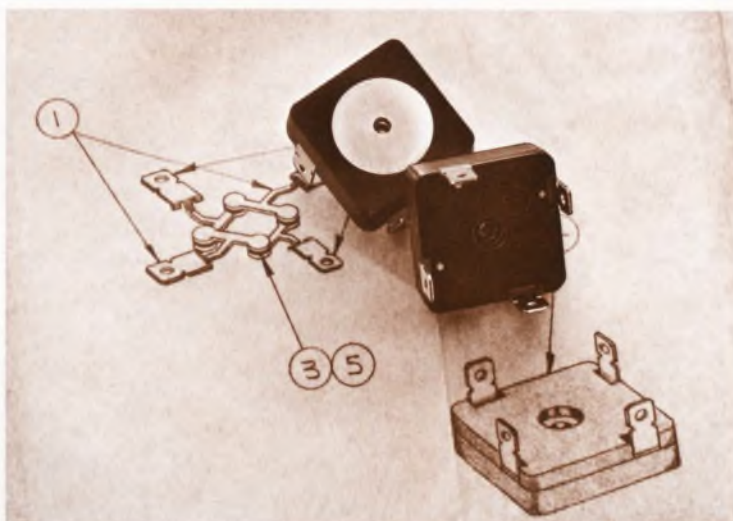

Four passivated silicon dice are combined in two compact, transfer molded packages (with or without metal insert) to form new high-surge Motorola MIDA bridges.

MIDA Bridges Now Have 12-27A Ratings

Motorola, the first to build economical MIDA (Miniature-Integrated-Diode-Assemblies) rectifier bridges, now offers the browniest power handling versions ever — the MDA980 series, with a dc output current rating of 12 Amps and the MDA990 series which handles 27 Amp loads (both at $T_C = 55^\circ\text{C}$). And, thanks to their unique structures — incorporating passivated, diffused-junction silicon dice, which have been carefully interconnected by integral heat-sinks and encapsulated in voidless, transfer-molded, compact packages — they provide above-and-beyond performance, even under the toughest environmental conditions.

For example, the MDA990 series has a built-in, electrically-insulated, aluminum disc heat-sink for high heat dissipation when metal-chassis mounted. Its top output current rating (27 Amps) is a

full two-Amps higher than similar, yet larger and more cumbersome encapsulated bridges. And, both series can easily take non-repetitive, one-half cycle surges up to 300 Amps (over 30% higher than other bridges in the same power class)!

All this, yet these “high current in a small package” single-phase, full-wave bridges carry cost/ampere prices comparable to discrete rectifiers having similar power output ratings. And, whether your job calls for reverse voltages below 50 Volts or up to 600 Volts, these bridges afford rectification efficiencies of up to 70%, or more, over a repetition recovery rate to 15 kHz.

A Designers Data Sheet, containing comprehensive curves as well as complete data, so fully describes these new MIDA bridges that the engineer gets all the information he needs from a single source — at a glance!

Series	I_o @ $T_C = 55^\circ\text{C}$	V_{RM} Range	I_{FM} (surge)	V_F (max)	I_R (max)	Prices (100-up)
MDA980	12 A	50 V to	300 A for	1.0 V @	0.5 mA @	\$2.40 to \$5.20
MDA990	27 A	600 V	$\frac{1}{2}$ cycle	$\frac{1}{2} I_o$	rated V_{RM}	3.00 to 5.90

For a copy circle Reader Service No. 131

New Ultra-Fast Plastic PNP Switches Offer Low Prices — Volume Availability!

Manufacturers of instrumentation equipment and plated-wire memories can now realize a substantial savings, in costs and delivery time, by specifying Motorola's new Unibloc (TO-92) plastic packaged MPS-L07/08 PNP high-speed silicon switching transistors. Their ultra-fast, efficient, parameters amply qualify them for applications such as digit-drivers

and complementary flip-flop designs.

For example, they have a typical combined t_{on} and t_{off} time of only 50 ns and maximum storage times of just 15 ns (MPS-L07) and 20 ns (MPS-L08), both at $I_C = 10$ mA. In addition, their exceptionally low saturation voltages — 0.07 V typ. at 10 mA — and high f_T 's (500 MHz and 700 MHz min., at 10 mA), ensure

For details circle Reader Service No. 133

High-Speed Switches Added To Micro-T Menage

The introduction of a new Micro-T packaged high-speed dual switching diode — the MMD7001 — along with a fast NPN saturated switching transistor (MMT3014), now expands Motorola's ability to serve designers of high-density and miniaturized circuitry.

The MMD7001 is particularly well suited for fast switching applications requiring high breakdown voltages (45 V min. @ 10 μA) and low capacitance values — just 3.5 pF, typ. Add to this a reverse-recovery time of only 3.2 ns (typ) @ $I_F/I_R = 10$ mA — along with a maximum forward voltage drop (at $I_F = 500$ mA) of 1.15 V — and you have a letter-perfect answer for high density switching designs requiring a comparatively high current handling capability.

As with the dual-diode, Motorola's new MMT3014 is speedy and efficient.

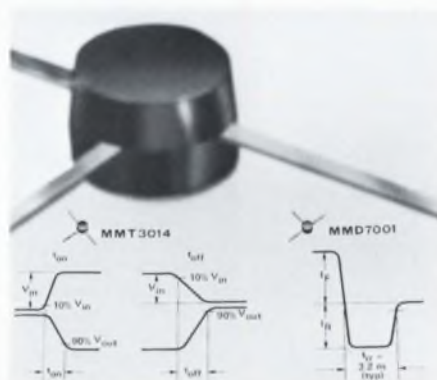

Both the Micro-T MMD7001 and MMT3014 have nanosecond switching speeds.

It has a combined t_{on}/t_{off} of less than 41 ns and a collector saturation voltage below 0.22 V, both at $I_C = 30$ mA. Capacitance is also low ($C_{ib} = 8$ pF and $C_{ob} = 5$ pF, max.). Its minimum f_T is a high 350 MHz @ 30 mA/10 V/100 MHz. It sells for \$1.52 (100-up).

For details circle Reader Service No. 132

efficient operation, even in the most demanding switching designs.

And, Motorola can deliver them fast — whether you need just a few or production volume quantities — at economy prices (just 25¢ for the MPS-L07 and 32¢ for the MPS-L08, in 5,000-up quantities)! Call your local distributor for immediate delivery from warehouse stock.



PRODUCT BRIEFS

TWO NEW LOW-NOISE RF SILICON TRANSISTOR SERIES

— Fulfill Both Critical And Economy Requirements Up To 1.0 GHz

Two new sets of NPN silicon RF, low-noise, high-gain amplifier transistors for military and industrial applications, have joined Motorola's broad line of small-signal devices to serve high-frequency design requirements. Both the premium 2N5031/32 versions and the lower priced MM8006/07 are well suited for video wideband and general-purpose amplifiers ranging from 50 MHz to 1.0 GHz.

They are all packaged in the TO-72 four-lead metal can and have breakdown voltages of 10V (min.) @ 1 mA and $V_{CE(sat)}$ of just 0.35V @ 80 mA.

Type No.	G_{pe} (typ) @ f	NF @ f	f_r (min)	$r_s \cdot C_c$ (typ)	C_{cb} (max)	Prices (100-up)
2N5031/32	17 dB @ 450 MHz	2.5 dB/3 dB* @ 450 MHz	1.0 GHz	5 ps @ 10 mA/6 V/ 31.8 MHz	1.5 pF @ 6 V/0.1 MHz	\$14 00/8 00
MM8006/07	25/20 dB @ 200 MHz	2.2 dB/2.7 dB† @ 200 MHz	@ $I_c = 5$ mA			\$ 4 00/2 50

*Maximum †Typical

For details circle Reader Service No. 134

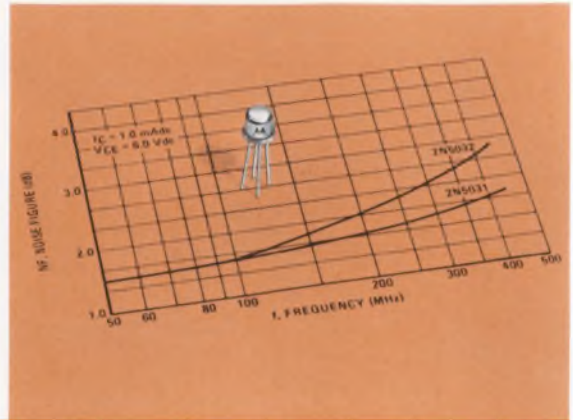

12.5-VOLT AND 28-VOLT RF POWER TRANSISTORS

— Operate From 470 MHz To 1.0 GHz At Efficiencies To 60%

Three new NPN BET silicon UHF high-current transistors — the 2N5644/45/46 — have now joined Motorola's broadening EIA registered, ceramic stripline packaged, RF power family. These devices are primarily designed for 12.5V supplies in industrial/consumer FM equipment operating up to 520 MHz. They have an excellent broadband capability thanks to their low lead-inductance stripline packaging. And, their balanced-emitter construction provides protection against destructive secondary breakdown.

In addition, four new microwave types (for use with 28V supplies) have been added to the RF power line. The MM4429 and MM4430 are multiple-emitter devices which are packaged in ceramic stripline cases, while the 2N4428 (also multiple-emitter) is packaged in the TO-39 case. Their prime usage is in military and industrial UHF and L-band (1-2 GHz) microwave power amplifiers and transmitters. The MM8009, on the other hand, is ideal for frequency-multiplier or oscillator applications to 1.68 GHz.

For details circle Reader Service No. 135

Type	P_{out}	G_{pe} (min)	@ f	V_{cc}	Efficiency η	Price (100-up)
2N5644	1.0 W	7.0 dB	470 MHz	12.5 V	60% (min)	\$ 8.30
2N5645	4.0 W	6.0 dB				11.90
2N5646	12 W	4.7 dB				22.50
MM4429	1.0 W	5.2 dB	1.0 GHz	28 V	45% (typ)	9.00
MM4430	2.5 W	5.0 dB				19.00
2N4428	0.75 W	10 dB	500 MHz	28 V	35% (min)	5.50

Type	P_{out}	@ f	f_r	V_{cc}	Efficiency η	Price (100-up)
MM8009	0.9 W (min)	1 GHz	1.0 GHz @ 50 mA	28 V	35% (min)	\$ 7.50
	0.3 W (osc) (typ)					

Packages: All in ceramic opposed-stripline cases (case 145A) except for the 2N4428 and MM8009 which are in TO-39 cases.

2-GHz OSCILLATOR MICROWAVE TRANSISTORS

— Eliminates Need for Costly Frequency-Multiplier Chains

Motorola's new MM8008/10/11 NPN silicon microwave transistors, designed primarily for military and industrial oscillator, frequency-multiplier, and UHF amplifier applications, represents a major high-performance vs. low-cost break-through. *Crystal and tuned-oscillators can now be economically developed which operate at frequencies previously possible only with expensive multiplier chains!* The result . . . not only a reduction in costs but also the simplification of circuitry, lower noise-levels and improved harmonic spacing.

Effective in the S-Band (2 to 4 GHz) and L-Band (1 to 2 GHz) microwave frequency spectrums, these devices are ideal for use in radar antenna systems, navigational instruments, telemetry, proximity fuzes and as varactor drivers.

Type No.	$P_{out(osc)}$		f_r (typ) @ I_c	C_{cb} (typ) @ V_{ca}	$V_{CE(sat)}$ (max)	Prices (100-up)
	Min @ 2.0 GHz	Typ @ 1.68 GHz				
MM8008	300 mW	550 mW	1.1 GHz @ 50 mA	1.3 pF @ 30 V	0.3 V @ $I_c = 100$ mA	\$17.50
MM8010	200 mW	450 mW				12.00
MM8011	100 mW	300 mW				7.10

Case Type — TO-107

For details circle Reader Service No. 136



NEW MRD500/510 SILICON PIN PHOTO DIODES

— Respond In Less Than 1.0 ns. And Are Sensitive To Low Radiation Levels

They turn-on in less than 1.0 ns (typ) and can be activated by low-intensity radiation sources. *They're the new Motorola MRD500/510 PIN photo diodes!* High radiation-sensitivity, fast turn-on-time and high signal-to-dark-current response make them ideal for use in such functions as: laser detection, light demodulation, light-emitting-diode coupling and shaft/position encoding.

Their Annular, passivated structures assure long-term stability. The MRD500 has a convex lens (for high sensitivity), while the MRD510's is flat, for use with external lens-systems.

Photo Diode Type	Response Time @ V_s/R_s (typ)	Radiation Sensitivity $\mu A/mW/cm^2$ (typ) Note(1) @ $\lambda = 0.8 \mu m$		Dark Current @ $V_s/R_s/I_A$ (max)	Breakdown Voltage (min)	Capacitance @ V_s/f (max)	Prices (100-up)
MRD500	1.0 ns @ 20V/50 ohms	1.8	6.6	2.0 nA @ 20V/ 1.0 meg/25°C	100V @ $I_A = 10 \mu A$	4.0 pF @ 20V/1.0MHz	\$7.25
MRD510		0.42	1.5				\$6.60

Note (1): Radiation Flex Density $H = 5.0$ mW/cm² — tungsten source (color temp. = 2870K)

For details circle Reader Service No. 137

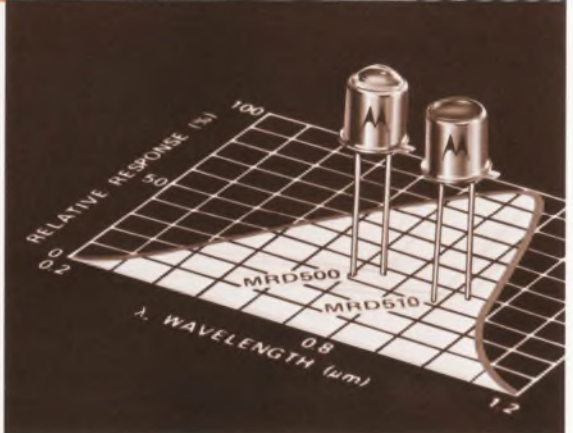

4th Edition "Data Book" Now Bigger-Than-Ever With An Improved Data-File System

Motorola's fourth edition of "The Semiconductor Data Book," the Bible of the industry, is now available! It's the largest yet — 2160 pages — and includes key specifications for all EIA registered discrete semiconductors. This latest edition has an improved format that makes it easier to quickly locate detailed data on Motorola products by type numbers.



As in the past, this issue includes a 185-page numerical listing section covering the key parameters of all semiconductors registered by the EIA. The largest part of the Data Book is devoted to data sheets that give complete information on all Motorola discrete semiconductors (3626 types). They are arranged in alphanumeric sequence for easy location of information on any device whose number is known. Other sections of the book include case outlines, selector guides and selected application notes.

It is still available for the same price as last year's issue (just \$4.95 per single copy). A supplemental service is available for just \$2.00 (a minimum of two supplements will be published). Use the special coupon in this issue to order.

It is still available for the same price as last year's issue (just \$4.95 per single copy). A supplemental service is available for just \$2.00 (a minimum of two supplements will be published). Use the special coupon in this issue to order.

It is still available for the same price as last year's issue (just \$4.95 per single copy). A supplemental service is available for just \$2.00 (a minimum of two supplements will be published). Use the special coupon in this issue to order.



New Motorola Prototype Kit Provides A Broad Scope Of FET & Bipolar Choppers

Motorola's new MK48C HANDYLab Kit will surely prove both a time and money savings aid in the design and prototyping of chopper circuits. It contains a broad assortment of popular FET and bipolar types (see table), all packaged in a convenient, sturdy, vinyl-covered carrying case.

The "kit" includes a comprehensive brochure which contains selector guides, complete data sheets on all Motorola chopper transistors and application notes covering both FET and bipolar design considerations.

The complete kit sells for just \$84.50! Considering that the total small-quantity price

of the units in the kit is over \$175.00*, you save more than \$90.00 just on the products alone! Order a MK48C Chopper Transistor kit from your Motorola distributor TODAY!

Offer expires April 1, 1970.

*based on current Motorola 1-99 published prices.

MK48C CONTENTS

FET	QUAN.	BIPOLAR	QUAN.
2N4091	2	2N2944	2
2N4093	2	2N2945	1
2N4351	4	2N2946	6
2N4352	4	2N5231	5
2N5555	6	MM4052	5
MFE2009	2	Value	\$179.75
MFE2012	2	Special	
3N155	2	Price	\$ 84.50

LITERATURE REQUEST FORM

NOTICE: Requests for literature on items described in this publication cannot be honored after April 1, 1970.

NEWSBRIEFS No. 7-69

Please circle the Reader Service number of item(s) you are interested in receiving.

ED						
121	122	123	124	125	126	127
128	129	130	131	132	133	134
135	136	137	138	139		

Please Print Clearly

NAME _____ TITLE _____

COMPANY NAME _____

DIVISION _____ DEPARTMENT _____

COMPANY ADDRESS (Street or P. O. Box) _____

CITY _____ STATE _____ ZIP CODE _____

If you wish to receive mail at a different address, fill out below:

STREET or P. O. BOX _____

CITY _____ STATE _____ ZIP CODE _____

Do you wish a Motorola Representative to contact you?

VISIT PHONE . . . Phone No. _____ Area Code _____

ORDER COUPON THE SEMICONDUCTOR DATA BOOK

Quantity	Extension
<input type="checkbox"/> Single Copy @ \$4.95/ea.	\$ _____
<input type="checkbox"/> 2-24 Copies @ \$3.50/ea.	\$ _____
<input type="checkbox"/> 25 or more Copies @ \$3.30/ea.	\$ _____
<input type="checkbox"/> Updating Subscription @ \$2.00/ea.	\$ _____
	Total \$ _____

Be sure to fill in your name and address on the other side of this coupon, tear along perforated lines and enclose in envelope with proper remittance.

Tear Along Perforated Line and Drop in Mail (No Postage Required)



FOLD HERE

FIRST CLASS
Permit No. 2565
PHOENIX
ARIZONA

BUSINESS REPLY MAIL

No postage stamp necessary if mailed in the United States

POSTAGE WILL BE PAID BY

Semiconductor NEWSBRIEFS No. 7-69

Motorola Semiconductor Products Inc.

P. O. Box 20924

Phoenix, Arizona 85036

FOLD HERE

For Fast Action!

... on delivery of literature for items described in this publication — fill out this coupon, fold as indicated and drop in the mail.

(NO POSTAGE IS REQUIRED)

Seal Here

ORDER FORM

To order copies of "The Semiconductor Data Book," fill out both sides of this coupon, tear along perforated edge, and mail in envelope with check, money-order or purchase-order(*) to:

Motorola Semiconductor Products Inc.
P.O. Box 20924, Phoenix Arizona 85036

Note: (*)P.O.'s for less than \$20.00 can not be accepted. Make payment to Motorola Inc.

Please Print Clearly

NAME _____ TITLE _____

COMPANY _____

ADDRESS _____

CITY _____ STATE _____ ZIP _____

NEW LITERATURE BRIEFS

69 New Application Notes Bring Total Subjects Covered in 1969 Catalog to 189

Since the issuance of Motorola's 1968 Application Note Catalog (approximately one

year ago), 69 new "notes" have been published. Abstracts on these latest additions have

now been incorporated into the new 1969 edition. The notes cover a broad spectrum of solid-state application ideas embracing practically every area of electronic and electromechanical design. They include both analog and digital circuitry spanning the frequency spectrum from dc to 12 GHz. The use of Motorola digital and linear ICs (both monolithic and hybrid) and discrete devices are detailed in the notes.

As a further aid in selecting pertinent notes, the catalog is divided into two parts. The first part indexes the notes by both semiconductor category and application area. The second, lists notes in numerical sequence and includes an abstract on each. The new notes are clearly indicated.



year ago), 69 new "notes" have been published. Abstracts on these latest additions have

For a copy circle Reader Service No. 138

State-of-the-Art Linear IC Brochure Bridges Applications-Information Gap

For the first time, in a 56-page volume, Motorola Application Engineers have compiled a series of "how-to-use" articles covering all major linear integrated circuit categories. These application discussions, reviewing the latest in Motorola product developments and capabilities, include: Op Amps, Voltage Regulators, Multipliers, High-Frequency ICs, Sense Amps and ICs for consumer designs.

They have been combined, in one brochure, in order to present the status of today's linear IC applications, and to "bridge the information gap" concerning the uses for the multitude of new linear circuits which Motorola has



recently introduced. It will prove a valuable aid to engineers who are already using, or are contemplating the use of linear ICs in their designs.

For a copy circle Reader Service No. 139

Motorola Semiconductor Products Inc., P. O. Box 20924, Phoenix, Arizona 85036



The circuitry shown external to Motorola products is for illustrative purposes only, and Motorola does not assume any responsibility for its use or warrant its performance or that it is free from patent infringement.

MTTL, Unibloc, Thermopad, BET, Designers, MIDA and Micro-T used in this publication are trademarks of Motorola Inc. Annular Semiconductors are patented by Motorola Inc. Nixie is a registered trademark of Burroughs Corp.

NOTE: If Motorola's Literature Request Coupon is missing, use magazine's standard Reader Service Card.



THICK SKINNED

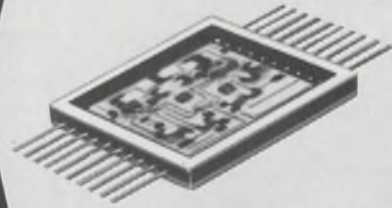

**That's why Columbia
custom hi-rel, thick film hybrids
pass all their survival tests.**

When we finish hybridizing one of your circuits, you can use it with confidence. Confident that it'll perform to your requirements. And confident that it won't fail. It's the result of the industry's most demanding quality control procedures.

At Columbia, from prototype to delivery, our hybrids are handled by skilled people, using the latest scientific methods, materials and equipment. And our Quality Control department continuously monitors all activities so that nothing is left to chance.

That's why our production and test procedures are, literally, a survival program. When we ship your circuit, we know it can't be better. We wouldn't have it any other way. Neither would you.

And whatever the circuit or quantity you require, we can produce it fast. If necessary, we'll even work with you to develop it. In short, we'll do everything we can to give you exactly what you want, when you want it.

So, write or call Hal Salzman at (516) 483-8200. He's thick skinned enough to listen to your most complex circuit problem. And help you survive it.



COLUMBIA COMPONENTS CORP.

A SUBSIDIARY OF COMPUTER INSTRUMENTS CORP.

60 MADISON AVENUE, HEMPSTEAD, NEW YORK 11550

(516) 483-8200 TWX 510-222-4189

...want a tantalum capacitor with proven performance?

Buy TYPE 150D TANTALEX[®] SOLID-ELECTROLYTE CAPACITORS



INFORMATION RETRIEVAL NO. 821

Hermetically-sealed in metal cases. Four case sizes, ranging from 1/4" to 3/4" length. Value-packed performance characteristics — low impedances at high frequencies, low dissipation factor, minimal capacitance drift with temperature, practically no change in capacitance with life. Low leakage current limits. Investigate new higher capacitance ratings.

48C-0144R1

Buy resistors with built-in dependability...

Vitreous-enamel BLUE JACKET[®] POWER WIREWOUND RESISTORS



INFORMATION RETRIEVAL NO. 822

All-welded end-cap construction eliminates moisture along the leads, also anchors leads securely to resistor body. Expansion coefficients of vitreous enamel coating, ceramic core, and end caps are closely matched. Standard wattage ratings include 1, 2, 2.5, 3, 5, 7, 10, and 11 watts. Also available with radial tab terminals in ratings from 8 to 230 watts.

For complete technical data on Type 150D Tantalex Capacitors, write for Engineering Bulletin 3520F. For information on Blue Jacket Resistors, request Bulletin 7410D. Write to: Technical Literature Service, Sprague Electric Co., 347 Marshall Street, North Adams, Massachusetts 01247.

48R-0145



'Sprague' and '®' are registered trademarks of the Sprague Electric Co.

THE BROAD-LINE PRODUCER OF ELECTRONIC PARTS

News

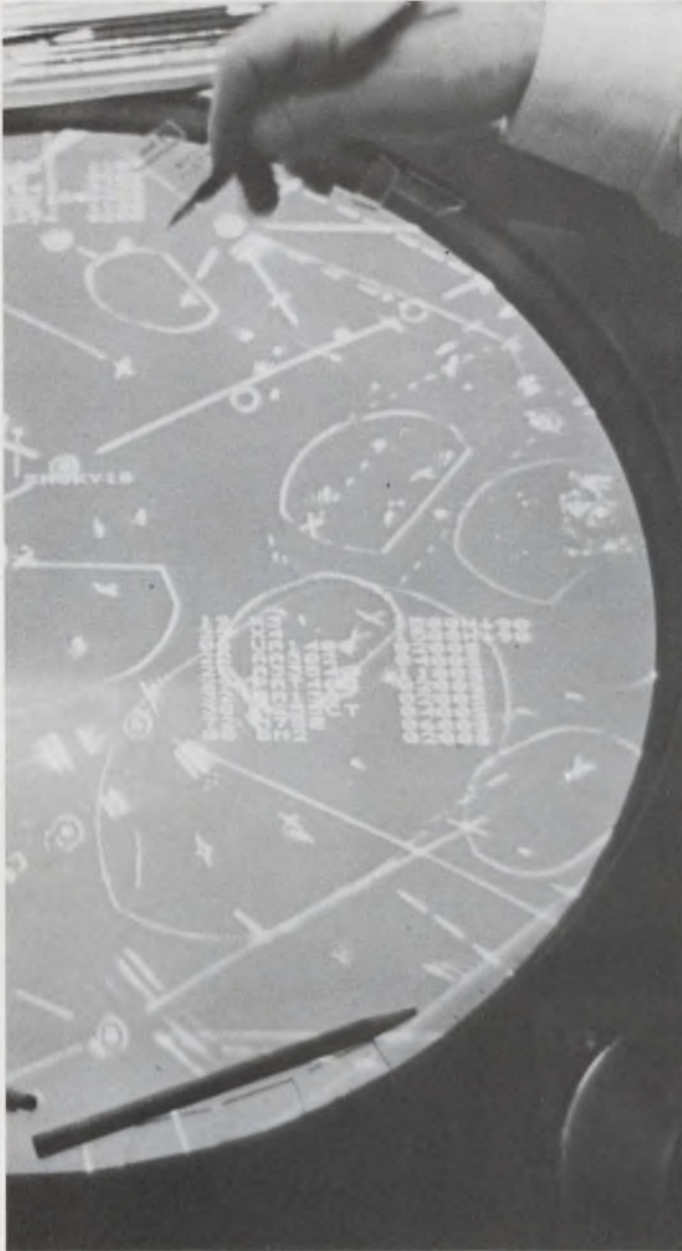

Radar can't prevent air collisions when it isn't cared for properly. ELECTRONIC DESIGN has uncovered evidence of FAA deficiencies. p. 25.



Looming as tall as this relay tower is the prospect of the nation's first private-line communications net. p. 32.

Also in this section:

Infrared sensors star in new displays, p. 36.

News Scope, p 21 . . . **Washington Report** p. 41 . . . **Editorial**, p. 51.

BURROUGHS DEVELOPS... SELF-SCANTM PANEL DISPLAY

the most significant development in electronic display

Burroughs, the originator of NIXIE[®] tubes, now revolutionizes display technology with the first commercially practical dot matrix display system. It took SELF-SCAN panel display, the remarkable Burroughs invention that takes the electronics out of the present electronic display ... reducing costly drive circuitry up to 90%.

With a minimum number of leads and drivers, Burroughs' system automatically scans data input into in-plane readout characters formed by glowing dots ... making possible a totally new combination of readability, minimal packaging and cost advantages.

The new flat-panel display is basically a matrix of small gas discharge cells hermetically sealed between heavy glass plates in a sandwich configuration. The matrix itself, formed of insulating material, has small grooves on its top surface to allow positioning of information anode wires which intersect each hole. Cathode conductors behind the center sheet intersect at each cavity with a second set of anode wires.



By utilizing the phenomena of preferential glow transfer and glow shifting, the initial glow caused by cathode ionization in the dot matrix may be moved through selected holes to a visible position on the top surface. A sequential flow of light is thus achieved without separate drivers for individual columns and rows.

Burroughs' alphanumeric SELF-SCAN panel displays are available with or without memory for any application requiring 16 or 18 digit readout.

Write today for descriptive brochure, Burroughs Corporation, Electronic Components Division, P. O. Box 1226, Plainfield, New Jersey 07061. Tel.: (201) 757-5000.

Burroughs 

Electronics potential high for ice tankers

"Several months will be required before a decision is made for construction of a fleet of super icebreaker tankers to carry Alaskan crude oil through the Northwest Passage," say officials of Humble Oil & Refining Co., New York City.

Should the firm decide to build the six ships, outfitting will include a multimillion-dollar purchase of electronic equipment, including an integrated navigation system, sonar, and a variety of high-power radio communication sets.

A vast amount of data collected by Humble's specially converted tanker SS Manhattan during its record-making journey through the Arctic ice pack early last September must be analyzed before economic tradeoffs can be made and the practicality of such a program determined, Humble says.

A company spokesman disclosed that a press conference on details of the research effort will be held in New York on Nov. 10. However, he indicated that detailed performance data will be withheld. The firm, he says, intends to prepare

and publish a formal report for subsequent sale to other interested petroleum companies. This will help reduce the \$35-million investment burden so far carried by Humble, he declared.

On August 25, the Manhattan, a certified tanker-oceanographic research craft, began its quest for a short route to carry crude oil from the enormous new oil fields in Alaska to the U. S. East Coast refineries. With a crew of 54 and 72 scientists, the ship followed a course from Thule, Greenland, across Baffin Bay and into the Canadian Arctic, then through Prince of Wales Strait and on to Point Barrow, Alaska. She was supported by two Canadian icebreakers and U.S. and Canadian reconnaissance helicopters. The Manhattan broke free of the crushing ice pack on Sept. 15 and reached her destination six days later.

The Manhattan, says Dr. H. Charles Baker, who directs Humble's Telecommunication Development and Planning Dept., carries "the most sophisticated state-of-the-art electronic gear ever assembled on a nongovernment ship." Three major shipboard systems were provided, he says.

Collins Radio Co. was responsible for all communications between the three ships and Humble Headquarters at Houston, Texas. The Manhattan employed all standard ship-to-shore equipment, plus high-power radio transmitters for voice, data and teleprinter. Long-range traffic was relayed through Collins' hf single-sideband facility at Cedar Rapids, Iowa.

Reconnaissance helicopters carried redundant voice communications, plus radio beacons, radio homing and distress signaling equipment to assure safety in the severe Arctic environment. For area reconnaissance, the helicopters

employed side-looking radar and infrared imagery.

Litton Systems, Inc., designed the fully integrated ship's navigation system. This included an ITT receiving subsystem for use with the Navy Navigation Satellite System, a Marquardt Corp. pulsed Doppler sonar subsystem and an inertial navigation subsystem. All inputs were processed by a Digital Equipment Corp. digital computer subsystem. Using high-latitude correction techniques, the system is intended to provide instantaneous position coordinates to "better than half a ship's length and true speed to better than 0.1 knot at all times," Dr. Baker says. The system also provided a record of subsurface water-current velocity throughout the voyage.

Taft Broadcasting Co. provided a specially developed remote-control closed circuit TV system to enable scientists to monitor ice cracking and ice flow dynamics. In addition, the Manhattan's bow and hull were fully instrumented with pressure and strain transducers to monitor and provide a record of ice-jam effects on the vessel.

IC sales in U.S. to hit \$900-million in 1973

Total dollar volume of monolithic IC shipments in the U.S. will hit \$900-million by 1973. So says Charles E. Sporck, president of National Semiconductor Corp. Santa Calra, Calif.

Speaking before the New York Society of Security Analysts, this month, Sporck predicted a total 1973 semiconductor market (ICs and discretets) of \$1-3/4 billion with the linear IC market accounting for \$200 million in that year. Sporck includes only U.S. shipments in these figures; he predicts that total U.S. semiconductor shipments will be about 50% of the 1973 world market.

Sporck expresses concern, however, that the U.S. semiconductor market faces a tough deal from its own government. The Federal Tariff Commission will hold hearings in November to consider raising the duty on products assembled in foreign countries. The duty paid now is computed on the value added to the product during assembly



Super icebreaker, SS Manhattan on the way to the Arctic.

News Scope

CONTINUED

(the cost of the labor). Sporck calls for protection of the U.S. semiconductor vendors from added tariffs. An increase, he says, will force them to move their entire operations overseas or to give up their industry leadership to Japanese manufacturers.

Is the Japanese challenge this serious? Sporck points to the takeover by that country of the radio industry. It can happen again in ICs, he says. And Japan is expected to grant, in the near future, automatic approval to investments abroad by Japanese companies. A proliferation of Japanese interests in low labor cost areas may well follow.

Will Soviets' manned lab speed up NASA's plans?

As the Soviet Union's three manned spacecraft orbited the earth, jockeying to dock and construct the first manned laboratory in space, the National Aeronautics and Space Administration made no indication that it would accelerate its own similar programs. If, however, the U.S. reacts to the Soviet achievement, observers say, NASA will at least do everything it can to prevent any slippage in its own programs.

For instance, the 12-man space base, which NASA has scheduled to fly in "1975 or 1976," will probably be in orbit in 1975. And if this deadline is achieved, the next two will probably also be met: extension to accommodate 50 men by 1980 and 100 men by 1984. Two teams will complete their \$2.9-million studies on this expandable laboratory by June, 1970, at which time another \$9-million will be waiting for the next phase. The team leaders are McDonnell-Douglas and North American Rockwell.

Expected soon by the big aerospace companies are requests for proposals from NASA to bid on shuttles to carry personnel and cargo between the earth and the space base.

The first manned laboratory scheduled by the U.S. is the three-man orbiting workshop that McDonnell-Douglas plans to deliver to NASA for flight in 1972. Boosted into orbit by a Saturn V, the workshop will be equipped with a high-resolution astronomical telescope. The craft will be launched uninhabited. A day later a three-man crew will be shuttled to the spacecraft by a Saturn IB for a 28-day stay. Later visits will last 56 days.

Foreign contracts give headaches to Intelsat

Building satellites with 13 major subcontracts let in 10 foreign countries requires "international manufacturing," said Allan Owens, Program Manager on Intelsat 4, at a recent Electronic Industries Association meeting in Los Angeles.

According to Owens, prime contractor Hughes Aircraft Co., Culver City, Calif., is having problems in four major areas:

- All components must be shipped in kit form to the foreign companies. Since Intelsat 4 has been entirely designed in the U.S. all parts are in accordance with U.S. standards and measurements. Therefore, Hughes ships every part, down to the smallest washer, to its international subcontractors for assembly. Errors caused in translation from the English system to the metric system can be very serious on a program such as this.

- Every country has its own unique customs procedures. Hughes must document every nut, bolt, washer and tube of epoxy that it ships out of this country. In return, this country expects monumental documentation on every item shipped in from outside. The combination of paperwork and time delays has been a tremendous problem.

- All original drawings were made by Hughes in the English language, so each foreign country must translate the drawings into its own tongue. This has resulted in both errors and delays.

- Major communications problems arise due to time-zone differences between the various countries. When the working day begins at Hughes, it is ending in Europe. When the working day

ends at Hughes, it is beginning in Japan.

Abbott Washburn, deputy U.S. representative to Intelsat, remarked: "Although the foreign members of the consortium will always want to participate in the manufacturing of the satellites and ground stations, the U.S. is pushing for all new contracts to be let on the basis of best quality, lowest price and shortest delivery." This point is meeting more than a little opposition from several foreign delegations.

\$9-billion market seen for computer services

The fastest-growing segment of the computer industry—services—should have revenues of \$9-billion by 1973, equalling the value of hardware shipments. And by the late 1970's, services income should surpass hardware revenues.

This forecast was made by James Stone, director of the Computer Technology Div. of Quantum Sciences Corp. of New York before a meeting of the Western Electronics Manufacturers Association in San Francisco.

Stone said that already computer users are spending about twice as much on services as on hardware. With the vast increase in computer capabilities and software complexity, the users are becoming less able to manage these complicated systems, he observed.

Because they are not receiving the maximum benefits from their rising data-processing expenditures, he said, companies will be looking for the technical expertise to be supplied by independent computer service companies.

Keeping an eye on magnetic space

Under a \$1.2 million contract, Avco Systems Div. of Wilmington, Mass., will develop and build a Magnetic Storm Satellite for the Air Force Office of Aerospace Research. The spacecraft, which is to be launched in 1970 or early 1971, will be instrumented to measure the intensity of magnetic storms and the interaction of solar activity in the earth's upper atmosphere.

Cermet

AND THE

Model 3082

TRIMPOT® POTENTIOMETER

Microminiature Size - Only .5" x .1" x .15"

TC ± 100 PPM/ $^{\circ}$ C over entire resistance and temperature range*



Designed and manufactured to meet your exacting requirements in the highest tradition of quality — by Bourns . . . the leader in adjustment potentiometers. Write or call the factory, your local field office or representative today for complete details!

*RESISTANCE RANGE 10 Ω TO 2 MEGOHMS
TEMPERATURE RANGE -65 $^{\circ}$ C TO +150 $^{\circ}$ C



BOURNS, INC., TRIMPOT PRODUCTS DIVISION • 1200 COLUMBIA AVE., RIVERSIDE, CALIF. 92507



Miniature Rotary Attenuator
0 to 60dB in 10dB steps
Model #103

Rotary Attenuator
0 to 109dB in 1dB steps
Model TAB-50A



*If you don't see
it here, write for
our catalog*



Toggle Switch Attenuator
0 to 82.5dB in 0.5dB steps
Model TG-9050A



Laboratory Rotary Attenuator
0 to 110dB in 1dB steps
Model TAD-50A

Toggle Switch Attenuator
0 to 62dB in 1dB steps
Model 8011



Catalog
Model 70A



Rotary Attenuator
0 to 100dB in 10dB steps
Model 8008-4

TELONIC ATTENUATORS

Whatever your needs for an RF attenuator, Telonic can provide one or a thousand to fit your application. They are available in such a variety of types (rotary, toggle, miniature), styles (panel-mounting, rack-mounting, bench type), ranges (up to 110dB) and prices (from \$65.00) that we can usually supply a stock unit to meet your requirements.

If you don't see it here, write for our catalog — and if you don't find it there, ask us about customized units. Here are some composite specs of over 20 different standard models.

Types: Rotary and Toggle Switch
Range: 0 to 110dB
Attenuation Steps: 0.1 to 40dB
Impedance:50 and 75 ohms
Frequency Range: DC to 2000 MHz
Quality: Maximum

 **TELONIC INSTRUMENTS**
A Division of Telonic Industries, Inc.
60 N. First Avenue
Beech Grove, Indiana 46107
Tel: 317 787-3231 • TWX: 810 341-3202

INFORMATION RETRIEVAL NUMBER 16

Why doesn't radar prevent midair collisions?

Indianapolis tragedy suggests that outmoded equipment and improper care are creating hazards

Jim McDermott
East Coast Editor

The visibility was clear as Allegheny Airlines Flight 853, cruising at 6000 feet, nosed down gently toward Weir Cook Municipal Airport in Indianapolis. At the same time a light, single-engine Piper Cherokee, a student pilot at the controls, was climbing slowly some miles away. Radar at the Indianapolis airport was sweeping the sky as the jetliner and the Piper converged 10 miles to the southeast last Sept. 9.

The newspapers reported the outcome this way: "83 Die as Jetliner and Small Plane Collide in Sky Near Indianapolis."

Later a Federal Aviation Administration traffic controller at Weir Cook Airport charged that the radar was a "killer." It was unable to detect the small plane in the midair collision because of a malfunction, he said. The FAA denied the accusation.

What is the true story about that radar and its role in the accident? And is there a lesson in it for other airports in the country? Investigation by ELECTRIC DESIGN has turned up these facts:

- Although the Indianapolis radar is the latest airport surveillance type available (ASR-6), the FAA is using small, outmoded displays with it at Weir Cook Airport. Use of these smaller scopes is contrary to the FAA's own official recommendations. It creates a loss in resolution that makes it harder to separate targets.

- As at many major airports in the country, radar maintenance at Indianapolis is poor, with excessive periods between tuneups and preventive care, according to the Professional Air Traffic Controllers Organization.

- The radar at Indianapolis may have been tampered with immediately after the accident to improve

its degraded performance and conceal any malfunction.

- Except for the equipment at one airport complex in the United States—that at Chicago—none of the FAA airport surveillance radars is fully redundant.

- The FAA and the traffic controllers agree that even when working at specified performance, present airport radars have substantial limitations. To overcome these, improved radars, or even a breakthrough in design, will be needed.

Target not visible

After the Indianapolis tragedy controllers at Weir Cook Airport said the small plane simply did not show up on their radar scopes, and so they were unable to give any warning of the im-

pending collision. But FAA Administrator John H. Shaffer, testifying the day after the accident before a Congressional hearing called by the House Committee on Interstate and Foreign Commerce, said:

"I am not a philosopher, but I choose to think that yesterday's accident was fate."

Was it?

James Knecht, the Indianapolis air traffic controller who has called the radar there a "killer," has since been removed from all traffic-control duties by the FAA and is no longer talking for publication, on advice of counsel. In light of his experience, controllers at the Indianapolis center are reluctant to be quoted by the press. But they will talk to qualified reporters, if given assurances that their names will not be used. From interviews with several, a picture of FAA ineptitude emerges.

There is, for example, the matter of the size of the plan position



This DC-9 overtook a slow-moving Cessna 150 at Lambert Field, St. Louis, one and a half miles from the runway. Despite radar advisories until shortly before collision, none of the three men in the airliner cockpit saw the light plane.

NEWS

(Collisions, continued)

indicator (PPI) oscilloscopes that are being used with the Indianapolis radar.

In disclaiming the charges by Knecht immediately after the midair collision, the FAA carefully sidestepped this point. It asserted:

"Contrary to the charges made by Knecht, the airport surveillance radar at Indianapolis, the ARS-6—first introduced in 1963 and installed at Indianapolis in late 1967—is the most advanced equipment available today."

And so it is, for civilian aviation. No one, not even Knecht, denies this. But a 22-inch scope is available and recommended for use with the ARS-6 radar. At Indianapolis the FAA is using two 10-inch and two 14-inch PPI oscilloscopes with its ARS-6 radars. The 10-inch scopes, designed originally for use with the ARS-2, are green and must be viewed in a darkened room. One of these was monitoring the jetliner in the Sept. 9 collision.

Why doesn't the Indianapolis center use the new 22-inch displays?

Well, when the ARS-6 radar was installed at Weir Cook Airport, the controllers say, the center was "cramped for space." The

larger scopes couldn't be squeezed in comfortably. But two rooms are available now in the airport tower building, and the bigger scopes could be placed there, the controllers add. One room has a Coke machine and several chairs in it, and the other is being used as a training room, with seats for 30 or 40 people. And even if there weren't this space, the FAA could always rent a trailer to house the larger equipment, one controller notes.

What happens when the smaller oscilloscopes are used with the modern ARS-6 radar? The FAA furnishes the answer in its own "National Aviation System Plan for 1970 to 1979," prepared as background information for the First Annual National Aviation System Planning Review Conference, held last April in Washington. This document states:

"... ASR-2, ASR-3 and CPB-18 display systems installed between 1952 and 1956 are still in use at many FAA facilities.

"Displays which have either 10 or 12-inch cathode-ray tubes are considered marginal for control of traffic in today's high-speed traffic system. Condensing a 40-mile area in a 10-inch display indicator (approximately 9-inch viewing area) presents control problems. For example, three

miles minimum radar separation between targets is equivalent to approximately three-eighths of an inch.

"Modern solid-state display systems (with 22-inch PPIs) provide increased reliability and improve controller performance."

When the small scopes were originally issued to airports by the FAA, the terminal approach areas at the fields—the circular areas monitored by surveillance radar—each had a radius of 15 miles. This radius has since been expanded to between 40 and 60 miles.

Improper maintenance charged

What of radar maintenance at Indianapolis and elsewhere in the FAA network?

James E. Hays, president of the Professional Air Traffic Controllers Organization, representing some 78,000 controllers in the nation, told ELECTRONIC DESIGN in an interview at the group's headquarters in Washington that the FAA has reduced its maintenance of radar equipment in recent months. This may be because of financial and manpower problems, but the fact is that without proper, periodic adjustment radar can get out of whack.

"At one facility in the Midwest

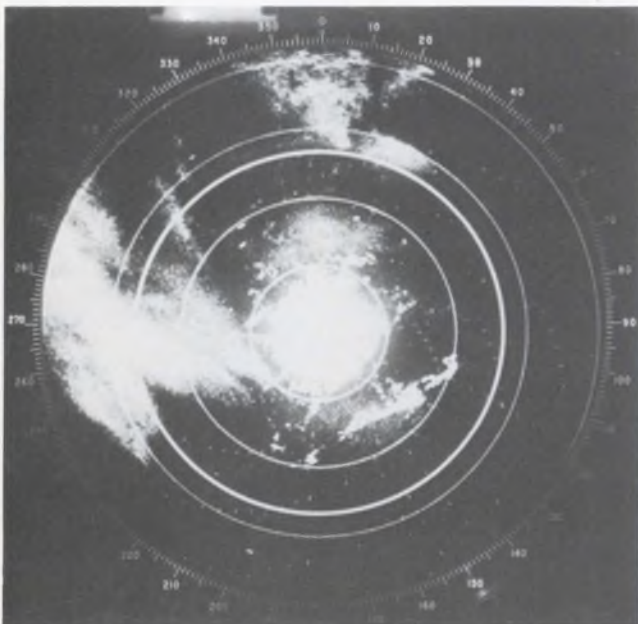

Improved radar performance is a continuing concern of the FAA. At left, bad weather clutter obscures the targets inside the storm—a major problem with all surveillance radars. The precipitation clutter is rejected, at

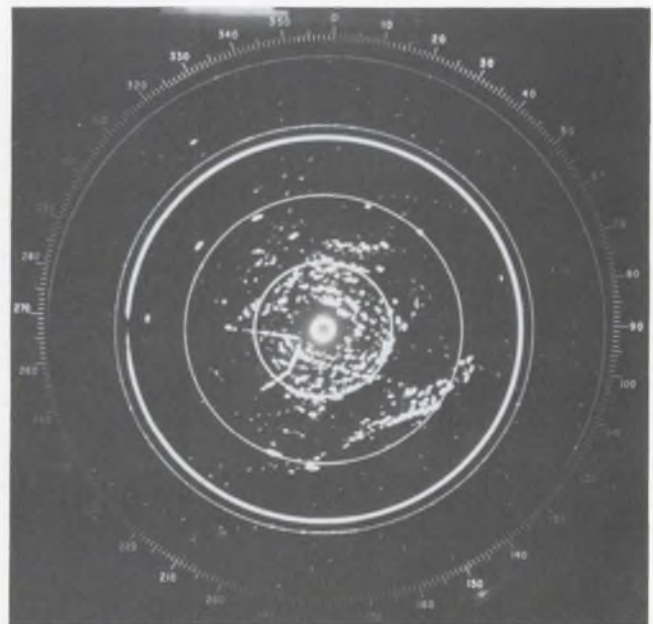

right, by recently developed log/fast-time-constant/anti-log circuits in the i-f amplifiers of the radar. As long as the aircraft signal amplitude is equal to or greater than that of the storm clutter, the aircraft can be tracked.



To make 56 applications, make one application.

Dear Signetics:

I herewith apply for my free copy of the brand new, second edition of your Applications Memos book. The one you've beefed up to a whopping 416 pages. And eight expanded sections. And a total of 56 applications.

I figure it can really help me come up with some great integrated circuit designs. (And when it comes to being helpful, your Applications Department wrote the book!)

Mail to: Mr. Stan Goodrich, Signetics Corporation, 811 E. Arques Ave., Sunnyvale, California 94086.

Name _____ Company _____

Address _____

City _____ State _____ Zip _____

Signetics 

Signetics Corporation A subsidiary of Corning Glass Works

INFORMATION RETRIEVAL NUMBER 17

NEWS

(Collisions, *continued*)

there are two side-by-side radar systems, but there is a five-mile range disagreement between them," Hays said, to illustrate the point.

And at Indianapolis there were maintenance deficiencies in the radar, Hays asserted. The same charge was made by controller Knecht immediately following the air collision, and Knecht added that despite the malfunctions, the FAA never did anything about his complaints.

Hays said that air traffic controllers in Indianapolis reported to the FAA early this year that there were "holes" in the radar coverage. Flight checks were made on April 15 and July 1, he recounted, and these flights verified that the airport radar was not getting proper returns from certain areas around Indianapolis. But no effort was made to adjust the radar system or to replace tubes, the controllers' leader charged.

Accusations of radar malfunctioning in the collision at Indianapolis draw emphatic denials from the FAA. But Hays, who was on the scene of the accident within hours after it occurred, adds this explosive allegation:

The FAA made emergency repairs to the radar system at Indianapolis shortly after the fatal collision.

"Two key tubes were replaced and the entire radar system tuned up before the required flight check was made after the accident," he asserts. The replaced tubes are reported to have been a magnetron and a thyratron, both critical elements in the transmitter.

This, too, is denied by the FAA.

Hays stands his ground. "The FAA was trying to have the record show that the radar was in top operational performance when the official investigation was made," he says, "although responsible people in the agency have known as far back as April that there was something wrong with the Indianapolis radar."

FAA flight checks of the Indianapolis equipment since the Sept. 9 accident have given the radar passing marks, but Hays says that without the new tubes and tuneup, the system would have proved defective.

Redundancy is limited

But even when a radar is operating properly, it may at a critical moment—as any mechanical or electronic equipment may—

fail when you need it the most. As the nation's space-exploration program has demonstrated, there is only one reasonably sure way to counter this threat, and that is full redundancy. If there is complete backup equipment waiting to take over in an emergency, the margin of safety is markedly increased. But so far as the nation's civilian air-traffic-control system is concerned, full redundancy is a luxury. Hays says:

"There is only one approach control radar in the U.S. that has a backup antenna [Chicago, although transmitting and receiving equipment is duplicated everywhere]. And it has only been since last summer that some centers have overlapping coverage to compensate for loss of one radar."

Improvements are planned

Is there a better way to run a national air traffic control system? Even the FAA concedes that there is. The nation is paying for years of neglect of this aspect of its transportation system. Major improvements are planned. The question is: How long do the American people want to wait to complete the improvements, and how much are they willing to pay to get the absolute best?



Air traffic controllers say they're overworked because of a shortage of personnel. In addition they charge that

the equipment they work with isn't always properly maintained.

THIS PROGRAM WAS SUPPLIED TO YOU VIA THE

APOLLO LUNAR CAMERA by

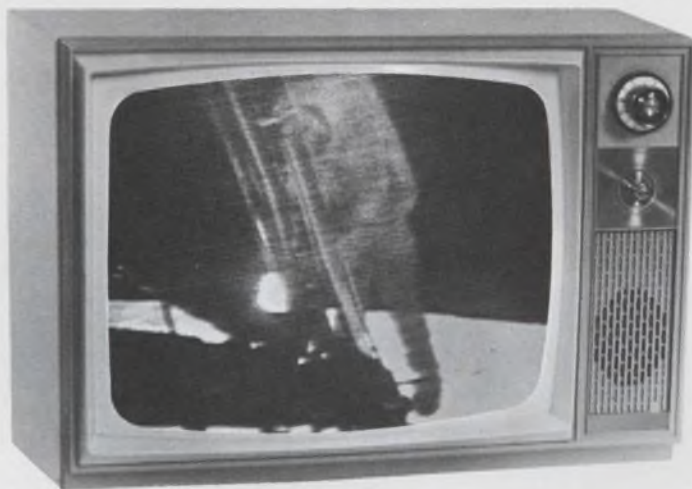

POWERCUBE[®] MODULES...

In a power supply that weighed less on earth than any conventional supply would weigh on the moon!

The power supply for the Apollo 11 portable lunar camera consisted of six standard Powercube modules — a Preregulator, a DC-AC Inverter, AC-DC Converters, and Multi-output Converters with a total earth weight of 4.8 ounces. Such a system is capable of delivering nine separate regulated voltages ranging from 5 to 400 Vdc from a single 28 Vdc input.

Although you may not have a need for a power supply on the Moon, Powercube can solve your size and weight, high power converter problems on Earth. Each standard off-the-shelf module, weighing 0.8 ounce with a 0.5 cubic inch volume, is capable of delivering 0 to 3500 volts at 30 watts.

Powercube's patented construction technique assures reliability in a product line that includes, in addition to the modules that powered the lunar camera, DC-DC Regulators, DC-DC Pulse Regulators, DC-AC Inverters, AC-DC Regulated Converters, and AC-DC Complementary Converters. All Powercube modules are identical in appearance and can be easily soldered or welded together to form subminiature power supplies.

Send for your 24 page designer's aid catalog.

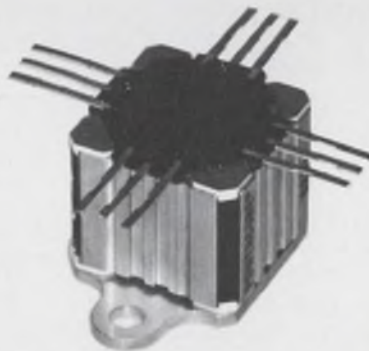

ACTUAL SIZE



POWERCUBE CORPORATION

214 CALVARY STREET, WALTHAM, MASS. 02154 (617) 891-1830

SUBSIDIARY OF UNITRODE CORPORATION
"RELIABLE HIGH POWER CIRCUITS AT A FRACTION THE SIZE"

INFORMATION RETRIEVAL NUMBER 18

(Collisions, *continued*)

In radar, for example, tube equipment is on the way out after being around since 1955, when the first ASR-1 set was delivered to the FAA. Leonard Crouch, chief of engineering systems detection equipment in the Communication Engineering Branch of the FAA, says that Texas Instruments, Dallas, is now in the final test phases of its development of the ARS-7, the first solid-state radar for airports.

The basic ASR equipment operates between 2600 and 2700 MHz and consists of two complete transmitters, receivers and moving-target-indication systems, but with a single antenna. One channel is on standby while the other is operative. All of the radars are designed to provide, by a directly reflected signal, the angle and distance information on targets within a radius of 60 nautical miles and to feed this to local or remote PPI indicators.

No ASR radar, however—not even the very latest—can tell when two planes are less than 1000 feet apart. The controller must spot them before they come this close together; that is the limit of the radar resolution. Finer resolution is undoubtedly available—at a price. Some of the more recent costly military radars, for example, could probably do better. But is the extra cost worth it? It's relatively easy to answer in the negative in this case by reasoning as follows: If a traffic controller hasn't spotted two modern aircraft on a collision course *before* they are 1000 feet apart, the odds of averting the accident are slim—particularly if jets are involved. There simply wouldn't be time for the pilots to respond to the warning and take evasive action.

Interference a constant threat

Some of the other shortcomings of the ASR radar are harder to dismiss. A prime complaint of controllers is that heavy rain or snow can seriously degrade the radar return or even mask a plane if it doesn't have a working transponder on board.

FAA proposes more positive control

Speaking before last month's Air Traffic Control Association Convention in Las Vegas, FAA administrator John Shaffer described details of a proposed rule intended to avoid collisions such as recently occurred at Indianapolis.

In the agency's proposal, all aircraft operating within 10 to 15 miles of 22 of the nation's major airports would be under direct radar control. In fact, no planes would be allowed to even enter

the area without clearance.

This would require that all planes operating in these high-density areas would be equipped with transponders.

The administrator conceded, however, that segregation of the airways and positive control of all aircraft, while highly desirable, would require more people, equipment and facilities, plus agreement on the part of various users of the airspace.

ASR radars also have great trouble picking up planes that are flying head-on to the radar or straight away from it. The radar works best when it can see a large cross-section of the plane. One air traffic controller at Indianapolis told *ELECTRONIC DESIGN* that the radar there can't pick up a Mooney—a light, single-engine plane—at a distance of 20 miles when the aircraft is approaching head-on or departing straight out.

Radar returns from elevated terrain in the vicinity of the radar may cause further difficulty by appearing as massive target areas. To counteract this, moving-target-indication circuits are included to remove the "ground clutter," so the flying aircraft can be seen clearly on the scope. However, in cases of severe ground clutter, use of the moving-target-indication circuit may, if the radar is not tuned properly for maximum sensitivity, cancel out the weaker returns from aircraft—such as from small planes without transponders. Some controllers at Indianapolis theorize that this may be what happened in the Sept. 9 midair collision. The radar was not properly tuned to begin with, they say, and by eliminating ground clutter with the moving-target-indication feature, the controller saw the jetliner clearly but did not get a signal from the Piper Cherokee. Investigation has established that the small plane did not have a transponder.

Other blind spots in the radar's antenna coverage pattern can be caused by local buildings.

For planes with transponders, many of the limitations can be overcome through use of what the FAA calls a "secondary surveillance radar"—a radar beacon system that is added to, and slaved with, the primary ASR antenna and display. The beacon system consists of an interrogator that transmits a pair of rf pulses at 1030 MHz to interrogate an airborne transponder. The transponder replies on 1090 MHz, and the reply is picked up by the radar beacon antenna and combined with the normal rotating PPI display. The returns are displayed on the scope. The controller can select and emphasize the returns of particular aircraft that he is monitoring—that is, those sending a requested "code."

In attempts to reinforce the returns from planes not equipped with transponders, the FAA has considered various types of passive reflectors and antenna arrays, but to date none has proven feasible. Crouch says.

The matter of money

And then there is always the matter of money. In past years Congress has not hesitated to clip the FAA budget to save millions. Today the agency appears almost bashful at times about requesting high sums of money—and the pity is that Congress is listening now, now that midair collisions are becoming all too familiar.

At the Congressional hearing the day after the Indianapolis tragedy, Rep. Richard L. Ottinger (D-N.Y.) told the FAA's Deputy Adminis-

trator, David D. Thomas:

"I think you are largely responsible for it [the collision]. I would think those 83 deaths are very much on your conscience, because I think you—the FAA as an agency—could have done something about this, ought to do something about it and ought to be scrambling to do something about it today."

To which Thomas replied: "I don't take all of the responsibility for the lack of people and the lack of equipment. What you are proposing is a three to fourfold increase in the duties and responsibilities of the present inadequate control staff, and I simply cannot accept it . . ."

Rep. Paul G. Rogers (D-Fla.) then challenged Thomas to explain why the FAA had not asked Congress for more money to do the job. Rogers said:

"You haven't requested funds for this. I have it in writing. And according to your figures, we need 167 control towers . . . 811 ILS [instrument landing system] systems, and 122 ASR systems."

Thomas admitted this was correct, and Rogers came back: "Yet the Congress has no request in the budget for the money to supply any of these. This is ridiculous. How are we going to supply safety to the public?"

To help avoid further midair collisions, it has been suggested that all aircraft be required to carry transponders. But this, too, presents inherent problems.

When two or more aircraft with operating transponders are within 3.3 nautical miles of each other at the same general bearing but not necessarily the same altitude, the in replies may overlap and cause garbling. In this case, the radar decoder equipment generates false targets between the aircraft. Further, part, or all, of either or both returns may be canceled out.

With a large volume of traffic, several interrogators could be operating within a few miles of each other, and a transponder might at times be activated by more than one interrogator, resulting in display interference called "fruit." Circuits can be installed to correct most of this, but heavy suppression of the interference may also eliminate the target. ■■

For critical circuits anywhere . . .



Nytronics RF Inductors

Because Nytronics research and development have created an inductor line that bypasses the limitations of the average inductor. Now, engineers have an inductor line that makes possible unprecedented heights of quality and performance. An inductor line that is as close to perfection as it is possible to come.

NEW!

WEE CHIP-INDUCTOR—Magnetically shielded, wrap-around termination permitting contact to either face or ends. Designed to meet MIL-C-15305, Grade 2, Class B. .280" x .195" x .100". Presently available .15 μ H to 1000 μ H.

NEW!

PEE-CEE-DUCTOR—Magnetically shielded Fixed Inductor—Range 0.1 to 100,000 μ H. Designed to MIL-C-15305, Grade 1, Class B. Epoxy molded 0.300" diameter x 0.270" height. Printed circuit mounting—0.200" grid spacing and unit has shielded construction to allow maximum density packaging.

MILI-DUCTOR—Subminiature Unshielded with Inductance Range 0.1 to 1000 μ H. Designed to MIL-C-15305, Grade 1, Class B. Molded Envelope: .095" diameter x 0.250" length.

MS LINE 90537 TYPE—Manufactured in accordance with MS90537, Molded Magnetically shielded with inductance range 0.1 to 100,000 μ H \pm 10% tolerance. Molded Envelope: 0.163" diameter x 0.410" length.

WEE-DUCTOR—Magnetically shielded with inductance range 0.1 to 180,000 μ H, designed to MIL-C-15305, Grade 1, Class B. Encapsulated Envelope: 0.157" diameter x .450" length.

SUPER WEE-DUCTOR—Manufactured in accordance with MIL-C-15305, Grade 1, Class B. Molded magnetically shielded with inductance range 0.1 to 100,000 μ H \pm 10% std. tolerance. Other tolerances and lead materials available on request. Molded Envelope: 0.163" diameter x 0.410" length.

SUPER WEE-WEE DUCTOR—Miniature shielded with inductance range 0.1 μ H to 10,000 μ H. Designed to MIL-C-15305, Grade 1, Class B. Epoxy Molded Envelope: 0.125" diameter x 0.335" length.

VARIABLE INDUCTOR—Unshielded with adjustable range 0.1 to 4700 μ H. Designed to meet MIL-C-15305, Grade 1, Class B. Encapsulated Envelope: 0.400" diameter x 0.500" length. Vertical or Horizontal mounting.

■ NEW CATALOG NOW AVAILABLE!



Nytronics

The quality line of standard components

550 Springfield Ave., Berkeley Heights, N.J. 07922 ■ (201) 464-9300 ■ TWX: 710-984-7977

INFORMATION RETRIEVAL NUMBER 19

Plan national private-line microwave net

Pending FCC go-ahead, firm will offer customized service with infrared and millimeter access loops.

Michael J. Riezenman
Technical Editor

Using his unprecedented victory over the Bell System as a Keystone, John D. Goeken, president of Microwave Communications, Inc., is pushing ahead with plans to build a nationwide private-line microwave communications network. His plans include the use of short-haul infrared and millimeter-wave communications links to connect subscribers with his main microwave net.

The history-making victory was an FCC decision handed down on August 14 (see *ELECTRONIC DESIGN* 18, Sept. 1, 1969, p. 21), which granted MCI permission to operate as a private-line common carrier between Chicago and St. Louis. Now Goeken has announced that a newly formed company, MCI New York West, Inc., has filed for a license to provide similar services between Chicago and New York via two separate routes (see map). Furthermore, a third company, Microwave Communications of America, Inc. (Mi-Com), has been set up in Washington, D. C., to serve as a service organization for a whole system of MCI-type companies that are now in the planning stage.

Both AT&T and Western Union have filed appeals with the FCC asking for reconsideration of the August 14 ruling. But MCI is so confident that the 4-to-3 decision will stand that it is proceeding with the construction of the St. Louis-Chicago system. In fact, construction permits have already been issued, according to Joe O'Byrne, chief engineer at Mi-Com.

Provides customized service

The MCI-type of service differs from that provided by the Bell System and other regulated carriers in two very important ways:

- It is a private-line—not a switched—network.

- It is a very flexible network, providing a wide variety of customized analog and digital services to its subscribers.

The Bell System, of course, is a switched network. Any of its approximately 110 million subscribers can call any of the others by dialing the proper number. By contrast, the MCI-type of system will simply provide a pair of users with a dedicated communications link connecting only themselves. In Goeken's words, "We will be a communications pipe, providing subscribers with exactly the transmission capacity they need for all forms of information, whether it is data, facsimilies, radio communications, teletype or voice."

The phrase "exactly the transmission capacity" is the theme of the MCI concept. Analog communications channels in 48 different bandwidths from 200 Hz to 960 kHz will be provided. And MCI will not dictate to the subscriber what kind of terminal equipment he may or may not connect to his line. Similarly, digital data channels in 20 different sizes from 75 bits/s to 19,200 b/s will be available. And the maximum error rates on these data lines are reported to be 1 in 10^7 .

Pay by the bit

Furthermore, subscribers can have full-time or half-time service, one-way or two-way links—or even two-way links with different capacities in each direction. The result of all this flexibility is economy: *The subscriber will pay only for the capacity he really needs for the time he needs it.*

The half-time service idea would provide a company with a communications link during only its daytime business hours. Then, at

night, the unused capacity of many such companies could be combined to provide some large institutions with very wideband channels at minimal rates for the transmission of data.

A particularly interesting feature that MCI is investigating is the possibility of charging data-channel users on the basis of the number of bits of data that they actually transmit. The key component needed for this operation is a really cheap counter. If one can be made, the MCI network will become attractive to the users of time-sharing computer terminals. Many small time-sharing customers will be able to share a data



A private-line microwave net formed by hundreds of towers like this is being planned by Microwave Communications of America, Inc., and its MCI affiliates. The reflector atop the tower directs energy from the dish at lower right to the next station down the line.

DISPLAY DEVICES

Low-cost display tube operates on low signal voltage.

New "Flurotron" fluorescent indicator tube is compatible with voltage levels available in computers.

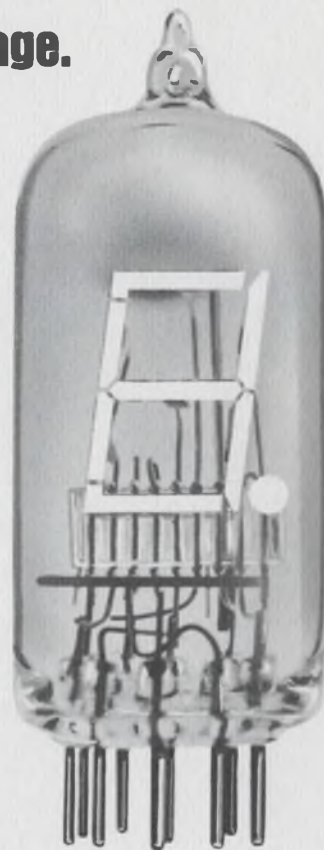
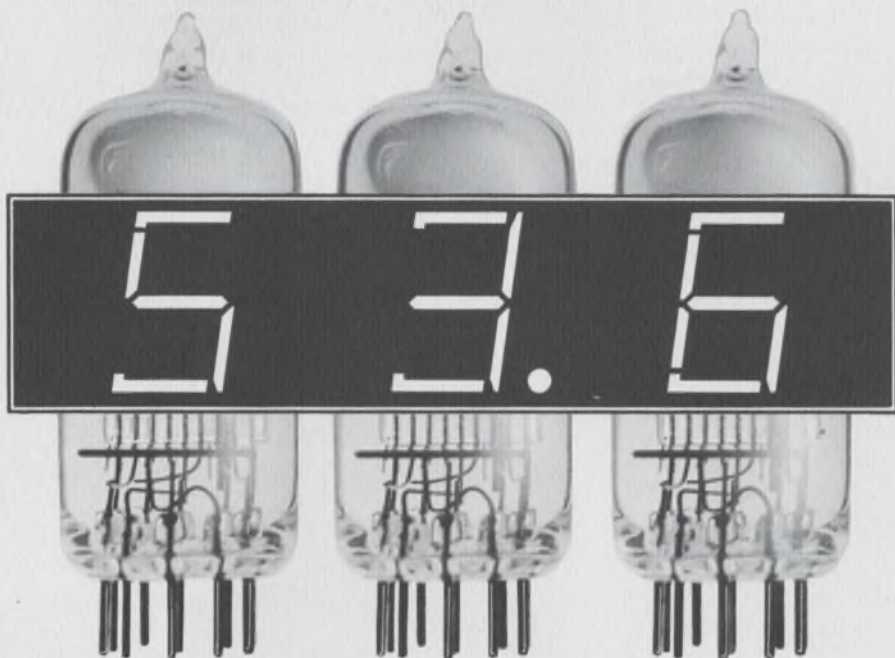

Our new "Flurotron" indicator tube combines the advantages of low cost with low signal and power operation. That alone should make it the device to consider for your next project requiring a numeric readout.

Priced at about $\frac{3}{5}$ the cost of comparable readout tubes, the "Flurotron" is an ideal display device for computer readouts, digital voltmeters, frequency counters and desk calculators. It operates from a 25 Volt signal as compared to 80 to 90 Volts required by other display tubes.

The "Flurotron" works on a simple principle and is not much more complicated than an ordinary incandescent bulb. It consists of directly heated cathode and eight anodes coated with fluorescent phosphor. When a voltage is applied to any of the anodes, they glow green. The anodes are arranged in a "figure-8" configuration (7 segments) so that any number from 0 through 9 can be formed by lighting the appropriate anodes.

Each "Flurotron tube" also includes a decimal point that may be used optionally. All connections to the "Flurotron" are made through a 10-pin base. The tube comes in a T-6 $\frac{1}{2}$ envelope and is designed for extra ruggedness. Light output is on the order of 200 foot-lamberts.

Because all fluorescent segments are located on a single plane near the tube wall, there are no parallax problems. The display can be viewed easily from a wide variety of angles. The in-line display also means that you don't have to look through a maze of unlighted characters in order to see the readout.

The "Flurotron" is a low current device. At 25 Volts, current requirements are only 0.5 mA per anode segment. The specially designed filament operates on only 1.4 Volts at low power drain. Low phosphor persistence provides a high-speed readout capability. With all of these advantages, doesn't it make sense to solve your next display problem with "Flurotron"? **CIRCLE NUMBER 300**

This issue in capsule.

Integrated Circuits

You can mix and match with our functional arrays.

EL Displays

New decoder-driver cuts EL display cost.

Circuit Assemblies

Variety adds spice to circuit board production.

Television

Here's a bright new 17" tube for your line of color sets.

Microwaves

Precision microwave resistors are current controlled.

CRTs

Our CRT designers solve engine tester problems.

Manager's Corner

How to make a good thing better.

INTEGRATED CIRCUITS

You can mix and match with our functional arrays.

No matter which TTL logic system you are designing with, Sylvania arrays will be compatible.

Our functional arrays are versatile. They'll work with any TTL logic system and most kinds of DTL logic, too. They have been specifically designed to have input/output characteristics that interface with all of these logic forms. As you can see from the table, our functional arrays match up with SUHL I, SUHL II, 7400N and 5400/7400 logic families.

The reason for this compatibility is a built-in commonality. All of our functional arrays use a 5-volt supply with TTL logic throughout. All have input/output buffering and all have the high noise immunity common to TTL circuitry. Sylvania functional arrays also have other advantages. They come in military and industrial temperature ranges.

But the really big advantage is the number of different functions available. These include fast adders, storage registers, scratch pad memories, binary and decade dividers and counters. The list shown is the most complete line of functional arrays available in the industry. All units are designed to give you the maximum in functional density at the lowest possible cost. All are available in 14-lead flat packs or dual in-line plug-in ceramic packages.

If you are designing with arrays or thinking of using arrays in your next project, you'll find our functional arrays applications booklet a handy design guide. Just circle the reader service number listed below to get your copy.

CIRCLE NUMBER 301

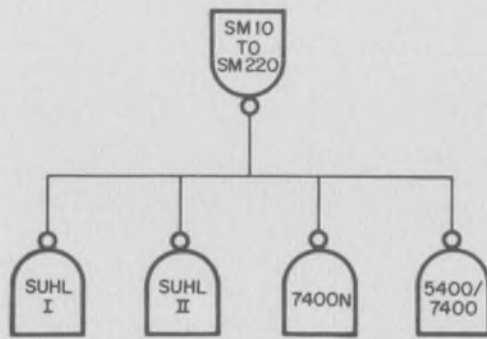

Sylvania arrays interface effectively with four major forms of TTL logic.

Compatibility of Parameters for Different TTL Families

	Logic	V _{cc}	V _{IL}	V _{IH}	V _{OL}	V _{OH}
Arrays	TTL	5	—	—	—	—
SUHL I	TTL	5	0.9	1.4	0.5	2.8
SUHL II	TTL	5	0.9	1.6	0.4	2.7
Sylvania 7400N	TTL	5	0.8	2.0	0.4	2.4
Sylvania 5400/7400	TTL	5	0.8	2.0	0.4	2.4

Functional arrays, typical characteristics (+25°C, +5.0 Volts)

Function	Type No.	t _{pd} (nsec)	Avg. Power (mw)	Noise Immunity +(Volts)—	Fanout
Full Adder	SM10 Series	Sum 22 Carry 10	90	1.0 1.0	These arrays are available in fanouts up to 15 and are completely compatible with SUHL I, SUHL II, and other TTL integrated circuits.
Dependent Carry Fast Adder	SM20 Series	Sum 22 Carry 10	125	1.0 1.0	
Independent Carry Fast Adder	SM30 Series	Sum 22 Carry 10	125	1.0 1.0	
Carry Decoder	SM40 Series	2	25	1.0 1.p	
4-Bit Storage Register	SM60 Series	20	30/bit	1.0 1.0	
Bus Transfer Output 4-Bit Storage Register	SM70 Series	20	30/bit	1.0 1.0	
Cascade Pullup Output 16-Bit Scratch Pad Memory	SM80 Series	25	250	1.0 1.0	
Decade Frequency Divider	SM90/92 Series SM91/93 Series	35MHz 30MHz	125 85	1.0 1.0 1.0 1.0	
4-Bit Shift Register	SM110 Series	25MHz	120	1.0 1.0	
Parity Generator/Checker	SM120 Series	22	125	1.0 1.0	
Comparator	SM130 Series	17	120	1.0 1.p	
Programmable Binary Divider	SM140 Series	25MHz	150	1.0 1.0	
Programmable Decade Divider	SM150 Series	25MHz	150	1.0 1.0	
Binary Counter	SM160 Series	25MHz	135	1.0 1.0	
Decade Counter	SM170 Series	25MHz	135	1.0 1.0	
Binary Up/Down Counter	SM180 Series	25MHz	205	1.0 1.0	
Decade Up/Down Counter	SM190 Series	25MHz	205	1.0 1.0	
BCD to 7-Segment Translator	SM200 Series	85	280	1.0 1.0	
Dual 4-Bit Multiplexer	SM210 Series	10-20	130	1.0 1.p	
Demultiplexer	SM220 Series	9-14	225	1.0 1.0	

EL DISPLAYS

New decoder-driver cuts EL display cost.

Compact unit plugs directly into back of electroluminescent display panel.

We've made a major reduction in both the size and cost of decoder-drivers for electroluminescent displays. Our new SME-160 and SME-161 decoder drivers have the lamp socket as a part of the printed circuit card. As a result, these units plug in directly to the back of the EL panel. A separate lamp socket is eliminated thus reducing the cost of the entire assembly.

The decoder-driver socket has been specifically designed to mate with the 1" size numeric digit and takes up only $\frac{1}{16}$ " of mounting depth behind the panel. Width of the driver module has been held to the width of the display digit, so that it is possible to mount individual modules side by side in multi-digit displays.

If you want to use these decoder-drivers with $\frac{1}{2}$ " digit sizes, we have a special adapter panel available to interface between the display panels and the decoder which is limited to two digits. For digit sizes larger than 1", adapter panels can be made with no restrictions on the number that can be mounted side by side. Use of the adapter panel increases mounting depth to approximately $\frac{3}{4}$ " behind the panel.

Electrically, the SME-160 and SME-161 decoder-drivers are identical to the larger and more expensive SM-158 and SM-159 modules. All special functions such as leading-edge zero suppression, lamp intensity modulation and lamp test input are standard features of these modules.

These modules are just one more reason for considering electroluminescent displays for all types of readouts. Among the many advantages of EL is the fact that catastrophic failures just don't happen. Power consumption is minimal. It takes as little as 1 mA at 250 Volts to drive a $\frac{1}{2}$ " EL numeric. Because of the low power levels, EL devices are cool running. There are no heat dissipation problems. In addition, the spectral output of an EL display closely matches the response curve of the human eye.

CIRCLE NUMBER 302

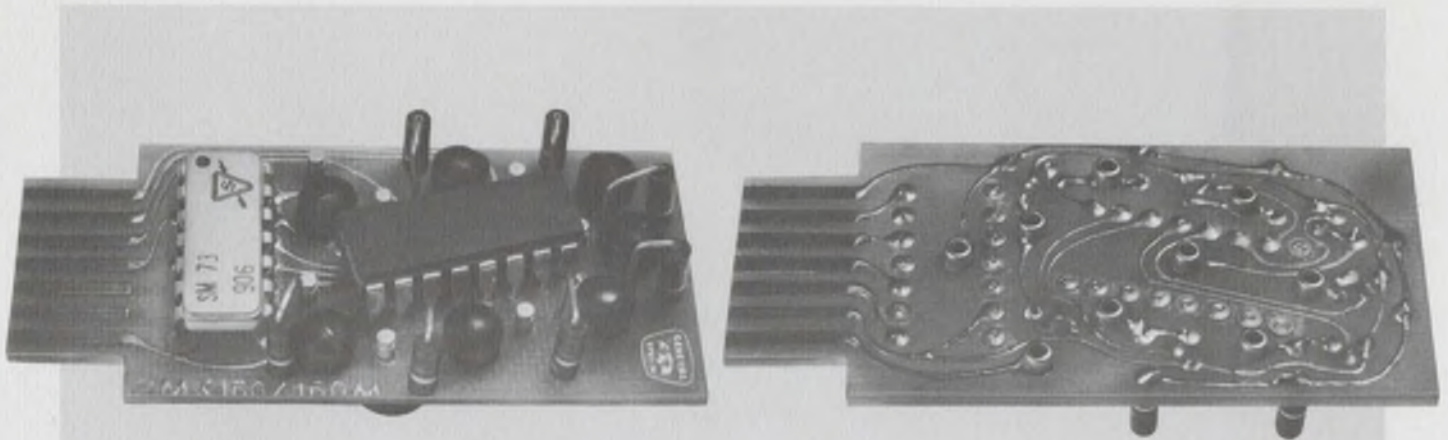

Decoder-driver mounts on the rear of 1" EL display.

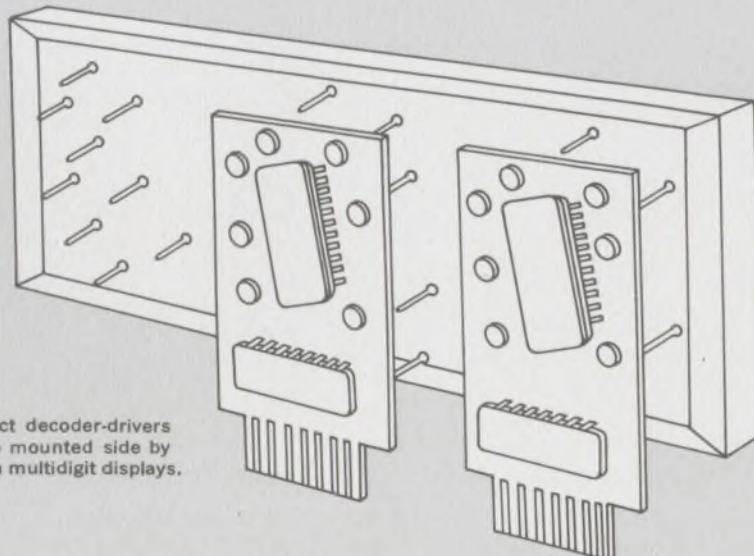

Compact decoder-drivers can be mounted side by side on multidigit displays.

CIRCUIT ASSEMBLIES

Variety adds spice to circuit board production.

Our circuit assembly facility is capable of taking on jobs with a wide variety of requirements.

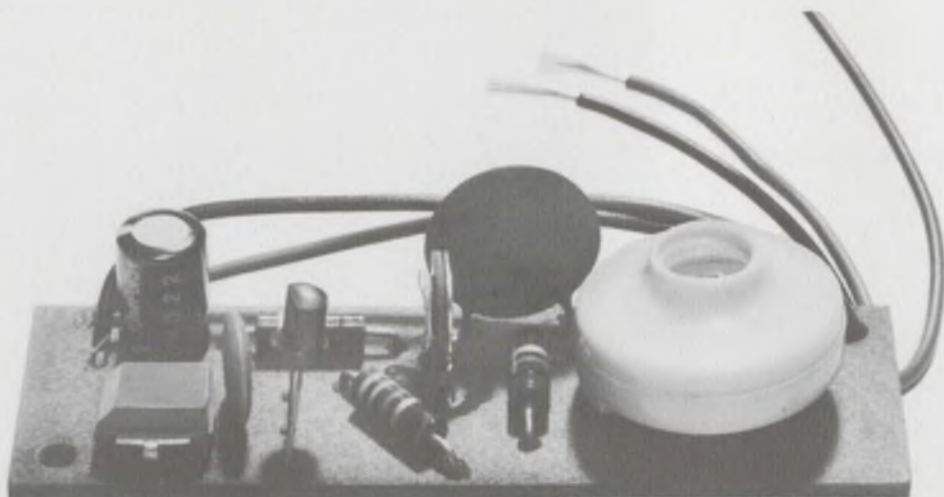

Simple circuit assembly for children's toy was turned out in large quantities at low cost.

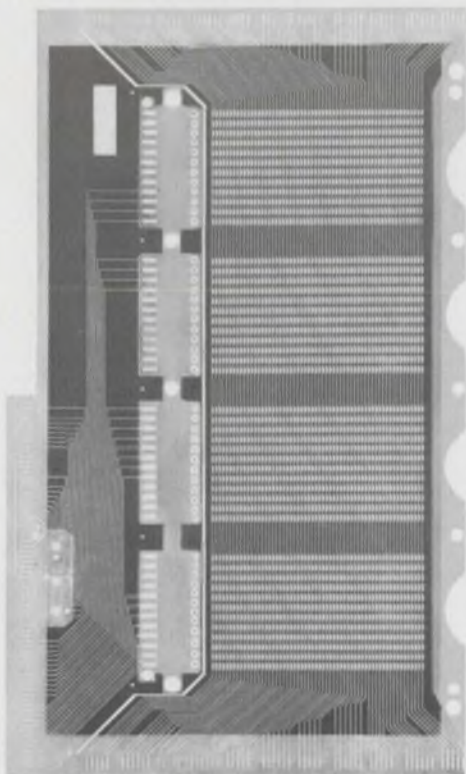

Large-size computer board holds 0.0005" tolerances over 20" span.

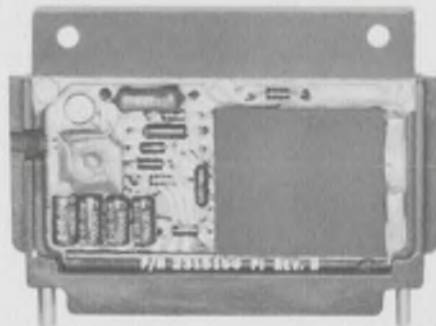

We've produced 20,000 of these NAFI modules in 82 different types.

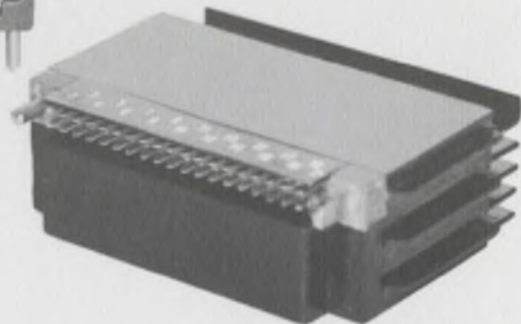

Not all printed-circuit board and circuit assembly production have the same standards of quality and reliability. Some jobs are high volume, some are low. But they all have one thing in common. They have to meet the customer's requirements. We at Sylvania have a high degree of flexibility built into our operation. As a result, we can handle work requiring ultra-high reliability for space missions or low-cost circuits for children's toys.

Here are four case histories that illustrate our flexibility and show how we can meet the varying requirements of our customers:

High reliability, high production—In our NAFI program, we have turned out over 20,000 printed-circuit assemblies in 82 different types. These modules are part of the Navy's Standard Hardware Program and have been used in the Fire Control and Guidance System for the Poseidon missile system. Of course, high reliability was a must. Specs called for a 30,000-hour operating life with a 10-year shelf life. In this project, we were supplied with input/output requirements. Our engineers were responsible for component selection, circuit layout, packaging

density to meet thermal and reliability requirements. **Ultra-high reliability, low volume**—Only 50 circuit boards were shipped to the customer in our lunar module circuit board production. But, very tight tolerances on these single and double sided boards made this a special project. Tolerances on these very high packing density boards were held to 0.0020" to 0.0025". Each board was inspected under 30 power magnification to make sure it measured up to specs.

Similar tight specs were required on a subassembly we made for Minuteman missile launch complex. These sub-assemblies are used in a checkout system and for a multi-aperture ferrite core driver.

High volume, commercial application—Typical of our capabilities for commercial applications is a circuit board made for a large computer manufacturer. This large-size board required holding dimensional tolerances of 0.0005" over a 20" span. Our fast-turnaround capability enabled us to get into production at a rate of 1200 boards a day only four weeks after start-up. **High volume, low cost**—A toy manufacturer needed a simple audio-activated control for a children's toy. He needed them at low cost and in large volume. We were able to come up with the assembly that would do the job for him. And we were able to produce them at the rate he needed—up to 2400 assemblies per day

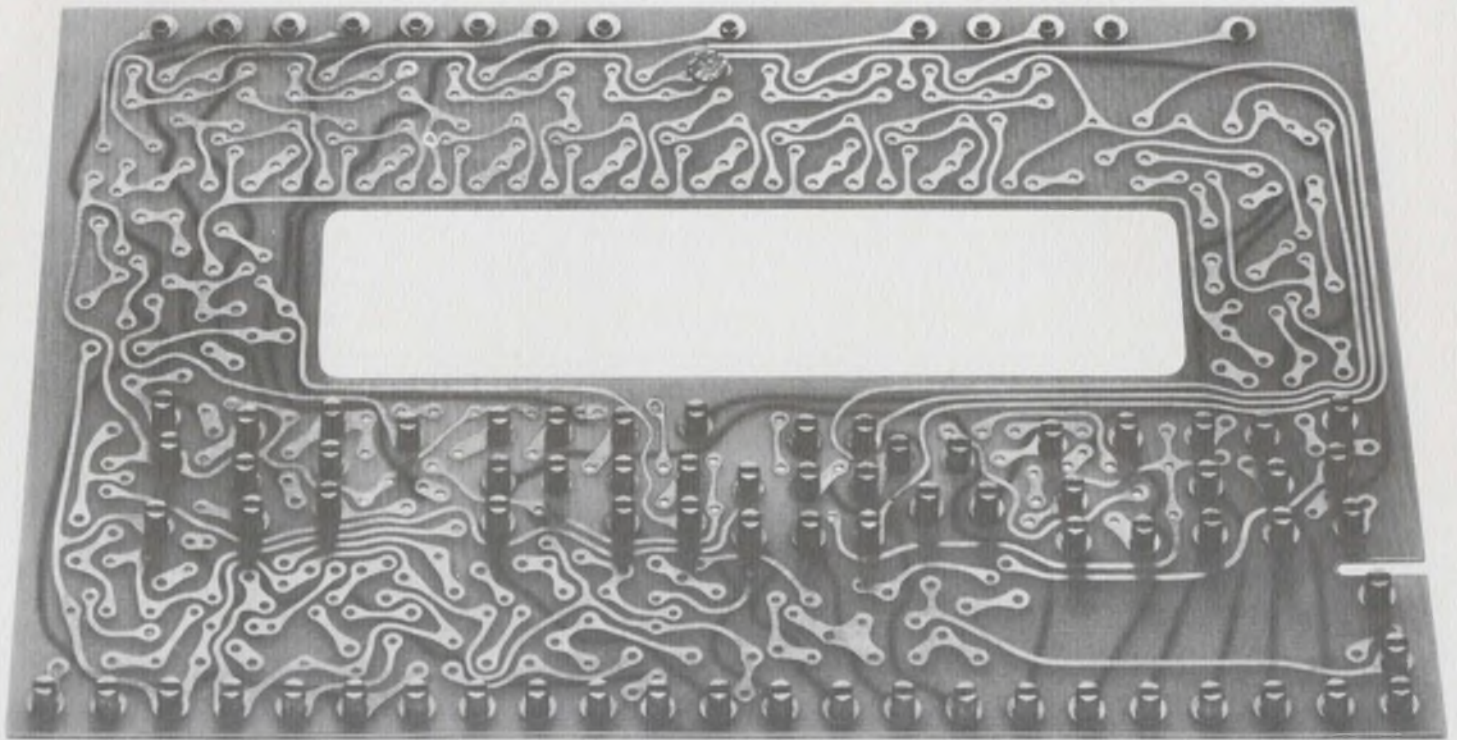

Circuit boards for lunar module required extremely tight specs in a small production run.

with 100-percent testing for the desired audio sensitivity.

As you can see, we can work with a wide variety of circuit and assembly board requirements, both military and commercial. And we'll work with you from any stage of the

game—from the drawing board, breadboard or from your own artwork. Our fast turnaround capability will enable us to meet your most demanding specs, whether they involve time, volume or tight tolerances. CIRCLE NUMBER 303

TELEVISION

Coming: a bright new 17" tube for your line of color sets.

New addition to color bright 85[®] line gives you a complete choice of sizes from 15" to 26" in 90° color tubes.

All of the well-known advantages of Sylvania's *color bright 85*[®] color picture tube line will be available in a 17" size. The new tubes, types ST-4773A and ST-4774A, are identical except that the ST-4774A comes with integral mounting brackets.

Both tubes utilize the Sylvania developed Europium activated yttrium vanadate phosphor that gives brighter reds. Brighter blues are obtained from an improved phosphor and brighter greens are attained by altering the chemical composition in conjunction with a change in particle size and distribution on the screen.

The brightness of the overall tube is further improved by Sylvania's patented process of depositing the phosphors in a dry state. This unique process optimizes the physical and chemical parameters that influence brightness and uniformity of coating.

As with all *color bright 85* tubes, an aluminized faceplate is used for enhanced brightness. A 48-percent neutral gray filter glass face panel is used to improve picture contrast.

These 17" color tubes also incorporate a low focus electron gun that provides circuit savings by eliminating the



Type ST-4774A color tube comes with integral mounting lugs.

need for an intermediate high-voltage supply. Generally, the depth of focus is very broad and the three electron guns can be focused sharply at a particular compromise focus voltage.

Each tube provides a 145-square-inch-usable viewing area and has kimcode implosion protection. This system eliminates the need for an integral protective glass cap of a separate safety-glass window. Another benefit is reduced weight. This tube type will be available in production quantities in 1970. CIRCLE NUMBER 304

MICROWAVES

Precision microwave resistors are current controlled.

Series resistance of PIN diodes is tested and specified over their operating range.

Now we've added an entirely new family to our PIN diode line. By specifying the series resistance of these diodes over their operating range, we can tell you exactly the resistance you will get at any current level. The result—a precision current-controlled microwave resistor.

These resistors are useful from 10MHz to X-band depending on the mounting structure. We classify them into the six categories shown in the charts to assure close tracking of series resistance from unit to unit.

This family of PIN diodes is fabricated by diffusing P-type impurities into one side of a wafer that has an epitaxially grown high-resistivity layer. This intrinsic layer provides the PIN diode with its unique properties at microwave frequencies. At low frequencies, these devices exhibit rectification properties as a PN junction does; however, at higher frequencies charge storage in the intrinsic region prohibits rectification.

The current-controlled microwave resistor has many uses in the RF and microwave regions. It can be used as a device for building precision attenuators, modulators, leveling circuits, AGC circuits, and many other circuits where a low frequency of DC controlled microwave resistor is needed.

CIRCLE NUMBER 305

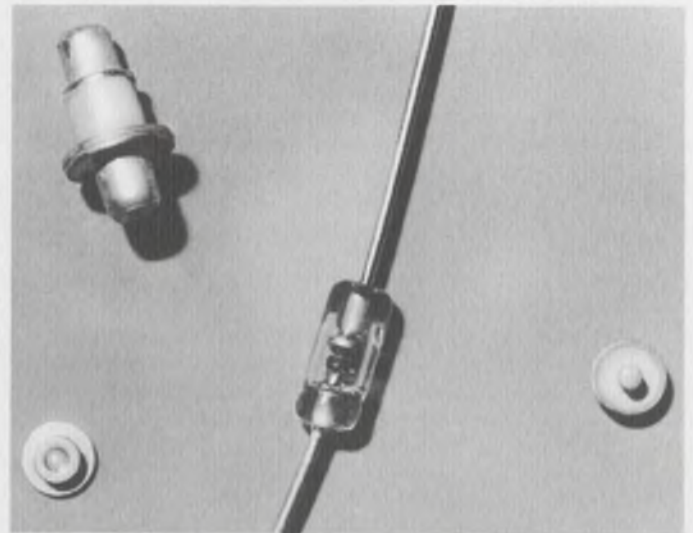

Current-controlled resistor family is available in a variety of package configurations.

Absolute maximum ratings:

Total Power Dissipation	P_T	See Note 1
Peak Power Handling Capability	P_P	to 10 Kw
Reverse Working Voltage	V_R	At breakdown voltage
Storage Temperature	T_{stg}	175°C
Operating Temperature	T_{opr}	150°C
Switching Time	T_s	4 nanoseconds typical

Note 1: $P_T = 150^\circ\text{C} - T_A$

$$R_{TD} + R_{TM}$$

P_T = Total Power Dissipation

T_A = Ambient Temperature

R_{TD} — Thermal Resistance of Diode

R_{TM} — Thermal Resistance of Mount

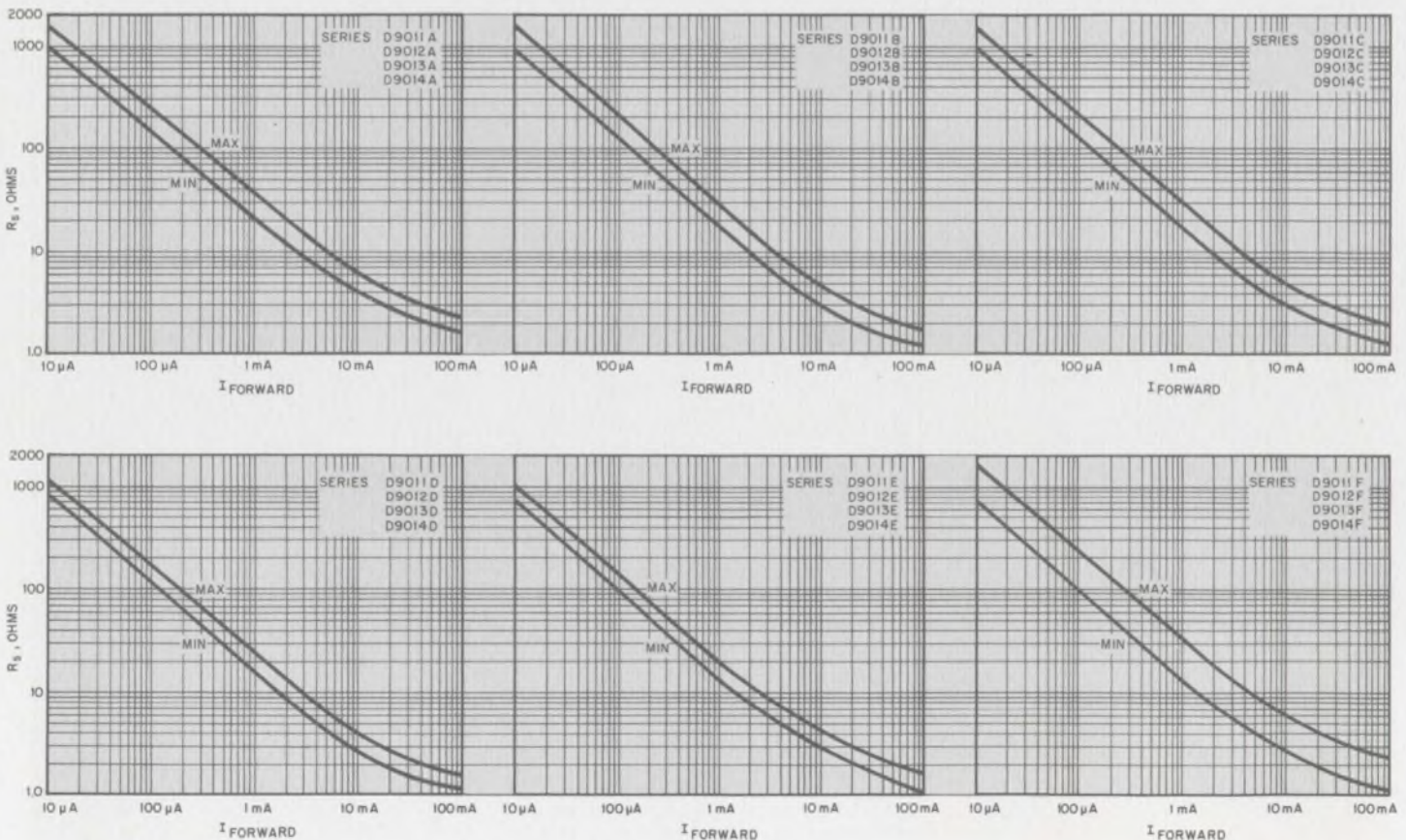

CRTs

Our CRT designers solve engine tester problem.

Unique scope requirement met by modified conventional TV tube.

When Sun Electric Corporation was developing its new 1120 electronic engine tester, everything was progressing smoothly except the scope for ignition-system testing. The scope is used to show primary and secondary ignition patterns in three different display positions (for easier diagnosis), and can also be used to test coils both on and off the engine.

The advanced design for the 1120 called for a CRT that was bigger in viewing area, yet smaller in overall size than previous tubes. The problem was that such a tube didn't exist. Sylvania's CRT engineers came up with a modified version of a conventional television picture tube that filled the bill perfectly. The result—a perfectly satisfactory display at a cost far less than that of a custom design. It is a 12" black-and-white tube modified for 6.3-Volt, 450-mA heater operation.

The tube has a rectangular gray filter glass faceplate with a viewing area of 74 square inches. The short neck—only 3.75 inches—made it possible to fit the tube into the cabinet of the engine tester. It also features a bonded frame integral implosion-protection system that eliminates the need for an extra safety-glass faceplate.

As used in the automotive tester, the Sun scope provides test facilities for analyzing all types of ignition systems. Sun uses a specially treated reticule faceplate to minimize annoying and distracting light reflections. The tester can be used on both conventional and transistorized ignition systems. The brilliant pattern retains constant width regardless of engine speed and the patterns can be displayed independently or superimposed just by flicking a switch.

This application of Sylvania CRT's is just another example of how our extensive background in industrial, military and commercial cathode-ray tube design can be put to work for you. If you've got a CRT problem, talk to us. We've got the men that have the answers.



Sun ignition scope uses conventional television picture tube specially modified by Sylvania.

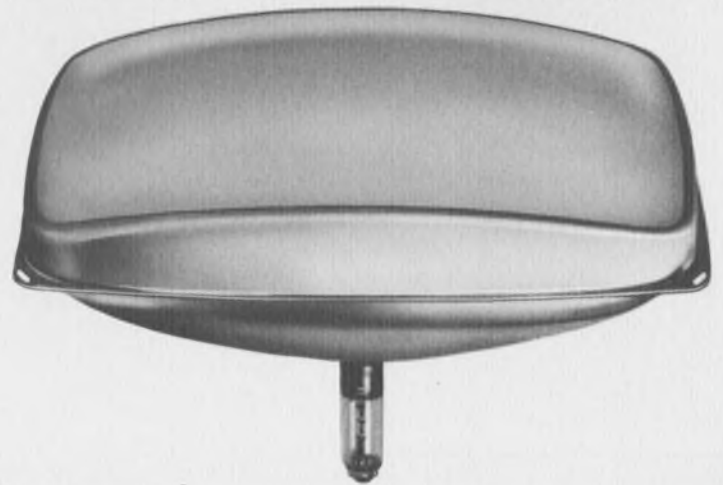

CIRCLE NUMBER 306

SEE OUR SPECIFICATIONS IN
VSMF
MICROFILM CATALOG FILE

Use Sylvania's "Hot Line" inquiry service, especially if you require full particulars on any item in a hurry. It's easy and it's free. Circle the reader service number(s) you're most interested in; then fill in your name, title, company and address. We'll do the rest and see you get further information by return mail.

BUSINESS REPLY MAIL
No Postage Stamp Necessary if Mailed in the United States

FIRST CLASS
Permit No. 2833
Buffalo, N. Y.

POSTAGE WILL BE PAID BY

Sylvania Electric Products Inc.
Sylvania Electronic Components
1100 Main Street
Buffalo, New York 14209

Dept. D 8 8 8

MANAGER'S CORNER

How to make a good thing better.

With all the talk about LSI, beamlead devices, computer-aided design, and other such glamorous happenings, the so-called typical engineer has relegated the receiving tube to a respected, but nonetheless lowly, slot in his thinking.

That's certainly not the case at Sylvania's receiving tube operation. Here our engineers are faced daily with the task of monitoring and constantly improving the performance and reliability of the "old workhorse" of the electronics business. And that's a full-time job, largely due to the demands of color television for better performing components at lower cost.

Particularly noteworthy from performance and reliability standpoints were sharply increased tube requirements for critical socket areas, such as horizontal deflection, vertical deflection, damper and horizontal regulation. The performance objectives of these sophisticated circuits were such that they uncovered problem areas in tube engineering not previously encountered. The problems of arcing, heat dissipation, thermal stress, heater failure and slumping emission, became increasingly magnified.

As a result, our engineers had to go back to their electronics, chemistry and metallurgy textbooks and came up with some basic state-of-the-art advances. For example—

(a) Cathode coatings with powdered nickel additive and reduced sodium content to improve emission, coating adherence to the cathode sleeve, and reduction of arcing.

(b) Reduction of heater wire crystallization and long life failures by the use of rhenium tungsten heater wire.

(c) Precise control of cathode materials by the use of powdered metals.

(d) Improvement of heat dissipation and transfer within

the tube by new and "sandwich-type" plate materials.

Sylvania also took a fresh look at mechanization and automation of manufacturing techniques and how they could be applied to tube production. Our Equipment Development organization for many years has provided Sylvania manufacturing plants with the highest caliber, most modern production machinery in the industry. Reduction or elimination of variables typical of manual methods has been accomplished by auto-grid machines, auto-mount assembly, auto-welding, auto-heater winding, auto-testing, etc. Uniformity of parts and sub-assemblies used in the finished tube has been amazingly well controlled, and uniformity and reliability of the finished product are natural results.

In a highly sensitive device, such as an electronic tube, cleanliness is synonymous with quality. Sylvania has sharply increased the use of controlled atmospheres (filtered air, temperature and humidity controls) in its manufacturing areas to reduce another group of variables adversely affecting product uniformity and reliability.

Sylvania's adherence to rigid quality control principles is well recognized. Its tube making organizations are essentially quality-oriented, with broad-based quality departments defining and monitoring all materials and processes from the raw material stage to the finished product. These are highly technical groups, well disciplined and with authority to take immediate action when the product quality deteriorates.

Sylvania's receiving tube organization gladly accepts the challenge of providing and maintaining the highest quality and reliability to the users of its products.

William J. Bowes

W. B. Bowes
Operations Manager, Receiving Tubes

This information in Sylvania Ideas is furnished without assuming any obligations.

SYLVANIA

GENERAL TELEPHONE & ELECTRONICS

NEW CAPABILITIES IN: ELECTRONIC TUBES • SEMICONDUCTORS • MICROWAVE DEVICES • SPECIAL COMPONENTS • DISPLAY DEVICES

D8

NAME _____

PLEASE PRINT

TITLE _____

COMPANY _____

ADDRESS _____

CITY _____ STATE _____ ZIP _____

Circle Numbers Corresponding to Product Item

300	301	302	303	304
305	306			

Please have a Sales Engineer call



HOT LINE INQUIRY SERVICE

Need information in a hurry? Clip the card and mail it. Be sure to fill in all information requested. We'll rush you full particulars on any item indicated.

You can also get information using the publication's card elsewhere in this issue. Use of the card shown here will simplify handling and save time.

link, just as they share a computer. This will substantially reduce the communications costs of remote computation—an important factor now limiting the growth of this area.

Segregation in communications

A major technical difference between the MCI operation and the Bell System is that MCI plans to keep its analog and digital transmission channels completely separate. Each microwave carrier will support a baseband bandwidth of 8.5 MHz divided into three master groups of about 2.4 MHz each. Initially at least, the upper two master groups will be standard single-sideband analog systems, but the bottom master group will carry a digital bit stream onto which all data traffic will be multiplexed in serial form. Of course, a subscriber who chooses to send digital data over an analog line is free to do so, but the digital system will provide lower error rates and greater economy.

The low error rate is achieved by employing regenerative repeaters for the digital signals. And also, Goeken is quick to point out, the impulse noise problems associated with a switched network will be eliminated.

Regenerative repeaters actually produce a new pulse for every one they receive rather than merely amplify what's given to them. In this way, the accumulation of distortion and errors that analog repeaters can cause is avoided.

In the initial system, only one three-master group carrier will be used. Actually, the same information will be placed on two different carriers to provide frequency-diversity protection against fading. Then, as the number of subscribers grows, additional carriers will be added. The analog-digital mix on the new carriers will be determined by user demand. Thus, if data traffic grows as rapidly as many people expect it to, some of the added carriers may be devoted entirely to digital traffic.

New market for exotic equipment

If the communications revolution that John Goeken and his associates at Mi-Com are starting is suc-

WE'VE GOT A BETTER WAY TO MAKE PRINTED CIRCUITS!

Here's some Industrial History you should know!

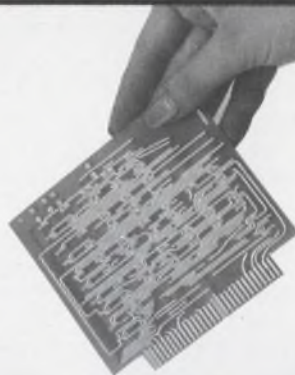

F-104

Developed new technique to produce circuit boards with more reliable plated-thru holes.



F-111

New industry technique was used to produce multilayer circuit boards with an internal heat sink.



707

Reliable circuit boards in high volume at low cost were produced for this project.



C5

We introduced circuit boards that had the highest density circuitry ever used before on a production basis.



OTHERS

Hundreds of projects use our circuit boards in all phases of civilian and military equipment. We've got a better way to make printed circuitry.



PHOENIX

Required new techniques for manufacturing heat sinks and insulation by chemical milling.



POSEIDON

Developed new technology for sequential laminating multilayer circuit boards with aluminum backbone.



MERCURY

Our company used a unique etch-back method for plated-thru holes in large quantities.

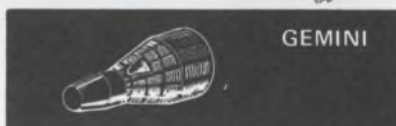

GEMINI

Again, top reliability was required and delivery on-time was made to the customer.



APOLLO

Our circuit boards were on Apollo, LEM, and seis. experiment. Sequential laminating, extra-fine line width and spacing, plated slots and edges.

This design & production experience can give you a BIG JUMP on your next project. CALL US NOW!

CONTROL DATA CORPORATION

CONTROL DATA CORPORATION

PRINTED CIRCUITS OPERATION
7800 COMPUTER AVENUE
MINNEAPOLIS, MINN. 55435
PHONE: (612) 920-8600

(MCI net, continued)

cessful, a vast new market for exotic communications gear will open up. In addition to the garden-variety type of multiplexing and microwave gear that the main microwave network will use, the operation will create demands in the following three areas:

- Short-haul infrared and millimeter-wave transmission equipment.
- Customer-owned multiplexing gear.
- Terminal devices.

The infrared and millimeter-wave gear is needed for the all-important local loops that will connect subscribers with the microwave net. Of course, standard Bell System lines are available for this function where the customer's terminal equipment, data rate and bandwidth are compatible with Bell's lines. The whole point of the Mi-Com system however, is that it does things that Bell doesn't do.

"Up until the MCI decision," Goeken told *ELECTRONIC DESIGN*, "there was technical interest in infrared and millimeter-wave equipment, but no market. Who needed a one-to-three-mile communication system?"

Now the picture may change.

"The market we're talking about is maybe 10,000 units over the next two to three years. And if the FCC licenses our other planned routes, that figure will prove very conservative," he said.

The units Goeken is talking about are infrared transmitters and receivers for installation on the tops of office buildings and the nearest microwave relay tower. The operating range of such units today is only about a half to one mile. But, as Goeken points out, there are a lot of potential customers within a mile of, say, the Empire State Building, in New York City.

He envisions an infrared system, aimed at the Empire State Building, on top of most office buildings in the city. All of the subscribers in the building, he says, would share the unit's cost and gain access to it through a cable running down a shaft in the building.

Another possibility for the local loops is millimeter-wave radio. Goeken points out that 18-GHz equipment is already available, but he'd rather work in the 50-GHz band because he foresees spectrum crowding around 18 GHz in the future. He said that his system might start out using 18-GHz gear and then change over to 50-GHz when the higher-frequency equip-

ment becomes available.

He was careful to point out that neither Mi-Com nor any of the MCI-type carrier companies has any intention of going into the hardware manufacturing business. He hopes that existing manufacturers will recognize that he and/or his subscribers are potentially very large customers, and that development efforts will be stepped up in these areas.

Anything goes

In the area of customer-owned multiplexing gear the possibilities are endless. The microwave net will provide a user with a piece of bandwidth on a carrier and permission to bolt his own equipment to a microwave tower, if desired. Anything the customer wants to do with his channel is OK. Portions of the customer's spectrum could be used as voice channels, others might carry video, some might be reserved for mobile radio communications, etc. The mobile radio would probably communicate directly with the nearest MCI tower by radio. Voice channels could be multiplexed together right at the customer's offices and then beamed to an MCI site by means of an infrared beam.

In the terminal equipment area, also, new vistas will be opened. With the wide variety of bandwidths and data rates that will be available, men's imaginations will be the only limiting factors.

For example, facsimile machines like the Xerox Telecopier today take six minutes to transmit a single 8½ × 11-inch image over standard telephone lines. This is too time-consuming and costly for people who want to send hundreds of pages of printed copy. But if low-cost high-speed lines are made available, a demand will be created for much faster telecopiers.

When will all of this happen? The answer, of course, lies with the FCC and the giant regulated common carriers. MCI New York West filed for its license on September 17. Interested parties have 60 days from that date to file objections. So far, no one has said anything. Meanwhile John Goeken and many other interested parties are waiting for Ma Bell's big shoe to drop. ■■

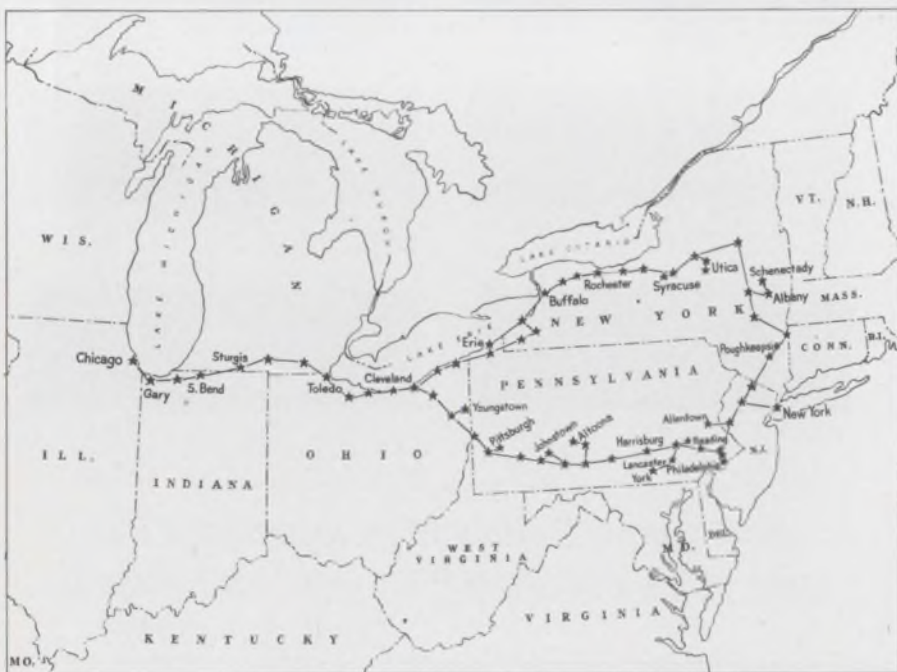

Two routes are proposed for the MCI New York West system connecting Chicago and New York. Stars indicate the location of microwave relay stations. Another route connecting Chicago and St. Louis has already been approved. Several others are in the planning stage.

ALLEN-BRADLEY

Metal-Grid resistor networks
combine a new measure of

precision, stability and performance in a sealed, compact package



Precision Metal-Grid resistor network shown
approximately 1½ times actual size

The advanced capabilities—developed from years of manufacturing Allen-Bradley Metal-Grid resistors—are now applied to a new line of resistor networks. This technology enables the production of complex resistive networks on a single substrate.

Allen-Bradley's exclusive simultaneous deposition method is used to obtain the best resistance tolerance and temperature coefficient matching. The reliability of interconnections on the common resistance plane is incomparable. Uniformity and quality are inherent in A-B networks. To illustrate, 2 PPM temperature tracking is normal.

A-B Metal-Grid networks offer a wide range of values—with individual resistances as low as 25 ohms and as high as 30 megohms. Both the inductance and capacitance are low, permitting efficient operation at high frequencies.

For additional details, please write to Marketing Department, Electronics Division, Allen-Bradley Co., 1201 S. Second St., Milwaukee, Wisconsin 53204. In Canada: Allen-Bradley Canada Limited. Export Office: 1293 Broad Street, Bloomfield, New Jersey, U.S.A. 07003.

BRIEF SPECIFICATIONS

Resistor Networks

Tolerances: $\pm 1.0\%$ to $\pm 0.01\%$
Resistance Matching: to 0.005%
Temperature Range: -65°C to $+175^{\circ}\text{C}$
Temp. Coef.: to ± 3 ppm/ $^{\circ}\text{C}$
Load Life (Full load for 1000 hr @ 125°C): 0.2% maximum change

Ladder Networks

Full Scale Accuracy: 12 bits or less, better than $\pm \frac{1}{4}$ least significant bit. More than 12 bits, better than $\pm \frac{1}{2}$ least significant bit.
Frequency Response: Less than 100 nanosecond rise time or settling time
Temp. Coef.: Less than 10 ppm/ $^{\circ}\text{C}$
Temperature Range: -65°C to $+175^{\circ}\text{C}$

ALLEN-BRADLEY
QUALITY ELECTRONIC COMPONENTS

Infrared sensors star in new displays

Infrared sensors are becoming increasingly important in converting scientific information to a form that can be displayed and readily understood. New potentials of applying a relatively old technology to unusual situations was stressed at last month's Electro-Optical Systems Conference held at the Coliseum in New York City.

"Thermal mapping" has now been proposed not only for gathering and displaying terrain information from the air, but also for detecting faulty equipment in electrical power generating stations, tracing hot-water effluent in waterways, producing thermal contours of ablating nose tips of space vehicles, and aligning the optical systems of infrared lasers.

Systems design for military

A paper by Peter J. Walsh and R. Spencer of Lockheed Electronics Co., Houston, Tex., described how infrared scanning/imaging systems produce outputs in the form of a strip map on film. These maps bear a striking resemblance to the characteristics of terrain observed visually. Formerly, these systems—designed for military reconnaissance—were classified. Now some of this equipment may be used in scientific remote sensing programs where "useful" data can in fact be obtained from them, according to the authors.

Walsh and Spencer point out that the instruments likely to be available to civilian scientists encompass a wide spectral band, and so the designation "thermal mapper" is perhaps a misnomer. Their paper discussed the general form of response equation for systems of this type.

Thermal mapping in the electric power industry was the subject of a paper by George B. Ordway of Barnes Engineering Co., Stamford, Conn., and J. A. Brouillard of the Hartford Electric Light Co., Hartford, Conn. In this connection,

infrared sensing systems were proposed as detectors to prevent interruption of electric service caused by equipment failures. The authors also showed how such sensors can monitor steam condenser coolant effluent that is discharged into rivers and lakes. Infrared thermograms were used to illustrate these applications.

Use for space-vehicle nose tip

A rather unique thermal mapping system was developed at Cornell Aeronautical Laboratory Inc., Buffalo, N. Y., to obtain a surface temperature history of the nose tip of a space vehicle re-entering the atmosphere. To do this would normally require a large number of radiation pyrometers. The simplified system proposed by J. F. Newton and H. M. Maynard of Cornell Aeronautical and Donald Howey of AVCO M.S.D., Cincinnati, Ohio, used a large-format motion-picture camera that incorporated a means for calibrating the amount of exposure for each frame with a specific surface temperature.

A flying spot scanner interfaced

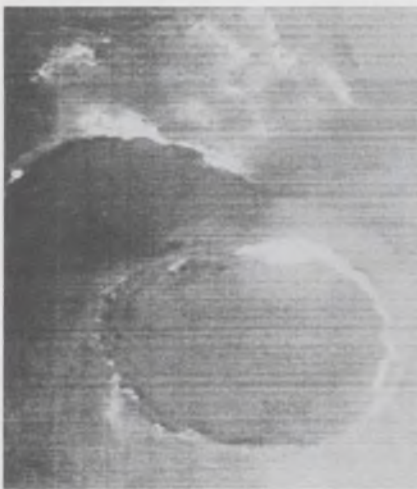

Infrared image of the summit of Mt. Rainier, Washington, shows areas of abnormal volcanic heat near the two summit craters.

with an IBM 360 computer records film density as a function of spatial coordinates. The resulting data is then read back onto the film to produce a vari-colored temperature contour map of the ablating nose tip. Resolution is that of a 1024×1024 element matrix. Information can be read out of the computer in 20 seconds. Temperature resolution according to the authors, is 20 to 30 degrees Kelvin. The motion picture camera takes up to 20- to 70-mm frames per second.

Color changes with temperature

In the area of laser research, infrared detectors have been made using liquid crystals. P. J. Allen of the Naval Research Laboratory, Washington, D. C., placed liquid crystals in tiny gelatin capsules (20 to 30 microns in diameter). The color of visible light scattered by liquid crystals changes with temperature. Thus an area heated by a laser beam is clearly defined by a color change.

Allen constructed two types of detectors, both with 4-inch-diameter screens composed of encapsulated liquid crystals. The more sensitive detector uses an encapsulated liquid crystal Mylar film stretched over a heater plate. The plate provides a thermal bias to establish optimum sensitivity. With this unit, Allen says he can detect an infrared laser beam of 10 mw/cm² or less.

The second detector uses encapsulated liquid crystals on a solid black anodized solid aluminum body that acts as a heat sink. This device is less sensitive but has good image resolution and fast response. Infrared light at 10.6 microns will produce a visual indication with an incident flux as low as 250 mw/cm².

The conference was sponsored by Electro-Optical Systems Magazine. The magazine's publisher, Milton S. Kiver, was the conference chairman. ■■

NEW



New Allen-Bradley hot-molded Type GD dual variable resistor shown actual size

**TWO
IN
ONE**

Allen-Bradley hot-molded dual variable resistor

Here's the most compact two section variable resistor currently available—the new Allen-Bradley dual Type GD. It's one-half inch in diameter and only a fraction of an inch longer than the popular single section type G control. The case is dust-tight as well as watertight. ■ Both resistance tracks in the dual Type GD are solid, hot-molded elements, which provide long operating life. As with the single Type G, the noise level is low initially and actually decreases with normal use. Adjustment is smooth at all times with virtually infinite resolution. And low inductance permits operation at frequencies far beyond the usable range of wirewound controls. ■ In addition to standard application, these new dual Type GD controls are ideally suited for use in compact attenuators. ■ Dual Type GD controls are available with nominal resistance values from 100 ohms to 5.0 megohms. You can get immediate delivery at factory prices from your authorized A-B industrialelectronics distributor. Or write: Marketing Dept., Electronics Div., Allen-Bradley Co., 1201 S. Second St., Milwaukee, Wis. 53204. Export Office: 1293 Broad St., Bloomfield, N.J., U.S.A. 07003. In Canada: Allen-Bradley Canada Limited.



ALLEN-BRADLEY
QUALITY ELECTRONIC COMPONENTS



We make components for guys who can't stand failures.

Everybody hates failures in their electronic gear. It's just that some guys hate failures a little bit more than others.

These are the guys that we try to please.

At Corning, we make our resistors and capacitors to perform like your whole system depended on them, because many times it does. We build an extra measure of performance into all our components to let you build extra reliability into the equipment you design.

Take our precision tin oxide resistors, for example. They're the best of the metal film class. Because the resistive tin film is completely oxidized and molecularly bonded to the glass substrate, our tin oxide resistors are impervious to moisture and environmental degradation. No other resistor can deliver the same stability and reliability over load life. They offer guaranteed moisture resistance across all ohmic values to set a standard of reliability that can't be matched by metal film, wire wounds, carbon comps or metal glaze resistors.

After a recent 56-day-long heat

test in an environment of extremely high humidity, our tin oxide resistors showed a resistance change of just 0.2 per cent. And in an ambient temperature test—now in its ninth year—not one of the 600 tin oxide resistors being tested has exceeded a resistance change of 1.5 per cent.

Take our glass capacitors. The U.S. Air Force has found that our glass capacitors have much better stability and much higher insulation resistance than the ceramic, mica and the other capacitor types they tested. That's why glass capacitors are designed into so many major aerospace and missile projects.

And we've got something to offer when economy and value are the prime considerations. We've developed the Glass-K™ capacitor to give you the volumetric efficiency and economy of monolithic ceramic capacitors, but with the much improved stability and reliability that only a glass dielectric can add. In resistors, our tin oxide resistors already offer long term economy over metal film, precision wire wound and metal glaze resistors.

Our new C3 resistors, in addition to giving you a small case size, compete costwise with carbon comps.

Another important Corning development is the flame proof resistor. These resistors can withstand overloads of up to 100 times rated power without any trace of flame. And because they open under overload, they provide protection for the rest of the system.

At Corning we make components for guys who can't stand failures. Guys like your most important customers. Guys like you. So, next time you're designing a system, reach for your CORNING® capacitor and resistor catalogs and call your local Corning authorized distributor for off-the-shelf delivery. They'll help you design-in an extra measure of performance.

If you don't have our catalogs, ask your Corning distributor for copies or drop us a line at: Corning Glass Works, Electronic Products Division, Corning, New York 14830.

CORNING
ELECTRONICS



The Ultramation Machine: A real-time computer that's more than just a mainframe.

Most computers start and end with a mainframe.
The Honeywell DDP-516 just starts there.

For example, you get one of the widest choices
of peripherals and subsystems offered today.

The latest: a Data Acquisition and Control
Subsystem that lets laboratory operators link
the computer to remote sensors, control elements,
and instrumentation.

The 516 is only one member of a family of
compatible 16-bit computers: Honeywell's
Series 16. So if you've been working with the
116, 316, or 416, you can bring all your
software along . . . and all your experience, too.
(More than 500 programs developed on Series
16 computers are available for use on the 516.)

We've been working with hundreds of DDP-516
applications: Data concentration in reservation
systems for almost a dozen airlines. Teamed with
other Honeywell instruments in automated medical
research and intensive care systems. Operating in
severe environments in the ruggedized version.
Time-sharing . . . Simulation . . . Data conversion . . .
and many more. So we know exactly what the
DDP-516 can do.

That's Ultramation . . . the ultimate in automation
by Honeywell computers.

Want to know more about the computer that's
more than just a mainframe? Get our new
DDP-516 literature kit. Honeywell, Computer
Control Division, Old Connecticut Path,
Framingham, Mass. 01701.

Honeywell
AUTOMATION

C-5A, hotly debated but approved



Round 2 in military fund fight

The battle over the military budget has ebbed, but it isn't over—even though both houses of Congress have approved bills. Now starts the in-fighting in conference as members of the Armed Services Committees of the Senate and House of Representatives meet to resolve the differences in their bills. The differences aren't piddling, either: More than a billion dollars is at stake.

The Senate bill, approved by an 81-to-5 vote following hot debate on ABM, the Air Force C-5A cargo jet and the MBT-70 tank, authorizes \$20-billion in spending. The House measure, passed 311 to 44 after limited debate, sets a budget of \$21.4-billion. The gap between the two arises mainly from \$1-billion extra in the House bill to modernize and expand the Navy fleet. That sum was tacked in at the insistence of Rep. L. Mendel Rivers (D-S.C.), chairman of the House Armed Services Committee.

Seldom in the history of the country has a military authorization bill in either house been so carefully questioned. The liberals and doves, particularly in the Senate, dug deeply into each request for funds. And while they won few battles on the floor, they did make their point—in the future, no military bill will be taken at face value.

'We must study the seas'

While admitting that the military is committed to oceanographic research, Dr. Jacques Piccard says that the effort is still far too small. "You have the power, the money, the technology, but you don't have the time to delay," the Swiss oceanographer has warned. "We must study the seas from space, from

Washington Report

CHARLES D. LAFOND
WASHINGTON BUREAU

the floor and from the surface to learn what is there."

Speaking before the American Oceanic Organization here recently, Dr. Piccard stressed that private funding alone could not be expected to support the cost of major oceanographic research and exploration. He cited major problems presently facing mankind and topped the list with the population explosion and the inability of the world to feed this growing mass. The oceans might contain the solution to some of the problems, he indicated.

Dr. Piccard only recently returned from his 30-day submerged drift within the Gulf Stream. He directed a six-man crew that used the Grumman Aircraft Corp. submersible Ben Franklin. The craft explored over 1600 miles during the venture, and data is still being analyzed.

B-52 being fitted with 'eyes'

Under contract with the Air Force at Boeing's division in Wichita, Kan., electronic eyes are being designed for installation on either side of the nose of B-52 bombers. The two turrets will carry steerable sensors: one a TV camera, and the other an infrared scanner. Called an electro-optical viewing system, the units will be developed and produced under a contract totaling nearly \$15-million.

The electronic viewers are intended to provide a clearer look at the external world under nearly any conditions of flight, whether flying blind or at night or when subjected to the brilliant light flashes of nearby detonations. The system will include a signal generator, a radar scan converter, a video distribution unit and video recorder, plus monitoring and control devices.

The electro-optical units will look forward and downward and the TV display will be in both the cockpit and navigator stations. First installation in a B-52H is expected around the turn-of-the-year, with flight testing next March.

Fighting fire with computers

What happens when a fire is ignited in a building and it begins to rage out of control? Can its path of destruction be predicted? The Institute for Applied Technology in the National Bureau of Standards put questions like these to a computer and successfully simulated the probable course of a fire. The effort, sponsored by the Factory Mutual Engineering Corp., is intended to lay the groundwork for understanding and predicting fire effects and, hopefully, for ultimate improvements in fire suppression.

In drawing up the computer program for the study, NBS researchers considered such variables as the type and quantity of combustibles at different sites in a building, the geometric features of the building that affect air movements, and the help that conventional fire-suppression devices might give in controlling the flames. The result was a simulation for predicting the probable course of a fire in a structure from ignition to extinguishment, NBS says.

As a simulation tool, a structure was divided into a number of cubicles (a typical one-family private dwelling required 44 cubicles). In the simulation, a structure of 437 cubicles required 2078 words of program instruction. During the computer run of 48 seconds, a fire was followed in one-minute steps for seven minutes as it spread through 17 cubicles. During this time, four sprinkler heads were considered activated.

While there is a multitude of variables

for any given fire, NBS says that its approach can be adapted for a wide range of situations simply by modifying the basic program. Researchers do not claim that accurate predictions with such an analysis can be made at present, but they do suggest that the feasibility of such predictions appears quite promising.

ABM critics switch to MIRV

Critics of the Safeguard ABM system, having been narrowly defeated on the issue, appear to be mounting a similarly vigorous campaign in opposition to MIRV (Multiple Independently-Targeted Re-entry Vehicles).

Late last month, the "Institute for Human Values, Inc." placed two-page advertisements in large city newspapers across the country expressing opposition to continuance of MIRV. Included was a long article opposed to MIRV development and deployment, reprinted from the August 30, 1969, issue of the *Saturday Review*, plus comments from Evangelist Billy Graham, national news commentators and politicians.

The gist of the advertisement—which preceded House passage of the military procurement authorization bill—was that if either the Soviet Union or the U.S. develops MIRV, the only result can be further arms escalation.

In support of their argument, the critics pointed to recent Congressional testimony by Secretary of Defense Melvin Laird in which he noted that the Soviet Union had resumed testing of FOBS (Fractional Orbital Bombardment System) and was continuing development of the SS-9 multiple-warhead ICBM. The doves declared that the Soviet FOBS testing resulted from passage by the Senate of the Safeguard ABM defense authorization.

The hawks, on the other hand, countered with the argument that the SS-9 can only be a first strike weapon and thus Safeguard was vindicated. They referred to recent testimony before the House, by program director Lt. Gen. Alfred D. Starbird in which he stated his belief that SS-9 by the mid-70's would have the capability to carry multiple warheads with a high degree of accuracy.



It takes guts to build a TV set

Lots of 'em. Dozens of assemblies and sub-assemblies and components. Each as important as the other. From plug to picture every item must perform. And perform well. The customer buys what he sees. And what he sees is determined by what he does not see. That's the guts of the story.

Stackpole makes more than a dozen types of components for black and white and color television receivers. Since 1947 mostly. But even before that we produced millions of high quality fixed composition resistors for the booming radio market. Still are, in fact.

From the earliest days of television, Stackpole supplied the first ferrite horizontal output transformer cores. First for black and white. Then for color. In 1954 Stackpole introduced

Ceramag® ferrite components for the 70° color deflection system. And again in 1964, the 90° color components. Today we're working on the color 110°. In addition, we've been involved with such major television advances as Automatic Pincushion Correction.

Stackpole engineering and production know-how has contributed much to the technology of television. Our components can be found in every domestic TV set. Not only ferrites and resistors, but variable resistors and linear potentiometers; slide and rocker switches; capacitors and hard ferrite magnets. More than any other manufacturer.

Have you got what it takes to build a good TV set? Be sure. Specify Stackpole electronic componentry wherever possible. You'll get the value and performance you need. Write or call: Stackpole Carbon Company, Electronic Components Division, St. Marys, Pa. 15857. Phone 814-834-1521. TWX: 510-693-4511.



STACKPOLE
ELECTRONIC COMPONENTS DIVISION

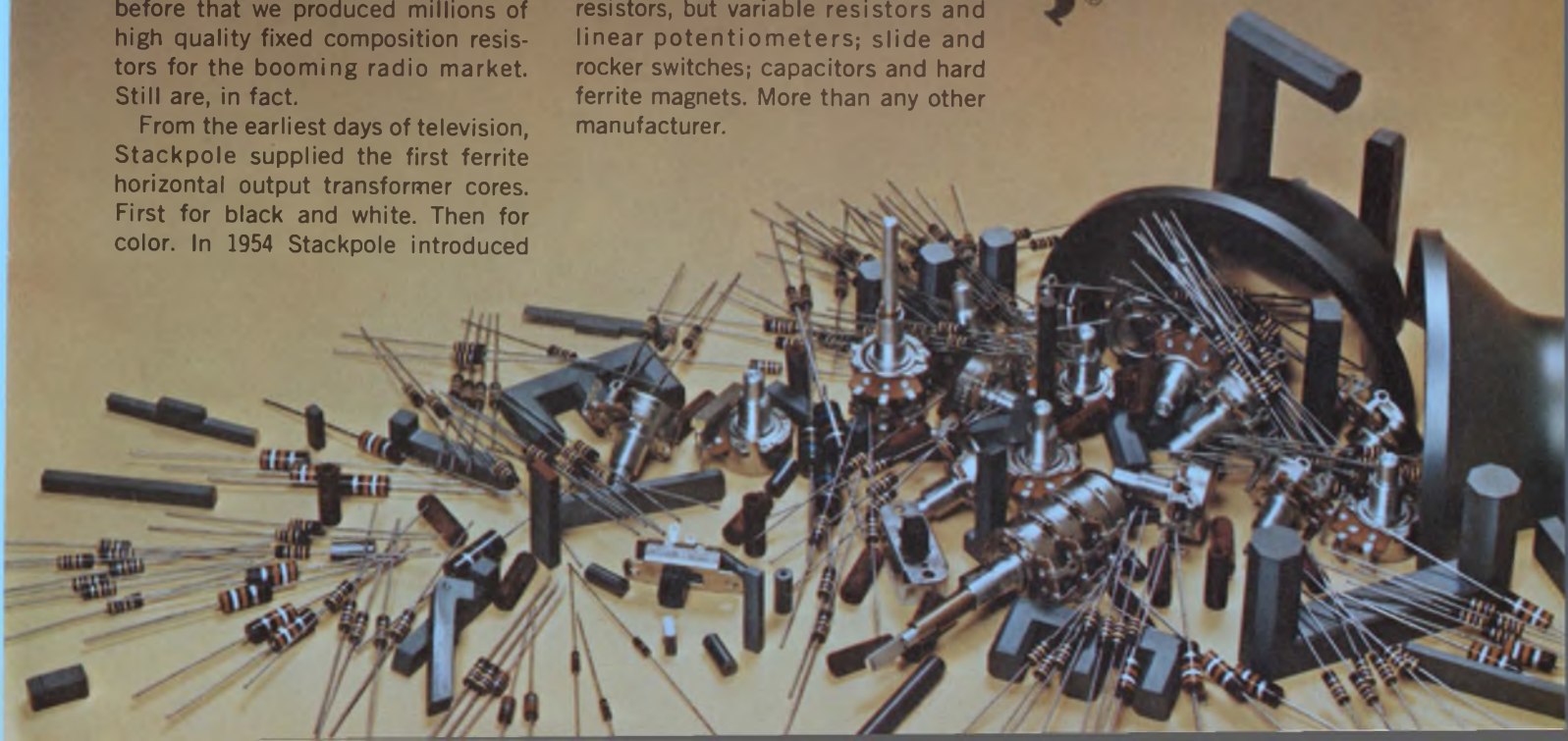

microtopics

New MOS 4-bit adder

Here's another unique MOS device from Philco-Ford . . . the pL4AO1C binary-BCD 4-bit adder . . . which can reduce package count and improve speed of your logic system. It can perform 4-bit parallel addition as fast as 2 microseconds. Compared to other MOS adders on the market, it has twice the "add" capability and considerably faster speed.

The pL4AO1C operates in either the 8-4-2-1 binary or binary coded decimal number system. In either system, addition of two 4-bit numbers and carry input yields a 4-bit sum output and carry output. It is supplied in a 24-lead flat pack.

INFORMATION RETRIEVAL NUMBER 121

New phase-locked avalanche oscillator source



For the first time anywhere, we've applied the stability of phase-lock control to an avalanche oscillator power source. Frequency stability equals that of conventional multiplier chain sources. Power output is an order of magnitude greater than conventional phase-locked transistor oscillators—up to 250 milliwatts in Ku band.

Its unique phase-lock loop provides

broad phase-modulation capability. Spurious output is minimized because the oscillator operates at its fundamental frequency, without need for multiplication.

This unique new power source is smaller and costs less than a multiplier chain source. It's available from C through Ku band, and operates from -25° to $+72^{\circ}\text{C}$.

INFORMATION RETRIEVAL NUMBER 122

Digital Crosspoint Quad Switch... another MSI bipolar array

Now you can do the equivalent of telephone-style crossbar switching in solid state, by means of Philco-Ford DCQ—Digital Crosspoint Quad—bipolar array. The DCQ is a 2×2 array of crosspoints which can be configured to produce a switching matrix of whatever complexity you require. It is now being used in communications switching networks, and is applicable to switching of input-output lines connecting peripheral equipment to computers, or for any switching application where the information to be switched is in digital form. Each crosspoint is bidirectional, and includes selection and hold logic.

The chip contains the equivalent in complexity of 20 NAND gates. Double layer metallization is used

for interconnections. The DCQ utilizes T²L logic and will interface directly with Series 74 circuits. Power dissipation is a low 36 milliwatts. Selection and hold mode is accomplished typically within 60 nanoseconds. Information can be transferred through the data lines at rates up to 2 MHz.

The master chip can perform other functions beside crosspoint switching, simply by customizing the multilayer interconnection pattern. Think of it as an array of four basic cells, each consisting of two AOI gates and one NAND gate . . . which you can receive from us hooked up in just about any configuration you want. Tell us your application, we'll be glad to examine feasibility.

INFORMATION RETRIEVAL NUMBER 123

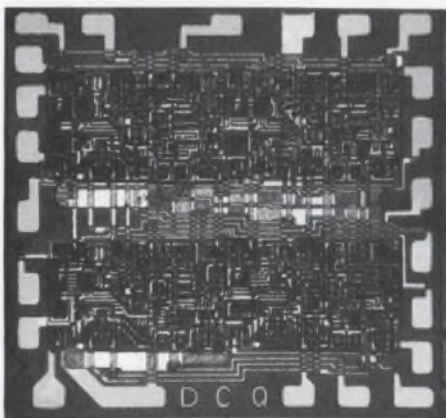

Something new in Series 74 T²L... glassivated chips in cerdip packages

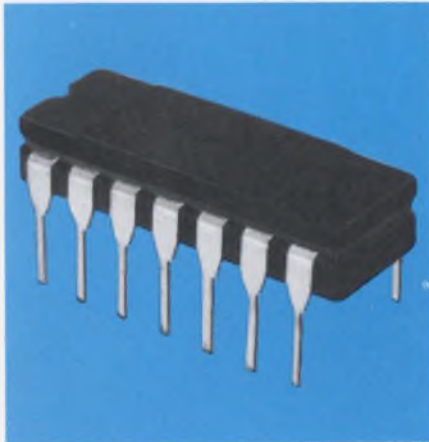

Why consider another source for Series 74 T²L? Here are three good reasons from Philco-Ford.

RELIABILITY

As a final production step, we put an added layer of glass over the completed chip. This glassivation process protects the circuit against damage, and gives an extra measure of reliability.

HERMETIC DUAL-IN-LINE PACKAGES

All Philco-Ford Series 74 circuits are manufactured in hermetically sealed ceramic dual-in-line packages...

AND at prices comparable to plastic. Your assurance of quality is the experience we have gained in manufacturing many millions of cerdip DTL and T²L circuits.

CLAMP DIODES

All Philco-Ford Series 74 circuits have been designed with clamp diode inputs to reduce ringing and improve system noise immunity.

All popular Series 74 circuits are now available from our Lansdale facility, one of the country's largest IC manufacturing plants.

INFORMATION RETRIEVAL NUMBER 124

16-channel MOS multiplexer for time-division systems

The pL4S16C is a different kind of switch that can add new versatility of multiplexing functions in your telemetry, data sampling or communication system. Offset voltage is zero. Leakage current is less than 10 nanoamps. And it is voltage-driven... needs no complicated drive net-

work. You can clock it externally, or allow it to free-run on its 100 KHz internal clock.

As a 16-channel multiplexer, the pL4S16C gives you a choice of random access switching, or sequential sampling of all 16 channels, or of

simultaneous sampling of two banks of 8 channels... just by changing external wiring. Stack them up, and you can get switching in sequential or random access modes, in multiples of 16 channels. Or, if you like, you can use it to switch 2 to 16 channels.

INFORMATION RETRIEVAL NUMBER 125

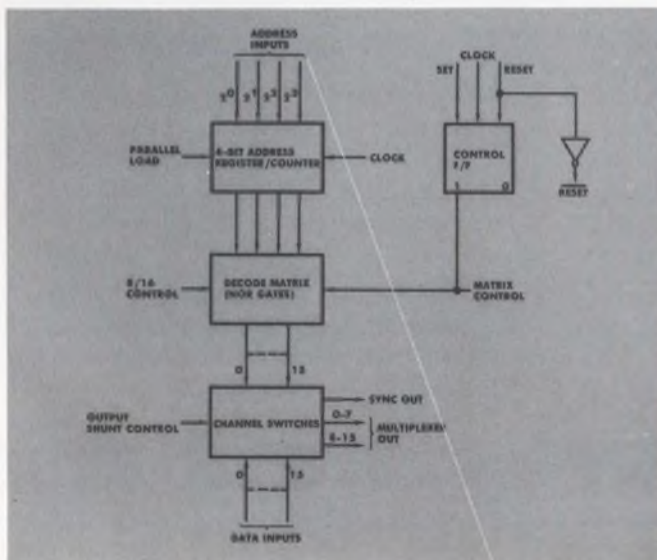

Typical Specifications

Offset voltage:	0 volts
Signal voltage swing:	10 volts max.
Channel leakage:	10 nA
"ON" resistance:	1000 ohms
Power dissipation:	150 mW max.
Input capacitance:	5 pF
Max. clock (sequential mode):	100 KHz
Package:	34-lead flat pack

See where you can't be with COHU TV.

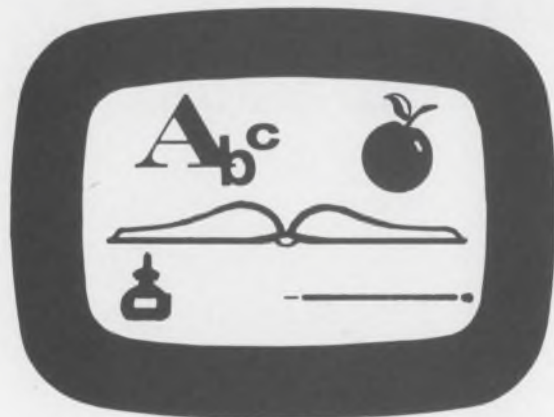

CLASSROOM INSTRUCTION



SPORTING EVENTS



MICROSCOPIC EXAMINATION

For more details contact your nearest Cohu representative or the TV Product Line Manager direct at 714-277-6700, Box 623, San Diego, Calif. 92112, TWX 910-335-1244.



Cohu will be at WESCON - Booth 2001
INFORMATION RETRIEVAL NUMBER 26

Letters

Who says France is an engineer's dreamland?

Sir:

Living in a country, France, which is both Latin and European, I have been greatly interested by the letter "I flatly refuse to work for my dog," published on p. 50, of the July 19, 1969, issue of ELECTRONIC DESIGN.

In that letter, a Baltimore Engineer states that: "In most European and Latin countries, engineers work shorter hours, receive up to three months vacation, and retire at a much earlier time. Their social standing is considerably higher."

In France, for example, if we have theoretically a 43-hour week, we are often obliged to work 50 hours or more, with no additional recompense, due to the lack of manpower. We have a one-month vacation; we retire at 65. And for the social standing! The mean salary, for a good 35- to 40-year-old electronic engineer with an MS or equivalent, is approximately \$800 a month, in a country where the life is more expensive than in the U.S. For example, a 1000-square-foot flat, of average quality, costs, unfurnished, no less than \$36,000, and you must pay \$400 a month to acquire it.

Frankly, I would be glad to know where is the European wonderland, perhaps in the dreams of this Baltimore Engineer. . .

Charles V. Andre

8, Rue Diderot
78-Saint Germain en Laye
France

Accuracy is our policy

In the Ideas for Design item, "Narrow-Band Rejection Filter Uses Twin-T" (ED 21, Oct. 11, 1969) the resistor labeled R₂ should actually be R/2.

The telephone number shown for E. F. Johnson's miniature PC jack (ED 19, Sept. 13, 1969, page 160, circle no. 343) should read 507-835-2050, not 617-278-1715.

Who says relay specs are dull reading?

Not us. We're sure you'll find the specs of these two popular models positively fascinating. Want more info? Write: 1550 W. Carroll Ave., Chicago, Ill. 60607



SERIES 1220



SERIES 1300



Normal Mode Noise Clouding Your Low-Level DC Measurements?

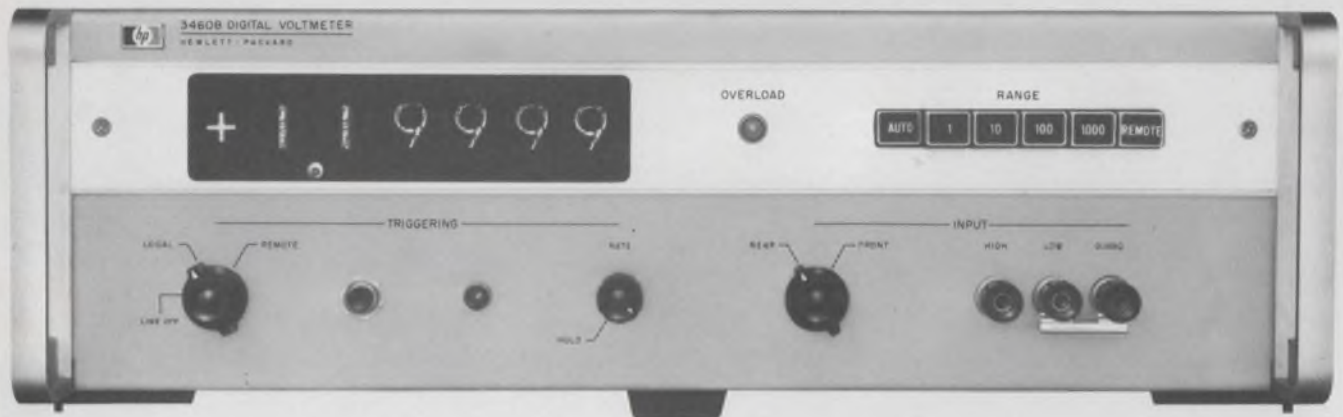

Not Here! The HP 3460B was introduced as a super accurate, 5-digit voltmeter. To make 0.004% of reading accuracy practical, a dual technique was utilized—integrating and potentiometric. The integration technique in itself gave a high common mode rejection of 160 dB at dc.

Now HP has added a filter option which is a programmable filter that cancels out frustrating noise picked up by leads and input devices. This

filter effectively adds 26 dB of ac normal-mode rejection at 60 Hz to rejection provided by integration. Now you can accurately measure low level dc signals with as much as 100% of range (peak) ac riding on the measured dc signal.

Other features of the 3460B include a sixth digit for 20% overranging, automatic polarity selection, four ranges from 1 V to 1000 V, guarded inputs, 15 readings per second (without filter) fully programmable functions with BCD output for systems compatibility.

To make the 3460B a multiple function DVM, add the HP 3461A AC/Ohms Converter-DC Preamplifier. Measure 0.1 V dc voltages with 1 μ V sensitivity, 50 Hz to 100 kHz ac measurements with 10 μ V sensitivity, and resistance measurements from 1

k Ω to 12 M Ω with 10 milliohm sensitivity on lowest range.

If you're interested in a precision DVM, look up the 3460B in your HP catalog. If you're interested in adding the filter option to pick low level dc out of noisy environments, call your local HP field office. (Price HP 3460B, \$3800; 3461A, \$2400. 3460B Option 002 or 003 is required for operation with 3461A. Price option 002 or 003, \$150. Filter option prices on request.) Or for a data sheet, write to Hewlett-Packard, Palo Alto, California 94304. Europe: 1217 Meyrin-Geneva, Switzerland.

099/1

HEWLETT  PACKARD
DIGITAL VOLTMETERS



The case for Centralab lighted, push button switches

Ask your Centralab representative to show you this push button demonstration kit. Discover how versatile a low cost switch can be.

Centralab solves your switching problems with more varieties of lighted, push button* switches at lower cost. Individual standard modules for printed circuit board or panel mounting are available in two, four, six or eight pole, double throw designs. Standard functions are momentary, interlocking and push-push. Each assembly is available with row-to-row locking as a space saving feature; remote release capability and lockout are also available. There's an almost infinite number of com-

binations of modules with 10 mm, 15 mm or 20 mm spacing to meet a variety of requirements. ■ The lighted push button can be customized to meet specific needs using various combinations of bulb caps, filters, and lenses. ■ Lexan[†] lenses and filters are available in nine standard colors as well as clear. Filters permit adjustment of light diffusion and color intensity. Hot stamping of lenses or filters is available.

Want to know more? Turn the page . . .



CENTRALAB

Electronics Division
GLOBE-UNION INC.

5757 NORTH GREEN BAY AVENUE
MILWAUKEE, WISCONSIN 53201

*ISOSTAT LICENSED †TM GE

Here are a few facts to help you judge the case for Centralab



Gang mounted modules

Individual modules may be ganged together on a common mounting bracket. Modules, when ganged, retain all the features of the individual modules and also provide the advantages of space-saving and of interlocking and/or clearing when desired.

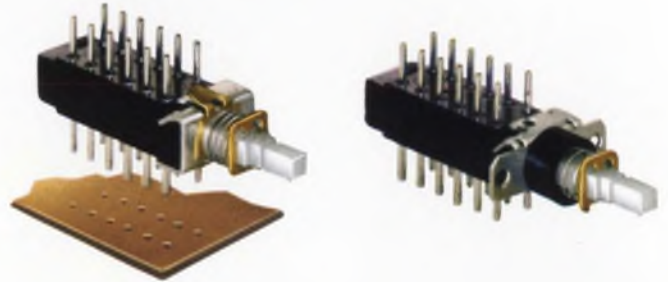

Circuit board or panel mount

An individual switch module or ganged modules may be electrically connected by assembly into a printed circuit board by the use of wire connectors or hand soldering. Switch can be mechanically mounted either through the circuit board or the switch mounting bracket.



Solenoid operation

A solenoid feature for Centralab Push Button Switches can be provided for remote operation of individual modules within a PB switch assembly. Can be furnished in various AC and DC voltages.



Selection of buttons

The typical button styles and sizes illustrated are available in nine standard colors and clear Lexan. Non-lighted buttons are available in black, white, red, grey, cream, and special colors and finishes. Buttons may be ordered in bulk or cemented onto the slider bar.



Your Centralab representative is ready to present his case for Centralab lighted, push button switches. He has the answers to your switching problems. Call him today or write: **Switch Sales Manager, Centralab Electronics Division, Globe-Union Inc., 5757 North Green Bay Avenue, Milwaukee, Wisconsin 53201.**



Easy bulb replacement

Field bulb replacement is easy without "behind the panel" disassembly. Simply snap out lens and remove bulb with a section of polyethylene tube ($\frac{1}{4}$ " I.D. x $\frac{3}{8}$ " O.D.).



New module line switch

New, 3-Amp A.C. line switch in module size, provides flexibility of positioning in any type of arrangement. Adaptable to either standard or lighted brackets.



CENTRALAB

Electronics Division
GLOBE-UNION INC.

5757 NORTH GREEN BAY AVENUE
MILWAUKEE, WISCONSIN 53201

SPECIFICATIONS

Mechanical

Stator Block: Phenolic per MIL-C-13428A and ASTM D700-57R, Type 2

Slider Bar: Thermoplastic acetal resin (Delrin®)

Contacts, Fixed: Silver plated copper wire

Contacts, Moving: Copper alloy with silver overlay

Lubrication: During assembly. No further lubrication required

Electrical

Contact Resistance: 4 milliohms, initial 10 milliohms after 25,000 cycles

Current and Voltage Ratings (at 25,000 cycles):
0.45 Amp at 115 VAC
1.00 Amp at 28 VDC

Dielectric Strength (VAC, R.M.S.):

Bracket to Pins — 1000
Pins to Pins — 1400

For applications requiring I.R. that will exceed standard unit values by a factor of 10² diallyl phthalate material may be substituted for general purpose phenolic.

Insulation Resistance (Megohms):

Between	General Purpose Material		Diallyl Phthalate Material	
	70% R.H. at 70° F.	After 96 hrs., 95 to 100% R.H.	70% R.H. at 70° F.	After 96 hrs., 95 to 100% R.H.
Bracket & Pin	6,000	100	1,000 K	100 K
Adjacent Pins (pole to pole)	65,000	185	1,000 K	600 K
Opposite Pins	50,000	210	1,000 K	500 K

CUSTOMBILITY



A new capability is provided by Centralab and our field assembly distributors, a capability that provides you with prompt delivery of versatile, low-cost, push button switches. There's an almost infinite number of switching functions with mounting styles to meet a wide variety of your switching requirements. Contact your Centralab push button field assembly distributor to fill your needs without delay at prices similar to these or lower, depending on specific switching function:

Cost per station (including button)

2 pole — \$1.31; 4 pole — \$1.43;

6 pole — \$1.64; 8 pole — \$1.79

Here are Centralab distributors with a new capability. More to come.

CALIFORNIA, LOS ANGELES 90022

Kierulff Electronics Inc.
Phone: (213) 685-5511

CALIF., PALO ALTO 94306

Fisher Switches, Inc.
Phone: (415) 321-4080

FLA., ORLANDO 32805

Hammond Electronics, Inc.
Phone: (305) 241-6681

INDIANA, SOUTH BEND 46618

Radio Distributing Co.
Phone: (219) 288-4666

MINN., ST. PAUL 55113

Gopher Electronics Co.
Phone: (612) 645-0241

NEW YORK, BUFFALO 14202

Summit Distributors Inc.
Phone: (716) 884-3450

OHIO, CINCINNATI 45237

United Radio Inc.
Phone: (513) 761-4030

OHIO, CLEVELAND 44103

Pioneer-Standard Elect.
Phone: (216) 432-0010

PENN., PITTSBURGH 15222

Cameradio Company
Phone: (412) 391-4000

WASH., SEATTLE 98108

Almac-Stroum
Phone: (206) 763-2300

WIS., MILWAUKEE 53209

Electronic Expeditors, Inc.
Phone: (414) 374-6666

**Isostat Licensed*

For more information, write:

DISTRIBUTOR PRODUCTS



CENTRALAB

Electronics Division

GLOBE-UNION INC.

5757 NORTH GREEN BAY AVENUE
MILWAUKEE, WISCONSIN 53201

SIDELIGHTS

The two-sided chip-bonding story

Is the chip-bonding problem really solved? IBM says yes, and points to its solder-bump technology. Raytheon says yes, and offers the designer beam-leaded devices. And Motorola says yes, and tools up for spider-bonded IC production. But what does the designer say? Are these new techniques really workable? And what advantages do they offer him?

The answers vary. Writing a special report on "Chip Bonding: Promises and Perils," Microelectronics Editor Raymond D. Speer interviewed semiconductor and hybrid-circuit engineers in Dallas, Phoenix, Los Angeles, the San Francisco Bay Area and along Boston's Route 128. He found that some engineers have tried the new bonding techniques, have been disappointed with the results, and are now extremely wary. They say wide use of bumped and beam-leaded chips is at least two years away. Other designers have specific needs that are filled only by the new chips, and they are cautiously applying them now. And designers of IBM's 360 computer point with satisfaction to 30 billion hours of field data on bumped chips; they claim failure rates as low as 0.003% per thousand hours.

Beckman Instruments' Mick Strief (see photo) says that his group tried flip-chips three times, and that the bumps fell off during bonding. The Beckman team hasn't bothered to try flip-chips lately. But IBM's Lewis Miller, advisory chemist, says that the bumped chips used in the IBM 360 are entirely successful.

Whether or not to adopt the new products is a tough decision. The devices require difficult processing, and process control often suffers because production volume is low and the finished products present the engineer with new handling and bonding problems. But the rewards can be great. For the full story on the state of the art in chip bonding, see page 61.



Two hybrid designers bemoan their flip-chip experience as Microelectronics Editor Raymond Speer (right rear) listens. Shown are Leon Hornberger (left rear), project development engineer, and Mick Strief, chief microcircuit engineer, both of Beckman Instruments' Helipod Div., Buena Park, Calif.

Technology sale.

Order Ray IV or Ray V now for prompt delivery.

Those brainy guys in our lab have really shifted into high gear when it comes to dreaming up semiconductor advancements. Here's a couple of new technologies they've established feasibility for, but haven't turned into chips yet. If one looks good to you, give us a call and we'll discuss a delivery date on a custom product or two.

Ray IV: Radiation Hardened Circuits. Just the ticket for digital and linear circuits, or discrete components. Ray IV isolates circuit elements with polycrystalline dielectrics. It bolsters hardening through new component geometries and diffusion profiles. It features thin film resistors. Beam lead techniques. And consistently uses low-Z metals wherever possible in chip and package.

Ray V: Micropower Digital Logic. Especially great for TTL. Ray V is lavished with state-of-the-art touches such as Schottky barrier Baker clamps, washed emitters, platinum silicide contacts and high density gold interconnects. It recognizes high impedance resistors for the long snaky rascals they are, and it cannily substitutes small-geometry transistors in current-regulating circuits. And thereby promises power dissipations as low as $50 \mu\text{W}$ per gate, and propagation delays down to 30 ns.

So look 'em over. Even if these aren't your cup of tea, they illustrate once again the abiding shrewdness of doing business with the company that gets the ideas. And delivers the goods. Raytheon Semiconductor, Mountain View, California. (415) 968-9211.

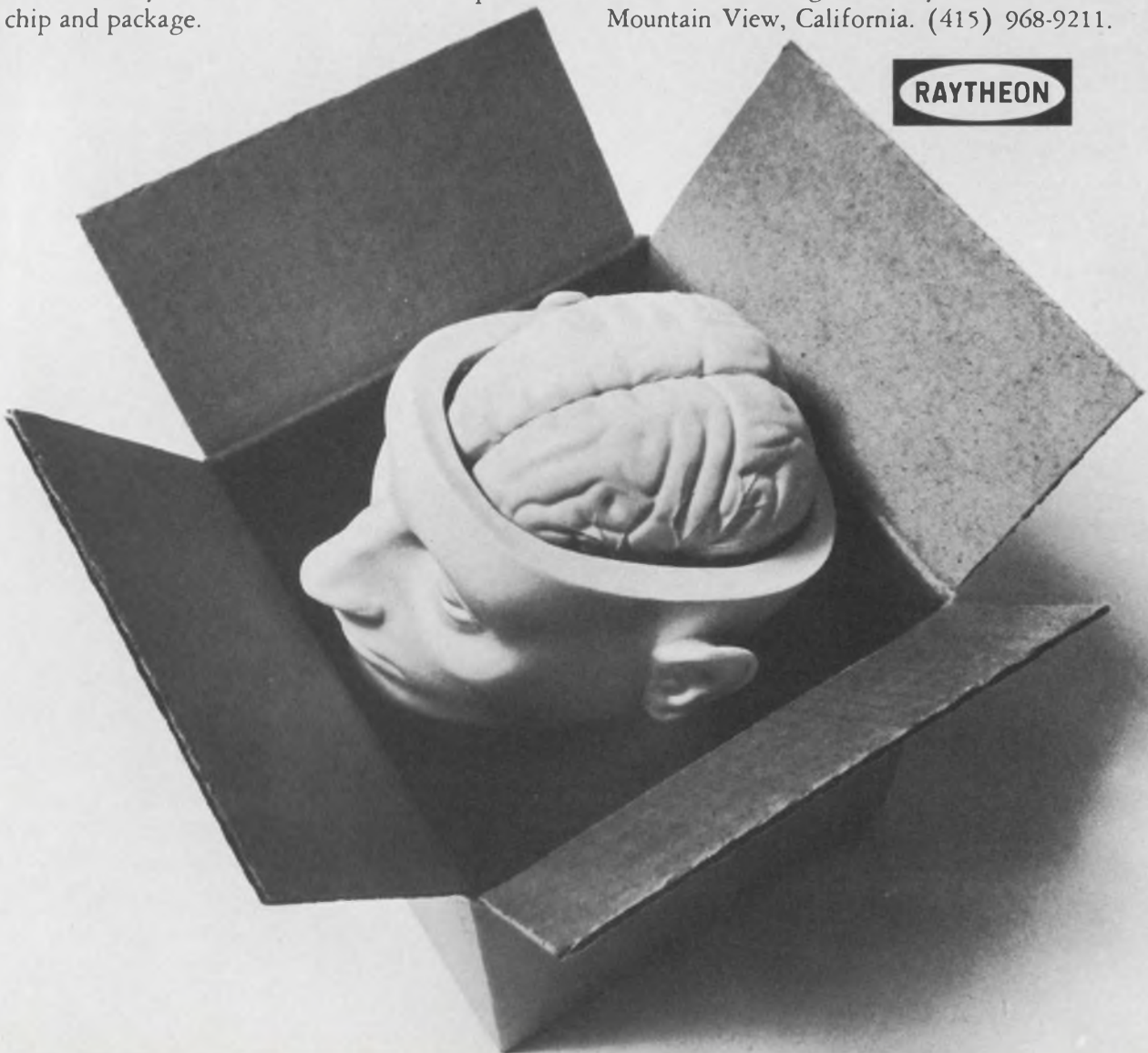
The Raytheon logo, consisting of the word "RAYTHEON" in a bold, sans-serif font, enclosed within a dark oval shape.

Publisher

Hugh R. Roome

Editor

Howard Bierman

Managing Editor

Frank Egan

Technical EditorsMilton J. Lowenstein
Michael J. Riezenman
Raymond D. Speer
Stella Lawrence**Management and Careers Editor**

Richard L. Turmail

News EditorsRalph Dobriner, Chief
John N. Kessler**Washington News Bureau**

Charles D. LaFond, Chief

Military-Aerospace Editor

John F. Mason

East Coast Editor

Jim McDermott

West Coast EditorsElizabeth deAtley
David N. Kaye**New Products Editors**Lucinda Mattera
Roger Allan**Directory Manager**

Greg Guercio

Copy Editor

Marion Allen

Editorial ProductionDollie S. Viebig
Richard D. Grissom**Art Director**

Clifford M. Gardiner

Art Assistant

William Kelly

Technical IllustratorsRita Jendrzewski
Lynn E. Thompson
JoJo Miskimmon**Production Manager**

Thomas V. Sedita

Asst. Production Manager

Helen De Polo

Production AssistantsBernard Wolinsky
Kathleen McConkey**Circulation Manager**

Nancy L. Merritt

Information Retrieval

Genate Piccinetti

EDITORIAL



Are you doing as well as you probably should?

Everyone likes to see where he stands in relation to his peers—and we're sure the electronics engineer is no exception.

With this in mind, *ELECTRONIC DESIGN* surveyed a cross section of its readership concerning their salaries, ages, education, job turnover, etc. The major results are presented in the article, "Are You Engineering Your Career?" It begins on page 98.

We know that most engineers will find the results interesting. We also hope that the information will be put to some practical use.

This doesn't mean waving the survey in your boss's face and demanding a salary increase based on the figures. Nor does it mean uprooting yourself and moving 1000 miles because the survey indicates that engineers on the East and West Coasts earn more.

No—the practical use intended in this case is something more along the lines of objective, self-evaluation. The survey provides averages, although rough ones, for comparing yourself with others.

More importantly, it indicates the extent to which engineers exert extra effort to advance themselves professionally and avoid technical obsolescence.

The evidence is unmistakable that there is a pronounced correlation between these extra efforts and salary. So if your salary doesn't quite stack up to the survey averages, maybe you ought to begin thinking seriously about graduate or refresher courses, about presenting a technical paper at a conference, or even about reading technical magazines more carefully and systematically.

Extracurricular activities such as these have a lot to commend them, not the least of which is possible financial reward.

We'd like to mention in passing one result of the survey that particularly pleased us. This was that 7 out of 10 of the respondents said they were satisfied with their jobs. Such figures would seem to indicate that for most engineers, the appealing job qualities of challenge, variety and freedom overshadow the negative factors of insufficient security, salary and prestige.

FRANK EGAN

Dow Corning presents four new star performers on the electronic circuit.

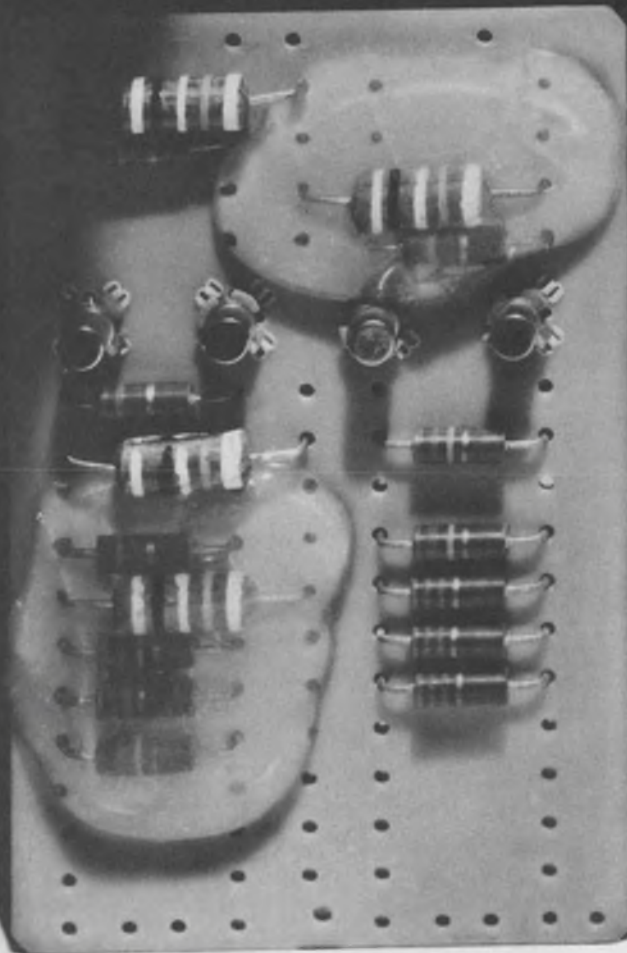

Now you see it

New Dow Corning® 3144 noncorrosive RTV adhesive/sealant is translucent to clear. You should see the job it does for corrosion-sensitive electrical or electronic equipment. It's a high-strength adhesive, too, cures at room temperature, and remains stable when the heat's on (long term to 250°C, short term to 300°C).

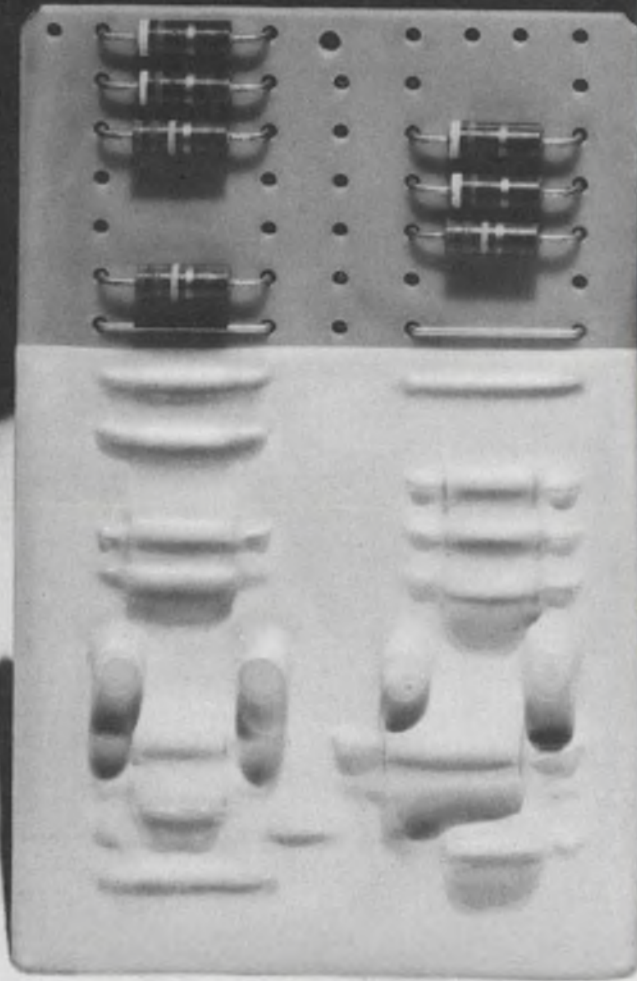

Now you don't

In case you have something to cover, use new opaque (white) Dow Corning® 3141 noncorrosive RTV coating. A new cross-linking prevents the buildup of corrosive by-products during cure. It's easily processed, easy to repair, and stays rugged in harsh environment.

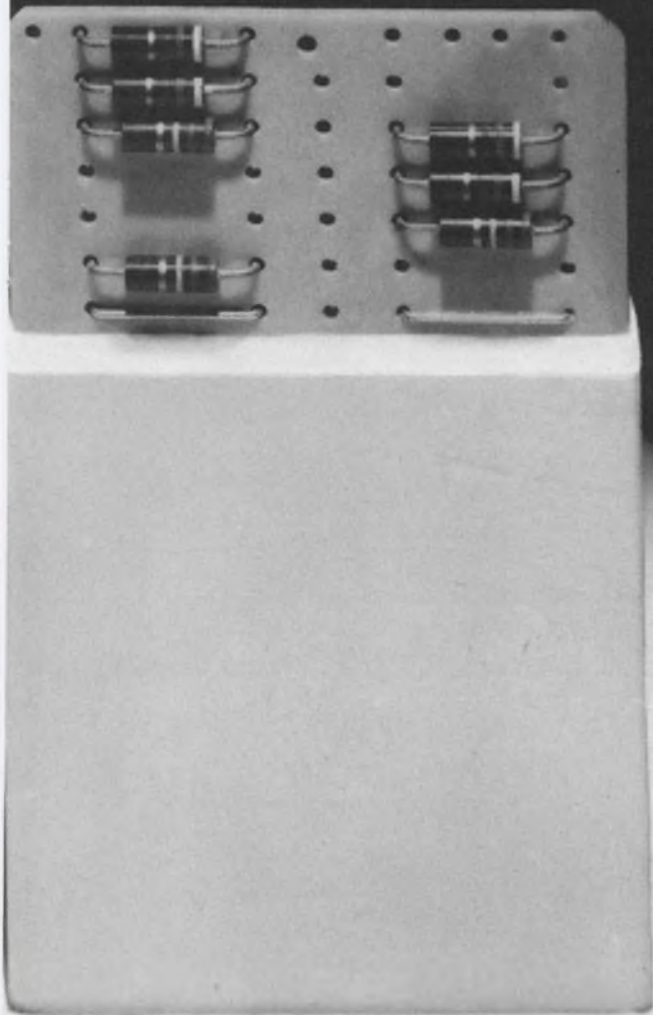

Effective immediately

New Dow Corning® 3101 low-density potting and encapsulating resin is ready for service right after cure. No postcure is necessary. And it cures in unlimited thicknesses in 24 hours at room temperature. It's great for potting aerospace electronic systems or for anywhere you need low-density and reversion resistance.

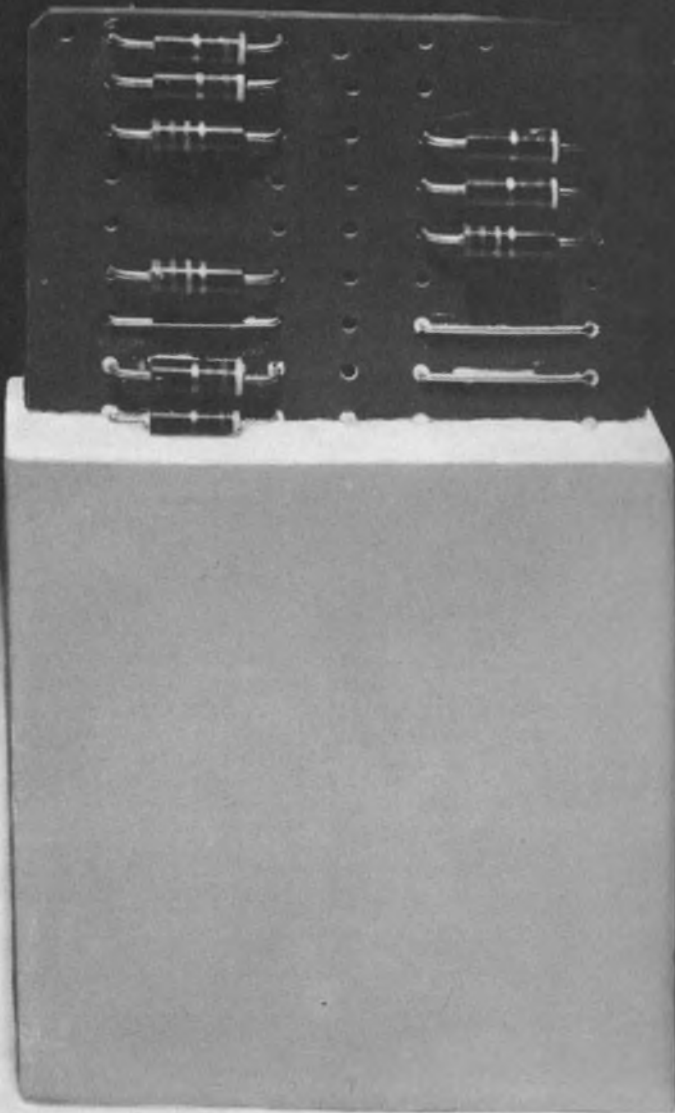

Set for life

New one-part, premixed, Sylgard® 3150 encapsulating resin lives a long life in extreme environments. It's a white, one-part, free-flowing low-viscosity encapsulant that heat cures in deep sections and is compatible with almost all material used in electronic assemblies.

There are many more encapsulants, coatings, and adhesive/sealants where these came from. Learn about them. On your letterhead, write Dept. B-9300, Dow Corning Corporation, Midland, Michigan 48640.

*Electrical/Electronic
materials from*

DOW CORNING

DOW CORNING

FIRST FULLY DECODED 64-BIT BIPOLAR LSI

A winner for
scratch pad
memories

i-3101

- Fast 60 nsec access
- Low power dissipation (6 mW per bit)
- DTL and TTL compatible
- OR-Tie capability

Guaranteed switching speeds

Test parameter	Speed	Conditions
Read cycle (chip select and/or address to output delay)	60 nsec max	2.5v pulse in. 5 ns rise & fall from 1v to 2v
Write recovery time	45 nsec max	$V_{CC}=5.0v$ $T_A=25^\circ C$

Guaranteed DC characteristics

Test parameter	Limit at 0°, 25° & 85° C	Conditions ($V_{CC}=5.0v \pm 5\%$)
Input load current	-1.6 ma max	$V_{in}=0.45v$
Input leakage current	40 μa max	$V_{in}=5.25v$
Input clamp voltage	-1.0 v max	$I_C=5.0 ma$
Output "low" voltage	0.45 v max	$V_W=V_S=0 v$
Output leakage current	100 μa max	$V_{CC}=5.25 v$ $V_S=2.5 v$
Power supply current	105 ma max	$V_A=V_i=V_d=0 v$
Input "high" voltage	2.0 v max	
Input "low" voltage	0.85 v min	

Prices

1 to 9 units: \$99.50	100 to 249 units: \$43.00
10 to 24 units: \$73.50	250 or more units: \$38.50
25 to 99 units: \$53.00	

Available at over 40 locations

throughout the U.S. and Canada. For delivery, call your Intel distributor, Cramer Electronics or Hamilton Electro Sales.

If more convenient, write or phone us directly. Call collect (415) 961-8080.

Intel Corporation is at 365 Middlefield Rd., Mountain View, Calif. 94040. Telex INTEL 34-8366.

Intel regional offices in Costa Mesa, Calif., phone (714) 545-8541 and in Andover, Mass., phone (617) 536-0700.

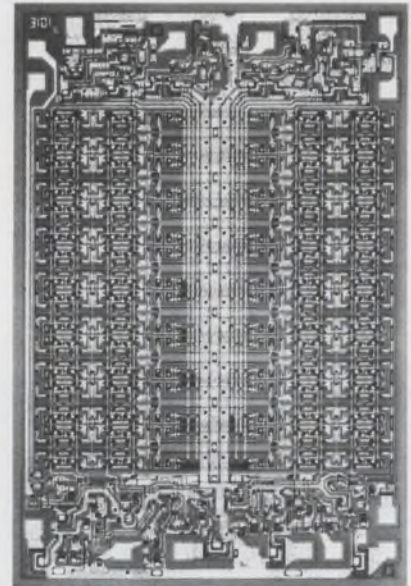

intel

Solid State Relays

Another big breakthrough from the "little relay" people

Little Relay



TO-5 Relay

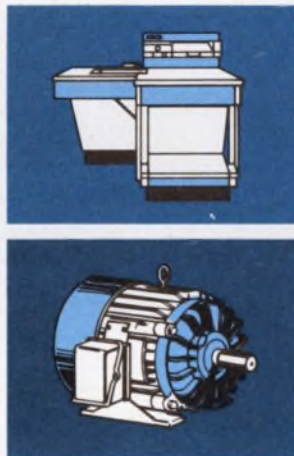

Big Breakthrough



Solid State Relay

We got our nickname "little relay" people because we usually put our *big* breakthroughs in *small* packages. (Our success started when we introduced the TO-5 relay.) Now, we've made another breakthrough . . . a completely solid state, four terminal relay with enormous power gain. Only 1 milliwatt switches up to 5 KVA, and it can be resistive, inductive, capacitive, tungsten or quartz lamp loads.

Our new relay operates on inputs up to 280 VAC or from

3.5 to 300 VDC (either polarity) permitting direct interface with TTL logic. Input-output isolation is 10^{11} ohms "coil" to "contact" and "coil" to mounting plate. Dielectric is 2000 VRMS. Output characteristics include contact ratings up to 21 amperes, 280 VAC, 60 Hz. Surge current ratings of 200 amperes, and "contact" resistance as low as 50 milliohms. And, . . . these are *real breakthroughs* for a relay which doesn't have "coil" or "contacts."

Available options include zero

voltage switching for RFI suppression and lamp life extension.

Prices start as low as \$18.30 in quantities of 100. For complete technical data on our Series 6 Solid State Relay . . . contact us . . . the "little relay" people.



TELEDYNE RELAYS
A TELEDYNE COMPANY

3155 West El Segundo Boulevard Hawthorne, California
90250 Telephone: (213) 679-2205

STORAGE / PLUG-IN

CONVENIENCE / MEASUREMENT FLEXIBILITY



Calibration aid used to extend plug-in.

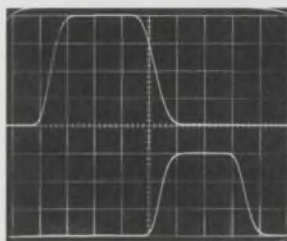

multi-trace

Make dual-trace measurements from DC-to-10 MHz with 35-ns rise-time capabilities and a 10 mV/div to 10 V/div deflection factor.

Type 3A6 Plug-In \$550

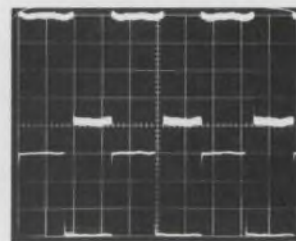

differential

Measure from DC-to-500 kHz with a 100 μ V/div deflection factor, dual-trace and a 50,000:1 common-mode rejection ratio.

Type 3A3 Plug-In \$950

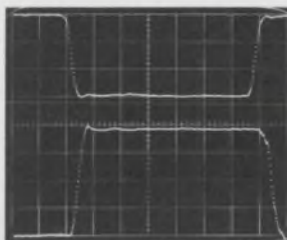

sampling

Extend your measurement capabilities to 14 GHz with 25-ps rise-time, internal triggering, dual-trace and sweep rates to 20 ps/div.

Type 3T2 Time-Base \$1100
Type 3S2 Amplifier \$ 950

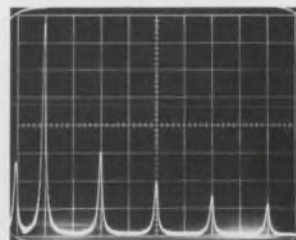

spectrum analysis

Analyze the frequency spectrum from 50 Hz to 1 MHz with calibrated dispersion and calibrated deflection factors.

Type 3L5 Plug-In \$1125

Split-screen bistable storage, automatic erasure and plug-in measurement flexibility . . . all are features of the Tektronix Type 564B MOD 121N.

STORAGE

The contrast ratio and brightness of stored displays produced by this instrument are constant and independent of viewing time, sweep speeds, or signal rep rates — a special feature of Tektronix "bistable storage". The auto-erasure mode is an operator convenience feature and may be used to view very slow changing waveform phenomenon by employing a continuous sequence of storing, viewing, and erasure of the upper half, lower half, or the entire screen. Variable viewing time allows observation of the stored display for up to 12 seconds before erasure. A "SAVE" mode retains the stored image up to 1 hour.

MEASUREMENT FLEXIBILITY

More than 25 plug-in units are available for the Type 564B MOD 121N, covering single channel, multi-trace, differential, sampling, spectrum analysis and other special purpose applications. Adapting your measurement capability to meet your changing measurement needs is assured.

Your local Tektronix Field Engineer will show you how storage lets you concentrate on the results of the measurement, rather than making it. Please call him. For detailed specifications, consult your current Tektronix catalog, or write: Tektronix, Inc., P. O. Box 500, Beaverton, Oregon 97005.

Type 564B MOD 121N Oscilloscope \$1250
Type 3B3 Time-Base Plug-in \$ 680

U.S. Sales Prices FOB Beaverton, Oregon



Tektronix, Inc.

committed to progress in waveform measurement

new

dimensions

WITH

QMF*

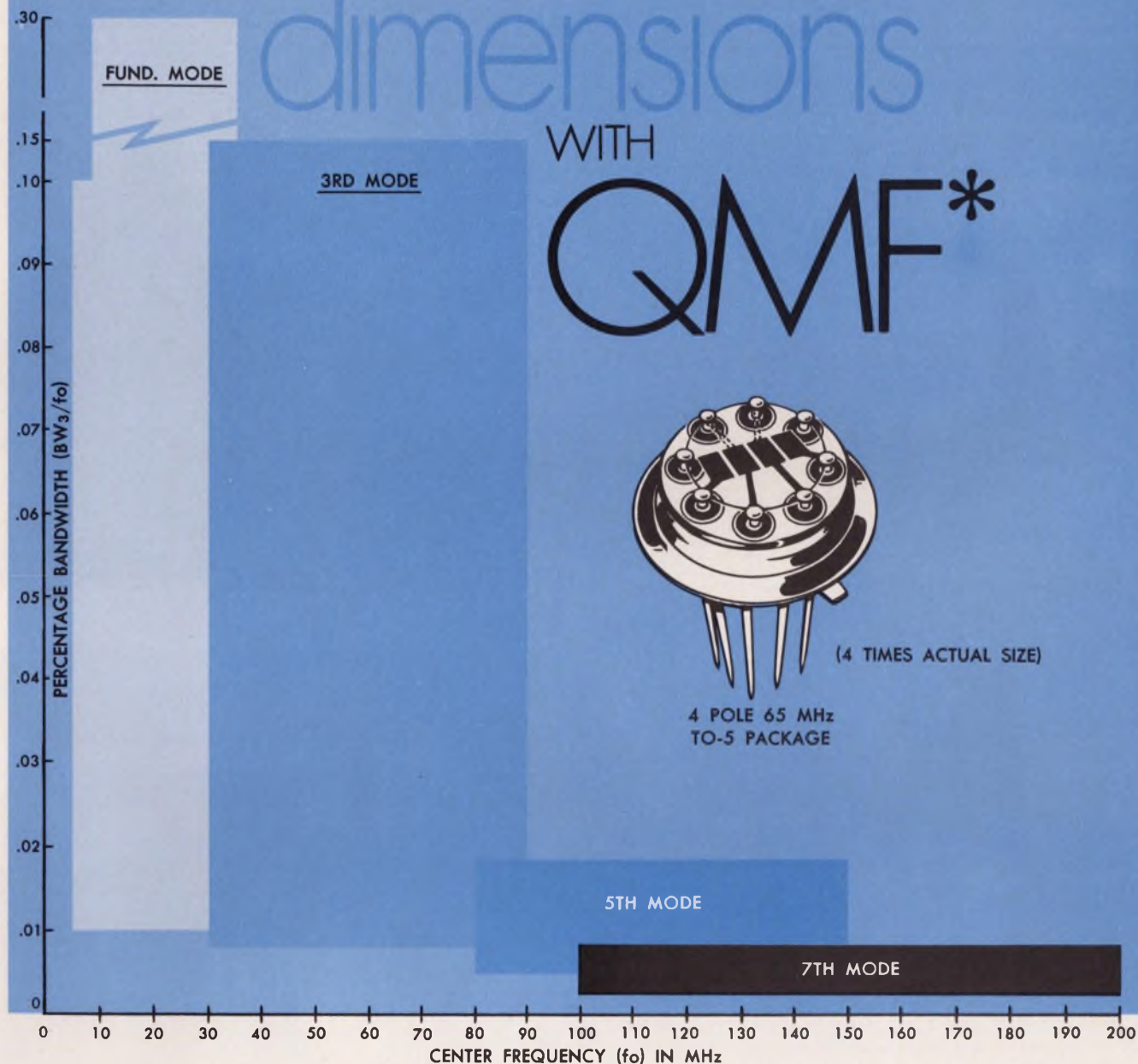

4 POLE 65 MHz
TO-5 PACKAGE

(here's valuable bandwidth information you'll want to save)

Regardless of what they are called, M^CCoy Electronics Co. makes available the most complete offering of multi-electroded devices in the industry. From 5 to over 200 MHz, both crystal and filter technologies are combined to provide you assurance of competence, quality and reliability. We engineer and fabricate...

***Quartz Mechanical Filters
Uncoupled Filter Devices
Custom Innovations...**



M^CCOY ELECTRONICS COMPANY
MT. HOLLY SPRINGS, PENNSYLVANIA 17065
Tel. 717-486-3411 TWX: 510-650-3548
a subsidiary of OAK ELECTRO/NETICS CORP

Put our experience to work for you!

INFORMATION RETRIEVAL NUMBER 35

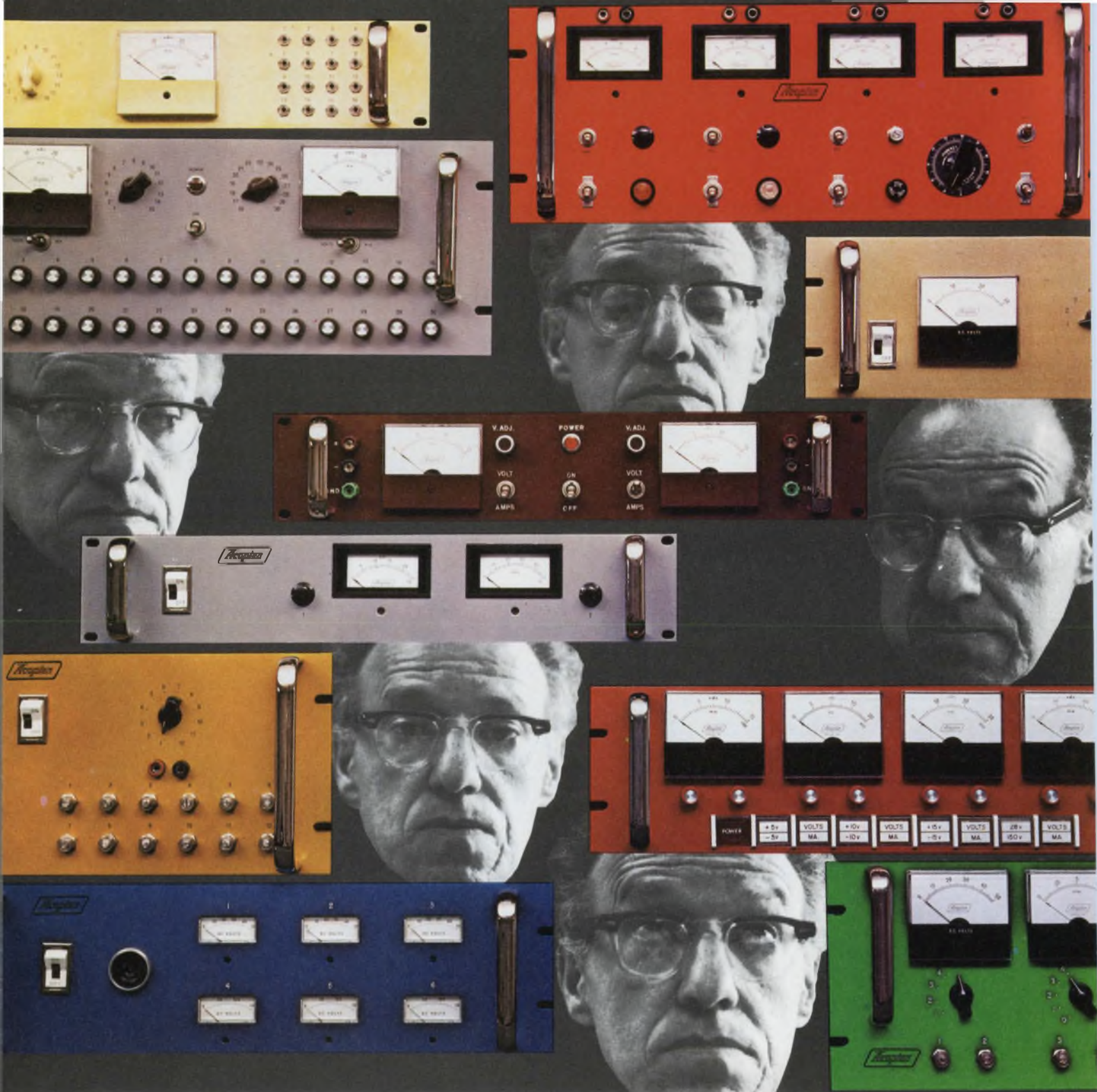

**Looking for a special power supply system?
Acopian will ship it in just 9 days!**

When you're looking for a multiple-output power supply system, and you need it in a hurry, look no further. Acopian will design it, build it, test it, and ship it...fully wired...*in just 9 days!*

Call 'hot line' 215-258-5441. Simply tell us the DC voltages and currents you need. We'll discuss—on the phone—the power modules, the panel size, accessories such as meters, terminations, test jacks, rotary

switches or any other feature you feel is important. Then—on the phone—we'll give you a firm price—and get the order going for guaranteed 9-day shipment.

Others make promises. Acopian makes power supplies. Power modules in 3 days, and now power systems in 9 days. For immediate service, call 215-258-5441. For literature, write Acopian Corporation, Easton, Pa. 18042.



Technology

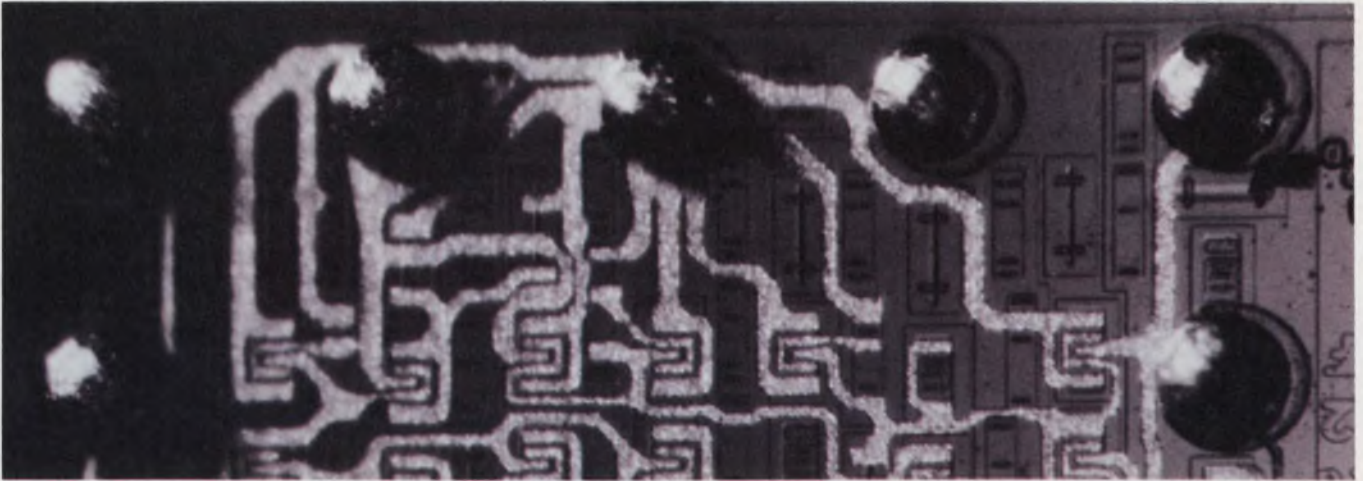

Vendors and their customers bump heads over new beam-leded, bumped and spider-

bonded chips. For the special report on bonding triumphs and troubles, see p. 61.

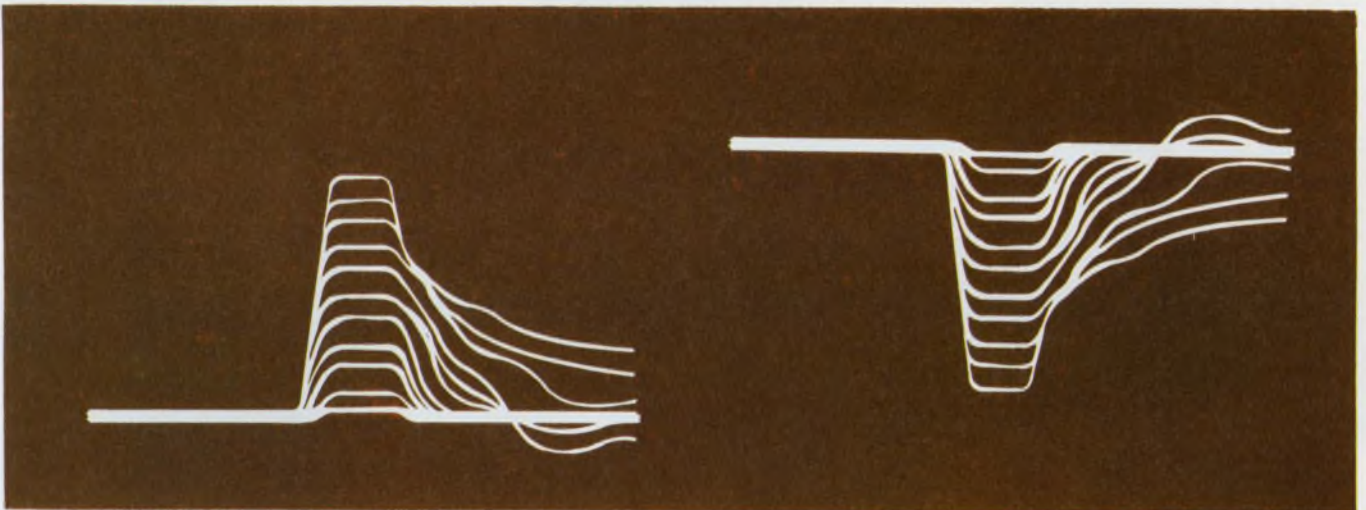

A high-speed dual-polarity log amplifier can be made by cascading differential amps.

The illustration is from a scope trace covering 90 dB. Rise time is 10 ns. p. 86.

Also in this section:

Convert Boolean algebra to arithmetic and simplify logic expressions. p. 82.

SCR model simplifies computer programs. p. 92.

How well are you engineering your career? Check yourself with this survey. p. 98.

Ideas for Design. p. 107.

The non-catalog connector.

If you can't buy it. We'll make it. Any kind of printed circuit connector.

Tell us how many positions, how many contacts. And what kind of shape it ought to be in.

We'll take it from there, and turn out a connector for you, at a price that's probably the lowest in the business.

The biggest reason is our contacts—because they're the biggest single factor in the price of connectors.

We put more gold at the contact area than any plater does. But we weld it there instead of plating it. So we use less gold overall.

As a result, our contacts are the best you can buy. (Maybe that's why many of our competi-

tors use them.)

We also do our own wire drawing, coining, forming, bending, and solder plating. We design our own tooling and mold our own plastic bodies. And we assemble and test the whole connector ourselves.

If you're looking for ordinary connectors look in ordinary catalogs.

But if you want something a little special, now you know where you can go.

Sylvania Metals & Chemicals, Parts Division, Warren, Pennsylvania 16365.

SYLVANIA
GENERAL TELEPHONE & ELECTRONICS

INFORMATION RETRIEVAL NUMBER 37

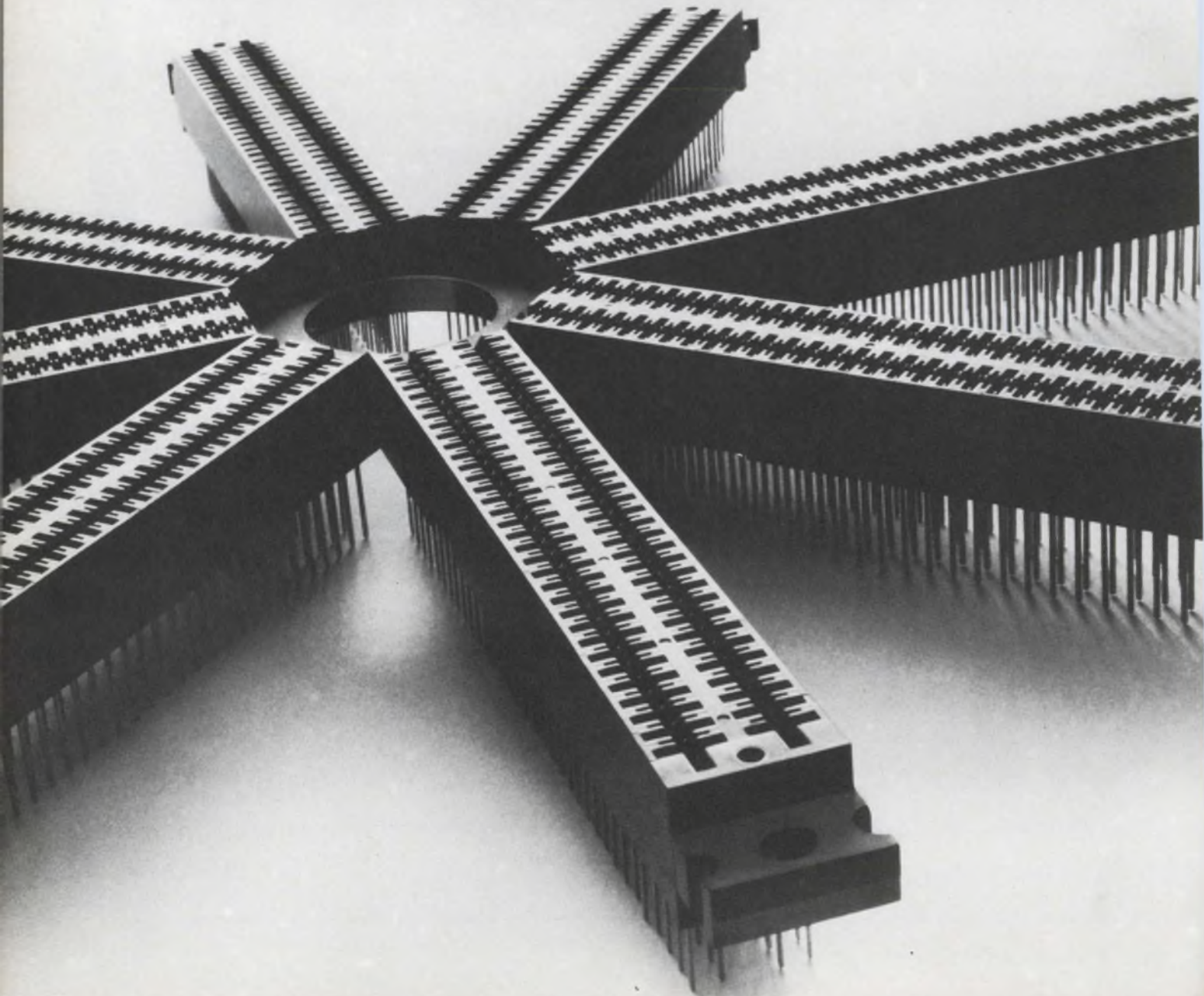

An Electronic Design Special Report

by Raymond Daniel Speer

**Chip bonding:
promises and perils**

Vendors promote their technology —but customers still await delivery

Finally, after over 10 years of development, sophisticated chip-bonding techniques offer hope for automated, fast, reliable and economical assembly of semiconductor chips into packages or hybrid circuits. That's what manufacturers are saying. But many customers are not yet convinced.

According to manufacturers, beam-leaded chip, bumped chip and spider-bonding processes have all been perfected. Raytheon, for instance has announced a new line of beam-leaded chips. Hughes Semiconductor offers chips with silver-tin bumps, and Motorola is turning out standard products with its new spider-bonding equipment.

A sampling of customers, on the other hand—especially hybrid circuit designers—shows a high degree of skepticism. Few appear ready to buy. The new bumped and leaded chips are expensive, and equipment for handling them is scarce. Designers feel that the new devices are not proven, and that even if they were, the manufacturers can't turn them out in volume. The customers have adopted, for the most part, a wait-and-see attitude.

The new devices are, of course, a natural evolutionary improvement in chip assembly. Since the earliest days of the transistor, the old standard-chip-and-wire technique has been considered best for bonding. Even today most of the chips in use are alloy-bonded to a substrate or package header and connected with 1-mil wire, one pad at a time, to package leads or to circuitry. But the old way is slow, because an operator must guide the

bonding machine every step of the way, and expensive, because the labor costs are high.

As the prices of transistors and ICs have plummeted, the labor involved in bonding chips into packages has become burdensome. Manufacturers have moved their assembly operations to low-labor-cost areas—to Korea, Japan, China and Mexico, where workers can be hired for a tenth of what they are paid for similar work in the U.S. Manufacturers have also invested heavily in perfecting new automated assembly techniques, and their efforts are about to bear fruit.

Beams for speed and reliability

Mel Snyder, manager of market and product planning for Raytheon Co., Mountain View, Calif., declares:

"We've announced to the world our beam-lead ICs, diodes and transistors. They're available off the shelf, through our distributors, and we supply thermocompression wobble-bonders to handle them with."

Snyder points out that offering beam-leaded chips to customers is Phase 1 of a four-phase Raytheon program. The company is laying out all its new device designs to be compatible with the beam-lead process, and it is making the extra two masks required to put beam leads on each device. Raytheon engineers are also going back to old designs and preparing beam-lead layouts for them, too. They plan to be capable of producing all of their chips in beam-lead form in the near future.

As Phase 2 of the program, Raytheon will offer customers arrays of beam-leaded chips on ceramic substrates. "Our first products will be memory elements," Snyder says. "We've de-

Report cover photo of a 40-lead advanced MOS/LSI chip bonded to a thick-film alumina substrate, courtesy North American Rockwell's Autonetics Division, Anaheim, Calif.

veloped a 64-bit memory element with decoding, sense and write amplifiers on the beam-leaded chip. We'll mount four, eight or 16 of these on a substrate to offer the market 256, 512 or 1024 bits of memory in a single package."

Snyder says that the Phase 3 products will be single beam-leaded chips mounted in packages, for customers who need the additional reliability over chip-and-wire packaging. With Phase 4 of the program, Raytheon will completely automate all standard product lines around beam-lead assembly—perhaps as soon as the end of 1970. "We'll bypass the high-cost assembly step in making our ICs by automating," Snyder says.

Dr. C. Robert Castor, vice president and general manager of Sylvania's Semiconductor Div. in Woburn, Mass., says that his company has had an active beam-lead engineering program going for three years now. "We're looking at beam leads as an assembly technique that lends itself to automation in packaging our standard products," he explains. "But our in-house thick-film hybrid facility is developing hybrid application techniques, too."

Castor points out that Sylvania is not producing any ICs today with beam-lead assembly techniques, and it isn't selling beam-leaded chips either, except for some microwave devices—diodes and capacitors—that it has been selling for over a year.

Why the beam-leaded development program, then? Castor says that the beam-lead technique offers higher inherent reliability than chip-and-wire. And he feels he must continually compare the costs of chip-and-wire assembly in low-labor-cost areas with the alternative—automation at home. "To fully use the new bonding technology," he says, "we would have to make a substantial investment in automated equipment. We must be in a position to evaluate the alternatives."

Motorola Semiconductor Products, Inc., Phoenix, is also in the beam-lead business, according to James A. Newton, operations manager for work connected with the Safeguard antiballistic-missile program. He says that Motorola's current major activity is production, under contract to Western Electric, of parts for the ABM program.

"These are custom hybrid, beam-lead silicon-nitride encapsulated devices on a custom header," he says. "They are Bell Labs designs and developments, and they use the basic Bell Labs technology. We're in production now—we've completed the preproduction engineering phases; we've built a plant and have it in operation, and we're shipping devices."

Newton says the company's plant in Mesa, Ariz., will have a production capability of 50,000 hybrid circuits a month when it is fully staffed. Each hybrid contains roughly six chips, with three to 28 beam leads on each chip.

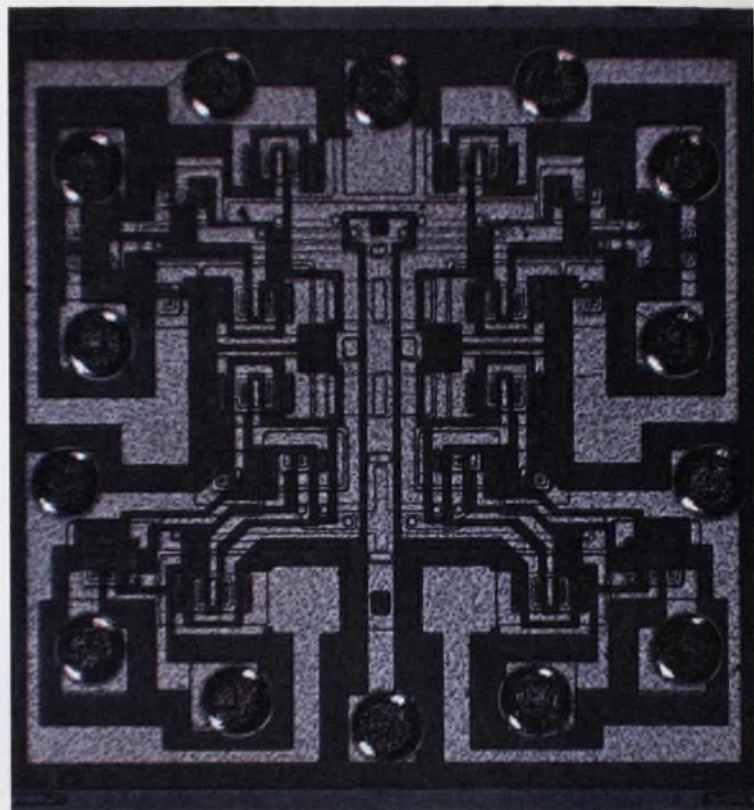

Manufacturers offer new devices, such as this aluminum-bumped TTL logic gate, and list their many advantages. But customers worry about handling problems, narrow product lines and vendors' production capabilities. Photo courtesy Texas Instruments, Inc., Dallas, Tex.

"Beyond the Safeguard program," he continues, "we're developing our own beam-leaded product line, which we'll announce by the end of 1969. We'll have a few elements of the TTL family and probably one linear device."

"We anticipate selling beam-leaded chips and finished devices—whatever people want—but most of the interest has been in the chip area. People want to assemble multichip arrays in their own houses. We won't be averse to selling chips—that's the way we expect to sell most of our beam-lead products."

But beam leads aren't the only way to go. Robert A. Sanborn, marketing manager at Hughes Aircraft's semiconductor plant in Newport Beach, Calif., looks very favorably on bumped chips.

Bumps and automatic handling

"We manufacture flip chips with silver-tin bumps," says Sanborn, "and we are revolutionizing the handling of flip chips. We're producing dimensionally controlled devices that can be handled by automatic equipment in circuit assembly."

"Our silver-tin bump technology is basically the same one that IBM and others have been using. We've spent a lot of money developing



"Chip-and-wire will give way to the beam-lead or the bumped chip, but it's difficult to say which one. We've got to keep both bets going, and we are."—Gene Blanchette, group director for integrated circuits, Fairchild Semiconductor, Mountain View, Calif.

that technology. We are now making these products and delivering them to large customers who are using them in their hybrid circuits."

The Hughes flip chips can be bonded to either thin- or thick-film circuitry, but Sanborn says that most of the company's experience has been with thin films.

"The chips are usually tacked down with ultrasonic energy and then reflowed, making a very strong bond," he notes.

"In volume production we will be directly competitive, with the chips delivered in a carrier, with similar devices chip-and-wired and delivered in a plastic package. I think a face-up chip itself will always be less expensive, but then it will cost more to put into a package."

Sanborn says that Hughes also has the capability for building aluminum-bumped flip chips, which they do not now sell on the market. "We are working actively on, beam-lead technology too, just to have it available if and when we decide to use it," he says.

At Motorola the big push is on spider bonding—the bonding of a lead frame directly to the chip metallization. Bob Helda, manager of mechanization for special projects, points out that the automated spider-bonding technology was developed to reduce drastically the high cost of wire bonding. It has been applied first to Motorola's plastic dual-in-line ICs.

The "spider" is a stamped aluminum lead-frame configuration with radiating fingers that match the bonding pads on the die at one extremity and corresponding package leads at the other. The leads are held together by a common frame element, which is removed after the bonding is completed.

Spider bonding for cost reduction

"Our goal for assembly-cost reduction was one order of magnitude, and the spider technique approaches that goal," Helda reports. "It allows continuous in-line assembly without accumulative handling cost."

The biggest single advantage of the system is that the spiders can be handled in continuous coils. Die bonding, frame bonding, molding, frame cutting and forming, and final testing can be done without interim handling or reloading of the individual packages into carriers.

"The single factor in this entire program that was most difficult to achieve," says Helda, "was the tooling that would repeatedly stamp the spiders to the accuracy and repeatability required to achieve uniform and highly reliable bonding of 14 leads at one time."

Moreover, 2-mil aluminum is a very soft material. The progressive die that must pilot the aluminum strip from station to station was more likely to bend or tear the soft material than move it through the machine.

"The stampers finally solved this problem with a special feed mechanism and new techniques of punch and die clearance for proper scrap control," Helda explains. "Our dimensions are now held over thousands of parts within very close tolerances."

Motorola is in production on DTL, RTL and TTL plastic spider-bonded encapsulations. Helda's group is now doing preliminary engineering and tooling to use the spider in the company's hermetic dual-in-line ceramic package, and the group is experimenting with cutting off the aluminum lead frame after the first bond to the chip, to arrive at a beam-lead-like configuration.

The group encapsulates the chip before cutting off the aluminum leads, to arrive at a structure dubbed the "pill package"—about 10 times the size of a beam-leaded chip.

Some cover all the bets

Sprague Electric's Semiconductor Div. in Worcester, Mass., is looking seriously at all three technologies, although it hasn't announced a capability yet. Dr. Robert S. Pepper, corporate manager of functional circuit design and technology, says that Sprague has sold bare chips for



"If I were a hybrid designer with no semiconductor facility of my own, I'd be afraid to go beam lead. Unless hybrid houses are willing to order beam-leaded parts in great volume, they'll have difficulty in getting them at anywhere near a competitive price."—Dr. C. Robert Cas-

tor, vice president and general manager, Semiconductor Division, Sylvania Electronic Components, Woburn, Mass., cautions hybrid designers. High-volume production of beam-leaded and bumped chips is still a dream of the future for most semiconductor vendors.

years, as well as some specially metallized chips with aluminum bumps, and is now providing sample quantities of beam leads.

Pepper plans to go to spider bonding in standard product assembly, too, as fast as possible. How soon? "We hope to begin spider bonding of our standard ICs during the first quarter of 1970," he says.

But Sprague's main emphasis will be on beam leads. "We definitely plan to offer a broad family of beam-leaded devices," the Sprague official says, "both linear and digital. But we won't announce them until we have a fairly broad family and a good delivery capability.

"We are concentrating our beam-lead efforts on doing what we think is the toughest type of circuit: high speed, 5 ns, TTL. These are small-geometry circuits which pose difficulty in applying beam leads, and there are processing problems with putting silicon nitride passivation on circuits which have been gold-doped to reduce storage time. When we can beam-lead these circuits at high yield, we'll know that we can do other circuits, too."

At Fairchild Semiconductor in Mountain View, Calif., Gene Blanchette, group director for integrated circuits, says that "unquestionably a very significant portion of the hybrid circuits and multichip arrays built in the next few years will use face-down bonded chips, whether beam-leaded

or bumped.

"But at this stage," he says, "it is very difficult to say which technology will find majority use."

Blanchette feels that the coming growth of the multichip-array memory market will boost the use of bumped and beam-leaded chips. He estimates that, right now, 95 per cent of the hybrid circuits made are of the old chip-and-wire construction. No one, he says, has progressed to the stage of combining the substrate and chip technology needed for bumped or beam-leaded chip use.

He expects chip-and-wire construction to give way gradually to either the beam lead or the bumped chip, but he adds: "It's very difficult to say which one. We've got to keep both bets going—and we are."

How about spider bonding? "I think spider bonding is one of the better approaches to economical monolithic bonding," Blanchette says carefully. "It is not necessarily the best way to go for hybrids, or for multiple-chip assemblies, but if you want to eliminate wire bonding on standardized high-volume chips for a really mass-produced high-volume market, it's a good way to go."

Regardless of the enthusiasm of the manufacturers, many customers are going to "wait and see."



"The biggest question in the designers mind is 'what's going to be available?' It's essential that the vendors be able to supply the wide range of devices that the designer needs."—Thomas Noe, member of the technical staff, semiconductor research and development laboratory, Texas Instruments Inc., Dallas, Tex.

At Beckman Instruments' Helipot Div. in Buena Park, Calif., Milton J. (Mick) Strief, chief engineer of microcircuit operations, says that to a designer, the new technology is just coming over the horizon.

Bad experience with bumps

"What we're doing is all chip-and-wire, period," he says. "We've looked into bumped chips and beam-leaded chips, but we aren't using either yet. And we've had a very bad experience with bumped chips.

"We've had a lot of trouble with the bumps coming off. Several times our supplier said they had the problem solved, but each time we tried them, the bumps would fall off. In the last year and a half we haven't tried them."

Strief concedes that he was working with only one supplier here.

He also contends there is a lack of product selection in the new chips.

"You're very limited in the selection of devices available in flip-chip or beam-leaded form," he says. "There are some npn and some pnp transistors available, but there's no wide spectrum of products. And power devices, SCRs and monolithic ICs are just not available in bumped chips.

"The chips that are available are not very reliable. The main reason for that probably is that the vendors aren't making many. They need to make a lot of devices, day after day—and to sell a large volume of the products—to get consistent processing, and IBM is really the only company

that's done that."

Perhaps volume is the key. Lewis Miller, advisory chemist at IBM's component division, Hopewell Junction, N. Y., says that his company's bumped-chip process, which it calls solid logic technology, is amazingly successful.

Bump success at IBM

"Almost every process in SLT," he says, "runs at yields of over 95 per cent." And he cites recently published IBM data on 30 billion hours of field data, in which total module failure rates in the IBM 360 computer, where solid logic technology is used, were less than 0.003 per cent per 1000 hours of operation. The modules contained up to six chips each, but with only three bumps per chip.

Questioned about the success of experiments with a greater number of bumps, Miller points to an advanced solid-logic-technology process, in which five to seven bumps per chip are used.

"To the best of my knowledge," he says, "these modules are even more reliable than SLT. The program was started later, and we had learned a lot."

The IBM bumps are formed of 4-mil-diameter copper balls, soldered to the chip.

Beckman's Strief expects bumped chips to be a little more expensive than conventional chips with bonding pads, but he, too, sees them as an economical approach in the long run. "If you're talking about quantities below 100,000," he says, "then bumped chips must cost two or three times as much as chips with bonding pads. If you want to buy quantities of several million, though, you may see only a 15 to 20 per cent premium charge for bumped chips. If you assume that a bumped chip can be assembled without many problems—and I'm sure it can—then it's much more economical to go the bumped-chip route."

Of the three techniques, though, Strief is most impressed by spider bonding, although he hasn't yet tested any spider-bonded products. "Spider bonding, from what I've seen of it, will be a real coming technique for low-cost IC assembly," he says.

Harold C. Gaither, process engineering manager in the Microcircuit Products Div. at Varo, Inc., Garland, Tex., would be willing to try any of the new assembly techniques, but he finds that the main drawback to beam-lead and bumped-chip devices is that they aren't available yet.

Availability is a problem

"You can't get beam-leaded devices in the particular transistor chip that you want," he says. "I don't know of anyone who will supply beam-leaded devices in quantity, and only three or

four companies can make them successfully even in the laboratory."

As for bumped chips, Gaither believes that in 5-, 7- or 10-lead devices the flip chip becomes an untenable solution to interconnection. "We've tried flip chips," he says. "If you have just three contact points to worry about, the surface that the chip is going onto doesn't have to be completely smooth. But for four or more bumps, if your surface isn't absolutely planar—within one-half mil to one mil—you won't bond some of your contacts. Soldering is a better technique than ultrasonic bonding, but you still have problems."

Gaither says that Varo isn't using flip chips, because the chips just aren't far enough along in their development. The same is true of beam-leaded chips. "We know of very few people who are successfully using these devices," he says. "The leads are very, very fragile. I think there are some very big handling problems to be overcome."

Lloyd Norman, manager of product design and development in the hybrid circuit branch of the Components Group at Texas Instruments, Dallas, agrees that flip chips are just not available to the designer right now. "These chips are just getting to the point now where they are feasible," he says. "But the beam-leaded chips have come ahead of the flip chip in development progress, at least at TI, and we have done beam-lead applications."

"Ideally, we would build most of our circuits using beam-leaded chips if they were available. We see beam-leaded chips as a big step forward in reducing the cost of microwave hybrid circuits. The initial cost of the device is higher, but the amount of labor required to mount them is lower, and they are much easier to test. Yields in hybrid construction would be greatly increased if beam-leaded active devices could be used."

Dr. Castor, vice president and general manager of Sylvania's Semiconductor Div. in Woburn, Mass., sympathizes with the designers. "If I were a hybrid designer with no semiconductor production facility of my own, I'd be afraid to go beam lead," he says. "There would be no question—I'd use chip-and-wire assembly."

Selection is very limited

Castor explains that hybrid manufacturers need access to a wide variety of semiconductor devices. They need op amps, perhaps 20 different logic circuits and a number of transistors and diodes. "Unless a hybrid house is willing to order beam-leaded parts in large volume," he says, "they'll have great difficulty in getting them from a semiconductor vendor at anywhere near a competitive price."

And Thomas Noe, member of the technical



"We've looked into bumped chips and beam-leaded chips, but we aren't using either yet. And we've had a very bad experience with flip chips."—Milton J. (Mick) Strief, chief engineer, microcircuit operations, Helipot Division, Beckman Instruments, Buena Park, Calif., sees the new technologies as "just over the horizon."

staff in the semiconductor research and development laboratory, Components Group, Texas Instruments, feels that the biggest question in the designer's mind is: "What's going to be available? What devices can a designer buy in flip-chip, beam-lead, or spider bonded form?"

"I think it's going to be essential that the vendors be able to supply whatever devices the designer needs," he says. "Right now we are making substantial efforts in both flip chips and beam-leaded chips. Whether we go beam lead or flip chip depends on the product application."

Noe says that Texas Instruments has a flip-chip production area that builds bumped devices for IBM, and that it also has a beam-lead production area that is building devices for the Safeguard program with the Western Electric process. "Both of these were set up as specialized areas," he says, "to produce a special product for a specific contract."

"But the markets that are really opening up for face-down bonding are the commercial, industrial and computer markets. A lot of people who are building hybrid circuits for the military market are still going to be building them, of course, but we have got to come up with new innovations which will meet the cost objectives of this nonmilitary market and still maintain the reliability that's required."

"Everybody in the semiconductor business seems to be turning to the problem of getting the cost of commercial devices down," he says. "That's our reason for looking at flip chips." ■■

New chips pose problems —from wafer processing to hybrid assembly

Why have the new semiconductor chips taken so long to develop? And why are they still in scarce supply? Why are some designers encountering problems in using them, even when they are available?

The reasons all stem from one fact: The new beam-lead, bump and spider processes are very complex. They require an intricate knowledge of metallurgy and some very precise machinery as well. And once the chips are formed, they still must be bonded to circuitry or packages.

Beam-lead contacts, for instance, are electroformed, usually of gold, on the surface of the specially prepared device, and they extend over the side of the chip. The beams serve as mechanical mounts and electrical connections, and they are easily visible and accessible from the back of the chip. Beam-leaded chips are bonded face-down, either ultrasonically or by thermo-compression, with the bonding head descending from the back side.

Extra processing for beam leads

Processing is more complex for beam-lead chips than for bare chips with aluminum metallization. The extra processing includes covering the chips with a silicon-nitride passivation layer, to protect them from dust or metal particles, and a glass overlay, to protect the metal interconnects from corrosion and abuse during handling.

Mel Snyder, manager of market and product planning at Raytheon Co., Mountain View, Calif. describes their beam lead structure as a multi-metal system of platinum contacts. "We looked at all of the schemes," he says, "and settled on a variation of the Bell Labs method.

"After the conventional diffusions have been

made, we put a layer of silicon nitride on top of the silicon dioxide. Then, using standard photolithographic methods, we cut windows to make contact to the active areas on the chip. Then we put the wafer in a sputterer and deposit on it a thin layer of platinum. We sinter the platinum, and then etch it off, leaving a layer only at the contact points.

"Then we put the wafer back in the sputterer and deposit on it a layer of titanium. The titanium enhances the adhesion of the gold beam to the silicon nitrate. We follow this with a layer of platinum, which prevents migration of the following gold layer, then we put on a very thin layer of gold. We take the wafer out of the sputtering machine and define the chip interconnect pattern, by normal masking methods. Then we electroplate gold onto the interconnect pattern to a thickness of about 20,000 Angstroms.

"After this we define where we want the beams—this takes another mask—and electroplate the beams up to 1/2 mil thickness. Our beams extend over the chip by 5 mils, they're 3 mils wide, and are spaced on 10-mil centers."

Snyder says that there are several good beam-lead processes. They chose the process best suited to their equipment and products.

Dr. W. Hans Legat, engineering development manager at Raytheon, points out that the beam-leaded chips are formed on wafers, with the beams interdigitated to save area. The chips are separated by etching from the back of the wafer.

"In a typical separation procedure," he says "the completed wafer is cemented face-down on a quartz disc with resin or wax, and the individual chips are chemically etched apart. The resin holds them in the original wafer orienta-

tion and the handling of individual devices is eliminated."

The chips can be probe-tested from the back side, or can be turned face-up by a transfer process. Legat favors the latter approach; it allows for visual inspection of the face of the chips.

Most manufacturers attempt to automate the probe-testing operation and to store the test results in a computer, rather than mark the chips visually. Wafer orientation is maintained in these schemes right up to the time that the chips are used.

Due to the extra processing required, beam-leaded chips are much more expensive to produce than conventional chips with bonding pads, and even a little more expensive than bumped chips. They are also subject to failure by shorting between the beam leads and the body of the chip, where the chip extends over the edge. At this point the leads are separated from the body by a thin layer of silicon nitride and glass, approximately 5 microns thick.

Bonding beam leads to substrates or package headers is easily done by thermocompression or ultrasonic means. The leads can be bent to some degree to accommodate the lack of coplanarity of the contacts they are bonded to, and the bonds that are made can be inspected visually. Because one end of each beam is already connected to the chip, there are only one-half as many bonds to make as with chip-and-wire method.

Bonders are available that bond all beams in one operation, under controlled conditions of pressure, time and temperature, with the positioning done by an operator. This appears to be a far superior technique to chip-and-wire technology, in that random faults of operator origin—such as misplaced bonds, bonds placed too closely together, incomplete bonds, bonds torn loose during tail-pull, or the collapse or shorting of wires—are eliminated.

Aluminum, solder and silver-tin bumps

Bumped chips are simply conventional silicon chips that receive additional treatment to give them raised contacts on the top surface.

The raised contacts or bumps are most popularly solder, aluminum or a silver-tin combination, chosen for compatibility with commonly used substrate materials and ease of bonding. The bumps must produce reliable electrical and mechanical joints with the bonding technique to be used, and they must be capable of sufficient deformation to compensate for lack of planarity in the bump height and the surface they are to be bonded to.

Two techniques for deforming the bumps during bonding are being used widely. The first is

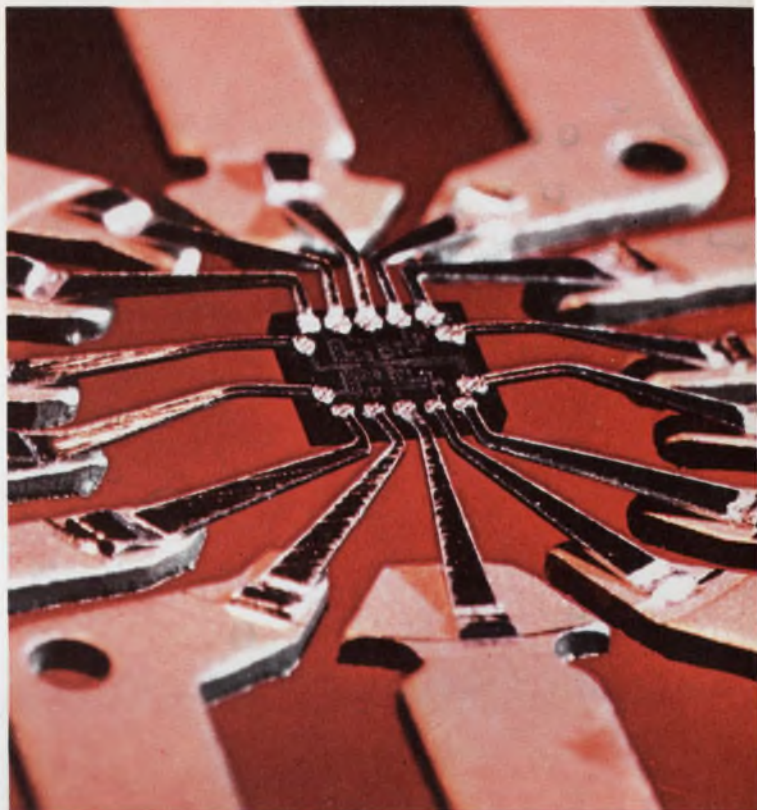

Spider bonding offers automation of the critical and costly assembly process. It's especially suited to low-cost plastic packaging and is now used in standard IC production at Motorola Semiconductor Products Inc., but it's not easily accomplished. Preparation of the 2-mil aluminum lead frames requires expensive tooling, and the automatic machinery for handling and bonding the lead frames and chips is exceedingly costly.

the application of pressure, as in thermocompression or ultrasonic bonding, and here it is important that plastic flow rather than elastic deformation occur. Materials that exhibit good plastic flow properties include gold, silver, aluminum and copper.

In the second technique, the contact material is liquid at some point in the bonding cycle. The liquid can be a conducting epoxy that dries after the chip is mounted, a low-melting-point indium mixture that undergoes a drastic rise in melting point as a result of diffusion between the mixture and the metals it joins, or a eutectic lead-tin, gold-tin, gold-germanium, or gold-silicon solder. Solders, in fact, are often plated on the bumps, on the substrate or package header, or on both, and solder reflow is a popular technique for bonding bumped chips.

Bumped-chip processing varies widely among manufacturers. An especially successful solder reflow process, according to Lewis Miller, advisory chemist at IBM's Component Division, Hopewell Junction, N.Y., is his company's solid logic technology, used to make modules for the IBM 360 computer.

"All of our chips are glassed by sedimentation," Miller says. "The glass frit is then fired

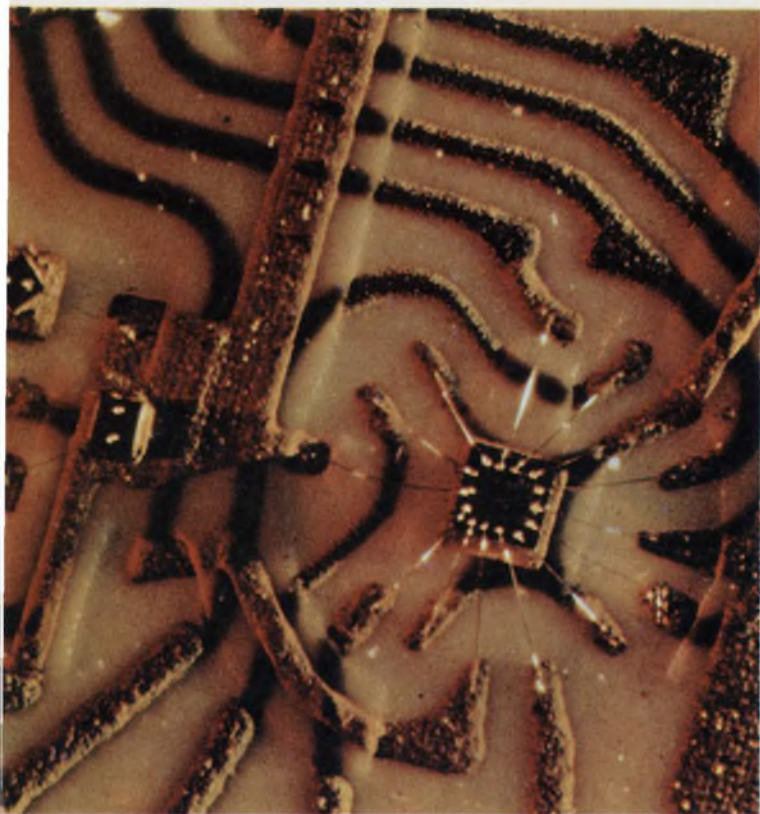

Chip-and-wire predominates in hybrid circuits built today. Experts estimate that 95% of all hybrid work is now done this way, but they expect beam-leaded and bumped chips to find increasing acceptance in the next few years. Shown is a portion of a typical hybrid circuit, an 8-bit digital to analog converter containing switching, ladder network, output buffer, reference supply, feedback scaling and bipolar offsetting resistors. Photo courtesy Beckman Instruments, Inc., Helipot Division, Fullerton, Calif.

to form a protective layer over the aluminum metallization on the chip. We etch holes in this layer, where the bumps are to be formed, and by a masking process put down a layer of chromium over the edge of the hole and down to the exposed aluminum metallization. We put a layer of copper on top of this, then a flash of gold, which prevents oxidation and completes the solderable area, and then evaporate through a mask a thick layer of 95/5 lead-tin solder to form a flat pad receptacle.

"Next we put over the whole wafer a mask which has holes in it that line up with the solder pad. We pour 5-mil copper balls over the mask to completely cover it, so that balls drop into all of the holes. Then we heat the assembly in an oven, and a ball is soldered to each solder pad. These form the bumps on our SLT chips."

IBM is switching to a different process—a ductile-pad approach—as chips get larger, in spite of its success with solid logic technology. Ductility in bumps is important to relieve thermal stress. This newer process is easier to manage than copper balls at finer tolerances, and it provides even greater tolerance to substrate roughness.

"Processing in the ductile-pad approach is essentially the same up to application of the solder balls," Miller notes. "In this process, after applying high-lead solder to the solderable areas, we heat the chip so that the solder reflows to form hemispherical bumps. Solder does not wet the oxide surfaces surrounding the gold-flashed area, and balls up to 5 mils in diameter are easily achieved. The substrates are prepared similarly with solderable dots to receive the pads, surrounded by a nonwetting surface. Devices are attached by reflow, and the surface tension of the solder holds the chips several mils off the substrate."

Robert Sanborn, marketing manager at Hughes Aircraft's semiconductor plant, says his company uses a similar process, but its chips have chromium-gold conductor patterns for interconnections, and silver-tin bumps. "The entire active area of the chip is sealed and protected by a sputtered glass layer, and contact bumps are electroformed of pure silver to a height of roughly 2 mils," says Sanborn. "Then silver-tin, low-melting point solder is deposited over them for easy reflow attachment."

Spider bonding: a machining triumph

In the spider-bonding process—pioneered by Motorola Semiconductor Products, Inc., the only company yet to use the technique in standard products—an accurately stamped lead frame (spider) is bonded directly to the bonding pads on a standard chip. The lead frame can then be cut to leave leads on the chip that resemble large beam leads, or it can be bonded to a regular dual-in-line copper lead frame for packaging.

The spider process is performed on conventional chips with bonding pads. Some extra processing is required, but Motorola's manager of mechanization for special products, Bob Helda, says that the extra cost of wafer processing is insignificant when compared with the bumped chip or beam-lead approaches. The lead frame presently used by Motorola is aluminum, but copper works well, too. If copper spiders are used, Helda says, the leads can be soldered or thermocompression-bonded directly to a printed-circuit board on a ceramic substrate.

Spider bonding is really quite simple in concept, but it requires intricate and precise equipment. Using Motorola's equipment, the operator places conventional chips with aluminum metallization face-down in a one-eighth-inch circle on a transparent platform. The bonding machine, by means of an optical comparator, then automatically positions the chip, at the operator's command, by moving the transparent platform in x , y , and θ coordinates. Then the bonding head automatically descends, picks up the chip, carries it to the

aluminum spider lead frame and ultrasonically bonds all leads simultaneously.

The pad sizes on the chips presently used at Motorola are 4-by-5-mils on 8-mil centers. Helda says it will probably be possible to use 3-mil-square pads on 6-mil centers, but the saving in real estate may not offset the loss in bonding yields.

While the bonds are being made, the operator is positioning the next chip to within roughly 30-thousandths of an inch in the circular target. A closed-circuit TV monitor allows checking of the critical bonding operation.

"The machine was made to work first on a 32-lead package," Helda says, "and it was, in every sense, successful. The repeatability was excellent and yield was over 99 per cent. The cost crossover point occurs at roughly 10 leads. For fewer leads, the chip-and-wire approach is still cheaper."

The savings gained through reduced labor are not the only advantage of the spider-bonding system. Helda says that the bonding process can be monitored by normal pull-test methods, and the devices go through routine visual inspection to insure good bonds and process control. After the spider is bonded to the chip, the die may be eutectically bonded to a header, if desired, for better heat dissipation. Helda points out that the bond to the chip metallization is aluminum-to-aluminum (which may be considered radiation-resistant) and that the spider cross-section is more rigid than that of wire, to better withstand the rigors of the flexing and deformation it encounters in handling and molding. The average pull strength of a spider lead, he says, is 24 grams, compared with 16 grams for 1.5-mil wire.

The Motorola process also provides for protecting the chip. As the strip of bonded devices indexes through the machine, a drop of a conformal coating is applied to the chip face and cured. This coating serves as a moisture barrier in the completed package.

The reel of aluminum spiders, with chips attached, can then be put on a second machine, which automatically bonds the outer extremity of the aluminum spider to a mating package lead frame of copper. The same machine also removes the excess aluminum material, completing the interconnection process.

The coils of copper lead frame, with aluminum spiders and chips attached, can then be run in tandem through a multiple-cavity, screw-transfer molding operation. The molded packages are cured on reels and then run in coil form through dies for shorting bar removal and forming.

Once the chips are formed, of course, whether spider-bonded, beam-leaded or bumped, all the usual problems of bonding must be faced. The two most practical bonding techniques, thermo-

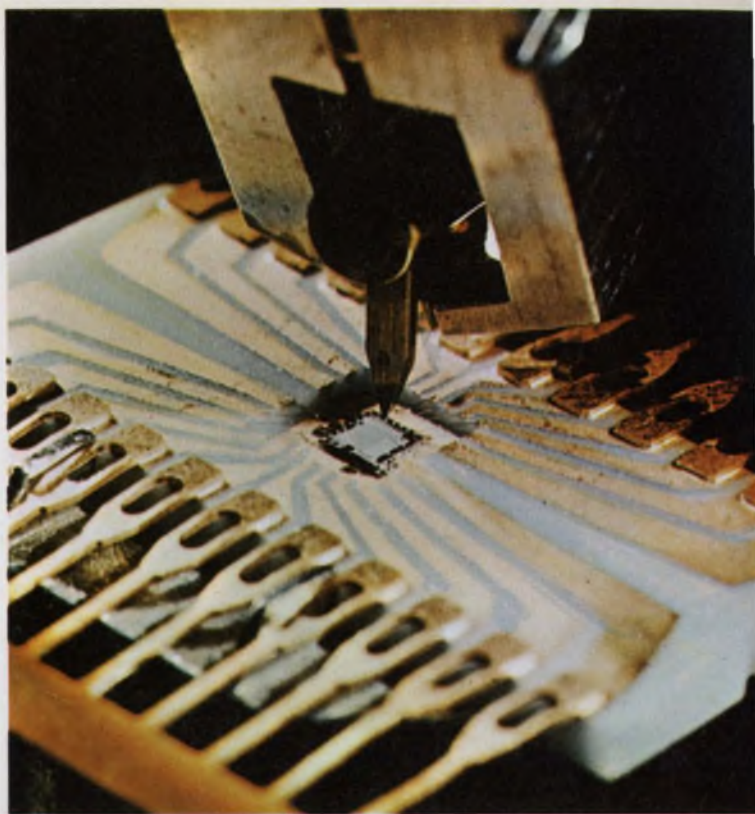

Ultrasonic wire-bonding offers an advantage over thermocompression bonding, in that it does not require general heating of the semiconductor chip. The vibrating bonding tip generates heat by friction only at the point at which the bond is to be made. This method is considered more critical than thermocompression bonding, because the tool pressure and the amplitude and duration of vibration must be precisely controlled. Adjustment of the equipment for mechanical resonance can be difficult.

compression and ultrasonic, unavoidably involve the application of heat and mechanical stress to the delicate chip.

Heat and pressure for bonding

In thermocompression bonding, heat and pressure, under very precise control, are applied at the point at which the bond is to be made. The two pieces of material to be bonded undergo a plastic deformation, and some diffusion of the materials occurs at their interface. The result is a good ohmic contact, very similar to a resistance weld. A thermocompression bond requires no flux or catalyst, but the surfaces to be bonded must necessarily be very clean for the diffusion to occur.

Gold wire is the most commonly used material for thermocompression bonds to semiconductor chips or metallized substrates. Gold bonds easily to a variety of materials, and it forms balls easily when cut with a flame. In addition it is easy to work with in wire form. Good thermocompression bonds on gold wire are strong enough to break the wire before the bond fails.

Heat is normally applied by electrically heated columns that hold the chip or substrate, and by temperature-controlled tungsten carbide capil-

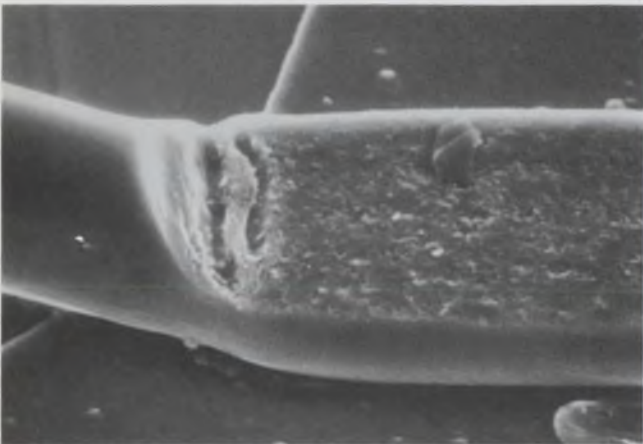
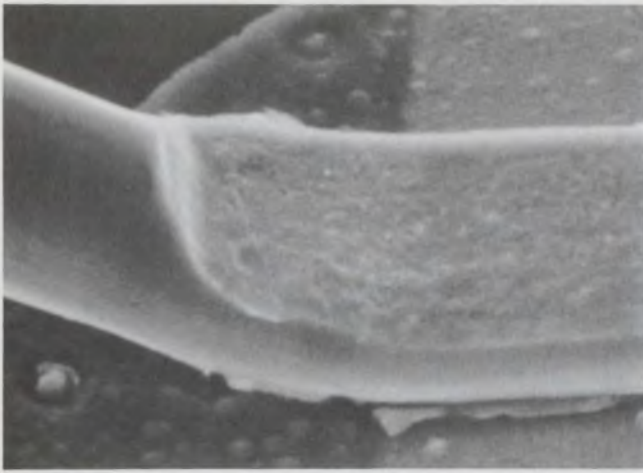

Electron-scan microscopy is a valuable aid to quality control in bonding. Good wire bonds, for example, should show deformation of the wire, no free-hanging loose wire ends, and no smearing of the metal bonding pads (top). The pressure and movement of the bonding tool must be carefully controlled, so that sufficient heat is generated from the friction to result in a good bond, but must not be rigorous enough to cause cracks (bottom), which greatly reduce the bond's strength. Photo courtesy National Semiconductor, Santa Clara, Calif.

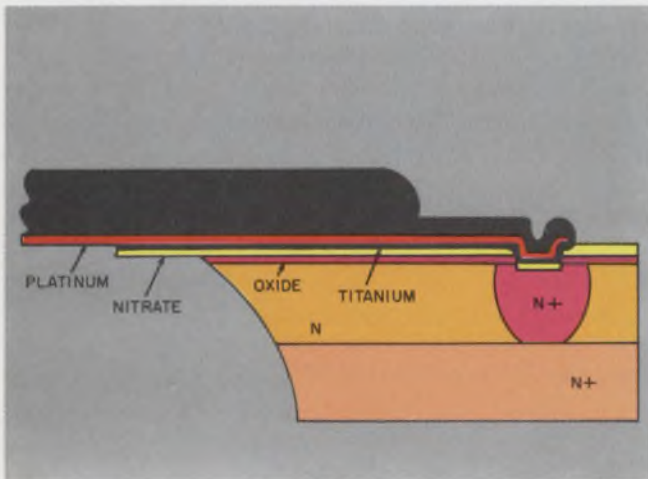

Beam leads are attractive but expensive. They are electroformed on the surface of the chip and extend over the side to allow easy bonding and bond inspection. The silicon dioxide and silicon nitride passivation makes the chip a hermetically sealed device, but the costly extra processing offsets these advantages.

laries. This dual application permits the use of lower temperatures in the heat column. Cold capillaries can be used, but if they are, the heat column must be held at temperatures approaching 350°C, and the bonds must be made in a non-oxidizing atmosphere of forming gas or pure nitrogen.

If the sole source of heat, on the other hand, is the capillary, there is some danger that the chip or substrate will conduct the heat away from the bond interface before a reliable bond has been made. This method is seldom used.

Three thermocompression bonds

Thermocompression wire-bonding processes can be classified—according to the way in which the materials are handled—as wedge, stitch and ball bonds.

Wedge bonds to a semiconductor chip or substrate are made by bringing the wire into contact with the metallization on the chip and then applying precisely controlled force at controlled temperature by means of a heated wedge-shaped tool, normally made of tungsten carbide.

Stitch bonds are simply a series of thermocompression bonds made with an unbroken length of wire. Stitch bonding is normally done with a heated capillary tube, but in some cases the capillary is unheated and the chip or substrate is heated instead.

Ball bonds are very similar to stitch bonds. The wire is fed through a capillary tube, but it is severed with a hydrogen flame, causing a ball to form on the end of the wire. This ball is then deformed by pressure and heat to make the thermocompression bond.

In a normal chip-bonding operation the ball bond is made to the pad on the chip and the bond

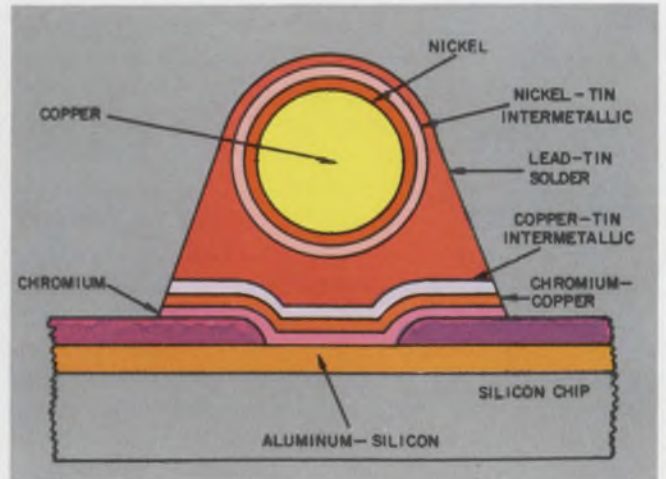

Bumped chips offer batch interconnection, if they are solder-reflow devices such as the IBM copper-ball flip-chip. Connection to a mating substrate is accomplished merely by raising the temperature to melt the solder, with the copper ball providing a solid stand-off during the heat processing.

to the substrate or lead frame is a stitch bond, made with the same capillary. When the capillary rises after this second bond, the wire is severed by the flame, a new ball is formed and the process is repeated.

Thermocompression bonding does offer the designer some problems, however:

- Assembly operators must have a high degree of skill and dexterity, as well as good eyesight.
- The equipment is more complicated than that used in either soldering or welding and therefore is more costly.
- Sources of heat are required, and the torch, the heated mount for the substrate or package header, and the capillary tip are hazards for the assembly operator.
- Feeding the wire through the small capillary tip, if it breaks, can be time-consuming.
- The wire and all surfaces to which it will be bonded must be extremely clean and free of oxides.
- The improper application of heat can produce nonconducting oxides at the joint interface.
- The bonding wire must have closely controlled dimensions and composition to form a uniform ball when cut with a flame.

Bonding by vibration

Ultrasonic bonding is very similar to thermocompression bonding, except its energy source is mechanical rather than thermal. An ultrasonic transducer vibrates a welding tip (at roughly 60 kHz) that transfers the vibration to the part to be bonded. This vibration causes movement between the parts to be joined.

The resulting friction cleans and heats the

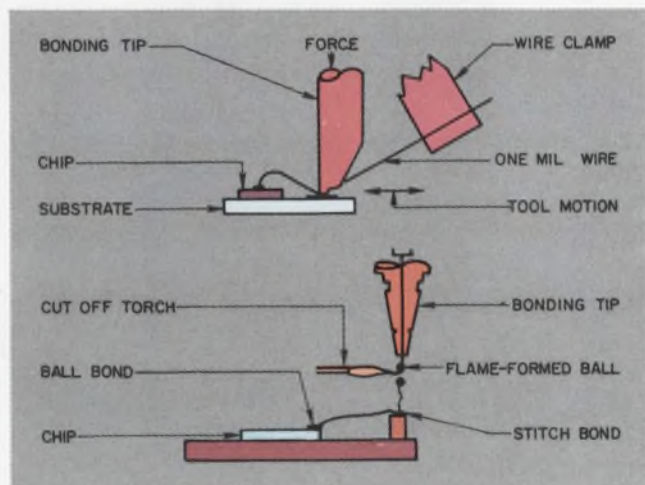

Thermocompression and ultrasonic bonds are very similar. In the first (bottom), heat and pressure are applied directly to cause interdiffusion of the metals, and in the second the heat is generated by friction between the mating surfaces. The ultrasonic scrubbing action also allows bonding of lightly oxidized surfaces.

surfaces, and if the pressure, amplitude of movement and duration of ultrasonic pulse are properly controlled, the metal interfaces flow together plastically just at the time that the surface cleaning is complete.

The ultrasonic technique is used very widely for bonding fine wires to chips and package leads or to hybrid circuits in the chip-and-wire construction. It is used also to bond bumped chips and beam-leaded chips to substrates or packages, and also for some die-bonding operations.

The absence of heat other than that generated by friction at the mating surfaces virtually eliminates "purple plague" problems (formation of a non-conducting compound of aluminum and gold in the presence of silicon at elevated temperatures), caused by heat during bonding. Though many metals can be bonded ultrasonically, gold and aluminum are the most commonly used, with aluminum being almost ideal.

Wire bonding is accomplished by gripping the wire in a grooved bonding tip, applying force to assure intimate contact between the wire and the bonding pad, and vibrating the tip by means of a transducer. The wire is scrubbed back and forth till seizure occurs. The equipment used must be capable of precise control of the bonding pressure and of the duration and amplitude of vibration.

A troublesome problem is related to variations in the frequency and damping of the mechanically resonant bonding tip. Ultrasonic tools must be tuned to resonance, which depends in part on the parts being bonded. Though newer ultrasonic generators are designed to compensate for variations in the damping effect of different semiconductor parts, the setting of power levels for proper bonding action is still difficult. Variations in pad or wire sizes may well affect the resonant frequency of the system.

One way to overcome this problem is to sweep the power supply over a band of frequencies to insure that the resonant point is reached during the bonding cycle. This mode of operation is available on most commercial bonders.

There are disadvantages to ultrasonic bonders, though. They include:

- The adjustment for resonance is troublesome.
- Only rigid parts can be joined, and the parts that are joined must withstand vigorous scrubbing.
- Work must be lined up under the bonder tip, so that movement from one spot to the other draws the wire under the bonding tool.
- Accurate control of bonding parameters is critical.
- The ultrasonic power applied can destroy semiconductor devices quite easily. ■■

Designers face the challenge —how best to apply the complex chips

The new chip-bonding methods offer the designer speed, reliability and economy, but they bring him some new problems, too. He must choose a bonding technique, for instance, that will provide adequate conduction of heat away from the chip. He must consider ease of handling in working with the chip in his own plant. He must avoid contaminating the chip with his new processes and watch carefully for potential inter-metallic problems. And he may have to ensure that his new circuit is radiation-hardened.

New techniques limit dissipation

The attachment technique used will, of course, determine the thermal resistance of the chip to its environment. The choice—bumped-chip, beam-leads, chip-and-wire, or spider—must be made in view of the power dissipation requirements of the chip.

David Metz, assistant director of central research laboratories at Motorola Semiconductor Products, Inc., Phoenix, Ariz., points out that the small cross-section of the gold beams on a beam-leaded chip, about 1/2 mil by 3 mils, and the comparatively long length of the beams, about 5 mils over the edge of the chip, result in a much greater thermal resistance than that in a conventional chip, alloy-bonded to the header or substrate.

The same is true, he says, of bumped chips. The metal pads provide a reduced area of contact to the substrate. If the pads are solder bumps, the heat conductance is very poor, because solder is a poor thermal conductor.

Some interesting figures are provided by R. Naylor, researcher with the Automated Systems Division of Ferranti Limited, Wythenshawe, Manchester, England. He finds that the thermal resistance between the heat source and the ambient is roughly 130°C per watt for a 16-bump flip chip, and 140°C per watt for a 16-lead beam-leaded chip. In arriving at these figures he assumes a thermal resistance of 11°C per watt for a solder bump and 135°C per watt for a beam lead.

“Maximum permissible junction temperatures are in the region of 170°C,” he says, “and if we assume a maximum ambient of 70°C this allows a 100°C temperature rise due to power dissipation.” A 16-lead bumped or beamed chip, according to this data, would be limited to approximately one-half watt of dissipation.

If a designer decides to use a bumped or a beam-leaded chip, he must not forget that it will operate at a higher temperature than it would in a conventional package. So its characteristics may be a little bit different from what they would be in a regular package, because current gain, leakage current, etc., are all functions of operating temperature.

And if he is dealing with matched components—matched transistors, for example—it's possible, since the thermal resistance is higher with beam leads and bumped chips than with die-bonded chips, that the difference in resistance may also be higher than it would be for two chips side by side on a substrate. So, for matched components that depend upon matched temperature, the designer can expect a greater loss of tracking. This

is true regardless of the metallurgy used, except as it affects the thermal resistance. If the overall thermal resistance is low, the difference in temperature between chip and substrate, caused by chip heating, will be smaller.

Metz also cautions against using filled plastics or organic potting compounds to increase the thermal conductance away from the chip. "It's a lot of trouble, and it just doesn't help much," he says.

Avoid filled potting material

"The thermal resistance of plastics is very very high. Consider a typical case: The manufacturer says that if a plastic that has a thermal resistance of 100 units is filled with gold, silver or aluminum, its thermal resistance can be reduced to 50 units. That sounds great, but even at 50 units, the resistance is still 10 times greater than that for an alloy bond to a substrate. The resistance is so high to begin with that cutting it in half doesn't help much.

"A better way to dissipate heat," according to Metz, "is to attach a fin to the back of the chip to increase the area of heat transfer between the heat source and the outside world."

One good way to improve the thermal conductivity of a beam-leaded chip is to attach the chip face up in a cavity in the substrate. If the cavity is the same depth as the thickness of the chip, the beam leads will be co-planar with the metallization pattern on the surface of the substrate. The bottom of the cavity and the back of the chip can be metallized, and the chip can be soldered into the cavity and the beam leads attached on top.

"This technique has been proposed and used," says Metz. "It gives higher dissipation, but it does lead to problems. The chip can't be simply pulled out for replacement; it has to be unsoldered. If it is unsoldered, a different metallurgy is left in the bottom of the cavity. The composition of the solder or brazing alloy changes with the remelting, and the second bond won't be as good."

Aside from the replacement problem, he says, putting metallization on the bottom of the cavity involves expensive processing. But it's comparatively easy to form substrates with cavities—in the green state the ceramic can be pressed with cavities in it.

Consider ease of handling

Metz sees beam leads as "very attractive from the user's point of view for two reasons—they are visible, and the bonds are repairable." When the chip is placed face down on a matched pattern on a substrate, the beams can be seen clearly pro-

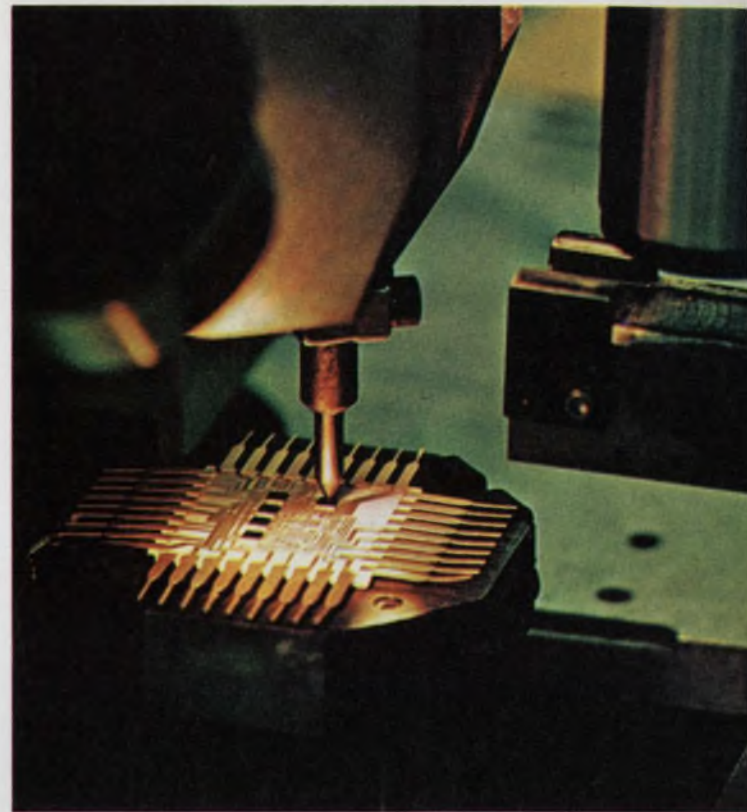

New bonding methods offer easier packaging and an opportunity to build economical multichip arrays. Here a 256-bit random access memory array, the Fairchild μ L4027, is built by interconnecting eight bumped chips on an alumina substrate. Each 16-bit RAM chip has 14 aluminum bumps, which are ultrasonically bonded to a two-layer metal interconnect pattern. A ceramic cover on the assembly provides a hermetic seal.

jecting beyond the edge of the chip. The engineer lines them up with the matching terminals on his board, and he can make a simple metallurgical joint.

If the board is gold plated, a thermocompression bond will suffice. If it's plated with copper or some other good conductor, the beams can be welded down. The chip is not overheated during bonding because the joint is made on the beam a few mils away from the chip. If the weld is made at the tip of the beam lead, the chip stays basically at room temperature—only a small amount of heat is conducted along the lead. And when the joint has been made, it can be tested—the leads can be pulled individually to check their strength.

"Thermocompression bonds on beam leads should be made very carefully," Metz says. "A thermocompression bond occurs only if the bonded material can flow a little bit. But when the material flows, it puts stress on the chip. The beams are pushed toward the chip on the inside of the bond and pushed away from the chip on the outside. The chip must be permitted to move to absorb this distortion in the leads. It must be allowed to rise a little off the substrate as the



Beam leads offer easy bonding and bond inspection, with a resultant increase in hybrid yields. Photo of a buffer-limiter circuit, employing a beam-leaded op amp and two 1N914 beam-leaded diodes on an aluminum substrate, courtesy Texas Instruments Inc., Dallas, Tex.

bond is made. If the chip is constrained directly against the substrate, there is a great risk of damaging it or deforming the gold sufficiently so that it makes contact against the side of the chip, causing a short-circuit."

The possibility of shorts must be considered with gold beam leads, because the leads come off the surface of the chip at a point where the only thing electrically separating them from the side of the chip—which is active—is a thin surface layer of oxide and nitride, at most 2 microns thick. Deformation of the gold along the edge of the chip can easily cause a short across this thin layer.

Investigate the bonding scheme

The beam lead is attractive to many hybrid manufacturers because it is easy for someone who does not have wire-bonding capability to bond beam leads. He can align a beam-leaded chip pretty easily, and he can easily make good thermocompression bonds between the gold leads and the gold on the substrate.

The gold-to-gold bonds are also attractive because they are repairable. "If you test your circuit after assembly," says Metz, "and find you have a defective chip, you can pull it off the substrate, pull off the pieces of gold beam that

are lying around and put a second chip down in the same place. All you will have done is leave some gold on the surface of the substrate metallization, and you bring the new gold beam against that gold surface again to make the thermocompression bond."

Metz says that the bonding process is not quite so easy with bumped chips. The pressure applied during bonding, for instance, must be carefully controlled. In the case of a solder-bumped chip especially, Metz says, "if you push too hard on the chip while you solder it to the substrate, you'll distort the molten solder bump and close up the gap between the chip and the substrate."

"The solder must go some place," he notes, "and it's got to go laterally, where it's trapped between the chip and substrate. It may short to an adjacent terminal."

Beckman Instruments' Mick Strief points out that with beam leads and bumped chips you force yourself to orient the layout pattern more carefully—and you have to bring those interconnects into exactly the right positions to meet the beams or bumps. You can do it, of course, but maintaining tight tolerances is expensive. Spacing has to be exact—you have to be able to screen easily to 5-mil line widths at 10-mil centers, and this is extreme precision for a thick-film operation. With chip-and-wire, on the other hand, there is a great deal of flexibility in the placement of wire bonds on the substrate.

But some of the experts feel that the repairability of circuits made with beam-leaded chips is overstated. They say that flip-chip bonds are repairable, too.

"You can easily replace a bonded flip chip, depending on the metallization involved and the type of bonding process used," says Noe. "We apply flip-chip technology to hybrid circuits, and we want to be able to make repairs. And ultrasonically bonded flip chips, particularly in an all-aluminum system, lend themselves fairly well to rework. It's possible to control the bonding parameters and regulate the bond strength to a certain desired level—adequate to a certain safety margin but low enough to allow removal of the chip."

In ultrasonic bonding the frequency of vibration is usually fixed, but the amplitude or duration of the ultrasonic pulse can be varied. Pressure can be varied, too, but Noe says his group hasn't found this necessary.

"We have found a desirable pressure," he says, "and we keep that constant." Noe feels that thermocompression bonding does not lend itself to rework. "A thermocompression bond," he says, "is a diffusion bond, as opposed to the solid-state surface weld of the ultrasonic bond, in which there's very little interdiffusion of materials. If you make a good thermocompression



"Fortunately, we have a semiconductor facility to supply beam-leaded and bumped chips for our hybrids. With an outside supplier we couldn't exercise proper process control."—David Nixen, group scientist, Microelectronic Products Division, Autonetics, Anaheim, Calif.

bond, you have a very strong bond, and you'll probably disrupt the surface of the substrate metallization when you break it."

Noe is also not overly impressed with the viewpoint that beam-lead bonds are easy to test. Pull-tests of the strength of each beam-lead bond are time-consuming and therefore very costly. He says flip-chip bonds are predictable, and that is all that's necessary.

"Our experience with testing or checking flip-chip bonds indicates that if the process is properly set up and the package is well designed, and if adequate screening procedures on the package or substrates assure continuous high quality, then you can have a very high-yield, high-reliability flip-chip bonding process that lends itself well to sampling as a control procedure," Noe reports. "We've been working on techniques for doing this in our lab that have been very successful."

The narrow space left between the chip and the substrate can be a problem, too. Metz sees at best two potential troubles.

"If it's a narrow space," he says, "one-half mil or less, as with a beam-leaded chip, two things can happen. A stray piece of metal can get in and short the chip to its substrate, or in handling and cleaning processes you can trap flux or other chemical residues in that capillary space. The

residues lead to surface problems later on. It's very hard to clean out a very narrow gap.

"The bumps on a flip-chip, however, are typically 0.5 to 1.5 thousandths of an inch high. This is considerably thicker than the usual gold beam lead. It gives more clearance between the chip and the substrate that you are attaching it to, and this clearance between the chip and the substrate is really quite important. It gives more access for cleaning out underneath."

But flip chips still have some disadvantages. Metz points out that the solder bump takes more chip area than the beam lead and process cleanliness can be a problem.

"To build up the 1.5-to-2-mil-high solder bump he says, "the solder pad must be quite a bit larger than this. Also, solder bumps, unlike the gold beam leads, must be kept perfectly clean to make bonds without using fluxes. Solder will corrode in industrial atmospheres, forming sulphides or oxides.

"Flip chips—indeed, chips of any kind—should be stored and handled in a controlled environment. Storage in an industrial atmosphere without protection will lead to problems in assembly or to degradation of characteristics. A general philosophy that I believe in is that it's better to keep the chips clean than to let them get dirty and plan on cleaning them later. From the very start, the user should treat chips as if they'll literally die if they get dirty."

Keep your chips clean

"Many customer's problems arise not from mechanical problems or outright breakage," says Metz, "but from changes in the chips' electrical behavior during assembly and packaging. These changes are often caused by surface contamination.

"Many people working with materials do not realize that the contaminants most damaging to semiconductors are the ionizable ones, and they don't know how to clean them off the chips. A completely neutral contaminant," says the Motorola expert, "a drop of SiO_2 on a chip, for instance, may produce no damage. A molecule of salt will likewise produce no damage, so long as it remains sodium chloride. But if there is moisture present, or if potentials are applied which ionize the contaminant, then the charged ions can induce effects in the silicon much like the effect of field electrodes. You get a field effect from ionized contaminants on the surface, just as you do from a charge on a plate on the surface."

Fluxes are a type of contaminant that should be carefully avoided, according to Metz, because flux residues seriously degrade transistor characteristics. If there is a process step in which fluxes must be used, the chip should be completely



Purple plague problems are avoided by using dummy chips in this Motorola hybrid circuit. Separate highly-doped chips of silicon are prepared with a top metallization of aluminum and a gold backing, and are mounted on the gold interconnect pattern on the substrate. Aluminum wire connections are then made from the IC chip to the aluminum top of the dummy chip, avoiding corrosion-prone gold-aluminum bonds.

and carefully cleaned off. And the cleaning should not be done with ordinary solvents.

One of the most common solvents used for industrial cleaning, for instance, trichlorethylene, is fine for removing grimes and oils, but is not a solvent for water-soluble ions. You can remove a fingerprint from a glass slide with trichloroethylene, but you won't remove the perspiration or water salts; they remain behind. It's extremely important that the cleaning processes used during chip-bonding operations be suitable for removing polar and ionizable contaminants. And the solvents themselves must be clean.

Acetone, for instance, widely used as a solvent, can actually become an effective contaminant. "It absorbs moisture from the air very quickly," says Metz, "and that moisture contains sodium and other contaminants. If acetone is used as a final rinse on a surface, it will remove the organic contaminants but it may leave residues of ionic contaminants."

Furthermore, when acetone evaporates, it does so very rapidly. It chills the surface of the chip, and moisture then condenses on it out of the air. The moisture usually contains contaminants.

"The best cleaning process," Metz says, "in-

variably ends with a very, very high-purity, high-resistivity water rinse. And the removal of the water should not be done by using acetone. A much better method is to blow the surface dry with a clean, dry gas—filtered air or nitrogen.

"There are some points to watch here, too. The way you blow the surface dry is important. A jet of air will aspirate surrounding contaminated air into the jet, so a blanket of clean air should surround the object to be blown dry and the jet itself. This sounds picky, but many customers have severe problems, and the difference between success and failure can be little things like this."

Bias for peak β

Metz points out that the customer's success with bonded chips depends also on the particular transistors chosen and how they are used. In general, the most stable bias point for a transistor, and the point at which it is least sensitive to surface contamination, is at the collector current at which the current gain β peaks. The further you move toward lower collector currents, the more sensitive the current gain characteristic is to surface contaminants. If a given amount of contamination will change by 50 per cent the β of a transistor biased at peak β , that same contamination will much more drastically reduce the current gain of the same transistor biased far from peak β .

"A 2N2222 for instance," Metz points out, "has a β that is specified all the way from 100 μ A to 500 mA. It peaks at about 200 mA. Surface contamination that will change the β from a value of 100 to a value of 90 at a 200 mA collector bias-current may cause it to drop from a value of 50 to a value of 2 or 3 if the bias current is 100 μ A.

"The selection of a transistor for a hybrid assembly should be done very carefully. The right chip to use is one that has a current gain which peaks in the neighborhood of the collector bias at which the transistor will be used."

And contamination problems are not all that the designer has to worry about. He must allow for metallurgical effects in all of the processes that he puts his chips through.

Know the process metallurgy

Semiconductor devices are made by high-temperature diffusion. At room temperature the diffusion rates are so slow that the device is considered absolutely stable. Even at 600°C the device junctions really don't change appreciably in minutes or hours. However, some of the metallurgy that is used to make contact to the silicon does change rapidly at temperatures of 400° to

500°C.

The metallization scheme that is used by the vendor to produce a solder bump, for instance, usually sets a maximum temperature limit that the chip will stand.

Metz describes a typical case in which aluminum metallization is used on silicon. "There is a eutectic, a low melting-point alloy that forms between silicon and aluminum at about 577°C," he says. "When we manufacture a device, we make sure in its heat treatment that formation of the eutectic—a dissolution of silicon into aluminum—does not proceed so far that the alloy can penetrate to any of the junctions and short them. If the user takes such a device and tries to assemble it at 600°C, he pushes the depth of the alloy further into the silicon than it was intended to penetrate. He can end up with a shorted junction."

Some special metallurgical problems await the designer who has to worry about keeping his circuits radiation resistant. Gold is not a suitable material for interconnects in this case, because gold, with its high density, has a high absorption coefficient. It absorbs incident energy and, if the radiation is intense, it vaporizes.

Aluminum is a much better material. It's about one-tenth the weight of gold, and its absorption coefficient is correspondingly lower. It can take much higher levels of radiation without melting.

"We use aluminum-germanium backing instead of gold on our radiation-resistant chips," says Texas Instrument's Lloyd Norman, manager of product design and development in the hybrid circuit branch, Components Group, "and we alloy bond them to aluminum on the substrate. We use aluminum metallization and bonding wires too."

Norman points out that the thickness of the aluminum substrate pad is important. It's one of



"We're staying with chip-and-wire for the next year or so. Only a few devices are available in beam-lead or bumped form, and the reliability of those few is unproven."—Eli Goldfarb, manager, hybrid integrated circuits, National Semiconductor Corporation, Santa Clara, Calif.

the keys to getting a good connection between the aluminum-germanium backing on the chip and the aluminum pattern. There is a definite optimum relationship, he says, between the thickness of the aluminum interconnect and the amount of material on the back of the chip. What that ratio is, he won't say. ■■

Bibliography:

- Bilous, O. and Rymaszewski, E. J., "Medium Density Monolithic Logic Technology," *IBM Technical Report*, August 18, 1969.
- Curran, L., "Rival Preleading Schemes Head for a Market Showdown," *Electronics*, December 9, 1968, pp. 88-96.
- Davies, D., "Standard Beam Lead Formats," Texas Instruments Inc., Dallas, Texas: Internal memorandum, June 4, 1969.
- Goldmann, L. S., "Geometric Optimization of Controlled Collapse Interconnections," *IBM Journal of Research and Development*, May, 1969 pp. 251-265.
- Gorgenyi, G. E., "New Device Bonding Techniques," Proceedings of the National Electronic Packaging and Production Conference, Philadelphia, Pa., June 11, 1969.
- Hill, W. H. and Wrench, G. D., "Recent Advances in Pulse-Heated Wire Bonding for Hybrid Microelectronics," Proceedings of the National Electronic Packaging and Production Conference, June 6, 1968.
- Hiner, H., "Handling and Assembling Transistor Chips," Hewlett-Packard, Palo Alto, California; internal memorandum, November 13, 1968.
- Hugle, W. B., Bamberg, J. L. and Pedrotti, D. G., "Flip-Chip Assembly," *Solid-State Technology*, August, 1969, pp. 62-67.
- IBM Journal of Research and Development*, May, 1969.
- Koshinz, E. F., "Face Bonding: What Does it Take?" *Solid State Technology*, August, 1969, pp. 53-57.
- Koshinz, E. F., "Interconnection Equipment for the Production Line," *Electronic Packaging and Production, Microcircuit Production Supplement*, October, 1967, pp. MC16-MC18.
- Larson, R. B., "Microjoining Processes for Electronic Packaging—Part 3," *Assembly Engineering*, November, 1966.
- Lepselter, M. P., "Beam-Lead Sealed-Junction Technology," *Bell Laboratories Record*, October-November, 1966, pp. 299-303.
- Miller, L. F., "A Survey of Chip Joining Techniques," *IBM Technical Report*, February, 6, 1969.
- Miller, L. F., "Controlled Collapse Reflow Chip Joining," *IBM Journal of Research and Development*, May, 1969, pp. 239-250.
- Miller, L. F., "Joining Semiconductor Devices with Ductile Pads," *IBM Technical Report*, September 30, 1968.
- Naylor, R., "A Comparison of the Thermal Impedance of Flip-Chip and Beam Lead Assemblies," *International Conference of Microelectronics*, June 3-5, 1969, pp. 21-22.
- Norris, K. C. and Landzberg, A. H., "Reliability of Controlled Collapse Interconnections," *IBM Journal of Research and Development*, May, 1969, pp. 266-271.
- Ohanian, M., "Bonding Techniques for Microelectronics," *SCP and Solid State Technology*, August, 1967, pp. 45-52.
- Rose, J. A., "Hybrids Move Ahead in '69," *EDN Magazine*, September 1, 1969, pp. 49-57.
- Rosvold, W. C., Legat, W. H., Ward, W. B., "Beam Lead Devices—The New Hybrid Circuit Element," Proceedings of the International Society for Hybrid Microelectronics, Chicago, Illinois, October 28-29, 1968.
- Segallis, W., "Beam Leads vs Flip-Chips," *Electronic Products*, March 15, 1969, pp. 10, 12, 16.
- Slemmons, J. W., "The Microworld of Joining Technology," Prepared for: American Welding Society—50th Annual Meeting and Welding Exposition, Philadelphia, Pa., April 29-May 1, 1969.
- Totta, P. A. and Sopher, R. P., "SLT Device Metallurgy and its Monolithic Extension," *IBM Journal of Research and Development*, May, 1969, pp. 226-238.

Equal

Gates

DM8000N (SN7400N)	Quad 2-Input, NAND gate
DM8001N (SN7401N)	Quad 2-Input, NAND gate (Open Collector)
DM8002N (SN7402N)	Quad 2-Input, NOR gate
DM8003N (SN7403N)	Quad 2-Input, NAND gate (Open Collector)
DM8004N (SN7404N)	Hex inverter
DM8010N (SN7410N)	Triple 3-Input, NAND gate
DM8020N (SN7420N)	Dual 4-Input, NAND gate
DM8030N (SN7430N)	Eight-Input, NAND gate
DM8040N (SN7440N)	Dual 4-Input, Buffer
DM8050N (SN7450N)	Expandable Dual 2-Wide, 2-Input AND-OR-INVERT gate
DM8051N (SN7451N)	Dual 2-Wide, 2-Input AND-OR-INVERT gate
DM8053N (SN7453N)	Expandable 4-Wide, 2-Input AND-OR-INVERT gate
DM8054N (SN7454N)	Four-Wide, 2-Input AND-OR-INVERT gate
DM8060N (SN7460N)	Dual 4-Input expander
DM8086N (SN7486N)	Quad Exclusive-OR-gate

Flip Flops

DM8540N (SN7472N)	MASTER-SLAVE J-K flip flop
DM8501N (SN7473N)	Dual J-K MASTER-SLAVE flip flop
DM8500N (SN7476N)	Dual J-K MASTER-SLAVE flip flop
DM8510N (SN7474N)	Dual D flip flop

Counters

DM8530N (SN7490N)	Decade Counter
DM8532N (SN7492N)	Divide-by-twelve counter
DM8533N (SN7493N)	Four-bit binary counter
DM8560N (SN74192N)	Up-down decade counter
DM8563N (SN74193N)	Up-down binary counter

Decoders

DM8840N (SN7441AN)	BCD to decimal nixie driver
DM8842N (SN7442N)	BCD to decimal decoder

Miscellaneous

DM8550N (SN7475N)	Quad latch
-------------------	------------

Spec-for-spec. Pin-for-pin. Second source on all popular 74N.

Opportunity

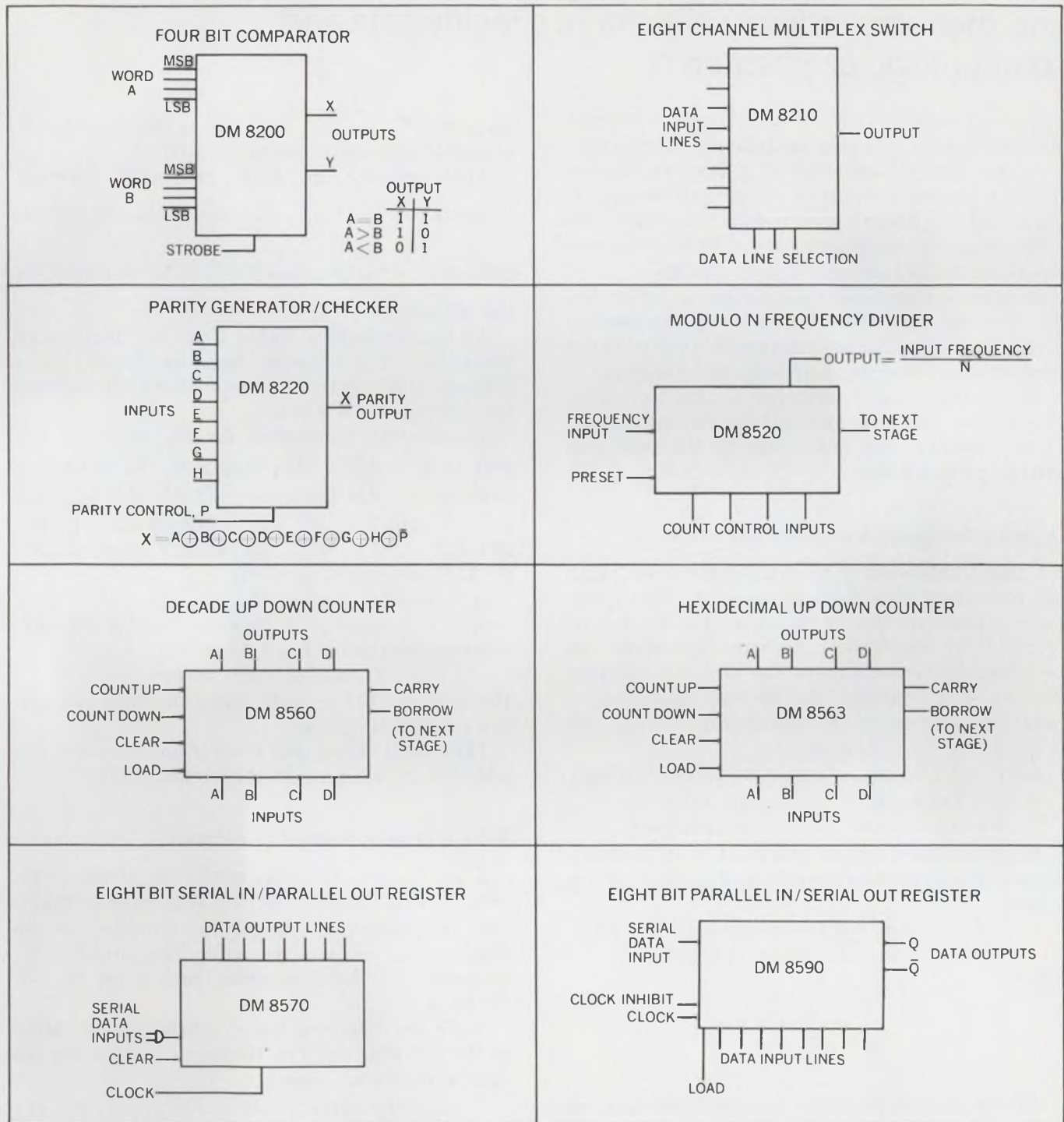

These exclusive National TTL MSI circuits offer designers increased opportunities for circuit savings in design time, board space and costs. Write or call for your free TTL Spec Guide, TTL Cross Reference Guide, and TTL Performance Tables. National Semiconductor, 2975 San Ysidro Way, Santa Clara, California 95051 (408) 245-4320 TWX: 910-339-9240 Cables: NATSEMICON

National/TTL

Convert Boolean algebra to arithmetic

and then use ordinary algebra to simplify gate and counter logic expressions.

Boolean logic provides a direct way to express involved logical concepts analytically. Sometimes, however, the manipulation of a Boolean expression can become difficult. A simpler alternative is to convert the Boolean expressions into equivalent arithmetic expressions which can be manipulated according to the rules of ordinary algebra.

In essence, a simple set of analogs can be written that provide arithmetic solutions of Boolean expressions. These analogs can then be applied to the simplification of systems of gates and flip-flops.

In the following description of this technique, upper-case characters are used for Boolean expressions, and lower case characters for the analogous arithmetic expressions.

Logical gates become products and sums

Table 1 lists a set of Boolean expressions which are commonly used to describe gates. The right-hand column of this table shows the arithmetic formulas by which these Boolean expressions can be evaluated according to the rules of common algebra. For example, the Boolean operation of inversion is analogous to subtracting from 1. This is shown by the following:

$$\begin{array}{ll} \text{for } T = \bar{A} \text{ (Boolean),} & \text{for } t = 1 - a \text{ (arithmetic)} \\ T = 1 \text{ if } A = 0 & t = 1 \text{ if } a = 0 \\ T = 0 \text{ if } A = 1 & t = 0 \text{ if } a = 1 \end{array}$$

Likewise, the Boolean operation AND is analogous to the numerical operation of multiplication, since

$$\begin{array}{l} T = A_1 A_2 \dots A_n = 1, \text{ if and only if all } A_i = 1 \\ t = a_1 a_2 \dots a_n = 1, \text{ if and only if all } a_i = 1 \end{array}$$

Thus,

$$t = \prod_{i=1}^n (a_i)$$

All the other arithmetic analogs listed in Table 1 can be derived from the first two analogs and DeMorgan's theorem ($\overline{AB} = \bar{A} + \bar{B}$; $A + \bar{B} = \overline{AB}$). For example, the OR gate in Boolean terms, namely $T = A + B \dots + N$, becomes, by DeMorgan's

theorem, $T = \overline{\bar{A} \bar{B} \dots \bar{N}}$, which is the formula for a NAND gate with inverted inputs.

Arithmetically the AND gate with inverted inputs is $t = \prod_{i=1}^n (1 - a_i)$, and its inverse, the NAND gate, is $t = 1 - \prod_{i=1}^n (1 - a_i)$, which is the formula for the OR gate.

All the elements of Table 1 can be functions of themselves. For example, consider the exclusive OR gate in which the functions of the OR gate are the outputs of AND gates.

The Boolean expression for the exclusive OR gate is $T = A\bar{B} + \bar{A}B$. Applying the analogous expressions, $A\bar{B}$ becomes $a(1-b)$, $\bar{A}B$ becomes $b(1-a)$, and $T = A\bar{B} + \bar{A}B$ becomes $t = 1 - [1 - a(1-b)][1 - b(1-a)]$. Expanding algebraically,

$$t = 1 - (1 - a + ab)(1 - b + ab)$$

$= 1 - 1 + b - ab + a - ab + a^2b - ab + ab^2 - a^2b^2$. But, $a^2 = a$ and $b^2 = b$, because a and b can only assume the values of 1 or 0. Thus,

$$t = b - 2ab + a = (a - b)^2.$$

However, $(a - b)^2 = |a - b|$, since the negative root in a solution is ignored.

This result shows that $t = 1$ if and only if $a \neq b$ which is the meaning of the exclusive OR.

Apply arithmetic method to counter

A significant advantage of the use of the arithmetic analog formulas is that they greatly facilitate the design of computing circuits. As an illustration, we will consider the problem of designing a 1-2-4-2 counter from a set of J-K flip flops.

Table 2a describes the synchronous operation of the J-K flip flop. The Boolean equation for the data in this truth table is:

$$T_i = JK\bar{T}_{i-1} + \bar{J}K + \bar{J}K\bar{T}_{i-1} \quad (1)$$

Applying the formulas for inversion, AND and OR from Table 1, and then simplifying yields the arithmetic equation:

$$t_i = t_{i-1}(1 - j - k) + j \quad (2)$$

This equation contains all of the information in Table 2a or b and it is a more succinct characterization of the flip flop than is the truth table.

Bernard T. Engel, Ph.D. and Phillip R. Thorne, Gerontology Research Center, Baltimore City Hospitals, Baltimore, Md.

Note that when $j = k = 1$, $t_i = 1 - t_{i-1}$, which is the analog of $T_i = \bar{T}_{i-1}$.

In Table 3, columns A, B, C, D list the states which must be present at the output of each of the four flip flops in order for them to perform like a 1-2-4-2 counter.

The values of J and K for a particular flip-flop at the i^{th} step in the counting sequence are obtained by substituting the appropriate values of T_i and T_{i-1} from columns A through D into Eq. 1 or the equivalent values of t_i and t_{i-1} into Eq. 2. Each substitution yields a unique value for J or K .

For example, consider flip-flop A during the shift from the count of 1 to the count of 2:

$$T_i = 0, T_{i-1} = 1 \text{ and } t_i = 0, t_{i-1} = 1$$

Substituting into Eq. 2

$$0 = 1(1 - j_A - k_A) + j_A,$$

or

$$k_A = 1$$

Therefore k_A should be 1 to advance A from 0 to 1 and the count from 1 to 2. Analogously, K_A must behave the same as k_A . These states are circled in Table 3.

The remaining, unspecified input is "free", and can be either 1 or 0. In Table 3 each free input is designated by an X. Each pair of input states contains one free input. Table 4 lists the possible flip-flop input state and the output changes of state they produce. In the example above, the output change is from 1 to 0, which requires that $k=1$.

The remaining columns in Table 3 list the J and K values (or states) which must be present in each flip-flop as the system sequences through the counting steps. Table 4 or Eq. 2 can be used to construct this table. Expressions which will satisfy the J and K input requirements can be derived by inspection or by the use of the appropriate Karnaugh maps.

States of logic systems can be analyzed

The last application of this method to consider is the analysis of changes in systems of gates. The equations in Table 1 permit straight-forward analyses of the states of any gating system. However,

Table 1. Arithmetic – Boolean analogs

Function	Boolean expression	Arithmetic analog
Invert	\bar{A}	$1 - a$
AND	$A_1 A_2 \dots A_n$	$\prod_{i=1}^n a_i$
NAND	$\overline{A_1 A_2 \dots A_n}$	$1 - \prod_{i=1}^n a_i$
NOR	$\overline{A_1 + A_2 + \dots + A_n}$	$\prod_{i=1}^n (1 - a_i)$
OR	$A_1 + A_2 + \dots + A_n$	$1 - \prod_{i=1}^n (1 - a_i)$

Table 2a. J-K truth table (Boolean)

CP _{i-1}		CP _i
J	K	T _i
0	0	T _{i-1}
1	0	1
0	1	0
1	1	\bar{T}_{i-1}

Table 2b. j-k truth table (arithmetic)

CP _{i-1}		CP _i
j	k	t _i
0	0	t _{i-1}
1	0	1
0	1	0
1	1	$1 - t_{i-1}$

Subscripts denote before and after clock pulse (CP)

Table 3. Input and output states of 1-2-4-2 counter

Count	Output states				Required input states							
	A	B	C	D	J _A	K _A	J _B	K _B	J _C	K _C	J _D	K _D
0	0	0	0	0	1	X	0	X	0	X	0	X
1	①	0	0	0	X	①	1	X	0	X	0	X
2	②	1	0	0	1	X	X	0	0	X	0	X
3	1	1	0	0	X	1	X	1	1	X	0	X
4	0	0	1	0	1	X	0	X	X	0	0	X
5	1	0	1	0	X	1	1	X	X	0	0	X
6	0	1	1	0	1	X	X	0	X	0	0	X
7	1	1	1	0	X	1	X	0	X	0	1	X
8	0	1	1	1	1	X	X	0	X	0	X	0
9	1	1	1	1	X	1	X	1	X	1	X	1

it is also possible to apply these equations to the analyses of *changes*. In order to do this we first define the quantities +1, -1 and 0 as

- +1 means the output was off and went on,
- 1 means the output was on and went off,
- 0 means the output did not change.

Consider the exclusive OR gate. As has already been shown, the output of this gate is given by:

$$T = \bar{A}B + A\bar{B} \text{ or } t = a - 2ab + b \quad (3)$$

The change in *t* as a function of a change in *a* is,

$$\begin{aligned} t' &= t_F - t_I \text{ where } F \text{ is final and } I \text{ is initial} \\ &= a_F - 2a_F b + b - (a_I - 2a_I b + b) \\ &= a_F - a_I - 2b(a_F - a_I) \\ &= a' - 2ba' \text{ (since } a_F - a_I = a') \end{aligned}$$

Therefore,

$$t' = a' (1 - 2b) \quad (4)$$

Thus, if *b* = 0,

$$t' = a'$$

if *a* went off,

$$t' = -1$$

if *a* went on,

$$t' = +1.$$

Note that Eq. 4 can be derived directly from Eq. 3 by a procedure similar to differentiation. (Where *t'* and *a'* are analogs of differentials.) Further-

more, this procedure is generally applicable to any of the arithmetic analogs in Table 1. For example, consider the OR gate:

$$t = 1 - \prod_{i=1}^n (1 - a_i) \quad (5)$$

The change in *t* as a function of a change in the *j*th element is given by:

$$\begin{aligned} t' &= 1 - \left[\prod_{\substack{i=1 \\ i \neq j}}^n (1 - a_i) \right] (1 - a_j)^F \\ &\quad - \left\{ 1 - \left[\prod_{\substack{i=1 \\ i \neq j}}^n (1 - a_i) \right] (1 - a_j)^I \right\} \\ &= - \left[\prod_{\substack{i=1 \\ i \neq j}}^n (1 - a_i) \right] [1 - a_{jF} - (1 - a_{jI})] \end{aligned}$$

$$t' = \prod_{\substack{i=1 \\ i \neq j}}^n [(1 - a_i)] a'_j$$

which is directly derived by rewriting Eq. 5 as

$$t = 1 - \prod_{\substack{i=1 \\ i \neq j}}^n (1 - a_i) (1 - a_j), \text{ and then "differentiating"}$$

with respect to *a_j*:

$$t' = - \prod_{\substack{i=1 \\ i \neq j}}^n (1 - a_i) (-a'_j)$$

$$\text{or } t' = a'_j \prod_{\substack{i=1 \\ i \neq j}}^n (1 - a_i).$$

This discussion of the arithmetic-Boolean conversion technique is only an introduction into the method. Obviously, considerable elaboration is possible. ■■

Bibliography:

Helmos, Paul R., *Algebraic Logic*, Chelsea Publishing Co., New York, 1962.

Table 4. Arithmetic input-output state for j-k flip flop

Input		Output	
j	k	t _{i-1}	t _i
0	X	0	0
X	1	1	0
1	X	0	1
X	0	1	1

Helipot slashes
voltage regulator prices
to

50%
\$

Now Models 809 and 859 Voltage Regulators are available
at \$5.82 each (1000 quantity) or \$8.95 (1-9) from local stock.

Beckman*

INSTRUMENTS, INC.
HELIPOT DIVISION
Fullerton, California 92634

INTERNATIONAL SUBSIDIARIES: AMSTERDAM; CAPE TOWN; GENEVA; GLENROTHES,
SCOTLAND; LONDON; MEXICO CITY; MUNICH; PARIS; STOCKHOLM; TOKYO; VIENNA

INFORMATION RETRIEVAL NUMBER 39

New log amp cascades to desired range.

Using a differential amp as the logarithmic element, it provides rise times as low as 10 ns.

A new type of logarithmic amplifier, using a differential amplifier as the logarithmic element, provides rise times as low as 10 nanoseconds and operates equally well on positive and negative signals. The dynamic range of this type of log amplifier is only about 15 dB, but several stages can be cascaded to increase this many times.

Basic log stage

Diodes and transistors are natural candidates for logarithmic amplification because of their exponential current-voltage characteristics.¹ For a diode, the current, I , is given by

$$I = I_s \exp(mV_{be}) \quad (1)$$

where I_s is the diode saturation current, $m = q/nKT$, n is a diode constant, K is Boltzmann's constant and T is the absolute temperature.

The differential amplifier (Fig. 1) is a good basic configuration for generating a logarithmic function. It permits dual-polarity inputs, is self-compensating for temperature and is relatively insensitive to noise.

The total current, I_T , flowing through the constant-current source is the sum of the two transistor currents. Thus

$$I_T = I_1 + I_2 \quad (2)$$

Summing the voltage drops around the input loop,

$$V_1 + (+e_{in}) - V_{be1} + V_{be2} - V_2 = 0 \quad (3)$$

Using Eqs. 1 — 3 as a starting point and assuming matched transistors and equal bias voltages,

$$e_{out1} = -\frac{I_T R_{C1}}{2} \left[\frac{\exp(me_{in}) - 1}{\exp(me_{in}) + 1} \right] \quad (4a)$$

$$e_{out2} = \frac{I_T R_{C2}}{2} \left[\frac{\exp(me_{in}) - 1}{\exp(me_{in}) + 1} \right] \quad (4b)$$

or
$$e_o = (I_T R_C / 2) \tanh(me_{in} / 2) \quad (4c)$$

where e_o is either e_{out1} or e_{out2} .

The temperature dependence of the output voltage is shown in Fig. 2. The output voltage is seen

to be a logarithmic function of the input over the temperature range of interest. Equations 4a, b and c show that if the input is too large the output will limit at:

$$e_o = I_T R_C / 2 \quad (5)$$

The slope, in volts per dB, of the basic log stage is an important parameter when many stages are to be cascaded. It is given by:

$$\text{SLOPE} = \frac{I_T R_C}{2} \left(\frac{(2m/8.68) [\exp(y/8.68)]}{\exp\{m[\exp(y/8.68)]\} + \frac{1}{\exp\{m[\exp(y/8.68)]\}} + 2} \right) \quad (6)$$

where y is the input intensity in dB below 1 volt.

The temperature dependence of the slope is shown in Fig. 3.

Cascading log stages

A complete logarithmic amplifier may be constructed by offsetting the individual log stages by proper gains (and attenuation) and sequentially summing the individual currents in a common load as shown in Fig. 4a. The linear amplifiers and attenuators are selected to phase in each log stage

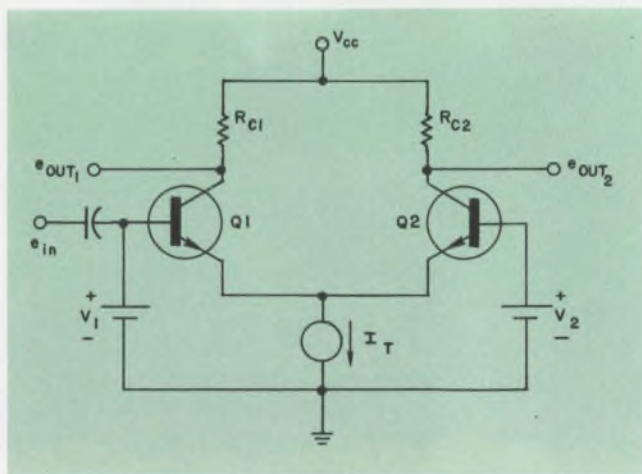

1. The basic logarithmic stage yields the negative of the log for positive inputs and the log for negative inputs. The constant-current source can be realized by a common-emitter transistor stage.

Richard S. Hughes, Senior Electronic Engineer, U. S. Naval Weapons Center, China Lake, Calif.

sequentially as the input intensity increases. The resultant composite output (Fig. 4b) approximates a true logarithmic response.

How are the gains of the linear amplifiers preceding each log stage to be chosen? The answer depends upon the range of input signal over which the stage must provide log action. As can be seen from Fig. 3, each stage is centered around the -28-dB point. Thus the lower limit of the input signal is $-28 \text{ dB} - (1/2) [\text{gain per stage}]$.

The gain preceding the first (lowest-level) stage should therefore be

$$G_L = -28 \text{ dB} - (1/2) [\text{gain per stage}] - \text{lower signal limit} \quad (7a)$$

and the gain of the linear amplifier preceding the n th stage is given by

$$G_n = G_L - (n-1) [\text{gain per stage}]. \quad (7b)$$

In the later stages, the gain may turn out to be negative; in that case, attenuators will be used instead of amplifiers.

Computer lends a hand

A computer program^{2,3} was written to analyze the performance of the log amp and to describe its deviation from perfect logarithmic operation. The program assumes that the log-amp stages have identical dc transfer functions in the form:

$$I_{out} = I_{dc} f \{ K_b \exp [m(\pm 10^{e_{in}/20})] \} \quad (8)$$

where I_{out} is the output current of a log stage, e_{in} is the input intensity in dB referred to 1 volt, I_{dc} is the dc bias current and K_b is a dc bias constant.

With this assumption, an expression for the output voltage of the multistage amplifier is derived. The computer program then evaluates this expression for discrete values of e_{in} over the dynamic range of the log amp. Typical outputs obtainable from the program are shown in Fig. 5.

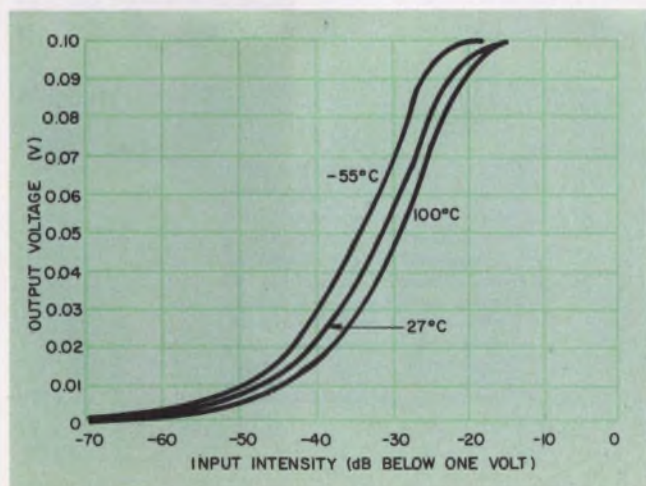

2. The output-input characteristic of a differential logarithmic amplifier (with $I_{TRC}/2 = 0.1$) is approximately logarithmic over the range of -40 dB to -20 dB at 27°C. Note that the circuit is not very temperature-sensitive.

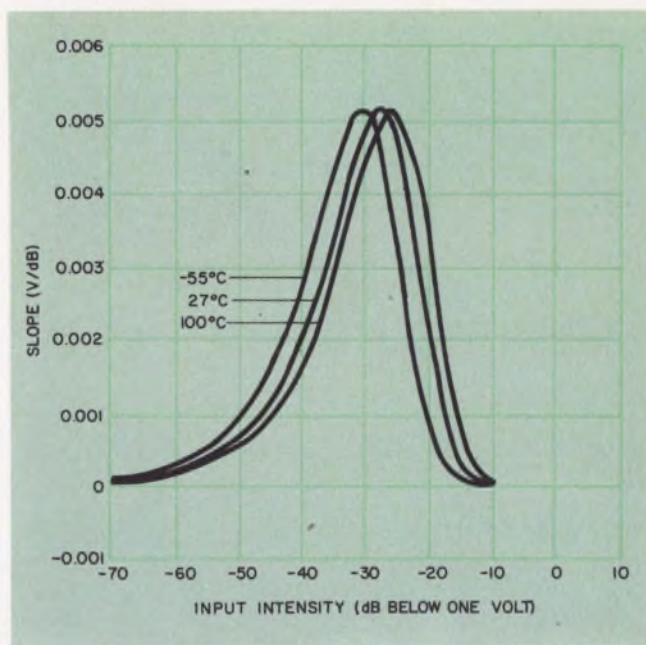

3. The peak values of the slope curves are the same although they occur at different levels of input intensity.

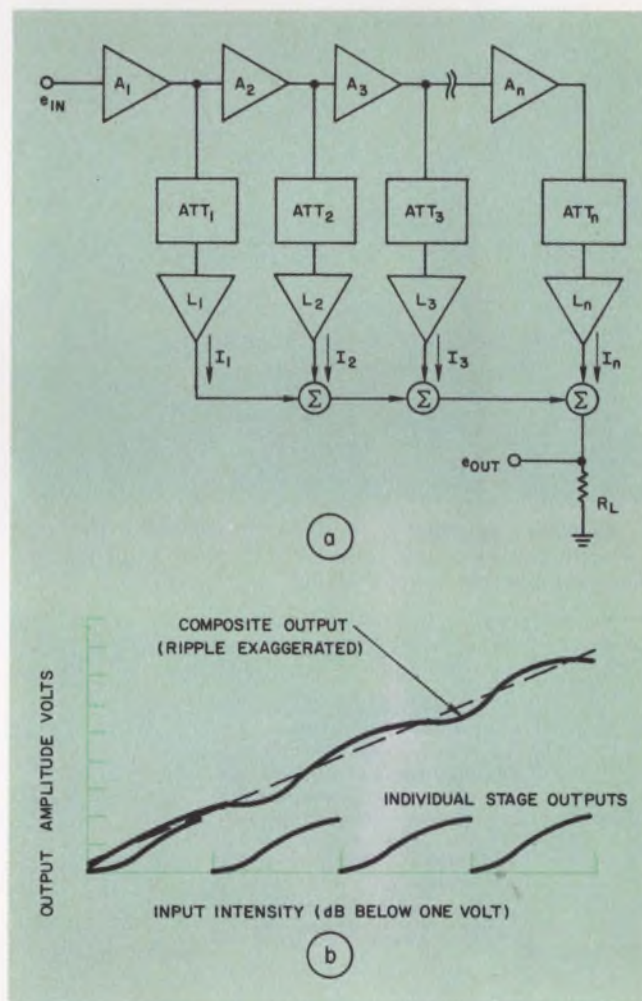

4. A multistage log amplifier consists of n log stages, which are summed. Each stage consists of a linear amplifier, A_n , an attenuator, ATT_n , and a log amplifier, L_n . (a). The composite output provides wide dynamic range by summation (b).

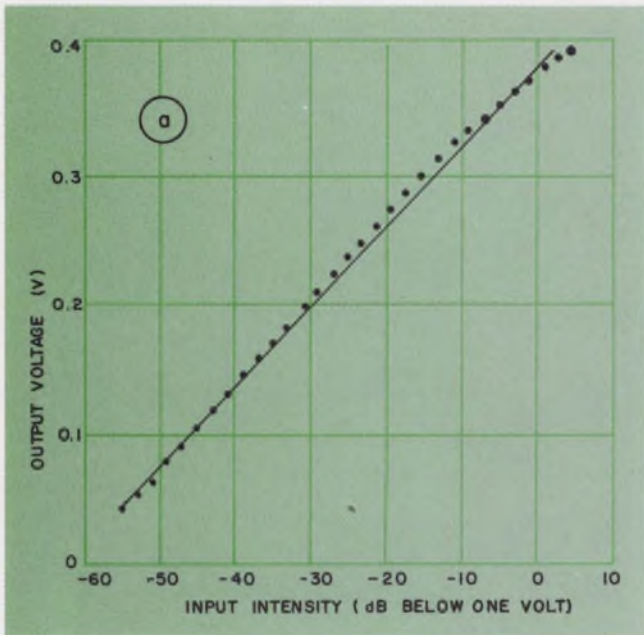

5. Computer analysis of a 4-stage 60-dB log amp for $I_T R_C / 2 = 0.1$ shows output vs input (a) and deviation

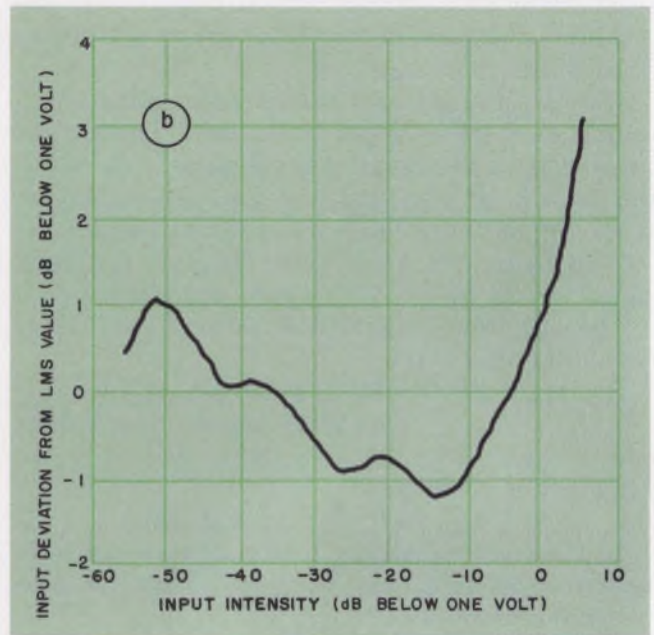

from true logarithmic response (b). Note that, in (b), the total vertical scale encompasses only 6 dB.

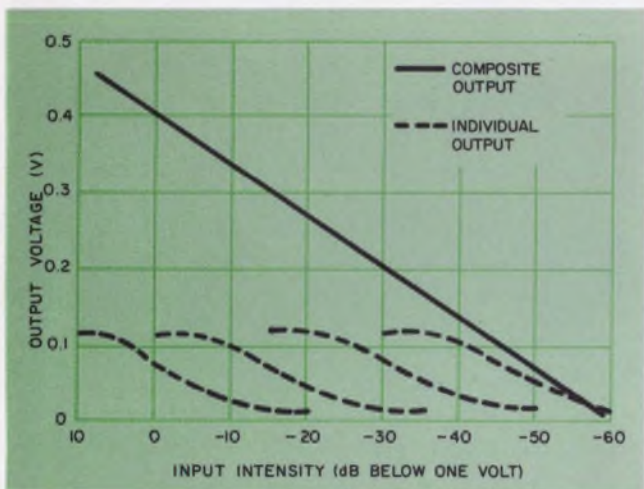

6. Excellent agreement is apparent between this experimental input-output data for the actual amplifier and the computer predictions of Fig. 5a.

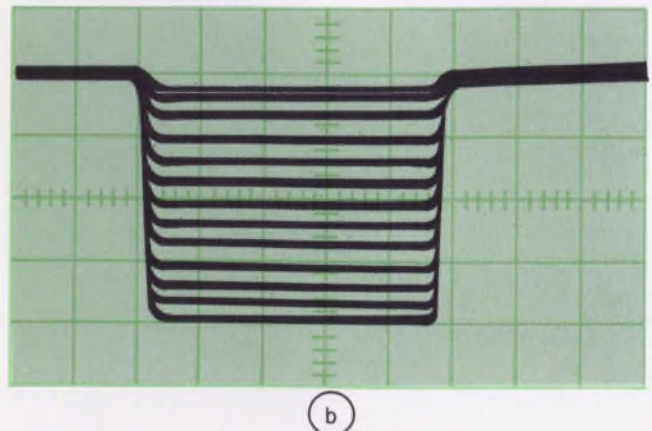
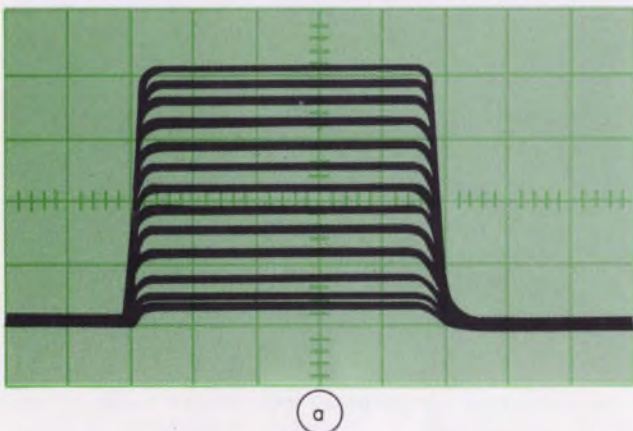

7. The output response of the log amplifier for positive output (a) and negative output (b) is shown. Inputs are

from -55 dB to $+5$ dB in 5-dB increments. The horizontal scale is 200 ns/cm, and the vertical is 0.1 V/cm.

To clarify the principles involved in this approach, the design of a dual-polarity logarithmic amplifier with a 60-dB dynamic range follows:

1. **Specify the gain per stage.** The higher the gain per stage, the greater the deviation from the ideal response. The computer program results show that a gain of 15 dB/stage yields a response that is within 0.3 dB of the ideal. This value will therefore be used.

2. **Specify the number of stages.** This is found by dividing the total dynamic range by the individual stage gain. In this case, $60 \text{ dB} / 15 \text{ dB} = 4$ stages.

3. **Specify the desired output slope.** Assume that a slope on the order of 6-7 mV/dB is desired.

4. **Determine I_T and R_C .** The slope is given by $S = (1/2) I_T R_C / \text{gain per stage}$. For a stage gain of 15 dB, this becomes $S = I_T R_C / 30 \text{ mV/dB}$, if I_T is

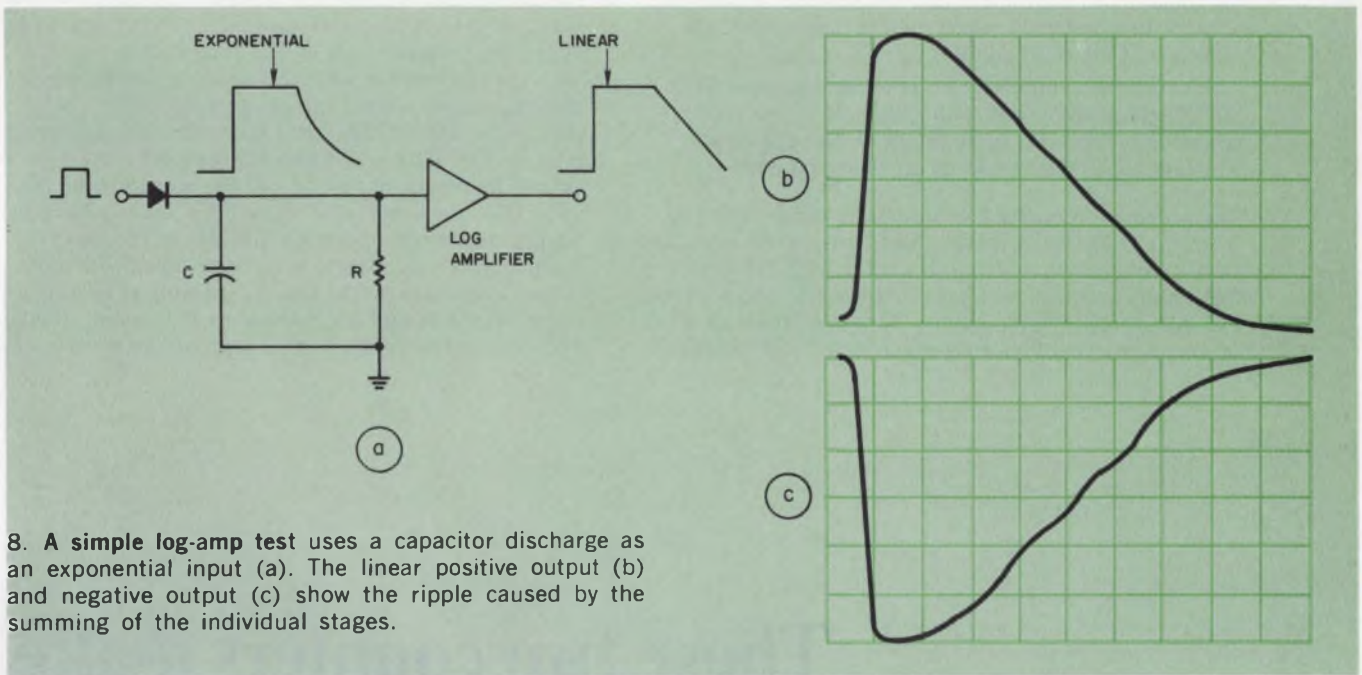

8. A simple log-amp test uses a capacitor discharge as an exponential input (a). The linear positive output (b) and negative output (c) show the ripple caused by the summing of the individual stages.

given in milliamperes. R_c should be kept small to keep the rise time down. If we choose $R_c = 100$ ohms, then we can pick $I_T = 2$ mA and $S = 6.65$ mV/dB, as desired.

5. Determine the gain of the linear amplifiers preceding each stage. Let's say our 60-dB dynamic range extends from -55 dB to $+5$ dB with respect to one volt. Then the lower signal limit is -55 dB, and we have enough data to evaluate Eq. 7. The results are:

$$\text{Stage 1 } -28 - 7.5 + 55 = 19.5 \text{ dB}$$

$$\text{Stage 2 } 19.5 - 15 = 4.5 \text{ dB}$$

$$\text{Stage 3 } 19.5 - 30 = -10.5 \text{ dB}$$

$$\text{Stage 4 } 19.5 - 45 = -25.5 \text{ dB.}$$

With these numbers, a four-stage amplifier was built. Two RCA Type CA-3026 dual differential amplifiers were used as the logarithmic elements.

When output vs. input data were plotted for the amplifier (Fig. 6), they indicated excellent agreement with the computer prediction (Fig. 5a).

Risetime is less than 10 ns

The wide dynamic range of the amplifier is demonstrated in Fig. 7, where the output is shown for inputs covering the full range.

Using a simple test setup (Fig. 8a) for applying an exponential input signal, the linearity of the amplifier output signal is as shown in Fig. 8. Note that the output is linear within $3/4$ dB.

The measured rise time of the amplifier is less than 10 nanoseconds over its entire dynamic range. Tests with sinusoids (Fig. 9) demonstrated proper log action up to about 35 MHz. Little change in the amplifier's characteristics was noted over a temperature range of -50 to $+55^\circ\text{C}$. ■ ■

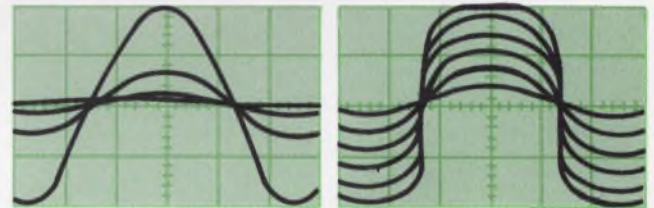

9. The amplifier's response to sinusoidal signals from 0 to -50 dB is shown here. The signals below -20 dB can't be resolved in the linear input display (left) but they show up fine in the log output (right). The signals are shown in 10-dB steps at a frequency of 1 MHz. Proper operation has been obtained up to 35 MHz.

References:

1. J. J. Ebers and J. L. Moll, "Large Signal Behavior of Junction Transistors," *Proceedings, IRE*, Vol. 42, December 1954, pp. 1761-1772.
2. R. S. Hughes, "A Dual-Polarity Logarithmic Video/IF Amplifier Technique." Paper presented at 1967 IEEE International Conference on Communications.
3. R. S. Hughes, "Logarithmic Amplification Using Sequential Current Summation," U.S. Naval Ordnance Test Station, China Lake, Calif., NOTS TP 4375.

Test your retention

Here are questions based on the main points of this article. Their purpose is to help you make sure you have not overlooked any important ideas. You'll find the answers in the article.

1. Why is a differential amplifier a good logarithmic device?
2. How are several log stages combined for increased dynamic range?
3. What simple test can be used to demonstrate the logarithmic nature of a log amp?

On the left you see the HP 5323A Automatic Counter at work in a system. On the right is our HP 5325B Universal Counter, making a hard test easy.

The counters could easily be reversed. Because both are programmable and with either of them you can count up to 20 MHz in a system or on your bench. The one you choose depends on what you need.

The Automatic Counter has automatic range selection from 0.125 Hz to 20 MHz. And it needs no switching from frequency measuring mode for high frequency measurements to period measuring mode for accurate low frequency measurements. That's because all measurements are made in the period mode, and internal

computing circuits invert the period measurements to frequency. Thus you get the speed and accuracy benefits of period measurements at low frequencies coupled with the convenience of direct readout in frequency at all frequencies. There's no accuracy penalty at any frequency. The 5323A has a score of other advantages built in. For instance, it can automatically measure the carrier frequency of pulsed signals. Some people buy the 5323A for bench and production line use because its simple, automatic operation and direct readout in frequency reduce errors, even with untrained users. It even keeps tabs on the user by refusing to display more digits than it should for a given measurement speed. For easy use in systems, it's programmable, of course.

These two counters make systems run smoother.



The Universal Counter is even more versatile but is less automatic. It will measure frequency to 20 MHz, time intervals from 100 ns to 10^s, and period, multiple period, ratio and multiple ratio. It will totalize input events or scale an input frequency. Time interval stop and start signals can be from common or separate inputs, with separate trigger-level, slope and polarity controls for each. And its very narrow trigger-level threshold band, less than 1.0 mV, prevents false counts when the trigger level setting is marginal. In addition, the Universal Counter generates two types of oscilloscope markers. These not only mark the start and stop points of a measured interval, but can also intensify the entire measured segment. For easy use in systems, it's

programmable, of course. The cost of this versatility for either system or bench use is \$2150 for the 5323A and \$1300 for the 5325B. Your local HP field engineer has all the details. So give him a call. Or write to Hewlett-Packard, Palo Alto, California 94304; Europe: 1217 Meyrin-Geneva, Switzerland.

HEWLETT  PACKARD

ELECTRONIC COUNTERS
INFORMATION RETRIEVAL NUMBER 40

And tests run faster.

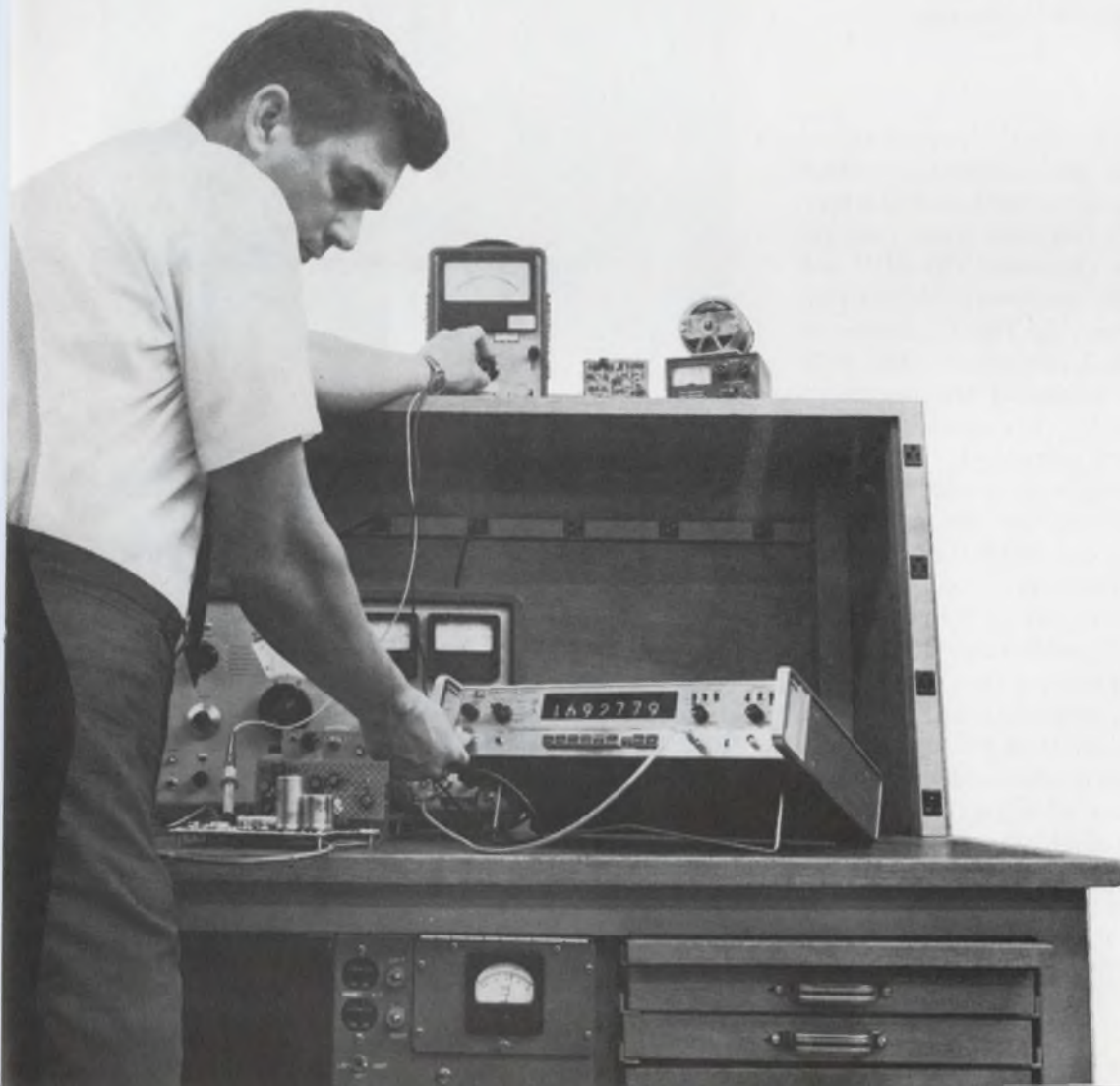

SCR model simplifies computer programs.

An equivalent circuit and a subroutine can be used with SCEPTRE or other computer-aided design techniques

The silicon-controlled rectifier (SCR) is a difficult device to describe mathematically, but the use of computer circuit-design programs requires this to be done. A helpful approach to the SCR model is based on piecewise linear approximations. It was originally meant to be used with a SCEPTRE circuit analysis program, but the method and the results may easily be adapted for use with other such programs.

The parameters describing the SCR model are usually available on manufacturers' specification sheets, but they may also be obtained by methods described here. Although approximations are made, the model is accurate enough for most switching applications. A list of all symbols used, and their definitions, is given in the box.

Define the parameters

Figure 1 illustrates the I-V static characteristics of a typical gate-controlled pnpn device from which the model is derived. The device will go into a high conduction state, ON, if the maximum forward blocking voltage (V_{fb}) is exceeded. The SCR will remain ON provided the anode-cathode current exceeds the holding current, I_h . The V_{fb} decreases as the gate bias current, I_g , increases. The SCR will enter an avalanche region if the maximum reverse blocking voltage, V_{rb} , is exceeded.

A fast rise of forward voltage, V_{ak} , may also cause the SCR to go into its high conduction state. Manufacturers usually specify the maximum dV_{ak}/dt that the device can withstand and yet remain in the forward blocking state.

The SCR is generally turned on by applying a trigger pulse to the gate. Specification sheets often list a range of pulse magnitudes that will trigger the device. There is an inverse relationship between pulse magnitude and turn-on time (T_r). (See Figs. 2 and 3). The gate-cathode characteristics of an SCR are essentially those of a pn junction and can be simulated with a diode current generator.

The mathematical model developed here simulates forward and reverse blocking characteristics, the gate-cathode input characteristics, the gate-

triggering turn-on characteristics and the dV_{ak}/dt withstanding capability. The hysteresis loop in the static characteristic (Fig. 1) is modeled by means of the FORTRAN subprograming feature of the SCEPTRE circuit analysis program.

Figure 4 is an equivalent circuit of an SCR, and Fig. 5 is the corresponding static I-V curve of the equivalent circuit. The element R_{ak} , which simulates the resistance between the cathode and anode, has two values, depending on whether the

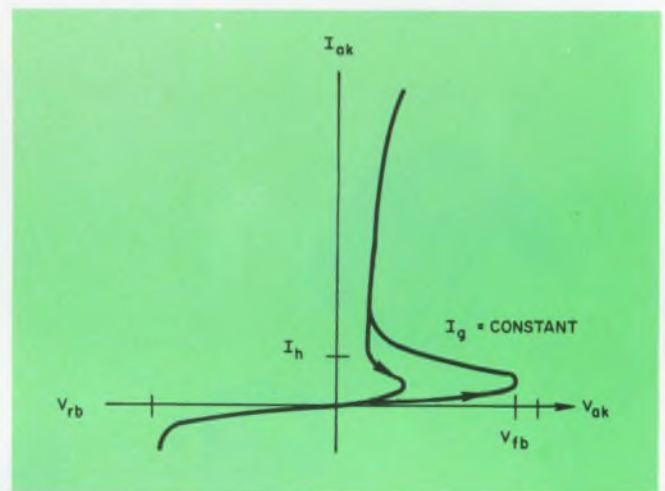

1. Hysteresis is exhibited in the plot of I-V characteristics.

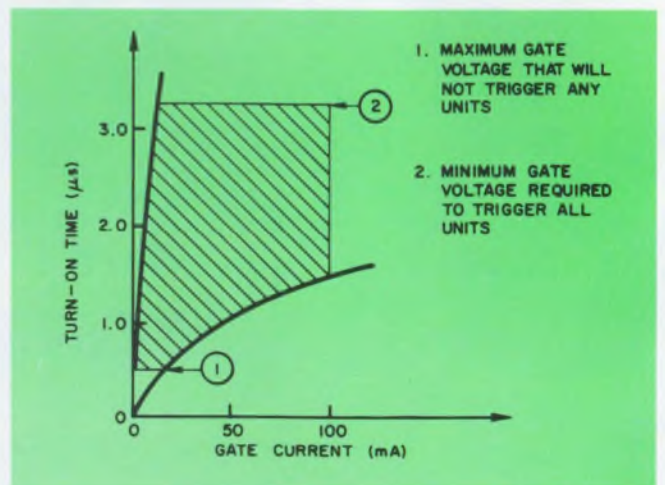

2. Wide variability of triggering levels is shown in the plot of gate firing characteristics.

D. N. Harstad, Sandia Laboratories, Albuquerque, N. M.

SCR is in a high (ON) or low (OFF) conducting state. E_b has three values: $E_b(F)$, 0, and $E_b(A)$. The three values correspond to the forward conduction, OFF, and avalanche region. J_g is a diode current generator that models the gate-cathode characteristics.

Pulse or steady-state voltages applied to the gate are monitored by the R_1, R_2, C_1 network. The values of R_1 and R_2 must be chosen so that they do not interfere with SCR operation. If a pulse of magnitude V_g is applied to the gate, the equation for V_{C_1} (the voltage across the capacitor C_1) is

$$V_{C_1} = \frac{R_1}{R_1 + R_2} (V_g) (1 - e^{-t/\tau})$$

where

$$\tau = \frac{R_1 R_2 C_1}{R_1 + R_2} \quad (1)$$

A good approximation is $R_1 = R_2$.

The specification sheet usually gives V_{gm} (the minimum trigger pulse required to fire all devices) and a typical turn-on time. By carefully choosing R_1 and C_1 , a threshold value for V_{C_1} can be set.

Above this value the SCR will turn on.

The inverse relationship between the magnitude of the trigger pulse and the turn-on time (T_r), is shown in the expressions:

$$T_r = \frac{-R_1 R_2 C_1}{R_1 + R_2} \ln \left(1 - \frac{V_{cm}}{V_{gm}} \frac{(R_1 + R_2)}{R_1} \right) \quad (2)$$

or

$$T_r = \frac{-R_1 C_1}{2} \ln \left(1 - \frac{2V_{cm}}{V_{gm}} \right) \text{ if } R_1 = R_2 \quad (3)$$

A SCEPTRE subprogram performs three tasks. It examines the variables $V_{ak}, I_{ak}, R_{ak}, V_{C_1}$ and dV_{ak}/dt ; it determines which state the device should be in; and it then assigns either the ON or OFF values to R_{ak} and E_b . The assigned values are

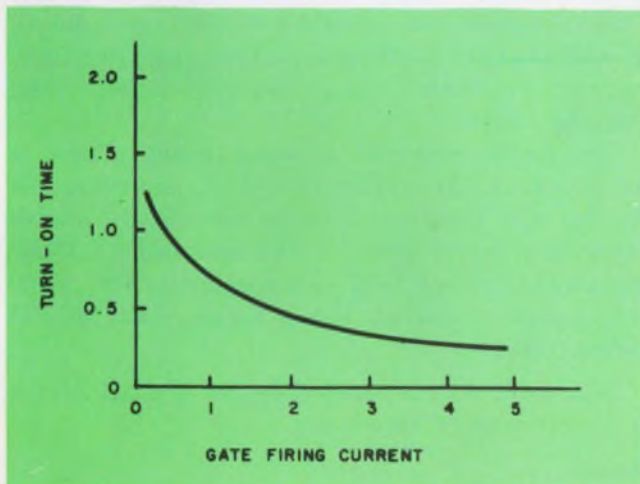

3. The harder the gate is driven, the shorter is the turn-on time. This is shown here in terms of normalized quantities.

entered into the circuit equations of the main program. A flow diagram for the subroutine is shown in Fig. 6.

Determine parameter values

The parameters that must be determined to construct the model are $R_{ak}(ON)$, $R_{ak}(OFF)$, $E_b(OFF)$, $E_b(F)$, $E_b(A)$, I_h , J_g , R_1 , R_2 , C_1 , V_{gm} , V_{cm} , V_{fb} , V_{rb} , $dV_{ak}/dt(\max)$ and T_r .

The values for I_h , V_{gm} , V_{fb} , V_h , I_{fb} and T_r are normally listed on the specification sheet. $R_{ak}(OFF)$ equals V_{fb}/I_{fb} ; $E_b(OFF)$ is zero; and $E_b(A)$ equals V_{rb} . Both $E_b(F)$ and $R_{ak}(ON)$ can be determined from a plot of the forward characteristic (high-conduction region). This is also usually included in the manufacturer's data.

A large variation in J_g exists among devices with the same 2N number. If a specific device is to be modeled, it is best to measure its $V_g - I_g$ characteristic in the laboratory (Fig. 7). For a generalized model, an average characteristic would be modeled using either the diode equation or, for SCEPTRE, a table (I_g vs V_g) which is sufficient.

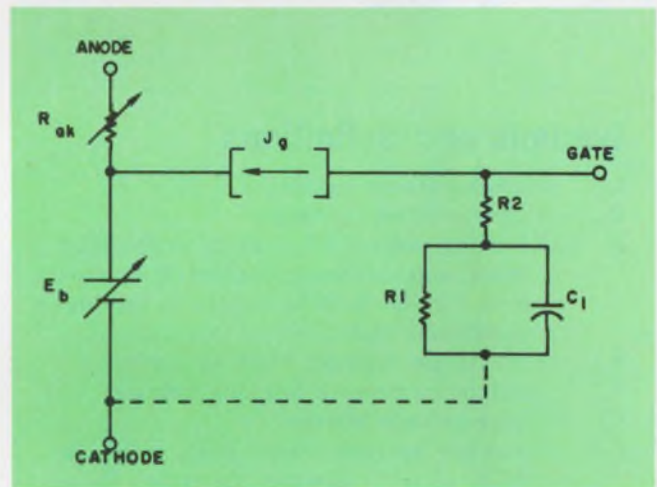

4. This SCR equivalent circuit serves as the device model.

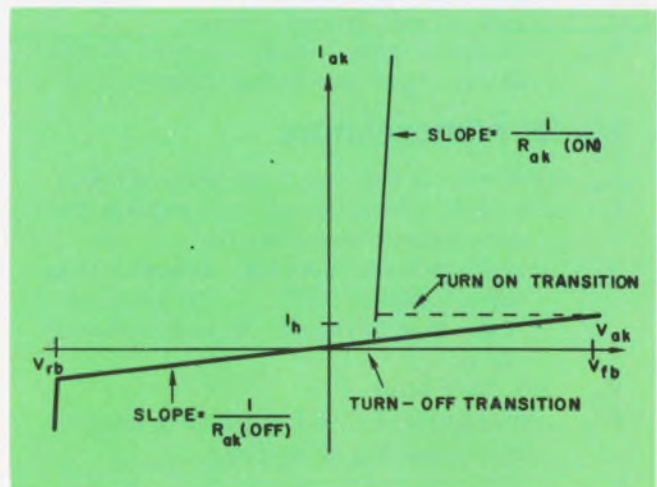

5. The static characteristics of the Fig. 4 model closely resemble the curve of the actual device.

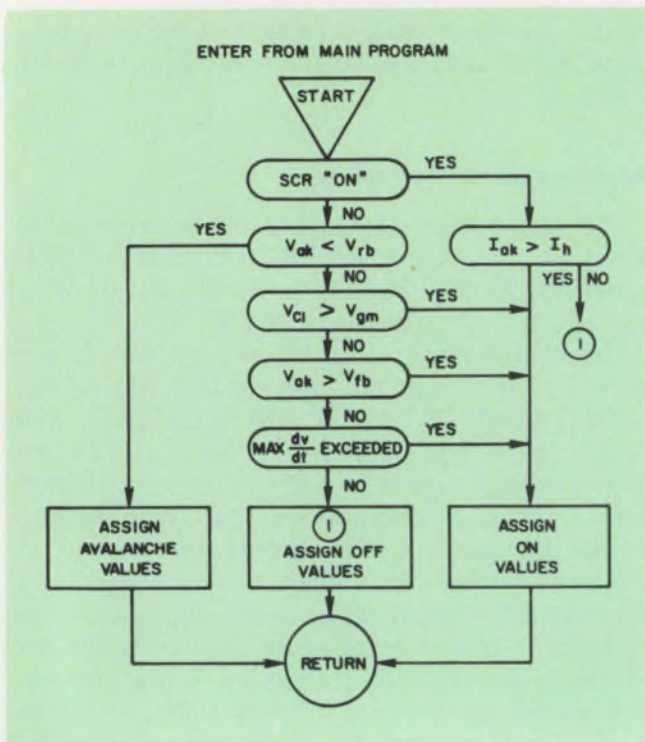

6. The SCR model is generated by a subroutine that follows this flow diagram.

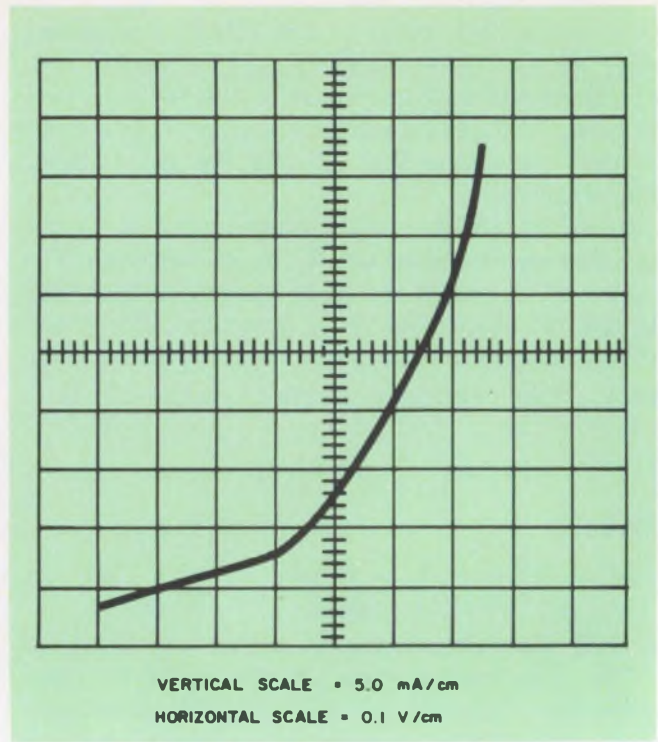

7. Laboratory measurements are the best way to determine gate I-V characteristics.

Symbols and definitions

- I_{ak} = anode-cathode current
 V_{ak} = anode-cathode voltage
 I_h = holding current (I_h), which is the minimum anode-cathode current that must flow for the SCR to remain in the high conduction state.
 V_{fb} = maximum forward blocking voltage
 V_{rb} = maximum reverse blocking voltage
 I_g = gate-cathode current
 I_{fb} = leakage current which flows when the SCR is off (forward direction, $V_{ak} = V_{fb}$)
 I_{fr} = reverse leakage ($V_{ak} = V_{rb}$)
 V_g = gate-cathode voltage
 V_{gt} = gate-cathode trigger voltage
 V_{gm} = minimum gate voltage required to fire all devices (refers to one family)

Model nomenclature

- R_{ak} = resistance between anode and cathode.
 J_g = current generator which simulates the gate-cathode characteristic.
 E_b = anode-cathode standoff voltage (has three values $E_b (F)$, O , $E_b (A)$, corresponding to the on, off, and avalanche status).
 V_{C_1} = voltage across C_1 .
 V_{cm} = magnitude V_{C_1} will reach if a pulse of magnitude V_{gm} is applied.
 τ = time constant which relates V_{C_1} to V_{gt} .
 T_r = turn-on time.

The parameters remaining are V_{cm} , R_1 , R_2 , and C_1 . If $R_1 = R_2$, C_1 and V_{cm} must be chosen so that Eq. 3 is satisfied. With T_r known, the equation can be solved by hand or by using the nomograph (Fig. 8). If Eq. 3 is to be solved manually, the easiest method is to set $R_1 C_1 = \tau = T_r$. Then $V_{cm} = 0.316V_{gm}$ and values for $R_1 C_1$ can be taken from the first section of the nomograph.

The piecewise-linear SCR model has been checked out in several circuits using the SCEPTRE circuit analysis program, and has functioned properly.

The model can be expanded to include other features. Temperature effects, for example, can be included. Several of the parameters used in the model are sometimes specified at 125°C and -65°C, as well as at 25°C. Worst-case temperature effects could be modeled by substitution of these extreme values.

The development of a more exact model is hindered by the variations that occur among devices with the same 2N-number. (Fig. 2 shows the wide range of gate I-V characteristics.) Until manufacturers can hold such parameters to closer tolerances, a search for a more exact model seems futile. ■ ■

This work was supported by the United States Atomic Energy Commission.

References

- George W. Zobrist, *Network Computer Analysis*, Boston Technical Publishers, Inc., Cambridge, Mass., 1969, pp 169-196.
- Op. cit. pp 189-191.

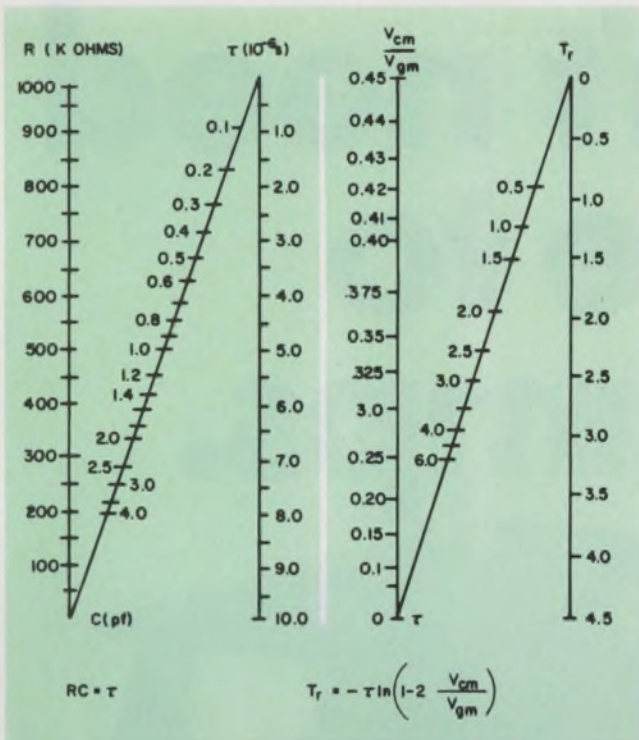

8. Nomograms can be used to solve Eq. 3 and thus determine some parameters.

Bibliography:

Daniel, M. E., "Development of Mathematical Models of Semiconductor Devices for Computer-Aided Circuit Analysis," *Proc. IEEE*, Vol. 55, November, 1967, pp. 1913-1920

Daniel, M. E., "Develop Useful General Models," *Electronic Design*, ED 20, September 27, 1969, pp. 68-72.

Mathers, H. W., Sedore, S. R., Sents, J. R., "Automated Digital Computer Programs for Determining Responses of Electronic Circuits to Transient Nuclear Radiation (SCEPTER)," *Air Force Weapons Laboratory TR-66-126*, February, 1967

Silicon Controlled Rectifier Manual, Fourth Edition, General Electric Co., New York, 1968

Sokal, N. O., Sierakowski, J. J., Sirota, J. J., "Transistor and Diode Models for Computer Analysis of Circuits," *Electronic Design*, ED 12,13,14, June and July 1967.

Test your retention

Here are questions based on the main points of this article. Their purpose is to help you make sure you have not overlooked any important ideas. You'll find the answers in the article.

1. What is the relationship between gate pulse magnitude and turn-on time?
2. What is the I-V characteristic of the gate-to-cathode circuit of an SCR?
3. In how many ways may an SCR be switched into conduction?

New! An economical way to get high performance filters.

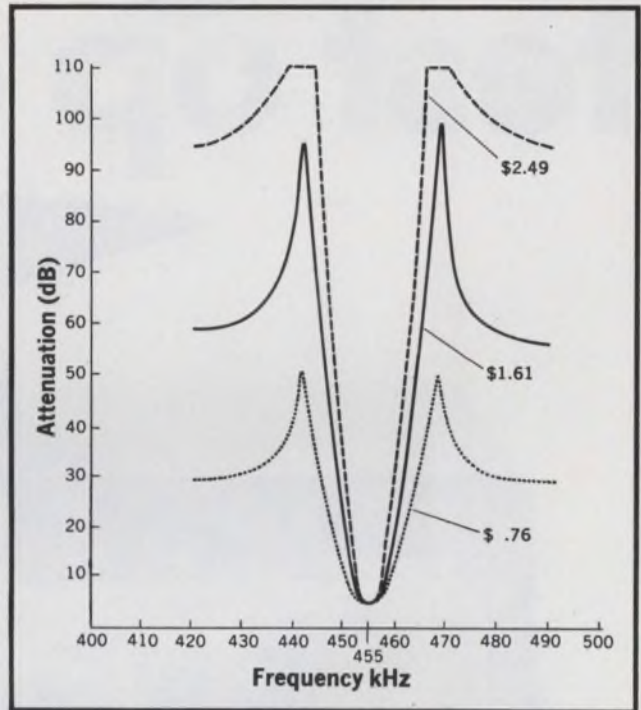

Typical response curves and component costs for three IR Filters—based on quantities of 500 resonators.

Now you can easily make your own ceramic filters—at low cost—with any of these performance factors:

Center Frequency	455 kHz
Stop Band Rejection	to 105 dB
Bandwidth @ 6dB	2-23 kHz
Shape Factor	better than 2:1

Here's a totally new concept from Clevite: high performance ceramic IF bandpass filters you build yourself. You do it by taking two or more standard Identical Resonators (IR's) and interconnecting them to known capacitors in a prescribed network configuration. Just check Clevite's tables for required capacitance values for given filter responses. And the tables are free for the asking.

Compared with conventional LC filters or IF cans, Clevite's IR approach offers extreme design simplicity and flexibility, plus economy. Here's an ideal way to get a special filter without paying a special price. In fact, the IR's cost just 35¢ in lots of 500.

Interested? A letterhead inquiry brings design tables and full information. Clevite Corporation, Piezoelectric Division, 232 Forbes Rd., Bedford, Ohio 44146, U.S.A. Or: Brush Clevite Company Ltd., Southampton, England.

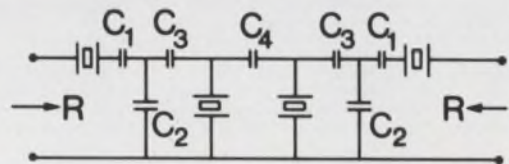

Example of IR filter with n=4 Identical Resonators. By changing capacitors C₁ to C₂, a continuous range of different filter responses becomes possible.

CLEVITE

INFORMATION RETRIEVAL NUMBER 41

You don't need a degree to test op amps.



Signetics' new Model 1410 is the most comprehensive, definitive, easy-to-use op amp tester on the market. And we can prove it.

Rather than shout about its many features, let us just tell you how it works and what it does:

First, you simply insert a program board (manufacturer's spec or your own) for the op amp to be tested. Plug in the device. All operations are now performed by pushing illuminated test buttons. Push the top left button and the lights immediately indicate what tests will be performed. Next, push the "Test" button. If all tests are passed all button lights go out and the "PASS" indicator lights up. If any test is failed, the button corresponding to that test stays lit and the fail light comes on.

Now, if you want to know to what degree a given parameter passed or failed its test, just push the button corresponding to that specific test. The

answer is read out immediately as a percentage of the specified test limit.

We call this real "decision language."

There are fourteen tests: power consumption overrange (greater than 200%), power consumption (less than 200%), offset voltage (source resistance zero ohms), offset voltage (source resistance programmed), + supply sensitivity, - supply sensitivity, common mode rejection, bias current, offset current, gain (programmed light load), gain (programmed heavy load), noise and oscillation. And for the first time there are tests you won't find on testers selling for ten times our price: + slew rate, - slew rate.

The Model 1410 has no knobs to turn or meters to interpret. Your secretary could learn to use it in about one minute. Optional input/output boards allow you print-out or data log complete

parameter measurement.

And there's more. But suffice it to say for now that we believe the 1410 represents a major breakthrough in linear testing. Many who have wanted to test op amps can now afford to do so because the 1410 makes op amp testing practical and cost-efficient.

We know that there are some prospects out there who could profit by paying eighty or ninety thousand for this tester.

We're happy to say that the price will not be more than a tenth of that. Plus tax.

See us at IEEE, booth number 3A01 to 3A04.

SIGNETICS CORPORATION
MEASUREMENT/DATA
A subsidiary of Corning Glass Works

For detailed information or a demonstration write Signetics, Measurement/Data, 811 E. Arques Ave., Sunnyvale, Calif. 94086, or contact one of the following:

AUTHORIZED SIGNETICS REPRESENTATIVES (Measurement/Data) Alabama and Tennessee Col-Ins. Co., Inc., Huntsville (205) 539-1771 California I and M Engineering, Inc., Inglewood (213) 678-5409; Santa Clara (408) 243-6661 Connecticut Datech Associates, Inc., New Haven (203) 624-7291 District of Columbia [see Silver Spring, Maryland] Florida Col-Ins.-Co., Inc., Orlando (408) 423-7615 Georgia Col-Ins. Co., Inc., Marietta (404) 422-8327 Illinois Carter Electronics, Inc., Chicago (312) 776-1601 Indiana Carter Electronics, Inc., Indianapolis (317) 293-0696 Maryland OED Electronics, Inc., Silver Spring (301) 588-8134 Massachusetts Datech Associates, Inc., Newtonville (617) 969-9710 Minnesota Carter Electronics, Inc., Minneapolis (612) 869-3261 Mississippi/Louisiana Col-Ins.-Co., Inc., St. Louis (504) 833-1116 New Jersey OED Electronics, Inc., Camden (215) 925-8711 New York OED Electronics, Inc., Mt. Vernon (914) 664-0080 J. A. Reagan Co., Inc., Albany (518) 489-4777; Binghamton (607) 723-9661; Newburgh (914) 561-4510; Syracuse (315) 471-7274; Utica (315) 732-3775; Rochester (716) 473-2115 North Carolina Col-Ins.-Co., Inc., Winston-Salem (919) 765-3650 Ohio WKM Associates, Inc., Cleveland (216) 885-5616; Dayton (513) 434-7800 Pennsylvania WKM Associates, Inc., Pittsburgh (412) 892-2953 Michigan WKM Associates, Inc., Detroit (313) 892-2500



ERIE

When you want radar as pure and coherent as a laser beam...

Symbolic electronic signal undistorted by EMI —
photographed by Howard Sochurek

bring ERIE in early.

31,000 feet... heavy traffic... ugly weather over the Plains. This isn't the time for "noise" in the radar. But, no sweat! RCA's exciting new AVQ-30X Weather Radar is up front, sweeping the sky... protected from EMI by 39 special ERIE filters. No other airborne radar has ever approached the single or dual system reliability of the AVQ-30. From the start, RCA has called on the outstanding research and component capability of ERIE TECHNOLOGICAL to help in the development of this great new unit. Proof, once again, that it pays to bring ERIE in early.

ERIE TECHNOLOGICAL PRODUCTS, INC.

644 West 12th Street, Erie, Pa. 16512
(814) 456-8592

how big *is a micron?*

*This page
could hold
16,914,128,443
round dots
one micron
in diameter*

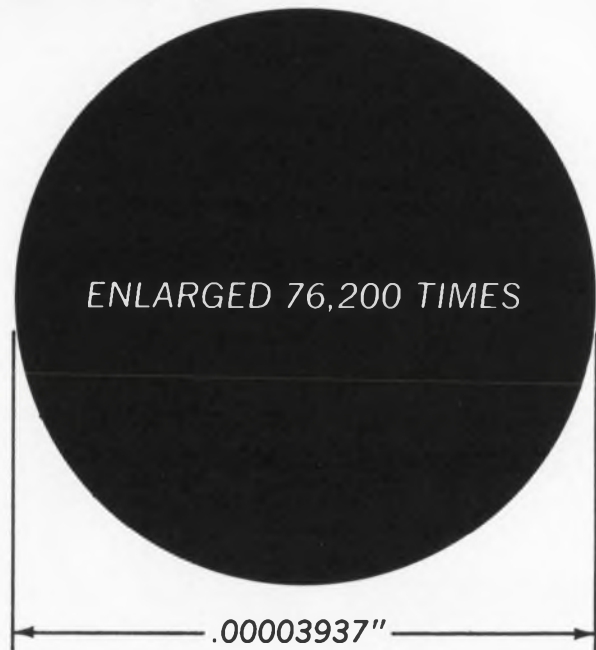

We etch metal to micron tolerances every day

Ultra-precise photomechanical reproduction of metal and glass parts is our business. We're very good at it. We've been precision etching on a quantity production basis since we made fire control reticles and other parts for the military in World War II. Now, with equipment like our new BMAPS computer-plotter system, we do it better and faster.

We picture a micron dot because we do work regularly to tolerances of microns, or even millionths of inches. As an example, with Buckbee-Mears electroforming we produce standard stock sieves down to 5 micron hole sizes, guaranteed accurate within ± 2 microns. These are shelf items, quantity produced. On hand-picked spe-

cial we can do better.

If you need a little less precision—for fewer dollars, of course—check our prices and delivery times for more routine etched metal or glass parts. We can make virtually any part that can be drawn on paper. Our prices are fair, and we think 10 days is long delivery.

Ask us about your requirements. We look upon ourselves as professional problem solvers. We have an impressive list of companies we have helped, and we'd like to add your name to the list. Call or write us today. The first man to talk to is Bill Amundson, our industrial sales manager.



BUCKBEE-MEARS CO.

245 E. 6th St., St. Paul, Minnesota 55101 / (612) 227-6371

The world leader in *precision photomechanical reproduction*

INFORMATION RETRIEVAL NUMBER 44

Has the No. 1 storage tube company turned square?

The inventor of storage tubes has invented a new one that's more square than round.

A versatile rectangular from Hughes. Able to produce alpha numerics, graphs and halftone displays. And give you the viewing area of a 7-inch round tube, while taking far less space.

Its resolution is 90 lines per inch @ 80% equilibrium. Brightness: 200 foot lamberts. Storage time: over two minutes without pulsing, up to an hour with pulsing.

Writing speed: 40,000 inches a second and up.

But although our new tube is sort of square, we aren't. Actually, we're great rounders.

Example: our Typotron® Direct-View Character-Writing Tube. It presents stored information much like typed copy. Over 25,000 characters a *second*. Nobody can estimate all its potential uses in education, research, business, industry.

Example: our neat little H-1201 scan converter tube. Only

half a foot long, and about an inch in diameter. Target diameter is .71 inches. Resolution: 750 TV lines/diameter, limiting resolution. Storage time: five minutes to 50% output.

Like our reference catalog? Just write: Hughes, Vacuum Tube Products Division, 2020 Oceanside Blvd., Oceanside, California 92054.

HUGHES

HUGHES AIRCRAFT COMPANY
VACUUM TUBE PRODUCTS DIV.
OCEANSIDE, CALIFORNIA

INFORMATION RETRIEVAL NUMBER 45

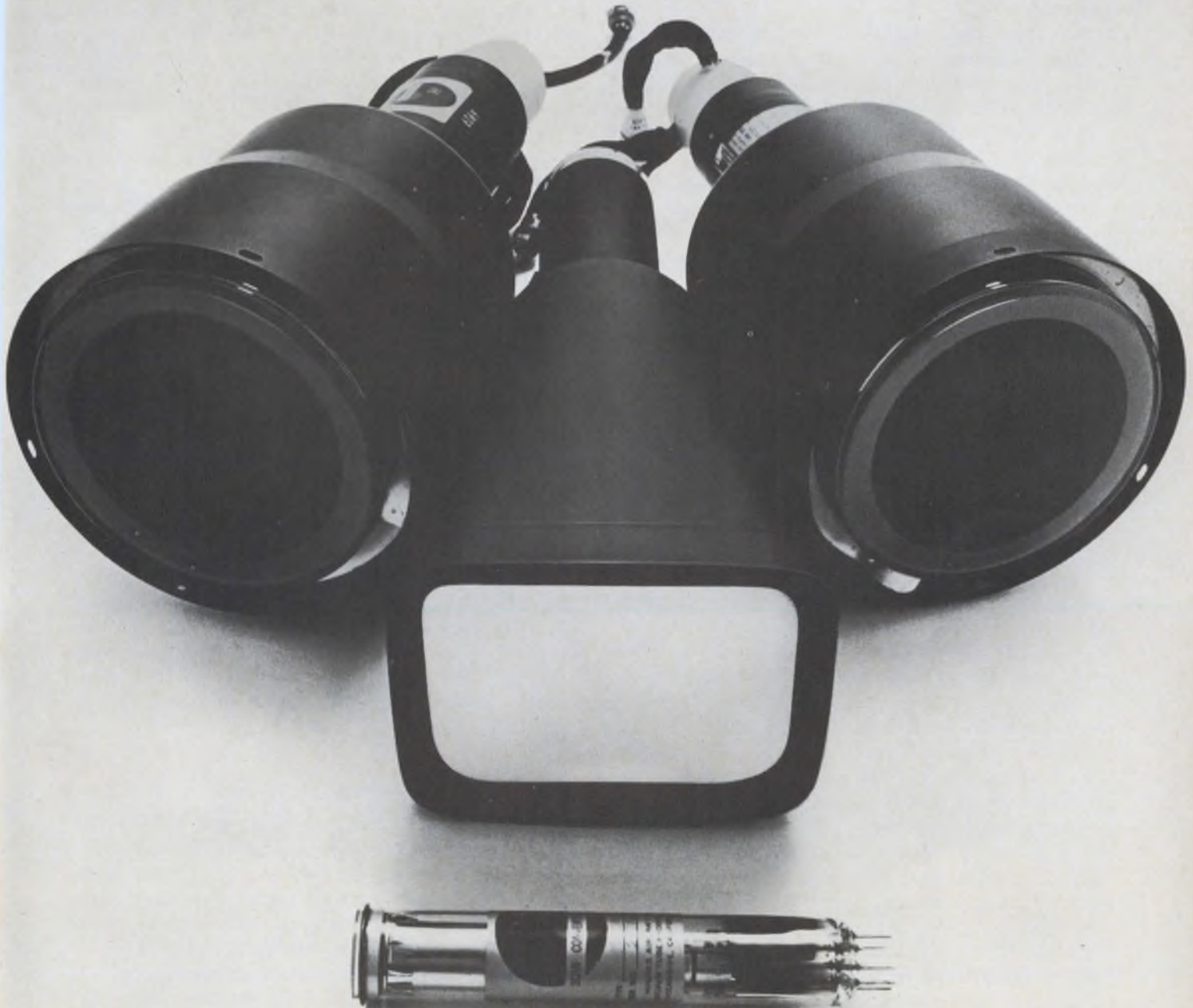

Are you engineering your career?

Check this survey article to see where you rank among other electronics engineers.

Richard Turmail, Management & Careers Editor

Have you asked yourself lately where you stand? That is, have you wondered whether or not the progress of your engineering career compares favorably with that of other EE's? More specifically:

How does your salary compare with earnings of other engineers in your age group?

Are engineers in other industries more satisfied with their work than you are with yours?

Does your employer offer you as many opportunities as the plant down the street? Or a similar plant 3000 miles across the country?

Are your gripes typical of your profession?

ELECTRONIC DESIGN was curious enough about the profile of the engineering profession to ask our subscribers about their careers. And of the nationwide sample canvassed, 51% responded to our questionnaire.

Surveying the highlights

Of course some of the standard assumptions about the engineering profession—like putting in a fairly long work week (between 40 and 45 hours) and a general disgust for paperwork—are confirmed by the survey. Some of the findings are surprising and, we hope, enlightening.

The more outstanding facts revealed are:

- There's only one aspect of their job that engineers dislike more than paperwork, and that's poor management. In that negative category, engineers place "politics" and a lack of communication, funds, support and time. Other recurring gripes include unchallenging work and infrequent advancement.

- Nearly half of all who replied have had technical papers published, and of these, three out of five have had two or more papers published. The top number of papers reported published per man is 10. (For an analysis of papers published by job title, see illustration 1 on page 100.)

- Over half of the respondents have pursued graduate study or have advanced degrees. (For a further percentage breakdown of education, see illustration 2 on page 100.)

- Electronics engineers can put up with a lot of things, but apparently boredom isn't one of them. The most appealing qualities of their jobs are, in order of preference:

1. Challenge.
2. Variety.
3. Work itself.
4. Freedom.

"Challenge," according to the survey, encompasses the qualities of achievement, responsibility and creativity. "Freedom" is expressed as being free of schedules, and free to work on the projects of one's choice.

- One-fourth of the engineers surveyed would leave the choice of a career up to their son. One-fifth of them would advise him to go into medicine, because he would make more money there and earn more respect than he would in any other profession. Third choice is engineering, but not necessarily electronics or electrical. Equal choices mentioned are law, science and business management.

Apparently, engineers are not too happy about salary, the lack of authority, and the lack of respect that they receive. One respondent wanted his son to be a shepherd so that he wouldn't have any worries. (Has he never heard of wolves?)

Rx for obsolescence

Three out of four who replied to the survey reported that they bone up on their technology by reading technical magazines. Two out of five keep themselves informed by attending college classes. (For complete figures on how the engineers surveyed stave off career obsolescence, see illustration 6, on p. 102.)

What about job-hopping?

Based on this survey, the engineer who works in the industrial controls, consumer, and sub-assembly industries is apt to change jobs more often than his colleagues. Either the job-hopper is not satisfied with his present position, or he finds a better position in the same field.

Least likely to change jobs seems to be the engineer who is employed by government agen-

SURVEY PROFILES

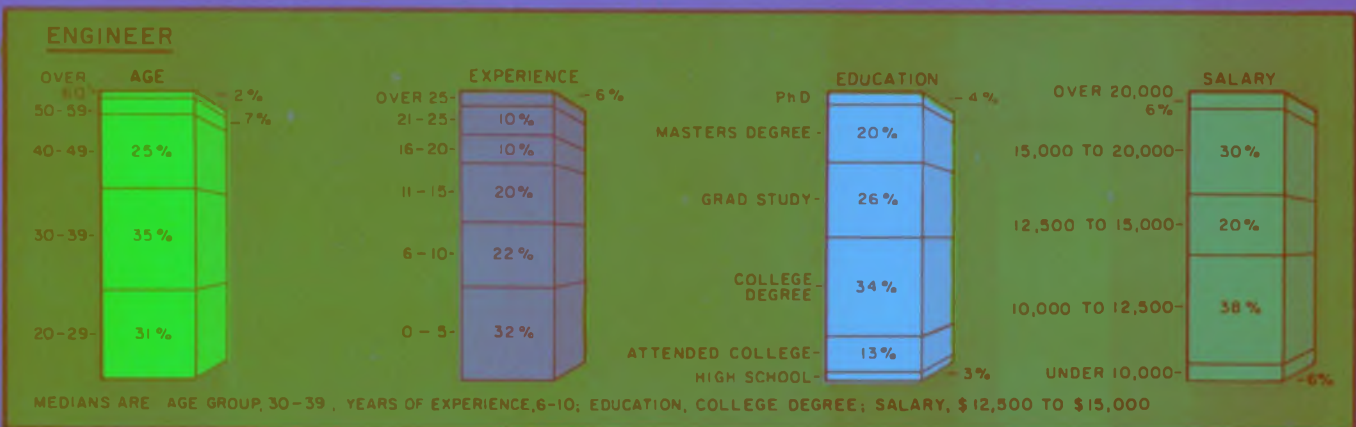
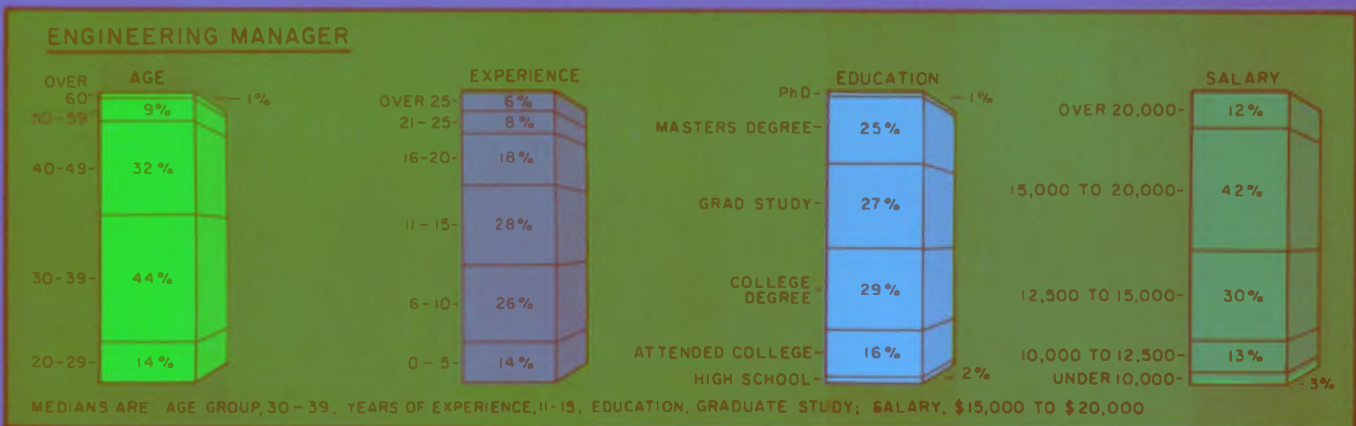
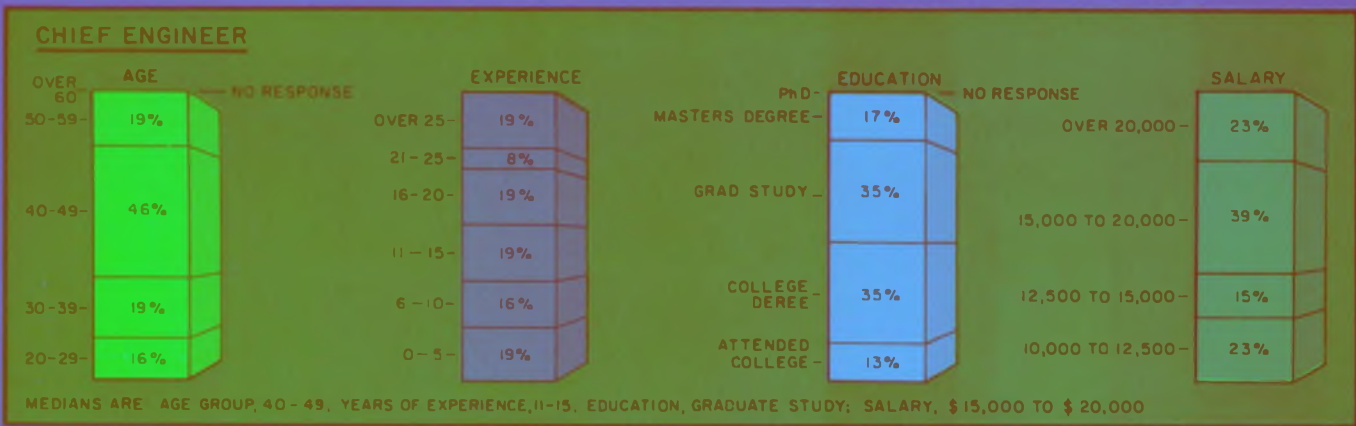
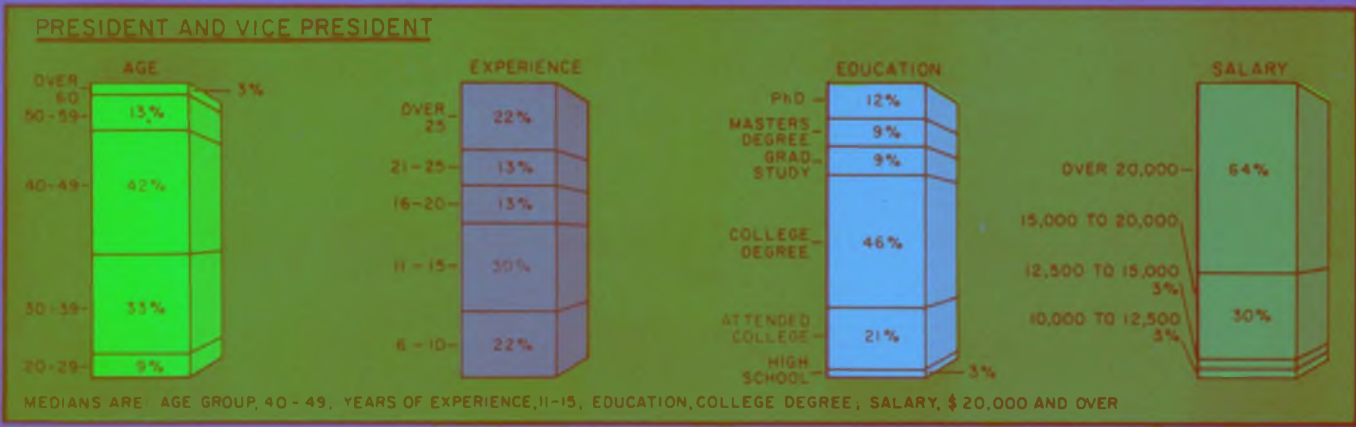

I. TECHNICAL PAPERS PUBLISHED

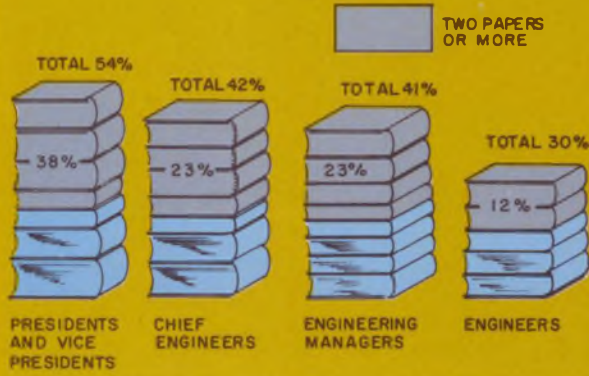

2. DEGREE OF EDUCATION

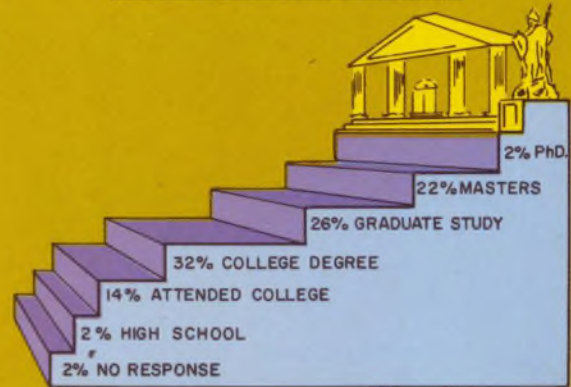

3. Satisfaction, opportunity and company potential

Industries (figures in parenthesis represent % of response.)	Are you satisfied with your job? yes	Does your company give you opportunity to improve yourself? yes	Does your company have growth potential? yes
Computers, Data Processing Mfr. (11%)	77%	87%	80%
Test Measurement & Instrument Mfr. (7%)	28%	43%	67%
Communications Systems and Equipment Mfr. (13%)	78%	89%	74%
Navigation & Guidance Systems Mfr. (5%)	52%	91%	57%
Consumer Electronic Equipment Mfr. (4%)	91%	83%	70%
Industrial Controls, Systems & Equipment Mfr. (7%)	83%	74%	71%
Component Mfr. and Materials & Hardware Mfr. (7%)	77%	94%	79%
Underseas, Aircraft, Missiles, Space & Ground Support (17%)	70%	86%	51%
Sub-Assembly Mfr. (1%)	67%	67%	67%
Independent Research, Test & Design Labs & Consultants (7%)	93%	90%	63%
Govt. Agencies & Military (18%)	80%	94%	28%
Averages	70%	82%	64%

Turnover

No. of jobs held by years of experience and industry						Average per industry
0 - 5 Years	6 - 10 Years	11 - 15 Years	16 - 20 Years	21 - 25 Years	Over 25	
1.7	2.5	2.7	5.3	3.1	1.0	2.6
1.3	2.4	2.4	4.0	3.7	no response	2.8
1.4	2.7	2.4	3.4	1.7	3.5	2.5
1.3	2.2	3.0	1.8	1.0	5.3	2.6
2.6	2.0	2.5	4.0	4.2	3.5	3.1
2.8	2.9	2.6	3.4	5.3	3.0	3.3
1.2	2.0	2.5	2.3	3.0	4.1	2.5
1.4	2.3	2.4	4.3	4.3	2.3	2.8
2.0	no response	3.5	no response	4.0	no response	3.1
1.8	3.0	2.8	3.3	2.0	4.8	2.8
1.3	2.2	2.1	2.2	2.5	3.0	2.2
1.7	2.4	2.6	3.4	3.2	3.4	Total Avg. 2.8

cies and the military. Reasons: security and—for four out of five engineers—satisfaction with their job. More than nine out of ten engineers in government occupations, claim they are given an opportunity to improve themselves.

Curiously enough, however, almost three out of four of these engineers also claim that their industry has a very poor growth potential. Perhaps, because of the lack of growth, there is a lack of jobs in this area, and hence a minimum of turnover.

The highest rates of job turnover occur in the Computer industry with engineers in the 16-20 years of experience category; in the Industrial controls industry with engineers in the 21-25

years of experience category; and in the Navigation and guidance systems industry with engineers who have over 25 years of experience. In all three instances, the average number of jobs held by each of the respondents was nearly five and a half.

Oddly enough the lowest rate of turnover (an average of 1-1/2 jobs per survey respondent) in the 16-20 and 21-25 years of experience categories occurs in the industry with the highest rate of turnover for engineers with over 25 years of experience, the Navigation and guidance systems industry. Complicating the picture even further is the fact that the lowest rate of turnover for engineers with over 25 years of experi-

1. What is your job title?

President	Technical Director, Group Leader
Vice President	Research Director, Section Head
Chief Engineer, Asst. Chief Engineer	Project Engineer, Senior Engineer, Dept. Manager, Dept. Head, and Their Assistants
	Engineer, Member of Technical Staff
	Designer, Consultant

2. Please indicate your age.

20-29	40-49	60 and over
30-39	50-59	

3. How many years have you been in the electronic engineering field?

0-5	11-15	21-25
6-10	16-20	Over 25

4. Please indicate next to the years you checked (above) how many different companies you have worked for.

5. Please indicate your highest educational level.

High School	College Degree	Masters Degree
Attended College	Graduate Study	Doctorate

6. Please circle the location of your employment.

East Coast	Mid-West	South	West Coast
------------	----------	-------	------------

7. What is your salary range?

under \$10,000	\$12,500-\$15,000	\$20,000 and over
\$10,000-\$12,500	\$15,000-\$20,000	

8. Have you had a raise within the last year?

Yes	No
-----	----

Survey data

This article reports the findings of a survey conducted in August, 1969, among subscribers to ELECTRONIC DESIGN. We mailed 1000 questionnaires to a random sample of our subscribers: 515 replies were returned to us in time for analysis. Respondents were told to remain anonymous.

The survey was designed to include two engineers for each manager, a job title ratio which adequately reflects our subscription list.

The questionnaire contained 20 items (see sample on this page). The engineers were told that the information they supplied on the form would be used in a Management & Careers survey article designed to inform them about their careers and those of their colleagues.

9. What was the percentage of your increase?

5%	10%	15%	20%	Over 20%
----	-----	-----	-----	----------

10. Which of these industry classifications best describes your work?

Computers, Data Processing & Peripheral Equipment Manufacturers
 Test Measurement & Instrumentation Manufacturers
 Communications Systems and Equipment Manufacturers
 Navigation & Guidance Systems Manufacturers
 Consumer Electronic Equipment Manufacturers
 Industrial Controls, Systems & Equipment Manufacturers
 Component Manufacturers & Materials & Hardware Manufacturers
 Aerospace, Aircraft, Missiles, Space & Ground Support Equipment Manufacturers
 Sub-Assembly Manufacturers
 Independent Research, Test & Design Laboratories & Consultants (Excluding Those Connected with a Manufacturing Company)
 Government Agencies & Military

11. How many hours a week do you work on the job?

25-30	30-35	35-40	40-45	45-50	50 and Over
-------	-------	-------	-------	-------	-------------

12. Are you

Satisfied	Dissatisfied
with your present position?	

13. What do you like most about your job?

14. What do you like least about your job?

15. What career would you advise your son to follow? Why?

16. How do you stave off career obsolescence?

Tech mags.	Home study courses
In-plant refresher courses	Other information sources
Formal university studies	

17. Have you had any technical papers published?

Yes	No	If so, how many?
-----	----	------------------

18. Does your company give you an opportunity to improve yourself?

Yes	No
-----	----

19. Does your company have a strong growth potential? Explain.

Yes	No
-----	----

20. Any comments on this questionnaire in general?

4. AREA DISTRIBUTION

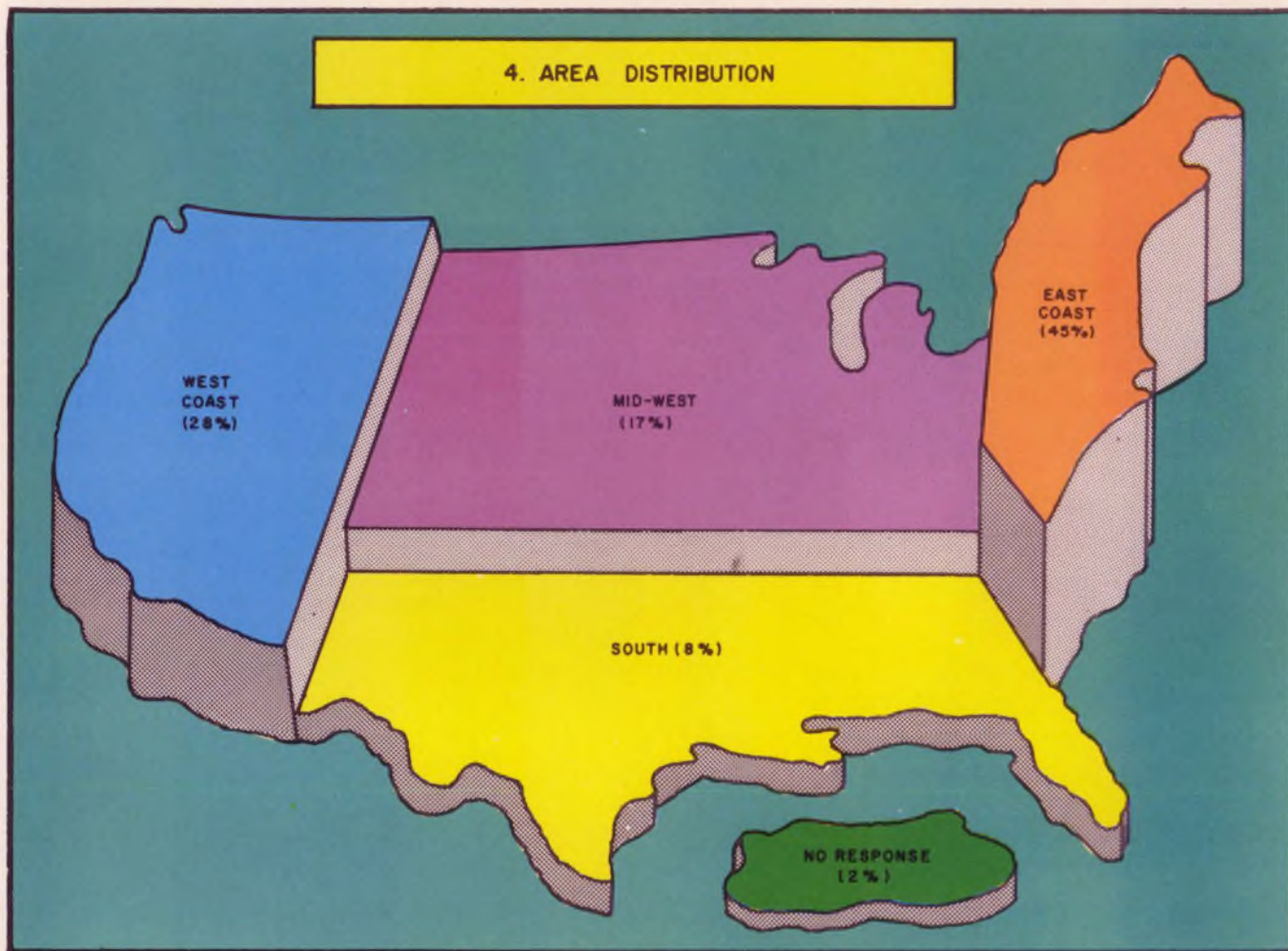

5. AGE DISTRIBUTION

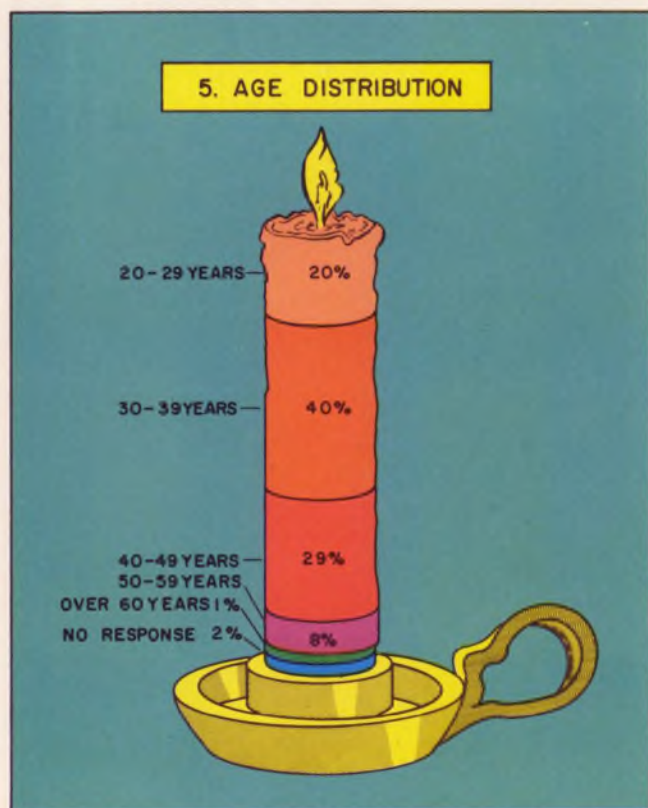

6. HOW EEs STAVE OFF OBSOLESCENCE...

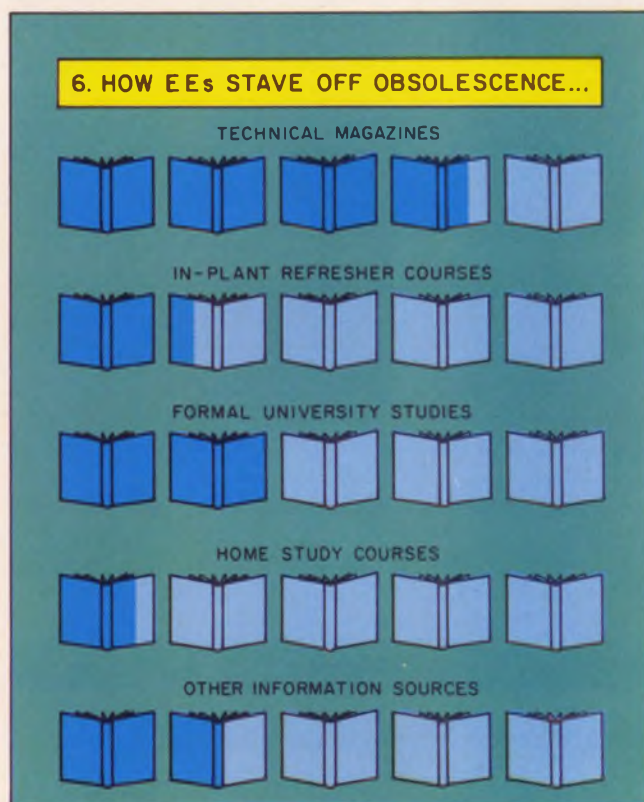

ence occurs in the Computer industry, the field of highest turnover for EEs with 16-20 years on the job.

According to our survey figures, electronics engineers have held just under three different jobs per career, a decidedly lower average figure than the popularly assumed one of four to five jobs per engineering career.

(For more information about jobs, by industry, see illustration 3 on page 100).

Comparisons—categorically speaking

By location: According to a salary survey of engineers in all fields of endeavor conducted by Engineers Joint Council, and published late last spring, the West Coast engineer earns a higher salary than his fellow engineers in other sections of the country. Our survey, which was sent to electrical and electronics engineers only, indicates that the East Coast EE earns more than his colleagues. Two out of five who replied say they are "Easterners." One out of four indicates that he is from the West (see illustration 4, on p. 102).

By age and wage: Though age distribution of the electrical and electronic engineering community may not reflect that of all engineers, the distribution shown (See illustration 5, page 102) accurately depicts the age spectrum of the 500-plus engineers described in this report.

If you are between 20 and 29 years old, the chances are that you are earning \$10,000 to \$12,500 per year, although one-third of you are earning \$12,500 or more. Only 1% of you are earning \$20,000 and over, and only 12% under \$10,000. The majority of you are not yet in managerial positions, and thus your wage is lower than that of the older age groups.

If you are between 30 and 39 years of age, you are most probably earning between \$12,500 and \$15,000. However, two out of five of you are making between \$15,000 and \$20,000 per year. An interesting fact is that, although the median for the group falls within the \$12,500 to \$15,000 category, practically all of those above the median fall in the \$15,000 to \$20,000 category. One explanation for this could be that the engineer in this age bracket is at, or nearing, the peak of his career. He is still young enough to be of real use to a company, and he has just enough experience to demand a higher wage. He is also probably moving into engineering management.

The engineer in the age category of 40 to 49 earns more (\$15,000 to \$20,000) than his younger colleagues, but the engineer who is 50 years of age or older tails off slightly in his power to earn higher raises. Many older engineers, who are earning a relatively high salary after many years of experience, receive a raise of about 5% per

year, as opposed to the average for all respondents of 10% per year. Perhaps it can be assumed that management believes that, although the percent of increases represented by raises given to older employees is lower than that for younger EEs, the amount of money involved is the same or more. Also the older, established engineer doesn't have to be wooed by his company.

Nine out of ten engineers who answered the questionnaire have had a raise in the last year.

By job title: Vice presidents, managers, and engineers have two things in common: most of them are in the 30-to-39 age group, and the overwhelming majority of them work 40 to 45 hours per week. Our survey says that all VPs have a college or graduate degree. While most managers indicate graduate study, the median education of responding engineers is a college degree. The chief fact that separates the presidents from the rest of the engineers is the claim that they work over 50 hours per week, whereas the other job-title groups work 40 to 45 hours per week on the average, according to the survey.

By industry: Seven out of ten engineers are satisfied with their jobs, and four out of five believe that their company offers them the opportunity to improve themselves. One-third of them, however, believe that their company has no growth potential.

Most satisfied with his work is the engineer who is in some form of independent research, usually because of the opportunities he is offered. Least satisfied, by a wide margin, is the engineer in the test measurement and instruments industry; he is of the opinion that his company does not offer him much chance for improvement. (For a percentage of industries represented in the survey, see illustration 3, on p. 100.)

In general, then, the typical electronics engineer is; between 30 and 39 years of age; earns \$12,500 to \$15,000 per year; has a college degree or better; is satisfied with his job and career opportunities, as long as poor management and excessive paperwork don't drive him to distraction; has managerial responsibilities; and more often than not, works on either Coast.

But perhaps the most revealing finding of all is his choice of career for his son—medicine, "because of more money offered and more respect given." Wouldn't it be interesting to find out how many doctors would advise their offspring to go into engineering? ■■

Our thanks . . .

to those 500 plus engineers and engineering managers who took time out to complete our questionnaire. You have performed a nationwide service for EEs.

more data
transmission
applications for
**ANALOG
SWITCHES
& OP AMPS**

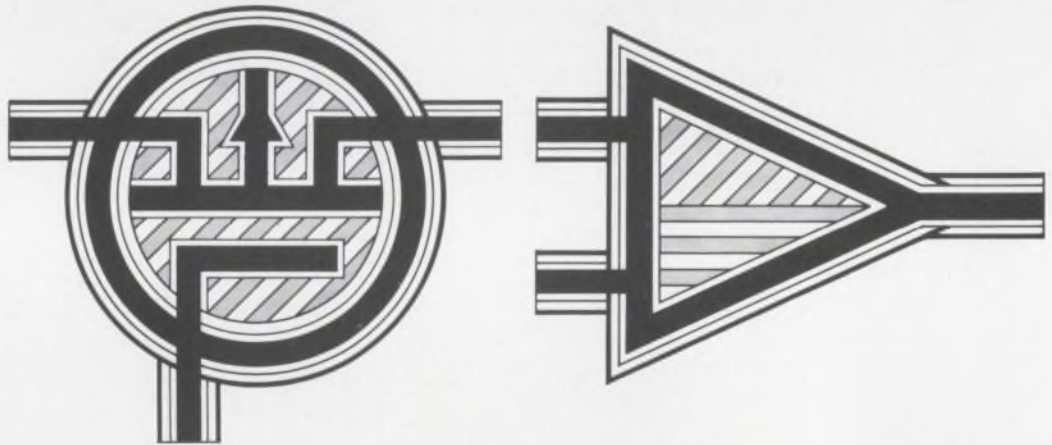

* Applications Power . . . A broad product line, an extensive network of stocking distributors and an experienced applications team waiting to serve you.

Here are two more examples that illustrate the versatility of Siliconix driver/FET switch packages in data transmission systems.

Functional Description	Channels	Type	Max. $I_{DS(ON)}$ (ohms)	Switch Type
DPST	3	DG120 121	600 600	PMOS PMOS
DPST	2	DG122 132	600 600	PMOS PMOS
DPST	2	DG126 129 140	80 30 10	N N N
SPECIAL FUNCTION	1	SI3001	600	PMOS

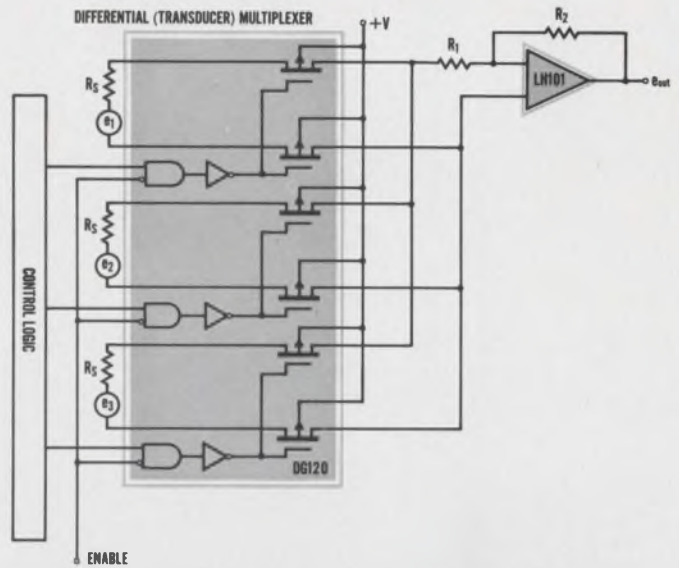

This three channel version of a transducer-multiplexer uses a single DG120 along with an LH101.

Functional Description	Channels	Type	Max. $I_{DS(ON)}$ (ohms)	Switch Type
DG110	2	111	600	PMOS
		112	600	PMOS
		133	30	N
		134	80	N
		141	10	N
		147	600	PMOS
DG116	4	118	600	PMOS
		125	600	PMOS
DG123	5	125	600	PMOS
		125	600	PMOS

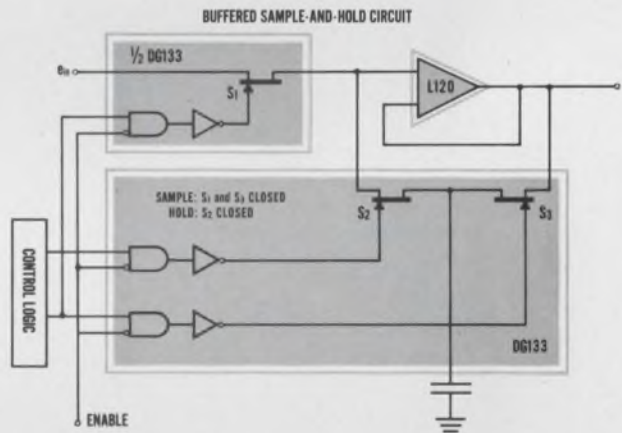

Low input leakage of the L120 OP AMP makes it ideally suited for sample-and-hold circuits. Two channels of this circuit require only three DG133s and one L120. An alternative approach would require two DG129s and one L120 for two channels.

SILICONIX OP AMPS	Max. input offset voltage -55 to +125°C	Max. input current	Min. open loop gain	Output voltage swing	Slew rate	
LM 101 LH 101 (Internally compensated)	6 mV	200 nA	50K	±12V	0.25V/μsec.	<ul style="list-style-type: none"> • Operation from ±5 to ±20V power supplies • Low current drain • Continuous short circuit protection • Same pin configuration as 709 amplifier
L 120	200 mV	50 pA	100	±12V	20V/μsec.	<ul style="list-style-type: none"> • Low input leakage • High slew rate • Unity gain stable • Ideal for sample and hold, integrating and fast voltage comparisons

Working on data transmission? Write today for complete information on all Siliconix FET switch combinations and OP AMPS.

For instant applications assistance, call the number below.

Our new address . . .
Siliconix incorporated
 2201 Laurelwood Road • Santa Clara, Calif. 95054
 Phone (408) 246-8000 Ext. 201 • TWX: 910-338-0227

BLACKBOXING...?

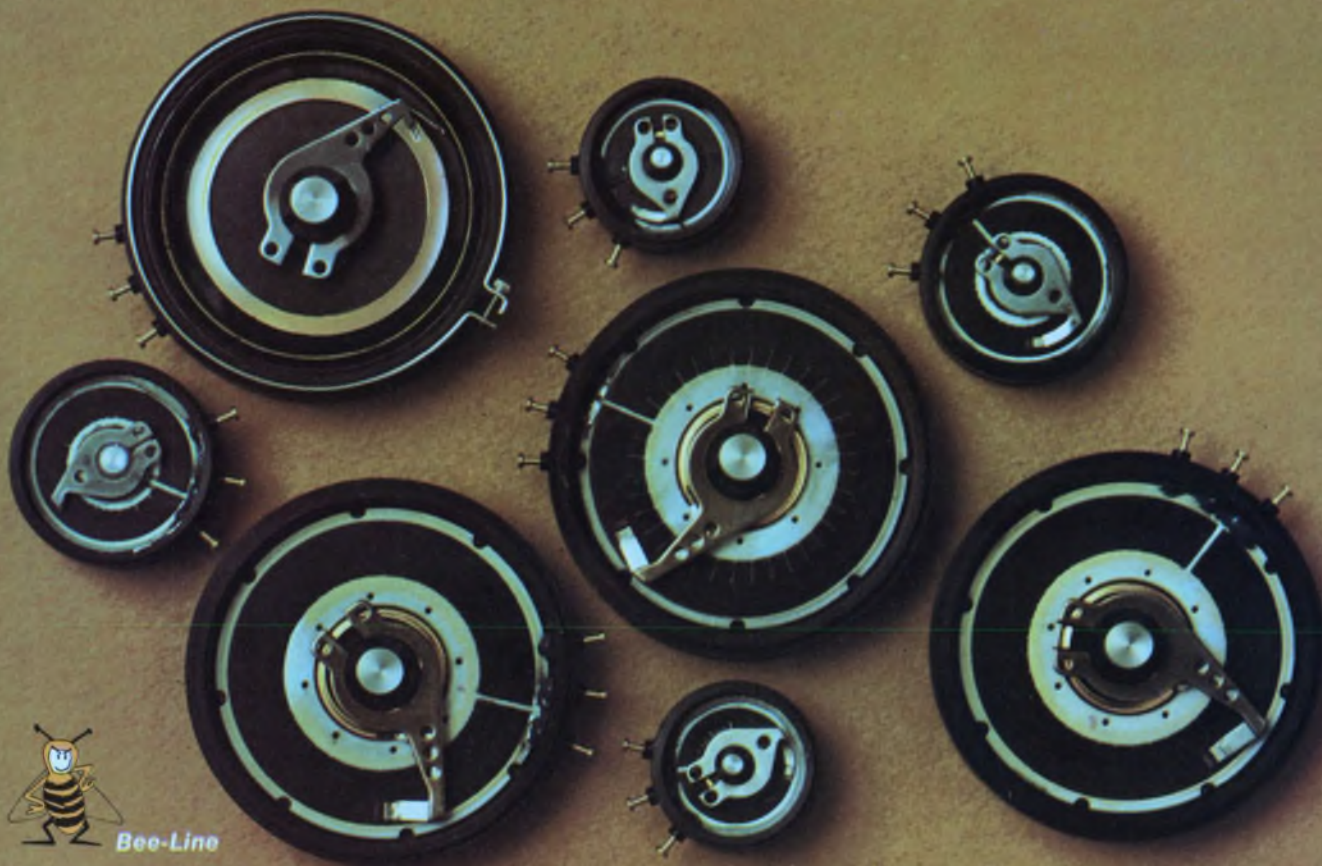

FORGET ABOUT POTENTIOMETER ELEMENT— ... DESIGN FOR SIZE AND DEPTH!

Eliminate size restrictions previously imposed by electrical application! *Bee-Line* does it! Regardless of the type of element — wirewound, conductive plastic, cermet or BiFilm™* . . . The *Bee-Line* series, in the new standard size and a compact, sturdy package, lets you design your black box before the elements are chosen!

To the packager

Three standard diameters — $\frac{7}{8}$ " , $1\frac{1}{16}$ " , 2". No more "hands-tied" electrical specifications that dictate overall size!

To the buyer

Standard size—0.2" per extra cup—avoid headaches of "almost the same as", "just like", etc.

To you

Whatever your function, the Bourns *Bee-Line* can solve a problem in your responsibility area. It truly provides an answer where no one before has dared to tread!

Get complete details on the versatile, slim, trim *Bee-Line* from the factory, your local Bourns Sales Office or Representative today!

*BiFilm is Bourns new, low TC Conductive Plastic



Phase-lock detector requires no external power supply

It is often necessary to generate different waveforms at the same frequency, or at harmonically related frequencies. Function generators with VCO inputs can be used if an external phase detector circuit is added.

The detector circuit shown requires no power supply and has excellent isolation between the two inputs. The MOSFET acts as a variable resistor controlled by the reference signal. The phase-locked signal, which should be centered about ground, is filtered to provide a dc output proportional to the phase difference of the input signals. The dc output is fed to the VCO input of the generator to maintain phase lock.

This detector operates with any input waveform, but is more sensitive for larger inputs. The filter capacitor, C , is selected for $X_c \ll 10$

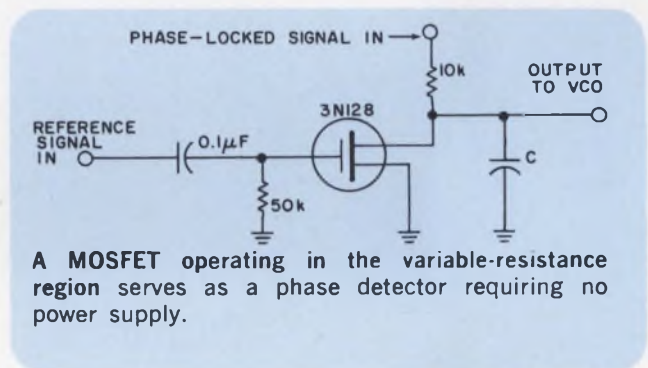

$k\Omega$ at the oscillator frequency.

Glen Worstell, Development Engineer, Hewlett-Packard, Loveland Div., Loveland, Colo.

VOTE FOR 311

Restorer and op amp convert pulses to dc level

A dc output voltage corresponding to input pulse amplitude may be obtained by using a dc restorer or pulse clamping circuit in conjunction with a differential amplifier.

Shown schematically in Fig. 1, the input pulse peaks (Fig. 2A) are clamped to ground by C , R and $D1$, and hence the base line varies with pulse amplitude (Fig. 2B)

If this clamped voltage is amplified with respect to its original input using a differential amplifier, the following equations result:

$$V_o = \frac{-R_f}{R_i} (0 - V) = \frac{R_f V}{R_i} \text{ for } t = T_1$$

$$V_o = \frac{-R_f}{R_i} (-V - 0) = \frac{R_f V}{R_i} \text{ for } t = T_2$$

Thus V_o remains constant for both T_1 and T_2

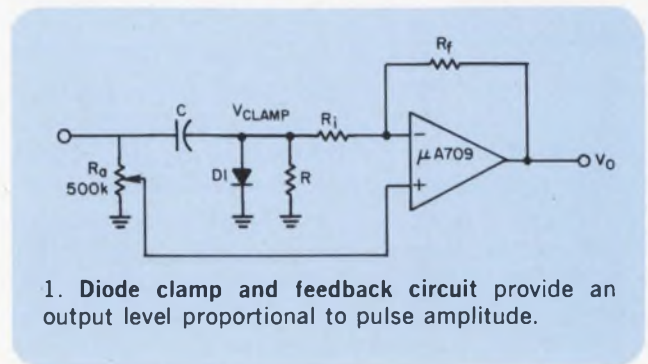

and is directly proportional to the input amplitude.

If the input pulses are on a base line, V_b , the above equations may be expanded to show that



Programming was pretty slow... Now, the Beckman 6401 is programmable to 136 MHz

In the Model 6401 Programmable Counter and Timer, Beckman offers a general purpose laboratory and production instrument that does what you want it to, at a price you can't resist... \$1375.

The 6401 provides direct frequency measurements to 136 MHz and complete programmability from contact closures. And the 6401 makes new measurements that were "unheard" of in the Good Old Days — like pulsed RF frequency or burst frequency measurements and period measurements from both channels for calibrated phase timing.

Timing measurements are a breeze with the exclusive trigger point monitor lamps in the 6401 for optimum attenuator and trigger adjustments. And maximum utilization of field replaceable IC's assures highest reliability and the lowest cost of ownership.

The 6401 is provided in a compact 3½" rackable package to conserve systems panel space, with 1-2-4-8 BCD outputs and scope markers as standard features. Options for serial input and output data, for nine digit display, and oscillator options with stabilities to 5 parts in 10¹⁰ per 24 hours are available.

Regardless of what "programmable" meant in the good old days, take advantage of what Beckman has

to offer today. For complete information, contact your local Beckman office, sales representative or the factory direct.

Specifications

Measurement Modes: Frequency: Input A, 0-136 MHz; Input B, 0-10 MHz. Burst Frequency: 0-136 MHz. Time Interval: A to B, 0.1 μsec to 10⁸ sec. Period: Input A, 0-10 MHz. Period Average: Input A, 1 to 10⁸ in decade steps. Ratio: (F_x ÷ F_y) × M with F_x = 0 to 136 MHz, F_y = 0 to 10 MHz, M = 1 to 10⁸. Totalize and Scale: Input A, 0-10 MHz scale; 136 MHz count, 1 to 10⁸ in decade steps. *Sensitivity:* Inputs A & B, 100 mV rms. *Crystal Frequency:* 10 MHz. *Stability Aging Rate:* Temperature: 2.5 × 10⁻⁶ from 0°C to 50°C; Line Voltage: 1 × 10⁻³ for ± 10% line voltage change. *Oscillator Output:* 10 MHz. *External Oscillator Input:* 10 MHz. *Time Base Output:* 3 V p-p. *Display:* 8 digits with overflow indication. Storage ON-OFF. Sample Rate: fast recycle and .1 sec to 10 sec display. Gate Lamp. *Remote Programming:* by switch closure to ground; BCD data at rear panel. *Temperature:* 0-55°C. *Power:* 115/230 V ± 10%; 50-400 Hz. *Price:* \$1375. *Options:* ACL: Laboratory Stability Oscillator, 3 parts in 10⁹ per 24 hrs; \$400. ACN: Ultra-high Stability Oscillator, fast warm up, 5 parts in 10¹⁰ per 24 hrs; \$800. 9 digits: \$100. Rear Inputs (A and B): \$50.



INSTRUMENTS, INC.

ELECTRONIC INSTRUMENTS DIVISION

RICHMOND, CALIFORNIA • 94804

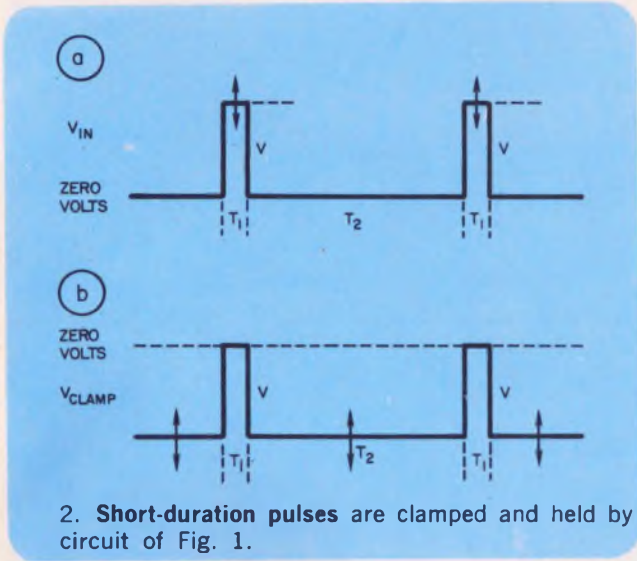

the output for both T_1 and T_2 will be

$$V_o = \frac{R_f}{R_i} [V + V_b]$$

The values of C , R , and R_i depend on the times T_1 and T_2 , while R_a is used to compensate for any losses in the clamping network.

By reversing $D1$, negative pulses may be treated similarly.

Peter Himmelheber, Senior Project Engineer, NESTEF, Patuxent River, Md.

VOTE FOR 312

Shunt diode protects load in SCR circuit

A shorted SCR can dump damaging power into a load. And the difference in rms currents between normal and shorted operation may be too small for reliable fusing, particularly where a wide range of temperatures or unusual fusing

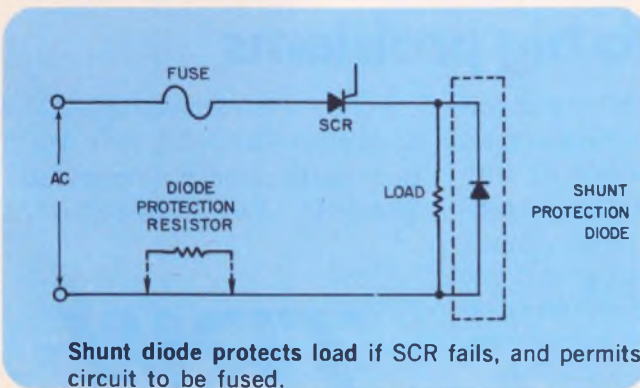

levels is encountered.

But if a bucking diode is placed across the load, the normally missing half cycle will draw high currents if the control element fails. This enables the circuit to be fused quite easily. The load shunting diode may be damaged by the short-circuit currents, but the circuit will fail safe. In some cases, it may be possible to incorporate enough limiting resistance to allow the fuse to blow without damage to the diode. (This circuit is patent pending.)

John T. Lamb, Research Engineer, The Tappan Co., Mansfield, Ohio.

VOTE FOR 313

IC operational amplifiers solve bias level problems

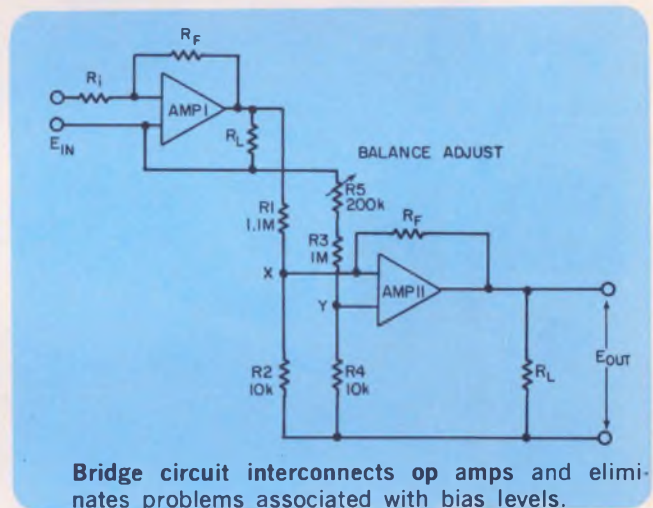

Two operational amplifiers connected by a bridge circuit can eliminate serious bias problems without regard for the maximum common-mode input voltage rating. Any ac or dc signal can be used to drive the first op amp, which feeds a bridge circuit. The second amplifier brings the signal back to the desired level. Bias voltage can be pulsed or continuously varied, without interfering with the signal, since the bridge is in balance at points X and Y. Input and output can be kept floating. Several hundred volts of bias can be applied to the circuit.

In the circuit, separate floating and insulated power supplies are required for Amplifier 1 and Amplifier 2. R_5 is used to balance the bridge. The ratios of $R_1:R_2$ and $R_3:R_4$ determine the maximum bias voltage rating. If, for instance, 110 volts maximum bias is required, R_1 and R_3 should be at least 150 k Ω and R_2 and R_4 should

TRW Polycarbonates

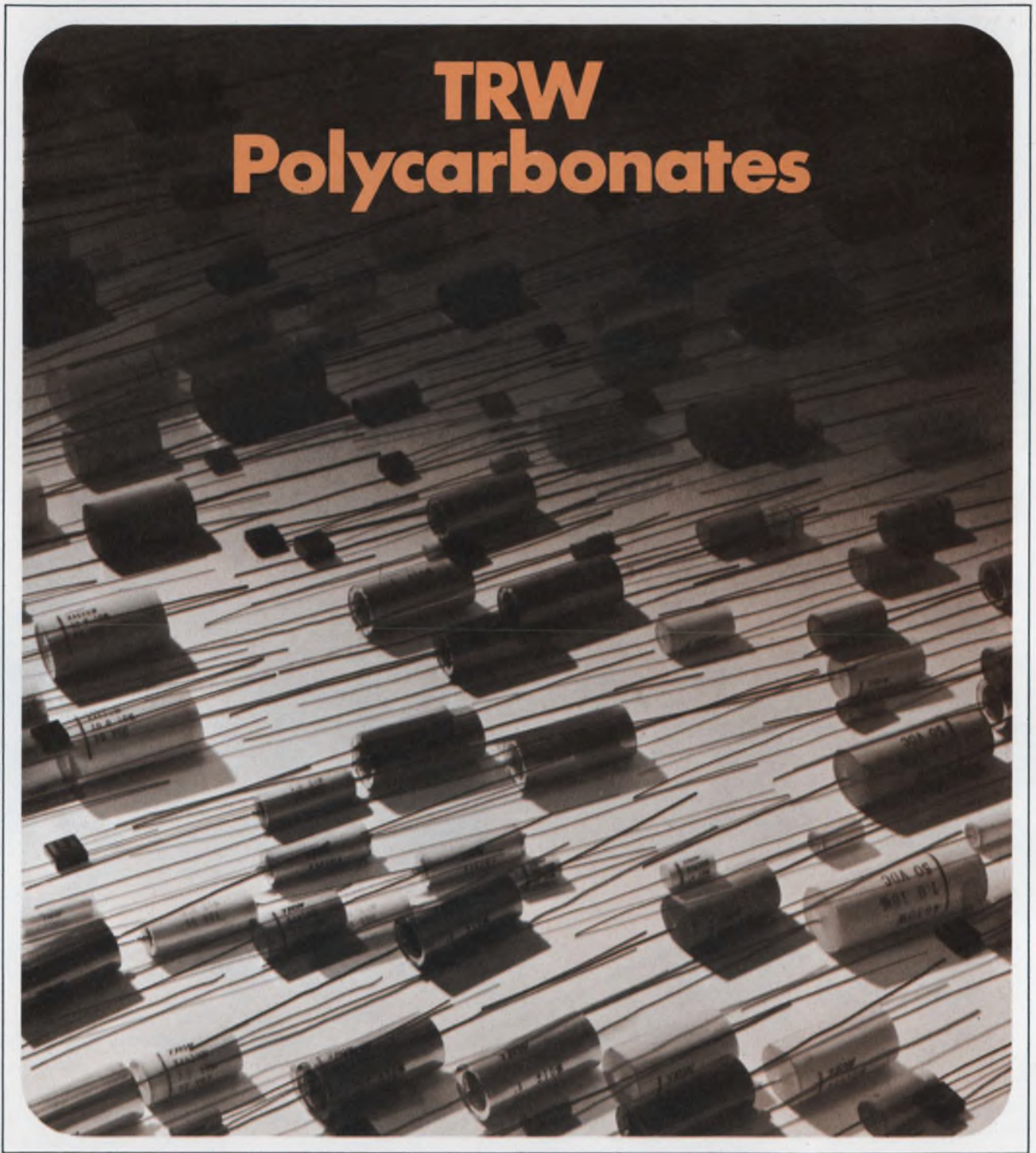

...small answers to big problems

Need capacitors with premium electrical and TC properties...and in the smallest possible package? Polycarbonate capacitors are your answer. And no one knows more about polycarbonates than TRW.

As the pioneer in polycarbonate capacitor development, TRW has the know-how to get that "extra

ounce of performance" out of this remarkable material. We can meet your design requirements with either metallized or foil wound polycarbonates in a wide range of capacitances, voltage ratings, shapes, and sizes. Standard types will solve most design problems...if not, let's talk about your special requirements.

For full information, contact TRW Capacitor Division, Box 1000, Ogallala, Nebraska. Phone: (308) 284-3611. TWX: 910-620-0321.

TRW®

INFORMATION RETRIEVAL NUMBER 48

be 10 kΩ to allow a safety margin between maximum possible voltage at points X and Y (6.9 V) and an assumed maximum common-mode input voltage of 10 volts at Amplifier 2.

For stability, wattage ratings of resistors R_1 through R_5 , R_7 and R_8 should be 10 times the actual dissipation during maximum applied bias

voltage. These resistors should be 1% types. R_7 and R_8 are determined by the the op amps and the desired gain.

Hans E. Weber, Electronic Engineer, Jet Propulsion Laboratory, Pasadena, Calif.

VOTE FOR 314

Triangular waveform generator is simple yet effective

Here is a simple triangular waveform generator consisting of a sawtooth generator, a phase inverter, and a diode circuit for converting the sawtooth waveform to a triangular waveform having excellent symmetry and linearity.

In the circuit (Fig. 1), $Q1$ and $Q2$ form a conventional ramp function generator. $Q1$ provides the constant current, which can be programmed by R_2 , and $Q2$ is a Programmable Unijunction Transistor (PUT). The linearity of the sawtooth can be improved by feedback, if necessary.

Capacitor C_2 couples the output of the saw-

VOTE

VOTE! Go through all Idea-for-Design entries, select the best, and circle the appropriate number on the Reader-Service-Card.

SEND US YOUR IDEAS FOR DESIGN. You may win a grand total of \$1050 (cash)! Here's how. Submit your IFD describing a new or important circuit or design technique, the clever use of a new component or test equipment, packaging tips, cost-saving ideas to our Ideas-for-Design editor. You will receive \$20 for each accepted idea, \$30 more if it is voted best-of-issue by our readers. The best-of-issue winners become eligible for the Idea Of the Year award of \$1000.

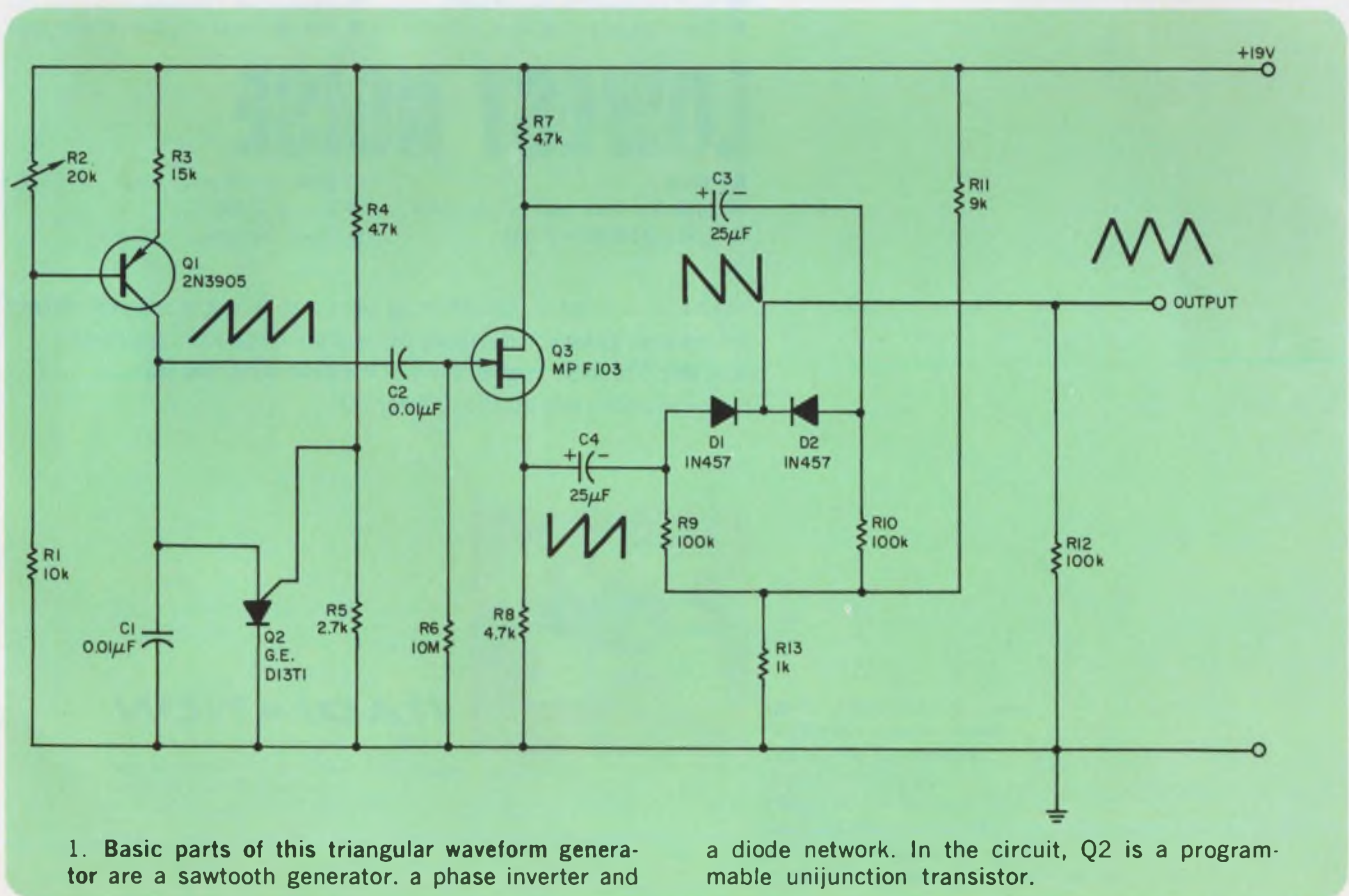

1. Basic parts of this triangular waveform generator are a sawtooth generator, a phase inverter and

a diode network. In the circuit, $Q2$ is a programmable unijunction transistor.

OP AMP FAMILY

FASTEST SLEW RATE

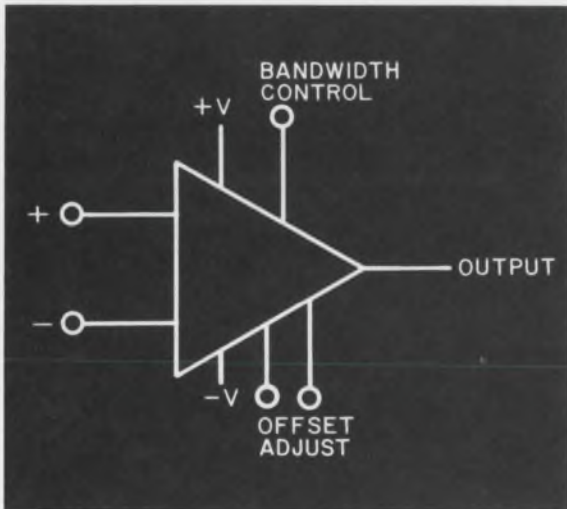

	RA 2520	RA 2510	RA 2500
● Slew Rate	$\pm 120\text{v}/\mu\text{s}, \text{Av}=2$	$\pm 60\text{v}/\mu\text{s}, \text{Av}=1$	$\pm 30\text{v}/\mu\text{s}, \text{Av}=1$
● Voltage Gain	15000	15000	30000
● Large Signal Bandwidth	2000kHz	1000kHz	500kHz
● Gain Bandwidth	24mHz	12mHz	12mHz
● Offset Current	10 nA	10 nA	10 nA
● Offset Voltage	4 mV	4 mV	2 mV
● Output Current	$\pm 20\text{ mA}$	$\pm 20\text{ mA}$	$\pm 20\text{ mA}$
● Input Impedance	100 megohms Non-Compensated	100 megohms Fully Compensated	50 megohms Stable at Unity Gain

HIGHEST IMPEDANCE

- | | |
|---|--|
| <p>RA 2600</p> <ul style="list-style-type: none"> ● Input Current = 2 nA ● Input Impedance = 200 megohms ● Slew Rate (at unity gain) = $\pm 7\text{v}/\mu\text{s}$ | <ul style="list-style-type: none"> ● Gain = 200,000 ● Gain Bandwidth = 12 mHz ● Short Circuit Protected ● Fully compensated (stable at unity gain) |
|---|--|

LOWEST NOISE

- | | |
|--|---|
| <p>RA 909A</p> <ul style="list-style-type: none"> ● Equivalent Noise Input = $1.0\mu\text{s RMS}$ ● Gain Bandwidth = 7 mHz | <ul style="list-style-type: none"> ● Slew Rate (at unity gain) = $+5\text{-}2.5\text{v}/\mu\text{s}$ ● Gain = 45000 ● Power Dissipation = 52 mW |
|--|---|

You can be assured of: Monolithic op amps that exceed hybrid performance
Off-the-shelf delivery, full military temperature range and compliance
with MIL-STD-883 . . . when you pick the BEST IC for the job
from Radiation's fast expanding linear line.



RADIATION
INCORPORATED

SUBSIDIARY OF HARRIS INTERTYPE CORPORATION
MICROELECTRONICS DIVISION

Lexington, Massachusetts (617) 862-1055
Norwalk, Connecticut (203) 853-3641
Washington, D.C. (202) 337-4914
Dallas, Texas (214) 231-9031
Long Beach, California (213) 426-7687
Palo Alto, California (415) 321-2280
Albuquerque, New Mexico (505) 268-3549
P.O. Box 37, Melbourne, Florida 32901 (305) 727-5430

INFORMATION RETRIEVAL NUMBER 49

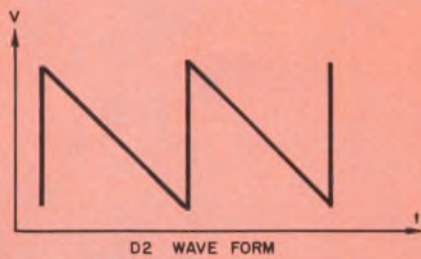

(a)



(b)

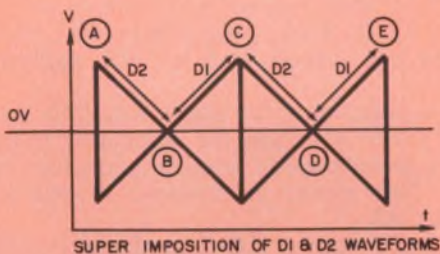

(c)

2. Opposite polarity sawtooths (a and b) are converted to a linear triangular waveform (c) by diodes D1 and D2.

tooth generator to the FET phase inverter. The drain and source waveforms are equal and opposite, and are coupled to the diodes.

Figure 2 shows how the conversion from a sawtooth to a triangular waveform takes place. The waveform at diode D2 is shown in Fig. 2a, and Fig. 2b shows the waveform which simultaneously appears at D1. Figure 2c shows both waveforms simultaneously.

Starting at point A on Fig. 2c, D2 is conducting while D1 is reverse biased. D2 conducts down to point B. At this point D1 and D2 are at the same voltage. From point B to point C, D1 con-

ducts while D2 is reverse biased. From point C to point D, D2 conducts, and from points D to E, D1 again conducts.

Since the sawtooth voltages are capacitively coupled to the diodes, points B and D are at zero voltage. The diodes will drop out at their threshold voltage, 0.6 volt, causing a flattening at the bottom of the triangular waveform. In order to overcome this, points B and D are placed at a positive voltage greater than the diode threshold voltage.

Herbert Cohen, President, Electret Corp., New York, N.Y. VOTE FOR 315

IFD Winners for June 21, 1969

Dany Delaporte, Electrical Engineer, Control Data Corp., Rochester, Mich. for his Idea "One-shot stays triggered until end of pulse train".

Jack L. Shagena, Jr., and Jack T. Shaul, Engineers, Bendix Communications Div., Baltimore, Md. for their Idea "Modified one-shot pulse-width range > 100:1".

Lieut. D. A. Feldman, Chief, Loran-C Branch, U.S. Coast Guard, Wildwood, N.J. for his Idea "Schmitt trigger self-adjusts to provide symmetric output".

Basil Ioannou, Design Engineer, Picker Instruments, Cleveland, Ohio for his Idea "One-shot has independent input and output pulse widths".

R. D. Hilton, Electronics Design Project Leader, & **F. C. Oropeza**, Technical Advisor, Naval Ordnance Station, Indian Head, Md. for their Idea "Multi-channel crystal oscillator can be digitally programmed".

These ideas have been voted the Most Valuable of Issue award.

Vote for the Best Idea in this Issue.

IFD Winner for July 5, 1969

R. Van Sickle, Design Engineer, KMS Industries, Ann Arbor, Mich. His Idea "Simple duplexer requires only inexpensive components" has been voted the Most Valuable of Issue Award.

Cast your vote for the Best Idea in this Issue.

**Our new
high energy
silicon power
transistors.
15 Amperes.
80 to 120 Volts.**

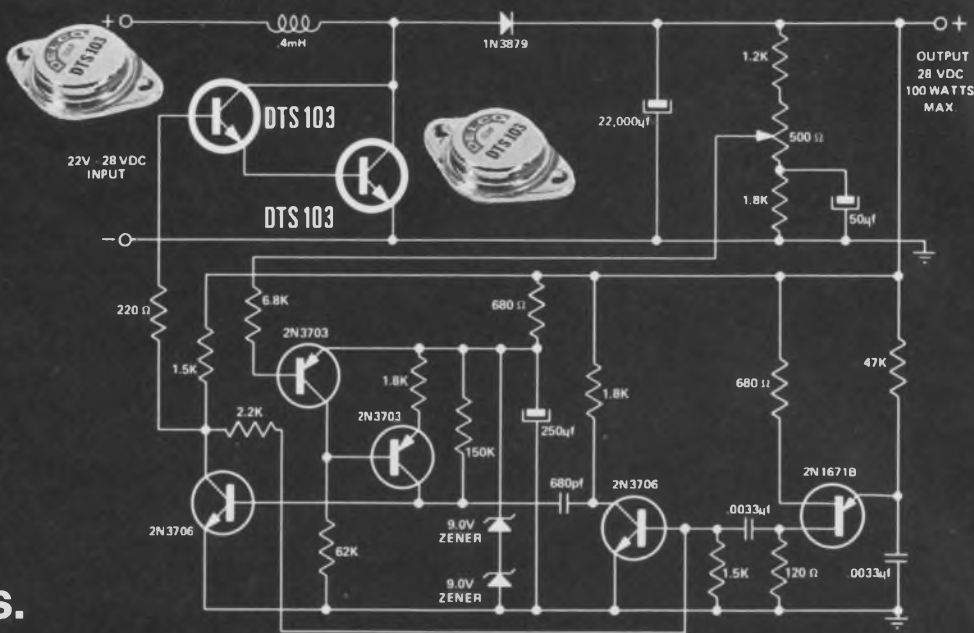

For Switching.

The Delco Radio DTS-100 series. NPN. Triple diffused. Rugged.

All the experience gained from our very high voltage silicon power line has gone into the development of these new transistors.

They were especially designed for the extreme under-the-hood environment of our I.C. voltage regulator. We found these devices ideal for applications requiring high efficiency switching or high power amplification.

The Delco triple sequential diffusion gives the DTS-100 series the high

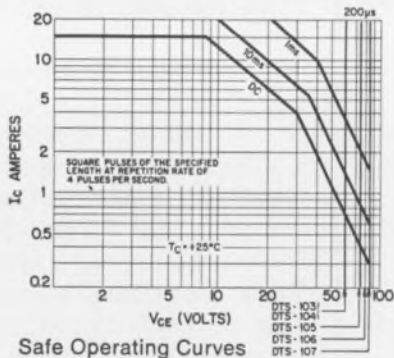

energy reliability that's needed for very tough switching jobs—resistive or inductive. The 28-volt shunt regulator above, for example, is amply handled by the DTS-103 (V_{CEX} of 80 volts). For complete data on this circuit, ask for our application note No. 42.

In the direct coupled audio amplifier above right, the DTS-107 displays the excellent frequency response, gain linearity and transconductance of this family. This circuit is covered in our application note No. 43.

Our solid copper TO-3 package provides maximum thermal capacitance to absorb peak power pulses. Its low thermal resistance ($0.75^{\circ}\text{C/W Max.}$) assures the extra reliability you expect from Delco.

Like more information? Just call us or your nearest Delco Radio distributor. All our distributors are stocked to handle your sample orders.

SEMICONDUCTOR DISTRIBUTORS

ALA., BIRMINGHAM • Forbes Distributing Company, Inc. (205)-251-4104

ARIZ., PHOENIX • Sterling Electronics, Inc. (602)-258-4531

CAL., LOS ANGELES • Kierulff Electronics, Inc. (213)-685-5511
• Radio Products Sales, Inc. (213)-748-1271

CAL., PALO ALTO • Kierulff Electronics, Inc. (415)-968-6292

CAL., SAN DIEGO • Milo of California, Inc. (714)-232-8951

COLO., COLORADO SPRINGS • L. B. Walker Radio Co. (303)-636-1661

COLO., DENVER • L. B. Walker Radio Co. (303)-935-2406

COLO., ENGLEWOOD • Hyer Electronics Co. (303)-771-5285

FLA., MIAMI • Mountain Electronics, Division of Mountain National Co. (305)-634-4556

FLA., WEST PALM BEACH • Mountain Electronics, Division of Mountain National Co. (305)-833-5701

ILL., ROSEMONT • F-J-R/Midwest, Inc. (312)-678-8560

ILL., SKOKIE • Merquip Electronics, Inc. (312)-282-5400

IND., INDIANAPOLIS • Graham Electronics Supply, Inc. (317)-634-8486

MD., BALTIMORE • Radio Electric Service Co. (301)-539-3835

MASS., NEWTON • The Greene Shaw Co., Inc. (617)-969-8900

MICH., KALAMAZOO • Electronic Supply Corp. (616)-381-4626

MINN., MINNEAPOLIS • Stark Electronics Supply Co. (612)-332-1325

MO., KANSAS CITY • Walters Radio Supply, Inc. (816)-531-7015

MO., ST. LOUIS • Electronic Components for Industry Co. (314)-647-5505

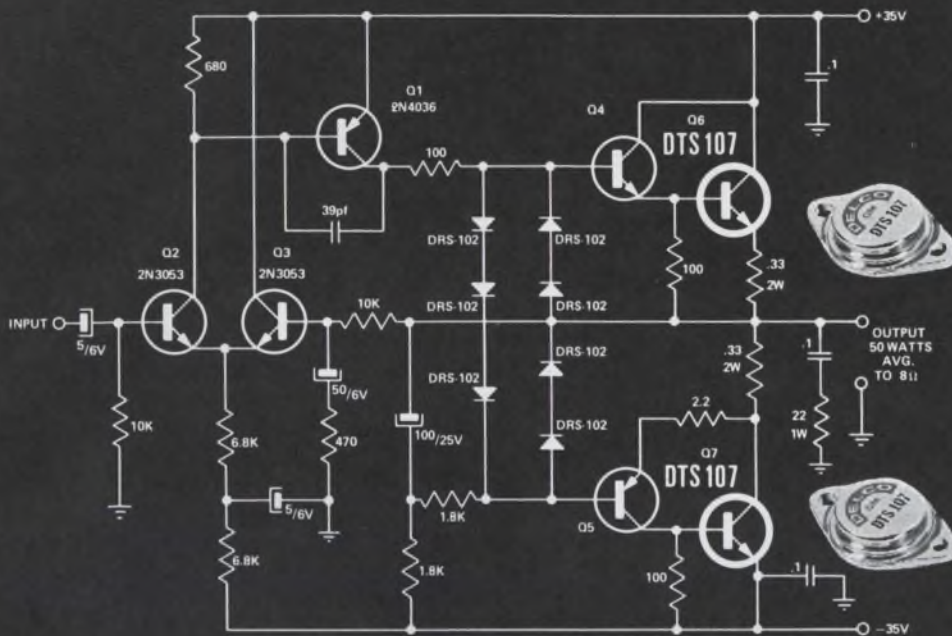

For Audio Amplification.

	I _c Cont. Amps.	I _c Pulsed Amps.	V _{CEX} @ .5mA Volts	V _{CEO} @ .25mA Volts	V _{CEO(SUS)} @ 250mA Volts	h _{FE} @ 5A	h _{FE} @ 20A (Min.)	V _{CE(sat)} @ 10A (Max.)	f _t MHz (Min.)	P _i Watts (Max.)
DTS-103	15	20	80	60	60	20-55	5	1.8	4	125
DTS-104	15	20	80	60	60	50-120	10	1.5	4	125
DTS-105	15	20	100	80	75	20-55	5	1.8	4	125
DTS-106	15	20	110	90	80	20-55	5	1.8	4	125
DTS-107	15	20	120	100	85	20-55	5	1.8	4	125

Kokomoan's Regional Headquarters

Union, New Jersey* 07083
Box 1018 Chestnut Station
(201) 687-3770

Chicago, Illinois* 60656
5151 N. Harlem Avenue
(312) 775-5411

Santa Monica, Calif.* 90401
726 Santa Monica Blvd.
(213) 870-8807

Kokomo, Ind. 46901
700 E. Firmin
(317) 459-2175 Home Office

Detroit, Michigan 48202
57 Harper Avenue
(313) 873-6560

*Office includes field lab
and resident engineer
for application assistance.



MARK OF EXCELLENCE



DELCO RADIO

DIVISION OF GENERAL MOTORS
KOKOMO, INDIANA

THE KOKOMOANS ARE IN POWER

N.J., CLIFTON • Eastern Radio Corporation (201)-471-6600
N.M., ALBUQUERQUE • Hyer Electronics Company (505)-265-5767
• Sterling Electronics Inc. (505)-247-2486
N.Y., BINGHAMTON • Federal Electronics, Inc. (607)-748-8211
N.Y., NEW YORK • Harvey Radio Co., Inc. (212)-582-2590
N.Y., WOODBURY, L.I. • Harvey Radio Company, Inc. (516)-921-8700
OHIO, CINCINNATI • United Radio, Inc. (513)-761-4030
OHIO, CLEVELAND • The W. M. Pattison Supply Co., Industrial
Electronics Division (216)-441-3000
OHIO, DAYTON • F-J-R/Ohio, Inc. (513)-278-9411
OKLA., OKLAHOMA CITY • Radio, Inc. (405)-235-1551
OKLA., TULSA • Radio, Inc. (918)-587-9123

PENN., PHILADELPHIA • Almo Electronics, Division of
Sterling Electronics (215)-676-6000
PENN., PITTSBURGH • RPC Electronics (412)-782-3770
TEXAS, DALLAS • Adleta Electronics Company (214)-742-8257
TEXAS, FORT WORTH • Adleta Electronics Co. (817)-336-7446
TEXAS, HOUSTON • Harrison Equipment Co., Inc. (713)-224-9131
UTAH, SALT LAKE CITY • Hyer Electronics Company (801)-487-3681
VA., RICHMOND • Meridian Electronics, Inc. (703)-353-6648
WASH., SEATTLE • Kierulff Electronics, Inc. (206)-763-1550
WASH., TACOMA • C & G Electronics Co. (206)-272-3181
CANADA, ONT., SCARBOROUGH • Lake Engineering Co., Ltd.
(416)-751-5980

INFORMATION RETRIEVAL NUMBER 50



Easiest pull-out since tissues!

Grant Slides are specifically designed to facilitate on-the-spot servicing. To get to a faulty component all you need do is gently pull and the unit *comes out to you, into position for fast, comfortable maintenance.* Grant makes the largest array of slides. They will carry

virtually any weight; are capable of being locked in "in", "out" or "tilted" positions. And Grant Slides move your equipment smoothly, without disturbing the sensitive accessories which may be riding on them.

Send for further information.

GRANT®
BIGGEST AND BEST

GRANT PULLEY & HARDWARE CORPORATION 21 High St., W. Nyack, N.Y. 10994/944 Long Beach Ave., Los Angeles, Calif. 90021

Products

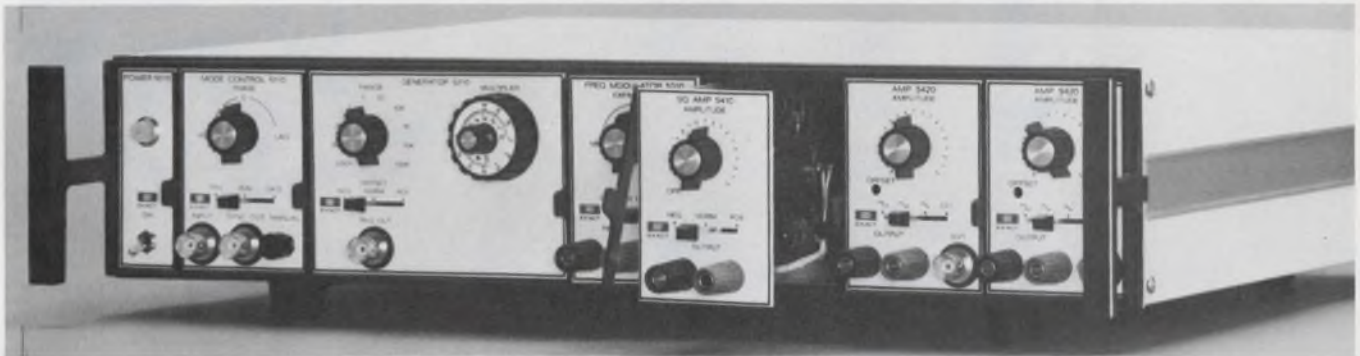

A complete waveform generating system, this new instrument can produce a number

of waveshapes and operating modes via combinations of its plug-in modules, p. 126.

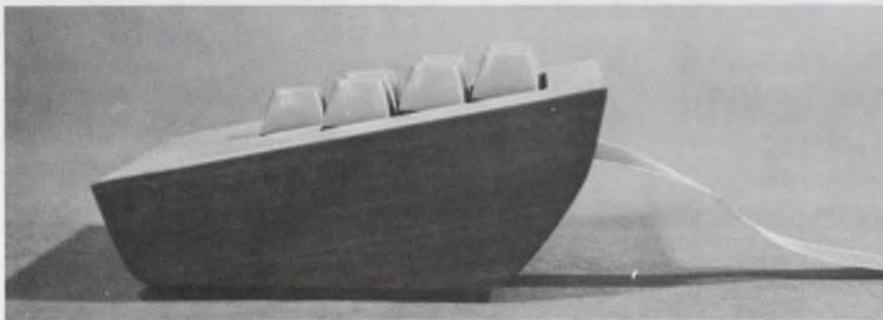

Two new modular economy keyboards offer a novel type of switching action. The mechanical unit (top) uses snap-in mercury-element keys, p. 122. The solid-state unit (bottom) features magnetic-core switching elements, p. 120.



Tiny pulsed laser diodes radiate in near-IR region with power output of 15 W at 75 A, p. 136.

Also in this section:

Magnetic tape system can record and reproduce at 15-MHz rates, p. 118.

Universal dc power supply supplants five conventional lab sources, p. 130.

Three-stage IC operational amplifier needs only 90- μ W standby power, p. 132.

Evaluation Samples, p. 150 . . . **Design Aids**, p. 152 . . . **Annual Reports**, p. 154

Application Notes, p. 156 . . . **New Literature**, p. 158.



Magnetic tape system performs at 15 MHz

Newell Industries Inc., 795 Kifer Rd., Sunnyvale, Calif. P&A: from \$54,000; January, 1970.

Operating at speeds up to 960 inches per second, a new magnetic tape system can record and reproduce analog signals up to 15 MHz. The model AV-15000R tape system is said to offer an information handling capacity that is an order of magnitude greater than conventional longitudinal magnetic tape equipment. These typically operate at speeds of 120 inches per second with a response of 1.5 to 2 MHz.

The new system can record up to 40 tracks on 1/2-in.-wide tape. It uses one-to-seven-head configurations, which are available with any combination of electronics.

Standard speeds from 15 to 960 inches per second are switch selectable in seven steps. Equalization of any two electrically switchable speeds is possible from the front panel.

Transfer rates in excess of 20 megabits per second are normal. Optional electronics allow fm recording to 7.5 MHz and digital recording to 20 kilobits per inch. Reportedly only rotary-head (video) recorders with a 6.5-MHz fm

response can approach this new system's capacity. However, with rotary-head equipment, time-base expansion or compression is not practicable.

In the AV-15000R system, the tape medium is totally supported on the capstan surface, from supply to take-up hubs. The capstan is the only driven member in this simple arrangement. A force system maintains contact between the flangeless tape rolls and the capstan. This allows the tape to be gently unrolled and rewound with virtually no internal stress, even at speeds of several thousand inches per second.

The novel drive system results in precise handling and high-speed operation, wide bandwidth, high packing density and high transfer rates.

Applications for the AV-15000R tape system include such fields as instrumentation, data processing and education. It is particularly useful in predetection recording of wideband analog, fm and digital signals, video programs storage and transfer for school systems, and in recording side-looking radar signals or transient waves in nuclear testing.

CIRCLE NO. 250

Desktop calculators work in milliseconds



Litton Industries, Monroe Div., 550 Central Avenue, Orange, N.J. Phone: (201) 673-6600.

Three new compact electronic calculators produce millisecond solutions to all types of business and technical calculations. Model 920 with a 12-digit readout weighs less than 9 lbs and can be stored easily in a desk drawer. Model 950, which has a 16-digit capacity, accumulates results automatically, does automatic squaring and handles mixed calculations. The 16-digit 990 will perform square-root functions and handle constants.

CIRCLE NO. 251

High-speed modems go to 96 kilobits/s



Astrocom Corp., 293 Commercial St., St. Paul, Minn. Price: \$3000.

Able to interface with Bell's 301/303 data sets, a new series of data modems provide transmission rates from 10 kilobits per second (series 410) to 96 kilobits per second (series 496). Astroset series 400 data communication systems are designed to operate on private wideband lines. Available operating configurations include simplex, half- and full-duplex, and party-line situations.

CIRCLE NO. 252

Data Technology comes out on top again!



The new Model 370 is the most accurate 5 digit DVM in the industry.

What does the smallest and most accurate 5 digit DVM cost? \$2,400. Repeat: \$2,400. Range 1 μ V to 1,000 Volts. What more can we say? Available Options include ac Volts, Ohms, and Ratio. Call collect for more facts.

"Make the best, then make it better"

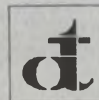

Data Technology
Instrument Division

1050 East Meadow Circle Palo Alto, Calif. 94303 (415) 321-0551

PERFORM WITH CHAMPIONS



ONLY \$44⁹⁵ ppd.

BUY THE BEST

MARK TEN®

CAPACITIVE DISCHARGE IGNITION SYSTEM

DELTAKIT only \$29⁹⁵
ASSEMBLE IT YOURSELF!

Now discover for yourself the dramatic improvement in performance of your car, camper, jeep, truck, boat—any vehicle! Delta's remarkable electronic achievement saves on gas, promotes better acceleration, gives your car that zip you've always wanted. Find out why even Detroit has finally come around. In four years of proven reliability, Delta's Mark Ten has set new records of ignition benefits. No re-wiring! Works on literally any type of gasoline engine.

COMPARE THESE PROVEN BENEFITS...

- ▲ Dramatic Increase in Performance and in Fast Acceleration
- ▲ Promotes more Complete Combustion
- ▲ Points and Plugs last 3 to 10 Times Longer
- ▲ Up to 20% Mileage Increase (saves gas)

Order Your MARK TEN Today Shipped Postpaid at once . . .



P.O. Box 1147 ED • Grand Junction, Colo. 81501

Enclosed is \$_____ Ship ppd. Ship C.O.D.
Please send:

- Mark Tens (Deltakit®) @ \$29.95
(12 VOLT POSITIVE OR NEGATIVE GROUND ONLY)
- Mark Tens (Assembled) @ \$44.95
- 6 Volt: Negative Ground only.
- 12 Volt: Specify Positive Ground Negative Ground

Car Year _____ Make _____
Name _____
Address _____
City/State _____ Zip _____



All-solid-state keyboards switch with magnetic cores

Licon Div., Illinois Tool Works Inc., 6615 W. Irving Park Rd., Chicago, Ill. Phone: (312) 282-4040. P&A: \$150 to \$395; 6 to 8 wks.

Built around a very reliable switching element, a new family of completely solid-state electronic keyboards uses magnetic-core switching to eliminate mechanical linkage, contact bounce and delicate IC chips. In addition, series 550 units offer a flexibility that is said to be previously unattainable in electronic keyboards.

These new keyboards have a unique method of encoding at the key station that enables the user to specify his own custom scheme. Available standard encoding formats include ASCII (American Standard Code for Information Interchange), BCD (Binary Coded Decimal), and EBCDIC (Extended Binary Coded Decimal Interchange Code).

The 550 units are compatible with 5-V IC logic, and can accept either negative or positive logic outputs. Minimum power consumption is 1.5 W.

Each key station provides a minimum life of ten million operations. The keybutton is remove-

able, and the operating plunger and return spring are replaceable.

All keyboards are modular in design. The housing incorporates integral plastic mounting clips for easy insertion into the mounting plate for the keyboard array.

The mounting plate, in turn, may take virtually any configuration desired. There is no predetermined fixed arrangement. Most plates use a standard typewriter offset of 3/8 to 3/16 to 3/8 in.

A number of keyboard options give the series 550 its broad flexibility. These include a parity bit for detecting transmission errors, and an output strobe signal for synchronizing the keyboard with external equipment. A delayed strobe signal is not required since keyboard switching action is free of contact bounce.

An optional multi-key interlock permits recognition of only one key at a time. There is also a two-key-rollover feature that allows a second key to be depressed very quickly after the first, while still transmitting both code signals to the output.

Another option permits a repeat of coding when the release of a depressed key is delayed.

CIRCLE NO. 253

Space-saving trimmers

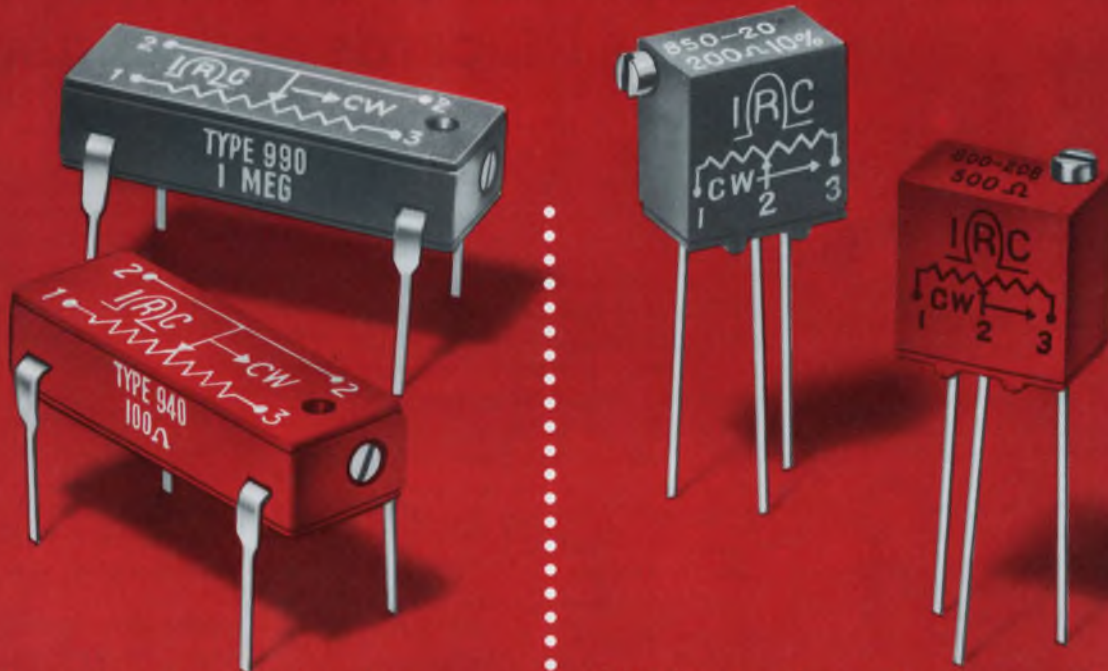

DIP construction matches IC size. Cuts assembly costs.

5/16-in. doubles performance of 1/4-in. trimmer—cuts cost almost in half.

These new IRC precision trimmers in dual-in-line packages simplify PC board layout. Only .200-in. high, their pin spacing is the same as the TO-116 size integrated circuit. It is fully compatible with high-speed automatic inserting equipment.

Pin spacing of these IRC 5/16-in. square trimmers matches the 1/4-in. square unit. Only .031-in. larger on each side, they can cut your cost almost in half and give you three times the power rating of the 1/4-in. and 40% better resolution.

Both DIP and 5/16-in. are available with precision wirewound and infinite resolution Metal Glaze elements. All units are fully sealed and impervious to common industrial solvents because of a silicone rubber shaft seal and epoxy bonding at all seams.

These units, like all IRC Metal Glaze trimmers, have a maximum guaranteed TC of $\pm 150\text{ppm}/^\circ\text{C}$ over the entire resistance range, with typical TC being $\pm 100\text{ppm}/^\circ\text{C}$, and at no added cost. For complete technical information and prices, contact your IRC Industrial Distributor or write IRC St. Petersburg Division of TRW INC., 2801 72nd St., North, St. Petersburg, Florida 33733.



DIVISION OF TRW INC.

INFORMATION RETRIEVAL NUMBER 54

The first plug-in curve tracer costs 1/3 less!



With U-Tech's plug-in and console units, any X-Y oscilloscope becomes a curve tracer displaying the dynamic characteristics of both NPN and PNP transistors, N Channel and P Channel junctions, FET's, MOS-FET's, bipolar, unijunctions, diodes, tunnel diodes and SCR's. You have curve tracer capabilities, without buying a complete curve tracer unit. In so doing you pay up to:

1/3 less!



U-Tech plug-in **MODEL 681**: \$655.00*. For use with Tektronix *560 Series Oscilloscopes.



U-Tech plug-in **MODEL 682**: \$675.00*. For use with Tektronix *530, 540, 550, 580 Series Oscilloscopes.



U-Tech console **MODEL 683**: \$685.00*. For use with any X-Y Oscilloscope.

Ask your distributor about these U-Tech curve tracer units or order direct from:

U-TECH

A DIVISION OF INDUSTRIAL PHYSICS AND ELECTRONICS COMPANY
4190 SOUTH STATE STREET
SALT LAKE CITY, UTAH 84107
(801) 262-2663

*Prices apply to purchase and shipments within U.S.A. fob Salt Lake City, Utah
® Registered Trademark Tektronix Inc.

INFORMATION RETRIEVAL NUMBER 55



Fully modular \$75 keyboard shuns PC cards and soldering

Mechanical Enterprises Inc., 5249 Duke St., Alexandria, Va. Phone: (703) 751-3030. P&A: \$22 for 14 keys, \$75 for 50 keys; stock to 2 wks.

Using a mechanical approach to solve an electronic problem, a new keyboard, which encodes data within the key module, completely eliminates the need for printed circuit boards and soldered connections. Instead, the Mercutronic coding keyboard achieves a switching action via mercury movement in a sealed flexible tube.

Due to the simplicity of its design, the new keyboard has a typical price tag of \$75 for production quantities of 50-key alphanumeric units. The ASCII code is standard, but any special code with up to 10 bits can be supplied.

The housing is a simple aluminum extrusion with five channels to hold individual key modules. A continuous flat 11-wire cable is routed along the bottom of each channel to an input/output connector on the outside of the cabinet.

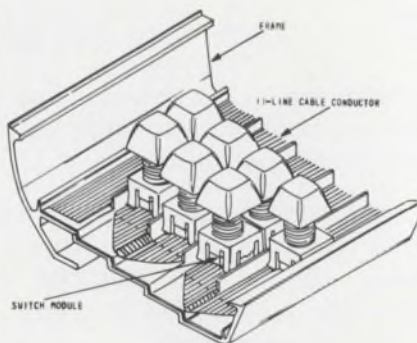

Low-cost encoding keyboard uses mercury switching element to eliminate PC boards and soldered connections. Key modules snap into channels lined with flat conductors.

connector on the outside of the cabinet.

To establish permanent contact between the coding output terminals and the cable, the key modules are simply snapped into the channels. This means that the customer can change his own keyboard configuration or replace individual key modules without special tools.

Inside the plastic key module are the necessary encoding diodes and the mercury switch. Each module base has ten possible diode positions. The placement pattern of the diodes determines the code for that particular key.

To ensure positive contact, the diode leads are held against the flat cable under constant spring tension. Diode leads are also gold plated for optimum signal transmission to the cable.

Mercutronic key modules have only two moving parts—the sealed flexible mercury tube and the plunger assembly. When a key module is depressed, the separated mercury in the tube unites to complete the circuit.

Because switching takes place in a sealed tube, all contact bounce is eliminated and noise filters are not required. The Mercutronic keyboard does not require standby power and operates with an input voltage of 5 V dc.

Individual switch modules have been successfully tested for over ten million cycles. One million cycles is the estimated equivalent of 10 years' use.

The Mercutronic is available with the usual standard keyboard options like shift and shift-lock keys.

CIRCLE NO. 254

TRW High Powered Switching Rectifiers

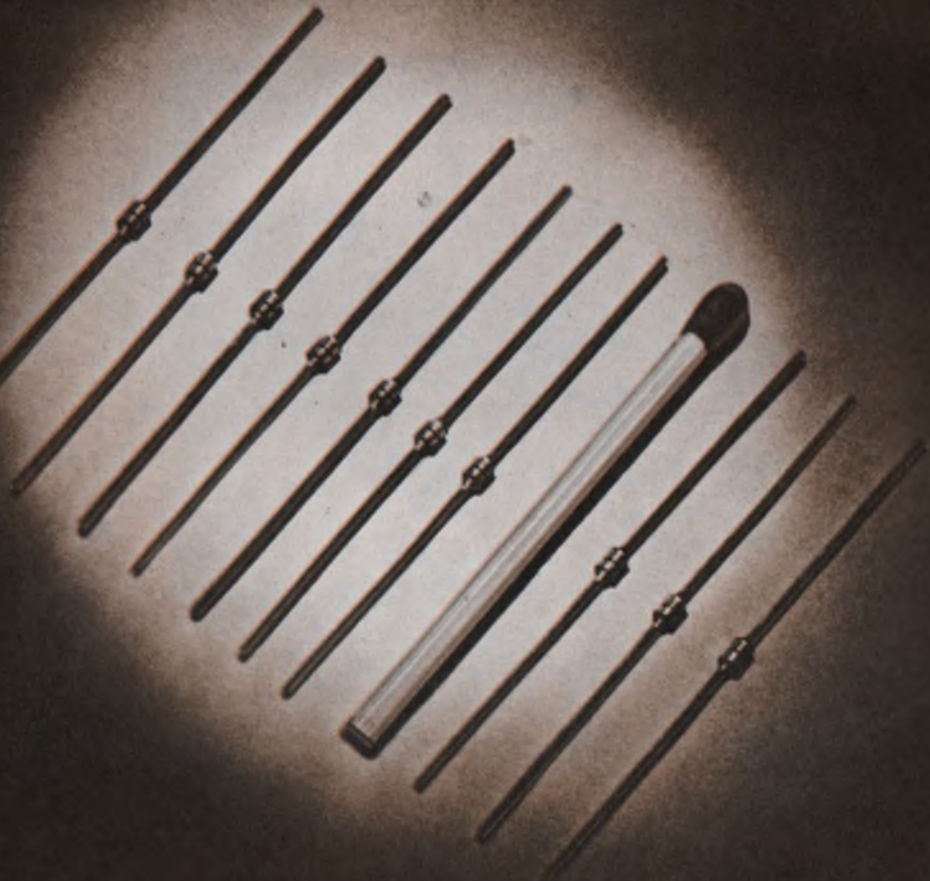

...unmatched speed and reliability

TRW double slug rectifiers are the fastest available in their current and reverse voltage range. At 2 amps and 100 volts, for instance, they'll switch in 20 nano-seconds. That is three times as fast as anything else you can buy ...ideal for high speed inverters and switching regulators.

They are extremely reliable, too. The die is passivated with oxide before encapsulation, and

the alkali-free glass is fused to the passivation for void-free reliability.

TRW now offers a complete family of low leakage zeners and rectifiers up to 10 watts as well as general purpose diodes to 600 volts in the same package. For complete information contact any TRW distributor or TRW Semiconductors, Inc., 14520 Aviation Blvd., Lawndale, Calif. 90260.

Phone (213) 679-4561. TWX 910-325-6206. TRW Semiconductors, Inc. is a subsidiary of TRW Inc.



TRW[®]

INFORMATION RETRIEVAL NUMBER 56

Plated-wire hardware allows doing it yourself



Rogers Corp., Rogers, Conn.
Phone: (203) 744-9605.

Tunnel structures for use in plated-wire magnetic memories are now available. These new devices are supplied with or without tooling or test wires in place. They are built to accommodate commercially available plated wires on centers ranging from 15 to 50 mils.

CIRCLE NO. 255

Three-wire 3-D memory cycles fully in 900 ns

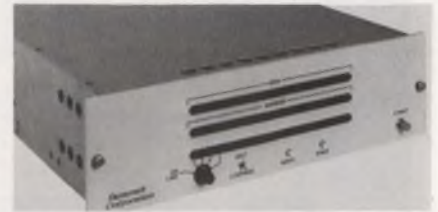

Datacraft Corp., P.O. Box 23550, Fort Lauderdale, Fla. Phone: (305) 933-2651.

Providing high reliability due to its simplified address, sense, and inhibit methods, a new high-speed three-wire 3-D magnetic core memory features a full-cycle time of only 900 ns. The DC-22 has a basic memory capacity of 8192 words with 20-bit lengths, or 4096 words with 40-bit lengths. Standard access time for this TTL-compatible device is 350 ns.

CIRCLE NO. 256

The optimum garble disposal.



CTC's new low level differential switch.
Super-speed time spectrum isolation and high CMR
... eliminates garble from desired signals!

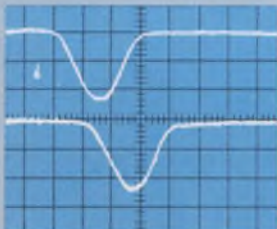

Fast pulse input and output signals:
Hor: 10ns/div Vert: 5mv/cm

From CTC ... where advanced state-of-the-art technology meets tomorrow's memory test requirements!

We call this esoteric device our Model UA-101 d-c coupled, wideband, linear, gated differential amplifier. Quite a mouthful. And quite a switch, too! CTC designed and built it to help test plated wire elements and memory arrays. Think of it: all these features *together*, in one switch no bigger than a match box.

- Super-speed gating—typically less than 50ns full turn-on time, for isolating a precise time spectrum to be analyzed.
- Differential input—providing a 40db CMR (Common Mode Rejection).
- Wide, flat frequency response (greater than 100 MHz).
- D-c coupling—for plated wire element testing, and for testing any memory array which utilizes common- or direct-coupled Sense and Digit lines.
- Extremely wide bandpass; flat frequency response characteristics, devoid of resonances.
- Extremely linear gain characteristics over the 2 to 150 MV range.

These features add up to a practical, precise measurement tool for a variety of switching applications. Tell us about your particular requirement. Or send for Bulletin No. 68—MZ-1.



COMPUTER TEST CORPORATION

THREE COMPUTER DRIVE • CHERRY HILL, NEW JERSEY 08034
PHONE: 609/424-2400 • TWX: 845120 • CABLE: COMPUTER

INFORMATION RETRIEVAL NUMBER 57

Real-time controller diversifies functions



Honeywell Computer Control Div., Old Connecticut Path, Framingham, Mass. Phone: (617) 879-2600. P&A: \$5000; 45 days.

Said to offer better real-time control and data security than existing machines, a new digital controller can function independently to control specific electric and electronic applications, or as part of a computer system. The H-112 is a stored-program machine that may act as a remote terminal, buffer unit, or as an electronic data assembler and message switcher.

CIRCLE NO. 257

Now, you can enjoy a choice of suppliers...



CLARE TF MILITARY RELAY
Three contact arrangements: 1 Form C
with base-connected movable contacts;
1 Form C and 2 Form C with movable
contacts insulated from case.

Clare's TO-5 meets or exceeds MIL-R-5757E!

In TO-5's, you can now enjoy a *choice* of suppliers—and you can sit back and enjoy Clare's dependable performance and prompt delivery. For Clare's TF (TO-5) Relays meet or exceed the requirements of MIL-R-5757E. TF features: a rigid frame to keep elements stable, balanced armature aligned; pressurized nitrogen to minimize arcing, extend contact life; hermetically-sealed case—all welded; optimized magnetic circuitry to assure maximum contact pressure. Withstands shock to 80 G, vibration to 30 G. Keeps going at temperatures from -65°C to $+125^{\circ}\text{C}$. 1,000,000 operations at low level, 100,000 at rated load.

For information, circle Reader Service number, call your Clare sales engineer or distributor, or write for Data Sheet 758. C. P. Clare & Co., Chicago, Illinois 60645...and worldwide.

LOOK FOR  CLARE ON THE RELAY

a GENERAL INSTRUMENT Company

TUBULAR,
BULKHEAD
MOUNTING TYPE

RFI/EMI FILTERS



Rtron

Cylindrical Style Interference Filters

that reduce or eliminate unwanted noise or signals. Small size, light weight, maximum attenuation. Voltage current or insertion loss characteristics required, determine physical size. Maximum isolation of terminals and high frequency performance are assured by threaded neck design for bulkhead mounting. Feed-thru capacitor circuitry conservatively rated for both military and commercial applications.

Rtron corporation

P.O. Box 743 Skokie, Illinois 60076

- Send catalog and prices.
- Have Representative call for appointment.
- Specifications enclosed on Multi-circuit or custom design filters. Send estimate.

Name _____

Firm _____

Address _____

City _____

State _____ Zip _____

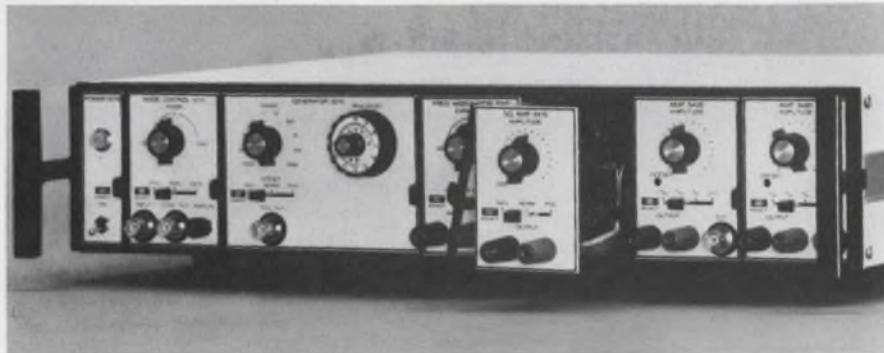

Building-block generator is a system in a console

Exact Electronics Inc., 455 S. Second St., Hillsboro, Ore. Phone: (503) 648-6661. P&A: \$290 to \$1030; stock to 3 wks.

A complete waveform generator system can be constructed, starting with a basic cabinet and power supply, by simply adding several plug-in building-block modules.

Basic to the system is the P5001 power supply and cabinet which contains space for three plug-in generators, three amplifiers, one modulator, and one mode-control unit.

The generators are frequency-controlled by a unique Kelvin-Varley divider. These are the G5210, the G5212 and the G5214.

The G5210 is a square/triangle-waveform generator with a frequency range of 0.0001 Hz to 1 MHz. The G5212 is a ramp generator with a time range of 1000 s to 1 μ s. It has built-in gating and triggering. The G5214 is a general-purpose ramp generator with a time range of 100 s to 10 μ s. It provides variable falltime, built-in gating and built-in triggering.

The amplifiers, all of which invert the output 180° out of phase with the input, are short-circuit

proof. They are the A5410, A5420 and A5422.

The A5410 is a square-wave amplifier with square-wave output only. It has positive or negative output selection and a variable output of 28 V pk-pk into 600 Ω . The A5420 is a general-purpose amplifier with a built-in sine-wave shaper for low distortion. It has front-panel selection of sine, square or triangle waveforms with dc offset. Output is 28 V pk-pk variable into 600 Ω . The A5422 is a ramp-function amplifier with a 13-V peak output into 600 Ω .

Also available for the system is a model M5310 voltage-controlled frequency modulator which sweeps over a 50:1 range with an extremely linear response.

Rounding out the system is the model C5110 mode-control unit which furnishes gating and triggering pulses to control operation modes of the different generators. A variable start/stop control enables the generator start point to be adjusted up to 90°, effectively adding the haversine and haversine-triangle waveforms. The unit can be controlled either manually or externally.

CIRCLE NO. 258

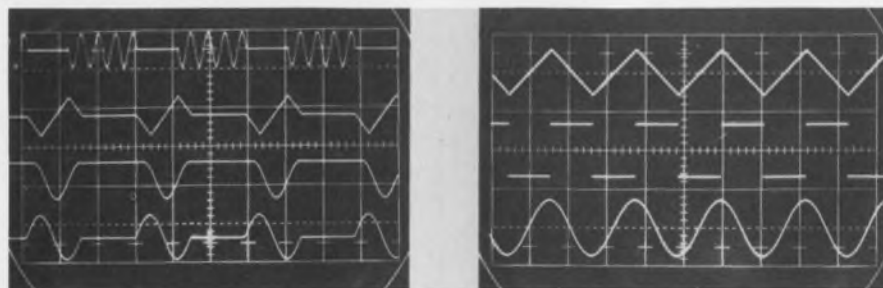

Using various plug-in combinations, a new generator system can supply a number of simultaneous waveforms (left) and control their modes (right).

Don't blow a fuse because your semiconductors aren't properly protected.

The new Airpax CEL-GARD® semiconductor fuses make fault-current protection easy for you! Now you can be sure that your rectifiers, thyristors, silicon-controlled rectifiers, and power transistors are properly protected . . . even in the face of short circuit disaster . . . by using the easy steps outlined in our new catalog.

CEL-GARD® fuses are designed specifically for the semiconductor. The fastest arc-quenching techniques available are used to insure the **shortest possible** total fault-clearing time. In addition, CEL-GARD® fuses offer more mechanical durability when subjected to frequent switching of maximum rated currents. This means **longer CEL-GARD® life and increased circuit reliability.** Protect your semiconductors properly. Send today for your catalog. Then you can be sure you're safe!

AIRPAX ELECTRONICS
Phone: (301) 228-4600
Telex: 8-7715
TWX: (710) 865-9655
Cambridge Division
Cambridge, Maryland 21613



Send for your AIRPAX CEL-GARD® fuse catalog today!

NAME _____
TITLE _____
COMPANY _____
ADDRESS _____
CITY _____ STATE _____ ZIP _____
PHONE _____

Mail to: AIRPAX ELECTRONICS, Cambridge Division, Cambridge Md. 21613

Pulse generator doubles functions



Tau-tron, Inc., 685 Lawrence St., Lowell, Mass. Phone: (617) 458-6871. P&A: \$2450; 4 wks.

Providing two pulse generators in one, a new instrument handles both high- and low-power test requirements from two separate but synchronized channels. The PG-100 pulse generator has one pulse-train output with 1-ns risetimes and fall-times, along with its logical inverse at rates from 1 Hz to 150 MHz. The other channel gives complementary outputs with 7-ns risetimes and falltimes from 1 Hz to 30 MHz.

CIRCLE NO. 259

Signal generator goes from lf to uhf



Singer Co., Instrument Div., 915 Pembroke St., Bridgeport, Conn. Phone: (203) 366-3201. P&A: \$3790; 90 days.

Using a three-digit display for its basic frequency range of 61 kHz to 512 MHz, a new signal generator extends its frequency range to 1024 MHz with a simple optional passive doubler. Model SG-1000 offers a-m, fm, pulse and video (100-MHz bandwidth) modulation, either individually or in simultaneous combinations. Typical frequency accuracy and resolution is 0.005%.

CIRCLE NO. 260

Precision generators give low-cost outputs



Wavetek, 9045 Balboa Ave., San Diego, Calif. Phone: (714) 279-2200. P&A: \$295 to \$495; 30 days.

A new series of generators with a range of 0.2 Hz to 2 MHz and outputs of 10 V pk-pk into 50 Ω provide precision waveforms at low costs. Model 130 provides sine, square, triangle and synchronous wave outputs with less than 1% sine-wave distortion for only \$295. Model 131 is a voltage-frequency-controlled unit with a 1000:1 programming range for only \$345. Model 234, which costs \$495, can be swept internally and externally.

CIRCLE NO. 261

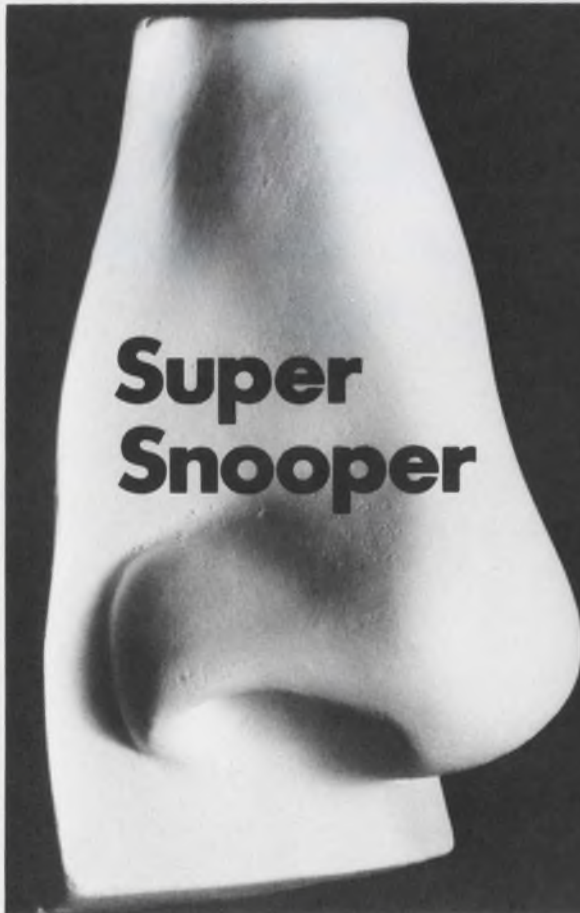

Super Snooper

Our current-sensing load relay responds to 2% variations in setting.

The Type LR relay stops motors on pre-set command. By sensing load variations before they exceed operating limits. It can prevent excessive feed rate in a machine tool, end a completed operation, or stop a machine should a part break.

Repetitive tripping accuracy of ±2% assures close, continuous control. Available in manual or automatic reset models, rated 0.5 to 450 amps.

Exceptional current range adjustability of 7-to-1 makes them both useful and versatile. Response is fast—50 milliseconds to energize, 16 milliseconds drop out. Pilot circuit rating, 110 to 600 V max. 15% differential between pickup and drop out.

Learn how you can use our AC load current relays, and our other motor control accessories. Call your Cutler-Hammer Distributor or circle Reader Service Number below.

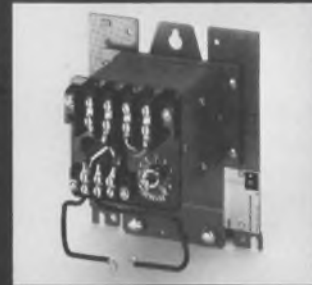

CUTLER-HAMMER 

POWER DISTRIBUTION & CONTROL DIVISION, Milwaukee, Wis. 53201

Think Straight.



RESOLON® CONDUCTIVE PLASTIC RECTILINEAR ELEMENTS UP TO 36" LONG

Now, Duncan Electronics builds new conductive plastic precision rectilinear elements, to take their rightful place beside our proven RESOLON® CP rotary elements. They're the direct result of over five years' developmental work and production experience in rotary elements and pots. Rectilinear elements are provided with standard electrical travel of 1/4" to 16", or custom designed up to 36" on special order. Servo-trimmed for improved linearity tolerances, elements can be ordered as separate segments or in custom housings engineered to your requirements. Write today for full information — if you want the 'straight' story.

RESOLON® CP Rectilinear High Performance Features:

Resistance per Inch:
200Ω to 50KΩ depending on track width

Resistance Tolerance:
Std: ±10%
best practical: ±2%

Linearity:
Std: ±2.0%
best practical: ±0.3%
(Where L = Electrical Travel in Inches)

Power Rating per inch:
0.25 to 1.0 watt depending on track width

Tempco:
— 300 ppm/°C max

Taps:
Voltage & current taps can be supplied.

Non-linear:
Many types of non-linear functions can be supplied. Conformity tolerance depends on the nature of the function and the electrical travel.

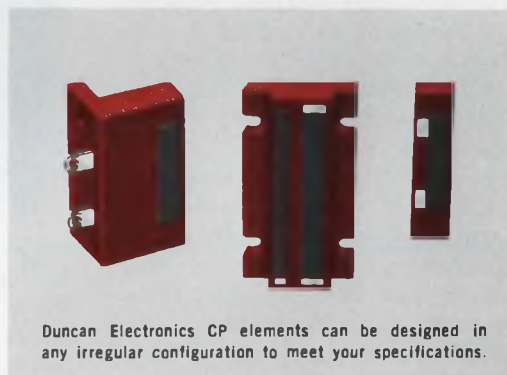

Duncan Electronics CP elements can be designed in any irregular configuration to meet your specifications.



DUNCAN ELECTRONICS
SUBSIDIARY

SYSTRON  DONNER

2865 FAIRVIEW ROAD □ COSTA MESA, CALIFORNIA 92626
PHONE: (714) 545-8261 □ TWX 910-595-1128

Universal power supply replaces five sources



Power Designs Inc., 1700 Shames Drive, Westbury, N.Y. Phone: (516) 333-6200. P&A: \$195; stock as of November 15, 1969.

Using a novel voltage regulator system, a new single-package universal dc power supply provides an output that is equivalent to five conventional laboratory power sources. Uniply model 6050 can deliver minimum outputs of 0 to 7 V at 5 A, 0 to 15 V at 3 A, 0 to 25 V at 2A, 0 to 50 V at 1 A, and 0 to 60 V at 0.5 A.

With its linear non-switching regulator circuitry, the new supply is no longer limited in power output by minimum ac line input voltage conditions. The useful output of the 6050 can be safely increased to twice the normal level at higher line voltages.

For example, Uniply can boost its rated output of 60 V at 0.5 A with a 105-V ac input to 60 V at 1 A when line voltage is over 115 V ac. Other output voltage levels also increase proportionately.

The new supply boasts completely electronic control; manual switching of operating ranges is not necessary. Beyond-rating operation is instantly indicated by a flashing lamp on the front panel.

Additional features of the new supply include 0.01% regulation, 1-mV pk-pk ripple and noise, remote voltage sensing, and remote voltage programming. There are also front and rear access output terminals, and provisions for separate line and load fusing.

The output of the power supply is fully protected from damage by an overload or short-circuit condition. A dual-range (0.5 or 5 A) adjustable current limiter automatically changes the panel-meter range.

CIRCLE NO. 262

Digital correlator signal-averages too



Hewlett-Packard, 1501 Page Mill Rd., Palo Alto, Calif. Phone: (415) 326-7000. P&A: \$8350; December, 1969.

Correlation and auto-correlation between signals as a function of their time delay is now made easy with an all-digital dc-to-250-kHz signal analyzer, which computes and displays in real time. Model 3721A can display 100-point correlation functions faster and more accurately than off-line computers and other correlators. It can also recover signals from noise by averaging and compute probability density histograms. CIRCLE NO. 263

All-silicon IC supply is 5 by 5 by 3 in.



Lambda Electronics Corp., 515 Broad Hollow Rd., Melville, N.Y. Phone: (516) 694-4200. Price: from \$75.

Measuring only 5 by 5 by 3 in., a new regulated power supply is claimed to be the industry's first all-silicon IC unit. Model LL-902 provides an output of 0 to 20 V dc at up to 1 A dc with a line and load regulation of 0.01%, from no load to full load. Other features are ripple and noise of 250 μ V rms and 1 mV pk-pk, respectively, and a temperature coefficient of 0.015% + 300 μ V/ $^{\circ}$ C.

CIRCLE NO. 264

Triggered-sweep scope costs only \$329.50



Lectrotech, Inc., 4529 N. Kedzie Ave., Chicago, Ill. Phone: (312) 463-0822. Price: \$329.50.

Featuring triggered sweep and a 10-MHz bandwidth, a new 5-in. oscilloscope sells for only \$329.50. Model TO-50 uses dc amplifiers to allow simultaneous ac and dc viewing. Full-scale sensitivity is from 20 mV/cm with a calibrated vertical attenuator and horizontal time base.

CIRCLE NO. 265

Precision multimeter retails for only \$61



SEP Instruments Div. of Scientific Educational Products Corp., 30 E. 42 St., New York, N.Y. Phone: (212) 867-9480. Price: \$61.

Featuring a 50,000- Ω /V dc sensitivity, ac and dc voltage and current measurements, as well as a resistance capability, a new precision multimeter costs only \$61. The model 61 unit has full-scale accuracies of 2% for dc and 3% for ac. It can measure 0 to 1000 V dc in seven ranges.

CIRCLE NO. 266

What price performance? Not much. These two new solid state DC Calibrators have been designed to satisfy both performance-minded engineers and their budget-battered bosses. Both of these fine instruments offer the kind of specs that will cost you up to fifty percent more elsewhere—and still not give you the performance you always get when the Fluke name goes on the front panel. Check them out.

Model 343A. Here's a calibrator equal in resolution (0.1 ppm) to the most expensive instrument on the market in only 3½" of panel space. Price is \$1695 for an absolute accuracy of 0.003% over a 0 to 1100 volt range. Stability is 0.0005%/hour. Quick amplifier response provides an output within 25 ppm five seconds after any range or setting

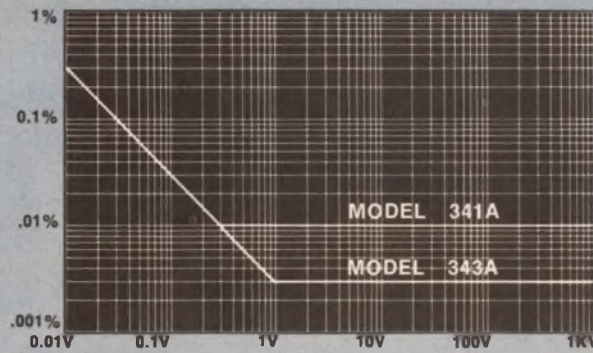

Models 341A & 343A Accuracy Over 3 Ranges

Model 341A. Here's the best buy in the calibrator market today. You get an accuracy of $\pm 0.01\%$ over a 10°C range for a low-low price of \$1195. Resolution is 1 ppm. Stability is 0.0007%/hour. All other specs are the same as the Model 343A.

For full details, see your Fluke sales engineer or contact us directly.

change. Four-terminal floating output is featured. Current is automatically limited at any preset level between 1 ma and 30 ma. Line and load regulation are 0.0005% of setting. Shock, vibration, and altitude specs of MIL-T-21200 are met. The Model 343A is housed in an attractive package for bench use and rack mounting weighing 23 pounds.

MODEL 341A DC Calibrator

MODEL 343A DC Calibrator

**They're our
new tight
money**

**DC
Calibrators!**



Fluke, Box 7428, Seattle, Washington 98133. Phone: (206) 774-2211. TWX: 910-449-2850. In Europe, address Fluke Nederland (N.V.), P.O. Box 5053, Tilburg, Holland. Phone: (04250) 70130. Telex: 884-50237. In the U.K., address Fluke International Corp., Garnett Close, Watford, WD2 4TT. Phone: Watford, 27769. Telex: 934583.



Simpson's new 2725.

Compare it with the electronic counter you were going to buy:

SPECIFICATIONS	SIMPSON 2725	YOUR COMPARISON
Wide frequency range?	YES. 5 Hz to 20 MHz.	
Measures frequency ratios?	YES. 1 to 1.99999×10^5 .	
Measures time periods?	YES. 300 μ seconds to 0.2 second.	
Measures time intervals?	YES. 300 μ seconds to 1.99999×10^5 seconds.	
Totalizes?	YES. 0 to 1.99999×10^5 counts.	
Crystal controlled time bases?	YES. 6 xtal-controlled bases, switch selected.	
Self-test circuitry?	YES. Front panel switch tests logic circuitry.	
Dependable solid state design?	YES. Integrated circuits.	
Number of full time digits	5. Plus automatic overrange indication.	
Accuracy	$\pm 0.01\%$ ± 1 digit	
Price	\$525. complete with probe and operator's manual. \$	

4-digit Model 2724 also available: \$450.

GET "OFF-THE-SHELF" DELIVERY OF THE NEW SIMPSON DIGITAL ELECTRONIC COUNTERS AT DISTRIBUTORS STOCKING SIMPSON INSTRUMENTATION PRODUCTS

Simpson

ELECTRIC COMPANY



5200 W. Kinzie Street, Chicago, Illinois 60644 • Phone (312) 379-1121
 Export Dept: 400 W. Madison Street, Chicago, Illinois 60606. Cable Simelco
 IN CANADA: Bach-Simpson Ltd., London, Ontario • IN INDIA: Ruttonsha-Simpson Private Ltd., International House, Bombay-Agra Road, Vikhroli, Bombay

INFORMATION RETRIEVAL NUMBER 64

ICS & SEMICONDUCTORS

Monolithic amplifier consumes 90 μ W

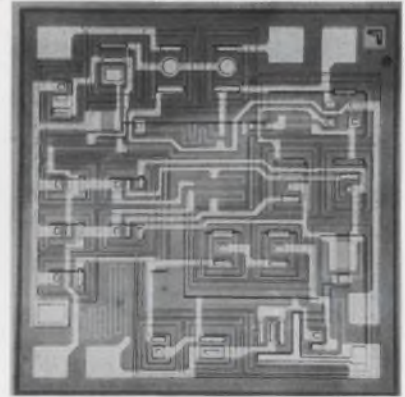

Fairchild Semiconductor, 313 Fairchild Drive, Mountain View, Calif. Phone: (415) 962-3563. Price: \$72.

Claiming a hundredfold reduction in power consumption compared with existing monolithic linear ICs, a new three-stage micropower operational amplifier requires only a 90- μ W standby power consumption with ± 3 -V supplies. In addition, model μ A735 can operate at an input offset current of 300 pA and an input offset voltage of 0.5 mV. Input current noise is 0.4 pA/Hz at 10 Hz.

CIRCLE NO. 267

Small-signal pair gain 17-dB power

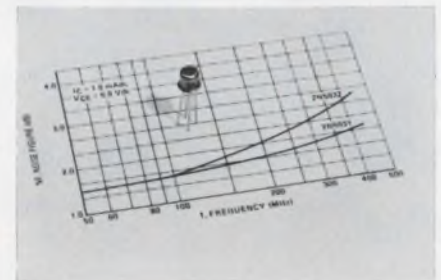

Motorola Semiconductor Products Inc., P.O. Box 20924, Phoenix, Ariz. Phone: (602) 273-6900. Price: \$8 or \$14.

Intended for use as high-gain, low-noise, small-signal amplifiers in military and industrial equipment, a new pair of rf small-signal transistors feature a power gain of 17 dB. Types 2N5031 and 2N5032 have a noise figure of 2.5 or 3 dB, and a current gain-bandwidth product typically above 1 GHz. They are hermetically sealed in TO-72 metal cans.

CIRCLE NO. 268

Transistor switches ignore temp changes

Film Microelectronics, Inc., 17 A St., Highland Industrial Park, Burlington, Mass. Phone: (617) 272-5650.

Series 1000 predictable FET (PREDFET) switches guarantee a precisely specified on-resistance, which remains stable regardless of ambient temperature variations. The new devices have a 100- Ω ($\pm 1\%$) on-resistance and an off leakage current that is also independent of temperature variations. Zero offset, negligible gating current and single-, dual- and quad-switching in a single package are other features.

CIRCLE NO. 269

Power switches turn-on in 100 ns

Solid State Products, One Pingree St., Salem, Mass. Phone: (617) 745-2900.

Capable of handling currents from 200 mA to 20 A and voltages from 40 to 400 V, a new line of power switching transistors feature a total turn-on time of less than 100 ns at 5 A. The high-voltage units are types 2N5660 to 2N5667. The lower-voltage devices include types 2N5658 (20 A), type 2N5552 (10 A), types 2N5487 and 2N5488 (5 A), and type SSP-3020 (2 A).

CIRCLE NO. 270

Sense amplifiers complement cores

Qualidyne Corp., 3699 Tahoe Way, Santa Clara, Calif. Phone: (408) 738-0120. Price: \$10 typical.

Low-cost dual-input sense amplifiers for core memory computer applications consist of three matched differential amplifiers, one acting as a reference with an externally set threshold level and two that amplify core signals. Models 7520N through 7525N are available in full-military-temperature-range versions, as are models 5520J through QC 5525J. All outputs are directly coupled to TTL gates.

CIRCLE NO. 271



Simpson's new 2700.

Versatile Digital System:

- New, fast warm-up*
- 4½ digits
- 0.05% accuracy
- 5 plug-in function modules



- Automatic Polarity Selection
- Built-in Self Calibration
- 100 Microvolt Resolution
- Optional BCD output
- IC Modular Design for reliability

*Just 1 minute for 0.1% accuracy. 5 minutes for 0.05%.

2700 DIGITAL SYSTEM \$615⁰⁰
complete with DC voltage range module, test leads, and operator's manual

AVAILABLE "OFF-THE-SHELF" AT ELECTRONIC DISTRIBUTORS STOCKING SIMPSON INSTRUMENTATION PRODUCTS.

Simpson ELECTRIC COMPANY



5200 W. Kinzie Street, Chicago, Illinois 60644 • Phone (312) 379-1121
Export Dept: 400 W. Madison Street, Chicago, Illinois 60606. Cable Simelco
IN CANADA: Bach-Simpson Ltd., London, Ontario • IN INDIA: Ruttonsha-Simpson Private Ltd., International House, Bombay-Agra Road, Vikhroli, Bombay

INFORMATION RETRIEVAL NUMBER 65

Pnp transistor switch survives bombardment

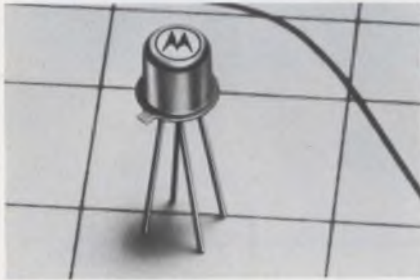

Motorola Semiconductor Products Inc., P.O. Box 20924, Phoenix, Ariz. Phone: (602) 273-6900. P&A: \$15.80; stock.

Showing an exceptional tolerance to neutron radiation, a new pnp silicon switching transistor retains more than 50% of its specified dc current gain after exposure to a fluence of 3×10^{14} neutrons/cm² at a neutron energy level of 1 MeV, or 1×10^{15} neutrons/cm² at greater than 10 keV. Model MM4261H has a typical current-gain bandwidth product of 3.5 GHz and current-mode switching performance characterized by a typical risetime of 0.5 ns.

CIRCLE NO. 272

Disc-like SCRs take 470 A



International Rectifier, Semiconductor Div., 233 Kansas St., El Segundo, Calif. Phone: (213) 678-6281. Price: \$66 to \$210.

Dubbed Hockey-Puks, a new series of flat disc-configuration silicon controlled rectifiers handle average currents from 115 to 470 A. The new devices offer a voltage rate of rise of 200 μ s to attain 1300 V. Applications include choppers, welders, regulated power supplies, phase control heaters and monitor drives.

CIRCLE NO. 273

Power transistors resist radiation

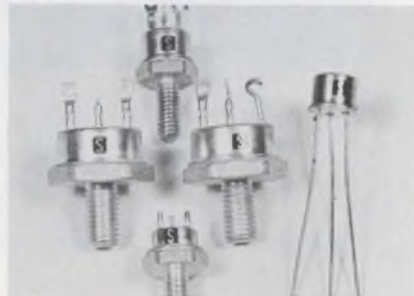

Solitron Devices, Inc., Transistor Div., 1177 Blue Heron Blvd., Rivera Beach, Fla. Phone: (305) 848-4311. Availability: stock.

Available as off-the-shelf devices, a new line of radiation-resistant npn silicon power transistors provide breakdown voltages as high as 90 V and peak collector currents up to 25 A. The units offer post-radiation gain and low values of collector-emitter saturation voltage after exposure to a flux as large as 3×10^{14} neutrons/cm²/s. Series BR100, 200, 300 and 400, as well as types JEDEC 2N5527 to 2N5538 come in standard package configurations.

CIRCLE NO. 274

Glass 1-W zeners sell for only 69¢



Unitrode Corp., Unitrode Div., 580 Pleasant St., Watertown, Mass. Phone: (617) 926-0404. P&A: 69¢; stock.

Christened the PZ series, a new line of 1-W zener diodes offer fused-in-glass metallurgically bonded performance for a price tag of only 69¢ each in quantities of 1000. These subminiature devices can handle 1.5 W continuous with proper mounting, and offer a 30-W surge rating. Their reverse leakage current is as low as 500 nA. Body dimensions are 0.085-in. dia by 0.25-in. long.

CIRCLE NO. 275

Matched npn/pnp pairs handle up to 60 V

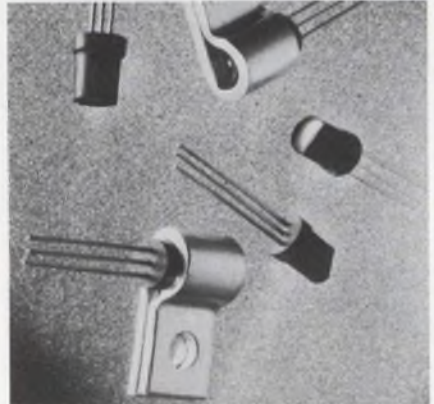

General Electric Co. Semiconductor Products Dept., 1 River Rd., Schenectady, N.Y. Phone: (518) 374-2211. P&A: 27¢ to 31¢; stock.

With a power dissipation rating of 500 mW at 25°C, a new series of general-purpose matched complementary silicon transistor pairs offer breakdown voltage ratings of 25, 40 and 60 V. They are ideally suited for the driver stages in high-current amplifiers, for control and television circuitry, and for the output stage of push-pull audio amplifiers.

CIRCLE NO. 276

Quad resistor FETs match down to 5%

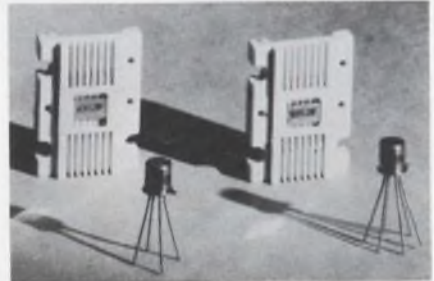

Siliconix Inc., 2201 Laurelwood Rd., Santa Clara, Calif. Phone: (408) 246-8000. P&A: \$5.05 to \$40.20; stock.

Four new voltage-controlled resistor FETs offer high pinch-off voltages, 8 to 12 V, that result in increased resistor linearity. The VCR11N dual and VCR13N quad devices have a guaranteed 5% match from 200 Ω to 2 k Ω , while the VCR12N quad unit offers a 10% match. A single unit, the VCR10, is also available. All the devices are n-channel FETs.

CIRCLE NO. 277

New power supply:
10-20 or 20-30 KV
Drift < .005% per hour
Regulation less than .001%
Ripple: 100 MV P-P max.

4¹/₂" x 4⁵/₈" x 9" (typ. 20 mv)

Costs \$850
(less by the bunch)



Sonofagun!

Get the high-powered details from Fred Martin,
Computer Power Systems,
722 East Evelyn, Sunnyvale, California 94086. (408) 738-0530.

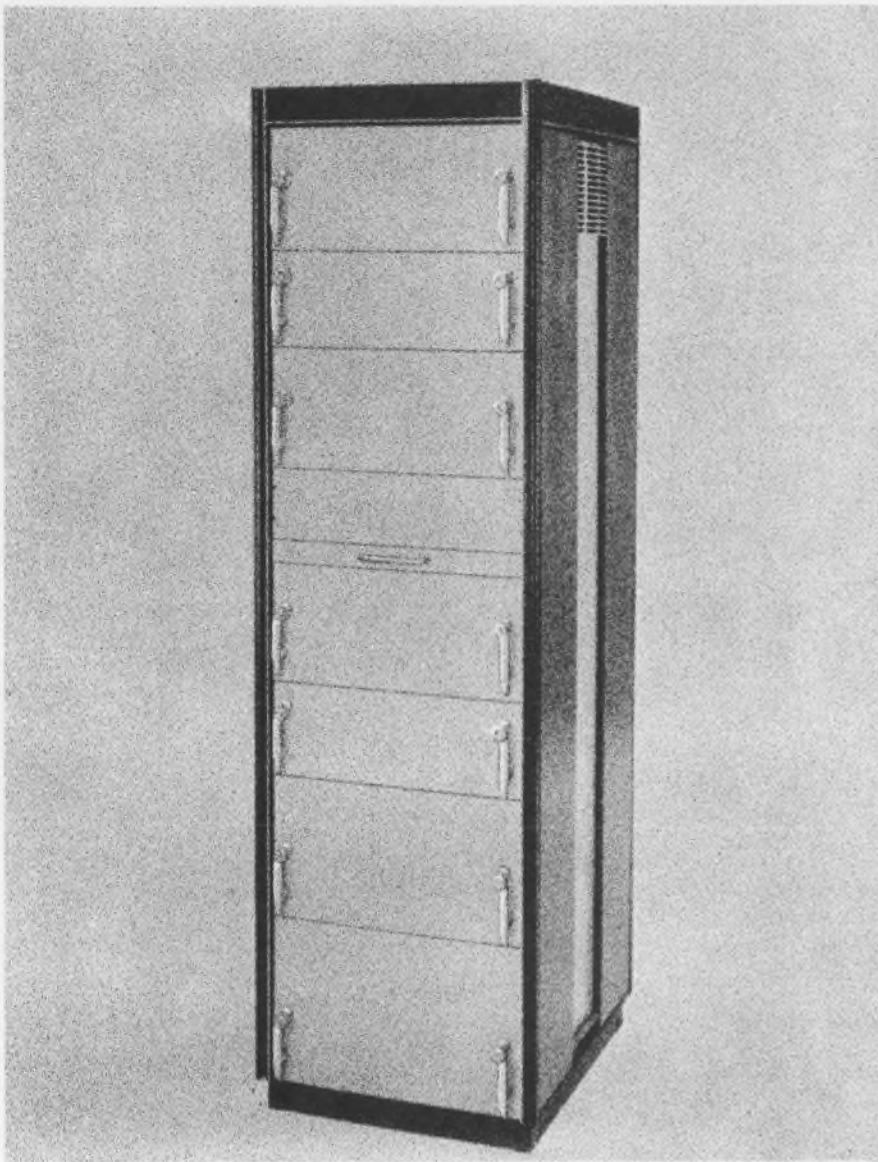

Safe deposit box

Expensive test and laboratory equipment deserves maximum protection. You can protect this valuable investment with the Vent-Rak Slim-Line 5000 Series Cabinet . . . designed and engineered to meet and exceed military specifications.

The Vent-Rak 5000 Series Cabinet is the first economically-priced, heavy-duty construction modular electronic enclosure in the market today.

Components are interchangeable, sides are easily removed,

and assembly is simple . . . accomplished with ordinary hand tools. Separate frames can be bolted together to form bays in unlimited combinations. Add handsome finish, aluminum trim, and choose from a host of accessories . . . the rugged 5000 Series Cabinet is ideally suited to almost any type of commercial electronic packaging need.

For more detailed information write Vent-Rak, Inc., 525 South Webster Avenue, Indianapolis, Indiana 46219.

VENT-RAK, INC.
525 South Webster Avenue
Indianapolis, Indiana 46219



INFORMATION RETRIEVAL NUMBER 67

MICROWAVES & LASERS

Desk-size cw laser socks out 1000 W



Sylvania Electric Products Inc., Electronic Systems Div., P.O. Box 188, Mountain View, Calif. Phone: (415) 966-9111. Price: \$50,000.

Hailed as the initial member of a new generation of lasers, a carbon-dioxide continuous-wave laser, which is about the size of a standard office desk, supplies an output of 1000 W. For this magnitude of power output, previous units typically measured up to 60 feet long. Called the Gas-Transport laser, the unit generates a power density of 10 million watts per square inch at its focus, producing a temperature of 20,000°C.

CIRCLE NO. 278

Near-IR laser diodes put out 15 W at 75 A



RCA/Electronic Components, 415 S. Fifth St., Harrison, N.J. Phone: (201) 485-3900.

Developed for pulse operation at room temperature, two new developmental-type gallium-arsenide laser diodes radiate in the near-infrared region (9050 Å) and feature a minimum radiant power of 15 W at 75 A. Model TA7699 and TA7699R are fabricated by a new close-confinement process that limits the radiation to the junction area for better performance. At 70°C, the diodes have a 5-W typical output. The TA7699R is a reverse-polarity type.

CIRCLE NO. 279

Tunnel diodes cutoff at 50 GHz



Aerotech Industries, 825 Stewart Dr., Sunnyvale, Calif. Phone: (408) 732-0880.

Offered in a choice of Ge, GaAs or GaSb compositions, a new line of microwave amplifier tunnel diodes include standard models with cutoff frequencies to 50 GHz. Also available is a family of detector/mixer tunnel diodes in a choice of Ge and GaAs models with low-noise characteristics. High-speed switching tunnel diodes can also be supplied.

CIRCLE NO. 280

Resistive substrates work in microstrip



Tek-wave, Inc., Raymond Road, Princeton, N.J. Phone: (609) 921-8910.

With chrome-film metalization on both top and bottom, new chrome/gold resistive substrates are now available for microstrip applications. Metalization is provided on 99.5% aluminum oxide on a 0.025-in. ground substrate, with a surface finish of less than 10 micro-inches. Resistivity values include 50, 100, 200, or 400 ohms per square. Substrate sizes are 1 by 1, 1 by 2, or 2 by 2 in.

CIRCLE NO. 281

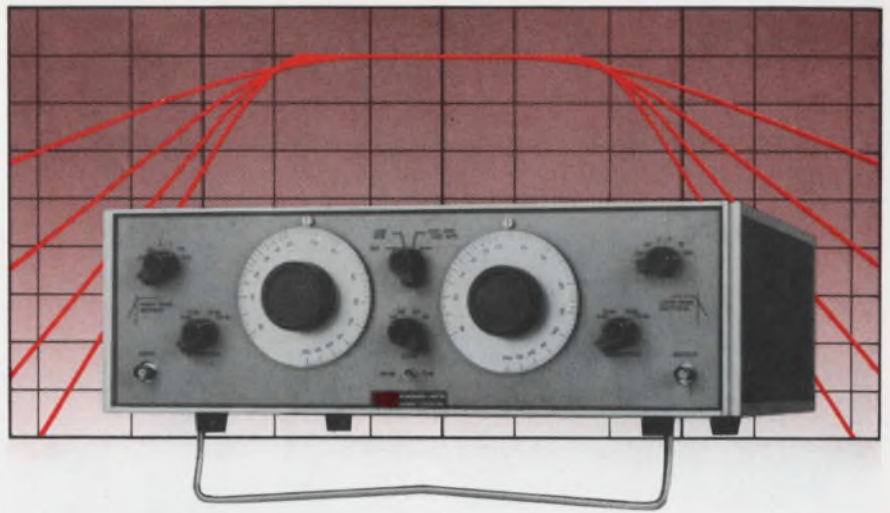

New multifunction filter with selectable attenuation slopes covers 0.02 Hz to 20 KHz

MODEL 3750 — All solid-state. Functions include low-pass, high-pass, band-pass, and band-reject. Attenuation slopes may be set at 6, 12, 18 or 24 db-per-octave, with maximum attenuation greater than 80 db. Gain switch may be set at 0 or 20 db. Designed for line or battery operation with batteries internal and rechargeable. Bench model: 5 $\frac{1}{4}$ " high x 16 $\frac{5}{8}$ " wide x 13 $\frac{11}{16}$ " deep. Rack model: 5 $\frac{1}{4}$ " high x 19" wide x 13 $\frac{11}{16}$ " deep.

Price, without batteries, \$850

MODEL 3700 — A new, all solid-state variable band-pass filter covering the 0.2 Hz to 20 KHz range. Attenuation slopes: 24 db-per-octave, extending to greater than 80 db. Selectable band-pass gain: 0 or 20 db. Line or battery operation with batteries internal and rechargeable. Bench model: 3 $\frac{1}{2}$ " high x 8 $\frac{5}{8}$ " wide x 13 $\frac{11}{16}$ " deep. Rack model: 3 $\frac{1}{2}$ " high x 19" wide x 13 $\frac{11}{16}$ " deep.

Price, without batteries, \$550

SEE THEM AT NEREM. Boston, November 5, 6, 7. Booth #1D22-23.

OVERSEAS SALES OFFICES: BELGIUM, C. N. Rood s. a. DENMARK, SC Metric A/S; FRANCE, Antares; GERMANY, Nucletron Vertriebs-GMBH; HOLLAND, C. N. Rood n. v.; ITALY, Dott. Ing. Mario Vianello; SWEDEN, Teleinstrument; ISRAEL, R.D.T. Elect. Eng. Ltd.; JAPAN, Shoshin Shoji Kaisha, Ltd.; AUSTRALIA, Sample Electronics (Vic.) Pty., Ltd.; G. B., B & K Inst. Ltd.

**KH KROHN-HITE
CORPORATION**

580 Massachusetts Ave., Cambridge, Mass. 02139, U.S.A.
Phone: (617) 491-3211 TWX: 710-320-6583

Oscillators / Filters / AC Power Sources / DC Power Supplies / Amplifiers

Cw gas lasers develop 500 mW



RCA/Electronic Components, 415 S. Fifth St., Harrison, N.J. Phone: (201) 485-3900. P&A: \$2750 or \$6750; 90 days.

Two new continuous-wave gas lasers are primarily designed for general laboratory research and experimentation, as well as holographic applications involving the generation of three-dimensional imagery. The LD2140 is an argon ion laser that has a power output of 500 mW for all lines. It can operate more than 3000 hours without tube pressure adjustments or gas refill. The LD2135 is a violet/ultraviolet helium-cadmium laser with a power output of 10 mW at 4416 Å and 2 mW at 3250 Å.

CIRCLE NO. 282

Accurate phase shifter covers 60 to 90 GHz



Baytron Co., Inc., Medford, Mass.

Featuring a precision ball bearing mechanism with a differential drive counter, a dial-calibrated variable phase shifter achieves a calibration accuracy to $\pm 3^\circ$ at any desired frequency between 60 and 90 GHz. Besides assuring accuracy and reliability, the unique dial mechanism of model 3E-13 also gives fine-readout definition. VSWR is 1.2 maximum with a minimum phase shift of 180° .

CIRCLE NO. 283

Tunnel-diode detectors span 1 to 12.4 GHz



Electro/Data, Inc., 1621 Jupiter Rd., Garland, Tex. Phone: (214) 341-2100. P&A: \$70 to \$95; stock to 2 wks.

Covering the frequency range from 1 to 12.4 GHz, series D broadband tunnel-diode detectors offer either type N or miniature inputs and are available with maximized sensitivity over octave or multi-octave bands. The new devices provide high sensitivity as well as a flat response from L through X band. They can be supplied with built-in dc returns.

CIRCLE NO. 284

Active multicouplers maintain signal level



HRB-Singer, Inc. Microwave Laboratory, P.O. Box 60, Science Park, State College, Pa. Phone: (814) 238-4311.

Covering the frequency range of 2 to 4 GHz, a new line of miniature microstrip transistorized multicouplers provide four outputs from a single input with no reduction in signal level. Any octave-band unit from 500 MHz to 4 GHz can be supplied in a package size of 1-1/4-in. wide by 3/8 in. thick by 4-1/8 in. long. Minimum isolation between outputs is 20 dB.

CIRCLE NO. 285

Bandpass filters go out to 10 GHz



Merrimac Research and Development, Inc., 41 Fairfield Place, West Caldwell, N.J. Phone: (201) 228-3890. Price: \$195 to \$225.

A new series of transmission-line bandpass filters, which cover frequencies from 750 MHz to 10 GHz, come in both interdigital and combline versions with bandwidths ranging from 1 to 70% of the center frequency. Series FB units can handle average powers of 100 W and peak powers of 1 kW. They are designed to meet the environmental standards of MIL-E-5400 and MIL-E-16400.

CIRCLE NO. 286

Multi-octave YIG filters keep tuning power down



Watkins-Johnson Co., 3333 Hillview Ave., Stanford Industrial Park, Palo Alto, Calif. Phone: (415) 326-8830.

Able to change tuning sensitivity without increasing tuning power requirements, two new electronically tuned multi-octave YIG filters are now available. The two-stage WJ-795 covers the frequency range from 1 to 18 GHz, requires less than 6-W tuning power, and has an integral self-shielded magnetic circuit. The WJ-756 is a three-stage unit for the 1-to-12.4-GHz range. Its required tuning power is under 3 W.

CIRCLE NO. 287



The Armadillo Connector proudly announces Son of Armadillo.

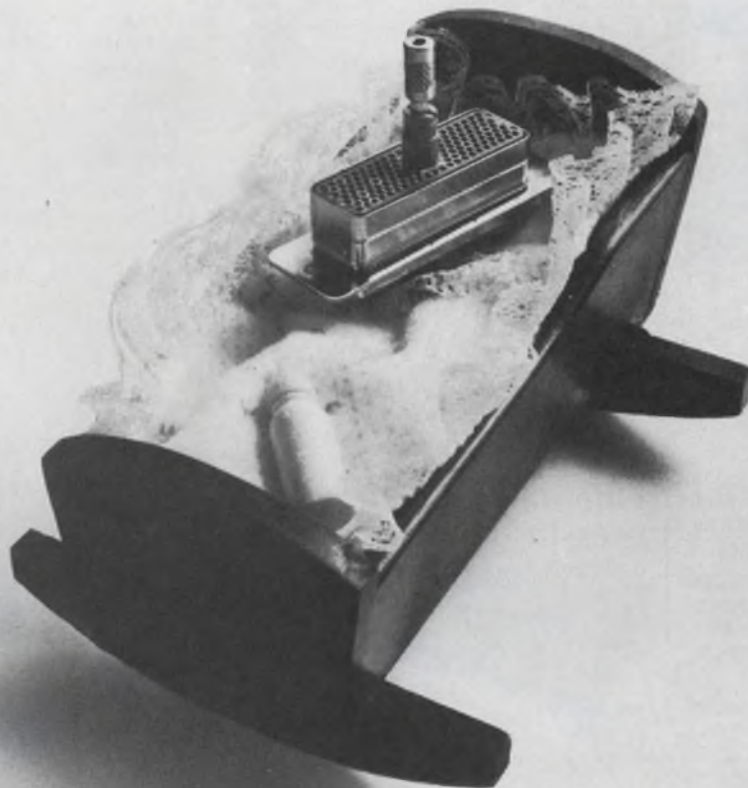

Some baby.

Our smaller, lighter subminiature now comes bundled in real hard-shell protection.

Just like our D Series Connectors. We call them the Armadillo Connectors because we encase them in stainless steel for extra protection against abuse.

Now the little fellows, too, have extra strength to keep them providing the service they were built to provide.

Which is plenty. These W Series

subminiatures are more fully packed. 110 contacts to the inch, without giving up contact size or spacing.

They align and polarize perfectly, with the Hughes PolarHex center jackscrew coupling system. Available in environmental, non-environmental and potting versions.

They come in arrangements to fit your needs, from 14 to 244 size 22 contacts. And they feature crimp snap-in contacts with the

famous Hughes retention mechanism.

You'll find they're more than a happening. They're a Blessed Event.

Write Hughes Aircraft Company, **GD** Connecting Devices, 500 Superior Avenue, Newport Beach, California 92663. Phone (714) 548-0671. TWX 714-642-1353.

HUGHES
HUGHES AIRCRAFT COMPANY

**If it's happening in connectors,
it probably started at Hughes.**

The Wizards of θZ

Like magic — vector impedance instruments read out complex impedance in an instant.

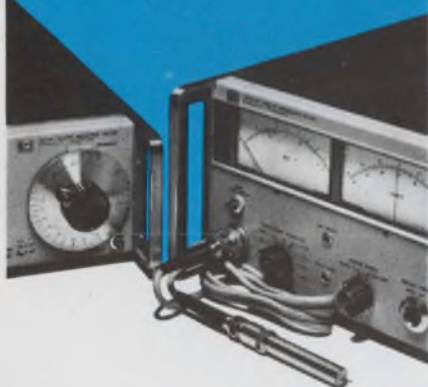

Bench or production line measurements involving impedance magnitude, Z , and phase angle, θ , no longer require tedious test procedures. These measurements are now as easy to make as voltage readings. No nulling . . . no balancing . . . no calculations to make. The wizardry of these HP instruments provides direct readout in terms of Z (in ohms) and θ (in degrees) over a continuous frequency range.

HP 4800A Vector Impedance Meter covers the 5 Hz to 500 kHz range. You set the frequency, select the impedance range and read: Z from 1 ohm to 10 Megohms, and θ from -90° to $+90^\circ$. \$1650.

HP 4815A RF Vector Impedance Meter covers 500 kHz to 108 MHz. Measures, via a probe, active or passive circuits directly in their normal operating environment. Z from 1 ohm to 100 K ohms; θ from 0° to 360° . \$2650.

Application Note 86 describes many applications of the 4800A and the 4815A Vector Impedance Meters including the measurement of Z , R , L , and C . For your copy and complete specifications, contact your local Hewlett-Packard field engineer or write: Hewlett-Packard, Green Pond Road, Rockaway, New Jersey 07866. In Europe: 1217 Meyrin-Geneva, Switzerland.

HEWLETT *hp* PACKARD

IMPEDANCE INSTRUMENTS

1093

INFORMATION RETRIEVAL NUMBER 70

COMPONENTS

Reed relay plus diode fit in a 0.05³-in. can

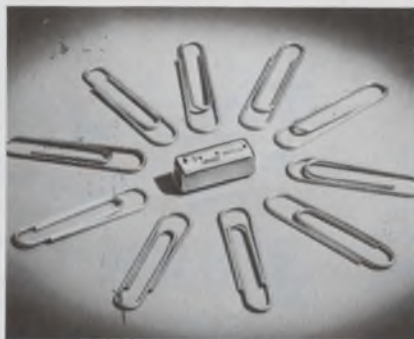

Wheelock Signals, Inc., 273 Branchport Ave., Long Branch, N.J. Phone: (201) 222-6880.

A new series of solid-state relays incorporates a reed relay and a blocking diode in one tiny package measuring 0.05 cubic inches. The 442DS series relays, which measure 0.25-in. high, allow a 50% PC-board space savings. For example, forty of these two-pole relays can be mounted on a 5-1/2- by 4-1/2-in. PC board. The units are available in two-, three-, and four-pole models with contacts rated at 7 W.

CIRCLE NO. 288

Fiber-optic CRT sees in darkness



Visual Electronics Corp., 356 W. 40 St., New York, N.Y. Phone: (212) 736-5840.

Combining the readout of a low-noise 3-in. image isocon tube with a single-stage image intensifier, a new cathode-ray tube yields good pictures even under overcast starlight conditions. The photo-cathode of type P8012 is fitted to the screen of the intensifier stage with fused fiber-optic faceplates. The intensifier has a curved faceplate for use with a mirror optical system.

CIRCLE NO. 289

Two-terminal lamp indicates at 180°

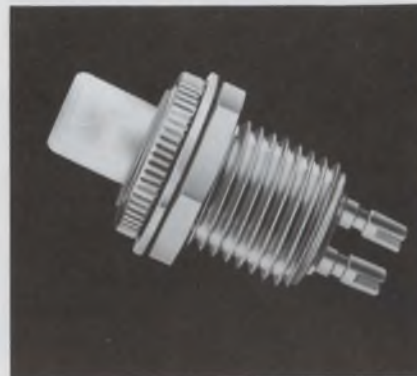

The Sloan Co., 7704 San Fernando Rd., Sun Valley, Calif. Phone: (213) 875-1123.

A new miniature two-terminal indicator light with a clean and uncluttered appearance enhances visibility to a 180° viewing angle. Model 856 accepts T-1-3/4 based incandescent or T-2 based neon lamps. Its high-temperature flat-surface molded lens comes in ten styles and six colors, in both translucent and transparent versions.

CIRCLE NO. 290

Lamp assembly displays 4 ways



Stacoswitch Div., Staco, Inc., 1139 Baker St., Costa Mesa, Calif. Phone: (714) 549-3041.

Miniature size, simple legend and lamp replacement, and a self-contained assembly are features of a new four-lamp illuminated display module. The module offers up to 384 changeable legends with up to four-way split display screens. There are six legend colors, eight screen styles and eight legend types. The module, which has a display area of 0.6-in. square, meets MIL-S-22885 requirements. Rfi/emi shielding is optional.

CIRCLE NO. 291

ДРУГАЯ ЛОЖЬ КАПИТАЛИСТОВ- ИМПЕРИАЛИСТОВ ОБНАЖЕНА

В современном издательстве "SSPI", — доклада знаменитого фабриканта транзисторов, который советские агенты в Америке перехватили, появилась другая капиталистическая ложь. Она новая из серии сказанных Буржуазными Империалистами и Вождями Соединённых Штатов.

Мы построили первый самолет, но Американцы украли эту честь от нас. Мы были первыми в формуляции "Coca-Cola", но империалисты взяли Славу за это. Теперь, — окончательное оскорбление — "SSPI" заявляет, что они построили мира первый энергию-переключательный транзистор. (Мы построили его в 1946 году. Планы сейчас заключены в подвале в Кремле.)

Доклад "SSPI" называемый "LITPAK-PST" — большая ложь с начала до конца. На пример: Так как этот доклад только крикливая пропаганда, Центральный Комитет объявил этот документ

Unitrode's SSPI Division has developed a new line of **POWER SWITCHING TRANSISTORS** . . . the world's first transistor family specifically designed for power switching applications, with every parameter important to power switching guaranteed. Transistors in our TO-5, TO-59, TO-66, and TO-111 packages all have noteworthy parameters for power switching. They're capable of handling from 40 to 400 volts and 0.2 to 20 amps. Available with: saturation voltages of less than 1 volt at 10 amps, minimum current gains of 100 at 1 amp, and turn-on times of less than 100 nanoseconds at 5 amps. For complete specifications and prices, contact Alex Polner (617) 745-2900, and ask for our LITPAK-PST.



**SOLID STATE
PRODUCTS**

DIVISION OF UNITRODE CORPORATION
ONE PINGREY STREET, SALISBURY, MASSACHUSETTS 01970
PHONE 617-745-2900, TWX 710-347-0226

неприличной и извращённой литературой. Люди имеющие копию "LITPAK-PST", или читающие его, будут считаться предателями советского народа.

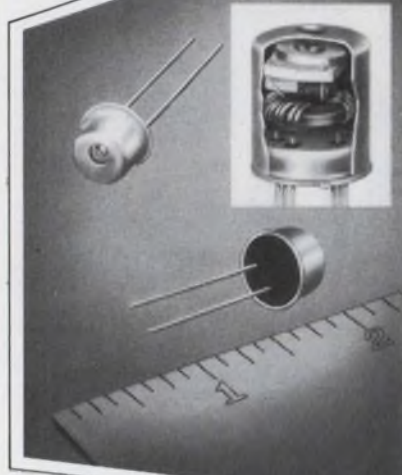
JFD**MTLC SERIES**

MICRO-MINIATURE TUNED-CIRCUIT PACKAGE

JFD MTLC TUNERS enable circuit designers to shrink various LC circuits into TO-5 configurations completely compatible with today's miniaturized or hybrid circuitry. The tuning element is a microminiature variable ceramic capacitor measuring: .208 x .280 x .120 in. thick. These variable ceramic capacitors offer high capacitance plus a choice of wide ΔC s in extra small, ultra stable units. New improved construction makes MTLC more rugged than ever.

JFD builds these miniature circuits with high quality ferrite and iron inductor toroidal cores, providing maximum Q for any given frequency. Where necessary, special JFD Uniceram fixed capacitors are used with Modutrim microminiature ceramic variable capacitors to yield lower center frequencies or to satisfy special circuit requirements.

Standard tunable LC networks are available for a wide range of applications such as: RF tank, FM discriminator, impedance matching, frequency multiplier, IF amplifier and many others.

Write for catalog.

JFD
**JFD ELECTRONICS CORP. /
COMPONENTS DIVISION**

15th Avenue at 62nd Street
Brooklyn, New York 11219
Phone 212-331-1000

SUBSIDIARY OF RIKER-MAXSON CORPORATION

COMPONENTS

Tiny PC-board switch works in 10 positions



Minelco, sub. of General Time, 600 South St., Holbrook, Mass. Phone: (617) 963-7717.

A new single-pole miniature rotary switch for PC-board mounting features positive detent action at 36° intervals, up to 10 positive-stop positions, and environmental sealing for high reliability. The SW62S switch uses gold contacts for maximum contact resistance of 0.05Ω and a contact rating of 0.25 A at 28 V dc. The switch measures 0.57 in. in diameter.

CIRCLE NO. 292

Piezoelectric element bends like umbrella

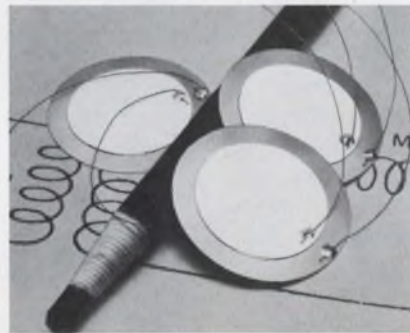

Clevite Corp., Piezoelectric Div., 232 Forbes Rd., Bedford, Ohio. Phone: (216) 232-8600.

Because its radial motion is restricted, a new piezoelectric element responds to alternating electric signals by flexing or bending in an umbrella-like manner. Uni-Morph consists of a single ceramic plate bonded to a mechanically active but electrically inactive substrate, for example, brass. It is a composite structure with a resonant frequency of approximately 2.5 kHz. Its electrical impedance at resonance is typically 1 k Ω shunted by 35 nF.

CIRCLE NO. 293

Pushbutton switches indicate position

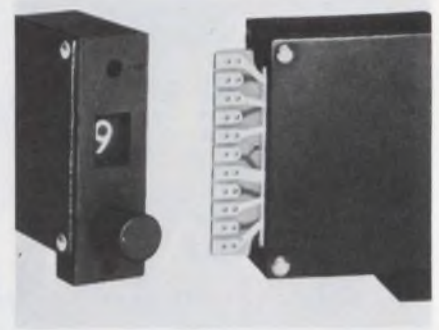

Digitran Co., 855 S. Arroyo Parkway, Pasadena, Calif. Phone: (213) 449-3110. Price: \$12 to \$18.

Easy and efficient manipulation, even with a gloved finger, is now possible with a new miniature switch for environmental applications. When Minibutton series 12000 units change dial position on the forward throw, the operator can hear and feel a click as the dial sets into position. The switches are available with 0.2-in. high characters and eight to ten dial positions with switching outputs.

CIRCLE NO. 294

Numeric readouts display in a line



Info-Lite, div. of Cartelli Technology, Inc., 45-12 108 St., Corona, N.Y. Phone: (212) 592-4700. P&A: \$7 to \$8; 2 wks.

Displaying character heights of 0.7 in., a new family of lighted numeric readouts comes in seven-bar modules. Series 68030 units are completely enclosed and ready for mounting into a panel cutout. Their light sources are standard T-1-3/4 incandescent or neon flange-based lamps that are replaceable from the front. Matching colors and BCD-to-seven-bar decoder/drivers can be supplied.

CIRCLE NO. 295



*Who ever heard
of a computer
that*

TALKS CONTROL?

The GRI 909 computer is the closest thing to it.
We call the technique Direct Function Processing.
*"If meter output is less than zero, go to alarm."
"Turn on tape reader."
"Send complemented output of analog-to-digital
converter to controller."*

These instructions are representative of GRI's
unique functional approach to assembly language.
When you have defined the functional operations
of your system, you have very nearly written the
control program for the GRI 909.

Direct Function Processing adds many new
dimensions to computerized system control.
To find out more, write for our new brochure
describing the GRI 909 computer.



GRI Computer Corp.
76 Rowe Street,
Newton, Mass. 02166
(617) 969-7346

gri-909

**You have never seen a computer
like this before. See it at the FJCC.**

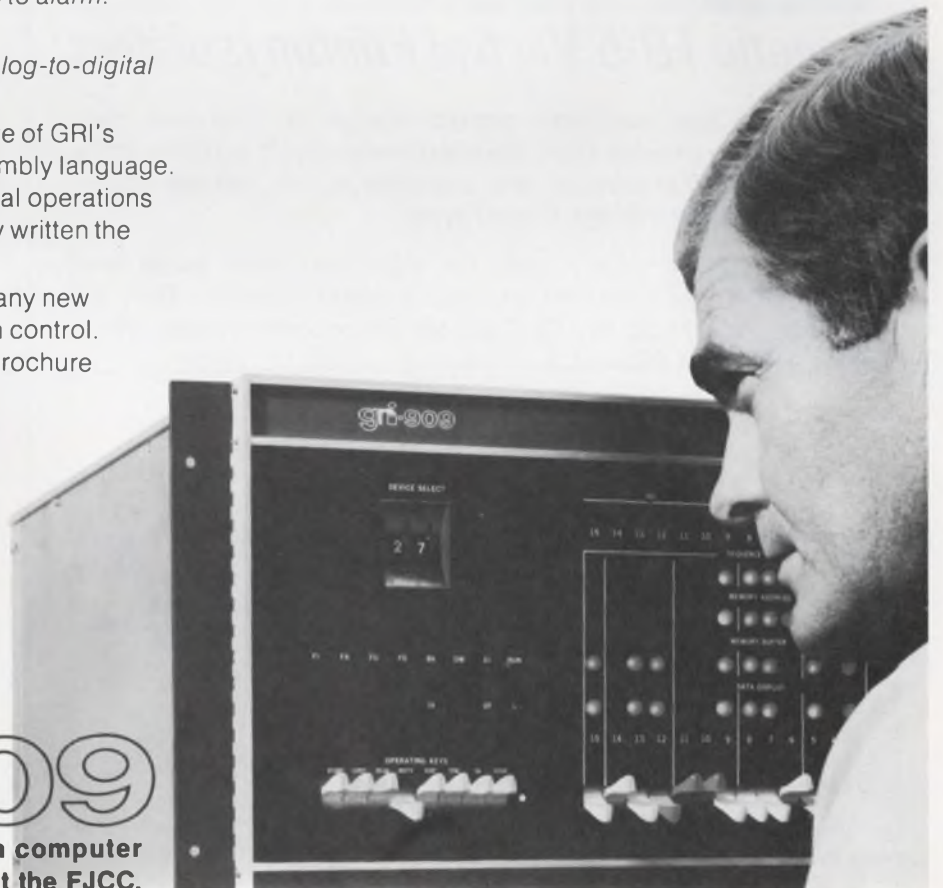

INFORMATION RETRIEVAL NUMBER 73

NEW VACTEC

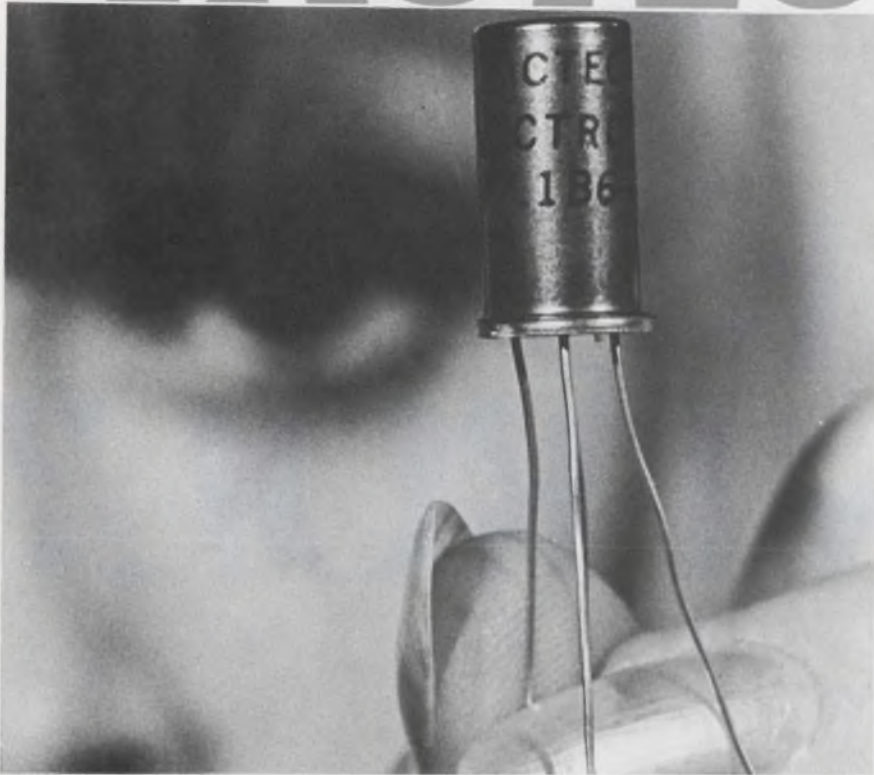

Hermetic TO-5 Vactrol Photon Isolators

Vactec's new photocell-lamp control module is filled with clear flexible resin to provide high vibration immunity. It is hermetically sealed in a TO-5 enclosure, and available in low voltage (incandescent) and high voltage (neon) types.

These devices are widely used for signal isolation, audio level controls, SCR and triac turn on, and noiseless switches. They are priced less than \$1.25 in 1,000 quantities for some models. Write today for Bulletin PCD 4C3.

Specifications at 25° C

Minimum off resistance 10⁷ ohms
 Cell voltage max. 150 V.
 Cell dissipation 100 MW.

Part Number	LAMP		PHOTOCELL		
	Voltage max.	Current (ma)	Max. ON (ohms)	Ascent Time ms	Decay to 100K ms
VTL1A1	1.5	50	400	80	350
VTL1A2	6.0	40	200	75	400
VTL1A3	10.0	14	800	60	150
VTL1A4	12.0	25	250	120	500
VTL1B5	150	1.2	1000	80	65
VTL1B6	90	.3	5000	6	50

VACTEC, INC.

2423 Northline Ind. Blvd.
 Maryland Heights, Missouri 83042
 Phone: (314) 872-8300



Specializing in standard Cds, Cdse, and Se cells; custom engineering for every photocell need.

Listed in EBG under "Semi-Conductors" and in EEM Sec. 3700.

INFORMATION RETRIEVAL NUMBER 74

MODULES & SUBASSEMBLIES

Unregulated supplies sell for only \$16.80



Computer Products, Inc., 2709 N. Dixie Highway, P.O. Box 23849, Fort Lauderdale, Fla. Phone: (305) 565-9565. P&A: \$16.80; 1 to 5 days.

Unregulated voltage outputs from 5 to 45 V dc at currents up to 440 mA are now available at costs as low as \$16.80 in single-unit quantities. The PM800 series of encapsulated power supplies comes in six models, each providing up to 2.5 W of output power. These units, which are housed in PC-mounting modules, also provide complete line isolation.

CIRCLE NO. 340

Economy servo amplifier supplies 60 W at 20 V



Torque Systems, Inc., 225 Crescent St., Waltham, Mass. Phone: (617) 891-5122. P&A: \$60; stock to 6 wks.

Designed to directly drive dc or ac torque motors, two new servo amplifiers that cost only \$60 can deliver 60 W at either 12 or 20 V. Models PA101 and PA102 have a gain-bandwidth product of 10,000 and a current-limiting feature for short-circuit protection. A plug-in card for adding servo compensation components is also available.

CIRCLE NO. 341

Amplifier/generators consume only 1 mW

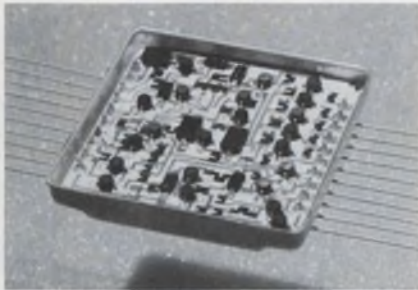

Lansdale Microelectronics, Inc., Advance Lane and Route 309, Colmar, Pa. Phone: (215) 822-0155. P&A: \$95 or \$150; 4 to 6 wks.

Compressing 78 components into a 1.5-in.-square package, new tiny amplifier/pulse-generator units consume only 1 mW of power. Series 9000 devices classify various excitation levels while generating a pulse output. Operating temperatures can range from -50 to $+100^{\circ}\text{C}$ with voltage levels of 5.5 to 35 V dc. These gain-programmable units have generator outputs that interface with low-impedance transducers.

CIRCLE NO. 342

Breadboarding system tests circuit design

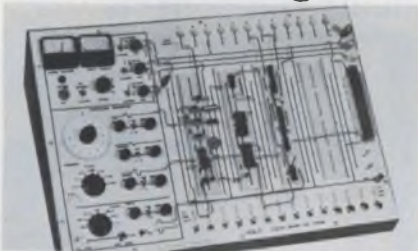

EL Instruments Corp., 250 Maywood Ave., Maywood, N.J. Phone: (201) 845-5476. P&A: \$1300; 60 days.

A new circuit design system allows the layout, testing and construction of breadboards with any combination of components and modules. The Elite 2 accepts all ICs in TO-5 cases, DIPs with 14-, 16-, 24- and 36-pin configurations, transistors, resistors, capacitors and diodes. Built-in components include three power supplies, two generators, a lamp display, switches, pushbuttons, binding posts and connectors.

CIRCLE NO. 343

Self-powered manifold breadboards op amps

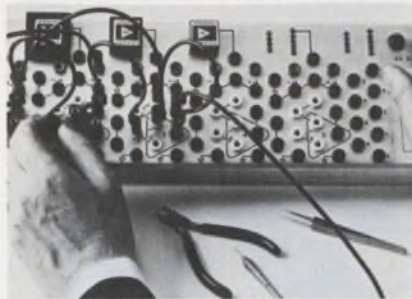

Analog Devices, Inc., 221 Fifth St., Cambridge, Mass. Phone: (617) 492-6000. P&A: \$250; stock.

Up to five operational amplifiers or other modules can be put on a new manifold for breadboarding, experimenting and teaching analog fundamentals. Built into the model 194 manifold is a power supply of ± 15 V at 100 mA. There are five Q-case-type sockets and $3/4$ -in.-spaced banana sockets mounted in an equilateral triangle form to easily accommodate resistors, capacitors, diodes and other components.

CIRCLE NO. 344

Current booster delivers ± 0.5 A



Optical Electronics, Inc., P.O. Box 1140, Tucson, Ariz. Phone: (602) 624-8358. P&A: \$63; stock.

Supplied in an encapsulated package measuring 1-in. square by 0.5-in. high, a new amplifier can deliver an output of ± 0.5 A when used either as a voltage follower or as a current booster in conjunction with an operational amplifier. Model 9682 has a $50\text{-k}\Omega$ input impedance and a 30-MHz bandwidth. Its slew rate is ± 600 V/ μs and its output voltage is ± 11.5 V into a 20- Ω load.

CIRCLE NO. 345

small power

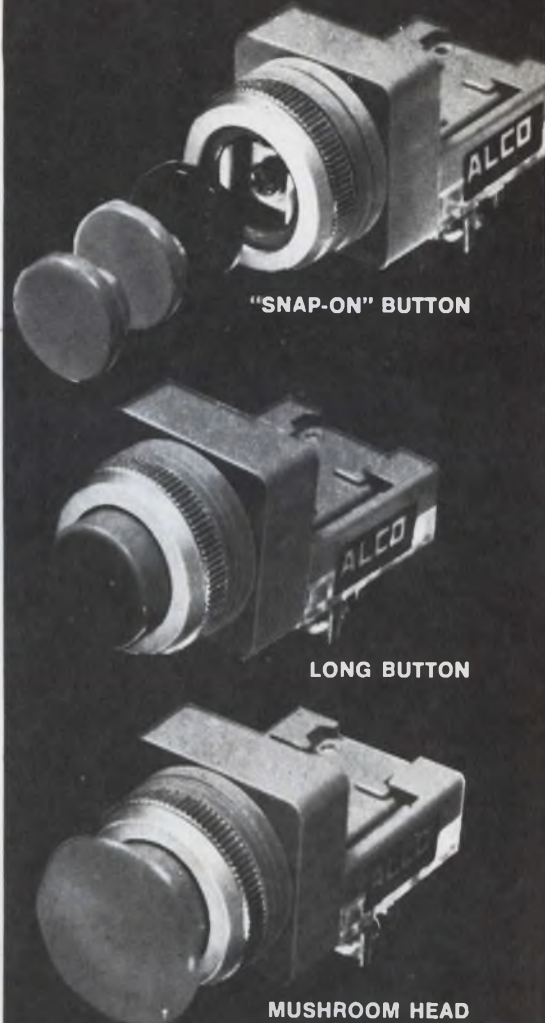

ALCO Power Switches combine compact size, modern appearance, and functional flexibility to meet today's control needs, and mount in a 1" hole.

New, snap-on push buttons simplify selection of colors, shapes and legends.

These versatile switches allow "add on" contact sections for maximum flexibility in switching.

Manufactured from approved materials for stringent requirements. Rated 6 amps @ 230 VAC to handle most power applications.

The low cost of these space-saving power devices will surprise you!

ALCO

ELECTRONIC PRODUCTS, INC.
Lawrence, Massachusetts 01843

Meet the Members of The Board...

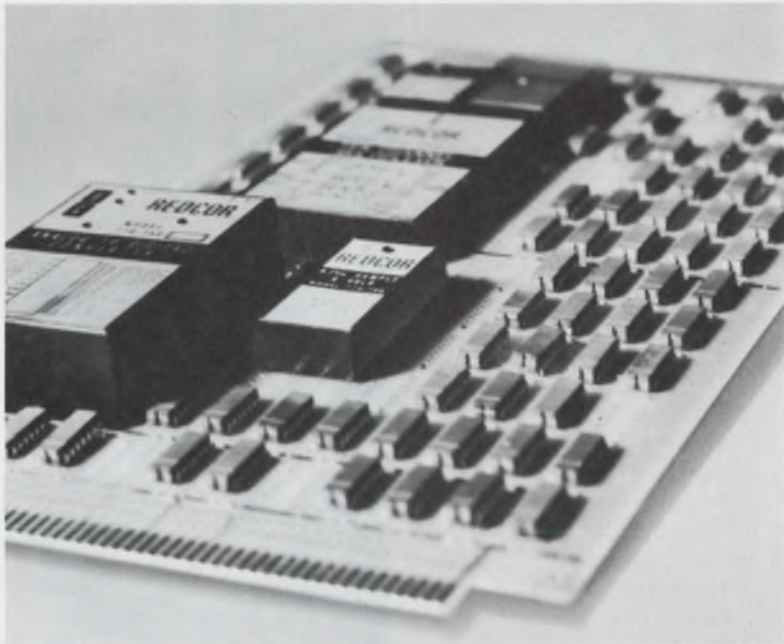

...Dual In-Line Conference

For the successful management of analog circuit design, the designer's board members must have background characteristics based upon dynamic response specifications and a proven performance with known sources and loads. The designer's board members must also have the ability to "fit in" with the others whether they be dual in-lines, discrete or flat-pack components. Our packaging configuration allows the designer this freedom.

The guaranteed performance of REDCOR's closed loop module concept frees the system designer from the concern, risk and expense normally experienced with other analog modules.

To support those special circuit and system design requirements, REDCOR can supply not only the modules, but the boards, chassis, and power supplies.

Analog-to-Digital Converters
Digital-to-Analog Converters
Multiplexers
Sample and Hold Amplifiers
TRICON Fast Settling Amplifiers

BUF-FET Ultra Fast Settling
Amplifiers
Dynamic Bridge Amplifiers
REDIREF Voltage Reference
Supplies
Comparators

REDCOR's board members come prepared to meet any situation. For a complete catalog listing specified performance, write or call:

REDCOR
CORPORATION

Complete Systems Capability / 7800 Deering Avenue, P.O. Box 1031,
Canoga Park, California 91304—(213) 348-5892

INFORMATION RETRIEVAL NUMBER 76

PACKAGING & MATERIALS

Molded sandwich seals guard instrument panels

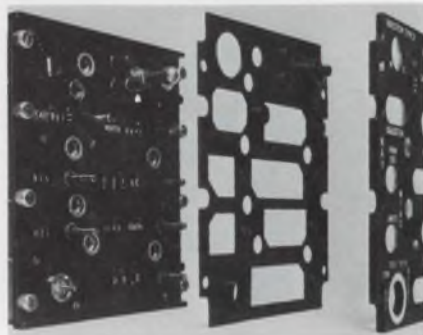

APM-Hexseal Corp., 44 Honeck St.,
Englewood, N.J. Phone: (201)
569-5700.

Providing protection against moisture, dirt, dust, and chemicals without interfering with the operation of panel controls, new full-panel silicon rubber seals fit between the top of an instrument panel and its edge-lighted face plate. These sandwich seals exactly follow the contours of pushbutton and toggle switch nuts, the shafts of rotary controls and other features of an instrument panel's topography.

CIRCLE NO. 346

Pedestal-type tray floats components



Sam Chinkes & Associates, 95
Park Terrace East, New York City.
Phone: (212) 569-8181. P&A: 10¢
typical, plus tooling; one month.

Able to hold small components such as semiconductors and integrated circuits, a new pressure-formed tray features pedestals or platforms that are spaced and dimensioned according to the items to be packaged. Each device rests on its own pedestal, previously coated with pressure-sensitive adhesive suitable to the product.

CIRCLE NO. 347

Conductive epoxy cures at room temp



National Beryllia Corp., Greenwood Ave., Haskell, N.J. Phone: (201) 839-1600.

Providing maximum protection to delicate electronic packages, a new thermally conductive heat-sink compound cures at room temperature in about one-half hour. Berlon E-303 is an epoxy resin that contains approximately 70% (by weight) of beryllium-oxide microspheres. It is supplied as a two-part compound. When cured, its dielectric strength is 300 V/mil.

CIRCLE NO. 348

Room-cure epoxy operates at 210°F

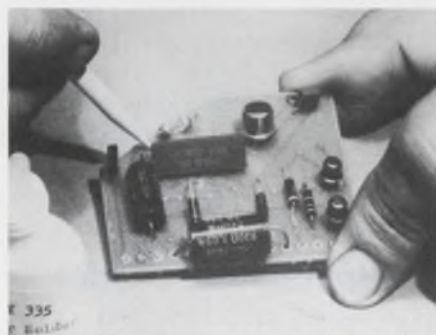

Dynaloy, Inc., 7 Great Meadow Lane, Hanover, N.J. Phone: (201) 887-9270. Price: \$9.50/2 oz.

A new two-component silver-filled epoxy alloy, type 335, cures at room temperature but will operate continuously at temperatures up to 210°F with no electrical drift or migration. It contains no solvents, volatiles, copper, carbon or plated fillers, and has excellent adhesion to ceramic, glass and other substrates. Its volume resistivity is less than 0.01 ohm-cm.

CIRCLE NO. 349

Tiny coax contacts integrate shields

U.S. Components Inc., 1320 Zerega Ave., Bronx, N.Y. Phone: (212) 824-1600.

Specially designed for use with miniature coaxial cables, a new line of shielded coaxial electrical contacts prevents stray signals or radio-frequency noises from causing circuit malfunctions or interference. Actually a contact within a contact, Co-ax contacts can be crimped to eight different sizes of miniature coaxial cables. They also can be intermixed with crimp-type power contacts.

CIRCLE NO. 350

Room-setting epoxy bonds under water

Epoxy Technology, Inc., 65 Grove St., Watertown, Mass. Price: \$10 per 4 oz.

Epo-Tek 201 is a new fast-setting general-purpose epoxy adhesive that cures at room temperature and will bond tenaciously to a wide variety of materials even when submerged in water. Thin films of the two-component compound will set to handling strength within five to ten minutes; after two hours, the lap shear strength reaches 600 to 700 psi. The new formula can also be used as a coating or sealant for glass, ceramics, wood, plastics and metals.

CIRCLE NO. 351

Non-flammable resin ends solvent fumes

3M Co., Adhesives, Coatings and Sealers Div., 3M Center, St. Paul, Minn. Phone: (612) 733-1110.

Designated as Scotch-Grip industrial adhesive 4213, a new water-dispersed crystal-clear synthetic resin adhesive is non-flammable during application and does not give off solvent fumes or objectionable odors. It is ideal for bonding almost all types of materials and provides high strengths and highly flexible bonds between wood, metal, plastics, plastic laminates, and glass.

CIRCLE NO. 352

designer's keyboard

SB-033 — INTERLOCK
SB-034 — MOMENTARY



28.50 User Net

The ALCO modular idea is a simple concept for the design engineer to create his own custom push button layouts from "stock" switch modules and assemblies.

The basic modules allow use of up to twelve (shown at right) switches per section. A designer may stack any number of these switch sections in a group by themselves or in conjunction with the ALCO mating 12-segment keyboard assemblies (shown above).

Highly efficient, single pole "normally open" reed switches are used throughout, thus assuring reliability and extremely long life expectancy.

For design-service assistance and price quotations, call (Area 617) 686-3887.

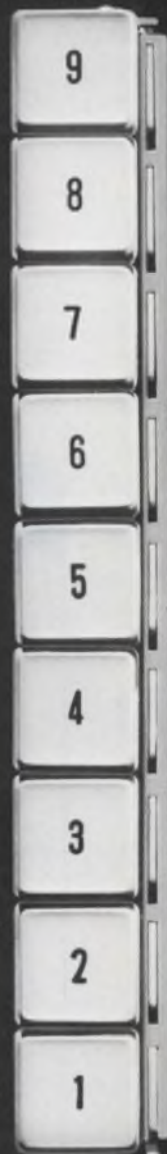
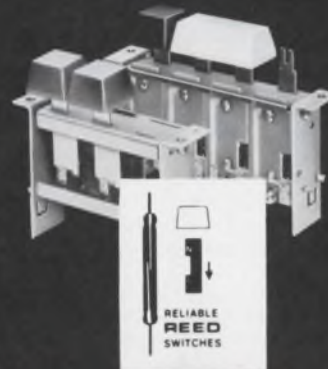

Available as
Momentary
and Interlock

ALCO

ELECTRONIC PRODUCTS, INC.

Lawrence, Massachusetts 01843

SPACE SAVERS!

**BARNES 041 SERIES
PRODUCTION-MOUNTING
SOCKETS FOR MAXIMUM
"TO" TRANSISTOR
PACKING DENSITY**



Want to socket-mount your transistors on P. C. boards? Pack them tightest with the new Space Savers from Barnes. These miniature production-mounting sockets feature extremely low profiles and small diameters for maximum packing density. Double wiping contacts assure reliable electrical contact, positive device retention. Temperature ranges from -55°C to 150°C . The low-cost Space Savers from Barnes: Write or call for free samples and more data.



barnes / THE FIRST WORD IN CARRIERS, CONTACTORS AND SOCKETS FOR I.C.'S

INFORMATION RETRIEVAL NUMBER 78

ECONOMY YOU CAN COUNT ON

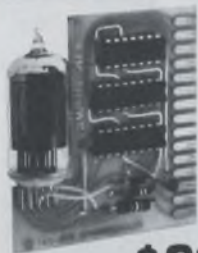

DM507

\$3140*

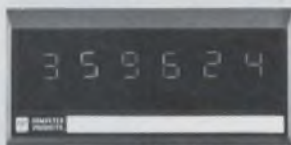

DDP900

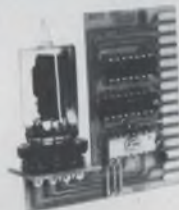

DM647

\$40.40*

DECIMAL COUNTER/DISPLAY MODULES AND ASSEMBLIES

DM647—7-segment incandescent indicator, RCA DR2000 Series, IC decoder/driver, decade counter, storage register. Standard plug-in PC card. TTL & DTL compatible. Decade counter and storage register BCD outputs available externally in both DM500 and 600 series.

DM507—Gas discharge indicator, IC decoder/driver, decade counter, storage register. TTL & DTL compatible. Standard 15-position plug-in card, 0.156" spacing. Amperex Type ZM1000 tube, 0-9 plus decimal point.

DDP800-900—Display Package, maximum 6 7-segment or 8 gas discharge tubes. Computer Products PM700 Series PS. Attractive snap-on bezel front. Behind panel space 6.20"W, 1.75"D, 3.28"H.

MODULE DELIVERY, 5 DAYS ARO . . . COMPLETE ASSEMBLY, 15-30 DAYS ARO

Call or write for complete prices and specs

Computer Products, Inc. • P.O. Box 23849 • Fort Lauderdale, Fla. 33307
Phone: 305/565-9565



COMPUTER PRODUCTS..
FORT LAUDERDALE

INFORMATION RETRIEVAL NUMBER 79

PRODUCTION

Lead bender and cutter simplifies operation

Electronic Tool Co., 3324 White Plains Rd., Bronx, N.Y. Phone: (212) 231-7760.

Offering accurate and easy loading and trouble-free cam action, a new cutting and forming tool provides burr-free operation coupled with smooth and even performance. With its interchanging dies, model 8001 can handle flatpacks, transistors or resistors. It is a lightweight portable tool that gives precision bends and cuts without injuring components.

CIRCLE NO. 353

Flatpack tool trims precisely

Mil-Tronic Tools, P.O. Box 303, Bethpage, N.Y.

Clamping, bending, and precision trimming of flatpack leads can be easily accomplished with a new flatpack bending and forming tool. This is accomplished by complete mechanical isolation of the lead from the component body before the forming and trimming sequence. It is said that model BCF 1-101 totally eliminates the human error factor in the forming and trimming of flatpack leads.

CIRCLE NO. 354

Flatpack lead bender handles diodes too

Techni-Tool, Inc., 1216 Arch St., Philadelphia, Pa. Phone: (215) 568-4457. Price: \$420.

Providing smooth, even and burr-free bending and cutting of leads, a new flatpack lead bender can also be used to trim and form transistors and diodes. The new tool, model 4920, features interchangeable dies, with additional dies costing only \$165 each. Trouble-free cam action and easy loading of components are other features of this hand-operated machine.

CIRCLE NO. 355

Component hand tool forms and measures



Pace, Inc., 9337 Fraser St., Silver Spring, Md. Phone: (301) 587-1696. Price: \$14.95.

ComForm I is a complete new component forming and measuring system, which fits in the palm of the hand, and makes leads conform to proper hole-to-hole spacing for all axial-lead components, while compensating for lead thickness and stress relief loops. The new system also bends all sizes and shapes of axial-lead components for horizontal and vertical mounting, while preventing the formation of stresses at lead seals.

CIRCLE NO. 356

Fiber-optic director guides device insertion



Hollis Engineering, Inc., Nashua, N. H. Phone: (603) 889-1121.

Using fiber optics to provide visual instructions to the operator, Optoline assembly director automates printed circuit board component insertion processes. When the operator places a printed circuit board over the readout panel, a set of instructions for component placement is dictated by light positions. The unit may be easily programmed for initial assembly, repairing, final assembly, or for any number of printed circuit boards.

CIRCLE NO. 357

Soldering tool doubles heat action

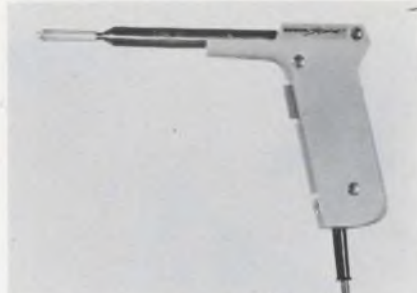

Edsyn Inc., 15954 Arminta St., Van Nuys, Calif. Phone: (213) 989-2324.

Combining the advantages of a soldering iron and a soldering gun, the Ersa Sprint is a 150-W lightweight soldering tool. It features a fast 10-second warm-up with the normal operation consumption reducing to approximately 80 W for continuous soldering. This action is achieved by dual heating elements that are connected in series. The new 7-oz tool fits comfortably in the hand.

CIRCLE NO. 358

Technician's knife kit offers flexibility

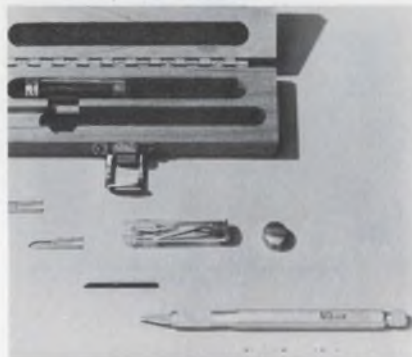

über Grafic Instruments, P.O. Box 4, Palo Alto, Calif.

Skiver rear-clutching technician's knife is now available in a fitted hardwood instrument case providing space for the knife and two vials containing a variety of blades with configurations useful for varied industrial purposes. The new kit has foam-plastic inserts that secure the tool and blades against motion and damage in handling and storage.

CIRCLE NO. 359

press... action

Press small buttons to control heavy currents with a compact ALCOSWITCH! Snap-action mechanisms allows quick make-and-break along with solid silver contacts for efficient switching capabilities.



NEWEST

Alco development—the illuminated push button Type MSPN is made to handle heavier currents. Over 50 varied buttons in colors and sizes to fit your specific applications. DPDT only. 6 amps @ 125 VAC.



NEW

"Mustang" features a miniature body with a standard 15/32" bushing and colored button. High impact case. Extra wide silver contacts. DPDT only. 6 amps @ 125 VAC.



WATERPROOF

"E Series" made to specifications exceeding industry standards. Miniature in size, and yet rugged. Available as momentary, or Push-ON or Push-OFF. In one, two and 4PDT models. 6 amps @ 125 VAC.



ORIGINAL

Alco snap-action MSP push buttons are our smallest, lightweight models. SPDT and DPDT. Rated 5 amps @ 125 VAC. Lightweight models. SPDT and DPDT. Rated 5 amps @ 125 VAC.

ALCO

ELECTRONIC PRODUCTS, INC.

Lawrence, Massachusetts 01843

Evaluation Samples

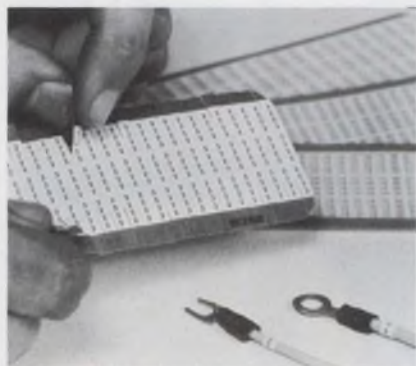

Small-wire labels

Able to identify small-diameter wires (up to 5/32-in. OD), E-Z Code adhesive-backed wire markers are designed for maximum around-the-wire legend visibility. They are available with number legends, letter legends, solid or in sequence; standard printing is black on white. These markers are produced on waterproof fabric tape and are resistant to temperatures as high as +300°F. Free evaluation samples are available. The Thomas & Betts Co., Inc.

CIRCLE NO. 360

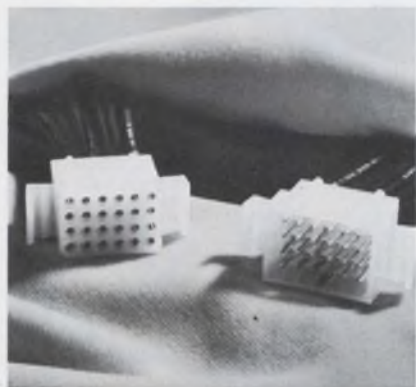

Miniature connector

Expanding an already extensive product line, a new 24-circuit miniature connector offers a nylon body with integrally molded mounting ears on both the plug and receptacle. Designated the 1625-24, the unit accepts crimp-type terminals, which are available in tin-plated brass, phosphorus bronze, and gold- or silver-plated brass. Applications for the new connector include business machines, computers, home entertainment units, and appliances. Molex Products Co.

CIRCLE NO. 361



Special lint-free paper

Ideal for the cleaning of delicate electronic parts, wrapped storage of optical components, and the cushioning of fragile instruments, a lint-free super-absorbent paper is soft and pliable, yet maintains its high strength, even when completely wet. Microwipes can be used with water and solvents without effecting their strength. Their content is 100% cellulose with a smooth non-abrasive finish that permits cleaning the most critical glass surfaces without damage. Each sheet is 8-1/2 by 11 in. in size. An evaluation sample is available free. The Texwipe Co., Inc.

CIRCLE NO. 362



Microwave contacts

Providing minimum inductance and positive contact force, new bellows contact springs for microwave and other applications can keep insertion loss to an absolute minimum. Outside diameters for this new line of contacts run from 0.037 to 0.245 in; bellows lengths range from 0.04 to 0.15 in. Both off-the-shelf units and custom sizes and designs are offered. A free evaluation sample of a typical contact spring is available. Servometer Corp.

CIRCLE NO. 363



Self-laminating markers

Shielding against abrasion, oils, and moisture, a new line of self-laminating wire markers keep legends permanently legible, without signs of wear. The printed legend portion is applied to the wire; a transparent section then wraps over the legend to form a clear tough cover. There are three styles available: half-length (7/8-in. long) markers identify wires up to 0.16-in. OD; full length (1-3/4-in. long) markers for wires up to 0.318-in. OD; and Porta-Pack Markers for cables up to 1.6-in. OD. W. H. Brady Co.

CIRCLE NO. 364



Releasable ties

Sta-Strap harness ties, clamps and marker ties feature this advantage: They can be released by hand prior to tool installation or final tightening by hand. The head of the harness tie is simply moved down, allowing the wedge end to be pulled away from the lead end of the cable tie. This permits easy adjustments in the harness, allowing the tie to be moved for revisions. These all-nylon, self-locking devices come in various sizes for harnesses up to 8-in. diameter. A free sample is available. Panduit Corp.

CIRCLE NO. 365



**Model 630-A
Laboratory V-O-M**

1. $\pm 1\frac{1}{2}\%$ DC, $\pm 3\%$ accuracy.
2. One selector switch minimizes chance of incorrect settings and burnouts.
3. Rugged $5\frac{1}{2}$ " suspension meter movement with $4\frac{1}{2}$ " mirrored scale. \$71 suggested USA user net price



**Model 630-APL
Laboratory V-O-M**

1. $\pm 1\frac{1}{2}\%$ DC, $\pm 3\%$ accuracy.
2. One selector switch minimizes chance of incorrect settings and burnouts. Polarity reversing for DC.
3. Suspension meter movement diode protected against instantaneous overloads. \$71 suggested USA user net price

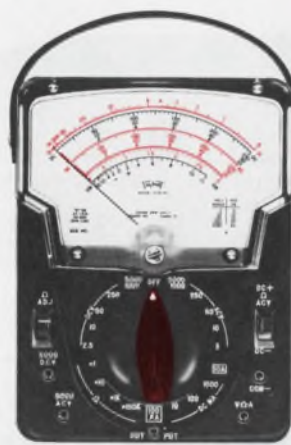

**General Purpose V-O-M
Model 630-PL**

1. One selector switch minimizes chance of incorrect settings and burnouts. Polarity reversing for DC.
2. 4.4 Ohms center scale, 0.1 ohm to 100 megohms resistance.
3. Meter movement diode protected against instantaneous overloads. \$61 suggested USA user net price



**General Purpose V-O-M
Model 630**

1. One selector switch minimizes chance of incorrect settings and burnouts.
2. 4.4 Ohm center scale, reads from 0.1 ohm up to 100 megohms resistance in 4 ranges.
3. 20,000 ohms per volt DC sensitivity; 5,000 AC. \$61 suggested USA user net price

Laboratory or General Purpose Triplett meets the need precisely

Products of Triplett's long experience in the design and manufacture of high-quality, high-performance V-O-Ms, these representatives of the great Model 630 series offer the most-wanted features combined as perfectly as the skills of dedicated craftsmen can guarantee.

See your Triplett representative or distributor for a free demonstration of any or all of these versatile instruments.



MANUFACTURERS OF THE WORLD'S MOST COMPLETE LINE OF V-O-Ms

INFORMATION RETRIEVAL NUMBER 81



Specify AUSTRON LORAN-C to CALIBRATE FREQUENCY/SET TIME

Loran-C from Austron is your best solution to calibrating precision frequency standards and setting local clocks. Austron's Model 2000 Loran-C Tracking Receiver calibrates rubidium standards *in two hours*, eliminates expensive portable clock trips.

Whenever time and frequency are important, consider the benefits of Loran-C systems from Austron. Write for detailed data sheets and application note.

Visit our NEREM Booth 1F13 for a demonstration.



10214 NORTH INTERREGIONAL HIGHWAY, AUSTIN, TEXAS 78753 TELEPHONE (512) 454-2581
INFORMATION RETRIEVAL NUMBER 82

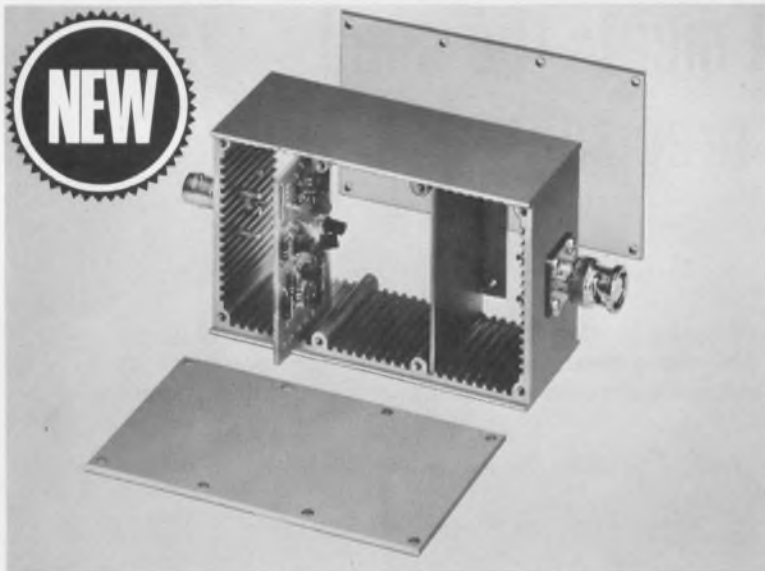

SHIELDED BOXES with CARD GUIDES

Rugged die-cast aluminum boxes, slotted to accept $\frac{1}{8}$ " circuit boards and shielding dividers. Excellent for packaging electronic circuitry. Boxes have removable top and bottom covers. Useable inside space: 4"x2"x1 $\frac{1}{2}$ ". Several models with various connectors.

Write for 1969 Catalog



POMONA ELECTRONICS CO., INC.
1500 E. Ninth Street, Pomona, California 91766

INFORMATION RETRIEVAL NUMBER 83

Design Aids



Communications calculator

Quick and accurate solutions of many of the problems encountered by radio communication engineers can be achieved with a new 8-in. circular slide rule. Such variables as line-of-sight distances, path loss, signal strength, and signal-to-noise ratios can be determined without pencil, paper or tables. This radio communications calculator is also valuable in solving multiplexing problems. The new calculator's price of \$10 includes an instruction manual and shipping charges. Aeronautical Radio, Inc.

CIRCLE NO. 366

Tape color charts

Three useful charts illustrate the wide variety of colors now available for industrial tapes. The charts reproduce colors like red, yellow, green, blue, gold, gray, maroon, black, and white. Type C-520 is a cloth/adhesive tape with polyethylene film laminate for high moisture resistance. Type C-504 is a vinyl-coated cloth tape with excellent scuff resistance. A pressure-sensitive vinyl tape, type C-320, has four-mil vinyl film backing with a high-hold adhesion of 25 ounces per inch. Arno Adhesive Tapes, Inc.

CIRCLE NO. 367

Plastics guide

A new chart-form selection guide on Kralastic ABS plastic compounds is now available. The physical, chemical, thermal and electrical properties of these tough materials are charted, along with their processing characteristics. The compounds are claimed to rival steel in their range of applications for automotive, appliance, electrical and other industry uses. Uniroyal Inc., Chemical Div.

CIRCLE NO. 368

Pay 25% Less* and get 500% Greater Reliability

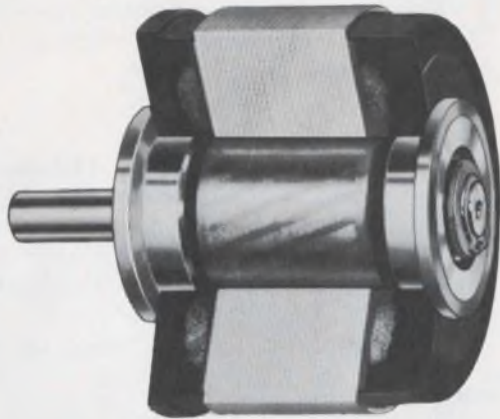

with CEDAR'S New JETLINE Servo Motor

No one else offers
so many features designed to increase
reliability and lower cost.

FEATURE	ADVANTAGE
FILLED-EPOXY MOTOR BODY	SIMPLICITY OF DESIGN (FEWER PARTS) • LOWERS COST
FULL-DIAMETER STATOR	NO METAL HOUSING • STATOR IS FULL DIAMETER OF THE MOTOR • ALLOWS MORE ROOM FOR THE WINDINGS
MACHINE-WOUND STATOR	ELIMINATES HAND INSERTION OF COILS • ASSURES HIGHEST RELIABILITY • LOWERS COST
LARGE FLANGED BEARINGS	DISSIPATE HEAT FASTER • RUN COOLER TO PROTECT THE LUBRICANT • OUTLAST CONVENTIONAL MOTOR BEARINGS
MOLDED STATOR INSULATION	CONTROLS INSULATION THICKNESS • ELIMINATES THIN SPOTS IN CRITICAL AREAS
SINGLE-DIAMETER BORE	ELIMINATES CONTAMINANT TRAPS INSIDE MOTOR
AVAILABILITY	STANDARD SIZE 8, 10 AND 11 MOTORS FROM STOCK • SPECIALS ON REQUEST
PRICE	LOWEST IN THE BUSINESS • *FROM \$16.50 EACH



Size 8 Jetline
Shown Full Scale

JETLINE Motor-Tachs to be available soon.

Digital Indicators • DC Low Inertia Motors • Stepper Motors • Stepper Drive Circuits • DC Torquers • Rotary Solenoids • AC Motors • Motor-Tachs • Resolvers • Accelerometers • Synchronous Hysteresis Motors • LVDTs • Motor Gear Heads • Subminiature Rate Gyros • Synchros • Servo Packages • Servo Motors

CEDAR CONTROL DATA
DIVISION CORPORATION

5806 West 36th Street, Minneapolis, Minn. 55416
Phone: 612/929-1681

INFORMATION RETRIEVAL NUMBER 84



Ultra Compact Rotary Switch 1/2" does a man-sized job

Rugged rotary outperforms its nearest competitors by the widest of margins, gives you man-sized performance at a bargain price. Don't believe it? Compare:

FEATURES	OAK 1/2" SWITCH	BRAND "A" SWITCH	BRAND "B" SWITCH
Double-wiping contacts	Yes	No	No
1/2" Diameter	Yes	Yes	Yes
Multiple Decks	Yes	No	Yes
P. C. Capability	Yes	Yes	Yes
Tri-Ball Detent	Yes	No	No
Adjustable Stops	Yes	No	No
Designed to Meet Mil-S-3786/19	Yes	No	No
Available through Electronic Distributors	Yes	No	No
COMPARE!	OAK LOWEST in Cost	Cost is 60% HIGHER	Cost is 140% HIGHER

GET OAK QUALITY PLUS THE
LOWEST PRICE IN THE INDUSTRY

For full details on the sub-miniature switch that does more, write today for Bulletin SP-299.



OAK MANUFACTURING CO.
A Division of OAK ELECTRO/NETICS CORP.
Crystal Lake, Illinois 60014
Phone: 815-459-5000 TWX: 910-634-3353

INFORMATION RETRIEVAL NUMBER 85

Annual Reports

Learn how to read annual reports in "How to investigate a company." For a copy, circle no. 474.

Advanced Computer Techniques Corp., 437 Madison Ave., New York, N.Y.: computer product services; net sales, \$2,475,068; net income, \$96,089; assets, \$1,616,192; liabilities, \$586,542.

CIRCLE NO. 369

Astrodata, Inc., 240 E. Palais Rd., Anaheim, Calif.: computer and data systems, instrumentation; sales, \$21,862,000; net income (loss), \$164,000; assets, \$10,624,000; liabilities, \$5,775,000.

CIRCLE NO. 370

Electro/Data, Inc., 1621 Jupiter, Garland, Tex.: high-frequency components, receivers and antennas; net sales, \$354,203; net income, \$43,202; assets, \$150,948; liabilities, \$45,303.

CIRCLE NO. 371

ITT Corp., 320 Park Ave., New York, N.Y.: telecommunications, industrial and consumer products, defense; sales, \$4,066,502,000; net income, \$192,404,000; assets, \$4,022,400,000; liabilities, \$2,370,308,000.

CIRCLE NO. 372

National Beryllia Corp., Greenwood Ave., Haskell, N.J.: beryllium oxide products; net sales, \$3,008,000; net earnings (loss), \$245,000; current assets, \$1,523,000; current liabilities, \$874,000.

CIRCLE NO. 373

VRW United Corp., 1600 Norton Bldg., Seattle, Wash.: chemicals, science, foods, home furnishings; sales, \$195,540,955; net income, \$3,974,723; assets, \$51,809,090; liabilities, \$19,603,010.

CIRCLE NO. 374

PUSH-IN TERMINALS

NEW MICRO-KLIP

TURNED TYPE TERMINALS

EYELETS

For holes .042", .062", .093" diameter

CUT CONSTRUCTION DELAY

T32A

Fits .093" holes
T32A-1 fits .062" holes

Solderless

USE VECTOR ZIP PUSH-IN TERMINALS, INBORD PINS, CUP RECEPTACLES

Quickly installed, easy to use Vector zip push-in terminals and inbord pins cut construction time and cost in many ways while providing reliable connections. Solderable and solderless terminals are available. They are designed for versatility and accept most wire sizes used in electronics. By inverting the new T42-1 Micro-Klip terminal and inserting it in "P" Pattern Micro-Vectorbord, it serves as a useful mounting device for D.I.P.'s. These terminals normally need no staking. Space saving Inbord Pins may be inserted in boards as required and function as component terminals or male connector pins. Hand insertion tools are available for all push-in terminals and inbord pins. Production type staking tools are available for turned type terminals. Vector also has eyelets, and hand staking tools.

Cup receptacles may be mounted anywhere and accept Inbord Plug Pins (.040"), Vector Edge-Pins, or any .040" diameter pin of proper length. Edge Pins attach to board edges to make Plug-In Cards.

INBORD PLUG PINS

For .025" and .042" dia. holes
Various lengths available

Pin Plug .040" diameter

Cup receptacle

T30N-2

Fits .093" holes

EDGE PINS

K23A & K25

* TM

Vector ELECTRONIC COMPANY, INC.
12460 Gladstone Ave., Sylmar, Calif. 91342

INFORMATION RETRIEVAL NUMBER 86

NEW HERMETIC TINY - PAK™ 741 & 201 OP AMPS

For Hybrids and Miniature Construction.

Actual size

New TINY-PAK™ OP AMPS by MINI-SYSTEMS, INC. provide guaranteed electrical performance in a miniature hermetic flat pack much smaller than any now available in the industry. The diameter of this package is approximately twice the maximum dimension of IC OP Amp dice.

This package has been perfectly tailored to the chip, thus maintaining its "size advantage" and at the same time providing ideal environmental protection. Standard lead spacing of .050" eliminates the need for special equipment and skills in handling, testing and mounting. Each TINY-PAK™ OP Amp is thoroughly tested for compliance with device specifications and further screened for abnormally high noise and capacitive loading instability. This provides a bonus in performance in reliability.

TINY-PAK™ OP Amp leads can be bent for insertion into PC boards or soldered.

Applications include all those of conventional "101" and "741" types, plus those now made possible by the miniature size of the TINY-PAK™ package. MS101, MS201, MS741 and premium selected MS741X, IC OP AMPS are available from stock. Other types are available on special order. e.g.: (LM)100, (LM)101A, (LM)107 & (LM)108. Price: \$9.50, "201" or "741C", quantity 1-24. f.o.b. North Attleboro, Massachusetts. For further information, write or call:

MINI-SYSTEMS, INC., P.O. Box 429, North Attleboro, Massachusetts 02761 (617) 695-0206

INFORMATION RETRIEVAL NUMBER 87

big cooling little blowers



TYPE	POWER	DIA.	RATED OUTPUT
VAX-1	a.c. or d.c.	1 1/8"	to 10 cfm @ .6" H ₂ O
VAX-2	a.c. or d.c.	2"	to 50 cfm @ 2.1" H ₂ O
VAX-3	a.c., d.c. & a.c./d.c.	3"	to 105 cfm @ 3.3" H ₂ O
PAX-3	a.c.	3 3/8"	to 120 cfm @ 0" H ₂ O

Stocked now and priced right—that's Globe's new deal on popular sizes of high performance blowers. If you use units like these for MIL-spec cooling applications, check your local Globe/TRW distributor today—Cramer in the east and south, EMC in the midwest, Hall-Mark in central and southern, Hamilton in the west. Save time and money. Request your copy of new Globe catalog today.

GLOBE INDUSTRIES DIVISION OF TRW INC
Dayton, Ohio 45404 513-228-3171



INFORMATION RETRIEVAL NUMBER 88

Here's A Switch Fast Response... No Bounce

The MERCUTRON SWITCH effectively combines the mechanical advantages of a snap-action switch with the electrical properties of a mercury switch. It is a miniature switch of unique and simple design relying on mercury movement in a flexible sealed tube for fast response with no bounce, perfect for direct switching of solid state circuits. Actuating a plunger simultaneously releases a pinch in the tube and "pumps" the divided mercury together to close the normally open circuit. A simple cricket spring in direct contact with the tube provides the snap-action.

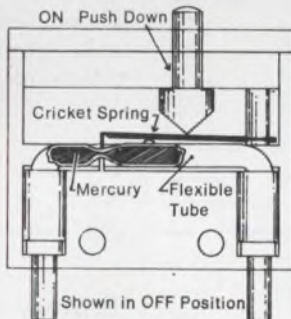

Switching Capacity	60 ma @ 24 VDC
Contact Rise Time	< 1 × 10 ⁻⁹ seconds
AC Contact Noise	10 Microvolts
Bounce Time	Zero
Maximum Cycling Rate	200 Hz
Life at Rated Load	250,000 cycles
Operating Temperature Limits	-30°C to 60°C
Shock Resistance	30 G's min.

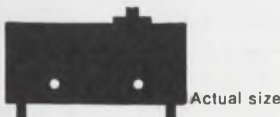

Actual size



For further information write or call
MECHANICAL ENTERPRISES

3127 Colvin Street, Alexandria, Virginia 22314, (703) 549-3434

INFORMATION RETRIEVAL NUMBER 89

ELECTRONIC DESIGN 22, October 25, 1969

Fall Joint Computer Conference



The
First Family*
invites you

to a reception to be
held at the Sahara Hotel
Las Vegas, Nevada
November 18th through
20th, 1969.



*Meet the first family at Booth No. 30005

INFORMATION RETRIEVAL NUMBER 90

155

C-COR AMPLIFIERS

— PULSE — Fast Rise-Time for

- High Resolution Video
 - Nuclear Instrumentation
 - Laser-Optics
 - Digital Computer Design
- 1 nS to 10 nS Rise times
5 Hz Response
12 V Peak, 50 Ω Load
Matched In/Out Impedances
\$95 — \$775

— FAMILY FEATURES —

- Low Frequency Response
- Output thru $\pm 25V$ Peak
- High Gain 20 thru 60 dB
- Spin-offs from AEC/NASA Advanced Design Projects
- Missile Reliability
- Adjustable Gain in Some Versions

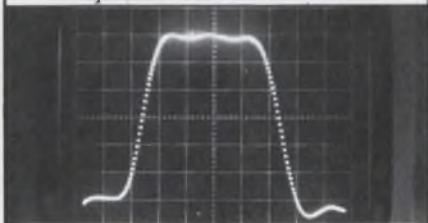

1 nS Response (10-90% levels)
Rise Time of a 5 nS Positive Pulse
Oscilloscope: Tektronic 561-B
Vertical: 200 mV/cm.
Horizontal: 1 nS/cm.

EXAMPLES

R.T.	Gain	Output	Model
1 nS	23dB	$\pm 6 V_p$	3010-AP
2 nS	40dB	$-6 V_p$	3364-G
3 nS	20dB	$+4 V_p$ $-8 V_p$	3329-F
4 nS	60dB	$+4 V_p$ $-8 V_p$	3388-F
5 nS	20dB	$\pm 1\frac{1}{2} V_p$	3518

Select from 17 models off-the-shelf.
"C-COR Amplifiers . . . Rated First
Where Performance is Rated First."

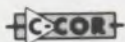

C-COR

ELECTRONICS, INC.

60 Decibel Road
State College, Pennsylvania 16801
814 238-2461

Application Notes



TTL IC manual

Detailing three series of integrated circuits (series 54/74, 54H/74H and 54/74L), a 424-page design handbook gives mechanical data, competitive cross-reference guides, design guidelines and TTL loading data. The collection of data sheets covers more than 90 distinct functions, including 35 medium-scale ICs. The MSI functions listed are data selectors/multiplexers, decoders, memories/latches, shift registers, counters, parity generators/checkers, and arithmetic elements. Texas Instruments Inc.

CIRCLE NO. 375

Motor handbook

Describing a full line of induction, synchronous, and torque motors, a new 88-page handbook contains a thorough explanation of motor design and operation. In its "Designer's Motor Selector" section, the new guide presents such useful information as selection factors and applications data. There are drawings, curves, performance data, and electrical and mechanical specifications given for more than 2000 motor designs. These include 15 different frame sizes, ranging from size 7 (0.75-in. OD) to size 46 (5.375-in. OD). Power ratings cover 1/5000 to 3 hp; torque can be as high as 510 oz-in. IMC Magnetics Corp., Marketing Div.

CIRCLE NO. 376



Thermistor guide

Designed specifically to assist engineers in the use of thermistors operated in the self-heat mode, a new 20-page thermistor E-I curve manual presents a complete story including detailed graphs, charts, working tables, and practical problems with solutions and/or answers. Thermistors suitable for use in this mode are listed along with their voltage-current (E-I) curves. Reference to these curves simplifies the selection of the proper thermistor and allows for the computation of other circuit parameters. The manual is available to qualified engineers. Fenwal Electronics Inc., Div. of Walter Kidde & Co., Inc.

CIRCLE NO. 377

Battery theory

Outlining applications for sealed nickel-cadmium batteries, a four-page article reprint runs through the general characteristics of the nickel-cadmium battery, like voltage, charging, temperature, charge retention, energy and power capabilities, and cycle life. It also illustrates an inside view of a sealed nickel-cadmium cell and contains a table on operating characteristics versus application considerations. Sonotone Corp., Battery Div.

CIRCLE NO. 378

We give it to you straight! If our new Tru-Glide® Slides didn't slide that way we would have given them another name. Honest!



Being conscientious, upright people, we simply couldn't have devised a brand new ball bearing steel slide that wouldn't have been approved by Mother. We named it "Tru-Glide" because it slides so good and so precisely. And even though we have priced it right down in the small change category you can be sure it's an OK slide. Not cheap, just inexpensive. Applicable to hundreds of design situations where space allotments are minimal and where quality action and ease of movement are of special importance. And where low cost is a factor! A big one.

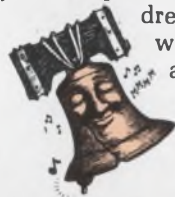

Yes, Tru-Glide is a hum-dinger. A bell ringer. A true blue MADE IN THE USA slide. We hope it wobbles your clapper. How can we make such a good all-purpose industrial / commercial / etc. slide? Well, let us remark that it's not exactly easy. Six years ago we had the basic design. Since then, we've come up with some completely new concepts in part fabrication (our parts), including a whizzer of an electronically-controlled production system that assures close tolerance, volume runs. Here at Jonathan we've had plenty of practice in this sort of thing. We keep on producing our famous Thinline extruded aluminum slides that gave us our shiny bright reputation in the first place. And our respected Ultrathin steel slides that we also produce for defense, aerospace and other sophisticated-type applications. We just keep

doing our best. Tru-Glide slides come in 150 lb. capacity Type 310 three-section ($\frac{5}{8}$ " wide x 2" high) or 100 lb. capacity Type 311 two-section ($\frac{15}{32}$ " wide x $1\frac{5}{8}$ " high) versions, with or without mounting brackets. Lock-out in "open" position or disconnecting models are optional. Both models are available in standard lengths and travels, based on 2" increments. The mo-o-o-ving mechanisms are free-riding, precision-placed steel ball bearings contained in special rigid vinyl ball retainers. Lubricated bearings. Trouble-free multi-thousand cycling. Tru-Glide slides make designers happy. Just right for computers, business machines, office copiers, appliances, desks and equipment, audio/visual systems, medical-dental equipment, good furniture, telephone systems and vending machines.



for instance. Or send along your special problems — we love 'em! So remember "Tru-Glide," an honest name for a straight-forward slide. An OK slide. Built by mothers' sons' — everyone of them!

© 1989, Jonathan

(left, Type 310; right, Type 311)



INFORMATION RETRIEVAL NUMBER 92

Clip, mail to: **Jonathan Mfg. Co.**
1101 S. Acacia,
Fullerton, Ca. 92631.

Quit fooling around, send facts.

NAME _____ TITLE _____

ADDRESS _____

CITY _____

STATE _____ ZIP _____



Silicon High Voltage Rectifiers



Available in production quantities now!

5KV — 50 KV		1000 PC PRICE
VF*	PIV	
VF5-5	5KV	\$1.08
7	7KV	1.15
10	10KV	1.32
12	12KV	1.49
15	15KV	1.55
20	20KV	2.00
25	25KV	2.50
30	30KV	3.00
40	40KV	4.00
50	50KV	5.00

*Fast recovery available at small additional cost. Also available in 10mA and 25mA ratings.



SEMICONDUCTOR DIVISION 1000 N. SHILOH ROAD, GARLAND, TEXAS 75040 (214) 272-4551

INFORMATION RETRIEVAL NUMBER 93

New Literature

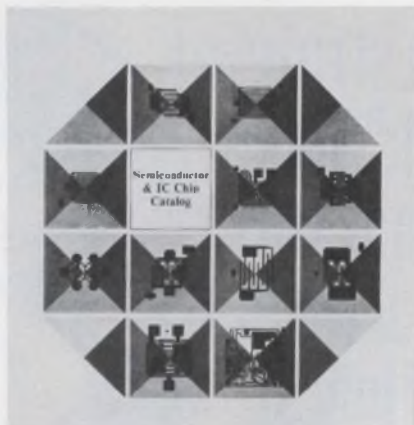

IC chips

A new semiconductor and IC-chip catalog describes silicon chips and wafers, and lists 13-separate categories of transistors and ICs by type numbers and important parameters. Fifteen chip-die diagrams are illustrated with size and thickness information. The catalog also covers parameter testing, shipping package information, AQL levels, and special services for specific customer needs. Union Carbide Corp., Semiconductor Dept.

CIRCLE NO. 379

Small tools

A new 16-page catalog details small tools for the communication, telephone and electronic industries. Covered are such items as adjuster tools, kits for numbering, lettering, and adjusting relays, contact burnishers, spring tension and thickness gauges, cable and wire tools, special wrenches and screwdrivers. P. K. Neuses, Inc.

CIRCLE NO. 380

Power supplies

Series 200, 1000, 2000 and 5000 high-voltage dc power supplies are described in a new 12-page catalog. The units have outputs up to 120 kV with currents as high as 200 mA and maximum power levels of 3 kW. Their ripple is 0.003% rms and regulation is $\pm 0.05\%$ for line or load changes. Raytheon Co., Sorensen Operation.

CIRCLE NO. 381

Glass fiber optics

Flexible glass fiber optics applications and product descriptions are given in a new eight-page illustrated booklet. Applications include lighting systems and fluid level monitoring in automobiles and trucks; indicator lights in autos and on entertainment units and various household appliances; light sources for dental and medical probes; and punched card or tape reading units. Presented is an illustrated technical summary of the operating parameters of standard fiber-optic bundles, description of end finishing capabilities, and outlines applications. Corning Glass Works.

CIRCLE NO. 382

Digital/analog blocks

A new line of solid-state digital and analog instruments is contained in a two-color eight-page catalog. Four pages describe and specify a line of solid-state bi-directional, frequency, variable-time-base and preset counters, as well as counter timers and the latest digital printer. Included are 13 counter illustrations and 40 standard and special counters. The other four pages are devoted to frequency to dc, frequency to frequency and dc to frequency converters; frequency indicators, deviation indicators and detecting switches. Included are 14 illustrations. Anadex Instruments Inc.

CIRCLE NO. 383

Semiconductor devices

Now available to aid engineering personnel and purchasing agents is a 24-page catalog covering a complete line of standard semiconductor products. The devices include semiconductor chips for use in thick- and thin-film hybrid microcircuits, zener diodes in microminiature packages, and solar cells for terrestrial photovoltaic sensing devices. Centralab Semiconductor Div. Globe-Union Inc.

CIRCLE NO. 384

Specify molded aluminum electrolytics for long life, quality, economy.

The best bargain in performance and value available. That's what you get when you use Mallory molded-case, aluminum-electrolytic capacitors in your circuit applications.

The remarkably good electrical characteristics of these capacitors result from a unique combination of quality materials and construction skills. Outstanding economy is made possible by Mallory's exclusive automated molding processes.

These molding techniques produce a moisture-proof, leak-proof, neat-appearing case of uniform size. The lead wires are uniformly positioned and spaced. And for the printed-circuit type (MTV), stand-off mounts are integrally molded to the case to assure mounting rigidity.

Mallory offers three types of tubular, molded-plastic, aluminum-electrolytic capacitors. Each type consists of a high-purity, aluminum-foil cartridge impregnated with a high-performance electrolytic system. The aluminum-foil

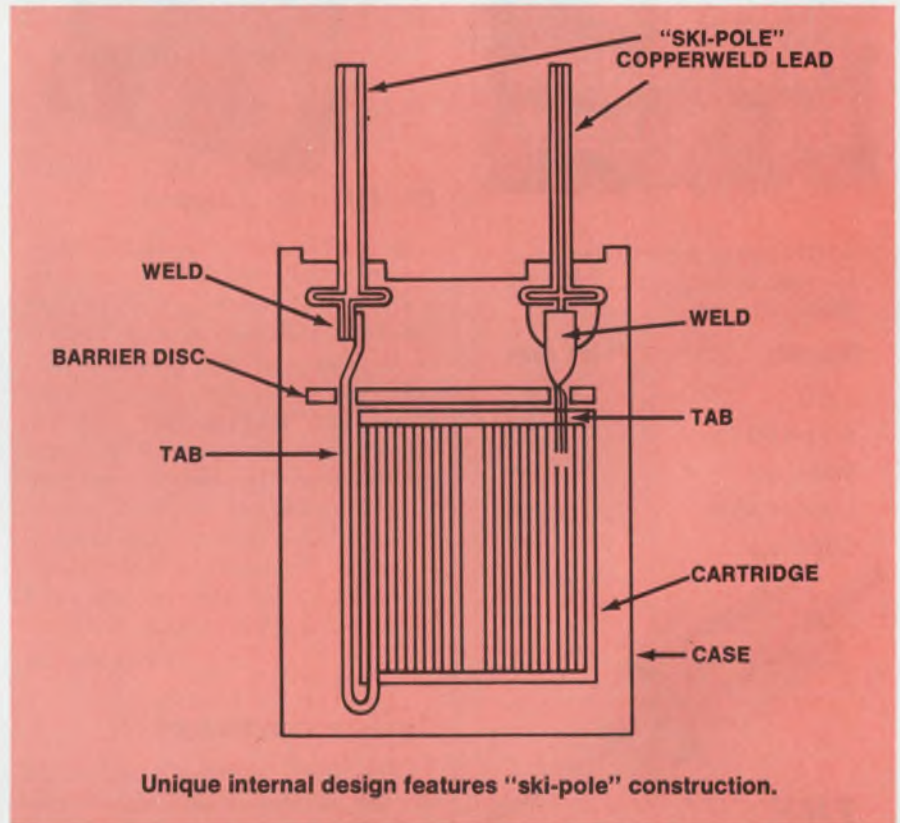

tabs are welded to the external lead wires. The cartridge is mounted and molded integral with the plastic case material.

Type MTA is an axial-lead, tubular-electrolytic available in several case sizes. The diameter range is $\frac{5}{16}$ ", $\frac{3}{8}$ ", $\frac{1}{2}$ " and $\frac{3}{4}$ ". Case lengths are $\frac{7}{8}$ ", $1\frac{1}{8}$ ", $1\frac{1}{2}$ " and $1\frac{7}{8}$ ". Voltage range is 3 to 100 volts in polar or nonpolar construction. Capacitance range is 1 to 3700 mfd.

Type MTV is a single-ended, plug-in type for printed-circuit board insertion. The lead wires are uniformly spaced .200" between leads. The cathode lead wire is #18 AWG; the anode lead wire is #20 AWG. The positive lead is identified by a row of (+) signs stamped on the cartridge. MTV capacitors are available in $\frac{3}{8}$ " and $\frac{1}{2}$ " diameters. Case lengths are $\frac{13}{16}$ ", $\frac{15}{16}$ ", 1",

$1\frac{1}{16}$ ", $1\frac{1}{4}$ " and $1\frac{1}{2}$ ". Voltage range is 3 to 100 volts; capacitance range to 1000 mfd. The MTV design features a "ski-pole" lead wire which provides rigid anchoring in the plastic case material and eliminates intermittent "opens" (see cutaway view).

Type MCT is a single-ended, tubular-electrolytic capacitor with insulated, flexible wire leads. Case diameter is $\frac{7}{8}$ ". Case lengths are $1\frac{1}{2}$ ", $1\frac{3}{4}$ ", 2" and $2\frac{1}{2}$ ". Voltage range is 3 to 100 volts, polar or nonpolar. Capacitance ranges to 7000 mfd.

All three types are suitable for +65°C and +85°C operation.

For data, write or call Mallory Capacitor Company, a division of P. R. Mallory & Co. Inc., Indianapolis, Indiana 46206.



Mallory Type MTA, MTV and MCT molded-case capacitors.

SCHAUER

1%

tolerance

1 WATT ZENERS ARE A REAL BUY!

ANY voltage from 2.0 to 16.0
at the industry's **LOWEST
PRICES!**

Quantity	Price each
1-99	\$1.07
100-499	.97
500-999	.91
1000-4999	.86
5000 up	.82



THE HI-RELIABLE!

No fragile nail heads.
Silicon junction aligned between two, parallel, offset tantalum heat sinks . . . great lead tension strength.
All welded and brazed assembly.
High pressure molded package.
Gold plated nickel-clad copper leads.
Write or phone for Form 68-4 for complete rating data and other tolerance prices.

Semiconductor Division

**SCHAUER
MANUFACTURING
CORP.** 4511 Alpine Avenue
Cincinnati, O. 45242
Ph. (513) 791-3030

NEW LITERATURE



Digital instruments

A complete line of digital panel meters and voltmeters are described in detail in a new 36-page catalog. Included in this catalog is a family of six compact, low-cost digital panel meters, two three-digit multimeters, and sophisticated four- and five-digit multimeters. The catalog also provides illustrations of each instrument, with a general description, technical highlights, detailed specifications, available options and prices. Data Technology Corp.

CIRCLE NO. 385

Circular connectors

Miniature circular connectors are the subject of an updated catalog. The brochure describes connectors using MIL-C-26482-type hardware with three-point coupling and five-key polarization, as well as general-purpose solder-pot, high-performance crimp, and high-contact-density connectors. Also included are rfi filtering versions as well as crimp tools. ITT Cannon Electric.

CIRCLE NO. 386

Digital readouts

Digital display readouts are covered in a new 16-page catalog. Fully illustrated and discussed are alpha-numeric, digital and redundant displays, decoder/drivers, decade counters, an integral numeric readout and coder, large digital readouts, miniature connectors, micro-miniature lamps, a truth table and lamp matrices. Pinlites, Inc.

CIRCLE NO. 387

Solid-state devices

A new catalog gives specific data on more than 1000 solid-state devices such as integrated circuits (linear, digital), transistors (bipolar, MOS), thyristors (triacs, SCRs, diacs), silicon rectifiers, tunnel diodes, diodes and optical products (photocells, emitting devices). A special format permits quick selection of a device by type number, function, or application. The catalog includes detailed index, special data charts, recommended applications and special features, and representative photographs shown in approximate actual size. RCA Electronic Components.

CIRCLE NO. 388

Magnetic-core guide

With a section on the formulas and mathematics of magnetics, a new 76-page catalog and designers' guide on Moly Permalloy powder cores contains technical information intended for the design engineer. This handbook tabulates the physical and electrical specifications for 25 standard-sized cores. In addition, Q curves show the permeability available for each size. There are also curves indicating ac permeability versus ac flux density, normal magnetization for various permeabilities, and incremental permeability versus dc bias. The Arnold Engineering Co.

CIRCLE NO. 389

Digital instruments

A new 12-page catalog features a new and complete line of digital instruments. Included are: a digital system capable of measuring 0.0001 to 999.9 V dc in four ranges; four- and five-digit electronic counters with accuracies of $\pm 0.01\%$, ± 1 digit; a digital VOM that measures ac and dc voltages, currents and resistance; a portable RLC bridge; and miniature strip-chart recorders. Simpson Electric Co., div. of American Gage & Machine Co.

CIRCLE NO. 390

Hung up on things analog?

Unscramble with Philbrick/Nexus amplifiers.

Like we did in this inexpensive instrumentation amplifier with our new, easy-to-use monolithic IC amplifiers.

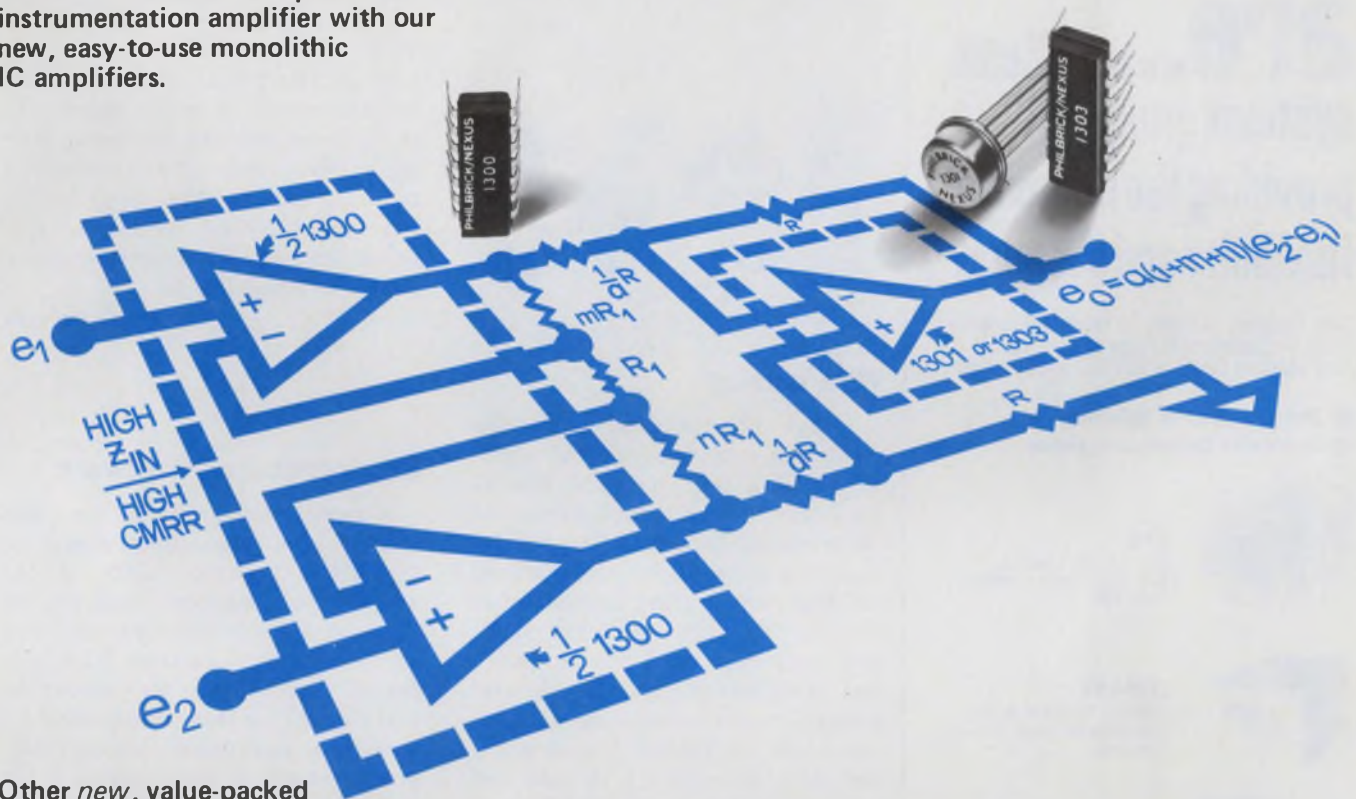

Other new, value-packed Op Amps from Philbrick/Nexus Hybrid & Monolithic

1405 — This differential FET input, high speed, hybrid op amp comes in a dual-in-line size package with no external stabilization required. Salient specifications include 1 MHz full output frequency, $A_0 = 500K$, slew rate of $50V/\mu\text{sec}$ and output current of ± 20 ma.

1300 — Dual amplifier monolithic chip in a dual-in-line size package. Two general purpose amplifiers in one package for the price of one. \$5.20 in hundred quantity.

1301/1303 — Single general purpose amplifiers in a dual-in-line size package (1303) and a TO-99 package (1301) compatible with $\mu A709$ size configurations. These amplifiers are *very stable*, free from latch-up, and output protected.

T82AH — Differential wideband IC amplifier in a 10-pin, TO-5 case with 70 MHz GBW, $20\mu V/^\circ C$ max. ($-55^\circ C$ to $+125^\circ C$), ± 10 ma output current, \$10.00 per hundred quantity. Has excellent performance in high speed comparator applications.

Discrete

1021 — A high CMRR economy differential FET input or better known as the "100-cubed" amplifier. CMRR of 100 dB (min.), full output frequency of 100 kHz (min.) and A_0 of 100 dB (min.) with a hundred quantity price of \$27.00 make this a "value-cubed" amplifier! Other salient specifications are $\pm 10V$ common voltage range, ± 20 ma output current and -30 pa (max.) bias current.

1022 — This differential FET input, high voltage amplifier picks up where the 20V amplifiers leave off. Specifications include power supply range of $\pm 40V$ to $\pm 150V$; output voltage of $\pm 30V$ to $\pm 140V$; common mode voltage of $\pm 25V$ to $\pm 135V$; full output frequency of 50 kHz (min.) and output current of ± 20 ma. Priced at \$78.00 in hundred quantity.

1018/1020 — The lowest drift, differential, non-chopper stabilized amplifiers available! $E_{0s} TC$ (max.) of 1.5/0.5/0.25/5/1.5/0.5/0.25 $\mu V/^\circ C$ ($-25^\circ C$ to $+85^\circ C$) and 1.5/0.5 $\mu V/^\circ C$ ($+10^\circ C$

to $+60^\circ C$) with hundred quantity prices starting at \$56.00 (101803) and \$33.00 (1020). These units are perfect replacements for chopper stabilized units in many cases with the added advantage of differential inputs.

1017 — An inexpensive, general purpose, high output current (± 125 ma from $-25^\circ C$ to $+85^\circ C$) amplifier in the standard small "Q" package. More power to you at \$29.50 in hundred quantity.

Write, today, for your free copy of the NEW 1969/70 Philbrick/Nexus Catalog.

For further information on any of these new Philbrick/Nexus products, contact your local Philbrick/Nexus field representative or Philbrick/Nexus Research, 46 Allied Drive at Route 128, Dedham, Massachusetts 02026. Telephone: (617) 329-1600.



No. 1 should do more . . . you expect us to.



PHILBRICK/NEXUS RESEARCH

A TELEDYNE COMPANY

TRYGON power supplies are... a New systems grouping providing the utmost in flexibility and economy

OEM Modules; ¼ racks; ½ racks; full racks
—all compatible with ruggedly constructed
rack adapters for up to 161 VDC and 70 amps.

- Complete Systems Reliability
- Unattended Continuous Operation



TPS
Super Trypack Series
Slot range system module
from \$56.



LVW-LVS
Liberator Sub-Rack Series
Slot and wide range modules.
from \$89.



LQS
Liberator Sub-Rack Series
¼ rack slot range.
optional metering
from \$135.



LHS
Liberator Sub-Rack Series
½ rack slot range.
optional metering
from \$219.



L3R/L5R
Liberator Series full rack systems power supply
from \$450.

TRYGON MEANS POWER!

Write now for complete data and pricing
of this new systems grouping.

TRYGON POWER SUPPLIES

111 Pleasant Avenue, Roosevelt, New York 11575
Tel: 516-378-2800 TWX: 510-225-3664
Trygon GmbH 8 Munchen 60, Haidelweg 20, Germany
Write for Trygon Systems Power Supply Catalog.
Prices slightly higher in Europe.

INFORMATION RETRIEVAL NUMBER 97

NEW LITERATURE

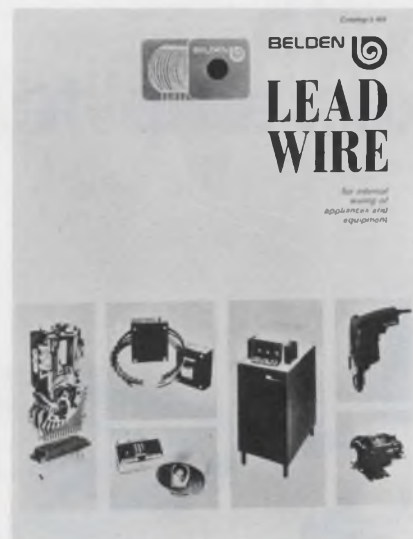

Wire catalog

A new 12-page catalog provides insulation specifications and application data for an entire line of lead wire for internal wiring of electrical appliances and apparatus. Special-purpose wires are featured for high-temperature and hermetic motors, mercury switches, coils and condensers, and switch, panel, and distribution boards. General insulation characteristics, such as maximum operating temperature, dielectric strength, UL thermal and voltage ratings, and relative resistance to chemicals and flame attack are tabulated. Belden Corp.

CIRCLE NO. 391

Counter/timer terms

The latest issue (No. 7) of the "Metricist" contains the first article of a two-part story on understanding and using counter/timer specifications. Clock stability and aging rate are the first terms to be dealt with; the second installment will take up direct frequency range (pulse pair resolution), trigger sensitivity, adjustability, stability, and modal versatility. There is also a discussion of how the model 501A programmer simplifies repetitive sequences of test procedures. Monsanto Electronic Instruments.

CIRCLE NO. 392

Enclosure styling

Described in a new 12-page full-color brochure is an interface enclosure system that permits highly individualistic styling to be easily and economically applied to a variety of enclosure structural systems. The brochure contains a styling selector chart that illustrates how enclosure styling combinations can be achieved through the use of seven vertical and seven horizontal trim extrusions. Also described is the versatility of combining different enclosure structural systems. Amco Engineering Co.

CIRCLE NO. 393

Semiconductor hardware

A new 12-page catalog describes mounting hardware for transistors, thyristors (triacs, SCRs, diacs) and silicon rectifiers. Included in this catalog are detailed exploded views to help illustrate the preferred procedures for mounting and connecting these solid-state devices into equipment. A quick reference chart is also included for quick access to the appropriate mounting information for a specific device. RCA Electronic Components.

CIRCLE NO. 394

Switches and uses

From moon flight to earth travel is the range of several switching applications covered in a new colorful booklet entitled "Uses Unlimited," No. 35. The applications include electric automobiles to speed commuters, an animated stadium scoreboard, textile processing control, and a milling machine that is automatically controlled from a master drawing. Three practical uses of special switches are sketched and explained as are questions on switch life. Micro Switch, a div. of Honeywell Inc.

CIRCLE NO. 395

Burr-Brown just made instrumentation amplifiers smaller in size...and price

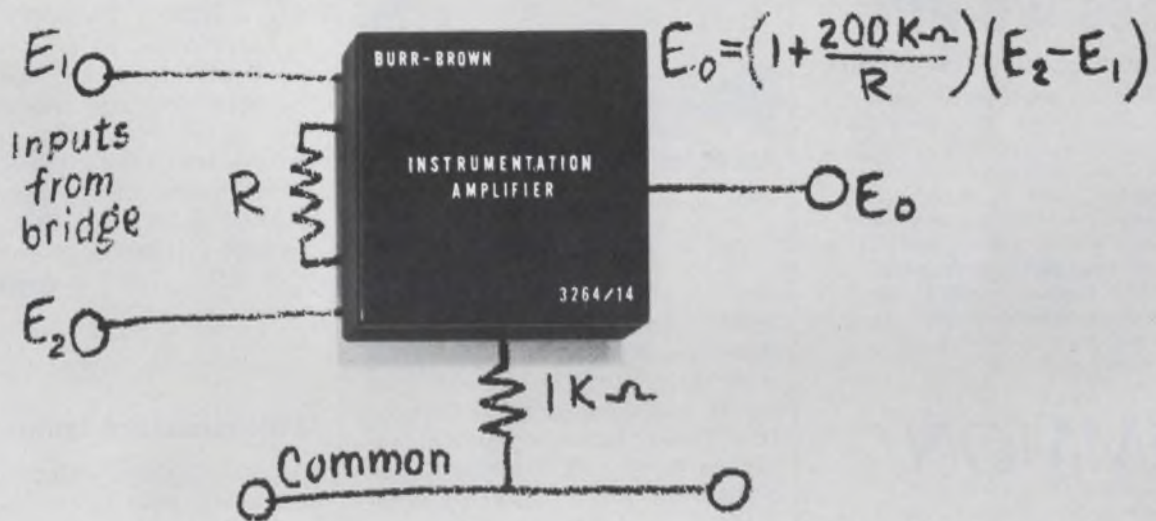

This one sells for only \$39.00

Don't let the size and price of this new differential-input instrumentation amplifier fool you. This little guy gives a man-sized performance. What's more, its 1.5" x 1.5" x 0.4" encapsulated package is designed for use in applications requiring high-density card spacing.

The Model 3264/14 has a maximum input voltage drift of $\pm 10\mu\text{V}/^\circ\text{C}$. If lower drift is needed, then a companion unit, the Model 3263/14, is available with a drift of only $\pm 3\mu\text{V}/^\circ\text{C}$ over a -25°C to $+85^\circ\text{C}$ temperature range. Both units require only one external resistor to set gain to any value from 1 to 1,000.

These two new units are ideal for such applications as: bridge amplifiers for strain gages, thermistors and thermocouples; variable-gain DC difference amplifiers; and buffer amplifiers for signal conditioning. Their small size enables them to be mounted near the bridge to reduce noise. The low prices make it possible to use one amplifier for each bridge and eliminate costly low-level multiplexers.

HIGHLIGHT SPECIFICATIONS

MODEL NO.	3264/14	3263/14
Input Drift at Gain of 1000 (Max.)	$\pm 10\mu\text{V}/^\circ\text{C}$	$\pm 3\mu\text{V}/^\circ\text{C}$
Gain	1 to 1000	1 to 1000
Input Impedance, Differential	300 M Ω	300 M Ω
Input Voltage Range	$\pm 10\text{V}$	$\pm 10\text{V}$
CMR, DC to 100 Hz		
Gain of 1000, balanced source	115 dB	115 dB
Rated Output	$\pm 10\text{V}$ @ $\pm 5\text{mA}$	$\pm 10\text{V}$ @ $\pm 5\text{mA}$
Price, 1-9	\$39.00	\$59.00
100 Unit Price	\$29.90	\$45.00

FOR 8-PAGE TECHNICAL BULLETIN

containing detailed applications information contact your Burr-Brown Engineering Representative or use this publication's reader service card.

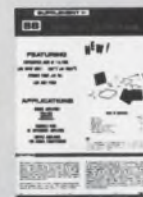

BURR-BROWN

RESEARCH CORPORATION

International Airport Industrial Park • Tucson, Arizona 85706
TELEPHONE: 602-294-1431 • TWX: 910-952-1111 • CABLE: BBRCORP



Operational Amplifiers
Instrumentation Amplifiers
Function Modules
Active Filters
Power Supplies



APT-1; 1 cu. in.,
3.15 oz. (actual size)

More torque, Less weight in moving coil mechanism

Highly stable, linear and accurate mechanism for indicating, control or recording systems. 18-0-18° linearity is 1%. Coil design with over 75% of winding "working" in high energy, uniform field air gap assures greater accuracy. Coil system weighs 0.85 gm, develops 26.4 mmg of torque; 31:1 T/W. Mechanism offers negligible vibration pivots and jewels — custom damping — wide range of sensitivities.

AMMON

AMMON INSTRUMENTS, INC.
345 Kelley St., Manchester, N.H. 03105

INFORMATION RETRIEVAL NUMBER 99



RF and POWER SWITCHES

A complete line of rotary, high voltage and high current ceramic-type switches for RF and low frequency applications.

Write for catalog, containing information on the mechanical and electrical properties of our standard line of switches.

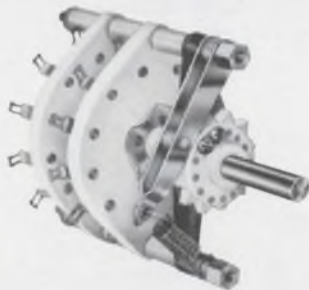

RADIO SWITCH CORPORATION

MARLBORO, NEW JERSEY

Telephone: HOpkins 2-6100 (Area Code 201)

INFORMATION RETRIEVAL NUMBER 100

NEW LITERATURE



Transfer lettering

Showing hundreds of type faces and sizes and other new innovations, a new 98-page catalog displays a large collection of dry transfer lettering. It features such items as laminated layout grids with matte surfaces, instant color blocks and color dots, a friction-free Teflon burnisher and a new cabinet for storing lettering sheets. All type faces are illustrated in actual size and lettering is offered in black, white, red, blue, yellow and gold. Prestype Inc.

CIRCLE NO. 396

Transformer test notes

"Test Methods and Interfacing Notes" is an eight-page illustrated booklet meant to assist designers in the application of their products and to enable engineers and production personnel to test them. Included are interfacing methods to make meaningful tests of high- and low-power wideband transformers and hybrids packaged in pin and microstrip form. Vari-L Co., Inc.

CIRCLE NO. 397

Resistors

Available in a condensed catalog is complete information on various types of resistors. There are photos, specifications, charts and diagrams on axial-lead, vitreous enameled, fixed and adjustable resistors. Lectrohm, Inc.

CIRCLE NO. 398

MIL-lamp selector

A comprehensive cross reference between Eldema MIL-Lites and revised MIL-L specifications is provided in a new seven-page brochure. The new brochure refers to MIL-L-3661B, MIL-L-3661A and MIL-L-6723B. Included in the cross-reference data are the revised MIL-L detail specification numbers, with the relevant military type designation, previous designation, mating parts, Eldema part number, and a generic part description. Eldema Div. Genisco Technology Corp.

CIRCLE NO. 399

Ultra-miniature lamps

A new series of ultra-miniature indicator lights is the subject of a new 16-page catalog. It provides data, specifications, drawings, lamp charts and ordering information. Described are choice of plug-in lamp cartridges, caps for use with hot-stamped or engraved legends, packages for use in program and instrumentation panels and dual-lamp indicators. The lamp series discussed include ones covered by MIL-L-3661B (type designations LH90/1, LH90/2 and LH90/3). Dialight Corp.

CIRCLE NO. 400

Connectors plus

A new two-color 18-page publication covers thousands of individual connectors, sockets, switches and a new line of coaxial cable/connector assemblies. Also included are tube and relay sockets, test and tip jacks, microphone connectors, home and industrial-type ac plugs and receptacles and coaxial connectors and switches. There are photographs, line drawings, electrical characteristics and mechanical specifications. The Bunker-Ramo Corp., Amphenol Distributor Div.

CIRCLE NO. 401

Substitution semiconductors

In numerical-alphabetical sequence, a new 40-page booklet lists more than 12,000 domestic and foreign semiconductor devices widely used in entertainment equipment and the recommended series SK replacement transistor, silicon rectifier or integrated circuit. This replacement guide also provides an applications chart, operating considerations, and typical performance data. RCA Electronic Components.

CIRCLE NO. 404

Microwave components

A new 12-page catalog describing a complete line of microwave transmitters, receivers and components is now available. The new catalog contains detailed specifications on over 300 individual models of microwave fm transmitters, receivers, mixer preamplifiers, linear and log amplifiers, discriminators, filters and multipliers. Photos and technical specifications describe the various models and their combinations. RHG Electronics Laboratory, Inc.

CIRCLE NO. 405

Memory guide

Covering the history, theory of operation, and applications of read-only memory systems, a comprehensive engineering guide includes a photographic section detailing the ease with which memory contents can be changed. Product specifications are shown for small and large braid systems, multiple systems, and special system capabilities. Memory Technology Inc.

CIRCLE NO. 406

Electronic filters

An extensive line of precision variable electronic filters, including a new programmable series is included in a new four-page catalog. The catalog includes descriptions, specifications, options and prices for 22 models. Rockland Laboratories, Inc.

CIRCLE NO. 407

Lamp readouts

A complete line of miniature neon and incandescent readout indicators plus their necessary decoder/drivers is listed and illustrated in a new eight-page catalog. Included are detailed specifications, code tables, dimensional and schematic drawings, wiring instructions, and prices. Alco Electronic Products, Inc.

CIRCLE NO. 402

MIC modules

A six-page brochure describes microwave integrated circuit (MIC) modules that combine separate-function assemblies into a compact single-package unit. The assemblies, which are available for any combination of functions, feature wide operating bandwidths and low losses. Sanders Associates, Inc.

CIRCLE NO. 403

We know where the jobs are and you don't. It's that simple.

In fact the 25 new regional offices keep track of job openings among more than 5,000 key firms with outstanding opportunities for engineers and scientists. So you can be sure the new 360/40 computer system linking these offices knows about thousands of opportunities available to you. Send in the form today and you'll be contacted by your nearest NMR office. Then watch them pull jobs from anywhere in the country. In seconds. Naturally there's never any fee. And we release your identity only if we have your OK. So go ahead and mail in this form along with your resume. **NMR** It's that simple.

My current base salary is _____

I prefer most to work in _____ (area of country)

Will you consider relocation? Yes No

U.S. Citizen Yes No

Level of security clearance _____

My identity may be released to:

____ All but present employer ____ No employer

Name _____

Address _____

City _____ State _____ Zip _____

Phone Number (_____) _____

Principal Industry Background _____

(Glass, Textiles, etc.)

Date Available _____

Attach this form to your resume and mail to:

NATIONAL MANPOWER REGISTER
 635 Madison Ave., New York, N.Y. 10022
 "We Know" Electronic Design 10/25/69

SOME ENGINEERS DON'T KNOW WHEN TO QUIT

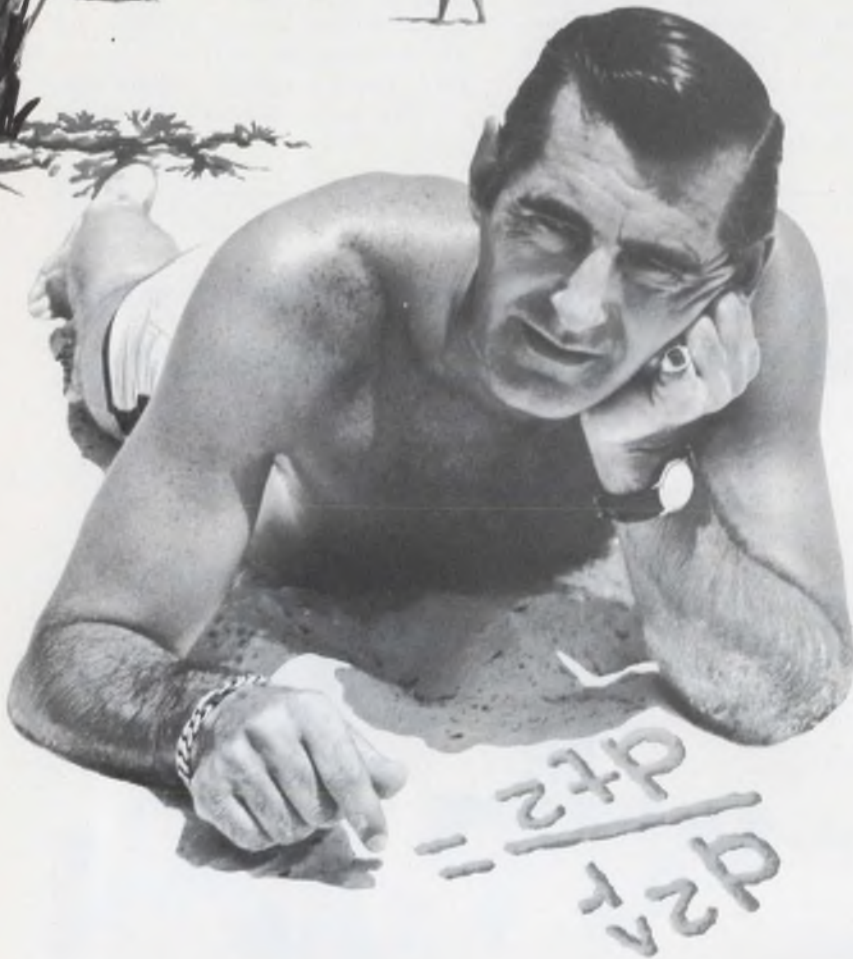

Give a guy a mile of sandy beach as a blackboard and you might find him doing equations from here to the moon . . . thinking about navigation and guidance systems.

At Honeywell-Florida we've got a lot of people who think engineering is an adventure. They create some of the world's most sophisticated equipment . . . computers . . . monolithic subsystems . . . plated wire memories . . . precision

components. We give 'em room to think . . .

provide a stimulating environment and then recognize their creative individuality.

We can't promise you can do all your engineering on the beach but we can promise an atmosphere where you'll always have the engineering freedom you need to do something significant. Of course while you're relaxing on the white sand beaches of the Gulf of Mexico you may get some of your best ideas.

If you and your family fit into the Florida picture tell us about your qualifications today. We have great opportunities for engineers with experience in logic, components, integrated circuits, computer memories, circuit or programming analysis, advanced packaging, manufacturing or industrial engineering, materials or quality assurance.

Write now to Owen M. Spring, Dept. 120-1, Honeywell Inc., 13350 Highway 19, St. Petersburg, Florida 33733 - or call collect (813) 531-8977, 7-10 P.M. (E.D.T.) Mondays through Thursdays.

Honeywell-Florida

An equal opportunity employer

To investigate professional openings in other Honeywell facilities, send resume to F. F. Laing, Honeywell, Minneapolis, Minnesota 55408.

INFORMATION RETRIEVAL NUMBER 902

Free Career Inquiry Service

Absolutely Confidential

Respond to the career opportunities advertised in this issue. Fill out and send us this handy resume. **Electronic Design** will do the rest – neatly typed copies of this form will be mailed to the companies of your choice, indicated by the circled Career Inquiry Numbers at the bottom of this page.

22

Name		Home Phone	
Home Address (Street)		City	State ZIP Code

Age	U.S. Citizen		Security Clearance
	<input type="checkbox"/> Yes	<input type="checkbox"/> No	

Prime Experience	Secondary Experience

Desired Salary	Availability Date
-----------------------	--------------------------

Employment History – present and previous employers

Company	City, State	Dates	Title
		to	
		to	
		to	

Education – indicate major if degree is not self-explanatory

Degree	College	City, State	Dates
			to
			to
			to

Additional Training – non-degree, industry, military, etc.

Professional Societies

Published Articles

- Career Inquiry Numbers:**
- | | | | | | | | | | | |
|-----|-----|-----|-----|-----|-----|-----|-----|-----|-----|-----|
| 900 | 901 | 902 | 903 | 904 | 905 | 906 | 907 | 908 | 909 | |
| 910 | 911 | 912 | 913 | 914 | 915 | 916 | 917 | 918 | 919 | 925 |

ELECTRONIC DESIGN
850 Third Avenue
New York, New York 10022

ELECTRONIC DESIGN'S function is:

- To aid progress in the electronics manufacturing industry by promoting good design.
- To give the electronic design engineer concepts and ideas that make his job easier and more productive.
- To provide a central source of timely electronics information.
- To promote two-way communication between manufacturer and engineer.

Want a subscription? ELECTRONIC DESIGN is sent free to qualified engineers and engineering managers doing design work, supervising design or setting standards in the United States and Western Europe. For a free subscription, use the postfree application form inside the back cover. If none is included, write to us direct for an application form.

If you do not qualify, you may take out a paid subscription for \$25 a year in the U.S.A., \$35 a year elsewhere. Single copies are \$1.50 each.

If you change your address, send us an old mailing label and your new address; there is generally a prepaid postcard for this inside the back cover. You will have to requalify to continue receiving ELECTRONIC DESIGN free.

The accuracy policy of ELECTRONIC DESIGN is:

- To make reasonable efforts to ensure the accuracy of editorial matter.
- To publish prompt corrections whenever inaccuracies are brought to our attention. Corrections appear at the end of the Letters column.
- To refuse any advertisement deemed to be misleading or fraudulent.

Microfilm copies are available of complete volumes of ELECTRONIC DESIGN at \$19.00 per volume, beginning with Volume 9, 1961. Work is now in process to complete the microfilm edition of Volumes 1-8. Reprints of individual articles may be obtained for \$2.00 each, prepaid (\$.50 for each additional copy of the same article) no matter how long the article. For further details and to place orders, contact the Customer Services Department, University Microfilms, 300 North Zeeb Road, Ann Arbor, Michigan 48106; telephone (313) 761-4700.

Want to contact us? If you have any comments or wish to submit a manuscript or article outline, address your correspondence to:

Howard Bierman, Editor,
ELECTRONIC DESIGN,
850 Third Avenue,
New York, N.Y. 10022.

Design Data from

Free: 2,500 Plastic Parts Catalog



New from Nylomatic, molders and fabricators of mechanical plastic components, a highly informative 48-page catalog of more than 2,500 standard parts. It can help you save time and money in design, test and production. Advantages of Nylomatic standard parts: no tooling charges, low unit costs, quick delivery, complete range of sizes. Nylomatic standard parts are made of Nylon, Delrin® and other thermoplastic materials. You'll find our new free catalog a real problem solver for designers, send for it today.

Nylomatic Corporation
Dept. P
Nolan Ave., Morrisville, Pa. 19067

174

Free Op-Amp Catalog/Handbook



Analog Devices' 1969 edition of "A Selection Handbook and Catalog Guide to Operational Amplifiers" contains design reference data, comprehensive specifications and applications information for over 100 op-amps. Also included is detailed information on Analog function modules, instrumentation amplifiers and modular power supplies.

An "instant action" registration card is included which may be used to request up-dating material on newly developed products and application techniques.

This 36 page catalog/handbook is a must for all engineers who design with operational amplifiers.

Analog Devices, Inc.
221 Fifth Street
Cambridge, Mass. 02142
(617) 492-6000

175

FUNDAMENTALS OF INTEGRATED CIRCUITS

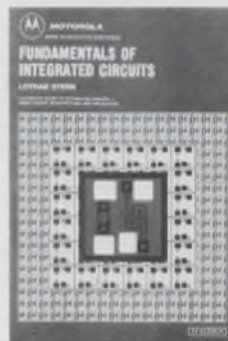

A practical guide to integrated circuits, their theory, manufacture, and applications. This new guide by Lothar Stern offers complete, highly readable coverage of the various techniques of circuit fabrication, and their effect on circuit design and performance. As to marketing considerations, it compares the characteristics of the numerous IC structures devised to date in terms of economics and logistics. A volume in the Motorola Series in Solid-State Electronics. 198 pages, 7 x 10, illustrated. \$8.95, clothbound. Send for 15-day examination copies.

Hayden Book Company, Inc.
116 West 14th Street
New York, N.Y. 10011

176

Manufacturers

Advertisements of booklets, brochures, catalogs and data sheets. To order use Reader-ServiceCard (Advertisement)

NEW RELAY SOCKET ASSEMBLIES CATALOG

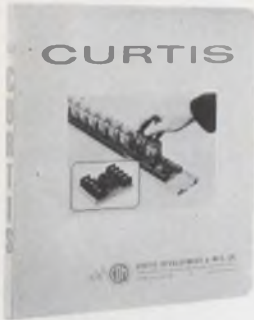

The new Curtis line of printed circuit snap-in track-mounted relay socket assemblies is completely illustrated in this new 2-color, 6 page catalog. Variations include RS8 octal relay sockets, as well as RS11 and RS15 with eleven and fifteen pin relay sockets. Complete dimensional drawings and list prices are included. All units snap in or pop out vertically from prepunched vinyl track and feature Curtis barrier terminal blocks. CSA approved. Send today for your free copy.

Curtis Development & Mfg. Co.
3236 North 33rd Street
Milwaukee, Wisconsin 53216

177

Electronic Component Drafting Aids Design Guide



Free Catalog! Free Samples! The industry's largest selection of electronic component drafting aids! All in a new 68-page printed circuit design guide and catalog. Includes the most advanced technical information — with hundreds of illustrations — on printed wiring master artwork. Plus the industry's only tested-and-proved system for absolute registration for two-sided printed wiring boards with the only complete photographically compatible Red and Blue System. Send now for Catalog 10. Free samples included.

Bishop Graphics, Inc. The Innovators
7300 Radford Avenue
North Hollywood, Calif. 91605 (213) 982-2000

178

10-DAY FREE EXAM Circuit Design For Integrated Electronics

BY HANS R. CAMENZIND, Signetics Corporation

For the practicing engineer with circuit design experience, this new book serves as a bridge to the field of integrated circuits. It provides overview of integrated circuit processes, detailed analysis of integrated components, and thorough discussion of design techniques for both digital and linear circuits.

266 pp, 277 illus. (1968) \$12.95

"... excellent illustrations, has an outstanding organization of material."

To order on no-risk 10-day free examination, circle reader service number below. If not satisfied return book and pay nothing.

ADDISON-WESLEY PUBLISHING CO., INC.
READING, MASS. 01867

179

Electronic Design

Advertising Sales Staff

Keith Aldrich
Sales Manager

New York 10022

Robert W. Gascoigne
Thomas P. Barth
Samuel M. Deitch
850 Third Avenue
(212) Plaza 1-5530
TWX: 867-7866

Philadelphia 19066

William C. Repetto
P. O. Box 206
Merion Station, Pa.
(215) MA-3-5888

Boston 01945

Richard Parker
P. O. Box 645
Clifton Station
Marblehead, Mass.
(617) 742-0252

Chicago 60611

Thomas P. Kavooras
Berry Conner, Jr.
200 East Ontario
(312) 337-0588

Cleveland

Thomas P. Kavooras
(Chicago)
(312) 337-0588
(call collect)

Los Angeles 90303

Stanley I. Ehrenclou
W. James Bischof
2930 Imperial Highway
Inglewood, Calif.
(213) 757-0183

San Francisco 94022

Arthur R. Shields, Jr.
175 San Antonio Rd., S 243
Los Altos, Calif.
(415) 941-3084

London W. 1

For United Kingdom and Holland
Brayton C. Nichols
44 Conduit Street
Tel: REGent 4714

Verviers, Belgium

For Continental Europe
Andre Jamar
1, Rue Mallar, 1
(087) 253.83 Telex 41563

Tokyo

Haruki Hirayama
Electronic Media Service
Rm. 601, Daini Miyauchi Bldg.
6-8-14, Roppongi,
Minato-ku
Phone: 402-4556
Cable: Electronicmedia, Tokyo

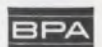

STABILITY & QUALITY

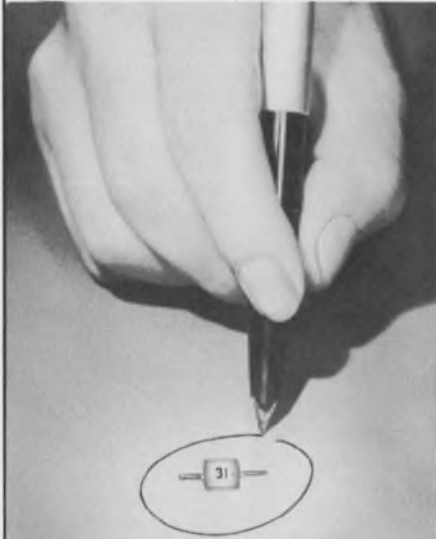

MATSUO

SOLID TANTALUM CAPACITORS FOR HYBRID ICs - "MICROCAP" -

Capacitance exceeding 10,000 picofarads obtained despite miniature size. "MICROCAP" features excellent heat resistance, solderability and mechanical strength comparable to conventional discrete components, for easy use in hybrid integrated circuits.

Specifications:

- Operating Temperature Range: -55°C to +85°C
- Standard Voltage Rating: 6.3, 10, 16, 20, 25, 35 VDC
- Standard Capacitance Value: .001 to 22MFD (E6 series)
- Standard Capacitance Tolerance: ±20% (M)

MATSUO'S other capacitors include: **Metalized Polyester Film Capacitors:**

Type FNX-H mylar wrapped.

Solid Tantalum Capacitors: Type TAX hermetically sealed in metallic case, Type TSX encased in metallic case and sealed with epoxy resin, Type TSL encased in metallic case and sealed with epoxy resin. **Polyester Film Capacitors:**

Type MFL epoxy dipped, Type MFK epoxy dipped, non inductive, Type MXT encased in plastic tube, non inductive.

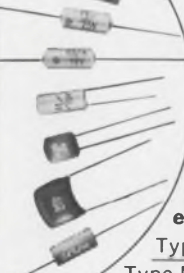

For further information, please write to:

MATSUO ELECTRIC CO., LTD.

Head Office: 3-5, 3-chome, Sennari-cho, Toyonaka-shi, Osaka, Japan
 Cable: "NCCMATSUO" OSAKA Telex: 523-4164 OSA
 Tokyo Office: 7, 3-chome, Nishi-Gotanda, Shinagawa-ku, Tokyo

Advertisers' Index

Advertiser	Page	Advertiser	Page
Acopian Corporation	58	JFD Electronics Corp./Components Division	142
Addison-Wesley	169	Jonathan Manufacturing Company	157
Airpax Electronics	127	Krohn-Hite Corporation	137
Alco Electronic Products, Inc.	145, 147, 149	McCoy Electronics Company	57
Allen-Bradley Co.	35, 37	Mallory Capacitor Company	159
American Micro-Systems, Inc.	15	Matsuo Electric Co., Ltd.	170
Ammon Instruments, Inc.	164	Mechanical Enterprises	155
Analog Devices, Inc.	168	Mini-Systems, Inc.	154
Austron, Inc.	152	Motorola Semiconductor Products, Inc. 16A—H	
Barnes Corporation	148	National Semiconductor Corporation	80, 81
Beckman Instruments, Inc., Electronic Instruments Division	108	Nylomatic Corporation	168
Beckman Instruments, Inc., Helipot Division	85	Nytronics, Inc.	31
Bishop Industries Corp.	169	Oak Manufacturing Co.	153
Bourns, Inc.	23, 106	Philbrick/Nexus Research, A Teledyne Company	161
Buckbee Mears Co.	96B	Philco-Ford Corporation	44, 45
Burr-Brown Research Corporation	163	Pomona Electronics Co., Inc.	152
Burroughs Corporation	20	Power/Mate Corp.	14
C-Cor Electronics, Inc.	156	Powercube Corporation	29
Cedar Division, Data Control Corporation	153	RCA Electronic Components and Devices	Cover IV
Centralab, the Electronics Division of Globe-Union, Inc.	48A-B, 49	R-Tron Corporation	126
Clare & Co., C. P.	125	Radiation, Incorporated	112
Clevite Corporation, Piezoelectric Division	95	Radio Switch Corporation	164
Cohu Electronics, Inc.	46	Raytheon Company, Semiconductor Operation	50
Columbia Components, Inc.	17	Redcor Corporation	146
Computer Power Systems	135	Schauer Manufacturing Corp.	160
Computer Products, Inc.	148	Signetics Corporation, Measurement/Data	96
Computer Test Corporation	124	Signetics Corporation	27
Control Data Corporation	33	Siliconix Incorporated	104, 105
Corning Glass Works, Electronic Products Division	38, 39	Simpson Electric Company	132, 133
Curtis Development & Mfg. Co.	169	Solid State Products Division of Unitorde Corporation	141
Cutler-Hammer	128	Sprague Electric Company	18
Dale Electronics, Inc.	171, Cover III	Stackpole Carbon Company	43
Data Technology, Instrument Division	119	Sylvania Electric Products, Inc. 32A—H, 60	60
Delco Radio, Division of General Motors	114, 115	Systron-Donner Corporation	2
Delta Products, Inc.	120	TRW, Inc., Capacitor Division	110
Dow Corning Corporation	52, 53	TRW Semiconductors, A Subsidiary of TRW, Inc.	123
Duncan Electronics	129	Tektronix, Inc.	56
Dynamic Systems Electronics	155	Teledyne Relays, A Teledyne Company	55
EMN Company	171	Telonic Instruments, A Division of Telonic Industries, Inc.	24
Elco Corporation	6, 7	Texas Instruments Incorporated, Components Group	12
Erie Technological Products, Inc.	96A	Triplett Corporation	151
Fairchild Systems Technology, A Division of Fairchild Camera and Instrument Corporation	4, 5	Trygon Power Supplies	162
Fluke Mfg. Co., Inc., John	131	U-Tech, A Division of Industrial Physics and Electronics Company	122
GRI Computer Corp.	143	Union Carbide Corporation	8, 9
General Radio Company	1	Vactec Inc.	144
Globe Industries, Division of TRW, Inc.	155	Varo Inc.	158
Grant Pulley & Hardware Corporation	116	Vector Electronic Co. Inc.	154
Guardian Electric Manufacturing Company	47	Vent-Rak, Inc.	136
Hayden Book Company, Inc.	168	Walker Company, Inc., O. S.	171
Hewlett-Packard Cover II, 13, 48, 90, 91, 140		Career Advertising	
Honeywell, Computer Control Division	40	Honeywell, Inc.	166
Honeywell Test Instrument Division	16	National Manpower Register	165
Hughes Aircraft Company, Connecting Devices	139		
Hughes Aircraft Company, Vacuum Tube Division	97		
Indiana General Corporation	10, 11		
Intel Corporation	54		

ELAPSED TIME INDICATORS

For a precise record of operating hours

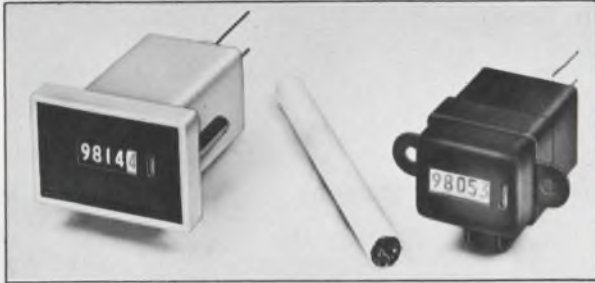

ENM presents a complete line of precision timing devices which provide an accurate and reliable count of operating hours for a wide variety of machinery and equipment.

Series T4 Miniatures

For panel or bracket mounting. Five digits. New synchronous motor drive. Panel unit: 1.59" x 1.03" x 2.03", 3½ oz. Bracket unit: 1" x .81" x 1.97", 2½ oz.

Series T5B Economy Line

For panel mounting. Five digits. With visual indication of motor operation. 1.89" x 1.89" x 1.83", 6oz.

WRITE FOR CATALOG SHEET
APPLICATION HELP AVAILABLE



ENM COMPANY

5306 W. Lawrence Ave., Chicago, Ill. 60630
PHONE: (312) 282-8787 TELEX: 02-5468
Representatives in principal cities

INFORMATION RETRIEVAL NUMBER 101

MSI
BIPOLAR
POWER SUPPLIES
now available for immediate delivery

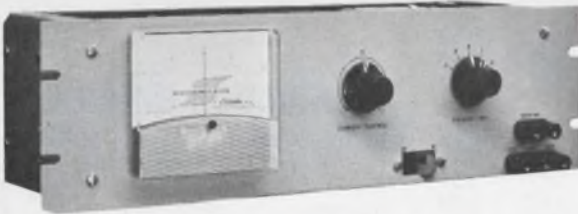

Meets rigid requirements for special systems and OEM applications. Ideal for use in systems designed for testing such things as magnetic samples—smooth transition through zero current, broad frequency range from dc. All solid state construction. Power: 115v, 60 cps, 50 watts.

Other 10 volt and 30 volt models also available. Ampere ranges from 2 to 20 amperes. And MSI is fully equipped and experienced to provide custom-made bipolar power supplies, designed to solve special problems.

Write for our new catalog today!



O. S. WALKER COMPANY, INC.

ROCKDALE STREET, WORCESTER MASS 01606
TELEPHONE 617-853-3232 TWX 710-340-7828

MAGNETIC SYSTEMS
& INSTRUMENTS DIVISION
(MSI Division)

INDUSTRIAL MAGNETICS DIVISION/SUX-SHRADER MAGNETIC PRODUCTS/WALKER HAGDU S.V. HOLLAND

INFORMATION RETRIEVAL NUMBER 102

ELECTRONIC DESIGN 22, October 25, 1969

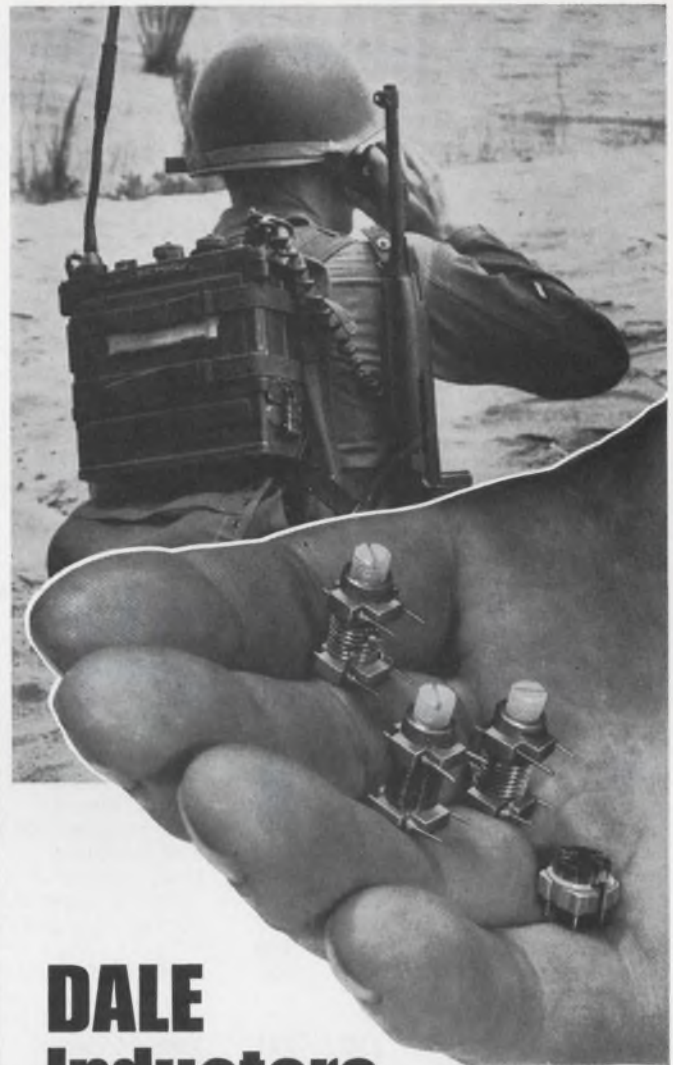

DALE Inductors... high Q in a back-pack

Few radios can take as much abuse as the Army's AN/PRC-25 Back-Pack. Designed for rugged field conditions, this transceiver, built by Memcor, Inc., Division of LTV Electrosystems, Inc., uses specially-developed Dale miniature high frequency inductors. These tiny core-tuned inductors provide high Q (approx. 170 @ 75 MHz) over a wide inductance range. Once tuned, they stay tuned—because of the positive action of a special core tension spring. Ability to meet the rigid requirements of MIL-C-15305C with mass-produced parts is only one of many broad inductive capabilities of Dale's Sioux Division.

Get the complete story—phone 605-665-9301 or write for new Facilities Report.



DALE ELECTRONICS, INC.
SIoux DIVISION Dept. ED
Yankton, South Dakota 57078

Producers of: Toroids, Series Resonant Traps, Variable Pitch Inductors, Miniature High Frequency Inductors, Degaussing Coils, Industrial and Military Coils, Sub-Miniature Coils, Surge and Lightning Arresters, Custom Assemblies, Motor Driven Potentiometers.

INFORMATION RETRIEVAL NUMBER 103

Information Retrieval Service

All products, design aids (DA), application notes (AN), new literature (NL), and reprints (R) in this issue are listed here with Page and Information Retrieval numbers. Reader requests will be promptly processed by computer and mailed to the manufacturer within three days.

Category	Page	IRN	Category	Page	IRN	Category	Page	IRN
Components			instruments (NL)	158	383	lead cutter	148	353
battery theory (AN)	156	378	instruments (NL)	160	390	soldering tool	149	358
connector (ES)	150	361	multimeter, low-cost	130	266			
connectors (NL)	160	386	multimeters (NL)	160	385			
connectors (NL)	164	401	oscilloscope	130	265			
cores, magnetic (NL)	160	389	power supplies, (NL)	158	381			
CRT, image isocon	140	289	power supply	130	262			
display module	140	291	power supply, IC	130	264			
hardware (NL)	162	394						
harness ties (ES)	150	365	Microwaves & Lasers					
lamp, indicator	140	290	calculator (DA)	152	366	New Literature		
lamp selector (NL)	164	399	components (NL)	165	405	chips, IC	158	379
lamps, miniature (NL)	164	400	detectors, diode	138	284	components, microwave	165	405
MIC modules (NL)	166	403	diodes, laser	136	279	connectors	160	386
motor handbook (AN)	156	376	diodes, tunnel	137	280	connectors	164	401
piezoelectric element	142	293	filters, bandpass	138	286	cores, magnetic	160	389
readouts, digital (NL)	160	387	filters, YIG	138	287	counter/timer terms	162	392
readouts, numeric	142	295	laser, 1000-W	136	278	DPMs	160	385
relays, reed	140	288	lasers, cw gas	138	282	enclosure styling	162	393
resistors (NL)	164	398	MIC modules (NL)	165	403	fiber optics, glass	158	382
switch, rotary	142	292	multicouplers	138	285	filters	165	407
switches (NL)	162	395	phase shifter	138	283	instruments	158	383
switches, pushbutton	142	294	resistive substrates	137	281	instruments	160	390
thermistor guide (AN)	156	377	springs, bellows (ES)	150	363	lamps, military	164	399
tools, small (NL)	158	380				lamps, miniature	164	400
transformer notes (NL)	164	397				lettering, transfer	164	396
			Modules & Subassemblies			memory guide	165	406
Data Processing			amplifier, current	145	345	MIC modules	165	403
calculators, desktop	118	251	amplifier/generators	145	342	multimeters	160	385
controller, digital	124	257	amplifier, servo	144	341	power supplies	158	381
hardware, plated-wire	124	255	breadboard, op amp	145	344	readouts, digital	160	387
keyboard, low-cost	122	254	circuit design system	145	343	readouts, lamp	165	402
keyboards, solid-state	120	253	filters (NL)	165	407	resistors	164	398
memory, core	124	256	MIC modules (NL)	165	403	semiconductor hardware	162	394
memory guide (NL)	165	406	power supplies (NL)	158	381	semiconductors	158	384
modems, high-speed	118	252	supplies, unregulated	144	340	semiconductors	160	388
recorder, tape	118	250				semiconductors	165	404
			Packaging & Materials			switches	162	395
ICs & Semiconductors			adhesive, resin	147	352	tools, small	158	380
amplifiers, sense	133	271	calculator (DA)	152	366	transformer notes	164	397
chips, IC (NL)	158	379	carrier, component	146	347	wire catalog	162	391
FETs, resistor	134	277	connectors (NL)	164	401			
hardware (NL)	162	394	contacts, coax	147	350			
IC manual (AN)	156	375	epoxy, room-cure	147	348			
lamp readouts (NL)	165	402	epoxy, room-cure	147	351			
op amp, micropower	132	267	epoxy, silver-filled	147	349			
SCRs, 470-A	134	273	enclosure styling (NL)	162	393			
semiconductors (NL)	158	384	fiber optics (NL)	158	382			
semiconductors (NL)	160	388	hardware (NL)	162	394			
switches, FET	133	269	harness ties (ES)	150	365			
transistor, hardened	134	272	labels, wire (ES)	150	360			
transistors	132	268	lettering, transfer (NL)	164	396			
transistors, hardened	134	274	markers (ES)	150	364			
transistors, npn/pnp	134	276	panel seals	146	346			
transistors, power	133	270	paper, lint-free (ES)	150	362			
zeners, 1-W	134	275	plastics guide (DA)	152	368			
			springs, bellows (ES)	150	363			
Instrumentation			tape charts (DA)	152	367			
correlator, digital	130	263	wire catalog (NL)	162	391			
counter terms (NL)	162	392						
DPMs (NL)	160	385	Production					
generator	126	258	assembly director	149	357			
generator, pulse	128	259	component former	149	356			
generator, signal	128	260	knife kit	149	359			
generators, function	128	261	lead bender, flatpack	148	354			
			lead bender, flatpack	148	355			

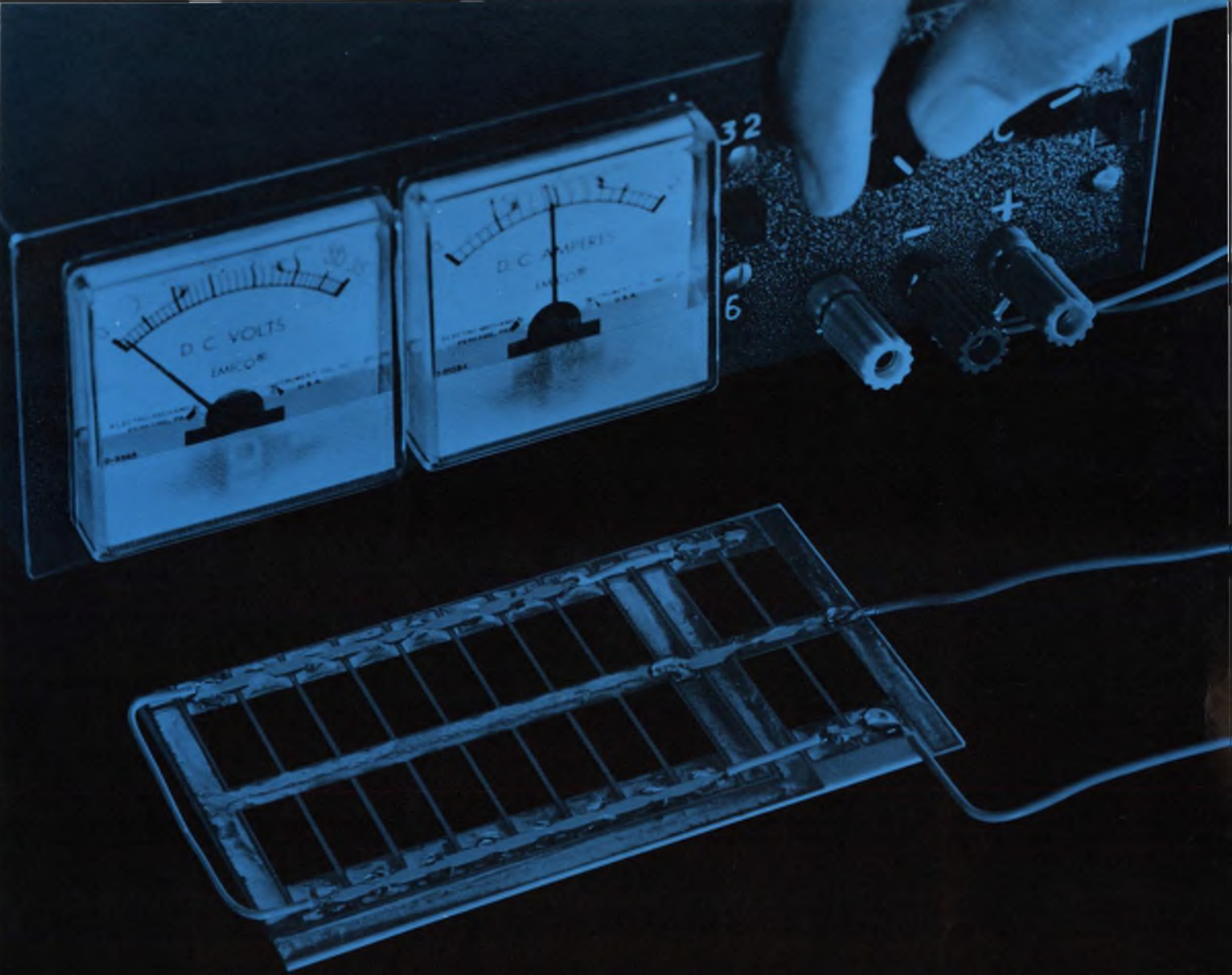

Dale puts the power in thick film networks

Dale makes thick film R-C networks

as standard as this dual in-line package and as small as this 1/4-inch square model.



Within this broad capability we've become known as power specialists.

Our ability to work with substrate, heat sink, package density and all the other network variables lets us deliver the power you need—in the size you need. "Big" jobs like the one shown above (5" x 2-1/2", 20 resistors, 60 watts) don't scare us a bit. Whether your next network is tremendous or tiny, give us a shot at it.

PROTOTYPES ON MOST DESIGNS IN LESS THAN THREE WEEKS... Call 402-564-3131 for complete details or write for Catalog A.

GENERAL NETWORK SPECIFICATIONS

Temperature Coefficient: ± 250 PPM max. from -55°C to $+150^{\circ}\text{C}$. T.C. as low as ± 50 PPM in limited resistance ranges.

Tolerance: Standard $\pm 10\%$. As low as 1% when required.

Power Loading: 16 watts/in.² standard with aluminum oxide substrate .015"-.040" thick. Substantially higher with heat sinking and beryllia substrates.

Terminations, Conductors and Land Areas: Platinum gold, palladium gold, gold and silver, depending upon application. Crossovers can be made. Lands for attaching active or passive components can be provided.

Moisture Changes: Meet Method 103, MIL-STD-202.

Resistor Patterns: Thick film resistive materials with resistivities from 1 ohm/sq. to 1 megohm/sq. can be used. Patterns can be made from 1/10 square to 10 squares.

Capacitors: Screened = $.01 \mu\text{fd}/\text{in.}^2$; Chip = up to $5 \mu\text{fd} \pm 10\%$ to $\pm 20\%$ or GMV. Dissipation Factor = Less than 1.5%. Working Voltage = 50.

Packaging: Dual-in-line packaging can be used with plated Kovar or other types of leads. Also conformal coatings can be applied to modules with wire or ribbon leads. Screened and cured silicone coatings can be used to protect specific areas of the circuit.

DALE ELECTRONICS, INC.

1372 28th Ave., Columbus, Nebr. 68601
In Canada: Dale Electronics Canada, Ltd.
A Subsidiary of The Lionel Corporation



Who's First... with 5,000,000 SILICON POWER transistors per month

- Over 300 standard types/over 500 custom types
- P-N-P and N-P-N
- From 50 mA to 100 A, 1 W to 300 W, 50 V to 500 V
- Using all the SILICON POWER technologies
 - Hometaxial Base
 - "Overlay"
 - Epitaxial
 - Plastic Power
 - Multiple Epitaxial
 - Triple Diffused
 - Diffused Planar
- Multiple packaging, including hermetic and plastic "VERSAWATT"
- Commercial, industrial, military high reliability specs
- Providing specific, versatile, economic answers to all your circuit needs

Who? The Leader in SILICON POWER



For more information, see your local RCA Representative
or your RCA Distributor. For technical data, write:
RCA Electronic Components,
Commercial Engineering, Section IG10-2, Harrison, N. J. 07029