

Electronic Design 19

VOL. 17 NO.

FOR ENGINEERS AND ENGINEERING MANAGERS

SEPT. 13, 1969

Counter doubles as data terminal for programmed test systems. As a counter, the unit provides all conventional counting and timing functions. And in a system, it

becomes a universal data terminal with programmable storage and display capability. Features include computing ability and dual-channel multiplexing. For details see p.126.



TRW/Globe sells motion



Application #5: mechanical motion

Anyone can sell you a motor. But the output of a high speed motor usually isn't much use all by itself. That's why TRW/Globe has spent over 20 years developing total systems which match motor capabilities precisely to your needs.

At TRW/Globe, we don't trust the manufacture of the critical mechanical components to other people—components like gear trains, clutches, brakes. We design and build our

own. We even make our own gears of high density powdered metal to assure greater strength, uniformity and system reliability.

TRW/Globe is in the business of solving problems in motion. Any kind of motion: rotary or linear, continuous or intermittent, fast or slow, movement of gas, liquid or mechanical linkage.

Perhaps you have a problem in mechanical motion which could

benefit from this kind of insight and attention to detail. Let TRW/Globe motor *systems engineers* have a look at it.

Contact Globe Industries Division of TRW Inc., 2275 Stanley Ave., Dayton, Ohio 45404. Phone (513) 228-3171.

TRW®

Customize this HP Function Generator to fit your Measurements

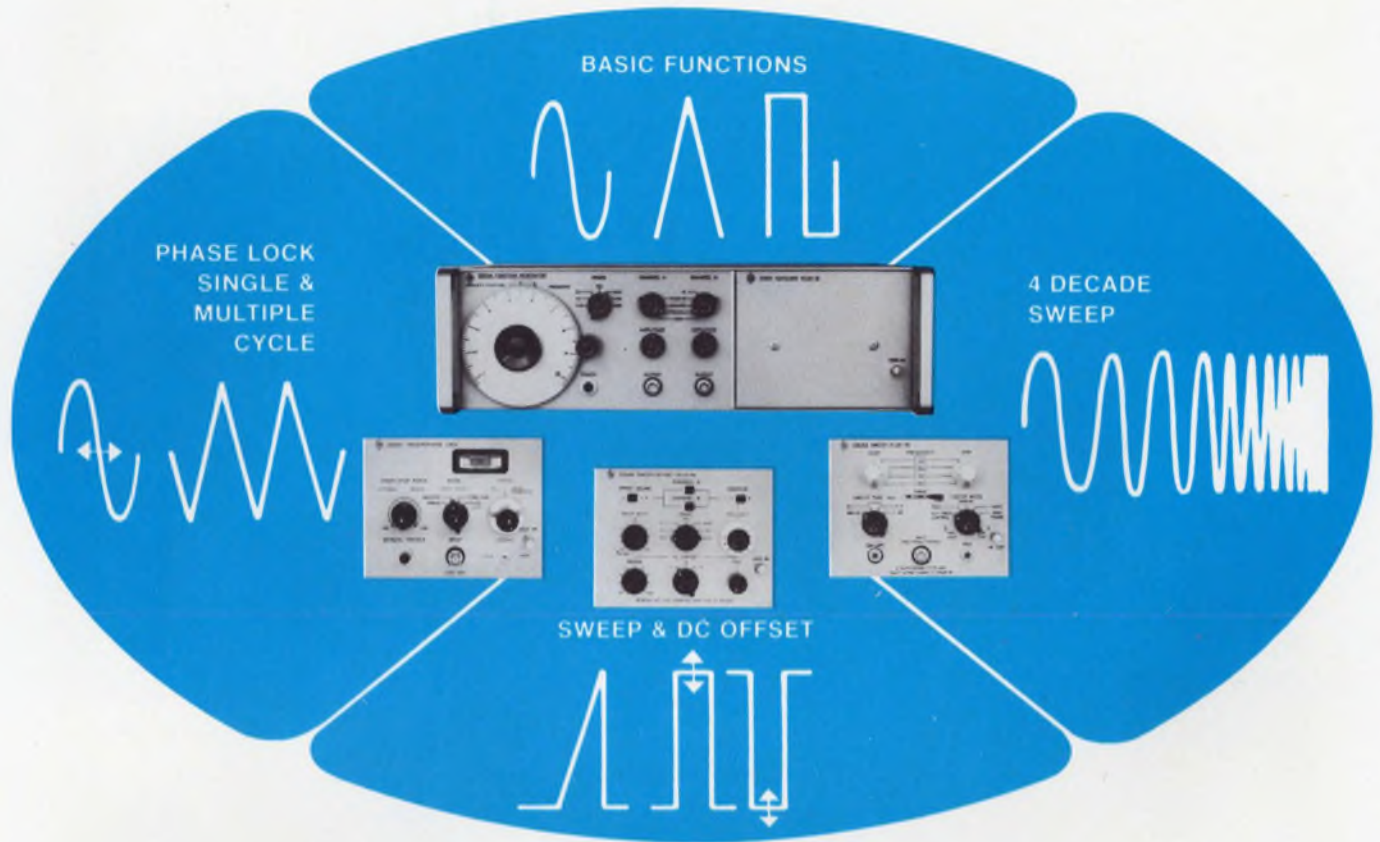

Start with the basic ability of the HP 3300A Function Generator—add the capability of its plug-ins—and you get a function generator that fits your specific needs. It's equally at home performing ordinary day-to-day lab tests or providing a sweeping signal that can be used to measure the impedance of an ape's brain. No matter what the task, you get the reliability and accuracy you need to get the job done.

The HP 3300A Function Generator gives two simultaneous outputs (sine, square or triangle) across a frequency range of 0.01 Hz to 100 kHz. Mix or match your output signals with individually selectable function and amplitude controls. Price, \$650; HP 3301A Auxiliary plug-in, \$30.

The HP 3302A Trigger / Phase-Lock plug-In lets you phase-lock any two functions to an external periodic signal. Phase can be controlled over a 360° range. Control single or mul-

ti-
ple bursts with an external signal or the front panel manual trigger. Price, \$225.

The HP 3304A Sweep/Offset plug-In provides a linear sweep adjustable in frequency and width within any decade over the entire frequency range. Variable dc offset of ± 16 Vdc is provided for each function including the internally generated sawtooth—makes hard-to-get driving functions readily available. Price, \$265.

The HP 3305A Sweep plug-in lets you sweep up to four decades without switching ranges. It sweeps logarithmically in any of three overlapping ranges for narrow or wide band testing between adjustable start/stop limits. Use the manual sweep for close inspection of any portion of the trace or for accurate frequency identification.

The 3305A's continuously adjustable sweep time of 0.01 to 100 seconds is slow enough for accurate

response testing of high-Q devices and fast enough for good visual displays of wide band response. For ease of automated testing, either the frequency or the sweep trigger can be externally controlled. Price, \$975.

Get the function generator that best fits your measurements. Consult your catalog and order by calling your nearest HP order desk. For data sheets, write to Hewlett-Packard, Palo Alto, California 94304. Europe: 1217 Meyrin-Geneva, Switzerland.

098/15

HEWLETT *hp* PACKARD
S I G N A L S O U R C E S

INFORMATION RETRIEVAL NUMBER 2

New Datapulse 112 gives you higher rep rates (to 125 MHz), faster rise times (1.3ns) and narrower pulses (to 3ns)—yet it costs you hundreds of dollars less.

What's more it has all the pulse parameter control you need to test high-speed circuits: simultaneous $\pm 5V$ outputs, single or double pulses, independent dc offset to $\pm 2V$, widths from 3ns to 5 ms, and delays to 5 ms.

You can control the pulse train with external gating pulses, produce complementary outputs for duty cycles approaching 100%, set the baseline at exact ground with a switch, and reduce rep rate to 10 Hz for low-speed testing.

No other high-speed pulser offers so much for just \$1595.00 . . . and the 112 is being delivered now. For a demo contact Datapulse Division, Systron-Donner Corporation, 10150 W. Jefferson Blvd., Culver City, Calif. 90230 213-836-6100.

Why buy a high-priced 100 MHz pulser? Here's 125 MHz for \$1595!



Oscilloscope photo. 2ns/div, 2v/div.

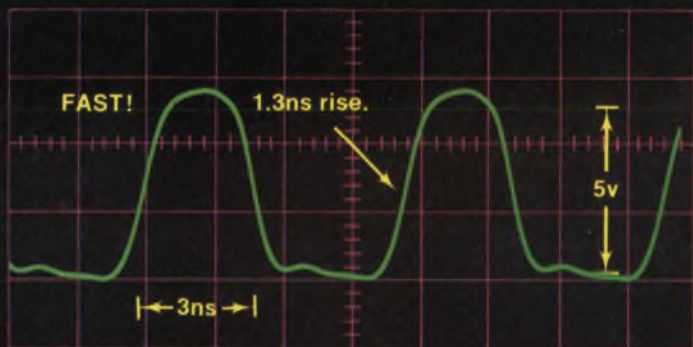

DATAPULSE

SYSTRON  DONNER

Another first. One of 135 Systron-Donner instruments

Electronic counters	Analog computers
Pulse generators	Digital panel meters
Microwave frequency indicators	Microwave signal generators
Digital clocks	Laboratory magnets
Memory testers	Data acquisition systems
Digital voltmeters	Microwave test sets
Time code generators	
Data generators	

NEWS

- 21 News Scope
- 25 **Dither over data: another crisis for the phone system?**
In New York City, telephone is in trouble and computer companies are predicting a breakdown
- 32 **Search for downed pilots made easier**
- 36 **Automated lab to transmit Antarctic data**
- 38 **S-3A to get totally integrated avionics**
Navy's most advanced antisubmarine-warfare aircraft will have computer-operated sensors and advanced displays
- 45 **Washington Report**
- 57 **Sidelights**
- 59 **Editorial: Are engineering unions really needed?**

TECHNOLOGY

- 80 **Try active overload protection** for your next dc voltage regulator. This sampling technique provides automatic restart.
- 84 **Analyze nonlinear systems by Popov's method.** It gives sufficient conditions for stability, independent of the nonlinearity's shape.
- 92 **Make linear models of op amps** using gain-frequency curves to obtain accurate equivalent circuits.
- 98 **Reduce stray reactances at vhf and uhf.** The boundary method of printed-circuit layout is one remedy discussed.
- 104 **Do you want to write technical articles?** An author-engineer offers some helpful tips on the whole process of getting published.
- 110 **Ideas for Design**

PRODUCTS

- 126 **Instrumentation:** Counter also serves as data terminal, display and coupler.
- 137 **Microwaves & Lasers:** He-Cd laser emits in deep blue and UV regions.
- 144 **ICs & Semiconductors:** Small-signal transistors cost only 19¢ each.
- 150 Components
- 154 Modules & Subassemblies
- 158 Data Processing
- 160 Packaging & Materials
- 164 Production

Departments

- | | |
|------------------------|-----------------------------------|
| 14 Designer's Datebook | 172 Application Notes |
| 167 Evaluation Samples | 174 New Literature |
| 168 Design Aids | 190 Advertisers' Index |
| 170 Annual Reports | 192 Information Retrieval Service |

Information Retrieval Service Card inside back cover

Cover Photo by William Skeahan

for Beckman Instruments, Inc., Electronic Instruments Div., Richmond, Calif.

**A new custom logic
element used to cost
about forty thousand
dollars, months of
design and production
time, and endless grief
in debugging and reliability**

How about a thousand dollars and we'll do it from memory?

Use logic programmed into an ROM (Read Only Memory) element. With a minimum of time, we can set up the pattern your logic table dictates and have your circuits coming down the chute. Costs about a thousand dollars and there's every probability your production run circuits will cost less, too.

ROM elements are far simpler to make than a new, untried logic design. They're highly repeatable and proven reliable. No logic race conditions. All of our ROMs will directly interface with TTL or DTL logic.

We've got a memorable packet of information for logic designers. Write or call National Semiconductor. 2975 San Ysidro Way, Santa Clara, California 95051. (408) 245-4320. TWX: 910-339-9240 Cables: NATSEMICON

Product number*	Bits	Organization	Package	100 up \$
MM520	256	256 x 1	8 pin TO-5	38.00
MM521	1024	256 x 4	16 pin DIP	45.00
MM522	1024	128 x 8 or 256 x 4	24 pin DIP	60.00
MM523	2048	256 x 8 or 512 x 4	24 pin DIP	96.00

* -25° to 70°C. Full mil temp also available.

National/MOS



MOS. Now.

20 standard Philco types are ready to ship from stock.

Our line of standard production MOS integrated circuits keeps growing broader every day. From our Lansdale plant, one of the largest MOS facilities in the country, you can now get instant delivery of many of the devices that you'll need for your next generation designs. For example:

- Shift registers; including the longest (256 bits) and the fastest (5MHz clock) commercially available in production quantities.
- Compatible gates, up to 2MHz clock, in a variety of configurations.
- Binary counters . . . 16-channel sequential/random access multiplexer . . . 1024-bit dynamic read-only memory, programmed to your bit pattern; off-the-shelf model is a sine look-up table.

Many more are being readied for production. When you want MOS *now*, we're the people to see. Write or call MOS Marketing, Philco-Ford Microelectronics Division, Blue Bell, Pa. 19422. (215) 646-9100.

the better idea people in MOS

PHILCO 

Device	Description
pL4C07C pL4C07AC(1)	7-stage binary counter 7-stage binary counter
pL4G10C pL4G10AC(2)	Hex 2 input NOR + 2 inverters Hex 2 input NOR + 2 inverters
pL4G11C pL4G11AC(2)	Dual 4 input NOR + dual 5 input NOR Dual 4 input NOR + dual 5 input NOR
pL4G12C pL4G12AC(2)	Dual 9 input NOR Dual 9 input NOR
pL4S16C	16 channel multiplexer
pL5R32C	Dual 8/16-bit shift register
pL5R40C	Dual 20-bit shift register
pL5R100C	Dual 50-bit shift register
pL5R96C	Dual 48-bit shift register
pL5R128C pL5R128AC(3)	Dual 64-bit shift register Dual 64-bit shift register
pL5R250C pL5R250AC(3)	250-bit shift register 250-bit shift register
pL5R256C pL5R256AC(3)	256-bit shift register 256-bit shift register
pM1024C	1024-bit read-only memory

(1) Clock rate 500KHz (2) Clock rate 2MHz
(3) Clock rate 5MHz



think
Bourns
Cermet
Model
3329!

.....*why?*

BECAUSE

it has a standard TC of ± 100 ppm/ $^{\circ}$ C over the entire temperature and resistance range. (-55 to $+150^{\circ}$ C & 10 ohms to 1 megohm).

BECAUSE

it is sealed to withstand wave soldering and immersion cleaning techniques;

BECAUSE

it is the first low-cost, commercial cermet single-turn to meet or exceed MIL-R-22097;

BECAUSE

it is now available in two new configurations . . . and if those aren't enough reasons . . .

BECAUSE

No Other $\frac{1}{4}$ " Diameter Potentiometer In The Industry Can Match It . . . *Not One!*

These units are as close as your telephone. Simply call your local Bourns sales office or authorized Bourns stocking distributor.





NOW GET CERAMIC TTL FOR THE PRICE OF PLASTIC

Specify ITT Series 7400 and Series 9000 Circuits

Last time you ordered TTL circuits, you had to choose between the reliability of ceramic packaging and the economy of plastic. Now you don't have to make that choice anymore.

ITT will ship you ceramic dual in-line 7400 series and 9000 series circuits immediately—at a price competitive with plastic. Ceramic 5400 series circuits are only slightly higher than their plastic counterparts. These are top quality circuits, 100% DC and dynamically tested before shipment. They're mechanically and electrically compatible with the Series 7400 and Series 9000 circuits of other manufacturers. Don't make a trade-off between price and reliability—let your ITT salesman or stocking distributor show you how to avoid it. ITT Semiconductors is a Division of International Telephone and Telegraph Corporation, 3301 Electronics Way, West Palm Beach, Florida 33407, Phone 305/842-2411.

semiconductors **ITT**

FACTORIES IN FLORIDA • MASSACHUSETTS • ENGLAND • FRANCE • GERMANY • PORTUGAL • AUSTRALIA

Excellent
references
required?

Use us for
dc-dc applications:



New Isolated Power Supplies

Model FRI-0018 +28 Vdc output
Model FRI-0015 +20 Vdc output
Model FRI-0014 +15 Vdc output
Model FRI-0012-1 +10 Vdc output
Input voltage: +28 \pm 4 Vdc
Temperature drift: \pm 0.002% / °F from -65°F to +200°F
Size: 1 3/4" x 1 1/4" x 3/4"
Plug-in mount
Priced from \$110 each

These new instrumentation quality power supplies may be just the references you need for your dc-dc excitation and input/output isolation applications. Highly reliable, they're not drifters . . . they perform beautifully over a wide temperature range. Equally important, you can't match them anywhere at the price.

Other excellent references offered include isolated multiple output power supplies for portable, airborne and space applications.

FAIRCHILD

CONTROLS

A Division of Fairchild Camera & Instrument Corp.
423 National Ave./Mountain View, CA 94040/Ph: (415) 962-2161/TWX: 910-379-6438
Europe: Fairchild Controls, Seestrasse 233, 8700 Kusknacht, Switzerland, (051) 906357

These eight Arrow-Hart plants



make 157,604 diversified products.

**Seven others off-camera
make 49,253 more,**

and we helped take the picture.

We're in the electrical equipment business—in a big way.

In six nations and three continents; in London, Toronto and Sydney, Australia, in Mexico City and New Zealand along with plants and subsidiaries that stretch across the breadth of the continental United States.

We're busy reaching for perfection, producing the high quality products that have come to be expected from us. Products like: motor controls, specialty switches, wiring devices, circuit breakers, power distribution equipment, enclosed switches and electronic devices.

From everyday electrical needs to the ultra-sophistication demanded of our space program, the Live Wires at Arrow-Hart are always looking for a better way to do things.

Now about this fantastic photograph. Whether it's electrical systems for an Air Force launching pad, intricate subminiature switches for a space vehicle, or controls for guidance and air conditioning systems, Arrow-Hart is very much a part of our nation's space program.

At Arrow-Hart, tomorrow is today.



**ARROW-HART, INC.
103 HAWTHORN ST.
HARTFORD, CONN.**

Move Up To 350 V Plastic Silicon Power For Low-Cost Line-Operation!

Move up to the high-voltage 2N5655-57 series Thermopad* silicon power transistors for your line-operated audio output amplifiers, low-current, high-voltage converters and line relays . . . and move weight, size and circuit complexity out of the "costly" column!

The new family furnishes up to 350 volts of CE sustaining voltage — making step-down transformers and associated hardware obsolete — with simple rectification the only additional consideration. In servo amps, for example, you can use one of these miniature-Thermopad units as direct control for 110-120V servo motors and realize substantial space-saving bonuses over metal-can counterparts.

In high inductive load switching or where transients and fault conditions lurk as unseen design elements, you can expect "hang tough" voltage-handling — in fact, they're triple-diffused, affording superior SOA (150V @ 65mA), switch-rated high frequency and low leakage.

- . . . top $V_{CE(sust)}$ ratings make them rugged.
- . . . low $V_{CE(sat)}$ makes them efficient.
- . . . Annular† makes them ultra-reliable.
- . . . excellent h_{FE} makes them performers.
- . . . 75¢ makes one yours!

And your Motorola distributor will make it to your door with one of these new, high-dissipation devices, or any of the others below, right away . . . call him now or write us for immediate data response! Box 20912, Phoenix 85036.

Type	I_c (cont.)	$V_{CE(sust)}$ V	h_{FE} @ I_c (min)	$V_{CE(sat)}$ @ I_c V	f_T @ I_c MHz (min)	I_{CEO} @ V_{CE} μA (max)	Price (100-Up)
2N5655		250	30-250	1.0	10	100 @ 150V	\$.75
2N5656	0.5A	300	@	@	@	100 @ 200V	.90
2N5657		350	100mA	100mA	100mA	100 @ 250V	1.10

You can step up to HV silicon power for a variety of other demanding consumer/industrial designs with other recently-introduced types . . . all state-of-the-art . . . all from Motorola leadership . . . all to your high-energy advantage!

Move up with Motorola high voltage silicon power!

Series/Type	High-Voltage Highlights
2N5629-34	140V/16A Industrial Economy
MJE340	300V, High Gain Plastic Power
MJ1800	Excellent, 500V/5A Gain Linearity
MJ9000	700V/6A Switching
MJ8400	1400V/3A Switching

†Annular semiconductors patented by Motorola Inc.

*Trademark Motorola Inc.



MOTOROLA
Silicon Power Transistors
- where the priceless ingredient is care!

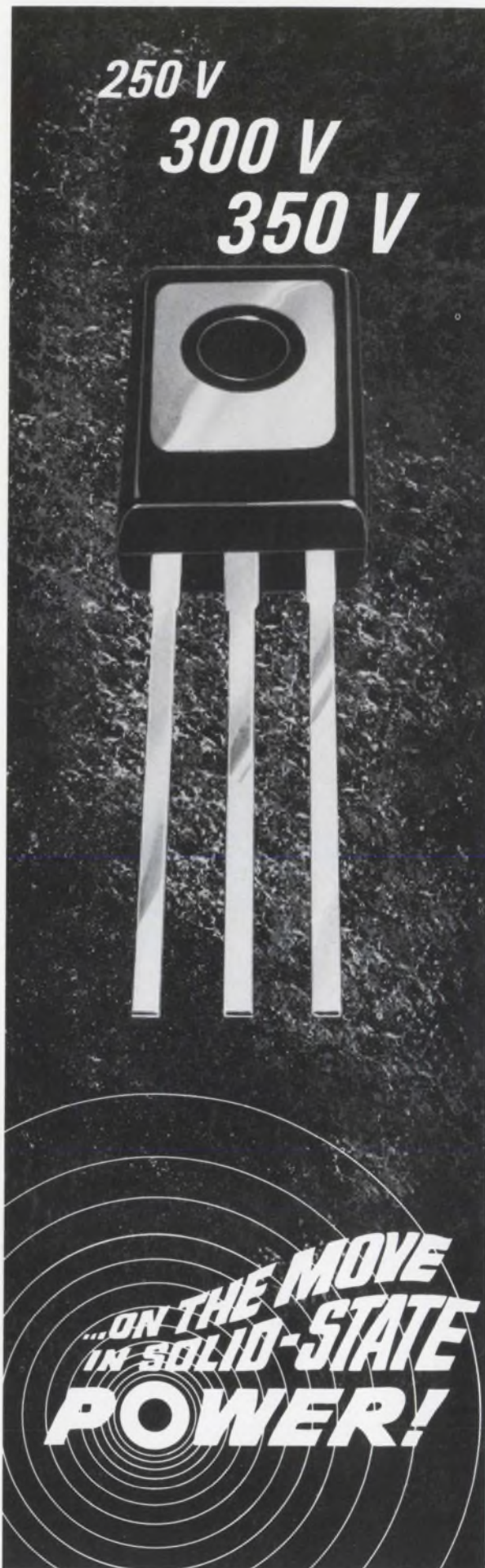



No other multimeter gives you all this

and no one but Cimron can make a claim like that stick

Here's the first and only 4-digit instrument that you can take with you and hook up for full multimeter performance anywhere. Cimron, the Customer Concern Company, puts your needs first. That's why this new Cimron 6453 is just one more the competition will have to catch up with.

You get the most advanced MSI and IC construction plus a thin film attenuator . . . which, by the

way, eliminates 75% of the normal calibration requirements. Single plane Digivac readout tubes result in the lowest power consumption of any digital multimeter, and make full-day battery operation possible. The same amplifier used in the most costly instruments provides an input impedance ten times greater than any meter in its class.

The basic instrument gives you 5 ranges of DC voltage measurement with 5th digit overrange, autoranging in all functions, autopolarity, and pushbutton selection. Add remote control, AC,

resistance, print output and the 8-hour battery pack options, and you have full remote programming capability anywhere.

And it's computer compatible. The 6453 . . . just 8 pounds and 3½" x 8" x 12", sells for only \$1,125. A full multimeter is less than \$1,600. *Call us for a demonstration.* Phone (714) 276-3200 or write

Cimron, Dept. D-110, 1152 Morena Blvd., San Diego, Cal. 92110.

CIMRON
first name in measurement

LEAR SIEGLER, INC.



CIMRON DIVISION

A Smart Way to Beat Your Power Supply Size Problem



abbott

1½" thin, 2¾" short, yet this converter produces 1000 volts DC, regulated, from a battery input of 28 VDC! It weighs less than 15 ounces. This is only one of our wide variety of many small light weight converters, inverters and power supplies — there are over 3000 models listed in our newest catalog, including size, weight, and prices. If you have a size problem, why not send for an Abbott catalog?

MIL SPEC ENVIRONMENT — All of the power modules listed in our new catalog have been designed to meet the severe environmental conditions required by modern aerospace systems, including MIL-E-5272C and MIL-E-5400. They are hermetically sealed and encapsulated in heavy steel containers. New all silicon units will operate at 100°C.

Please write for your FREE copy of this new catalog or see EEM (1968-69 ELECTRONIC ENGINEERS MASTER Directory), Pages 1727 to 1740.

abbott transistor

LABORATORIES, INCORPORATED

5200 W. Jefferson Blvd./ Los Angeles 90016
(213) WEBster 6-8185 Cable ABTLABS

RELIABLE — Highest quality components are used in Abbott power modules to yield the high MTBF (mean time between failure) as calculated in the MIL-HDBK-217 handbook. Typical power modules have over 100,000 hours MTBF — proving that the quality was built in from the beginning.

WIDE RANGE OF OUTPUTS — Any voltage from 5 volts DC to 10,000 VDC is available by selecting the correct model you need from our catalog with any of a variety of inputs including:

- 60 ϕ to DC, Regulated
- 400 ϕ to DC, Regulated
- 28 VDC to DC, Regulated
- 28 VDC to 400 ϕ , 1 ϕ or 3 ϕ
- 60 ϕ to 400 ϕ , 1 ϕ or 3 ϕ

TO: Abbott Transistor Labs., Inc., Dept. 57
5200 West Jefferson Blvd.
Los Angeles, California 90016

Sir:
Please send me your latest catalog on power supply modules:

NAME _____ DEPT. _____

COMPANY _____

ADDRESS _____

CITY & STATE _____

Designer's Datebook

OCTOBER 1969						
Sun	Mon	Tue	Wed	Thu	Fri	Sat
			1	2	3	4
5	6	7	8	9	10	11
12	13	14	15	16	17	18
19	20	21	22	23	24	25
26	27	28	29	30	31	

NOVEMBER 1969						
Sun	Mon	Tue	Wed	Thu	Fri	Sat
						1
2	3	4	5	6	7	8
9	10	11	12	13	14	15
16	17	18	19	20	21	22
23	24	25	26	27	28	29
30						

For further information on meetings, use Information Retrieval Card.

Oct. 6-8

Canadian Electronics Conference and Exposition (Toronto) Sponsor: IEEE, R. DeBuda, International Electronics Conf., 1819 Yonge St., Toronto 7, Canada

CIRCLE NO. 421

Oct. 13-19

International Astronautical Federation Congress (New York City) Sponsor: AIAA, American Institute of Aeronautics and Astronautics, 1290 Avenue of the Americas, New York, N.Y. 10019

CIRCLE NO. 422

Oct. 21-23

Thermionic Energy Conversion Conference (Carmel, Calif.) Sponsor: IEEE, W. E. Harbaugh, RCA, Electronic Components, Lancaster, Pa. 17604

CIRCLE NO. 423

Oct. 26-30

Mathematical and Computer Aids to Design Conference (Anaheim, Calif.) Sponsor: IEEE, ACM, SIAM, J. F. Traub, Computing Science Research Center, Bell Telephone Laboratories, Murray Hill, N. J. 07974

CIRCLE NO. 424

Oct. 27-29

Southeastern EMC Symposium (Atlanta, Ga.) Sponsor: IEEE, D. Vrooman, P.O. Box 331, Smyrna, Ga. 30080

CIRCLE NO. 425

Oct. 27-29

Electronic & Aerospace Systems Convention (EASCON) (Washington, D.C.) Sponsor: IEEE, H. P. Gates, Jr., Sect. of Army for Southeast Asia Matters, The Pentagon, Washington, D.C. 20310

CIRCLE NO. 426

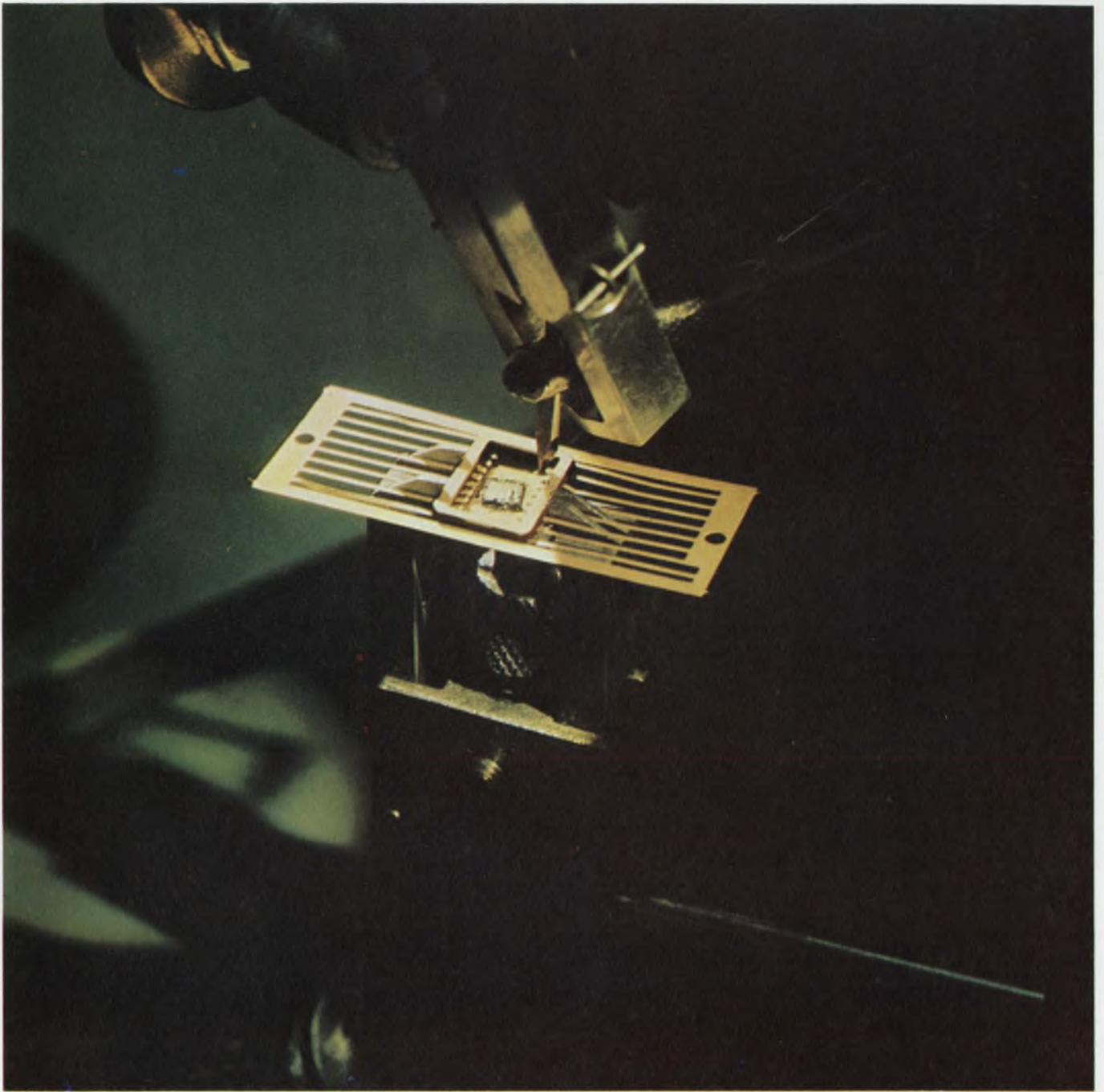

SHIFT REGISTERS, that is — new AMI/MOS Dynamic Shift Registers are rolling off our expanded production line. For instance, the AMI Dual 100 Bit Shift plugs into existing systems pin-for-pin. Other family members are just as shifty, but more lengthy — bit lengths to 1024, plus the “N”-length soon to be unveiled. The entire family is compatible with TTL, DTL, CCSL logic. Send for details. Better yet, hop a jet and visit our new MOS facility — America’s largest.

NOW IN PRODUCTION DYNAMIC FAMILY OF SHIFTS



AMERICAN MICRO-SYSTEMS, INC.

3800 Homestead Road, Santa Clara, California 95051
Telephone 408-246-0330, TWX 910-338-0018
CUSTOM & STANDARD MOS ARRAYS/MEMORIES/REGISTERS/LOGIC

INFORMATION RETRIEVAL NUMBER 13

Tips on cooling off hot semiconductors

See how other circuit designers use IERC heat sinks/dissipators to hold junction temperatures below rated maximums, improve circuit performance and reliability

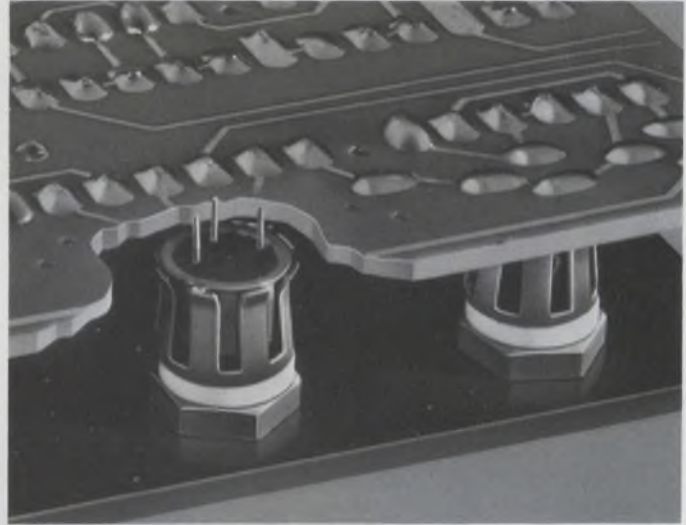
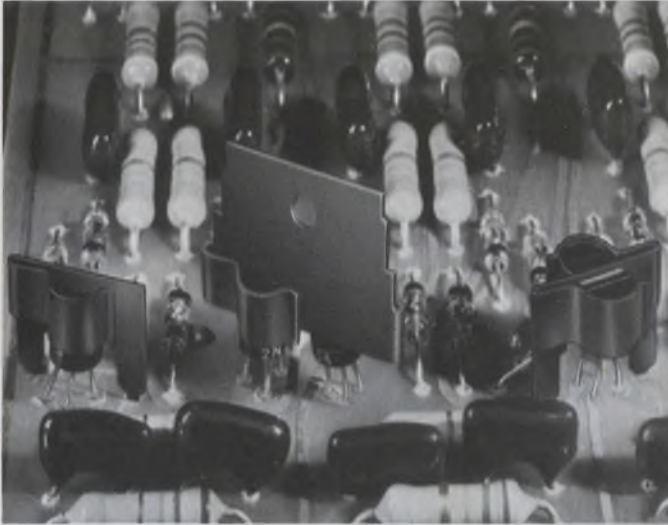

RO97's, RO97A's, X20's (D-Style) and other lead mounted, low power "plastic" transistors can be operated at up to 65% more power with IERC dissipators. They cost only pennies, provide excellent retention in severe environments, reduce failures from solder heat during assembly. 5 different styles; both single and dual models.



Replace elaborate forced air cooling systems for power devices. IERC fluid cooled systems provide up to 1,000 watts of dissipation in less than 45 cu. in. Parallel or series flow; open or closed loop systems. All standard mounting hole patterns; specials, too. Lengths from 6" to 3' standard.



TO3's, TO66's, TO15's and other case-mounted devices can be operated with many times more power when mounted in UP's. In still air, the staggered fingers dissipate by radiation and convection. In forced air, turbulence moves the air around each finger. Efficient in any direction. Outperforms extrusions dramatically.

For low capacitance between transistor and chassis, use IERC Thermal Links with BeO washers. BeO has the thermal conductivity of aluminum, yet cuts capacitance up to 2/3rds. Excellent dissipators and retainers. Each size fits a complete JEDEC case diameter range for TO5's and TO18's. Dual and quad models also.

Is yours a special heat problem? Talk to the thermal specialists at IERC. They have the problem solving experience to come up with a practical, low cost solution.



Free 4-page Short Form Catalog. Complete ordering and pricing information on the world's broadest line of heat sinks/dissipators and retainers for lead and case mounted semiconductors.

Heat Sinks/Dissipators





When you're under pressure (8,000 psi) to get facts fast . . .

Composite Histogram showing 4 oceanographic parameters. Photograph by Anthony Baloghy.

bring ERIE in early.

Current speeds and directions . . . temperatures . . . pressures . . . salinities. Essential data if Oceanography is to achieve its predicted \$9 Billion potential by 1978. Geodyne Division of EG & G International makes instruments combining multiple sensor packages . . . each capable of measuring up to eight such parameters. And, through new high-speed digitizing systems, all parameters are recorded almost simultaneously. From the start, Geodyne has relied on ERIE TECHNOLOGICAL for the Thick Film Hybrid Circuitry so vital to these new systems. Our unique single-source capability assures total control of substrates, precious metal formulations, components and encapsulants. Proof, once again, that it pays to bring ERIE in early.

ERIE TECHNOLOGICAL PRODUCTS, INC.

644 West 12th Street, Erie, Pennsylvania 16512
(814) 456-8592

THE PRACTICAL REFERENCE SHELF

FUNDAMENTALS OF INTEGRATED CIRCUITS

Lothar Stern

A practical guide to integrated circuits — their theory, manufacture and applications. This book offers complete discussion of the various techniques of integrated circuit fabrication and their strong influence on circuit design and performance. From a marketing viewpoint, it compares the relative qualities of the numerous IC's devised to date in terms of economics and logistics.

The book covers basic semiconductor principles, monolithic integrated circuits, thin-film circuits and their characteristics, hybrid and other integrated structures. There is also discussion of packaging, design and layout principles, and LSI. A volume in the Motorola Series in *Solid-State Electronics*. 208 pages, 7 x 10, illustrated, cloth cover.
#5695 \$8.95

LEVEL-HEADED LETTERS

Dr. Dugan Laird and Joseph R. Hayes.

Will help the executive to write better letters, faster. In practical, down-to-earth style, this book shows how to find the real reasons for writing; provides a simple plan for organizing ideas logically and psychologically, and points out ways to get affirmative responses from readers. Shows how to avoid cliches, verbiage and how to inject an air of informality into letters. Key feature is the programmed learning section on painless grammar. 134 pages, 6 x 9.

Paper cover, #5032 \$3.50
Cloth cover, #5033 \$4.95

PROJECT ESTIMATING BY ENGINEERING METHODS

Paul F. Gallagher.

A practical approach to attaining consistently accurate estimates by summarizing many general practices and introducing specific methods proven valuable in various kinds of work. Five methods of estimating are discussed, the fifth of which combines the two most important developments in the field: standard hours and the learning curve. To insure complete understanding, full coverage is given to construction and use of learning curves. Nearly 100 pages of learning curve tables appear in the appendix. 344 pages, 8½ x 11, illustrated, cloth cover.
#5018 \$15.00

PRACTICAL PA GUIDEBOOK: HOW TO INSTALL, OPERATE AND SERVICE PUBLIC ADDRESS SYSTEMS

Norman H. Crowhurst

A practical guide covering all aspects of the subject. The book shows how to select and install the appropriate equipment, covers routine operation and maintenance of the finished system. Special attention is given to solving the problems encountered in providing successful service. 136 pp., 6 x 9, illus., paper.
#0778 \$3.95

THEORY AND APPLICATIONS OF TOPOLOGICAL AND MATRIX METHODS

Keats A. Pullen.

The dependence of electrical circuit theory on topology (theory of line graphs) is of growing importance because line graphs for networks represent their flow patterns. Application of topological methods has lagged behind the use of matrix methods only because of minor application problems. This volume resolves these problems in a logical and understandable way. 100 pages, 5½ x 8½, paper cover.
#0300 \$2.50

INDUSTRIAL STROBOSCOPY

Gilbert Kivenson.

A comprehensive description of the history, development and use of stroboscopy in industry, commerce and research. Stroboscopy for analysis and measurement has spread to many specialized areas of science and engineering, such as high-speed cinematography, photometry, radiometry, torsional vibration and other areas. This book discusses the state of the art today and areas of further usage. 284 pages, 6 x 9, illustrated, cloth cover.
#5045 \$9.95

DESIGN OF LOW-NOISE TRANSISTOR INPUT CIRCUITS

William A. Rheinfelder.

Design engineers and others interested in low-noise circuit design will find this book a real time saver. Gives a multitude of labor saving graphs and design curves for the practical circuit designer. Simple derivations of all important formulas help the reader obtain a deeper insight into the fundamentals of practical low-noise design. 128 pages, 6 x 9, illustrated, cloth cover.
#5014 \$5.50

WAVEFORM MEASUREMENTS

Rufus P. Turner.

Complete how-to information on the various techniques of electrical waveform measurement—from troubleshooting to signal synthesis. Book details procedures for the isolation and measurement of a single harmonic from a multitone mixture, measurement of total distortion, calculation of harmonic values from heights of the wave patterns, etc. 96 pages, 5¾ x 8¼, illustrated, paper cover.
#0775 \$2.95

UNDERSTANDING SILICON CONTROLLED RECTIFIERS

Saul Heller

A compact, illustrated guide to the capabilities and operation of the versatile SCR and the triggering circuits associated with these devices. Throughout the book, schematic diagrams illustrate the application of the various SCR's as static switches, phase-control switches, inverters, choppers, etc. Emphasis is placed on choosing the right SCR to do a given job. 134 pages, 5¾ x 8¼, illustrated, paper cover.
#0782 \$3.50

TRANSISTOR AND DIODE NETWORK PROBLEMS AND SOLUTIONS

Harry E. Stockman.

This two-way reference demonstrates the practical application of theory and serves as sourcebook of step-by-step mathematical solutions to practical problems. With schematic situations covering the entire field of transistor and diode networks, the reader develops effective techniques by comparing his own solution methods with the author's. 352 pages, 6 x 9, illustrated.
#5694 \$9.95

TRANSISTOR AND DIODE LABORATORY COURSE

Harry E. Stockman

Structured on engineering concepts and facts, this new course first provides a groundwork in transistor technology. Two-part theory viewpoints are applied continuously to give the work an engineering slant. The balance of the experiments deal with more intricate transistor networks, such as the theory and operation of multivibrators, and the concept of parametric action. 128 pages, 7¼ x 10, illus.
#5671 \$3.95

REVIEW ANY OF THESE BOOKS FOR 10 FULL DAYS — FREE!

HAYDEN BOOK COMPANY, INC. 116 W. 14 St., N. Y., N. Y. 10011

Please send me the books circled below, on a 10-day free examination. At the end of that time I will remit payment, plus postage, or return the books without obligation.

5695	0778	5014
5694	5032	0775
5671	5033	0782
5018	0300	5045

Payment enclosed (Hayden pays postage). Same return privilege.

Name _____
Firm _____
Address _____
City _____ State _____ Zip _____

On all overseas orders, payment in U.S. dollars must be enclosed. Publisher pays postage with same return privilege.

ED-869

HAPPENING IN ELECTRONICS

September, 1969

Design your own Decoder-Driver-Display Unit

You can do it with a minimum of devices and a maximum of ease thanks to MSI*. Follow these four steps:

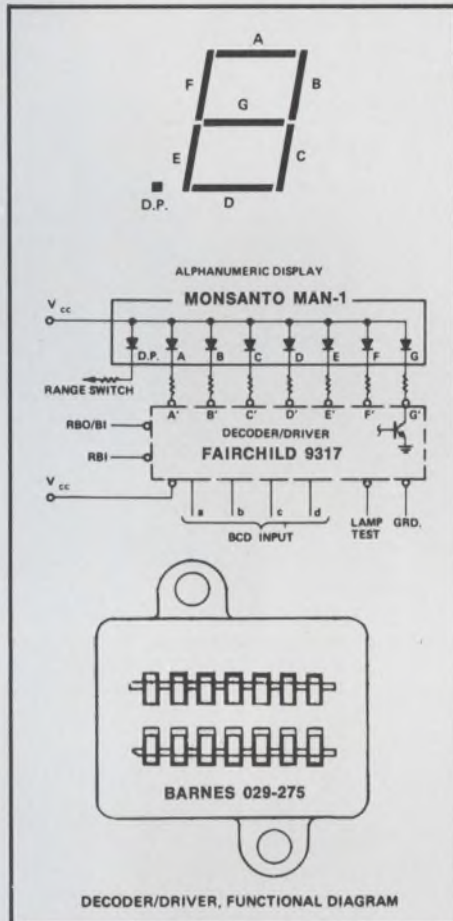

1. Acquire a Fairchild MSI 9317. This device will decode four binary coded decimal (BCD) lines and convert them into a seven line output suitable for illuminating a seven-segment display unit. The 9317 will drive directly the segments of the display unit without the need for discrete transistors.
2. Acquire a Monsanto MAN-1. This unit is a solid-state seven-segment matrix display used for representing the decimal numbers 0 to 9. It will provide you with a visible red numeric readout of high brightness with single plane, wide angle viewing, and shock resistant, long operating life. For a booklet describing Monsanto's MAN-1, circle No. 241.
3. To properly mount these two devices, acquire two Barnes sockets: 029-275-11 for the Monsanto unit and 029-275-12 for the Fairchild unit. The Barnes sockets have large tapered lead entrances to facilitate the insertion of multiple leaded devices as well as having flanges for chassis mounting applications. (They are also available without flanges for printed circuit boards at same cost.)
4. Acquire seven Mepco Green Line resistors RN55C1210F. Now you are ready to wire. For full information on complete package circle No. 242.

*Medium Scale Integration.

Type No.	Prices		
Fairchild	1-24	25-99	100+
U6B931751X (Mil. Temp.)	28.00	22.40	18.80
U6B931759X (Com'l. Temp.)	14.00	11.20	9.40
Monsanto	1-9	10-99	100+
MAN-1	48.00	44.00	38.00
Barnes	1-49	50-99	100+
029-275-11 (14-pin)	1.70	1.55	1.40
029-275-12 (16-pin)	1.90	1.70	1.55
Mepco			
RN55C1210F	12¢ each when ordered with package.		

Three more jump aboard Schweber's Chip Bandwagon

In our June issue we announced the availability of Motorola Zener diode chips from Schweber stock for use primarily in hybrid circuits. This month Schweber announces three more chip lines which should interest companies with in-house capabilities in thin and thick film hybrid circuits:

1. Semiconductor & I/C Chips from Union Carbide

Schweber will supply in chip form a broad selection from Union Carbide's silicon integrated circuits and discrete semiconductors. Single FETs, dual FETs, monolithic dual bipolar transistors, linear integrated circuits, and MOS devices are available in chip form. All Union Carbide chips are of silicon epitaxial planar construction. Special chip carriers enable parameter testing without removal from carrier. Circle No. 243.

2. Ceramic Chip Capacitors from Vitramon

Monolithic ceramic chip capacitors in a capacitance range of 10 to 470,000 pf in ten physical sizes from .050" x .040" through .220" x .240" are now in Schweber stock. They have noble metal terminations providing a high degree of solderability. Voltage rating @ 85°C is 100 VDC and @ 125°C is 50 VDC. Temperature range -55°C to +125°C. Circle No. 244.

3. Solid Tantalum Chip Capacitors from Kemet

Solid tantalum capacitors in chip form complement ceramic chip capacitors by extending the capacitance range all the way to 100 uf. Its high volumetric efficiency is an ideal virtue in any application where the name of the game is microscopic size. Add to this, stable parametric performance and extended storage and operating temperature capabilities and you know you have a device that is made for the hybrid field. Circle No. 245.





MSI

Sprague Series 54/74 ICs. Illustration: 54/7491 8-Bit Shift Register

More Stuff Inside. Sprague 54/74 arrays.

Design is easier. Package count and costs go down. Equipment gets smaller, neater, simpler. Simply because you get more inside every DIP or flatpack with Sprague Series 54/74 arrays.

So buy fewer parts. And make every part count. Move into MSI. With Sprague Series 54/74 arrays. Get the straight answers on complex arrays. Types. Prices. Delivery. Call Sprague now.

Decade Counter	54/7490	4-Bit Binary Full Adder	54/7483
Divide-By-Twelve Counter	54/7492	8-Bit Shift Register	54/7491
4-Bit Binary Counter	54/7493	BCD Decoder/Driver	54/7441
Gated Full Adder	54/7480	Quad Bistable Latch	54/7475
2-Bit Binary Full Adder	54/7482		

Call Sprague Info-Central (617) 853-5000 extension 5474.

Or call your Sprague industrial distributor. He has Sprague Series 54/74 circuits on the shelf. For complete specifications, circle the reader service number below.



News

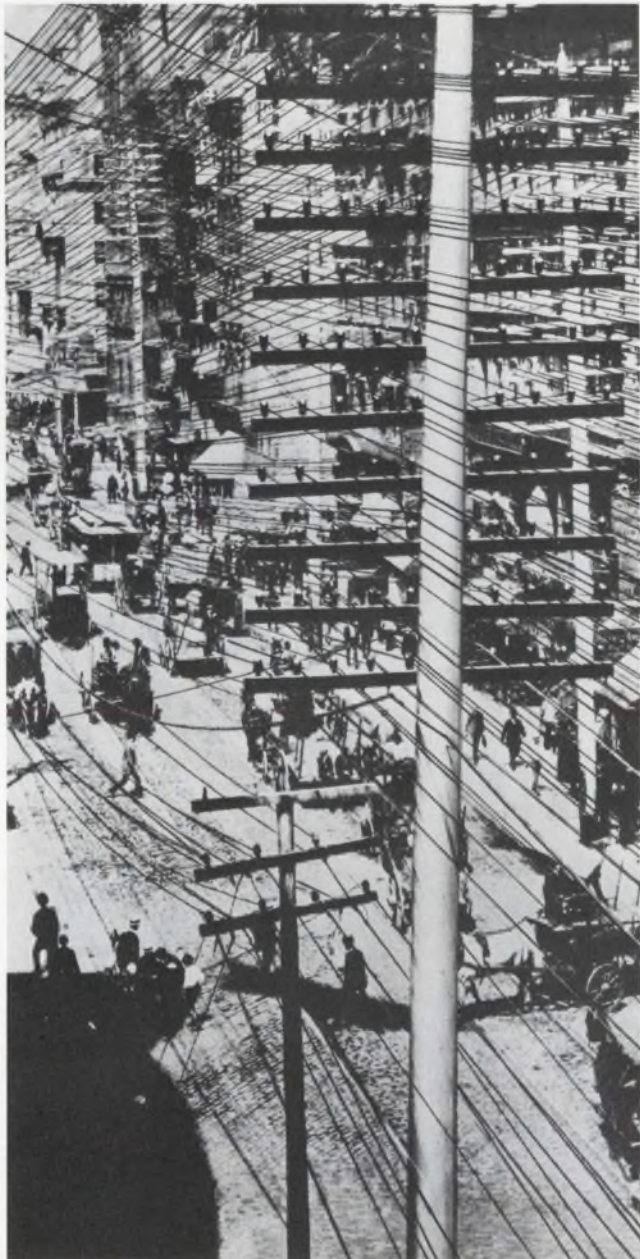

The nation's telephone system may be faced with problems as confusing as this maze of wires in an early New York street scene. p. 25



To speed up rescue, the Army is adding uhf to pilots' homing beacons and the Air Force is improving direction finders. p. 32.



S-3A carrier-based, antisubmarine warfare aircraft will have integrated avionics, computer-operated sensors, selective displays. p. 38.

Also in this section:

Automated laboratory to transmit Antarctic data. p. 36

News Scope, p. 21 . . . **Washington Report**, p. 45 . . . **Editorial**, p. 59

...like more capacitance in aluminum 'lytics?

Get SPRAGUE Type 36D POWERLYTIC[®] CAPACITORS



INFORMATION RETRIEVAL NUMBER 821

Large cylindrical electrolytic capacitors for use in digital computer power supplies, industrial control equipment, energy storage applications, etc. Low impedance construction. Largest case (3" dia. x 8⁵/₈" high) provides 650,000 μ F at 3 volts! Can be operated at +85 C. Tapped No. 10-32 terminals simplify filter bank assembly. Available with or without outer plastic insulating sleeves.

45C-9153

...want high volume efficiency in tubular 'lytics?

Use SPRAGUE Type 39D POWERLYTIC[®] CAPACITORS



INFORMATION RETRIEVAL NUMBER 822

Provide maximum capacitance in smaller cases with axial leads. No internal riveted or pressure connections. Welds at critical anode and cathode terminals. Molded end covers. Life expectancy of 10 years or more in normal service. Very low effective series resistance and leakage current.

45C-9154

For complete technical data on Type 36D Capacitors, write for Engineering Bulletin 3431C. For information on Type 39D Capacitors, request Engineering Bulletin 3415. Write to: Technical Literature Service, Sprague Electric Co., 347 Marshall Street, North Adams, Massachusetts 01247.



'Sprague' and '®' are registered trademarks of the Sprague Electric Co.

THE BROAD-LINE PRODUCER OF ELECTRONIC PARTS

FAA takes steps to automate airways

The Federal Aviation Administration is taking the first steps toward getting rid of a bag full of problems that have plagued the agency and the nation for a long time. With new equipment under contract, it hopes eventually to decrease the workload of the long-suffering and nearly mutinous air traffic controllers, as well as to tighten up—with increased safety—the spacing between aircraft during final approach. This would, of course, cut down landing delays that have been a growing nightmare for air travelers and the airlines for the past few years.

FAA plans to achieve these improvements in two steps:

- It will add at 64 big-city airports data-processing equipment that will enable controllers to put tags on all aircraft on the screen whether the aircraft are equipped with radar beacons or not.

- It will provide equipment to patch radar inputs from two or more ground radars onto one controller's screen—giving him a mosaic picture of a larger area.

At present the only alphanumeric tags on the controller's screen are those automatically generated by radar beacons. Most commercial aircraft are equipped with such beacons, but few business and private planes have them. Those without beacons are to the controller unidentified, hazardous blips on his screen. He can identify them by voice interrogation, but without tagging them alphanumerically he soon forgets which one is which.

With the new modular unit, he will interrogate the pilot and then tell the computer to give the blip a tag that will follow it wherever it goes.

Enroute radars now being installed between airports already have this capability built in. Unfortunately, the data-processing

units used on them are not adequate for the terminal radars because of the extra load these busier radars must handle.

Under contract to design these modular units for the big airports is the Univac Federal System Div. of Sperry Rand Corp., St. Paul, Minn. The initial letter contract to make a preliminary design amounts to \$85,000. The second phase will begin by December, 1970, and this calls for a developmental model—hardware and software. Phase 3 will be awarded for procurement of general-purpose components needed for testing. After this a production award will be made.

Next, in FAA's long-awaited improvement program, will be a follow-up contract with Univac for feeding computerized data from two or more radars to a single TV-like radar screen. The advantages of a mosaic picture of this kind are that the controller gets a view of a larger hunk of airspace, plus the assurance of radar coverage by at least one radar if another one should fail.

A facility for multiprocessing is necessary for this operation—that is, two or more computers are needed to digest and piece together the mosaic picture. This will entail still another contract, also with Univac.

World electronics sales to triple by 1980

The world electronics original equipment market (EOEM) will soar to \$90-billion by 1980, compared to the \$33-billion level for 1967, according to Hugh D. Kennedy, vice president of Ness International, Palo Alto, Calif. The non-U.S. segment will account for \$43-billion in 1980, a sharp increase over the 1967 level of \$12-billion.

Today exports account for one-third of the market served by the U.S. electronics firms; by 1980, about half of the industries' output will be slated for overseas sales.

To illustrate the trend, Kennedy cited that, during the past three years, U.S. electronics exports have grown by 75% with the largest gains garnered by semiconductors (142%), computers (122%) and broadcast equipment (115%).

The U.S. market is expected to expand from \$21-billion to \$47-billion in 1980 with \$7-billion for consumer products, \$21-billion for military/NASA and \$19-billion for the industrial market.

Kennedy urged U.S. firms to expand their overseas marketing horizon beyond Europe and Japan and to pay particular attention to small, underdeveloped countries where electronics would eventually be in heavy demand.

Automated MOS design from Collins Radio

Automated MOS design and fabrication are now offered by Collins Radio Co., Newport Beach, Calif. Bob Johnson, vice president and general manager, has announced that a Collins customer can now communicate directly with the Collins automated MOS/LSI design facility via remotely located computer terminals. Inputs to the system can be in the form of logic, equations or FORTRAN statements.

The customer, Johnson says, in effect commands Collins' entire MOS process during design and production. His instructions to the system, called the C-System, may be input from terminals located in Collins facilities, or from a terminal installed in his own plant.

Johnson says that Collins' capability at present is 100 designs per month, with turnaround, at a cost of \$8,000 to \$12,000 for a sample quantity. The company can now turn out 10,000 chips/month, and expect to increase this capacity to 100,000 chips/month by December, 1969. Chip size can go as large as 160 × 160 mils.

Electrical parameters, logic and supply levels are all fixed by the Collins process, although process

types and some functional variables can be specified by the customer. The system incorporates logic simulation, automatic placement, routing, and interconnect programs and automatic graphic display of the array design. Mask generation is automatic, by means of a computer-controlled variable-aperture camera.

Federal research funds may move from campus

Government-supported applied research, much of it of an electronic nature, may soon begin a drift away from university campuses, thanks to the actions of militant and dissident students. And the shift may prove a bonanza in the form of federal research funds for electronics companies.

So said Charles A. Anderson, president of Stanford Research Institute, during an address at the recent WESCON Sponsors Luncheon. But the shift will not be without its unpleasant side effects, says Anderson.

"... when federal research funds come into your plants and facilities you might be well advised to see if there are militants close behind. Just as the projects follow the researchers, so the militant students and their tactics will follow. In short, gentlemen, your companies could well be the next targets."

Based on his experience at Stanford Research Institute, which is now terminating its long-standing affiliation with Stanford University as a result of dissident student activities, Anderson suggested three basic preparatory steps for industry management:

- Through your actions and public posture make it quite clear to those who might be planning harassment that you cannot and will not condone violence, and that you will not tolerate disruption of your work. You should make it clear that when laws are broken the civil authorities will be asked to take appropriate and swift action so you

can go about your business.

- Get the people in your organization conditioned to the fact that harrassing tactics from small, well-organized and tenacious groups could be forthcoming in your plants and offices.

- Seek the understanding and support of groups and individuals in the communities in which you operate.

Electron-beam masking ups yields, cuts costs

Electron-beam mask generation will eliminate the problems of contact printing, raise yields and cut costs in IC manufacturing, according to Stephen J. Angelo, consultant with Westinghouse Research Laboratories, Pittsburgh, Pa.

The new process, developed at Westinghouse with Air Force funding will avoid the yield losses due to wafer damage and the low mask lifetime characteristic of the present contact printing methods, according to Angelo. IC patterns, in the new process, are printed directly on sensitized silicon wafers by means of electron-beam projection.

Dr. Hogle, president of Hogle Industries Inc., which participated in the development and has exclusive rights to manufacture and market the system, says, "A nine-fold reduction in yield losses is possible by going to the new system, and the system can provide up to an 8.5-to-1 cost advantage.

The electron-beam system is also said to offer greater potential resolution, by a factor of five, than optical systems, and a much greater depth of focus. The high resolution may result in greater chip complexity. First deliveries of the system are expected in the last quarter of 1970.

Electronic thermostat offers portability

For the homeowner or commercial-building owner who thinks he has everything, a Brooklyn, N.Y., laboratory has introduced "the world's first wireless, portable electronic thermostat for central heating and air-conditioning."

The thermostat, called Space-

Temp 100, works this way, according to an announcement by its developer, Kimco Laboratories, Inc.:

"It sends an electronic signal to the responder unit at the furnace or air-conditioner, commanding it to produce the exact heat or cool air required. Then, it automatically monitors the temperature electronically to make sure it's continually on target."

There are these advantages, the developer says: The thermostat can be moved from room to room, "guaranteeing accurate control of the temperature wherever it is located." And since it's all circuitry, with no moving parts, "it is unaffected by external factors such as dirt, dust, moisture and other afflictions that cause service problems with conventional thermostats.

Giant telescope to probe sun's secrets

Next month on a dry and cloudless mountaintop in New Mexico, Air Force scientists will try out the most elaborate solar telescope in the world. With the \$3.3-million, 365-foot-high facility they will unveil secrets of solar disturbance that have long fouled up man's communications on earth and his delicate instruments in satellites. Now it endangers man himself as he goes farther into space.

Central core of the telescope is a 321-foot cylinder—227 feet of which is underground—with a maximum diameter of 10 feet. The cylinder weighs 250 tons and is evacuated to 250 torr, a pressure equivalent to that at an altitude of 180,000 feet. It is suspended like a pendulum, floating on a 11-ton pool of mercury.

The mercury provides a friction-free bearing for the entire core assembly, which rotates to follow the sun at one revolution per minute.

The telescope contains three evacuated spectrographs, each 68 feet long with diameters of five feet.

The telescope is operated by stored programs in an SDS-Sigma 2 computer.

Air Force Cambridge Research Laboratory sponsored the development of the project.

Dual Transistors



17 tight trackers

Tight thermal tracking. Low drift. High stability. All essential in circuits which process matched signals. They're yours when you design with TI dual and matched-pair transistors.

Use them for high and low current applications in your operational and differential amplifier designs...as flip-flops, emitter-followers, gates and counters in your switching and logic circuits...and for audio, compound and pulse amplifiers.

From its line of 73 standards and hundreds of specials, TI has selected 17 dual and matched-pair transistors that meet the majority of multi-channel circuit needs.



TI Preferred Dual and Matched-Pair Transistors					
Type	Polarity	Package	Type	Polarity	Package
TIS92*	NPN	TO-18 SILECT**	2N2920	NPN	TO-77
TIS92M*	NPN	TO-18 SILECT**	2N2977	NPN	TO-71
TIS93†	PNP	TO-18 SILECT**	2N2979	NPN	TO-71
TIS93M†	PNP	TO-18 SILECT**	2N3350	PNP	TO-77
2N2060	NPN	TO-77	2N3680	NPN	TO-77
2N2223	NPN	TO-77	2N3838	NPN/PNP	FLAT PACK
2N2639	NPN	TO-77	2N4854	NPN/PNP	TO-77
2N2642	NPN	TO-77	2N5045	N-CH.FET	TO-71
2N2643	NPN	TO-77			

They're part of TI's line of preferred semiconductors, selected after months of computer demand analysis to save you time and money in specifying discrete devices.

To obtain data and specifications on preferred dual and matched-

pair transistors, write for TI's *Preferred Semiconductors and Components Catalog*: Texas Instruments Incorporated, PO Box 5012, MS 308, Dallas, Texas 75222. Or just circle reader service card number 115.



*† Matched-Pairs
** Trademark of Texas Instruments

TEXAS INSTRUMENTS
INCORPORATED

Burr-Brown introduced these new products at WESCON

Here's your chance to get complete information.

NEW OPERATIONAL AMPLIFIERS

- Four new FET input units offering a combination of 20 or 50 $\mu\text{V}/^\circ\text{C}$ voltage drift and 5 or 20 mA output current. Priced from \$10.90 in 100 quantity.
- Four new FET input units offering any combination of the above specifications plus a high CMR of 94 db. Priced from \$16.90 in 100 quantity.
- Four new transistor-input units offering any combination of 5 or 20 $\mu\text{V}/^\circ\text{C}$ voltage drift and 5 or 20 mA output current. Priced from \$10.00 in 100 quantity.
- A new high-voltage ($\pm 100\text{V}$) chopper stabilized unit designed for operation from ± 60 to $\pm 120\text{V}$ power supplies.

For Details Circle Reader Service No. (221)

NEW INSTRUMENTATION AMPLIFIERS

Two new low-priced instrumentation amplifiers offering

- Voltage drifts of 3 $\mu\text{V}/^\circ\text{C}$ and 10 $\mu\text{V}/^\circ\text{C}$.
- 1 to 1000 gain.
- Small encapsulated packages (1.5" x 1.5" x 0.4").
- Priced from \$29.90 in 100 quantity.



For Details Circle Reader Service No. (222)

NEW ACTIVE FILTERS

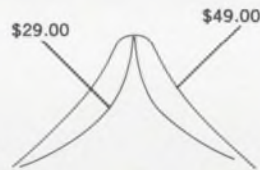

- A new encapsulated single-tuned bandpass unit priced at \$29.00 in 100 quantity.
- A new encapsulated stagger-tuned bandpass unit priced at \$49.00 in 100 quantity.
- These are additions to the industry's most comprehensive line of standard, encapsulated active filter modules . . . all pre-tuned at the factory to customer requirements.

For Details Circle Reader Service No. (223)

NEW MULTIPLIERS

Two new 4-quadrant units capable of performing multiplication, division, and square-rooting . . .

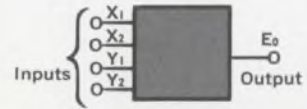

- and of accepting both differential or single-ended inputs. Both units have good power supply rejection, high input impedance and require no external trimming.
- 1% accuracy* unit priced at \$49.00 in 100 quantity.
- 2% accuracy* unit priced at \$39.00 in 100 quantity.

* % of full scale (MAX) including offset, scale factor (gain) error and nonlinearity.

For Details Circle Reader Service No. (224)

BURR-BROWN
RESEARCH CORPORATION

International Airport Industrial Park • Tucson, Arizona 85706
TELEPHONE: 602-294-1431 • TWX: 910-952-1111 • CABLE: BBRCORP



Operational Amplifiers
Instrumentation Amplifiers
Function Modules
Active Filters
Power Supplies

Dither over data: another phone system crisis?

In New York City, telephone is in trouble and computer companies predict a breakdown

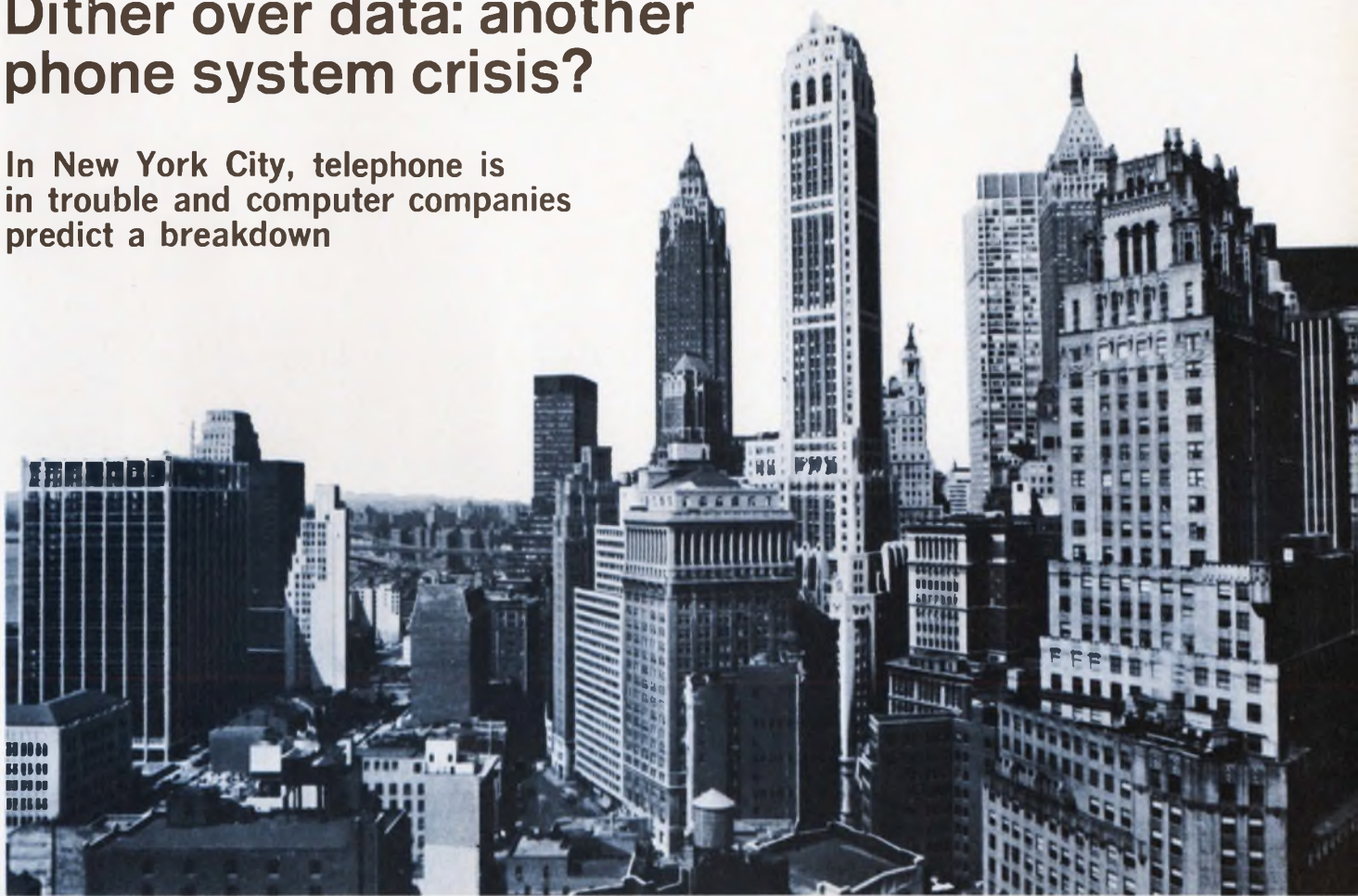

John N. Kessler
News Editor

Telephone systems in urban areas are in trouble, and the question is: With the data communications explosions just beginning, will the phone company be able to handle intercity data transmission?

The problem was dramatically illustrated in New York City recently when an electronic switching system went "down" three times for about 50 minutes each. The response of the public was immediate: three companies took ads in *The New York Times* to complain about the service — and the city's Department of Consumer Affairs says that if customers don't get service, they don't have to pay their bills.

How do the problems in New York City relate to computer serv-

ices? Lewis C. Clapp, president of Dial Data, Inc., of Englewood, N.J., told *ELECTRONIC DESIGN* that his company "was advised confidentially by people within the phone company that a serious overload problem was developing in Manhattan and that we should try to stay out of the area."

Telephone blackout predicted

Clapp predicts that "unless drastic and dramatic measures are taken to correct and improve the situation now, then by 1972 we will be experiencing national telephone blackouts." Dial Data is typical of the numerous computer design and consulting firms that use the telephone switched network to transmit data to their customers.

William B. Quirk, AT&T mar-

keting director — data communications, was quoted in *The New York Times* (August 20) as saying that the computer data transmissions over telephone lines now account for about 3 per cent of all telephone time consumed in the United States. "By 1980," he predicted, "we figure it will probably grow to somewhere around 5 per cent."

Yet in a recent speech, president Paul A. Gorman of Western Electric said that "data information transmitted in 1980 will equal that of all voice communications." Back in 1967, former AT&T president F. R. Kappel said, "In a few year's time, data communications will actually exceed in sheer volume the communications of speech." Referring to that speech, Stanley Damkroger, an AT&T assistant vice

NEWS

(telephone, continued)

president, said, "Some may have doubted that (Kappel's) prediction, but at the rate data communications is growing in the private line field this may have happened."

James M. Freeman, director of press relations of AT&T, explains that the Gorman and Kappel estimates of usage have to do with volume of information, not the amount of circuits or circuit time.

However, neither Freeman nor his counterparts at Bell Laboratories and at Long Lines could tell ELECTRONIC DESIGN how much data is being sent over telephone lines. The Bell System, it was explained, has worked hard to make telephone

service able to accommodate both voice and data. But if such information is unavailable can the phone company be assured it can handle future data transmission?

Dial Data Inc. estimates that by 1975, more than 30 per cent of the revenues of the telephone companies will come from computer-related data transmission. "Companies such as Dial Data," says President Clapp, "provided the phone companies with detailed projections going several years into the future."

A. D. Little and Stanford Research Institute estimated that by 1975 more than 70 per cent of all computer use would involve time-sharing and that this would place heavy demands on the telephone

system.

In an article in *Scientific American* (September, 1966) John R. Pierce, executive director, research, Communication Sciences Div. at Bell Telephone Laboratories, charts the growth of interstate phone circuits for voice and non-voice. Back in 1945, the total number of all interstate circuits totaled about 10,000 with 1000 for facsimile, TV and data. But according to Pierce, non-voice circuits "are expected to exceed message circuits next year (1967)."

By 1970, Pierce forecast there will be nearly 600,000 circuits for the Long Lines Co. (a division of AT&T) and that conventional telephone messages should constitute about one-third of the total use.

Data transmission over the telephone network is a particularly touchy subject because the hearings now before the FCC will determine who will carry data in the future. And AT&T lost an important decision when the FCC voted to permit a small independent company, Microwaves Communications, Inc., of Washington, D.C., to set up a private-line point-to-point microwave link between St. Louis and Chicago. (See ED 18, Sept. 1, 1969, p. 21.)

There are 150 time-sharing computer companies in the U. S., and their number is growing, particularly in urban areas like New York, Boston, Atlanta and Detroit.

The complaint is cost

A major complaint of these companies is costs. Martin Cooperstein, executive vice president of Data Architects, Inc. of Waltham, Mass., says that the cost of data Communication where telephone lines are 90 miles or more exceeds the cost of computer service itself.

Cooperstein contends that "certain remote-access computer businesses are not coming into being because of communications costs."

What are the costs to those companies? The same as the costs to everybody else. But the difference is that most telephone customers use their phones relatively infrequently. A computer expert says that the call volume from computer companies is 100 to 1000 times greater than from individual telephone customers or businesses.



Long Lines cable—part of network of 300,000 interstate telephone circuits. The cost per circuit mile is now down to \$12.00.

Four ways to improve your memory:

1. Improve your computer's memory with Linear Circuit 525. It's the one, the only high-speed core memory sense amplifier of its type that lets you set the threshold internally. (Or externally; take your pick.) More unforgettable features: 1) uncertainty range, $\pm 4\text{mV}$; 2) propagation delay, 30 ns; 3) low power consumption: 110mW; 4) high common mode range: $+4.5\text{V} - 3.5\text{V}$.

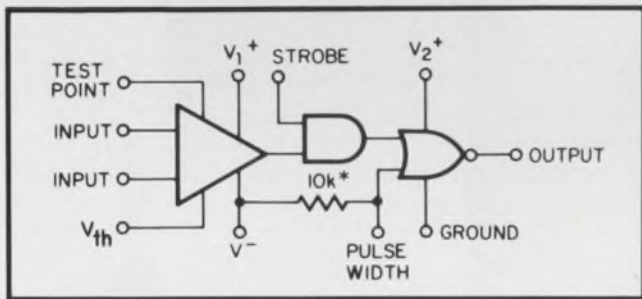

2. Improve your computer's memory with Linear Circuit 511. This one's a versatile transistor array. It's also a pre-amp — with DC characteristics that are 50 to 100% better than competing devices! Other memorable points: 1) low offset voltage $\pm 2\text{mV}$; 2) low offset current; 3) single power supply; 4) AGC capability.

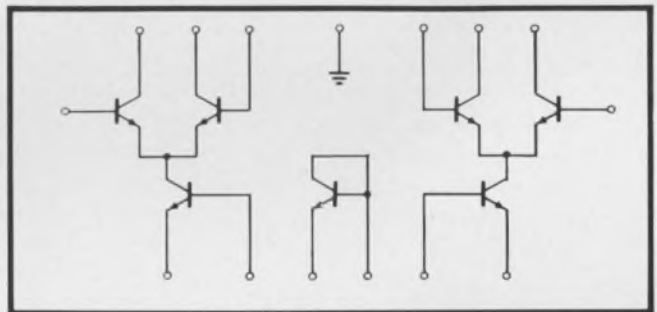

3. Improve your computer's memory with Linear Circuit 526 — the high-speed comparator that's beyond compare! (Do you know of another comparator with a propagation delay of 30 ns?) Other features to remember: 1) operates from $\pm 5\text{V}$ supplies; 2) overdrive recovery, 20 ns; 3) fanout of 10; 4) high gain operation; 5) output compatible with DCL, DTI, and TTL.

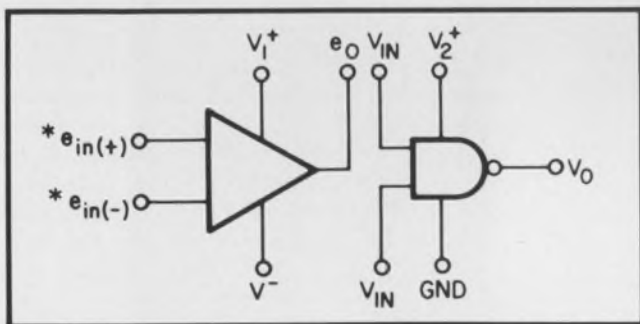

4. Improve your computer's memory with Linear Circuit 5733. It's the video amplifier that operates over — are you ready? — 120 MHz band width! Differential in/differential out with minimal phase distortion, too. And as a pre-amp in computer applications, don't forget: 1) 10 ns rise time; 2) fixed gains of 10, 100, 400 available (variable between 10 and 400 with a single, external resistor); 3) internally compensated (no external frequency compensation components required.)

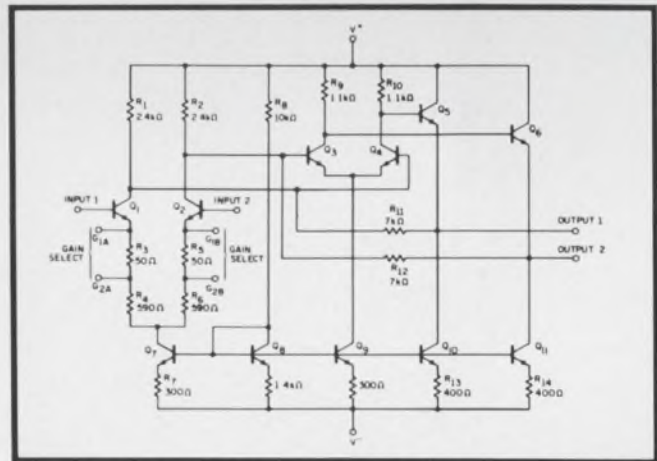

P.S. We almost forgot: all four of these monolithic linear circuits are available right now — in production quantities. So are all the specs, facts, figures. Send for them today — before you forget!

Signetics

Signetics Corporation / 811 E. Arques Ave., Sunnyvale, California 94086 / A subsidiary of Corning Glass Works

INFORMATION RETRIEVAL NUMBER 16

NEWS

(telephone, *continued*)

When Southern Bell requested an increase in rates because the message volume from computer companies used up a large number of its trunks in the Atlanta area, the regulatory commissioner asked the phone company to expand its flat-rate calling area. When the phone company complied, the computer companies increased in number.

Computer companies are concerned over the possibility of a rate increase that would apply to them because their holding times are supposed to be longer than other customers. "Actually," says Clapp, "the average holding times for computer traffic have been dropping steadily over the last two years."

In many remote computer inquiries over the telephone line, a data customer wants to find a specific fact, such as a credit balance for an account. In such cases, says, Clapp, the holding time is much less than that for normal voice use.

Clapp says that in some areas the telephone company has ques-

ted a 50 percent increase in rates for computer time-sharing customers. But a spokesman for New Jersey Bell says he has heard of no such plans and in fact took the position that if rates went up for the computer companies they would be singled out unfairly.

The Bell System is not engineered for all its phones to be in use 24 hours a day. But to make best use of communication channels this is just what a company should do, especially where there is a flat fee for service. Cooperstein says, "If we buy higher cost services we'd like to share the cost of the services with other people, but this is restricted. This poses a problem because we can't make 100 per cent use of these channels."

Another complaint of the computer companies is the modem used to couple computers and terminals to the telephone network. Lewis Clapp of Dial Data says, "This device costs a user about \$25 a month. The unit probably doesn't cost more than \$100 to manufacture. Our average computers use 40 lines. This means we have to rent 40 of these modems a month."

There are other ways to couple to the telephone network. Acoustic

couplers have been on the market for several years. These units cost between \$200 and \$400 a piece. According to Clapp, their biggest advantage is economy and portability. And they can be purchased off the shelf.

Charles Carter, engineering director-methods, at Long Lines, says that the increasing use of customer-provided modems "is complicating our line testing." The Bell System is required to service such equipment, but customers are still accustomed to going to Ma Bell to help them out.

Politics may be another factor affecting telephone service, Clapp says that "Ninety per cent of all time-sharing users use the Teletype. But the FCC is exerting pressure on the phone company to sell its TWX service to Western Union. Consequently, the phone company is not interested in investing in teletypewriter equipment."

Carter of Long Lines, while agreeing that "the Bell System does have a limited line of data terminals — all manufactured by Teletype — also points out that a new printer has been developed. It is called Data Speed and operates at 1050 words a minute, with transmission between paper tape and paper tape. Carter says a printer for this system will soon be available, and it will print at the 1050 rate. This Inktronic system squirts jets of ink at the paper and deflects each droplet electronically.

Slow processing of orders is another complaint from the computer companies. But a spokesman for New Jersey Bell points out that it's difficult to get sufficient lead time to provide telephone equipment and switching facilities for new companies. "This is increasingly true," he says, "of time shared computer companies that often operate secretly and jump into an area to get a specific group of customers. And they use phone lines at a very heavy rate."

New Jersey Bell says that only about 1 per cent of its telephone usage is for non-voice. But this usage is not evenly spread out. "It's a small percentage, but when demands increase in localized areas, there is a capacity problem, particularly when we have a little lead



Master control center for New York Telephone Co.'s electronic switching system, one of five in the city. It handles 40,000 calls an hour and serves about 10,000 telephone customers.

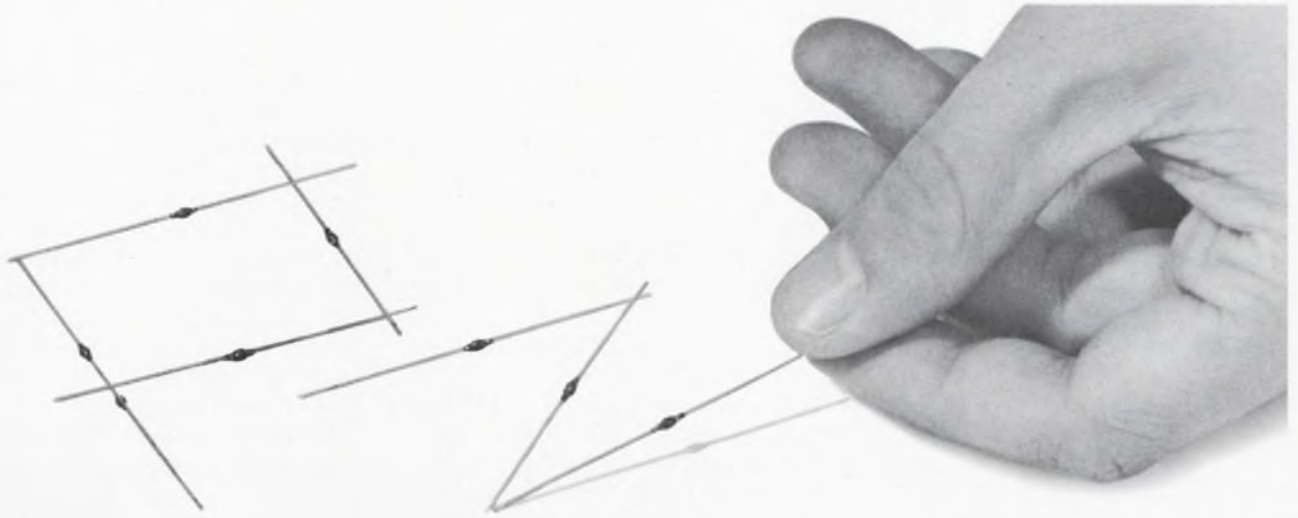

Introducing the PZ Zener

The new fused-in-glass
1 watt zener . . .

Typical Unitrode fused-in-glass
stability and high-performance at
the price of an ordinary device

Order your free samples today

- Fills the bill from 400 mw thru 1 watt
- Voltages from 6.8 to 200 V
- 8 millisecond surges to 30 watts
- Low reverse current — to 500 nA
- A quarter the size of a conventional 1 watt
- Weighs less than 1/4 gram
- No plastics, epoxies, silicones, oxides, gases, or solders are used

580 Pleasant St., Watertown, Mass. 02172 • (617) 926-0404

UNITRODE



TOUGH AS ALL GET-OUT FROM THE INSIDE OUT

With the silicon die metallurgically bonded between terminal pins of the same thermal coefficient, the hard glass sleeve is fused to the entire outer silicon surface. Result — a voidless, monolithic structure.



4 EASY WAYS TO GET FREE SAMPLES AND SPECS

1. Call Bud Anderson COLLECT, at (617) 926-0404.
2. Call your nearest Compar office.
3. Call your nearest Daniel & Co. office.
4. Check off the magazine Reply Card number.

INFORMATION RETRIEVAL NUMBER 17

NEWS

(telephone, continued)

time to anticipate the needs of these companies."

Phone company sees no problem

In considering Clapp's prediction of a telephone blackout, an AT&T spokesman said that during the great northeast power failure in 1965, it was Ma Bell who supplied all her vital services. In testifying before the Public Service Commission, William G. Sharwell, New York Telephone vice president said, "There never has been, nor are we now faced with, a massive communications failure of wide-scale telephone network breakdown."

But the telephone system is an entity that is sympathetic to every part of it. "If one city is in trouble," says Carter, "you feel it throughout the network." An organization at Long Lines has been set up especially to handle sudden overloads or catastrophic failures

caused, for example, by Hurricane Camille.

In situations where telephone plant has been damaged, "the general bogey," says Carter, "is to get the first master group (600 lines) working within 10 minutes. This is the objective we have set for ourselves, and we aim to lower that bogey."

There are eight Long Lines restoration control centers in the U.S. These are the extensions of the network management group. Each center has a preplanned routine for restoring service in the fastest possible way. This system is manually operated and attended now, but Long Lines has plans for a computer system that would speed up restoration service for a master group to about three minutes, says Carter.

Long Lines now has about 300,000 circuits for handling interstate telephone traffic. In 1968, it added 9000 circuits. This year,

it will add 25,000. And there are new transmission systems that will greatly augment present facilities.

The newest coaxial cable — L4 — carries 32,000 lines. This is more circuit capacity than the entire Long Lines network in 1959. By 1973, it will have installed between Pittsburgh and St. Louis an improved coax — L5 — that can handle 90,000 circuits. The field trial for this cable will begin in New Jersey next year.

Carter says that millimeter-wave transmission systems won't be ready or required for use until about 1978. But Long Lines has a trial program set for a millimeter-wave system between Netcong and Chester, N.J., for 1974. It lies along the Boston-Philadelphia route so that it can be placed into service at a later time. Millimeter waveguides will have a capacity of about 250,000 lines, according to Carter. The system will be digital; it will transmit 64,000 bits per second for every one of its voice channels.



Radio relay tower for Bell's TH3 microwave system. TH3 transmits 10,800 simultaneous telephone conversations.

Circuit costs dropping

In recent testimony to the FCC, Long Lines indicated that 75 per cent of the circuits it will have in operation in 1980 have yet to be built. And while Long Lines' total plant investment is now about \$5 billion, the increase over the years will not be proportionate. The costs per circuit mile have been decreasing rapidly. Carter says that the cost per circuit mile is now about \$12. Part of the reason is that Long Lines has a program of retrofitting installed facilities to increase system capacity.

In the area of switching, Carter expects to see a brand-new electronic switching system. "It will probably be called TESS — the total ESS," and it will handle from 10,000 to 30,000 circuits.

AT&T and Long Lines with Comsat have presented to the FCC a plan for a multipurpose domestic satellite system. This would intermix space communications with present ground facilities. But the domestic satellites system — what Carter calls "an electro-political question" — is still up in the air.

Why can't I make a trouble-free long-distance call? "That's a local exchange problem," says Carter ■■

Breakthrough For Automation!

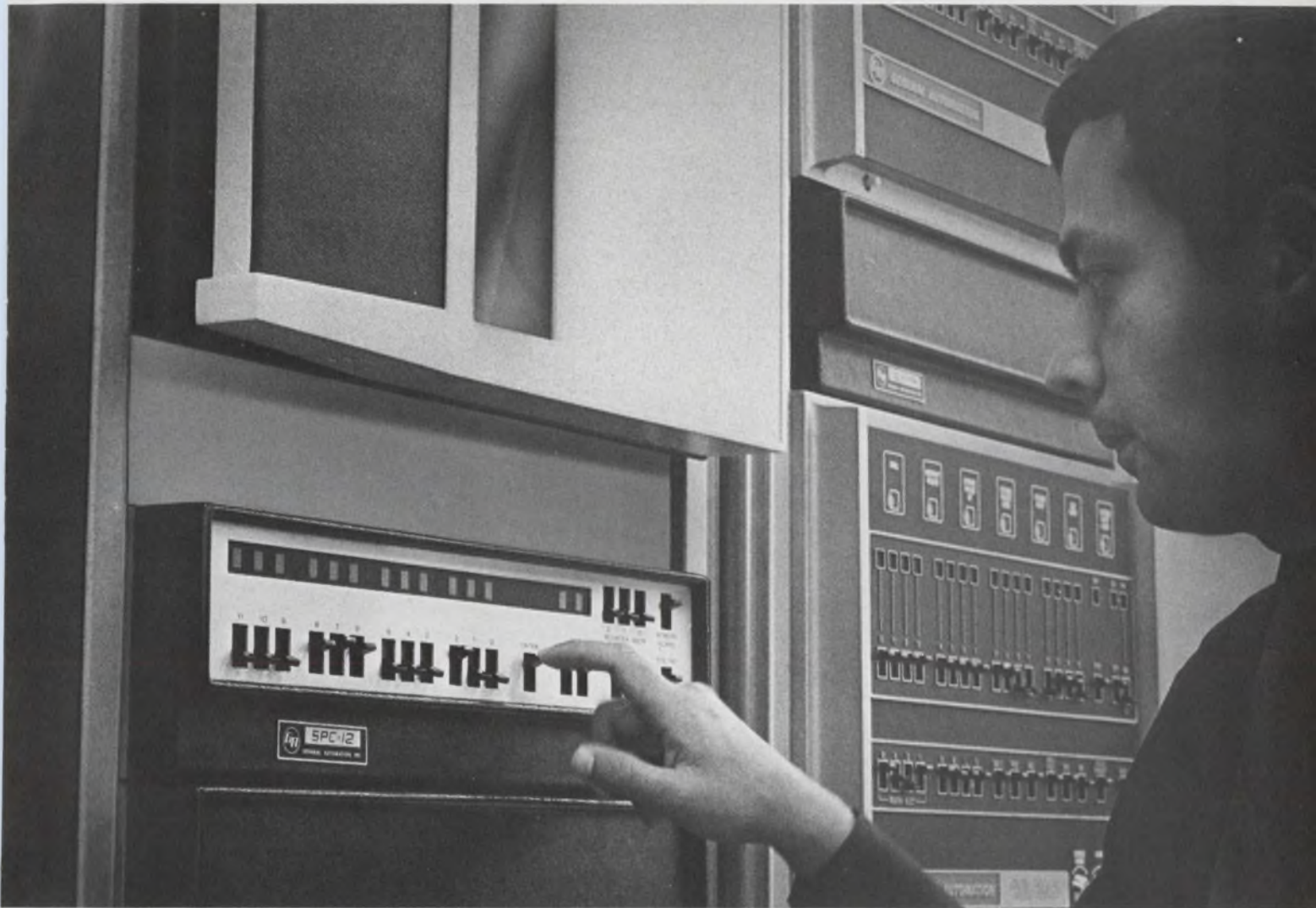

A COMPLETE, LOW-COST AUTOMATION SOLUTION

If you need an OEM computer for your next automation product, General Automation has the complete, low-cost solution . . . pre-engineered and ready to install . . . and that includes all the computers, interfaces, software and services.

Our SPC-12 automation computer offers you new levels of computer value and reliability . . . it's specifically designed to work in industrial environments. The SPC-12 plugs in and works, the first time, and keeps on working. Hundreds are on the job working.

And to add even more value to your product, our unique family of mini-controllers tie the SPC-12 directly to

machines, devices, communications networks, sensors and instruments, eliminating excessive and redundant electronics. Your products can serve more markets.

If you require software or services our Automation Sciences Division will provide you with complete software programs and technological services to get your product to the market faster.

Put this complete low-cost automation computer in your product today for only \$5000.00 . . . and much less in OEM quantities. You'll be surprised just how easy it is. Call or write today, there's a General Automation office near you.



GENERAL AUTOMATION, INC.
Automation Products Division

706 West Katella, Orange, Calif. (714) 633-1091, TWX 910-593-1601

Sales Offices: Waltham, Mass. (617) 899-6170 • New Rochelle, N.Y. (914) 235-9300 • Silver Spring, Md. (301) 593-6010 • King of Prussia, Pa. (215) 265-6525 • Atlanta, Ga. (404) 261-6203, 261-6204 • Cleveland, O. (216) 351-2275 • Des Plaines, Ill. (312) 298-4650 • Dallas, Tex. (214) 358-0271 • Los Altos, Calif. (415) 941-5966 • Orange, Calif. (714) 639-3791

INFORMATION RETRIEVAL NUMBER 18

Search for downed pilots made easier

Air Force and Army testing more sensitive direction finders and improved homing beacons

David N. Kaye
West Coast Editor

The Air Force and the Army are both testing ways to improve their methods of locating pilots who are shot down.

All pilots in combat carry radio homing beacons in their emergency kits but, according to the Air Force, they only bring a rescue aircraft within a mile of the downed man. (The Army claims its rescue aircraft do a little better.) Then, the rescue pilot has to search by eye. If the stranded pilot is wounded or concealed by high grass, he might not be found.

The Air Force hopes to remedy this by installing more sensitive airborne direction finders in its aircraft. Air Force engineers are evaluating one now produced by Cubic Corp., San Diego, Calif. It is called the ELF (for electronic location finder) by the company, and is designated AN/ARD-21 (XAI) by the military. The device is being tested by the Limited War Office, Aeronautical Systems Div., Wright-Patterson Air Force Base, Ohio.

Four antennas get signals

The system consists of four flat spiral antennas that mount on the bottom of a helicopter and a 6 × 7 × 10-inch receiver-processor that mounts inside. The antennas, which weigh about 20 pounds, have beam widths of 120 degrees. According to Wayne Taylor, Cubic's project engineer, "The side beam width is necessary in order for the helicopter to detect a signal regardless of where the downed pilot is."

During a rescue mission, the antennas receive signals transmitted by a pocket-sized radio carried by all airmen. The phase dif-

ference between the signals received by two of the antennas gives the X coordinate of the airman's position and the phase difference between the signals received by the other two antennas gives the Y coordinate.

The receiver-processor translates the phase information into a standard localizer display of the type carried in most rescue helicopters. The display consists of a circle and two cross-hairs. When the circle is centered over the junction of the cross-hairs, the helicopter is right over the target.

Sling cuts through foliage

After locating the downed airman with the ELF system, a 250-foot rescue sling that will cut through dense foliage is lowered to the ground. Taylor says that "at an altitude of 200 feet, ELF will allow the sling to be dropped less than 10 feet from the target."



Four, flat, spiral antennas, with beam widths of 120 degrees, will lead rescue aircraft to downed pilot's radio homing beacon. Maximum error is 3 degrees.

At any altitude, the maximum error in location is about 3 degrees.

ELF can find a target, regardless of the type of modulation on the transmitter. "An early problem in the development of ELF," says Taylor, "was what to do when the helicopter tilted, or did not remain stable. The solution is to feed back gyro information to the processor, which automatically adjusts the pilot's display to correct for the tilt."

With an all-weather capability, ELF functions in darkness, fog, rain, over water and heavily wooded or rough terrain with a high degree of accuracy.

"During the hovering period," says Taylor, "when pickup is being executed, the ELF system cannot be jammed by other nearby radio beacons."

Army tests rescue beacon

The Army is also looking for ways to upgrade its airborne direction finders. But its first goal is to add channels to the rescue beacon so that more aircraft will be able to hear its signal.

The radio beacon it uses now sends out a distress call on vhf/fm only, which limits its reception to Army aircraft. A new beacon being tested also transmits — as well as receives — on uhf/am, the band used by Air Force and Navy aircraft. Its range is 10 miles.

The Army wants to improve this range as well as the homing accuracy of the airborne equipment.

Designated AN/URC-68, the beacon being tested was developed by the Magnavox Co., Fort Wayne, Ind., under the technical direction of the Avionics Laboratory of the Army Electronics Command, Fort Monmouth, N. J.

The radio is undergoing environmental and electromagnetic compatibility tests at the Electronic Proving Ground, Fort Huachuca, Ariz. ■■

**Integrated
Circuit**

IDEAS

FROM
SYLVANIA

How SUHL ICs keep track of trains.

Automatic car identification system uses 28 different varieties of SUHL TTL integrated circuits.

By 1970, every freight car in the United States will be carrying a label similar to that shown at the lower right. It's all part of an automatic car identification system called KarTrak*. The KarTrak ACI system was designed and developed by Sylvania and has been adopted for use by the Association of American Railroads.

Heart of the KarTrak ACI system is an electronic scanner that reads the color coded strips on the label. The basic decoder unit utilizes 9 integrated circuit boards each containing 40 SUHL

TTL packages for a total of 360 integrated circuits. The decoder section processes the information from the labels as they are scanned on a passing train. This data includes identification of the owning railroad, and the car number. Other information such as car weight can also be included.

The SUHL integrated circuits have to work in an extreme environment. The trackside scanning units are placed in open areas all over the United States and have to bear the heat of summer

as well as the cold of winter. No special precautions were taken with the SUHL circuits. They are all standard off-the-shelf units. In addition to the basic decoder section, SUHL circuits are used in other portions of the system. A message generator that gives information on complete trains uses 60 SUHL TTL integrated circuits. A core memory storage section uses 360 SUHL TTL circuits.

Also available are five communications interface options, only one of

continued next page

*Trade Mark



This issue in capsule

IC Types

Now we have total TTL capability.

LSI

The Unicell approach to large-scale integration.

Hybrid Circuits

Hybrid shift register has many advantages.

IC Applications

Up-down counters run at speeds up to 20 MHz.

IC Developments

Isylithic beamlead ICs rival discrete components.

Manager's Corner

What does MIL-STD-883 really mean?

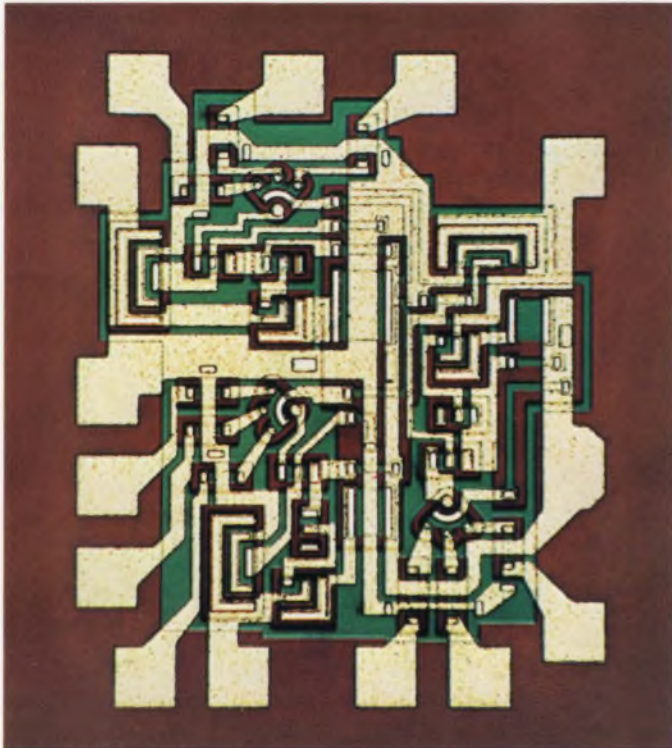

SG-190 triple 3-input NAND/NOR gate.

which is used at a time in a given system. Each interface unit consists of three circuit cards containing 40 SUHL ICs for a total of 120 circuits per system.

A read-only memory is also available as an option. This unit converts numeric input to alphanumeric output information. The read-only memory is made up of four circuit cards, each carrying 25 SUHL TTL ICs.

One of the main reasons that SUHL IC logic was selected for the KarTrak ACI system is the large numbers of logic forms available in the family. SUHL logic has the broadest line in the industry. More than 28 different types of SUHL circuits are used in the KarTrak ACI system.

This wide range of device types enabled the design engineers to tailor the system to the optimum configuration. Package count was kept to a minimum and actual design was simplified.

CIRCLE NUMBER 300

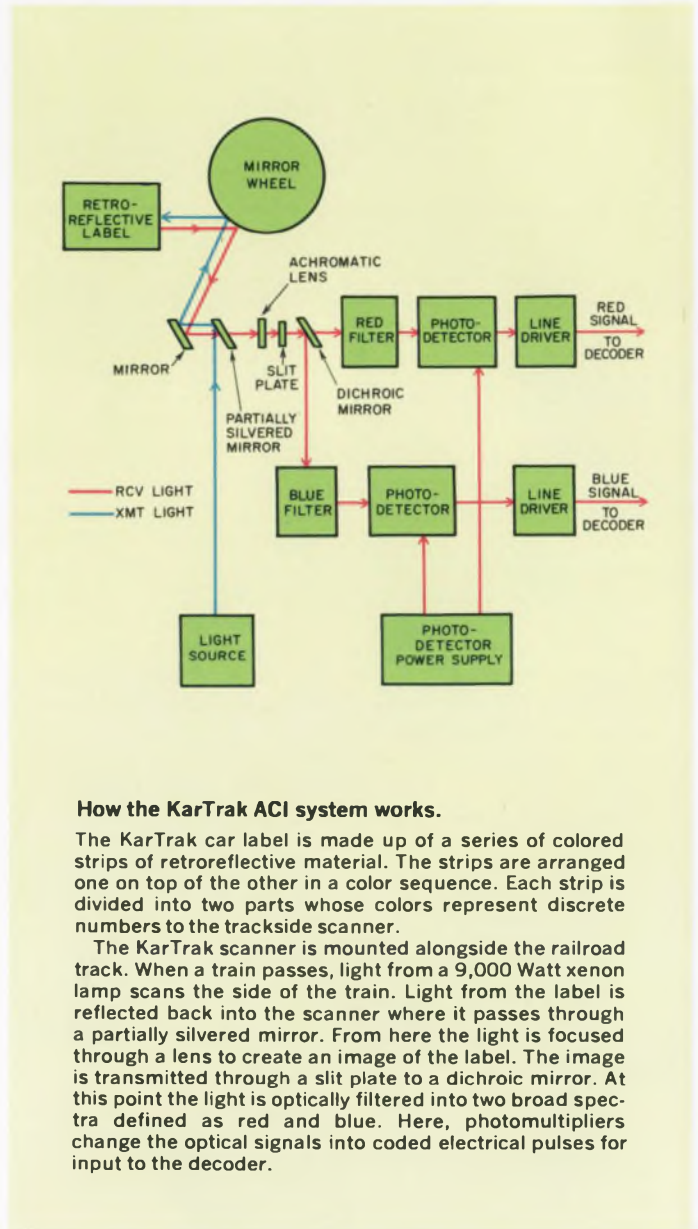

How the KarTrak ACI system works.

The KarTrak car label is made up of a series of colored strips of retroreflective material. The strips are arranged one on top of the other in a color sequence. Each strip is divided into two parts whose colors represent discrete numbers to the trackside scanner.

The KarTrak scanner is mounted alongside the railroad track. When a train passes, light from a 9,000 Watt xenon lamp scans the side of the train. Light from the label is reflected back into the scanner where it passes through a partially silvered mirror. From here the light is focused through a lens to create an image of the label. The image is transmitted through a slit plate to a dichroic mirror. At this point the light is optically filtered into two broad spectra defined as red and blue. Here, photomultipliers change the optical signals into coded electrical pulses for input to the decoder.

Now we have total TTL capability.

Addition of two new TTL product lines makes Sylvania's TTL the broadest and most diversified line available anywhere.

In today's highly selective integrated circuit market, TTL is the most popular digital logic form. And there are good reasons why. These reasons include a superior speed/power product, high noise immunity and the wide variety of functions available.

Sylvania pioneered the shift to TTL over five years ago with the introduction of SUHL (Sylvania Universal High-level Logic) integrated circuits. These products proved the superiority and practicality of the TTL technology.

Since then, the SUHL I and SUHL II families have been

constantly expanded as Sylvania continues to lead the way in TTL. A wide range of monolithic functional arrays have also been introduced to further enhance the line.

Now we've added two complete new lines of TTL logic to our constantly growing family. These new lines give you the widest choice of TTL circuits available anywhere. Now you can fill all of your TTL needs from a single reliable source—Sylvania.

CIRCLE NUMBER 301

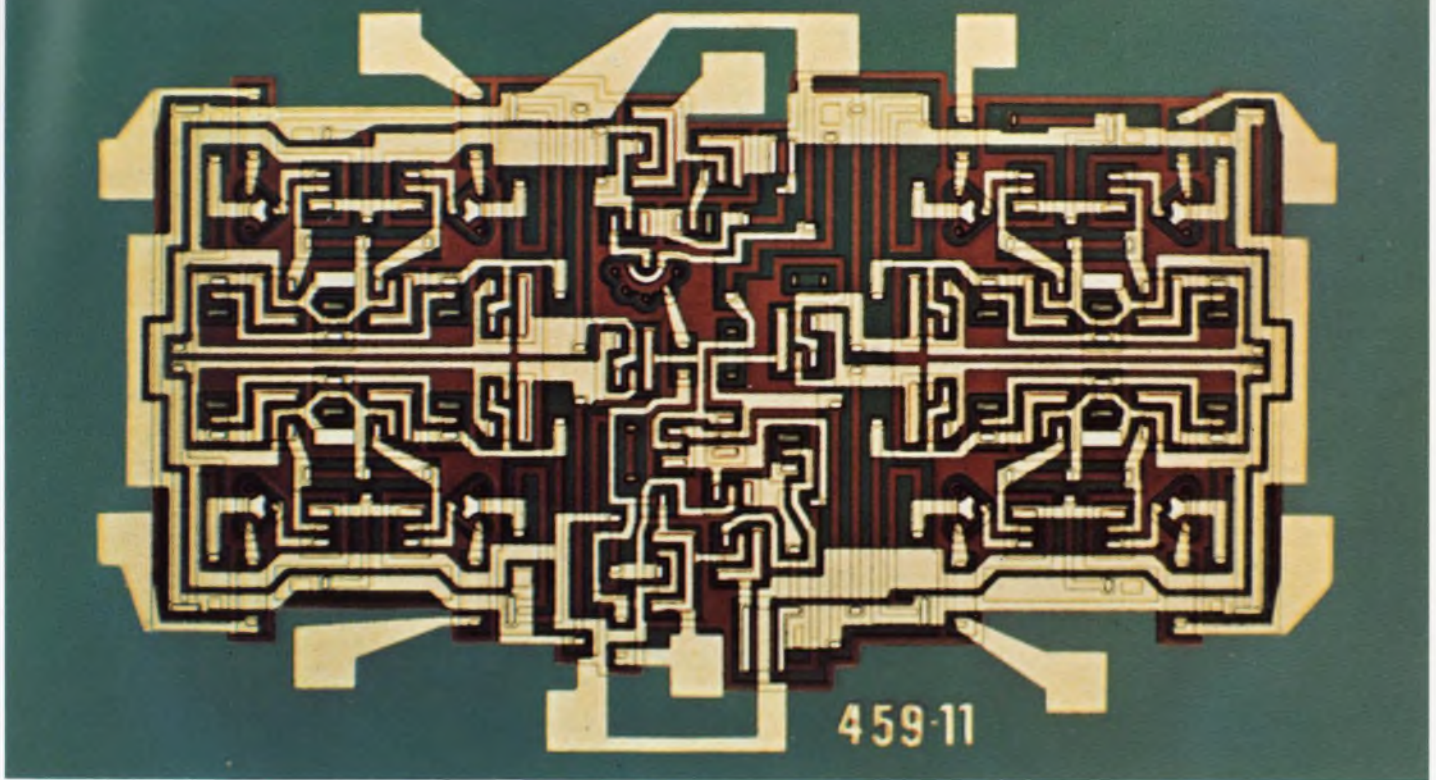

SM-120 parity generator/checker.

Sylvania TTL Integrated Circuits

Function	SUHL I	SUHL II	5400/7400	7400N
Dual 4-Input NAND/NOR Gate	SG40, 41, 42, 43	SG240, 241, 242, 243	SG5420, SG7420	SG7420N
Single 8-Input NAND/NOR Gate	SG60, 61, 62, 63	SG260, 261, 262, 263	SG5430, SG7430	SG7430N
Expandable Single 8-Input NAND/NOR Gate	SG120, 121, 122, 123	SG200, 201, 202, 203		
Dual 4-Input Positive NAND Buffer	SG130, 131, 132, 133		SG5440, SG7440	SG7440N
Quad 2-Input NAND/NOR Gate	SG140, 141, 142, 143	SG220, 221, 222, 223	SG5400, SG7400	SG7400N
Triple 2-Input Bus Driver	SG160, 161, 162, 163			
Triple 3-Input NAND/NOR Gate	SG190, 191, 192, 193	SG320, 321, 322, 323	SG5410, SG7410	SG7410N
Expandable 4 Wide 2-Input AND-OR Invert Gate	SG50, 51, 52, 53	SG250, 251, 252, 253	SG5453, SG7453	SG7453N
4 Wide 2-Input AND-OR Invert Gate			SG5454, SG7454	SG7454N
Dual 2 Wide 2-Input AND-OR Invert Gate	SG70, 71, 72, 73	SG310, 311, 312, 313	SG5451, SG7451	SG7451N
Exclusive OR with Complement	SG90, 91, 92, 93			
Expandable Triple 3-Input OR Gate	SG100, 101, 102, 103	SG300, 301, 302, 303		
Expandable Dual 4-Input OR Gate	SG110, 111, 112, 113	SG210, 211, 212, 213		
Quad 2-Input Lamp Driver	SG351, 353		SG5401, SG7401	
Quad 2-Input Positive NOR Gate	SG330, 331, 332, 333	SG340, 341, 342, 343		SG7402N
Hex 1-Input Inverter	SG370, 371, 372, 373	SG380, 381, 382, 383		
Dual Pulse Shaper/Delay AND Gate	SG80, 81, 82, 83			
Dual 4-Input AND-OR Gate	SG280, 281, 282, 283			
Dual 4-Input AND Expander	SG180, 181, 182, 183			
Quad 2-Input OR Expander	SG150, 151, 152, 153	SG230, 231, 232, 233		
Dual 4-Input OR Expander	SG170, 171, 172, 173	SG270, 271, 272, 273		SG7460N SG7450N
Expandable Dual 2 Wide 2-Input AND-OR Invert Gate				
Single Phase SRT Flip Flop	SF30, 31, 32, 33			
J-K Flip Flop (AND Inputs)	SF50, 51, 52, 53	SF200, 201, 202, 203		
J-K Flip Flop (OR Inputs)	SF60, 61, 62, 63	SF210, 211, 212, 213		
Dual D Flip Flop	SF80, 81, 82, 83	SF90, 91, 92, 93	SF5474, SF7474	SF7474N
Dual 35 MHz Flip Flop (Separate Clock)	SF100, 101, 102, 103	SF120, 121, 122, 123		
Dual 35 MHz Flip Flop (Common Clock)	SF110, 111, 112, 113	SF130, 131, 132, 133		
J-K Master Slave Flip Flop				SF7472N SF7473N
Dual J-K Master Slave w/Clear				

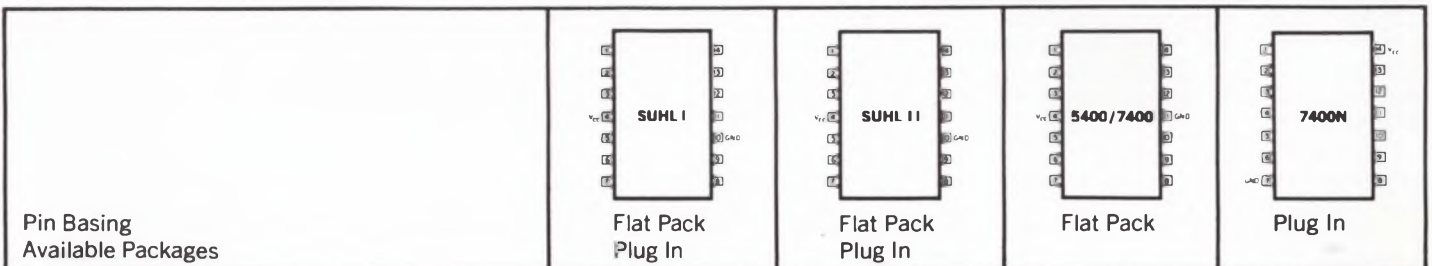

The Unicell approach to large-scale integration.

Basic cellular method gives a high degree of flexibility to design of LSI circuits.

Our research into large-scale integration has centered on a method of realizing arrays of a complexity of from 50 to 150 gates while retaining the design flexibility usually associated with less complex circuits.

We call our approach "Unicell." In our method, twenty to forty components are diffused in a fixed repetitive pattern resulting in a series of very small area cells. Cell can be made into gates, buffers, flip-flops or other logic elements simply by selecting the proper metallization pattern.

Assume you have a system requiring X number of 8-input gates, Y number of 4-input gates, and Z number of flip-flops. Further, assume that these elements must be interconnected to form a system function.

Here's how we go about it. The first step is to isolate enough cells on the wafer to provide a sufficient number to produce the needed logic elements. This group of cells becomes an array. Now the entire wafer has been divided into a series of arrays, each consisting of many cells (Fig. 1).

Next, the components in each cell are interconnected to form the required number of 8-input gates, 4-input gates, and flip-flops. The result is a series of arrays containing the required number of functional elements, but as yet the cells have not been interconnected with each other. That comes in the next series of steps.

At this point in the process, the entire wafer is covered with insulation. Then, windows are opened and the cells within each array are connected to each other in the vertical direction. Another layer of insulation is put down, windows opened, and interconnections are made in the horizontal direction (Fig. 2).

Thus, we have about one hundred identical arrays on a wafer, all internally interconnected to perform a system function. All that remains to be done is to test and package the individual arrays.

To accommodate the large number of functions built into each array, packages with 24, 36 or more leads are necessary.

Another feature of the Sylvania ap-

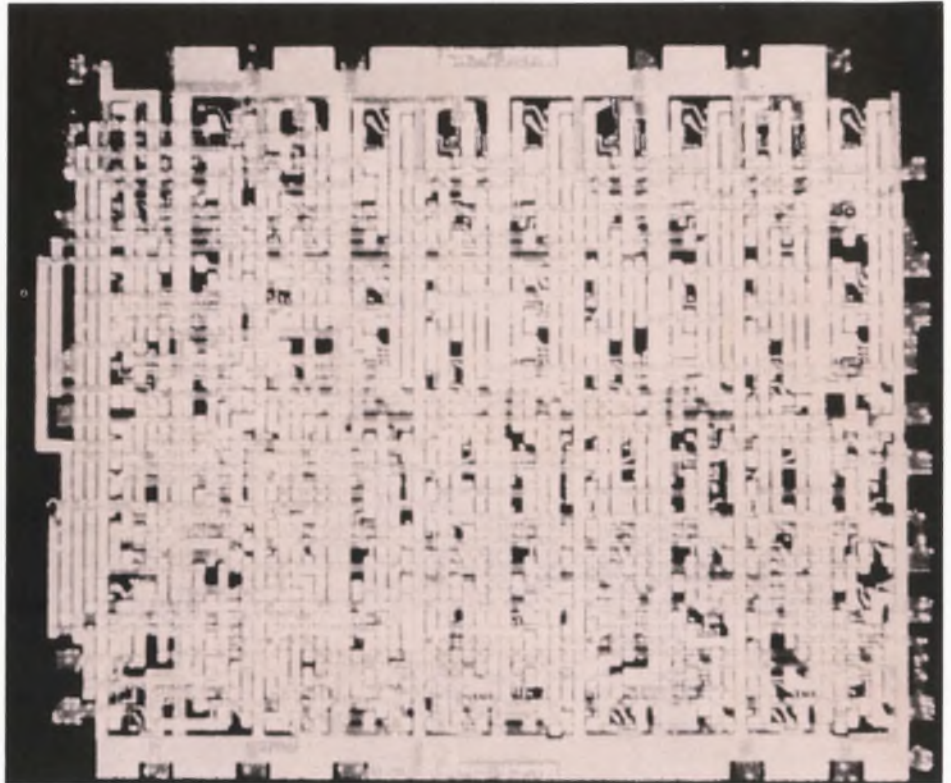

Adaptive 4-bit shift register uses 3-layer metallization.







proach to LSI is that each cell can be designed for either high speed or low power operation. Characteristics of typical circuits are shown in the table. The low power logic cells have a power dissipation of 3.5 mW and a propagation delay of 10 ns. The high speed logic cells dissipate 12 mW and have a propagation delay of 3 ns.

The finished arrays interface well with SUHL, TTL and DTL integrated

circuits having the same drive capability, loading factors and noise margins.

Some of the advantages of LSI can be seen from one logic system we designed on an experimental basis. One Unicell LSI package replaced 43 standard integrated circuits and 500 wired interconnections. The reduction in power dissipation over the IC breadboard version was a factor of three. Improve-

Unicell characteristics

	HIGH-SPEED CELL			LOW-POWER CELL		
	LOGIC GATE	DRIVER GATE	BUFFER INVERTER	LOGIC GATE	DRIVER GATE	BUFFER INVERTER
1. LOGIC (POSITIVE NAND)	 A · B · C · D = E	 A · B · C = D	 A = \bar{A}	 A · B · C · D = E	 A · B · C = D	 A = \bar{A}
2. POWER DISSIPATION	12 MW	15 MW	15 MW	3.5 MW	12 MW	15 MW
3. PROPAGATION DELAY	3 NS	8 NS	5 NS	10 NS	10 NS	5 NS
4. LOGIC FAN-IN	4 (EXP)	3 (EXP)	1 (EXP)	4 (EXP)	3 (EXP)	1 (EXP)
5. LOGIC FAN-OUT	10 4(W/O)	10 4(W/O)	10	10 8(W/O)	20 4(W/O)	20

Hybrid shift register has many advantages.

Monolithic MSI on ceramic substrates provides complex logic functions without problems of LSI.

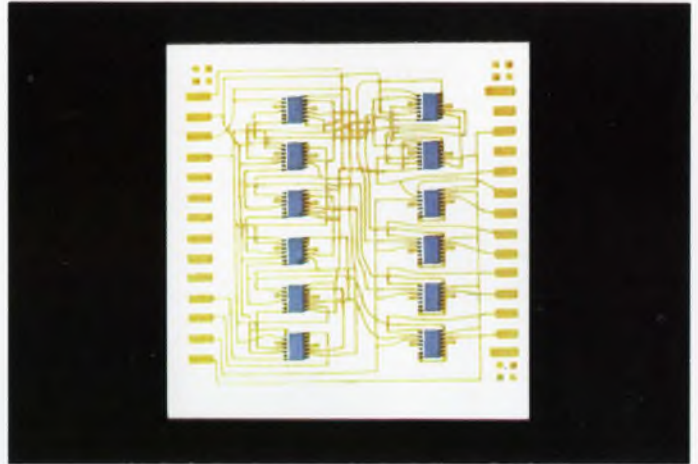

Hybrid 48-bit shift register uses 4-layer ceramic substrate.

Our new 48-bit shift register uses Sylvania MSI integrated circuits and a 4-layer ceramic substrate to obtain many advantages over large-scale integration systems and conventional printed-circuit board approaches.

The new design gives packing densities 8 to 10 times greater than can be obtained using printed circuits and flat packs. Because of the smaller size, short, narrow film conductors reduce interwiring capacitances to typically 1/5 to 1/10 that of multilayer printed circuit boards. Short lead lengths result in greater system speed.

The use of high purity alumina substrates also has advantages in thermal control. Thermal conductivity is about 100 times that of glass epoxy boards. Thermal resistance from junction to substrate is better than for conventional flat packs mounted on a printed-circuit board. The ceramic substrate is stable under prolonged exposure to temperatures up to 150°C.

The high-speed printing techniques used to make the ceramic multilayer logic arrays are inherently less expensive than photoetching, plating and laminating steps required for multilayer printed circuit board constructions.

In comparison to large-scale integrated circuit approaches our hybrid design has many advantages, too. For one thing, initial tooling cost is 1/10 to 1/100 the cost for monolithic LSI devices. Production costs are also far lower because the monolithic MSI integrated circuits used in our hybrid shift register are standard off-the-shelf items produced in high volume.

The hybrid approach also gives you design flexibility. Changes are easier to make. You can combine bipolar, MOS and other devices on the same ceramic substrate. And they can all be off-the-shelf devices.

We've also increased the reliability of our shift register by using beamlead ICs. In connections alone, use of beamleads has reduced the number from 42 man-made joints to 12 machine-made joints per IC.

With all of these advantages, wouldn't it pay you to investigate our hybrid shift register for your next application problem?

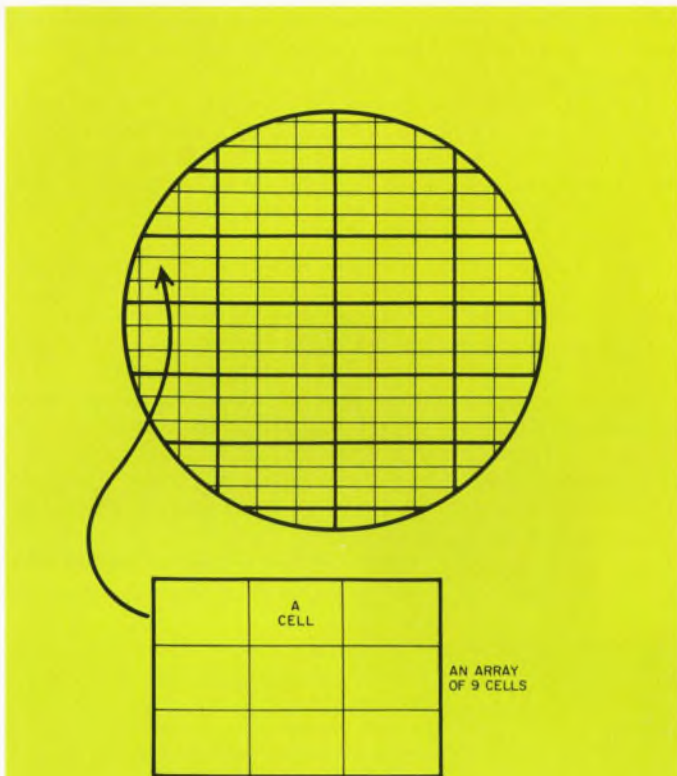

Fig. 1. Wafer is divided into a series of arrays, each consisting of many cells.

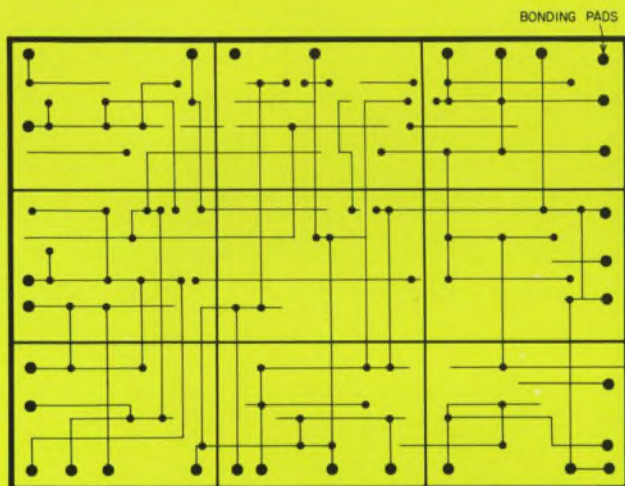

Fig. 2. Interconnections between cells are made by separate horizontal and vertical metallizations.

ment in propagation delay through the longest gate chain was a factor of two.

Improvement in speed/power product by a factor of 5 to 10 over standard integrated circuit families have been realized in other arrays that have been produced.

If you're considering LSI for your next design project, talk to Sylvania's engineers. They'll show you how to get high-level performance without losing design flexibility.

CIRCLE NUMBER 302

CIRCLE NUMBER 303

Up-down counters run at speeds up to 20 MHz.

High-speed devices cut package count, reduce wiring, and lower power drain.

Our new SM-183 and SM-193 up-down counters are functional arrays that contain four J-K flip-flops. Both are 4-bit synchronous up-down counters capable of speeds up to 20 MHz. The SM-183 is a binary counter and the SM-193 provides a binary coded decimal output. A mode control input switches internal gating to select up or down counting. An additional advantage that both the SM-183 and SM-193 have over conventional 4-bit counters is that appropriate flip-flop outputs are internally ANDed with the clock input. This provides a decoded clock signal to trigger the next counter stage for near synchronous systems operation.

The SM-183 binary up-down counter (1248 code) is designed for computer applications. Its decoded clock goes

high with the clock input when the counter is counting up and is in the "1111" state or when the counter is counting down and is in the "0000" state.

The SM-193 binary coded decimal counter is suitable for use in display devices or anywhere a coded decimal output is required. The decoded clock of the SM-193 goes high with the clock input when the counter is counting up and is in the "1001" state or when the counter is counting down and is in the "0000" state.

Each flip-flop in the counters has an external Q output, an asynchronous SET input and a common reset input. A logic "0" at the RESET input causes all four flip-flop outputs to go to a logic "0". A logic "0" at any SET input causes the corresponding output to go to a logic "1".

The SM-183 and SM-193 up-down counters are compatible with SUHL I and SUHL II integrated circuits as well as other Sylvania arrays. They are immediately available for operation over the industrial temperature range of 0°C to +75°C in your choice of 14-lead hermetic packages, flat packs or dual in-line packages.

CIRCLE NUMBER 304

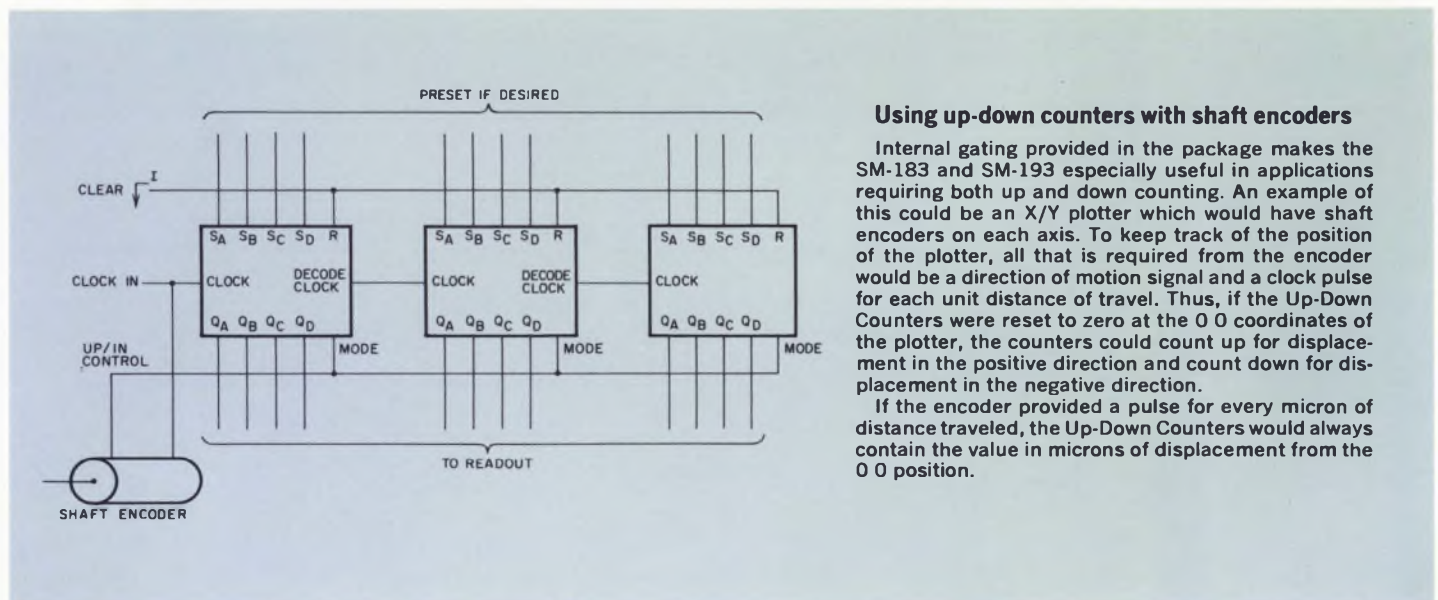
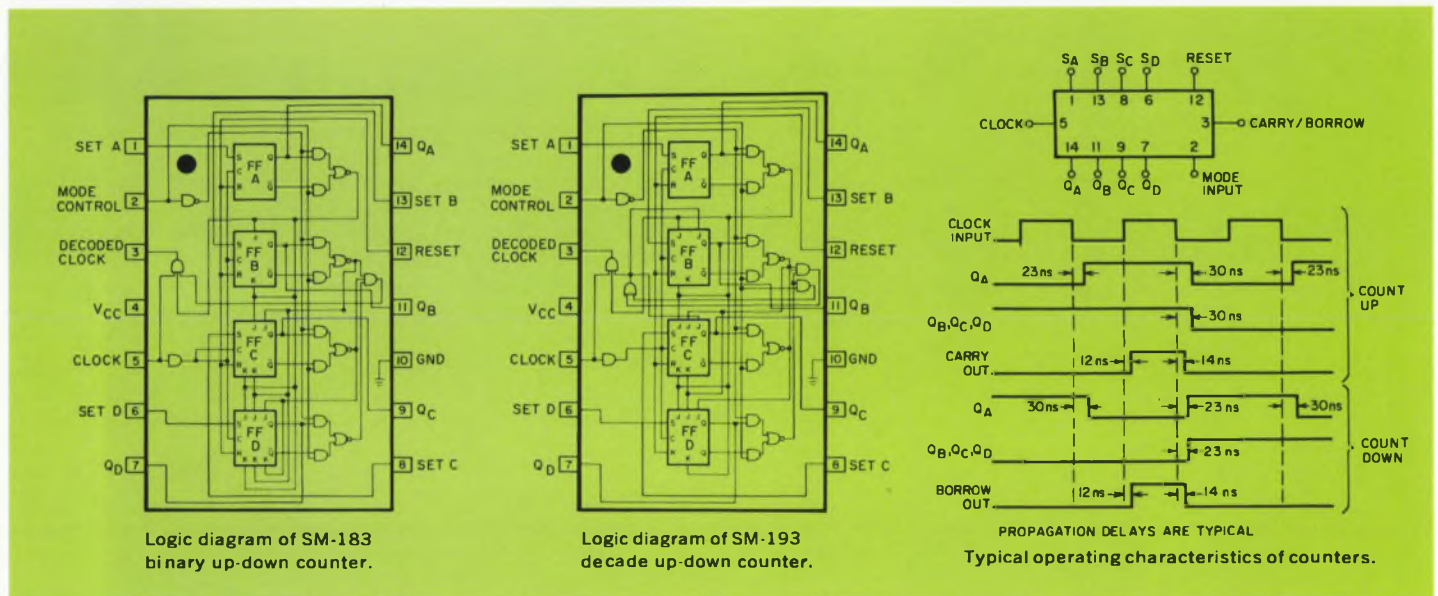

Using up-down counters with shaft encoders

Internal gating provided in the package makes the SM-183 and SM-193 especially useful in applications requiring both up and down counting. An example of this could be an X/Y plotter which would have shaft encoders on each axis. To keep track of the position of the plotter, all that is required from the encoder would be a direction of motion signal and a clock pulse for each unit distance of travel. Thus, if the Up-Down Counters were reset to zero at the 0 0 coordinates of the plotter, the counters could count up for displacement in the positive direction and count down for displacement in the negative direction.

If the encoder provided a pulse for every micron of distance traveled, the Up-Down Counters would always contain the value in microns of displacement from the 0 0 position.

Isylithic beamlead ICs rival discrete components.

Isolation process eliminates parasitic capacitances, gives 1 to 2 nanosecond switching speeds.

Sylvania is now developing an Isylithic beamlead process for making integrated circuits that are a match for the best discrete components in most respects and are even better when it comes to speed.

In Isylithic devices, circuit elements are air isolated from each other. This eliminates parasitic capacitances and permits performance equal to discrete device systems. The use of beamlead construction permits closer interconnection of components and lower lead inductance. This makes possible switching speeds in the 1 to 2 ns range.

Isylithic devices are made in a manner similar to the process for ordinary integrated circuits except that the buried layer and isolation diffusion steps are eliminated. After the diffusion processes have been completed a thin-film metallization pattern is deposited and heavy gold beamleads are electroplated on top of the metallization. Isolation of the circuit elements is obtained by selectively etching the back of the wafer to provide air isolation between the elements.

The finished integrated circuit is now ready for face bonding into film hybrid or microstrip circuits.

Sylvania has been working with beamlead devices for over three years and finds that they have definite advantages over other types of flip chip mounting.

Among the chief advantages of beamlead are the visibility of the bonds for inspection, reliability of the metallurgy, and the possibilities for low-cost assembly. The beams are about 0.5 mil thick and extend about 6 mils from the edge of the circuit. The beams can be bonded directly and simultaneously to a metallized substrate. The resulting bonds can be inspected, tested and even individually repaired if needed.

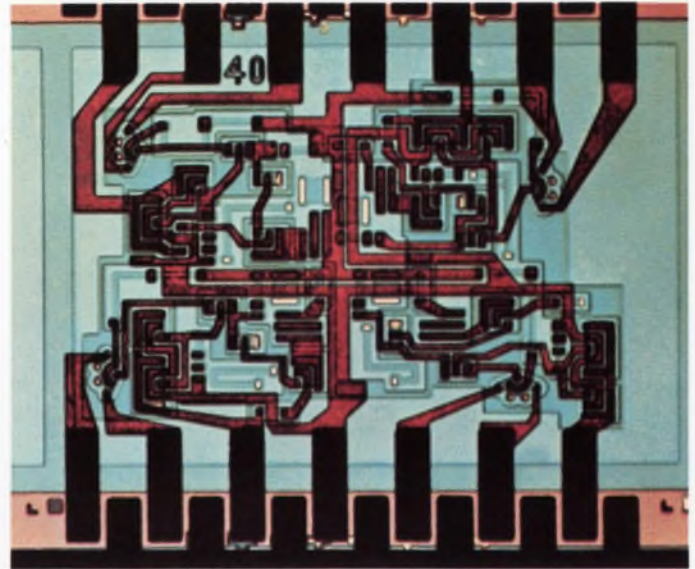

Isylithic beamlead device.

The beams, being flexible, will tolerate differences in height of the substrate metallization. This can be an important factor in their use with thick-film circuitry where silk-screened metallization always has a certain degree of irregularity.

Our Isylithic devices are passivated with silicon nitride. This provides a chip that is completely protected against ion migration and requires only mechanical protection.

For assembly of beamlead Isylithic devices, we are developing computer controlled automatic equipment that will position the substrate, position the Isylithic device on the substrate and simultaneously bond all connections. This equipment is the forerunner of a completely automated assembly line.

Although the Isylithic process is still in the development stage at Sylvania, we are producing beamlead devices for use at microwave frequencies.

CIRCLE NUMBER 305



HOT LINE INQUIRY SERVICE

Need information in a hurry? Use Sylvania's "Hot Line" inquiry service. It's easy and it's free. Just circle the reader service number(s) you're most interested in. Then fill in your name, title, company and address. We'll do the rest and see that you get further information by return mail.

You can also get information by using the publication's inquiry card elsewhere in this issue. However, using the card shown here will simplify handling and save time.



Fold here

FIRST CLASS
Permit No. 2833
Buffalo, N. Y.

BUSINESS REPLY MAIL
No Postage Stamp Necessary if
Mailed in the United States

POSTAGE WILL BE PAID BY

Sylvania Electric Products Inc.
Sylvania Electronic Components
1100 Main Street
Buffalo, New York 14209

Dept. D 7 7 7

Fold and seal with tape or glue. (Do not staple.)

MANAGER'S CORNER

What does MIL-STD-883 really mean?

There has been a lot of confusion surrounding MIL-STD-883 and what its purpose is and how it can be most effectively used. This publication is the first attempt at codification of a military standard for test methods and reliability specifications especially for microelectronics. It was prepared by Rome Air Development Center with suggestions and recommendations being made by major suppliers in the industry prior to publishing.

The genealogy of MIL-STD-883 can be traced through a long line of military specifications including MIL-E-1, MIL-STD-202, MIL-S-19500 and MIL-STD-750. Many of the test procedures in "883" are similar to or identical to methods previously used in these earlier specifications; often, only the method numbers being changed.

MIL-STD-883 is similar to its predecessors in that it offers a wide variety of options as to stress levels and alternate methods for performing many of the tests. Thus, the phrase often used by some customers that their ICs must be processed, in accordance with "883", is completely meaningless unless specific procedures and stress levels are called out. If the customer is not sure which procedures and stress levels he needs, assuming he has already determined that one of our standard Sylvania test plans is inadequate, he should discuss his requirements with our Field Engineering and Quality Control groups prior to requesting a quotation.

In addition to the standard types of environmental, mechanical, electrical and life tests, "883" contains some new

and relatively controversial methods on Internal Visual (Precap) Inspection (2010), Screening Procedures (T5004) and Lot Qualification Inspection (T5005). These and other procedures are often the heart of many high reliability specifications. Sylvania has developed alternative precap and screening procedures which are less costly but still provide the desired level of reliability.

For our part, we believe firmly in the concept of "building the quality in" and have tried to develop in-process Quality Control procedures that are aimed more at corrective rather than weed-out techniques. We have adopted and have been using since its inception, many of the procedures in "883". For example, our monthly life and design (Group B and C) tests are exactly the same as those specified in Method T5005 Qualification Inspection. We have also developed many of our own methods which are completely compatible and consistent with them. These procedures are generally spelled out in our Reliability Brochure (SM-1057-9P) and in detail in our Integrated Circuit Quality Control Manual.

In summary, the value of any specific procedures can be assessed only in the light of the intended application for the device; however, we at Sylvania heartily endorse "883" as a good first step in the right direction toward much needed standardization in the integrated circuit industry.



D. M. Russell
Manager, Quality Assurance and Reliability

This information in Sylvania Ideas is furnished without assuming any obligations.

SYLVANIA

GENERAL TELEPHONE & ELECTRONICS

NEW CAPABILITIES IN: ELECTRONIC TUBES • SEMICONDUCTORS • MICROWAVE DEVICES • SPECIAL COMPONENTS • DISPLAY DEVICES

I am especially interested in ICs for following application(s) _____

NAME _____

TITLE _____

COMPANY _____

ADDRESS _____

CITY _____ STATE _____ ZIP _____

Circle Numbers Corresponding to Product Item

300

301

302

303

304

305

Please have a Sales Engineer call



Four big reasons why you need

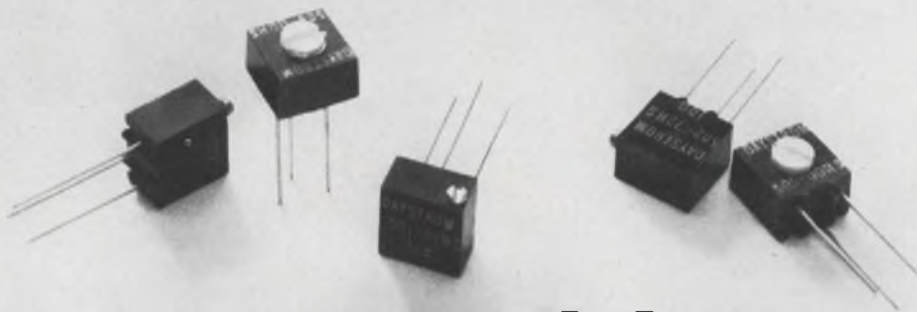

The Immersibles.

There are many reasons why our Daystrom 501 thru 505 series industrial potentiometers have become a favorite of design engineers. Their space-saving $\frac{5}{16}$ " size, for one. Weston's patented wire-in-the-groove construction, 5% standard tolerance, superior resolution, low noise and low cost, to name a few others. Now, with the option of total immersibility, we're offering you four more

—complete protection against water, cleaning solvents, flux, and encapsulating compounds. All five configurations are available O-ring sealed to meet MIL-STD-202, Method 106, moisture resistance requirements. And at a price you'd expect to pay for unprotected pots. Play it safe and specify The Immersibles. Your choice of 15-turn or single turn types, top or side adjustable,

in our standard 10 ohm to 20K range are in stock now at selected distributors. Higher values on request. Write today for data sheets and evaluation samples. WESTON COMPONENTS DIVISION, Archbald, Pennsylvania 18403, Weston Instruments, Inc.

a Schlumberger company

WESTON[®]

INFORMATION RETRIEVAL NUMBER 19



We make components for guys who can't stand failures.

We make our capacitors and resistors to perform like 40 million people were watching in on the count down.

And we build an extra measure of performance into all of them, to let you make sure your equipment delivers all you designed into it. Because like you and the guys who use your equipment, we can't stand failures either.

Take our glass capacitors, for instance. There's only one reason why they've been designed into the Surveyor, Minuteman, Gemini, Apollo, Saturn, Titan, Syncom, Sparrow, Hawk, and a number of other major aerospace and missile projects. With our glass capacitors, circuit designers could get the proven stability and reliability that these important systems demanded. U.S. Air Force tests have established that our glass capacitors have much better stability and much higher insulation resistance than ceramic and mica capacitors can deliver.

And take our precision tin oxide resistors. They're the best of the metal film class. Because the resistive tin film is completely oxidized and

molecularly bonded to the glass substrate, our tin oxide resistors are impervious to moisture and environmental degradation. No other resistor can deliver the same stability and reliability over load life. They offer guaranteed moisture resistance across all ohmic values to set a standard of reliability that can't be matched by metal film, wire wounds, carbon comps or metal glaze resistors. After a 56-day-long heat test in an environment of extremely high humidity, our tin oxide resistors showed a resistance change of just 0.2 per cent. And in an ambient temperature test—now in its ninth year—not one of the 600 tin oxide resistors being tested has exceeded a resistance change of 1.5 per cent.

But don't only think of Corning for aerospace and other precision applications. We've got something to offer when economy and value are the prime considerations. At Corning we've been active in improving these important capacitor and resistor characteristics, too.

We've developed the Glass-K™ capacitor to give you the volumetric efficiency and economy of mono-

lithic ceramic capacitors, but with the much improved stability and reliability that only a glass dielectric can add.

In resistors, our tin oxide resistors already offer long term economy over metal film, precision wire wound and metal glaze resistors. And our new C3 resistors, in addition to giving you a small case size, compete costwise with carbon comps.

At Corning we make components for guys who can't stand failures. Guys like your most important customers. Guys like you. So, next time you're designing a system, reach for your CORNING® capacitor and resistor catalogs and call your local Corning authorized distributor for off-the-shelf delivery. They'll help you design-in that extra measure of performance.

If you don't have our catalogs, ask your Corning distributor for copies or drop us a line at: Corning Glass Works, Electronic Products Division, Corning, New York 14830.

CORNING
E L E C T R O N I C S

Automated lab to transmit Antarctic data

We can get three-day delivery on samples of moon rock, but it takes up to 12 months for raw data to arrive from the Antarctic. Scientists need the Antarctic data to fill in their knowledge of the earth—its changing magnetic fields, its earthquakes and its weather. But no telemetry exists, and the weight and cost of flying the data by air transport is high. Hundreds of pounds of charts and magnetic tape are carted by ships during the brief "summer season" from November to February.

To update this sled-and-husky approach to data acquisition, an automated geophysical observatory is being built, and the first components will be installed near Byrd Station by the end of this year. A six-foot-high, cylindrical aluminum capsule to house the instruments, a six-foot dish antenna and a tubular pyramidal mount to hold the installation 15 feet above ground (see photo) will be put in place in the snow and ice. If the structure survives the whipping polar winds and meets all test specifications, the observatory will probably be fully instrumented for experimental duty in December, 1970, says John Katsuftrakis, project leader, Stanford University (which designed the unit for the National Science Foundation).

Nuclear power supply considered

Instrumentation will include a data encoder, command receiver, transmitter, power conditioners and other subsystems. Nickel cadmium batteries recharged by windmills would provide power the first year or two, says Katsuftrakis, but as soon as possible this source would be replaced by a nuclear power supply of the type planned to be put on the moon by one of the early post-Apollo flights.

If the pilot test station is successful, says Katsuftrakis, it could lead to a whole system of commercially produced, automated ob-



Antarctic observatory capsule and its 15-foot-high pyramidal mount are getting finishing touches.

servatories throughout the Antarctic. The information would be telemetered to synchronous satellites above the Atlantic and Pacific oceans and these would relay it to stations in the United States.

Katsuftrakis estimates that all the equipment needed to set up an automated observatory could be carried in two plane flights. After that, one flight a year would suffice to maintain it, check out its instruments and make needed changes. By contrast it takes 68 flights a year to supply fuel alone to Byrd station today.

Spinoff from space

The instrumentation and techniques to be used in the observatory represent a spinoff from the space program, Katsuftrakis says.

"In effect, we are taking a satellite and providing an interface between it and the earth's atmosphere," he notes. In the Antarctic this atmosphere is more harsh for instruments to withstand than the temperature extremes and occasional flying rocks encountered in space. Although the Antarctic temperature never reaches the absolute zero of shady spots in space, it is cold for instruments—minus 80° F—and the winds are 100 mph.

Such winds not only challenge the mechanical design of the support structure, Katsuftrakis points out, but they also make it difficult to dissipate the heat generated by the instruments inside the capsule. "You can't just open a louvre as you would in a space satellite," he notes. If you did that, the winds would whip through the opening and deposit snow on the instruments. The snow would melt inside the warm capsule, and the instruments would be in water.

To let out the heat without letting in the wind and snow, a special passive pipe has been designed. It transfers heat by successive evaporation and condensation of a working fluid.

Snow is a slower-working enemy of instruments than wind, but it is just as relentless. It piles up with every storm, and it never melts in the Antarctic. Consequently the level rises steadily about two feet every year. No structure can survive longer than a few years before being buried in a snowbank. This is one of the most severe problems encountered in manned stations now. These stations provide food, fuel and living space for several men. Katsuftrakis points out, and they are therefore too large and heavy to be lifted out and set on the surface every few years. By contrast, the support structure of the unmanned observatory would be relatively inexpensive, and a new one could be put on top of the snow when the old one became submerged. ■■



All components shown actual size



Only the new Allen-Bradley Type S cermet trimming resistors have all these features

Type S
shown twice actual size



for side adjustment

for top adjustment

The Allen-Bradley Type S is a one turn cermet trimmer in which you will find incorporated a wider range of features than in any other trimmer now on the market. Here are a few of the more important features.

- **COMPACT**—body is $\frac{3}{8}$ " dia.
- **BUILT FOR EITHER TOP OR SIDE ADJUSTMENT**
- **50 OHMS THRU 1 MEGOHM**
- **THE SEALED UNIT** is immersion-proof
- **TEMPERATURE COEFFICIENT** less than 250 ppm/°C over all resistance values and complete temperature range
- **UNIQUE ROTOR DESIGN** provides exceptional stability of setting under shock and vibration
- **SMOOTH CONTROL**, approaches infinite resolution
- **PIN TYPE TERMINALS** for use on printed circuit boards with a 1/10" pattern

- **VIRTUALLY NO BACKLASH**
- **WIDE TEMPERATURE RANGE** from -65°C to +150°C
- **RATED $\frac{1}{2}$ watt @ 85°C**
- **EXCEPTIONAL STABILITY** under high temperature or high humidity
- **MEETS OR EXCEEDS ALL APPLICABLE MIL SPECS**
- **COMPETITIVELY PRICED!**

You'll find the new Type S trimmer equal to the traditional Allen-Bradley quality. You really ought to know more about the Type S. Won't you write for detailed specifications? Allen-Bradley Co., 1201 S. Second Street, Milwaukee, Wis. 53204. Export Office: 1293 Broad Street, Bloomfield, New Jersey, U.S.A. 07003. In Canada: Allen-Bradley Canada Limited.



S-3A to get totally integrated avionics

Navy's most advanced antisub aircraft to employ computer-operated sensors and advanced displays

John F. Mason

Military-Aerospace Editor

The Navy's S-3A antisubmarine warfare aircraft, now being developed by Lockheed Aircraft Corp., "will have the most totally integrated avionic system the Navy has ever built," Lt. Cmdr. Frank J. Quigley told ELECTRONIC DESIGN. Commander Quigley, a 34-year-old electronics engineer, is avionics system project officer for the carrier-based, two-engine aircraft.

The manager for the whole program, which began with a \$461-million research and development contract that will run into the billions when production begins, is Capt. Fred H. Baughman. Captain Baughman is 43 years old, a graduate of the U.S. Naval Academy with long experience as an ASW patrol plane pilot. Under his easy-going affability lies a firm deter-

mination to make his program a technological and economic success.

Computer heads the show

The S-3A will carry a formidable array of sub-hunting sensors, such as high-resolution radar, forward-looking infrared, sonobuoys, magnetic anomaly detectors, and photographic cameras.

"The aircraft's dual-processor, general-purpose digital computer will almost run the whole show," Commander Quigley says. "The sensors feed information into the computer which interprets it and sends it on to the display system. Then the operator decides what to do, tells the computer, which in turn takes action. This may mean activating other sensors to get more information, it may compare the instructions with stored data,

it might suggest firing weapons, or it could repeat the whole sensor operation to get a new reading."

Captain Baughman adds: "The computer has tremendous control. When it receives important information from a sensor it flashes a warning to the man in charge of making the sub-fighting decisions on the aircraft, the tactical coordinator. When the coordinator has time, he can ask the computer to show him what it's learned."

The other members of the four-man crew are the pilot, copilot and sensor operator, and each one has a set of integrated controls with which he can talk to the computer and turn sensors on or off.

The computer is going to aid the crew in detecting and identifying a submarine. "Every object in the sea that returns sound has a unique signature," Commander Quigley says. "We're going to try to store signatures of interest in the general-purpose computer memory with the hope that they will

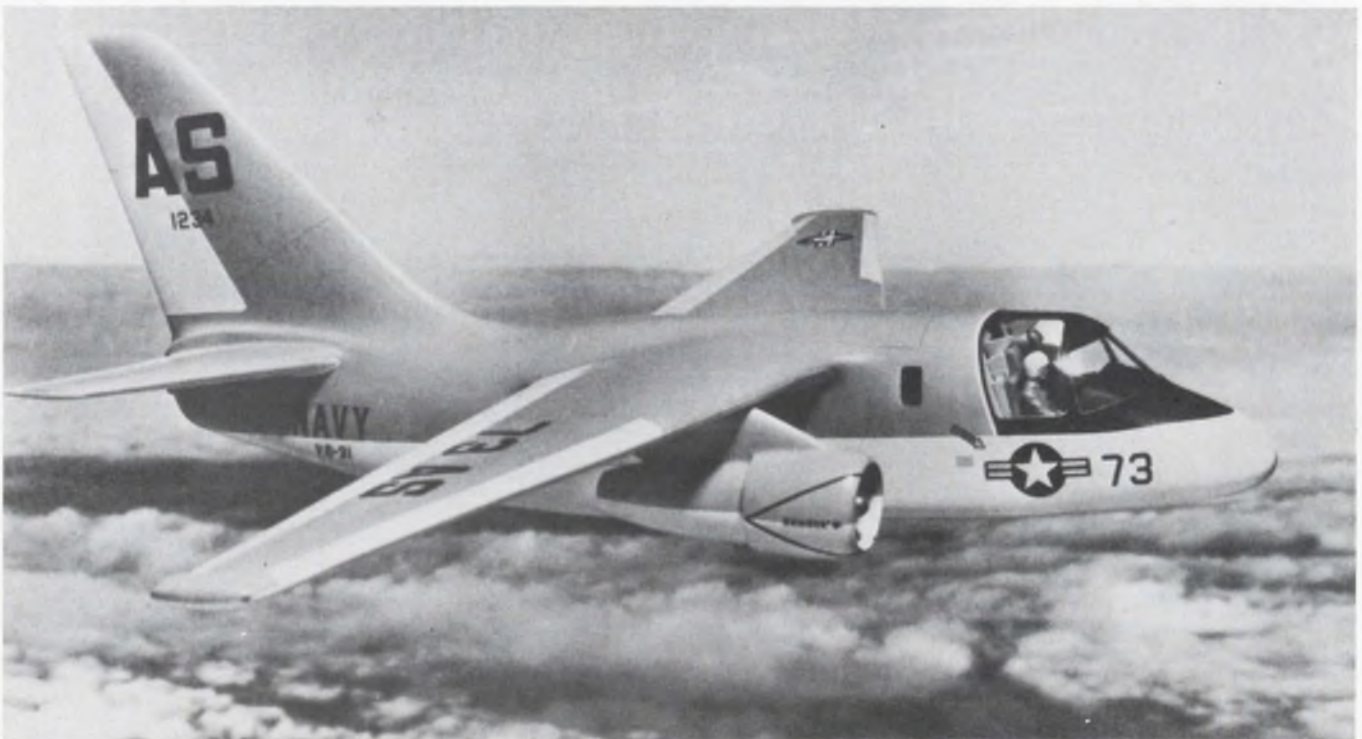

S-3A will carry a formidable array of sub-hunting sensors when it takes off from its carrier base.

It will use high-resolution radar, forward-looking infrared, sonobuoys and magnetic anomaly detectors.

ALLEN-BRADLEY

Metal-Grid resistor networks
combine a new measure of

precision, stability
and performance
in a sealed,
compact package



Precision Metal-Grid resistor network shown
approximately 1½ times actual size

The advanced capabilities—
developed from years of manu-
facturing Allen-Bradley Metal-Grid
resistors—are now applied to a new
line of resistor networks. This technology
enables the production of complex resistive
networks on a single substrate.

Allen-Bradley's exclusive simultaneous deposition
method is used to obtain the best resistance tolerance
and temperature coefficient matching. The reliability of
interconnections on the common resistance plane is incom-
parable. Uniformity and quality are inherent in A-B networks.
To illustrate, 2 PPM temperature tracking is normal.

A-B Metal-Grid networks offer a wide range of values—with
individual resistances as low as 25 ohms and as high as 2.0
megohms. Both the inductance and capacitance are low, per-
mitting efficient operation at high frequencies.

A-B engineers will be pleased to cooperate in developing net-
works for your specific need. For additional details, please write to
Henry G. Rosenkranz, Allen-Bradley Co., 1201 S. Second St.,
Milwaukee, Wis. 53204. Export Office: 1293 Broad St., Bloomfield,
N.J., U.S.A. 07003. In Canada: Allen-Bradley Canada Ltd.

BRIEF SPECIFICATIONS

Resistor Networks

Tolerances: $\pm 1.0\%$ to $\pm 0.01\%$
Resistance Matching: to 0.005%
Temperature Range: -65°C to
 $+175^{\circ}\text{C}$
Temp. Coef.: to ± 5 ppm/ $^{\circ}\text{C}$
Load Life (Full load for 1000 hr
@ 125°C): 0.2% maximum change

Ladder Networks

Full Scale Accuracy: 10 bits or less,
better than $\pm 1/4$ least significant bit. More
than 10 bits, better than $\pm 1/2$ least
significant bit.
Frequency Response: Less than
100 nanosecond rise time or settling time
Temp. Coef.: Less than 10 ppm/ $^{\circ}\text{C}$
Temperature Range: -65°C to $+175^{\circ}\text{C}$

(S-3A, continued)

tell the operator when he's got a real target."

An in-flight performance monitoring program constantly checks the whole system. If we detect a fault in any of the black boxes," says Commander Quigley, "we can call for the diagnostic routine to isolate the malfunction. With this system we cannot pinpoint the malfunction down to a specific module, but we can get it down to a given black box."

The computer, which will be furnished by the contractor, is a Univac 1832. "It is essentially two input-output controllers that address a series of core memories," the commander says. "The reason for having two is for redundancy. The P-3C land-based ASW aircraft has only one processor, a Univac 1830.

Choose your displays

"We are going to be able to choose the information we want displayed in this system," Commander Quigley states. "For example, surface ships are sometimes very important for the sensor operator to know about, but at other times, they just clutter up the display. On the S-3A the operator will be able to ask to see certain things and eliminate others."

The pilot and copilot both have their own small cathode-ray-tube display and a key set to ask for specific tactical information. All the sensors in the aircraft are operated through key sets similar to the ones the pilots have.

The system has two kinds of radar displays: a scan-converted plan-position-indicator (PPI) and a B-scan. The PPI shows the whole area being surveyed in a TV picture-like rendition. The B-scan "takes a chunk of the area between two limits of range and between two azimuth lines and presents just that. It's like a zoom lens on a camera," Commander Quigley explains. "With this equipment we can automatically track a target. We can ask its range, bearing and how long it will take to fly to it."

The system has an elaborate supply of alphanumerics to anno-

tate almost anything that occurs in the tactical situation.

Seeing with sound

The primary sensors for finding submarines are acoustic devices. Sonobuoys are ejected by the aircraft to form a pattern in the sea, and they transmit to an acoustic processor in the aircraft the information they pick up. The processor is capable of handling such advanced sonobuoys as DIFAR (directional low-frequency analyzer and ranging), which can detect, classify and pinpoint submarines. It can also handle CASS (command activated sonar source), a system that activates sonobuoys to ping, measures the time to echo, calculates the range and radios the results to the plane. The S-3A's processor can handle more channels than the one in the P-3C.

The system will carry bathythermograph buoys to provide the operator with a temperature vs depth profile of the sea.

Low-light-level television, which has been used with success on combat aircraft in Southeast Asia and is going into the P-3C, will not be used on the S-3A.

Instead, a forward-looking infrared (FLIR) sensor will be used. "FLIR," Commander Quigley notes, "has the potential for enabling the operator to detect submarines, as well as to identify them. Low-light TV is useful only to identify one after it's spotted."

Prime contractor Lockheed has not yet chosen a FLIR, but is looking at units built by Hughes Aircraft, Aerojet-General and Texas Instruments.

MAD (magnetic anomaly detector), which is the most reliable sensor for confirming the presence of a submarine, will of course, go into the S-3A. The same unit, AN/ASQ-81, is already in the P-3C. The set is built by Texas Instruments.

The S-3A's radar, Texas Instruments' AN/APS-116, will use two tricks to detect snorkels and small periscopes in a rolling, choppy sea. Pulse compression, to make shorter pulses and improve resolution, is one; the agile frequency technique—skipping from one frequency to another with the hope that one frequency will ignore the sea clutter

and reveal the periscope—is the other.

"Tests have shown us," Commander Quigley says, "that this radar is orders-of-magnitude better than any previous radar used for this purpose."

The aircraft will be equipped with a photographic camera controlled by the computer.

Know where you are

The CAINS (carrier aircraft inertial navigation system), being built by Litton, will provide precise navigation for the S-3A—"more accurate than the system on the P-3C," Commander Quigley says. "A unique aspect of CAINS is that it can be aligned by information from the ship's inertial system by data link instead of cable. This will make alignment simpler, as well as faster—five minutes as opposed to 30 with cable."

Here Captain Baughman adds, "Incidentally, all the ASW carriers are going to be equipped with SINS, the extremely accurate ships inertial navigation system used on Polaris submarines."

Commander Quigley resumes, "In addition to the inertial system, we will have Omega—to update the inertial, doppler, Tacan and a low-frequency radio direction finder. We haven't decided on a specific doppler unit yet."

"The avionics system is even more integrated than the one going into the Navy's F-14 fighter aircraft now being developed, because we're multiplexing our internal subsystem connections," the commander says. "Instead of having a bunch of wire bundles running from one black box to another, we send our control monitoring signals over coaxial runs, or twisted pairs of wires. We use both time and frequency multiplexing.

"We're using solid-state logic," he adds. "This does away with relays or switching devices. We have silicon control switches and rectifiers, and logic matrices to perform the various relay functions. This increases reliability and cuts down the size."

Captain Baughman ends the description of the S-3A on a note of satisfaction: "There won't be a tube on the aircraft. We're using a lot of ICs, LSIs and MSIs." ■■

Is your passive component supplier as reliable as his components?

He's fine at meeting industry specifications. Even exceeding them. But what about customer service? Does he sometimes act as if that's a necessary evil?

And have you been telling yourself that you have to put up with this kind of an attitude in order to be sure of getting components that are truly reliable?

Then it's time you learned about us. We're one of the leaders in component reliability—and we deliver in every other area as well. You bet we meet deadlines—speed samples—maintain competitive prices—and provide prompt technical assistance. If this kind of extra reliability would be a nice innovation, why not put us to the test. Give us an urgent request for technical assistance. Or an urgent

order. Write AIRCO SPEER ELECTRONIC COMPONENTS, St. Marys, Pennsylvania 15857.

Then watch us perform.



The passive innovators at **AIRCO** Speer

Speer resistors Resistor and conductor paste Jeffers JC precision resistors Jeffers JXP precision resistors and networks Jeffers inductors Jeffers capacitors PEC variable resistors and trimmer potentiometers.

For 14 months we would have said "no"



to even the President of the United States.



"Sorry, Mr. President."

That's what we would have said.

When we got into the MOS business in 1967, we resolved not to follow the over-enthusiastic marketing practices of the industry.

So we didn't sell to *anybody* until our products were fully tested, documented, and deliverable in volume.

That's why you didn't hear from us until February of this year—14 months after we began our operations.

Electronic Arrays is a volume producer of state-of-the-art MOS products. That's all we do.

We work with no other technology.

We have the know-how to manufacture complex circuits at low cost by packing a lot of electronic function into tiny silicon chips.

Our EA 3500, a 2560 bit Read-Only Memory, for example, is made with 3000 transistors all contained in a chip of silicon .065 inches by .094 inches—about as small as the head of a pin.

Our experience with MOS integrated circuits goes way back. In fact, Gene Stephenson, our director of manufacturing operations, designed the very first MOS circuit in 1964. Others on our staff account for the next three, along with many current designs.

Our plant is already over 27,000 square feet. Production standards are impeccable. This year, we will deliver about 100,000 circuits. And next year, many times this number.

We worked a long time behind the scenes. Now we're delivering.

Address your purchase orders to Electronic Arrays, Inc., 501 Ellis Street, Mountain View, California 94040. (415) 964-4321.

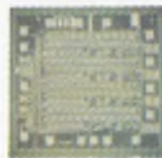

To the left is our EA 1200, the industry's only Quad 32 bit shift register. Other products include dynamic and static registers, random access read/write and read-only memories and logic arrays.



**electronic
arrays, inc.**

Proven MOS products delivered in volume

Design Now...



...Specify Later



WIREWOUND



CERMET



CONDUCTIVE PLASTIC



BIFILM



Would you believe a **WIREWOUND CERMET CONDUCTIVE PLASTIC BIFILM?**

It's true! Bourns new *Bee-Line* permits project design without first considering potentiometer element to be used!

STANDARD SIZES

Available in $\frac{7}{8}$ ", $1\frac{1}{16}$ ", 2" diameters! Each potentiometer can be ganged up to 10 cups in increments of only 0.2"!

VERSATILE ELEMENTS

Your choice of wirewound, cermet, conductive plastic or BiFilm™* — Linear or Nonlinear — available interchangeably, singly or in combination!

Complete details on the new, versatile *Bee-Line* are available from the factory, your local Bourns Sales Office or representative.

*BiFilm is Bourns new, low TC Conductive Plastic



Helicopter has radome antenna



Chopper antenna for Tacsatcom

A radome-enclosed antenna to be installed above the rotor of a helicopter is being designed for use with the RCA-developed super-high-frequency global tactical satellite communications system (TACSATCOM) of the Defense Dept.

Bell Aerosystems Co., a Textron Division, won out with its above-rotor design over a below-rotor configuration as a means to avoid the "chopping" effect of rf transmissions caused by the rotor blades when located between the antenna and an orbiting satellite. Bell developers note that placement of the antenna above the helicopter blades greatly increases structural design problems because of the severe vibration environment. But Bell engineers concluded in their feasibility studies that they can design round the problem and minimize vibrations through use of an "advanced gyro-stabilization" technique.

The nearly \$500,000 contract was revealed by the Air Force, which also noted that the R&D effort is sponsored by the USAF Avionics Laboratory, Wright-Patterson AFB, Dayton, Ohio, and the Army Satellite Communications Agency, Fort Monmouth, N.J.

The first flight test is expected by the end of this year aboard a Bell UH-1F helicopter (see photo).

New FCC chairman sought

Who will succeed Rosel H. Hyde who is retiring as chairman of the Federal Communications Commission? The Nixon Administration needs a successor who will be acceptable both to industry and to the Congress. In fact it may

Washington Report

CHARLES D. LAFOND
WASHINGTON BUREAU

need two successors, for James J. Wadsworth, another of the seven-man commission, has indicated his desire to resign to join the International Telecommunications Satellite Consortium.

Both men—the 69-year-old Hyde and the younger Wadsworth — are Republicans, and both have been conservative influences with the Commission. For some time, the so-called conservative element has dominated FCC decisions and been strongly supported by the broadcast industry. The names of at least two members, who are considered liberals—Kennedy Cox and Nicholas Johnson—are not high up on the list of potential candidates for commission chairman.

Some of those now being considered for the job are: Dean Burch, former Republican party chairman in 1964; Frank Shakespeare, head of the U.S. Information Agency and a former vice president of CBS; William Safire, White House speech writer; and Mark Evans, a Metromedia TV official and former TV-radio broadcaster. It is believed that Burch currently heads the list, though many others are known to be quietly seeking the position.

NASA picks up the glory tab

NASA is fast discovering that, along with the success of the Apollo 11 moon landing, comes a high price tag. For example, as part of its celebration honoring the July 20 moon landing, the Manned Spacecraft Center in Houston held a luncheon for its personnel early in August—and the tab, \$2800. Now if you add to that the price of the subsequent dinner called for by the President

Washington Report

CONTINUED

at the Century Plaza Hotel in Los Angeles, the total runs somewhere between \$80,000 and \$100,000.

The Space Agency may not yet quite understand the proceedings, but somehow or other it has managed to get stuck with nearly every charge associated with the well-publicized state dinner honoring the three astronauts and their wives. To start off, the White House is expected to direct NASA to pay most of the \$75,000 dinner tab at the Century Plaza. Then, to send several hundred NASA space officials and their wives to Los Angeles for the affair and bring them back by chartered aircraft cost another \$19,343. On top of this, Congressman George P. Miller (D-Calif.), chairman of the House Space Committee, forced NASA to pick up the Air Force charge of \$5,522 for flying 32 members of his committee and their wives to the West Coast and back. (Defense Secretary Melvin R. Laird, it is reported, flatly turned down any suggestion that DOD pick up the flight expense.)

Volpe endorses international air show

Offers of national support for a permanent U.S. biannual international air show and exhibition has been triggered by the highly successful Second National Air Exposition held last month at Dulles International Airport near Washington, D.C.

John A. Volpe, secretary of the Transportation Dept., not only declared a need for such a continuing U.S.-sponsored exhibition "to report flight advances to the nation," but he added: "Many leaders of Congress have . . . asked the Dept. of Transportation to endorse such a program. We not only endorse the concept but we are

ready to assume responsibility for its organization and management if the Congress acts favorably on proposed legislation which is now awaiting consideration.

During the two public-attendance days at the recent air show it is estimated that nearly 500,000 viewed the ground and aerial displays. The air show featured exhibits by the nation's aerospace and avionics manufacturers, nearly two miles of civil and military aircraft displays from four nations, and daily aerial demonstrations.

Sound-flame studied by Air Force

Its discovery that by passing an electrical impulse through fire, an audible sound can be reproduced and amplified with high-fidelity quality, has brought United Technology Center, a division of United Aircraft Corp., a contract from the Air Force Office of Scientific Research for further study on the subject.

The division, more usually associated with the development of solid propellant fuels, has pioneered work on the amplification of sound through flame for several years since its initial discovery. The concept is referred to by UTC as electrothermal sound and has been dubbed "the singing flame." Sounds transmitted by the flame are emitted omnidirectionally.

The division, located at Sunnyvale, Calif., is now attempting to produce ultrasonic sound at high intensity in air. It is also seeking commercial application for the acoustical output for use in high-speed data transmission and in a new form of super-high-fidelity amplifier system.

UTC also notes the technique may serve as a means for introducing sound into the combustion chambers of rocket motors to determine or measure combustion stability. It may also prove useful as a means for obtaining acoustical recording of the combustion process itself.

A big part of developing our new keyboard was in helping the operator operate faster. Without goof-ups.

Here's what we came up with:

Two-key rollover. This allows "burst-speed" typing. An electronic interlock eliminates errors when two keys are pushed at the same time.

That old typewriter feel. Key spacing is the same as on office typewriters. And spring loading simulates typewriter touch.

Shift lock. A handy option for dual applications that require

extensive typing in the shifted position.

And several choices. Sloped or stepped key rows. Standard and custom key character sets. Over 500 legends (and we're continually developing more to meet your growing needs). A whole bunch of button colors as well as several button shapes.

They're all part of another thing we came up with, the world's first use of an integrated circuit as a keyboard switching element.

This micro-miniature circuit eliminates mechanical linkages.

Electromechanical parts. Moving contacts. Black boxes. And a big price tag.

But it retains the reliability of our other keyboards. Proven by tens of thousands of operators, in hundreds of applications.

"Condensed Keyboard Guide" briefly discusses MICRO SWITCH keyboards and options. Become a fast operator.

Write for a copy.

MICRO SWITCH

FREEPORT, ILLINOIS 61032

A DIVISION OF HONEYWELL

Our new all solid-state keyboard. It makes even fast operators operate faster.



Intech takes on the Op Amp Boys.

We're a David among Goliaths. And we know it. So does Philbrick/Nexus, Analog, Burr-Brown, et cetera, et cetera.

They're our competition, and maybe your present Op Amp supplier.

We're out to change that... and to give you better FET input op amps.

Here's our story.

We've put together the best component and design engineering talent the industry had available. We let them have the run of the house.

What they do constantly amazes us.

Like the A-130: a high speed, FET input Op Amp that has a slewing rate of $600\text{V}/\mu\text{s}$ (typ) and a settling time to 0.01% of final value in less than $0.5\ \mu\text{s}$ in an amplifier with a 6 dB roll-off. The price is almost half of the competition's.

Don't believe us, or our engineers, though. In this business specifications, performance, and price are the considerations. A test is worth a thousand words.

For more information on our operational amplifier line, contact your nearest Intech representative, or call or write us direct.

Intech Incorporated, 1220 Coleman Avenue, Santa Clara, California 95050. (408) 244-0500.



intech



Here are some of our boys

REPRESENTATIVES

Washington, Oregon, Idaho, Montana
British Columbia, Alberta

Arneson Associates, Inc.
Seattle, Washington 98108
(206) 762-7664

Arneson Associates, Inc.
Beaverton, Oregon 97005
(503) 646-3416

California, Nevada

Measurement Associates
Sunnyvale, California 94086
(408) 739-7785

Measurement Associates
Inglewood, California 90309
(213) 671-7651

Texas, Arkansas, Louisiana, Oklahoma

Carter Associates
Garland, Texas 75040
(214) 276-7151 TWX 910-860-5097

Colorado, Utah, New Mexico

Waugaman Associates, Inc.
Denver, Colorado 80033
(303) 423-1020

Alabama, Georgia, Tennessee, Mississippi

20th Century Marketing, Inc.
Huntsville, Alabama 35805
(205) 536-1596

Massachusetts, Maine, New Hampshire,

Vermont, Rhode Island, Connecticut
KCA Components Inc.
Lexington, Massachusetts 02173
(617) 861-9024

Illinois, Indiana, Wisconsin, E. Iowa

Gassner & Clark Company
Chicago, Illinois 60645
(312) 764-6121

Ohio, Michigan, Western Pennsylvania

J. C. Hofstetter Company
Medina, Ohio 44256
(216) 241-4880

Northern New Jersey, New York City,

Fairfield County, Connecticut
Salsbury Associates, Inc.
Hicksville, New York 11801
(516) 938-1080

Up-State New York

Graydon-Sherman
Fayetteville, New York 13206
(315) 637-9861 TWX 710-545-0241

Southern New Jersey, Eastern Pennsylvania,

Maryland, Virginia, West Virginia, Delaware
Biechler Associates, Inc.
Narberth, Pennsylvania 19072
(215) 667-1827 TWX 510-657-4361

Florida

Conley-May Associates, Inc.
Oviedo, Florida 32765
(305) 365-3283

Conley-May Associates, Inc.
Pompano Beach, Florida 33060
(305) 943-8284

Conley-May Associates, Inc.
St. Petersburg, Florida 33733
(813) 822-0161

intech

Letters

Engineers look to unions to improve their Lot

No representation—no recognition

Sir:

Please refer to the letter, "I flatly refuse to work for my dog" in your July 19, 1969 issue. I believe the point that engineers need representation is particularly well taken because all other professional groups (teachers, doctors, lawyers, etc.) have representation that is very effective in advancing their goals (usually at the expense of the rest of the community). Without representation, engineers and scientists will not receive the recognition and the rewards that are due them.

Hermann F. Schmid

Research Engineer
Stanford Electronics Laboratories
Stanford, Calif.

Challenging tasks or ill-considered proposals?

Sir:

In answer to "Baltimore Engineer's" letter I wish to make the following comments, based on nearly twenty years of observations as a graduate engineer who has served both staff and line functions.

1. The "challenging" tasks are too often the result of ill-considered and hastily prepared proposals and plans that have been based on an unfounded optimism by higher level managers, or a hope that *this* time the engineers will receive divine guidance or that a specialist can be hired.

2. In this period of large scale contracting the great majority of engineers work for a living—not for personal gratification, entrepreneur's benefits, or professional recognition. Even then, recognition is not a goal in itself. It is sought because it can lead to increased in-

come from the present employer or a new one.

3. Engineers problems *are* real. The abuse of the term "professionalism" falls in three categories. First, it is too often equated with the willingness to work unlimited unpaid overtime; also, the lack of recognition of educational status, or need of special working conditions is legend. Very few people, for instance, can continually meet the demand to think creatively in noisy, dirty, or crowded environments. Second, salaries subject to the sacred employe/company relationship are actually controlled by local labor market, personnel salary curves, and level of contract backlog. Many engineers are fed-up with so called merit reviews which do not even keep pace with the cost-of-living. Only unfavorable comparisons result from viewing incomes of truck drivers, plumbers, and electricians. Third, working hour demands are often unreasonable because of deliberate under-bidding of costs in contract work, excessively optimistic performance promises, and unrealistic delivery time schedules.

I find the decreasing enrollment in engineering schools perfectly understandable. The effort and expense of a college degree is better justified as an investment in a true profession. I would not encourage any youth to enter engineering. A few years ago, even the concept of an engineers' union resulted in my violent opposition. Today, I view engineers as viewed by most companies—not as junior members of management, not as professional employees, but as a form of trade labor differing only in type from machine operators and assemblers. Yes, engineers do work for a living, for the opportunity to do interesting work, and to achieve some degree of recognition. The union

(continued on p. 53)

In the beginning there was the Crystal...

... then there was BULOVA

The silicone dioxide mineral that nature created Bulova refined, shaped and put to use. Today, our expertise in crystals extends from the raw stone to the finished crystal device.

With the quartz chosen by a trained eye and cut with near-surgical precision, Bulova specialists in circuit design and thermodynamics add their talents. This knowledge is correlated with selective computer programming for optimum circuit performance.

The result is a crystal capability that should be on your side when you tackle frequency control problems.



CRYSTALS

A full line of crystal cuts and enclosures in both low and high frequencies . . . from 2KHz to 33MHz fundamental and 150-MHz overtone . . . in every type of packaging — Coldweld, Glass-sealed, Solder-seal metal holders. New Coldweld line of miniaturized packages

available in TO-5 Series, HC-6/U, HC-18/U, HC-25/U and TO-8 cans, in tolerances as close as $\pm .0005\%$ from -10°C to $+60^{\circ}\text{C}$.

CRYSTAL FILTERS

A complete capability from 4KHz to 30MHz for such typical use areas as — Band Pass / Linear Phase / Time Delay / Single Side Band. Computer Programs determine design tradeoffs quickly and economically — A staff of application and production engineers provide in-depth experience in the following crystal filter designs: 1. Butterworth, 2. Butterworth-Thompson, 3. Chebyshev, 4. Bessel, 5. Elyptic, 6. Lerner, 7. Gaussian (Transitional), 8. Image Parameter.



CRYSTAL OSCILLATORS

Choice examples of our capability are . . . PCOXO-101, a high stability crystal oscillator, with an output frequency of 1MHz or 5MHz, an aging rate of $1\text{PP}10^9$ per day, and a frequency stability of $\pm 1\text{PP}10^6$ over an ambient temperature of -55°C to $+70^{\circ}\text{C}$ and TCXO-30, a temperature compensated crystal oscillator, in a frequency range of 3 to 5MHz, has a stability of $\pm 5\text{PP}10^7$ over a temperature range of -55°C to $+85^{\circ}\text{C}$.

For further technical data on crystals, crystal filters or crystal oscillators, call (212) 335-6000, see EEM Section 2300, or write —



BULOVA FREQUENCY CONTROL PRODUCTS

Electronic Division of Bulova Watch Company, Inc.
61-20 Woodside Ave., Woodside, N. Y. 11377 (212) 335-6000

Go Bulova, and leave the designing to us!

Solid State Relays

Another **big** breakthrough from the "little relay" people

Little Relay



TO-5 Relay

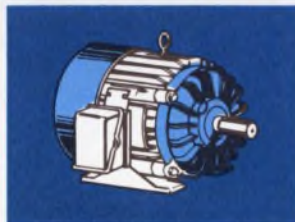

Big Breakthrough

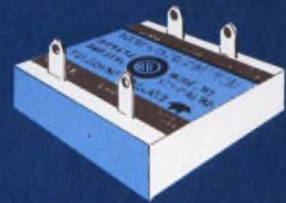

Solid State Relay

We got our nickname "little relay" people because we usually put our *big* breakthroughs in *small* packages. (Our success started when we introduced the TO-5 relay.) Now, we've made another breakthrough . . . a completely solid state, four terminal relay with enormous power gain. Only 1 milliwatt switches up to 5 KVA, and it can be resistive, inductive, capacitive, tungsten or quartz lamp loads.

Our new relay operates on inputs up to 280 VAC or from

3.5 to 300 VDC (either polarity) permitting direct interface with TTL logic. Input-output isolation is 10^{11} ohms "coil" to "contact" and "coil" to mounting plate. Dielectric is 2000 VRMS. Output characteristics include contact ratings up to 21 amperes, 280 VAC, 60 Hz. Surge current ratings of 200 amperes, and "contact" resistance as low as 50 milliohms. And, . . . these are real *breakthroughs* for a relay which doesn't have "coil" or "contacts."

Available options include zero

voltage switching for RFI suppression and lamp life extension.

Prices start as low as \$18.30 in quantities of 100. For complete technical data on our Series 6 Solid State Relay . . . contact us . . . the "little relay" people.



TELEDYNE RELAYS
A TELEDYNE COMPANY

3155 West El Segundo Boulevard Hawthorne, California
90250 Telephone: (213) 679-2205

**Now you can revise your thinking
about the size of latching relays!**



KUL Relay

New P&B magnetic latching relay cuts mounting space in half



KUB Series

KB Series

KBP Series

Our new KUL takes up only about half the chassis area of mechanical interlocking latching relays. Only one relay is used, not two. The price (starting at \$6.05) is a lot less, too.

The secret? A unique magnetic circuit design. Voila! A small latching relay with excellent memory stability... one designed for continuous duty but which will stay latched without power on the coil. And remember, there are no mechanical interlocking members to wear out.

Single or dual-wound (polarized) coils are available for DC operation to 110 volts. Single coil, two-input, AC units (to 120 volts) employ diodes for pulse separation. Contact arrangements up to 3 Form C are available for switching 5 or 10 amperes. Quick-connect/solder terminals fit nylon socket rated for 10 amperes.

KUL relays are recommended for a host of commercial applications such as process controls, business machines, alarm systems, battery chargers and the like.

Wide Choice of Other P&B Latching Relays

KUB SERIES. Latching relay employs two KU relays. Quick-connect/solder terminals. Coils operate on same or different voltages. Exceptionally rugged, die-cast zinc base.

KB/KBP. Two KA relays with mechanical interlocking feature. Solder terminals (KB) or octal-type plug and nylon case (KBP).

Need more information? Call your local P&B sales engineer or the factory direct. Potter & Brumfield Division American Machine & Foundry Company, Princeton, Indiana 47570. Telephone: (812) 385-5251.

AMF

POTTER & BRUMFIELD

(continued from p. 49)

trend is increasing; in five years it will be widespread. The professional associations are not serving this function; contrast the American Medical Association!

(name withheld by request)

Pay may not be first but it ranks high

Sir:

Baltimore Engineer's belligerence and exaggerations rather overshadow a few valid points. Effective representation of engineers in industry, of the type afforded teachers by the National Education Association, for example, is desirable and fairly rare. Reasonable working hours, yes, but three months vacations and early retirement are pie in the sky.

Mr. Speer's assertion in the ED 26, Dec. 19, 1968 editorial that "Pay, by itself, often ranks low on the list of rewards that such workers seek," is, I feel, inaccurate. Pay may not rank first with the majority, but it surely ranks high. A pay increase enhances an individual's feeling of being appreciated as well as his material well-being. Also, his advice to project managers on sharing the involvement, etc. seems hardly necessary. Surely, any competent project manager knows this.

(name withheld by request)

Engineers are treated as common workers

Sir:

In comment to the letter written by a "Baltimore Engineer," I must admit a total agreement. I think the key word, which seems to be missing from his letter, is "professional."

Unfortunately, too many engineers are treated as common workers when it comes to rewards and working hours, and I like professionals only when it comes to making sacrifices for "the company." Hopefully, as more engineers start

fighting for their rights, as does our friend from Baltimore, a pleasant environment with decent benefits and salaries will be obtainable.

If articles I have read are true, management and some companies are giving their engineers a fair shake. Possibly industry should look at the success of one of these companies, Signetics Corp.

Gerald Goldschein

New York

Individuals play against a stacked deck

Sir:

The author of the letter "work for my dog" seems to be more of a philosopher than an engineer, but he hit the nail right on the head. He gives us a classic example of the Modern American Tragedy—the Rat Race!

The working hours, holidays, vacations, and retirement age in most foreign countries puts us to shame. Even the Russians, who are supposedly competing with the West, went to a 30-hour week a few years ago. I see no reason why a dog should lead a more comfortable life than his master. Progress is not solely more business mergers and higher corporate profits, but an easier life.

Fortunately, our predicament is not entirely hopeless. The Generation Gap spells doom for the architects of the Rat Race. Corporate profits will go down, but the quality of life in America will surely go up.

As far as engineering unions are concerned, I feel that dealing with a company (organization) on an individual basis is like playing against a stacked deck. The individual is no match and will always come out on the bottom. It takes an organization to deal with another organization if the outcome is to be fair to both sides.

In view of the present general situation, an engineering union is essential for our very economic and social survival!

(name withheld by request)

Looking beyond the 'specs' with P&B

Time Delay Relays



With  CD-38 style

±5% Accuracy

±1% Repeatability

Dependable!

A wide range of time delay requirements can be met with these accurate, easy-to-use solid state relays. All built to P&B's exacting standards of reliability, the series offers a multitude of advantages, including timing repeatability of ±1%; nearly instantaneous (milliseconds) reset; a choice of sizes, mountings and terminations; long-life inherent with non-mechanical solid state switching. Three modes of timing are available — knob-adjustable, resistor-adjustable, and fixed.

The CD Series is available for delay on operate or on release with the relay in the same enclosure as the solid state unit or with an external auxiliary relay. There are four case styles in this series:

The CD-21 designed for use with an external KRP relay can also be supplied with an internal DPDT relay.

The CD-31 style designed for use with an external KHP relay.

The CD-38 style has an internal 10 amp DPDT relay.

The CD-45 style designed for use with an external PR relay.



CD-21 style

CD-31 style

CD-45 style

PLUS P&B Capabilities and Facilities that insure

- Controlled Quality ■ Reliability
- Long Life ■ On Time Deliveries

AMF

POTTER & BRUMFIELD
Division of American Machine & Foundry Co.
Princeton, Indiana 47570

INFORMATION RETRIEVAL NUMBER 31

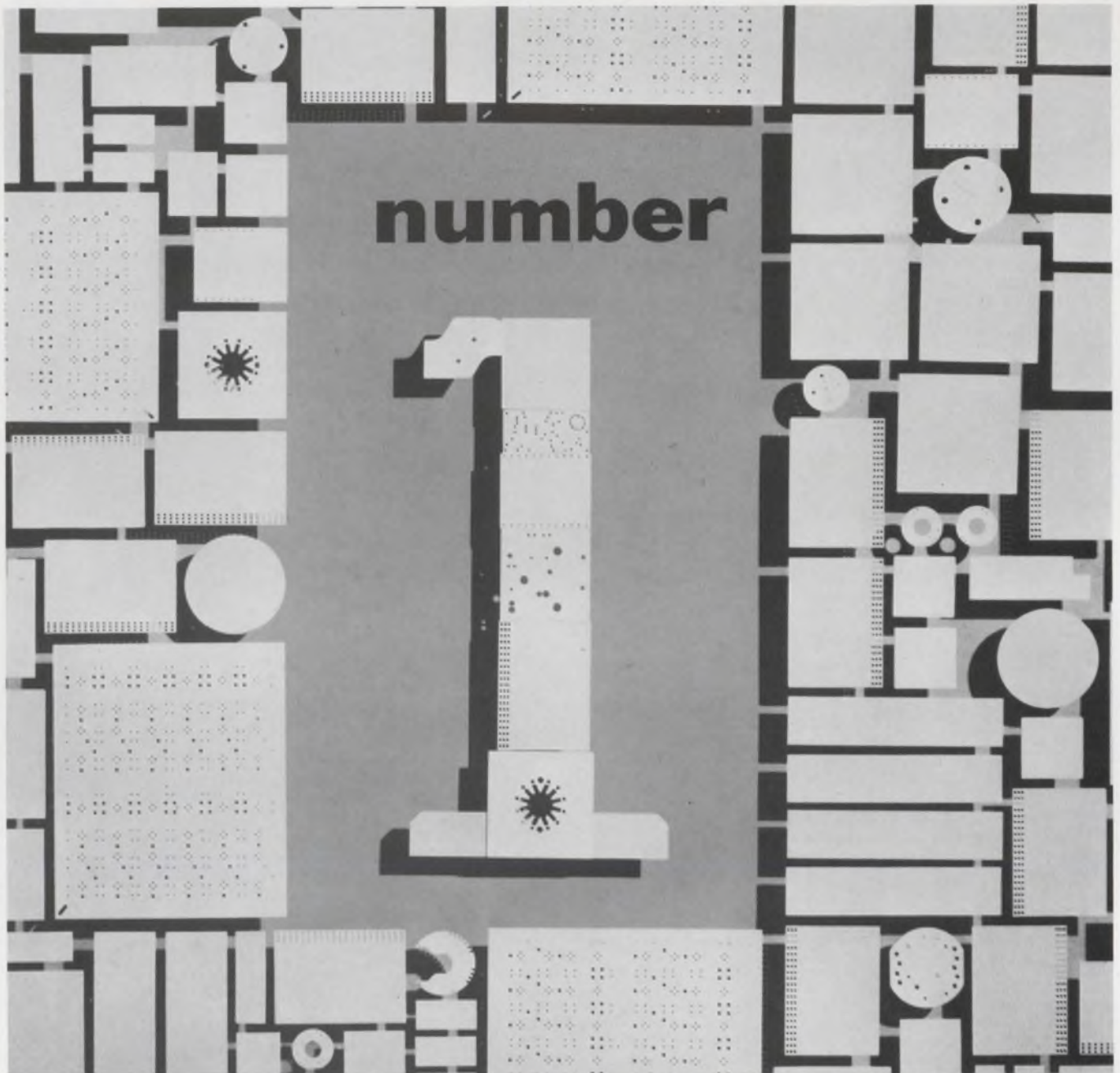

number

Coors Porcelain Company is the Number 1 producer of high-alumina ceramics and a major producer of alumina-ceramic substrates for thick- and thin-film circuits. This produces a number of benefits for you. Namely:

LOW COST—Whether your substrate order is large or small, you'll always find fair, competitive prices at Coors.

QUICK DELIVERY—Large-quantity substrate orders normally require only 6 to 8 weeks to complete. Small orders and prototype quantities usually take 2 weeks or less. Stocked blanks are shipped within 48 hours.

HIGHEST QUALITY—Coors has long been known as *the quality* manufacturer of technical ceramics. This means you can be sure Coors substrates will have uniform surfaces, precise dimensions,

maximum strength, maximum flatness, minimum camber, minimum waviness.

Coors can produce substrates to your specifications from either glazed or unglazed 96% alumina ceramic or unglazed 99.5% alumina ceramic. Both of these ceramics are dense, impervious, resistant to high temperatures, easily metallized, and have excellent electrical-insulation characteristics and good heat-transfer properties.

For details on Coors ceramic substrates, send for Bulletin 1400. Coors Porcelain Company, 600 Ninth Street, Golden, Colorado 80401.

9/2



FIRST again... with the largest lineup of new linear ICs



order your free copy today!

Call 516-733-3243 or write General Instrument Corporation, Dept. H, 600 West John St., Hicksville, L.I., N. Y. 11802.



INFORMATION RETRIEVAL NUMBER 33



It's what's up front that counts!

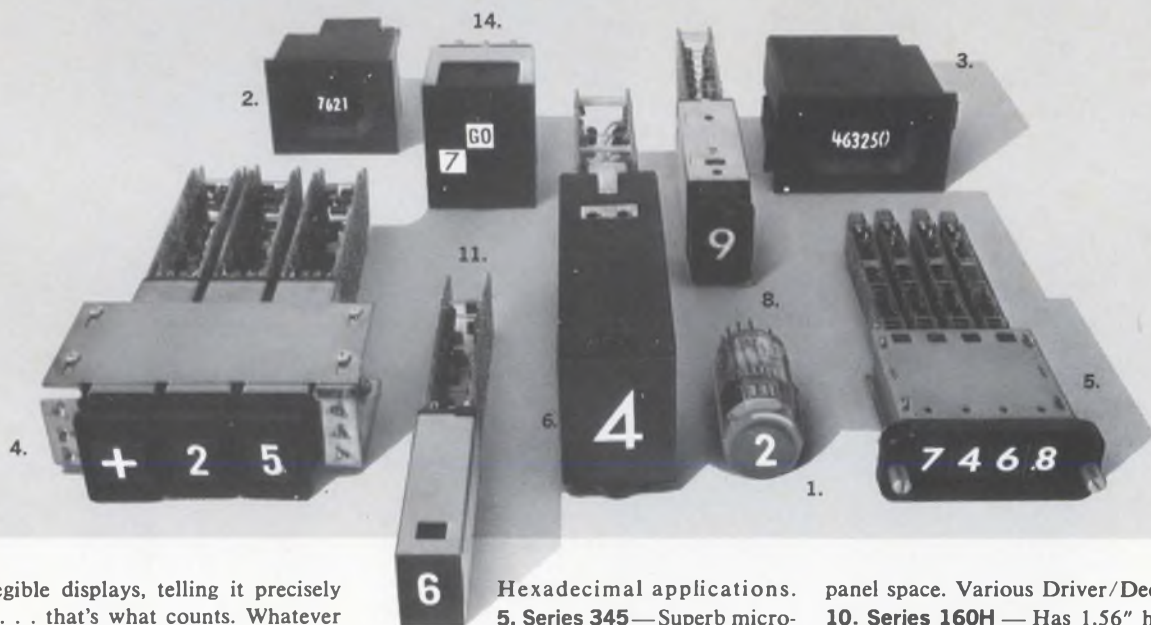

Bright, legible displays, telling it precisely like it is . . . that's what counts. Whatever the application, IEE has a readout and mating driver/decoder geared to deliver unsurpassed displays, up front . . . *where the action is.*

1. **nimo™, single-decade** — Single plane, 10 gun CRT. Displays numbers, letters and words with unsurpassed brightness and clarity. Driver/Decoder with BCD input.
2. **nimo™, 4-decade display** — 1.13" dia; 3/8" high characters. \$3.50/decade. Various Driver/Decoders, MSI/LSI compatible.
3. **nimo™, 6-decade display** — Ideal for instrument use, read bright and clear at 75 F.L. — low, \$2.90/decade. Highly compatible electronic interface cards.
4. **Series 860 Cue Switch** — Unique readout and data input unit; displays up to 24 messages. Depressing viewing screen/switch initiates or changes inputs.

Hexadecimal applications. 5. **Series 345** — Superb micro-miniature readout with 1/2" w x 3/4" h screen. 20' viewing distance, 175° viewing angle. Matching miniature Driver/Decoder assures optimum performance.

6. **Series 10H** — World's most popular rear-projection readout. Projects any numeral, character, message, color, etc. High performance Driver/Decoder.
7. **Series 120H** — Miniature readout, only 1" wide, presents 5/8" h characters. Readability unmatched at 30'. High reliability potted Driver/Decoder for military application.
8. **Series 220H** — Optimum clarity even under high ambient light conditions. Front plug-in capability: press viewing screen, remove insert. New IC Driver/Decoder.
9. **Series 360H** — Jumbo size (2") characters, clearly visible from 50'. Unit is 3" h x 2" w; mounts on 2" centers for minimum

panel space. Various Driver/Decoders.

10. **Series 160H** — Has 1.56" h x 1.12" w message area, readable at 30'. Lamps are decoded and driven by one of three styles of IEE Driver/Decoders, 14 models in all.
11. **Series 880** — Compact, sub-panel readout offers 0.50" message area, choice of 12 Driver/Decoders, with or without data storage, plus many options.
12. **Series 80** — The "Big Boy" (3 3/8" h characters). Suited to many annunciator applications, control boards, etc. Easily read from 100'. New Driver/Decoders.
13. **Bina-View** — Unique readout utilizing up to 64 character plates. Accepts any binary code up to 6 bits. Self decodes and displays in any color.
14. **Status Indicator** — Back lighted multi-message indicator. Displays one or all (12) messages simultaneously. Ideal for sequential instructions or operational procedures.

The World's broadest line of rear-projection readouts.



Industrial Electronic Engineers, Inc.
7720 Lemona Ave., Van Nuys, California 91405
Telephone: (213) 787-0311 • TWX 910-495-1707

"Speaking of lamps..."



IEE builds subminiature lamps with stabilized filaments, longer life, uniform brilliance, unmatched reliability . . . at half the cost of competition. Seems like magic, but it isn't. It's extra long aging at rated voltages. (Forced aging shortens lamp life.) It's extra care in selection. It's such features as handmounted Swiss tungsten filaments and multi-point testing, all inherent in a stringent, quality assurance program for over 500 varieties. Let your IEE representative shed a little light on lamp savings for you today. (Get the rub?) Industrial Electronic Engineers, Inc., 7720 Lemona Avenue, Van Nuys, California 91405. (213) 787-0311, TWX-910-495-1707.

IEE
SUB-MINIATURE
LAMPS

INFORMATION RETRIEVAL NUMBER 35

ELECTRONIC DESIGN 19, September 13, 1969

The day Electronic Design out-jinxed a jinx

Aug. 13, 1969. If you're superstitious, you take special precautions on any day with a "13" in it. Like avoiding cats, ladders or broken glass. If you've got a bad case, you stay home in bed, maybe, with the covers over your head. You *don't* go fishing, because, as any fool knows, when you're a fisherman, you're courting luck. So . . . with technical-minded aplomb and thorough disregard for the conventions of superstition, ELECTRONIC DESIGN's editorial staff stayed away from the office on Aug. 13, 1969—and went fishing.

Led by Editor Howard Bierman and Managing Editor Frank Egan, the staffers turned up wide-eyed at 7 a.m. at Sheepshead Bay in Brooklyn, N. Y., where the jolly boat Mako II is based. In a day on the bounding Atlantic off Jersey's north shore, the editors and writers learned several interesting things. Like: Bluefish don't have a very efficient sensor system; they think wiggling yellow plastic tubing a half inch in diameter is a fish. And wouldn't it be nice if people had built-in gyroscopes?

Hard luck? None to speak of. Art Director Cliff Gardiner slept all day. Too much Dramamine. But nobody broke a leg or wrapped a fishhook around a colleague. In all, the staff caught about 50 pounds of fish—21 blues. Maybe it was because Aug. 13, 1968, was a Wednesday instead of a Friday?

(P.S.: *There was fishing for ideas on the trip, too. It's our way of getting the staff away from the office routine a couple times a year to discuss freely and openly ways of improving the magazine. We believe that on occasion you can mix business and pleasure.*)



August 13 was an unlucky day—but only for the bluefish in the picture. ELECTRONIC DESIGN's editorial staff took the day off to go fishing—for ideas as well as blues.



It takes guts to build a TV set

Lots of 'em. Dozens of assemblies and sub-assemblies and components. Each as important as the other. From plug to picture every item must perform. And perform well. The customer buys what he sees. And what he sees is determined by what he does not see. That's the guts of the story.

Stackpole makes more than a dozen types of components for black and white and color television receivers. Since 1947 mostly. But even before that we produced millions of high quality fixed composition resistors for the booming radio market. Still are, in fact.

From the earliest days of television, Stackpole supplied the first ferrite horizontal output transformer cores. First for black and white. Then for color. In 1954 Stackpole introduced

Ceramag[®] ferrite components for the 70° color deflection system. And again in 1964, the 90° color components. Today we're working on the color 110°. In addition, we've been involved with such major television advances as Automatic Pincushion Correction.

Stackpole engineering and production know-how has contributed much to the technology of television. Our components can be found in every domestic TV set. Not only ferrites and resistors, but variable resistors and linear potentiometers; slide and rocker switches; capacitors and hard ferrite magnets. More than any other manufacturer.

Have you got what it takes to build a good TV set? Be sure. Specify Stackpole electronic componentry wherever possible. You'll get the value and performance you need. Write or call: Stackpole Carbon Company, Electronic Components Division, St. Marys, Pa. 15857. Phone 814-834-1521. TWX: 510-693-4511.

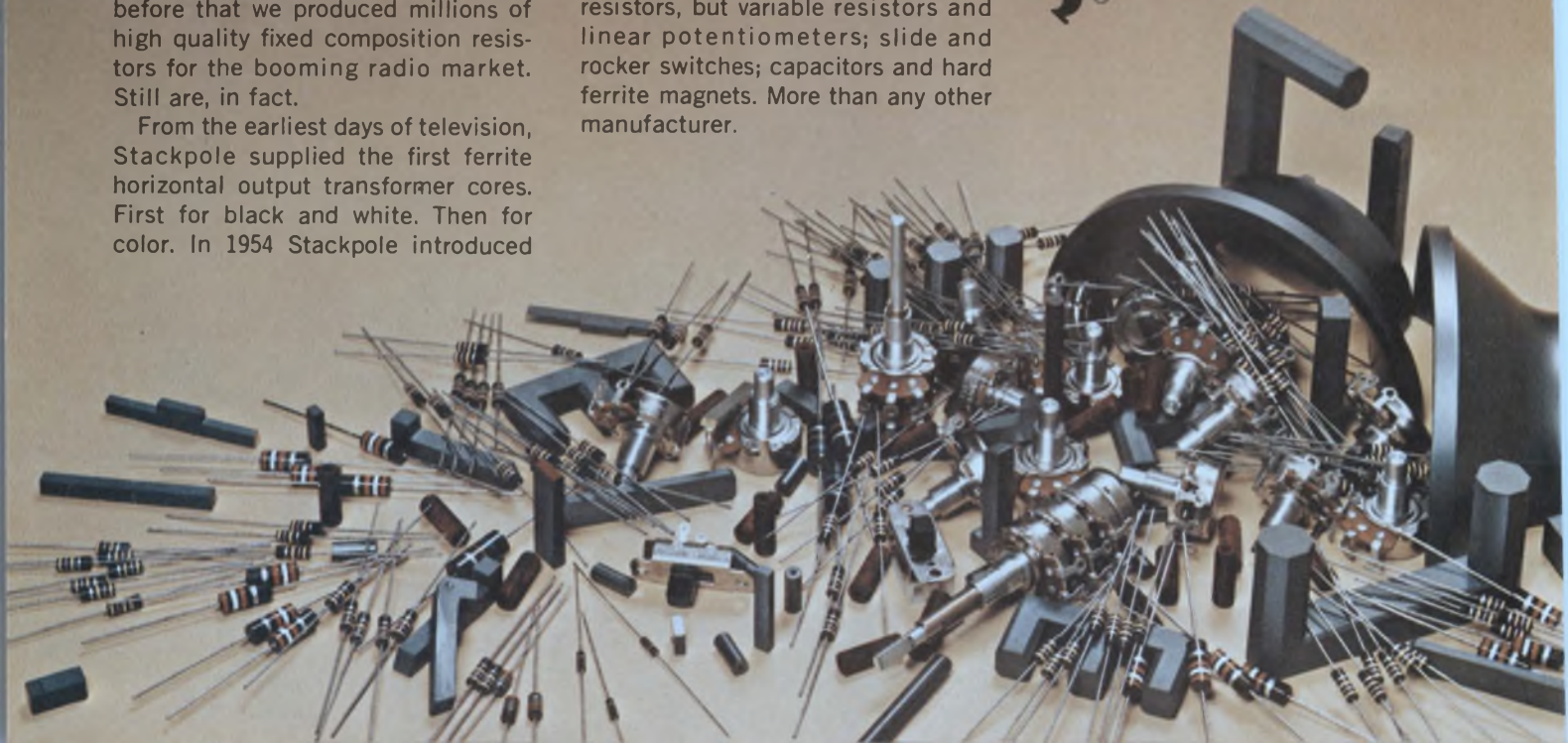

Publisher

Hugh R. Roome

Editor

Howard Bierman

Managing Editor

Frank Egan

Technical EditorsMilton J. Lowenstein
Michael J. Riezenman
Raymond D. Speer
Stella Lawrence**Management and Careers Editor**

Richard L. Turmail

News EditorsRalph Dobriner, Chief
John N. Kessler**Washington News Bureau**

Charles D. LaFond, Chief

Military/Aerospace Editor

John F. Mason

East Coast Editor

Jim McDermott

West Coast EditorsElizabeth deAtley
David N. Kaye**New Products Editor**

Lucinda Mattera

Copy Editor

Marion Allen

Directory Manager

Greg Guercio

Editorial ProductionDollie S. Viebig
Anita F. Needleman**Art Director**

Clifford M. Gardiner

Art Assistant

William Kelly

Technical IllustratorsRita Jendrzewski
Lynn E. Thompson**Production Manager**

Thomas V. Sedita

Asst. Production Manager

Helen De Polo

Production AssistantsBernard Wolinsky
Kathleen McConkey**Circulation Manager**

Nancy L. Merritt

Information Retrieval

Genate Piccinetti

EDITORIAL



Are engineering unions really needed?

Engineers are growing more and more uneasy about their salaries, job security, and professional recognition, and many are pushing for union representation to cure all the ills. But are unions really necessary?

A Baltimore engineer, for instance, assures us that he flatly refuses to work for his dog. He disagrees with our editorial "Who does a man really work for . . . ?" (ED 26, Dec. 19, 1968) in which we suggested that engineers are more interested in challenging work and professional recognition than in salary. In his letter (see Letters, ED 15, July 19, 1969) he tells us he has a nice house, nice wife, nice kids, wall-to-wall carpeting, two cars and a boat, but that he is working all the time and only his dog is home to enjoy the good life. He says that he doesn't strive first in his work for personal growth, cultural broadening, or recognition from his peers. He wants money, not challenges, and extended vacations, not overtime. And he looks for union representation to get it for him.

We have received letters from a number of other engineers who support his view, in whole or in part (see Letters, page 49). They want higher salaries, more job security, shorter workweeks, professional recognition and interesting work. And they say repeatedly that they want union representation.

No one argues—higher salaries would be great. But if an engineer is not satisfied with his salary perhaps he should ask himself if he's really worth the extra money to his company. If he is, why does he need a union to ask for it? And if his company doesn't share his view, shouldn't the onus be on him to find more rewarding work? Shouldn't he look for more responsibility with a different company?

Some argue against this idea. They say they have mortgages and kids in school and they can't afford to move. So they want union action to force salaries up in the job they now hold. But are an engineer's personal obligations and commitments really the company's responsibility? Should they ever be?

And is it realistic to demand job security through union action in an industry such as aerospace, which is by its nature dependent on uncertain contracts? Don't aerospace engineers receive higher salaries in lieu of job risk? (The Engineers Joint Council data indicates that they do—engineers are more highly paid in L.A. than in, say, the south-central states). Surely, to ask for guaranteed employment when contracts cannot be obtained throws an unreasonably heavy burden on the company.

These points can easily be forgotten in the heat of argument. Shouldn't they be more carefully considered?

RAYMOND D. SPEER

BELDEN...new ideas for moving electrical energy

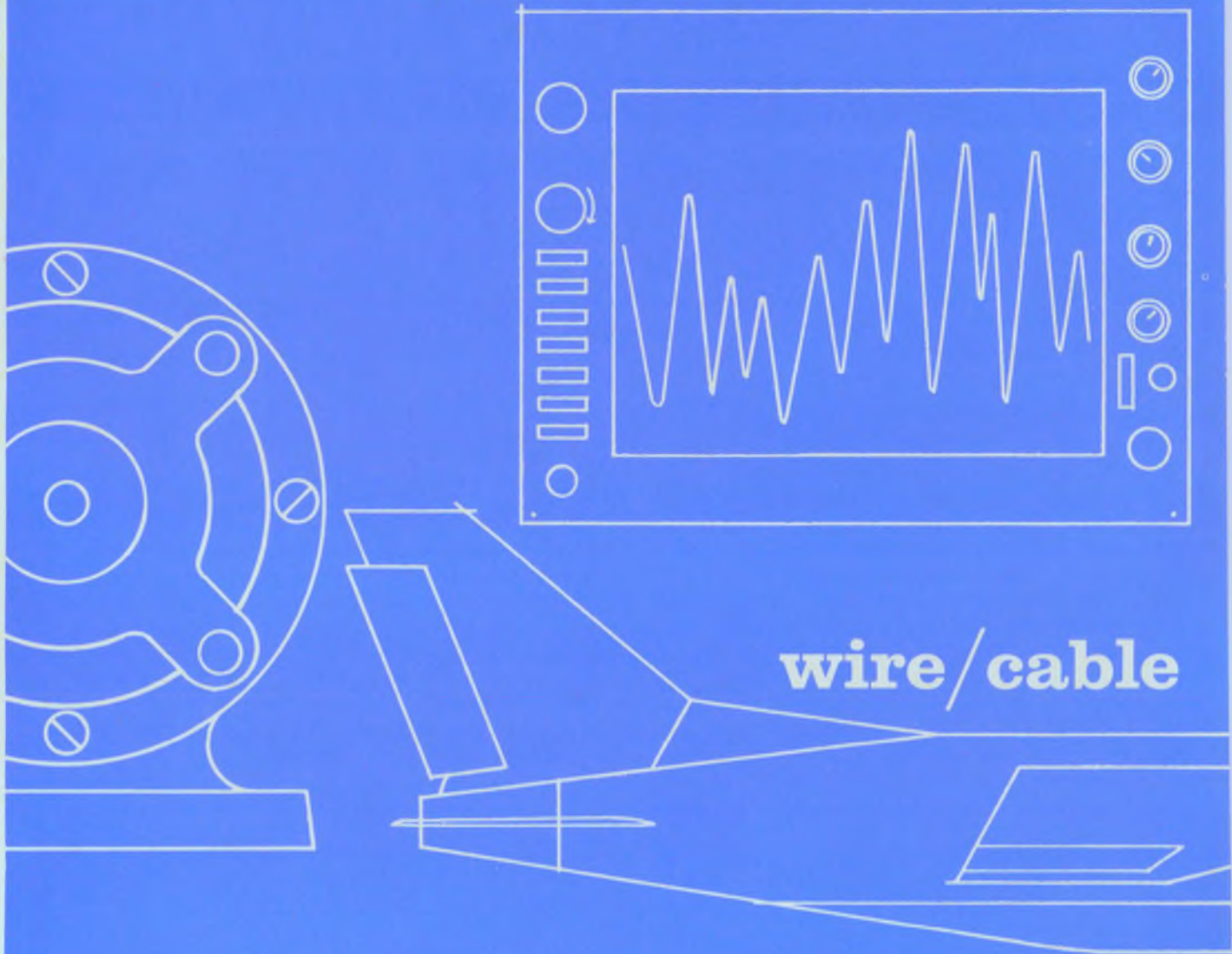

BELDEN

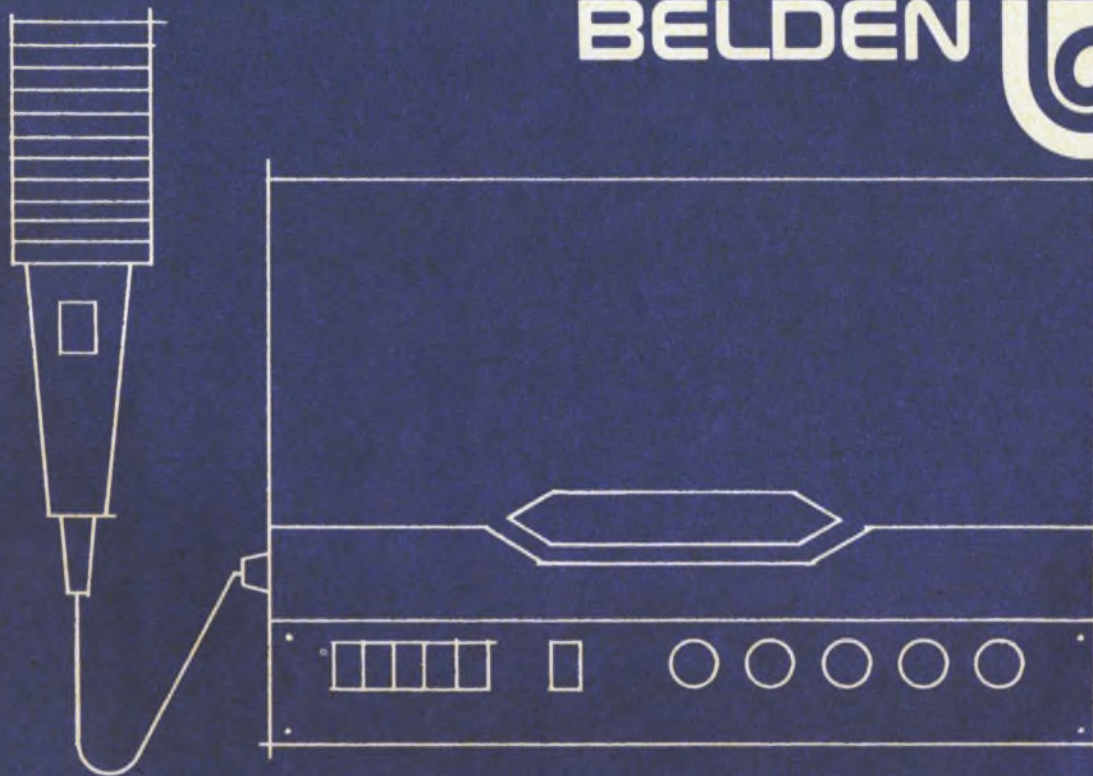

systems turn us on

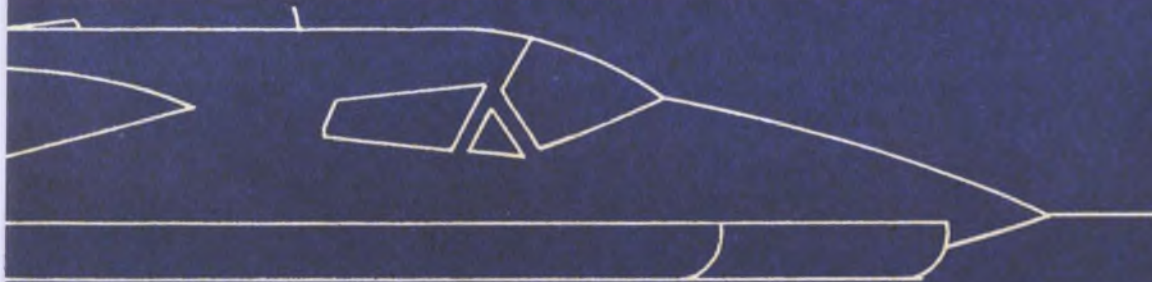

We have an active imagination when it comes to wiring. Because it's sparked by a lot of savvy about wire and cable and its capabilities. With applied imagination we can create fresh ideas that help a customer get a better value for his dollar. Our Wire Systems Specialists are trained to explore every wire-related aspect of a product—compatibility, production, packaging, operating environment . . . the entire system. And then put their imaginations to work. To eliminate a shielding or stripping problem*. Or save money. Or enhance the product's reliability. And whatever type of wire or cable it takes to turn an

idea into reality . . . well, we make all kinds of wire for all kinds of systems. Why not see what we can imagine for your product? Call or write: Belden Corporation, P.O. Box 5070-A, Chicago, Illinois 60680. And ask for our catalog, and the reprint article, "Key Questions and Answers on Specifying Electronic Cable."

*For example: We've insulated some of our lead wire with silicone. So no glass braid protection is needed. This means that stripper blades will last much, much longer. And a potential health hazard to stripper operators is eliminated.

G-1-8

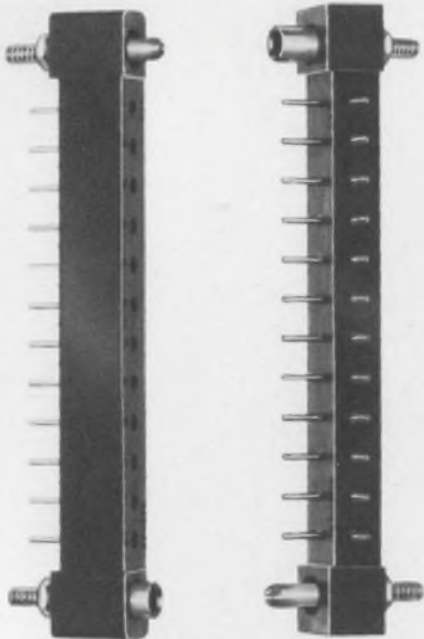

683-12 Right Angle Pin & Socket

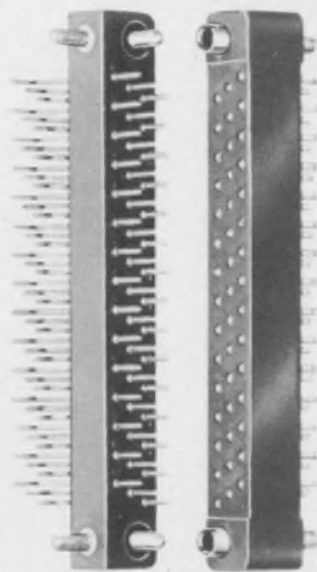

600-1-45 Right Angle Pin & Socket

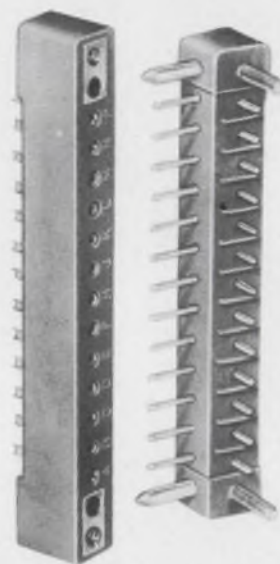

600-70 Right Angle Pin & Socket

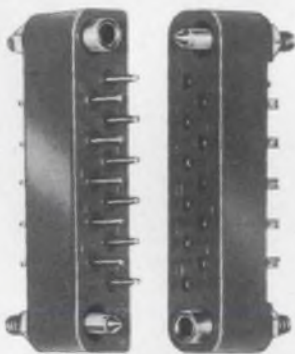

145-5 Right Angle Pin & Socket

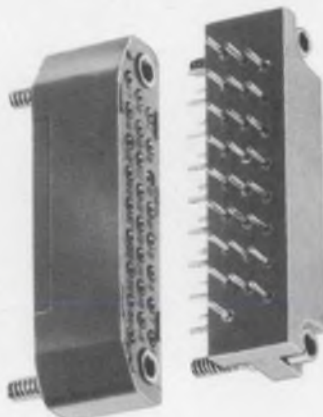

MMM 25 Right Angle Pin & Socket with Crimp Removable Contacts



1800-16-26 Plug with Right Angle Pin; MM 26-22S-socket

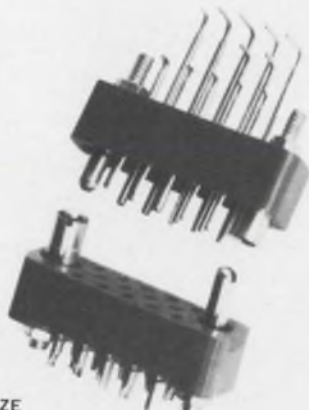

145-14 Right Angle Pin & Socket

ALL ILLUSTRATIONS ACTUAL SIZE

**For connectors
that meet
MIL-E-5400K...**

**Continental has
the right angles
FOR PRINTED CIRCUIT BOARDS**

The MIL-E-5400K specifications for airborne electronic equipment do not permit the use of printed circuit board plug-in connectors. Continental's right angle connectors meet all the design requirements of this revised Mil spec—dip soldering directly to the PC board or flexible cable. A broad range of right angle, microminiature, removable contact and flexible cable connectors are available for you to choose from. Call or write us today for complete information.

For the Sales Representative Nearest You, See Our Listings in EEM and VSMF Directories.

CONTINENTAL  CONNECTORS

CONTINENTAL CONNECTOR CORPORATION • WOODSIDE, NEW YORK 11377

INFORMATION RETRIEVAL NUMBER 47

ISIS



**CENTRALAB
SEMICONDUCTOR**

Division

GLOBE-UNION INC.

4501 NORTH ARDEN DRIVE
EL MONTE, CALIFORNIA 91734

silicon semiconductor chips made specifically for use in hybrid microcircuits... available from Centralab Semiconductor... designed and fabricated to be compatible with all thick and thin film hybrids... to bond to all types of substrates without problems. We're the chip house. Our hybrid applications engineering group is available to help you with tough problems. Their services are free. And at nominal cost we can supply you with a zener chip sampling kit made for designers' use.

Contact us for information on chips, the zener chip sampler kit or for engineering assistance.

silicon chips in zeners, temperature-compensated zeners, scr's, rectifiers, core drivers, general purpose diodes and tunnel diodes.

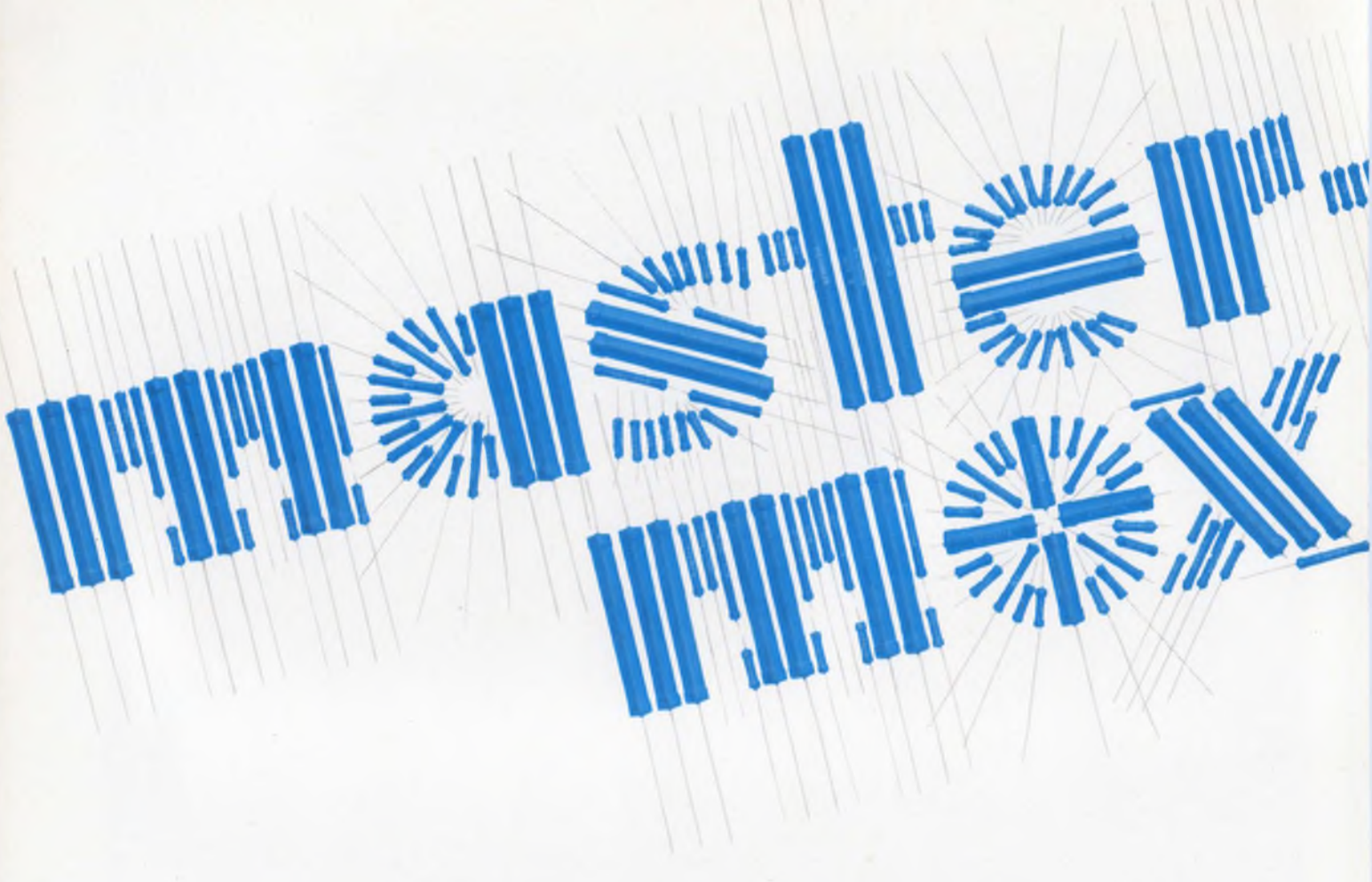

A Mastermox is something more than a metal film.

A Mastermox is a metal oxide glaze resistor. Mastermox resistors combine metal powders with molten glass to bring resistor technology to a new high. Revolutionary design creates high resistance range accuracy — 10K ohms to 10,000 Megohms. Space-savings too. Provides more watts per cubic inch.

Stability? Drift as low as 1% full-load in 2000 hours. On the shelf — less than 0.1% drift per year. Changes in voltage and temperature barely influence Mastermox performance.

Obtain Mastermox critical capability in high

voltage dividers and bleeders, meter multipliers, high voltage probes, oscilloscopes and vacuum tube voltmeters, plate load resistors, pulse forming networks, and similar applications.

Mastermox. Victoreen's master resistor.

Model	Resistance Range	Power Rating @ 70°C	*Max. Oper. Volts	Length Inches	Diameter Inches
MOX-400	1 - 2500 megs	.25W	1,000V	.420 ± .050	.130 ± .010
MOX-750	1 - 5000 megs	.50W	2,000V	.790 ± .050	.130 ± .010
MOX-1125	1 - 10000 megs	1.00W	5,000V	1.175 ± .060	.130 ± .010
MOX-1	10K - 500 megs	2.50W	7,500V	1.062 ± .060	.284 ± .010
MOX-2	20K - 1000 megs	5.00W	15,000V	2.062 ± .060	.284 ± .010
MOX-3	30K - 1500 megs	7.50W	22,500V	3.062 ± .060	.284 ± .010
MOX-4	40K - 2000 megs	10.00W	30,000V	4.062 ± .060	.284 ± .010
MOX-5	50K - 2500 megs	12.50W	37,500V	5.062 ± .060	.284 ± .010

*Applicable above critical resistance. Maximum operating temperature. 220°C. Encapsulation: Si Conformal. Additional technical data in folder form available upon request. Or telephone: (216) 795-8200.

VICTOREEN INSTRUMENT DIVISION
10101 WOODLAND AVENUE • CLEVELAND, OHIO 44104
 EUROPE: ARNDALE HOUSE, THE PRECINCT, EGHAM, SURREY, ENGLAND • TEL: EGHAM 4887

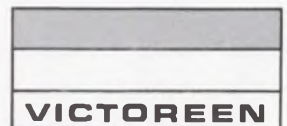

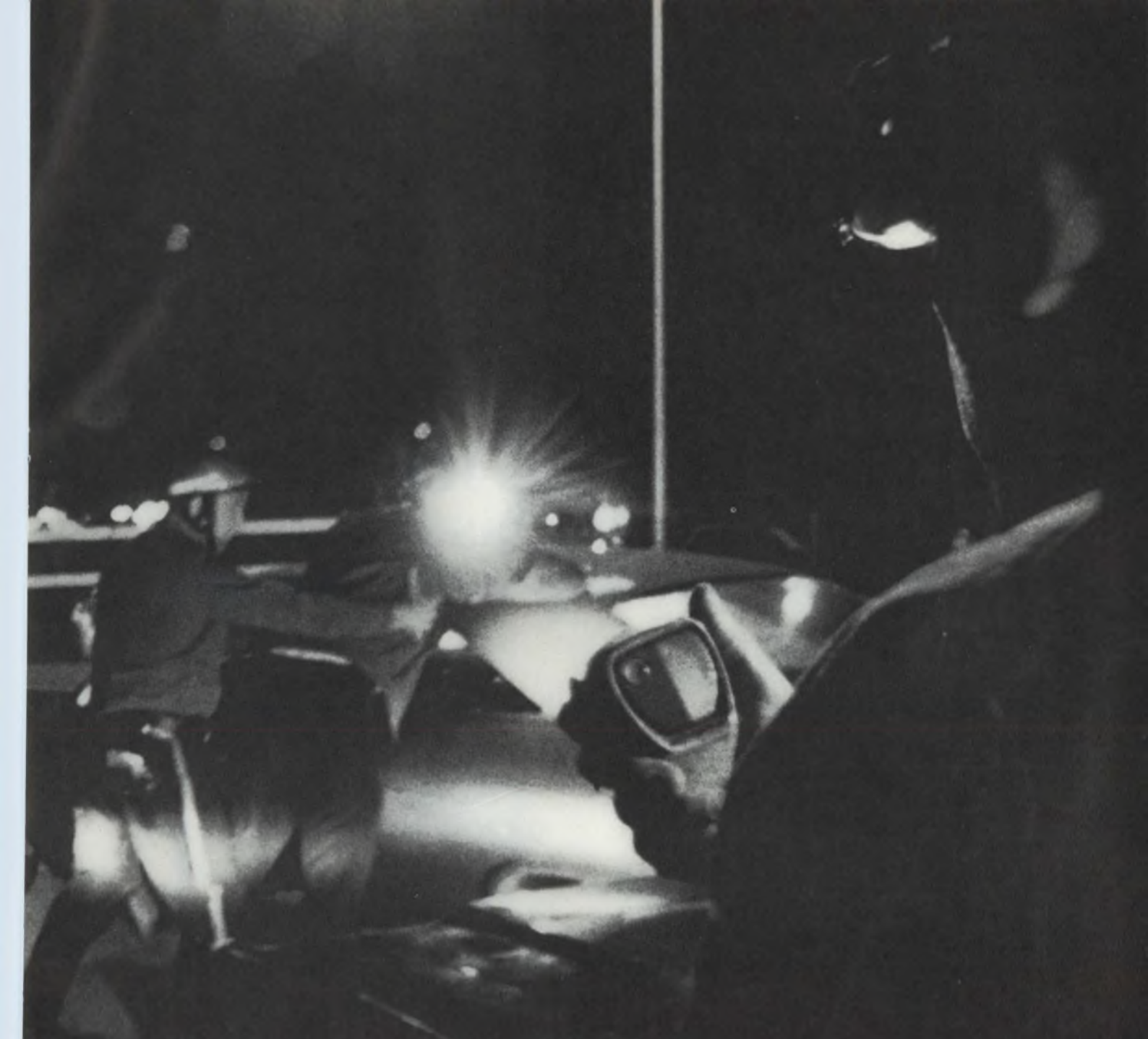

**We make our frequency components too good
rather than merely good enough.
Because sometime, somewhere, it might make a difference.**

**Motorola's dependable,
precision frequency components
are now available.**

Many of our frequency components are used in emergency communications equipment. That's one reason why we will not compromise our insistence on quality.

And now, for the first time in 30 years, you and other designers and OEM manufacturers can take advantage of Motorola's experience and large production capa-

bilities for frequency components: crystals, filters, oscillators, tone modules, and resonant reeds.

You can choose from an extensive line of off-the-shelf precision components. Or we'll gladly design and produce your devices on a custom basis. If you need it, you'll get application assistance. And all components are made under clean room conditions.

Whatever application you have

in mind for our frequency components, you can count on one thing. All are designed with the same precision, the same quality, the same dependability. Because we won't settle for second best.

And neither should you.

Send for Bulletin TIC-3401. Write Component Products Dept., Motorola Communications & Electronics, Inc., 4501 W. Augusta Blvd., Chicago, Illinois 60651.



MOTOROLA TOTAL COMMUNICATIONS

The Choice is TTL.

$$Y = A \oplus B$$

TI's new MSI SN5486/SN7486 does it fast.

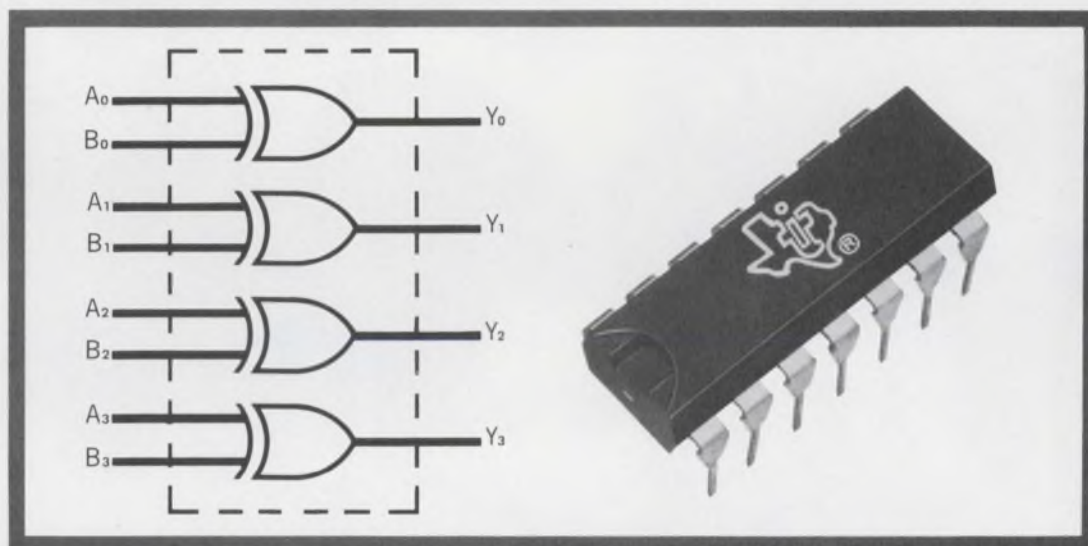

(And easy on the pocketbook.)

Typical propagation delay of this new TI monolithic quadruple 2-input exclusive-OR gate is 12 ns. Power dissipation per exclusive-OR function is only 39 mW. In 100-999 quantities, the plastic dual-in-line carries a \$3.00 price tag.

TI's low-power version, SN54L86/SN-74L86, will help ease your critical power dissipation situations. Power dissipation: 3.75 mW per exclusive-OR function. Propagation delay: 58 ns. Cost: \$3.41 for the plastic dual-in-line.

You can get both versions promptly

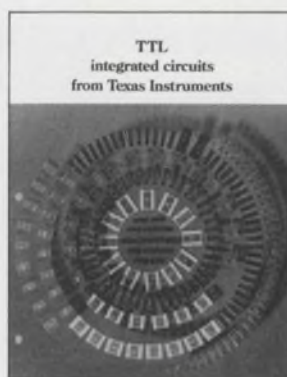

and both are fully compatible with TI's growing family of Series 54/74 integrated circuits.

For all the facts, fast and easy, get our data sheet on the SN5486/SN7486. We'll also send along our new 80-page brochure on our Series 54/74 ICs. Circle 190 on the Reader Service Card or write Texas Instruments Incorporated, P.O. Box 5012, M. S. 308, Dallas, Texas 75222. Or call your nearest authorized TI Distributor.



TEXAS INSTRUMENTS INCORPORATED

**Meet Datapoint.
It's 20 times faster
than other multipoint recorders.
And infinitely more versatile.**

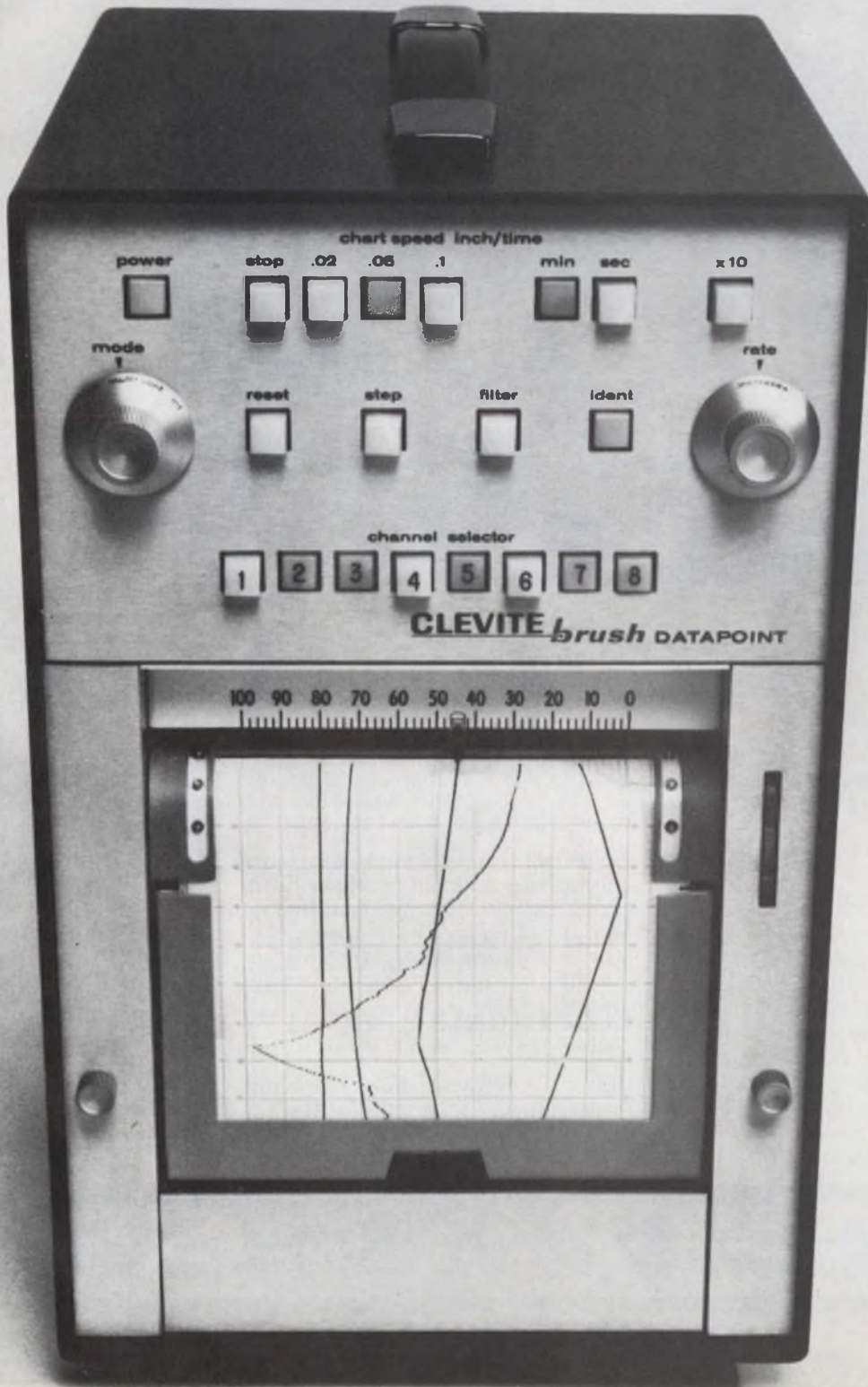

This new high-speed multipoint recorder by Brush runs off as many as 20 samples per second on 2 to 8 channels. So it's great for monitoring fast-changing variables in temperature, flow, pressure, strain, chemical processes, displacement dynamics and the like.



Datapoint handles mixed inputs from high and low level inputs. All on one chart. Recordings come out clear, crisp, uncluttered. And Z-folded. You've got a choice of 12 chart speeds, pushbutton controlled.

About that versatility. Datapoint works in three modes: multipoint sampling, intensified sampling, for channels of high dynamic content, or continuous single channel recording. So you get much more than just a fast multipoint recorder. Without paying more to get it.

And Datapoint is accurate, too. A full 99.5%, enforced by a non-contact position-feedback system. It's a first in this type of recorder. (But a proven success in countless Brush direct writing oscillographs.)

Speed. Versatility. Accuracy. These make Datapoint a new concept in recording. There's never been anything like it. You'll find more proof in the Datapoint brochure. Send for your copy today. Clevite Corporation, Brush Instruments Division, 37th and Perkins, Cleveland, Ohio 44114.

CLEVITE BRUSH

now!
minimum current switching



in a low-cost relay

New Electronic Specialty 79N, all-welded military-type, crystal can, dry circuit to 3-amp relay, per MIL-R-5757D/10C.

Put the new 79N relay into your circuit . . . you'll get reliable minimum current switching and cut costs at the same time.

This new relay gives you the same reliability in switching of minimum current as dry circuit or load current . . . and at prices competitive with conventional relays. A unique contact design lets the 79N meet the 100,000-cycle, no-failure military requirements for minimum current previously found only in higher cost, more exotic relays.

If you're designing state-of-the-art circuitry with 100 mA to .5 A switching requirements, as well as dry circuit and load current to 3 amps, you should know all about the 79N.

For complete information—or assistance in solving your switching problems with 2 & 4 pole 10 amp, or 2, 4, & 6 pole dry circuit-to-3 amp relays contact your nearest Electronic Specialty representative. Or write:

ELECTRONIC SPECIALTY CO.
PORTLAND ELECTRONICS DIVISION
Dept. ED • 18900 N. E. Sandy Boulevard
Portland, Oregon 97220 • Phone (503) 665-0121

A COMPLETE LINE OF MINIATURE MILITARY RELAYS WITH PROVEN PERFORMANCE

ES





Applications Power*

HF DUAL FETs

for wideband diff amps,
and balanced RF circuits

Wideband Differential Amplifier Ideal for a preamplifier where high input impedance and low noise over a wide frequency range is desired. At 25 MHz the input impedance is approximately 250K in parallel with 3 pF.

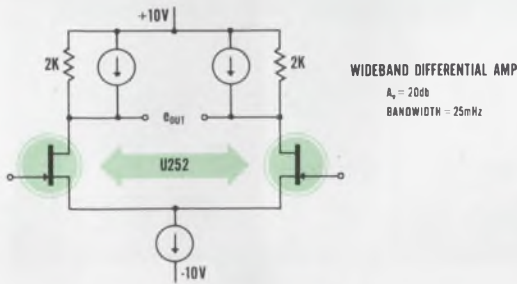

CHARACTERISTIC	SYMBOL	MIN	MAX	CONDITIONS
Transconductance	g_{fs}	5,000 μ mho		$V_{DG} = 10V$ $I_D = 5 mA$
Input Capacitance	C_{ISS}		5 pF	
Offset Voltage	$ V_{GS1} - V_{GS2} $		10 mV*	
Differential Voltage Drift	$ V_{GS1} - V_{GS2} /\Delta T$		20 $\mu V/^\circ C$ *	

* The U253 has an offset of 20 mV and a differential drift of 40 $\mu V/^\circ C$ Max.

Balanced Mixer The FET's square law characteristic allows this mixer to handle large dynamic signal power while producing low spurious products. Oscillator power drive requirements are extremely low, thanks to the FET's high input impedance.

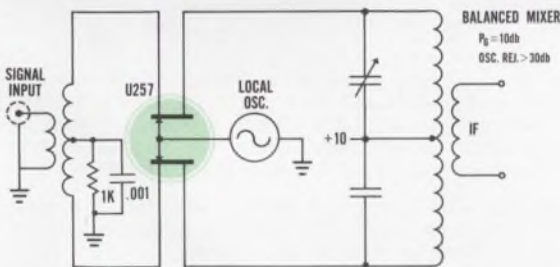

CHARACTERISTIC	SYMBOL	MIN	MAX	CONDITIONS
Transconductance	g_{fs}	5,000 μ mho		$V_{DG} = 10V$ $I_D = 5 mA$
Input Capacitance	C_{ISS}		5 pF	
Offset Voltage	$ V_{GS1} - V_{GS2} $		100 mV	

These high frequency duals may be used up to 450 MHz depending upon the application and performance desired. If your present design situation is VHF or UHF, if you want instant applications information, call the number below. It's a direct line to our applications group. *That's applications power.

... in Europe Siliconix Ltd.
Siliconix House
Sketty Park
Saunders Way
Swansea, U.K.



Our new address . . .

Siliconix incorporated

2201 Laurelwood Road • Santa Clara, Calif. 95054
Phone (408) 246-8000 Ext. 201 • TWX: 910-338-0227

here's a new waveform generator that'll still be new in '72

P5001
Main
Frame/
Power
Supply
Regulator
section is
Plug-In
5010

Mode Control
5110 provides
gating and
triggering to
generator.
variable
start/stop;
adds haversine
and haversine
angle to
generator.

Generator G5210 produces square
and triangle waveforms from 0001 Hz
to 1 MHz; 2 MHz in positive or
negative offset. Triangle used for
sine shaping in A5420.

Frequency
Modulator M5310
adds voltage-
controlled
frequency to
G5210. Features
sweeping
direction and
expansion
control, with
input signal
conditioning

General Purpose
Amplifier A5420
with square
triangle and sine
outputs. Features
built-in sine
shaper and
external input
capability.

Generator G5212: Ramp generator,
with a range from 1000 sec. to
1 μ sec., can be used to drive M5310
for sweeping operation. Two 5212's
make a simple X-Y system.

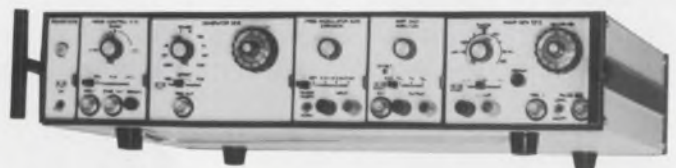
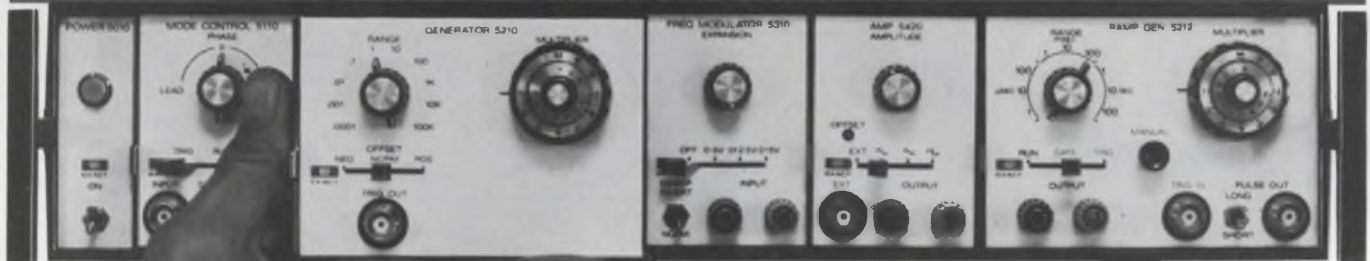

Three years is a long time to expect any electronic instrument to stay abreast of the state-of-the-art. But Exact's new System 5000 Modular Waveform Generator not only enables you to build an instrument exactly as you want it now, but also anticipates your future needs as well as advances in the state-of-the-art.

System 5000 has a building-block concept that lets you start with a mainframe/power supply unit, then add generators, mode controls and amplifiers as your needs dictate. The initial complement of plug-in modules includes a mode control unit, three generators, a frequency modulator and three amplifiers.



Packaged in a compact, 3 1/2-inch-thin cabinet, the System 5000 features a convenient new module ejector device, smart black-and-white styling and a tilt stand.



EXACT
electronics, inc.

Box 160
Hillsboro, Oregon 97123
Telephone (503) 648-6661

INFORMATION RETRIEVAL NUMBER 55



DESIGNERS: AVOID SHOTGUN MARRIAGES

For design freedom, 12 sizes, all 550 Mu



Use Magnetics Inc. 550 Mu Powder Cores

Magnetics Inc. first filled the void between 300 Mu powder cores and nickel laminations with the 550 Mu moly-permalloy powder core. We introduced it in three sizes.

And this perm is still exclusive with us. However, now you can get it in 9 new sizes—an O.D. range of .250" to 1.602". These fixed-gap toroids keep you from being forced into undesirable component marriages, let you tighten design to meet packaging requirements, cut total assembly costs in filters, chokes, transformers, inductors. They also provide: 1. A high inductance-to-size ratio. 2. Reduced d.c. copper resistance. 3. Less distributed capacity. 4.

Greater temperature stability than laminations. Avoid shotgun designing and get more freedom in using magnetic cores for circuit components. Try 550 Mu—we can ship from stock all 12 sizes. For additional information on 550 Mu powder core advantages, write Dept. ED-105 for Bul. FLC-02. Magnetics Inc., Butler, Pa. 16001.



Tape, bobbin, ferrite, powder cores • Laminations • Photo-etched parts • Specialty metals • Engineered control systems

INFORMATION RETRIEVAL NUMBER 56

If Hybrid IC Active Filters
with passive filter
stability could solve your
problems,
you'd
probably
pay more
for them
than \$30
per pole pair.



Try our FS-20 (delivery is off the shelf!)

■ Here's what you get: Band-pass, high-pass and low-pass outputs simultaneously ■ Any desired form of the second order transfer function ■ Complex zeros anywhere in the S-plane ■ Multi-loop negative feedback for added stability ■ F_c and Q of basic unit can be tuned by adding external resistors ■ Frequency range from DC to 50 kHz ■ Q range from 0.1 to 500 ■ Voltage gain is adjustable to 40 dB ■ Supply voltages from $\pm 9V$ to $\pm 15V$ with 250 mW power consumption ■ Dimensions: (14-pin DIP) 0.804" x 0.366" x 0.474".

PRICES:	1-5	\$47	26-99	\$37
	6-10	\$42	100-999	\$35
	11-25	\$39	1000-2000	\$28

Gentlemen at KTI:

Please send me more information on:

- FS-20 All Active Filters Hybrid Subsystems
 Put me on your permanent mailing list

Name _____

Company _____

Address _____

City _____

State _____ ZIP _____

My applications are: _____

KTI

KINETIC TECHNOLOGY, INCORPORATED

17465 Shelburne Way, Los Gatos, California 95030

(408) 356-2131 TWX: 910-597-5390

The name to remember for Hybrid Integrated Systems and Active Filters . . .

You say you want a

low-profile snap-in mounting push button switch or matching indicator that is interchangeable with most 4-lamp displays . . . available in a full range of cap colors . . . with a choice of bezels with or without barriers in black, gray, dark gray or white.



and a

legend presentation that's positive (like this one) or negative (like the one below) or just plain (like the one above) . . . one that's white when "off" and red, green, yellow (amber), blue or light yellow when "on" . . . or colored both "on" and "off."



and a

highly reliable switch proven in thousands of installations . . . available in momentary or alternate action . . . N.O., N.C. or two circuit (one N.O., one N.C.) . . . that accommodates a T-1 $\frac{3}{4}$ bulb with midjet flanged base, incandescent, in a range of voltages from 6–28V.



*etc.
etc.
etc.*

Now, Dialight gives you custom panel designing with a standard line of push-button switches and matching indicators

Dialight offers a broader range of switch and indicator possibilities than you'll find anywhere in a standard single-lamp line. Sizes: $\frac{3}{4}$ " x 1", $\frac{5}{8}$ " square and round. Send today for our new full-color catalog L-209.

DIALIGHT

Dialight Corporation, 60 Stewart Ave., Brooklyn, N.Y. 11237

DT-124

INFORMATION RETRIEVAL NUMBER 58

We spent a bundle developing these filters and capacitors.

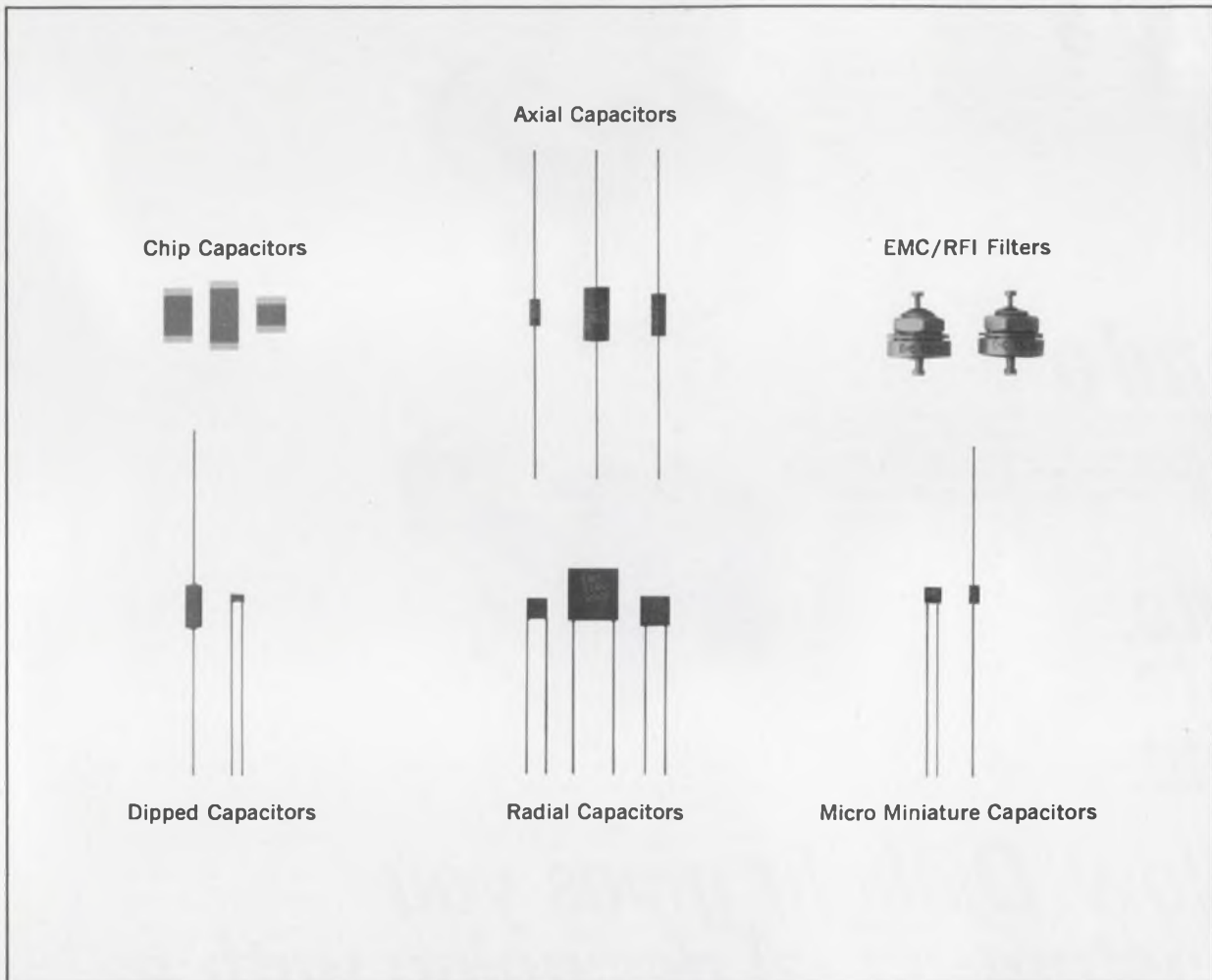

Information about them is free.



Represented by COMPAR

itw **Electro Materials**
Division Illinois Tool Works Inc.
11620 Sorrento Valley Road, San Diego, California 92121
Phone (714) 459-4355, TWX 910 322-1130

INFORMATION RETRIEVAL NUMBER 59

INFORMATION RETRIEVAL NUMBER 60 ►



10 KHz — 115 MHz Sweep Plug-In



50 KHz — 110 MHz Sweep Synthesizer

KAY



50 KHz — 110 MHz Sweep & Marker Generator

3 accurate 110 MHz sweepers!

Require no markers!

For those with uncalibrated vision:

- VARIABLE PULSE MARKERS
- VARIABLE BIRDIE MARKERS
- CRYSTAL PULSE MARKERS
- CRYSTAL BIRDIE MARKERS
- HARMONIC MARKERS
- VERTICAL MARKERS
- HORIZONTAL MARKERS
- RF TURN-OFF MARKERS

10 KHz — 115 MHz
SWEEP PLUG-IN

- Log Sweep To Below 10 KHz
- Two Band Sweep Function
- Residual FM 100 Hz

50 KHz — 110 MHz
SWEEP
GENERATOR

- Plug-In Markers
- Companion to 159C
300 MHz Wide Sweep

All three
all solid-state
100 MHz wide
sweeps

Full-time controls

50 KHz — 110 MHz
SWEEP
SYNTHESIZER

- Phase Locked Sweep & CW
- Drift < 5PPM/min.
< 20PPM/hr.
- Residual < 10 Hz @ 10 MHz
< 40 Hz @ 70 MHz

KAY ELECTRIC COMPANY

Maple Avenue, Pine Brook, N.J. 07058 • (201) 227-2000

Standard Circuit of the Month

SPECIFICATIONS:

- Compatible with DTL/TTL logic levels
- Built-in 2-input expandable AND gate
- Delivers 40W to load
- Built-in flyback protection for inductive loads
- Load connected from output to ground
- Full military temperature range

Relay, Lamp, Core Driver

Maximum ratings:

Power Dissipation: 1.0W (continuous ON)
Operating Temperature: -55°C to +125°C
Storage Temperature: -65°C to +175°C
Supply Voltages: 40VDC & Max V_{DTL}

Mepco's new driver circuit is a high speed hybrid device designed for reliable interfacing between low level signals and devices or circuits requiring high power inputs.

Rugged hermetically sealed TO-8 packaging provides positive environmental protection while affording space and weight saving advantages. This standard functional unit eliminates the need to stock and assemble varied discrete components.

While operating from low level signals the Mepco driver can deliver 40W of power to a load. Flyback protection is built in for inductive loads. These units are

compatible with DTL/TTL logic levels and an expandable 2-input AND gate permits use with other signal sources such as switch closures and photocells. An added feature is the ability to use loads that have one side grounded.

The Mepco driver is one of a series of Standard Hybrid Microcircuits designed to meet the most stringent design requirements while offering the time and cost advantages of mass production.

For further information about this product and Mepco's complete line of standard microcircuits, call collect or write for Data Sheet MC-7.

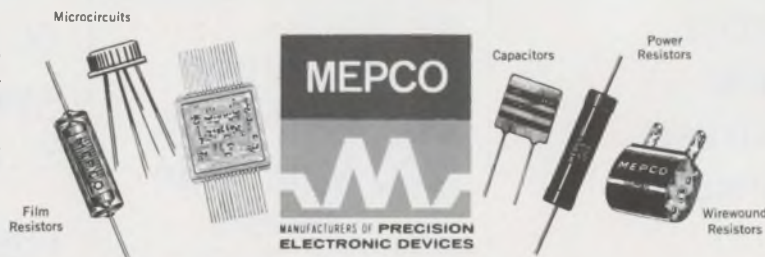

Before you make book on any other pot, we suggest you take a good close look at the small print. Pixiepot® is the smallest precision 10-turn wirewound potentiometer on the market today, and the only pot under \$3.50 with all these high performance features:

- Length: ONLY 3/4"
- Diameter: ONLY 7/8"
- Linearity: ±0.25%
- Resistance Range: 100 ohms to 100K ohms
- Power Rating: 2 watts @ +20°C
- Temperature Range: -25°C to +85°C
- Resolution: Better than ANY wirewound pot TWICE its size
- Slotted Stainless Steel Shaft/C ring

Specify Model 3253 Pixiepot for as low as \$3.47 each in production quantities and only \$4.95 each for 1-24 units. In-stock delivery, of course. Call, write or wire Duncan Electronics today for complete specifications. When it comes to mini-pots, we wrote the book.

One PIXIEPOT® is worth 1,000 words



DUNCAN ELECTRONICS

SUBSIDIARY



SYSTON • DONNER

2865 FAIRVIEW ROAD
COSTA MESA,
CALIFORNIA 92626
(714) 545-8261



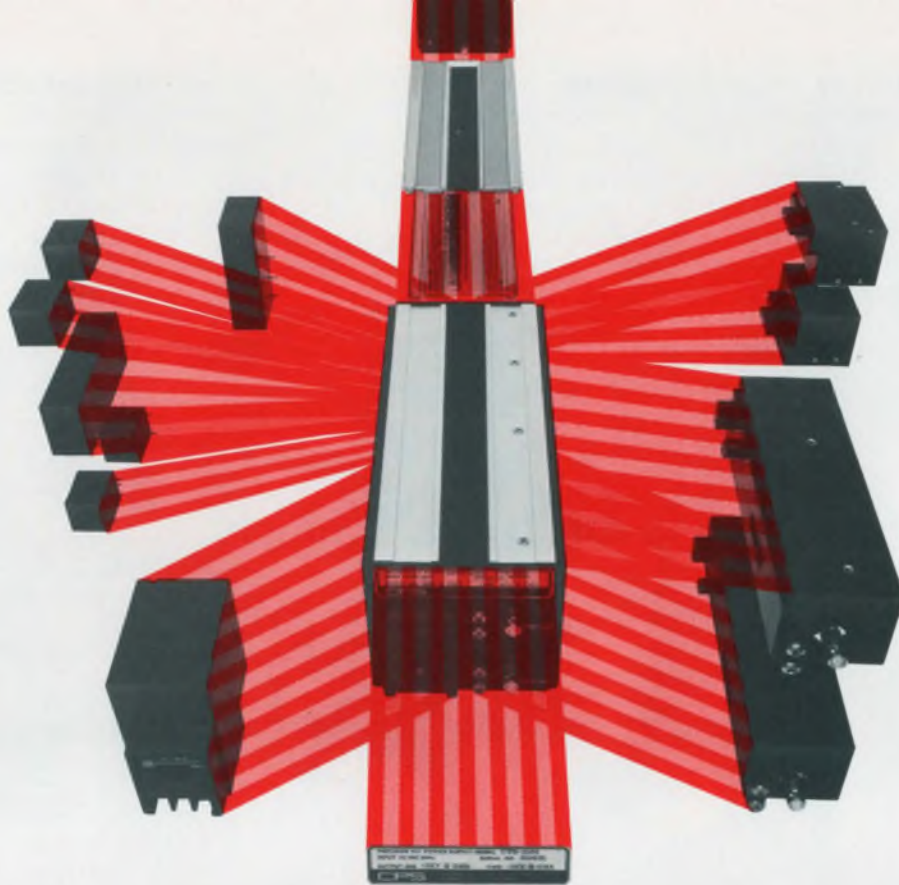

Computer Power Systems invents the wireless.

Our new 2000-series
power supplies not only give you
the best specs in the
business*, save space and
money (prices start at \$410),
they're also fun to pull apart.

* 500 V to 5 KV, single or dual. Drift .005% / hr., .01% / 24 hours. Precision regulation, less than .001%. Ripple 2 MV P-P max. (Typ. 1 MV). Fred Martin will tell you how this supply will help your CRT, COM, PM-TUBE, FSS or nuclear instrumentation. Ask him. **Computer Power Systems**, 722 East Evelyn Avenue, Sunnyvale, California 94086. (408) 738-0530.

Technology



John Greenbaum, GE project engineer, tells how to make op-amp linear models. p. 92.



Reduce stray reactances with the boundary method of layout. p. 98.

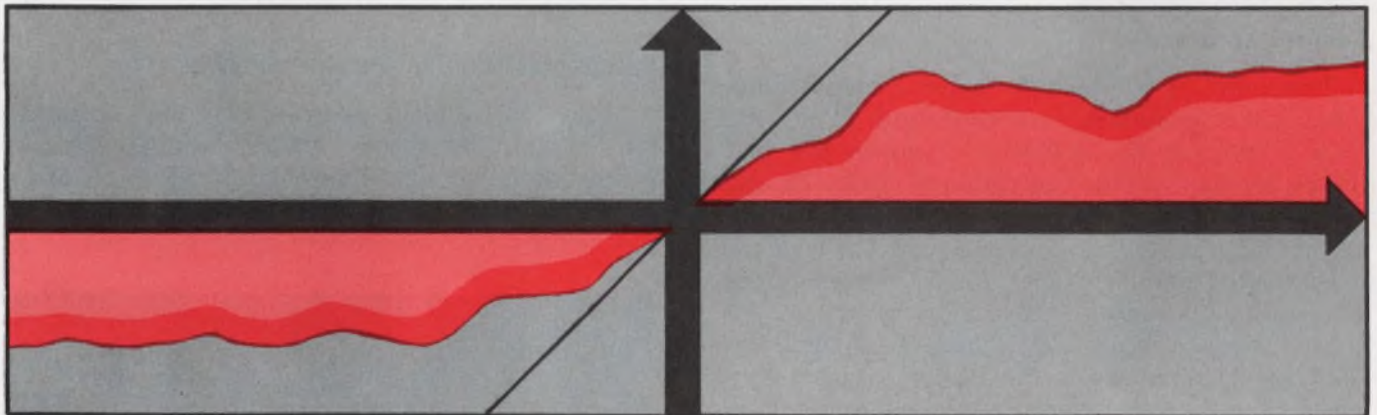

Nonlinear control systems can be analyzed by Popov's method, giving conditions that

are sufficient for stability independent of the shape of the nonlinearity. p. 84.

Also in this section:

Try active overload protection for your next dc voltage regulator. p. 80.

Practical tips on writing articles are offered by an author-engineer. p. 104.

Ideas for Design. p. 110.

Try active overload protection for your dc voltage regulator. This versatile sampling technique provides automatic restart and minimum power dissipation.

Protection of a dc voltage regulator against overloads caused by line transients or load malfunctions is usually a power-supply design requirement. Such protection can be provided by fuses, circuit breakers or various circuit techniques,¹ but usually at a sacrifice of precision or speed, or at the cost of high power dissipation.

All the desirable characteristics of overload protectors, however, can be attained by using an active sampling technique that can provide rapid sensing and current limitation, current interruption, automatic reset and low overload power dissipation. In addition, this technique can be readily applied to most series or shunt voltage regulators, so that the regulation circuit best suited to the load requirements can be selected. Furthermore, an integral overload indicator can easily be added to provide a visual trip-out signal.

Test for an overload

The sampling overload protector operates somewhat like a monostable multivibrator. When the load is normal the protector assumes the rest state, similar to the untriggered state of the monostable. Upon sensing an overload, the protector disconnects the regulator from the load for a controlled period of time; it then re-examines the load and permits a return to normal operation if the overload is no longer present. If the overload persists, however, the regulator is disconnected for the same period of time and again re-examines the load.

This cyclic sampling of the load conditions continues until the overload is cleared. The interruption interval during which the load and regulator are electrically isolated is similar to the triggered state of the monostable. The repetition frequency for cyclic sampling and the sampling interval can be selected to achieve optimum performance from the power supply/load combination.

From a system standpoint, many overload protection methods are difficult to use. This technique, however, is versatile. For example, where transient or short-term overloads are part of normal operation, circuit time-constants can be adjusted to suppress reaction to this type of overload.

Large capacitive loads offer a different problem. After an overload has occurred and the regulator is attempting to turn on, large regulator currents are required to charge the load capacitance. Here, either the sampling pulse width or peak current can be increased to charge the load capacitance.

The trip-out of one voltage in a multivoltage power-supply system as a result of a fault may require several other voltages to be turned off. The use of a protection technique controlled by a common sampling pulse generator enables easy adaptation to this requirement.

Design protection for a shunt regulator

Figure 1 is a block diagram of a high-voltage, low-current, shunt-type voltage regulator power supply designed to deliver 500 V dc at 10 mA. It uses a sampling overload protector.

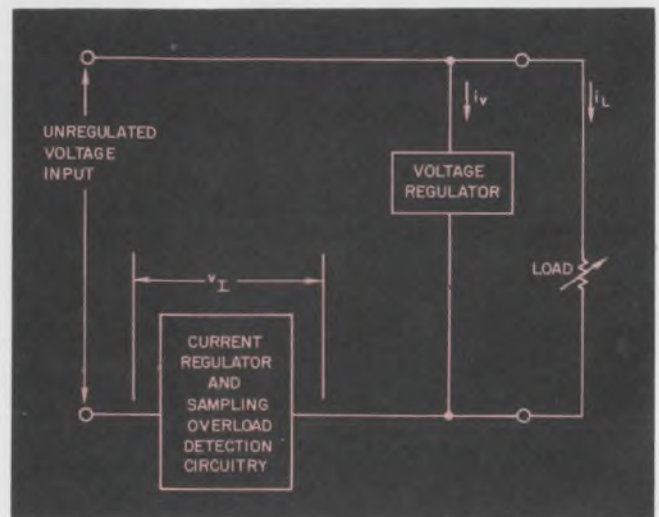

1. In the shunt regulator the sampling circuit operates in series with the load.

Paul A. Kaden, Senior Staff Engineer, Hartman Systems Co., Inc., Huntington Station, N. Y.

The unit maintains the total current (voltage regulator current i_v , plus load current i_L) constant over the normal operating range of load impedances. The voltage drop, v_i , across the current regulator is therefore constant over this range (assuming no variation in power-supply input voltage).

When the load impedance drops below the minimum normal value, the shunt regulator is no longer able to maintain a constant total current, and the voltage drop across the current regulator increases. This increase in voltage drop is used to initiate overload protection.

A complete schematic diagram of the regulator is shown in Fig. 2. Transistors Q_4 , Q_5 and Q_6 constitute a conventional shunt voltage regulator, and Q_3 is the current regulator.² Q_1 is normally cut off. The voltage appearing across zener diode $CR10$ and the total resistance in the Q_3 emitter circuit determine the Q_3 collector current.

In the event of an overload, the increased voltage drop across Q_3 is applied to the base of Q_1 by the voltage divider R_2 , R_4 , and R_6 , thus causing Q_1 to conduct. (Diode $CR12$ provides temperature compensation for Q_1). The base current of Q_3 rapidly decreases to near zero, causing the load current to also drop. The bistable pair, Q_1 and Q_3 , is now in a stable OFF state, and Q_3 power dissipation is reduced to a low value.

A means must be provided to trigger Q_3 ON to provide for sampling of the load. This is accomplished by unijunction transistor Q_2 , which is connected as a relaxation oscillator.³ Interbase voltage for Q_2 is supplied from zener diode $CR9$.

When Q_3 is on the OFF state, capacitor C_2 charges through R_8 until the Q_2 emitter voltage reaches the peak-point value. The emitter is then forward biased, and C_2 is discharged through the Q_3 emitter-base junction, momentarily turning Q_3 on. Capacitor C_2 is connected so that the dis-

charge path is through R_7 . This limits the peak pulse current of Q_3 when the load is a short circuit.

If the overload is still present, Q_3 returns to the OFF-state and the sampling cycle repeats at intervals determined primarily by the values of R_6 and C_2 . The duty cycle of the Q_3 ON time during an overload can be made quite small, thus lowering the average Q_3 power dissipation.

Once the overload is removed, Q_3 remains in the ON condition after a sampling pulse, and the current regulator returns to normal operation.

The addition of the unijunction transistor, Q_2 , converts the bistable pair of Q_1 and Q_3 into a monostable circuit as long as a fault remains on the load. The Q_2 relaxation oscillator does not operate when the load current is within design limits.

Transistors Q_1 , Q_2 , and Q_3 can be connected in a variety of configurations. However, since this is a high-voltage power supply, care must be exercised. Should the load be short-circuited, Q_3 is OFF and must withstand the full rectifier output voltage. It is, therefore, desirable to maintain a low-resistance path from the base to the emitter of Q_3 to avoid the possibility of excessive leakage. For this reason, Q_1 is connected in parallel with the Q_3 base-emitter circuit.

. . . and for a series regulator

The sampling overload protector shown in Fig. 3 is used to protect a low-voltage, high-current, series type of voltage regulator. The protection circuit consists primarily of resistors R_5 , R_6 and R_7 and transistors Q_4 , Q_5 , and Q_7 .

Normally, the voltage across R_5 is insufficient to cause Q_4 to conduct. However, when a predetermined load current is reached, Q_4 begins con-

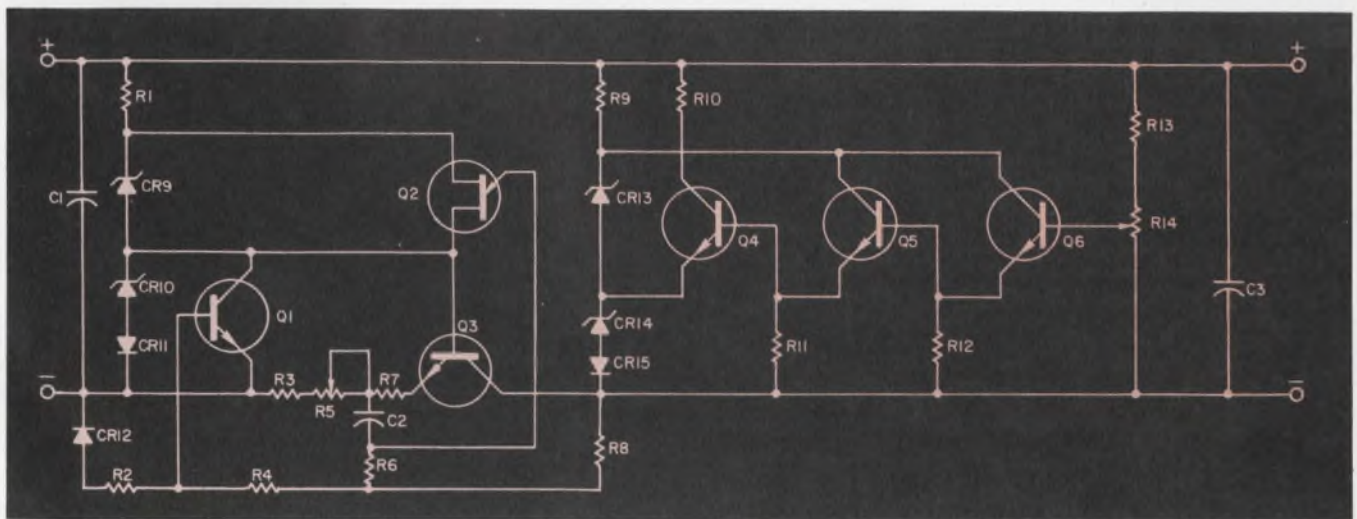

2. Relaxation oscillator Q_2 is the key component in the active sampling circuit of this shunt regulator.

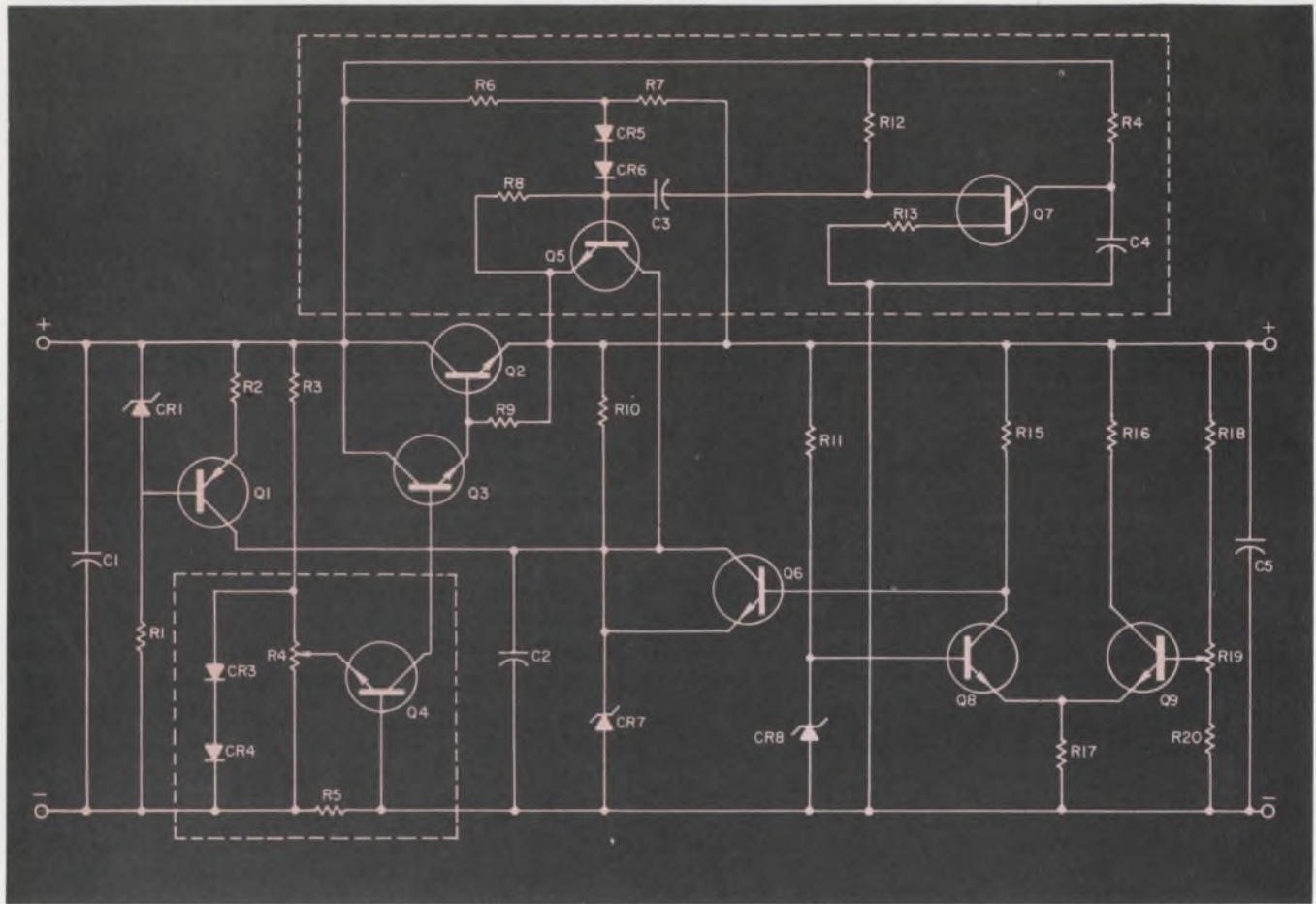

3. The series regulator also uses a unijunction transistor, Q7, to initiate sampling of the load condition.

ducting, increasing the voltage drop across the series regulating transistors, Q2 and Q3. A further increase of load current causes most of the unregulated input voltage to appear across the series regulating transistors.

When this occurs, Q5 is saturated by voltage divider R_6 and R_7 and thus applies a high voltage to the emitters of the series regulating transistors. These, in turn, stop conducting because their base-to-emitter junctions become reverse-biased. And this condition continues until relaxation oscillator Q7, which operates continuously, triggers Q5 OFF, permitting the series regulator to sample the condition of the load.

If the overload remains, the series regulator rapidly returns to the OFF state and awaits the next sampling period, as controlled by the relaxation oscillator Q7 triggers Q5 OFF, permitting relaxation oscillator time-constant. If the voltage across R_2 and the load have returned to normal, the regulator will assume its proper operation.

The sampling technique of overload protection can be adapted to regulators having a wide range of current and voltage ratings. The use of the technique not only permits automatic restart of the regulator when the overload is removed but also minimizes power dissipation in the regulated supply during overload ■■

References:

1. "Silicon Transistor Voltage Regulator Overload Protection," *Texas Instruments Application Note*, June, 1960.
2. E. C. Wilson and R. T. Windecker, "DC Regulated Power Supply Design," *Texas Instruments Application Note*, August, 1960.
3. *Transistor Manual*, Seventh Edition, General Electric, 1964, p. 312.

Test your retention

Here are questions based on the main points of this article. Their purpose is to help you make sure you have not overlooked any important ideas. You'll find the answers in the article.

1. What are the disadvantages of commonly used overload protection techniques?

2. What special problem occurs in a multi-voltage power supply?

3. Which component provides the recycle capabilities of the sampling protection circuit described?



Red Alert

A bright red light, visible across the room even at a 45° angle, switches on in less than 10 nanoseconds. No matter how long it's been sitting there, how many vibrations have jarred it, how severe the environment, the signal flashes the status of a circuit or a steady condition. Conceivably, it could shine a million hours before half-brightness.

Yet the HP 5082-4400 Visible Light Emitting Diode is packaged in a small hermetically sealed TO-46 can, uses only 15 mW drive power, combines with IC devices, and costs only \$2.90 in quantities of a 1000. You can use it anywhere you need high reliability, long life, small size, low drive power and resistance to shock.

If you'd like more information on an indicator light that never blows out, call your HP field engineer. Or write Hewlett-Packard, Palo Alto, California 94304; Europe: 1217 Meyrin-Geneva, Switzerland.

HEWLETT  **PACKARD**

SOLID STATE DEVICES

INFORMATION RETRIEVAL NUMBER 64

01905A

Analyze nonlinear control systems

using Popov's method. It gives sufficient conditions for stability independent of the shape of the nonlinearity.

Although a great deal of material has been published on the stability analysis of nonlinear control systems, only one technique has emerged that is general enough to be useful to most engineers. This technique—destined to equal in importance the Bode and Nyquist criteria—is the Method of Popov.

Popov, a Russian, in 1961 developed a criterion¹ that gives sufficient (but not necessary) conditions for a nonlinear system (Fig. 1) to be stable *independent of the exact shape of the nonlinearity*.

This is quite remarkable considering that, previously, it was believed no general method of analysis of nonlinear systems was possible. Because of the usual time lag between theoretical developments in one country and practical applications in another, few books on nonlinear control systems^{2,3} discuss the applications of Popov's method.

The method applies to any feedback system that can be reduced to the form of Fig. 1. It is assumed that $G(s)H(s)$ is of the form $P(s)/Q(s)$, where $P(s)$ and $Q(s)$ are polynomials in s with no repeated roots, and that $G(s)H(s)$ is open-loop stable; that is, $Q(s)$ has no roots in the right half of the s -plane. The nonlinearity is described by the functional relationship $n[x(t)]/x(t)$. Thus, if the input to the nonlinear element is $x(t)$, the output is $\{n[x(t)]/x(t)\}x(t) = n[x(t)]$.

Two requirements must be met

Two conditions are imposed on the nonlinearity in order for Popov's method to work:

- (1) $0 < \frac{n[x(t)]}{x(t)} < k$, and
- (2) $n(0) = 0$.

The first condition says that the nonlinearity must exist in a sector $(0, k)$ bounded by the x -axis and a straight line with slope k passing through the origin. Since k is positive, this re-

stricts the nonlinearity to the first and third quadrants.

The second condition simply states that, when no input is applied to the nonlinear element, no output should be obtained.

The conditions are made clear by the graphs of a diode (A) and a saturating amplifier (B) in Fig. 2.

The Popov stability criterion can be stated as follows for physical systems that can be placed in the form of Fig 1¹:

If a straight line (known as the Popov line) can be drawn to intersect the $\text{Re}[G(j\omega)H(j\omega)]$ axis at $-1/k$ so that the locus of all points of the curve of $\omega \text{Im}[G(j\omega)H(j\omega)]$ vs $\text{Re}[G(j\omega)H(j\omega)]$ lies entirely to the right of this line for all $\omega > 0$, then the system is stable for all nonlinearities in the sector $(0, k)$.

To see how the method is applied, let's re-examine the linear system analyzed in Box 1 and see what effect a nonlinear element would have on it.

We recall that the open-loop transfer function $G(s)H(s)$ is given by $(s+5)/s(s+2)$. For con-

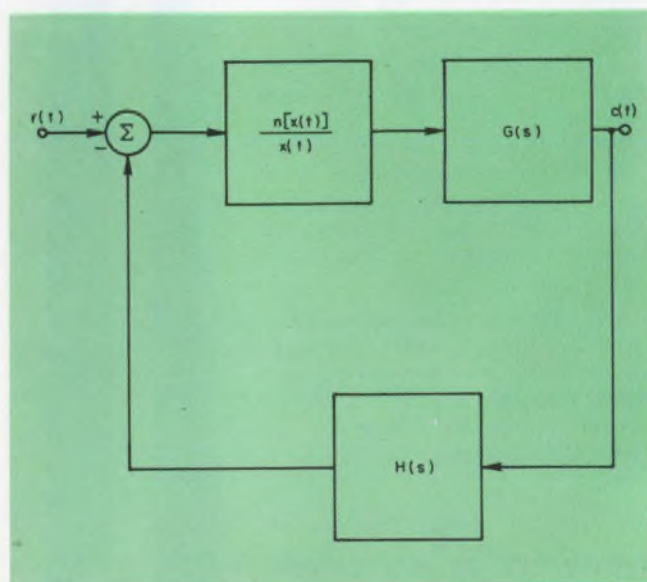

1. Nonlinear feedback systems like this can be analyzed for stability by using the Popov method.

John D. Markel, Electrical Engineering Dept., University of California at Santa Barbara.

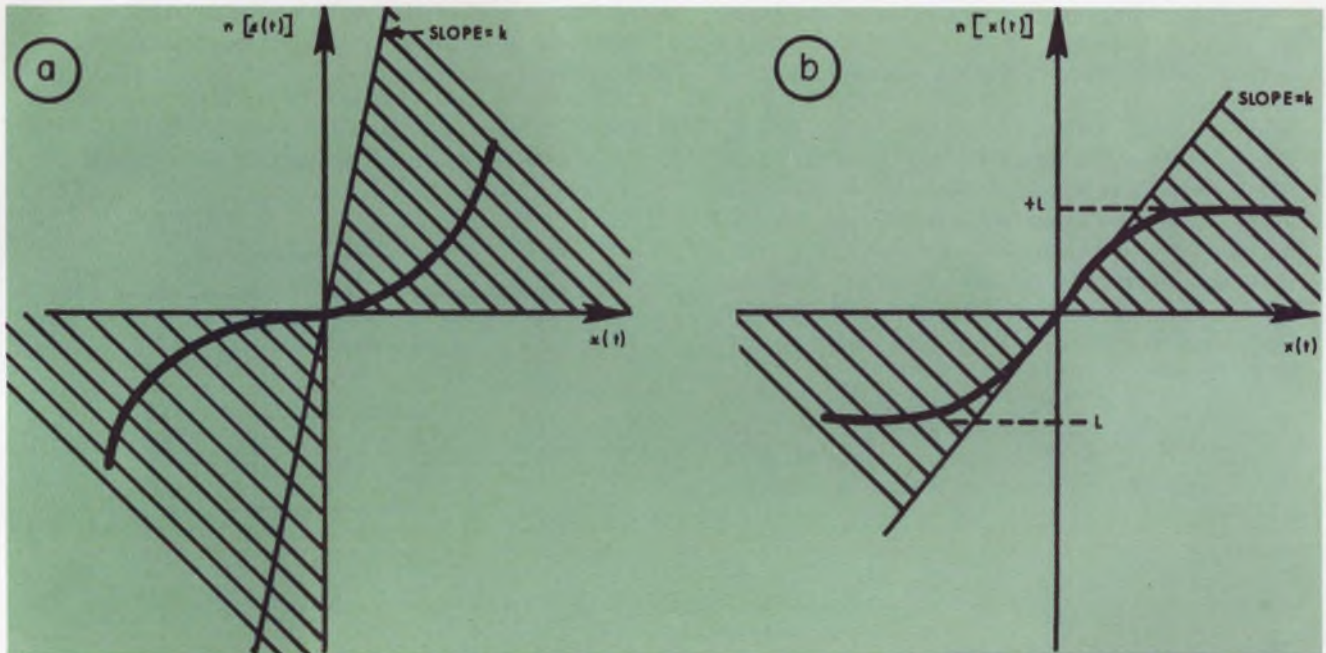

2. The two Popov conditions are satisfied by these curves. Graph (a) represents a diode and graph (b)

represents an amplifier with saturation level L. The sector (0, k) is shaded in both cases.

venience, let $G(s)H(s) = M(s)$.

To apply Popov's criterion, we must calculate $\text{Re}[M(j\omega)]$ and $\omega \text{Im}[M(j\omega)]$. A little algebraic manipulation reveals that:

$$\begin{aligned} \text{Re}[M(j\omega)] &= -3/(\omega^2 + 4) \text{ and} \\ \omega \text{Im}[M(j\omega)] &= (-\omega^2 + 10)/(\omega^2 + 4). \end{aligned}$$

By plotting these two quantities against each other for all ω from zero to infinity, the graph of Fig. 3 is obtained. The Popov line shown in the diagram can clearly be drawn arbitrarily close to the origin; thus $-1/k$ can approach arbitrarily close to zero. This means that k can approach infinity. Infinite k implies that for any nonlinearity contained in the first and third quadrants and passing through the origin, the system will be stable.

Computers lighten the load

With higher-order systems the stability analysis calculations, though simple, become rather

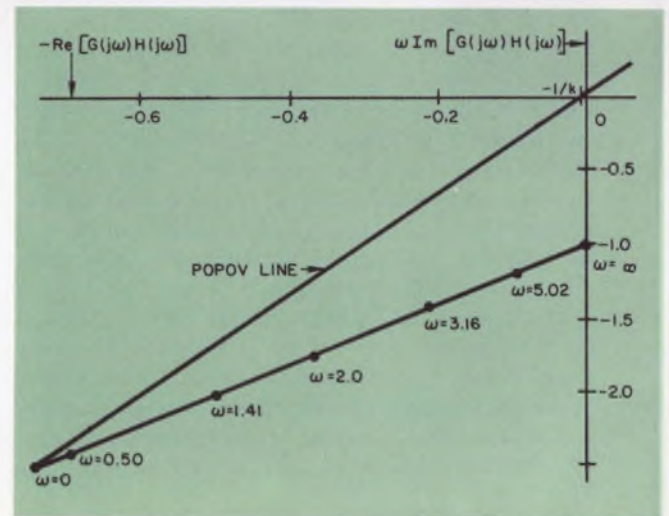

3. The Popov line can cross the abscissa arbitrarily close to the origin in this example. Thus, the system is stable for all nonlinearities contained in quadrants I and III and passing through the origin.

1. Linear control system analysis

The stability condition

Since an understanding of linear system stability analysis is a prerequisite for the study of nonlinear systems a brief review is provided.

To most engineers, a stable system is one that does not oscillate. And translating this definition into mathematical terms is the first step in formulating a linear theory.

The block diagram is a general representation, in Laplace notation, of a single-input single-output (SISO) linear feedback system. All SISO linear systems can be placed in this form by applying block diagram reduction techniques or Mason's gain formula.^{5,6} (We consider only SISO systems here mainly because of their wide usage. Multiple input/output systems can be handled by state variable techniques.⁶)

In this form, $H(s)$ is the feedback element, $G(s)H(s)$ is defined as the open-loop transfer function and $C(s)/R(s)$ is defined as the closed-loop transfer function.

From the diagram, $C(s)/R(s) = G(s)/[1 + G(s)H(s)]$. The denominator, known as the characteristic equation of the system, contains all of the information required to determine whether

or not the system is stable. Recall from Laplace transform theory that negative roots (poles of $C(s)/R(s)$ or zeros of $1 + G(s)H(s)$ in the left half of the s -plane) imply decaying exponentials in the time domain, roots on the $j\omega$ -axis mean sinusoidal variations in output response, and roots in the right half of the s -plane mean increasing exponentials in the output response. Thus stability can be defined mathematically as follows:

The closed-loop systems $C(s)/R(s)$ will be stable if, and only if, there are no zeros of $1 + G(s)H(s)$ in the right half of the s -plane.

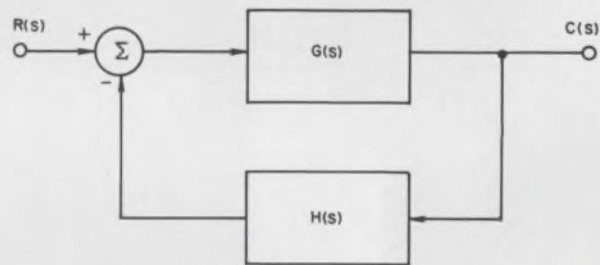

The Nyquist criterion

The Nyquist criterion is based on a result from complex-variable theory, and it states:

If $G(s)H(s)$ is analytic within a closed contour, except for a finite number of poles and zeros, then the number of times that $-1 + j0$ in the $G(s)H(s)$ plane is encircled in traversing the closed contour equals the number of zeros of $1 + G(s)H(s)$ minus the number of poles of $1 + G(s)H(s)$ in the right half of the s -plane.*

If $G(s)H(s)$ is a minimum-phase function (no poles or zeros in the right half plane) then by plotting a graph of $\text{Re}[G(j\omega)H(j\omega)]$ vs $\text{Im}[G(j\omega)H(j\omega)]$ for $0 < \omega < \infty$ and shading to the right of the path as $G(j\omega)H(j\omega)$ is traversed from $\omega = 0$ to $\omega = \infty$, the system will be stable if $-1 + j0$ is not enclosed. Otherwise, the system will be unstable.

Only minimum-phase systems are considered in this article. The reader is referred to other books^{5,6} for discussion of the nonminimum cases.

As an example of the application of the Nyquist criterion, consider a unity feedback system defined by $G(s) = (s+5)/s(s+2)$ and $H(s) = 1$.

The Nyquist plot is formed by the locus of points $G(j\omega)H(j\omega)$ as ω varies from zero to infinity. Separating the expression into its real and imaginary parts, we get

$$\begin{aligned} G(j\omega)H(j\omega) &= (j\omega + 5)/j\omega(j\omega + 2) \\ &= -3/(\omega^2 + 4) + j(\omega^2 + 10)/\omega(\omega^2 + 4). \end{aligned}$$

Substituting various values of ω in this expression, we form the Nyquist plot shown. It is apparent that the $-1 + j0$ point is not encircled by shading to the right of the path; hence the linear model is stable.

*The poles of $1 + G(s)H(s)$ are the same as the poles of $G(s)H(s)$, which therefore may be used for this computation.

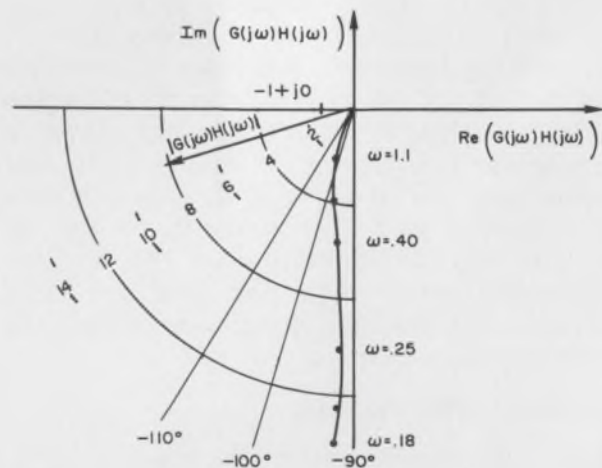

The Bode plot

The Bode plot conveys the same information as the Nyquist criterion for the minimum-phase case under consideration. (The general statement of the Nyquist criterion must be invoked for nonminimum-phase cases.) The advantage of the Bode diagram is that it is relatively easy to sketch without performing detailed calculations as in the Nyquist case. And the approximate closed-loop system response can be obtained if the system has unity feedback, $H(s) = 1$.⁶ In addition, cascade compensation of linear systems⁵ is easily studied with the Bode diagrams.

The diagram is drawn by plotting the following two quantities:

$$20 \log_{10} |G(j\omega)H(j\omega)| \text{ vs } \log \omega$$

$$\text{Angle } [G(j\omega)H(j\omega)] \text{ vs } \log \omega.$$

Clearly this job can be considerably simplified by using semi-log paper.

Applying the Bode plot approach to the same problem that we treated with the Nyquist approach, the first step is to place $G(j\omega)H(j\omega)$ in normalized form:

$$G(j\omega)H(j\omega) = \frac{2}{5} \left(\frac{1 + j\omega/5}{j\omega(1 + j\omega/2)} \right)$$

$$\begin{aligned} \text{Then, } 20 \log_{10} G(j\omega)H(j\omega) &= 20 \log_{10}(2/5) \\ &+ 20 \log_{10} [1 + (\omega/5)^2]^{1/2} - 20 \log_{10} \omega \\ &- 20 \log_{10} [1 + (\omega/2)^2]^{1/2} \end{aligned}$$

$$\text{and Angle}[G(j\omega)H(j\omega)] = \tan^{-1}(\omega/5) - \pi/2 - \tan^{-1}(\omega/2).$$

Each term is plotted individually, and they are all then summed to give the final result. The phase margin is 180 degrees plus the phase shift existing at the frequency at which the magnitude plot crosses the 0-dB line. The gain margin is 0 dB minus the magnitude at the frequency at which the angle plot crosses the minus 180° line.

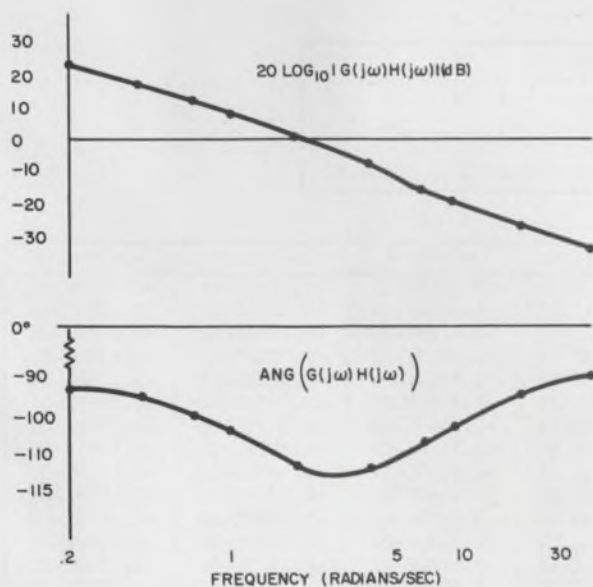

tedious. Because of the similarity between the various frequency domain methods presented, it is possible to develop a rather concise Fortran computer program to carry them out. The program shown in Box 2 can:

- Analyze nonlinear systems with Popov's method.
- Analyze linear systems with Nyquist diagrams.
- Analyze linear systems with Bode diagrams.
- Calculate the closed-loop frequency response of linear systems.

It can evaluate any rational function $F(s)$ for $s=j\omega$. The function $F(s)$ is given by

$$F(s) = \frac{A_1 s^{KN} + A_2 s^{KN-1} + \dots + A_{KN+1}}{B_1 s^{KD} + B_2 s^{KD-1} + \dots + B_{KD+1}}$$

The program inputs and outputs are defined in Box 2.

To use an example, consider a nonlinear feedback system in which the limited dynamic range of the system amplifiers can be modeled by the function

$$y(t) = \frac{n[x(t)]}{x(t)} \cdot x(t) = L \tanh \frac{kx(t)}{L}.$$

This function is a good mathematical model for a saturating amplifier with gain k and limit level L , as can be seen in Fig. 2B.

Let's let the linear portion of the system be described by

$$G(s) = \frac{s + 2}{s(s + 5)(s^2 + 3.2s + 64)}$$

and $H(s) = 1$.

Expanding $G(s)H(s)$ as the ratio of two polynomials,

$$G(s)H(s) = \frac{s + 2}{s^4 + 3.7s^3 + 65.6s^2 + 32s}$$

This is the function of $F(s)$ for the computer program.

The problem is to determine how large the gain k can be with a fixed limit level L while insuring stability. The roots of $G(s)H(s)$ are 0, -5, and $-1.6 \pm j7.8$, which satisfies the condition that $G(s)H(s)$ is open-loop stable and the poles are nonrepeated. (The pole at $s = 0$ is considered as being in the left half plane, since physical systems can only approximate the mathematical representation $1/s$ by a term of the form $1/(s + \epsilon)$, where $\epsilon > 0$ and ϵ is very small with respect to other time constants of the system.)

The input data to the computer is determined as follows: The degree of the numerator polynomial is 1, thus $KN = 1$; the degree of the denominator polynomial is 4, thus $KD = 4$. There is no rule stating what the upper and lower limits of frequency should be. A large enough range should be obtained so that the shape of the curve is apparent. (The exact values at $\omega = 0$ and $\omega = \infty$ can easily be obtained analytically from $F(s)$.) Somewhat arbitrarily the range of ω is

2. Automating Popov's method

Fortran Program Listing (Main Program)

```

1    DIMENSION A(15),B(15),W(2000)
    READ(5,10)KN,KD,KL,KU,NP
    C1=180./3.1415927
    C2=ALOG(10.)
    MN=KN+1
    MD=KD+1
    M=KU-KL
    NPTS=M*NP+1
    READ (5,20)(A(I),I=1,MN)
    READ (5,20)(B(I),I=1,MD)
    WRITE(6,10)KN,KD,KL,KU,NP
    WRITE(6,20)(A(I),I=1,MN)
    WRITE(6,20)(B(I),I=1,MD)
    DO 30 I=1,M
    DO 30 J=1,NP
    K=J+(I-1)*NP
    30  W(K)=10.***(I+KL-1)*EXP ((J-1)*C2/NP)
    W(NPTS)=10.**KU
    DO 40 I=1,NPTS
    CALL EVAL(W,I,KN,A,FRN,FIN)
    CALL EVAL(W,I,KD,B,FRD,FID)
    FMAG=SQRT((FRN*FRN+FIN*FIN)/(FRD*FRD+FID*FID))
    FDB=20.*ALOG10(FMAG)
    CALL ANG(FRN,FIN,FRD,FID,ANGLE)
    FANG=C1*ANGLE
    FRE=FMAG*COS(ANGLE)
    FIM=FMAG*SIN(ANGLE)
    WFIM=W(I)*FIM
    40  FREQ=W(I)/6.2831854
    10  WRITE(6,20)W(I),FREQ,FMAG,FDB,FANG,FRE,FIM,WFIM
    20  FORMAT(5I10)
    20  FORMAT(8E11.4)
    GO TO 1
    END
    
```

Fortran Program Listing (Subroutines)

```

SUBROUTINE EVAL(W,I,N,C,XR,XI)
DIMENSION W(2000),C(15)
XR=0.
XI=0.
K=1
NN=N+1
DO 10 JJ=1,NN,2
J=JJ-1
K=K+1
XR=XR+C(N+1-J)*W(I)**J*(-1)**K
IF(N-J)10,10,20
20  XI=XI+C(N-J)*W(I)**(J+1)*(-1)**K
10  CONTINUE
RETURN
END
    
```

```

SUBROUTINE ANG(FRN,FIN,FRD,FID,ANGLE)
XRE=FRN*FRD+FIN*FID
XIM=FIN*FRD-FRN*FID
IF(XRE)1,2,3
1  ANGLE=ATAN(XIM/XRE)-3.1415927
GO TO 5
2  IF(XIM)6,6,7
6  ANGLE=-1.5707963
GO TO 5
3  ANGLE=ATAN(XIM/XRE)
GO TO 5
7  ANGLE =1.5707963
RETURN
END
    
```

Input definitions

- KN* — Degree of numerator polynomial
- KD* — Degree of denominator polynomial
- KL* — The lower limit of ω is 10^{KL} .
- KU* — The upper limit of ω is 10^{KU} .
- NP* — Number of points per decade to be used in evaluating $F(j\omega)$. (Must be a multiple of 10.)
- A(I)* — The coefficients of the numerator polynomial. *I* runs from 1 to *KN*+1 for decreasing powers of *s*.
- B(I)* — The coefficients of the denominator polynomial. *I* runs from 1 to *KD*+1 for decreasing powers of *s*.

Output definitions

- W(I)* — The radian frequency, ω , equally spaced on a logarithmic scale from *KL* to *KU*.
- FREQ* — Frequency in Hertz ($FREQ = W(I) / 2\pi$.)
- FMAG* — Magnitude of $F(j\omega)$
- FDB* — $20 \log_{10} |F(j\omega)|$
- FANG* — Phase angle of $F(j\omega)$
- FRE* — Real part of $F(j\omega)$
- FIM* — Imaginary part of $F(j\omega)$
- WFIM* — $\omega \text{Im} [F(j\omega)]$.

Input Data Set

Column Number	11	22	33	44	55
Card 1	1	4	-3	3	20
Card 2	0.1000E 01	0.2000E 01			
Card 3	0.1000E 01	0.3700E 01	0.6560E 02	0.3200E 02	0.0000E 00

Portion of Output Data for above Input Data Set

ω (rad/sec)	f (Hz)	$ F(j\omega) $	$20 \log_{10} F(j\omega) $	ANG [F(j ω)]	Re [F(j ω)]	Im [F(j ω)]	$\omega \text{Im} [F(j\omega)]$
0.1778E 01	0.2830E 00	0.1333E-01	-0.3750E 02	-0.1280E 03	-0.8208E-02	-0.1051E-01	-0.1868E-01
0.1995E 01	0.3176E 00	0.1140E-01	-0.3886E 02	-0.1271E 03	-0.6875E-02	-0.9099E-02	-0.1816E-01
0.2239E 01	0.3563E 00	0.9838E-02	-0.4014E 02	-0.1261E 03	-0.5798E-02	-0.7948E-02	-0.1779E-01
0.2512E 01	0.3998E 00	0.8568E-02	-0.4134E 02	-0.1252E 03	-0.4939E-02	-0.7002E-02	-0.1759E-01
0.2818E 01	0.4486E 00	0.7545E-02	-0.4245E 02	-0.1244E 03	-0.4267E-02	-0.6222E-02	-0.1754E-01
0.3162E 01	0.5033E 00	0.6727E-02	-0.4344E 02	-0.1239E 03	-0.3756E-02	-0.5581E-02	-0.1765E-01
0.3548E 01	0.5647E 00	0.6085E-02	-0.4432E 02	-0.1238E 03	-0.3389E-02	-0.5054E-02	-0.1793E-01
0.3981E 01	0.6336E 00	0.5600E-02	-0.4504E 02	-0.1233E 03	-0.3158E-02	-0.4624E-02	-0.1841E-01
0.4467E 01	0.7109E 00	0.5264E-02	-0.4557E 02	-0.1257E 03	-0.3073E-02	-0.4274E-02	-0.1909E-01
0.5012E 01	0.7977E 00	0.5083E-02	-0.4588E 02	-0.1285E 03	-0.3162E-02	-0.3979E-02	-0.1994E-01
0.5623E 01	0.8950E 00	0.5075E-02	-0.4589E 02	-0.1336E 03	-0.3498E-02	-0.3678E-02	-0.2068E-01
0.6310E 01	0.1004E 01	0.5260E-02	-0.4558E 02	-0.1429E 03	-0.4196E-02	-0.3172E-02	-0.2002E-01
0.7079E 01	0.1127E 01	0.5511E-02	-0.4518E 02	-0.1602E 03	-0.5186E-02	-0.1863E-02	-0.1319E-01
0.7943E 01	0.1264E 01	0.5094E-02	-0.4586E 02	-0.1885E 03	-0.5038E-02	0.7523E-03	0.5976E-02
0.8912E 01	0.1418E 01	0.3541E-02	-0.4902E 02	-0.2179E 03	-0.2795E-02	0.2173E-02	0.1936E-01

chosen as $10^{-3} < \omega < 10^3$; thus $KL = -3$ and $KU = 3$. The main requirement on NP , the number of frequency points per decade, is that sufficient resolution must be obtained to accurately draw the locus of $F(s)$. Usually 10-20 points per decade is sufficient. For this problem $NP = 20$ is required to point out the rather strange behavior of the locus near the origin.

This data is typed on the first data card (see Box 2) in the order just mentioned. The numbers are integers and are typed flush to the right-hand side of each group of ten columns.

The second card contains the coefficients of the numerator polynomial in descending powers of s . The format statement allows seven coefficients (sixth-degree polynomial) to be read in on one card. If polynomials of higher order are incurred, one simply continues listing the coefficients in descending order on the next card, and so forth. The numbers are specified in the form $a.bE \pm c$ which means $a.b \cdot 10^{\pm c}$. The coefficients must be listed in descending powers of s every eleven columns (placing zeros for missing powers of s). Within the eleven columns the coefficients can be placed anywhere as long as a decimal point is used after the number preceding E .

The third data card has the denominator coefficients typed according to the same rules listed. The formats of all three data cards for this problem are shown in Box 2, along with a partial printout of the results. The graph of Fig. 4 was drawn from the complete printout.

The Popov line intersects the real axis at $-1/k = -2.6 \times 10^{-2}$, thus $k = 38.5$. Since all of the requirements of Popov's method have been met, we know that the gain of the saturating amplifier can be varied between zero and 38.5 without causing the system to become unstable. Note that the limit level, L , is not included in the result; therefore the system is stable in this region, independent of the value of L .

Do linear analyses as well

To perform analyses of linear systems using the Bode and Nyquist methods, the quantities $20 \log_{10} |F(j\omega)|$, $\text{Angle}[F(j\omega)]$ and $|F(j\omega)|$ are needed. As can be seen from the sample printout, these quantities are provided by the program.

The closed-loop frequency response of a linear system can also be calculated by using this program. Whereas the rational function $F(s)$ was used to represent $G(s)H(s)$ in the stability calculations, it must now represent $C(s)/R(s)$ —the system transfer function. A little algebraic manipulation shows that, in this case,

$$F(s) = C(s)/R(s) = G(s)/[1 + G(s)H(s)].$$

Thus the program can be quite useful for a variety of calculations for which the quantity of interest is a rational function. ■■

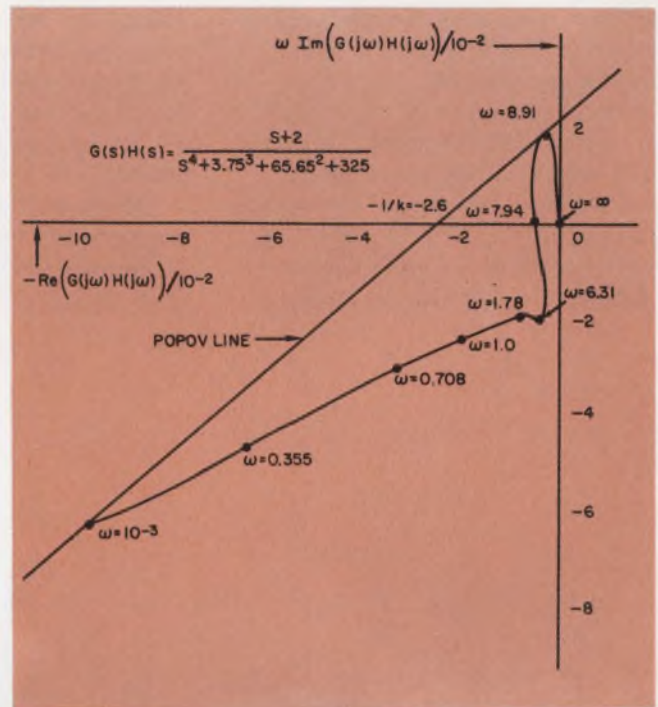

4. The computer program provided the data for this graph. The Popov line crosses the abscissa at -2.6×10^{-2} . Thus, $k = 38.5$. Note that the saturation level, L , does not enter the picture.

References:

1. V. M. Popov, "Absolute Stability of Nonlinear Systems of Automatic Control," *Automation and Remote Control*, Vol. 22, No. 8, August, 1961, p. 857-875.
2. Rajko Tomovic, *Introduction to Nonlinear Automatic Control Systems*, John Wiley and Sons, New York, 1966.
3. Solomon Lefschetz, *Stability of Nonlinear Control Systems*, Academic Press, New York, 1965.
4. R. W. Brockett and J. L. Willems, "Frequency Domain Stability Criteria—Part I," *IEEE Transactions on Automatic Control*, July, 1965.
5. Stanley M. Shinnars, *Control System Design*, John Wiley and Sons, New York, 1964.
6. Distefano, III et al, *Feedback and Control Systems*, Schaum Publishing Co., New York, 1967.
7. D. G. Schultz and J. L. Melsa, *State Functions and Linear Control Systems*, McGraw-Hill, New York, 1967.

Test your retention

Here are questions based on the main points of this article. Their purpose is to help you make sure you have not overlooked any important ideas. You'll find the answers in the article.

1. What are the two conditions that a nonlinearity must meet for Popov's method to work?
2. State the Popov stability criterion.
3. Does this criterion provide necessary conditions for stability or merely sufficient ones?
4. What condition is imposed on the function $G(s)H(s)$ for Popov's method to work?

No other general purpose counter is so useful in so many ways. No other counter offers you so many accessories to fit so many measurement jobs.

First, you can get the Model 5248M with a time base that's stable to better than 5 parts in 10^{10} per day, a precision frequency standard in itself. You can measure any frequency from dc to 135 MHz to 8 places ± 1 count. Or use to 18 GHz at the same accuracy with simple plug-ins.

You can measure period, multiple period average, frequency ratio, multiple ratios, or you can scale frequencies or totalize.

With accessories that plug into the front panel you can:

Resolve time interval to 10 nano-seconds.

Measure to 18 GHz with a 1 Hz resolution in 4 seconds.

Measure CW or pulsed signals out to 18 GHz.

Prescale for direct readout to 350 MHz. Increase sensitivity to 1 millivolt. Make dc voltage measurement up to 1000 volts.

Normalize readings to engineering units or perform high speed batch counting or control.

And with the newest plug-in, the 5268A Frequency Multiplier, you can make high accuracy low-frequency measurements as much as 1000 times faster

You can get much more out of this counter. Because you can put much more in.



than you ever could before.

Plug-in accessory performance is unequaled. Even the 18 GHz heterodyne converter is completely free of spurious responses. And the transfer oscillator plug-in operates on a new principle which offers versatility, range (50 MHz to 18 GHz) and performance you can't get elsewhere. Add-on accessories even further extend counter usefulness by permitting manual measurements to

40 GHz or automatic measurements from 0.3 to 12.4 GHz.

The 5248M is but one member of a series of 10 closely-related models based upon the highly popular 5245L Counter. All models use the same accessories. And you'll get the same quality and field-proven design no matter whether you choose the top-of-the-line 5248M for \$3300, the original 5245L for \$2480, the economy model 5246L for \$1800 or any of the

seven other models.

For a 32-page guide to the highly versatile "5245 Series" call your local HP field engineer. Or write Hewlett-Packard, Palo Alto, California 94304; Europe: 1217 Meyrin-Geneva, Switzerland.

HEWLETT  PACKARD

ELECTRONIC COUNTERS

02908

INFORMATION RETRIEVAL NUMBER 65



Make linear models of op amps

for computer-aided design by a simple technique that uses gain-frequency curves to obtain accurate equivalent circuits.

Thanks to their versatility, operational amplifiers are used in an extraordinary variety of applications. And as computer-aided design becomes more universal, the need for accurate models of op amps grows increasingly critical.

By applying a simple, yet reliable, technique, very serviceable linear ac models of integrated-circuit and hybrid op amps can be established. These models, derived from the op-amp gain-frequency curves, are usable with CORNAP,¹ INAP,² SCEPTRE,³ and other designer-oriented computer programs. In these programs the circuit to be analyzed is described topologically to the computer, and only a minimal knowledge of computer programming is required of the designer.

Op amps are complex

Simplicity is desirable in the models because op amps are extremely complex devices. To obtain the desired gain, frequency response and stability, as many as 18 active devices (transistors and diodes) and an equal number of resistors are often required in a single package. On the other hand, many computer circuit analysis programs limit the number of elements that can be entered. This requires the op amp to be modeled as a unit, as simply as possible, while retaining the operational characteristics of the device.

The ideal op amp has infinite open-loop gain, input impedance and bandwidth, and zero output impedance. It is generally represented as an amplifier with an output that is proportional to the voltage across a resistor placed across the input terminals of the device (Fig. 1).

Unfortunately, this representation provides satisfactory results only when the magnitude of the gain (dc or low-frequency operation) or the effects of external components are of primary interest. This ideal circuit representation is inadequate where frequency response, transient effects, phase or impedance relationships must be taken into account. At higher frequencies and for decreasing open-loop gain, the effects of both

the error factor and the input impedance assume increasing importance.

All of the limitations can be avoided by using the gain-frequency curve technique.

Models illustrate the method

Practical models are developed by locating the op-amp break-frequency points from the manufacturer's gain-frequency curves and choosing appropriate lead and lag networks to provide the poles and zeros (Fig. 2). To get the approximate pole and zero locations, the linear portions of the gain-frequency curves are extended to where the 0-dB/decade, 20-dB/decade or 40-dB/decade extensions intersect (Fig. 3).

The ease of this method is apparent when we synthesize models for three typical op amps—Analog Devices' 202 and 180 and the μ A709.

The first op amp, the Analog Devices' 202 (Figs. 3 and 4), is modeled by cascaded voltage equivalent (Thevenin) circuits. As shown in Fig. 3 there are three break points in the gain-frequency curve occurring at approximately 0.004 Hz, 2 Hz, and 20 kHz.

To model the first pole, at 0.004 Hz a value $RA = 5 \text{ k}\Omega$ is selected (Fig. 4); then the value of CA is found from the relation:

$$f_1 = \frac{1}{2\pi(RA)(CA)} = \frac{1}{(6.28)(5)(10^3)(CA)} \\ \approx 0.004 \text{ Hz, and} \\ CA = 0.008 \text{ farad.}$$

To model the first zero at 2 Hz, values for RB and CA are selected to satisfy the condition:

$$f_2 = \frac{1}{2\pi(RB)(CA)} = \frac{1}{2\pi(RB)8(10^{-3})} \\ \approx 2 \text{ Hz, and}$$

$$RB = 10 \Omega.$$

Note that a -20-dB/decade slope has now been obtained from 0.004 to 2 Hz and a 0-dB slope above 2 Hz. To obtain the -40-dB/decade slope above 20 kHz, RB and CB , and RC and CC are selected to have the same value and thus provide two identical poles. Here,

John R. Greenbaum, Project Engineer for Computer Aided Design, General Electric Co., Syracuse, N. Y.

CURRENT EQUIVALENT MODEL

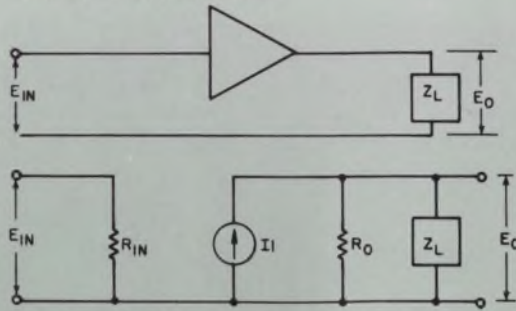

$I_1 = G_m \times E_{IN}$
 $E_0 = I_1 \times R_0$
 $G_m = A/R_0 = I_{OUT}/E_{IN}$
 $A = \text{MFRS. OPEN LOOP GAIN}$

VOLTAGE EQUIVALENT MODEL

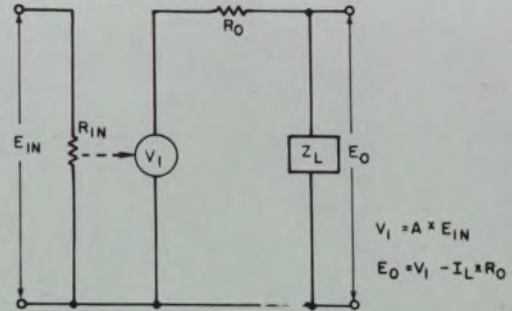

$V_1 = A \times E_{IN}$
 $E_0 = V_1 - I_L \times R_0$

1. Ideal models are inadequate where frequency response and transit effects, must be dealt with.

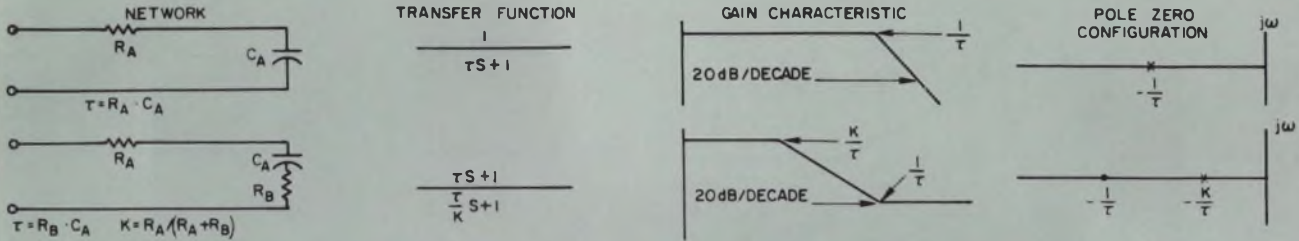

2. Gain characteristics serve as the basis for choosing appropriate lead-lag networks.

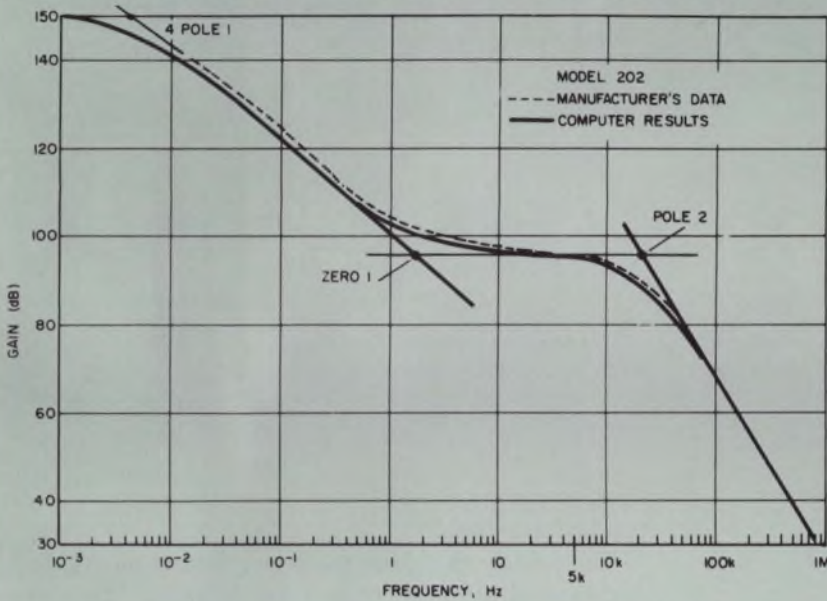

3. Use the break frequency points to choose appropriate lead-lag networks. This curve was used to develop the model for Analog Devices' 202 op amp.

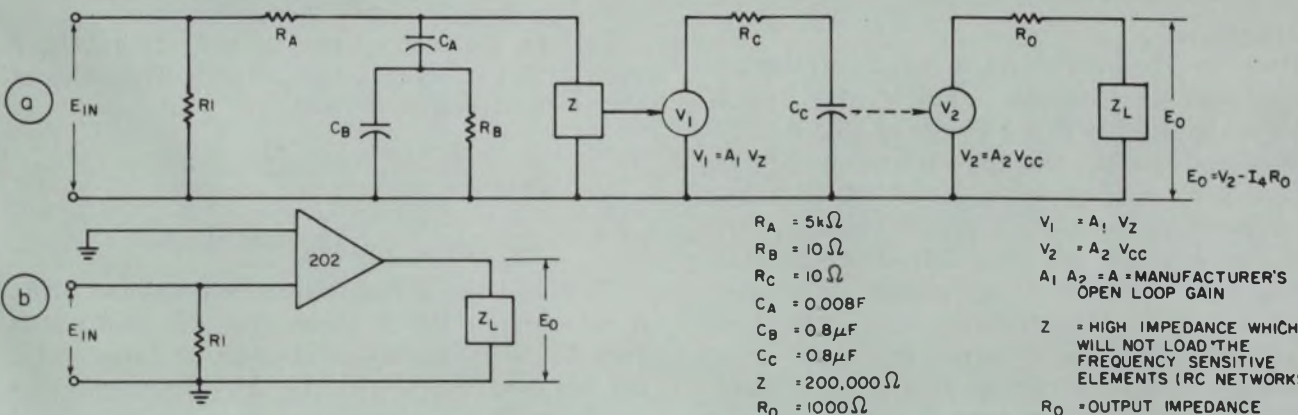

- $R_A = 5k\Omega$
- $R_B = 10\Omega$
- $R_C = 10\Omega$
- $C_A = 0.008F$
- $C_B = 0.8\mu F$
- $C_C = 0.8\mu F$
- $Z = 200,000\Omega$
- $R_0 = 1000\Omega$
- $V_1 = A_1 V_Z$
- $V_2 = A_2 V_{CC}$
- $A_1 A_2 = A = \text{MANUFACTURER'S OPEN LOOP GAIN}$
- $Z = \text{HIGH IMPEDANCE WHICH WILL NOT LOAD THE FREQUENCY SENSITIVE ELEMENTS (RC NETWORKS)}$
- $R_0 = \text{OUTPUT IMPEDANCE}$

4. The Thevenin (voltage equivalent) network (a) shown above was used to model the Analog Devices' 202 op

amp (b) for the CORNAP (Cornell Network Analysis) program discussed in the text.

FREQUENCY COMPENSATION CIRCUIT

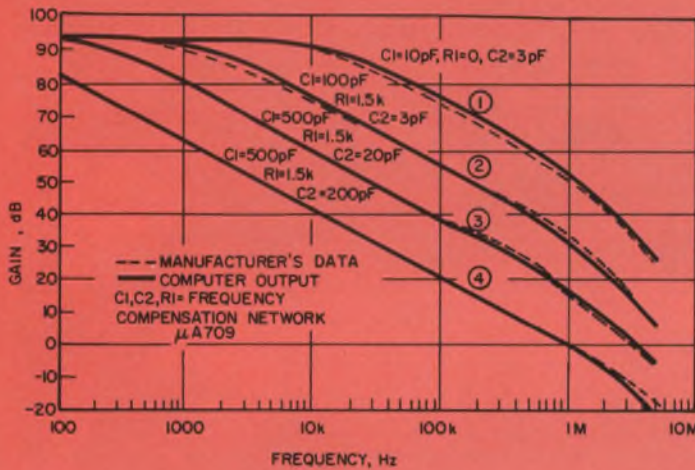
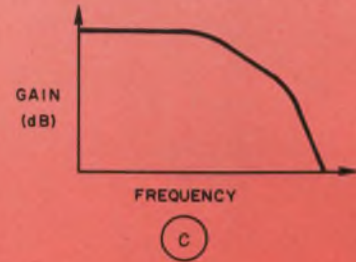
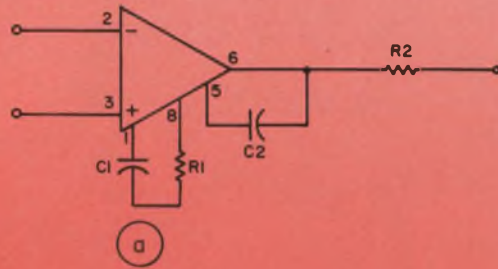

(b)

①	②	③	④
RA = 750 Ω	7500 Ω	50 kΩ	400 kΩ
RB = 10 MΩ	10 MΩ	5 MΩ	50 MΩ
CA = 0.016 μF	0.016 μF	0.016 μF	0.016 μF
CB = 0.016 pF	0.016 pF	0.016 pF	0.016 pF

5. Frequency compensation circuits (a) are required to obtain the open-loop response curves shown in (b). The typical curve (c) is used as the basis of equivalent

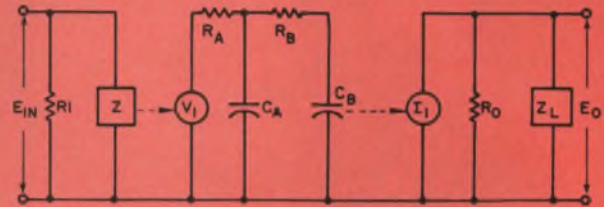

(d)

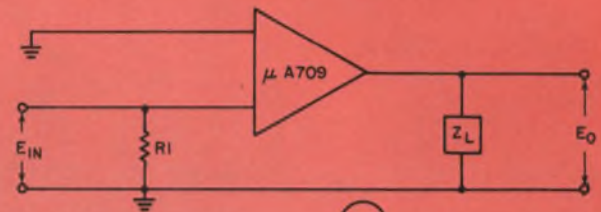

(e)

Z = 400,000 Ω
 RO = 150 Ω
 OPEN LOOP GAIN: 25,000
 70,000
 VI = I × VZ

I1 = Gm × VCB
 gm = $\frac{I_{OUT}}{E_{IN}} = A / R_O$
 A = MFGR OPEN-LOOP GAIN
 EO = I1 × RO

voltage/current model (d) of the μA 709 op amp (e). This model was designed for use with the CORNAP (Cornell Network Analysis) CAD program.

$$f_s = \frac{1}{2\pi(RB)(CB)} = 20 \times 10^3$$

$$= \frac{1}{(6.28)(10)(.8)(10^{-11})} = 20 \times 10^3, \text{ so}$$

$$CB = 0.8 \mu\text{F}$$

Extremely close matching to the manufacturer's data over the frequency range 10^{-3} Hz < f < 1 MHz was obtained with the model of Fig. 4.

The second specific example covers one of the most popularly used op amps, the μA709 (Fig. 5). It is modeled by means of a hybrid (voltage/current) cascaded network (Fig. 5d). The amplifier must be used with frequency compensation circuits¹ (Fig. 5a). Manufacturers' frequency response curves for four different frequency compensating networks are shown in Fig. 5b. (Curve 4 of 5b also represents the response of the μA741, a second-generation op amp in which the frequency compensation has been incorporated into

the op amp itself.)

To model the frequency-compensated circuit corresponding to Curve 1 of Fig. 5b, the two break points at 13.3 kHz and 1 MHz are represented by means of two poles.

For the lower-frequency pole, at 13.3 kHz, a value of RA = 750 Ω is selected first. The value of CA is then computed from

$$f_1 = \frac{1}{2\pi(RA)(CA)} = 13.3 \times 10^3$$

$$CA = \frac{1}{2\pi \cdot 13.3 \times 10^3 \cdot 750} = 0.016 \mu\text{F}.$$

To model the upper frequency pole of 1 MHz, a value of 10 MΩ is chosen for RB, and CB is then found in the usual manner. A large value for RB is chosen so that the high-frequency circuit will not load down the low-frequency circuit and thus shift the pole location.

When a degenerative feedback loop is added

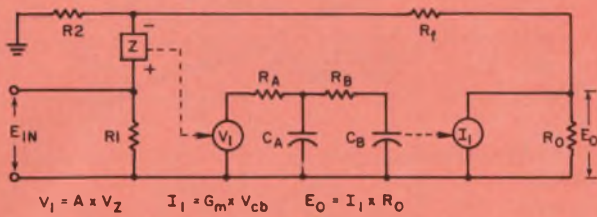

$$V_1 = A \times V_Z \quad I_1 = G_m \times V_{cb} \quad E_O = I_1 \times R_O$$

(a)

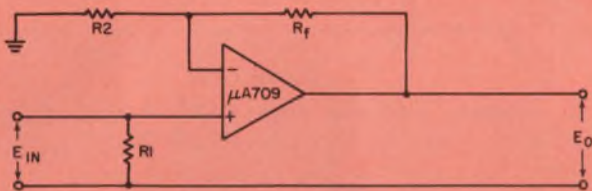

(b)

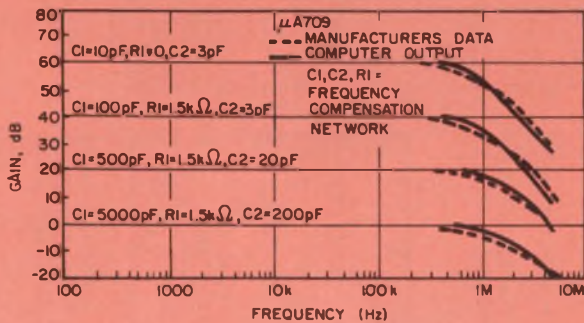

(c)

7. Open-loop op-amp model of Fig. 5d is used (a) to represent the $\mu A 709$ (b) in closed-loop applications. Computer results based on the model closely match the manufacturer's data (c).

around the op amp, a second set of gain-frequency curves applies. These are also provided by the manufacturer, as shown in Fig. 7 for the $\mu A 709$ model for the $\mu A 709$, shown in Fig. 5d, is still used, modified to include provision for the feedback (Fig. 7b).

The values of R_1 and R_2 , added externally, are as follows:

dB	$R_1(k\Omega)$	$R_2(k\Omega)$
60	1000	1
40	100	1
20	10	1
0	100	deleted

In simple circuit applications of the $\mu A 709$ the gain of the total package is determined by R_1 and R_2 . Gain variations due to elevated temperatures can therefore be compensated (in CAD applications), if required, by changing the values of R_1 and R_2 .

Watch the phase margin

However, it is the phase-shift frequency relationship within the device that is important. The phase-margin, which is the amount of phase shift at the unity-gain frequency that would just produce instability, is the indicator of the circuit sensitivity to minor transient perturbations. It helps measure whether the circuit will oscillate or respond in an undesirable manner.

Experience with these models in circuit-analysis applications has demonstrated that the phase-frequency analysis results obtained from the computer provide an excellent indication of the phase margin. An example of the value and accuracy of the phase computations provided by the computer is seen by examining the phase and gain relationships of Fig. 8. The dashed curve represents the circuit when the frequency compensation was appropriate for obtaining the results shown for Curve 1 of Fig. 5b.

Use series inductor for transient response

Operational amplifiers do not produce an exact replica of the input signal when operated under transient or step input signal conditions. Generally, one of two situations occurs: either the slew rate limits the device response time by a considerable amount, or a minor delay is observed between the input and output signals, with a small overshoot in the output signal.

For either of the two conditions, the models previously described are not satisfactory. For the slew-rate situation, the RC time constants are too short. For the overshoot condition, the RC constants do not allow the voltage to overshoot.

To permit the model to duplicate the manufacturer's published response to a step input signal, it is necessary to provide a circuit that will change the frequency response of the model under the conditions described. By providing a tuned circuit, one sensitive to high frequencies, the model will provide proper response to step input signals but still retain the gain-frequency relationships required for linear applications at lower frequencies. This result (Fig. 9) is obtained by adding an inductance, $L1$, in series with capacitor CB in the model of Fig. 5d. As long as the impedance at the resonant frequency, determined

by CB and $L1$, is at least one order of magnitude greater than that determined by RB and CB , the circuit is generally insensitive to additional changes in the value of the inductance. To meet the above requirements, a 0.001-MHz inductor was selected for this model.

Can models be simplified?

Experience has indicated that some simplification of the models is possible, but considerable judgment is required to determine the degree of simplification permitted in any particular application.

For example, it can be seen from Fig. 5b that if a $\mu A709$ is to be used at frequencies below about 5 kHz, elimination of the high-frequency pole network would probably cause no inaccuracy in the computed results. However, for the model 202, with its low-frequency poles and zeros, and the 40-dB/decade response above 10 kHz, it is recommended that no simplification be undertaken, unless it is certain that circuit response above about 100 Hz is not important. Then the higher frequency poles can probably be eliminated without major inaccuracies in the computed results.

Experienced judgment is especially necessary if the designer is attempting to use the op amp at gains and frequencies that approach the device limits. Since the saving of a few components and/or nodes that may result from this simplification is generally not significant in arriving at the limits of the capacity of the programs or computers to handle the circuits, the total model should nearly always be used. ■■

References

1. C. Pottle, "Comprehensive Active Network Analysis by Digital Computer—A State Space Approach," Proceedings of the Third Allerton Conference, Urbana, Ill., October, 1965.
2. D. A. Calahan, "Linear Network Analysis and Realization Digital Computer Programs: An Instruction Manual." University of Illinois, Urbana, Ill., Engineering Bulletin 472, College of Engineering, approx. 1967.
3. H. W. Mathers, S. R. Sedore, and J. R. Sents, "Automated Digital Computer Program for Determining Responses of Electronic Circuits to Transient Nuclear Radiation, (SCEPTRE)." Oswego, N. Y., IBM Corp., Technical Report No. AXWL-TR-66-126, Vols. 1 and 2, February, 1967.
4. J. N. Giles, "Linear Integrated Circuits Handbook," Fairchild Semiconductor, Mountain View, Calif., 1967.

Acknowledgment

The author wishes to thank A. W. Hamilton for his aid, advice, and encouragement in the preparation of this paper.

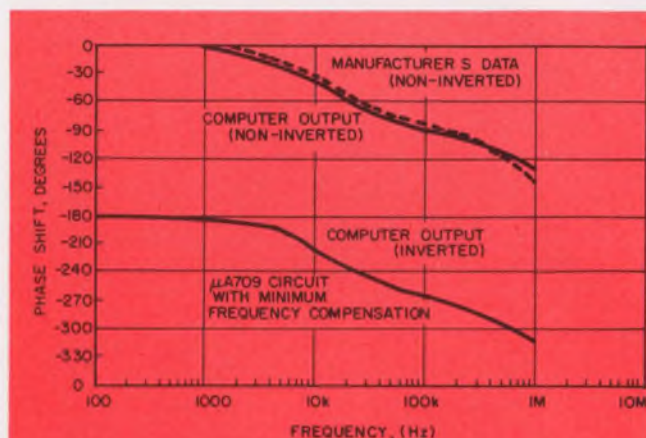

8. Accurate open-loop phase-shift information is obtained from op-amp phase-shift model of $\mu A709$.

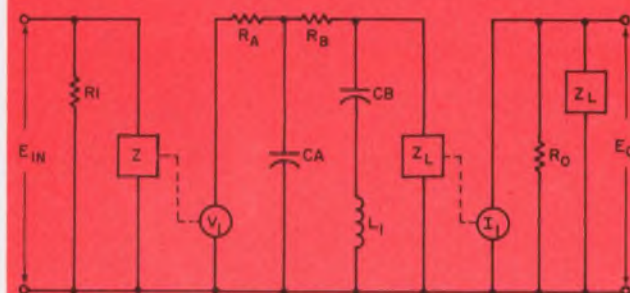
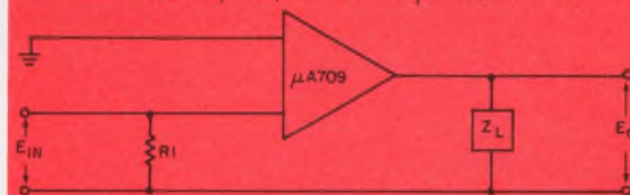

9. When a series inductance, $L1$, is added to the equivalent circuit of Fig. 5d, the resulting model accurately duplicates the transient performance of the $\mu A709$.

Test your retention

Here are questions based on the main points of this article. Their purpose is to help you make sure you have not overlooked any important ideas. You'll find the answers in the article.

1. How are appropriate lead or lag networks chosen in making the op-amp models decided?

2. What basic types of equivalent circuit are used?

3. What modification must be made in the equivalent circuit to obtain a model that will accurately represent the behavior of the operational amplifier when it is operated under transient conditions?

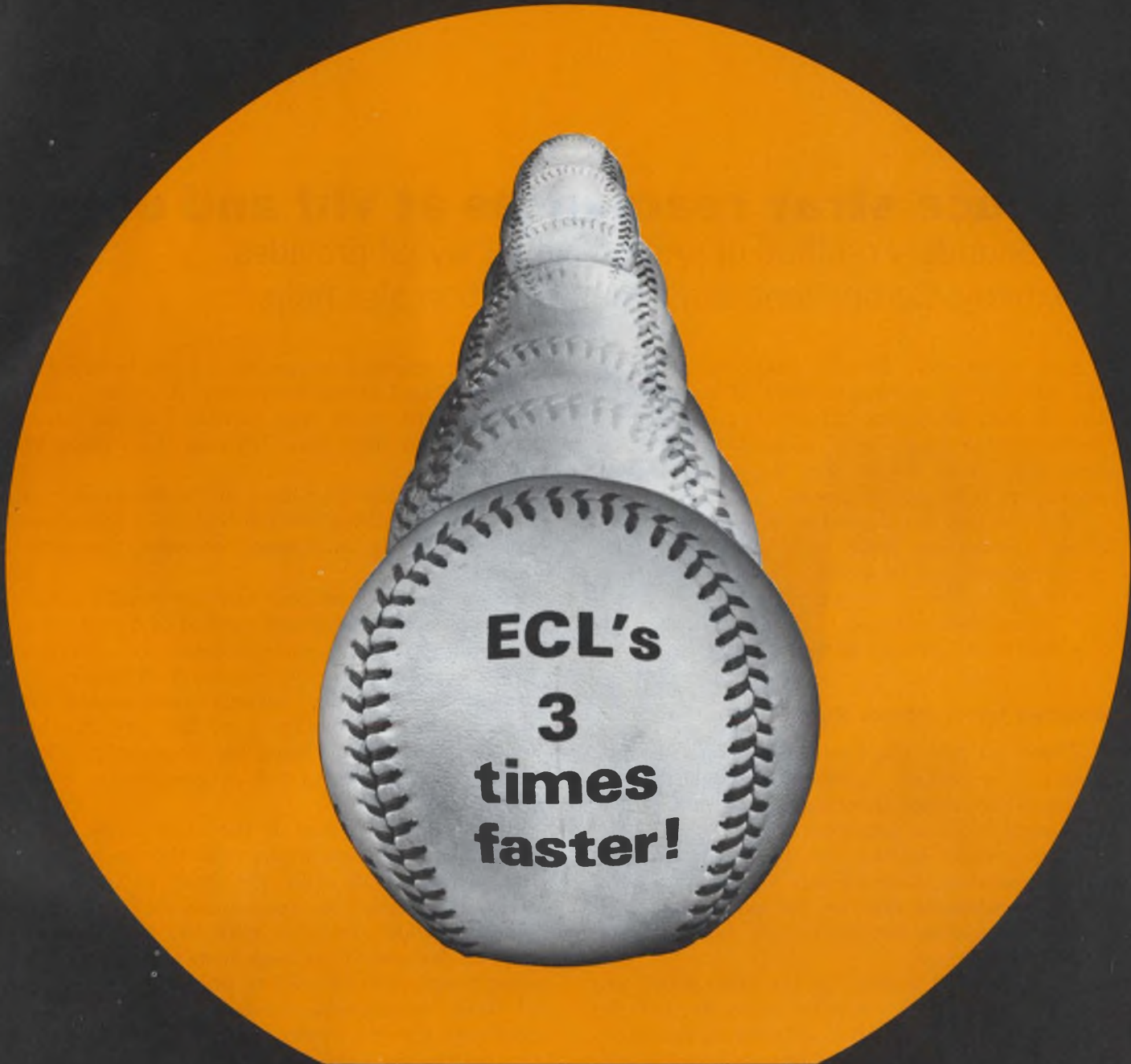

SPEED WINS THE BALLGAME!

In computers, too, time is money; and the lowest computer time often wins the ballgame. So if speed is important to you, why settle for typical TTL times of 13 nanoseconds when you can have typical ECL II times of 4 nanoseconds?

At Stewart-Warner, the high-speed logic of the future is available today. We are now announcing another 14 new ECL II's in both the industrial series (1000) and military series

(1200). We have previously announced 14 circuits in these two ultra-high-speed series, as well as 11 ECL's in the high-speed 300 and 350 series.* Since ECL's offer the designer the same functional capability and design freedom as he has with the slower TTL logics, there's no longer any need to compromise when speed is important...especially when Stewart-Warner ECL prices may be lower than what you have been paying for TTL's.

For more information, send for our ECL data sheets. And, for off-the-shelf delivery, call your local Stewart-Warner Microcircuits Distributor.

*All Stewart-Warner ECL's interchangeable with Motorola MECL and MECL II units.

STEWART-WARNER COMPANIES	SYMBOL OF SW EXCELLENCE
STEWART-WARNER MICROCIRCUITS, INC. 730 EAST EVELYN AVENUE, SUNNYVALE, CALIFORNIA 94086 PHONE 408/245 9200 TWX 910 339 9210	

Reduce stray reactances at vhf and uhf

The boundary method of printed-circuit layout provides a remedy. Component and circuit selection also help.

Radio-frequency circuits, particularly of the vhf and uhf types, always seem to be trying to trip up their designers. It is very rare for one of them—even a simple one—to work properly the first time it is tested. Yet the cause is well known: it is stray reactances.

While it may be impossible to eliminate these strays, there are three basic areas in which improvements can be made:

- Physical circuit layout.
- Component selection.
- Electrical circuit configuration.

Boundary layout reduces strays

There are two big problems in the physical layout of a circuit: Interconnecting leads give rise to stray series inductances, and component placement to stray capacitances.

Point-to-point wiring, the traditional method for minimizing these effects, unfortunately requires substantial skill on the part of the assembler and does not lend itself to automated production.

Printed-circuit boards, on the other hand, are easily adaptable to automatic assembly, but the resulting circuits are often inferior to the hand-wired models. This is usually caused by errors in layout.

The boards are often made too large. Too many circuits are placed on a single board in an effort to reduce the number of boards in the final assembly. And the interconnecting lines on the boards are often made too thin.

For best results at vhf and uhf, the individual boards should be kept simple—usually just one circuit per board. Connections between boards should be made with coaxial cable unless the distance is so short (about 3/8-inch) that the cable cannot be practically handled. In that case, connections can be made with a piece of buss wire or a component.

Each power and control lead should be brought into the board at one point only. A single distribution board would then provide for the interconnection of these leads between the various rf circuits.

The interconnecting lines should be as wide as possible. When they are too thin, they introduce excessive series inductance between the components.

These stray inductances can be virtually eliminated by using a boundary method of layout. The principal goal of this method is to leave as much foil as possible on the board. A boundary is drawn through the various components to separate the current nodes of the circuit, and foil is removed only along the boundaries. This leaves large islands of foil connecting the components (Fig. 1).

The board is a map of the node areas, with essentially no inductance between the components tied to a common node. The stray capacitances across the boundaries are kept small by making the gaps wide compared with the thickness of the foil. Because of the large node areas, a single-sided board must be used to prevent the buildup of stray capacitances through the board. This does not impose a restriction on the designer if the boards are kept simple and the power and control leads are on a board of their own.

The boundary method of layout is particularly valuable when used with transistor circuits. Vhf and uhf transistors have very low input and output impedances, and an additional series component, even a small one, is quite disruptive. Small shunt capacitances, by contrast, are not very troublesome in these low-impedance circuits.

Component selection is important

A second area where stray reactances arise is in the circuit components themselves. At vhf and uhf the true complex nature of components becomes painfully apparent. And the effects of stray reactances are an overriding consideration in the component selection at these frequencies.

Capacitors have a small series inductance as

Ronald W. Hankins, Sr. Engineer, and Harry W. Lamberty, Staff Engineer, Communications Section, Martin Marietta, Orlando, Fla.

a stray reactance, and inductors a small shunt capacitance. Both display a resonance because of these strays, and good design practice demands that these components should be operated well below their self-resonant frequencies.

Table 1 shows representative resonant frequencies for some standard capacitors and chokes. Values such as these have been found to be quite consistent (within 10%) for units from one manufacturer, but they vary substantially between others. Actually, the chokes don't vary by more than about 10% from one manufacturer to another, but the capacitors do. For example, 1000-pF capacitors from one source resonated at 80 MHz, while those from another resonated at 100 MHz. Both were MIL type CK05. The table, in all cases, reflects the lowest frequencies observed.

Table 1. Self-resonant frequencies

Capacitors		Inductors	
Cap. (pF)	Freq. (MHz)	Induct. (μ H)	Freq. (MHz)
100	320	1.0	400
150	245	1.5	200
220	200	2.2	150
330	175	3.3	140
470	140	4.7	120
680	100	6.8	100
1000	80	10.0	70

MIL type CK05 capacitors with leads cut off 1/8 inch long and soldered together.

MIL type LT4 chokes (body size 0.095" dia by 0.025" lengths) with leads cut 1/4 inch long.

Measurements made with Measurements Corp. Model 59 Megacycle Meter

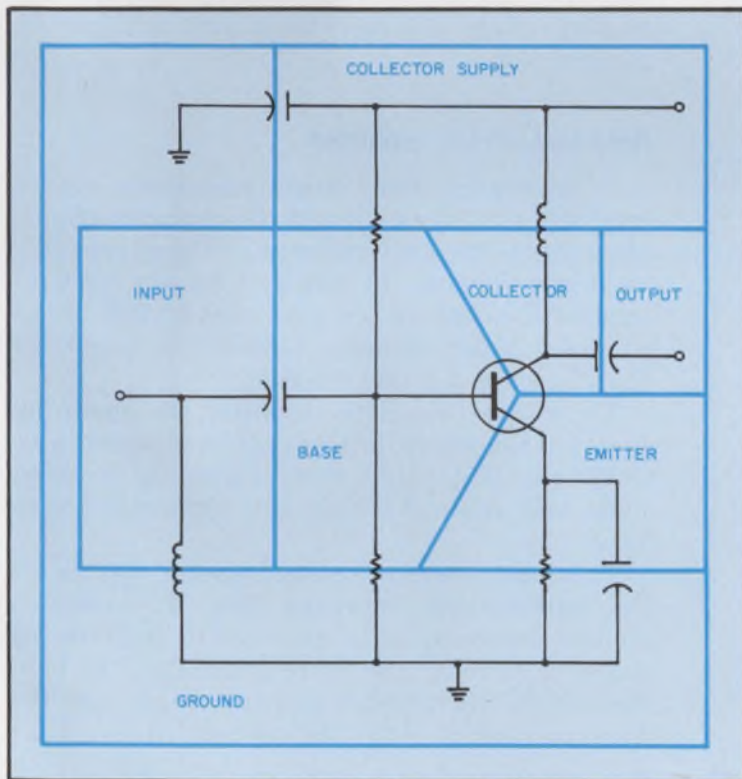

1. Lead inductance is reduced by the boundary method of layout. Boundaries are drawn through the circuit

components (left); then foil is removed along the boundaries, leaving large conducting islands (right).

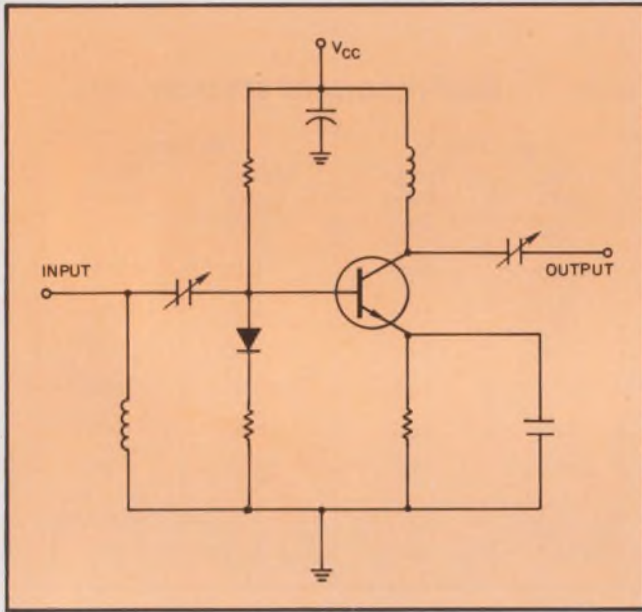

2. The disadvantage of the three-resistor method of biasing is that the emitter is not grounded. This not only unnecessarily limits the dynamic range of the circuit; it creates bypassing problems as well.

Table 2. Resistor reactances

Resistance (ohms)	Inductance (mH)	Capacitance (pF)
15	8.0	—
22	8.5	—
33	9.0	—
47	9.0	—
68	9.5	—
100	10.0	—
150	8.0	—
220	5.0	—
330	—	0.1
470	—	0.2
680	—	0.2
1000	—	0.2
10,000	—	0.2

Resistors from 15 ohms to 68 ohms are MIL type RC07; those of 100 ohms or greater are MIL type RN60. Measurements were made with a Boonton Radio Corp. Type 250-A RX Meter.

Since the self-resonant frequency of a component is not a generally specified parameter, you will either have to measure it yourself or specify it when ordering parts. You should also remember that the characteristic resonant frequency is strongly affected by additional strays introduced by the installation of the component into the circuit. Capacitors are principally influenced by lead length, which increases the series inductance, and inductors by proximity to metal, which increases the stray shunt capacitance.

Resistors are characterized by both a series inductance and a shunt capacitance. The inductance is more significant for low values of resistance and the capacitance for the high values. Table 2 shows this effect for various values of resistance at 100 MHz.

It is important to realize that these reactances are inherent in the construction of the component. A 100-pF capacitor bypasses at 300 MHz better than a larger value, and often several in parallel must be used to achieve adequate bypassing where a larger value just will not do the job.

Keep that emitter grounded

A third area where stray reactances can be combated is in the design of the circuit configuration itself. The configuration of the rf circuitry is largely dictated by external factors such as impedance-matching considerations. The selection of a biasing scheme, however, is largely at the discretion of the designer.

The biasing circuitry stabilizes the operating points of the active devices against changes in dc conditions that result from variations between units and from changing environmental conditions.

The most commonly used biasing scheme is the three-resistor approach (Fig. 2) in which emitter degeneration is employed to stabilize the collector current. The current through the base bleeder resistors is made large compared with the base current to keep the voltage at the base terminal constant. A diode in the bleeder chain compensates for variations in V_{BE} due to temperature.

Changes in collector current cause corresponding changes in the voltage drop across the emitter resistor. This, in turn, varies the base current in the direction that tends to counteract the original change in collector current. The heavier the base bleeder current and the larger the emitter resistor, the better the stability.

Unfortunately, because of component limitations, it is very difficult to do an effective job of bypassing at vhf and uhf. This is especially true of the emitter terminal of a transistor since a small impedance at this point has a considerable effect on the operation of an amplifier.

Thus, if the three-resistor approach is used, gain will suffer because of bypassing difficulties. A further objection is that the dynamic range of the amplifier is reduced by the voltage across the emitter resistor since it subtracts from the available collector swing.

A way out of this difficulty* is to operate the rf transistor with its emitter grounded, and to use a second transistor as a feedback amplifier to stabilize the collector current (Fig. 3).

Stability is achieved by sampling the current in R_1 , and amplifying the changes with Q_2 . This, in turn, changes the base current of Q_1 , which reduces the change in Q_1 collector current.

Since the variations in collector current are controlled by the product of the betas of the two transistors, the series resistor (R_1), can be made much smaller than it could be with the three-resistor method for the same degree of stability. The dynamic range of the amplifier is thus increased.

This increase, however, is just a by-product of the biasing system. The primary goal is the elimination of stray reactances associated with bypassing of the emitter resistor in the three-resistor method. ■■

*Editor's Note: This technique was developed independently and approximately concurrently by the authors and Horwitz (Ref. 1).

Reference:

1. Jerome H. Horwitz, "Design Wideband Uhf Power Amplifiers," *Electronic Design* (ED 11), May 24, 1969, p. 75.

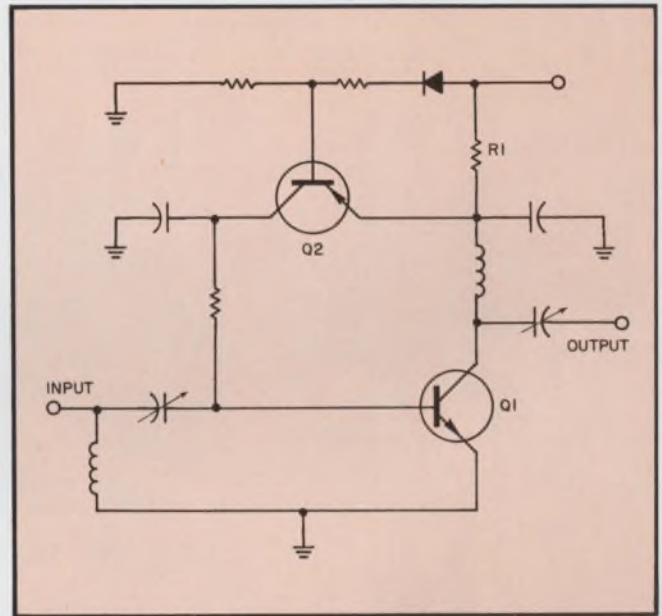

3. By employing feedback to stabilize the collector current, this design permits the emitter of Q_1 to be grounded. Transistor Q_2 is the active element in the feedback loop whose input is the voltage across R_1 .

Test your retention

Here are questions based on the main points of this article. Their purpose is to help you make sure you have not overlooked any important ideas. You'll find the answers in the article.

1. How does the boundary method of layout reduce stray inductances in rf circuits?

2. Is it advisable to use double-clad board when employing the boundary method?

3. What rule should be applied to the selection of components in an rf circuit?

4. Why is it desirable to operate rf transistors with their emitters grounded?

5. How can a transistor be biased for Class A operation when its emitter is grounded?

Dow Corning presents four new star performers on the electronic circuit.

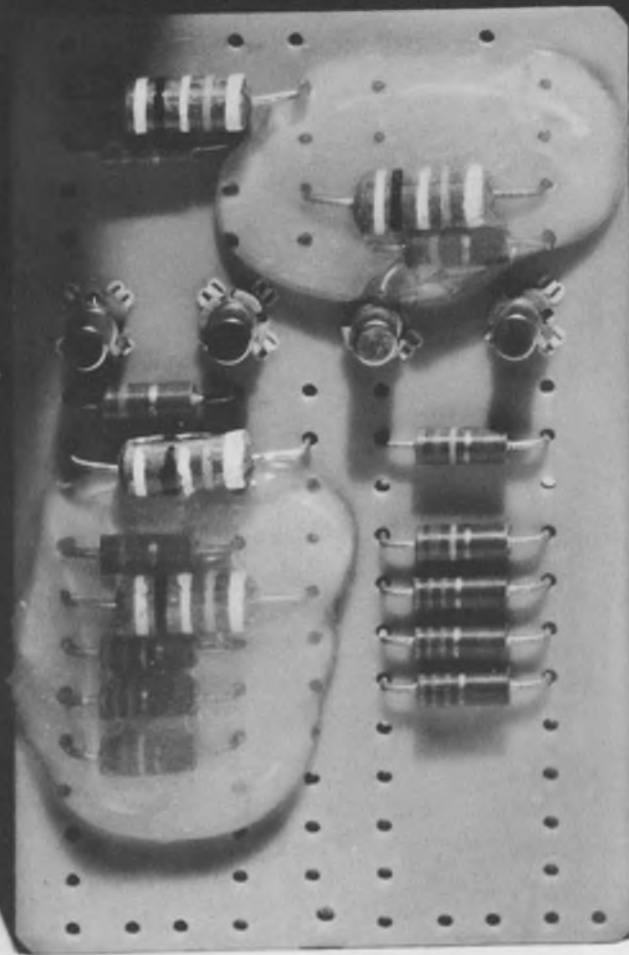

Now you see it

New Dow Corning® 3144 noncorrosive RTV adhesive/sealant is translucent to clear. You should see the job it does for corrosion-sensitive electrical or electronic equipment. It's a high-strength adhesive, too, cures at room temperature, and remains stable when the heat's on (long term to 250°C, short term to 300°C).

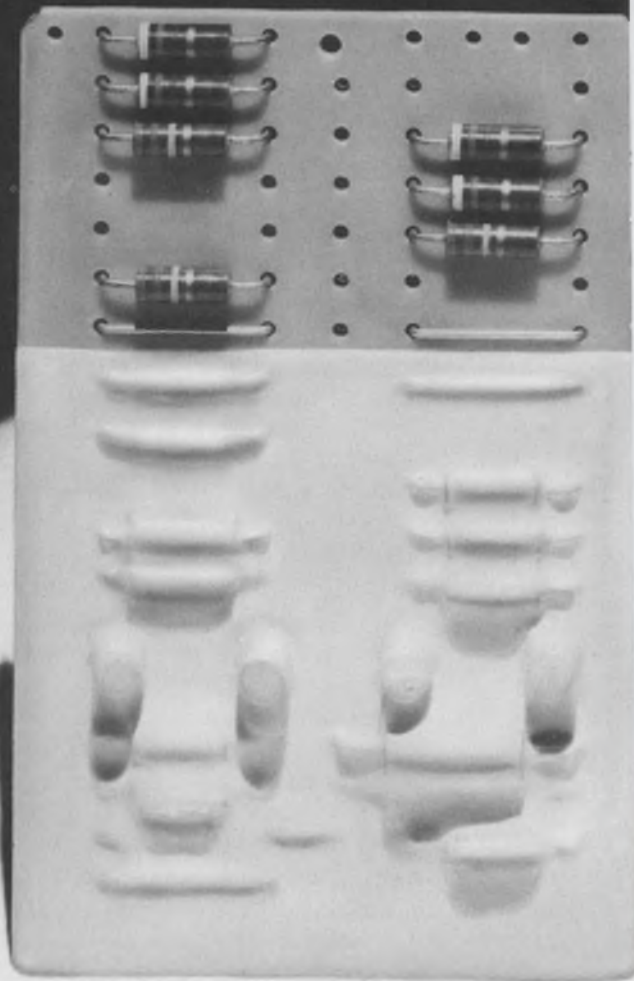

Now you don't

In case you have something to cover, use new opaque (white) Dow Corning® 3141 noncorrosive RTV coating. A new cross-linking prevents the buildup of corrosive by-products during cure. It's easily processed, easy to repair, and stays rugged in harsh environment.

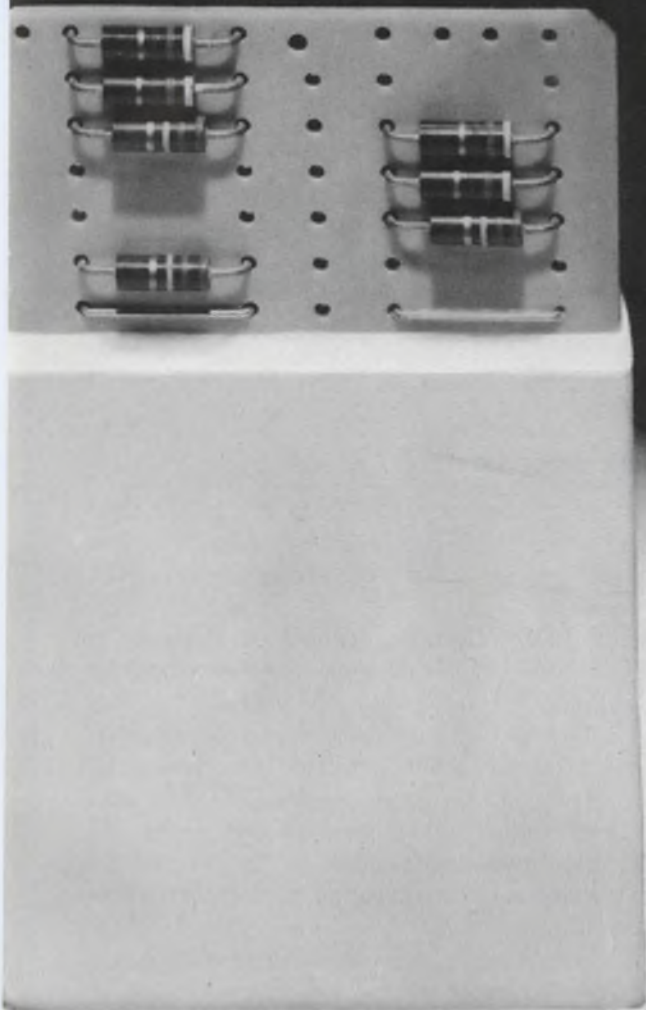

Effective immediately

New Dow Corning® 3101 low-density potting and encapsulating resin is ready for service right after cure. No postcure is necessary. And it cures in unlimited thicknesses in 24 hours at room temperature. It's great for potting aerospace electronic systems or for anywhere you need low-density and reversion resistance.

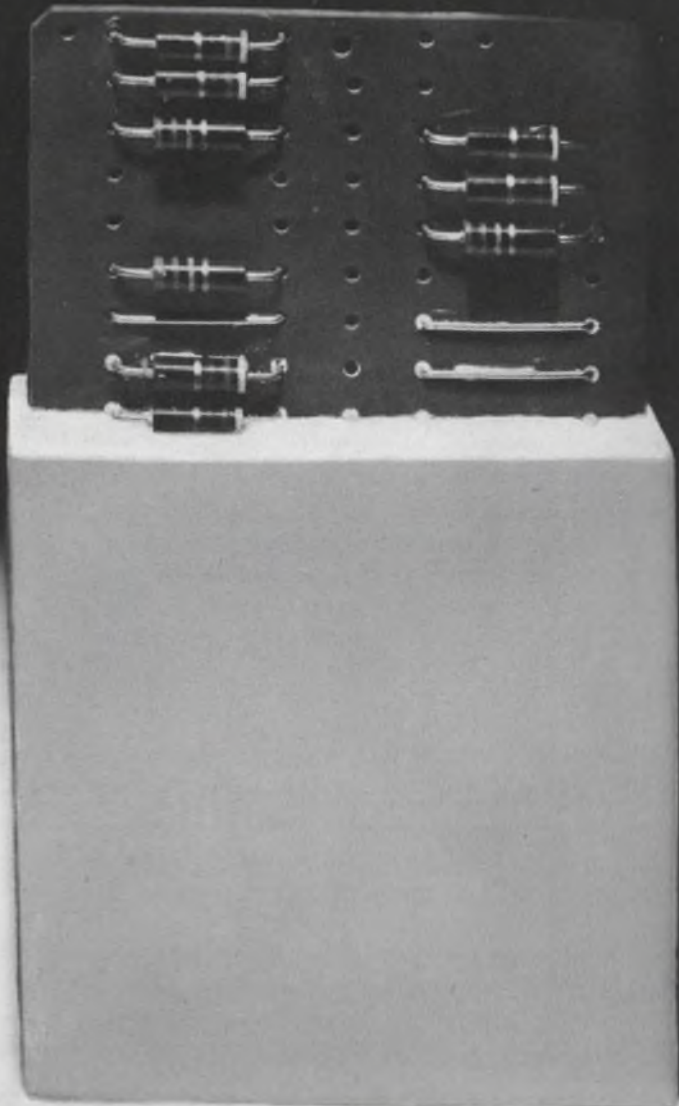

Set for life

New one-part, premixed, Sylgard® 3150 encapsulating resin lives a long life in extreme environments. It's a white, one-part, free-flowing low-viscosity encapsulant that heat cures in deep sections and is compatible with almost all material used in electronic assemblies.

There are many more encapsulants, coatings, and adhesive/sealants where these came from. Learn about them. On your letterhead, write Dept. B-9300, Dow Corning Corporation, Midland, Michigan 48640.

*Electrical/Electronic
materials from*

DOW CORNING

DOW CORNING

INFORMATION RETRIEVAL NUMBER 67

Join the 'experts'—publish!

This author-engineer offers pointers designed to familiarize the engineer with the publication process.

One of the most direct roads to professional recognition is the one marked "Publication." The company man who has articles, or technical papers published on a regular basis becomes an "expert," whose opinions have been recognized. And this recognition is to management roughly equivalent to watching one's wife receive an appreciative glance from a stranger.

If publication does not affect attitudes very much where you are presently employed, watch a prospective employer take interest when you show him a collection of your printed work. The published article is usually acceptable evidence that one is dealing with an expert in technology.

The natural barriers to writing

If being published, then, is a promising route to fame, why haven't more engineers written technical articles? Perhaps they would if they weren't stymied by the natural barriers to writing.

Inertia and *procrastination* are two of the highest obstacles the unpublished author has to overcome. The man who wants recognition and promotion, however, must be willing to exact the price from his limited budget of time and physical capacity.

Another barrier for potential authors is the one they build for themselves when they decide that their ideas are *not worthy of publication*. This attitude is based on the notion that a technical magazine should communicate only specialized information from the frontiers of technical research. Alas, only so many people are capable of manning those frontiers. The rest of us must concern ourselves with the small piece of technology we have carved out for ourselves.

Too often, the prospective author decides that his offerings, which might not be sufficiently theoretical for the scientific journals, are "unworthy." How often have you been unimpressed with a feature article in a business publi-

cation simply because you felt that you could have written the same article yourself? And you probably could have, because someone with a background similar to yours did. We assume that what we know is common knowledge to everyone working in our field, but an idea does not have to be new to be publishable, if it is given a special and different treatment.

The publication 'maze'

One of the most prevalent barriers to writing is unfamiliarity with the seeming "maze" of the publication process. But the steps are simpler than you think.

Assume that you have decided you want to publish an article. First, look for help within your company. If you work for a company progressive enough to recognize the enormous publicity potential of good articles and technical papers, search out the man responsible for that activity and follow his advice to the letter. If no such department exists, talk to the company's technical writers or advertising and public-relations specialists.

If you cannot get help from your company, you can help yourself providing that you:

- Determine the significance of your subject by asking yourself if you, as a technical man in your specialty, would be interested in reading about it. More important: Will this information be helpful to the reader in performing his job? (This, incidentally is a major criterion of business-magazine editors in judging manuscripts.) If you can honestly say that your idea is interesting, helpful, and as far as you know, not previously treated in just this way, then the subject is probably appropriate for publication.

- Determine if your potential subject lends itself to magazine treatment. To do this you must define the subject matter so that you can complete your article within a limit of about 2000 to 5000 words. That range is not rigid. Some magazines will serialize an important and interesting subject. And there is always space for the one-page or shorter feature items.

Roger M. D'Aprix, Manager, Management Communications, Xerox Corp., Rochester, N. Y.

PROOFREADERS' MARKS

Marks	Explanation	Marks	Errors Marked
<i>h</i>	Take out letter, letters, or words indicated.	<i>h</i>	He marked the <u>proof</u> .
#	Insert space where indicated.	#	He marked <u>the</u> proof.
<i>9</i>	Turn inverted letter indicated.	<i>9</i>	He marked the proof.
<i>h</i>	Insert letter as indicated.	<i>h</i>	He maked the proof.
<i>lc</i>	Set in lower-case type.	<i>lc</i>	He <u>X</u> arked the proof.
<i>wf</i>	Wrong font.	<i>wf</i>	He marked the proof.
<i>x</i>	Broken letter. Must be replaced.	<i>x</i>	He <u>r</u> arked the proof.
<i>ital</i>	Reset in italic type the matter indicated.	<i>ital</i>	He marked the <u>proof</u> .
<i>rom</i>	Reset in roman (regular) type the matter indicated.	<i>rom</i>	He marked <u>the</u> proof.
<i>bf</i>	Reset in bold-face type word, or words, indicated.	<i>bf</i>	He marked the <u>proof</u> .
o	Insert period where indicated.	o	He marked the proof.
<i>tr</i>	Transpose letters or words as indicated.	<i>tr</i>	He <u>the</u> proof marked.
<i>stat</i>	Let it stand as it is. Disregard all marks above the dots.	<i>stat</i>	He <u>marked</u> the proof.
/=	Insert hyphen where indicated.	/=	He made the proofmark.
<i>eg. #</i>	Equalize spacing.	<i>eg. #</i>	He marked <u>✓</u> the proof.
[or]	Move over to the point indicated. [if to the left; if to the right]	[He marked the proof.
]	Lower to the point indicated.]	He marked the <u>proof</u> .
[Raise to the point indicated.	[He marked the <u>proof</u> .
,	Insert comma where indicated.	,	Yes he marked the proof.
'	Insert apostrophe where indicated.	'	He marked the boys <u>proof</u> .
" "	Enclose in quotation marks as indicated.	" "	He marked it <u>proof</u> .
H	Replace with a capital the letter or letters indicated.	H	He marked the <u>proof</u> .
sc	Use small capitals instead of the type now used.	sc	He marked the <u>proof</u> .
+	Push down space which is showing up.	+	He <u>ma</u> arked the proof.
(Draw the word together.	(Sulphuric Acid is HSO.
^	Insert inferior figure where indicated.	^	$a^2 + b^2 = c^2$
^	Insert superior figure where indicated.	^	He <u>proof</u> .
<i>Out, see copy</i>	Used when words left out are to be set from copy and inserted as indicated.	<i>Out, see copy</i>	Caesar marked the proof.
<i>ae</i>	The diphthong is to be used.	<i>ae</i>	He <u>filed</u> the proof.
<i>fi</i>	The ligature of these two letters is to be used.	<i>fi</i>	He marked the <u>21</u> proof.
<i>spell out</i>	Spell out all words marked with a circle.	<i>spell out</i>	reading. <u>The</u> reader marked
¶	Start a new paragraph as indicated.	¶	marked.
<i>No ¶</i>	Should not be a separate paragraph. Run in.	<i>No ¶</i>	The proof was read by
?	Query to author. <u>Encircled in red.</u>	?	The proof read by
?	This is the symbol used when a question is to be set. Note that a query to author is encircled in red.	?	Who marked the <u>proof</u> .
=	Out of alignment.	=	He marked the <u>proof</u> .
$\frac{1}{em}$	1-em dash.	$\frac{1}{em}$	He marked the <u>proof</u> .
$\frac{2}{em}$	2-em dash.	$\frac{2}{em}$	He marked the <u>proof</u> .
$\frac{1}{n}$	En dash.	$\frac{1}{n}$	He marked the <u>proof</u> .
□	Indent 1 em.	□	<u>He</u> marked the proof.
□	Indent 2 ems.	□	<u>He</u> marked the proof.

The next step to being published is to select a target publication and to dress up your idea for submission:

Zero in on your target

- Make a list of the business magazines you find particularly useful, and establish an order of preference for the submission of your idea.
- Determine the basic objective of the article, and make an outline. It will help you decide what information should be included or left out, and how to reach the most readers.
- Next, make a few very rough sketches of the material you feel must be presented visually and, if possible, include any relevant photographs.
- Get your outline typed and write a short abstract (150-200 words) of the article.
- Find out what your company's policy is on publication clearances. Even if there is no formal approval mechanism, you would be well advised to show the material to your immediate manager and get his approval in writing. Approval routines protect the author and the company against the release of proprietary or classified information or simply "sensitive" information.
- When all the company approvals are in, put the whole preliminary package together and send it to your first choice of publishers as an exclusive offering.
- Do not send the same article outline simultaneously to six or seven editors. What would you do if they all accepted it? An editor is much more inclined to look favorably on an article idea if it carries an "exclusive" tag.

Don't be discouraged

The elapsed time from the preparation of your outline to publication of the complete article can be anywhere from three months to more than a year. The two most common reasons for the delay is that either the magazine has a large backlog of manuscripts, or the editor has not yet made a decision about your material.

Some magazines normally acknowledge receipt of outlines and make decisions within a month or less. On the other hand, some publications do not acknowledge receipt of submitted material and may take as long as two or three months to decide if they want it.

If your outline is turned down, don't be discouraged until you've received a few rejections. You may simply be trying the wrong magazines.

Let the editor polish it

Once an editor expresses interest he will usually work with you, indicating where he feels you might improve your outline. He will also set a

tentative date for submission of the manuscript. Follow his directions as carefully as you can and comply with the deadline that's set. Publication schedules are not very flexible, and you can put your editor in an embarrassing position if you leave him with three or four pages of his magazine to fill at press time.

In preparing the manuscript, concentrate on the information you are communicating. Give the maximum amount of well organized information per page, and leave the polishing to the editor. You're the technical expert, he's the writer. If he does his job well, your manuscript will probably be edited rather heavily. You may not even recognize the style as yours when he finishes, but it will be concise and readable.

Assembling the package

When you submit your company-approved manuscript to the editor, send him an original copy typed double or triple-spaced on good white bond paper. Leave wide margins. The first page should include the title of the article, your name, and company affiliation. Keep at least one copy as insurance against loss.

Any photos submitted should preferably be 8 by 10 glossy prints for good reproduction. Drawings need be only penciled sketches, but be sure they are sharp and well labeled, and separate them from the manuscript. Include captions on a separate sheet keyed to the illustrations and the text.

In most cases the editor will give you an opportunity to review his version of your manuscript before publication. He wants you to check for technical accuracy to be sure he has not misunderstood and changed your idea. And this is exactly the way you should review the manuscript: Change only the misleading or inaccurate statements.

Don't hold out for your original style, or you may very well find a polite rejection letter returned to you with your manuscript.

Recognition is the payoff

When the final package is submitted, you have nothing to do but sit back and wait for the published article—and perhaps a modest check if the magazine pays its authors an honorarium. This payment, which is strictly a fringe benefit, usually runs anywhere from \$75 to \$150 for an average-length article. The fee is not intended to be payment for your time and effort; it is simply a token sum in appreciation for your contribution.

The payoff for you, personally and professionally, is the recognition you will receive from the magazine's readers and from your own company and colleagues. ■■

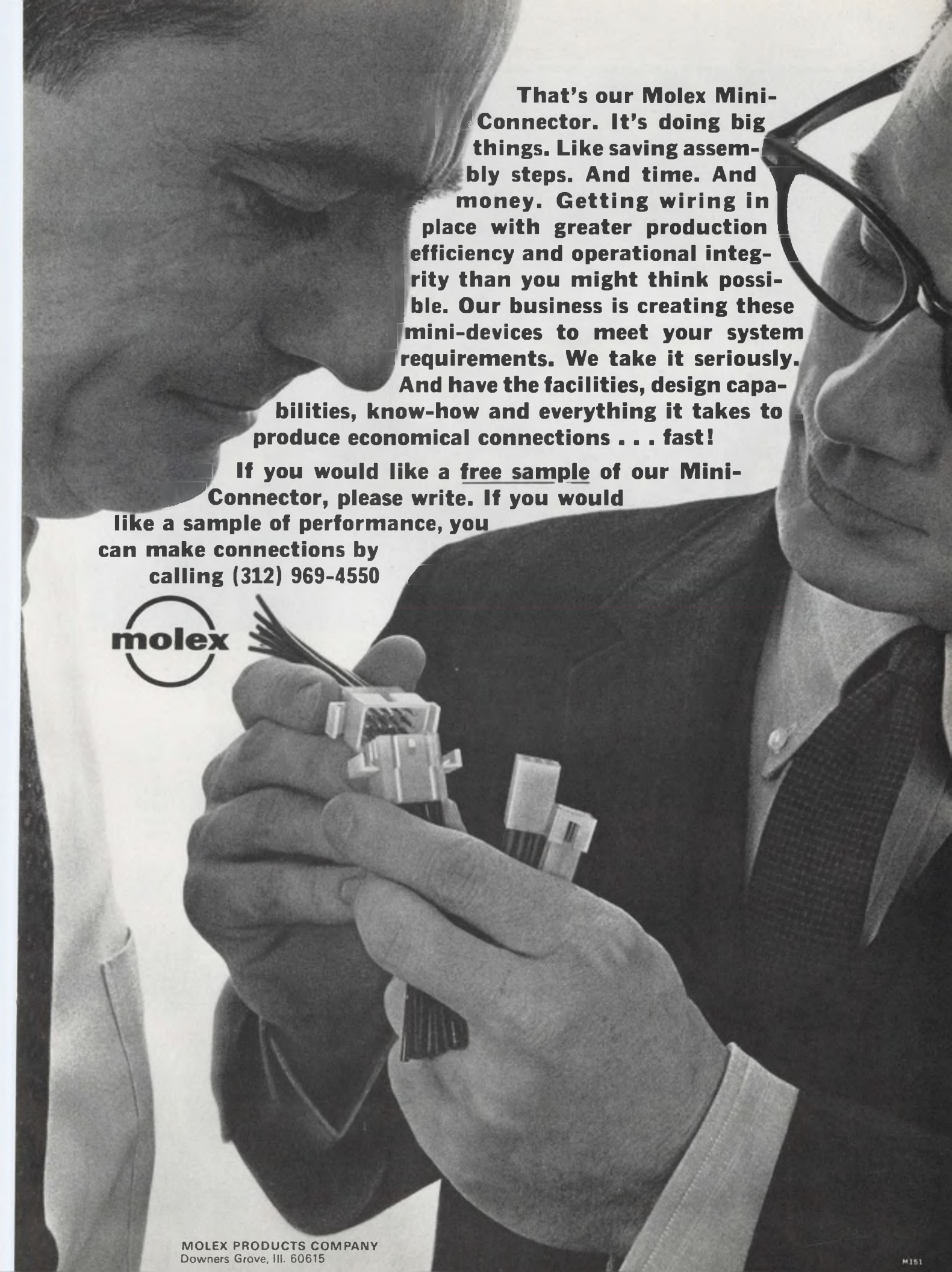

That's our Molex Mini-Connector. It's doing big things. Like saving assembly steps. And time. And money. Getting wiring in place with greater production efficiency and operational integrity than you might think possible. Our business is creating these mini-devices to meet your system requirements. We take it seriously. And have the facilities, design capabilities, know-how and everything it takes to produce economical connections . . . fast!

If you would like a free sample of our Mini-Connector, please write. If you would like a sample of performance, you can make connections by calling (312) 969-4550



After 5,000,000 bits of bipolar memory . . .

64 BITS and 16 low-power BITS

64-Bit Bipolar Memory has full TTL compatibility

Introducing the 64-bit bipolar memory cell . . . another industry "first" from Transistron, which has already produced and shipped over 5 million bits of bipolar memory. Transistron's TMC6464 is compatible with all major TTL series, and provides substantial savings in space and power requirements.

The new cell is arranged in a 16 x 4 matrix, with internal address coding and address-enable, four data inputs, four sense amplifiers, and write-enable. It operates from a nominal supply voltage of 5V, with addressing, writing and sensing voltage levels compatible with TTL logic circuitry.

The TMC6464 is available in a 16-pin dual in-line ceramic package. For many applications it provides significant advantages over the 16-bit cell:

1. Since the 64-bit cell provides its own address decoding, one package replaces six (four 16-bit cells plus two input gates)
2. System speed can be increased by as much as 50%
3. Power-per-bit is reduced over 50%

New 16-Bit Bipolar Memory Cell features low power drain

A low-power version of the 16-bit bipolar memory first introduced to the industry several years ago by Transistron is now available for immediate shipment.

The new cell reduces drive current requirements by half . . . has a power dissipation of only 175mW vs. 250mW for the standard device. This makes the unit ideal for aerospace systems and other applications using battery power.

Aside from its low power requirements, the cell is identical to the standard unit in all other characteristics, including full compatibility with all TTL devices.

Two types are presently available. The TMC3262 operates over the full military temperature range, -55° to +125°C; the TMC3264 is rated for 0° to +70°C. Both units provide 20mA fanout current, and are available in flat pack or dual-in-line package. Price is only about 10% above the standard cell.

Send for complete technical data on these
exciting new Transistron developments.

Transistron
electronic corporation
168 Albion Street, Wakefield, Mass. 01880

TRW METALLIZED POLYCARBONATES



...good things come in small packages

A 10 mfd 50 volt type X483 capacitor measures a scant .670" x 1 $\frac{1}{16}$ ". It's hermetically sealed and provides outstanding temperature stability and electrical properties. Meets all MIL-C-18312 and MIL-C-19978 requirements.

Type X483 are advanced technology capacitors tailor-made for advanced technology applications. Values from .001 to 10 mfd, 50, 100, 200 and 400 volts.

Contact TRW Capacitor Division, Box 1000, Ogallala, Neb.

INFORMATION RETRIEVAL NUMBER 70

Phone: (308) 284-3611. TWX:
910-620-0321.

TRW[®]

Fast differential amplifier has high slew rates

A direct coupled fast differential operational amplifier has a higher slew rate than is available in IC or packaged form. The amplifier has an inverting and non-inverting input. All input resistors and the feedback resistor are frequency compensated to give good differential gain and high common mode rejection to a fast step input

with a minimum of leading edge degradation and no apparent droop. With plus and minus 15 Vdc power supplies, the maximum output signal swing is over 13 volts positive and 6 volts negative from either input. A larger signal swing may be achieved with higher power supply voltages.

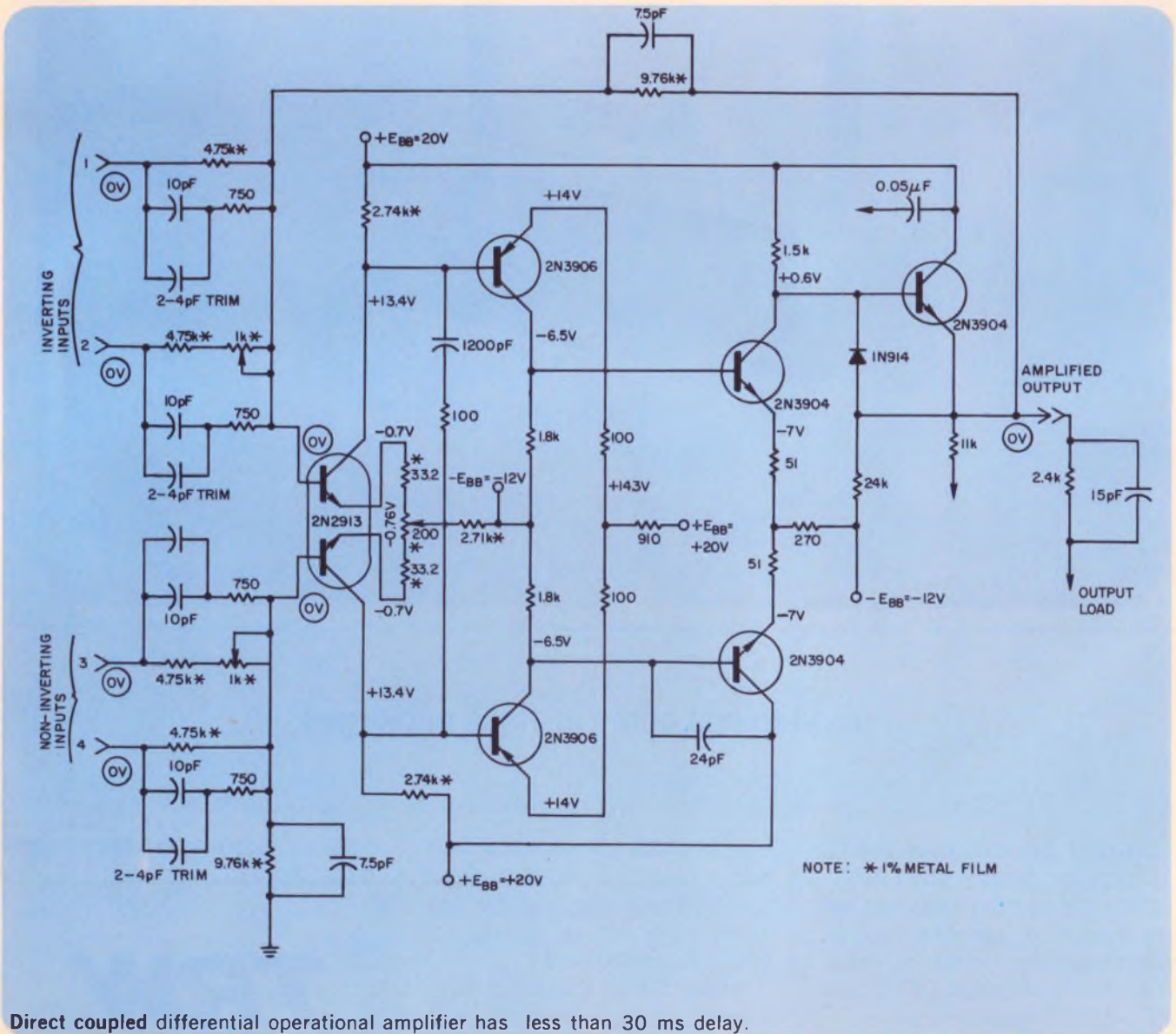

Direct coupled differential operational amplifier has less than 30 ms delay.

$\pm 50 \text{ ppm}/^{\circ}\text{C}$

in all Helipot Cermet Trimmers

This significant advance in Helipot's cermet technology is now available at only a dime/unit more . . . 100 ohms thru 2 megohms. In addition, you get essentially infinite resolution, environmental stability, reliability, no catastrophic failures — all superior to wirewound trimmers. We'll also deliver off-the-shelf, locally stocked trimmers with a standard tempco of $\pm 100 \text{ ppm}/^{\circ}\text{C}$ in the 100 ohm thru 2 megohm range.

Beckman

INSTRUMENTS, INC.

HELIPOT DIVISION

FULLERTON, CALIFORNIA • 92634

INTERNATIONAL SUBSIDIARIES: AMSTERDAM, CAPE TOWN, GENEVA, GLENROTHES, SCOTLAND, LONDON, MEXICO CITY, MUNICH, PARIS, STOCKHOLM, TOKYO, VIENNA

The operational resistors are set up for a voltage gain of 6 dB. The delay through the circuit to a fast step at any input is less than 30 nanoseconds with little signal deterioration. Output level and gain adjustment potentiometers are included. The 2 to 4 pF capacitors across the 10 pF input network capacitors are set to trim the output response.

Final balance and response trimming is not critical. However, good circuit techniques, power filtering, and a ground plane should be used. The output offset voltage is on the order of 80 microvolts/°C. This is not exceptional and may be improved if the dual input transistor (2N2913) is replaced by a dual with better matched characteristics. Also the resistors shown by "*" can be replaced with units with lower temperature coefficient. Heat sinking to the ground plane is used on all transistors.

To obtain a greater gain than 6 dB the input

resistor values may be reduced to increase the feedback input resistor ratio. More input resistors than two may be assumed on each input. Remember to keep the resistance into the inverting and non-inverting inputs equal and to properly compensate them. This insures that the absolute value of gain from either input to output is equal. The input resistors values shown were chosen to make the loading presented to the input drive circuitry similar to a large variety of switching circuitry. For practical purposes this amplifier can be treated as either a linear circuit or as a logic "black box." When used as a logic element it has the advantage of allowing logic signals to be added, subtracted, inverted, amplified, or offset. Signals to be processed are applied at inputs 2 and 3 while constant offset voltages are applied at inputs 1 and 4.

D. A. Paris, Design Engineer, Andersen Labs., Inc., Bloomfield, Conn. VOTE FOR 311

Symmetrical threshold converter operates over wide conditions

The requirements for precise conversion of a sine-wave input to symmetrical square-waves under large variations of both temperature and input amplitude may pose a difficult problem for the circuit designer. Present techniques for such conversion are adequate under limited and specified conditions; generally, though, they suffer

when applied in an environment of widely fluctuating temperature or input amplitude.

The simple circuit shown in Fig. 1 provides accurate sine- to square-wave conversion even when the input amplitude varies from a few millivolts to many volts peak (assuming limit protection) and under mil-spec temperature ranges. Two $\mu A710$ comparators and a DT $\mu L946$ logic element (wired as a set-reset flip-flop) are used in the circuit, which makes full use of the advantage of the IC comparators, and even makes use of an undesirable feature—input offset.

Due to the inherent matching of the comparators, their quiescent as well as dynamic offsets closely duplicate and track each other. By operating the comparators in a complementary fashion, symmetry is preserved, since the phase shift caused by the negative offset is added to that caused by the positive offset (Fig. 2). This is implemented by having the set-reset action occur with the leading edges of the comparator outputs.

Random pairing of four sets of $\mu A710$ s with a common flip-flop, and operating the circuit at 1 kHz, revealed a maximum symmetry error of under one per cent when: (1) the sine-wave input was varied between 300 mV and 10 V,

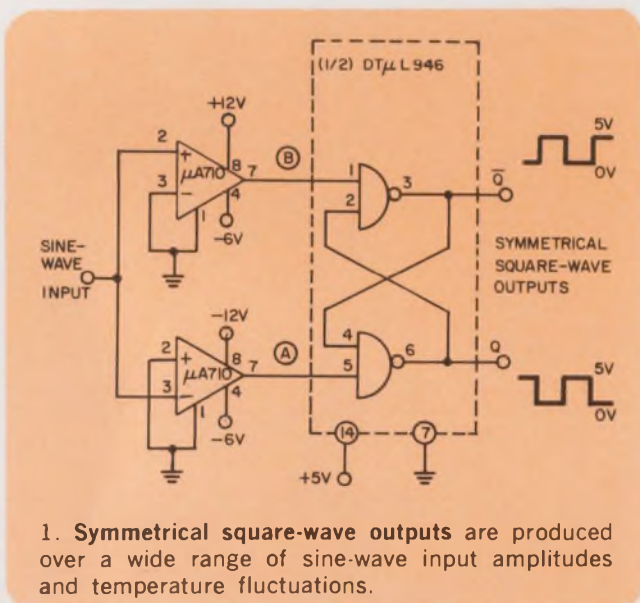

new

16 CHANNEL ANALOG MULTIPLEXER

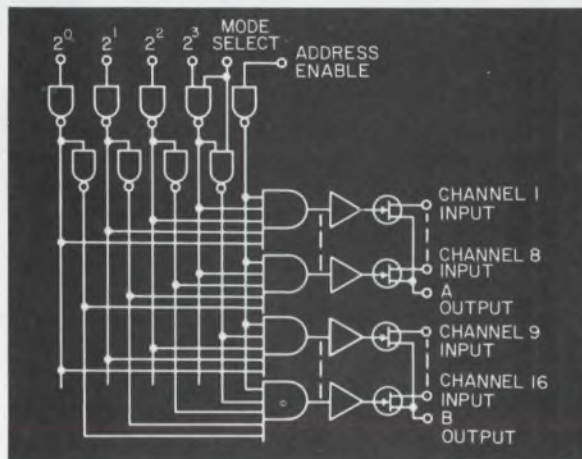

The first LSI subsystem employing NPN's, PNP's and J-FET's in a monolithic structure.

- Bipolar signal handling range in excess of 20 volts
- Full military temperature range
- Lowest input leakage current
- Most versatile multiplexer with random access capability
 - 16 channel
 - Dual 8 channel
 - Differential 8 channel
 - Enable input for all channel blanking or address expansion
- TTL address decoding logic for TTL or DTL compatibility
- Complies with MIL-STD-883
- Off-the-shelf delivery

You get the BEST IC for the job from Radiation's fast expanding linear line.

P. O. Box 476, Lexington, Massachusetts 02173
Area Code 617, 862-1055

600 Old Country Road, Garden City, New York 11530
Area Code 516, 747-3730

2600 Virginia Avenue, N.W., Washington, D.C. 20037
Area Code 202, 337-4914

P. O. Box 30667, Dallas, Texas 75230
Area Code 214, 231-9031

6151 West Century Boulevard, Los Angeles,
California 90045 - Area Code 213, 670-5432

260 Shendan, Palo Alto, California 94306
Area Code 415, 321-2280

P. O. Box 37, Melbourne, Florida 32901
Area Code 305, 727-5430

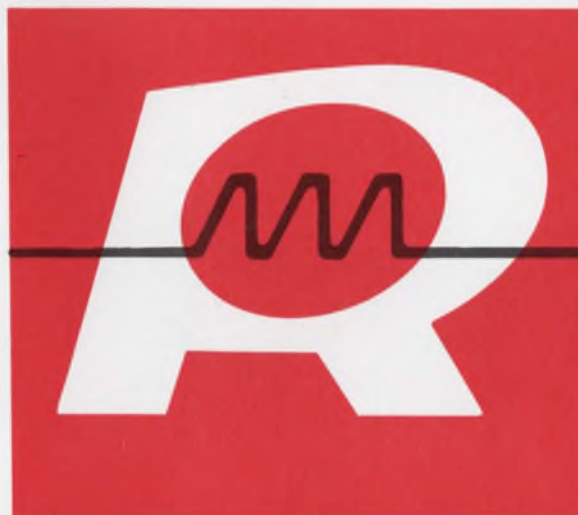

RADIATION
INCORPORATED
SUBSIDIARY OF HARRIS-INTERTYPE CORPORATION
MICROELECTRONICS DIVISION

INFORMATION RETRIEVAL NUMBER 72

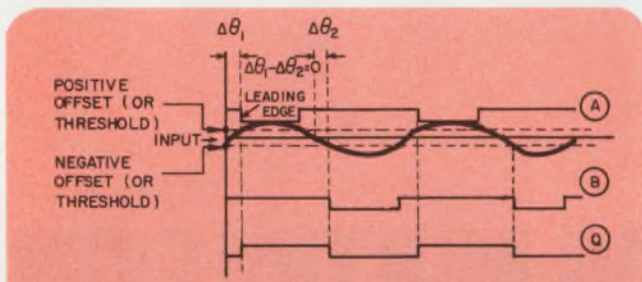

2. Symmetry of the output at Q results because the positive and negative offsets, which are essentially equal and opposite in polarity, produce equal but opposite phase shifts.

peak-to-peak, at ambient temperature, and (2) the temperature was varied from 0° to 60°C in an oven with the input amplitude held at 1 V, peak-to-peak. Selective matching of the $\mu A710$ s

for offset parameters should yield far smaller symmetry errors.

Although the source impedance should be kept as low as possible to allow maximum input-amplitude range, the effects of input bias current are negligible. This is again due to the complementary operation.

The circuit can be modified easily to include threshold adjustments for any degree of noise immunity without affecting output symmetry. Threshold adjustments may also be incorporated without affecting symmetry.

The frequency range of the circuit extends from virtually dc to approximately 6 MHz. It is worth mentioning that—due to the nature of the circuit—its construction on a single monolithic IC chip could render it a near-ideal device.

George Oshiro, Consulting Engineer, Los Angeles, Calif. VOTE FOR 312

Tunnel-diode VCO is both linear and inexpensive

Voltage-controlled oscillators (VCOs) for high frequencies are usually built with varicap-tuned oscillators. However, the output frequency of such units is not linear with varicap voltage. Complicated nonlinear networks are, therefore,

needed at the input.

These difficulties can be overcome by using a tunnel-diode oscillator for the VCO. A circuit of this type, which can be tuned from 60 to 80 MHz, is shown in Fig. 1.

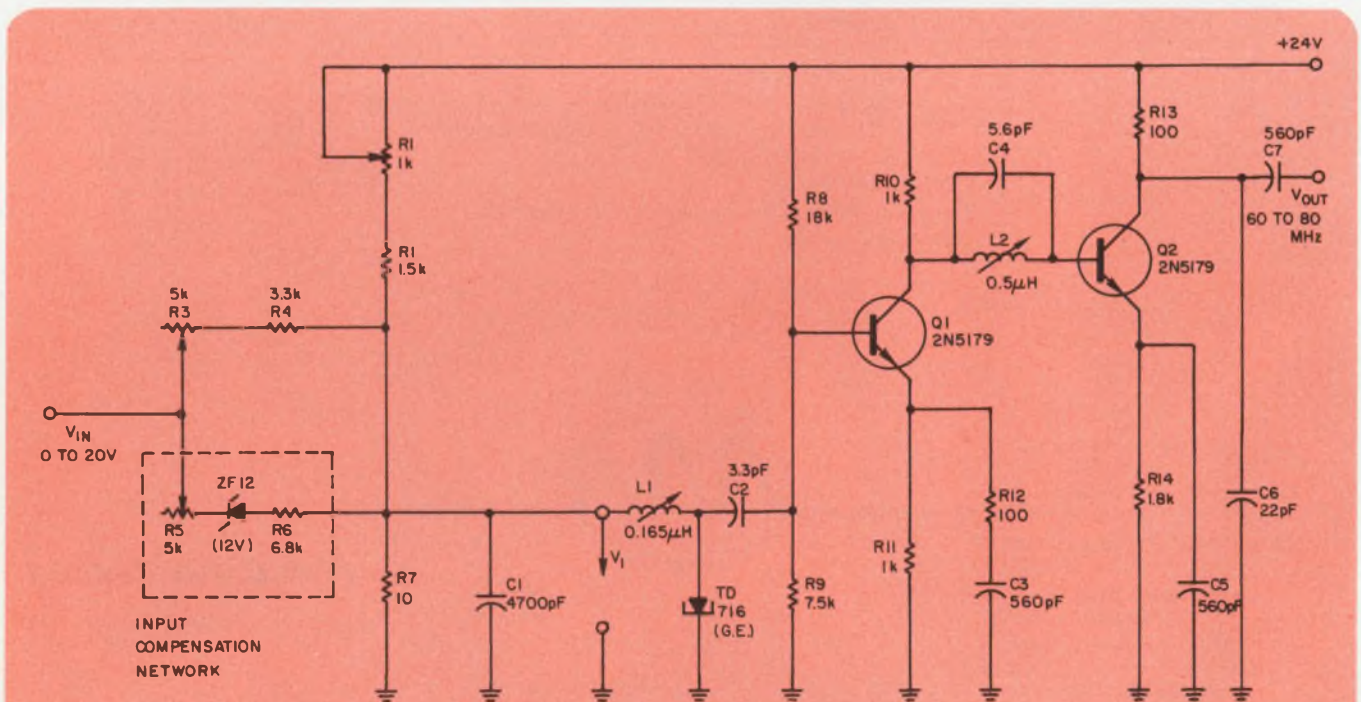

1. Tunnel diode oscillator forms the basis of this linear VCO. The output voltage level is constant within $\pm 2\%$.

new

HIGH SLEW RATE AMPLIFIER

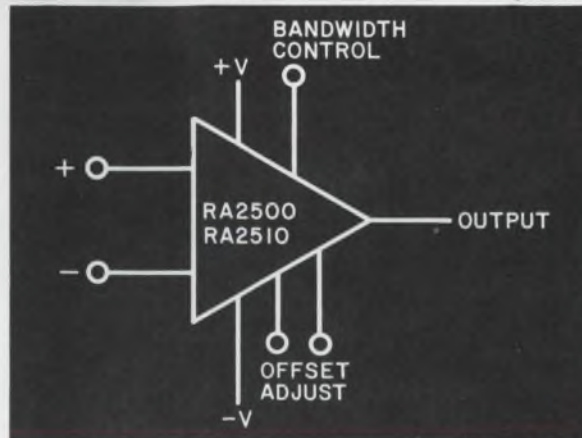

- The highest speed fully compensated-stable at unity gain-Op Amp available today
- Full military temperature range
- Complies with MIL-STD-883
- Off-the-shelf delivery

	RA-2510	RA-2500
• Slew Rate (at unity gain)	$\pm 50\text{v}/\mu\text{s min.}$	$\pm 25\text{v}/\mu\text{s min.}$
• Gain	15000	35000
• Large Signal Bandwidth	500 KHz	200 KHz
• Gain Bandwidth	15 MHz	15 MHz
• Offset Current	20 nA	20 nA
• Offset Voltage	2 mV	2 mV
• Output Current	$\pm 20\text{mA}$	$\pm 20\text{mA}$
• Input Impedance	50 megohms	25 megohms

You get the BEST IC for the job from Radiation's fast expanding linear line.

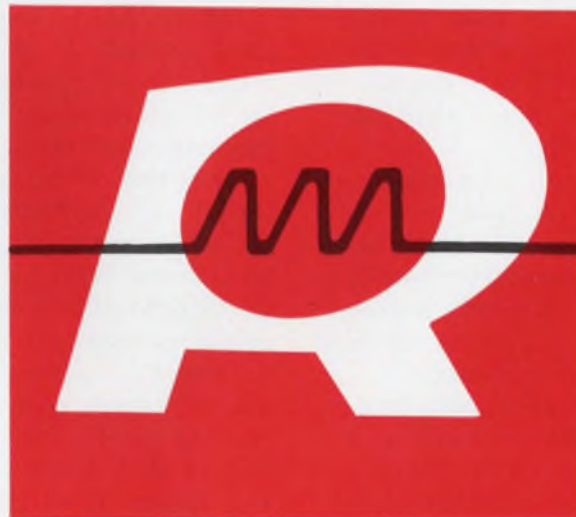

RADIATION
INCORPORATED
SUBSIDIARY OF HARRIS-INTERTYPE CORPORATION
MICROELECTRONICS DIVISION

P. O. Box 476, Lexington, Massachusetts 02173
Area Code 617, 862-1055

600 Old Country Road, Garden City, New York 11530
Area Code 516, 747-3730

2600 Virginia Avenue, N.W., Washington, D.C. 20037
Area Code 202, 337-4914

P. O. Box 30667, Dallas, Texas 75230
Area Code 214, 231-9031

6151 West Century Boulevard, Los Angeles,
California 90045 - Area Code 213, 670-5432

260 Sheridan, Palo Alto, California 94306
Area Code 415, 321-2280

P. O. Box 37, Melbourne, Florida 32901
Area Code 305, 727-5430

INFORMATION RETRIEVAL NUMBER 73

In the circuit, the tunnel diode and inductance L_1 function as a relaxation oscillator. The tunnel diode is a low-cost type, and has a 5 mA peak-point current. For an input control voltage V_1 , the output frequency is given by:

$$f = K \times \frac{V_1}{L_1 (I_p - I_v)} \times \frac{V_v - 0.8 \times V_1}{V_v} \quad (1)$$

where V_p and I_p are the peak-point characteristics and V_v and I_v are the valley-point characteristics of the tunnel diode. K has a value between 0.6 and 0.8. Oscillation occurs at

$$V_p < V_1 < V_v \quad (2)$$

Since $(V_v - 0.8 \times V_1)$ is the nonlinear term in Eq. 1, V_1 should be chosen as small as possible.

For a limited sweep width of 30%, a linearity of better than $\pm 1\%$ can be obtained, as shown in Fig. 2. Potentiometer R_1 adjusts the starting point at low frequencies (point A in Fig. 2), and R_3 sets the frequency-voltage ratio of 1 MHz/V.

An additional input network, containing R_5 , R_6 and zener ZF-12 can be used to improve the linearity-error to better than $\pm 0.4\%$, as shown by curve c in Fig. 2. The function of R_1 in this case is the same. The portion A-B of curve b in Fig. 2 can be adjusted by R_5 , and the portion B-C by R_6 .

Stages Q1 and Q2 make up a buffer amplifier that isolates the oscillator from the output. The input time constant of the buffer is determined by capacitor C_2 , to compensate for the voltage drop of the oscillator at high frequencies. The higher harmonics of the relaxation oscillator are

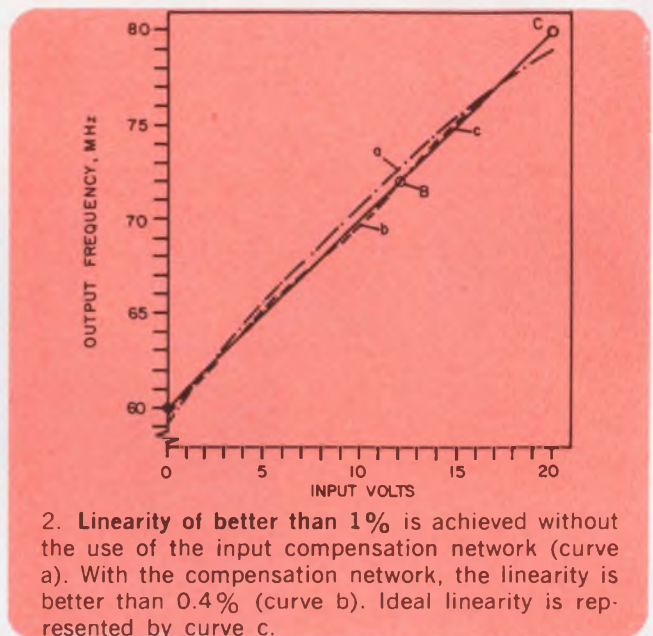

2. Linearity of better than 1% is achieved without the use of the input compensation network (curve a). With the compensation network, the linearity is better than 0.4% (curve b). Ideal linearity is represented by curve c.

damped by a π -lowpass filter, consisting of L_2 and C_1 , together with the output impedance of Q1 and the input impedance of Q2.

The output voltage level from the circuit is 0.1 V rms, $\pm 2\%$, over the entire frequency range.

Willi K. Rychetsky, Dipl.-Ing., Institut fuer Allgemeine Nachrichtentechnik, T. H. Darmstadt, Germany

VOTE FOR 313

Schmitt trigger and comparator combine to form window detector

Window detectors are used to pass signals when a control voltage is between two preset levels. A Schmitt trigger and a differential comparator, when combined, allow independent adjustment of the on and off levels.

Transistors Q1, Q2 and Q3 with associated resistors form a complementary Schmitt trigger with a differential input (Fig. 1). This configuration provides good temperature stability of the trigger level set by R9. R3 allows adjustment of the hysteresis from millivolts up to about one volt according to requirements.

Transistors Q5, Q6 and associated components make up a differential comparator Q4 acts as a switch. The comparator is similar to the Schmitt, but it has no positive feedback and no hysteresis.

Initially Q3 is held on by the V_1 level set at its base and Q6 is held on by V_2 . When V_{in} reaches V_1 , Q2 conducts and switches Q1 on and Q3 off, allowing the supply voltage to appear at the output terminal. V_{in} , continuing to increase, reaches the reference level V_2 which is greater than V_1 . Q5 conducts and switches Q4 on and Q5 off, allowing the supply voltage to appear at the Q4 collector. This increases V_1 above V_{in} causing Q3 to conduct and cutting Q2 and Q1 off. The output voltage falls to zero.

Thus V_{out} is zero until V_{in} becomes greater than V_1 where upon V_{out} becomes 15 volts. V_{out} remains at 15 volts until V_{in} becomes either greater than V_2 or less than V_1 at which point V_{out} reverts to zero. The window is "open" as

new

HIGH INPUT IMPEDANCE OP AMP

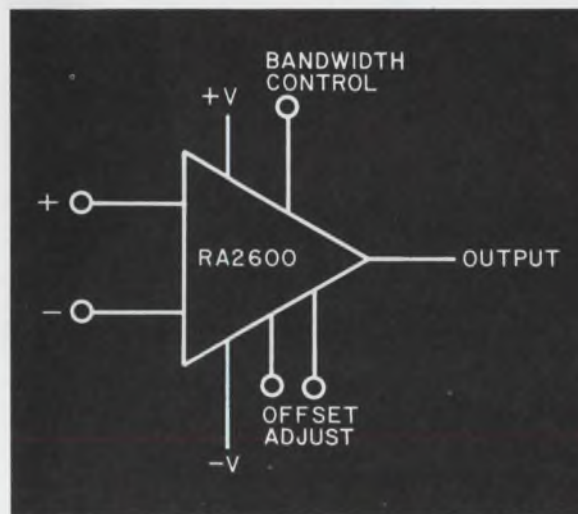

- Input Current = 3 nA
- Input Impedance = 50 megohms
- Slew Rate (at unity gain) = $\pm 5\text{v}/\mu\text{s}$
- Gain = 200,000
- Gain Bandwidth = 12 MHz
- Short Circuit Protected
- Fully compensated (stable at unity gain)
- Full military temperature range
- Complies with MIL-STD-883
- Off-the-shelf delivery

You get the BEST IC for the job from Radiation's fast expanding linear line.

P. O. Box 476, Lexington, Massachusetts 02173
Area Code 617, 862-1055
600 Old Country Road, Garden City, New York 11530
Area Code 516, 747-3730
2600 Virginia Avenue, N.W., Washington, D.C. 20037
Area Code 202, 337-4914
P. O. Box 30667, Dallas, Texas 75230
Area Code 214, 231-9031
6151 West Century Boulevard, Los Angeles,
California 90045 • Area Code 213, 670-5432
260 Sheridan, Palo Alto, California 94306
Area Code 415, 321-2280
P. O. Box 37, Melbourne, Florida 32901
Area Code 305, 727-5430

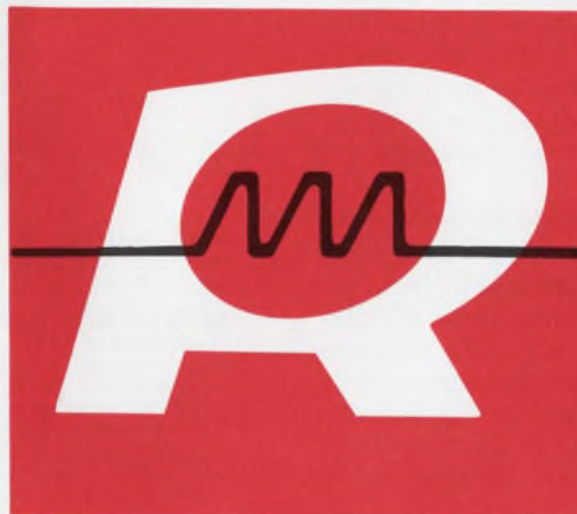

RADIATION
INCORPORATED
SUBSIDIARY OF HARRIS-INTERTYPE CORPORATION
MICROELECTRONICS DIVISION

INFORMATION RETRIEVAL NUMBER 74

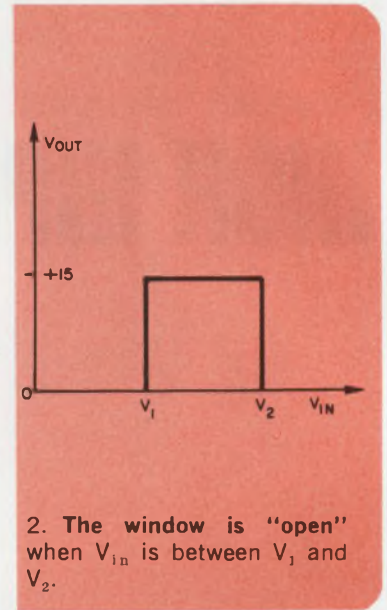
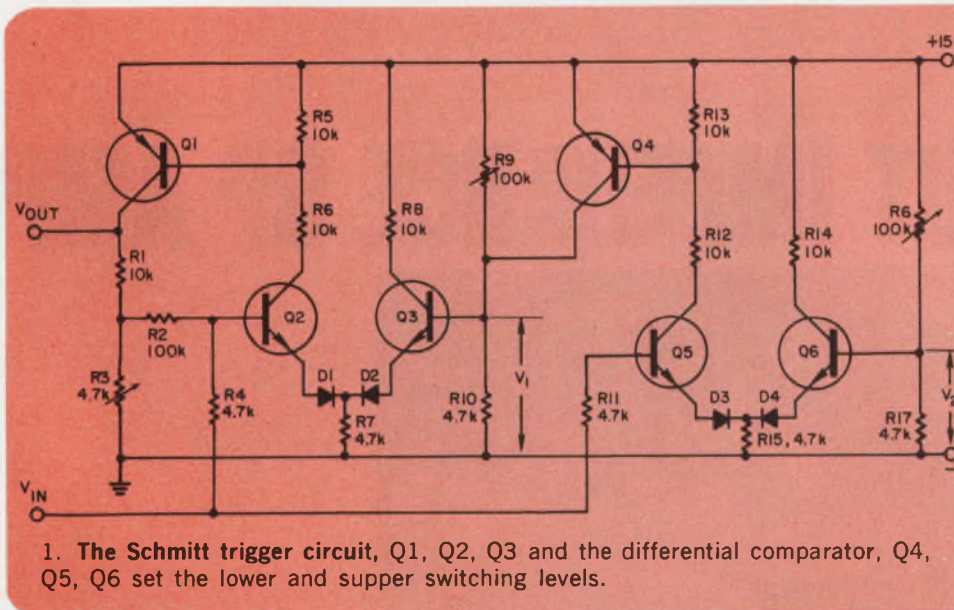

long as V_{out} is high.

A plot of V_{out} vs V_{in} is shown in Fig. 2. Several differential comparators similar to the Q4, Q5, Q6 circuit can be cascaded allowing several windows (or gaps) to be detected. Diodes, D1, D2, D3, D4, protect the emitter-base junctions of

transistors from reverse breakdown.

Convenient semiconductors are 2N2219 or 2N1711 for Q2, Q3, Q5, Q6, 2N2905 for Q1 and Q4 and 1N914 for the diodes.

Robert L. Billon, Design Engineer, U N I T E C, Grenoble, France.

VOTE FOR 314

Reduce common mode voltage in multiplexed systems

In a data handling system one of the main problems is the reduction of stray capacitance between the amplifier input terminals and ground. A typical installation is shown in Fig. 1A and is redrawn as a bridge in Fig. 1B. The capacitance between the transducer leads and the cable shield is not shown in Fig. 1B. This is because the shield is connected to the common mode voltage also and the capacitance between it and the leads is therefore bootstrapped.

If $\frac{R_1}{R_2} = \frac{C_2}{C_1}$ the bridge is unbalanced and com-

mon mode will be fed into the amplifier to be amplified along with the genuine signal thereby reducing the signal to noise ratio. The problem is particularly acute when a multiplexing switch is being used to switch a number of transducers to the same amplifier as it is difficult to completely screen the multiplexer. A solution is shown in Fig. 2.

The common mode voltage, taken from the shield, is amplified by a non-inverting amplifier with a gain of two and applied via capacitors C_3

VOTE

VOTE! Go through all Idea-for-Design entries, select the best, and circle the appropriate number on the Reader-Service-Card.

SEND US YOUR IDEAS FOR DESIGN. You may win a grand total of \$1050 (cash)! Here's how. Submit your IFD describing a new or important circuit or design technique, the clever use of a new component or test equipment, packaging tips, cost-saving ideas to our Ideas-for-Design editor. You will receive \$20 for each accepted idea, \$30 more if it is voted best-of-issue by our readers. The best-of-issue winners become eligible for the Idea Of the Year award of \$1000.

new

PARTY-LINE RECEIVER

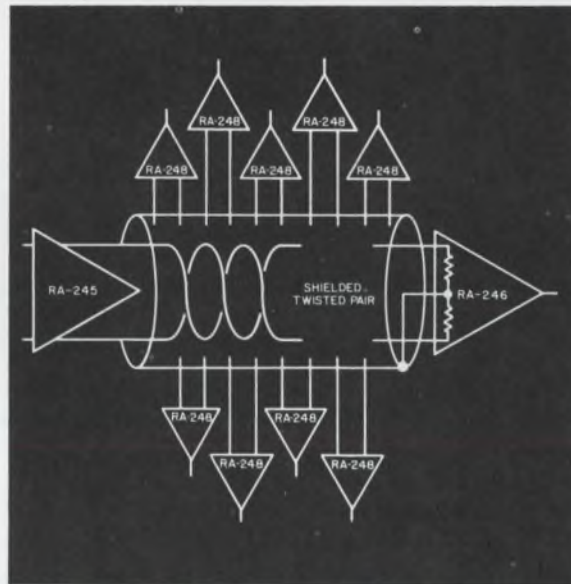

- 10 Party-Line Receivers driven by a line transmitter
- Balanced current mode eliminates switching transients
- Extremely low power consumption
- 3 circuits per package
- No standby power required for idle circuits
- Compatible with TTL and DTL
- Full military temperature range
- Complies with MIL-STD-883
- Off-the-shelf delivery

You get the BEST IC for the job from Radiation's fast expanding linear line.

P. O. Box 476, Lexington, Massachusetts 02173
Area Code 617, 862-1055

600 Old Country Road, Garden City, New York 11530
Area Code 516, 747-3730

2600 Virginia Avenue, N.W., Washington, D.C. 20037
Area Code 202, 337-4914

P. O. Box 30667, Dallas, Texas 75230
Area Code 214, 231-9031

6151 West Century Boulevard, Los Angeles,
California 90045 • Area Code 213, 670-5432

260 Sheridan, Palo Alto, California 94306
Area Code 415, 321-2280

P. O. Box 37, Melbourne, Florida 32901
Area Code 305, 727-5430

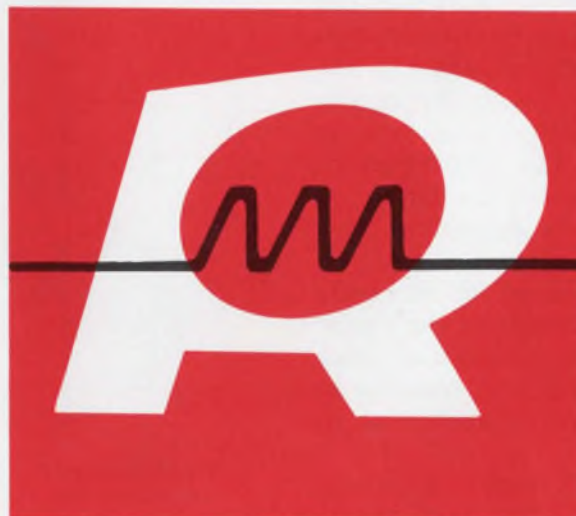

RADIATION
INCORPORATED
SUBSIDIARY OF HARRIS-INTERTYPE CORPORATION
MICROELECTRONICS DIVISION

INFORMATION RETRIEVAL NUMBER 75

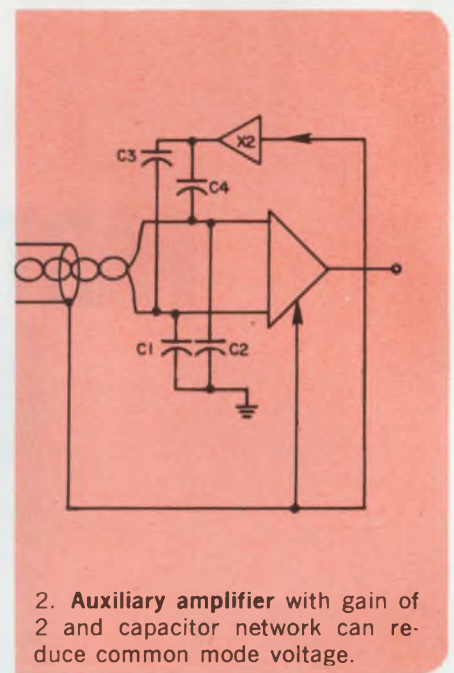
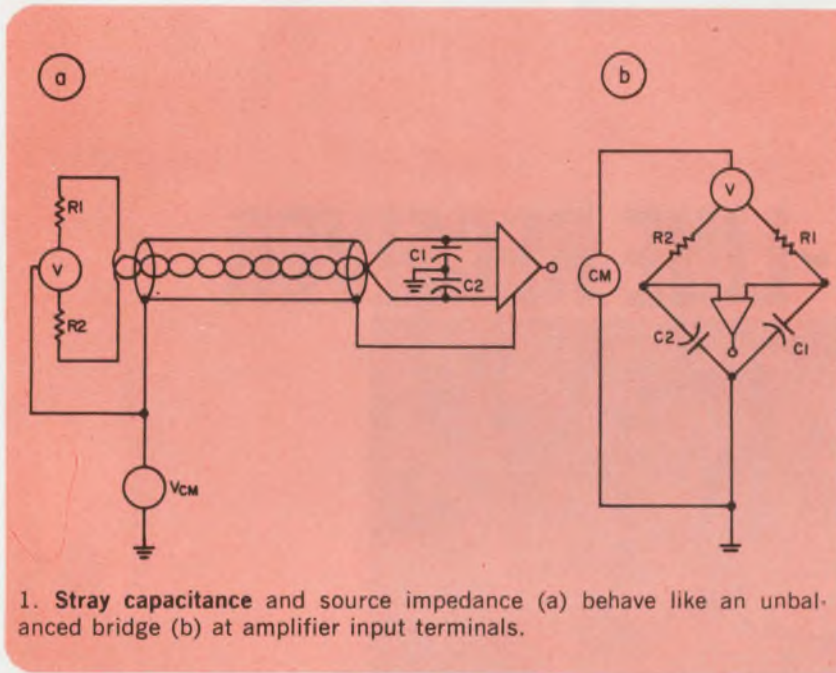

and C_1 to the amplifier inputs. The ac currents which were formerly drawn from the transducer are now supplied from the X 2 amplifier.

In practice the gain of the X 2 amplifier is not critical and it does not need, in view of the final ac coupling, to be level stabilized. It is set to approximately X 2, a 1000 ohm assymetry is introduced into one side of the input and C_1 and C_3 are empirically determined as that value giving minimum common mode at the amplifier

output. The procedure is repeated for C_2 and C_4 at the other input pole.

A 40 channel multiplexer using FETs as switching elements was constructed and found to have a common mode ratio of 80 dB at 60 Hz with a 1000 ohm assymetry. The use of the above circuit enabled this to be increased to more than 100 dB.

G. Harries, Design Engineer, St. Mande, France.
VOTE FOR 315

Sync signal controls frequency of UJT oscillator conveniently

Applying a sync signal to a UJT oscillator can be difficult due to the unreasonable impedances involved. As shown in the diagram, applying the sync signal to B_1 presents a reasonable impedance, and controls the oscillator frequency by varying the firing threshold. The polarity of the sync signal determines which way the frequency is pulled, while the magnitude determines how far the frequency is pulled.

This scheme is presently used to eliminate power line transients and commercial clock sync signals, (3 and 6 kHz) from a real-time clock input. The UJT oscillator is set to free-run at 60 Hz, and a 3-volt sine wave is applied at B_1 , for sync.

M. C. Middleton, Circuit Design Engineer, General Electric Co., Phoenix, Ariz. VOTE FOR 316

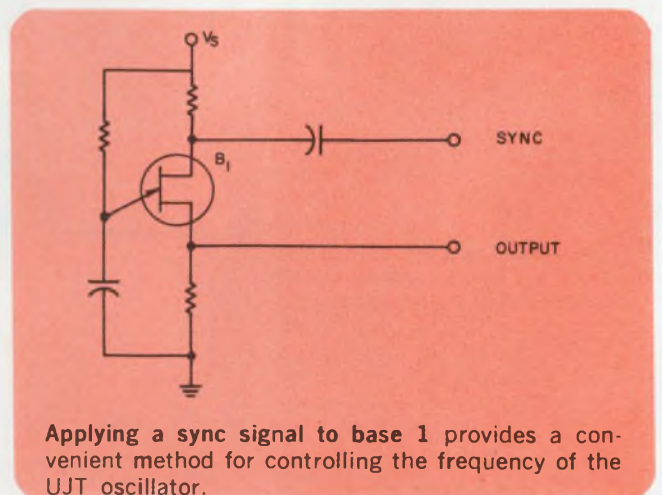

new

HARDENED SERIES 54H CIRCUITS



- Dual type D Flip-Flop
- Quad 2-Input NAND Gate
- Dual 2-Input AND-OR INVERT Gate
- Dual 4-Input NAND Gate
- Quad 2-Input AND-OR INVERT Gate
- Two orders of magnitude more resistant to radiation environment
- Dielectrically isolated
- Thin film resistors
- Optimized device geometries
- Low Z mono-metallic metalization system
 - Aluminum interconnect
 - Aluminum die attach
 - Aluminum wire bond
 - Aluminum package posts
- Compatible with 930 Hardened DTL product line
- Full military temperature range
- Complies with MIL-STD-883
- Off-the-shelf delivery

You get the BEST IC for the job from Radiation's fast expanding hardened circuit line.

P. O. Box 476, Lexington, Massachusetts 02173
Area Code 617, 862-1055

600 Old Country Road, Garden City, New York 11530
Area Code 516, 747-3730

2600 Virginia Avenue, N.W., Washington, D.C. 20037
Area Code 202, 337-4914

P. O. Box 30667, Dallas, Texas 75230
Area Code 214, 231-9031

6151 West Century Boulevard, Los Angeles,
California 90045 - Area Code 213, 670-5432

260 Sheridan, Palo Alto, California 94306
Area Code 415, 321-2280

P. O. Box 37, Melbourne, Florida 32901
Area Code 305, 727-5430

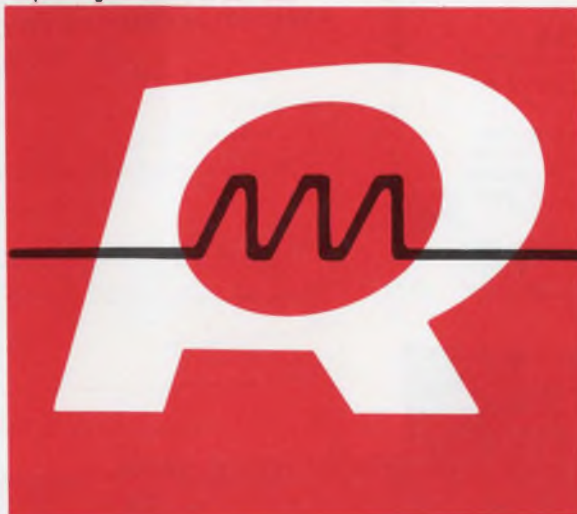

RADIATION
INCORPORATED
SUBSIDIARY OF HARRIS-INTERTYPE CORPORATION
MICROELECTRONICS DIVISION

INFORMATION RETRIEVAL NUMBER 76

PARELCO BULLETIN BOARD

A 1-minute look at what's new in relays

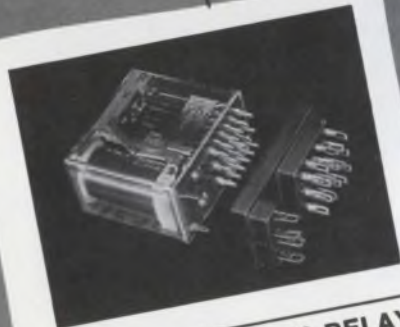

THE PARELCO R10 RELAY
2 times more pull force

Optimum distribution between magnetic core and pole piece cross sections and coil volume, and a low reluctance armature bearing produces a force-displacement product of 140 gm/mm at .050". The result is higher contact pressure and greater overtravel. Sensitivities to 20 mw/pole.

Contacts: From 2 to 8 Form C. 6 types from heavy duty 10A silver cadmium oxide to bifurcated cross bar gold — platinum — silver for dry circuits.

Coils: 3 to 115 vdc. Recognized under the Component Program of Underwriters Laboratories, Inc.

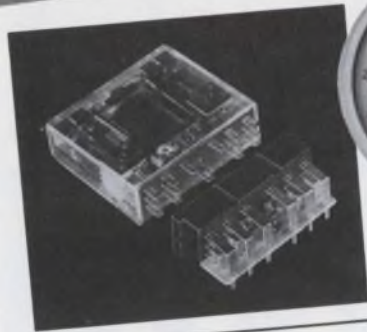

THE PARELCO R40 SLIMLINE®
.43" max. thickness

Lowest profile industrial relay available. Higher switching density: .18 cu. inches/Form C. Easy pc board layout. Lower cost, wider switching range (dry circuit to 10A) than dry reed packages. 5 mounting options.

Contacts: 2 and 4 Form C. 5 types from heavy duty 10A silver cadmium oxide to bifurcated cross bar gold — platinum — silver alloy for dry circuits.

Coils: From 3 to 115 vdc.



THE PARELCO R12 VARIABLE TIME DELAY RELAY

1/3rd the size of the relay you're now using!

All the R10 features plus a superior delay circuit using silicon transistors throughout. No false operations. Critical timing capacitor meets MIL-specs. Measures only 7.35 x 1.187 x 1.375 (2 pole) or 1.580 (4 pole). Delay range from .1 to 120 seconds — specials to 300 seconds. High resolution, 15 turn pot. The *only* 4 Form C time delay currently available. Three mounting choices.

Contacts: 6 types from dry circuit to 10 amps.

Coils: 12, 24 and 48 vdc.

See EEM Section 4500

OTHER STANDARD MODELS

R11 guarded, low capacitance relay for instrumentation.

R30 magnetic latching relays.

R10-T octal base relays. Custom

Coils and contacts — various mounting modes — special engineering.

Quick Delivery — 110 standard models always in stock. Prototypes in 3 days — production quantities in 3 weeks!

EVALUATION SAMPLES TO QUALIFIED DESIGNERS!

GIVE US:

Time delay range, secs. _____

Input voltage _____

Contact characteristics _____

I'll use _____ relays in the next 12 months. Application _____

Name _____

Title _____ Phone _____

Company _____

Street _____

City _____ State _____ Zip _____

AMF PARELCO OPERATIONS
POTTER & BRUMFIELD

26181 Avenida Aeropuerto • San Juan Capistrano, California 92675 • Phone (714) 493-4507 TWX (910) 596-1412

INFORMATION RETRIEVAL NUMBER 77

ELECTRONIC DESIGN 19, September 13, 1969

new

PLATED-WIRE, HARDENED SENSE AMP

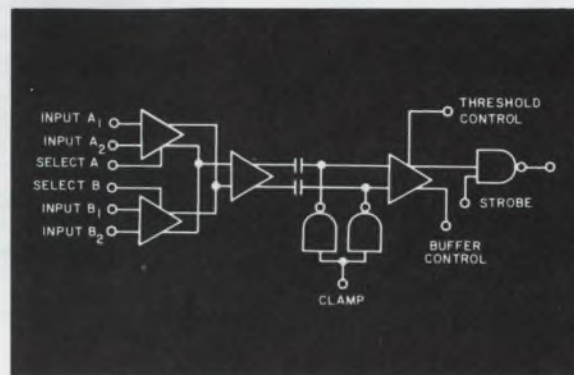

- The first application of linear and digital technology in one monolithic subsystem
- The RA-2540 system in a single chip performs the functions of a hardened differential amplifier and a hardened voltage comparator
- 1 mv signal sensitivity in high noise environment
- 10 ns access time
- Internal D.C. restoration
- Selectable dual channel
- Hardened
 - Photo current compensation
 - Dielectric isolation
 - Thin film resistors
 - Advanced device design
- Complies with MIL-STD-883
- Off-the-shelf delivery

You get the BEST IC for the job from Radiation's fast expanding hardened digital line.

P. O. Box 476, Lexington, Massachusetts 02173
Area Code 617, 862-1055

600 Old Country Road, Garden City, New York 11530
Area Code 516, 747-3730

2600 Virginia Avenue, N.W., Washington, D.C. 20037
Area Code 202, 337-4914

P. O. Box 30667, Dallas, Texas 75230
Area Code 214, 231-9031

6151 West Century Boulevard, Los Angeles,
California 90045 - Area Code 213, 670-5432

260 Sheridan, Palo Alto, California 94306
Area Code 415, 321-2280

P. O. Box 37, Melbourne, Florida 32901
Area Code 305, 727-5430

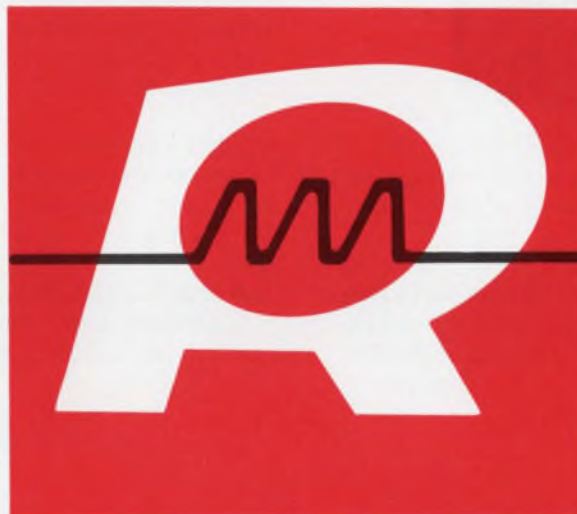

RADIATION
INCORPORATED
SUBSIDIARY OF HARRIS-INTERTYPE CORPORATION
MICROELECTRONICS DIVISION

INFORMATION RETRIEVAL NUMBER 78

Introducing - THE AMBIDEXTROUS RECORDER

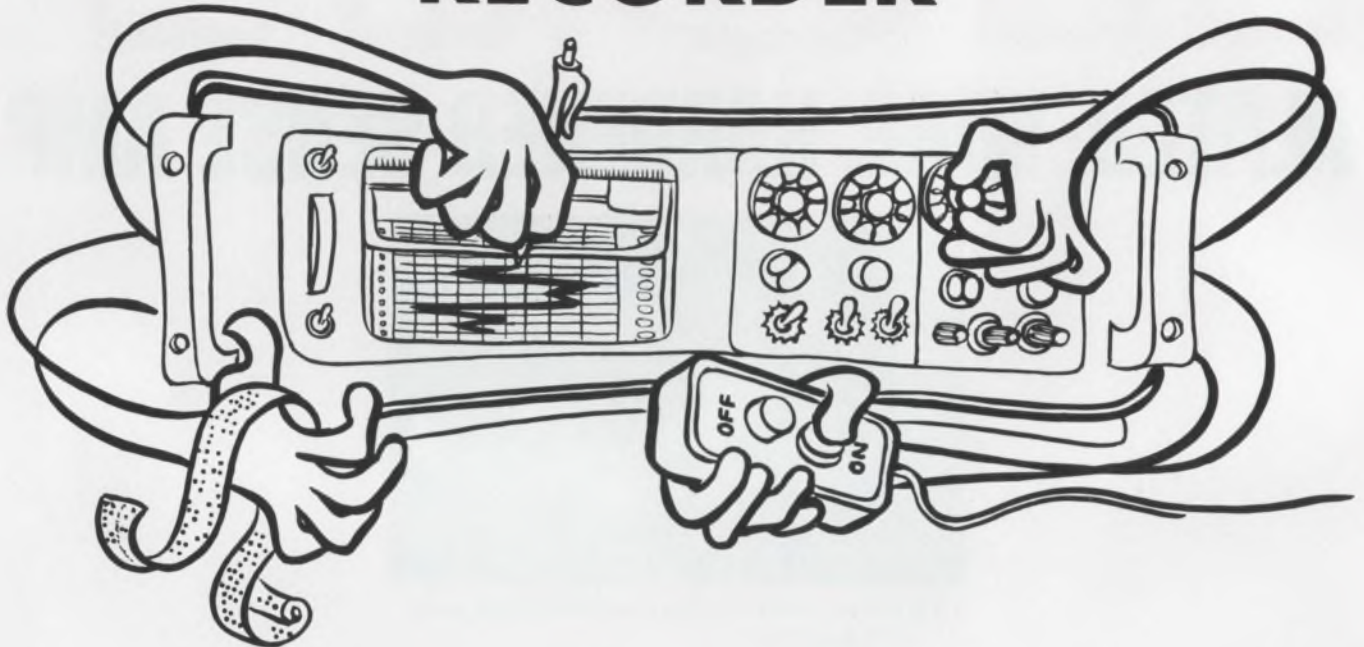

Designed with Systems in Mind.

A high-speed dc strip-chart recorder
... that can be remotely programmed
... and can program itself automatically
... and can program other devices, controls, and processes

Adding hands to this recorder couldn't have made it a more versatile and unique systems component.



The 1522 recorder can be remotely programmed. Simple switch-closure commands will select one of 18 chart speeds, start the chart in forward or reverse and stop it; lift the pen; and actuate two event markers.

Or, the 1522 recorder can program itself. Control marks along the chart paper's edge are sensed photoelectrically for automatic internal control of any of the above recorder functions.

Or, the 1522 recorder can program other devices such as sort/select mechanisms. It can activate go/no-go systems or warning signals if plotted information exceeds preset high or low limits. It can be used to program additional test equipment and synchronize other 1522 recorders.

That's not all. The 1522 by itself is a superb dc recorder. It writes with a pen speed of 65 inches per second - it takes only 70 milliseconds for full-scale traverse. Linearity is $\frac{1}{4}\%$ of full scale; accuracy is $\frac{1}{2}\%$ of full scale. Eighteen paper speeds from 2 inches per second to 1 inch per day to accommodate both rapid plotting and continuous monitoring of long processes. There are 15 dc voltage ranges and 18 dc current ranges from 2 mV or 0.2 μ A per inch to 100 V or 100 mA per inch.

The 1522 adds "hands" to your system. We don't claim it to be smarter than any other machine. It's just a darn good worker and you can put the 1522 on your payroll for \$1915 in the U.S.A.

For complete information, write General Radio, W. Concord, Massachusetts 01781; telephone (617) 369-4400. In Europe: Postfach 124, CH 8034, Zurich 34, Switzerland.

GENERAL RADIO



Products

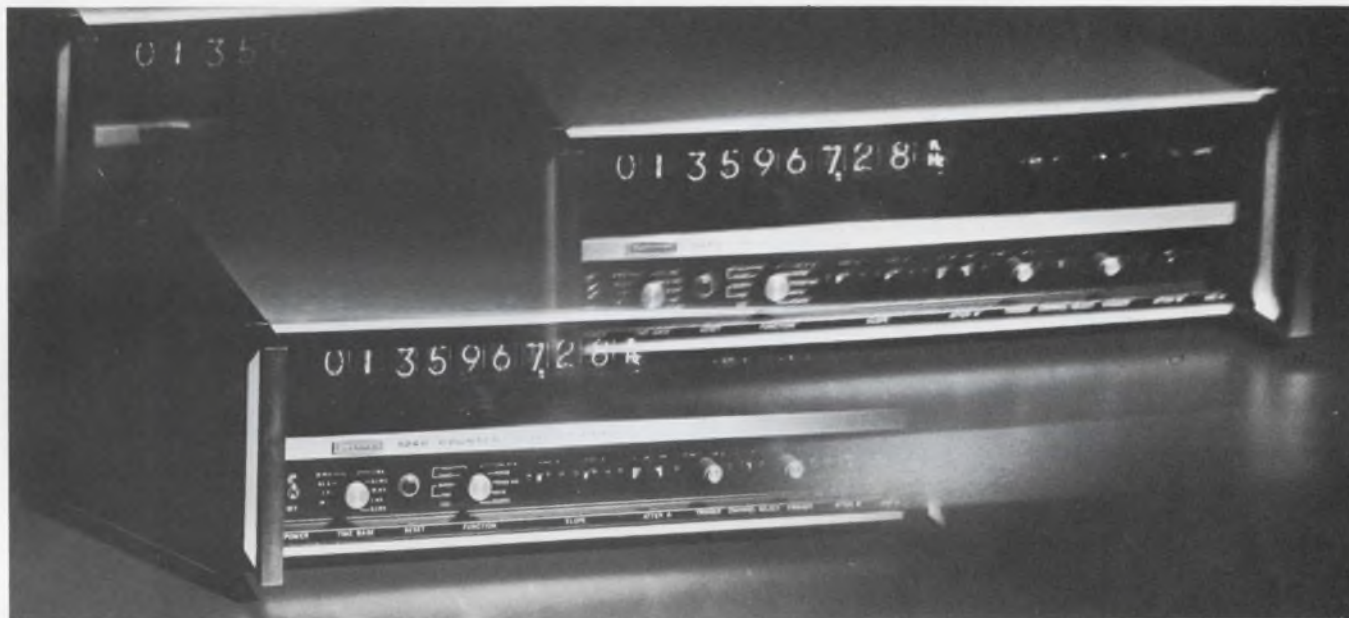

Truly a universal instrument, a new electronic counter is a versatile subsystem that

can also function as a data terminal, data display and data coupler, p. 126.

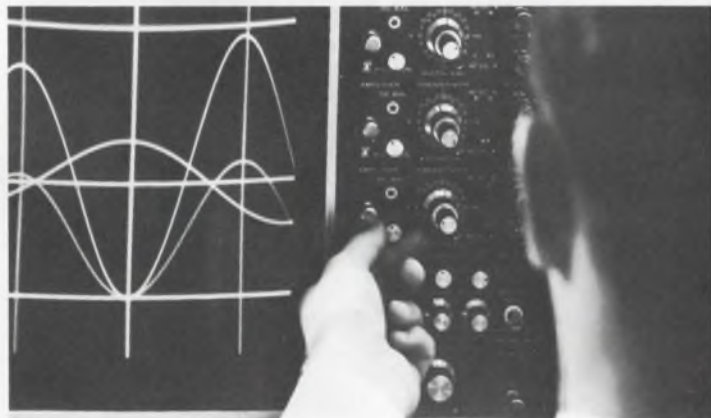

Tri-color CRT display system presents each of three inputs in a different color, p. 128.

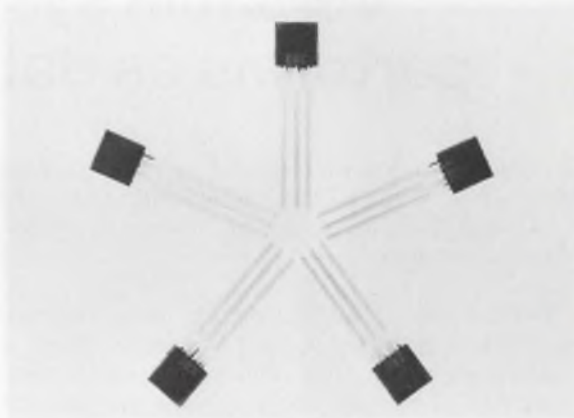

Small-signal transistors in TO-92 plastic packages cost only 19¢ each, p. 144.

Also in this section:

Helium-cadmium cw laser emits in deep blue and ultraviolet regions, p. 137.

Palm-sized tunable solid-state oscillator delivers 10 mW in S band, p. 140.

Thin-film chip resistors feature symmetrical on-chip center tap, p. 150.

Evaluation Samples, p. 167 . . . **Design Aids**, p. 168 . . . **Annual Reports**, p. 170.

Application Notes, p. 172 . . . **New Literature**, p. 174.



Versatile systems counter-timer performs as data terminal and display

Beckman Instruments, Inc., Electronic Instruments Div., 2200 Wright Ave., Richmond, Calif. Phone: (415) 526-7730. P&A: \$2200 basic unit, \$3050 with options; 60 days.

Besides providing all of the basic measurement capabilities found in standard counter-timers, a new instrument is the first electronic counter designed primarily to be used as a systems component. This new counter data terminal can perform many new systems functions related to data manipulation for meaningful display and digital recording.

When operating as a standard counting instrument, the 1248 data terminal can measure frequencies to 136 MHz, period or period average to 100 ns, and time interval to 100 ns. In addition, it can accumulate pulses with 4-ns width and separation, as well as measure frequency ratio and the frequency of a pulse burst.

Completely addressable from external binary coded commands, the 1248 is a versatile subsystem that becomes a universal data terminal, data display and data coupler. It has the interface mobility to accept parallel or serial control and data logic of various codes and levels. BCD coded outputs are also provided.

Either of the instrument's two channels may be selected remotely. In addition, its accumulator and

time base may be preset to any value from external data. This allows measurements to be offset and scaled. The storage elements also accept internal data, permitting the 1248 to act as a general-purpose display and interface to a printer.

Programing is supplied in optional blocks so that excess capability is not built into every instrument. Optional programing modules include function, time base, input attenuators, and input trigger levels.

In a small system, the new counter data terminal can result in significant savings since it eliminates the need for separate output buffers and displays. This feature also allows the 1248 to take full advantage of a system computer. It can make a frequency or time measurement, transfer this to a computer for processing, receive the manipulated data back from the computer, and display the result.

Since measurements can be offset and scaled, the 1248 can count frequency and display in other units. For example, it could measure the frequency from a temperature transducer and then display the equivalent temperature.

Under the remote control of a data processor, the new counter data terminal can be programed to accept any measurement, and the measurement can be multiplied by or added to remotely supplied quantities.

CIRCLE NO. 250



Quite simply, the most versatile preset counter ever.

It's the new 5330B Preset Counter from Hewlett-Packard. It can do about twice as much work as the second best preset counters. Yet it's priced about the same.

This 10 MHz counter can:

- Normalize counted data to units such as gpm, psi and rpm.

- Issue control signals when preset count or count rates are reached.

- Introduce a selected offset in the reading. Be programmed remotely by automatic systems.

- Totalize, find ratios and time intervals.

The 5330B gate times can be selected by a 5-decade front-panel "N" switch to any number of time units between 1 and 100,000. With a choice of 1 μ s, 10 μ s,

0.1 ms and 1 ms time units ("M"). So you can get normalizing factors from 1 to 10⁹.

This flexibility, together with the two limit control switches (L1 and L2), lets you virtually automate many processes such as batching. The limit switches generate output signals when the preset count is reached. These signals become the commands for your computer-run system.

The optional zero offset can be set at any number between 0 and 99,999. This lets your count start from a specific number and return to that number automatically.

All four of these functions can be remotely preset. It's also the first preset counter to offer an anti-noise option. This rejects high frequency noise that might mask low-frequency data.

You can also use this preset counter as a frequency divider. As a delay generator. Or as a precise, digitally selectable pulse generator.

If the 5330B is too versatile for you, the 5330A should be just right. It does slightly less (without limits, but zero offset option available), and costs slightly less.

The 5330A is \$1200. The 5330B is \$1550. To find out just how much they can do for you, call your local HP field engineer. Or write to Hewlett-Packard, Palo Alto, California 94304; Europe: 1217 Meyrin-Geneva, Switzerland.

HEWLETT  PACKARD

ELECTRONIC COUNTERS

IT'S WHAT'S INSIDE THAT COUNTS!

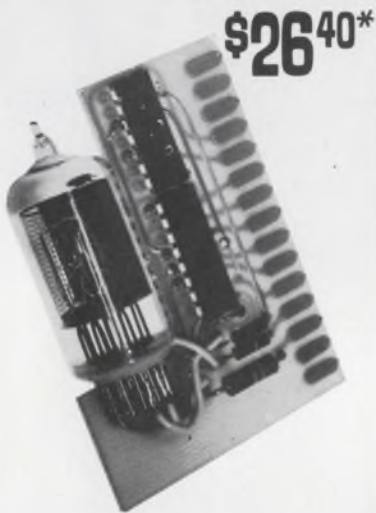

\$26⁴⁰*

DM519 DECIMAL COUNTING UNIT

A compact (2.5" x 1.75" x .75") decimal display with IC decoder / driver and decade counter, the DM519 has TTL and DTL compatible inputs and outputs and is compatible with standard connectors — 15 position, 0.156" spacing. BCD counter output is available externally, and there also is an external reset input. Indicator tube provides numerical readout 0 through 9, including decimal point.

An attractive bezel and mounting chassis is available with the DM500 Series Displays and Counters. Also available are models with storage register.

Economy you can count on!

Price: 1-3 \$32.90, *10-29 \$26.40

CALL OR WRITE FOR COMPLETE INFORMATION ON THE ENTIRE DM500 SERIES—A CALL WILL BRING SHIPMENT WITHIN 3 DAYS.

Computer Products, Inc.
P. O. Box 23849

Fort Lauderdale, Florida 33307
Phone: 305/565-9565



**COMPUTER
PRODUCTS™**

FORT LAUDERDALE

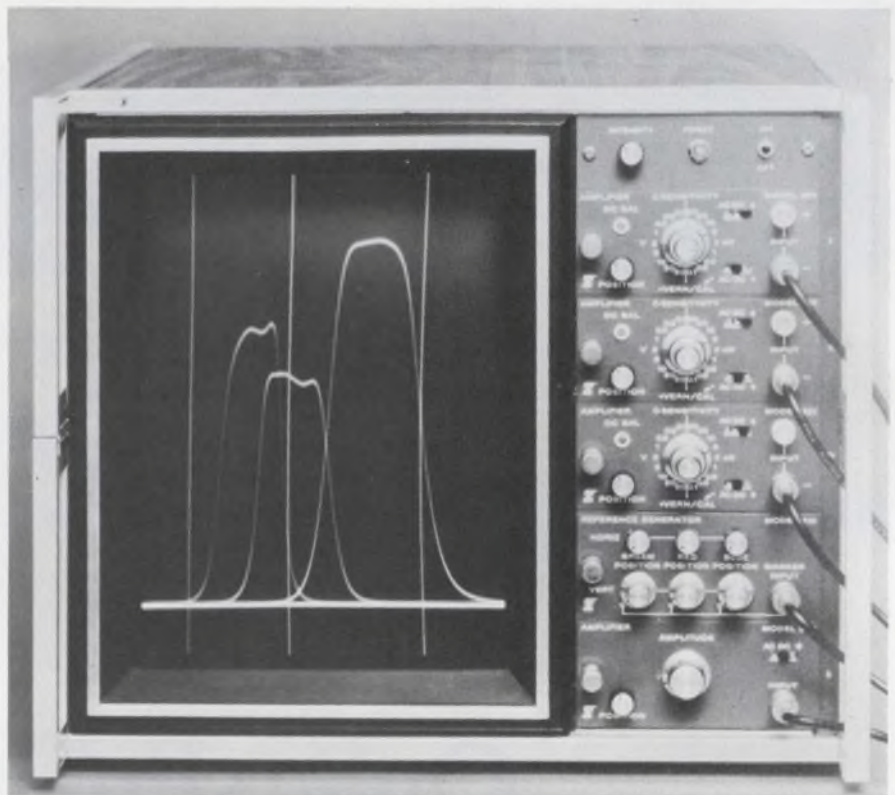

Three-channel CRT display shows inputs in three colors

Telonic Systems, div. of Telonic Industries, Inc., 21282 Laguna Canyon Rd., Laguna Beach, Calif. Phone: (714) 494-9401. P&A: \$2400 to \$3550; 12 wks.

Featuring tri-color presentation on a 15-in. cathode-ray tube, a new display system accepts up to three input signals and shows each in a different color—red, green and blue. Since total discrimination between signals is made possible by this multiple-color presentation, the full face of the CRT is available for all signals, further enhancing the instrument's resolution.

Model 201 tri-color CRT display system incorporates plug-in amplifiers for each input channel. These have a sensitivity of 100 μ V per inch up to 100 V per inch, assuring maximum resolution regardless of the input level.

The vertical amplifiers are available in two versions: a basic unit with a sensitivity range of 100 mV per inch to 10 V per inch, and a

high-gain differential model with the range mentioned above. Horizontal deflection can be provided by an external source, such as a sweep generator, or internally by an optional time-base generator, which is also a plug-in unit. A calibrated control on the time base permits sweep speeds from 1 ms per inch to 1 s per inch.

A reference line generator, another optional plug-in unit, supplies three horizontal lines and three vertical lines on the CRT in red, green and blue. These can be used for a wide variety of functions. Vertical lines, for example, could be generated by a frequency marking device to calibrate the display; horizontal lines could be limits showing high and low levels. The reference line generator plug-in has separate controls for each horizontal and vertical line, as well as an input for externally generated signals like a time or frequency marker pulse.

CIRCLE NO. 251



OFFICE OF THE EMBASSY
18 Newbury Street, Boston, Massachusetts 02116

15 August 1969

Cmsr. Ivan Nyork
INTERSAB
1919 Blorvich Blvd.
Moscow, U. S. S. R.

Dear Comrade Ivan:

Regarding the Capitalist Imperialist capabilities in the area of power transistors:

Our sources reveal that their foremost manufacturer, SSPI, has introduced such a wide number of power transistors that we can only suspect the Americans of not knowing what they really want. SSPI offers devices rated from 300 m.a. up to 30 amps, for five different current ranges, capable of handling up to 150 watts, in 10 different packages. This wasteful display of versatility suggests that SSPI is merely showing off for the favors of the Design Engineer. The devices all display an extravagantly high and flat Beta.

As for dependability: we have tested 53,789 of them, without a single failure. However, we remain optimistic.

Actual specs and prices are documented in the attached power-transistor literature package called LITPAK-POWTRAN. (We have not yet been able to translate this word.) Comrade Petrasha obtained the document under his cover name (Comrade Hilton) by writing direct to Mr. Alex Polner at SSPI, 1 Pingree Street, Salem, Massachusetts 01970, (617) 745-2900, as the American engineers do.

My kindest regards to your wife Anna, and to your brother Alexei after his unfortunate disagreement with Department policy. I am sure that the mines, and the salt air, will be beneficial to his bronchial condition.

Faithfully,

Nikita
Nikita

LITPAK
POWTRAN
SOLID STATE
PRODUCTS
SSPI
DIVISION OF UNITED CORP.

МИНИСТЕРСТВО ПИЩ
ПРОМЫШЛЕННОСТИ
РОСГЛАВТАБ

ПАПИРО
ВЫСШЕГО СОР
"БОГАТ
10

ТАБАЧНАЯ ФАБРИКА
"ЯВА"
"МОСКВА" CLAS

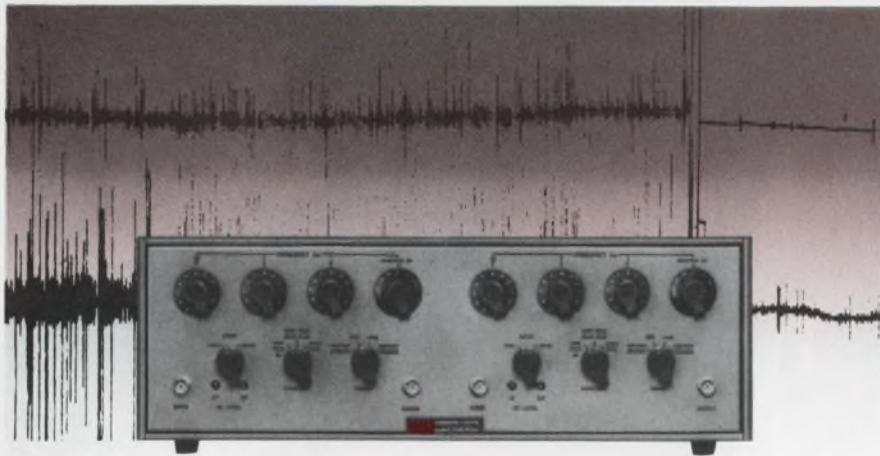

**We're still
No. 1
in variable filters!**

There must be a reason.

Krohn-Hite, a pioneer in the initial development of variable filters, has maintained leadership by keeping pace with an ever-changing state-of-the-art. Conversion from tubes to solid state, modern packaging techniques and addition of versatile new instruments to meet new engineering parameters, add up to the most comprehensive line in the industry.

Series 3300, for example, are all silicon, solid state, low distortion, variable electronic filters that are digitally tuned over the range from 0.001 Hz to 99.9 kHz. Models 3320 (Single channel) and 3322 (Dual channel) provide 24 db per octave attenuation slopes per channel, and Models 3340 (Single channel) and 3342 (Dual channel). Illustrated) have slopes of 48 db per octave per channel.

Recent additions to the Series are Models 3341 (Single channel. Price \$995) and 3343 (Dual channel. Price \$1825). Frequency range is 0.01 Hz to 99.9 kHz. Attenuation slopes are 48 db per octave per channel.

All Models in Series 3300 feature line or battery operation, with batteries internal and rechargeable.

Write for the new 1969 Catalog containing complete specs on the entire Krohn-Hite line.

OVERSEAS SALES OFFICES: BELGIUM, C. N. Rood s. a, DENMARK, SC Metric A/S; FRANCE, Antares; GERMANY, Nucletron Vertriebs-GMBH; HOLLAND, C. N. Rood n. v.; ITALY, Dott. Ing. Mario Vianello; SWEDEN, Teleinstrument; ISRAEL, R.D.T. Elect. Eng. Ltd.; JAPAN, Shoshin Shoji Kaisha, Ltd.; AUSTRALIA, Sample Electronics (Vic.) Pty., Ltd.; G. B., B & K Inst. Ltd.

**KH KROHN-HITE
CORPORATION**

580 Massachusetts Ave., Cambridge, Mass. 02139, U.S.A.
Phone: (617) 491-3211 TWX: 710-320-6583

Oscillators / Filters / AC Power Sources / DC Power Supplies / Amplifiers

INFORMATION RETRIEVAL NUMBER 83

INSTRUMENTATION

Multi-function counters divide and generate



Hewlett-Packard, 1501 Page Mill Rd., Palo Alto, Calif. Phone: (415) 326-7000. P&A: \$1200 or \$1550; October, 1969.

Providing several functions in a single package, a new preset counter can measure and control, as well as divide frequencies, and generate precision delays and pulses. Able to be programed remotely, model 5330B can measure frequencies or rates from dc to 10 MHz, totalize, find ratios, determine time intervals, and normalize all these if desired. There is also a lower-cost preset counter, model 5330A, with all the basic features of the 5330B except count limits.

CIRCLE NO. 252

Real-time oscilloscope spans 200-MHz band



E-H Research Laboratories, Inc., 515 11th St., P.O. Box 1289, Oakland, Calif. Phone: (415) 834-3030.

Combining a 200-MHz bandwidth with a high input impedance, a new real-time oscilloscope can be used with either active or passive probes. Model SS-212 has a vertical-channel input impedance of 1 MΩ. Its horizontal deflection system features sweep speeds to 1 ns/cm with stable triggering to 200 MHz. It also offers a large 6 by 10-cm display on a front panel of only 8-1/2 by 10 in.

CIRCLE NO. 253

INFORMATION RETRIEVAL NUMBER 84 ►

If this
new
plus
doesn't
grab you,

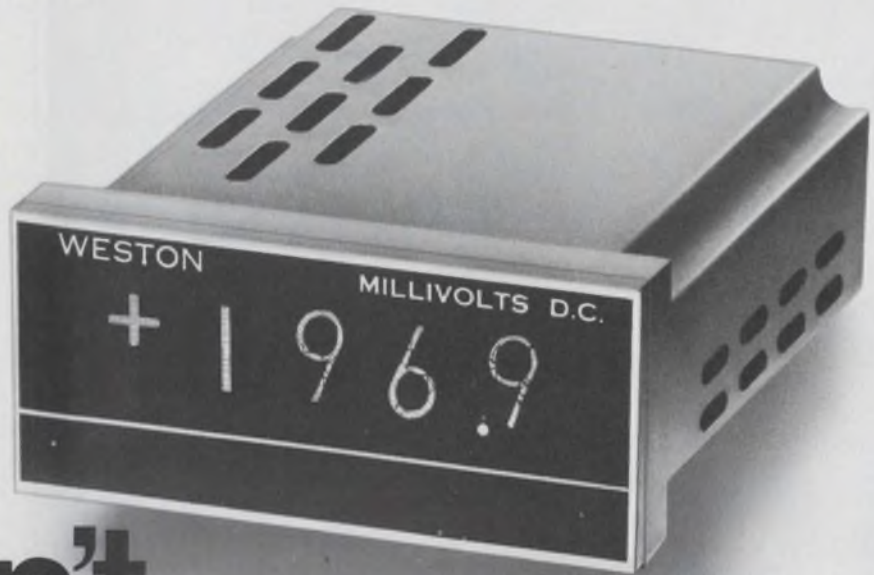

the others will.

As you can see, our latest Model 1292 DPM* is bi-polar. It's a 3½-digit compact with 100% over-range, plug-in Nixie** tubes, front panel serviceability, and 0.1% ± 1 digit accuracy. Full BCD output, non-blinking storage display and Weston's patented dual slope integration are standard, of course.

What you can't see are several other new plus features designed to broaden your applications for the Model 1292. Input impedance, for example, is greater than 100 megohms on a 100 MV range, greater than 1,000 megohms on 1 volt, and 10

megohms on all other voltage ranges.

Independent references for positive and negative measurements provide extremely good stability at near zero input levels—difficult to obtain with conventional circuits.

Decimal points are "wired out" for remote control positioning.

Finally, a new range has been added to the standard ranges available—1 μ a full scale giving 1 nanoamp resolution.

Add them up and we think you'll agree that the Weston bi-polar Model 1292 DPM is the world's

most advanced unit. Yet it costs only a few dollars more than our 3½-digit mono-polar Model 1290 and is fully compatible also with our economy Model 1260. Get complete specifications now on this big new plus in the fastest growing line of digital panel meters.

WESTON INSTRUMENTS DIVISION
Weston Instruments, Inc., Newark, N.J. 07114.
a Schlumberger company

WESTON®

*U.S. Pat. No. 3,051,939 and patents pending.

**Registered trademark, Burroughs Corp.

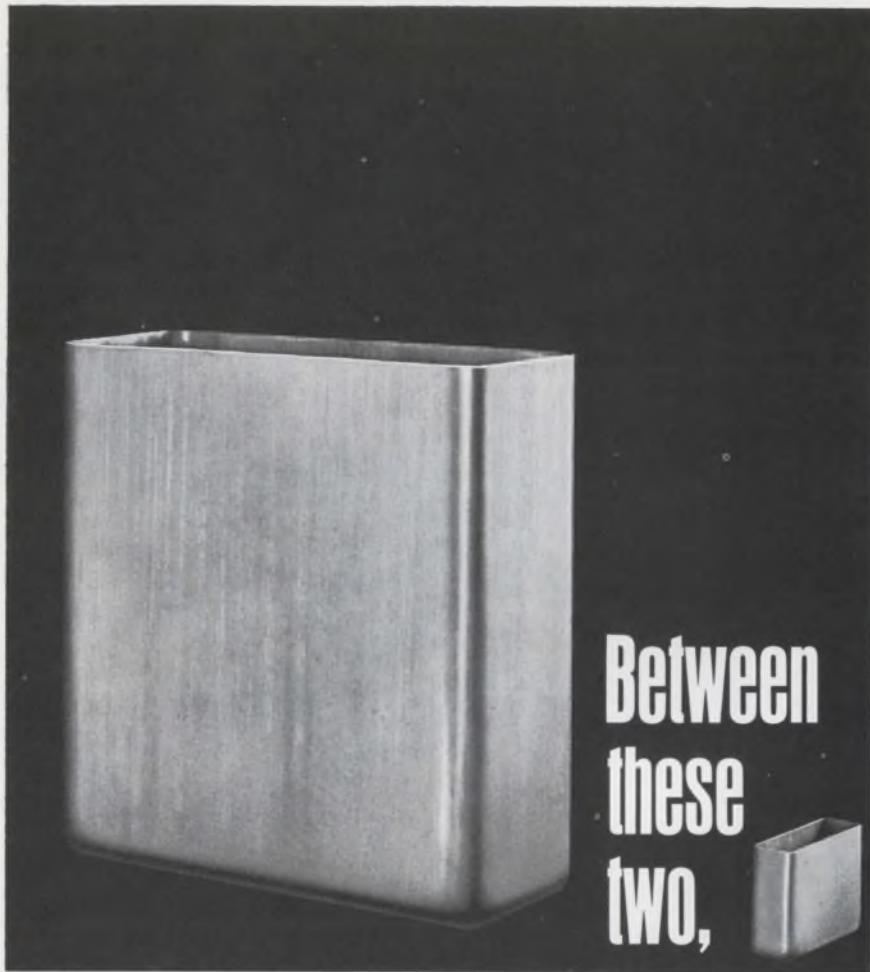

Square shapes. Rectangular shapes. Round shapes. Five-sided shapes. All shaping up into aluminum cans and covers in the largest selection of sizes available anywhere. Which means you can figure on getting what you want from Moorlee right off the shelf. With no tooling around. At the right price and with the right delivery, too.

In fact, Moorlee has over 200 more sizes in square, rectangular or five-sided cans and covers than the manufacturer with the next largest selection. And over 250 more sizes in round cans and covers.

We have complete facilities, too, for all secondary operations as well as for custom tooling. Plus over 25 years of experience.

See for yourself what's going on at Moorlee. It's all down in our new catalog. Everything on aluminum cans and covers—all arranged so you can find the right size and shape fast. Send now for your free copy. There's more in it than you can imagine.

**Moorlee
Manufacturing
Company**

120 WEST SLAUSON AVE., LOS ANGELES, CALIFORNIA 90003

INFORMATION RETRIEVAL NUMBER 85

**you
can't
imagine
what
goes
on!**



INSTRUMENTATION

Pulse generator is fully pushbutton



Applied Electronics, 877 Cowan Rd., Burlingame, Calif. Phone: (415) 697-2701. P&A: \$310; stock to 3 wks.

Model 541 pulse generator features full pushbutton selection of pulse width and pulse spacing ranges, pulse polarity or a combined positive/negative pulse, and voltage range output amplitude. Pulse width and spacing are continuously variable from 10 μ s to 10 s in six ranges. Voltage output amplitude is continuously variable from 0 to 0.2, 0 to 2, and 0 to 20 V.

CIRCLE NO. 254

Digital ac/dc instrument measures and calibrates



RFL Industries, Inc., Instrumentation Div., Boonton, N.J. Phone: (201) 334-3100. Price: \$2995.

Providing both calibration and measurement capabilities in a single package, a new instrument is not only a digital source of ac/dc voltages and currents, frequencies and resistance, but will also measure these parameters with no loss in accuracy. Model 829G is an ac/dc and ohms calibrator with an ac accuracy of 0.05% of reading, and a dc and ohms accuracy of 0.02% of reading.

CIRCLE NO. 255

Small frequency meter can count out to 1 MHz



Beckman Instruments, Inc., Electronic Instruments Div., 2500 Harbor Blvd., Fullerton, Calif. Phone: (714) 871-4848. Price: \$450.

A new digital frequency meter not only measures frequencies up to 1 MHz, but can also be used to measure time intervals from 10 μ s to 10⁶ s. Heart of the model 4034 is a crystal oscillator that establishes time intervals to an accuracy of $\pm 0.01\%$. Six gate periods, from 1 ms to 100 s, are available. The new instrument has a four-digit display.

CIRCLE NO. 256

Bipolar panel meter presents 1-G Ω input



Weston Instruments, Inc., a Schlumberger Co., 614 Frelinghuysen Ave., Newark, N. J. Phone: (201) 243-4700. P&A: \$200; stock.

Boasting a 3-1/2-digit display, a new bipolar digit panel meter provides an input impedance of greater than 100 M Ω on a 100-mV range and greater than 1000 M Ω on a 1-V range. Input impedance is 10 M Ω on all voltage ranges. Model 1292 has separate references for both end points of the range, thus making the zero point independent of end-scale adjustments.

CIRCLE NO. 257

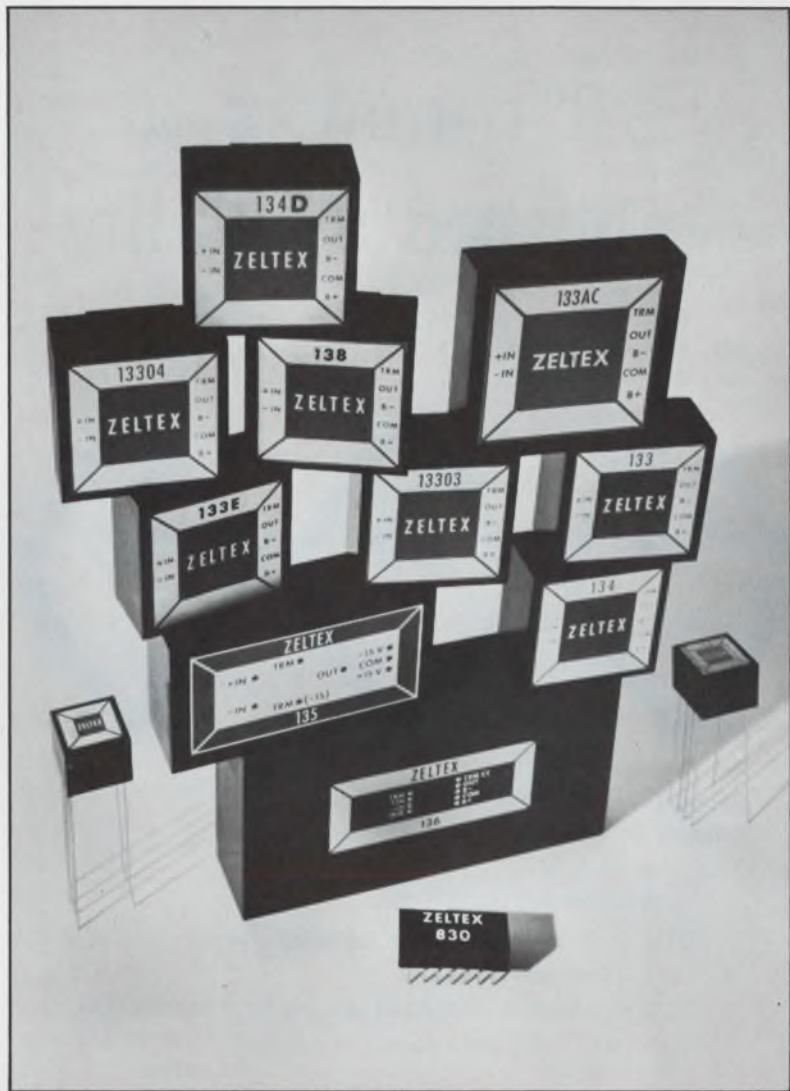

Here are 13 solutions to your FET OP AMP problems

Thirteen FET-input op amps to solve just about any problem you have—whether it's drift, slew rate, package size, CMRR, settling time, input bias current, common-mode input voltage or cost.

But we didn't stop there. We've developed another five-dozen specials tailored to our customers' individual needs.

Get the point? If you're looking for a FET-input op amp, you should be looking at our data sheet. The one with all the answers.

ZELTEX, INC.

A subsidiary of REDCOR CORP.

1000 Chalamar Road, Concord, Calif. 94520
(415) 686-6660

INFORMATION RETRIEVAL NUMBER 86

3/8" trimmers *with* established reliability for MIL-R-39015/RTR24

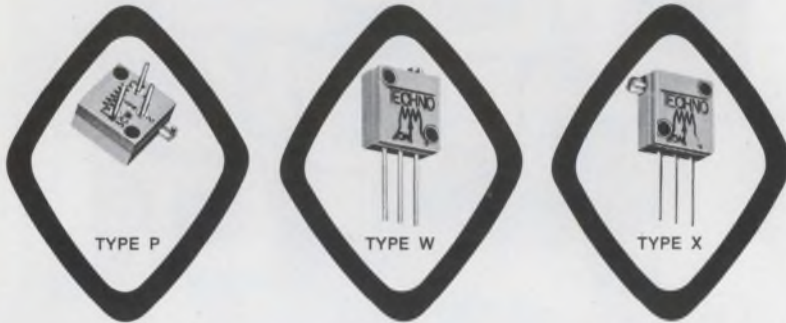

- ✓ Statistically Documented Reliability
- ✓ Complete Traceability
- ✓ 10,000-Hour Life Test
- ✓ One Hundred Percent Screening
 1. 100% burn-in for 96 hours at full rated power.
 2. 100% immersion test.
 3. 100% mechanical inspection before and after assembly.
 4. 100% peak noise and total resistance test.

CONFIDENCE LEVEL	FAILURE RATE PER 1000 HOURS
M	1%

SPECIFICATIONS

Resistance Values: 10 to 10k ohms
 Power Rating: 3/4 watt at 85°C
 Standard Resistance Tolerance: ±5%
 Operating Temperature: -65° to 175°C

Call or write for complete technical data:

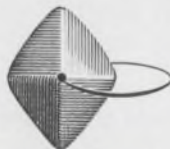

TECHNO-COMPONENTS CORP.

A SUBSIDIARY OF OAK ELECTRO/NETICS CORP.

7803 Lemona Avenue, Van Nuys, California 91405
 (213) 781-1642 TWX 910-495-2015

INSTRUMENTATION

Lab power amplifier supplies 3 W at 110 MHz



Electronic Navigation Industries Inc., 1337 Main St. East, Rochester, N. Y. Phone: (716) 288-2420. Price: \$485.

Covering the frequency range of 0.25 to 110 MHz with a maximum power output of 3 W, model 300 L broadband class A amplifier may be used to extend the power output capability of virtually all laboratory signal and sweep generators. The new amplifier is completely solid state and is untuned, making it reliable and easy to use.

CIRCLE NO. 258

Time-interval counter resolves down to 10 ns



Eldorado Electrodata Corp., 601 Chalomar Rd., Concord, Calif. Phone: (415) 686-4200. P&A: \$1750; 2 to 3 wks.

With a resolution of 10 ns, a new 10-ns time-interval counter, model 784, provides single-event measurements of period, pulse width and pulse time. Full input signal conditioning of both start and stop inputs is also featured. This allows variable trigger point definition with 100 mV to 100 V rms in three ranges: 1, 10 or 100 V.

CIRCLE NO. 259

Relax!
MDS has done your
digital strip printer
homework for you.

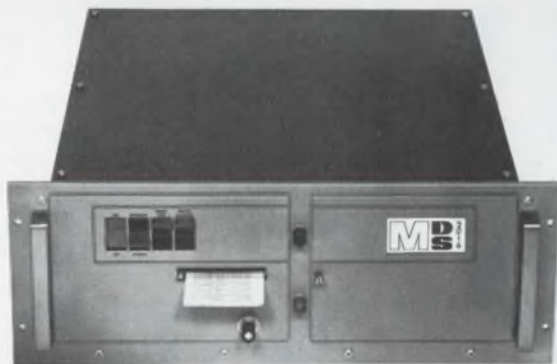

The MDS 2016 prints 8 to 20 columns. Size is 7"H x 19"W x 17"D



Printed circuit boards, with easily accessible switches permit unusual flexibility for Programmable Zero Suppress.

Specify the MDS 2016
Digital Lister Printer.

It incorporates, as standard, most features you ordinarily order as extra-cost options.

If you're sweating out specifications for Digital Strip Printers . . . up to your neck in options, trying to get everything you need in a single unit . . . drop the whole business and call MDS.

Chances are good that our new 2016 Digital Lister Printer has everything you want . . . in the *standard* unit . . . at a price much lower than you'd expect.

You'll get Full Buffering; Programmable Zero Suppress; Asynchronous Operation; 50 or 60 cycle, user-controlled; External Paper Advance; Out-of-Paper Status Line; Format Control; Positive Logic; Operate/Inhibit Switch.

PROGRAMMABLE ZERO SUPPRESS: The variable zero suppress fields within a line of print, or the number of zero suppress positions in a field, are programmable by switches.

BUFFER provides control for lock-out, activated upon receipt of a print command. An instruction is stored, and printer is inhibited until the instruction is executed. Lock-out also is generated by out-of-paper signal, external paper feed, manual paper advance, print test and printer off-line status.

Phone or write for literature. Your Man from MDS will gladly help you make your decision. Ask about other MDS Digital Strip Printers: 120A, 800, 1200, 1600, 2200, 3200, 2015.

HELP FOR OEM
DECISION-MAKERS

MOHAWK MDS
DATA SCIENCES CORPORATION
OEM MARKETING

P. O. Box 630 • Palisade St., Herkimer, N.Y. 13350
 Tel. 315/866-6040

REGIONAL MANAGER OFFICES:

Orlando, Fla., Phone 305/841-3091 • Waltham, Mass., Phone 617/891-5870 • Des Plaines, Ill., Phone 312/298-4141 • Los Angeles, Calif., Phone 213/685-5165

BUFFERED TAPE UNITS • DIGITAL STRIP PRINTERS • LINE PRINTERS • CARD PUNCHES AND READERS • PAPER TAPE PUNCHES AND READERS

INFORMATION RETRIEVAL NUMBER 88

More Power

than you
ever
pressed
into a
heat sink
before!



35 and 44 amps! Two new Tung-Sol diffused junction silicon power rectifiers in the JEDEC DO-21 package.

Both feature high surge capability and they cost less than equivalent-rated, stud-mounted units. Plus the economy of pressfit installation.

Use this coupon to get complete information in only a couple of days.

Quick-Action Coupon

Tung-Sol Division/Wagner Electric Corporation
630 W. Mt. Pleasant Avenue
Livingston, N.J. 07039

Please send data on new high power pressfit rectifiers:

35 amp 44 amp both

Name _____

Company _____

Address _____

City _____ State _____ Zip _____

INSTRUMENTATION

Stable noise generator pins down amplitude



Hewlett-Packard, 1501 Page Mill Rd., Palo Alto, Calif. Phone (415) 326-7000. P&A: \$775; stock.

A new audio-range noise generator synthesizes noise with a stable output level that is predictable within 0.2 dB at full amplitude. In addition, amplitude accuracy is determined primarily by the instrument's widerange output attenuator, which is accurate within ± 0.5 dB. Model 8057A has a three-decade amplitude attenuator that allows the output to be set with 0.1-dB resolution over a 110-dB range.

CIRCLE NO. 260

High-power pulsers deliver 6 kV at 1.5 A



Microwave Cavity Laboratories, Inc., div. of KMS Industries, Inc., 10 N. Beach Ave., LaGrange, Ill. Phone: (312) 354-4350

Series 10299B portable high-power pulse modulators offer a choice of three plug-in adjustable output voltage modules: 0 to 1.5 kV at 6 A peak, 0 to 3 kV at 3 A peak, or 0 to 6 kV at 1.5 A peak. Risetimes range from 170 to 400 ns, while falltimes vary from 200 to 400 ns, depending on the model. Maximum pulse droop is 8% at 10- μ s pulse width.

CIRCLE NO. 261

MICROWAVES & LASERS

He-Cd cw laser emits at 3250 Å

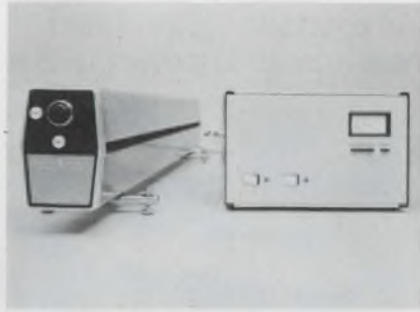

Spectra-Physics, 1250 W. Middlefield Rd., Mountain View, Calif. Phone: (415) 961-2550. Availability: 60 days.

Truly a new type of laser, the model 185 helium-cadmium laser is claimed to be the first reliable low-threshold source of continuous coherent light in the deep blue (4416 Å) and the ultraviolet (3250 Å) regions. The new unit emits more than 50 mW at 4416 Å and more than 5 mW at 3250 Å.

CIRCLE NO. 262

Kit-form He-Ne laser supplies 1-mW output

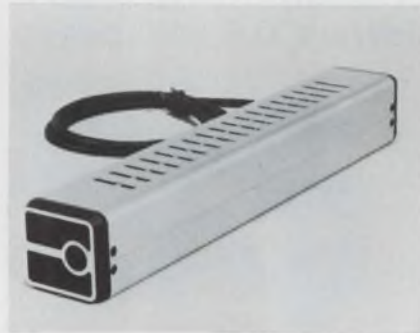

Quantum Physics Inc., 1295 Forge-wood Drive, Sunnyvale, Calif. Price: \$170/kit, \$225.

Supplied in kit form or fully assembled, model 301 He-Ne gas laser produces a full milliwatt of uniphase optical energy at 6328 Å. The unit features an isotopic gas-filled plasma tube with long-life, cold-cathode, prealigned, integral mirror mounts. These mirror mounts contain polarizing elements that prevent mirror degradation due to the damaging effect of UV radiation impinging upon the mirror surface.

CIRCLE NO. 263

What Can a Lamb Electric Blower 'System' do for your Product

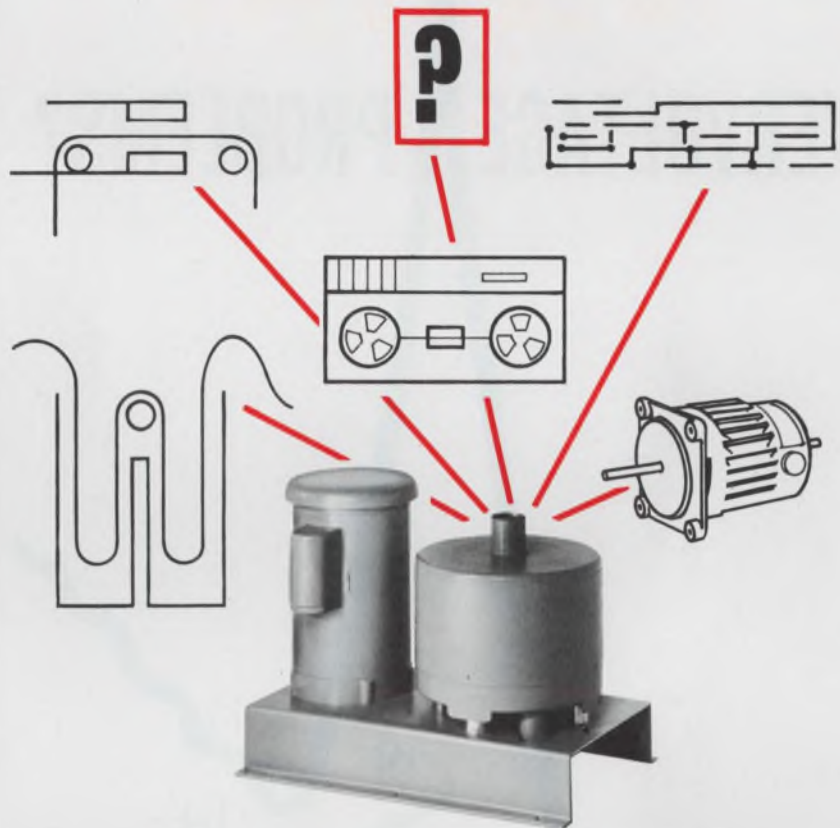

Do you design and manufacture business machines, card sorters and readers, computers, peripheral equipment, magnetic tape transports, fluidic devices . . . or other equipment requiring cooling and/or vacuum air supplies?

Then you'll want to know all about Lamb Electric's new "systems" approach, based on the famous WINDJAMMER Blower, motorized versions.

We'll design you a "system" which will provide simultaneous pressure air for such functions as servo motor and hot spot cooling, and vacuum air, for magnetic tape cleaning, automatic tape feed, vacuum buffer chambers . . . plus other specialized air moving applications you may design into your equipment.

In addition to your new air moving "systems", we also offer linear and rotary actuators for use in printing equipment . . . servo motors for use in photo copiers, film processors, and computer peripheral equipment . . . gearmotors for telephone answering sets, chart recorders, card readers, and line printers.

Lamb has the engineering and manufacturing capability! You have the needs! Bring them to Lamb where you'll find the expertise and experience to satisfy your air moving requirements in a wide variety of applications.

For free copy of our new general catalog, Bulletin No. 69, and data on our "systems" capability, write to:

AMETEK/Lamb Electric, 627 Lake Street, Kent, Ohio 44240.



INFORMATION RETRIEVAL NUMBER 90

OVERVOLTAGE PROBLEMS?

Signalite SOLVES THEM WITH SPARK GAPS

Here are a few applications where Signalite Spark Gaps protect components against overvoltage damage . . .

- Computer Input Voltage
- Broadcast Transmitters
- Power Supplies
- Solid State Circuitry
- Magnetrons
- Pulse Transformers
- Pulse Forming Networks
- Charging Chokes
- High Powered Klystrons
- Filter Chokes & Capacitors

Need a Spark Gap...

(Two Electrode or Triggered)

It's probably listed in the SIGNALITE 300 BROCHURE with over 300 others . . . complete with application notes, characteristics, mounting arrangements, photographs, etc.

IF NOT, WE'LL MAKE IT!

Signalite INCORPORATED

A General Instrument Company



NEPTUNE, NEW JERSEY 07753
(201) 775-2490



MICROWAVES & LASERS

Inexpensive gas laser reaches 75% power in 2 s



Edmund Scientific, 380 Edscorp Building, Barrington, N.J. Phone: (609) 547-3488. Price: \$99.50.

With a low price tag of \$99.50, a new helium-neon laser delivers 75% power within two seconds after turn-on, and full power within three minutes. Model 79,004 supplies a steady 2%-ripple laser light of moderate power that is particularly useful for studies and experiments in holography, interferometry, spectroscopy, communications and diffraction.

CIRCLE NO. 264

Economy He-Ne laser delivers 0.5-mW power



Metrologic Instruments, Inc., 143 Harding Ave., Bellmawr, N.J. Phone: (609) 933-0100. P&A: \$99.50; stock to 2 wks.

Selling for only \$99.50, a new helium-neon laser operates at 6328 Å and emits about 0.5 mW of power (0.3 mW minimum) with a beam divergence of 0.5 milliradian. Model 310 is ruggedly housed and is simple to take apart and reassemble. Its tube, which is made of rugged coaxial glass with sealed optics, measures about 9-in. long by 1 in. in diameter.

CIRCLE NO. 265

Our new retina sees red everywhere

**New photocathode responds from 300 nm to 950 nm.
Best yet for GaAs laser beam detection.**

The prosaic designation, S-25, for our new red sensitive translucent photocathode belies its exciting characteristics and usefulness.

With a spectral response that ranges from 300 nm to 950 nm, the S-25 needs no additional infrared source, sensing instead natural radiation such as moonlight and airglow. Fact is, under a night sky our new S-25 is 4 times more sensitive than S-1 or S-20.

Increased spectral range

This extreme spectral range makes possible increased contrast in detecting man-made objects versus

foliage. Obvious advantage: Extremely sensitive military night vision devices. Note, too, that because the response of the S-25 is particularly outstanding between 840 and 890 nanometers, it is ideal for gallium arsenide laser beam detection. A characteristic that should be of interest to those involved in distance measuring equipments for bridges and tunnels, or military range finders.

For those with scientific turn of mind, the S-25 operates well in high electric field gradients, is capable of high peak current output without electric field distortion or defocus-

sing, and is adaptable to multi-bounce optical trapping for even greater sensitivity.

Configurations available

You can, of course, expect to get the S-25 photocathode in a host of phototube configurations and end-on photocathode designs such as Vidisector® camera tubes, photomultipliers, image intensifiers and vacuum photodiodes.

Want more information? Write: ITT Electron Tube Division, International Telephone and Telegraph Corporation, P.O. Box 100, Easton, Pa. 18042

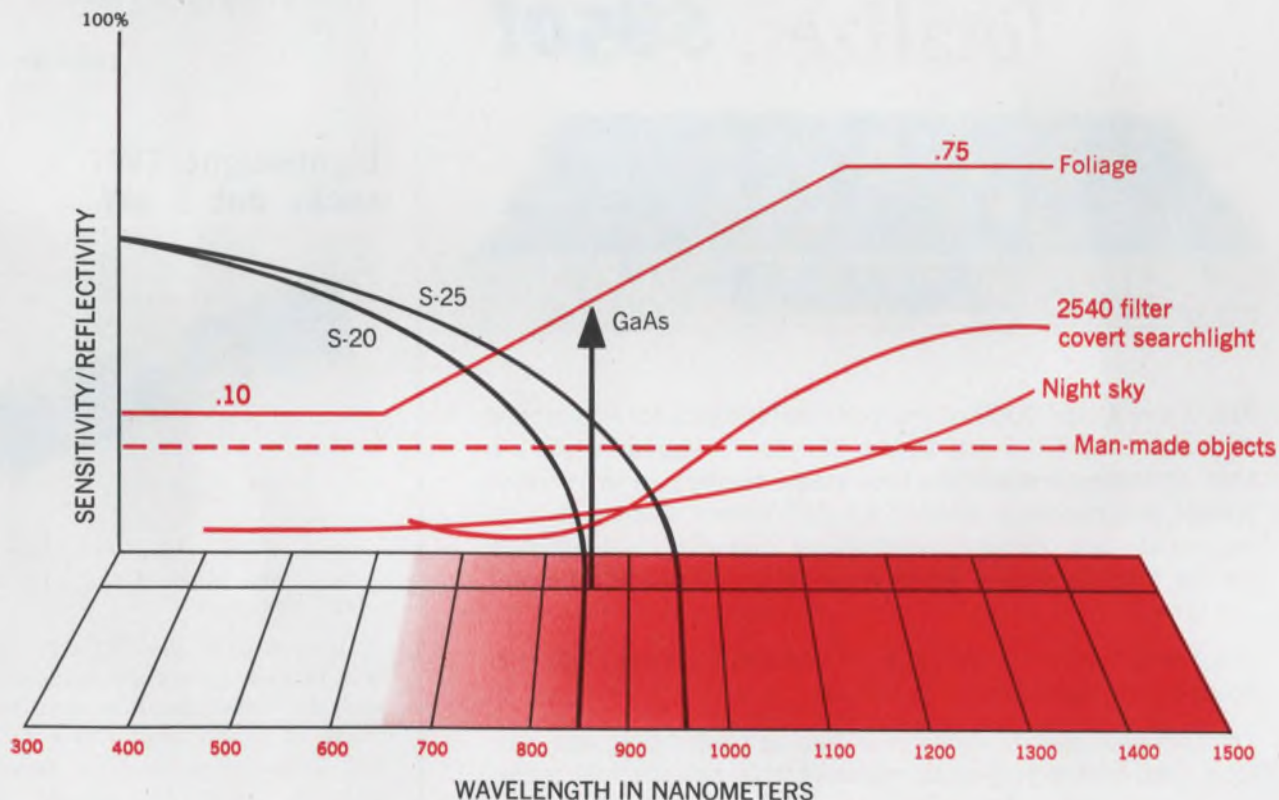

ELECTRON TUBE DIVISION **ITT**

**Atec's new
12.5 MHz
universal
counter/timer
measures
Frequency,
Time Interval,
Ratio, Period,
Multiple Period,
and
Totalizes. *That's
quite
a bit
for
\$850!***



Atec's new Model 2000 offers more performance for less money than any competitive instrument. Standard features include a 1 MHz crystal-controlled time base stable to one part in 10^8 /day, remote programming, and 1-2-4-8 BCD output. Options include display storage, oven-stabilized crystal, and additional digits (to seven). Modular plug-in design makes it simple to add options at any time.

Input sensitivity is 10 mV (DC to 5 MHz) and 30 mV to 12.5 MHz. Front panel height is only $1\frac{3}{4}$ inches.

For complete specifications or a free demonstration, call your local Atec engineering-sales representative, or write Atec today.

Atec, Inc.

1125 LUMPKIN STREET, HOUSTON, TEXAS • PHONE (713) 468-7971
MAILING ADDRESS: P.O. BOX 19426 • HOUSTON, TEXAS 77024

INFORMATION RETRIEVAL NUMBER 93

MICROWAVES & LASERS

**Palm-sized oscillator
supplies 10 mW at 4 GHz**



Hewlett-Packard, 1501 Page Mill Rd., Palo Alto, Calif. Phone: (415) 326-7000. P&A: \$1190; 30 days.

Self-contained in its hermetically sealed palm-sized package, a new electronically tunable solid-state S-band oscillator delivers more than 10 mW from 2 to 4 GHz. Model 35009A is a YIG-tuned transistor oscillator and buffer amplifier built as a thin-film hybrid microcircuit on a sapphire substrate. When the load is 50 Ω , the output level will vary no more than 1.5 dB.

CIRCLE NO. 266

**Lightweight TWT
socks out 1 kW**

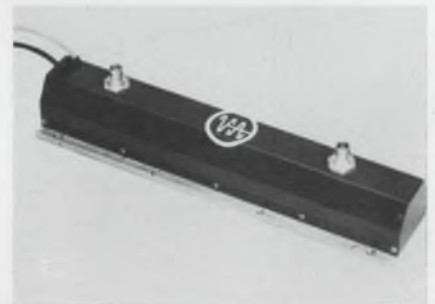

Varian TWT Div., 611 Hansen Way, Palo Alto, Calif. Phone: (415) 326-4000.

Designated as the VTC-5261J1, a new cathode-pulsed traveling-wave amplifier tube produces more than 1 kW of peak output power at an 8% duty rating from a package weighing only 4.5 pounds and measuring slightly more than 12 in. long. It is intended for use as a driver or output tube in advanced pulse-radar missile-guidance systems that operate between 5.4 and 5.9 GHz.

CIRCLE NO. 267

Vhf/uhf transistors give 20 W at 400 MHz



Motorola Semiconductor Products Inc., P.O. Box 20924, Phoenix, Ariz. Phone: (602) 273-6900. P&A: \$4.28 to \$46; stock.

Three new families of balanced-emitter transistors for uhf and vhf power applications feature outputs up to 20 W at 400 MHz with a 28-V supply (2N5637), 40 W at 175 MHz with a 28-V supply (2N5643), or 25 W at 175 MHz with a 13.5-V supply (2N5591). These new devices consist of many small transistors in parallel, with a small thin-film resistor in series with each of the emitters.

CIRCLE NO. 268

Portable emi meter goes out to 10 GHz



Stoddart Electro Systems, 2045 W. Rosecrans Ave., Gardena, Calif. Phone: (213) 770-0270. P&A: from \$13,000; January, 1970.

Covering the frequency range from 1 to 10 GHz, a new portable solid-state emi meter derives its power from an integral rechargeable battery pack. Model NM-65T is ideal for determining the source and analyzing the characteristics of electromagnetic interference. Typical uses include microwave propagation studies and radiation pattern measurements.

CIRCLE NO. 269

We call these astronauts' little helpers "Superpots"—because they're almost indestructible—built to take all kinds of environmental punishment without any impairment in performance. Fairchild potentiometers and other Fairchild Controls products were on the last Apollo flight around the moon, doing their jobs faithfully, along with thousands of other components. In fact, Fairchild Controls components have been tied up with every major U.S. space shot from Mercury to Apollo. We mention the

space program to illustrate a point: If you want out-of-this-world reliability from your precision potentiometers, call on Fairchild Controls... the down-to-earth company that makes them.

FAIRCHILD
CONTROLS
A DIVISION OF FAIRCHILD CAMERA AND INSTRUMENT CORPORATION
225 PARK AVENUE, HICKSVILLE, L. I., NEW YORK
TELEPHONE: (516) 938-5600 • TWX: (510) 221-1854
CABLE: FAIRCON-HICKSVILLE, NEW YORK, U. S. A.

Our potentiometers went around the moon with Apollo 8.

We think that proves something.

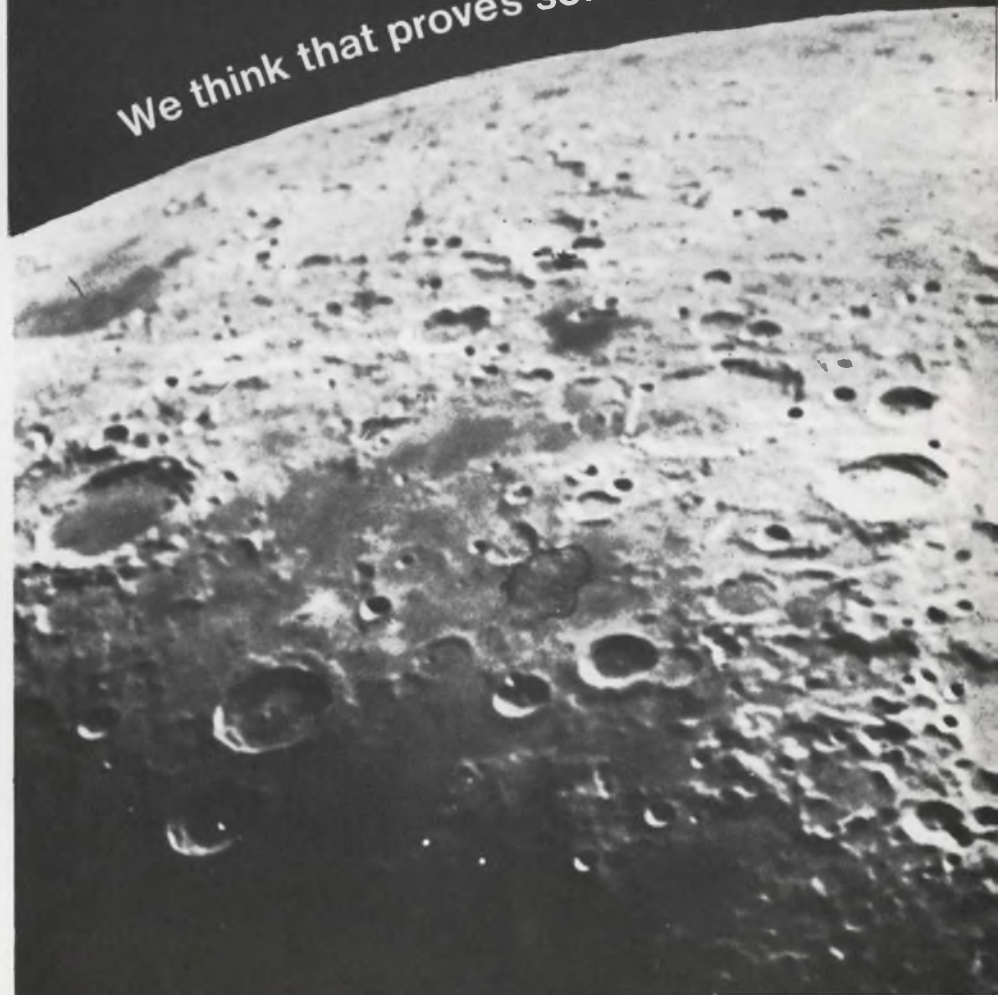

Acoustic delay lines keep loss to 18 dB

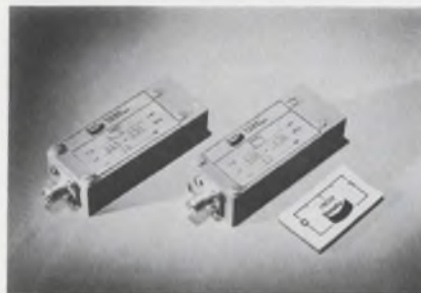

Bendix Corp., Research Laboratories Div., 20800 10-1/2 Mile Rd., Southfield, Mich. Phone: (313) 353-3500.

Using thin piezoelectric films with a high transfer efficiency, a new series of compact microwave acoustic delay lines feature typical insertion losses of less than 18 dB at bandwidths approaching 30%. The new devices cover the frequency range of 100 to 500 MHz with delays up to 10 μ s. They can be supplied in either single- or double-ended configurations.

CIRCLE NO. 270

Comblin 100-W filter has 48% bandwidth



Peninsula Microwave Laboratories, 855 Maude Ave., Mountain View, Calif. Phone: (415) 969-3303.

Designed primarily for high-power telemetry radar, a new combline filter with a 48% bandwidth covers the frequency range of 1.4 to 2.3 GHz with 0.35-dB maximum insertion loss and 1.3 maximum VSWR. Model F537A has a power handling capability of 750 W peak and 100 W average. Stopbands are dc to 1 GHz and 2.6 to 8 GHz with a minimum rejection of 45 dB.

CIRCLE NO. 271



Our new counting wheel gives you two important high-performance options in "D" Series instrument counters.

Operate your "D" at standard speeds and you'll have substantially longer counter life. Or run it at a speed 50% higher than was possible with the old wheel (3000 rpm vs. 2000 for the old) and you'll have the same counter life as before.

These benefits are the direct result of a breakthrough in molding techniques and materials that let us reduce the standard Delrin wheel's weight by 30%. This means the new wheel has 20% lower torque requirements, lower inertia, and creates far less radial load and strain on the counter mechanism. And that a counter equipped with it operates 30% more quietly, regardless of speed.

The new Delrin wheels are available in two styles. One has a bronze bushing. Use this if you need exceptionally high performance or very long counter life. The other style has no bushing, and is ideal for standard applications.

Both styles are fully interchangeable with wheels supplied on previous "D" models. Figures are permanently impressed into the Delrin, and meet Mil specs for readability. Dull instrument finish is standard. For full information write for Instrument Counter Catalog, 622 N. Cass St., Milwaukee, Wis. 53201.

Versatile "D" series 3, 4, 5, or 6-figure model without case. 3000 rpm. 1/4" Delrin wheels. special unit wheels available. 44 different models.

Compact "Y" series Small. Speeds to 1500 rpm continuous, 2000 rpm intermittent. Open or closed design. Some models resettable. all add and subtract.

Sub-miniature "S" series 3, 4, or 5-figure sub-miniature model without case. For use where space and weight are limited. 2500 rpm intermittent. 1/8" figures. 12 different models.

See the difference! Wheel samples free with request for information.

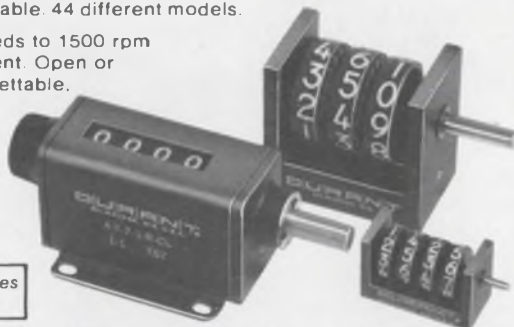

DURANT
DIGITAL INSTRUMENTS

A CUTLER-HAMMER COMPANY

In Europe: Durant (Europa) N.V. Barneveld, Netherlands

INFORMATION RETRIEVAL NUMBER 95

New IRC rectangulars trim circuit space and cost



Metal Glaze and Wirewound types

These 3/4-inch-long rectangular trimmers are made and perform like bigger, more costly units. Only IRC offers a miniature general-purpose unit with these features:

- All-metal adjustment shaft that eliminates breakage or distortion, even under repeated use.
- Silver brazed terminations on Metal Glaze and Wirewound types end resistance buildup associated with pressure connections.
- Ultrasonic bonding of the housing into a one-piece unit that is free of seams or laps.
- Resistance to normal board washing. Units sealed to MIL-R-27208 are also available.

Metal Glaze Type 950 has a rugged, thick-film element that provides excellent high-frequency characteristics and infinite resolution over the entire resistance range of 100Ω to 1 megohm. 1/4-watt @ 25°C. ±10% tolerance.

Precision Wirewound Type 900 has a long-wearing precious metal wiper spring that reduces noise and contact resistance. 1 watt @ 40°C. 100Ω to 20K. ±10% tolerance.

PIN CONFIGURATIONS

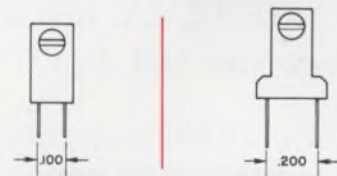

WIREWOUND	METAL GLAZE	WIREWOUND	METAL GLAZE
900-20 Std.	950-20 Std.	920-20 Std.	970-20 Std.
910-20 Sealed	960-20 Sealed	930-20 Sealed	980-20 Sealed

Immediate delivery from stock or from IRC Industrial Distributors. For information and prices write:

IRC St. Petersburg Division of TRW INC.
2801 72nd St., North, St. Petersburg, Fla. 33733



DIVISION OF TRW INC.

EMI filters shouldn't be a big deal so we make the smallest ones

You've convinced me EMI filters shouldn't be a big deal. So send me specs before I forget about them completely.

I'm still worried, and anyone can write specs. Send a representative with loads of solutions to the problem I've attached.

Name _____

Company _____

Title _____

Address _____

City _____ State _____ Zip _____

Send to: Genisco Technology Corporation, Components Division
18435 Susana Road, Compton, California 90221

Our 50,100 and 200 VDC miniature filters for π , T, L, 2L circuits are at least 20% smaller than any others.

But size isn't their only advantage: resistance is as low as .005 ohms typical, combined with high insertion loss per Mil-Std 220A. And each gold-plated filter meets the ever-popular MIL-F15733.

If the 49 filters described in our spec sheets can't solve your problems, it's not a big problem. We've been designing EMI filters for 15 years. So designing one for you won't cause a hassle. Or high prices.

So send in the big coupon. It can solve a multitude of small problems.



GENISCO TECHNOLOGY CORPORATION
18435 SUSANA ROAD
COMPTON, CALIFORNIA 90221
(213) 774-1850

INFORMATION RETRIEVAL NUMBER 97

ICs & SEMICONDUCTORS

Plastic transistors sell for only 19¢

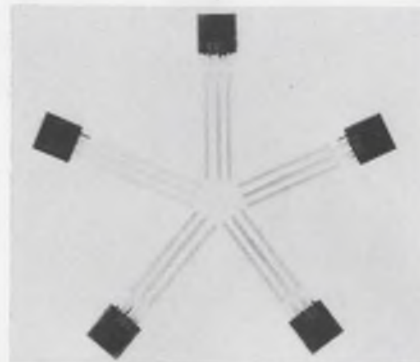

Motorola Semiconductor Products Inc., P.O. Box 20924, Phoenix, Ariz. Phone: (602) 273-6900. Price: 19¢ to 25¢.

Costing as little as 19¢ each in quantities of 100, three new small-signal silicon transistors come in TO-92 plastic packages. Types MDSA10, MDSA20 and MDSA70 are designed especially for low-level audio amplifiers and general-purpose low-frequency amplifiers, or as switches in audio, radio and television circuits. Breakdown voltage is 40 V minimum.

CIRCLE NO. 272

Monolithic one-shot defines trigger level

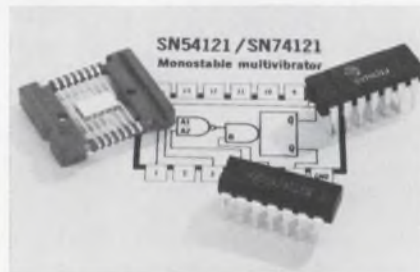

Texas Instruments Inc., Components Group, P.O. Box 5012, Dallas, Tex. Phone: (214) 238-2011. P&A: \$4.40, stock to 4 wks.

A new monolithic TTL monostable multivibrator integrated circuit, the SN74121, triggers at a specific voltage level of the input pulse. Once fired, the device's inputs are inhibited and the duration of the output pulse, which is externally variable from 40 ns to 40 s, is dependent only on the value of the timing resistor and capacitor.

CIRCLE NO. 273

INFORMATION RETRIEVAL NUMBER 238 ►

from telonic

**...a new
concept for
information
display!**

- for the research and development laboratory
- in production testing and quality control
- for medical diagnosis and patient monitoring
- as a teaching aid in classroom demonstration



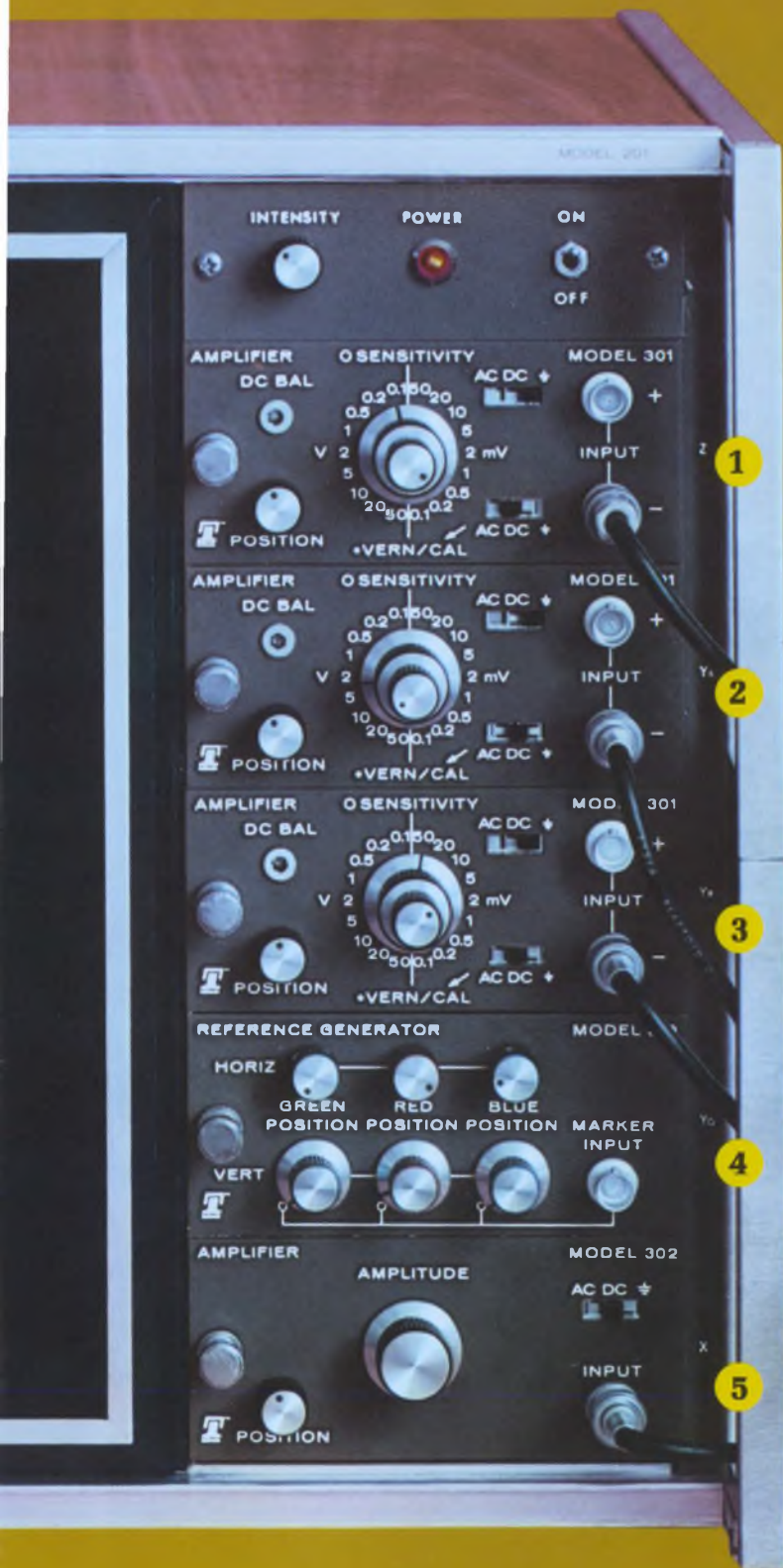

OPTIONAL TIME BASE Horizontal deflection in the 201 System is usually obtained from an external sweep signal. A calibrated Time Base is also available as an optional plug-in unit to provide sweep rates from 1 to 1000 milliseconds per inch. A vernier control extends sweep time to 10 seconds per inch.

SOLID STATE — MODULAR DESIGN The 201 System is completely solid state with the exception of the CRT. For maximum versatility, the Model 201 consists of a basic display chassis and functional plug-in units. Operating characteristics of the System are determined by the plug-in units selected.

Plug-ins presently available include vertical and horizontal amplifiers, a reference line generator, and a time base. Future units may occupy the entire plug-in area to provide the total signal processing and display functions for multiple parameter measurements.

VERTICAL AND HORIZONTAL PLUG-IN AMPLIFIERS Three vertical amplifier plug-in units **1 2 3** are required for normal operation of the 201 Display System — one for each signal channel. If horizontal deflection is to be obtained from an external signal, an additional amplifier will be required for this channel **5**. The Model 320 Time Base plug-in unit can be used in place of the horizontal amplifier to provide a linear calibrated horizontal sweep.

Two amplifiers are available — the Model 301 High Gain Differential unit and the Model 302 Basic Amplifier. Both units are direct coupled, enabling display of dc levels and low frequency signals. Either model may be used for vertical or horizontal channels.

The calibrated deflection factor of the Model 301 differential unit is adjustable from 100 μ V/inch to 50 V/inch, providing maximum versatility for both low-level and general purpose applications. The vernier control can be used to reduce the deflection factor to 100 V/inch. In differential operation, the common mode rejection is 30 dB.

The Model 302 Basic Amplifier plug-in is a general purpose unit with a continuously variable sensitivity of 100 mV/inch to 10 V/inch.

TIME BASE PLUG-IN The Model 320 Time Base plug-in is available for use in the horizontal channel **5** and provides calibrated sweep times of 1 to 1000 msec/inch in four ranges. The vernier control extends the slowest sweep range to 10 seconds/inch. The unit can be triggered by external or internal signals or by the power line.

Trigger slope and level adjustments enable triggering at any point on the waveform.

REFERENCE LINE GENERATOR PLUG-IN

The Model 310 Reference Generator **4** furnishes three vertical and three horizontal electronic cursors in red, green, and blue which can be positioned anywhere on the screen by independent front panel controls. These reference lines may typically be used to set min/max signal limits for both level and frequency, to compare amplitudes of various input signals, or as a "memory," enabling the user to return the signal amplitude to the original level if desired. Any one of the vertical reference lines may be triggered by an external time or frequency marker pulse.

is illustrated in the display shown in Figure 1. The blue vertical frequency markers were triggered by a sweep generator. The red and blue horizontal reference lines represent the specification limits of the unit under test.

Phase and amplitude relationships of three signals are displayed in Figure 2.

Figure 3 illustrates the variety of data that can be presented to provide maximum information in a single display — the response characteristics of three tuned circuits, vertical frequency markers, and upper and lower limit reference lines.



Figure 3

**the telonic
model 201
tri-color
display system
displays up to
three different
input signals
plus horizontal
and vertical
reference lines,
each in a
separate color
with high
resolution and
sensitivity.**

THREE-COLOR DISPLAY The 201 is a large screen, multi-channel, tri-color display unit that provides an entirely new perspective in analog presentations. Three vertical signal channels may be displayed on the 15" CRT simultaneously in red, green and blue with three vertical and three horizontal reference lines in the same colors. This multi-color presentation assures positive identification of each input, regardless of its proximity to the other signals. Even overlapping traces can be easily identified.

HIGH RESOLUTION, HIGH SENSITIVITY The unique three-color presentation also enables each signal to be displayed at **full screen height** for high resolution and accurate comparison without sacrificing trace identification. It is not necessary to restrict each signal to a separate segment of the display area.

The 201 System utilizes a separate amplifier for each input channel to provide maximum control of each signal and complete channel-to-channel isolation. Input signal sensitivity range is 100 μ V/inch to 100 V/inch assuring maximum resolution regardless of input level.

ELECTRONIC REFERENCE LINES The tri-color vertical and horizontal reference lines can be adjusted to any position on the screen by individual front panel controls. A vertical reference line may also be externally triggered by a time or frequency marker pulse.

These reference lines cover the full screen, facilitating relative frequency and level comparisons between each of the input signals.

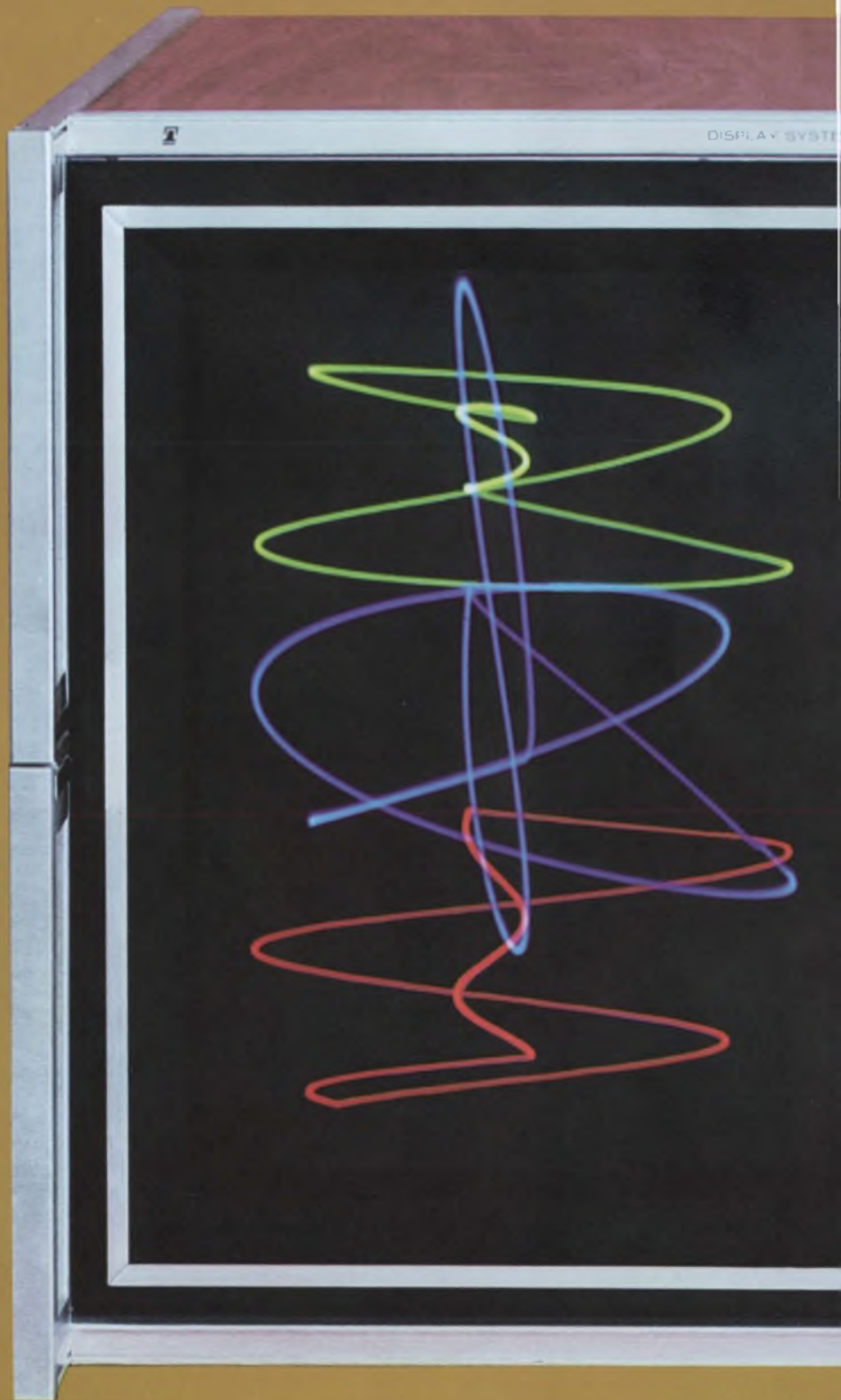

applications

The high sensitivity, direct coupling, and large screen area of the Model 201 make it an ideal display system for many applications in the fields of electronics, medicine, and education. Applications include any situation in which dc or video information is to be displayed with respect to time or frequency.

A swept frequency measurement of the gain and VSWR of a broad band amplifier



Figure 1

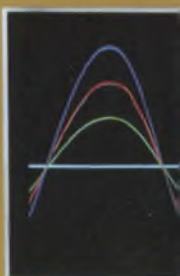
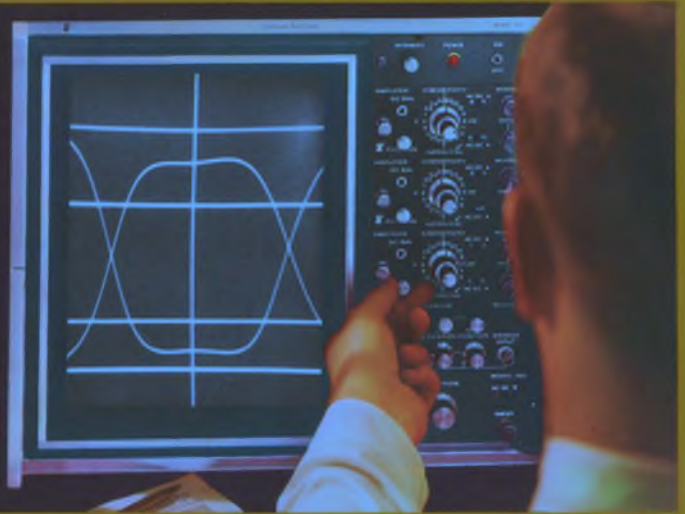

Figure 2

model 202 monochrome display system

The Telonic Model 202 Monochrome Display System provides all the features of the Model 201 with the exception of color. The advantages of a large screen display system, adjustable reference lines, and plug-in versatility are all available on the Model 202. This monochrome unit is capable of high resolution, low flicker displays with a choice of CRT phosphors. All plug-in units described are applicable to the 202 System.



specifications

GENERAL The vertical sections of the Model 201 and 202 Display Systems utilize a scan/sampling technique. The CRT electron beam is scanned vertically at a 36.2 kHz rate. During down-scan the input signals are sampled producing a dot for each signal. During up-scan the reference lines are displayed. The rapid scan rate provides a high dot density. The highest frequency that can be displayed by the vertical channels is dependent upon both the scan rate and the video bandwidth of the plug-in amplifier being used.

The frequency response of the horizontal channel is dependent upon the small signal bandwidth and the maximum undistorted slew rate. These parameters are primarily a function of the display chassis.

MODEL 201 TRI-COLOR DISPLAY CHASSIS A three channel scan/sampling system providing simultaneous display of three input signals in red, green, and blue. The Model 201 has separate facilities for vertical, horizontal, and reference line functions.

Usable Screen Area: 10.5 inches by 7.9 inches

Vertical Scan Rate: 36.2 kHz

Horizontal: Small Signal Bandwidth (3 dB), 50 kHz. Maximum Undistorted Slew Rate, 10 inches/msec.

Accelerating Potential: 20 kV.

Power: 115/230V, 50/60Hz, 350 watts.

Dimensions: 17" wide, 14" high, 18½" deep.

Weight: 80 pounds.

Price: \$2100

MODEL 202 MONOCHROME DISPLAY CHASSIS A three channel sampling system provides simultaneous display of three input signals. Separate facilities for vertical, horizontal, and reference line functions. Optional long persistence cathode-ray tube available.

Usable Screen Area: 10.5 inches by 7.9 inches.

Vertical Scan Rate: 36.2 kHz.

Horizontal: Small Signal Bandwidth (3dB), 50 kHz. Maximum Undistorted Slew Rate, 10 inches/msec.

Cathode-ray Tube: P4 phosphor; P7 long persistence phosphor also available.

Accelerating Potential: 15 kV.

Power: 115/230V, 50/60 Hz, 300 watts.

Dimensions: 17" wide, 14" high, 18½" deep.

Weight: 80 pounds.

Price: \$1850 (with P4 phosphor) \$1950 (with P7 phosphor)

MODEL 301 HIGH GAIN DIFFERENTIAL AMPLIFIER

Deflection Factor: 0.1 mV/inch to 50 V/inch in 18 calibrated steps, 1-2-5 sequence; accuracy $\pm 5\%$; vernier provides continuous adjustment between steps and extends the 50 V/inch step to at least 100 V/inch.

Noise: maximum $10 \mu V$ p-p referred to input at maximum sensitivity.

Video Bandwidth (3dB): DC to 200 kHz; DC to 5 kHz at 0.1 mV/inch; DC to 9 kHz from 0.2 to 0.5 mV/inch. Maximum input frequency dependent upon video bandwidth and system scan rate.

Common Mode Rejection: 30 dB.

Input Coupling: AC, DC, or GND.

Input RC: 1 megohm shunted by 47 pF.

Price: \$350

MODEL 302 BASIC AMPLIFIER

Deflection Factor: Adjustable from 100 mV/inch to 100 V/inch.

Video Bandwidth: 50 to 200 kHz dependent upon vernier setting. Maximum input frequency dependent upon video bandwidth and system scan rate.

Input Coupling: AC, DC, or GND.

Input RC: 1 megohm shunted by 47 pF.

Price: \$150

MODEL 310 REFERENCE LINE GENERATOR

Marker Trigger Sensitivity: 13V pulse, max. rise time 5 μ secs or birdy type marker.

Input Impedance: 47 kilohms.

Price: \$250

MODEL 320 TIME BASE

Sweep Time: 1, 10, 100, 1,000 msec/inch calibrated to $\pm 5\%$. Vernier provides continuous adjustment between steps and extends the 1,000 msec/inch range to 10 sec/inch.

Trigger Sources: Line, external AC or DC, Internal.

Trigger Requirements: Internal, 1-inch deflection. External, ± 0.5 V to 20 V peak

Price: \$300



BLANK PANELS

Blank plug-in unit panels are available for Systems not requiring all of the available plug-in units. The panel fits the space taken by one of the plug-ins listed above.

Price: \$12 Model 315 Blank Panel

RACK MOUNTING

Hardware for rack mounting the 201 or 202 Display Systems is included with each chassis

how to order

1. Select either the Model 201 Tri-Color Display Chassis or the Model 202 Monochrome unit.
2. Choose the vertical amplifiers. For three-channel operation, three separate vertical amplifiers are required; for two-channel, two amplifiers, etc.
3. Order the reference generator or, if this function is not desired, a blank panel may be used in this space.
4. Select either a horizontal amplifier or time base unit for the horizontal channel.

NOTE: The Model 201 and 202 Systems must have at least one vertical amplifier and a horizontal plug-in unit installed in order to operate.



telonic systems

A Division of Telonic Industries, Inc.

21282 Laguna Canyon Rd. • Box 277 • Laguna Beach, Calif. 92652

Phone: (714) 494-9401

TWX: 910 596-1320

© 1969 Telonic Industries, Inc. • Printed in USA • 1000/244M/789/JA

PATENT APPLIED FOR

Tiny flag-lead diodes complement hybrids



MicroSemiconductor Corp., 11250 Playa Court, Culver City, Calif. Phone: (213) 391-8271. P&A: from 22¢; stock.

Especially suited for use in hybrid circuits, Hybridiode diodes permit characteristics testing prior to bonding into the circuit, as well as high reliability processing and stress testing. Their flag-type leads may be used for contact to the pad by soldering, welding or thermo-compression bonding. These leads can also be removed and contact made directly to top and bottom of the pellet.

CIRCLE NO. 274

Miniature rectifiers recover in 150 ns



Solitron Devices, Inc., 256 Oak Tree Rd., Tappan, N.Y. Phone: (914) 359-5050.

Said to be the smallest units of their kind, new miniature 1-A silicon rectifiers provide recovery speeds as fast as 150 ns. Series TS A23F devices are hermetically sealed in a package measuring only 0.107 in. in diameter by 0.210 in. long. PIV voltage ratings range from 15 through 800 V and leakage currents at dc reverse voltage are 10 μ A maximum.

CIRCLE NO. 275

Reed Relays that deliver more of what you need most...

VERSATILITY ■ RELIABILITY ■ ECONOMY



Standard and Miniature Reed Relays



Special Design Reed Relays



Front-Connected Screw Terminal Socket

Automatic Controls' Reed Relays — standard, miniature, or your special designs — offer individually supported reed switches, magnetic foil wrapped coils, non-magnetic terminals, and rhodium plated contacts, providing peak performance and reliability. Standardized contact configurations assure off-the-shelf delivery and maximum economy. For more of what you need most — specify Automatic Controls' Reed Relays everytime!

NEW from Automatic Controls... Front-Connected Screw Terminal Socket.

Accommodates the Automatic Controls' "family" of general purpose plug-in relays and time delay relays.

Automatic Controls

Division



COOK ELECTRIC

200 East Daniels Rd., Palatine, Ill. 60067

FREE LITERATURE!

Write for illustrated brochures and technical information:

- #800 Industrial Relays
- #700 Pressure Switches
- #940 Reed Relays
- #720 Military Relays
- #830 Ice Detection Systems
- #874 Contactors
- #859 Program Timers

Specify above by numbers



this is Simpson's 2700 digital system...

*New-Fast warm-up**

- 4½ digits
- 0.05% accuracy
- 5 plug-in function modules



- Automatic Polarity Selection
- Built-in Self Calibration
- 100 Microvolt Resolution
- Optional BCD output
- IC Modular Design for reliability

*Just 1 minute for 0.1% accuracy. 5 minutes for 0.05%.

2700 DIGITAL SYSTEM \$615⁰⁰
complete with DC voltage range
module, test leads, and operator's manual

AVAILABLE "OFF-THE-SHELF" AT ELECTRONIC DISTRIBUTORS STOCKING
SIMPSON INSTRUMENTATION PRODUCTS.

Simpson ELECTRIC COMPANY

5200 W. Kinzie Street, Chicago, Illinois 60644 • Phone (312) 379-1121
Export Dept: 400 W. Madison Street, Chicago, Illinois 60606. Cable Simelco
IN CANADA: Bach-Simpson Ltd., London, Ontario • IN INDIA: Ruttonsha-Simpson
Private Ltd., International House, Bombay-Agra Road, Vikhroli, Bombay



DIVISION

INFORMATION RETRIEVAL NUMBER 101

ICS & SEMICONDUCTORS

MSI data selectors delay only 10 ns

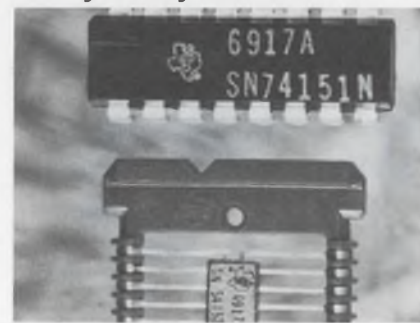

Texas Instruments Inc., Components Group, P.O. Box 5012, Dallas, Tex. Phone: (214) 238-2011. P&A: \$4.83 to \$12.10; 2 wks.

Offering input clamping diodes, full on-chip buffering, and typical propagation delay times of 10 ns, three new series 54/74 TTL MSI data selectors/multiplexers are now available. The SN54150 and SN-74150 are 16-bit units, and the SN-54151, SN74151 and SN54152 are eight-bit devices. These new circuits can serve as function generators, perform random or sequential parallel-to-serial conversion, multiplex, or function as memories.

CIRCLE NO. 276

MSI frequency dividers are programmable chips

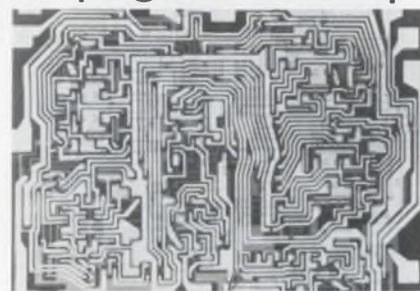

Sylvania Electric Products, Inc., Semiconductor Div., 100 Sylvan Rd., Woburn, Mass. Phone: (617) 933-3500. P&A: \$8.80; stock.

Two new TTL medium-scale integrated circuits are programmable frequency dividers that produce an output frequency at a repetition rate that is the reciprocal of the applied input frequency. The SM143 binary divider can perform frequency division by any whole number up to 16; the SM153 decade divider performs frequency division by any whole number up to 10.

CIRCLE NO. 277

Who's First... with 5,000,000 SILICON POWER transistors per month

- Over 300 standard types/over 500 custom types
- P-N-P and N-P-N
- From 50 mA to 100 A, 1 W to 300 W, 50 V to 500 V
- Using all the SILICON POWER technologies
 - Hometaxial Base
 - "Overlay"
 - Epitaxial
 - Plastic Power
 - Multiple Epitaxial
 - Triple Diffused
 - Diffused Planar
- Multiple packaging, including hermetic and plastic "VERSAWATT"
- Commercial, industrial, military high reliability specs
- Providing specific, versatile, economic answers to all your circuit needs

Who? The Leader in SILICON POWER



For more information, see your local RCA Representative
or your RCA Distributor. For technical data, write:
RCA Electronic Components,
Commercial Engineering, Section IG9-2, Harrison, N. J. 07029

INFORMATION RETRIEVAL NUMBER 102

Do you think you have to sacrifice performance because no single capacitor possesses all your critical requirements?

Don't think negative... think DEARBORN

METALIZED POLYCARBONATE FILM CAPACITORS

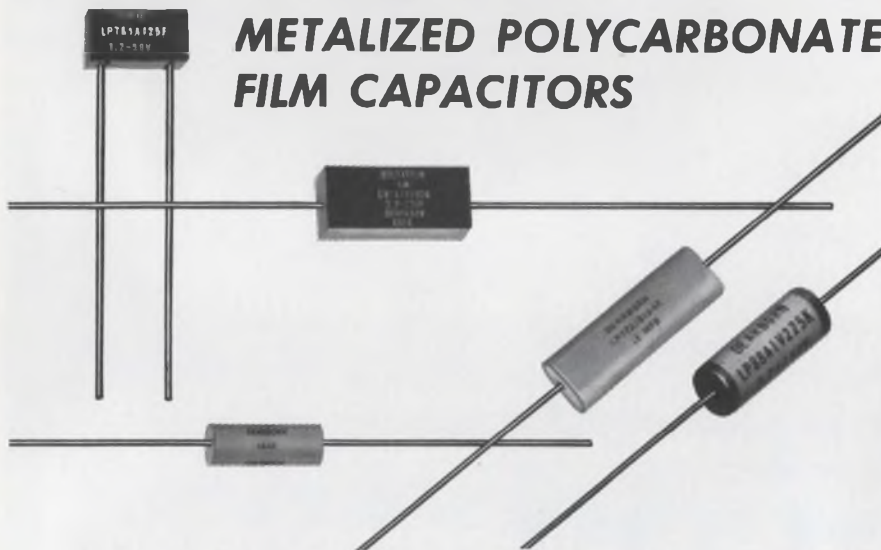

- Extremely low leakage current
- Low dissipation factor
- Non-polar construction
- 125 C operation without derating
- Light weight
- Mini-size
- Suitable for ac/rf applications
- Low temperature coefficient
- Long term stability
- Close capacitance tolerance
- Low dielectric absorption
- Consistent retrace
- Capacitance values to 100 μ F
- Voltage ratings, 50 V to 400 V

There's a style for every circuit need...

Style No.	Description
LP8	Hermetically-sealed metal-case tubular
LP9	Hermetically-sealed metal-case tubular, insulating sleeve
LP7A	Epoxy-case rectangular, axial leads
LP7S	Epoxy-case rectangular, radial leads
LP66	Wrap-and-fill round tubular
LP77	Wrap-and-fill oval tubular
LP88	Fuz-ion® sealed tubular

For engineering bulletins on the capacitor styles in which you are interested, write to Dearborn Electronics, Inc., Box 530, Orlando, Fla. 32802.

Dearborn Electronics, Inc.
(a subsidiary of the Sprague Electric Company)
FOREMOST IN FILM CAPACITORS

10-9101

INFORMATION RETRIEVAL NUMBER 103

148

ICS & SEMICONDUCTORS

FET amplifier family holds noise to 0.1 dB

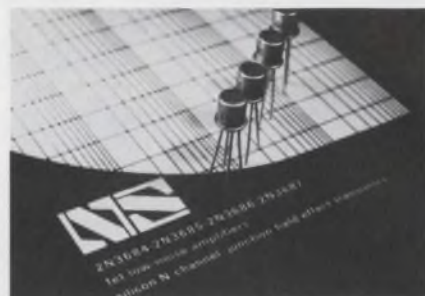

National Semiconductor Corp., 2975 San Ysidro Way, Santa Clara, Calif. Phone: (408) 245-4320. P&A: \$1.90 to \$2.60; stock.

A new series of low-noise FET amplifiers, types 2N3684, 2N3885, 2N3686 and 2N3687, provide noise figures of 0.1 dB typical and 0.5 dB maximum. In addition, leakage currents are only 100 pA maximum and pinch-off voltages are as low as 1.2 V. The new devices can be used in various dc, audio, video and rf applications.

CIRCLE NO. 278

Power transistor takes 300-V video



General Electric Co., Semiconductor Dept., 1 River Rd., Schenectady, N.Y. Phone: (315) 456-2396. Availability: stock.

Packaged in silicone, a new 300-V video output transistor features a free-air rating of 1.33 W at 50°C ambient, and a 6.25 W rating at 25°C tab temperature. Model D40N is directly interchangeable with TO-5 metal-can devices and has a glass-passivated pellet. Maximum collector capacitance is 3 pF at 20 V, and unity-gain crossover frequency is 75 MHz minimum at 20 V.

CIRCLE NO. 279

Hybrid switch powers itself

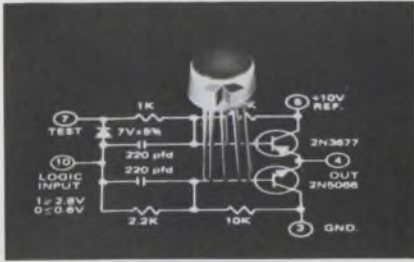

Crystalonics, a Teledyne Co., 147 Sherman St., Cambridge, Mass. Phone: (617) 491-1670. P&A: \$38; stock.

Designed for direct-from-logic operation in digital-to-analog converters, model CDA4 hybrid IC ladder switch requires no external power, but derives all its operating currents from the logic and reference supply. When used in conjunction with a 10-to-20-k Ω ladder network, this new switch provides a 12-bit accuracy. Settling times well under a microsecond allow high-speed operation.

CIRCLE NO. 280

Dual sense amplifier cycles in 400 ns

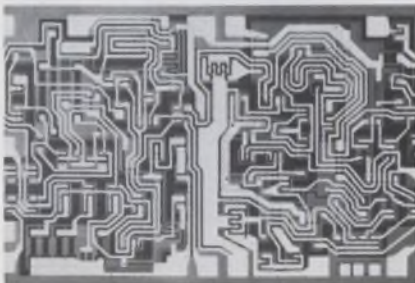

Fairchild Semiconductor, 313 Fairchild Drive, Mountain View, Calif. Phone: (415) 962-3563. Price: \$13.50.

Achieving cycle times of less than 400 ns, a new high-speed dual-channel sense amplifier is a subsystem containing compatible analog and digital logic functions within the same package. Model μ A731 performs all memory data register functions on the chip; no external digital circuitry is needed to implement these functions.

CIRCLE NO. 281

another quality product from Adlake!



FLAT PACK

Our NEW Series AWCF (Form C) and AWDF (Form D) mercury wetted contact relays—NOW make it possible for you to utilize $\frac{1}{2}$ " or less board to board centers.

We have combined our Sub-Miniature Mercury Wetted Capsule—a unique magnetic circuit—diallyl phtalate packaging (internal shielding) with Adlake engineering and quality to produce a low profile (0.300") dimension relay.

If board drainage is your concern, we have a larger model equipped with solder standoffs—its profile is a towering 0.320".

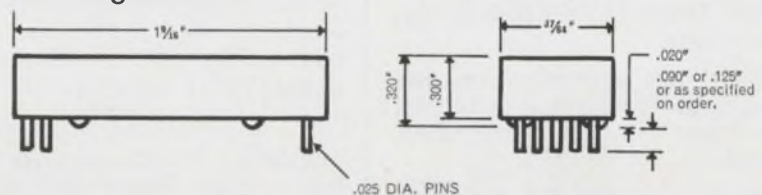

FOR COMPLETE SPECIFICATIONS...
WRITE FOR ADLAKE BULLETIN MW-7.



THE ADAMS & WESTLAKE COMPANY

ELKHART, INDIANA 46514 • 219-264-1141 • TWX 219-522-3102 • TELEX 25-8458 • CABLE ADLAKE



SUBSIDIARY OF
ALLIED PRODUCTS CORPORATION

INFORMATION RETRIEVAL NUMBER 104

Introducing a little revolution in fail-safe reed switching.



This new Cunningham Hystareed™ Magnetic Latching Relay operates *without permanent biasing magnets* or holding currents. Latches and stays latched. Won't change its programmed state because of vibration, shock, power interruptions or transients. Needs no adjustment or calibration. Available with up to six form A's, or four form C's in a single assembly. Operates as standard relay for scanning.

Ideal for: data acquisition, low-level switching, computer interfacing, logic control, industrial machinery control.

Samples available. For complete facts, request Brochure No. 606B. Write or phone Cunningham Corporation, Carriage St., Honeoye Falls, N. Y. 14472. Phone (716) 624-2000.

Cunningham Corporation

SUBSIDIARY OF GLEASON WORKS

INFORMATION RETRIEVAL NUMBER 105

150

COMPONENTS

Segmented readouts can be seen in sunlight



RCA/Electronic Components, 415 S. Fifth St., Harrison, N.J. Phone: (201) 485-3900. P&A: \$1.75 to \$3.05; fourth quarter, 1969.

Said to be viewable in sunlight, a new family of low-cost segmented incandescent readout tubes, called Numitron, is now available. Four models initiate the family: the DR 2000 for displaying numerals 0 through 9, the DR2010 for numerals plus decimal point, the DR 2020 with numeral 1 and a plus or minus sign, and the DR 2030 displaying a plus or minus sign.

CIRCLE NO. 412

Readout switch shows 12 messages

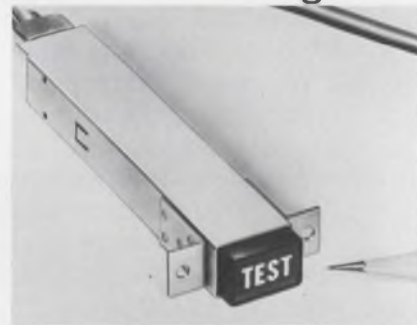

Shelly Associates, Inc., 111 Eucalyptus Drive, El Segundo, Calif. Phone: (213) 322-2374.

A new pushbutton readout switch combines a 12-message rear-projection readout with a dpdt momentary snap-action switch. The ROS-90 switch assembly is activated by depressing the viewing screen, which measures 0.65 by 0.46 in. Up to 12 messages, each 7/16-in. high, can be displayed. Messages can be projected in color or in black and white.

CIRCLE NO. 413

Multi-beam one-gun CRT intensifies brightness

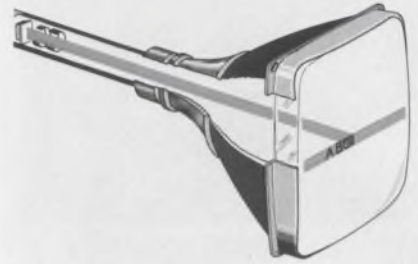

Sylvania Electric Products Inc., Electronic Tube Div., Seneca Falls, N.Y. Phone: (315) 568-5881.

Designed for computer readout applications, a new seven-beam single-gun cathode-ray tube is claimed to have a potential brightness seven times that of a conventional single-beam CRT. The SC-5299 multi-beam CRT provides characters approximately 5/32-in. high. The seven electron beams are controlled by a common focus coil; each beam may be individually modulated.

CIRCLE NO. 282

Thin-film resistors have on-chip center tap



Dickson Electronics Corp., P.O. Box 1390, Scottsdale, Ariz. Phone: (602) 947-2231. P&A: \$187/kit; stock.

Featuring a symmetrical on-the-chip center tap, a new family of thin-film chip resistors encompass standard RETMA values from 33 Ω to 470 k Ω , with tolerances of $\pm 10\%$. Supplied in kit form, the new chips have a typical substrate size of only 25-mil square. Their insulation resistance is 10^9 M Ω and temperature coefficient is ± 50 ppm typical. Power dissipation is 250 mW maximum.

CIRCLE NO. 283

INFORMATION RETRIEVAL NUMBER 106 ►

Introducing the 7½ minute prototype.

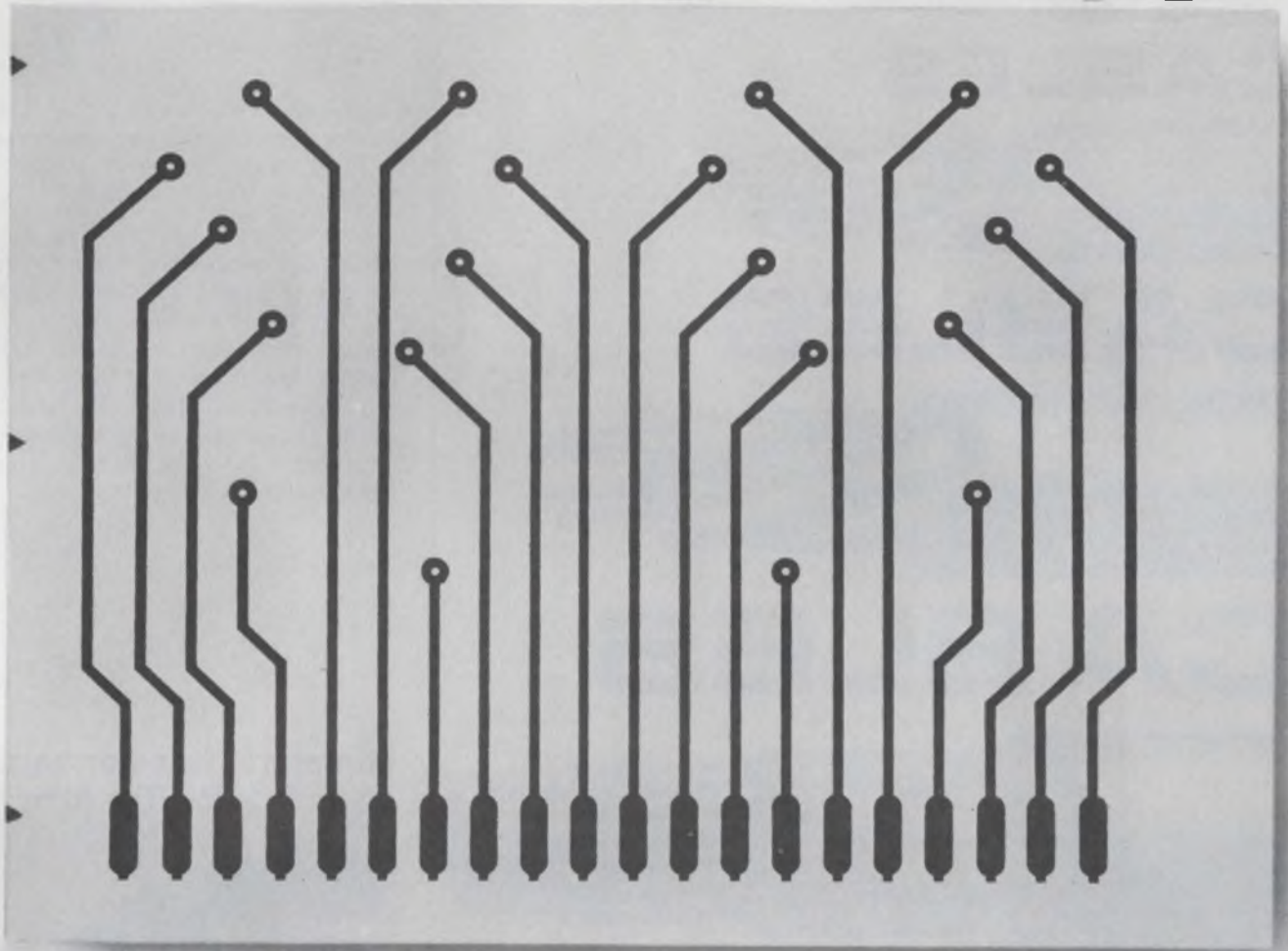

Getting prototype circuit boards used to be the biggest nuisance in design projects.

It took a lot of man-hours, expense, and a lot of space for bulky, awkward equipment.

No more. With Xerox Standard Equipment, chemical resist images can be transferred to copper-clad laminates and prepared for conventional etching—in 7½ minutes flat.

For just pennies per prototype.

And there are no wet, messy chemicals (the xerographic process is

completely dry).

No air-controlled darkroom (the Xerox equipment can be set up in a small corner almost anywhere).

No need for highly-trained technicians (most people can learn to handle it in just 60 minutes).

Of course, the 7½ minute prototype is only one of the ways you can use Xerox Standard Equipment.

If you have another 7½ minutes, we'll explain some of the others. Write Dept. BC14, Xerox Corporation, Rochester, New York 14603.

XEROX

CABLES



CABLES



CABLES



CABLES

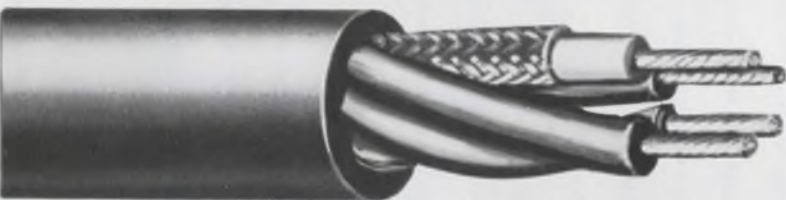

CABLES



All produced by **LENZ!**

Yes, Lenz makes cables of all styles and sizes—to suit innumerable varieties of applications.

Since 1904 Lenz has been making cables—long before the advent of radio.

Lenz has the facilities and experience to service your cable requirements. We invite you to take advantage of this experience to help solve your cable design problems—at no obligation.

Write for catalog!

LENZ ELECTRIC MFG. CO.

1755 No. Western Ave., Chicago, Ill. 60647

In Business Since 1904

In Conn., Mass., N.J., N.Y., Penn., contact R. E. Breuer Co. Inc.
1 Barstow Rd., Great Neck, N.Y. 11021. Phone: 516/466-3030



INFORMATION RETRIEVAL NUMBER 109

COMPONENTS

Dual photocell tracks to $\pm 5\%$

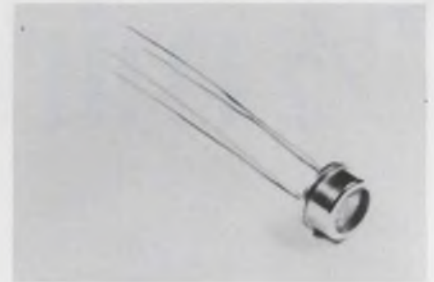

Vactex, Inc., 2423 Northline Industrial Blvd., Maryland Heights, Mo. Phone: (314) 432-4200.

Consisting of two matched isolated photoconductive elements on a common ceramic substrate, a new TO-5 photocell provides close tracking of $\pm 5\%$ from 0.5 to 50 foot-candles and close matching from ± 5 to $\pm 20\%$. Model VT 334/2 can be illuminated by incandescent, neon, or fluorescent light, or by light-emitting diodes.

CIRCLE NO. 284

Miniature transformers span 0.1 to 700 MHz



Relcom, 2329 Charleston Rd., Mountain View, Calif. Phone: (415) 961-6265. P&A: \$13 to \$30; stock.

A new line of miniature wide-band transformers operate over the frequency range of 0.1 to 700 MHz and have an insertion loss of less than 0.5 dB. Impedance transformations include 50 ohms to 12.5, 25, 50, 100, 200 and 800 Ω . They are packaged in either a high-temperature epoxy container or a hermetically sealed TO-5 metal can.

CIRCLE NO. 285

Small switches
cycle 10^5 times

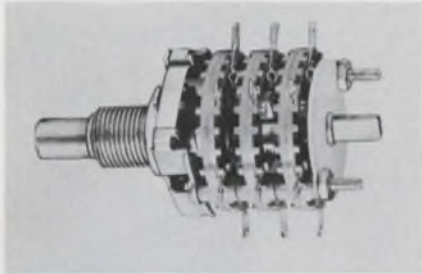

CTS Electronics, Inc., 1010 Sycamore Ave., South Pasadena, Calif. Phone: (213) 254-9141. Availability 4 to 5 wks.

Measuring only one inch in diameter, series 223 rotary switches feature a detent rotational life of 100,000 cycles, through 12 positions and return at 10 cycles per minute. The units have standard contacts of silver-plated brass; solid silver alloy contacts are available. All the switches meet the performance specifications of MIL-S-3786C.

CIRCLE NO. 286

Pushbutton switches
offer flexibility

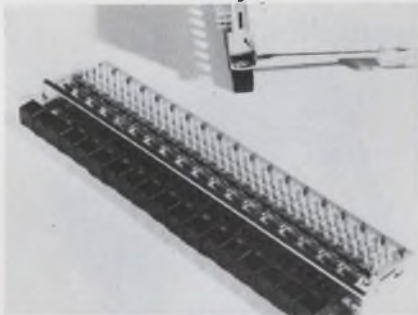

Oak Electro/Netics Corp., Oak Manufacturing Co. Div., Crystal Lake, Ill. Phone: (815) 459-5000.

Offering expanded contact and switching capacity in less panel space, series 800 Econo-Line pushbutton switches provide circuit flexibility in five switching configurations, including momentary, push-push, interlock, blockout and any combination of these. Using double-wiping silver-plated brass contacts, the units are rated from 0.5 A at 28 V dc to 0.25 A at 110 V ac for resistive loads.

CIRCLE NO. 287

ONLY VISHAY PACKS ALL THESE SPECS INTO ONE PRECISION RESISTOR

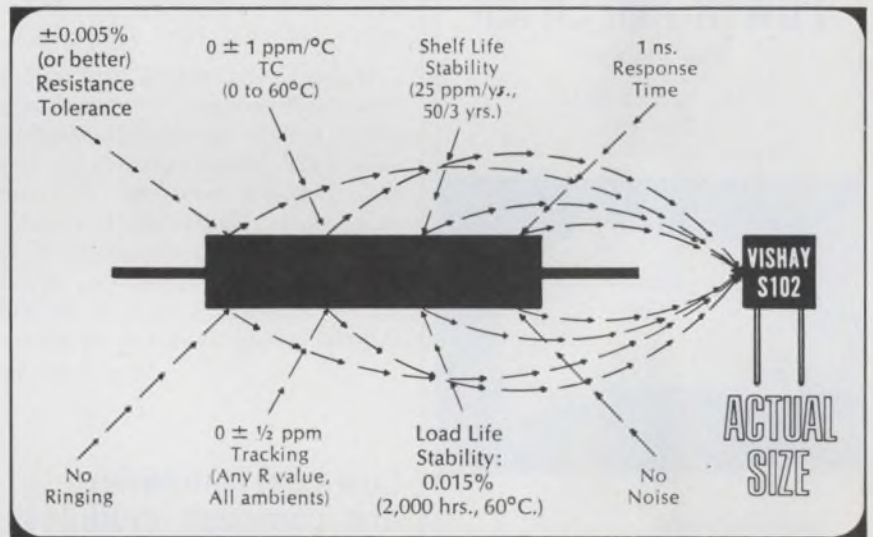

Only Vishay does it in a practical small size, available in production quantities with fast delivery. And at competitive prices too!

Precision plus speed? Never in a wirewound.

Speed *plus* precision and TC? Never in a conventional evaporated film.

No other precision resistor gives you all this performance in a production size unit. So, why trade-off when you don't have to? Simplify your circuit designs, avoid special compensating circuits and get better system performance.

These valuable guides to new thinking in resistor and network performance are free. Write for your copies today.

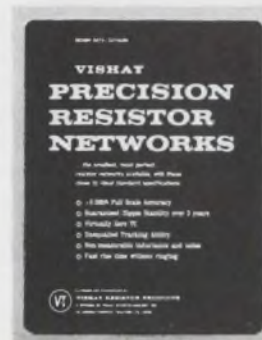
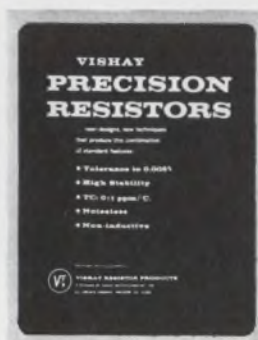

VISHAY
RESISTOR
PRODUCTS

a division of Vishay
Intertechnology, Inc.
63 Lincoln Highway
Malvern, Pa. 19355

INFORMATION RETRIEVAL NUMBER 110

C-COR AMPLIFIERS

Go From Breadboard
To Prototype Faster
... With Better Design
When You Use The
**NEW MIN-ECON
POWER AMPLIFIER**

200 Milliwatts

0.5 to 325 MHz
(typical)

Measures only 1½" x 3" x 2"

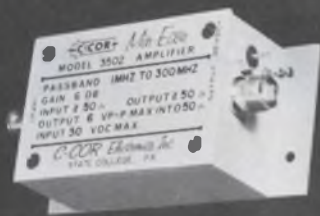

Specifications:

Flatness	1 dB
Gain	6 dB
VSWR	1.5: 1
Impedance	50 Ohms
Power Required	20 Vdcat 175 ma

Write for Technical Data Sheet No. 3502

Model 3502 Min-Econ Power Amplifier is cascadeable with seventeen other Min-Econ Amplifier units. Write for your free Min-Econ Catalog of system designers building blocks . . . C-COR's economical audio, video, pulse and feedback amplifiers . . . all available from stock.



C-COR
ELECTRONICS, INC.

60 Decibel Road
State College, Pennsylvania 16801
(814) 238-2461

MODULES & SUBASSEMBLIES

Military op amp has 10-pA bias

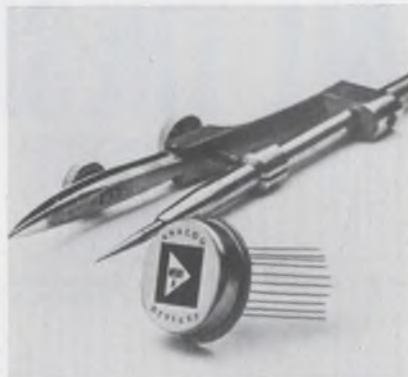

Analog Devices, Inc., 221 Fifth St., Cambridge, Mass. Phone: (617) 492-6000. P&A: \$35; stock.

Hermetically sealed in a miniature TO-8 package, a new military-grade hybrid operational amplifier uses FET input circuitry to provide a 10-pA maximum bias current drift. Model M501 matches most conventional monolithic IC op amps in physical size. Its small-signal bandwidth is 4 MHz and full-power bandwidth is 70 kHz.

CIRCLE NO. 288

Low-cost amplifiers are compact modules

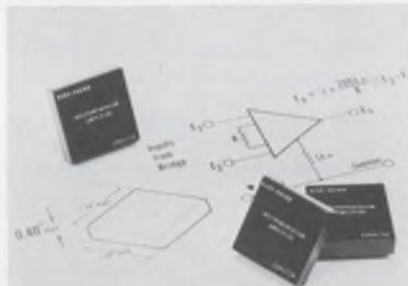

Burr-Brown Research Corp., International Airport Industrial Park, Tucson, Ariz. Phone: (602) 294-1431. P&A: \$39 or \$59; stock to 4 wks.

Two new low-cost instrumentation amplifiers, which measure only 0.4-in. high by 1.5-in. square, can be mounted on a PC board or inserted into a mating connector. Model 3264/14 has a maximum input voltage drift of $\pm 10 \mu\text{V}/^\circ\text{C}$, while model 3263/14 offers a maximum voltage drift of only $\pm 3 \mu\text{V}/^\circ\text{C}$ over the entire temperature range of -25 to $+85^\circ\text{C}$.

CIRCLE NO. 289

TO-8 timing module delays 0.1 to 100 s

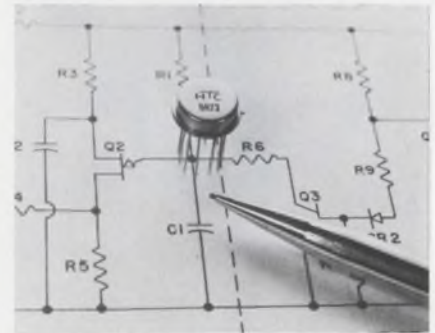

Hi-Tek Corp., Electronics Div., 2220 S. Anne St., Santa Ana, Calif. Phone: (714) 540-3520. P&A: \$25; 3 to 4 wks.

Occupying less than 1/20 the space of a compact time-delay relay, a new miniature TO-8 timing module provides delays from 0.1 to 100 seconds with an accuracy of $\pm 3\%$ and a repeatability of $\pm 2\%$. Model 333-3500 features an SCR output rated at 0.5 A at 28 to 32 V dc. It operates with voltages between 18 and 32 V dc.

CIRCLE NO. 290

D/a converter multiplies too



Hybrid Systems Corp., 95 Terrace Hall Ave., Burlington, Mass. Phone: (617) 272-1522. P&A: \$350; stock to 2 wks.

Performing with an accuracy of 0.025%, a new 12-bit multiplying d/a converter allows an externally supplied reference to be ac as well as dc. Because of the multiplying aspect, model 302 can be used to digitally modulate a signal, to act as a digitally gain controlled amplifier, or to operate with analog and digital signals.

CIRCLE NO. 291

take
the headaches
out of designing



by putting this
tiny-tiger*
to your task—

**power slide switch—Type 23-021-012 illustrated.*
Outperforms and outlives any switch sold in competition.
Here are the happy facts

- A. Measures 0.25" x 0.5" x 0.300", 6, 4, 3, or 2 terminals
- B. Resistive load up to 3 amps at 125 VAC, contact resistance .020 ohms
- C. More than 250,000 operations Mechanical Life
- D. High and low energy capabilities



CHICAGO SWITCH, INC.

2035 Wabansia Avenue • Chicago, Illinois 60647
(312) 489-5500

INFORMATION RETRIEVAL NUMBER 112

CORRECT CHASSIS HOLE MISALIGNMENT WITH NEW PRESSERT CAPTIVE FLOATING NUTS



Free floating threaded insert (movable .015" in any direction, thru 360°) permits adjustment for hole misalignment in mild steel, brass, aluminum or thermo-plastic panels, parts or chassis. Provides strong, permanent, wear resistant stainless steel threads that won't pull, push or torque out. Available in regular and self-locking types.

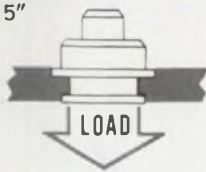

Send for new **FREE** catalog.



PRECISION METAL PRODUCTS CO.

41 ELM ST., STONEHAM, MASS. 02180
Telephone: (Area Code 617) 438-3650

INFORMATION RETRIEVAL NUMBER 113

ELECTRONIC DESIGN 19, September 13, 1969

Build a Better Modes Trap



With New Chartpak® Pressure Sensitive Electronic Circuitry Drafting Aids

Now Chartpak offers engineers and draftsmen the complete range of pressure-sensitive materials for making electronic circuitry masters. Our precision line of time-saving, cost-cutting drafting aids is bigger and better than ever.

With Chartpak, you get it all. The most complete spectrum of precision tapes, pads, clusters, connector strips, sequential reference designations, letters, numbers, die-cut symbols, targets and accessories. Over 500 standard electronic circuitry drafting aids plus unlimited special order capabilities are available to you from one dependable source. Chartpak!

Manufactured to meet the most exacting requirements in the preparation of electronic circuitry artwork. All Chartpak tapes are precision-slit guaranteed to $\pm .002$ " accuracy. And Chartpak will fill special, individual requirements on a custom-order basis. See all the many ways our pressure-sensitive materials can help you build that better modes trap. Easier. Faster. More economically. Write for our new free catalog detailing the full line of Chartpak Pressure Sensitive Electronic Circuitry Drafting Aids.

CHARTPAK ROTEX

A Division of Avery Products Corp. 
Santa Ana, Calif. & Leeds, Mass.

Look in The Yellow Pages under Drafting Supplies.

INFORMATION RETRIEVAL NUMBER 114

Rx for your Power Supply Problems:

Technipower Catalog/Design Data Book

Over 400 models available from stock.

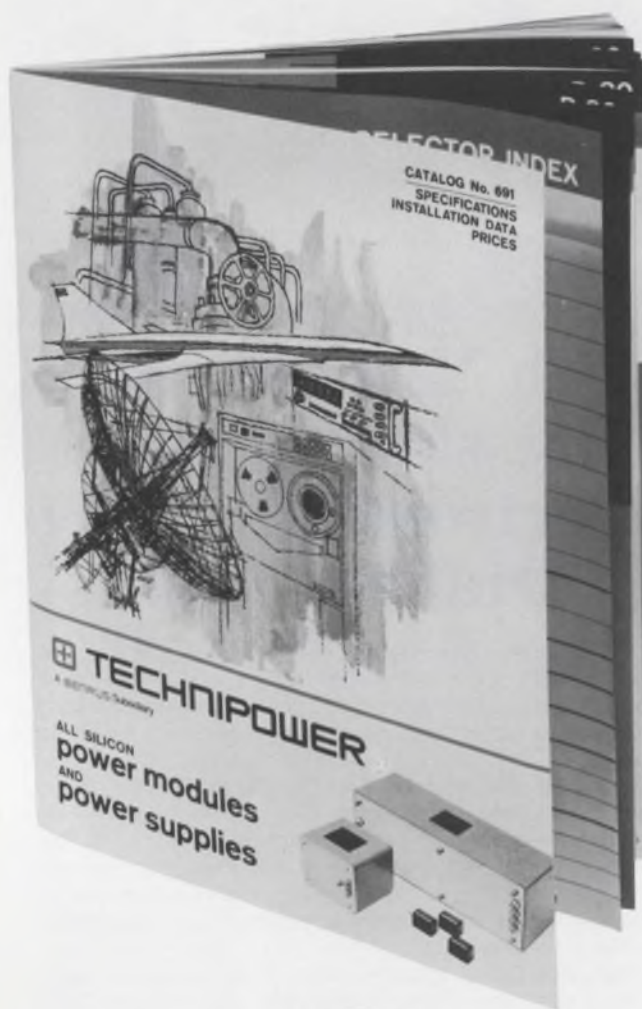

64 pages filled with complete electrical, thermal, and design information as well as the largest variety of modular power on the market.

Reliability —
State-of-the-art —
Small size —
Widest selection —
These are reasons why you should call Technipower for your power supply requirements.

Send for your
free copy
now!

TECHNIPOWER, INC.

A BENRUS SUBSIDIARY

Benrus Center, Ridgefield, Conn. 06877 Phone 203-438-0333 TWX: 710-450-3631
In Europe contact:
TECHNIPOWER, Benrus Technical, 20 Avenue des Planches, 1820 Montreux, SWITZERLAND

INFORMATION RETRIEVAL NUMBER 116

MODULES & SUBASSEMBLIES

Wideband multiplier works independently



GPS Instrument Co., Inc., 14 Burr St., Framingham, Mass. Phone: (617) 875-0607. P&A: \$95; stock to 1 wk.

Operating without external amplifiers, a new small hybrid multiplier features a total accuracy of 1%, including errors due to linearity, scale factor and offset. Model M-4030 has a bandwidth of 1.5 MHz with a slewing rate of 15 V/ μ s. Feedthrough is less than 30 mV pk-pk at 50 kHz, output noise is below 1 mV rms, and drift is below 0.02%/°C. The device measures 1.12 by 1.12 by 0.4 in.

CIRCLE NO. 292

Dc-to-dc converters occupy just 3 in.³



MIL Electronics, Inc., Dvacut Rd., Hudson, N.H. Phone: (603) 889-6671. P&A: \$79; stock to 10 days.

Operating from 12, 24 or 28 V dc, series S dc-to-dc converters deliver 3 W of output power in less than three cubic inches. Single outputs are available from 5 to 250 V dc; dual outputs from ± 5 to ± 100 V dc. The new units feature $\pm 1\%$ regulation as well as overvoltage and reverse polarity protection. Their operating temperature range is 20 to 71°C.

CIRCLE NO. 293

Diode matrix modules substitute for gates

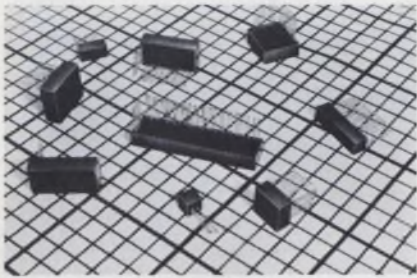

Info-Lite Div., Cartelli Technology, Inc., 41-10 102nd St., Corona, N.Y. Phone: (212) 334-6070. P&A: 15¢ to 35¢/bit; stock to 4 wks.

Able to replace gate networks, a new line of diode matrix modules can be employed in such applications as: read-only memories, BCD encoders, decimal-to-seven-bar encoder/drivers, process control programming, alphanumeric encoder drivers and trigonometric/logarithmic function memories. Package density ranges from 81 to 100 bits per square inch.

CIRCLE NO. 294

Thick-film hybrid eliminates noise



Hybrid Electronics, Inc., Bedford, Mass. Phone: (617) 275-7110.

Basically a highly efficient oscillator that is transformer-coupled to a rectifier, filter, and transistor switch, a new thick-film hybrid circuit eliminates interference to data transmission in noisy environments. The Digital-Isolator removes ground-loop and common-mode line noise to end one of the most common sources of erratic digital system operation. It is directly driven from logic signals.

CIRCLE NO. 295



Introducing PLUSISTOR VECO



slayer of dragon-size heat regulation problems

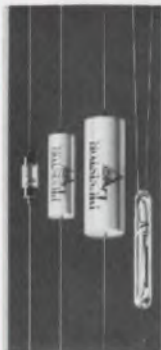

PLUSISTOR is VECO's all-new positive temperature coefficient thermistor for temperature measurement and compensation. A solid state silicon resistor, PLUSISTOR features an average coefficient of $+0.7\%/^{\circ}\text{C}$ which remains virtually constant through the range of -60°C to $+150^{\circ}\text{C}$. These small-but-stalwart heat defenders are available to you in a variety of designs—

- ¼ & ½ watt axial lead, molded design
- ¼ watt, hermetically sealed can
- ¼ watt axial lead, glass body adjacent lead, glass probe

Available in decade multiples of E.I.A. standard resistance values from 10Ω to $10\text{K}\Omega$... 10% standard tolerance or tighter tolerances and special values other than standard where required. PLUSISTOR is just one of a complete line of thermistors from VECO designed to solve the most gigantic of problems.

VECO VICTORY ENGINEERING CORPORATION
 VICTORY ROAD, SPRINGFIELD,
 NEW JERSEY 07081
 (201) 379-5900 • TWX 710-983-4430

DATA PROCESSING

Desktop calculator has mosaic readout



Dictaphone Corp., 120 Old Post Rd., Rye, N.Y. Price: \$875 or \$1075.

Providing solutions on a visual display incorporating mosaic lamps, a new electronic calculator is a 14-digit machine with a 10-key system and a single memory unit. Model 1420 is also equipped with a floating decimal and a decimal control and placement system. A second model, the 1620, offers 16 digits and two memory banks, and provides keys for automatic square root and percentages.

CIRCLE NO. 296

Data terminal varies coupling



Data Access Systems, P.O. Box M418, Landing, N.J. Phone: (201) 398-2345. P&A: \$1595; stock.

A new input/output terminal for communications and time-sharing applications allows both hardware coupling and acoustic coupling to standard telephone circuits. Designated the Multi-Mode model DF33ASR-1, the new system insures completely distortion-free transmission in any environment while hardwired. The same unit may be used with any available telephone.

CIRCLE NO. 297

Multiplexer/converter accepts 256 channels



EMR-Telemetry, A Schlumberger Co., P.O. Box 3041, Sarasota, Fla. Phone: (813) 958-0811.

The 2076 analog multiplexer accepts up to 64 analog channels and time-multiplexes the data for remote entry into its companion 2705 analog-to-digital converter. The 2705 converter, which can be positioned as far away as 1000 feet, accommodates four 2706 multiplexers, thereby providing a remote multiplexing capability of up to 256 channels.

CIRCLE NO. 298

Multiplexing system handles 45 terminals



American Data Systems, 20747 Dearborn St., Chatsworth, Calif. Phone: (213) 882-0020.

Designated the ADS-660 data distribution system, a new data concentrator is capable of simultaneously multiplexing up to 45 (or more) remote terminals over a single telephone line. Designed specifically for time-sharing applications, the new multiplexer can intermix up to three baud rates at the same time. Channel capacity is determined by the baud rate speeds of the terminal devices used and the transmission speed of the telephone line modems.

CIRCLE NO. 299

Lead Frames for I. C. Packaging

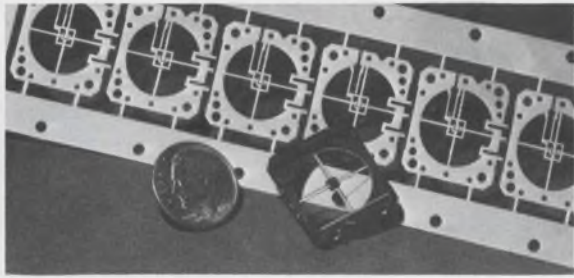

Etched lead frames for integrated circuits. Any configuration can be made adequately framed for support. Leads are flat ribbons down to 0.002 inches wide and from .002, .004, .005 and .010 inches thick. We etch kovar, nickel, alloy 42, copper, aluminum and other metals for microcircuit packaging.

Nickel, copper, silver, and gold plating on lead frames. Thinnest plating is 15 micro inches, thickest is 250 micro inches. We can go beyond this for special orders.

Etching or photoforming to tolerances of $\pm .000039$. Call or write sales manager Bill Amundson for more information.



**BUCKBEE - MEARS
COMPANY**

245 E. 6th St., St. Paul, Minn. 55101 / (612) 227-6371

INFORMATION RETRIEVAL NUMBER 118

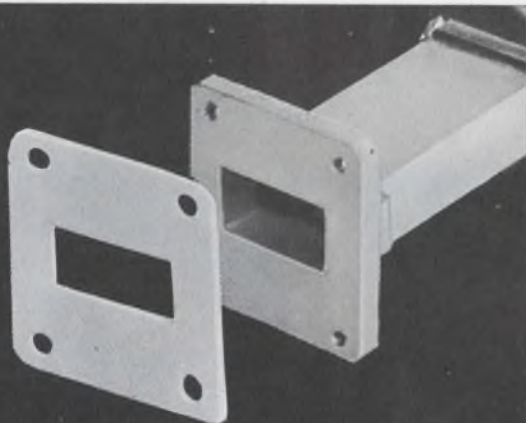

EMI/RFI SHIELDING GASKET CONDUCTIVE SILVER/SILICONE

CONSIL ■ Highly conductive, low volume resistivity; .001 ohm-cm³ ■ All pure silver-silicone rubber compound; 30 to 80 durometer ■ Operating temp. -65°F. to +450°F ■ Available in sheets, molded components, cut gaskets and connector gaskets ■ Write for data #850, and FREE sample.

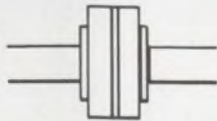

CONSIL — Waveguide flange gaskets or "O" rings.

TECKNIT TECHNICAL WIRE PRODUCTS, INC.

East Division • 129 Dermody St., Cranford, N. J. 07016 (201) 272-5500
West Division • 427 Olive St., Santa Barbara, Calif. 93101 (805) 963-1867

INFORMATION RETRIEVAL NUMBER 119

*no lower price
for
mechanical
refrigeration
to -100° F*

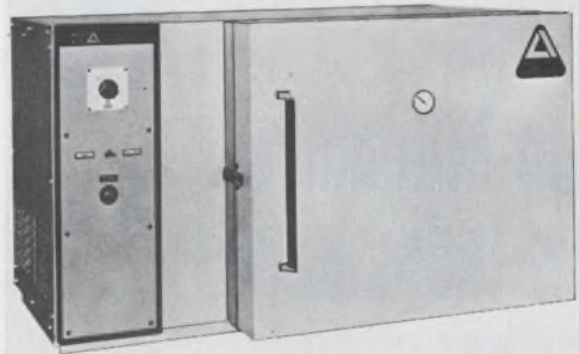

Single compressor and solid state controller mean economy plus reliability

Associated's Model SW-5101 Temperature Chamber offers a new concept in mechanical refrigeration that enables you to perform all military low-high temperature tests.

- full 1 cubic foot test area
- temperature range from -100 to +350°F.
- all solid state controller with $\pm 3/4$ °F stability
- delivery from stock
- adjustable high-temperature fail-safe with signal lamp
- indicating thermometer in door
- combination hinged and removable door
- bench-top design, can be modified for stacking
- stainless steel feed-through port, 3/4" diameter

Check the SW-5101 specifications against your testing requirements. You'll find they add up to outstanding performance at a down-to-earth price — without sacrifice of quality or reliability.

The new Associated catalog of environmental chambers is yours for the asking. Write for your free copy today.

**ASSOCIATED TESTING
LABORATORIES INC.**



200 Route 46 Wayne, New Jersey 07470 • (201) 256-2800

West Coast Office:
6100 Wilmington Ave., Los Angeles, Calif. 90001 • (213) 589-9196

INFORMATION RETRIEVAL NUMBER 120

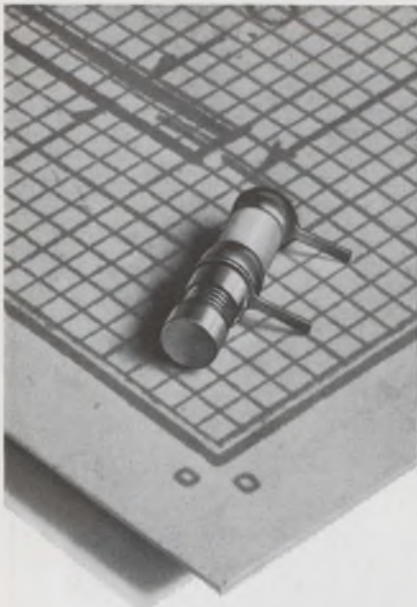

Sub-Miniature Low-Inductance Capacitor

High Q > 1500 @ 500 mc

10:1 capacitance ratio in micro miniature size — extra fine tuning <.35 pF per turn. High Q, (greater than 1500 at 500 mc).

Specifications

Size: 1/8" diameter, 1/2" length
Capacitance Range: 0.35 pF to 3.5 pF
Working Voltage: 250 VDC
 (test voltage, 500 VDC)
Q @ 100 mc: >5000; @ 250 mc, >2000
Insulation Resistance: >10⁶ Megohms
Temperature Range: -55°C to 125°C
Temperature Coefficient: 50
 ± 50 ppm/°C

Features 570° Solder. Prevents distortion. Not affected by conventional soldering temperatures.

Call or write for complete information.

Johnson

**MANUFACTURING
CORPORATION**

400 Rockaway Valley Road
 Boonton, N.J. 07005 • (201) 334-2676
 Electronic Accuracy Through Mechanical Precision

INFORMATION RETRIEVAL NUMBER 121

PACKAGING & MATERIALS

LID package eases assembly



Circa Tran, Inc., P.O. Box 832, Wheaton, Ill. Phone: (312) 858-3727.

Completely tested and ready to be assembled into thick- or thin-film hybrid microcircuits, a new ceramic-cup leadless semiconductor package will not change its electrical parameters during normal circuit assembly. The new package, Circap CT-1, is said to be able to accommodate virtually any type of semiconductor.

CIRCLE NO. 340

PC lamp socket lowers profile



Display Devices Inc., Second & E Sts., Encinitas, Calif. Phone: (714) 753-0113. P&A: 15¢; stock.

Using conventional mounting tools, a new bayonet-base socket for T-3-1/4 lamps mounts with minimum protrusion on the back side of a panel. The unit rests firmly and flatly on single-sided 0.062-in. printed circuit boards. It is available with either cadmium- or gold-plated contacts.

CIRCLE NO. 341

Microminiature coax has only 0.04-in OD

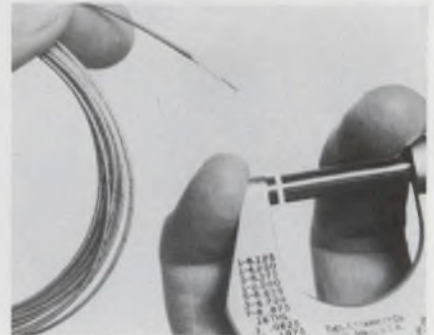

Berk-Tek, Inc., P.O. Box 60, Reading, Pa. Phone: (215) 376-8071.

With an outside diameter of only 0.04 in. and a AWG #32 center conductor, a new microminiature coaxial cable features a solid center conductor and solid drain wire that can readily be used in wire-wrap operations. This coaxial cable transmission line has a 50-Ω characteristic impedance in the air and on a ground plane. Cross talk is minimized by the use of an aluminumized Mylar shield. The dielectric is Teflon and the jacket is nylon.

CIRCLE NO. 342

Miniature PC jack mounts horizontally

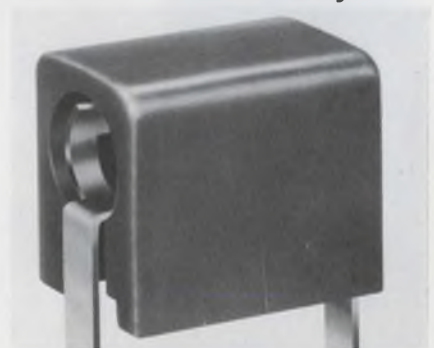

E. F. Johnson Co., Components Div., Waseca, Minn. Phone: (617) 278-1715.

Measuring just 0.203 in. high (mounted) by 0.208 in. long by 0.15 in. wide, a new horizontal printed circuit jack accepts a 0.08-in. diameter tip plug at either end. It has maximum current capacity of 5 A and an operating voltage of 1500 V rms at sea level. Contact resistance is less than 2 mΩ; capacitance between adjacent jacks is less than 1 pF at 1 MHz.

CIRCLE NO. 343

TRUE SOLID-STATE RELAY



Opening New Relay Applications in Multiplexing, Isolated Sensing, High Speed Isolated Control, etc. Offered in A - B - C Contact Configurations for Direct Replacement of Mechanical Types.

- Switching Time less than 65 μ sec
- Contact Open Resistance . . . 10⁹ ohms
- Contacts Capable of switching DC to 4 M HZ
- Non-Polarized Effective Coil
- Effective Coil Accuate/Release Voltage Hysteresis . . . less than 10 mV . . .
- Non-Polarized Contacts
- No Reference Required Between Effective Coil and Effective Contacts
- Life Expectancy—tested to 10¹⁰ operations with no failure.

SHAFFSTALL-BALL CORPORATION

5149 E. 65th Street, Indianapolis, Indiana 46220
Phone: 317-257-6296

INFORMATION RETRIEVAL NUMBER 122

*** FROM STOCK *
IMMEDIATE DELIVERY**

knobs

mil & commercial

TACTILE SHAPE CONTROL KNOBS CRANK KNOBS
POINTER KNOBS SAFETY KNOBS

Circle No. 211 on Reader Service Card.

rubber bumpers • grommets

mil & commercial

BUTTON MACHINE STEM TACK RECESSED

Circle No. 212 on Reader Service Card.

shielding materials

tape & foil, flexible tubing

FULL SPECTRUM ELECTROMAGNETIC RADIO FREQUENCY

Circle No. 213 on Reader Service Card.



russell industries inc.

96 STATION PLAZA, LYNBROOK, L. I., N. Y. 11563 • (516) 887-9000

Take a Good Look

(You'll Never Have To See
Traces Like These Again)

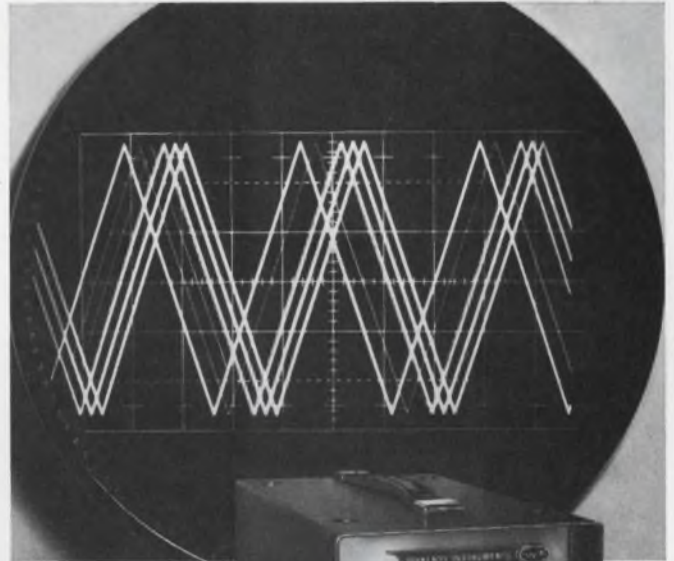

Wanlass Scopac™

Scope Conditioner
Eliminates AC Line Disturbances
From Your Oscilloscope

Merely plug your scope into SCOPAC. Let it provide the necessary noise filtering of 50 db to 1 MHz and line regulation to ¼%. You can proceed immediately with consistent, accurate oscilloscope readings. Gone are problems associated with jitter, zero-line stabilization, false triggering (top photo above), jumping off scale, erroneous signals and readings caused by normal plant or laboratory AC-line disturbances.

SCOPAC Model P-TEK operates all 300, 400 and 500 Tektronix scopes as well as those from Hewlett-Packard, Dumont and other scope manufacturers. Available off-the-shelf, priced at \$375. Contact factory or local representative for literature.

WANLASS INSTRUMENTS



a division of WANLASS ELECTRIC COMPANY
A SUBSIDIARY OF AMBAC INDUSTRIES INC.

1540 EAST EDINGER AVENUE ■ SANTA ANA, CALIFORNIA 92707
TELEPHONE (714) 546-1811 ■ TWX: 910-595-1526

INFORMATION RETRIEVAL NUMBER 123

Machinable ceramic withstands 1100°C



Aremco Products, Inc., P.O. Box 145, Briarcliff Manor, N.Y. Phone: (914) 762-0685. Availability: stock to 1 wk.

Aremcolox grade 502-1100 machinable ceramic, which develops the hardness of tool steel after curing, can be used for a variety of processes at temperatures as high as 1100°C. Readily machined with conventional machine shop tooling, the ceramic cures by heating it to 2000°F in an air oven.

CIRCLE NO. 344

PC-board sockets ignore lead size

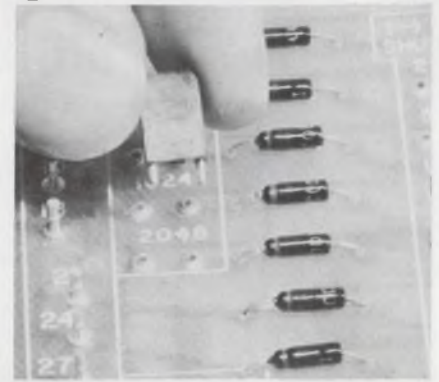

SAE Advanced Packaging Inc., 1357 East Edinger Ave., Santa Ana, Calif. Phone: (714) 547-3935. P&A: 5¢ to 15¢; stock.

Providing excellent maintainability of PC-board components, a new line of sockets accepts component and connector leads of varying diameters. Cirkut sockets are installed in circuit boards by a simple swaging operation, and then wave or bit soldered. When installed, they project only 0.04 in. above the board surface.

CIRCLE NO. 345

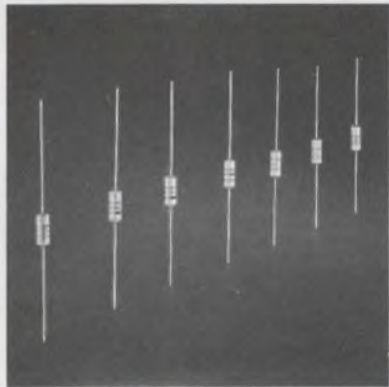

MS 90537 Molded Shielded RF Chokes

Miller Part No. 9250	MS. No. 90537	Inductance Microhenries ±10%	Rated DC Current Milliamps	Miller Part No. 9250	MS. No. 90537	Inductance Microhenries ±10%	Rated DC Current Milliamps
-101	-1	0.10	2900	-333	-31	33.0	490
-121	-2	.12	2800	-393	-32	39.0	410
-151	-3	.15	2750	-473	-33	47.0	400
-181	-4	.18	2200	-563	-34	56.0	380
-221	-5	.22	1700	-683	-35	68.0	370
-271	-6	.27	1500	-823	-36	82.0	360
-331	-7	.33	1300	-104	-37	100.0	325
-391	-8	.39	1100	-124	-38	120.0	290
-471	-9	.47	1000	-154	-39	150.0	275
-561	-10	.56	900	-184	-40	180.0	260
-681	-11	.68	750	-224	-41	220.0	250
-821	-12	.82	600	-274	-42	270.0	240
-102	-13	1.00	1900	-334	-43	330.0	225
-122	-14	1.20	1600	-394	-44	390.0	200
-152	-15	1.50	1300	-474	-45	470.0	180
-182	-16	1.80	1200	-564	-46	560.0	174
-222	-17	2.20	1100	-684	-47	680.0	168
-272	-18	2.70	950	-824	-48	820.0	152
-332	-19	3.30	800	-105	-49	1,000.0	135
-392	-20	3.90	750	-125	-50	1,200.0	115
-472	-21	4.70	650	-155	-51	1,500.0	110
-562	-22	5.60	550	-185	-52	1,800.0	105
-682	-23	6.80	500	-225	-53	2,200.0	99
-822	-24	8.20	475	-275	-54	2,700.0	83
-103	-25	10.0	450	-335	-55	3,300.0	80
-123	-26	12.0	400	-395	-56	3,900.0	67
-153	-27	15.0	620	-475	-57	4,700.0	63
-183	-28	18.0	610	-565	-58	5,600.0	56
-223	-29	22.0	600	-685	-59	6,800.0	54
-273	-30	27.0	500	-825	-60	8,200.0	52
				-106	-61	10,000.0	49

CALL OR WIRE FOR SHIPMENT TODAY

Get factory prices from your local distributor in quantities to 750; ask for new full line catalog.



J.W. MILLER COMPANY

19070 REYES AVE. ■ P.O. BOX 5825 ■ COMPTON, CALIF. 90224

Aerosol cleaner is safe for plastics



DCMC International Inc., 239 Great Neck Rd., Great Neck, N.Y. Price: \$1.95.

Intended for use on electronic and delicate equipment, a new cleaner and lubricant in aerosol form contains a blend of special solvents with extremely high grease removing power but which do not attack most plastics. Known as electronic switch cleaner and lubricant No. 825, the new aerosol contains a silicone oil that provides an inert long-lasting lubricant and corrosion inhibitor.

CIRCLE NO. 346

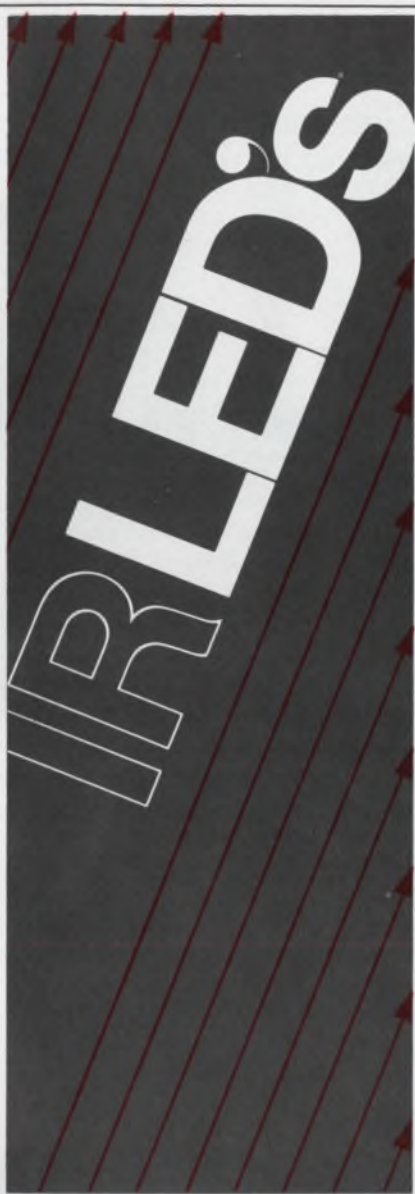

Great little performers: 1.5 mW min. @ 100 mA.

And all the power they need is .15 W.

Fast, too. Switching time is light-quick — typically 1 nanosecond.

Long life and reliability are assured by our with-it planar solid-state technology.

Put those features together with their instant availability and you've got a good reason to call Schweber, Kierulff, K-Tronics or Semiconductor Specialists.

Get all the details about our four varieties of IR LED's by writing to us at 10131 Bubb Road, Cupertino, California 95014.

Monsanto

PACKAGING & MATERIALS

Conductive epoxies minimize drift



Amicon Corp., Polymer Products Div., 25 Hartwell Ave., Lexington, Mass. Phone: (617) 861-9600.

New high-conductivity silver-filled Uniset epoxies do not drift in conductivity after prolonged exposure to high temperatures or strong electrolytes. When heat cured, these conductive epoxies can be soldered using 60/40 solder. They cure rapidly at temperatures 100°F lower than minimum cure temperatures for previous one-part epoxies.

CIRCLE NO. 347

Cermet pastes retain shape



Electro-Science Laboratories, Inc. 1133 Arch St., Philadelphia, Pa. Phone: (215) 563-1360. Availability: 10 days.

A new series of noble-metal high-performance resistive cermet pastes is intended for use in tight-tolerance applications or where reduced sensitivity to geometrical variations is required. Series ESL3800 materials are relatively insensitive to minor changes in firing profile and may be fired at peak temperatures between 980 and 1050°C.

CIRCLE NO. 348



(click!)

If you're looking for a swift (and noiseless!) electronic switch that offers high voltage isolation of $10^{11}\Omega$ I/O, consider our MCT 1 coupled GaAs/LED phototransistor pair.

- 2500 volts isolation
- current transfer ratio of 35%
- isolating capacitance: 3pf
- input/output IC-compatible
- light, rugged, reliable
- analog or digital applications

Call your orders to Semiconductor Specialists, K-Tronics, Kierulff or Schweber. Want more details? Write us at 10131 Bubb Road, Cupertino, California 95014 Phone (408) 257-2140

Monsanto

EUTECTIC PREFORMS

for semiconductor assembly



with quality service to match quality products

CRM makes perfect preforms of eutectic alloys of Gold-Tin, Gold-Silicon, and Gold-Germanium.

CRM preforms can help you to produce perfect ICs, hybrids, transistors, and diodes. Quality is controlled from the ingot on, including not only standard tests, but also checks of foil surface finish and flow characteristics. The extensive die inventory at CRM makes most preforms available without delay and without a tooling charge.

CRM will meet your strictest specifications.

CRM delivers what it promises. CRM delivers on TIME.

Call or write CRM for a quotation on your preforms or the CRM catalog with a list of over 300 stock dies.

**CONSOLIDATED
CRM REACTIVE
METALS, INC.**

a Division of CONSOLIDATED REFINING CO. Inc.
110 Hoyt Avenue, Mamaroneck, N.Y. 10543
Tel: (914) 698-2300 □ TWX 710-566-1112

INFORMATION RETRIEVAL NUMBER 127

PRODUCTION

Contact burnisher cleans all metals



Jonard Industries Corp., Precision Tools Div., 3047 Ribbett Ave., Bronx, N.Y. Phone: (212) 549-7600. Price: \$3.90.

Originally designed for the communications, telephone and electronic industries, using relay-actuated equipment, a new pocket pen-type burnisher/cleaner works on all types of contacts, including silver, platinum, gold, palladium, tungsten, molybdenum, as well as precious metals. This contact burnisher leaves no grit or dust on the contact to start a new carbonaceous build-up.

CIRCLE NO. 349

Desoldering tool comes on a spool



American Electrical Heater Co., American Beauty Div., 6110 Cass Ave., Detroit, Mich. Phone: (313) 875-2505. Availability: stock.

Named Dri-Wick, a new desoldering tool desolders a typical miniature connection in about one second, at a material cost of about one cent. Supplied in spool form, the product is woven of ultra-fine copper strands, each coated with water-white rosin. To use, the operator lays Dri-Wick on the joint, applies the tip of a 30/40-W soldering iron, and then lifts away the iron and the Dri-Wick simultaneously.

CIRCLE NO. 350

Lightweight pump vacuums up solder



Swiss American Precision Imports, Inc., Dept. T2P, 505 S. Douglas St., El Segundo, Calif. Phone: (213) 772-5431. Availability: stock.

Precista T2 vacuum desolder pump is a lightweight, compact, easy-to-use tool that eliminates operating hazards and reduces waste motion in desoldering electronic circuitry. The new pump may be loaded and unloaded with one hand, and need not be in any special position. The tip is cleared of solidified solder each time the pump is loaded for use.

CIRCLE NO. 351

Flux dispenser maintains level



E.P.E. Corp, 6 Kane Industrial Drive, Hudson, Mass. Phone: (617) 562-9123. P&A: \$5.50; stock.

Using a hydrostatic principle to minimize surface skinning, a new dispenser provides a constant level of flux for dipping leads and components prior to soldering or tinning. Model FD-1 flux dispenser, which is a three-piece assembly for ease of cleaning, is resistant to most solvents and chemicals. The flux storage level can be easily observed in the 3-in.³ translucent reservoir.

CIRCLE NO. 352

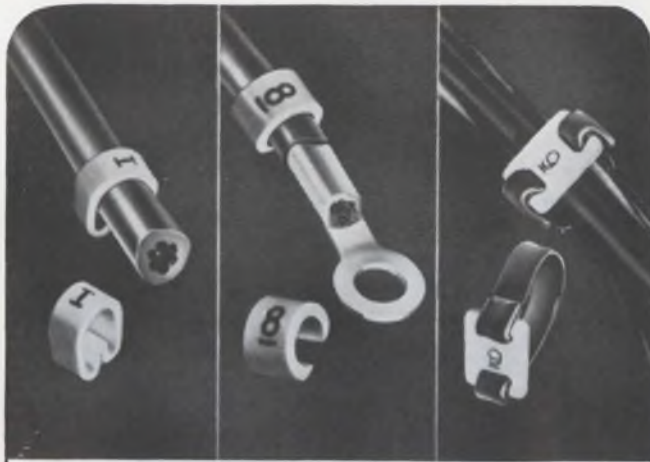

INDESTRUCTIBLE MARKERS

Available in three types — slip-on, clip-on, and crimp-on ---- to accommodate a wide variety of wire and cable applications. Can't rub-off, peel-off or fall-off, yet can be easily removed when necessary. Molded of indestructible PVC (polyvinylchloride) to last the life of the wire and cable under all conditions.

Send for Free Samples

ELECTROVERT INC.

Components Division
86 Hartford Ave., Mt. Vernon, N. Y. 10553
Milwaukee, Wis. • Burbank, Calif.



SOLD COAST-TO-COAST THROUGH AUTHORIZED DISTRIBUTORS.

INFORMATION RETRIEVAL NUMBER 128

FOR EXCELLENCE IN PUSH BUTTON SWITCHES SPECIFY GRAYHILL

A WIDE SELECTION TO CHOOSE FROM...

- Ratings To 10 Amp.
- SPST, SPDT, DPST, DPDT
- Diameters From 1/4" To 3/8"
- Behind Panel Dimension As Small As .32"
- Momentary - Push-Pull - Lighted - Alternate Action (Push-On, Push-Off)
- Wiping, Snap Action And Butt Contacts
- Solder Lug, "Faston" Or Printed Circuit Terminals
- Life Expectancy Up To 1,000,000 Operations

For your
Grayhill Engineering
Catalog offering complete
technical data—contact



565 Hillgrove Avenue
LaGrange, Illinois 60525
Area Code 312, Phone 354-1040

... the Difference Between Excellent and Adequate

INFORMATION RETRIEVAL NUMBER 129

ELECTRONIC DESIGN 19, September 13, 1969

Need a reversible AC hysteresis synchronous motor



Dale has one for less than \$2

Dale reversible AC hysteresis synchronous motors give you the industry's best combination of miniature size and low price. Length 1.85"... diameter 1.250"... price, under \$2 in quantity. Designed for long life in continuous use, they're finding wide application in low power driving mechanisms, timing controls, blowers, etc. Output shaft and mounting to your specification.

SPECIFICATIONS

Operating Voltage: 6, 12, 24, 117 VAC or any specified

Power Input: 7.5 Volt Amperes

Output: 1800 RPM no load

Torque: 0.125 oz./in.

CIRCUIT DIAGRAM

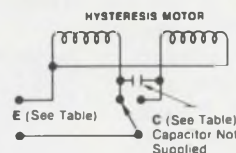

E - VOLTAGE	NOMINAL C - CAPACITANCE	C - VOLTAGE
6	170 MFD	20
12	50 MFD	25
24	16 MFD	50
117	0.68 MFD	300

Want to try one?... Phone 605-665-9301



DALE ELECTRONICS, INC.
SIOUX DIVISION Dept. ED
Yankton, South Dakota 57078
A subsidiary of The Lionel Corporation

INFORMATION RETRIEVAL NUMBER 130

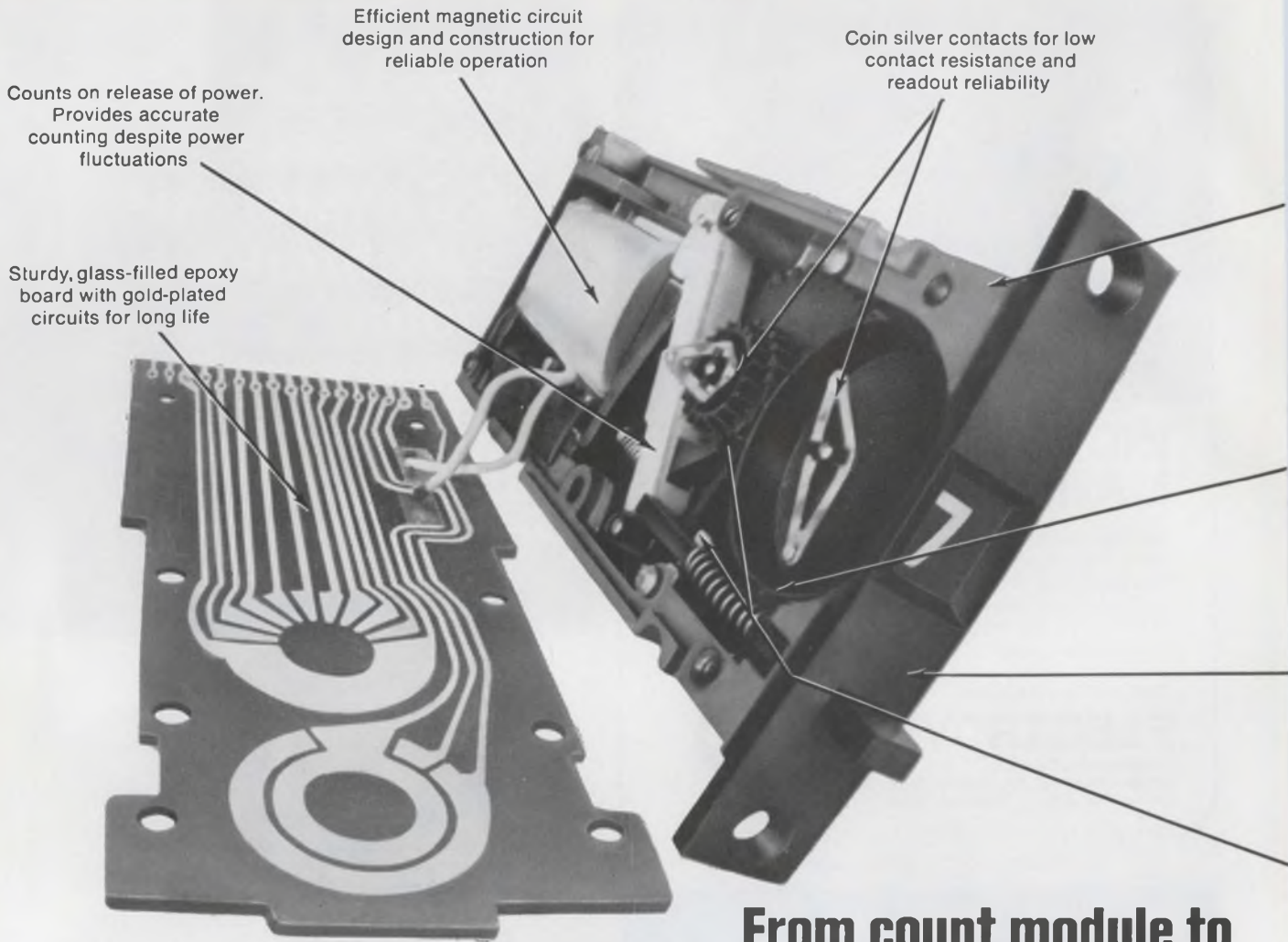

From count module to preassembled control package, that's the versatile Veeder Decade

You'll like the great design flexibility of the Veeder Decade*, a module that's easily stacked into a compact, multidigit counter package. It's the ideal unit for high-speed count accumulation, storage and transfer in data processing, and control equipment systems.

The Series 1969 is a single wheel electric counter with electric readout (BCD or decimal), transfer and reset, and 2400 cpm speed. It combines large figure readability with narrow width for space economy. Another Veeder Decade model, the Series 7266, offers wheel configurations for recording time and counting dozens and denominations of money.

If you're after preassembled packages, we've got those, too. For example: The Series 710810 and 20 Digi-Con* Predetermining Counters which—unlike most electronic counters—won't reset during a power failure. The Series 710830 Digi-Con Totalizer is both a self-contained



counter and a module for more sophisticated control systems. And the Series 710840 Digi-Clock* time display features a wide range of optional features for computer input. For information about our complete line, write for Design Kit: Veeder-Root, Hartford, Conn. 06102.

*Trademark of Veeder-Root

Evaluation Samples

Rugged, self-supporting die-cast Zamak frame

Molded Delrin parts reduce wear

8 mounting configurations. Modules stack for custom multidigit counter

No-back pawl and nonoverthrow feature for accurate figure positioning

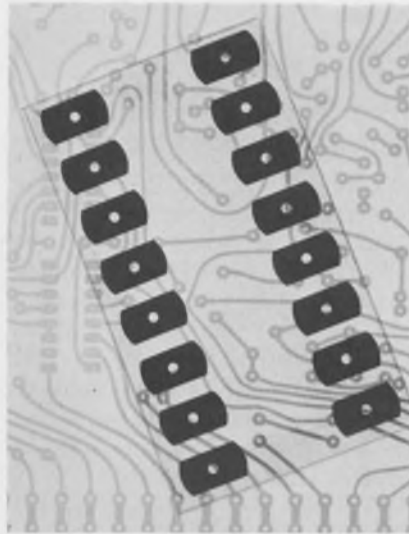

Layout patterns

Self-sticking drafting symbols in pre-spaced configurations for integrated circuits, transistors and contact fingers feature unusual accuracy, opacity and dimensional stability, with tolerances of ± 0.002 in. at a 4:1 reduction ratio. Image size and spacing are uniform from one set of layout patterns to another so that dimensions never vary, assuring accuracy and consistency of completed artwork and printed circuit. Each pattern appears on its own individual non-static transparent film base for easy handling and application. Free samples are supplied. W. H. Brady Co.

CIRCLE NO. 353

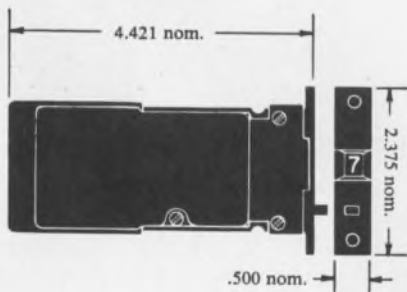

Gold-plated terminals

Providing the benefits of gold-plating at minimum expense, a new line of selectively plated terminals can significantly reduce costs without sacrificing connector integrity. Typical is a metal strip with only 20% of its surface coated with the precious metal and a strip of terminals made from a similar band. Only the mating surfaces have been plated. Free samples of these terminals are available. Molex Products Co.

CIRCLE NO. 354

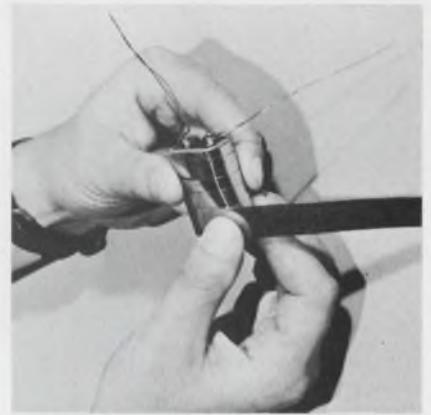

Metal shim

Cutting peeling time in half, Lamipeel metal shim assembly easily separates from its shim lead at the outer edge using an ordinary penknife—or even with just a flick of a finger or fingernail. The loosened edge is then easily grasped and pulled off its leaf quickly and easily. Inner surfaces of Lamipeel are plastic-bonded to keep the shim assembly intact so it will not come apart in normal handling. However, the outer edges of each laminated layer in the shim are specially conditioned not to adhere to each other layer. A free sample is available. Laminated Shim Co.

CIRCLE NO. 355



Wire-wrap leads

Containing eight standard wire-wrap leads, a new sample card includes specifications and a length of wire with various insulations. These are polyvinylchloride, Kynar, Teflon, Vylex, Teflon with Hardcoat, Kapton film, and Teflon with Kapton Film. The sample card, which is available free, affords the user an opportunity to check and test specifications and characteristics according to his own particular application. Berk-Tek.

CIRCLE NO. 356

VEEDER-ROOT

INNOVATORS IN NUMERICS



Veeder-Root World-Wide: Australia: So. Melbourne, Victoria
Brazil: Sao Paulo • USA: Hartford, Connecticut
England: New Addington, Surrey • Scotland: Dundee
West Germany: Neuhausen Filder • Canada: Toronto

INFORMATION RETRIEVAL NUMBER 131

The Wizards of OZ

Like magic — vector impedance instruments read out complex impedance in an instant.

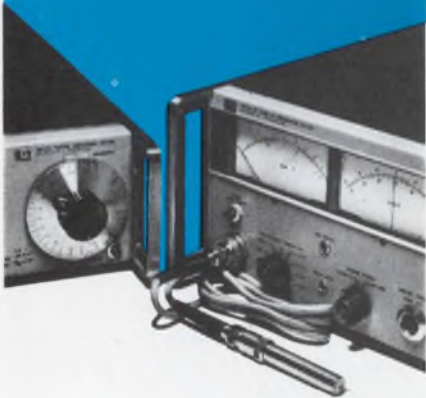

Bench or production line measurements involving impedance magnitude, Z , and phase angle, θ , no longer require tedious test procedures. These measurements are now as easy to make as voltage readings. No nulling . . . no balancing . . . no calculations to make. The wizardry of these HP instruments provides direct readout in terms of Z (in ohms) and θ (in degrees) over a continuous frequency range.

HP 4800A Vector Impedance Meter covers the 5 Hz to 500 kHz range. You set the frequency, select the impedance range and read: Z from 1 ohm to 10 Megohms, and θ from -90° to $+90^\circ$. \$1650.

HP 4815A RF Vector Impedance Meter covers 500 kHz to 108 MHz. Measures, via a probe, active or passive circuits directly in their normal operating environment. Z from 1 ohm to 100 K ohms; θ from 0° to 360° . \$2650.

Application Note 86 describes many applications of the 4800A and the 4815A Vector Impedance Meters including the measurement of Z , R , L , and C . For your copy and complete specifications, contact your local Hewlett-Packard field engineer or write: Hewlett-Packard, Green Pond Road, Rockaway, New Jersey 07866. In Europe: 1217 Meyrin-Geneva, Switzerland.

HEWLETT  PACKARD

IMPEDANCE INSTRUMENTS

1093

INFORMATION RETRIEVAL NUMBER 132

Design Aids

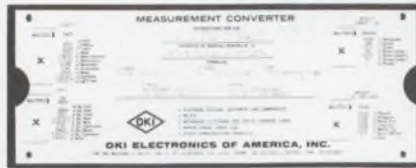

Conversion slide rule

Useful to any design engineer working with lengths, weights and dimensions, a new measurement converter is now available in slide-rule form. This handy item easily tells you how many ounces there are in a kilogram, how many gills in a cubic inch, how many miles in a kilometer, and many other useful relationships. OKI Electronics of America, Inc.

CIRCLE NO. 357



Digital IC guide

Designed to speed integrated circuit selection, a six-page full-color guide graphically compares the operating characteristics of several families of digital ICs. Ideal for mounting, this selection-guide is a three-page center spread that divides, by color, Motorola's MRTL, MDTL, MTTL, MHTL and MECL families. The colors used for the chart match the respective technical data brochure for the same family. Typical illustrated characteristics include: operating temperature range, power supply range, basic gate fanout, gate dissipation, average propagation delay, flip-flop toggle frequency, and noise margins. Also shown are basic gate configurations and case dimensions. Motorola Semiconductor Products Inc.

CIRCLE NO. 358



Relay selector rule

A new selector slide-rule disc cross references relays from Cornell-Dubilier and Potter Brumfield, giving equivalent ac or dc general-purpose relays of the open or enclosed type. The relays covered have contact ratings of 10 A. Cornell-Dubilier Electronics, Div. of Federal Pacific Electronic Co.

CIRCLE NO. 359

Photometry nomograph

Supplied as part of a photoconductive cell design manual, a photometry nomograph relates brightness in foot-candles and candle power to distance from an illuminated lamp. The nomograph also provides such useful definitions as lux, point source, lambert and foot-lambert. The design guide includes a discussion of light measurement, and photocell theory and applications. Clairex Electronics, Inc.

CIRCLE NO. 360

Coatings chart

Providing a concise guide to protective coatings for electronics applications, a colorful four-page chart summarizes the properties of ten frequently used Humiseal materials. The charted information includes recommended curing conditions, pot and shelf life, and thermal, physical, electrical and chemical properties. Humiseal Div., Columbia Technical Corp.

CIRCLE NO. 361

Isolation was the only thing preventing a high-frequency Reed Switch Matrix Until now.

The Cunningham Reed Switch Matrix reduces high frequency crosstalk and interference to a new low. In a unique "sandwich" design, matrix-mounted reed switches are sealed, shielded and separated from their controls, achieving maximum open circuit isolation and negligible crosstalk.

- **Excellent signal characteristics:** 50-ohm, distributed. Matches 50-ohm transmission line. Broadband handling characteristics, with excellent isolation. Very low thermal noise.

- **100% Random access:** Any number or combination of crosspoints can be set, any place, any direction, vertical or horizontal, without affecting the condition of other crosspoints in the matrix.

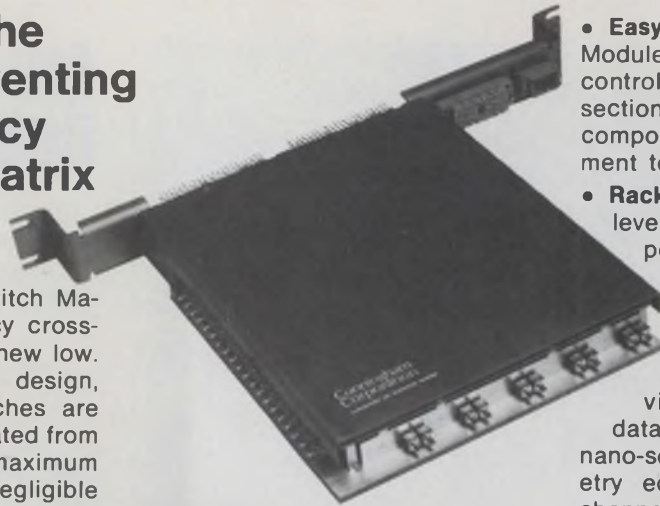

- **Computer compatible:** Can be directly addressed by all computers using +5 volt logic. No additional interfacing required. Single power supply.

- **One package** contains all signal switching elements and coil drivers as well as the logic required to translate the co-ordinate inputs into crosspoint address.

- **Reliability proven:** Up to 100 million operations.

- **Easy inspection and maintenance:** Module can be unplugged and the control separated from the signal section for easy access to all active components. No adjustment or alignment to perform after re-assembly.

- **Rack mounting:** Standard one-level matrix of 10x5x1 crosspoints. Plug-in and expandable to larger matrices.

The new Cunningham Reed Switch Matrix is ideal for interconnecting video channels, broadband data switching, test systems for nano-second digital pulses, telemetry equipment for multiple data channels, antenna switching, and medical data monitoring.

Write or call for Data Sheet No. 603, Cunningham Corporation, 10 Carriage Street, Honeoye Falls, New York 14472. Phone (716) 624-2000.

Cunningham Corporation

SUBSIDIARY OF GLEASON WORKS

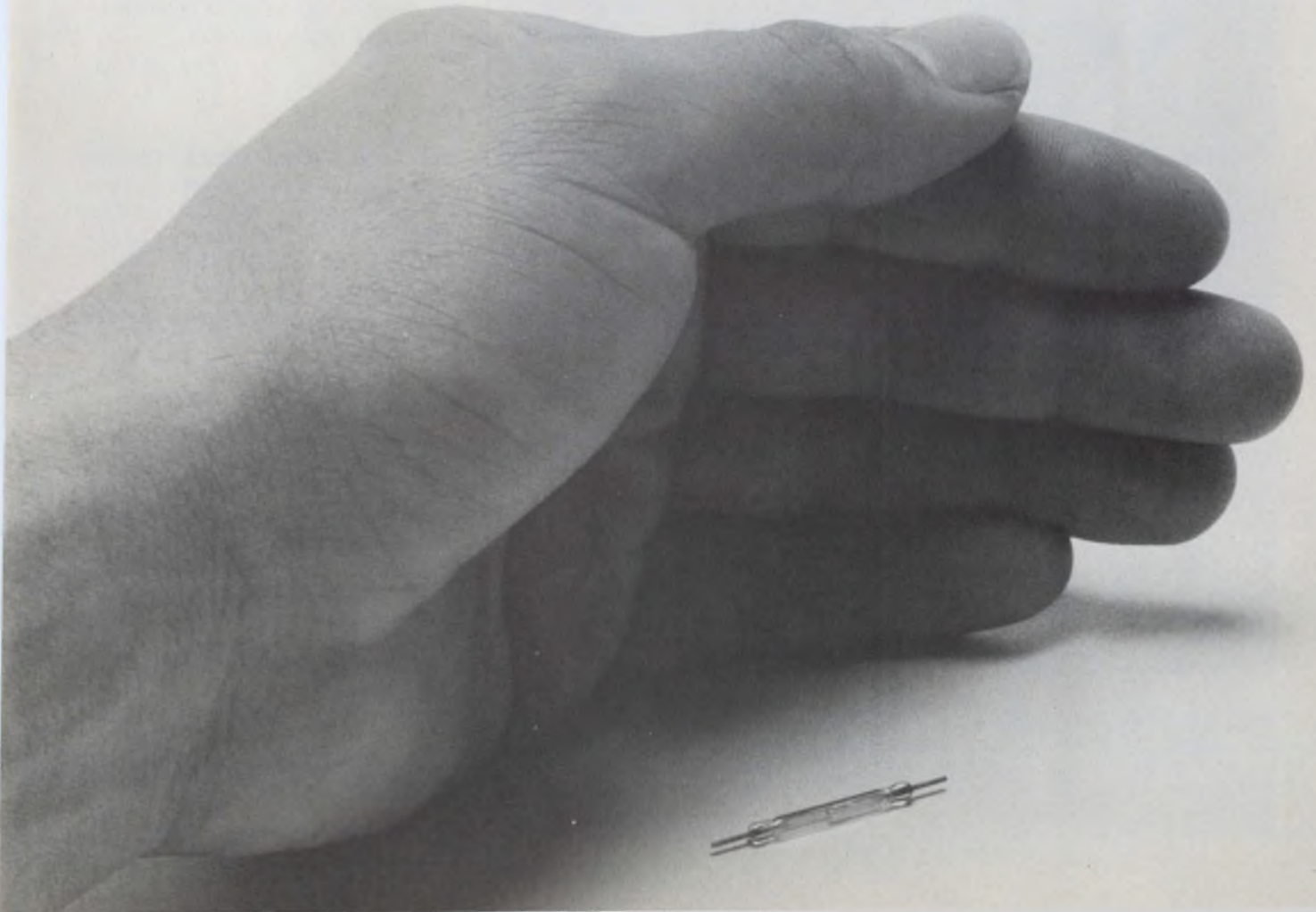

The Heavyweight says reduce system costs

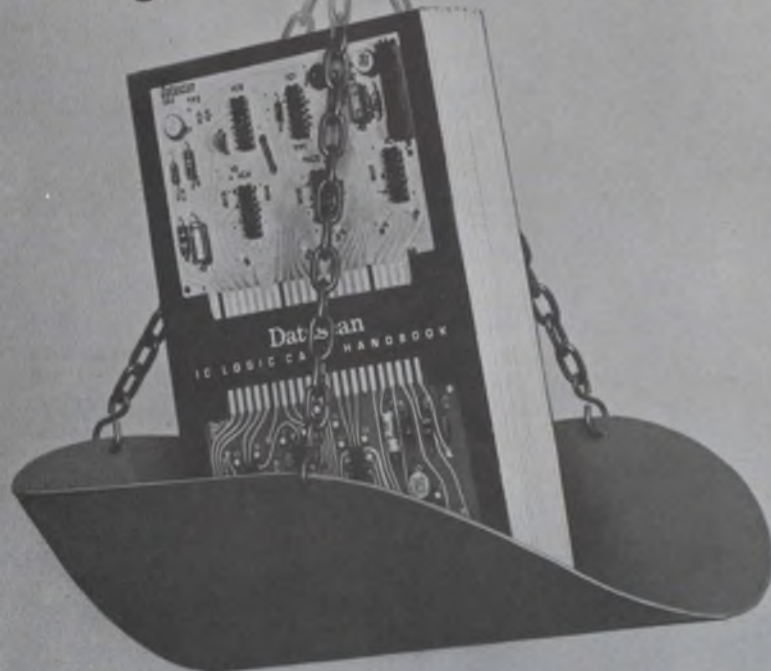

There are hundreds of pages in our new I.C. Logic Card Handbook to help you lower costs — not just card costs but *total system costs*. As an example — there are probably more function-cards illustrated and all with Dynamic Decoupling*, than in any other single logic card source. Function cards means less cards, less back plane wiring, less testing — and *less system costs*.

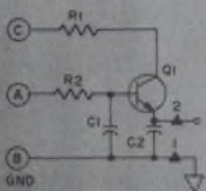

*Dynamic Decoupling™ is a Datascan exclusive — it's a circuit right on the card which eliminates high and low frequency noise for extremely reliable system operation. You get a clean 5V DC power bus *on each card* — reducing system costs by eliminating system debugging.

Our many services to reduce costs start with letting you know what we have to offer — *get your own copy of Datascan's new Logic Card Handbook* — and see all the DTL, HTL (for high noise environment) and TTL circuits you don't have to design.

Datascan

DATASCAN, INC.

1111 Paulison Avenue, Clifton, N. J. 07013 • Telephone 201-478-2800

903

Annual Reports

Learn how to read annual reports in "How to investigate a company." For a copy, circle no. 474.

Ampex Corp., 401 Broadway, Redwood City, Calif.: audio, video and data recording; net revenue, \$300,278,000; net earnings, \$13,702,000; assets, \$215,293; liabilities, \$91,255,000.

CIRCLE NO. 362

Datamation Services Inc., 461 8th Ave., New York City, N.Y.: computer services; revenues, \$5,613,937; net income, \$328,895; assets, \$1,774,344; liabilities, \$1,151,638.

CIRCLE NO. 363

Diebold Computer Leasing Inc., 35 Journal Square, Jersey City, N.J.: computer leasing; revenues, \$12,813,000; net income (loss), \$1,098,000; assets, \$149,991,000; liabilities, \$119,891,000.

CIRCLE NO. 364

Edo Corp., 1404 111th St., College Point, N.Y.: Sonar systems, electronic counter systems; sales, \$38,019,420; net earnings, \$1,754,829; assets, \$20,783,184; liabilities, \$8,021,095.

CIRCLE NO. 365

Kollmorgen Corp., Holyoke, Mass.: motors, generators, computers, colorimeters, spectrophotometers, optics; net sales, 23,052,344; net income, \$855,452; assets, \$11,393,821; liabilities, \$2,893,290.

CIRCLE NO. 366

Newell Industries Inc., 795 Kifer Rd., Sunnyvale, Cal.: magnetic tape systems; net sales, \$58,421; net earning, \$238,593; total assets, \$2,721,643; total liabilities, \$414,241.

CIRCLE NO. 367

OVEN OSCILLATORS CAN'T COMPETE WITH ARVIN TCXOs

Instant Response
Greater Reliability
As Small as 1 cu. in.
Lighter Weight
Frequency to 200 MHz
Stability to $\pm 1 \text{ pp } 10^7$
Input Voltage $\pm 12 \text{ VDC } \pm 5\%$
Power Input 50 MW
Output 1 MW RMS Across 50Ω



Arvin Temperature Compensated Crystal Oscillators are working now in satellites, missiles, aircraft, and portable communications equipment by the hundreds. Many TCXO models available off-the-shelf, others designed to your requirements. Write for Arvin TCXO bulletin, or phone (317) 463-2589.



ARVIN FREQUENCY DEVICES

ELECTRONIC SYSTEMS DIV., ARVIN INDUSTRIES, INC.
2505 N. Salisbury, West Lafayette, Indiana 47906

INFORMATION RETRIEVAL NUMBER 135

Thermal Linkage Cup Clips

For TO-5 and TO-18 case style transistors, Series 260 Cup Clips are insulated (epoxy or beryllium oxide) or non-insulated.



WAKEFIELD Cup Clips have 3 types of bases:

1. Plain Base . . . for soldering, bonding or use with pan head screws.
2. Tapped Base . . . attach with screws.
3. Stud Mounting Base.

Write today for Bulletin 260A for specifications.

WAKEFIELD
ENGINEERING, INC.

WAKEFIELD, MASS. 01880 ■ (617) 245-5900

INFORMATION RETRIEVAL NUMBER 136

ELECTRONIC DESIGN 19, September 13, 1969

New Oak Versatility



OAK ECONO-LINE
PUSHBUTTONTM

JUST 25¢ A BUTTON*

*For most applications

We've got the button . . . throws from 1 PST to 8 PDT per button; sizes: .388" sq., .388" x .585" or .388" x .782"; legends engraved to your specifications; black or white buttons are standard, other colors on special order.

Push Rod Stroke . . . $\frac{3}{32}$ " plus $\frac{3}{4}$ " overtravel; push rod lengths optional at $\frac{1}{2}$ ", $\frac{5}{8}$ " standard length, $\frac{3}{4}$ ", $\frac{7}{8}$ " and 1".

Easy to wire . . . clips are Oak-pioneered double-wiping. For printed circuit boards or wire-soldering, PCB terminals are $\frac{3}{32}$ ", $\frac{1}{8}$ ", $\frac{3}{16}$ " standard length, $\frac{3}{32}$ " and $\frac{1}{4}$ " shoulder to tip. Choose terminals for wiring only or P.C. dual-purpose which have the wire hole in addition to the P.C. lug.

Compact Convenience . . . more buttons per area—24 on .394" centers, 16 on .591" centers, 12 on .788" centers. Any switching—momentary, push-push, interlock, or blockout or combinations. For full details, write today for Bulletin SP-346.



OAK MANUFACTURING CO.

A Division of OAK ELECTRO/NETICS CORP.
Crystal Lake, Illinois 60014
Phone: 815-459-5000 TWX: 910-634-3353

INFORMATION RETRIEVAL NUMBER 137

TRYGON power errrr supplies...

the *NEW* Super Trypack System / OEM Modules!



TPSA Series
3.2 to 30 VDC, up to
1.25 amps. Integral
OV on IC output
ratings. From \$56.



TPSC Series
3.2 to 30 VDC, up to
5 amps. Integral OV
on IC output ratings.
From \$80.

Super Trypack units offer the system designer two modular sizes to choose from with complete flexibility for systems integration or rack adapter usage with Trygon Liberator units of even higher ratings.

Dual output modules, covering 11.5 to 15.5 VDC, and up to 1.8 amps, are also available in this series.

- Overvoltage Protection
- Precision Performance
- Complete System Reliability
- Unattended Continuous Operation
- Compatible with Liberator Systems Group in Rack Adapter Combinations for up to 161 VDC and 70 amps operation.

TRYGON MEANS POWER!

Write now for complete data and pricing of these new power modules.



111 Pleasant Avenue, Roosevelt, New York 11575
Tel: 516-378-2800 TWX: 510-225-3664
Trygon GmbH 8 Munchen 60, Haidelweg 20, Germany
Write for Trygon Systems Power Supply Catalog.
Prices slightly higher in Europe.

INFORMATION RETRIEVAL NUMBER 138

Application Notes

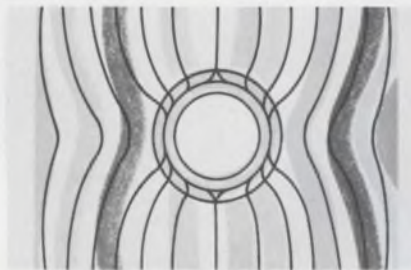

Emi shielding manual

Consisting of 48 pages, a new electromagnetic shielding design manual covers all terms used in emi shielding, tells how a shield works, and shows, complete with formulas, tables and graphs, how to design an effective emi shield. The manual also discusses shielding in and shielding out, and gives calculations for shielding out. Magnetic Metals Co.

CIRCLE NO. 368



Antenna guide

"Selecting Proper Antenna Systems to Meet Communication Requirements" is a 28-page illustrated manual that is a basic guide for selecting the optimum antenna type for both base and mobile installations. Discussed is relative antenna efficiency, effective height, receiver sensitivity and selectivity, and transmitter power. Other sections cover the effects of transmission loss and antenna gain. Antenna Specialists Co.

CIRCLE NO. 370



Encoder guide

Detailing encoder technology and providing extensive data on encoder applications, a new 12-page guide begins with a simplified description of how encoders convert various inputs into useable information. Discussed are analog-to-digital conversion systems, natural binary notation and conversion equivalents, the gray code, and incremental encoders. There is also a section on how to avoid ambiguity. Collectron Corp.

CIRCLE NO. 369

Transmission lines

Featuring a graph that correlates the reduction of voltage standing wave ratio (VSWR) with decibels (dB) of attenuator pads, a new six-page application note covers trade-offs in radio-frequency (rf) measurements and line impedance selection. The graph permits optimum compromise between component isolation and power loss. A brief history and technical background on the selection of 50 Ω as the standard impedance for coaxial power transmission is also included, along with basic breakdown-voltage and power-capacity formulas for concentric lines. Bird Electronic Corp.

CIRCLE NO. 371

The new Fluke 893A will retire lots of good old Fluke voltmeters.

They won't be the only ones to go!

All kinds of differential voltmeters are likely to find quick retirement when you check out the new solid state Fluke Model 893A AC/DC Differential Voltmeter. Here's a low cost differential voltmeter with infinite resistance at null to 1100 volts, dc accuracy of 0.01%, ac accuracy of 0.05%, and integral battery pack operation.

Available in both half and full rack models, price is \$995 for either. Battery operation can be added at any time for only \$100. Grounded recorder output is available for \$50 more.

Ranges are 1, 10, 100, and 1000 volts ac and dc with 10% overranging. Resolution is 1 ppm of range. Reference regulation is the best available. Reference stability is 15 ppm/hr.

Using the instrument in the battery mode assures portability and complete isolation from the effects of power line interference. In the ac mode, the useful frequency range is 5 Hz to 100 KHz with a 1 mv accuracy. In the TVM mode, input resistance is 100 megohms, so you get the same advantages of low source loading as with older vacuum tube differentials.

Other user features include large, in-line readout with 360° rotation of voltage dials, virtual immunity to damage by accidental overload, and automatic decimal switching with range.

Ready to make the change?

We'd like to help. Your friendly Fluke sales engineer (listed in EEM and EBG) has all the facts as well as demo equipment. Call him or contact us directly if it's more convenient.

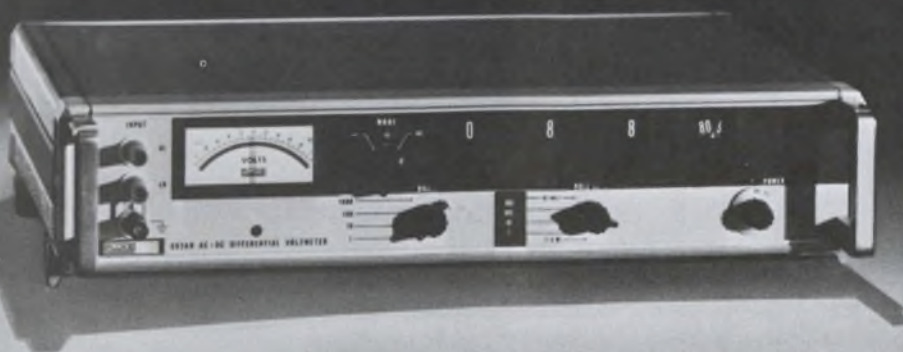

Fluke, Box 7428, Seattle, Washington 98133. Phone: (206) 774-2211.
TWX: 910-449-2850.

In Europe, address Fluke Nederland (N.V.), P.O. Box 5053, Tilburg, Holland.
Telex: 884-50237. In the U.K., address Fluke International Corp., Garnett Close,
Watford, WD2 4TT, England. Phone: Watford 27769. Telex: 934583.



New Literature



Test equipment

Insulation test equipment, electronic test and measuring instruments, high-voltage power supplies, and automatic component testers are covered in a new 32-page catalog. Described are dielectric and voltage breakdown testers, arc-resistance testers, insulation test sets, and megohmmeters. The test and measuring instruments include kilovoltmeters, impedance bridges, Wheatstone bridges and low-range ohmmeters. Beckman Instruments, Inc.

CIRCLE NO. 372

Calibration standards

A six-page short-form brochure lists and describes calibration consoles, emf standards, potentiometers, and resistance standards and networks. The equipment described includes calibration consoles for dc voltage, current, resistance and temperature measurements. Also presented are permanently calibrated bridges, precision comparators, oil-baths for standard cells, temperature and resistance instrumentation, thermionic bridges, volt-boxes, shunts, galvanometers and selector switches. Guideline Instruments, Inc.

CIRCLE NO. 373

Voltage stabilizers

Selection of unfiltered and harmonic-filtered enclosed ac line voltage stabilizers is the topic of an eight-page publication. The stabilizers are used to provide constant voltages for electronic and electrical equipment, such as industrial process, X-ray, numerical control and computer systems. The booklet includes complete descriptive information, operating characteristic curves, performance charts, connection tables, dimensions, drawings, and prices and ordering information. General Electric Co.

CIRCLE NO. 374

Ultrasonic cleaning

An ultrasonic wire drawing and cleaning system is described in a new four-page brochure. Designed to mount in existing drawing or cleaning tanks, the hollow-core/ultrasonic transducer allows the wire to pass through its center, thereby concentrating the high-intensity ultrasonic energy directly on the wire. The brochure lists the common solutions in which the transducer may be immersed and the recommended ultrasonic lenses for each solution. Gulton Industries, Inc.

CIRCLE NO. 375

Limericks for engineers

Authored by a gentleman who understandably prefers to remain anonymous, "Limericks for the Technologically Employed" is a pleasant 20-page diversion from the engineer's work-a-day world. Practically guaranteed to produce at least one chuckle per reader, this booklet also contains a brief appendix devoted to circuit breakers, relays, motors and protective devices. Heinemann Electric Co.

CIRCLE NO. 376

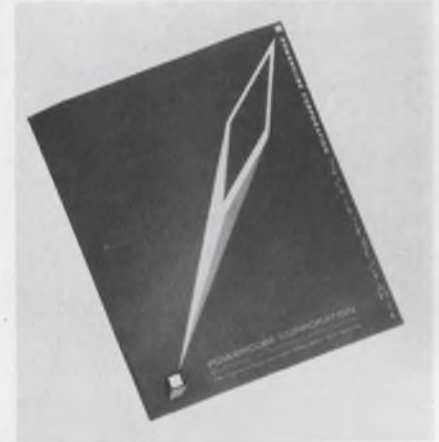

Miniature supplies

A 24-page designer's aid catalog for specifying subminiature high-power supplies is now available. It has data on a complete line of sub-miniature Powercube modules intended for the engineer who is faced with critical size and weight requirements. Powercube Corp.

CIRCLE NO. 377

Marking glossary

Terms associated with embossing seals, stencils, rubber stamps, marking inks and pads, and steel marking tools and dies are fully defined in a glossary of marking device terminology. The information is especially useful to purchasing agents, designers, and others working with or using marking tools. Marking Device Association.

CIRCLE NO. 378

Environmental ovens

Providing a complete selection guide, a new 48-page catalog describes and illustrates a full line of industrial ovens. The models shown cover a full scope of applications. They include gravity, forced-air, mechanically convected, benchtop and floor types, low-skin-temperature, chromatography and vacuum ovens. Hotpack Corp.

CIRCLE NO. 379

Announcing a small breakthrough in 4-track instrumentation recorders.

At 50 pounds, our new HP 3960 is a true instrumentation tape recorder that can go just about anywhere. And starting at \$3800, it's about half the price you'd expect to pay for this performance in a 3-speed, 1/4" tape machine.

For instance, our instrument provides an FM signal-to-noise ratio of better than 46 dB at 15/16 ips. With it, you can record signals that would be buried in noise on the average 40 dB rated machine. This exceptional performance is achieved *without* the use of flutter compensation or external filtering. Offering direct response to 60 kHz and FM to 5 kHz, performance is equal to or better than the most expensive instrumentation recorders now available. This high performance is achieved through the use of a single casting capstan assembly, phaselock servo drive system, and HP quality electronics.

This combination of large-scale performance and small-scale portability makes our recorder the ideal instrument for work in a number of fields: vibration and stress analysis; research and clinical areas of medicine; acoustical work; oceanography, and many others. And its basic simplicity and ruggedness help it to meet stringent environmental specifications.

•• For a close-up of our small breakthrough in the 4-track instrumentation recorder field, just call your local HP field engineer. Or write Hewlett-Packard, Palo Alto, California 94304; Europe: 1217 Meyrin-Geneva, Switzerland.

HEWLETT  PACKARD

MAGNETIC RECORDERS

42904



KEEN CRYSTAL DETECTORS

10 MHz to 12.4 GHz
 ± 0.5 db Response
 SWR less than 1.5



With flat frequency response and low SWR, Alfred broadband crystal detectors, Models 1001, 1002, and 1003 provide top performance in your leveling, power measurement, broadband RF detection and reflectometer requirements.

Brief Specifications.

Frequency Range: 10 MHz-12.4 GHz

Frequency Response: ± 0.5 db full range

SWR: Less than 1.5 full range
 Sensitivity (no load); Power input required to produce 0.1 v rectified output—no greater than 0.4 mw

Square Law Response: Within ± 0.5 db, low level to 1 mw input when properly terminated.
 Maximum Input Power: 100 mw
 Connectors: Input, Model 1001 Type N, Model 1002 OSM, and Model 1003 APC-7 output BNC.
 Price: \$115 with BNC, \$160 with OSM Connector, and \$175 with APC-7 Connector.

For more information, call your Alfred sales engineer or write Alfred Electronics, 3176 Porter Drive, Palo Alto, California 94304. Phone: 415-326-6496. TWX: 910-373-1765.

ALFRED ELECTRONICS

INFORMATION RETRIEVAL NUMBER 141

NEW LITERATURE



Wire markers

A complete line of pressure-sensitive adhesive-backed markers for identifying wires and other items is described in a 20-page illustrated catalog. Included and illustrated in the catalog are wire markers containing numbers, letters, combinations of letters and numbers, machine-tool markers and miscellaneous electrical markers. The markers are available in a variety of materials including paper, vinyl, aluminum foil, acetate cloth, flame resistant fiberglass, polyester, and self-laminating vinyl plastic. The Thomas & Betts Co.

CIRCLE NO. 380

Epoxy coatings

Giving full details on Corvel epoxy coating materials, a new 12-page brochure explains what they are, how they are made, and what are their uses and applications. Also discussed are the advantages of these epoxies for insulation and anti-corrosion applications. Resins Division of the Polymer Corp.

CIRCLE NO. 381

Glass components

A four-page short-form catalog lists performance characteristics, physical descriptions and military designations of glass and glass-ceramic capacitors and glass tin-oxide film resistors. Corning Glass Works.

CIRCLE NO. 382

Find it fast! in the **FREE NEW 1970** **Newark industrial electronic catalog**

A \$9,000,000 INDUSTRIAL ELECTRONIC INVENTORY
 720 PAGES • OVER 70,000 ITEMS; 500 MAJOR LINES
 INCLUDING THE COMPLETE LINE OF

**NEW
 LOW COST TI**



**NPN/PNP
 Complimentary**

**Power
 Transistors**

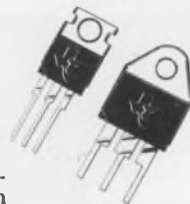

Reduce power circuitry costs with these new plastic package units. Available in four basic types, 1, 3, 10 and 25 amps, with power dissipations to 90 watts.

Will mount in old TO-3 or TO-66 metal can sockets without adapter hardware. Reliability documentation available.

*Immediate delivery from stock—factory OEM prices
 —fast efficient service from 11 Newark warehouses.*

*One source for the products
 you need, in the quantities
 you need.*



For your free catalog write to:

Main Office & Warehouse

NEWARK ELECTRONICS CORPORATION

500 North Pulaski Chicago, Illinois 60624
 (312) 638-4411

AUTHORIZED TI WAREHOUSES IN

- Chicago, Illinois (312) 638-4411
- Detroit, Michigan (313) 548-0250
- Cincinnati, Ohio (513) 421-5282
- Grand Rapids, Michigan (616) 452-1411

OTHER NEWARK WAREHOUSES IN

- Minneapolis, Minn. (612) 331-6350
- New Orleans, Louisiana (504) 834-9470
- Denver, Colorado (303) 757-3351
- Dallas, Texas (214) 271-2511
- New York City (212) 255-4600
- Houston, Texas (713) 782-4800

INFORMATION RETRIEVAL NUMBER 142

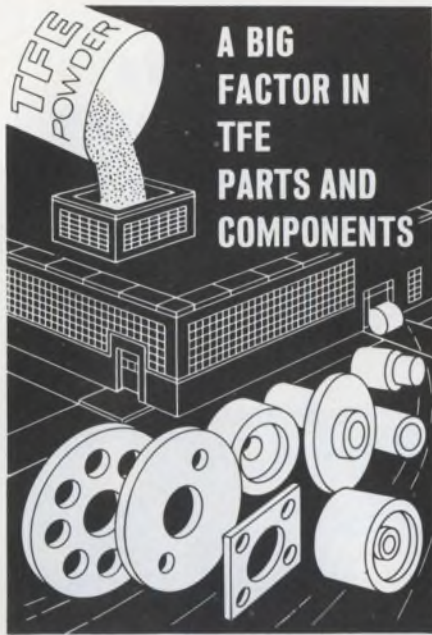

**A BIG
FACTOR IN
TFE
PARTS AND
COMPONENTS**

IS THE CAPABILITY OF YOUR FABRICATOR

That's why you should investigate Crane Packing Company's manufacturing facilities and know-how:

- A completely modern plant especially designed for manufacturing of TFE basic forms and products.
- Climate control to insure proper density, piece after piece.
- Air filtration systems to eliminate impurities.
- The latest in extruding, molding, curing and machining equipment.
- Quality control second to none to insure freedom from flaws and other defects and to maintain uniformity.
- A pioneer from the very beginning of TFE, with over 20 years experience.

Request full details. Send b/p or specs. for a prompt quotation.

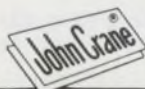

**DUPONT TEFLON
HALON
OTHER FLUOROCARBONS**

CRANE PACKING COMPANY

6432 Oakton St., Morton Grove, Illinois 60053

PLANTS IN: Canada, Mexico, Brazil
England, Australia and Japan

INFORMATION RETRIEVAL NUMBER 143

ELECTRONIC DESIGN 19, September 13, 1969

NEW LITERATURE



Hardware reference

Cross-referencing the part numbers of leading manufacturers, as a second source, to meet spare parts requirements, a new 128-page catalog is now available on standardized precision instrument components. The conversion guide also includes a listing of federal stock numbers assigned to standardized components, plus a section on new products. Winfred M. Berg, Inc.

CIRCLE NO. 383

Cabling systems

Outlining proper selection, specification and termination procedures, a new six-page brochure describes in detail how connectors interface with flat cable or discrete wire to wire-wrap posts and printed circuit boards. The connectors feature simultaneous termination of 14 to 64 conductors on 0.05-in. centers. Engineering data describing contact performance during current cycle, vibration and thermal testing is included. 3M Co.

CIRCLE NO. 384

Enclosure styling

Permitting highly individualistic styling to be easily and economically applied to a variety of enclosure structural systems, a new enclosure styling system, called Interface 33, is completely described in a 12-page full-color brochure. There is a styling selector chart that illustrates how unique enclosure styling combinations can be achieved through the use of seven vertical and seven horizontal trim extrusions. Amco Engineering Co.

CIRCLE NO. 385

**ATTENUATE
& MODULATE,
250 MHZ-
12.4 GHz
for \$550!**

Model E-150 shown 1/2 size



For less than half the cost elsewhere, the Alfred Model E-150 PIN Modulator provides electronically controllable attenuation in one unit over a broad frequency range with wide dynamic range and low SWR at all attenuation levels.

The E-150 replaces four single band units for maximum economy and flexibility. To provide control and power signals for one or two PIN modulator units, Alfred offers the Model E-150P PIN Controller. Using the E-150P, attenuation and modulation can be varied continuously. The PIN Controller provides both local and remote operation. Price of the E-150 is \$550; the E-150P, \$175.

For more information, call your Alfred sales engineer or write Alfred Electronics, 3176 Porter Drive, Palo Alto, California 94304. Phone: 415-326-6496. TWX: 910-373-1765.

ALFRED ELECTRONICS

INFORMATION RETRIEVAL NUMBER 144

New Low Power AC Sources.



Prices even lower.

175 VA—\$565

350 VA—\$1120

CML has been making the best low power AC sources around. For years. Now low power hits a new low in price. All with interchangeable oscillator modules for fixed or adjustable output frequencies from 45 to 6000 Hz. All feature excellent frequency stability and load regulation, low distortion, and lightning-fast response. Write or call today.

	Model NS175 (175 VA)	Model NS350 (350 VA)
With fixed 400 Hz oscillator	\$565	\$1120
Adjustable 350-450 Hz	685	1225
Adjustable 45-6000 Hz	785	1385

CML, Inc.

A Subsidiary of
Tenney Engineering, Inc.
350 Leland Avenue
Plainfield, N.J. 07062
(201) 754-5502 • TWX 710-997-9529



INFORMATION RETRIEVAL NUMBER 145

NEW LITERATURE



Spring washers

Intended to supplement an earlier catalog (40A), a new brochure shows additional parts for crescent, wave and Belleville style spring washers. Also included is a new section on dome washers. Seastrom Manufacturing Co. Inc.

CIRCLE NO. 386

Microwave loads

Four basic types of microwave water loads, all of which offer low VSWR, are discussed in a 16-page catalog. Described are high-power miniature loads of the ceramic block type, broadband loads of the glass tube type, high-power broadband compact loads of the Teflon wedge type, and high-power broadband coaxial loads. A description of various calorimeters, and calorimetric measurement information is also included. Varian Electron Tube and Device Group.

CIRCLE NO. 387

High-voltage supplies

Information on regulated solid-state, unregulated rf, and series-regulated high-voltage power supplies is contained in a new six-page condensed catalog. Besides miniature encapsulated modules, over 300 models of rack-mounted, portable and modular power supplies are priced and described. Spellman High Voltage Electronics Corp.

CIRCLE NO. 388

flying spot
scanner,
photometer,
densitometer,
or
scintillation
counter



The new range of EMI photomultipliers with "SUPER" S-11 photocathodes will enhance your project performance. High quantum efficiency, (23/24%) high gain at relatively low overall voltage, and low dark current at the rated overall sensitivity are typical of these types. They maintain the EMI standard of excellent gain stability and linearity. The narrow spread in characteristics makes these types ideal for systems or for multiple installations. The table below gives the typical values for the significant parameters.

Dia.	Type No.	Amps/ Lumen	Volts/ Overall	Anode Dark Current Nanoamps
2"	9656R	50	1150	2
3"	9708R	50	1250	5
3.5"	9531R	200	1300	.25
4"	9732R	50	1250	10
5"	9709R	50	1350	15

Note that the anode dark current is given for the overall voltage at the specified overall sensitivity. The maximum overall sensitivity is 10 times the values given above. Each Tube is individually calibrated and data is supplied with the tube.

Send for our new 64 page catalog giving data and technical information on the complete range of EMI photomultipliers.

GENCOM DIVISION
varian/EMI

80 EXPRESS STREET PLAINVIEW, N. Y. 11803
TELEPHONE (516) 433-5900

INFORMATION RETRIEVAL NUMBER 146



Modular components

Giving specifications, configurations, applications and prices, a new six-page catalog contains information on several types of modular components. These include dual power supplies, analog multiplier/dividers, FET followers and operational amplifiers. Intronics, Inc.

CIRCLE NO. 389

Sealed connectors

A complete line of hermetically sealed connectors is described in a new 20-page catalog. The publication contains specifications and illustrations for seven hermetic connector families, including miniature, double-ended, submarine, space and missile system units. Each series description includes data on connectors available for mating with the hermetics. Bunker-Ramo Corp., Amphenol Connector Div.

CIRCLE NO. 390

Frequency devices

The electrical and mechanical characteristics of a broad line of frequency instrumentation products are fully described in a comprehensive 10-page two-color catalog. Included are frequency synthesizers, multipliers, dividers, crystal frequency standards and precision crystal oscillators. The Hallicrafters Co.

CIRCLE NO. 391

A VOLTAGE-TUNED BANDPASS FILTER

Here's a miniature filter you can tune simply by applying voltage from an external source. Capable of operating over a full octave, this new Telonic TVF Filter has a varactor circuit which tunes the filter passband center frequency according to the voltage applied. A solder pin, adjacent to one of the coax connectors, is used for making the voltage connection.



The "standard" version is a helical resonator type with a passband center frequency range of 225 to 400 MHz — covering the NEW military communications band. Other ranges and combine configurations are also available.

It's an ideal filter for use as a manually or automatically tuned preselector in receivers — without the cost or hysteresis problems of YIG filters. Its size and weight also make it attractive for airborne applications.

For complete specs, write or call our Marketing Dept.



TELONIC ENGINEERING

A Division of Telonic Industries, Inc.
21282 Laguna Canyon Road • Box 277
Laguna Beach, California 92652
Tel: (714) 494-9401 • TWX: 910 596-1320

INFORMATION RETRIEVAL NUMBER 147

HIGH DENSITY IC PACKAGING PANEL

With Wire Wrap Connector Available

**HIGH PERFORMANCE
FAST DELIVERY
LOW COST**

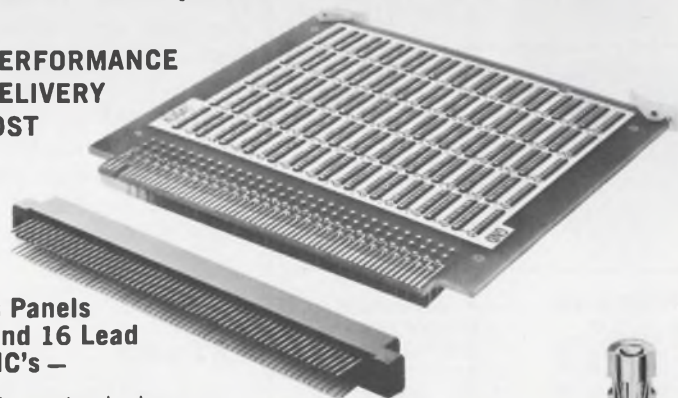

**R-Series Panels
For 14 and 16 Lead
Plug-In IC's —**

- 60 patterns standard
- Accepts Augat's new 120 contact edge connector with Wire Wrap terminations. Connector supplied separately.
- 1/8" double-sided board has power and ground planes connected to each IC pattern.
- Machined contacts assure high reliability and retention.
- Wire Wrap terminations on IC patterns.

Request Complete I. C. Folder

AUGAT INC.

Tel: 617-222-2202
31 Perry Ave., Attleboro, Mass. 02703



INFORMATION RETRIEVAL NUMBER 148

Wedge-Action*



Relays

Hermetically-sealed, electromagnetic relays that provide high performance and reliability under the most difficult operating conditions in dry-circuit to 2 amp applications.



2 PDT
MARK II, SERIES 500
MIL-R-5757/9



6 PDT 4 PDT
(1" x 1")
MARK II, SERIES 300
(6 PDT).
SERIES 350 (4 PDT).
MIL-R-5757/1 and
MIL-R-5757/7



6 PDT
MARK II, SERIES 085
(-55°C to +85°C)
SERIES 100
(-65°C to +125°C),
SERIES 200
(-65°C to +200°C).
MIL-R-5757/1.



4 PDT, 10 AMP
MARK I, SERIES 600-02
MSFC-339/22A

*Wedge-Action



The moving contacts are mounted between two stationary contacts. On actuation, they drive into the stationary contacts, creating high pressures and low

contact resistance at all current levels. In addition, wedge-action contact wipe provides self-cleaning of the precious-metal contacts.

*Patented

For complete data write Relay Sales and Engineering Office, P. O. Box 667, Ormond Beach, Fla. 32074, Phone 904-677-1771, TWX 810-857-0305.

Electro-Tec Corp.

A DIVISION OF KDI CORPORATION KDI

INFORMATION RETRIEVAL NUMBER 149

NEW LITERATURE

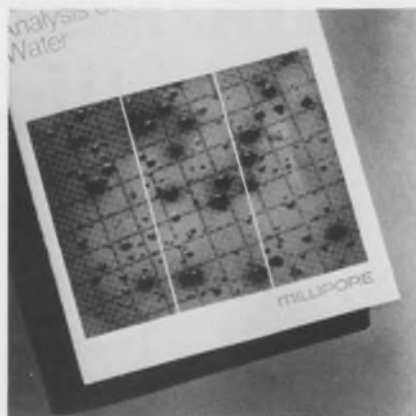

Water analysis

Compiled by bacteriologists, a new 25-page manual describes membrane filtration procedures for isolating and analyzing microorganisms in municipal water supplies, swimming pools, treated sewage or in industrial process, rinse or waste water. In addition to routine coilform analyses, the manual outlines procedures for identifying such organisms as fecal coilform, fecal streptococci, pathogenic bacteria and enteric viruses. Millipore Corp.

CIRCLE NO. 392

Metal lugs

A complete line of metal lugs for stand-off, wiring, and tie-point applications is shown in a new six-page catalog. It contains outline drawings and dimensional information for all types of metal lugs including swage-type and screw-type, as well as a variety of special-purpose configurations. All these metal lugs meet or exceed the requirements of MIL-T-55155. Sealectro Corp., Components Div.

CIRCLE NO. 393

CRT data

Standard and high-resolution cathode-ray tubes that are ideal for computer terminals, video displays, and medical monitoring systems are now listed in a new four-page booklet. The CRTs are indexed according to tube type, minimum resolution (maximum center spot diameter), screen dimensions, and electrical characteristics. Westinghouse Electric Corp.

CIRCLE NO. 394



Probe lights up to check logic levels in a flash

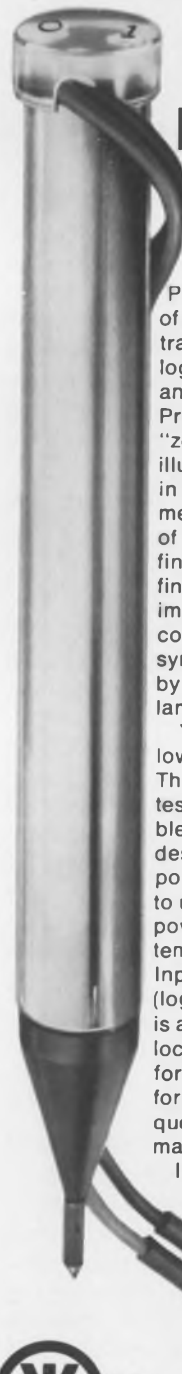

Make contact with the new Kurz-Kasch Logic Probe ... With the speed of light, you can visually trace pulses or test the logic levels of DTL, TTL and related circuits.

Probe flashes "true" and "zero" logic readings by illuminating signal lamps in the end of the instrument. Like having a lab of test equipment at your fingertips. Indicates "infinity" too, identifying improper logic or a disconnection. Displays symmetrical wave forms by illuminating both lamps.

You'll light up at the low user price of \$29.97. The probe is used for testing, inspection, troubleshooting and circuit design. Fits in a shirt pocket; leads attach to unit being tested for power. Responds to systems from 3.75 to 6.5 vdc. Input impedance: 150 kΩ (logic "true"). Logic Probe is available through your local electronic distributor for immediate delivery, or for demonstration upon request. For additional information write Kurz-Kasch, Inc., Logic Instrument Division, 1421 S. Broadway, Dayton, Ohio 45401. (513) 223-8161.



Kurz-Kasch, Inc.

INFORMATION RETRIEVAL NUMBER 150



Drawn aluminum

Thousands of sizes and shapes in off-the-shelf drawn aluminum cans and covers are listed in a new 84-page design guide and catalog. Basic ordering information and complete specifications are given for square, rectangular and round enclosures. An illustrated section covers practical "how-to" information for the design engineer. Moor-lee Manufacturing Co.

CIRCLE NO. 395

Instrument rental

Listing more than 200 new items, a new 42-page catalog gives monthly rates and ordering information for a wide variety of analytical instruments, electromechanical measuring devices, and electrical and electronic instrumentation. General Electric Co.

CIRCLE NO. 396

Pulse measurement

Described in a four-page application engineering bulletin is a solid-state microwave pulse height detector. The unit permits accurate observation of the average spike leakage power or observation of pulses that have excessive amplitudes. Topics include transmitter function and spike leakage effects, operating principles and performance, package options, functions, attenuator setting for measuring leakage, transmitter tube evaluation, and other applications. Varian Solid State Microwave Project.

CIRCLE NO. 397

AN RF BANDPASS FILTER ONLY 1/4" DIAMETER

Here's another Telonic filter developed to solve a designer's dilemma — it's only 1/4" in diameter, weighs less than an ounce.

This TBS Filter can be provided with 2 to 8 sections — depending on cutoff characteristics required—with center frequencies anywhere between 200 and 2300 MHz.

Bandwidths? How's 1.5 to 20%. Insertion loss? Less than 1dB.

Physically, the filter is tubular, length is 1.5" to 5.0" depending on number of sections. Connectors are available in several miniature types, with and without cables.

The TBS is truly a bandpass filter that can fit any application within its frequency range. Write our Marketing Dept. for details.



ACTUAL SIZE

(Ours is the one on the bottom)



TELONIC ENGINEERING

A Division of Telonic Industries, Inc.
21282 Laguna Canyon Road • Box 277
Laguna Beach, California 92652
Tel: (714) 494-9401 • TWX: 910 596-1320

INFORMATION RETRIEVAL NUMBER 151



PUNCH, NOTCH, SHEAR, BEND, RIVET, GROOVE, RIP, CRIMP circuit boards

Sheet metals of all kinds and gauges can be worked and formed with ease using Whitney-Jensen hand tools. You have great flexibility of application when breadboarding or designing prototypes.

Free Ninety pages of information on metalworking tools are yours for the asking. Hand, bench, floor, manually operated, foot-operated and power tools are detailed along with standard and special dies.

WHITNEY METAL TOOL COMPANY
2833 HUFFMAN BLVD.
ROCKFORD, ILLINOIS 61101



WHITNEY-JENSEN

INFORMATION RETRIEVAL NUMBER 152

ECCOAMP

ELECTRICALLY CONDUCTIVE ADHESIVES & COATINGS



New four page folder describes materials from 0.0001 to 100 ohm-cm. Adhesive pastes to replace hot solder, thin liquids, silver lacquer in aerosol spray, lossy coatings, etc.

INFORMATION RETRIEVAL NUMBER 191

THERMAL CONDUCTIVE DIELECTRICS



Electrically insulating, thermally conductive . . . for bonding, encapsulating, coating or sealing heat sinks, components or cryogenic devices where rapid heat transfer is desired. New four-page folder describes materials and applications.

INFORMATION RETRIEVAL NUMBER 192

NEW BOOKLET DESCRIBES SURFACE COATINGS FOR ELECTRONICS



ECCOCOAT® Surface Coatings include transparents for PC boards and components; dip-coats for transformers and coils; easy-mix and one-part systems for automatic production; and a wide range of special properties such as 500°F capability; resistivities to 10^{14} ohms/sq. Several chemical types. Send for copy.

INFORMATION RETRIEVAL NUMBER 193

Emerson & Cuming, Inc.



CANTON, MASS.
GARDENA, CALIF.
NORTHBROOK, ILL.
Sales Offices
in Principal Cities

EMERSON & CUMING EUROPE N.V., Oevel, Belgium

NEW LITERATURE

Kynar applications

Technical information on the use of components made with Kynar for chemical processing systems is contained in a new 16-page brochure. Numerous illustrations show Kynar's unique applications in the aerospace, electronics, chemical and petrochemical industries. Kynar can be used as a protective coating for metal parts, as a film for packaging, and as a material that must resist aging, abrasion and biological attack. Also presented are charts, listing its important physical, mechanical, thermal and electrical design properties. Pennwalt Corp., Plastics Dept.

CIRCLE NO. 398

Electrical maintenance

A new 16-page catalog for electrical maintenance personnel provides detailed information on various types of electrical test equipment. Among the instruments covered are dc dielectric breakdown tester, low-range ohmmeter, temperature rise bridge, insulation oil tester, combustibles analyzer, ac and dc insulation testers, megohmmeters, ac and dc voltage breakdown testers, and a variety of cable-fault locators. Photographs, circuit diagrams and full specifications are given. The bulletin focuses on insulation tests and operational tests. Beckman Instruments, Inc.

CIRCLE NO. 399

Transformer design

Recent design advances in dry-type specialty transformers, with special emphasis on insulating materials, is the subject of a four-page article reprint. The article explores improved transformer design techniques over the past 25 years utilized in high-and low-voltage transformers, power distribution centers, mercury lamp ballasts, cast coils, and high-temperature insulating materials. Projections on future design trends and materials in the industry are also given. General Electric Co.

CIRCLE NO. 400

invaluable



NEW 5TH EDITION OF THE WORLD-FAMOUS Reference Data for Radio Engineers

Now contains 50% MORE DATA to include major information developed over the past 12 years. Prepared by an outstanding group of practicing engineers, professors, and industry and government experts, under the direction of the International Telephone and Telegraph Corporation staff.

OVER 160,000 COPIES SOLD IN THE FOURTH EDITION

The new FIFTH EDITION of this widely used reference work has been completely revised and updated. It provides in a single volume comprehensive data on all basic phases of electronics, including tables, formulas, standards, and circuit information—PLUS—all-new data on microminiature electronics, space communications, navigation aids, reliability and life testing, international telecommunication recommendations, switching networks and traffic concepts, and quantum electronics. 45 data-packed chapters provide invaluable information for practicing radio and electronics engineers. Includes over 1300 charts, nomographs, diagrams, tables, and illustrations. 1155 pages, plus 41-page index.

10-Day Free Examination

Howard W. Sams & Co., Inc. Dept. ED-3
A Subsidiary of International Telephone and Telegraph Corp.
4300 W. 62nd St., Indianapolis, Ind. 46268

Send me REFERENCE DATA FOR RADIO ENGINEERS for 10-day examination, without cost or obligation.

If I decide to keep the volume, I will send:
 \$20.00 (plus postage), or \$7.00 (plus postage) in 10 days, and \$6.50 per month for 2 months. Otherwise, I will return the book postpaid within 10 days.

\$20 payment enclosed. Send my copy postpaid with full 10-day return privilege. (Include sales tax where applicable.)

Name _____

Company _____

Address _____

City _____ State _____ Zip _____

INFORMATION RETRIEVAL NUMBER 153



Gasket materials

Detailed information regarding tolerances for resilient gaskets, an explanation of the minimum sealing stress concept and a listing of military and government specifications can be found in a new 22-page gasket materials catalog. Charts, graphs and photographs provide easy reading and quick reference. Armstrong Cork Co.

CIRCLE NO. 401

Rotary switches

Complete technical specifications on six new series of miniature switches are detailed in an expanded engineering handbook. Included are modifications for switches designed for printed circuits and switches with coded outputs such as; decimal-to-binary units. RCL Electronics Inc.

CIRCLE NO. 402

Antenna catalog

High-frequency, very-high-frequency, and ultra-high-frequency antennas are the subject of a new six-page catalog. Presented are a detailed set of specifications along with complete operating characteristics. Antenna Products Co.

CIRCLE NO. 403

Data communications

Specifications and features of high-speed data communications equipment plus answers to typical questions on communications are available in a newly issued catalog. Described are data modems, acoustic data couplers and data interfacing equipment. RFL Industries, Inc.

CIRCLE NO. 404

A BANDPASS FILTER SHORTER THAN "CHEBYSCHEV"

That's right, the TSA Filter is a truly subminiature version of Telonic's well-known helical resonator filter series. Packaged for minimum size and maximum convenience, the TSA can be specified with center frequencies from 100 to 1500 MHz, 3dB bandwidths of 1 to 20%, and insertion loss as low as 1 dB. A .01 dB Chebyshev device, the filter uses discrete materials and optimum spacing to arrive at high Q factors and low insertion losses.

A typical cross section of the filter is $\frac{1}{4}$ " x $\frac{3}{16}$ " allowing direct mounting on circuit boards. The average volume of any TSA is only $\frac{1}{4}$ cubic inch. It can be supplied with a variety of miniature connectors located laterally or axially, and with or without cable leads. Full details are available from our Marketing Dept.; write or call today.

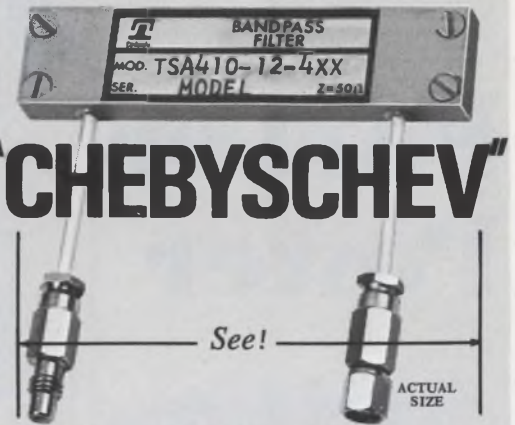

TELONIC ENGINEERING
A Division of Telonic Industries, Inc.
21282 Laguna Canyon Road • Box 277
Laguna Beach, California 92652
Tel: (714) 494-9401 • TWX: 910 596-1320

INFORMATION RETRIEVAL NUMBER 154



Precision X-Y CRT Displays

Beta builds better. It's as simple as that. Our CRT displays have proven themselves in situations ranging from applesauce processing to creating the recently televised Apollo moon pictures. Take our new PD1400. It resolves over 4000 elements/diameter. It can be used for film recorders and readers, flying spot scanners, bubble chamber experiments, video recorders, scan converters, even hard copy printers.

	PD900	PD1100	PD1200	PD1400
Resolvable Elements/Diameter	1700	2100	3400	4200
CRT Diameter	5 inches	5 inches	5 inches	7 inches
Maximum Spot Size	0.0025	0.002	0.00125	0.0015
Small Signal Bandwidth	1 MHz	1 MHz	1 MHz	1 MHz
Settling Time	10 μ sec	12 μ sec	20 μ sec	50 μ sec

Beta Instrument

377 Elliot St., Newton Upper Falls, Massachusetts 02164 / Tel. 617 969-6510 / TWX 710-335-6973

INFORMATION RETRIEVAL NUMBER 155

Parker Power



our tough, reliable
Control Meter!!

the ER-35

Complete control functions in minimum space, at minimum cost, retaining advantages of maximum readability and reliability. Design simplicity and standard options give you total flexibility in design and application.

the E-35

Matching indicator for use with ER-35 Control Meter when read-out only is required. Same appearance and panel cutout for uniform panel appearance.

Parker Instrument

A growth company dedicated entirely to manufacture and sale of Panel, Edgewise, and Control meters.



INSTRUMENT CORPORATION
200 Harvard Avenue • Stamford, Connecticut 06904
Telephone (203) 325-4361 • TWX 710-474-2277

INFORMATION RETRIEVAL NUMBER 168

NEW LITERATURE



Insulating resins

Characteristics of electrical insulating resins and factors to consider when selecting a resin are described in a four-color brochure. The advantages of different resin systems for various electrical applications are cited, along with physical and electrical properties and applications data. The resin systems, which are categorized as to type of cure include polyurethane liquid, foam-in-place epoxy, one and two-part liquid epoxies, and one-part powdered epoxies. 3M Co.

CIRCLE NO. 405

Computing multiplier

A five-digit multimeter with sixth-digit overranging is described in a four-page brochure. Using a new computing rms technique, the unit measures ac signals with an accuracy of 0.1% in 300 ms, despite the presence of distortion. Dana Laboratories, Inc.

CIRCLE NO. 406

Ac and dc motors

Fractional-horsepower ac and dc motors designed to fill a wide range of special applications are described in a new six-page publication. The dc motors are available with ratings of 1/12 to 1 horsepower for use on motor-generator sets and 32-V battery power supplies. Forty models of ac motors feature power ratings of 25 mhp to 1/8 hp, depending on frame size selected. General Electric Co.

CIRCLE NO. 407

He has a new view of life



He's had a heart attack, but he's back on the job. He saw for himself how modern drugs, coronary care units, and new methods of rehabilitation are helping doctors fight the Nation's Number 1 killer.

Heart scientists predict many exciting advances in the foreseeable future, provided more funds are available for research, education and community service. Help make these predictions come true. Give generously to fight the Number 1 threat to your life.

GIVE...
so more will live
**HEART
FUND**



Contributed by the Publisher

Superimposed Noise Problems Solved!



-TR-5589L 250MHz Universal Counter

This counter employs a unique **ANS Circuit** (Automatic Noise Suppressor...patent pending) in its input circuit. If a large signal to be measured and superimposed noises are fed to a counter, the counter may count both the signal and noise since the trigger threshold level is extremely narrow.

The **ANS** solved the noise problems by keeping the input signal level constant at all times regardless of the magnitude of the input, thereby maintaining the trigger threshold level at the optimum value.

When considered from the input side, the trigger threshold level will increase when a large signal is received, or, decrease when a small signal is received. These operation reduces the error due to noise mixed in the input signal. Since the counter has an input sensitivity of 10mV rms, frequency measurement of an extremely low voltage signal is possible, and measurement of 100V rms signal is also possible with the single range without the use of an attenuator because of the 80dB dynamic range.

FREQUENCY RANGE—Counts directly up to 250MHz in decimal, up to 500 MHz with prescaler plug-in unit, covers 10Hz to **12.5 GHz** with frequency converter plug-in unit.

HIGH STABILITY—Long term stability **5 parts in 10^{10}** per day

HIGH SENSITIVITY—10mV to 100V rms in a single range—wide dynamic range—80dB.

DISPLAY—9-digit storage display.

BCD OUTPUT—8-4-2-1 code output.

PLUG-IN VERSATILITY—8 plugin units increase the counter's versatility as required.

Universal Counter, Digital Voltmeter, Digital Integrator, Electrometer, Frequency Counter, Frequency Synthesizer, Frequency Standard, Data Acquisition System, Operational Amplifier.



Takeda Riken Industry Co., Ltd.

1-32-1, Asahi-cho, Nerima-ku, Tokyo, 176, Japan. Tel: Tokyo 930 4111. Telegramme: TRITRONICS TOKYO

Agents:

Litton Precision Products International Inc.—(West Germany, France, Belgium, Switzerland, England)

Ing. S & Dr. Guido Beloffi Ltd.—(Italy) Nores & Co.—(Finland)

Ingenjorsfirma Carl-Eric Larsson AB—(Sweden)

Semco Semiar & Co.—(Denmark)

NEW LITERATURE

Rotary switches

Complete mechanical and electrical specifications for a line of rotary switches are given in a new 24-page technical catalog. Information is also provided on proper switch selection, pre-wired terminal boards, multiple-deck units and military and high-reliability types. These precision switches are suitable for use in computers, telemetering systems, test equipment, instruments, programing and automatic checkout equipment. Aero-vox Corp.

CIRCLE NO. 408

Logic ICs

A handy two-color pocket-sized brochure contains information on monolithic TTL integrated circuits that are members of the SULH I and SUHL II families. Logic diagrams, descriptions and type numbers are given, indexed according to family and function. In addition, the folder has typical electrical characteristics for each circuit and shows available package dimensions. Sylvania Electric Products Inc.

CIRCLE NO. 409

Drum memories

All essential facts about a standard line of drum memories, which cover a storage range of 0.56 to 71.6 megabits, are shown in a new six-page folder. Also provided is a design summary, basic specifications of four models, dimensioned photographs, and digital interface lines. Vermont Research Corp.

CIRCLE NO. 410

Subminiature lamps

Complete specifications, configurations and characteristic curves are contained in a two-page brochure on subminiature lamps. Also shown are filament outline drawings and indicator lamp specifications. Inter-Market Inc.

CIRCLE NO. 411

PARKER: FIRST ON THE MOON!!

Reliable • Compact • Rugged
but above all.... **RELIABLE!**

For the Apollo 11 moon-landing mission a Parker instrument was selected to provide oxygen quantity indication for the astronauts' Portable Life Support System.

*History's greatest demand
for absolute reliability.*

PARKER
INSTRUMENT CORPORATION
200 Harvard Avenue • Stamford, Connecticut 06904
Telephone (203) 325-4361 • TWX 710-474-2277

Free Career Inquiry Service

Absolutely Confidential

Respond to the career opportunities advertised in this issue. Fill out and send us this handy resume. **Electronic Design** will do the rest – neatly typed copies of this form will be mailed to the companies of your choice, indicated by the circled Career Inquiry Numbers at the bottom of this page.

19

Name				Home Phone	
Home Address (Street)			City	State	ZIP Code
Age	U.S. Citizen <input type="checkbox"/> Yes <input type="checkbox"/> No		Security Clearance		
Prime Experience			Secondary Experience		
Desired Salary			Availability Date		
Employment History – present and previous employers					
Company					
City, State					
Dates		to		to	
Title					
Specialty					
Education – indicate major if degree is not self-explanatory					
Degree					
College					
City, State					
Dates		to		to	
Additional Training – non-degree, industry, military, etc.					
Professional Societies					
Published Articles					

- Career Inquiry Numbers:**
- | | | | | | | | | | | |
|-----|-----|-----|-----|-----|-----|-----|-----|-----|-----|-----|
| 900 | 901 | 902 | 903 | 904 | 905 | 906 | 907 | 908 | 909 | |
| 910 | 911 | 912 | 913 | 914 | 915 | 916 | 917 | 918 | 919 | 925 |

ELECTRONIC DESIGN
 850 Third Avenue
 New York, New York 10022

Relay Race!



1 amp. switching.
HATHAWAY HIGH ENVIRONMENTAL SERIES DRIEED RELAY

Who's the toughest contender in the rugged drieed relay race? Back up to the two operative words—toughest and rugged. That's the way we build Hathaway's "R" Series relay team of up to 12 Form A's and 4 Form C's in a variety of configurations. Try them in a starting line up and watch their track record.

Send for our full line mini-catalog.
Address: 5250 East Evans Avenue,
Denver, Colorado 80222, (303) 756-8301—
TWX 910-931-0569.

HATHAWAY

components

A DIVISION OF HATHAWAY INSTRUMENTS, INC.

*To buy less
would cost you more*

INFORMATION RETRIEVAL NUMBER 158

LAFAYETTE RADIO ELECTRONICS



FREE!

**1970 LAFAYETTE
CATALOG 700
496 Pages**

Lists Lafayette's Own Value Engineered Components plus Quality Designed Equipment From Many Leading Manufacturers for

- HOME • INDUSTRY
- LABORATORY

Semiconductors • Capacitors • Connectors • Controls • Fuses and Circuit Breakers • Relays • Resistors • Wire and Cable • Transformers • Test Equipment

All Components Are Immediately Available From Stock!

LAFAYETTE Radio ELECTRONICS Dept. 45099 P.O. Box 10
Syosset, L.I., N.Y. 11791

Please Send the FREE 1970 CATALOG 700 45099

Name _____

Address _____

City _____

State _____ Zip _____

INFORMATION RETRIEVAL NUMBER 159

ELECTRONIC DESIGN 19, September 13, 1969

USE YOUR LOGIC!

(And there is only one choice)



Logically you'd choose this new Contronics Lochpulse™ instrument because it is the **only** logic pulse generator in the world that provides COMPLEMENTARY outputs at 10 volts.

Logically you'd want this instrument because it features independent variability on each simultaneous COMPLEMENTARY pulse output along with independently variable 2 volt DC offset on each.

Logically you'd like another Contronics Lochpulse™ feature... this new instrument provides a 100% duty cycle at 10 MHz.

Logically you'd be pleased with other features, too. Features like a very clean pulse — free of jitter and ringing; very precise and stable gating circuits; light weight and compact size.

And logically you'd have to be impressed with this instrument's modest price: an illogically low \$395 (lowest price in the field) yet an instrument that offers greater performance and higher quality workmanship than the most expensive.

So logically the easiest way to find out more about the new Contronics Lochpulse™ series CPG-300 Logic Pulse Generators is to check the coupon below and send it along with your name and address to:

International **Contronics Inc.**

1038 W. Evelyn Ave., Sunnyvale, Ca. 94086 (408) 736-7620
3555 Torrance Blvd., Torrance, Ca. 90503 (213) 371-7100

I've read your ad and I'd like more information on the Lochpulse™ CPG-300 series Logic Pulse Generator.

Rush _____ new instruments. My purchase order is enclosed. (Specify CPG-300 series; \$395 each.)

I understand you offer a 10 day free trial. Let's hear about it.

INFORMATION RETRIEVAL NUMBER 160

YOKE SPECIFYING PROBLEM?

**ASK AN
EXPERT...**

A SYNTRONIC DEFLECTION YOKE SPECIALIST

Since we make more types of yokes than anyone else, it's natural enough for our team of experts to know more about yoke design, application engineering, and quality control.

Specifying can be a challenging problem, and with this in mind, we put our experience at your disposal. Don't hesitate to call or write us when you're puzzled as to the right deflection yoke for your display.



syntronic

INSTRUMENTS, INC.

100 Industrial Road, Addison, Illinois
Phone: Area 312, 543-6444

INFORMATION RETRIEVAL NUMBER 165

Lawrence Radiation Laboratory with over 5700 employees is located in the San Francisco Bay Area and is engaged in virtually all phases of nuclear research and development.

TECHNICAL WRITER

Electronics Engineering

Is there such a person? Responsible assignment as a Publications Specialist in a fast growing publications group. Work includes some writing, editing, instructional counselling and guidance to potential engineer-writers. Will function in a liaison capacity between our Technical Information and Electronics Engineering Departments. EE degree and publication writing experience required.

For further information, please send resume or inquiries to Personnel Department, P. O. Box 808, (88-99), Livermore, California 94550.



U. S. Citizenship Required
An Equal Opportunity Employer

Looking for a great vacation?

You don't have to look very far.

America with all its natural and man-made marvels is right in your own backyard

You'll find everything from historical monuments, mile-high mountains, sand-duned deserts, bustling cities—and more. The natives, friendly.

America. It's a great place to visit, and aren't you glad you live here.



Space Contributed By
Hayden Publishing Company, Inc.

Electronic Design

ELECTRONIC DESIGN's function is:

- To aid progress in the electronics manufacturing industry by promoting good design.
- To give the electronic design engineer concepts and ideas that make his job easier and more productive.
- To provide a central source of timely electronics information.
- To promote two-way communication between manufacturer and engineer.

Want a subscription? ELECTRONIC DESIGN is sent free to qualified engineers and engineering managers doing design work, supervising design or setting standards in the United States and Western Europe. For a free subscription, use the postfree application form inside the back cover. If none is included, write to us direct for an application form.

If you do not qualify, you may take out a paid subscription for \$25 a year in the U.S.A., \$35 a year elsewhere. Single copies are \$1.50 each.

If you change your address, send us an old mailing label and your new address; there is generally a prepaid postcard for this inside the back cover. You will have to requalify to continue receiving ELECTRONIC DESIGN free.

The accuracy policy of ELECTRONIC DESIGN is:

- To make reasonable efforts to ensure the accuracy of editorial matter.
- To publish prompt corrections whenever inaccuracies are brought to our attention. Corrections appear at the end of the Letters column.
- To refuse any advertisement deemed to be misleading or fraudulent.

Microfilm copies are available of complete volumes of ELECTRONIC DESIGN at \$19.00 per volume, beginning with Volume 9, 1961. Work is now in process to complete the microfilm edition of Volumes 1-8. Reprints of individual articles may be obtained for \$2.00 each, prepaid (\$.50 for each additional copy of the same article) no matter how long the article. For further details and to place orders, contact the Customer Services Department, University Microfilms, 300 North Zeeb Road, Ann Arbor, Michigan 48106; telephone (313) 761-4700.

Want to contact us? If you have any comments or wish to submit a manuscript or article outline, address your correspondence to:

Howard Bierman, Editor,
ELECTRONIC DESIGN,
850 Third Avenue,
New York, N.Y. 10022.

INFORMATION RETRIEVAL NUMBER 902

Advertisements of booklets, brochures, catalogs and data sheets. To order use Reader-Service Card.
(Advertisement)

Advertising Sales Staff

New York 10022

Edward F. Clancy
Sales Service Manager
Robert W. Gascoigne
Thomas P. Barth
Samuel M. Deitch
Byron Adams
850 Third Avenue
(212) Plaza 1-5530
TWX: 867-7866

Philadelphia 19066

William C. Repetto
P. O. Box 206
Merion Station, Pa.
(215) MA-3-5888

Boston 02110

Richard Parker
P.O. Box 645
Clifton Station
Marblehead, Mass.
(617) 742-0252

Chicago 60611

Thomas P. Kavooras
Berry Conner, Jr.
200 East Ontario
(312) 337-0588

Cleveland

Thomas P. Kavooras
(Chicago)
(312) 337-0588
(call collect)

Los Angeles 90303

Stanley I. Ehrenclou
John V. Quillman
W. James Bischof
2930 Imperial Highway
Inglewood, Calif.
(213) 757-0183

San Francisco 94022

Arthur R. Shields, Jr.
175 San Antonio Rd., S 243
Los Altos, Calif.
(415) 941-3084

London W. 1

For United Kingdom & Holland
Brayton C. Nichols
44 Conduit Street
Tel: REGent 4714

Verviers, Belgium

For Continental Europe
Andre Jamar
1, Rue Mallar, 1
(087) 253.83 Telex 41563

Tokyo

Yoshiro Takemura
IPS Group Ltd.
Box 36, Ohsaki Post Office
Phone (504) 1485
Cable Joshplans, Tokyo



Bus Bars For Noise Reduction

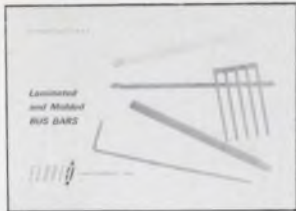

A 16 page Technical Bulletin is now available, describing a new concept in power or signal distribution. Basic mechanical and electrical design principles, along with descriptive pictures and diagrams, are included in this bulletin. These compact buses can replace bulky cable harnesses and repetitive wiring for computer or modular application. This method of construction satisfies the demanding requirements of low inductance and resistance of high speed, solid state systems, while controlling electrical noises.

Send For Free Sample

Eldre Components, Inc.

1239 University Avenue
Rochester, New York 14607

174

A FREE Cross Reference Guide



to better Printed Circuit drafting

No engineer or draftsman should be without the NEW By-Buk Printed Circuit Drafting Aids P-45 Catalog with color-coded MIL-SPEC sizes. Also contains over 2000 pads, shapes, tapes, transistor tri-pads, spaced integrated circuit terminal pad sets and many other drafting aids for faster, more accurate, distortion-free printed circuit master drawings. Send for your FREE catalog.

By-Buk Company

4326 West Pico Blvd., Los Angeles, Calif. 90019
Telephone: (213) 937-3511

175

Quality Fasteners For All Designs



This 8-page catalog provides design data on the complete group of DZUS 1/4-turn self-locking fasteners for standard, high speed and panel applications, as well as universal high strength multiple thread fasteners for high tensile and shear stresses. Dzus stud assemblies, wire forms and receptacles offer an exceptional, wide variety of combinations from stock to fit specific fastening requirements. Diagrams and tables give full details for rapid, unlimited design selection. Condensed or complete Catalog available on request.

Dzus Fastener Co., Inc.

425 Union Boulevard
West Islip, L. I., N. Y. 11795

176

Advertisers' Index

Advertiser	Page	Advertiser	Page	Advertiser	Page
Abbott Transistor Laboratories Incorporated	14	Fairchild Controls, A Division of Fairchild Camera and Instrument Corporation	9, 141	Precision Metal Products Co.	155
Adams & Westlake Company, The	149	Fluke Mfg. Co., Inc., John	173	RCA Electronic Components and Devices	147, Cover IV
Airco Speer Electronic Components	41	Gencom Division, Varian/EMI	178	Radiation, Incorporated	113, 115, 117, 119, 121, 123
Alfred Electronics	176, 177	General Automation, Inc.	31	Russell Industries, Inc.	161
Allen-Bradley Co.	37, 39	General Instrument Corporation	55	Sams & Co., Howard J.	182
American Micro-Systems, Inc.	15	General Radio Company	124	Schweber Electronics	17
Ametek/Lamb Electric	137	Genisco Technology Corporation	144	Shaffstall Ball Corporation	161
Arrow-Hart, Inc.	10, 11	Golay, S. A. Bernard	16B	Signalite, Incorporated	138
Arvin Frequency Devices	171	Grayhill, Inc.	165	Signetics Corporation	27
Associated Testing Laboratories, Inc.	159	Hathaway Components, A Division of Hathaway Instruments, Inc.	187	Siliconix Incorporated	69
Atec, Inc.	140	Hayden Book Company, Inc.	16A	Simpson Electric Company	146
Augat, Inc.	179	Hewlett-Packard	1, 83, 90, 91, 127, 168, 175	Solid State Products Division of Unitrode Corporation	129
Automatic Controls Division of Cook Electric	145	IRC, Division of TRW, Inc.	143	Sprague Electric Company	18, 20
Beckman Instruments, Inc., Helipot Division	111	ITT Electron Tube Division, A division of International Telephone and Telegraph Corporation	139	Stackpole Carbon Company	58
Belden Corporation	60, 61	ITT Semiconductors, A Division of International Telephone and Telegraph Corporation	8	Stewart Warner Microcircuits Inc.	97
Beta Instrument Corp.	183	Industrial Electronic Engineers, Inc.	56, 57	Sylvania Electric Products, Inc., Electronic Components Group	32A-H
Bourns, Inc.	7, 44	Intech, Incorporated	48, 49	Syntronic Instruments, Inc.	188
Buckbee Mears Co.	159	International Contronics, Inc.	187	Systron-Donner Corporation	2
Bulova Electronics Division of Bulova Watch Company	50	International Electronic Research Corporation	16	TRW, Inc., Capacitor Division	109
Burr-Brown Research Corporation	24	Johanson Manufacturing Corp.	160	TRW, Inc., Globe Industries Division	Cover II
By-Buk Company	189	Kay Electric Company	75	Takeda Riken Industry Co., Ltd.	185
C-Cor Electronics, Inc.	154	Kinetic Technology, Incorporated	72	Technipower, Inc., A Benrus Subsidiary	156
CML, Inc.	178	Krohn-Hite Corporation	130	Technical Wire Products, Inc.	159
Centralab Semiconductor Division, Globe-Union, Inc.	63	Kurz-Kasch, Inc.	180	Techno-Components Corp.	134
Chartpak Rotex, A Division of Avery Products Corp.	155	Lafayette Radio Electronics	187	Teledyne Relays, A Teledyne Company	51
Chicago Switch, Inc.	155	Lear Siegler, Inc., Cimron Division	13	Telonic Engineering, A Division of Telonic Industries, Inc.	179, 181, 183
Cinch-Graphik, Division of United-Carr	157	Lenz Electric Manufacturing Co.	152	Telonic Industries, Inc.	144 A-B-C-D
Clevite Corporation, Brush Instruments Division	67	M & T Chemicals, Inc.	191	Texas Instruments Incorporated, Components Group	23, 66
Computer Power Systems	78	Magnetics, Inc.	71	Transitron Electronics Corporation	108
Computer Products, Inc.	128	Mepco, Inc.	76	Trygon Power Supplies	172
Consolidated Reactive Metals, Inc.	164	MicroSwitch, A Division of Honeywell	47	Tung-Sol Division, Wagner Electric Corporation	136
Continental Connector Corporation	62	Miller Company, J. W.	162	Unitrode Corporation	29
Coors Porcelain Company	54	Mohawk Data Sciences Corporation	135	Veeder-Root	166, 167
Corning Glass Works, Electronic Products Division	34, 35	Molex Products Company	107	Victoreen Instrument Division	64
Crane Packing Company	177	Monsanto Company	163, Cover III	Victory Engineering Corporation	158
Cunningham Corporation, Subsidiary of Gleason Works	150, 169	Moorlee Manufacturing Company	130	Vishay Resistor Products, A Division of Vishay Intertechnology, Inc.	153
Curtis Development & Mfg. Co.	191	Motorola Communications & Electronics, Inc.	65	Wakefield Engineering, Inc.	171
Cutler-Hammer, Specialty Products Division	191	Motorola Semiconductor Products, Inc.	12	Wanlass Instruments, A Division of Wanlass Electric Company	161
Dale Electronics, Inc.	165	National Semiconductor Corporation	4, 5	Weston Instruments, Inc., Newark Division	131
Datascan, Inc.	170	Newark Electronics Corporation	176	Weston Instruments, Inc., Archbald Division	33
Dearborn Electronics, Inc.	148	Oak Manufacturing Co.	171	Whitney Metal Tool Company	181
Dialight Corporation	73	Parelco Operations	122	Xerox Corporation	151
Dow Corning Corporation	102, 103	Parker Instrument Corporation	184, 185	Zeltex, Inc.	133
Duncan Electronics	77	Philco-Ford Corporation, Microelectronics Division	6	Career Advertising:	
Durant Digital Instruments, A Cutler Hammer Company	142	Potter & Brumfield Division of American Machine & Foundry Company	52, 53	Lawrence Radiation Laboratory	188
Dzus Fastener Co., Inc.	189				
Eldre Components, Inc.	189				
Electro Materials, A Division of Illinois Tool Works, Inc.	74				
Electro Tec Corp.	180				
Electronic Arrays, Inc.	42, 43				
Electronic Specialty Co.	68				
Electrovert, Inc.	165				
Emerson & Cuming, Inc.	182				
Eric Technological Products, Inc.	16A				
Exact Electronics, Inc.	70				

small wonder.

Where else can you find gold-plated contacts in an economical ultraminiature pushbutton?

These tiny new pushbuttons pack a lot of value into a mighty small package. They're the first ultraminiature devices offering Cutler-Hammer quality for computer, office machine and instrument applications. Cost is ultraminiature, too.

Exclusive gold-plated contacts and wiping action make them ideal for dry circuits. Since .040" overtravel is standard, they make fine ultraminiature limit switches. Available from stock in single-pole only, with NO or NC circuits, with red or black operator buttons. Ten colors of decorator button caps and a protective boot seal are also available.

Rating at 125 VAC (Resistive); 1/2 amp, NO and 1/4 amp NC. Contact Resistance: 10 Milliohms max., initial. Life expectancy 50,000 minimum operations at rated load. Call your Cutler-Hammer Sales Office or Stocking Distributor.

CUTLER-HAMMER 
SPECIALTY PRODUCTS DIVISION, Milwaukee, Wis. 53201



INFORMATION RETRIEVAL NUMBER 161

TERMINAL BLOCKS

CURTIS

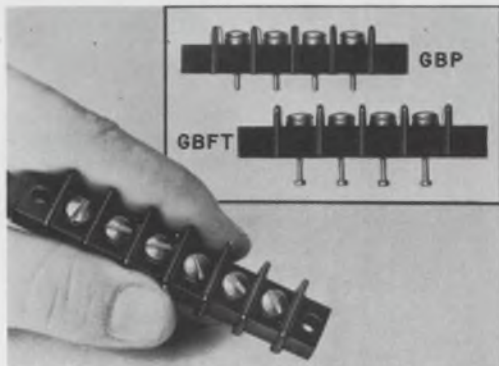

FEED-THRU GB-SERIES

Versatile flat base feed-thru terminal blocks with choice of interior turret-type solder terminals or .062 dia. printed circuit pins. Inserts are bright tin plated for excellent solderability, conductivity, and long shelf life.
Rated — 20 amps, 300 volts.
Available — 1 to 18 terminals, 3/16" center-to-center terminal spacing.
#6-32 screw connections accept up to #12 AWG wire.

FREE! Full details, descriptions and prices in new Curtis 24-page illustrated catalog.



CURTIS DEVELOPMENT & MFG. CO.
2326 N. 33rd St. • Milwaukee, Wis. 53216



INFORMATION RETRIEVAL NUMBER 162

ELECTRONIC DESIGN 19, September 13, 1969

TRANSTECTOR

CIRCUIT PROTECTOR



prevents transients from causing "unexplainable" circuit failures.

Don't blame circuit failures on bad luck. Voltage transients can cause circuits to fail or suffer undetected and progressive damage.

Transtector* circuit protector, a new solid state device, senses transients within nanoseconds, absorbs the surge and resets itself. Gives continuous protection for tubes, transistors, diodes and integrated circuits.

Find out about Transtector Systems from M&T Chemicals Inc., 1161 Monterey Pass Road, Monterey Park, Calif. 91754. Tel. (213) 264-0800.

M&T Chemicals Inc. 
SUBSIDIARY OF AMERICAN CAN COMPANY

*Trademark of M&T Chemicals Inc.

INFORMATION RETRIEVAL NUMBER 163

191

Small wonder:



**Our new "4th generation"
12.5 MHz universal counter/timer**
Wonderful versatility.
Wonderful small package.
Wonderful small price.

With the new Model 100A you can measure average frequency, frequency ratio, single period or time interval, or count total events. It has a crystal-controlled clock, Monsanto integrated circuit construction, and built-in compatibility with a rapidly growing assemblage of accessory modules.

With its \$575 price tag, FOB West Caldwell, New Jersey, you can have big-league counter/timer performance at costs never before possible. Small wonder we are selling and delivering Model 100A's just as fast as we can build them. Accessory modules are also comparably modestly priced.

For a demonstration of our "Small Wonder," the Model 100A universal counter/timer, or for full technical details call your local Monsanto Field Engineer, or contact us directly at: Monsanto Company, Electronic Instruments, West Caldwell, New Jersey 07006, (201) 228-3800.

Monsanto

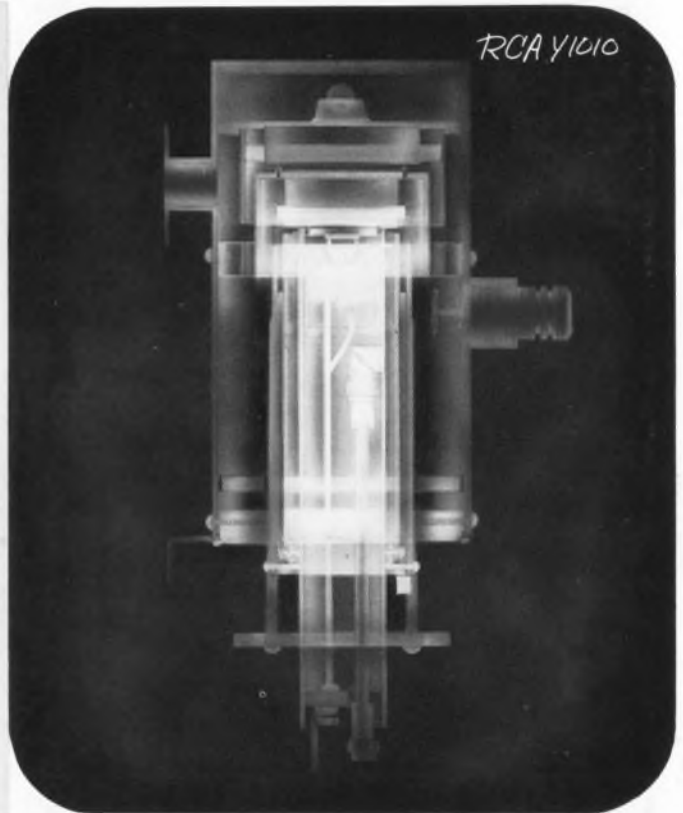
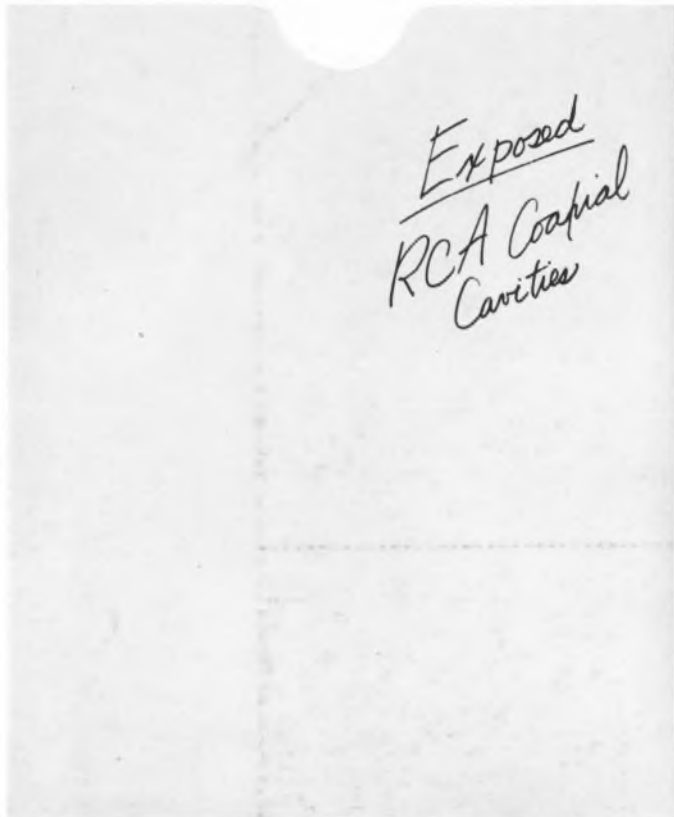

Now—continuing its leadership in the development of electronic products—RCA announces a complete range of coaxial cavities to assure optimum performance from its line of CERMOLOX® Power Tubes.

Suitable for use either as complete amplifiers or as oscillators, these cavities assure specified performance with fully engineered circuitry, minimum RF losses, simplified connections, and high overall efficiency.

To fulfill your requirements, cavities are available for frequencies up to L-band and powers up to 10 kW.

The performance, reliability, and efficiency of CERMOLOX tubes have been proved. This line of cavities will augment and assure these benefits. In addition, if your requirements call for special parameters, our Application Engineers will gladly modify existing cavities or develop new ones to assure you of optimum equipment performance.

For more information on RCA coaxial cavities and RCACERMOLOX Tubes, see your local RCA Representative. For technical data on specific types, write: RCA Electronic Components, Commercial Engineering, Section I-18T-3, Harrison, N. J. 07029.

RCA Coaxial Cavities—Available Off-the-Shelf

RCA TYPE	TUBE	POWER OUTPUT (Watts)	MODE	FREQUENCY (MHz)
Y1010	8226	100	CW	1170
Y1044	8501	10,000	pulse	400
Y1050	7651	5,000	pulse	500
Y1051	8227	450	pulse	500
Y1052	8227	400	pulse	350
Y1054A	7651	5,500	pulse	150
Y1059	7214	12,500	pulse	150
Y1070	7651	6,500	pulse	200
Y1086	7651	375	pulse	200

RCA