

Electronic Design 26

VOL. 15 NO.

FOR ENGINEERS AND ENGINEERING MANAGERS

DEC. 20, 1967

Photodiode-op-amp combination shares the same split-level TO-5. The dynamic duo spans the light spectrum from the visible to the infrared, for needs that range from

card readers and laser radiation detectors to blackbody sensors. The hybrids can operate on only 50 mW and provide an output impedance of 250Ω (page 114).

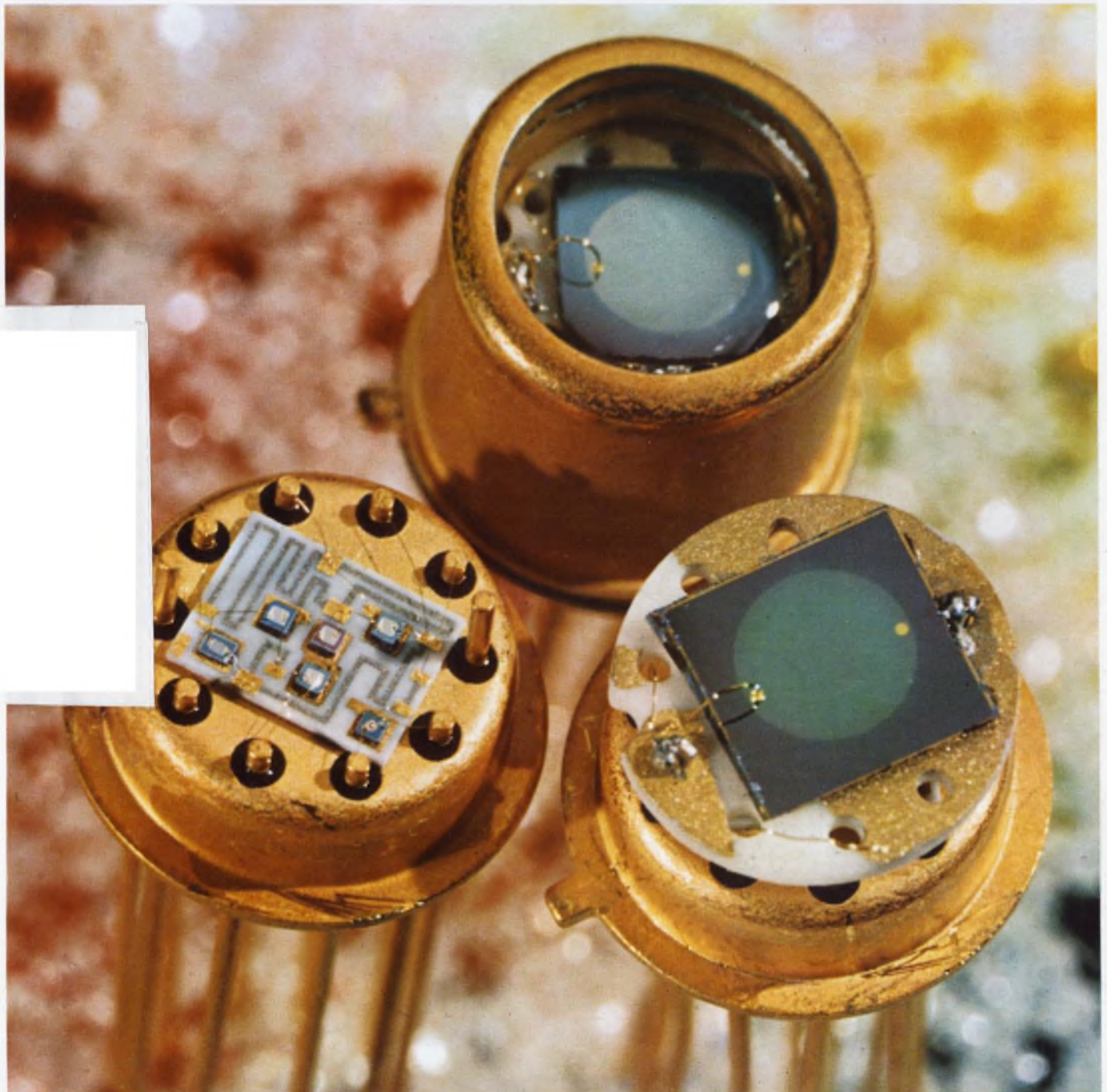

hp140A—The Scope System that gives you

BETTER PERFORMANCE



1421A—Time Base and Delay Generator



1402A—20 MHz Dual Trace Amplifier

Get 20 MHz bandwidth and delayed sweep readability. With this scope you can choose from 17 plug-ins that cover the entire measurement spectrum. If you need wideband performance, for example, you can use the dual-trace 1402A vertical amplifier and get DC to 20 MHz at 5 mv/cm, algebraic addition, built-in delay line for viewing fast-rise pulses, full 6 cm deflection and a wide dynamic range.

For easy readability of complex waveforms and accurate time interval measurements, Model 1421A time base provides extreme magnification and sweep speeds from 1 sec/cm to 20 ns/cm. It also offers the additional advantage of exclusive hp mixed sweep. This feature combines display of the first portion of a trace at normal sweep speeds and simultaneously expands the trailing portion of the trace at faster delayed sweep speeds to allow step-by-step magnified examination.

An alternate mainframe (141A) provides equal versatility plus the advantages of variable persistence and storage. Price of the wideband system with 140A mainframe, 1402A vertical plug-in and 1421A horizontal plug-in is \$1795. Price with the 141A mainframe is \$2595.

Ask your hp Sales Engineer for brochure (data sheet 140A) with specs on the 140A wideband system as well as 140A high-sensitivity, TDR or 12.4 GHz sampling systems. You'll find they give more and better measurements in less time. Hewlett Packard, Palo Alto, California, 94304. In Europe: 54 Route des Acacias, Geneva.

087/37



hp 140A: PERFORMANCE IN ANY DIRECTION
20 MHz Wideband • High-Sensitivity, no drift
• 150 ps TDR • 12.4 GHz Sampling
• Variable Persistence and Storage

HEWLETT  PACKARD
An extra measure of performance

ON READER-SERVICE CARD CIRCLE 2



115V
NL

100V
NL

100V
FL

130V
FL

130V
NL

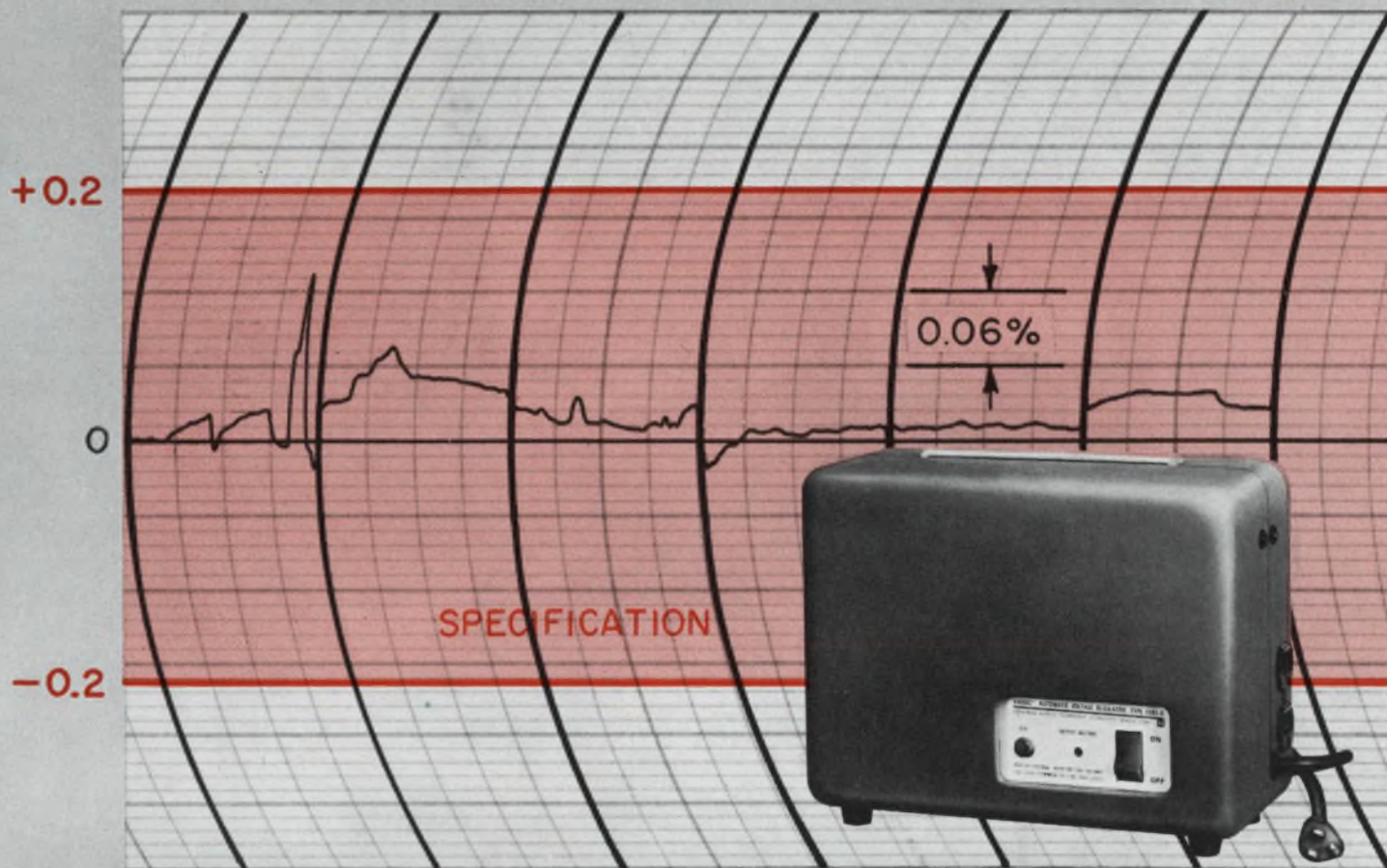

1591 Variac® Automatic Voltage Regulator, \$295 in U.S.A. (115 V)

NOW... a low-cost line-voltage regulator for every bench ... for every rack

High performance, proven reliability, small size, and low cost are the key words that identify GR's new 1-kVA line-voltage regulator.

By performance we mean that this regulator will maintain a 115-volt output (adjustable from 105 to 125 volts) within ± 0.2 percent for *simultaneous variations* of: input-line voltage from 100 to 130 volts, load from no load to full load, power factor from 1.0 to 0 leading or lagging, and line frequency over a range of $\pm 10\%$.

By reliability we mean continued high performance even under conditions far worse than those any regulator is likely to encounter in actual use. The tests indicated on the above chart were performed on a randomly selected unit that had already been subjected to a one-year, round-the-clock life test plus an accelerated life test in which the input signal was modulated at a 3.5-hertz rate. At the time this recording was made, the motor-gear train, Variac® autotransformer, and control circuitry had been subjected to 10 million oscillations

while operating at nearly full-load rating. No lubrication or adjustments were required.

By small size we mean $12\frac{3}{4} \times 9\frac{1}{2} \times 5\frac{3}{8}$ inches and a weight of 17 pounds for the portable model.

By low cost we mean a price of \$295 for a single portable model; rack and 230-volt models are slightly higher. Quantity discounts are available for all models.

Because there is no distortion added to the input waveform, average and peak voltage values are held as constant as the rms value. Response time is 6 cycles + 1.5 cycles per volt under worst conditions for the 115-volt model.

For complete information, write General Radio Company, W. Concord, Mass. 01781; telephone (617) 369-4400; TWX (710) 347-1051.

GENERAL RADIO

ON READER-SERVICE CARD CIRCLE 3



Rack model, \$325 in U.S.A. (115 V)

If you buy HP counters, we have news for you.

Systron-Donner makes advanced counter instrumentation that has no equivalent in the HP catalog. That's why it pays to check with Systron-Donner before you buy. You'll find equipment with unique capability like:

1. A plug-in that will extend your counter's frequency range to 15 GHz – measuring FM and pulsed RF as well as CW and AM. The only way to get the full dc to 15 GHz range in one cabinet. No calculations. Displays final answer.



3. "Thin Line" counters that take only 1¼" of rack space. Built with ultra-reliable integrated circuits to give you automatic frequency measurements – dc to 100 MHz or 0.3 to 12.4 GHz.

These are the highlights of expandable systems that will make just about any measurement possible with counters. The accuracy of our basic 50 MHz and 100 MHz counters is unsurpassed. (Time base aging rate is only 5 parts in 10^{10} per 24 hrs.) All devices to extend the range or add functions are convenient plug-ins – not rack mounts. The newest are a prescaler to extend counter range to 350 MHz and a heterodyne converter to measure noisy signals in the 0.2 to 3 GHz range.

Are you surprised that Systron-Donner is a step ahead of HP in counter technology? How else could we stay in business?

Systron-Donner Corporation, 888 Galindo Street,
Concord, California 94520

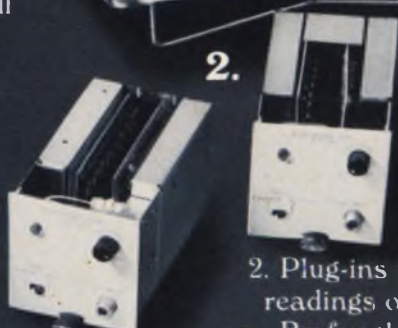

2. Plug-ins that produce automatic readings of microwave frequencies. By far the most compact and economical equipment for producing automatic readings in the 0.3 to 3 GHz band or the 5 to 12.4 GHz band.

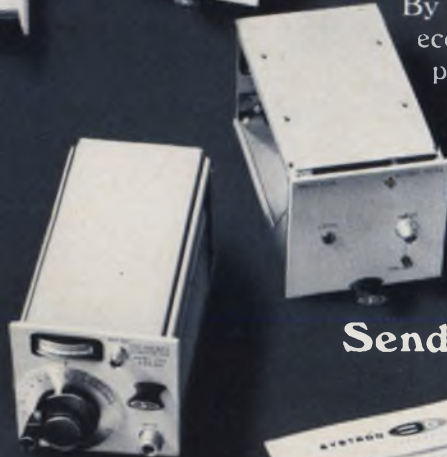

Send for catalog.



SYSTRON  DONNER

ON READER-SERVICE CARD CIRCLE 4

NEWS

- 21 News Scope
- 25 **Over-the-horizon radar scans skies for FOBS**
Soviet missile systems spur development of ionospheric-bounce techniques
- 30 **Army tests hearing aids that bypass the ears**
Devices transmit sounds by sending modulated rf signals through the skin.
- 34 **Thin-film capacitor is sensitive bolometer**
JPL device reported order-of-magnitude better than existing units.
- 38 Ceramic dielectric is feat of clay.
- 43 Washington Report
- 48 Letters
- 58 Sidelights of the Issue
- 61 **Editorial:** Two-sided rules needed for the old contract game.

TECHNOLOGY

- 64 **ILLIAC IV: route to parallel computers.** A university-industry project is crystalizing system design for unconventional multimachine array.
- 72 **Use statistics to speed video bandwidth design.** What counts in creating efficient optical and radar scanning systems is what the human eye doesn't see.
- 76 **Iron out ferrite core design wrinkles** with three nomograms. Given L and Q, the right cup core, bobbin and wire size are easy to find.
- 82 **How good is you differentiator?** When checking a passive RC type, include the effects of stray impedances; they can destroy an ideal input.
- 86 Test Your IC IQ
- 90 **Listen! Don't just hear.** Your success on the job depends strongly on how well you communicate orally. Here are hints to help you listen effectively.
- 98 NASA Tech Briefs
- 102 Ideas for Design

PRODUCTS

- 114 **Cover Feature:** Photodiode and op-amp share same TO-5 can.
- 116 Semiconductors
- 118 Systems
- 126 Production Equipment
- 127 Test Equipment
- 128 Components
- 136 Microwaves
- 138 Materials

Departments

- 140 Application Notes
 - 141 Design Aids
 - 142 New Literature
 - 146 Reprints
 - 148 Advertisers' Index
 - 151 Designer's Datebook
- Reader Service card inside back cover

Mating game:

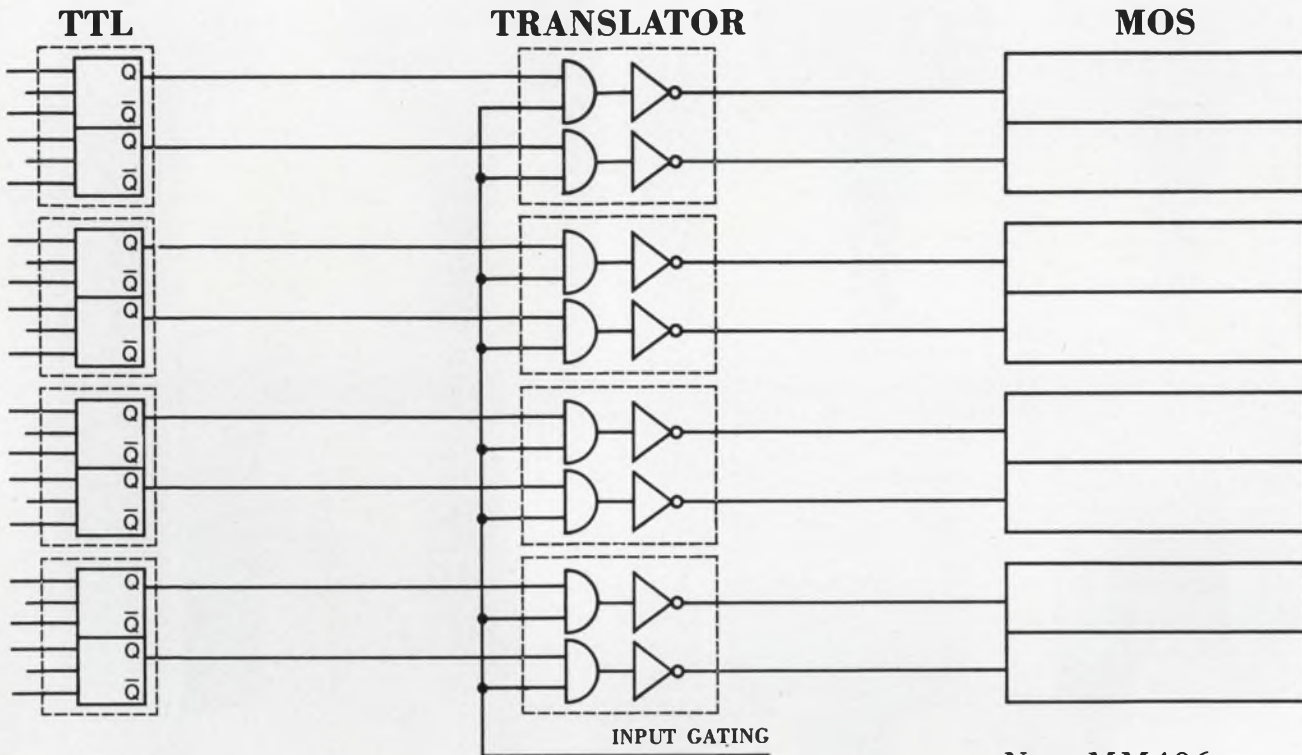

New DM7501 dual JK flip flop used as a TTL shift register for an 8-bit word.
 Monolithic.
 Hermetically sealed.
 SN5473 equivalent.
 Price: \$8.80 (100-199), \$4.00 for commercial DM-8501 (SN7473 equivalent).
 Immediate delivery.
 Circle Number 105.

New DM7800 dual voltage translator to change bi-polar logic voltage levels to MOS logic voltage levels.
 Monolithic.
 Gated inputs.
 Input voltage levels DTL- and TTL-compatible.
 Output levels variable between +25V and -25V.
 Price: \$15.00 (100-199), \$10.00 for commercial DM-8800.
 Immediate delivery.
 Circle Number 106.

New MM406 stores one hundred 8-bit words at 10¢ per bit in electronic "drum" memories.
 Dual 100-bit MOS dynamic shift register.
 1 MHz operation.
 Price: \$60.00 (100-199), \$20.00 for commercial MM-506.
 Immediate delivery.
 Circle Number 107.

Data sheets, a list of distributors and a picture postcard of Niagara Falls are yours for the circling.

Or write: National Semiconductor Corporation
 2975 San Ysidro Way
 Santa Clara, Calif. 95051

National Semiconductor

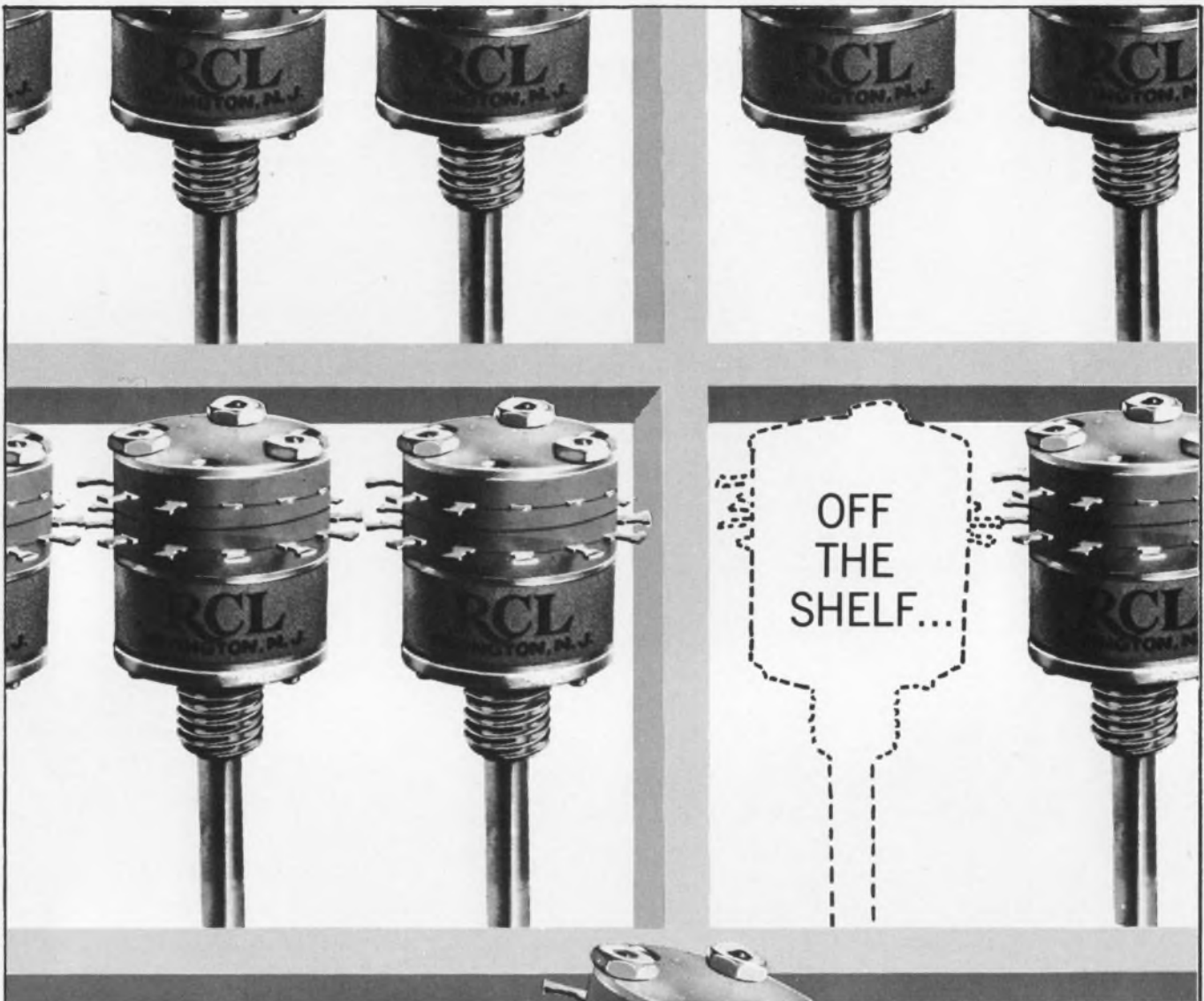

INDUSTRY'S
BEST DELIVERY...
1/2" MINIATURE
ROTARY SWITCHES

Write For Engineering Catalog

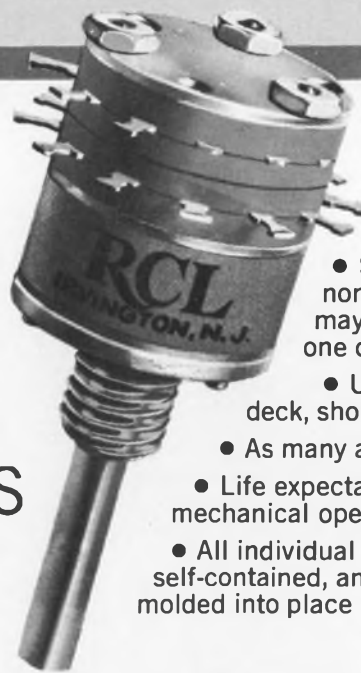

- Shorting **AND** non-shorting poles may be grouped on one deck in any combination
- Up to 12 positions per deck, shorting **OR** non-shorting
- As many as 6 poles per deck
- Life expectancy 200,000 mechanical operations
- All individual deck parts are self-contained, and are permanently molded into place

RCL ELECTRONICS, INC.

General Sales Office: 700 South 21st Street, Irvington, New Jersey 07111

Rugged, Reliable and Versatile!

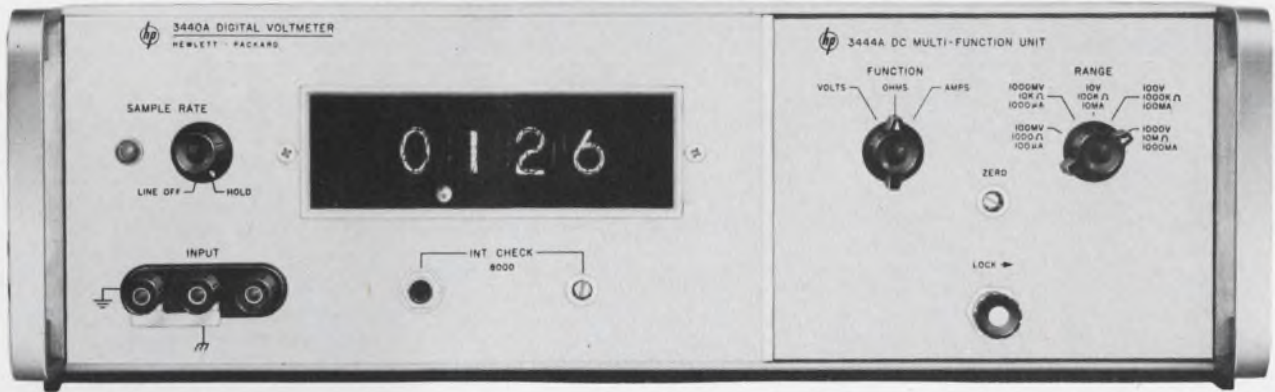

USE THIS hp DVM ANYWHERE!



LABORATORY



PRODUCTION



SYSTEMS

The hp Models 3439A and 3440A Digital Voltmeters are compact, accurate, rapid, multiple function instruments—built rugged, reliable and versatile! With the appropriate plug-in, you get automatic ranging, remote or manual operation with an accuracy of 0.05% of reading on a four-digit readout; 50 Hz to 50 kHz bandwidth with 10 μ V; 10 nA sensitivity!

Rugged!—Models 3439A and 3440A are built with solid-state circuitry and reed relays to provide a rugged instrument. Use of solid-state components also gives a lighter weight for easy portability. These units are test operated at temperatures from 0°C to 50°C with relative humidities of 0 to 95%, vibration tested at 10 to 55 Hz at 0.010" peak-to-peak excursion, and drop-tested four times from four inches. Construction and testing assure you of a rugged instrument—ideal for bench or systems applications.

Reliable!—With either the 3439A or 3440A, you get an internal calibration source with a TC better than 0.002%/°C and a stability typically better than $\pm 0.005\%$ over a three month period. You can verify accuracy of these models simply by pressing a front panel button. You get digital readout on large rectangular display tubes which hold the previous reading until the input voltage is changed. Long-term reliability is assured with solid state components—but, if something should happen, the easy-to-service plug-in circuit cards mounted in the modular enclosure can be quickly replaced to minimize down-time.

Versatile!—You get a dc accuracy of better than $\pm 0.05\%$ of reading ± 1 digit. Specified accuracy is retained to 5% beyond full scale. The ac filter has a rejection of 30 dB at 60 Hz. Response time to a step change is 450 msec to read 99.95% of final value. The 10 M Ω impedance presents a constant load on all voltage ranges.

Add the capability of six plug-ins to these features and you have a truly versatile instrument! *But—that's not all!* You can make true RMS measurements using the dc output of the hp Model 3400A RMS Voltmeter and either the 3439A or 3440A. The 3440A has a BCD recorder output to operate with the hp

Model 562A Digital Recorder to produce a printed, six-column readout.

Plug-in*	3441A	3442A	3443A	3444A	3445A	3446A
AC volts 10V to 1000V	**	**	**	**	X	X
DC volts 10V to 1000V	X	X	X	X	X	X
DC volts 100mV to 1000V			X	X		
DC amps				X		
Ohms				X		
Manual ranging	X	X	X	X	X	X
Auto-ranging		X	X		X	
Remote ranging		X	X		X	X
Remote function						X
Floating input	X	X	X	X	X	X

*3439A and 3440A require a plug-in to operate

**Average response measurements: 100 μ V to 300 volts. 50 Hz to 500 kHz—hp-457A or 1 mV to 300 volts. 10 kHz to 10 MHz with -hp-400E/EL. True RMS measurements: 1 mV to 300 volts. 10 Hz to 10 MHz use -hp-3400A.

Get the full story on the rugged, reliable, versatile hp Model 3439A or 3440A Digital Voltmeter from your nearest hp field engineer. Or, write to Hewlett-Packard, Palo Alto, California, 94304. Europe: 54 Route des Acacias, Geneva. Price: hp model 3439A, \$950.00; hp Model 3440A, \$1160.00, plus plug-ins (\$40.00 to \$575.00).

097/9

HEWLETT  **PACKARD**
An extra measure of quality

ON READER-SERVICE CARD CIRCLE 6

Major Price/Performance Breakthrough
for New Economy
in Industrial, Military, and Commercial Equipment

RCA's MAX VALUE PHP LINE

Performance/Hermeticity/Price

High-Performance
Silicon N-P-N Amplifiers
and Switches
in High-Temperature,
High-Dissipation
Hermetic Packages

at prices
as low as

19¢ 1000+
2N5183











PHP

RCA's MAX VALUE line now brings you the results of RCA's most successful silicon planar and epitaxial technologies at unprecedented savings... Performance/Hermeticity/Price. Contact your RCA Field Representative for more information.

Or write RCA Commercial Engineering, Section CG12-3 RCA Electronic Components and Devices, Harrison, N.J. 07029. Check your RCA Distributor for his price and delivery.

†1000 plus quantities, OEM prices shown.
*RCA's MAX VALUE line offers military-type reliability control. For each type marked with the asterisk, production lots are subjected to and meet the mechanical, environmental, and life-test requirements of Military Specification MIL-S-19500.

 <p>2N5179 PHP Price 39¢† LOW-NOISE UHF AMPLIFIER</p> <p>TO-72</p> <p>20mW min oscillator output @ 500 MHz; 4.5 dB max NF @ 200 MHz; 15 dB min neutralized power gain @ 200 MHz; $f_T = 1\text{GHz}$ min $C_{cb} = 1\text{ pF}$ max. *Plus RCA Reliability Control</p>	 <p>2N5180 PHP Price 29¢† LOW-NOISE VHF AMPLIFIER</p> <p>TO-104</p> <p>4.5 dB max NF @ 200 MHz; 12 dB min unneutralized power gain @ 200 MHz; $f_T = 900\text{ MHz}$ typ; $C_{cb} = 1\text{ pF}$ max.</p>	 <p>2N5181 PHP Price 27¢† HIGH GAIN RF AND IF AMPLIFIER</p> <p>TO-104</p> <p>Max usable gain = 24 dB typ @ 200 MHz (neutralized); 3.5 dB typ NF @ 200 MHz; $f_T = 700\text{ MHz}$ typ; $C_{cb} = 0.34\text{ pF}$ max; new terminal arrangement for max isolation between collector and base terminals.</p>
 <p>2N5182 PHP Price 24¢† HIGH-GAIN RF AND IF AMPLIFIER for low-current applications</p> <p>TO-104</p> <p>Max usable gain = 24 dB typ @ 200 MHz (neutralized); 4.5 dB typ NF @ 200 MHz; $f_T = 700\text{ MHz}$ typ; $C_{cb} = 0.34\text{ pF}$ max; new terminal arrangement for max isolation between collector and base terminals.</p>	 <p>2N5183 PHP Price 19¢† 1-AMPERE GENERAL PURPOSE AMPLIFIER</p> <p>TO-104</p> <p>$h_{FE} = 50$ min @ $V_{CE} = 1\text{V}$, $I_C = 300\text{ mA}$; $V_{CEO} = 18\text{ V}$ max; $V_{CE}(\text{SAT}) = 0.5\text{ V}$ max @ $I_C = 300\text{ mA}$, $I_B = 15\text{ mA}$; $f_T = 200\text{ MHz}$ typ; Planar epitaxial construction.</p>	 <p>2N5184† PHP Price 27¢† HIGH-FREQUENCY HIGH-VOLTAGE AMPLIFIER</p> <p>TO-104</p> <p>$V_{CEO} = 120\text{ V}$ max; $I_C = 50\text{ mA}$ max; $f_T = 100\text{ MHz}$ typ; $C_{cb} = 3.5\text{ pF}$ max.</p>
 <p>2N5185 PHP Price 31¢† HIGH-FREQUENCY HIGH-VOLTAGE AMPLIFIER</p> <p>TO-104 with integral radiator</p> <p>1 watt dissipation capability; $V_{CEO} = 120\text{V}$ max; $I_C = 50\text{ mA}$ max; $f_T = 100\text{ MHz}$ typ; $C_{cb} = 3.5\text{ pF}$ max.</p>	 <p>2N5186 PHP Price 24¢† HIGH-SPEED SWITCH</p> <p>TO-52</p> <p>$V_{CBO} = 10\text{V}$ max; $t_{on} = 25\text{ ns}$ max @ $I_C = 10\text{ mA}$, $I_B = 1\text{ mA}$; $t_{off} = 25\text{ ns}$ max @ $I_C = 10\text{ mA}$, $I_B = 1\text{ mA}$; $V_{CE}(\text{SAT}) = 0.3\text{V}$ max @ $I_C = 10\text{ mA}$, $I_B = 1\text{ mA}$. *Plus RCA Reliability Control</p>	 <p>2N5187 PHP Price 27¢† MEDIUM-CURRENT HIGH-SPEED SWITCH</p> <p>TO-52</p> <p>$V_{CBO} = 25\text{V}$ max; $t_{on} = 18\text{ ns}$ max @ $I_C = 100\text{ mA}$, $I_B = 10\text{ mA}$; $t_{off} = 21\text{ ns}$ max @ $I_C = 100\text{ mA}$, $I_B = 10\text{ mA}$; $V_{CE}(\text{SAT}) = 0.5\text{V}$ max @ $I_C = 100\text{ mA}$, $I_B = 10\text{ mA}$. *Plus RCA Reliability Control</p>
 <p>2N5188 PHP Price 33¢† HIGH-SPEED HIGH-VOLTAGE 1/2-AMPERE SWITCH</p> <p>TO-39</p> <p>$V_{CBO} = 60\text{V}$ max; $t_{on} = 35\text{ ns}$ max @ $I_C = 150\text{ mA}$, $I_B = 15\text{ mA}$; $t_{off} = 50\text{ ns}$ max @ $I_C = 150\text{ mA}$, $I_B = 15\text{ mA}$; $h_{FE} = 20$ min @ $V_{CE} = 1\text{V}$, $I_C = 500\text{ mA}$ (pulsed). *Plus RCA Reliability Control</p>	 <p>2N5189 PHP Price 39¢† HIGH-SPEED HIGH-VOLTAGE 1-AMPERE SWITCH</p> <p>Similar to TO-39</p> <p>$V_{CBO} = 60\text{V}$ max; $t_{on} = 40\text{ ns}$ max @ $I_C = 1\text{A}$, $I_B = 100\text{ mA}$; $t_{off} = 70\text{ ns}$ max @ $I_C = 1\text{A}$, $I_B = 100\text{ mA}$; $h_{FE} = 15$ min @ $I_C = 1\text{A}$, $V_{CE} = 1\text{V}$. *Plus RCA Reliability Control</p>	<p>IN RCA'S MAX VALUE line you get the kind of performance/economy combination that only a hermetic metal package can give. This broad line offers you top silicon performance PLUS shielding, dissipation, and operating-temperature characteristics that plastic packages can't match.</p> <p>CHECK the performance of RCA'S MAX VALUE line—then check your RCA Field Representative or your RCA Distributor for further details.</p>



RCA Electronic Components and Devices

The Most Trusted Name in Electronics

ON READER-SERVICE CARD CIRCLE 7

3.0 watts @ 1 GHz

(35% efficiency, $f_T > 1$ GHz, $\theta < 10^\circ \text{c/watt}$)

How's that for power...

It's the **S 1000**, our newest amplifier transistor for stripline applications.
The following are other devices available from stock:

Application	Device	Frequency (MHz)	Power Out (watts)	Power Gain min. (db)	Efficiency min. (%)	f_T Typ. (MHz)	TJ (centigrade)	Vcc	Case
Large Sig Hi Power Oscillator Amplifier	V409	260	40.0	6.0	50	300	200	28	TO-60
Large Sig Med. Power Oscillator Amplifier	2N3866	400	1.0	10.0	45	800	200	28	TO-39
	S704	400	1.0	10.0	45	1,000	200	28	TO-39
VHF/UHF Oscillator Multiplier Amplifier	VX3375	400	4.0	6.0	50	650	200	28	VX*
	2N3375	400	3.0	4.8	40	600	200	28	TO-60
Large Sig Hi Power Oscillator Amplifier	2N3733	400	10.0	4.0	45	400	200	28	TO-60
	2N4440	400	5.0	4.7	45	600	200	28	TO-60
	2N5016	400	20.0	5.0	50	700	200	28	TO-60
	V410	400	25.0	5.5	50	700	200	28	TO-60
Large Sig VHF/UHF Oscillator Amplifier	VX3733	400	10.0	4.0	45	400	200	28	VX*
	VX3866	400	1.0	10.0	45	800	200	28	VX*

*stripline package

These RF power devices, as well as wafers and dice, channel- and lid-mounted units, high-speed NPN switches, small signal / high frequency amplifiers, differential amplifiers, and silicon dioxide capacitors are available from the newly formed Electronic Components division of United Aircraft Corporation. For more information, call (215) 355-5000, TWX 510-667-1717, or write Marketing Manager.

Electronic Components DIVISION OF **United Aircraft**

TREVOSE, PENNSYLVANIA 19047

ON READER-SERVICE CARD CIRCLE 8

ELECTRONIC DESIGN 26, December 20, 1967

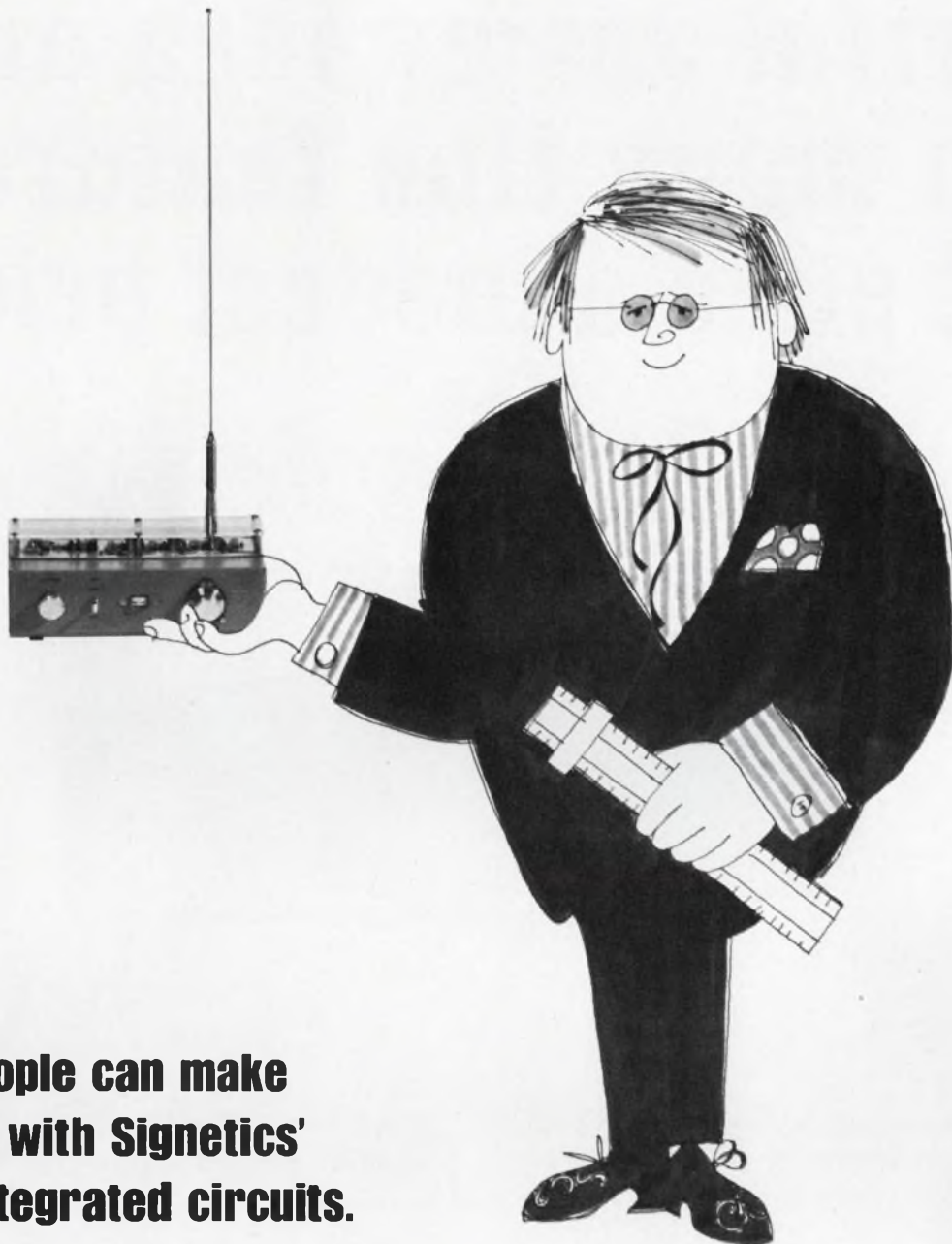

Some people can make anything with Signetics' linear integrated circuits.

Like this FM receiver our friend put together. Its IF strip is made up of Signetics' new 510 Dual RF/IF Amplifiers. It will never win a prize for either industrial or electronic design—but then, it wasn't intended to. Does it work? We had it running continuously during the recent WESCON show. Our booth traffic indicator says that some 20,000 engineers saw it, heard it, and thought it sounded pretty good. We know that lots of them can design a better receiver with the same parts. That's their business. Ours is making integrated circuits.

Want to know more about the Signetics' 510 Dual RF/IF Amplifier? Send for a data sheet and a reprint of Ralph

Seymour's WESCON paper on its design and applications.

Want to know more about Signetics' other new linear IC's—the 515 Differential Amplifier and 516 Operational Amplifier—or about the field-proven 501 Video Amplifier and 518 Voltage Comparator? Just ask. We'll get data sheets and application notes to you...fast.

**SIGNETICS
INTEGRATED
CIRCUITS**



A SUBSIDIARY OF CORNING GLASS WORKS

SIGNETICS SALES OFFICES: Metropolitan New York (201) 992-3980; Upper New York State (315) 469-1072; Southwestern (214) 231-6344; Western Regional (213) 272-9421; Orange County (714) 636-4260; Eastern Regional (617) 245-8200; Washington-Baltimore (301) 946-6030; Mid-Atlantic (609) 858-2864; Southeastern (813) 726-3734; Midwestern Regional (312) 259-8300; Northwestern (408) 738-2710.

DISTRIBUTORS: Compar at all locations listed below. Semiconductor Specialists, Inc. (312) 279-1000; Terminal Hudson Electronics (212) 243-5200; Wesco Electronics (213) 684-0880; Wesco Electronics (405) 968-3475; Hammond Electronics (305) 241-6601; Avnet Electronics Corp. of Massachusetts (617) 272-3060; Pioneer Standard Electronics Inc. (301) 427-3300; Kieruluff Electronics (206) RO 3-5510.

DOMESTIC REPRESENTATIVES: Jack Pyle Company (415) 349-1266. Compar Corporation at the following locations: Alabama (205) 539-8476; Arizona (602) 947-4336; California (213) 245-1172; California (415) 697-6244; Colorado (303) 781-0912; Connecticut (203) 288-9276; Florida (305) 855-3964; Illinois (312) 775-5300; Maryland (301) 484-5400; Massachusetts (617) 969-7140; Michigan (313) 476-5758; Minnesota (612) 922-7011; Missouri (314) 428-5313; New Jersey (609) 429-1526; New Mexico (505) 265-1020; New York (518) 436-8536; New York (607) 723-8743; New York (516) 921-9393; North Carolina (919) 724-0750; Ohio (216) 333-4120; Ohio (513) 878-2631; Texas (214) EM 3-1526; Texas (713) 667-3420; Washington (206) 763-1711.

INTERNATIONAL SALES: France, Germany, Italy, Belgium, Holland, Luxemburg, Spain—Sovcor Electronique, 11, Chemin de Ronde, Le Vesinet, (S-8-0) France. United Kingdom, Ireland, Sweden, Denmark, Norway, Switzerland, Austria, Portugal—Electrosil Ltd., Lakeside Estate, Colnbrook-BY Pass Slough, Buckinghamshire, Great Britain. Australia—Corning, 1202 Plaza Building, Australia Square, Sydney, N.S.W. 27-4318. Canada—Corning Glass Works of Canada, Ltd., Leaside Plant, Ontario, Canada (416) 421-1500. Israel—Optronix, P.O. Box 195, Ramat Gan, Israel 724-437. Japan—ASAHI Glass Co., Ltd., Corning Products Sales Dept. No. 2, 3 Chome Marunouchi, Chiyoda-ku, Tokyo, Japan.

ON READER-SERVICE CARD CIRCLE 9

artful design idea and
so many fine features
at such a modest price

tilt·a·view CABINETS

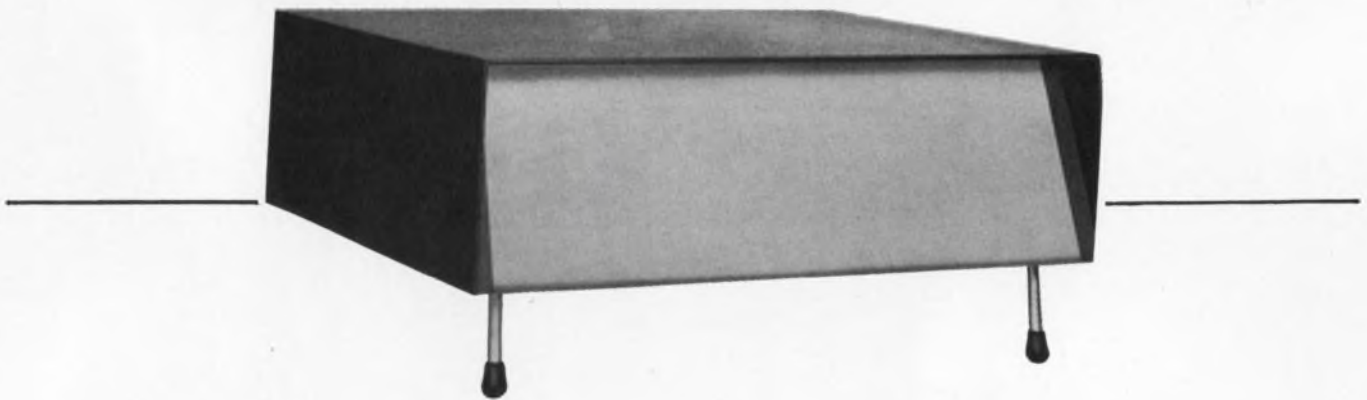

Innovated to permit the viewer of the action of meters, or the position of dials and recorders to select the most advantageous angle of vision. Employment of the detachable legs lowers or raises the position of the enclosure. It may be placed on desks, cabinets of various heights, or wall mounted.

Two piece steel construction allows immediate clear access to interior for installation and service of components. Inventive arrangement of vertical flanges and channels into which the top and bot-

tom sections interlock assures strength and rigidity. Fasteners at bottom secure the two elements. Body is finished in scratch resistant vinyl charcoal gray while panels are sand vinyl texture.

See these handsome new enclosures at your nearby authorized Bud distributor. If you don't know him, let us introduce you. Write us for his name. He can give you complete descriptive literature or we will be glad to send it to you.

your product *Belongs* in a **BUD** cabinet



BUD RADIO, INC.

4605 East 355 Street, Willoughby, Ohio 44094

ON READER-SERVICE CARD CIRCLE 10

Alfred breaks the square law barrier with a swept power level and ratio measurement system with 60 db dynamic range.

Here's a typical test application of the Alfred 8000/7051 measuring attenuation and return loss of an Alfred precision attenuator. Signal source is an Alfred sweep oscillator.

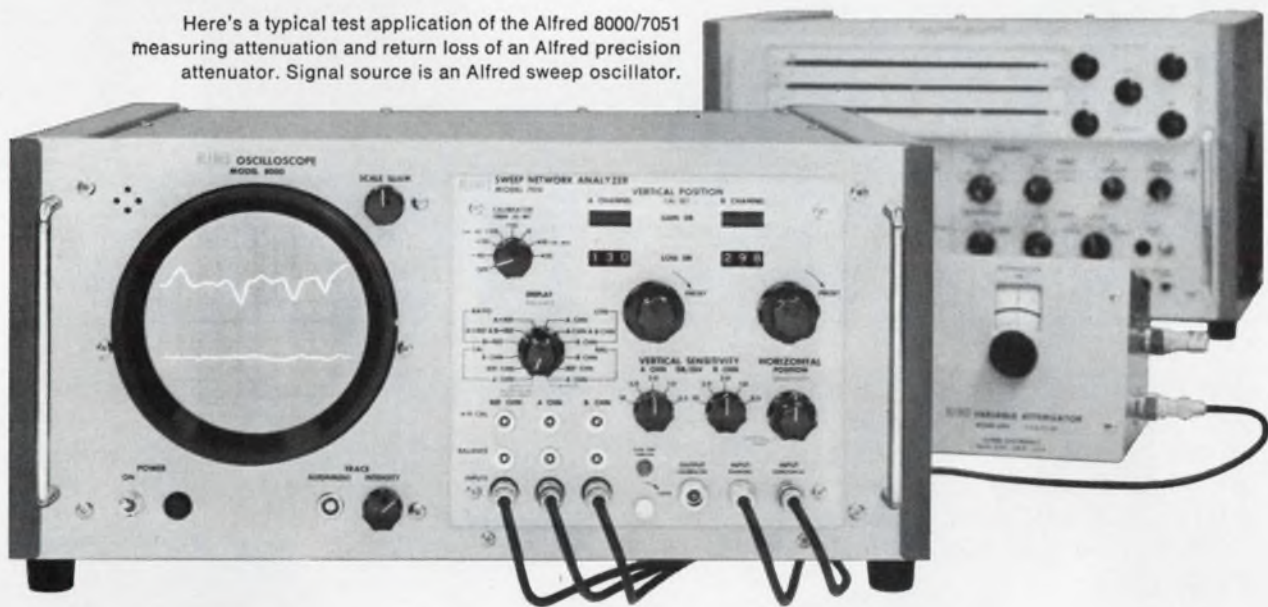

Now, with one totally new instrument, measure gain, loss, absolute or relative power levels, VSWR, and impedance magnitude (reflection coefficient). The new Alfred 8000/7051 system speeds and simplifies rf and microwave measurements.

Ten key features overcome deficiencies in present day equipment. You won't find them anywhere else!

1. 60-db measurement range. Operates with crystal detectors; internal analog electronics compensates for crystal performance above the square-law region.
2. Built-in precision rf signal generator provides calibration for power level measurements; has an accuracy of ± 0.3 db at +20 dbm, and ± 0.6 db at -40 dbm.
3. Unique ratiometer mode measures the db ratios of any two signal levels compared to a third, with 2% accuracy. This permits direct readout of reflection or transmission performance.
4. Direct db or dbm readout over the full 60-db range; CRT sensitivity adjustable from 0.5 db/cm to 10 db/cm to allow quick-look or detailed examination.
5. Does not require source modulation or leveling. Thus, the full power and stability of the signal source can be utilized.
6. Makes swept or single-frequency measurements; internal sweep spreads single-frequency displays. Works with either automatic or manual sweeps.
7. Drift free operation.
8. Dual-channel presentation permits simultaneous measurement of two parameters, such as reflected and transmitted power levels. Recorder outputs are provided.
9. Offset adjustment of up to 60.0 db gain or loss direct reading to 0.1 db, independently in each channel, eliminates the need for external precision attenuators.
10. Costs only \$1680 for the Model 8000 Oscilloscope with the Model 7051 Sweep Network Analyzer plug-in.

There's more to the story. Call your ALFRED representative or write for details. Address Alfred Electronics, 3176 Porter Drive, Palo Alto, California 94304.

ALFRED ELECTRONICS

ON READER-SERVICE CARD CIRCLE 11

How Engineers fighting* with

Easy—be aware!

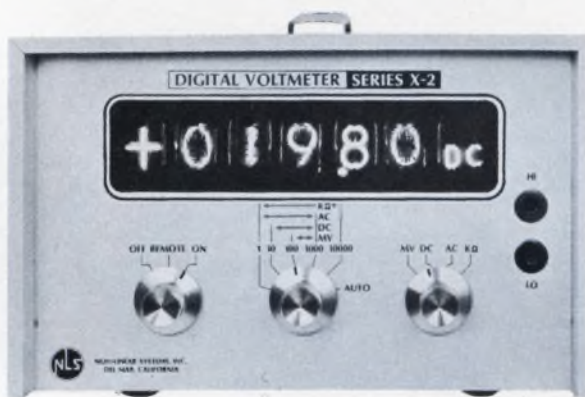

Be aware that for \$980 you can buy a 5-digit 20% over-range Multimeter that's half rack or bench operation with anti-bobble. Yes, buy any other voltmeter, and you'll short change yourself on function and features.

Features:

- .01% Class
- Portable
- Auto Ranging
- IC Construction
- Integrating
- DC Volts, AC Volts
- Ratio & Resistance
- Function Display



circle #101 for immediate action



Be aware that for \$2450 you can buy an X-1, 6-digit voltmeter. Yes, buy any other voltmeter with X-1's capabilities, and you'll pay as much as \$2315 more.

Features

- .005% Accuracy
- DC Volts, AC Volts
- Ratio & Resistance
- 20% Over-Range
- All Solid-State
- Automatic
- Remote Programming
- 6 ms Digitizing



circle #102 for immediate action

* We know that engineers and purchasing agents don't really fight, but we also know they both have a job to do, so we create products that allow both parties to work together at maximum efficiency.

Call Collect!



Originator of the Digital Voltmeter
NON-LINEAR SYSTEMS, INC.
 DEL MAR, CALIFORNIA 92014
 [714] 755-1134/TWX: 910-322-1132

can avoid Purchasing...

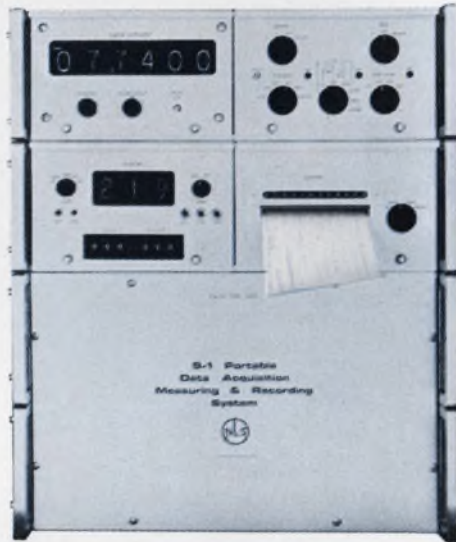

Be aware that for \$9,950 you can buy an S-1 Data Acquisition System. Yes, buy any other data acquisition system with the S-1's capabilities, and you'll pay at least \$6,000 more.

Features

- 200 channels, 3-wire
- DC volts, AC volts
- Resistance & Ratio
- 21 inches high
- .005% Accuracy
- .001% Resolution
- 1 Microvolt to 1000 Volts
- Completely Automatic

Many Options

- High Speed Printer
- Magnetic Tape
- Punched Tape
- IBM Paper Tape
- IBM Punch Cards
- Flex-O-Writer
- Typewriter
- Digital Clock



circle #103 for immediate action



Be aware that for \$695 you can buy an X-3 Digital Multimeter with "VTVM" capabilities. Buy any other multimeter with X-3's features and functions, and it will have a needle on it. Even then it won't have X-3's capabilities.

Features

- DC Volts, AC Volts
- Current & Resistance
- 10 Microvolts to 10 KV
- 100 Megohm Input Z
- .01% + 1 digit
- 25 Ranges
- 100% Over-Range
- Over-load Indication
- Auxiliary Power Supply



circle #104 for immediate action

VALUE THROUGH INNOVATION

*it's small . . .
and
lightweight too!*



Merrimac's New Variable Microwave Attenuator

The AUM-15A is a variable microwave attenuator designed for modern and future electronic systems. It is small. It is rugged. And it is reliable.

This broadband attenuator covers the frequency range 2 GHz to 8 GHz. At 4 GHz, the attenuation range is more than 0-20 db with an insertion loss of less than 0.5 db. The AUM-15A is designed for miniaturized 50-ohm coaxial systems and exhibits a VSWR of less than 1.5:1. The AUM-15A is the first miniaturized mem-

ber of Merrimac's broad lineup of variable attenuators. The entire family covers DC to 12 GHz with attenuation ranges from 0-15 db to more than 0-80 db. For more details on Merrimac's micrometer-driven, direct reading, and electronically-controlled attenuators, be sure to write or phone us.

MERRIMAC RESEARCH AND DEVELOPMENT, INC.

41 FAIRFIELD PLACE, WEST CALDWELL, N. J. 07006 • 201-228-3890

ON READER-SERVICE CARD CIRCLE 13

ON READER-SERVICE CARD CIRCLE 14▶



A word to the do-it-yourself module builder:

Don't.

Buy our J Series modules instead.

The J Series is our new family of general purpose, all integrated circuit logic modules. Their performance almost matches that of our famous T Series modules, but they cost about 25% less. They're made to the same dimensions as the T Series, with the same 52 pin connectors, so they're physically interchangeable. We make them for our own seismic recorder systems, so they're rugged and reliable. Now, as of January, you can buy them (com-



These will cost you less.

plete with mounting hardware, racks and power supplies, if you wish) in any of 25 different functions.

And save yourself the time and cost of making your own: designing, assembling, testing, new procedures, new equipment, new personnel, additional training, to say nothing of the added paper work.

If you're building systems, you must have better things to do than go into the module assembly business. Such as reading our J Series catalog.

It's free.

SDS
Scientific Data Systems,
Santa Monica, California

First from Sprague Electric!

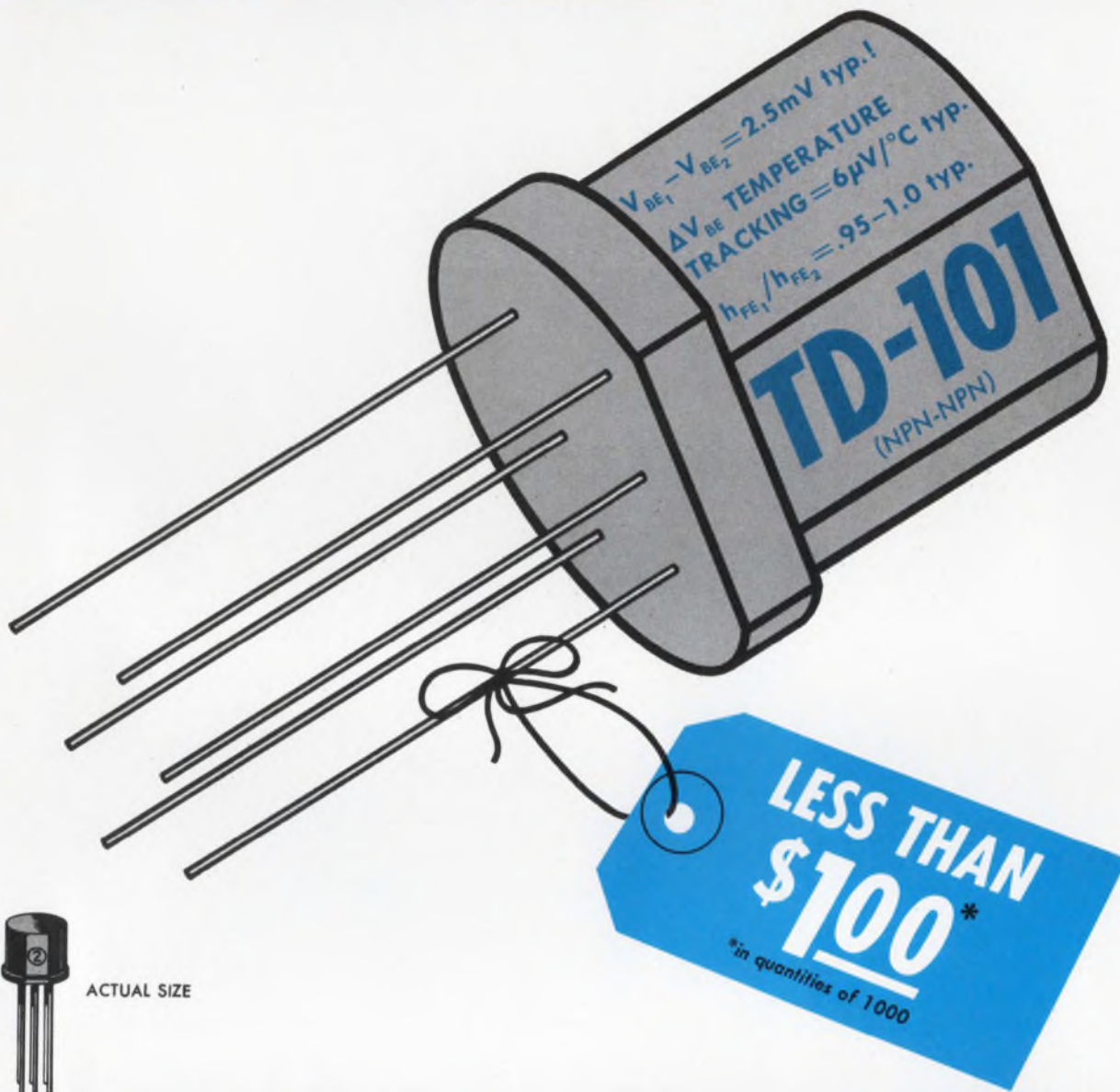

ECONOLINE[★] SILICON PLANAR PLASTIC DIFF AMP PAIRS

Other Sprague Econoline[★] differential amplifier transistor pairs available as PNP-PNP and NPN-PNP types.

For samples and complete technical data, call your Sprague district office or representative, or write on your letterhead to Sprague Electric Co., Concord, N.H. 03301.

★Trademark

SPRAGUE COMPONENTS

TRANSISTORS
INTEGRATED CIRCUITS
THIN-FILM MICROCIRCUITS
CAPACITORS
RESISTORS
455-7130

PULSE TRANSFORMERS
INTERFERENCE FILTERS
PULSE-FORMING NETWORKS
TOROIDAL INDUCTORS
ELECTRIC WAVE FILTERS

CERAMIC-BASE PRINTED NETWORKS
PACKAGED COMPONENT ASSEMBLIES
BOBBIN and TAPE WOUND MAGNETIC CORES
SILICON RECTIFIER GATE CONTROLS
FUNCTIONAL DIGITAL CIRCUITS



Sprague and 'S' are registered trademarks of the Sprague Electric Co.

ON READER-SERVICE CARD CIRCLE 15

ELECTRONIC DESIGN 26, December 20, 1967

News

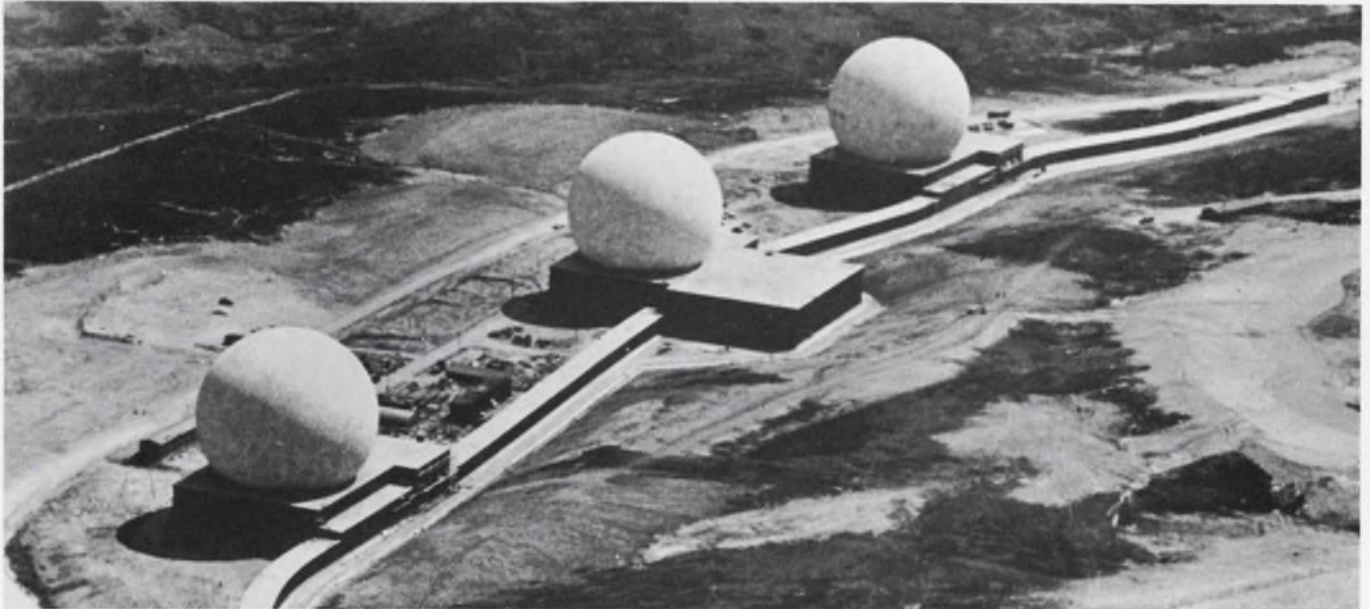

Over-the-horizon radars, supplementing existing BMEWS sites (above), will bounce

radio energy off the ionosphere to detect missiles thousands of miles away. Page 25.

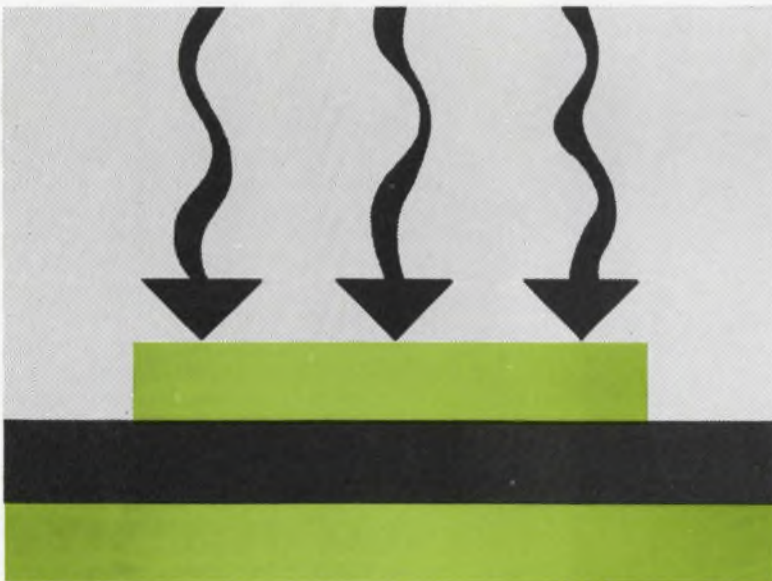

Thin-film capacitor bolometer has sensitivity an order-of-magnitude greater than present units'. Page 34



The deaf hear modulated rf by way of the skin and nerves. Page 30

Also in this section:

Elastic ceramic doubles as dielectric and bonding material. Page 38

News Scope, Page 21 . . . **Washington Report**, Page 43 . . . **Editorial**, Page 61

THE connector THING

A periodical periodical designed to further the sales of Microdot Inc. connectors and cables. Published entirely in the interest of profit.

Everybody wins! Play Microdot

In the words of Virginia Woolf, it's time for fun and games.

For this new national pastime, you simply need a smattering of history, mythology and current events. And some information about Microdot's cable products. We'll supply you with the latter. For the rest, go listen to Walter Cronkite.

We got started on this activity while we were sitting around one evening with a bottle of Slivovitz (we ran out of Scotch), trying to think of memorable ways to remind you of the various unique features of Microdot cables. Like —

Like our Mini-Noise cable — reduces noise voltage from shock and vibration by a factor of more than 100 to 1 compared to untreated cable. This makes possible the transmission of extremely faint signals through coax cable without audio frequency noise. Off-the-shelf.

Like our microminiature coax cable — uses a fine silver-plated copper steel-covered wire. You get 50 ohm impedance, and even with the addition of dielectric, outer shield and protective jacket, the nominal O.D. does not exceed .080". And we can get that O.D. down to .025" in a range of hundreds of different cables.

Like our new complete in-house capability to produce precision quality multiconductor cables, which includes twisting, extruding, shielding and jacketing — the whole deal. All under one roof. And we can cable hundreds of conductors into one unit.

Like we're the only one to produce a high temperature, low weight, low capacitance coax cable through the use of a cellular Teflon dielectric. Especially suited to the requirements of video tape recorders.

Historical

Spaghetti Grams

Like Microdot's Twinaxial cable — to be used when you need to send two signals from a single source which must both terminate at the same point. No need to use two coax cables; therefore lower cost and greater flexibility.

Now when you think of cables, you think of cablegrams. And when you drink a lot of Slivovitz, it sort of takes you back through time and you come up with stuff like this:

WIN
YOUR
OWN
CABLE
FORK

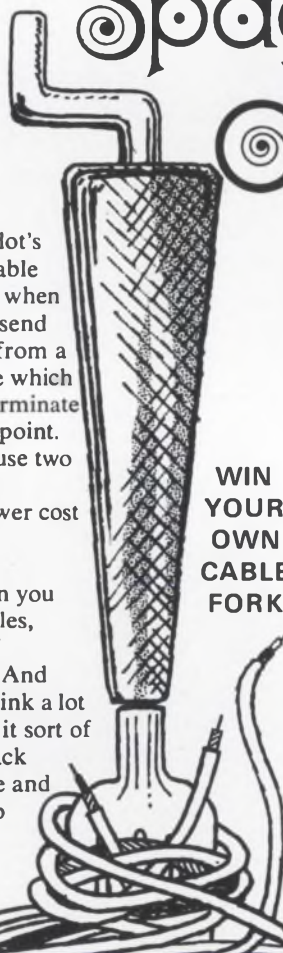

Low noise Spaghetti-Gram:
"You lose. Signed, Calvin Coolidge!"

High temperature Spaghetti-Gram:
"Julius, honey, ain't nobody home tonight but me. Signed, Cleopatra!"

Miniature size Spaghetti-Gram:
"Cancel that order for bras. Signed, Twiggy!"

Dual shield Spaghetti-Gram:
"I can lick any guy in the joint. Signed, Brunhilde!"

Large size multiconductor Spaghetti-Gram:
"Send more elephants. Signed, Hannibal!"

Get the idea. You can use any of the features of any of our cable products, such as low noise (Mini-Noise), special requirements (Multiconductors), high temperature, low weight, and, of course, small size. You don't really need the Slivovitz. It works well even with Sanka.

About the fork

No, Melvin, we won't explain the relationship between cable and spaghetti. We call it a cable fork, and if you don't want to use it for eating cables that's your problem. The manufacturer describes this handy gadget as a "revolutionary breakthrough that leaps forward from antiquated hand labor to the modern machine age!" We won't try to top that. We'll just explain that you stick it into the pasta and then turn the little handle to save getting spaghetti all over your celluloid collar.

Want one for your very own? Okay. Just send us a Microdot Spaghetti-Gram scribbled on company stationery and taking off from any of the product features we've discussed. We'll send you a beautiful cable fork along with more literature on our cable products than we care to mention.

But hurry. We've already run out of Slivovitz. It won't be long before we run out of cable forks. (That means offer is limited.)



**MICRODOT
INC.** 220 Pasadena Avenue
South Pasadena, Calif. 91030.

Mini-Noise is a registered trade-mark of Microdot Inc. Cable Fork is open to question.



News Scope

Block-long array radar to track space objects

Sometime next year, a 13-story-high, block-long, sloping structure, housing the largest phased-array tracking radars ever constructed, will be turned over to the U.S. Air Force. Its task is to detect, track, identify and catalog some 1300 man-made objects orbiting the Earth.

Designated AN/FPS-85, the radar is undergoing final checkout at Eglin Air Force Base in Florida. It is a significant addition to the 496L Spacetrack Program, the nation's defensive satellite-tracking network.

Data gathered by the giant radar will be coordinated with information from other conventional radars, electronic-detection systems and telescopic cameras around the world. All data will be forwarded to the North American Air Defense Command headquarters (Norad) at Colorado Springs, 1300 miles away.

The Ballistic Missile Early Warning System (BMEWS), a group of radars spread 6000 miles across the north from Alaska to Britain, is a part of Space-track.

The Sea-Launched Ballistic Detection and Warning System, now being developed, will also become a part.

Over-the-horizon radars, such as the Air Force's 440L (see p. 25), are now monitoring Soviet missile launchings. They will be joined by RCA's ANFPS/95 to give additional warning time on the launching of any ballistic missiles.

The giant radar at Eglin is expected to be able to track 200 satellites or to search for 40 unknown space targets in near-real time. It has been under construction for about two and a half years under the Air Force's Electronic Systems Div. at Bedford, Mass. The principal contractor is the Bendix Corp., Towson, Md.

The structure housing the radar is 350 feet long and 155 feet high. The transmitting and receiving apertures are on the side facing south. The side slopes back at an angle of 45 degrees. Thousands of antenna receiving and transmitting elements are positioned on the sloping face, beneath a protective plastic cover.

The FPS-85 uses three IBM/360 central processors for dynamic control of the radar and for processing and identifying the target data. Also included are two IBM 360/65s (see Nike-X: A merger of radars and computers," ED 22, Oct. 25, 1967, p.p. 17-24) for data control—one as standby—and an IBM 360/40 for control of peripheral equipment.

The computers monitor radar sightings and classify them as known or unknown by comparing them with a stored list of 300 operating satellites and 900 orbiting objects regarded as space debris. The latter include rocket booster stages and "dead" space probes and satellites.

If a sighting is classified as unknown, the computers calculate the object's orbital track. The information is displayed at the radar site and simultaneously transmitted to Norad headquarters.

The radar site is protected by \$3 million worth of equipment, to prevent a recurrence of the fire that destroyed the original system in 1964.

New group to foster design by computer

"We must bring design automation techniques to a far wider group—the mechanical engineers, the architects, the city planners and so on."

The speaker, Alan Halpin, manager of a TRW Systems group investigating the use of computers in engineering design, was telling why a new national group, the Design Automation Steering Committee, was being formed. In an interview at the TRW laboratories in Redondo Beach, Calif., he said that the design group would be set up next March 15.

Halpin was for many years a member of Share, a group formed by International Business Machines to encourage the users of its computers to share their knowledge on computers and computer science. An offshoot of that group is the Design Automation Workshop, which Halpin and nine other members are now making plans to expand into the new national group.

Halpin says that "design automation scientists are becoming an

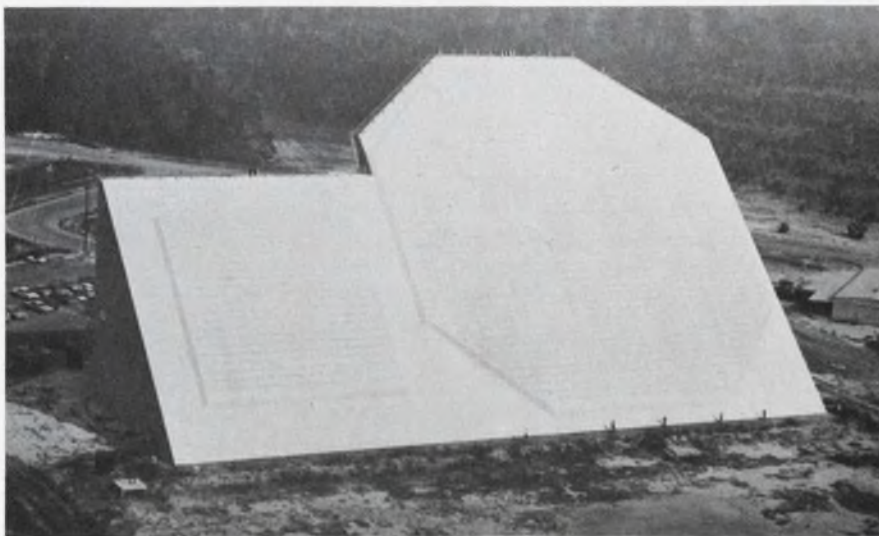

Phased array radar tracks space objects.

'in' group." The Design Automation Steering Committee, being set up by an informal group headed by Halpin and Morton N. Weindling of Douglas Aircraft, Huntington Beach, Calif., is intended to broaden the field of computer design.

The new group, Halpin hopes, will serve as a coordinating organization for all professional societies and other national groups whose members should be learning about design automation. Membership will be limited to two delegate members from each participating organization.

Projected activities, according to Halpin, include annual national conferences, tutorial seminars, rapid information services and a clearinghouse for computer-aided design programs.

No winner yet in AF troposcatter competition

Field trials of two lightweight tropospheric-scatter communications systems for the U.S. Air Force will continue for another 10 months. The Pentagon says that tests of the Bell Aerosystems AN/TRC-104 and the Motorola AN/TRC-105 (see "News Scope," ED 17, Aug. 16, 1967, p. 14) were inconclusive.

The systems were evaluated at Eglin Air Force Base in Florida. Both appear capable of performing as required, but both need modification, Pentagon informants have indicated.

The two tropospheric-scatter systems employ tactical radio sets weighing less than 500 pounds. Both will be moved to northern New York State, where parallel 100-mile test links will be established between Verona, near the Rome Air Development Center, and Model City, near Niagara Falls. The sites reportedly were selected to provide rigorous winter operation and still be in proximity to the Rome air center, which is directing the development program.

Tests will run from late January to October, 1968.

In the Eglin tests, each system experienced difficulties but demonstrated 99.98 per cent communications reliability. Bell is believed to have achieved 90 per cent operating time on the air, but its systems had problems maintaining duplex operation. Motorola employed a deficient power supply at each terminal and only achieved about 50 per cent operating time on the air. The Motorola unit overheated, causing transformer failures and power instability. Also, it suffered rapid fade or flutter due to multipath effects from passing planes.

Excluding these problems, which can be corrected, both sets greatly exceeded Air Force requirements.

Apparently, the Defense Department's Directorate for Defense Research and Engineering has recommended that no additional procurements be made for the operational AN/TRC-97, an RCA 2000-pound troposcatter system. Some doubt exists, however, whether this reflects a satisfactory inventory of the present budget squeeze.

It is believed that present plans call for a selection next year of one of the new lightweight systems for service testing in 1969. This would permit completion in time for a production award late in 1969 and assure equipment in the inventory in 1970. A contract of \$10 million to \$30 million is expected for from 100 to 300 terminals.

Plastic explosive built into military subsystems

Several U.S. manufacturers of electronic-warfare systems are now making chassis with plastic explosives built in. Sander Associates, of Nashua, N.H., for example, is designing such hardware for the Air Force under a classified airborne-countermeasures program. To what extent the technique is being used remains classified.

A Dupont explosive (an integral mixture of pentaerythritol tetrinitrate and an elastomer) is what has made the method possible. The compound is highly flexible, lightweight and relatively safe. It can be stripped onto the sides and back plates of electronic subsystems.

It is detonated with either an electrical or a mechanical fuse, which has to generate a high-velocity adjacent shock wave. The substance is tolerant of high temperatures, burns in fire without exploding, is impervious to small-arms fire, is waterproof, and can be readily extruded or cut into diverse shapes.

Latest moon findings show no new hazards

New findings by the Explorer 35 spacecraft, which has been orbiting the moon since last July, do not indicate any new hazards to the Apollo manned lunar landing program.

Dr. Norman F. Ness, project scientist at the NASA Goddard Space Flight Center in Greenbelt, Md., reported these findings by the satellite:

- No supersonic shock front precedes the moon to impede the flow of solar wind toward the lunar surface.

- A sizable solar-wind void exists behind the moon and away from the sun. This "wake" region, which flows from the sun with the solar wind, tends to distort weak interplanetary magnetic fields.

- The moon has practically no magnetic field and no complex magnetospheric envelope.

- No radiation belts surround the moon and there is no evidence of a lunar ionosphere.

- The moon's average electrical conductivity is low, implying internal lunar temperatures under 1800°F.

TV X-ray hazard to get nationwide attention

The U.S. Public Health Service has asked the Electronic Industries Association to cooperate in a nationwide program to evaluate potential health hazards posed by excessive radiation from color TV sets.

The request follows on the heels of a recent survey in Pinellas County, Fla., which disclosed excessive side radiation emitted by General Electric TV sets that had been previously modified to correct for downward-directed X-ray leakage.



Now, you can build a 5 ns
8-bit buffer register
with just four dual R-S flip-flops
(MECL II MAKES IT POSSIBLE!)

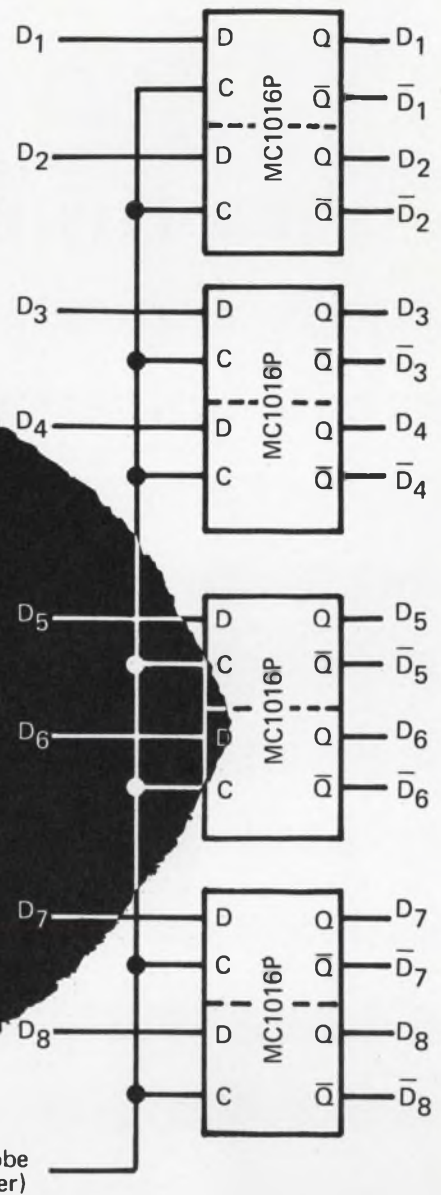

Clock or Strobe
(6ns or greater)

Yes, there's a new, simplified, less-expensive way to build a highly-versatile, widely-used 8-Bit Buffer Register. Simply use four MC1016P integrated circuits from Motorola's MECL II line.

These new dual R-S Flip-Flops reduce can count and system cost by increasing the number of functions per package. And, as a result, the interesting logic configuration shown above can be achieved with minimum cost and complexity.

The versatile MC1016P is an excellent clocked R-S flip-flop with single-rail input and dual-rail outputs. It can be used as a temporary storage element (as shown); as a memory data register; or, as a clocked R-S flip-flop with no undefined logic state.

This dual circuit employs two dc Set-Reset flip-flops with a positive enable or clock input provided for each flip-flop. Typical propagation delay is 5.0 ns, operating over the 0 to +75°C temperature range. Typical power dissipation is 125 mW at an operating frequency of 80

MHz. Minimum dc fan-out of 25 for each output is guaranteed.

Available in the 14-pin Unibloc* plastic package, the MC1016P brings to 27 the total number of MECL II functional elements — in the fastest, most flexible I/C logic line available. A comparable circuit — MC1216F — is also available in the 14-pin ceramic flat pack; and, provides identical performance over the -55 to +125°C temperature range.

For complete details, including data sheets, application notes and prices, circle the reader service number. Then, contact your franchised Motorola Semiconductor distributor for evaluation units that you can try right now. You'll see why MECL II is being specified for many new system designs.



MOTOROLA
Semiconductors

— where the priceless ingredient is care!

The Hottest IC!

MOS-TYPE BCD TO DECIMAL CONVERTER



+125°C operating!

+200°C storage!

A new monolithic silicon integrated circuit that uses P-channel MOS enhancement mode transistors to convert a four-line binary coded decimal input to a ten-line decimal output. It is ideal for use as a data format converter in MOS systems. The UC6000 MOS circuit has built-in protection that eliminates the need for special precautionary handling. The circuit is mounted in a 22-lead flat package with a diameter of 0.036 inch. The operating temperature range is -55°C to $+125^{\circ}\text{C}$. Contact your local distributor for information and off-the-shelf availability.

NOW FROM SAN DIEGO
This integrated circuit is the first in a series of MOS I.C.'s now being manufactured at our new technical center in San Diego, California. Among other MOS products that will be available during 1968 are: 5-channel multiplexers, 21-bit shift registers, up-down 4-bit counters, nixie drivers, and dual 25-bit biphase dynamic registers.



ELECTRONICS

Semiconductor Department/365 Middlefield Road, Mountain View, California 94040/Telephone: (415) 961-3300/TWX: 910-379-6942

ON READER-SERVICE CARD CIRCLE 18

Over-the-horizon radars scan skies for FOBS

Soviet orbiting-missile system spurs development of ionospheric-bounce techniques to spot launchings

John Mason, Military-Aerospace Editor
Neil Sclater, East Coast Editor

Disclosure of the Soviet Union's Fractional Orbital Bombardment System (FOBS) has pressed into 24-hour-a-day service the few over-the-horizon radars that are operational and has given top priority to development of more and better systems.

Begun some 20 years ago as a technical experiment, over-the-horizon radars were eventually put to use to extend the range of the Ballistic Missile Early Warning System (BMEWS), so that enemy intercontinental ballistic missiles might be detected a few minutes sooner. Now, with the emergence of the FOBS, over-the-horizon radar has a mission all its own. Since the BMEWS radar beams are line-of-sight, the low-flying FOBS (100 miles maximum altitude as opposed to the ICBM's 800 miles) can get dangerously close to its target before it enters the

BMEWS beams. With over-the-horizon radar, on the other hand, a high-frequency or very high-frequency signal is bounced off the ionosphere and back to earth, to pick up missile plumes thousands of miles away right after the missile is launched.

The program cost only \$65 million from its very beginning through fiscal 1967, but now the Dept. of Defense will not release budget figures for 1968 or 1969. It is known, however, that the Air Force will spend up to \$20 million in 1968. When the systems are produced and installed the cost will mount to hundreds of millions of dollars a year.

Air Force, Navy are involved

Both the Air Force and the Navy are developing over-the-horizon radar. The Air Force's main empha-

sis has so far been on forward-scatter radars. Raytheon Co. built these radars for the Air Force and provided the initial ionospheric characteristic measurement work. This was done under the name of COZI (communication zone indicator).

Now, the Air Force System Command's Electronic System Div. Hanscom Field, Mass., has a full-fledged program for over-the-horizon radar designated 440-L. One of the main contracts is with the Radio Corp. of America's Surface Radar Div. at Moorestown, N.J., for the AN/FPS-95 radar. Although the project is classified, it is presumably a backscatter system. RCA's contract is to develop, build and install the system.

RCA's experience with backscatter radar goes back to the Naval Research Laboratory's project Madre, seven or eight years ago. Madre (for magnetic drum receiving equipment) was a backscatter, single-skip system with a range of from 1000 to 2600 miles. It operated in the 3-to-30-MHz range, with 100-kW power. Pulse Doppler

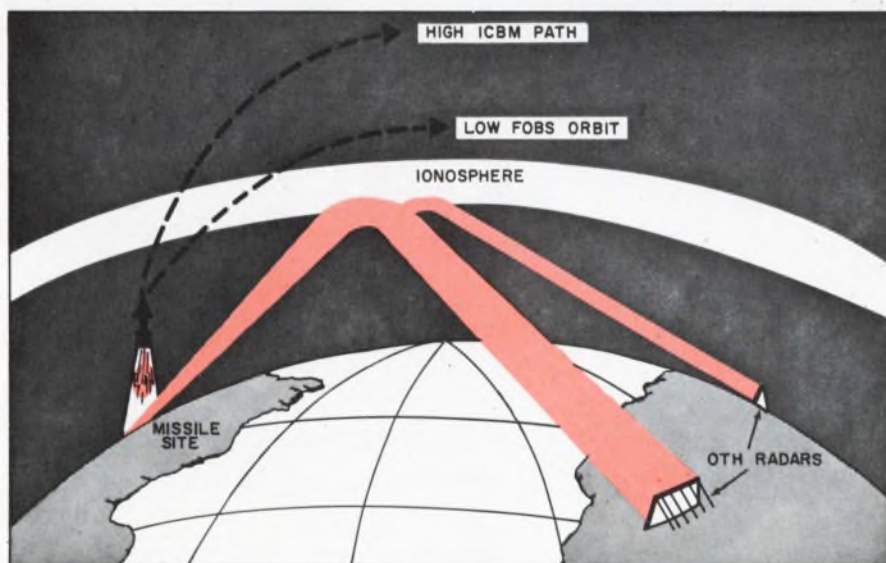

Over-the-horizon radar avoids line-of-sight restrictions by bouncing off the ionosphere to detect launchings of ICBMs and FOBSs alike at the site. A signal that bounces off the horizon only once can reach a target as much as 2000 miles away. Those that zigzag up and down twice or more reach much farther.



North American Air Defense Command headquarters in Colorado Springs plots missile-launching data from over-the-horizon radars.

(FOBS, *continued*)

was used to determine the velocity of the target. The location accuracy was said to be within 10 miles for range and several degrees for azimuth.

Madre used a drum correlator to separate targets from noise. The

General Electric Co. built the hardware and a random-sampling process to work with a drum recorder.

Another Navy project was Teepee, a forward-scatter, multihop system.

Scatter techniques are also being explored in an Air Force project called IDA (Ionosphere Detection Array). Built by General Electric

Co., the radars are gathering data by monitoring missile launchings at Cape Kennedy.

Other companies known to be working in the field are Sanders Associates, Inc., the International Telephone and Telegraph Corp., General Electric Co., Continental Electronics Co. and Sylvania Electric Products, Inc.

Radar rebounds over the horizon

Over-the-horizon radar is expected to use hf and vhf communications in the 2-to-60-MHz band. It covers great distances by means of sky wave propagation. That is, radiated energy is aimed at the ionosphere and is refracted back to earth several hundreds of thousands of miles away. Multihop transmission bounces the radiated energy between the ionosphere and earth several times, greatly extending the radar's range.

The shallower the angle of radiation is, the greater will be the distance between the antenna and the point at which the energy first returns to earth. Therefore to cover the farthest distance with a single bounce, the radiation must be directed at the lowest possible angle.

The ionosphere extends from about 30 to 250 miles above the earth, depending on the time of day and season of year. Two of its principal regions are the E region, about 60 to 90 miles up, and the F region, about 90 to 250 miles up. By day the F region consists of two layers, the outer of which is known as the F_2 layer. At night only the F_2 layer exists.

Refraction of energy takes place at night in the F region; by day the energy may be bounced back by the E region. At an equal angle of radiation a single-hop transmission may therefore cover a greater distance by night than by day. Such differences in refraction by the ionosphere are the greatest problem in designing over-the-horizon radar.

The following facts also apply to sky wave propagation.

- The more intense the ionization of a region is, the more rf energy will be refracted.

- The lower the frequency is, the greater the refraction of a wave will be.

- Beyond a certain angle of propagation, all rf energy passes through the ionosphere and does not return to earth. This angle is known as the critical angle.

High-frequency radiation is more prone to pass through the ionosphere without refraction and be lost in space than low-frequency radiation. Lf radiation on the other hand may be returned to earth, even if it is beamed straight upwards. The critical angle may thus be very wide if the ionization is intense and frequency is low. Conversely, it will be acute if the ionization is low and frequency high.

The effective height of the ionosphere can be determined by sounding—that is, beaming lf pulses vertically and measuring the time lapse between emission of the pulse and reception of its echo from the ionosphere.

If the frequency is increased during sounding, it will be found that above a certain frequency no echoes are returned. This is known as the critical frequency.

Pulses of this same frequency, however, will be returned to

earth at a distance from the transmitting antenna if the angle of radiation is reduced.

The critical frequency for echoes from the E region is from 1 to 4 MHz, depending on the region's ion density. By day the critical frequency for the F_2 critical frequency for the F_2 layer is about 2.5 MHz; by night it is approximately 12.5 MHz.

Another critical factor is the lowest usable frequency (luf). This is the frequency at which the strength of the returned signal barely exceeds background noise. Since higher frequencies will be lost and lower frequencies attenuated in the ionosphere, a maximum usable frequency (muf) has to be defined. Predictions of the muf are based on averages made over a long period of time.

The operating frequency that is chosen is one that will not shift above the muf when sudden changes occur in the various ionospheric regions. Known as the optimum working frequency (owf), it is about 15 percent below the muf for F_2 transmission.

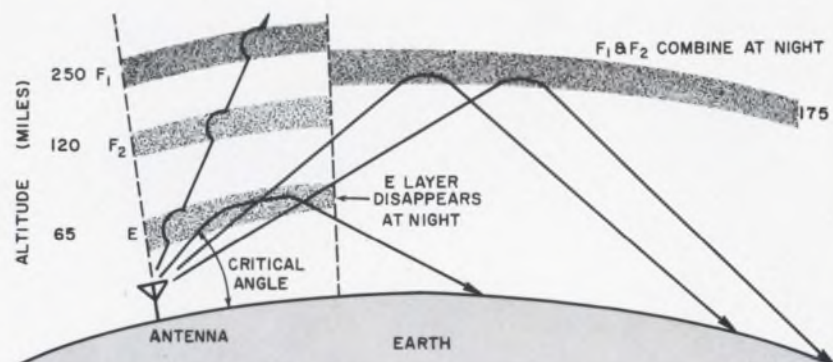

Three ionospheric layers are generally available in the daytime for bouncing high-frequency radio signals down over the horizon to missile sites. At night, the lowest layer, the E region, disappears, and the two layers (F_1 and F_2) of the upper F region combine to form one. If the angle of transmission is greater than the critical angle, the signal will pass right through the ionosphere and not be returned.

Plugboard programming systems? MAC ships off-the-shelf!

Compatibility is the difference between components and systems. Because we match plugboards, plugwires and receivers for such characteristics as conductivity, crosstalk, shielding and convenience, we can actually say that we ship simple systems off-the-shelf. But if you're thinking of a system that is really

different, that may take us a little longer . . . a matter of weeks, maybe. We are constantly exercising our ingenuity and engineering expertise in the creation of new systems, to order. If you're thinking now, and want delivery anytime soon, we should be talking. Or designing. Would tomorrow be too soon?

MAC O.E.M. DIVISION

MAC Panel Co., Box 5027, High Point, N. C. 27262

On Reader Service Card Circle 194



NEWS

(FOBS radar, *continued*)

The simplest way to build an over-the-horizon radar—and the approach used on radar that is now operating—involves the technique called forward-scatter propagation. The transmitter is in one place—Japan, say—and the receiver lies in front of it—half way around the world, say, in Western Europe. The receiver detects the disturbance created by a missile plume but does not reveal its location.

More complicated, but also more effective, is the backscatter approach. With a solid ionosphere, high power and a good receiver, enough signals will bounce back from the target, to the ionosphere and back to the transmitter-receiver site, to reveal not only the presence of a target but also its range (see box on p. 26).

A third possibility, called the bistatic-scatter technique, is to use both radar types, checking the results of one against the other.

The problem of pinpointing the target when forward scatter is used can theoretically be solved by using several transmitter-receiver combinations. Triangulation and timing techniques are used to obtain the best fix possible.

How the system operates

Over-the-horizon radar works because radio energy in the 2-to-60-MHz range will bounce off the ionosphere and back to earth some distance from its point of origin when it is beamed at relatively flat angles (see box). One bounce, un-

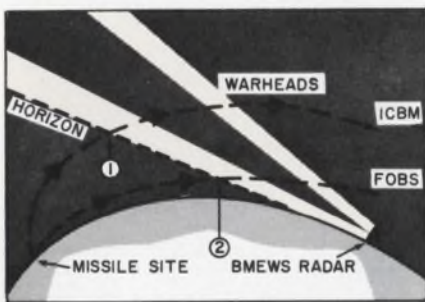

The low-flying FOBS travels a long way before it is detected by the line-of-sight Ballistic Missile Early Warning System (BMEWS). ICBMs, for which BMEWS was designed, fly much higher and disturb the radar's lower, fan-shaped beam soon after leaving the pad.

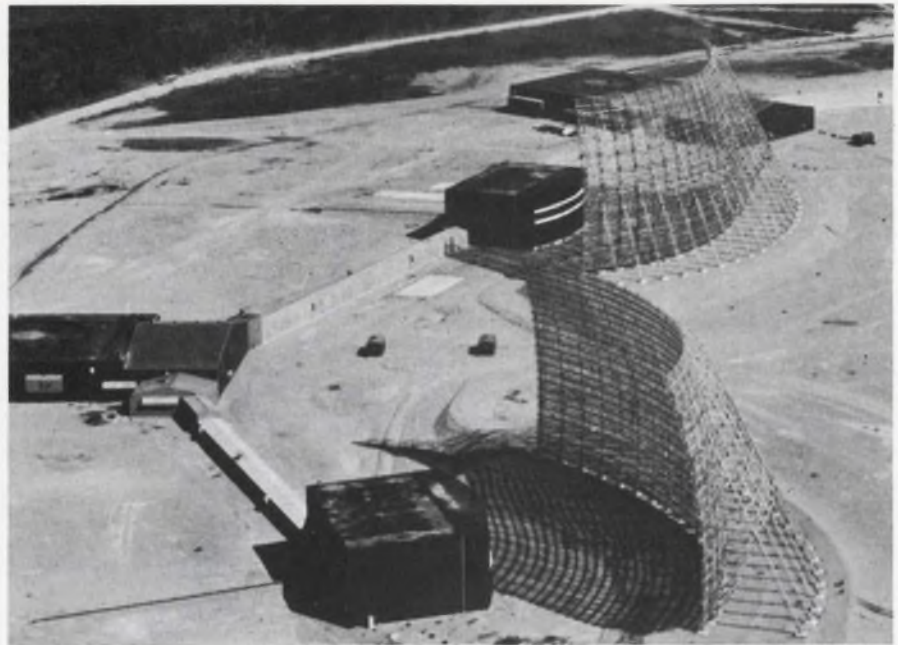

Ballistic Missile Early Warning System Site II at Clear, Alaska, has been scanning the skies for a possible missile attack since 1961.

der the right conditions, using the highest ionospheric layer (about 250 miles up), can reach a distance over the earth's surface of 2600 nautical miles or more. Two bounces, called multihop (and hence Teepee because of the zig-zag path), can cover 4000 miles.

Multihops naturally require tremendous energy because of the loss along the way. When this technique is used, the highest frequencies possible are brought into play.

Besides natural energy loss and atmospheric noise, there is also a lot of man-made noise to contend with. Unfortunately, frequencies desirable for over-the-horizon radar are also most popular for other communication equipment.

To pull out meaningful information from all this noise, signals are coded in such a way that only interaction with a missile plume will interrupt them. Advanced data correlation techniques are needed for this. The transmitted signal code is recorded and compared with the returned signal. Earlier methods used analog correlations, new methods employ digital schemes.

Because of the ever-changing density and altitude of the ionosphere, the layers have to be monitored constantly, and this information is fed to the transmitters. To do this, the results of ionospheric soundings are fed into computers that automatically change the fre-

quencies and angles of propagation.

With a working knowledge of how the ionosphere changes with time, latitude, season, and solar conditions combined with a knowledge of frequency and bounce distance, it is believed possible to sweep radio energy across large geographical areas in regular patterns.

The Defense Communications Agency has announced some details of its high-frequency ionospheric sounding equipment that would be applicable to an over-the-horizon radar. It has sounders that are operating on a worldwide basis from ships and ground stations. They monitor 120 frequency channels between 4 and 32 MHz.

Using short pulses transmitted on each frequency channel, the equipment is able to make rapid soundings of transmission paths with millisecond pulses. Each sounder scan requires 24 seconds and each path is sounded once every 10 minutes. The data from the high-frequency sounding receiver are digitized, reduced to minimum essential information and transmitted to frequency selection computers.

Collins Radio Co., Dallas, and Granger Associates, Palo Alto, Calif., are among the contractors who have built automated ionospheric-sounding equipment of this kind. ■■

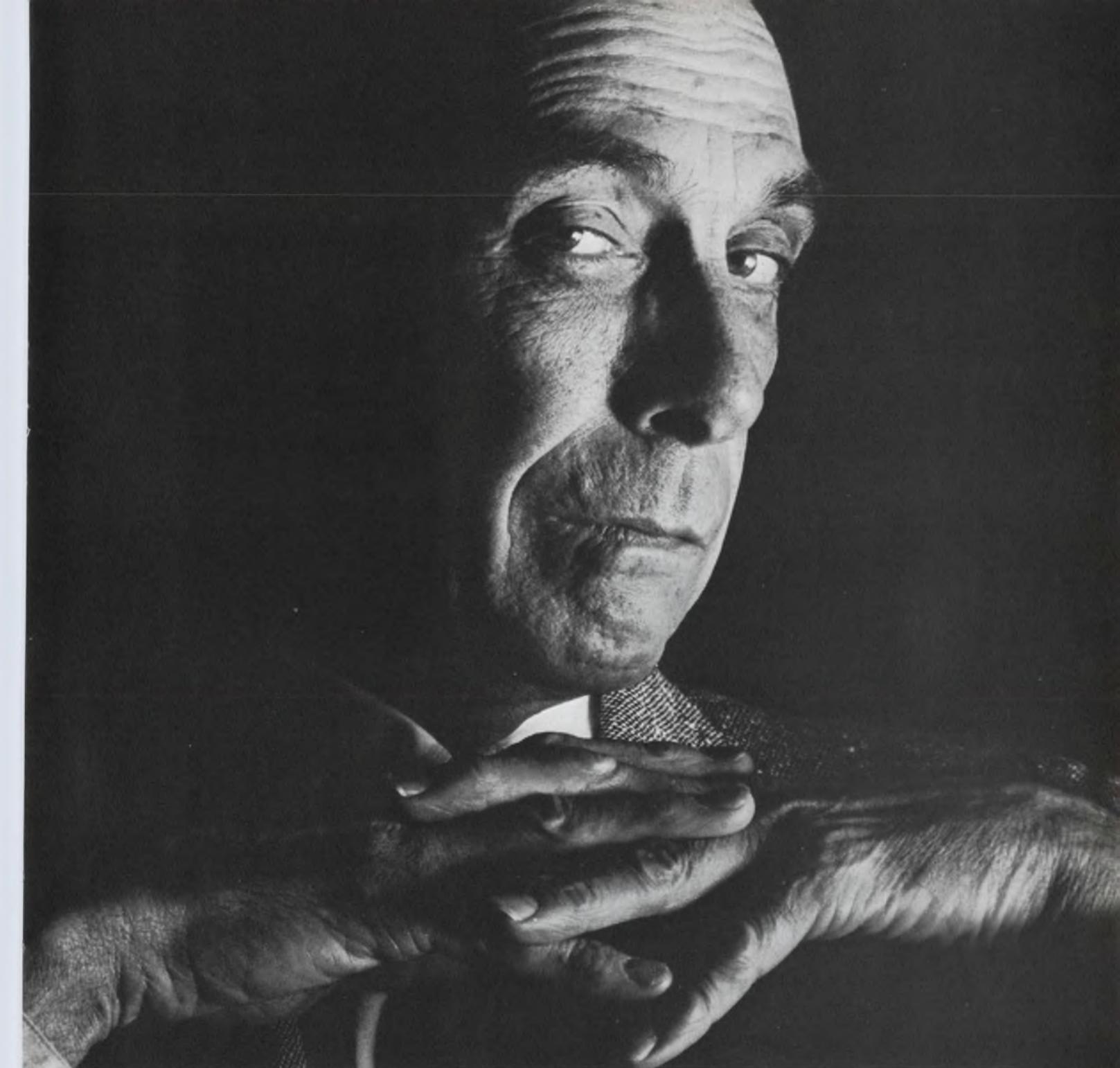

**Would you give
gallium arsenide
to your wife?**

Only if you were married to an optical encoder. Then she'd light right up. You see, gallium arsenide is the light source for the most desirable encoder you can acquire. Virtually unshockable. With dependability you can count on. Comes in sizes to your liking. Will do anything you ask. Add to this a long, carefree life and you begin to see how attractive the low ultimate cost of ownership will be. Come to Litton Encoder Division. Let us put you and gallium arsenide together for life. Encoder Division, 20745 Nordhoff St., Chatsworth, California.



 **LITTON INDUSTRIES
ENCODER DIVISION**

Army tests hearing aids that bypass the ears

New devices transmit sound by coupling rf signals through the skin to nerves in the head

Richard N. Einhorn
News Editor

Faced with the problem of maintaining even routine conversation in the ear-shattering din aboard Chinook helicopters and the airboats (Fig. 1) used in Vietnam, the Army is evaluating experimental hearing devices that bypass the ears.

Based on some quantum effect that apparently no one really understands, amplitude-modulated rf signals are routed through the skin into the nerves of the head, and the nerves themselves demodulate the carrier to extract the audio. The "sounds" induced in the nervous system are almost indistinguishable from those entering the ears.

There is a possibility that hearing aids based on these principles will one day help restore hearing to totally deaf persons, but so far formal medical approval is lacking.

The neural hearing devices, which are being investigated by several companies, generally couple an rf carrier in the 40-100 kHz range to the human body. The terminals are two plastic-insulated

electrodes that are held on the skin just in front of the ears, in the area of the facial nerves. The electrodes act as the plates of a capacitor and the tissues as the dielectric, thus completing an LC series-resonant circuit with the instrument. Hold one of the electrodes away from the skin, and it is impossible to "hear" anything through the nerves.

Two companies actively engaged in this research are the Inteletron Corp. of New York City and Listening Inc. of Arlington, Mass. The Army Electronics Command, Fort Monmouth, N. J., is interested in the patented devices being developed by Inteletron. According to Warren G. Austin, vice president and general manager of Inteletron, his company will produce two prototype units to be installed in an aircraft or helicopter for testing. Each unit will consist of a 3-by-5-by-1-1/2-inch control box and a helmet-mounted headset. The control box will permit an operator to select the normal audio channels, the neural hearing channel (Fig. 2), or a combination of the two. The headset portion con-

sists of an adapter that encases the audio earphones. Electrodes in the adapters make contact with the skin around the ears.

The self-resonating oscillator (on which Inteletron holds a separate patent) senses the phase of the current in the electrodes and automatically changes its frequency to keep the output circuit resonant when the load changes. Compensating circuits allow for variation in the placement of the electrodes.

Linear integrated circuits are used in the audio preamplifier and in the compensating circuit that senses the carrier phase. The modulator also uses a linear integrated circuit that can produce about 1 watt of power and 60 dB of operating circuit gain.

While the neural hearing device resembles an ordinary superheterodyne receiver, a quick look would show that one stage is missing—the demodulator. The nerves in the head receive the entire signal—envelope and all—and detect the audio. But it is not as simple as that, since there is a definite interaction with the normal hearing apparatus, according to Dr. Henry K. Puharich, president of Inteletron, and Dr. Joseph L. Lawrence, vice president.

Dr. Puharich, whose doctorate is in medicine, explains:

"This type of hearing is in large part a function of the brain as well as of the cochlea." The cochlea, the seat of hearing, is a tiny chamber shaped like a snail's shell. It is a transducer that converts mechanical energy into electrical signals.

Dr. Puharich and Dr. Lawrence say that the amplitude-modulated rf carrier causes tissues to vibrate more or less linearly to the modulating signal. This can be demonstrated by placing the electrodes on a person's face and feeding in speech or music. A second person would be able to hear faint signals if he held a stethoscope to the first person's head.

Dr. Puharich and Dr. Lawrence



1. Neural hearing devices may enable crewmen on airboats in Vietnam to talk to each other despite 125-dB noise level. Craft is from Bell Aerosystems.

Hearing with the nerves

What does it feel like to "hear" with your nerves?

I recently had the opportunity to try neural-hearing devices made by Intelectron Corp. of New York City and Listening Inc. of Arlington, Mass. The signals were almost, but not quite, like airborne sounds.

Of the two devices, I thought that Intelectron's was far more efficient—I could easily hear pure tones from 30 Hz to 15 kHz, as well as speech and music. While an associate held the electrodes on his head, I used a stethoscope to pick up the sounds induced in his neck. We also chatted, using microphones and wires connected to two sets of electrodes, while we sat in different rooms.

I had to strain to hear anything with the Neurophone.

—Richard N. Einhorn

think that the electrical signal undergoes a piezoelectric effect in the tissues, which convert the electrical signals into acoustic waves that are sensed by the cochlea of each ear.

Moreover, they say, the cochlea is equipped with nerves, so that it can be excited electrically as well as acoustically. Thus the electrical pressure stimulates microphonics in the cochlea. This activates the fluid in the cochlear canal so that a mechanical pressure wave is sensed. The electrical signal requires 20 dB less drive for pure tones than the sensing of airborne signals by the normally functioning ear. Therefore it adds 20 dB of gain to the hearing threshold.

A third phenomenon is also involved, Dr. Puharič and Dr. Lawrence say—the direct application of electrical signals to various nerves that supply information to the brain. This means that some signals could get through even if the auditory mechanism were totally destroyed in the physical sense.

The deaf may hear again

The implication is clear: devices using these principles may one day bring the sensation of hearing to persons with 100 per cent hearing loss—something that no conventional hearing aid can do. But there is danger that nerves may be

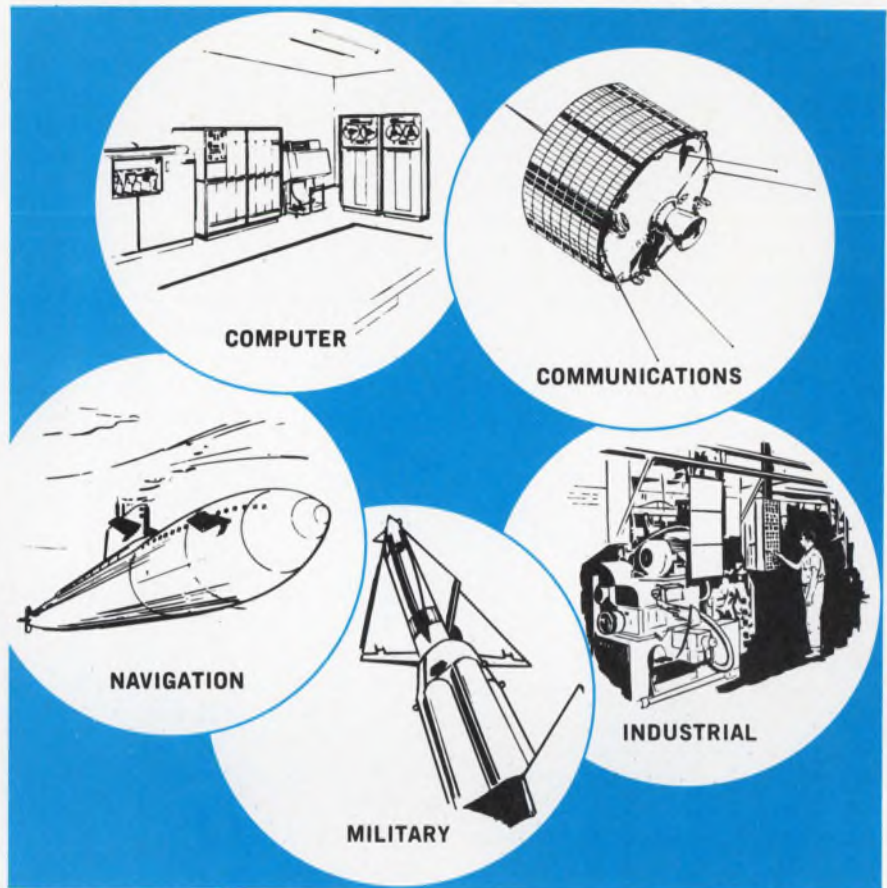

There's a rumor in engineering circles...critical circuits need Nytronics Ceramic Capacitors.

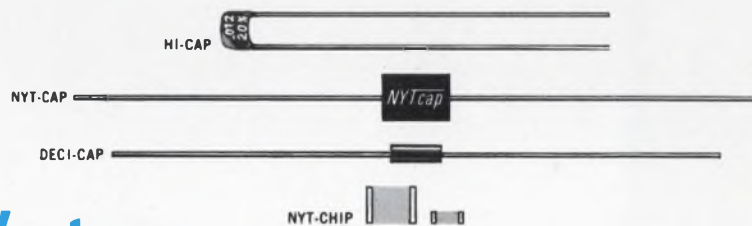

It's true...

because continuous Nytronics research and development, linked with our unique standard line concept, have achieved the highest degree of precision performance together with rapid volume production. Our wide range of miniature capacitors has an exceptionally large capacitance-to-size ratio.

NYT-CAP: Molded epoxy package 0.1" diameter by 0.250" long ...4.7 to 220 pf; and 0.350" by 0.250" by 0.1" ...270 to 4700 pf; T/C does not exceed ± 40 ppm/ $^{\circ}$ C (–55 $^{\circ}$ C to +125 $^{\circ}$ C); and 200 WVDC.

HI-CAP: .01 to 2.5 mfd.; $\pm 20\%$ tolerance; 100 WVDC; no derating to 125 $^{\circ}$ C; and meets MIL-C-11015.

DECI-CAP: Epoxy molded envelope 0.100" diameter by 0.250" long ...4.7 to 27,000 pf; and $\pm 10\%$ tolerance.

NYT-CHIP: 0.170" by 0.065" by 0.070" ...4.7 to 220 pf; and 0.280" by 0.195" by 0.070" ...270 to 4700 pf; T/C does not exceed ± 40 ppm/ $^{\circ}$ C (–55 $^{\circ}$ C to +125 $^{\circ}$ C); and 200 WVDC.

In addition to ceramic capacitors and inductors, we maintain inventories of high quality delay lines and resistors. Complete engineering data on all products will be sent on request.



NYTRONICS®

...for Precision Electronic Components

550 Springfield Ave., Berkeley Heights, N.J. 07922 ■ (201) 464-9300 ■ TWX: 710-984-7977

ON READER-SERVICE CARD CIRCLE 21

NEWS

(Neural hearing, continued)

permanently damaged by long-term excitation, and no neural-hearing device has yet been sanctioned by the medical profession. Before the American Medical Association will give its approval, the effects on the nerves would have to be rigorously analyzed and clinical safety standards established.

The reason neural-hearing devices enhance speech-discrimination ability in high-noise environments is that the signals are coupled directly into the nerves and do not have to compete with the sounds in the air until they, too, are converted into electrical impulses. Dr. Puharich and Dr. Lawrence estimate the increase in intelligibility to be 50 dB.

Intelectron's general manager, Austin, says the Army has supplied the company with tapes of sounds from helicopters and airboats for simulation of the actual environments in an acoustic isolation chamber. This room is equipped with two 60-watt amplifiers and two loudspeaker systems that produce a background of 125 dB.

Austin, Dr. Puharich and Dr. Lawrence emphasize that their prototype military devices are designed for persons with normal hearing, not for the deaf, and that Intelectron does not have anything it can sell to handicapped individuals at this time.

Joseph De Clerk, an Army Electronics Command scientist, says the Army will test the Intelectron devices before it uses them in the field.

"We are impressed with what we have heard, and we think it shows great promise," he says.

De Clerk points out that the the Army will not order the de-

vices until they have been approved by the medical profession. "We think no less of our foot soldiers and our airmen than we do of patients, and I'm sure Dr. Puharich would agree," he says.

Dr. Puharich and Dr. Lawrence summarize their main findings on the electrical parameters of the devices as follows:

- Amplitude-modulated carriers are required for undistorted signal transmission. Frequency modulation and single sideband do not work at all, and pulse modulation not very well.

- Optimum energy transfer takes place at 36 to 43 kHz, but for high-noise environments, carriers up to 100 kHz are used "because you are fighting for fidelity."

- Modulation is generally from 70 to 100 per cent, and 30 per cent is the absolute minimum.

- Power dissipated at the electrodes (but not absorbed by the head) is 1.2 W.

Boy wonder develops unit

At Listening Inc., 23-year-old G. Patrick Flanagan is developing the Neurophone (Fig. 3), which also works on the phenomenon of neural hearing. Flanagan explains his device this way:

"The Neurophone is an amplitude-modulated radio-frequency carrier source operating at 100 kHz. It is designed to be coupled to the human body through two electrodes. These electrodes are made of plexiglass covered on one side with conducting silver epoxy. The silver epoxy acts as the plates of a capacitor. A thin film of Mylar is placed on top of the epoxy as insulation.

"When the electrodes contact the skin, they generate a peak voltage

of 1 volt through the skin into the nervous system. Usually the best placement of the electrodes is under the temple, just in front of the ears. The Neurophone cannot work with direct coupling, only with capacitive coupling.

"The intensity of the signal is entirely dependent on the peak-square to mean-square power ratio of the signal coupled into the skin. Therefore amplitude modulation will work, whereas straight fm will not work, because you don't get a power density change. Pulse width or pulse position modulation works to a certain extent, because you do get a power change."

Like Dr. Puharich, Flanagan is not sure how the nerves demodulate the audio signals.

Can the Neurophone operate at any other radio frequency?

"Oh, yes," says Flanagan. "We've chosen 100 kHz because it's convenient. It gives us a bandwidth of 20 kHz." Flanagan says that the Neurophone Model GPS-1, used primarily in research on hearing, is flat in modulation response, ± 1 dB to 20 kHz.

Flanagan reports that Dr. J. Brad Allard, an audiologist at Western Illinois University, has completed intelligibility tests on the Neurophone, using persons with normal hearing as subjects.

Dr. Allard told ELECTRONIC DESIGN that the tests were inconclusive, because the output of the device, and therefore the intensity of the applied signal, was low. ■■

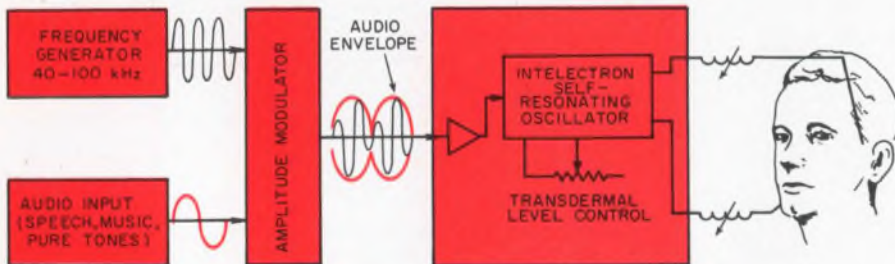

2. Device pumps rf signal into head and nerves demodulate the audio. Insulated electrodes act as plates of a capacitor, and tissues as the dielectric, in a series-resonant LC circuit. Unit handles speech as well as pure tones. Self-resonating oscillator adjusts to shifts in electrode placement.



3. Neurophone is checked out by Fred Gray of Listening Inc. Set has been tested by hearing research laboratories.



RE SERIES POWER SUPPLIES

HIGH PERFORMANCE — LOW COST POWER SUPPLY

... for system and laboratory applications

The Rowan RE series is designed for both precise laboratory and systems applications. The units are convection cooled and use all silicon semi-conductors throughout. The RE series can be operated in either a constant voltage mode or a constant current mode and features circuitry providing automatic crossover to either mode.

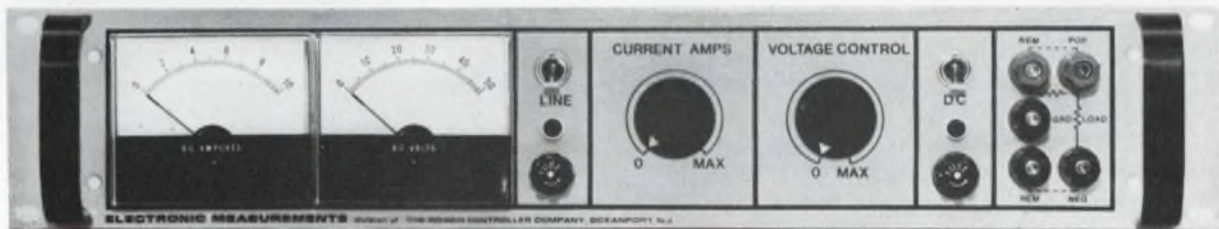

RE 40 - 5ML

FEATURES:

- All silicon semi-conductors
- Convection cooled
- Automatic E/I crossover
- Constant voltage/constant current operation
- Series master-slave operation
- Remote sensing
- Remote programming
- Single knob voltage control with dual knob resolution

RE SERIES SPECIFICATION TABLE

Model	Output volts	amps	Regulation line or load %*	Ripple MV RMS	Meters Ammeter Voltmeter	Terminals F - front R - rear	Size 19" panel	Weight	Price
RE 40 — 5	0 - 40	5	.01 or 2 MV	0.5	No	R	3½ H x 17¼ D	36#	\$290.00
RE 40 — 5M	0 - 40	5	.01 or 2 MV	0.5	Yes	R	3½ H x 17¼ D	36#	315.00
RE 40 — 5ML	0 - 40	5	.01 or 2 MV	0.5	Yes	F & R	3½ H x 17¼ D	36#	320.00
RE 60 — 2.5	0 - 60	2.5	.01 or 2 MV	0.5	No	R	3½ H x 17¼ D	36#	290.00
RE 60 — 2.5M	0 - 60	2.5	.01 or 2 MV	0.5	Yes	R	3½ H x 17¼ D	36#	315.00
RE 60 — 2.5ML	0 - 60	2.5	.01 or 2 MV	0.5	Yes	F & R	3½ H x 17¼ D	36#	320.00

*whichever is greater. Input for all models 105-125, 50-63 HZ

ELECTRONIC MEASUREMENTS

division of THE ROWAN CONTROLLER CO. | 2 CRESCENT PLACE | OCEANPORT, N.J. 07757

Thin-film capacitor is a sensitive bolometer

JPL device is reported an order of magnitude better than existing thermistors and thermopiles

Ron Gechman
West Coast Editor

A thermal detector, said to have an order of magnitude improvement in sensitivity over present room-temperature thermal detectors, has been developed at the Jet Propulsion Laboratory in Pasadena, Calif.

The new experimental detector is a thin-film capacitive bolometer in which capacitance is highly dependent on temperature.

The bolometer was made from a film of titanium dioxide, sandwiched between two layers of thin-film aluminum and deposited on a mica substrate (see figure). The mica serves to insulate the bolometer from the titanium frame, which supports the device.

According to its developer, Dr. Joseph Maserjian, supervisor of JPL's semiconductor research group:

"Because the detector is a thin-film device, very high thermal impedance and a high thermal rise can be achieved."

High thermal impedance prevents heat from the absorbed en-

ergy to be dissipated. Therefore the higher the thermal impedance, the higher the temperature rise.

"So the sensitivity of the device to a temperature change is quite good," Dr. Maserjian emphasizes, "and compares favorably with thermistors, other types of bolometers and thermopiles."

He explains the theory of the thin-film capacitive bolometer this way: Changes in capacitance caused by temperature variations are due to the tunneling process of electrons through the titanium oxide dielectric. Titanium dioxide contains a large ionic space charge resulting from a large density of impurities in the material. With the titanium dioxide as a dielectric, sandwiched between aluminum electrodes, electrons are able to tunnel through the dielectric.

The width of the tunnel path, however, is highly dependent on temperature, and it decreases with increasing temperatures. Narrowing the tunnel path causes a rapid rise in capacitance.

According to Dr. Maserjian, this variation of capacitance with tem-

perature is orders of magnitude larger than that caused by a change in the dielectric constant.

The detectivity (D^*) is the most commonly used figure of merit for comparing different thermal detectors. Dr. Maserjian says that the larger D^* achieved in the capacitive bolometer, compared with other kinds of thermal detectors, means that weaker radiation signals can be detected.

"This is of great importance in space exploration, for detecting the black-body radiation of lunar and planetary surfaces," he says. "At present the best thermal detectors adopted to spacecraft use are thin-film thermopiles, which can detect black-body radiation from surfaces no lower than 150°K ."

Dr. Maserjian believes the bolometer is well-suited for imaging arrays, such as infrared scanners and trackers, and can be packaged into integrated circuits as a temperature-measuring device.

Unlike the thermopile, which requires a dc input, the new bolometer operates from ac. No dc chopper-amplifier is used, since the ac output, which is proportional to temperature, can be amplified directly by an ac amplifier. The frequency is typically 10 to 30 KHz but can operate from 5 to 100 KHz with an amplitude of about 1 volt.

Research on the device is continuing, with emphasis on perfecting a suitable manufacturing process. ■■

Commonly used thermal detectors

Thermal detector	D^*	Operating temperature	Frequency (Hz)	Noise source	Remarks
Thin-film capacitive bolometer	2×10^{10}	295°K	10	Nyquist† or photon	Simple circuit can balance out temperature drift.
Thin-film resistive bolometer	10^9	375°K	10	Nyquist†	Same as above.
Thermistor	2×10^8	295°K	10	Nyquist† and current	Same as above.
Thin-film thermopile	1.3×10^8	295°K	5	Amplifier limited	Requires chopping to separate signal from temperature drift.
Golay cell	1.7×10^7	295°K	10	Temperature, vibration	Fragile mechanical construction.
Superconducting bolometer	4.8×10^7	15°K	360	Unknown	Requires cryogenic refrigeration and precise temperature control.

†Noise caused by the internal resistance (similar to Johnson noise).

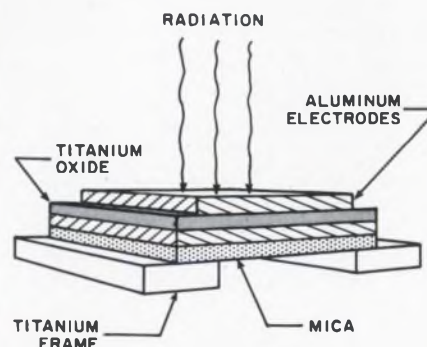

The capacitive bolometer, developed by Jet Propulsion Laboratory, is bonded to a supporting mica film over a hole in a titanium frame.

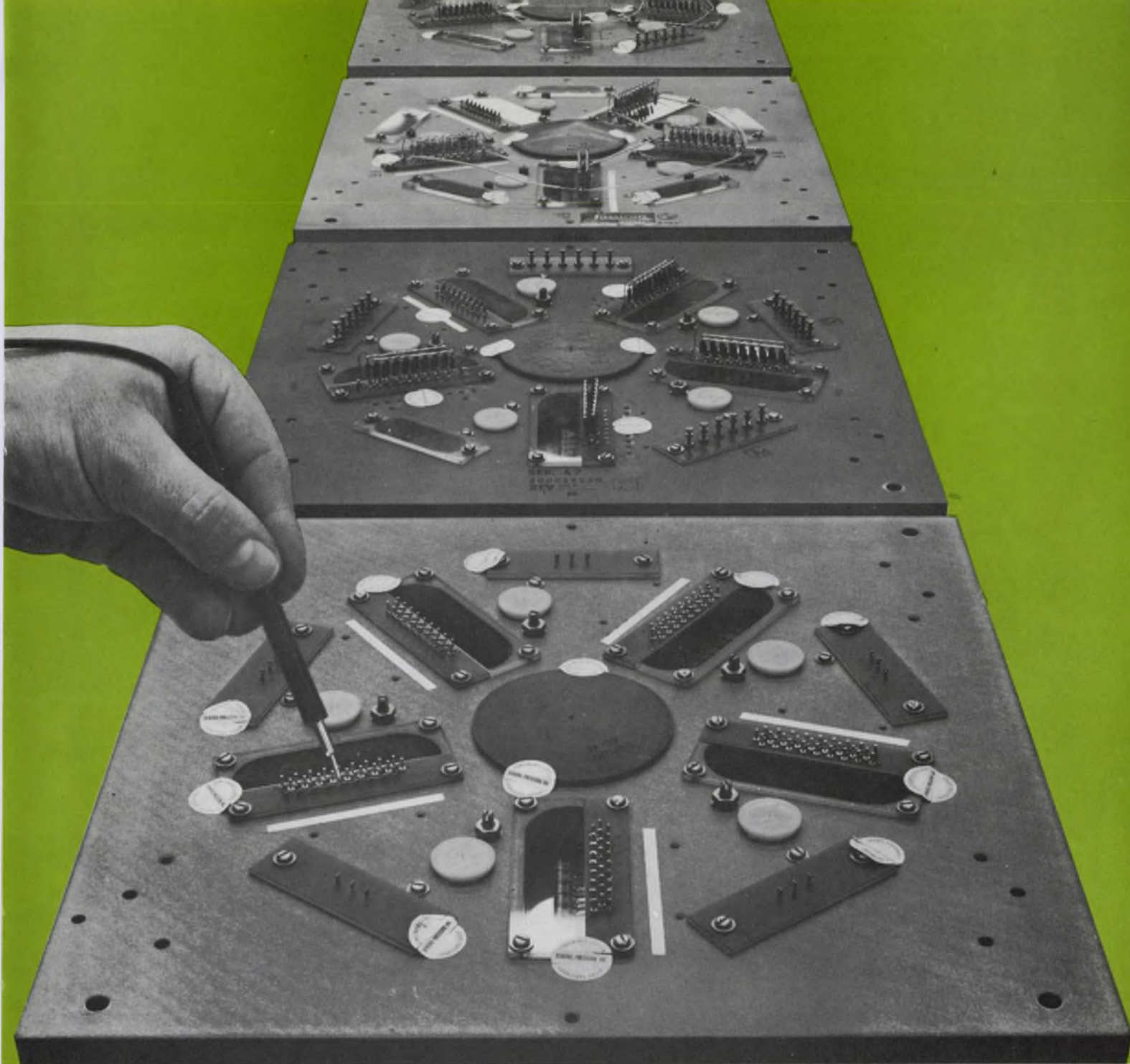

Fairchild has these fond memories of Librascope



Unlimited programmed testing with flexible test sequencing is one reason why. That's the advanced state-of-the-art job called for by the programming unit of Fairchild's new Series 4000M Automatic Integrated Circuit Testing System. Librascope's Series L100 Disc Memory got the call. Each stores 900 test programs—grouped in sequences of 25—and runs up to 60 per second. The same testing line accepts a variety of devices for high-speed processing. A simple keyboard programs the disc—no accessory hardware needed. And an entire sequence is reprogrammed in minutes. Proven reliability (over 600 L100 units in use) stems from conservative, no-compromise design. Yet the L100 is probably the lowest-cost disc memory on the market.

Thanks for the memory order, Fairchild—reputations are made of this. For the brochure detailing the longest line of discs in memory, write: General Precision Systems Inc., Librascope Group, Components Division, 808 Western Avenue, Glendale, California 91201.

**GENERAL
PRECISION
SYSTEMS INC.**
LIBRASCOPE GROUP
A SUBSIDIARY OF GENERAL PRECISION EQUIPMENT CORPORATION

What Kind of Panel Meter Do You Need ?



crisp, classic Horizon Line?

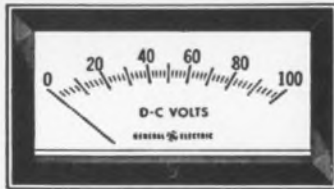

trim, built-in Horizon Line?

Built-in or front-mounted, General Electric HORIZON LINE® panel meters add quiet sophistication that accents, never dominates your electronic equipment. Check these distinctive HORIZON LINE features: smart, low-profile; clean, soft line; fine-precision markings. All ratings are available in 2½", 3½", and 4½".

distinctive Big Look?



Add bold, exciting, truly distinctive styling to your electronic equipment with General Electric BIG LOOK® panel meters. Panelboards take on added flair with such BIG LOOK features as . . . big, bold numerals, uncluttered display, tapered pointer, stylish shape, plus many others. All ratings are available in 1½", 2½", 3½", 4½".

Besides saving you valuable panel space, General Electric slim-line Type 185 EDGEWISE panel meters add exceptional styling and readability to your electronic equipment. These 2¼" Type 185 EDGEWISE panel meters can be mounted individually or in space-saving clusters of two, three, or more. All ratings are available for vertical or horizontal mounting, with or without bezels.

smart, slim edgewise?

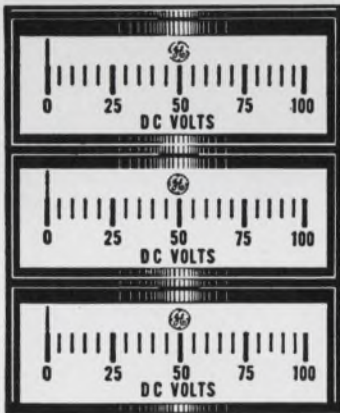

style-matched time meters?



Distinctive BIG LOOK styling is yours with General Electric BIG LOOK elapsed time meters. These "look-alike" time meters combine to give your equipment uniformity and beauty. G-E elapsed time meters measure either hours or minutes with or without a reset knob. All ratings are available in 2½" and 3½".

bright, bold meter relay?



Add years ahead BIG LOOK styling to your equipment with General Electric Type 195 contactless meter relays, featuring a totally new, solid-state, light-sensitive switch for the ultimate in control simplicity and readability. "Piggyback" control modules make for faster, easier installation. Companion pyrometers are also offered. All ratings are available in three sizes (2½", 3½", 4½") with single or double setpoints.

You can get it...from General Electric's full line

And, of course, General Electric's full line of panel meters is unmatched for accuracy and reliability. They're as near as your dependable G-E electronic distributor or sales office. You get fast delivery, too. For free descriptive bulletins describing G.E.'s full line of panel meters, write General Electric Co., Section 592-25A, Schenectady, New York 12305.

GENERAL  ELECTRIC

ON READER-SERVICE CARD CIRCLE 24

Elastic dielectric is feat of clay

An elastic dielectric ceramic? Exactly that, two International Business Machines engineers told the American Ceramic Society's 20th Pacific Coast Regional Meeting in San Francisco. Dubbed "Composition P," the material can be used as a hermetic encapsulant, a dielectric for printed capacitors, and a metal-to-ceramic bond.

Composition P, a research development, is a mixture of lead titanate, lead zirconate and borosilicate glass. It exhibits many characteristics not shared by other polycrystalline lead-IVB oxides.

Details of the new material were given by Ronald A. Delaney of IBM's Components Div., Burlington, Vt., and Richard K. Spielberger of the company's Components Development Laboratory, East Fishkill, N.Y.

Many encapsulating compositions tend to develop microfissures in the protective coating, owing mainly to a mismatch between the thermal coefficients of expansion of the coating, the device and the substrate. This mismatch does not occur when Composition P is used.

After being fired at 700° to 900° C, the "sandwich" of en-

capsulant, electronic device and substrate begins to cool. Each layer contracts, but the encapsulant contracts only until a critical temperature region is reached—typically 300° to 500°C. Then, quite unexpectedly, it begins to expand. Once having passed through this temperature region, the encapsulant again begins to contract until room temperature is reached.

The ceramic has also been used to fabricate printed thick-film capacitors. Experimental printed capacitors (2100 picofarads per square inch) were observed to change less than 5 per cent in capacitance and dissipation factor for either a temperature change of 0° to 100°C or a frequency change of 100 Hz to 100 MHz.

In addition, because of its elastic properties, Composition P has been used as a bonding cement for joining metals to ceramic materials. The materials differ substantially in their thermal coefficients of expansion. The IBM researchers have successfully bonded 5-mil-thick, 10 mil-wide silver ribbon (thermal coefficient of expansion of 191×10^{-7}) to an alumina substrate (60×10^{-7}). ■■



**Now
Easy
Replacement
of
Relays**

with



Methode's **NEW** relay connectors are specifically designed for use with plug-in relays, and are available in a full range of sizes and types to meet military and commercial specifications. They are made to fit all types of relays (*crystal can, military, power and numerous others*) and can be mounted in a variety of convenient ways. All types of termination are available: crimp, solder pockets or dip solder. All available from stock. Available in prices at, or below, competition.



Send for illustrated catalog with full technical data. Write to:



7447 W. Wilson Ave., Chicago, Illinois 60656
312/867-9600

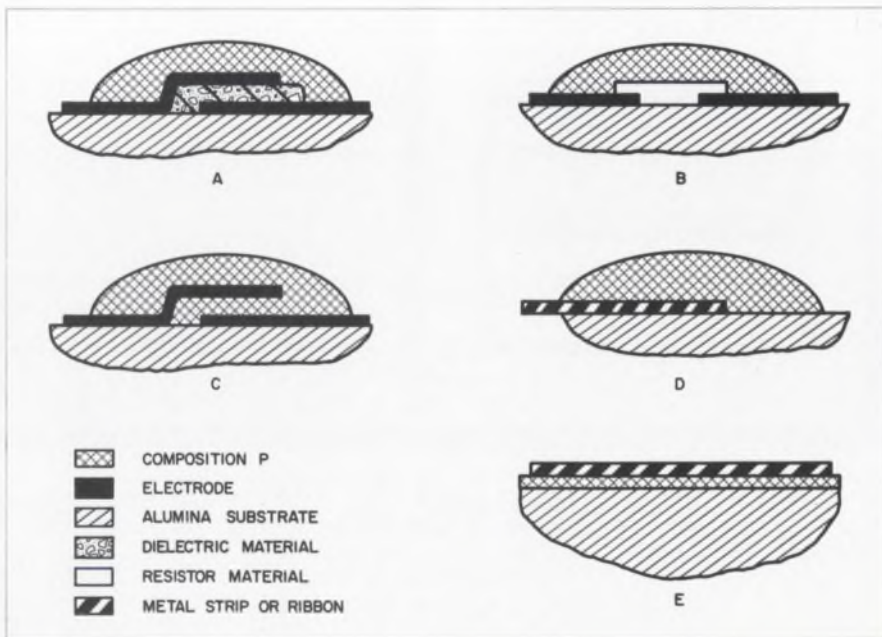

Elastic ceramic material serves as a hermetic encapsulant for printed thick-film capacitors (a) and resistors (b), a dielectric for printed capacitors (c), an elastic clamp for joining a metal ribbon to a ceramic substrate (d), or a bonding cement for a metal-to-ceramic seal (e).

NOW

RCA LOW-POWER DTL

2 PACKAGES

NEW LOW PRICES

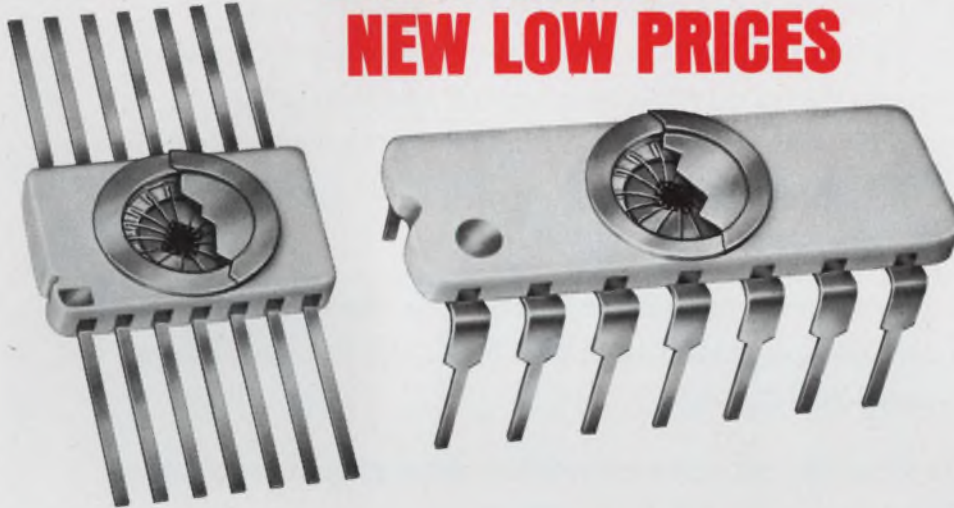

RCA's Unique High-Reliability Hermetic Packages...Single Welded Cap Leads do not pass through seal...lead abuse can't affect hermeticity.

RCA 2.3mW DTL in Hermetic Ceramic packages for -55°C to +125°C operation

DESCRIPTION	IN FLAT PACK	IN DUAL IN-LINE	PRICE (1000+)
Dual 4-Input Expandable NAND Gate	CD2200	CD2200D	\$3.15
Quadruple 2-Input NAND Gate	CD2201	CD2201D	\$3.30
Dual 4-Input Expandable NAND Buffer Gate	CD2202	CD2202D	\$3.30
J-K Flip-Flop; 2 "J", 2 "K", 2 Set and 2 Reset inputs, Split Clock	CD2203	CD2203D	\$4.20
Dual 4-Input Gate Expander	CD2204	CD2204D	\$2.25
Dual 3-Input Expandable AND-OR-NOT Gate	CD2205	CD2205D	\$3.15

NOW AVAILABLE IN PRODUCTION QUANTITIES. CALL YOUR RCA REPRESENTATIVE

Basic Gate Configuration

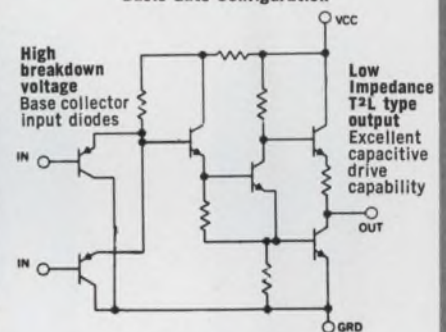

High noise immunity 1.2V (typ) @ 25°C

Device dissipation (typ) 2.3mW per Gate —7mW per Flip-Flop. Full military operating temperature range— -55°C to +125°C Flip-Flop clock frequencies (typ) 3MHz. Single power supply +3.8V to +6.3V; 4V optimum. NAND gates pin-compatible with popular 930 DTL circuits.

Data sheets and extensive application notes available for both—CD2200 series in 14-lead Flat-Pack and CD2200D series in Dual In-Line package. Call your RCA Sales Representative, your RCA Distributor or write to RCA Commercial Engineering, Section ICG12-3, Harrison, N.J. 07029.

CHECK YOUR RCA DISTRIBUTOR FOR HIS PRICE AND DELIVERY.

RCA Electronic Components and Devices



The Most Trusted Name in Electronics

For micro-accuracy... Starrett measures up

When it comes down to the ultimate in measurement control, or even for fine increments of movement with or without linear measurement, it's time for Starrett. Starrett micrometer heads are precision built to give you the preciseness that your design requires. Starrett is world-known as the leader in precision tools. When you just can't afford to be wrong, be precision-perfect with Starrett.

Starrett micrometer heads are stocked in a wide range of standard designs, and custom-built heads can be manufactured for special applications.

Write today for additional information about what Starrett can do for you to make your design better.

The L. S. Starrett Company,
Athol, Massachusetts.

Starrett®
WORLD'S GREATEST TOOLMAKERS

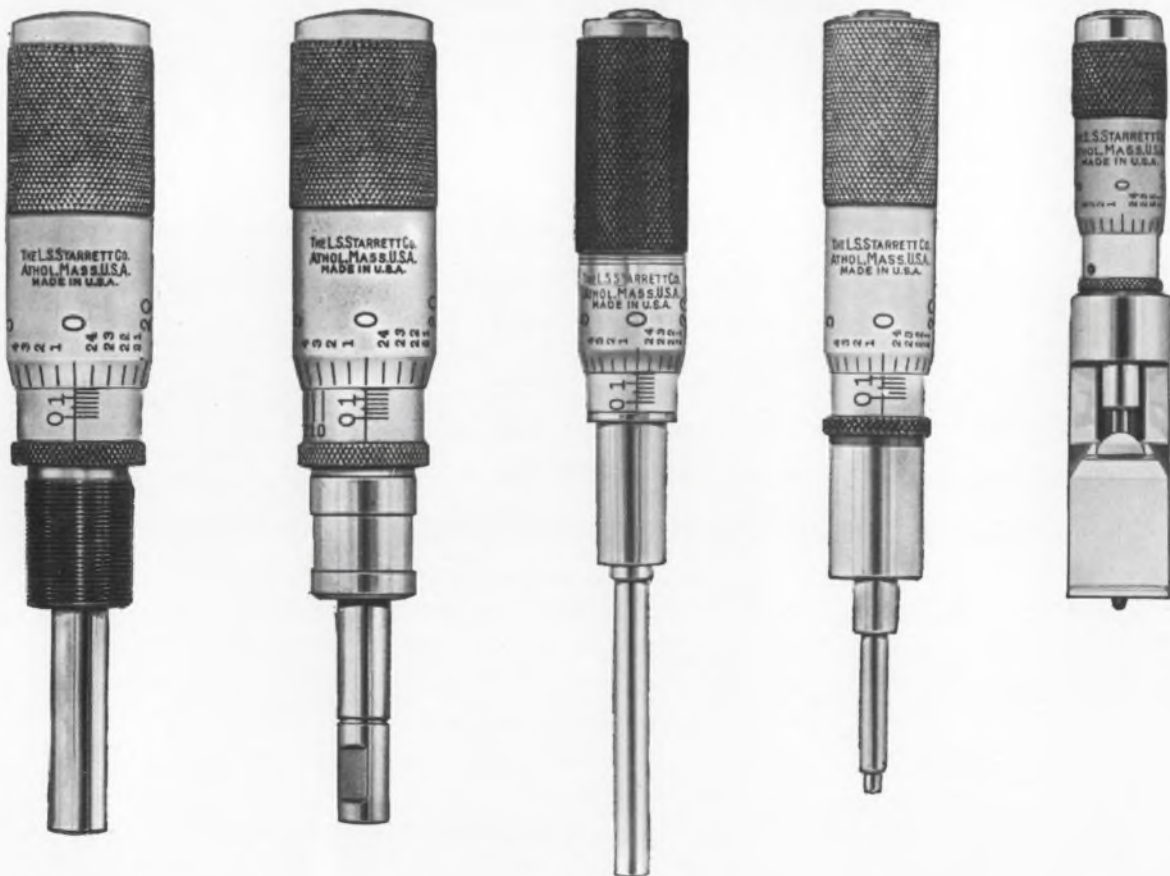



SWITCH CRAFT FORUM

You'd think I was asking for the moon! All I need is an audio connector that's quality made, looks

good and doesn't need a Ph.D. to put it together.

Let's look at our Series "Q-G" connector (Fig. 1.) It's style will complement today's modern equipment; microphones, amplifiers, etc. Plus, it's unique design guarantees fool-proof disassembly or assembly on the production line or in the shop.



Fig. 1

That's great! I've seen some connectors really mangled because somebody forgot to make it simple. How does your's work?

We literally patented easy-assembly when it comes to the "Q-G" connector.

Fig. 2. shows how Switchcraft's "Captive Design" (left-hand threaded) insert screw turns down into the insert assembly so that it may be removed for installing cable. The screw never leaves the one-piece insert assembly. Once the cable is installed, the insert assembly is positioned in the shell and the insert screw is turned out until it engages the shell once more.

Sounds like you've really simplified the assembly process. What else is different about these connectors?

Positive grounding or shielding. The insert mounting screw provides electrical continuity between the ground terminals, ground contactors and the connector housing, when it is tightened against the connector shell.

This ground path means you can gain an extra pin for circuit use, or any circuit can be readily grounded to the connector shell by "jumping" the contact to the "ground terminal".

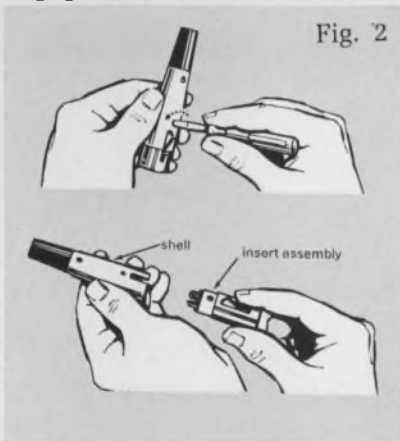

Fig. 2

I like the idea of getting that extra pin for circuit use. That would take care of my standard size 3, 4 & 5 conductor needs. But, we also get into single conductor circuits, miniaturization and even special styling.

No problem.

The Switchcraft Series 2500 microphone connectors are specifically made for single conductor, shielded applications. Each connector has a flexible "cord protector spring" for cable strain relief. This Series can also be furnished with the connector molded directly to the cable. The Series 5500 "Mini-Con" connectors are half the size of our Series 2500 connectors. Lapel microphones, musical instruments, any miniaturized audio equipment are ideal applications for these connectors.

Switchcraft Series 2504, 4-pin "Slim-Line" connectors are compactly designed for the more stylized audio equipment. Just circle the reader service number for complete catalog information which, incidently, includes a complete line of phono plugs and jacks, RF phono plugs & jacks and AC receptacles and adapters.

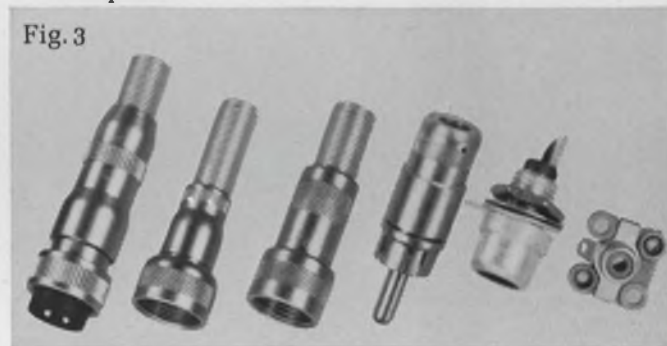

Fig. 3

What kind of "connections" does my staff need to get complete engineering information on these connectors?

Just have them request our "Forum Facts on Connectors" handbook on your company stationery. We'll be glad to send them a copy and also add their names to our TECH-TOPICS mailing list. Every other month they'll receive this application engineering magazine that often features connector application stories. 10,000 design engineers tell us the publication is very worthwhile in posting them on current application trends.

SWITCHCRAFT
INC.

5529 North Elston Avenue • Chicago, Illinois 60630

ON READER-SERVICE CARD CIRCLE 27



**New I/C 500-600 nsec
Memory System . . .**

**. . . Stores 1/4 million bits in
single 5-1/4" high unit, features
MTBF of 12 years under normal
40-hour week operation**

Now you can get the new μ -STORE ICM-500 in standard systems: 600 nanoseconds full cycle time. Special systems: cycle times as low as 500 nanoseconds. Up to 16,384 words with 54 bits/word; or up to 4096 words with 72 bits/word. (Over 3/4 of a million bits in little more than 15" of vertical rack space — including power supply). You also get I/C construction for all major functions including X-Y current drivers plus a choice of mechanical packaging.

Get the full story. And take advantage of our eight years' experience in solving core memory problems. Write today for our new brochure. Honeywell, Computer Control Division, Old Connecticut Path, Framingham, Massachusetts 01701.

*Patent applied for.

Honeywell

 **COMPUTER CONTROL
DIVISION**

Electrostatic gyro goes inertial



USAF reports new gyro success

The first inertial navigation system to employ electrostatic gyroscopes (ESG) as position sensors has completed a highly successful series of 14 test flights, Dr. Alexander H. Flax, Assistant Secretary of the Air Force for Research and Development, has reported to Congress. In development by Honeywell for over 11 years, the ESGs employ electrostatically suspended, highly polished beryllium spheres as rotors. Spherically near-perfect, the rotors are contained in an evacuated shell and, after run-up to 60,000 rpm, they are capable of long-term operation without spin power. Pick-offs are obtained optically from reference lines scribed on each sphere.

Development is being sponsored by the Avionics Laboratory, Aeronautical Systems Div., at Wright Patterson Air Force Base in Dayton, Ohio. The program goal is to obtain at least an order-of-magnitude accuracy improvement over conventional inertial systems. The ESGs are adaptable to either gimballed or strap-down systems, Honeywell claims.

The flight test system, carried in a C-124 transport, employed two miniature two-degree-of-freedom ESGs installed in a four-gimbal stable platform. Motion data were obtained from three miniature hinged pendulous accelerometers. The ESG navigator project engineer, Maj. E. J. DeNezza, reported that the test data were "acquired under conditions calling for self-contained alignment and calibration of the platform and direct printout from the system computer."

Pentagon okays antisubmarine aircraft

What may well be Defense Secretary Robert S. McNamara's last major military-system purchase was made last month when the nod was given to the Navy's long-sought antisubmarine aircraft, the VSX. The cost of

Washington Report

CHARLES D. LAFOND
WASHINGTON BUREAU

the aircraft alone, including contract definition and R&D, is expected to total \$2 billion. As much as \$1 billion more may be required for support equipment and the aircraft-carrier modifications needed to be able to deploy the aircraft operationally.

The VSX will be assigned the task of countering any submarine threat. As an antisubmarine vehicle, it will carry a variety of special sonar gear, be capable of extended flights, and be provided with sufficient armaments to destroy its intended targets. The ordnance carried is expected to include acoustic homing torpedoes. The aircraft will operate from Essex-class aircraft carriers. Four to five years will be required to bring the VSX to operational status.

The next few months will see the contractors narrowed down to two who will bid in the competitive contract-definition phase. Top contenders include a Lockheed-LTV team, General Dynamics, Grumman Aircraft, McDonnell-Douglas and North American-Rockwell.

AT&T unveils atom-proof cable center

A nearly \$4 million underground communications center built by American Telephone and Telegraph Co. (AT&T) has been inaugurated about 25 miles west of Washington, D. C., in suburban Virginia. A part of a \$210 million system that will extend from Boston to Miami, Fla., the new Dranesville facility was designed to withstand anything from floods and hurricanes to all but a direct nuclear blast.

Some \$118 million has been spent so far; final links from Washington to New York and on to Boston are scheduled for completion during the next two years, AT&T said. The path from Dranesville to Miami is already in operation. Large cities, considered potential target areas should war break out, are

bypassed and over 20 branch cables tie these metropolitan areas to the main interstate cable system.

Terminals are interconnected by a 20-tube coaxial cable now carrying 2000 circuits but expandable to a full capacity of 32,400 circuits by 1970. Normally, the tube bundle is buried at a depth of from 4 to 5 feet, the firm said.

Eleven intermediate terminal centers will be constructed along the 1800-mile path. The underground terminal structures are fabricated from 18- to 24-inch-thick slabs on top. The floor slabs are 42 inches thick. The above-ground structures are of normal construction. Access doors to the protected structure are lead-lined and electrically controlled. Doors are double and one must close before the second will open.

Designers claim the center will survive a 20-megaton nuclear explosion 2.4 miles away. For earthquake protection, the structure will withstand up to a 6-inch lateral movement without cracking, they disclosed. Soon some 40 blast-sensing valves will be installed to seal off the center automatically in the event of a nuclear detonation.

Computer controls aircraft simulator

A most unusual trainer developed by Martin-Marietta at its Baltimore facility simulates the responses of a variety of military aircraft through computer-directed flight control.

Called the Variable Stability Trainer, or VST, the modified F-106B jet fighter is designed to simulate the operation of an F-4, F-104, F-111, and even the X-15 research vehicle with absolute fidelity, the firm claims. The company added that the unique landing maneuvers of the X-24 lifting-body can also be simulated.

The concept involves use of a model-following control system driven by an analog computer installed in the aircraft nose. The mathematical model of the flight characteristics of the simulated aircraft is inserted into the computer for each flight.

In actual flight, as the pilot performs his normal control function, each action is directed

automatically to the computer to be analyzed, processed and converted in real time. The result, then, is an aircraft response corresponding to that which would result from the same control manipulation had it been performed in the simulated vehicle. A specially modified autopilot serves as the follower loop in the system, Martin said.

Constant power for DOD communications

The Defense Communications System's Pentagon facility will soon be provided with a 250-kilowatt uninterruptible power supply. Developed by Westinghouse Electric, the static inverter is designed for immediate emergency use and will provide ac power for up to 15 minutes. This would permit stand-by generators to be energized and to stabilize before assuming the load.

Energy is provided by 48,000 pounds of lead-calcium storage batteries with a dc output that is converted to ac through an inverter system. When not in use, the battery supply is continuously under recharge from commercial power. Three 156-kVA units are operated in parallel and any two are sufficient to satisfy critical load, Westinghouse said. Together they occupy a space of 22.5 by 5 by 8 feet.

ITU settles on new marine frequencies

International agreement has finally been obtained on frequency allocations for oceanographic and meteorologic data transmissions at sea. Pushed by the U.S. for the past five years through the World Maritime Radio Conference, the International Telecommunications Union has established six ranges in the hf portion of the spectrum from 4.16 to 22.16 MHz:

4.1625 - 4.1660	12.4795 - 12.4830
6.2445 - 6.2480	16.6365 - 16.640
8.3280 - 8.3315	22.1605 - 22.164

The new allocations become effective April 1, 1969, according to the U.S. National Council on Marine Resources and Engineering Development here in Washington. A ratification proposal for the revised ITU Radio Regulations will be sent to the U.S. Senate by the President.

Frequency changes are expected to affect both manned and unmanned ship, shore, and satellite stations as well as buoys used to transmit either oceanographic or meteorologic data.

Which is more important to you, lower prices or a choice of connectors?

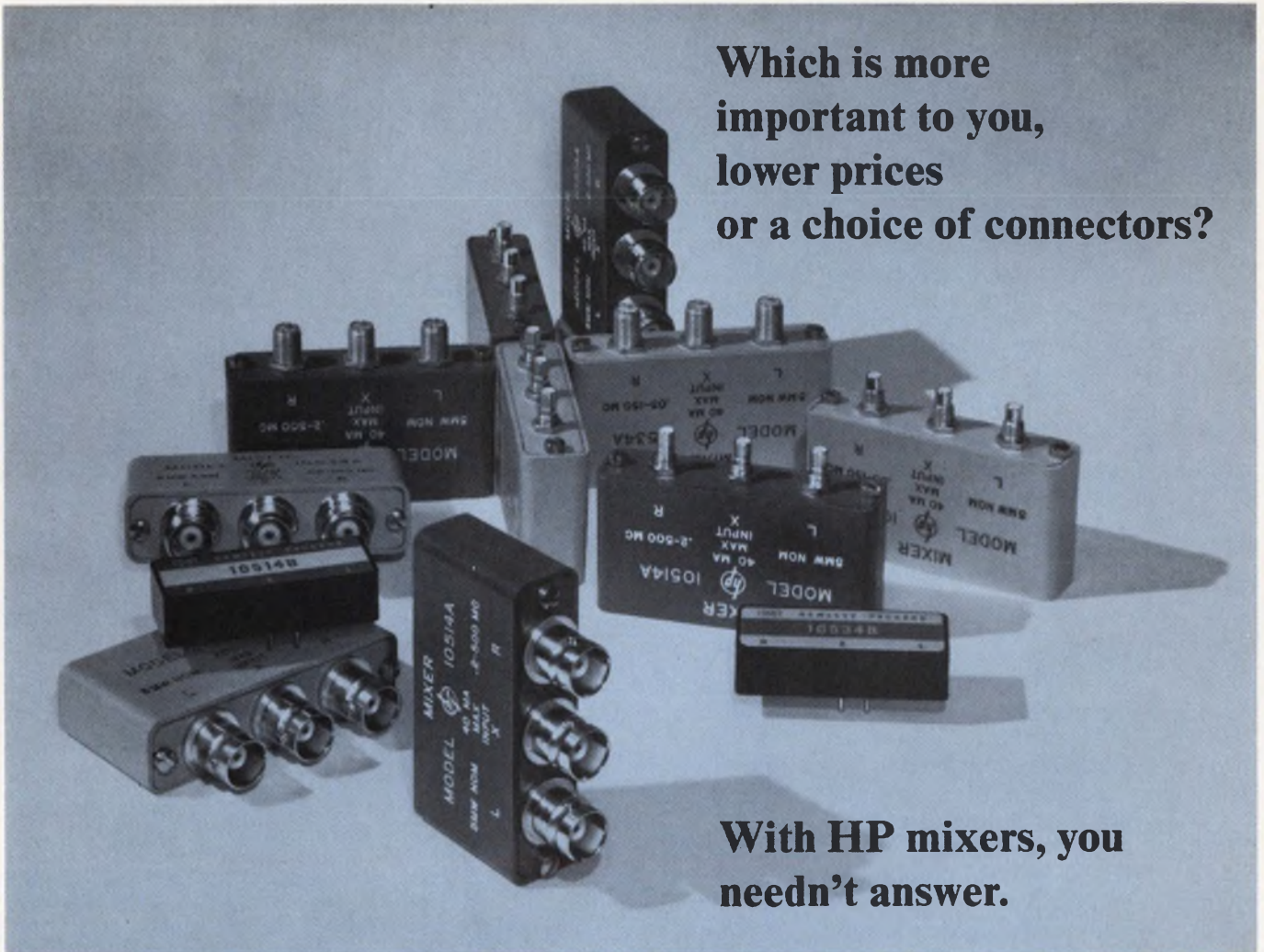

With HP mixers, you needn't answer.

HP mixers are now even lower in price than before, and with a wide choice of connectors. They all offer:

- **Lowest (and fully specified) 1/f noise.**
- **Complete testing, with all parameters specified in detail.**
- **Guaranteed performance over a wide environmental range.**

Low 1/f noise characteristics mean high performance in any phase detector application such as phase-locked loops or short-term stability measurements by phase noise methods. Note that single-sided noise is specified all the way down to 50 kHz on the DC-coupled port.

And our performance and environmental testing save you extra time and concern. This family meets specs and works wherever you need it.

Use these HP mixers for extracting frequency sums or differences, as modulators, spectrum or comb generators, phase detectors, current-controlled attenuators, doublers... or to extend spectrum analyzer range.

For complete application information call your local HP field engineer or write Hewlett-Packard, Palo Alto, Calif. 94304; Europe: 54 Route des Acacias, Geneva.

BRIEF SPECIFICATIONS

Model	Freq. range MHz ⁽²⁾	Conversion Efficiency		Prices ⁽¹⁾		
		0.5-50 MHz	0.2-500 MHz	1-4	5-9	10-24
10514A	0.2 -500	7 dB	9 dB	\$95	\$85	\$78
10514B	0.2 -500	7 dB	9 dB	\$85	\$75	\$68
		0.2-35 MHz	0.05-150 MHz			
10534A	0.05-150	6.5 dB	8 dB	\$70	\$63	\$58
10534B	0.05-150	6.5 dB	8 dB	\$60	\$53	\$48

(1) Prices are lower in larger quantity.

(2) "L and R" ports: "X" ports extend to DC for phase detector applications. The 1/f noise is specified on all models as <math><100\text{ nV per } \sqrt{\text{Hz}}</math> at 10 Hz, and is typically much better. Single-sided noise figure specification is the same as the conversion efficiency specification shown above, but with the frequency of the "X" port extending from 50 kHz to the upper limit frequency. Balance specifications are excellent, 12 to 45 dB (typical performance much better), depending upon frequency and test connections.

Price for connector options (Models 10514A, 10534A): Option 01, TNC Connector, \$5; Option 02, OSM No. 211 Connector, \$25; Option 03, Sealectro Screw-on No. 50-043-0000, \$5; Option 04, Sealectro Snap-on No. 51-043-0000, \$5. Standard connector: BNC. Models 10514B and 10534B have pins for printed circuit mounting.

HEWLETT *hp* PACKARD

SOLID STATE DEVICES

ON READER-SERVICE CARD CIRCLE 29

If it's so great, how come it's so cheap?

It's only \$5,000 because you said that's what it ought to cost. Our market research boys told us there was a tremendous need for an IC tester specifically designed for QC, QA, reliability testing, and everyday engineering evaluation. They also told us we could sell four times as many at \$5,000 as we could at \$7,500.

So we gave our design department a list of functions, a \$5,000 pricetag, and locked the door. Here's what came out: A \$5,000 IC tester that:

- Performs both pulse and dc parameter tests as well as functional tests without external equipment.
- Has a measurement accuracy of 1% (0.1% with an optional digital readout DMM.)
- Can be operated by a bright girl with half-a-day's training.
- Programs with thumbwheels in less than 60 seconds for most IC's.
- Has power supply accuracy of 0.1% \pm 1mv. (All supplies have adjustable current or voltage limiting and will both source or sink current.)

- Has Kelvin connections to the device under test.
- Has self powered, line-isolated modules.
- Has a complete line of device adaptors available.

How were we able to deliver so much machine per dollar? It was a snap. All we did was make every damn penny do a dime's work. We did it by committing to an annual agreement wherever there was a price advantage.

We did it by cutting out the fat. If a function was non-essential, it went. (This is one ungilded lily.)

We did it with painstaking project engineering. For example, the loads module: We could have made 1% capacitive loads. But it would have cost three times as much, and no one knows what to do with capacitive accuracy of better than 5% anyhow. Another example: the thumb-wheel switches. We found a great one, but discovered the price included \$2 each for a pair of stainless-steel screws. We bought them knocked-down,

assembled them ourselves and used 6¢ screws instead.

Or the pulse generator. Ours is equivalent to two single-channel output units like the ones that Datapulse sells for \$775. They're great, but by sacrificing separate control and adjustment (which isn't necessary in our tester anyway) and the fancy case cut the price in half.

We found a terrific \$15 digital switch. But we didn't use it. We built one without superfluous extras for a buck and a half apiece.

We're handling the AC-switching with 32 controlled planar devices. This saves 192 reed relays, that is to say, greenbacks.

One thing we did was hardest of all. We cut the profit margin. We're honest-to-gosh taking only $\frac{3}{4}$ the typical profit.

One more thing. The 990 turns out to cost \$4,950 instead of \$5,000. Use the extra \$50 to take the little woman out to a show and dinner.

Write for complete technical data, or if you're in a hurry, call us collect.

Redcor's 990 IC tester



Redcor Corporation/7800 Deering Avenue/Canoga Park, California/(213) 348-5892/TWX 910-494-1228

ON READER-SERVICE CARD CIRCLE 30

In our new Super-J DPDT relays coils and contacts live in separate worlds.

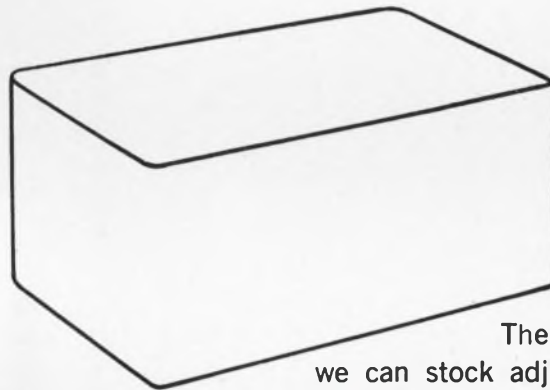

Hermetically sealed worlds. Switching modules are separately sealed. Coil assemblies are mounted as a separate unit. Result: a completely inorganic switching module with consistent contact performance regardless of load.

It's Deutsch-Filtors' new and unique relay design; eliminating even the minor problems of the best hermetically sealed relays on the market today. Problems like inconsistent contact operation, varying contact resistance, and, contact failure.

The Super-J design concept means we can stock adjusted and individually sealed switching modules, ready to accept coil assemblies to your specifications. That means faster deliveries. Solve your contact problems. Write Deutsch-Filtors Relay Division, East Northport, New York 11731.

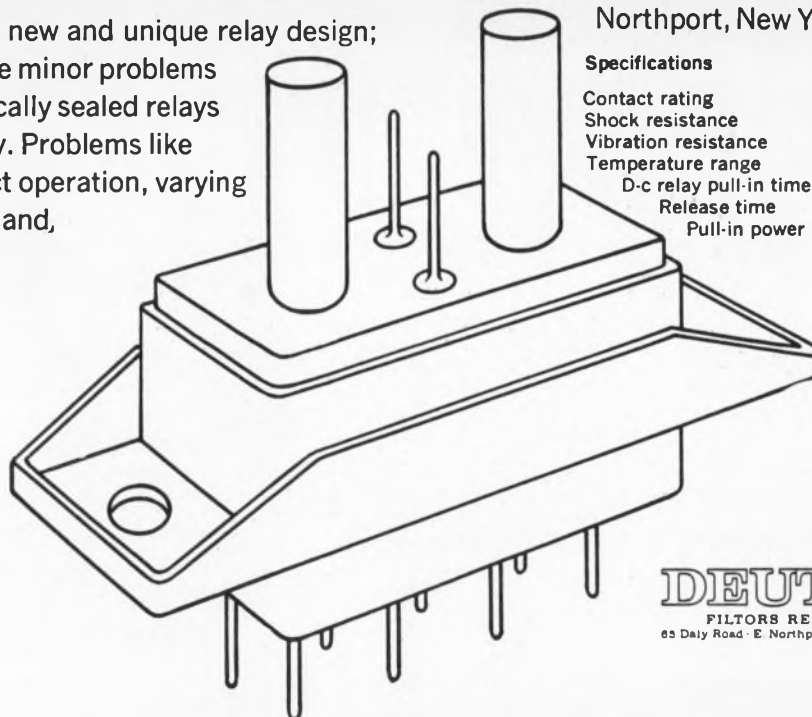

Specifications

Contact rating	2 amps
Shock resistance	250 g's, 11 msec
Vibration resistance	50 g's at 3 khz
Temperature range	-65° to 125°C
D-c relay pull-in time	5 msec, max at 25°C
Release time	5 msec
Pull-in power	340 mv, max.

DEUTSCH
FILTORS RELAY DIVISION
65 Daly Road · E. Northport, Long Island, New York

ON READER-SERVICE CARD CIRCLE 31

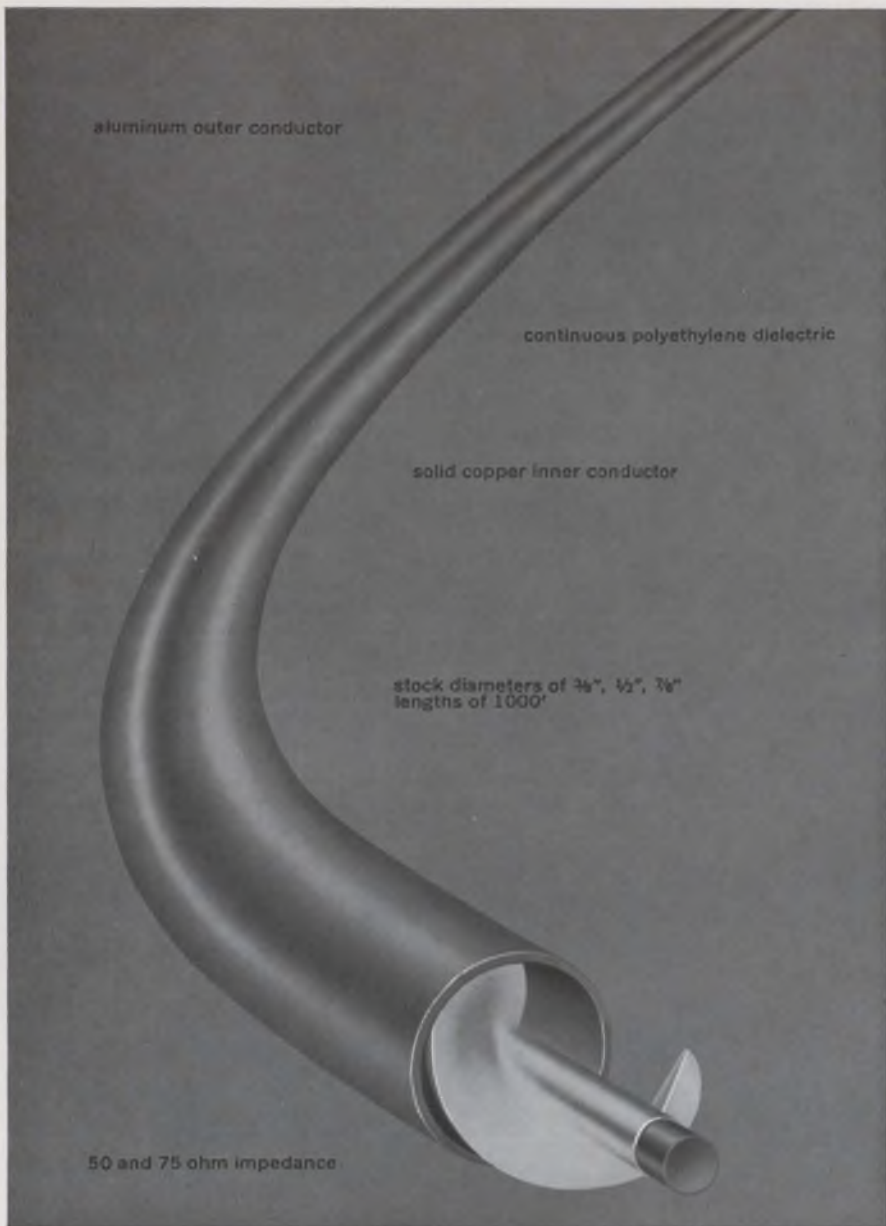

SPIRAFIL® II

Here's the most significant breakthrough in coaxial cable design since we introduced Foamflex in 1959. Spirafil® II is ideal for high frequency communications and UHF air-to-ground communications.

What makes Spirafil® II so radically different is a solid polyethylene helix which completely covers the solid copper center conductor without interruption. Among other things, this means great

mechanical stability with an absolutely non-collapsible helix and higher voltage breakdown. Add to this the advantage of unusually attractive electrical characteristics: low attenuation, extremely high velocity of propagation and excellent dielectric constant.

Price, believe it or not, is competitive with conventional foam cables.

Can we tell you more? Write for your copy of *Bulletin SL Issue 1*.

PHELPS DODGE ELECTRONIC PRODUCTS
NORTH HAVEN, CONNECTICUT



ON READER-SERVICE CARD CIRCLE 32

Letters

'Ideal rectifier' designer answers his critics

Sir:

The interesting but incorrect argument offered by Nathan Sokol and Myron Wolf in your Letters column [ED 21, Oct. 11, 1967, p. 46] to support the view that my equal-resistor "ideal rectifier" circuit published in your Ideas for Design section ["Ideal rectifier uses equal-value resistors," ED 13, June 21, 1967, p. 96] does not work has prompted me to derive an equation to prove that it *does* work. It turns out that the equal-resistor version is a special case and that, in general, the resistors can be unequal as long as they satisfy Eq. 3 below, which is derived in the following manner.

The voltage gain for plus input, as Sokol and Wolf correctly stated, is:

$$G(+)=e_o/e_i \\ = (R2/R1) (R5/R4). \quad (1)$$

This is the gain of two tandem-connected inverting operational amplifiers.

For minus input there are two feedback paths to the summing junction of $A1$, one from each amplifier output (Fig. 1 on p. 50). Mathematically this is expressed as:

$$i_1 = i_2 + i_3$$

or

$$e_i/R1 = e_o/(R2 + R4 + R5) \\ + e_3/R3;$$

since:

$$e_3 = e_4 \\ = e_o(R2 + R4)/(R2 + R4 + R5),$$

then:

$$1/G(-) = e_i/e_o \\ = R1 [1/(R2 + R4 + R5) \\ + (R2 + R4)/R3 \\ \times (R2 + R4 + R5)]. \quad (2)$$

This is equated with $1/G(+)$ = $[(R1/R2) (R4/R5)]$ to ensure equal output for plus and minus inputs. The resulting identity is solved for $R2/R3$:

$$R2/R3 = (R4/R5) + [(1 \\ - R2/R4)/(1 + R2/R4)]. \quad (3)$$

Inspection of Eq. 3 shows that if $R2 = R4$ the second term drops out and $R3 = R5$. Furthermore, for unity gain, $R2 = R3$ and $R2 = R3 = R4 = R5$; the result is the circuit

(continued on p. 50)

ON READER-SERVICE CARD CIRCLE 33 ►

LOW PROFILE

hot-molded trimmer for
close circuit board stacking



Basic Type Y unit
shown actual size



With wheel for
side adjustment



With attachment for
horizontal mounting and
wheel for side adjustment



With attachment for
horizontal mounting

New Type Y single turn trimmer is especially designed for use on printed circuit boards. It has pin-type terminals for use on boards with a 1/10" pattern. And the new low profile easily fits within the commonly used 3/8" space between stacked printed circuit boards.

For greater operating convenience, the Type Y can be supplied with an optional thumb wheel for side adjustment, or an optional base for horizontal mounting, or both. The Type Y enclosure is splash-proof as well as dust-tight, and the metal case is isolated to prevent accidental grounding.

While featuring a new low profile, this new Type Y trimmer retains the popular Allen-Bradley solid resistance element, which is produced by A-B's exclusive hot-molding technique. With virtually infinite resolution, adjustment is smooth at all times. Being essentially noninductive, the Type Y can be used at frequencies where wirewound units are inadequate. The Type Y is rated 1/4 watt at 70°C and is available in resistance values from 100 ohms to 5.0 megohms. Standard and special tapers are available.

Let us send you complete specifications on this newest addition to the Allen-Bradley line of quality electronic components. Please write: Allen-Bradley Co., 1344 S. Second St., Milwaukee, Wis. 53204. In Canada: Allen-Bradley Canada Ltd. Export Office: 630 Third Ave., New York, N. Y., U.S.A. 10017.

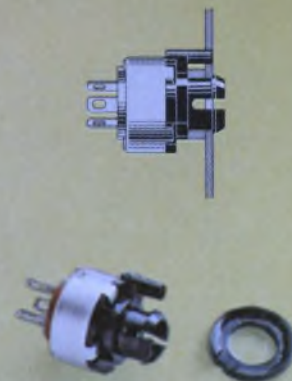

New Type Y with handy
snap-in panel mount,
supplied with spacers for use
on panels up to 1/8" in thickness



ALLEN - BRADLEY
QUALITY ELECTRONIC COMPONENTS

Now see what HIGH VOLTAGE SUPPLY performance and economy really mean with the NEW KEITHLEY 246



It lets you dial
0-3100 volts dc,
stable to 0.01%,
for only \$450.00

It's a perfect power supply companion for Keithley electrometers and picoammeters. Ideal for photo-multipliers, electron multipliers, semiconductors—you name it!

Compare what we've put into the Keithley 246 for an idea of what you'll get out of it. Voltages selectable in calibrated 10-volt steps. 0.001% line regulation. Less than 1 millivolt rms noise. Built-in overload protection. Output current limited to less than 13 milliamperes and recovery from overload automatic. Maximizing convenience and ease of operation, the Keithley 246 has a variable trim potentiometer with

better than 50 mv resolution, front and rear outputs and front panel meter for checking output polarity and magnitude.

Meet the best source for outstanding lab performance. Call your experienced Keithley Sales Engineer for our technical engineering note and personal demonstration. Keithley Instruments, Inc., 28775 Aurora Road, Cleveland, Ohio 44139. In Europe: 14 Ave. Villardin, 1009 Pully, Suisse. Prices slightly higher outside the U.S.A. and Canada.



KEITHLEY

LETTERS

(continued from p. 48)

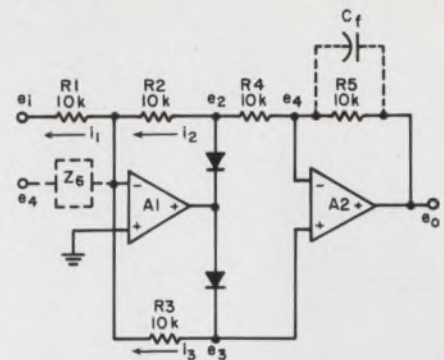

1. Ideal rectifier circuit with equal resistors really works. Design equation is Eq. 3.

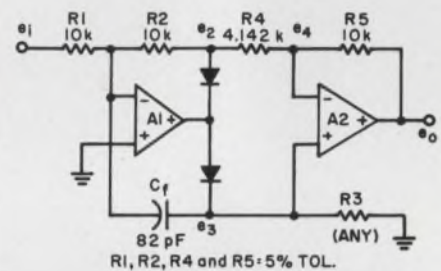

2. Degenerate form of ideal rectifier uses only four precision resistors.

shown in the Idea for Design. If current gain is required from A1, $R2/R4 > 1$ and Eq. 3 is used to calculate R3 after R2, R4 and R5 have been selected. If the calculated value of R3 is negative, R5 is reduced and R3 is recalculated.

A new circuit results if R3 is allowed to go to infinity and the non-inverting input of A2 is returned to ground through a resistor of arbitrary value (Fig. 2). This is an ideal rectifier circuit that requires only three precision resistors (four, if R1 is counted in). If a further constraint that three of these resistors must be equal is imposed, the resistor ratios are:

$$R1 = R2 = R5 = R;$$

$$R4 = (2^{1/2} - 1) R;$$

$$|G| = 2^{1/2} + 1.$$

In general:

$$R2 > R4;$$

$$R4/R5 = (R2/R4 - 1)/(R2/R4 + 1);$$

$$|G| = (R2/R1)(R5/R4)$$

$$= (R2 + R4 + R5)/R1.$$

The gain is fixed at $1 + 2^{1/2}$ for both plus and minus inputs. One difficulty with the circuit of Fig. 2 is that the forward path for negative inputs consists of the full open-loop gain of A1 and A2 in tandem. A value for Cf of 82 pF was sufficient to stabilize (continued on p. 52)

Printed circuit board from General Radio Type 1680 Automatic Capacitance Bridge showing use of A-B Type CB ¼ watt fixed resistors and Type F ¼ watt adjustable resistors.

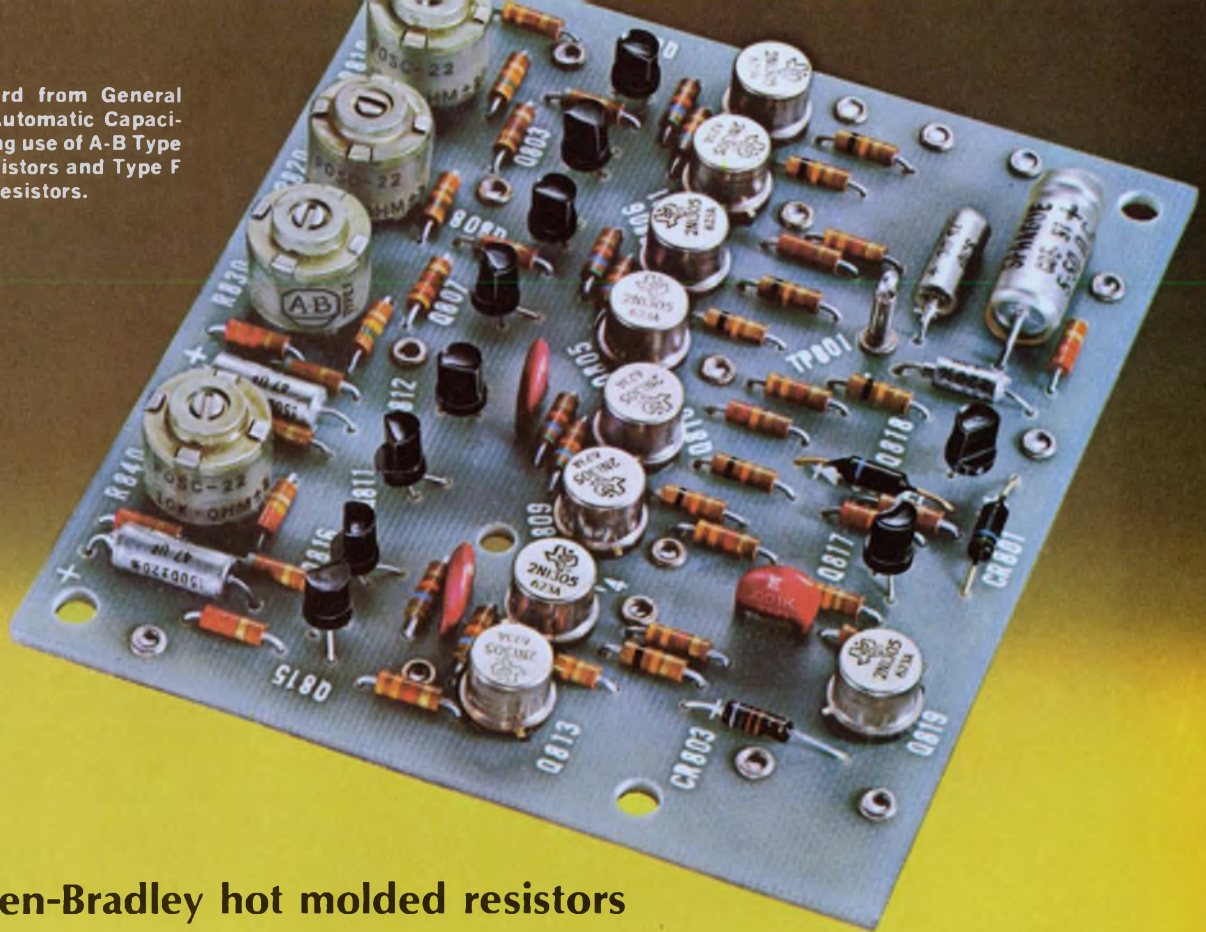

“we use Allen-Bradley hot molded resistors because their consistent, stable characteristics—month to month and lot to lot—ensure repeatable measurements by our instruments.” GENERAL RADIO CO.



General Radio Type 1680 Bridge automatically measures capacitance and loss simultaneously, generates coded digital output data, and displays measured values in about one-half second. The basic accuracy is $\pm 0.1\%$ and the range is from 0.01 pF to 1000 μ F.



Type F variable resistor with pin type terminals for mounting directly on printed wiring boards. Rated ¼ watt at 70°C. Total resistance values from 100 ohms to 5 megohms. Shown actual size.

A-B hot-molded fixed resistors are available in all standard resistance values and tolerances, plus values above and below standard limits. **A-B hot-molded resistors meet or exceed all applicable military specifications including the new Established Reliability Specification.** Shown actual size.



Just as surely as automatic equipment saves its users' money when it is in operating condition, it is virtually worthless when failure of a component has made the entire device inoperative. To insure the reliable and accurate performance of their new automatic capacitance bridge, General Radio designers selected Allen-Bradley hot molded fixed and variable resistors.

Allen-Bradley resistors are made by a hot molding process using completely automatic machines developed by Allen-Bradley. This results in such precise uniformity from one resistor to the next—year in and year out—that long term resistor performance can be accurately predicted. Furthermore, there is no known instance of catastrophic failure of an Allen-Bradley hot molded resistor.

The same manufacturing technique is used with the Type F variable resistors. Their solid hot molded resistance track assures smooth control from the very beginning and which improves with use—and are completely devoid of the abrupt changes to be expected of wire-wound controls. In addition, A-B variable resistors are essentially noninductive, permitting their use at frequencies far beyond range of wire-wound units.

For more complete information on the full line of Allen-Bradley quality electronic components, please write for Publication 6024: Allen-Bradley Co., 1344 S. Second St., Milwaukee, Wis. 53204. In Canada: Allen-Bradley Canada Limited. Export Office: 630 Third Ave., New York, N. Y., U.S.A. 10017.



ALLEN - BRADLEY
QUALITY ELECTRONIC COMPONENTS



This is Gen/Stik™ tape. Here, try it.

Here's a quick and easy way to eliminate a sticky problem forever. Cover the problem with Teflon®, the wonderful plastic that won't let anything stick to its own surface. It is heat and moisture resistant... has tremendous impact resistance and high dielectric strength. The fastest way to apply Teflon is with Gen/Stik.

Gen/Stik is an adhesive-backed, Teflon-coated glass tape that will stick to just about any surface. It will lend all the advantages of Teflon to

your product. It's a permanent way to solve sticky problems with cable bundles, harnesses, and thousands of other design applications.

Gen/Stik tape is available in ¼" to 36" widths, in any length. Also in non-adhesive-backed forms such as glass fabrics, tapes, yarns, cordage and laminates.

Just tell us your needs and we'll gladly send samples. General Cable Corporation, 730 Third Avenue, New York, New York 10017.

GCC

Teflon® is a DuPont Trademark.

ON READER-SERVICE CARD CIRCLE 36

LETTERS

(continued from p. 50)

an operating breadboard made with low-cost commercial units.

Allan G. Lloyd

Project Engineer
Avion Electronics, Inc.
Paramus, N.J.

'Ideal rectifier': design vindicated

Sir:

Allan Lloyd, whose Idea for Design "Ideal rectifier uses equal-value resistors" was published in ED 13, June 21, 1967, p. 96, is quite correct—as he has no doubt proved by actually building and using the circuit.

His critics in the October 11 issue [Letters, ED 21, p. 46] have missed the point that the input current through R_1 divides between R_2 and R_3 when the lower diode is conducting.

[Nathan Sokal and Myron Wolf claimed that Lloyd's circuit rectified positive and negative inputs unequally. They said positive inputs were amplified by +1.0 and negative by -1.5. The cure for this, they said, was to make R_3 two-thirds the value of the other resistors. — Ed.]

Consider, for example, inputs of +5 volts, and -5 volts. When e_i is +5 V, the upper diode conducts, $e_2 = -5$ V, $e_3 = 0$ (no current flows through R_3), and e_o is +5 V.

When e_i is -5V, the lower diode conducts, but, and this is the tricky part, e_3 and the negative input of A_2 must be at the same potential, so the current divides between R_3 and the series string $R_3 + R_4$. Thus e_3 is +3.33 V, e_2 is +1.67 V, and by Kirchoff's law e_o must be +5 V. Note that this does not hurt

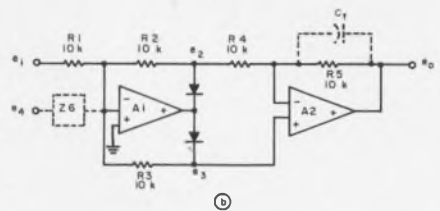

Full-wave rectifier amplifies equally with the value of R_3 shown here.

(continued on p. 56)

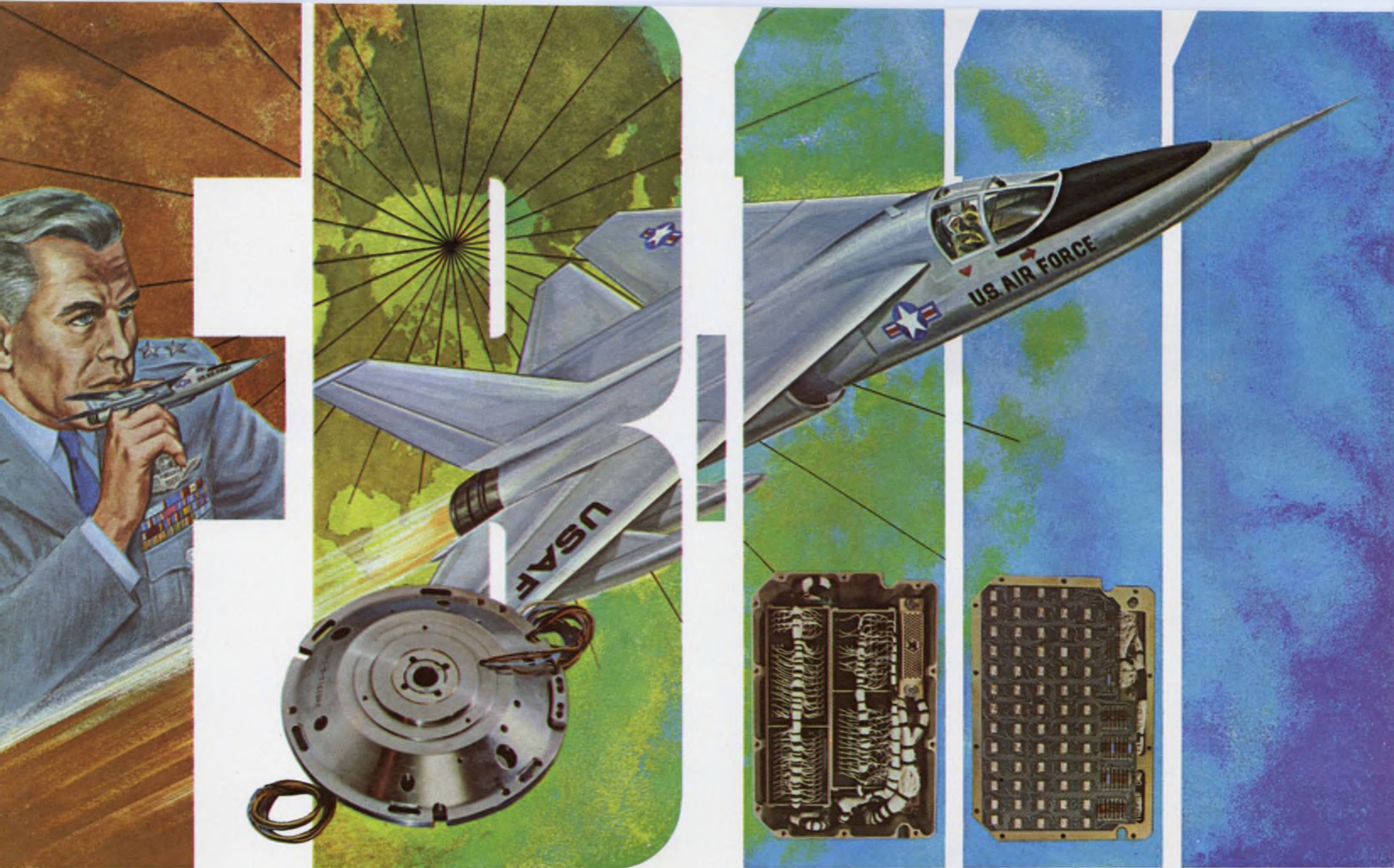

PINPOINT NAVIGATION for the FB-111

Clifton's A/D, D/A Converters consisting of multispeed transducers combined with miniature, all solid state integrated circuitry, offer ideal solutions in the navigation equipment of the FB-111. They are a rugged, high density package, highly accurate, with system resolution from 13 to 21 bits. Talk about state-of-the-art. This is it! In a practical, in production piece of hardware.

DITRAN Division of Clifton *Advances The State-Of-The-Art*

CLIFTON 
DIVISION OF LITTON INDUSTRIES



Type FT Type HG2MT Type HGS2MT Type MR2MT

quiet, please,

not just "whisper" quiet, but circuit quiet—relays that switch microvolt signals with maximum signal fidelity.

Most contact noise and thermal voltage problems are eliminated by Clare Low Level Relays. Four types furnish a wide range of switching speeds and sensitivities. Module packaging is compatible with advanced pcb applications.

Type HGS2MT and HG2MT relays are built around mercury-wetted contact switches, to provide multi-billion operation service with complete freedom from maintenance. Type MR2MT uses the MicroClareed switch to provide faster switching speeds in modules of minimum size. Type FT, in the popular crystal can size, meets extreme conditions of temperature, shock, and vibration.

To keep your circuits quiet, circle Reader Service Number, or ask Clare for Data Sheet 1251B... write Group 12A12,



C. P. Clare & Co., Chicago, Illinois 60645

a GENERAL INSTRUMENT company

- Low thermal voltages at varying duty cycles and ambient temperatures... as low as $1 \mu\text{v}$ at 10% duty cycle $+25^\circ\text{C}$ ambient
- Extremely low contact noise... as low as $5 \mu\text{v}$ at 600 cps band width, 5 ms after energization
- Low and constant contact resistance... 50 milliohms max.; ± 2 milliohms variation over complete life (with mercury-wetted contacts)
- Life: up to 22×10^9 operations

CLARE LOW LEVEL RELAYS

for industrial process control, data logging and instrumentation, analog system calibration, military ground support equipment

ON READER-SERVICE CARD CIRCLE 38

CONRAC
CORPORATION

CHOOSES VISHAY

RESISTORS (over 100 of them) FOR NEW
SOLID-STATE AIR-DATA COMPUTER

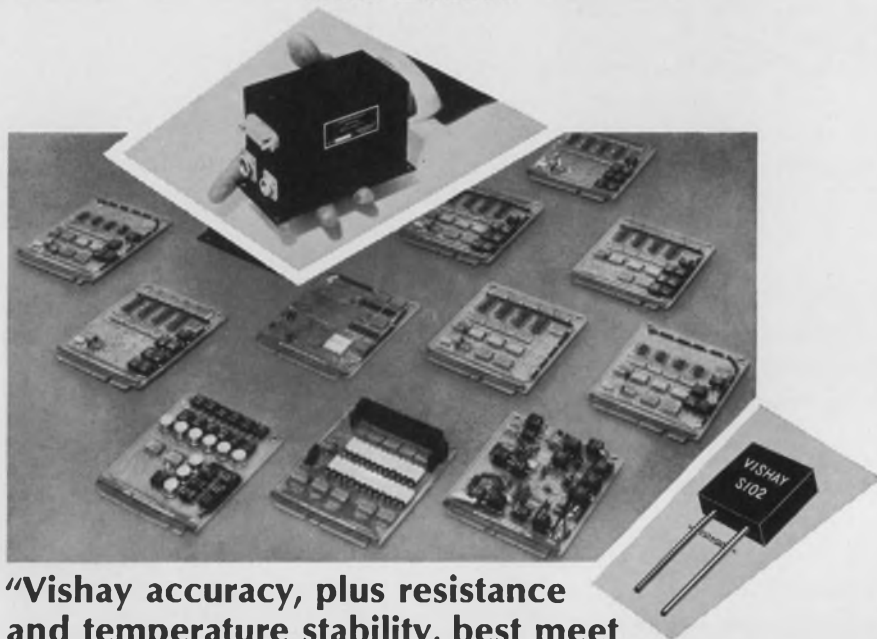

"Vishay accuracy, plus resistance and temperature stability, best meet D-A ladder network's need for resolution of 1 part in 2¹⁵. Also chosen for use in voltage divider of function generator . . . for same spec combination."

Conrac Corporation's 3 lb., 58.5 cu. in. ADC shrinks size 10 times, weight 3-5 times, and simplifies maintenance . . . with unique solid state design.

Conrac engineers met critical space and accuracy requirements by relying on the "no-trade-off" performance of more than 100 Vishay resistors. Vishay's **standard** performance specs (even better on special order) include:

- 0.01% absolute tolerance
- $0 \pm 1 \text{ ppm}/^\circ\text{C}$. TC (0° to $+60^\circ\text{C}$. range)
- Stability—Shelf: Guaranteed 25ppm/yr. (50/3yrs.)
Load: 0.030% (2000 hrs., 125°C .)
- Fast Speed (<1 ns. to 100 MHz. and above)
- No noise ▪ Very small size

These and other Vishay features (including reliability) are expanding the design and performance possibilities in the most demanding applications. Your Vishay man can tell you for whom and where.

The "why" is in these two free brochures. Send for your copies today.

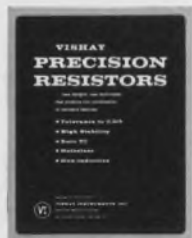

VISHAY
RESISTOR
PRODUCTS



a division of Vishay
Intertechnology, Inc.
63 Lincoln Highway
Malvern, Pa. 19355

ON READER-SERVICE CARD CIRCLE 39

LETTERS

(continued from p. 52)

precision at all: the upper diode remains firmly shut off.

Operational amplifiers are fun to invent—but they should always be checked by first principles rather than formulas.

Daniel H. Sheingold
Applications Engineering Manager
Philbrick/Nexus Research
Dedham, Mass.

Accuracy is our policy

In the Materials listing of the Products section of ED 22, Oct. 25, 1967, p. 154, the illustrations for "Wiring clip formed of ABS plastic" and "Flexible cable withstands 20 million flexes" are exchanged.

In "Light source delivers 2500 W," in the Systems listing of the Products section of ED 22, Oct. 25, 1967, the final sentence should read: "Life at the rated 2500 W is 1500 (not 15, as printed) hours."

In "Magnetic reed switch handles 1875 V/A at 125 Vac," ED 23, Nov. 8, 1967, p. 126, the abbreviation V/A wherever it occurs should read VA—that is, voltamperes, not volts per ampere as printed.

In "Inexpensive IC comprises low-power flip-flop," in the Ideas for Design section of ED 23, Nov. 8, 1967, p. 122, half the circuit was omitted from the published schematic because of a printer's error. The complete circuit schematic is published below:

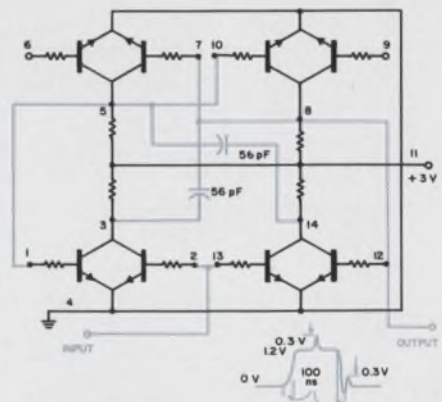

ON READER-SERVICE CARD CIRCLE 40 ▶

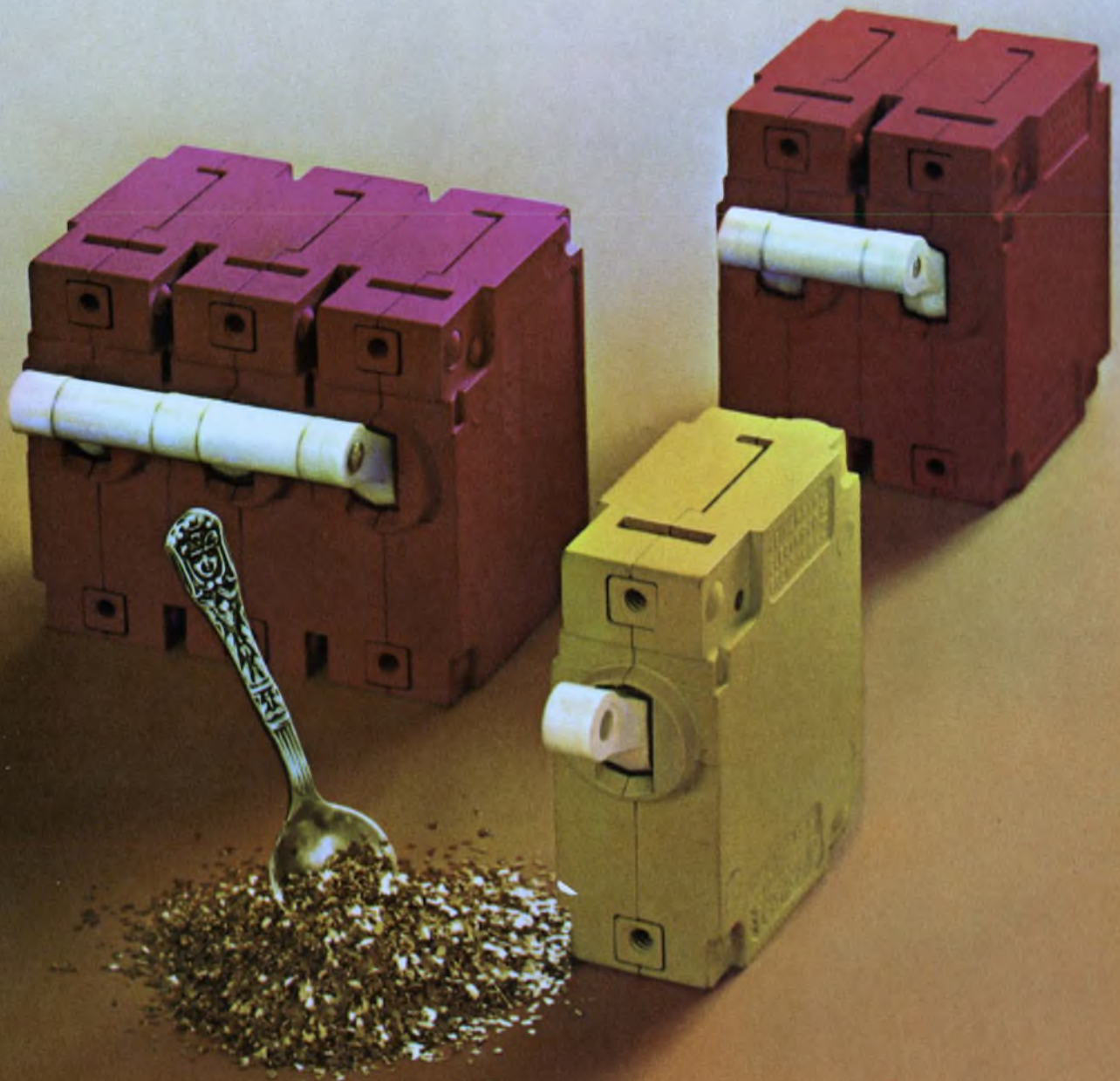

Our 'instant color' circuit breakers.

(The second surprise is that they don't cost a lot of gold.)

Nobody has ever accused Heinemann of being down in the bargain basement of the circuit breaker world. (But almost everyone will admit that our performance well justifies our price.)

The Series JA is a breaker of a somewhat different stripe. The usual Heinemann features are all there—temperature-stable trip-points, precise current ratings, choice of time delays, optional special-function internal circuits. But they cost less in the JA wrapper.

And you can have color, too. Not all over the breaker, of course—just in the part that shows. The mounting boss.

A very simple arrangement of color caps lets you change the boss from basic black to any of eight other colors. You can thereby instantly color-code the breakers to pilot lights, operational sequences, or anything else you might have in mind. Or, you can use them just because they dress up a panel handsomely.

The JA can be had in any integral or fractional current rating from 0.100 to 30 amperes. Standard maximum voltage ratings are 250vac, 60 or 400 Hz; 65vdc. Our Bulletin 3350 will give you complete specs and catalog data. A copy is yours for the asking, of course. Heinemann Electric Company, 2700 Brunswick Pike, Trenton, New Jersey 08602.



HEINEMANN

AMPERITE

GLASS ENCLOSED Thermostatic DELAY RELAYS



Offer true
hermetic
sealing—

— assure
maximum
stability
and life!

Delays: 2 to 180 seconds

Actuated by a heater, they operate on A.C., D.C., or Pulsating Current . . . Being hermetically sealed, they are not affected by altitude, moisture, or climate changes . . . SPST only — normally open or normally closed . . . Compensated for ambient temperature changes from -55° to $+80^{\circ}$ C. . . Heaters consume approximately 2 W. and may be operated continuously. The units are rugged, explosion-proof, long-lived, and inexpensive!
TYPES: Standard Radio Octal and 9-Pin Miniature . . . List Price, \$4.00
PROBLEM? Send for Bulletin No. TR-81.

AMPERITE

BALLAST REGULATORS

Hermetically sealed, they are not affected by changes in altitude, ambient temperature (-50° to $+70^{\circ}$ C.), or humidity . . . Rugged, light, compact, most inexpensive.

List Price, \$3.00

Write for
4-page
Technical
Bulletin
No. AB-51

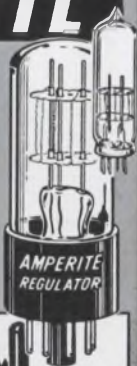
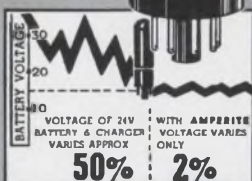

AMPERITE

600 PALISADE AVE., UNION CITY, N.J.
Telephone: 201 UNION 4-9503

In Canada: Atlas Radio Corp., Ltd.,
50 Wingold Ave., Toronto 10

Adding s-t-r-e-t-c-h to radar range

By traveling over the horizon—to Texas, New Jersey, upstate New York and Massachusetts—East Coast Editor Neil Sclater collected facts on the development of over-the-horizon radar. Military-Aerospace Editor John Mason and he then collaborated to write the story that starts on p. 25. Unlike ordinary ground-based radar, which is limited by the curvature of the earth to a range of 150 miles or so, the highly classified over-the-horizon systems scan targets up to 4000 miles away by bouncing signals off the ionosphere.

Mason, who has had more than a decade of experience writing about military electronics, is the latest addition to ELECTRONIC DESIGN's news staff.



Sclater (r.) ponders the layout of the radar report with News Chief Ralph Dobriner (l.) and Art Assistant Bill Kelly (foreground).

Testing . . . 1, 2, 3, 4

The initial feedback from readers favors ELECTRONIC DESIGN's new feature, "Test Your Retention," at the end of technology articles. The self-testing aid, designed to check understanding of articles, is drawing such comments as these in Editorgrams to ED: "Sharpens power of synthesis. Please continue it" (from an electronic engineer in Rochester, N.Y.); "I like the idea" (design engineer in Kokomo, Ind.) and "Aids fast reading of articles and provides quick check of highpoints" (field engineer, Burlington, Mass.).

Deafness may be thing of the past

News Editor Richard Einhorn reports on p. 30 on one of the most inspiring developments in electronics—a device that may someday abolish deafness altogether. He personally tested two neural hearing devices. One made his hair stand on end and its apparent loudness made him wince, yet with it he was able to hear clearly through the nerves in his head. His only complaint: he didn't like the music played.

Small wonder:



Our new "4th-generation" 12.5 MHz universal counter/timer. Wonderful versatility in a wonderfully small package — at an even more wonderfully small price.

With the new Model 100A you can measure average frequency, frequency ratio, single period or time interval, or count total events. It has a crystal-controlled clock, Monsanto integrated circuit construction, and built-in compatibility with a rapidly growing assemblage of accessory modules.

With its \$575* price tag (accessory modules are pegged at comparably modest rates) you can have big-league counter/timer performance at

costs never before possible. Small wonder we are selling (and delivering) Model 100A's just as fast as we can build them.

Call your local Monsanto field engineering representative for full technical details, or contact us directly at: Monsanto Electronics Technical Ctr., 620 Passaic Avenue, West Caldwell, New Jersey 07006. Phone (201) 228-3800; TWX 710-734-4334.

*U.S. Price, FOB West Caldwell, New Jersey.

Monsanto
ELECTRONICS

Smallest 4-pole relays to qualify for U/L Component Recognition Program

P&B Quality, too!



Meet our new KHU relays... companions to our KHP series

These new 4-pole relays have an extraordinary combination of features. Small size (only slightly larger than one cubic inch), 4-poles, exceptional electrical stability over a long life, a wide choice of mountings . . . all of these and Underwriters' recognition, too. Spacings provided are 1/16" through either air or over the surface and are maintained between any uninsulated live part of opposite polarity or grounded part, including the grounded frame.

Switch four circuits from low level to 3 amps

The KHU, available in both AC and DC versions, has gold flashed silver contacts rated 3 amps 120V AC (80% PF), 3 amps 28V DC (resistive), and 1/10HP 120V AC (40-50%PF). Coil ratings are to 120V 60Hz, and to 120V DC.

Minimum power requirement for AC relays is 0.55 volt amperes at 25°C. DC relays will operate on only 0.5 watts at 25°C. Expected mechanical life is exceptionally great; 100 million cycles for DC relays; 50 million for AC relays.

Variety of mountings

The relay has pierced solder terminals with a No. 3-48 mounting stud. Three sockets are available, two having solder terminals and one having printed circuit tabs. Each is acceptable for mounting under U/L File No. E22575 when the combination is found suitable by Underwriters' Laboratories.

Send for complete specifications or contact your local P&B representative or the factory direct for complete information.

P&B STANDARD RELAYS ARE AVAILABLE AT LEADING ELECTRONIC PARTS DISTRIBUTORS



POTTER & BRUMFIELD

Division of American Machine & Foundry Company, Princeton, Ind. 47570
Export: AMF International, 261 Madison Avenue, New York, N. Y. 10016

Co-Publishers

James S. Mulholland, Jr.
Hugh R. Roome

Editor

Howard Bierman

Managing Editor

Robert C. Haavind

Technical Editors

Jeffrey N. Bairstow
Peter N. Budzilovich
David H. Sorgan

Management and Careers Editor

Howard S. Ravis

News Editors

Ralph Dobriner, Chief
Richard N. Einhorn

Washington News Bureau

Charles D. LaFond, Chief

East Coast Editor

Neil Sclater

West Coast Editor

Ron Gechman

New Products Editor

Steven B. Futterman

Copy Editor

Peter Beales

Editorial Production

Dollie S. Viebig
Phyllis Gura

Art Director

Clifford M. Gardiner

Art Assistant

William Kelly

Technical Illustrators

Cheh Nam Low
Sheila F. Ward
William Alvarez

Production Manager

Thomas V. Sedita

Asst. Production Manager

Helen De Polo

Production Assistants

Bernard Wolinsky
Gregory A. Bannon

Circulation Manager

Nancy L. Merritt

Reader Service

Diane Mandell

EDITORIAL

Two-sided rules needed for the old contract game

The much publicized developmental problems encountered with the F-111 fighter-bomber, the M-16 infantry rifle and the Apollo program raise a serious question: Is something wrong with the Government's procurement procedures?

In contracting for new equipment, our democracy traditionally has placed high faith in the competitive-bidding process. Government engineers and other specialists set the general specifications for the equipment. The Government procurement agency then issues a request for proposals from a selected number of bidders, based on their experience and past records of performance. On receipt of proposals, the procurement agency narrows the specifications and issues bids to those contractors that are expected to come closest to fulfilling the requirements.

Cost is an extremely important factor in the selection of the successful contractor. And in many cases the Government's requirements are realistic and the contractor's price is right; the Government gets what it wants, and the successful bidder makes a profit and enhances a good reputation. In other cases, unfortunately, the goals are unrealistic and the contractor, either through excessive zeal, greed or wishful thinking, submits the lowest bid and takes on an assignment that he cannot fulfill. Or if he does complete the job, he does it poorly.

The result is well known. These are the cases that crash into the headlines in newspapers around the country. Fines are levied by the Government, funds withheld and there is a public washing of dirty linen in which charges and countercharges are freely traded. The contractor holds the bag in these cases, but should he always?

Investigations of the fiascos ignore such questions as: Was the contract poorly written? Are the specifications realistic? Nobody in government is held responsible. In many cases the Government procurement team, responsible for overseeing the contract, has changed its membership several times. Meanwhile heads have rolled in industry to expiate the default, and the Government issues other contracts to "clean up the mess."

There's got to be a better way to do it! Here's one suggestion.

The Government should consider appointing permanent procurement boards whose experience and professional standing is equal to or greater than that offered by the contractors. Top pay should be offered to attract top talent. These boards should then have a stronger hand in resolving production difficulties. Considering the importance and cost of our major systems efforts, we believe the Government must accept more responsibility in the execution of its contracts.

NEIL SCLATER



Tektronix Type 453 portable oscilloscope

takes the guesswork out of triggering

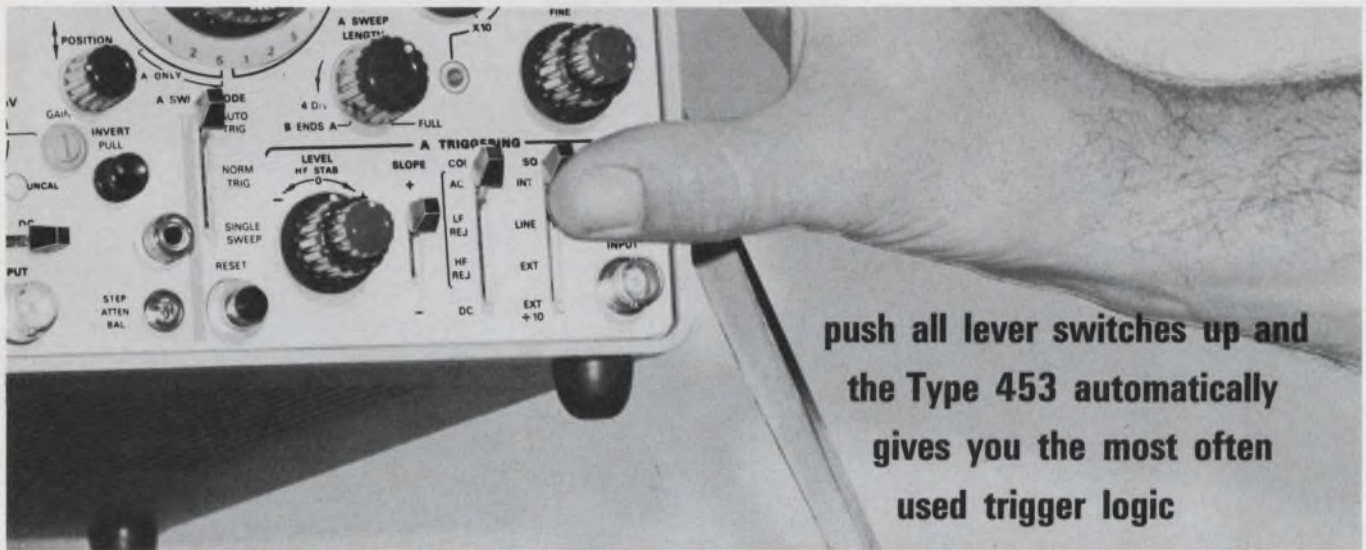

push all lever switches up and
the Type 453 automatically
gives you the most often
used trigger logic

The Type 453 provides the following features when all lever switches are up: automatic triggering that allows discrete trigger level selection with the presence of a signal and provides a bright base line at all sweep speeds when no signal is present; + slope triggering; AC coupling that gives positive triggering regardless of vertical positioning; and internal triggering that makes full use of the vertical amplifier gain and the compact internal delay line. The Type 453 will trigger to well above 50 MHz and a green light gives a positive indication of a triggered sweep.

The Type 453 is a portable instrument with rugged environmental capabilities plus the built-in high performance normally found only in multiple plug-in instruments.

The vertical amplifier provides dual trace, DC to 50 MHz bandwidth with 7 ns risetime from 20 mV/div to 10 V/div. (DC to 40 MHz, 8.75 ns T_r at 5 mV/div.) The two included Type P6010 miniature 10X probes maintain system bandwidth and risetime performance at the probe tip—DC-50 MHz, 7 ns—with an increase in deflection factors of 10X. You can also make 5 mV/div X-Y and 1 mV/div single trace measurements.

For a demonstration, contact your nearby Tektronix field engineer or write: Tektronix, Inc., P. O. Box 500, Beaverton, Oregon 97005.

You can operate the delayed sweep with ease. Lever control to the right and HORIZ DISPLAY switch to A INTEN DURING B gives delayed sweep operation. Setting the B TIME/DIV and the DELAY-TIME MULTIPLIER to meet your requirements and switching to DELAYED SWEEP allows $\pm 1.5\%$ delay measurements to be made.

The Type 453 is a continuation of the Tektronix commitment to quality workmanship. Its design and layout make it easy to maintain and calibrate. Transistors plug in and are easily removed for out-of-circuit testing. An accurate time ($\pm 0.5\%$) and amplitude ($\pm 1\%$) calibrator permits quick field calibration.

The front panel protection cover carries all the accessories with the complete manual carried in the rain/dust cover. The Type C-30 Camera and a viewing hood that fits in the rain cover also are available.

Type 453 (complete with probes and accessories)	\$1950.00
Type C-30 Camera	\$ 420.00
Collapsible Viewing Hood	\$ 7.50

U.S. Sales Prices, FOB Beaverton, Oregon



Customer training courses



... part of the Tektronix commitment
to continuing customer service

Technology

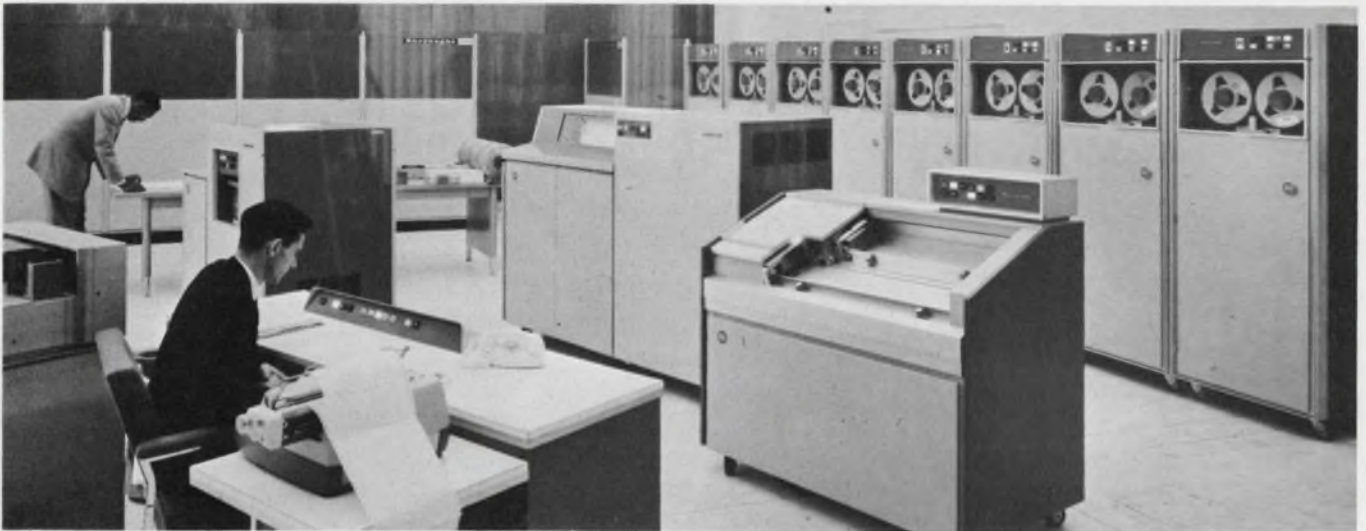

ILLIAC IV parallel processor heads toward one billion operations a second. System for

the multimachine array is being designed by a joint university-industry project. Page 64

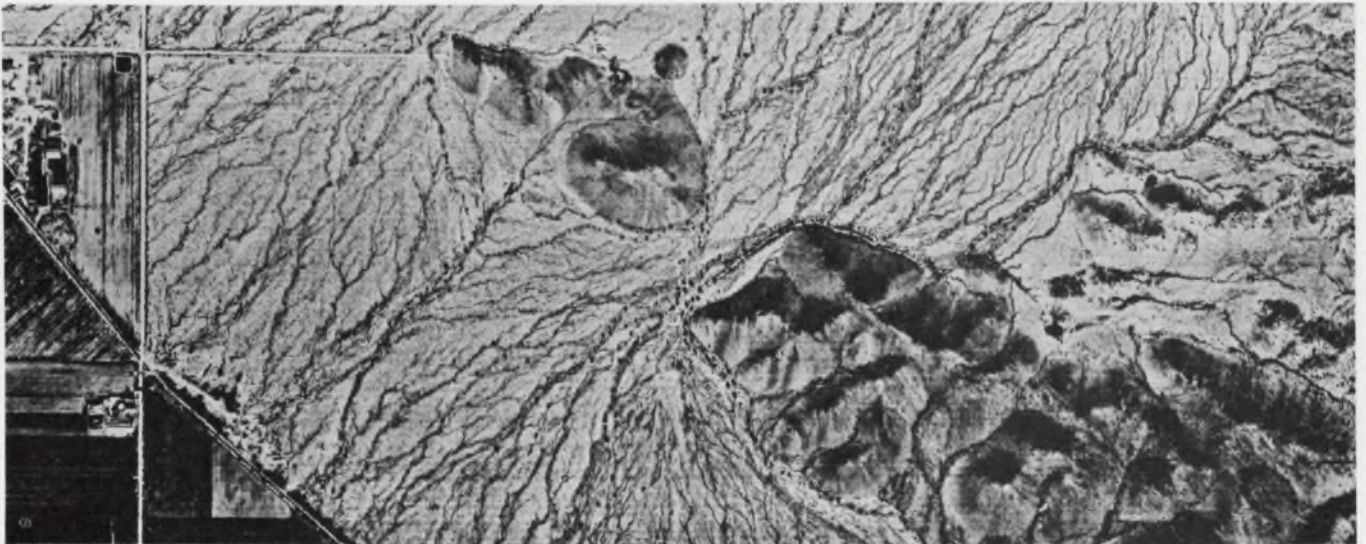

Statistics speed the video bandwidth design for surveillance mapping systems. What the

eye does not see is what counts in efficient optical and radar scanning systems. Page 72

Also in this section:

Ferrite core design is made less tedious by use of three nomograms. Page 76

In checking passive RC differentiators, include stray impedances. Page 82

Learn how to listen in order to communicate well. Page 90

ILLIAC IV: route to parallel computers

A university-industry project is crystalizing system design for this unconventional multimachine array.

On the road to the billion-operations-per-second computer, two important limitations are becoming increasingly apparent within the present framework of design. They are:

- The limits of component speed.
- The limits of serial machine organization.

Except in the unlikely event of the appearance of radically new and faster components, the most promising design approach would seem to be a new concept of machine organization, such as the parallel processor. Such a machine is the ILLIAC IV computer,* a joint project of the University of Illinois and the Burroughs Corp.

The major system design decisions for ILLIAC IV have already been taken and detailed design work is now under way. This article, then, is a review of the system design and the rationale behind the design decisions.

Pipeline computers near their limit

Since the initial concept and design of the stored-program computer, throughput has been improved in two essential ways: by increasing the operating speed of the hardware components, and by selectively adding functional features to the machine organization, to improve the execution time of strings of serial instructions. Such features as index registers, instruction look-ahead, associative memories, multistation arithmetic algorithms and operand look-ahead have generally been used to speed the single instruction strings. Computers that employ this type of organization, known as "pipeline" computers, are about at the practical limit for executing serial programs.

Component speed, the other serious limitation, is a function of line capacitance, heat dissipation and signal-wire delay. Industry has now come to the point where it can no longer count on faster

components to yield a traditional "order-of-magnitude" improvement in forthcoming generations of machines.

New machine organization evolves

In contrast to these limitations, some promising developments in packaging techniques and component economy are available. The development of the integrated circuit is such that more and more logic functions can be installed on a single chip at an ever lower cost per function. The growth of thin-film systems is also in this direction, so that the cost per unit function will continue to decline.

Parallelism with shared control

The larger problem of increased performance can be simply stated as how to improve machine throughput by using more components. Since the practical limit has been reached with single serial-instruction strings, improvement must be in the direction of finding some way to parallel the program by concurrently executing several instruction strings. Functional parallelism is still the most practical way.

For important classes of problems, many repetitive loops of the same instruction string are executed with different and independent data blocks for each loop. Parallelism may be applied here by using N computers, each executing the identical program concurrently on separate data blocks. This will improve execution time by a factor of N for that program. Similarly, since each computer is executing the identical program, much of the control logic of the computers could be made common. This is the fundamental proposition of the ILLIAC IV computer.

Figure 1a shows a three-step evolution from conventional design to the ILLIAC IV. The top schematic shows three identical loops of a program ($I1, I2, I3$) operating on three different data blocks ($D1, D2, D3$) in series. The block element shown is a computer (without input-output or memory) that is functionally separated into a control part and an execution part.

Figure 1b shows a simple application of parallelism that produces a threefold increase in through-

*Project supported by the Advanced Research Projects Agency as administered by the Rome Air Development Center under USAF contract No. 30(620)4144. See also "ILLIAC IV development goes to Burroughs and Illinois U," ED 5, March 1, 1967, pp. 21-22.

Richard A. Stokes, Technical Director, ILLIAC IV Program, Burroughs Corp., Paoli, Pa.

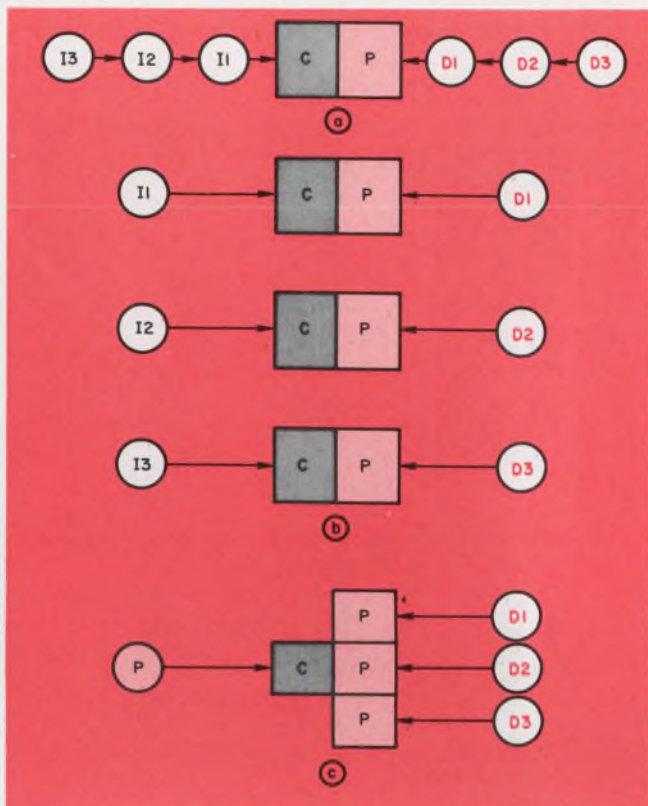

1. **Development of parallelism** began with the aim of improving the throughput of the pipeline computer (a). Simply paralalled identical processors (b) executing the same program could have common control logic (c).

put. The final schematic in Fig. 1c shows the ILLIAC IV approach with its simplifications and economies over the above method.

The ILLIAC IV system approach requires a distributed memory system in which each execution element has uninhibited access to an assigned data block within its own memory. If a common mass memory were used, much time would be wasted in routing data to and from the memory. Thus the four major elements of the ILLIAC IV, are the control unit (CU), the processing element (PE), the processing-element memory (PEM), and the input-output (I/O) subsystem.

The ILLIAC IV system

The combination of a PE and a memory module is called a processing unit. A control unit directly governs 64 processing units (Fig. 2). In the ILLIAC IV system there are four such identical arrays called quadrants, making a total of four control units and 256 processing units. Quadrants may function jointly or separately.

Each processing unit is labeled with a unique three-digit octal number. The first octal position is the quadrant number and the second two positions are the PU number within a quadrant. The four "nearest neighbor" connections within the array are defined in terms of direct parallel word

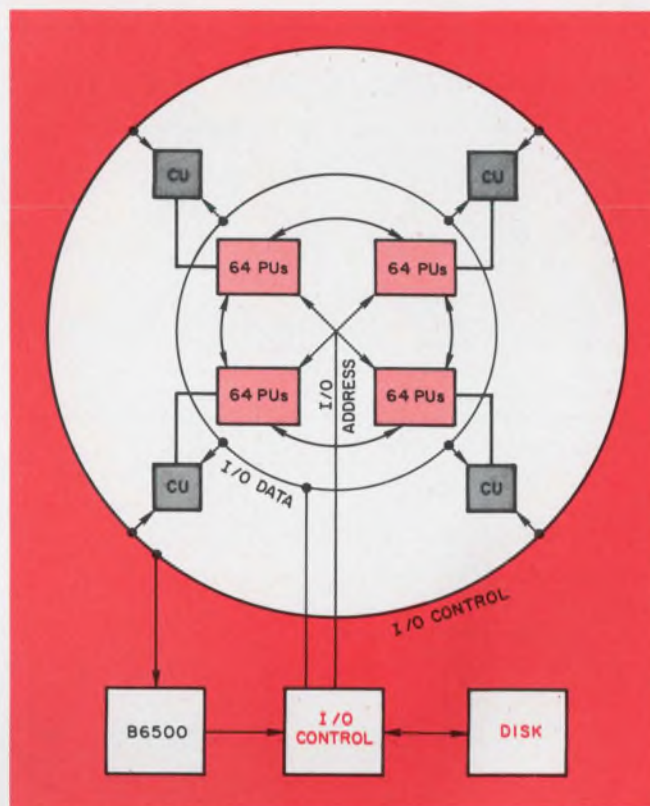

2. **The basis of ILLIAC IV** is four quadrants of 64 processing units under the command of four control units. Each PU is a computer with an individual thin-film memory of 2048 sixty-four-bit words.

transfer paths between one PU and others with labels that have values plus or minus eight, or plus or minus one, from the value of the former PU's label (Fig. 3). Thus PU 33 can transfer directly only to PUs 23, 32, 34 or 43. This connectivity is maintained for both separate or joined quadrants and enables a variety of physical images to be modeled—for example, weather maps—by means of a combination of these transfer paths. All control units have full-word data interconnections for programs that operate in more than one quadrant.

The Burroughs parallel disk file (Fig. 4) is the principal secondary storage element. Successor to the present head-per-track disk files, this file will provide a storage capacity of 161×10^6 bits per storage unit with a transfer rate of 500×10^6 bits per second. Six such storage units will be provided for the initial ILLIAC IV system. Data will be routed in and out of the disk files through the I/O control and the quadrant data busses.

Set a computer to control a computer

To complete the system, a B6500 computer (Fig. 6) will serve as the principal managing element. All executive control, facility allocation, peripheral-equipment control, I/O processing and initialization, fault recovery, and program assembly (and compilation at some future time) will be

The Gauss-Jordan reduction of a matrix

The Gauss-Jordan method is a scheme for reducing a matrix to a diagonal matrix:

$$\begin{bmatrix} 1 & 0 & 0 \\ 0 & 1 & 0 \\ 0 & 0 & 1 \end{bmatrix}$$

Such a diagonal matrix may be used for computing the inverse of a matrix or the direct solution of a set of linear, nonhomogeneous algebraic equations. As an example of the operations involved in the reduction to a diagonal matrix, consider the complete solution of the set of linear algebraic equations:

$$2x_1 + x_2 + 2x_3 = 2$$

$$3x_1 - 2x_2 - x_3 = -2$$

$$2x_1 + 3x_2 + 3x_3 = 1$$

The augmented matrix is:

$$\begin{bmatrix} 2 & 1 & 2 & 2 \\ 3 & -2 & -1 & -2 \\ 2 & 3 & 3 & 1 \end{bmatrix} \text{ or generally } \begin{bmatrix} a_{11} & a_{12} & a_{13} & a_{14} \\ a_{21} & a_{22} & a_{23} & a_{24} \\ a_{31} & a_{32} & a_{33} & a_{34} \end{bmatrix}$$

The first step is to reduce the a_{11} term, the pivot element, to 1 by dividing the first row, the pivot row, by the value of a_{11} :

$$\begin{bmatrix} 1 & 1/2 & 1 & 1 \\ 3 & -2 & -1 & -2 \\ 2 & 3 & 3 & 1 \end{bmatrix}$$

The remaining elements on column 1, the pivot column, are now reduced to zero by subtracting the appropriate

multiple of row 1 from each of the remaining rows. For example, for row 2, $3 \times$ (each element of row 1) is subtracted from each corresponding element in row 2.

$$\begin{bmatrix} 1 & 1/2 & 1 & 1 \\ 0 & -7/2 & -4 & -5 \\ 2 & 3 & 3 & 1 \end{bmatrix}$$

Similarly for row 3, $2 \times$ (each element in row 1) is subtracted from each corresponding element in row 3.

$$\begin{bmatrix} 1 & 1/2 & 1 & 1 \\ 0 & -7/2 & -4 & -5 \\ 0 & 2 & 1 & -1 \end{bmatrix}$$

The process is now repeated with row 2 as the pivot row and element a_{22} as the pivot element.

$$\begin{bmatrix} 1 & 1/2 & 1 & 1 \\ 0 & 1 & 8/7 & 10/7 \\ 0 & 2 & 1 & -1 \end{bmatrix} \quad \begin{bmatrix} 1 & 0 & 3/7 & 2/7 \\ 0 & 1 & 8/7 & 10/7 \\ 0 & 0 & -9/7 & -27/7 \end{bmatrix}$$

Then finally with row 3 as the pivot row and element a_{33} as the pivot element.

$$\begin{bmatrix} 1 & 0 & 3/7 & 2/7 \\ 0 & 1 & 8/7 & 10/7 \\ 0 & 0 & 1 & 3 \end{bmatrix} \quad \begin{bmatrix} 1 & 0 & 0 & -1 \\ 0 & 1 & 0 & -2 \\ 0 & 0 & 1 & 3 \end{bmatrix}$$

This completes the reduction to a diagonal matrix, which can then lead to computer solution of large matrices. In this simple example, the solution to the original set of equations is easily seen:

$$x_1 = -1, x_2 = -2, x_3 = 3.$$

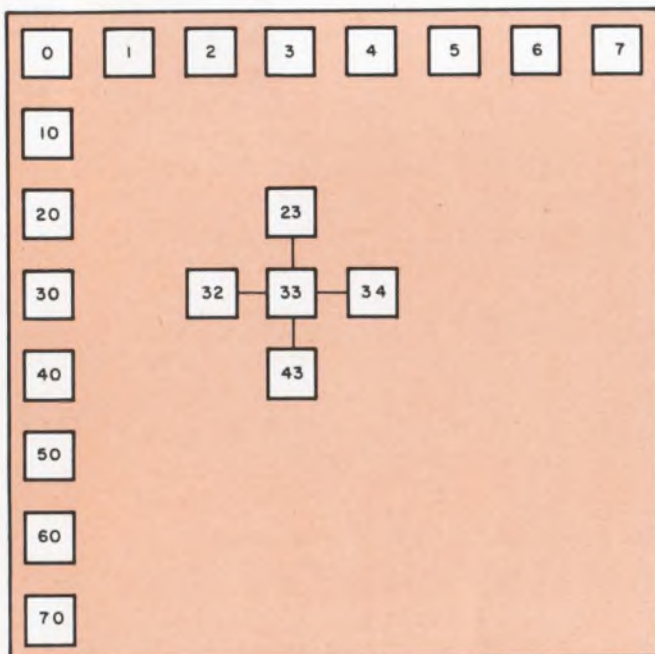

3. Direct parallel word transfers between processing units are only allowed between nearest neighbors. The transfers are maintained for both separate and joined quadrants. Note the octal numbering system.

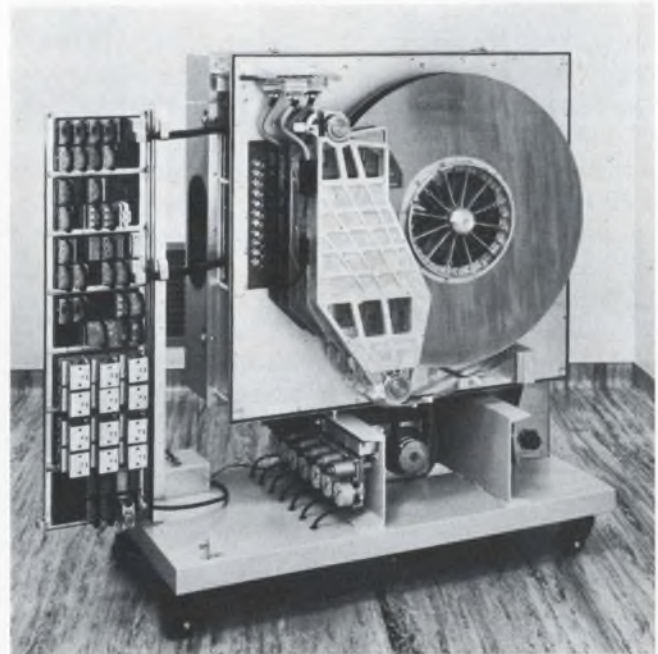

4. The principal secondary storage will be a parallel disk file similar to the current model of Burrough's head-per-track disk file (shown here). Transfer rates will be up to 500 million bits per second.

Matrix reduction with ILLIAC IV

To see how the elements of ILLIAC IV are used, consider the pivoting operation that occurs in the Gauss-Jordan reduction of a matrix. This operation is the major part of a scheme for matrix inversion. It consists of subtracting an appropriate multiple of the pivot row from each of the other rows in the matrix (a different multiple from each row), so that the elements in the pivot column are reduced to zero. The pivot row itself is normalized by division by the pivot element, and the pivot element is thus replaced by unity. In the case where the inverse matrix is to be generated on top of the original matrix, the elements of the pivot column, apart from the pivot element, are changed in sign and divided by the pivot element.

The matrix to be inverted is stored skewed. The interconnections between PEs are used so that the array acts as a linear array with end-around connection. The array connections and the storage allocation are illustrated in the diagram.

To subtract a multiple of the pivot row from another row, it is necessary for the corresponding elements of the two rows to be available in the same PE. The strategy to achieve this is to route the normalized pivot row round the array a distance of one PE at a time. In practice the routing is from S register to S register and it is the negative of the normalized pivot row that is routed. In each successive orientation, the pivoting operation is carried out on all rows with which the pivot row is currently aligned.

The steps for this are:

1. The element in the pivot column of the row aligned is broadcast.
2. The negated pivot row is copied into the A register from the S register and multiplied by the quantity broadcast in the previous step.
3. The current element of the row aligned is added to the product.
4. The result is stored in local memory on top of the element.
5. All other rows aligned are treated in the same way.
6. The pivot row is then rotated one further position round the array and the whole process is repeated. Routing is from S register to S register.
7. After routing through eight positions, a further set of eight elements from the pivot column are fetched from the PE memories and stored in the CU local memory for subsequent broadcasting, one at a time, in step 1.
8. If the size of the matrix (number of rows and columns)

exceeds the number of PEs in the array, the pivot row must be routed in sections. It is convenient to route each section in turn a distance of eight before routing the first section any further.

9. In the case where the pivot row is being routed in sections there are as many sections as there are 8-word segments of the pivot column maintained in the CU local data buffer. Each segment is appropriate for one of the rows aligned in any storage.

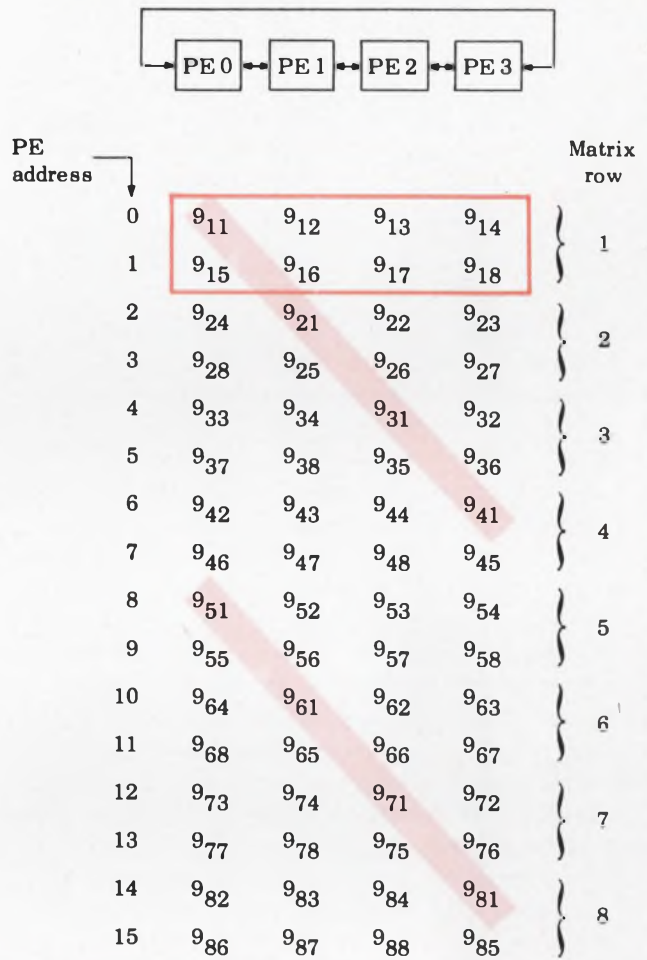

done by this subsystem. Figure 2 shows a direct data link between the B6500 system and the control units. It is this link that the B6500 uses to set the initial state word in each CU. The state word contains the initial value of the program counter, the control state and the configuration of the array. The configuration describes which quadrants are working jointly on the same program and which, if any, are operating independently. The B6500 will also institute the necessary disk-to-array memory transfer of program and operands before allowing the control units to proceed.

The I/O controller, supplied with start address information by the B6500, provides the necessary intermediate memory address to the control unit and the disk file during a transfer. Data transfers

are made directly to or from the processing units. Once the required number of instructions and operands have been transferred from the disk, the control unit will begin with an initial instruction fetch and proceed in the conventional manner of a stored program computer. Instructions as well as operands may be transferred across quadrant boundaries, so they need to be stored only once, regardless of the configuration.

The control unit smooths the instruction path

The control unit is the part of the computer system that performs all the necessary initial instruction processing up to and including the generation of the instruction microsequences (see box) for a

An example of a PE microsequence

The following microsteps are accomplished in the execution of the microsequence for a floating-point add instruction (see Fig. 7).

- | | |
|-------------------------------|---|
| 1. <i>Fetch operand</i> | Transfer to B register (RGB) the operand identified by address field of the instruction |
| 2. <i>Difference exponent</i> | Subtract exponent fields of operands in A register (RGA) and RGB |
| 3. <i>Mantissa alignment</i> | Shift the mantissa of the operand in RGA or RGB by amount determined from step 2 |
| 4. <i>Add mantissa</i> | Add mantissa field of operands in RGA and RGB |
| 5. <i>Normalize</i> | Normalize sum in RGA |



5. The manager of the ILLIAC IV will be a B6500 computer. Its functions will include executive control, I/O processing, peripheral-equipment control, fault recovery, and program assembly and compilation.

step-by-step control of the processing elements.

Figure 2b is a block diagram of this single cabinet unit. Contained within the control unit are five separate operating elements, which perform specialized processing tasks on a semi-independent basis. The program look-ahead unit fetches instruction words in 8-word blocks from the array memory into a 64-word content-addressable memory used as an instruction stack memory. Individual instructions are located by an associative memory that holds all but the four low-order bits of each instruction. The value from an instruction counter is sent to the associative memory to locate the proper 8-word group in the instruction stack. Then the four low-order bits are used to pick the individual instruction. This element provides a queue of up to 128 instructions for execution and rapid local access of instruction loops contained within the instruction stack.

From the instruction stack, instructions are fed in turn to the Advanced Station (ADVAST), which is the principal housekeeper of the system. Such functions as address arithmetic, loop control, mode control, interrupt processing and configuration control are performed here. The hardware complement of ADVAST consists of a 64-word operand stack, four full-word accumulators and a combinatorial logic unit. The logic unit permits functions such as adds, compares, shifts, bit testing, etc. This station provides all those activities generally described as program control to be performed concurrently in advance of, and separately from, the main processing activity.

Instructions fall into two general categories: those executed at ADVAST and those executed at the final station (FINST). Since all instructions are first at ADVAST, those instructions intended for execution at FINST are transferred to FINST over a final queue (FINQ). This element is composed of eight instruction storage positions, which perform a time smoothing function between ADVAST and FINST. When programs contain a disproportionate number of one or other type of instruction, the function of this element is frustrated. Extensive simulation of practical programs has justified the use of this unit, however.

The final station decodes each instruction into a control microsequence, which is broadcast to 64 array elements over a control bus (Fig. 2). FINST also broadcasts full-word operands, shift counts, test values and other common array parameters on a data bus. For timing purposes, the FINST and the 64 array elements are lock-stepped, except for the fixed transmission delay of the intervening control bus.

The memory service unit resolves the conflicts of the four users of the array memory: I/O, ADVAST, FINST, and program look-ahead. It also transmits the appropriate address to memory and exercises control over the memory cycle. As a hardware expedient, the addresses are transmitted over the same common data bus mentioned above.

Processing element is a building block computer

The array element, the execution portion of the computer shown in Fig. 1c, is called a processing

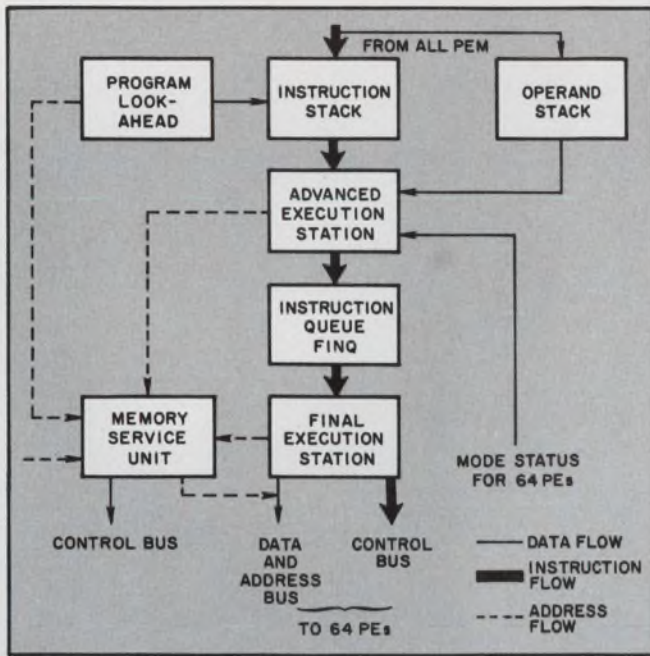

6. Generation of initial instructions and microsequences for each quadrant will be handled by a control unit. It will provide a queue of up to 128 instructions in a content addressable memory.

element (PE). A processing element is devoid of all independent control with the exception of mode and some data-dependent conditions. Mode permits a PE to accept or ignore a broadcast control sequence from the control unit.

Figure 7 is a block diagram of PE. It is essentially a 3-register arithmetic unit which performs a full repertoire of instructions of 64-, 32- and 8-bit operands. Full floating-point operations are included for the 64- and 32-bit words. It uses 64-pin ECL with 3-ns gate delay.

A carry-save adder tree and a parallel adder with carry look-ahead logic combine to give a floating-point multiply time on the order of 400 nanoseconds and a floating-point add time of 200 nanoseconds. Both times include post normalization. Other logic elements include a barrel switch for rapid data-shifting, a leading-one's detector and a logic unit for Boolean operations. Instruction operands may originate in any of the PE registers, the common data bus, the nearest orthogonal neighboring PEs or the array memory.

The array memory (or PEM) consists of independent thin-film memory modules with each module collocated and assigned to a PE. Each module has 2048 words of 64 bits. The memory is being designed for a 250-nanosecond read-write cycle. The PE memory address register supplies memory addresses. A separate address adder and index register permits independent memory indexing and addressing. Such independence provides important flexibility for addressing data stored in a variety of ordered forms. ■ ■

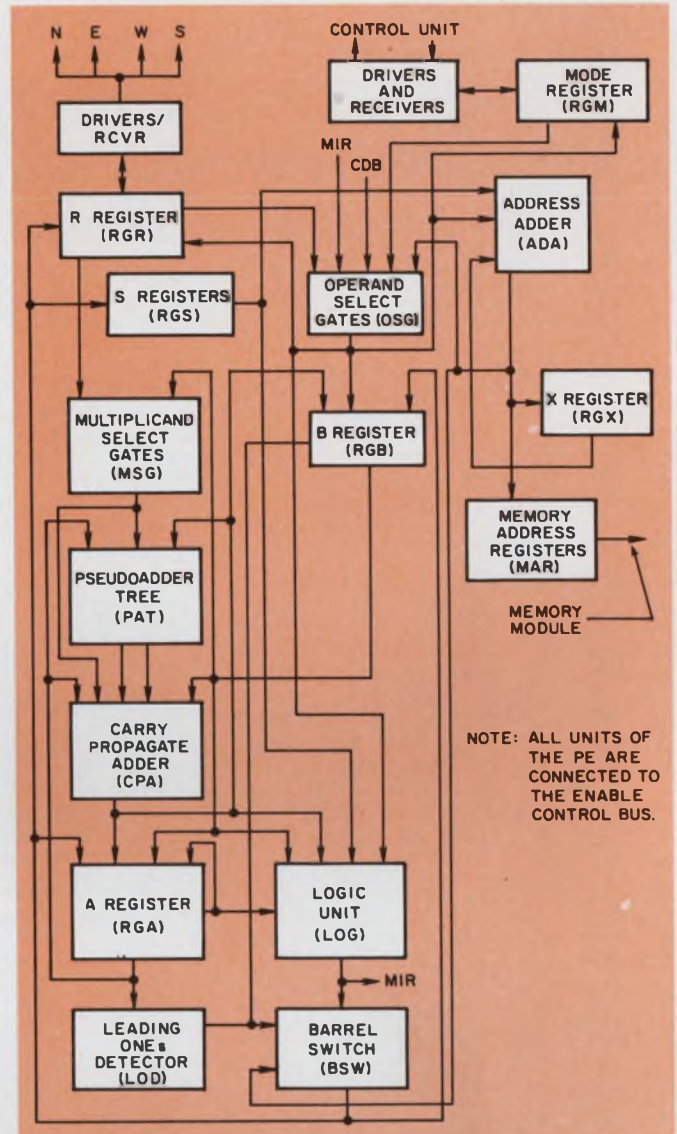

7. The processing element has three principal registers. It will be built from 64-pin ECL logic packages. Instruction execution times are typically 200 ns for floating point add and 400 ns for floating point multiply.

Test your retention

Here are questions based on the main points of this article. They are to help you see if you have overlooked any important ideas. You'll find the answers in the article.

1. What are the principal methods of increasing the throughput of the stored-program computer?
2. Why does ILLIAC IV use a distributed memory system?
3. What are the functions of the B6500 computer used as a part of the ILLIAC IV system?
4. What is a microsequence and how is it generated and executed?
5. What are the differences between the advanced and final stations? What are their functions?

**PROBLEM:
YOUR CIRCUITS NEED
THE LOW COST
OF HIGH VOLTAGE.**

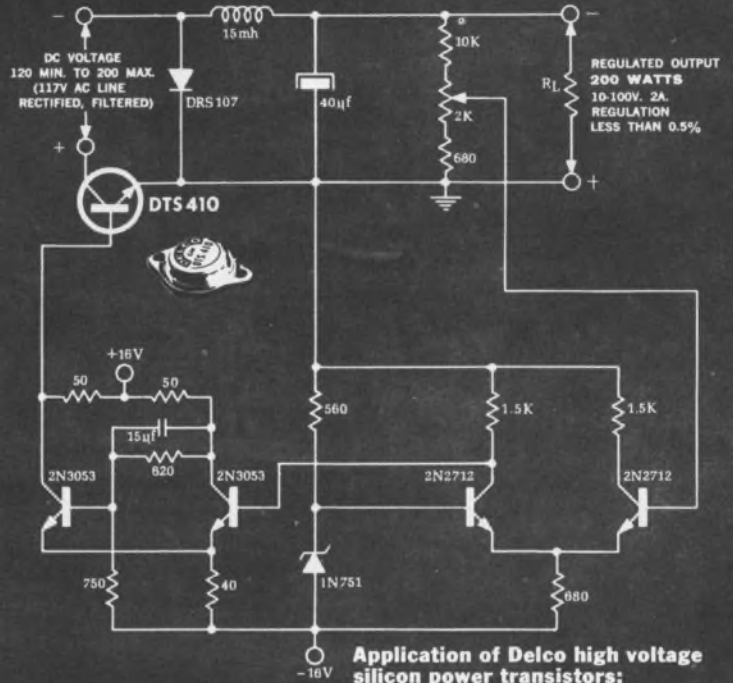

**SOLUTION:
DELCO SILICON POWER.**

Application of Delco high voltage silicon power transistors: the switching regulator.

Delco high voltage silicon power transistors provide high energy capability at the lowest possible cost. Take the applications pictured above: switching regulators, DC to DC convertors and DC voltage regulators. Unit prices? Just \$1.70 for the DTS-410*, \$4.95 for the DTS-423* and \$3.95 for the DTS-413*.

There are other cost cutting advantages to our high voltage silicon power transistors. You can reduce the number and complexity of input-output and filtering components, which means more compact circuitry. Greater reliability. Lower assembly costs.

Other high energy circuits where Delco silicon power transistors have proved capabilities include: ultrasonic power supplies, VLF class C amplifiers, off-line class A audio output, and magnetic CRT deflection (several major TV manufacturers are using them in big screen horizontal and vertical sweep circuits).

They're available in production quantities. For prices, delivery, data, or applications information, just give us a call. Or call your local Delco distributor.

With Delco silicon power transistors, everything's high powered but the price.

*When purchased in quantities of 1,000 and up. Prices subject to change without notice.

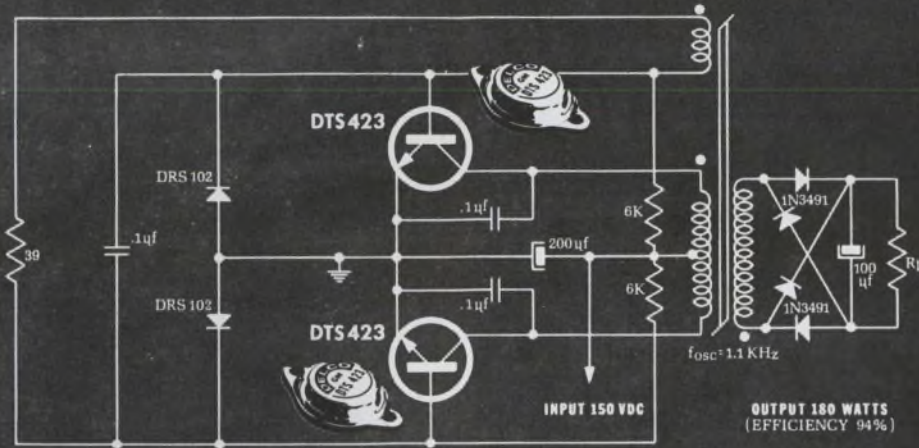

Application of Delco high voltage silicon power transistors: the DC to DC Converter.

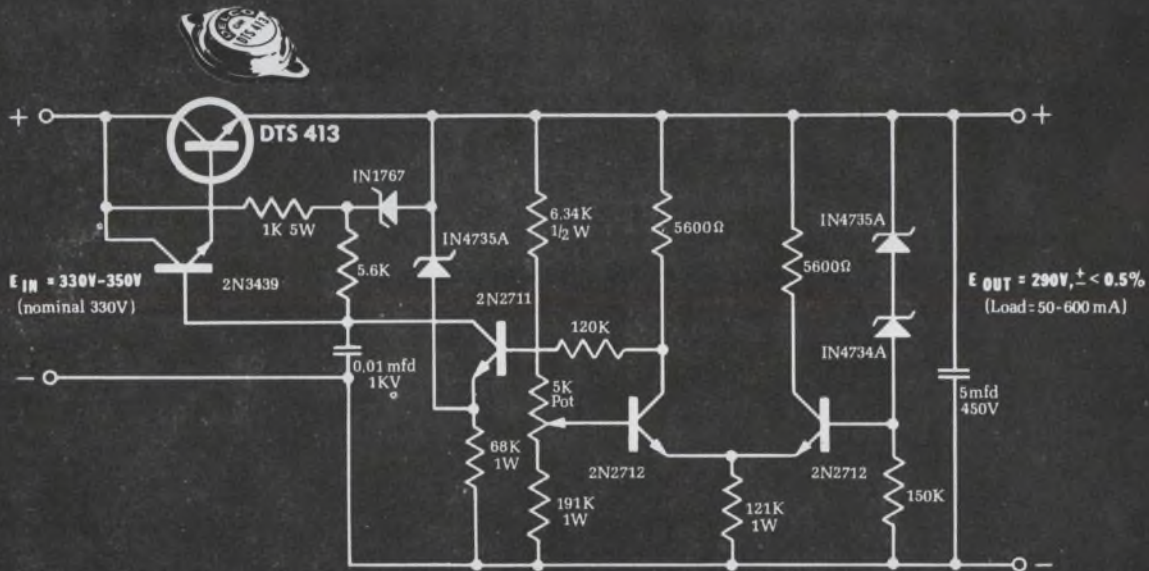

Application of Delco high voltage silicon power transistors: a DC voltage regulator.

TYPE	V _{CEX}	V _{CEO} (sus) min.	I _c max.	h _{FE} min. V _{CE} = 5 V @ I _c	P _d max.	PRICE 1000-and-up QUANTITIES
DTS-410	200V	200V	3.5A	10 @ 2.5A	80W	\$1.70
DTS-411	300V	300V	3.5A	10 @ 2.5A	100W	\$2.20
DTS-413	400V	325V	2.0A	15 @ 1.0A	75W	\$3.95
DTS-423	400V	325V	3.5A	10 @ 2.5A	100W	\$4.95
DTS-424	700V	350V	3.5A	10 @ 2.5A	100W	\$7.00
DTS-425	700V	400V	3.5A	10 @ 2.5A	100W	\$10.00
DTS-430	400V	300V	5.0A	10 @ 3.5A	125W	\$12.00
DTS-431	400V	325V	5.0A	10 @ 3.5A	125W	\$18.00

NPN silicon transistors packaged in solid copper TO-3 case.

DELCO RADIO

Division of General Motors, Kokomo, Indiana



Field Sales Offices: Union, New Jersey* 07083 Box 1018 Chestnut Station (201) 687-3770; Detroit, Michigan 48202 57 Harper Avenue (313) 873-6560; Santa Monica, Calif.* 90401 726 Santa Monica Blvd. (213) 870-8807; Syracuse, New York 13203 1054 James Street (315) 472-2668; Chicago, Illinois* 60656 5151 N. Harlem Avenue (312) 775-5411; General Sales Office: 700 E. Firmin, Kokomo, Ind. 46901 (317) 459-2175

*Office includes field lab and resident engineer for applications assistance.

ON READER-SERVICE CARD CIRCLE 44

Statistics speed video bandwidth design.

What counts in efficient optical and radar scanning systems is what the human eye doesn't see.

No matter how complex a surveillance mapping system may be, the final scanning is performed by the human eye. And therein lies a design hint.

The eye is not 100 per cent accurate. So why use a rigorous mathematical derivation to find the system bandwidth? For all practical purposes, a novel statistical approach is faster and just as good. The resulting error in image resolution will be much too small for the eye to notice in any case.

To use the statistical approach, assume that the mapping system consists of two black boxes. A simple formula then yields the maximum bit rate and, hence, the minimum video bandwidth.

Relate video bandwidth to resolution

A real-time, on-line reconnaissance mapping system, such as a side-looking radar, sends data through a wide-band radio link from the mapping sensor in an airborne vehicle to a display device in a ground station. The video information bandwidth and the data rate depend on the picture resolution of the display device and on the sensor characteristics.

The first step in system design is to determine the video information bandwidth required to minimize degradation of picture detail.

The video bandwidth depends upon several factors, including these:

- The type of surveillance mapping sensor and the manner in which it is employed.
- The information data rate.
- The type of data transmission (real-time or stored).
- The statistical reliability of the picture resolution, as evidenced by the quality of picture detail.
- The number of stages that are cascaded to form the over-all system.

The analysis of these factors requires good definitions of picture resolution and of the relationship that exists between picture resolution and video bandwidth.

Suppose a side-looking radar is to be de-

signed. How would the statistical method affect the system?

Observer defines picture resolution

For a side-looking radar system, resolution is defined as the ability—in at least 50 per cent of the cases—to form an image of the reflections produced by a radar signal that illuminates two corner reflectors on the ground at a range of, say, 30 miles and separated from each other by 20 feet. This applies to focused as well as nonfocused radar systems. The human eye can resolve objects to within only one minute of arc, and this is also in close agreement with the Rayleigh criterion for the limit of resolution.¹

Notwithstanding the precision with which resolving power may be defined, the measurable result that can be obtained in a given image (photograph, kinescope or other display medium) may only be realized in a very subjective sense.² It depends on the statistical average resolution value, as determined by a number of human observers who must inspect the image under a standard set of conditions—light level, contrast, magnification, etc. This human indeterminacy allows the designer to use the statistical approach for calculating the video bandwidth.

Radar scanning reduces bit rate

A side-looking radar system is a coherent, pulsed-Doppler radar that makes use of a synthetic-aperture antenna and pulse compression and correlation techniques to achieve fine mapping resolution. A block diagram of this mapping system is shown in Fig. 1a. This radar is used to illuminate the ground, as shown in Fig. 1b.

If this sensor has a resolution of 20 feet and a mapping width of 50 nautical miles is assumed, then the number of picture elements scanned in each radar pulse burst may be computed as follows:

$$N_r = M_s/r, \quad (1)$$

where M_s is the swath width in feet and r is the radar resolution in feet. Thus:

$$N_r = 6068 \times 50/20 = 15,200 \text{ elements per line.}$$

Anthony Paolantonio, Senior Engineer, RCA, Van Nuys, Calif.

The picture data bit rate can be computed by dividing the number of elements per line by the round-trip, differential propagation time per line. P_{rt} :

$$B = N_e / P_{rt} \quad (2)$$

Substitute number, noting that the round-trip radar rate of propagation is 500 ft/ μ s:

$$P_{rt} = 50 \times 6080 / 500 \\ = 608 \mu\text{s per line.}$$

$$B = 15,200 / 608 \mu\text{s.}$$

$$B = 25 \times 10^6 \text{ b/s.}$$

A block diagram of a typical real-time mapping system is shown in Fig. 2a. With the principle of superposition (Fig. 2b) the diagram may be redrawn, as shown in Fig. 2c. This is valid because the recorder or display device is part of the sensor apparatus. In effect, then, the system becomes a two-stage cascaded amplifier. The consideration of bandwidth-shrinking effects in cascaded amplifiers³ leads to an upper frequency limit for the individual components, or stages in the system, which is given by the relation:

$$f_1 = f_s (2^{1/n} - 1)^{-1/2}, \quad (3)$$

where n is the number of stages, f_s is the upper frequency limit for the over-all system, and f_1 is the upper frequency limit for each stage. For the side-looking radar, where $n = 2$ stages and $f_s = 25 \times 10^6$ b/s, the limit becomes:

$$f_1 = 25 \times 10^6 (2^{1/2} - 1)^{-1/2} \\ = 39.3 \times 10^6 \text{ b/s.}$$

Statistical computation of bandwidth

The subjective nature of the observable resolution, as judged by the human photo interpreter, gives rise to a statistical error probability in the measured results. (A 50 per cent error probability factor is normally assumed for side-looking radar resolution.) Because of this, it can be argued that a rigid mathematical computation to determine bandwidth may be meaningless. If it is assumed that a normal or Gaussian probability curve applies, the over-all system resolution becomes equal to the root-sum-squared resolution of the individual stages. Apply this to the two-stage cascaded amplifier equivalent in Fig. 2c of the side-looking radar. The desired over-all system resolution, R_o is again 20 feet:

$$R_o = [(R_1)^2 + (R_2)^2]^{1/2} \quad (4)$$

where $R_1 = R_2$, the individual stage "resolution." Solve for R_1 (or R_2):

$$R_1 = 2^{-1/2} R_o = (2^{-1/2}) 20 \text{ ft} = 14 \text{ ft.}$$

This may be converted to equivalent data bit rate with Eq. 2:

$$B = N_e / P_{rt} \\ = 1 / (14 \times 2 \times 10^{-6}) \\ = 35.7 \times 10^6 \text{ b/s.}$$

If Eq. 3, yielding a mathematically rigorous solution were used, it would result in:

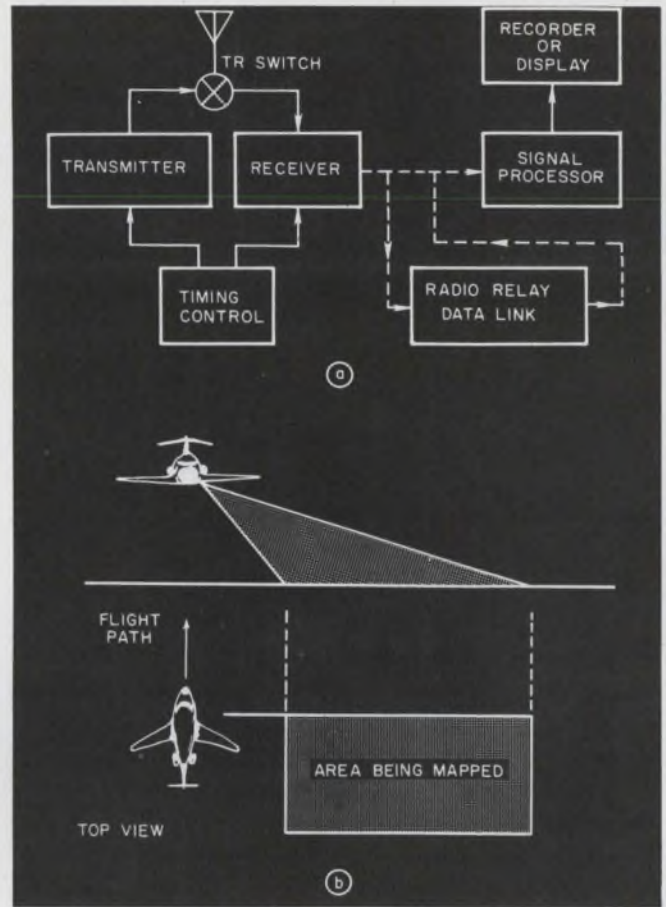

1. Side-looking radar mapping system is based upon a pulsed-Doppler radar, which makes use of a synthetic aperture system and pulse compression and correlation techniques, to achieve a fine mapping resolution (a). The mapping geometry is shown in (b).

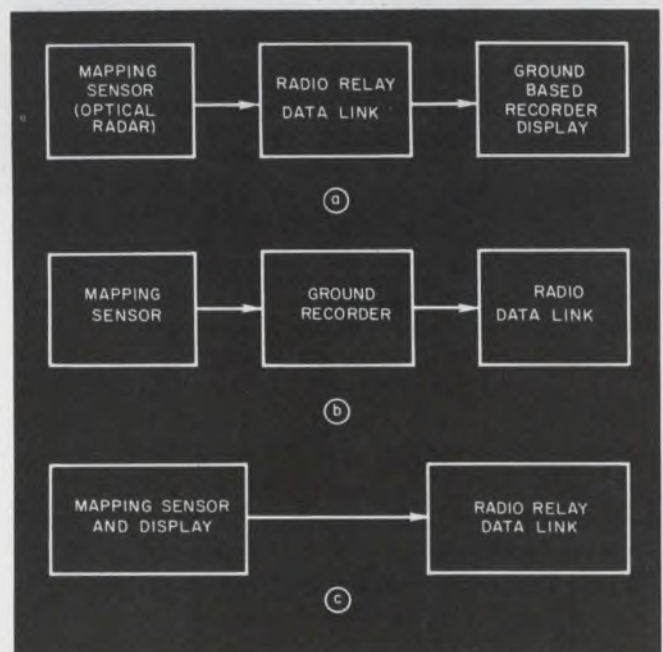

2. The mapping system may be 'boxed' into three stages (a), which can be reduced to a two-stage cascaded-amplifier equivalent (c). This presentation is permitted because the recorder, or display, is really a part of the sensor apparatus (b).



What is
the latest
In Electronics?
Come and see how men,
ideas and
techniques
have advanced
in a year.

Be
present
at the

INTERNATIONAL EXHIBITIONS OF ELECTRONIC COMPONENTS AND OF AUDIO-EQUIPMENT

FROM APRIL 1st TO 6th 1968 - PARIS
PORTE DE VERSAILLES



INTERNATIONAL CONFERENCE ON COLOUR TELEVISION

scientific and technical considerations
FROM MARCH 25th TO 29th 1968 - PARIS

Programme and registration conditions on request

S.D.S.A. - RELATIONS EXTERIEURES
16, RUE DE PRESLES - 75 PARIS 15^e - FRANCE

Official air-lines of the Exhibition call for information : AIR-FRANCE

ON READER-SERVICE CARD CIRCLE 45

$f_1 = 39.3 \times 10^6$ b/s, as shown previously.

The difference between the two results is about 9 per cent. This is a small error, compared with the 50 per cent probability of achieving the desired resolution for the side-looking radar system. Undoubtedly this difference in the final image resolution could not be seen by an observer.

Sampling increases bandwidth needs

In recent years the development of the sampling oscilloscope has made it possible to display very high-frequency signals with a relatively slow sweep repetition rate. It would seem that this technique might be applied to a surveillance mapping system, to reduce the data rate.

This cannot be done, however, because the sampling system used in an oscilloscope depends on sampling a repetitive, or redundant, wave train, and not on an asynchronous, random signal such as that received by the optical or radar sensors. If signal sampling is to be used for the mapping signals, it will be necessary to use a sampling rate equal to two or three times the highest data bit rate⁴ to be expected. This would certainly increase rather than diminish the video information bandwidth needed for the radio relay link. ■ ■

References:

1. Francis Weston Sears, *Optics* (3rd ed.; Cambridge, Mass.: Addison-Wesley Press, 1949), p. 260.
2. W. A. Penn, "Signal Fidelity in Radar Processing," *IRE Trans. on Military Electronics*, April 1962, pp. 204-218.
3. H. P. Westman (ed.), *Reference Data for Radio Engineers* (4th ed.; New York: International Telephone and Telegraph Corp., 1956), pp. 451-452.
4. *Ibid.*, p. 538.

Test your retention

Here are questions based on the main points of this article. They are to help you see if you have overlooked any important ideas. You'll find the answers in the article.

1. What factors determine video bandwidth?
2. How is resolution defined for a side-looking radar system?
3. What would be the error in the bandwidth, as calculated by the two methods, of a side-looking radar having a mapping width of 200 nautical miles and a resolution of 10 feet?
4. What order of error is to be expected by using the statistical method of bandwidth calculation?
5. Why can't sampling techniques be used for surveillance systems?



First full-range*
DC Voltage Calibrator
with .01% accuracy for under \$1000—



Cohu's new Model 324A!

*Output voltage ranges: 10-V Range: 0 to 11.11110 volts (10 μ V steps)
 100-V Range: 0 to 111.1110 volts (100 μ V steps)
 1000-V Range: 0 to 1111.110 volts (1mV steps)

Output current capability: 0 to 25 milliamperes nominal at any voltage setting.

Accuracy: 0.01% of setting.

Stability: Within 30 PPM for 24 hours, 50 PPM for 30 days.

Visual display: In-line readout, automatic decimal point positioning.

Dimensions: Cabinet: 10 $\frac{1}{2}$ " W x 5 $\frac{1}{4}$ " H x 15 $\frac{1}{2}$ " D.
 Rackmount: 19" W x 5 $\frac{1}{4}$ " H x 15 $\frac{1}{2}$ " D.

Price: Cabinet (324A): \$995. Rackmount (324AR): \$1050.
 F.O.B. San Diego. Additional export charge.

Delivery: Immediate, from stock.

For full details, contact your Cohu engineering representative.

For illustrated brochure on how this instrument is applied in the industry, write for bulletin ED5-29



Box 623
 San Diego, California 92112
 Phone: 714-277-6700

ON READER-SERVICE CARD CIRCLE 46

Iron out ferrite core design wrinkles with three nomograms. Given L and Q , the right pot core, bobbin and wire size are easy to find.

Transferring an inductance value from a schematic to an operating circuit has brought ferrite pot cores into wide use. It is mainly because of its ease of adjustment that the ferrite core is now widely preferred to the molybdenum permalloy toroid as a filter inductor, but it also has other advantages—increased inductances and Q , better shielding, and easier and less expensive assembly.

Nomograms simplify design

Once the engineer has determined the required values of inductance and Q , the nomograms shown here can simplify the design of a pot core inductor assembly in the audio-through-rf-range. Nomogram 1 assumes that Q is directly calculable from dc copper loss and is generally valid in the audio range where dc copper loss is the most significant contributor to total loss. This frequency limitation does not apply for estimating the number of turns needed for a given inductance (nomogram 2). The nomograms are based on pot cores and bobbins that have been dimensioned in accordance with the recommendations of the International Electrotechnical Commission (I.E.C. Publication 133). The standard size designations are shown in the table, on the opposite page, together with reference numbers for using the nomograms.

How many turns of what size wire?

An example will illustrate the use of the nomograms. Suppose a pot core assembly has to be designed to give an inductance of 1 mH with a Q of 95 at 10 kHz. As a first step, select from manufacturers' published data a ferrite material that meets the temperature coefficient and Q requirements. Then check the circuit's physical size limitation and select the largest possible core to obtain the highest Q values. The manufacturers' data on the material will usually give what value to use for a given core size in millihenries per 1000 turns,

and the material's temperature coefficient. In the present example, an Indiana General 45-to-150-ppm/°C temperature-coefficient ferrite core is used. This has an inductance of 100 mH/1000 turns from 0° to 60°C.

Using nomogram 1 (opposite page) find the number of turns needed by drawing a line from 100 on the far left scale through 1 on the mH scale and extending it to the next (N) scale. This yields 100 turns as the amount of wire required. Next, the proper wire size must be found, given the pot core size to be used.

Assume the size limitation is such that a 14 x 8 mm (No. 01) International Size pot core is the largest that can be used. Then draw a line from 100 on the number of turns scale (N) through the 01 point on the bobbin series scale and extend it to reference line 1. Now, working from the right-hand edge of the nomogram, project a line through the specified Q (95) and frequency (10 kHz) on the relevant scales to intersect reference line 3. Connect this point of intersection with the required inductance (1 mH) on the adjacent scale and extend this line to reference line 2. Now, simply draw a line joining this intersection point on reference line 2 to the intersection point on reference line 1. Where this last line intersects the wire scale shows the required AWG wire size—in this case, No. 30.

Will the bobbin hold the coil?

The second step is to select a bobbin from the manufacturers' data that will fit the No. 01 pot core. In most cases, single- and multiple-section bobbins will be listed. Multiple-section bobbins are used for coils requiring low distributed capacitance. For this example, a single-section bobbin is selected for the No. 01 pot core. To check whether the bobbin will accommodate the 100 turns of AWG No. 30 wire, use nomogram 2 (p. 78). Connect the bobbin number (left-hand scale) with 30 on the wire (center) scale, and extend the line to the turns (N) scale. (BB-01-1 on the scale represents a single-section bobbin for a No. 01 pot core. BB-01-2 is a double-section bobbin, etc. The middle digits correspond to the core size, the final digit indicates the number of sections in the bobbin.) In this case,

Melvin Eisenberg, Engineering Manager, Indiana General Corp., Electronics Div., Keasbey, N.J.

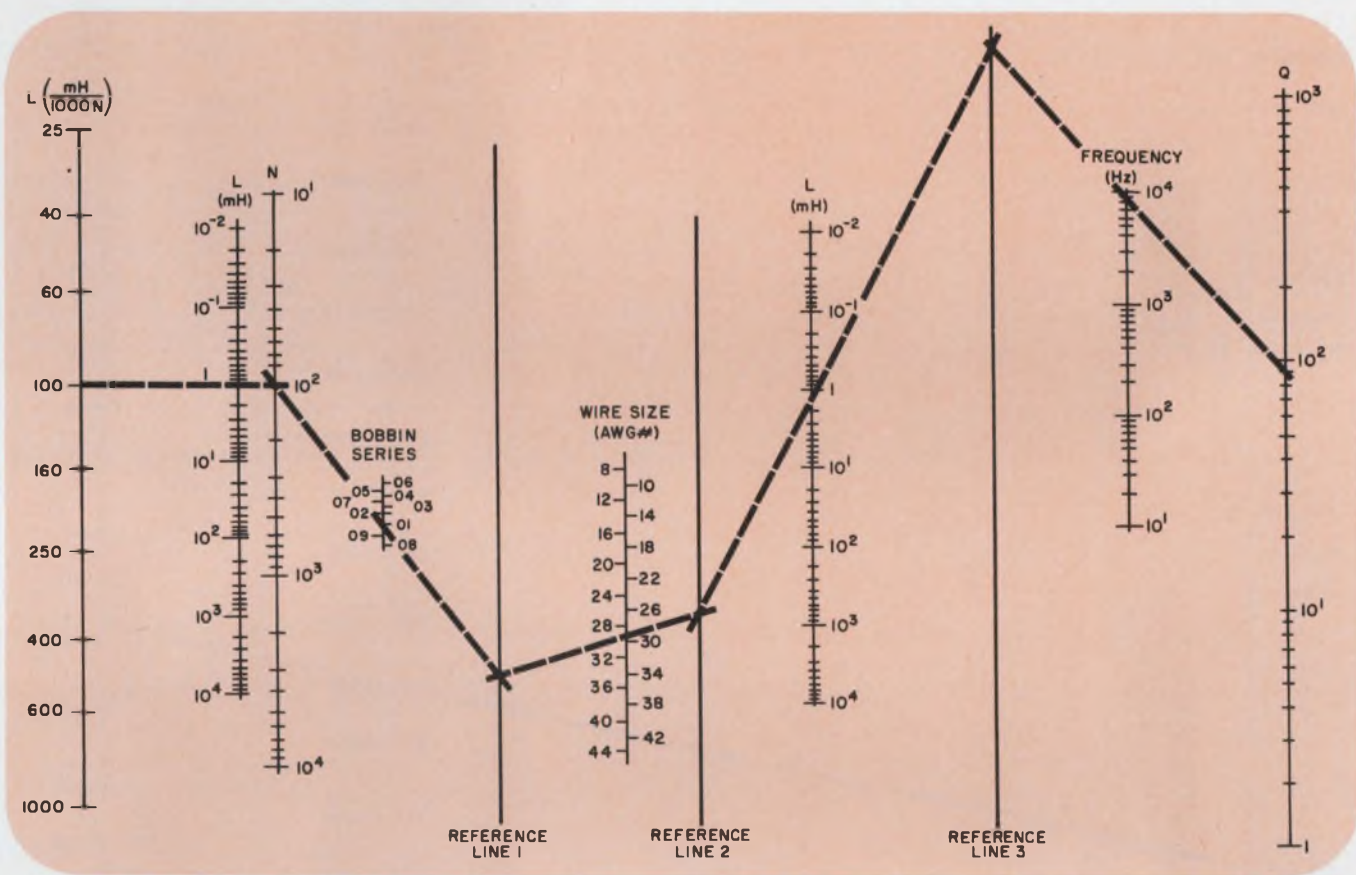

Table: International series of pot core sizes

Dimensions (mm)	14 x 8	18 x 11	22 x 13	26 x 16	30 x 19	36 x 22	23 x 17*	9 x 5	11 x 7
Reference No.	01	02	03	04	05	06	07	08	09

*Not an I.E.C. size

the bobbin will accommodate up to 130 turns, so it can be used.

To determine the assembly's dc copper resistance, use nomogram 3 (p. 78). Simply connect the bobbin number (01) on the left-hand scale with the number of turns (100) on the *N* scale and extend the line to the reference line. From this point, draw a line to No. 30 on the wire-size scale and project it to the dc copper resistance scale. The total dc copper resistance of the final design is seen to be just under 1 Ω . ■ ■

Test your retention

Here is a problem based on the technique described in this article. It can be solved quickly using the three nomograms. You'll find the answer on page 146.

Design a 2-mH inductor with a *Q* of 70 at 4 kHz. Assume that your circuit layout dictates a size 01 core of 160-mH/1000-turns ferrite material. Use a single-action bobbin. How many turns of wire are needed? What size? What is the total dc copper resistance?

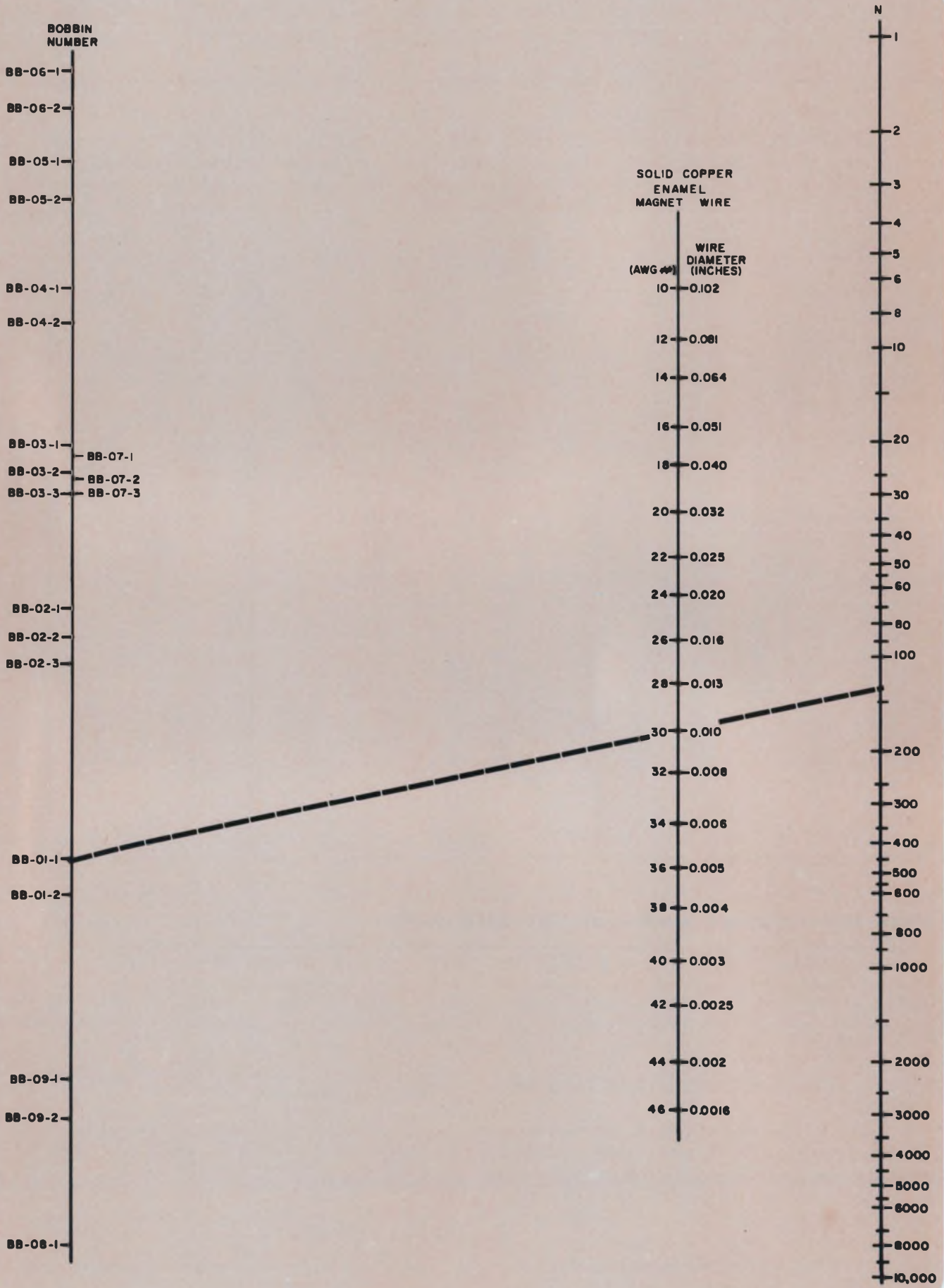

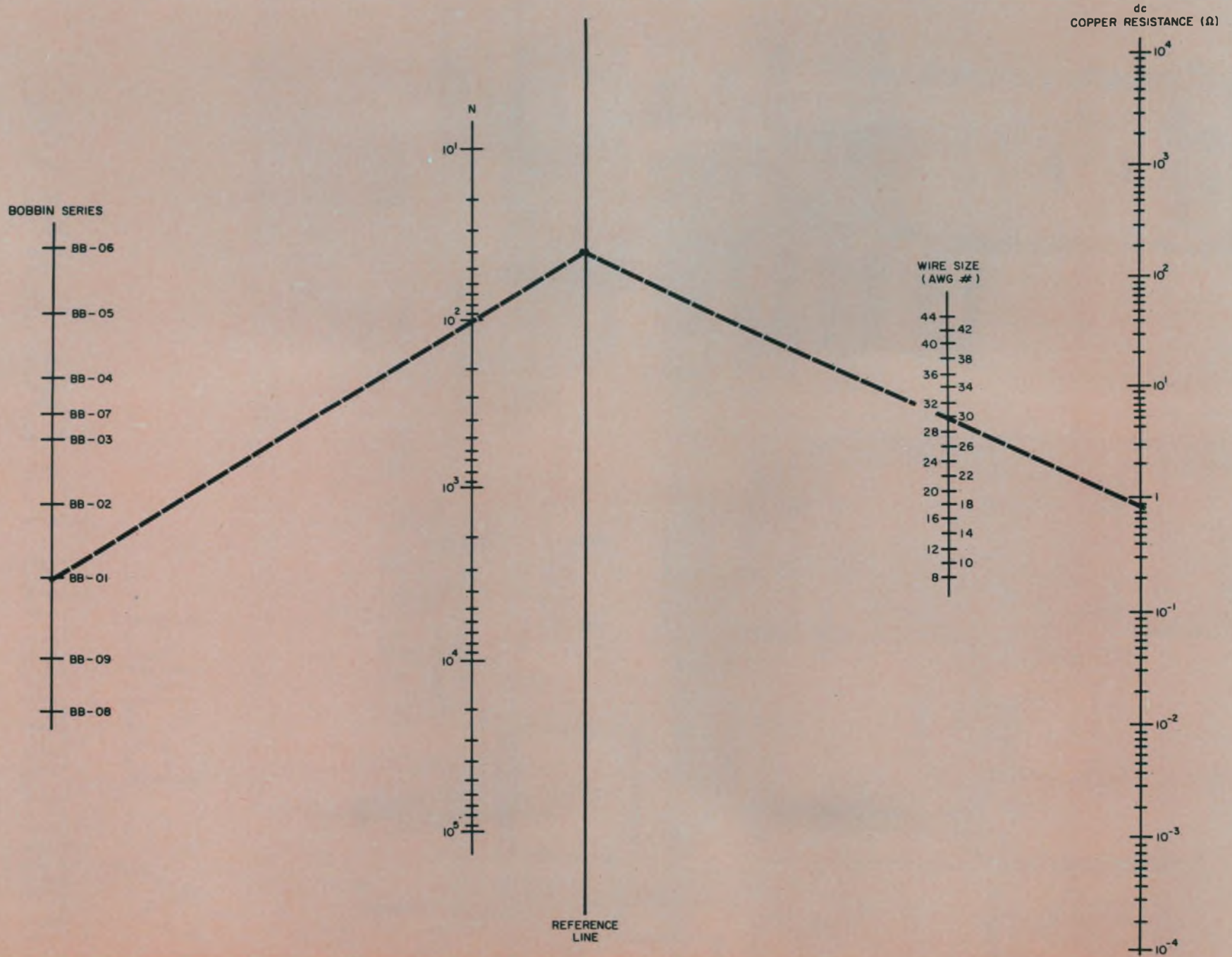

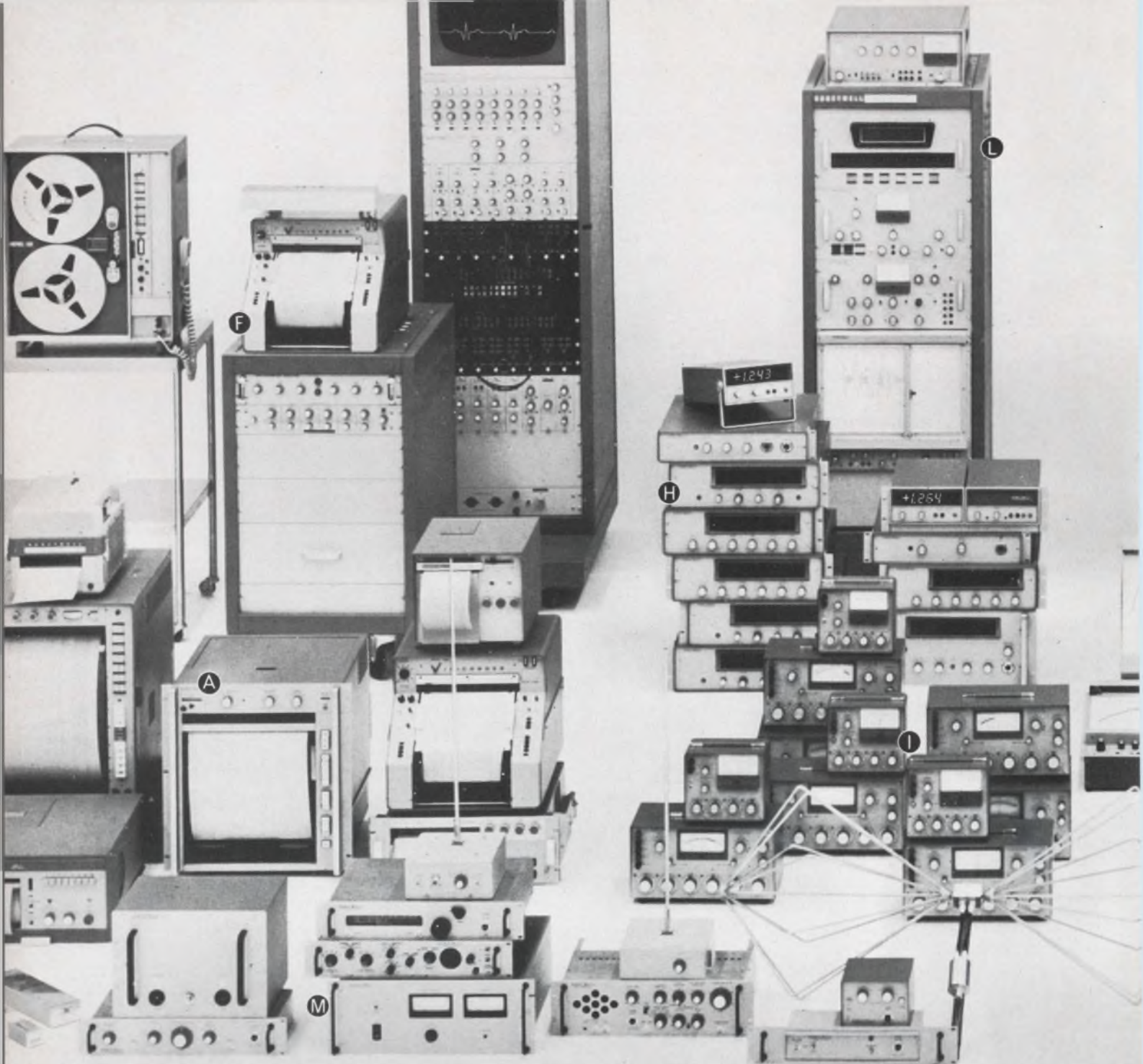

Here's just part of the full Honeywell line, which includes: **A** 117 Visicorder direct-recording oscillographs in 6", 8", and 12" models; **B** 2 Model 1806 fiber-optics CRT Visicorder oscillographs; **C** 26 magnetic tape systems, including the 7600 Series in 10½" and 15" reel versions; **D** 84 amplifiers and other signal-condi-

We build **847**
instruments to be sure we
have the exact **1** you need.

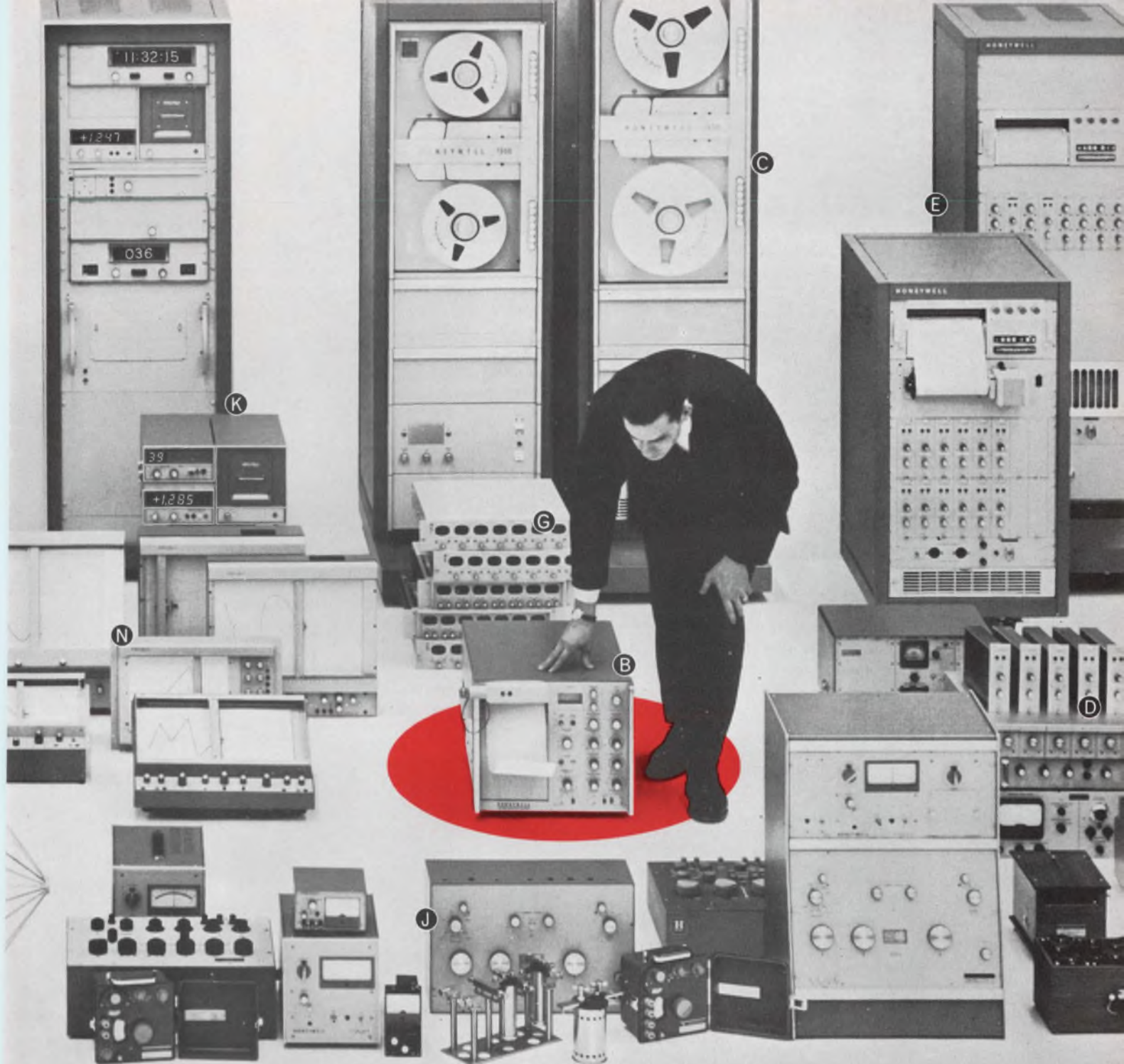

tioning units; **B** 78 analog recording systems; **F** 46 electronic medical systems; **G** 14 oscilloscopes; **H** 37 digital multimeters; **I** 29 differential voltmeters; **J** 179 precision laboratory standards and test instruments; **K** 128 data loggers; **L** 9 analysis systems; **M** 61 EMI products; **N** 37 X-Y graphic recorders.

Your Honeywell sales engineer can zero in on the *precise* solution to your instrumentation problems. Quickly and efficiently. You won't have to settle for "almost" what you need because the Honeywell sales engineer isn't handicapped by a limited line. He can choose from 847 basic instruments whose combinations and permutations approach the infinite.

The solution might be a Visicorder recording oscillograph. Or one of our modular magnetic tape systems. Or an X-Y recorder, a digital multimeter, or a portable potentiometer. But whether it's a single instrument or a complete data system, you can be sure the solution will be the right one, carefully thought out with your future requirements considered as well as your current needs.

Local service and nationwide metrology facilities back up your Honeywell instrument or system. And, we can even provide factory training courses for *your* operating personnel. For the full story on how Honeywell can help you, call your local sales engineer or write: Honeywell, Test Instruments Division, Denver, Colorado 80217.

Honeywell

Honeywell engineers
sell solutions

How good is your differentiator?

When checking a passive RC type, include the effects of stray impedances; they can destroy an ideal input.

Differentiators are usually simple circuits but they can disrupt the operation of a multimillion-dollar computer system. If their input is not ideal, their output may be delayed in time and attenuated. The designer must know these delays and learn how to control them if he is to design computers with bit rates that require picosecond timing, for example.

The usual input is a step function. The differentiator passes the leading edge, but not the dc level, which is the top of the step. Therefore any change in the leading edge, even that caused by stray capacitances and resistances, must be considered. The amplitude of the output and the time at which the peak occurs are affected by the actual rise time of the input. A set of nomograms helps to predict the output as a function of step rise time and RC time constant.

Lag network accounts for stray impedances

A typical R-C differentiator is shown in Fig. 1a. The effect of stray impedances may be accounted for by taking an ideal step function and passing it through a lag network, such as shown in Fig 1b where the values of R and C will be very small, but significant. The output of the lag network will be a step function that is practical and can be used to check the differentiator. The lag circuit is the same as an elementary charging circuit, and therefore a practical step, created by stray resistances and capacitances, will be described by $E[1 - \exp(-t/T)]$, where T is the product of the strays.

Stray microhm resistances are found in some circuits, and at times they may even be in ohms. Stray capacitances are almost always between 10 and 100 pF, although they have been known to reach thousands of picofarads. These strays are significant in any circuit which is designed to yield a step with a sharp leading edge. The product of these strays is the time constant which represents the shortest time in which the step can rise to 63.2% of its maximum. It is seldom practical to measure these strays and therefore it is easier to think of T as the

time it takes the practical step to reach 63.2% of its maximum value.

Differential output defined by time constant

The sum of the voltage drops in the time domain around the circuit in Fig. 1b gives the following:

$$E[1 - \exp(-t/T)] = (1/c) \int i dt + iR.$$

The Laplace transformation yields:

$$[E/s] - [E/(s + 1/T)] = (1/sC + R) I(s),$$

which can be manipulated into the form:

$$I(s) = (E/TR) / \{[s + (1/T)] [s + (1/RC)]\}.$$

The inverse transform of this expression is given in the tables of Laplace transformation:

$$i(t) = \frac{E}{TR} \left(\frac{1}{1/T} - \frac{1}{1/RC} \right) \left(-e^{-t/T} + e^{-t/RC} \right).$$

Multiply this expression by R to find an equation for output voltage as a function of the practical step's leading edge and of the differentiator's components:

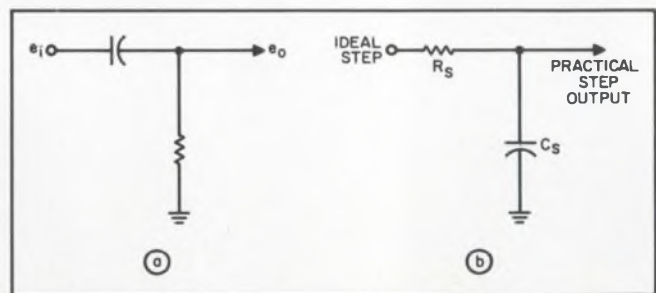

1. Passive RC differentiator (a) passes leading edge of step input but discriminates against a dc level. Equivalent circuit of stray resistance and capacitance (b) is really a lag network. The time constant is difficult to measure — it is easier to think of it as the time it takes the practical step function to reach 63.2% of its maximum value.

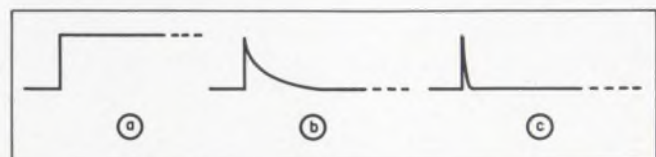

2. The input step (a) is differentiated by the circuit in Fig. 1a. Large RC products yield long trailing edges (b), small RC products have sharp skirts (c).

Donald W. Moffat, Electronic Engineer, San Diego, Calif.

$$e_o = E [(T - RC)/T] (e^{-t/RC} - e^{-t/T}).$$

The locus of this equation rises rapidly to a peak and then trails off asymptotically to zero as indicated in Fig. 2b. To find the time at which the peak occurs and its amplitude, first differentiate e_o with respect to time:

$$\frac{de_o}{dt} = E \frac{T-RC}{T} \left(\frac{1}{T} e^{-t/T} - \frac{1}{RC} e^{-t/RC} \right).$$

Then equate it with zero to solve for the point of maximum:

$$0 = [(1/T)e^{-t/T}] - [(1/RC)e^{-t/RC}].$$

Add the last term to both sides, and take the natural logarithms:

$$\ln(1/RC) - t/RC = \ln(1/T) - t/T;$$

This last equation gives the time at which the maximum occurs. This maximum can occur before or after the input has reached its defined level at T . Figure 4 brings out this fact by the range of ratios included for t/T on the last scale.

The substitution of the value of t , given by the last equation, into the equation for e_o gives the maximum amplitude the differentiated output will reach. Nomograms will be of unquestionable value in finding numerical solutions.

Rules of thumb work well

When the RC time constant is equal to the leading edge's time constant, T , the differentiated output will peak at 38% of the step input, and this peak will occur at $t = T$. As either RC is made larger or T is made smaller, the output will reach a higher amplitude and will occur later.

The trail-off time of the differentiated output increases, however, at a rate many times faster than the increase in peak amplitude. Trade-offs are therefore necessary, as narrow spikes can be achieved only at a sacrifice of amplitude. Low amplitudes and narrow durations go with early maxima; outputs approaching the amplitude of the input and with long duration go with higher values of t/T at the peak.

The nomograms are simple to use. Draw a straight line through the selected values on the first two scales of Fig. 3. This line will solve for the product, RC , on the middle scale. If the RC product is known, start working the nomogram at the middle scale.

From the RC value draw a line to cross the fourth scale at the correct value of T , the time it takes the input step to reach 63.2% of its maximum. At the last scale of Fig. 3 this line will give the ratios of the output peak to input peak, and of t to T , when the peak occurs.

Transfer these ratios, one at a time, to the middle scale of Fig. 4 where absolute values of peak output and time can be found. Work left from the center scale to find the voltage, and right from the center scale to find time.

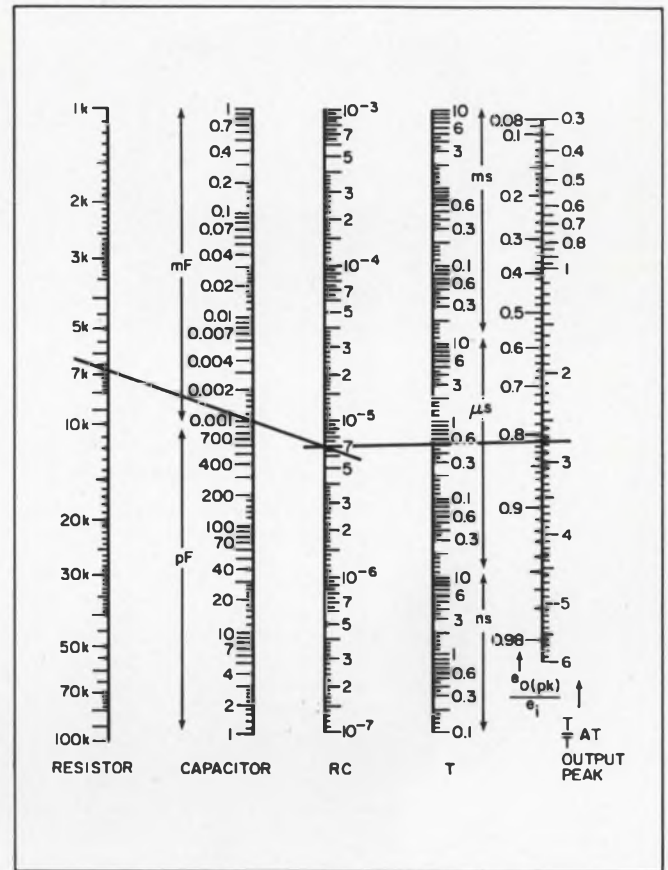

3. Nomogram for finding voltage and time ratios.

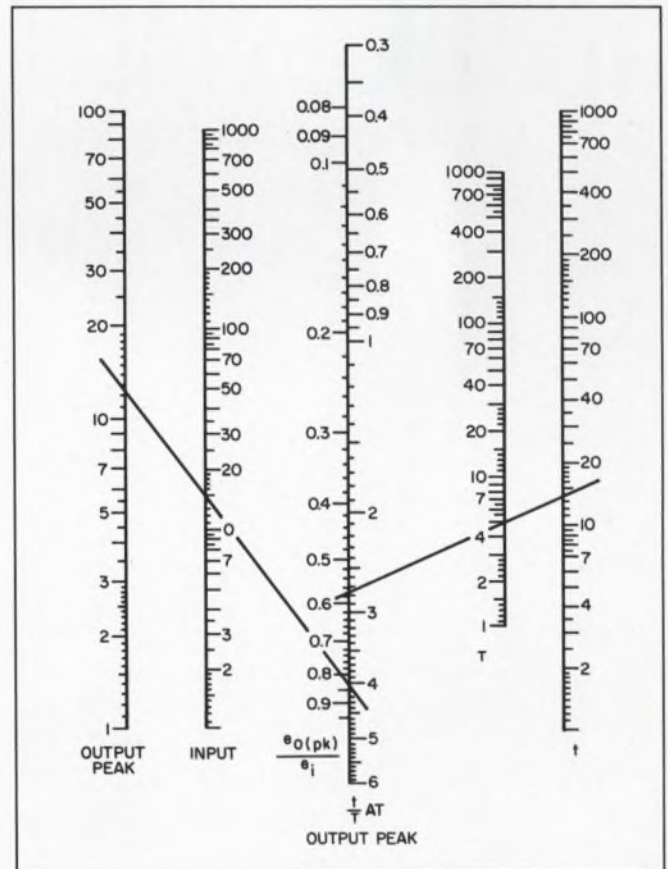

4. Nomogram for finding absolute values.

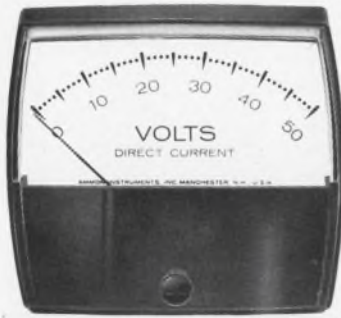

2 1/2 in. AP-2

Snap-in Dial

2% full scale accuracy,
self-shielded panel meters

New! Panel meters with plastic bezels give you tailor-made meters at no increase in price. Covers snap off . . . interchangeable dials snap in. High torque mechanism offers 1% linearity, 2% accuracy and sensitivity to 20 ua. Magnetic system is unaffected by external field influences, mounts on any material without interaction. Size: 2 1/2". Choice of colors and finishes. ASA/MIL 3 or 4-stud mount.

AMMON

AMMON INSTRUMENTS, INC.
345 Kelley St., Manchester, N.H. 03105

ON READER-SERVICE CARD CIRCLE 48

TERMINAL BLOCKS

CURTIS

INSULATED FEED-THRU GFT SERIES



RATED: 20 Amps.
300 Volts

Versatile, compact GFT Series eliminate costly insulating and mounting procedures to meet UL and CSA requirements. Fully insulated inserts give 1/4" solder terminal to ground clearance on 1/8" thick chassis.

SURFACE TERMINALS: 3/8" center-to-center spacing of #6 or #8 screws take up to #12 AWG wire.

INTERNAL CONNECTIONS: Variations include turret-type solder posts, printed circuit pin (.062 dia.), #6-32 screws, or turret-type posts with axial #53 taper pin receptacle.

AVAILABLE: 1-18 bright tin plated terminals per block with end mounting positions or flush ends with Tinnerman nut mounting.

FREE! Full details, descriptions and prices in Curtis 24-page illustrated catalog.

CURTIS DEVELOPMENT & MFG. CO.
3236 N. 33rd St., Milwaukee, Wis. 53216



ON READER-SERVICE CARD CIRCLE 49

The transfer of these values from Fig. 3 to Fig. 4 has been simplified by including tick marks on the middle scale of Fig. 4 at exactly the same values as are found on the last scale of Fig. 3.

Any convenient set of units can be assigned to the scales of Fig. 4 as long as the two scales to the left are assigned the same units (volts, kilovolts, microvolts, etc.) and the two on the right are assigned the same units (seconds, milliseconds, microseconds, etc.). The center scales are both ratios and thus are dimensionless.

Design example shows the method

A numerical example will illustrate the process. A 15-volt step reaches 63.2% of its maximum in half a microsecond. It is applied to a passive differentiator which is built with a 6.8-k Ω resistor and 1- μ F capacitor. When will the output reach its peak and how much will it be?

Locate the two component values on the first two scales of Fig. 3. A line drawn through those points crosses the middle scale at an RC time constant of 6.8×10^{-6} . From that point on the middle scale draw a line through 0.5 on the fourth scale. The fifth scale shows that the output peak will reach 82.5% of the input amplitude, and this peak will occur when t/T equals 2.78.

On Fig. 4, draw a line from 0.825 on the middle scale, through 15 on the input scale, and note that the output peak will be 12.4 volts. Finally, working from the right-hand side of the middle scale, draw a line from 2.78 through 5 on the fourth scale (having decided that the two time scales in Fig. 5 are in units of tenths of microseconds). This line crosses the last scale at 13.8 tenths of microseconds, or 1.38 microseconds—the time at which the peak occurs. ■ ■

Test your retention

Here are questions based on the main points of this article. They are to help you see if you have overlooked any important ideas. You'll find the answers in the article.

1. If the input to a differentiator is not ideal how will the output be affected?

2. Under what conditions will the differentiated output peak at 38% and when will this peak occur?

3. What are the units of the scales of Fig. 5?

4. A 50-volt step is applied to a passive differentiator consisting of a 77-k Ω resistor and a 10-pF capacitor. If this step reaches 63.2% of its maximum in 0.25 seconds when will the output reach its peak and how much will it be?



It's the grand prize in Electronic Design's annual "Top Ten" ad contest. And, if you can't have Paris, there's an exciting list of 60 additional prizes to be claimed:

- 1 Deluxe Heathkit "Paramount" Transistor Theatre Organ**
- 1 Deluxe Heathkit "180" Color TV in Contemporary Walnut Cabinet**
- 8 EICO "Cortina" All Silicon Solid State 70 Watt Stereo Amplifier Kits**
- 50 Copies of "Microelectronic Design"**

One of these tempting prizes will go to each of the 61 readers who pick the ten ads in the Jan. 4 issue they think will be best remembered by their fellow readers, as determined by Reader Recall methods.

Your Jan. 4 copy of Electronic Design will contain an entry blank as well as contest rules and further details.

Remember...the action's in the Jan. 4 issue. The "Top Ten" contest plus a fascinating and vital news feature—"Electronics in the Cities." Don't miss it!

The top winners in last year's contest were:

- Robert Mergliano, Vitro Labs
- R. E. Brouillard, Pacific Northwest Bell Telephone
- Ben Spaisman, Vitro Labs
- W. D. Clifton, NASA
- A. V. Painter, Interstate Electronics
- W. W. Steger, Los Alamos Scientific Labs
- Sam Gargano, Griffis AFB
- A. Cokus, General Electric Company

Test your IC IQ

Question: What are the advantages and disadvantages of multichip hybrid integrated circuits?

Answer: The multichip is usually the fastest and most economical form of integrated circuit to construct, particularly for prototype purposes, for it is made up of semiconductor passive components and transistors. Even for this type of construction, the design engineer needs specialized equipment to handle and test the small semiconductor chips and make interconnections with fine wires (approximately 1 mil dia). Compared with other integrated-circuit forms, however, multichips require the least amount of tooling. There is now a wide selection of transistor, resistor and capacitor chips commercially available. These make it possible to build, test and modify circuit designs with almost as much freedom as with discrete components. (See photo on this page.)

The assembly of multichip circuits is inherently expensive in high-volume production. The parts are assembled and interconnected in a one-at-a-time procedure. Thus multichip circuits find their application in areas of specialized, high-performance designs which are incompatible with other forms of circuit integration or where low quantities do not justify higher tooling costs. They are also useful for breadboarding prototype assemblies quickly, to simulate and evaluate potential monolithic designs.

Question: Contrast the applicability and the economics of thin-film and thick-film hybrid integrated circuits.

Answer: Compared with monolithic integrated circuits, each type of film circuit takes relatively economical tooling for either short or moderately long production runs. Thin films, because of either vacuum or reduced-pressure (sputtering) require-

ments, require a considerably larger capital investment than do thick films, which can be silk screened in the ambient environment.

Both thick- and thin-film techniques permit wider ranges of resistor values per unit area (Ω/sq) than monolithic and have greatly reduced, associated parasitic effects (capacitance, junction or transistor). Tolerances of thin-film resistors, as they are deposited (untrimmed), are better than those achievable with monolithic resistors. Thick-film resistor tolerances, however, are considerably poorer without trimming. IBM, which is by far the largest user of thick-film hybrid circuits, employs a sandblast trimming process which leads to tighter resistor tolerances than available from the thin-film or monolithic fabrication techniques. (See photos on opposite page.)

The most serious shortcoming of thin-film hybrid circuits remains the lack of reliable, deposited active elements (thin-film transistors). This means that these critical elements must be assembled on the circuit substrate in separate, time-consuming operations. Even with some of the newer, time-saving assembly techniques (flip-chip assembly), this is still quite expensive. Thin-film circuits are

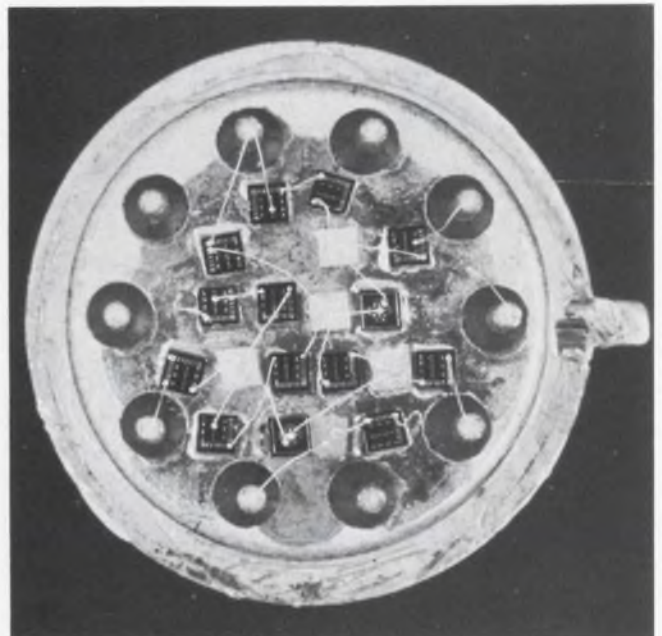

Resistors are diffused into the chips on this multichip header. The resistor chips have many bonding pads, one for each pick-off point. The other two chips are transistors.

Test your IC IQ is a collaboration between the editors of ELECTRONIC DESIGN and the staff of ICE (Integrated Circuit Engineering) Co., Phoenix, Ariz. Readers of this new column are invited to submit their questions to Test your IC IQ, ELECTRONIC DESIGN magazine, 850 Third Ave., New York, N.Y. 10022.

most useful where only passive components (particularly resistors) are required.

Question: Can high-frequency linear circuits and high-speed, saturating logic circuits be fabricated on the same wafer of silicon?

Answer: The primary difficulty in fabricating high-frequency linear circuits and saturating logic circuits at the same time is the procedure employed to kill lifetime in the silicon wafer. This process step usually involves gold doping and is necessary for the saturating logic circuits only. To satisfy the increased switching-speed requirements, the lifetime of the material must be reduced to permit the circuit to come out of saturation more rapidly. This is accomplished by reducing hole storage in the base region with gold atoms. Since linear circuits are seldom operated in saturation, gold doping is undesirable: it causes gain reduction of the linear circuit transistors since, in the non-saturating mode, the gold is simply an unwanted impurity.

Most of the procedures employed make it difficult to isolate the areas in which lifetime is reduced by the gold. When both types of devices are made on the same wafer, a compromise must be made. Many companies are now working on techniques for patterning the area of gold doping, but these techniques are still in the laboratory stage. Usually where both types of devices are required, separate wafers are employed for each. Thus, the same process is used for both wafers with the exception of the additional step for killing lifetime, which is employed for the digital circuit wafers.

Question: Are any firms flip-chipping a large number of microcircuits on to a substrate to achieve large-scale integration?

Answer: At the present time, a number of commercial systems companies are using this technique as an approach to LSI, to obtain large packaging densities and relatively reasonable integrated-circuit production economics. Amelco is producing substantial quantities of integrated circuits designed for this type of assembly for Teledyne. This is part of Teledyne's molecular, modular assembly (MEMA) program. On the average, these arrays contain 25 silicon monolithic integrated circuits flip-chip-mounted or wired together on a ceramic substrate approximately one inch square.

Question: What is the most popular logic type currently used in airborne computers?

Answer: Low-power versions of TTL lead the popularity parade for applications in airborne computers. This is particularly true for new designs; many older designs still in production employ RTL and DTL. The trend toward TTL is based on a higher frequency of operation and improved noise immunity characteristics. These improvements are the result of further exploitation of monolithic design rules, which allow extensive use of transistors. This makes more stringent demands on transistor parameters such as inverse beta, but it can be implemented with standard monolithic process.

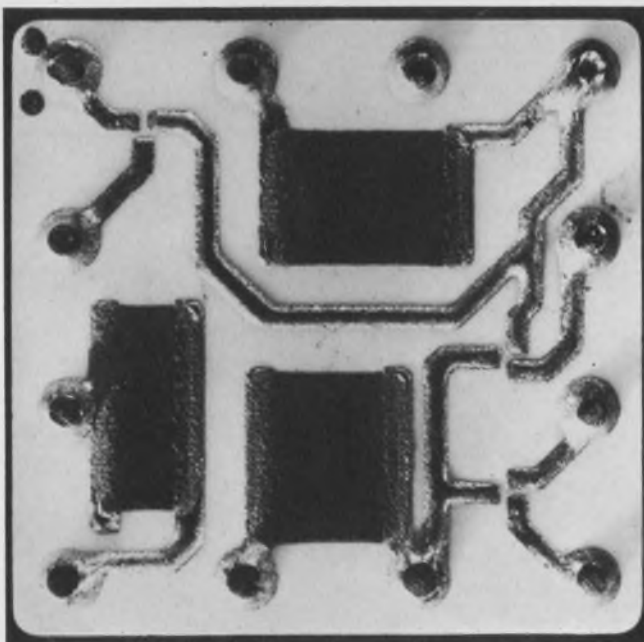

Untrimmed resistors adorn the circuit (left), which is made for an IBM computer. IBM trims down the resistors' values by an automatic sandblast technique (right). This gives the

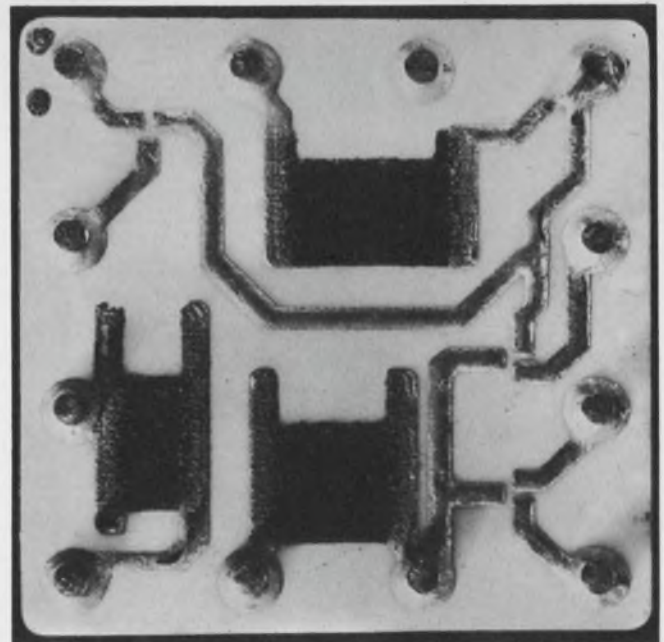

circuit designer the advantages of high-resistivity thick-film circuits, which are inexpensive even in relatively low volume, and the accuracy of automatic trimming.

Reader's Choice

IEE bright, legible, wide-angle readouts:

Any characters desired
Any colors or combinations
Any input, BCD or decimal
Any input signal level
Any mounting, vertical or horizontal

Many sizes
Many configurations
Many lamp lives (to 100,000 hours)
Many brightness choices
Many options and accessories



Standard Readouts: Rear projection principle, like all IEE readouts. A lamp in the rear of the unit illuminates one of the 12 film messages, and projects it to the front viewing screen. Unbeatable readability and versatility.



Large Screen Readouts: For reading distances up to 100 feet. Maximum character size 3 3/8".



Miniature Readouts: Only 1" wide x 1-5/16" high, yet can be read at 30 feet because of clarity of one-plane projection. Character size: 3/8".



Micro-Miniature Readouts: Only 1/2" wide x 3/4" high, but 20 foot viewing distance and maximum 175° viewing angle because of front-plane display. Character size: 3/8".



Hi-Brite Readouts: Special lens system increases character brightness 50%. Particularly good when high ambient light conditions exist.



Cue-Switch Readouts: Rear projection readout with push-button viewing screen. Combination switch and display device.



Bina-View Readout: Accepts binary or teletype code, decodes, and displays the proper character.



Status Indicator Readout: Displays up to 12 different messages, individually or in combination. Viewing screen only 3 sq. in.



Indicator Assemblies: Available with up to 11 rear projection readouts, for indicating seconds, minutes, hours, days, etc.



Driver/Decoder Module: Designed to work with IEE Readouts. Accepts a variety of binary codes for decimal conversion.

The new IEE Display Devices catalog gives complete information and specifications on these products, and their accessories. Ask for it.



"I-double-E", the world's largest manufacturer of rear projection readouts.
Industrial Electronic Engineers, Inc. 7720 Lemona Avenue, Van Nuys, California

ON READER-SERVICE CARD CIRCLE 50

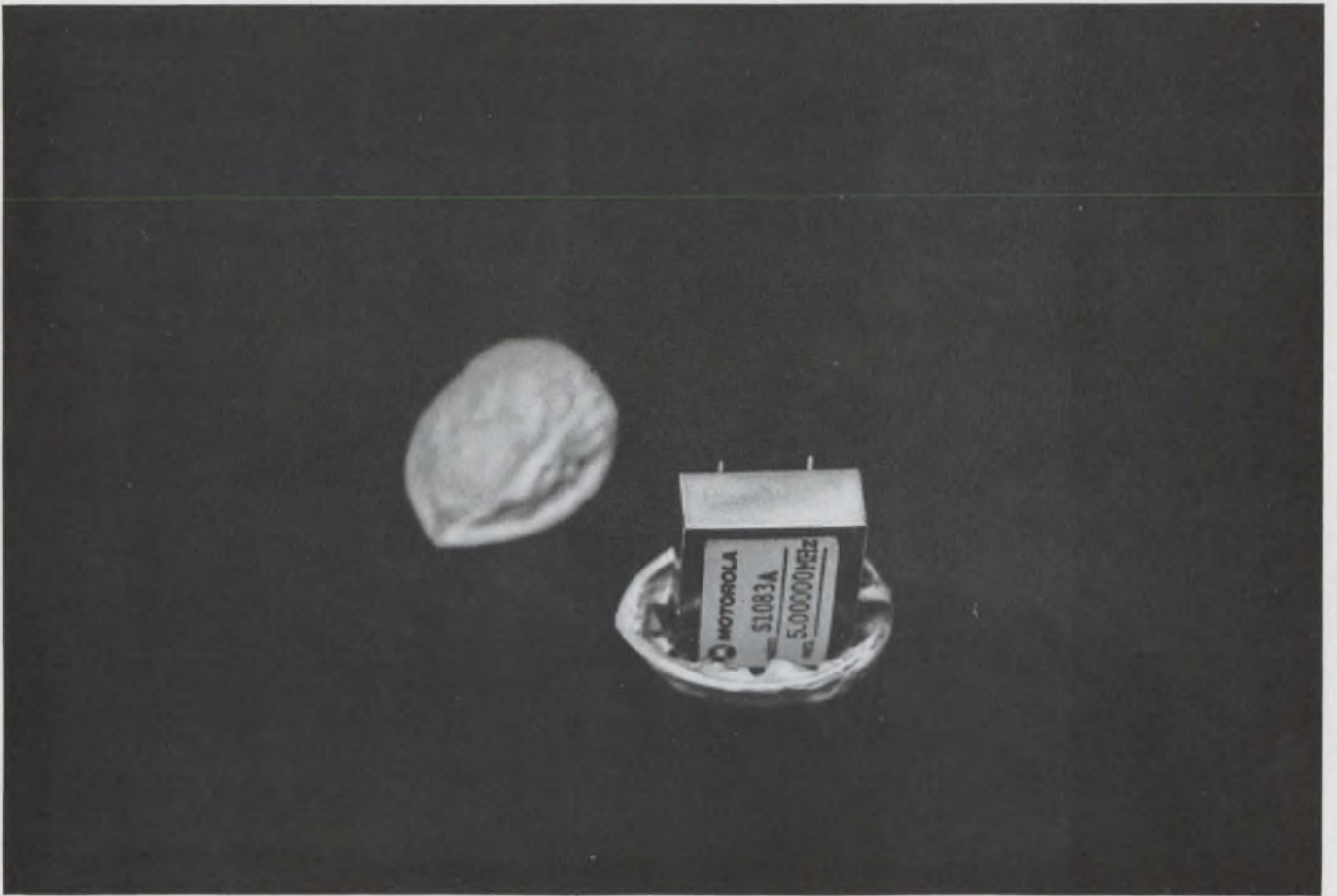

a TCXO that fits almost anywhere

and offers exceptional frequency stability between -55°C and $+85^{\circ}\text{C}$

Only about $\frac{1}{2}$ of a cubic inch in size, this TCXO (temperature compensated crystal oscillator) offers excellent frequency stability; 5 ppm over a temperature range of -55°C to $+85^{\circ}\text{C}$. It's one of four new miniature TCXO's from Motorola. The slightly larger models offer stabilities as low as ± 1 ppm. Zener diode regulated compensating circuits provide on-frequency operation the instant they're turned on. All-silicon solid-state construction provides exceptional reliability. Take a look at these facts.

SMALL SIZE: Sizes range from 0.58 cubic inch to 3.4 cubic inches.

WIDE TEMPERATURE RANGE: From -55°C to $+85^{\circ}\text{C}$.

HIGH FREQUENCY STABILITY: Available as low as ± 1 ppm.

WIDE FREQUENCY RANGE: From 1 MHz to 30 MHz.

LOW POWER CONSUMPTION: As low as 100 milliwatts.

NO WARM-UP TIME: Adjusts instantly to temperature conditions.

FOR MORE INFORMATION contact your Motorola representative. Or write for bulletin TIC-3213.

MOTOROLA COMMUNICATIONS AND ELECTRONICS INC.
 Dept. ED, 4900 West Flourney Street
 Chicago, Illinois 60644. A subsidiary of Motorola Inc.



MOTOROLA
PRECISION
INSTRUMENT
PRODUCTS

ON READER-SERVICE CARD CIRCLE 51

Listen! Don't just hear. Your success on the job depends strongly on how well you communicate orally. Here are hints to help you listen effectively.

A movie critic for a newspaper writes: "What a stupendous waste of fine actors and a great story that could otherwise have made this one of the year's outstanding films!"

The ad quotes the critic: "Stupendous . . . fine actors . . . great story . . . one of the year's outstanding films!"

Cutting a few crucial words has turned the criticism into praise.

We're all familiar with this sort of distortion. Not all of us will admit, however, that we're adept at it, too. We tend to do the same thing while listening to people. It's an example of biased listening.

Here's another illustration of how not to listen to someone: A colleague has button-holed you, and you find yourself trapped by an essentially boring, meaningless oration. You try to fool the speaker by nodding and grunting from time to time, but you can never fool yourself. What should you really do?

Accomplished listeners know that it doesn't pay to pretend to listen to someone. If you have no reason at all for listening, make an excuse and leave. Don't waste the speaker's time and yours.

Good listening is an art that can pay high dividends in productivity and personal satisfaction on the job. *Listening can be learned.*

A company once looked into the reasons why some of its foremen were successful and others weren't. Workers said of the successful foremen in interview after interview: "He listens," or "I can talk to him." A disgusted worker summed up his feelings of an unsuccessful foreman this way: "He knows it all. And he don't know nothing! He always says, 'Why don't you tell me?' But if I try to, he won't let me tell him."

If your company asked its technicians what they thought of you as an engineer, would you pass or flunk the listening test? Or suppose you're a manager and engineers were asked to evaluate you?

Let's examine some rules for good listening that can help you to job success.

Learn the right ways

Listening is an active process. You can't, if you want to be successful, just lean back dreamily and listen. That may work well for music, but you must be alert and attentive when you're trying to take part in communication. As a good listener, you show it: your face and posture reflect the fact that your mind is alert. You show your interest further by questions and comments that encourage the speaker to express his ideas fully. If you've ever tried to talk with a poker-faced, bored, silent listener, you can readily appreciate the difference.

There are four stages to effective listening:

1. Actually hearing the speaker's words.
2. Understanding what the words mean.
3. Evaluating what the speaker is saying.
4. Understanding the speaker's point of view.

The first two stages are not quite as simple as they appear. The same word may have quite different meanings to different hearers. This is not surprising when you realize that the 500 most commonly used words in English have 14,070 dictionary meanings.

In his book *The Second World War*, Sir Winston Churchill told of a long argument that developed in a meeting of the British and American Chiefs of Staff Committee. The British brought in a memo on an important point and proposed to "table" it, which to them meant to discuss it right away. The Americans protested that the matter must not be tabled, and the debate grew quite hot before the participants realized they all wanted the same thing.

Connotations can shade a word's original meaning. To a manager the word "efficiency" probably connotes increased results from the same expendi-

This article is adapted from a chapter by Lydia Strong in the book **Effective Communications on the Job**, published by the American Management Association. The author was a former editor with the A.M.A., and this adaptation appears with the consent of the publisher.

Dave Ports (left), senior engineer in semiconductor manufacturing development engineering at Allentown (Pa.) Works of Western Electric Co., hears about a new product design from Nate Hardwick, Bell Laboratories mechanical engineer. They will collaborate in the final design stages and its introduction into manufacture.

*"Good listening is an art that can pay
high dividends in productivity."*



ture of energy. To a worker it may mean pay increase or pay cut, layoff or promotion, depending on his own, his family's and his friend's experiences.

Evaluating what the speaker is saying and understanding his point of view are the real tests of whether you are really listening. In evaluating what he is saying, you are judging the worth, relevance, strengths and weaknesses of his remarks. In understanding his viewpoint, you are doing what psychologists call "listening with empathy"—that is, with imaginative understanding. It takes courage to listen with empathy. One psychologist, Carl R. Rogers, once explained: "If you really understand another person . . . you run the risk of being changed yourself. You might see it his way; you might find yourself influenced in your attitudes or your personality."

Many people—engineers, managers and others—erect barriers to communication and understanding. There are ways to overcome some of the more common barriers.

Some 'don'ts' to avoid

Don't listen intellectually to the words alone. If the words were all that mattered, why hold interviews or conferences? Why travel across the country to see a sales prospect? Why not do all the work with memos? The answer is, of course, that face-to-face communication adds something that words alone can't convey. The speaker's tone, gesture, posture and facial expression may reinforce, amplify or even contradict his oral statement. Listening without observing is like getting the words of a song without the music.

Don't be a biased listener. You may decide just from looking at a speaker or listening to his voice that he has nothing to contribute. This could be true, of course, but it could be far wide of the mark most of the time. External features, such as the shape of the speaker's nose, the curl of his lip or

the pitch of his voice, may be quite beyond his control. They're not likely to tell you much about the worth of what he has to say.

Or some word, phrase, or idea may similarly cut across your prejudices, and you just stop listening. The speaker says: "We've got to stop making widgets . . ." This is a sore point with you, this widget fight. So you consider him an enemy, and you either interrupt him or stop listening. As a result, you don't hear the end of his sentence, which is, ". . . until Tuesday, because this shipment of raw materials was delayed."

A more subtle, harder-to-spot form of prejudice is to distort the speaker's presentation, to hear only those parts of it that seem to support your point of view. This is the deception that movie and theater producers sometimes employ to counteract a bad review. They choose only those words of the critic that flatter the film or play; they ignore the condemnation.

Nobody can free himself completely from all forms of prejudice. The best you can do is expose yourself to facts and try to allow in advance for subjective kinks in your point of view.

Don't let boredom overcome you. It has been calculated that you can think four or five times faster than you can usually speak. If you're not deeply interested, if the subject matter seems too simple, or if the speaker is on the dull side, you tend to go off on your own private mental tangents.

You can stay on the same track as the speaker without slowing down to his pace if you use your spare time to get clear in your mind what you hope to learn, and listen especially for this. Try to anticipate the speaker's next point; review the points he has made already; weigh his evidence. Watch his expression and movements to get the fullest possible understanding of his point of view.

Apathy sets in also when the subject matter is too difficult or when the speaker is incomprehensible. If circumstances permit, you can help yourself and other listeners who may be present



Self-listening: Even if interested in someone else's comments, we concentrate more on what we are going to say.

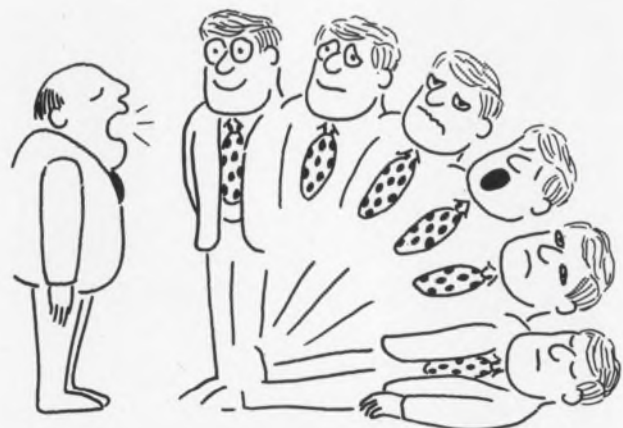

Going, going, gone: Boredom is a block to good listening. Having empathy with the speaker can avert this.

by asking the speaker to clarify his point.

Don't pretend to listen. You may fool the speaker, but it's better for all concerned if you face the fact squarely: You either have or you don't have a reason for listening. If you do—even if your reason is only inescapable social pressure—listen. If you don't, find the excuse to break away.

Practice listening exercises

Certain procedures can help you improve your listening. One is to practice by listening to a speaker on television or radio. Try to sort out the speaker's main theme from his digressions, irrelevancies and supporting subject matter. Try to evaluate his argument. Notice any words or statements that touch off your antagonism or sympathy. Note also any propaganda techniques: appeals to prejudice, the use of stereotyped symbols, statements that are cleverly worded to sound logical, even though they're not.

When the speaker has finished, write a single paragraph giving his main idea and supporting evidence and stating why he has or has not made out a convincing case. If you do this in a group, the group members can compare reactions. This practice, incidentally, will make you a more skillful speaker as well as a better listener.

Suppose there is to be a company meeting, and the arrangements are up to you. One thing that helps is to provide the best possible physical conditions. Arrange the seats so they are close enough for people to hear without straining: face to face for an interview, in a circle or square for a conference. Try to exclude distracting noises and interruptions. If notes must be taken, have pencil and paper ready. It pays to prepare yourself mentally and emotionally for listening. Give some thought to the subject of the meeting. If it's controversial, try to recognize your own prejudices and your possible private goals.

Once the meeting starts, your newly acquired listening skills come into play. You listen for the main points and supporting evidence, identify bias and propaganda appeals. *But use your skills with, not against, the other person.* Chances are you'll be working with him in the future.

Taking notes may be unavoidable, but you'll do well to keep them as brief as possible. Your time is better spent in concentrating on the speaker.

Put listening skills to work

Suppose you're to interview a subordinate on a proposed change in design which will require his full cooperation. You're for the change—in fact, it's your idea—and you already know that he's opposed.

If you decide that you really will listen, then you start by admitting to yourself from the start

How's your listening?

Here's a listener's checklist which will help you gauge your own listening habits. Try to answer each question objectively. Then, in a month or two from now, take the test again and see if you have improved your listening skills.

When taking part in an interview or group conference, do you:

	Usually	Sometimes	Seldom
1. Prepare yourself physically by sitting facing the speaker, and making sure that you can hear?			
2. Watch the speaker as well as listen to him?			
3. Decide from the speaker's appearance and delivery whether or not what he has to say is worthwhile?			
4. Listen primarily for ideas and underlying feelings?			
5. Determine your own bias, if any, and try to allow for it?			
6. Keep your mind on what the speaker is saying?			
7. Interrupt immediately if you hear a statement you feel is wrong?			
8. Make sure before answering that you've taken in the other person's point of view?			
9. Try to have the last word?			
10. Make a conscious effort to evaluate the logic and credibility of what you hear?			

Score yourself as follows:

Questions 1, 2, 4, 5, 6, 8, 10: 10 points for "usually," 5 for "sometimes," 0 for "seldom." Questions 3, 7, 9: 0 for "usually," 5 points for "sometimes," 10 for "seldom."

If your score is below 70, you have developed some bad listening habits; if it is 70-85, you listen well, but could improve; if it is 90 or above, you're an excellent listener.



Don't fake it: Pretended listening is a damaging form of non-listening. It wastes his time and yours.

that the other person may just have good reasons for his opposition; also, you can't know these reasons fully until he has explained them fully, no matter what you've heard on the grapevine.

As he speaks, you listen closely and sympathetically. Your attention warms him, puts him at ease, lessens his (and your) aggressiveness. Because we all perform better when we feel at ease, he opens up, explains himself more ably than he could to a hostile listener. Instead of concentrating on your rebuttal, you take in his objections and try to judge their relevance.

After speaking his mind, he feels freer to listen to your point of view which in turn may have been modified by his statement. Sooner than you expect, you may find yourselves reaching a cordial consensus instead of a hard-fought compromise.

Will this happen every time? No, but it happens often enough to make listening worthwhile.

Should you interrupt?

Let's say that a person whose point of view is opposed to yours makes a ridiculous, indefensible statement. On a debating team you'd pounce on the statement, make the man look foolish. But the usual purpose of a company meeting is cooperation, not competition. Should you interrupt him?

In a situation like this, the answer is yes. But do it in such a way as to ease any embarrassment for him. A timely question, for example, may help the speaker clarify a more obscure point, bring him back to the point if he has strayed. But remember: interruption and contradiction should be used sparingly. If you pounce on the speaker, he'll only get flustered or angry, and the result will be an even less effective presentation by the speaker.

Here are some interruption guidelines:

- If mentally you question a statement that is not actually erroneous, give the speaker a chance to complete his discussion of the item. If by that time he hasn't clarified the point to your satisfaction, interrupt then with a question intended to clarify what he means.

- If the speaker makes an obvious misstatement, interrupt as soon as is convenient, and tactfully ask him to repeat the statement in question or per-



Split personality: Don't half-listen. The speaker deserves all of your attention, not just half of it.

haps say, "Did you say . . .?"

- Don't interrupt the speaker to agree with him. Let him finish what he has to say. Then it's your turn. Prolonged or continued interruptions only make it harder for the speaker to maintain his train of thought.

Develop listening empathy

Would you like a final test of good listening? Here's a suggestion: Next time an argument develops at a company meeting, stop the discussion and specify that each person may speak for himself only after he has first stated the ideas and feelings of the previous speaker. Any distortion may be corrected immediately by the original speaker.

This means, of course, that before presenting your own arguments you must place yourself in the other person's frame of reference; you must understand his ideas well enough to summarize them. You'll find this tough but rewarding. First of all, you'll open your ears as you never have before. Then, as you consider the other speaker's arguments carefully, you may find your own point of view changing. You will have achieved empathy.

There are benefits in this for the other person, too. He hears how his statement sounds to you. He may not have meant it just that way. He, too, may make changes. Quite suddenly, the heat goes out of the argument. The differences are easier to reconcile. In the end everyone feels he has gained some benefit. The conferees go out saying, "That was a good meeting." Not: "You can't win." ■ ■

Test your retention

Here are questions based on the main points of this article. They are to help you see if you have overlooked any important ideas. You'll find the answers in the article.

1. What barriers do we erect that block us from listening effectively?
2. What four steps can we take to overcome these barriers?
3. When should you interrupt? When shouldn't you interrupt?

PROJECT LEADERS

(present & future):

Look at your capabilities. Then look at ours. As a catalyst.

A catalyst in terms of significant projects, with important contributions yet to be made. A catalyst in terms of environment, with solid technological competence in a wide variety of areas, both to draw upon and to grow into. And, equally important, a catalyst in terms of your future development with an in-writing 'people development' plan that charges each supervisor with developing his own replacement before he moves up the ladder.

Anti-Submarine Warfare Laboratory

ASW activities are concentrated in three separate departments: Hydroacoustics, Electroacoustics, and Special Development—each with its own technical facilities and staff. Among the newest and most intriguing programs you might work on are the advanced marker/launcher system for USW; an advanced integrated sonar system for surface ships, and the use of special hydroacoustics sources for deep submergence sonar. Special facilities support these projects in design and testing: a fully instrumented, 48-ft. diameter sonar tank; a nearby lake—600-ft. deep and ice-free; and a completely instrumented, 165-ft. self-propelled barge capable of testing transducers weighing up to 35 tons.

Data Communications Laboratory

Data Communications is currently designing at the state-of-the-art in hardware and systems for digital communications equipment. Two strong areas of current R&D interest are (1) the application of modulation and coding theory to data communications for transmission via many different media (2) development of frequency—differential signaling for high-speed data transmission in the high frequency band, studies of propagation and polarization phenomena at high frequency, and frequency measurement in the microwave band. The subscriber terminal equipment for AUTODIN, a world-wide digital communication network, is just one of the current programs in the data lab.

Communications & Avionics Laboratory

The RF Group is involved in ground and air communications hardware and systems. Their interest involves all frequencies ranging from HF through UHF. Included are secure communications pack sets, receiver design utilizing micro min techniques, and advance communication systems integrating black box design and techniques into mobile or shelter installations. Currently avionics design work is being concentrated on the micro min of the F106

TACAN. This involves complex design utilizing the state-of-the-art in integrated circuits and solid state devices.

Aerospace Ground Equipment Laboratory

The F-111 places heavy demands on an AGE engineer. This most complex and advanced combat aircraft in the U.S. arsenal must be tested with even more complex simulation equipment in order to test the diversified types of the F-111 for its various missions and their respective avionics. The magnitude of the systems and design problems to be encountered are illustrated by the following intricacies of this ground support equipment: It's a highly automated test and fault-location system which includes a video station, radar receiver/transmitter modulation station, indicator/controls station, central air data computer station, radar servo and indicator station, UHF—HF and TACAN stations, HF flightline tester, IR digital station—each sophisticated enough to test the state-of-the-art. And to create responsible positions in engineering and management within this laboratory.

Microelectronics Application Laboratory

This technical service laboratory is now in its embryo stages of development. Its purpose will be to provide the above product labs with the most advanced designs in micro min techniques for the development of their individual needs. This task involves a close partnership with the product development laboratory, aiding in the design of circuits and utilizing thin and thick film techniques. At present positions are available at both Junior and Senior salary levels for those who have experience in circuit design using integrated circuits and/or the actual design of ICS and micro-miniaturization techniques.

Your Opportunities:

If you have background/interest in one or more of the above areas, we'd like to tell you more about the year-round creative climate we offer. Send a resume to Mr. J. P. O'Reilly, Dept. 142.

GENERAL DYNAMICS

Electronics Division

1400 N. Goodman St., Rochester, N.Y. 14601 *An Equal Opportunity Employer (M&F)*

At ECI in St. Petersburg, Florida . . .
Communication Systems Opportunities

For a special breed of engineer

If you're one of that special breed of communication engineers who finds a challenge in projects beginning with applied research and advanced development and continuing through prototype and product design, you may well be the kind of person we're looking for.

Check this partial list of systems engineering activities at ECI. If you'd like to help push the state-of-the-art in any of these or other areas in communications, send us your resume. You'll design systems and equipment for satellite communications, multiplexing, electronic switching, command and control and advanced radio communications for some of the nation's major defense and space programs.

Communication Systems Engineering Activities:

- Propagation Analysis
- Advanced Antennas
- Coding Theory
- Detection Techniques
- Communication System Design
- Communication System Integration
- Reliability Techniques

CHALLENGE, GROWTH . . . and LOCATION TOO!

At ECI your job will be challenging. At ECI you'll find real opportunity for growth instead of just another confining groove — two-thirds of all advanced development is done in regular engineering development areas. And, at ECI you'll like where you're living just as much as you'll like your job. We'll match subtropical, sunny St. Petersburg against any location in the U. S. for stimulating, comfortable living.

SEND YOUR RESUME TODAY — in confidence — to K. D. Nipper, Supervisor of Professional Placement, Electronic Communications, Inc., P. O. Box 12248, St. Petersburg, Florida 33733.
(An equal opportunity employer, M & F.)



ELECTRONIC COMMUNICATIONS, INC.
ST. PETERSBURG DIVISION



Free Career Inquiry Service

Absolutely Confidential

Respond to the career opportunities advertised in this issue. Fill out and send us this handy resume. **Electronic Design** will do the rest – neatly typed copies of this form will be mailed to the companies of your choice, indicated by the circled Career Inquiry Numbers at the bottom of this page.

26

Name		Home Phone	
Home Address (Street)		City	State
			ZIP Code
Age	U.S. Citizen	Security Clearance	
	<input type="checkbox"/> Yes <input type="checkbox"/> No		

Prime Experience	Secondary Experience

Desired Salary	Availability Date
-----------------------	--------------------------

Employment History – present and previous employers

Company	City, State	Dates	Title	Specialty
		to		
		to		
		to		

Education – indicate major if degree is not self-explanatory

Degree	College	City, State	Dates
			to
			to

Additional Training – non-degree, industry, military, etc.

Professional Societies

Published Articles

- Career Inquiry Numbers:**
- | | | | | | | | | | |
|-----|-----|-----|-----|-----|-----|-----|-----|-----|-----|
| 900 | 901 | 902 | 903 | 904 | 905 | 906 | 907 | 908 | 909 |
| 910 | 911 | 912 | 913 | 914 | 915 | 916 | 917 | 918 | 919 |

ELECTRONIC DESIGN
 850 Third Avenue
 New York, New York 10022

Plotter design measures vidicon transfer characteristic

Problem: Develop a technique for measuring the transfer characteristic of vidicons and other image sensors. The usual way is to use a light source of constant spectral emission that can be varied in intensity. To measure the transfer characteristic, the output of the image sensor is read on a current meter and the data are then plotted on a graph. The method is time-consuming and may result in high errors.

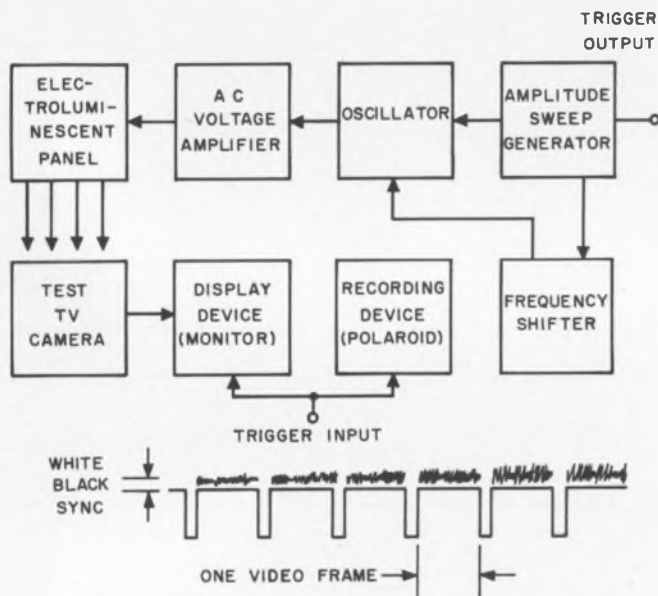

Solution: Measure the light from a calibrated electroluminescent panel as a function of the current output of the image sensor. The plot of current output vs the calibrated light output of the electroluminescent panel is the transfer characteristic of the vidicon.

The vidicon tube to be tested is placed in the TV camera and operated at the desired line and frame rates. The camera is set in light communication with the electroluminescent panel, to illuminate the photosensitive area of the vidicon. The sweep rate of the oscillator output voltage is adjusted to allow many frames of video to be exposed during one sweep of the oscillator output. As the oscillator amplitude increases, the luminance of the electroluminescent panel increases. Any change in color temperature is compensated for by the frequency shifter. As the luminance increases on the electroluminescent panel, the vidicon under test converts the light into an electrical signal, which is processed by normal means. The signal is then displayed on a device, which may be a TV monitor, and recorded by a photographic copier, video tape recorder or recording oscillograph. The video output appears as shown in the lower figure.

This plot of current output vs calibrated light output of the electroluminescent panel is the transfer characteristic of the vidicon.

This method saves much time, because it controls all the standard conditions for the test and automatically plots the output response. The electroluminescent panels permit a wide range in the choice of illumination characteristics.

This development is in a conceptual stage only, and neither a model nor prototype has been constructed.

Inquiries may be directed to: Technology Utilization Officer, NASA Pasadena Office, 4800 Oak Grove Drive, Pasadena, Calif., 91103. Reference: B67-10206.

FET subcarrier oscillator is temperature-compensated

Problem: Design a temperature-compensated telemetry subcarrier oscillator whose output frequency will be an essentially linear function of the magnitude of an input signal from a sensor. The oscillator must be low-power, have a high input impedance and be temperature-stable.

Solution: Use an input buffer with a field-effect transistor which effectively serves as a solid state temperature-compensating element.

The subcarrier oscillator includes an astable multivibrator consisting of a pair of regeneratively coupled transistors and an input buffer, which provides temperature-compensated base voltage to the transistors as a function of the sensor signals.

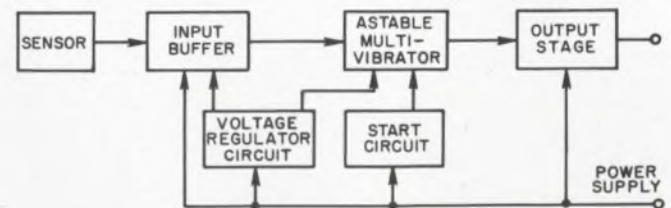

The input buffer includes a field-effect transistor with a gate electrode coupled to the input signal from the sensor and a source electrode coupled to the base electrodes of the multivibrator transistors. The FET drain electrode is connected to an adjustable drain-current-control circuit. This circuit is adjusted to compensate for the collector-emitter saturation voltage variations of the multivibrator and for any mismatch in buffer-component temperature coefficients. Transistorized circuitry in the input buffer provides the high input impedance for the subcarrier oscillator. Temperature-compensated collector voltage to the multivibrator transistors is ensured by a voltage regulator.

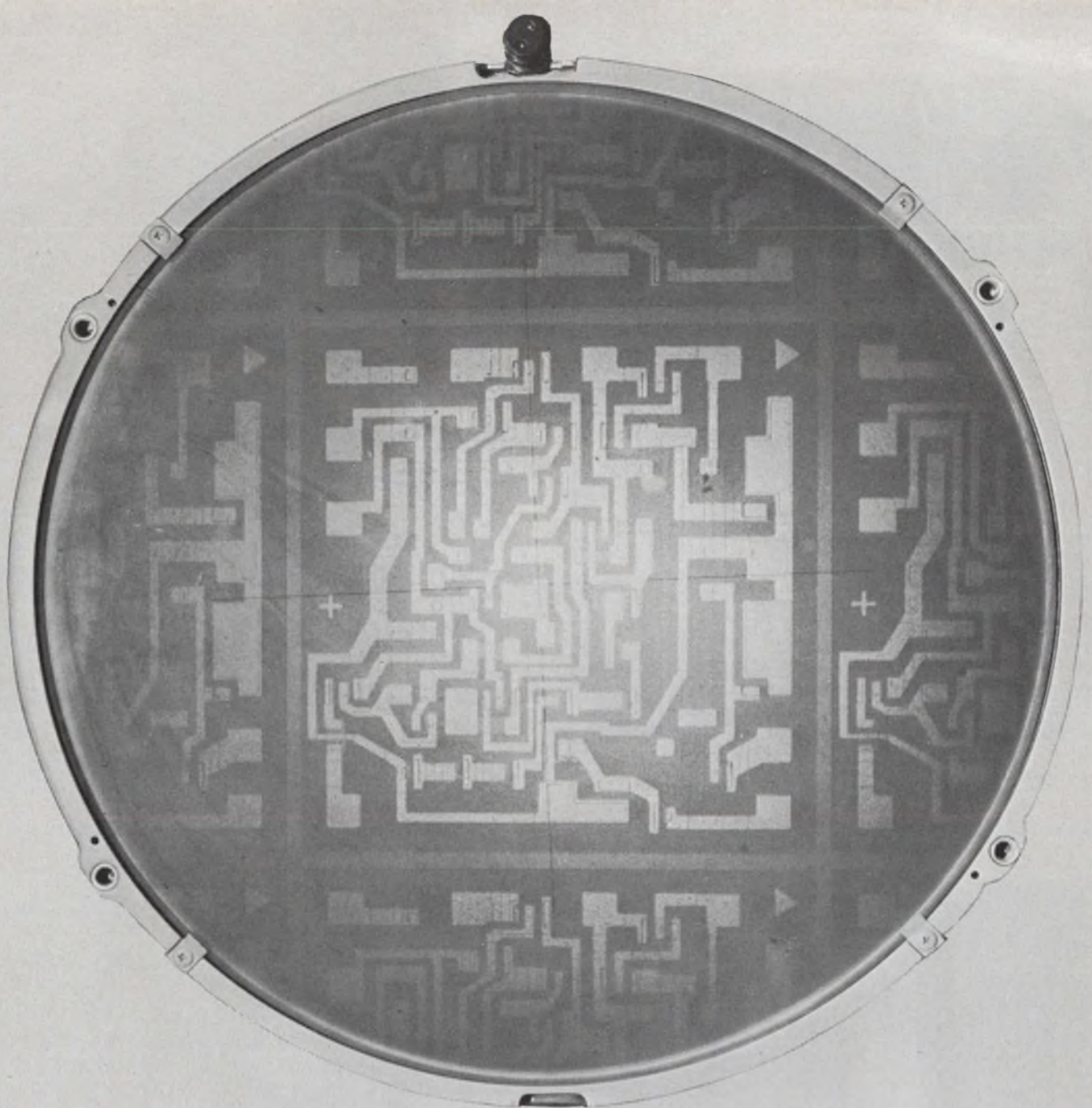

Challenge In Microelectronics

You'll find it at Delco Radio in a variety of research/development and manufacturing programs. Rapid expansion of microelectronics and silicon device projects has created new career opportunities for the B.S., M.S., Ph.D. in Chemistry, Electrical Engineering, Mechanical Engineering, Metallurgy, Physics, Physical Chemistry, and related fields.

Research and Development Programs in:

Linear and digital circuitry, embracing monolithic . . . thick film . . . thin film . . . and hybrid microcircuits

Silicon transistors from low power 10 milliampere through 25 ampere; voltages to 1200

High frequency transistors to 1GHz

Thyristors from 50 milliampere through 500 ampere, 2000 volts

Silicon rectifiers from milliampere through 250 ampere, 3000 volts

Process Engineering Positions:

Unlimited opportunities in this area to develop and create new processes for manufacturing germanium and silicon semiconductor devices, integrated circuits, and automobile radios. Includes development of automatic and semiautomatic fabrication equipment, pilot line operation and general cost savings investigations pertinent to semiconductor manufacturing.

Call us collect for an interview or more information. Area Code 317/459-2808. Ask for C. D. Longshore. Or send your resume to Mr. Longshore, Supervisor, Salaried Employment, Dept. 103, Delco Radio Division of General Motors, Kokomo, Indiana.

DELCO RADIO

DIVISION OF GENERAL MOTORS • KOKOMO, INDIANA

An equal opportunity employer



NEW and Unique

The Lundey Clinch-Loc[®] HERMETIC TEFLON^{*} TERMINAL

the ultimate in simplicity

IT'S DUAL-PURPOSE
... and economical

* Dupont Trademark

Use it as a moisture-proof terminal or a conventional panel feed-thru and get low initial cost, fast and economical assembly, ruggedness and mechanical reliability — plus the excellent thermal and electrical values of Teflon.

U.S. Patent 3,166,634
Canadian Patent 727,204
Other Foreign Patents
Applied For

Designed to meet Mil-T-27B
requirements



WRITE NOW FOR SAMPLE KIT

includes product samples and literature

another quality product in THE LUNDEY LINE

LUNDEY ASSOCIATES, INC.

694 Main St. Waltham, Mass. 02154

ON READER-SERVICE CARD CIRCLE 52

THUMBWHEEL SWITCHES

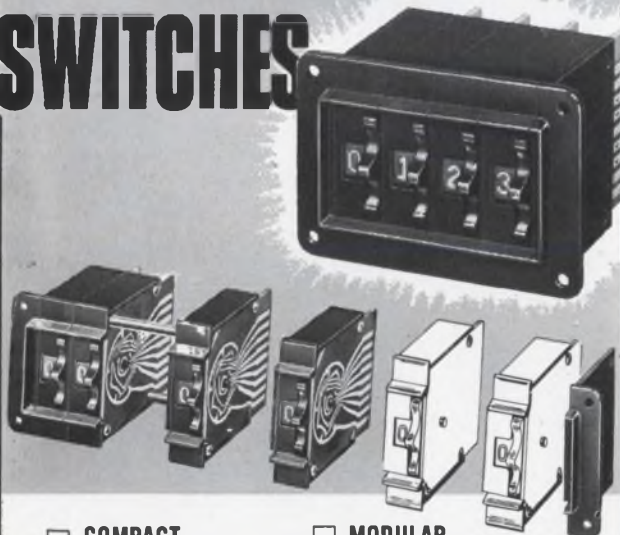

- | | |
|--|---|
| <input type="checkbox"/> COMPACT | <input type="checkbox"/> MODULAR |
| <input type="checkbox"/> POSITIVE OPERATION | <input type="checkbox"/> WIDE RANGE OUTPUT |
| <input type="checkbox"/> SIMPLE, CLEAN
INSTALLATION | <input type="checkbox"/> EDGE LIGHTING
AVAILABLE |
| <input type="checkbox"/> ECONOMICAL | |

Send for further information

TECH LABORATORIES, INC.

Palisades Park, New Jersey

Phone: 201 — 944-2221 • TWX: 201 — 947-4730

ON READER-SERVICE CARD CIRCLE 53

NASA TECH BRIEFS

Inquiries concerning this invention may be directed to: Technology Utilization Officer, NASA Pasadena Office, 4800 Oak Grove Drive, Pasadena, Calif. 91103 (reference B67-10251).

This invention has been patented by NASA (U.S. Patent No. 3,325,749), and royalty-free license rights will be granted for its commercial development. Inquiries about obtaining a license should be addressed to NASA, Code GP, Washington, D.C. 20546.

Transient analysis generator simulates electrical networks

Problem: Construct a computer program to simulate both transient and dc steady-state behavior of lumped linear, bilateral and passive networks.

Solution: TAG (the Transient Analysis Generator program) was developed. It is termed an analysis generator because it makes a special analysis program for each circuit described to it. It also prints out the actual equations that it generates to simulate a circuit's behavior. These equations appear in a matrix in symbolic form and allow the user to double-check against errors in his circuit description. Easy manipulation of the simulation program makes for flexibility in the number and type of simulations that can be performed.

The TAG system consists of two basic parts. The first part, which actually generates the solution program, is called the generator or preprocessor. The preprocessor interprets the user's circuit description, generates the proper set of simulation equations, and imbeds them in a Fortran solution program. This solution program is peculiar in the given circuit topology and is available in punch-card form as an output of the TAG system.

The second part of TAG is the execution or simulation system. This comprises the set of sub-routines required actually to run a generated solution program. The subroutines provide the detailed solution and control processes required by the simulation program. While the preprocessor is stored on magnetic tape to be called into use by special control cards, the execution system is stored on cards in relocatable binary form and must be included in all TAG system decks submitted for a simulation run. Preprocessing and execution may be combined in a single computer run.

The program uses Fortran II and FAP on an IBM 7094 computer and an SC 4020 plotter.

Inquiries concerning this program may be directed to: COSMIC Computer Center, University of Georgia, Athens, Ga. 30601. Reference: B67-10319.

Lockheed's, "secret weapon" for winning electronics engineers

It's scope. A unique range of projects and assignments at Lockheed, covering the entire spectrum of electronics from major systems to solid state devices.

Programs include:

Poseidon and
Advanced

Polaris, strategic
ballistic missiles; P-3C Orion, the U.S.
Navy's foremost ASW search plane and
other airborne anti-submarine

systems; YF-12, the
world's fastest jet,
now in major develop-
ment phase; airborne monitoring
systems; gunfire control systems;
electronic sub-systems; MADAR (Mal-
function Detection Analysis and Record-
ing) equipment; computer-aided design;
memory devices and systems; advanced
3D radar systems; and many more.

Immediate openings at Lockheed include:

Circuit design, hardened circuitry,
metrology, flight control electronics,
reentry electronics, reentry elec-
tronics systems design, underwater
instrumentation, optical/radar
systems, airborne electrical power
systems, hybrid microelectronics,
electromechanical packaging, radar
communications, RF and solid

state circuit design, CRT
and solid state displays,
real-time programming,
memory core design, elec-
tronics systems design, antenna systems,
phased array antennas, microwave de-
vices, and others.

To summarize: Electronics engineers at
Lockheed find themselves in a "choice"
position. With a choice of projects,
assignments and geographic locations
from coast-to-coast.

Address inquiries to Electronics
Engineering
Employment
Manager
at the Company
of your choice.

*Lockheed-California
Company, Burbank,*

*California. Lockheed Electronics
Company, Plainfield, New Jersey—*

*for locations in Plainfield as well as
Houston, Texas, Los Angeles, California,
Greenbelt, Maryland. Lockheed-Georgia
Company, Atlanta, Georgia. Lockheed
Missiles & Space Company, Sunnyvale,
California—for locations in Sunnyvale
and Palo Alto, California, or Huntsville,
Alabama. Lockheed is an equal
opportunity employer.*

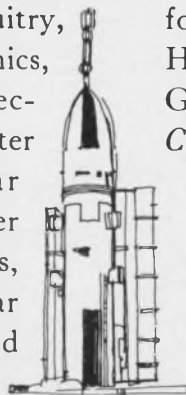
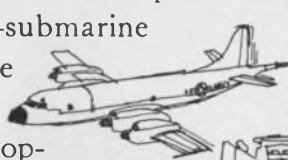
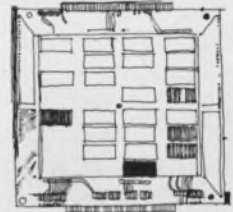

LOCKHEED
LOCKHEED AIRCRAFT CORPORATION

ON CAREER-INQUIRY CARD CIRCLE 903

Simple circuit gives fast, high current pulses to drive a GaAs laser pulser

Capacitor discharge circuits for GaAs diodes provide the current necessary for numerous operations. Existing SCRs act as fast switching elements capable of delivering 80-ns, 160-amp peak current pulses. The upward trend of power-handling capabilities has created a need for 300-amp peak currents at repetition rates of 10 kHz.

This design (see figure) employs three parallel banks of capacitor charge-discharge circuits. Each capacitor bank is charged by its respective high-voltage charging transistor. Sufficient gate current drive will easily ensure simultaneous SCR firing. Individual energy discharges are then summed at a common point in series with the laser diode. Charging transistors are turned off by the voltage pulse developed across *D1* resulting from capacitor discharge *C1*.

Series SCR operation presents problems of current charging and triggering which demand SCR matched pairs. Parallel circuit operation eliminates these problems and permits the use of randomly selected SCRs. The circuit shown will give 300-amp peak current pulses at 10 kHz with a half width of 80 ns.

The circuit may be extended to achieve much higher peak-current values with no change in pulse width. A prototype consisting of five parallel cir-

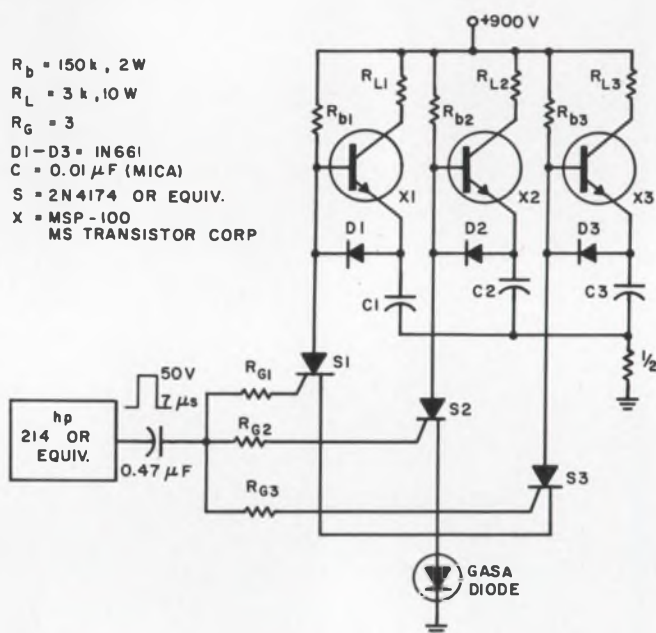

- $R_b = 150\text{ k}, 2\text{ W}$
- $R_L = 3\text{ k}, 10\text{ W}$
- $R_G = 3$
- D1-D3 = IN661
- C = 0.01 μF (MICA)
- S = 2N4174 OR EQUIV.
- X = MSP-100 MS TRANSISTOR CORP

300-A, 80-ns pulses needed to operate a GaAs laser are delivered by this three-parallel-stage circuit at 10 kHz.

uits has given 820-amp peak current pulses into a 1/2-ohm resistive load. Repetition rate was limited to 250 Hz owing to resistor charging.

(This research was partially supported by U.S. Army Electronics Command, Fort Monmouth, N.J., under Contract Number DA28-043-AMC-02471(E).)

J. R. Frattarola, Quantum Electronics Group, RCA Laboratories, Princeton, N.J.

VOTE FOR 110

Transistors compensate diodes in triangle-to-sine convertor

In the design of a broad-band function generator, a triangle wave and a square wave are generated simultaneously by connecting a wide-band integrator and a precision bistable switch in a regenerative configuration as shown in the simplified block diagram (Fig. 1a).

A sine wave is then obtained by shaping the *(text continued on p. 106)*

VOTE! Go through all Idea-for-Design entries, select the best, and circle the appropriate number on the Reader-Service-Card.

SEND US YOUR IDEAS FOR DESIGN. You may win a grand total of \$1050 (cash)! Here's how. Submit your IFD describing a new or important circuit or design technique, the clever use of a new component or test equipment, packaging tips, cost-saving ideas to our Ideas-for-Design editor. You will receive \$20 for each accepted idea, \$30 more if it is voted best-of-issue by our readers. The best-of-issue winners become eligible for the Idea Of the Year award of \$1000.

The Fluke 891A and AR are the first low cost solid state differential voltmeters with an 1100 volt reference which provides infinite input resistance at null. In the TVM model with 100 megohms input resistance, you can get the advantage of low source loading just as you can with older Fluke vacuum tube differentials. □ Differential accuracy of the Fluke 891A is $\pm(0.01\% + 0.001\%$ of range $+ 10 \mu\text{V})$. Ten percent overranging is featured. Reference regulation is the best on the market. Reference stability is 15 ppm/hr. Grounded recorder output can be added at any time for \$50. Price of either model is \$695. □ For complete details and a demonstration, call your full service Fluke sales engineer (listed in EEM) or write us for full information.



Now, the low cost differential voltmeter with infinite input resistance at null to 1100 volts, the new Fluke 891A and 891AR. TVM input resistance is 100 megohms. Order in half or full rack models. Add battery operation at any time for \$100.



Fluke: Box 7428, Seattle, Washington 98133. Phone: (206) 774-2211 • TWX: (910) 449-2850
In Europe, address, Fluke International Corporation, P. O. Box 5053,
Ledeboerstraat 27, Tilburg, Holland. Telex: 844-50237.



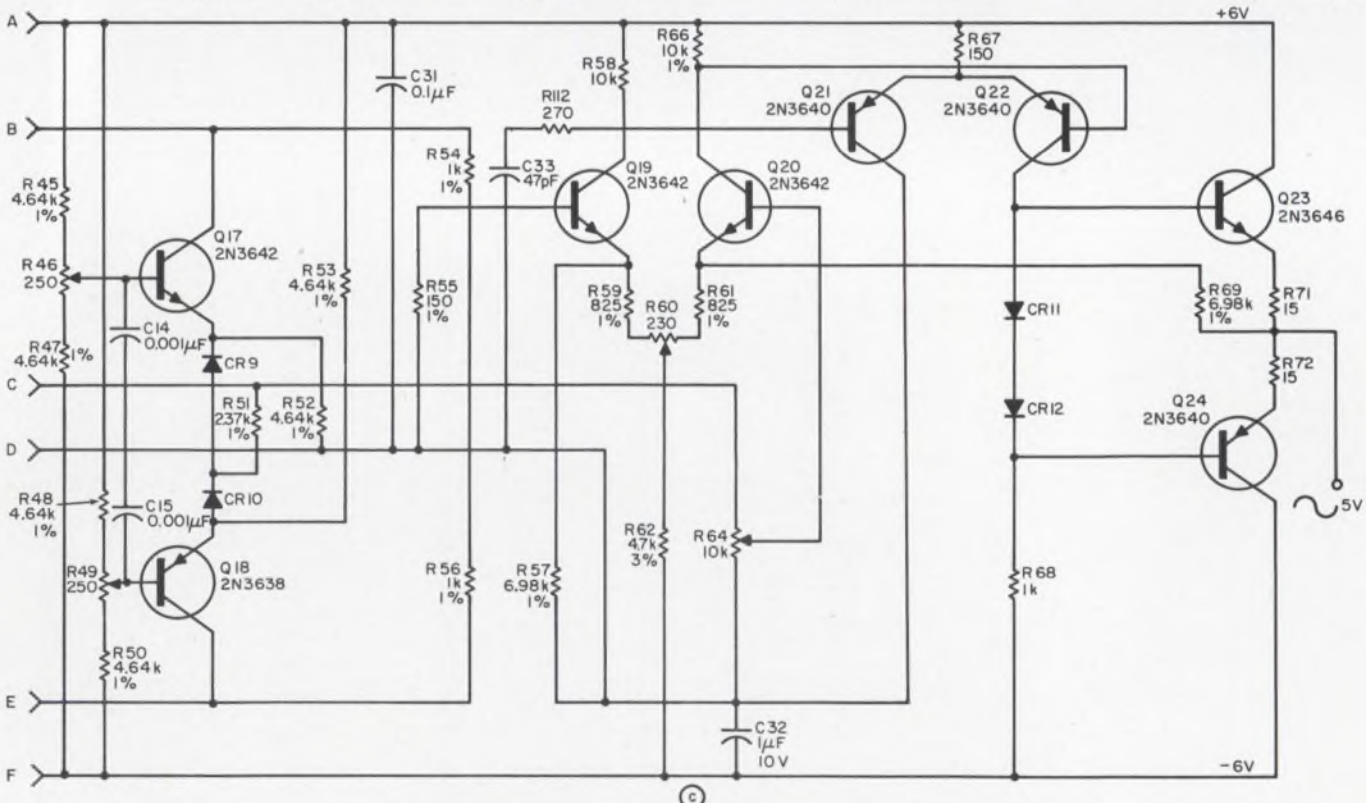
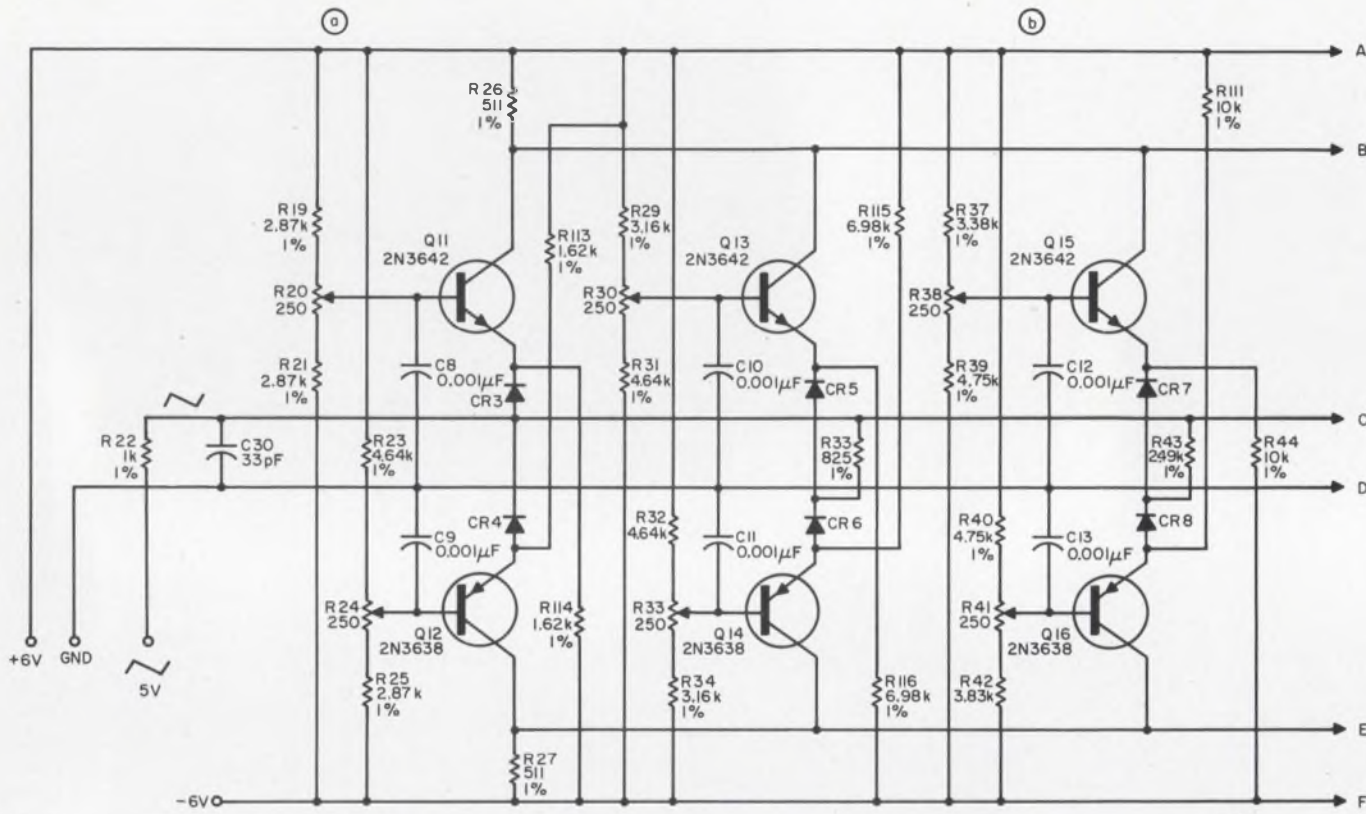
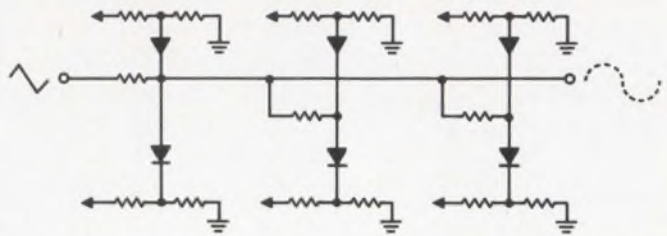
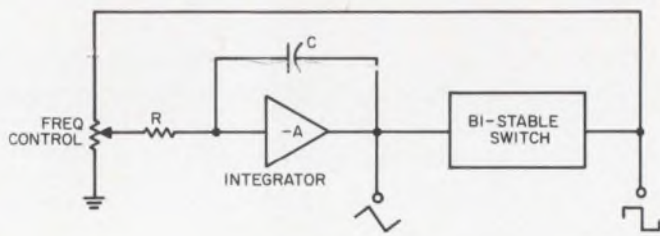

Sine waves obtained from (c) are derived from the basic triangle- and square-wave generator (a) after clipping in

(b). In (c) clipping adjustment is accomplished in the bases of emitter followers Q11 through Q18.

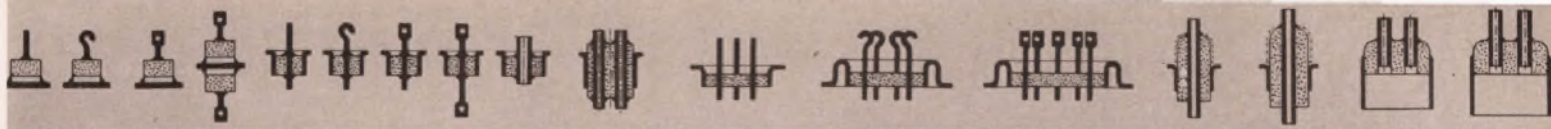

New

CERAMETERM™

CERAMETERM (CERAMIC METAL TERMINAL) IS A TRADEMARK OF CERAMICS INTERNATIONAL CORP.

a complete line of super strength ceramic-to-metal products with "off the shelf" availability

Now you can use the complete CERAMETERM line for all applications, electrical, mechanical, or chemical — because CERAMETERM makes all other seals obsolete. You get super-strength, and a truly hermetic seal at no extra cost.

For the first time, the CERAMETERM line offers ceramic-to-metal seal cost economies which are competitive to all other seals . . . Now the world's best seal makes all other seal mediums inadequate.

- Glass seals crack too easily.
- Plastic epoxy seals leak too easily.
- Electrical connectors which are glued are easily broken.

CERAMETERM seals are super-tough, and non-corrosive under normal atmospheric conditions. They can withstand mechanical shocks and thermal stresses up to 10,000 g's acceleration, and temperatures up to 700°C. A complete line of standard configurations of standoffs, small feedthrus, tubular feedthrus, and multi-pin headers is available off the shelf, in any quantity.

WRITE FOR FREE SAMPLE and our new illustrated brochure, or call Ceramics International Corp., 201-529-2802.



CERAMICS INTERNATIONAL CORP.
MAHWAH, NEW JERSEY 07430

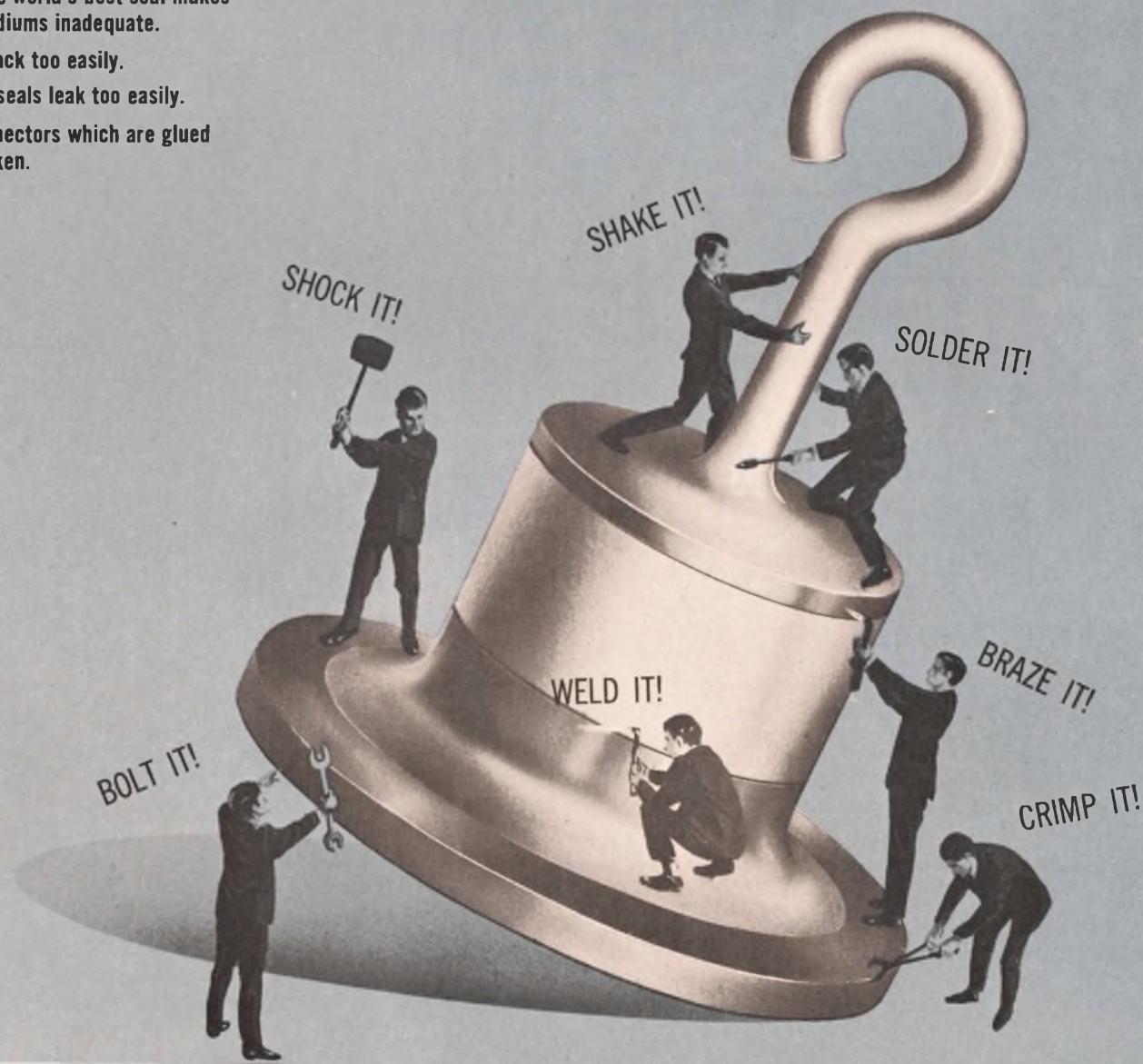

triangle wave. This can be done with simple diode shaping networks to clip the positive- and negative-going portions of the triangle. Each set of diodes clips a different level of the triangle until a sine wave is obtained (Fig. 1b).

The clipping points are adjusted for minimum harmonic distortion. Some of the disadvantages are that the changes in the diode characteristics with temperature cause a change in the clipping points and an increase in harmonic distortion, and the very peaks of the triangle are not clipped. Attenuation occurs in the clipping process and the output resistance is not desirable.

Figure 1c illustrates a circuit to overcome these disadvantages. The clipping diodes are biased by transistor emitter followers and, as a result, the offsetting temperature coefficients of the emitter base junctions compensate the diodes. Clipping-point adjustment is accomplished in the bases of the emitter followers (Q11 through Q18). A potentiometric amplifier is added (Q19 through Q24) to reestablish the amplitude and offer a low output impedance to the load. The very peaks of the triangle are not clipped and are present on the signal at the base of Q20. These peaks are also present at the collectors of the emitter followers in the shaping network. The collectors are returned to the supplies through the common impedance of R26 and R27. These peaks are applied to the minus input of the amplifier at the base of Q19. Peak cancellation occurs in the amplifier and the result is a clean sine wave at the output.

Jerry F. Foster, Chief Engineer, Wavetek, San Diego, Calif.

VOTE FOR 111

Build a pulse generator with four components

A need for a quick, simple pulse generator to calibrate pulse-sensitive test gear was met by using a pnpn four-layer diode in the simple circuit shown.

The circuit is a sawtooth-wave generator formed by R1, C1 and the four-layer diode. The capacitor charges up through R1 to the breakdown voltage of the diode. The diode fires and the capacitor discharges through the diode and R2. The value of R1 is kept high enough to limit the current below the holding current of the diode. Therefore the diode cuts off when the capacitor discharge current decreases to below the holding current value. The cycle then repeats.

The output may be varied since R2 is a potentiometer. The repetition rate is determined by the

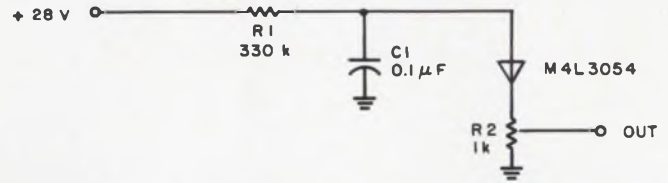

Fast pulses are obtained from a circuit that can be built in about 10 minutes.

value of R1 and C1. The pulse width will be affected by the value of R2 and C1.

A. G. Richardson, Supervisor, Test Evaluation, Teledyne Automated Specialties, Charlottesville, Va.

VOTE FOR 112

A simple generator produces linear sawtooth

During run-down, Q1 and Q2 (see figure) are isolated by diodes D1 and D2. Q2, R3, C1 and R4 act as a simple Miller-type charging circuit in which the rate of charge is controlled by C1 and R4. Q1 is bottomed by base-current through R1.

When Q2 bottoms, D2 conducts, switching off Q1 and initiating a fly-back pulse. During fly-back C1 is discharged through R2 and D1. The circuit is completed by Q2 base-emitter, so that Q2 is fully bottomed.

As C1 discharges, current flows through R3 and

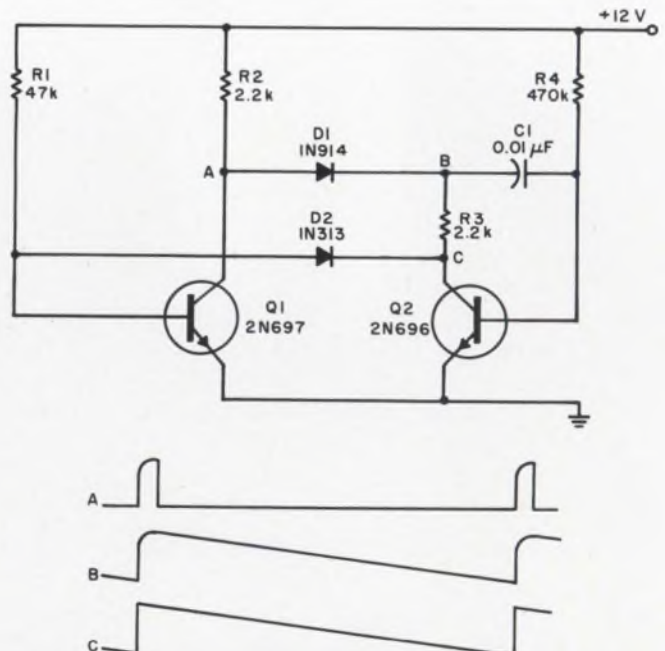

A linear sawtooth is obtained from this simple circuit. With the values shown the period is about 2.5 ms. Waveshapes existing at various points are shown below the schematic.

BRAND-REX SLEEVING	CHARACTERISTICS	IEEE CLASS	DIELECTRIC STRENGTH	TEMP. RANGE	GRADES	SPECS.
TURBO® Varnished Sleeving	High tensile strength; excellent flexibility; low moisture absorption; oil and acid resistant.	A	To 7,000 volts	-10°C to +105°C	A-1 thru C-3	NEMA VS 1, Type 1 MIL-I-3190 ASTM D-372
TURBOGLAS® Varnished Glass Sleeving	Strong; flexible; tear, moisture and chemical resistant.	B	To 7,000 volts	-10°C to +130°C	A-1 thru C-3	NEMA VS 1, Type 2 MIL-I-3190 ASTM D-372
TURBOTUF® Vinyl Coated Glass Sleeving	Abrasive resistant; highly flexible; retains dielectric strength under severe handling.	B	To 8,000 volts	-10°C to +130°C	A-1 thru C-1	NEMA VS 1, Type 3 MIL-I-3190 MIL-I-21557
TURBOCRYL® Acrylic Coated Glass Sleeving	Tough; flexible; moisture, abrasion and chemical resistant. Compatible with magnet wire coating.	F	To 7,000 volts	-10°C to +155°C	A-1 thru C-2	NEMA VS 1, Type 6 MIL-I-3190 ASTM D-372
TURBOSIL® Silicone Coated Glass Sleeving	Chemically inert; oil, moisture, abrasion and peel resistant. Compatible with magnet wire coating.	H	To 7,000 volts	-65°C to +200°C	A-1 thru C-3	NEMA VS 1, Type 4 MIL-I-3190
TURBO 117® Silicone Rubber Coated Glass Sleeving	Extremely tough; radiation resistant; electrical properties unaffected by bending or twisting.	H	To 8,000 volts	-70°C to +200°C	A-1 thru C-3	NEMA VS 1, Type 5 MIL-I-3190 MIL-I-18057
BRAND-REX TUBING	CHARACTERISTICS		TEMP. RANGE		COLORS	SPECS.
TURBOTHERM 105® High-temperature vinyl tubing	High dielectric strength; retains flexibility and elongation at elevated temperatures where conventional vinyls may crack. Odorless, tasteless. Recommended for potting application.		-20° to +105°C		Clear and colors	UL-105 ASTM D-922 Grade c
TURBOLEX 105® High-temperature vinyl tubing	Flame and fungus resistant; retains clarity through use of light-stable fungicides.		-20° to +105°C		Clear and colors	MIL-I-631 Grade c, Class 1 Category 1 UL-105
TURBOLEX 85® General-purpose vinyl tubing	For use where moderate heat and occasional exposure to oil are encountered. Easily printed, retains legibility.		-32° to +60°C		Colors only	ASTM D-922 Grade a
TURBOLEX 76A® General-purpose and low temperature vinyl tubing	Good dielectric and low temperature properties. Fungus-resistant, noncorrosive.		-46° to +80°C		Clear and colors	MIL-I-621 Grades a & b, Class 1 Category 1
TURBOLEX 40® Low-temperature vinyl tubing	Low temperature tubing for military applications with excellent high temperature characteristics. Flame and fungus resistant.		-55° to +80°C		Clear and colors	MIL-I-22076
TURBOZONE 40® Low-temperature vinyl tubing	Flame retardant; fungus-resistant; noncorrosive; available in Types I and III in all sizes.		Class I: -90° to +80°C Class II: -67° to +80°C		Clear and colors	MIL-I-7444C
TURBOTEMP® Teflon TFE tubing	Chemically inert; moisture-resistant; excellent dielectric.		-70° to +250°C		Natural and colors	MIL-I-22129

Now that you've found a complete line of tubing and sleeving, cut out this bookmark to keep your place.

AMERICAN ENKA CORPORATION

BRAND-REX DIVISION

WILLIMANTIC, CONNECTICUT 06226
PHONE 203 423-7771



ON READER-SERVICE CARD CIRCLE 57

Q_2 , so that the collector current of Q_2 rises while its base current falls, until a point is reached where Q_2 is no longer bottomed. D_2 cuts off, Q_1 rebottoms and Q_2 starts the next run-down.

The forward drop across D_2 plus the saturation voltage of Q_2 when passing R_1 current must be less than the cut-off voltage of Q_1 .

The repetition time is independent of supply

voltage and is proportional to C_1 from $0.01 \mu\text{F}$ upwards. When $R_4 = 470 \text{ k}\Omega$, the period is approximately $C_1/4$ seconds (C_1 in microfarads).

D_1 should have low stored charge if C_1 is less than $0.01 \mu\text{F}$.

D. Gold, Engineer, Crosfield Electronics, Ltd., London, U.K.

Notch amplifier built with a single IC

A simple, inexpensive low-frequency notch amplifier can be built (see figure) with an IC differential/operational amplifier (SN724) and a few capacitors and resistors.

The very narrow-band frequency response is achieved by inserting the input signal differentially with a negative feedback signal which has passed through a narrow-band balanced-parallel-tee filter circuit. The feedback loop provides negative feedback for all frequencies except the center frequency of the filter.

A roll-off capacitor, C_1 , is needed to eliminate high-frequency oscillations. Oscillations at the

center frequency will occur if the loop is regenerative. To ensure stability, the closed-loop forward gain should be slightly less than the open-loop forward gain. If this is not so, a slight increase in R_1 will make the loop slightly degenerative without appreciably changing the center frequency.

The circuit with the values shown yields a center frequency of approximately 36 Hz with a 3-dB bandwidth of about 0.5 Hz. The forward gain is typically 100 and the input impedance is 7 M Ω . The short-circuited input noise is approximately 4 μV . The circuit can be used up to several kilohertz with appropriate changes in the notch filter.

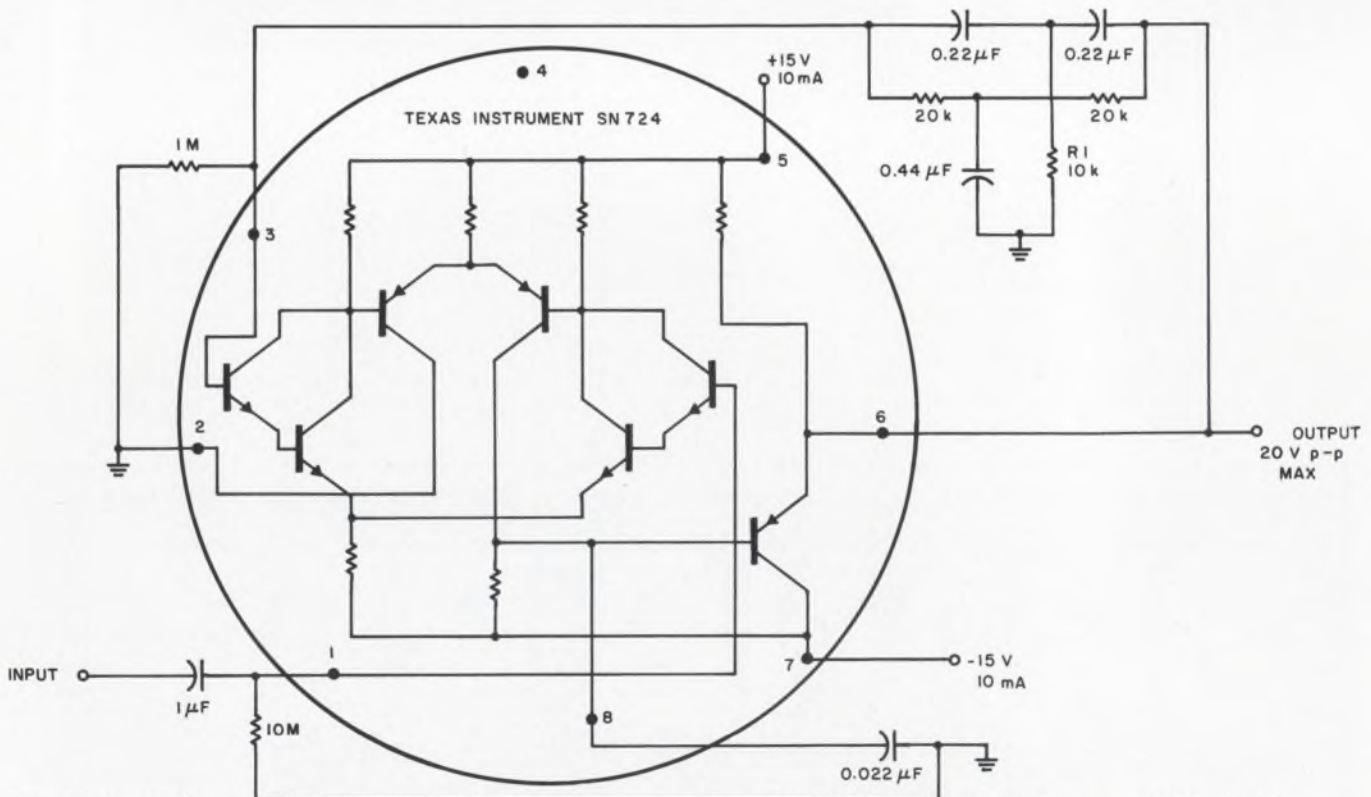

A 3-dB bandwidth of about 0.5 Hz at a center frequency of about 36 Hz is obtained from this simple notch amplifier.

3 to get ready

COAXICON* BNC Connector—three parts. One crimp. One tool. 15 seconds from stripped cable to completed contact. Center conductor, braid and insulation crimped simultaneously. For all coaxial and shielded cable—even sub min. No guess work. Lowest applied cost.

*Trademark of AMP Incorporated

PUT YOUR IDEAS INTO ACTION WITH THE HELP
OF AMP ENGINEERING . . . WORLDWIDE

AMP



AMP INCORPORATED
Harrisburg, Pa. 17105

I'm ready. Please send me more information on COAXICON Connectors.

NAME _____
COMPANY _____
ADDRESS _____
CITY _____ STATE _____
ZIP _____

The circuit can serve as a signal purifier, an error amplifier in a narrow-band feedback control loop, or two-cascaded as a low-level ac null detector.

Louis Mourlam, Jr., Design Engineer, Ames Laboratory, Iowa State University, Ames, Iowa. (Work was performed in the Ames Laboratory of the U.S. Atomic Energy Commission: Contribution No. 2135).

Volume compressor needs no power supply

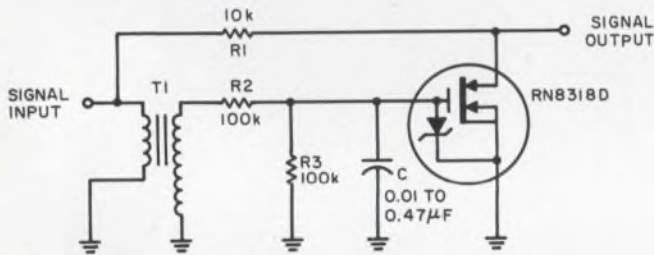

No power supply is needed for this simple volume compressor circuit.

A powerless volume compressor can be made with a device such as the HRN8318D MOSFET. The MOSFET acts as a variable resistance, the value of which changes from millions to hundreds of ohms according to the value of a negative voltage at its gate terminal. A voltage of approximately -3 volts causes the device to have a resistance greater than $10k \Omega$, -10 volts results in a resistance of 300Ω .

In the schematic, resistor $R1$ and the MOSFET form a divider which attenuates the input signal. As the level of the input signal increases, more negative voltage is developed at the gate of the MOSFET, causing its resistance to decrease. Transformer $T1$ steps up the signal level to generate a voltage great enough to operate the MOSFET. The turns ratio of the transformer should be at least 20:1. Higher values will allow more flexibility and signal control in the biasing circuitry for the field-effect device. Resistors $R2$, $R3$ and capacitor C form the attack and decay time constants of this automatic signal attenuator. The clamping diode is an integral part of the MOSFET device.

Variations of this basic circuit will allow a wide range of signals to be handled and combinations of attack and decay times to be realized. No power supplies are required since the MOSFET is biased by the signal source.

Carroll R. Perkins, MOS Production Manager, Raytheon Co., Mountain View, Calif.

Simple circuit converts any waveform into a sawtooth

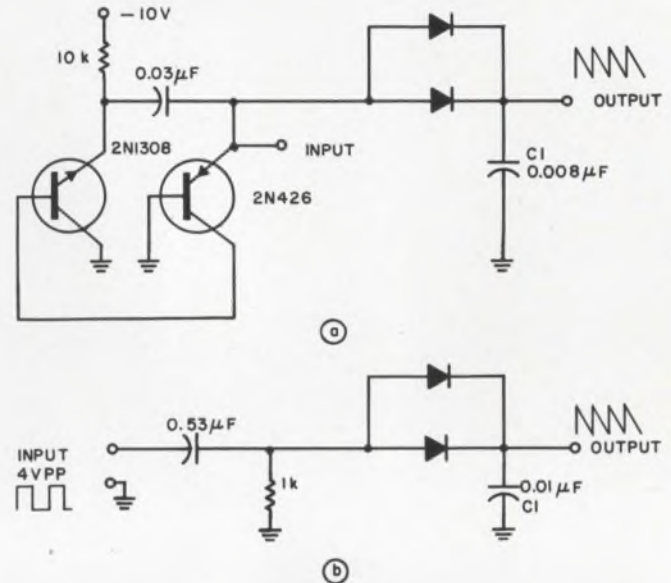

Sawtooth is obtained when a sine, square, or triangular waveform of 4-V pk-pk is applied to the input (a). For square waves the circuit reduces to (b). Two diodes are used to lower output resistance to increase rise time.

A requirement to convert a sine wave directly into a sawtooth was met with the circuit in Fig. 1a. In fact, it will convert any waveform (sine, square or triangular) into a sawtooth. In case of a square wave, the transistors are not required and the circuit reduces to that of Fig. 1b.

The peak-to-peak amplitude of the input signal should be about 4 volts, 80 to 800 Hz. The sawtooth is about 1.5 volts at the lower frequency and 0.3 volt at the higher frequency. $C1$ would have to be increased when the circuit is loaded to preserve the waveshape. Any diode (such as IN457) can be used.

The circuit, obviously, is not intended for use as an accurate sawtooth source. Rather, as a quick means to get the sawtooth in the absence of a suitable source.

Christopher Eddy, Electronics Engineering Major, New Mexico State University, Las Cruces, N.M.

IFD Winner for September 13, 1967

Allan G. Lloyd, Project Engineer, Avion Electronics, Inc., Paramus, N. J.

His Idea, "Voltage follower has high impedance," has been voted the \$50 Most Valuable of Issue Award.

Cast Your Vote for the Best Idea in this Issue.



**YOU'LL JUMP
FOR JOY...**

**when you see the complete specs
and prices on our new**

**“PIXIEPOT”TM
POTENTIOMETER!**

Never before in the history of the pot industry have you been able to get a TEN-TURN, WIRE-WOUND PRECISION potentiometer at prices like these. The Duncan Model 3253 “PIXIEPOT” is yours for as low as **\$3.97** each in production quantities and only **\$5.95** each for 1-24 units.

Match the following “PIXIEPOT” features with any other similar pot on the market.

- **Length: ONLY ¾”**
- **Diameter: ONLY ⅞”**
- **Linearity: ±0.25%**
- **Resistance Range: 100 ohms to 100K ohms**
- **Power Rating: 2 watts @ +20°C**
- **Temperature Range: -25°C to +85°C**
- **Resolution: Better than ANY wirewound pot TWICE its size!**
- **Slotted Stainless Steel Shaft**

A Duncan “PIXIEPOT” can save you dollars on your instrument and system requirements. If you want to know just how many, call or write us today. The full story on the “PIXIEPOT” will be in the mail to you within 24 hours. And when it arrives, be prepared to jump for joy!



DUNCAN electronics, inc.

A DIVISION OF SYSTRON-DONNER CORPORATION

2865 FAIRVIEW ROAD, COSTA MESA, CALIFORNIA 92626

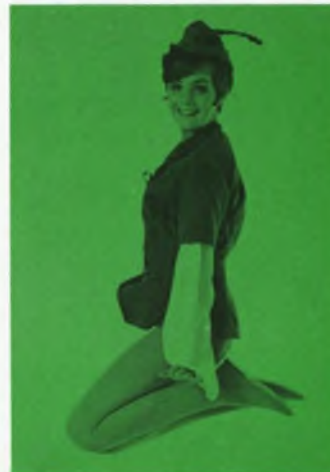

ON READER-SERVICE CARD CIRCLE 59

A better V-F Converter? Look no farther.

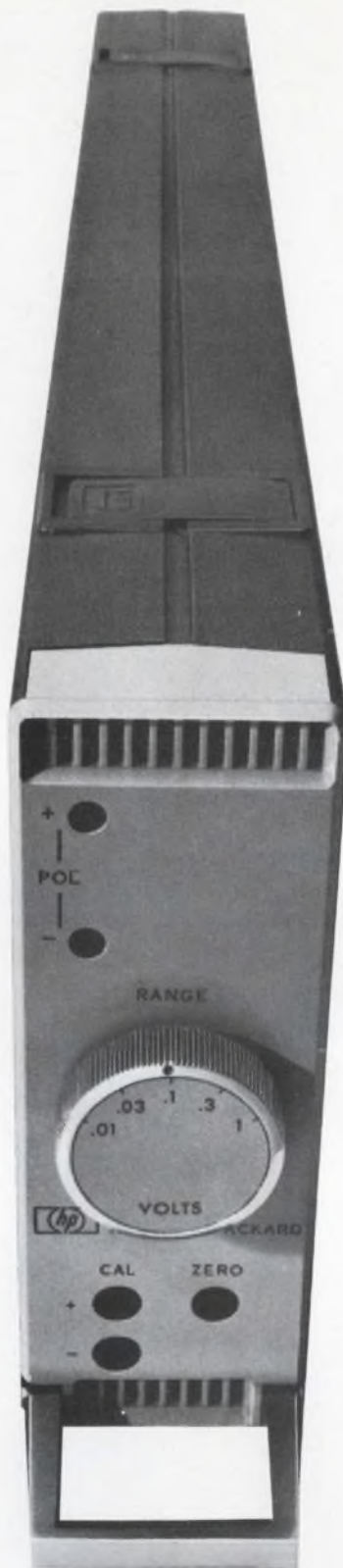

Take this voltage-to-frequency converter, couple it with your electronic counter — and you have a highly accurate, low-level integrating digital voltmeter with high rejection of superimposed and common mode noise. Use it with a preset counter and you can scale or normalize analog signals. Or integrate signals crossing zero with a reversible counter. Use two converters for ratio.

The Hewlett-Packard 2212A is more accurate, stable and linear, faster responding, smaller than any other V-F converter on the market. Input ranges down to 10 mV for 100 kHz output. Bipolar response with polarity output. 120 dB common mode rejection. And the 2212A is immediately available. Price, \$995.

Call your local HP field engineer for complete specifications, or write Hewlett-Packard, Palo Alto, California 94304; Europe: 54 Route des Acacias, Geneva.

HEWLETT  PACKARD

06720

Products

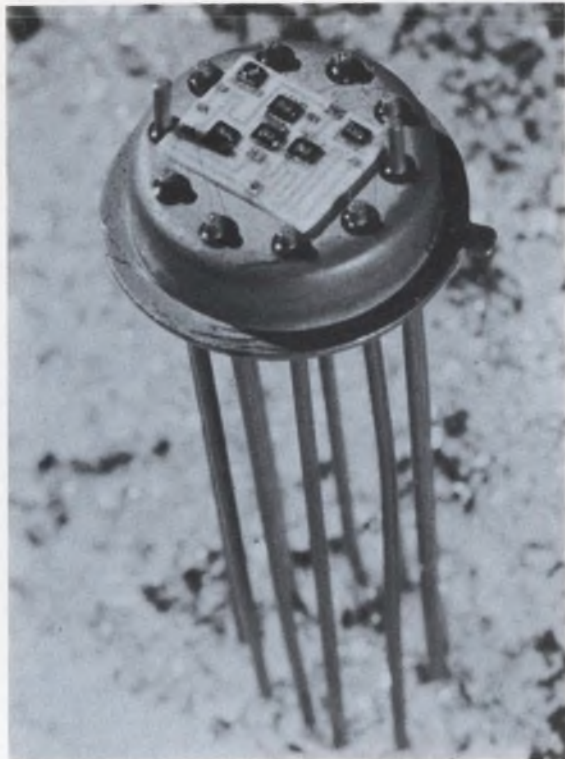

Photodiode op amp for full-spectrum detection in a TO-5 can. Page 114.



Diff-amp drifts less. A dual-transistor input circuit keeps its stability down in the picoamps. Page 128

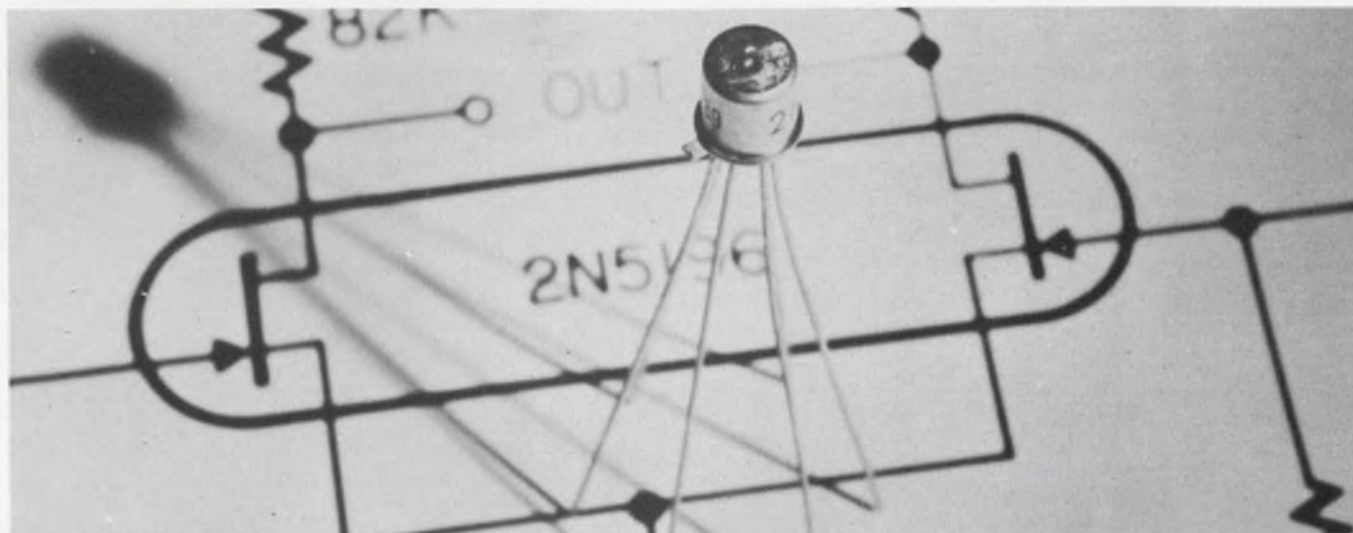

Matched FET-pairs track from $5\mu\text{V}/^\circ\text{C}$ with an input (gate) current of 15 pA. Page 116

Also in this section:

Hand-held demagnetizer simplifies degaussing recorder-head assemblies. Page 118

Design Aids, Page 141 . . . Application Notes, Page 140 . . . New Literature, Page 142

Photodiode and op-amp share same TO-5 can

EG&G, Inc., 160 Brookline Ave., Boston. Phone: (617) 267-9700. P&A: HA-100, \$175 ea., HAD-130, \$295 ea.; stock.

Combined in a single TO-5 can, a sensitive silicon photodiode and a hybrid high-gain operational amplifier have applications in high-speed card readers, and in detecting radiation from lasers, from the tail pipes of jets, and from heavenly bodies.

The photodiode is a circular, planar-passivated device with an active area equal to 0.087 cm^2 . Its response time alone is 5 ns (slew rate of the pair is $0.4 \text{ V}/\mu\text{s}$). Sensitivity is $0.5 \mu\text{A}/\mu\text{W}$ at 0.9 microns. Its spectral response range is 0.45 to 1.1 microns. Full irradiance at the active area of the silicon is secured by means of a 0.61-cm-dia glass window in the TO-5 cover cap.

The operational amplifier contains silicon transistors, including the input FET, and a spare chopper transistor for optional use in, say, a dc restorer circuit. Power supply requirements are minimal: less than 50 mW from +15- and -6-volt supplies. Output impedance is less than 250Ω .

The reverse-biased photodiode is the signal source presented to the operational-amplifier input terminals. For this biasing condition, the photodiode exhibits a very high junction impedance and for all practical purposes is a current source. Photon current generated in the photodiode by incident photon energy can flow either into the amplifier input or through the feedback resistor connected between the amplifier output and input. Because

the amplifier input impedance is greater than $10^{11} \Omega$, all the photon current flows through the feedback resistor and develops a voltage across that resistor. When no current flows into the amplifier, the amplifier input is at a virtual ground. In this condition, the amplifier output voltage will be zero. The output voltage vs input light is linear to about 5 V, after which no increase in voltage will be obtained by increasing the light input.

The sensitivity of the device is such that $1 \mu\text{W}$ of monochromatic light at 0.9 microns will produce an output voltage of approximately 5 volts when a 15-M Ω resistor is used as the feedback resistor.

Noise performance of the package is a function of the thermal noise voltage generator in the conducting channel of the input FET. The value of noise voltage produced by this generator far exceeds the photodiode shot noise and is the primary contributor to total input noise. A typical value of NEP ($\lambda, 1000, 1$) for the device would be less than 8×10^{-12} watts.

The packaging techniques employed in the HAD-130 fabrication permit a wide range of photodiodes to be substituted for the normal-size photodiodes. The hybrid operational amplifier is also available without the photodiode as a model HA-100 operational amplifier. As an aid to the applications engineer and system designer, information booklets are available that describe the operation and performance of the HAD-130 and the HA-100, with emphasis on practical applications.

CIRCLE NO. 384

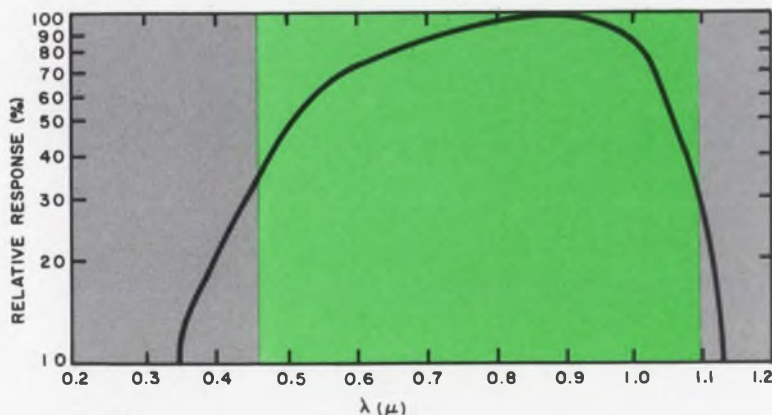

The response of the photodiode is 5 ns from 0.45 to 1.1 microns, or from the near ultraviolet to the near infrared.

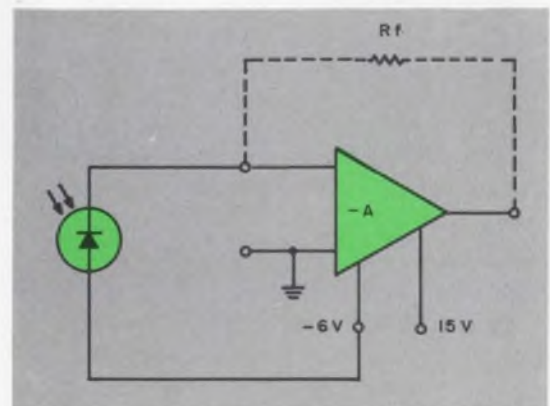

Simplified diagram of the HAD-130 shows the externally mounted feedback resistor.

ARNOLD IS

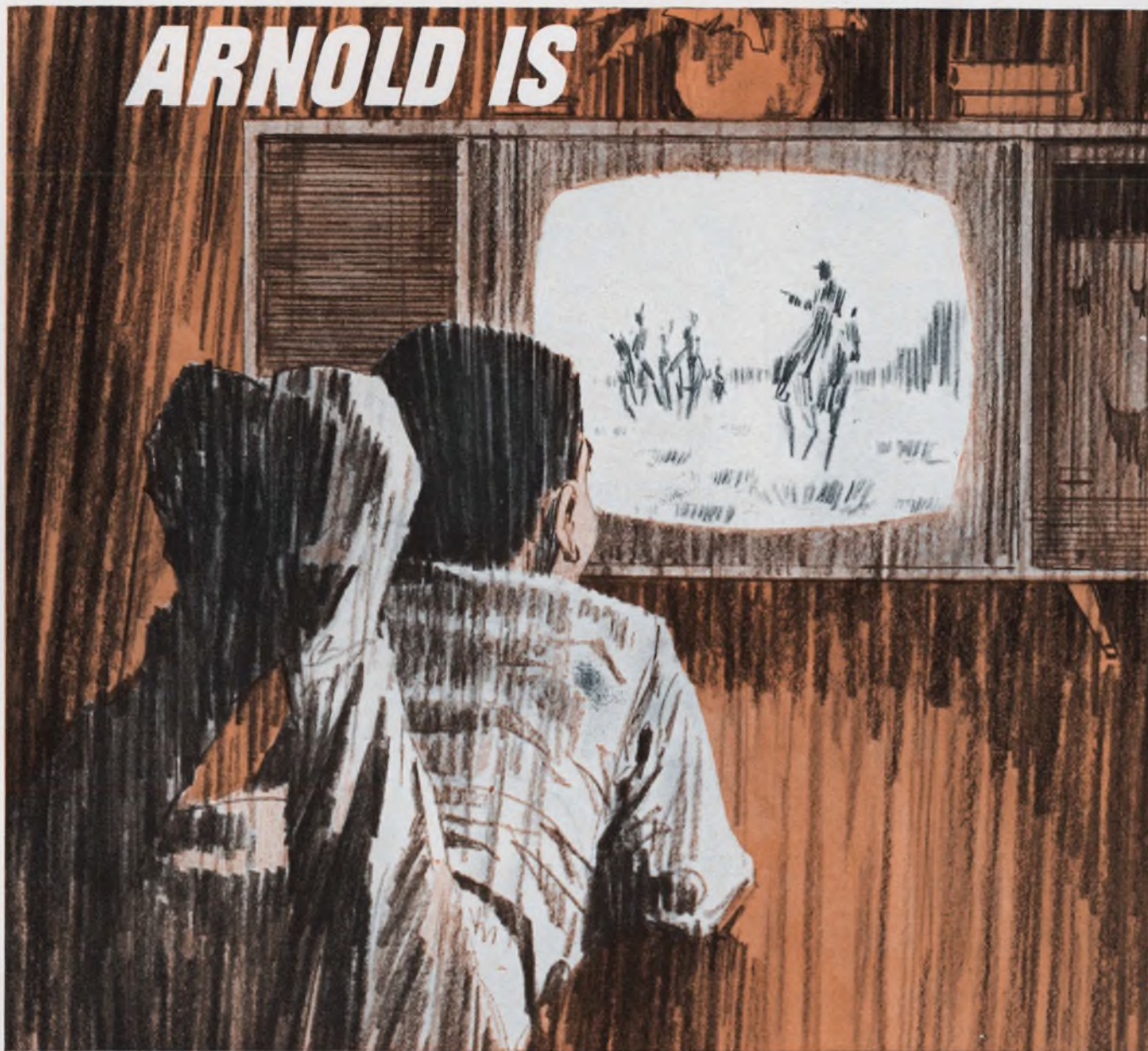

IRON POWDER CORES

From 5" dia. to Subminiature Toroids

Arnold has total capability across all design configurations—toroids, insert cores, threaded cores, plain cores, bobbin cores, sleeve and hollow cores, cup cores and subminiature toroids. All the necessary raw materials are carried in stock to provide optimum performance over the specified frequency spectrum. Our facilities include the most modern powder processing, pressing, quality control and final test equipment available in the industry.

Call us, write us, TWX us, we can handle any problem.

Arnold is also ■ Permanent Magnets ■ Tape Wound Cores ■ MPP Cores ■ Magnetic Shielding ■ Electrical Alloy Transformer Laminations ■ Transformer Cans and Hardware ■ Silatron Cores ■ Special Magnetic Materials.

 **ARNOLD**
SPECIALISTS in MAGNETIC MATERIALS

THE ARNOLD ENGINEERING COMPANY, Main Office MARENGO, ILL.
BRANCH OFFICES and REPRESENTATIVES in PRINCIPAL CITIES

ON READER-SERVICE CARD CIRCLE 61

SEMICONDUCTORS

SCR devices handle 40 A

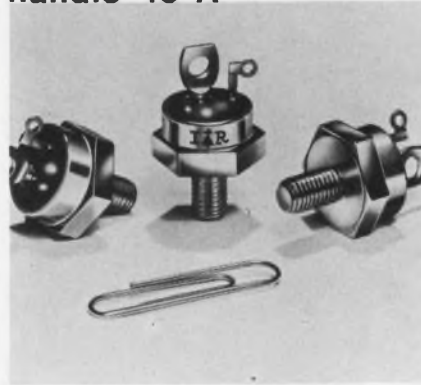

International Rectifier, 233 Kansas St., El Segundo, Calif. Phone: (213) 678-6281.

Types 40RCS5 through 40RCS60 are capable of handling 40 A with voltage ratings from 50 to 600 V. These devices pass the humidity and temperature tests in Mil-Std-750, methods 1021 and 1051. They exhibit an 800-A-max peak surge current; max on-state current of 63 A rms; 0.5-W max average gate power; and a max peak on-state voltage drop of 1.75 V at 25°C.

CIRCLE NO. 368

Stud-mounted Zener handles 350-W surge

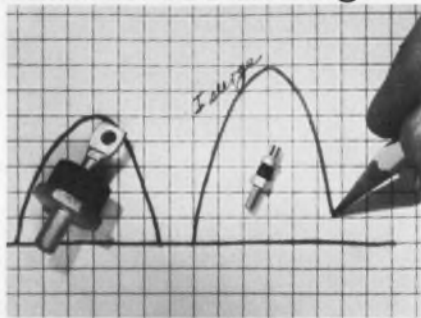

Unitrode Corp., 580 Pleasant St., Watertown, Mass. Phone: (617) 926-0404. P&A: \$4.50 (1000 up); stock.

This miniature 10-W stud Zener diode has a surge rating of 350 W. The silicon wafer is bonded directly between the terminal pins, eliminating the whisker. Under conditions of shock, acceleration and vibration the device exceeds the requirements of MIL-S-19500.

CIRCLE NO. 369

FET pairs track from 5 $\mu\text{V}/^\circ\text{C}$

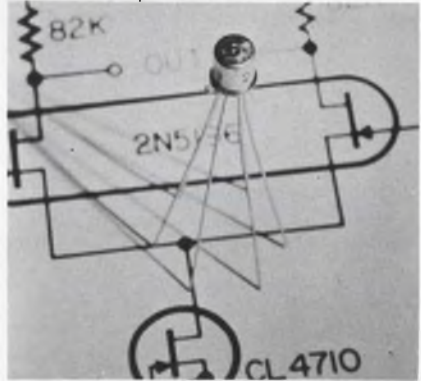

Siliconix Inc., 1140 West Evelyn Ave., Sunnyvale, Calif. Phone: (408) 245-1000. P&A: \$7.75 to \$29.20 ea. (100 lots); stock.

Matched on all critical parameters, the dual n-channel FET's 2N5196, 7, 8 and 9 are designed for high-input-impedance differential amplifiers. The most closely matched pair, the 2N5196, has 5-mV max offset with less than 5 $\mu\text{V}/^\circ\text{C}$ tracking. Tracking on the 2N5197, 8 and 9 is 10, 20 and 40 $\mu\text{V}/^\circ\text{C}$, respectively.

CIRCLE NO. 370

Passivated diode dice recover in 2 ns

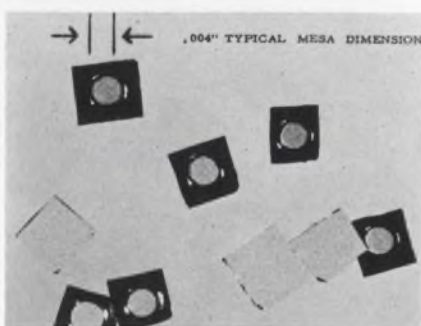

Microsemiconductor Corp., 11250 Playa Court, Culver City, Calif. Phone: (213) 391-8271. P&A: 15¢ ea; (1000 units); stock.

Silicon-glass passivated mesa dice that measure 0.15 x 0.015 x 0.005 in. have a recovery speed of less than 2 ns. Electrical specifications include 2-pF capacitance. Larger die sizes and varieties of metalized die surfaces are available for termination ease at up to 400°C.

CIRCLE NO. 371

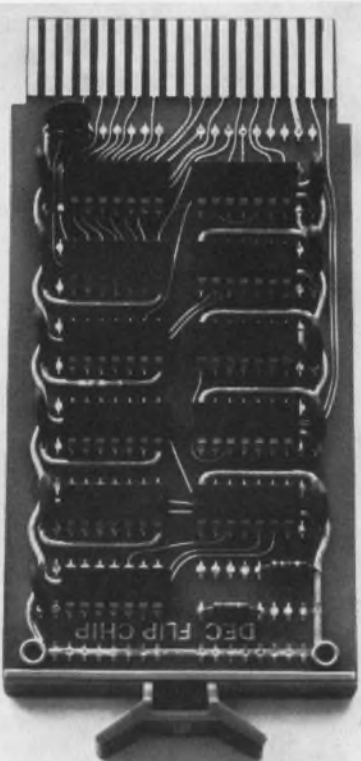

Digital makes 1½ million logic modules a year, 300 types.

Here's why:

DIGITAL is the world's leading manufacturer of logic modules. Our high production capabilities assure low prices. And versatility. DIGITAL supplies over 300 types of modules to meet exactly your special logic control requirements. Our K Series, for example, are specifically designed to replace awkward relays, timers, etc., in industrial applications. K Series have been deliberately slowed to make them virtually noise immune. They're compact, inexpensive, and easily installed. M Series is our new TTL monolithic I/C general purpose line, operating at computer speeds and using the latest advances in integrated circuit technology. W Series are designed specifically for data communications; A Series offers a full range of analog to digital conversion; R Series for computer interfacing. Other lines are available for special applications. Free copies of our 300 page Industrial Control and 450 page Logic Handbooks are available on request.



ON READER-SERVICE CARD CIRCLE 62

Microdiode pellet for dc reference



Microsemiconductor Corp., 11250 Playa Court, Culver City, Calif. Phone: (213) 391-8271. Price: \$1.69 (100 lots).

Temperature-compensated Zener reference microdiode pellets are intended for use as dc voltage references. The devices, designed for reliability in military and aerospace environments, meet MIL-S-19500 specifications. Silicon oxide-glass passivation isolates pn junctions in injurious environments. The initial product line encompasses voltages of 6.28, 7.65 and 8.71 V and a TC of less than 0.001%/°C with dynamic impedance of less than 10 Ω.

CIRCLE NO. 372

5-MHz IC logic cards packaged in plastic

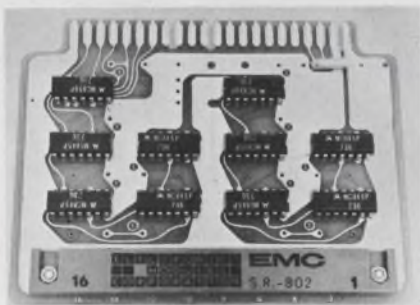

Electronic Modules Corp. P.O. Box 141, Timonium, Maryland. Phone: (301) 666-3300.

Five-MHz logic cards use plastic, dual-in-line packaged ICs. The glass-epoxy cards incorporate an edge connector with 44 rhodium plated tabs. A quality test point block accepts 16 standard 0.08-in. probes. Cards are keyed to prevent insertion in the wrong connector. Circuits operate from 0° to +75°C with a +5-V power supply.

CIRCLE NO. 373

New Analog Multipliers



DC-4 MHz Response



4 Quadrant Operation

Solid State

No External Amplifiers Needed

	Model 350RP2	Model 9380CP5	Model 384CP5
Frequency Response	DC-100 Hz	DC-30KHz	DC-4MHz
Phase Shift	<1° at 5Hz	<1° at 15KHz	<1° at 1MHz
Linearity	±0.5% FS	±0.5% FS	±1% FS(x input dc) ±2% FS(y input dc)
Transfer Function	$V_o = \frac{XY}{10}$	$V_o = \frac{XY}{10}$	$V_o = \frac{XY}{100}$
Delivery Price (1 to 9)	\$219 stock	\$335 stock	\$495 stock

All Multipliers accept 0 to ±10V at both inputs, and require + and - 15V DC power.

Complete data sheet, application notes, and short form catalog now available.

Write TWX or call (ask for Steve Goldschmidt)



Transmagnetics, Inc. 134-25 Northern Boulevard, Flushing, New York 11354
Phone: (212) 539-2750 TWX: 710-582-2472

ON READER-SERVICE CARD CIRCLE 63

DELAY LINES



GENERAL

Delay .4 to 10,000 usec at frequencies from 10 to 400 mc. Wide bandwidth and low spurious response for excellent pulse reproduction and dynamic range.

COMPUTER STORAGE SYSTEMS

Ultrasonic delay lines using fused quartz or special glasses represent an ideal medium for high-speed Computer Storage, up to 20 mc rates.

Send for Microsonics' Brochure #5350.

DIGITAL DELAY LINES

Delay lines for storage of high-speed digital pulses with zero temperature coefficient of delay for Computer applications. Design Bulletin available on request.

MAGNETOSTRICTIVE DELAY LINES

Microsonics, Inc. has a broad delay line and systems experience with capability to deliver both off-the-shelf and custom-designed systems for any specific application.

Systems provide for the delay or storage of both analog and digital signals and are available to handle all modes of modulation (RZ, NRZ and Bipolar). Output signals are available in either clocked or unclocked signal.

Send for Microsonics' Brochure #M735.

VARIABLE AND TAPPED DELAY LINES

Featuring all usual advantages of superior fixed Delay Lines.

MICROSONICS INC.

A subsidiary of the
SANGAMO ELECTRIC CO.

60 Winter Street
Weymouth, Mass.

Area Code (617) 337-4200



DELAY LINES
QUARTZ CRYSTAL PRODUCTS

SYSTEMS

Digital memory handles 4096 words



Electronic Memories, 12621 Chadron Ave., Hawthorne, Calif. Phone: (213) 772-5201. Price: \$3000.

A compact commercial memory system offers a range of storage capacities of from 512 to 4096 words of 8 bits. It has a 2.5- μ s cycle time and an access time of 0.9 μ s. Operating temperature range is 0° to +50°C. Integrated TTL circuits are used. All magnetics and electronics are on plug-in boards.

CIRCLE NO. 374

Shift register draws 1.2 W quiescent



LFE Electronics, 1075 Commonwealth Ave., Boston. Phone: (617) 254-4233. P&A: \$3000; 60 days.

In its quiescent state, the model 1487 shift register draws 1.2 W and can operate in standby condition with zero current. Functioning over a 0-to-250-kHz bit rate, this serial/serial device has a capacity of 1024 bits. It interfaces with DTL and TTL and maintains its parameters over 0-to-50°C.

CIRCLE NO. 375

Serial printer writes at 10 characters/s



Potter Instrument Company, Inc., East Bethpage Road, Plainview, N.Y. Phone: (516) 249-0790.

A high-speed printer provides a minimum serial print rate of 10 characters/s in a 26-column format, with a 64-character complement. The model HSP-3604, and its associated basic electronics, is packaged for mounting in an enclosure of 6.75 x 9 x 16.25 in. Silicon semiconductors are used throughout.

CIRCLE NO. 376

Thin-film memory digests 50 bits



Fabri-Tek, Inc., 5901 S. Country Rd. 18, Minneapolis. Phone: (612) 935-8811.

A thin-film memory with a capacity of 8000 words of 50 bits is capable of being expanded to 32,000 words of 50 bits in the same frame size. The cycle time for the system is 300 ns. The thin-film memory switches film elements in 10 ns, and it automatically compensates strobe time with a signal delay.

CIRCLE NO. 377



San Francisco is just one of the reasons

There are many reasons for working for Memorex, and one of them is certainly the area where we are located. Memorex is in the Santa Clara Valley, less than an hour away from San Francisco. But more important than the location is the company itself. We are a growth-minded corporation that has become a multi-million dollar company in just six years and the leader in the field of precision magnetic tapes. We need individuals who can help us continue to grow and who have the ability to grow with us.

Electronic Engineer Creative BSEE needed for our tape and test development program. Prefer individual with previous magnetic experience to help in the investigation of current and future projects. Should have 5 years' engineering experience with 2-3 years' video circuits experience desired.

Project Engineer (Video) Requires creative ability to solve analytical and tape

systems problems. BSEE required plus 5 years' experience, 2 years' which have been in magnetics. Work will involve the supervision and design of experimental video systems and the training of test technicians to evaluate tape and machine performance.

Project Engineer (Recording) Opportunity exists for an individual with an EE or Physics degree plus 5 years' experience to work in the area of sophisticated broadband recorders. You will be given considerable professional freedom to get the job done as you want it done. Requires thorough knowledge of the processes of magnetic recording.

Electronic Engineer (Solid State Circuit Design) To design solid state digital and analog circuits. The digital circuits range from DC to 5MHz. The analog circuits include servos from DC to 2KHz and linear amplifiers from 100Hz to 10MHz. 2-5 years' solid state circuit design experience since BSEE.

Development Engineer Innovative individual needed to help design and develop new test equipment. Must be digital oriented with a BSEE plus 2 years' experience. Previous logic design experience preferred.

Electronic Engineer (Senior) Should be digital oriented with a knowledge and understanding of production equipment. BSEE required with mechanical engineering experience desired.

Interested applicants should direct their resumé to: Professional Employment Office, 1180 Shulman Avenue, Santa Clara, Calif. 95050. An Equal Opportunity Employer.

MEMOREX
CORPORATION

ON CAREER-INQUIRY CARD, ON PAGE 97, CIRCLE 905

Always connect subminiatures with Winchester Electronics.

Take cable and panel mounted rectangulars. We've got them with solder or crimp removable contacts. From 4 to 50 contacts with current ratings of 3 to 7.5 amps. Standardized high-density rectangulars also, that allow you three current ratings — 3, 5, or 7.5 amps — with one size connector and one size panel cutout.

Need pc connectors? We've got edge-board, right-angle or flat-mounted pc's on .050, .078 or .100 contact centers. With solder, eyelet or dip solder terminations for 1/32 to 1/4-inch boards. And we've got micro-miniature pc connectors for use

with integrated thin film and semi-conductor circuitry.

If you're looking for circular cable or panel mounted connectors, you'll find them with 1 to 12 contacts. Contact centers from .025 to .040 with current ratings of 3 to 7.5 amps.

They're all on the shelf of



SYSTEMS

Core memory hold 80,000 bits

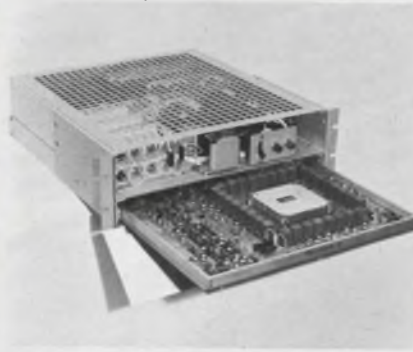

Ampex Corp., 401 Broadway, Redwood City, Calif. Phone: (415) 367-4151. P&A: \$4000 to \$8500; March.

An 80,000-bit core memory with data access time of 400 ns and full cycle time of 1 μ s is designed for multiple memory applications. The model RF 4 is completely contained on a 17-in.-square printed-circuit board and offers a half-cycle time of 650 ns. Capacity is 512 to 4096 words of four to 20 bits.

CIRCLE NO. 356

Switching matrix DTL- or TTL-controlled

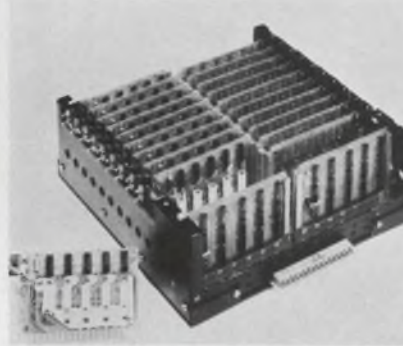

A.D. Data Systems, Inc., 830 Linden Ave., Rochester, N.Y. Phone: (716) 381-2370. P&A: \$595 to \$940; 30 days.

The Datareed matrix can be controlled directly from either DTL or TTL logic and will interface with most IC computers. The crosspoint to be latched or unlatched is selected by applying +3.6-V control signals momentarily to one X coordinate lead and one Y coordinate lead.

CIRCLE NO. 357

Binary-to-BCD converter translates in 1 μ s



AIC Corp., 6214 Royalton St., Houston. Phone: (713) 664-0353. P&A: \$375; 45 days.

The model 3000 binary-to-BCD converter translates binary inputs into 1-2-4-8 BCD output at a rate of one decimal digit per microsecond. The unit accepts unipolar binary inputs, or bipolar inputs in one's-complement or two's-complement code. Binary inputs of up to 20 bits with BCD outputs of up to six decades are available.

CIRCLE NO. 358

Control station converts signals from D to A



Motorola Instrumentation Control Inc., P.O. Box 5409 Phoenix. Phone: (602) 959-1000.

A process-control instrument converts a true value or incremental voltage output from a digital computer to a 4-20 mA dc analog signal. It can be used for operating valves, motor drives, and other control devices. It offers triple output redundancy, with three totally independent outputs: computer control, analog automatic control and manual control.

CIRCLE NO. 359

Expandable memory cycles in 900 ns



Ampex Corp., 401 Broadway, Redwood City, Calif. Phone: (415) 367-4151.

A modular expandable core memory has a cycle time of 900 ns, data access time of 350 ns and capacities up to 5 million bits. It is the only memory of its speed to use the 3-D 4-wire core-stringing design. The basic RG module accommodates up to 16,384 words by 40 bits, 8,192 words by 56 bits, or 4,096 words by 80 bits.

CIRCLE NO. 360

Incremental plotter uses fiber-tip pens

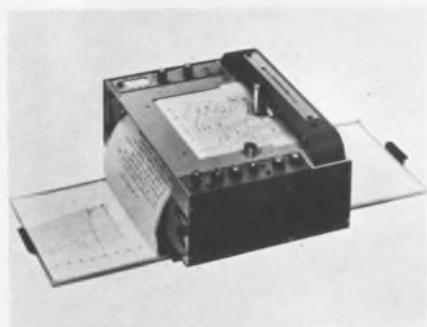

Houston Instrument, 4950 Terminal Ave., Bellaire, Tex. Phone: (713) 667-7403. P&A: \$2850; 4 wks.

The 6650 digital incremental plotter, for use in on-line or off-line operation with digital computers, is available with both ball-point and fiber-tip pens. The pens will draw a continuous trace or will plot prints utilizing the programming inputs to the pen lift circuitry.

CIRCLE NO. 361

Ladder networks respond in 1 μ s

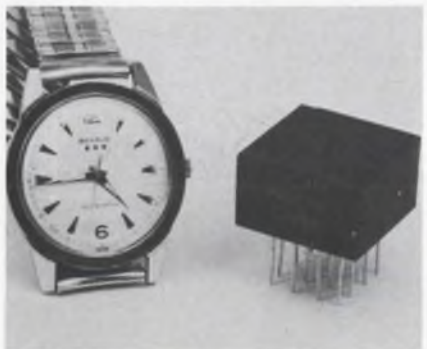

General Resistance, Inc., 430 Southern Blvd., Bronx, N.Y. Phone: (212) 292-1500.

Low-profile plug-in ladder networks feature accuracies of better than one-half the least significant bit over all temperature conditions. The series L14L10Q units use wire-wound, film and hybrid-circuit components to achieve up to 14 bits. Standard response time is better than 1 μ s and approaches 100 ns. All components are MIL-qualified.

CIRCLE NO. 362

3-D memory system responds in 1 μ s



RCA, Memory Products Div., 150 "A" St., Needham Heights, Mass. Phone: (617) 444-9766.

This solid-state coincident-current memory system uses ICs. It has a storage capability of up to 32,768 words of 72 bits with a 1- μ s full-cycle time and access times as fast as 400 ns. High-level TTL provides excellent noise immunity, exceptional reliability and low power consumption. The 3-wire system operates over a temperature range of 0° to 50°C.

CIRCLE NO. 363

Data logging system monitors 100 channels

Lear Siegler, Inc., Cimron Div., 1152 Morena Blvd., San Diego, Calif. Phone: (714) 276-3200. P&A: \$11,614; 60-75 days.

This system uses the model 3600 digital voltmeter and can be supplied with either the model P9000B series or model 4600 series digital voltmeter. This system will monitor 100 channels of input signals, measure and record the data. The use of a programmer module allows the digital voltmeter to be remote controlled to match the type and magnitude of the signal to be measured. Operation of the system can be set to automatically scan the preset number of required channels, to the lower scan channel and then rescan. The system can also be set to scan the prescribed channels and then stop to await a new system start command, or it can be commanded to step only one channel per command.

CIRCLE NO. 364

Head demagnetizer runs 105 to 125 V



Ampex Corp., 401 Broadway, Redwood City, Calif. Phone: (415) 367-4151. P&A: \$50; stock.

A hand-held demagnetizer demagnetizes complex record/reproduce head assemblies of high-frequency instrumentation tape recorders. Head assemblies may be demagnetized without having to be removed from the recorder. Ability to reduce residual magnetization is due to the magnetic field which the unit creates. It is ten times higher than fields induced by other hand-held demagnetizers.

CIRCLE NO. 365

TRW
announces

**50 W at
500 MHz**



ACTUAL SIZE

28 Volts...5dB Gain...60% Efficiency!

TRW announces a major breakthrough in communication transistor technology with the introduction of this high efficiency, high gain 50 watt/500 MHz device.

In high power military aircraft transmitters, a single 2N5178 will do the job formerly requiring vacuum tubes or multiple-transistor circuits. The 2N5178 is also

well suited for use in radar pulse circuits.

This state-of-the-art device employs a patented cellular construction in a grounded emitter strip-line package comparable in size to the TO-37. A 25-watt version, type 2N5177, is also available.

For evaluation quantities and complete technical details, con-

tact any TRW distributor or TRW Semiconductors, 14520 Aviation Blvd., Lawndale, Calif. 90260. Phone: 679-4561, TWX: 910-325-6206. *TRW Semiconductors Inc. is a subsidiary of TRW INC.*

TRW[®]

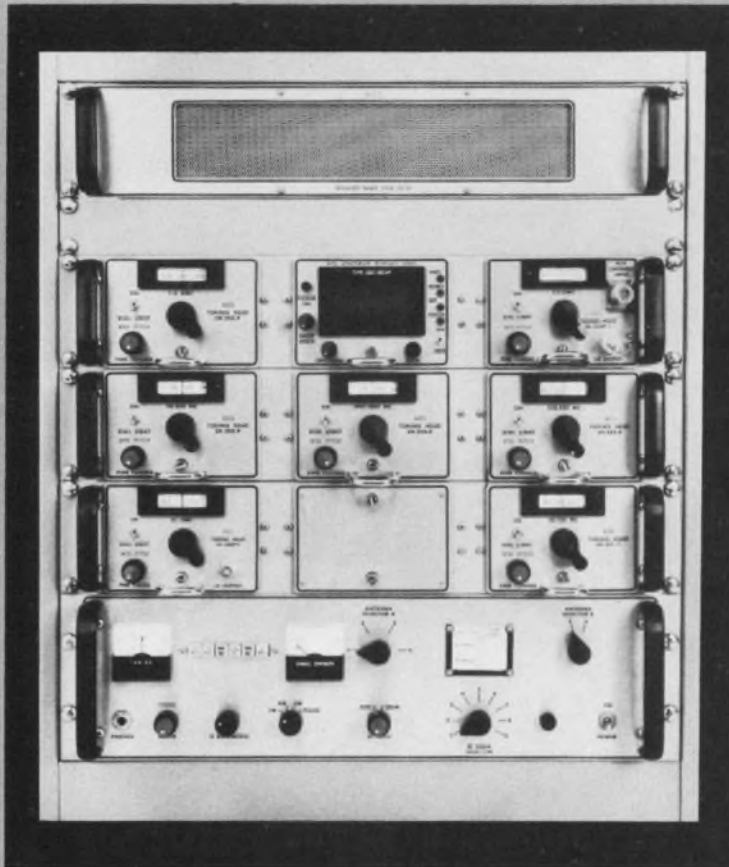

ACL

SR 209-4 RECEIVING SYSTEM

Plug-in RF Tuners

Frequency Range 2 MHz to 4 GHz

IF Bandwidths 1 KHz to 8 MHz

Signal Display Units

AM - FM - CW - PULSE

Write or phone for detailed specifications

ACL

ASTRO COMMUNICATION LABORATORY, INC.
9125 GAITHER ROAD, GAITHERSBURG, MD. 20760
TELEPHONE (301) 948-5210 TWX 710-828-9706

ON READER-SERVICE CARD CIRCLE 68

SYSTEMS

Digital printer shows 30 column

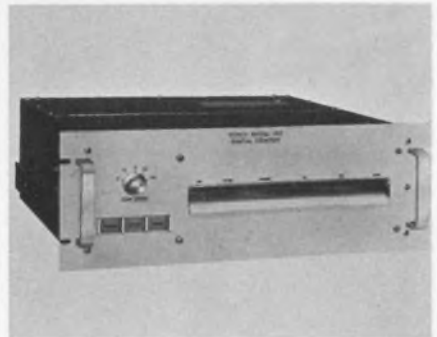

Sonex, 20 E. Herman St., Philadelphia, Pa. Phone: (215) 843-6400.

The Sonex model 152 digital printer is utilized in digital data systems where printing for a permanent record and a visual readout are required. Printing speed is variable up to 240 lines per minute. Data input can be either serial or parallel entry with storage input speed for serial entry in excess of one-million bits per second. Any standard 4-line BCD input or 10-line decimal input is utilized for character code.

CIRCLE NO. 366

A to D converter provides 8 outputs



Avco Corp., 2630 Glendale-Mildord Rd., Cincinnati, Ohio. Phone: (513) 771-8931.

This converter was designed as a low-cost unit. It is used without buffering since it has a 100 M Ω input impedance. Weighing three oz, it accepts analog inputs from 0 to +5 V and provides 8-parallel binary outputs. Encoding is accomplished in less than 65 μ s with 0.03% linearity and 1% stability from -20 to +85°C. It may be packaged to meet individual requirements.

CIRCLE NO. 367

There's a new name in telemetry:



Communications Products Department
Norden
~~Vector~~ Division
United Aircraft Corporation
Trevose, Pennsylvania 19047

Norden now produces and supports all Vector telemetry products.

Today Norden's new Communications Products Department supplies total systems capability, plus field support, to all users of Vector telemetry products.

And Norden continues to supply the same wide range of Vector products and systems: a full line of FM, Digital, and RF equipment, microminiature and conventional components, subsystems and total systems for airborne or ground-based tele-

communications assignments.

Research, development and production of Vector telemetry products and systems will continue at the newly expanded United Aircraft facility in Trevose, Pennsylvania. For information, or detailed specifications, call or write the Communications Products Department, Norden Division, United Aircraft Corp., Trevose, Pa. 19047. Phone (215) 355-5000.

Norden

DIVISION OF UNITED AIRCRAFT CORPORATION
U
A
C

ON READER-SERVICE CARD CIRCLE 69

Philter Pharmacy



If you're involved in anything utilizing conventional crystal filters in the range of 10.7 to 200 MHz, and beyond, here's something to think about. PTI's new IXF integrated crystal filters obsolete all conventional filter designs in this range. Simply put, there's no filter so small in size, yet so big in reliability and versatile in application.

The facts: IXF filters are the result of recent advances in acoustical wave theory and thin film technology. Unlike conventional crystal filters, the IXF integrated crystal filter does not require hybrid transformers. This results in monolithic construction, improved reliability, extreme size and weight reduction and improved stopband performance.

The Specs: Standard center frequencies are 10.7, 21.4, 70, 112 and 156.8 MHz with a 3 db bandwidth of 20 kHz. Custom filters can be furnished at other center frequencies and bandwidths. Each unit has a two-pole response characteristic. Standard IXF filters are furnished in an enclosure 0.4" x 0.32" x 0.15" at 156.8, 112 and 70 MHz, and 0.75" x 0.75" x 0.34" at lower frequencies. Units can be cascaded for four-pole response in larger sealed units with 50 ohm termination.

The standard IXF filter at 112 MHz (Model 272A) is available off the shelf at \$35 each in quantities of 10 or less. Other models \$75-\$95 with 3-6 week delivery. Quantity prices — 1000 and up — under \$25.00.

Piezo Technology Inc.

2400 DIVERSIFIED WAY
ORLANDO, FLORIDA / 305 425-1574
a subsidiary of Weller Kidde & Company, Inc.

PRODUCTION EQUIPMENT

Photoresist spinner runs at 15,000 rpm

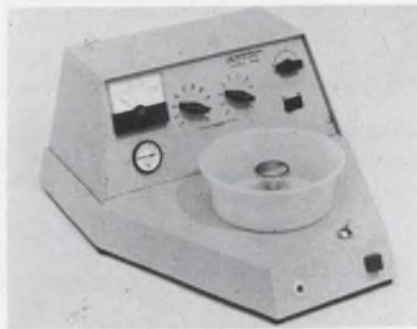

Macronetics, Inc., 220 California Ave., Palo Alto, Calif. Phone: (415) 321-6750. Price: \$975 up.

For silicon wafers, glass, metal or ceramic substrates, the single-spindle Model 1201 photoresist spinner provides a vacuum gauge and a 0-15,000 rpm speed range. Rapid acceleration, dynamic braking and automatic time controls are other features. The cup has an inside diameter of 6-3/4 in.

CIRCLE NO. 378

Screen chase controls thickness to ± 0.5 mil

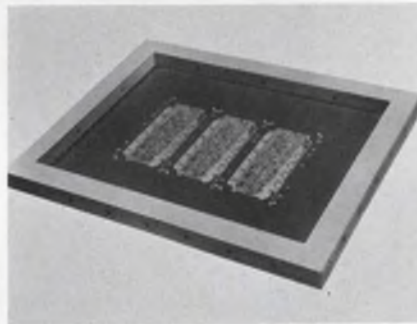

Dia-Print Co., Inc., P.O. Box 926 BB (Round Hills), Williamsport, Pa. Phone: (717) 326-3301. Price: \$157.92 up.

The chase fits all standard printers and provides positive control of circuit thickness to ± 0.0005 in. Circuit patterns can be laid down as small as 0.003 in. wide. The width and position of patterns can be maintained at this tolerance over a 16-in.² area.

CIRCLE NO. 379

Wire stripper runs on compressed air



Eubanks Engineering Co., 225 West Duarte Rd., Monrovia, Calif. Phone: (213) 358-4531.

Powered by compressed air and electrically controlled, the model 88 contains a pneumatic clamp that grips the wire and feeds it into the cut and strip mechanism. Wire length is determined by clamp travel, and is changed by altering the stroke of the air cylinder with a micrometer. The device cuts and strips wire as small as 37 AWG.

CIRCLE NO. 380

Point to point wirer speeds assembly



Product Improvement Corp., Santa Ana, Calif. Phone: (714) 540-7755.

Automatic positioning with pre-programmed tape instructions eliminates positioning error and is said to increase wiring production over 700% compared to manual techniques. Two hundred wires per hour is a reasonable rate. The unit is numerically controlled and is capable of using either the Gardner-Denver, Standard Pneumatic or other common wire wrap guns. Two different sizes are available.

CIRCLE NO. 381

ON READER-SERVICE CARD CIRCLE 70

Electrostatic mV meter has a remote probe

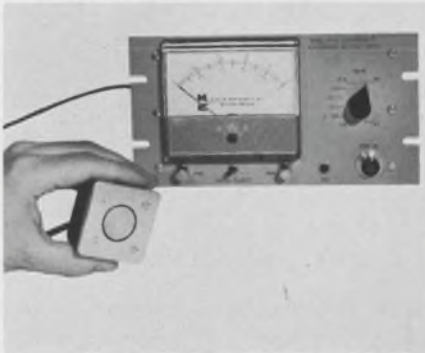

Monroe Electronics, Inc., 5 Vernon St., Middleport, N.Y. Phone: (716) 735-3721.

The all-solid-state Model 147 electrostatic millivoltmeter features a small, remote probe that permits noncontacting dc potential measurements in the 0.001-to-10-V range. A feedback-driven probe technique acts as voltage follower and the meter's circuitry provides accuracy of 0.1%. Drift is measured to be less than 5 mV/day, noncumulative.

CIRCLE NO. 382

Fission chamber measures neutron flux

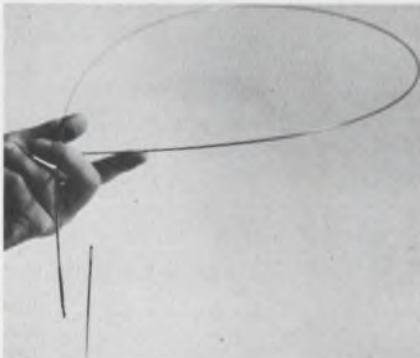

Westinghouse Electric Corp., Box 2278, Pittsburgh, Pa. Phone: (412) 391-2800.

This 90-mil-dia, 22.5-in.-long fission chamber is designed for use inside the core of atomic reactors. It operates at ambient temperatures up to 650°F and measures thermal neutron fluxes up to 3×10^{13} neutrons/cm²/s. The chamber is constructed of stainless steel and it uses a high-purity alumina insulation.

CIRCLE NO. 383

THE GENERAL ELECTRIC SSL'S

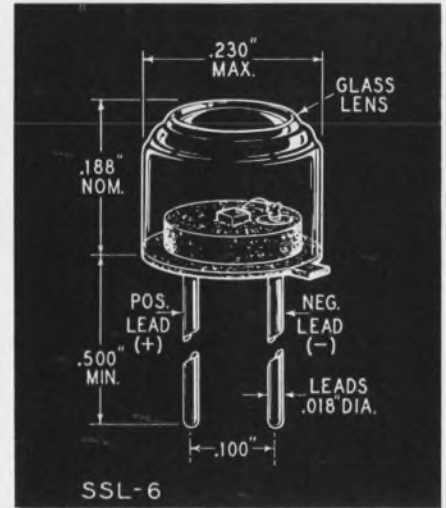
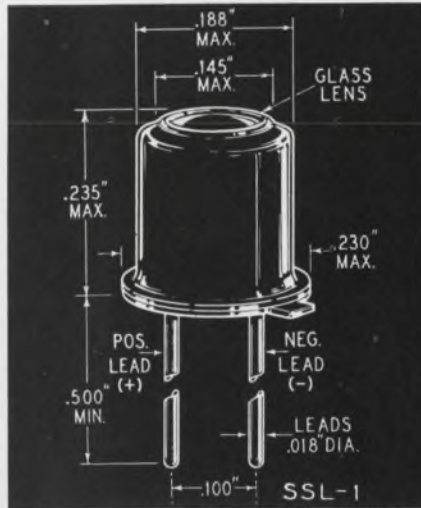

Order your samples now of these new solid state lamps

SSL-1 and SSL-6 are 2-5 volt light sources that substitute a silicone carbide crystal for the conventional tungsten filament. They have scores of applications in computers, missiles, telephone equipment and aircraft.

Anywhere, in fact, that a tough tiny lamp is required.

The SSL-1, with its 60° viewing angle, is a perfect photocell driver. The all-glass cover on the SSL-6 gives it a 180° viewing angle, excellent for indicating jobs.

Both have a surface brightness of 40 footlamberts end on at 50 ma. Both turn on and off at 10,000 cycles per second. Both resist shock and vibration better than any filament lamp. And will last indefinitely with no loss of efficiency.

ORDER SAMPLES TODAY. New SSL lamps can help save space, improve performance, reduce maintenance costs in your products. Order samples now and find out how. They're \$9.50 each. Mail your check, money order or purchase order with the coupon below. Or see your regular GE lamp representative.

Need more information? Send for free technical bulletin #3-7041 (SSL-1) and #3-7235 (SSL-6).

Miniature Lamp Department



TO: General Electric Company
Miniature Lamp Department
P. O. Box 2422, Nela Park, Cleveland, Ohio 44112
Attn: J. D. McMullin

ED-12

Please send me _____ new GE SSL-1 lamp(s) at \$9.50 ea.
 Please send me _____ new GE SSL-6 lamp(s) at \$9.50 ea.
 Total enclosed \$ _____

Name _____
 Company _____
 Address _____
 City _____ State _____ Zip _____

Differential op amp drifts only 3 $\mu\text{V}/^\circ\text{C}$

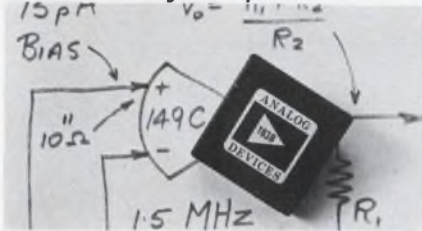

Analog Devices, Inc., 221 Fifth St., Cambridge, Mass. Phone: (617) 491-1650. P&A: model 183 A, \$30 (1 to 9), model 183 B, \$40 (1 to 9); stock.

A compact differential operational amplifier shows a maximum drift in voltage of only $3\mu\text{V}/^\circ\text{C}$ and an offset current of $50\text{ pA}/^\circ\text{C}$. A companion amplifier, model 183A, is identical except for a $6\mu\text{V}/^\circ\text{C}$ max drift figure.

The key to the 183 series' stability specifications is a dual-transistor input circuit, which replaces the two separate input transistors used in conventional operational amplifiers. Intimate placement of the dual transistors' two junctions, plus very low thermal mass and accurate matching of drift characteristics, makes the devices ten times less susceptible to thermal gradients than ordinary amplifiers.

When a differential amplifier is set near power transistors, heat-dissipating resistors, power supplies and similar heat sources—or even in drafts, one side of the encapsulated package tends to become hotter than the other. This in turn creates a temperature gradient across the amplifier that often causes one input transistor's junction to be slightly hotter than the other's. An amplifier's drift specification, however, refers only to the matching between transistors when both junctions are at the same temperature. There is often no specification to cover the effects of thermal gradient and shock, which can produce $240\mu\text{V}$ of offset for every 0.1°C temperature difference between the input transistor junctions.

The series 183 amplifiers, owing to the ease with which the two input junctions attain uniform temperature, has tenfold better stability in the face of thermal shock and gradients than conventional discrete-component amplifiers.

Solid-state ac relay can carry 40 A

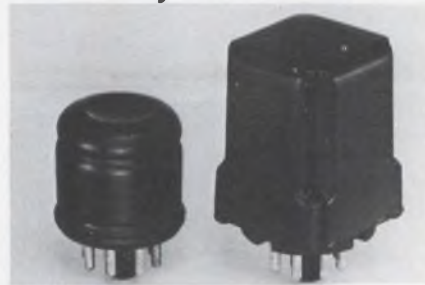

Relax Corp., P.O. Box 9397 Phoenix. Phone: (602) 997-8611.

A completely solid-state relay is encapsulated, making it shock-, vibration- and water-resistant. Load currents range from 1 to 40 A. Single-throw or double-throw relays are available. Performance features include the use of low-power ac or dc control voltages.

CIRCLE NO. 388

Current-sensing switch turns off at 30 M Ω

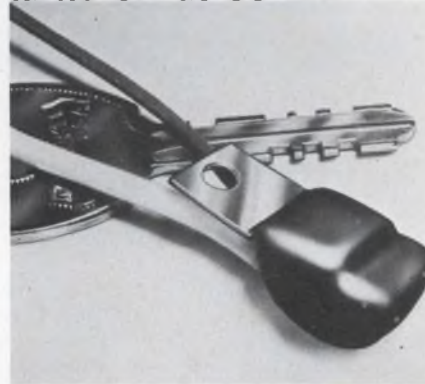

Blake Electronics, Muskego, Wis. Phone: (414) 422-0040. Price: \$3.50 (1000 lots).

Able to sense the flow of a minute signal current through an object or material, this switch has typical ratings that include a turn-on resistance of $5\text{ M}\Omega$, turn-on capacitance of 250 pF and a turn-on sensing current of $60\mu\text{A}$ with supply voltage of 117 V rms (60 Hz). The maximum ambient turn-off resistance is $30\text{ M}\Omega$; maximum turn-off capacitance is 75 pF .

CIRCLE NO. 385

Fiber optics withstand 600 $^\circ\text{F}$

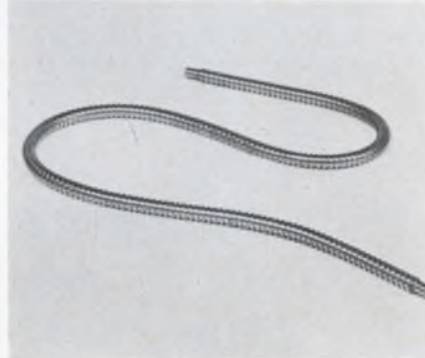

Dolan Jenner Industries, Inc., 10 Ingalls Court, Melrose, Mass. Phone: (617) 662-8200.

High-temperature fiber optics are available for applications where temperatures rise to 600°F . Extended temperature range and rugged construction permit applications in operating environments and ambient temperatures that are presently not suitable for conventional glass fiber optics, nor for synthetic fibers which are limited to 170°F .

CIRCLE NO. 386

Power modules deliver 5 V dc



Transistor Devices, Inc., 65 Route #53, Mt. Tabor, N.J. Phone: (201) 625-0250.

A small power module delivers 5 V dc at 25 A with regulation of 125 mV and rms ripple of 15 mV. Called the Model IC 5-25, it measures $5\text{-}1/4 \times 3\text{-}1/2 \times 7\text{-}1/2$ in. and weighs 6 lb. The IC series, which are all silicon, operate from any ac source of 105-125 V at 50, 60 or 400 Hz. All models have full isolation between line and load, and are short-circuit-proof.

CIRCLE NO. 387

Carry $\pm 1 \times 10^{-11}$ absolute accuracy in this portable primary frequency standard/atomic clock

You never need to take the Hewlett-Packard 5061A home for referencing to a primary frequency standard ... because it is a primary atomic frequency standard. The periodic referencing you have to do with crystal oscillators and rubidium standards is no longer necessary. Absolute accuracy of $\pm 1 \times 10^{-11}$ is ensured by a cesium beam tube atomic resonator. In addition, you can change time scales with convenient thumbwheel switches. Options make it a compact self-contained atomic clock with built-in standby power.

Option 01 for the 5061A incorporates a built-in digital divider and clock. The divider's 1 pulse per second output is of excellent quality: <20 ns jitter, <50 ns rise time, $<1 \mu\text{s}$ fall time, 10 V into 50Ω . A built-in digital delay generator shifts pulse timing from $1 \mu\text{s}$ to 1 s by 6 thumbwheel switch decades. Internal and external timing pulses can be synchronized, when desired, simply by pressing the "Auto Sync" button.

Option 02 adds a built-in standby power supply with conservative $\frac{1}{2}$ -hour battery capacity (1-hour typical) for use if external line power fails or for transportation. Recharging is automatic upon the return of line power.

Prices: 5061A Cesium Beam Frequency Standard, \$14,800; Option 01, \$1500; Option 02, \$600.

The 5061A accuracy specifications are backed up by extensive data on HP cesium beam standards: (1) comparison against the U.S. Frequency Standard (USFS, NBS-II and NBS-III) over a two-year span; (2) by three annual "flying clock" experiments in which HP cesium standards were flown around the world and compared to timekeeping standards of many nations; and (3) by comparisons of more than 100 cesium beam standards.

For complete information call your local HP field engineer or write Hewlett-Packard, Palo Alto, Calif. 94304; Europe: 54 Route des Acacias, Geneva.

HEWLETT  PACKARD
FREQUENCY STANDARDS

02712

Model 5061A Primary Standard with new built-in clock and standby battery options.

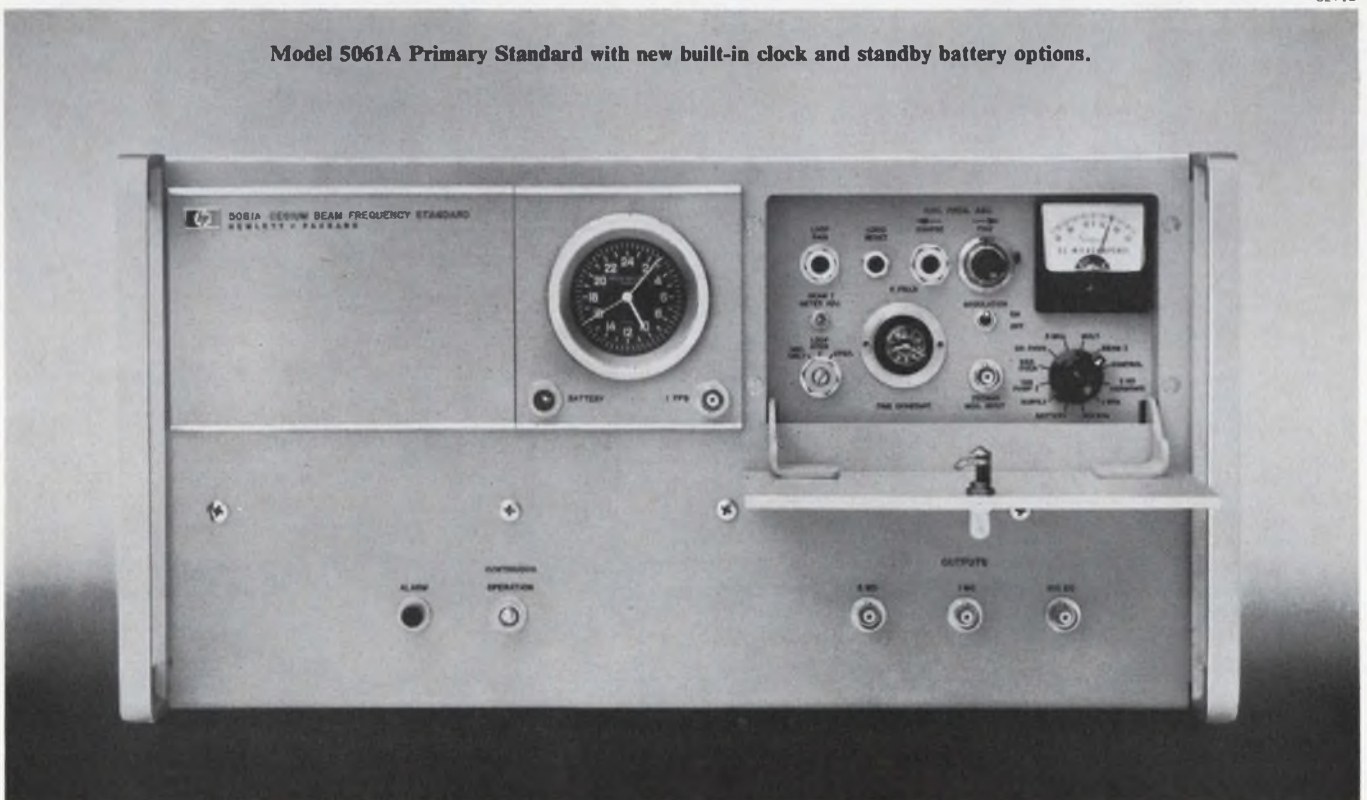

ON READER-SERVICE CARD CIRCLE 72

What do we know about switches and military relays?

We wrote the "books"!

Free: four new catalogs from Cutler-Hammer—covering the most versatile line of switches and relays in the industry. Order the ones you want!



Military Switches

Here is complete descriptive data on the Cutler-Hammer switch line, designed especially for military applications—everything from push-buttons to "Positive Action" switches (nearly everything that flies uses Cutler-Hammer "Positive Action" switches!).

ON READER-SERVICE CARD CIRCLE 241



Commercial Specialty Switches

New 36-page catalog is filled with detailed information on hundreds of switches for every application . . . appliances . . . power and hand tools . . . photo equipment . . . business machines . . . you name it! Truly a buyer's guide for quality switches.

ON READER-SERVICE CARD CIRCLE 242

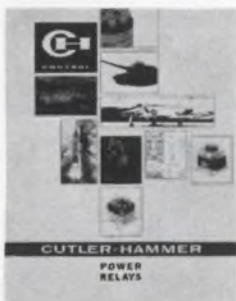

Power Relays

Here is the book on performance-tested relays designed for electrical control on aircraft, space vehicles, ordnance, ground-support equipment. Contains illustrative photos, engineering data, drawings and ratings on our full line of power relays.

ON READER-SERVICE CARD CIRCLE 243



Shallcross Rotary Switches

A brief but complete booklet on all Shallcross rotary switches. Series 1 (1-inch deck), Series 2 (1 3/4-inch deck), Series 4 (2 1/2-inch deck) round ceramic switches and oval ceramic switches. Includes description, design characteristics and selection tables.

ON READER-SERVICE CARD CIRCLE 244

CUTLER-HAMMER

Milwaukee, Wisconsin 53201



COMPONENTS

Thermistors range from 0.5 to 100,000 Ω

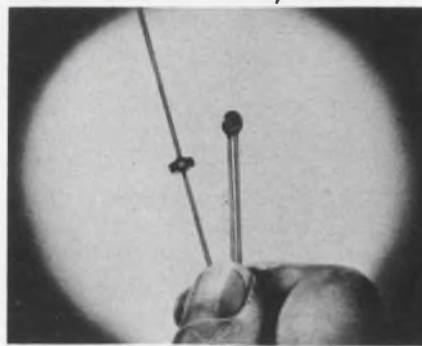

Fenwal Electronics, Inc., 63 Fountain St., Framingham, Mass. Phone: (617) 875-1351.

Low-resistivity thermistors, with nominal resistance values of 25°C from 0.5 to 100 Ω , are well suited for low-temperature applications of temperature measurement, indication and control, as well as temperature compensation of copper coils. High-resistivity units, with nominal values at 25°C from 1000 to 100,000 Ω are available.

CIRCLE NO. 331

Power transformer operates at 400 Hz

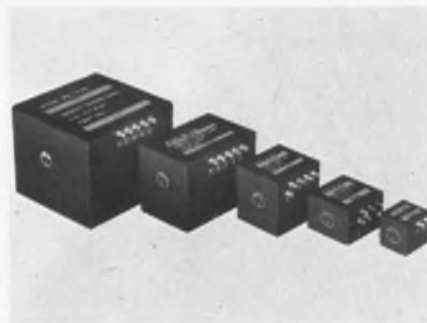

Abbott Transistor Labs., Inc., 3055 Buckingham Rd., Los Angeles. Phone: (213) 936-8185. P&A: \$12; stock.

Power transformers for 400-Hz airborne applications come in a wide variety of power levels, from 2 to 175 W, at almost any output voltage between 5 and 5000 V ac. All secondary voltages are center-tapped. Encased in diallyl phthalate the 2-W units measure 0.87 x 0.74 x 0.78 in., and the 175-W models measure 2.75 x 2.71 x 2.31 in.

CIRCLE NO. 332

Vacuum thermocouples respond in 1/10 s



Harry Levinson Co., 1211 East Denny Way, Seattle. Phone: (206) 328-5700.

Tracking accuracy of a thermocouple matched pair over a $\pm 20^{\circ}\text{C}$ temperature range is 0.5% for the Model 219 and 0.2% for the Model 219-1. Response time for both is approximately 1/10 s, 0-90%. Other specifications include a nominal current of 6.6 mA, heater resistance of 170 Ω , couple resistance of 1-1.5 Ω and an output of 7 mV.

CIRCLE NO. 333

Flange-mount motors produce 1/35 to 1/7 hp



Carter Motor Co., 2764A W. George St., Chicago, Ill. Phone: (312) 588-7700.

Continuous ratings for a line of flange-mount motors range from 1/35 to 1/7 hp in universal series and dc shunt types. Series motors are offered for 6-to-220-V input at 3600 to 10,000 rpm, and 1/40-to-1/15-hp shunt models operate on 6 to 115 V dc at 1800 to 5000 rpm. The round body frame is approximately 3-5/16 in. in diameter and 4-1/2 or 4-7/8 in. long in the various models.

CIRCLE NO. 334



With the Vent-Rak 5050 you get design and functional strength...the girl is ours!

Beneath the attractive, modular styling of this Vent-Rak 5050 Series Cabinet lies a reinforced 12-gauge steel frame. Highly versatile, the 5050 Cabinet will meet wide requirements for single or multiple installations. The 5050 Writing Surface is a functional, though rugged accessory.

Economy, accessibility, interchangeable steel components, and ease of assembly make the 5050 Series ideal for your complete electronic packaging, or to supplement your present installation.

For complete information, write:

VENT-RAK, INC.
525 South Webster Ave.
Indianapolis, Indiana 46219

**VENT
RAK**®

ON READER-SERVICE CARD CIRCLE 74

STANDARD FREQUENCY RECEIVERS

FREQUENCY STANDARDIZATION TO THE
NATIONAL BUREAU OF STANDARDS



Model T-60 60 KHZ Time Code Receiver
Round The Clock WWVB 60 KHZ Binary Time Code Broadcasts - Most Accurate Time Signal Available - Can Be Recorded Continuously
Radio Station WWVB is broadcasting complete time information using a level shift carrier time code (10 db level changes). This code, which is binary coded decimal (BCD) is broadcast continuously and is synchronized with the 60 khz carrier signal. \$480.00

Model T-60A Rack Model (3½" H x 19" W x 5" D)



Model SR-60 Price: \$850.00
Model SR-60. WWVB-60 khz. Will calibrate any local standard up to 5-10¹⁰ within a short period. Can be easily operated by any technician and performs in any part of the Continental United States.



Model SFD-6R Modular Construction:
A complete system for distribution of standard frequency throughout a plant. All solid State—fail safe—reasonably priced. Price depends upon Modules selected (\$90.00 each). Several Modules available.



Model WVTR Mark II All Silicon Transistor
Five different models of Receivers for WWV and WWVH are available. They receive all frequencies transmitted by WWV and are all crystal controlled double conversion superheterodynes. \$590.00

Special Antenna Assemblies for both VLF and HF are in stock.



Model WWVT \$590.00
Mark II
All Silicon Transistor
Overall Size
7¼" x 9½" x 5"
Approx. Weight—7 lbs.

MODEL SR-7H
\$345.00



Crystal controlled front end receiver covering 2.5, 5, 10, 15, 20 and 25 MHz with double conversion 2 MHz first I.F. and 175 kHz second I.F. Also available in rack model.

Send for complete specifications. Prices and specifications subject to change without notice. F.O.B. Woodland Hills, Calif.

SPECIFIC PRODUCTS

P. O. Box 425 / 21051 Costanzo Street
Woodland Hills, California
Area Code: 213 340-3131



ON READER-SERVICE CARD CIRCLE 75

COMPONENTS

Triggered spark gaps operate from 1 to 15 kV



Signalite, Inc., Div. of General Instrument Corp., 1933 Heck Avenue, Neptune, N.J. Phone: (201) 775-2490.

Nine triggered spark gaps are available, with main static breakdown ratings varying from 1 to 15 kV dc. The minimum trigger voltage pulse varies from 2.5 —3 kV for the 1-kV-dc TG-240 to 4.5-8 kV for the 15-kV-dc TG-248 in Mode A operation, where the trigger and electrode are both positive.

CIRCLE NO. 327

Potentiometer displays 0.035% linearity

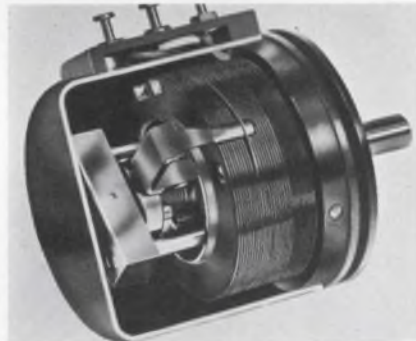

Vogue Instrument Corp., 31 Commercial St., Plainview, N.Y. Phone: (516) 938-9500.

A series of multiturn potentiometers with exceptionally linear resistance over their mechanical range is available in sizes 18 and 33. The 10-k Ω , 40-turn, size-33 potentiometer, for example, has an independent linearity of 0.0035%. This performance is achieved through a design which completely eliminates the common step function output.

CIRCLE NO. 328

8-track tape deck runs on ac or dc

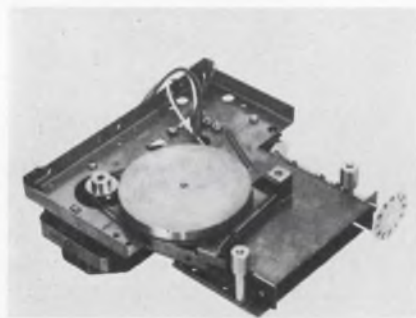

Auricord Corp., 35-41 29th St., Long Island City, N.Y. Phone: (212) 361-7400. P&A: \$20; stock.

Two eight-track tape cartridge mechanisms run on 115 V ac, 60 Hz, or 12 V dc. They can be used in communications, information retrieval, slide and film-strip sound synchronization and alarm-system design. The assemblies are available in many optional forms to meet the applicable head configuration.

CIRCLE NO. 329

Quartz filters stable to 1 dB



Clevite Corp., 232 Forbes Rd., Bedford, Ohio. Phone: (216) 232-8600.

Four-pole crystal filters, with center frequencies of 10.7, 15, 20, 30 and 45 MHz, have 1-dB peak-to-valley stability. They are packaged in a standard HC 6/U crystal can. Typical characteristics include temperature stability of $\pm 0.005\%$ maximum from -40 to $+85^\circ\text{C}$. The HC 6/U package is $3/4 \times 3/4 \times 3/8$ in.

CIRCLE NO. 330

**Spurious-free
3 GHz Dispersion!**

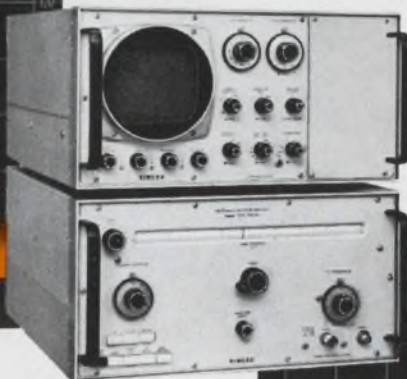
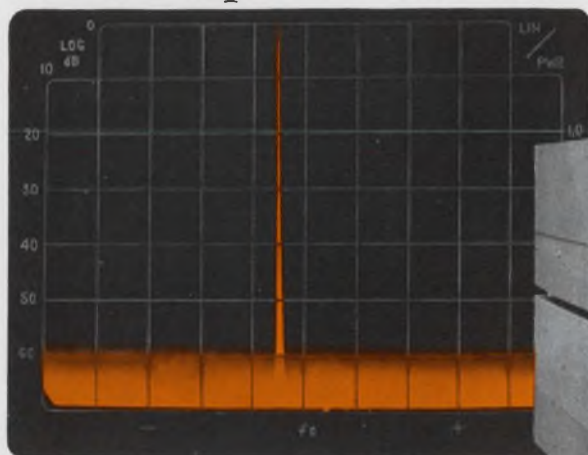

**Calibrated
10 kHz Dispersion!**

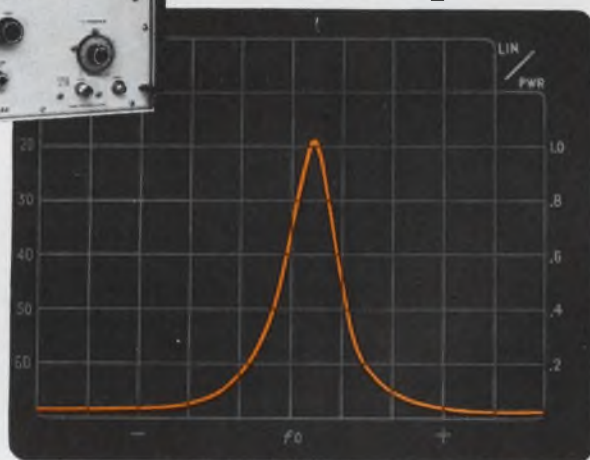

only one...
the Panoramc SPA-3000
Microwave
Spectrum Analyzer
delivers both!

You can have full 3 GHz dispersion in the 0.01 to 9.0 GHz range and greater than 2 GHz dispersion up to 40 GHz at sensitivities from -105 dbm with the new Panoramc Model SPA-3000. And, you don't have to buy an expensive preselector to eliminate inband images and multiple responses — even at maximum dispersions. In addition, the SPA-3000 provides calibrated dispersion ranges as low as 10 kHz.

Ideal for wideband surveillance and narrow pulse measurements, the Model SPA-3000 is a stable solid-state swept-front-end analyzer, with an easy-to-use internal phase-lock for the BWO, resulting in less than 100 Hz peak-to-peak incidental FM for a true 1 kHz resolution capability. A calibrated 60 db on-screen log display permits accurate comparison of CW and pulse signals of greatly differing levels, even those requiring the wide 1-MHz Bandwidth for optimum frequency analysis. Time domain measurements can also be made using the synchroscope capability offered by the unique combination of wide bandwidth and fast sweep rates.

This new analyzer features built-in stepped RF, as well as stepped and continuously variable IF attenuators to preclude IM products; RF and IF frequency markers for auto-calibration; stepped and continuously-variable dispersion and bandwidth settings; smallest size, lowest weight and power consumption.

The Model RF-3000 Tuning Unit is also available separately as an add-on module to convert Panoramc's moderately-priced Models SPA-100 and SPA-100A into the Model SPA-3000; offering maximum flexibility to meet any combination of application and budgetary requirements.

Call or write for a demonstration or complete technical data.

SINGER
INSTRUMENTATION

PANORAMIC • EMC • EMPIRE • GERTSCH • SENSITIVE RESEARCH

THE SINGER COMPANY, METRICS DIVISION • 915 Pembroke St., Bridgeport, Conn. 06608, U.S.A. • Phone (203) 366-3201 • TWX 710-453-3483

Delay line rises in 1.8 μ s

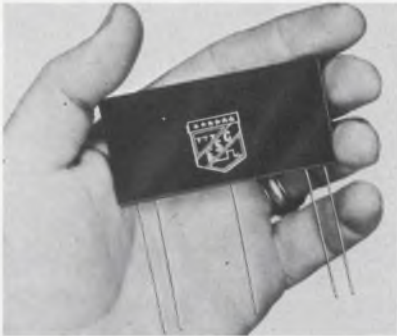

ESC Electronics Corp., 534 Bergen Blvd., Palisades Park, N.J. Phone: (201) 947-0400.

Delay line model 54-67 has a time delay of 29 μ s with a tap at 11 μ s. The rise time is 1.8 μ s max with an impedance of 400 Ω and an attenuation of 2 dB maximum. The device is encapsulated in epoxy resin and is designed to meet the specifications of MIL-D-23859A. Dimensions are 3 in. long by 0.25 in. wide by 1.5 in. high.

CIRCLE NO. 316

Toroidal inductor reacts over 180°C range

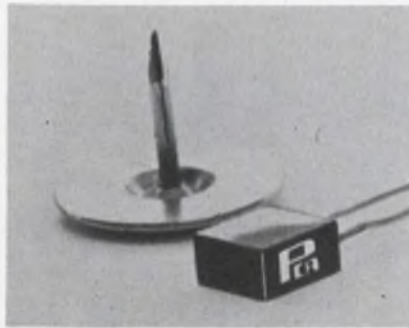

PCA Electronics, 16799 Schoenborn St., Sepulveda, Calif. Phone: (213) 892-0761. P&A: \$3; 4 wks.

This toroidal inductor measures 0.2 x 0.2 x 0.1 in. and is stable from -55° to +125°C. It is suitable for application in printed or microminiature circuit boards, ground and airborne electronic equipment and computers, and a wide variety of digital, automation and process equipment. Units claim an inductance up to 15 μ H.

CIRCLE NO. 317

Low-power commutator needs only 40 mA



Stellarmetrics, Inc., 416 E. Cota, Santa Barbara, Calif. Phone: (805) 963-3566. P&A: \$1000; 60 days.

Weighing less than 10 oz., the model 251 commutator requires an input power of 40 mA at 28 V for low battery drain in airborne applications. Other features include an input impedance of 5 M Ω during the ON cycle, so transducers are not loaded during sampling. General specifications include a channel rate of 6750 pps, frame rate of 150 fps and frame-rate stability of $\pm 3\%$.

CIRCLE NO. 318

Designed with a particular type of Customer in mind

Total quality control, advanced engineering and long field experience combine to give Howard customers the superior performance, longer life and insurance against costly breakdowns that they look for in motors, gear motors, fans and blowers.

For immediate delivery of Cyclohm fans and blowers, contact Standard Motor Product Sales, 23 Broadway, Des Plaines, Ill. 60016.

For complete information on the Howard motor, gear motor, fan and blower lines, address

HOWARD INDUSTRIES
MSL Industries, Inc./Motor Group
2420 18th St., Racine, Wis. 53403

ON READER-SERVICE CARD CIRCLE 77

FREE ENGINEERING CATALOG of PUSH BUTTON and ROTARY SWITCHES, MINIATURE ELECTRONIC COMPONENTS, and MOLDED PARTS

More than a catalog!

This New Engineering Catalog provides valuable reference material on the effects of environment, duty cycle, altitude, etc., on switch performance. Shows the relationship between switch loads and useful life. Also completely describes Grayhill's line of miniature, sub-miniature and ultra-miniature electronic switches and components.

Write for your free copy today.

Grayhill
... the Difference Between Excellent and Adequate

565 Hillgrove Avenue
LaGrange, Illinois 60525
Area Code 312, Phone 354-1040
"PIONEERS IN MINIATURIZATION"

ON READER-SERVICE CARD CIRCLE 78

Chip resistors use thick film

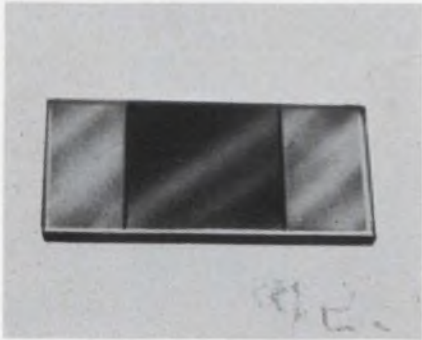

EMC Technology, 1300 Arch St., Philadelphia, Pa. Phone: (215) 563-1340. P&A: 50¢ to \$2; stock.

Thick-film chip resistors provide a resistance range from 1 Ω to 1 M Ω , tolerances of 1%, 5% and 10% and typical load life change of less than 1% 1000 h at 125°C. The CR-15 chip resistor is 0.15 in. long, 0.075 in. wide and 0.021 in. thick, and is rated 1.4 W at 125°C. The CR-12 measures 0.12 \times 0.06 \times 0.012 in. and is rated at 1/8 W.

CIRCLE NO. 319

Crystal oscillators stable to 0.1 ppm

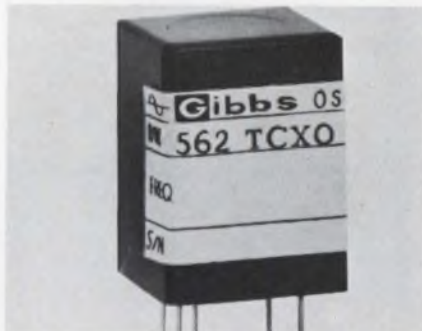

Gibbs Manufacturing and Research Corp., Janesville, Wisc. Phone: (608) 754-4467. Price: \$99; (100 lots).

Crystal oscillators with a frequency-stability rating of 0.1 ppm per day under static ambient conditions, have a frequency drift of no more than 5 ppm from 0 to 50°C. Frequency adjustment is ± 10 ppm minimum. The supply voltage required is 5 V ± 0.5 V dc. Output frequencies from 60 Hz to 250 kHz ± 2 ppm calibration tolerance at 25 ± 5 C are available. The case size for output frequencies below 50 kHz is 1 in. square by 1-1/4 in. long.

CIRCLE NO. 320

SCOTCH COOLER

by McLean



McLEAN "COMPUTER AGE" RACK-MOUNTED BLOWER

Thr...r...riest Blowers in America!

The traditional key to economy is to make a little go a long way. But our problem at McLean is to make a great deal go by the shortest possible route.

In equipment cooling, this saves you money. By moving volumes of air through tight spaces — and doing it reliably, unfailingly, with miniaturized units — McLean protects millions of dollars worth of electronic installations each year. But whether it be in the rack-mounted blower shown here, or in tonnage-volume units for industry, McLean delivers more for less.

And you pay less for more.

SEND FOR
NEW 1967
CATALOG



McLEAN ENGINEERING
LABORATORIES

Princeton Junction, N. J. 08550
Phone 609-799-0100 • TELEX 84-3422





Please send me the latest Acopian catalog that lists

**62,000
DIFFERENT
POWER
SUPPLIES**

available
for shipment
in 3 days.

Name _____

Title _____

Company _____

Address _____

City _____

State _____

ZIP _____

ACOPIAN CORP.
EASTON, PENNSYLVANIA
TEL: (215) 258-5441



ON READER-SERVICE CARD CIRCLE 80

MICROWAVES

**Bandpass filters span
910 to 2350 MHz**



Applied Microwave Dynamics Corp., 287 Sherman Ave., Newark, N.J. Phone: (201) 242-8866.

An interchangeable package for a line of single-knob, tuned telemetry bandpass filters covers the uhf bands of 910 to 1000 MHz, 1435 to 1535 MHz, 1700 to 1850 MHz and 2150 to 2350 MHz. Each filter assures low insertion loss, high selectivity, constant bandwidth and low VSWR.

CIRCLE NO. 335

**Waveguide isolators
cover 18 to 40 GHz**

E&M Laboratories, 7419 Greenbush Ave., North Hollywood, Calif. Phone: (213) 875-1484.

Waveguide isolators that are 0.05 in. long cover the entire frequency spectrum from 18 to 40 GHz. Standard bandwidths range from 100 MHz to GHz. Typical characteristics of 25 dB min isolation, 0.4 dB max insertion loss and VSWR of less than 1.2 are provided from -40° to $+85^{\circ}$ C.

CIRCLE NO. 336

**Rotary coupler
covers 5 channels**

Kevin Manufacturing Co., Inc., 24 Conn St., Woburn, Mass. Phone: (617) 935-4800.

A 5-channel rotary coupler has an octave or more on all channels with complete coverage from dc to 18 GHz. The model 7700 is available with miniature TNC or type-N connectors. The device's length is 18-1/2 in., its diameter 3-1/2 in. and it weighs 15 lb.

CIRCLE NO. 337

**Waveguide switch
carries 500 kW cw**

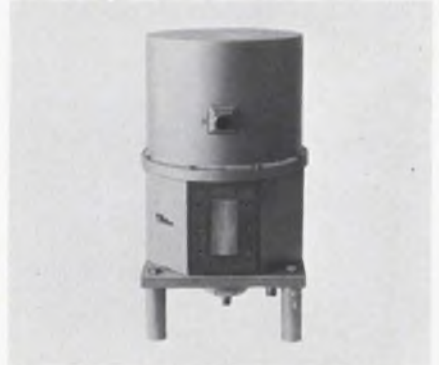

Microlab/FXR, 10 Microlab Rd., Livingston, N.J. Phone: (201) 992-7700.

A four-foot, high-power waveguide transfer switch operates from 2 to 2.4 GHz with a power-handling capacity of 500 kW cw. This switch incorporates a liquid cooling system. Of copper construction, the unit has isolation of 80 dB min, VSWR less than 1.03, and insertion loss of 0.01 dB.

CIRCLE NO. 338

**Telemetry test set
provides rf signals**

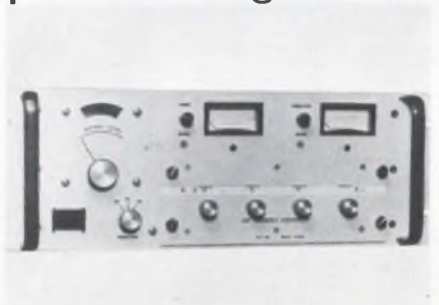

TRF Inc., 6627 Backlick Rd., Springfield, Va. Phone: (703) 451-5131.

The model TMT 102 telemetry test set offers rf signals derived from a true frequency synthesizer. It can be used as a secondary frequency standard for calibrating and testing telemetry and for tracking receiving systems. Frequency increments of 1, 10 or 100 kHz are available in the 136 to 138, 215 to 260, 400 to 406, 1435 to 1535, or 2200 to 2300 MHz frequency bands, with 0.0002% stability over a 50°F range.

CIRCLE NO. 391

ON READER-SERVICE CARD CIRCLE 81 ►



**Now the
industry-
accepted TTL
has a double,
pin for pin...**

**Westinghouse TTL.
Available now.**

The new direct replacement for industry-accepted SUHL II is here. Westinghouse TTL is a true mechanical and electrical replacement, pin for pin. Here's a second source TTL that can help keep your products competitive into the 1970's. □ Circuits now available in industry standard dual-in-line and flat packages include: 6G241 Dual NAND/NOR Gate; 6G221 Quadruple NAND/NOR Gate; 6F251 JK Flip-Flop, AND input; 6F261 JK Flip-Flop, OR input. □ For evaluation quantities, contact your Westinghouse Electronic salesman. Or phone Westinghouse at (301) 796-3666. Or write Westinghouse, Molecular Electronics Division, Box 7377, Elkridge, Maryland 21227.

You can be sure if it's Westinghouse



J-09141

Ceramic chip carrier is three-leg type

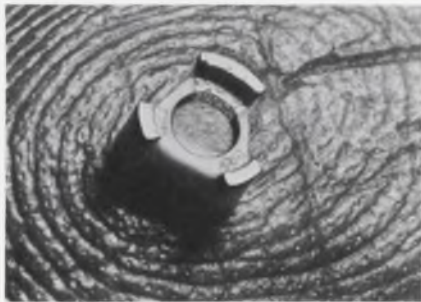

Frenchtown/CFI, 8th and Harrison St., Frenchtown, N.J. Phone: (201) 996-2121. Price: 2¢ ea. (10 million lots).

The CM329's circular design allows crossover metalization under the carrier and noncritical alignment on a printed-circuit board. Mass-production equipment can therefore be used to attach all carriers to the substrate simultaneously. The device has only three legs, however, so is suitable only for diode and transistor mounting.

CIRCLE NO. 321

Gold transfer tape for ceramic substrates

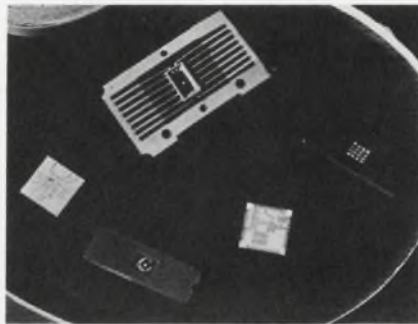

Vitta Corp., Wilton, Conn. Phone: (203) 762-8366.

A gold transfer tape has been developed for metalizing at low temperatures and for attaching semiconductor chips directly to ceramic substrates and components. The tape eliminates high-temperature moly manganese metalizing and subsequent expensive gold electroplating. Silicon-chip attachment and wire bonding can be performed directly.

CIRCLE NO. 322

Solder lead wires with indium alloy



Cerro Corp., 300 Park Ave., New York. Phone: (212) 688-8822.

A problem of soldering lead wires to a ferrite memory core without heat cracking it was solved with Cerroseal 35. This patented alloy of indium and tin softens at 240°F and is liquid above 260°F. The alloy is supplied as 1/16-in. wire which is sliced into 1/32-in. buttons. The wafer material or leads will withstand a 200-gram pull test.

CIRCLE NO. 324

A New Waterproof Series
MINIATURE
 TOGGLE SWITCHES

New case design with double high voltage barriers, and low-loss, high impact, high temperature materials. Wide silver contacts. Waterproof 'O' rings and sealed terminals. Available in One, Two, Three and Four Pole configurations all in compact unitized bodies. 6 Amps @ 125 VAC.

FREE PRODUCT PLANNING CATALOG

SPECIFY THE NEW "E" SERIES BY

ALCOSWITCH

DIV. OF ALCO ELECTRONIC PRODUCTS INC., LAWRENCE, MASS.

ON READER-SERVICE CARD CIRCLE 82

Momentary or Push On, Push Off
MINIATURE
 Push Button Switches

Exceptionally high current. Positive snap-action with fast make and break contacts. SPDT, DPDT & 4PDT, useable as either a Normally Open or Normally Closed switch. Silver contacts and terminals.

FREE 12-PAGE CATALOG WRITE!

ALCOSWITCH

DIV. OF ALCO ELECTRONIC PRODUCTS INC., LAWRENCE, MASS.

ON READER-SERVICE CARD CIRCLE 83

"IT'S GOOD BUSINESS TO HIRE THE HANDICAPPED."
 ISN'T THAT A GREAT IDEA, SNOOPY?

THE PRESIDENT'S COMMITTEE ON EMPLOYMENT OF THE HANDICAPPED, WASHINGTON, D. C.

Dual-in-line package provides 16 leads

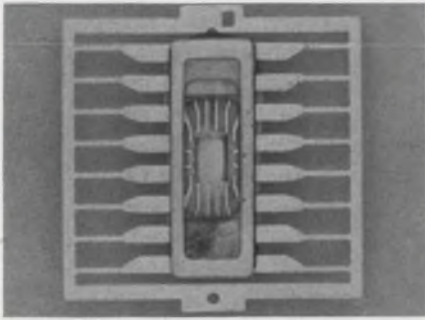

H. J. Electronic Seal Co., 366 Ely Ave., S. Norwalk, Conn. Phone: (203) 838-8426.

A 16-lead, glass-to-metal, dual-in-line package is plated with 100 μ in. of gold. This manufacturer of hermetic seals, specializing in flat-packs for ICs and other semiconductor bases, notes that the package—composed of Kovar leads, Corning 7052 and alumina glass for ruggedness—has a die mounting area of 0.085 x 0.12 in. on a lower plane than internal leads.

CIRCLE NO. 325

Conductive epoxy coats withstand up to 500°F

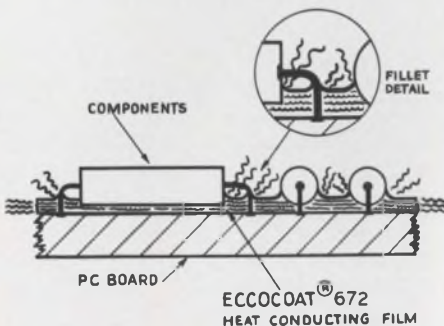

Emerson & Cuming, Inc., Canton, Mass. Phone: (617) 828-3300. Price: \$2 per lb.

An epoxy-based coating designed for heat dissipation provides electrical insulation, moisture protection and adhesive bonding of components to heat sinks. It is capable of withstanding continuous exposure to temperatures of 500°F. Because it is based on an epoxy resin, its adhesion to a wide variety of substrates is excellent. The coating will effectively act as a heat path into a circuit board.

CIRCLE NO. 326

A COMPUTER DESIGNED FILTER CAN MAKE YOUR ENGINEERING EASIER

Telonic RF and Microwave Filters cover such a wide range of frequencies, types, and performance characteristics that you don't have to design "around" them. Your specific requirements are programmed into an engineering computer, the filter designed and then produced to those precise parameters.

Basically modular, Telonic filters can be manufactured from elements in stock, providing another benefit in fast delivery.* With over 100,000 filter designs already produced, even so-called special types may already be standard. Here is the broad selection you have in designing—Frequencies from 30 MHz to 12 GHz • Lowpass • Bandpass • Tubular • Miniature • Cavity • Interdigital • Tunable. With that variety, quick delivery, and high performance, do you even need a second source?

*Three-day, Jet Order Service Available.

Telonic ENGINEERING CO.

A Division of Telonic Industries, Inc.
Box 277 • Laguna Beach, Calif. 92652 • Tel.: 714-494-9401

Representatives throughout the U.S. and foreign countries. Factory offices in Maidenhead, England, Frankfurt, Germany, and Milan, Italy.

• 52 PAGE FILTER TEXTBOOK •

Telonic's new catalog contains never before published data on filter insertion loss, attenuation, physical size, frequency and bandwidth tolerances, and pass band relationships. Send for your copy.

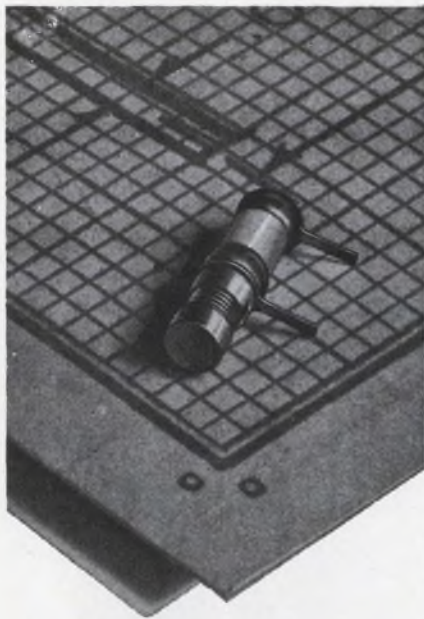

Sub-Miniature Low-Inductance Capacitor

High Q > 1500 @ 500 mc

10:1 capacitance ratio in micro miniature size — extra fine tuning <.35 pF per turn. High Q, (greater than 1500 at 500 mc).

Specifications

Size: 1/8" diameter, 1/2" length
Capacitance Range: 0.35 pF to 3.5 pF
Working Voltage: 250 VDC
 (test voltage, 500 VDC)
Q @ 100 mc: >5000; @ 250 mc, >2000
Insulation Resistance: >10⁶ Megohms
Temperature Range: —55°C to 125°C
Temperature Coefficient: 50
 ± 50 ppm/°C

Features 570° Solder. Prevents distortion. Not affected by conventional soldering temperatures.

Call or write for complete information.

Johanson

**MANUFACTURING
CORPORATION**

400 Rockaway Valley Road

Boonton, N.J. 07005 • (201) 334-2676

Electronic Accuracy Through Mechanical Precision

ON READER-SERVICE CARD CIRCLE 85

Application Notes

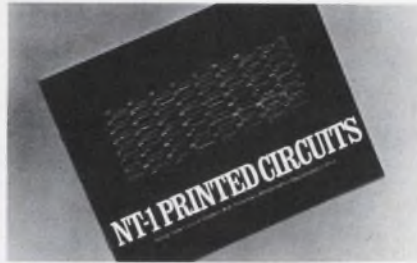

Printed-circuit boards

A repair manual for printed-circuit boards has been issued by the Institute of Printed Circuits. The manual is identified as IPC-R-700, and includes information on the following: damaged or defective conductors; damaged printed edge board contacts; blistered multilayer boards; lifted conductors; warped printed-circuit boards with and without components; lifted, damaged or missing terminal areas; component replacement; gold plating that is thin, scratched, pitted, powdered, flaking or delaminated; missing or damaged conductors, and improperly installed eyelets. The manual also contains a bibliography and includes maintenance procedures for parts mounted on printed-circuit boards.

Available for \$5 from the Institute of Printed Circuits, 3525 W. Peterson Rd., Chicago.

Microwave Materials

Single crystals and polycrystalline microwave materials are designed for use in circulators, switches, isolators, phase-shifters, delay lines, filters, duplexers, power limiters and other devices. Data sheets comparing magnetic saturation vs temperature curves are offered. The basic material is purified yttrium iron garnet, with a saturation magnetization of 1780 gauss. It yields lower values of saturation magnetization and changes other parameters when substituted singly, or in various combinations with aluminum, gadolinium, or holmium. Magnesium ferrite and nickel ferrite are also available as standard materials. Harshaw Chemical Co.

CIRCLE NO. 311



Infrared thermistors

A discussion of current infrared detector technology is contained in technical bulletin MFN173. The bulletin describes the infrared spectrum, and traces the history of IR detectors and of thermistor bolometers since the latter's first appearance in the literature in 1956. A glossary of IR terminology and a table listing typical applications for IR radiation with corresponding wavelength bands and nominal wavelengths make this bulletin especially useful. Victory Engineering Corp.

CIRCLE NO. 312

Time-code applications

A "Handbook on Precision Time Code Generation, Synchronization and Tape Search Systems" describes in detail the four principal areas of a time-code system: time-code generation, time-code synchronization, tape searching and editing, and code formats. The publication contains block diagrams of various systems and gives complete pictorial descriptions of eight different IRIG and NASA time codes. Systron-Donner Corp.

CIRCLE NO. 340

CRT design

In a booklet, "Information Displays," Sylvania provides precise information on the parameters to be considered in choosing the optimum CRT to fit your next design. Consideration is given to such areas as deflection: electrostatic vs magnetic, sensitivity and defocusing; pattern distortion, brightness and resolution. Sylvania Electric Products, Inc.

CIRCLE NO. 313

Design Aids

Circular slide rule

Anyone who must perform simple calculations will find this convenient, pocket-size calculator extremely useful in his work. Operation of the rule is simple and the results are accurate. To multiply, divide and find proportions with this convenient circular rule, follow instructions that will be included with each one. General Industrial Co.

CIRCLE NO. 314

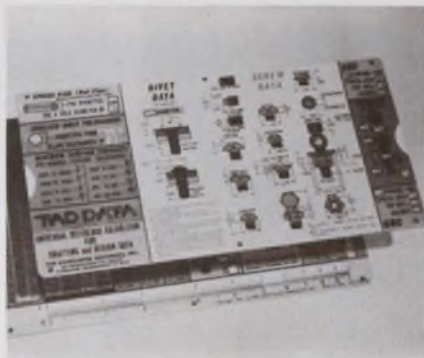

Reference calculator

At a glance, this data finder shows screw, rivet, and roll-pin data, pipe threads, minimum bend radii, drill, sheet metal, and wire sizes, drilled-hole tolerances, wrench clearances, minimum surface finishes and decimal equivalents. Standard C and D slide-rule scales also are provided.

Available for \$4.50 from TAD Products Corp., 639 Massachusetts Ave., Cambridge, Mass. 02139.

Radiography technique

This technical paper entitled "Radiography of Parts with Wide Variations in Thickness," originally delivered at the recent Society For Non-Destructive Testing convention in Montreal, has been reprinted with minor alterations, as a Technical Bulletin. Charts and tabular information are available with the bulletin. Balteau Electric Corp.

CIRCLE NO. 315



Large
or
Small...

Methode Printed Circuit quality
assures "full measure"
performance everytime!

Sub-miniature to king size, single to multi-layer printed circuits with as many as 20 layers, Methode quality assures "full measure" performance and reliability in any product application — military or commercial.

Methode is staffed, equipped, and experienced to provide you with practically limitless printed circuit production capability without compromising quality standards or delivery schedules.

We invite your inquiry at any time. We are confident our "gained-from-experience-knowledge" in serving sophisticated circuitry needs, can prove beneficial to your product's performance and profit picture.

Try us and see.



Printed Circuit Division

Methode Electronics, Inc.

General Offices:

7447 W. Wilson Ave., Chicago, Illinois 60656 • 312/867-9600

ON READER-SERVICE CARD CIRCLE 86



The 12 cranks from Pleasant Avenue.

A dozen mild-mannered men who love children, dogs and apple pie. Until they come to work at Pleasant Avenue at 0300GMT. Then they take off their jackets and turn into SUPER-CRITICS! Outright cranks!

They make sure that if any Trygon power supply isn't made exactly the way it's supposed to be made, it becomes our problem; not yours.

Thanks to the Cranks, for example, you can order any of the Trygon Half-Rack Series with complete confidence. These compact units offer power in ranges up to 160 volts, 10 amps with Constant Voltage/Constant Current/0.01% regulation/0.5mv ripple/0.05% stability (with even 0.01% optional) and such niceties as Trygon developed and patented over-voltage protection if you want it. (We think you should want it.)

Check into Trygon's half-rack series. It's been awarded the Scowl of Approval by the Twelve Cranks of Pleasant Avenue.

Model	Volts	Amps	TRYGON HALF RACK SERIES CONSTANT VOLTAGE/CONSTANT CURRENT		
			Standard Model	Overvoltage Protection (OV)	High Stability Option (H)
HR20-1.5	0.20	0.15	\$167	\$90	\$125
HR40-750	0.40	0.075	167	90	125
HR20-5B	0.20	0.5	325	95	125
HR20-10B	0.20	0.10	389	95	125
HR40-3B	0.40	0.3	320	95	125
HR40-5B	0.40	0.5	349	95	125
HR40-7.5B	0.40	0.75	425	95	125
HR60-2.5B	0.60	0.25	349	95	125
HR60-5B	0.60	0.5	415	125	125
HR160-2B	0.160	0.2	495	125	125
SHR20-3A	0.20	0.3	225	95	125
SHR40-1.5A	0.40	0.15	225	95	125
SHR60-1A	0.60	0.1	235	95	125
SHR160-500B	0.160	0.05	295	—	125

Most models slightly higher priced in Europe



Trygon Power Supplies
111 Pleasant Avenue, Roosevelt, L.I., N.Y. 11575
Trygon GmbH 8 Munchen 60, Haidelweg 20, Germany

ON READER-SERVICE CARD CIRCLE 87

New Literature



Diode-transistor guide

A reference that provides comparative prices on diodes, transistors and integrated circuits manufactured by leading companies is available on a subscription basis. It consists of four issues and four supplements. The information includes prices on quantities from 1 to 10,000 on 1N, 2N, MIL, TX and house numbers. Data-Tek.

CIRCLE NO. 339



Radio electronic master

An illustrated volume that includes standard electronic components is aimed at those who buy, sell, specify, design and service electronic parts and equipment. The 1776-page book is organized into 32 product sections for rapid reference and an index pinpoints the items displayed.

A list of distributors offering the 1968 edition is available from United Technical Publications, 645 Stewart Ave., Garden City, N.Y. 11530.

Pushbutton switches

Information on lighted and unlighted pushbuttons, contact blocks, indicating lights, compact indicating lights, lighted push-pull switches, legend plates, potentiometers, stations and accessories is contained in a 24-page catalog. In addition to specifications and circuitry, the brochure covers heavy-duty and electronic-duty oiltight lighted and unlighted pushbutton switches. Micro Switch, Div. of Honeywell.

CIRCLE NO. 341



Silicon transistor guide

A reference folder of silicon power transistor types—including Thermopad plastic-encapsulated devices—spans devices with collector currents from 30 mA to 30 A, collector emitter voltages to 400 V, power dissipation ratings from 3.75 to 200 W and f_T s from 1 to 60 MHz. A section on metal and plastic complementary types from 3 to 15 A outlines off-the-shelf npn/pnp capability and a cross-reference table and dimensional drawings, including TO-3, TO-5, TO-61, TO-66 and Thermopad types, provide useful, convenient data for the user. Motorola Semiconductor Prod., Inc.

CIRCLE NO. 342

Instruments for rent

Rentals 68 lists 400 different instruments with descriptions and monthly rental rates. Several plans to assist the user are mentioned, such as the call collect, the purchase option, the annual contract, and an inexpensive insurance plan. Continental Leasing Co., Inc.

CIRCLE NO. 343

Printed circuits catalog

Information on printed circuit boards manufactured by a new process is given in a 12-page bulletin. It emphasizes the simplicity and reliability of the process, and discusses improved performance characteristics. Photocircuits Corp.

CIRCLE NO. 344

pH supplies

Reference tables for selecting and ordering equipment supplies for pH meters, and for selecting the buffer standards for precise pH measurements are contained in a 16-page bulletin. Descriptions, prices and ordering information are provided for frequently used electrodes, including glass, reference, combination and metallic electrodes, and the thermocompensators. Other items include supplies for pH measurements, Model K and Aquameter titrators, the Electroscan 30 electroanalytical system. Beckman Instruments.

CIRCLE NO. 345



Plastics properties

Two brochures listing metric values for the properties of Phenolite laminated plastics, molded polyester fiber glass and Forbon vulcanized fiber contain data such as density, lengthwise and crosswise tensile strength, flexural strength and modulus of elasticity. Information on electrical values, dielectric strength, dissipation factor, dielectric constant, insulation resistance and arc resistance is included. NVF Company.

CIRCLE NO. 346



LOW-COST SOLUTION TO RESISTOR ADJUSTMENT

Bunker-Ramo's Unique Lease Arrangement Puts Precision Equipment in Your Plant

Now you can lease Bunker-Ramo's unique precision adjuster at a low monthly rate plus 1 cent per pulse . . . our substrates are also available, providing a complete microelectronics package with no investment in capital equipment.

Bunker-Ramo's proprietary equipment and processes have been thoroughly tested in daily production of custom microcircuits over a five-year period. We trim thin-film resistors to .01% and match the temperature coefficient of resistance to track to within $\pm 5\text{ppm}/\text{C}^\circ$.

A demonstration will convince you that we have the unique technical know-how that allows you to get exactly the precision you want in the package that meets your needs . . . and it's available for installation on your premises now!

Contact Joe Crist, Sales Manager, Microelectronics Operation, (213) 346-6000, Extension 546, or write to:



THE BUNKER-RAMO CORPORATION
DEFENSE SYSTEMS DIVISION
8433 FALLBROOK AVENUE • CANOGA PARK, CALIFORNIA 91304

ON READER-SERVICE CARD CIRCLE 88

The original lacing tape is still the best . . .

. . . and saves money too!

That's
GUDELACE® 18

You ought to try
a sample . . .



GUDELACE
ties tight, makes
firm harnessing—*fast!*

It is important, of course, for you to use tape that complies with military specs, or commercial stipulations, but the usual allowances for wax content in such specs give no consideration to the best lacing conditions. Gudebrod GUDELACE is made within the specs—BUT, it's made too, for easy handling, tight knotting, firm harnessing. THAT'S WHERE IT SAVES MONEY, in the harnessing operation. GUDELACE, the original harness lacing tape, is manufactured under strict control. Every yard is impregnated exactly the same, exactly right. You can count on that—and on getting better harnessing—*fast*—with minimum rejects. Why not send for a sample, test it any way you want. Let your harness crew try it. You'll be glad you did! (Remember, the Gudebrod Lacing Tape line includes tape for nearly every special situation—ask for The Product Data Book.)

**NOW—GUDEBROD HAS
TWO AIDS TO FASTER—
BETTER HARNESSING**



**CABLE-LACER®
& GUDE-SNIPS®**

The production tested Cable-Lacer is now reduced in price—only \$9.95. Holds bobbin of tapes—makes tight knots. The palm held GUDE-SNIPS provide convenient tape cutting—using either right- or left-hand, \$3.75.

G **GUDEBROD**
Electronics Division

GUDEBROD BROS. SILK CO., INC.
Founded 1870
12 SOUTH TWELFTH STREET
PHILADELPHIA, PA. 19107

ON READER-SERVICE CARD CIRCLE 89

NEW LITERATURE

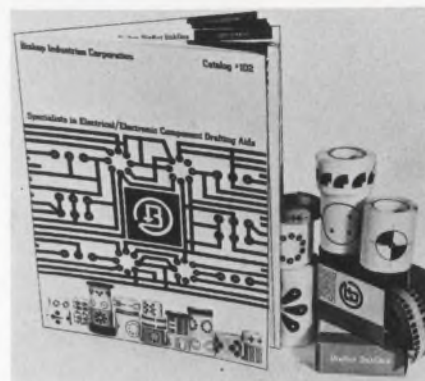

Drafting aids

Standard, electrical and electronic engineering and drafting aids are discussed in a 28-page catalog. The manufacturer's line of electronic symbols for integrated circuits, printed circuits, micrologic, welded modules, flatpacks and transistors is described. Also included are pads, elbows, corners, toes, ells, tapes, connector strips, reference numbers, letters and schematic symbols. Bishop Industries Corp.

CIRCLE NO. 347

Tube and device manual

A 600-page manual contains mechanical and electrical ratings and basing diagrams for television receiving and picture tubes, as well as for other types of electron tubes and semiconductor devices. The tube data, plus information on industrial and military cathode-ray tubes, semiconductor diodes, rectifiers and photoconductive devices, make the manual a useful reference for design engineers. Other features include replacement charts for foreign types, an interchangeability guide and a section on application, construction and handling of electron tubes.

Available for \$1.50 from *Sylvania Electric Co., 1100 Main St., Buffalo, N.Y.*

The Experimenter

This month's booklet contains information on 3 types of line voltage regulators and their typical characteristics. The catalog is available to qualified design engineers on a subscription basis. Charts, graphs, schematics and specifications for each regulator are provided. General Radio Co.

CIRCLE NO. 348

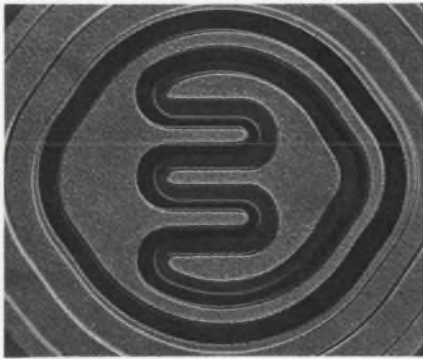

Semiconductor testing

A 22-page color brochure titled "Fairchild Reliability—The Unique Program" describes a semiconductor manufacturing and testing program for aerospace and defense contractors. It suggests available products to meet systems specifications. The brochure provides a listing of features and options, a description of test-inspection procedures and summary of such manufacturing processes as the planar process, metal overlay, field plate and ultrasonic bonding. Illustrations, charts, diagrams and photographs are included. Fairchild Semiconductor.

CIRCLE NO. 349



Radar reflectors

An illustrated folder describes various types of passive reflectors of radar energy. They are broadbanded throughout the microwave frequency range and are useful in a number of applications, some of which are illustrated by photographs. Performance characteristics are shown graphically and data covers both monostatic and bistatic reflectors and omni-azimuth and omnidirectional units. Tables show the theoretical radar cross section of the different reflector types as a function of frequency and reflector size. Emerson & Cuming, Inc.

CIRCLE NO. 350

FOR BETTER, FASTER WIRE HARNESSING—

GUDEBROD CABLE-LACER[®]
 NOW REDUCED TO **\$9.95**
 [10% OFF, LOTS OF 50] ea.

Production economics enable Gudebrod to offer the production tested Cable-Lacer at a new low price. Holds bobbin of tape. Facilitates lacing and knotting.

GUDEBROD GUDE-SNIPS[®]
 NEW HANDY TOOL— **\$3.75**
 [\$37.50 IN DOZEN LOTS] ea.

Unique, palm held tape snips. Allow free use of fingers while holding in hand. Right- or left-hand use. Sharp, drop-forged cutlery steel blades. Spring action.

Special Offer!

So that you may try them and see the money-saving way they facilitate the harnessing operation—we'll send you postpaid, one Cable-Lacer, one Gude-Snips and a bobbin of lacing tape for just \$14.00. Test for yourself how these tools can help you make better harnesses, faster and for less money.

GUDEBROD BROS. SILK CO., INC.

Founded in 1870

12 South Twelfth Street
 Philadelphia, Pa. 19107

Check enclosed, send me, postpaid:

- The special offer of Cable-Lacer, Gude-Snips and bobbin— **\$14.00***
- I just want the Cable-Lacer— **\$9.95***
- Send only the Gude-Snips— **\$3.75***

Name _____

Company _____

Address _____

*In Pennsylvania please add sales tax.

GUDEBROD
Electronics Division

ON READER-SERVICE CARD CIRCLE 90



What's black and white and read all over?

Old joke, great product. Digiswitch® and Miniswitch® are the industry's standard in thumbwheel switches. You'd almost think we'd pioneered the thumbwheel switch. (We did.)

Digitran switches set quickly. Read clearly. Save you up to 50% in panel space over old fashioned rotary switches. Absolute simplicity means absolute reliability. A million counts guaranteed.

As the world's largest manufacturer

of thumbwheel switches we happen to have the world's largest library of thumbwheel switch applications. Want more information about how Digitran can help with your switching problems? Send for our catalog, and we'll give it to you in black and white.

THE DIGITRAN COMPANY

Subsidiary of Becton, Dickinson and Company [BD]
855 S. Arroyo Pkwy./Pasadena, Cal. 91105
Tel: (213) 449-3110/TWX 910-588-3794

ON READER-SERVICE CARD CIRCLE 91

EXHIBITS
NEW YORK COLISEUM

TECHNICAL SESSIONS
NEW YORK HILTON

Monday through Thursday

- 48 GENERAL SESSIONS at the New York Hilton. Hours: 10:00-12:30; 2:00-4:30.
- FOUR FLOORS OF EXHIBITS at the N. Y. Coliseum including over 750 firms. Hours: 10 a.m.-8 p.m. 4 Days.
- GALA ANNUAL BANQUET—Wednesday 7:15 p.m. N. Y. Hilton Grand Ballroom—\$16.00.
- FREE SHUTTLE BUSES between the Hilton and the Coliseum—every few minutes.

- REGISTRATION—Good all days—General Sessions and exhibits. In and out privileges.—IEEE Members \$3.00. Non-members \$6.00. Ladies \$1.00. High School Students \$3.00 if accompanied by an adult—One student per adult; Thursday only—limit of 3 students per adult.
- REG-IDENT CARD speeds request for exhibitors' literature. Ask for one when registering.
- ESCALATORS/EXPRESS ELEVATORS to the Fourth Floor.



IEEE Exhibition MARCH 18-21, 1968

ON READER-SERVICE CARD CIRCLE 92

NEW LITERATURE

Papers on plastics

Six hundred eighty papers from 31 technical conferences on plastic materials and related technology have been included in Plastec report 31, *Subject Index, Bibliography and Code Description of Technical Papers on Plastics: 10 March 1966 - 18 May 1967*. From the subject index of the report, the reader can determine what papers were presented on the material, process or application in which he is interested, and from the code description he can determine the nature of the information given.

Available for \$3.00 from Clearinghouse for Federal Scientific and Technical Information, Springfield, Va. 22151.

Power measurement

A VSWR nomograph and other radio-frequency measurement data are included in a 60-page catalog of coaxial load resistors and attenuators, absorption wattmeters, directional peak and average wattmeters, rf filters and power sensors. The reference rf measurement instrumentation from 25 milliwatts to 250 kilowatts in the frequency range of 0.45 to 2300 MHz has 30 listings. Bird Electronic Corp.

CIRCLE NO. 355

Answer to Problem on p. 77

Answer: 100 turns of AWG No. 32 wire will do the job. Total dc copper resistance will be about 1.5 Ω.

Reprints available

The following reprints are available free and in limited quantities. To obtain single copies, circle the number of the article you want on the Reader-Service Card.

Don't pay too much for stability (No. 250)

Suppress harmonics at the source (No. 251)

Maintainability specs bothering you? (No. 252)

Advertising Representatives

New York 10022

Robert W. Gascoigne
Thomas P. Barth
Samuel M. Deitch
Byron Adams
850 Third Avenue
(212) PLaza 1-5530
TWX: 867-7866

Philadelphia

William C. Repetto
P. O. Box 206
Merion Station, Pa. 19066
(215) MO 4-1073

Boston

Richard Parker
7 Redstone Lane
Marblehead, Mass. 01945
(617) 742-0252

Chicago 60611

Thomas P. Kavooras
Berry Conner, Jr.
720 N. Michigan
(312) 337-0588

Cleveland

(216) 247-7670

Los Angeles 90303

Stanley I. Ehrenclou
Terrence D. Buckley
W. James Bischof
2930 W. Imperial Highway
Inglewood, Calif.
(213) 757-0183

San Francisco

Ashley P. Hartman
175 South San Antonio Rd
Ste. 243
Los Altos, Calif. 94022
(415) 941-3084

Southwestern 75206

Tommy L. Wilson
6200 North Central Express-
way
Dallas, Tex.
(214) EMerson 1-2311

London W. 1

Brayton C. Nichols
44 Conduit Street

Verviers, Belgium

Andre Jamar
1, Rue Mallar, 1
(087) 253.85

Tokyo

Yoshihiro Takemura
International Planning
Service, Inc.
Room 231 Tokyu-Mita Bldg.
1, Shiba-Mita Koun-cho
Minato-ku, Tokyo



Instant electronic heaven.

All you add is nothing.

Yummyyummyyum. Redcor/Modules' 770-401 buffer amplifier is a tasty little gem with scrumptious specs like 0.02% accuracy gains from 1 to 50, high cmr (80DB), and high cmv ($\pm 10v$) simultaneously. Its closed-loop design frees you from long hours over a hot slide rule designing feedback circuitry. Available in three flavors: operational, potentiometric, and differ-

ential. With a settling time of only 6 μ secs to 0.02%, and a price of \$95 (cheap) you're bound to love the 770-401 or our name's not Betty Crocker. Come to think of it, it's not, but what the hell it's a fine piece of gear so request complete data.

REDCOR

7800 DEERING AVENUE
CANOGA PARK,
CALIFORNIA 91304

(213) 348-5892 • TWX 910-494-1228

ON READER-SERVICE CARD CIRCLE 93

Need Fast Decay in Photocells?

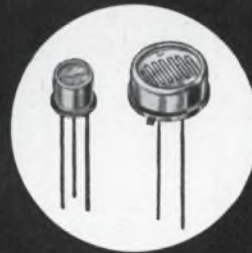

Clairex Type 7H cells offer .0006 sec. at 100 ft-c

In addition to fast decay time, Clairex Type 7H photocells also provide 240 ohms @ 100 ft-c and CdS stability. They are available in TO-18 and TO-5 cases and in 6 resistance ranges.



CLAIRES ELECTRONICS, INC. ■ 1239 BROADWAY, NEW YORK, N.Y. 10001

ON READER-SERVICE CARD CIRCLE 94

-MATSUO-

THE SPECIALIST OF FILM AND TANTALUM CAPACITORS

POLYESTER FILM CAPACITORS

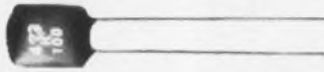

Type MFL epoxy dipped
Standard voltage rating: 35V, 50V, 100V, 200V D.C.
Standard capacitance value: .001 MFD to .22 MFD (E-6 series)



Type MFK epoxy dipped, non inductive
Standard voltage rating: 100V, 200V, 400V, 600V D.C.
Standard capacitance value: .01 MFD to .47 MFD (E-6 series)



Type MXT enclosed in plastic tube, non-inductive
Standard voltage rating: 100V, 200V, 400V, 600V D.C.
Standard capacitance value: .001 MFD to .22 MFD (E-6 series)

METALIZED POLYESTER FILM CAPACITOR



Type FNX-H mylar wrapped
Standard voltage rating: 100V, 200V, 400V, 600V D.C.
Standard capacitance value: .33 MFD to 10 MFD

SOLID TANTALUM CAPACITORS

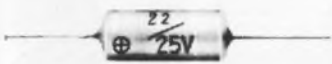

Type TAX hermetically sealed in metallic case
MIL-C-26655B
Standard voltage rating: 6V, 10V, 15V, 20V, 25V, 35V, 50V, D.C.
Standard capacitance value: 1 MFD to 220 MFD (E-6 series)



Type TSX enclosed in metallic case and sealed with epoxy resin
Standard voltage rating: 3V, 6V, 10V, 15V, 20V, 25V, 35V D.C.
Standard capacitance value: 1 MFD to 220 MFD (E-6 series)

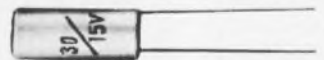

Type TSL enclosed in metallic case and sealed with epoxy resin
Standard voltage rating: 3V, 6V, 10V, 15V, 20V, 25V, 35V D.C.
Standard capacitance value: 1 MFD to 220 MFD (E-6 series)

For further information, please write to:

MATSUO ELECTRIC CO., LTD.

Head Office: 3-5, 3-chome, Sannari-cho, Toyonaka-shi, Osaka, Japan
Cable "NGC MATSUO OSAKA" Telex: 523-4164 OSA
Tokyo Office: 7, 3-chome, Nishi-Gotanda, Shinagawa-ku, Tokyo

ON READER-SERVICE CARD CIRCLE 95

Advertisers' Index

Advertiser	Page	Advertiser	Page
AMP, Incorporated	109	McLean Engineering Laboratories	135
Acopian Corporation	136	Mac Panel Company	27
Alco Electronic Products, Inc.	138	Matsuo Electric Co., Ltd.	148
Alfred Electronics	13	Merrimac Research and Development, Inc.	16
Allen-Bradley Co.	49, 51	Methode Electronics, Inc.	38, 141
Allied Systems Corp.	152	Microdot, Inc.	20
Ammon Instruments, Inc.	84	Microsonics, Inc.	118
Amperite	58	Monsanto Company	59
Arnold Engineering Company, The	115	Motorola Communications & Electronics, Inc.	89
Astro Communication Laboratory, Inc.	124	Motorola Semiconductor Products, Inc.	23
Bishop Industries	151	National Semiconductor Corporation	4, 5
Brand Rex, Division of American Enka Corporation	107	Non-Linear Systems, Inc.	14, 15
Bud Radio, Inc.	12	Nytronics, Inc.	31
Bunker Ramo Corporation, The	143	Phelps Dodge Electronic Products	48
Ceramics International Corp.	105	Piezo Technology, Inc.	126
Clairex Electronics, Inc.	147	Potter & Brumfield Division of American Machinery & Foundry Company	60
Clare & Co., C. P.	54, 55	Power/Mate Corp.	150
Clifton, Division of Litton Industries	53	RCA Electronic Components and Devices	8, 9, 39, Covers IV
Cohu Electronics, Inc.	75	RCL Electronics, Inc.	6
Curtis Development & Mfg. Co.	84	Redcor Corporation	46, 147
Cutler-Hammer	130	Rowan Controller Co., The	33
Dale Electronics, Inc.	Cover IV	Salon International des Composants Electroiques	74
Data-Tek	150	Scientific Data Systems, Inc.	17
Delco Radio, Division of General Motors	70, 71	Signetics Integrated Circuits, A Subsidiary of Corning Glass Works	11
Deutsch Filters Relay Division	47	Singer Company, The—Metrics Division	133
Digital Equipment Corporation	116	Specific Products	132
Digitran Company, The	146	Sprague Electric Company	18
Duncan Electronics, Inc.	111	Starrett Company, The L.S.	40
Eldre Components, Inc.	151	Switchcraft, Inc.	41
Electronic Design	85	Systron-Donner Corporation	2
Fluke Mfg. Co., Inc., John	103	TRW Semiconductors, Inc.	123
General Cable Corporation	52	Tech Laboratories, Inc.	100
General Electric Company	36, 37	Tektronix, Inc., Oscilloscopes	62
General Electric Company, Miniature Lamp Dept.	127	Telonic Engineering Co.	139
General Precision Systems Inc., Librascope Group	35	Transmagnetics, Inc.	117
General Radio Company	1	Trygon Electronics, Inc.	142
Grayhill, Inc.	134	Union Carbide Corporation	24
Gudebrod Bros. Silk Co., Inc.	144, 145	United Aircraft, Norden Division	125
Heinemann Electric Company	57	United Aircraft Corporation, Electronic Components Division of	10
Hewlett-Packard	Covers II, 7, 45, 112, 129	Unitrode Corporation	149
Honeywell, Computer Control Division	42	Universal Instrument Corp.	150
Honeywell Test Instrument Division	80, 81	Vent Rak, Inc.	131
Howard Industries, MSL Industries Inc. Motor Group	134	Vishay Resistor Products, A Division of Vishay Intertechnology Inc.	56
IEEE Exhibition	146	Westinghouse Molecular Electronics Division	137
Industrial Electronic Engineers, Inc.	88	<i>Career Advertising</i>	
Johanson Manufacturing Corp.	140	Delco Radio Division, General Motors	99
Keithley Instruments	50	Electronic Communications, Inc.	96
Kistler Instrument Corporation	151	General Dynamics	95
Litton Industries, Encoder Division	29	Lockheed Aircraft Company	101
Litton Industries, Winchester Division	120, 121	Memorex Corporation	119
Lundy Associates, Inc.	100		

new...

smaller...

4 amp

50-100 nanosec.

ultra-fast recovery

controlled avalanche

high voltage epitaxial

rectifiers

THE UNIQUE UNITRODE CONSTRUCTION

With the silicon die metallurgically bonded between terminal pins of the same thermal coefficient, the hard glass sleeve is fused to the entire outer silicon surface. Result — a voidless, monolithic structure.



ACTUAL SIZE

**the only
lead mounted 4 amp with
100 nanosec. max recovery
PIV's to 250 V**

**80 amp surge capacity
Full power operation
at frequencies up to
100 kHz square wave
and 350 kHz sine wave
1/10 the size . . .**

**1/14 the weight of
a comparable stud-mount.**

Check 323 Readers Service Card

ACTUAL SIZE

**2 amp
typically 50 nanosec. recovery
PIV's to 250 V**

**25 amp surge capacity
Full power operation
at frequencies up to
100 kHz square wave
and 350 kHz sine wave
1/7 the size . . .**

**1/3 the weight of
comparably rated devices.**

Check 323 Readers Service Card

UNITRODE®

580 PLEASANT ST., WATERTOWN, MASS. 02172
TELEPHONE (617) 926-0404 TWX (710) 327-1296

Electronic Design

ELECTRONIC DESIGN's function is:

- To aid progress in the electronics manufacturing industry by promoting good design.
- To give the electronic design engineer concepts and ideas that make his job easier and more productive.
- To provide a central source of timely electronics information.
- To promote two-way communication between manufacturer and engineer.

Want a subscription? ELECTRONIC DESIGN is sent free to qualified engineers and engineering managers doing design work, supervising design or setting standards in the United States and Western Europe. For a free subscription, use the postfree application form inside the back cover. If none is included, write to us direct for an application form.

If you do not qualify, you may take out a paid subscription for \$25 a year in the U.S.A., \$35 a year elsewhere. Single copies are \$1.50 each.

If you change your address, send us an old mailing label and your new address; there is generally a prepaid postcard for this inside the back cover. You will have to requalify to continue receiving ELECTRONIC DESIGN free.

The accuracy policy of ELECTRONIC DESIGN is:

- To make reasonable efforts to ensure the accuracy of editorial matter.
- To publish prompt corrections whenever inaccuracies are brought to our attention. Corrections appear at the end of the Letters column.
- To refuse any advertisement deemed to be misleading or fraudulent.

Microfilm copies are available of complete issues of ELECTRONIC DESIGN and individual articles, published since the beginning of 1961. Complete issues cost 4¢ a page, articles cost 50¢ a page; shipping and handling charges are extra. The minimum charge is \$3. For further details and to place orders, contact University Microfilms, Inc., 300 N. Zeeb Road, Ann Arbor, Mich. 48106; telephone (313) 761-4700.

Want to contact us? If you have any comments or wish to submit a manuscript or article outline, address your correspondence to:

Howard Bierman, Editor,
ELECTRONIC DESIGN,
850 Third Avenue,
New York, N.Y. 10022.

Adjustable 0-34V, 1.5A Power Supply



- Regulation: 0.005% or 1 MV
- Ripple: 250 μ V
- Output: Adjustable 0-34V, to 1.5A
- Completely short circuit proof
- Designed to meet environment MIL-E-5272
- All silicon semiconductors
- Operate to 71°C
- Compact 3 1/4" x 3 7/8" x 6 7/8" size
- Top quality components & construction
- Units operate in series or parallel
- Temp. Coef: 0.01%/°C
- Response: less than 20 μ s
- MTBF: greater than 100,000 hrs. per MIL HDBK 217
- Remote sensing
- Universal 3-position mounting
- Three year warranty
- Only \$88.00 F.O.B. Hackensack, N. J.
- Write today.

Power/Mate Corporation

163 Clay St., Hackensack, N. J. 07601
(201) 343-6294

174

High Speed Printed Circuit Assembly



Send for cost analysis data and 24-pages of engineering information on the latest customer-proven automatic systems for sequencing and inserting (N/C and pantograph) . . . axial lead components . . . DIP's . . . jumper wires . . . transistors . . . into printed circuit boards. Assembly speeds up to 4,500 parts an hour per head. Over 100 photos and schematics show equipment operation and PC board design guidelines. Important educational reference for design and assembly engineers.

Universal Instrument Corp.

East Frederick St.
P. O. Box 825
Binghamton, N.Y. 13902

175

FREE DIODE/TRANSISTOR PRICE GUIDE



Data-Tek, the first comprehensive guide that provides comparative prices on all diodes, transistors and integrated circuits manufactured by the leading 70 companies, is now available on a yearly subscription basis, consisting of four full issues and four supplements. The information includes latest prices on quantities from 1 to 10,000 on 1N, 2N, MIL, TX and house numbers, with comparative prices from every manufacturer. A free samples copy of this invaluable purchasing and design tool is available from:

DATA-TEK
16290 CANELONES
HACIENDA HEIGHTS, CALIF. 91745

176

Manufacturers

Advertisements of booklets, brochures, catalogs and data sheets. To order use Reader-ServiceCard. (Advertisement)

Laminated and Molded Bus Bars For Noise Control



A 16 page Technical Bulletin is now available, describing a new concept in power distribution. Basic mechanical and electrical design principles, along with descriptive pictures and diagrams, are included in this bulletin. These compact buses can replace bulky cable harnesses and repetitive wiring for computer or modular application. This method of construction satisfies the demanding requirements of low inductance and resistance of high speed, solid state systems while controlling electrical noises.

Eldre Components, Inc.

1239 University Avenue
Rochester, New York 14607

177

SEQUENTIAL REFERENCE AIDS, LETTERS AND NUMBERS



Bishop Industries now offers the only complete catalog of sequential reference designations, letters and numbers, especially developed for the electronics industry. The new 12-page Catalog No. SRD-1, features the time saving, easy to use, StikOn drafting aids in the most commonly used sizes for electronic circuit and assembly layouts. Individually precut symbols are available in opaque black, transparent red and blue. Also reverse black, red and blue for absolute registration on two sided boards from single art. Included are illustrations, range of sizes and complete price and ordering information. Send today for your free copy.

BISHOP INDUSTRIES CORP.

11728 Vose Street
North Hollywood, California 91605

178

New Way to Shock-Test Transistors



Bulletin 2111067 gives complete specifications on a new, ultra-rigid, statically calibrated quartz transducer which revolutionizes shock-testing of small components such as transistors, IC's, and fluidic devices. A simple calculation is described by which the impact force of an object on the Model 912H can be quickly translated into a peak shock figure. The Bulletin explains that the new transducer can serve also as a rigid load cell and as a calibration standard for shock-measuring instruments.

Kistler Instrument Corporation

8969 Sheridan Drive
Clarence, N.Y. 14031

179

Designer's Datebook

JANUARY						
Sun	Mon	Tue	Wed	Thu	Fri	Sat
	1	2	3	4	5	6
7	8	9	10	11	12	13
14	15	16	17	18	19	20
21	22	23	24	25	26	27
28	29	30	31			

FEBRUARY						
Sun	Mon	Tue	Wed	Thu	Fri	Sat
				1	2	3
4	5	6	7	8	9	10
11	12	13	14	15	16	17
18	19	20	21	22	23	24
25	26	27	28	29		

For further information on meetings, use Reader Service card.

Jan. 4-7

Conference on Solid-State Physics (Bristol, England)

Sponsor: Institute of Physics; Meetings Officer, Institute of Physics and The Physical Society, 47 Belgrave Square, London, S.W.1.

CIRCLE NO. 392

Jan. 16-18

Reliability Symposium (Boston)

Sponsor: IEEE; L. J. Blumenthal, Melpar, Inc., 7700 Arlington Blvd., Falls Church, Va. 22042.

CIRCLE NO. 393

Jan. 16-19

Dynamic Measurements in Ocean Sciences (Cocoa Beach, Fla.)

Sponsor: ISA; Ocean Sciences Short Course, ISA Headquarters, 530 William Penn Place, Pittsburgh, Pa. 15219.

CIRCLE NO. 394

Jan. 22-26

Marine Sciences Instrumentation Symposium (Cocoa Beach, Fla.)

Sponsor: Instrument Society of America; M. Reed, Meetings Coordinator, Instrument Society of America, 530 William Penn Place, Pittsburgh, Pa. 15219

CIRCLE NO. 395

Jan. 27

Quality Control Conference (Pomona, Calif.)

Sponsor: San Bernardino Section of the American Society for Quality Control; W. J. Willey, 327 Cimmaron Trail, Glendora, Calif. 91740.

CIRCLE NO. 396

Jan. 28-Feb. 2

Winter Power Meeting (New York)

Sponsor: IEEE; IEEE Headquarters, Technical Conference Services, 345 E. 47 St., New York, N.Y. 10017.

CIRCLE NO. 397

we've made a mistake

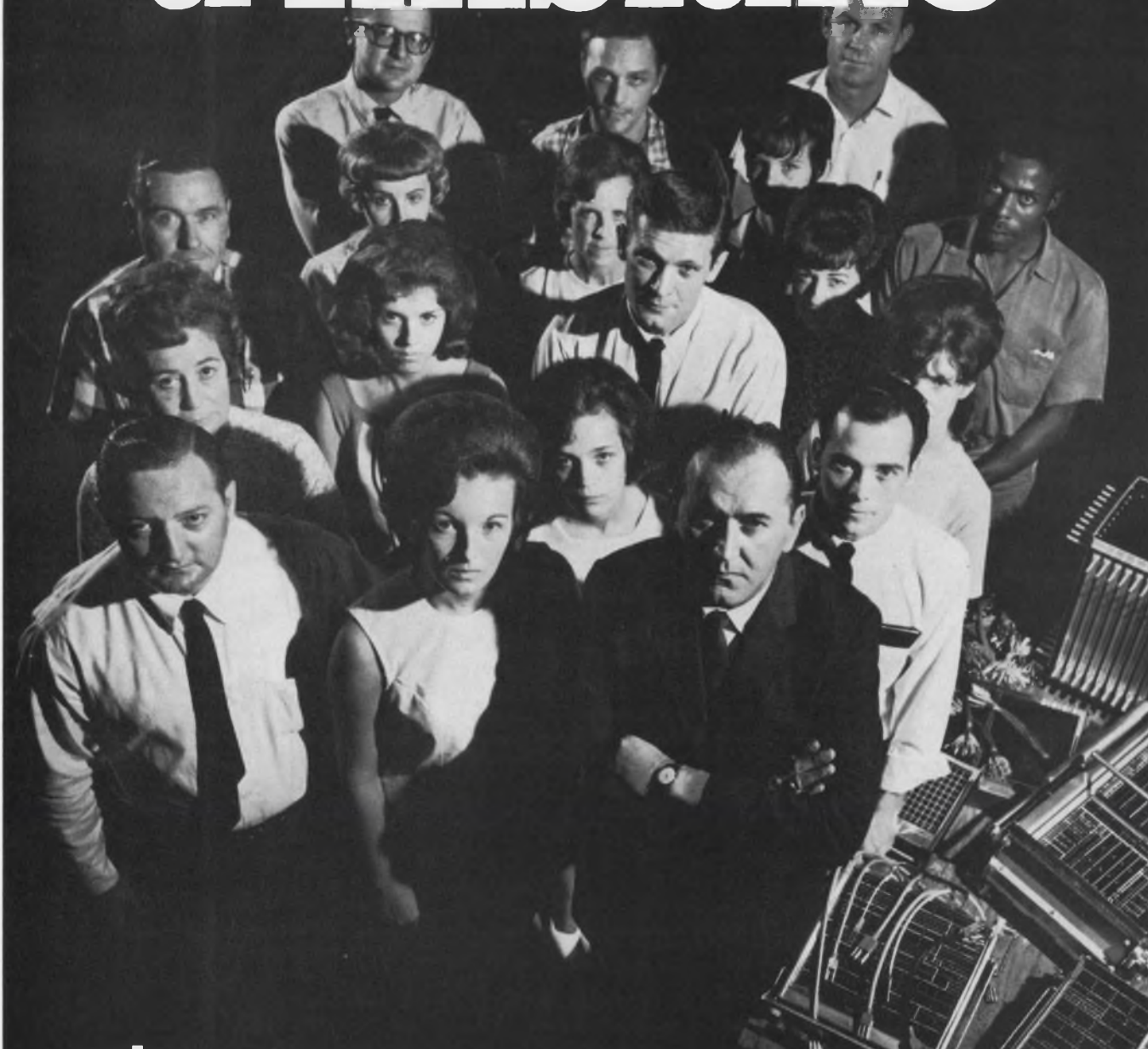

...unless there's no further engineering development in patchboard programming systems. We've made a mistake unless there's no need for faster deliveries. We've made a mistake unless there's no need for innovation and design improvements in receivers, removable patchboards, patchcords and accessories. □ Most of us have been in the programming business long enough to know these needs exist. So... here we are. Give us a try. If we're right you'll be hearing a great deal about us... if we're wrong you won't see us again. Send for Catalogs 567 and 667 and find out. ALLIED SYSTEMS CORP., 4 Tri-Port Circle, Greensboro, N.C. 27420

A

You've named it!

Here's the winner:
Dale's new



"Econo-Trim"



**Our contest proved it...
you want a better 1" commercial
trimmer (for less than a buck).***

Our 2300 Series has created so much industry interest that several thousand engineers, procurement specialists and even a few vice presidents suggested names for it. For example:

J. P. Thompson of Lockheed MSC wanted to call it the *Sta-Set*; which has merit because the way we install the 2300's lead screw creates excellent setting stability.

Abe Pearlman of Westinghouse suggested *Quik-Trim*. Good idea, but maybe a bit too close to competitive models (with which our 2300 Econo-Trim Series is directly interchangeable).

We picked **Econo-Trim** submitted first by **Barry Donohue of Teledyne**. It describes the cost and performance breakthroughs made by Dale in the commercial trimmer field. What's an *Econo-Trim*? It's a lot of mil-style trimmer features for less than a buck.*

**Call us today for Econo-Trim details — including
delivery information. Phone 402-564-3131.**

SPECIFICATIONS:

Standard Resistance Range: 10 ohms to 50K ohms

Resistance Tolerance: $\pm 10\%$ standard

Resolution: .18% to 1.82%

Power Rating: 0.5 watt at room temperature to 0 watt at 85° C

Operating Temperature Range: -55° C to 85° C

Mechanical Adjustment: 15 turns nominal

Mechanical Stops: None. Clutch mechanism permits overtravel without damage

Dimensions:
1.0" L x .36" H x .28" W

Terminals:
P.C. terminals (Model 2387)
Hook-type solder lugs (Model 2389)

*In 1,000 quantities



DALE ELECTRONICS, INC.
1328 28th Ave., Columbus, Nebraska 68601
In Canada: Dale Electronics Canada, Ltd.



RCA "Overlay" Transistors

at home anywhere in the RF power range

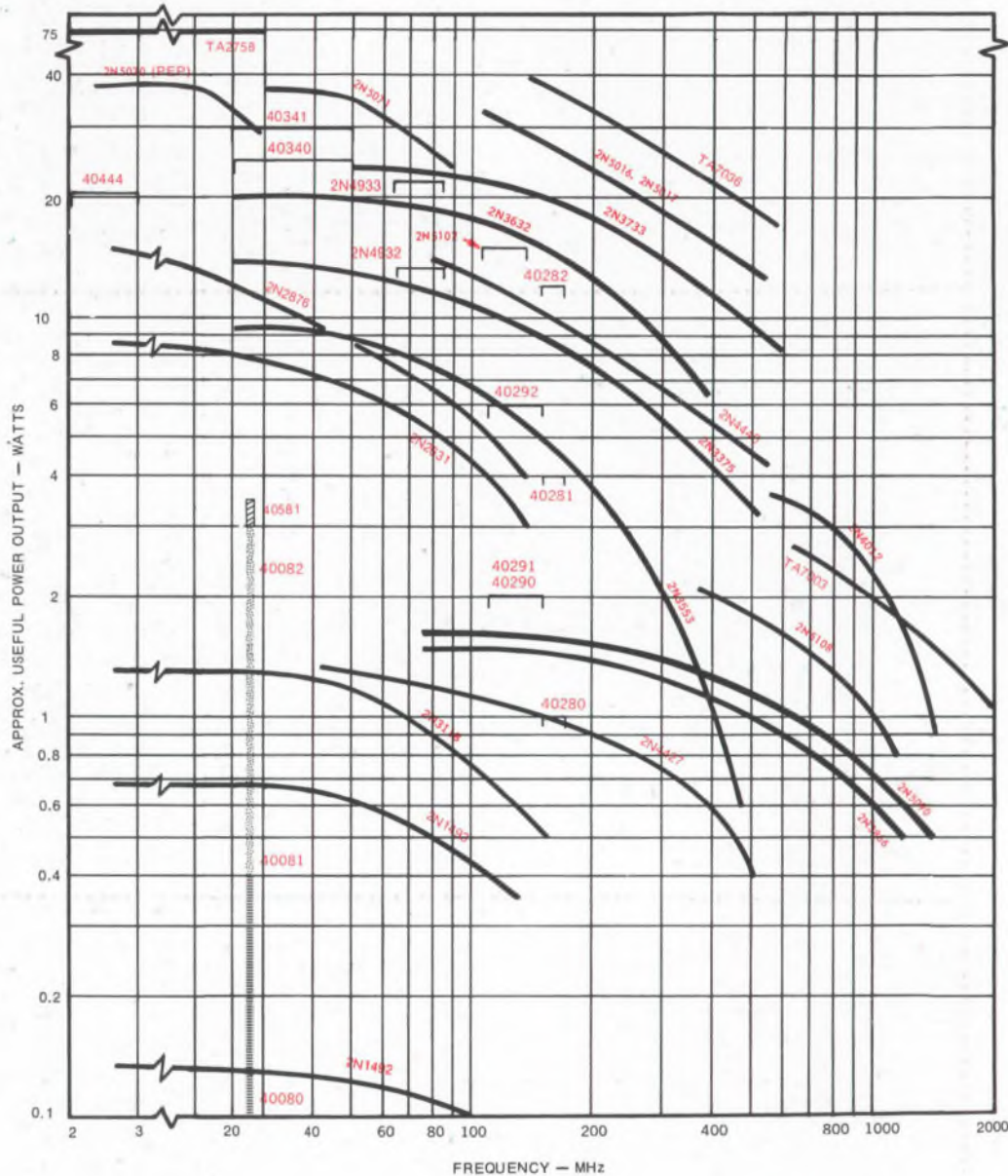

RCA offers you the broadest line of rf-power transistors in the industry. For more information on RCA "overlay" transistors see your RCA Representative or your RCA Distributor. For technical data on specific types, write: RCA Commercial Engineering, Section I612-3, Harrison, N.J. 07029.

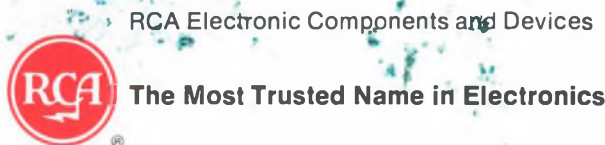

ON READER-SERVICE CARD CIRCLE 123